

# Electronic Design 12

VOL. 20 NO.

FOR ENGINEERS AND ENGINEERING MANAGERS

JUNE 8, 1972

**DIP-sized MW amplifier offers** 24-dB power gain and bandwidth of 1 to 2 GHz. The units can be cascaded to boost gain without significantly affecting bandpass characteristics. Reducing both size and weight without a major increase in price creates many new applications, especially in airborne designs. See page 81.

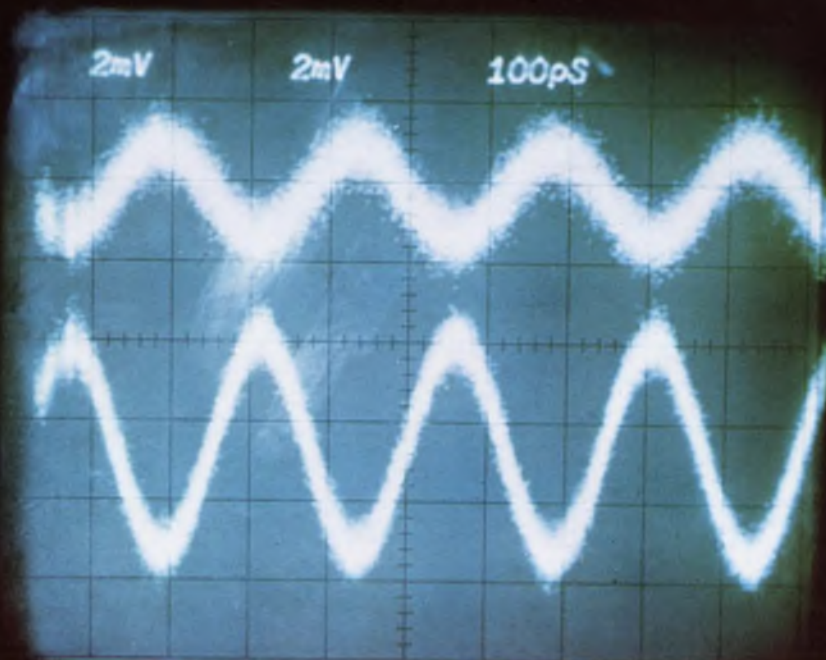

RECEIVED  
NO 1972

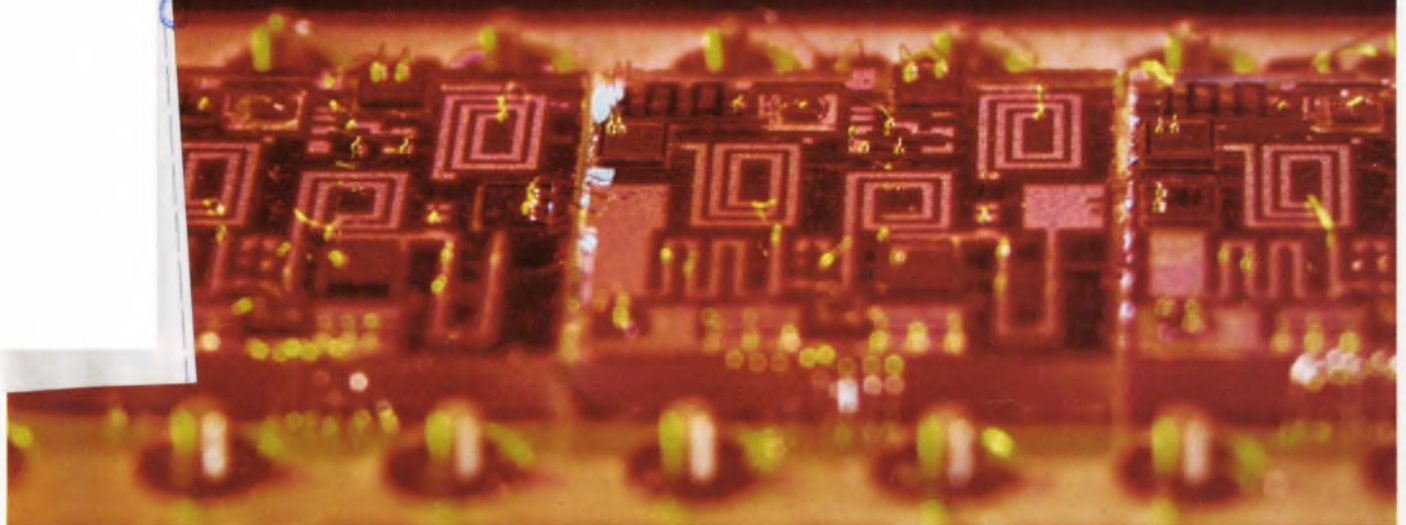

Do you face a make or buy decision on power supplies?

# BUY LAMBDA'S NEW LOW COST LQ 5000 SERIES

ferroresonant dc power supplies  
up to 25 amps...up to 48 volts...from \$100 to \$125

## LQ 5000 SERIES

### Regulated voltage

regulation, line . . . 2% for line changes from 105 to 132 VAC for any load between 25% and 100% of full load.  
regulation, load . . . 5% from 1/2 load to full load or full load to 1/2 load (LQS-DA-5106 is 0.5V).  
ripple and noise . . . 2% RMS (LQS-DA-5106 is 500mWV).

### Frequency coefficient

2.4%/cycle max.

### Accuracy

±2% at 25°C, 115 VAC, 60Hz input and 100% load.

### AC input

line . . . . . 105 to 132 VAC; 59 to 61 Hz.

### Size

5" x 7 1/2" x 10".

### Ambient operating temperature range

0°C to 60°C; consult factory for operations above 40°C.

### Overvoltage protection

supply is inherently overvoltage protected; any internal component failure results in loss of power supply output voltage at power supply terminals.

### Overload protection

all units automatically limit output current upon external overloads, including short circuit, protecting load as well as supply.

### Mounting

one mounting surface (three mounting positions) designed to mount in the following Lambda standard rack adapters: LRA-10, LRA-6, LRA-11, LRA-7.

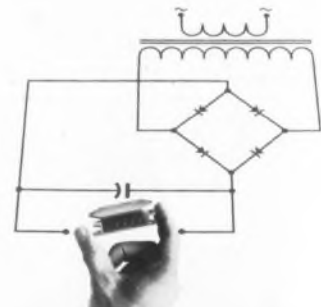

LQ 5000 SERIES	MODEL	DC OUTPUT VOLTAGE	AMPS AT 40° C	PRICE
Single output voltage models 5" x 7 1/2" x 10"	LQS-DA-5124	24	5	\$100
	LQS-DA-5128	28	5	100
	LQS-DA-5148	48	2.5	100
	LQS-DA-5106	6	25	125
	LQS-DA-5324	24	10	125
	LQS-DA-5328	28	10	125
	LQS-DA-5348	48	5	125

ALL IN STOCK FOR 1-DAY DELIVERY

GUARANTEED 5 YEARS

**WHETHER  
YOU MAKE  
OR BUY...**  
**LAMBDA**  
ELECTRONICS CORP.  
A  Company

MELVILLE, NEW YORK 11746 515 Broad Hollow Road Tel. 516-694-4200 ARLINGTON HEIGHTS, (CHICAGO) ILL. 60005 2420 East Oakton St., Unit Q Tel. 312-593-2550  
NORTH HOLLYWOOD, CALIF. 91605 7316 Varna Ave. Tel. 213-875-2744 MONTREAL, QUEBEC 100C Hymus Blvd., Pointe-Claire, Quebec-730 Tel. 514-697-6520

# Discover the value of power...



## and how it saves you money on your mini.

Discover the all-new SPC-16 family of minicomputers. The first minis to save you substantial money in system implementation. They're from General Automation... the fast-growing, pace-setting mini maker.

For total value, SPC-16's put those other two highly-touted brands of minis to shame. With features like the most powerful instruction set of all. Features like exclusive OR. Compare and bit/byte word instructions. A unique one-word Load All Registers/Store All Registers capability. Eight true (16 optional) general purpose registers that can save you up to 4K (about \$2500) worth of core. Plus programs that let you code your problem in half the time. And a lot more.

Including the right price, the best quantity discounts in the industry and the easiest OEM buying policy of all.

SPC-16's are available as I/O and memory-integrated models for dedicated in-house applications. Or as unbundled versions for OEM users or large system applications requiring up to 65K of memory. Six models in all, in three speeds.

No other minis come close to SPC-16's in giving you so much performance for your money. Give us a benchmark, we'll prove it. Meantime, send today for a detailed brochure.



**GENERAL AUTOMATION, INC.** 1055 So. East Street, Anaheim, Ca. 92805 (714) 778-4800 TWX 910-591-1695  
'Discover The Value Of Power'

INFORMATION RETRIEVAL NUMBER 2

# Siemens



**No one knows ferrites like a ferrite user.  
We produce and use more quality ferrites than anyone.**

Siemens, a world leader in the design and manufacture of sophisticated telecommunications and computer systems, has also become the world's leading producer of linear, memory and microwave ferrites. Ferrites that are performance and reliability engineered to meet our demanding

system requirements.

Siemens pioneered T38 with permeabilities of 10,000, T9 and T10 high-density ferrites for recording heads, SM6 and M6 filter inductors for high packing densities, 12 mil extended temperature cores, plated wire memories and CVB7 microwave material.

Siemens design engineers are ready to assist you in solving your ferrite problems.

Siemens Corporation, 186 Wood Avenue South, Iselin, N.J., 08830. (201) 494-1000. Siemens. A three billion dollar name in quality products. **SIEMENS**



---

## NEWS

- 23 **News Scope**
- 26 **OICs: When they come, they'll revolutionize communications.**  
A look at a new technology for exploiting optical bandwidths.
- 32 **Laser machining process** makes circuits in one step.
- 34 **New temperature-independent ferrite material** could lead to 20-fold increase in core memory density.
- 37 **Solar-cell efficiency surges** to 18% with gallium arsenide.
- 38 **Technology Abroad**
- 41 **Washington Report**

---

## TECHNOLOGY

- 50 **Focus on fast logic: A special report on design tradeoffs** in today's faster standard logic family lines.
- 60 **Design your own dynamic phase shifter.** Made with an op amp, it covers nearly 180° and can be used in testing or to build an all-electronic resolver.
- 66 **ROMs are versatile in digital systems.** Use the semiconductor types for code conversion, character generation or computer microprogramming.
- 72 **Ideas for Design**

---

## PRODUCTS

- 81 **Microwaves & Lasers:** Tiny high-gain rf amps are housed in 16-pin DIPs.
- 86 **Packaging & Materials:** Do-it-yourself kit for custom connectors.
- 90 **ICs & Semiconductors:** 1024-bit Si-fuse bipolar pROM guarantees 45-ns access time.
- 93 **ICs & Semiconductors:** FIFO memory chip buffers data-communication systems.
- 94 **ICs & Semiconductors:** Monolithic clock chip offers flexibility in digital systems.
- 97 Data Processing
- 104 Instrumentation
- 100 Modules & Subassemblies
- 108 Components

---

## Departments

- 49 **Editorial:** Everybody's specs are conservative.
- 7 Across the Desk
- 112 Evaluation Samples
- 113 Design Aids
- 114 Application Notes
- 114 New Literature
- 120 Bulletin Board
- 126 Advertisers' Index
- 122 Vendors Report
- 128 Product Index
- 122 Information Retrieval Card

**Cover:** Photo by William Eymann, courtesy of Avantek, Inc., Santa Clara, Calif.



# Think Twice:

## Extra contribution is one way to the top. Specifying HP scopes will help you, too.

### Here's why.

You're an engineer on the way up. Your ideas, your designs, your work all reflect the extra contribution you're making. (You might even slip back to "the shop" after dinner and on weekends.) Rewards won't be long in coming.

There's one more thing you can do for yourself and your management. Show them a way to cut operating expenses and boost profits. How? By being critical and downright hardnosed in making your cost/performance comparisons on instrument purchases.

#### Scopes Have Changed.

Take laboratory oscilloscopes for instance. In the past several years, scope design and performance have changed—for the better. Many companies, maybe yours, are in the process of replacing older scopes, to take advantage of the extra capability these new models offer. To get the best buy now, you're going to have to do more than look at the name tag and spec sheet. Plug-ins are not compatible. Calibration is completely different. Controls and operations have changed radically. It's a whole new ball game. *Little* that you learned or used on older scopes—*whether theirs or ours*—can be transferred to the new models. You need new techniques, new training materials, new parts. Here are three specific reasons why you should investigate the HP 180 Series... why you should think twice.

#### HP Scopes Cost Less To Buy

Analyze your total measurement needs, then ask both manufacturers to submit prices. On latest model plug-in lab scopes, you'll find that HP can consistently save you money—lots of it. For example on a 75 MHz non-delayed sweep, plug-in system, ours is 24% less (with delayed sweep, 18% less); at 100 MHz, ours is 16% less; for 1 GHz sampling, you'll pay 54% less if you buy ours.

#### HP Scopes Cost Significantly Less To Operate

Because scopes have changed, training, operation, calibration, and repair are expenses that you'll have to contend with—no matter which make you buy. HP's new scopes are supported by simplified operation and live or videotaped training and repair sessions that can substantially cut your start-up and overall operating costs.

Calibration? We've cut the number of adjustments by 50%—and eliminated interactive adjustments. Therefore, when you're comparing oscilloscopes be sure to include in that comparison the cost of calibrating each manufacturer's unit.

Our users are reporting shorter training periods, faster, surer measurements, and savings up to 50% on calibration time and costs. Some companies buying Hewlett-Packard, cite this as the main reason.

#### HP Technological Leadership. More Performance. Fewer Problems.

HP innovations in general purpose lab scopes include: the first scope with a real time bandwidth of > 250 MHz; the first 18 GHz sampling scope; the first 100 MHz variable persistence and storage scope; and the first and only 100 MHz scope with a "big-picture" CRT (8x10 div, 1.3 cm/div). These are meaningful, functional innovations that boost your performance, not your costs.

Think twice! Once you make the comparison, we're certain you'll choose HP. Many engineers like yourself—engineers on the way up—have already made the switch. For more information on how you can help your company boost profits and how you can help yourself make faster, more positive measurements, write for our free "No Nonsense Guide To Oscilloscope Selection."

Hewlett-Packard, Palo Alto, California 94304. In Europe: 1217 Meyrin-Geneva, Switzerland.

**Scopes Are Changing;  
Think Twice!**

HEWLETT  PACKARD  
O S C I L L O S C O P E S

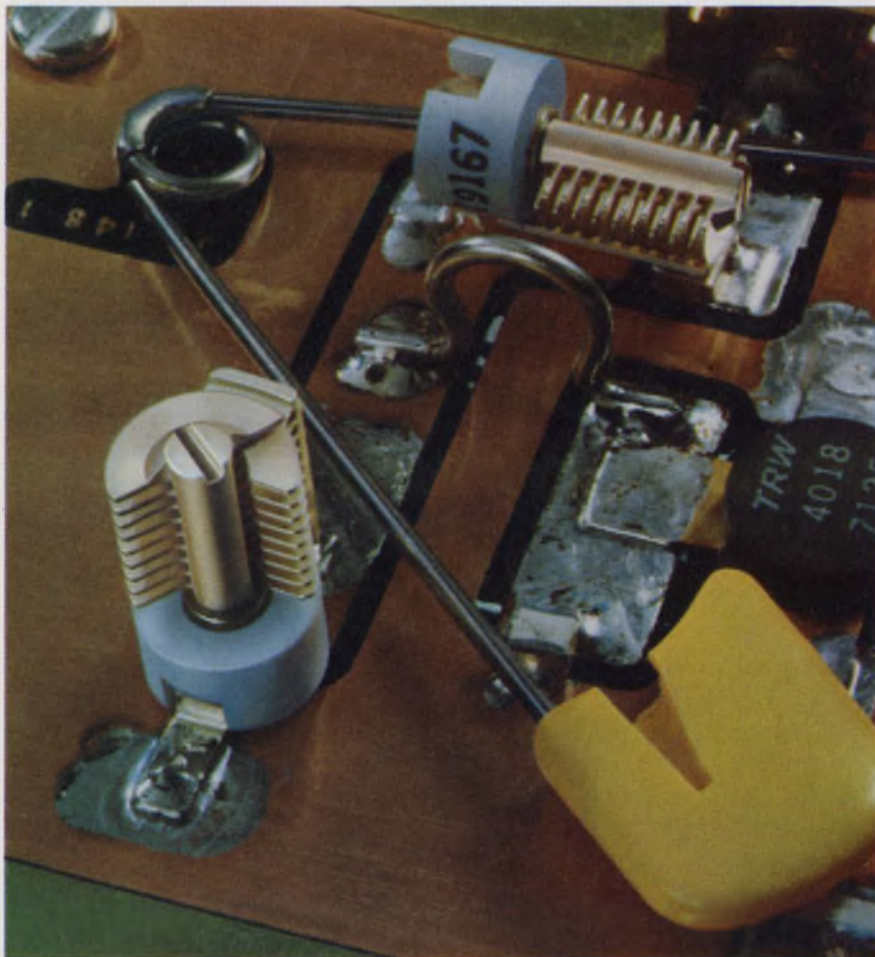

## The smallest 180° tuning air variable capacitors just had babies!

Right. Johnson's exclusive subminiature type "T" air variable capacitors (PC mounts) now come with stripline terminals for microwave applications, either vertical or horizontal tuning.

These space-savers are only about 1/3 the volume of a "U" capacitor, but they offer extraordinarily high mechanical and electrical performance for critical applications.

Rotors and stators are as stable and uniform as precision machining from solid brass extrusion can make them. A high 1 1/2 to 8 ounce-inches torque holds the rotor securely under vibration.

Temperature coefficient is very low plus 30 ± 15 ppm/° C. Q is high, typically 1800 at 200 MHz. Three capacitance ranges span from 1.3 pF to 15.7 pF.

Our 45 years of experience really shows up in these new capacitors. But why take our word for it when a stamp will get you a couple of freebies and you can check them out for yourself.

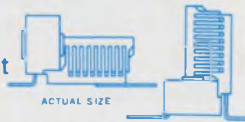

E. F. JOHNSON COMPANY/3306 Tenth Ave. S.W./Waseca, Minnesota 56093

Check type and range of sample(s) needed:	Capacitance range	1.3 to 5.4	1.7 to 11.0	1.9 to 15.7
Horizontal tuning		<input type="checkbox"/>	<input type="checkbox"/>	<input type="checkbox"/>
Vertical tuning		<input type="checkbox"/>	<input type="checkbox"/>	<input type="checkbox"/>

Name \_\_\_\_\_ Phone \_\_\_\_\_

Firm \_\_\_\_\_ Title \_\_\_\_\_

Address \_\_\_\_\_

City \_\_\_\_\_ State \_\_\_\_\_ Zip \_\_\_\_\_



**E. F. JOHNSON COMPANY**

INFORMATION RETRIEVAL NUMBER 5

### Publisher

Peter Coley

### Editors

Editorial Offices  
50 Essex St.  
Rochelle Park, N.J. 07662  
(201) 843-0550  
TWX: 710-990 5071  
Cable: Haydenpubs Rochellepark

Editor: George Rostky

### Managing Editors:

Ralph Dobriner  
Michael Elphick

### Associate Editors:

Jules H. Gilder  
Richard Lee Goldberg  
Morris Grossman  
John F. Mason  
Stanley Runyon  
Edward A. Torrero  
Richard L. Turmail

### Contributing Editor:

Peter N. Budzilovich

### Editorial Field Offices

#### East

Jim McDermott, Eastern Editor  
P.O. Box 272  
Easthampton, Mass. 01027  
(413) 527-3632

#### West

David N. Kaye, Senior Western Editor  
2930 West Imperial Highway  
Inglewood, Calif 90303  
(213) 757-0183  
Les Brock, Western Editor  
95 Main St.  
Los Altos, Calif. 94022  
(415) 941-3084

#### Washington

Don Byrne, Washington Editor  
1111 S. Army Navy Drive  
Arlington, Va. 22202  
(202) 296-8982

### Editorial Production

Marjorie A. Duffy

### Art

Art Director, William Kelly  
Richard Luce  
Anthony J. Fischetto

### Production

Manager, Dollie S. Viebig  
Helen De Polo  
Maxine Correal  
Anne Molfetas

### Circulation

Manager, Nancy L. Merritt  
Ron Deramo

### Information Retrieval

Peggy Long



## across the desk

### Some added points on a/d conversion

A recent article describing a new compact analog-to-digital converter ("Compact Analog-to-Digital Circuit Performs 8-Bit Conversion in 100 ns," ED 6, March 16, 1972, p. 122), overlooked significant points on high-speed analog-to-digital conversion.

Basically what you described is what we at Inter-Computer Electronics prefer to call an analog-to-digital encoder. The unit described in the article uses a circuit technique that has been available for some time (see "An Electronic Design Practical Guide to a/d Conversion," ED 25, Dec. 5, 1968, pp. 49-72).

Your March 16 article reported that the \$4000 price differential between Datel's encoder and a complete analog-to-digital converter system was solely for power supplies. But the \$4000 buys much, much more than just power supplies. It provides the other key components of a complete analog-to-digital conversion system—components that actually permit the conversion to digital format of signals with frequency components approaching half the conversion rate.

For example, in my company's conversion systems the following items are included:

- A sample-and-hold amplifier with an aperture time of less than 100 ps and an input bandwidth that ranges from dc to 100 MHz, with gain variations of less than 0.02% over that bandwidth. This is necessary to encode a 5-MHz signal.

- Carefully matched signal transmission lines, with correct VSWR ratios, to guarantee the converter's accuracy for high input-signal frequencies.

- Careful mechanical design, with grounding techniques that insure appropriate and electrically isolated paths to ground for analog and digital portions of the conversion system.

- Interface amplifiers between successive parallel stages of the subrange sections of the encoder. These amplifiers have slew rates of 500 V/ms or more and settle to within 0.04% of full-scale accuracy in less than 50 ns. This is essential if one is to have a reasonable time budget for this type of analog-to-digital encoder.

- Other extras, such as an automatic test system.

- Test data that verify not only dc conversion performance but conversion performance with high-frequency inputs.

Everyone in the industry welcomes technological advances, as described in your article. But your readers should be aware that the encoder is only the first step in design of a high-speed analog-to-digital conversion system.

*James J. Connolly*  
President

Inter-Computer Electronics, Inc.  
Box 507  
Lansdale, Pa. 19446

### Dual decade counter fills designer's wish

Earlier this year a logic designer, in listing his New Year's wishes, raised the question of why a United States semiconductor manufacturer hadn't produced a dual decade counter in a 16-pin package, (see "A New Year's Wish From Logic Designer," ED 2, Jan. 20, 1972). At the Motorola Semiconductor Products Div., samples of our McMOS MC14518 Dual Decade Counter are now available. Each

*(continued on p. 10)*

Electronic Design welcomes the opinions of its readers on the issues raised in the magazine's editorial columns. Address letters to Managing Editor, Electronic Design, 50 Essex St. Rochelle Park, N. J. 07662. Try to keep letters under 200 words. Letters must be signed. Names will be withheld on request.



## SENSITIVE and STANDARD GATE TRIACS

World's leading triac producer offers fast delivery, electrical isolation and competitive pricing.

### SENSITIVE GATE TRIACS

TO-5 Metal and Plastic; THERMOPAK® and THERMOTAB® Packages

$I_{T(RMS)}$	0.8 - 3 amps
$I_{gt}$	3 & 10 ma (all 4 quadrants)
$I_{TSM}$	20 amps
$V_{DROM}$	200 - 400 volts

### STANDARD GATE TRIACS

THERMOTAB and THERMOPAK Packages (13 other packages available up to 40 amps)

$I_{T(RMS)}$	0.8 - 40 amps
$I_{gt}$	25 & 50 ma max.
$I_{TSM}$	20 - 300 amps
$V_{DROM}$	200 - 800 volts

All ECC triacs feature heavily glass passivated junctions for high reliability. They are available from your nearest ECC Sales Representative or Authorized Distributor.

New Condensed Catalog contains technical data on these and other ECC semiconductors. To receive your copy, circle No. 248.



# ECC

CORPORATION

P.O. Box 669 • Euless, Texas 76039  
817/267-2601

INFORMATION RETRIEVAL NUMBER 6

**For years,  
people thought  
Teletype  
machines only  
talked to  
themselves.**



Ever since the information explosion and solid-state technology, our machines have been running in a very fast crowd.

With computers.

In fact, Teletype equipment is compatible with practically every computer-based communications system. For proof, you don't have to look any further than our product line.

We built the model 33 to offer economy and reliability. For an economical wide-platen terminal, look at our new model 38. If you need heavy-duty operation, we make the model 35. And for the utmost in flexibility and vocabulary, check out our model 37.

Teletype's keyboard terminals operate at standard speeds. But if your speed requirements are greater, all our terminals are compatible with the 2400 wpm Teletype 4210 mag tape unit. We

also manufacture a series of paper tape senders and receivers with speeds up to 2400 wpm.

When you look into our product line-up, you'll find we're very big on flexibility. In assembled ASR, KSR and RO terminals. Or in individual components—printers, keyboards, readers and punches.

Take interface options. We offer three. Built-in modems, current interfaces and EIA Standard R-232-C interfaces.

We offer platen widths that range all the way up to 15 inches.

And optional character sets. Like Greek letters, algebraic and chemical symbols, as well as other graphics for charts and molecular structures.

We also cover error detection and station control with a complete group of solid-state accessories.

We're big on economy, too. Because on a price/performance basis, you won't find a better buy than Teletype equipment.

And we didn't forget service. Our applications engineers will work with you to make sure what you get is exactly what you need. And after the sale, we'll set up a maintenance program for you. Or, if you prefer, we'll train your people in the proper maintenance procedures.

It takes more than manufacturing facilities to build the machines Teletype Corporation offers. It also takes commitment. From people who think service is as important as sales. In terminals for computers and point-to-point communications.

That's why we invented a new name for who we are and what we make. The computercommunications people.



For more information about any Teletype product, write or call TERMINAL CENTRAL: Teletype Corporation, Dept. 89F, 5555 Touhy Avenue, Skokie, Illinois 60076. Phone 312/982-2500

Teletype is a trademark registered in the United States Patent Office.

# NEW Low-Cost, 12-Bit A/D Converter



## Takes Ratios Too!

ADC560-12C-E

- Fast — Converts in 20 $\mu$ S
- Input — 10V Range
- Compact — 2" x 4" x 0.4"
- Complete — Ready to Use

**\$99.**  
in singles

**Absolute and Ratio Measurements** — The ADC 560 can operate as a conventional A/D converter with its own built-in reference . . . plus it can take measurements relative to an external signal. The digital output is proportional to the ratio of the two analog inputs . . . an excellent value.

The unit is complete with built-in reference, logic, clocks, etc., with full DTL, TTL compatibility — all pretrimmed and ready to convert. Contact us for full details.



## HYBRID SYSTEMS CORPORATION

87 Second Ave., Northwest Industrial Park, Burlington, Mass. 01803  
Telephone: 617-272-1522 TWX: 710-332-7584

INFORMATION RETRIEVAL NUMBER 8

## ACROSS THE DESK

(continued from p. 7)

6-MHz counter, fabricated via the complementary MOS technology, has both master reset and clock enable pins.

*Bernard Schmidt*

*McMOS Design Manager*

Motorola, Inc.

Semiconductor Products Div.

5005 E. McDowell Rd.

Phoenix, Ariz. 85008

## Corrections

In Michael Sinutko's Idea for Design in the April 27 issue ("Logic Probe Responds to TTL Pulses of Less Than 10 ns in Width," ED 9, p. 76), the gate model numbers were inadvertently omitted. Gates G1 through G4 are each one-quarter of a Motorola MC3003P. Inverters I1 through I6 are each one-sixth of a Motorola MC3008P.

The RK05 DECpack disc drive from Digital Equipment Corp., described in the April 27 News Scope item "Domain-Tip Memories Challenging Discs" (ED 9, p. 21), has a capacity of 2.45 million bytes—not 2.45 megabits, as was indicated. The price is \$5100.

In Ernest F. Wilson's Idea for Design in the March 16, 1972 issue ("Convert Four-Bit-Binary to Binary-Coded Decimal," ED 6, p. 160), the drawing contained three errors. The correct version is shown below.

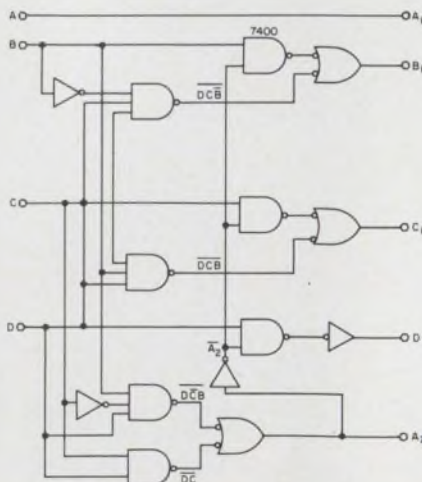

INFORMATION RETRIEVAL NUMBER 10 ►

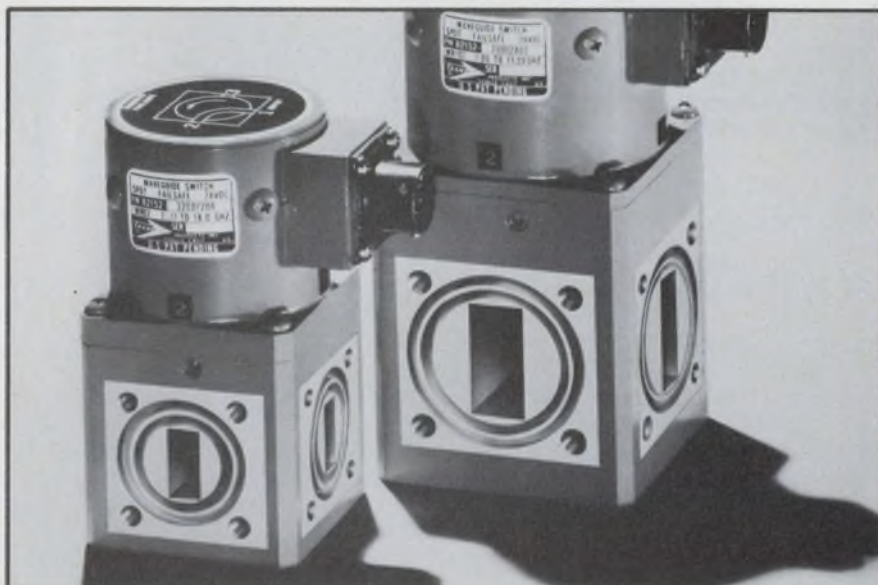

# NEW TYPE WAVEGUIDE SWITCH ACTUATOR



Type-GR utilizes the unique TRANSACTOR actuator which means RELIABILITY, longer life, 1/3 the current, available Latching or Failsafe, WR-62 to WR-284.

Transco Products, Inc., 4241 Glencoe Ave., Venice, Calif. 90291

INFORMATION RETRIEVAL NUMBER 9

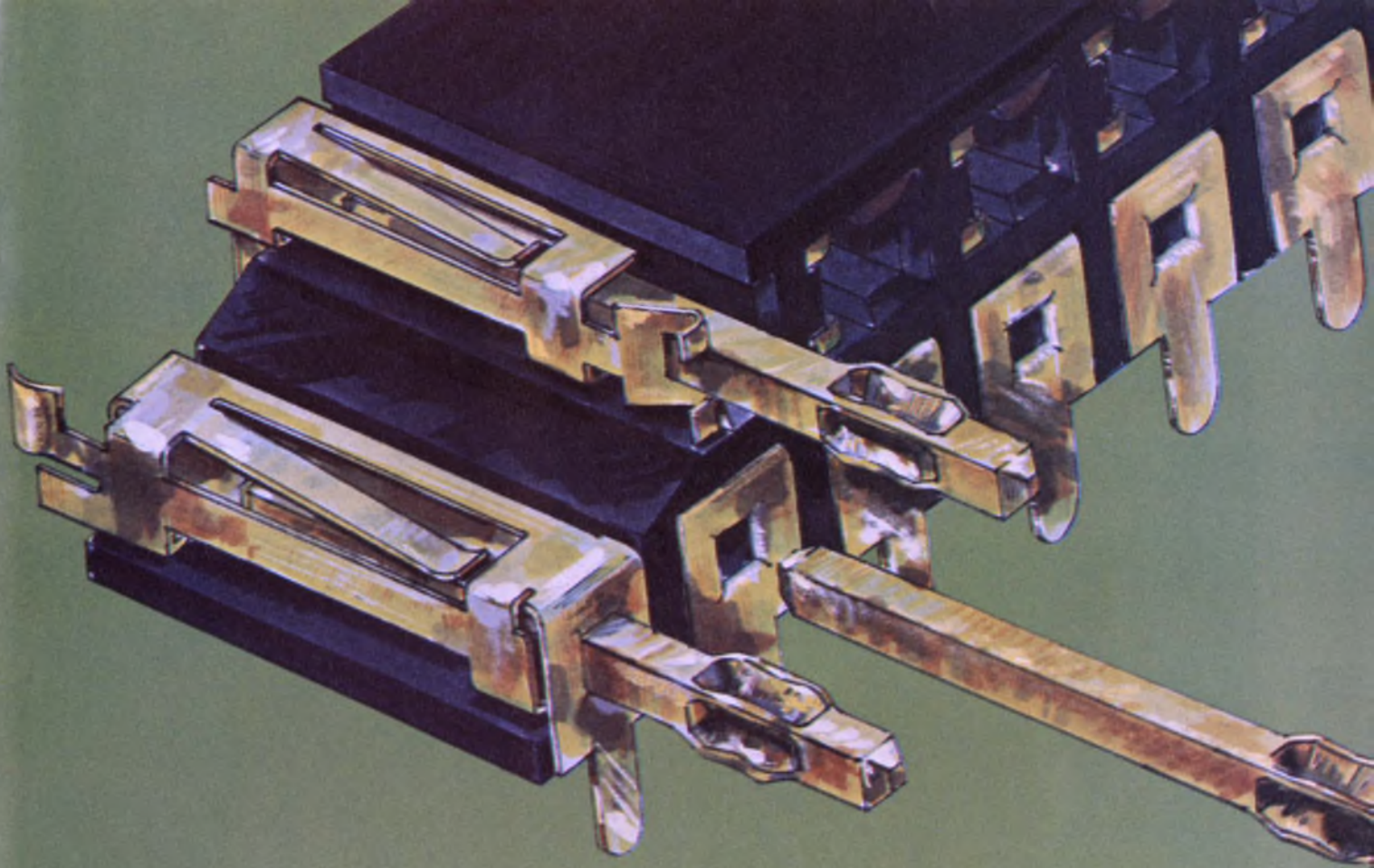

## THE PERFECT MATING

Any .025" square post, yours or ours. And Elco's Varipost Box™ connector. For true togetherness in board-to-board and cable-to-board connections. Our new single row (Series 8243) and dual row (Series 8242), connectors will mate with any .025" square posts on the market, even if they're wire-wrapped one level. Which means you can hold with your existing design and still make the connections you need.

Let's peek inside one of our Varipost Box™ connectors and see why they're so receptive.

First, the contact surfaces of the spring members are parallel to the surface of the p.c. board, and thus can span post-to-post tolerance deviations in your board. This compensates for misalignment between posts and contacts, so you get a perfect mating every time. Competi-

tive box connectors—on the other hand—have perpendicular contact surfaces that demand tighter post-to-post tolerances to insure the mating of every contact with its corresponding post.

The spring contacts in our Varipost Box™ connector are longer, deflect farther and provide a longer wiping action than competitive connectors. Our contacts extend all the way to the entrance of the connector, so they'll mate with shorter-than-standard posts. And if your posts are longer than standard, a built-in stop prevents the posts from extending out the rear of the connector and shorting out with the upper row of contacts in the dual row version.

There's more. Our contacts can be removed from the housing and replaced without deformation. And sequential mating in dual row con-

nectors—first one row, then the other—reduces insertion forces by half.

A wide range of models is now available . . . right off the shelf. Cable-to-board units with contact spacing on .100" and .125" centers in single row (with up to 25 contacts) and dual row with up to 50. Board-to-board (.100" centers) versions with up to 50 contacts, and dual row (.100" by .100") with up to 100 contacts.

As companion pieces, we offer our new .025" square posts, Elco Variposts™. And we've the insertion equipment to stake these posts into the board. So we can supply your p.c. board with posts already inserted, ready for mating.

Leave it to Elco, the Matchmaker. Another service in keeping with CONNECTRONICS, Elco's Total Connector Capability.



Elco, Willow Grove Division,  
Willow Grove, Pa. 19090  
(215) 659-7000

Elco, Pacific Division, 2200 Park Place,  
El Segundo, Calif. 90245  
(213) 675-3311



# CTS *has the answer in*

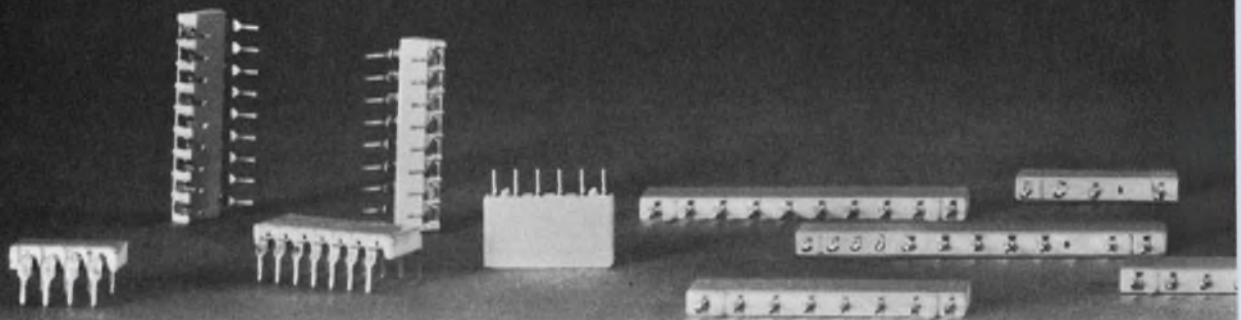

You name it—we have the exact cermet resistor network size and characteristics you need. Here's the choice you get right now: our *750 line* includes: .100" centers with 4, 6 & 8 pins; .125" centers with 2, 4, 6 & 8 pins; and .150" centers with 4 through 13 pins. And we're working on new designs right now!

All compact, extremely stable and highly reliable. Recently we packed even more circuitry into our *760 series*, giving you a choice of four popular space-saver packages: 8, 14, 16 and 18 flat lead styles. Packed with up to 17 resistors per module with flat leads standard (round leads on request).

# *cermet resistor networks.* So ask us!

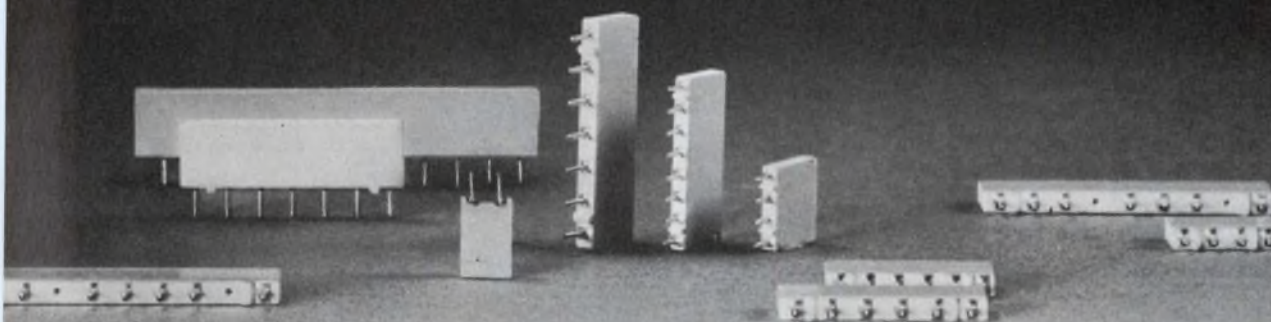

Our broad line provides an infinite number of circuit combinations, all with excellent TC, load and temperature characteristics supported by millions of hours of reliability testing. Ask your CTS sales engineer for data. Or write CTS of Berne, Inc., Berne, Indiana 46711. Phone (219) 589-3111.

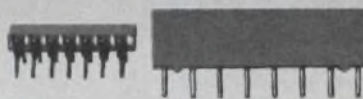

ACTUAL SIZE



**CTS CORPORATION** *Elkhart, Indiana*

A world leader in cermet and variable resistor technology.



# broad band-rated™



**ferramic®**  
components  
for circuits  
that care

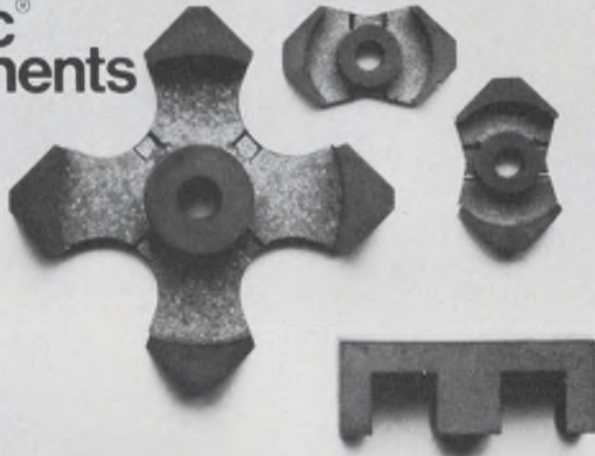

■ When bandwidth is critical, ferrite inductors and transformers must deliver electrical performance over your entire frequency spectrum. Or else your circuit is dead.

*Broad Band-Rated Ferramic* components guarantee the electrical performance required in critical circuits for communications, instrumentation, data transmission, telemetry, and radar applications.

First, we make this special breed of components specifically for broad band applications. So you get extra design latitude to begin with.

Then, we test our *Broad Band-Rated* components. Not as ordinary magnetic material, but as broad band components.

So we can specify bandwidth characteristics under your circuit conditions.

This testing gives you electrical data you need for precise, efficient design. You get pertinent design information, characteristic curves, response curves and applications data.

*Broad Band-Rated* components are part of our growing line of new ferrites designed to meet specific design needs. With guaranteed electrical specs to match their improved performance.

So get in touch with us for design samples. Or get our 24-page bulletin of applications data, performance curves, and specs that make sense. For design assistance in any ferrite problems, contact Indiana General, Electronic Products, Keasbey, N.J. 08832. Or phone (201) 826-5100.

*National distribution through seven Permag locations.*

**indiana general** 

a division of Electronic Memories & Magnetics Corp.



Nobody  
can match  
Allen-Bradley's  
resistor cost

...on the board.

If you're really  
serious about cost,  
be serious about quality.

Paying the lowest price doesn't mean you're getting the lowest cost. Many fixed resistor brands lose their identification in the PC board cleaning process. Some don't have true colors to begin with. Or the color bands darken and become illegible from the heat produced in normal

usage. The result is costly identification errors. Contrast this with the bright, crisp identification of Allen-Bradley's specially formulated paints. Baked on to resist aging, rough handling and solvents. Why gamble with questionable quality that can lead to unforeseen costs?

Learn the facts. Ask your nearest A-B distributor for our free booklet, "7 ways to tell the difference in fixed resistors." Or write Allen-Bradley Electronics Division, 1201 S. Second St., Milwaukee, WI 53204. Export: Bloomfield, N. J. 07003. Canada: Galt, Ont. U.K.: Bletchley, Bucks.

**ALLEN-BRADLEY**  
QUALITY ELECTRONIC COMPONENTS



# How to stuff a lot of hot semiconductors into a small space and not get burned.

We've developed an ingenious new printed circuit board that conducts heat, radiates heat, and offers an effective area for convection of heat to the surrounding air, just like heat sinks and dissipators do.

So now you can mount concentrations of heat-producing devices directly on our new circuit board and save the space, weight, and cost of heat sinks, heat dissipators, blowers, and conduction planes while you operate your circuit at high power densities and let our circuit board keep junction and case temperatures at safe, comfortable levels.

## Simple secret ingredient

Our new circuit boards permit these power densities—from 4 to 13 times those possible using G-10 epoxy boards—because they are made out of aluminum.

So that our metal circuit board can function like normal circuit boards do, we coat it—all over and through the holes—with an electrically insulating material on which we plate the circuit and plate through the holes.

## The difference that makes the difference

But here's where our 15 years of working with heat sink coatings makes heat dissipating metal circuit boards possible. Our exclusive new coating—tough, hard, resistant to solder, solvents and thermal shock, and displaying high dielectric strength plus high surface and insulation resistance—has excellent thermal qualities.

That means you can take one of our

circuit boards—called "MCCB" for Metal Core Circuit Board—and put circuitry on it developing four times the power that a circuit on a G-10 board of the same size and weight can handle while both hold case and junction temperatures to the same, safe levels.

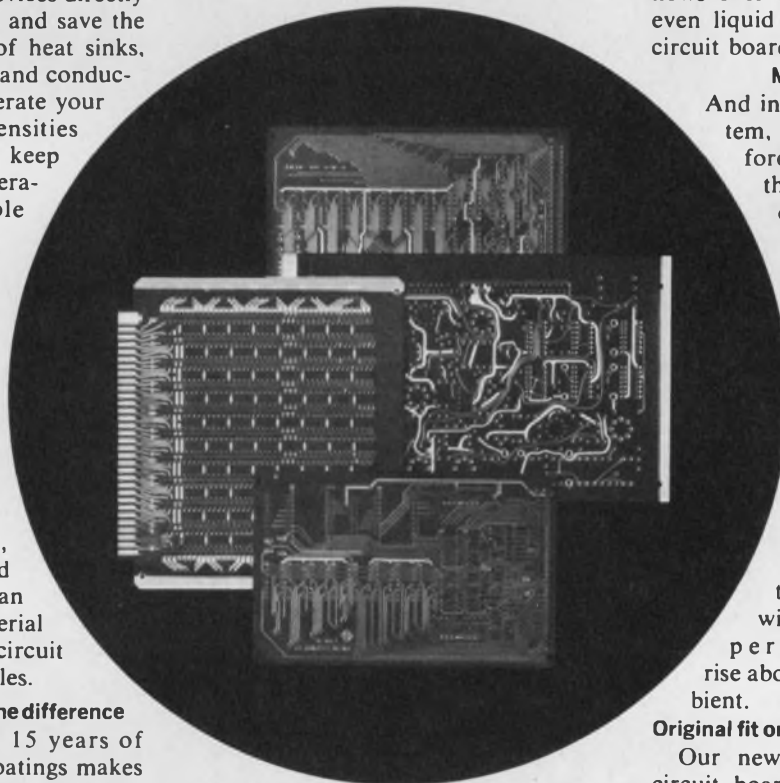

can thermally ground it. And when you do, it will dissipate up to 13 times the power of a simple epoxy board while maintaining recommended temperatures.

That kind of ratio means you're replacing big blowers moving strong air flows over bulky heat sinks—maybe even liquid systems—with a printed circuit board.

## Missing link found

And in a thermally grounded system, MCCB supplies a heretofore nonexistent link between the heat generating semiconductor—or resistor or whatever—and the natural conduction path from metal board retainers through the chassis to the outside world. Another MCCB advantage you won't want to overlook is high conductor current carrying capacity. For instance, a .033" wide conductor printed on our MCCB will carry over three times the current as the same conductor on G-10 with the same conductor tem-

perature rise above ambient.

## Original fit or retrofit

Our new metal circuit boards can revolutionize your next packaging design, and they can clear out hot spots in existing designs as well. Write, phone, or circle for all the details. Or send us your artwork for a quotation. International Electronic Research Corporation, a corporate division of Dynamics Corporation of America, 135 West Magnolia Blvd., Burbank, Calif. 91502. (213) 849-2481.



## When you're hot, you're hot

Looking at it the other way, if you're stuck with a hot circuit and you'd like to tuck it away in a nook somewhere, loading it on an MCCB will let you put it in about half the space you could get away with using an epoxy board plus the required heat dissipators and other thermal management devices. And it will weigh about half as much to boot.

But here's where our MCCB really gets unfair to the G-10 competition: You

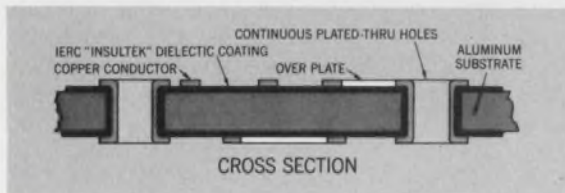

# A better way to specify oscillators.

We have a special coding sheet that lets you specify one or more models from over 700 different temperature compensated and clock oscillators.

Our oscillators are made with a unique cold weld crystal which eliminates heat and flux contamination found in regular sealing methods. As for size, we have models as small as 1.16 cubic inch.

So now, the only paper you need is one of our brochures. Write to Motorola Component Products Dept., 4545 W. Augusta Blvd., Chicago, Illinois 60651



# Take stock in yourself.

In addition to the benefit it provides for the country as a whole, the U.S. Savings Bond Program provides an easy and safe way to set aside funds for future needs.



Robert W. Sarnoff

This year, Robert W. Sarnoff, RCA Chairman of the Board and Chief Executive Officer, has agreed to head the U.S. Savings Bond Program in the electronics industry.

RCA has been an enthusiastic supporter of the U.S. Savings Bond Program since it began. Last year, 87.2 percent of RCA employees participated in this systematic method of saving.

A lot of people in the electronics industry are finding that the best way to help themselves is to help their country.

# Take stock in America.

Buy U.S. Savings Bonds.



## Interface with the special cable specialists

CALL (317) 966-6681

■ **It's Belden's Electronic Custom Design Center:** Designers, engineers, production and cost analysis people. The kind you can talk to about special cable problems. And count on for straight answers and action.

■ They can tell you if your idea is feasible. What it might cost in quantity. Even give you production and delivery data. ■

Water-blocked cable; extra-high voltage applications; medical instrumentation; low-level signal interference problems; unusual environmental conditions . . .

they have tackled most of the problems that might confront you. ■ So try the direct line to special cable answers:

(317) 966-6681. ■ Or send for a Custom Cable Design Kit. Write: Belden Electronic Division, Custom Design Center, P.O. Box 1100; Richmond, Indiana 47374.

8-28/2

**BELDEN** 





## A complete mini computer system in an integrated, attractive package.

Why start from scratch every time you build a mini system? You're going to need an operator console, display and bulk storage in addition to the processor. The Datapoint 2200 has all these built right in along with the computer. And the computer will satisfy the most demanding programmer. Fourteen general purpose registers, push-down stack, interrupts, and up to 16K bytes of fast read-write memory give it plenty of power.

If you spend your time with paper tapes you'll like the cassette magnetic tape operating system. Without touching anything but the keyboard, you can edit, assemble, run and debug in either assembler language or DATABUS, the Datapoint 2200 high-level language. There's nothing else required but the 2200 to generate applications software.

Software doesn't stop with essentials. The catalog has fixed and floating arithmetic routines, communications handlers, terminal simulators plus a high-level language system, DATABUS.

Expand the computing capability when you need it. Add memory, 30 c.p.s. and 135 l.p.m. printers, an 8½" industry-compatible tape and a cartridge disc. If you need to hook up with someone else, communications

adaptors will get you on line from 37.5 to 9600 Baud asynchronous or synchronous. There's even a parallel data interface for interfacing to instrumentation or other data processing equipment.

Call your Datapoint man—he'll tell you how to get your system out of the box and into the action. Price begins at \$6040 (even less for OEM's).

Hundreds of Datapoints 2200 systems are now installed worldwide. Sales and systems engineering available in all major cities with service nationwide.

For your free copy of the Datapoint 2200 systems booklet, write or call the Computer Terminal office nearest you.

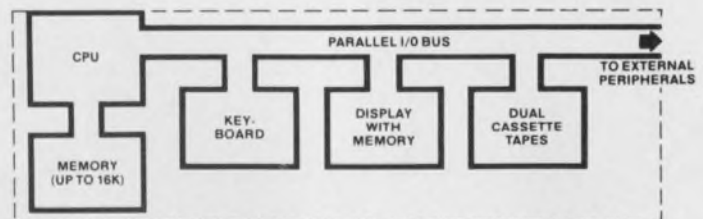

# Datapoint 2200

THE COMPLETE MINI COMPUTER SYSTEM

## Computer Terminal Corporation

**Home Office:**  
9725 Datapoint Drive/San Antonio, Texas 78284/(512) 696-4520

**Field Office:**

Boston/(617) 359-4296	Denver/(303) 244-2451	Minneapolis/(612) 771-4926
Chicago/(312) 671-5310	Detroit/(313) 557-6092	New York/(212) 759-4656
Cleveland/(216) 831-1777	Houston/(713) 626-0010	Portland/(503) 289-9655
Dallas/(214) 637-4166	Los Angeles/(213) 645-5400	San Francisco/(408) 732-9953
		Washington, D. C./(301) 587-3910

**International Representatives:**  
TRW Communications/Toronto, Ontario, Canada/(416) 481-7288  
TRW Communications/Lyss/Berne, Switzerland/Telex: 34446  
TRW Electronics-International/Los Angeles, California/Telex: 674593



# The timer of 1001 uses.

(Priced so low it's measured in cents.)

At last. A true standard IC timer with almost universal applications. The new low-cost 555. From Signetics-Linear, of course.

And the most extraordinary advantage of 555: it's so ordinary, and so simple to use. With designed-in flexibility that's never been matched, spec for spec.

555 functions interchangeably as a time delay, oscillator, pulse detector or power modulator. Timing from microseconds through one hour. With time delays completely resettable.

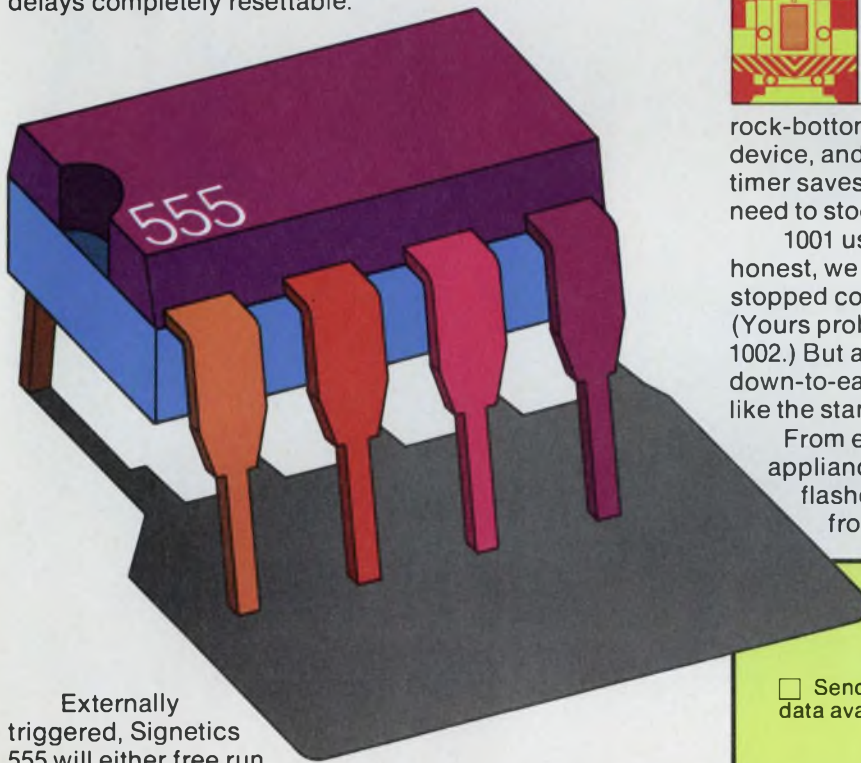

Externally triggered, Signetics 555 will either free run or latch, in adjustable duty cycles from 50% to 0.01%. Timing can be changed 10:1 with control. Operating from 5 to 15 volts with only a 1% change in timing. Output can source or sink 200mA. Temperature stability: 0.005% per °C.

And applying the adaptable 555 is practically child's play (if the kid knows basic math). Requires only a resistor and capacitor to do the job. With all kinds of options for starting the timing action. And you can operate 555 from just a single power supply.

All this, in one simple 8-pin dual in-line circuit. Available off-the-shelf now, from your distributor at



rock-bottom cost. The 100-up price is only 75¢ per device, and the multi-function capability of our 555 timer saves you still more on the parts you no longer need to stock.

1001 uses? To be honest, we haven't stopped counting yet. (Yours probably makes 1002.) But a versatile down-to-earth IC timer

like the standard 555 suggests applications unlimited.

From exotic technology to household appliances... from copying machines to barricade flashers... Start thinking. And you can take it from there.

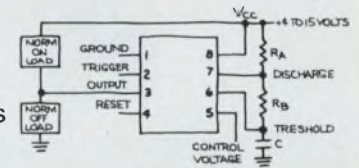

Signetics-Linear  
811 E. Arques Avenue  
Sunnyvale, California 94086

Send all the literature, specs and applications data available for the great 555 breakthrough.

Name		
Title		
Company		
Address		
City	State	Zip
Telephone		

Signetics Corporation. A Subsidiary of Corning Glass Works

**signetics**

INFORMATION RETRIEVAL NUMBER 19

# Ampex memory power. Core modules at stack prices.

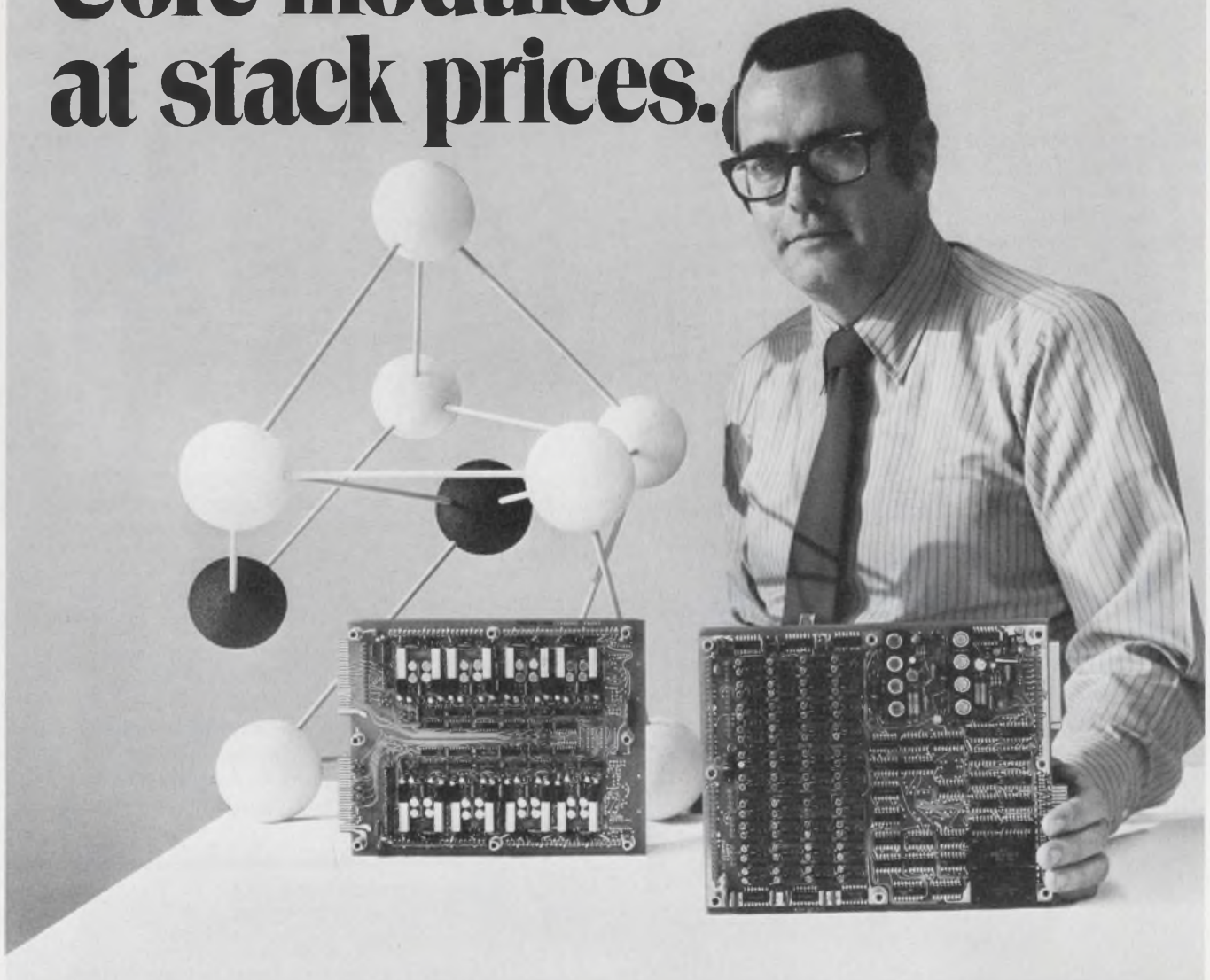

## So why design your own memory?

Ampex 1800 memory modules make real economic sense in both performance and design. No longer any need to design around purchased stacks.

The compact 1800 series modules give you twice the memory in half the space. Up to eight thousand 18 bit words in just 170 cubic inches. Combine any number of modules for the capacity and word length you need. High performance, too: access times of 250 and 340 nanoseconds.

For effortless design, all 1800 modules have decoding circuits, buffered data outputs, require only two voltages, need no temperature compensation or power sequencing. In other words, no external logic required.

Ampex 1800 modules were the first of their kind . . .

and are still the best, and, of course, they come with Ampex worldwide service.

For details on how to get best memory module performance with least design effort, call your Ampex computer expert. He can fill you in on Ampex tape and disk drives, too. Or write.

# AMPEX

**Ampex Computer Products Division**  
13031 West Jefferson Boulevard  
Marina del Rey, CA 90291. (213) 821-8933



## U.S. aims new thrust at import 'dumping'

Early last year, after an extensive inquiry, the United States Treasury Dept. and the Tariff Commission both ruled that Japanese companies were dumping television sets in the United States—that is, selling them at less than "fair value." But finding the evidence in import invoices to back up the findings has proved elusive. Now the Treasury Dept. is looking into what it believes could be another kind of infraction—the subsidizing of Japanese electronics exports by their Government.

If investigation shows that Japanese electronics manufacturers are indeed being subsidized, a 75-year-old U.S. countervailing duty law may be trotted out. It would enable the U.S. to assess additional duty on products manufactured by government-subsidized concerns. The subsidies may be in the form of "payments, bestowals, rebates or refunds," the U.S. law states.

Japan isn't the only country being investigated for subsidization, according to Eugene T. Rossides, Assistant Treasury Secretary for Enforcement and Trade Affairs. "It's about time the rules of international trade are obeyed," he says.

The prod for the Treasury Dept.'s action against Japan was furnished by Magnavox Co. in March following a complaint two years before by the Zenith Radio Corp. Both companies say that the reason why Japanese companies have been able to move into the American consumer market with such muscle is because their Government helps pay the way.

Japanese Embassy officials deny this, saying that there is no basis for U.S. countervailing duties. Some American manufacturers also fear such a move, pointing out that foreign countries could retaliate against them. Merchant marine ships built in the U.S., to give one

example, get a hefty U.S. Government subsidy of 50%.

Rossides concedes that foreign countries may well strike back, but he believes that fewer U.S. companies than foreign competitors will be hurt in the long run.

## Radar warns drivers of tailgating hazard

An automobile radar to help prevent rear-end collisions on the highway by sounding a warning when the separation distance becomes unsafe has been developed by RCA Laboratories, Princeton, N.J.

Mounted on the front of a car, the radar transmits a continuous signal at 9 MHz, which is received by a cooperative, passive reflector on the rear of the vehicle ahead. The reflector doubles the frequency to 18 MHz and reflects it back. By making the radar receiver responsive only to the doubled frequency from the reflector—the second harmonic—the problem of receiving false targets from the highway, signs, bridges and trees has been eliminated. The power output is 100 mW.

The radar transmitter-receiver measures 17 by 8 by 2-1/2 inches. The reflector is the same size, except that it's only a half inch thick. The speed sensor is a microwave doppler radar developed by RCA Electronic Components.

Within five years a radar and reflector set could be sold for as little as \$50 to \$100, RCA says.

## Russians unimpressed by components show

Three Soviet engineers who attended the recent Electronic Components Conference in Washington, D.C., at the direction of their Gov-

ernment expressed mild disappointment at the papers and discussion presented there.

Anatoliy Karatsyuba, spokesman for the group, told ELECTRONIC DESIGN that many of the papers reviewed developments that would be considered tutorial by Soviet engineers.

Topics on beam lead devices, microcircuit packaging, and thick-films used in optoelectronics aroused their greatest interest.

On a visit to the RCA Semiconductor Products Div. plant in Mountaintop, Pa., the three engineers were impressed by the efficiency of the manufacturing operation. They expressed interest in the working conditions, the "discipline" of the employees and the productivity of the plant.

Mr. Karatsyuba works in optoelectronic research at the Ministry of Electronic Industry in Moscow. He is developing the "opton," a LED-photodetector coupler that is in a single package. His education includes a Ph.D. from the University of Hull, England.

## Skin 'transducer' used in touch communication

When poor lighting, noise or other distractions make communicating by sight and sound extremely difficult, one way to get around the problem is to communicate by touch. A skin "transducer" made by Newvitronics, Inc., Wichita, Kan., can be used to do just that.

Joseph A. Radwan, president of Newvitronics, says the unit can be

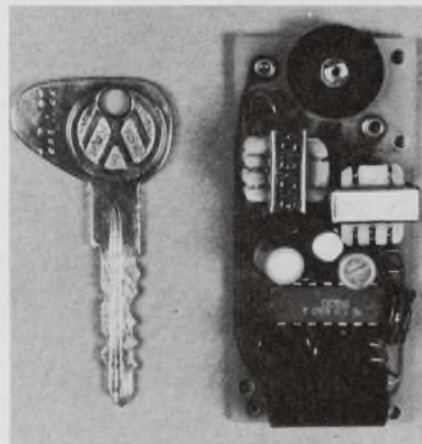

The Newvitronics skin "transducer" can be used in tactile alarm and communication systems. An automobile ignition key is shown for size comparison.

triggered to produce a distinct feeling on any skin area. Beech Aircraft of Wichita is investigating the possibility of using it as a tactile alarm for pilots: Metal tape is placed on the aircraft control wheel or stick, and the pilot is stimulated when alarm conditions occur. The Secret Service is using the device in conjunction with a ferrous metal detector to determine if airline passengers are carrying concealed weapons, Radwan says.

Although it is called a skin transducer, it really isn't. It is essentially a gated blocking oscillator that produces bipolar pulses—a 50- $\mu$ s pulse with an amplitude of up to 100 V, followed by a pulse of opposite polarity and longer duration.

The bipolar pulses are necessary, Radwan says, to cancel the chemical effects often associated with electro-stimulation. The pulses from the Newvitronics device are then applied to the real transducer—a conducting element that acts as an interface between the skin and the device. The conducting element can be an electrode, conductive rubber or cloth, or any material that is an electrical conductor.

The interfacing transducer, when attached to the Newvitronics device, applies a current to the skin, resulting in a tingling sensation. The unit weighs about 3 ounces and operates from a 9-V battery.

Applications still to be explored, Radwan says, include use of the unit in a device to let deaf people know that the telephone is ringing, or in a device for communicating with skin divers, or in gas-warning devices and military mine detectors. Of the latter, Radwan says, his company's device makes every soldier "a walking mine detector."

Radwan says the unit sells "in quantity" for anywhere between \$12 to \$15. An ELECTRONIC DESIGN editor purchased a similar device made by the same company in a surplus shop in New York for 99 cents.

## IBM plans 5-year study of computer security

International Business Machines Corp. has announced a five-year, \$40-million program to develop

data-access safeguards in computer systems.

T. Vincent Learson, chairman of the board, who made the announcement at the recent Spring Joint Computer Meeting in Atlantic City, N.J., said:

"Our goal is to give the customer the means to control access to sensitive data in his system and shut the unauthorized person out."

Access, Learson said, will be controlled by "locks and keys." Users will be able to set their own thresholds according to need.

## Modular midcomputer to be placed on market

Multimodular, microprogrammable midcomputers are about to emerge from Varian Data Machines in Irvine, Calif. They will be readily expandable, fast computers selling—depending upon options—for between \$15,000 and \$100,000.

Called the Varian 73 system, the machines will have a 16-word length and be capable of transferring data at up to 3.03 million words a second. The basic system is expected to hit the market some time in September.

James Dobbie, vice president of engineering at Varian, reports: "Memory types in the system can be mixed. Both core and semiconductor memory modules are available in capacities of up to 8,192 words per module."

Varian is using MOS memory from Advanced Memory Systems and the American Micro Systems 6002 circuits. The latter are 1024-bit, p-channel MOS chips. The memory system cycle time is 330 ns,

compared with 660 ns for core-memory modules. With options to be offered later, the system will be expandable to 262,144 words of memory.

## "Electronics 1985:" A blurred vision

Attempting a long-range look at the future of their industries, about 400 top executives of the electronics industry gathered in Chicago for a conference sponsored by the Electronic Industries Association.

The conference, called "Electronics 1985," was held last month, and the views were as diverse as the total of 50 speakers and panelists. The result was a blurred picture, with few startling predictions. Typical of the comments:

Dr. John A. Pierce, professor of electrical engineering, California Institute of Technology, pointed out that new electronic technologies by 1985 would depend "as much on an aggressive, open, risk-taking course on the part of business and government as on our excellence in science and engineering."

"An Economic Forecast," published by the EIA in conjunction with the conference, said that the average annual growth rate for world electronics and equipment consumption would decrease between now and 1985, just about equaling the rate of growth for the gross world product. All this implies that the early spectacular growth of the electronics industry is leveling off as the industry reaches new levels of maturity, according to the EIA.

## News Briefs

Magnusonic Devices, Inc. of Hicksville, N.Y. reports that it has developed a **process for coating the face of high-speed magnetic heads with a hard ceramic material** that increases head life five to 10 times over that of uncoated heads.

A three-year, \$3-million **research project to explore the potential of high-power lasers to produce controlled thermonuclear fusion** will be conducted by the University of Rochester with support from the

Esso Research and Engineering Co. and General Electric Research and Development Center.

General Motors semiconductor researchers are studying a **dielectric-film material that they say may replace silicon dioxide** in advanced solid-state electronic devices. The material—niobium oxide—has a higher dielectric constant than silicon dioxide, permitting reduction of the area occupied by capacitors in ICs.

# VACTEC PHOTOCELLS *in the rocks*

The finest imported gin, ice and vermouth mixture can't penetrate Vactec's positive hermetic seals. Even the plastic passivated types are exceptionally stable. Other environmental extremes are just as routinely endured by Vactec Photocells. Capable of storage from  $-55^{\circ}\text{C}$  to  $85^{\circ}\text{C}$ . Continuing to operate at liquid nitrogen cold ( $-196^{\circ}\text{C}$ ), and up to boiling water ( $100^{\circ}\text{C}$ ).

You simply can't buy a better photocell *anywhere*, and Vactec is competitive with import prices because of automated processing, assembling, and testing. Take advantage of Vactec engineering, research, and manufacturing in the heart of America. Because Vactec has 249 different types of cells in stock, we can ship before your order reaches an overseas supplier. Included is a complete line of visible detectors: photoconductors (CdS and CdSe); photovoltaic cells (Se and Si); couplers of LED's or lamps and photoconductors called Vactrols. Vactec also has a photometer which measures from .0002 to 10,000 fc, for as little as \$300.00.

You needn't compromise. Vactec has it all. Quality, economy, and service.



**VACTEC, INC.**

2423 Northline Industrial Blvd  
Maryland Heights, Mo. 63043  
Phone (314) 872-8300

# OICs: When they come, they'll revolutionize communications

A new technology with the unlikely nickname of OICs (pronounced OYKs) is developing rapidly to exploit the tremendous bandwidths available in the optical spectrum for communications.

OICs stands for optical integrated circuits, and the fabrication techniques are borrowed directly from the semiconductor IC industry.

Although still in the purely developmental stage, sufficient work has been done to indicate that these OICs will be key elements in terminals and repeaters for both short and long-distance optical communications.

Experimental work has established that OICs will eventually provide the coupling, lasing, switching, modulating, filtering and multiplex functions for these future optical systems. Researcher estimates of when this will become reality range, however, from two to 10 years. And the major researchers tend to be close-mouthed about what the big hangups are.

## Signal carrying is no problem

The "wires" are already here. Corning's development of an optical, single-mode fiber with losses of only 20 dB/km provides a means of carrying broadband optical signals from point to point.

In present short-range, narrow-band optical data systems, infrared light-emitting diodes (LEDs) provide the optical energy (see "Fiber Optics Is Finding Growing Use in Data Transmission," ED 4, Feb. 17, 1972, p. 26). But these LEDs are nonlasing, and they produce a relatively broad spectrum of energy that is transmitted along

the fibers in a multi-mode, lossy fashion. Present systems are thus limited to a few hundred feet of fiber optical conductors, with maximum response in the 100-MHz range.

To propagate the energy with acceptably small losses and at the same time take advantage of the extremely wide potential bandwidths of the optical system, laser light is needed to transmit the energy along the fiber optics waveguide in single-mode fashion.

To guide and process the laser energy in the proposed optical communications systems, attempts are being made to develop microminiature planar structures—both passive and active—that would be imbedded in or superimposed on the OIC substrates.

For passive structures, Bell Telephone Laboratories of Murray Hill, Crawford Hill and Holmdel,

all in New Jersey, have put considerable effort into fabricating micron-sized, thin-film dielectric waveguides on transparent substrates. Patterns of these guides for the transmission, coupling and filtering of laser energy are expected to take the forms shown in Fig. 1.

An example of a laser beam being injected into an experimental lightguide at Bell Laboratories is shown in the photograph below. This type of guide is a glass film deposited by sputtering onto a glass plate. As J. E. Goell, a member of the technical staff at Bell, describes the process, oxygen was used as the sputtering gas. The lightguide was made by depositing on a glass substrate a thin film of glass of higher index of refraction—in this case, 1.62. Then a masking and etching process similar to that used in conventional ICs



A laser beam is being injected into an experimental optical waveguide by J. E. Goell of Bell Laboratories. The waveguide, made by a masking and etching process similar to that used for ICs, is a deposited glass film.

Jim McDermott  
Eastern Editor

removed the excess sputtered material. The film thickness of the guide itself was determined to be about  $0.3 \mu\text{m}$ .

The potential for mass-producing waveguide OICs with the standard techniques used to make ICs seems great. However, when photoresist is exposed and removed by the regular photolithographic process, roughness in the edges of the finished waveguide produces excessive losses.

Goell says that unless the waveguides are exceptionally smooth, scattering of light occurs, thus limiting the amount of energy guided by the wave.

Computations have shown, the Bell Laboratories researcher points out, that a loss of about 1 dB/cm results from an edge with a  $500\text{-\AA}$  rms deviation—this for a refractive index difference of 1% between the waveguide and its surrounding media at a wavelength of  $1 \mu\text{m}$ .

An edge smoothness of between  $100 \text{\AA}$  and  $200 \text{\AA}$  is considered necessary for optimum conduction of energy.

To minimize these scattering losses, Goell has tried electron-beam processing to make a  $3.5\text{-}\mu\text{m}$ -wide optical waveguide.

A plastic film was exposed to the electron beam through a deposited aluminum mask.

Bell Laboratories continues to

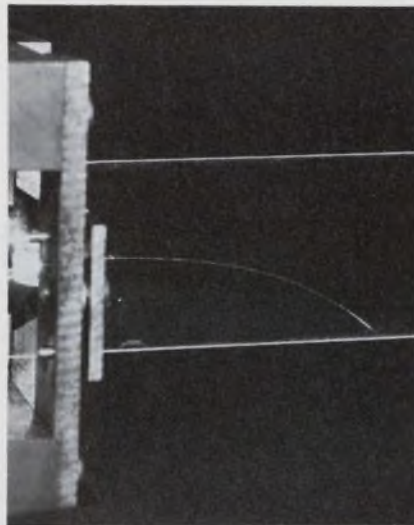

**Curved optical waveguide of sputtered glass**, from Bell Laboratories, is  $20 \mu\text{m}$  wide and about  $0.3 \mu\text{m}$  thick.

try different methods of producing these static OICs.

While Bell has expended considerable effort in fabricating static types of thin-film waveguides, Dr. Amnon Yariv, professor of electrical engineering and fellow scientists at the California Institute of Technology, Pasadena, Calif., have concentrated on developing active optical waveguides and circuits.

For the last five years Yariv's group, under the sponsorship of Government agencies, including the Advanced Research Projects Agency, have worked upon the fabrication of optical waveguides in gal-

lium-arsenide compounds by the deposition of epitaxial films and by ion implantation.

At the Naval Electronics Laboratory in San Diego, Dr. H. F. Taylor and his group have produced waveguide effects in the II-VI compounds, including zinc selenide diffused in cadmium.

### Connecting OICs with lasers

Whatever type of OIC used—passive or active—a means to put laser energy into the device and to extract it is required. For this, two principal methods have emerged to date.

The first uses prisms placed very close to the surface—on the order of a wavelength of the laser light away. The second method is the use of gratings etched or superimposed on the waveguide surface.

In general, prisms are much more efficient than gratings, says H. L. Bertoni, associate professor of electrophysics at the Polytechnic Institute of Brooklyn. But he points out that for use with OICs, the prism has limitations.

To begin with, he says, a prism is more difficult and costly to fabricate, compared with gratings. Also, it is necessary to take care to maintain the micrometer-sized air gaps between the prisms and the thin-film waveguide surface.

This poses mechanical problems that make the grating approach seem more suited to a practical OIC structure, Bertoni says.

In describing the coupling of energy into and out of thin-film structures, Bertoni points out that the dielectric film may support a surface wave, or a leaky wave.

The surface wave travels along and in the thin film. The leaky wave represents a field that is guided by the film. But this field sheds energy as it progresses down the waveguide (Fig. 2).

The leaky wave is guided out of the thin film by either the prism or the grating. Proper design of the prism or grating system optimizes the transfer of energy from the surface to the leaky wave. In practise, the transfer may be as high as 80%.

Bertoni points out that the loss in efficiency encountered with a real beam, because of a symmetri-

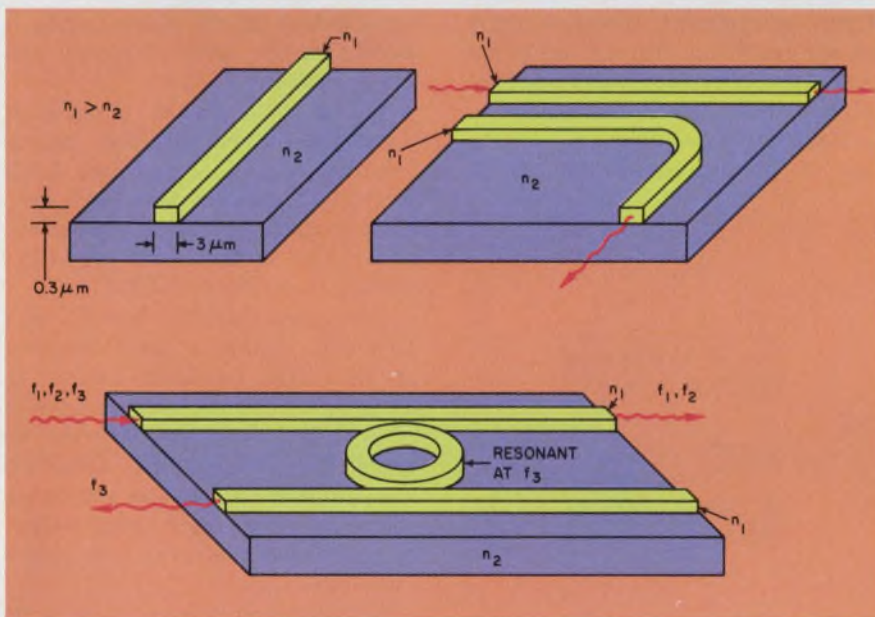

1. Representative types of proposed passive waveguide structures for optical integrated circuits. They range from a simple, single-mode structure (a) to a directional coupler (b) and to a frequency-selective filter (c).

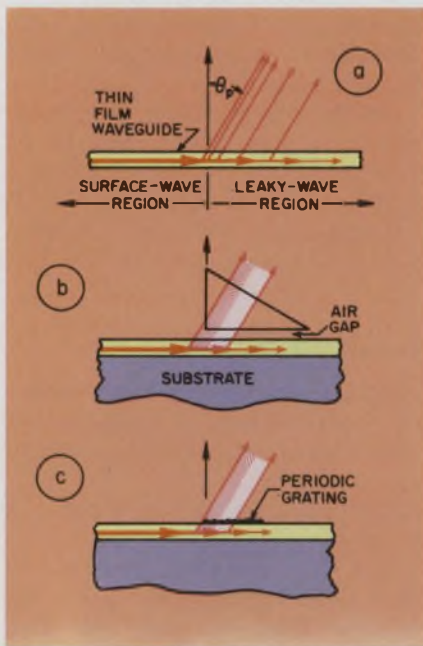

2. Two principal methods of coupling laser beams into and out of thin-film waveguides are prisms and periodic gratings. They capture energy from surface waves, along the film.

cal profile, can be minimized by using a technique employed in leaky-wave microwave antennas. This consists of modifying the geometry of the prism coupler by means of a tapering gap, or modifying the grating by tapering the size of the periodic scatterers.

If variation in the taper of the air gap or grating is correct, Bertoni says that close to 100% of the energy will emerge in a symmetric Gaussian beam (Fig. 3). This action is reciprocal, so that if the same symmetric beam enters the prism or grating from the right, it will produce a surface wave that emerges on the left, and vice versa.

Prof. Jay H. Harris of the Department of Electrical Engineering at the University of Washington in Seattle, one of the early researchers in guiding light along thin films, reports that he has obtained close to 100% efficiency for special tapered prisms of his own design.

Of the diffraction gratings used to couple energy into and out of the passive optical waveguides, two types have been exploited: a standard diffraction grating and a so-called Bragg grating.

An example of the standard diffraction grating is one generated

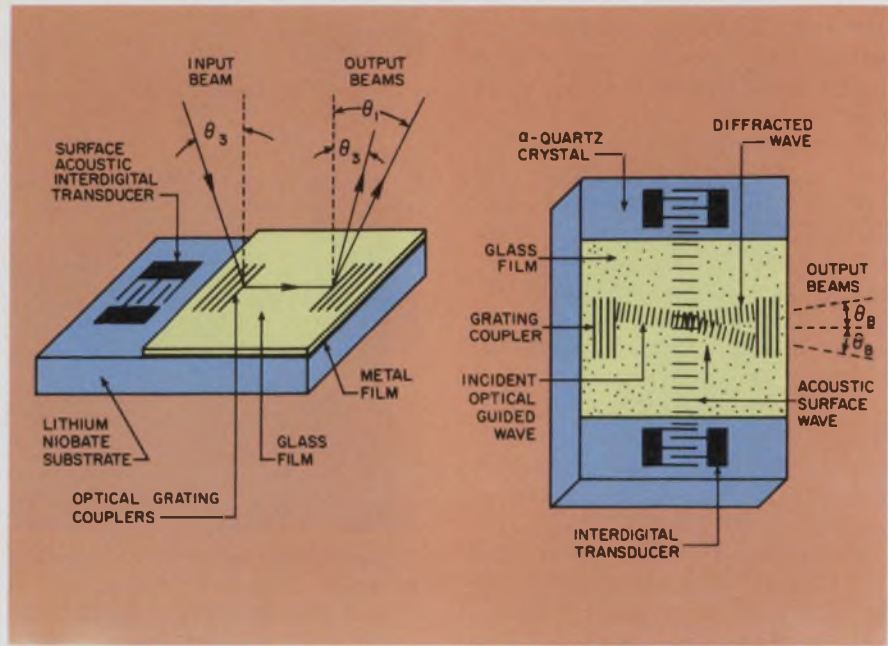

4. Two types of acoustic-optic devices developed by IBM for the control of energy laser energy in optical thin films. In "a" the surface acoustic wave coupling changes the waveguide modes from one stable state to another. In "b" periodic variation in the refractive index of the glass, due to the compression and expansion of the sound waves, deflects the beam from side to side.

for experiments at the IBM Research Center, Yorktown Heights, N.Y. The optical waveguide material is dense flint glass,  $0.76 \mu\text{m}$  thick, sputtered onto a glass substrate of lower refractive index.

The diffraction grating is comprised of a layer of photoresist deposited on the flint glass film. The pattern was formed by exposing the photoresist to the interference fringe pattern of a  $4880 \text{ \AA}$  laser. Upon development, the periodicity of the resulting grating was about  $0.67 \mu\text{m}$ . Efficiency was somewhat higher than 40%.

Routing of signals and sorting out of frequencies in the passive

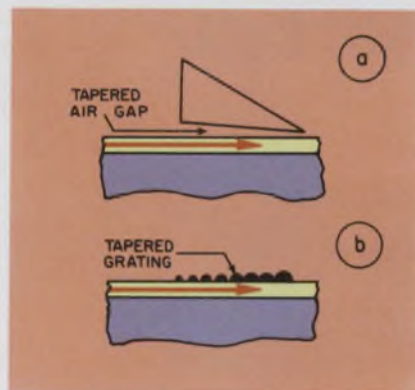

3. The efficiency of coupling optical energy from the waveguides is increased by the use of tapered air gaps (a) and tapered gratings (b).

optical-waveguide circuits can be done by the use of configurations of resonators, tuned filters and directional couplers (Fig. 1). Energy transfer is effected by proximity to the input and output waveguides.

Passive circuits, however, have their limitation in that they are inherently lossy devices—that is, they cannot regenerate signals but require external amplification. Also, selection of the signal paths is purely on the basis of optical signal frequency.

For digital signal processing, direct deflection of the optical beam is desirable, and two basic methods for doing this have been investigated. The first—deflection of light by surface-wave ultrasonic energy—was done at IBM.

One acoustic-optic device, says Lawrence Kuhn, a staff member at the IBM Research Center in Yorktown Heights, was comprised of an active quartz crystal on which an  $0.8\text{-}\mu\text{m}$ -thick, thin-film waveguide structure was sputtered, complete with input and output optical photoresist grating couplers (Fig. 4b).

A  $6328 \text{ \AA}$  helium-neon laser beam was coupled into and out of the film. An acoustic wave, generated in the quartz crystal by one in-

# THE TRIMLINE SERIES

DISTINCTIVE ELECTRONIC ENCLOSURES



**PREMIER METAL PRODUCTS COMPANY**

A DIVISION OF SUNSHINE MINING COMPANY

337 MANIDA STREET, BRONX, N. Y. 10474 (212) 991-6600



SEE US AT THE NEPCON-SHOW BOOTH # 5208

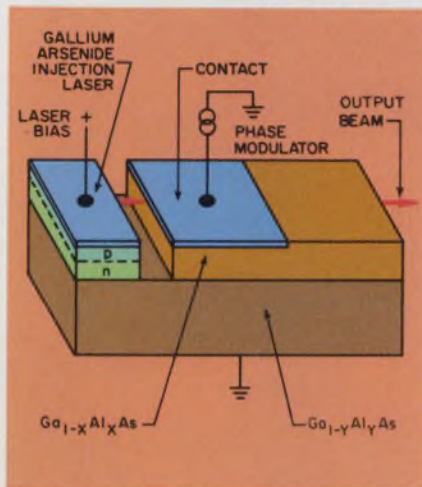

5. Schematic view of a thin-film gallium-aluminum-arsenide waveguide structure incorporating an injection laser and a phase modulator.

terdigital transducer, propagated across the surface about at right angles to the optical guided wave.

The acoustic wave, through photoelastic coupling in the film, generates a strain wave in the optical guide that appears as a periodic variation in the refractive index of that guide. When the angle between the acoustic and optical waves satisfies the Bragg condition, a deflected beam appears in the film at twice the Bragg angle from the original beam, or 1.36 degrees.

For 2.5 W input power, a deflection efficiency of 66% was observed.

In another device described by Kuhn, a surface acoustic wave coupling occurs this time in line with the optical energy. This coupling changes the waveguide mode from one stable state to another, thus causing the output beam to change its angle vertically.

For the in-line or colinear action of the sound and optical energy to be effective in changing the waveguide modes, it was necessary to phase-match these elements by adjusting the frequency. For this reason, lithium niobate was used as a broadband transducer.

Coupling was observed between the  $TE_1$  and  $TE_2$  and the  $TM_1$  and  $TM_2$  modes, but none between the TE and TM because of the amorphous material. Mode conversion was observed as the corresponding change in exit angle of the beam.

The acoustic driving frequency

was 321 MHz. Maximum conversion efficiency for 1.6 W input was 55%. This corresponds to a surface-wave amplitude of 7.5 Å.

The ideal type of material for fabricating dielectric optical waveguides and active elements in an OIC should have several key characteristics, according to Yariv of Cal Tech. They are:

- The material should have good optical qualities and be transparent at the wavelength at which it operates.

- It should be suitable for thin-film and semiconductor type processing and fabrication.

- It should possess large photoelastic and electro-optic figures of merit, so that modulation and switching of light can be effected by applying ultrasound or voltages.

- It should be capable of light generation and detection.

The material that possesses all of the qualities, Yariv says, is gallium arsenide and its aluminum compounds.

### Semicon waveguides developed

Over this period thin-film semiconductor waveguides have been prepared by the deposition of epitaxial  $n$  or  $n+$  films in gallium arsenide, by the epitaxial preparation of gallium-aluminum-arsenide films, and by ion (proton) implantation in gallium-arsenide material. The latter effort has been undertaken by Yariv in cooperation with R. G. Hunsperger of Hughes Research Laboratories, Malibu Beach, Calif.

To date, gallium arsenide waveguides made by ion bombardment and annealing have given losses of slightly less than 8 dB/cm, and "substantially better" performance is expected in the future, according to Yariv.

The material most widely used for injection diodes is gallium arsenide, Yariv points out. A thin-film gallium arsenide OIC is shown in Fig. 5.

The presence of a fraction of aluminum in a gallium-arsenide compound changes the refractive index of the material. As a result, a simple waveguide can be fabricated by growing an epitaxial gallium-aluminum-arsenide layer on a substrate that contains a larger

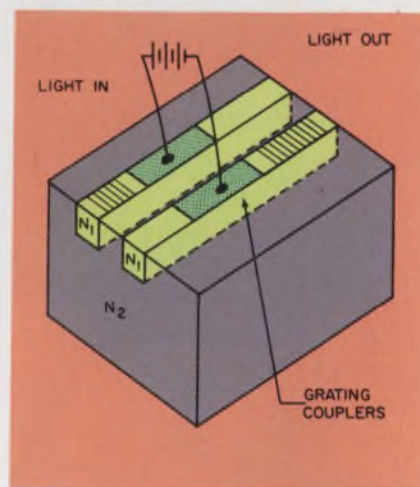

6. A basic gallium-arsenide structure for electrically varying the coupling between two waveguides. Power is thus transferred between them.

aluminum concentration.

Epitaxial techniques can also be adapted for growing several layers with difference indices of refraction; Yariv sees OICs stacked one on top of each other and coupled together.

A main attraction for using the electro-optic effect, Yariv notes, is its promise for low-power, high-speed switching. The power reduction can be more than 100 to 1 when compared with ultrasonic switching on a lithium niobate substrate.

Wideband modulation in these thin gallium-arsenide films can be obtained at about 1 V of excitation and milliwatts of power, Yariv says.

One way in which the electro-optic effect can control the flow of energy in the various modes is by varying the penetration of the mode energy into the adjacent substrate of lower index.

Changing the excitation voltage from a large positive value to one about or below zero can reduce the output to close to zero, thus producing on-off switching.

Another potential application of electro-optic control is in varying the degree of coupling between two adjacent waveguides (Fig. 6). By controlling the voltage applied between the two guides, all or part of the power launched into one guide can be transferred to the other. The electro-optic effect can thus be used for switching, modulation or coupling. ■■



# BOURNS LOW COST FAMILY

OF INDUSTRIAL *TRIMPOT*<sup>®</sup>  
POTENTIOMETERS

OFF THE SHELF AS LOW AS **49**\* ¢

**POWER:** ½ WATT (or better) AT 70°C.

**TEMPCO:** AS LOW AS 100PPM/°C OVER TEMPERATURE RANGE  
OF -55° TO +125°C AND -55° TO +150°C.

Bourns **LOW-COST FAMILY** was designed specifically to fill the requirements of cost-conscious industrial users — so *were the prices!* Imagine how they reduce on large production-run quantities. As a bonus, you get Bourns TRIMPOT potentiometer quality, reliability and performance.

#### AVAILABILITY

All models shown are stocked in depth **RIGHT NOW**, so delivery is off-the-shelf from the factory or your local Bourns distributor.

Complete data on all models of the **LOW-COST FAMILY** is available upon request. Just write, or call, your local Bourns Sales office, representative, or distributor.

\*1000-piece price Model 3389, U.S. dollars, F.O.B., U.S.A.

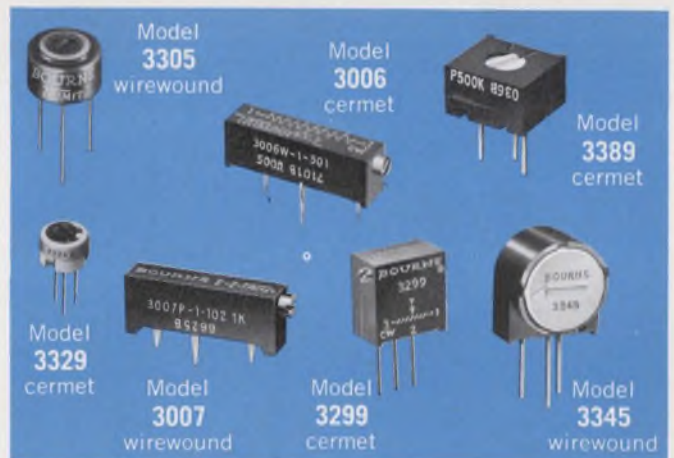

BOURNS, INC., TRIMPOT PRODUCTS DIVISION • 1200 COLUMBIA AVE., RIVERSIDE, CALIF. 92507  
INFORMATION RETRIEVAL NUMBER 23

# Laser-machining process makes circuits in one step

Circuit patterns may soon be machined directly onto a ceramic substrate with a computer-controlled laser.

Devised by Bell Telephone Laboratory engineers at Murray Hill, N.J., the single-step experimental process is intended to replace conventional methods that involve mask-making, photo-resist application and chemical etching.

In the laser-machining process as many as 48 substrates, each measuring 1 by 3 inches and coated with a thin film of conductive metal, are mounted on the outside surface of a circular drum. As the drum rotates, each substrate is successively exposed to a focused neodymium YAG laser beam that is modulated or switched on or off, according to patterns stored in the computer memory. The laser beam is pulsed at 960 W for 250 nsec. In this way tiny regions on the metal coating of each substrate are either selectively vaporized or left intact. Unwanted material is then removed from the substrates along a line that extends all the

way across each substrate.

After each revolution of the drum, a reflecting mirror steps the laser beam to the next line to be machined. A movable lens automatically keeps the laser beam focused at each point on the rotating substrate.

## Advantages are cited

Commenting on the advantages of the laser-machining method, one of the developers, W. W. Weick, says: "A complete circuit is made very simply by this process. It leaves the surface uncontaminated by organic residues. It is a noncontact process which avoids damaging the metal film. It is insensitive to dust, eliminating the need for clean-room conditions, and the laser's depth of focus easily overcomes substrate surface irregularities. Also, it is repeatable, since there are no photographic masks to wear out."

The system will be tried out within six months at Western Electric's plant in Allentown, Pa. ■■

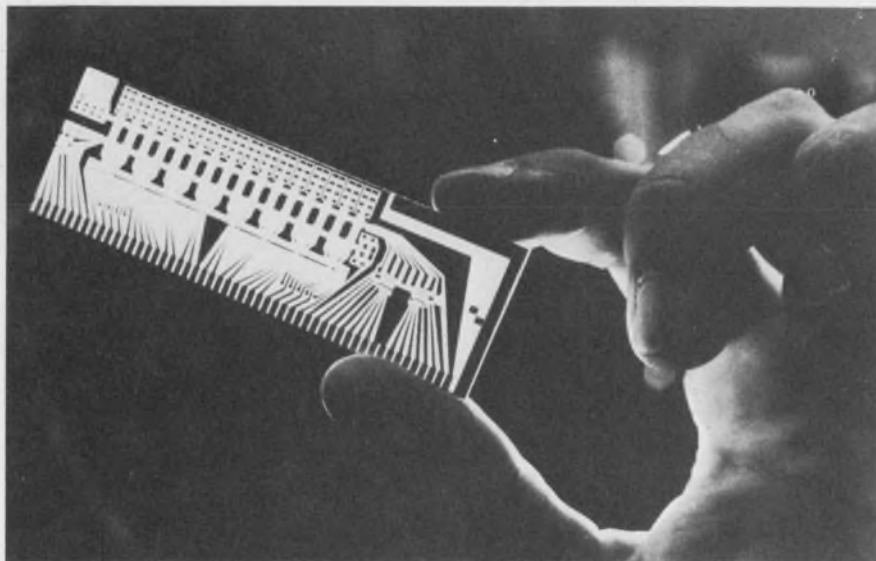

Laser machining technique forms circuit patterns directly onto insulative substrate. Process eliminates the need for clean room conditions.

**Take  
it.  
It's  
yours.**

This handy 28-page brochure gives you quick reference to the entire Dale line including new

- resistors
- trimmers
- networks
- inductors

**What...  
somebody's  
already  
taken it?**

Send Dale's special return postcard and we'll rush your personal brochure right away.

**Need to know now?**

Phone 402-564-3131  
We're ready.

**DALE ELECTRONICS, INC.**  
1300 28th Avenue  
Columbus, Nebraska 68601  
*A subsidiary of The Lionel Corporation*



# The pollution problem. Maybe your engineers deserve a little help.

The engineers will be the ones to find the technical solutions to pollution problems. There's no doubt about it.

But pollution is a people problem, too. And the engineers' technological approach to pollution isn't going to solve people problems.

Maybe this booklet can help. It lists some of the things all people can do to

fight pollution. And with all the people supporting your engineers we'll have a better chance of winning the fight.

For a free copy or a list of bulk rates write to Keep America Beautiful, Inc., Box 1771, Radio City Station, New York, N.Y. 10020

## Keep America Beautiful

Advertising contributed for the public good



People start pollution. People can stop it.

# Twentyfold increase in memory promised with new core material

A new temperature-independent ferrite material has been developed that could lead to core memory planes that are 20 times larger than any core plane on the market today.

Manufactured by Ampex Corp. of Marina del Rey, Calif., the material—called TIN—can be operated over the temperature range of  $-25$  to  $+100$  C without temperature compensation. Ampex declines to divulge the composition of the material.

"We can now consider up to 10 million bits of memory on a practical core plane," says Victor Sell, senior core product manager at Ampex. He believes that TIN will replace the lithium ferrite core as the standard of the industry.

Sell notes that the material can

even be extended further if some temperature compensation is used.

Temperature is one of the main limiting factors in determining maximum core plane size. With lithium cores, normal compensation techniques and heat sinking, practical core planes today do not go much larger than 500,000 cores. Larger planes do exist, but they cannot be produced in volume at reasonable prices, according to Sell.

"During the write portion of the cycle," he points out, "an inhibit current is introduced into the core plane to prevent particular cores from switching. This causes a power dissipation that could give rise to a temperature increase of as much as 50 C if heat sinks or air flow were not used."

This in-circuit heating, when combined with ambient temperature changes, requires that temperature-compensation circuitry al-

most always be included with lithium core memory planes. The compensation circuitry makes a current adjustment for B-H loop (magnetic characteristic) changes as a function of temperature.

Because of the temperature independence of the new material, Sell notes, the designer will no longer need air flow, can greatly reduce heat-sinking requirements and does not need any temperature-compensation circuitry at all.

Lithium cores cannot be used above 75 C with less than 500 mA of drive. The new TIN cores, says Sell, can go up to 100 C with as little as 360 mA of drive. With over 700 mA of drive, they can go up to 150 C. At this point, Sell points out, the drive and sense circuitry becomes the limiting factor rather than the cores.

Timing of the sense and drive circuitry is no longer very critical either. Since the core characteristics don't change with temperature, the strobe window is almost 20 times as wide with TIN cores as with lithium cores.

One other big advantage of these cores is that, at a given drive level, the signal/noise ratio is about 20% higher than with lithium.

"Because of lower noise," Sell predicts, "we will be able to go from 16K to 32K cores per sense winding and to increase the core density by at least 20%."

Ampex is currently producing 18-mil TIN cores and expects to make soon 13-mil TIN cores. With the reduced temperature-testing requirements, TIN cores will sell for 10 to 20% less than lithium cores in equivalent volumes. Since temperature compensation is no longer needed, core-memory systems should sell for up to 25% less, Sell says. ■■

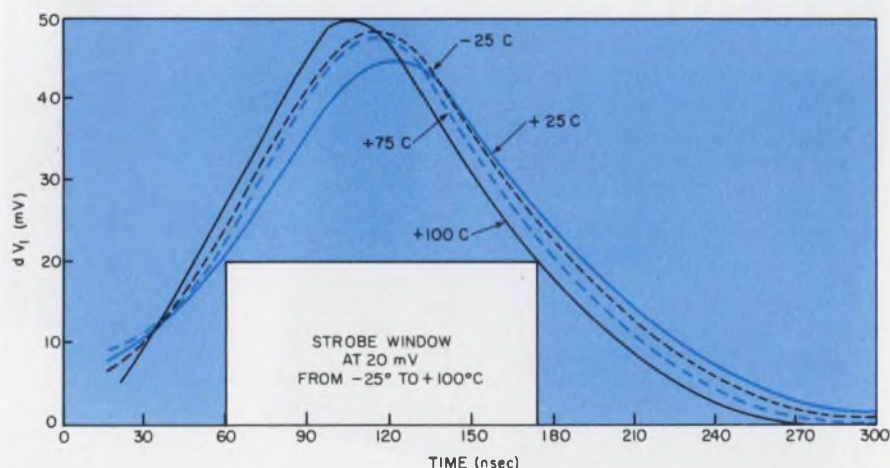

Relaxed timing requirements of Ampex TIN core is evident from these curves of core response as a function of time in switching from a ZERO state to a ONE state. Each curve shows the core response at a different temperature. The strobe window is the timing slot that the designer can use if the memory must work over the full specified temperature range. The curves are taken at a constant drive level of 475 mA.

You shouldn't have to buy cheap modular power supplies just because you can't afford expensive components. The risk is that it'll cost you later.

That's why Sola engineered the new OEM line of modular power supplies for OEM designs. It works just as reliably as the Sola premium line, but you don't pay for anything you don't really need. We've eliminated some of the extras.

For example, maybe you don't have to have overvoltage protection; overcurrent will do. Maybe rated

current is sufficient and temperature compensation isn't essential. Or the cover may not be necessary.

What we've done is made the most advanced power supply module also the most economical. What we've tried to do is make the state-of-the-art a lot more practical.

All Sola Modular Power Supplies—OEM, Premium and CV lines—are interchangeable with other units you may be using. Thirty-eight models in all are standard and immediately available for off-the-shelf delivery. Contact your local Sola representative

or Sola Electric directly for full engineering information. See what's new in the state-of-the-art in voltage regulation.

Sola Electric, 1717 Busse Road, Elk Grove Village, Ill. 60007, 312/439-2800.



**NEW OEM MODULAR POWER SUPPLIES—Series regulated**

- Regulation—0.05% + 1mV line or load
- PARD—0.01% RMS
- Convection cooled
- Constant voltage
- Remote sensing
- Completely protected—short circuit proof, automatic current limiting
- Complete serviceability
- Designed for both bench or rack



**NEW PREMIUM MODULAR POWER SUPPLIES—I-C regulated**

- Regulation—0.01% + line or load
- PARD—0.01% RMS
- Integrated circuit for increased stability
- Convection cooled
- Remote sensing
- Completely protected—short circuit proof, automatic current limiting
- Overvoltage protection
- Overtemperature shutdown
- Complete serviceability



**NEW MODULAR POWER SUPPLIES—CVDC**

- Regulation—1% line, 4% to 10% load
- PARD—3% RMS
- Convection cooled
- Completely protected—short circuit proof
- Ferroresonant design, highly reliable
- Complete serviceability

**all new OEM modular power supplies:  
low cost, long life, fail-safe performance,  
zero maintenance and  
totally interchangeable.**

see  
**SOLA,**  
U.S.A.

The state-of-the-art in voltage regulation

# SCIENCE / SCOPE

NASA's Earth Resources Technology Satellite, scheduled for launch this summer, will carry an experimental multispectral scanner developed by Hughes. The scanner's single optical system will record signal data in four separate bands of the electromagnetic spectrum and convert the light emissions into photo-like images. The resulting "signatures" of the solar energy emitted by agricultural crops, forests, and rivers will indicate their environmental health. The scanner will "see" a swath 100 nautical miles wide during each polar orbit over the U.S.

NADGE is the first major real-time air defense system to be implemented with a high-level compiler language (JOVIAL) using two Hughes-built processors in a multi-processing mode. Hughes developed software programming for the 37 computer sites in the NADGE (for NATO Air Defense Ground Environment) system around common modules that can be adapted to solve problems peculiar to the various locations. Eighteen of the computer sites have been tested and accepted without any delay due to software programming problems. The entire NADGE system is scheduled for completion by the end of the year, except for some site work in Greece.

The first long-life hydrazine thruster systems, which Hughes developed for NASA's ATS-4 and 5 satellites, have proved superior to the conventional hydrogen peroxide thruster for making the radial and axial corrections that keep a synchronous satellite on its precise orbital station. The hydrazine thruster is safer, more reliable, longer lived, easier to restart in space, and less costly. Two new hydrazine engines, in 1- and 5-lb. thrust, are now available. Hughes is using the 1-lb. thruster on Canada's Anik 1 domestic communications satellite.

The U.S. Navy's AWG-9 weapon-control system which launches the Phoenix missile, both built by Hughes for the F-14 fighter, has a "look down" capability that enables it to pick out moving targets from the ground clutter that normally obscures conventional radar signals. A Phoenix missile demonstrated its ability to combat the anti-ship missile threat when it was launched from a test platform at 10,000 feet and hit a cruise-missile target flying at 800 feet, while another launched from 29,000 feet "killed" two targets flying close together at 10,000 feet. The AWG-9 can also launch the F-14's Sparrow and Sidewinder missiles and direct the firing of its M-61 Vulcan 20mm cannon.

Hughes needs software/programmer specialists with experience in software systems, real time applications, and technical data management systems. Also: business programmer/analysts with IBM 370/165 OS/MVT/ASP experience. U.S. citizenship required. Please write: Mr. R. S. Roth, Hughes Aircraft Company, P.O. Box 3310, Fullerton, CA 92634. An equal opportunity M/F employer.

New products from Hughes include a low-cost one-watt CW argon laser featuring the same sealed, cylindrical head as Hughes' "Hip Pocket" helium-neon lasers; the power supply is air cooled, permitting a compact 7x16x19-inch design for standard rack mounting . . . and a miniaturized scan converter designed for video data processing in a wide range of information display applications; it offers high speed and high resolution, as well as selective erasure and rewriting capability.

Creating a new world with electronics

**HUGHES**

HUGHES AIRCRAFT COMPANY

# Solar-cell efficiency surges to 18% with gallium arsenide

A big step forward in solar-cell efficiency—the first in 10 years—has been announced by researchers at the International Business Machines Corp.

With recent advances in the technology of gallium arsenide, the new cells have demonstrated a conversion efficiency of sunlight to electricity of 18%. With more refinements, IBM says, the efficiencies may go even higher. The best previously reported efficiency for GaAs cells was 13%, and for silicon cells, 14%.

Besides gallium arsenide—the cells' active material—ternary alloys of gallium and arsenic, plus elements from columns III or V of the periodic table, are used.

Fabrication consists of growing a layer of GaAlAs, heavily doped with zinc, on top of a crystal of n-type GaAs. Growth is by liquid-phase epitaxy. As the GaAlAs layer grows, zinc diffuses into the

GaAs, forming a p region. Depending on growth conditions, the depth of the zinc diffusion can be controlled to form a p-n junction from one-half to about  $7 \mu$  below the surface of the GaAs. A depth of 1 to  $2 \mu$  appears to be optimum. Control of the depth of the junction is simple, and the whole process is easily reproducible.

Another plus for the new cells is that they provide useful output at much higher temperatures than previous solar cells. They are at least 5% efficient at 300 C, a temperature at which silicon cells have no output. This feature makes them attractive for use on space missions close to the sun and for exploring such hot planets as Venus and Mercury.

The cells also mark a big step toward solar-energy earth applications because of their high efficiency and relatively simple fabrication. ■■

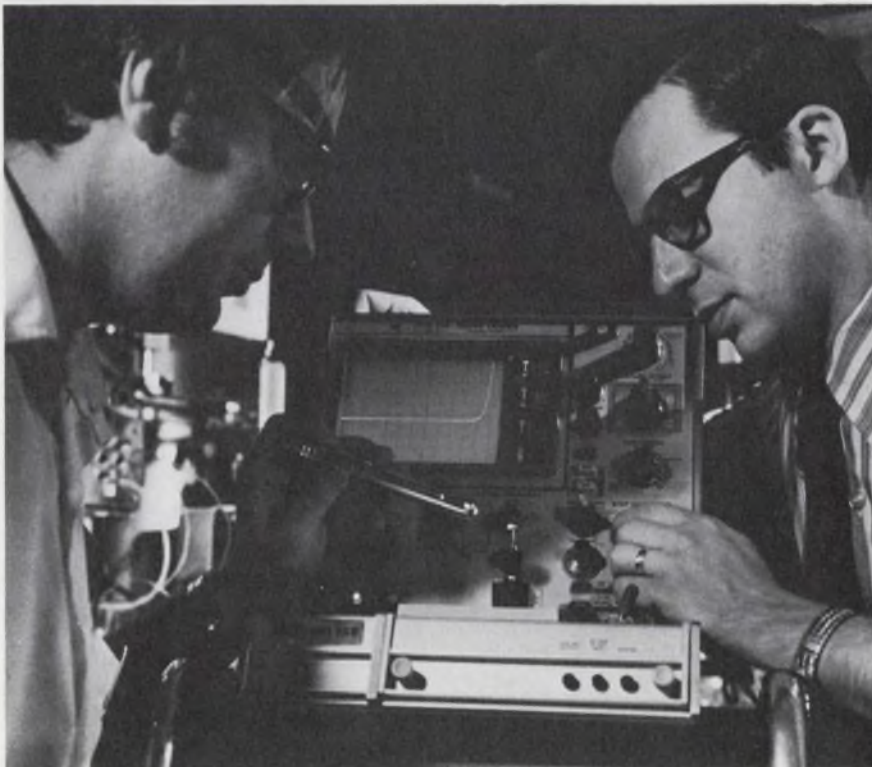

Gallium-arsenide solar cell's response to illumination is being checked by a flashlight by IBM engineers Jerry Woodall (left) and Harold Hovel. The oscilloscope reading shows the cell's very low resistance.

## Hughes is in industrial electronics, too: components, equipment and systems.



MOS integrated circuits (RS 283)



Gas lasers (RS 293)



Display systems (RS 291)



NC positioning tables and systems (RS 297)



FACT automatic circuit testers (RS 298)



Special assemblies (RS 286)

For complete information, write Bldg. 6, Mail Station D-135, Culver City, CA 90230. Or request by Reader Service (RS) numbers.

# HUGHES

HUGHES AIRCRAFT COMPANY

# MAKE THE SWITCH



**to the worlds  
smallest  
power supplies**

PRICES START AS LOW AS \$79.00  
HIGH EFFICIENCY  
THOUSANDS ALREADY DELIVERED  
DELIVERY FROM STOCK

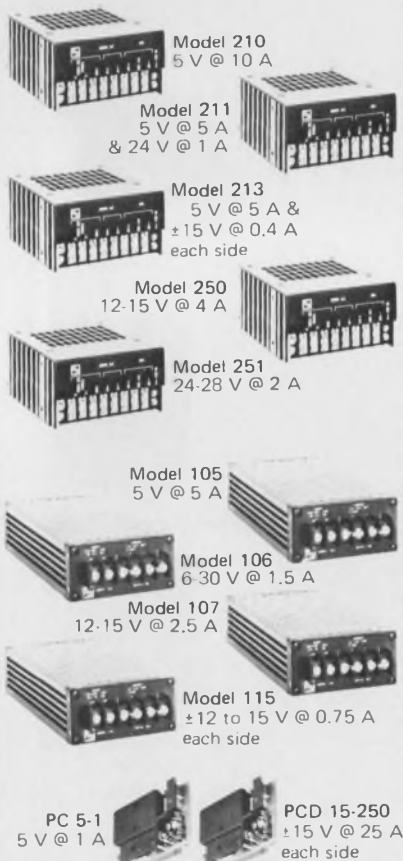

Model 210  
5 V @ 10 A

Model 211  
5 V @ 5 A  
& 24 V @ 1 A

Model 213  
5 V @ 5 A &  
± 15 V @ 0.4 A  
each side

Model 250  
12-15 V @ 4 A

Model 251  
24-28 V @ 2 A

Model 105  
5 V @ 5 A

Model 106  
6-30 V @ 1.5 A

Model 107  
12-15 V @ 2.5 A

Model 115  
± 12 to 15 V @ 0.75 A  
each side

PC 5-1  
5 V @ 1 A

PCD 15-250  
± 15 V @ 25 A  
each side



RO Associates, Inc.  
3705 Haven Avenue  
Menlo Park, California 94025  
Ph: (415) 322-5321

## technology abroad

An uncommitted logic array that can be programmed like a ROM is described as a new application for Ferranti Semiconductor's CDI high-density process in England. On a single microcircuit chip Ferranti has packed a number of standard logic building blocks, including gates and flip-flops. To design a particular random logic array, the customer specifies the interconnections between logic elements. A single mask is then prepared by Ferranti. This mask connects the elements in a single metalization layer. Ferranti engineers indicate that the chip will have about 200 gates on it.

CIRCLE NO. 441

A new marine navigation system that uses two helium-neon lasers to keep vessels on course has been produced by Britain's Decca. Single laser beams are also used as channel guideways but are difficult to locate once the ship has gone astray. In the Decca system, the two lasers have overlapping beams. The beams are flashed alternately in two-second cycles and are so spread that vessels on the correct path see a continuous beam, while those off course see a flashing light. The duration of the flash indicates whether the ship is to port or starboard of the desired course.

CIRCLE NO. 442

A new zinc-air cell, half the weight of a mercury cell but producing the same current with double the life, has been announced by Energy Conversion Devices of Basingstoke, England. At the same time Multitone, the world's largest manufacturer of pocket paging systems, says it will market the new cell worldwide and use it in its pocket pagers. Mercury cells had been considered the most efficient energy source for small,

low-current equipment. In fact, the Energy Conversion Devices battery has an energy density of 140 W per pound, compared with 18 for a lead-acid battery and between 18 and 35 for a Leclanche cell. Energy Conversion was set up initially to exploit zinc-air batteries under a license from Leeson Moos Laboratories, Great Neck, N.Y., but the English company developed the new battery independently, and instead of a replaceable central electrode, it has adopted a throw-away approach. Shelf-life has been substantially improved, with batteries showing 90 to 95% of their original capacity after one year, according to the company.

CIRCLE NO. 443

A new atomic battery is capable of powering Germany's first atomic heart pacemaker for at least 10 years, according to Siemens, its developer. The radioisotope device has been operational for over 12,000 consecutive hours. The unit is 3-cm long, but its energy source is a pea-sized capsule of plutonium-238. The heat generated by nuclear decay in this 200-milligram capsule produces a thermoelectric dc voltage to power the pacemaker.

CIRCLE NO. 444

A two-month test of ship-to-shore communications via satellite is being conducted by Cunard and the Comsat Corp. They are using the Intelsat IV satellite, which is in synchronous orbit over the Atlantic. The liner Queen Elizabeth II has been specially fitted with an eight-foot parabolic dish antenna on her top deck, together with an antenna-control and stabilization system. Pointing angles for the shipboard antenna were calculated at Comsat's laboratories in Maryland.

CIRCLE NO. 445



# NEW! A/D ENCODER CIRCUIT.

Contains all the digital circuitry necessary to build an 8-bit successive approximation A/D converter.

## HI-0180

This new device replaces three conventional TTL MSI packages, resulting in significant space and cost savings.

### Features:

Both serial and parallel output data compatible with DTL/TTL.

"Data Ready" output pin indicates when conversion is complete and can be used for serial word synchronization, gating of parallel data, or actuating an analog sampling circuit.

"Reset" and "Enable" inputs which allow the device to convert continuously or stop on completion of a conversion until externally restarted.

### Applications:

The HI-0180 can be used with the HI-1080, 8-bit D/A converter, the HA-2111 comparator, and a reference voltage source to implement a complete 8-bit A/D system capable of converting unipolar or bipolar signals with 1/2 L.S.B. accuracy at up to 40,000 conversions per second.

### Other applications include:

Point of measure A/D converters in data acquisition systems.

Encoders and decoders for digitally multiplexed audio, instrumentation, or control transmission systems.

### Supplied:

16-pin ceramic DIP	100-999 units
HI-1-0180-2 (-55°C to +125°C)	\$17.70
HI-1-0185-5 (0°C to +75°C)	\$ 8.85
CFO-0185-6 (Chips)	\$ 5.35

For details see your Harris distributor, representative or write direct.

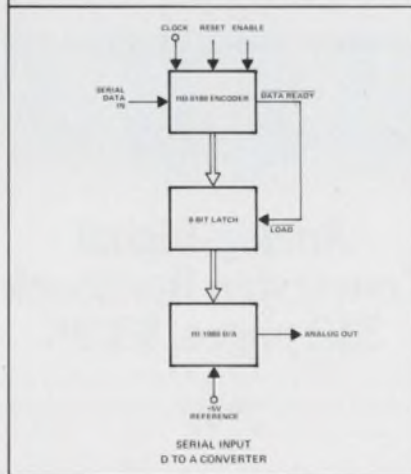
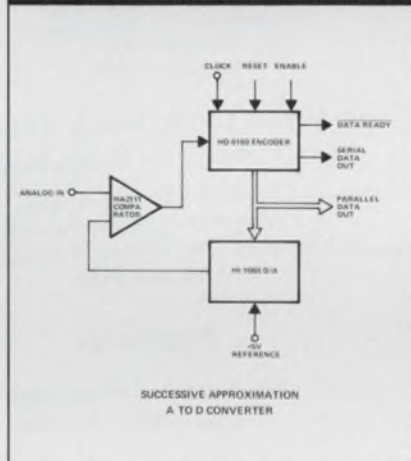
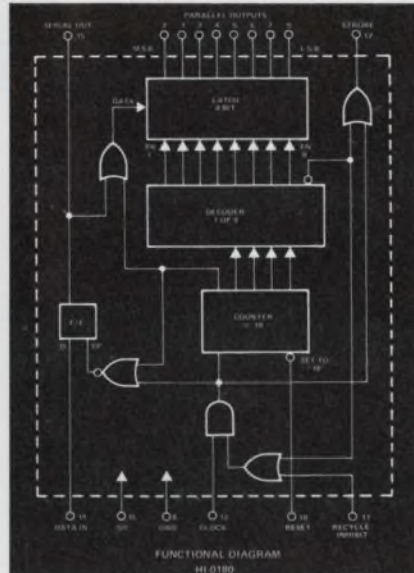

## Special Introductory Offer! Complete 8-bit A/D Converter System Kit

For a limited time we are making available a complete 8-bit A/D converter system in kit form for both commercial and military applications. Kits also contain a prewired PC card and information package. Both versions may be ordered only through your Harris distributor, but be sure to place your order early because quantities are limited.

The military version consists of our new HI-0180 encoder, the HI-1080 D/A converter, the HA-2111 voltage comparator. **\$65.00** in 1-99 quantities.

The commercial kit contains our HI-0185 A/D encoder, the HI-1085 D/A converter, and the HA-2311 voltage comparator.

**\$36.80** in 1-99 quantities.



**HARRIS**  
**SEMICONDUCTOR**

A DIVISION OF HARRIS-INTERTYPE CORPORATION

P.O. Box 883, Melbourne, Florida 32901  
(305) 727-5430

**DISTRIBUTORS:** **Schweber Electronics:** Westbury, New York (516) 334-7474; Rockville, Maryland (301) 881-2970; Hollywood, Florida (305) 927-0511 / **Harvey/R & D Electronics:** Lexington, Massachusetts (617) 861-9200 / **Semiconductor Specialists, Inc.:** Chicago (312) 279-1000; Detroit (313) 255-0300; Minneapolis (612) 884-8132; Kansas City (816) 452-3900; St. Louis (314) 428-6100; Dallas (214) 358-5211; Indianapolis (317) 243-8271; Pittsburgh (412) 781-8120; Dayton (513) 278-9455 / **R. V. Weatherford Co.:** Albuquerque (505) 265-5671; Anaheim (714) 547-0891; Austin (512) Enterprise 1443; Dallas (214) 231-6051; Denver (303) 427-3736; Glendale (213) 849-3451; Houston (713) Enterprise 1443; Palo Alto (415) 321-5373; Phoenix (602) 272-7144; Pomona (714) 623-1261; San Diego (714) 278-7400; Seattle (206) 762-4200. **HARRIS SALES OFFICES:** Wellesley, Massachusetts (617) 237-5430; Wayne, Pennsylvania (215) 687-6680; Palos Heights, Illinois (312) 597-7510; Melbourne, Florida (305) 727-5430; Palo Alto, California (415) 321-2280; Melville, New York (516) 249-4500; Syracuse, New York (315) 463-3373; Washington, D.C. (202) 337-4914; Dallas, Texas (214) 231-9031; Scottsdale, Arizona (602) 946-3556; Long Beach, California (213) 426-7687.

INFORMATION RETRIEVAL NUMBER 28

# This is what you have to know to know everything about converters.

## Table of Contents

Analog-Digital Conversion Handbook

### I. Converters at Work

Data-System Components  
Data Acquisition & Distribution  
Circuit Tricks with Components

### II. Applications of Converter Systems

Automatic Testing  
Communications and Signal Analysis  
Displays  
Commerce and Industry

### III. Converters

Understanding Converters  
Converter Design & Testing  
Specifying & Applying Converters Successfully

### IV. System Accessories

Operational Amplifiers  
Instrumentation Amplifiers  
Multiplexers  
Sample-Holds

### V. What To Do When Things Don't Seem To Work Right

Basic Questions People Always Ask  
and Where to Find the Answers  
The 10 Mistakes Users Most Commonly Make  
If All Else Fails

### Appendix

Glossary & Definitions  
Some Useful Tables

## Analog-Digital Conversion Handbook 312 pages. \$3.95

Since you make more kinds of A-D and D-A converters than anyone else, I wouldn't pass up your handbook for anything. Enclosed is my check for \$ \_\_\_\_\_ for \_\_\_\_\_ copies.

Name \_\_\_\_\_ Title \_\_\_\_\_

Company \_\_\_\_\_ Street \_\_\_\_\_

City \_\_\_\_\_ State \_\_\_\_\_ Zip \_\_\_\_\_

Please allow 4-6 weeks for delivery.

Mail to: Analog Devices, Inc., Box 796, Norwood, Mass. 02062



**ANALOG  
DEVICES**

ED

# washington report



Don Byrne  
Washington Bureau

## Space shuttle contract set for July

The space-shuttle program is "home free for this year at least," says a NASA spokesman, despite the fact the space agency's budget has not yet been approved by Congress. NASA's confidence stems from a resounding defeat in the Senate of attempts to remove \$227.9-million for space-shuttle development from the over-all \$3.42-billion NASA authorization bill. Critics contended the shuttle is merely the first step of a program that includes a permanently orbiting space station and that could run as high as \$50-billion. NASA expects to be able to select a contractor and begin final negotiations on the shuttle orbiter by mid or late July. North American Rockwell, Grumman Aerospace, Lockheed and McDonnell Douglas have submitted bids for the reusable orbiter. The House and Senate have now both approved a \$3.43-billion NASA authorization. The NASA appropriation bill, the final step in funding, is expected to be presented to Congress shortly.

## OTP consultant sees bright future for CATV, broadband

An independent consulting firm on contract to the White House Office of Telecommunications Policy sees a prosperous future for the broadband microwave transmission systems, the backbone of the CATV industry. The firm, Marlarkey, Taylor and Associates, based its reports on a study of experiments in cable television now in progress. The report recommended a special pilot project for a "wired city," in which about 100 residential users and several hundred nonresident users would be hooked up with two-way broadband frequency communications. The firm recommended that OTP should take the lead by providing direct Government grants, as well as by getting equipment manufacturers to provide research and development studies and outright grants. It was also suggested that the White House Office tap the country's charitable foundations for grant money. Users in the "wired city" would be equipped with alphanumeric keyboards, hard-copy-printout video screens and alphanumeric storage capacity—in short, a home information center.

## Laird unveils ULMS plans

The Navy's submarine program for the future, the undersea long-range missile system (ULMS), has a new name and a definite goal for the first time. Defense Secretary Melvin Laird has revealed that the Navy wants to build 10 of the new subs to replace a portion of the 41 Polaris-Poseidon

submarines now in existence. The new boats, which will cost in excess of \$1-billion each, will be called Trident. The Navy at one time was talking about possible construction of 25 of the new subs, but Congressional resistance has been building sharply because of the cost—approximately that of a nuclear carrier.

The defense budget this year contains over \$900-million for Trident R&D in contrast with the \$170-million spent over the previous four years. Among the electronic innovations sought for the Trident submarines are super-quiet equipment, decentralized data processing, integrated displays and communications, and improved inertial navigational systems. The subs will carry an as-yet undeveloped missile called the C-4, which has a range of 5000 to 6000 miles—approximately twice that of the Poseidon. The Lockheed Missile and Space Div. in Sunnyvale, Calif., is defining the characteristics of the C-4 under a Navy contract.

## **Jockeying resumes in import quota battle**

By a 26-vote margin, the House has beaten back an attempt to levy import quotas on goods produced overseas under working conditions that are below standard in the United States. The measure was attached as a rider to a bill on minimum wages, and it now goes to the Senate, where the rider could, of course, be reintroduced. For more than a year, the Hartke-Burke bill, which would set quotas, has been bottled up in committee as the Administration, the United States Chamber of Commerce and large U. S.-based international concerns have battled to kill it. On the other side of the coin, organized labor has been battling just as hard to send the bill to the floor.

With the bill tied up, it now appears that the pro-quota forces will be trying to attach pieces of the Hartke-Burke bill to other important legislation by amendments on the floor. The Hartke-Burke bill would limit imports to the level that they were between 1965 and 1969, and would make immediately taxable any profits earned overseas by American international concerns. These profits are not taxable now until the money is returned to the United States.

## **Action on defense budget due in House**

Defense experts expect Congress to cut "at least" \$3-billion from the \$84-billion defense-budget request for the coming fiscal year. The defense authorization bill is due for floor action in the House late this month. It originally was scheduled for action late in May, but the public protests stirred by mining North Vietnamese ports reportedly made it inadvisable to bring it up at that time.

Another thing holding up action on the defense budget is said to be doubts in Congress about whether the Litton Shipyard in Pascagoula, Miss., will be able to fulfill all the terms of its contract to build the Navy's DD963 destroyers. The shipyard's timetable and costs for the Navy's LHA amphibious assault ship have both changed for the worse, and Congressmen are reported to fear the same thing may happen to the destroyer. The problem is said to be that the shipyard is having trouble hiring locally the type of sophisticated worker needed, and the workers recruited from out of state are inclined to leave because of the town's "poor living facilities." At times the turnover rate of skilled workers is said to run as high as 50%.

There are also technical problems in the Litton yard, committee sources add, and Congressmen fear that this could lead to cost overruns.

# If you need **cool,** accurate, **reliable** DPMs ... **Buy Triplet**

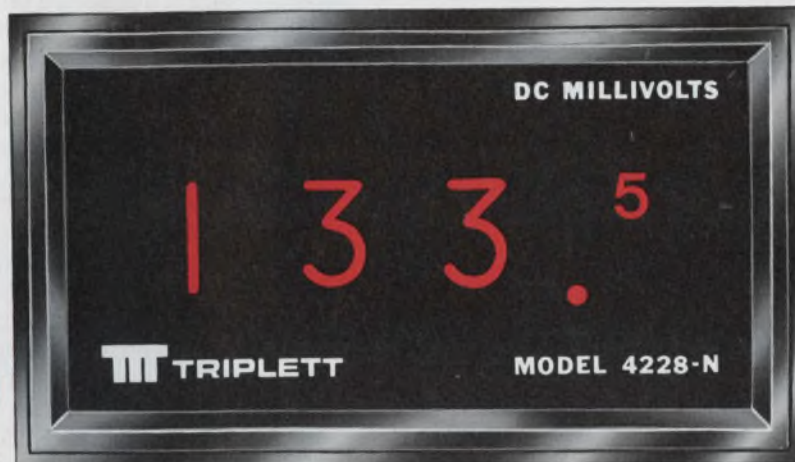

Model **4228-N**

actual size

**\$140**

1. 2 $\frac{3}{4}$  digits — Provides double the accuracy (0.25% of reading  $\pm$  1/2 digit) and double the resolution at lower cost.
2. Instantaneous Response — 16-millisecond display rate with 60 times per second sampling rate.
3. Fool-proof Numeral display blurs beyond over-range and with negative polarity.

Designed for OEM applications as well as R&D, production, quality control, maintenance and education use, Triplet's line of digital panel meters combine compactness, convenience and capability with characteristic Triplet accuracy and quality.

To 2 Watts power consumption (for reduced heat and increased reliability) and positive over-range and reverse polarity indications, Triplet's Model 4228-N adds a unique (patent pending) 2 $\frac{3}{4}$ -digit display that effectively doubles the accuracy and resolution of 2 $\frac{1}{2}$ -digit instruments . . . at the cost of 2 $\frac{1}{2}$ -digits. Accuracy is  $\pm$  0.25% of reading  $\pm$  1 digit.

Model  
**4235-F \$240**

1. 3 $\frac{1}{2}$  digits with auto-polarity.
2. Low Power Drain — provides low operating temperature and long-lived reliability.
3. Single-plane, Seven-bar Readout — for accurate, wide-angle readability.

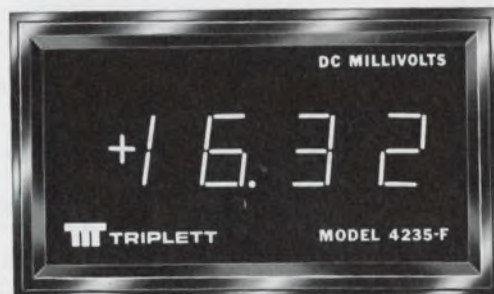

The Model 4228-N is a real value at \$140, so call your local Triplet Sales/Service/Modification Center or Triplet sales representative right now. Either will also be pleased to demonstrate two companion products: Triplet's Model 4225-N at \$125 which merely omits the neon lamp "1" (thus reading to 995) and offers  $\pm$  0.50%  $\pm$  1 digit accuracy; and the Model 4220-N at \$110 — a 2-digit instrument (reading to 99) with  $\pm$  1%  $\pm$  1 digit accuracy.

Mounted in the same size case and boasting the same low power consumption and positive over-range indication, Triplet's 3 $\frac{1}{2}$ -digit Model 4235-F adds auto-polarity

(with polarity indication) display hold capability, high input resistance (from 10 to 1,000 megohms depending on range) and a 3 $\frac{1}{2}$ -digit single-plane seven-bar fluorescent display. For many users, the wide-angle viewing capability — enhanced by a green, circularly-polarized viewing window that eliminates confusing internal reflections — will make the 4235-F the obvious choice.

Boasting a voltage accuracy of  $\pm$  0.10% (current  $\pm$  0.15%) of reading  $\pm$  1 digit, Triplet's Model 4235-F sells for \$240. Its companion, the 3-digit Model 4230-F, is \$220. More information, or a free demonstration of both models, is available from your Triplet Sales / Service / Modification Center or your Triplet sales representative. Triplet Corporation, Bluffton, Ohio 45817.

**TRIPLET**

Manufacturers of the World's most complete line of V-O-Ms.

# Every single thing about our new fine tuner is fine. Even the price.



Precise fine tuning has always been a problem. Until now. Raytheon's new Microvernier control knob utilizes the principle of harmonic drive to provide a new, low-cost method of obtaining high-resolution tuning or precise zero setting.

The patented performance-proven Microvernier control knob is more economical. Because it's gearless. Yet its zero-backlash performance is precise enough to meet the most sophisticated electronic standards. It features both 40:1 and 1:1 tuning ratios. And it's available now in three sizes to keep all your fine tuning under control. Write Raytheon Company, Fourth Avenue, Burlington, Massachusetts 01803.

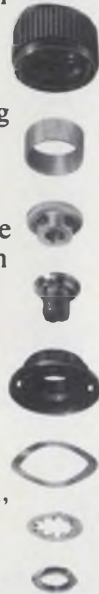

INFORMATION RETRIEVAL NUMBER 31



designing  
Point-of-Sale?

## consider DigiWand!™

Nortronics' new DigiWand is a pencil-sized, azimuth-independent magnetic reader pen designed to accurately read ABA and IATA encoding formats for Point-of-Sale (credit card) systems. Its circular gap configuration sharply reduces error rates by permitting the operator to tilt the pen 20° in any direction. Just another example of Nortronics innovation translated into product reality. Write today for detailed information.



'world's leader in magnetic heads'

**NORTRONICS**  
COMPANY, INC.

8101 Tenth Avenue North  
Minneapolis, Minnesota 55427 • (612) 545-0401

INFORMATION RETRIEVAL NUMBER 32

Choose  
Quick - Connect

## Terminal Blocks

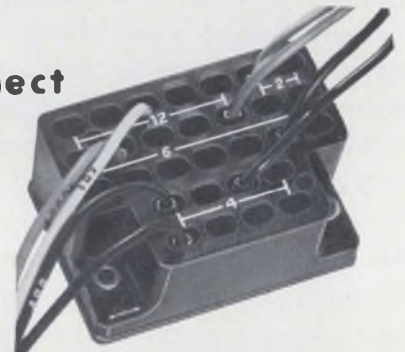

from our  
wide range of stock molds  
.250, .187, .110 terminal sizes

- Centralized wiring assembly
- Temperature resistant
- Completely insulated
- Specific identification
- Kit-form blocks available
- Easy laboratory or experimental assembly

Underwriters Safety Device Co. delivers all of these features and more in the versatile terminal blocks offered out-of-stock. If we do not have the stock mold to suit your purpose, our staff will design one to fit your specific need. Send for brochure describing many models.

## Underwriters Safety Device Company

4332 N. Kedzie Ave., Chicago, Ill. 60618 • 312-583-4080

INFORMATION RETRIEVAL NUMBER 33

ELECTRONIC DESIGN 12, June 8, 1972

# are you a designer who demands ultimate reliability at lowest possible cost?

then consider Telex TERMI SERIES  
digital cassette recorders!

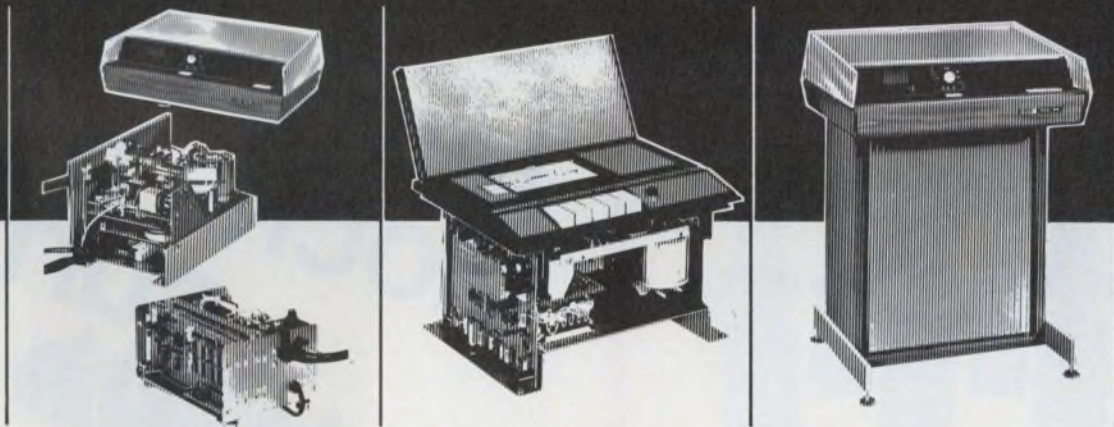

Telex — world's leading manufacturer of recording equipment — offers industry's most comprehensive series of high-reliability, low-cost digital cassette recorders and memories; pre-engineered, field-proven units for virtually every modern application.

TERMI SERIES includes models ranging from basic cassette transports to complete systems designed for buffered terminals, data capture, point-of-sale equipment, peripheral storage, numerical control and other digital data handling missions.

Perhaps most important, Telex provides decks with unique mechanical enhancements; subsystems with Read/Write electronics, Power Supply and a range of data interfaces from phase encoded, NRZ, parallel to communications RS-232; and complete high-performance computer peripheral memory systems for low-speed paper tape replacement (10, 15, 30 CPS) or high-speed paper tape replacement to 300 CPS.

Telex has combined more than thirty-five years of recording expertise to create TERMI SERIES — the *only* complete line of digital cassette recorders and memories expressly designed for high-volume OEM applications where low cost and high reliability are critical specifications.

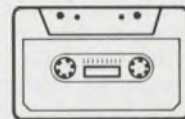

**new-breed™**  
digital recorders

Contact Telex today for detailed technical literature and application data.

**TELEX®**  
COMMUNICATIONS DIVISION

9600 Aldrich Avenue South  
Minneapolis, Minnesota 55420  
Tel: (612) 884-4051

# Celco

# DEFLECTION YOKES

# Celco

THE BEST YOKE FOR YOUR DISPLAY



**FASTEST SPOT RECOVERY**  
Spot recovery times to 0.1% in less than 2 micro-seconds.



**LOW RESIDUAL MAGNETISM** Residuals as low as 0.005%. Lower on your special order.



SEND FOR THE NEW CELCO YOKE GUIDE LISTING OVER 175 TYPES. FIND THE ONE YOKE FOR YOUR SPECIAL DISPLAY APPLICATION.



**HIGH Q FERRITE STATORS**  
High sensitivity yokes for both resonant, direct drive.



**ULTRA HIGH RESOLUTION Deflectrons** Low astigmatism with a minimum spot growth.



**HI SENSITIVITY LOW I<sup>2</sup>**  
High efficiency with minimum deflection driving power.



**MAGNETIC WRITING YOKES** High sensitivity character yokes. Frequencies to 30 MHz.



**LOW COST TERMINAL YOKES** For computer terminals, airline or stock price displays.



**DIRECT VIEW STORAGE CRTS** Maximum information obtained by use of low driving power.

CONSTANTINE ENGINEERING LABORATORIES COMPANY

70 Constantine Dr., Mahwah, N.J. 07430

Tel. 201-327-1123

TWX: 710-988-1018

INFORMATION RETRIEVAL NUMBER 35

## SWITCH/INDICATORS

Unlimited Variety



Aren't these what you're looking for? Endless variety and options. Million-cycle reliability! Low, off-the-shelf prices. Compact design. TEC's got 'em... in switches matchmated with TEC-LITE Indicators to give your panel a more handsome design. For information about TEC's complete line of switch/indicators • readouts • display panels • data entry keyboards • CRT display terminals, call (602) 297-1111 or write: TEC, Incorporated, 9800 N. Oracle Road, Tucson, Arizona 85704.



INFORMATION RETRIEVAL NUMBER 36

## terminal blocks by curtis

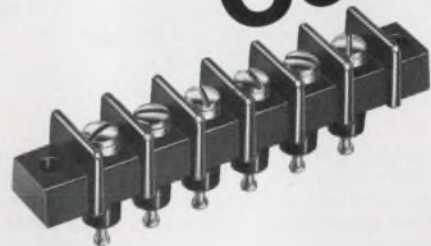

**GFT Series:** The industry's most versatile terminal block. Get tremendous versatility with 1 thru 26 screw-type terminals on  $\frac{7}{16}$ " centers, for #12 wire. Rated 20 amps. 300 volts. Available with internal solder post connections, printed circuit pins (.062" dia.), screw connections or turret-type posts with axial #53 taper pin receptacle (all bright tin plated).

In any variation, GFT insulated, feed-through terminal blocks meet CSA and UL standards; no additional insulating or mounting procedures required. Fully-insulated GFT terminals provide a full  $\frac{1}{4}$ " solder terminal to ground clearance, even on  $\frac{1}{8}$ " thick chassis.

Contact factory for your nearest local Curtis representative, distributor, or for additional information.

**CURTIS DEVELOPMENT & MFG. CO., INC.**  
3236 N. 33rd St. • Milwaukee, Wis. 53216



INFORMATION RETRIEVAL NUMBER 37

ELECTRONIC DESIGN 12, June 8, 1972



# Centralab Substrates/ScoreStrates™... in line with your design requirements



Write  
Centralab  
for  
Bulletin  
No. 1057TC3

**YOUR FIRST STEP**

1. BARE CERAMIC SUBSTRATE
2. METALLIZED THICK FILM CONDUCTOR PATTERN
3. INSULATING GLAZE FOR ELECTRICAL INSULATION
4. DEPOSITED AND ADJUSTED RESISTORS
5. SOLDER TINNING OF CONDUCTORS AND LEADS ATTACHED
6. DISCRETE TRANSISTORS AND IC'S ATTACHED
7. THICK FILM HYBRID — CONFORMAL COAT AND STAMPING

## Your first step—your most important

Centralab Substrates and ScoreStrates have already made the circuit in computers, office machines, communications equipment, home and portable appliances and a variety of other electronic uses. They've helped microcircuit designers get reliability every step of the way.

They can help you. Whatever your designs require, Centralab has it available. Specify aluminas — 99.6% or 95% — steatites, titanates, plain or metallized.

Active in engineered ceramics since 1928, Centralab pioneered thick film circuitry and substrate requirements with the first Packaged Electronic Circuit in 1945. Today, our proprietary tooling and fabricating processes are keeping pace with the demands of microelectronic applications. We offer you substrates for most types

of deposition. Available in simple or complex shapes, a range of thicknesses with holes, slots or plain; as ScoreStrates with accurate break lines and a choice of finishes. And they all meet or exceed industry standards for quality, price and lead time.

Today, we're a leading supplier of substrate materials to other manufacturers, and we are also our own largest customer (over 500 million in ten years). To us developing better and more reliable substrate materials for electronics means higher quality for Centralab electronic components. It will mean the same to your products. And your customer's products, too!

Your first step is your most important. Let Centralab help you make your circuit. For complete information, write Centralab Technical Ceramic Sales.

### GET CENTRALAB THE "IN LINE" FOR YOUR DESIGN

Hybrid Microcircuits  
Pushbutton & Rotary Switches  
Capacitors  
Potentiometers  
Technical Ceramics  
Ceramic Packages  
Semiconductor Devices



**CENTRALAB**

Electronics Division  
GLOBE-UNION INC.  
5757 NORTH GREEN BAY AVENUE  
MILWAUKEE, WISCONSIN 53201

INFORMATION RETRIEVAL NUMBER 38



# It's as simple as a PDP-8.

Anyone can interface a PDP-8. You just plug everything into the OMNIBUS.<sup>TM</sup> Anywhere. In any order. Any time.

Now if you want to write PDP-8 software you have to know programming. But you don't have to know much. PDP-8 is one of the easiest to program computers ever made. And it has the biggest library

of minicomputer software in the world. So you might not need any new software anyway.

Where you might want some help is in selecting the peripherals. There are over 60 standards to pick and choose from. Plus specials.

But you won't have to waste time figuring out if the PDP-8 can do your job. Every job being done by minicomputers is being done by a

PDP-8. And it'll do your job for a long, long time. PDP-8's have been known to run flat out, 24 hours a day, 7 days a week, for two years straight.

You see, when you get a PDP-8, you won't get stuck.

Digital Equipment Corporation, Maynard, Mass. 01754. (617) 897-5111.

**digital**

## Everybody's specs are conservative

We're working in a wonderful industry. If we know how to read, we can never go wrong on anything we buy. Manufacturers always give us more than they promise on the spec sheet.

I was reminded of this recently when I received a letter from an old buddy who chided me for severe inadequacies in an article I recently wrote. It seems I had failed to point out that his company's products were far superior to anybody else's; his company always had something better.

I had written, for example, that another company's instrument had the broadest bandwidth. He argued that his "usable" bandwidth was just as broad and the only reason his spec sheet didn't give a broader bandwidth was that his company was extremely conservative. On another score, he needled me for calling attention to the fact that his instrument's high-frequency square waves might look rather sinusoidal because rise time and fall time were slow. Well, he argued, those transition times look slow because, "we are extremely conservative and, in fact, we recently changed our spec sheets to show the much better transition times that the instrument actually has."

This case was by no means unique. I frequently get complaints from companies who scold me for not recognizing that their products are much better than their published specs because—you guessed it—they are extremely conservative. They invariably amplify by pointing out that they never ship a product unless it has passed published specs by a margin of 20%—or 30%, or 40%, or whatever. And each of these men seems to feel there is something unique about having a quality-control standard that's tighter than the spec.

The conclusion is obvious. We simply can't go wrong in buying anything from anybody because everybody's product is better than his specifications. And we all know we've never purchased a product that didn't meet its specs. Don't we? After all, if you can't believe what you see in print, what can you believe?



A handwritten signature in dark ink, which appears to read "George Rostky". The signature is fluid and cursive.

GEORGE ROSTKY  
Editor

# Focus on Fast logic

Designers of high-speed logic systems used to worry about getting the right custom circuits for ever faster logic. Though some standard circuits were available, the lines were limited to just a few functions. Today it's different. Competing standard logic-family lines have emerged with speeds high enough to satisfy most requirements.

But, ironically, choosing the right family is now more difficult than ever. Once a choice is made, engineers and production facilities are likely to be committed for years to come. And the subtle tradeoffs between the two leading high-speed logic lines don't make the selection easy.

## ECL and S-TTL are the basic families

For the highest speeds generally required in new systems—2-to-3-ns typical propagation delays—the choice is between ECL (emitter-coupled logic) or S-TTL (Schottky-clamped transistor-transistor logic).

Both offer substantial speed advantages over standard TTL. And like TTL, ECL and S-TTL products are available in volume and in a wide range of functions from original or alternate sources. But because of the high speeds involved, each type requires carefully designed interconnections (usually involving rf techniques) to achieve optimum circuit performance.

ECL has the lower propagation delay—about a nanosecond less than S-TTL. Unless you're designing large-scale computers, where ECL has been widely used to achieve high speed, the one-nanosecond difference may not be the deciding factor. And to achieve that nanosecond reduction in gate delay, the logic designer is forced to grapple with the OR/NOR logic techniques required

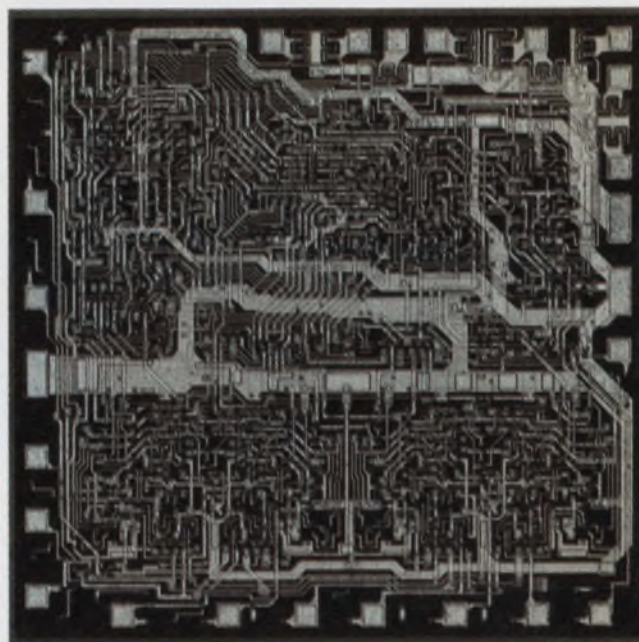

Motorola's MC10181 an arithmetic logic unit with a complexity equivalent to about 75 gates, performs 16 logic and 16 arithmetic operations on 2 4-bit words.

for ECL rather than with the more familiar AND/NAND logic.

S-TTL, of course, provides TTL compatibility. But compared with lower-speed TTL families, edge speeds are faster; so noise problems are more difficult to control. And if you're looking down the road to the next system, there isn't yet a faster generation of TTL that can be used to upgrade system performance further.

## Specs can be misleading

The data sheets may not be of much help in the selection process either. The critical spec—propa-

gation delay—is normally listed as typical. Guaranteed maximum delays can approach values that are 50% higher. Therefore it's possible—at least on paper—that a lower-limit S-TTL IC could be faster than an upper-limit ECL device.

Moreover specs on MSI chips sometimes boast an improvement by a factor of two (compared with SSI configurations) for the on-chip gate propagation delay. But here, as always, it's the input/output characteristics that count most to the user.

Another key spec, typical power dissipation per gate, can be misleading if the user isn't aware that the value is given for basically a dc condition, or that external resistors (which boost total system dissipation) are sometimes required. A number of ECL products, for example, require external pull-down resistors to terminate transmission lines. The power dissipated in the resistor can approach that listed for the gate. And S-TTL gate-power dissipation isn't constant with frequency. In a typical situation, the dissipation for speeds around 60 MHz is twice the dc value.

To insure that the choice of a logic family is based on a careful analysis of the tradeoffs, let's look at some of the relative merits of each family.

### ECL advantages

ECL is a nonsaturating form of logic. While switching from one logic level to the other, the transistors are never actually OFF or totally ON. Schottky-TTL achieves much the same effect by the use of Schottky-barrier diodes that prevent normally saturating transistors from reaching that state.

While faster ECL logic circuits are available, the ECL lines getting the most attention offer about 2-ns typical gate delays (and avoid some of the limitations of the faster circuits). They are the ECL 10,000 series, first introduced by Motorola, and the 9500 series, originally introduced by Fairchild. Between these ECL lines the following advantages are offered over S-TTL:

- Typical gate propagation delay is 2 ns. And the typical power dissipation is 25 mW per gate for a speed-power product of 50 pJ.

- Power dissipation per gate is essentially constant with frequency. This results from the constant-current nature of ECL.

- Smaller logic swing (about 0.8 V) together with slower edge speeds (typically 3.5 ns) reduce system crosstalk caused by energy transfer between adjacent signal paths.

- Complementary outputs and wired-OR capabilities help reduce gate and package count.

### Schottky-TTL advantages

On the other hand, Schottky-TTL—originally introduced by Texas Instruments—offers these advantages:

- S-TTL is fully compatible with slower speed TTL lines. All types have the same 5-V supplies, logic functions, pin configurations and packaging.

- AND/NAND logic rules apply. Digital logic designers are far more familiar with this logic than they are with the OR/NOR logic of ECL.

- S-TTL specs can usually be achieved without resorting to matched transmission lines. But wiring rules are more stringent and PC board geometries require greater care when compared with high-speed TTL (54H/74H series).

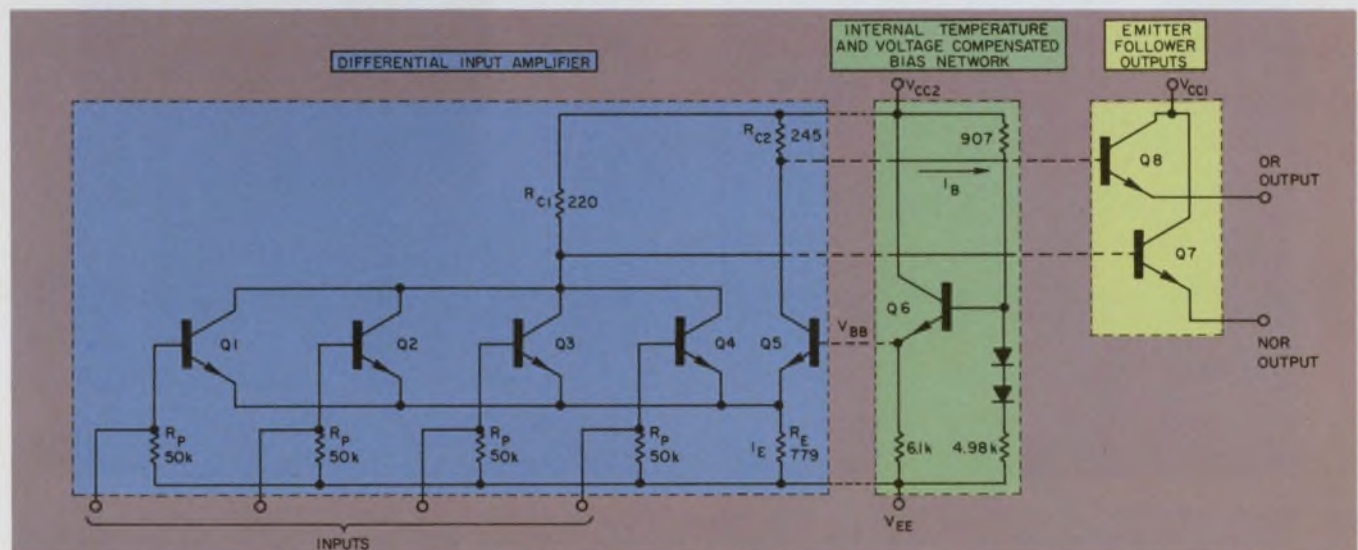

1. The basic circuit in the MECL 10,000 series is this gate. The OR/NOR outputs provide simultaneous com-

plementary functions. And gate power is unaffected by switching rates. External terminations are required.

■ Operating temperatures cover the  $-55$  to  $125$  C MIL-spec range. And in this range, noise immunity is guaranteed at  $700$  mV (logic ONE) and  $300$  mV (logic ZERO).

While there is a range of applications where the advantages of ECL 10 k and TTL overlap, at the extremes one logic family is generally superior to the other. One guideline frequently used is this: When system delays—the delay of a mounted logic chip including interconnection effects—are around  $5$  ns or less, ECL is the way to go. Otherwise S-TTL is the more economical choice. In the 3-to-6-ns system-delay range, either S-TTL or ECL would probably do equally well.

In this range some designers have gone to

S-TTL when upgrading existing TTL systems for improved performance. For new systems, the choice of ECL has been made.

For a closer look at the case for each logic family, let's start with ECL.

### Internal circuitry of ECL 10,000

The basic ECL 10-k gate consists of a differential input amplifier, a temperature and voltage-compensated bias network and emitter-follower outputs (Fig. 1). Within the differential-amplifier section, a current-steering element provides the logic gating for the circuit. Moreover the section furnishes the needed voltage gain for the

## High-speed logic lines fill 10-to-1 ns delay range

Between conventional TTL and the fastest ECL are a number of logic lines. While each satisfies a specific speed/power requirement, there are enough lines to fully cover the 10-to-1 ns gate-delay range. And a faster series doesn't always have to be a higher power one.

Two basic and widely used circuits are TTL (transistor-transistor logic) and ECL (emitter-coupled logic). The most well known of each are the 54/74 family (Texas Instruments' TTL) and the MECL family (Motorola's emitter-coupled logic). The evolution of each of the families to ever faster speeds resulted, in large measure, from the competition provided by the other

family's ever faster line.

One of the first lines on the scene was standard 54/74 TTL. Weighing in at  $10$  ns (typical propagation delay) and  $10$  mW (typical gate power dissipation) it is today the workhorse of the industry.

The MECL answer to 54/74 TTL was MECL I. This line—boasting 8-ns delays, but along with a power rating of  $31$  mW—was in turn challenged by 54H/74H with a 6-ns delay and  $22$  mW gate dissipation.

This evolutionary process was broken when MECL II (4 ns delays) was followed by MECL III, with a 1 ns gate delay and  $60$  mW gate

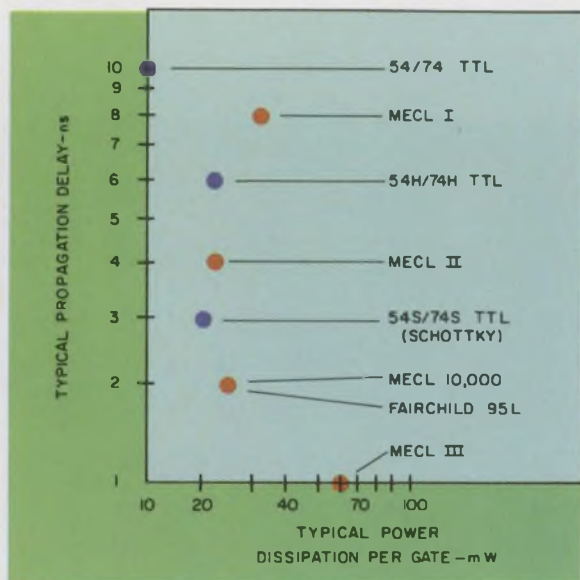

Some available logic lines illustrate a common problem in choosing the next series. For a higher speed, the price is often higher gate power.

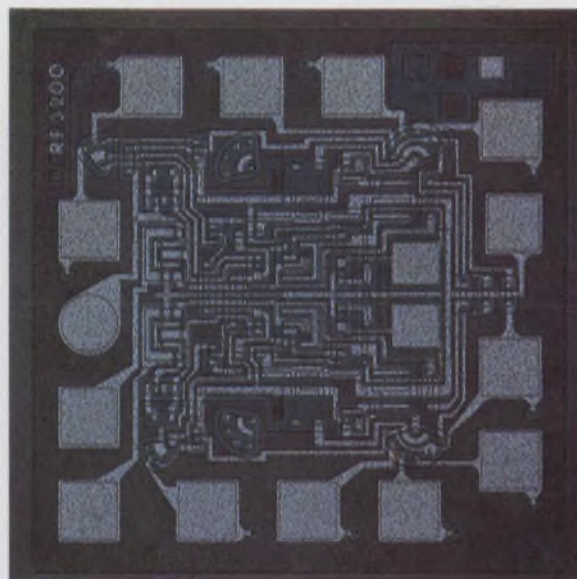

An AND-input J-K flip-flop is offered in the RAY III series from Raytheon Semiconductor. Termed the RF3200, it has a listed speed of  $10$  ns.

narrow, linear threshold region.

The internal bias network supplies the reference voltage for the differential amplifier. With a supply voltage of  $-5.2$  V and ambient temperature of  $25$  C, voltage  $V_{BB}$  is set at  $-1.29$  V—the midpoint of the input logic swing. The diodes, together with transistor Q6, maintain a level consistent with the midpoint of the logic levels over the operating temperature range. This temperature compensation insures constant noise immunity.

In addition the bias supply can track supply-voltage variations. Circuit operation is guaranteed with  $\pm 10\%$  power-supply regulation.

The emitter followers—output drivers for the

circuit—provide level shifting between the input amplifier and the output. They also furnish a low output impedance ( $7 \Omega$ ) for driving transmission lines. Internal pull-down resistors are avoided, since line terminations provide the output loading.

Because the circuit is intended for transmission-line driving, two power supplies are needed. Voltage  $V_{CC1}$  supplies current to the output drivers and the relatively heavy-current transmission lines. The specified output current is about  $22$  mA. Voltage  $V_{CC2}$  supplies the remainder of the circuit.

Separate  $V_{CC}$  feed lines are recommended to eliminate crosstalk between circuits within a pack-

power. For many requirements, the speed seemed too high; the power dissipation, excessive. The result was the introduction later of MECL 10,000 (perhaps MECL II $\frac{1}{2}$  would be a more descriptive designation) that offers 2-ns delays at  $25$  mW dissipation.

Of course, the 54/74 and MECL families aren't the only choices. For example, the RAY III line (a TTL line from Raytheon Semiconductor) offers typical gate delays of 7-to-9 ns at full fanout and competitive power dissipation.

And if higher power dissipation can be tolerated, you might want to try Fairchild's CTL

(complementary-transistor logic). Typically 3 ns gate delays are obtainable at full fanout, but power dissipation can be much higher than that of most other logic configurations.

CTL—a basic logic configuration, along with TTL and ECL—uses a pnp-npn complementary nonsaturating transistor pair as the basic circuit element. The output transistor is an emitter follower having virtually no threshold level. The result for the user: conventional back panel wiring can be used with substantial reduction in inductive and capacitive noise usually generated in other high-speed logic families.

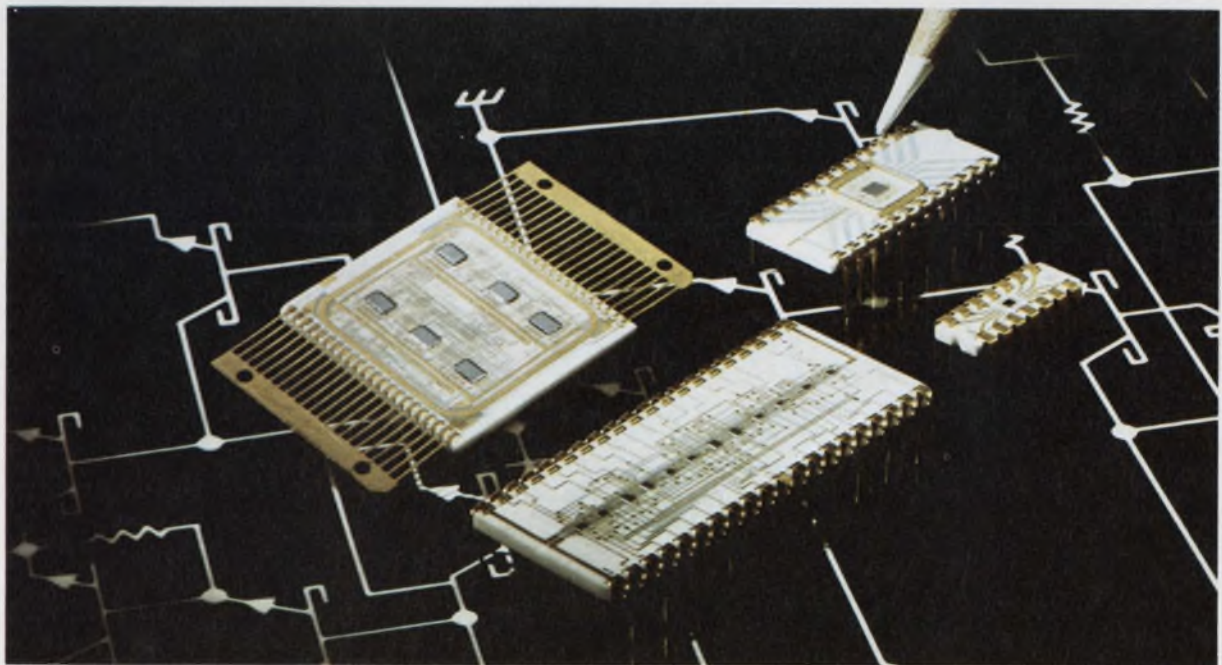

Beam-lead low-power Schottky TTL boasts  $19$  pJ speed-power product—the lowest of any standard line. Not intended for the higher speed ranges, the

54LS/74LS series has a typical gate delay of  $10$  ns and average dissipation of  $1.9$  mW. The new line has about  $20$  SSI and MSI circuits.

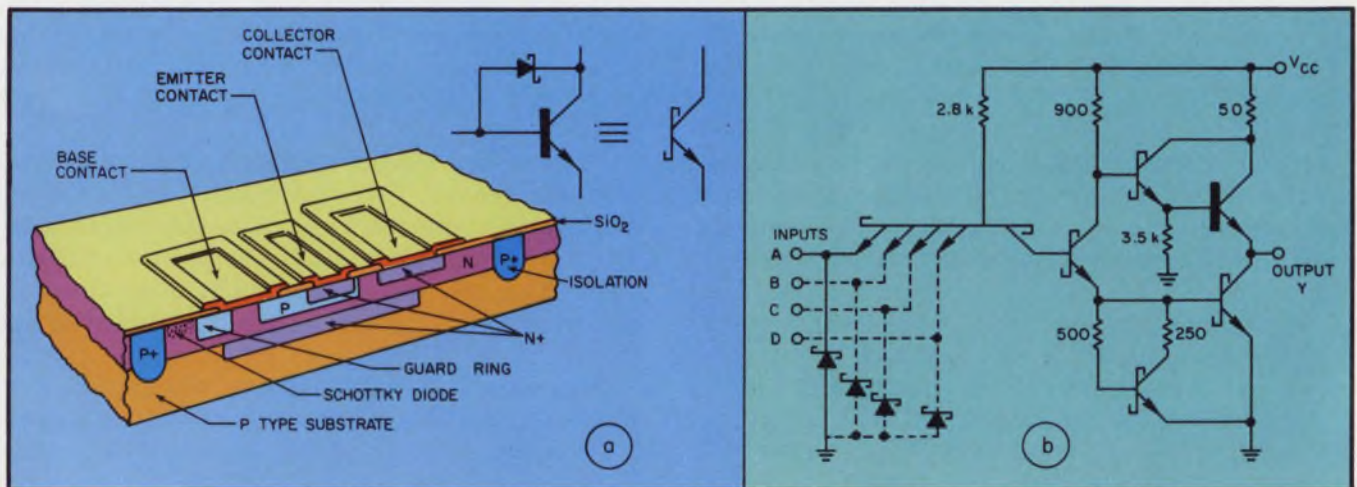

2. A Schottky barrier diode in parallel with the base-collector junction of saturating npn transistors (a) form the basis of S-TTL. There is no stored charge and the Schottky diode has a lower forward voltage drop than a

silicon pn junction. In a Schottky NAND gate (b), the upper output transistor is not clamped because it never saturates. Typical gate delay is 3 ns and gate power is listed as 20 mW.

age. More important, separate lines speed circuit performance by eliminating voltage spikes on voltage  $V_{BB}$ . The spikes would otherwise occur because of the relatively large output currents.

The large input pull-down resistors—all 50 k $\Omega$ —serve to drain off the input-transistor leakage current. The resistors hold unused inputs at a fixed zero level. Hence unused inputs can be left open.

### Transmission lines are a must

System layouts with ECL 10 k pose special problems because of the high frequencies involved and the need to terminate circuit outputs. All interconnects become, in effect, transmission lines. And circuit performance can vary markedly, depending on whether the load (pull-down) resistor is at the sending or receiving end of the line.

The importance of terminations for ECL 10 k is emphasized in the data sheets. The specs assume that matched transmission lines will be used with a characteristic impedance of typically 50  $\Omega$ .

With unmatched lines, the chief effect is to increase noise margin. Transient reflections on the line cause damped oscillations or ringing to appear on the output pulse waveform. This pulse distortion is characterized by overshoots and undershoots. Of the two, undershoots are more critical. If large enough, undershoots lead to false changes of state.

Of course, it's generally impractical to attempt to match all lines completely. And it's not really required. The manufacturers generally recommend that undershoots be held to within 12% of

the total logic swing, or about 100 mV. Usually this leaves an ample margin for external noise sources.

Overshoots are not as serious a problem. They cause the logic level to go more deeply into a particular state. Accordingly overshoots up to 45% of the logic swing can be tolerated. The limiting factor here is a slowdown of clock rates.

Another design factor that favors use of ECL 10 k is the availability of MECL III—Motorola's term for the company's highest-speed standard ECL line. MECL III, which is fully compatible with ECL 10 k, boasts a typical gate delay of about 1 ns. A new design using ECL 10 k could therefore be upgraded with MECL III.

### MECL III needs more power

A disadvantage of the higher-speed line is the increased power dissipation. The listed gate dissipation for MECL III is 60 mW (compared with 25 mW for ECL 10 k), and the speed-power product reaches 60 pJ (against 50 pJ with ECL 10 k). In part, of course, the increased dissipation is an inevitable consequence of the higher speed. More energy is required to provide faster switching rates for the same logic-level swing.

In some cases users may not have to go to MECL III for increased performance. Motorola has already announced a faster version of its ECL 10-k line, though the range of available devices is very limited. Termed the MECL 10,200 series, typical propagation delays are listed as 1.2 ns, with power dissipation per gate about the same as standard MECL 10 k. The increase in speed is obtained by a tradeoff of edge speed for faster gate speed; the 10,200 devices have a



gate speed of about 50% that of standard MECL 10-k units.

At present the circuits available in the 10,200 series are limited to dual high-speed gates and D flip-flops (with typical toggle rates of 200 MHz). By the latter part of this year a high-speed line receiver is expected.

In addition Motorola expects shortly to announce a MIL-spec temperature version of the MECL 10-k line. In this new 10,500 series, the increase in operating temperatures is obtained basically by boosting the driving impedance to 100  $\Omega$  (against 50  $\Omega$  for standard MECL 10 k). About 17 devices are anticipated in the new line.

### 9500 line eases wiring problems

One drawback of the ECL 10-k line—the need for terminated lines—can be minimized with the 9500 ECL series. This series features on-chip, pull-down resistors—either 2-k $\Omega$  or 50- $\Omega$  in value—at the output. Because the line terminations are already designed onto the chip, the 9500 line has a point-to-point wiring capability up to a radius of eight inches on simple double-sided PC boards—and without external termination resistors.

One disadvantage of this approach, of course, is significantly higher on-chip power dissipation. Another possible drawback is a limitation on the types of interconnections that can be used if terminations become necessary. In that case, layouts and PC-board geometries are restricted to those configurations that furnish the right impedance, as determined by the fixed on-chip resistance.

Another key feature of the 9500 series is on-chip temperature-compensation circuitry for output logic levels. Over the operating temperature range of 0 to 75 C, logic levels are maintained essentially constant. This feature—an advantage over ECL 10 k—becomes important when circuits at different operating temperatures (due to unequal power dissipation or different physical location) must interface without loss of noise margin.

In a recent development, Fairchild has announced a voltage-compensated version of its 9500 line. Termed the 95100 series, the new line offers logic-level stabilization against supply-voltage variations, as well as the temperature compensation features of standard 9500 devices.

With 95100 devices, supply voltage regulation can be relaxed to a range of 20% (assuming a nominal supply voltage of 5.2 V). And because of the temperature compensation, noise margins are maintained for the worst-case situation, where cascaded devices have temperature differentials of greater than 50 C.

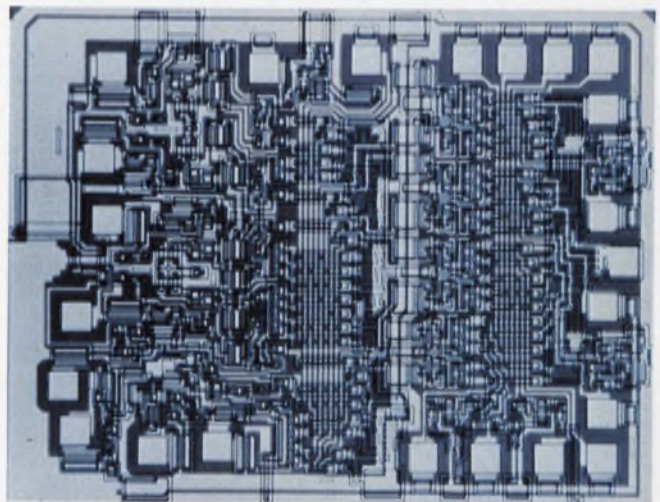

Texas Instrument's 4-bit arithmetic unit dissipates about 700 mW (typical), or less than 10 mW per gate. Typical addition/subtraction time for the 74S181 is 15 ns.

In addition, 95100 devices don't have on-chip load resistors. Hence, the listed dissipation per gate is the same as that for ECL 10 k (about 25 mW).

### The Schottky-TTL story

What about Schottky-TTL? Designated the 54S/74S series by Texas Instruments, this high-speed logic family is an extension of the company's standard TTL line. The Schottky version achieves a typical gate-propagation delay of 3 ns, along with a power dissipation of 20 mW per gate. And rise and fall times are in the 2-to-3-ns region. The improved performance results from the use of Schottky-barrier diodes (SBD) to clamp internal transistors.

A major benefit for users results from the compatibility of Schottky-TTL with conventional TTL. Both share the same thresholds, logic levels and power supplies. Hence one power supply regulated to  $\pm 10\%$  can serve both. And interfacing to TTL and low-threshold MOS circuitry doesn't require level shifters or logic circuits. This convenience simplifies the mixing of TTL, MOS, high-speed TTL and Schottky-TTL for an optimum cost/performance tradeoff.

In Schottky-TTL the SBD acts as a Baker clamp across the base-collector junction of an npn transistor (Fig. 2). The base contact extends beyond the base diffusion and over the collector n region. There it forms a metal-silicon or SBD structure. The metallization serves both as the contact to the base and to the anode of the SBD.

The SBD, free from minority carriers, has no stored charge. And the forward voltage drop is

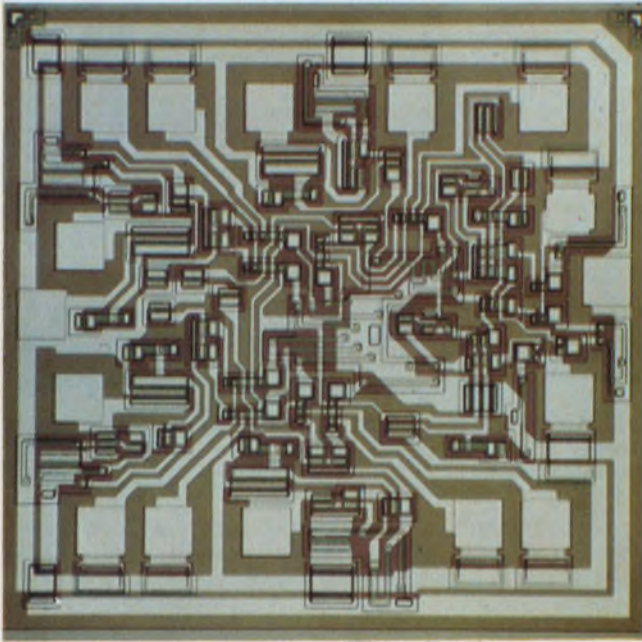

The SN74S00 is a quad 2-input positive NAND gate in Texas Instrument's Schottky-TTL series. The fanout is 20 high-level, 10 low-level loads.

lower than that of a silicon pn junction. This means greater protection against negative voltage transients and positive line reflections.

Also, the reverse input characteristic of an S-TTL gate more closely approximates an ideal termination than is the case with standard pn diode clamps (as in conventional TTL). Hence resistive terminations are not usually required for lines with impedances between 50 and 150  $\Omega$ .

The diode, in parallel with the base-collector junction, clamps the transistor by diverting most of the excess base current. The transistor avoids the usual saturation, and stored charge is essentially eliminated in both the Schottky diode and the transistor.

Other improvements over conventional TTL include smaller geometries. Because the transistors in S-TTL can be about half the area of standard TTL transistors, the faster logic has lower parasitic capacitance. This, in addition to the clamping, helps reduce propagation delay. And the use of Schottky clamps, together with the elimination of gold-doped slice processing, improves the stability of ac delays and dc thresholds over operating temperature ranges.

#### Current spiking increases dissipation

A significant difference with S-TTL, compared with ECL, is the presence of current spikes in S-TTL circuits. In addition to being a potential noise source, the spikes lead to increased dissipation as switching rates are raised.

pation as switching rates are raised.

Current spikes result from stray capacitances at the output of a S-TTL device, and they occur during switching transitions. They are significant during one of the two changes in logic state. For the other switching direction, the output capacitance is essentially shorted.

With higher switching rates, the density of the spikes inevitably increases, leading to a net increase in the average power dissipated. By about 10 MHz, the dissipation becomes significant. And at 100 MHz, a simple S-TTL device has a power dissipation of around 50 mW—or 2-1/2 times its listed dc dissipation.

Compared with the listed power for ECL at the same frequency, there would seem to be an advantage for S-TTL by a factor of 2. However, when the dissipation of the terminated line required by uncompensated ECL (with an external resistor) is added on, the power values at 100 MHz are actually comparable. Moreover, at lower frequencies, S-TTL (which does not require matched lines) has the lower system dissipation.

Of course, an important limitation of S-TTL to some designers remains its status as perhaps the last stage in the evolution of TTL. No higher-speed TTL line is currently available as a standard line to allow the upgrading of future systems. But this situation could change.

Texas Instruments is investigating an upgraded 54S/74S line. The new line would represent some kind of tradeoff among three major design features of the present Schottky line: an operating temperature range of  $-55$  to  $125$  C, full TTL compatibility and noise immunity consistent with that of lower-speed 54/74 families. An upgraded Schottky line is not thought to be feasible unless some of these constraints are relaxed.

#### Who makes fast logic?

The prime sources for high speed logic are Fairchild Semiconductor of Mountain View, Calif., Motorola Semiconductor Products of Phoenix and Texas Instruments of Houston.

Fairchild's 9500 series consists of about a dozen functions including a 160-MHz flip-flop and a 3-to-8 decoder. In the 95L and 95H subset line, low power (about 20 mW per gate) and high speed (typically 1.7-ns gate delay), respectively, are featured. The 95100 series covers about 14 SSI and MSI devices, including a 4-bit arithmetic logic unit (ALU).

In the 9S series, Fairchild is alternate sourcing S-TTL circuits. About eight SSI devices are available.

Motorola's MECL 10-k line presently consists of about 32 devices. Some new products, either

announced or expected, include a 4-bit right/left shift register and a dual two-line multiplexer with latch. In the MECL III series, which presently consists of about two dozen circuits, new products include a 500-MHz D flip-flop and 4-bit shift register.

At Texas Instruments, the 54S/74S S-TTL line is filled out in SSI devices, and includes a number of MSI circuits. In the latter category is a 4-bit arithmetic unit with carry look-ahead. Expected shortly is a look-ahead carry generator, for the 4-bit arithmetic unit, to give what is believed to be the fastest IC adder/subtractor available. Other new products are 8-to-1 and quad 2-to-1 multiplexers.

In addition, TI expects to have available shortly an alternate-source ECL 10-k line. The initial offering consists of about 16 parts up to MSI, and includes the ECL 4-bit ALU. Termed the SN 10100, the line will be augmented by about a dozen new units by the end of the year.

The alternate sources include National Semiconductor of Santa Clara, Calif.; Raytheon Semiconductor at Mountain View, Calif.; Signetics Corp. in Sunnyvale, Calif. and Transitron Electronic Corp. of Wakefield, Mass.

National plans to alternate-source both ECL 10 k as well as S-TTL. In the ECL line, the initial device offerings are four basic gates. Around 20 circuits are expected by year's end. The S-TTL line, a parallel development, starts off with perhaps six devices to be followed later with around a dozen ICs.

Raytheon is probably the only US semiconductor house alternate sourcing the 9500 and 95100 ECL series. Four to six devices, including a 250-MHz prescaler, are being made available. The 95100 equivalent line, termed TPECL, is expected shortly.

Raytheon also plans an alternate Schottky line. By the end of the year, the company expects

to have a complete offering in its 54S/74S series. In the same period, Raytheon anticipates an alternate-source line for the 82S series of Signetics; about 16 MSI devices are being made available.

Signetics offers both ECL 10 k and S-TTL, as well as 82S—a proprietary Schottky MSI line. The ECL 10 k alternate series covers many basic gate and flip-flop circuits; about two dozen devices are either available or expected shortly. Similarly, the company's alternate Schottky line consists of about a dozen circuits. Signetics' 82S series includes an eight-input digital multiplexer, binary-to-octal/BCD-to-decimal decoder, and a 9-bit parity generator and comparator.

From Transitron comes the T74S series—an alternate S-TTL line. With about 20 circuits, the T74S line covers gates, flip-flops and MSI arrays.

### Subnanosecond barrier already broken

What's ahead? Considering that the highest speed standard logic family (MECL III) lists 1-ns gate delays, it would seem that the next step is subnanosecond logic.

The fact of the matter is that under-1-ns logic, as a technology, is already here (ELECTRONIC DESIGN, March 16, 1972, p. 28). In one subnanosecond ECL circuit discussed at the recent ISCC, a cascaded-gate propagation delay of 400 ps, with a speed-power product of 16 pJ, was reported.

But manufacturers are not investing in volume production of subnanosecond logic circuits. And they probably won't until some kind of consensus is reached on packaging and level of integration, and user demand is demonstrated. Until that time, those who need subnanosecond logic will have to roll their own—as Bell Laboratories, Holmdel, N.J., HP, Palo Alto, Calif., Hitachi, Tokyo, Japan, and other companies have. ■■

## Need more information?

The products cited in this report don't represent the manufacturers' full lines. Readers may consult with the following for additional details by circling the appropriate information retrieval number:

Fairchild Semiconductor, 464 Ellis St., Mountain View, Calif. 94040. (415) 962-3715. (David A. Laws, New Product Planning, Bipolar Products) **CIRCLE 401**

ITT Semiconductor, 3301 Electronics Way, W. Palm Beach, Fla. 33407. (305) 842-2411. (Terry Diedrich, Marketing Manager) **CIRCLE 402**

Intel Corp., 365 Middlefield Rd., Mountain View, Calif. 94040. (415) 969-1670. (Mike Markula, Marketing Manager) **CIRCLE 403**

Motorola Semiconductor Products, 5005 E. McDowell Rd., Phoenix, Ariz. 85008. (602) 237-4441. (Lloyd Maul, Manager, Computer Applications Engineering) **CIRCLE 404**

National Semiconductor Corp., 2900 Semiconductor Dr., Santa Clara, Calif. 95051. (408) 732-5000. (Tom Thorkelson, Digital Bipolar Product Marketing Manager) **CIRCLE 405**

Raytheon Co., Semiconductor Div., 350 Ellis St., Mountain View, Calif. 94040. (415) 968-9211. (Stephen Fry, Manager, Digital IC Marketing) **CIRCLE 406**

Signetics Corp., 811 E. Arques Ave., Sunnyvale, Calif. 94086. (408) 739-7700. (T. Eugene Miles, Manager of Digital IC Applications) **CIRCLE 407**

Sprague Electric Co., Semiconductor Div., 115 Northeast Cutoff, Worcester, Mass. 01606. (617) 853-5000. (C. J. Grandmaison, Product Marketing Manager) **CIRCLE 408**

Stuart-Warner Microcircuits, 730 E. Evelyn Ave., Sunnyvale, Calif. 94086. (408) 245-9200. (Ron Rich, Marketing Manager) **CIRCLE 409**

Texas Instruments Inc., 12201 Southwest Freeway, P.O. Box 1443, Houston, Tex. 77001. (713) 494-5115. (Jack C. Carsten, Manager, Marketing and Product Engineering, Digital Circuits) **CIRCLE 410**

Transitron Electronic Corp., 168 Albion St., Wakefield, Mass. 01880. (617) 245-4500. (William B. McMakin, Product Marketing ICs) **CIRCLE 411**

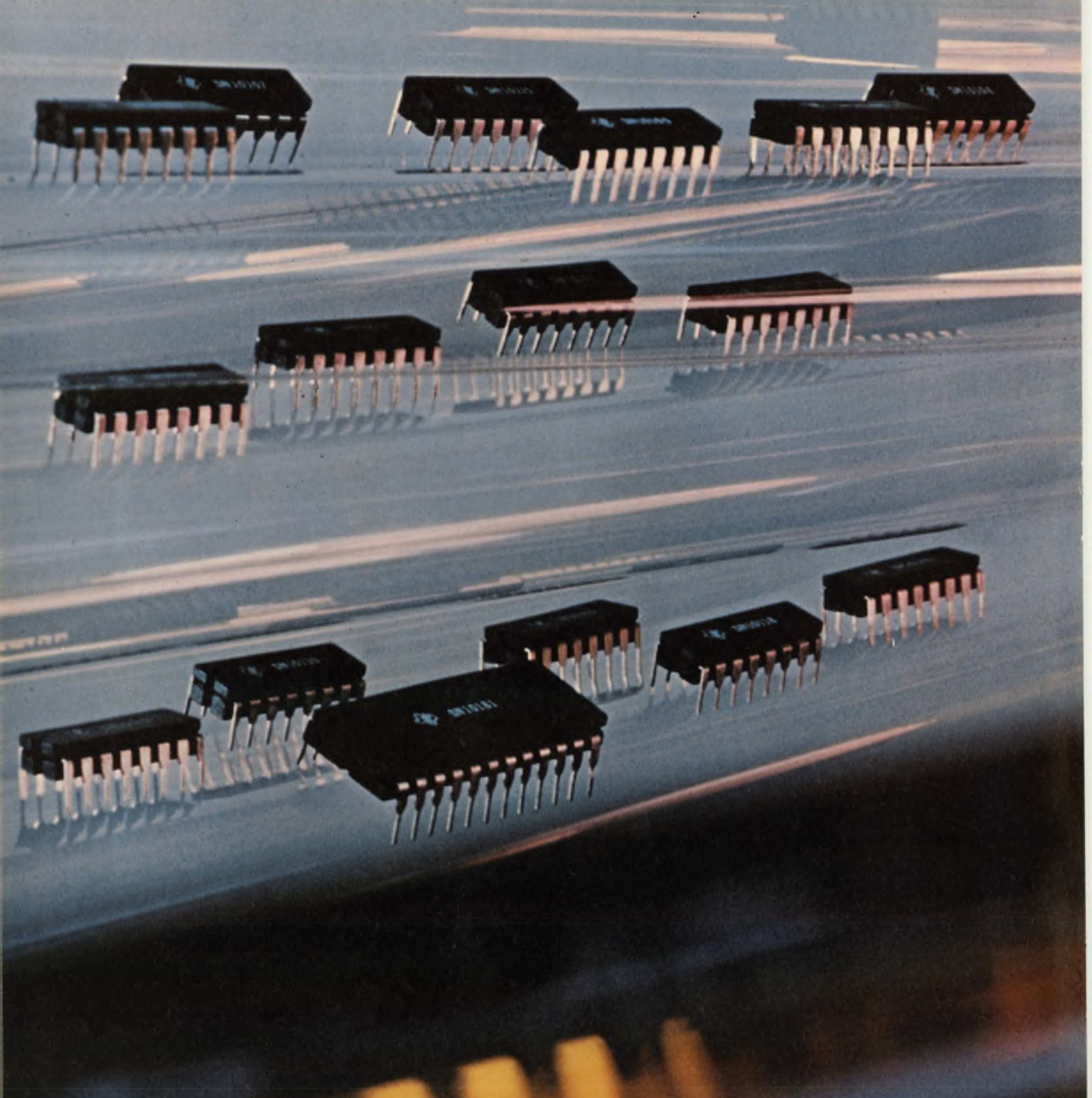

More TI integrated circuits are used in today's electronic systems than any other brand in the world. And for the reasons you'd expect: Technology. Volume. Price. Breadth. Dependability. Service. Quality. Weigh them all when you buy ECL.

# SN100000

# TI announces a new standard line of high-speed, low-power ECL: 2 ns at 25 mW SN10000.

To its capabilities as the major supplier of custom ECL circuits, TI has added a broad new standard family. Series SN10000.

Now, in weighing the long-range pros and cons of designing with emitter-coupled logic, you can add the assurance of TI's technological development and volume-production capability.

## TI can deliver now — including MSI

All SN10000 devices listed below are immediately available in evaluation quantities through authorized TI distributors or direct from factory inventories. All are in ceramic dual-inline packages — including the 24-pin ALU circuit — and are pin-for-pin equivalents to the MECL 10,000 series over the 0° to 75°C temperature range. Production quantities can be delivered 6 to 10 weeks after receipt of order.

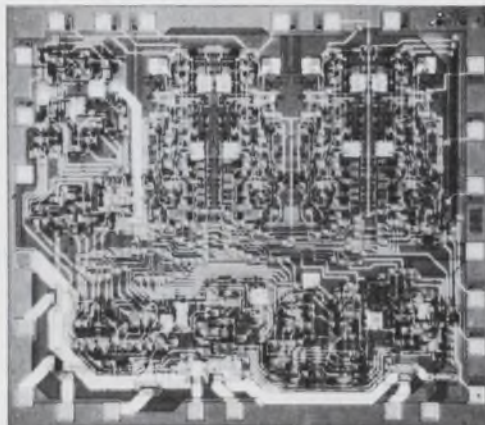

SN10181 ALU . . . 75 equivalent gates.

	DESCRIPTION	100-PIECE PRICE
SN10101	Quad 2-Input OR/NOR Gate (One input common)	1.65
SN10102	Quad 2-Input Gate (3 NOR, 1 OR/NOR)	1.65
SN10103	Quad 2-Input Gate (3 OR, 1 OR/NOR)	1.65
SN10105	Triple OR/NOR Gate (2, 3, 2 inputs)	1.65
SN10106	Triple NOR Gate (4, 3, 3 inputs)	1.65
SN10107	Triple 2-Input Exclusive OR/NOR Gate	2.10
SN10109	Dual OR/NOR Gate (4, 5 inputs)	1.65
SN10115	Quad Line-Receiver	1.65
SN10116	Triple Line-Receiver (Complementary outputs)	1.65
SN10117	Dual 2-Wide 2-3 Input OR-AND/NOR-OR Gate	2.10
SN10118	Dual 2-Wide 3-Input OR-AND Gate	2.10
SN10119	4-Wide 4-3-3-3 Input OR-AND Gate	2.10
SN10130	Dual D-Type Latch	4.45
SN10131	Dual D-Type Master Slave Flip-Flop	5.65
SN10179	Carry Look-Ahead	6.80
SN10181	4-Bit Arithmetic Logic Unit/ Function Generator	20.00

## Fast, cool and stable

The new Series SN10000 has a speed/power product of 50 pJ (2 ns at 25 mW per gate). You can take full advantage of the 2-ns speed without cooling problems. What's more, SN10000 offers an improved inter-

nal reference generator which relaxes power supply tolerances and power distribution requirements — thereby reducing overall system costs.

## Economical system design

In addition to power supply savings, you can achieve many other important design economies with Series SN10000.

Special PC boards are not required. Switching rise and fall times are slow enough so that conventional, two-sided boards can be used.

Savings in gate and package count are significant because the open emitter outputs and high impedance inputs permit wire-ORing of several gating levels. Data "bussing" and two-way data transfer are also possible with the open emitter outputs, which further make possible great flexibility in terminating schemes and logic interconnects.

Still more reductions in system gate and package count are possible because complementary outputs are readily available from ECL gates.

And now, with the availability of ECL/MSI, you can add the benefits of increased complexity — reduced package count, fewer interconnections, and smaller PC boards. All of which means lower component and system costs per gate.

## Much more to come — soon

These devices are only the beginning of a large and complete logic family . . . including memory functions as well as MSI and SSI logic circuits.

Planned, among others, are a quad 2-input AND gate, ECL/TTL level translators, a 12-bit parity checker/generator, an 8-line multiplexer, a quad latch, and a 64 x 1 RAM.

## Full specifications available now on all functions

For complete data sheets on TI's Series SN10000, circle 241 on the Reader Service Card. Or write Texas Instruments Incorporated, P. O. Box 5012, M.S. 308, Dallas, Texas 75222.



TEXAS INSTRUMENTS  
INCORPORATED

# Design your own dynamic phase shifter.

Made with an op amp, it covers nearly 180° and can be used in testing or to build an all-electronic resolver.

Someday you may be called upon to perform dynamic testing or simulation of a phase-variable system. The odds are that you won't find the signal sources to do this on your test bench. Here's how to design your own and avoid tedious point-by-point measurements.

You may recognize the simple operational-amplifier, phase-shift circuit in Fig. 1. The phase of its output can be adjusted by varying the control resistor  $R_c$ . However, the need is for a voltage-controlled system. Therefore  $R_c$  must be replaced by a voltage-controlled resistor.

Of the available practical, voltage-controlled resistors, none is very linear. The problem can be overcome by incorporating the controlled resistor and the op-amp phase shifter in a closed-loop feedback circuit. A near-linear phase response, controlled by a command voltage, is obtained.

Fig. 2 shows how the basic op-amp phase shifter is incorporated in a feedback loop, along with other circuit elements. In this circuit a phase detector compares the shifter's output phase with its reference. The output of the phase detector

is a pulsed signal whose average (dc) level is a measure of the phase difference of its two inputs. This signal, after buffering and filtering, is then subtracted from the phase-command input voltage. The resulting error signal is fed to an error amplifier, which drives the input of the voltage-controlled, variable-resistance device, thus completing the loop.

## Dissecting the op-amp phase shifter

The basic resistance-controlled phase shifter of Fig. 1 delivers a constant output amplitude for a fixed input voltage, regardless of the amount of phase shift. As the control element,  $R_c$ , is varied from open-circuit to zero resistance, the output voltage will lead the input by angles ranging from near zero to almost 180 degrees.

The phase vs resistance relationship is easily derived. Referring to Fig. 1, and with point "a" disconnected and the noninverting amplifier input grounded, we get

$$E_o (-) \text{ (due to inverting input)} = -E_i \quad (1)$$

With point "b" disconnected and grounded, and  $E_i$  fed to the noninverting input via C and  $R_c$ , we get

$$[E_i \cdot R_c / (R_c + 1/j\omega C)] - E_o/2 \cong 0, \quad (2)$$

George M. Strauss, Senior Engineer, Kollsman Instrument Corp., 80-08 45th Ave., Elmhurst, N. Y. 11373

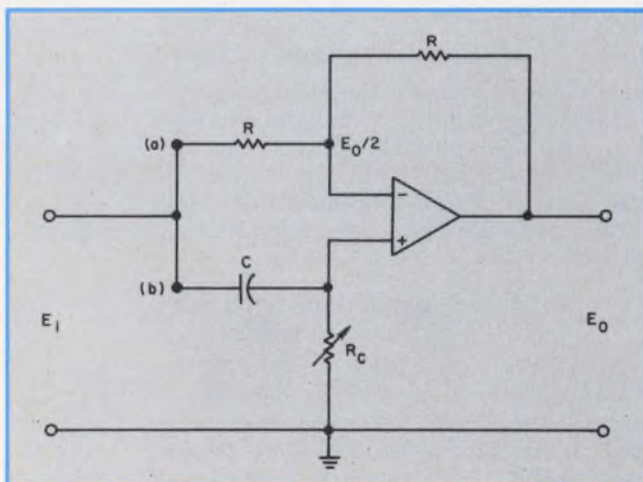

1. This basic op amp shifter provides a constant voltage output,  $E_o$ . The output phase leads the input by an amount controlled by resistor  $R_c$ .

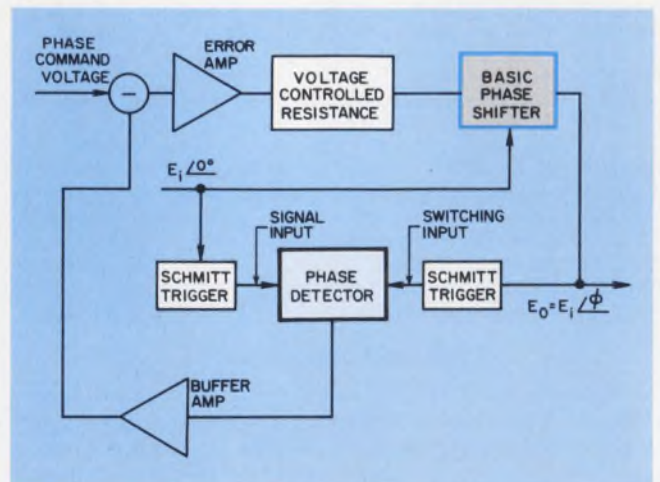

2. When the basic op amp phase shifter is connected into a feedback loop, the phase-command voltage can shift the output signal linearly over nearly 180°.

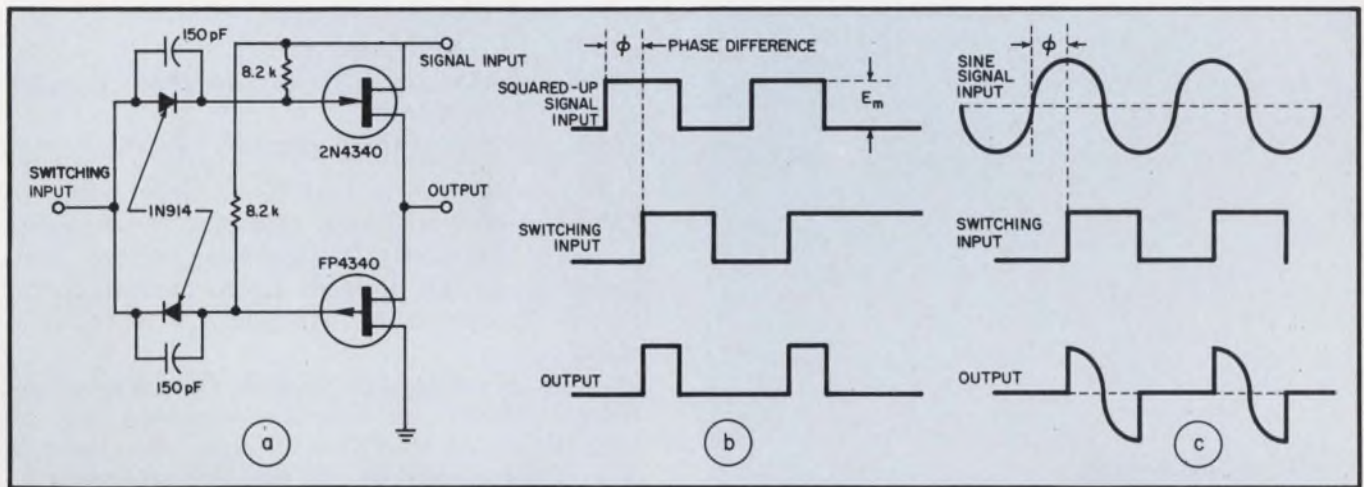

3. This typical phase detector circuit provides a pulsed output. Its average value is directly proportional to the phase difference of the inputs when a squared-up signal input is applied, as in 3(b). The phase-detector output

equals the cosine of the phase difference when the signal input is a sine wave, as in 3(c). A squared up signal input is used in the basic circuit, and sinusoidal inputs in the resolver application.

because for a very high-gain, negative-feedback amplifier, the net differential input approaches zero. Therefore

$$E_o (+) \text{ (due to noninverting input)} = \frac{2E_i j\omega R_c C}{(1 + j\omega R_c C)} \quad (3)$$

The output due to the combined inputs becomes

$$E_o = E_o (+) + E_o (-) = -E_i \frac{(1 - j\omega R_c C)}{(1 + j\omega R_c C)}, \quad (4)$$

and in polar form:

$$E_o / \pi - 2 \tan^{-1} \omega R_c C = E_i / \phi = E_o \quad (5)$$

If  $R_c C = 1$ , the output voltage leads the input voltage by  $90^\circ$  ( $\pi/2$  radians). In practice the zero-to- $180^\circ$  range is not quite attainable, but 2 to  $178^\circ$  is easily achieved.

### Choosing the operational amplifier

In a typical design the choice of the phase-shifting op amp will depend primarily on the minimum phase shift required. Eq. 5 shows that maximum  $R_c$  yields the minimum phase shift. The op-amp input resistance, which in effect shunts  $R_c$ , will limit the maximum effective  $R_c$  and thus the minimum phase shift. A high-impedance, FET-input amplifier can help achieve almost zero phase shift.

If, for example, a CK-1116 Raysistor is used for  $R_c$ , the nominal resistance range will be  $1000 \Omega$  to  $10 \text{ M}\Omega$ . A FET-input op amp will not appreciably shunt the  $10\text{-M}\Omega$  maximum value. Then, for an operating frequency of  $1 \text{ kHz}$  and with a  $1000\text{-pF}$  capacitor.

$$\omega R_{\text{max}} C = 20\pi = \tan 89^\circ.$$

This yields a minimum attainable phase shift of about  $2^\circ$ . For a minimum value of  $R_c$ , at the same capacitance and frequency, we find that  $\omega R_{\text{min}} C = 0.006$ . This means that the maximum

attainable phase shift is less than a degree away from  $180^\circ$ .

### Selecting a voltage-controlled resistor

The Raysistor is a relatively slow element. For phase-shifting of low-frequency carriers, sweep rates to about  $10 \text{ Hz}$  are possible. Where greater modulation rates are required, a controlled resistor with faster response, such as a FET, can be used. One advantage of the Raysistor's slow response is that the pulsed output of the phase-detecting circuit needs little filtering, since the unit will automatically respond to the average (dc) level of the signal at typical carrier frequencies of  $100$  to  $10,000 \text{ Hz}$ . With a different type of controlled resistor that can respond to higher frequencies, however, output filtering becomes more important.

### Phase-detector operation

Fig. 3a shows a typical phase detector that can be used in this phase-shifter system. It consists of two opposite-polarity FETs, one in series and one in shunt and both controlled by Schmitt-trigger outputs. The Schmitt-trigger circuits—many suitable types are available—supply a squared-up version of their input signals. Also, their outputs should have constant amplitude and accurate phase response. The use of square-wave inputs (Fig. 3b) to the phase detector causes the phase detector to provide a signal whose (dc) average (duty-ratio) is linearly proportional to the phase difference of its two inputs.

If, however, the signal-input side of the phase detector is a sine wave (Fig. 3c), then the aver-

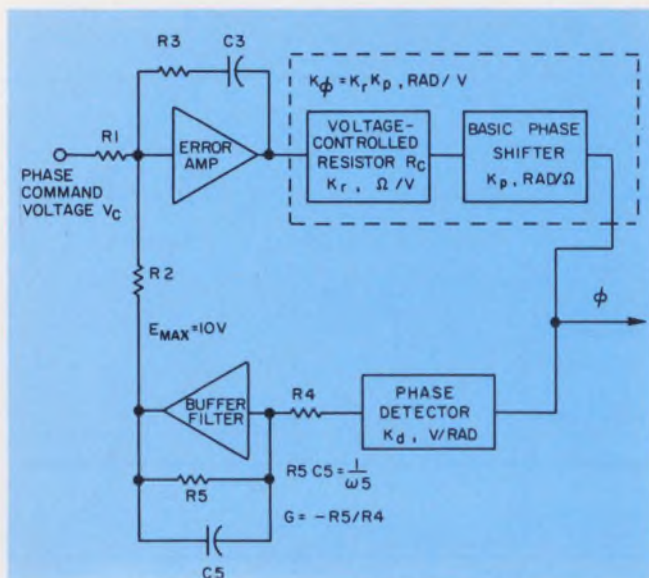

4. A block diagram shows the feedback system and aids analysis of the voltage-controlled phase shifter. Transfer functions and major parameters shown are those used in the text.

age of its (dc) output will be proportional to the cosine of  $\phi$ . This relationship is useful in other applications, but it is not the desired function in a feedback circuit, where we are looking for a linear response.

Squaring-up the switching-input side of the phase detector provides clean and unambiguous switching points. Amplitude stability of the Schmitt circuit driving the signal-input side of the phase-detector will contribute to a stable and accurate phase-shifting system.

If the phase detector's signal input has a peak value  $E_m$ , then—for zero phase displacement between the signal input and switching input—the detector output will be at its maximum with an average value of  $E_m/2$  (50% duty cycle). Conversely when the two inputs to the phase detector are 180 degrees out of phase, the detector output is zero. Between the two extremes, output is a linear function of phase.

The phase-detector output is buffered, and with use of an op amp connected for low-pass operation, some filtering is obtained (Fig. 4).

#### Analyzing the complete system

To analyze the voltage-controlled phase-shifting system in Fig. 4, we can employ some simplifying assumptions. First, we will assume, as is usual with feedback amplifiers, that the error amplifier has a high open-loop gain, so that its closed-loop gain is primarily a function of  $R_1$ ,  $R_2$ ,  $R_3$  and  $C_3$ , so that

$$K_d K_\phi G R_3 \gg R_2.$$

In Fig. 4 the following terminology is used:

$K_r$  = transfer ratio of the voltage-control-

led resistor in  $\Omega/V$ .

$K_p$  = Transfer ratio of the basic shifter circuit in  $\text{rad}/\Omega$ .

$K_\phi = K_r K_p$  in  $\text{rad}/V$ .

$K_d$  = transfer ratio of the phase detector in  $V/\text{rad}$ .

$G$  = buffer-filter gain =  $-R_5/R_4$ .

The assumption is that  $K_\phi$  is linear. But, in fact, it is quite nonlinear. However, the complete system's closed-loop configuration almost completely solves this problem. In the over-all operation of the system  $K_\phi$  nonlinearity has minimal effect.

Again, in calculating the gain,  $G$ , of the buffer-filter amplifier, we take the open-loop gain as very high, and therefore its closed-loop gain is determined largely by the static components  $R_4$  and  $R_5$ . Based upon these assumptions, the phase shift may be taken as:

$$\phi = \frac{V_c R_2}{K_d G R_1} \cdot \frac{1 + 2 \zeta s / \omega_n}{s^2 / \omega_n^2 + 2 \zeta s / \omega_n + 1}, \quad (6)$$

with the system's natural frequency as

$$\omega_n = \sqrt{\frac{K_d K_\phi G}{R_2 C_3 T}}. \quad (7)$$

The damping factor is

$$\zeta = \frac{\omega_n R_3 C_3}{2} = 1/2 \sqrt{\frac{K_d K_\phi G R_3^2 C_3}{R_2 T}}. \quad (8)$$

The time lag,  $T$ , results primarily from the voltage-controlled resistor in the phase-shifter block, especially if a relatively slow type, such as the Raysistor, is used.

Examination of Eq. 6 indicates that the steady-state phase accuracy of the system depends only on  $R_2$ ,  $K_d$ ,  $G$  and  $R_1$ . Of these,  $K_d$  is the only factor not mainly dependent upon resistors. Therefore the Schmitt-trigger circuits, which determine the stability of  $K_d$ , should be carefully designed for constant-voltage output and trigger constancy.

It is noted that the operating carrier frequency does not explicitly appear in these equations. It mainly affects the open-loop gains of the amplifiers, which have been assumed to be high. Within the flat part of the frequency range of the selected amplifiers, this assumption is valid. Even near the limits of the amplifiers' frequency response, however, proper operation can be expected. Careful selection of  $C$  (Fig. 1) and the fact that phase is actually measured and used to close the feedback-loop insures linear wide-range operation.

Now we can plug some numbers into the equations to test the circuit's practicality. Based on the Raysistor's characteristics, a 3-V change will cause approximately  $180^\circ$  of phase change. Therefore, taking  $K_\phi = (\pi/3)$   $\text{rad}/V$  and  $E_{\max} =$



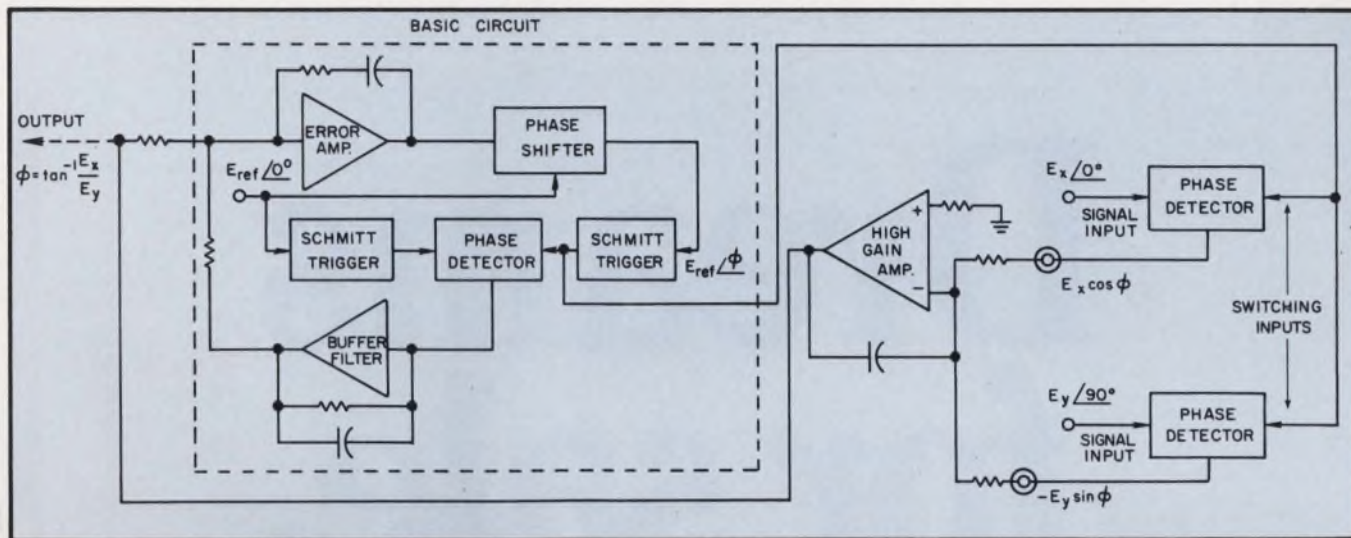

5. An all-electronic resolver is an interesting application for the wide-range phase shifter. Outputs from the two extra phase detectors,  $E_x \cos \phi$  and  $E_y \sin \phi$ , are dc analogs of the resolved sin/cos components of the ac

inputs. When these are summed at the virtual ground input of the high-gain amplifier, the closed-loop system shown provides a dc output signal proportional to input "shaft angle."

10 V (peak voltage of the phase detector output), we get  $K_1 = (5/\pi)$  V/rad. Choosing  $G$  equal to, say,  $-2$ , we obtain a 10-V maximum output from the buffer-filter amplifier. With the Ray-sistor's time constant  $T$  taken as approximately 0.25 s, we continue with these calculations:

Taking  $\omega_n = 20 \pi$  rad/s for a 10-Hz phase-change rate (within the capability of the Ray-sistor) and rewriting Eq. 7, we obtain

$$R_2 C_3 = \frac{K_1 K_\phi G}{\omega_n^2 T} = 0.033 \text{ s.} \quad (9)$$

If  $C_3 = 0.1 \mu\text{F}$ , then  $R_2$  becomes 33 k $\Omega$ . The feedback resistor,  $R_3$  has a value calculated from Eq. 8. Thus, for  $\zeta = 1$ ,  $R_3$  becomes 330 k $\Omega$ .

We can now test the first of the original assumptions—that  $K_1 K_\phi G R_3 \gg R_2$ . Putting in the required values, we obtain  $K_1 K_\phi G R_3 \cong 30 R_2$ , justifying the assumption.

### Looking at the buffer-filter amplifier

Because the buffer-filter amplifier acts as a low-pass filter, we get a dual advantage: It provides a measure of filtering for its pulsed input (though not absolutely necessary when a Ray-sistor is used) and a place where some controlled stabilization can be introduced into the feedback loop. If we set  $\omega_s = 500$  rad/s, by the appropriate selection of  $C_3$  (Fig. 4), a frequency "break" is obtained in the loop gain characteristic, an additional safety margin for stability.

### Application as an all-electronic resolver

This form of dynamic phase shifter can find immediate use in the testing of phase-locked loops

or possibly to simulate the target range of a cw, sinusoidally modulated radar system. One especially interesting application is as an all-electronic resolver.

The addition of two more phase detectors and a differential op amp (Fig. 5) modifies the circuit for use as an all-electronic resolver. The additional phase detectors are both triggered by a common switching waveform. This is derived from the phase-shifted output in the basic circuit that drives the phase detector used for loop closure. An analog ac sinusoidal signal, in phase with the reference, is applied to the first of these additional phase-detector inputs. This produces a phase-detector output whose average (dc) level is proportional to the product of the sinusoid's peak voltage and the cosine of the phase-angle command input. If in the second added phase detector the sinusoid is  $90^\circ$  out of phase with the reference, the average phase-detector output will be proportional to the sine of the phase-angle command. Two dc analog voltages,  $E_x \cos \phi$  and  $E_y \sin \phi$ , are thus obtained, representing the resolved components of the ac inputs.

These signals are combined in the differential inputs of a high-gain op amp, and the resultant function ( $E_x \cos \phi - E_y \sin \phi$ ) is fed back to the input via the high-gain amplifier. The high gain forces the function ( $E_x \cos \phi - E_y \sin \phi$ ) down toward zero at the input to the amplifier and causes the system to seek a dc level proportional to the angle  $\phi = \tan^{-1}(E_x/E_y)$ . This dc voltage represents an analog of the resolver's shaft angle  $\phi$ .

The bulk of the work described was done under a U.S. Navy contract. A patent application has been filed. ■■



The U. S. Government does not pay for this advertisement. It is presented as a public service in cooperation with The Department of the Treasury and The Advertising Council.

# Dreams for sale.



Everybody's got a dream lurking around in the back of his mind. A dream vacation. A dream cottage. A dream car.

Dreams can be a lot more fun if you know you're doing something to make them come true.

And that's what the Payroll Savings Plan is all about. When you sign up an amount you specify is set aside from each paycheck and used to buy U.S. Savings Bonds.

Now Bonds mature in less than six years. That's the shortest maturity period ever, and makes Bonds a practical way to save for dreams you want to come true while you're still young enough to enjoy them.

See the folks in the payroll office where you work. They've got dreams for sale.



Now E Bonds pay 5 1/2% interest when held to maturity of 5 years, 10 months (4% the first year). Bonds are replaced if lost, stolen, or destroyed. When needed they can be cashed at your bank. Interest is not subject to state or local income taxes, and federal tax may be deferred until redemption.



## Take stock in America.

Now Bonds mature in less than six years.

# The **R**eliables...

## R**V**R

## R**E**R

## R**B**R

## CAL-**R**

...and you thought the "**R**" stood for Resistors.

**Power Wirewound Resistors** — RWR71, 74, 78, 80, 81, 84 & 89. MIL-R-39007.

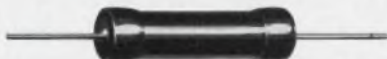

**Power Wirewound Resistors**  
Chassis Mounted — RER40, 45, 50, 55, 60, 65, 70 & 75. MIL-R-39009.



Resistor Networks and Matched Sets are CAL-R specialties.

**Precision Bobbin Wirewound Resistors** — RBR52, 53, 54, 55, 56, 57 & 71. MIL-R-3905.



## CAL-**R**/CapTech

Cal-R, Inc. a CapTech, Inc. Company

1601 Olympic Boulevard  
Santa Monica, California 90404  
(213) 451-9761 TWX 910-343-6966

# ROMs are versatile in digital systems.

Use the semiconductor types for code conversion, character generation or computer microprogramming.

The speed and capacity of semiconductor read-only memories are going up, while the cost and size are coming down. Result: Digital designers are finding more and more applications for these ROMs.

Whatever the digital equipment you're designing, you can probably simplify it by using semiconductor ROMs. The memories are most useful when controlling standard operating hardware. In such cases permanently stored ROM data control different operating sequences. In addition semiconductor ROMs can be used to replace magnetic ROMs and logic ICs.

The range of applications includes these:

- Arithmetic operations.
- Code conversion.
- Character generation.
- Random-logic generation.
- Microprogramming.

A growing list of semiconductor ROMs is available to do the job. Already MOS (metal-oxide-silicon) ROMs up to 4096 bits in capacity can be obtained in 24-pin DIPs. And 1024-bit bipolar ROMs are available in volume, with 4096-bit types on the way. As for speed, MOS ROMs provide access times down to about 500 ns. Bipolar ROMs are accessed in tens of nanoseconds.

## Begin with lookup tables

In most cases the application itself is actually a variation on lookup-table operation, where the ROM functions as a kind of digital dictionary. An address input word becomes a reference to locate a new word.

Take a look at the programming for a typical sine lookup table (Fig. 1). The table is stored in a ROM with seven inputs, for a seven-bit input resolution. The full table covers only the first quadrant, since sine values repeat in the remaining three. Each binary address is the code word for an argument  $x$ . And  $x$  represents one of 128 angular increments from  $0^\circ$  to  $90^\circ$  ( $\pi/2$  radians). The individual values of  $x$  are  $\pi/2$

INPUT TABLE							SINE LOOKUP TABLE											
A <sub>7</sub>	A <sub>6</sub>	A <sub>5</sub>	A <sub>4</sub>	A <sub>3</sub>	A <sub>2</sub>	A <sub>1</sub>	ADDRESS							OUTPUT CODE				
							A <sub>7</sub> THRU A <sub>1</sub>	B <sub>8</sub>	B <sub>7</sub>	B <sub>6</sub>	B <sub>5</sub>	B <sub>4</sub>	B <sub>3</sub>	B <sub>2</sub>	B <sub>1</sub>			
0	0	0	0	0	0	0	0	0	0	0	0	0	0	0	0	0		
0	0	0	0	0	0	0	1	1	1	0	0	0	0	0	0	0		
0	0	0	0	0	0	1	0	2	0	1	1	0	0	0	0	0		
0	0	0	0	0	1	1	1	3	1	0	0	1	0	0	0	0		
0	0	0	0	1	0	0	0	4	0	0	1	1	0	0	0	0		
0	0	0	0	1	0	1	1	5	1	1	1	1	0	0	0	0		
0	0	0	0	1	1	0	0	6	1	1	0	0	1	0	0	0		
0	0	0	0	1	1	1	1	7	0	1	1	0	1	0	0	0		
0	0	0	1	0	0	0	0	8	1	0	0	1	1	0	0	0		
0	0	0	1	0	0	1	1	9	0	0	1	1	1	0	0	0		
0	0	0	1	0	1	0	0	10	1	1	1	1	1	0	0	0		

1. The first 10 entries of a 128-entry sine lookup table are related to their address inputs. In this ROM lookup-table operation, the binary addresses are code words for values of the sine argument.

radians multiplied as follows:

$$\frac{A_7}{2} + \frac{A_6}{4} + \frac{A_5}{8} + \dots + \frac{A_1}{128}$$

Address location 1 stores the sine value for  $90/128 = 0.7$  degree. The corresponding output, a binary fraction, has B8 worth  $1 \times 2^{-8}$ , B7 worth  $1 \times 2^{-7}$  and so on to B1 worth  $1 \times 2^{-1}$ . Thus the output from location 1 is  $1/256 + 1/128 = 0.012$ , which is close to the sine of 0.7 degree. The accuracy of the output reaches  $\pm 1/2$  bit in  $2^{-8}$ , or  $\pm 1$  bit in  $2^{-9}$ .

While this demonstrates a basic lookup table, it's not necessarily the most efficient method of using ROMs to derive mathematical functions. To look up a sine value directly with an input resolution of 11 bits and an output accuracy of 12 bits, for example, requires  $2^{11} \times 12$  bits, or 24,576 bits of read-only memory.

The arrangement in Fig. 2, on the other hand, gives almost the same accuracy with just 4096 bits. A trigonometric expansion of  $\sin x$  permits the simplification.<sup>1</sup> The input resolution is 11 bits, and the output accuracy is  $1 = 5/8$  bits in  $2^{-12}$ .

Techniques similar to this—but implemented with four ROMs storing 4096 bits, for a total of 16,384 bits—can generate sine tables with 15-

Richard Percival, Digital Systems Applications Engineer, National Semiconductor Corp., 2900 Semiconductor Dr., Santa Clara, Calif. 95051

# Programming the ROM

Semiconductor ROMs (read-only memories) can be called "write-once-only memories." This is true for transistor-array and also diode-matrix ROMs. The writing step is part of the manufacturing process, while the reading is part of hardware operation. The user must tell the manufacturer what to write by means of ROM programming.

The programming defines the stored data according to the states of the address inputs and the required states of the output words. Solid-state ROMs are generally programmed by wafer-fabrication mask changes.

In most cases the user programs with a table (Fig. A). The numerical values of the input addresses are the decimal values of the binary input address states.

The ROM user fills out the table by writing the required output states in the blanks opposite the numbers. Then the ROM manufacturer uses the table to prepare the wafer-fabrication mask.

Suppose the table runs to address 255—a total of 256 addresses with zero—and each output word has eight bits. The ROM must store  $256 \times 8 = 2048$  bits. It has eight address input lines to define the  $2^8 = 256$ -word locations in the memory, and eight parallel output lines for the word bits.

Most general-purpose ROMs contain address decoding logic. However, they can be addressed in any code. The ROM user simply determines the binary value of the input code word and uses that value to select the word location.

For example, in Gray code the eight-bit word

0000-1000 has a decimal value of 15. In binary this word has a value of 8. If an input value of 15 in Gray code accesses an output of 10101010, these states are placed opposite address location 8 in the table.

Whatever input code is used, the equipment designer has a choice of  $2^n$  unique input combinations, where  $n$  is the number of ROM inputs. He also has up to  $2^n$  unique output combinations.

But he doesn't have to use them all. The input code, for instance, might contain only 100 eight-bit words. Then he simply calls for an output from the other 156-word locations that the system will ignore, such as an output of all ONEs or all ZEROs.

Note also the chip-enable input in Fig. A. This can be called the  $N+1$  address input. If this input is TRUE, the sense amplifiers are enabled and an output is obtained. If it is FALSE, there is no output. Chip-enable inputs allow ROMs to be addressed in parallel with only one ROM selected for output.

Some ROMs have three chip-enable inputs, allowing up to eight ROMs to be addressed in parallel by  $n+3$  address bits. If there are 256 words in each ROM, an 11-bit address allows up to 2048 words to be selected.

In addition some ROMs can have more than one operating mode. An example is the MOS/ROM in Fig. B. It can operate as a  $256 \times 8$  or  $512 \times 4$  ROM, depending on whether  $A_9$  is used and on the state of the mode control input. In any case, the chip-enable can be considered a tenth address bit.

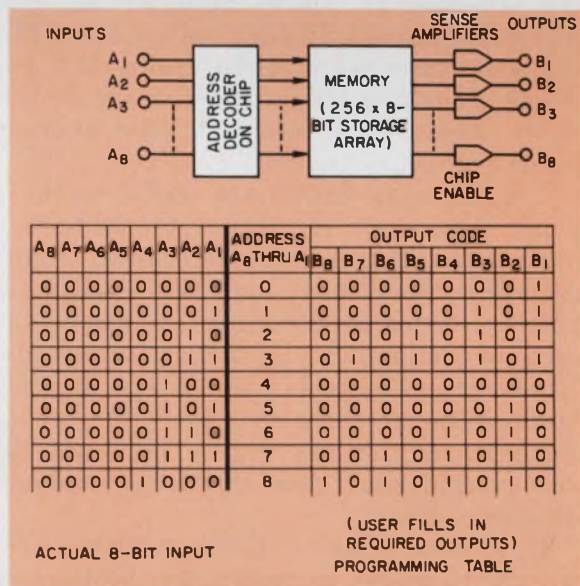

A. The programming of a ROM—such as this 2048-bit configuration—begins with a user filling in the desired output states in a table. In operation, the output word 10101010 is found from the input 00001000.

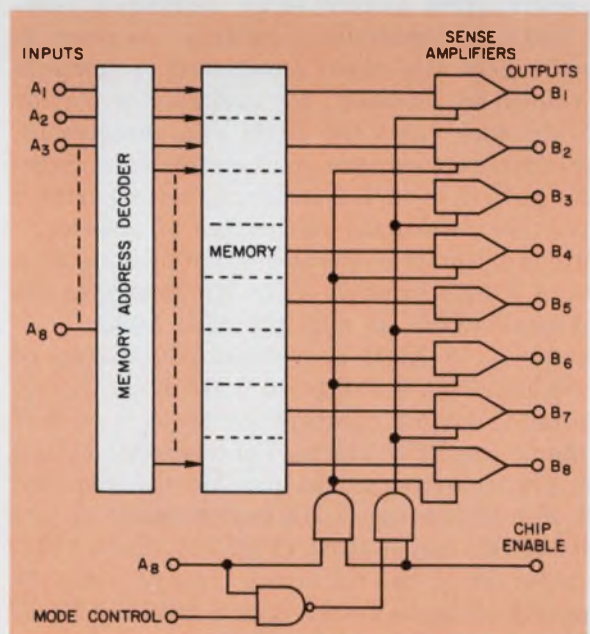

B. Some ROMs have variable configurations. This MM 4230/MM 5230 model, for example, can be either a  $256 \times 8$  or  $512 \times 4$  ROM.

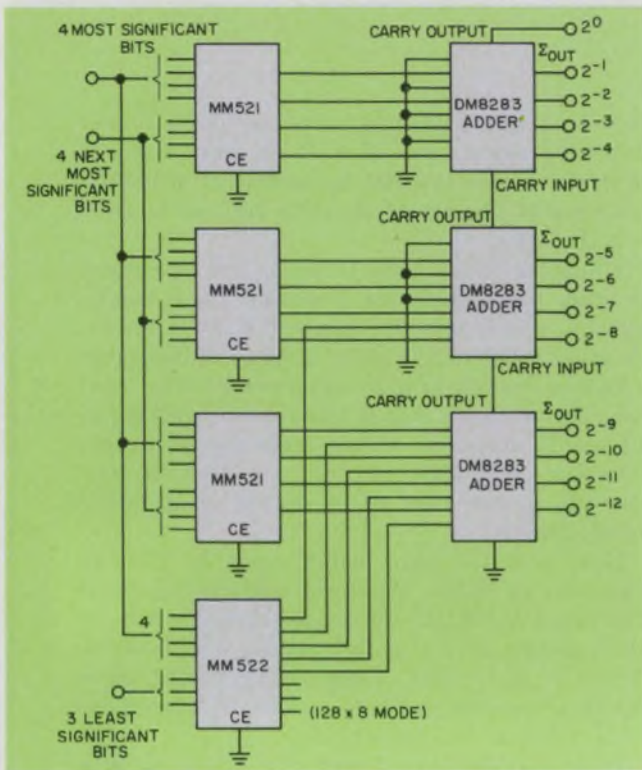

2. This four-ROM lookup table is more efficient for deriving accurate mathematical functions, such as  $\sin x$ . It can generate 2048 values of  $\sin x$  by the use of an interpolation technique.

bit input resolution. The output accuracy is  $\pm 3/4$  bit in  $2^{-15}$ . To achieve this accuracy with direct lookup would take some 480,000 bits of read-only memory.

### Arithmetic with ROMs

Extending this parallel-entry technique, however, leads to diminishing returns. A point is reached where it's more economical to compute sine values sequentially, by summing a Taylor series. In such cases the ROM can supplement, rather than replace, the arithmetic logic. Storing the powers of  $x$ , for instance, helps perform the function generation as the sum of a series.

Various arithmetic operations can be done with ROMs. A simple example (Fig. 3) illustrates the use of small ROMs as multiplication tables.

The  $256 \times 8$  ROM provides direct lookup of any product from  $0 \times 0$  to  $15 \times 15$  if the inputs are binary four-bit numbers, or up to  $9 \times 9$  if the inputs are BCD digits. The eight-bit output words are programmed to provide the required result. For higher speed, the configuration of two smaller ROMs can be used (Fig. 3b). Each 1024-bit bipolar ROM has an access time of about 60 ns—nearly 10 times faster than a 2048-bit MOS/ROM.

In general, it doesn't really matter which four address inputs are used for the most significant digit, or which output is the most significant bit.

The ROMs can be programmed to provide whatever input-output organization is most convenient for the system layout.

### Converting codes with ROMs

In code conversion, many conversions are difficult or impractical to perform with random logic. There may be no mathematical relationship between the words in one data code or machine language and the words in another.

As a result, widely used data-interchange codes in computer peripherals and communications equipment are generally converted with standard mask-programmed ROMs.

The memories are fabricated with standard programs. Among the codes for which standard ROMs are available are the Baudot teletypewriter code, ASCII (American Standard Code for Information Interchange), BCDIC and EBCDIC (Binary Coded Decimal Interchange Code and Extended BCDIC), Hollerith Punched-Card Code, IBM Selectric bail code and the EIA Numerical Control Code (EIA Standard RS 244).

MOS ROMs, while slower than bipolar versions, are usually fast enough for code conversions, since the codes are most often used at electromechanical or man-machine interfaces.

Another ROM application is systematic generation of codes. For instance, a ROM easily generates Hamming Single-Error Correcting Codes. The information bits address the ROM, which is programmed to output the parity bits. And these make up the error-correcting code.

Normally there are fewer check bits in the error-correcting code than there are information bits. An excellent type of ROM for this application might be the kind designed for  $5 \times 7$  display character generation. These store 512 five-bit words. Thus nine-bit information words can directly access check words of the appropriate length,<sup>2</sup> which is five bits.

Code-exerciser ROMs are useful to the communications engineer. These standard-programmed memories generate an ordered string of communication code words when the address inputs are cycled by a counter. An early example of these was a  $128 \times 8$  ROM. It generated in Baudot (CCITT No. 2) and ASCII-7 the familiar keyboard exercise message. "The quick brown fox jumped over the lazy dog." The larger ROMs now available could generate the message in eight different codes.

ROMs that generate character strings are also starting to be used as push-button bootstrap loaders for minicomputers. The ROM replaces the conventional paper tape and teletypewriter input, with much improved speed and reliability. Up to 512 characters are entered automatically through use of the system clock to raise a binary counter.

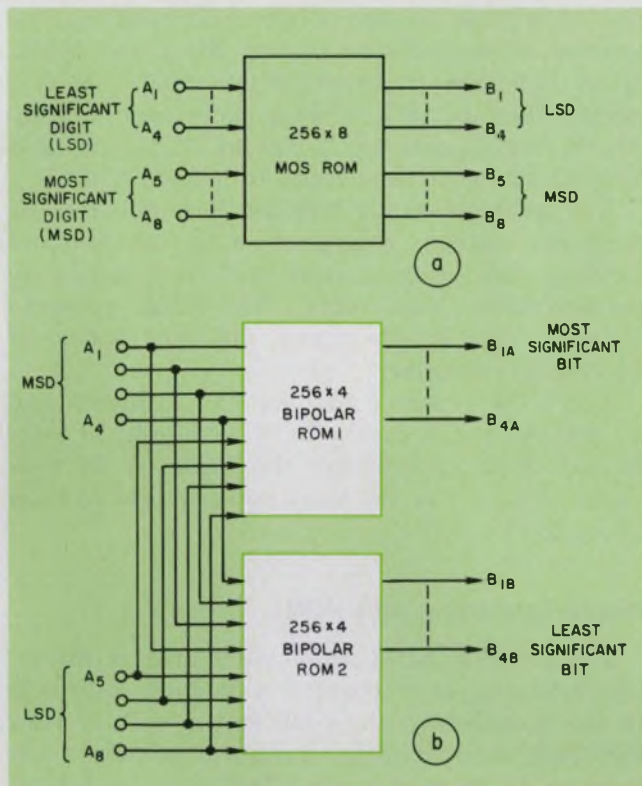

3. ROMs as multiplication tables can be configured with a single 2048-bit MOS ROM (a) or, for faster access, with two 1024-bit bipolar ROMs (b). In either case up to 225 can be calculated for binary four-bit numbers as the input.

Its outputs form the address inputs of the ROM.

A similar technique is starting to replace paper-tape loops and readers in machine control applications.

The number of control-word sequences stored in each ROM can vary with the number of control actions in each sequence. One 4096-bit (512 x 8) MOS/ROM can provide 32 sequences of up to 16 eight-bit words (Fig. 4).

Another important ROM application, character generation, includes dot-matrix characters for CRT displays and LED matrices for display or

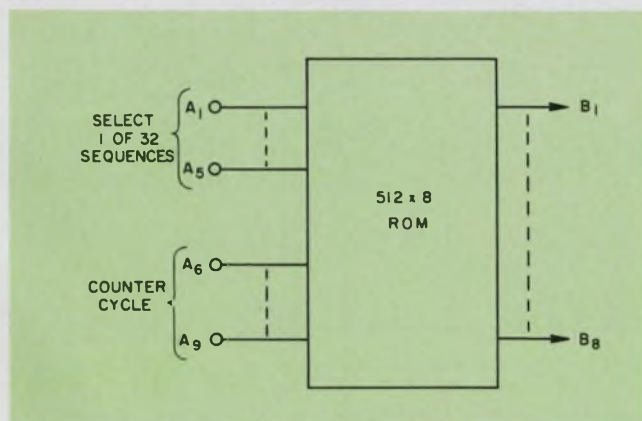

4. Control-word sequences vary with the number of control actions. With this 4096-bit MOS/ROM, 32 input sequences of 16 eight-bit output words are possible.

film annotation. Here, the ROMs are the modern versions of the coded mechanical linkages found in early printing-card punches. In most cases the counter-cycling technique is used.

Two possible generation techniques result in a raster scan (Fig. 5) or a vertical scan (Fig. 6). For both, the ASCII input selects the character, while the control logic, represented by the counters, selects the dot rows or columns.<sup>3</sup> There are actually  $8 \times 5 \times 64$  bits stored in the raster-scan ROM and  $6 \times 8 \times 64$  bits in the vertical-scan ROM. The extra rows and columns generate the blank spaces between lines and characters on the display or printout.

A raster-scan ROM is generally used when the display is a television monitor tube. The ASCII codes for all the characters in a display line are presented to the A1 through A6 inputs while the line counter changes state. Eight sweeps of the CRT beam display a complete line of characters. A shift register converts the parallel ROM outputs to a serial-bit stream that controls the CRT beam intensity. This results in ONE output bits producing dots on the screen. Alternately, with an inverter, it gives a white "page" with black writing on it.

Vertical-scan generators usually operate high-resolution sawtooth-scan CRTs or paper-tape printers. Two of these ROMs can be operated in tandem to generate  $8 \times 12$  raster-scan characters. Or two raster-scan type ROMs can be used to generate  $10 \times 8$  vertical-scan characters.

With four  $512 \times 8$  ROMs,  $16 \times 16$  raster-scan or vertical-scan characters can be formed. And the two chip-enable inputs for each of the four vertical-scan generators can be mask-programmed, so additional decoding logic is required for the extended row or column address.

### ROMs for random logic

When ROMs are used as random-logic generators, the basic approach begins with a time-sequential flow chart of a logic-controlled system. The chart defines each state that the controller could ever be in as a function of how it could get into those states, and it also gives the logic operations to get it out of each state.

Once the system designer can describe precisely how the system will react to any event or input, he draws a system-state diagram. Then the states on the flow chart are linked by decision lines. Generally states are identified by numbers, which are encoded and stored in flip-flops.

While the system is in some particular state, an input stimulus can generate a response without a change in the state. This is akin to the state combination gating a signal line. But if a stimulus is stored during a particular state, the system has moved to a new state.

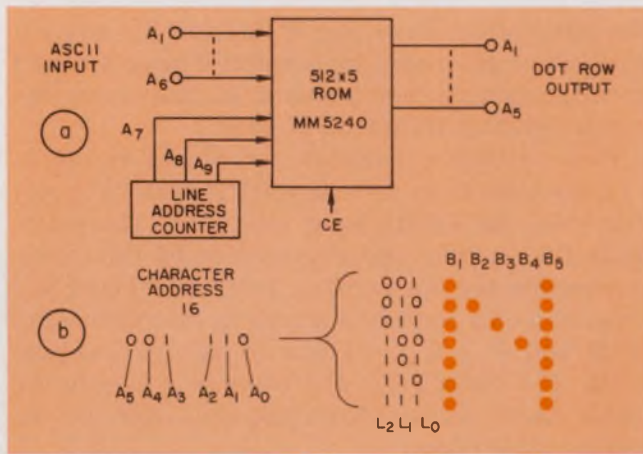

5. A raster-scan circuit for the generation of ASCII characters (a). The output provides the dot-row information for a typical  $5 \times 7$  character (b). This technique is often used for TV monitor tubes. A total of  $8 \times 5 \times 64$  bits are stored in the ROM.

This approach to logic-system design allows a ROM to be used for random control sequencing or random-logic synthesis. As an example, the circuit of Fig. 7 shows how to control a system with up to 32 flip-flops—a rather large number of possible states—with one 4096-bit ROM. The ROM itself, however, is driven through a multiplexer by four sets of seven variables. This limits the number of controller state variables to  $2^7 \times 2^4$ , or 512—often an adequate amount for many types of branching processors.

The multiplexing method allows only one group of eight flip-flops to be worked on at any given time by one of the sets of seven variables. But the states of the flip-flops controlled by one group of variables can be used as input parameters to another group of flip-flops.

Maximum system response time is limited by

the cycle time of the ROM multiplied by the number of multiplexed passes. Since the MOS/ROM cycle time is somewhat less than  $1 \mu\text{s}$ , this means that one full system cycle can be completed every  $3 \mu\text{s}$  or so. If bipolar ROMs are used instead, the cycle time drops to around 300 ns.

The technique really reduces the number of IC packages needed, compared with conventional random-logic designs. And the same hardware configuration, with only the ROM contents changed, can handle many different kinds of processing problems.

In all, the system controller has 28 inputs and 32 outputs, but it can be built with only 14 integrated circuits, including the ROM. A conventional controller of the same power might contain about 200 logic ICs.

### Microprogramming with ROMs

The growing ROM application area is microprogramming. It encourages a modular approach in the architecture and reduces the bulk of random logic used hitherto. It also allows the main memory to be used more effectively, by taking away the lower-level housekeeping functions. Usually a computer requires some specific microprogram, or micro-instruction set, for each type of operation performed.

The computer user works with a source program, or macroprogram, described with one of the standard high-level languages, such as FORTRAN, COBOL or ALGOL. These languages are designed to simplify the tackling of a scientific or business problem by using forms of expression that are familiar to the specialist user.

Each statement in the source program must be expanded by a compiler program—a long list of

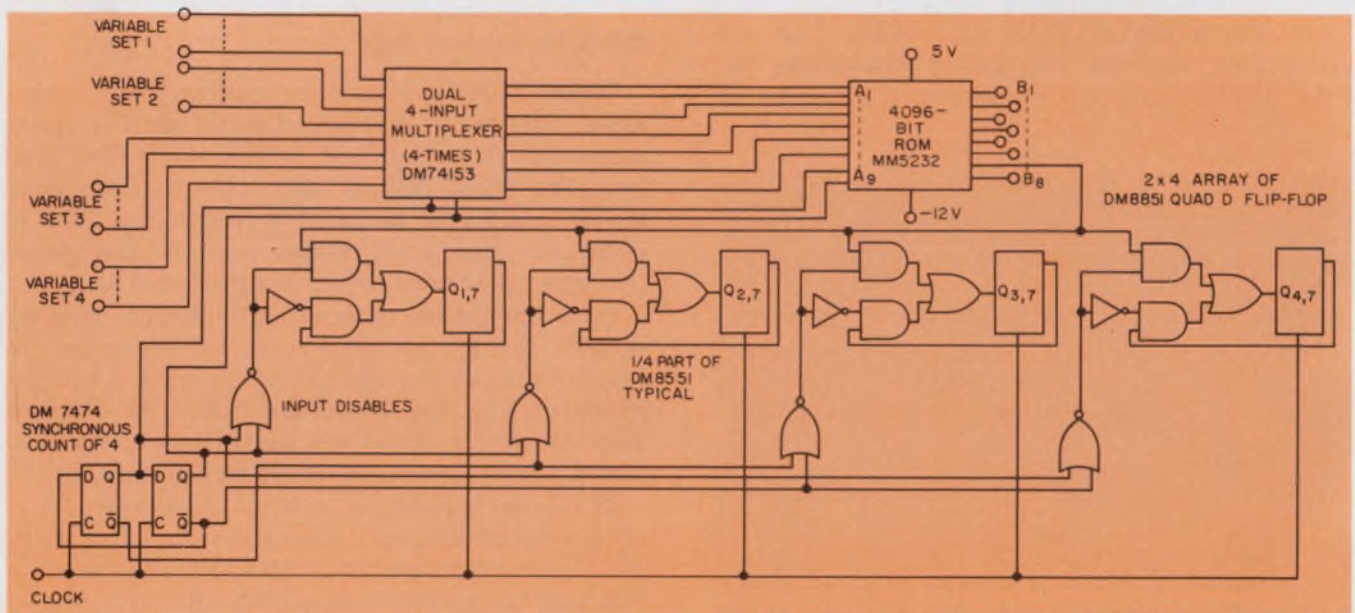

7. Any ROM can be used for random-control sequencing or random-logic synthesis. In this application a multi-

plexer-driven ROM controls a system represented by up to 32 flip-flops.



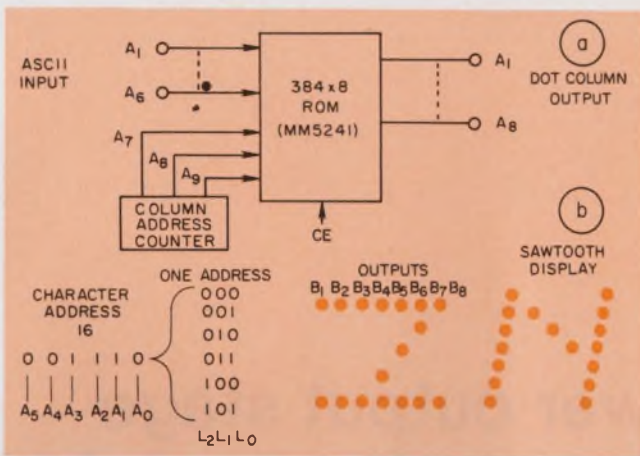

6. An alternate character-generation technique, vertical scanning with a ROM (a), provides high-resolution characters for sawtooth-scan CRTs or paper-tape printers (b). In all,  $6 \times 8 \times 64$  bits are stored in the ROM. The character matrix is  $7 \times 5$ .

instructions to the computer. An instruction might be "49—ADD THE ACCUMULATOR INTO THE CONTENTS OF THE ADDRESS WHOSE LOCATION IS SPECIFIED IN THE INDEX REGISTER." One such instruction can require a large number of logic housekeeping operations unique to that particular computer. These are the microinstructions, or microprogram.

In the past, microinstructions have been defined in the computer logic by "hard wiring." They cause the operations to be carried out in the necessary timing order by such devices as one-shots and combinational gating. Recently developed computers accomplish the microprogramming with instruction sequences stored in ROMs. These ROMs operate general-purpose logic.

Since a number of microinstructions need to be performed during each main-memory cycle, the ROMs must be very fast. Therefore, bipolar ROMs are used. Also, since the microinstructions will be the same every time a particular program instruction is accessed in main memory, these instruction words access a specified number of microinstructions. The microinstructions are sequenced by timing logic.

In principle the ROM control is similar to that for character generation, except that the main program word replaces the code word and the number of microinstructions may vary from instruction to instruction. The variation can be controlled, for example, by programming the modulus of the address-cycling counter. ■■

#### References:

1. Ross, C. and Mrazek, D., "Trig Function Generators," *MOS Brief 10*, National Semiconductor Corp., Santa Clara, Calif.
2. Chu, Y., *Digital Computer Design Fundamentals*, p. 84, McGraw-Hill Book Co., New York, N.Y.
3. Carter, G. and Mrazek, D., "The Systems Approach to Character Generators," *AN-40*, National Semiconductor Corp.

## WHY BUY ANOTHER PRECISION WIREWOUND?

...OUR T.C. IS BETTER

...OUR TRACKING IS BETTER

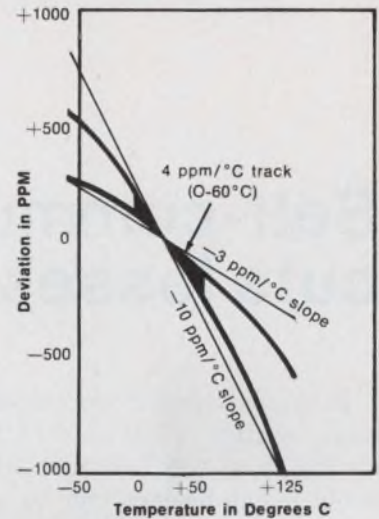

OUR PRICE IS LOWER...  
...WE DON'T CHARGE EXTRA

for non-inductive winding . . . Virtually non-measurable inductance is standard in all Vishay Bulk Metal Film Resistors!

and we are

**DIRECT  
PHYSICAL  
REPLACEMENTS**



The M series resistors shown above are direct size-for-size replacements for RB precision wirewounds, but with improved stability.

**SO WHY PAY MORE FOR LESS?**

Write now for Bulletin V100 which describes Vishay's complete line of direct replacements for precision wirewounds.

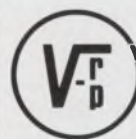

**VISHAY  
RESISTOR  
PRODUCTS**

63 LINCOLN HIGHWAY  
MALVERN, PA. 19355  
PHONE: (215) 644-1300  
TWX: 510-688-8944

## Self-commutating power output stage cuts losses in switching-mode converter

In a switching-mode converter that has time-ratio control (TRC), simultaneous conduction during crossover produces high dissipation. The problem can be overcome by use of a single-ended output stage instead of the usual push-pull.

The single-ended circuit shown eliminates high dissipation during crossover. The fall time of the pass transistor Q2 in the switching-mode converter is reduced from 10 ms to about 2  $\mu$ s without requiring any power or signal information from the TRC circuitry. Since all semiconductors are clamped for low-voltage operation in both the forward and reverse direction, the circuit consumes a negligible amount of power. This permits a single-ended drive to be used in the power output stage without compromising the efficiency inherent in an ideal switching converter.

Transistors Q3 and Q4 comprise the single-ended drive stage, which transmits control signals to pass-transistor Q2. When Q2 is conducting, capacitor C1 charges to the  $V_{B+}$  level, with the polarity shown, via diode D1 and resistor R2. When an OFF signal is applied to Q4, the base drive is removed from Q3, causing its output to decay. The base drive of Q2 then diminishes, causing the pass transistor to enter the storage state as Q3's output continues to decay.

While the emitter current of Q2 decays, inductor L1 begins to fly back, causing the emitter voltage of Q2 to drop. When the emitter voltage drops about 1 V, the charge on capacitor C1 causes Q1 to conduct. This causes Q1 to attract excess minority carriers out of the base of Q2, so that Q2's emitter current falls even more rapidly. The choke responds with a more negative voltage at the emitter of Q2. The process regenerates until Q2's emitter voltage is driven below ground by the forward voltage drop of D2.

Since the saturation voltage of Q1 is significantly less than the forward base-emitter voltage of Q2, transistor Q2 is clamped off until C1 discharges. This permits Q1 to resume its blocking

state. The cycle repeats when Q3 is again turned on.

Transistor Q3 is well into its decay state (if not completely off) when Q1 receives its ON pulse. With proper selection of C1 and R2, Q1 will have recovered its blocking state before Q3 receives its next ON command. There is thus little or no simultaneous conduction of Q3 and Q1.

Since transistor Q1 receives its base drive information from the power circuit, it requires no synchronization or sequencing information from the TRC circuit. The voltage across Q1 is clamped to the forward base-emitter voltage of Q2 (about 1 V). The reverse base-emitter voltage of Q1 is clamped at about 1 V by D1. Since Q1 thus operates in a low-voltage/low-duty-cycle mode, its power dissipation is negligible.

*Sidney E. Millman, TRW Systems, Inc., One Space Park, Redondo Beach, Calif. 90278*

CIRCLE No. 311

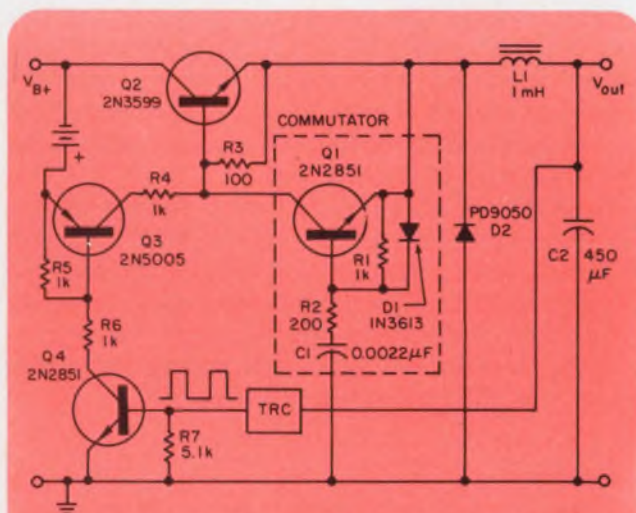

A commutator circuit and a single-ended output stage reduce the fall time of power-pass transistor Q2 in a switching-mode converter.

# New from Helipot: the lowest trimmer profile in the business.

SHOWN ACTUAL SIZE

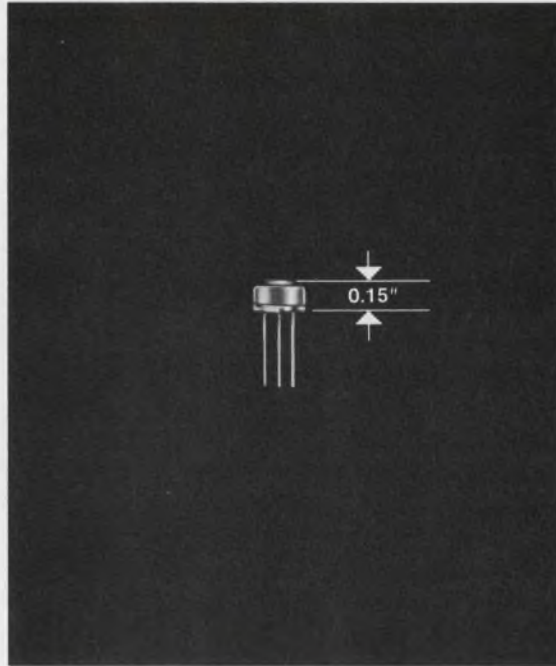

You can't do better than our Series 82 Trimmers for small size and low cost . . . and, of course, Helipot dependability. These  $\frac{1}{4}$ " single-turn, general-purpose cermet models have the lowest profile in the industry with a proven cermet resistance element that can be set to any voltage ratio within 0.05% of full scale. Sealed metal housings, solid stops, and essentially infinite resolution. They'll save you space—they'll save you money. (Our prices start at \$1.40 list.) Two good reasons to write for specs and prices today.

**Beckman** INSTRUMENTS, INC.

**HELIPOT DIVISION**

2500 Harbor Blvd. Fullerton, Calif. 92634

HELPING SCIENCE AND INDUSTRY IMPROVE THE QUALITY OF LIFE

INFORMATION RETRIEVAL NUMBER 43

# IC one-shot generates pulses with programmable widths

A single 9601 TTL monostable multivibrator, connected as shown, generates pulses of width  $T$ , which depends on the external time constant  $R1 \cdot C$ .

The outputs of the TTL gates G1 and G2 are initially in the ONE state (HIGH), thereby back-biasing diodes D1 and D2. Both gates are now OFF, and pulse width  $T1$  results.

When "PW Control A" goes HIGH (to a ONE state), the output of G1 goes LOW (to a ZERO) state. This output forward-biases diode D1, drawing current through R2. The effective time constant,  $R1 \cdot C$  that determines the pulse width is then reduced. This is due to the introduction of R2, effectively in parallel with R1. A new pulse width,  $T2$ , is thus obtained when gate G1 is ON and G2 is OFF.

A third pulse width,  $T3$ , is obtained when gate G2 is ON and G1 is OFF.

This scheme permits pulse-width adjustments of up to 15%. Larger adjustments would require values of R2 and R3 closer to R1. The node connecting R1, R2, R3 and C would then have a bias potential far below 5 V, while the 9601 is in its OFF state. Thus there will be some degradation in device performance because of the modification.

*Srirama Durvasula, Honeywell Information Systems, Framingham, Mass. 01701.*

CIRCLE NO. 312

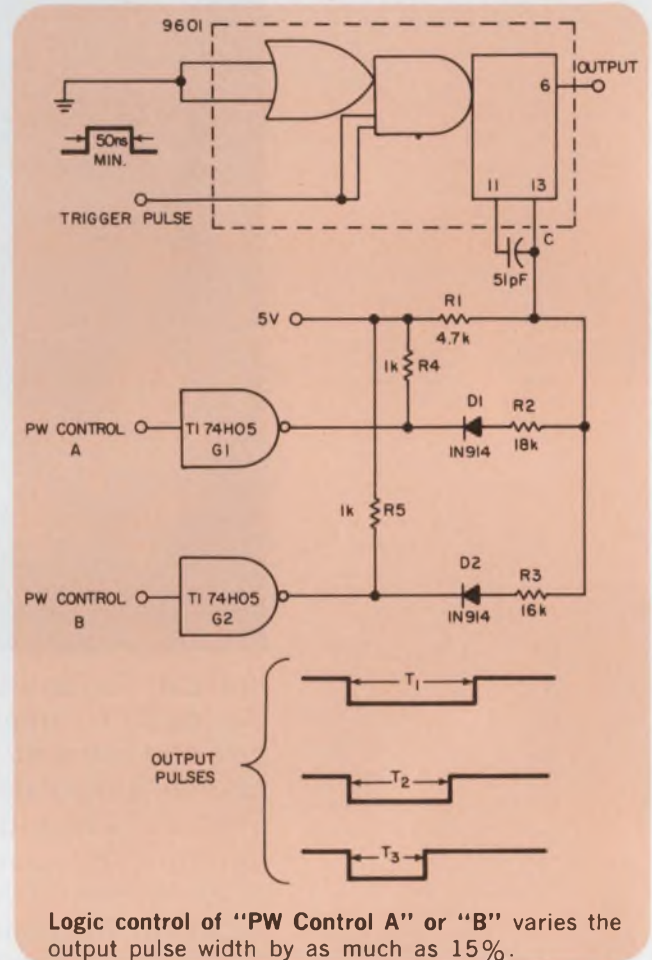

# Variable voltage gain need not depend on the control-voltage slope

With this circuit (Fig. 1) the voltage gain vs control-voltage characteristic (Fig. 2) is linear within 1 dB from +10 dB to -50 dB of gain.

The variable gain circuit is inspired by Motorola's MC1590 wideband agc amplifier but is designed for low-frequency operation. The input, which may be as large as 2 V rms, can be decoupled. The response extends to 100 kHz, and a low-frequency cutoff of 1.5 Hz results from the

integrator RC time constant and the open-loop gain. The upper 3-dB frequency, determined by the compensating capacitor C1, is nominally 100 kHz, but a 3:1 variation in cutoff frequency is not unusual for an IC amplifier.

Most simple agc circuits have an attack and decay time constant that is determined by the slope of the control characteristic, the integrator RC time constant and other gains and losses in the

# Instrumentation Amplifiers. We only make five. But they're the only five you need.



In addition to simplifying your choice, we made it a better choice. So you can do more with less and spend less doing it.

Just look at our line-up.

Our model 605 gives you the best premium performance of any instrumentation amplifier. It's available with three drift options including the industry's lowest drift,

to  $0.5\mu\text{V}/^\circ\text{C}$ . It also has the best non-linearity, 0.005%. All without compromising its 120dB of CMR. Starting at \$59, it's a first choice.

Our 604 is a higher speed version of our high accuracy 605. Giving full power bandwidth to 50 kHz and settling time of  $20\mu\text{s}$  to 0.01%. At \$155, it gives you performance comparable to rack and panel devices.

Our 520 is the world's first I.C. instrumentation amplifier at the world's lowest price. Only \$18.

For general purpose applications, choose our 603 FET input model at \$39. Or our 602 with fixed gain and an active shield drive terminal for \$55.

When you know even more about our line of instrumentation amplifiers, you'll see why our five are the only five to look at.

We can send you data sheets on all five. As well as our 1972 Product Guide which shows all the other things we make to solve more of your problems better than anyone else.

Analog Devices, Inc., Norwood, Mass.  
02062, (617) 329-4700.

 **ANALOG  
DEVICES**

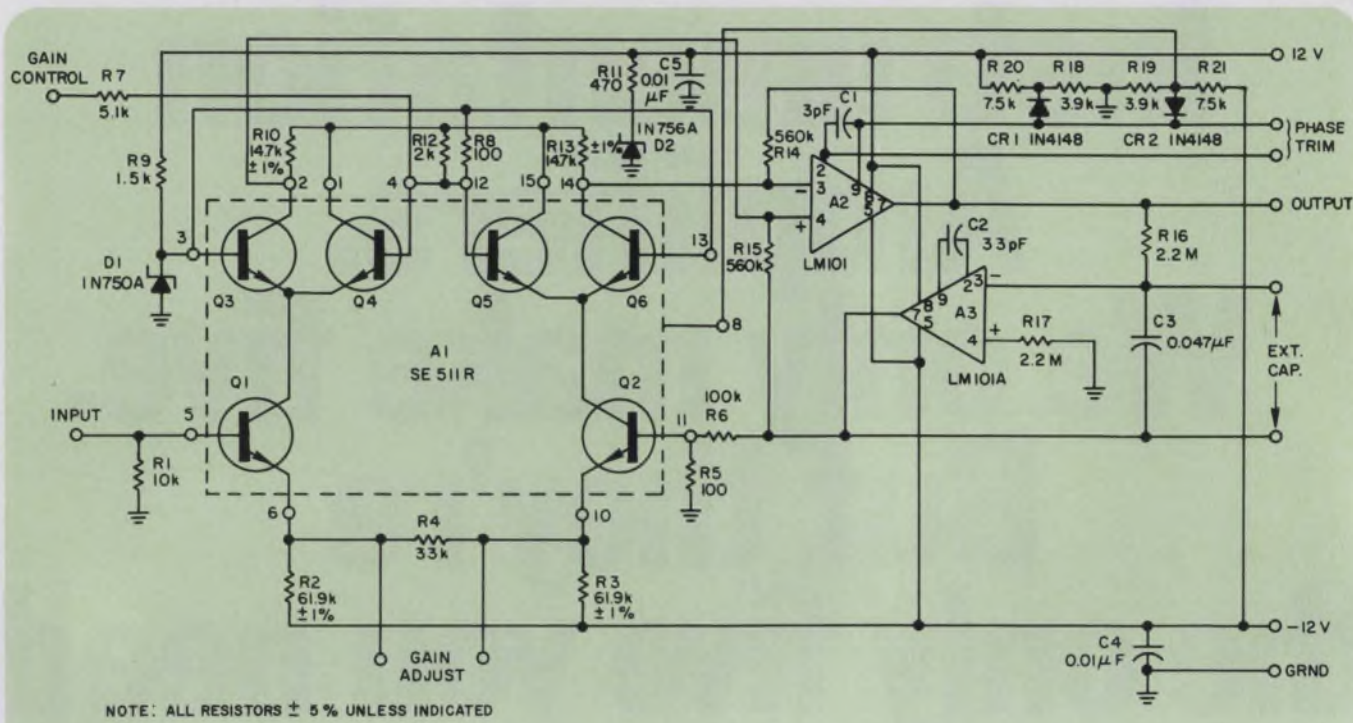

1. Variable gain circuit finds applications in signal-processing systems that use remote control or agc.

loop. This problem is avoided with the circuit shown.

In Fig. 1, transistors Q1 through Q6 are an integrated transistor array, SE511, which has internal connections that are particularly suited to this application.

Transistors Q1 and Q2 act as current sources that are modulated by the input signal. Their collector currents are steered through Q3 and Q6 to the load resistors R10 and R13, or through Q4 and Q5, bypassing the load, depending on the voltage at the Q4 and Q5 base.

A linear gain vs control voltage characteristic is obtained when the source impedance is low; therefore a 100- $\Omega$  resistor, R8, is used. The control characteristic (Fig. 2) tends to be nonlinear at high gain settings, because of the noise and cutoff characteristics of Q4 and Q5.

In the output op amp, A2, the control signal is canceled because it is common-mode, but the ac signal is additive. The integrator in the feedback loop keeps the output at dc ground, compensating for circuit unbalance and canceling input dc up to  $\pm 100$  mV. The large amount of dc feedback to A2 allows circuit operation with up to 0.5 V of dc input.

Output is limited to  $\pm 4$  V by diodes CR1 and CR2 and by voltage dividers R18, R20 and R19, R21. The connection to pin 8 of the SE511R is necessary to bias the substrate more negative than the peak of the largest signal.

Russ Kincaid, Sanders Associates, Inc., Daniel Webster Highway South, Nashua, N.H. 03060

CIRCLE NO. 313

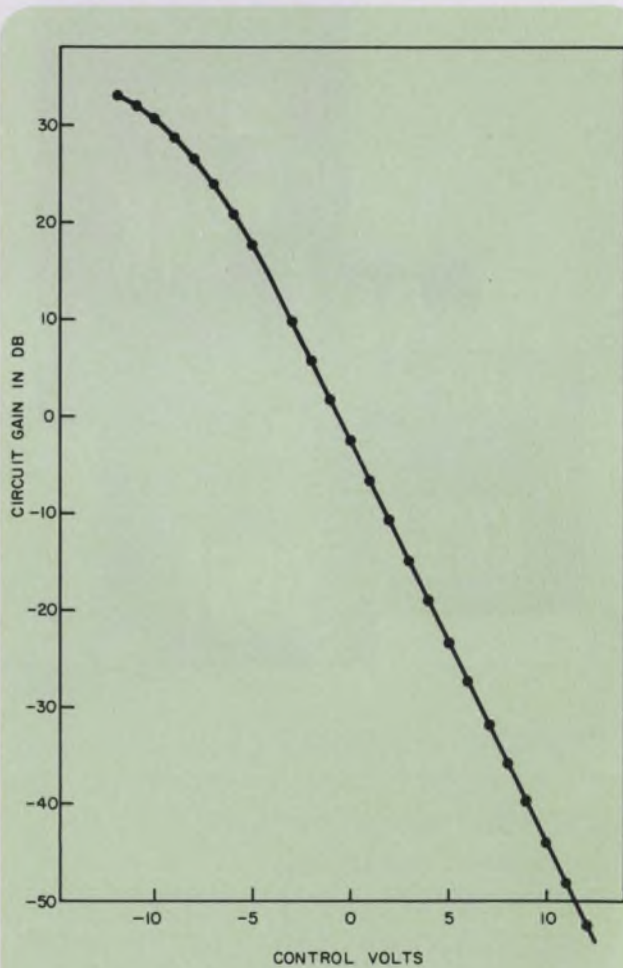

2. The control characteristic is nonlinear at high gain because of the noise and cutoff characteristics of transistors Q4 and Q5.

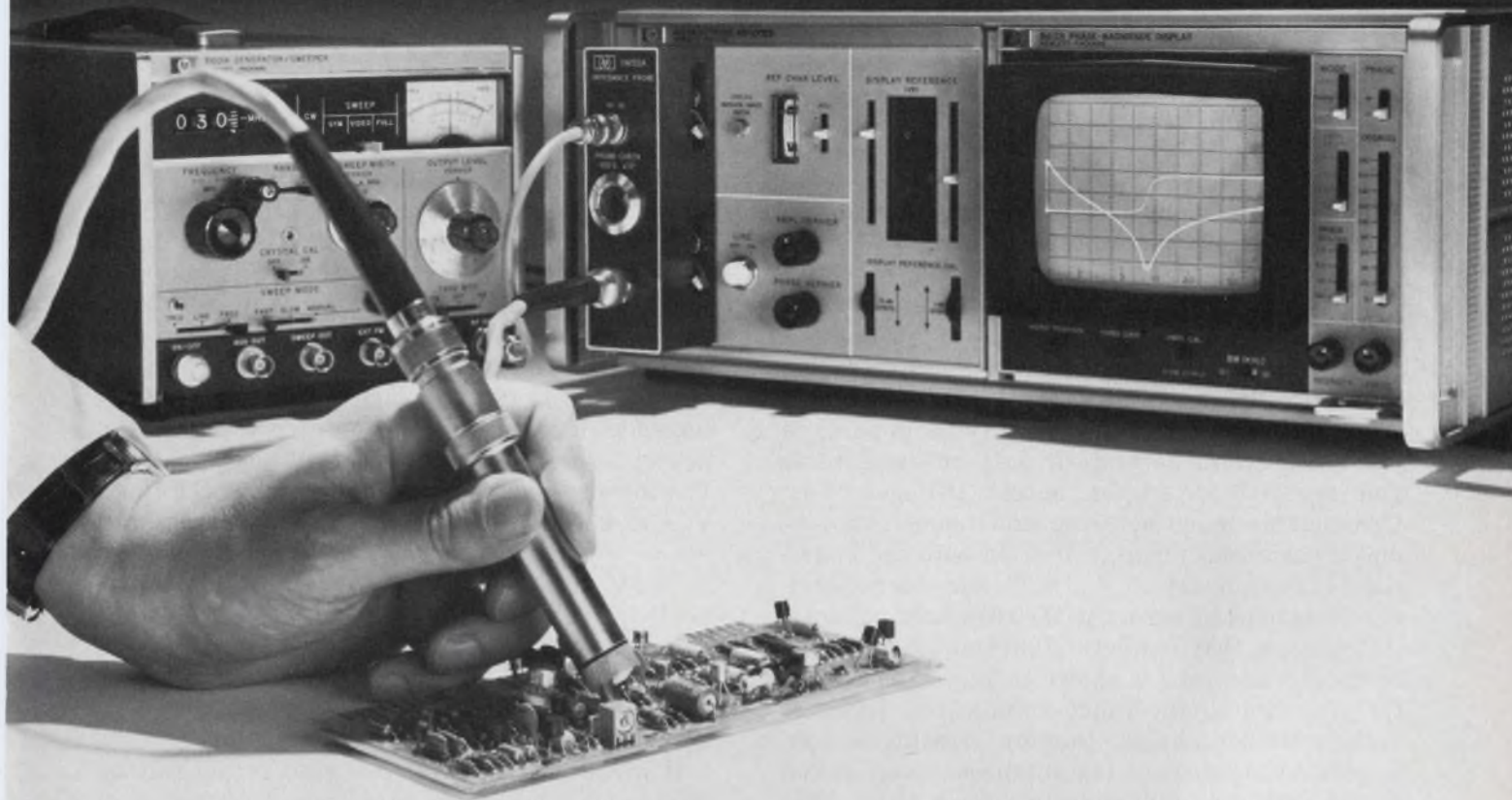

## Introducing “touch & see” swept impedance measurement. Now the “do-everything” RF test system does even more.

Just add our new impedance probe to the HP 8407A Network Analyzer, and you can measure complex impedance of circuits, coax systems, discrete components. View impedance excursions over the wide range from  $0.1\Omega$  to  $10K\Omega$  as you sweep between 500 kHz and 110 MHz.

The HP 8407A Network Analyzer itself makes comprehensive swept RF measurements quickly, and with high accuracy. You see important characteristics like gain/loss, phase shift, voltage and current transfer functions, group delay, impedance, return loss and S-parameters. Dynamic range is greater than 100 dB, yet you can resolve 0.05 dB. It has  $360^\circ$  phase range with  $0.2^\circ$  resolution.

The 8407A Network Analyzer with the 8412A Phase-Magnitude Display costs \$4650. The new impedance probe (Model 11655A) costs \$750. Other accessory kits for circuit probing and for general measurements in coaxial systems are also available, priced from \$325 to \$500.

To learn more about how our “do-everything” network analyzer can help you in design and production test applications, call your field engineer or write Hewlett-Packard, Palo Alto, California 94304; Europe: 1217 Meyrin-Geneva, Switzerland.

HEWLETT  PACKARD

NETWORK ANALYZERS

04112 A

# Add FET to threshold detector to improve hysteresis

To improve the hysteresis characteristics of an op-amp threshold detector, try adding a FET to the usual circuit. Hysteresis error will be better than 1%, and will be maintained over an 85 C temperature range.

The typical way to provide hysteresis is through resistive feedback (Fig. 2). With this circuit however, the accuracy of the upper and lower trip points depends directly on the positive and negative saturation output voltages,  $V_{out}$ . Unavoidable manufacturing and temperature-induced variations of up to 10% in both the amplitude and symmetry of  $V_{out}$  will cause corresponding variations or errors in the threshold voltages.

A circuit that exhibits significantly improved hysteresis accuracy is shown in Fig. 2. The FET, Q1, presents to the input voltage two separate voltage-divider chains, thereby creating a hysteresis, or dead-zone. Instantaneous snap action occurs with each switching transition of Q1. This snap action preserves the desirable effect of positive feedback in producing sharply defined output voltage changes, as with the basic detector of Fig. 1. In the circuit of Fig. 2, however, the feedback is obtained without the limitation in trip-point accuracy.

Prior to its turn-on, the FET is held at pinch-

off by the forward-biased diode, D, since  $V_{out}$  is at its maximum negative value. When the upper threshold voltage is reached, the FET is turned on by  $V_{out}$  at its positive extreme. Capacitor C provides rapid discharge of the charge stored in the gate-source capacitance of the FET when the trip action occurs. Accuracy of the threshold voltages depends almost entirely on the characteristics of the voltage divider of R1, R2, and R3. The threshold voltages (with respect to the input  $V_{in}$ ) and hysteresis are defined by the equations

$$V_{ut} = \frac{R1 + R2 + R3}{R3} \cdot V_{ref}$$

$$V_{lt} = \frac{R1 + R3}{R3} \cdot V_{ref}$$

$$\text{Hysteresis} = V_{ut} - V_{lt} = V_{ref} \left( \frac{R2}{R3} \right)$$

If wirewound resistors are used in the voltage divider, hysteresis repeatability of better than 1% is possible. The FET ON resistance (typically 20  $\Omega$ ) is not included in the equations, since analysis shows that its error contribution amounts to less than 0.1%.

George S. Oshiro, Consulting Engineer, P.O. Box 90876, Los Angeles, Calif. 90009

CIRCLE NO. 314

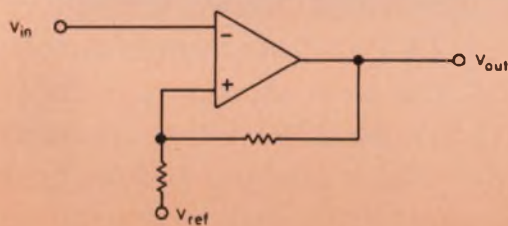

1. Conventional op-amp threshold detector provides hysteresis, but it has shortcomings in the accuracy of the voltage trip points.

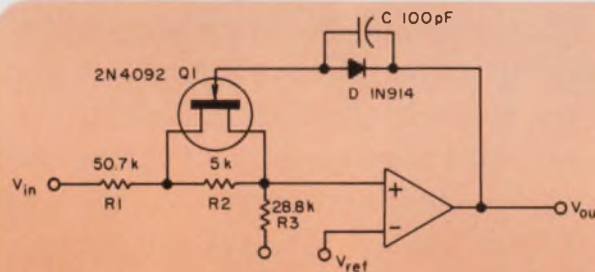

2. FET-controlled threshold detector exhibits hysteresis repeatability of better than 1% over a temperature range of 0-85 C.

## IFD Winner of February 3, 1972

O. Anthony Horna, Communications Satellite Corp., Comsat Laboratories, Box 115, Clarksburg, Md. 20734. His idea "One-shot multivibrator uses single IC" has been voted the Most Valuable of Issue award.

Vote for the Best Idea in this issue.

**SEND US YOUR IDEAS FOR DESIGN.** You may win a grand total of \$1050 (cash)! Here's how. Submit your IFD describing a new or important circuit or design technique, the clever use of a new component or test equipment, packaging tips, cost-saving ideas to our Ideas for Design editor. Ideas can only be considered for publication if they are submitted exclusively to ELECTRONIC DESIGN. You will receive \$20 for each published idea, \$30 more if it is voted best of issue by our readers. The best-of-issue winners become eligible for the Idea of the Year award of \$1000.



**Unbeatable  
portability  
and range  
coverage!**



the  
new

# Simpson<sup>®</sup> 460 DIGITAL VOM



- Completely portable . . . no separate battery pack or power supply needed. Self-contained battery or line operation.
- Non-blinking 3½-digit display of 26 most used ranges . . . 5 each AC/DC voltages and AC/DC currents . . . 6 resistances . . . with "plus" and "minus" and overrange . . . analog meter readout . . . analog to digital converter uses the dual slope technique.
- A compact, lightweight, multi-use Digital VOM for lab, in-field or general testing . . . . . only \$395.00 (less batteries)

NOW IN STOCK AT YOUR LOCAL ELECTRONICS DISTRIBUTOR • WRITE FOR BULLETIN T-811



## SIMPSON ELECTRIC COMPANY

GENERAL OFFICES AND EXPORT:

5200 West Kinzie Street, Chicago, Illinois 60644 • (312) 379-1121 • CABLE: SIMELCO

IN CANADA: Bach-Simpson, Ltd., London, Ontario

IN INDIA: Ruttonsha-Simpson Private, Ltd., International House, Bombay-Agra Road, Vikhroli, Bombay



DIVISION

INFORMATION RETRIEVAL NUMBER 46

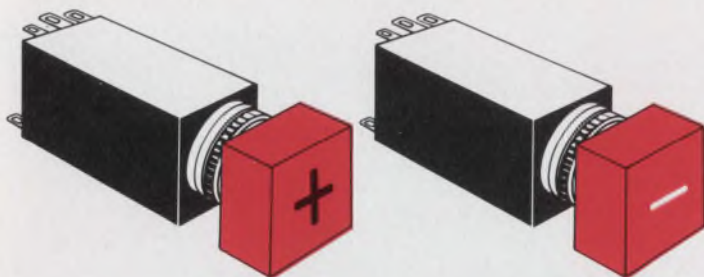

Contactless solid state switches

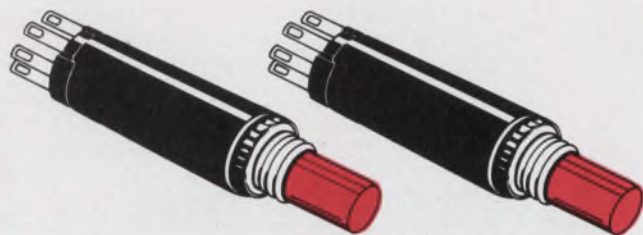

Incandescent or neon lighted switches

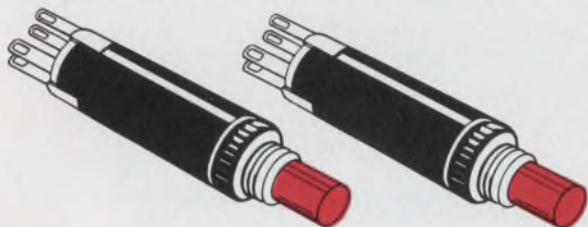

LED lighted switches... panel mounting

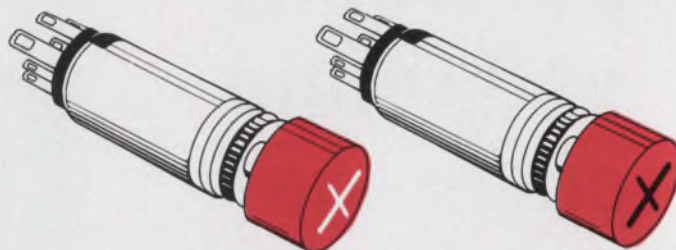

Incandescent lighted switches... panel mounting

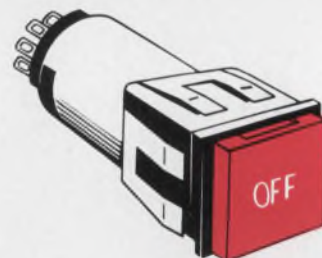
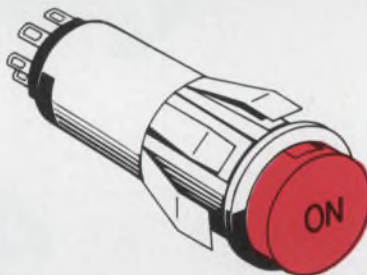
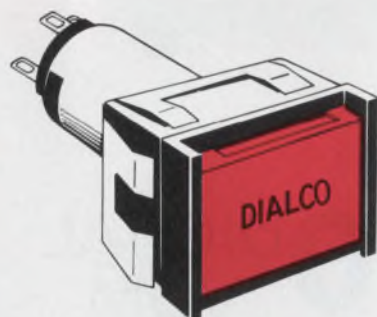

Incandescent lighted switches... snap-in mounting

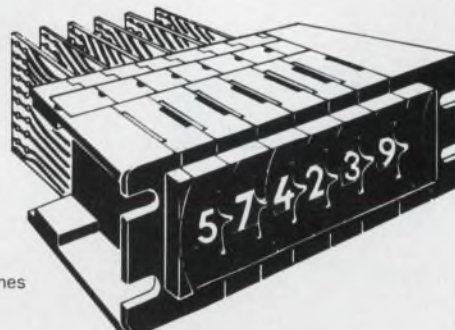
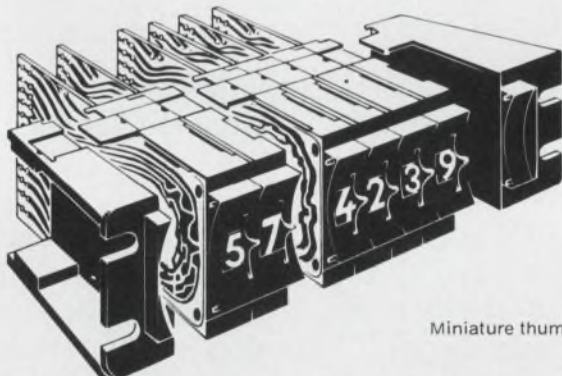

Miniature thumbwheel switches

## Switches?

**Talk to the specialists at Dialight first.  
You won't have to talk to anyone else.**

Dialight has a switch for virtually any application. That means complete freedom to design for the job without compromising on physical or electrical parameters. Dialight can give you push button switches with unlimited cap and bezel options...solid state switches that eliminate all mechanical switching

problems...LED lighted switches...thumbwheel switches that snap together to provide any number of decades you require... switches with transistorized indicators. If you have a special problem, tell us about it. Chances are, the specialists at Dialight have seen it before. Meanwhile, ask for our switch catalog.



DIALIGHT CORPORATION, A NORTH AMERICAN PHILIPS COMPANY • 60 STEWART AVENUE, BROOKLYN, N.Y. 11237 • (212) 497-7600

INFORMATION RETRIEVAL NUMBER 47

## new products

# Tiny high-gain rf amps are housed in 16-pin DIPs

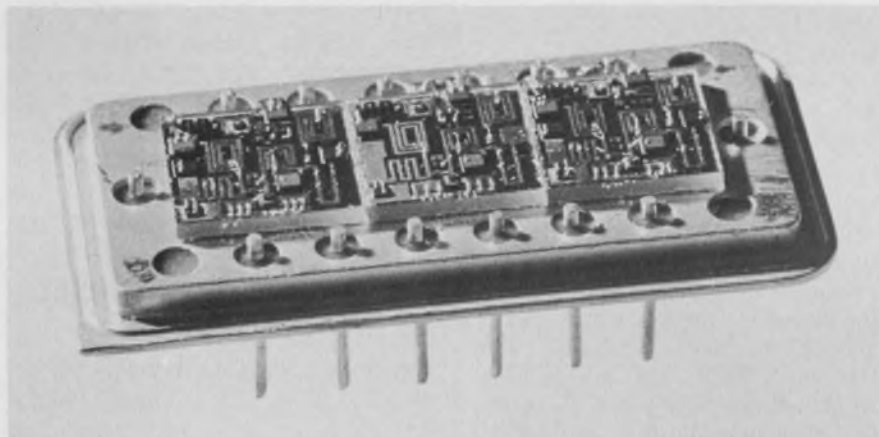

Avantek, Inc., 2981 Copper Rd., Santa Clara, Calif. 95051. (408) 739-6170. P&A: see text; stock.

Three tiny high-gain microwave amplifiers from Avantek are packaged in a 16-pin, DIP-size can. Each has performance equivalent to three of Avantek's earlier metal-can TO-8 units.

The new units occupy only 10% of the volume and are less than 5% the weight of any competitive off-the-shelf amplifier, while the price is only 20% more.

The three amplifiers—Avantek's UDP-2032 (24-dB gain), UDP-2332 (22-dB) and UDP-4003 (9-dB)—cover the bandpass ranges of 1 to 2, 2.2 to 2.3 and 2 to 4 GHz. The gain flatness (or deviation from true flatness) of each of the amplifiers varies  $\pm 1.0$  dB,  $\pm 5$  dB and 0.2 dB in the respective pass bands. At the  $-1.0$  dB gain compression point, the amplifiers can deliver +8 dBm (2032 and 2332) and +11-dBm (4003).

Designed to meet the size, weight and environmental requirements of airborne communication, radar, ECM and navigational systems, these hermetically sealed UDP-series amplifiers weigh 0.15 ounces while occupying 0.1 cubic inch. For convenience in stripline

application, the input pin and output pin are positioned at opposite ends of the package and centered between two rows of six pins, each row 0.3 inch apart. These 12-inline pins are used for power and ground distribution.

Avantek uses thin-film conductors on sapphire substrates, together with chip microwave transistors, resistors and capacitors.

The UDP-series amplifiers can be cascaded, without interstage matching, to yield any desired gain without reducing the bandwidth. However, since the gain flatness can be cumulative, a three-stage amplifier of the UDP-2032 type would have a total gain of 72 dB but a possible deviation of  $\pm 3.0$  dB from true flatness.

The manufacturer guarantees noise figures of less than 5.5 dB for the 2032 and 2332 models and 9.0 dB for the 4000. VSWR at both the input and output are guaranteed to be less than 2:1 (2032 and 2332) and 1.5:1 (4003). The power-supply dissipations at 15 V dc are typically 65 mA (2032 and 2332) and 40 mA (4003).

In quantities of 1 to 10 units, the UDP-2032 and UDP-2332 sell for \$650 and the UDP-4003 for \$550.

CIRCLE NO. 250

## Microwave switch has top rating of 1 kW



American Nucleonics Corp., 6030 Variel Ave., Woodland Hills, Calif. (213) 347-4500. \$300; 4 wks.

A 2200 to 2300 MHz solid-state switch is capable of handling up to 1 kW of power, with an average of 1 W. The SPDT switch, termed the S-108, has a VSWR of 2.0:1 max. Switching rate is 1000 Hz  $\pm 5\%$ , and switching time is less than 100 ns. The line impedance is 50  $\Omega$ , insertion loss is 0.5 dB max and isolation is 30 db min. The S-108 measures 4.0  $\times$  2.0  $\times$  2.0 inches, excluding connectors, and weighs 12 ounces.

CIRCLE NO. 251

## Tunable filters for 48 MHz to 3 GHz range



K & L Microwave Inc., 203 Newton St., Salisbury, Md. (301) 749-2424. Stock.

Each model of a series of tunable filters covers an octave in the 48 MHz to 3 GHz range. Center frequencies are indicated on a direct-reading dial, which is calibrated to 1% accuracy. Ball bearing inserts eliminate RF leakage and intermittent contact. Typical insertion loss of 1 dB with a VSWR of 1.5:1 is achieved with a 5-stage Chebyshev design. The 3-dB points are obtained at 5% of the center frequency.

CIRCLE NO. 252

## Industrial CO<sub>2</sub> laser delivers at least 20 W



Hadron Inc., 800 Shames Dr., Westbury, N.Y. (516) 334-4402. \$2650; stock.

A flowing-gas, air-cooled, carbon dioxide laser, the Model 1020, has a minimum output power of 20 W. The laser is equipped with trimming controls to align the resonant-cavity reflectors for peak output power. The unit measures 6 × 10 × 36 inches. Within this volume, along with the laser tube, are the power supply, air cooler, and gas fittings. Applications range from cutting plastic and glass films to welding, fusing and sealing of metal components.

CIRCLE NO. 253

## Q-switch boasts picosecond switching

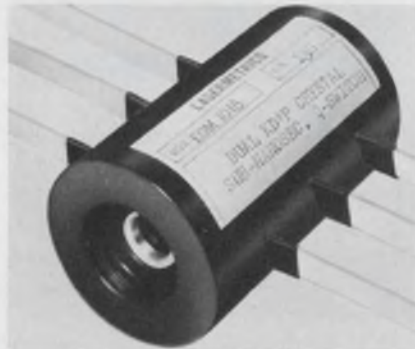

Lasermetrics, Inc., 19 Legion Pl., Rochelle Park, N.J. (201) 843-5780.

The EOM-1018 series of high-speed Q-switches are capable of picosecond switching at peak optical power densities of up to 750 megawatts per cm<sup>2</sup>. They are available in 10 and 15-mm aperture sizes and use dual crystals connected electrically in parallel and optically in series. This connection reduces operating voltages to a max of 10 kV—that's a factor of two less than the voltage of single-crystal units.

CIRCLE NO. 254

## Magnetrons permit radar frequency/scan changes



Varian Assoc., Eastern Tube Div., 8 Salem Rd., Beverly, Mass. 01915. (617) 922-6000.

The company's line of Accu-tune magnetrons permit the operating frequency of radars to be changed with each scan of the antenna. Moving-target indicator (MTI) systems—one application area—can now be made frequency agile, with only 50 ms needed to tune 400 MHz in X-band. The magnetrons are offered in X, K<sub>u</sub> and K<sub>a</sub> bands with peak output up to 250 kW.

CIRCLE NO. 255

## 8-18 GHz spiral antenna for phase tracking

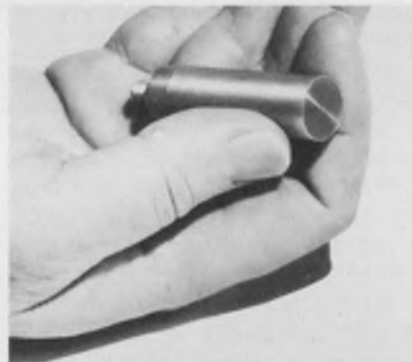

American Nucleonics Corp., 6036 Variel Ave., Woodland Hills, Calif. (213) 347-4500. \$150; 3 wks.

An 8 to 18-GHz spiral antenna, for airborne and ground use, features good phase tracking characteristics. Phase and amplitude tracking units are available with a tolerance of ±6° and ±0.5 dB, from boresight to ±45°. Designated the AM-264, the antenna has VSWR of 2.0:1 max across the band. Nominal gain is -7.0 dBI at 8 GHz, and 0 dBI at 10 to 18 GHz. The squint is 4 degrees nominal. Standard polarization is right-hand circular.

CIRCLE NO. 256

## 9-GHz isolator/coupler only 1-3/4 inches long

Trak Microwave Corp., 4726 Eisenhower Blvd., Tampa, Fla. 33614. (813) 884-1411. \$600; 8 wks.

A miniature ferrite isolator/coupler, the Model 1420-1916, measures 1-3/4 × 1 × 3/8 inches. Designed to operate at 9.3 GHz, the new device has a bandwidth of 200 MHz (min). The operating temperature range is 0 to 70 C. Additional features of the three-port device include 60 and 80-dB isolation between uncoupled parts, 1.5 dB insertion loss (max) between transmission ports and 23 ±1 dB coupling between input and coupled ports. The input VSWR is 1.5 maximum.

CIRCLE NO. 257

## Double balanced mixer in low-cost DIPs

The Vari-L Co., 3883 Monaco Parkway, Denver, Colo. 80207. (303) 321-1511.

A doubly balanced mixer—for the frequency range 0.2 to 500 MHz—is offered in low-cost DIP packages. In quantities of 100-999, the unit price for the new DBM-166 is \$6.95. The mixer features MIL-grade Schottky barrier diodes and Z-Match wireband transformers. The operating temperature range is -55 to +100 C. Conversion loss is typically 6 dB and interport isolations of 40 dB are typical up to 100 MHz.

CIRCLE NO. 258

## K<sub>a</sub>-band paramp is 6 in.<sup>3</sup> small

Micromega Div., Bunker-Ramo Corp., 12575 Beatrice St., Los Angeles, Calif. (213) 391-7137.

The company is now offering a solid-state 15-GHz parametric amplifier suitable for space applications or in systems where small size, light weight, and low power are important. Operating over an instantaneous bandwidth of 500 MHz, this mini-paramp features a noise temperature of 330 K in a package size of 6 cubic inches. Total weight of the unit, including Gunn-effect pump source, is 9 ounces. Similar paramps are available at S and C-band.

CIRCLE NO. 259

Stackpole's phenomenal  
Ceramag® ferrite bead

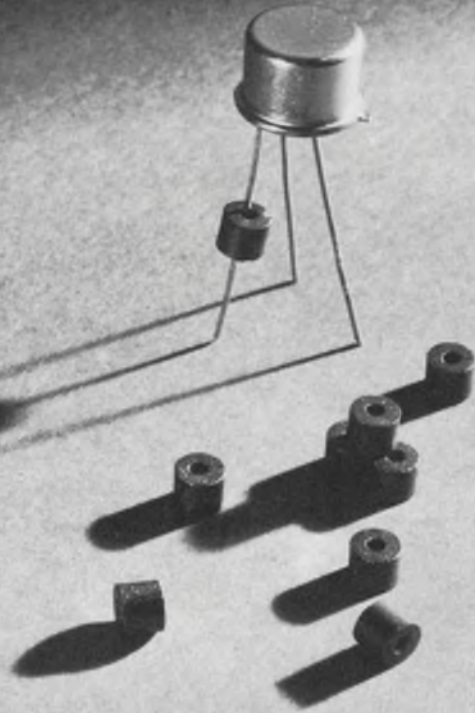

# The Silencers

## Ceramag® Beads Do Away with Noise

Stackpole ferrite beads offer a simple, yet effective means of suppressing spurious RF signals to prevent them from entering areas susceptible to such "noise." No other filtering method is as inexpensive as a ferrite bead.

How can you use a bead? Consider it as a frequency-sensitive impedance (Z) element. Beads are available in a variety of

Stackpole Ceramag® materials. Depending upon the material selected, beads can provide increasing impedances. From 1 MHz to over 200 MHz. Keep in mind, the higher the permeability, the lower the frequency at which the bead becomes effective.

Should a ferrite bead be small? Not necessarily. The unique, giant bead shown below is used by IBM to eliminate the effect of transient noise.

The impedance of Stackpole ferrite beads can be changed by simply varying the length or the O.D.-I.D. ratio.

Installation of Stackpole beads is easy. And inexpensive. Simply slip one (or several) over the appropriate conductor(s) for the desired noise suppression or high frequency isolation.

Additional savings in production time and labor costs are possible by utilizing automatic insertion equipment to install ferrite beads *with leads* in printed circuit boards.

## CERAMAG® FERRITE BEAD CHARACTERISTICS

	24	7D	5N	11
Initial Permeability	2500	850	500	125
Volume Resistivity @ 25°C	1.0x10 <sup>2</sup>	1.4x10 <sup>5</sup>	1.0x10 <sup>3</sup>	2.0x10 <sup>7</sup>
Effective Suppression At:	1 MHz.	20 MHz.	50 MHz.	100 MHz.
Curie Temperature	205	140	200	385

Beads are available in sleeve form in a range of sizes starting at .020 I.D., .038 O.D., and .050 long. For special compact filtering applications, beads can be supplied to tight mechanical tolerances.

Sample quantities of beads and beads with leads are available upon request. Send your requirements to: Stackpole Carbon Company, Electronic Components Division, St. Marys, Pa. 15857. Phone: 814-781-8521. TWX: 510-693-4511.

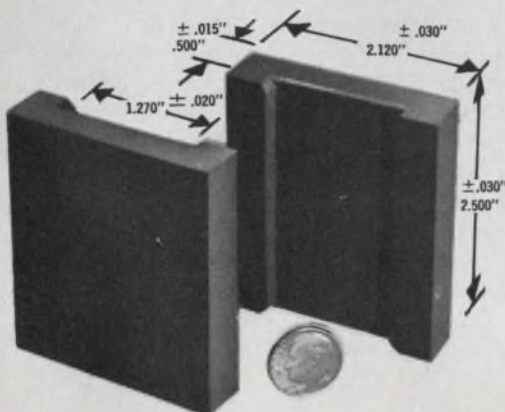

**STACKPOLE**  
ELECTRONIC COMPONENTS DIVISION

### Gunn-effect source gives 75 mW at 42 GHz



Varian, Solid State West, 611 Hansen Way, Palo Alto, Calif. 94303. (415) 493-4000.

The VSQ-9035, a low-noise Gunn effect oscillator, delivers 75 mW (min) at 42 GHz. The new source features power stability of less than 0.01 dB/°C and frequency stability of less than 1.0 MHz/°C in any 10 C range from 0 to 65 C. It operates into a 1.3 VSWR (maximum load). Nominal input voltage is 12 to 28 V dc regulated within ±10%, with 1.2 A dc maximum input current.

CIRCLE NO. 260

### Solid-state amps hold distortion under 1 dB



Watkins-Johnson Co., 3333 Hillview Ave., Stanford Industrial Park, Palo Alto, Calif. 94304. (415) 326-8830.

Two transistor amplifiers exhibit less than 1-dB pulsed distortion under overdrive. Designated the WJ-780-20, for 1 to 2.6 GHz, and the WJ-5090-11, for 2 to 4.5 GHz, these units provide a small signal variation of ±1 dB and saturated output power variation of 3 dB. These amplifiers are particularly suited for use in instantaneous frequency-display equipment.

CIRCLE NO. 261

### 55-GHz mixer diodes boast 6-dB noise figure

Sperry Electronic Tube Div., Dept. 9002, Waldo Rd., Gainesville, Fla. 32601. (904) 372-0411. 30-45 days.

A line of gallium-arsenide, Schottky-barrier mixer diodes feature over-all double sideband noise figures of 6.0, 6.5 and 7.0 dB at 55 GHz. Designated the SSV-44040 series, these diodes have an i-f frequency of 100-to-200 MHz, VSWR of 2:1 (max), forward current of 10 mA and dc bias of 0.6 V. The operating temperature range is -60 to +100 C. The diodes are available as single units or matched pairs (with a conversion loss of about 0.3 dB).

CIRCLE NO. 262

### YAG laser delivers 50-W cw power

Hadron Inc., 800 Shumes Dr., Westbury, N.Y. 11590. (516) 334-4402. \$8,500 (425), \$10,000 (450). 60 days.

The Models 425 and 450 YAG lasers (1.06-μ wavelength) offer continuous multimode power of 25 and 50 W, respectively. Each uses two 6-kW krypton lamps that are pumped in series. The two lasers have beam diameters of 3 mm, with divergences of less than 5 mr. The Model 425 laser system operates from a 6-kW power supply; the Model 450, from a 10-kW supply. Both models can be cooled with tap water at 3-to-6 gpm, 25 psi and 65 F inlet.

CIRCLE NO. 263

### Wideband mixer has high i-f for fast pulses

Aerotech Industries, 825 Stewart Dr., Sunnyvale, Calif. (408) 732-0880. \$750; 30 days.

A wideband, double-balanced Orthostar mixer, the MX12056, has an input frequency range of 4.6 to 10.6 GHz, and an i-f range of 1 to 2 GHz. This mixer has been designed for application as an up or down converter, a modulator, or a phase detector. It is particularly useful as a broadband first converter in ECM receivers. Conversion loss is specified at 9 dB, but it is typically under 7 dB from 5.6 to 10.6 GHz. Isolation is 20 dB minimum with 23 dB typical.

CIRCLE NO. 264

### X-band magnetron offers ±10-MHz resolution



English Electric Valve Co. Ltd., Chelmsford Essex, England CM1 2QU.

The X-band magnetron, Type M5097, is tunable to ±10 MHz in the frequency range of 9.2 GHz to 9.6 GHz. It is of the same flat pack metal/ceramic design used in the company's EEV Type M599 series of fixed-frequency pulse magnetrons. The new tube gives an output power of 6.75 kW, and has a fast warm-up time of 30 seconds. Over-all dimensions are 135.7 × 100 × 63.5 mm and weighs approximately 1.25 kg.

CIRCLE NO. 265

### 12-GHz mixer has i-f range of dc to 2 GHz

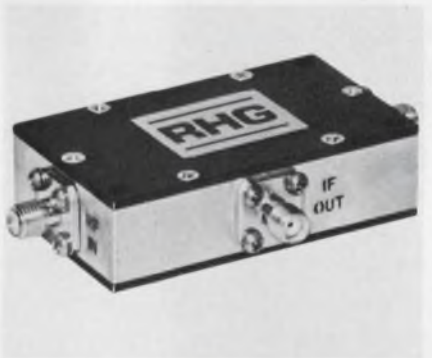

RHG Electronics Laboratory, Inc., 94 Milbar Blvd., Farmingdale, N.Y. 11735. (516) 694-3100. \$625 (small quantities); 30 days.

Multi-octave mixers, known as the DMX series, feature rf coverage to 12 GHz, with several units and i-f coverage from dc to 2 GHz for all units. The rf ranges per unit are 2-4, 4-8, 8-12 and 2-10 GHz. The noise figure is typically 8 dB, and LO-rf isolation is greater than 20 dB. Applications include up or down converter, phase detector and modulator.

CIRCLE NO. 266

# What do you get when you cross a signal source with a calculator?

Automatic testing with HP's new 3330B AUTOMATIC SYNTHESIZER. In this one outstanding instrument, you get a flexible synthesizer, a top-performing sweep generator, and a precision level generator—all under digital control. Its built-in controller adds computer flexibility—you can forget about tying up an external computer for your automatic testing on the production line, and for the first time make this level of testing economically feasible in your lab.

For man-machine interfacing, 3330B's convenient swing-out keyboard, coupled with 9-digits of frequency and 4-digits of amplitude readout, gives you complete flexibility for setting up your test routines.

As a frequency synthesizer spectral purity is exceptional. Spurious is down 70 dB, and harmonics at least 40 dB below the carrier. Through its easy-to-use keyboard, you can, with 0.1 Hz resolution, set in any frequency between 0.1 Hz and 13 MHz, then automatically or manually increment (tune) that frequency by any amount. Each point has the synthesizer stability of  $\pm 1$  part in  $10^6$ /day.

You can repeat the same automatic or manual sweeping operation with amplitude level. Its 100 dB range, 0.01 dB resolution and flatness of  $\pm 0.05$  dB make the 3330B a precision level generator.

Call on Model 3330B for your sweep generator needs, and you'll get performance levels of accuracy, linearity, and resolution never before available. That's because the internal serial microprocessor controls digital sweeping of synthesized frequencies or precise amplitudes. Through its keyboard and front-panel controls, you enter all sweep parameters—your 3330B takes it from there.

Systems Designers will find the standard 3330B fully programmable—ready for low-cost interfacing to other ASCII instruments and controllers, like marked card programmers, calculators, and computers.

Price? If you think about it, you would have bought a synthesizer, a sweeper, a marker generator, a counter, a programmable attenuator, and some computer time to come anywhere close to solving the same problems now done by the 3330B. At \$6000 for a complete frequency lab, we think you'll agree that the price-performance ratio of the 3330B is great. (Model 3330A, priced at \$5100, performs identically to the 3330B but has manual amplitude control and 13 dB range.)

For further information on the 3330A/B, contact your local HP field engineer. Or, write Hewlett-Packard, Palo Alto, California 94304. In Europe: 1217 Meyrin-Geneva, Switzerland.

A092/1

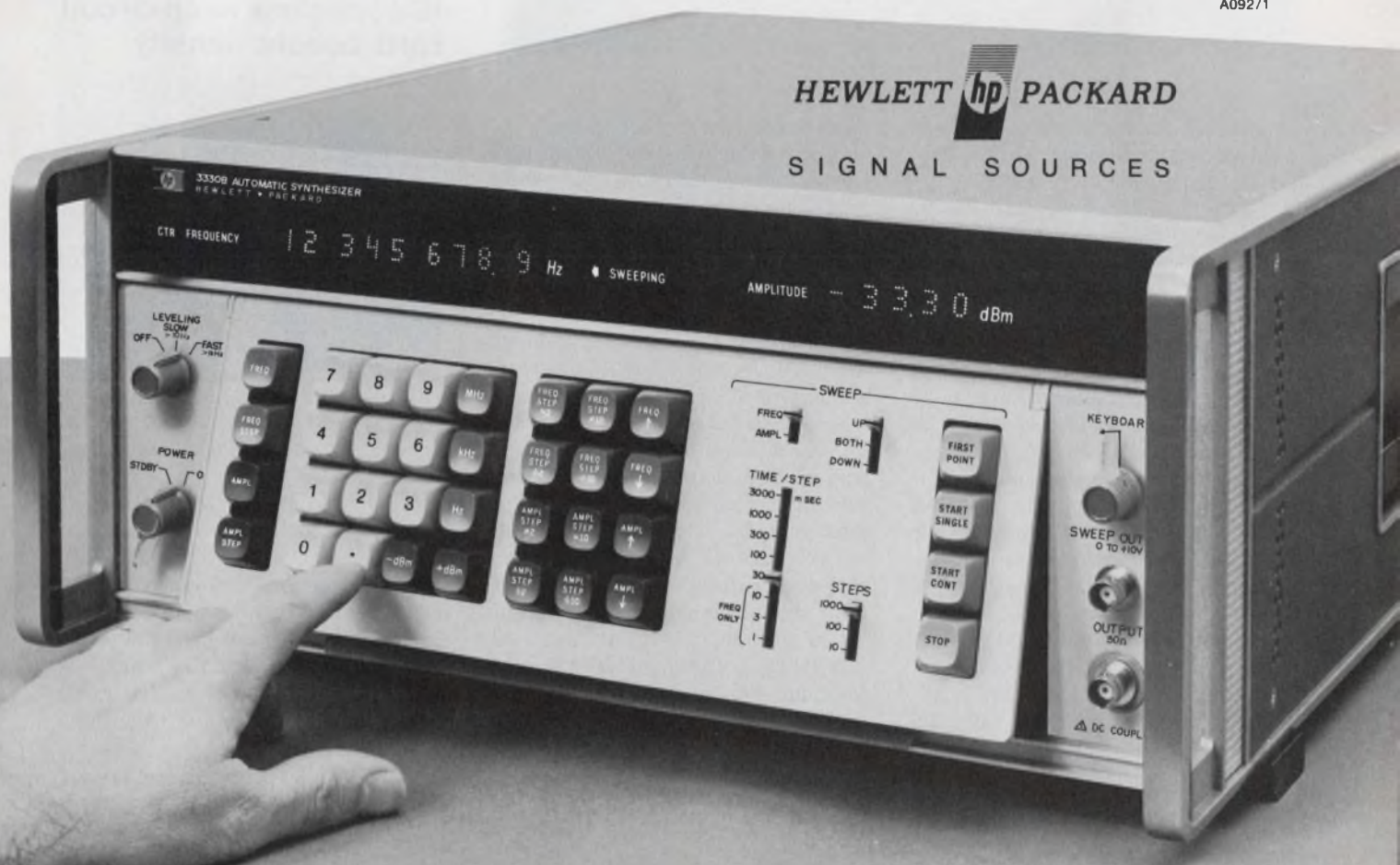

## Do-it-yourself kit for custom connectors

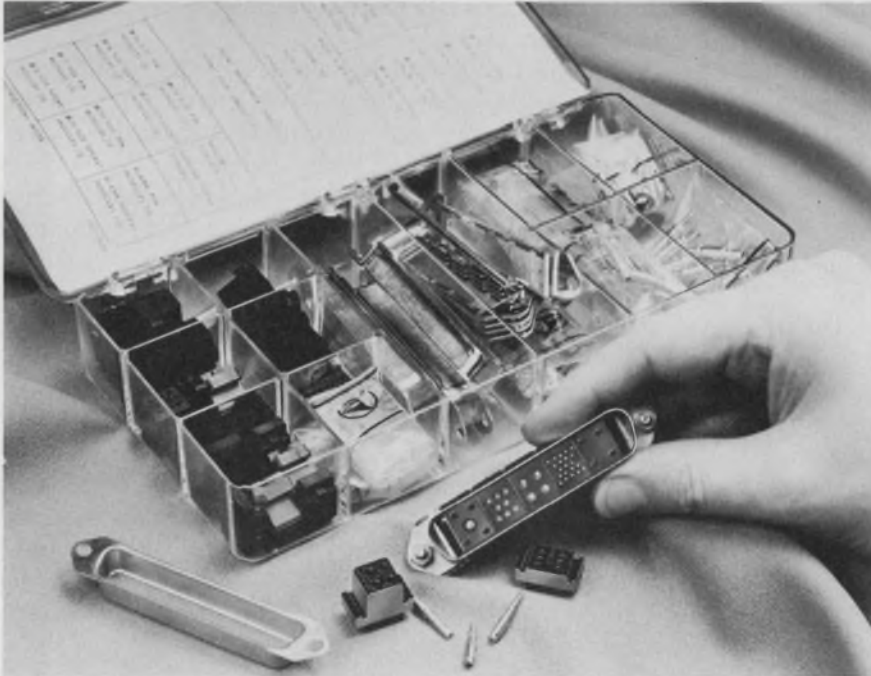

*Amphenol Industrial Div., 1830 S. 54th Ave., Chicago, Ill. 60650. (312) 242-1000. \$25; stock.*

If Amphenol has its way, short-run sales of custom miniature rack-and-panel connectors are going to plummet. Thanks to the 137 series Mic-Kit, engineers will be able to assemble their own custom connectors in half an hour or so at a cost of a few dollars, then wire them up. This should save them the typical cost of \$300 to \$500 for making a single model-shop prototype, and the typical six to eight weeks of waiting for a model that may be only marginally operative.

When the engineer has but a short production run, he can use modules from the kit (and replenishment modules that Amphenol provides) instead of waiting, typically, 12 to 14 weeks while the manufacturer tools up for his custom connectors—and instead of paying

high custom-connector costs.

The kit includes shells and module-mounting brackets, for three mated pairs, and five types of modular inserts, each 7/16-inch square at the mating surface. The kit contains three each of both pin and socket insert modules for accepting one coax or one No. 12 contact, four No. 16, and eight No. 20 contacts. There are also two each of pin and socket modules for 21 No. 24 contacts, and four each of pin and socket module blanks. Almost enough contacts are provided to fill each module. The contacts have 30 microinches of gold, plated on a phosphor-bronze alloy. The necessary mounting hardware is included in the kit.

The wide range of inserts may preclude the need for special connectors for a mix of contact sizes and types.

CIRCLE NO. 267

## Fixed point probe cards carry up to 50 probes

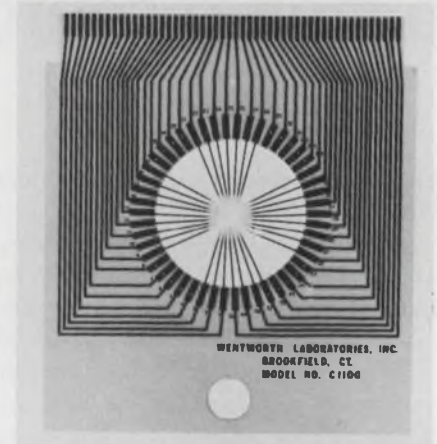

*Wentworth Laboratories Inc., Route 7, Brookfield, Conn. 06804. (203) 775-1750. \$24.*

A line of fixed point probe cards, Model C-1100, are designed specifically for both thick and thin film circuit probing of large geometry hybrids. The cards carry up to 50 probes Kelvin connected. Typical substrate sizes range from approximately 1/4-inch square up to approximately 1 × 1 inch or larger. Probe needles are beryllium copper with a point diameter of 2.5 mils.

CIRCLE NO. 268

## IC solderless wrap circuit card boasts density

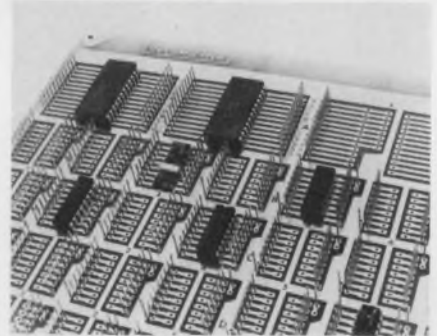

*Interdyne, 14761 Califa St., Van Nuys, Calif. 91401. (213) 873-6510. \$39.30 (100 quantities); stock.*

A low profile integrated circuit card can be solderless wrapped and then converted to all PC connections for high production. Because the ICs and solderless-wrap interconnections are on the same side, Slim-wrap cards may be mounted on 0.6-inch centers, compared to 1.3 inches for other circuit cards.

CIRCLE NO. 269



## MOS/LSI packages offer aluminum insert contact

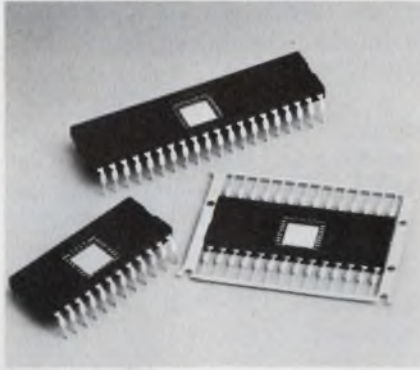

SCS Corp., 601 Walnut Circle East, Garland, Tex. 75040. (214) 272-5481.

The P600 series pre-molded cavi-tied plastic package has 24, 28 and 40 leads which bend on 600 mil rows. The series has a 250 mil square gold plated die attach area. An anodized aluminum insert supports the die attach pad and bond fingers.

CIRCLE NO. 270

## Splicer connects wires to edge pins



General Staple Co., Autosplice Div., 380 Second Ave., New York, N.Y. 10010. (212) 674-4370.

A simple adapter attaches wires to PC board edge connector pins and eliminates the need for solder, pre-formed crimps or solderless wrap. The Autosplice system uses a continuous coil of flat wire from which the splice-connection is cut, formed and then crimped. Pins spaced as close as on 100 mil centers in single or multiple rows can be spliced without touching, regardless of whether they are square, rectangular, round, tapered or tabs.

CIRCLE NO. 271

## Another Sprague Breakthrough!

### PRODUCTION-ORIENTED SOLID TANTALUM CAPACITORS

Solid flame-retardant epoxy with precise dimensions for automatic insertion. Completely shock and vibration resistant.

Flat surface permits clear easy-to-read marking.

No rundown to interfere with seating of capacitors on printed wiring board.

Rugged 0.025" dia. tinned leads maintain alignment. 0.100" lead spacing for standard PWB grids.

Top flat for easy identification of positive lead either visually or by touch.

Standoff feet on base to eliminate moisture entrapment and facilitate cleaning of wiring boards.

Formed leads with either 0.200" or 0.250" spacing to permit interchangeability with dipped capacitors.

ACTUAL SIZE

## Type 198D Low-cost Econoline\* Tantalum Capacitors Lead in Performance!

When it comes to low-cost solid tantalum capacitors, the new Sprague Type 198D Econoline Capacitors outperform all other designs. Here are some additional advantages:

- Low d-c leakage
- Low dissipation factor
- Wide voltage range, 4 to 50 VDC
- Capacitance range from 0.1 to 100 $\mu$ F
- Withstand severe temperature cycling and temperature shock over -55 C to +85 C
- Speedier handling for insertion
- Easier-to-read markings

The new Sprague Type 198D epoxy-encased Econoline Capacitor is tooled for mass production and priced competitively with imported dipped units. Investigate this new Sprague breakthrough without delay.

Call your nearest Sprague district office or sales representative, or write for Engineering Bulletin 3546 to: Technical Literature Service, Sprague Electric Co., 347 Marshall Street, North Adams, Mass. 01247.

\*Trademark

THE BROAD-LINE PRODUCER OF ELECTRONIC PARTS



INFORMATION RETRIEVAL NUMBER 51

## Potting compound is flame retardant

Dow Corning Corp., Midland, Mich. (517) 636-8000. \$2.50/lb (1000 lb kits).

A flame retardant silicone elastomer is designed to provide maximum safety in potting, encapsulating and conformal coating applications. The new two-part, low viscosity, black product, Sylgard 170 A&B silicone elastomer, has a typical "limiting oxygen" number of 43 in flame tests. In vertical flame tests, strips exposed for 10 seconds to a torch extinguish themselves within one second after the torch is removed.

CIRCLE NO. 272

## Silicone grease improves thermal cooling path

Castall Inc., Weymouth Industrial Park, E. Weymouth, Mass. 02189. (617) 337-6075. \$3/4 oz.

A silicone grease, Castall 800, displaces the air gap between mating surfaces to provide a thermal path to the heat sink. When used as a non-curing seal between the semiconductor and the heat sink, the grease also protects the junction from shock and vibration. The compound maintains a toothpaste-like consistency over a broad temperature range, from -55 C to 205 C. It has dielectric strength of 250 to 350 V/mil and a relatively low dissipation factor of 0.006 at 25 C, 100 kHz. Though highly water resistant, the grease is soluble in toluene, xylene, mineral spirits, and other chlorinated and aromatic hydrocarbons.

CIRCLE NO. 273

## Contact connectors boast small size

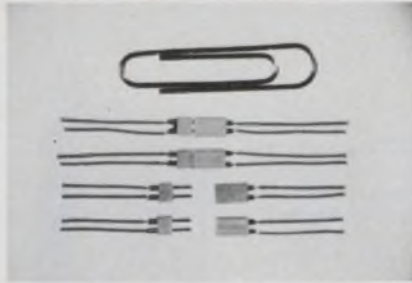

Microtech, Inc., The Park Square Bldg., 777 Henderson Blvd., Folcroft, Pa. 19032. (215) 532-3388. 65¢ (1000 quantities); stock to 2 wks.

Two contact connectors consisting of a male plug and a female receptacle are less than 1/16 × 1/8 × 1/8 -inch and 1/16 × 1/8 × 1/4-inch respectively. The connectors are used in medical instruments, hearing aids, transducers, high density IC packages, computers and in numerous micro-miniature customs applications.

CIRCLE NO. 274

## DIP packages provide rapid programming

Aura Manufacturing, Co., 59 McDermott Rd., North Haven, Conn. (203) 777-2541.

A line of DIP cases for mounting miniature components and crossover circuits are identical in all dimensions to standard IC packages. The standard and custom DIP packages have various sized interlocking covers which can be cemented for air-tight circuit protection. Devices as high as 1/4-in. and as wide as 5/32-in. can be accommodated.

CIRCLE NO. 275

## Flat ribbon cable has PVC insulation

Circuit Assembly Corp., 3025 S. Kilson Dr., Santa Ana, Calif. (714) 540-5490.

A line of flat, ribbon, PVC-insulated cable consists of single, twisted-pair, coaxial, or shielded round conductors laid in parallel rows and chemically bonded together. The process allows conductors to be separated easily for termination without physical or electrical damage to the wire.

CIRCLE NO. 276

## Dielectric coating dries in 10-20 minutes

Cotronics, 37 W. 39th St., New York, N.Y. (212) 695-7997. \$12.50/qt. (1-4); stock.

Duralco 7000, a flexible polyurethane dielectric coating, provides in a single-component room-temperature-curing material, the properties associated with two-component, or bake-on products. Applications include conformal protective coatings for PC boards.

CIRCLE NO. 277

## LED sockets for alpha-numeric displays

Aries Electronics Inc., P.O. Box 231, Frenchtown, N.J. 08825. (201) 996-6200. \$1 to \$2.25; 8 wks.

A line of 14-pin LED sockets especially adaptable to alpha-numeric displays are available for PC board mounting on standard 100 mil grid. The 60° angle mounting provides optimum viewing angle for desk top devices.

CIRCLE NO. 278



**ANALOGY**  
INTECH'S A-206 KEEPS YOU ON SCALE THRU 8-10dB STEPS OF INPUT VOLTAGE. WITH GAIN STATUS READOUT. WHAT OTHER FET-INPUT DTL/TTL/RTL COMPATIBLE, WIDEBAND DATA AMPLIFIER FOR THERMOCOUPLES STRAIN GAUGES CAPACITANCE AND FORCE-BALANCE TRANSDUCERS WILL DO THAT? USE A-206 FOR LOW DRIFT OR ANCHOR IT WITH A-207. WRITE ANA FOR DETAILS.

**intech** INCORPORATED  
(408) 244-0500  
1220 COLEMAN, SANTA CLARA, CALIF. 95050

## PC board also serves as heat sink and chassis

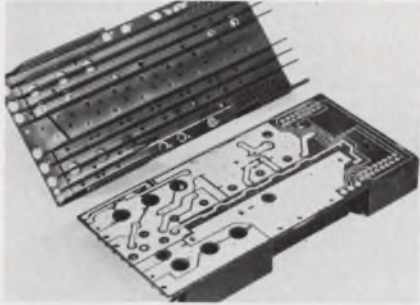

International Electronic Research Corp., 135 W. Magnolia Blvd., Burbank, Calif. 91502. (213) 849-2481.

A chassis-like PC board combines the functions of circuit board, heat sink, and structural element in one component with the capability of dissipating an unprecedented amount of circuit power. A high-current power supply was operated at a power density of 170 W with the case temperature of all semiconductors within acceptable tolerances. The same circuit on a G-10 epoxy board would be able to operate at a power level no higher than 12 W.

CIRCLE NO. 279

## Free-standing IC terminals boast low cost

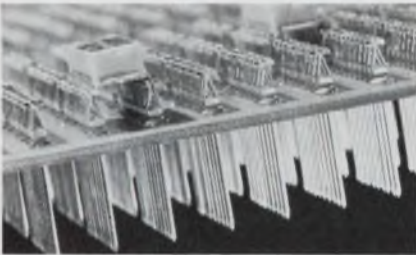

Amphenol Industrial Div., 1830 S. 54th Ave., Chicago, Ill. 60650. (312) 652-1220. 2¢ (million quantities); stock.

The first one-piece IC terminals to accept DIP packages and discrete components guarantee 20-mil tip position from a datum point on a board. The 352 series free-standing terminals accept round pins up to 15 mils dia. or rectangular leads 10 by 20 mils. The terminal posts accept up to three levels of solderless wrap. The price—at about 2¢ (in million quantities) for the contacts and 1/2¢ for drilling and staking each hole—compares with up to 6¢ per terminal for existing approaches.

CIRCLE NO. 280

## NEW AUTORANGING DIGITAL MULTIMETER... IN-PROBE DISPLAY, HIGH-SPEED READOUT, BATTERY OPERATION... \$325.



For AC or DC voltage, resistance and even current, our Model 167 with unique in-probe readout lets you make time-saving measurements directly at the point of measurement. With up to 3-month battery life. The Model 167's combination probe/readout, with 3½ digit LED display, automatically indicates decimal point, polarity, range and function. Front panel terminals and probe receptacle allow alternative use as a bench instrument. The neat, sweet-to-hold 167 Auto-Probe DMM is only \$325 (less in quantity). Check it out and get our latest "How Sweet" button.

**Measures easily ...** 1 mV to 1000 VDC  
• 1 mV to 500 VAC RMS • 1 ohm to 20 megohms  
**with the convenience of ...** 55 megohms input resistance • 2-sec. reading time to rated accuracy • 1200 volts overload protection • Complete choice of accessories.



**KEITHLEY INSTRUMENTS**  
U.S.A.: 28775 AURORA ROAD, CLEVELAND, OHIO 44139  
EUROPE: 14, AVENUE VILLARDIN, 1009 PULLY, SUISSE

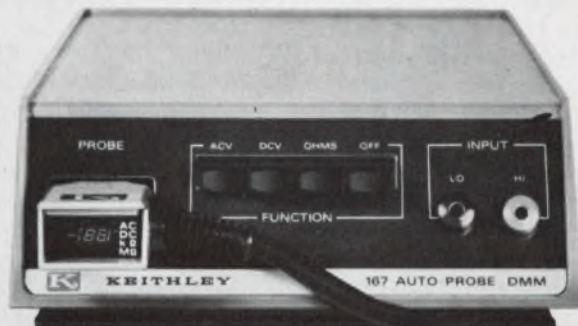

The Model 167... another how-sweet-it-is Keithley Multimeter  
*Buy now using BankAmericard or Master Charge*

## 1024-bit Si-fuse bipolar pROM guarantees 45-ns access time

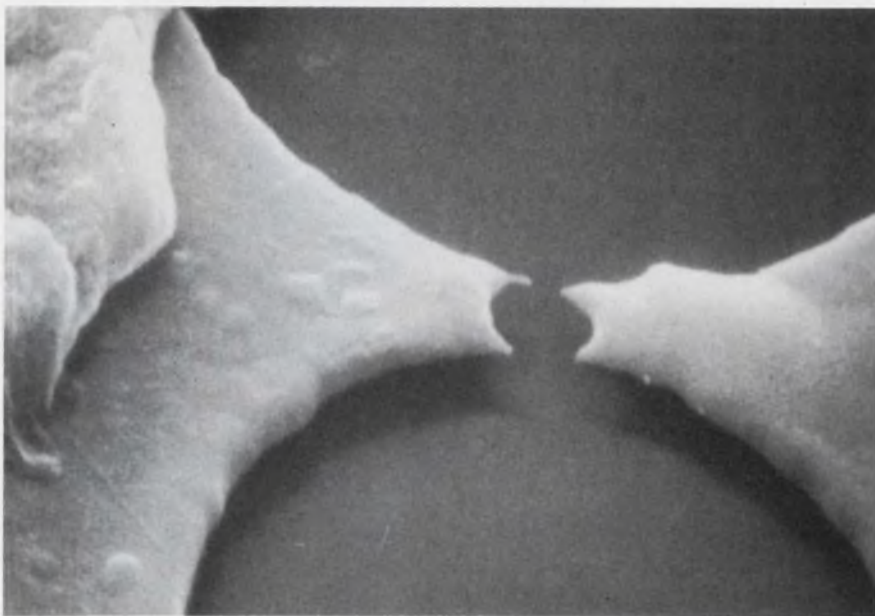

Intel Corp., 3065 Bowers Ave., Santa Clara, Calif. 95051. (408) 246-7501. \$55 (100 up); stock.

By combining elements of two standard technologies—silicon-gate and Schottky-TTL—Intel has come up with what it calls the fastest 1024-bit field-programmable, read-only memory (pROM). With a capacity of 4 bits by 256 words, the Intel 3601 uses the same polycrystalline-silicon process that silicon-gate MOS technology employs to form fusible links (see photo) on the Schottky-TTL ROM.

There are at present four manufacturers of 1024-bit bipolar pROMs: Intel; Intersil, Inc., of Cupertino, Calif.; Harris Semiconductor, Melbourne, Fla., and Monolithic Memories, Inc., Sunnyvale, Calif. All of their pROMs have the same I/O pin connections, although the speeds differ significantly and three different fusible link techniques are involved:

- The Intel 3601 has a maximum access time of 45 ns and blows a silicon fusible link to produce an OFF state at an output.

- The Intersil IM5603 features a maximum access time of 80 ns and shorts a back-biased base/emitter junction of a transistor, which turns a decoded output transistor OFF.

- The Harris HPROM-1024A offers a typical 50-ns access time and blows a fusible nichrome link to change a normally OFF output to an ON low state.

- The Monolithic Memories MM6300 guarantees a maximum access time of 60 ns and blows a fusible nichrome link to change a normally OFF output to an ON low state.

None of the pROMs is yet price-competitive with mask-programmable ROMs at the 100-quantity level. Thus pROMs are still largely restricted to low-volume applications.

Current 100-level pricing stands at \$55 for Intel, Harris and Monolithic Memories and \$45 for Intersil. Intel anticipates that by the fourth quarter of 1972 the 3601 will be priced only about 20% higher than the 3301 mask-program-

mable ROM—a 3601 equivalent. The 3301 currently sells for \$12 in quantities of 100 after a one-time mask charge of \$600.

To simplify pROM programming by the user, each manufacturer either makes or will recommend a programmer that meets the specific circuit requirements (each technology needs a different programmer). Silicon fuses need an increasing pulse width from one to eight  $\mu$ s of 15 V with a 50% duty cycle. Whereas shorted junctions and fused nichrome links require a constant duty cycle of 85% and 20% respectively.

Programming yield—how many good pROMs there will be out of 100 units—must be considered in the total components cost. Intel claims that better than 95% yield can be expected, because of its fuse-geometry control and the inherent compatibility (Si on Si) of the silicon-fuse technology. However, Intersil claims at least 97% for its shorted-junction technology.

Intel and Intersil report their pROMs can be programmed in about 1 s (1 ms/bit). Harris and Monolithic Memories, however, require 100 msec/bit—or about 100 sec to program 1024 bits.

Intel can give one-day turnaround on programs TWX'ed into its Santa Clara facility in the format shown on the back of its data sheet.

The new silicon-fuse technology promises substantial manufacturing economies and, even at present prices, the guaranteed access time of 45 nsec for 1024-bit of field-programmable ROM information definitely favors the Intel 3601 in high-speed applications.

Intel Corp.	CIRCLE NO. 300
Intersil Inc.	CIRCLE NO. 301
Harris Semi.	CIRCLE NO. 302
Monolithic Memories	CIRCLE NO. 303

## Differential amplifier has 120-MHz bandwidth

National Semiconductor Corp., 2900 Semiconductor Dr., Santa Clara, Calif. 95051. (408) 732-5000. \$2.95 (100).

The LM733, a high-gain monolithic video amplifier, boasts a bandwidth of 120 MHz. In addition, the new device has selectable gains of 10, 100 and 400 without external components, requires no frequency compensation and offers 60-dB common-mode rejection at 5 MHz. Input/output resistances are 250 k $\Omega$  and 10  $\Omega$ , respectively. Supply range is  $\pm 3$  to  $\pm 8$  V with a  $\pm 5$  V differential input capability at maximum supply voltage.

CIRCLE NO. 304

## 1103 version has no critical timing specs

Fairchild Semiconductor, 464 Ellis St., Mountain View, Calif. 94040. (415) 962-3816. \$14 (100-999).

A 1024-bit MOS dynamic RAM can serve as a pin-for-pin replacement for the 1103 MOS RAM, while eliminating the critical system timing requirements associated with the 1103, according to the company. Designated the 3534/1103, this version has a basic memory cell of four transistors interconnected to form a latch. In addition, the new device has equal read and write times, and the read and write cycles are defined as voltage levels rather than as pulses.

CIRCLE NO. 305

## MOS read-only memory boasts 16,384 bits

Electronic Arrays, 501 Ellis St., Mountain View, Calif. 94040. (415) 964-4321. \$52.50 (100 quantities); stock.

The EA 4800 ROM is a 16,384-bit MOS read-only memory. Operating on 5 V and -12 V supplies, the new ROM has a maximum access time of 1.2  $\mu$ s and maximum power dissipation of 0.032 mW per bit. The 16,384 bits are organized as 2048 words with 8 output bits/word or 4096 words by 4 output bits/word. The open drain output stage has two output enable controls for wire-ORing the outputs.

CIRCLE NO. 306

## 10 amps of switching in a 1" cube!

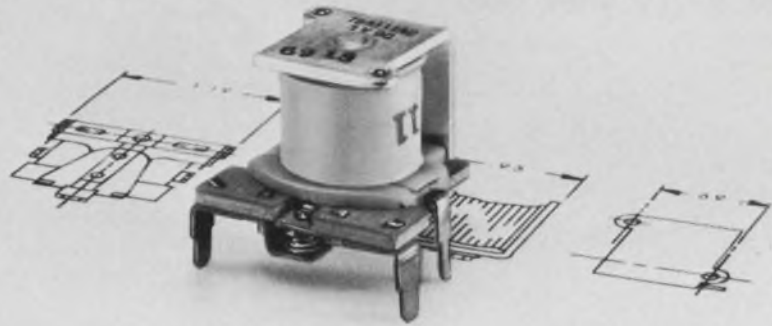

## We call it our Series 19 Relay. You'll call it one of the most compact and reliable packages you've ever used.

Remarkable 10 amp Series 19 relay is low in cost, too — less than \$1.00 each in quantity. But price is only part of the story. The Series 19 also offers the advantages of miniaturization and the capacity to handle heavy switching loads. Result: more performance in a smaller overall package. Contact arrangement is SPDT. Rated 10 amps at 28 vdc or 115 v, 60 hz. Coil voltages available range from 3 to 24 vdc. The Series 19 is an ideal choice for a multitude of low level to 10 amp switching applications, including remote control, alarm systems and many other industrial and commercial uses. Equally important, the Series 19 is part of a whole family of interrelated low-cost relays which will lend themselves to multiple usage in the same system. Included are:

### Series 10.

Sensitive; low cost, highly reliable SPDT relay rated at 3 amps, 28 vdc. Coil voltages 3-24 vdc. Can be used for a



wide range of industrial and commer-

cial control functions and alarm systems.

**Series 28.** Same as Series 10, but furnished with a dust cover for use in appliance controls, remote TV tuning, industrial process controls and similar functions.



**Series 38.** DPDT, 3 amp 28 vdc contacts. Coil ratings 3-24 vdc. Applications include business machine controls, antenna rotor controls, industrial process controls, etc.



**GP.** A miniature general purpose relay with 2, 4, or 6 PDT contacts, rated 1, 2 or 5 amps, 28 vdc or 115 v, 60 hz. Coil voltages: 6-115 vdc. Consider the GP for copiers, business machines, control or alarm systems, etc. Available with single or bifurcated contacts.



Send for information. Complete technical data on NAPCC relays available on request. Write today.

PRICE ELECTRIC RELAYS

**NORTH AMERICAN PHILIPS CONTROLS CORP.**

A NORTH AMERICAN PHILIPS COMPANY  
E. Church & 2nd St. • Frederick, Md. 21701 • (301) 663-5141

INFORMATION RETRIEVAL NUMBER 50

### Op amp offers 1300 V/ $\mu$ s slew rate



M. S. Kennedy Co., 168 Pickard Bldg., E. Molloy Rd., Syracuse, N.Y. 13211. (315) 437-5616. \$98 (1-9), \$89 (10-24); stock.

The company's Model 770 operational amplifier features a slew rate of 1300 V/ $\mu$ s, an output current of 80 mA and a gain-bandwidth product of 200 MHz. Optimized for high frequency summation and other linear applications, the 770 operates over the full MIL temperature range of -55 to 125 C.

CIRCLE NO. 307

### Dual Darlington ICs cut space requirements



Unitrode Corp., 580 Pleasant St., Watertown, Mass. 02172. (617) 926-0404.

Three npn Darlington devices offer reduced space advantages through the packaging of two power Darlington transistor pairs in a single unit. Each dual Darlington circuit has a 10-A rating. Additional features include power rating up to 30 W,  $V_{CE0}$  up to 100 V, minimum current gain at 5 A up to 2000,  $V_{CE(sat)}$  as low as 1.5 V at 5 A and turn-on times as fast as 0.5  $\mu$ s. In 100-lot quantities, prices are \$10 for 30-W PIC500, \$6.50 for 20-W PIC501 and \$4.90 for 20-W PIC502.

CIRCLE NO. 308

### Triple gate has both NOR/OR, AND/NAND

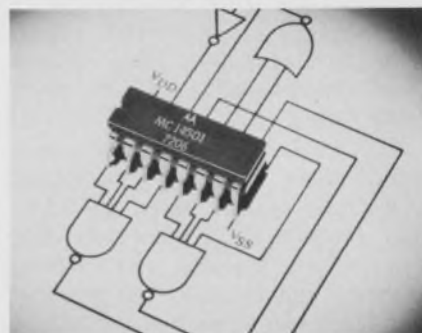

Motorola Semiconductor, P.O. Box 20912, Phoenix, Ariz. 85036. (602) 273-3465. \$1.99 (100-999).

The MC14501AL/CL triple gate provides a feature not often found in a single digital IC package: This CMOS logic device has both a 2-input NOR/Invert gate and two 4-input NAND gates. By properly biasing the gate with one external pin interconnection, a 2, 3, or 4-input AND function is available. Using two external pin interconnections, up to an 8-input AND/NAND function can be implemented.

CIRCLE NO. 309

**World's smallest**

**power supply for op amps...\$14**

This 2.3x1.8x1-inch module has tracking outputs of  $\pm 15$  V @ 25 ma with regulation of  $\pm 0.1\%$  and ripple of 1 mv. It costs \$14.00 in 1,000 lots and only \$24.00 for one. Requisition Model D15-03. (For  $\pm 12$  V @ 25 ma, order Model D12-03.) Three-day shipment guaranteed.

Acopian Corp., Easton, Pa. 18042  
Telephone: (215) 258-5441

INFORMATION RETRIEVAL NUMBER 54

### Inexpensive lighted pushbuttons.

Our new Series 4 is one of the least expensive precision lighted pushbuttons in existence.

□ Precision—because a reliable SM snap-action basic does the switching. Inexpensive—because our standard price includes assembled product with lamp. □ Just snap the Series 4 into the front of your panel. Quick-connect terminals make wiring a snap, as well. Relamping? Pull out the display screen and the lamp is automatically extracted from its socket.



### MICRO SWITCH

FREEPORT, ILLINOIS 61032  
A DIVISION OF HONEYWELL

□ Choose from low energy (1 amp, 125 vac) or power load (5 amps, 250 vac) switching—UL listed. Bezel and barrier housings plus matching indicators are also available. □ See your MICRO SWITCH Branch Office or Authorized Distributor (Yellow Pages, "Switches, Electric"). Or write for our product sheet.

INFORMATION RETRIEVAL NUMBER 55

ELECTRONIC DESIGN 12, June 8, 1972

# FIFO memory chip buffers data-communication systems

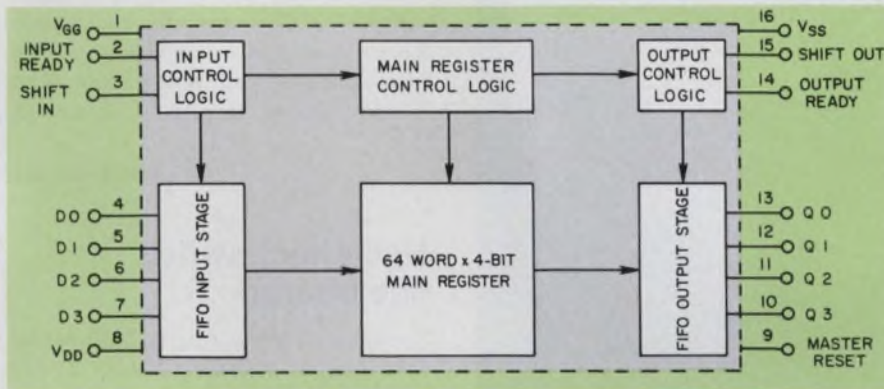

Fairchild Semiconductor, 464 Ellis St., Mountain View, Calif. 94040. (415) 962-5011. \$20 (100-up); stock to 2 weeks.

For the first time, two systems with different clock rates can communicate easily by using a single MOS/LSI chip. The new type 3341 4-bit-by-64-word first-in/first-out (FIFO) memory from Fairchild Semiconductor functions as an asynchronous data buffer. It can interface from low to high speeds, or vice versa, over a frequency range from dc to 1 MHz.

Not only will this monolithic FIFO circuit reduce component cost; it will slash the parts count and power requirements by more than an order of magnitude over existing data buffer systems, resulting in further savings.

Data strobed into the 3341 FIFO propagate or ripple through the entire register at less than 0.5  $\mu$ sec for each stage, stacking up at the last empty storage location. When data have been transferred into the 64th location (in less than 32  $\mu$ sec), the OUTPUT READY output goes HIGH, indicating that data can be shifted out of that location by a HIGH/LOW transition at the SHIFT OUT (SO) terminal. When all 64 word locations are filled, the INPUT READY output will go LOW, indicating that the register

is full. As long as the INPUT READY is HIGH, a HIGH/LOW transition at the SHIFT IN input will shift data into the FIFO.

Easy expansion of both number of words and bits per word is possible with the 3341's convenient pin configuration. By combining the INPUT READY outputs in one AND gate, the OUTPUT READY outputs in another and tying the SI inputs and SO inputs together, the 3341 FIFO can be expanded to any number of words and bits without degrading the maximum 1-MHz operating speed.

Because of the unique characteristics of the SI and SO inputs and the INPUT READY and OUTPUT READY outputs while the number of words is being expanded, the OUTPUT READY drives the SI input, and the INPUT READY drives the SO input directly. The only clock connections required are at either end.

The FIFO memory's storage capacity expands or contracts to compensate for differences in I/O data rates. When the peripheral equipment supplies data faster than the computer can handle it, the FIFO stores the surplus. Conversely, if the peripheral data-handling rate is too slow, the FIFO will store information to minimize computer usage.

CIRCLE NO. 310

# Now the famous 829 has a "G" for good measure!

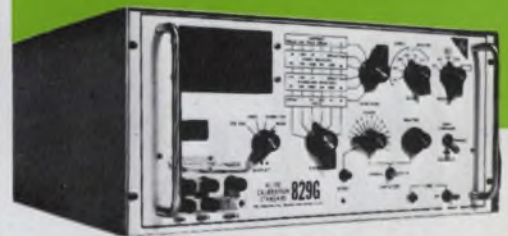

Calibrate or Measure  
with the

## RFL Model 829G

RFL's famous 829, for 15 years the industry calibration standard, now gives way to the new 829G — still the industry calibration standard, but now it's twice as useful. The 829G provides a precision source of AC and DC volts, amps and ohms — plus precision measurements of these parameters from external sources. It offers four-terminal sensing in both source and measurement modes, and high accuracy, resolution and regulation, with 5-digit readout. 5 ranges of AC or DC, 0.1 to 1000V. 6 ranges of current, 100  $\mu$ A to 10A. 50, 60, 400, 1000 Hz AC plus EXT. And many other features — all for just \$3,600.  Write for complete data today. RFL Industries, Inc., Instrumentation Div., Boonton, New Jersey 07005. Tel: (201) 334-3100 / TWX: 710-987-8352 / CABLE RADAIRCO, N. J.



**RFL Industries, Inc.**

## Monolithic clock chip offers flexibility in digital systems

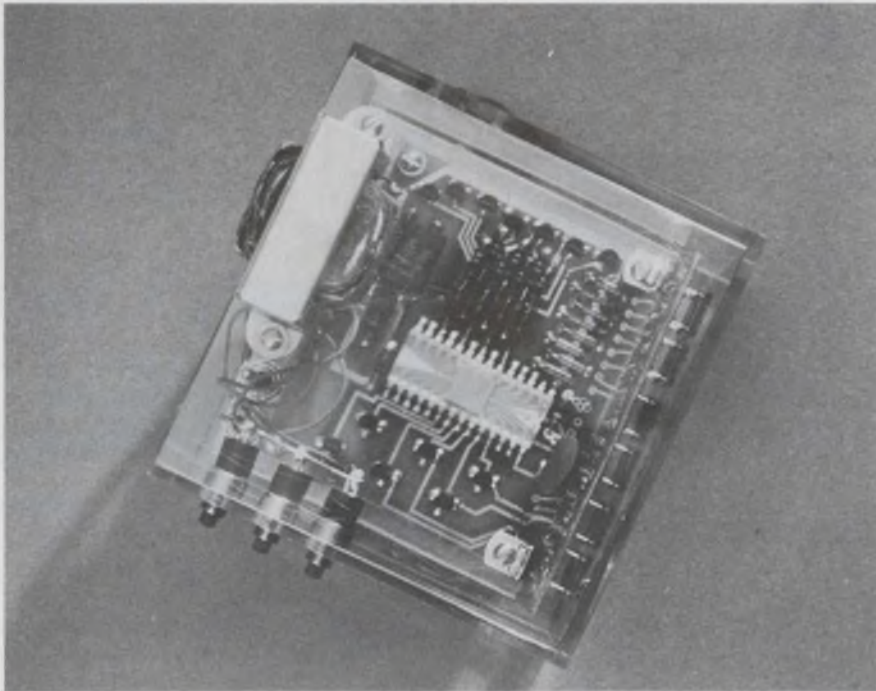

National Semiconductor, 2900 Semiconductor Dr., Santa Clara, Calif. 95051. (408) 732-5000. P&A: see text.

A monolithic digital clock, the MM5311, contains all the logic required to give a four or six-digit, 12 or 24-hour display from a 50 or 60-Hz input. The outputs of the p-channel low-threshold MOS circuit include multiplexed seven-segment selects, multiplexed BCD and digit enables. Only one power supply—typically 14 V dc—is required for operation.

The 50 or 60-Hz reference input for the MM5311 must be half-wave rectified externally. It is squared internally by a shaping circuit that has 5-V hysteresis. Then it's divided by either 50 or 60, depending on the logic state at a "50/60 Hz SELECT" input. Three other counter stages complete the division to 12 or 24 hours, depending on a "12/24 hour SELECT" input.

Logic gates between counters allow correct time setting at the rate of one hour digit (or one minute digit) per second. A hold input allows the stopping of the entire counter chain.

A multiplexer samples the out-

puts from the seconds, minutes and hours (in the six-digit mode) or from the minutes and hours counters (in the four-digit mode). These data are then routed to a programmable ROM that's programmed to provide BCD and seven-segment outputs.

The multiplex oscillator and divider, both on the chip, control the multiplex rate. Six (or four) divider states are decoded and brought out on six (or four) digit-enable lines. Each indicates, in succession, the digits information being presented at the BCD or seven-segment outputs.

The multiplex oscillator frequency is controlled by external components, normally just a resistor and capacitor. The BCD and seven-segment outputs can be gated by the output strobe line. All outputs are compatible with discrete bipolar devices.

The MM5311 operates over the temperature range  $-25$  to  $+70$  C, and is available in ceramic and plastic packages. In quantities of 100, unit prices are \$15 (plastic) and \$16.50 (ceramic). Delivery is from stock.

CIRCLE NO. 320

## 256-bit shift register is TTL-compatible

American Micro-Systems, Inc., 3800 Homestead Rd., Santa Clara, Calif. (408) 246-0330. \$22.50 (1-24); \$15.75 (25-99); \$12.60 (100-999); stock.

The S1705 dual 256-bit MOS dynamic shift register, consisting of two registers with common TTL-level clocks, is fully TTL compatible without external resistors. Each register has recirculate capability that is commonly controlled. There are pull-up devices on the inputs and a push-pull output that is capable of sinking 1.6 mA at 0.4 V.

CIRCLE NO. 321

## Hall-effect switch line offered

Sprague Electric Co., 347 Marshall St., North Adams, Mass. (413) 664-4411.

The ULN-3000 line of magnetically-activated IC switches feature a Hall effect device and a Schmidt trigger on one chip. Switching is activated with a flux of 750 gauss; the deactivation flux is 100 gauss. In the OFF state, the output can sustain up to +5.5 V dc with less than 100  $\mu$ A of leakage current. In the ON state, the output sinks up to 20 mA with a voltage drop of less than 400 mV. The supply voltage can range between 4.75 V dc and 5.25 V dc, and the ambient operating temperature range is 0 to 70 C.

CIRCLE NO. 322

## FET-input op amp offers 1 pA input current

Intersil Inc., 10900 N. Tantau Ave., Cupertino, Calif. 95014. (408) 257-5450.

The 8007 FET-input IC op amp boasts an input current of 1-to-2 pA. A version of the device, the 8007A, offers an input bias current of 1 pA maximum at 25 C. The device is a pin-for-pin replacement for the 101A, 709, 740 and 741 op amps. In addition, the op amp offers a 6 V/ $\mu$ s slew rate,  $10^{12}$ - $\Omega$  input impedance and internal frequency compensation. It is packaged in an 8-pin TO-99 case.

CIRCLE NO. 323



# Introducing

*a new  
PLUG-IN  
test and  
measurement  
system*

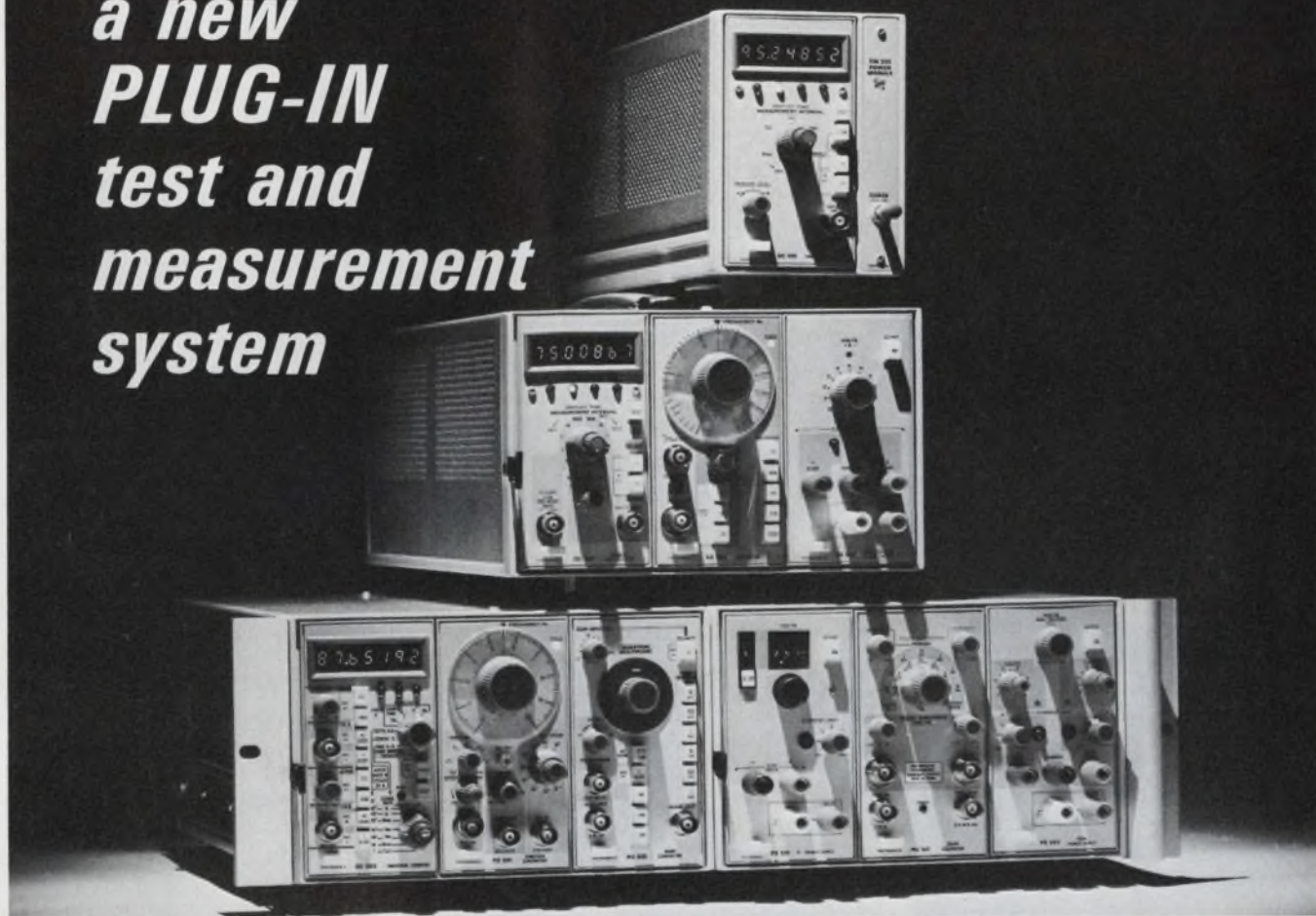

## The TM 500 Series

**Low-cost, space-saving modules you can mix and interface for specific applications.** Any single unit and its compact, single-hole mainframe offers a good value. For only \$35 more, the three-hole mainframe gives you extra room to grow, and extra flexibility. Here's an example of what you can do: Combine a ramp generator, function generator, and universal counter in the 3-hole mainframe. Using the intra-compartment interface you can use the ramp generator to sweep the function generator, and monitor the output with the counter. Complete cost of this system is only \$1345.

The TM 500 has these plug-in functions available:

- 550-MHz digital counter**
- 100-MHz digital counter**
- 100-MHz universal counter**
- Digital multimeter**
- 1-MHz function generator**
- 10- $\mu$ s ramp generator**
- 50-MHz pulse generator**
- 1-MHz RC Oscillator**
- 20-V single- or dual-tracking power supplies**

### **Need a compact 3-function system for your bench?**

The TM 503 power module accepts any 3 plug-ins, i.e., digital multimeter, function generator, ramp generator, yet only occupies 6 by 8.7 by 15.3 inches on your bench.

### **Need a rack installation?**

Mount one or two TM 503s in a rack, and get 3 or 6 functions in only 5 $\frac{1}{4}$  inches of rack height. Compatible large-screen monitors available.

### **Need mobility?**

The TM 501 accepts any single plug-in module for maximum carrying ease. The 203-3 Scope-Mobile<sup>®</sup> powers any 3 plug-ins, stores up to 4 more, and supports a scope or other instrument on its tilting platform.



**TEKTRONIX<sup>®</sup>**

P. O. BOX 500  
BEAVERTON, OREGON 97005

in Europe—TEKTRONIX LTD., Guernsey, C. I., U. K.

More



INFORMATION RETRIEVAL NUMBER 57

# The Elegant Custom Coils



Inductor coils made with a jeweler's touch. At mass-production prices. Elegant answers to applications that demand exacting performance. Like solenoid control valves. And coils for computer disc drives. With custom bobbins, windings and transfer-mold encapsulation executed under a single roof. So turnaround is fast — even when you want sample or pilot quantities.

At U.S. Electronics, you'll find all the precision and finesse you expect from an EAI component company. Look to EAI also for transformer kits. For thick-film



audio and servo amps. For capacitors. Active filters. Analog/digital converters and other special-function modules. Plus a growing list of other elegantly crafted etceteras.

# USEC

U.S. Electronics Corporation  
Orient Way and New Jersey Avenue  
Lyndhurst, New Jersey 07071  
Tel. (201) 438-2400

A Subsidiary of Electronic Associates, Inc.

INFORMATION RETRIEVAL NUMBER 58

## ICs & SEMICONDUCTORS

### 8-A plastic SCR has guaranteed 50 V/ $\mu$ s

*International Rectifier Corp., Semiconductor Div., 233 Kansas St., El Segundo, Calif. 90245. (213) 678-6281.*

An 8-A SCR, the IR122, has a guaranteed  $dV/dt$  rating of 50 V/ $\mu$ s. The SCR is believed to be the first of its class with such a guarantee. The IR122, a 50-to-400 V unit in TO-66 compatible plastic case, also features a maximum hold current of 30 A (at 25 C and with a 22-V supply), and a turn-on time of 1.1  $\mu$ s. The SCR is intended for use in controlling large appliances such as washers, driers and ovens.

CIRCLE NO. 324

### Monolithic timer has 1 $\mu$ s to 1 hour range

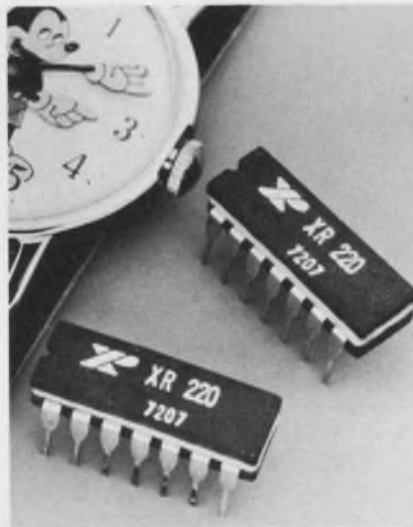

*Exar Integrated Systems, Inc., 733 N. Pastoria Ave., Sunnyvale, Calif. 94086. (408) 732-7970. \$6.50 (100 quantity).*

A monolithic timing IC, the XR-220, has delay output pulses ranging from 1  $\mu$ s to one hour. This range is believed to be the largest of any IC. The XR-220 generates a timing pulse with an accuracy of 0.5% and has a temperature stability of 0.002% per °C over the specified temperature range (both MIL and industrial ranges are available). The XR-220 has a power consumption of 10 mW, and an output current drive capability of 100 mA.

CIRCLE NO. 325

### Monolithic ALU believed first with latch

*Advanced Micro Devices, Inc., 901 Thompson Pl., Sunnyvale, Calif. (408) 732-2400.*

An arithmetic logic unit, the Am2506, is the first with a built-in-latch, according to the company. The latch portion of the device offers essentially zero propagation delay as well as zero power dissipation. Accordingly, the design advantages include speed, power and number of packages. For example, using standard ALUs for a 16-word, 16-bit arithmetic register slice would require 13 packages. With the Am2506 the application needs only 11 packages, and offers a 20% increase in speed and a 15% reduction in power.

CIRCLE NO. 326

### 2240-bit character generator ROMs offered

*Intel Corp., 3065 Bowers Ave., Santa Clara, Calif. 95051. (408) 246-7501. \$17.50 (1311, 1312), \$15.00 (1313). 100-999.*

Three fully decoded ROM character generators—type 1311, 1312 and 1313—feature 2240-bit ( $64 \times 7 \times 5$ ) capacity and TTL/DTL compatibility. Character access time over the temperature range of 0 to 70 C is 900 ns for the 1312 and 1313. For higher speed requirements, the 1311 offers an access time of 400 ns.

CIRCLE NO. 327

### Photoswitch believed to be first CDI product

*Ferranti Electric Inc., E. Bethpage Rd., Plainville, N. Y. (516) 293-8383. \$3.90 (100 up).*

A monolithic photoswitch that combines the functions of photo-detector, level sensor and TTL output stage is reported to be the company's first standard IC made with the high-density CDI (Collector Diffusion Isolation) process. Termed the ANP 100, the new photoswitch provides a logic output for a predetermined incident light level. Special features include a single 5-V supply, variable sensitivity over the range 10 to 10,000 W/cm<sup>2</sup>, variable hysteresis and TTL outputs with a drive capability of 4.8 mA.

CIRCLE NO. 328

## DATA PROCESSING

### PDP-16M uses pROM, cuts mini cost



Digital Equipment Corp., Main St., Maynard, Mass. (617) 897-5111. \$1995 (unit), \$895 less chassis and power supply (200); stock.

The PDP-16M microprocessor provides the power of the general-purpose mini at lower cost, according to DEC. It replaces hard-wired architecture with a programmable read-only memory. Four basic plug-in modular subassemblies are used: programming, memory, arithmetic operations, and input/output control. Space is provided for expansion of capabilities. PROMs are programmed using special software on the PDP-8. Its assembler language has only five basic instructions.

CIRCLE NO. 329

### Paper-tape punch has built-in keyboard



Data Products, 6219 DeSoto Ave., Woodland Hills, Calif. (213) 887-8000. \$220; 30 days.

The model 58A low-cost portable punch for preparing paper or mylar tape weighs 5 lb and measures 7 x 9 x 2-1/2 in. It can be used for creating or correcting 5- and 8-channel tapes, and has a built-in keyboard and space bar. The unit has high speed automatic advance and a counter with a reset button.

CIRCLE NO. 330

### Universal controller uses ROM for its logic

Peripherals General, Inc., Cherry Hill Industrial Park, Cherry Hill, N.J. 08003. (609) 424-2008.

The Model 844 universal controller is said to interface with any major manufacturer's CPU, and can operate with either single-track, double-track, or double-density discs, or those with a mix of the two track densities. It also handles other peripheral units such as tape drives, printers and readers. It owes its versatility to a microprogrammed ROM which replaces most of the conventional-type control logic. The ROM also provides for built-in automatic test. MTBF has been calculated at 10,000 h with a MTTR of 15 min.

CIRCLE NO. 331

### Lower cost tape system replaces IBM units

Ampex Corp., 13031 W. Jefferson Blvd., Marina del Rey, Calif. 90291. (213) 821-8993. See text; July/Aug.

Ampex's Model TM-34 tape drives and Model TC-38 controllers are lower cost replacements for 360 and 370 IBM tape subsystems using 3420, 2420 or 2401 tape drives and 3803 or 2803 controllers (two of IBM's 3420-V drives and a 3803 controller at \$80,800 vs two of Ampex's TM-34s and a TC-38 for \$68,000). The Ampex replacement requires no hardware or software modification. The controller and the drive each measure 60 x 30 x 30 in. Various purchase and lease plans are available.

CIRCLE NO. 332

### Two printing heads speed data output

Centronics Data Computer Corp., One Wall St., Hudson, N.H. 03051. (603) 883-0111. \$5390; July.

Line printer, Model 102B, uses a 9 x 7-dot matrix and prints 132 characters/line at speeds of 125 lines/min. It uses two printing heads which print simultaneously in opposite directions. Standard features include: paper runaway control, manual line spacing, hardware code selector, and 64-character output. It will interface with most popular mini-computers.

CIRCLE NO. 333

## PLUG-IN COUNTERS



DC 502 measures frequency to 550 MHz. Costs only \$895. DC 501 measures frequency to 100 MHz. Costs only \$550. DC 503 performs PERIOD, RATIO, TIME INTERVAL, TOTALIZE and TIME MANUAL functions and measures frequency to 100 MHz. Costs only \$695. All have 7-digit stored LED displays with automatic decimal positioning, leading-zero blanking. Standard time base accurate to 1 part in 10<sup>5</sup>. Optional time base accurate to 5 parts in 10<sup>7</sup>.

TM 503 Mainframe powers any 3 units ..... \$150  
TM 501 Mainframe powers one unit ..... \$115

U.S. Sales Prices FOB Beaverton, Oregon

Part of the TEKTRONIX TM 500 Modular Instrumentation System



More

**TEKTRONIX®**

P. O. BOX 500  
BEAVERTON, OREGON 97005

INFORMATION RETRIEVAL NUMBER 59



## Augat enclosures. You can do a lot with 3 1/2 inches.

Example: Augat's 3 1/2-inch-high drawer assembly will package up to 720 DIP's. That's a lot. What's more DIP's are always in easy reach. Panel frames have unique two-way hinges for accessibility or removal.

Augat rack assemblies also give you plenty of packaging density. Plus flip-up access to panels for fast repairs or design changes.

Smallest of all, our new mini-rack assembly — with small racks and plug-in panels — lets you subdivide logic more flexibly than before.

Whichever way you want to go, you can count on Augat for all your enclosure needs. And probably pay less money than you're paying now, thanks to our off-the-shelf supply.

Augat. The ones who pioneered the plug-in panel. Call us for panels (with automatic wire wrapping available), enclosures, sockets, accessories. Or write for our catalog.

Augat Inc., 30 Perry Avenue, Attleboro, Mass. 02703. (617) 222-2202. Our representation and distribution is nationwide and international.

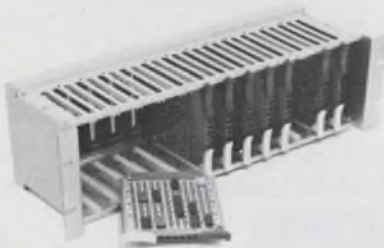

### Plug into Augat®

See our new packaging developments at The NEPCON EAST Show, New York. Booths 4521-4523

## DATA PROCESSING

### Asynchronous terminal echoes data for checking

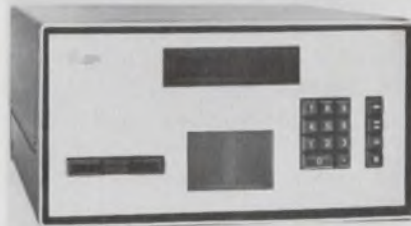

Modular Computer Systems, 2709 N. Dixie Highway, Fort Lauderdale, Fla. 33308. (305) 563-4392. \$2000.

Designed to permit a remote operator to enter, receive and verify computer data, and Model 5710 terminal is provided with a static-card reader and a numeric keyboard. Full duplex asynchronous interfacing allows the data to be echoed back for transmission verification. There are two output methods: a numeric display with decimal point (0.00001 through 99999) and a rear-projection screen, with 24-message displays.

CIRCLE NO. 334

### Buffer add-on interfaces Selectric to computers



Terminal Equipment Corp., 750 Hamburg Tpke., Pompton Lakes, N.J. (201) 839-3000. \$1455; stock.

The Holmes Tycom Buffered Applique interfaces between the customer supplied Selectric II typewriter and a computer. It handles all timing sequences, the data, and the ready-busy signal for keyboard operation. Since it provides a parallel ASCII-coded output, it can be used with various minicomputers, CRT terminals and other I/O devices. The Tycom permits full use of Selectric II features.

CIRCLE NO. 335

### Naked Mini and Alpha lines go Jumbo size

Computer Automation, Inc., 895 W. Sixteenth St., Newport Beach, Calif. 92660. (714) 642-9630. \$11,115 (200 and up).

Designed to meet OEM requirements for large-scale minicomputer-based systems, the Jumbo versions of earlier Naked and Alpha minicomputer lines incorporate up to 32 k 16-bit words of core memory and up to 12 plug-in I/O peripheral-interface modules. Parallel processors, with 156 instruction sets, are provided. In a typical communications system, a Jumbo Alpha-16 accommodates in a single 10-1/2-inch chassis, 24 k of 1600 ns memory plus 48 multiplexed RS232 communications channels in a variety of formats at data rates from 100 to 2400 baud. There is also room for a disc or magnetic tape controller.

CIRCLE NO. 336

### Mini calculator in two sizes: small and smaller



Unicom Systems, Inc., 10670 N. Tantau Ave., Cupertino, Calif. 95014. (408) 255-3650. 801: \$219.50; 802: \$229.50.

Two small electronic calculators, Unicom 801 and 802, weigh only 30 and 20 ounces, including battery packs. Both units add, subtract, multiply, divide, have automatic credit balance, hold constant factors, perform chain calculations and automatically place decimals in answers. The smaller 802 uses a LED display, and the 801, a Digi-tron display.

CIRCLE NO. 337

## Pocket-size calculator has floating decimal



Titan RBM, 12 W. First St., Havre, Mont. 59501. (406) 265-9131. under \$150; stock.

Shirt-pocket sized, this solid-state calculator performs competitively with desk-size machines. Measuring only 4 × 3 × 4 in., this 10-oz, made in the U.S., calculator adds, subtracts, multiplies, divides and makes chain calculations like  $([6 \times 5 \div 5] + 2)$ , providing answers on its LED readouts. It boasts a floating decimal point, constant "memory" key and, on an overflow greater than eight, digits will automatically indicate an answer in powers of ten.

CIRCLE NO. 338

## Graphic display features signature verification



Electro/Optical Display Business Operations, Owens-Illinois, Inc., P.O. Box 1035, Toledo, Ohio. (419) 242-6543.

The Model 80-83 Digivue displays alphanumeric, graphs or hand-written signatures. Its 2-1/2 × 8 in. display panel is a matrix of 80 by 256 lines with a resolution of 33 lines per inch. The matrix is formed by metallic conductors deposited on two sheets of glass. The conductors are at right angles and separated by an inert gas. Signatures may be digitized and displayed in less than a second.

CIRCLE NO. 339

## Core memory accesses in 250 ns and is compact

Data Products, 6219 DeSoto Ave., Woodland Hills, Calif. 91364. (213) 887-8000; 90 days.

Reported to be "low-cost" (but no price given), the Store 336, Data Products' newest family of core memory systems, has an access time of 250 ns and a cycle time of 650 ns. Basic capacity is 8192 words by 18 bits in a compact 2 × 8 × 11 in. plug-in package made of three stacked boards. The memory system can be expanded to 32 k × 18 and fits in a 5-1/4-in. chassis or to 65 k × 18 in an 8-3/4-in. chassis. Store 336 is available as a complete system or as an individual module.

CIRCLE NO. 340

## FM discriminator tunes over 200 Hz to 2 MHz

EMR Telemetry, Box 3041, Sarasota, Fla. 33578. (813) 958-0811.

The 410 UTD offers a tunable FM discriminator with a selectable deviation and data cutoff. It is both manual and computer controlled. With built-in automatic calibration, this unit can be programmed to demodulate all IRIG, PBW and CBW, FM subcarrier or other channels with center frequencies between 200 Hz and 2 MHz. Signal deviations between ±1 and ±40%, and data cutoffs from 1 Hz to 400 kHz are handled.

CIRCLE NO. 341

## Terminal stores TV image for 30 minutes

Systems Research Laboratories, 2800 Indian Ripple Rd., Dayton, Ohio 45440. (513) 426-6000.

This Model 324 video-storage terminal contains a silicon-target scan-converter tube which permits storage and retrieval of signals at resolutions to 800 lines and in 10 shades of gray. The stored signals are scanned in the "read" mode, and the output signals drive standard-TV monitors, printers and other devices. During readout of signals, additional information can be simultaneously added to the stored image by use of a light pen. The stored information can be held 30 min. Erase time is one TV frame (less than 33 ms).

CIRCLE NO. 342

# PLUG-IN GENERATORS

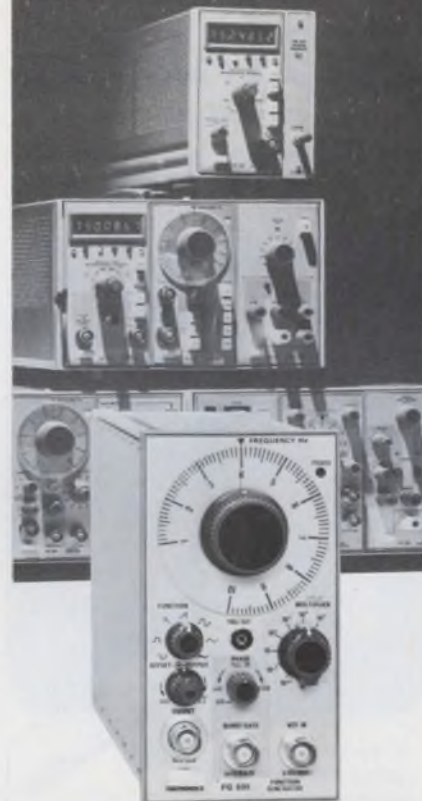

The FG 501 is a .001 Hz to 1 MHz function generator with sine, square, triangle, pulse, and ramp outputs. Harmonic distortion is low. VCF input has 1000:1 range. Gate/burst input has phasing variable from -90° to +90°.

Function Generator	FG 501	\$325
50-MHz Pulse Generator	PG 501	\$295
10-μs Ramp Generator	RG 501	\$175
1-MHz RC Oscillator	SG 502	\$295

TM 503 Mainframe powers any 3 units ..... \$150  
 TM 501 Mainframe powers one unit ..... \$115

U.S. Sales Prices FOB Beaverton, Oregon

Part of the TEKTRONIX TM 500 Modular Instrumentation System.

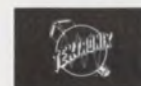

More 

**TEKTRONIX®**

P. O. BOX 500  
 BEAVERTON, OREGON 97005

INFORMATION RETRIEVAL NUMBER 61

1%  
AMERICAN MADE

# Tolerance SCHAUER 1-Watt ZENERS

## Immediate Shipment Low Prices

ANY voltage from 2.0 to 18.0

Quantity	Price each
1-99	\$1.07
100-499	.97
500-999	.91
1000-4999	.86
5000 up	.82



All welded and  
brazed assembly

No fragile  
nail heads

Write for complete  
rating data and other  
tolerance prices.

## Buy the kit- Save a lot



Kit contains a 51-piece assortment of SCHAUER 1% tolerance 1-watt zeners covering the voltage range of 2.7 to 16.0. Three diodes of each voltage packaged in reusable poly bags. Stored in a handy file box. Contact your distributor or order direct.

A \$54.57 value for  
ONLY **\$24<sup>50</sup>**

Semiconductor Division

# SCHAUER

Manufacturing Corp.

4511 Alpine Ave. Cincinnati, Ohio 45242  
Telephone: 513/791-3030

## MODULES & SUBASSEMBLIES

### 2000 V/ $\mu$ s op amp gives 100 mA output



Zeltex Inc., 1000 Chalomar Rd., Concord, Calif. 94520. (415) 686-6660. \$99 (1-24); stock.

The ZA910M1 op amp meets high speed, high-output current and fast-settling requirements simultaneously. It features a slew rate of 2000 V/ $\mu$ s (guaranteed minimum at 100 mA output); 70-MHz GBW; 30-MHz full frequency out; and 300-ns settling time (to 0.01%).

CIRCLE NO. 343

### Small crystal oscillator provides 25 Hz sinusoid



Fork Standards, Inc., 211 Main St., W. Chicago, Ill. 60185. (312) 231-3511. \$59 ea.; 3-4 wks.

Crystal-stable sine-wave outputs at frequencies as low as 25 Hz are possible with the Model BQ modular oscillator. Intended primarily to provide high-stability, low-distortion audio frequencies, the unit features a hermetically-sealed steel case and rugged construction. Frequency stability and accuracy of the standard model can be as high as 0.001%, 0 to 50 C. Standard output levels into a 10 k $\Omega$  load are 2 V rms, minimum, at 25 to 200 Hz and 3 V rms, minimum, at 200 Hz to 10 MHz with 12 V supply. Size is 2 x 2 x 3/4 in. and weight is 3 oz.

CIRCLE NO. 344

### Small pulse transformers operate at 4 ns

Sprague Electric Co., 87 Marshall St., North Adams, Mass. 01247. (413) 664-4411.

The Type 66Z line of miniature pulse transformers operate in the nanosecond region and come in a complete range of sizes, lead styles, volt-microsecond products and turns ratios. Rise times down to 4 ns are available. The unique "step bottom" case shape permits a choice of lead mounting through printed wiring board holes or surface mounting with leads bent at right angles to the case.

CIRCLE NO. 345

### Hybrid coupler is tuned electronically

R. F. Power Labs, Inc., 924 - 104th Ave. N.E. Suite 103, Bellevue, Wash. (206) 454-3886. 2TH-1: \$249; 2TH-1A: \$379; 3 weeks.

The Model 2TH-1 is an electronically tuned power combiner/splitter which can compensate for mismatches of up to 1.5:1, and can vary bandwidth by  $\pm 10\%$ . The unit can handle a frequency range of 30 to 300 MHz at 1.0 W. Another model, the 2TH-1, can handle 10 W. Insertion loss is 0.3 dB at most frequencies and isolation at the center frequency is 50 dB minimum. A key feature is that the tuning can be accomplished remotely by control voltages of 0 to +10 V and 0 to +100 V.

CIRCLE NO. 346

### Small regulated supply delivers 50 W

Abbott Transistor Labs, Inc., 5200 W. Jefferson Blvd., Los Angeles, Calif. (213) 936-8185. \$219; 7 days.

Fifty watts of regulated power from a package that measures only 4 in. x 6 in. x 2-1/4 in. and weighs just 3 lb. That's what the Model Z3.5 delivers when plugged into the ac line (47 to 440 Hz). Outputs between 17.5 and 18.5 V dc are regulated to within 0.15% total, for input voltage changes of 100 to 132 V rms and load changes from no load to full load. Ripple is less than 0.02% rms or 50-mV pk-pk. TC is typically less than 0.01%/ $^{\circ}$ C from -20 to +80 C.

CIRCLE NO. 347

## Ac amplifier auto ranges gain

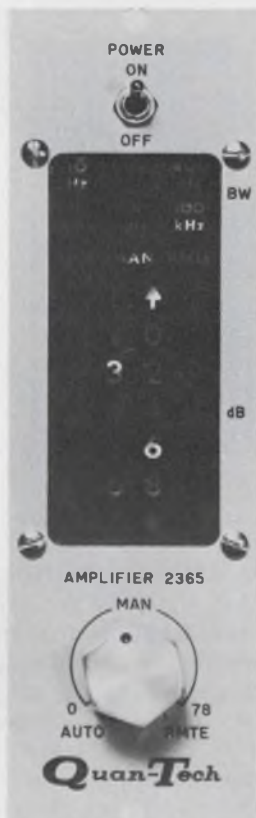

Quan-Tech Div., KMS Industries, Inc., 43 S. Jefferson Rd., Whippany, N.J. (201) 887-5508. \$1350.

The Model 2365 is an automatic ranging ac amplifier with gain settings from 0 to 78 dB in 6 dB steps in either autoranging, manual or remote program (BCD) modes. Built-in switchable band-pass filters permit a broad selection of signal conditioning between 10 Hz and 100 kHz. Front panel readout and rear panel coding are provided.

CIRCLE NO. 348

## HV mini-power module drives seven Nixies

Acopian Corp., 131 Loomis St., Easton, Pa. 18042. (215) 258-5441. \$35 ea.; 3 days ARO.

Up to seven high-voltage indicators, such as Nixie displays, can be driven by the Model NX-25 mini-power module. It accepts a 115 V ac input and provides a nominal output of 185 V dc @ 25 mA. Dimensions of 3.5 x 2.3 x 1.0 in. permit it to be integrated into a display assembly, or it may be soldered onto a printed circuit board.

CIRCLE NO. 349

## Active band-reject filter has controlled bw

WIDE WELL ACTIVE BANDREJECT FILTER

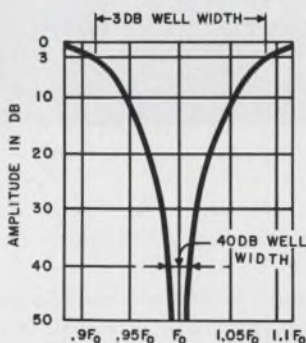

WELL DEPTH SHAPE FACTOR =  $\frac{3\text{DB WELL WIDTH}}{40\text{ DB WELL WIDTH}}$

Polyphase Instrument Co., Bridgeport, Pa. (215) 279-4660. Model 9060: \$120.

The Series 9000 filters have controlled ratio of 3 dB and 40 dB bandwidths, called the "Well Depth Shape Factor." The ratio has a nominal value of 10, whereas values of 50 are typical for notch filters. The 60 Hz Model 9060, with a Wellwidth of 1 Hz at 40 dB and a Well Depth Shape Factor of 10, has a Wellwidth of 10 Hz at the 3 dB level. It rejects, at 40 dB attenuation, the 60 Hz line frequency (60 Hz  $\pm$  0.3 Hz). The filters use  $\pm$ 15 V dc, are encapsulated, and are available from 0.01 to 100 kHz.

CIRCLE NO. 350

## Flat-pack quad hybrids offer 5 to 160 MHz

Merrimac Research and Development Inc., 41 Fairfield Pl., W. Caldwell, N.J. 07006. (201) 228-3890. \$45; stock to 30 days.

The series QHF-2A are ultra-miniature, quadrature hybrids in a flat-pack. Standard center frequencies range from 5 to 160 MHz. All models exhibit 10 per cent bandwidths and  $\pm$ 0.5 dB output equality. Minimum isolation is 23 dB with -3 dB coupling. Other minimum performance specifications include VSWR of 1.3:1, impedance 50  $\Omega$ , insertion loss 0.3 dB, phase 90  $\pm$  2 $^\circ$  and average power 250 mW. Standard models weigh 0.09 oz. and measure only 1/8 x 3/8 x 1/2 in.

CIRCLE NO. 351

# PLUG-IN POWER SUPPLIES



These high density, easy to operate supplies are designed for today's devices. Ideal for circuit investigation, device testing and educational applications. The PS 503 is a dual power supply with precisely regulated, shortproof outputs variable independently or at a constant ratio. All plug-ins have a +20 V floating supply and +5 V ground referenced supply.

0-20 V 0-400 mA	PS 501	\$ 95
0-20 V, 0.5% 0-400 mA	PS 501-1	\$130
10-20 V Dual Tracking	PS 502	\$130
0-20 V, 0-40 V Dual	PS 503	\$180

TM 503 Mainframe powers any 3 units ..... \$150

TM 501 Mainframe powers one unit ..... \$115

U.S. Sales Prices FOB Beaverton, Oregon

Part of the TEKTRONIX TM 500 Modular Instrumentation System



See previous 3 pages

**TEKTRONIX®**

P. O. BOX 500  
BEAVERTON, OREGON 97005

INFORMATION RETRIEVAL NUMBER 63

## 15-bit d/a module converts in 1 $\mu$ s

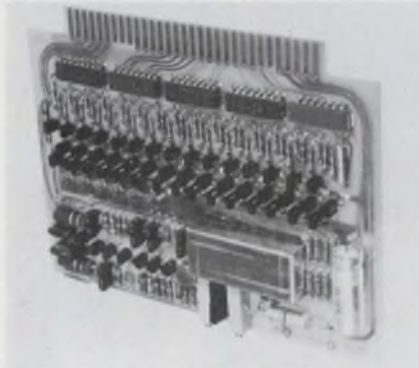

Tustin Electronics Co., 1656 S. Minnie St., Santa Ana, Calif. 92707. (714) 835-0677. \$500; stock to 2 wks.

The Model 1535 is a 15-bit (plus sign), high speed, d/a converter. Its total conversion time is 1.0  $\mu$ s to rated accuracy of  $\pm 0.005\%$  of FS. Output voltage is  $\pm 10.0$  V and tempco is 10 ppm/ $^{\circ}$ C. Output current is  $\pm 10$  mA, short circuit protected. Its overshoot is 1%, worst case, for a step change from one FS output voltage to the opposite FS value. External filters and amplifiers are not required. Wide-band noise (1.0 MHz bw) is 100  $\mu$ V rms. Required power is  $\pm 15.0$  and +5.0 V dc.

CIRCLE NO. 352

## Two active filters in single DIP

Kinetic Technology, Inc., 3393 De La Cruz Blvd., Santa Clara, Calif. (408) 296-9305. \$5/section; 3-6 weeks.

The FD-200 series is a dual active filter which offers any combination of lowpass, highpass, or bandpass sections in a single DIP package. Cutoff/center frequencies between 300 and 3000 Hz and Qs less than 15 may be specified. Each section is pre-tuned to the customer's spec with a frequency tolerance of  $\pm 2\%$  and a Q tolerance of  $\pm 10\%$ . The unit measures 0.804  $\times$  0.475  $\times$  0.250 in. Operating temperature is 0 to 70 C. Power supply requirement is 2.8 mA at  $\pm 15$  V. Input range is  $\pm 3$  to  $\pm 18$  V.

CIRCLE NO. 353

## Laminated LED display is custom-fabricated



Display Devices, Inc., P.O. Box 667, Encinitas, Calif. 92024. (714) 753-0113.

A multi-laminate construction technique provides low-cost, custom-fabricated LED display panels up to 30  $\times$  40 in. The panels feature clear point source indications in high ambient light, with 140 $^{\circ}$  off-axis viewing. Total panel depth, including PC board, is less than 1/2 in. (exclusive of electrical and/or special mechanical mounting considerations). Visible graphics may be surface or subsurface printed.

CIRCLE NO. 354

## Para amp guarantees $\pm 5$ femtoamps bias



Teledyne Philbrick, Allied Dr. at Route 128, Dedham, Mass. 02026. (617) 329-1600. \$52 (100 quantities); stock.

The Model 1702 is a varactor-input, ultra-low bias current op amp. The unit is said to have the lowest bias current of any varactor amplifier in the industry ( $\pm 5$  femtoamperes, maximum). The bias current specified is the maximum for either the inverting or non-inverting inputs. Its size of 1.5  $\times$  1.5  $\times$  0.6 in. is claimed to be the smallest of any paramp. Guaranteed specs include a full output frequency response of 40 Hz, CMRR of 100,000, and an offset voltage drift of 30  $\mu$ V/ $^{\circ}$ C.

CIRCLE NO. 355

## 3 1/2-digit a/d converter sells for \$49 in 1k units



Cycon, Inc., 1080E Duane Ave., Sunnyvale, Calif. 94086. (408) 732-8311. \$89 ea.; \$49 (1000).

A 3-1/2-digit, BCD, a/d converter, the CY3638, features 100 measurements/second, standard input voltage ranges of  $\pm 1.999$  V (10 M $\Omega$  input impedance) and  $\pm 19.99$  V (80 k $\Omega$  input impedance). Specific input ranges from  $\pm 1.999$  to  $\pm 7.999$  can be accommodated with only two external resistors in a ratio circuit. Linearity is  $\pm 1/2$  LSB, with monotonicity guaranteed over the entire 0-70 C operating temperature range. The circuit has built-in reference and requires +5 V (250 mA) and  $\pm 15$  V (40 mA).

CIRCLE NO. 356

## Power source handles 25 op amps

Reliability Inc., 5510 Greenbriar, Houston, Tex. 77005. (713) 529-5817. \$44.50; 2 weeks.

The V-PAC is designed to supply the special voltages for monolithic op amps from standard, +5 V, IC supplies. A single unit occupies only 1/3 cubic inches and can power as many as twenty-five, 709 op amps. Leads conform to standard 24-pin DIP spacing so the units can be assembled on the same card as the op amps. Available are the VA 15-15, giving  $\pm 15$  V, the VA 12-12 ( $\pm 12$  V), and the VA 12-6 (+12 and -6 V). The V-PAC input may be floated above or below ground at an ac or fixed dc level, for special applications.

CIRCLE NO. 357



**NOW AVAILABLE! FREE!**  
**Complete thermal data on**  
**COMPACT HEAT EXCHANGERS**



For the first time designers can now have a wealth of general engineering information and performance data on a complete line of Compact Heat Exchangers. Twelve off-the-shelf models cataloged, from 2.5 to 20 kw, single or double pass. Send for 12 page Wakefield Catalog No. 30.

**WAKEFIELD**  
 WAKEFIELD ENGINEERING, INC.  
 Wakefield, Mass. 01880 617-245-5900

INFORMATION RETRIEVAL NUMBER 64

Image Intensifiers.  
 by Electro-Optics.  
 Large variety.  
 UV — visible — near IR.  
 Up to 75 mm.  
 Compact. Thin.  
 Light weight.  
 Small power requirement.

The Bendix Corporation.  
 Electro-Optics Division  
 Galileo Park.  
 Sturbridge, MA 01518  
 (617) 347-9191

*Electro-Optics makes light work.*

INFORMATION RETRIEVAL NUMBER 65

ELECTRONIC DESIGN 12, June 8, 1972

**emi/rfi filters...**

**STOCK**  
**TO**  
**TWO**  
**WEEKS**

**...from USCC/Centralab**

If you have an EMI/RFI problem—contact us first. That's because we've amassed an extensive distributor inventory on popular size EMI/RFI filters ready for immediate delivery. In addition, we've stocked our production shelves with all the components necessary to deliver other sizes in not more than two weeks. And if you have a custom requirement we have a staff of applications engineers whose business is solving your specific problem... and fast.

Before you buy, contact a reliable source for highest quality EMI/RFI filters—USCC/Centralab, 2151 N. Lincoln St., Burbank, California 91504 • (213) 843-4222.



Send for your free copy of our EMI/RFI Catalog containing complete technical data on: Miniature Ceramic 1000/2000 Series, Subminiature Ceramic 3000 Series, 8000 Series for Data Processing Equipment, and 9000 Series Ceramic Feed-thru Filter/Capacitors.



U.S. CAPACITOR  
 CORPORATION



CENTRALAB  
 Electronics Division • GLOBE-UNION INC.

INFORMATION RETRIEVAL NUMBER 66

**A precision pair...  
for tone  
signaling,  
coding and  
decoding.**

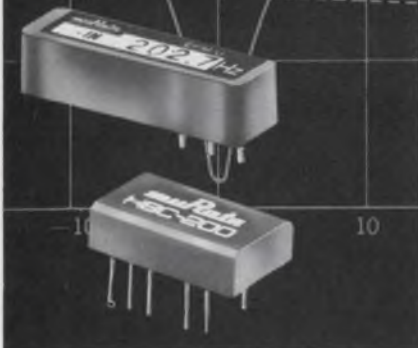

## The New Microfork EFM-U Tuning Fork and Companion H8C-200 Hybrid Amplifier.

Murata's new EFM-U piezoelectric tuning fork — hybrid amplifier combination is designed to provide a new era in precision and flexibility for audio frequency coding and decoding applications. Designed to provide exceptional performance as a pair, these two units operate well as a transmitter for coding and as a receiver for decoding while providing outstanding reliability and accuracy over a wide range of environmental conditions.

Additional applications for these new units include:

- Traffic Signal Controllers
- Paging Systems
- Remote Control Systems
- Sound Multiplexing Devices
- Garage Door Openers
- Alarm Systems

A complete selection of standard audio frequencies, ranging from 150 to 1700 Hz, is available to meet virtually every application requirement. All E.I.A. standard frequencies in this range are also available.

Write today! We'll send along complete technical information that, we're sure, will impress you with the capabilities of our new precision pair.

# muRata

**MURATA CORPORATION OF AMERICA**  
2 Westchester Plaza, Elmsford, New York 10523  
Telex: Murata EMFD 137332  
Phone: 914-592-9180  
Subsidiary of Murata  
Manufacturing Co., Ltd., Japan

INFORMATION RETRIEVAL NUMBER 67

## INSTRUMENTATION

### Active filters give Butterworth or Bessel



Ithaco Inc., 735 W. Clinton St., Ithaca, N.Y. 14850. (607) 272-7640. \$695 to \$765.

The Series 4210 variable electronic filters are active networks covering 0.01 Hz to 1.0 MHz. Independent control of the cutoff frequencies permits operation as either a dc-coupled low-pass; a band-limited high-pass; or as a bandpass filter. Normally, the filter characteristic is a four-pole Butterworth. In the time domain, the low-pass filter can be switched to a four-pole Bessel (linear phase). Frequency accuracy is  $\pm 1\%$ , phase shift is  $\pm 2^\circ$ , and amplitude response is  $\pm 0.2$  dB. A table with the  $-3$  dB BW, center frequency, noise BW and gain is printed on the top.

CIRCLE NO. 358

### Signal-conditioning amp features six plug-ins

Princeton Applied Research Corp., Box 2565, Princeton, N.J. 08540. (609) 452-2111. \$595 plus \$250 to \$525 for plug-in.

A new general-purpose laboratory amplifier features a selection of 6 plug-in preamps that provide low-noise matching to virtually any signal source. The Model 114 offers switch-selectable gains of up to 2,500,000; switch-selectable, 6 dB/octave, low and high frequency roll-offs; and overload protection. The unit functions as a conventional voltage amplifier or as a high-gain current-to-voltage converter with one volt output for input currents as low as  $5 \times 10^{-12}$  A. Over-all frequency response depends on the preamp, but ranges from 0.2 Hz to 1 MHz.

CIRCLE NO. 359

### Solid-state meter relay handles vibrations



LFE Corp., Process Control Div., 1601 Trapelo Rd., Waltham, Mass. 02154. (617) 890-2000.

API Compack solid-state controllers are intended for use where shock and vibration rule out other units. The Compack's design separates all control functions from the meter: instead, functions are accomplished with ICs. The unit consists of five components: an input amplifier; a panel meter mechanism for indication of amplified signal level; a linear pot mounted on the meter jewel center; a linear dial to read both indicated signal level and pot setting; and a differential amplifier for switching relay circuitry. The unit has a standard response time of one second, with 100 ms optional.

CIRCLE NO. 360

### Pulse generator gives 9 kV at 1-ns rise



EG&G Inc., Electro-Optics Div., 35 Congress St., Salem, Mass. 01970. (617) 745-3200.

The PG-1 is a nanosecond, kilovolt pulse generator. The unit, which has a characteristic impedance of 50  $\Omega$ , provides an output of 1 to 9 kV with a rise and fall time of 1 ns and a delay of 20 ns. Pulse rates up to 100 Hz are provided. The instrument can be triggered manually by push button or electrically with repetitive 3 V pulses.

CIRCLE NO. 361

## Audio analyzer system has scope digital display



McAdam Electronics Inc., 7360 Convoy Court, San Diego, Calif. 92111. (714) 278-0300.

The Model 2000 replaces many separate units previously needed to evaluate audio equipment. The unit measures harmonic distortion (from 20 Hz to 20 kHz), IM distortion, true power output and true rms volts. Readings appear as absolute numerical values on the digital display. A built-in scope monitors all signals and a monitor switch compares the input and output of the unit under test.

CIRCLE NO. 362

## FET multimeter is size of two tubes

Sencore Inc., 3200 Sencore Dr., Sioux Falls, S.D. 57107. (605) 339-0100. \$80.

A new portable multimeter is called the Little Henry because of its small size (as small as two 5U4 tubes) and toughness. The D'Arsonval meter of the Model FE23 is fully protected to 1,000 × overload by both internal circuits and a sliding cover in the unbreakable case. The unit features battery operation and an automatic-turn-off snap-cover on the lead compartment. The snap automatically turns off the B<sup>+</sup>, the ohms and the meter illumination batteries. The light on the meter allows the operator to take readings in the dark and can be shut off separately to save batteries. Push-button switches are used throughout. Other features of the FE23 include a full range of voltage up to 6 kV, ohms and current, high voltage readings up to 30 kV and a near-lab accuracy of 1.5% with a low 15 M de input.

CIRCLE NO. 363

## 2-1/2 digit DPM sports \$65 price tag



Faratron Corp., 290 Lodi St., Hackensack, N.J. 07601. (201) 488-1440. \$65.

Faratron is taking off after its competition with a standard size 2-1/2 digit DPM sporting a \$65 price tag and two display options. The manufacturer claims the new 2500 series is dimensionally interchangeable with equivalent competing units. The new meter includes a seven-segment incandescent display as standard equipment. The locking method of the unit uses a spring-loaded mechanism in place of standard screw mounts. Over-and-under range indicator lights are standard on the unipolar DPM. Power input options are the standard +5 V dc; or 117 V ac or ±12 V dc.

CIRCLE NO. 364

## Attention Advertisers:

Could you use copies of your ad exactly as it appeared in ELECTRONIC DESIGN? Then order your reprints directly from us; the minimum unit order is 500 copies.

Please specify if you would like the reprint line omitted on your copies and mail your/written order to:

Production Dept.  
ELECTRONIC DESIGN  
50 Essex St.  
Rochelle Park, N.J. 07662

	500	1,000	Add'l M
<b>8x10 or smaller</b>			
1 color, 1 side	\$74.70	82.95	18.15
2 color, 1 side	95.47	108.00	25.28
4 color, 1 side	311.03	342.00	44.33
<b>Spreads</b>			
1 color	113.66	126.65	25.98
2 color	191.19	205.98	29.58
4 color	354.17	380.76	53.19

Prices FOB Waseca, Minn.

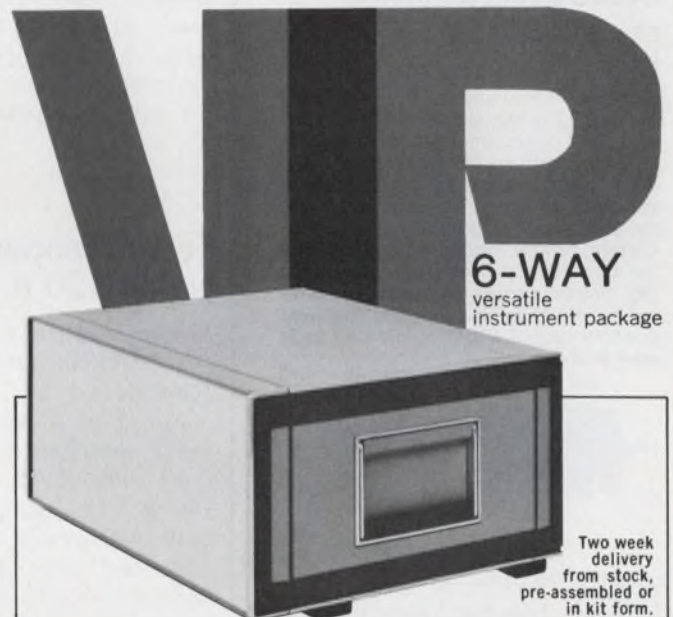

**Multiple function + contemporary styling + affordable prices.**

(1) Vertical Nestable; (2) Vertical Interlockable; (3) Horizontal Interlockable; (4) Rack Mountable; (5) Briefcase Portable; (6) Tilttable... in 14 standard sizes.  
**Call or write for free VIP Design Guide and Prices.**

### Zero Manufacturing Co.

Zero-West (213) 849-5521 • 1121 Chestnut St. • Burbank, Ca. 91503  
Zero-East (413) 287-5561 • 288 Main St. • Monson, Mass. 01057  
Zero-South (813) 531-8991 • Int'l Airport • St. Petersburg, Fla. 38732

Two week delivery from stock, pre-assembled or in kit form.

INFORMATION RETRIEVAL NUMBER 69

# Create your own Power Supply System

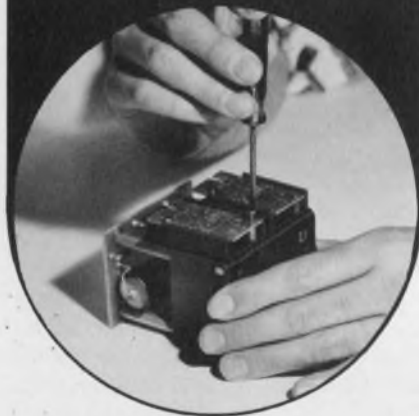

## Choose from any combination of two basic elements

ERA Transpac's low-cost, modular, point-of-load power supply systems bring new economies and efficiency to power installations. By combining these ERA unregulated power sources and ERA component-regulators you can assemble an almost limitless variety of power supply systems. Customize your designs, reduce inventory, simplify repairs. The four-terminal regulators can be located at any point in the circuit or mounted directly on to the power center. Write for catalog today. 16 regulator models, 9 power centers, plus OV protectors and heat sink add-ons.

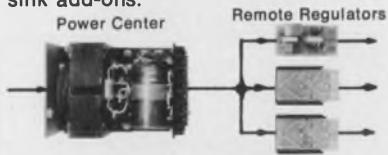

### Typical Models

#### Remote Regulators

OUTPUT VDC	CURRENT	MODEL	PRICE
5	0-1 amp	RR 51	\$13.75
15	0-1 amp	RR151	\$14.25
5	5 amps	RR 55	\$17.95

#### Power Centers (Unreg. Power Source)

10, 12.5	1 amp	PC 1K	\$29.00
10, 12.5	5 amps	PC 5K	\$41.00
10, 12.5	25 amps	PC25K	\$97.00



## ERA TRANSPAC CORPORATION

A Subsidiary of Electronic  
Research Associates, Inc.  
67 Sand Park Road,  
Cedar Grove, N.J. 07009 (201) 239-3000

INFORMATION RETRIEVAL NUMBER 70

## INSTRUMENTATION

### HI/GO/LO comparator gives 0.6% FS accuracy



Hewlett-Packard, 1601 California Ave., Palo Alto, Calif. 94304. (415) 493-1311. \$510; stock.

A new analog comparator, the Model 4050A, compares an unknown voltage with preset limits and indicates HI, GO or LO with lights on the front panel. A relay, operating with the lights, may be used to actuate external sorting devices. The limits are independently set with digital dials and can be extended to 125% of FS. A three-position switch on the rear sets the range to 0.1, 1.0 or 10 V FS. Polarity is selected by a switch inside the cabinet. Accuracy is  $\pm 0.6\%$  of FS with a response of 0.1 s.

CIRCLE NO. 365

### Ferro-resonant supply yields 130 A at 5 V

North Electric Co., Electronics Div., Galion, Ohio 44833. (419) 468-8244.

For those IC applications requiring a high-capacity power supply, the C19005 EAV offers 5 V dc @ 130 A. The basic design of this unit features a patented, SCR-controlled ferro-circuit. With this approach, North is able to achieve 60% unit efficiency under loads of 40 to 100%. Key features of this power supply include line isolation from transients and ferro-resonant short circuit protection. Regulation is 0.4% for line and load and ripple is less than 50 mV rms. The unit can be operated at  $-20$  to  $+71$  C. Size is  $6.97 \times 19 \times 17.5$  in. and weight is 110 lbs.

CIRCLE NO. 366

### IC handler sorts 7000 DIPs/hour

Ramsey Engineering Co., Electro-Mechanical Products Div., 1853 W. County Rd. C, St. Paul, Minn. 55113. (612) 633-5150. under \$5000; stock to 4 wks.

A new IC handler, the Model IC-7000, can handle and sort up to 7,000 DIP packages per hour. The unit is suited for production testing, incoming inspection, or AQL sampling. It accepts 14 and 16-pin DIP packages directly from shipping magazines and sorts them into three categories: two grades of ACCEPT; one grade of REJECT. The handler operates under the control of an associated testing system.

CIRCLE NO. 367

### Four-digit DMM offers 26 ranges

Traco Inc., 509 Rolling Hills Rd., Somerville, N.J. 08876. (201) 725-5333. \$535.

The DV357A is a digital multimeter featuring 26 ranges for dc and ac voltages, dc and ac currents and resistance measurements. Read-out is four, nonblinking, display tubes with automatic overrange and polarity indication. All voltage ranges are protected against brief overloading up to 1200 V. Accuracy is 0.05% of rdg  $\pm 1$  digit for dc V and 0.2%  $\pm 1$  digit for ac V. Input impedance is 22 M $\Omega$  for dc and 1 or 3 M $\Omega$  for ac, depending on range.

CIRCLE NO. 368

### PC board drilling system makes $10^5$ holes/hour

Vero N. C. Developments Ltd., 7 S. Mill Rd., Regents Park, Southampton, Hants, England. Southampton 71061.

Up to 100,000 holes/hour can be drilled in PC boards with this British-made multi-spindle numerically-controlled machine. Strike rate, depending on the type of board being drilled, can be as high as 90/min. The Vero machine will drill within a hole-to-hole accuracy of 0.003" positional-tolerance zonal diameter and a repeatability of  $\pm 0.00025$ " at a table traverse rate of 225 in/min. Drill speed is steplessly variable between 30,000 and 70,000 rpm.

CIRCLE NO. 369

## Function generator sells for \$395



*Microdot Inc. Instrumentation Div.,  
19535 E. Walnut Dr., City of Industry,  
Calif. (213) 965-4911.  
Price: see text.*

The Series 500 consists of the Model 501 (5-MHz trigger/variable start-stop), \$395; Model 510 (10-MHz VCF generator), \$495; and the Model 511 (10-MHz trigger/variable start-stop), \$695. Output waveforms are sine, triangle, pulse, ramp, squarewave, and dc modes. The 10-MHz units offer a 2500 V/ $\mu$ s bipolar linear output amplifier capable of handling pulse widths of 50 ns at 50% duty cycle, and rise and fall times of less than 10 ns. The instruments provide 1000:1 VCF sweep on the main dial; 20 Hz-20 kHz special audio range; 5-95% variable symmetry control.

CIRCLE NO. 370

## X-Y recorders withstand abuse

*Hewlett-Packard Co., 1601 California Ave., Palo Alto, Calif. 94304.  
(415) 493-1311. 7044A: \$1350,  
7045A; \$1675; 4 wks.*

The Models 7044A and 7045A X-Y recorders withstand abuse and rough handling. The 7044A has a slewing speed of 20 in./s; the 7045A is faster with a slewing speed of 30 in./s. Acceleration of the 7045A on the Y axis is 3000 in./s<sup>2</sup>, and on the X axis, 2000 in./s<sup>2</sup>. Input ranges of both models are from 0.5 mV/in. to 10 V/in. Input resistance is 1 M on all ranges. Input is floating, 500 V dc or peak ac. Accuracy is  $\pm 0.1\%$  of FS and resettability is 0.1% of FS. Overshoot is less than 2% of FS. Both units use a servo-actuated ink pen. Writing area is 10 by 15 in. Special paper is not required.

CIRCLE NO. 371

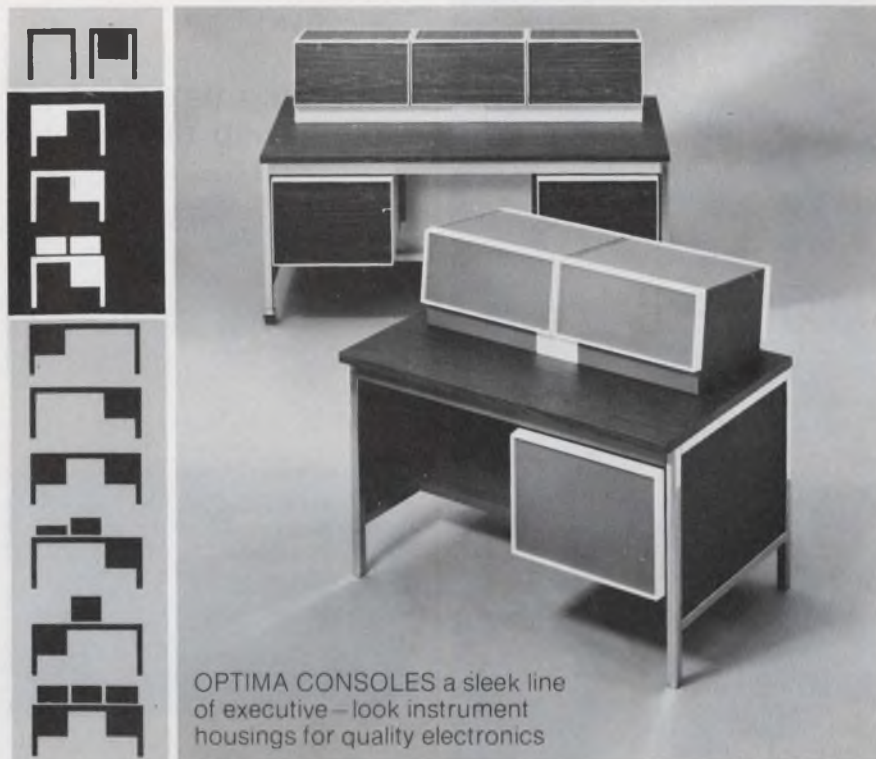

OPTIMA CONSOLES a sleek line  
of executive-look instrument  
housings for quality electronics

optima enclosures  
a division of Scientific-Atlanta, Inc.



2166 Mountain Industrial Blvd. Tucker, Georgia 30084 Telephone 404-939-6340

INFORMATION RETRIEVAL NUMBER 71

# Sockets

Whatever your IC connection need, we can solve your problem—from our complete line of 800 standard socket products.



Besides being able to furnish everything from IC Sockets to a total IC interconnection system—with anytime availability through our local distributors, we've a couple more compelling reasons why you should contact us first: Robinson-Nugent quality and competitive pricing. For prompt attention to your requirements, contact the Socket People:

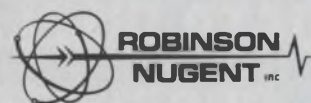

800 East Eighth Street  
New Albany, Indiana 47150  
(812) 945-0211 TWX 810-540-4082

INFORMATION RETRIEVAL NUMBER 72

# PUT A LITTLE LIGHT IN YOUR DESIGN

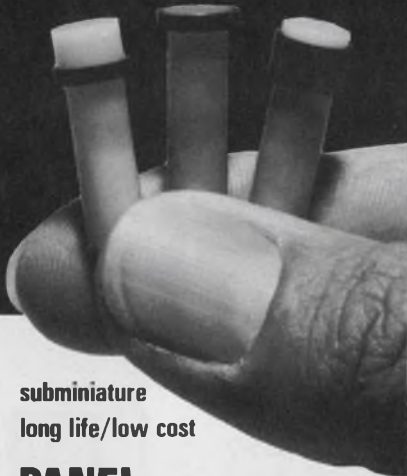

subminiature  
long life/low cost

## PANEL INDICATOR LIGHTS:

- LED's (3/16" & 1/4" mtg. dia.)
- Self-Driven  
Incandescents  
(built-in drivers & keep alive bias)
- Standard Neons  
& Incandescents
- Customs too!

Ruggedly built with shock proof and fully insulated bodies. ■ Attractively designed and available in several lens and collar colors. ■ Low profile and standard mounting models. ■ Life ratings to 30 years ■ Front panel replaceability with optional panel mount sockets. ■ Low cost and ready availability.

Call or write for more information today!

the little light people

## DATA DISPLAY PRODUCTS

8036 Westlawn Ave., Los Angeles, Ca 90045  
(213) 641-1232

## COMPONENTS

### Miniswitch has single, wiping snap element

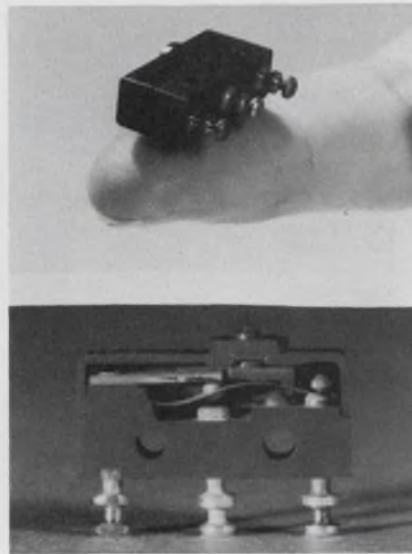

Airpax Electronics, 1836 Floradale Ave., S. El Monte, Calif. 91733. (213) 579-2531. \$2.09 (moisture-proof); \$5.25 (water-tight); (1-9); 2 wks.

This subminiature switch, designated BSM 2001, uses a single "sinuous" moving element that creates a snap-action and contact wipe. Designed to meet MIL-S-8805/2F and MS25085, these switches are available with solder lugs or single or double turrets. Specs include: actuate, 5 oz. max., release, 1 oz. min.; resistive rating: 5 A at 120 V ac or 28 V dc; inductive rating: 5 A at 120 V ac or 3 A at 28 V dc.

CIRCLE NO. 372

### Tapped delay line available in DIP

Vanguard Electronics, 930 W. Hyde Park Blvd., Inglewood, Calif. 90302. (213) 678-7161. \$5 (unit quantity); 4-6 wks.

The in-line packaging of a series of toroids makes feasible the design of circuits said to be formerly impractical. The DipLine delay lines offer, in DIP packages, impedances of 50, 100 and 200 ohms, with delay times of 50 to 150 ns. Standard rise times range from 12 to 35 ns. Units have up to 10 taps and come in 14 or 16-pin versions. Custom-designed units are available.

CIRCLE NO. 373

### Gas discharge display operates from batteries

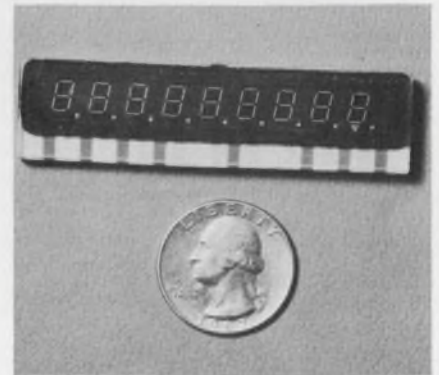

Burroughs Corp., Electronic Components Div., Box 1226, Plainfield, N.J. 07061. (201) 757-5000. \$1.10 per digit (50,000, 8-digit units); stock.

Panaplex II panel display is designed for hand-held calculators and small instruments operating on battery power. The 0.209-in. character height is sized for direct viewing. Its eight-digit panel has an over-all size of 2.65 × 0.69 × 0.197 in. (not including tubulation). Power consumption is between 0.35 and 3.0 mW per segment, depending on the brightness needed. Typical applications use 1 mW per segment.

CIRCLE NO. 374

### Safety thermal cut-out is small and low cost



Micro Devices Corp., 1881 Southtown Blvd., Dayton, Ohio. (213) 294-0581. 21.2¢; stock

The MICROTAMP type 4D is a ceramic-based package designed to provide protection against hazardous overheating. The unit requires little space and uses only two holes for mounting. It can handle up to 30 A at 300 V. Available temperature ratings are from 136 to 468 F.

CIRCLE NO. 375

## Indicators available with EMI shielding

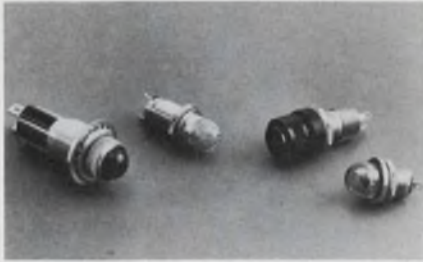

Marco-Oak Industries, 207 S. Helena St., Anaheim, Calif. 92803. (714) 535-6037.

EMI-shielded indicators are offered in miniature and standard sizes. They meet government specs for EMI, and many have a press-to-test feature. Lengths from 0.58 to 1.70 in. and diameters of 0.23 to 0.75 in. are available. A variety of domed and flat, round caps with heights of 0.28 to 0.58 in. may be specified. Units use T 1-3/4 incandescent or neon lamps in miniature models and T 3-1/4 lamps in standard versions.

CIRCLE NO. 376

## 360 degrees phase shift provided at rf or i-f

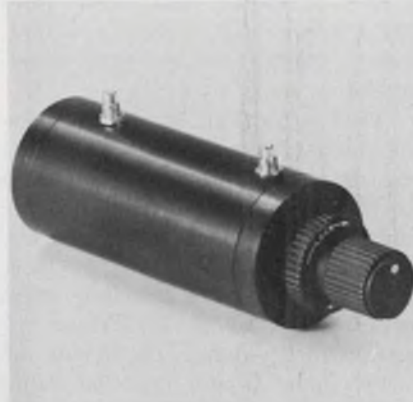

Timing Systems, Inc., Marblehead, Mass. (617) 631-0335. Stock to 3 weeks.

The 30 series operates at an i-f or rf frequency and provides a full 360 degree phase shift with 0.01 degrees resolution. The outstanding feature is the low insertion loss. Standard center frequencies are available in the 0.1 to 45.0 MHz range with 50-ohm load impedance.

CIRCLE NO. 377

## Annunciator bleeps 70-dB warning



Cybersonic Div., C. A. Briggs Co., P.O. Box 151, Glenside, Pa. (215) 885-2244.

The Bleptone emits an alerting signal of 70-86 dB at a distance of 1 meter and a frequency of 2500 Hz  $\pm$  500 Hz. Because it has 20% signal distortion, the masking effect of background noise is minimal. The unit operates from 8 to 16 V dc, with low current drain (5 to 9 mA) and no RFI. Both a nylon ring and a horn adaptor, for a 1-5/32 in. diameter hole are available for mounting.

CIRCLE NO. 378

## NEW '71 Edition Stock Die List of BOKER'S 'Bastard' Washers and Spacers

### FREE

Over 1600 sizes, with 400 new ones included. Select your Boker Washer from the hundreds of die sizes in stock. Order any quantity, any material from stock die without die charge. For a size not listed you will find Boker's die charge is low. Either way, stock special or special special, delivery is quick, cost is low, quality certified.

Send print for prompt quote or PHONE.

BOKER'S Complete Stamping Service includes tooling, stamping, forming, drawing, welding, secondary operations and thorough inspection including metallurgical lab. Quantities from a handful to a carload. Send print for prompt quote.

Phone, 612, 729-9365.

Stamping Specialists **BOKER'S, INC.** Since 1919  
3107 Snelling Ave. So. • Minneapolis, Minn. 55406



Hundreds of sizes  
I.D., .027" to 1.637"  
O.D., .086" to 1.935"  
Thickness .004" to  
.190" Material, ANY.

## Introducing the expensive dual-trace scope that doesn't cost a lot.

The B&K Precision Model 1470.

The compact 5-inch solid-state 1470 is specially designed to meet 80% of all industrial scope applications.

It has DC to 10 MHz bandwidth with 10 mV/cm sensitivity. Sixteen triggered-sweep speeds range from 1  $\mu$ sec/cm to 0.2 sec/cm. Triggers on input signals as low as 5mV.

# \$499<sup>95</sup>

Sound good? Our prices become even more remarkable once you see our specs.

Call your B&K distributor. Or write Dynascan Corporation.

In stock at your parts distributor.



Product of  
Dynascan Corporation  
1801 West Belle Plaine Avenue, Chicago, Illinois 60613

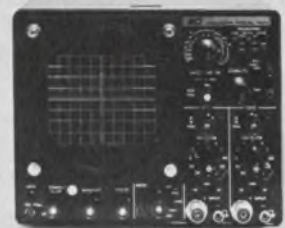

INFORMATION RETRIEVAL NUMBER 74

ELECTRONIC DESIGN 12, June 8, 1972

INFORMATION RETRIEVAL NUMBER 75

109

# Reduce Car Maintenance Increase Engine Performance.

Put a Mark Ten Capacitive Discharge Ignition (CDI) System On Your Car.



Even Detroit finally recognizes that electronic ignition systems dramatically increase engine performance. Chrysler is now putting them on their new models. The Mark Ten CDI, the original electronic ignition system, has been giving increased performance with lower maintenance to hundreds of thousands of satisfied customers for over eight years. Install a Mark Ten CDI on your car, boat or truck and eliminate 3 out of 4 tune-ups. Increase gasoline mileage up to 20%. Enjoy improved engine performance. Or put a Mark Ten B on your car. It was especially designed for engines with smog control devices. By reducing combustion contaminants, the Mark Ten B restores power losses caused by these devices. Equipped with a convenient switch for instant return to standard ignition, the Mark Ten B is applicable to ANY 12 volt negative ground engine. Both systems install in 10 minutes with no rewiring. Order a Mark Ten or Mark Ten B CDI today.

- Mark Ten (Assembled) \$44.95 ppd.
- Mark Ten (DeltaKit) \$29.95 ppd.  
(Kit available in 12 volt only, positive or negative ground.)
- Mark Ten B \$59.95 ppd.  
(12 volt negative ground only)

Superior Products at Sensible Prices  
Mfg. in U.S.A.



Dept. ED  
**DELTA PRODUCTS, INC.**

P.O. Box 1147/Grand Junction, Colo. 81501  
(303) 242-9000

Please send me free literature.

Enclosed is \$ \_\_\_\_\_  Ship ppd.  Ship C.O.D.

Please send:

- \_\_\_ Mark Ten B @ \$59.95 ppd.
- \_\_\_ Standard Mark Ten (Assembled) @ \$44.95 ppd.
- \_\_\_ 6 Volt: Neg. Ground Only
- \_\_\_ 12 Volt: Specify
- \_\_\_ Positive Ground \_\_\_ Negative Ground
- \_\_\_ Standard Mark Ten (Deltakit®) @ \$29.95 ppd.  
(12 Volt Positive Or Negative Ground Only)

Car Year \_\_\_\_\_ Make \_\_\_\_\_  
Name \_\_\_\_\_  
Address \_\_\_\_\_  
City/State \_\_\_\_\_ Zip \_\_\_\_\_

## COMPONENTS

### DIP-packaged resistors convenient for logic

CTS of Berne, Inc., 406 Parr Rd., Berne, Ind. (219) 589-3111. 760-3: \$0.74; 760-1: \$0.91 (500-999).

The Series 760, 14-pin DIP cermet resistors provide seventeen, 7-resistor units (760-3) from 68  $\Omega$  to 22 k $\Omega$  and eighteen, 13-resistor units (760-1) from 100  $\Omega$  to 22 k $\Omega$ . Resistance tolerance is  $\pm 2\%$ . Operating characteristics include max. of 1.5 W at 70 C (1/8 W per resistor) with temp coefficient of  $\pm 300$  ppm/ $^{\circ}$ C and tracking value of  $\pm 50$  ppm/ $^{\circ}$ C. They have a short-term overload capability of 2.5 times rated for 5 s.

CIRCLE NO. 379

### Solid-state relay comes in 62 new varieties

Ohmite Manufacturing Co., A North American Philips Co., 3601 Howard St., Skokie, Ill. (312) 675-2600. \$7.69 (100); stock to 6 wks.

Ohmite has added 62 varieties of solid-state and hybrid relays to its line, totaling 162 models. Load ratings are 2, 5, 10 and 15 A at 120 and 240 V ac. Standard and synchronous (zero voltage turn-on) switching options, with choice of spst-N.O., spdt and dpst-N.O., are available. Input voltages can be dc (3 V to 32 V at 4 mA) or ac (15 V to 120 V). All types are self-protected against false activation and damage by inductive loads.

CIRCLE NO. 380

### Opto-isolator offers tenfold gain in speed

Monsanto Commercial Products Co., 10131 Bubb Rd., Cupertino, Calif. 95014. (408) 257-2140. \$5.40 (1-99); stock.

The new MCT2F opto-isolator is 10 times faster than the company's previous devices and has twice the gain  $\times$  bandwidth of any others on the market, according to Monsanto. It has a typical rise-fall time of 2  $\mu$ s at 50 mA drive and is TTL compatible. Saturated turn-on time is 4  $\mu$ s and saturated turn-off time is 17  $\mu$ s, maximum, at  $I_c = 16$  mA. Packaged in a 6-pin DIP, this 2-kv unit provides isolation like a relay.

CIRCLE NO. 381

### Timer/programmer has two 60-point actuators

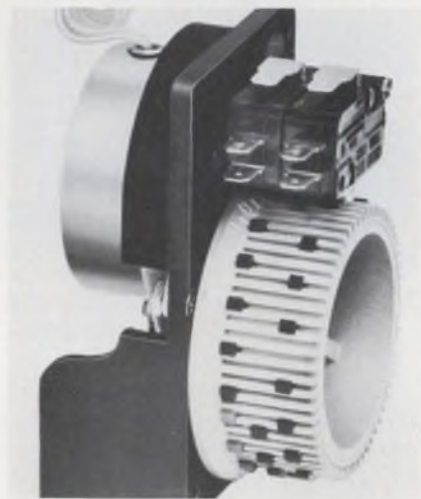

Sealelectro Corp., Programming Devices Div., 225 Hoyt St., Mamaroneck, N.Y. (914) 698-5600.

A field-adjustable timer/programmer, using momentary and bridging type actuators positioned on a rotating drum, provides two channels of 60 control points. The timer operates two independent 15-A, snap-action, switches. Drum speeds of 1 rph, 1 rpm, 2/5 rpm and 1/24 rpm are standard. Unused actuators are stored on the drum in an inactive position.

CIRCLE NO. 382

### Keyboard is one-eighth inch thin has low ohms



Wild Rover Corp., 97 Oak St., Norwood, N.J. (201) 768-8393.

One-piece, apparently flat-surfaced, "Mono-lithic" keyboards are available in almost any size or shape, with units as thin as 1/8 in. They are totally sealed and shock, vibration, dust, oil, and water resistant. A resistance of 10 to 30 m $\Omega$  remains throughout the switch life. Life expectancy of any keyboard system is said to be 1 to 10 million cycles depending on current handled.

CIRCLE NO. 383



## Matched tuning diodes operate to 500 MHz

KEV Electronics Inc., Wilmington Industrial Park, Wilmington, Mass. 01887. (617) 658-6970.

A family of hyper-abrupt vhf tuning diodes, KV2001 through KV-2701, allows octave tuning up to 500 MHz or straight-line-frequency tuning with a 1.5:1 frequency ratio over a 3-to-8 V range. With an available capacitance range of 10 to 500 pF, and "high" Q (how high, not given), the diodes have "large signal handling" capability (how large, not stated). Standard units are available at no additional cost in matched sets. The premium line, KV2001A through KV2701A, provides a tolerance of  $\pm 5\%$ . The diode's reproducibility is attributed to the use of ion-implantation technology. Applications include: frequency and phase modulators, FM and TV tuners, sweep generators.

CIRCLE NO. 384

## DIP socket is 1/8-inch thick, has 22 contacts

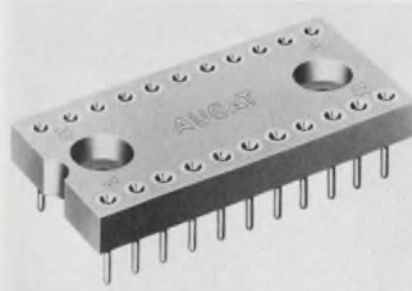

Augat, Inc., 33 Perry Ave., Attleboro, Mass. (617) 222-2202. \$1 to \$2; stock to 3 wks.

A 22-contact DIP socket offers printed circuit or Wire-Wrap terminations and includes machined beryllium copper, gold-plated contacts with a choice of gold-over-nickel or tin-plated sleeves. The 1/8-inch thick, glass-filled nylon sockets accept DIPs with round or flat leads on 100-mil spacing with 400 mils between rows.

CIRCLE NO. 385

## LED interchangeable with incandescent lamp

Dialight Corp., 60 Stewart Ave., Brooklyn, N.Y. (212) 889-7767. \$0.84 (1000 and up).

Developed as a direct replacement for a T-1 3/4 incandescent lamp, Dialight's series 549 Bi-Pin LED lamp comes in voltages from 1.7 to 14 V and currents to 30 mA. The LED, made from a gallium-arsenide phosphide, is capped with a red-diffused lens. It has a built-in limiting resistor and termination pins molded into a plastic case. Its life and reliability are much greater than those of incandescent equivalents. The rigidity of its 0.025-in. gold-plated pins permits socket or direct PC mounting. Gold plating helps soldering. Lamps can be driven directly from DTL and TTL logic. With life measured in years, they are immune to shock and vibration that would destroy a filament lamp.

CIRCLE NO. 386

## SPECIAL INTRODUCTORY SAVINGS ON ACTIVE FILTERS!



A.P. Circuit's Active Filters are cheaper to buy than to build. Save 50% on the cost of a standard 24 Db/Octave skirt Low-Pass or High-Pass A.P. Circuit Filter. (Offer good to July 15th; one unit per customer. Any breakpoint frequency in 2 Hz to 10 kHz Range.)

We also offer: • Sharp Skirt 8 pole 48 Db/Octave Low-Pass, High-Pass or Band-Pass Filters. • High Q narrow bandwidth Notch Filters. • Variable Frequency Multipurpose Filters. • Voltage Controlled Filters.

Fill out Order Blank below and mail to:

### A.P. CIRCUIT CORPORATION

865 WEST END AVENUE, NEW YORK, N. Y. 10025

#### ORDER BLANK

Yes! Please send me the following filter at a 50% savings  
 Check one: High Pass  Low Pass  \$26.50 (Reg. \$53.00)  
 Break Point Frequency: \_\_\_\_\_  
 Purchase Order Number \_\_\_\_\_ Information only \_\_\_\_\_  
 Name \_\_\_\_\_  
 Company \_\_\_\_\_ Title \_\_\_\_\_  
 Address \_\_\_\_\_  
 City \_\_\_\_\_ State \_\_\_\_\_ Zip \_\_\_\_\_

INFORMATION RETRIEVAL NUMBER 77

ELECTRONIC DESIGN 12, June 8, 1972

## Introducing the expensive curve tracer that doesn't cost a lot.

The B&K Model 501A.

It hooks up to any scope, old or new. (Like our Model 1460 triggered-sweep scope.)

And it analyzes all semi-conductors including J-FET's, MOS-FET's, signal and power bipolar transistors, SCR's, UJT's and diodes. Fast and easy.

Constant current and voltage steps with 3% accuracy make the Model 501A an exceptional value. In fact, it performs like \$2,000 units. Yet you can afford one on each engineer's bench. And another for incoming quality control.

Call your B&K distributor. Or write Dynascan Corporation.

In stock at your parts distributor.



Product of Dynascan Corporation  
 1801 West Belle Plaine Avenue, Chicago, Illinois 60613

# \$129<sup>95</sup>



INFORMATION RETRIEVAL NUMBER 78



## evaluation samples

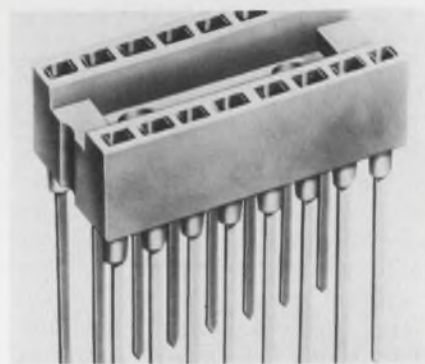

### 16-pin socket

A 16-pin solderless wrap D.I.L. socket—the A23-2042—accommodates 16 lead packages. The socket body is molded in glass loaded nylon A190 and is fitted with gold plated pre-tensioned double wiper blade contacts. The terminal posts are standard 25 mil and provide over 0.5-inch of wrapping length. The over-all dimensions of less than  $0.8 \times 0.4$  inch allow close packing on a 0.1-inch matrix. Prices are 70¢ each for quantities of 250. Jermyn.

CIRCLE NO. 387

### Brake calculator

A caliper disc brake and clutch calculator determines the torque required to start or stop a rotating mass or moving vehicle or object. It also helps determine how much heat will be generated, thus allowing the user to select a clutch or brake/disc combination based on torque required and heat to be dissipated. Tol-O-Matic.

CIRCLE NO. 388

### Display reproductions

Printed self-adhesive strips exhibit reproductions of Sperry displays digits and characters. The strips were developed to aid designers in visualizing the appearance of Sperry displays on prototype equipment and mock-ups. Strips are available for both the 1/3 and the 1/2-inch Sperry displays in both natural orange and filtered red. Sperry Information Displays Div.

CIRCLE NO. 389

# Learn how to guard against heart attack

Ask your Heart Association for vital information on the early warning signs of heart attack and what you should do to reduce your risk.

You can also learn more about high blood pressure, stroke, inborn heart defects and other heart and blood vessel diseases in interesting booklets prepared by medical experts. They are free — an educational service made possible by your gifts to the Heart Fund.

**GIVE...** so more will live **HEART FUND**

Contributed by the Publisher



## Potting epoxy

A solvent-free, low-viscosity (2000 cps) communications epoxy compound assures high reliability terminations in electrical and telephone cables under a wide variety of environmental conditions. Tra-cast 3033 is a two-part system that offers superior adhesion to most metals, elastomers and plastics commonly used in cables and connector hardware. The mixed material has a 20-minute pot life, and cures overnight at room temperature. It retains resiliency over a -60 C to 120 C temperature range. Tra-Con, Inc., Resin Systems Div.

CIRCLE NO. 390

## Cable ties

Locking and releasable one-piece nylon cable ties are offered in a variety of sizes and types. A series of catalog bulletins also describe cabling tools and accessories. Panduit Corp.

CIRCLE NO. 391

# design aids

## Silica reactions

A two-color chart presents the rate of attack of silica glass by alkalis and other selected reagents. The chart distinguishes among six different responses—no change, coating or staining, spots of devitrification, surface devitrification, severe devitrification, and failure due to devitrification—at temperatures ranging from 300 to 1450 C. The chart presents data on 32 elements, 9 oxides, two hydroxides, two carbonates, and 14 halides. General Electric Co., Lamp Glass Dept.

CIRCLE NO. 392

## Gear calculator

An analog slide rule type scale defines addendum, tooth thickness, working depth, whole depth and circular pitch for standard involute spur gears. Pic Design Corp.

CIRCLE NO. 393

## Conversions wall chart

A two-color, 34-in. × 22-in. wall chart presents material on digital codes, d/a conversion factors, pulse nomenclature, dB/voltage/current/power relationships, time-domain/frequency-domain conversions, peak average/rms conversions. Ballantine Laboratories, Inc.

CIRCLE NO. 394

## Vacuum calculator

A pocket-sized vacuum calculator for engineers and designers working in high-vacuum systems contains two scales providing a choice between a Stokes single stage Microvac or a two-stage mechanical pump. The back of the calculator contains a pressure/time scale making the selection of a Stokes mechanical booster simple and quick. The new calculator also contains conversion factors along with other information pertinent to the vacuum sciences. Pennwalt Corp., Stokes Div.

CIRCLE NO. 395

## ROGAN'S NEW 500 SERIES



### VERSATILITY IN CONTROL KNOBS

How can a control knob be versatile? By being available in four sizes in both plain and aluminum-skirted styles. By being available with round shaft hole and set screw *or* with threaded female insert *or* with threaded stud.

Achieve a unified front panel appearance by specifying the versatile "500 Series" by Rogan. Write for our complete catalog.

**Rogan**

8015 N. Monticello Ave. • Skokie, Ill. 60076  
(312) 675-1234 TWX: 910-223-4547

## Introducing the expensive digital multimeter that doesn't cost a lot.

The B&K Precision Model 281.

This 2½-digit unit is so versatile, its range covers 99% of your measurements. And its DC accuracy is 1%. The stable 281 also gives you positive over-range and wrong-polarity indications. It's easy to use (even for semi-skilled people). And easy to read across all 26 ranges, 100mV to 1000V.

Naturally, we're enthused about our Model 281. You will be, too, when you see our complete specs.

Call your B&K distributor. Or write Dynascan Corporation.

In stock at your parts distributor.



**\$169<sup>95</sup>**



Product of Dynascan Corporation  
1601 West Belle Plaine Avenue, Chicago, Illinois 60613

INFORMATION RETRIEVAL NUMBER 79

ELECTRONIC DESIGN 12, June 8, 1972

INFORMATION RETRIEVAL NUMBER 80

113

## application notes

### Conversion factor

A summary chart listing frequently used scientific factors includes metric conversion for various electrical terms. Aremco Products, Inc., Briarcliff Manor, N.Y.

CIRCLE NO. 396

### Thermocouple calibration

The latest calibration tables for thermocouples just released by the National Bureau of Standards are available in a new CT-3 Thermocouple Calibration Tables and Alloy Data Reference Book, which contains calibration tables for all thermocouples in use in industry. These new tables supersede all tables listed in NBS Circular #561, which has been the standard for the temperature measurement industry since 1955. The new handbook contains no advertising or product information. Omega Engineering Inc., Stamford, Conn.

CIRCLE NO. 397

### Comm systems manual

EMR Computer has announced the availability of a 30-page "Communications Systems General Information Manual." Discussion centers around EMR's 6100 Series systems, including the 6135 computer and the new 6145 computer. EMR Computer, Minneapolis, Minn.

CIRCLE NO. 398

### Tracking a/d converters

An eight-page application note provides details on the design, construction and performance of a compact high performance 8-bit tracking a/d costing less than \$30. This converter uses the aimDAC-100-CCT1 10-bit d/a converter and monoCMP-01CJ fast precision comparator plus only three logic packages. A ten-bit accuracy version can be built for about \$40 by using the aimDAC100-ACT1, the monoCMP-01CJ and four logic packages. The completed converter has  $\pm 1/2$  LSB linearity from 0 to 70 C and is capable of tracking 10 Vp-p sine waves up to 4.5 kHz. Precision Monolithics Inc., Santa Clara, Calif.

CIRCLE NO. 399

## new literature



### Microwave diodes

A comprehensive 70-page, fully-illustrated guide to microwave diodes describes over 1000 styles and types. Included is in-depth technical data, discussion of product applications, a standard test program, burnout information and facilities capabilities. A full set of outline drawings showing commonly used microwave semiconductor packages is also included. Most importantly, these case styles show dimensions in both the inch and metric systems. Alpha Industries, Inc., Woburn, Mass.

CIRCLE NO. 400

### Microwave amplifiers

A new short form catalog covering a full line of transistor amplifiers includes full specifications and outline drawings for quick reference capability. Over 40 configurations of amplifiers are included which cover such applications as communications and telemetry, low noise UHF, low noise wideband, medium power requirements, special bands and TWT replacements. Aertech Industries, Sunnyvale, Calif.

CIRCLE NO. 412

### DIP sockets

Two production mounting sockets eliminating need for desoldering devices or expense of replacing entire PC boards are described in a technical bulletin. The bulletin provides material descriptions, line drawings, mechanical specifications and photographs of both dual-in-line and "Quad Pak" sockets. Barnes Div. of Bunker Ramo Corp., Lansdowne, Pa.

CIRCLE NO. 413

### DACs

Five series of d/a converters are described in a new four page brochure. All electrical and mechanical specifications, performance data and application data are listed. The devices can be used for a wide variety of converter applications, including very low cost single-channel a/d converters, CRT display and servo drivers, with additional uses in data transmission via modems, programmed/feedback control systems and digital frequency synthesizers. Datel Systems, Inc., Canton, Mass.

CIRCLE NO. 414

### Angle-to-digital converters

A series of angle-to-digital converters and plug-in modules are described in an eight-page brochure. The series, known as the Model ADC Series, adapts to either a synchro-resolver-to-digital converter or to a programmable bridge by the use of plug-ins. The series includes three mainframes and four plug-ins. A full selection chart is included, along with comparisons between converters and bridges and a glossary of terms. Singer Instrumentation, Los Angeles, Calif.

CIRCLE NO. 415

### Hybrid relays

A four-page folder, "Solid State Hybrid Relays—Applications and Information," is designed to help the potential hybrid relay user in matching the right solid state hybrid with his particular application requirements. Six hybrid relay models are presented with appropriate terminal wiring diagrams, general input and output parameters and detailed application information. Potter & Brumfield, Princeton, Ind.

CIRCLE NO. 416

### Photocells

Detailed information on a complete line of Cd/S, Cd/Se and selenium photocells and optical isolators is described in a four-page brochure. Temperature coefficient curves, on-off resistance levels and response time information is also included. Solar Systems, Inc., Skokie, Ill.

CIRCLE NO. 417

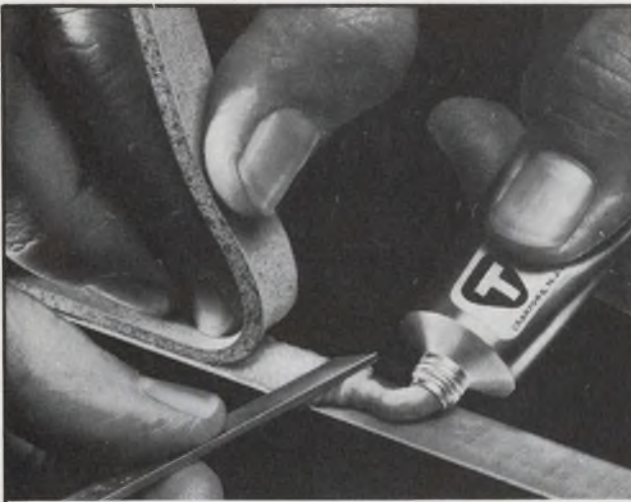

## ONE-PART CONDUCTIVE SILVER/SILICONE ADHESIVE

CONDUCTIVE SYSTEM 72-00002 • EMI/RFI shield and fluid seal • Fast, room-temperature cure • Permanent flexibility • Highly compressible • Pure silver and silicone • Copper and solvent free • Unaffected in salt spray environment • Volume resistivity: 0.010 ohm-cm • No mixing or measuring • Operating temperature: -75°F. to +350°F. • Available in 2.0 ounce kits • Write for data #721 on Conductive System 72-00002.



East Division • 129 Dermody St., Cranford, N. J. 07016 (201) 272-5500  
West Division • 427 Olive St., Santa Barbara, Calif. 93101 (805) 963-1867

INFORMATION RETRIEVAL NUMBER 81

If you need a relay of special design; not listed in any catalog and you need it in a hurry — then contact LINE ELECTRIC right now, because that's our specialty.

It has been for 22 yrs.

201/887/8200



**LINE ELECTRIC**

**A UNIT OF ESTERLINE CORPORATION**

Line Electric Company, U.S. Highway 287, Parsippany, N.J. 07054

INFORMATION RETRIEVAL NUMBER 82

ELECTRONIC DESIGN 12, June 8, 1972

## A CAMBION® Double "QQ" Product Line

Not every design engineer will opt for putting his IC's in separate sockets, but an increasing number are doing it every day.

And for three good reasons.

First, serviceability. IC's are easier to service and replace.

Second, protection. A DIP should not be subjected to elevated temperatures of pin soldering.

Third, reliability. Wire-wrapping requires true position and precisely formed contacts for hand or automatic wiring.

You know the reasons for socketing. Now, let's tell you why the CAMBION Double "QQ" line of sockets will serve you better.

First, quality. In both design and manufacture, CAMBION controls the body design and materials, contact plating, contact retention, profile and durability.

Second, quantity. In body design and variety, CAMBION has 8, 14, 16, 18, 22, 24, 28, 36 and 40 pin sockets, either Wire-Wrap\* or solder.

These add up to the CAMBION Double "QQ" approach: traditional CAMBION quality in quantity. With CAMBION Sockets, the quality stands up as the quantity goes on.

To be plugged in, get the full CAMBION Socket story by asking for our Callout and latest Catalog #99.

They're both free. Cambridge Thermionic Corporation, 445 Concord Avenue, Cambridge, Massachusetts 02138. Phone: (617) 491-5400. In Los Angeles, 8703 La Tijera Blvd. 90045. Phone: (213) 776-0472.

## Three basic reasons for socketing IC's



INFORMATION RETRIEVAL NUMBER 83

## Data conversion

A full line of data conversion products and systems with specifications and prices is presented in a new brochure. The brochure discusses in detail data conversion capabilities as well as the company's exclusive PINTO (pin test oriented) packaging concept which permits the standard product modules to plug in or be wire-wrapped into any printed circuit card system. Xincom Corp., Chatsworth, Calif.

CIRCLE NO. 418

## Power hybrid circuits

The Power Hybrid Circuits Product Guide, PHC-600, contains abbreviated data on linear amplifiers with current capabilities up to 7 A, series voltage regulators for 5, 12 and 15 V with 1 and 3% regulation, Darlington circuits with current gains of 650 minimum at 2 A, high-current output arrays, and building blocks. Typical data includes device schematic diagrams, functional diagrams, applications, socket data (if applicable) and electrical characteristics. RCA Solid State Div., Somerville, N.J.

CIRCLE NO. 419

## Electrical contact tape

A revised 28-page edition of a brochure on Econ-o-tape contact tape presents the most advanced and versatile concept in electrical contact application and fabrication technology. Complete with charts, tables and engineering data, the brochure covers contact material selection, design and application. Engelhard Minerals & Chemicals Corp., Murray Hill, N.J.

CIRCLE NO. 420

## Digital multimeters

Two brochures describe digital voltmeters/digital multimeters. Topics covered are description and applications, theory of operation, specifications and productivity analysis. Julie Research Laboratories, Inc., New York, N.Y.

CIRCLE NO. 421

## Chip resistors

A four-page, two-color brochure describes a complete line of thin film tantalum nitride chip resistors for hybrid IC applications. The brochure contains complete technical specifications for standard units and describes the firm's capabilities in the custom network field. Semi Films Technology Corp., W. Hurley, N.Y.

CIRCLE NO. 422

## Dc power supplies

A full line of standard OEM dc power supplies with complete specifications, prices and delivery schedules is presented in a new catalog. Custom power supply capabilities are also included. And application data as well as outline drawings with mounting provisions are shown. Powertec, Inc., Chatsworth, Calif.

CIRCLE NO. 423

## Flatbed recorders

An eight-page booklet describes Model 2741A and Model 2742A single or multi-range, single or dual channel flatbed recorders. Information includes specifications, ordering information and optional equipment. Simpson Electric Co., Chicago, Ill.

CIRCLE NO. 424

## Delivery systems

A new air/surface distribution program is described in the leaflet Tekair. The Tekair program moves both instrument and parts orders faster than surface transportation. Tektronix, Inc., Beaverton, Ore.

CIRCLE NO. 425

## Power supplies

Overvoltage protectors, Series M, A, B, C, D and E modules, rack adaptors and power supplies are described in a 16-page catalog. Specifications, prices and custom design capability are included. Todd Products Corp., Farmingdale, N.Y.

CIRCLE NO. 426

## Relays

An expanded 28-page catalog gives condensed specifications, dimensions and prices for over 500 relays and motor controls. New additions to the 1972 catalog are a low-cost line of 30-A power relays, 1 to 3 pole open and enclosed plug-in relays and solid state hybrid relays and timers. Struthers-Dunn Inc., Pitman, N.J.

CIRCLE NO. 427

## Pressure transducers

A 4-page catalog outlines a series of gauge and absolute pressure transducers with ranges from 0-15 to 0-12,500 psi. Models include: a general purpose; a high pressure replaceable diaphragm; a five volt, hi-output, general purpose with electronics; a wet-wet differential and others. Transducers, Inc., Sante Fe Springs, Calif.

CIRCLE NO. 428

## Trimming potentiometers

A new short form trimming potentiometer catalog describes the growing line of precision cermet and wirewound trimmers for general purpose and military applications. Mechanical, electrical and environmental characteristics are included. Weston Components, Archbald, Pa.

CIRCLE NO. 429

## Burroughs bulletins

Two bulletins are available describing panel meters and electronic components and systems. Technology, formats, a table of common terms and product applications are presented in an eight-page brochure, "Burroughs Self-Scan Panel Displays." Specifications, truth tables, drawings and diagrams are shown for panel displays, indicator tubes, modules, counting units, decoder/driver and tube bezel assemblies in a catalog entitled, "Burroughs Specifying Guide." Burroughs Corp., Plainfield, N.J.

CIRCLE NO. 430

# Allochiral

The most rugged, reliable, solderless interconnect system available. Available now. (And you'll be pleased at its low cost!)

**Lowest profile available**  
(.025" above board) permits more packaging density!

**Allows for visual inspection** of point of connection to component lead!

**Greater contacting surface** - approximately 60% of lead perimeters!

**One-piece construction** for higher reliability, substantial savings - per contact, per board, per finished assembly!

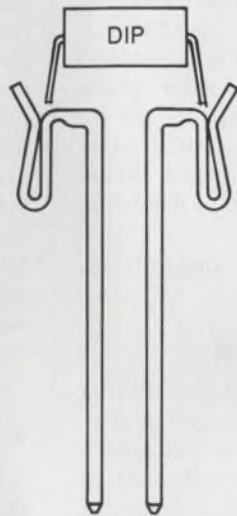

**Permits extremely short lead-length** - as short as .035" below device for full contact!

**30° angle lead-in arms** - for easier automatic or manual insertion!

**And more, much more.**

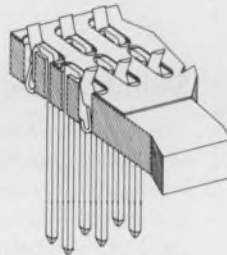

Robinson-Nugent invites your attention to its new, unique one-piece contact/terminal concept. When inserted in board, the unit becomes a properly aligned, self-supporting connector/socket for ICs or a complete back panel solderless interconnection system.

From the Socket People:



800 East Eighth Street  
New Albany, Indiana 47150  
(812) 945-0211 TWX 810-540-4082

INFORMATION RETRIEVAL NUMBER 84

## How long must you keep important papers?

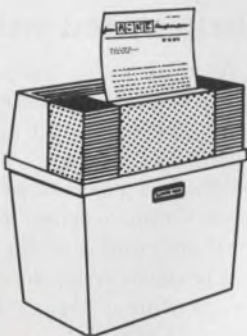

Write for free booklet, ED-6. **RECORD RETENTION TIMETABLE**, describing Retention Periods as allowed by government authorities, and how to dispose of them safely without loss or worry!

**EW ELECTRIC WASTEBASKET CORP.**  
145 West 45th St., New York, 10036  
Selected dealers all over the United States.

## Need 0007 MOS Clock Driver pin-for-pin replacement?

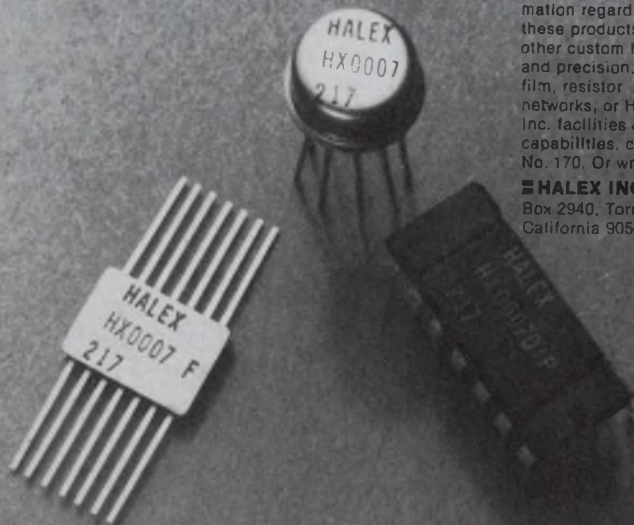

Halex, Inc., pioneer microcircuit manufacturer, now offers HX 0007, TO-100 package pin-for-pin replacement, priced at \$17.50 each, in 100-piece lots, off-the-shelf delivery.

For your new design requirements, consider Halex HX 0007 F flat pack, and HX 0007 DIP dual in-line packages.

For more information regarding these products, other custom hybrid and precision, thin-film, resistor networks, or Halex, Inc. facilities and capabilities, circle No. 170. Or write

**HALEX INC.**  
Box 2940, Torrance, California 90509.

INFORMATION RETRIEVAL NUMBER 85

## 32-bit computers

Full capabilities of Systems 85 and Systems 86 real-time computers are described in a 32-page brochure. The brochure stresses the compatibility strengths of the two distinct computer systems and also provides detailed information on options, peripherals and front-end interface equipment. Actual installations of the computer systems are also described in terms of how the company's family of hardware-software capabilities lend themselves to various operating situations. Block diagrams show how system elements are configured to meet widely different application requirements. Tables set forth the basic system specifications and list complete instruction sets including execution speeds of each instruction. Systems Engineering Laboratories, Inc., Fort Lauderdale, Fla.

CIRCLE NO. 431

## Equipment enclosures

A realistic color-coding chart for steel enclosures is shown in a four-page brochure. Colors are available in textured or smooth semi-gloss finish. Amco Engineering Co., Chicago, Ill.

CIRCLE NO. 432

## Op amps

A new comprehensive catalog gives complete technical specifications and pricing on 97 operational amplifiers and analog function modules. A convenient operational amplifier selection guide is included in the new catalog to simplify the choice of an operational amplifier. Optical Electronics, Inc., Tucson, Ariz.

CIRCLE NO. 433

## Oscilloscopes

All products introduced since March, 1971, are described in a 76-page catalog. In addition to oscilloscopes, other products listed include: automated test systems, computer display terminals, machine control products and TV test instruments and monitors. Tektronix, Inc., Beaverton, Ore.

CIRCLE NO. 434

## Power line assemblies

A data sheet describes RF filtered power line assemblies which meet virtually all industrial, federal and military standards as well as Underwriters Laboratory and NEMA specifications. According to the data sheet, Series GFP 6425 assemblies can be used whenever filtering of the power lines is desired in shielded rooms and for nondistribution type installations. The data sheet contains schematic drawings and a rating table which compares number of filters per assembly and amp rating with voltage range, weight and price. Genisco Technology Corp., Anaheim, Calif.

CIRCLE NO. 435

## Switchcraft catalog

A short form catalog listing over 6000 mechanical and electro-mechanical components features a numerical-alphabetical index which facilitates location and ordering of products. With the index, each part is shown by page number, the column on the page in which it is described and the numbered line on which it appears on the page. The catalog lists phone jacks and plugs, lever, slide, pushbutton switches, connectors and audio accessories. Switchcraft, Inc., Chicago, Ill.

CIRCLE NO. 436

## Instrument rentals

A 60-page Instrument Rental Catalog contains specifications and rental prices for more than 25 different kinds and literally hundreds of different models of electronic test and production equipment. Rental Electronics, Inc., Gaithersburg, Md.

CIRCLE NO. 437

## Plastic sockets

Sockets, accessories, transistor pads, converters, epoxy and micrologic pads, heat sinks, heat transfer washers and miscellaneous plastic products are described in a 16-page catalog. Jermyn, San Francisco, Calif.

CIRCLE NO. 438

## Test accessories

The general catalog of electronic test accessories contains more than 500 products designed to meet rigid industrial and military specifications. New products featured include: a test clip named "DIP CLIP" for testing 14 or 16-lead dual in-line IC packages; six new connecting leads, 10 new coaxial test adapters and accessories; four new banana plug/pin tip splices; two miniature test probes; plus several new additions to existing product lines. The catalog provides illustrations and complete engineering information on all products, including dimension drawings, schematics, specifications, features and operating ranges. Pomona Electronics Co., Inc., Pomona, Calif.

CIRCLE NO. 439

## X-Y recorders

Bulletin L-1012A describes Model 2745 battery or line operated portable x-y recorders and gives specifications and ordering information. Bulletin L-1014 describes Model 2747 potentiometric x-y recorder and gives specifications and ordering information. Simpson Electric Co., Chicago, Ill.

CIRCLE NO. 440

## Electronic test instruments

A mini-guide listing four lines of electronic test instruments gives you a fast glance at all major specifications needed for selecting DVMs; two series of data amplifiers; two series of electronic counters; and a series of frequency synthesizers. Also included is price information. Dana Laboratories, Irvine, Calif.

CIRCLE NO. 448

## Pin diode switches

Bulletin M870/M871 describes the latest additions to the expanding line of ultra broadband PIN diode control devices, the Model M870 SP2T and the Model M871 SP4T switches. General Microwave Corp., Farmingdale, N.Y.

CIRCLE NO. 449



## Quartz crystal filters

The entire commercial range of quartz crystal filters is now presented in a compact catalog and is set out logically in tables to simplify filter selection. Mechanical details are given in a separate section. The introduction includes a graphical representation of the present limits of crystal filter practicability and an explanation of some of the terms used in filter specification. Salford Electrical Instruments Ltd, Eccles, Manchester M30 OHL, U.K.

CIRCLE NO. 450

## Parylene coatings

"Parylene Conformal Coatings," a 16-page brochure describes a cold-coating system utilizing parylene. Parylene coatings provide unequalled thin-layer protection for precision parts, including electronic components and assemblies. The brochure discusses process of application, characteristics of coatings and current commercial uses of parylene. Union Carbide Corp., Long Island City, N. Y.

CIRCLE NO. 451

## Conductive glass

Transparent conductive glass for electronic applications is described in a 12-page technical booklet. Included are product descriptions, performance characteristics and applications for NESAs and Nesatron electrically conductive glasses. The custom products consist of a transparent flat glass substrate coated with an ultrathin layer of a metallic oxide. PPG Industries, Pittsburgh, Pa.

CIRCLE NO. 452

## Photomask substrates

Chemically strengthened alumina-soda-lime substrates for use in microcircuit photomasks are described in a two-page data sheet. Physical properties of the substrates are listed and charts show their light transmission and thermal expansion characteristics. Corning Glass Works, Corning, N.Y.

CIRCLE NO. 453



# think woven

for versatility

You name it. Any type of conductor. Any combination of functions, sizes, colors and insulation (unboundables included.) It's loom-made by Woven Electronics like nobody else can make it!

**WOVEN ELECTRONICS**  
A DIVISION OF SOUTHERN WEAVING COMPANY  
P.O. Box 189, Mauldin, S.C. 29662, (803) 288-4411

INFORMATION RETRIEVAL NUMBER 87

# dip clip

T.M.

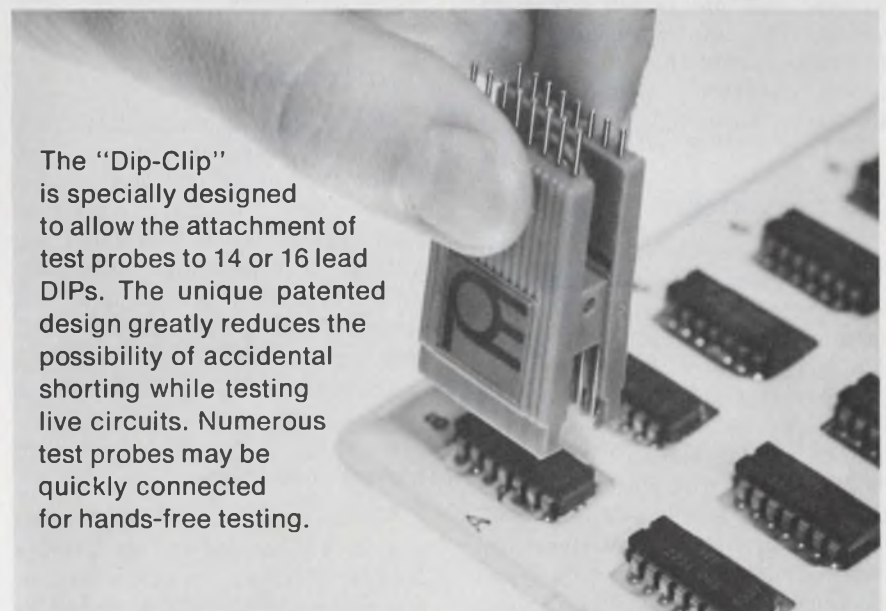

The "Dip-Clip" is specially designed to allow the attachment of test probes to 14 or 16 lead DIPs. The unique patented design greatly reduces the possibility of accidental shorting while testing live circuits. Numerous test probes may be quickly connected for hands-free testing.



**POMONA ELECTRONICS**

1500 E. Ninth St., Pomona, Calif. 91766 • Telephone: (714) 623-3463

INFORMATION RETRIEVAL NUMBER 88

## Electronic instrumentation

The 1972 condensed catalog (No. 412) details the complete line of electronic test and measurement instruments including automated and programmable equipment. The product categories covered are: computer-compatible digital ac instrumentation, true RMS wideband ac voltmeter/amplifiers, logarithmic voltmeter/amplifiers, wideband portable oscilloscopes and accessories, oscilloscope calibrators, ac/dc precision high voltage calibrators, primary ac/dc transfer standards and accessories and accessories (usable with a number of instruments rather than one particular instrument). Ballantine Laboratories, Inc., Boonton, N.J.

CIRCLE NO. 454

## 8000 series MSI

An 80-page catalog covers the 8000 Series MSI line, 26-8200 circuits and 2-8T circuits. Included are complete specifications on each device plus data on design considerations and detailed packaging and pin configurations. Design considerations covered include output structures, decoupling MSI, power supply and ground distribution systems, isolation diodes, disposition of unused inputs, input clamp diodes and signal processing. Typical applications are described and diagramed for each circuit. The catalog includes logic diagrams and truth tables for each device. Raytheon Semiconductor, Mountain View, Calif.

CIRCLE NO. 455

## D/a converters

A comprehensive 32-page handbook includes three sections that are devoted to d/a converters. One section provides basic theory on d/a converters, included are typical circuits and definitions of key parameters. Another section describes a wide variety of applications for such devices, while a third section describes a line of ultraminiature d/a converters, including detailed mechanical and electrical specifications on 48 models of four series. Datel Systems, Inc., Canton, Mass.

CIRCLE NO. 456

## Card readers for System/3

A new brochure describes eight low-cost, high-speed card readers for IBM System/3 installations. The card readers offer simplicity, multiple card reading capability and reading speeds ranging from 250 to 750 cards per minute. Five of the card readers are plug-compatible with the System/3 Mod 10 and three with the Mod 6. Bridge Data Products, Inc., Philadelphia, Pa.

CIRCLE NO. 457

## Add on core

Service considerations, advantages, and quality procedures of add-on core memory for System 360 computers are described in a 12-page brochure. Such considerations as installations, maximum enhancement levels of the various IBM models and the type of cost savings available from independent core memory manufacturers are covered. Information Control Corp., Los Angeles, Calif.

CIRCLE NO. 458

## Desk-top recorders

A four-page bulletin describes Models 2741 and 2742 potentiometric desk-top recorders. Information includes specifications, ordering information and accessories. Simpson Electric Co., Chicago, Ill.

CIRCLE NO. 459

## Card readers

A brochure describes the innovative mechanical techniques that enable the Model 600 card reader to provide virtually error-free read rates of up to 600 cards per minute. The brochure also discusses operation, performance and specifications. True Data Corp., Newport Beach, Calif.

CIRCLE NO. 460

## Power modules

Miniaturized power supplies designed for mounting on printed circuit boards and in other limited-space applications are described in a four-page brochure. Acopian Corp., Easton, Pa.

CIRCLE NO. 461

# bulletin board

Varian Data Machines has announced three software packages for its 620 line of minicomputers. The three packages are designated BEST, PERT and RPG IV/MOS. The name BEST is derived from Basic Executive Scheduler and Timekeeper, a real-time monitor which allows a variable number of core resident routines to operate concurrently within a relative priority system. PERT is an exclusive minicomputer-based system for performing scheduling analyses by the popular Program Evaluation and Review Technique. The RPG IV compiler has been incorporated under Varian's Master Operating System. This compiler is an advanced version of the RPG Report Generating System now widely used in commercial applications, but it incorporates many automatic features and powerful procedural statements not found in earlier RPG systems.

CIRCLE NO. 462

Fairchild's MOD has announced a program of product expansion and pricing changes aimed at small-volume users of visible LEDs. Fairchild has cut low and medium quantity prices of solid state lamps used as panel lights and circuit status indicators in instruments, control systems and other equipment. Reductions in 1-99 quantities bring prices below a dollar. In 100-999 quantities prices are now less than 70 cents with reductions ranging from 31 to 36 percent. MOD also has announced 11 new visible light LEDs.

CIRCLE NO. 463

Intersil, Inc. is delivering the Harris series 2500 high slew rate op amps. These amplifiers are made using dielectric isolation and on-chip precision thin film resistors, resulting in slew rates up to 120 V/ $\mu$ s with no positive feedback compensation. The amplifiers are available in a variety of types, with prices ranging from \$7.35 to \$26.70 in 100-999 quantities.

CIRCLE NO. 464

# Do you want to have the whole picture on Japan's great leap forward?

## The Japanese Miracle and Peril Willard Price

Leading the world's nations in electronics, shipbuilding, cameras, watches, literacy rate . . . gaining rapidly in other areas, Japan has risen meteorically from the ashes of World War II. Such is the Japanese miracle. Within it looms the peril, expansionism, a Japanese passion that has recurred throughout her history. Willard Price, who has been interpreting Japan to the West for more than half a century, provides a fascinating, informative account of these inter-related themes as he probes Japan's history and the Japanese character for the root explanations of her dynamism.

256 pages, #6103-x, paperback

\$3.85

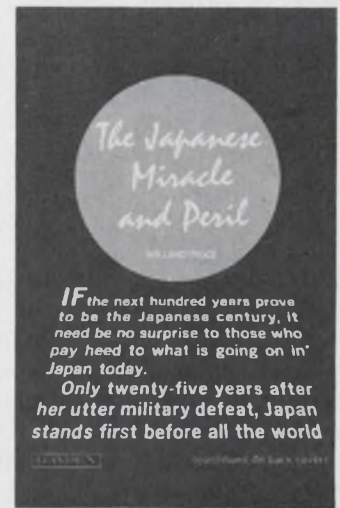

## Other New and Informative Books from Hayden

### Eight Lives in Jazz: Combo U.S.A.

RUDI BLESCH

Here are the stories behind the music, intimate portraits of the people who put their genius and dreams into a distinctly American sound. They all come alive in these pages: the late, legendary Louis "Satchmo" Armstrong; Sidney Bechet, Jack Teagarden; Lester Young; the bitter-sweet "Lady Day", Billie Holiday; Gene Krupa; Charlie Christian; and Eubie Blake.

240 pages, illustrated, #6104-8, paperback

\$3.65



### America the Vanishing: Rural Life and the Price of Progress

Edited by SAMUEL OGDEN

From paradise to pollution-riddled land, the sorry fate of the American countryside is recounted by some of our best-known writers. Audubon, Muir, Twain and others evoke the small-town and rural life that has virtually disappeared. In stark contrast, E. B. White, Rachel Carson, and other contemporaries portray the impact of progress on our environment and way of life.

256 pages, illustrated, #6105-6, paperback

\$3.95

### The Due Process Revolution: The Warren Court's Impact on Criminal Law

FRED P. GRAHAM

Demolishing the myth that the Supreme Court handcuffed the police, New York Times Supreme Court reporter Fred P. Graham reveals the background of such landmark decisions as Mapp, Escobedo, Miranda, and Wade. He places in perspective the Warren Court's courageous affirmation of the Constitution's promise of equality to all Americans.

377 pages, #6101-3, paperback

\$3.75

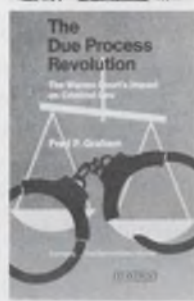

### The Politics of Fear:

### Joseph R. McCarthy and the Senate

ROBERT GRIFFITH

This compelling, award-winning study of a shameful episode in recent American history views McCarthyism as a political phenomenon created and sustained by politicians hungry for power or fearful of the passions aroused in a divided nation. In its eventual censure, the Senate side-stepped the real issues and assumptions upon which McCarthy built his career.

376 pages, #6100-5, paperback

\$3.75

### The Electronic Invasion

ROBERT M. BROWN

Anyone concerned with Big Brother's methods will find this best-selling exposé fascinating and instructive. It details all types of snooping gadgetry, names major manufacturers and buyers. The extent of governmental and corporate bugging is surveyed, and legal strictures are fully covered.

188 pages, illustrated, #0779-5, paperback

\$4.95

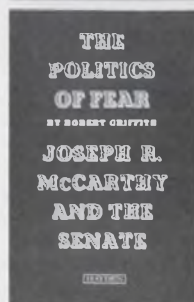

### Humanizing Schools: New Directions, New Decisions

DOUGLAS H. HEATH

A disturbing analysis of today's youngsters and of where their schools are failing them. Reporting as one intimately involved as both educator and psychologist, Douglas H. Heath presents a realistic framework for deciding what must be done, and a compelling argument, why?

240 pages, #6003-3, cloth

\$6.95

At your bookstore or by mail with this convenient coupon.

 HAYDEN BOOK COMPANY, INC., 116 W. 14th St., New York, N.Y. 10011

Please send the book(s) whose code numbers I have circled below. Enclosed is my check for the total amount, plus 25¢ to cover postage and handling on my order.

6103-X 6101-3 6105-6 6003-3 6104-8 0779-5 6100-5

If not satisfied, I may return the book(s) for full refund.

Amount enclosed: \$ \_\_\_\_\_

Send free 96-page catalog of all Hayden Books.

Name \_\_\_\_\_

Address \_\_\_\_\_

City \_\_\_\_\_

State \_\_\_\_\_ Zip \_\_\_\_\_

72-35 ED

## Price reductions

A 10% reduction in price during the month of June on all **doubly balanced mixers** has been announced by **Aerotech Industries**. These devices range in frequency from 1 to 18 GHz. The Orthostar mixers have high environmental specifications and applications in down converters, up converters, phase detectors, attenuators and modulators.

CIRCLE NO. 465

**RHG Electronics Laboratory, Inc.** has reduced prices on 42 different items of **microwave receivers, transmitters and components** and, at the same time, extended the product warranty to two years on many standard models. The changes result from increased sales volume, design and production efficiencies, and greater customer acceptance. The price reductions range from a low of \$10 on a linear IF amplifier to a high of \$550 for a log IF amplifier, with the average reduction about \$50.

CIRCLE NO. 466

**Data Technology, Inc.**, has reduced prices up to 26% for its **Opticon encoder line**. For example, the heavy-duty industrial model with a resolution of 2500 lines, originally marketed at \$520 each (in 1-9 quantities), has been reduced in price to \$395. Quantity discounts have been increased and additional quantity breaks have been added. For example, unit prices in the 75 to 99 piece category which were discounted by 7.5%, are now discounted by 15%.

CIRCLE NO. 467

Prices have been reduced by up to 33-1/3% on **Dialight Corp.'s diode-lite GaAsP solid-state LED lamps**. Affected are two twin-lead models 521-9165, which is red diffused, and 521-9166, which is clear diffused. Also affected are two tri-lead models 521-9167, which is red diffused, and 521-9168, which is clear diffused.

CIRCLE NO. 468

## vendors report

Annual and interim reports can provide much more than financial-position information. They often include the first public disclosure of new products, new techniques and new directions of our vendors and customers. Further, they often contain superb analyses of segments of industry that a company serves.

Selected companies with recent reports are listed here with their main electronic products or services. For a copy, circle the indicated number.

**TRW Inc.** Spacecraft, military communications systems, connectors, semiconductors, wire and cable, PC boards, resistors and capacitors.

CIRCLE NO. 469

**Hewlett-Packard Co.** Test equipment, computers, calculators, light-emitting diodes and LED readouts, specialized semiconductors.

CIRCLE NO. 470

**Indian Head Inc. (Information Handling Services)**. Information storage, coding and indexing systems.

CIRCLE NO. 471

**Texas Instruments Inc.** Semiconductors and ICs.

CIRCLE NO. 472

**San Fernando Electric Manufacturing Co.** Capacitors, precision potentiometers.

CIRCLE NO. 473

**The Superior Electric Co.** Stepping motors, positioning systems.

CIRCLE NO. 474

**American Telephone and Telegraph Co.** Telephone and data-transmission systems.

CIRCLE NO. 209

**John Fluke Mfg. Co., Inc.** Differential voltmeters, digital voltmeters and multimeters, frequency synthesizers, automatic test systems.

CIRCLE NO. 210

**Westinghouse Electric Corp.** Control instrumentation, CRTs, CATV systems.

CIRCLE NO. 211

**Hazeltine Corp.** Video display terminals, communications systems, signal processors, aerospace systems.

CIRCLE NO. 212

**Union Carbide Corp.** Polyethylene and vinyl resins for wire and cable batteries.

CIRCLE NO. 213

**The Plessey Co.** Glass-to-metal and ceramic-to-metal seals, microwave absorbers, ceramic substrates, semiconductor alloys, lead frames, electrochemical timers, magnetic coatings for discs and drums, drum memories, record changers, and turntables, tape-cassette mechanisms, connectors.

CIRCLE NO. 214

**Datametrics Corp.** Data printers.

CIRCLE NO. 215

**Western Electric Co., Inc.** Telephone and teletypewriter equipment.

CIRCLE NO. 216

**Diebold Venture Capital Corp.** Venture capital.

CIRCLE NO. 217

**Conrac Corp.** TV monitors, CRT terminals, computer peripherals, information-retrieval systems, aircraft instrumentation, encoders, transducers, timers and counters, digital cassette recorders.

CIRCLE NO. 218

**American Precision Industries Inc.** Inductors, electromechanical clutches and brakes, air-pollution control equipment.

CIRCLE NO. 219

**McGraw-Edison Co.** Fuses, attenuators, rotary switches, delay lines.

CIRCLE NO. 220

**Itek Corp.** Duplicating systems, electro-optics.

CIRCLE NO. 221

**Storage Technology Corp.** Magnetic-tape and disc systems.

CIRCLE NO. 222

**Wagner Electric Corp.** Readouts, small motors, power supplies, silicon rectifiers, lamps, thyratrons, metal-film resistors, vacuum photodiodes.

CIRCLE NO. 223

**Eastman Kodak Co.** Photographic and radiographic film and chemicals, data-recording and handling systems.

CIRCLE NO. 224

**Trio Laboratories, Inc.** Power supplies.

CIRCLE NO. 225

**The Electron Machine Corp.** Automatic-control and process-control instrumentation, thickness-measuring instruments.

CIRCLE NO. 226

**International Telephone and Telegraph Corp.** Communications systems, semiconductors.

CIRCLE NO. 227

**Owens-Illinois, Inc.** TV CRT bulbs, high-density, gas-discharge displays.

CIRCLE NO. 228

**Western Union Corp.** Communications systems.

CIRCLE NO. 229

**Hoffman Electronics Corp.** Audio-visual systems, navigation and communications systems.

CIRCLE NO. 230

**T-Bar Inc.** Switching components and systems.

CIRCLE NO. 231

**Philip A. Hunt Chemical Corp.** Printed-circuit etchants, photo-resists.

CIRCLE NO. 232

**Cartridge Television Inc.** Video-tape record/playback systems.

CIRCLE NO. 233

**International Business Machines Corp.** Computers and peripherals.

CIRCLE NO. 234

**Communications Satellite Corp.** Satellite communications.

CIRCLE NO. 235

**Fairchild Camera and Instrument Corp.** Semiconductors and ICs, CRTs, photomultiplier tubes, audiovisual systems, semiconductor testers.

CIRCLE NO. 236

**Aeronautical Radio, Inc.** Air-to-ground and intercity communications.

CIRCLE NO. 237

**ARINC Research Corp.** Data communications and systems analysis.

CIRCLE NO. 238

**Unitrode.** Core-memory diodes, semiconductors, integrated power-circuit modules.

CIRCLE NO. 239

**Airco, Inc.** Resistors, capacitors, radio-frequency choke coils, cermet pastes, cryogenics and medical equipment.

CIRCLE NO. 240



## Sapphire substrates. More for less.

Polished, single crystal sapphire substrates cut from sapphire ribbon stock. Standard lengths from 1/4 to 4 inches. Standard widths in 1/4, 1/2, 3/4 and 1 inch sizes. For thin film and epitaxial requirements. Available with 1102 orientation for SOS work. Free of microvoids. Low in cost. Check 'em out. Call Frank Reed, Marketing Manager, for price and delivery.

**NYCO saphikon division** 16 Hickory Drive • Waltham, Mass. 02154 • (617) 890-2400  
INFORMATION RETRIEVAL NUMBER 90

## POWER for PEANUTS

Single and Dual Regulated  
Outputs as low as \$19<sup>95</sup><sub>(1-9)</sub>

*The first real low cost  
Power Supply Modules are now  
UL LISTED\**

LCD  
POWER  
SUPPLIES

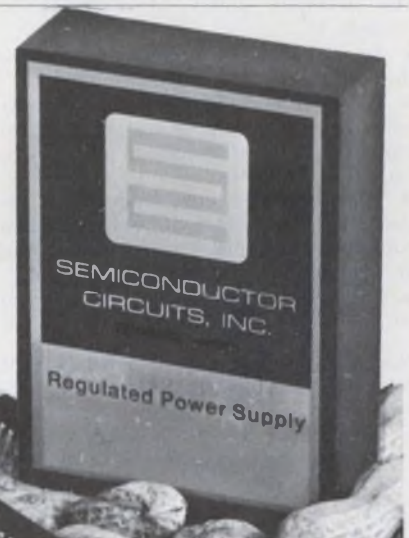

- ±15V @ 25mA\*
- ±15V @ 100mA\*
- 5V @ 500mA
- ±15V @ 50mA\*
- ±15V @ 200mA
- 5V @ 1A

**REGULATION: 0.20% max. RIPPLE & NOISE: 1 mV rms  
SHORT CIRCUIT PROTECTED**

**Plus 9 other off-the-shelf standard models**

Designed to complement the latest generation of linear and digital IC's, op amps, converters, and function modules.



**SEMICONDUCTOR CIRCUITS, INC.**

306 RIVER STREET ■ HAVERHILL, MASSACHUSETTS 01830  
(617) 373-9104

INFORMATION RETRIEVAL NUMBER 91

ELECTRONIC DESIGN's function is:

- To aid progress in the electronics manufacturing industry by promoting good design.
- To give the electronic design engineer concepts and ideas that make his job easier and more productive.
- To provide a central source of timely electronics information.
- To promote communication among members of the electronics engineering community.

**Want a subscription?** ELECTRONIC DESIGN is sent free to qualified engineers and engineering managers doing design work, supervising design or setting standards in the United States and Western Europe. For a free subscription, use the application form bound in the magazine. If none is included, write to us direct for an application form.

If you do not qualify, you may take out a paid subscription for \$25 a year in the U.S.A., \$35 a year elsewhere. Single copies are \$1.50 each.

If you change your address, send us an old mailing label and your new address; there is generally a postcard for this bound in the magazine. You will have to requalify to continue receiving ELECTRONIC DESIGN free.

**The accuracy policy of ELECTRONIC DESIGN is:**

- To make diligent efforts to ensure the accuracy of editorial matter.
- To publish prompt corrections whenever inaccuracies are brought to our attention. Corrections appear in "Across the Desk."
- To encourage our readers as responsible members of our business community to report to us misleading or fraudulent advertising.
- To refuse any advertisement deemed to be misleading or fraudulent.

Microfilm copies are available of complete volumes of ELECTRONIC DESIGN at \$19.00 per volume, beginning with Volume 9, 1961. Work is now in process to complete the microfilm edition of Volumes 1-8. Reprints of individual articles may be obtained for \$2.00 each, prepaid (\$.50 for each additional copy of the same article) no matter how long the article. For further details and to place orders, contact the Customer Services Department, University Microfilms, 300 North Zeeb Road, Ann Arbor, Michigan 48106 telephone (313) 761-4700.

**Want to contact us?** If you have any comments or wish to submit a manuscript or article outline, address your correspondence to:

Editor  
ELECTRONIC DESIGN  
50 Essex Street  
Rochelle Park, N.J. 07662

# Design Data from

## Low-Noise High-Gain Pre amplification



Complete specifications of a variable-bandwidth high-gain preamplifier are contained in the P.A.R. data sheet, T-224. Included are typical noise figure contours illustrating the amplifier's exceptionally low noise, which is as low as .05 dB at mid frequencies with a 1 megohm source. Other illustrations include typical plots of the equivalent input noise and common mode rejection, which exceeds 100 dB at 60 Hz at all gain settings. The data contained in the specification sheet will be of interest to all engineers and researchers looking for a preamplifier with calibrated gain and rolloffs from dc to 300 kHz. CIRCLE NO. 171

**Princeton Applied Research Corporation**  
Box 2565, Princeton, New Jersey 08540 - (609) 452-2111

## "Zoom In" on Any Portion of the Spectrum During Real-Time Analysis

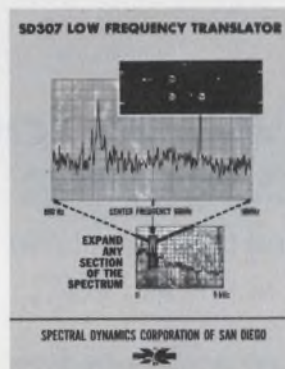

Closely spaced harmonics in a frequency spectrum can be clearly separated, analyzed and displayed in real time by combining the SD307 Low Frequency Translator with any SD301-series Real Time Analyzer. In effect, it expands a given spectrum band like a zoom lens, to enable detailed examination. Resolution can be increased by as much as 1000 to 1. The combination is especially valuable for detecting very low level periodic signals normally buried in noise. The SD307 selects any one of four "windows": 50 Hz, 100 Hz, 500 Hz and 1 kHz, providing detailed narrowband analysis of 0.15 Hz, 0.3 Hz, 1.5 Hz and 3 Hz, respectively. Send for data.

**Spectral Dynamics Corporation**  
P.O. Box 671, San Diego CA 92112

CIRCLE NO. 172

## PC Drafting Aids Catalog

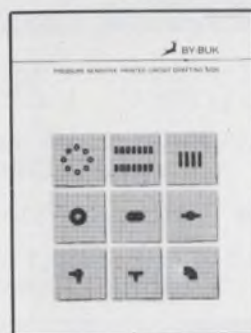

Thousands of time saving, cost saving artwork ideas are found in the By-Buk P-50 catalog of pressure sensitive printed circuit drafting aids. With the most practical artwork patterns for: TO cans, multi-pads, dual-inlines and flat packs featured. Donuts, connector strips, teardrops, ovals, tapes, tees, elbows, etc., by the hundreds are included in the most comprehensive list of sizes. Opaque black, transparent red and transparent blue materials for one and two-sided board designs. For a free copy and samples, write today.

**By-Buk Company**  
Subsidiary of Webtek Corp., 4326 W. Pico Blvd.  
Los Angeles, California 90019 (213) 937-3511

CIRCLE NO. 173

# Manufacturers

Advertisements of booklets, brochures, catalogs and data sheets. To order use Reader-ServiceCard (Advertisement)

## Create Your Own Power Supply Sub-Systems



New T. D. I. brochure offers designers complete details in grouping its famous line of adjustable range TDM (single output) and TDMD (dual output) power supply modules in a single package to meet exact requirements, without expensive cabling, racks or accessories. All modules feature front panel voltage and current limit adjustment, test points and indicator lamps. OV crowbar protection is built in. Outputs available 1.0 to 305 VDC and 0.06 to 60.0 AMPS.

CIRCLE NO. 174

### Transistor Devices, Inc.

85 Horsehill Road, Cedar Knolls, N. J. 07927  
Tel. (201) 267-1900

## Giant Free Catalog! 4,000 Unusual Bargains

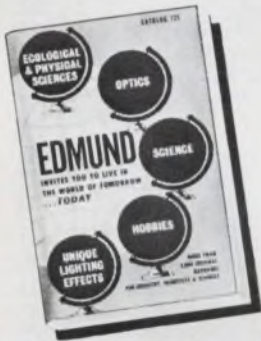

New 148-page catalog! Packed with 1,000's of hard-to-find buys in Optics, Science, Electronics. Loaded with optical, scientific, electronic equipment available from stock. Rare surplus buys. Many "one-of-a-kinds". Ingenious scientific tools. Components galore: lenses, prisms, wedges, mirrors, mounts, accessories. 100's of instruments: pollution test equipment, lasers, comparators, magnifiers, microscopes, projectors, telescopes, binoculars, photo attachments, unique lighting. Shop, save by mail! Request free Catalog "DA".

CIRCLE NO. 175

### Edmund Scientific Co.

America's Largest Science-Optics-Electronics Mart  
300 Edscorp Bldg., Barrington, New Jersey 08007 (609) 547-3488

## Economical High Performance Electrometers



New P.A.R. electrometers offer superior performance at low cost. Model 134, with wide range and high stability, is priced at \$615; Model 135, with self-contained battery power supply, \$675; and Model 136 with digital display and BCD output, \$1125. Drift, offset and noise figures are lowest available in this price range. Other features include guarded input circuits and fast recovery from large overloads. Full line of accessories available. Request new brochure, demonstration or applications assistance.

Princeton Applied Research Corporation  
Box 565, Princeton, New Jersey 08540 — (609) 452-2111

CIRCLE NO. 176

# Electronic Design

## Advertising Sales Staff

Bryce Gray  
Sales Manager

### Rochelle Park, N.J. 07662

Robert W. Gascoigne  
Daniel J. Rowland  
50 Essex Street  
(201) 843-0550  
TWX: 710-990-5071

### Philadelphia

Thomas P. Barth  
50 Essex Street  
Rochelle Park, N. J. 07662  
(201) 843-0550

### Boston 02116

Richard L. Green  
20 Columbus Avenue  
Boston, Mass.  
(617) 482-7989

### Chicago 60611

Thomas P. Kavooras  
Berry Conner, Jr.  
200 East Ontario  
(312) 337-0588

### Cleveland

Thomas P. Kavooras  
(Chicago)  
(312) 337-0588  
(call collect)

### Los Angeles 90303

Stanley I. Ehrenclou  
Burt Underwood  
2930 Imperial Highway  
Inglewood, Calif  
(213) 757-0183

### San Francisco 94022

Jerry D. Latta  
95 Main Street  
Los Altos, Calif.  
(415) 941-3084

### London W. 1

For United Kingdom and Holland  
Brayton C. Nichols

For Eastern Europe

Peter Kehr

The American Magazine Group

27 Maddox Street  
London, W. 1, England  
Phone: 499-0180

Cable: Ammagnic, London

### Verviers, Belgium

For Continental Europe

Andre Jamar  
1, Ru Mallar, 1  
087) 253.83 Telex 41563

### Tokyo

Haruki Hirayama  
Electronic Media Service  
5th Floor, Lila Bldg.,  
4-9-8 Roppongi  
Minato-ku  
Phone: 402-4556  
Cable: Electronicmedia, Tokyo



**AMERICAN BUSINESS PRESS, INC.**

# advertiser's index

Advertiser	Page	Advertiser	Page	Advertiser	Page
A. P. Circuit Corporation.....	111	Dynacor, Div. of Vectrol.....	127	Larkton Scientific .....	127
Acopian Corp. ....	92	Dynascan Corporation .....	109, 111, 113	Line Electric, a Unit of Esterline Corporation .....	115
Aertech Industries .....	16 A-B	ECC Corporation .....	7	MicroSwitch, A Division of Honeywell .....	92
Allen-Bradley .....	15	ERA Transpac Corporation.....	106	Molex, Incorporated .....	Cover III
Ampex Computer Products Division ..	22	Edmund Scientific Company.....	125	Motorola Component Products Dept. ..	17
Analog Devices, Inc.....	40, 75	Elco Corporation .....	11	Murata Corporation of America.....	104
Augat, Inc. ....	98	Electric Wastebasket Corp.....	117		
		Electronic Associates, Inc.....	96		
Beckman Instruments, Inc., Helipot, Division .....	73			North American Philips Controls Corp. ....	91
Belden Corporation .....	19	Federal Scientific Corporation.....	126	Nortronics Company, Inc.....	44
Bendix Corporation, The Electro-Optics Division .....	103	Fork Standards, Inc.....	127		
Boker's, Inc. ....	109			Philips Industries, Test and Measuring Instruments Division... ..	2
Bourns, Inc., Trimpot Products Division .....	31	General Automation, Inc.....	1	Pomona Electronics Co., Inc.....	119
By-Buk Company .....	124			Premier Metal Products Company... ..	29
		Halex, Inc. ....	117	Princeton Applied Research Corp. ....	124, 125
CTS Corporation .....	12, 13	Harris Semiconductor, A Division of Harris Intertype Corporation... ..	39		
Cal-R, Inc., a CapTech, Inc. Company .....	65	Hayden Book Company, Inc.....	121	RCA Corp. ....	18
Cambridge Communications Corp.....	115	Hewlett-Packard .....	4, 5, 77, 85	RCA Solid State Division.....	Cover IV
CELCO (Constantine Engineering Laboratories Co.) .....	46	Hughes Aircraft Company.....	36, 37	RFL Industries, Inc.....	93
Centralab, the Electronics Division of Globe-Union, Inc. ....	47	Hybrid Systems Corp.....	10	RO Associates, Inc.....	38
Computer Terminal Corporation.....	20			Raytheon Company .....	44
Constantine Engineering Labs. Co. (CELCO) .....	46	Indiana General, Electronic Products Intech, Incorporated .....	14 88	Rectifier Components Corp.....	127
Curtis Development & Mfg. Co. ....	46	International Electronic Research Corporation .....	16	Robison Electronics, Inc.....	127
				Robinson Nugent, Inc.....	107, 117
Dale Electronics .....	32, 32-1 thru 32-28, 32-28 A-B	Johanson Manufacturing Corp.....	127	Rogan Brothers, Inc.....	113
Data Display Products.....	108	Johnson Company, E. F.....	6		
Delta Products, Inc.....	110			Schauer Manufacturing Corp.....	100
Dialight Corporation .....	80	Keithley Instruments, Inc.....	89	Scientific Atlanta, Inc.....	107
Digi-Data Corp. ....	127			Semiconductor Circuits, Inc.....	123
Digital Equipment Corporation.....	48	Lambda Electronics Corp.....	Cover II	Siemens Corporation .....	2

## Design Data from Manufacturers

Advertisements of booklets, brochures, catalogs and data sheets. To order use Reader-Service Card. (Advertisement)

### Search Out 5 Peaks in Real-Time Spectrum

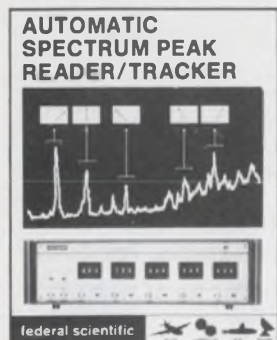

New Model 49B Peak Reader/Tracker reads out 5 selected peaks in the real-time low frequency spectrum sweep of any Ubiquitous® 200/400/500-line Analyzer. The 5 peaks can be read continuously in time on an analog or digital meter, or on 5 pens of a chart recorder. Any of the signal outputs from a Ubiquitous Analyzer or Averager (with running averaging) can be used as the output to the Model 49B — log, linear, or square law (power). Since the monitored signals may vary slightly in frequency during a test, the Model 49B searches for the highest peak within a window. The window width may be set from 10 to 20 resolution elements wide. CIRCLE NO. 177

#### Federal Scientific Corp.

A subsidiary of Elgin National Industries, Inc.  
615 West 131st Street, New York, N.Y. 10027

TEC, Incorporated .....	46
Technical Wire Products, Inc.....	115
Tektronix, Inc. ....	95, 97, 99, 101
Telecommunications Industries, Inc.....	127
Teletype Corporation .....	8, 9
Telex, Communications Division .....	45
Texas Instruments Incorporated, Components Group .....	58, 59
Transco Products, Inc.....	10
Transistor Devices, Inc.....	125
Triplett Corporation .....	43
Tyco Saphikon Division.....	123
U. S. Capacitor Corporation.....	103
U.S. Electronics Corporation.....	96
Underwriters Safety Device Company .....	44
Vactec Inc. ....	25
Vishay Resistor Products, A Division of Vishay Intertechnology, Inc. ....	71
Wakefield Engineering, Inc.....	103
Woven Electronics .....	119
Zero Manufacturing Co.....	105



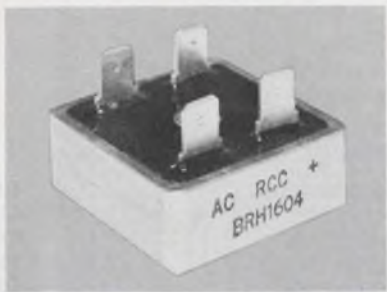

**RCC BRH1600 series 16 amp./65° C. single phase silicon bridge rectifiers.** Available voltage types of 50 to 800 volts peak with single cycle surge current ratings of 125 amps. peak. 1-99 quant. \$3.30 to \$6.60 dep. on voltage type. Rectifier Components Corp., Freeport, N.Y. 516-868-0470.

INFORMATION RETRIEVAL NUMBER 181



**Tape errors are obsolete.** Dual buffered recorder system automatically detects and skips bad tape areas and rewrites perfect tape. Additional features are: asynchronous recording rates to 50000 characters per second, no IR gap delays and selected file search. Digi-Data Corp., Bladensburg, Md. (301) 277-9378.

INFORMATION RETRIEVAL NUMBER 182



**Thin-Trim capacitors** are designed to replace fixed tuning techniques. Applications include crystal oscillators, CATV amplifiers, communication and test equipment. Series 9410 has high Q's with capacitance ranges of 1.0 - 4.5 pf and 10.0 - 50.0 pf. Johanson Manufacturing Corporation, Boonton, N. J. (201) 334-2676

INFORMATION RETRIEVAL NUMBER 183

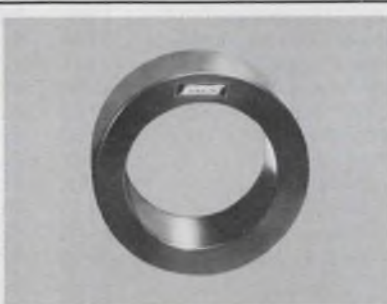

**Dynacor® miniature square-loop tape cores** (2 kHz to 500 kHz) in O. D. sizes from .203" to .675" at low cost. Low-power/High freq. for magnetic amps or guaranteed max. magnetizing current at hi-freq. over wide temp. range. For DC to DC converters. Dynacor, 1010 Westmore Ave., Rockville, Md. 20850 (301) 424-6900.

INFORMATION RETRIEVAL NUMBER 184



**Compact low frequency sine wave crystal oscillator Model BQ** provides .001% stable sine wave output from 25 Hz to 40 MHz. Hermetically sealed, 2x2x3/4" h. Priced from \$74 single quantity, depending on frequency, accuracy and output specs. Fork Standards, Inc., 217 Main St., West Chicago, Illinois 60185. (312) 231-3511.

INFORMATION RETRIEVAL NUMBER 185

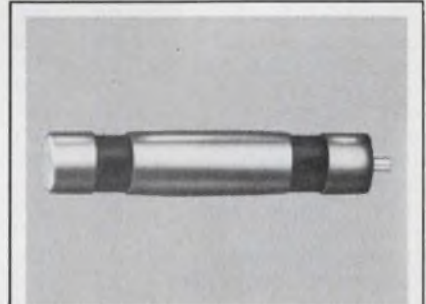

**TIL-16 gas tube arresters** stop metallic surges cold! Will withstand without damage 20 amp. a.c. for 1 sec. repeatedly on any one section, or more than 150mA a.c. for 3 hrs. For sensitive equipment or systems. Telecommunications Ind. Inc., Copiague, N.Y. 516-842-5000.

INFORMATION RETRIEVAL NUMBER 186

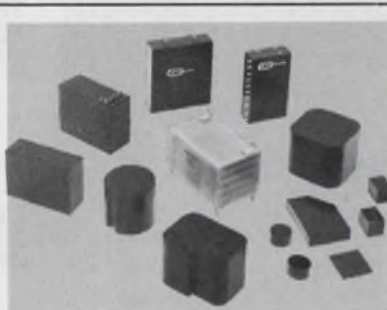

**Glass laminated epoxy 155°C cases** for component and circuit packaging are available in thousands of sizes. Thin wall tubes and headers offer optimum protection in all applications. Literature and samples available. Stevens Tubing Corp., 128 North Park Street, East Orange, New Jersey 07019. Telephone 201-672-2140.

INFORMATION RETRIEVAL NUMBER 187

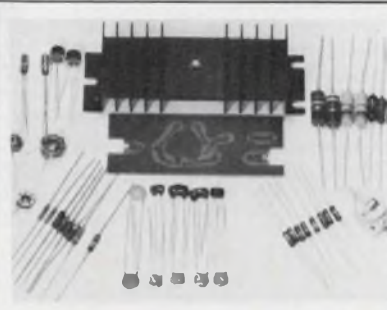

**Broad Band—No Tuning Power amplifier** in kit form. Frequency range 500 kHz to 100 MHz with 25 watts of cw power. It accepts inputs of AM, SSB, pulse and other complex modulation. The unit withstands a +15-dB overdrive including and open-circuit loads. Larkton Scientific, P.O. Box 302 Monroeville, Pa. Phone: (412) 731-6829.

INFORMATION RETRIEVAL NUMBER 188

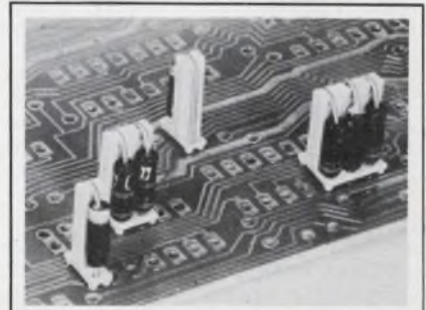

**Verti-Mount Insulators** permit vertical mounting of DO-7, DO-34, and DO-35 diodes and 1/8-, 1/4-, and 1/2-watt resistors on printed circuit boards. Verti-Mounts increase packaging density by 200%. Robison Electronics, Inc., 2134 W. Rosecrans Avenue, Gardena, Calif. 90249. Phone: (213) 321-0080.

INFORMATION RETRIEVAL NUMBER 189

# product index

**Information Retrieval Service.** New Products, Evaluation Samples (ES), Design Aids (DA), Application Notes (AN), and New Literature (NL) in this issue are listed here with page and Information Retrieval numbers. Reader requests will be promptly processed by computer and mailed to the manufacturer within three days.

Category	Page	IRN	Category	Page	IRN	Category	Page	IRN
<b>Components</b>			relay, meter	104	360	contact tape	116	420
annunciator	109	378	<b>Microwaves &amp; Lasers</b>			converters	114	415
delay line, DIP	108	373	amplifier, rf	81	250	converters	116	418
diodes, tuning	111	384	amplifiers	84	261	converters, d/a	114	414
display, panel	108	374	antenna,	82	256	converters, d/a	120	456
indicators, EMI shielded	109	376	CO <sub>2</sub> laser	82	253	delivery system	116	425
keyboard, thin	110	383	filter	81	252	diodes, microwave	114	400
LED, replaces filament	111	386	Gunn-effect source	84	260	displays	116	430
miniswitch, snap-action	108	372	isolator/coupler	82	257	enclosures	118	432
opto-isolator, fast	110	381	magnetron	82	255	filters, quartz	119	450
phase shift	109	377	magnetron	84	265	glass, conductive	119	452
relay, solid state	110	382	mixer	82	258	ICs, MSI	120	455
resistors, DIP	110	379	mixer	84	264	instrumentation	120	454
socket, DIP, thin	111	385	mixer	84	266	memory, core	120	458
thermal cut-out	108	375	mixer diode	84	262	multimeters, digital	116	421
timer/programmer	110	380	paramp	82	259	op amps	118	433
<b>Data Processing</b>			Q-switch	82	254	oscilloscopes	118	434
calculator, small	98	337	switch	81	251	photocells	114	417
calculator, small	99	338	YAG lasers	84	263	pots, trimming	116	429
controller, disc memory	97	331	<b>Modules &amp; Subassemblies</b>			power line assembly	118	435
core memory, compact	99	339	amplifier, ac	101	348	power supplies	116	426
discriminator, FM	99	341	amplifier, operational	100	343	power supplies	120	461
display, graph	99	340	amplifier, parametric	102	355	power supplies, dc	116	423
image storage, TV	99	342	converter, a/d	102	356	recorders	116	424
interface, Selectric	98	335	converter, d/a	102	352	recorders	118	440
mini, "Jumbo" size	98	336	coupler, hybrid	100	346	recorders	120	459
minicomputer	97	329	display, LED	102	354	relays	114	416
printer, high-speed	97	333	filter, active	101	350	relays	116	427
tape drive, controller	97	332	filter, active	102	353	resistors, thin-film	116	422
tape punch	97	330	oscillator, crystal	100	344	sockets	118	438
terminal asynchronous	98	334	power supplies	100	347	sockets, DIP	114	413
<b>ICs &amp; Semiconductors</b>			power supply	102	357	substrates	119	453
ALU, monolithic	96	326	power supply, hv	101	349	switches	118	436
clock, digital	94	320	quad-hybrid	101	351	switches, diode	118	449
Darlington, dual	92	308	transformer, pulse	100	345	test instruments	118	437
Hall-effect switch	94	322	<b>Packaging &amp; Materials</b>			test instruments	118	448
memory	93	310	cable, flat ribbon	88	276	transducers	116	428
memory, programmable	90	300	circuit card	86	269			
op amp	92	307	coating, dielectric	88	277	<b>application notes</b>		
op amp, FET-input	94	323	connectors, contact	88	274	computer	114	398
photodetector	96	328	connectors, panel	86	267	conversion factor	114	396
RAM, 1024-bit	91	305	DIP cases	88	275	converters, a/d	114	400
SCR	96	324	grease, thermal	88	273	thermocouples	114	397
shift register, dynamic	94	321	packages, MOS/LSI	87	270			
timer, IC	96	325	PC board	89	279	<b>design aids</b>		
triple gate	92	309	potting materials	88	272	calculator	113	393
video amplifier	91	304	probe cards	86	268	chart, silica reactions	113	392
16 k-bit ROM	91	306	sockets, 14-pin	88	278	wall chart	113	394
2240-bit ROMs	96	327	splicer	87	271			
<b>Instrumentation</b>			terminals	89	280	<b>evaluation samples</b>		
amplifier, conditioning	104	359				cable ties	113	391
analyzer, audio	105	362	<b>new literature</b>			calculator	112	388
comparator, analog	106	365	accessories, test	118	439	calculator	113	395
driller, PC board	106	369	amplifier, microwave	114	412	calculator	113	395
filter, active	104	358	card readers	120	457	epoxy	113	390
generator, function	107	370	card readers	120	460	reproductions	112	389
generator, pulse	104	361	circuit, hybrid	116	419	socket	112	387
handler, IC	106	367	coatings, parylene	119	451			
multimeter, digital	106	368	computers	118	431			
multimeter, FET	105	363						
panel meter, digital	105	364						
power supply, Ferro	106	366						
recorder, X-Y	107	371						



**HERE ARE TWO EASY WAYS TO SOLVE LIGHTED PUSH BUTTON SWITCH PROBLEMS. Economically. Reliably. Fast. The Molex 1175 snap mounts. Offers spade or wire terminals for fast, easy assembly. A choice of nine colors, 500 variations. And look at the Molex 1820. You can use one, or a gang of them, for an infinite variety of applications. Lighted push button can be wired to light independently of the switch. And it's available in colors galore. Best of all . . . both switches are priced considerably under one**

**dollar in quantity. ■ These components are good examples of the Molex creative approach to design problems. And we have the ability to design reliability and ease of assembly into a product without letting costs run wild due to over-engineering. ■ If this makes sense, and you would like a *free sample* of either the 1175 or 1820 switch, write: Molex Incorporated, Downers Grove, Illinois 60515. Or phone (312) 969-4550.**

*...creating components that simplify circuitry*



# Call RCA if you want to talk about **MIL-M-38510** COS/MOS

Now, for high-reliability types in COS/MOS ICs – for full MIL-STD-883 – call RCA.\* And let's talk about advanced MIL-M-38510 techniques. In RCA's rapidly evolving 38510 program, high-reliability type product becomes not just the result of screening, it will be built in, through procedures being developed to the specification:

- Scanning electron microscope (SEM)
- Radiographic inspection
- Product traceability for permanent product control
- Rigorous operator training to maintain high quality-control standards

The COS/MOS CD4000A series is available in high-reliability types now being produced under MIL-STD-883, with SEM inspection specified in NASA-Goddard Space Flight Center specification GFSC-311-P12A, on special order.

And, since RCA's COS/MOS production is a single, integrated process, process advances that are developed for high-reliability product are automatically reflected in the commercial type you specify.

If you want the leader's standard of quality plus volume capability and systems cost effectiveness, go COS/MOS. See your RCA Representative or your RCA Distributor. Or write, RCA Solid State, Section 57F-8 Box 3200, Somerville, N.J. 08876. International: RCA, Sunbury-on-Thames, U.K., or P.O. Box 112, Hong Kong. In Canada: RCA Limited, Ste. Anne-de-Bellevue 810, Quebec.

*\*For information on high-reliability COS/MOS and our MIL-M-38510 progress, call RCA's high-reliability marketing specialist, Garry Miller (201) 722-3200 Ext. 2805.*

**RCA** Solid State  
products that make products pay off

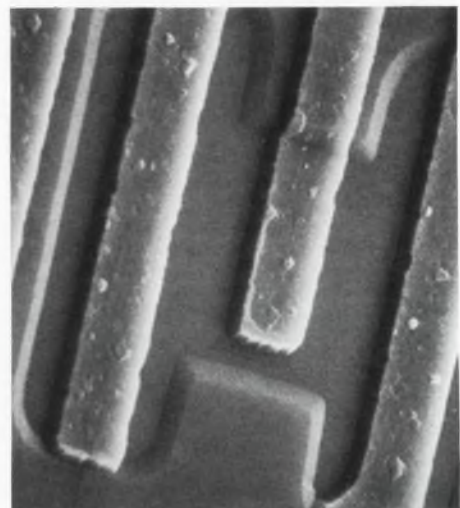

RCA's scanning electron microscope at 1000 X magnification shows excellent conformity of conductors over wafer contours, assuring continuity and reliability of metal interconnects. This is a dramatic example of process refinements achieved under the RCA high-reliability program which are automatically applied to commercial products.



6000 X magnification shows excellent metal coverage over an oxide step. The scanning electron microscope has become a major tool in RCA's diagnostic and high-reliability procedures.