

Electronic Design 10

VOL. 20 NO.

FOR ENGINEERS AND ENGINEERING MANAGERS

MAY 11, 1972

Rotating memories, anyone? The discs and drums are rolling up exciting advances — like shorter access time, more capacity and reduced prices. But beware the cost-per-bit trap if you're in the market to buy. Throughput and data rate are critically important. So is environment. Check the specs that aren't there. Page C16.

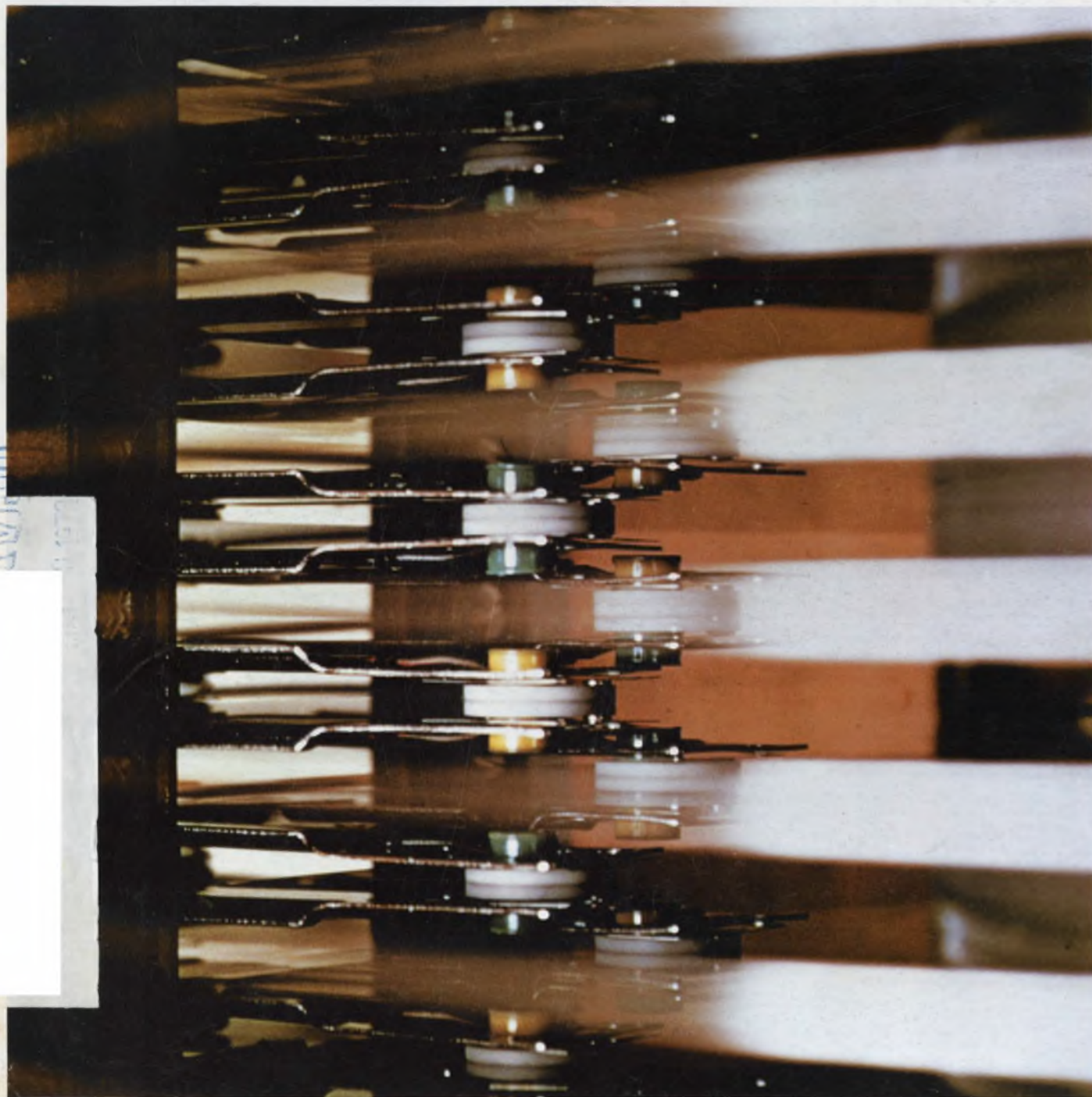

Signetics chooses 10,000

Two years from now you'll wonder why you waited.



Take the time for a good hard look into ECL 10,000's high speed/performance advantages. And engineer your own head-start into tomorrow's optimized logic. Available today—and tomorrow—from the major new source for ECL series 10,000. Signetics.

Because Signetics never settles for less than total IC capability, we researched your future requirements in high speed logic. And cut through the claims of existing ECL alternatives without mercy. All the know-how, the back-up, the all-out commitment you expect in Signetics linear, digital and MOS, stands behind our development and production of proven, line-ready ECL 10,000 devices.

What's in it for you? A constant reliable supply of the best high speed/low power trade-off yet. Typical speed level: 2.0 ns propagation delay per gate. Low power dissipation of 25mW—with no special cooling required in any environment, still air or forced. Switching rise and fall times compatible with conventional system layouts (3.0 ns edge speed).

ECL 10,000 delivers outstanding design/function flexibility. Multi-

level gating on a single chip, through open emitter outputs and high impedance inputs, means a significant savings in gate and package count. Plus a free choice of terminating schemes and logic interconnects.

Packaged in plastic Silicone DIP or Cerdip, Signetics ECL 10,000 line will provide a complete high speed logic family—some already on-shelf in factory or distributor stock, the remainder due by summer.

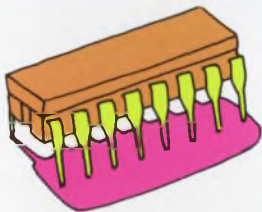

Contact your Signetics salesman, rep or distributor for availability information. He will also rush you our informative ECL 10,000 booklet, free upon request. Or write Signetics/ECL directly, 811 E. Arques Avenue, Sunnyvale, California 94086.

SIGNETICS ECL 10,000 SERIES

10101 Quad 1-Input OR/NOR Gate
 10102 Quad 2-Input NOR Gate
 10105* Triple 2,3,2-Input OR/NOR Gate
 10106* Triple 4,3,3-Input NOR Gate
 10107 Triple 2-Input Exclusive OR/NOR Gate
 10109 Dual 4,5-Input OR/NOR Gate
 10110 Dual 3-Input 3-Output OR Gate
 10111 Dual 3-Input 3-Output NOR Gate

10112 Dual 3-Input 1-OR/2-NOR Gate
 10113* Quad Exclusive -OR Gate/Comparator
 10115* Quad Differential Line Receiver
 10116 Triple Differential OR/NOR Line Receiver
 10117 Dual 2-wide 2,3-Input OR-AND/OA Invert Gate
 10118 Dual 2-wide 3,3-Input OR-AND Gate
 10119* 4-wide 4,3,3,3-Input OR-AND Gate
 10121* 4-wide 3,3,3,3-Input OR-AND/OA Invert Gate

10130 Dual D-Type Clocked Latch
 10131* Dual D-Type Master-Slave Flip-Flop
 10161 1 of 8 Demultiplexer/Decoder (Low)
 10162 1 of 8 Demultiplexer/Decoder (High)
 10170* 9 + 2-Input Parity Circuit
 10171* Dual 1 of 4 Demultiplexer/Decoder (Low)
 10172* Dual 1 of 4 Demultiplexer/Decoder (High)

*Coming soon.

signetics



Choose. Don't compromise.

The most experienced maker of storage tubes offers you a choice: the broadest selection of devices in a wide range of sizes to meet most any display requirement you may have. There's no need to compromise. If you don't see what you need in our long line of standard models, we'll design one for you.

Write for new brochure: 2020
Oceanside Blvd., Oceanside, CA
92054. Or call (714) 757-1200.

HUGHES

HUGHES AIRCRAFT COMPANY
INDUSTRIAL PRODUCTS DIV.

INFORMATION RETRIEVAL NUMBER 2

Siemens

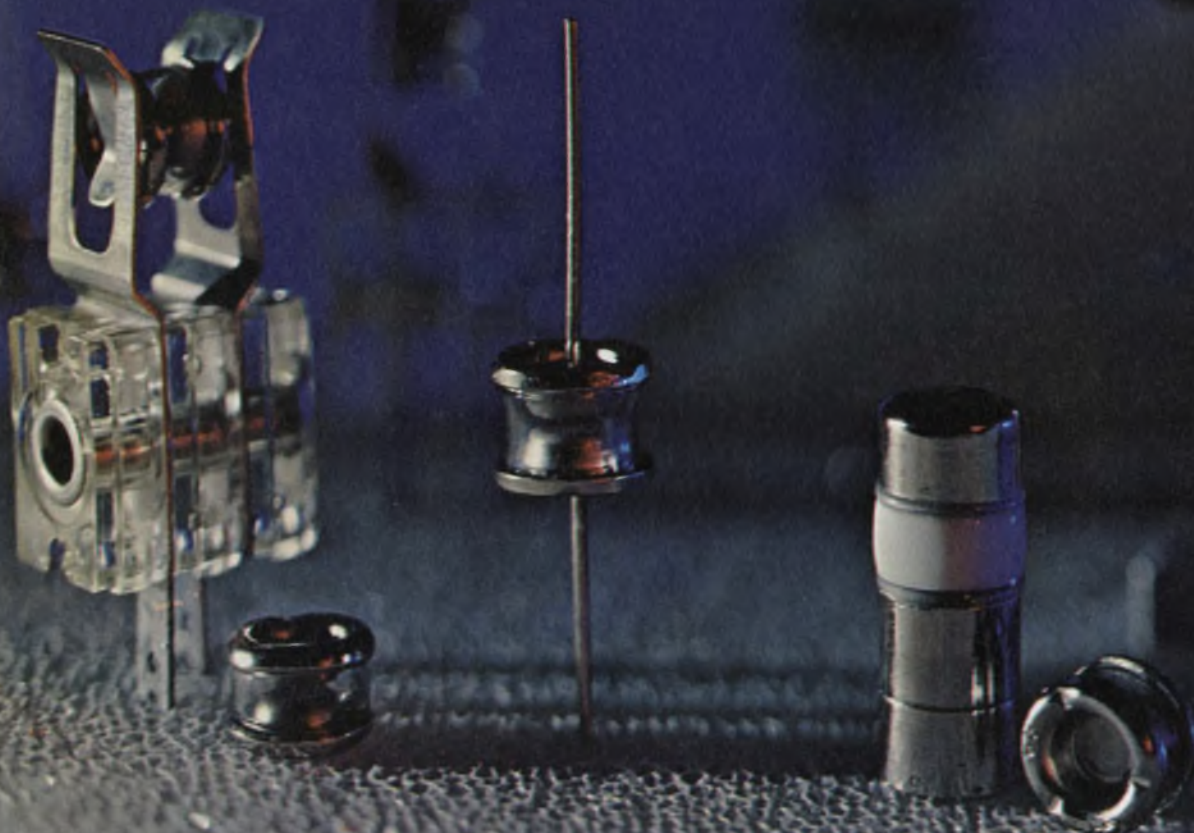

Low-cost SVP™ devices can save your valuable equipment from destruction by voltage transients.

You can no longer overlook the need for protecting your circuits. New sources of transients are cropping up every day. And any one of them might cause operational failure of your equipment.

Now there is an easy low-cost way to protect your circuitry from these transients. It's a simple little

gas-filled surge voltage protector. We call it an SVP. Only this Siemens SVP offers high-current capability (up to 50 kiloamps) in such a small package and a high impedance when not conducting (10^{10} ohms, 1 to 6.8 pF depending on model).

Siemens is the world's largest manufacturer of surge voltage

protectors. More engineers are using them every day. You can benefit by doing the same.

Siemens Corporation, 186 Wood Avenue South, Iselin, N.J., 08830. (201) 494-1000.

Siemens. A three billion dollar name in quality products.

SIEMENS

NEWS

- 23 **News Scope**
- 26 **100-million-bit electron-beam memory** developed at Stanford Research Institute promises fast access at .01 cents per bit.
- 28 **Solid-state weather station** is housed in a single package.
- 30 **The LHA: A communications 'first.'**
- 34 **Can radar 'field tests' be conducted in the laboratory?**
Yes, and with better results.
- 37 **Multilayer Density Improved Vastly.**
- 38 **Technology Abroad**
- 41 **Washington Report**

TECHNOLOGY

- C1 A special section: The Spring Joint Computer Conference.
- C4 It's a new world for computer graphics.
- C16 Focus on disc and drum memories.
- C28 Get the minicomputer you really need.
- C39 New products at SJCC.
- 52 **Build-it yourself stepper motor drive** maximizes speed with velocity ramping and minimizes power dissipation in the standby mode.
- 56 **Generate noise-free timing pulses** with an IC peak sampler from periodic waveforms that can vary in amplitude and frequency.
- 66 **Ideas for Design**

PRODUCTS

- 72 **Instrumentation:** Analyzer reads direct transmission gain/loss, VSWR and return loss.
- 74 **Instrumentation:** Quick-change readout in low-parts-count DPM.
- 84 **ICs & Semiconductors:** TTL-compatible MOS circuit is complete counter time base.
- 88 **Data Processing:** More flexibility for minis provided by 4-deck tape unit.
- 78 Components
- 82 Microwaves & Lasers
- 80 Packaging & Materials
- 83 Modules & Subassemblies

Departments

- 45 **Editorial: It's a great idea for the other guy.**
- 7 Across the Desk
- 94 New Literature
- 92 Evaluation Samples
- 99 Bulletin Board
- 90 Design Aids
- 102 Advertisers' Index
- 93 Application Notes
- 104 Information Retrieval Card

Cover: Photo by Don Shapero, courtesy of Memorex Corp., Santa Clara, Calif.
The cover shows recording heads between magnetic discs in a Memorex 660 disc.

Here's life insurance for minicomputer

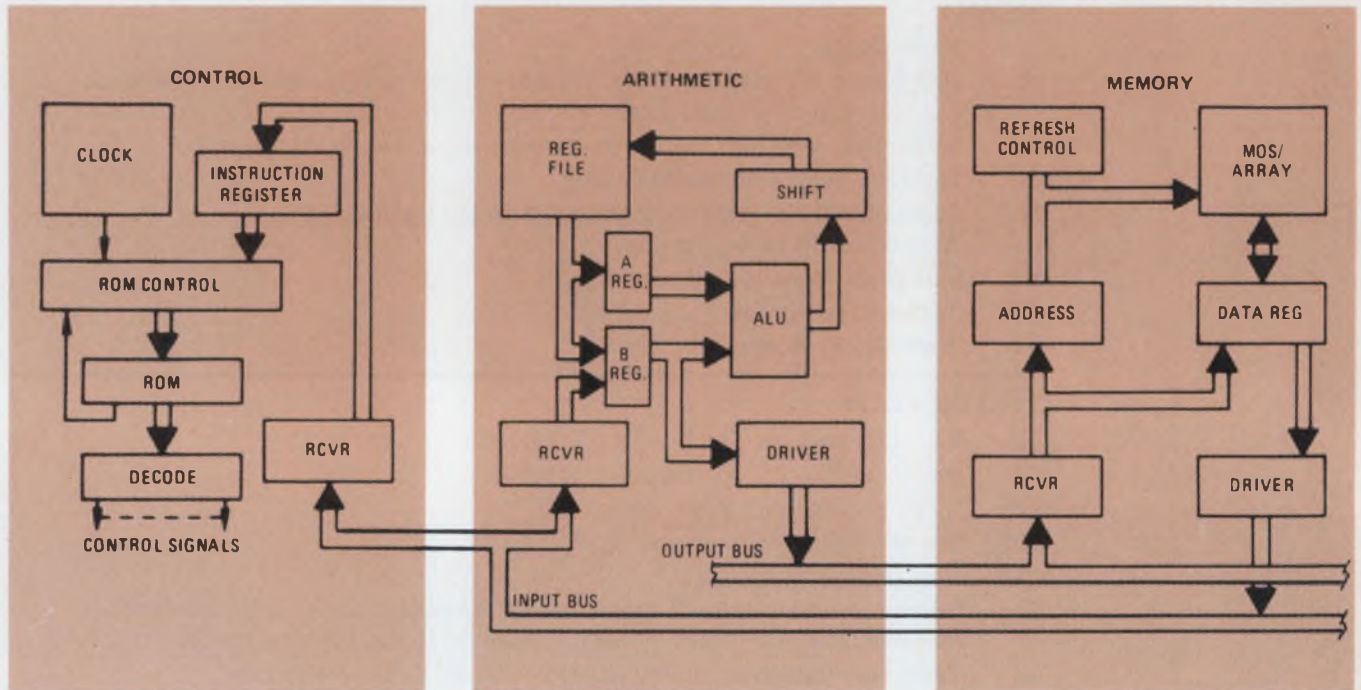

Control — The trend is to use microprogrammed ROM techniques to implement the control section. By comparison, the MECL 10,000 control section cycles four times as fast as the TTL version, needs about the same number of ICs and board area, uses about 1½ times the power, and provides a better cost/performance ratio.

Arithmetic — MECL 10,000 MSI functions reduce delay times considerably as this comparison illustrates:

Function	Delay in Nanoseconds TYP/Worst Case	
	TTL	MECL 10K
Access Register File	35/60	7/12
Load Register A	30/50	3/5
Access Register File	35/60	7/12
Load Register B	30/50	3/5
ALU	60/92	16/21
Shift/Swap/Select	15/25	4.5/7
Store Result in Reg. File	30/50	7/12
TOTAL DELAY	235/377	47.5/74

Memory — MECL 10,000 allows the designer to fully utilize current memory technologies. As memory speeds increase, logic delays become limiting factors when considering total memory system cycle time. TTL delay times are almost as long as memory access times making TTL unsuitable. By using MECL 10,000, memory systems may be upgraded to faster types without any change in control logic except for clock speed.

designs...

MECL 10,000

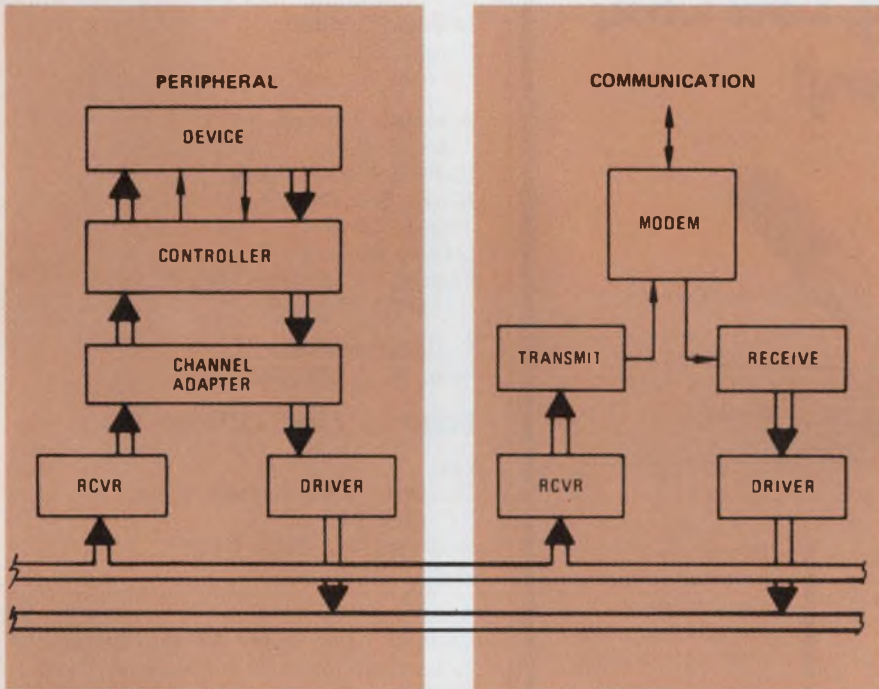

Peripheral — MECL 10,000 enables the bus to operate at very high speeds by minimizing the time required for handshaking. To illustrate, the delay path from the output bus, thru the line receiver, address compare, channel control, multiplexer and line drivers was calculated for both TTL and MECL 10,000. For TTL the delay is 133 ns typical, 211 ns maximum. MECL 10,000 performs the function in 20 ns typical, 26 ns maximum.

Communication — Systems oriented MOS functions (MC2257 Terminal Transmitter and MC2259 Terminal Receiver) minimize cost, size and power. The savings are dramatically represented as follows:

	TTL	PMOS
Number of ICs	71	2
Power (Typ/Worst Case)	5.1/11.5 Watts	0.30/1.0 Watt
Board Area	110 Sq. In.	3 Sq. In.
IC Cost	\$28.14	\$28.20

To maintain the competitive edge in today's minicomputer market, designers must effectively react to new technologies that increase machine capabilities. IC memories with their fast cycle times are extending minicomputer performance. And as memory speeds increase, new designs will be logic limited unless implemented by high speed logic families.

MECL 10,000 provides the balance needed between memory speed and logic speed for next generation minicomputers. We compared a typical TTL design and a MECL 10,000 system utilizing MOS memories and system oriented MOS functions. The result was a dramatic improvement in price/performance. This improved state-of-art performance is yours when you design around MECL 10,000.

Get the whole story from our comparison study "New Technologies In Minicomputer Design." Write to Motorola Semiconductor Products Inc., P. O. Box 20912, Phoenix, AZ 85036. And after you have compared, contact your nearby Motorola distributor for off-the-shelf evaluation devices. You really won't know how competitive your minicomputer is . . . until you evaluate what MECL 10,000 can do.

MECL 10,000 eliminates the alternatives. Evaluate and compare!

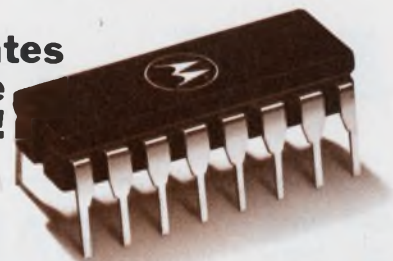

MOTOROLA MECL

... for faster computers & systems

INFORMATION RETRIEVAL NUMBER 4

New Miniature Open Frame DRY REED BABCOCK RELAYS... Greater Sensitivity, Low Cost, Fast Delivery!

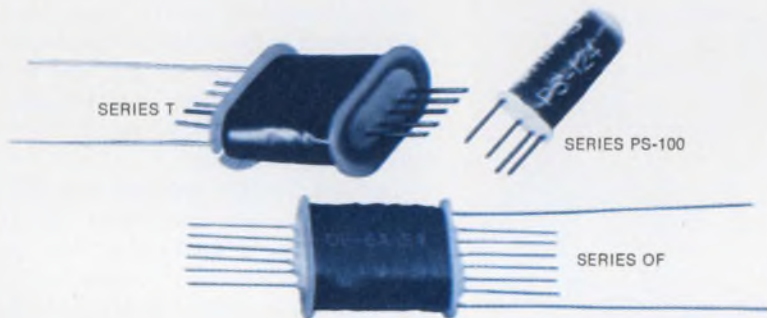

These new, miniature Babcock open frame dry reed relay series offer the engineer a wide variety of configurations to meet virtually any design requirement. High sensitivity, low-cost, extremely fast switching speeds to 0.5 ms., low power consumption, high density packaging, and a reliable long life to 100,000,000 operations are among the many features. From 1 to 6 contacts, in forms A, B and C — or combinations —

provide greater in-system versatility. These models are rated from 3 to 10 watts, for switching 28 to 250 VDC, at 0.25 and 0.50 amp. Other configurations — mercury-wetted, R.F., high voltage — are available. Magnetic and/or electrostatic shielding are optional on axial-lead versions.

**About Delivery —
off-the-shelf for
standard units, and
only 2 weeks for
specials.**

Get complete technical data on these miniature Babcock reed relays today from Babcock Control Products, Babcock Electronics Corp., Subs. of Esterline Corp., 3501 No. Harbor Blvd., Costa Mesa, Calif. 92626 — or better still, call (714) 540-1234.

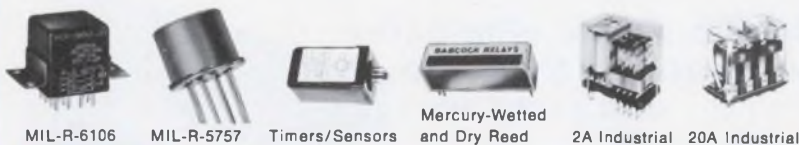

BABCOCK

A UNIT OF ESTERLINE CORPORATION

INFORMATION RETRIEVAL NUMBER 5

Publisher

Peter Coley

Editors

Editorial Offices
50 Essex St.
Rochelle Park, N.J. 07662
(201) 843-0550
TWX: 710-990 5071
Cable: Hydenpubs Rochellepark

Editor: George Rostky

Managing Editors:

Ralph Dobriner
Michael Elphick

Associate Editors:

Jules H. Gilder
Richard Lee Goldberg
Morris Grossman
John F. Mason
Stanley Runyon
Edward A. Torrero
Richard L. Turmail

Contributing Editor:

Peter N. Budzilovich

Editorial Field Offices

East

Jim McDermott, Eastern Editor
P.O. Box 272
Easthampton, Mass. 01027
(413) 527-3632

West

David N. Kaye, Senior Western Editor
2930 West Imperial Highway
Inglewood, Calif 90303
(213) 757-0183
Les Brock, Western Editor
95 Main St.
Los Altos, Calif. 94022
(415) 941-3084

Washington

Don Byrne, Washington Editor
1111 S. Army Navy Drive
Arlington, Va. 22202
(202) 296-8982

Editorial Production

Marjorie A. Duffy

Art

Art Director, William Kelly
Richard Luce
Anthony J. Fischetto

Production

Manager, Dollie S. Viebig
Helen De Polo
Maxine Correal
Anne Molfetas

Circulation

Manager, Nancy L. Merritt
Joan Licari

Information Retrieval

Peggy Long

across the desk

What can 'one guy' do? Plenty, reader says

With reference to the editorial in the March 2 issue ("Don't Be a 'Don't Know,'" ED 5, p. 39):

At least, by making a choice, you did more than the average "don't know" type.

I have wrestled with some of the problems that your editorial writer faces—that is, what type of political society do we support?

Supporting a lobbying organization, I believe, is wrong. Lobbyists are powerful today simply because the average individual says "I don't know" too often or, "I don't care." Lobbyists would be out of a job if every voter voiced his opinion directly to his Representative in Congress. I don't care whom you talk to—plumber, doctor, farmer, engineer, employed or unemployed—the average person hasn't written one word to his Representative in his lifetime!

At one time I, too, had to admit that I was failing to write my Congressman. So how could I expect him to do my bidding? In the last couple of years I have taken up this art of writing to Congressmen, and it has produced some measure of results. I don't stop with just the Congressmen, but I write to every friend that I can think of who might share my opinion and ask him to write to his Congressman.

The last paragraph of your editorial holds the answer to straightening out many of the problems in American society: Stand up and be counted. Somehow we have got to stamp out the feeling that so many Americans have—"what can one guy do?"—and replace it with an attitude that reflects the fact that this country is made up of 200 million "one guys." If each car-

ries his share by making himself heard, we would go a long way toward restoring the government that was framed in the Federal Constitution.

Roy E. Crocker

CBC Inc.
P.O. Box 602
Kailua, Hawaii 96734

A clarification from TI on TTL reliability

I was pleased to see that my discussion with Jules Gilder of your staff resulted in the appearance of a newsworthy article, "Low-power Beam Leads Hailed" (ED 3, Feb. 3, 1972, p. 35), but I would like to call your attention to an apparent misunderstanding in the third paragraph of the article. Specifically:

"... the less reliable low-power chip and wire-connected ICs or the more reliable, but higher-power ICs."

This is an inaccurate statement of my views, and in addition it is not consistent with industry reliability data, which confirm that the low-power TTL logic is as reliable as higher-power ICs. The source of added reliability in the beam-lead products is the elimination of the wire bond.

Larry Gast

Senior Project Engineer

Texas Instruments, Inc.
Components Group
P.O. Box 5012
Dallas, Tex. 75222

Ed.: Mr. Gast is right. The statement that engineers were previously forced to make a tradeoff between reliability and power consumption was a conclusion incorrectly drawn from the interview.

(continued on page 10)

Electronic Design welcomes the opinions of its readers on the issues raised in the magazine's editorial columns. Address letters to Managing Editor, Electronic Design, 50 Essex St. Rochelle Park, N. J. 07662. Try to keep letters under 200 words. Letters must be signed. Names will be withheld on request.

The Elegant Tone Filters



A full string of active filters. In the standard frequency steps: 687 Hz to 1633 Hz $\pm .5\%$. In lots of 100:

About \$19.95 each

Precise specs from precise craftsmanship. Delivered economically through computer-aided design. That's what you'll find in all components by EAI. Thick-film audio amps. Capacitors. Analog/digital converters plus other special function modules. Custom coils. Solenoids. Transformer kits. Molded plastic parts. And a growing list of other elegantly crafted etceteras.



Electronic Associates, Inc.
193 Monmouth Parkway
West Long Branch, New Jersey 07764
Tel. (201) 229-1100

INFORMATION RETRIEVAL NUMBER 6

TWT amplifier line four models: 10, 20, 100 and 200 watts solid state with protective circuitry beam and helix current metering modular construction

The industry's most advanced TWT amplifier line can now provide the microwave power and stability you need for EMI/susceptibility testing, antenna pattern measurement, RF power instrumentation calibration and component testing.

Modular construction and plug-in boards allow the versatility to accommodate a wide variety of TWTs. Options include VSWR protection, harmonic filtering and variable output. Solid state components (except series regulator and TWT) and conservative design provide the reliability and performance necessary in modern electronic instruments.

Beam current and voltage protection are built in along with regulation of all power supplies.

Maximum TWT life is assured through efficient cooling: the 10 and 20 watt systems use conventional air cooling and the 100 and 200 watt are cooled with a liquid to air heat exchanger for quiet, reliable and efficient operation.

One of our twenty-six TWT amplifiers will meet your power, gain, and frequency requirements. And all have a one year warranty. For complete specifications call (312) 354-4350 or write: MCL, Inc., 10 North Beach Avenue, La Grange, Ill. 60525.



10 and 20 watt TWTA

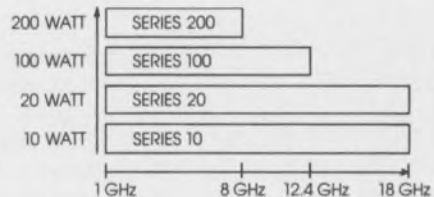

100 and 200 watt TWTA



Opportunities developing now for RF engineers at MCL, Inc. — an equal opportunity employer.

INFORMATION RETRIEVAL NUMBER 7

INFORMATION RETRIEVAL NUMBER 8 ►

McMOS

EASIER INTERFACE, REDUCED
SUPPLY REQUIREMENTS

SIMPLIFY DIGITAL-LINEAR DESIGNS

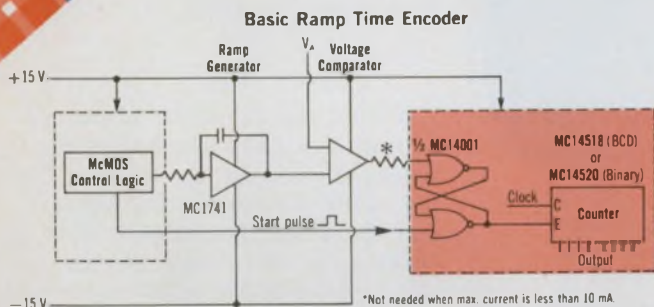

Motorola's rapidly expanding McMOS* complementary MOS line is designed to provide a combination of benefits other digital technologies can not.

Put aside for a moment, but don't forget, the facts that complementary MOS in general, and McMOS in particular, has the best noise immunity (45% of V_{DD}) and the lowest system power dissipation of any logic form.

Take note of the rapidly expanding number of available McMOS devices, with seven new MSI functions introduced since March, twelve since the first of the year, and many more coming in the several months ahead. Remember that McMOS combines the most popular second source units with original devices to fill the gaps.

Now, concentrate on less publicized but no less significant aspects of McMOS' system optimized desirability. As indicated in this basic Ramp Time Encoder for simplified A/D conversion, digital-linear systems can be built with reduced power supply requirements. Its wide supply voltage range allows McMOS to operate from the +15 V linear supply. Interfacing is simplified too, because McMOS' ultra low drive current requirements permit nearly direct connection.

McMOS has many advantages for many sorts of systems. Complete information on McMOS is available in a new book, McMOS '72, which is yours simply by circling the reader service number or by writing to Motorola Semiconductor Products Inc., P. O. Box 20912, Phoenix, AZ 85036. Get it. Then get McMOS.

*TRADEMARK OF MOTOROLA INC.

EXPANDING McMOS FAMILY

Motorola Device #	Function	Replaces Pin-for-Pin	Price (100-999)
MC14001AL/CL	Quad 2-input NOR gate	CD4001AD/AE	\$ 4.15/ 1.18
MC14002AL/CL	Dual 4-input NOR gate	CD4002AD/AE	4.30/ 1.22
MC14011AL/CL	Quad 2-input NAND gate	CD4011AD/AE	4.15/ 1.18
MC14012AL/CL	Dual 4-input NAND gate	CD4012AD/AE	4.30/ 1.22
MC14013AL/CL	Dual Type D flip-flop	CD4013AD/AE	5.95/ 2.40
MC14015AL/CL	Dual 4-bit static SR, serial in/parallel out	CD4015AD/AE	12.65/ 5.60
MC14021AL/CL	8-bit static SR, serial or parallel in/serial out	CD4C21AD/AE	12.24/ 5.20
MC14027AL/CL	Dual J-K flip-flop	CD4027AD/AE	6.60/ 3.18
MC14501AL/CL	Triple gate	—	4.30/ 1.99
MC14507AL/CL	Quad exclusive OR gate	CD4030AD/AE	4.74/ 1.86
MC14508AL/CL	Dual 4-bit latch	—	24.70/13.75
MC14519AL/CL	4-bit AND/OR select, Quad exclusive NOR gate	—	4.75/ 2.10
MCM14505AL/CL	64-bit RAM	—	31.30/17.50
MC14025AL	Triple 3 NOR gate	CD4025AD/AE	\$ 4.30
MC14025CL	—	—	1.22
MC14510AL	BCD Up Down Counter	—	12.60
MC14510CL	—	—	7.00
MC14512AL	8-channel Data Select	—	7.20
MC14512CL	—	—	4.00
MC14514AL	4-bit latch, high output	—	24.70
MC14514CL	—	—	13.75
MC14515AL	4-bit latch, low output	—	24.70
MC14515CL	—	—	13.75
MC14518AL	Dual BCD Up Counter	—	12.90
MC14518CL	—	—	7.20
MC14520AL	Dual Binary Up Counter	—	12.60
MC14520CL	—	—	7.00

recent introductions

 **MOTOROLA MOS**
Directions in digital designs



These guys know a good thing when they see it. Nothing else on the market puts so much performance into such a small package. And for hundreds—in most cases *thousands*—of dollars less than the big ones.

Our all new VADC is designed for use in video data logging and analysis systems. The VADC is rugged, has wide operating ranges and is packaged to *FIT* into your system.

New? Sure. But already, the VADC is being used for sonar and radar digitizing, video data transmission, MTI systems and waveform signature recognition. One of these many systems is already in flight tests.

- Resolution is 8 bits at better than a 6 MHz word rate.
- Input dynamic range is 5V. Zero to +5 or ± 2.5 .
- Input impedance is 10 M Ω and 10 pF.
- Outputs are parallel, TTL data, binary or offset binary.
- VADC has an integral sample-and-hold with better than 100 ps aperture time.

What's more, it doesn't take up a whole rack. It mounts on two compact PC boards. The entire unit measures only 6.8 by 4.5 by 3.0 inches and weighs only 40 ounces.

The VADC is not all. DDC also offers a 16 MHz 4 bit A/D, 25ns D/A, 100 ps aperture S & H, video multiplexer. Write us, or phone direct to either Steve Muth or Jim Sheahan (516) 433-5330.

ANALOG/DIGITAL CONVERTERS



ILC DATA DEVICE CORPORATION

100 TEC STREET, HICKSVILLE, N. Y. ED5-11

INFORMATION RETRIEVAL NUMBER 9

ACROSS THE DESK

(continued from page 7)

Editorial stirs a cheer —and a firm dissent

George Rostky's editorial titled "The Curse of Courtesy" (ED 2, Jan. 20, 1972, p. 39) is excellent. We believe that this subject matter could stand deeper coverage in a full-size article in your magazine.

We are in continual contact with engineering firms, and we find that all lack a "vice-president in charge of anti-bureaucratism." Most guilty are the governmental agencies working on pollution-abatement problems. The field of pollution abatement is in itself extremely challenging and is the area that will require some original thinking plus a considerable amount of habit-breaking if we are to cope with the problem. More editorials like "The Curse of Courtesy" can only help.

Roy E. Crocker

CBS Inc.,
333 Uluniu St.,
Kailua, Hawaii 96734

Mister, you're guilty of overreacting! You have a point: A poor design should be cut short. But not with whispers of "fathead" and shouts of "horseshit." This is closer to a curse than courtesy—which, incidentally, is not a curse; the misapplication of it is. Proper application of courtesy in reacting to a poor design is to appreciate the man's well-intended efforts and, with a firm positive and *considerate* hand, to redirect him.

We talk of the need for professionalism in engineering. Base language has no place in it. Nor does kick-in-the-rear management. I ask that you reconsider what you have printed. Please!

Ralph L. Charnley

Pako Corp.
6300 Olson Highway
Minneapolis, Minn. 55440

Overheard

... At the desk of Bill Farnbach, design engineer at the Colorado Springs Div. of Hewlett-Packard: "If the Lord had wanted man to work with electrons, he would have made them big enough to see."



Small BIG NEWS

Your Guardian Angel presents:

a **very small** addition to a
line of **small** enclosed relays



NEW "MINI" 1330 RELAYS: DPDT, 5 amp relays less than three-quarters of a cubic inch small . . . with a small price to match. Mechanical life? 100 million operations DC, 50 million AC. Choice of printed circuit or plug-in termination . . . plus mating sockets with solder lug or printed circuit terminals.

AMAZINGLY VERSATILE 1310 RELAYS: 4PDT, 5 amp miniature relays in four variations: Plug-in or printed circuit termination, built-in "test" lamp and push-to-test. Mating sockets with solder lug or printed circuit terminals, too. Mechanical life: 50 million operations AC, 100 million DC.

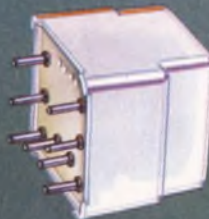
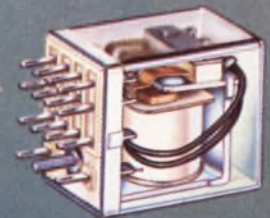

UNIQUE NEW 1360 RELAYS: 5 to 50 amp, single or double pole relays with all terminals on .1" grid spacing to mount directly on PC boards. Or, mount thru chassis cutout using special mating socket.

**COMPLETE APPLICATION DATA
IS YOURS FOR THE ASKING**



GUARDIAN[®]

GUARDIAN ELECTRIC MANUFACTURING CO.
1550 West Carroll Avenue, Chicago, Illinois 60607

In a hurry? Call your Guardian Distributor.



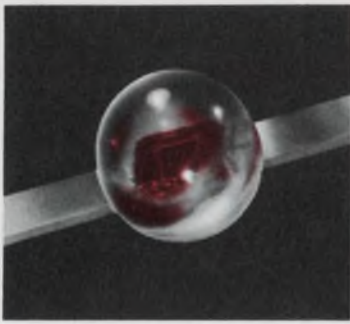

MLED50 Red LED Shows Big Performance

- 1 mcd luminous intensity
- PC-board mountable
- Wide viewing angle

CIRCLE NO. 211

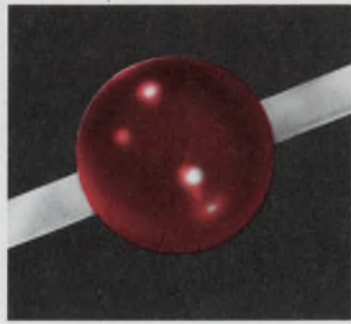

MLED55 LED Turns Red from Any Angle

- 140° viewing angle
- New diffusing lens
- 600 μ cd luminous intensity

CIRCLE NO. 212

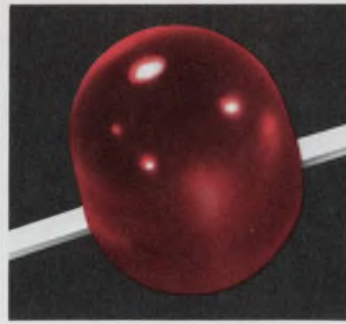

MLED600 Mini-T* Gives High-Visibility Red

- 1,100 fL brightness
- Economical plastic
- Unique, molded lens

CIRCLE NO. 213

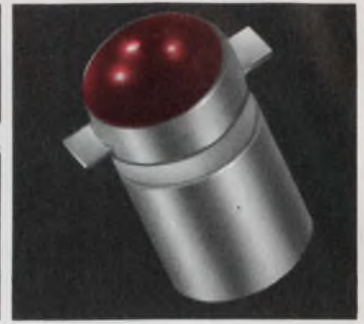

MLED610 LED Offers High-Density Reliability

- Tiny, metal "pill" design
- 1,100 fL brightness
- Easy, PC-board mounting

CIRCLE NO. 214

TRADEMARK MOTOROLA INC

See Us Speak In Our

Everybody talks about optoelectronic capability but nobody documents anything about it. Nobody but Motorola.

DOCUMENTATION #1:

Motorola opto products are made on the same machines that turn out millions of plastic transistors *each week*. The same machines made Motorola the unquestioned production leader in this field in a few short years. Same stripline, leadframe stamping machines . . . same

automatic die and wire bonders . . . same molding encapsulation processes. All tuned to instantaneous production of opto devices. Optomation.

DOCUMENTATION #2:

Lower-cost, highly-available opto products are final-tested on fully-automated and computerized semiconductor test equipment. You get Motorola's traditional, fast factory turnaround on all your factory orders. Optomation again.

Plastic IR LEDs Do Invisible Things @ 9,000 Å

- Spectrally-matched to silicon
- 350 or 550 μ W output @ 50 mA
- Naturals for card/tape reading

CIRCLE NO. 219



Metal IR LEDs Emit 9,000 Å, Small or Large

- Tiny "pill" or TO-18 case
- 150 to 650 μ W output
- Hermetically-sealed

CIRCLE NO. 220



MRD500/510 PIN Photodiodes Respond In Nanoseconds

- 1 ns typical response
- Convex or flat lenses
- Sensitive through visible/near IR range

CIRCLE NO. 221



Plastic Photo Darlington Offer Economical Sensitivity

- 40-cent, 100-up prices
- typical sensitivities to 4 mA/mW/cm²
- Ideal for high-volume insertion

CIRCLE NO. 222





MLED630 Shines Out From TO-18 Package

- 120° field-of-view
- 1,100 red fL
- Panel indicator

CIRCLE NO. 215



MLED650 Lights Up Panel Indicators

- Wide viewing angle
- Mounting hardware available
- 200 mil bright viewing surface

ADVANCE INFORMATION

CIRCLE NO. 216

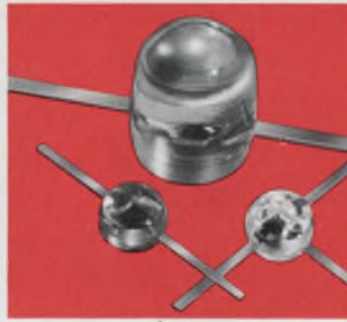

Plastic Photodetectors For All Arrangements

- High (MRD150) or moderate (MRD450) mounting densities
- Low-as-75¢, 100-up
- Sensitivities to 0.2 mA/mW/cm²

CIRCLE NO. 217

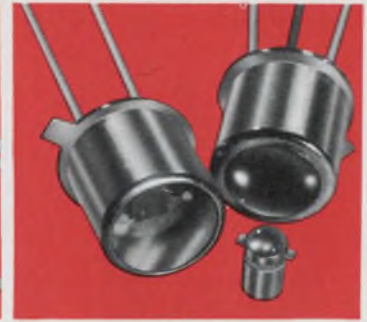

Metal Photodetectors Are Fast And Rugged

- TO-18 or "pill"-cased
- Microsecond switching
- Curved or flat lenses

CIRCLE NO. 218

Volumes Living Color

DOCUMENTATION #3:

Motorola's huge investment in in-house, III-V raw material facilities including crystal-pulling and epitaxial deposition will ensure unparalleled wafer supplies to satisfy any and all high-volume requirements. Motorola, the production house of the industry.

DOCUMENTATION #4:

The largest factory and distributor sales organization in the semiconductor industry — over 750 trained

technical salesmen and engineers — in 96 U. S. and Canadian locations — is ready to serve your prototype or production needs. Right now.

For the latest word on optoelectronics in new-design considerations, write on your letterhead for "Opto Glossary" — a handy new designer's aid with opto terminology, a complete offering of LEDs, couplers, displays and photodetectors plus comprehensive cross-reference data. Box 20912, Phoenix, AZ 85036.



MOTOROLA OPTO

Let There Be Light 

Custom Display Panels Count Up, Spell Out

- Available with or without decoder drivers
- Any combination of alpha or numeric digits
- Ultra-reliable 0.7" digits

ADVANCE INFORMATION
CIRCLE NO. 223

Opto Couplers Isolate Interfacing Perfectly

- 1,500 V dielectric isolation
- 60% transfer ratio — phototransistor
- Phototransistor or photodarlington

CIRCLE NO. 224

MOR10 Excellent Character For New Readout Role

- 0.120" character light
- Wide angle, single plane
- Straight or spread leads

CIRCLE NO. 225

MDP70 Displays 7/10" Readouts Through BCD Inputs

- Readable to 20 feet
- Compatible with T²L
- Easy insertion to connector

ADVANCE INFORMATION
CIRCLE NO. 226

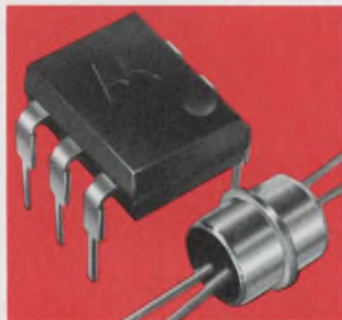

**Our R-10 series
offers more design
options than any other
single industrial
relay.**

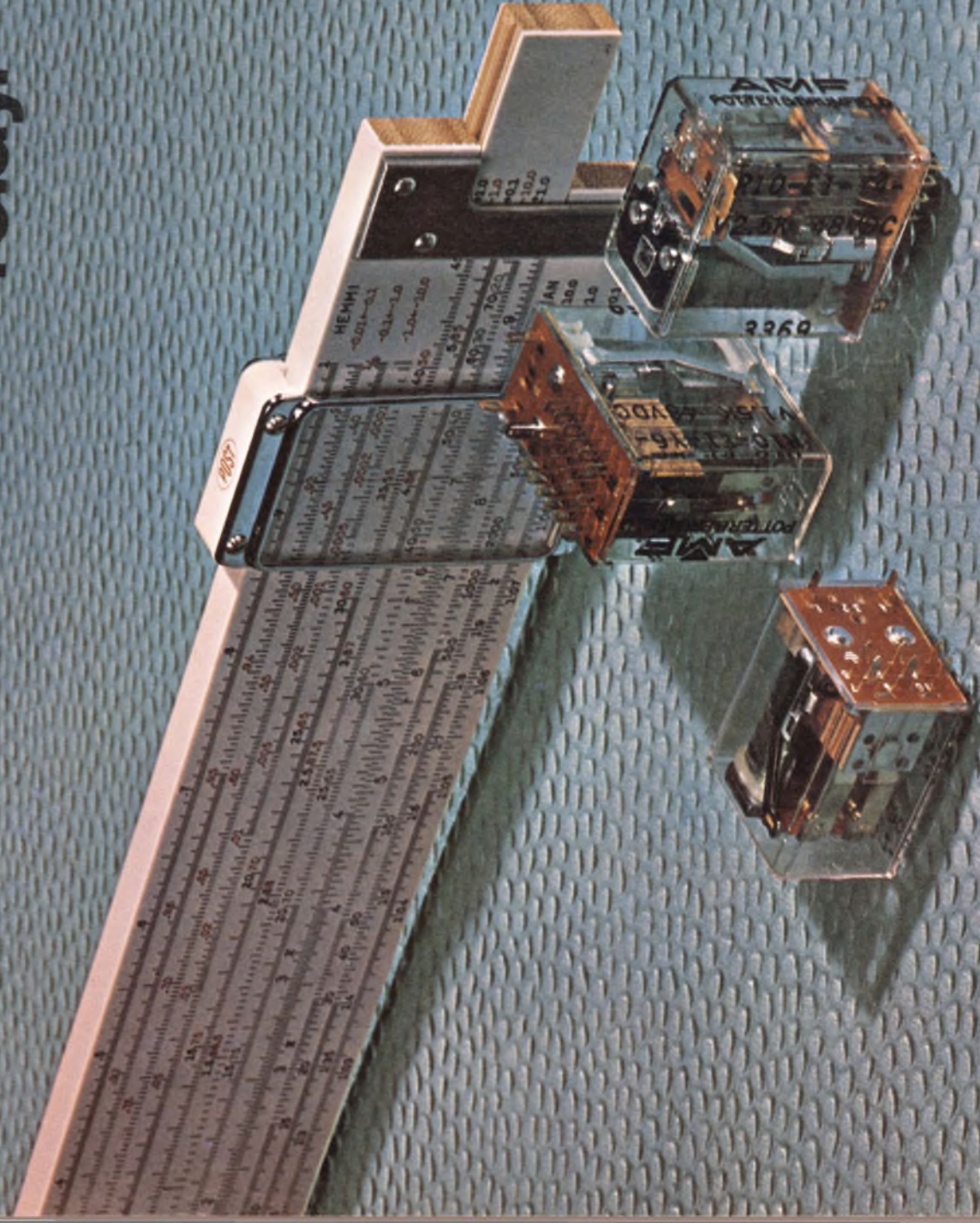

The P&B R-10 Series offers designers a whole family of AC and DC industrial relays that combine extraordinary versatility in application, the reliability of telephone-type relays, and small size (less than a cubic inch). They are widely used in copiers, computer peripherals, business machines and precision instruments.

So versatile is this series that each model is literally designed by you, to meet your special needs. You use a single family of

relays, with common mechanical dimensions and common mounting techniques, to cover the whole range of switching loads you may desire, from dry circuit to 10 amps, 28 V DC, 120 V AC. There are several terminal styles for solder or pc board mounting. Special octal plug mounting is available, and sockets multiply design options even more.

R-10's can now be ordered with Form A, B and D contacts as well as Form C, with arrangements up

to 8 Form C. Underwriters' Laboratories, Component Recognition, File 42810. DC relays have a continuous power dissipation of 2.2 watts maximum. Standard sensitivity is 125 milliwatts per pole. Mechanical life is up to 100 million operations, electrical life ranges from 100,000 to 100 million operations. Special light emitting diode (LED) indicator, a convenient check when trouble shooting a circuit is available as an option on R-10 relays.

Take just four easy steps to "design" the R-10 relay that fits your requirements perfectly.

1 Decide on the type of terminal mounting you want:

Solder terminals. Stud or plug-in mounting



Printed circuit terminals. No stud mounting



Tapped holes for mounting directly to surface

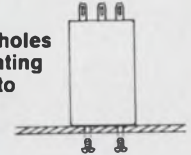

2 Select desired rating and contact form:

Rating	10 amp†		5 amp (Bifurcated)		5 amp		2 amp		Low Level (Bifurcated)		Dry Circuit (Cross Bar)	
	Poles	Forms	Poles	Forms	Poles	Forms	Poles	Forms	Poles	Forms	Poles	Forms
Contact form	2 4 6	A,B,C,D A,B,C,D A,B	2 4 6 8	A,B,C,D A,B,C,D A,B,C A,B,C	2 4 6 8	A,B,C,D A,B,C,D A,B,C A,B,C	2 4 6 8	A,B,C,D A,B,C,D A,B,C A,B,C	2 4 6 8	A,B,C,D A,B,C,D A,B,C A,B,C	2 4 6 8	A,B,C,D A,B,C,D A,B,C A,B,C
Contact data	.125 DIA. 		.100 DIA. 		.100 DIA. 		.078 DIA. 		.062 DIA. 		.017 DIA. 	
Resistive load* @ 28 VDC or 115 VAC	Typ. 7.5 Amps Max. 10 Amps Min. .200 Amps		Typ. 5 Amps Max. 7.5 Amps Min. .200 Amps		Typ. 5 Amps Max. 7.5 Amps Min. .050 Amps		Typ. 2.0 Amps Max. 3.0 Amps Min. 0.01 Amps		Typ. 0.1 Amp Max. 2.0 Amps Min. 0.001 Amp		Typ. 500 mA Max. 250 mA Min. Dry Circuit	

*Total load not to exceed 30 amperes per relay. †Use ungrounded frame for loads over 5 amperes.

3 Choose the proper coil resistance:

- Standard and sensitive DC voltage coils available from 3.0 to 115 volts @ 25°C.
- AC voltage coils from 12 to 115 V @ 25°C.
- DC sensitivity as high as 20 milliwatts per pole.
- Bifilar coils to protect relay drive transistors available to 48 V nominal.

4 Pick the socket that fits.



R-10 Relay Socket

Retains floating terminals of either solder or P/C pin configurations.



Printed Circuit Right Angle Socket

Allows relay to mount flat on P/C board, reduces height from 1.720" to .860" max.



Bracket Mount Socket

Allows solder terminal relay to mount flat on a chassis.

Versatile R-10 industrial relays, with their almost limitless design options and application capabilities, are available nationwide from leading electronic parts distributors. Or call your P&B representative. For a free 214 page relay catalog, write Potter & Brumfield Division AMF Incorporated, Princeton, Indiana 47670. Telephone 812 385-5251.



P&B makes more of more kinds of relays than anybody in the business.

Anybody.

You probably need a programming system unlike any other ever built.

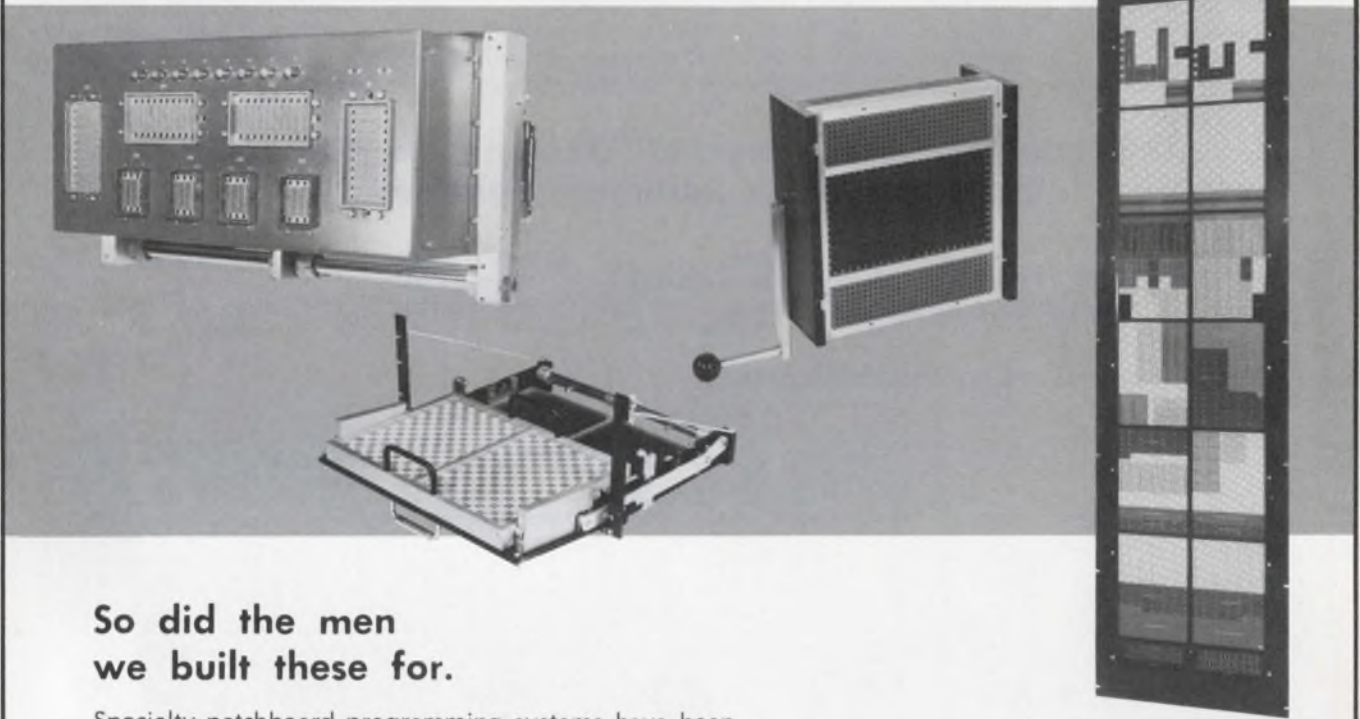

So did the men we built these for.

Specialty patchboard programming systems have been Virginia Panel Corporation's business for nearly a decade. We create giants like the Fixed System on the right with nearly 10,000 contacts; or the first True-Through Shielded Coaxial Cable programming system next to it; the "System-in-a-Drawer" for space-saving consoles; or the 2,560-contact Roll Cam system that terminates in only 13 quick-change connectors.

And we stock more than 80 standard models.

Helping people like you make rapid or frequent changes in wiring sequences is what our designers and engineers do for a living. VPC systems can be found all over the world in analog computers, aerospace, communications, and specialized electronic test equipment.

You can rely on VPC for all accessory products, for complete service, and for special training if necessary. Our experienced marketing and technical men are based in every major city.

Let us mail you our 40-page catalog today. If you prefer, telephone (703) 942-8376 and a VPC programming systems specialist will be in your office whenever you say. We want to start working with you.



Virginia Panel Corporation
1400 New Hope Road
Waynesboro, Virginia 22980
TWX 710-839-0406

Fluke problem solvers

The New .005% 8300A DVM: Bare Bones, \$1195; 5 Ranges DC, \$1295; 5 Ranges DC & 5 Ranges of Ohms, \$1445

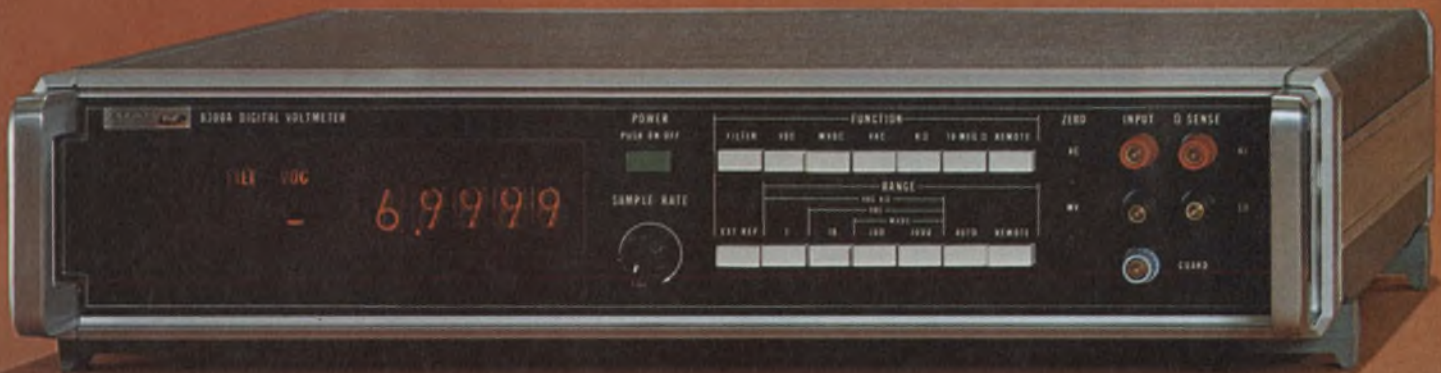

Remember the original great Fluke 8300A... the first reasonably priced 5½ digit high accuracy DVM ever offered.

Now, after two years' high production and plenty of time on the learning curve, we've come up with a whole new family of 8300A's with lower prices overall and package deal prices on the most popular configurations.

There's the basic 0.005% unit with three ranges of dc (10, 100, & 1000 volts). It's the 8300A-00. It sells for a miserly \$1195. If you need millivolt dc ranges (0.1 & 1.0 v) added, we'll give you the 8300A-10 for just \$1295. For a few dollars more we'll give you the 8300A-20 with five ranges of dc volts and five ranges of ohms for \$1445.

So here's your chance to get famous Fluke quality at new low prices. And because we use single mainframe

construction throughout, you can add all the other options to make a full bench multimeter or systems box in the field an option at a time, anytime.

And remember, only Fluke can use the patented recirculating remainder A-to-D conversion technique with up to five times fewer parts than comparable DVM's for greater reliability and the best MTBF in the industry.

So, if you're looking for a very fine 5 digit DVM with 0.005% accuracy, plenty of low cost options, including ac voltage, external reference (ratio), fully isolated outputs, remote programming and complete systems compatibility including timing signals and ready indicator at package deal prices, take advantage of Fluke's great new DVM deal right away. For details, call your nearest Fluke sales engineer today or contact us directly.

Fluke, Box 7428, Seattle, Washington 98133. Phone: (206) 774-2211. TWX: 910-449-2850/In Europe, address Fluke Nederland (N.V.), P.O. Box 5053, Tilburg, Holland. Phone: (04250) 70130. Telex: 884-52337/In the U.K., address Fluke International Corp., Garnett Close, Watford, WD2, 4TT. Phone: Watford, 33066. Telex: 934583.



The difference and Alpha™ is only

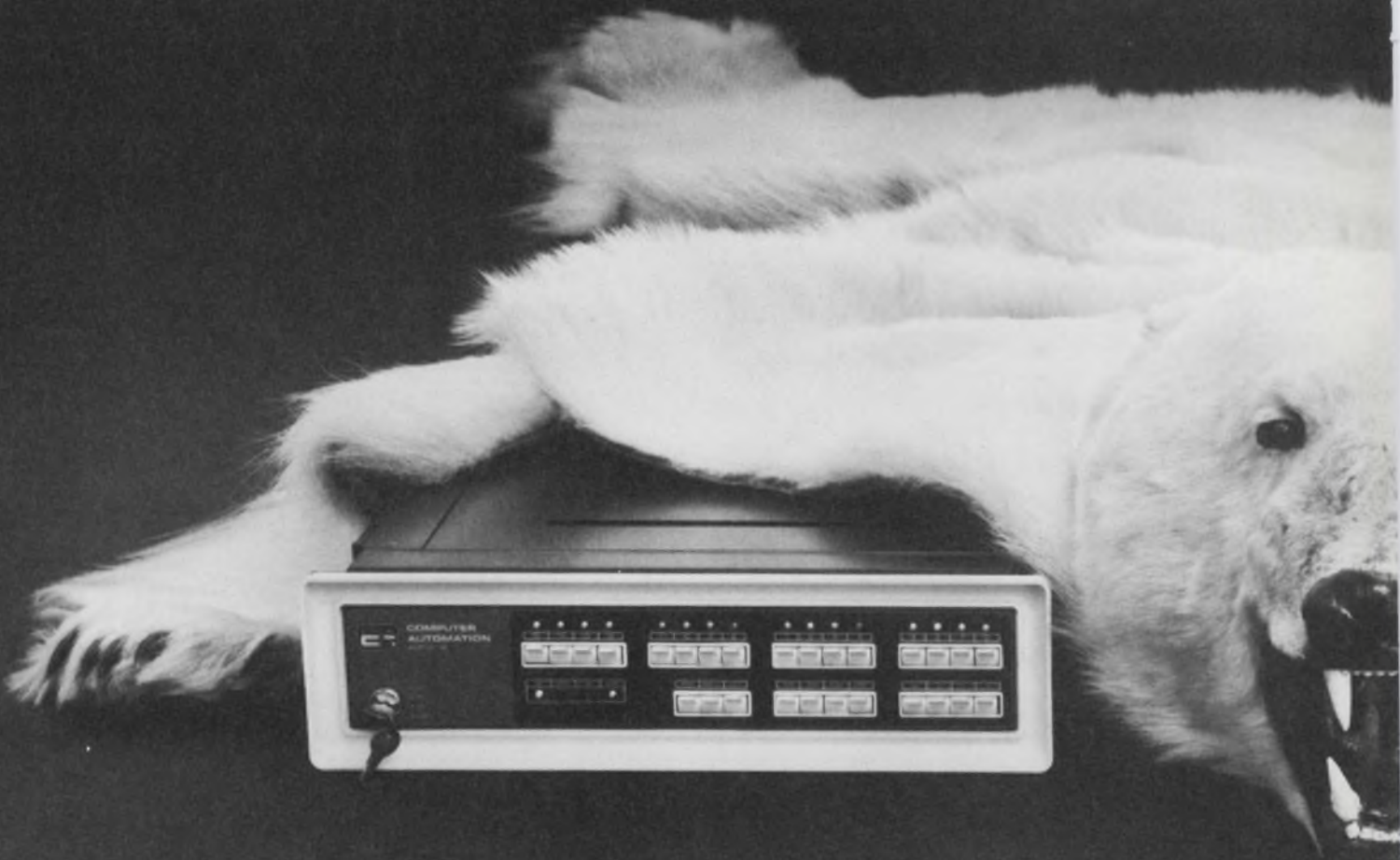

Actually the NAKED MINI is the ALPHA with its clothes off. We designed both with the same specifications for the same high performance. In fact, both are backed by the same one year unconditional warranty. The only difference is that the NAKED MINI is a computer that's really a component.

At first blush, you may think that the NAKED MINI is stripped. But it's not. It is just designed so that you can integrate a powerful mini-computer into your product and increase your profit margin.

How?

Because you don't get skinned by the NAKED MINI'S prices. In OEM quantities you get the NAKED MINI 8 for only

\$1450, and the NAKED MINI 16 for \$1995. And that includes 4K words of memory.

If you already have power and controls in your system, you may not need a control console, power supply and fancy enclosure with your computer. You may simply want to bury the computer in your product as another component. Yet you do want a complete and powerful general purpose computer that will add performance and reliability to your product.

That is exactly what you get from the NAKED MINI. Full computer power at drastically reduced prices. Fully parallel byte and word processing, direct memory I/O channels. hardware multiply/divide, vectored priority interrupts, 4 K

between the **NAKED MINI™** skin deep.



plug-in memory expandable to 32 K words. All this plus the industry's most powerful and straightforward instruction set, 156 basic instructions with many multi-function instructions.

What this means is simplified programming for producing shorter programs that take less core and run faster. And this saves you money in many ways. The NAKED MINI'S full broadside I/O and priority interrupt structure make it the easiest of all mini-computers to interface



with your equipment — and this saves you money also.

We offer a complete line of standard software and options including power fail restart, real time clock, parity, memory protect, buffered I/O cards, communication controllers, and multiplexers as well as all types of peripherals.

The bare fact is, you'll be impressed by all of THE NAKED MINI'S vital statistics. To get better acquainted call or write the NAKED MINI Company today.

COMPUTER AUTOMATION, INC.
895 West 16th Street • Newport Beach, California
92660 • Phone (714) 642-9630 • TWX 910-596-1377

MANY-TAPE MINI

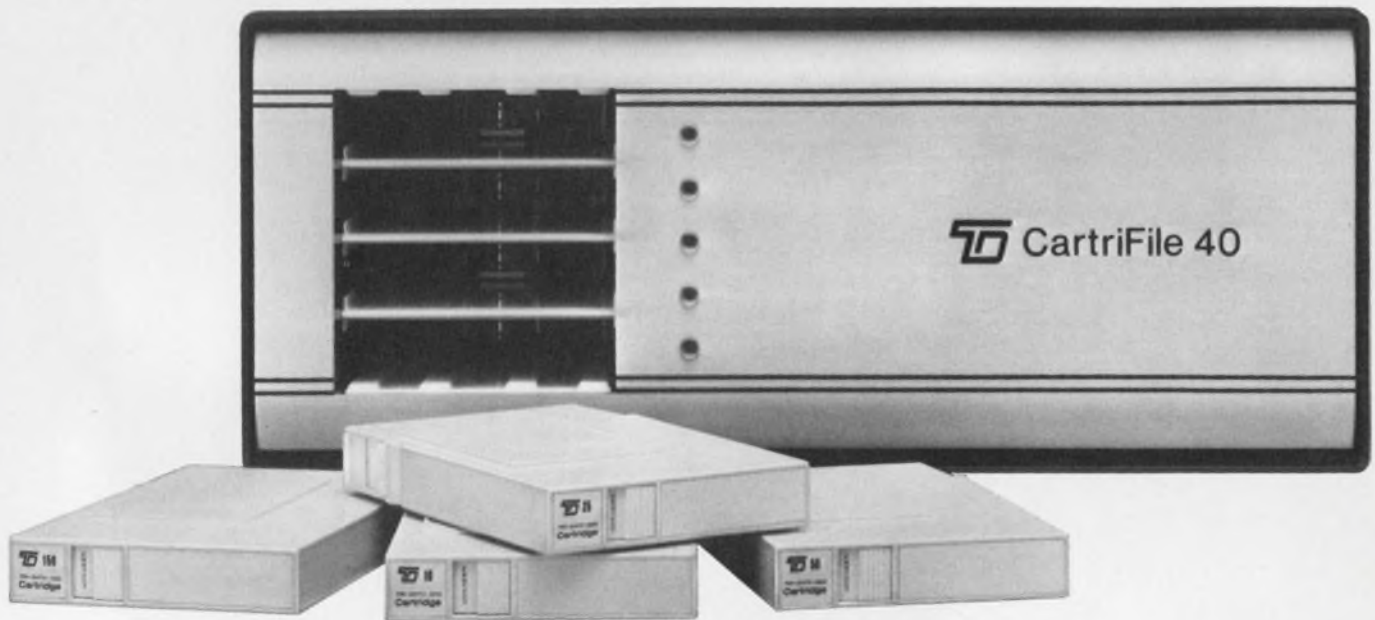

Put these FOUR mag tape drives to work and you'll add real flexibility and power to your minicomputer system. Each drive in the CartriFile® 40 is independently controllable—and reads or writes up to 18,000 bits per second. You can use each drive by itself or in combination with the others.

CartriFile 40 comes complete with electronics (read, write, and controller) plus integral power supply. Also, interfacing, cables, and basic software for all popular minicomputers.

It operates with convenient, single-tape cartridges: new Tri-Data 1000 Series. These are available in 10-, 25-, 50-, and 150-foot lengths. With four 150-foot cartridges, the system can store nearly 13 million bits.

And the price? You'll like it. Only \$4950 with interface; \$3015 in small OEM quantities (without interface).

Get all the facts on the "many-tape mini"—CartriFile 40.



TRI-DATA

800 Maude Avenue / Mountain View / CA 94040
Phone (415) 969-3700 / TWX 910-379-6978

INFORMATION RETRIEVAL NUMBER 16



Interface with the special cable specialists

CALL (317) 966-6681

■ It's Belden's Electronic Custom Design Center: Designers, engineers, production and cost analysis people. The kind you can talk to about special cable problems. And count on for straight answers and action. ■ They can tell you if your idea is feasible. What it might cost in quantity. Even give you production and delivery data. ■ Water-blocked cable; extra-high voltage applications; medical instrumentation; low-level signal interference problems; unusual environmental conditions . . . they have tackled most of the problems that might confront you. ■ So try the direct line to special cable answers: (317) 966-6681. ■ Or send for a Custom Cable Design Kit. Write: Belden Electronic Division, Custom Design Center, P.O. Box 1100; Richmond, Indiana 47374.

B-2A-2

BELDEN 



World's Smallest High-Performance Tape Drive.



25-125 ips, auto-threading, vacuum tape handling.

The Ampex TMA Tape Drive gives you top performance in the most compact package on the market. Only 19x24x18", it designs itself into your OEM system. Bargain priced, too, for more computer power.

Performance: 25 to 125 ips, 10½" reels, ANSI/ECMA 7 or 9 track standards, NRZI with 200, 556, 800 bpi or 9 track 1600 bpi. Diode and triac switching for all control circuits. Option of auto-threading or manual. Single capstan. Linear reel servo system with vacuum columns for tender loving care of your tape. A series of drives and electronics to meet your needs.

Reliable all the way. A compact performance giant.

And a super-charged buy — the best price/performance computer tape drive you can find. Special bargains

when you buy in quantity. All this backed by Ampex worldwide service, 95% interchangeable parts. Get more details on better tape drives, plus Ampex disk drives and core memories, with a call to your Ampex computer specialist.

AMPEX

AMPEX COMPUTER PRODUCTS DIVISION
13031 West Jefferson Boulevard
Marina del Rey, CA 90291, (213) 821-8933

China market reported a tough nut to crack

Despite some 800 million potential consumers, the electronics market in mainland China is still small and competition in it is among the toughest in the world, the Electronic Industries Association reports.

China's imports have been traditionally low, the Triad International Corp. of Tokyo, an American-owned marketing concern, told the EIA. Imports of heavy electrical and electronics equipment were less than \$11-million in 1969.

The best showing, Triad reports, was in 1966, with some \$34-million of electrical and electronic equipment imported.

Another hurdle for U.S. manufacturers, Triad points out, is Japan, which had 50% of the market by last year. The total market

for imports then was only \$7-million, Triad says.

One of the biggest electronic sales categories—test equipment—came to less than \$800,000 last year, according to Triad, and consumer electronics to only \$3000.

The reasons for the poor market are reported to include a low priority for electronics in the Chinese economy, limited foreign-currency reserves—estimated at between \$600-million and \$1-billion—and a basic Chinese policy of developing things at home.

In the face of these obstacles, Triad advises American manufacturers to avoid cost-cutting in competing with Japan and to emphasize the technical superiority and quality of equipment.

Quad amps offered, one at lowest op amp price

Almost simultaneously, two semiconductor manufacturers—Motorola and National—have announced the availability of monolithic, internally compensated quad op amps that operate off a single power supply.

Both devices are current amplifiers, as opposed to the more common voltage amplifiers. Though similar in construction and application, the prices for each differ greatly.

National's device, known as the LM 3900 Quad Amp sells for 75¢ each in quantities of 100. That figures out to less than 19¢ an op amp, the lowest available op amp price. The Motorola unit, designated the MC 3401, sells for \$1.75 each in similar quantities.

The new op amps are designed specifically for the single-power supply applications in industrial control systems and automotive electronics. Each device contains

four independent amplifiers that can be used simultaneously. This contrasts with the Harris PRAM, a four-channel programmable op amp. While there are four amplifiers in the Harris package, it's possible to use only one at a time. The two new quad amps are ideal for use in active filters, multi-channel amplifiers and any other application where multiple amplifiers are required in a small space.

Prior to the introduction of these new devices, the only multiple op-amp device available—aside from the PRAM—was the dual op amp. In many cases extra time, money and space were taken up by the inclusion of an extra power supply for the op amps alone.

Electronics tunes new optical filter

A new type of electronically tunable, narrow-band optical filter, suitable for use in pollution measurement and control instrumenta-

tion as well as in laser applications, has been developed.

The solid-state filter, which can change its frequency of optical transmission in response to the frequency of an applied ultrasonic signal, measures 1-1/2 inches wide, 1-1/2 inches high and 4 inches long. Competing systems—ruled grating and prism systems that are moved mechanically to sort out different colors from a broadband light source—are much bigger.

The new filter was developed by the Isomet Corp. of Oakland, N.J. A prime advantage of the device, says Dr. Warren Ruderman, president of Isomet, is its ability to scan across the optical frequency band in 1 or 2 ms. Mechanical methods take much longer.

The resolution of the filter is high. For example, at 5000 Å the resolution is 1 to 2 Å. Half-widths of lines in this vicinity range from about 1 to 4 Å.

The Isomet filter consists of a single crystal into which an acoustic wave ranging from 30 to 90 MHz is projected by a piezoelectric transducer. This gives filtering from 7500 to 4100 Å. The wavelength of the optical passband is inversely proportional to the ultrasonic signal frequency.

The sound waves rotate the polarization of a very narrow spectral component of the optical energy, giving the filter its unique wavelength-selection capability.

Optical transmission is 80%, with an extinction ratio outside the passband of 5000:1. Power consumption ranges from 1 to 3 W. The time required to shift from one optical frequency to another is about 25 μs, Isomet says.

Army speeds design of microwave ICs

Microwave integrated circuits that normally take three to six months to design are now being turned out in a week at the Army Electronics Command at Fort Monmouth, N.J.

"A software program in an IBM 360/65 computer permits an engineer to outline his problem to the computer and receive in return a sheet with all the information he needs to lay out the microwave IC design on an alumina substrate,"

explains V. G. Gelnovatch, who developed the software. Gelnovatch heads the command's microwave integrated circuits team.

Called Demon, for Diminishing Error Method for Optimization of Networks, the program was devised to speed the design of miniature microwave transistor amplifiers. The Army command has given the software program to approximately 15 Government laboratories and six industrial concerns for testing.

"This is the only complete optimum-seeking software system for the design of microwave ICs in the country, except for one offered by Optimal Systems Research, Inc., in Manasquan, N.J.," Gelnovatch says. "The software analyzes the problems submitted to the computer, synthesizes them and provides the optimum solution."

In a typical design, about six million calculations are performed in six minutes as the computer seeks better and better solutions in a restorative process. The program permits the rapid solution of complex equations involving as many as 30 variables of the amplifier.

Display society planning show with wide appeal

The most diversified technical program ever assembled on information display is promised by the Society for Information Display at its 1972 international symposium and exhibition.

The show, which will run from June 6 through June 8 in San Francisco, will have 12 day sessions on such topics as plasma, liquid-crystal, solid-state and CRT displays.

The program chairman, James H. Becker, notes that information-display systems have traditionally been military oriented but that this year the society is broadening its conference to concentrate more on the commercial aspects of display systems.

Another important feature of the conference, Becker reports, will be informal evening panel discussions by experts in numeric displays, image storage in display terminals, interactive cable TV and other fields.

A special two-day program on "Information Display Mechanisms"

is being planned for the week of the conference by the University of California at Berkeley. This program is scheduled for June 5 and June 9, so that persons attending the symposium can enroll without conflict with the show date. The registration fee for the two-day program is \$100.

A radar-radiometer to offer best of each

A hybrid airborne radar-radiometer being developed by the Jet Propulsion Laboratory in Pasadena, Calif., receives both passive radiometric emissions from the earth and reflected radar pulses from the same target at the same time.

The objective is to acquire unique combinations of polarization signatures that will accurately identify trees, bushes crops, sand, rocks, plowed land and ocean currents.

The sensor is being tested now on a 55-foot-high cherry picker. Later it will be placed in an aircraft and flown at 30,000 to 40,000 feet. Eventually it will fly 500 to 1500 km in a satellite.

Besides its earth-resources job, for which the National Aeronautics and Space Administration has funded the project for the past three years, the hybrid sensor could conceivably be used on planetary probes to check, for example, what lies below the clouds that cover Venus.

Receiving both active and passive emissions in an aircraft has been done before but with different sensors, according to Allan Lader-

man, task manager for the program at JPL. "A radar might be used and then replaced by a radiometer," he noted.

JPL's hybrid system sensors operate alternately. Between pulses the radar is switched off and the radiometer on, allowing for several thousand samples to be taken by each instrument every second.

Both sensors operate at 9.3 GHz, although eventually, Laderman says, they may use several radar channels—"perhaps three."

Both sensors use the same receiver—an X-band traveling-wave tube and a low-noise amplifier. The signal received is converted to L band and further amplified by a solid-state transistor.

"The system is unique," Laderman says, "because of its capability for variable polarization and for making measurements simultaneously."

The radar is a forward-looking, coherent, pulse system that operates on a specular return basis—that is, it works with the first return rather than a scattered return. The radar is IC logic-controlled and has a pulse-repetition frequency that is variable from 500 per second to 10,000. The pulse width is also variable, "ranging from 30 nanoseconds or lower up to microseconds," according to Laderman. The present system has a 40 ns pulse width. Peak power of the radar transmitter is 1 kW.

The readout on the present system is on chart paper. Later versions, Laderman says, will use an a/d converter and will store the information on magnetic tape.

News Briefs

Kakuei Tanaka, Minister for International trade and Industry in Japan says the Government has obtained "broad agreement" from Japanese electronics manufacturers to restrict exports voluntarily. The Japanese hope the move will forestall possible import restrictions by the U.S. and Europe. The controls will apply to color and monochrome TV sets, tape recorders, small calculators and radios.

Research and development spending in the United States will hit \$28-billion in 1972, according to an estimate by the National Sci-

ence Foundation—a rise of 4% over the 1971 level. More than a half million scientists and engineers were employed in R&D during 1971, the foundation says—"more than one-third of all the scientists in the U.S."

Video tape cartridges of feature-length movies will be available for rental next month by individuals, organizations or businesses from the Cartridge Rental Network, 460 Park Ave., New York, N.Y. The network is a joint venture of Columbia Pictures Industries, Inc., and Cartridge TV, Inc.

Bendix printed circuit board connectors put an end to close order drilling.

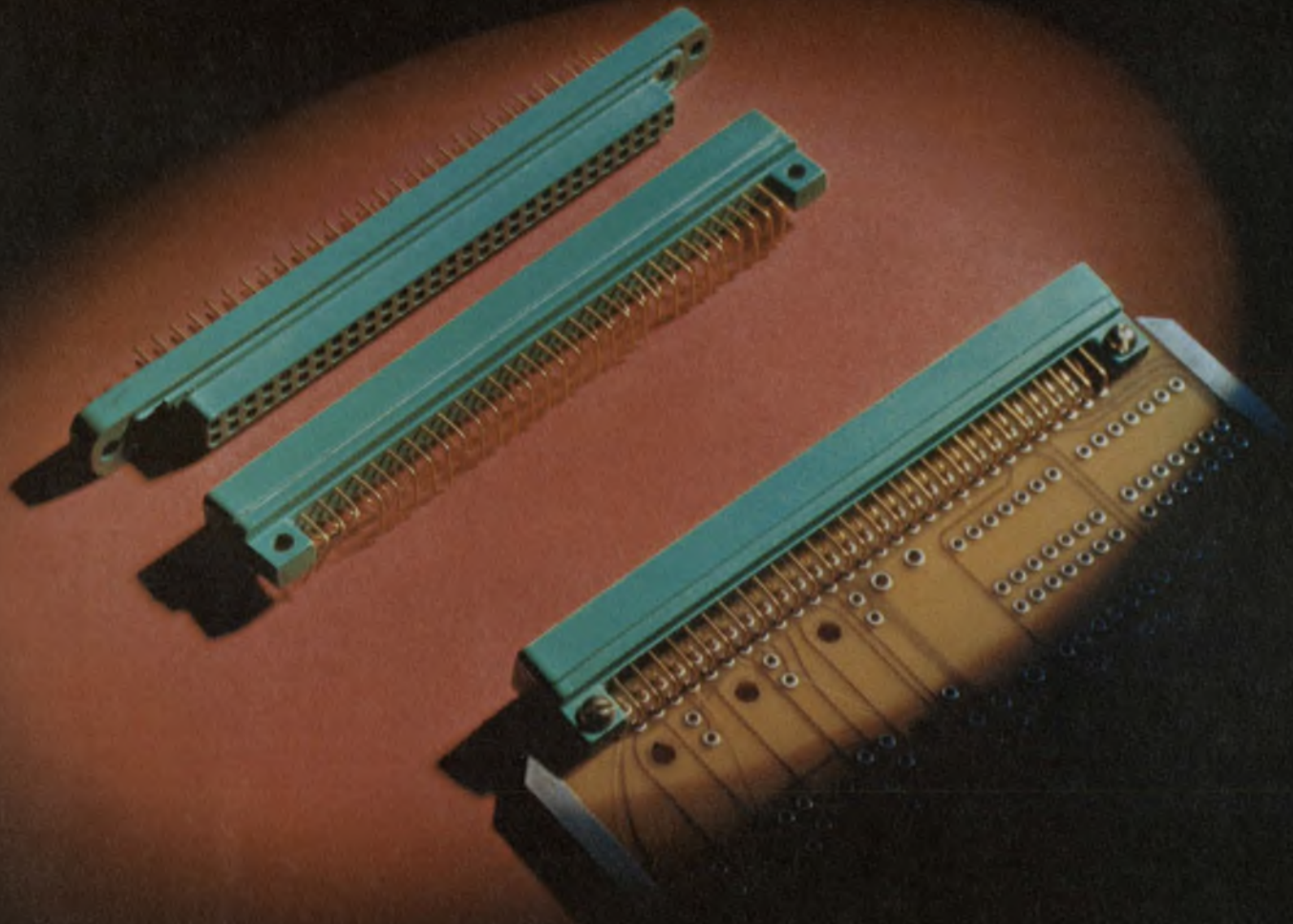

You know close order drilling. It's what's called for to produce ultraprecise hole locations in printed circuit boards. Eliminate this need and you'll cut costs for sure. Bendix P.C.B. connectors help you do precisely that. Their optional floating pin terminations "give" enough to make it easier to align pins with the printed circuit board holes.

Bendix boasts other features, too. Options like wire wrap or solder termina-

tions. Straight or right angle. Insertable crimp contacts.

Applications? Wherever printed circuit boards are used, such as switching circuits, computers, business machines, process controls, etc.

Chances are, Bendix Printed Circuit Board connectors can help you. Why not find out. The Bendix Corporation, Electrical Components Division, Sidney, New York 13838.

Bendix

100-Mbit electron-beam memory promises fast access at .01¢/bit

A new approach to random-access, mass-storage memory systems allows bit storage densities of 10^8 bit/cm² at a cost of only 0.01 cent/bit. The new system, an electron-beam memory, has been built in prototype by the Stanford Research Institute of Menlo Park, Calif.

In an electron-beam memory, miniature capacitive storage cells are addressed by a precisely controlled electron beam for both the read and write operations. According to Louis N. Heynick, physical electronics group manager at SRI, the typical access time can be a few microseconds, depending upon the peripheral electronics. The de-

velopment work at the institute has shown that practical electron-beam memories are economically feasible.

Late this year, the Microbit Corp. of Lexington, Mass., which has been working with SRI, plans to introduce an electron-beam memory system that is to be competitive with existing fixed-head-per-track disc memories. Donald Smith, president of Microbit, says his system will not only be faster but cost less than disc systems of equal storage capacity.

Microcapacitors store data

The SRI electron-beam memory consists of an array of micro-capacitors (μ -caps) etched into a conductor/dielectric/conductor sandwich (see figure). These capacitors can be as small as $0.5 \mu\text{m}$ (10^{-6}

meters) in diameter with center-to-center spacing of $1 \mu\text{m}$ for an aluminum oxide dielectric system. The energy (eV) of the electron beam addressing these cells produces more secondary electrons than originally strike the μ -cap surface. This condition is described as a secondary electron yield that is greater than unity.

The read/write electron beam of approximately 50 nA current has a diameter of about $0.5 \mu\text{m}$. A beam energy of 2000 electron volts (2 KeV) will produce a secondary electron yield of greater than unity. When the substrate is -50 V and the potential of the μ -cap is around -40 V , the cell is defined as being in the logical ONE state. Conversely a cell potential near the zero volt surface (top) potential is defined as a logical ZERO. The read/write operations occur as follows:

■ Write ONE—If a logical ZERO state exists in the cell and the substrate potential is switched from -50 V to zero volts, the μ -cap is driven positive with respect to the grounded surface. When the electron beam is turned on, the secondary electron yield will be less than unity, forcing the μ -cap toward a negative potential until it reaches approximately zero volts. Then, with the beam off, the substrate is returned to -50 V , pull-

Les Brock
Western Editor

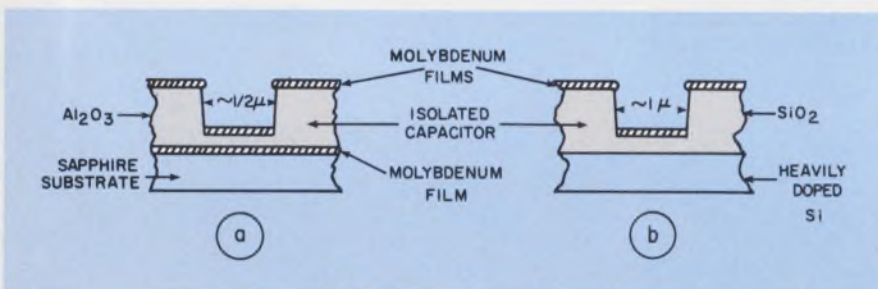

Physical characteristics of two storage cells using (a) an aluminum oxide dielectric and (b) a silicon dioxide dielectric.

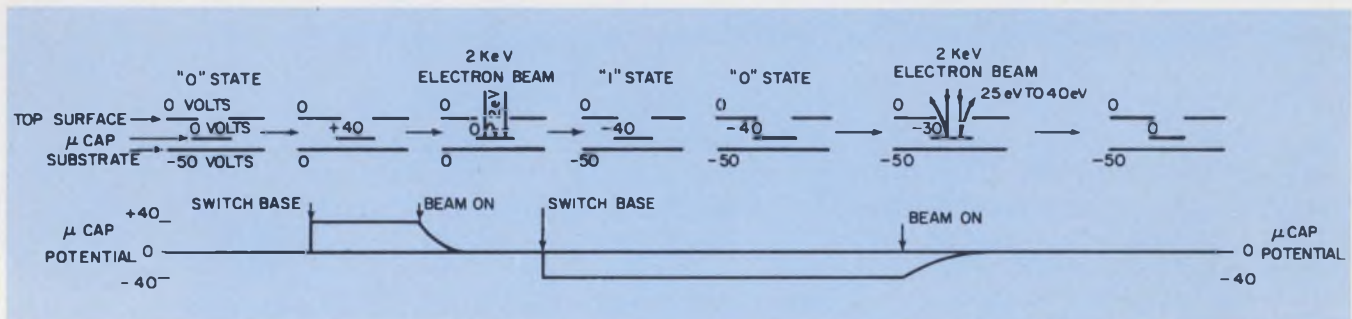

Information is written with a 2-KeV electron beam that is $0.5 \mu\text{m}$ in diameter. Both a logical ONE and a logi-

cal ZERO can be written by just changing the potential of the substrate or base material.

VACTEC PHOTOCELLS

boiled to perfection

Heat, water, steam, or a combination of all three, can't penetrate Vactec's positive hermetic seals. Even the passivated plastic types are exceptionally stable. Vactec Photocells not only endure boiling water temperatures (100° C), but also other environmental extremes down to liquid nitrogen cold (-196° C).

Long term moisture like 500 to 5000 hours in a humidity chamber can be even more destructive than boiling. If you put Vactec to this test, be sure to include some competitive cells for comparison.

You simply can't buy a better photocell *anywhere*, and Vactec is competitive with import prices because of automated processing, assembling, and testing. Take advantage of Vactec engineering, research, and manufacturing in the heart of America. Because Vactec has 249 different types of cells in stock, we can ship before your order reaches an overseas supplier. Included is a complete line of visible detectors: photoconductors (CdS and CdSe); photovoltaic cells (Se and Si); couplers of LED's or lamps and photoconductors called Vactrols. Vactec also has a photometer which measures from .0002 to 10,000 fc, for as little as \$300.00.



VACTEC, INC.

2423 Northline Industrial Blvd.
Maryland Heights, Mo. 63043
Phone (314) 872-8300

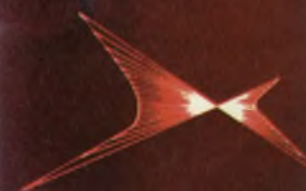

ing the μ -cap to approximately -40 V by capacitive voltage division.

■ **Write ZERO**—With the base or substrate at -50 V, the beam is turned on and the addressed μ -cap is charged positively by secondary electron emission until the μ -cap potential is equal to the grounded surface potential.

■ **Readout**—Secondary electron velocities of 2 to 3 eV for the ZERO state elements and 40 eV for the ONE state elements are easily differentiated by a simple electron velocity selector. The selector admits only the 40 eV electrons into the electron multiplier/amplifier while excluding the 2 to 3 eV. Signal-to-noise ratios in excess of 100:1 are practical with this system.

Everytime a read operation is performed on a logic ONE cell (-40 V), its potential is raised toward zero volts. However, several

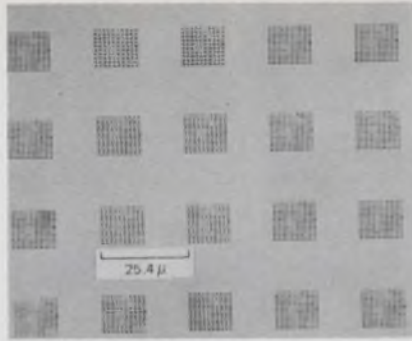

Typical array of storage elements in a Mo/SiO₂/Si sandwich.

read operations are possible before the information is completely destroyed. Refreshing of all cells simultaneously can be accomplished by flooding the entire memory with electrons of a specific energy. The energy of this refresh electron beam is set precisely to produce a secondary electron yield of greater than unity for cells in the logic

ZERO state, thereby charging them toward zero volts. For cells in the logic ONE state, the secondary electron yield will be less than unity, driving them toward -50 V.

Two versions of this memory have been investigated by SRI with excellent results. The first consists of a molybdenum (Mo)/aluminum oxide (Al₂O₃)/molybdenum film sandwich on a sapphire substrate. Because of the availability of very-high-quality silicon wafers, a Mo/silicon oxide (SiO₂)/silicon (heavily doped) system was also evaluated.

In its present state of development, the SiO₂ dielectric system can yield $1\text{-}\mu\text{m}$ elements on $2\text{-}\mu\text{m}$ centers—about a quarter of the original packing density obtained with the Al₂O₃ dielectric system. The loss in packing density can be offset by a significant increase in cell yield with the silicon wafers now available. ■■

All the weather from one compact station

A weather-reporting station that transmits in real time once a minute is the first of its kind to be developed as a completely integrated unit, with all meteorological sensors and electronics in one 60-pound package.

Designed primarily for aviation use, it substitutes new solid-state elements and electronics for sensors that have remained unchanged for years.

In addition the station incorporates a solid-state laser for making what meteorologists consider to be one of the most difficult measurements—cloud height. The same laser system can also be used for determining ground visibility, and it is being considered by the Arizona Dept. of Highways in Phoenix for measurement of highway obscuration by dust storms.

For remote operations, the outputs of the various elements in the weather station are digitized and applied to multiplexing circuits for transmission over wire lines or

radio links. For local monitoring, such as at an airfield, the results are displayed to the observer.

The new weather system, called the Integrated Environmental Detection and Ranging System, is designed as a competitor for the automatic meteorological observing stations (AMOS III-70) now being set up by the National Weather Service. Instead of a combination of stations, the new system gives, in a single station, wind direction and speed, dew point, barometric pressure, temperature and cloud height.

Solid-state improvements

Frederick J. Schulz, developer of the system and manager of the Environmental Systems Div. of Sola-dyne International, Inc., San Diego, says that the use of solid-state techniques was decided upon to provide performance that would be equal to or better than that of the traditional sensors, with improved reliability and simple maintainability. The latter features are important in remote operation.

Among the new developments is

the system's wind sensor, an acoustic device that looks like an inverted nine-inch dinner plate with the sensor in the center. This unit supplants the traditional anemometer and wind-direction vane. The acoustic output gives wind speed and direction as well as peak gusts.

In operation, Schulz explains, the peak gust figure is updated. If a gust reading is constant for three minutes, the reading becomes that of the prevailing wind.

The dew-point sensor is a solid-state device that makes use of a change in capacitance to signal the formation of moisture on it. In contrast to the popular, low-cost lithium chloride sensors, which are delicate, easily contaminated by salt air and not suitable below 11% relative humidity, the Environmental Systems dew-point sensor measures from close to zero to 100%.

Whereas the spray from a salt-air environment can contaminate the lithium chloride cell within three weeks, Schulz says, a nine-month maintenance is reasonable with the dew-point cell.

(continued on p. 30)

“When I buy an air trimmer capacitor, I don't want the plates shorting.”

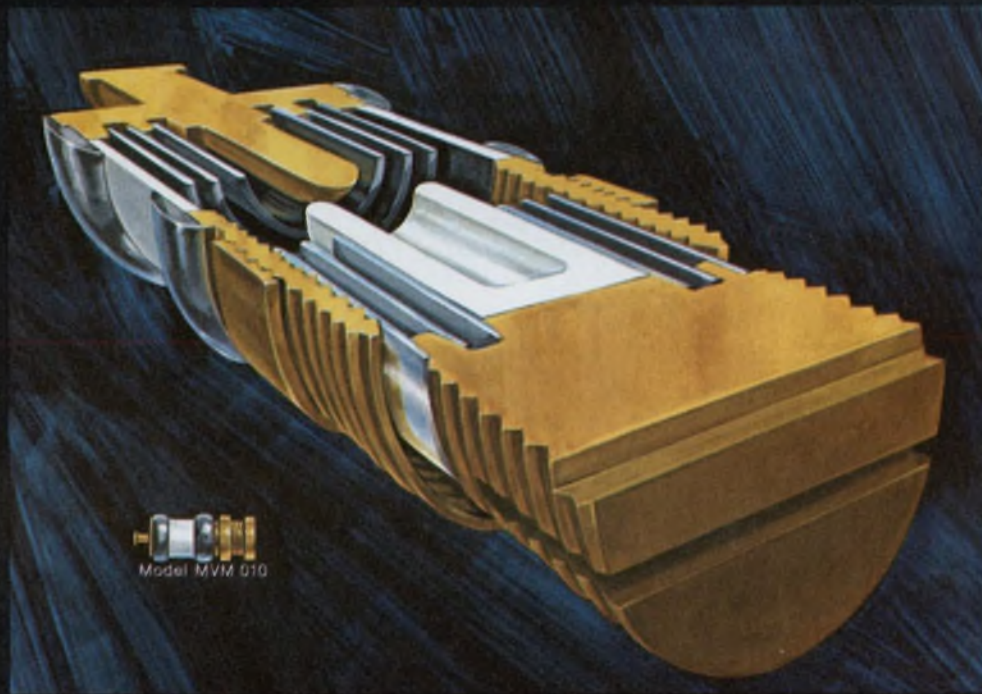

What you do want is linearity and resolution while you're trimming, and stability against acceleration, vibration and shock. Our exclusive new concentric Teflon™ guide maintains constant spacing between rotor and stator throughout the tuning range under the most adverse environmental conditions. And a special insulator at the bottom of the rotor insures positive stop without short circuiting at maximum adjustment.

The integrity of this product is assured from the selection of materials in design, to the precision mating of male and female threads. Specially constructed machining equipment, combined with painstaking assembly techniques under the most stringent quality control, offer you long tuning life and excellent resolution free of intermittent shorts due to flaking metal particles.

This kind of attention to detail in design, materials and construction, results in reliable performance from every capacitor we ship.

So when your application calls for extremely small, stable, air trimmer capacitor with low loss, high Q, as well as low inductance at high frequencies, check JFD. Eight capacitance ranges available from .35 pF–3.5 pF, to 1–20 pF. Temperature coefficients as low as 0 ± 20 PPM/°C. Rugged construction using 590°F solder assures you of optimum performance.

A final plus: quick selection. You don't have to waste your valuable time pouring over detailed charts to pick the one you want. With four basic body sizes and a variety of top tuned, stripline, printed circuit type leads and turret caps, you can get a trimmer capacitor to satisfy virtually every requirement to meet your present drawing.

Find out for yourself. Ask for your copy of our reprint of Characterization of Air Variable Capacitors, up to 8 gigahertz, and for a copy of our latest catalog #AV-71. Write, or call JFD Electronics Corporation,

15th Avenue at 62nd Street, Brooklyn,
New York 11219. (212) 331-1000.

JFD

A Riker-Maxson Subsidiary

The new system has temperature-control and compensation units for the barometric-pressure sensor. This, Schulz says, improves long-term repeatability and accuracy. The barometric sensor is mounted in a temperature-controlled oven, along with the electronic circuits for processing the output. A constant temperature of $120^{\circ} \pm 5$ F is maintained, Schulz reports.

Laser measures cloud height

The laser cloud-height range-finder is designed to measure the distances of diffuse interfaces, such as the heights of a thin cloud or fog over an airport runway. The laser uses auto-correlation techniques. It is a gallium-arsenide-diode array and transmits a string of pulses at a 1-kHz repetition rate. A 5-MHz crystal clock in the temperature-controlled oven provides radar pulse timing.

Each laser pulse is 30 ns wide and has a peak output of 300 W. However, Kenneth Jarvis, design specialist with Environmental Systems says that the average power is below that of the Surgeon General's recommendation to prevent bodily injury.

The train of transmitted pulses is reflected to a larger or smaller extent by the density of the cloud interface. For thick clouds, returns are good, and the signal-to-noise ratio provides a sharp, distinct signal.

However, for measuring the range of returns down that are cloaked by noise, such as for thin cloud cover, the use of a range-bin technique is effective. As the laser is pulsed at 1000 pps, range bins

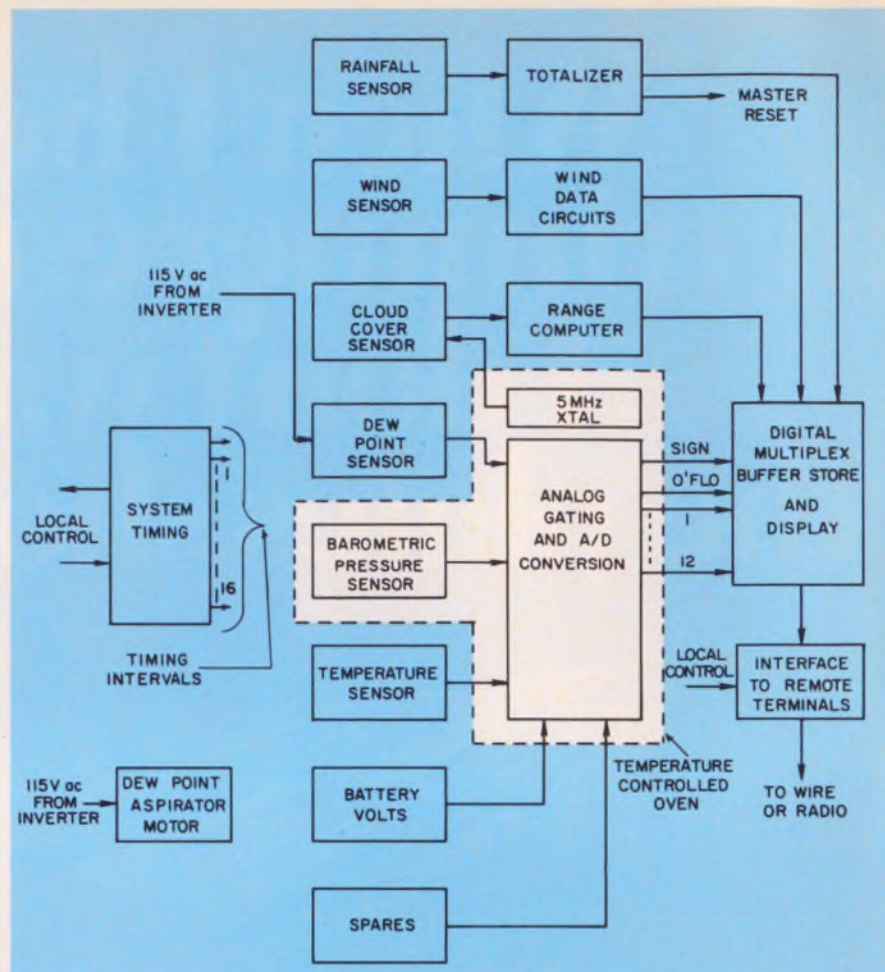

All the sensors and electronics of this weather-reporting system are packaged in one unit, operating from batteries or ac. Sensor outputs are converted to digital for multiplexing and are updated every 60 seconds.

are generated by logic circuits at return intervals of 100 feet. When the pulse returns exceed the receiver threshold for eight out of 16 pulses for a given bin, the height of the cloud cover is read out.

All returned signals are put into the bins. As one bin is filled, the return pulses fill up the next one,

and so on until the system runs out of bins or pulses.

Cloud measurement takes place in less than two seconds. The nominal range for the cloud-base measurement is 100 to 3000 feet, but system capability extends to 4000. Beyond that, the display reads out as "no cloud cover." ■■

The LHA: A communications 'first'

When the Navy's first LHA amphibious assault ship goes to sea in 1975, it will carry the most integrated and automated shipload of transmitters, receivers and antennas ever put together.

John F. Mason
Associate Editor

The captain will be able to pick up an ordinary telephone, dial a number and be in immediate voice contact with terminals in more places than any ship's system has ever provided before.

If he's calling the ward room for the dinner menu, the interior voice communications switching center will put the call through the ship's

normal telephone system.

If it's to a helicopter pilot taking off, landing or hovering some miles away, the number he dials will alert the switching center to direct the call to a shipboard terminal that has access to a radio. This terminal, in turn, will alert a switching matrix, which, from instructions stored in a computer,

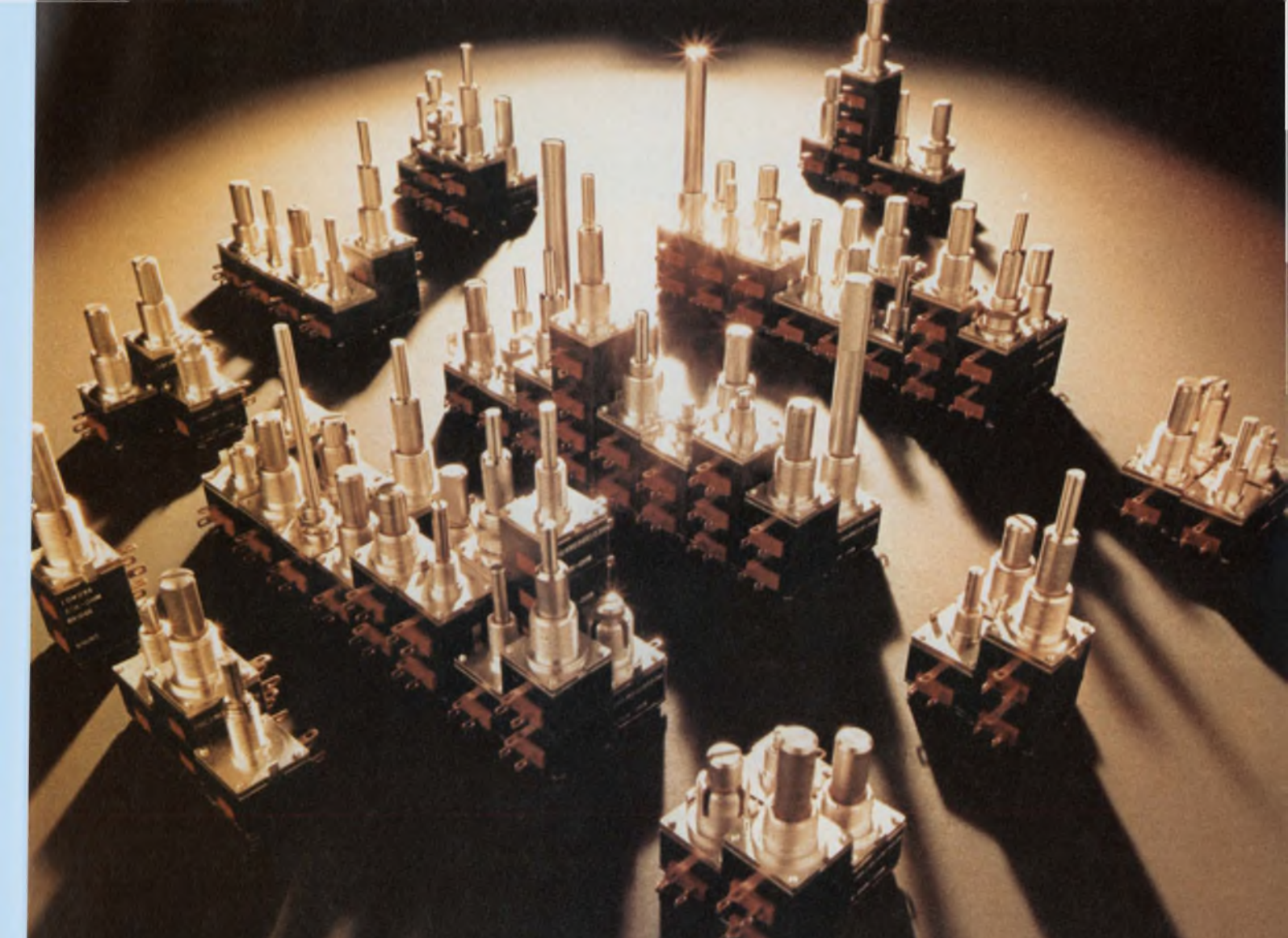

MOD POT™ versatility is unmatched. Hundreds of standard modules give you millions of options.

MOD POT is the most versatile $\frac{5}{8}$ " square potentiometer available today. A whole family of cermet or hot-molded composition resistive

modules, switch options and vernier drives with single or concentric shafts. These pre-engineered, pre-tested modules form single, dual, triple or quadruple section controls. Millions of possible combinations to solve your unique control problems. Cermet elements are rated at 2 watts (70°C) with resistances from 100 ohms to 5 megs. Composition elements rated at 1 watt (70°C) with

resistances from 50 ohms to 10 megohms, five standard tapers. And if you need something truly special we're equipped to handle that too. Call your appointed A-B distributor for details, or write: Allen-Bradley Electronics Division, 1201 South Second Street, Milwaukee, WI 53204. Export: Bloomfield, N. J. 07003. Canada: Galt, Ontario. United Kingdom: Bletchley, Bucks.



Actual Size

ALLEN-BRADLEY
QUALITY ELECTRONIC COMPONENTS





A computer will configure a special transceiver—transmitter, antenna and power amplifier—for every call made on the Navy's new LHA ships.

will select a transmitter operating on the appropriate frequency band—uhf, in this case—and will actually configure the radio system to be used. The switching matrix will instruct the transceiver to interface with an antenna that's not in use and also with an unoccupied power amplifier. This will reduce both equipment and personnel and improve the performance of the equipment. Besides choosing the correct frequency band for each particular call, the matrix will combine components for best results. It also will sense when a component is failing and be able to switch to one that's performing better.

The LHA, which looks like a sawed-off aircraft carrier in design representations, will be 781 feet long at the waterline, 820 feet at the flight deck and 106 feet in beam. It will displace 39,300 tons fully loaded and have a top speed in excess of 20 knots.

Telephones on board the amphibious ship will be priority coded, making it impossible for certain telephones to call terminals off the ship. And it will enable high-priority stations to break in on lower-priority links.

Typical terminals will include a vhf walkie-talkie network for use on board ship, vhf and uhf units for assault boats and for troops while landing, uhf transceivers in fighter aircraft, a variety of radios ranging from vlf to hf in other ships and submarines, and hf radios for long-haul calls to ports

and even to the Pentagon.

"No other combat ship, with the possible exception of an aircraft carrier, has the severe communications requirements of an LHA," says Thomas L. McCleery, manager of combat systems engineering at the Litton Ship Systems Div., Culver City, Calif., prime contractor for the LHA. "We may have to talk with 40 or more people at a time."

The communication system was designed by the Litton Data Systems Div. in Van Nuys, Calif., and the ship is being built by Litton Industries' Ingalls Shipyard Div. in Pascagoula, Miss.

Responsible for the interior voice communications system is RCA in Camden, N. J. A walkie-talkie system, called Man-on-the-Move, is being supplied by the Bendix Corp. in Baltimore, and Collins Radio in Cedar Rapids, Iowa, is providing the radios. Chu Associates in San Diego designed the antennas. The Litcom Div. of Litton Industries in Melville, N.Y., built the switching matrix. And a AN/UYK-7 computer is being provided by the Univac Corp., Blue Bell, Pa.

The interior communications system is primarily a voice network with a reed-relay space-division matrix capable of passing dc to 100 kHz. The system consists of two redundant switching centers, each containing a Mylar tape reader for program tape or maintenance-test-tape loading and a teleprinter for maintenance, status,

memory dump and terminal table printouts.

Each processor is a single-address machine using 26 instructions, with a capability of expanding to 64. DTL ICs are used throughout the machine.

The Univac AN/UYK-7 will control the "exterior" communications system—the one involving use of radios. The computer will keep tabs so closely on what all the equipment is doing that it will permit transmitters to share antennas. There will be from 50 to 55 transmitters on the LHA, covering all the frequency bands that the Navy uses—from vlf to uhf. "Sometimes eight radios will use a single antenna," Litton's McCleery says.

The computer also will perform a diagnostic function, warning the operator if certain equipment is about to fail. Collins' radios are being designed so the computer can query them digitally on their condition at all times.

Screening of incoming messages

Besides putting together radio units for transmitting messages, the computer will also be programmed to screen incoming messages. It will check the addresses, recording on discs only those messages intended for its own ship. It also will alert the operator when a high-priority message comes in. It will be able to handle as many as 2000 messages a day.

There will be five switching matrices on each ship, each able to reconfigure communication circuits at a moment's notice on command from the computer, says James J. Heigle, Jr., manager of advanced program development at Litton Systems' Litcom Div. in Melville, N.Y., where the matrices were built.

Each matrix will be able to reconfigure automatically 75 input channels to 75 output channels, with manual control available, if necessary.

The matrices will be housed in vertical sliding drawers. Maintenance will be based on a throw-away philosophy to cut training and test-equipment costs. The system will be equipped with high-reliability miniature reed relays, life-tested for more than 50 million operations. ■■

$\pm 10 \mu\text{V}/\text{mo.}$ (max)

AD508 CHOPPERLESS.

No one else gives you this kind of long term drift performance. In fact, there's only one other I.C. you can call "chopperless." It's also ours.

Our AD508 series are extremely stable and highly accurate monolithic I.C. operational amplifiers.

They feature all the precision performance of our AD504 series along with superbeta processing. Which means you get bias currents of 10nA. Offset Voltage Drift of $0.3 \mu\text{V}/^\circ\text{C}$. Common Mode Rejection of 120dB. Open Loop Gain of 140dB. And fully protected inputs and outputs.

And you get all this along with guaranteed low drift with time. We do this by burning in all our AD508's—the AD508L for almost a month—and monitoring their performance. So you can be certain of their accuracy.

You can now achieve circuit precision on the order of a few parts per million in a hermetically sealed package. Along with the economy advan-

tages of using an integrated circuit.

Our 508 is perfect for high precision analog computing and data acquisition. Instrumentation amplifiers. Ultra stable voltage references. High accuracy bridge measurements. Or wherever your error budget demands guaranteed excellent stability with temperature and time.

The AD508J, AD508K and AD508L are ready now. And we can send you an evaluation package of five at our hundred piece price. As well as our 1972 Product Guide which shows all the things we make to solve more of your problems better than anyone else.

Analog Devices, Inc.,
Norwood, Mass. 02062.
(617) 329-4700.

 **ANALOG
DEVICES**

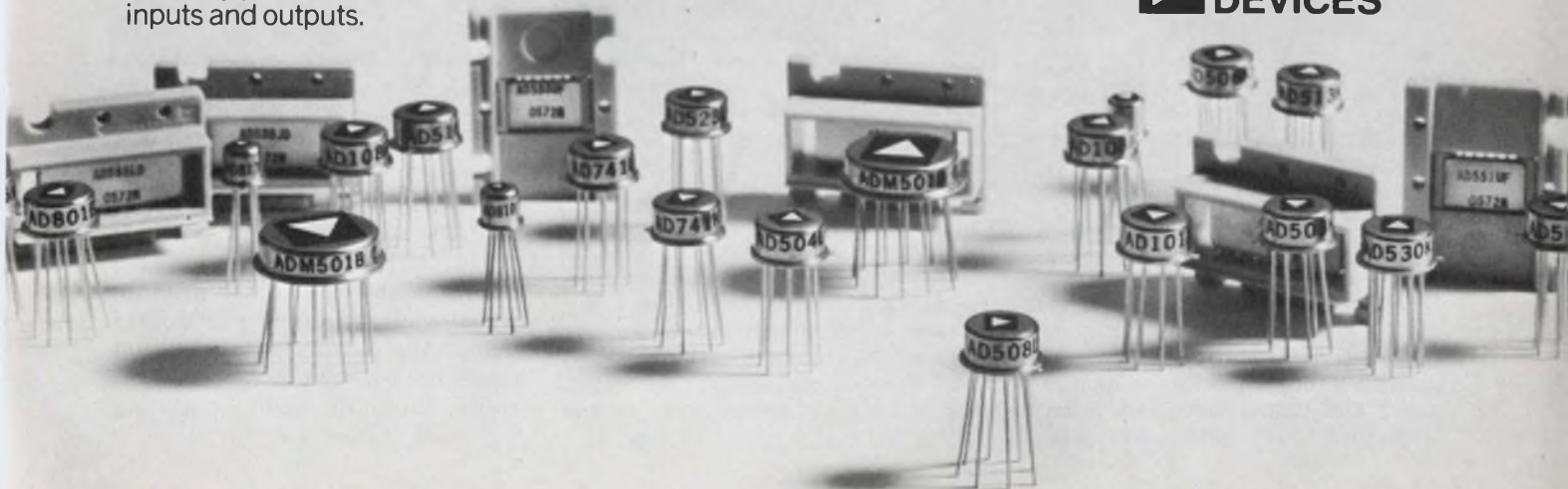

Radar 'field test' in the lab? Yes, and with better results

Radar systems can be tested in the field realistically only under actual operating conditions. Right?

No. New simulation techniques developed by the Technology Services Corp. in Santa Monica, Calif., allow the field conditions to be simulated in the laboratory. A computer simulation is generated, and then a programmable signal generator feeds realistic radar returns into the radar under test.

This is not a new concept. But, Technology Services has gone a step further. Dr. Peter Swerling, president of the company, reports:

"We are improving the realism with which one can use simulation. The basic models we use are more realistic and comprehensive than any previously used. We deal with unwanted as well as real targets. We consider ground clutter, birds, chaff, decoys and other target-

masking techniques. We also model the propagation medium. Thus we don't have to wait for the proper weather conditions. We can model any weather conditions."

Bird watching was the clue

Swerling notes that the models now used arose from work that the company did for the Army Electronics Command at Fort Monmouth, N.J. In that instance the TPQ-28 mortar-location radar had a high false-alarm rate. Technology Services determined through a computer model that the problem was birds. The centroid of a flock of birds moves like a mortar shell.

The computer models for Technology Services' present radar work are being refined for a new Fort Monmouth project—the design of an artillery locator and tests for it.

Software models developed on the program for target geometry, clutter, environment and the like

are modified in a computer by the radar geometry and antenna pattern. This gives the ideal average response at the input to the radar receiver. To this is added random statistical variation and thermal noise, to get a real input to the video section of the receiver. This signal is combined with the real video response of the receiver to give a realistic output from the video section of the receiver. This video response is in the form of an in/phase and a quadrature/phase component, each as a separate channel in digital form.

Dr. Richard Mitchell, co-manager of simulation at Technology Services, points out that so far this video response has been generated on a computer tape. The hardware to convert the tape into signal-generator outputs has not yet been built.

Hardware has been designed. Dr. Glenn Gray, associate manager of development at Technology Services, says that the digital tape from the simulation program will first be stored in a mass memory. Then it will be transferred in pieces to a high-speed buffer memory. The output of the buffer memory can be used directly for testing as a digital video signal. Otherwise the buffer will feed the in/phase and quadrature/phase signals to a pair of digital-to-analog converters. The two analog signals will each be used to modulate a carrier. Each signal will then be multiplied by an offset oscillator, and the resulting signals will be added. Depending upon the frequency of the carrier, the resulting signal could be an rf or an i-f signal. If the outputs of the digital-to-analog converters are used directly, the output will be an analog video signal. ■■

David N. Kaye
Senior Western Editor

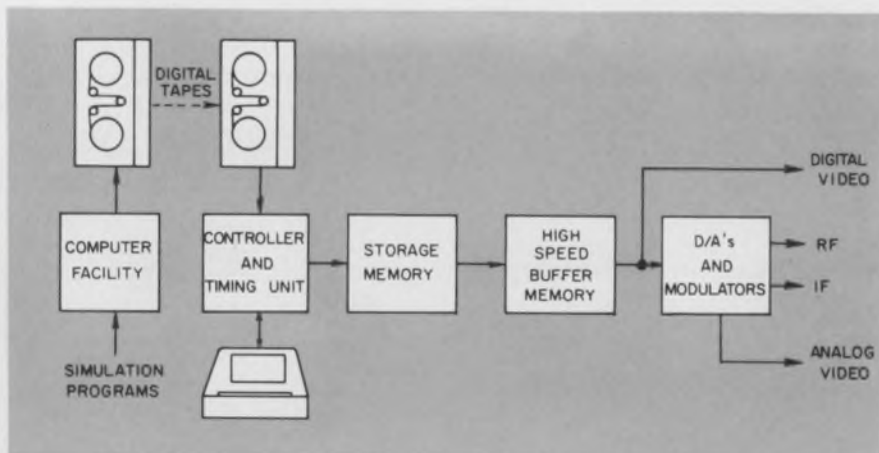

Radar-signal simulation requires that a digital signal be generated from a set of computer models. The digital representation of the signal is recorded on magnetic tape, and the tape is played into a mass storage memory. After passing through a buffer memory, the digital signal is converted to an analog signal and used to modulate a carrier. The modulated carrier serves as the test signal to the radar under test.

RCA engineers wrote the books!

Comprehensive library of solid state theory and applications.

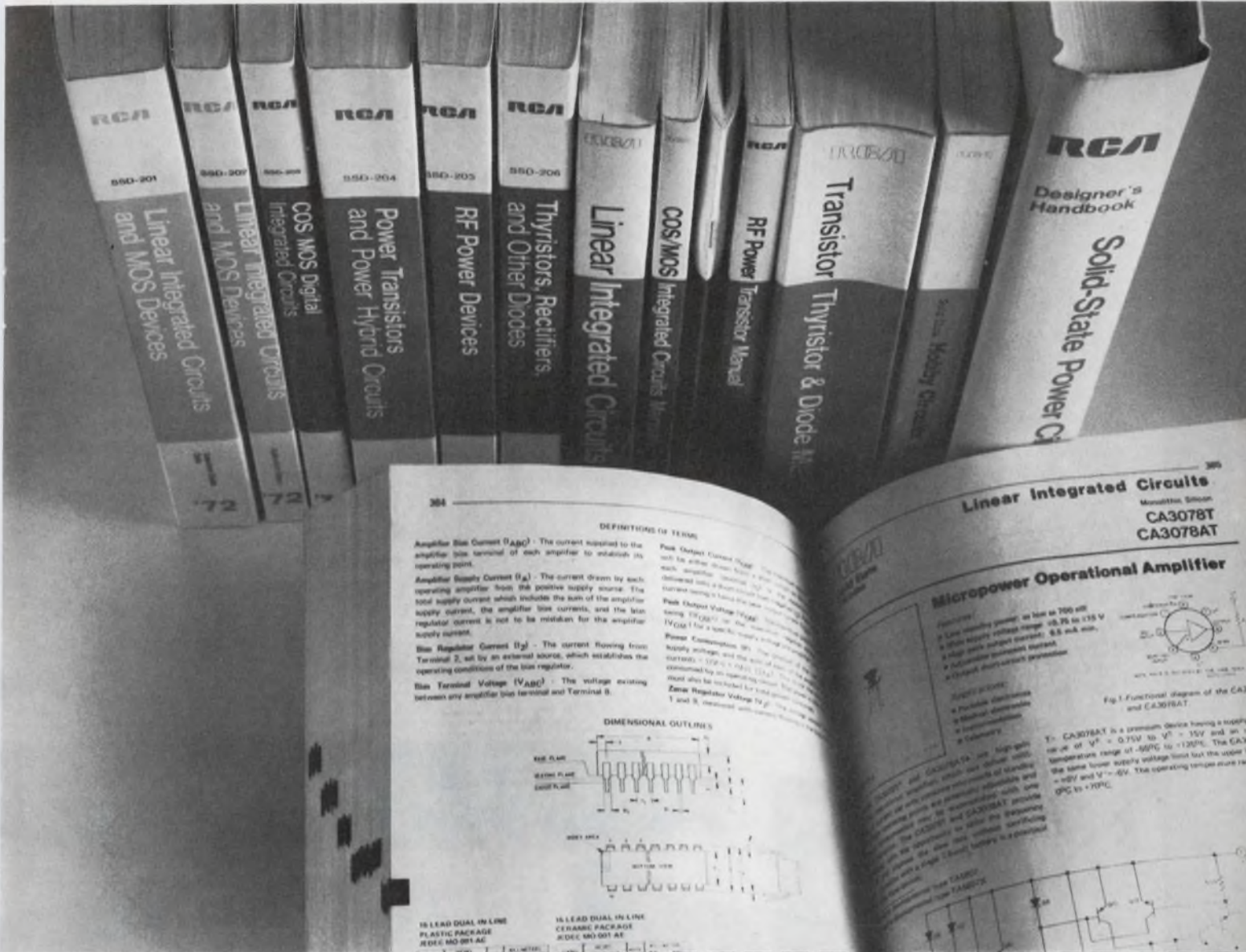

An extensive library of solid state theory and applications from the men who know the field best. RCA design engineers. RCA application experts. And RCA research scientists.

Get the entire library of 13 volumes — 5,600 pages of information — or just the books you need.

The seven technical manuals and six DATABOOKS are available from RCA distributors or directly from RCA.

Act now. See your RCA Distributor, or mail coupon with check, money order, or purchase order to: RCA Corporation, Solid State Division, Section ED-2, Box 3200, Somerville, New Jersey 08876.

DATABOOKS

- Linear Integrated Circuits and MOS Devices (Data and Selection Guide) SSD-201 \$2.50
- Linear Integrated Circuits and MOS Devices (Application Notes) SSD-202 \$1.50
- COS/MOS Digital Integrated Circuits SSD-203 \$3.00
- Power Transistors and Power Hybrid Circuits SSD-204 \$2.00
- RF Power Devices SS-205 \$2.00
- Thyristors, Rectifiers and Other Devices SSD-206 \$2.00
- All six DATABOOKS \$13.00

Complete library of six DATABOOKS and seven technical manuals \$34.45

Technical Manuals

- Linear Integrated Circuits IC-42 \$2.50
- COS/MOS Integrated Circuits Manual CMS-270 \$2.50
- High-Speed, High-Voltage, High-Current Power Transistors PM-81 \$2.00
- RF Power Transistor Manual RFM-430 \$2.50
- Transistor, Thyristor, & Diode Manual SC-15 \$2.50
- Solid-State Hobby Circuits Manual HM-91 \$1.95
- Solid-State Power Circuits (Designer's Handbook) SP-52 \$7.50

RCA Solid State, Box 3200, Somerville, New Jersey 08876.

Please send books as indicated on this coupon. Check, money order, or purchase order enclosed. Payable to RCA Corporation.

Name _____

Address _____

City _____

State _____ Zip _____

Payment by: Check ; Money Order ; Purchase Order .

RCA Solid State
products that make products pay off

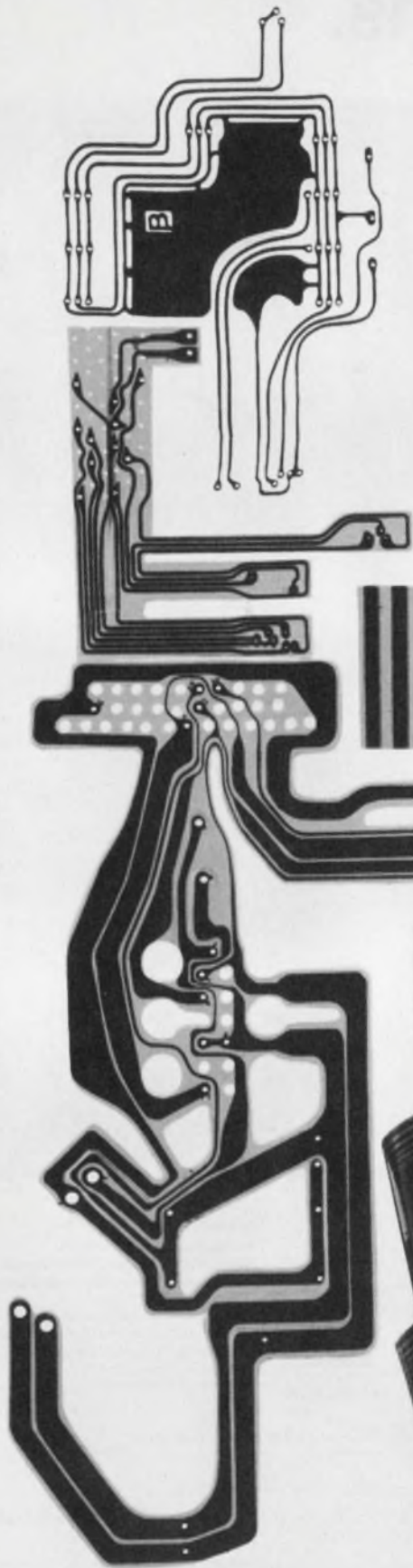

We started something in flexible cable 13 years ago when we pioneered Contour™ Cable for the Surveyor moon probes, Minuteman missiles and for the special needs of new high-speed computers.

And we can terminate it, too. We've everything you need to interconnect your circuits. Flat flexible continuous cable, flexible etched circuits — and 19 different types of connectors.

We're the only one offering a total interconnection systems approach, with the experience and on-going production to give you the benefit of all three (cables, circuits and connectors) now.

Want to make something of it?

We'll show you how. Write for our new 6-page Contour™ Cable catalog: 500 Superior Avenue, Newport Beach, California 92663.



™—Contour Cable is a trademark of Hughes Aircraft Company.

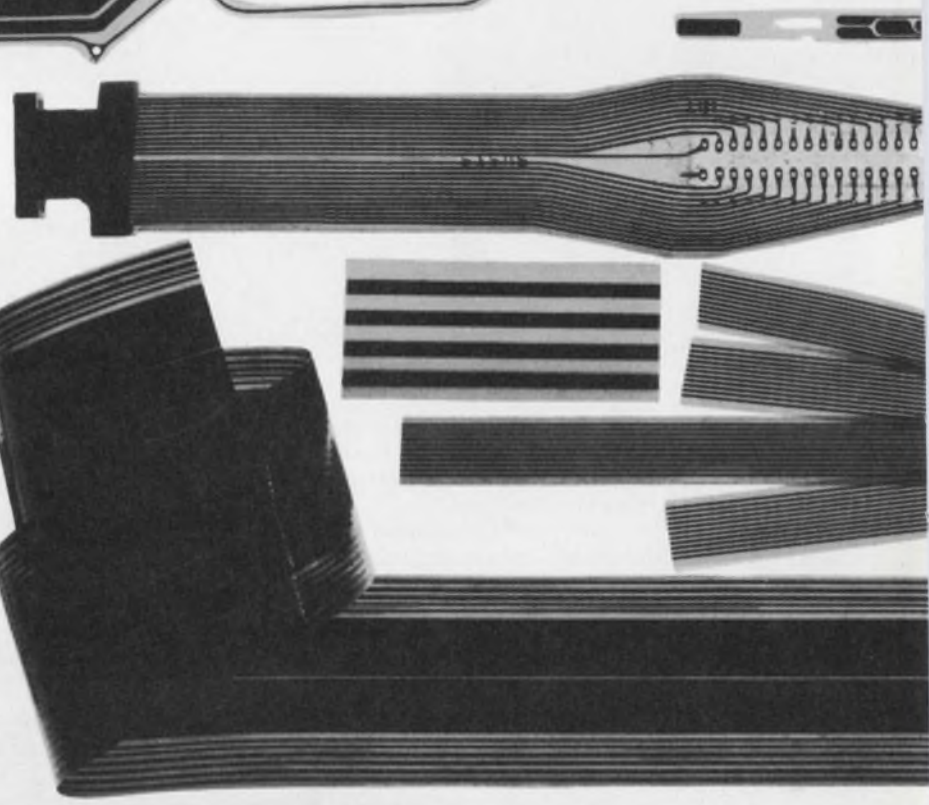

**If it's happening in interconnections,
it probably started at Hughes.**

Multilayer density boosted

A twenty-fivefold improvement in the volumetric circuit density of multilayer printed-circuit boards is reported as a result of a new transfer process.

Developed by Photronics, Inc., of Goleta, Calif., the process yields flush circuits with no plated-through holes, no voids and a surface finish of better than 4 micro-inches RMS.

Nathan Pritikin, president of Photronics, says: "Conventional multilayer circuit boards use plated-through holes as vias to interconnect layers. We use solid electroformed posts that take up less space and will never break, even after many temperature cycles."

Pritikin claims at least 100 million hours MTBF per interconnect when solid posts are used.

Photronics' process costs about 33% more than standard epoxy-glass multilayer boards but less than half the cost of ceramic multilayer boards. A two-layer circuit, Pritikin says, would cost 75 cents to \$1 per square inch.

Layer by layer built up

Starting with a flat surface, Photronics electro-plates the surface conductor pattern. This pattern is covered by a layer of a resin deposited everywhere but at the

holes for the vias. The vias are electroformed in place, and the next layer of conductor pattern is electroplated and connected to the vias where desired. More resin is laid in place, and the process is repeated until all of the layers are down. The multilayer structure is then covered with a plated ground plane or some other substrate that forms the base of the sandwich. Finally the structure is lifted off the flat starting surface, to expose the top of the multilayer board.

Resin layers serve as a dielectric insulator. They can be as thin as 0.5 mil but are typically 1 mil. The dielectric breakdown of the proprietary resin used is about 1000 V/mil.

One advantage of solid vias, as opposed to plated-through holes, is that the solid posts can be much thinner and spaced much more closely together. This accounts for much of the volumetric density improvement.

Solid cermet conductive posts are often used on ceramic multilayer boards as vias. However, these have a resistance of about 2Ω vs only about 0.1Ω for the solid copper posts that Photronics uses.

Flush circuitry has previously been used primarily in contacting commutators. ■■

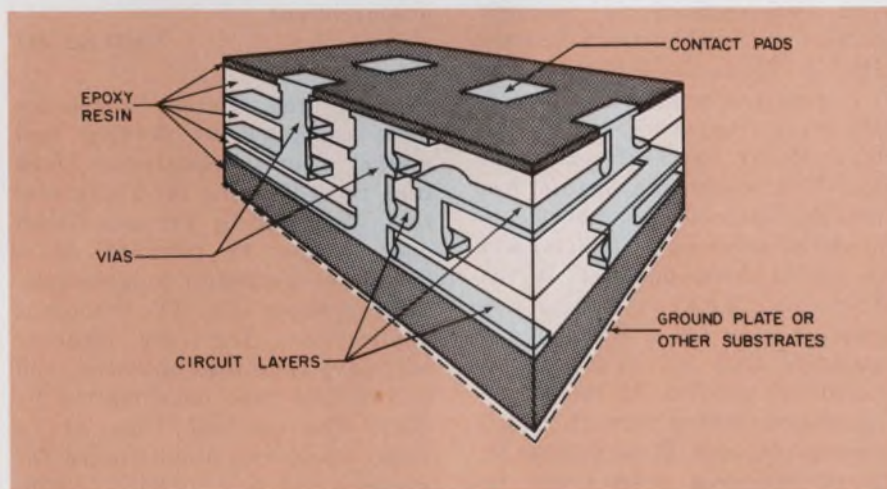

Flush multilayer printed-circuit boards are constructed of alternating layers of conductor pattern and epoxy resin. The circuit is tied together by solid posts that connect layer to layer, and the entire multi-layer circuit floats in a sea of epoxy resin. The process improves circuit density 25-fold.

Hughes is more than electronic components and systems.

It's equipment, too.



Microwave TWTs, TWTAs and solid state products (RS 289)



Displays (RS 291)

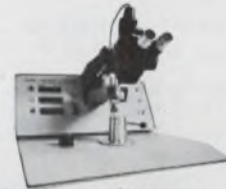

Microcircuit production equipment (RS 294)



Gas lasers (RS 293)



Thermal energy transfer (RS 299)

For complete information, write Bldg. 100, Mail Station C-512, Culver City, CA 90230. Or request by Reader Service (RS) numbers.

HUGHES

HUGHES AIRCRAFT COMPANY

Industrial Electronic Products

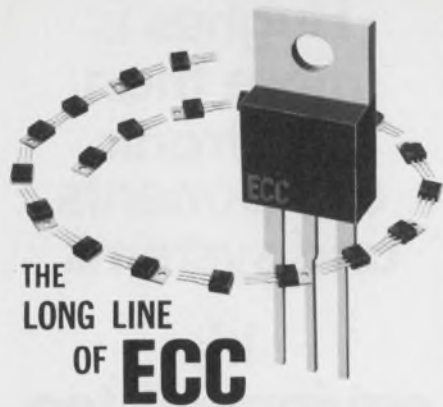

THE
LONG LINE
OF **ECC**

THERMOTAB® & THERMOPAK*
TRIACS

**World's leading
Triac producer offers
fast delivery,
electrical isolation
and competitive pricing.**

THERMOTAB and THERMOPAK TRIACS
(Electrically isolated tab)

- Wide current range
 $I_{T(RMS)}$ 0.8 - 16 amps
- High voltage capability
 V_{DROM} 200 - 800 volts
- High surge current ratings
 I_{TSM} 20 - 150 amps
- Sensitive gate triggering
 I_{gt} I, III 3, 5, 10, 25, 50 ma

All ECC triacs feature heavily glass passivated junctions for high reliability. They are available from your nearest ECC Sales Representative or Authorized Distributor.

* trademark of ECC



**NEW
CONDENSED
CATALOG** contains technical data on these
and other ECC semiconductors.

To receive your copy, circle No. 246.

ECC
CORPORATION

P. O. Box 669 • Euless, Texas 76039
817/267-2601

**technology
abroad**

Police patrol cars in Nuremberg, West Germany, are now automatically tracked at headquarters by a Siemens VSR-1600 process-control computer. The computer is linked to the car radios and a network of four receiving antennas. The antennas cover an area of five kilometers square. Each car, when addressed by a control transmission, sends back signals in a fixed pattern. These signals are picked up by the four antennas, are demodulated and routed over the telephone lines to Police Headquarters. At headquarters, the Siemens computer calculates an interrogated car's position from the differences in propagation times of the radio signal as it travels between the car and the four antennas. The system is programmed to eliminate false data caused by multiple propagation paths. A headquarters computer-operated display, updated every 30 seconds, can handle up to 100 vehicles.

CIRCLE NO. 458

A tunable, far-infrared laser uses a relatively new crystal material called Proustite, or silver arsenide trisulphide, which has a non-linear transmission characteristic. This nonlinear property is exploited in the fabrication of tunable devices demonstrated by research workers at Southampton University in England. Proustite was first grown as large artificial crystals some five years ago at the Royal Radar Establishment, Malvern. The Southampton team has used the material in two devices—an optical parametric oscillator and an optical down-converter. In the first application, tuning was achieved from 1.8 to 2.55 μm , but operation from 1.2 to 9.5 μm is considered possible. In the second application, tuning from 10 to 12.5 μm was obtained. These tunable infrared radiation sources can be used in infrared spectroscopy, in pollution monitors and in process control in chemical plants.

CIRCLE NO. 459

A novel resonance technique to determine metal thickness from 0.12 to 1.2 mm, with an accuracy of 2.5 μm , is used in a new ultrasonic thickness gauge. Developed by the Non-Destructive Testing Centre, Atomic Energy Research Authority, Harwell, England, the gauge has an electronic controller that sweeps the ultrasonic transducer through a range of frequencies. At the resonant frequency of the metal being checked, there is large absorption of energy. This point is sensed by location of the center point of a resultant echo. Since thickness is proportional to the reciprocal of the frequency at the resonant point, either an analog or digital display of thickness can be provided.

CIRCLE NO. 460

A doppler-effect microwave radar to indicate closing velocities when docking has been fitted to two of Britain's largest tankers. The ships, over 255,000 tons, have the radar amidships, where it can indicate closing velocities from 0 to 100 ft/min at a range of up to 1000 feet. The heart of the radar is a Gunn-effect diode that operates at 14.1 GHz. It is housed in a cylindrical body measuring 16 inches long by 13.5 inches in diameter, and it can be aimed like a searchlight.

CIRCLE NO. 461

German and Dutch companies have combined to develop and market a new helical-scan video tape recorder. The recording system, developed by Fernseh GmbH and Philips, is intended as a lower-cost competitor to quadruple-head systems for TV broadcast applications. The new recorder will have simplified operation and will reduce tape consumption by 30%. The one-inch tape has a video track, two audio tracks for stereo sound broadcasting, a control track and an auxiliary track for cue and address-code purposes.

CIRCLE NO. 462



TO-114 CASE

the Powerhouse

250A PLANAR NPN SILICON POWER TRANSISTORS

Solitron's new family of planar power transistors are the most versatile high power, high current devices now available to you. Three individual series have been developed to meet various application requirements for high current switching such as motor controls and power supplies. Identified as the SDT 5840, SDT 5850 and SDT 5860 Series, these silicon power transistors are constructed with the largest planar chip in the industry.

FEATURING:

- Hi-Rel Construction
- $f_t = 15$ MHz Typical
- Low Saturation Voltage (1.0V max. @ $I_C = 120A$, $I_B = 12A$)
- Power Dissipation @ $100^\circ C = 300W$
- Low Thermal Resistance, $\theta_{J-C} = 0.33^\circ C/W$

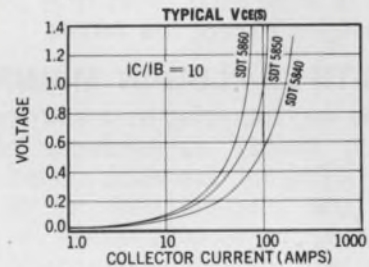
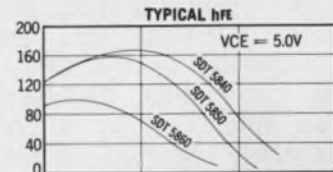
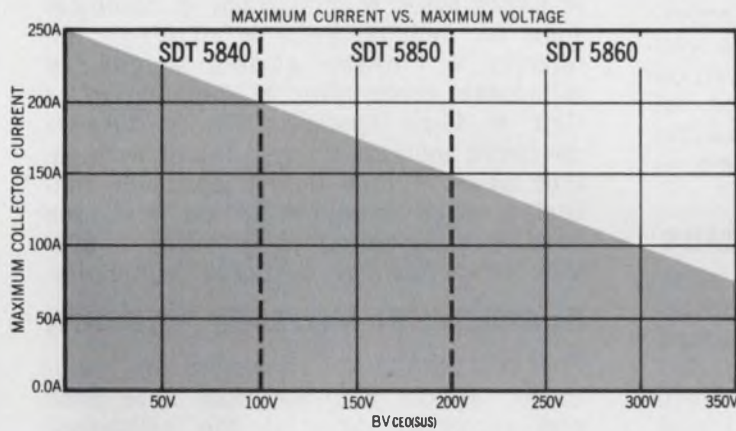

From the House of Power

For complete information, prices and engineering application assistance, dial toll-free 1-800-327-3243. Or write:

Solitron

DEVICES, INC.

1177 BLUE HERON BLVD. / RIVIERA BEACH, FLORIDA / (305) 848-4311
TWX: (510) 952-7610

SAN DIEGO, CALIF.
8808 Balboa Ave.
CMOS, PMOS Circuits
Diodes, Rectifiers, &
Zeners
FET & Dual FET
Transistors
High Voltage Assemblies
Linear & Monolithic IC's

RIVIERA BEACH, FLA.
1177 Blue Heron Blvd.
Hi-Rel Power Transistors
Si & Ge Power
Transistors
Hi-Rel Power Hybrids
PNP-NPN Industrial
Transistors

PORT SALERNO, FLA.
Cove Road
Microwave Connectors
Plaxial (R) Cable
Precision RF Coaxial

JUPITER, FLA.
1440 W. Indiantown Rd.
Microwave Stripline
Components
Microwave Diodes
RF and Microwave
Transistors
Hi-Rel Power
Transistors

TAPPAN, N.Y.
256 Oak Tree Road
Diodes & Rectifiers
Ferrite & Ferrite Devices
High Voltage Assemblies
Power Rectifiers
Thick Film
Hybrid Circuits

KENT, ENGLAND
Tubbs Hill House
London Road.
Sevenoaks
Solidev, Ltd.
Full line of
Solitron devices

BEN BARAQ, ISRAEL
51 Hayarkon Street
AEL Israel, Ltd.
Full line of
Solitron devices

TOKYO 105, JAPAN
Rm No. 21,
Kyodo Bldg
No. 4-10, 2 Chome
Higashi Shinbashi
Minato-ku
Full line of
Solitron devices

THE GROWING



TEKTRONIX®

7000-Series Oscilloscope Systems



7904 Oscilloscope

Exclusive to the 7000 Series is:

CRT READOUT—

Deflection factors and sweep speeds, the DMM and counter outputs, invert and uncalibrated symbols, etc., are automatically displayed on the CRT—where you look for information. CRT Readout can be ordered initially or as a conversion kit that is easily installed. In each case the cost is only \$400. And it is available in all scopes except the 7403N.

MULTIPLE-PLUG-IN MAINFRAMES

Three or four-plug-in mainframes allow up to twenty combinations of vertical and horizontal operating modes. You can now use plug-ins with widely different features . . . simultaneously. If you wish, start with only one horizontal and one

vertical plug-in and add more as your measurement requirements change.

PLUG-IN VERSATILITY

Plug-ins are available to make virtually any measurement desired. Examples are:

- single trace
- dual trace
- combinations for multiple trace
- 10 μ V/div differential
- 1 mA/div current amplifier
- differential comparator
- Sampling to 14 GHz
- 45-ps risetime TDR
- 1.8 GHz spectrum analyzer
- curve tracer
- single time bases
- dual time bases with calibrated mixed sweep
- 500-ps dual time base with triggering to 600 MHz
- 525-MHz direct counter
- digital multimeter.

RUGGEDIZED MILITARY VERSION

The AN/USM-281C consisting of main-frame, vertical plug-ins, dual time base and accessory cover is the militarized version of the 7403N Oscilloscope System.

From 500 MHz at 10 mV

or: 1 GHz @ <4 V/cm direct access plug-in

For those who have requirements in between 500 MHz and 50 MHz there's the 150-MHz 7704 (R7704 rackmount), 90-MHz 7504 (7514 storage), all with 4 plug-in compartments; 90-MHz 7503 with 3 plug-in compartments.

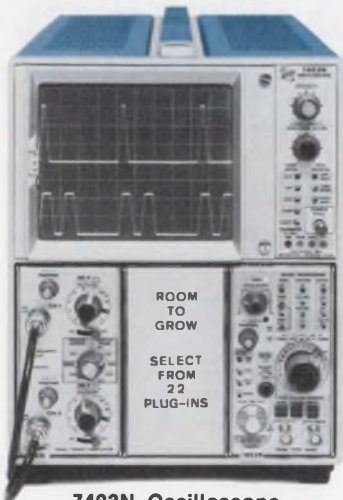

7403N Oscilloscope
(R7403N 5 1/4-inch rackmount)

to 50 MHz at 5 mV

dual-trace, 6½-inch CRT and delaying sweep for only \$2200

7000-Series Scopes, complete with plug-ins, start as low as \$1670. Call your nearby TEKTRONIX Field Engineer today for a demonstration of the scopes that make *more* measurements *easier* and *quicker* or write: Tektronix, Inc., P.O. Box 500, Beaverton, Oregon 97005.

U.S. Sales Prices FOB Beaverton, Oregon

Tektronix lease and rental programs are available in the U.S.

washington report



Don Byrne
Washington Bureau

Navy sees off-the-shelf hardware for new frigates

Most, if not all, of the electronic gear aboard the Navy's proposed fast, light patrol frigates will be off-the-shelf equipment. No electronic R&D funding is planned for the ships. Navy brass recently told the House Armed Services Committee that the electronics would include the AN/SQQ-23 PAIR sonar, the AN/STS-49 search radar, AN/STS-55 surface search radar, the Mark 92 duo-channel fire-control system and the Mark 13 guided-missile launching system. The Navy is seeking approval of 50 of the ships for patrol duty. Each would cost in the neighborhood of \$45-million. The Bath Iron Works of Bath, Me., has been awarded a \$3.15-million engineering design contract for the ship and its propulsion system, and the Todd Shipyards Corp. of Seattle has received a \$1.8-million contract to perform "similar design work of lesser scope."

Western Union kicks off microwave scramble

The Western Union Telegraph Co. has become the first established common carrier to file a tariff in competition with a specialized microwave common carrier—a move that should be duplicated more and more as the Federal Communications Commission grants more applications for systems now pending. Western Union filed tariffs to compete with Microwave Communications, Inc., on its Chicago-St. Louis system. MCI became the forerunner of all specialized microwave common carriers following a landmark decision by the FCC. AT&T has not yet filed a competitive tariff but can be expected to do so soon.

Meanwhile the FCC has granted construction permits to a second specialized microwave common carrier, the Data Transmission Co. (Datran) for a 61-station system from Houston, Tex., to Palo Alto, Calif. That's about half of Datran's proposed digital-only transmission system. So far no other systems have been granted construction permits.

It's spring again at the FAA—and here's latest plan

Every spring the Federal Aviation Administration takes a long, hard look at its needs for the next 10 years and draws up a blueprint. Then, new administrators come along and change the over-all concept, the mood of Congress shifts or there is a change in Administration. Finally, the original 10-year plan is buried by revisions.

But here, for the record, is the FAA's newest 10-year-request: \$1.05-billion for the en-route portion of the national airways system. Included will be \$306.8-million for long-range radar, \$134.1-million for improvement in microwave links, \$389.4-million for automation equipment, \$306.5-million for improved landing systems (including \$138.6-million for the introduction of a microwave landing system) and \$109.1-million for en-route navigational aids.

In terminal areas, the FAA says it will need \$941.5-million over the same period. More than half of the facilities and equipment costs for these areas will be accounted for by terminal radar—\$484.1-million. A total of \$132.2-million more will be needed in terminal areas for automation equipment.

Space shuttle avionics may cost half billion

The value of the avionics in the \$5.2-billion space shuttle project will not be known until the airframe contract is awarded in July, but the National Aeronautics and Space Administration says that studies indicate that the guidance, communications and navigational systems will range in cost from \$200-million to \$600-million. North American Rockwell, General Dynamics, McDonnell Douglas, Martin Marietta, Grumman, Boeing, Lockheed and Chrysler are expected to file bids for the shuttle award.

Although the number of personnel needed to build the shuttle will depend on the award, the space agency believes several thousand engineers will be needed by the Government and its contractors at Cape Kennedy and Vandenberg Air Force Base, Calif., the launching sites. NASA has begun planning and designing modifications to pads at Kennedy. The construction, which is expected to begin late next year, will cost about \$150-million, with somewhere between 10 and 15% of that going for electronics. At Vandenberg, construction is expected to cost about \$500-million, with 10 to 15% in electronics. Construction of the West Coast site is not scheduled to start, however, until fiscal 1975 or 1976.

Capital Capsules: Watch for the Federal Aviation Administration to issue shortly a bid for color air-traffic control displays. Different types of data would be presented in different colors, making an air traffic controller's search for particular information easier. . . . NASA will use a helicopter-mounted laser system to measure the plankton in Chesapeake Bay areas. Plankton absorb the laser beams and give off a faint infrared radiation, which can be measured. At the same time NASA says it has awarded a \$175,000 contract to RCA's Aerospace Systems Div. to build a laser land-surveying system. Delivery is expected in 10 months. The project is for the U.S. Forest Service. . . . The Navy finds itself beleaguered on both sides of Capital Hill these days. The Senate Armed Services Committee is investigating spiraling F-14 costs, while the House Armed Service Committee is scrutinizing sizable overruns in the DD-963 destroyer program. Grumman says that if the Navy enforces the current F-14 contract the company will be forced to close that portion of its business. It says it can't meet the original cost estimates.

Teradyne's L100 Automatic Circuit Board Test System speaks for itself.

<pre> PASSED GOOD: 43 BAD: 8 </pre>	<pre> FAILED FAILURE COUNTERS (BAD/TOTAL): FTEST 0/36 MTEST 5/83 BTEST 0/1 TTEST 0/2 </pre>
<pre> MT44 D8 THIS TEST PASSED MTEST ON PINS: M LIMIT :+ 500. MV ACTUAL:+ 248. MV </pre>	<pre> TT39 THIS TEST FAILED TIME FROM PIN 18 TO 21 ACTUAL: 00.195 US TMIN: 00.050 US TMAX: 00.190 US </pre>
<pre> FT35 THIS TEST FAILED <ALARMS>S1 FAILING PINS: .20 Z K </pre>	<pre> FT15 THIS TEST FAILED FAILING PINS: S R P N M L J </pre>

If you test circuit boards, you get the message. The L100 doesn't just tell you a bad board is bad. It helps you find out why. And in a fraction of the time you'd usually spend troubleshooting. We'd like to send you a brochureful of reasons why the L100 is the most money-saving system you can buy.

Write: Teradyne
183 Essex Street
Boston, Mass. 02111

TERADYNE



OUR ANGLE: Modular D/S and S/D Converters



Do Low Cost
Repairable
Circuit Cards
Make Sense
from Your Angle?

North Atlantic's new 701 D/S and 711 S/D Converters offer unmatched advantages for the digital/analog interface at low-low cost . . . typically \$1000. Open-card construction is easily and economically maintained. Adaptable to systems needs, interchangeable converter cards are compatible with your automatic test, simulation or digital control systems.

Compared to 19" panel designs, these units provide a choice of accuracy, frequency, resolution, and systems customization without the extra bulk and expense of unnecessary power supplies and other panel controls. They are ideal for multi-channel applications where a converter is assigned to a specific function.

These new converters are available to meet a wide range of systems needs. The 701 D/S has selectable accuracies of 9 or 12 bits with resolution of 8 through 14 bits, transformer output isolation and short circuit protection, operation at 60 Hz or 400 Hz with 1VA or 10VA output. The 711 S/D has 0.05° accuracy, 13 bit resolution with input transformer isolation, and continuously tracks 400 Hz synchro data to 1000°/second.

Don't these converters make sense from any angle? Talk it over with your North Atlantic sales engineering representative today.

NORTH ATLANTIC
industries, inc.

200 TERMINAL DRIVE, PLAINVIEW, NEW YORK 11803
cable: noatlantic / twx: 510-221-1879 / phone: (516) 681-8600

It's a great idea — for the other guy

If you have a son who has just learned about the metric system, you've no doubt been reminded that many of our measurement units are pretty nutty. Your boy may be simmering about the cruelty of a country (and school system) that insists a kid manipulate factors like 12, 36 and 5280 for measures of length and 16 or 2000 for measures of weight, while most European youngsters need merely shift a decimal.

Most of us, in fact, quietly curse those English kings who gave us inches, feet and yards, while we contemplate the staggering, but perhaps necessary, cost of switching to the metric system.

Like most engineers, I strongly favor adoption of the metric system—for, after all, it won't cost *me* anything. Or will it? I wasn't so certain when I received a letter from Robert H. Armstrong of Addressograph Multigraph's Graphics Research and Development Center in Warrensville Heights, Ohio.

Pointing out that the metric system would do away with furlongs, acres, fathoms, pints, etc., Armstrong asked what units I might suggest for replacing three measures of print: the point, the pica and the em. The point, normally used as a measure of print height, equals 0.01387 inch, which is as close as anyone needs to get to 1/72 inch. The pica, used mainly to specify line width, is 12 points, or about 1/6 inch. And the em is a variable measure, if you can imagine one, that depends on the specific type face and size; it's the space occupied by the letter m.

I'm comfortable with these units. It's easy for me to tell our printer to set this editorial in 10-point Century Expanded, with the first 13 lines 19 picas wide and the remainder 30 picas wide. Pressed to the wall, I'm sure I could learn to ask for 3.5138-mm type, with the first 13 lines 80.1146 mm wide and the rest, 126.497 mm wide. But I'd be far from comfortable.

Fortunately, I probably won't have to make these changes. The point, pica and em are accepted and understood internationally. But I wonder about other changes, perhaps more beneficial and less comfortable, that I (or you) might readily accept and endorse—for the other fellow; not for us.



A handwritten signature in cursive script that reads "George Rostky".

GEORGE ROSTKY
Editor

The 'unconventional' conventional oscilloscope

Storage, variable persistence and normal operation all on a single instrument

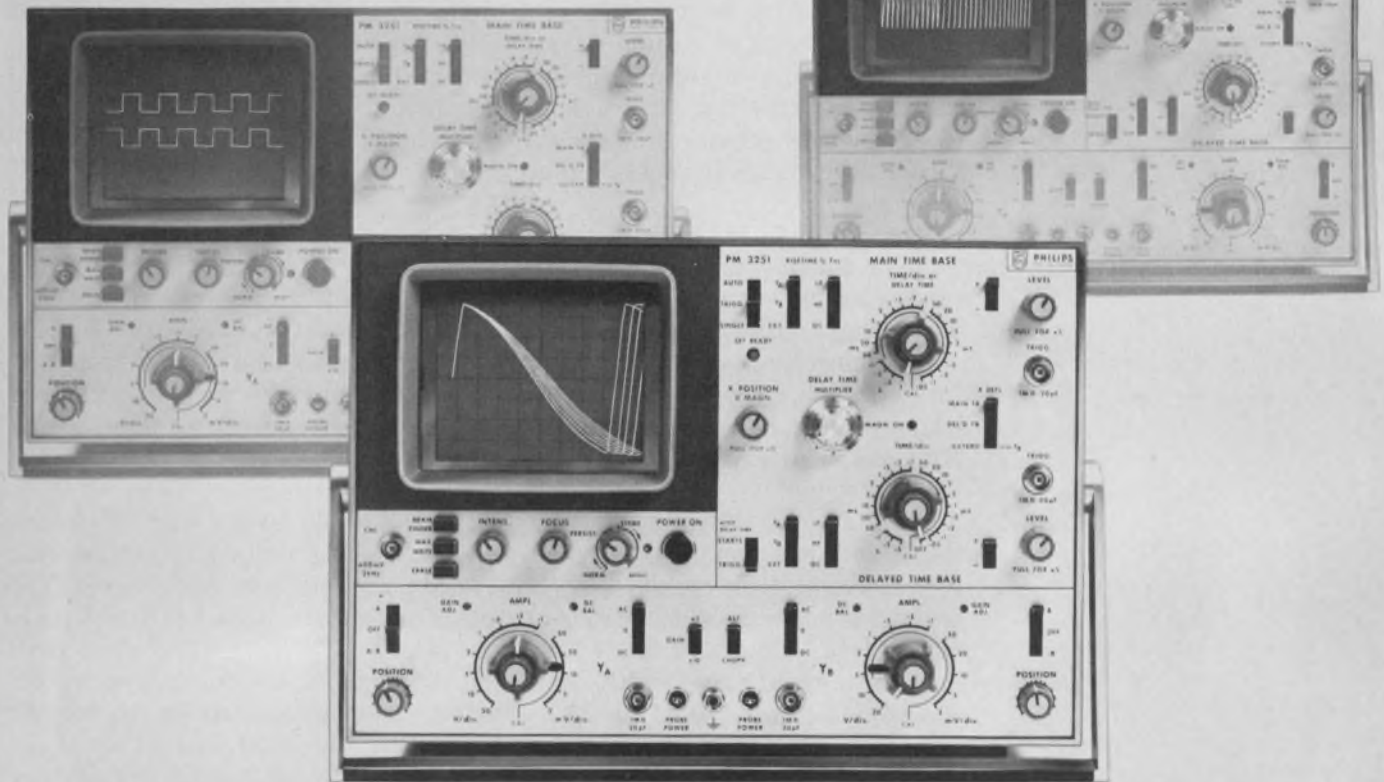

Philips PM 3251, a dual-trace, triple mode 'scope with unequalled bandwidth/sensitivities.

Switch to normal and it's a 50 MHz/2 mV or extra stable 5 MHz/200 μ V instrument. A complete all-purpose 'scope with no DC drift.

Switch to variable persistence, anywhere between 0.3 s to 10 mins. Waveforms that flicker now become stable. By combining variable persistence with storage, you can display several events at the same time. Or compare slow moving signals so the old fades as the new writes.

Now switch to storage, variable from 10 mins to 2 hrs. And it's storage with a difference.

One, it's not limited to a few MHz as before. By addition of charges in the memory, very fast risetime, low repetition rate ns pulses are displayed at full intensity.

Two, a unique halftone CRT with excellent luminance and 1.2 μ s/div writing speed gives the same operational life as a conventional tube. No frequent tube changing.

Three, this new tube is much more operator proof than any other previous storage CRT, where too high intensities could damage the storage layer.

If you think this 'scope should have knobs-a-plenty, look at the panel - the bare minimum.

PM 3251 applications aren't limited to electronics. Physics, mechanics, biology, medicine - to name a few.

Price? Unconventional, too, compared with other storage oscilloscopes - around Hfl 12,500*.

Philips Industries,
Test and Measuring Instruments Dept.,
Eindhoven, The Netherlands.



TEST AND MEASURING INSTRUMENTS

PHILIPS

* Subject to local taxes and duties

HOW TO BEAT THE SYSTEM.

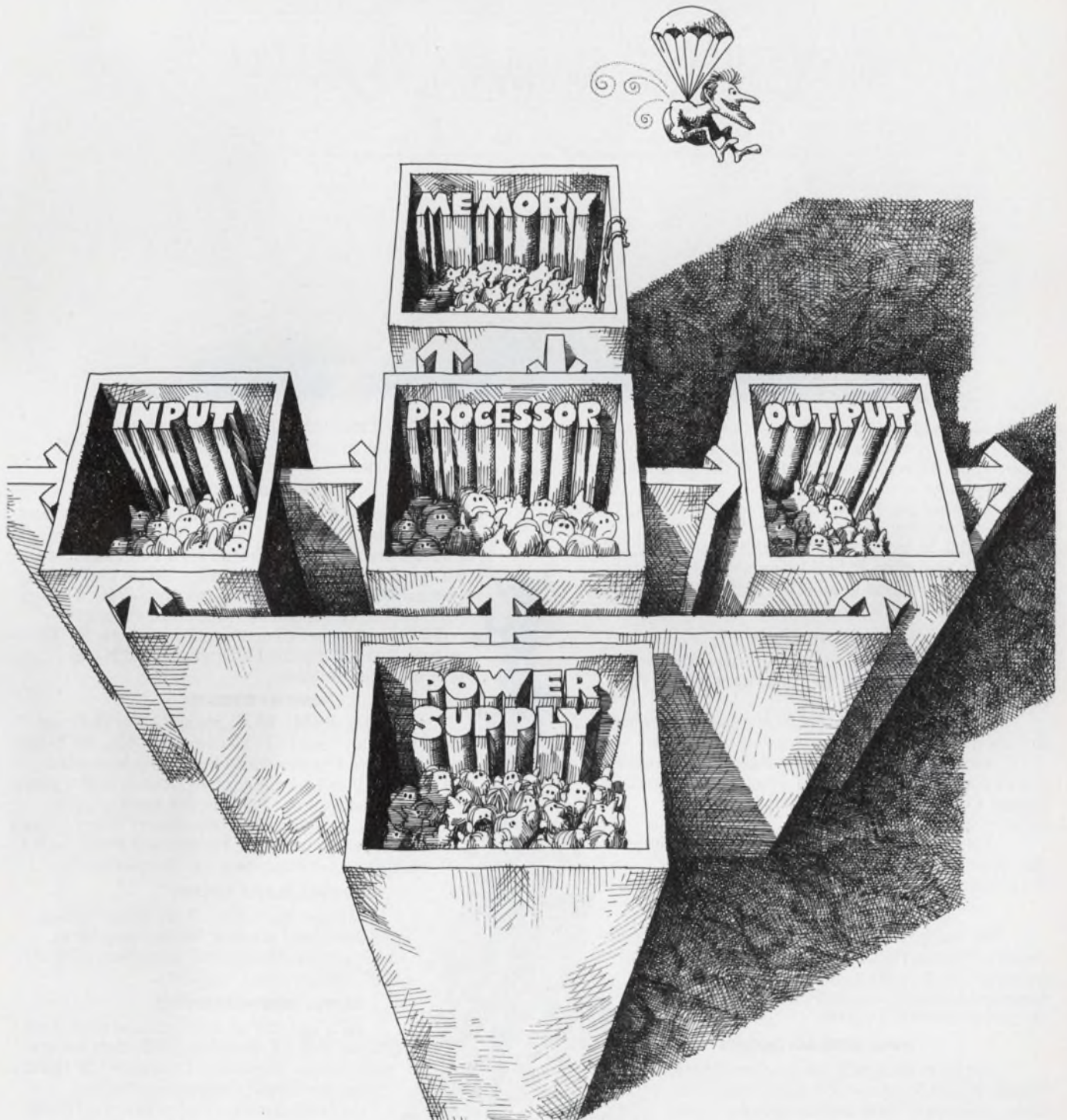

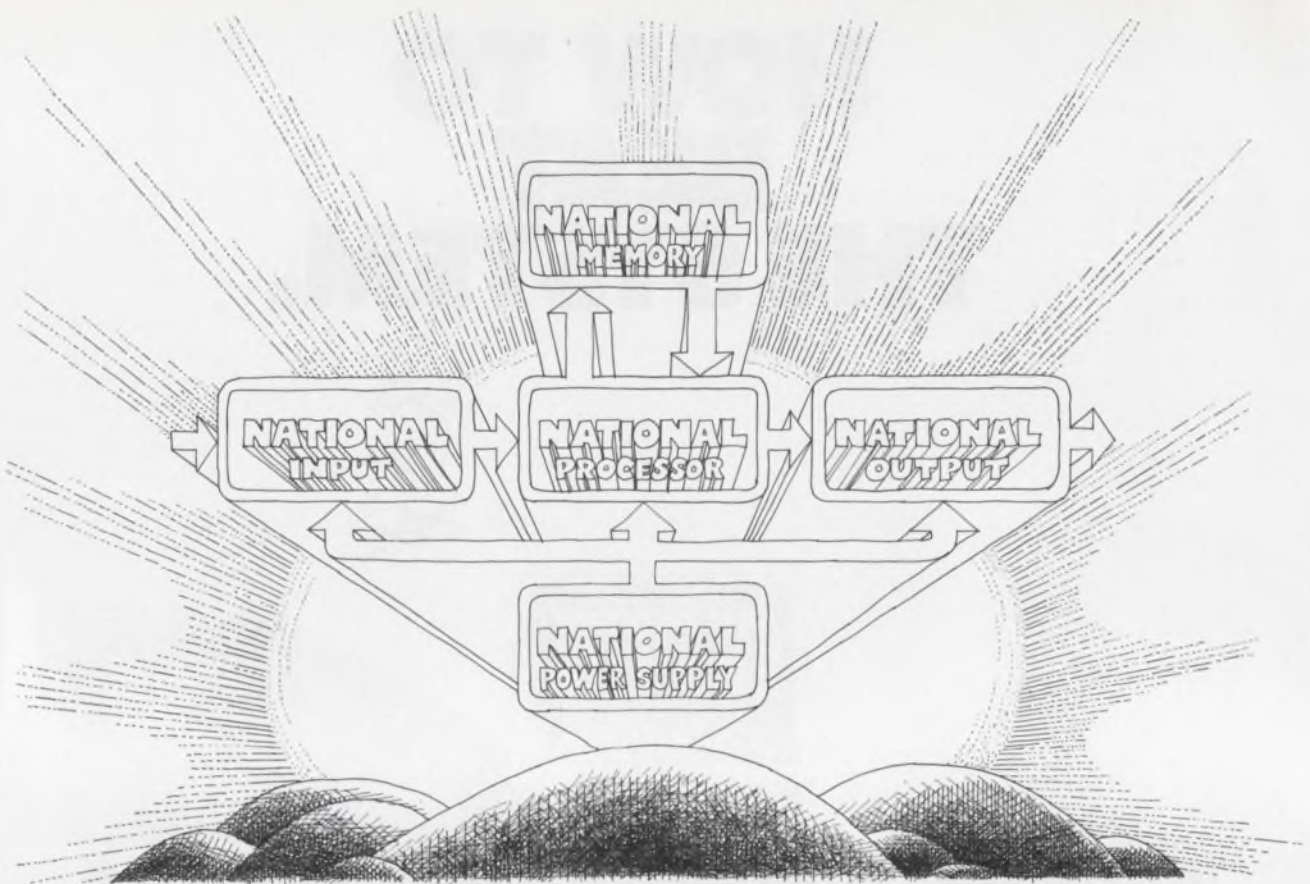

For the most part, until recently, system design consisted of linking together a string of components, with little or no regard toward the cost effectiveness of the system as a total integrated unit.

So, while pennies were being saved in one part of the system, dollars were being lost somewhere else.

Today, in order to be competitive, you've got to look beyond the cost of an individual component as to how it functions in relation to all other parts of the system.

Which is where we come in.

OUR COMMERCIAL

We make products to fit every part of the system. Input Interface. Processor. Memory. Power Supply. And Output Interface.

Products designed to perform a specific function. But always in the context of the system as a whole.

Products built so that the system you build doesn't end up costing an arm and a leg. Whether it's a computer system. Consumer system. Industrial system. Or military system.

On this page, we've taken the liberty of listing the types of products we make for each part of the system.

FRIENDS IN THE FIELD

No matter what kind of system you've got to beat, there's a National Field Applications Engineer in your area who's ready, willing and able to help. For his name and number, ask your local National distributor. Or call us at (408) 732-5000.

INPUT INTERFACE CIRCUITS

Single or dual NPN low level amplifiers; Single or dual N-channel low noise amplifiers; Code converters; Table look-up devices; Analog switches, hybrid and monolithic; Operational amplifiers; Comparators and buffers, linear and

digital; EIA line receivers; Digital line receivers; MOS transmitter/receivers; Bus line transceivers; VHF and UHF oscillators.

PROCESSOR CIRCUITS

Series 54/74 TTL, SSI and MSI; Series 54/74 Compatible Tri-State* (TSL) Logic, SSI and MSI; Series 54S/74S TTL, SSI and MSI; Series 54H/74H TTL, SSI and MSI; MOS and bipolar ROMs and RAMs; Series 10,000 ECL; Series 930 DTL, SSI; CMOS, Series 54C/74C; Custom MOS; Microprogrammable Arithmetic Processor (MOS/LSI); Linear communications circuits; RF/IF amps; N and P channel FET switches; NPN and PNP saturated switches.

MEMORY CIRCUITS

Dynamic RAMs, MOS; Static RAMs, MOS and digital bipolar; Read Only Memories (ROMs), MOS and bipolar digital; Programmable Read Only Memories (pROMs), MOS and bipolar digital; Dynamic shift registers; Static shift registers; Character generators; Code converters; NPN and PNP core memory drivers; Clock drivers; Sense amplifiers; Peripheral drivers; 54/74 multiplexers, comparators and control circuits.

POWER SUPPLY CIRCUITS

Voltage regulators, \pm tracking; Voltage regulators, fixed positive; Voltage regulators, fixed negative; Operational amplifiers; NPN and PNP medium power amplifiers.

OUTPUT INTERFACE CIRCUITS

NPN and PNP general purpose amplifiers; NPN and PNP RF amplifiers; NPN high voltage video output amplifiers; Custom MOS; Operational amplifiers; Comparators/buffers; Peripheral drivers; Display drivers; Hybrid power amplifiers; Hybrid level shifters and digital drivers; Sample and hold hybrid circuits.

*Tri-State is a trademark of National Semiconductor Corporation.

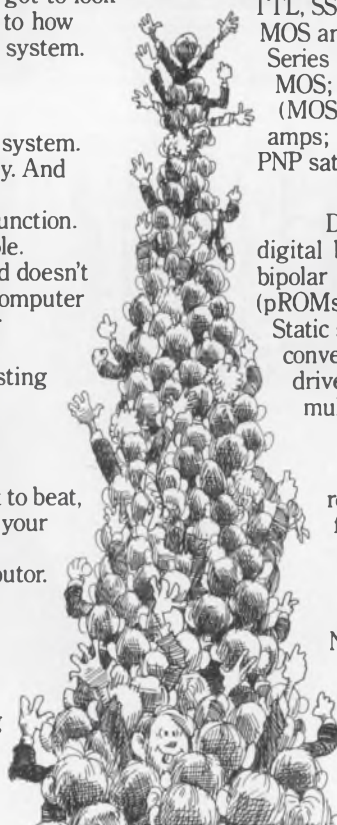

FOR EXAMPLE:

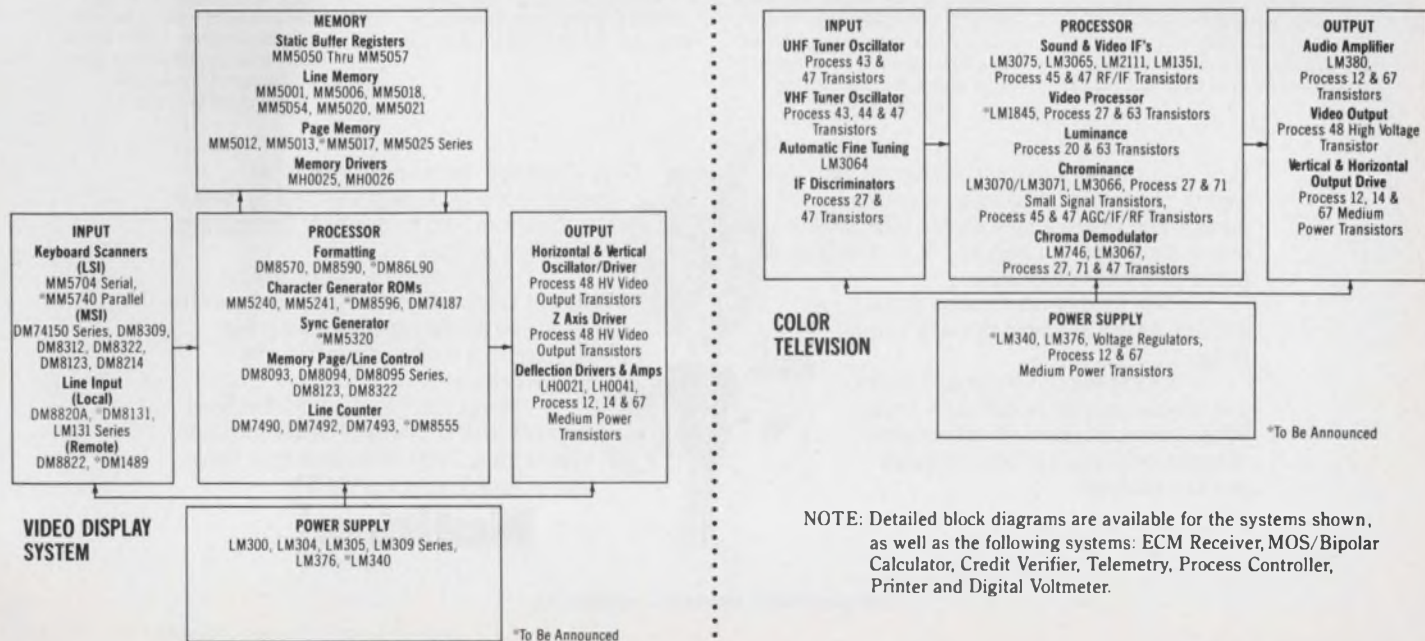
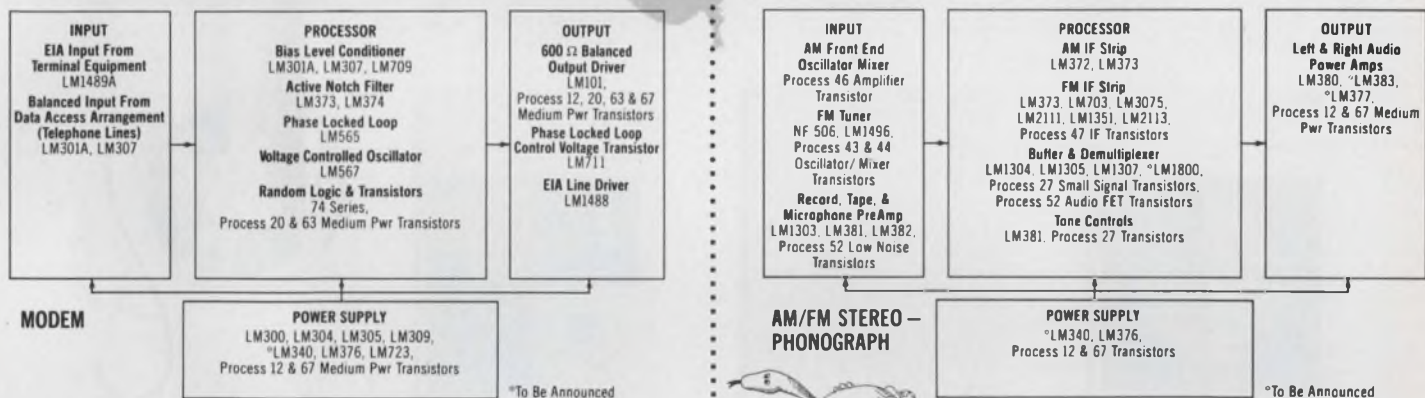
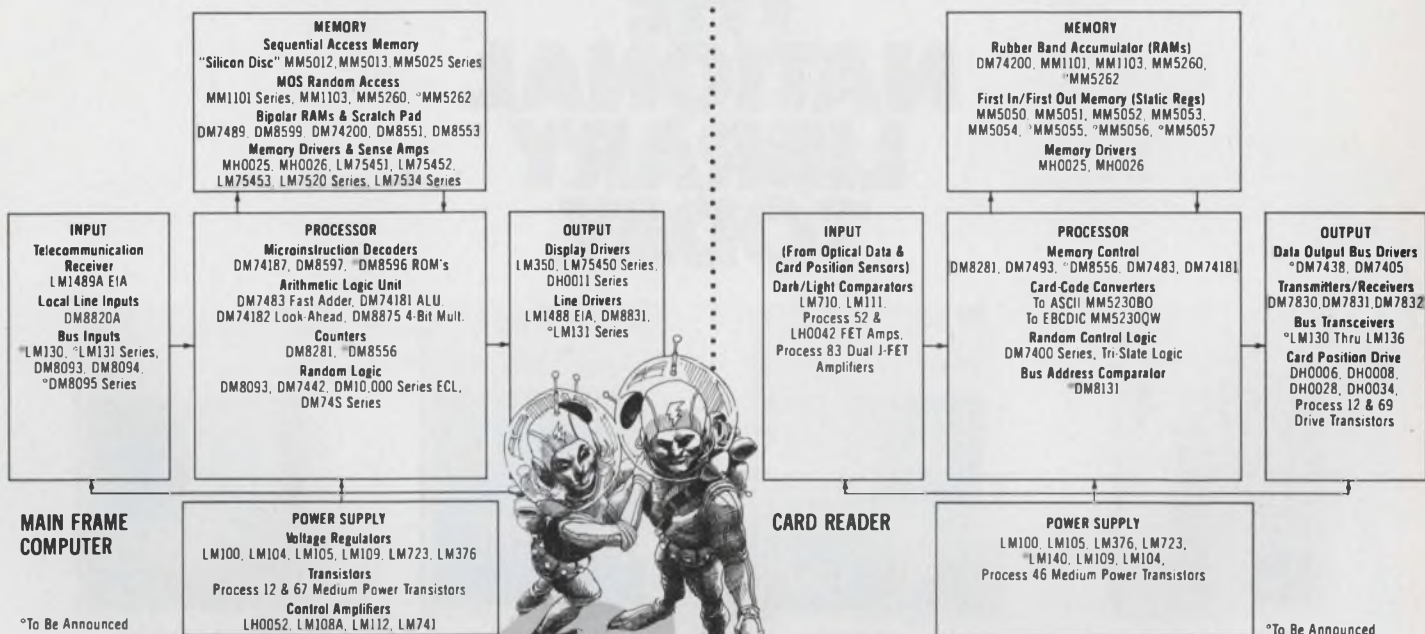

NOTE: Detailed block diagrams are available for the systems shown, as well as the following systems: ECM Receiver, MOS/Bipolar Calculator, Credit Verifier, Telemetry, Process Controller, Printer and Digital Voltmeter.

JOIN THE NATIONAL LIBRARY TODAY.



National Anthem

One of the nation's up-and-coming bi-monthly publications. "A must for anyone who's deeply concerned about the quality of semiconductor life in this country," says Charles Sporck.



Linear IC Catalog

"A delight to read!" 205 pages. Comprehensive guide to National Linear products. Hundreds of illustrations.

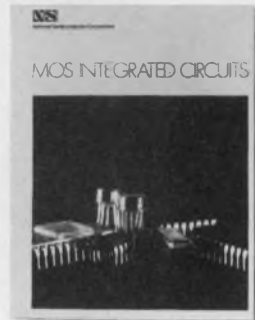

MOS IC Catalog

"As big as a phone book and lots more informative," says R. G. Phelps of Cleveland. 280 pages of everything you ever wanted to know about National's MOS IC's, but were afraid to ask.



Transistor Catalog

"Revealing!" No-holds-barred 126-page expose of National's complete line of small signal and bipolar field-effect transistors.



Linear IC Applications Handbook

"A real mind-boggler!" Perfect companion to the *National Linear IC Catalog*. A virtual plethora of linear IC applications using both monolithic and hybrid circuits. 304 pages fully indexed and cross-referenced for your reading pleasure.

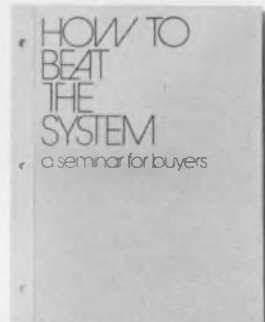

How to Beat the System Booklet for Purchasers

Here's the one that has the Vegas big-shots cringing. Jimmy the Greek says, "A sure thing if you've got to save your company some bread." An informative course designed for purchasers who want to "beat the system!"



Digital IC Catalog

"Eye-opening!!" A complete guide to digital IC's as designed by National. More than 200 pages. Including dozens of illustrations. More than 50,000 copies now in print.



National Semiconductor Memory Seminar Film

A 30-minute filmic experience you won't want to miss. Five-part semidocumentary pic of the new super-realism genre. Use of actual memory experts adds a nice touch of authenticity. Length: 30 minutes (Color).

Here's your chance to gain access to a veritable wealth of product, application and design information from a single source. The kind of information that will help you to do your job better and more efficiently.

The kind of information that's sometimes not available through normal Bingo Card channels.

By joining the National Library, you choose *only* the selections you want. When you want them. Without being deluged by pounds of non-pertinent product pitches.



Best of all, there are no dues to pay. No overdue fines. No Dewey Decimal System to confuse you. And no crochety librarians to shush you around.

So write today for your official National Library Card. When you do, we'll also send you a Bibliography listing our current selections (some of which we've detailed above).

Simply write on your letterhead to: "LIBRARY," National Semiconductor Corporation, 2900 Semiconductor Drive, Santa Clara, California 95051.

National



The book is about some 70,000 scientists, engineers, technicians, and supporting personnel who make up New Jersey's R&D industry. It's about the nearly 800 diversified R&D facilities in the State — their past accomplishments and current projects. It's about all the reasons why big minds select little New Jersey to carry on their scientific pursuits. It's about the \$3 billion per year spent on R&D in New Jersey by some of the most brilliant professionals in the world. "Brainpower: New Jersey" is, indeed, an intelligence report. And it's free to you. Wouldn't it be an intelligent move to send for your copy today? Maybe we'll include you in our next edition.

PSE&G		11
BOX RD		
70 Park Place		
Newark, N. J. 07101		
Name	_____	
Company	_____	
Address	_____	
City	_____	
State	_____	Zip _____
Please rush my free copy of your new in-depth report of R&D in New Jersey		
MAIL THIS COUPON NOW		



Build-it-yourself stepper motor drive

maximizes speed with velocity ramping and minimizes power dissipation in the standby mode with two circuits.

A simple driver circuit for stepper motors can be improved by adding two modifications: a velocity ramping circuit to maximize speed and a circuit for minimizing power dissipation in the standby mode.

Commercially available motor drive circuit boards do not, in general, incorporate these techniques, and those controllers that do range upwards in price from \$700. The complete do-it-yourself circuit—with modifications—can be built for a hardware cost of less than \$30.

A typical four-phase stepper motor can be made to rotate by switching the motor coils in a suitable sequence. Fig. 1 shows a basic drive circuit in which a logic switching and sequence network actuates switches SW1 - SW4 (which are usually power transistors). The network steps the current through the coils—and hence rotates the motor shaft—in the proper sequence (Table I). The stepping rate is determined by the input signal E_{clk} .

Velocity-ramping circuit raises speed

To bring a stepper motor up to speed from standstill, it's best to start with a low stepping rate (slow clock) and later to switch to a higher stepping rate.

Ideally, a voltage-controlled-oscillator would generate a smooth, constantly increasing input frequency that eventually would stabilize at a predetermined maximum. The process would be reversed when stopping the motor. This method would achieve high torque at start-up and maximum running speed in minimum time. Also, registration of the stop point would tend to be more accurate.

The idea design, however, involves several complex networks. A simpler circuit is shown in Fig. 2. This can substitute for the ideal, provided the motor has an adequate torque rating for the particular load and can develop the torque over the full range of operating speeds. While there are no provisions for "ramping down," the motor can reach its maximum operating speed and still stop accurately.

Harold Minuskin, Staff Consultant, Vought Div., Computer Equipment Corp., 290 Fischer Ave., Costa Mesa, Calif. 92626

In the circuit of Fig. 2, a unijunction transistor replaces a voltage-controlled-oscillator. When control signal E_c is removed from its grounded position, the UJT oscillator begins to generate a slow clock, E_{clk} . Transistors Q1 and Q2 are now off.

When applied to the switching and sequence network (Fig. 1), the clock sequences the stepper motor at a rate described by the equation

$$T = (R1 \cdot C1) \ln \left(\frac{1}{1-n} \right),$$

where n is intrinsic standoff ratio of the UJT. Pulses E_p begin to charge capacitor C2 through resistors R3 and R4.

After a given number of slow clock pulses, (E_{clk}), the base voltage of Q1 (Fig. 2) will be high enough to turn on both transistors Q1 and Q2. The resulting new time constant will change the slow clock to a fast clock, with a rate given by the equation

$$T_f = \left(\frac{R1 \cdot R2}{R1 + R2} \right) \cdot C1 \cdot \ln \left(\frac{1}{1-n} \right).$$

The motor operates at the fast clock stepping rate until it is stopped by grounding control signal E_c .

Circuit minimizes power dissipation

To minimize power dissipation when the motor is stopped, less current should flow through the motor coils. However, when a stepper motor begins rotating, maximum power is required to get it up to speed and to keep it going at a specific rate under load. When the motor is not rotating, this same amount of power would have to be dissipated, largely as heat, in resistors R_{s1} and R_{s2} (Fig. 3). Yet some holding current is required to keep the motor detented in its last sequenced position. A circuit that minimizes power dissipation in the standby mode, while maintaining sufficient holding current, simply switches the motor coil power supply to a lower voltage. This lowers the coil current.

During the standby mode, a current in the motor coils (determined by the 5-V dc supply) detents the motor at a reduced power dissipation. Transistors Q1, Q2 and Q5 are ON, while Q3 and Q4 are OFF. Diodes D1 and D2 prevent reverse-current flow

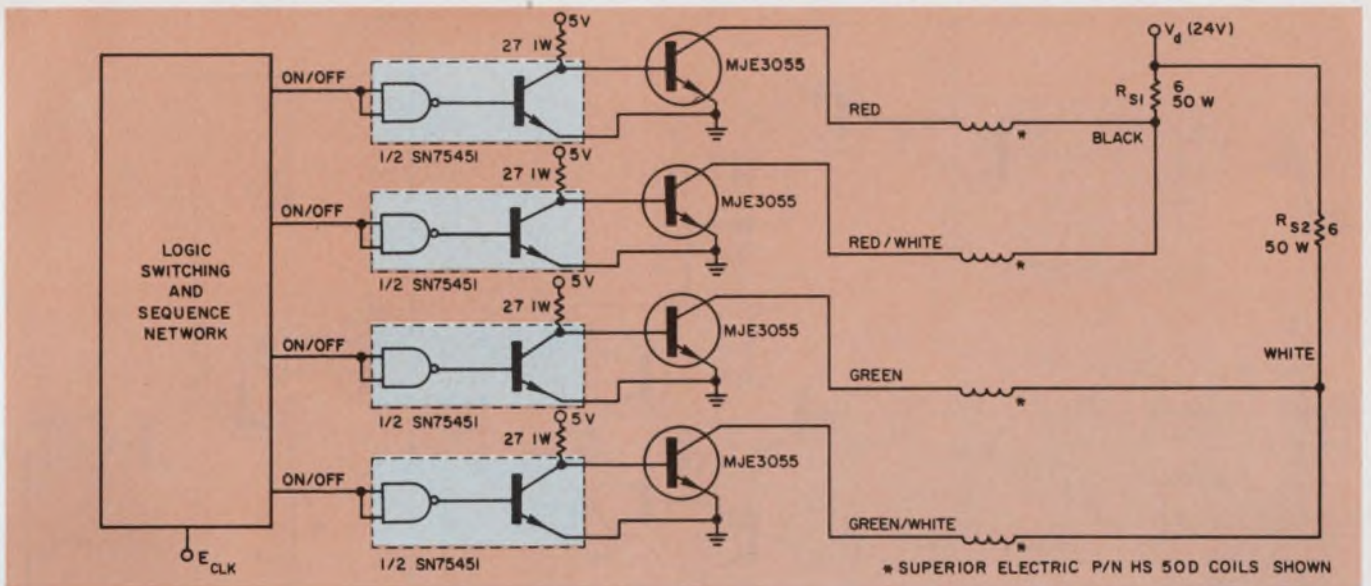

1. Four-phase motor drive steps the motor according to the logic switching and sequence network.

Switching sequence for motor rotation

Sequence	SW1	SW2	SW3	SW4
CW 1	on	off	on	off
2	on	off	off	on
3	off	on	off	on
4	off	on	on	off
1	on	off	on	off
2 CCW	on	off	off	on

from the 24-V dc power supply to the 5-V dc.

During the run mode, transistor Q2 is switched OFF by Q1, and Q3 is turned ON by Q4. Maximum current now flows through the motor windings.

Two other important factors should be dealt with

for a thorough design. These concern arc suppression of the motor coils and damping resistance of the circuit.

A modification to suppress motor coil arcs

When any of the four current switches—SW1 through SW4—are turned OFF, the current through the particular motor coil is interrupted. A resultant reverse voltage, $\frac{Ldi}{dt}$, appears across the motor coils. This voltage must be limited to protect the transistor switch, but it should not be totally suppressed, because the energy can be used to give the motor an extra kick to get it to its next position.

A convenient method to limit the reverse voltage is to connect across each motor coil a 2-A diode in

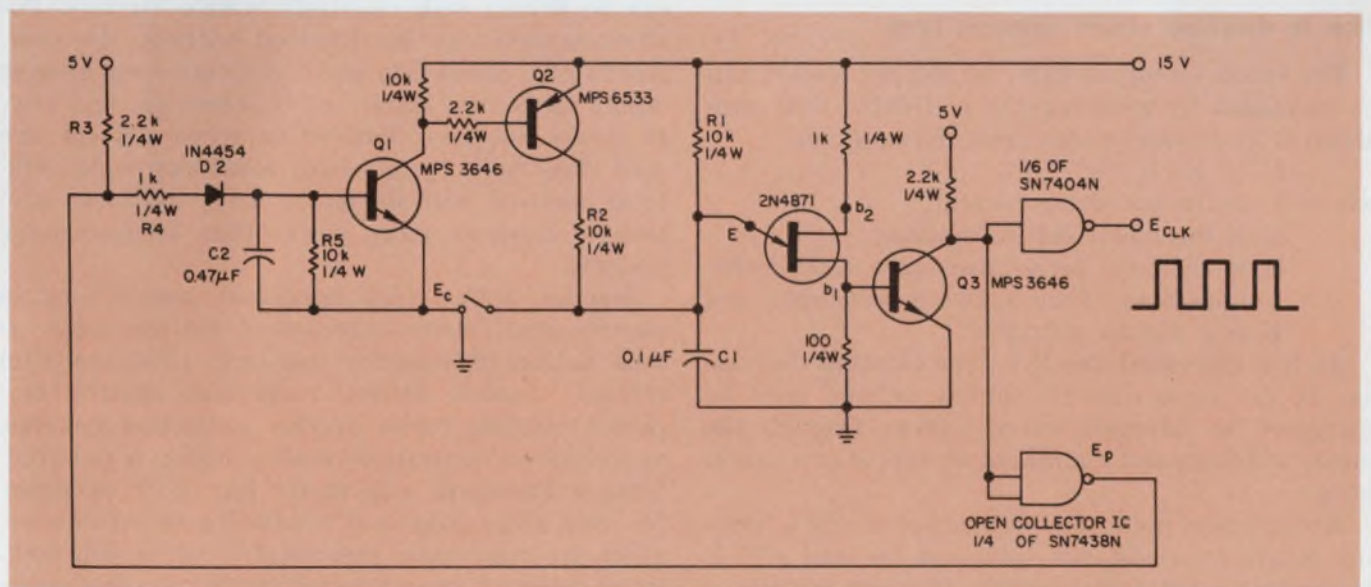

2. Velocity ramping circuit generates the clock pulse train E_{CLK} and varies its rate as governed by $R1 \cdot C1$.

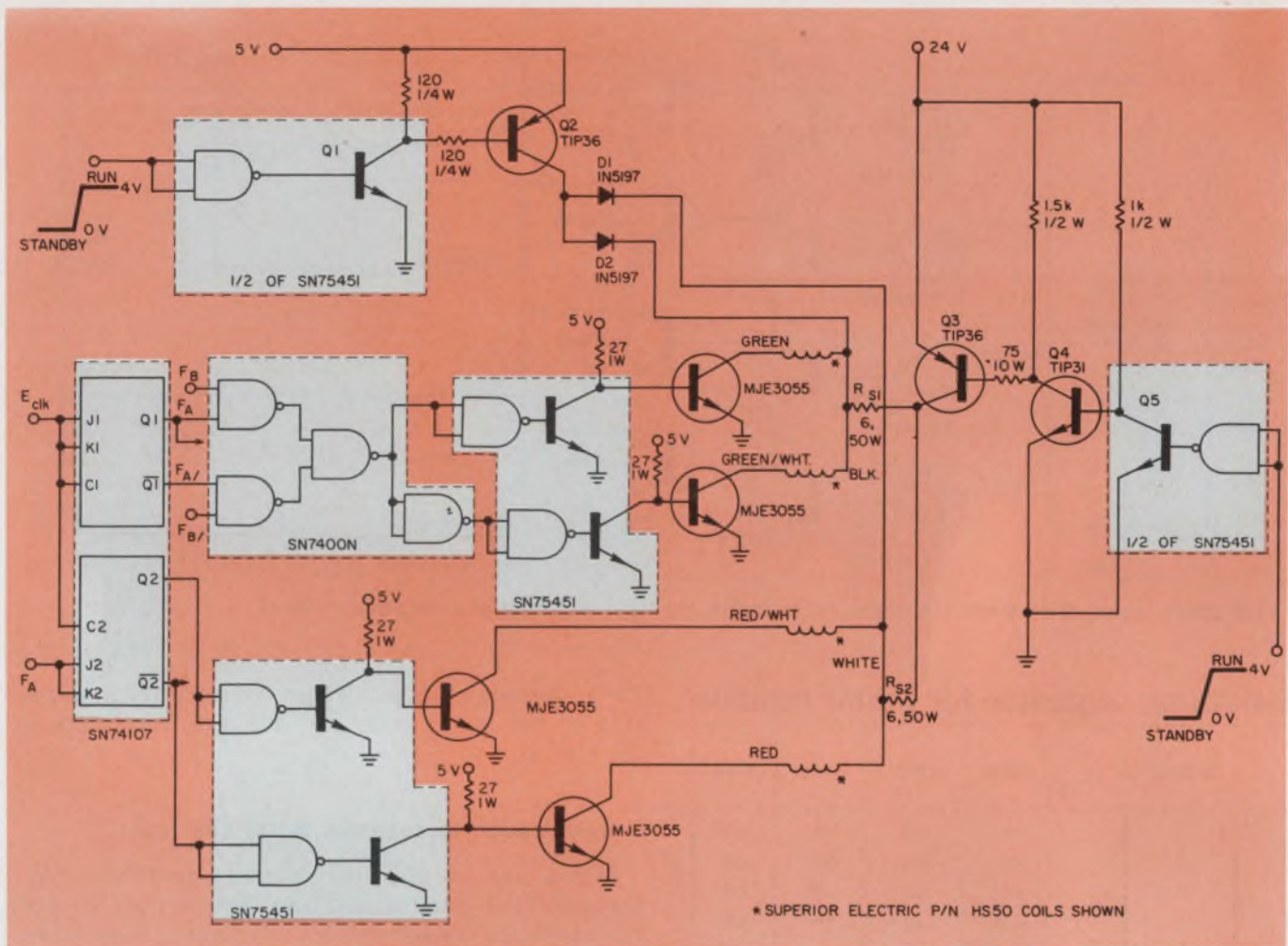

3. Power dissipation in the standby mode is minimized by diodes D1 and D2 and transistor Q2.

series with either a 15-Ω resistor or a 20-to-30-V zener diode. The 2-A diode in series with either the resistor or the zener diode will reduce the reverse voltage without totally suppressing it.

How to decrease circuit damping time

The speed (stepping rate) of stepper motors can be increased by reducing the coil drive time constant, R/L , as can be seen from the equation

$$I = K [1 - e^{-R/(L)}],$$

where I is the coil drive current,

L is the motor coil inductance,

R is the total series resistance (coil resistance plus circuit network resistance, and K is a circuit constant.

As R is increased, the R/L time constant decreases. At the same time the supply voltage must be increased so adequate current flows through the motor windings and maintains the torque at a usable level.

An optimum point may be reached where a limiting maximum resistance value can be used with a reasonably sized power supply. If space permits, a programmed power supply—which increases its

output voltage as a function of the increased motor speed—can be used. But since power dissipation increases as the square of the applied voltage, velocity ramping techniques should be considered first.

An advantage of stepper motors is that they can be driven with relatively simple circuits. Position control can be achieved without the complexity of a closed-loop servo, thus allowing greater design flexibility, easier trouble-shooting, and fewer power supplies than when servo drivers are used. The more complicated closed-loop servo systems required with dc motor drive networks also tend to dissipate more power than stepper-motor systems.

Stepper motors find important applications in electro-optics, electro-mechanical systems such as tape drives, incremental plotters, precision film camera capstan drives, numerical control machines, rotating forms overlay projection systems, and whatever accurate start-stop motion is required. Since a 1.8-degree step motor has $\pm 3\%$ accuracy for each step, positional accuracies of ± 0.054 degrees are attainable. Positional error is noncumulative, since after each complete rotation the motor shaft is essentially back to its starting position. ■■

Pass the word... our XT wet tantalums are out of this world.



With reliability proven since 1949, our XT series of liquid-electrolyte high-temperature tantalum capacitors is widely used in aerospace, missile, and airborne equipment. Precision industrial components, too.

Rugged construction makes the XT series especially suitable in environmental extremes... from -55°C to $+175^{\circ}\text{C}$. The true hermetic glass-to-metal seal prevents penetration of vapor or liquids in amounts that could damage

internal construction. And double-case construction provides high resistance to corrosion.

Plus... excellent stability, long operating life at high temperatures. Great versatility with a broad line in a wide range of terminal arrangements. Long shelf life. High capacity—up to 2200 mfd in a single small case.

For detailed information and specifications, write for Bulletin 4-84. Or see your authorized Mallory distributor.

MALLORY

MALLORY CAPACITOR COMPANY

a division of P. R. MALLORY & CO. INC.
Indianapolis, Indiana 46208

Electrical and Electronic Components • Sequence Timers • Metallurgical Products • Batteries

INFORMATION RETRIEVAL NUMBER 37

Generate noise-free timing pulses

with an IC peak sampler from periodic waveforms that can vary in amplitude and frequency

Timing or sampling pulses are often needed in data communications, signal processing and industrial control systems. They are used to synchronize events occurring in different parts of a system. Such pulses are usually derived from a periodic waveform (or periodic motion) that then becomes the system master timing reference.

The two conventional techniques for generating these pulses—zero-crossing detection or sensing threshold voltages near the reference-wave peaks—either fail to produce noise-free timing signals, or can't tolerate amplitude and frequency variations in the reference waveform, respectively.

A surprisingly simple circuit, Fig. 1a, obtained by modifying a standard peak detector, Fig. 1b, solves both of these problems. Called a "peak sampler," it puts out noise-free timing pulses, extracted from a "dirty" periodic wave in spite of large amplitude and frequency variations. In one case such a peak sampler produced very good timing pulses from an input with amplitude swings between 0.5 to 3.0 V (peak-to-peak) and frequency changes from 200 to 1500 Hz.

Develop peak-sampler design equations

While the operation of the peak sampler is very simple and is almost obvious from Figs. 1a and 2a, complete analytical understanding is a must for designing a circuit that will work over the desired limits. The difficulty in assessing the performance limits of the peak sampler occurs because the circuit dynamics involve exponentials that must be related to the frequency and amplitude variations of the reference. Furthermore, these variations must be related to the op-amp characteristics.

Referring to Fig. 2a, the operation of the peak sampler can be divided into two parts:

1. Charging of the capacitor, C, when E_{in}

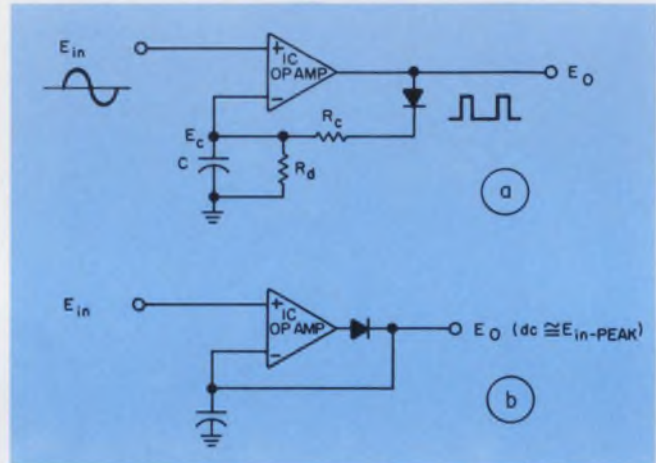

1. Noise-free timing pulses are extracted from a sine-wave with a "peak-sampler," (a), that is built by modifying a standard peak detector, (b).

(defined in the figure) is greater than E_c .

2. Discharging C when E_{in} is smaller than E_c .

The equivalent circuit for the period of charging C is shown in Fig. 2b and the dynamic conditions existing at this time are described by

$$E_c(t)_C = E_T + (E_{cmin} - E_T) e^{-(t/T_c)}, \quad (1)$$

where: $E_T = E_0 [R_d / (R_c + R_d)]$

$$T_c = [R_c R_d / (R_c + R_d)] C.$$

The equivalent circuit for the period of discharging of C is shown in Fig. 2c and the corresponding dynamic conditions are described by

$$E_c(t)_D = E_{cmax} e^{-(t/T_d)}, \quad (2)$$

where: $T_d = R_d C.$

Starting with these two basic equations, we can now illustrate the relative immunity of the peak sampler to amplitude variations of V_p , see Fig. 3. Noting that t_c and t_d are considerably smaller than T_c and T_d , respectively, the angles α and β are essentially fixed. Thus for a fixed frequency and a given circuit, the triangle $E_{cmin} - E_{cmax} - E_{cmin}$ will remain essentially constant for large changes in the amplitude of V_p . The peak sampler, then, can track slow, but relatively large, input-amplitude variations. This tracking ability, however, breaks down if V_p quickly drops to the point where $V_p = E_{cmax}$. Let us de-

George S. Oshiro, Consulting Engineer, P.O. Box 90876, Los Angeles, Calif. 90009.

velop a definition for this point in terms of the circuit parameters.

Since E_{cmin} is the voltage at the end of the discharge time, t_d , of $E_c(t)_D$ given by Eq. 2, then

$$E_{cmin} = E_{cmax} e^{-(t_d/T_d)}. \quad (3)$$

Similarly, from Eq. 1, it follows that

$$E_{cmax} = E_T + (E_{cmin} - E_T) e^{-(t_c/T_c)}. \quad (4)$$

Substituting E_{cmin} from Eq. 3 into Eq. 4, get

$$E_{cmax} = E_T + [E_{cmax} e^{-(t_d/T_d)} - E_T] e^{-(t_c/T_c)}. \quad (5)$$

Finally, substituting V_{pmin} for E_{cmax} and rearranging terms, we get

$$V_{pmin} = E_T [1 - e^{-(t_c/T_c)}] / [1 - e^{-(t_d/T_d)} e^{-(t_c/T_c)}] \quad (6)$$

Thus for proper peak-sampler operation we must make V_p larger than V_{pmin} given in Eq. 6. The upper amplitude limit of V_p is determined mainly by the op amp characteristics of differential input voltage limit and maximum excursion of the output voltage. These will be detailed in the design example.

The peak sampler is also invulnerable to relatively large frequency variations in the input, as long as V_p is greater than V_{pmin} and T_c is at least four times $1/f$ over the operating frequency range (f is the input-signal frequency). This means that θ in Fig. 3 remains essentially fixed. Furthermore, Fig. 3 shows that, if α and β are to remain fixed while the frequency changes (i.e., the side $E_{cmin} - E_{cmin}$ of the triangle $E_{cmin} - E_{cmax} - E_{cmin}$ varies), the angle θ must remain constant. The result is that t_c varies inversely with the frequency. The upper frequency limit (with all other parameters held constant) is, as in the case for maximum V_p , solely dependent on the op amp characteristics—primarily the slew rate.

An expression defining t_c in terms of R_c can be derived by first assuming that $R_c \ll R_d$. Then

$$E_T = E_0, T_c = R_c C.$$

Directly from Eq. 4, we get

$$E_{cmax} = E_0 + (E_{cmin} - E_0) e^{-(t_c/R_c C)}.$$

Solving for t_c , we obtain

$$t_c = -R_c C \ln [(E_{cmax} - E_0) / (E_{cmin} - E_0)]. \quad (7)$$

Therefore, t_c is directly proportional to R_c (for a fixed C). This immediately implies that an adjustable pulsewidth can be obtained using a potentiometer for R_c . A suitable high-resolution, stable potentiometer is usually available since the value of R_c will be small in most applications.

Although the effect of slew-rate capability of the op amp on t_c is negligible, as long as the slew rate is high enough, an idea of its effect can be derived as follows.

Large-signal bandwidth = (slew rate) / $2\pi V$, where V is the op amp peak-to-peak voltage excursion. For proper peak sampling, we must have $(1/t_c) \geq 1/2$ (large-signal bandwidth), or $(1/t_c) \geq \pi V / (\text{slew rate})$.

In other words, the greater the slew rate, the greater is the safety margin for proper peak sampling.

Let's design a peak sampler

Suppose we have to derive a pulse train based on the positive peaks of a 400-Hz sinewave having a peak-to-peak amplitude of $28 \pm 5\%$ volts. The desired pulsewidth of the timing pulses is $100 \mu\text{s}$. We want to determine the amplitude-variation tolerance, and also to select the proper op amp.

To simplify calculations, let us make these practical assumptions:

1. E_{cmax} = maximum positive input voltage = 11 V.
2. $T_d = 10 (1/f) = 10 (1/400) = 2.5 \times 10^{-2}$ s.
3. $C = 1.5 \mu\text{F}$.

From the above value of C , we have

$$R_d = (2.5 \times 10^{-2}) / (1.5 \times 10^{-6}) = 16.7 \text{ k}\Omega.$$

Directly from Fig. 2a, we obtain

$$t_d = (1/f) - t_c = (1/400) - (1 \times 10^{-4}) = 0.24 \times 10^{-2} \text{ s}.$$

From Eq. 5, $E_{cmin} =$

$$E_{cmax} e^{t_d/T_d} = 10 \text{ V}.$$

From Eq. 7, $t_c = (100 \times 10^{-6})$

$$= -R_c C \ln [(11 - 10) / (10 - 10)],$$

so that

$$R_c = 320 \Omega.$$

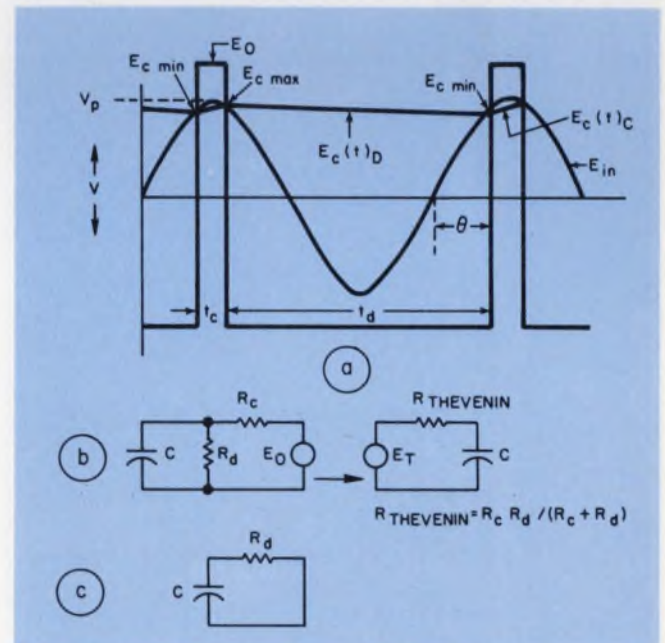

2. The simplicity of peak-sampler operation is apparent from (a). Expressions for voltages shown in (a) are derived using an equivalent circuit (b) for the period of charging capacitor C . For the period when C is discharging, circuit (c) applies.



It's easy to diagnose sick circuits.

Do it with *ThermoProbe* or *Circuit Ryder*.[®] They're easy-to-use non-contact Infrared Thermometers that tell you at a glance when a specific circuit component is too hot—without touching it. Accurate heat readings, time after time, from room temperature to 500° C. on spots as small as 0.050 inch. Highly accurate readings in an instant for small motors, wires, armatures and brushes, too.

□ *ThermoProbe* is a highly versatile bench instrument for measuring minute components with a high degree of accuracy. It allows continuous temperature monitoring and recording. A built-in spotlight pinpoints the target you're measuring.

And our famous *Circuit Ryder*, a portable, battery operated pistol, is extremely valuable for spot checking.

□ An entire line of non-contact Raytek Infrared Thermometers, giving accurate heat readings from 60 to 3,000° F., is available for almost any product or application. For more information or a no-obligation demonstration, write today to

Peter Bliven, C.D.
(Circuit Doctor), Raytek, Inc., 1277 Terra Bella Ave., Mountain View, Calif. 94040.



RAYTEK

A Division of Optical Coating Laboratory, Inc.

Just take their temperature. (without contact)

3. Proper peak sampling is unaffected by either input-signal amplitude or frequency variations, as long as V_p is larger than E_{cmax} . See text for detailed explanation.

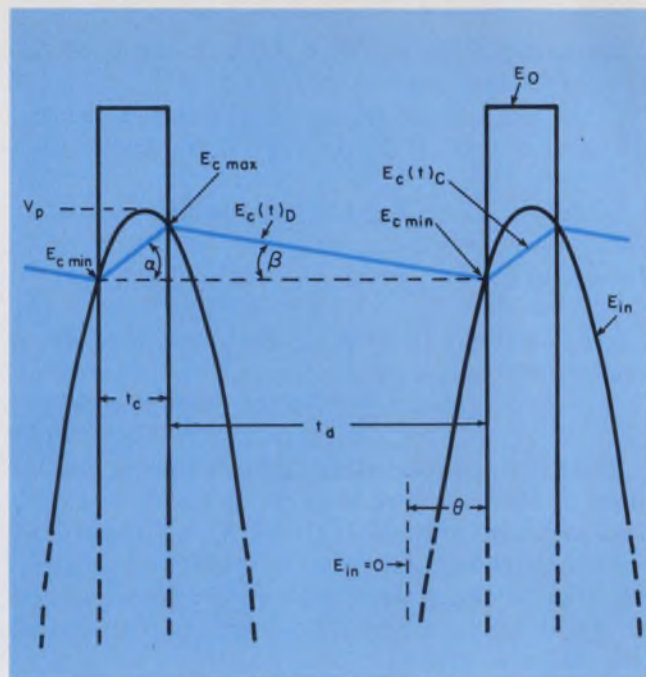

3. Proper peak sampling is unaffected by either input-signal amplitude or frequency variations, as long as V_p is larger than E_{cmax} . See text for detailed explanation.

To determine the margin of amplitude tolerance, we use Eq. 6, which, omitting the arithmetic, yields

$$V_{pmin} = 11.6 \text{ V,}$$

so that:

$$\begin{aligned} \text{Margin of tolerance} &= 14 - [(0.05)(14)] \\ &= 11.6 = 2.3 \text{ V.} \end{aligned}$$

The minimum required slew rate is determined from Eq. 8; using $V = 15$ volts:

$$\begin{aligned} \text{Minimum slew rate} &= \pi V t_c \\ &= 1.88 \text{ V}/\mu\text{s.} \end{aligned}$$

The differential input voltage limit of the op amp is dictated by the maximum expected excursion of the input voltage, or

$$\begin{aligned} \text{Minimum diff. input voltage} &= \\ &= 28 + [(0.05)(28)] = 29.4 \text{ V.} \end{aligned}$$

In summary, here are the peak-sampler parameters:

$$R_i = 320 \Omega.$$

$$R_{i1} = 16.7 \text{ k}\Omega.$$

$$C = 1.5 \mu\text{F}.$$

$$\text{Minimum op amp slew rate} = 1.88 \text{ V}/\mu\text{s.}$$

$$\text{Amplitude tolerance margin} = 2.3 \text{ V.}$$

$$\begin{aligned} \text{Minimum differential input} \\ \text{voltage limit of op amp} &= 29.4 \text{ V.} \end{aligned}$$

Note that in this design example, the positive saturation of the op amp sets the limit for the maximum expected positive input amplitude. If this limit did not exist, the margin of amplitude tolerance calculated above would mean that the input could vary by as much as $\pm 10\%$ from the nominal 28 volts and still not cause errors. ■■

This Man
Makes Some
People
Angry...

**But
Few
Ignore
Him!**



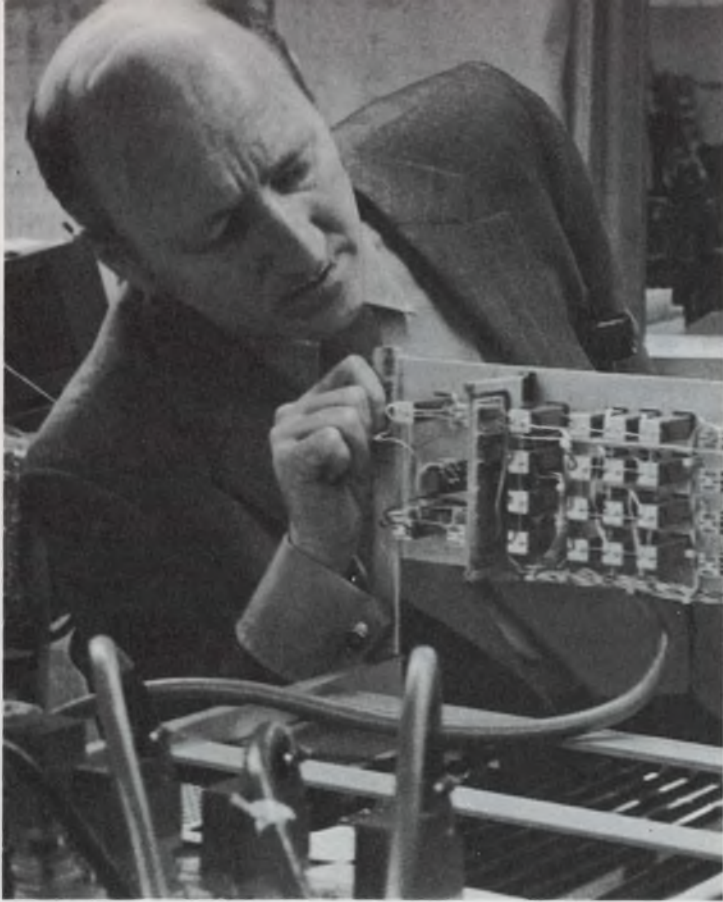

Meet Electronic Design's Editor Extraordinary . . . George Rostky

Tough...and Respected For It!

Readership doesn't just happen . . . editors make it happen. Here are some of the ways George Rostky and his editorial team build unprecedented readership for *Electronic Design*.

George Rostky is the toughest and most controversial editor in electronics publishing. Tough on engineers, tougher on fellow editors, toughest on advertisers, George says what he thinks without fear of favor. They all respect him for it.

As editor of *Electronic Design*, Rostky must carry forward the basic editorial concept pioneered by the magazine two decades ago. It's an awesome responsibility because *Electronic Design* now boasts a readership level that is unmatched in business-paper publishing. The fact that Rostky has pushed readership even higher is well known to advertisers. But how he does it is not so clearly understood. Yet, it's the "how" that separates *Electronic Design* from other media in the field.

One of the reasons Rostky can function so effectively as editor of *Electronic Design* is because he began his career in journalism here, serving on the staff from 1957 to 1961. Another is the singleness of purpose which always has—and always will—be uniquely identified with the magazine. George has so effectively engrained *Electronic Design's* editorial

policies among his associates, that he says, "If I left the paper tomorrow, God forbid, it would still keep on going the same way." He is the fifth editor to maintain this tradition.

When Rostky speaks, engineers listen. That's because they know he knows what he's talking about. And, he's not afraid to come out and say it in their own language. A PR man once said of him, "That s.o.b. Rostky keeps me honest."

While advertisers constantly bombard his door with publicity stories and requests for covers, Rostky notes that, paradoxically, they also probe for signs of editorial weakness. Here is where Rostky's strength is most keenly felt. He stands firmly for the reader.

Rostky believes a magazine can be aloof, distant, and professorial, or it can be close and personal. He and his carefully picked editorial team can preach to them and engineers may listen—if they feel they must, but Rostky knows they'll listen quicker if the editors talk like engineers. Rostky's group want to be part of the engineering community, not the publishing community . . . to think like engineers, talk like engineers, feel like engineers. Their success is *Electronic Design's* success. Their victories are *Electronic Design's* victories.

While Rostky is dead serious about serving his engineering audience, he has a quick sense of humor. He tells some of the best jokes in the electronics industry—and some of the worst.

Some of this humor creeps into *Electronic Design*. Rostky



George Rostky heads a carefully picked team of 14 managing, associate, and regional editors. Here, Rostky is flanked by co-managing editors Ralph Dobriner (left) and Mike Elphick as they "critique the issue."



"How close a book gets to the reader is important."

thinks that's good. Engineers aren't squares. They're human. And they love a joke about themselves or about their industry. A dash of humor once in a while heightens the seriousness of the rest of the book. But Rostky has to know his readers. He has to know what they laugh at.

Know the reader. That's the first lesson he pounds into new editors. Due to *Electronic Design's* tightly controlled circulation, he stresses, "we have one reader—the engineer." And so the editors write only to him. They don't write to students, professors, marketing men, ad men, treasurers, vice-presidents in charge of acquisitions and hobbyists. That makes an editor's job easier.

But Rostky never lets the job get too easy. Because of its single audience, he feels *Electronic Design* must serve the engineer better than anybody else possibly can. So the editors must work harder. He demands that editors learn what makes the engineer tick, as well as what he buys and what problems he has that *Electronic Design* can help solve.

He insists that editors learn to challenge what they read and hear. He wants them to know what a company *withheld* from its press release; he wants them to check the specs that aren't in the headline. He wants them to look for missing specs and fragmented specs that are separated in print though they influence each other in a product. He asks editors to study pictures, too, for pictures don't always match product descriptions.

"The engineer's victories are our victories."

"The unusual units on the meter face," he once wrote, "are not the beginning of a new trend, but rather, a result of excess enthusiasm on the part of the photographer." That was a gentle way to let readers know the equipment probably wasn't available yet—something an engineer may desperately need to know. If he has a tight project deadline, he may want the product NOW.

This kind of attention to detail once resulted in a famous Rostky tag line. A company boasted that it had packed a circuit into a one-inch cube, but some arithmetic showed that the volume was 1.43 cubic inches. That wasn't *much* bigger, but it was bigger. With a dash of irony, Rostky wrote, "The company can be forgiven the 43% rounding off..."

In a similar vein, when a company announced "the world's smallest capacitor," Rostky checked some records, then wrote, "The unit is almost as small as the world's smallest capacitor introduced by the company last year."

Rostky feels that this kind of writing, which doesn't appear in other magazines, is impossible without deep product knowledge. And an editor can't achieve that kind of knowledge if he's a generalist. So each *Electronic Design* editor must specialize and become expert in an assigned field—semiconductors, instrumentation, data processing, circuit modules, passive components, electromechanical components, etc.

That makes it possible to put products in their proper perspective—to write, for example, that an op amp has excellent drift specs but awful slew rate. That's important, says Rostky.

It's all too easy, he feels, to rewrite a press release and announce, for example, that a new scope has a bandwidth of 500-MHz and a sensitivity of 10 mV per division. Editors

"It doesn't have to be dull to be technical."



can assume that the readers know the significance. But Rostky thinks that's a cop-out; a lazy editor's excuse for not doing his homework. It's the editor's responsibility to tell his readers why he's writing the story. If the 500-MHz scope has the widest bandwidth of any real-time, high-sensitivity scope, then it's his obligation to say so and to show how it stacks up against competing scopes—to tell readers *who* held the bandwidth crown before the 500-MHz scope was introduced, and to tell them what trade-offs were made in the new scope.

Though Rostky feels it's his obligation to call attention to misleading or omitted specs, he's just as much obligated to hail an important development and to show the kind of excitement an engineer shows when he hears about it. George reminds his editors that buying products is an extremely important part of an engineer's job. Engineer's send *Electronic Design* a million and a half inquiries a year—and that's not because they enjoy reading product literature. They *need* the information to make intelligent buying decisions. "We've got to help them, and we do help them, even if we use strong adjectives like 'sensational' and 'superb'—if we back them up with hard facts and research."

"The editors must learn what makes an engineer tick."



The "facts" that Rostky looks for must be *useful* to electronics engineers—not merely interesting. When a new editor justified an article on the grounds that it was "interesting," Rostky almost exploded. "No, dammit, we're not looking for stuff that's 'interesting.' We've got to dig up material that's *useful* to engineers."

After that, George and his editors get to work to give the material interest and appeal. They use every professional trick they know to make articles inviting. That's why they pay special attention to graphics as well as writing style. It's essential, they feel, to present a



"Our job is to help the engineer do his job—engineering."

good story to the engineer, but it's also essential to present it so handsomely and invitingly that an engineer *wants* to start reading. "That's part of what it takes to make an article interesting," George adds, "but interesting is not the justification for an article . . . usefulness is. Interest is the gravy. Usefulness is the meat."

Though Rostky takes liberties with the English language in face-to-face conversation, he insists on perfect English usage in *Electronic Design*. But he also insists on bright, colorful, fast-paced writing that helps an engineer absorb information quickly. He rejects the notion that "it's got to be dull to be technical," and squirms with distaste at heavy, pompous and ostentatious writing. "We want to punch the message through," he says. "We don't want to bog the reader down with cluttered sentences."

Though his speech and writing are sprinkled with engineering jargon and slang, Rostky surprises some people when he quotes Shakespeare, or Alexander Pope or a character in a Mozart opera to make an engineering point more vivid.

"Aren't you talking over the heads of your readers?" someone asked. "Hell no!" he slammed back. "An engineer is a rounded individual. He has many interests—art, music, literature, boating, skiing, and, I'm told, blondes. But we don't serve all his interests."

"We help him become a stronger engineer or a stronger engineering manager. We don't teach him the arts. We don't help him become a better marketing man or advertising man, nor a better public speaker or lecturer, nor a sharper investor. Our job is to help the engineer do his job—*engineering*."



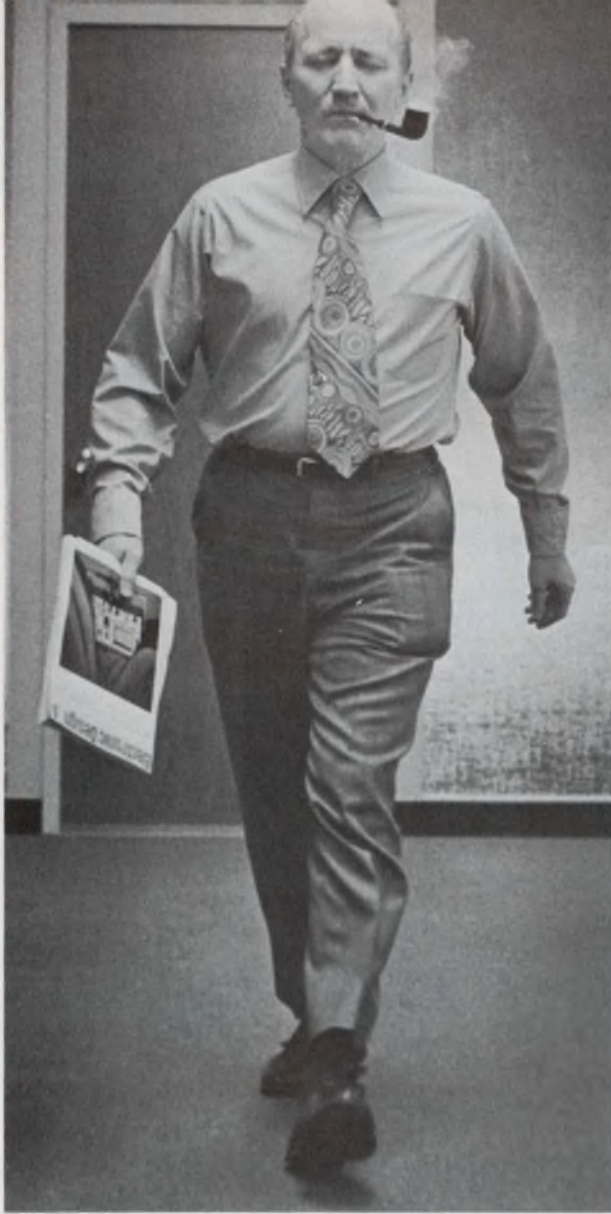

What manner of man is this?

Though all *Electronic Design* readers are familiar with the technical and vitriolic side of George Rostky, few people know anything about the personal side.

Rostky holds a B.E.E. degree from City College of New York and worked for five years as a design/development engineer for a number of firms including Sperry Gyroscope Co., Underwood Computer Division, and Bell Telephone Laboratories.

He entered electronic journalism in 1957, joining *Electronic Design* as a technical editor. Subsequently he moved to Mactier Publishing Corp., serving first as editor of EEE, and then as editorial director of the company's three publications, EEE, Electro-Procurement, and BM/E (Broadcast Management/Engineering). He returned to *Electronic Design* as special projects editor in April 1971.

He and his wife, Rhoda, have a 16-year old son, Mark, and a 12-year old daughter, Lisa. In his spare time, he likes to tinker with electronic equipment, read, or listen to music. He is extremely fond of the opera and chamber music, and his all-time heroes are Beethoven, Bach and Mozart.

George Rostky of **Electronic Design**

...The Industry's Most Quoted Editor

Here are a few hard-hitting lines from editor Rostky's pen:

"When business is bad, we seem hell-bent on making it rotten. And when it's good, we're miserable unless we can make it sensational... let's not foul up the upturn."

"More than any other industry, ours is dominated by engineers. And we supposedly make decisions based on fact and reason; we don't get caught up in a swirl of emotional reactions. Do we?"

"Arguing against safety standards is akin to arguing against flag and motherhood or taking a public stand on the side of sin. But a proposed safety standard for lasers leaves me feeling that someone's hanging his banner on a twig."

"Worrying about 50,000 lasers and neglecting 87,000,000 cars is like campaigning against dandruff in Vietnam."

"The really sharp engineer keeps challenging himself. He doesn't allow himself to fall prey to structures—even structures he himself created."

"If President Nixon can really get his new technology opportunities program off the ground, we'll have a great new day for engineers... if the N-T-O-P, a vast program of federal support for non-war technology, can get going without the usual morass of red tape and boondoggling, we'll have more than lots of new jobs; we'll have new pride."

"The pages of the recent history of our industry are splattered with the blood of companies that lacked the man with the authority and guts to shout the right word at the right time."

Electronic Design

A Hayden Publication Peter D. Coley, Publisher

50 Essex Street, Rochelle Park, New Jersey 07662 •

Phone: 201-843-0550

An Electronic Design Special Report

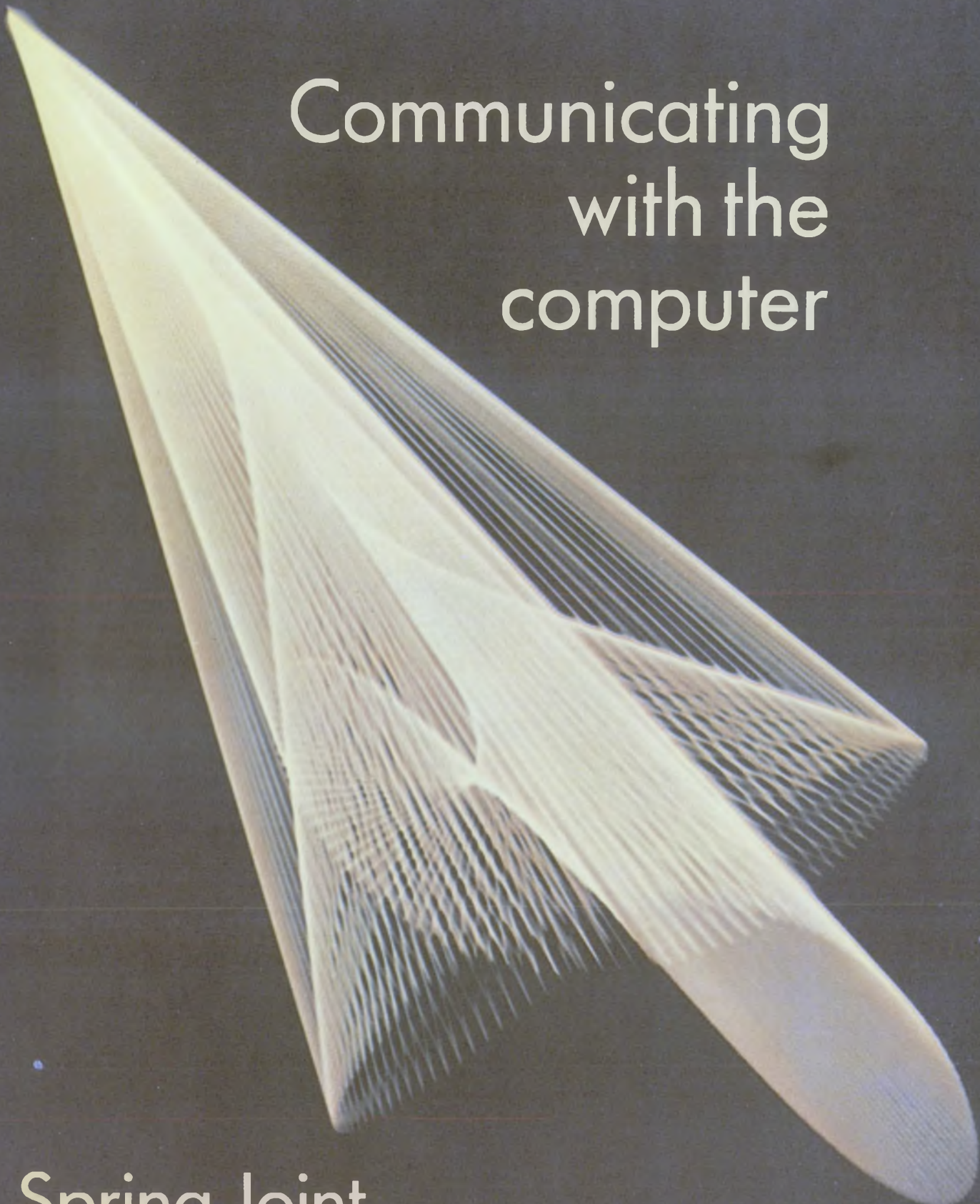

Communicating
with the
computer

Spring Joint
Computer Conference 1972

NOW AVAILABLE—

A line of cathode ray monitor tubes



**...developed specifically
for computer terminals
and other information displays.**

- A range of sizes, 4 inches to 15 inches diagonal
- High resolution from center to edge, assuring good legibility of characters
- Excellent ratio of usable screen to total bulb size
- Flicker-free picture, reducing eye fatigue
- Good price/performance ratio

For more information on these professional CRT's for monitor applications, contact us by mail or phone:
Electro-Optical Devices Division, Amperex Electronic Corp.,
Slatersville, Rhode Island 02876.
Telephone: 401-762-3800

 **Amperex®**

TOMORROW'S THINKING IN TODAY'S PRODUCTS

Sold through
North American Philips Electronic Component Corporation

1972 Spring Joint Computer Conference

Special Report

It's a new world for computer graphics. Five years ago interactive terminals were very expensive and found limited use. Today they can be bought for as little as \$4000 and from more than 35 suppliers. . . . C4

Focus Report

Disc and drum memories are generating a great deal of excitement. Access time is down, capacity is up and prices are coming down. But specs aren't all they appear to be C16

Technical Article

Get the mini you really need by investigating what the manufacturer's specifications mean in terms of computer processing power C28

Products

Desk-top calculator rivals minicomputer in capability and memory capacity C39

Domain-tip memory offers core speed at disc prices. C40

Plotter microprocessor saves memory core space. . . . C42

Pen-entry system uses sound to digitize data. C44

Cover photo courtesy of Adage, Inc., Boston



It's a new

Ralph Dobriner Managing Editor

Whatever happened to the bright, promising world of interactive computer graphics? The promise has become reality, that's what.

As recently as five years ago the use of interactive graphics—a method of communicating with a computer through static or animated diagrams via a display terminal—was limited to a few aircraft manufacturers, automobile companies and military agencies. The reason: Typical systems were rather complex and cost anywhere between \$100,000 and \$200,000. That was just for the hardware, and usually the user had to invest an order of magnitude more on software to get new productivity from the hardware. Also, only about a dozen suppliers offered commercial equipment.

All this has changed dramatically.

Today the price of admission has dropped considerably. Graphic terminals can be purchased for as little as \$4000. Turnkey-applications software packages are available. And the buyer can choose from among more than 35 hardware and system suppliers, who are offering over 60 different models.

Use of terminals is rising

Carl Machover, vice president of marketing for Information Displays, Inc., Mt. Kisco, N.Y., estimates that there are currently about 1200 high-cost graphic terminals and about 700 low-cost graphic terminals installed in the U.S. In general, high-cost terminals are priced at \$50,000 and up, and low-cost terminals at \$10,000 or less. Five years ago, Machover notes, about 300 high-cost terminals had been installed and no low-cost terminals were available.

Interactive terminals like this IBM 2250 are being used increasingly for circuit design and analysis in industry.

world for graphic terminals

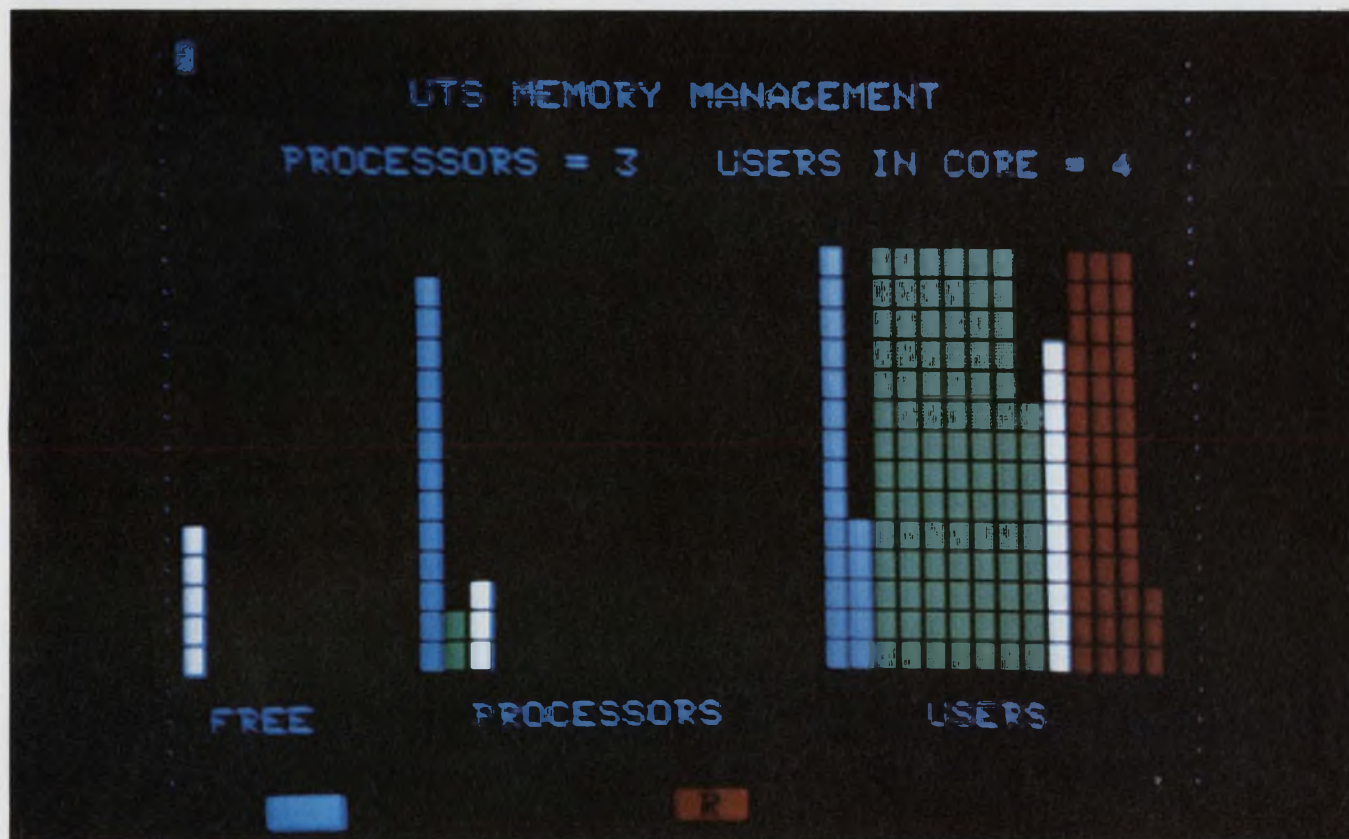

Color displays, such as those generated on the Xerox BC 100 and BC 200 display stations, are finding wider

use in management information systems. Up to eight colors are offered on a 12, 17 or 19-inch screen.

Though some aspects of terminal performance have not changed much over the last few years, such as the maximum screen data content (number of flicker-free points, characters and lines), significant advances have been made in other areas. These include:

- The development and increasing use of the storage tube, which marked the beginning of low-cost graphic terminals.
- A growing trend toward "intelligent terminals," which include their own commercial mini or midi general-purpose computers.
- The development of new, low-cost operator input devices—especially the graphic tablet.
- The availability of price-competitive color

displays that incorporate the Penetron, a dual phosphor color tube that offers essentially the same resolution as monochrome displays do.

The basic display

In its basic configuration, an interactive CRT graphic display terminal consists of a display generator, CRT display and input devices (see diagram). The terminal is usually attached to either a large or medium-scale computer, which provides processing capability for the display. The vector, character and circle generators create the appropriate analog voltages to draw the lines or characters on the CRT display.

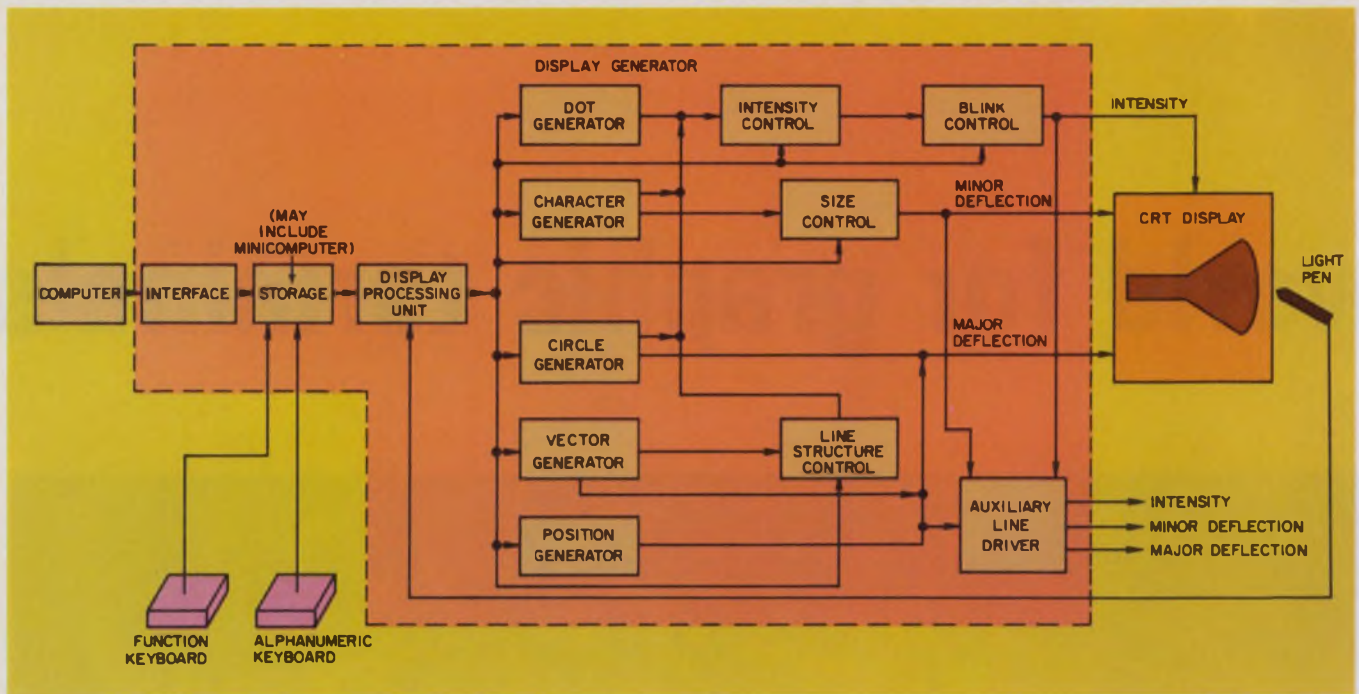

Interactive CRT graphic display terminal consists essentially of a display generator, CRT display and such oper-

ator input devices as a light pen. The terminal is attached to a digital computer, which provides the processing.

The operator can "converse" with the computer on-line and in real time with such input devices as the light pen, joystick, trackball, graphic tablet, "mouse" and function keys. The display processing unit, in its simplest form, acts as a decoder. It decodes the computer data words and routes the information to the appropriate function generators and function-generator modifiers.

In standard CRT terminals the display is refreshed somewhere between 10 and 40 times a second. Ordinarily this would have to be done by the central processor. To lighten the processing load on the computer as much as possible, many terminals use a storage of some type—random-access core or semiconductor memory. Then the central processor need only load the memory with a frame of data. The only time the processor is required is when a picture must be changed. In fact, there is a growing trend to the "intelligent terminal," in which the storage and part of the mode control are replaced by a minicomputer, thereby reducing the load on the central processor even further.

Software-supported "intelligent" terminals—which include their own commercial mini or midi general-purpose computers—are being offered by Adage, Inc., Bunker-Ramo, Control Data Corp., Digital Equipment Corp., Information Displays, Inc., IBM, Sanders Data Systems and Systems Engineering Laboratories.

The Conographic Corp., Imlac Corp. and Systems Concepts, Inc., furnish software-supported "intelligent" terminals with their own minis.

Foremost of the graphic terminal developments in recent years is the storage CRT. This tube can retain a visual image for some time, or until intentionally erased, so that it is not necessary to refresh to avoid flicker. The picture can therefore be written at a slower rate and the full visual density used. The absence of refresh eliminates the refresh memory, an expensive unit.

As Machover of Information Displays points out: "Storage tubes have introduced one of the major changes in terminal configurations." Until about four years ago, he notes, virtually all graphic terminals used refreshed CRTs, with tube sizes ranging from 16 inches in circumference to 23 inches and with usable display areas of about 10 by 10 inches up to 14 by 14 inches.

After Tektronix introduced the Model 611 X-Y storage tube, with a 6-by-8-inch usable area, several companies began to market interactive terminals incorporating the Model 611. These storage-tube terminals marked the beginning of low-cost CRT graphics. Originally introduced in the \$12,000-to-\$15,000 price range, the units are now selling for about \$8000. Late last year Tektronix introduced a limited graphic storage terminal for less than \$4000.

But tube has shortcomings

But the exuberance over the storage tube is not shared by Sol Sherr, vice president of North Hills Associates, Glen Cove, N.Y. He notes that the tube has deficiencies in visual performance, such as low luminance and contrast, and that

More ways to light a one light.

*Licon has added LED's to one LPB switch line ...
another line offers neon or incandescent lamps ...
both feature patented Butterfly® switching.*

You always get a great choice with Licon® LPB switches. For example, take just two of our many lines – Types 01-700 and 01-600 single light switches. Our 01-700 line is now available with integral Light Emitting Diodes. That means virtually infinite light life and negligible operating current. And the 01-700's low profile design assures maximum light intensity. Or choose neon or incandescent lamps instead. In either line. Mounting styles? Type 01-600 line features bezel or bezel-barrier, in

a single switch or multiple in matrix. Time-saving, snap-in mounting. Switching action? Choose from momentary or alternate – plus a selection of non-lighted switches or non-switching indicator lights in matching styles. But whatever you choose, you also get patented double-break Butterfly switching which offers greater reliability and other advantages not possible with single-break switches. Licon LPB's are easily installed and serviced. Test light them yourself.

Call your local Licon rep or distributor for a lighted demo in your office. Or call or write for a Licon Switch Catalog.
**Licon, Division
Illinois Tool Works
Inc., 6615 W. Irving Park
Road, Chicago,
Illinois 60634.
Phone
(312) 282-4040.
TWX 910-221-0275.**



i t
w **LICON**



An estimated 10% of all utilities are using or planning to install graphic terminals. Here is a complete dispatch control center, installed at the Philadelphia Electric Co. It was designed by North American Rockwell Information Systems in Anaheim, Calif.

there is a need to rewrite the entire picture if any element is changed.

"It has its place in certain applications," Sherr points out, "but is not necessarily the nostrum it had been initially presented as."

In the last two years several other terminals selling for less than \$10,000 and using either refreshed displays or some form of TV (either scan conversion or digital TV) have been introduced. Included are refresh displays from the Imlac Corp. and Information Displays Inc., scan-converter displays from Princeton Electronic Products and digital TV displays from the Data Disc Corp. These low-cost units are available

with varying levels of software support.

Machover notes that, typically, the low-cost graphics terminals involve some compromise in terminal performance, such as small picture area, low contrast, restricted dynamic motion, poorer picture quality, lower resolution and some line drawing limitations and no gray levels. However, for many applications, these are acceptable compromises, Machover agrees.

Many sizes and capabilities

Graphic-display consoles come in many different sizes, data-presentation capabilities, data-storage capacities, transmission characteristics and data-entry devices.

The alphanumeric and line data presented on graphic displays vary considerably. The number of lines that are presented depends largely on the deflection and line generation subsystems. The number of characters per line ranges up to 128 and the number of lines varies from about 28 to 64. The typical graphic terminal can display 1000 to 6000 alphanumerics and symbols. Data-storage capacities range from 1 k to 8 k words.

Graphic displays are available that operate on a "stand alone," or multistation, basis. The display configuration depends on the type of computer used and the location of the display relative to the computer. Parallel data transfer is used when a large amount of data must pass between the computer and display.

Word formats used for graphic displays are quite different from system to system and application to application. The number of bits in a word can be as few as eight or as many as 36. The character code widely used is ASCII, but other codes are also used.

Among the switches in display systems are push-button, rotary and thumbwheel switches. Push-button switch keyboards are used with either Hall-effect, photoelectric, magnetic or reed switch devices to extract data from keyboards.

Pointer devices are used to interrogate data presented on the viewing screen. These devices include the following:

- Light pen—a pen that detects the dynamic light changes from the CRT and sends a signal back to the computer corresponding to the data that were intercepted. It can be used either in a pointing mode or to enter information directly.
- Joystick—a stick operated remotely from the viewing surface. As it is moved, a marker on the CRT moves in response.
- Track-ball—a marker, such as a small circle, that is moved on the CRT screen in response to the manual movement of a ball, the latter rotating freely in an assembly.
- Graphic tablet—a stylus that inserts data into the CRT by moving over the surface of an

the rugged rectifiers!

These rectifiers are rugged, both mechanically and electrically. The General Electric A14 (IN5059-62) and A15 (IN5624-27) feature 2.5 and 5 ampere capability respectively, and up to 1000 volts.

POWER-GLAS™ passivation provides a void free inorganic protection of the P-N junction. A dual heat sink glass encapsulated package offers the utmost in long term stability and mechanical integrity. Millions of hours of proven performance attest to the value of General Electric's POWER-GLAS™ passivation process.

For high frequency application, General Electric offers the 2 ampere A114 and the 5 ampere A115—with 200 nsec maximum reverse recovery.

We'd like to show you our RUGGED RECTIFIERS; for free samples write on company letterhead to: General Electric Semiconductor Products Dept., Electronics Park, Syracuse, New York 13201.

GENERAL  ELECTRIC



Complex line drawings and patterns can be generated on the System 32 interactive graphics display terminal from Lundy Electronics & Systems, Inc.

electronic data tablet.

- Mouse—an assembly containing wheels, which are attached to position transducers. Moving the assembly over a surface provides x and y coordinate signals.

Although the light pen and keyboard continue to be the major operator input devices for CRT graphic terminals, the graphic tablet is a fast comer, especially since the light pen cannot be used with storage-tube systems. Early versions, such as the Rand tablet, were expensive—about \$10,000 to \$15,000, compared with about \$1500 for the light pen. But Sylvania, at one time, offered a digital version of the graphic tablet for about \$7000, and at least two units selling for less than \$3000 are available. One of the latter is from Science Accessories—the Graf Pen, using an acoustic principle—and the other from Compu-tek—using a resistance technique.

With the advent several years ago of a new color tube, the Penetron—introduced by several tube manufacturers, including Thomas Electronics, Sylvania and General Electric—color displays became a practical reality. Early systems employing the commercial shadow-mask tube were costly, difficult to keep aligned and had poor resolution—350 by 350 resolution elements, compared with the 470 in monochrome tubes.

The single-gun Penetron uses a dual phosphor, and color changes—over the range from red, through orange to green—are obtained by switching the anode potential, usually over a range from 6000 to 12,000 V. Switching times are currently on the order of 150 μ s for each color. Penetron systems offer essentially the same

resolution as monochrome systems at a cost about \$7500 higher.

A range of applications

Where are these interactive terminals being used?

Computer-driven, interactive, dynamic graphic display systems are turning up in a wide range of applications—from circuit design and analysis to the production of final drawings for complex mechanical assemblies. They are being used in airframe and automobile body designs, management information systems, architectural and road-building programs and urban planning, as well as in circuit design and automatic drafting.

Over the last five years the use of graphic terminals in electric utilities, for control and simulation of electrical generating transmission, and in distribution systems has been accelerating. Machover estimates that about 10% of all investor-owned utilities are now using or planning to install graphic terminals.

In utility use, a line schematic or simulation of a portion of the electrical system is shown on the display. The schematic shows the state of the system, the position of switches and circuit breakers, the location of transformer taps and so on. An operator can designate a point on the schematic and, with his light pen or cursor and a keyboard, specify a particular action. This can be on-line in response to a critical situation or a simulation to determine the effect of an operation on system loads before the operation is carried out.

A way to speed design work

Computer-aided design continues to be the biggest application area, particularly in the aerospace and automotive industries. And it is finding increasing use in architecture, shipbuilding and civil engineering. In the electronics industry, terminal-based computer graphics is being used for circuit design and analysis, particularly by the major semiconductor manufacturers in the design of masks for custom and production ICs.

Circuit-analysis techniques that use computers have been around for a number of years. Such programs as ECAP and SCEPTRE were run in purely batch modes. Data on circuit performance were printed out, with large amounts of paper used and a new printout needed every time a parameter was changed. This often took days and weeks of computer time. With the advent of interactive graphics, the central processor can now be programmed to draw resistors, transistors, diodes and other circuit components on the display in any desired circuit configuration. The engineer then assigns values to the components,

Not New...Just the Best



ERIE RED CAP

Miniature Ceramic Capacitors

WIDEST SELECTION OF MINIATURIZED CERAMIC CAPACITORS IN THE INDUSTRY!

Erie is in the Red Cap winner's circle because of a well engineered component that's backed by a unique process control system. Combine this with talented, motivated people and you have Erie as the leader in its field. These tiny high quality capacitors are not new... but they are the best. Our customers attest to it. Our test laboratories prove it.

Red Cap dielectrics are manufactured by Erie's exclusive Monobloc Process™... a modern, time-proven ceramic film technology. And tough environmental extremes routinely are endured by our own Jet-Seal, a hard, bright red polymeric protective coating. (The superior aesthetic appearance of Jet-Seal comes to you at no charge.)

Erie Red Caps have it all. 21 temperature characteristics. 1pF to 10uF capacitance range. Ratings from 25 to 500 Vdc. You name the application we've got a Red Cap for the job. All this is due to Erie's total in-house capability... from exclusive ceramic formulations to unique packaging. So on your very next buy of ceramic capacitors, do it the easy way... specify Erie Red Caps.

Write TODAY for Red Cap brochure 8000... or call our nearby factory representative.

CAPACITANCE RANGE
1pF to 10uF

21 TEMPERATURE Characteristics

Voltage Range
25 to 500 Vdc

Encapsulated by "JET-SEAL"

Meet or Exceed Requirements of MIL-C-20 MIL-C-11015 As applicable

ERIE TECHNOLOGICAL PRODUCTS, INC.
Erie, Pennsylvania 16512

and analysis programs provide almost instant information on the characteristics of the circuit. The operator can change circuit configurations, assign new values and obtain a circuit analysis almost instantaneously. If desired, a printout can be made for further study. In some cases a complete circuit analysis can be made in as little as a half hour. The savings in time and materials, as opposed to breadboarding of the circuit, can be substantial.

But the use of interactive graphics for design in the electronics industry is still limited to relatively large companies that can afford the \$100,000 to \$200,000 for medium to large-scale interactive systems and the \$50 or \$100 it costs for each hour of console time.

As Sherr of North Hill Associates points out: "How many times do you design a circuit, even in a big electronics company? As console costs begin to drop to between \$5 and \$10 an hour—which can be anticipated within five years—it then might become economical, but even then it's not a large-scale operation."

Sherr sees, instead, an expanding use of interactive graphics in electronics manufacturing to keep drawings up to date and to perform other drafting functions.

"It costs between \$5 and \$10 an hour for a draftsman, and it will take him eight hours to do what an interactive system might accomplish in less than an hour," he says.

A look at future displays

What about tomorrow's interactive systems? It's generally agreed that the trend to low-

cost, multi-function terminals will continue. There will be increased use of multicolor graphic displays, with even better resolution than in current Penetron systems.

A major technical obstacle to greater use of computer-aided design is the lack of generalized software. Most of the applications so far have been implemented with specialized programming or, at most, Fortran type of languages. What is needed is a universal graphic language.

Tomorrow's displays will incorporate complex, relatively low-cost, integrated circuits, along with such special-purpose hardware as low-cost mini-computers. These will replace the computational functions previously done by software.

Flat-panel readout devices—the Owens-Illinois' Digivue plasma panel, for example—may eventually replace the CRT, although breakthroughs in driving and addressing such a flat panel are still needed. Light-emitting diodes, liquid crystals or magnetic dipoles are also in the running as a CRT replacement.

New data-entry devices will be developed to provide more natural man-machine interaction. One potential technique that might become a reality is a speech-recognition system that allows the operator to "talk" to the computer via the display.

Finally, Sherr makes this prediction:

"Just as calculators are becoming single-chip devices, it might be possible, using microcircuit techniques, to put all of the electronics on the back of a flat-panel display. You could carry the display along in your briefcase, set it down wherever you are, plug it into a telephone, dial into a computer and you're ready to go." ■■

Need more information?

For more details on graphic terminal products readers may wish to consult the manufacturers listed below. You may write, telephone or circle the information retrieval number.

- | | |
|--|--|
| Adage, Inc., 1079 Commonwealth Ave., Boston, Mass. 02215.
(617) 783-1100. | IBM, 1133 Westchester Ave., White Plains, N.Y. 10604. (914)
696-2422. |
| Bunker-Ramo Business & Industry Div., 445 Fairfield Ave.,
Stamford, Conn. 06904 (203) 348-4291. | Circle 385 |
| Computek, Inc., 143 Albany St., Cambridge, Mass. 02159.
(617) 864-5140. | Imlac Corp., 296 Newton St., Waltham, Mass. 02154 (617)
891-1600. |
| Computervision Corp., South Ave., Burlington, Mass. 01803
(617) 272-7240. | Circle 386 |
| Conographic Corp., 6 Gill St., Woburn, Mass. 01801. (617)
935-7300. | Information Displays, Inc., 333 N. Bedford, Rd., Mt. Kisco,
N.Y. 10549. (714) 241-1000. |
| Control Data Corp., 8100 34 Ave. So., Minneapolis, Minn.
55804. (612) 853-8100. | Circle 387 |
| Data Disc Inc., 686 W. Maude Ave., Sunnyvale, Calif. 94086.
(408) 732-7330. | Information International Inc., 12435 W. Olympic Ave., Los
Angeles, Calif. 90064. (213) 478-2571. |
| Digital Equipment Corp., 146 Main St., Maynard, Mass.
01754. (617) 897-5111. | Circle 388 |
| Evans & Sutherland, 3 Research Road, Salt Lake City, Utah
84112. (801) 582-5847. | ITT Data Equipment & Systems, 157 E. Union Ave., East
Rutherford, N.J. 07073. (201) 935-3900. |
| Hazeltine Corp., 59-25 Little Neck Parkway, Little Neck, N.Y.
11362. (212) 423-4800. | Circle 389 |
| Honeywell Information Systems, Inc., 60 Walnut St., Wellesley
Hills, Mass. 02181. (617) 237-4100. | Lundy Electronics & Systems, Inc., 28 Park Place, Paramus,
N.J. 07652. (201) 262-5400. |
| | Circle 390 |
| | Monitor Systems, 401 Commerce Dr., Ft. Washington, Pa.
19034 (215) 646-8100. |
| | Circle 391 |
| | Princeton Electronic Products, P.O. Box 101, N. Brunswick,
N.J. 08902 (201) 297-4448. |
| | Circle 392 |
| | Sanders Data Systems, Inc., Daniel Webster Hwy., So.
Nashua, N. H. 03060. (603) 885-4321. |
| | Circle 393 |
| | Sperry Rand Corp., Univac Div., P.O. Box 500, Blue Bell,
Penn. 19422. (215) 646-9000. |
| | Circle 394 |
| | Systems Concepts, Inc., 524 Second St., San Francisco,
Calif. 94107. (415) 433-5400. |
| | Circle 395 |
| | Systems Engineering Laboratories, 6901 W. Sunrise Blvd.,
Ft. Lauderdale, Fla. 33313 (305) 587-2900. |
| | Circle 396 |
| | Tasker Industries, 4561 Colorado Blvd., Los Angeles, Calif.
90039. (213) 246-6761. |
| | Circle 397 |
| | Tektronix, Inc., P.O. Box 500, Beaverton, Ore. 97005. (503)
644-0161. |
| | Circle 398 |
| | Vector General, Inc., 8399 Topanga Cyn. Blvd., Canoga Park,
Calif. 91304 (213) 346-3410. |
| | Circle 399 |
| | Xerox Data Systems, 701 S. Aviation Blvd., El Segundo,
Calif. 90245. (213) 679-4511. |
| | Circle 400 |

It's tough to get lipstick
to go where it's supposed to go.

But Clare can help. We understand interface technology and we've designed components to meet your requirements. We know how to pluck the right tube of lipstick out of inventory with an automated system. And we've learned a lot about delicate batch processing. And sensitive power control. No matter what you're trying to do, we know how to design and apply components that help you translate computer talk into reliable processing and control.

Clare engineering keeps pace with your interface problems—and your imagination. That's why we refined and developed mercury-wetted, dry and wetted reed relays—then built the most comprehensive lines available in the industry. We make everything,

from the capsule to the completed relay.

Mercury-wetted relays for low-level analog signals. Clareed® for standard dry reed applications. MicroClareed® for subminiature, high-speed performance. Picoreed® relays for high-density mounting situations. All give you fast, reliable performance with total input/output isolation characteristics. All are immediately available in a variety of configurations and combinations.

And if we haven't designed what you need yet, we'll get into that too.

The point is, Clare has the capability to participate with you in interface design, no matter how complex the problem.

We've published a free booklet on interface applications. Six minutes of ideas that may trigger some thoughts for you. Send the coupon for your free booklet, or call your Clare representative directly.



C. P. Clare & Co., 3101 Pratt Blvd., Chicago, Illinois 60645

Name _____
Company _____
Address _____
City _____ State _____ Zip _____



a GENERAL INSTRUMENT company

**Our terminal capabilities outnumber
your problems.**



The answer to your remote-computing needs is probably right on this page.

Like our model 33. Economy and reliability have made it the most popular data terminal of its kind. Or like our new wide-platen model 38. We loaded it with big machine features but we left off the big machine price tag. For high-volume operations, our model 35 is built to run day and night, year in and year out. And if your system is highly complex, our model 37 delivers the utmost in flexibility and vocabulary.

To move information on-line at speeds up to 2400 wpm, all our keyboard terminals are compatible with the Teletype® 4210 mag tape data terminal. We also manufacture paper tape senders and receivers with speeds up to 2400 wpm.

To make sure you get what you need, we sell assembled ASR, KSR and RO terminals, as well as components—printers, keyboards, readers and punches.

You can also select from three different interface options: a built-in modem; a current interface; and an EIA Standard R-232-C interface.

Platen widths range all the way up to 15 inches.

Besides alphanumeric, we can give you Greek letters, algebraic and chemical symbols, as well as special graphics.

We also cover error detection and station control with a complete group of solid-state accessories.

And our machines never have to stand alone. Our applications engineers will work with you to make sure the terminal you buy from us is exactly what you need. And our maintenance

people are ready to make sure things keep running smoothly.

So whatever data terminal problems you're up against, come to us for help. Because when it comes to flexibility, reliability and economy, you can't beat the machines that carry our name.

It takes more than manufacturing facilities to build the machines Teletype Corporation offers. It also takes commitment. From people who think service is as important as sales. In terminals for computers and point-to-point communications.

That's why we invented a new name for who we are and what we make. The computer-cations people.



INFORMATION RETRIEVAL NUMBER 126

For more information about any Teletype product, write or call **TERMINAL CENTRAL**, Teletype Corporation, Dept. 89C, 5555 Touhy Avenue, Skokie, Illinois 60076. Phone 312/982-3500

Teletype is a trademark registered in the United States Patent Office.

FOCUS

on
Disc and drum
memories

Cost per bit is the magic number for rotating memories, as it is for others, but it's not easy to find. It's necessary to determine which is the true cost and which are the useful bits. And that can be sticky. Of course, if the memory breaks down or fails in any way, you don't get many bits, so the cost per bit approaches infinity. Vendors never quote such high prices.

The magic number should probably be expanded to include time, which would provide a better

criterion—cost per bit per second. Thus, if one memory system has one-quarter the access time of another but costs twice as much for equal bit capacity, it can provide greater throughput at lower cost than the less expensive but slower memory.

Even with the expansion, the basic criterion is inadequate. It's an oversimplification. There are many important specifications that do indeed become parts of cost, bit capacity and time—but indirectly. So they merit separate study. There-

David N. Kaye
Senior Western Editor

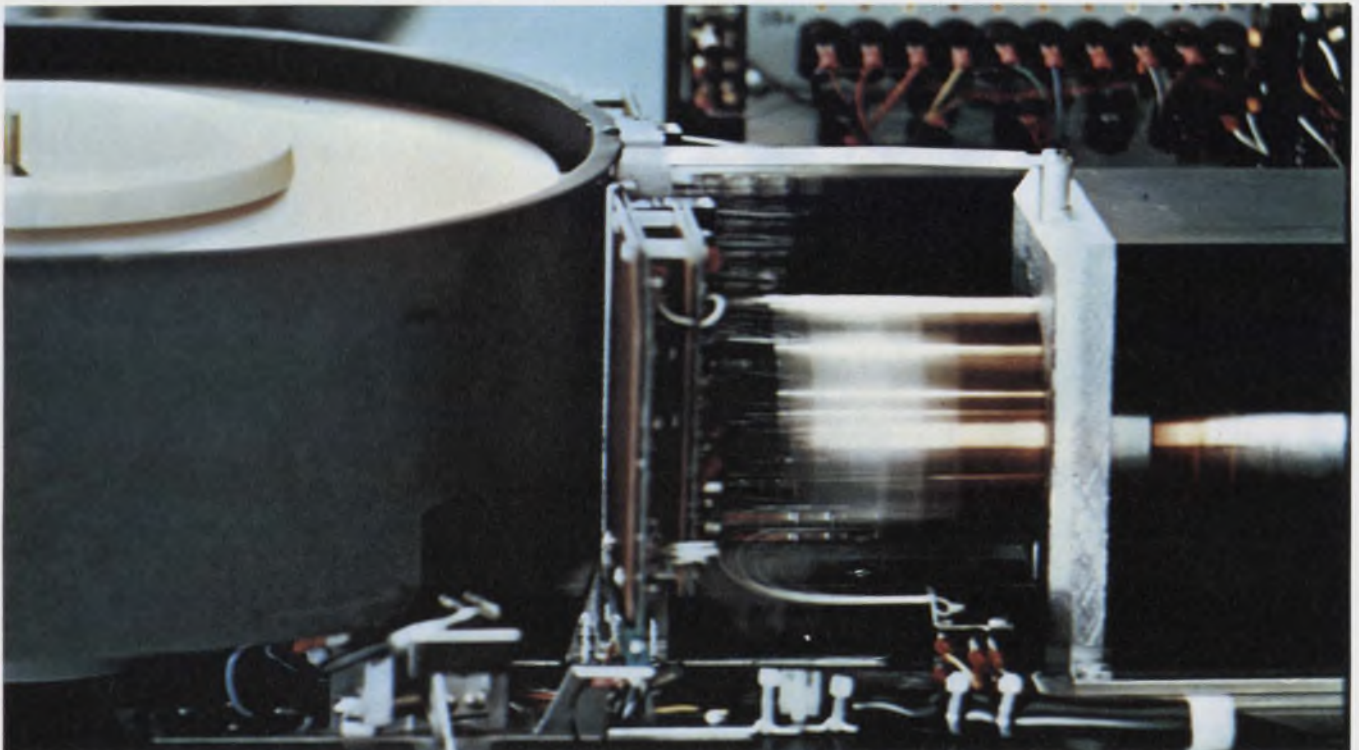

Linear-motor head positioning is used on the Memorex 660 disc drive, as well as on most other modern moving-head disc drives. The linear motor, called a voice coil,

consists of a coil of wire inside a permanent magnet. As the coil moves in and out of the magnet, the recording heads move in and out of the disc pack.

fore the user should thoroughly evaluate usable capacity, realistic access time, data rate, reliability, working environment, available service and mechanical noise.

Why discs and drums?

Magnetic disc and drum systems provide mass data storage in the performance and price range between magnetic-tape systems and core or semiconductor systems. For the same bit capacity, they cost more than tape but provide faster access. They cost less than semiconductor or core, but they give slower access.

Rotating memory systems fall into these main categories:

- Moving-head, removable-media disc.
- Moving-head, fixed-media disc.
- Fixed-head/track, fixed-media disc.
- Fixed-head/track drum.

Media are defined as those devices on which data are recorded. A medium is usually a nickel-cobalt plated disc or drum, or an iron oxide coated disc. A disc pack is a removable package containing from one to 12, two-sided discs mounted on a common spindle. All removable-media disc drives use disc packs.

Data are recorded on the disc or drum on parallel tracks. Discs and drums record from

tens to hundreds of tracks per recording surface.

Moving-head systems contain one recording head, mechanically moved from track to track, for each recording surface.

Most modern drives use a voice-coil linear motor to drive the head. Fixed-head/track systems contain one magnetic recording head per track of recorded data. These heads never move from their dedicated tracks.

In most systems the recording head or heads are designed to fly on an air bearing at 50 to 150 microinches above the recording surface when the disc or drum gets up to speed. Some lower-performance disc systems use heads that are always in contact with the recording surface. Some high-performance disc systems fly their heads at only 10 to 15 microinches to pack more bits/inch onto the data track.

Credit for the first random-access moving-head disc system goes to IBM, which designed it in 1956 and called it the RAMAC. It stored 40 million bits and had an average access time of 0.6 second. By comparison, the new IBM 3330 moving-head disc system stores 800 megabits and has an average access of 27 ms.

A typical disc or drum memory contains a disc drive and a controller. The controller connects the disc or drum system to the computer's communication interface. Some users of rotating memories prefer to design their own controllers. Others buy them from drive manufacturers. Still others use controller manufacturers who are not related to the drive manufacturers. When the controller is priced out in combination with the drive, the cost/bit question is considerably muddied. This is because controllers can contain:

- Track-address decoding.
- Sector-address comparison.
- Word count.
- Level shifting.
- Buffer storage.
- Error detection.
- Error-correction strategy.
- Write/read control.
- Sector formatting.
- Serial/parallel conversion.
- Multiple-drive control.

Most of these functions are contained in most controllers. However, some are often options and, depending on the combination of features, the price can vary by as much as 75%.

When pricing the drive system, almost every



Optical interference patterns are used to measure the flying height of the recording head above the disc. Here, the measurement is made at Data Disc, where the heads fly at only 10 to 15 microinches off the disc surface.



The 733 moving-head disc drive is ITEL's competitor to IBM's 3330. It is an 800-Mb drive with servo-surface head positioning. It uses the IBM 3336 disc pack, with 19 recording surfaces.

manufacturer considers a different set of features as standard equipment and options. The price may or may not include power supplies, rack-mounting hardware, a cabinet, read/write electronics, decoding electronics or a controller. All manufacturers recommend that the power supplies be purchased with the drive. Often regulation requirements are quite severe, and an unusual combination of voltages is required. Drive manufacturers always design their own power supplies.

Which capacity?

Storage capacity may be any of the following: capacity, unformatted capacity, full-track capacity, sectorized capacity and net capacity. The first three terms express the total number of data bits that can be recorded on the media. They are developed by multiplying the number of tracks by the number of bits per track. The number can mislead.

When a data record is recorded on a disc or drum, it is always preceded by a fixed number of bits, called a preamble, and followed by a fixed number of bits, called a postamble. The preamble initializes the read electronics, and the postamble turns off and discharges the write electronics. In a new system by the Digital Development Corp., the postamble also serves to allow time for translation of a coding scheme that the company calls Rice code. Many other manufacturers also use the postamble to run parity or cyclic-redundancy-code bit-error checks.

Since the preambles and postambles require bit locations on the media, they subtract bits from the usable capacity. Data are recorded in a specified length of track called a sector, and every time a read or write command is given by the controller, an entire sector is read or written. So the number of sectors specified for the media determine the number of necessary preambles and postambles and the number of nonusable bits. Thus only sectorized, or net, capacity gives the true usable capacity of the media.

The access-time myth

Given enough time, a disc system can provide near-infinite storage—limited only by the number of available discs. The access time would equal the time required to fetch and install new disc packs. That's not the access time manufacturers quote.

The more usual term, "average access time," is defined as the time required to make an infinite number of random seeks on the media, divided by the number of seeks. That definition isn't very helpful, because most users can't check it by waiting for an infinite number of seeks, then dividing by infinity.

It turns out, however, that average access is generally the time required to move the head about one-third the number of tracks and to let it settle in place. The current definition of average access time for fixed-head/track systems is the time required for the media to rotate 180°. This is called latency.

For moving-head systems, the average access time ranges from 27 ms for the IBM 3330 to 60 to 95 ms for several smaller systems aimed at the minicomputer market. Unfortunately these numbers don't mean much. First, latency is rarely included. Since most of these drives rotate at 1800 or 3600 rpm, latency is either 16.7 or 8.35 ms, respectively. Second, and more important, a programmer can clump data in memory so that the seeks are very short. Thus access times can be much shorter than the quoted *average* access times.

For fixed-head systems, the average access time ranges from 2.5 ms for the new IBM 2305 to 17.5 ms for smaller 1800-rpm machines. Most fixed-head/track systems rotate at 1800, 2400, 3600 or 6000 rpm. If motors were perfect and there were no slip or head drag, these speeds would correspond to latencies of 16.7, 12.5, 8.35 and 5.0 ms, respectively. But motors aren't perfect and heads do give the media a drag constant, and, if the medium isn't perfect, it has its own drag factors.

Therefore realistic manufacturers quote latencies that are slower than the theoretical. Com-

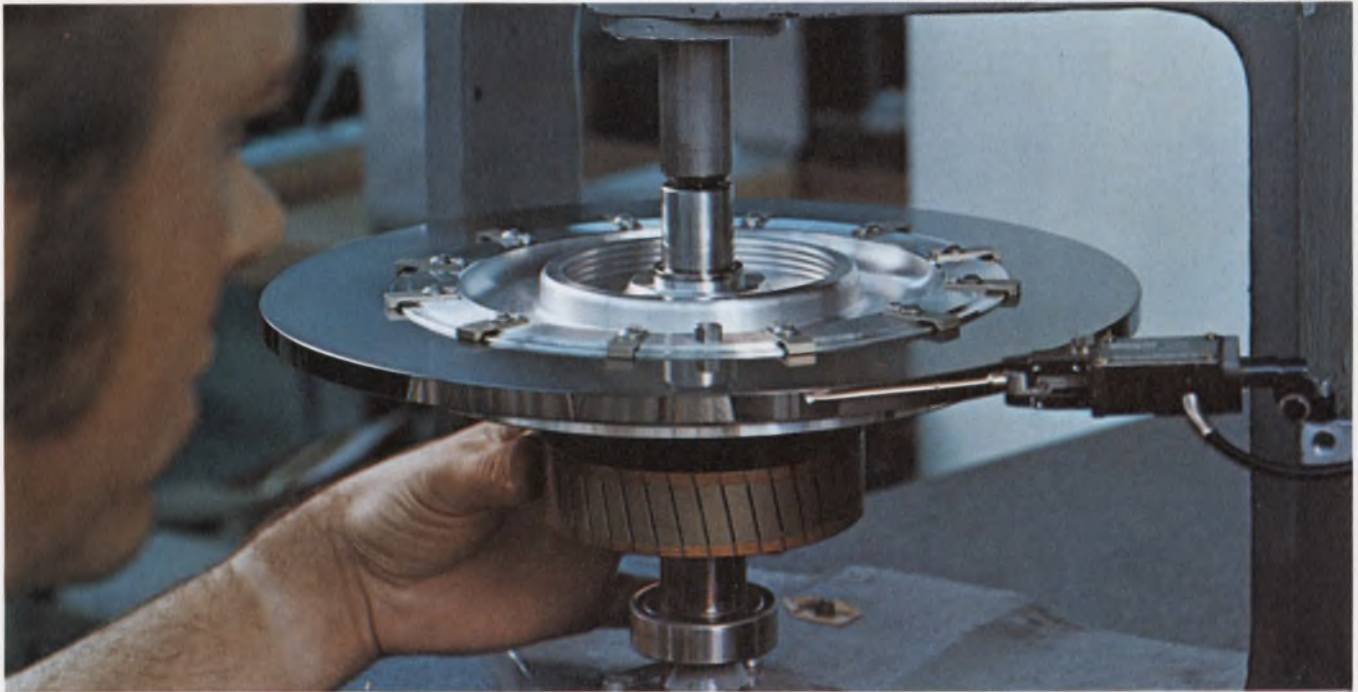

Disc balancing and calibration is an important part of the fixed-head/track assembly operation. A nickel-cobalt

plated disc is being calibrated for a 6000-series disc memory at Digital Development Corp.

monly quoted latencies are 17.5, 12.7, 8.5 and 5.1 ms.

Some manufacturers, however, ignore head drag and quote the theoretical value for latency. It's a more flattering number. IBM quotes 2.5-ms average access for the 2305. But this system uses two heads per track, cutting latency in half.

Latency is not a bad figure for average access time in fixed-head/track systems if one rule is preserved. The preamble must be long enough so that if you want to write on one track and immediately read on an adjacent track, the read amplifiers have time to recover. If they can't, access time doubles. This quantity of time appears on most data sheets as track-to-track switching time.

Though average access-time figures can be unscrambled and compared, it might be best if manufacturers were to provide maximum and minimum access times.

It's so fast, we can't use it

To give the user more capacity per square inch of media, many vendors play a horsepower game called, "Our bit density is greater than yours." Bit density is usually quoted in bits/inch, but sometimes in bits/track. Typically it ranges from 2200 bpi to 4400 bpi, or from 30,000 to 150,000 bpt. These numbers don't correspond to one another, because different manufacturers use different track lengths.

When you multiply the number of bits/inch by the rotational speed of a point on a track in

inches/second, you get the data rate in bits/second. Data rate is one of the glamour specs. Manufacturers compete with numbers that range from 1.2 megabits/s (Mb/s) for several small systems to 24 Mb/s for the IBM 2305.

If the computer can't communicate with the memory at the specified data rate, it writes into memory too slowly to take advantage of the full capacity of the system. For example, if you write into a 24-Mb memory at the rate of 1.25 Mb/s when it accepts 2.5 Mb/s, it becomes a 12-Mb memory. You never fit a data record in a single sector. The solution is a buffer memory between the computer and the memory. The buffer, which may or may not be built into the controller, accepts slow data and writes them into memory at the proper speed.

Missing: Bit-error rate

The specifications that are not on the data sheet can be just as important as the ones that are. One spec that is rarely printed is reliability in terms of bit-error rate—that is: How often will the memory make a mistake? Also rarely called out are MTBF and MTTR—mean time between failures and, once the equipment fails, mean time to repair. Much of the mystery over reliability arises from difficulty in making these measurements. Typical numbers for moving-head systems should be about 10^{11} bit-error rate, or one wrong bit out of every 10^{11} bits recorded, and two hours' MTTR. Typical numbers for fixed-head track systems are 10^{12} bit-error rate or 10,-



Part of Varian Data Machines' 620/f, Pertec's D5000 moving-head disc drive uses an IBM 2315 front-loading disc cartridge or equivalent. In this case it's a Caelus HD-24 cartridge.

000 hours' MTBF, and a half-hour MTTR. A manufacturer doesn't often quote these specs. When he does, he rarely shows how he arrived at them.

Did he calculate them, measure them, estimate them or cite experience in the field? If he cites experience in the field, is it on the same memory system he's selling now?

The acquisition cost of a small memory system, in the \$3000-to-\$5000 range, can easily be matched by repair expenses in a three-to-five year span if you have a service call every 90 days. Under continuous operation, 2000 hours of operating time can be generated in this period. Therefore even a 5000-hour MTBF may not be good enough.

In any discussion of MTBF it's necessary to define a failure. In rotating memories, there are three types:

- Mechanical failures, or head crashes into the media.
- Electronic failures.
- Nonrecoverable errors.

The first two are clear, but the third is subject to interpretation. Every controller has designed into it an error strategy—that is, if it detects a bit error through parity checks or coding, it instructs the memory to seek that location again to see if the bit error corrects itself. If it doesn't, it goes back and checks again. The number of times it tries is specified by the person who programs the controller. If the error is eventually eliminated, it is called a soft error. If after a

finite number of tries the error is still there, it is declared a hard error. Most users consider a hard error to be a failure.

About 96% of the errors are corrected within three tries. But manufacturers vary widely—very widely—in their try recommendations. The recommendations range from three on some small systems to 28 for the IBM 3330. Since the 3330 is a moving-head system, arm position may be the cause of a bit error. So the second 14 tries include small changes in head position.

Which environment?

Once disc and drum memory systems leave the protected confines of a computer room, environmental specs become important. Because drums can be built to stand a harsher environment than discs, most military systems have used them. Drums can stand more shock and vibration and are often sealed against corrosive environments. However, fixed-head/track disc systems are now also being built to withstand the environment of a factory. Moving-head disc systems are also being touted for rugged environments. But even with improved air-filtration systems, they can be affected by smoke and other contaminants.

Temperature is the most serious environmental problem. Most drives will not read and write accurately if the read and write operations are done at temperatures that differ more than 25 F. Though manufacturers quote a larger temperature range, it's always wise to read and write at close to the same temperature.

To operate in harsh environments, systems use one of two approaches: Either the unit is sealed, as in the case of many fixed-head/track drives, or it has an air-filtration system. Sealed units have either air or an inert gas sealed within. The Digital Development Corp. uses helium in some drives and nitrogen in others. Most companies use air, and many use air under pressure. If the system is not a positive-pressure one, it is impossible for the manufacturer to prove that the unit is sealed. If it is a positive-pressure system, it may eventually leak and require service.

Most moving-head systems use positive-filtration air-flow systems. These include a fan, a positive filter and, sometimes, a coarse filter. The positive filter is usually of the 0.3- μ variety with an efficiency of between 95 and 99.999%. The closer the flying height of the heads to the media, the more efficient the filter must be. Since 0.3 μ is 11.8 microinches, drives that fly their heads at 50 to 80 microinches usually use 99.97% efficiency filters. The amount of air flow is also important—the more the better. Typically air flow ranges from 15 to 100 cfm. Manufacturers with less say they don't need any more. However,

when asked to warranty the drive for operation in a smoky environment, they balk.

Filters should always be downstream from blowers and motors and as close to the head and disc area as possible. If they're not, contaminants from the blower and motor may eventually get on the disc and cause a failure.

One final environmental concern is noise pollution. Some drives make a lot of noise. And this generally doesn't appear in the specs.

Explore the service problem

If the drive is to be used in an on-line application, down time can be a critical parameter. It's particularly important then to raise a few crucial questions: Does the manufacturer service what he sells? Does he do it at the user's facility? Can the user perform routine service himself? The answer to these questions, in the case of many manufacturers, is no. But several manufacturers make it easy for a user to service his own drive.

If the unit is a fixed-head/track type and a head goes out, there are usually spare heads and tracks on the drive. Head switching can require considerable disassembly, or it can be done at the flip of a switch. The electronics may exist on one convenient circuit board or on many small boards that are not so easy to work with. The unit may come apart readily, or it may require a factory-trained mechanic. Few small-memory manufacturers have service people in the field at all times.

It's wise to use the "fly-before-buy" philosophy. Specs can mislead. So it's a good idea to run a benchmark on any system and to know the test procedure that the manufacturer used. To avoid overspecifying, it's a good idea to pose some questions:

Is the application on-line or off-line? Is fast access necessary to maximize system throughput? Will the memory operate in a hostile environment?

If the application is for off-line storage, removable media are indicated. Disc packs can be stored on shelves to be used only when needed. If the application is on line, but extremely fast access time is not important, removable-media, moving-head disc drives are once again dictated. If the application is on line with fast access, fixed-head/track discs or drums are the only way to go. If the memory must go into a hostile environment, a drum system will likely be the choice.

In the very large moving-head, high-performance, disc-drive field, IBM leads with its 3330 drive. This drive takes a 3336 disc pack, containing 19 recording surfaces and storing up to 800 Mb with 27-ms average access time. Bit density



Top-loading cartridges of the IBM 5440 or equivalent are used in the new Caelus 303 moving-head disc system. This memory uses a fixed disc as well as a removable one to achieve 48 Mb of storage capacity.

is 4040 bpi, with 192 data tracks and a 6.4 Mb/s data rate. A unique feature of this drive when it is used with its 3830 controller is called rotational position sensing. The controller doesn't pay attention to the drive until the head is three sectors away from the desired data record. This allows the controller to handle up to eight 3330s.

Another unique feature of the 3830 is that the upper surface of the middle disc has a prerecorded surface, the servo surface, for head-positioning information. As the head seeks a particular storage location, its acceleration and settling characteristics are governed by the information on the servo surface. This allows head positioning to be a function of the disc pack rather than of the drive itself. Most other modern drives use an optical positioning system that is a part of the drive rather than of the media.

Several other manufacturers make plug-compatible drives with the same characteristics as the 3830. They include Memorex, Intel, Century Data Systems and others.

Aimed at the minicomputer market are several small moving-head, removable-media disc drives. Some use the IBM 2315 front-loading, single-disc cartridge or an equivalent, and others use the IBM 5440 top-loading cartridge or equivalent. Among the advocates of the front-loading cartridge are Iomec, Diablo, Perdec and Hewlett-Packard.

Among those favoring the top-loading cartridge are Caelus, Diablo, IBM and XLO Computer Products. Most of these make single-disc

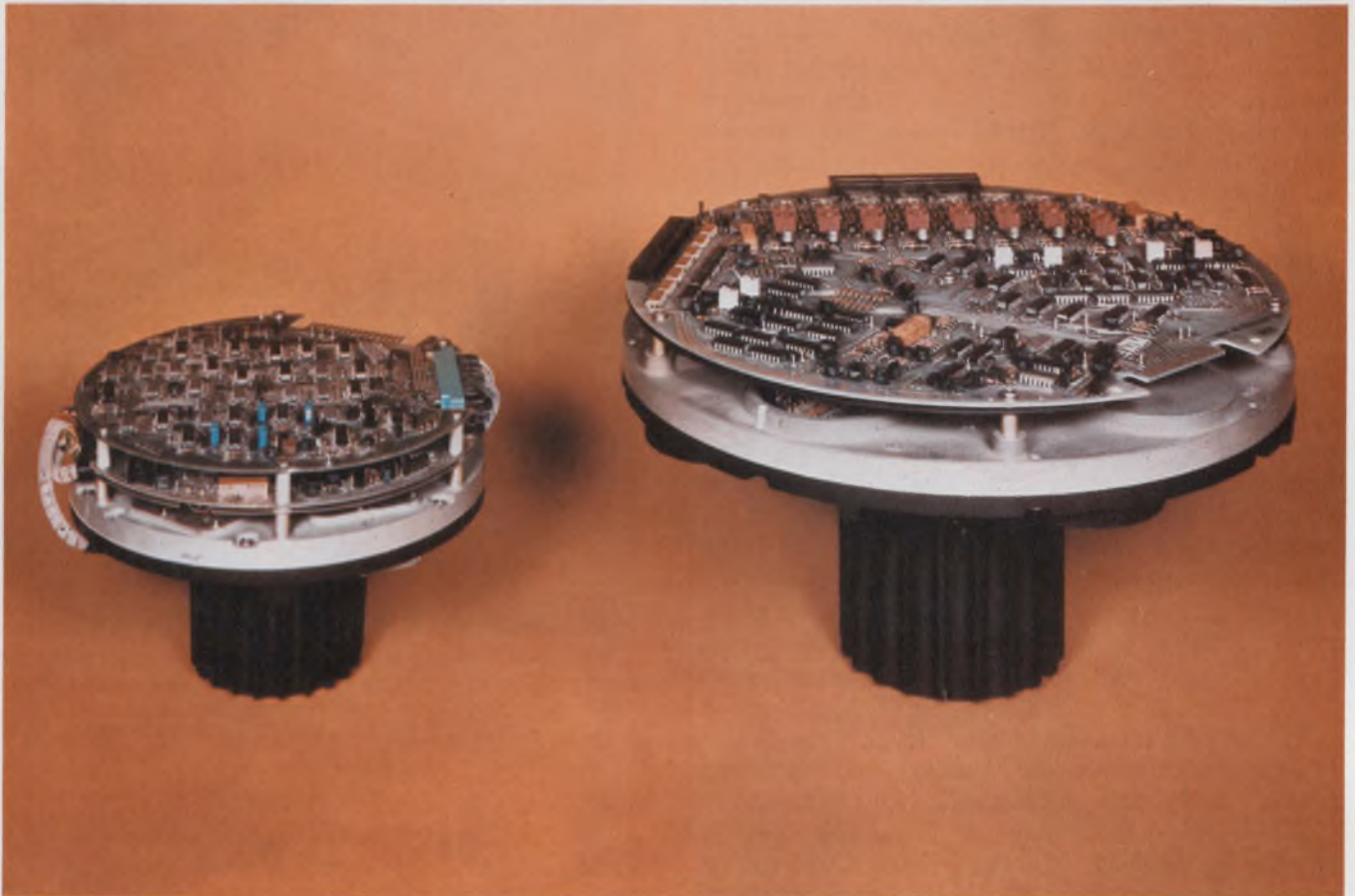

Librascope's L107A and L107B fixed-head/track memories have from 0.4 to 17.92 Mb of storage capacity.

Access times are 8.5 or 17 ms, depending on the model. Circuit boards contain read/write electronics.

and dual-disc versions of their machines. The dual versions use a built-in disc as well as a disc pack.

XLO is the most recent entry into the business with its 3322 drive. In its dual-disc version, it has 150-Mb capacity, average access time of 35 ms, latency of 8.3 ms and a data rate of 6.5 Mb/s. This is a belt-driven disc that will be one of the first small drives on the market, with a bit density of 4000 bpi.

Diablo is also introducing a new dual-disc, top-loading drive, the Series 40. It will have 38-ms average access time, 48-Mb capacity and a transfer rate of 2.5 Mb/s. These small moving-head drives usually cost between \$3000 and \$6000 in small quantities.

Also aimed at the minicomputer market is a large selection of fixed-head/track disc memories with capacities ranging from 1 to 20 Mb. Leading companies in this field include Digital Development, Data Disc, Inc., Singer Librascope, EDP/Tally, Pacific Micronetics, Applied Magnetics, Alpha Data, Xerox and others.

Most of these drives have similar specs, but they are considerably different in construction. They have access times between 8.3 and 17.5 ms, unformatted capacities of 1 to 20 Mb and

data rates of 1 to 4 Mb/s. They usually cost between \$2000 and \$15,000 in small quantities.

Some of these units, such as those from Alpha Data, come with provision for keeping the heads off the media, even when at a rest. Others drop the heads to the disc when it stops. If the heads come to rest on the disc, it's worth checking to be sure that a bit error-rate measurement is made only after about 250 start/stops.

Small drum memories are also being made for the minicomputer market. Two companies making minidrums are Datum and California Electro Mechanisms. They cover the same capacity range with roughly the same specifications as the minidisks.

Larger fixed-head/track drum systems come from XLO, Vermont Research, Univac and Control Data. They have tens of megabits of capacity, 2-to-6 Mb/s transfer rates and access times similar to those of the discs they compete with. However, they are more expensive, more rugged and heavier.

There are also large fixed-head/track discs. The leader is IBM, with its 2305 storing 43.2 Mb. The access time is 2.5 ms, and the transfer rate is 24 Mb/s. Others in the field include Univac, Burroughs, Digital Development and Pacific Mi-

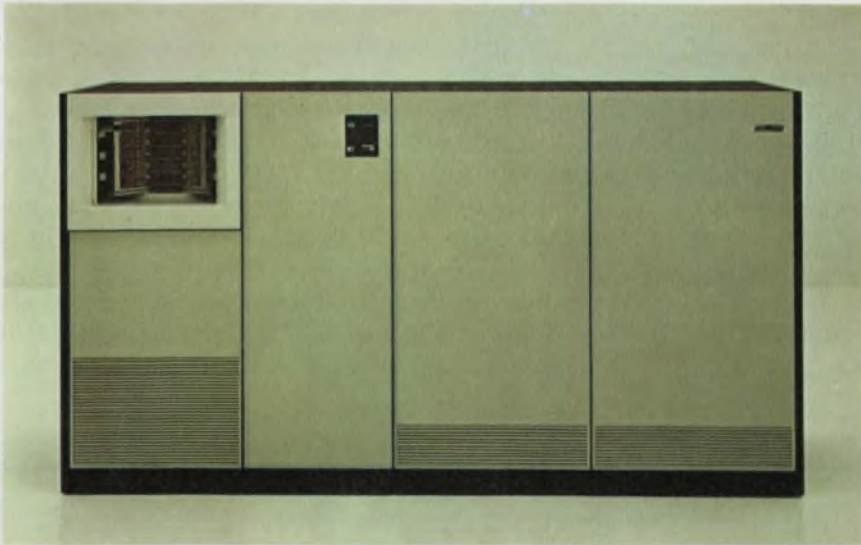

IBM's 2305 fixed head/track memory system is the fastest-access disc memory. It uses two heads per track and achieves an average access time of 2.5 ms. It is one of the few fixed-head/track memories to use iron oxide coated discs. The 2305 can store 43.2 Mb, and it has a data rate of 24 Mb/s. An 89.6-Mb unit, the Model 2, is also available.



tronetics. The latter has already demonstrated a 6000-rpm drive to customers.

Military rotating-memory requirements have long been filled with drum systems. The leading contenders in this market are Hughes Aircraft and RCA.

As cassette recorders have begun to invade the market for low-cost data storage in the 1 to 2-Mb range, disc-drive manufacturers have joined the fray. They are offering superior performance at cassette-drive prices. The idea came from IBM when it developed the "floppy disc" recorder for



Iomec's Series One, Model 20 drives two 3M cartridge discs. Each contains a flexible Mylar disc that flattens out when spinning. Each disc stores 2 Mb and can be accessed, on the average, in 60 ms. The model 20 contains a master electronics package that can operate an additional six discs in either single or dual-disc drives. Each cartridge disc sells for between \$15 and \$20, depending on quantity.

the 3830 controller and the 370 series CPUs. The medium is an oxide-coated Mylar disc in an envelope. It resembles a 45-rpm phonograph record and is used for loading microprograms. IBM doesn't sell the drive by itself.

Memorex and Century Data Systems have taken the idea and developed commercial small drives with these discs. The Memorex 650 is farthest along, with 1.4-Mb capacity, 20-ms track-to-track access and a 0.2-Mb/s data-transfer rate. The drive has a moving head, with the head contacting the medium. It will sell for about \$1000. The

discs will cost about \$5 each. A 2315 cartridge costs from \$70 to \$90.

More impressive is a new small drive just introduced by Iomec. It is called the Series One, and it comes in single-cartridge and dual-cartridge versions. The drive has a noncontacting moving head, with voice-coil positioning, as in the larger drives. The Memorex 650 uses a worm gear to position the head.

Series One drives take a small Cartridisc developed jointly by Iomec and the 3M Corp. The Cartridisc will sell for between \$15 and \$20. It incorporates an oxide-coated Mylar disc that flat-

tens out when it gets up to speed. Each disc has 2-Mb capacity and accepts a data density of 3325 bpi. The drive has an average access time of 60 ms and a data rate of 1.2 Mb/s. This is much faster than the Memorex 650, since the 650 takes 20 ms to go track-to-track. Thus a 10-track access takes 200 ms.

The Series One single drive costs \$4400 and the dual drive \$5500 in single quantities. Up to eight discs can be operated from a single master electronics package that is contained within the first drive. Additional satellite drives cost \$1000 less without the master electronics package. ■■

Need more information?

The products cited in this report have, of necessity, received only cursory coverage. And they don't represent the vendors' full lines. Readers may wish to consult the manufacturers listed here for more details. For quick response, circle on the retrieval card the boldface numbers that are shown below:

- Alpha Data, Inc., 8759 Remment Ave., Canoga Park, Calif. 91304, 213/882-6500, Jerry Lessard, Director Marketing. **Circle 401**
- American Totalisator Co., Uni-Tote Div., 383 Hillen Rd., Towson, Md. 21204, 301/825-5500, R. C. Hardin, Vice President. **Circle 402**
- Ampex Corp., Computer Products Div., 13031 W. Jefferson Blvd., Marina del Rey, Calif. 90291, 213/870-2121, Chris Hoppin. **Circle 403**
- Applied Magnetics Corp., Computer Memory Div., 75 Robin Hill Rd., Goleta, Calif. 93017, 805/964-4881, William A. Wells, Sales Manager. **Circle 404**
- BCD Computing Corp., P. O. Box 240, Buffalo, N.Y., 14225, 716/632-7533, Gary Pache, Marketing Manager. **Circle 405**
- Burroughs Corp., Burroughs Bldg., Detroit, Mich. 48232, 313/972-7000, Peter Carney, Manager Editorial Services. **Circle 406**
- Burroughs Corp., OEM Product Sales, 1649 Wilshire Blvd., Los Angeles, Calif. 90017, 213/483-1425, E. L. Lyons, Manager OEM Sales. **Circle 407**
- Caelus Memories, Inc., 967 Matury Rd., San Jose, Calif. 95133, 408/298-7080, Hal Sowle, Director of Sales Support. **Circle 408**
- California Computer Products, Inc., 2411 W. La Palma Ave., Anaheim, Calif. 92801, 714/821-2001 Robert Kovacev, Marketing Manager. **Circle 409**
- California Electro Mechanisms, 22519 S. Normandie Ave., Torrance, Calif. 90501, 213/328-2151, Frank C. Phillips, President. **Circle 420**
- Century Data System, Inc., 1630 State College Blvd., Anaheim, Calif. 92806, 714/632-7111, Robert Chartrand, National Sales Manager. **Circle 410**
- Computer Specialties Corp., 87 Burlaw Court, Hackensack, N.J. 07601, 201/487-4116, E. Silver, President. **Circle 411**
- Control Data Corp., 8100 34th Ave. S., Minneapolis, Minn. 55440, 612/853-4439, Robert A. Koenig, Marketing Requirements. **Circle 412**
- Data Disc, Inc., 686 W. Maude Ave., Sunnyvale, Calif. 94086, 408/732-7330, Ron Troxell, Manager of Marketing Services. **Circle 413**
- Data Memory, Inc., 1255 Terra Bella Ave., Mountain View, Calif. 94040, 415/961-9440, William Gaskins, Vice President Marketing. **Circle 414**
- Data Systems Design, Inc., 1122 University Ave., Berkeley, Calif. 94702, 415/849-1102, Sheila Lewis, Marketing Manager. **Circle 415**
- Datum, Inc., 1802 N. American St., Anaheim, Calif. 92801, 714/879-3070, Bob Manciet, Product Manager. **Circle 416**
- Diablo Systems, Inc., 24500 Industrial Blvd., Hayward, Calif. 94545, 415/783-3910, Samuel J. Wiegand, Vice President Marketing. **Circle 417**
- Digital Development Corp., 5575 Kearny Villa Rd., San Diego, Calif. 92123, 714/278-9920, Frank Veloz, Manager of Marketing. **Circle 418**
- Digital Equipment Corp., 146 Main St., Maynard, Mass. 01754, 617/897-5111, H. Steine, Public Relations. **Circle 419**
- Dynacoustics, Inc., 1980 National Ave., Hayward, Calif. 94545, 415/783-5614, D. G. Setera, President. **Circle 421**
- EDP/Tally, 1701 Colorado Ave., Santa Monica, Calif. 90404, 213/829-3696, Barry Garfein, President. **Circle 422**

- Friden Div., the Singer Co., 2350 Washington Ave., San Leandro, Calif. 94577, 415/357-6800, Paul Osterlie, Director Business Planning. **Circle 423**
- Hewlett-Packard, Cupertino Div., 1601 California Ave., Palo Alto, Calif., 94304, 408/257-7000 Dave Asplund, Inquiry Supervisor. **Circle 424**
- Honeywell, Information Systems Div., 200 Smith St., Waltham, Mass. 02154, 405/946-5421, J. B. Stroup, Director Communications. **Circle 425**
- Hughes Aircraft, Centinela and Peale Sts., Culver City, Calif. 90230, 213/391-0711, Ed Skinner. **Circle 426**
- IBM Corp., Data Processing Div., 1133 Westchester Ave., White Plains, N.Y. 10604, 914/949-1900 Ken Foege. **Circle 427**
- Information Data Systems, 7550 Walnut Lake Rd., Walled Lake, Mich. 48088, 313/624-5525, E. E. Ecklund, Marketing Manager. **Circle 428**
- Information Storage Systems, Div. of Intel, 10435 N. Tantau Ave., Cupertino, Calif. 95014, 408/257-6220, Robert Daniel, Manager Planning. **Circle 429**
- Infotechnics, Inc., 15730 Stag St., Van Nuys, Calif. 91406, 213/780-3615, G. E. Zenzefilis, President. **Circle 430**
- Iomec, Inc., 345 Mathew St., Santa Clara, Calif. 95050, 408/246-2950, Avery Blake Vice President Marketing. **Circle 431**
- Kemper Engineering Co., 9337 Shoshone Ave., Northridge, Calif. 91324, 213/886-0121, D. Kemper, Chief Engineer. **Circle 432**
- Keonics, Inc., 1600 Victory Blvd., Glendale, Calif. 91201, 213/243-8822, James D. Flora, President. **Circle 433**
- Librascope Div., the Singer Co., 808 Western Ave., Glendale, Calif. 91201, 213/245-8711, Jim Norwood. **Circle 434**
- Marshall Data System Div., Marshall Industries, 2065 Huntington Dr., San Marino, Calif. 91108, 213/684-1530, T. J. Williams, Marketing Manager. **Circle 435**
- Memorex Corp., 1200 Memorex Dr., Santa Clara, Calif. 95050, 408/987-1000, Bob Rude, Director of Sales. **Circle 436**
- Microdata Corp., 644 E. Young St., Santa Ana, Calif. 92705, 714/540-6730, Robert Oakley. **Circle 437**
- NCR Industrial Products Div., Main and K Sts., Dayton, Ohio 45409, 513/449-2000, L. M. Solganik, Assistant Vice President. **Circle 438**
- North American Rockwell Corp., Autonetics Div., 3370 Miraloma Ave., Anaheim, Calif. 92803, 714/632-0955, John Gasper, Program Development Manager. **Circle 439**
- Pacific Micronetics, Inc., 5037 Ruffner St., San Diego, Calif. 92111, 714/279-7500, Klaus Spengler, Director of Marketing. **Circle 440**
- Pertec Corp., 9600 Irondale Ave., Chatsworth, Calif. 91311, 213/882-0030, Tazz Pettebone, Disc Products Specialist. **Circle 450**
- Potter Instrument Co., 532 Broad Hollow Rd., Melville, N.Y. 11745, 516/694-9000, J. Richardson, Manager OEM Products. **Circle 441**
- RCA Electromagnetic Aviation and Systems Div., 8500 Balboa Blvd., Van Nuys, Calif. 91409, 213/894-8111, Gary Spellman, Manager Data Systems Marketing. **Circle 442**
- Telex Corp., 6422 E. 41st St., Tulsa, Okla. 74135, 918/629-2333, G. H. Ashbridge, Vice President. **Circle 443**
- Univac Div. of Sperry Rand Corp., 311 Turner Street, Utica, N.Y. 13501, 215/646-9000, D. L. Prasky. **Circle 444**
- Vermont Research Corp., Precision Park, North Springfield, Vt. 05150, 802/886-2256, W. Austin, Marketing Manager. **Circle 445**
- Wang Emory Systems, Inc., Div. of Wang Laboratories, 836 North St., Tewksbury, Mass. 01876, 617/851-7311 S. Lambert. **Circle 446**
- Xebec Systems, Inc., 566 San Xavier Ave. Sunnyvale, Calif. 94086, 408/743-9444, Andy Mester, Marketing Director. **Circle 447**
- Xerox Data Systems, 701 South Aviation Blvd., El Segundo, Calif. 90245, 213/679-4511, ext. 1956, Ted Charter. **Circle 448**
- XLO Computer Products Div. of Ex-Cell-O Corp. (formerly Bryant Computer Products), 850 Ladd Rd., Walled Lake, Mich. 48033, 313/624-4571, Bob Tilley, Marketing Services. **Circle 449**

Thinking flexible etched cable? Think AMP. Our capabilities are unique. And complete.

Imaginative design is our specialty. We like to tackle . . . and solve . . . knotty problems like the cable illustrated here. We can control impedance from 50 to 125 ohms. Build a shield plane on one side of the circuit. Create performance values you've been reaching for but never before attained.

Long lengths. We can manufacture continuous lengths of cable, with repeat patterns up to 50 feet long. Widths to 22 inches.

Reliable termination. Our insulation displacement crimp technique assures interface with proved environmental stability, with the cost savings of automated application.

New economy. AMP solderless interconnection method lets us use lower temperature insulating film, eliminates costly complications.

Complete capability. We can supply you etched cable with all connectors assembled, ready to plug into your equipment. Let's start thinking together. For a consultation, write or call **AMP Incorporated, Industrial Division, Harrisburg, Pa. 17105.**

AMP
 INCORPORATED

Manufacturing and direct sales facilities worldwide: Barcelona, Brussels, Buenos Aires, Frankfurt, London, Mexico City, Paris, Puerto Rico, Sao Paulo, s'Hertogenbosch (Holland), Sydney, Stockholm, Tokyo, Toronto, Turin, Vienna.

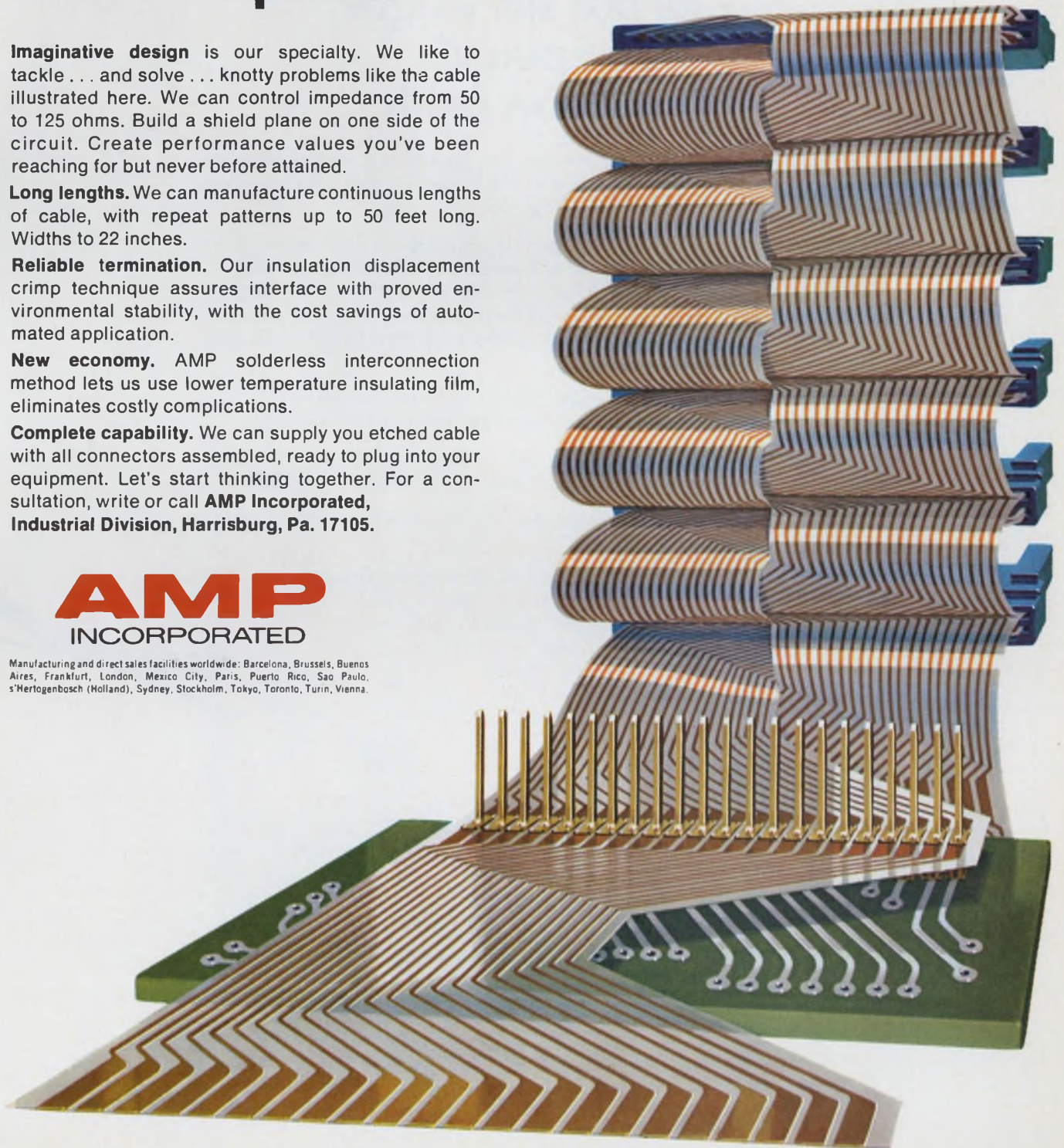

We regretfully announce that we were system into our old calculator box.

All we could get in were 52 times as many memory registers plus 16 times as many programming steps, a lot more logic, and a magnetic card reader. The rest of the stuff we had to leave outside.

Our box still weighs 22½ pounds, but it now holds

Up to 522 memory registers, in increments of 64. There's 4-rule arithmetic and special key functions into and out of all registers, and you won't destroy the contents when you turn off the machine.

Up to 4,096 steps of programming, in increments of 512. You can do an entire program from the keyboard and see all your steps printed out for debugging. Symbolic addressing makes branching and jumping very simple. You can backspace, correct errors, and insert steps without having to re-enter the program. You can program the decimal-point printing format, do 16-level nesting.

A magnetic card reader/writer that lets you input programs, write programs, put data into memory, save programs and memory contents.

Fully algebraic keyboard arithmetic, with nesting of parentheses. You enter equations the way you write them, not the way the machine wants them.

Multiple key interlock and rollover, with buffering so you can enter data while the machine is calculating.

Labeled keys for logs, antilogs, a^x , and all common mathematical and trigonometric functions including hyperbolics, and also input/output in degrees-minutes-seconds, full 4-quadrant coordinate conversion, statistical summation (n , \bar{x} , x^2), standard deviation and mean, factorial, sum-square backout (correction of summations), plus optional user-definable function keys.

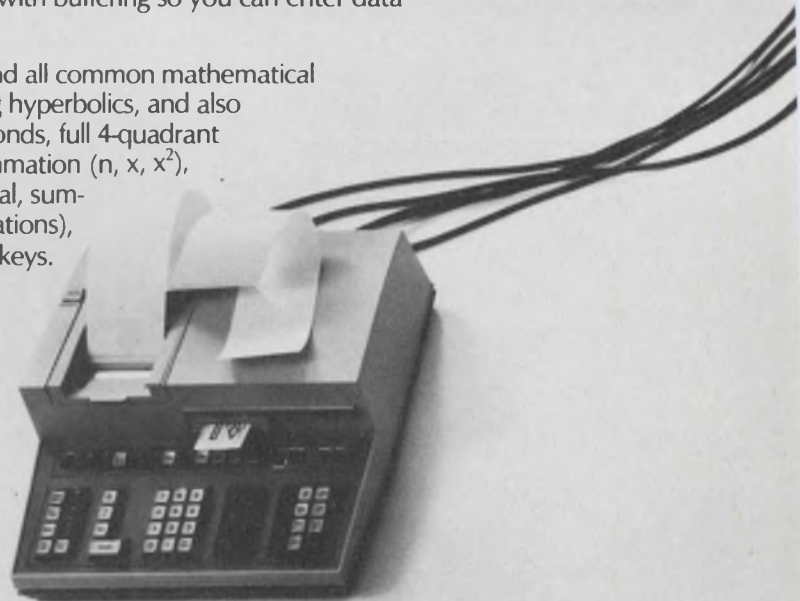

CompuCorp.

unable to cram all of our new computer

It doesn't hold

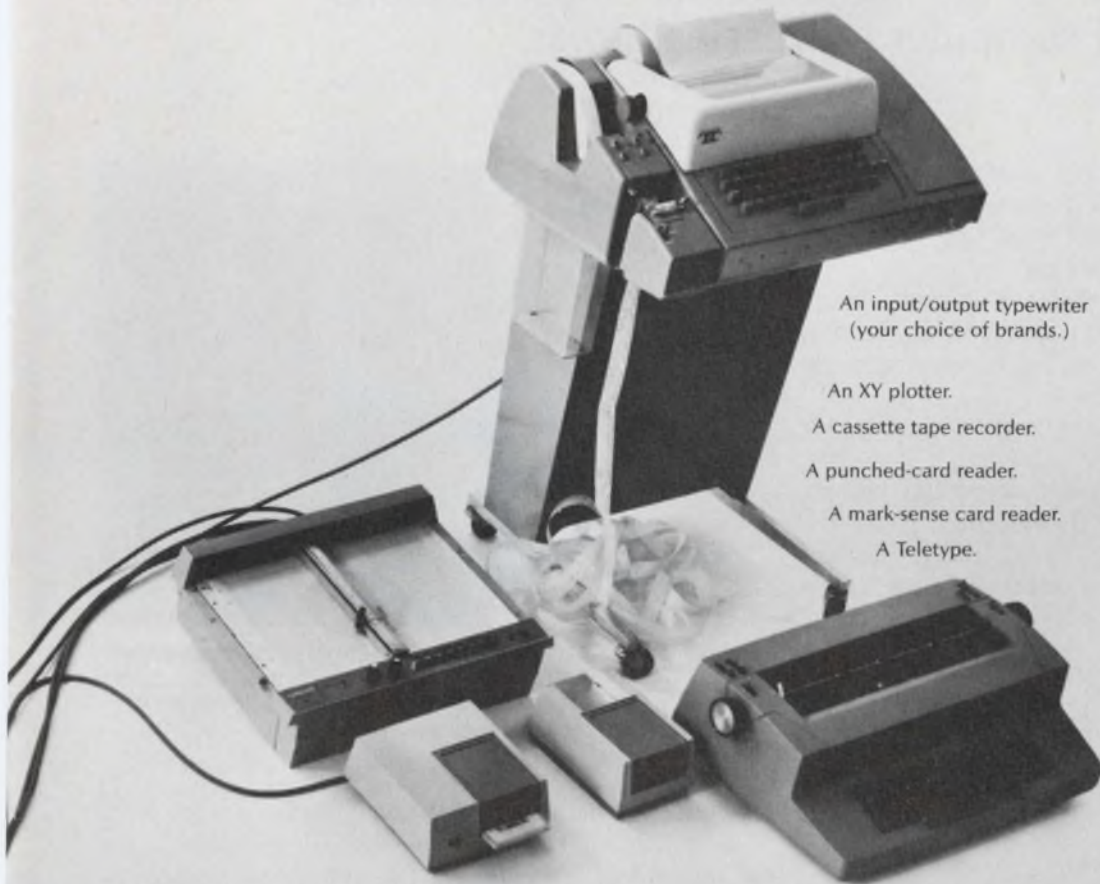

An input/output typewriter
(your choice of brands.)

An XY plotter.

A cassette tape recorder.

A punched-card reader.

A mark-sense card reader.

A Teletype.

We're talking about the new 400 Series of desktop computers that complements and extends our Compucorp calculator line. The Model 425 is for engineers, scientists and surveyors, the 445 is for statistical folks.

We've made more than 30,000 of our other models in the last couple of years. They come in little boxes that sit on a corner of your desk. Each one has an array of powerful one-punch keys that solve the problems of a particular kind of user. They have up to 20 storage registers and 256 steps of programming.

There's a wide range of prices so you can buy enough power to do your job without having to pay for more than you need.

But many customers have said, "That's not enough machine for me." Hence the 400's.

The 400's are as easy to operate as our other models (easier, in fact.) They're enormously powerful and versatile, they interface with an array of peripherals, and they come in the same little box.

The 400's start at \$3,750, our other models a lot lower.

Write down what you need on your letterhead. We'll show you a calculator or a desktop computer that fits your problems and your pocketbook.

Get the mini you really need

by investigating what the manufacturer's specifications mean in terms of computer processing power.

Say you are shopping for a minicomputer. You look at some catalogs and spec sheets, call a few minicomputer salesmen and reps. You are now ready to place an order. Right?

You'd better not. If you follow this route, you'll wind up either thoroughly confused or in possession of a machine that isn't even close to what you had in mind, unless you:

- Know precisely what every minicomputer maker means in his specs.
- Prepare a complete specification list beforehand of the mini that will do the job.

Why the need for such care? First, because there are no standards for minicomputer specifications. Second, because salesmen will be happy to confuse you by feeding you claims that aren't important, while ignoring necessary specifications. And third, because there are many factors that determine the processing power of a minicomputer—and processing power is what you're really after.

Know what you need, first

The first step in selecting a minicomputer is to push aside all of the minicomputer catalogs and other literature and write down what you need *in terms of your job parameters*. One way to do this is to pose and answer such questions as these:

How much input/output (I/O) is going to be done—a little or much? Will it be "character" I/O (like teletypes and communication) or "word-length" I/O (like a/d converters) or bits (like process control)?

Are you going to do data transfers with high-speed devices, such as discs, magtape or drums? Are you planning to use equipment like card readers? Do you want to interface the minicomputer with your equipment and have a lot of digital control signals, such as a security-system annunciator panel? Your concern here is both the amount of I/O and also how fast it must be sent.

What kind of processing is required? Are you

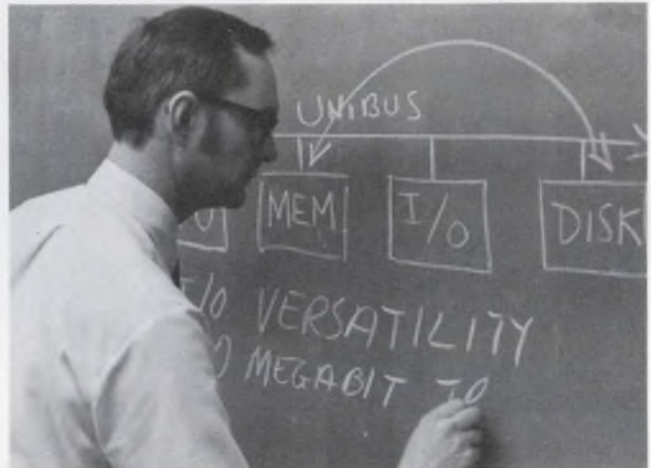

Before you buy a minicomputer, list your requirements and then investigate the manufacturer's specifications, advises Roger Cady. Only then, he says, will you be sure of getting the processing power you need.

going to write the job in machine language, or do you need FORTRAN or BASIC or some other higher-level language? Do you need arithmetic computation? Do you need multiplication and division capability? Does the job require file-handling and a great deal of sequential input and output, with very few computations—like in a magtape-to-printer system? Is there a real-time requirement? If so, will you need a computer that responds very rapidly to a few signals and interrupts, or to many of them?

Will the machine have to do many computations, like fast Fourier transforms? Is it possible to use a dedicated slow processor for the system control and to do the processing later?

Peripheral selection is just as critical as the mainframe. Follow the same questioning procedure:

Do you need a disc for data storage or for program storage? Do you need magtape for accumulating and transferring data to another computer? Does the magtape have to be compatible with another machine, or will its accumulated data be processed by the same computer? What about I/O equipment, like line printers, teletypes, and CRT displays?

The checklist in Table 1 can help you draw up your detailed requirements. Once a complete job

Roger C. Cady, PDP-11 Engineering Manager, Digital Equipment Corp., Maynard, Mass. 01754

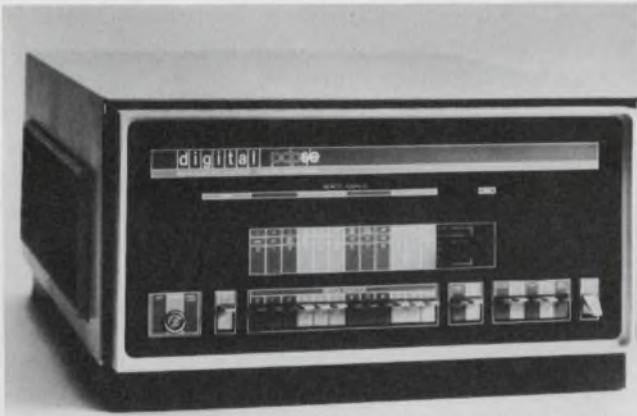

There is a wide range of possibilities between this minimal desktop PDP-8/E with a core of 4-k, 12-bit words (left) and a typical larger system (right). The latter has 32 k of core, four DECTapes, disc storage, a CRT and a LA-30 impact printer. Choosing the right one can mean dollars saved.

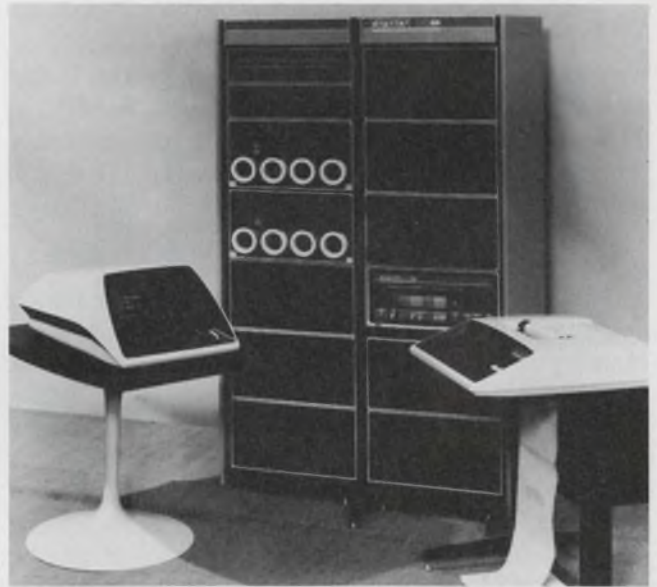

description is prepared, you can start looking at the minicomputer specs and deciphering their meaning.

Choose a suitable word length

The basic information unit in a digital computer is the binary digit, or bit. Thus a fundamental description of a minicomputer is its "word length," or the number of bits in a computer word. Common minicomputer word lengths are eight, 12, 16 and 18 bits.

The word length is related to a number of things that are internal to the machine and that show up in other specs, notably the instruction power and the addressability (an address space large enough for a fair-sized program or data base).

The primary thing to consider in the word length is how well it is suited to the type of data that you want to process. For example, if data are coming from a 10-bit a/d converter, then a 12-bit machine is adequate. However, if the computer input is coming from character-oriented devices—teletype or communication lines—and it is in the eight-bit format, a computer with an eight-bit word length (or a multiple of eight bits) would be a better choice. If the job involves

considerable computation, then the longer the word, the more precision will there be in a single-word operation of the machine. But if the computational use is light, a shorter word-length machine might be better, provided it can handle multiple word-length data arithmetically.

To boil it all down, you must *analyze* the job and the type of data to come up with the right word length for your machine. Always bear in mind that there may be more than one word length to do the job. At present the most popular minicomputer word length is 16 bits, and you'll find the widest variety of performance and prices in this category.

Don't equate cycle time and throughput

Cycle time is among the most frequently published, yet least meaningful, specs to help you select the computer. Cycle time is defined by most manufacturers as the time required to read or write a computer word into the central (usually core) memory. To a degree, it is representative of the maximum rate at which the central processor could operate, since it requires memory for data. But in newer, asynchronous machines cycle time and central-processor time are not necessarily equal. Cycle time tells you only about the

mechanics of getting data into and out of memory, not about the processor's ability to handle or process the data. That information is in the instruction repertoire and has no quantitative number. Once again, the important thing in a computer is its ability to do a certain *job*. Cycle time may give you an idea how fast the machine can do individual steps, but the real key to processing power is throughput, or how much a computer can do in a given time. This may or may not have any relevance to cycle time (see graph).

What size memory?

An important measure of the computer is the amount of memory that can be installed in it. This is not important if the job requires only a small data base, but it becomes vital if the job is large or not too well-defined, or if future expansion is anticipated.

Normally memory is measured in units of 1024 words, referred to as 1 k. Thus a 4-k machine designates a minicomputer with 4096 words of memory. Mainframe memories can be as large as 131 k.

Some manufacturers specify memory in terms of bytes, while others speak about words. A byte is a data unit comprising a fraction of a word, most frequently eight bits. Thus a memory for a 16-bit machine in terms of bytes might be given as "8-k bytes," which would be equivalent to just plain 4 k in the case of a manufacturer who used the more common definition—computer words.

In addition to the memory size, memory type

should also be considered. In general, core memory retains its data when the power goes off, while a semiconductor memory does not. Obviously, while this consideration is important, other factors might also influence the final decision.

Ease of addressing is important

The basic programming problem is how to address the computer memory—that is, how to define the address of each memory cell in the instruction. This is an extremely important measure of the machine's ability to process data in minimum time and with minimum program effort. If the addressability is small—say, 128 or 256 word "pages"—then additional processor time and memory space might be required to address data in all of the memory. In general, machines that have direct addressability to larger portions of their memories will be more efficient in processing a program that has a moderate amount of data.

Addressability is closely related to various techniques:

"Direct addressing" refers to a memory portion that you can reach with a single instruction—that is, the computer should not limit you to "pages," such as 256 or 1024 words.

"Indirect addressing" means the use of a memory cell as the address of the desired piece of data. This feature is almost always present in small machines, and it can simplify programming considerably.

"Relative addressing" permits you to write a program in which the address is relative to the

Table 1. Job description checklist

The primary computer function	Running-time limits
The secondary computer functions	Programming requirements
Mass-storage requirements	Machine language-
Size, data rates	File handling
For program or data	I/O monitor required
Sequential (tape) or random access (disc)	Can you use existing programs and subroutines: List them
Removable or permanent	Estimated programming time
Peripherals	High-Level languages
Performance specs	Interactive (BASIC FOCAL)
Data rates	Single user or multiterminal
Interfaces	How sophisticated? (Matrices, strings)
To what—analogue or digital?	Batch (FORTRAN, COBOL)
Who should design them?	Is compatibility required?
Total I/O rates	(ANSI IV or IBM 1130)
Kinds of data	Real-time constraints, performance desired
Bits—for control & status	Estimated program and data sizes
Bytes—character handling, I/O	Future expandability
Words—what arithmetic precision?	Services needed
Arithmetic power required	Training
Logical decision-making required	Hardware maintenance (final installation site)
Time constraints	Software development, support
Real-time data acquisition or control	Custom design, system engineering
Real-time computation	

program location. This, in turn, permits the program to be shifted to another memory location or moved about, as necessary, to meet the system requirements.

"Indexed addressing" refers to the use of index registers. In some machines indexing is done with special core-memory locations, and in these cases you should evaluate the execution time of the indexing instruction and the flexibility of the indexing mode.

"List sequential addressing" means an ability to get at sequential pieces of data with the "auto-indexing" or "list-sequential" features of the processor. Addressing via list-sequentials or auto-indexing hardware makes programming considerably simpler for many routines by removing the bookkeeping from the program.

Consider the 'architecture'

The heart of a minicomputer system is the central processor. It does the data processing and, in general, handles all the I/O transfers. Its capability depends largely on its organization and the structure. These factors—the "architecture" of the machine—determine how instructions will be carried out and how easy or difficult it will be to program the minicomputer.

Programming may be the most expensive part of your system. In a system configuration you will almost invariably spend more money for programming than for the central processor itself. Thus ease of programming and the instructions that the machine can execute are most important considerations in the minicomputer selection. Ex-

tra dollars invested in a more versatile central processor will almost always pay off in speed and ease of programming and program efficiency.

In examining computer architecture, always consult your programmer. Some checkpoints for evaluation are listed in Table 2.

Data format can affect versatility

The data format that can be accepted by the computer often has a direct bearing on its overall versatility. Can the central processor handle bits? Individual bits are used to indicate the on-off condition of I/O devices or the state of a control system being operated by the computer. A single bit could indicate that a light is on or off, or that a valve is open or shut. If the computer handles bits well, programming for process and instrument-control systems will be greatly simplified.

The computer's ability to handle bytes is probably even more important, because bytes are among the primary forms of I/O data format. Teletype, paper-tape readers, communication lines are all byte-oriented devices. Many small cassette tape systems, printers, and card readers are also byte-oriented. Alphanumeric terminals, CRT displays and other such devices usually communicate with bytes. (A byte here is eight bits long.)

Most computers handle words quite well, since this is the primary data format that computers are designed for. Look carefully, however, at the instruction set and at the completeness of the instructions that operate on words. The degree of completeness of the instruction set will determine the over-all performance of the computer.

In computational work, multiple words—or "multi-words," as they are sometimes called—are often used when extra precision is required for an arithmetic operation. Two or three words represent the arithmetic quantity rather than a single word.

Registers and what to look for

Table 2 lists the kinds of registers in the minicomputer. Every computer has at least one accumulator, but the rule here is: The more accumulators there are, the easier the programmer's job. This is because the accumulator generally is the congestion point in most small computers. Look carefully at the instructions that require the accumulator, because in many machines one or more accumulators are always used in the instruction execution, placing more demands on the accumulator structure. Beware of the "multi-register" machines that have dedicated register assignments.

Index registers are useful because the address

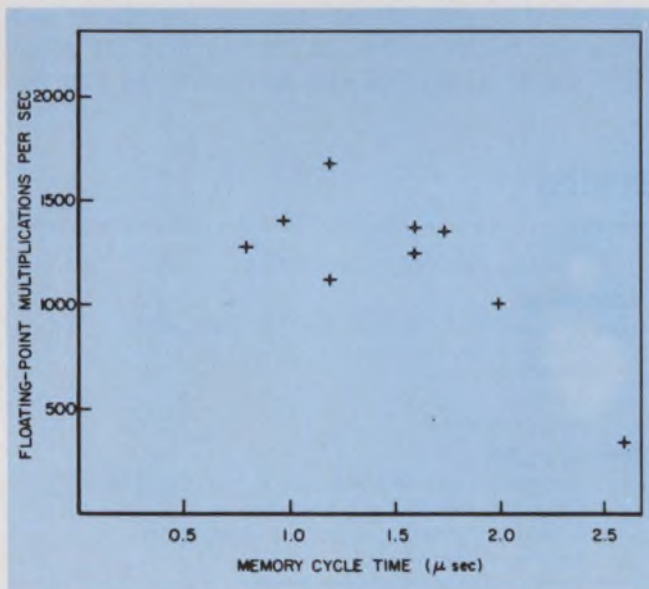

Don't be misled by a fast memory cycle time into believing that this means a fast central processor. As this plot—based on data from various minicomputer makers—shows, the time it takes to perform a typical operation bears little relation to the cycle time.

of the required data item is often calculated or indexed, similar to the way you use subscripts to write an arithmetic expression. An index register thus holds the subscript, and it is used in computing the address for the piece of data. Multiple-index registers are quite helpful, since in many instances several indexes must be kept simultaneously. If there are multiple-index registers, the indexes can be kept in registers rather than shuffled in and out of core memory.

Auto-index registers keep track of the sequence when handling list data: They increment automatically, pointing to the next item in the list. This type of indexing is of tremendous help for input and output data processing or for handling character (or data) strings of any kind.

In general, registers are solid-state memory elements within the central processor, and they do not use main core memory for storage. This means that they are faster, and usually easier to get to, than would be the case if they were using the main memory. To reduce costs, however, some computers are built with the registers in core memory. Such a machine, even with multiple registers, may be better than one with a single accumulator, but it still will be slow.

Check instruction repertoire closely

The capability of the minicomputer is almost totally reflected in its instruction repertoire. It must be examined in great detail, and all ambiguous or unclear statements must be discussed with the manufacturer's sales and application engineers. Are there instructions for handling individual bits or bytes? Is there a "compare" instruction that simplifies looking for a match between two quantities or characters? Are there adequate arithmetic capabilities? Just having an "add" or "subtract" instruction is not enough

here. Look closely at *how* the instruction handles the arithmetic operation. For example, is an indicator set when there is an overflow? If you are interested in data reduction, ask your programmer to look closely at the indicator set to make sure that the instructions do what you want.

What is the logical capability of the machine? What kind of decision network can you build with the instructions in it? There should be instructions that do things like testing individual bits or bytes or words for unique conditions.

Logical decisions are generally made with either skip or branch instructions. Look carefully at the conditions that signal skipping or branching. In general, branching is more powerful than skipping because, in the single instruction, you can make the logical decision and go directly to another point in the program. Also, look for ability to make equality and inequality decisions.

Keep in mind that not all instructions that seem alike are alike. In some machines an ADD instruction can only add registers to one another. Some add memory to registers, while at least one on the market adds memory to memory, memory to register, register to memory, register to register and even mainframe registers or memory to I/O registers.

In checking the instruction repertoire look at what each instruction does and how it does it, not just its name. The more powerful an instruction is, the faster and more program-efficient a processor will be, independent of cycle time.

How effective is the subroutine call?

Check the processor to be sure that it does the following in subroutines: linking, parameter passing and re-entry. Does the subroutine call somehow mark where you are, so that when you fin-

Table 2. Computer architecture checklist

<p>Data-handling. Instructions for:</p> <ul style="list-style-type: none"> Bits—set test and clear individual bits Bytes—manipulation in memory and I/O Words (standard) Multi-words—multiple precision handling <p>Registers (usable by program)</p> <ul style="list-style-type: none"> Accumulators—How many? Flexibility Index registers—How many? Flexibility Auto index—list pointers General registers or fixed use <p>Instruction repertoire</p> <ul style="list-style-type: none"> Complete for each data type? Compare logical and arithmetic testing Branch conditions Arithmetic power, overflows Subroutine calling—linkage, parameter passing, and re-entrancy I/O instruction. How powerful? Can instruc- 	<p>tions go directly to memory?</p> <p>Addressing</p> <ul style="list-style-type: none"> Direct (What limits?), word or byte level Indirect Relative Indexed List sequential <p>Interrupt power</p> <ul style="list-style-type: none"> Device priority structure. Is it truly multilevel? Program control over priorities Interrupt service program priorities Interrupt identification True interrupt response times <p>Direct memory access</p> <ul style="list-style-type: none"> Costs and multiplexers Latency times Transfer rates
--	--

BOURNS LOW COST FAMILY

OF INDUSTRIAL *TRIMPOT*[®]
POTENTIOMETERS

49^{*}¢

OFF THE SHELF AS LOW AS

POWER: ½ WATT (or better) AT 70°C.

TEMPCO: AS LOW AS 100PPM/°C OVER TEMPERATURE RANGE
OF -55° TO +125°C AND -55° TO +150°C.

Bourns **LOW-COST FAMILY** was designed specifically to fill the requirements of cost-conscious industrial users — so were the prices! Imagine how they reduce on large production-run quantities. As a bonus, you get Bourns TRIMPOT potentiometer quality, reliability and performance.

AVAILABILITY

All models shown are stocked in depth **RIGHT NOW**, so delivery is off-the-shelf from the factory or your local Bourns distributor.

Complete data on all models of the **LOW-COST FAMILY** is available upon request. Just write, or call, your local Bourns Sales office, representative, or distributor.

*1000-piece price Model 3389, U. S. dollars, F.O.B., U.S.A.

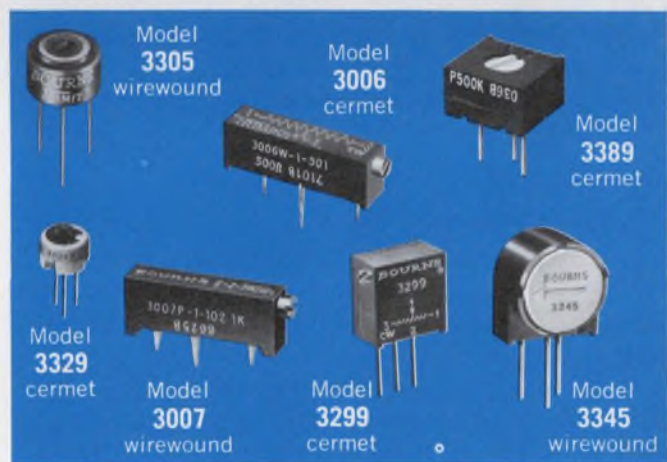

BOURNS, INC., TRIMPOT PRODUCTS DIVISION • 1200 COLUMBIA AVE., RIVERSIDE, CALIF. 92507

INFORMATION RETRIEVAL NUMBER 129

ish the subroutine you can return to the original program? Does it use a dedicated register or memory cell? This is called linking.

Parameter (or argument) passing in the subroutine is also important. For example, if you call a routine to output characters to the teletype, the arguments might be the location of the characters to be printed and how many there are. Examine how argument passing from the calling program to the subroutine is done.

The subroutine call is "re-entrant" when a subroutine can call itself—or, even more important, when a subroutine can be called by another program. This is especially significant in real-time processing.

If the subroutine call does not pass arguments and does not keep its return linkage so it can be re-entered, it can't be used to call a re-entrant subroutine. This means that several copies of a subroutine may be necessary because of the limitation of a single instruction.

Interrupts can be tricky to evaluate

Among the most difficult things to evaluate in most small computers are the interrupt structures, or the ways in which the central processor responds to peripheral equipment or sensors. Most powerful computers assign priorities, defining the order in which the external devices will be recognized for interrupts. But make sure the manufacturer is offering a true priority-interrupt structure, with *priority for running the program*, and doesn't merely mean that there is a fixed sequence for recognizing the devices if *all* request an interrupt simultaneously.

When you see the term "interrupt response time," ask what this really means and what happens during that time interval. The important time is that from the initial interrupt request by the peripheral device to when the computer begins to execute an instruction for that device.

Interfacing: Examine the documentation

After checking such basic items as word-length compatibility, ask for documentation on the interfacing. Is the documentation complete? Does it have sample schematics with explanatory information?

If the documentation on the interfacing is unclear, it might be very difficult to interface to that machine. If the designer can't describe it, how are you going to interface to it?

Make sure the I/O bus is designed just as reliably as the memory bus. Many manufacturers spend much effort designing a reliable and noise-immune memory bus and then forget that the I/O bus must be just as good.

Ask the vendor about special interface hard-

ware that might suit your requirements. For one-of-a-kind and short-run systems, this can be the least expensive way to interface.

Software can make or break you

Software specifications are either nonexistent or vary so much from vendor to vendor as to make meaningful comparison virtually impossible. Obviously your programmer can be of great help. But there are basic areas to examine.

First, check the program development aids that you would need to write the software, if you plan to write programs in machine language. These aids include the assembler, the editor and debugging packages. For a moderate amount of program generation, a disc operating system may well pay off in programmer savings.

Next, look over the utility programs, which include conversion programs—such as octal to ASCII, fixed point to floating point—and math programs—such as sine, cosine etc.

Even in small systems, if the vendor supplies an I/O executive system (monitor programs), you will save considerable programming.

High-level languages—like FORTRAN, BASIC, FOCAL—are becoming very popular with small computers. They make the programming easier, but they are slower and need more memory than machine languages. A good tradeoff may be possible here, especially with newer machines. Since all languages with the same name don't necessarily have the same features, make a point-by-point evaluation.

Software efficiency can be evaluated by looking over the operational data for various programs. Get the execution times, and keep the storage requirements in mind.

Software documentation should be clear and concise. Ask: Are such manuals available? Are there program listings? And how detailed are they? Also, find out who wrote the software package; some manufacturers have outside companies prepare their software.

The software libraries of manufacturers can be a good source for programs, and the quality and completeness of such libraries should also be examined.

Finally, check over the company you are dealing with and ask about services that will help you get the most out of the computer. These include scheduled, professionally staffed, schools for teaching the "how to" of both software and hardware. Make sure there is a local service center; don't rely on the "send it back to the factory" bit. Local service centers should be able to provide both hardware and software support.

And ask about special service groups for both software and hardware. Their assistance may help you cut costs dramatically. ■■



It's as simple as a PDP-8.

Anyone can interface a PDP-8. You just plug everything into the OMNIBUS.TM Anywhere. In any order. Any time.

Now if you want to write PDP-8 software you have to know programming. But you don't have to know much. PDP-8 is one of the easiest to program computers ever made. And it has the biggest library

of minicomputer software in the world. So you might not need any new software anyway.

Where you might want some help is in selecting the peripherals. There are over 60 standards to pick and choose from. Plus specials.

But you won't have to waste time figuring out if the PDP-8 can do your job. Every job being done by minicomputers is being done by a

PDP-8. And it'll do your job for a long, long time. PDP-8's have been known to run flat out, 24 hours a day, 7 days a week, for two years straight.

You see, when you get a PDP-8, you won't get stuck.

Digital Equipment Corporation, Maynard, Mass. 01754. (617) 897-5111.

digital

Come to where



A.

A.
RCA 2N3440, 2N5804, 2N5838, and 2N6175 offer a high-voltage line-up for every high-voltage socket in color TV — video output, picture-tube driver, high-voltage regulator, class-A audio, horizontal driver, and vertical and horizontal deflection.



B.

B.
RCA 2N5804, 2N5838, 2N6077, and 2N6249 are employed in inductive or capacitive discharge ignition systems or electronic carburetors. Device ruggedness is documented in RCA's second-breakdown data and the industry's only thermal fatigue ratings. If your specs don't require thermal fatigue ratings, you can't be sure you're protected.

C.
RCA types 40850, 40851, 40852, 40853, and 40854 perform in off-line switching mode power supplies. Why not improve your system costs two ways: first, through RCA's exclusive thermal fatigue ratings to assure longer service life and, second, through competitive prices.

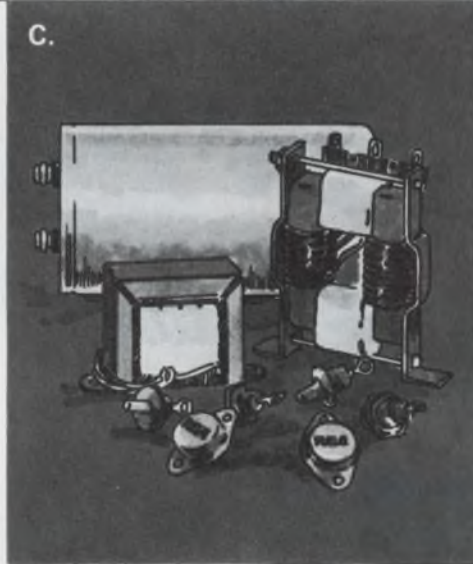

C.

Ratings within the basic families listed below vary from 200 to 400 volts. Custom selections with ratings above 400 volts are available.

Basic Family	Max. Ratings		Pkg.	100-Unit Price (Each)
	P_T (W)	I_C (A)		
2N3440	10	1	TO-5	\$0.65
2N5415*	10	-1	TO-5	0.90
2N6175	20	1	TO-5 (P)	0.59
2N3583	35	5	TO-66	0.96
2N6211*	35	-5	TO-66	2.70
2N6077	45	10	TO-66	1.80
2N5838	100	10	TO-3	1.98
2N5239	100	10	TO-3	2.16
2N5804	110	15	TO-3	3.30
2N6249	175	30	TO-3	6.00

*p-n-p types

For more information on these and other RCA silicon power transistors, see your local RCA Representative or RCA Distributor. Or call Gene Van Wagner, Power Transistor Marketing Manager, at (201) 722-3200, ext. 3381. For technical data on specific types write: RCA Solid State Division, Section 57E.11 /UTL-28, Box 3200, Somerville, N.J. 08876. International: RCA, Sunbury-on-Thames, U.K., or P.O. Box 112, Hong Kong. In Canada: RCA Limited, Ste. Anne de Bellevue 810, Quebec.

RCA Solid State
products that make products pay off

high voltage is...

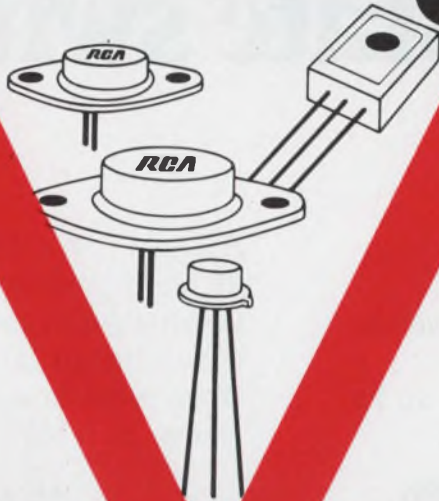

RCA

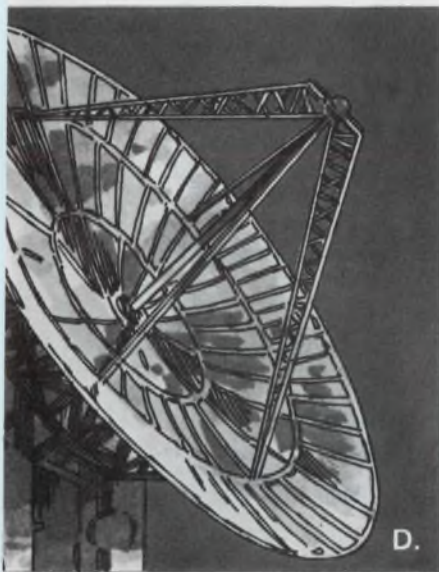

D.
RCA 2N5415, 2N5838, and 2N6077 are utilized for high-reliability service in antenna PIN diode phase-shift drivers. For this — and other high-voltage military applications — check RCA's high-voltage devices from one of the lines of combined JAN, JAN TX and equivalent types.

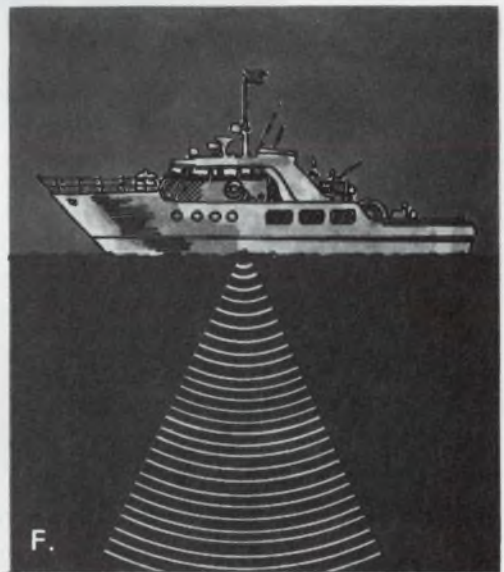

F.
RCA 2N5804, 2N5838, and 2N6249 are engaged in ultra-sonic transducer/driver and output applications where reliability is essential, based on forward-bias, second-breakdown-free operations and thermal-fatigue ratings.



E.
RCA's high-voltage p-n-p devices contribute to the broadest high-voltage line in the industry. From it, select 2N3440, 2N3583, 2N5415, and 2N6211 for electrostatic and magnetic deflection applications requiring high-voltage complementary device performance.

Four solid reasons for solid state switching.

Right now, you feel pretty safe with conventional switching techniques. You know what they can do. As well as what they can't. Great. Except solid state can do so much more.

Solid evidence for solid state.

There's speed. Easily up to 100,000 operations per second.

There's reliability. Nothing moves, so nothing wears out. Billions of test

operations have proved this.

There's no contact bounce. No contacts, so no bounce or contamination. There's size. Or lack of it. Most are no bigger than the eraser on your pencil.

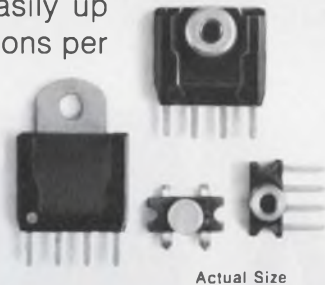

How it works.

The secret of our solid state switches is the Hall-effect principle.

It's locked in a single silicon-integrated circuit chip package. Pass a magnetic field by the package and the switching action takes place, without the magnet ever touching.

It's versatile.

Just consider the ways a magnet can be moved past a switch. The list is almost endless. The specifications of our switches are also broad.

Operating Temp. Range: -55° to $+125^{\circ}\text{C}$ are available. □ Voltage

Range: From 4.5 to 7.5 VDC. □ Output: 20 Ma digital signal. □ Magnet Size: Determined by the operating distance. (For instance, a 0.06" operating distance requires a magnet 0.187" in diameter by 0.187" long.)

An example.

Problem: To make certain the hole has been punched in a tab card.

Solution: Put a magnet on the punch and locate our solid state switch so it's actuated by the magnet when the punch moves.

Benefits: Long life. No effect from paper dust. Direct control of digital circuits.

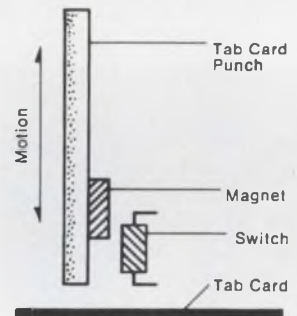

We're versatile too.

MICRO SWITCH has been in precision snap-action switching since 1932. And into solid state switching for more than 15 years.

Bring us your problem. We have experienced engineers who'll work with you to solve it. And if one of our existing products won't do the job, we can design one that will. It's all in a day's work. The quickest way to get started is a phone call to your MICRO SWITCH Branch Office. Or write to us direct.

MICRO SWITCH makes your ideas work.

MICRO SWITCH

FREEPORT ILLINOIS 61032
A DIVISION OF HONEYWELL

MICRO SWITCH products are available worldwide through Honeywell International.

INFORMATION RETRIEVAL NUMBER 132

SJCC products

Desk-top calculator rivals minicomputer in capability and memory capacity

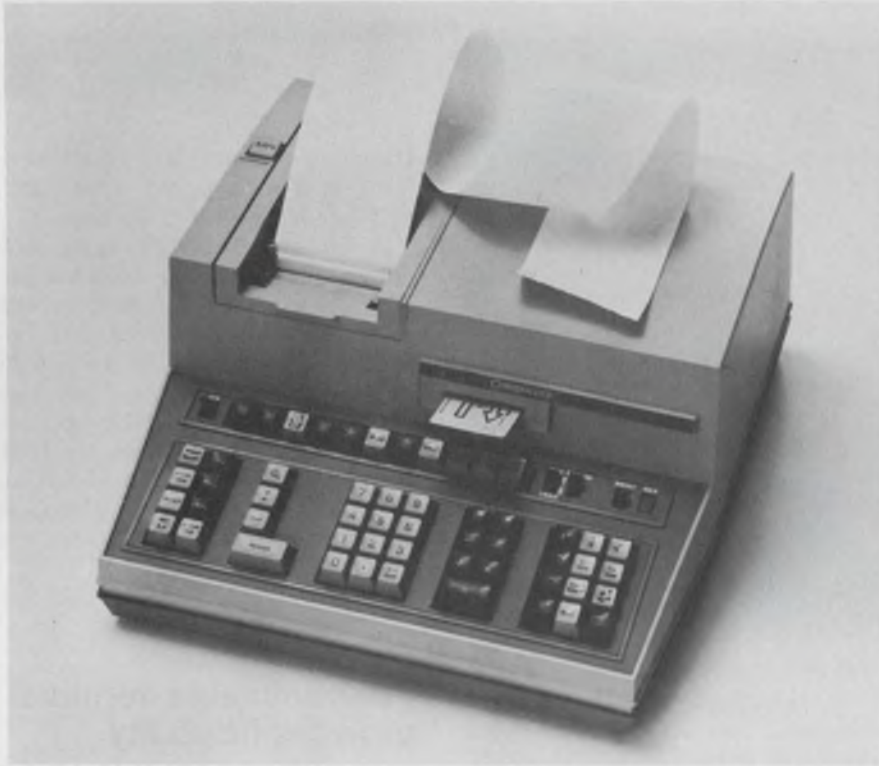

Computer Design Corp., 1734 21st St., Santa Monica, Calif. (213) 828-7597. \$3750 and up; May, 1972.

The Model 425 desk-top calculator packs so much memory and program power that the Computer Design Corp. is calling it a desk-top computer. The machine can store more than one program at one time and solve long and complex problems without segmentation.

The program capacity permits up to 4096 steps. The basic capacity is 512 steps, and it can be expanded in increments of 512.

Programs don't occupy any data storage space. The user can start small and add more internal memory or programming capacity at any time. The memory is nonvolatile; therefore there is no chance of losing data or destroying a whole program if somebody turns off the machine.

Key-selected functions don't occupy programming space either. Key entries are buffered by 10

scratch-pad and up to 512 memory registers in increments of 64.

Full four-rule arithmetic functions (plus, minus, multiply and divide) can operate into and out of all registers. And because the keys are buffered, the user can keep on entering data even while the machine is calculating.

Single keys give all the common mathematical functions, including logs and antilogs, and a choice of trigonometric functions, including hyperbolics. Single keystrokes give statistical summation and error backout, standard deviation and mean, and full-four-quadrant cartesian/polar conversion. Optional keys are available for special functions.

Decimals can be entered directly from the keyboard, and it's possible to alter the demical settings in any desired way in program subroutines. The Model 425 has a floating, or fixed-decimal, output with automatic autopoint override and a dynamic range of 10^{+99} to 10^{-99} . It calculates to 13 digits and

prints 10 with a sign, a two-digit exponent and identifying symbols for each function.

Keyboard operations are completely algebraic; there's seldom a need to rearrange equations to make them fit the machine. Complicated expressions, including nested parentheses, can be entered exactly as you would write them. The user can enter even the most complex programs directly from the keyboard and see each step printed out for editing, or debugging. A back-up key permits retracing of steps to correct a program error. And an insert key allows steps to be added without need for re-entering the entire subsequent program.

The calculator also lets user branch, or jump, to decimal addresses every 10 steps, or to pick from 96 symbolic address points that allow jumping to any point in the program. A magnetic-card reader/writer records programs and stores data on a pocket-sized magnetic card. The card can be reused or updated any number of times.

The manufacturer offers a number of peripherals—such as an X-Y plotter, I/O typewriter, a mark-sense/punched-card reader and a magnetic-tape cassette—for attachment to the calculator.

Booth No. 209 Circle No. 250

Cassette tape enables typing-error correction

Quindata Industries, Div., Quindar Electronics, Inc., 60 Fadem Rd., Springfield, N.J. (201) 379-7400. \$7495; 60 days.

An automatic typewriter, the QuinType-80, with the use of a cassette-magnetic recorder, enables a typist to correct errors, add or delete material and produce an error-free document at over 175 words/min. It uses a heavy-duty Selectric typewriter with a standard typewriter keyboard.

Booth No. 308 Circle No. 251

Domain-tip memory offers core speed at disc prices

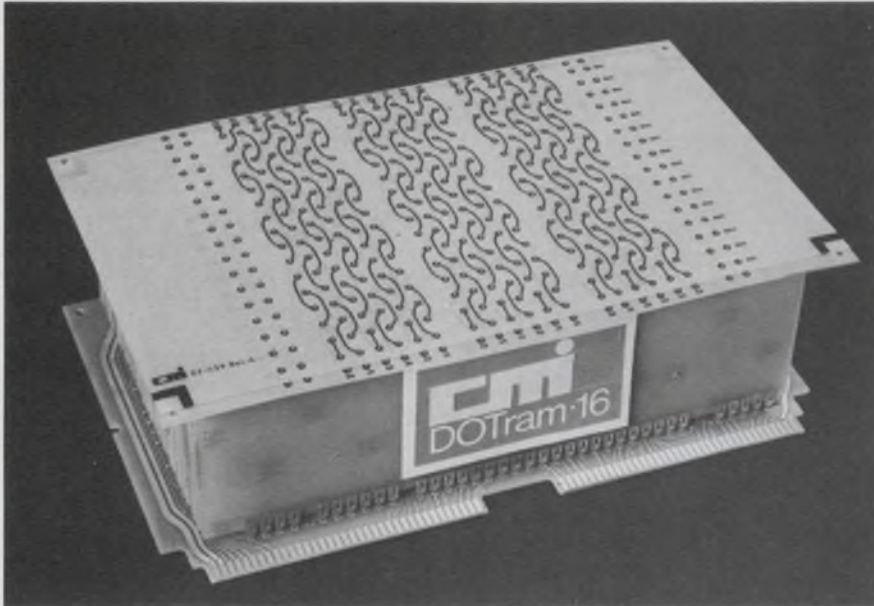

Cambridge Memories Inc., 285 Newtonville Ave., Newtonville, Mass. (617) 332-3100. \$2300; June, 1972.

Monolithic magnetic domains (DOTs) act as the storage elements in a memory that can replace existing discs and drums. The DOTram-16 is a nonmechanical, nonvolatile, fast magnetic memory. Since there are no moving parts, the control electronics are simple and require little power. The resulting compactness allows the memory device—at $19 \times 10\text{-}1/2 \times 22$ inches for 4-million bits—to be much smaller than conventional disc and drum systems.

The DOTram-16 is a block-oriented, random-access memory. Each block is randomly accessed in $1 \mu\text{s}$, and the information within the block is sequentially read, producing an average word-access time of 1.75 ms. This compares with 50 ms for a disc system like the recently introduced Digital Equipment Corp. RK05 DECpack, which costs \$5100 for 2.45-Mb storage.

The capacity of the DOTram-16 is $65 \text{ k} \times 16$, with expansion to 128 megabits projected. The word

length is variable from 8 to 36 bits. Interfaces to various minicomputers are planned, with both input and output levels TTL/DTL-compatible. Power consumption is 90 W for the $65 \text{ k} \times 16$ unit.

Domain-tip technology is a relatively old idea that is similar in principle to the bubble memories of Bell Telephone Laboratories. DOTs use an inexpensive nickel-iron-cobalt compound that is vacuum-deposited on a glass substrate. The process uses only two masks and a tough polycrystalline magnetic film. It is less critical and produces higher yields than semiconductors. Batch-fabrication problems originally blocked full development of DOT technology, but a storage density of 10,000 bits/inch² has brought the cost down to 0.23¢ per bit. The densities of 72,000 bits per inch² that are expected by the end of the year should bring the cost down to 0.09¢ per bit.

Since the DOTram-16 has no mechanical wear and is nondegradable, it will offer an attractive alternative to existing mass-storage devices. Availability will be 60 days after deliveries start in June. Booth No. 13, 15 Circle No. 463

Tape transport features dynamic braking



DigiData Corp., 4315 Baltimore Ave., Bladensburg, Md. (301) 277-9378. \$1927 (OEM); 60 days.

A family of single-capstan tape transports, the 1600 Mididek series, operates at standard speeds of 25, 18.75 or 12.5 in./s with options for speeds of 37.5 or 6.25 in./s. All units feature densities of 200 to 1600 characters/in., accommodate 8-1/2 in. reels, are IBM compatible and mount in 12-1/4-in. of rack space. Dynamic electrical braking and edit features are standard.

Booth No. 1

Circle No. 253

Programmable terminal provides flexibility



Incoterm Corp., 6 Strathmore Rd., Natick, Mass. (617) 655-6100. \$4640 (5-19); 60 days.

Combining a CRT data terminal with a stored-program minicomputer, the SPD 10/20 offers flexibility at a price competitive with hard-wired units. It has a core memory of 2048 words, a 1.6- μs cycle time and a repertoire of 58 instructions. The keyboard is under software control, and character positions can be changed or whole phrases per key designated.

Booth No. 2228

Circle No. 254



Model 880 3766
66 Key ASCII Tri-Mode

HOW TO SAVE MONEY ON KEYBOARDS:

UNLOCK REALLY BIG SAVINGS WITH THIS NEW... ..GOLD "CROSSPOINT" CONTACT KEY

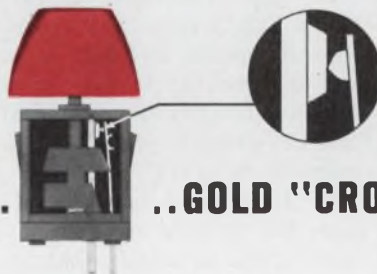

ACTUAL SIZE

Gold "Crosspoint" Contacts plus simplified electronics enhance reliability and provide long life, low profile, low power consumption and low, low cost.

HOW TO DESIGN YOUR OWN KEYBOARD: Call or write for the new six-page **Cherry Keyboard Designer's Specification Sheet** and the full-color **Cherry Keyboard Brochure** describing the reliable new Gold "Crosspoint" Key Module and Keyboards.

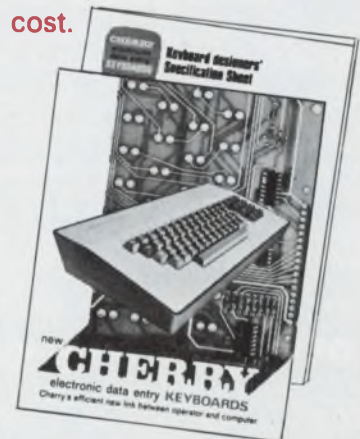

CHERRY



CHERRY ELECTRICAL PRODUCTS CORP.

3609 Sunset Avenue, Waukegan, Illinois 60085 • (312) 689-7600

Makers of patented Leverwheel/Thumbwheel Switches, Matrix Selector Switches, Snap-Action Switches and Keyboards.

INFORMATION RETRIEVAL NUMBER 133

Now...from
AMPERITE-

**UTMOST
RELIABILITY in
SOLID STATE
(HYBRID)
TIME DELAY
RELAYS**

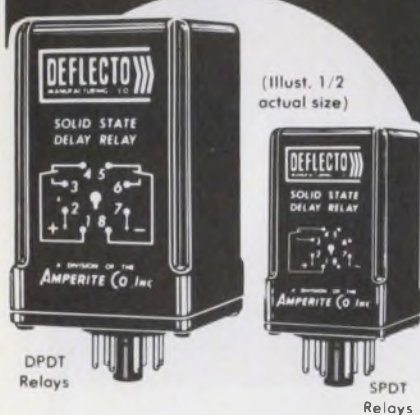

Maximum Dependability
at **LOW COST**
--backed by over 30 years
of Relay experience.

FEATURES:

- CONTACTS:** SPDT, 3 Amps;
DPDT, 10 Amps.
- VOLTAGES:** 24V AC or DC;
28V AC or DC; 115V AC or DC.
- 5 TIMING RANGES:**
From .1 to 300 Seconds.

- Repeat accuracy of $\pm 5\%$; screwdriver adjustable time delays.
- Recycle time of 100 milliseconds. Transient and polarity protected.
- Relays plug into standard octal socket.

PRICES:

SPDT Relays: \$8.45 in 100 lots; wt. 2 ozs.
DPDT Relays: \$13.65 in 100 lots; wt. 6 ozs.

Write for Bulletin No. DSR-1

DEFLECTO Mfg. Co.

Div. of Amperite Co., Inc.

600 Palisade Ave., Union City, N.J. 07087
(201) 865-5648

SJCC PRODUCTS

Plotter microprocessor saves memory core space



Hewlett-Packard Co., 1601 California Ave., Palo Alto, Calif. (415) 943-1501. \$3400; 45 days.

With writing speeds compatible with minicomputers, HP's new Model 7210A plots X-Y coordinate pairs at speeds up to 20 a second, and it draws up to five symbols a second. Virtually silent, even at full tilt, the graphic plotter is said to compete favorably in speed with many higher-cost incremental plotters. Its writing mechanism uses high-torque dc motors that can accelerate the pen to 10 inches a second in only 12 ms. The plotter can be driven by either a computer or "intelligent" terminal.

A built-in microprocessor takes a substantial load off the computer, thus eliminating the need for complex software and saving several thousand words of computer-core storage. A typical program written in assembly language requires less than 250, 16-bit words of memory.

Coordinate locations can be absolute or relative, as directed by the computer. When the plot is in absolute coordinates, the accuracy of a point doesn't depend on the accuracy of the previous point. In the relative coordinate mode, each

new position is defined relative to the last. This mode saves computer memory, because it isn't necessary to calculate the absolute coordinates of each point.

Data input can be accepted by the plotter in either binary or BCD codes. The control program selects either BCD or binary, as required. A versatile input circuit permits adaptation to a variety of different computer interface requirements. The plotter can be readily matched to machines with word lengths from 8 to 36 bits. A plug-interface board in the plotter takes care of any needed level shifting and data packing or buffering.

The plotter draws any number of different line lengths in any direction, and the computer doesn't have to calculate the intermediate points. The resulting plot is smooth and free of the stairstep pattern that is characteristic of incremental plotters.

The plotter uses almost any type of graph paper in sizes to 11 x 17 inches. Scaling controls on the front panel adjust for various graph patterns and sizes.

Booth No. 2420 Circle No. 255

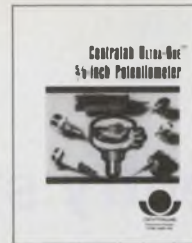

Write
Centralab
for
Bulletin
No. 1526P3

Centralab Potentiometers... in line with your design requirements

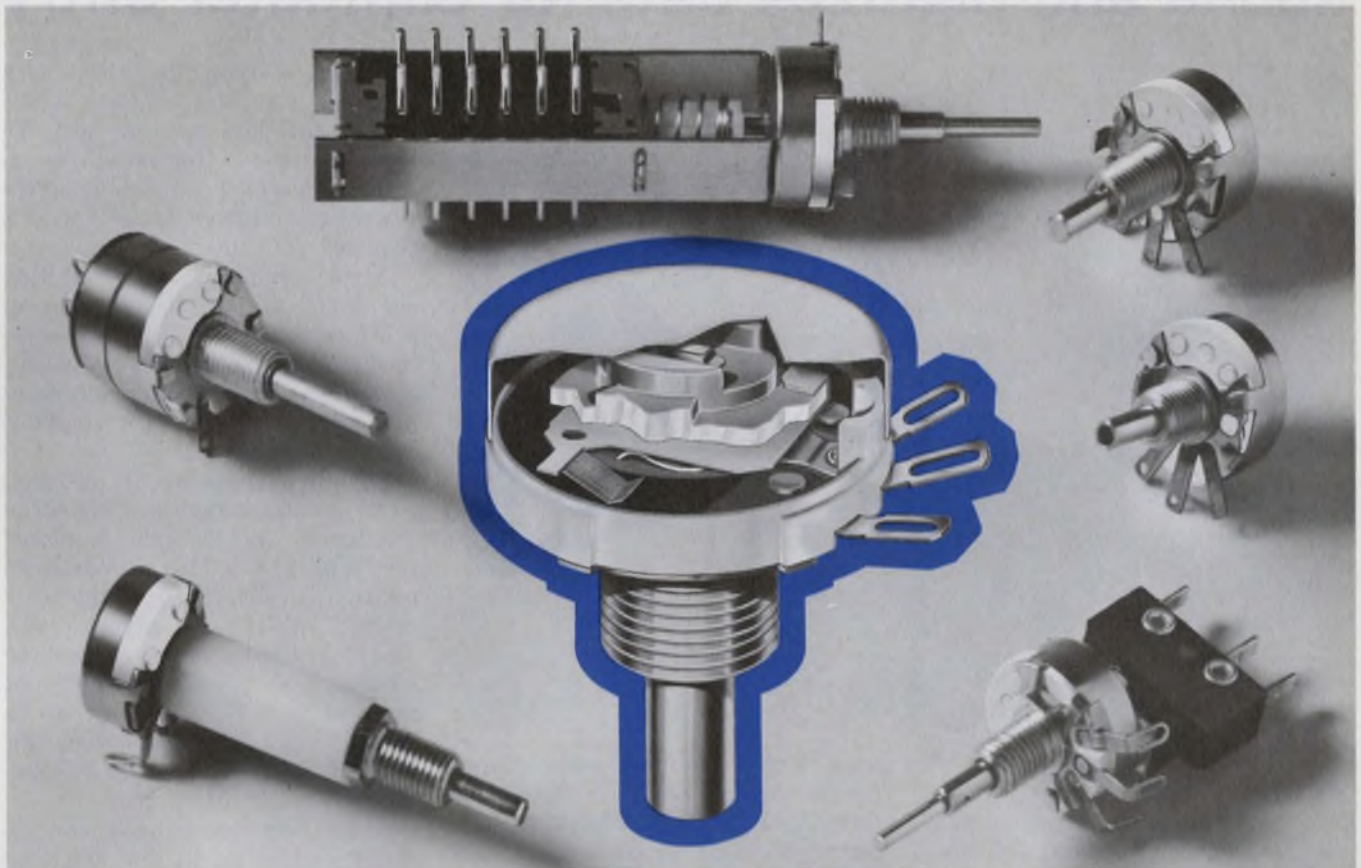

You can't tell a pot by its cover

You have to look inside to see how a potentiometer is made. Centralab's new ULTRA-ONE™ 5/8-inch potentiometer simply has more quality under its gold finished cover.

The extremely quiet ULTRA-ONE operates within 0.5% maximum CRV (contact resistance variation) for linear tapers—not just initially—but through 100,000 cycles!

We did it by an improved resistor system and by using a new contact. This quiet combination is a smooth conductive plastic element and a ten-fingered contact. The result is that

CRV is almost unmeasurable throughout the life of the potentiometer.

For versatility, the ULTRA-ONE can be coupled with snap-action, line and push button switches. It's available with a high-voltage bushing and shaft—with hollow shaft—and a high-torque feature.

ULTRA-ONE is the industrial potentiometer line that gives you more design flexibility . . . low noise operation, component add-ons, long life, and high-quality . . . in an extremely attractive package.

For complete specs, write Potentiometer Sales Manager, Centralab.

GET CENTRALAB THE "IN" LINE FOR YOUR DESIGN

Hybrid Microcircuits
Pushbutton & Rotary Switches
Capacitors
Potentiometers
Technical Ceramics
Ceramic Packages
Semiconductor Devices

ULTRA-ONE features

- 0.5% maximum noise through 100,000 \sim
- Multi-fingered contact
- Conductive plastic element
- ± 250 PPM/ $^{\circ}$ C
- 1/2 watt at 40 $^{\circ}$ C
- 500 volts DC
- $\Delta R < 10\%$ after load life
- $\Delta R < 10\%$ after 100,000 \sim



CENTRALAB

Electronics Division
GLOBE-UNION INC.
5757 NORTH GREEN BAY AVENUE
MILWAUKEE, WISCONSIN 53201

INFORMATION RETRIEVAL NUMBER 135

Pen-entry system locates position by sound and digitizes data for computer entry

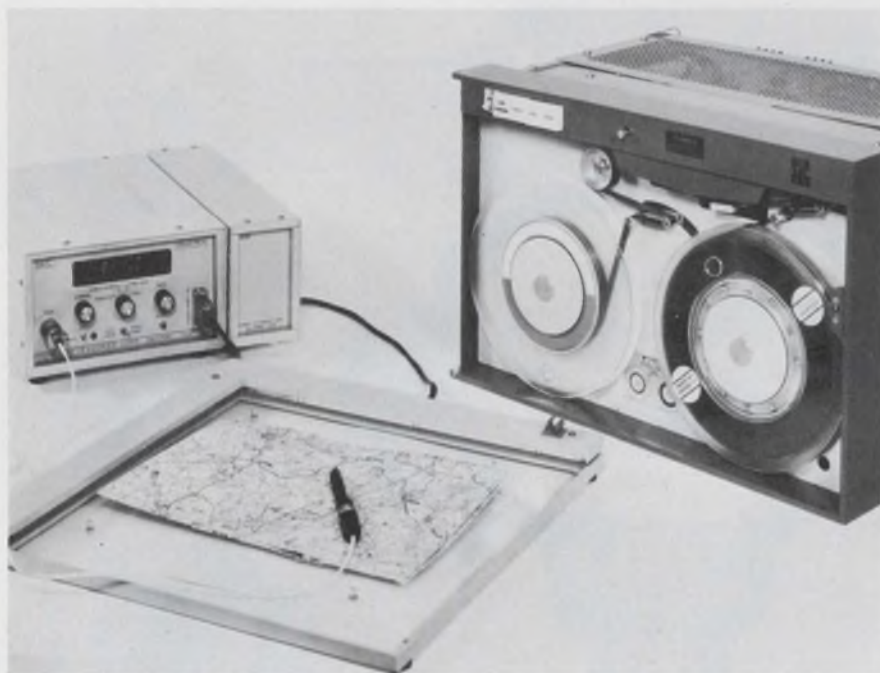

Science Accessories Corp., Div. of Ampere Electronic Corp., 65 Station St., Southport, Conn. (203) 255-1526. Price: See text, 4-6 wks.

Graf/Pen is a data-entry device for both graphic and alphanumeric information. With a specially designed ballpoint pen, it enters the data into a system at the same time that the user records the information on paper.

Models 2021/22 enter data into an incremental, digital, magnetic-tape unit, and they sell for \$8155 in a seven-track version and \$8645 in a nine-track. Models 2012 (binary code) and 2013 (BCD code) enter data into a punched tape unit and are priced at \$5995 and \$6295, respectively.

Graf/Pen uses sound transmission to define the movement of the pen. The equipment consists of a stylus, tablet and control unit.

The stylus combines a ballpoint pen (any type of writing instrument can be employed) with a low-energy spark generator at the tip of the pen. The standard tablet consists of a 14-by-14-inch transparent plate, with strip sound

sensors placed along the two coordinate edges of the plate. Both the tablet size and its 2000-by-2000-point resolution are expandable.

The sensors pick up signals generated by the stylus spark and transfer them to a control unit. The control unit interprets the data to determine the X-Y position of the stylus, digitizes the position information and transfers the data to either a magnetic tape, paper-tape unit or computer. An optional CRT display can show the data as they are entered. Graf/Pen can also interact with film viewers.

It can be used for computer inputs from graphs, rough sketches of drawings, land-contour outlines, weather patterns, tracings of X-rays and other photographic images. In the latter case, a frosted Lucite plate permits images to be projected from the rear of the tablet, making tracing easier. By using various design forms and character-recognition algorithms, Graf/Pen also performs the functions of a mark reader, hand-print reader or keyboard-input device.

The mark-reader operation is

done by correlating the mark meaning with the location of the pen as the data are recorded. To interpret the information on a form, a special logic package, representing an image of the form, is required.

A more sophisticated recognition algorithm can permit on-line handprint recognition. Because the recorded data are monitored on-line, a more accurate handprint technique than is otherwise available can be obtained.

Keyboard operation is performed by placing a keyboard layout on the tablet. As the pen is placed over a particular character box, its position is converted into the character's ASCII (or other) code. Many keyboard layouts can be strategically placed on different parts of the tablet, or they can be overlaid, with a separate code, indicating that another class of characters is being referenced.

Graf/Pen terminals can be placed on-line or off-line and coupled with many other terminals. CRTs, for example, can be used, not only for verification but, by overlaying a form on the tube face, for direct, interactive applications as a light-pen replacement.

Booth No. 331 Circle No. 256

Private phone system tailored to your needs

RCA, Service Co., Cheery Hill Offices, Camden, N.J. (609) 963-9000. \$500 per month (10 yr. lease); 200 line system.

Subscribers to this private-interconnect telephone system enjoy fixed communication costs, with installation and maintenance service, on a lease basis with the option of purchase. Some features include: extension-to-extension direct dialing; restricted service for select extensions; toll diversion; storage of calls to busy extensions.

Booth No. 1817 Circle No. 257

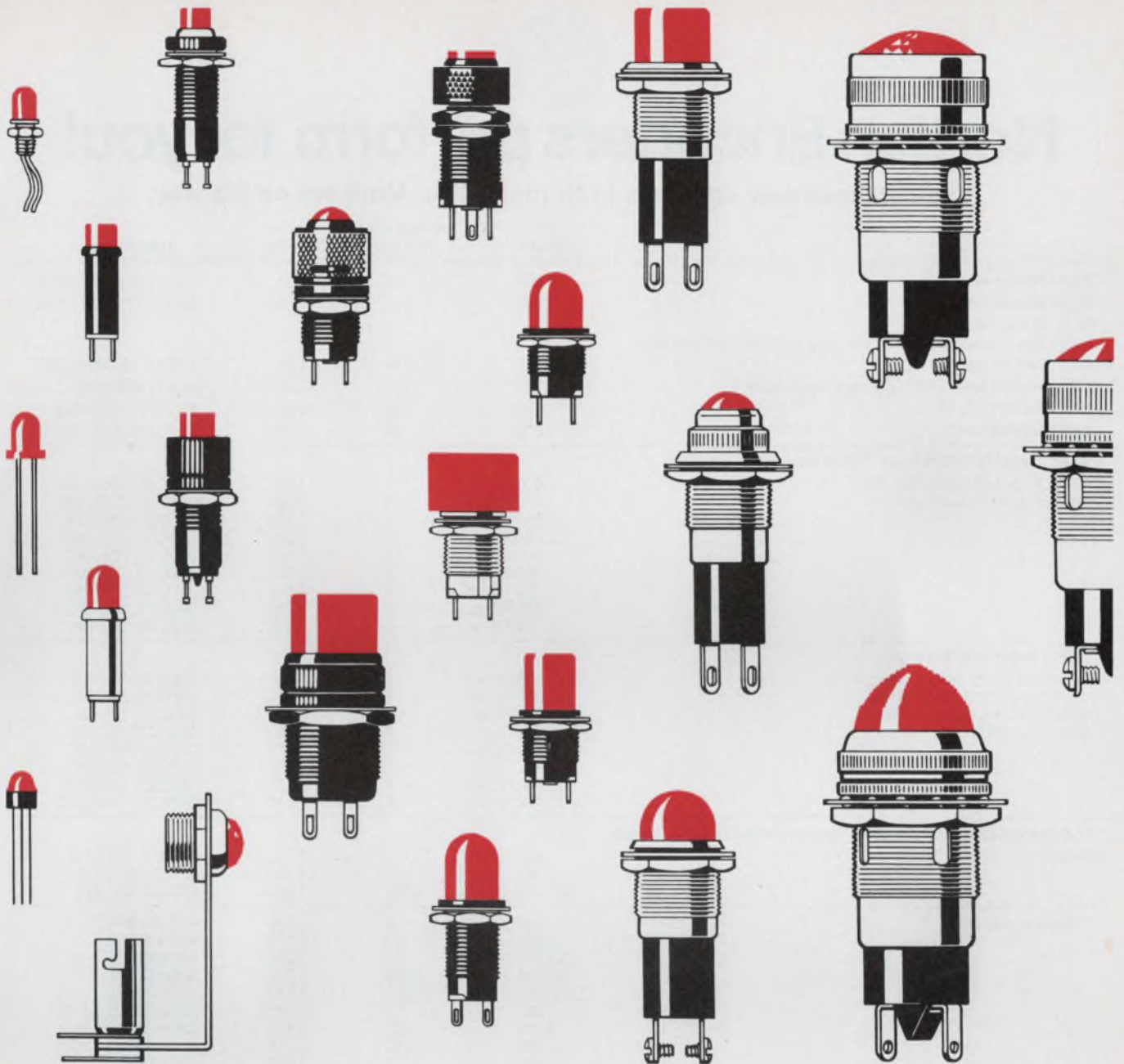

1,500,000 Indicator lights?

**Talk to the specialists at Dialight first.
You won't have to talk to anyone else.**

Permutations on the indicator lights shown here (and others not shown) give you 1,500,000 different ones to choose from. This is no mere mathematical exercise. Thousands are available from stock; any other can be quickly made up for you. Just specify the size, shape, color and type of illumination (incandescent, LED, neon) you want. If you need a specialty—oil-tight,

flashing, MIL spec . . . whatever—order it. You'll get what you asked for. Promptly. Because we and our distributors stock more varieties of indicator lights than anyone else. Our Selector Guide shows you how to find your way quickly to the indicator light you need. Send for your free copy and see how easy it is to find the one best suited to your needs.



DIALIGHT CORPORATION, A NORTH AMERICAN PHILIPS COMPANY • 60 STEWART AVENUE, BROOKLYN, N.Y. 11237 • (212) 497-7600

INFORMATION RETRIEVAL NUMBER 136



Norden Encoders perform for you!

Look at these new additions to Norden's line. More are on the way.

	Total Count	Revolutions for Full Count	Diameter"	Model Number
NEW! Optical Absolute	10,000	50	2.25	OADC-23/4/BCDQ-200L
NEW! Optical Absolute	1,000	1	2.25	OADC-23/3/BCD-1000L
NEW! Optical Incremental: Series now available with shaft seal—permits drenched operation.				
NEW! Contact Size 11	8,192	32 or 64	1.06	ADC-11/13/BNRY-256L
NEW! Contact Size 11 Altitude Reporting Encoder	1,280	16	1.06	ADC-11-ALT-1280
NEW! Contact Size 11	10,000	100	1.06	ADC-11/4/BCDX-100
NEW! Contact Size 11	3,600	36	1.06	ADC-11/4-36/BCDX-100
NEW! Rugged Industrial Grade Optical Incremental Encoders				
All available with quadrature and internal squaring circuit options	2,000 Pulses	1	3.500	OADC-35/2000/INC
	1,500 Pulses	1	3.500	OADC-35/1500/INC
	1,250 Pulses	1	3.500	OADC-35/1250/INC
	1,000 Pulses	1	3.500	OADC-35/1000/INC
	600 Pulses	1	3.500	OADC-35/600/INC
	500 Pulses	1	3.500	OADC-35/500/INC
	300 Pulses	1	3.500	OADC-35/300/INC
	200 Pulses	1	3.500	OADC-35/200/INC
	100 Pulses	1	3.500	OADC-35/100/INC
Optical Incremental Encoders				
All available with index marker, quadrature outputs and internal squaring circuit options. Other counts on special order	100 Pulses	1	2.250	OADC-23/100/INC
	250 Pulses	1	2.250	OADC-23/250/INC
	256 Pulses	1	2.250	OADC-23/256/INC
	336 Pulses	1	2.250	OADC-23/336/INC
	500 Pulses	1	2.250	OADC-23/500/INC
	512 Pulses	1	2.250	OADC-23/512/INC
	1,000 Pulses	1	2.250	OADC-23/1,000/INC
	1,024 Pulses	1	2.250	OADC-23/1,024/INC
IC-Compatible Encoders. For direct interface with TTL & DTL circuits				
Binary	128	1	1.750	ADC-ST7-BNRY-E/L
	8,192	64	1.750	ADC-13-BNRY-E/L
	524,288	4,096	1.750	ADC-19-BNRY-E/L
Binary-Decimal Code	100	1	2.250	ADC-ST2-BCD/L
	1,000	10	2.250	ADC-3-BCD/L
	10,000	100	2.250	ADC-4-BCD/L
	100,000	1,000	2.250	ADC-5-BCD/L
	1,000,000	10,000	2.250	ADC-6-BCD/L
	360	1	2.250	ADC-3-36BCD-E-360L
	3,600	10	2.250	ADC-4-36BCD-E-360L
	36,000	100	2.250	ADC-5-36BCD-E-360L
	360	1	3.250	ADC-ST3-36-BCD/L
	3,600	36	2.250	ADC-4-36-BCD/L
	36,000	360	2.250	ADC-5-36-BCD/L
	360,000	3,600	2.250	ADC-6-36-BCD/L
External Logic V-Scan Binary Encoders				
	128 or 256	1	1.750	ADC-7/8-BNRY-XB
	8,192 or 16,384	64	1.750	ADC-13/14-BNRY-XB
	524,288 or 1,048,576	4,096	1.750	ADC-19/20-BNRY-XB
Single Turn Gray Code Encoders				
Available with various levels of RFI suppression	256	1	1.066	ADC/11/8/GRAY
	256	1	1.750	ADC-ST8-GRAY
	512	1	2.250	ADC-ST9-GRAY
	1,024	1	3.062	ADC-ST10-GRAY
Multiturn Gray Code Encoders				
Available with various levels of RFI suppression	1,024	4	1.062	ADC-11/10GRAY256
	1,024	16	1.062	ADC-11/10GRAY 64
Low Cost Magnetic Noncontacting Encoders				
Incremental	128	1	1.750	MADC-18/128/INC
Binary	128(V scan)	1	1.750	MADC-18/7/BV
Binary	8,192(V scan)	64	1.750	MADC-18/13/BV
Binary	524,288(V scan)	4,096	1.750	MADC-18/19/BV

For more information and detailed specs, write Norden, Att: Components Dept., 200 Helen Street, Norwalk, Conn. 06856. Phone (203) 838-4471. TWX: 710-468-0788.

Norden

DIVISION OF UNITED AIRCRAFT CORPORATION



If you've been looking for a miniature crystal-controlled clock oscillator in a 14 pin DIP package to fit standard PC board sockets, stop looking and start ordering. Get details on model K1091A from Motorola Component Products Dept. 4545 W. Augusta Blvd. Chicago, Ill. 60651.  *MOTOROLA*

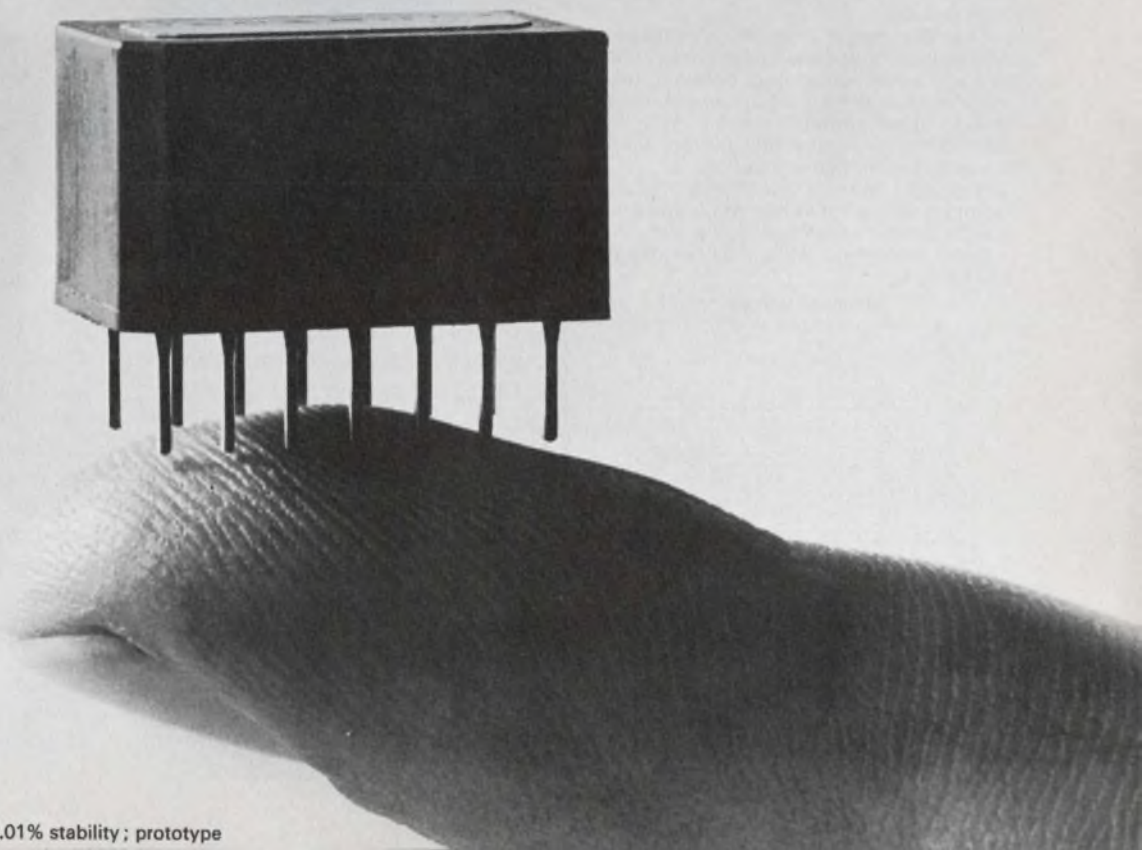

ANNOUNCING:

Cool power

Model CP-5-5



for IC logic

These new power modules from ERA provide cool performance, total protection for specialized use in IC, computer, telemetry, strain gauge and transistor applications.

The Transpac CP series is equipped with unique heat sinking for cool (71°C, free air) operation at high currents, protects itself and your equipment through built-in short circuit protection with instant recovery, adjustable current limiting and overvoltage protection.

A special burn-in test program at the factory assures reliability while compact silicon design saves space.

Send for catalog. Write today — before you design.

STANDARD MODELS

Output Voltage VDC	Current @			Model
	50°C	60°C	71°C	
3.6	3.2	2.8	2.5	CP-3P6-2P5
5	3.2	2.8	2.5	CP-5-2P5
3.6	6.5	5.7	5.0	CP-3P6-5
5	6.5	5.7	5.0	CP-5-5
3.6	13.0	11.4	10.0	CP-3P6-10
5	13.0	11.4	10.0	CP-5-10
3.6	22.0	19.5	17.0	CP-3P6-17
5	22.0	19.5	17.0	CP-5-17
3.6	32.0	28.5	25.0	CP-3P6-25
5	32.0	28.5	25.0	CP-5-25



ERA TRANSPAC CORPORATION

A Subsidiary of
Electronic Research Associates, Inc.
67 Sand Park Road, Cedar Grove, N.J. 07009
(201) 239-3000

INFORMATION RETRIEVAL NUMBER 139

C48

SJCC PRODUCTS

Impactless printer does 240 characters per sec.



Data Interface Associates, Box 33, Brookfield Center, Conn. (203) 792-0290. \$4100; July '72.

Featuring dry operation and magnetic printing, the DI-240 prints on plain paper. It uses a 10 × 12 print matrix and can produce the complete 96-character ASCII set. Printing in Russian, Greek or Hebrew characters is available. Operation is asynchronous with input rates up to 50,000 b/s with serial or parallel ASCII or Baudot entry codes. It can produce an 8 × 10 in. page in 20 seconds.

Booth No. 1610 Circle No. 258

Disc memory withstands 10-g shock, 2-g vibration



Singer, Librascope Div., 808 Western Ave., Glendale, Calif. (213) 245-8711. \$7450 and up; 90 days.

Up to 18 million bits of storage on 256 racks are provided by the L107B disc memory. The system features TTL-NRZ interfaces and is available with either 8.5 or 17-ms average access time and a 2-MHz bit rate. A flying head-per-track design is used. It is ruggedized for industrial applications and can operate at 10-g shock and 2-g vibration without special mounting.

Booth No. 3, 5 Circle No. 259

Terminal copier can multiplex inputs



Tektronix, Inc., P.O. Box 500, Beaverton, Ore. (503) 644-0161. \$3550; 8 wks.

The 4610 hard-copy unit is available for use with the 4010 computer display terminals. It produces dry copies via a thermal process using a CRT, and prints on 3M-Type 777 dry-silver paper. Copy time is 18 seconds for the first copy, on a 8-1/2 × 11 in. page. An option for multiplexing up to four terminals is available.

Booth No. 720 Circle No. 260

High-speed page reader uses laser scanning



Creative Logic Corp., 80 E. Ridgewood Ave., Paramus, N.J. (201) 265-7700. \$30,000; 3 months.

The LV-2000 page reader scans at speeds greater than 2000 characters per second. It employs a laser beam, fiber optics and reads a special typewritten font typed below the normal characters. The reading head recognizes only this special font. A vacuum transport accepts 3 × 5 to 9 × 11 in. page sizes.

Booth No. 2329 Circle No. 261

Harris' Family of Op Amps. They're a different breed. By design.

Harris op amps have always been a little bit different ever since we introduced the industry's first internally compensated op amp back in 1966.

Today, we still make our op amps a little different. For example, our PNP's, or better put, our \overline{PNP} are vertical instead of lateral to give you superior AC performance without sacrificing DC characteristics.

Then take our designs. We employ a single gain stage to provide better behaved frequency response. Our bias networks are a bit more complex for uniform performance over a wide range of supply voltages and temperature ranges, and our output stages have better output current capabilities. In testing we're different too—more thorough. In fact, we were guaranteeing slew rates and rise times long before other manufacturers did. Consider just two examples:

Harris wide band general purpose op amps offer:

- Close loop bandwidth up to 100 times greater at the same gain or 100 times greater gain capability for the same bandwidth than the common 741 types.
- Much lower closed loop phase shift, lower gain error, and lower distortion at all frequencies.
- Superior response at higher gains.
- Hundreds of times better DC performance (for example, the HA-2600/2620 has a 5nA bias current, 300M Ω input resistance, and 100K minimum open loop gain).

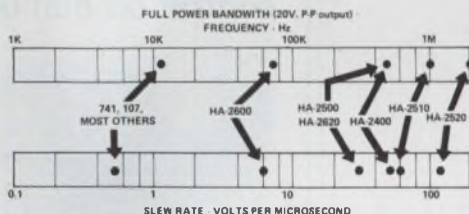
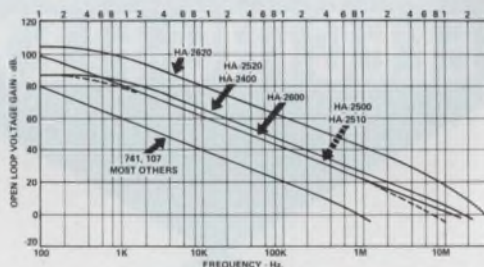

Harris high slew rate series offer:

- The only monolithic high slew rate amplifiers that are true operational amplifiers. They can be operated inverting, non-inverting, or balanced with fast settling times. In fact, they provide improved performance in virtually any standard hookup.
- The fastest settling time of any monolithic op amp. (For example, the HA-2520 settles in 250 ns to 0.1%.)
- Higher output voltage swing at high frequencies. (If you have ever tried to put a 10V peak 1MHz sine wave through a 741 type, you know what we mean.)

In summary, Harris makes a difference . . . our family of proprietary devices and popular alternate source devices can offer you the best price/performance op amp package for your system.

Full military temperature range (-55°C to +125°C):

HA-2101A	HA-2600	HA-2620	HA-2500	HA-2520	HA-2909
HA-2101	HA-2602	HA-2622	HA-2502	HA-2522	HA-2700
HA-2107			HA-2510		HA-2400
HA-2107-3			HA-2512		

Commercial/Industrial (0°C to +70°C):

HA-2301A	HA-2207	HA-2505	HA-2525	HA-2704	HA-2404
HA-2201A	HA-2605	HA-2515	HA-2911	HA-2705	HA-2405
HA-2307					

All in standard 741 pin-compatible configuration. (Except HA-2400/2404/2405 4-channel op amp.) For details see your Harris distributor, representative, or contact us direct.



HARRIS
SEMICONDUCTOR
A DIVISION OF HARRIS-INTERTYPE CORPORATION

P.O. Box 883, Melbourne, Florida 32901
(305) 727-5430

DISTRIBUTORS: Schweber Electronics: Westbury, New York (516) 334-7474; Rockville, Maryland (301) 881-2970; Hollywood, Florida (305) 927-0511 / Harvey/R & D Electronics: Lexington, Massachusetts (617) 861-9200 / Semiconductor Specialists, Inc.: Chicago (312) 279-1000, Detroit (313) 255-0300; Minneapolis (612) 884-8132; Kansas City (816) 452-3900; St. Louis (314) 428-6100; Dallas (214) 358-5211; Indianapolis (317) 243-8271; Pittsburgh (412) 781-8120; Dayton (513) 278-9455 / R. V. Weatherford Co.: Albuquerque (505) 265-5671; Anaheim (714) 547-0891; Austin (512) Enterprise 1443; Dallas (214) 231-6051; Denver (303) 427-3736; Glendale (213) 849-3451; Houston (713) Enterprise 1443; Palo Alto (415) 321-5373; Phoenix (602) 272-7144; Pomona (714) 623-1261; San Diego (714) 278-7400; Seattle (206) 762-4200. **HARRIS SALES OFFICES:** Wellesley, Massachusetts (617) 237-5430; Wayne, Pennsylvania (215) 687-6680; Palos Heights, Illinois (312) 597-7510; Melbourne, Florida (305) 727-5430; Palo Alto, California (415) 321-2280; Melville, New York (516) 249-4500; Syracuse, New York (315) 463-3373; Washington, D.C. (202) 337-4914; Dallas, Texas (214) 231-9031; Scottsdale, Arizona (602) 946-3556; Long Beach, California (213) 426-7687.

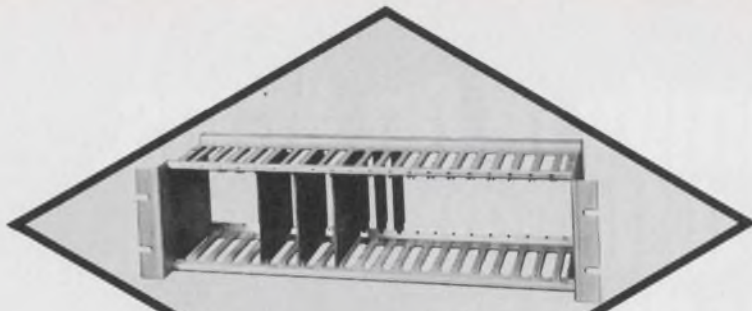

ELECTRO-FLEX^{T.M.}

**PRINTED CIRCUIT
CARD ENCLOSURES**

You're looking at a card enclosure that no one wants
EXCEPT the engineer who needed to house 19 boards 4-1/8" by 7.310" on .650 centers with connectors offset .187 to the right. You see, we know that no two packaging requirements are alike . . . and the designer who is forced to cannibalize a "standard" rack is wasting time and dollars. That's why **ELECTRO-FLEX** offers you total design flexibility with no limitations on size, card spacing, connector or back plane mountings or special holes and hardware. For precision fabrication at costs that are the most competitive in the industry, call or write for literature and assembly prints. Standard or special, you'll get what you want.

ELECTRO-SPACE FABRICATORS, INC.

TOPTON, PENNSYLVANIA 19562 • (215) 682-7181

INFORMATION RETRIEVAL NUMBER 141

SJCC PRODUCTS

**Batch data terminal
saves phone-line time**



Teletype Corp., 5555 Touhy Ave., Skokie, Ill. (312) 982-2000. \$2200 to \$2375; 4-6 months.

The Model 4210 magnetic-reCORD, data terminal operates at speeds to 2400 baud. In a batching mode, it operates unattended, receiving data over phone lines at high speed and stores up to 150,000 characters/cartridge. When connected to a Model 38 teleprinter, once a batch of data is received, the tape is automatically reversed, and copy is printed at 100 words/minute. When printing is complete, the 4210 returns to its unattended answer mode.

Booth No. 2108 Circle No. 262

**Modem uses ARQ-error
control on dial-up line**



Paradyne Corp., P.O. 5144, 2040 Calumet St., Clearwater, Fla. (813) 442-5126. \$6450; 30 days.

The Bisync-48 operates at 4800 b/s on 2 or 4-wire unconditioned dial-up networks. It can directly replace a conventional modem like Bell's 201A. Features include automatic equalization, two-block, continuous, A R Q - e r r o r control, throughput meters, poor-circuit indicators, lock status and an equalizer monitor.

Booth No. 2214 Circle No. 263

"WHERE ARE THE SPEC SHEETS FOR THIS DRAWING?"

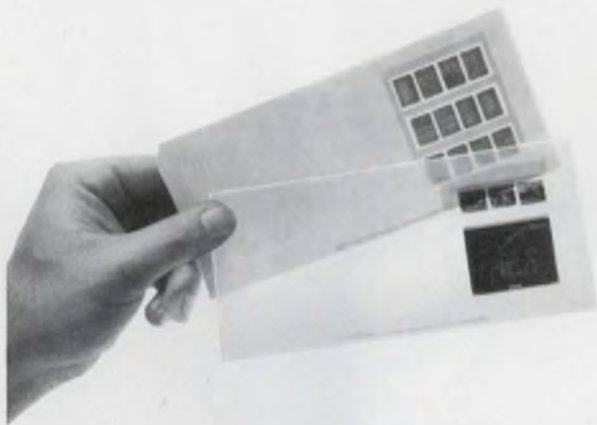

The new RECORDAK Aperture Cards keep it all together.

It's a real nuisance when a drawing gets separated from its support data. But you can keep that from happening by using the new Recordak aperture cards.

Available in several formats, the new cards feature a transparent protective envelope that holds various combinations of 35mm and 16mm microfilm, for drawings and related information. A special translucent version accepts written or typed notations which reproduce, along with the film image, on tab-size diazo copies.

Other advantages of the aperture cards include fast, automated reference, simple updating, and easy, inexpensive reproduction.

Want the full story? Send in the coupon and we'll put it all together for you.

Please send me complete details on the new Recordak aperture cards.

Name _____

Position _____

Company _____

Address _____

City _____ State _____ Zip _____

Eastman Kodak Company
Business Systems Markets Division
Dept. DP835, Rochester, N.Y. 14650

**ENGINEERING SYSTEMS
BY KODAK**



Mux handles 18 data channels on a phone line



GTE Lenkurt Inc., 1105 County Rd., San Carlos, Calif. (415) 591-8461. Single-channel: \$450; 8-channel: \$2580; 30 days.

Handling up to 18 data channels at speeds from 110 to 600 bauds, the 25C data-transmission system multiplexes them over a single voice circuit. It uses frequency-shift-keyed modulation and is all solid-state. A desk-top single-channel subset and a terminal-shelf eight-channel unit is available.
Booth No. 2429 Circle No. 264

Teleprinter uses 5 x 7 impact print matrix



International Teleprinter Corp., 493 Washington Ave., Carlstadt, N.J. (201) 438-1770. RO: \$1100; KSR: \$1400; ASR: \$2000 (500-up); RO;KSR-July, ASR-Nov.

The Series 30 teleprinter is a serial-impact page printer that operates asynchronously at 30 characters per second. It uses a 5 x 7 wire-dot matrix to print 64 characters, and five carbons can be produced. Operation is half or full-duplex. It uses friction or sprocket feed on roll or fan-fold paper without the need to change parts.
Booth No. 1709 Circle No. 265

System oriented mini provides flexibility



Lockheed Electronics Co., Inc., 6201 E. Randolph St., Los Angeles, Calif. (203) 722-6810. \$4295; 2 months.

Carrying the acronym SUE, for System User Engineered, this mini is organized into independent plug-gable systems modules that fit into a multilayer, printed-circuit board. SUE systems are available standard or custom assembled, and are field alterable. Asynchronous communications between modules via a common, high-speed bus are monitored by a bus controller at 200-ns intervals.
Booth No. 1621 Circle No. 266

The UnPlotter

the first graphic digitizer that is rapid, accurate and affordable.

Plotted data is piling up. You need it quickly converted to computer format. Key punching is too time-consuming and inaccurate.

The practical solution: The Ruscom Digitizer from Electronetic Systems! So easy to use that a new operator is easily trained within minutes. It's fast and exceptionally economical. Accuracy, resolution, and repeatability are all held within 0.01". Keyboard entry and display are standard. And the UnPlotter drives any computer peripheral you can list.



Less than \$8000! With so much more to offer! Contact Electronetic Systems today for complete details on the Ruscom Digitizer. The UnPlotter for any budget.

ELECTRONETIC SYSTEMS
62 ALNESS STREET, DOWNSVIEW, ONTARIO, CANADA
TEL (416) 636-3673 ■ TELEX 02-21374 ■ TWX 610-492-1333



inverter- ratedTM

**ferramic[®]
components**

instead of
guessing a lot

■ *Inverter-Rated* components end guesswork in your inverter designs. They're tested under actual inverter conditions to give you guaranteed, relevant electrical parameters, not just routine magnetic material data.

Inverter-Rated Ferramic components not only make your design and selection more precise—they work. Developed, tested and specified for inverter applications. So the reliability you design in—stays in.

For applications with unipolar or bipolar switching of direct currents, *Inverter-Rated* Ferramic components deliver. No trial and error selection. No rejects due to cores that only meet a material spec.

Ferrites for inverters are the latest in our growing family of application-rated components. And they're available now in Pot Cores, U Cores, Cross Cores, E Cores and Toroids.

We'd like to send you samples of our new Ferramic components that work in inverter applications. And specs that make sense. Or to consult with you about your design problems. Just contact Indiana General, Electronic Products, Keasbey, N. J. 08832. Or call (201) 826-5100.

National distribution through seven Permag locations.

indiana general 

a division of Electronic Memories & Magnetics Corp.

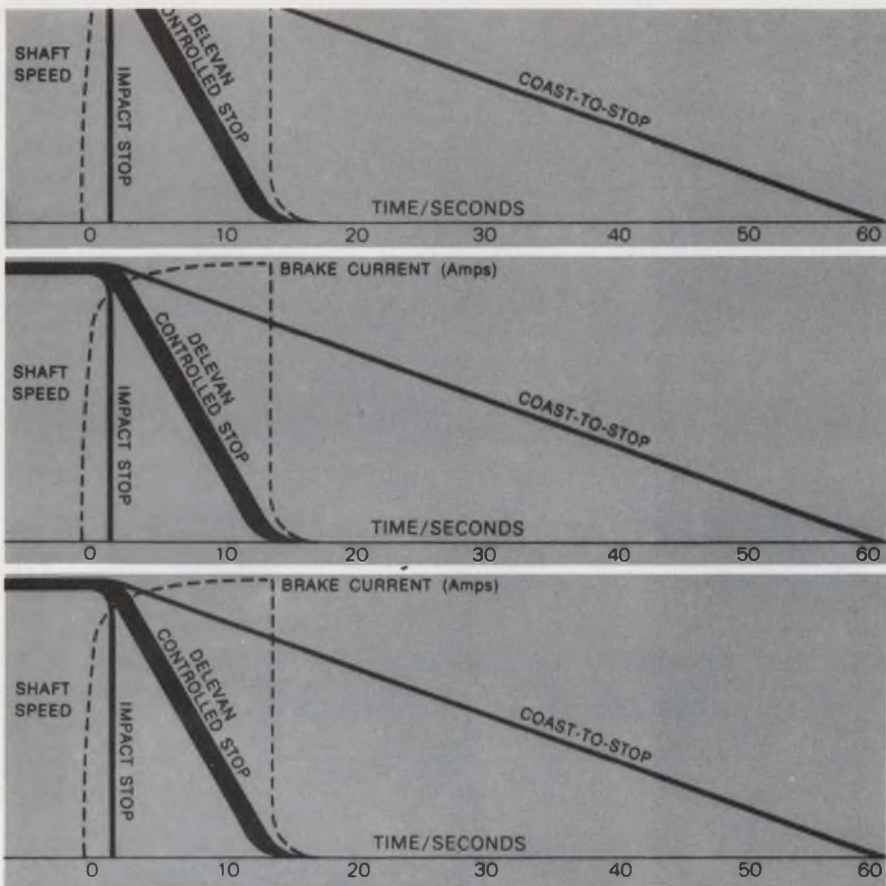

If you've seen one stop with the Delevan Hysteresis Brake...you've seen them all!

That's because Delevan Hysteresis brakes develop repeatable torque. In contrast with the peaked torque developed by other methods, the Hysteresis brake produces controlled torque with linear deceleration. No danger of overtorquing the system and damaging the disc pack.

The Delevan Hysteresis Brake also adds tremendous savings in time for swapping discs in your computer data bank. Less than 1/2 Amp. produces rated torque with minimum power consumption, and virtually eliminates electronic noise.

There's no metal to metal contact. No mechanical noise or wear. No metallic dust to foul up your system. It's inherently clean...at a competitive price.

Sizes and torque ranges to meet specific computer designs. Shaft or through-hole rotors...mounting flexibility to any plane.

For complete selection, write for catalog.



Delevan
Division  **AMERICAN PRECISION INDUSTRIES INC.**

274 QUAKER RD./EAST AURORA, N. Y. 14052
TELEPHONE 718/652-3800 TELEEX 081-283
OTHER DIVISIONS OF AMERICAN PRECISION INDUSTRIES INC.:
BASCO • OUSTEX • MOELLER INSTRUMENT CO • OXFORD CORP.

INFORMATION RETRIEVAL NUMBER 145

SJCC PRODUCTS

Serial printer has throw-away ink rollers

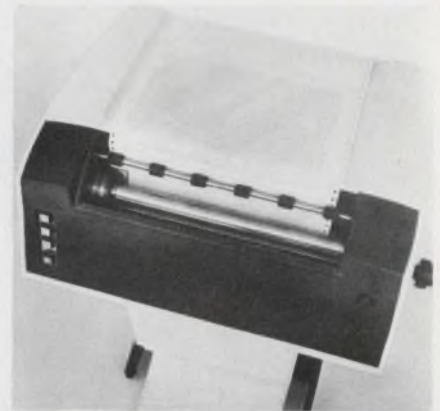

Printer Technology Inc., Sixth Rd., Woburn Industrial Pk., Woburn, Mass. (617) 935-4246. \$2200; 2 months.

Offering an output rate of 100 characters/s, a serial impact printer keeps pace with normal human reading speed. Key features of the Printec-100 include a built-in interface for ASCII input data, 136-characters/line at 10-character/in. spacing, a throw-away ink roller (good for 30-million impressions) and a unit for tabulations and check writing.

Booth No. 2122 Circle No. 267

Controller interfaces cassette data recorders



Sykes Datatronics Inc., 375 Orchard St., Rochester, N.Y. (716) 458-8000. 2120: \$1860; 2200: \$2690; 30 days.

The Series 2000 general-purpose tape controller interfaces one or two Model TT120 cassette transports with computers and data terminals. It uses a record/file format with variable-length records selected automatically by data availability. A search feature allows backspace or skipping records or files. An eight-bit character register permits parallel data transfer with minimum timing restraints on external devices.

Booth No. 221 Circle No. 268

can your present supplier make the following statement?

"We guarantee 24 hour shipment, after receipt of order, from the following list of 7400 TTL and linear IC's"

WE DO!
Now Check Our Prices:

CATALOG NUMBER	ANY QUANTITY PER ITEM			MULTIPLES OF 10 PER ITEM			CATALOG NUMBER	ANY QUANTITY PER ITEM			MULTIPLES OF 10 PER ITEM		
	1-99 MIX	100-999 MIX	1000-UP MIX	100-990 MIX	1000-9990 MIX	10,000-UP MIX		1-99 MIX	100-999 MIX	1000-UP MIX	100-990 MIX	1000-9990 MIX	10,000-UP MIX
7400	.26	.25	.23	.22	.21	.20	7496	1.18	1.12	1.05	.99	.93	.87
7401	.26	.25	.23	.22	.21	.20	74100	1.52	1.44	1.36	1.28	1.20	1.12
7402	.26	.25	.23	.22	.21	.20	74107	.52	.49	.47	.44	.42	.39
7403	.26	.25	.23	.22	.21	.20	74121	.56	.53	.50	.48	.45	.42
7404	.28	.27	.25	.24	.22	.21	74122	.70	.67	.63	.60	.56	.53
7405	.28	.27	.25	.24	.22	.21	74123	1.21	1.06	1.00	.94	.89	.83
7406	.52	.50	.47	.44	.42	.39	74141	1.63	1.55	1.46	1.38	1.29	1.20
7407	.52	.50	.47	.44	.42	.39	74145	1.41	1.33	1.26	1.18	1.11	1.04
7408	.32	.30	.29	.27	.26	.24	74150	1.63	1.55	1.46	1.38	1.29	1.20
7409	.32	.30	.29	.27	.26	.24	74151	1.20	1.13	1.07	1.01	.95	.88
7410	.26	.25	.23	.22	.21	.20	74153	1.63	1.55	1.46	1.38	1.29	1.20
7411	.28	.27	.25	.24	.22	.21	74154	2.43	2.30	2.16	2.03	1.89	1.76
7413	.58	.55	.52	.49	.46	.44	74155	1.46	1.39	1.31	1.23	1.16	1.08
7416	.52	.50	.47	.44	.42	.39	74156	1.46	1.39	1.31	1.23	1.16	1.08
7417	.52	.50	.47	.44	.42	.39	74157	1.56	1.48	1.39	1.31	1.23	1.15
7420	.26	.25	.23	.22	.21	.20	74158	1.56	1.48	1.39	1.31	1.23	1.15
7421	.26	.25	.23	.22	.21	.20	74160	1.89	1.79	1.68	1.58	1.47	1.37
7426	.34	.32	.31	.29	.27	.26	74161	1.89	1.79	1.68	1.58	1.47	1.37
7430	.26	.25	.23	.22	.21	.20	74162	1.89	1.79	1.68	1.58	1.47	1.37
7437	.56	.53	.50	.48	.45	.42	74163	1.89	1.79	1.68	1.58	1.47	1.37
7438	.56	.53	.50	.48	.45	.42	74180	1.20	1.13	1.07	1.01	.95	.88
7440	.26	.25	.23	.22	.21	.20	74181	5.20	4.90	4.59	4.28	3.98	3.67
7441	1.73	1.64	1.55	1.46	1.37	1.27	74182	1.20	1.13	1.07	1.01	.95	.88
7442	1.27	1.21	1.14	1.07	1.01	.94	74192	1.98	1.87	1.76	1.65	1.54	1.43
7443	1.27	1.21	1.14	1.07	1.01	.94	74193	1.98	1.87	1.76	1.65	1.54	1.43
7444	1.27	1.21	1.14	1.07	1.01	.94	74198	2.81	2.65	2.50	2.34	2.18	2.03
7445	1.71	1.62	1.53	1.44	1.35	1.26	74199	2.81	2.65	2.50	2.34	2.18	2.03
7446	1.24	1.17	1.11	1.04	.98	.91	NE501	2.99	2.82	2.66	2.49	2.32	2.16
7447	1.16	1.10	1.04	.98	.92	.85	NE531	3.81	3.58	3.36	3.14	2.91	2.69
7448	1.44	1.37	1.29	1.22	1.14	1.06	NE533	3.81	3.58	3.36	3.14	2.91	2.69
7450	.26	.25	.23	.22	.21	.20	NE536	7.31	6.88	6.45	6.02	5.59	5.16
7451	.26	.25	.23	.22	.21	.20	NE540	2.16	2.04	1.92	1.80	1.68	1.56
7453	.26	.25	.23	.22	.21	.20	NE550	1.24	1.17	1.11	1.04	.98	.91
7454	.26	.25	.23	.22	.21	.20	NE560	3.57	3.36	3.15	2.94	2.73	2.52
7460	.26	.25	.23	.22	.21	.20	NE561	3.57	3.36	3.15	2.94	2.73	2.52
7470	.42	.40	.38	.36	.34	.32	NE562	3.57	3.36	3.15	2.94	2.73	2.52
7472	.38	.36	.34	.32	.30	.29	NE565	3.57	3.36	3.15	2.94	2.73	2.52
7473	.50	.48	.45	.43	.40	.38	NE566	3.57	3.36	3.15	2.94	2.73	2.52
7474	.50	.48	.45	.43	.40	.38	NE567	3.57	3.36	3.15	2.94	2.73	2.52
7475	.80	.76	.72	.68	.64	.60	N5111	.90	.86	.81	.77	.72	.68
7476	.56	.53	.50	.48	.45	.42	N5556	1.87	1.77	1.66	1.56	1.46	1.35
7480	.76	.72	.68	.65	.61	.57	N5558	.80	.76	.72	.68	.64	.60
7483	1.63	1.55	1.46	1.38	1.29	1.20	N5595	3.40	3.20	3.00	2.80	2.60	2.40
7486	.58	.55	.52	.49	.46	.44	N5596	1.87	1.77	1.66	1.56	1.46	1.35
7489	4.25	4.00	3.75	3.50	3.25	3.00	709	.42	.40	.38	.36	.34	.32
7490	.80	.76	.72	.68	.64	.60	710	.42	.40	.38	.36	.34	.32
7491	1.43	1.35	1.28	1.20	1.13	1.05	711	.44	.42	.40	.37	.35	.33
7492	.80	.76	.72	.68	.64	.60	723	1.00	.95	.90	.85	.80	.75
7493	.80	.76	.72	.68	.64	.60	741	.44	.42	.40	.37	.35	.33
7494	1.18	1.12	1.05	.99	.93	.87	748	.48	.46	.43	.41	.38	.36
7495	1.18	1.12	1.05	.99	.93	.87							

We stock over 500,000 IC's and all items not shipped within 24 hours will be given an automatic 10% discount.

Please write to IC Retail Division for quotations on requirements over 25,000 pieces.

Order Desk: 1-800-325-2595 (Toll Free)

SOLID STATE SYSTEMS, INC.

P.O. BOX 773, COLUMBIA, MO. 65201

PHONE (314) 443-3673 TWX 910-760-1453



not
for
everybody

UL Recognized RFI EMI Filters for Data Processing Equipment

Rtron has developed 14 stock filter types (U.L. specification 478), for the RFI/EMI suppression requirements of data processing equipment. Terminal and bracket variations cover virtually every mounting need.

Custom designed multi-circuit RFI/EMI Filters in square, rectangular, bathtub and other enclosures are available.

Whatever your filtering needs may be, Rtron can design, produce, and deliver high reliability filters on time.

Phone or write for complete details.

Rtron

P.O. Box 743, Skokie, Ill. 60076

312 • 327-4020

SJCC PRODUCTS

Impact printer employs plastic hammer



Odec Computer Systems Inc., 25 Greystone St., Warwick, R.I. (401) 738-9500. \$7900; 3-4 months.

Operating at speeds of 110 and 250 lines per minute, Series 1300 printers work on ASCII or EBCDIC codes. Available with 48, 64 and 96-character fonts, the medium-speed line printers have plastic impact hammers and need no clip-guide lubrication. Character slugs can be snapped on or off the carrier belt, individually. Options include parity checking, special characters and an RS-232-B communications interface.

Booth No. 1616 Circle No. 269

Core memory expands PDP-11's capacity



Standard Memories, Inc., 2801 E. Oakland Pk. Blvd., Fort Lauderdale, Fla. (305) 566-7611. \$4500 and up; 60 days.

The Ecom F-11 is offered as a PDP-11, plug-to-plug compatible package in sizes of 4 k to 32 k words, in 4 k or 8 k increments. Cycle time is 750 ns. It may be purchased in its minimum capacity and upgraded by the insertion of single-card, digital stacks.

Booth No. 1018 Circle No. 270

Data recorder sorts 300 cards per minute



Decision Data Computer Corp., 100 Witmer Rd., Horsham, Pa. (215) 674-3300. \$8400; 90-120 days.

The 9660 data recorder is a buffered key entry device for punching, printing and verifying 96-column cards. It also performs auxiliary operations such as card sorting, reproducing, gangpunching, interpreting and data posting. Many other standard and optional functions are available. It reads 300 cards per minute and punches 60 cards per minute.

Booth No. 409 Circle No. 271

Minicomputer combines core and semi memories

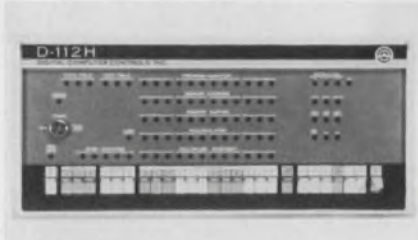

Digital Computer Controls Inc., 12 Industrial Rd., Fairfield, N.J. (201) 227-4861. \$9400; 45 days.

Both semiconductor RAM with 200-ns access and a 1- μ s core memory are intermixed in the D-112H/SC minicomputer. Special look-ahead circuits determine if the next address is for the semiconductor or core memory. Core memory can be increased from 4096 12-bit words to a maximum of 32,768 words, while the semiconductor comes in 256-word increments. The architecture and instruction repertoire are fully compatible with the PDP-8 and have additional instructions for handling extra capabilities.

Booth No. 400 Circle No. 272

New from the "expensive" switchlight maker...

...an inexpensive one!

If switches turn you on, you know that our line has always been known for quality. From now on we will be recognized for quality at a startlingly low price. Call it a breakthrough, if you like, but we'd prefer you call it "the monoform family" of switchlights.

monoform I (the single lamp, momentary & alternate, rated 2 amp 120 Vac) and monoform II (two independent lamps for hori-



zontal split legends, mom. & alt., 2 amp 120 Vac) are available now. monoform III (the 10 amp, 1/4 H.P. power switch version) is coming soon. And this means a new low-cost range of models . . . readily available, easy to mount for almost every application.

...in the \$2 range!

CLARE-PENDAR™
Phone 208-773-4541

INFORMATION RETRIEVAL NUMBER 148

a better way.

JOT DRAFT™

RUB... IT'S TRANSFERRED

PERFECT REGISTRATION because you position patterns first, then rub them down.

CORRECTIONS ARE EASY because you can lift patterns with a knife and reuse them.

TOUGHER THAN STICK-ONS because the ink is underneath a hard plastic over-coat.

Try the JotDraft Sampler and convince yourself. It's an assortment of 746 patterns and pads (2X scale) for \$4.50. Or write for a free sample and catalog. You'll be glad you did!

The **DATAK Corporation**

85 Highland Avenue • Passaic, New Jersey 07055

INFORMATION RETRIEVAL NUMBER 149

THE INTERCHANGEABLE 1.

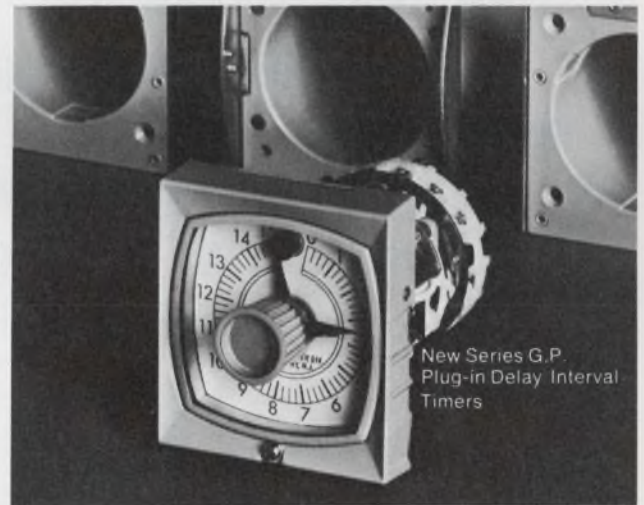

Completely interchangeable with over 80% of the most widely used Plug-in Delay/Interval Timers

Who ever heard of a line of plug-in delay/interval Timers that is reliable, economical and interchangeable for as little as \$27.90? You just did.

Delivery is stock to 6 weeks,

depending upon quantity. Consult us for further information and the G.P. Bulletin 310. Call 201-887-2200.

INDUSTRIAL TIMER
A UNIT OF ESTERLINE CORPORATION

Industrial Timer Corporation, U.S. Highway 287, Parsippany, N.J. 07054

INFORMATION RETRIEVAL NUMBER 150

Our one-two punch knocks heat problems cold. It delivers up to 125 cfm against the toughest opposition. We call it, "The Tandem Boxer."

Synergistic. Push-pull operation of the Tandem's impellers moves volumes of air through systems where high density component packaging would otherwise impede air flow. Nearly twice the output of two equivalent fans working independently.

Parallel redundancy. Wiring and fusing the fan motors in parallel adds an extra measure of protection.

Interchangeable with all standard Boxers (or the other contenders). Only depth dimension is increased.

Eliminates the problem of premature air-mover specification.

Other airmovers? Of course!

Send for our full-line catalog No. ND4r. It's free, and contains performance data, electrical and mechanical specifications on more than 100 units.

And valuable application information too.



For immediate service, contact us at **IMC Magnetics Corp., New Hampshire Division**, Route 16B, Rochester, N.H. 03867, tel. 603-332-5300. Or the IMC stocking distributor in your area. There are more than 50 nationwide and overseas.



INFORMATION RETRIEVAL NUMBER 151

The Answer Fan. Low-profile installation? It's a mere 3⁵/₈" sq., 1¹/₂" deep. High output vs back pressure? It packs a 46 cfm cooling wallop. We call it, "The Mini Boxer."

MiniBoxer fights the damaging effects of heat in rack panels, tape decks, main frames and similar space-critical applications.

10 high performance models, ball or new Grand Prix sleeve bearing types, provide 10 or more years normal operating life. Also available in rugged Mil Spec versions.

Other airmovers? Of course!

Send for our full-line catalog No. ND4r. It's free, and contains performance data, electrical and mechanical specifications on more than 100 units.

And valuable application information too.



For immediate service, contact us at **IMC Magnetics Corp., New Hampshire Division**, Route 16B, Rochester, N.H. 03867, tel. 603-332-5300. Or the IMC stocking distributor in your area. There are more than 50 nationwide and overseas.

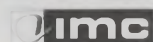

INFORMATION RETRIEVAL NUMBER 152

SJCC PRODUCTS

Asynchronous terminal prints line or character



Computer Transceiver Systems, Inc., 317 Route 17, Paramus, N.J. (201) 261-6800. Keyboard send-receive: \$4500; 90 days.

An asynchronous serial impact printing terminal with a speed of 120 characters per second, is compatible with low and medium-speed teletypewriters. Designated the Execuport 1200, it can print one character at a time at speeds of 10 through 120 cps, or a full 132-column line from a buffer. The basic character set is ASCII, but is also available in EBCDIC, or both as an option.

Booth No. 301 Circle No. 273

Magnetic-tape cartridge is self threading



3M Company, St. Paul, Minn. (612) 733-9134. \$5 (10-up); stock.

By eliminating manual threading, the C142 cartridge speeds loading operations and protects tape from damage. It wraps around a tape reel and snap-locks in place. The cartridge can remain permanently in place and serves as a dust-protective collar. C142 cartridges are fully compatible with all IBM 2420 and 3420 automatic-threading tape drives.

Booth No. 2111 Circle No. 274



FREE YOKE SELECTION KIT

Information you need to know about selecting and specifying a precision yoke for your CRT display. Indicates the interaction between circuitry, CRT and yoke. Includes an application checklist to simplify your work. Send for your kit.

SYNTRONIC INSTRUMENTS, INC.
100 Industrial Road Addison, Ill. 60101 (312) 543-6444

syntronics



INFORMATION RETRIEVAL NUMBER 153

If you need a relay of special design; not listed in any catalog and you need it in a hurry — then contact LINE ELECTRIC right now, because that's our specialty.

It has been for 22 yrs.

201/887/8200



LINE ELECTRIC

A UNIT OF ESTERLINE CORPORATION

Line Electric Company, U.S. Highway 287, Parsippany, N.J. 07054

INFORMATION RETRIEVAL NUMBER 154

Maximize your mini.

Heath/Schlumberger's new Computer Interface brings the inside of your PDP-8 outside to the real world



The new EU-801E Mini-Computer Interface allows owners of any PDP-8 family computer (with positive I/O bus) to take full advantage of their mini's capabilities...by allowing direct input of measurement data and output of processed data and control information. The 801E is ideal for interfacing a variety of digital instruments...designing complex dedicated interfaces...or just learning about interfacing. All connection points necessary for a functioning interface are readily available outside the computer: all signals required for any given data transfer operation are legibly and logically presented on the top of a plug-in card in the 801E ADD unit. Connection points on the card top include 12-bit digital inputs and outputs (Accumulator In, Accumulator Out and Buffered Memory Bus), three control lines, five timing lines and two status lines. And because the 801E is a patch system using positive-contact connectors and ordinary hook-up wire, there is no soldering. Simple data transfer circuits can be patched and tested in a few minutes. Signal modification and device control circuits can be quickly developed and refined. For detailed information on the new Heath/Schlumberger EU-801E Mini-Computer Interface, send coupon below for free brochure...and learn how you can turn your PDP-8 into a maxi-mini.

EU-801E System, 42 lbs.\$1250.00*

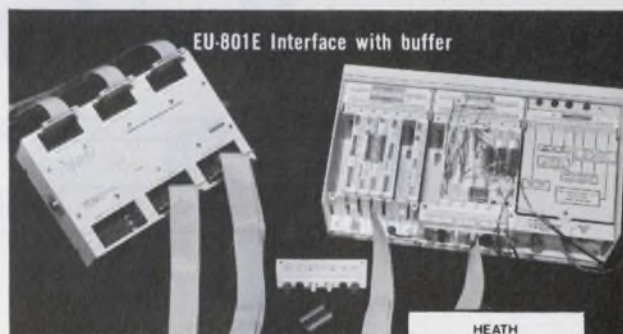

Heath/Schlumberger Scientific Instruments
Department 511-264
Benton Harbor, Michigan 49022

HEATH
Schlumberger

- I'm convinced and I need a maxi-mini now. Enclosed is \$ _____ plus shipping for _____ EU-801E(s).
- I'm interested but not convinced. Please send EU-801E brochure.
- Please send 1972 Instrumentation Catalog.

Name _____

Title _____

Company/Institution _____

Address _____

City _____ State _____ Zip _____

*Mail Order price; F.O.B. Benton Harbor, Michigan EK-329

INFORMATION RETRIEVAL NUMBER 155

RO printers use pressure-sensitive paper



Extel Corp., 5255 N. Michigan Ave., Rosemont, Ill. (312) 678-0430. \$1300; stock.

The Series AC and AD receive-only printers are fully compatible with ASCII and Baudot teleprinter codes at speeds to 15 cps. The AC uses a 50 character/line format on 6-in. paper, the AD, 74 characters/line on 8-1/2-in. paper. Printing is by means of a 5 x 7 dot matrix acting directly on pressure-sensitive paper. Three copies can be printed.

Booth No. 1705 Circle No. 275

Magnetic tape head uses Hall effect



Pioneer Electronics Corp., c/o IMAI Marketing Associates, Inc., 525 W. Remington Dr., Sunnyvale, Calif. (408) 245-3511. \$40 (100-up); June.

The CRH-7201 is a two-channel tape head for reading digital data. It meets ABA and IATA standards and is constructed of ferrite and crystalized glass, both known for their good wear qualities. The device can respond to 100 in./s of recorded data.

Booth No. 320 Circle No. 276

Modem maintains synch on frequency offset lines



Sangamo Electric Co., P.O. Box 3347, Springfield, Ill. (217) 544-6411. \$3750; stock.

A family of 4000-b/s, data sets offers built-in equalizers for a range of phone lines from C2-conditioned private lines to most unconditioned facilities, in three models, T4800 A, B or C. A pseudo-random scrambler desensitizes the modems to data patterns and presents a constant average power output. The modulation method is an eight-level system using four phases and two amplitudes.

Booth No. 2322 Circle No. 277

Pertec introduces the new Data Communication Building Blocks.

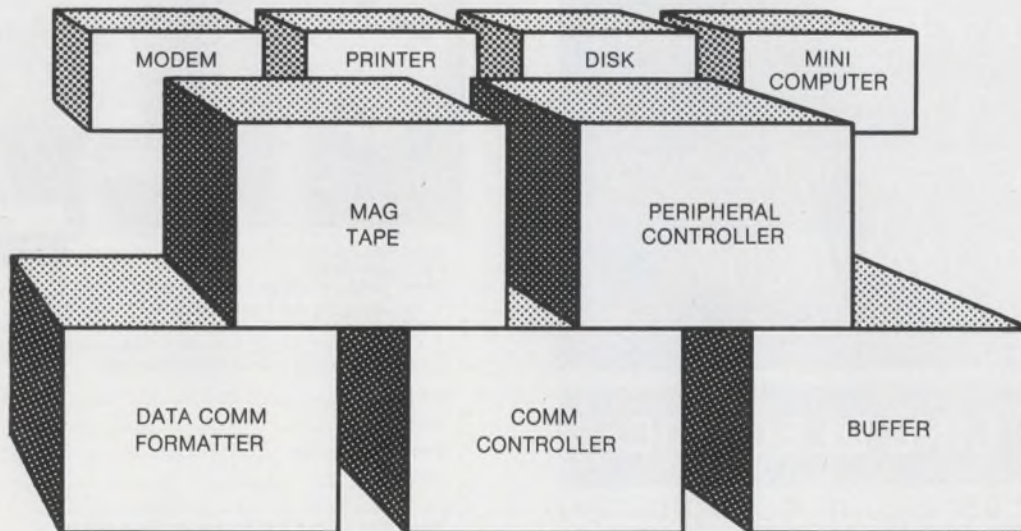

SALES OFFICE: Los Angeles (213) 882-0030 • Orange County (714) 830-9323 • San Francisco (415) 964-9966 • Chicago (312) 696-2460 • Philadelphia (215) 849-4545

FFT system uses flexible hard/software mix



Unicomp, Inc., 19749 Bahama St., Northridge, Calif. (213) 882-6313. \$25,000 and up; 6 months.

Under control of a central processor, this fast-Fourier-transform (FFT) processor performs the Fourier transform or its inverse on data stored in the central-processor memory. The user may start with a minimal hardware system with most computations performed by software. Hardware can be added when need arises for greater speed. Hardware for sine/cosine and other needed tables and functions is available. This saves computation time.

Booth No. 214

Circle No. 278

Data collection system writes directly on tape



Bell & Howell, Electronics & Instruments Group, 360 Sierra Madre Villa, Pasadena, Calif. (213) 796-9381. \$9300 and up; 30 days.

The Mark-Tape, a data collection system, reads pencil marked, key-punched, or preprinted data (or combinations) from tab cards or page-sized documents. Data are optically read, translated and written directly on either a seven or nine-track computer tape. ASCII, EBCDIC and other output codes are available. The system scans and writes at 70 to 140 characters/s. Many variations and options are offered.

Booth No. 1803

Circle No. 279

Moving-coil servo positions pickup head

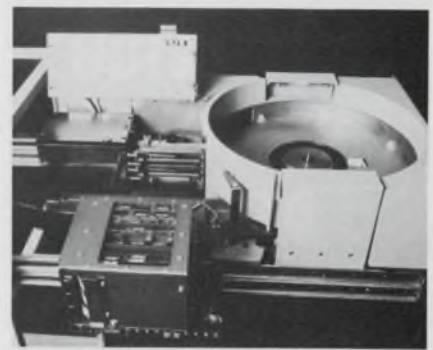

Diablo Systems, Inc., 2000 Commonwealth Ave., Newton, Mass. (617) 332-4694. \$5200; 60 days.

For small computer systems, the Series 40 cartridge disc drive provides mass-storage capability to 48-million bits. The recording bit density is 2200 b/in. at 100 tracks/in. The equipment has a bit transfer rate of 2500 kHz. Head positioning is done by a moving-coil linear motor and noncontacting transducer servo system. The average access time is 38 milliseconds.

Booth No. 1101

Circle No. 280

A modular approach to low cost IBM compatible data communication capability for your system.

Now you can add low cost data communications capabilities to your remote terminal, point-of-sale, or data collection system.

With Pertec's powerful building blocks, a whole spectrum of IBM compatible Binary Synchronous Communication (BSC) facilities can be constructed to suit your requirements. Working into a standard modem interface, the units can simulate either the 2770 or 2780 interface and handle ANSI, EBCDIC, or EBCDIC transparency codes and are available for multi-point or point-to-point operation.

Coupled with any one of Pertec's Buffered Tape Transports the resulting stand-alone Tapecomm™ system can synchronously transmit data recorded on IBM compatible magnetic tape to any telecommunication system equipped for BSC or a similar Pertec installation. In this configuration the system can perform extended tape error recovery functions, horizontal and vertical data compression, multi record blocking, ANSI/EBCDIC translation, and 9 track to 7 track code conversion. It also has a cute audio alarm, adjustable of course.

The new BSC communications system is backed by a complete factory-trained customer service and support organization in 30 U.S. cities and 20 foreign countries.

If you want to economically add data communications capabilities we can help you. Write or call today. Pertec Corporation, Peripheral Equipment division, 9600 Irondale Avenue, Chatsworth, Calif. 91311. (213) 882-0030.

PERTEC
PERIPHERAL EQUIPMENT

Boston (617) 890-6230 • Washington, D.C. (703) 573-7887 • New York (203) 966-3453 • Detroit (313) 769-4376 • London Reading 582115

INFORMATION RETRIEVAL NUMBER 156

PUT A LITTLE LIGHT IN YOUR DESIGN



subminiature
long life/low cost

PANEL INDICATOR LIGHTS:

- LED's (3/16" & 1/4" mtg. dia.)
- Self-Driven
Incandescents
(built-in drivers & keep alive bias)
- Standard Neons
& Incandescents
- Customs too!

Ruggedly built with shock proof and fully insulated bodies. ■ Attractively designed and available in several lens and collar colors. ■ Low profile and standard mounting models. ■ Life ratings to 30 years. ■ Front panel replaceability with optional panel mount sockets. ■ Low cost and ready availability.

Call or write for more information today!

the little light people

DATA DISPLAY PRODUCTS

8036 Westlawn Ave., Los Angeles, Ca 90045
(213) 641 1232

SJCC PRODUCTS

Batch terminal offers wide in-out flexibility



Badger Meter Inc., Electronics Div., 150 E. Standard Ave., Richmond, Calif. (414) 355-0400. \$42,500; 30 days.

The DTS-100 programmable remote batch data terminal acts as a communications link to larger computers at remote locations. Features include a card reader (to 600 cards/min), a printer (to 1000 lines per minute) and other input and output devices. In the communications mode it meets EIA-RS-232 interface standards at 2000 to 9600 bauds in standard increments. Modular configuration provides for a large variety of peripheral devices and options.

Booth No. 1719 Circle No. 300

Tape drive minimizes mechanical parts



Computer Operations, Inc., 10774 Tucker St., Beltsville, Md. (301) 345-5377. \$3950 single drive; 30-60 days.

A single or dual Line tape transport, Model CO-500, offers bidirectional, high-speed operation with direct access to any block. It can load a 16-bit, 4096 word computer memory in under one second. Other features include: write protect; permanent-prerecorded block addresses; and 63-ms block-traverse time (256 word blocks). The system has no capstans, pinch rollers or mechanical brakes.

Booth No. 1704 Circle No. 301

Medium-speed printer mates to minis & modem



Vogue Instrument Corp., Shepard Div., 131 St. at Jamaica Ave., Richmond Hill, N.Y. (212) 641-8800. \$9800; 30 to 60 days.

An impact printer featuring a carriage width of 132 characters and a print speed of 600 lines per minute, the 400C is matched to the latest minicomputers and telecommunications applications. Complete interfacing, including on-site equipment installation, is provided for the following equipment: PDP-18, 11, 15, HP-2100 Series, Nova, Varian 620, Honeywell 316 and 516, as well as the 201 and 202 modems.

Booth No. 1620 Circle No. 302

Multi-point modem has automatic equalizing



Codex, Inc., 15 Riverside Ave., Newton, Mass. (617) 969-0600. \$5755 and up; 30 days.

For use in multi-point, polled networks, the 4800-b/s Codex 4800 provides automatic equalization for each point in the network. Throughput is maximized by eliminating operator adjustments. The modem includes comprehensive systems diagnostics along with hands-off operation.

Booth No. 516 Circle No. 303



designing
Point-of-Sale?

consider DigiWand!™

Nortronics' new DigiWand is a pencil-sized, azimuth-independent magnetic reader pen designed to accurately read ABA and IATA encoding formats for Point-of-Sale (credit card) systems. Its circular gap configuration sharply reduces error rates by permitting the operator to tilt the pen 20° in any direction. Just another example of Nortronics innovation translated into product reality. Write today for detailed information.



'world's leader in magnetic heads'

NORTRONICS
COMPANY, INC.

8101 Tenth Avenue North
Minneapolis, Minnesota 55427 • (612) 545-0401

INFORMATION RETRIEVAL NUMBER 158

FOR TOP
PERFORMANCE
choose

**THE
QUIET
DEPENDABLE
ONE**



DEL MODEL 12 DRD .25-1 CATHODE RAY TUBE POWER SUPPLY

The silent partner in peak performance, with no audible noise...dependable performance built into every feature: automatic shutdown and recovery on overload...low energy storage...input reverse voltage protected...input transient protection to 60V...short circuit proof. Result: optimum image resolution at low cost for computer display applications—plus optimum dependability that has made Del the standard by which quality and performance are judged.

Operates from 24 to 32 Volts DC • Three outputs: 12 KV at 250 microamperes with line regulation of .1% and load regulation of .05% from .5 to F.L., .1% RMS ripple. Auxiliary output voltages of 500 Volts and -190 Volts at 1 MA regulated to .25% for line and load.

Other output voltages and MIL versions available

SEND FOR OUR COMPLETE CATALOG OF
HIGH VOLTAGE EQUIPMENT AND CAPACITORS

DEL ELECTRONICS CORPORATION

250 E. Sandford Blvd., Mt. Vernon, N.Y. 10550



INFORMATION RETRIEVAL NUMBER 159

ELECTRONIC DESIGN 10, May 11, 1972

vero

MODULE RACK
part of a complete
packaging capability

provide electronic
engineers with
money-saving
variations

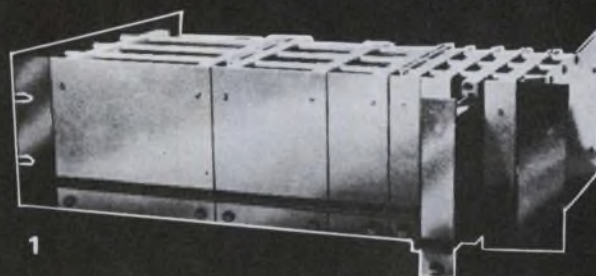

1

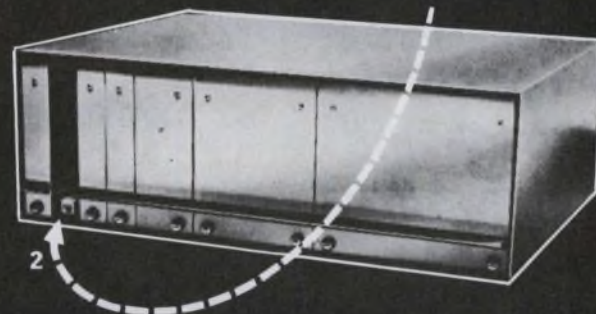

2

1. Vero Modular Rack Units 19" Mounting

Permitting 1,000's of variations using basic standard components. Module widths available are 1", 2", 4", 6", 8" and 16" in panel heights of 5¼", 7" and 8¾" with module depths of 7¼" and 10¼".

2. Vero 'C' Series Cases

Designed with an integral guide system to accept standard Vero Modules, case widths are 4", 6", 8" and 16", the latter housing the same module combinations as the 19" framework. Standard guide configuration suits one module or modules on 1" centres. Heights 5¼", 7" and 8¾"

These are only a small part of Vero's systemised products which are all compatible to each other. Send now for full details of our complete packaging systems.



VERO ELECTRONICS INC.

171 BRIDGE ROAD
HAUPPAUGE, N.Y. 11787
TEL: 516 234-0400
TWX: 510 227-8890

INQUIRE ABOUT OUR
NEW DESIGN SERVICE

INFORMATION RETRIEVAL NUMBER 160

C63

Murata Ceramic Ladder Filters are Sharp...

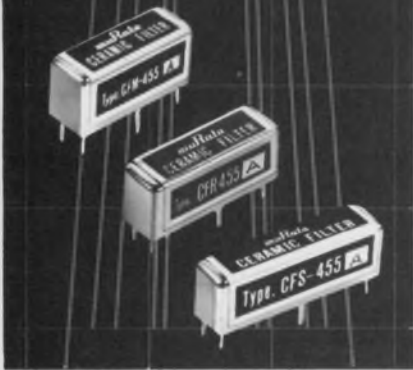

*in response,
in price and
in reliability.*

Murata's complete line of 455 KHz ceramic piezoelectric filters are designed to provide exceptional performance and reliability in communications receiver applications. Models offering bandwidths from 50 dB at ± 30 KHz to 70 dB at ± 4.5 KHz and with up to 15 ladder connected lead zirconate — titanate ceramic elements, provide an unexcelled selection to meet every application requirement.

These units are particularly suited for use in transistorized communications equipment where their unusually small size and light weight, combined with low impedance and high selectivity, may be used to best advantage.

To find out how these filters can perform for you, write for our new technical data.

muRata

MURATA CORPORATION OF AMERICA

2 Westchester Plaza, Elmsford, New York 10523

Telex: Murata EMFD 137332

Phone: 914-592-9180

Subsidiary of Murata

Manufacturing Co., Ltd., Japan

INFORMATION RETRIEVAL NUMBER 161

C64

SJCC PRODUCTS

Tape reeler features switchless take-up



Lilton ABS OEM Products Div.,
600 Washington Ave., Carlstadt,
N.J. (201) 935-2200. \$150; 60
days.

Compatible with ANSI standard tape reels the OEM 92A uses a triac motor control which operates during slack-tape or no-tape conditions but automatically senses a tight tape without switches and stops. Low rfi is featured.

Booth No. 1617 Circle No. 304

Static card reader uses optical hole sensing

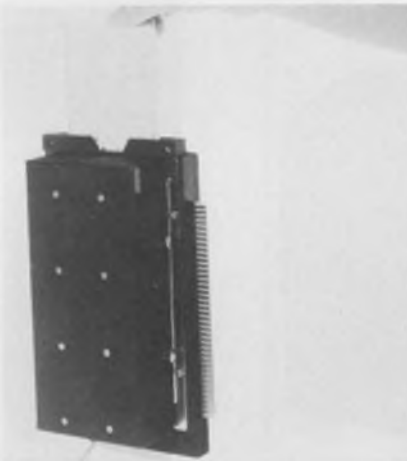

Panasonic, Pan Am Bldg., 200 Park
Ave., New York, N.Y. (212) 973-
5710. \$1500; 5 weeks.

Standard 80-column cards are read in a static condition by the Model ZU960HC-3IL reader. It is composed of a light-sensor matrix (12 x 80), a card slot and light sources. Cards are inserted manually, one at a time. The reader output is compatible with TTL logic, uses incandescent bulbs at 5 V dc and consumes 12 W.

Booth No. 2316 Circle No. 305

Sound dampeners quiet noisy EDP equipment



Van San Corp., 32 S. San Gabriel
Blvd., Pasadena, Calif. (213) 681-
8444. \$169.50 and up; stock.

Softening the noise generated from IBM Selectric and MTST typewriters is the job of these acoustically dampened cabinets. These Soundoff dampeners offer hinged plexiglass lids for visibility and access. Models are available for a variety of equipment.

Booth No. 111 Circle No. 306

Voltage regulators keep computers on line



Sola Electric, 1717 Busse Rd., Elk
Grove Village, Ill. (312) 439-2800.
Standard units: \$2657 to \$19,800;
stock.

Protection against computer-room, power-line variations is provided by the Solatron LVR series voltage regulators. Transient response is complete within 4-1/2 cycles. With a combined line and load regulation of $\pm 1/2\%$ and a $\pm 7\%$ adjustable output, the regulators have capacities from 10 to 225 kVA.

Booth No. 203 Circle No. 307



VACUUM FLUORESCENT TUBES

FLEXIBLE, ECONOMICAL, DEPENDABLE

FREE SAMPLES!

Supply limited — first come, first served. Check the box next to the GE Vacuum Fluorescent Tube that meets your requirements. Typical applications: calculators, clocks, instruments, scales, timers, cash registers, control, etc. Fill out the coupon and send it to: General Electric Imaging & Display Devices, 316 E. 9th Street, Owensboro, Kentucky 42301.

NAME _____

COMPANY _____ STREET _____

CITY _____ STATE _____ ZIP _____

APPLICATION _____

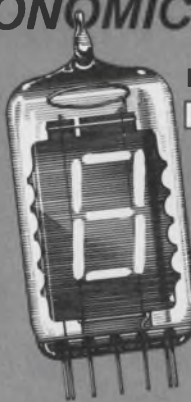

IN T6½ ENVELOPE

- Y1938 — displays A,C,E,F,G,H,I,J,L,O,P,S,U and 0 through 9
- *Y1939 — same as Y1938 but with decimal point
- *Y4102 — displays number 1 with ± and decimal point

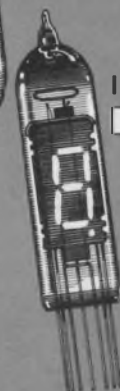

IN T3 ENVELOPE

- Y4075 — same characteristics as Y1939
- *Y4105 — same characteristics as Y4102

*Samples not offered on this form. For literature on these, and the other types listed, use the reader service card.

GENERAL ELECTRIC

363-03

THIS SYMBOL REAFFIRMS OUR NO. 1 GOAL IN 1972: TO MAKE GENERAL ELECTRIC YOUR BEST BUY IN QUALITY, SERVICE, AND TOTAL VALUE



send this coupon today

INFORMATION RETRIEVAL NUMBER 162

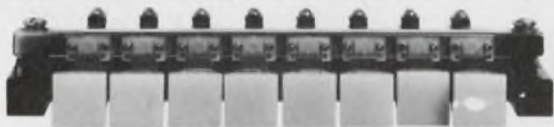

DESIGNERS and ENGINEERS

BEFORE YOU START,

CONSIDER MANUAL PUSH BUTTON SWITCHES CAPABLE OF REMOTE CONTROL

CHANCES ARE A CAPITOL MECHANICALLY OPERATED SWITCH IS

BETTER *provides many more contacts and circuits in less total space

CHEAPER *frequently eliminates auxiliary equipment — transformers, relays, their installation and space

MORE RELIABLE*

Simple, quality construction. Fewer components insures greater reliability

ILLUMINATED SWITCHES CAN ELIMINATE PILOT LIGHTS

Mechanical actions: interlocking, no-two operate, accumulative lock-up, push to lock push to release, momentary. Combinations of all these are available on the same strip. Plus, many combinations of contact assemblies.

* Proven by Vending machine, communication, Computer, Recording and many other industries

CAPITOL

WRITE FOR CATALOG
THE CAPITOL MACHINE AND SWITCH CO.
87 Newtown Road, Danbury, Conn. 06810

Representatives in principal cities Tel: 203-744-3300 TWX:710-456-0365

INFORMATION RETRIEVAL NUMBER 163

Expand your audio transformer choice



Get the new Expander — TRW/UTC's big 48-page designer's guide listing all UTC audio transformers by impedance. The guide also contains a full audio catalog, to reduce your matching and finding task to a simple look-up. The book is indispensable!

Best of all, TRW/UTC offers real application assistance and real local inventories to meet your transformer needs in a hurry, through your distributor.

Send for the guide today. TRW/UTC Transformers, an Operation of TRW Electronic Components, 150 Varick Street, New York, N. Y. 10013. Tel: (212) 255-3500.

TRW

UTC TRANSFORMERS

INFORMATION RETRIEVAL NUMBER 164

If you spec'd an I/O printer that would turn your 'mini' into a 'maxi' accounting system...
it would look like this

Removable Print Wheel
48 or 96 character.
BCD or ASCII

Wide Carriage
Direct Tabbing in two directions (192 print positions) enables operator to simultaneously make entries on invoices, purchase journal and sales journal. A tremendous time-saver.

Front Form Feed
For easy insertion of ledger cards, invoices, passbooks, journal rolls and continuous forms.

Separate Numeric Keyboard
Faster entries with less chance of error and ease of operation.

Speed
Twice as fast as an IBM Selectric I/O writer. Three times faster (30 cps) than TTY or any other low-cost printer on the market.

Split Platen
Independent feed for simultaneously performing a multiplicity of accounting functions.

Electric Line Finder (Optional)

Reliability
Few moving parts. Proven record. Ruggedized.

so, why bother?

We also have a full line of readers and punches

SJCC, BOOTH 167
For more information
call Frank Misiewicz
OEM Products
(201) 935-2200



LITTON ABS

Automated Business Systems
600 Washington Avenue, Carlstadt, N. J. 07072

INFORMATION RETRIEVAL NUMBER 165

1/16" Wire Wrap Panels Save Space!

New Funnel-Entry™ Wire-Wrap[®] Terminals

E.M.C.'s brand new Funnel-Entry™ design (pat. appl. for) simplifies manual or automatic insertion of I.C. leads. Terminals available in 2 or 3 levels of wrap, for 100-grid centers, separately or with E.M.C. panels (below).
Low-Profile for minimum space requirements.
Nurl-Loc[®] Terminals prevent twisting during wrapping.
Four-finger contact assures positive electrical connection.

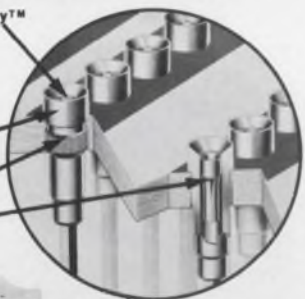

Save space, and plug into present PC connectors of any make! Brand new high-density packaging panels from EMC utilize 1/16" non-warping glass epoxy boards, and low profile Nurl-Loc terminals. Typical board shown is 60-position mix pattern, for 40 14-Pin (voltage and ground committed) and 20 16-Pin (uncommitted) dual-in-line I.C.'s. Standard test jacks are accessible from front. Eight decoupling networks are positioned for a cleaner voltage.

Write or Phone for Computer Products Catalog No. 71

ELECTRONIC MOLDING CORPORATION
96 Mill Street, Woonsocket, R. I. 02895
(401) 769-3800 • TWX 710-387-1350



Wire-Wrap[®] Gardner-Wharfedale Co.

*Pat. No. D-223,109

WIRE-WRAP[®] I.C. PACKAGING PANELS • TRANSISTOR AND IC SOCKETS • TEST JACKS • TERMINALS • LAMP SOCKETS • BINDING POSTS

INFORMATION RETRIEVAL NUMBER 166

advertiser's index

Advertiser	Page
AMP, Incorporated	C25
Amperex Electronic Corporation	C2
Bourns, Inc.	C33
Capitol Machine & Switch Co.....	C65
Centralab Electronics Division, Globe-Union, Inc.	C43
Cherry Electrical Products Corp.....	C41
Clare & Co., C. P.....	C13
Clare-Pendar	C57
Computer Design Corporation.....	C26, C27
Data Display Products.....	C62
Datak Corporation, The.....	C57
Deflecto Mfg. Co.	C42
Del Electronics Corporation.....	C63
Delevan, Division of American Precision Industries, Inc.	C54
Dialight Corporation	C45
Digital Equipment Corporation.....	C35
ERA Transpac Corporation.....	C48
Eastman Kodak Company.....	C51
Electro-Space Fabricators, Inc.....	C50
Electronic Molding Corporation.....	C66
Electronetic Systems	C52
Erie Technological Products, Inc.....	C11
General Electric Company, Tube Dept.	C65
General Electric Company, Semiconductor Products Department	C9
Harris Semiconductor, A Division of Harris Intertype Corporation....	C49
Heath/Schlumberger, Scientific Instruments	C59
IMC Magnetics Corporation.....	C58
Indiana General, A Division of Electronic Memories & Magnetics Corporation	C53
Industrial Timer Corporation.....	C57
Licon, Division Illinois Tool Works, Inc.	C7
Line Electric Company.....	C59
Litton Automated Business Systems.....	C66
3M Company	C68
MicroSwitch, A Division of Honeywell	C38
Motorola Component Products Dept.	C47
Murata Corporation of America.....	C64
Norden Division of United Aircraft Corporation	C46
Nortronics Company, Inc.....	C63
Peripheral Equipment Corporation	C60, C61
RCA Solid State Division.....	C36, C37
Remex a Unit of Ex-Cello Corporation	C67
RtroN Corporation	C56
Solid State Systems, Inc.....	C55
Syntronic Instruments, Inc.....	C59
TRW/UTC Transformers, An Operation of TRW Electronic Components	C65
Teletype Corporation	C14, C15
Vero Electronics, Inc.....	C63

Before you start building your next minicomputer, phototypesetter, automatic test equipment, numerical control or other system, why don't you get in touch with us.

You see, it won't cost you a penny to talk to us about how we can help you make your equipment better.

How do we do it? That's easy. By showing you why it's smart to have some of our peripheral equipment designed into whatever you're putting together.

Our staff will show you how it's possible to save time, money and effort by designing one of our digital magnetic tape cassette systems, compact perforator/reader combinations, tape readers or reader/spooler combinations into your product.

You'll be back again and again to pick our brains and buy our products. That'll be good for business, yours and ours.

We've built our reputation as a peripheral innovator over the past

decade this way. Our price/performance has helped, too.

Use your head by using ours. Remex, 1733 Alton St., Santa Ana, California 92705. In Europe and the U.K., contact S.p.A., Microtecnica, Torino, Italy.

Give us a call (714) 557-6860. If a genius answers, hang on.

REMEX



Pick our brains.



A UNIT OF



EX-CELL-O CORPORATION

INFORMATION RETRIEVAL NUMBER 167

For built-in reliability, design with "Scotchflex" Flat Cable/Connector Systems.



"SCOTCHFLEX" IS A REGISTERED TRADEMARK OF 3M CO.

"Scotchflex" Flat Cable and Connectors can offer you trouble-free packaging for your next generation equipment.

There's built-in reliability for your circuit inter-connects. Our flat, flexible PVC Cable has up to 50 precisely spaced conductors. The gold plated U-contacts are set into a plastic body to provide positive alignment. They strip through the insulation, capture the conductor, and provide a gas-tight pressure connection.

Assembly cost reductions are built-in, too. "Scotchflex" Connectors make up to 50 simultaneous connections without stripping or soldering. No special training or

costly assembly equipment is needed.

Off-the-shelf stock offers you flat cable in a choice of lengths and number of conductors from 14 to 50. Connector models interface with standard DIP sockets, wrap posts on .100 x .100 in. grid, or printed circuit boards. Headers are available to provide a de-pluggable inter-connection between cable jumpers and printed circuit boards (as shown). Custom assemblies are also available on request.

For full information on the "Scotchflex" systems approach to circuitry, write to Dept. EAH-1, 3M Center, St. Paul, Minn. 55101.

3M
COMPANY

Microdata gives you a new kind of minicomputer

The Twin Mini doubles throughput for just a few dollars more

Put two microprogrammable CPU's with separate control memories and I/O facilities into a Micro 1600 cabinet where they share a common core memory. That's the idea behind the Twin Mini. And it works wonders. For the first time, core memory is used so efficiently that your throughput rate is more than double that of other CPU's. Applications which normally call for much larger or more expensive computers can now be handled simply and economically by this effective combination of Micro 1600 parts.

You show us your requirements. We'll show you how to build a system with unmatched processing power per dollar. Your system may fit into a single Micro 1600 cabinet or overflow into two. Either way, the performance will match our claims or your money back. Find out how easy it is to do business with Microdata. Write for details.

MicrodataTM

Microdata Corporation
644 East Young Street
Santa Ana, Calif. 92705
(714) 540-6730

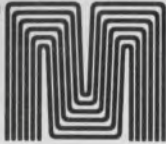

TM trademark Microdata Corporation



Optical coupling isolates ac current limiter to insulate load circuit from line power

An SCR switch provides foolproof short-circuit and overload protection for ac power supplies (Fig. 1). Optical coupling insures continued isolation of the load circuit from the ac line.

The relatively low primary current required for the protection circuit allows use of inexpensive epoxy components, for a parts cost of around \$5. The circuit's performance does not depend on load voltage, and the technique is applicable over a wide range of load currents. It works faster than fuses or ordinary circuit breakers, and is completely automatic, resetting itself when the fault is corrected.

Current-sampling resistor R_s sets the limiting point. When the voltage across R_s becomes sufficient for the lamp to glow, the resistance of the

cadmium sulphide cell in the optical coupler drops, shutting off the SCR (which is normally on) and opening the primary circuit. As the lamp extinguishes, the SCR turns on briefly. In the limiting region, the SCR triggers every few cycles, settling at a duty cycle that keeps the average secondary current from rising above a safe level (Fig. 2).

The lamp operates well below its 6-V rating to insure long life. The fuse is included only for protection against catastrophic component failure.

Maxwell G. Strange, Senior Engineer, Experiment Engineering Branch, NASA, Goddard Space Flight Center, Greenbelt, Md. 20771.

CIRCLE No. 311

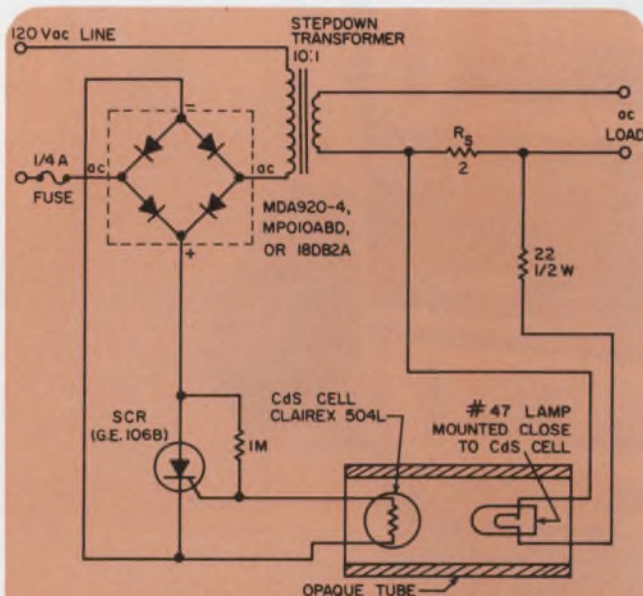

1. Excessive current drops enough voltage across R_s to light the lamp, thus reducing the resistance of the CdS cell and cutting off the SCR. This opens the primary circuit.

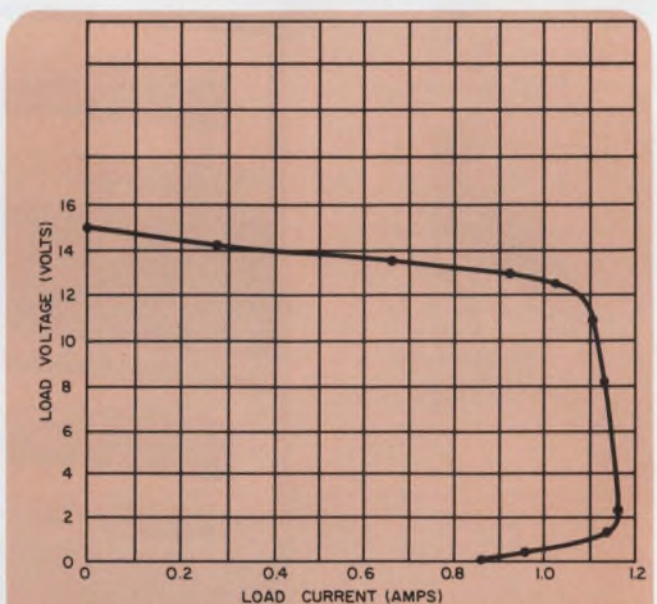

2. The duty cycle of the SCR limits average secondary current until the load fault is corrected. The current-limiting curve is for $R_s = 2 \Omega$. Foldback is caused by thermal inertia and SCR hysteresis.



Now, Helipot offers covered cermet trimmers for low-budget projects.

There's not much sense in using cheap wirewound or carbon trimmers anymore. Not when the new Helipot Series 91 Cermet Trimmers are available *off-the-shelf* for a few cents more.

These single-turn, $\frac{3}{8}$ " , covered trimmers come in 10 different mounting styles and 19 standard resistance values from 10 ohms to 2 megohms. Covered construction helps protect against moisture, corrosive atmospheres, dust, oil and other

contamination. Which means, in addition to cermet stability and better resolution, you get long-term dependable performance.

The breakthrough price is just 35¢ each in the 50,000 piece quantity, and they're equally well-priced in other quantities.

Send now for complete data on the Series 91 Trimmers . . . the finest of their class. We've made them for your projects where the budget may be tight, but you don't want to compromise performance.

Beckman®
INSTRUMENTS, INC.
HELIPOT DIVISION
Fullerton, California

HELPING SCIENCE AND INDUSTRY IMPROVE THE QUALITY OF LIFE

INTERNATIONAL SUBSIDIARIES: AMSTERDAM, CAPE TOWN, GENEVA, GLENROTHES, SCOTLAND, MEXICO CITY, MUNICH, PARIS, STOCKHOLM, TOKYO, VIENNA

INFORMATION RETRIEVAL NUMBER 40

Broadband Low Distortion RF Power Amp

- 10 watts output
- Flat response from .05 to 80 MHz



Model RF-805 is a solid-state amplifier with -30 db harmonic and intermodulation distortion. Gain is 47 db minimum, constant within 1 db for full output with less than 0.1 volt at 50 ohm input.

Tunable 10-500 MHz RF Power Amp

- Up to 8 watts into 50 ohms
- Small and lightweight
- 35 db minimum gain



Model RF-815 is tunable in six band-switched ranges from 10 to 500 MHz. All solid state except for the one tube output stage, the unit's simple mechanical design makes maintenance easy. Output metering and overload protection are provided.

Applications

Radio Communications • Laser Modulation • Accelerator Driver • NMR • RF Power Calibration • Ultrasonics • Transmitter Driver

HARRIS



RF COMMUNICATIONS, INC.

Electronic Instrumentation Operation
1680 University Avenue
Rochester, New York 14610
Telephone: 716-244-5830 TWX: 510-253-7469
A Subsidiary of Harris-Intertype Corporation

IDEAS FOR DESIGN

Circuit monitors TTL outputs for minimum output voltages

The outputs of TTL logic circuits can be monitored by a Schmitt-trigger circuit to verify that they are meeting the minimum specified output voltages—0.4 V for a logic ZERO and 2.4 V for a logic ONE. Data-bus or any other TTL-compatible outputs may be checked by this approach to guarantee reliable interfacing.

Two TTL inverters arranged with feedback via R4 form the Schmitt trigger (see diagram). The circuit switches V_{out} from a high state (about 3.4 V) to a low state (0.1 V) when V_{in} reaches 0.4 V or below. The output remains low until the input reaches 2.4 V or higher, then it switches to the high state again. The hysteresis of the Schmitt trigger insures that the circuit will not change state until these minimum voltage levels are met at the input.

The hysteresis can be changed by altering the value of R4, and the threshold by changing R3. If discrete resistor values do not give thresholds exact enough, variable resistors should be used for R3 and R4. With specified values of $R4 = 562 \Omega$ and $R3 = 422 \Omega$, the circuit has a hysteresis of 2 V and a lower threshold of 0.4 V.

Sink current to the driving device, in the zero state, may be varied by changing resistor R1.

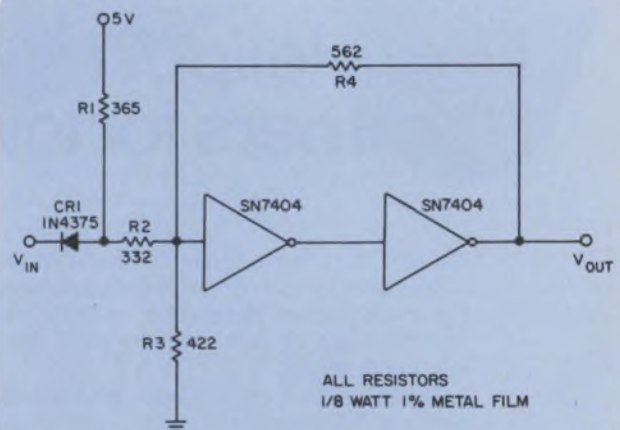

Schmitt trigger consists of two SN7404 inverters. Feedback resistor R4 varies the hysteresis, resistor R3 adjusts the lower threshold, and R4 provides sink current.

However, R1 must provide enough current to raise the input of the Schmitt trigger high enough to change state. With $R1 = 365 \Omega$ as shown, a sink current of 10 mA is provided.

John C. Bernath, Jr., Electronic Tooling Engineer, Hewlett-Packard, 1900 Garden of the Gods Rd., Colorado Springs, Colo. 80907.

CIRCLE NO. 312

Simple recursion solves ladder networks

Ladder networks are widely used because many circuits—active and passive—can be put into this convenient form (Fig. 1). And now, with a suitable FORTRAN program (Fig. 2), the analysis of these circuits is greatly simplified.

Consider the passive r-th section of the network of Fig. 1. If Z_r is the impedance of the series component, Y_r the admittance of the shunt component, G_r the section input admittance and V_r the input voltage, then

$$G_r = \frac{1}{\left(Z_r + \frac{1}{(Y_r + G_{r+1})} \right)} \quad (1)$$

$$V_r = \frac{V_{r+1}}{(1 - Z_r \times G_r)} \quad (2)$$

These two equations form the basis of the recursion used in the program. The attenuations can be determined throughout the network for each section.

Even transistors or other active components may sometimes be included in the networks. If the current gain of the transistor is h_{te} , the standing dc current through it is I mA and Z_e and Z_L are the emitter and collector load impedances, then at low frequencies the following approximation is reasonable:

$$G_r = \frac{1}{(h_{te} + 1) \times \left(Z_e + \frac{25}{I} \right)} \quad (3)$$

$$V_r = \left(1 + \frac{1}{h_{te}} \right) \left(Z_e + \frac{25}{I} \right) \left(G_{r+1} + \frac{1}{Z_L} \right) \times V_{r+1} \quad (4)$$

Two Top Choices Frequency Synthesizer



- 1 kHz to 80 MHz in 1 kHz Steps
- 1 Hz Resolution Optional
- Fully Programmable

Model RF-828 is offered with 1 kHz phase-locked steps. An optional vernier provides 1 Hz resolution. The RF-828 is fully programmable with contact closures, RTL, DTL or TTL logic.

Or Synthesized Signal Generator



- AM/FM/Pulse Modulation
- Manual and Automatic Sweep
- 160 db Output Level Range

Model RF-808 is three instruments in one: signal generator and frequency synthesizer and sweeper. Frequency range is 0.05 to 80 MHz in 1 kHz phase-locked steps with a vernier for 1 Hz resolution. Frequency, modulation and attenuation are programmable.

Applications

Automated Test Systems • General Lab Use • Computer-Controlled Signal Sources • Semi-Automatic Test Systems • Receiver and Transmitter Systems • Nuclear Magnetic Resonance • Crystal Calibration and Resonance

HARRIS



RF COMMUNICATIONS, INC.

Electronic Instrumentation Sales
1680 University Avenue
Rochester, New York 14610
Telephone: 716-244-5830; TWX: 510-253-7469
A subsidiary of Harris-Interbyte Corporation

INFORMATION RETRIEVAL NUMBER 42

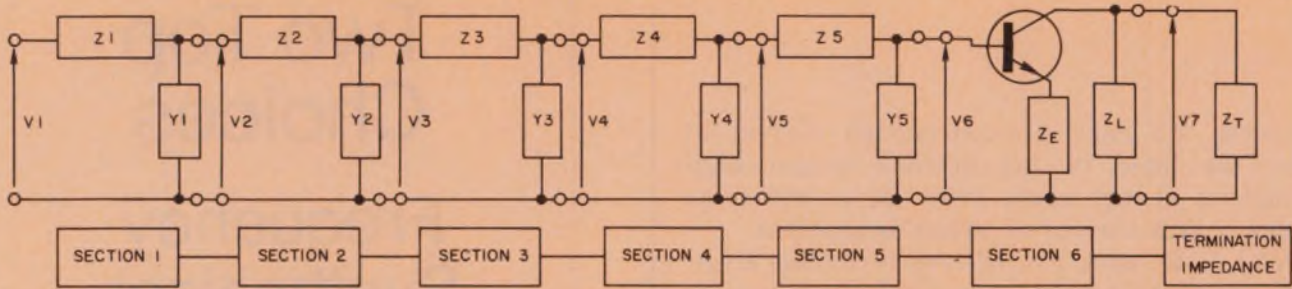

1. Suitable active sections can be introduced anywhere in the basic ladder network.

In the recursion, (3), (4) then replace (1), (2) for this section.

To illustrate how equations 1, 2, 3, and 4 can be used, the attenuation response of the circuit is found with the computer program. All of the series impedances are resistive, all of the shunt admittances are capacitive, and a single transistor stage forms the sixth section. Its emitter resistor R_E is bypassed by a capacitor C_E in series with the resistor R_G . Its collector load resistor is R_L . The termination resistor is R_T .

The program was originally written to run on IBM's Call-360 time-sharing service, but it can be simply adapted to run on other computer services.

M.H.E. Ward, Section Leader, Mobile Radio Laboratory, Pye Telecommunications Ltd., Newmarket Rd., Cambridge, England.

CIRCLE NO. 313

VOTE! Go through all Idea-for-Design entries, select the best, and circle the appropriate number on the Reader-Service-Card.

SEND US YOUR IDEAS FOR DESIGN. You may win a grand total of \$1050 (cash)! Here's how. Submit your IFD describing a new or important circuit or design technique, the clever use of a new component or test equipment, packaging tips, cost-saving ideas to our Ideas-for-Design editor. You will receive \$20 for each accepted idea, \$30 more if it is voted best-of-issue by our readers. The best-of-issue winners become eligible for the Idea Of the Year award of \$1000.

IFD Winner of January 6, 1972

Glen Coers, Electronic Devices Div., Texas Instruments Inc., P. O. Box 5012, Mail Station 84, Dallas, Tex. His idea "Discharge Capacitors with a MOSFET" has been voted the Most Valuable of Issue award.

Vote for the Best Idea in this Issue

```

100 "PROGRAM TO ILLUSTRATE SOLUTION OF LADDER NETWORKS BY RECURSION"
110 COMPLEX V,ZE,G(7),V(7),Z(5),Y(5)
120 DIMENSION R(5),C(5)
130 PI=3.14159265
140 WRITE(6,10)
150 10 FORMAT(1H0,T15,'FILTER RESPONSE'//)
160 "ENTER CIRCUIT:*****"
170 WRITE(6,20)
180 20 FORMAT(' INPUT:R1,R2,R3,R4,R5 OHMS')
190 READ(5,*)R(I),I=1,5)
200 WRITE(6,30)
210 30 FORMAT(' INPUT:C1,C2,C3,C4,C5 FARADS')
220 READ(5,*)C(I),I=1,5)
230 WRITE(6,40)
240 40 FORMAT(' INPUT:HFE,DC CURRENT(MA),RE,RL,RT,RG(OHM),CE(FARAD)')
250 READ(5,*)HFE,DCI,RE,RL,RT,RG,CE
260 G(7)=1.0/RT
270 V(7)=1.0
280 "ENTER FREQUENCY SWEEP:*****"
290 WRITE(6,50)
300 50 FORMAT(' INPUT:FMIN,FMAX,NSTEP (HZ)')
310 READ(5,*)FMIN,FMAX,NSTEP
320 WRITE(6,60)
330 60 FORMAT(1H0,'FREQ.(HZ)',7X,'ATTEN.(DB)')
340 J=NSTEP+1
350 DO 3000 I=1,J
360 FREQ=FMIN+(I-1)*(FMAX-FMIN)/NSTEP
370 W=CMPLX(0.0,2.0*PI*FREQ)
380 "CALCULATE TRANSISTOR SECTION:*****"
390 ZE=1.0/(1.0/RE+1.0/(RG+1.0/(W*CE)))
400 G(b)=1.0/((HFE+1.0)*(ZE+25.0/DCI))
410 V(b)=(1.0+1.0/HFE)*(ZE+25.0/DCI)*G(7)+1.0/RL)*V(7)
420 "SET UP IMPEDANCES AND ADMITTANCES:*****"
430 DO 4000 M=1,5
440 Z(M)=R(M)
450 4000 Y(M)=W*C(M)
460 "RECURSION:*****"
470 DO 5000 M=1,5
480 K=b-M
490 G(K)=1.0/(Z(K)+1.0/(Y(K)+G(K+1)))
500 V(K)=V(K+1)/(1.0-Z(K)*G(K))
510 5000 CONTINUE
520 "OUTPUT RESPONSE:*****"
530 ATTEN=20.0*ALOG10(CABS(V(1)))
540 WRITE(6,70)FREQ,ATTEN
550 70 FORMAT(F10.1,5X,F10.2)
560 3000 CONTINUE
570 STOP
580 END

```

FILTER RESPONSE

```

INPUT:R1,R2,R3,R4,R5 OHMS
?1E3,680,680,680,1E3

INPUT:C1,C2,C3,C4,C5 FARADS
?33E-9,10E-9,10E-9,10E-9,33E-9

INPUT:HFE,DC CURRENT(MA),RE,RL,RT,RG(OHM),CE(FARAD)
?100,4,820,2E3,2E3,10,50E-6

INPUT:FMIN,FMAX,NSTEP (HZ)
?50,10E3,15

```

FREQ. (HZ)	ATTEN. (DB)
50.0	-20.98
713.3	-24.10
1376.7	-23.15
2040.0	-21.83
2703.3	-20.35
3366.7	-18.82
4030.0	-17.30
4693.3	-15.81
5356.7	-14.37
6020.0	-12.97
6683.3	-11.63
7346.7	-10.33
8010.0	-9.07
8673.3	-7.86
9336.7	-6.69
10000.0	-5.56

STOP TIME 2 SECS.

2. Attenuation response of the ladder network shown in Fig. 1 is calculated with the described FORTRAN program.

We packed even more circuitry into CTS cermet resistor networks.

*8,-14,-16 and -18 lead styles
Series 760 Dual In-Line Packages.*

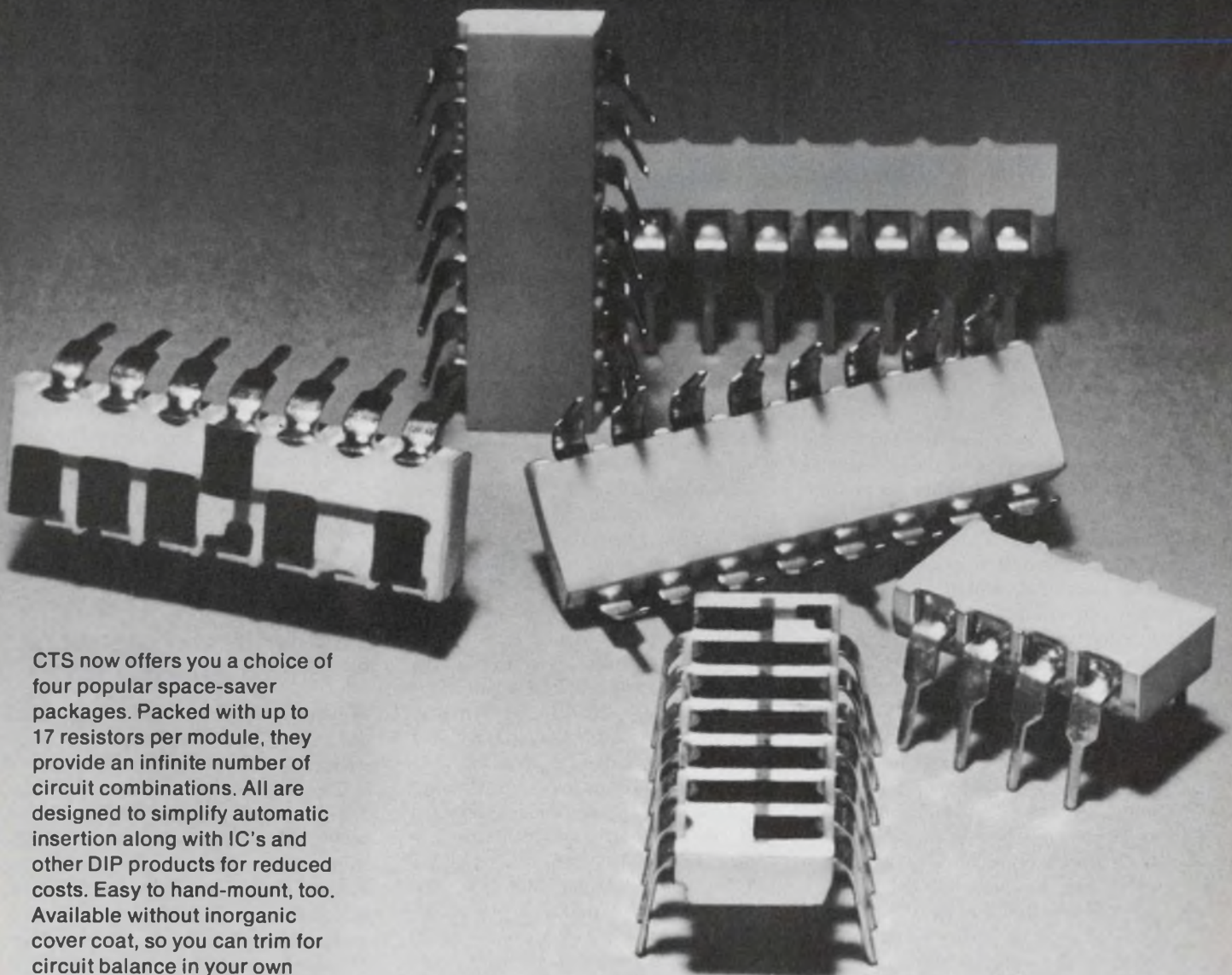

CTS now offers you a choice of four popular space-saver packages. Packed with up to 17 resistors per module, they provide an infinite number of circuit combinations. All are designed to simplify automatic insertion along with IC's and other DIP products for reduced costs. Easy to hand-mount, too. Available without inorganic cover coat, so you can trim for circuit balance in your own plant. 5 lbs. pull strength on all leads; .100" lead spacing; rated up to 2 watts on 18 lead style. Choose from standard circuit available for immediate delivery (see data sheet 3760 . . . or custom design to specifications).

CTS of Berne, Inc., Berne,
Indiana 46711. (219) 589-3111.

Series 750 edge mount
cermet resistor packages
available in infinite
number of resistor
patterns and wide
selection of package
configurations.

CTS CORPORATION

Elkhart, Indiana



A world leader in cermet and variable resistor technology

INFORMATION RETRIEVAL NUMBER 43

Analyzer reads direct transmission gain/loss, VSWR & return loss



Vari-L Co., Inc., 3883 Monaco Pkwy, Denver, Colo. (303) 321-1511. \$3950.

If you've ever had to stop in the middle of a series of gain, loss and reflection measurements to change the circuit configuration, you'll appreciate the Vari-L TRA-1001 Transmission/Reflection analyzer. The new unit, which also provides the convenience of absolute calibration via a direct reading meter, lets the user select reflection and transmission modes directly from front-panel pushbutton switches. Eliminating initial calibration procedures and the need to disconnect and reconnect between measurements can save considerable time.

Three matched diode detectors, at an additional cost of \$625 are necessary to make all the various switch-selectable measurements. Four full-scale ranges for return loss, transmission gain and loss and three VSWR ranges are selected by a set of pushbuttons. They are: 40, 15, 6 and 1 dB for gain/loss, and 1.02 to ∞ , 1.44 to ∞ , and 3 to ∞ for VSWR.

Unlike most meters, the dB/VSWR meter reads from right to left, thus placing the 2% error on the low, or least important, end of

the scale. In addition to direct reading of gain, loss, return loss and VSWR over a standard range of 1 MHz to 12.4 GHz, the unit features a 60-dB dynamic range, with a resolution of 0.001 dB. However, the specified sensitivity of -65 dBm (for 10-dB signal-plus-noise/noise ratio) applies only over a 40-dB range. The user selects either of two operating ranges by pushbutton: the -60 to -5 dBm button gives the larger dynamic range but less sensitivity; the -65 to -25 dBm button provides the greater sensitivity but reduces the range by 15 dBm.

Sensitivity, at least on the low end of the range, is also affected by the channel bandwidth which is user selectable with still another set of pushbuttons: 20, 100, 200 and 400-Hz settings are provided.

The 0.001-dB resolution, intended for measurement of small variations around a large nominal gain or loss level, is obtained by use of a meter offset feature consisting of a set of six pushbutton-controlled attenuators (1, 2, 3, 6, 10 and 20 dB) plus a 0 to 1-dB three-digit vernier.

To make measurements over the full 60-dB dynamic range, one uses

a series of attenuators (one set per channel). Attenuations of 0 to 30 dB are provided, selectable in 10-dB steps.

Other key features include two identical signal channels; automatic input-attenuation offset; and front-panel outputs, useful for swept-frequency scope displays, X-Y recordings or DVM display of gain or loss. Use of an external DVM eliminates the ubiquitous 2 percent meter error.

Power gain or loss in the individual channels can be displayed on a separate power meter calibrated in dBm.

The accuracy achieved is 0.025 dB per dB, plus or minus the two percent meter error. Channel attenuator accuracy is ± 0.04 dB per 10 dB and offset attenuator accuracy is ± 0.1 dB per step. The latter, however, may be adjusted to be zero. Temperature stability of the Model TRA-1001 is 0.05 dB/ $^{\circ}$ C, referenced to 25 C.

CIRCLE NO. 324

Fast-write storage scope is almost burnout proof

Hewlett-Packard, 1501 Page Mill Rd., Palo Alto, Calif. (213) 877-1282.

The Model 181 variable persistence, high brightness scope lets the user view traces directly in ambient light. Previously, the traces had to be photographed. A unique reduced scan mode coupled with new storage surface processing provides greater than 200 div/ μ s writing speed. This is fully compatible with a single-shot 10-ns rise time transient with an amplitude greater than 1 cm. The new tube is almost impossible to burn out. The storage time control allows a trade off of viewing brightness for storage time (up to two hours).

CIRCLE NO. 325

*New
from HP...
Modular
Power Supplies*

today

*for those who
think about
tomorrow!*



HEWLETT  PACKARD

POWER SUPPLIES

21201

Value has always been synonymous with HP power supplies, and these new 62000-series modular power supplies are no exception. They're competitively priced (with quantity and OEM discounts), reliable, systems compatible, and available now. Coverage is from 3 to 48 volts, at up to 200 watts, with performance assured to specifications. Best of all, HP offers applications assistance and service support before and after the sale. It's all backed up with an international network of 220 offices to serve you. For detailed information, contact your local HP field engineer. Or, write: Hewlett-Packard, Palo Alto, California 94304. In Europe: 1217 Meyrin-Geneva, Switzerland.

INFORMATION RETRIEVAL NUMBER 44

TEC LED LITE

LED READOUTS

READY TO MOUNT



\$23.00
each*

When you buy a TEC-LITE IC compatible readout, you buy a unit that's ready to mount to your panel with two screws — nothing else! Or you can specify an attractive TEC aluminum bezel and mount up to 10 (or more) readouts** in your panel with just two nuts.

TEC has designed and built more completely packaged LED indicators, switch-indicators and readouts than anyone else — you expect more from the information display leader.

LED PACKAGES

LED/SWITCH PANEL



LED status indicators are combined with TEC-LITE switches in this attractive, easy to mount panel assembly. Your choice of number and type of switches/indicators. Priced from \$2.25* complete, ready to mount.

PANEL MOUNT LED's

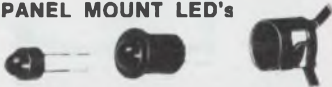

Slip bezel assembly in panel hole from the front, secure with Tinnerman clip from the rear. Replaceable LED snaps in place from the front. \$1.50* with clip.

PCB MOUNT LED's



Molded polycarbonate lamp holders are soldered to PCB. LED plugs into unit at right... permanently mounted in device at left. Priced from \$1.50*.

*100-499 quantity
**80¢ a position

See TEC-LITE for the complete line of readouts, indicators, switches, display panels, keyboards, CRT terminals.

TEC, Incorporated; 9800 North Oracle Road, Tucson, Arizona 85704; or phone (602) 297-2203.



INFORMATION RETRIEVAL NUMBER 45

Quick-change readout in low-parts-count DPM

Weston Instruments, Inc., 614 Frelinghuysen Ave., Newark, N.J. (201) 243-4700. Price: see text. Availability: stock.

A single, 24-pin LSI chip in Weston's 1295-series digital panel meter replaces nine or more 14-pin ICs normally found in bipolar, 3-1/2-digit DPMs. The reduction from 126 to 24 of IC pin connections, common sources of failure, allowed Weston to package all but the readout circuitry on a single board, eliminating at least one connector.

The only connector on the board is the one that accepts the plug-in readout module, which can include a LED or seven-segment readout. The LED readout is Opcoa's gallium phosphide display, with 0.334-inch characters. The seven-filament readout, from Pinlites, has 0.44-inch characters. The complete DPM consumes 2.5 W with Opcoa's display, 3 W with Pinlites'.

The availability of interchangeable, plug-in readouts offers a particular advantage to manufacturers with some customers preferring one type and others with a preference for the other. Prices in quantities of one to nine are identical, \$185, but the 100-up price is \$4.75 lower, at \$95, for DPMs with the seven-filament display than for the LED-display DPMs.

The readout card is easy to replace. You snap off the front bezel, give the main circuit board a slight shove from the rear, then lift out the readout card. It's almost as easy to change ranges.

To provide a 1-V range instead of the standard 100-mV range, you simply melt away a small solder bridge. With the bridge in place, you can provide one of five current ranges from 10 μ A to 100 mA by adding a single resistor or one of three voltage ranges from 10 V to 1000 V by adding three resistors. There's room on the internal cir-



A LED readout or seven-filament readout can be plugged into the single board that contains the remainder of the circuitry in Weston's 1295 DPM. Most of the circuitry is in the LSI chip, just behind the readout receptacle.



This compact DMM was first to use the LSI chip that allowed Weston to mount all but the readout circuitry in a new DPM on a single board.

cuit board, thanks to the space saved by the LSI chip.

The chip, manufactured for Weston by Mostek, has all the digital logic as well as the threshold-crossing comparator and circuitry for polarity sense, out-of-range sense (which blanks the three least-significant digits and blanks the over-range 1), strobe synch and storage.

It's the same chip that Weston used to slash the cost of the Model 4440 digital multimeter, introduced in December, 1971. At \$285, that instrument is the lowest-priced, battery-operated DMM with 3-1/2 digits. And the price includes the four required nickel cadmium C cells and a battery charger.

For the DMM CIRCLE NO. 320
For the DPM CIRCLE NO. 321

Simpson® has the world's largest selection of

PANEL METERS and METER RELAYS

OVER 1500 RANGES, SIZES AND TYPES IN STOCK AT ELECTRONIC DISTRIBUTORS NATIONWIDE



WIDE-VUE
1½", 2½", 3½", 4", 8"



DESIGNER SERIES
3½", 4½"



NEW CENTURY SERIES
1½", 2½", 3½", 4"



BOLD-VUE
2½", 3½"



RECTANGULAR
2½", 3½"
round style available



RUGGED SEAL
3½", 4½", 4" x 6"

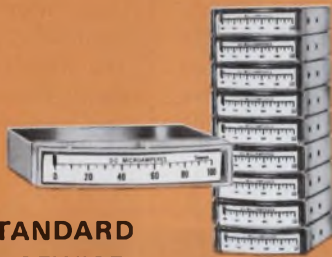

STANDARD EDGEWISE
1½", 2½"

STACKABLE EDGEWISE
1½", 2½"



NEW 3½" STACKABLE EDGEWISE METER



RECTANGULAR
4½"



DIGITAL
Model 2800



PYROMETERS
4½"



METER RELAYS
3½", 4½", 4" x 6"



NEW 3½" EDGEWISE CONTROLLER
Many features.
Request Bulletin C1206

• THE ABOVE PANEL METERS ARE AVAILABLE IN AC/DC VOLTMETERS, AMMETERS, MILLIAMMETERS, MICROAMMETERS . . . DC MILLIVOLTMETERS AND GALVANOMETERS . . . RF AMMETERS AND MILLIAMMETERS.

• METER RELAYS AVAILABLE IN DC MICROAMPERES, MILLIAMPERES AND MILLIVOLTS . . . AC AMPERES

• MATCHING WATTMETERS, RADIO FREQUENCY, SEGMENTAL, VU AND DB, RECTIFIER AND ELAPSED TIME METERS ALSO AVAILABLE.

• SIMPSON CAN MAKE CUSTOM PANEL METERS AND METER RELAYS TO YOUR SPECIFICATIONS. ANY PRACTICAL RANGE CAN BE SUPPLIED. SEND US YOUR REQUIREMENTS.

GET "OFF-THE-SHELF" DELIVERY FROM YOUR LOCAL ELECTRONIC DISTRIBUTOR. WRITE FOR NEW CATALOG 4100.



SIMPSON ELECTRIC COMPANY

5200 W. Kinzie St., Chicago, Ill. 60644 • (312) 379-1121 • Cable: SIMELCO

IN CANADA: Bach-Simpson Ltd, London, Ontario

IN INDIA: Ruttonsha-Simpson Private Ltd, International House, Bombay-Agra Road, Vikhroli, Bombay



MANUFACTURERS OF THE WORLD FAMOUS SIMPSON 260®

INSTRUMENTATION

Digital IC tester has 0.2% accuracy



Alma Corp., 1061 Terra Bella Ave., Mountain View, Calif. (415) 961-9837. \$5750.

The Model 380 digital IC tester features full functional, input current and fan in and fan out testing to manufacturers specs. Programming and controls are designed to provide fast error-free testing with full capability for auto handling and probing systems. Throughput rate depends on auto-handler cycle speed and can be as high as 4000 parts per hour. Measurement accuracy for all dc parameters is 0.2%.

CIRCLE NO. 326

Function generator gives 9 modes for \$495



Krohn-Hite Corp., 580 Massachusetts Ave., Cambridge, Mass. (617) 491-3211. \$495.00; 30 days.

The Model 5200 offers nine modes of operation. Functions include separate waveform and ramp outputs, pulse, sweep and burst modes and external voltage control of the main output frequency. In external and sweep modes, the frequency range extends from 0.00003 Hz to 3 MHz. Maximum main output is 20 V p-p open circuit, or 10 V across 50 ohms; maximum ramp output is 10 V pk with 200 ohm source impedance. Pulses as narrow as 200 ns are possible at rep-rates anywhere between 100 kHz and 0.1 Hz.

CIRCLE NO. 327

12.5 MHz counter sells for \$395



Systron-Donner, 888 Galindo St., Concord, Calif. (415) 682-6161. \$395.

The Model 114 frequency counter comes with a universal tilt base but can be mounted as a panel meter. Frequency range is 1 Hz to 12.5 MHz. The readout includes: four digits (5th and 6th optional), an auto-positioned decimal point, a "kHz" annunciator, and display storage. Accuracy of readings is ± 1 count \pm power line frequency. The unit can also perform limited time interval measurements. With optional crystal oscillator, range is 100 μ sec to 10 s. Without the tilt stand the unit weighs five pounds and measures 3-1/4 x 7 x 8-1/2 in.

CIRCLE NO. 328

Low cost power supplies for relays, lights...



... and high voltage displays. These unregulated power modules plug into a standard octal socket and carry a five-year warranty. Shipment: Three days.

Nominal Voltage	Current Amp. DC	Model	Price	Case Size
12	1.5	US12	\$35	G
12	5.0	U12	65	Q
24	1.5	US24	35	G
24	5.0	U24	65	Q
28	1.0	US28	35	G
28	5.0	U28	65	Q
180	0.1	US180	55	G

"G" case size—3.40 x 3.28 x 5.0 inches
"Q" case size—4.15 x 3.33 x 7.0 inches



Acopian Corp., Easton, Pa. 18042
Telephone: (215) 258-5441

Environmental Control?

We've been doing it for 40 years with...

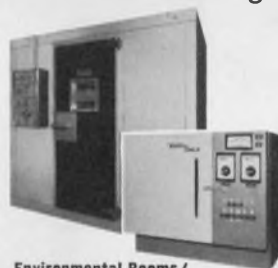

Environmental Rooms/
Temperature Humidity Chambers
Bench-top to walk-in.



TenneySphere
For simulation of
temperature, humidity, vacuum.



Laminar-Flow
Clean Stations



Multi-Range Precision
Temperature Baths

Write or call for further information on any of these, or autoclaves, packaged refrigeration systems, thermal snoods, low temperature storage chests, etc.



Tenney
ENGINEERING, INC.

1090 Springfield Rd., Union, N. J. 07083
(201) 686-7870 • (212) 962-0332

674A

MOS Memories

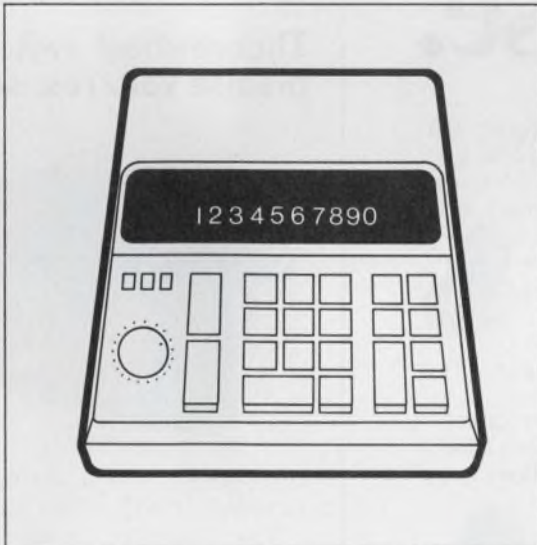
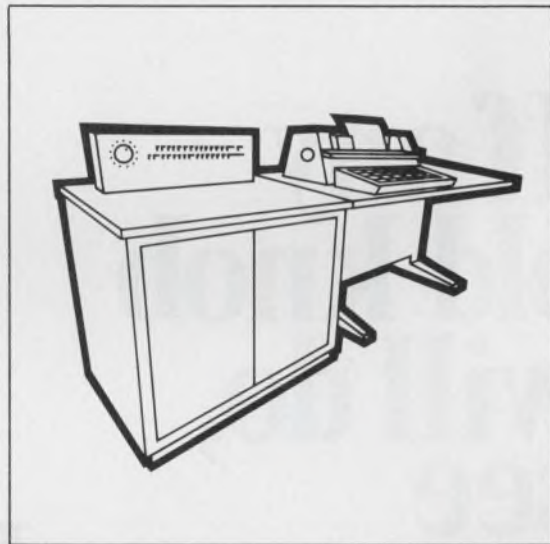
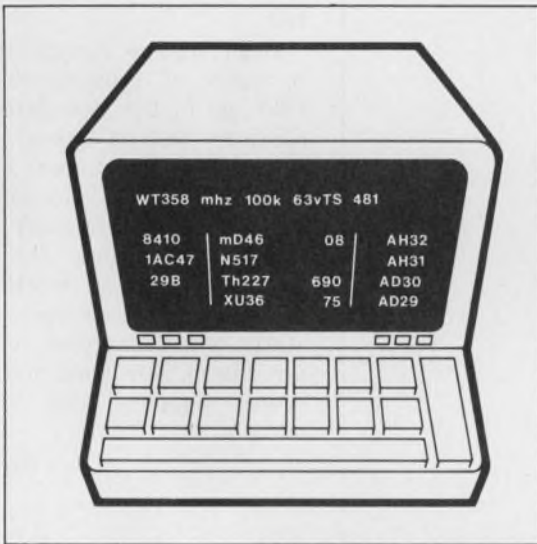

The FIRST source for standard ROM's is AMI. Trade-up by using AMI 1K to 16K bit ROM's. Why use 2, 4, 8 or more when one will do it.

Production quantities of the following are available at prices that are hard to beat, try us.

Description	Model #
128 x 12, Hollerith to ASCII	S8457
128 x 12, ASCII to Hollerith	S8539
64 x 7 x 5, char. gen., static	ME51L
64 x 7 x 5, char. gen., dynamic	S8327
64 x 5 x 7, char. gen., static	S8499
256 x 10, static	S8614
512 x 8, static	S8772
512 x 10, static	S8771
64 x 7 x 9, static	S8866
64 x 9 x 7, static	S8564
2048 x 4, dynamic	S8865
COMING — 4096 x 4	

Whatever your memory requirements, from code conversion to programmable memories, contact AMI. The company that shipped over 1 billion bits of memory in 1971.

Send today for current specifications, price list and memory application work sheet.

STANDARD
MASTERS OF MOS
^

AMI Micro-Products
A DIVISION OF AMERICAN MICRO-SYSTEMS, INC.
© 3800 Homestead Rd. Santa Clara, CA 95051 (408) 246-0330 TWX (910) 338-0018

COMPONENTS

Proximity switch goes solid state

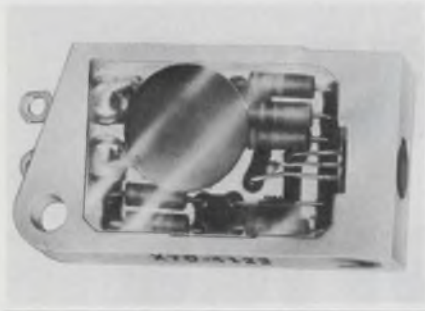

Licon—Div. Illinois Tool Works Inc., 6615 W. Irving Park Rd., Chicago, Ill. (312) 282-4040.

Licon's solid-state, proximity switch offered for use on machine tools and in-process control is said to be compact (but no dimensions are given), consists of a single transistor high-Q oscillator. Magnetic material 0.025 in. from the sensing element (L of the oscillator) will inhibit oscillation, changing the output from 14 V at 2.6 mA to 2 V dc at 8 mA drain.

CIRCLE NO. 329

High voltage rectifier product line introduced

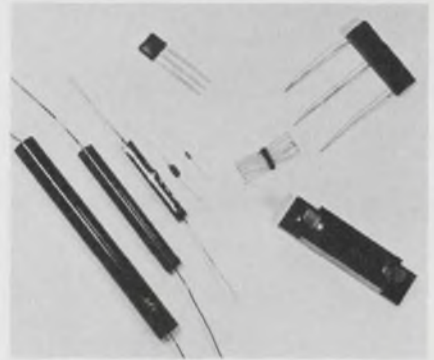

Arthur Fallon Industries, 400 Warburton Place, Long Branch, N.J. (201) 229-8300. \$0.45 to \$15 (100-999).

High voltage rectifiers available in range of 1000 to 50,000 volts PRV, up to 3 A, standard and fast recovery (200 ns typical) with low reverse leakage current (10 nA to 1 μ A typical). Designated the 3NV, NV, MR, 7S, 35ST and FRR Series, applications for the new rectifiers include high voltage multiplier power supplies, electrostatic power supplies for copiers, air filters, television high voltage power supplies and microwave ovens.

CIRCLE NO. 330

If any old knob will do, see someone else.

If the knob you require doesn't require things like careful craftsmanship and precision performance, maybe you don't need Raytheon. Maybe you should turn to somebody else.

But if the kind of knob that will do for you must be a high quality, reliable component, we're the only ones to see. Raytheon knobs have set a new standard of excellence. Because with Raytheon, excellence is standard.

Each Raytheon knob is made to exacting military specifications and injection molded of the highest quality impact resistant plastic. Every knob surface is clearly defined, mar-free, with no flash marks or conspicuous gate marks. And every knob features double set-screws and corrosion-resistant

aluminum bushings.

Our Standard, Designer, 400 and Panelrama Series offer a distinctive variety of stock sizes, styles and colors to match most any application. And our new Microvernier control knob provides a better, low-cost method of obtaining high-resolution tuning or precise zero setting.

If you have unique requirements, we'll customize a knob to suit your specifications. So don't make do with any old knob. Write Raytheon Company, Fourth Avenue, Burlington, Massachusetts 01803.

RAYTHEON



Thumbwheel switch is precise volt/res. source

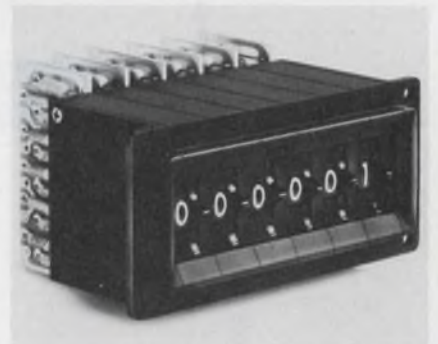

Digitran Co., 855 S. Arroyo Pkwy., Pasadena, Calif. (213) 449-3110.

The Digidiver using a Kelvin-Varley configuration with a standard accuracy to $\pm 0.01\%$ full scale voltage ratio has a resolution up to 0.0001%. The Digidecade selects precision resistances rather than voltages. The Digidiver/Digidecade eliminates sensitive positioning required of a potentiometer dial.

CIRCLE NO. 331

**Silicone breakthrough:
Flame-retardant
pourable elastomer
at general-purpose
prices.**

New Sylgard® 170 A & B silicone elastomer now offers silicone security at prices competitive with organics! This flame-retardant, low-price, two-part silicone cures, when catalyzed, to a rubber with excellent electrical insulating properties. Developed for general potting, encapsulating and conformal coating, Sylgard 170 does more. It now permits designers to utilize the superior resistive advantages of silicones on lower cost, high-volume products.

If this new material stimulates your thinking about silicones in applications where greater safety and improved flame retardance is important, we'd like to help. For a free sample of Sylgard 170, write us on your company letterhead describing your application.
Dow Corning, Dept.
A-2317, Midland,
Michigan 48640.

Encapsulants and sealants from

DOW CORNING

DOW CORNING



PACKAGING & MATERIALS

Alumina 40-lead package is on a single plane

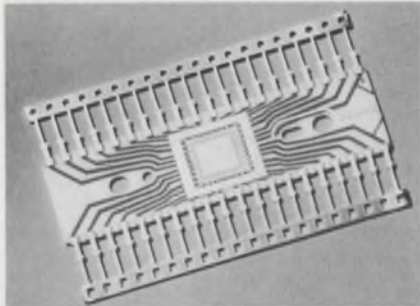

American Lava Corp., Manufacturers Rd., Chattanooga, Tenn. (615) 265-3411.

A single-plane 40-lead all-alumina ceramic package costs 35% less than the three-tier design, according to the manufacturer, who didn't cite prices. Except for the seal ring, all metallization is on one plane. The device area is 0.2-in. x 0.22-in. To help insure high yields with the single plane construction, adequate isolation paths have been designed between the seal ring and the lead fingers and also between the lead fingers and the chip pad.

CIRCLE NO. 332

Circuit zaps now come in assortments



International Rectifier Corp., Semiconductor Div., 233 Kansas St., El Segundo, Calif. (213) 678-6281. CZ100-\$7.95; CZ200-\$15.99; stock.

Two packaged assortments of Circuit Zaps, copper component patterns, pads and conductor paths, enable design engineers to create prototype or customized circuit boards without the use of chemical photoprinting, etching and other costly steps associated with prototype fabrication. Assortment CZ200 contains various quantities of all 15 patterns—a total of 104 pieces. The CZ100 assortment has 48 patterns and a printed circuit board.

CIRCLE NO. 333

Fiber optic components come in assortments



International Rectifier Corp., Semiconductor Div., 233 Kansas St., El Segundo, Calif. (213) 678-6281. \$23.95; stock.

A special assortment of plastic fiber optic materials, contains all of the fiber optic components and accessories needed to construct engineering applications, hobbyist projects, or equipment for use by service technicians. The assortment, Model OP808, believed to be the most complete available, includes 264 feet of Mono Fiber in four sizes (0.010, 0.020, 0.030 and 0.087-in.); nine feet of jacketed light guides in three sizes from 0.087-in. to 0.152-in.; a four-channel light head; a low voltage power source; plus bulbs, eyelets, and adhesive/end-treat compound.

CIRCLE NO. 334

STRIP BUS
by Rogers

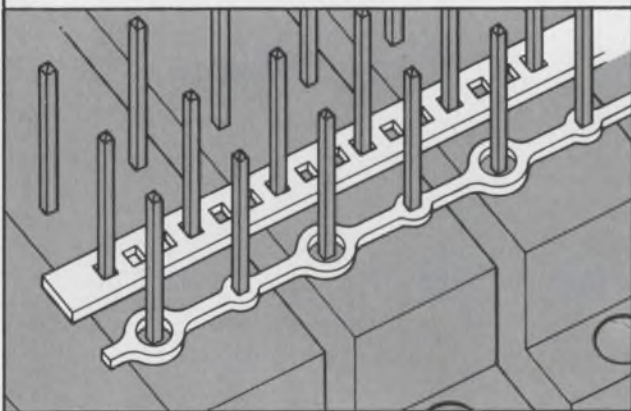

Low Cost Bussing Systems
Easy Installation
Reliable Solder Joints
Greater Pin Exposure



Write or call for details

Rogers Corporation / Rogers, Conn. 06263 (203) 774-9605

INFORMATION RETRIEVAL NUMBER 52

relays... general purpose, sensitive, miniature, mechanical and magnetic latching

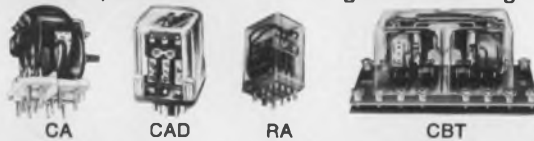

stepping switches...



accessories...

plugs, sockets and dust covers



HIGH QUALITY • LOW COST • IMMEDIATE DELIVERY

SEND FOR FREE CATALOGS



1140 Broadway, New York, New York 10001 Tel: (212) 683-0790

INFORMATION RETRIEVAL NUMBER 53

ELECTRONIC DESIGN 10, May 11, 1972

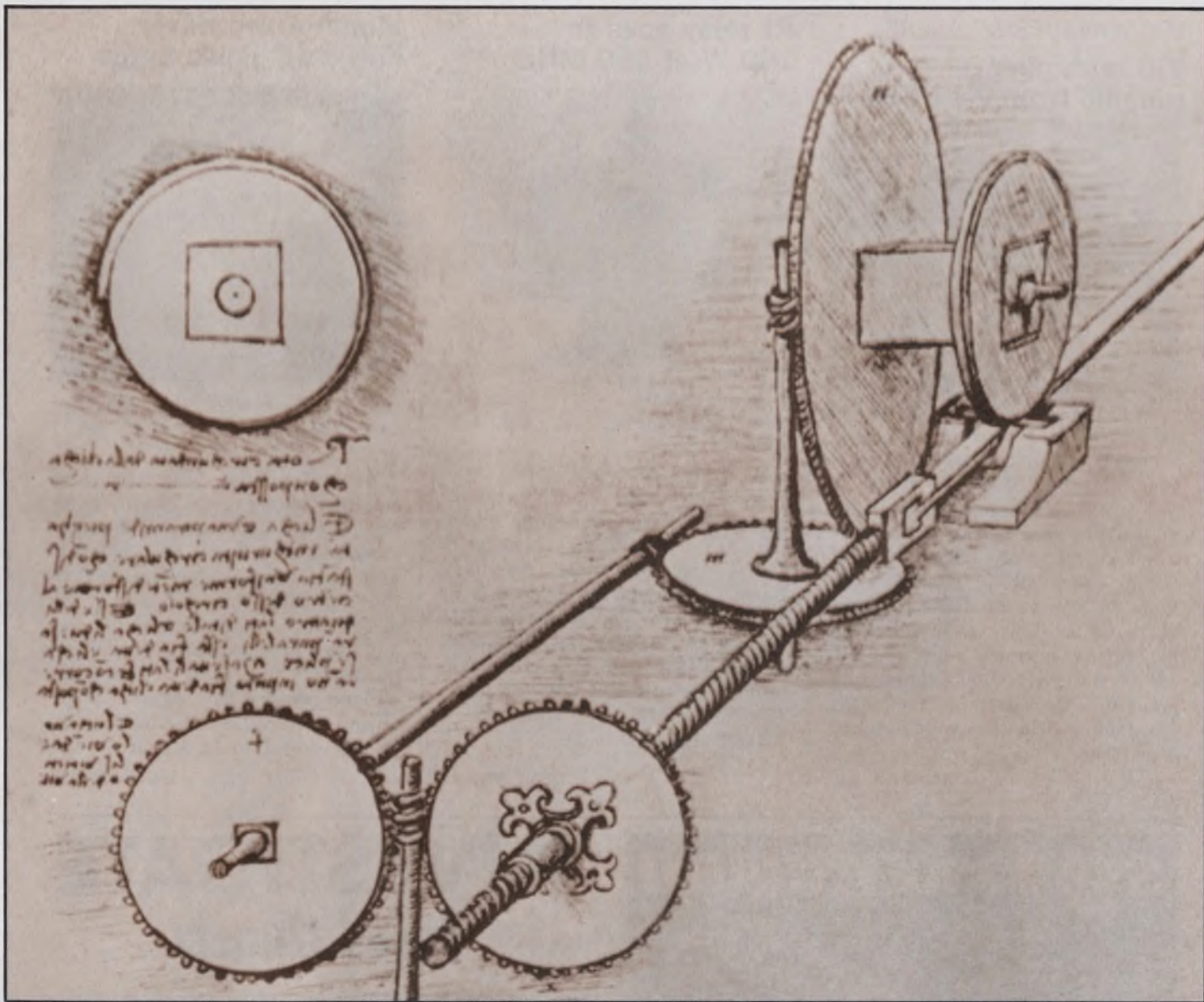

Culver Pictures

Invention.

Making something new. Solving old problems with new answers. Making progress from inertia.

Invention is what makes the difference between a good company and a great company. Invention shows that a company knows how to give as well as receive. It shows that a company's not just living off its markets, but operating as a vital force within them. Invention is life.

Matsushita Electric has been built on invention. As the parent of Panasonic, we're always trying to do things a little better. We're always trying to stay "just slightly ahead of our time."

When we heard of a demand in the magnetic recording industry for a better head material, we found one. HPF.[™] Matsushita's HPF material is produced by a unique, patented sintering process. It offers much better magnetic and mechanical properties than conventional high density ferrites.

HPF is available now — in configurations suitable to most any application.

Then there's our Optical Static Card Reader. It meets the need for something between super-sophisticated high speed card readers and conventional mechanical devices. It reads Hollerith cards or badges, from 10 x 10 to 12 x 80 matrix. It's compact, reliable, and easy to operate.

These are only two Matsushita inventions. There are many, many more. New components, new motors, new compressors, new switches. From now on, when you think of invention, think of Matsushita and Panasonic. We learn something new every day.

Panasonic/Matsushita Electric

Industrial Division, 200 Park Avenue, New York, N. Y. 10017

MICROWAVES & LASERS
YIG multiplier is tunable from 2-12 GHz

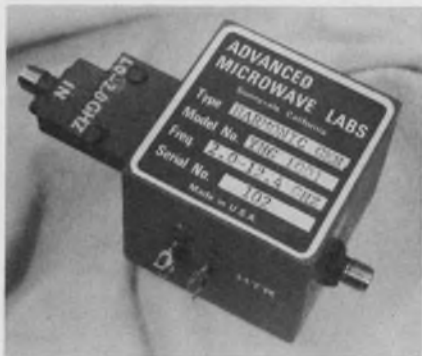

Advanced Microwave Labs., 825 Stewart Dr., Sunnyvale, Calif. (408) 245-5770. \$1895; 6 wks.

A new YIG-tuned harmonic multiplier, the YHG1001, can be tuned continuously from 2.0 to 12 GHz. The available power varies from 30 mW at 2.0 GHz to 2 mW at 12 GHz. Power is obtained by generating harmonics of a 1 W, 1.0 to 2.0 GHz input signal and selecting the desired frequency harmonic with the voltage-tuned YIG filter.

CIRCLE NO. 335

Rf relay goes to 150 W at 500 MHz

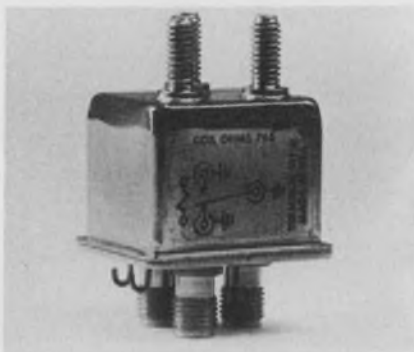

General Electric, 777 14th St., N.W., Washington, D.C. (202) 393-3600.

A radio-frequency relay, the 3SBW, has spdt rf contacts designed for frequencies from 0 to 2 GHz. Power handling capacity is 150 W at 500 MHz. Auxiliary Form C contacts for up to 2 A at 28 V dc are also available. The typical rf response characteristics of the 3SBW include an insertion loss of 0.08 dB at 1 GHz, an isolation of 30 dB at 1 GHz, and a VSWR of 1.05 at 1 GHz.

CIRCLE NO. 336

Miniaturized mixer has 8-dB noise figure

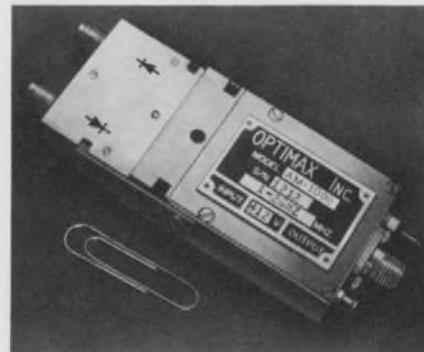

Optimax, Inc., P.O. Box 105, Advance Lane, Colmar, Pa. (215) 822-1311. \$895.

A miniaturized integrated pre-amplifier offers a maximum noise figure of 8 dB. Designated the integrated mixer preamp AM-1000, this unit has a conversion gain of 29 dB. An additional feature is the delivery of a 1-dB compression input level of +10 dBm. The model measures 3.56 x 1.44 x 0.50 inches and weighs 2.5 ounces. Four models are available in the frequency range of 1 to 12 MHz.

CIRCLE NO. 337

\$995 KEYBOARD

Economy priced! N.O. momentary action; rated 100 ma @ 24 VDC. Gold clad contacts, long operational life. Two models 0-9 and Decimal or 1-12 numeral keyboard. Two shot molded keytops. CR Series.

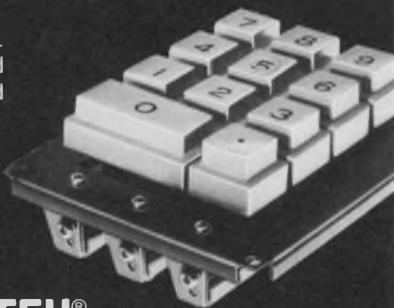

ALCOSWITCH®

DIV. OF ALCO ELECTRONIC PRODUCTS, INC., LAWRENCE, MASS.

INFORMATION RETRIEVAL NUMBER 55

REED KEYBOARD

Low-profile reed module switches rated 100 @ 48 vdc. Reed life 10-million cycles. Choose 2 models 0-9 and Decimal or 1-12 numeral keyboard. Complete assembly - \$18.25 or single switch - \$1.45 for CS Series.

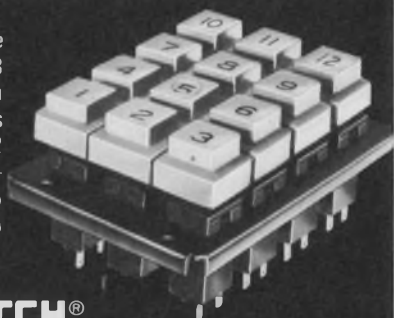

ALCOSWITCH®

DIV. OF ALCO ELECTRONIC PRODUCTS, INC., LAWRENCE, MASS.

INFORMATION RETRIEVAL NUMBER 56

INVESTIGATE Fused Quartz



Send for illustrated technical literature

Type 124 fused quartz is a General Electric specialty featuring high purity and the absence of large bubbles. Almost equivalent to Type 204, long the standard in high purity quartz tubing, Type 124 finds ideal application as semiconductor stock, commercial stock, mirrors, high temperature uses and any application where low cost and high purity are needed. Prompt delivery in ingot sizes up to 72 in. in diameter. Type 125 fused quartz features the absence of large bubbles combined with low stress birefringence and high transmissivity

in both the near ultraviolet and infrared wavelengths. Typical applications: domes, plates, lab use, optical flats, infrared windows, epitaxial plates and as stock for slice racks. Type 125 can replace any commercial grade you now use and can frequently replace more expensive grades selected to meet bubble size requirements. Available in single piece solids up to 22 in. in diameter and 11 in. thick.

LAMP GLASS DEPARTMENT, GENERAL ELECTRIC COMPANY
 24400 Highland Road, Richmond Heights, Ohio 44143

GENERAL ELECTRIC

INFORMATION RETRIEVAL NUMBER 57

ELECTRONIC DESIGN 10, May 11, 1972

C-S op amp doesn't spike

Teledyne Philbrick, Allied Dr. at Rt. 128, Dedham, Mass. (617) 329-1600. 1703; \$33 (100), 17031; \$42 (100); stock.

A chopper-stabilized op amp, the Model 1703, eliminates spiking. The device may be used where low initial offset voltage ($\pm 40 \mu\text{V}$), low drift ($2 \text{ pA}/^\circ\text{C}$), low bias current ($\pm 50 \text{ pA}$), and a low offset voltage t_c ($\pm 1 \mu\text{V}/^\circ\text{C}$) are of prime importance. A selected version, the Model 17031, with improved initial offset voltage and higher thermal stability, is available. Size is $1.5 \times 1.5 \times 0.42 \text{ in.}$

CIRCLE NO. 338

Tiny dc/dc converter provides big 5 watts

Datel Systems, Inc., 1020 Turnpike St., Canton, Mass. (617) 828-6395. \$79; stock.

The Model BPM-15/150-D5 dc/dc converter operates from 5 V dc and provides $\pm 15 \text{ V dc @ } 150 \text{ mA}$ (5 watts). At constant input voltage the output regulation—no load to full load—is $\pm 0.1\%$ and voltage regulation for line changes at constant load is $\pm 0.05\%$. Input to output isolation is greater than 100 megohms. Temperature coefficient is $\pm 50 \text{ ppm}/^\circ\text{C}$ and output voltage stability is $\pm 0.05\%$ from 0 C to $+71 \text{ C}$. The unit is epoxy cast into a black anodized case approx. four times the size of a 24-pin DIP IC.

CIRCLE NO. 339

Analog comparator gives 5-ns response

Optical Electronics, Inc., P.O. Box 11140, Tucson, Ariz. (602) 624-8358. \$69 each; stock.

The unique feature of the 9050 is its 5 nanoseconds max response time, 3 nanoseconds with TTL logic. The 9050 can also interface with MOS with 10 to 15 V logic levels. The 9050 comes in a 1.125 in.^2 by 0.5 in. module and also features: 10 V output swing; 1000 $\text{V}/\mu\text{s}$ min I/O slewing rate; voltage gain of 1000 and a differential input impedance of $10,000 \Omega \text{ min.}$

CIRCLE NO. 340

Another Sprague Breakthrough!

PRODUCTION-ORIENTED SOLID TANTALUM CAPACITORS

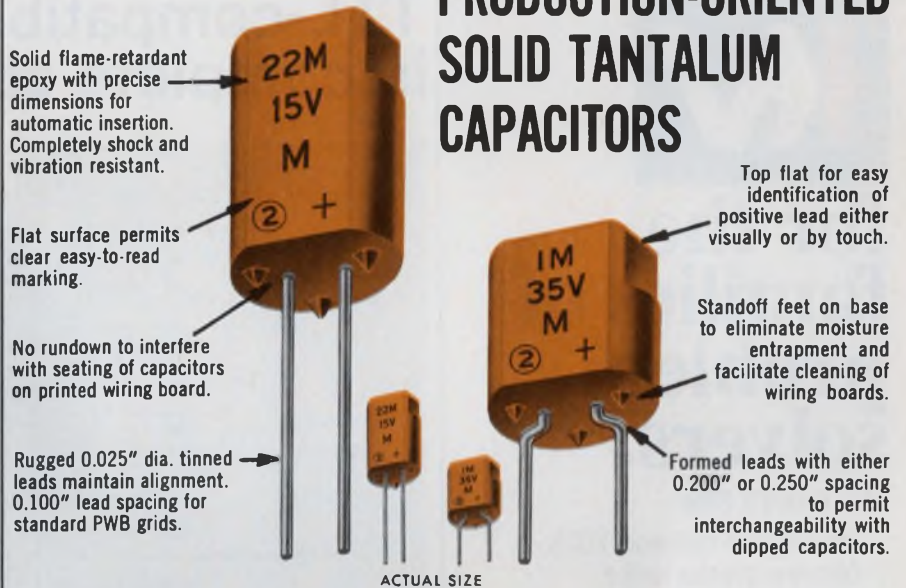

Type 198D Low-cost Econoline* Tantalum Capacitors Lead in Performance!

When it comes to low-cost solid tantalum capacitors, the new Sprague Type 198D Econoline Capacitors outperform all other designs. Here are some additional advantages:

- Low d-c leakage
- Low dissipation factor
- Wide voltage range, 4 to 50 VDC
- Capacitance range from 0.1 to $100 \mu\text{F}$
- Withstand severe temperature cycling and temperature shock over -55 C to $+85 \text{ C}$
- Speedier handling for insertion
- Easier-to-read markings

The new Sprague Type 198D epoxy-encased Econoline Capacitor is tooled for mass production and priced competitively with imported dipped units. Investigate this new Sprague breakthrough without delay.

Call your nearest Sprague district office or sales representative, or write for Engineering Bulletin 3546 to: Technical Literature Service, Sprague Electric Co., 347 Marshall Street, North Adams, Mass. 01247.

*Trademark

THE BROAD-LINE PRODUCER OF ELECTRONIC PARTS



Tune to



for the families of problem solvers.

VVC DIODES FOR:

- Straight-line-frequency VCO's
- Octave or greater tuning
- Sweep generators
- VCXO/TCXO's
- Voltage-tuned filters
- Frequency or phase modulators
- AM/FM tuners
- TV tuners and chroma control

Now available. HF, VHF, UHF families for off-the shelf delivery; ion-implanted KEVICAP™ VVC diodes, abrupt and hyper-abrupt with broad spectrum capabilities. Audio frequencies to 800 MHz; capacitance range 10-500 pF; ultra-high Q. Our ion-implantation process allows superb reproducibility in production quantities at low cost. Hi-rel components for military and aerospace applications.

Write today for more information.

KEV

ELECTRONICS CORP.
WILMINGTON INDUSTRIAL PARK
WILMINGTON, MASS. 01887
PHONE (617) 658-6970

Pioneers in ion implantation

TTL-compatible MOS circuit is complete counter time base

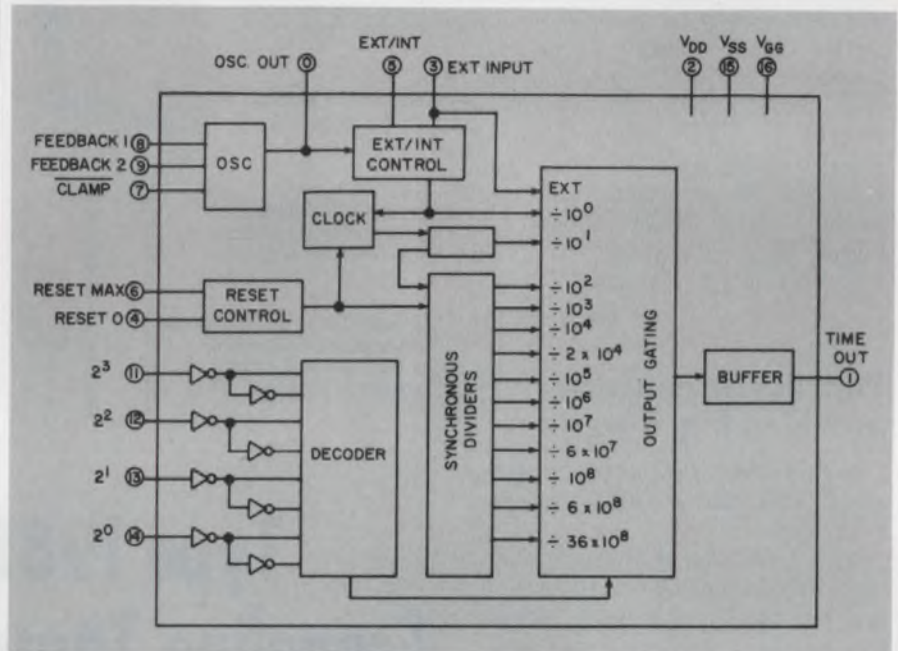

Mostek Corp., 1400 Upfield Dr., Carrollton, Tex. (214) 242-1494. P&A: See text.

First came a digital voltmeter on a single chip (from Mostek). Then a signal generator on a chip (Exar Integrated Systems). The latest entry in the movement toward large-scale integration of instrument circuits is a MOS digital-counter circuit on a chip made by Mostek.

Actually Mostek's new programmable divider and oscillator—the MK 5009 P—is not an entire frequency counter, but it does provide, in a single 16-pin ceramic DIP, the time base that every counter requires. Since it offers frequency-division ratios from 1 to 36×10^8 , a 1-MHz reference can be divided into the basic time periods needed for most frequency-measuring instruments— $1 \mu\text{s}$ through 100 s. In fact, with the addition of an external 100 K- Ω resistor and a 0.1- μF capacitor, timing periods can be derived from the chip's own internal oscillator or from 16×10^{-3} s to 58×10^6 s (1.8 years).

Without the MK 5009 P, eight 14-pin, TTL decade counters would

be required to do the same job. Eight decades of TTL counters dissipate about 1.3 W. The Mostek chip dissipates only 50 mW.

To achieve full TTL compatibility, Mostek used ion implantation to set the P-channel MOS device threshold voltages.

Period-to-period timing accuracy in frequency-counter applications requires low-edge jitter on the output timing signal. The Mostek chip, therefore, has been designed to have an output edge jitter of less than 15 ns.

A separate oscillator output is available for use with other measurement equipment, as is usually the case on commercially available frequency counters. BCD selection of the time-base period makes automatic ranging of the time base possible with the addition of a simple counter.

Pricing for the MK 5009 P is \$15 in unit quantities and \$9 at the 100-to-499 level. The circuit will be available from distributor stock after June 1.

For Mostek

CIRCLE NO. 322

For Exar

CIRCLE NO. 323

TI ups voltages 300%.

We drop prices 20%.

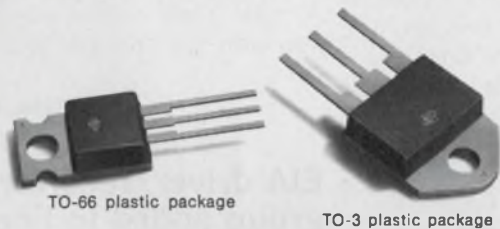

TO-66 plastic package

TO-3 plastic package

On Texas Instruments plastic power components.

Big news. TI has just introduced new extended voltage ranges* up to 400 volts on their versatile plastic silicon power transistors.

Not to be outdone, Weatherford's marking the occasion with a 20% -off-list-price offer, for the next 30 days, on any quantity of TI's entire line of plastic power devices: transistors, SCRs, triacs. Look 'em over. Get a quote on what you need from the most complete family of power semiconductors in the business.

Ask about TI's new 816-page Power Semiconductor Data Book, available right now.

We've got them.

In stock. All of them. Even the new-voltage-range transistors. Call us and enjoy the kind of service that's made us TI's largest independent distributor. Eight (count 'em) TI-authorized offices throughout the West.

Albuquerque: (505) 265-5671
 Anaheim: (714) 547-0891
 Denver: (303) 427-3736
 Glendale: (213) 849-3451
 Palo Alto: (415) 493-5373
 Phoenix: (602) 272-7144
 Pomona: (714) 623-1261
 San Diego: (714) 278-7400
 Other sales offices
 Dallas: (214) 231-7141
 Seattle: (206) 762-4200

Plastic Power Transistors

Type		V _{CE0}	P _D 25°C	Package Equivalent
NPN	PNP			
TIP29	TIP30	40V	30W	TO-66
TIP29A	TIP30A	60V	30W	TO-66
TIP29B	TIP30B	80V	30W	TO-66
TIP29C	TIP30C	100V	30W	TO-66
TIP31	TIP32	40V	40W	TO-66
TIP31A	TIP32A	60V	40W	TO-66
TIP31B	TIP32B	80V	40W	TO-66
TIP31C	TIP32C	100V	40W	TO-66
*TIP47		250V	40W	TO-66
*TIP48		300V	40W	TO-66
*TIP49		350V	40W	TO-66
*TIP50		400V	40W	TO-66
TIP41	TIP42	40V	65W	TO-66
TIP41A	TIP42A	60V	65W	TO-66
TIP41B	TIP42B	80V	65W	TO-66
TIP41C	TIP42C	100V	65W	TO-66
TIP33	TIP34	40V	80W	TO-3
TIP33A	TIP34A	60V	80W	TO-3
TIP33B	TIP34B	80V	80W	TO-3
TIP33C	TIP34C	100V	80W	TO-3
TIP3055	TIP2955	60V	90W	TO-3
*TIP51		250V	100W	TO-3
*TIP52		300V	100W	TO-3
*TIP53		350V	100W	TO-3
*TIP54		400V	100W	TO-3
TIP35	TIP36	40V	125W	TO-3
TIP35A	TIP36A	60V	125W	TO-3
TIP35B	TIP36B	80V	125W	TO-3
TIP35C	TIP36C	100V	125W	TO-3

Plastic Power SCRs

Type	V _{DRM}	I _T	Package Equivalent
TIC106Y	30V	5A	TO-66
TIC106F	50V	5A	TO-66
TIC106A	100V	5A	TO-66
TIC106B	200V	5A	TO-66
TIC106C	300V	5A	TO-66
TIC106D	400V	5A	TO-66
TIC116F	50V	8A	TO-66
TIC116A	100V	8A	TO-66
TIC116B	200V	8A	TO-66
TIC116C	300V	8A	TO-66
TIC116D	400V	8A	TO-66
TIC116E	500V	8A	TO-66
TIC116M	600V	8A	TO-66
TIC126F	50V	12A	TO-66
TIC126A	100V	12A	TO-66
TIC126B	200V	12A	TO-66
TIC126C	300V	12A	TO-66
TIC126D	400V	12A	TO-66
TIC126E	500V	12A	TO-66
TIC126M	600V	12A	TO-66

Plastic Power Triacs

Type	V _{DRM}	I _T	Package Equivalent
TIC226B	200V	8A	TO-66
TIC226D	400V	8A	TO-66

WEATHERFORD

Subminiature transistor for thick-film circuits



Sprague Electric Co., 347 Marshall St., North Adams, Mass. (413) 664-4411.

A subminiature epoxy transistor, only 0.090 inches in diameter and 0.060 inches thick, has been designed specifically for thick-film hybrid circuits. The new transistor has 5-mil thick tab leads which can easily be soldered or welded to thick-film ceramic-based circuits or printed wiring boards. The Sprague transistors, termed METs, may be obtained with dual collector leads, as shown, or with CEB or CBE lead configurations.

CIRCLE NO. 341

MOS shift register boasts 10-MHz rate

Hughes Aircraft Co., P.O. Box 90515, Los Angeles, Calif. (213) 670-1515. \$20 (100); stock.

The HDSR 1024, a 1024-bit multiplexed dynamic shift register, provides a 10-MHz shifting rate over the full MIL-spec temperature range (-55 to +125 C). The device is structured as a single 1024-bit shift register, and is also available as a dual 512-bit (HDSR 1025) and a quad 256-bit (HDSR 1026). Clock capacitance is 100 pF and power dissipation, for 5-MHz operation with 25% duty cycle clocks, is typically 150 mW at 25 C.

CIRCLE NO. 342

McMOS device provides data routing control



Motorola Semiconductor Products, Inc., P.O. 20912, Phoenix, Ariz. (602) 273-3465. \$2.10 (CL), \$4.75 (AL); 100-999. Stock.

The MC14519 AL/CL 4-bit AND/OR Select device provides low power data routing control. Using two control bits, one of two 4-bit information channels can be selected for output distribution. This device can also provide a quad-Exclusive NOR gate function. The MC14519AL operates from a supply in the range of 3.0 to 18 V over the -55 to +125 C range; the MC14519CL values are 3.0 to 16 V and -40 to +85 C.

CIRCLE NO. 343

Seven-segment display with BCD data outputs

Harris Semiconductor, Melbourne, Fla. (305) 727-5430. \$7.55 (commercial), \$11.25 (military); 100 to 999. Stock.

A bipolar monolithic 4-bit latch/decoder/display driver with BCD data outputs provides a high speed, high current data handling capability for LEDs and other types of numerical displays. Termed the HD-0140, the circuit provides 40 mA output to drive a single seven-segment numeric display. Typical data rate for the HD-0140 is 10 MHz.

CIRCLE NO. 344

High voltage pnp and npn transistors

Industro Transistor Corp., 35-10 36th Ave., Long Island City, N.Y. (212) 392-8000. 400, \$3; 800, \$7 (1000 quantities).

A line of low-priced, high voltage pnp and npn transistors feature the highest voltages available in commercial models, according to the manufacturer. The units, designated the 400 to 800, have a V_{ce0} range of 400 V to 800 V (sustained) respectively. The characteristics of the units include a V_{EB} of 6 V min, h_{fe} of 25 to 300, V_{CE} (sat) of 1.5 V max and V_{RE} (sat) of 1.0 V max. These values are the same for both the pnp and npn transistors.

CIRCLE NO. 345

EIA driver/receiver group added to line

Advanced Micro Devices, Inc., 901 Thompson Pl., Sunnyvale, Calif. (408) 732-2400.

A line driver and receiver group designed to the specifications of EIA standard RS232C, extend the company's line of interface devices. The Am1488 is a quad line driver that operates from a ± 9 -V supply to produce a ± 6 -V output (3-k Ω load). The device offers a short-circuit protected output and slew-rate control through the use of an external capacitor. The Am1489 is a quad line receiver that can accept signal swings of up to ± 30 V. Both devices have built-in feedback resistors for ac noise immunity. The Am1489A offers a higher noise margin.

CIRCLE NO. 346

ANALOGY

INTECH'S A-132 AND A-134 ARE THE FASTEST FET-INPUT DIFFERENTIAL OP AMPS AROUND. WE GUARANTEE A SLEW RATE OF 1000 V/US, 0.01% SETTling TIME OF 200NS, AND LESS THAN 5% UNDERSHOOT OR OVERSHOOT. TYPICALS ARE 1,500 V/US AND 100 NS SETTling TIME. THE A-132 DRIVES HIGH-SPEED LOGIC AND OTHER LOADS TO 1,000 PF WITH ITS 10 MA OUTPUT, WHILE THE A-134 DRIVES VIDEO CABLES AND OTHER HEAVIER LOADS WITH ITS 100 MA OUTPUT.

intech INCORPORATED
(408) 244-0500
1220 COLEMAN, SANTA CLARA CA 95050

Surface-Wave Delay Lines

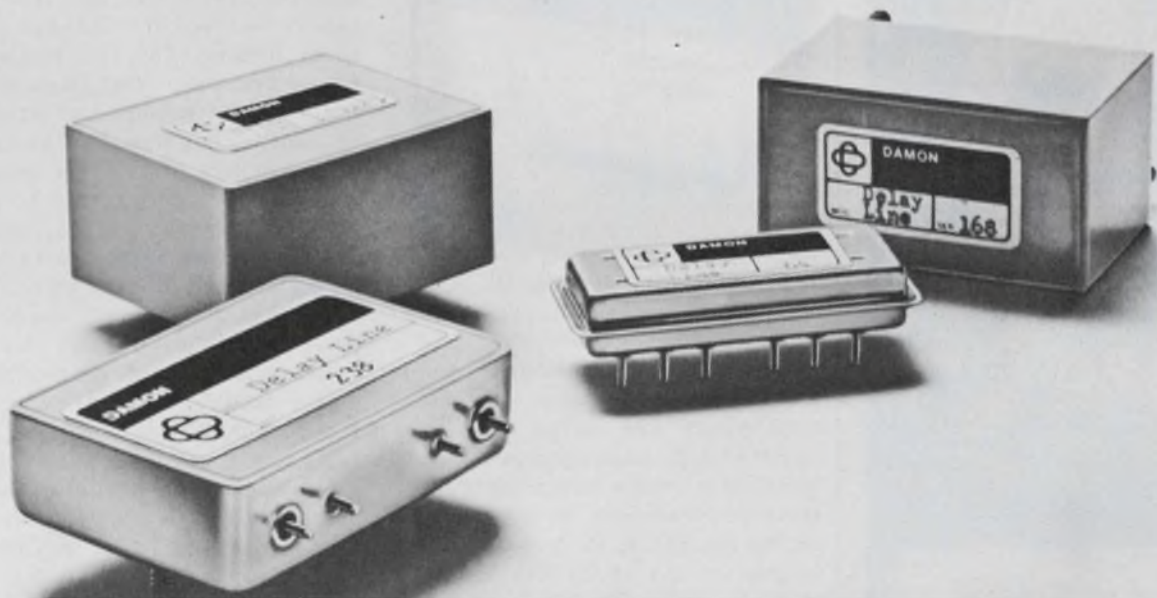

...a new state-of-the-art development.

By transferring the signal across the surface instead of through the body, the new Surface-Wave concept results in substantially smaller packages, lower cost in production quantities and superior performance over a 20 MHz to 200 MHz range.

Damon Surface-Wave Delay Lines consist of coupled transducer arrays accurately spaced on a lithium niobate or quartz substrate, using precision photo-etching techniques. The delay of signal propagation is controlled by varying the distance between the interdigital structures. The devices are ideal for use in radar, communications and sonar and have potential use as i-f filters for color television and acoustic logic for computers. Delivery in evaluation quantities in 6-8 weeks. For complete information or evaluation samples write Damon Electronics Division, 115 Fourth Avenue, Needham Heights, Mass. 02194.

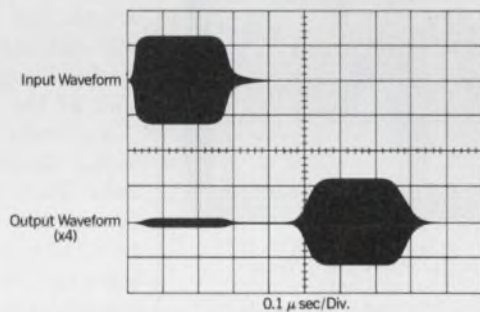

Typical waveforms for a 0.5 microsecond delay line driven by a 0.25 microsecond pulsed carrier at 60 MHz.

RANGE OF PARAMETERS

Frequency Range:	20 MHz – 200 MHz
Time Delay Range:	0.5 microsecs. – 10 microsecs.
Bandwidth at –3dB:	3% – 30% of center frequency
Insertion Loss:	10 – 20 dB
Spurious Responses:	25 – 30 dB below desired response
Environment:	Full military temp., shock, vibration available
Typical Size:	Less than one cubic inch



DAMON/ELECTRONICS DIVISION

INFORMATION RETRIEVAL NUMBER 61

New
from
General
Electric



Rechargeable
Nickel-cadmium
Goldtop
Batteries
for elevated
temperature
applications



Here's the rechargeable battery for your tough, high-temperature design applications. General Electric's new Goldtop nickel-cadmium batteries have a maximum sustained temperature capability of 65°C — permitting their use in spots previously too hot for nickel-cadmium batteries. And, at 65°C cell temperature, Goldtop batteries have a longer life expectancy than conventional units at 50°C cell temperature. Goldtop batteries are also available in a quick-charge version that can be recharged in 3½ to 4 hours using a standard charger. These cylindrical cell batteries are available in a wide variety of sizes and ratings.

For more information, write Section 452-02, General Electric Co., Schenectady, New York 12345, or circle reader service card.

452-02

GENERAL ELECTRIC

INFORMATION RETRIEVAL NUMBER 62

DATA PROCESSING

More flexibility for minis provided by 4-deck tape unit



Tri-Data Corp., 800 Maude Ave., Mountain View, Calif. (415) 969-3700. \$4950.

With four-independently-controlled tape drives to log, compare, sort, collate and merge data, the CartriFile 40 adds increased capability to a mini's range of operation. It reads or writes up to 18,000 b/s in 16, 12 or 8-bit word lengths on any of its four tapes—and can simultaneously loadpoint/search the other three. The unit will operate with a tape cartridge loaded in only one or any combination of the drives.

Tri-Data 1000 Series endless-loop, single-tape cartridges are used. They are available in 10, 25, 50 and 150 foot tape lengths. With four 150-foot cartridges, the system can store nearly 13 million bits of data. Computer grade, certified error-free, 1/4-in. tape is provided.

The tape unit uses a two-track format with a bit-serial, phase-encoded recording technique that occupies only two tracks near the center of the magnetic tape. The edges of the tape are avoided, thus dropouts due to edge damage are eliminated.

The CartriFile system is available complete with interface circuitry, cabling and software for use with small computers such as the PDP-8, PDP-11, Nova, Hewlett-Packard, Interdata and others.

For programming use, typically, one tape is reserved for the operating programs, such as editors, assemblers and debuggers. A second tape is reserved for the object program library. The two remaining tapes are used for input-source programs, to be edited or assembled, and output files for the editor or assemblers. Using this arrangement, a new program can be processed from raw input, edited, assembled, and cataloged into the object program library without operator intervention to change or move tapes. Alternative file arrangements are, of course, available to the programmer. Any of the four available tapes may be used for any file without restriction.

It also provides flexibility in production test systems. Typically, one tape is reserved for operating programs, one is reserved for test patterns and the remaining two are used for data logging. Utilizing two tapes for data logging allows continuous operation, since it is not necessary to halt the system when one tape reaches its capacity.

In systems where one computer is controlling several test or production machines, it may be advantageous to assign one tape to each device being controlled. For example, if a single computer is controlling four NC machine tools, it is likely that the four machines will be making totally different parts. It simplifies the system if a separate source file is provided for each NC machine.

The four independently controlled tapes make the CartriFile suitable for sorting and merging files. Tri-Data tape cartridges provide a convenient method of storing master files and transaction data for historical records. Each 150-foot tape will store in excess of 300,000 alpha-numeric characters.

CIRCLE NO. 347

A CAMBION® Double "QQ" Product Line

As often as you want, too. The design of the jack and the materials from which it is produced give it the strength to be cycled more than 50,000 times (we've done it) without appreciable change in contact resistance.

And we didn't just do it once "in the lab."

We have tens of millions of these jacks out, in use by customers. ID's range from .016" to .080". And are available in different shapes and types for mounting components, patching, plugging, or whatever you have in mind.

All CAMBION cage connectors are standard, immediate delivery items. You can have them fast in whatever number you want. That's the CAMBION Double "QQ" approach, the quality stands up as the quantity goes on. Ask for a sales engineer or a catalog. Cambridge Thermionic Corporation, 445 Concord Avenue, Cambridge, Mass. 02138. In Los Angeles, 8703 La Tijera Blvd. 90045.

This cage jack was built for recycling!



INFORMATION RETRIEVAL NUMBER 63

NEW! THE LOVE SWITCH

Our Customers Love Its
1,000,000 Detents
(for high quality)
And Low Cost
(for savings)!

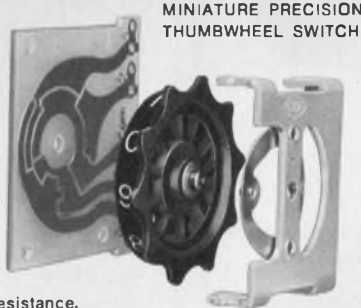

MINIATURE PRECISION THUMBWHEEL SWITCH

9 Top Quality Features

1. .05 ohms max. contact resistance.
2. 200 megohms min. insulation.
3. 1,000 volts min. dielectric strength.
4. 2 amps @ 115VAC current carrying capability.
5. 125 ma @ 115VAC current breaking capability.
6. Mounts on 1/2" centers only 1 1/2" behind panel.
7. Glass laminate with precious metals contacts & plating.
8. Multi-applications—you name it.
9. Over 1,000,000 detents.

IMMEDIATE DELIVERY. ASK THE PRICE—BE PLEASANTLY SURPRISED.

CHICAGO DYNAMIC INDUSTRIES, INC.

PRECISION PRODUCTS DIVISION

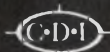

1725 Diversey Blvd., Chicago, Ill. 60614. Phone 312, WE 5 4600

INFORMATION RETRIEVAL NUMBER 64

ELECTRONIC DESIGN 10, May 11, 1972

looking for a....

LOW COST HIGH QUALITY POPULAR SIZE

....ceramic capacitor?

Well, look toward USCC/Centralab.

Our Mono-Kap™, a radial lead, epoxy coated monolithic ceramic capacitor could be the answer. They're available in six sizes from .100 x .100 to .500 x .500 in NPO, W5R, Z5U and Y5V dielectrics. Capacitance values range from 4.7pF to 10Mfd in 50, 100 and 200 VDC ratings.

USCC/Centralab has developed highly automated assembly techniques for Mono-Kap and our other ceramic capacitor products—from raw materials to chip capacitors to leaded capacitors with no sacrifice to quality. All this makes possible the fastest delivery in the industry on the wide variety of USCC components. Ask us, we'll give you our best.



For FREE Mono-Kap evaluation samples, write on company letterhead to USCC/Centralab, 2151 N. Lincoln Street, Burbank, California 91504. For complete technical data on Mono-Kap, and a FREE copy of our Ceramic Capacitor Catalog, circle the information retrieval number below.

USCC

U.S. CAPACITOR CORPORATION



CENTRALAB

Electronics Division • GLOBE-UNION INC.

INFORMATION RETRIEVAL NUMBER 65

A.W. Haydon Company motors... problem-solvers for Hewlett-Packard

Minimum magnetic interference, reversibility, accurate positioning and low cost are some of the features offered by two A. W. Haydon motors used in the Hewlett-Packard Model 10 programmable calculator.

Amazingly versatile, the calculator combines plug-in modules with a wide number of options which allow it to be adapted to a host of disciplines using mathematics, statistics and other functions.

One option, for instance, permits often-used programs to be stored on magnetic cards. The cards can then be fed through a built-in magnetic card reader for speedy data and program entry.

But herein lay design problem No. 1. Find a motor capable of feeding the cards in and out at a smooth, constant speed. Also, one which would keep electromagnetic interference to a minimum to prevent the input data from being adversely affected.

The answer? An A. W. Haydon

43100 reversible dc motor. Widely used for timing and control applications, the 43100 series features permanent magnet construction encased in a steel shell to minimize stray electromagnetic fields. Another design advantage: a hollow cage ironless rotor which eliminates cogging. Result: the magnetic card is fed through the reader at a smooth constant rate of speed.

Problem No. 2 was to find a motor capable of driving the Model 10's alphanumeric printer. Accurate positioning and economy were essentials. The answer was "on the shelf" . . . a standard A. W. Haydon 12 vdc ID05 stepper motor which offers accuracy and dependability at an attractive low cost.

If your own design problems encompass timed motion or control, our broad range of synchronous, dc timing and stepper motors — plus our extensive engineering experience — can help solve these problems and lower your costs. Try us and see.

Write for our Motor Catalog.



A. W. HAYDON CO. PRODUCTS

NORTH AMERICAN PHILIPS CONTROLS CORP.

A NORTH AMERICAN PHILIPS COMPANY
232 North Elm St. · Waterbury, Conn. 06720 · (203) 756-4481

INFORMATION RETRIEVAL NUMBER 66

design aids

Plastic fastener terms

The first industry-wide glossary of standard terms for plastic fasteners has been developed and published by the Industrial Fasteners Institute (IFI), an association of the leading North American manufacturers of bolts, nuts, screws, rivets, and all types of special industrial fasteners. Standard No. IFI-120, Glossary of Terms Relating to Plastic Fasteners, was prepared by IFI's recently formed Division III—Plastic Fasteners, to establish uniform terminology for all producers and users of plastic fasteners. The new standard defines 125 terms grouped according to product classifications, materials, and additives, physical properties, manufacturing and testing and inspection. Industrial Fasteners Institute.

CIRCLE NO. 348

Torsional coupling chart

A handy two-color slide chart enables the user to calculate torsional isolation and select the proper elastomeric coupling to suit his particular application. One side of the 4-3/4 × 8-1/2-in. slide chart is designed to determine torsional response characteristics of a drive train. The other side can be used to select specific Lord part numbers from Lordco Supply, a service of the parent company. Lord Manufacturing Co.

CIRCLE NO. 349

Waveforms comparisons

A picture-reminder of how ten different basic waveforms look in terms of five different processing domains is printed on a 10 × 12-in. wall-chart. The waveforms consist of five examples of repetitive waveshapes and five different random signals. The typical functions shown are: time, auto-correlation, averaged frequency spectrum (PSD), probability density, and cumulative distribution. Federal Scientific Corp.

CIRCLE NO. 350

miniature terminal blocks by curtis



SE Series: versatility through variations in a miniature terminal block.

This series includes a variation for any application, from the simplest surface connection with #2-56 binding screws, clamps for positive connection without bending or hooking wires, variations providing 2 to 6 quick-disconnect tabs per pole, and feed through, internal connection pins in either the turret-type for soldering or the straight type for printed circuits. The blocks, available with 1 to 26 terminals, are black, molded thermo-set phenolic with the poles on 1/4" centers. Rated at 5 amperes, 300 volts, for use with wire up to #16 AWG.

Contact factory for your nearest local Curtis representative, distributor, or for additional information.

CURTIS DEVELOPMENT & MFG. CO., INC.
 3236 N. 33rd St. • Milwaukee, Wis. 53216

INFORMATION RETRIEVAL NUMBER 67

BUCKEYE

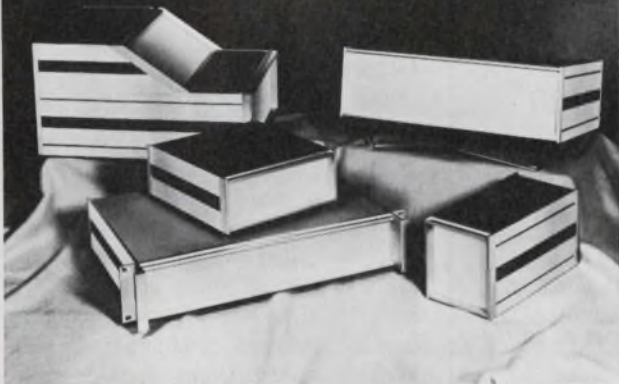

DESIGNER SERIES **CASES** Instrument packaging

For the sizes demanded and for styles preferred — Buckeye's revolutionary instrument case concept. Ingenious assembly system of anodized aluminum extrusions and components give strength and flexibility for configurations never before available with "off-the-shelf" units. Harmonizing suede-finish color panels individualize one unit or a system — rack mounted or bench type using Buckeye's exclusive retractable locking tilt stand. Sizes available with 4 1/2" or 6" P.C. board guides installed.

Write today for your free catalog.



 **the BUCKEYE stamping co.**
 555 Marion Road, Columbus, Ohio 43207
 Quality Products Since 1902

INFORMATION RETRIEVAL NUMBER 68

ELECTRONIC DESIGN 10, May 11, 1972

146 MONO-KAP™ Monolithic capacitor values

NOW IMMEDIATELY AVAILABLE FROM YOUR CENTRALAB DISTRIBUTOR

The superior reliability of Centralab MONO-KAP capacitors has already been tested and proven. Now they're available, for the first time, from Centralab Distributors. That means the same tested and proven local service you've come to expect on other Centralab components.

Let your distributor prove his reliability for immediate delivery of the most complete range of radial lead, epoxy-coated monolithic capacitor values in the industry. You can rely upon his complete stock for the prototype or small production quantities you need. Let your distributor prove how fast and how well he can handle your requirements.

Remember, he also stocks a complete line of Centralab ceramic disc capacitors as well as other highly reliable special purpose ceramic capacitors. You can depend on him for feed-thru, variable trimmer and transmitting types plus a wide range of polystyrenes and miniature electrolytics. Check your requirements, then call your Centralab Distributor. He has just the right capacitors you need. Immediately!

Need complete Mono-Kap technical data and the name of your closest distributor? Write Centralab Distributor Products, Dept. MK-1.

DISTRIBUTOR PRODUCTS



CENTRALAB

Electronics Division
 GLOBE-UNION INC.

5757 NORTH GREEN BAY AVENUE
 MILWAUKEE, WISCONSIN 53201

INFORMATION RETRIEVAL NUMBER 69

think woven

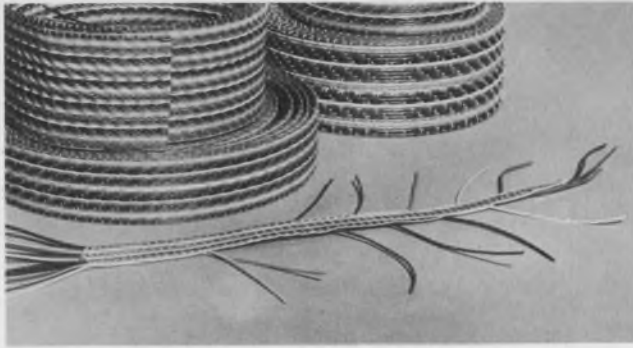

for precision

When you don't think an interconnect can be made to do precisely what you want it to. Think again. Think Woven! Programmed lead break-outs and other exacting custom features by Woven Electronics offer cable capabilities never before available.

WOVEN ELECTRONICS

A DIVISION OF SOUTHERN WEAVING COMPANY

P.O. Box 189, Mauldin, S.C. 29662. (803) 288-4411

INFORMATION RETRIEVAL NUMBER 72

evaluation samples

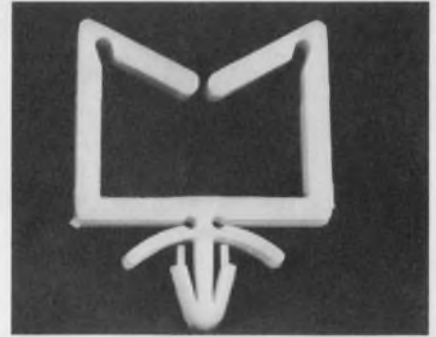

Wire saddle fastener

A WWS-2N wire saddle fastener features a barbed arrow insertion tip for permanent installation. Simple finger-tip pressure compresses the tip into a 0.187-inch diameter hole. Once inserted, the tip expands to lock permanently in position and cannot loosen or fall out. The new locking design, for which a patent is pending, is so effective that the fastener will withstand even forcible removal. Made of nylon, the WWS-2N is wider than previous designs and will saddle an area 750 mil in width and 500 mil in height. Richlok Corp.

CIRCLE NO. 351

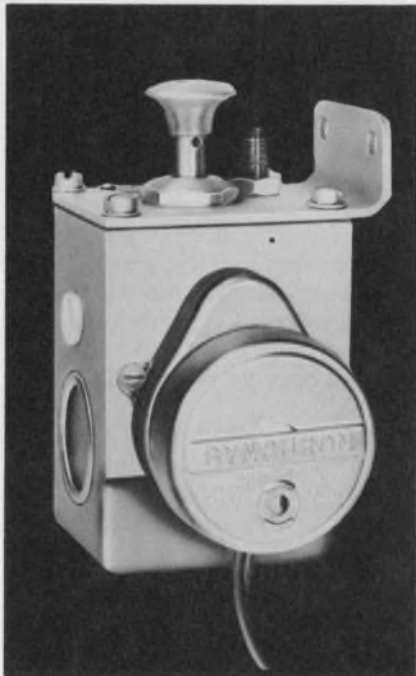

Reliably accurate timing and drive by Synchron®

Several of the large computer manufacturers now protect their expensive printers with Bijur lubricators. These lubricators accurately meter minute quantities of oil at regular intervals to provide carefully controlled lubrication. Too much oil could result in disfiguring or staining the paper. Too little could result in failure of printers that cost upwards of five figures. Thus, dependability and long life are essential. "That's why we use Hansen Synchron® motors to time and drive lubricating pumps used for this type of application," says Ira Stanley, Bijur Purchasing.



Why don't you depend on Synchron motors when you have a lot at stake?

HANSEN MFG CO., INC.—PRINCETON, INDIANA 47670

HANSEN REPRESENTATIVES: Carey & Associates, Houston and Dallas, Texas; R. S. Hopkins Co., Sherman Oaks, Calif.; Melchior Associates, Inc., San Carlos, Calif.; The Fromm Co., River Forest, Ill.; John Orr Associates, Grand Rapids, Mich.; H. C. Johnson Agency, Inc., Rochester, N.Y.; Winslow Electric Co., Essex, Conn.; Kiley Electric Co., Villanova, Pa.; and Herbert Rude Associates, Inc., Teaneck, N.J.
EXPORT DEPARTMENT: 2200 Shames Drive, Westbury, N.Y. 11590

INFORMATION RETRIEVAL NUMBER 70

Glass substrate

Glass, as thin as 6 mils, and up to 10 × 14 inches in size can be equipped with a pattern of through holes and other etched patterns in one or both surfaces. These in turn can be filled with various materials. Through holes as small as 8 mils in diameter and other details can be held to ±0.0005 in. tolerances. Applications include substrates for thin film memory planes and display tubes of various types. Dynamics Research Corp.

CIRCLE NO. 352

Epoxy adhesive

Epoweld 8173 epoxy adhesive sets in 3-5 minutes. It bonds to metal, wood, most plastics, concrete, and fabric surfaces. The epoxy is packaged in disposable Double/Bubble twin packets. Hardman Inc.

CIRCLE NO. 353

application notes

Transformer selection

An eight-page booklet provides information on the selection of instrument transformers. Entitled, "How to specify an Instrument Transformer," the booklet provides information on how to properly select an instrument transformer and tips on how to avoid buying more transformer than is really needed, thereby keeping costs down. Ritz Instrument Transformer Co., Redondo Beach, Calif.

CIRCLE NO. 354

MOSFET fm tuner design

An application report on designing an fm tuner using MOSFETs provides test data and helpful hints on designing with the 3N201 dual-gate MOSFET at 100 MHz. Bulletin CA-164, eight pages, includes dc considerations for a 100-MHz rf amplifier and for a mixer. The high gain, low noise, and large agc range that the dual-gate MOSFET provides and an rf amplifier are described. Texas Instruments, Inc., Dallas, Tex.

CIRCLE NO. 355

Hybrid design manual

The design of hybrid micro-circuits is outlined in a 20-page manual. Advantages of hybrid design and various packaging techniques are described. Airpax Electronics, Controls Div., Ft. Lauderdale, Fla.

CIRCLE NO. 356

Testing MOS RAMs

A four-page application note completely describes test procedures used on MK 4006 P and MK 4008 P MOS RAMs. The new report is being made available in response to user interest in testing MOS/LSI RAMs and the difficulties frequently encountered. The tests are all performed under worst-case address change, refresh and other applicable conditions. Mostek Corp., Carrollton, Tex.

CIRCLE NO. 357

Bare bones recorders

- Save up to 50%... No fancy Panels or Cases
- d.c. — 150HZ
- Complete with amplifier, power supply, and chart drive

Bare Bones Recorders... that's what we call these precision O.E.M.* High Speed Recorders. They are: Very Low Cost, Compact, Highly Accurate... but without fancy cases, or push buttons. Just the "bare bones" of features, performance and quality.

Now, for the first time, you can buy an O.E.M. configuration recorder at the low O.E.M. prices.

These are complete recorders. Included are: precision high speed galvanometer (d.c. to 150HZ), integrated circuit amplifier, regulated power supply, two speed chart drive.

*O.E.M. to the uninitiated is *Original Equipment Manufacturer* who incorporates these recorders in his own equipment with his own name. Now these recorders are available *direct* to you, the user.

\$286! One Channel

\$575! Two Channel

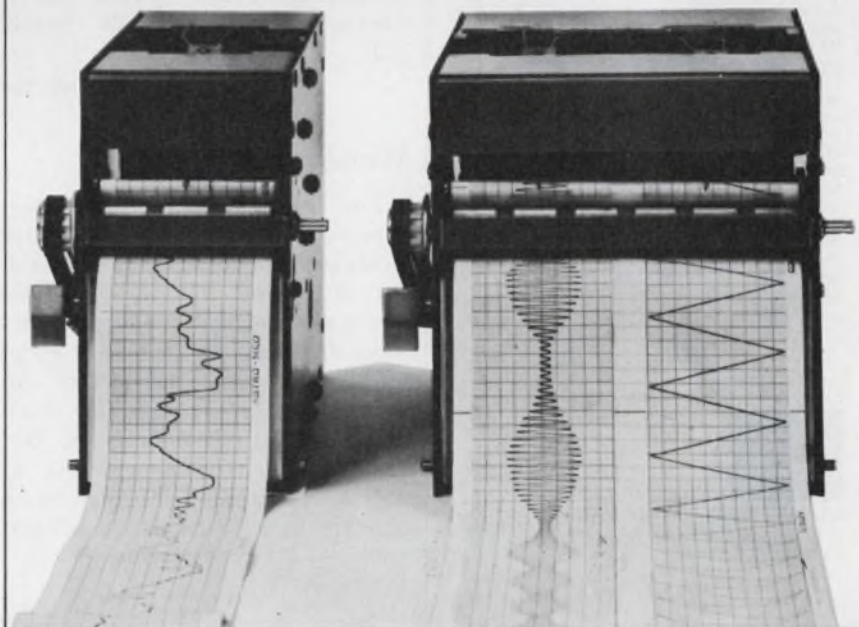

ASTRO-MED



A DIVISION OF ATLAN-TOL INDUSTRIES, INC.
ATLAN-TOL INDUSTRIAL PARK
WEST WARWICK, RHODE ISLAND 02893
(401) 828-7010

Gentlemen:
Please send complete literature.

Our application is _____

Telephone _____

Name _____

Title _____

Organization _____

Street _____

City _____

State _____ Zip _____

NEW PRODUCTS FROM EDC

ELECTRONIC DEVELOPMENT CORP.
BOSTON, MASSACHUSETTS



DC TWIDDLE BOX WITH GALVANOMETER (& Δ V/M) Measurements from $\pm 1 \mu\text{V}$ to 10 Vdc. Accuracy (Worst Case - Limit of Error) $\pm 0.005\%$ of setting. Z_{in} at null: ∞ ; Z_{in} off null = 10 M Ω . Sensitivities from $\pm 1 \mu\text{V}$ to ± 10 V. High Linearity, off-null-measurements for Differential Voltmeter (Δ V/M) use. The bucking Voltage Standard is an active Calibrator (Source) with $\pm 0.005\%$ accuracy (Limit of Error). 50 mA current and $Z_{out} = 10$ milliohms. Two ranges: 10 V, resolved to 10 μV , and 100 mV output resolved to 100 Nanovolts (1 ppm). "Confidence Indicator" shows that the instrument is operating with sufficient line power, no short, no overload and no malfunction. Weight: 8 - 1/2 lbs. Delivery 2 weeks. Price: Model MV 100 B = \$770 (calibrator only); Model MV 100 B/G = \$995 (Calibrator and Galvanometer). Instruments available for engineering evaluation.

Circle #168



AC CALIBRATOR
EDC Model AC 1000 D/B. Push a frequency button and direct dial the amplitude. 4 ranges include: 10 μV to 1111 Vac. 5 fixed frequencies: 50, 60, 400, 1000 Hz, plus one optional frequency. External oscillator may be used to operate at other frequencies. Burden 50 VA (2A max). At calibration frequency, Accuracy: 0.025% rms, Distortion: 0.2%, Stability: 0.0075%. Protected against over-load and short circuit. APPLICATIONS: Calibration of AC Voltmeters, DVMS, VOMS, dynamometers and accelerometers. Reference for A/D converters. Power Source in design and evaluation of amplifiers, converters, filters, rectifiers, regulators, and servo, gyro and wattmeter applications, demodulators, xfms, inductors, RMS converters, gain-control circuits and oscillators. Test & calibrate SCR's and switching circuits. Instruments available for Engineering Evaluation. Price: Model AC 1000 D/B \$3100. Delivery 2 weeks. For engineering information, call Robert Ross: (617) 268-9696.

Circle #169



Electronic Development Corporation
11 Hamlin Street • Boston, Mass. 02127
(617) 268-9696

new literature



Test instruments

A 12-page illustrated catalog describes in detail the company's line of test instruments and subsystems for data communications. Among the products described are their tech controls/systems, test/monitor systems, modular data test sets, "Mini-Cheks" (a new line of field portable packs), voice-frequency instruments, militarized test sets and miscellaneous test equipment. Digitech Data Industries, Inc., Ridgefield, Conn.

CIRCLE NO. 358

Extension cable

Two designs of served armor wrap thermocouple extension cable in 18 possible constructions are described in a new catalog sheet. Thermo Electric, Saddle Brook, N.J.

CIRCLE NO. 359

Miniature connectors

The UMI series of ultra-miniature connectors is now detailed in a concise, two-color illustrated catalog designated No. UMI-C. The ten-page specifications manual provides full data on the seven series of ultra-miniature connectors. Also included are charts, materials data, compatibility analyses, test reports and recommendations, as well as background information on military specifications compliance, patents. U. S. Components, Inc., Bronx, N. Y.

CIRCLE NO. 360

Portable Guardohm[®]

may cut your Testing Time in Half!



If your people are still using the calibrate, calculate and speculate method of testing and troubleshooting, now is the time for you to purchase a Portable GUARDOHM, and switch to time-saving, In-Circuit component testing.

The exclusive Guard Circuit in the GUARDOHM employs operational amplifiers and electrically isolates the component under test to permit accurate, fool-proof, in-circuit testing.

This economical, portable test instrument uses the same Guard Circuit that has been proven by years of operation in Systemation's \$40,000 production PC board testing systems, and offers many advantages:

- No need to unsolder components, ever!
- Direct meter readout of actual component values, no parallel value calculations.
- Measures resistance, checks polarity of capacitors, impedance and IR drop of diodes, transistors, and integrated circuits at specified current.
- Accurate to $\pm 3\%$, easy to read linear meter, measures 10 ohms to 10 megohms, 100NA to 100MA, 0.1 V to 1,000V.

IN-CIRCUIT-TESTING is as simple as A,B,C! To test R_1 , connect test leads to A and B, and Guard lead to C. Read the meter.

ONLY
\$139
COMPLETE

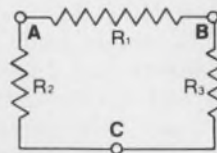

Systemation Inc.

Clifton Park, Elmhurst, New York 12065
Telephone 518-877-7424



AM/FM/SSB service monitor

An 8-page brochure describes a new communication service monitor, Model FM-10C. Features and design philosophy are described in full, together with specifications and applications. The FM-10C provides a complete AM/FM/SSB servicing package in the range 50 kHz to 512 MHz. Singer Instrumentation, Los Angeles, Calif.

CIRCLE NO. 361

High noise immunity

A 64-page brochure shows complete family characteristics for Series 300 high noise immunity logic, including absolute maximum ratings, summary of propagation delays and I_{cc} currents, pinout reference guide, device data and applications. Teledyne Semiconductor, Mountain View, Calif.

CIRCLE NO. 362

Oiltight pushbuttons

A 24-page brochure describes type PW miniature oiltight pushbutton switches. Included are lighted and unlighted pushbuttons, one and two-lamp indicators, selector units and contact blocks. Micro Switch, Freeport, Ill.

CIRCLE NO. 363

Thermoplastic resin

A full color, 19-page brochure focuses on the unusual combination of engineering properties found in VALOX thermoplastic resin. Some of these properties are: resistance to most organic chemical environments, low surface friction and wear, outstanding fatigue endurance, Underwriters' Laboratories SEO and Class I recognition, superior electric properties, very low water absorption rate, plus molded-in color, and excellent dimensional stability. General Electric Co., Pittsfield, Mass.

CIRCLE NO. 364

Optical filters

A 20-page catalog contains descriptions, curves, specifications and prices for optical filters, infrared optics and CR-39 plastics. Pomfret Research Optics, Inc., Stamford, Conn.

CIRCLE NO. 365

if you're hearing comments like...



INFORMATION RETRIEVAL NUMBER 74



Sapphire substrates. More for less.

Polished, single crystal sapphire substrates cut from sapphire ribbon stock. Standard lengths from 1/4 to 4 inches. Standard widths in 1/4, 1/2, 3/4 and 1 inch sizes. For thin film and epitaxial requirements. Available with 1102 orientation for SOS work. Free of microvoids. Low in cost. Check 'em out. Call Frank Reed, Marketing Manager, for price and delivery.

LYCO saphikon division 16 Hickory Drive • Waltham, Mass. 02154 • (617) 890-2400

INFORMATION RETRIEVAL NUMBER 75

the only printed circuit Relay

that plugs into your PC board without SOCKETS or SOLDERING

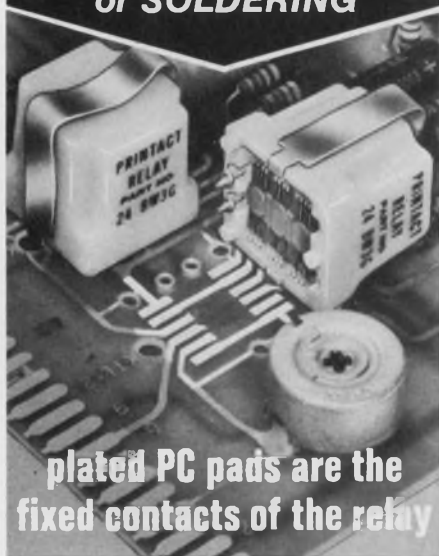

plated PC pads are the fixed contacts of the relay

Printact[™] MAGNETIC LATCHING AND NON-LATCHING RELAYS

The only relay designed to make full use of printed circuit technology. Unlike others adapted with terminal pins or sockets for solder mounting, Printact plugs directly into your module. Precious metal plated PC pads mate with shorting bar contacts on the pivoting armature, which is the single moving part. Held by a permanent magnet, it eliminates return springs, pigtailed, electrical and mechanical connections—assuring reliability for millions of cycles.

Inherent Custom Features include: Low Thermal EMF, Low Contact Bounce, Impedance Matching, 45-60 db Isolation, Bifurcated Contacts, and Encapsulated Coil—all at low cost!

Send for Test Sample and PC Board Preparation Aids to simplify design and production of your module.

For action write or call 212—EX 2-4800.

Executone

PRINTACT RELAY DIVISION
P.O. Box 1430ED
LONG ISLAND CITY, N.Y. 11101

INFORMATION RETRIEVAL NUMBER 76

NEW LITERATURE

Miniature PC socket

A miniature PC socket, which provides repeated pluggability for ICs, LSIs, lamps, transistors, LEDs and other components, is described in a 4-page bulletin. Berg Electronics, Inc., New Cumberland, Pa.

CIRCLE NO. 366

Potentiometric recorders

An 8-page catalog covers Series 400 Potentiometric strip chart recorder line. The catalog describes the Model 400 miniature single channel recorder, the Model 3400 dual channel recorder and the single channel Model 1400 for EIA rack mounting. A number of features and options for each model is also shown. Rustrak Instrument Div., Gultron Industries, Inc., Manchester, N.H.

CIRCLE NO. 367

Data storage system

A 2-page spec sheet describes a cartridge disc memory system for minicomputers. Data capacity, access time, adapters and read/write logic are discussed. Iomec, Inc., Santa Clara, Calif.

CIRCLE NO. 368

Line driver module

Bulletin 819 details complete electrical specifications for the type 14 balanced-differential line driver module as applied to the transmission of incremental encoder pulses down long lines and in noisy environments. The module contains the complete driver circuitry including a voltage regulator. Trump-Ross Industrial Controls, Inc., North Billerica, Mass.

CIRCLE NO. 369

Digital cassette recorders

A 4-page brochure describes the Termi Series of digital cassette recorders and memories for point-of-sale equipment, data capture, peripheral storage, data communications, keyboard-to-tape and other modern applications. Text and comprehensive specifications are supplemented by illustrations of each unit. Telex Communications Div., Minneapolis, Minn.

CIRCLE NO. 370

Free Samples



Low-price reed relay

A new low-cost reed relay is being offered for as low as 29¢ (1 million quantities). Other price breaks are: 39¢ for 100,000; 56¢ for 10,000; and 80¢ for 1000 quantities. This new relay features MIL-Q-9858A specifications, a magnetic shield for high-density packing and contact resistance of less than 100 mΩ. Its contacts are rated at 1A or 250-V switching at 20 W. Coils are available for 1, 3, 5, 6, 10, 12, 15 and 24 V. The relay's size is 0.275-in. in outside diameter by 0.95-in. long. Free samples are available.

Electronics Applications Company
2213 Edwards Ave.
South El Monte, Calif. 91733

INFORMATION RETRIEVAL NUMBER 77

Three chicks in all. One will surely lay a gold egg.



Nippon Pulse's ultra compact 4-phase stepper motor — that is! Ranging from the above pictured PF1-20, seven models in all, with MSI drive unit. Diameter ranges from 12 to 51mm; maximum torque, from 0.4 to 3,200 gr-cm; and stepping angle, from 7.5 to 18°. All, giving you a long dependable service, are offered at strongly competitive prices. For details, write us today.

PF1-20: Diameter, 12mm; Max. Pull-out Torque, 0.4 gr-cm; Max. Pull-in Rate, 440 pps; Max. Pull-out Rate, 1000 pps; Stepping Angle, 18°

International Department
NIPPON PULSE MOTOR CO., LTD.
No.13-16, 2-chome, Hongo, Bunkyo-ku, Tokyo
Japan Cable: NIPULSEMOTOR TOKYO
INFORMATION RETRIEVAL NUMBER 78
ELECTRONIC DESIGN 10, May 11, 1972

Power conversion equipment

A 12-page catalog enables the electronic system designer to "Design as he orders" custom power conversion equipment. The catalog describes the features, specifications, modifications, and mounting dimensions for the company's miniature and subminiature power conversion equipment. Arnold Magnetics Corp., Culver City, Calif.

CIRCLE NO. 371

Electronic test instruments

A mini-guide is now available listing four lines of electronic test instruments. The easy-to-use guide gives a fast glance at all major specifications needed for selecting any one of Dana's five series of DVMs; two series of data amplifiers; two series of electronic counters; and a series of frequency synthesizers. Also included is price information. Dana Laboratories, Inc., Irvine, Calif.

CIRCLE NO. 372

Panel meter spec terms

Precise definitions of terms used to describe d'Arsonval movement panel meter performance are presented in an 8-page booklet. Limited to terms describing parameters of major importance to the meter user, the discussion draws distinctions among such concepts as "accuracy," "calibration accuracy," "full-scale accuracy," and "tracking accuracy," as well as related terms. The practical importance of the major specifications is also indicated. Beede Electrical Instrument Co., Inc., Penacook, N.H.

CIRCLE NO. 373

A/d-d/a converters

A comprehensive jacket catalog contains detailed electrical and mechanical information on a new line of ultraminiature analog-to-digital converters and digital-to-analog converters plus modular data acquisition systems. The hardware described forms the basic building blocks for many forms of data acquisition, data analysis, data reproducing, and graphic display equipments. Datel Systems, Inc., Canton, Mass.

CIRCLE NO. 451

then it's time you looked into Visual Search Micro Film.

VSMF Design Engineering System:

- Arranges products by parameter.
- Allows rapid comparison of like products.
- Contains complete data sheets.
- Provides paper copies instantly.
- Is updated every 30 days.

"Hey, this is easy."

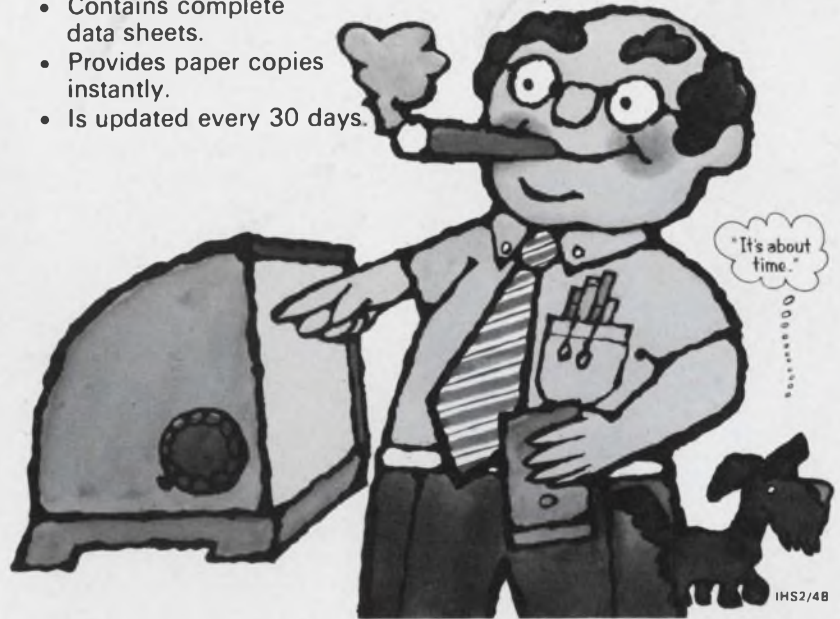

INFORMATION RETRIEVAL NUMBER 74

ENGINEERS WHO KNOW ZENER DIODES SPEC DICKSON

That's because Dickson has earned a reputation for excellence in voltage regulating (Zener) and reference (TC) diodes. Since Dickson has always been a specialist in Zeners, engineers expect the best and they get it . . . from a hi-rel military unit to low-cost industrial devices. Give us a try! Write, today, for our 6-page Zener Selection Guide.

"The Specialists"



"Where Quality Makes The Difference"



DICKSON
ELECTRONICS CORPORATION

PHONE (602) 947-2231 TWX 910-950-1292 TELEX 667-406
P. O. BOX 1390 • SCOTTSDALE, ARIZONA 85252

INFORMATION RETRIEVAL NUMBER 79

AMERICAN **1** MADE

Tolerance
SCHAUER
1-Watt
ZENERS

Immediate Shipment
Low Prices

ANY voltage from 2.0 to 18.0

Quantity	Price each
1-99	\$1.07
100-499	.97
500-999	.91
1000-4999	.86
5000 up	.82



All welded and brazed assembly

No fragile nail heads

Gold plated leads

Write for complete rating data and other tolerance prices.

Buy the kit-
Save a lot



Kit contains a 51-piece assortment of SCHAUER 1% tolerance 1-watt zeners covering the voltage range of 2.7 to 16.0. Three diodes of each voltage packaged in reusable poly bags. Stored in a handy file box. Contact your distributor or order direct.

A \$54.57 value for

ONLY **\$24⁵⁰**

Semiconductor Division

SCHAUER
Manufacturing Corp.

4511 Alpine Ave. Cincinnati, Ohio 45242
Telephone: 513/791-3030

NEW LITERATURE

Negative thermistors

An 8-page brochure describes the company's line of negative temperature thermistors. Easy to follow charts offer thermistor dimensions as well as characteristics of values from 4 to 500 Ω . Siemens Corp.

CIRCLE NO. 452

ISSCC digest

The fifteenth ISSCC report, DIGEST of TECHNICAL PAPERS, with 256 pages and more than 500 captioned illustrations, featuring condensations of all papers—invited, contributed and keynote—and a complete index of papers and authors is now available at \$15 per copy (IEEE members) and \$20 (nonmembers) from H. G. Sparks, The Moore School of Electrical Engineering, University of Pennsylvania, Philadelphia, Pa. 19104. Orders for the DIGEST should be accompanied by remittance in U.S. currency payable to Solid-State Circuits Conference, 1972 IEEE International Solid-State Circuits Conference, Philadelphia, Pa.

Audio frequency amplifier

An 8-page application bulletin describes the LM354, monolithic integrated circuit which serves the functions of amplification in lower frequency. The LM354 is particularly designed for use as an audio amplifier in TV, record players and other industrial uses. European Electronic Products, Corp., Culver City, Calif.

CIRCLE NO. 453

Digital and linear ICs

Four handbooks, 54/74 TTL Handbook, "8000" Series TTL/MSI and Memory Handbook, MOS Silicon Gate 2500 Series Handbook and Linear Integrated Circuits, Volume I, in the form of a complete "how-to-do-it" reference pack are now available. The handbooks describe 275 different MOS ICs, bipolar digital devices and linear circuits. A nominal fee to cover postage and handling costs of \$3.00 for the complete package of four handbooks is charged. Individual books can be obtained for \$1.00 each. Signetics, 811 Arques Ave., Sunnyvale, Calif.

MONOLITHIC
CRYSTAL FILTERS



Bicycle Built For Two



Tandem bikes are a current fad. Tandem monolithics are more than a fad—they're the state of the art. And for good reason. If you need four-pole performance, or better, you probably need a tandem monolithic crystal filter. Like to know more? Talk with us. We make monolithics and tandem monolithics—more of them than anyone else—and we'll be glad to discuss which is best for your application.

Who Gets Your Business



Many companies know a little bit about making a lot of things. We know a lot about making just one thing—monolithic crystal filters. The fact that we are the only specialists in the field is a reassuring point for you. Especially when you need assistance and technical know-how in solving filtering problems.

Standard Versus Custom Models



In the horse-and-buggy days of electronics (year-before-last) all crystal filters were custom models—expensive and uncertain in price, performance and delivery. We've changed all that with a wide, wide selection of standard models. Twenty-one new models at 21.4 MHz. Over twenty-five models at 10.7 MHz. All available from stock. Plus many others, all using our proven monolithic technology. Standard models save time, save money, and you know what you're going to get. When you do need custom filters, we can help. From writing specifications to delivering on time.

Like more information on monolithics? Drop us a line or call us.

Pi

Piezo Technology Inc.

2400 Diversified Way
Orlando, Florida 32804
305-425-1574

The standard in monolithic crystal filters.

bulletin board

Litton Industries' Monroe 1300 series of electronic business calculators offers both LED display readout and tape printout in the same machine. The machines provide a wide choice of modular keyboards specifically tailored to individual customer requirements and are priced from \$745 to \$895.

CIRCLE NO. 454

Mercutronic Unicluster keyboards vary in price between the unit price of \$249 and the price for quantities of 500 of \$87.15. The price in lots of 50 is \$174.30 and for 100 is \$136.95.

CIRCLE NO. 455

Price reduction

DEC has reduced prices on PDP-11 minicomputer systems by 13-24% by introducing a cartridge disc drive unit and an 8 k memory system. The new RK05 DEC-pack cartridge disc drive replaces a similar system formerly manufactured for Digital. It is priced at \$5100 compared to \$8000 for the previous unit. The redesigned ME11-L 8 k core memory system is priced at \$5200 with add-on incremental 8 k memory units at \$4400 each, up to the 24 k capacity of the system. Previous DEC 8 k core cost \$7500. Quantity discounts of up to 36% are now available on both new systems and on the standard core memory.

CIRCLE NO. 456

Digital Computer Controls has reduced prices on its D-112 series of 12-bit minicomputers. A D-112 with a 4 k memory, TTY interface, programmers console, power supply and chassis is now \$3690, reduced \$300 from \$3990. An 8 k D-112 with the same description is now \$5590, reduced \$775. A 4 k D-112 with programmers console, power supply and chassis is now \$3390. A 4 k D-112 with TTY interface, turnkey console, power supply and chassis is now \$3490, reduced \$300 from \$3790. An 8 k D-112 with turnkey console, power supply and chassis is now \$4990.

CIRCLE NO. 457

VSMF keeps it simple, you find it fast

- Cuts search time up to 90%.
- Puts information where you need it: . . . Data Centers and Satellite units.
- Reduces file maintenance.

VSMF costs less than a file clerk.

For a demonstration, write



Information Handling Services

An Indian Head Company

P. O. Box 1154, Dept. ED-5,
Englewood, Colorado 80110

Or, call
(303) 771-2600

"This could be the start
of something big."



INFORMATION RETRIEVAL NUMBER 74

THIS IS A VERY LOW COST
FREQUENCY RESPONSE
ANALYZER WITH AUTO-
MATIC HIGH NOISE AND
HARMONIC REJECTION.



Single Units : \$2875.
In Quantities: \$2450.

READS AMPLITUDE AND PHASE
vs FREQUENCY 0.1 TO 20,000 Hz.
■ FAST OPERATION ■

WRITE FOR BULLETIN 7172 ON
OUR COMPLETE LINE OF FRE-
QUENCY RESPONSE ANALYZERS.

BAFCO, INC. 717 Mearns Road
Warminster, Pa. 18974
Telephone (215) 674-1700

INFORMATION RETRIEVAL NUMBER 82

filters BANDPASS & NOTCH

- Seven day delivery
- Low cost
- Computer designed
- PC board mounting
- Excellent frequency stability
- Encapsulated



Information from
**BEUKERS
LABORATORIES, INC.**

1324 Motor Parkway
Hauppauge, New York 11787
516-234-2200

INFORMATION RETRIEVAL NUMBER 83

ELECTRONIC DESIGN's function is:

- To aid progress in the electronics manufacturing industry by promoting good design.
- To give the electronic design engineer concepts and ideas that make his job easier and more productive.
- To provide a central source of timely electronics information.
- To promote communication among members of the electronics engineering community.

Want a subscription? ELECTRONIC DESIGN is sent free to qualified engineers and engineering managers doing design work, supervising design or setting standards in the United States and Western Europe. For a free subscription, use the application form bound in the magazine. If none is included, write to us direct for an application form.

If you do not qualify, you may take out a paid subscription for \$25 a year in the U.S.A., \$35 a year elsewhere. Single copies are \$1.50 each.

If you change your address, send us an old mailing label and your new address; there is generally a postcard for this bound in the magazine. You will have to requalify to continue receiving ELECTRONIC DESIGN free.

The accuracy policy of ELECTRONIC DESIGN is:

- To make diligent efforts to ensure the accuracy of editorial matter.
- To publish prompt corrections whenever inaccuracies are brought to our attention. Corrections appear in "Across the Desk."
- To encourage our readers as responsible members of our business community to report to us misleading or fraudulent advertising.
- To refuse any advertisement deemed to be misleading or fraudulent.

Microfilm copies are available of complete volumes of ELECTRONIC DESIGN at \$19.00 per volume, beginning with Volume 9, 1961. Work is now in process to complete the microfilm edition of Volumes 1-8. Reprints of individual articles may be obtained for \$2.00 each, prepaid (\$.50 for each additional copy of the same article) no matter how long the article. For further details and to place orders, contact the Customer Services Department, University Microfilms, 300 North Zeeb Road, Ann Arbor, Michigan 48106 telephone (313) 761-4700.

Want to contact us? If you have any comments or wish to submit a manuscript or article outline, address your correspondence to:

Editor
ELECTRONIC DESIGN
50 Essex Street
Rochelle Park, N.J. 07662

King of Korrelators® Conquers Fuzziness

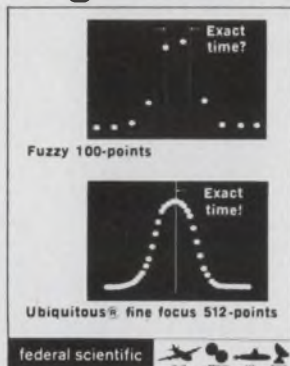

UC-201B calculates fastest, is most sensitive, and has the finest time resolution of any digital correlator. A complete time-domain measurement lab for real-time auto/cross correlation, signal enhancement, probability. For underwater acoustics, fluid dynamics, medical, noise/vibration analysis. Exact time measurements with digital dial; computes integral & differential of any stored function; pre-computational delay built-in (up to 8192 samples optional); zero time can be at center of display; sampling increments 1/2 usec to 2 sec; complete ext. (computer) control plus digital outputs; built-in test signals check all modes; small, portable, easy to use. Many options.

CIRCLE NO. 171

Federal Scientific Corporation
a subsidiary of Elgin National Industries, Inc.
615 West 131st Street, New York, N. Y. 10027

Measure Vector Angle, Magnitude And Components



The new PAR™ Model 129 Two Phase Lock-In/Vector Voltmeter, enables you to simultaneously measure the magnitude and phase angle with respect to a reference signal of virtually any low-level signal within its range of 0.5 Hz to 100 kHz—even if the signal is buried 60 dB beneath background noise. At the flip of a switch, you can also measure the in-phase and quadrature components of the vector. The Model 129 features fully automatic reference tracking, independent output expansion and filtering for each channel. Complete specifications are contained in bulletin T-314, available on request.

CIRCLE NO. 172

PRINCETON APPLIED RESEARCH CORPORATION
P.O. Box 2565
Princeton, New Jersey 08540

Circuit Zaps® for Instant PC Boards



Circuit Zaps® are 1 ounce copper circuit component patterns, pads, and conductor paths, precision-etched on 5 mil (.005") glass epoxy base material, backed by a special pressure-sensitive adhesive. Circuit Zaps® completely eliminate the artwork, photography, photoprinting, touch up, etching, stripping, and other time-consuming steps in PC board development.

Write today for the FREE TECHNICAL BULLETIN 1003 with FREE SAMPLE.

CIRCLE NO. 173

Bishop Graphics, Inc.
7300 Radford Avenue (ED)
North Hollywood, California 91605
(213) 982-2000 Telex 674672

Manufacturers

Advertisements of booklets, brochures, catalogs and data sheets. To order use Reader-ServiceCard (Advertisement)

PC Drafting Aids Catalog

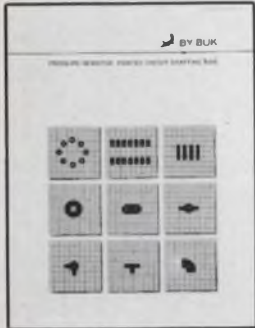

Thousands of time saving, cost saving artwork ideas are found in the By-Buk P-50 catalog of pressure sensitive printed circuit drafting aids. With the most practical artwork patterns for: TO cans, multi-pads, dual-inlines and flat packs featured. Donuts, connector strips, teardrops, ovals, tapes, tees, elbows, etc., by the hundreds are included in the most comprehensive list of sizes. Opaque black, transparent red and transparent blue materials for one and two-sided board designs. For a free copy and samples, write today.

By-Buk Company

Subsidiary of Webtek Corp., 4326 W. Pico Blvd.
Los Angeles, California 90019 (213) 937-3511

CIRCLE NO. 174

New Brochure Describes Low-Cost Power Supply Systems



A new brochure by Transistor Devices offers designers and engineers technical data on its expanded range, multiple output, X-L Series of power supplies. Such features as short circuit protection, remote sensing, adjustable outputs and 0.25% regulation, with outputs of 1-30V and current levels of 0.7 to 8 amps give designers a wide selection of models priced from \$48.50 to \$115.00.

CIRCLE NO. 175

Transistor Devices, Inc.

85 Horsehill Road, Cedar Knolls, N. J. 07927
Tel. (201) 267-1900

Free Booklet On Programmable Instruments

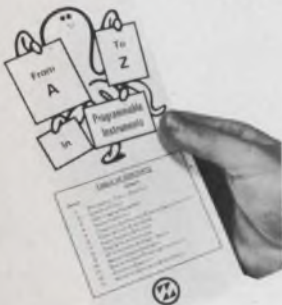

Zehntel's Testpac is a unique automatic test system which interfaces with all makes of programmable instruments; HP, Dana, Kepco, Systron-Donner etc. We've compiled into a slimline booklet, a listing of hundreds of these standard instruments from amplifiers through voltmeters. It's entitled "From A to Z in Programmable Instruments" and is must reading for anyone concerned with automatic testing. We'll also include a brochure on Testpac, which annually saves thousands of dollars for companies who manufacture components, circuit boards, modules, instruments, sub-systems and systems.

An affiliate of Electronic Memories and Magnetics Corporation.

CIRCLE NO. 176

Zehntel Inc.

1450 Sixth Street, Berkeley, California 94710
(415) 527-5440 TWX 910-366-7047

Electronic Design

Advertising Sales Staff

Bryce Gray
Sales Manager

Rochelle Park, N.J. 07662

Robert W. Gascoigne
Daniel J. Rowland
50 Essex Street
(201) 843-0550
TWX: 710-990-5071

Philadelphia

Thomas P. Barth
50 Essex Street
Rochelle Park, N. J. 07662
(201) 843-0550

Boston 02116

Richard L. Green
20 Columbus Avenue
Boston, Mass.
(617) 894-2700

Chicago 60611

Thomas P. Kavooras
Berry Conner, Jr.
200 East Ontario
(312) 337-0588

Cleveland

Thomas P. Kavooras
(Chicago)
(312) 337-0588
(call collect)

Los Angeles 90303

Stanley I. Ehrenclou
Burt Underwood
2930 Imperial Highway
Inglewood, Calif
(213) 757-0183

San Francisco 94022

Jerry D. Latta
95 Main Street
Los Altos, Calif.
(415) 941-3084

London W. 1

For United Kingdom and Holland
Brayton C. Nichols
For Eastern Europe
Peter Kehr

The American Magazine Group
27 Maddox Street
London, W. 1, England
Phone: 499-0180
Cable: Ammagnic, London

Verviers, Belgium

For Continental Europe
Andre Jamar
1, Ru Mallar, 1
(087) 253.83 Telex 41563

Tokyo

Haruki Hirayama
Electronic Media Service
5th Floor, Lila Bldg.,
4-9-8 Roppongi
Minato-ku
Phone: 402-4556
Cable: Electronicmedia, Tokyo



The SPACE SAVERS from tecnetics .316 CUBIC INCH HYBRID CONVERTERS AND REGULATORS

As a team they're a miniature DC-DC regulated converter. Or, take them individually.

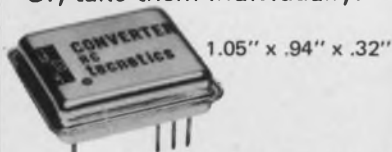

HC hybrid converter:

- converts voltages at the point of load
- output isolated from input
- 3W output maximum
- less than 4W input typical
- outputs to 300 volts

HC hybrid converters:
\$59 hermetically sealed;
\$49 non-hermetic.
1-9 quantity.

VR regulator:

- maximum output current 250mA with 1W max. internal power dissipation
- output voltage +3 to +36 or -3 to -36 VDC
- continuous short circuit protection
- power dissipation limited

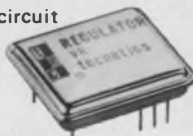

VR regulators: \$39
hermetically sealed only
1-9 quantity.

Hybrid converters and regulators—the space savers from Tecnetics. 2 x DIP mounting and off-shelf delivery.

(See EEM catalog vol.1 pp.880-885)

tecnetics inc.

P.O.Box 910, Boulder Industrial Park, Boulder, Colorado 80302
(303) 442-3837 TWX 910-940-3246

Advertiser's Index

Advertiser	Page	Advertiser	Page
AMI Micro-Products	77	Information Handling Services	95, 97, 99
AMP, Incorporated	C25	Intech, Incorporated	86
Acopian Corp.	76	JFD Electronics Corp./Components Division	29
Alco Electronic Products, Inc.	82	Kev Electronics Corp.	84
Allen-Bradley Co.	31	Licon, Division Illinois Tool Works, Inc.	C7
Amperex Electronic Corporation	C2	Line Electric Company	C59
Ampex, Computer Products Division	22	Luton Automated Business Systems	C66
Analog Devices, Inc.	33	3M Company	C68
Astro-Med, A Division of Atlan-Tol Industries, Inc.	93	MCL, Inc.	8
Babcock, A Unit of Esterline Corp.	6	Mallory Capacitor Company	55
Bafco, Inc.	99	Microdata Corporation	65
Beckman Instruments, Inc.	67	MicroSwitch, A Division of Honeywell	C38
Belden Corporation	21	Molex, Incorporated	Cover III
Bendix Corporation, The, Electrical Components Division	25	Motorola Component Products	C47
Beukers Laboratories, Inc.	99	Motorola Semiconductor Products, Inc.	4, 5, 9, 12, 13
Bishop Graphics, Inc.	100	Murata Corporation of America	C64
Bourns, Inc.	C33	National Semiconductor Corporation	47, 48, 49, 50
Buckeye Stamping Co., The	91	Nippon Pulse Motor Co., Ltd.	96
By-Buk Company	101	Norden Division of United Aircraft Corporation	C46
CTS Corporation	71	North Atlantic Industries, Inc.	44
Cambridge Thermionic Corporation	89	Nortronics Company, Inc.	C63
Capitol Machine & Switch Co.	C65	Panoramic/Matsushita Electric Corporation	81
Centralab Electronics Division, Globe-Union, Inc.	C43, 91	Peripheral Equipment Corporation	C60, C61
Cherry Electrical Products Corp.	C41	Philips Industries	46
Chicago Dynamics Industries, Inc.	89	Piezo Technology Inc.	98
Clare & Co., C. P.	C13	Potter & Brumfield Division of AMF Incorporated	14, 15
Clare-Pendar	C57	Princeton Applied Research Corp.	100
Computer Automation, Inc.	18, 19	Public Service Gas & Electric Co.	51
Computer Design Corp.	C26, C27	RCA Solid State Division	35, C36, C37, Cover IV
Conner-Winfield Corp.	103	RF Communications, Inc.	68, 69
Curtis Development & Mfg. Co.	91	Raytek, A Division of Optical Coating Laboratory, Inc.	58
Damon/Electronics Division	87	Raytheon Company	78
Data Display Products	C62	Requested Data Delivery Service	96-C-D
Data Precision	103	Remex a Unit of Ex-Cello Corp.	C67
Datak Corporation, The	C57	Rtron Corporation	C56
Deflecto Mfg. Co., Div. of Amperite Co., Inc.	C42	Robison Electronics, Inc.	103
Del Electronics Corporation	C63	Rogers Corporation	80
Delevan Electronics, A Division of American Precision Industries	C54	Schauer Manufacturing Corp.	98
Dialight Corporation	C45	Schrack Electrical Sales Corp.	80
Dickson Electronics Corporation	97	Schweber Electronics	96 A-B
Digi-Data Corporation	103	Servo-Tek Products Company	104
Digital Equipment Corporation	C35	Shallico, Inc.	103
Dow Corning Corporation	79	Siemens Corporation	2
ECC Corporation	38	Signetics Corporation	Cover II
ENM Company	104	Simpson Electric Company	75
ERA Transpac Corporation	C48	Solid State Systems, Inc.	C55
Eastman Kodak Company	C51	Solitron Devices, Inc.	39
Edmund Scientific Company	104	Sprague Electric Company	83
Electro-Space Fabricators, Inc.	C50	Syntronic Instruments, Inc.	C59
Electronic Systems	C52	Systemation Inc.	94
Electronic Associates, Inc.	7	TEC, Incorporated	74
Electronic Development Corporation	94	TRW/UTC Transformers	C65
Electronic Molding Corp.	C66	Tecnetics, Inc.	102
Electronics Applications Company	96	Technitol, Inc.	103
Erie Technological Products, Inc.	C13	Tektronix, Inc.	40
Executone, Inc., Printact Relay Div.	96	Teletype Corporation	C14, C15
Federal Scientific Corporation	100	Tenney Engineering, Inc.	76
Fluke	17	Teradyne	43
General Electric Company, Lamp Glass Dept.	88	Transistor Devices, Inc.	101
Tube Dept.	C65	Tri-Data	20
Semiconductor Products Dept.	C9	Tyco Saphikon Division	95
Guardian Electric Manufacturing Company	11	U. S. Capacitor Corporation	89
Hansen Mfg. Co., Inc.	92	Vactec Inc.	27
Harris Semiconductor, A Division of Harris Intertype Corporation	C49	Vero Electronics, Inc.	C63
Hayden Company, A. W. The	90	Virginia Panel Corporation	16
Heath Schlumberger, Scientific Instruments	C59	Weatherford	85
Hewlett Packard, New Jersey	73	Woven Electronics	92
Hughes Aircraft Company	1, 36, 37	Yewtec Corporation	104
ILC Data Device Corporation	10	Zehntel, Inc.	101
IMC Magnetics Corporation	C58		
Indiana General	C53		
Industrial Timer Corporation	C57		

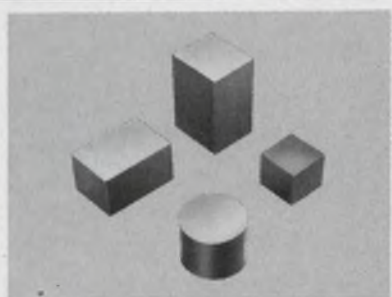

Encapsulation Shells are precision molded in flame-proof glass-fibre filled Diallyl Phthalate, conforming to MIL-M-14, Type SDG-F. Over 1600 standard shells are available in oblong, round and square styles. Robison Electronics, Inc., 2134 W. Rosecrans Ave., Gardena, Calif. 90249. Phone: (213) 321-0080.

INFORMATION RETRIEVAL NUMBER 181

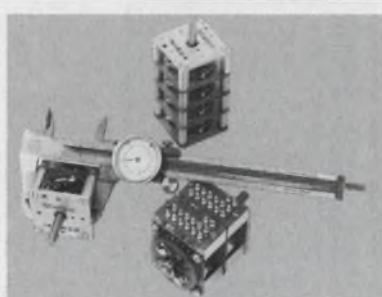

Precision rotary switches are competitively priced and available for prompt shipment. Select from three sizes. Up to 48 positions per pole; up to 6 poles per deck. Request Catalog 201. Shallco, Inc., P. O. Box 1089, Smithfield, N. C. 27577.

INFORMATION RETRIEVAL NUMBER 182



Best Buy: 5½ DMM, \$1195, delivers outstanding performance, 50% saving. Model 2540 gives DVC, ACV, resistance, voltg. ratio, auto-ranging, auto-polarity, isolated BCD outputs, remote triggering and ranging. ±0.001% f.s., ±0.007% rdg., ±1 digit, guaranteed 6 mos. certf. of conformance. Eights models. Data Precision, Audubon Rd., Wakefield, Ma.

INFORMATION RETRIEVAL NUMBER 183

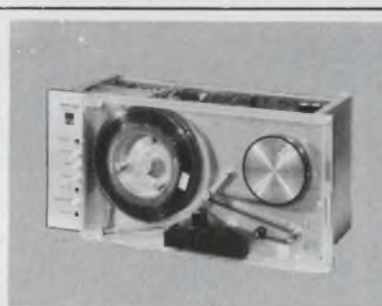

A minicomputer Interface, tape unit and formatter from \$4,650. Ultra high speed incrementals, 3000 characters/second and up from \$3,350. Continuous, incremental and low power tape units from \$1,950. Digi-Data Corporation, 4315 Baltimore Avenue, Bladensburg, Maryland 20710

INFORMATION RETRIEVAL NUMBER 184

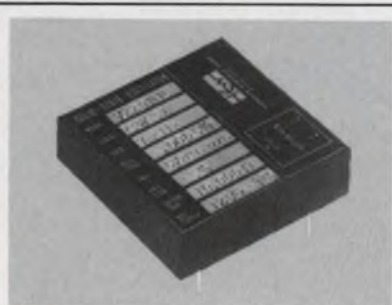

VCXO at freqs. from .00005 Hz to 50 MHz, freq. tol. ±.0005% 0°C to +50°C, control voltage range +10V to -10V changing freq. 20 ppm/V, linearity ±.002%, 1.75" sq. x 0.5", Supply 5 to 15Vdc ±1%, Sq. wave 24V into 200Ω at Vdd = 5V, 9.5V into 10KΩ at Vdd = 10 V; stock to 3 weeks; Connor-Winfield Corp., Winfield, Ill. 60190, Tel. 312-231-5270.

INFORMATION RETRIEVAL NUMBER 185

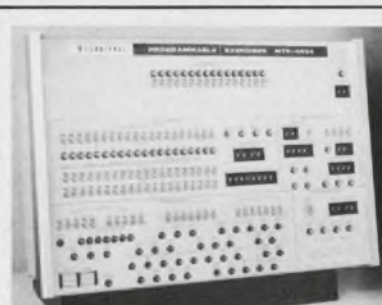

Model 4604 mos-bipolar memory exerciser — 10 MHz. 20 add bits in 4 fields sized for diagnostic testing of system, card or chip. 16 data bits, T²L, refresh with management. Step and loop repeats, English language programming via front panel, internal memories or external mag. tape. Program key lockout. Techni-trol, Inc., Phila., Pa. (215) 426-9105.

INFORMATION RETRIEVAL NUMBER 186

Advertisers wishing to reserve Quick Ad units should note the following mechanical requirements: Specs—Supply glossy photo of product and approximately 40 words which will set no more than 10 lines of 34 characters each. AFTER SUBMISSION NO COPY CHANGES CAN BE ACCEPTED. Quick Ads cost only \$300 per insertion, less for frequency advertisers.

RATES:

1x
\$300

7x
\$280

13x
\$255

19x
\$250

26x
\$245

39x
\$240

52x
\$235

104x
\$230

SINGLE BEARING



Don't give up in search of simplified generator mountings. Servo-Tek's D-C GENERATOR simplifies coupling and alignment by eliminating one bearing. Be first with this simplified mounting technique.

- Design Ease
- No Front Bearing
- Outputs 3v to 10v/1000 rpm
- Increases Mechanical Life

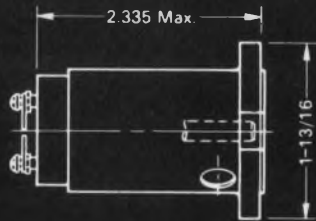

Ask for a copy of our NEW catalog.

SERVO-TEK PRODUCTS COMPANY

1086 Goffle Road, Hawthorne, N. J. 07506 • 201 — 427-3100

Servo-Tek of California, Inc.

8155 Van Nuys Blvd., Van Nuys, California 91402 • 213 — 786-0690

INFORMATION RETRIEVAL NUMBER 85

SCIENCE · OPTICS · ELECTRONICS UNUSUAL & HARD TO FIND BARGAINS NEW PRODUCTS · NEW MATERIALS · NEW METHODS



FLEXIBLE IMAGE TRANSMITTER

Hi-resolution image-transmitter lets you see into remote, inaccessible illuminated areas; through pipes, tubes or any 3/8" + opening no matter how intricate. Provides clear, wide sighting. 7X magnifying eyepiece focuses from less than 1/2" from subject to infinity. Ideal for monitoring hazardous processes, surveillance instrument, demonstrate fiber optics. Over 4,000 coherent glass fibers (.002" dia. 3/8" dia. semi-rigid gooseneck sheathing. Stock No. 60.857DA \$40.00 Ppd.



50-150-300 POWER MICROSCOPE

Amazing Value—3 Achromatic Objective Lenses on Revolving Turret! Color-corrected, cemented achromatic lenses in objective give far superior results to single lenses usually found in this microscope price range. Results are worth the difference! Fine rack and pinion focusing. Imported! Stock No. 70.008DA \$24.50 Ppd.

MOUNTED 500 POWER OBJECTIVE

Threaded achromatic lenses. 3mm F.L. Stock No. 30.197DA \$5.88 Ppd.



AMAZING NEW Wankel Engine Kit!

Build your own sea-through motorized model of revolutionary pistonless type engine, rights for which GM recently paid \$50 million! Only one, engine experts think economically modifiable to meet new pollution standards. Replaces piston, cylinder, crank assemblies with rotating discs (sections removed for firing chambers). Smaller than conventional; fewer parts, greater reliability, same speed w/less horsepower. Switch. Req. 2 — 1.5V batt. (not incl.). Stock No. 71.424DA (4 1/4" x 5" x 9") \$6.75 Ppd.



GIANT FREE CATALOG

Completely new 1972 edition — 148 pages. Bargains galore! New categories. Items, illustrations, 1,000's of buys for industry—Optics, Ecological and Physical Sciences, Electronics, On-the-Job helps, quality control aids, Optics for research labs, design engineers, experimenters. Instruments for checking, measuring; improve quality, cut costs. Hard-to-get surplus bargains. Write for catalog "DA".

EDMUND SCIENTIFIC CO. 300 EDCORP BLDG. BARRINGTON, NEW JERSEY 08007
ORDER BY STOCK NUMBER · OPEN ACCOUNT TO RATED FIRMS · MONEY-BACK GUARANTEE

INFORMATION RETRIEVAL NUMBER 87

THE GREATEST ACHIEVEMENT YET IN ELAPSED TIME INDICATORS!



CompaC T12

Yes, ENM has put it all together in a small package and gift wrapped it for you. Everything you've ever wanted in an elapsed time indicator that records to 100,000 hours. Epicyclic gearing conserves space and delivers an easy-to-read 6 digit indicator only 1.72" wide. And it even counts tenths of hours.

The versatile CompaC T12 is interchangeable with competitive devices and may be base mounted or back panel mounted for multiple stacking in minimum space. Or add a bezel for front panel mounting.

And we didn't forget price, either. How does \$5.68 in 100 lots grab you? That's the gift wrapping.

WRITE FOR LITERATURE



ENM COMPANY

5340 Northwest Highway, Chicago, Ill. 60630
PHONE: (312) 775-8400 TELEX: 02-5468

INFORMATION RETRIEVAL NUMBER 86

TAUTBAND, 0.5% AND... Low Cost*



There are many other words that describe our complete line of portable standard instruments, too — like rugged, versatile and available. Yokogawa Electric has over 55 years of experience in the manufacture of precision instruments and is now introducing this complete line of taut-band portable standards

to the U.S. These instruments are renowned, world-wide, for their quality and precision. Write for our complete technical data and prices today. We're confident that we have a portable AC or DC standard voltmeter, ammeter or wattmeter that will more than meet your requirements at prices that will surprise you.

- * low cost like . . .
- AC Ammeter 2/5/10/20 Amps \$65.00
- DC 17 Range Volt/Ammeter, 3 to 1,000 V, 1 mA to 30 A \$145.00
- AC/DC Wattmeter 5/25 A, 120/240 V \$155.00



Yokogawa Electric
In the USA, contact:
Yewtec Corporation • 1995 Palmer Ave.
Larchmont, N.Y. 10538 • 914-834-3550

INFORMATION RETRIEVAL NUMBER 88

ELECTRONIC DESIGN 10, May 11, 1972

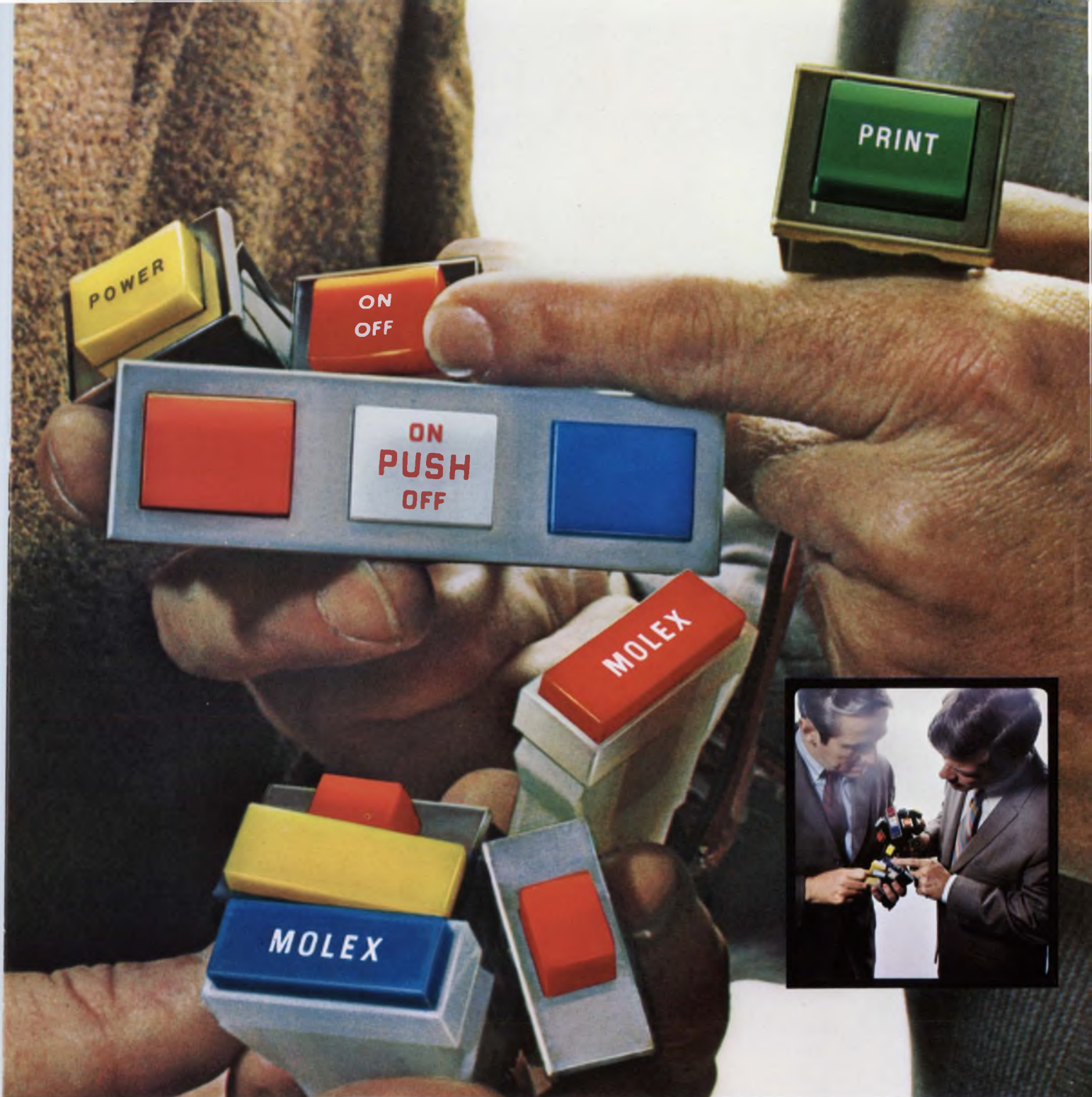

HERE ARE TWO EASY WAYS TO SOLVE LIGHTED PUSH BUTTON SWITCH PROBLEMS. Economically. Reliably. Fast. The Molex 1175 snap mounts. Offers spade or wire terminals for fast, easy assembly. A choice of nine colors, 500 variations. And look at the Molex 1820. You can use one, or a gang of them, for an infinite variety of applications. Lighted push button can be wired to light independently of the switch. And it's available in colors galore. Best of all . . . both switches are priced considerably under one

dollar in quantity. ■ These components are good examples of the Molex creative approach to design problems. And we have the ability to design reliability and ease of assembly into a product without letting costs run wild due to over-engineering. ■ If this makes sense, and you would like a *free sample* of either the 1175 or 1820 switch, write: Molex Incorporated, Downers Grove, Illinois 60515. Or phone (312) 969-4550.

... creating components that simplify circuitry



RCA's glass-passivated /center-gate thyristor line continues to expand—in plastic.

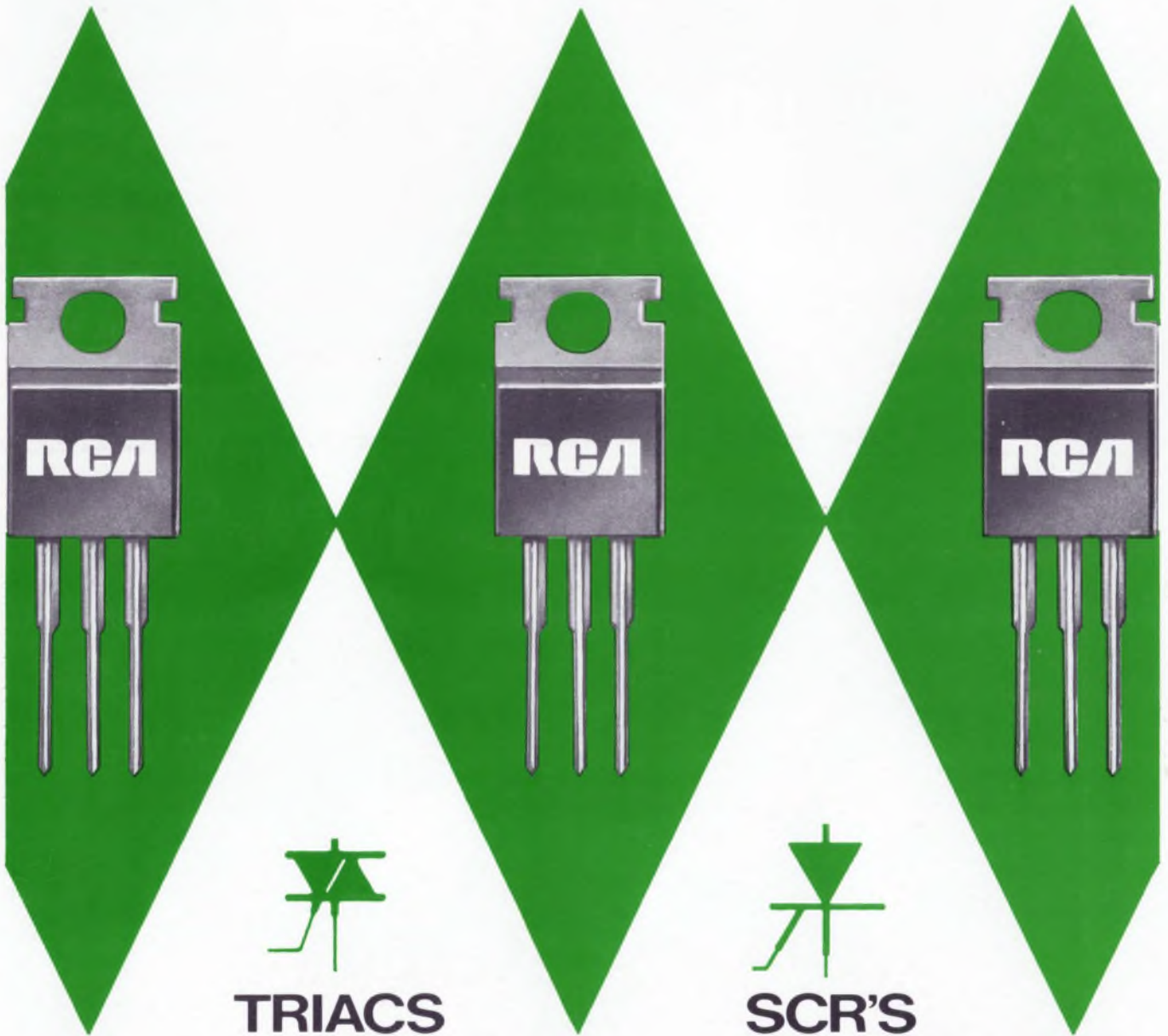

TRIACS

SCR'S

To its popular 40668/40669 triacs and 40868/40869 SCR's, RCA now adds 8 A ISOWATT triacs and 4 A SCR's—all available now—in the industry-accepted VERSAWATT package. Leads are custom-formed to your requirements, of course.

- ISOWATT triacs, 40900, 40901, 40902. These 8 A units are ceramic isolated versions of 40668/40669, providing great flexibility in chassis mounting.

- RCA-106 and 107. Here are 4 A SCR's that fill your needs for low-cost circuit areas that require triggering at 200 and 500 μ A. These RCA microamp gate SCR's

have extended voltage ratings to 500 V and 600 V (corner-gate design).

- 40668/40669. Use these 8 A triacs for control of AC loads for power control and industrial lighting applications.

- 40868/40869. Select these 8 A SCR's for applications in power switching and motor speed controls.

RCA triacs are gate-controlled in all four modes.

RCA VERSAWATT thyristors employ glass-passivated/center-gate chips for quality performance. With the RCA VERSAWATT thyristor, you get ease of mounting, low thermal impedance for operation

at elevated temperatures, and minimum heat sink requirements—all at excellent cost effective levels.

With RCA's full plastic capability, you can cover full- and half-wave applications with currents from 1 to 15 A and voltages from 15 to 600 V.

See your local RCA Representative for details. For technical data, write: RCA Solid State Division, Section 57E-11/UR14, Box 3200, Somerville, N.J. 08876. International: RCA, Sunbury-on-Thames, U.K. or P.O. Box 112, Hong Kong. In Canada: RCA Limited, Ste. Anne de Bellevue 810, Quebec.

RCA Solid State
products that make products pay off