

# Electronic Design 23

FOR ENGINEERS AND ENGINEERING MANAGERS

VOL. 19 NO. 11  
NOV. 11, 1971

RECEIVED  
NOV 09 1971  
CALIFORNIA

**What's hot in computing?** Minis and their peripheral equipment, software for circuit analysis and new programmable calculators for scientific research — all surged forward in the last year. Why? Greater computing power, more features, lower cost and greater versatility. For a report on the major developments, see p.C1.



**RENEW NOW!**  
Use card inside front cover.



# CUTLER-HAMMER HAS THE RIGHT ILLUMINATED SWITCH FOR EVERY DESIGN.

Does your new product design call for an illuminated switch? Or would it be a better, more saleable product if it did?

Then Cutler-Hammer is ready to help with the broadest selection of illuminated switches you'll find anywhere.

We've got lighted toggles and rockers and paddles and pushbuttons. Standard sizes and miniatures. With lots of color choices and decorative hardware.

They come in a broad array of configurations—like double rockers and maintained or momentary action. With a range of electrical ratings that's sure to meet your specs. Including replaceable and non-replaceable lamps in several lamp types and many operating voltages.

Your Cutler-Hammer Sales Engineer or Stocking Distributor is ready to show you these switches in operation and to supply prototypes to match your designs. Contact him today and get the full story.

**CUTLER-HAMMER**

SPECIALTY PRODUCTS DIVISION Milwaukee Wis. 53201



Switch  
to No. 1

More than just switches;  
prompt availability,  
field help, innovation,  
quality assurance, too.

INFORMATION RETRIEVAL NUMBER 3







# Feel Free To Flex

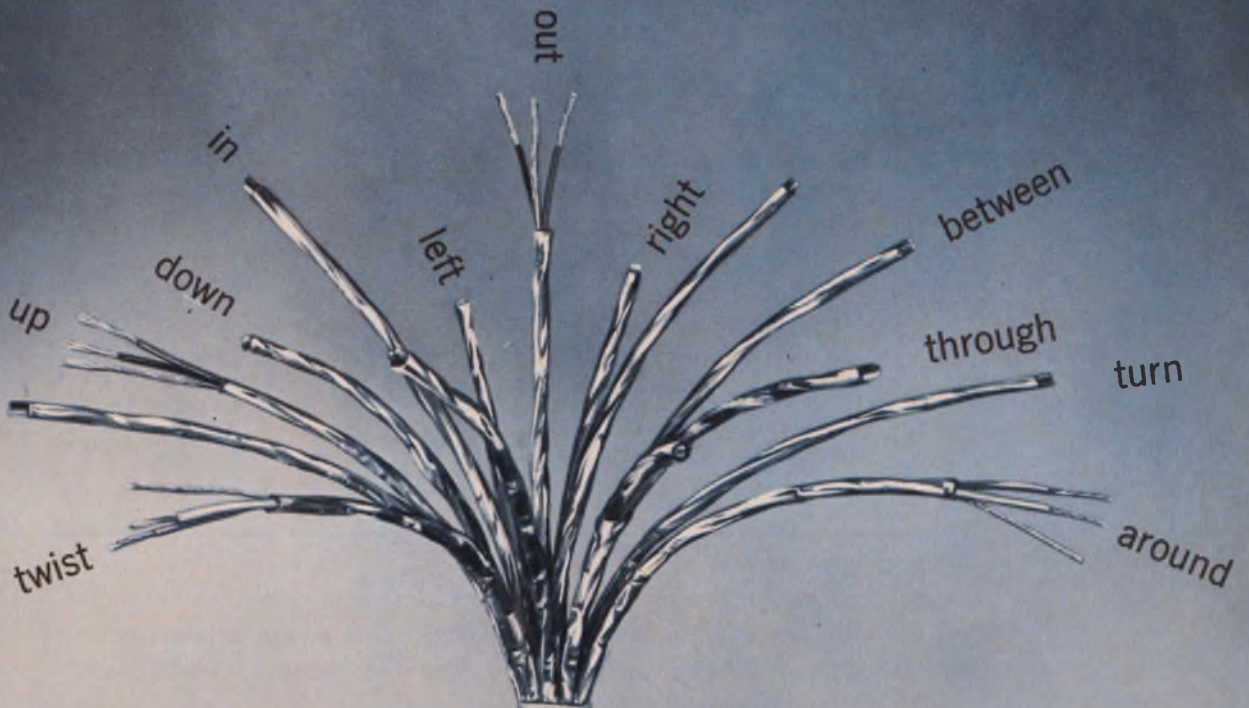

Yes, we know . . . we used to recommend Beldfoil Shielded Cable only for fixed applications. We were too modest. Extended testing proves Beldfoil, even after repeated flexing, provides more physical shield coverage than braided wire or spiral wrapped (served) shields. And greater shield effectiveness. □ Beldfoil is a layer of aluminum foil bonded to a tough polyester film (for insulation and added strength). A Belden invention. We apply it in different ways for different applications. We can even form a unique shield that's like a continuous aluminum tube. This we call ISO-Shield™. □ When new (or in fixed applications) Beldfoil ISO-Shield is extremely effective in limiting crosstalk or interference . . . whether from outside sources or between shielded elements in the same cable. □ Under frequent flexing minor separations may occur in the foil. But special Beldfoil construction features prevent performance from becoming seriously affected. We do, however, recommend that you tell us if cable flexing is to be extreme. We have special designs available to meet severe flexing requirements. □ Beldfoil makes possible a small, lightweight cable that terminates easily and is modest in

price. Your Belden distributor stocks or can quickly obtain just about any size or type you need . . . from single conductor audio and sound cable up to data cable having 27 individually shielded pairs (more pairs available on special order). Ask him for the latest "Belden Electronic Wire and Cable Catalog." Or for technical information, contact Electronic Sales Service Dept., Belden Corporation, Richmond, Indiana 47374.

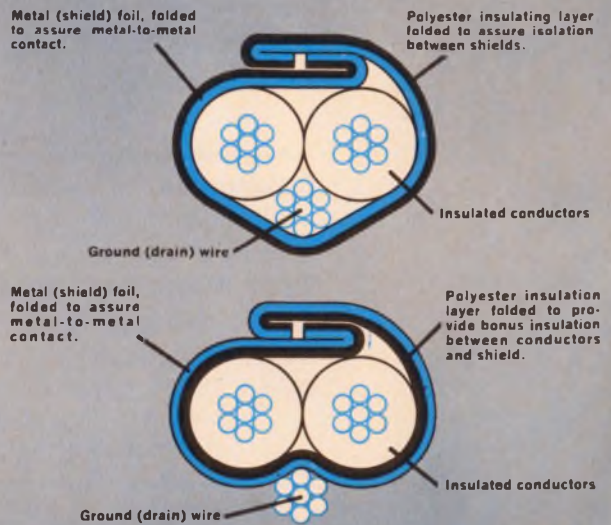



# Beldfoil<sup>®</sup> Shielded Cable

-shield effectiveness remains outstanding

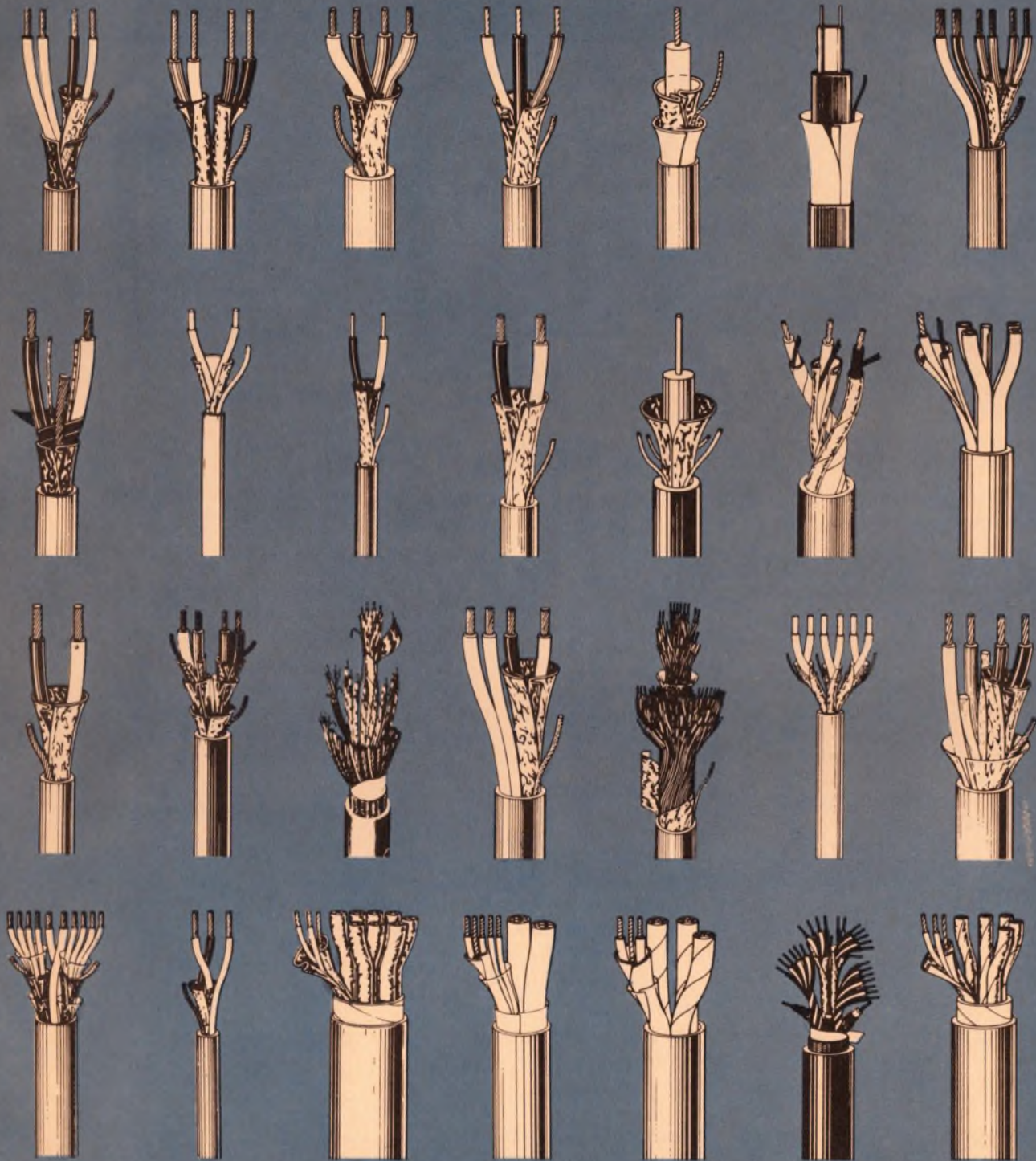

**BELDEN**



8-5-96

*new ideas for moving electrical energy*

INFORMATION RETRIEVAL NUMBER 4



# When You Buy a Power Supply, Why Not Get the Best?

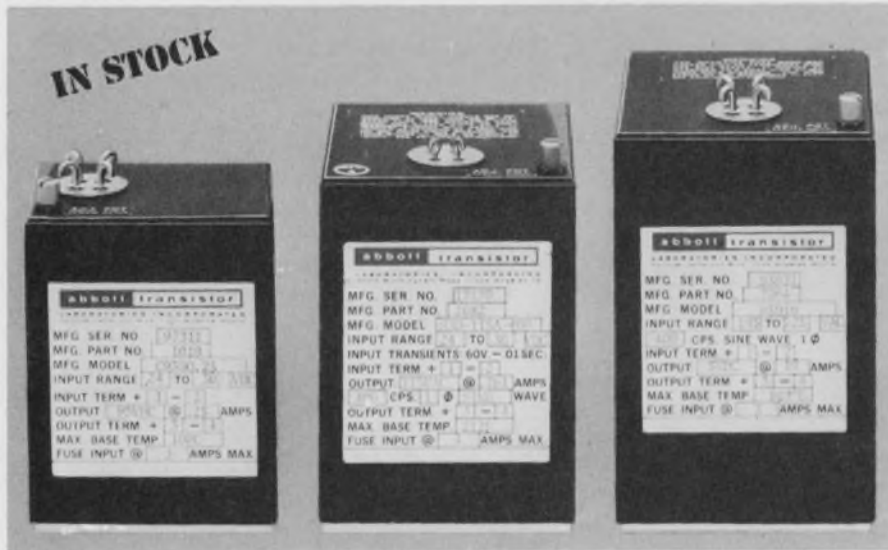

**28 VDC to DC**  
(55,463 Hrs.)  
Model C95D

**28 VDC to 400 A**  
(61,387 Hrs.)  
Model S3D

**400 A to DC**  
(56,148 Hrs.)  
Model W5D

## Abbott's New Hi-Performance Modules

are designed to operate in the stringent environment required by aerospace systems — (per MIL-E-5400K or MIL-E-5272C) and MIL-STD-461 for electromagnetic interference.

**RELIABILITY** — MTBF (mean time between failures) as calculated in the MIL-HDBK-217 handbook can be expected in excess of 50,000 hours at 100°C for all of these power modules. The hours listed under the photos above are the MTBF figures for each of the models shown. Additional information on typical MTBF's for our other models can be obtained by phoning or writing to us at the address below.

**QUALITY CONTROL** — High reliability can only be obtained through high quality control. Only the highest quality components are used in the construction of the Abbott power module. Each unit is tested no less than **41 times** as it passes through our factory during fabrication — tests which include the seru-

tinizing of the power module and all of its component parts by our experienced inspectors.

**NEW CATALOG**—Useful data is contained in the new Abbott Catalog. It includes a discussion of thermal considerations using heat sinks and air convection, a description of optional features, a discussion of environmental testing, electromagnetic interference and operating hints.

**WIDE RANGE OF OUTPUTS** — The Abbott line of power modules includes output voltages from 5.0 volts DC to 3,650 volts DC with output currents from 2 milliamperes to 20 amperes. Over 3000 models are listed *with prices* in the new Abbott Catalog with various inputs:

- 60A to DC, Regulated
- 400A to DC, Regulated
- 28 VDC to DC, Regulated
- 28 VDC to 400A, 1 $\phi$  or 3 $\phi$
- 24 VDC to 60A, 1 $\phi$

Please see pages 930 to 949 of your 1970-71 EEM (ELECTRONIC ENGINEERS MASTER Catalog) for complete information on Abbott modules.

Send for our new 68 page FREE catalog.



**LABORATORIES, INCORPORATED**  
5200 W. Jefferson Blvd./Los Angeles 90016 1224 Anderson Ave./Fort Lee, N.J. 07024  
(213) 936-8185 Cable ABTLABS (201) 224-6900

INFORMATION RETRIEVAL NUMBER 5

## Publisher

Peter Coley

## Editors

Editorial Offices  
50 Essex St.  
Rochelle Park, N.J. 07662  
(201) 843-0550  
TWX: 710-990 5071  
Cable: Haydenpubs Rochellepark

Editor: George Rostky  
Managing Editor: Ralph Dobriner  
Managing Editor: Raymond D. Speer  
Microelectronics, Steven A. Erenburg  
Computers, Raymond D. Speer  
Microwaves, Michael J. Riezenman  
Circuits, Edward A. Torrero  
Special Projects, George Rostky  
Management, Richard L. Turmail  
Military-Aerospace, John F. Mason  
News, Michael P. London  
New Products, Roger Allan

## Field Offices

**Massachusetts**  
Jim McDermott  
P.O. Box 272  
Easthampton, Mass. 01027  
(413) 527-3632

**West Coast**  
David Kaye  
2930 Imperial Highway  
Inglewood, Calif. 90303  
(213) 757-0183

**Washington**  
Don Byrne  
1111 S. Army Navy Drive  
Arlington, Va. 22202  
(202) 296-8982

## Editorial Production

Dollie S. Viebig

## Art

Art Director, William Kelly  
Richard Luce  
Anthony J. Fischetto

## Production

Manager, Thomas V. Sedita  
Helen De Polo  
Maxine Correal  
Anne Molfetas

## Circulation

Manager, Nancy L. Merritt

## Information Retrieval

Peggy Long



# letters

## What good is a title if you can't produce?

Your "letters" column certainly is a reflection of the economic hard times. Nearly 75% of the letters of late have dealt with job protection, teaching as a secondary job, etc.

One of the more distressing of these "job protection" letters appeared in ED 18, Sept. 2, 1971. In that letter an anonymous Senior Engineer lobbied for restricting the title of engineer to those people who have an engineering degree. Don't misinterpret — I'm not against minimum standards. But anyone who's been a practicing engineer knows that a piece of paper that says "Bachelor of Science" doesn't make him an engineer. In such a fast-moving profession as ours, colleges are inevitably behind the times. All they can hope to do is provide the prospective engineer with a few basic tools with which he can build his own professional competence.

So if we must have minimum standards, let them be a degree plus some number of years experience — or several more years of direct experience and no degree requirement. In addition, all engineers must show adequate technical competence.

Engineers in foreign lands are not going to sit still while we try to build artificial barriers around our jobs. So let's have less bickering and more action before we lose the battle to those people by default.

*Donald A. White*  
Consulting Engineer  
Reg. Prof. Engineer  
S. B.

10 Town Farm Road  
Westminster, Mass. 01473

In reference to the letter in ED 18 by Mr. Senior Engineer (name withheld), it is precisely his attitude that sometimes contributes

to a poor working relationship among engineers in a department or company.

As any manager knows, it is performance and the ability to get a job done that count, not academic credentialism. Witness the number of inventors and industrial leaders without formal schooling.

Mr. Senior Engineer and many college boys have good cause to worry in times of economic recession. When management takes a look at performance, some of them will no longer be able to hide behind credentials. Many engineers are well educated but not well schooled.

*David C. Ivarson*  
James G. Biddle Co.  
Plymouth Meeting, Pa.

## An idea for simplifying an Idea for Design

In your issue of Sept. 30, you presented an Idea for Design titled "Fix Lag/Lead Relation in Digital 90° Phase Shifter" (ED 20, p. 67). The circuit presented used a capacitor, transistor and two resistors to produce a reset pulse to guarantee output phase relationships. The same relationships can be assured without the reset circuit by connecting the Q output of FF2 to the D input of FF1, as shown below. Note that with deletion of

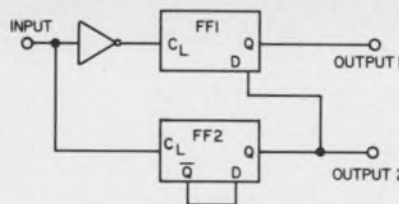

the RC network, the circuit speed is only limited by the inherent capability of the logic elements.

*Gary T. Rosiak*  
Design Engineer  
Systems Group of TRW, Inc.  
Redondo Beach, Calif. 90278

Electronic Design welcomes the opinions of its readers on the issues raised in the magazine's editorial columns. Address letters to Managing Editor, Electronic Design, 50 Essex St., Rochelle Park, N. J. 07662. Try to keep letters under 200 words. Letters must be signed. Names will be withheld on request.

# At last!



## A portable 2KHz-2GHz receiver with spectrum display under \$6800!

Now commercially available  
Model A-2 Receiver

- Rugged, portable design
- 2 KHz — 2 GHz R.F.
- 1-5 uv sens.
- AM-FM-CW
- Spectrum Display Unit
- Signal Meter
- Battery and AC operation
- 17 x 12 x 6 inches — 28 lbs.
- Over 7 years of field use.

Partial sets available for as low as \$1590 with limited frequency coverage.

Write or phone today for specs on Mason A2 Receiver . . .

**M**  
**E I F . G .**  
**MASON**  
**ENGINEERING**

Fairfield, Conn. 06430 • 203/255-3461  
1700 Post Road • Heritage Square

INFORMATION RETRIEVAL NUMBER 6



**"ISOPLANAR  
IS HERE, AND  
IT WORKS"**



**For openers, a 256-bit TTL RAM that's dense as MOS but fast as bipolar. Debugged and deliverable now.**



Comparison of one bit of memory in conventional bi-polar design (top) and new isoplanar technique (bottom).

#### There Were Times We Had Doubts.

In March, when we announced the isoplanar process, we also announced that we weren't really sure it was commercially feasible.

We had had a lot of experience in production LSI bipolar memory components and systems (last year we shipped more than 8 million bits to Illiac IV alone). So we went ahead—antsy but optimistic.

We selected a fully-decoded 256-bit RAM to prove we could produce a device of that complexity quickly, efficiently, and profitably, using the isoplanar process.

We could. And did.

Presenting—debugged and deliverable—our new isoplanar 93410 256-bit RAM. Fast, small, dense.

As Les Hogan, our President, said: "Isoplanar is here, and it works." Beyond our expectations.

And, looking ahead, isoplanar is where it is going to happen.

#### Isoplanar Technology. Briefly.

The old-fashioned planar process required a large region for  $p^+$  isolation and isolation-to-base clearance. The isoplanar process shrinks

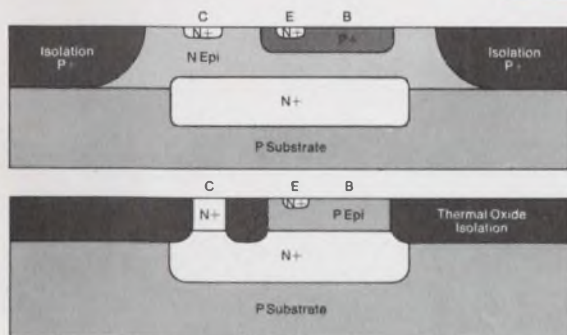

No space is required between base and collector regions and isolation in isoplanar bi-polar (bottom) compared to conventional planar bi-polar (top).

this region and fills it with thick insulating silicon oxide that needs no separation from base and collector regions.

Selective etching of silicon nitride, without harming the oxide, provides simpler masking rules and a self-aligning base. Transistor geometries are smaller and parasitic capacitance is reduced. The structures are less sensitive to defects in manufacturing (reduction of the active isolation area, for example, eliminates failures due to oxide pinholes). The surface of the chip is flat, so the traditional metal-over-oxide step problems are eliminated; metallization is simpler and more reliable.

We got smaller, denser, more reliable products with higher yield. At a low cost to our customers. Plus a reasonable profit for us.

What we hoped for, we got.

#### Isoplanar Is Good for You.

What do you get?

- More electronics for your dollar.
- MOS density.
- Speed of bipolar.
- Higher reliability from an essentially coplanar structure.
- Devices that are compatible with voltage and logic levels of standard ECL and TTL families.
- Wider choice of speed / power trade-offs— isoplanar design uses energy more efficiently.
- Smaller chip real estate, which reduces costs no matter how you look at it.
- Low-cost advantages from our higher yields.
- Devices that are available now.

#### The First Isoplanar Production IC in the World.

The 93410 high-speed TTL RAM is designed for scratchpad memory, buffer, and distributed main memory application.

- Operates from 0 to 75° C.
- Three chip select lines.
- Uncommitted collector outputs.
- Chip select access time: 20 Nsec.
- Read access time: 50 Nsec.
- Power dissipation: 2 mW / bit.

The 93410 is built on a 96 x 126 mil chip. It uses conventional, high-volume, reproducible metal widths and clearances. (For comparison, our own 256-bit 93400 bipolar memory for Illiac IV occupies a 110 x 140 mil chip, has only partial decoding, and typical access time of 50 Nsec.) It is available now in sample quantities (100-up) at \$21.50 each in 16-pin ceramic DIP.

The 93410 is a superior product, per se. More important, it proves the economic feasibility of the isoplanar process. Today,

for production of low cost TTL or ECL read / write memories. Soon, hopefully, for a host of other semiconductor devices.

#### Tomorrow's Memories.

With the 256-bit isoplanar RAM a current reality, let's look at what isoplanar holds for tomorrow's memories.

We have in the works a temperature-compensated 9500 Series ECL-compatible 256-bit RAM.

We are in the development cycle of a 1024-bit fully-decoded TTL bipolar memory chip (93415)

that's only slightly larger than our 256-bit isoplanar chip. The great potential in the isoplanar process will begin to be realized in this device. The 93415 is designed for high-speed buffer and main frame applications.

- Address access time: less than 100 Nsec.
- Chip select access time: less than 50 Nsec.
- Uncommitted collector outputs.
- Power dissipation: 0.5 mW / bit.
- 16-pin hermetic ceramic DIP package.

Both the ECL 256-bit RAM and the 1024-bit RAM will be available early in 1972.

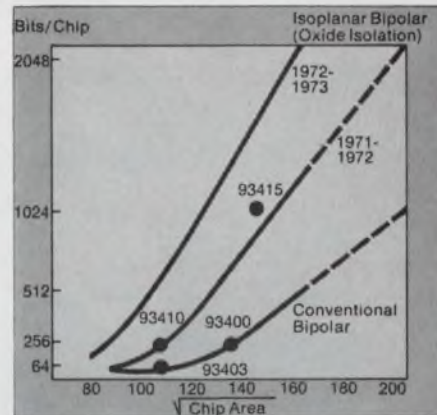

The graph gives you some idea of where we've been and where we're going with bipolar memories and isoplanar. It indicates the feasibility of 2048 and 4096-bit read / write memories for 1973. By then we fully expect isoplanar to dominate memories in high-performance and small systems. Memory designers please note that our estimates of packing density and time scale are at least as conservative as our original announcement of the process.

#### Beyond Memory.

But isoplanar doesn't stop with memories.



The process, we feel, will profoundly effect the architecture of future generations of computers. Ultimately isoplanar technology will be used to fabricate together, on the same chip, combinations of logic and memory of

much greater complexity than have been considered to date. Examples are content-addressable memories and multi-port registers. What we have learned thus far indicates that, in the long run, isoplanar will prove valuable in *all* complex bipolar circuits.

The process will also bring about significant improvements in high-frequency low-noise transistors, diodes, linear devices, in low-cost realization of monolithic complementary MOS devices, in radiation-resistant circuits—in the universe of semiconductor devices.

#### For More Information.

We've put together a package of information about the isoplanar process, products and prognosis. It's available for the asking.

Fairchild makes advanced products to uniform standards throughout the world.

**MADE IN  
FAIRCHILD**

INFORMATION RETRIEVAL NUMBER 7



# Dow Corning silicones seal, bond, insulate, cool, encapsulate...

## and how's this for repairability?

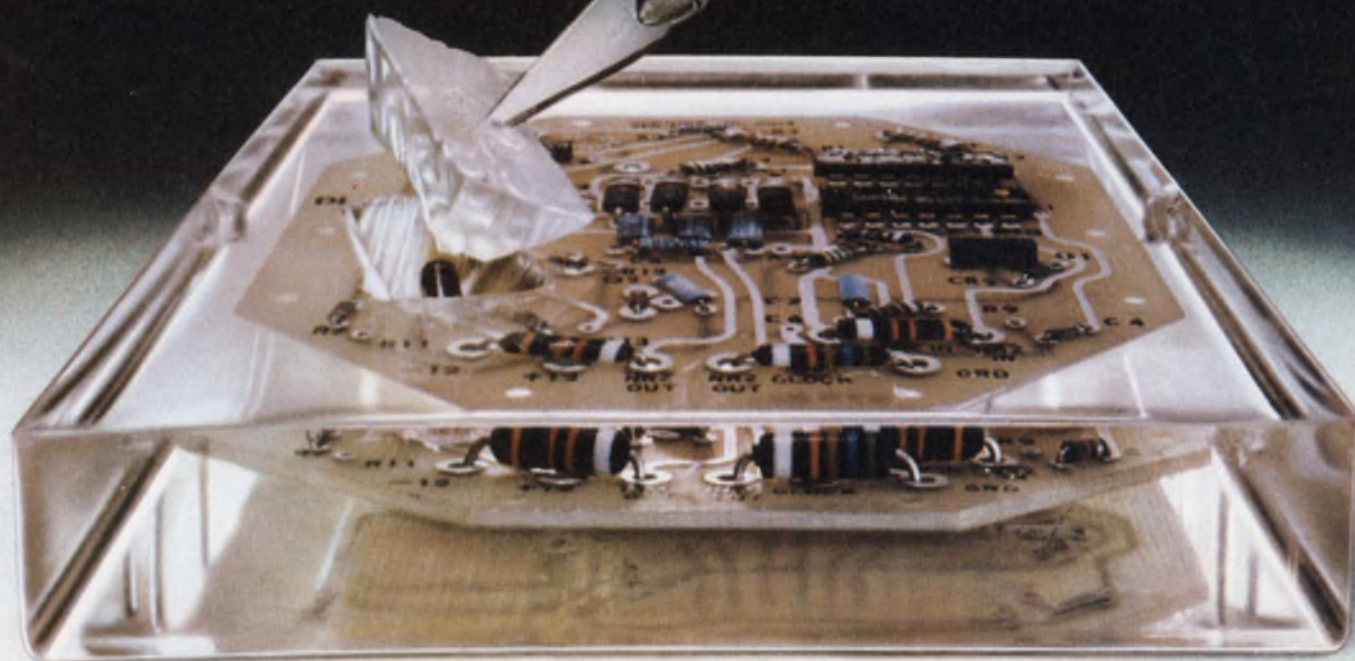

**See-through silicone package speeds repair.** Encapsulation of microcircuits with a clear resilient Sylgard<sup>®</sup> brand resin pays off with more than just protection. When circuits are under development, the encapsulant can be cut away to expose components for testing and modification. And, if fast field repair is a factor, defective components are more quickly located and replaced. Voids are merely filled with the silicone resin and protection is again intact. Sylgard resins also eliminate cure shrinkage associated with other encapsulants. They easily meet the most exacting shock, vibration, temperature and moisture resistant requirements. Circle Information Retrieval Number 821.



Silicone materials are unusually versatile. But whether they are used to seal, bond, insulate, impregnate, encapsulate or cool—their one basic function is to protect. And they protect better because of inherent silicone resistance to change—regardless of environment. When electronic equipment must function reliably in hostile atmospheres, look

to silicones from Dow Corning to shut out trouble. Described here are a few ways our materials can ensure the integrity of your designs. Many others are described in our Silicone Electronic Materials brochure available from your Dow Corning distributor. His name appears on the following page. Or write Dept. A-1220, Midland, Michigan 48640.

*Electrical / electronic materials from*

**DOW CORNING**

DOW CORNING

#### **Noncorrosive silicone sealants.**

For critical electronic insulating requirements on corrosion-sensitive materials. Four noncorrosive, acid-free curing silicone sealants are available from Dow Corning—two are pourable, self-leveling liquids for conformal coatings; the other two are nonslump materials for sealing, mounting and bonding. All are ready to use, cure at room temperature and are serviceable over a wide temperature range. Circle Information Retrieval Number 822.

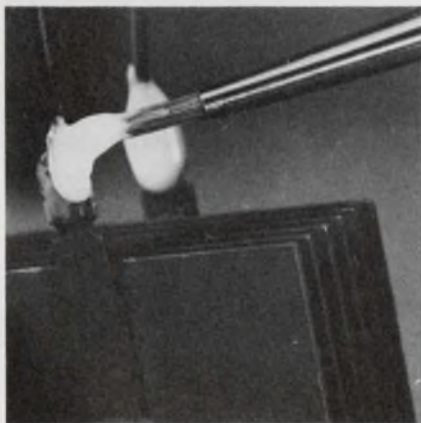

#### **Dissipate heat fast with silicones.**

You can use silicone materials to protect from heat, or to get rid of it. A Dow Corning® brand heat sink compound helps cool components such as transistors, diodes and rectifiers by transferring operating heat to heat sink or chassis. Thermal conductivity is effective as high as 200 C with this noncorrosive, metal-oxide filled silicone material. Ask about silicone fluid coolants also. Circle Information Retrieval Number 823.

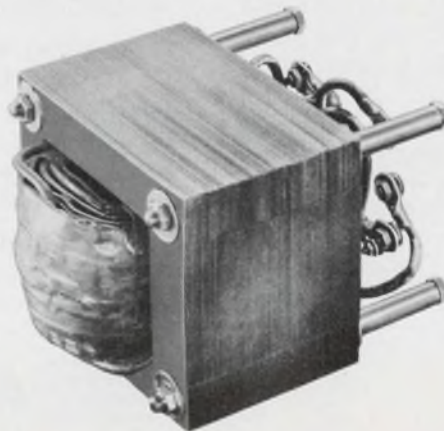

#### **Silicone varnish aids miniaturization.**

When operating temperatures of new spacesaving power supplies such as transformers hit the 200 C mark, protection with Dow Corning® brand silicone impregnating varnishes ensures performance. These materials are the most reliable insulating resins available. And they are easy to apply. Stators, chokes, coils, solenoids and other electronic equipment are protected by simply dipping, brushing, flooding or impregnating. Circle Information Retrieval Number 824.

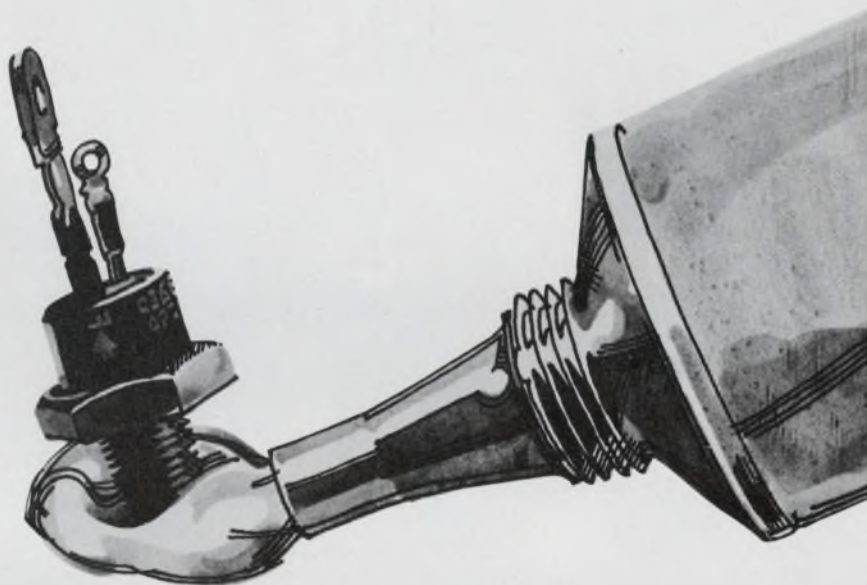



# Our new DIP gives you just what you need



## and no more.

First we put four fixed resistors and a trimmer in one module. We called it our TRN (Trimming Resistive Network) package. Great.

Now you can get the same module, with the same dimensions for automatic insertion and the same excellent characteristics, in a DIP trimmer. And just a trimmer.

Not just a 3/4-inch commercial trimmer turned on its side, but one that has been developed from the ground up to meet all dimensions in accordance with EIA Microelectronic Outline DIP Family with 0.300-inch-row spacing.

Resistance range of our new DIP is from 10 ohms to 1 megohm. The resistance tolerance is  $\pm 10\%$ .

And like the TRN, the DIP offers excellent TC of 100 ppm standard with 50 ppm available. The operating temperature range of this DIP is  $-55^{\circ}\text{C}$  to  $+125^{\circ}\text{C}$ . Power rating is 3/4-watt at  $40^{\circ}\text{C}$ .

So if you want the whole works—trimmer and from 1 to 4 fixed resistors—in one package, get our TRN. But if you want a trimmer and no more, then our new DIP will give you just what you need. Both are now available through Amphenol's distributor network.

For more information write Amphenol Controls Division, Bunker Ramo Corporation, 120 South Main Street, Janesville, Wisconsin 53545.

**BUNKER RAMO** AMPHENOL



# designer's calendar

## DECEMBER 1971

S	M	T	W	T	F	S
			1	2	3	4
5	6	7	8	9	10	11
12	13	14	15	16	17	18
19	20	21	22	23	24	25
26	27	28	29	30	31	

### Dec. 6-9

Ultrasonics Symposium, (Miami Beach), Sponsor: IEEE, Herbert Matthews, Sperry Rand Research Ctr., Sudbury, Mass. 01776

CIRCLE NO. 420

### Dec. 7-9

Vehicular Technology Conference, (Detroit) Sponsor: IEEE, A. E. Marshall, Ford Motor Co., 23400 Michigan Ave., Dearborn, Mich. 01776

CIRCLE NO. 421

## JANUARY 1972

S	M	T	W	T	F	S
						1
2	3	4	5	6	7	8
9	10	11	12	13	14	15
16	17	18	19	20	21	22
23	24	25	26	27	28	29
30	31					

### Jan. 25-27

Symposium on Reliability, (San Francisco), Sponsor: IEEE, J. H. Simm, Beckman Inst. Inc., 2200 Wright Ave., Richmond, Calif. 94804

CIRCLE NO. 422

### Jan. 30-Feb. 4

Power Engineering Meeting, (New York City), Sponsor: IEEE, J. W. Bean, AEP Service Corp., 2 Broadway, New York, N. Y. 10004

CIRCLE NO. 423

## DOW CORNING SILICONE PROTECTORS

A full line of silicone encapsulating, insulating, sealing, coating and dielectric materials is available from Dow Corning Distributors at the following warehouse locations:

<b>ARIZONA</b>	<b>Phoenix</b>	Essex International Inc.—I.W.I. Div. 602-278-8568
<b>CALIFORNIA</b>	<b>Berkeley</b>	C. D. LaMoree 415-841-0601
	<b>Culver City</b>	E. V. Roberts & Associates, Inc. 213-870-9561
	<b>Los Angeles</b>	Essex International Inc.—I.W.I. Div. 213-264-7000 C. D. LaMoree 213-225-5666
	<b>Mountain View</b>	K. R. Anderson Company, Inc. 415-961-6007
	<b>San Diego</b>	A. E. Yale Enterprises 714-296-6148
	<b>San Francisco</b>	Essex International Inc.—I.W.I. Div. 415-626-5351
<b>COLORADO</b>	<b>Denver</b>	Waco Electronics, Inc. 303-322-7708
<b>FLORIDA</b>	<b>Fort Lauderdale</b>	Cramer/Florida Inc. 305-947-6517
	<b>Orlando</b>	Brownell, Inc. 305-424-5634 Electrical Insulation Suppliers, Inc. 305-855-7100
<b>GEORGIA</b>	<b>Atlanta</b>	Electrical Insulation Suppliers, Inc. 404-355-1651
	<b>Hapeville</b>	Brownell, Inc. 404-767-9301
<b>ILLINOIS</b>	<b>Chicago</b>	Prehler Electrical Insulation 312-384-6100
	<b>Mt. Prospect</b>	Magnuson Electronics, Inc. 312-956-0700
	<b>Niles</b>	Essex International Inc.* 312-647-0044
<b>INDIANA</b>	<b>Fort Wayne</b>	Essex International Inc.—I.W.I. Div. 219-742-7441
	<b>Hammond</b>	Electric Supply Corp. 219-932-8840
<b>IOWA</b>	<b>Marion</b>	Ensco Distributing Corporation 319-377-6313
<b>KENTUCKY</b>	<b>Louisville</b>	E & H Electric Supply 502-587-0991
<b>LOUISIANA</b>	<b>New Orleans</b>	Williamson Distributing Corp. 504-486-5584
	<b>Shreveport</b>	Williamson Distributing Corp. 318-424-6638
<b>MARYLAND</b>	<b>Baltimore</b>	Essex International Inc.—I.W.I. Div. 301-644-0140 Pyttronic Industries, Inc. 301-539-6525
<b>MASSACHUSETTS</b>	<b>Cambridge</b>	Brownell, Inc. 617-864-7500
	<b>Newton</b>	Cramer Electronic, Inc. 617-969-7700
	<b>Peabody</b>	Essex International Inc.—I.W.I. Div. 617-531-7100
<b>MICHIGAN</b>	<b>Detroit</b>	Essex International Inc.* 313-921-6000
	<b>Madison Heights</b>	McNaughton-McKay Electric 313-399-7500
<b>MINNESOTA</b>	<b>St. Paul</b>	Magnuson Electronics, Inc. 612-227-8495
<b>MISSOURI</b>	<b>Kansas City</b>	Essex International Inc.—I.W.I. Div. 816-842-1613
	<b>St. Louis</b>	Ensco Distributing Corp. 314-542-3935 Essex International Inc.—I.W.I. Div. 314-371-2616
<b>NEW JERSEY</b>	<b>Livingston</b>	Robert McKeown Co., Inc. 210-992-0700 or 212-267-9264 (NYC)
	<b>Moonachie</b>	Essex International Inc.—I.W.I. Div. 201-641-4400 or 212-695-7495 (NYC)
	<b>North Bergen</b>	Electrical Insulation Sales 201-864-2376 or 212-564-6273 (NYC)
<b>NEW MEXICO</b>	<b>Albuquerque</b>	Waco Electronics, Inc. 505-268-2409
<b>NEW YORK</b>	<b>Buffalo</b>	Summit Distributors, Inc. 716-884-3450
	<b>New York City</b>	Brownell, Inc. 212-691-7900 or 212-924-6000
<b>NORTH CAROLINA</b>	<b>Charlotte</b>	Brownell, Inc. 704-399-9791 Electrical Insulation Suppliers, Inc. 704-392-2306 Essex International Inc.—I.W.I. Div. 704-394-1315
<b>OHIO</b>	<b>Cincinnati</b>	Cramer/Tri States, Inc. 513-771-6441 Electrical Insulation Suppliers, Inc. 513-771-4073 Sheridan Sales Co. 513-761-5432 Essex International Inc.* 513-771-6500
	<b>Cleveland</b>	Essex International Inc.* 216-781-2310 Prehler Electrical Insulation 216-267-2650
	<b>Columbus</b>	McGraw-Edison Co. National Electric Coil Division 614-488-1151
<b>OKLAHOMA</b>	<b>Oklahoma City</b>	Essex International Inc.—I.W.I. Div. 405-236-5411
<b>OREGON</b>	<b>Portland</b>	Essex International Inc.—I.W.I. Div. 503-665-0138 C. E. Riggs, Inc. 503-226-3286
<b>PENNSYLVANIA</b>	<b>Harrisburg</b>	Pyttronic Industries, Inc. 717-233-6591
	<b>Montgomeryville</b>	Pyttronic Industries, Inc. 215-643-2850
	<b>Philadelphia</b>	Brownell, Inc. 215-632-3030 Essex International Inc.—I.W.I. Div. 215-236-7100 Prehler Electrical Insulation 215-725-5914
	<b>Pittsburgh</b>	Essex International Inc.* 412-244-1145
<b>TENNESSEE</b>	<b>Memphis</b>	Brownell, Inc. 901-323-7693 Electrical Insulation Suppliers, Inc. 901-947-4176
<b>TEXAS</b>	<b>Dallas</b>	Essex International Inc.—I.W.I. Div. 214-339-8346 Specialized Products Company 214-358-4663 Williamson Distributing Corp. 214-741-5831
	<b>Houston</b>	Essex International Inc.—I.W.I. Div. 713-227-6358 Williamson Distributing Corp. 713-672-1715
<b>WASHINGTON</b>	<b>Seattle</b>	Atlas Packing & Rubber Co. 206-623-4697 Essex International Inc.—I.W.I. Div. 206-763-8650 C. E. Riggs, Inc. 206-623-5707
<b>WISCONSIN</b>	<b>Milwaukee</b>	Essex International Inc.* 414-342-3927 *IMC/I.W.I. Div.

Electrical/electronic materials  
from

# DOW CORNING

DOW CORNING



# A better way to specify oscillators.

We have a special coding sheet that lets you specify one or more models from over 700 different temperature compensated and clock oscillators.

Our oscillators are made with a unique cold weld crystal which eliminates heat and flux contamination found in regular sealing methods. As for size, we have models as small as 1.16 cubic inch.

So now, the only paper you need is one of our brochures. Write to Motorola Component Products Dept., 4545 W. Augusta Blvd., Chicago, Illinois 60651





# DANA

5 DC RANGES

COMPLETE AUTORANGING

ANALOG OUTPUT

1  $\mu$ V RESOLUTION

.005% DC ACCURACY

**only \$1295**



... for Dana's 5300 ... A five digit, premium quality, high performance DVM ... Take a look ... You get a standard instrument featuring 5-DC Ranges (.1-1000V) with 1  $\mu$ V resolution; .005% DC accuracy, complete auto-ranging; 74 dB noise rejection at 60Hz; analog output; and 10,000 megohm input resistance. But that's not all ... by using field expandable plug-in options you can extend the capability of the 5300. Add 6 ranges of 4-terminal ohms with 1m $\Omega$  resolution; 4 ranges of AC (1-1000V) with 10  $\mu$ V resolution over a broad band from 30 Hz to 250 kHz; 5 ranges of bipolar 4-wire DC/DC ratio; isolated remote programming and BCD output; 100 readings per second (fully programmable) ... There is much more to the 5300 than we can possibly tell you here ... so let us show you.

You have the budget and the decision, Dana has the Digital Voltmeters.

**DANA**

DIGITAL VOLTMETERS

Dana Laboratories, Inc.  
2401 Campus Drive, Irvine  
California 92664 (714) 833-1234

*When Test and Measurement Count*



# THE CROWN STREET NEWS

## Modern Methods

### Flexible Etched Cable Offers Substantial Cost Savings Over Conventional Harnesses

#### Fairchild Engineers Use Flexible Etched Cable

##### How to Beat the \$ Squeeze

In a recent independent cost reduction study, Fairchild engineers discovered a 4 to 1 savings could be achieved using flexible etched cable, supplied by Teledyne Electro-Mechanisms.

Fairchild Industries, a leading manufacturer of military and space systems, conducted an exhaustive study because electrical noise problems could not be controlled. Although each component in the system satisfied its specification requirements, collectively they produced a unique set of random problems which became intolerable in system operation.

Because hand-fabricated harness cables permitted variations up to two inches on average wire runs, changes in internal harness characteristics could not be controlled to tolerable levels. Packaging constraints did not permit larger wire sizes or additional shielding in the given package volumes.

Fairchild engineers recommended the following changes:

**Noise:** Using flexible printed circuitry, it is possible to achieve improvements in decoupling of 90% or better.

**Standardization:** Using flexible etched cable, internal harness(es) is manufactured with specific mechanical tolerances. . . no miswiring is possible because all wire runs are fixed by mechanical constraints. Flexible etched cables are not restricted by space problems as are normal hand-wired harnesses.

**Maintenance:** Changing a P.C. connector causes such problems as miswiring, ringout and retest. Using flexible etched cable it is possible to change a connector in 30% of the usual time without encountering these problems.

The study also showed significant assembly and test savings were possible using flexible etched cables, supplied by Teledyne Electro-Mechanisms.

## What's Happening—

\* \* \*

### The Economy

**T**IGHT MONEY may become more relaxed later this year. Some large banks have begun to reduce their interest rates. But what can be done right now to keep your profits from getting lost in the dollar squeeze? One way is for your company to look inside for ways to maintain profit levels. But often cutting back on spending just isn't enough to keep up with a plunging sales curve — real economy has to begin on the drawing board. That's where Teledyne Electro-Mechanisms flexible etched cable can give you a competitive edge.

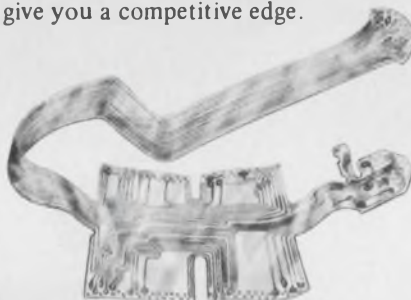

\* \* \*

**It's a Fact** that the Fairchild Space and Electronics Division cost reduction study showed substantial savings could be obtained by replacing hand-wired internal harnesses with flexible etched cable. Etched cable by Teledyne Electro-Mechanisms requires much less time to assemble and has a number of technical advantages.

Teledyne Electro-Mechanisms flexible etched cable can cut assembly and test costs by as much as 50 per cent, weight by as much as 60 per cent, and volume by as much as 80 per cent. When you couple these savings with the reduction in production rework and test costs you can beat the dollar squeeze.

\* \* \*

**Early Assembly Failures** due to faulty harness and hand wiring can make your product prohibitively expensive by increasing test and rework costs. A field failure can injure your company's reputation and undermine your best sales efforts. If your customer's demands for reliability are not satisfied, you are developing sales for your competition with each unit you deliver.

\* \* \*

**You Can Reduce Costs** by improving reliability. Teledyne Electro-Mechanisms can help you improve product reliability, and by so doing, hone your competitive edge with flexible etched cables designed to your own specifications.

\* \* \*

**Circle Our Inquiry Number** to receive our free design guide. It's full of good packaging ideas and contains design and special fabrication tips. Discuss your own packaging problems with us and find out for yourself how easily a troublesome interconnect problem can be solved. We can design and manufacture almost any interconnect without using a single wire. Think of the production and test economies.

\* \* \*

**TELEDYNE  
ELECTRO-MECHANISMS**

29 Crown Street  
Nashua, N.H. 03060

Telephone (603) 889-6191  
TWX 710-288-1663



# Designer's Bonanza!

# VVC TUNING

## SELECT THE EPICAP\* TUNING DIODE THAT'S JUST RIGHT FOR YOUR DESIGN

- Wide package variation, in plastic, ceramic or glass — in TO-92, Mini-L, DO-7, DO-14 and Case 45 outlines.
- Broad capacitance ranges and ratios — with nominal values from 1.0 pF to 550 pF and a selection of maximum working voltages from 12 to 60 volts.
- Very high Q with minimum values guaranteed.
- EXTRA values . . . like a wide variety of abrupt and hyper-abrupt junctions, and hot-carrier diodes for VHF and UHF mixer and detector applications and miscellaneous picosecond switching requirements.

## Write for your FREE Designer's Manual today!

This comprehensive new fact-book will show you Q, tuning ratio and nominal capacitance for each device. It will give you working voltages, package types, plus significant series highlights. It also contains detailed data sheets covering all of Motorola's extensive tuning diode lines.

In addition, there's a new cross-reference guide and four enlightening application notes of unusual interest to circuit designers.

To get your copy, write for "Designer's Manual for VVC Tuning Diodes" to Motorola Semiconductor Products Inc., P. O. Box 20912, Phoenix, Arizona 85036.

\*Trademark of Motorola Inc.

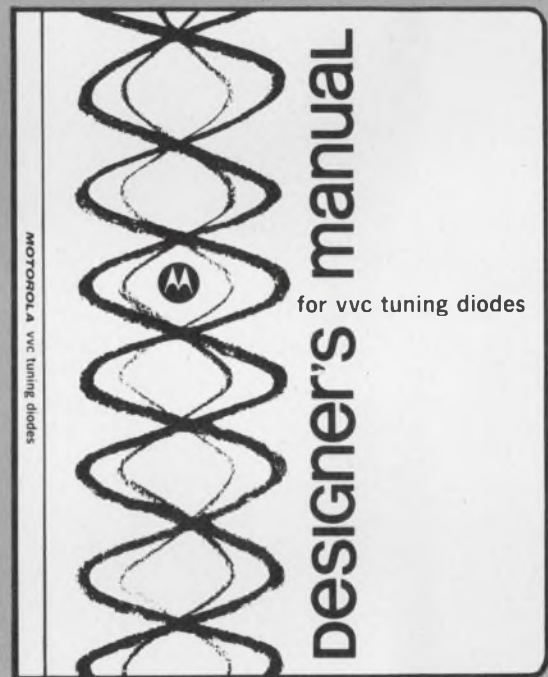

# DIODES



**MOTOROLA TUNING DIODES**

— The Designer's First Choice!



# Metal Glaze resistors don't crack up under stress and strain.

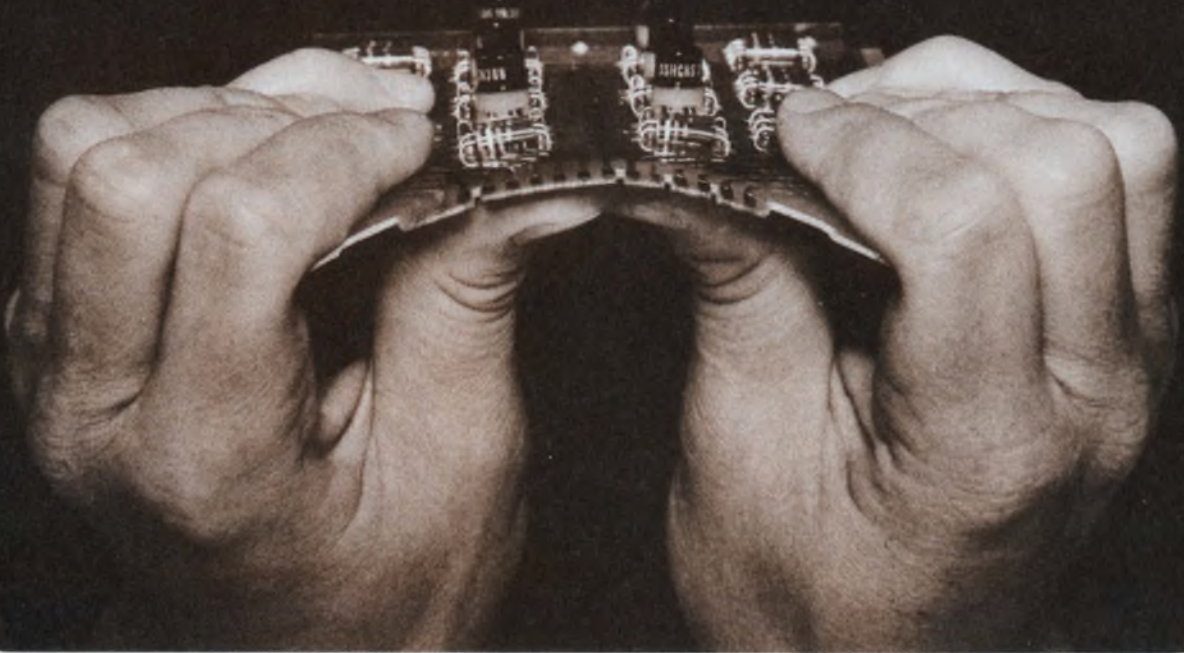

Metal Glaze™ resistors are made to take stresses and strains that crack up so many other types. Physically and electrically, they're tough customers.

Metal Glaze resistors can take PC card flexing, exposure to solvents, automatic machine insertion, potting—and general knocking around. The glass-hard Metal Glaze film is permanently fused to a solid ceramic core. Lead wires are soldered to the core in a patented process. This makes the resistive element and the terminations one continuous component which, even in its

sub-assembly form, is mechanically stronger than many finished resistors. Molded in a tough, environmentally protective envelope, Metal Glaze resistors are practically indestructible.

Metal Glaze resistors can take their share of electrical jolts, too. For power handling they're conservatively rated, and often can be operated at twice rated power without degradation. Short-time overload and high temperature characteristics are excellent.

Competitively-priced Metal Glaze resistors are available in power ratings

from 1/8 watt to 2 watts, in  $\pm 1\%$  to  $\pm 5\%$  tolerances.

TRW Metal Glaze resistors are available in quantity from your local TRW industrial distributor. Or contact TRW Electronic Components, IRC Boone Division, Boone, North Carolina 28607. Phone (704) 264-8861.

**TRW**<sup>®</sup>  
**IRC RESISTORS**

INFORMATION RETRIEVAL NUMBER 13



## LSI arrays to give NASA a 10-pound, 15-W computer

A computer being designed for the National Aeronautics and Space Administration will weigh 10 pounds, occupy one-half cubic foot and require only 15 W. It will, however, be capable of processing functions handled by room-size commercial computers.

The miniature machine is being built by RCA Advanced Technology Laboratories in Camden, N.J., for the Marshall Space Flight Center in Huntsville, Ala.

Beyond its uses in manned and unmanned spacecraft, the machine could also find application in test equipment, communications, navigation and many areas in industry and military data processing, according to James Vollmer, RCA's laboratory manager.

The computer will have 15 large-scale integrated arrays, each consisting of four to six one-eighth-inch-square chips. Each chip will contain up to 600 electronic elements. The LSI C/MOS chips will be designed, manufactured and tested with an RCA computerized design and automation system. Automating this phase of the design, Vollmer estimates, will reduce engineering costs by 75% over conventional chip design processes, as well as decrease manufacturing time.

Called the Spaceborne Ultrareliable Modular Computer, the first model will be a 16-bit-word-length, fixed-point machine. Expansion capabilities, however, will provide for a full 32-bit, floating-point design. It will have a speed of 100,000 operations per second.

The first model will use a core memory plus semiconductor memories for micro-programming and as scratch pads. Subsequent models will replace the core memory with a plated wire. CMOS technology will be used in the computer's logic.

Responsible for the computer's

small size is the extensive use of LSI and beam-leaded technology, says Paul Hamby, chief of the Marshall Computer Design Section. In the first model, chips will be mounted in 40-lead in-line packages. Later, beam-leaded chips will be mounted on ceramic substrates, probably four to six beam-leaded chips per substrate. "We will have between 40 to 60 beam leads per chip," Hamby says.

The Marshall Space Flight Center is also building, in-house, another minicomputer (see "For Long Space Missions: A New Computer," ED 16, Aug. 5, 1971, p. 25). This machine will use bipolar logic plus a 4000-word-by-32-bit miniature (2-mil) plated-wire memory built by Honeywell in St. Petersburg, Fla. It will be faster than RCA's computer, Hamby says, but the RCA machine will use only a tenth the power.

### ... but for future, NASA seeks bubble computers

For future computer memories, NASA is placing its bets on magnetic bubbles.

In a paper to be presented at next week's 17th Conference on Magnetism and Magnetic Materials in Chicago, IBM engineers will discuss the design of a  $10^8$ -bit bubble-domain memory. Being developed for the space program under a NASA contract, the memory will occupy less than 100 cubic inches, weigh about 10 pounds, consume about 10 W and have extremely high reliability.

Reliability is the key to the design, with a less than 1% probability of failure in two years, according to the designers. This performance will be obtained by using bit-per-chip memory organization, in which there will be 800

bits per register, 128 registers per chip, 16 chips per plane and 112 planes.

Power dissipation is being kept to a minimum by activation of only seven planes at a time. A word will consist of one bit from each chip on the seven active planes, resulting in a 112-bit word. This word will use 64 bits to carry data and 48 bits to check and correct errors.

The memory will have random access to blocks of closed-loop shift registers, and it will use bubble-domain chips with on-chip decoding. The 48 check bits of the data word will provide for correction of any possible combination of errors in one plane of memory.

The memory is being designed on a modular basis and will consist of fourteen  $1.1\text{-by-}10^7$ -bit electrically and magnetically independent modules.

### Device speeds speech without distortion

A new device that will enable phonograph, tape and cassette recorder manufacturers to build in variable-speed speech control should be available commercially by next summer.

The solid-state module, approximately one cubic-inch in size, permits playback to be controlled so that normal speech (about 125 words a minute) can be varied from less than 90 words a minute to more than 500 without alteration of the pitch. The unit speeds voice without the usual "Donald Duck" quality associated with high-speed playback; speech remains clearly understood at two to four times its normal speed.

The device has been patented by the Cambridge Research and Development Group in Westport, Conn., and is expected to sell for less than \$10. Although developed primarily for use by the blind (for recording of books and other reading matter), it has additional application in educational, business and commercial markets.

The heart of the variable-speed unit is a "bucket brigade" integrated circuit developed by the Ampere Electronic Corp., a division of North American Philips. The object of considerable interest for many years, the IC consists of a chain of storage capacitors and



charge-transfer circuits that act as an analog shift register with an externally controlled shift rate.

Information is stored in the array of capacitors as charge deficit rather than charge level. This permits the use of a single transistor per capacitor, resulting in a circuit that is much less complex than earlier analog shift registers. The result is a P-channel MOS IC that contains 32 analog shift-register stages, or "buckets," plus an input sampling circuit and an output follower.

"A most urgent need today for the 21 million functionally blind and visually handicapped is for greater speed in listening equipment," notes Kenneth N. Sherman, general partner of the Cambridge Research and Development Group. While the average sighted person reads about 250 words a minute and speed readers up to 1,000 words, a reader of Braille can read only between 60 and 90 words.

In education, Sherman says, "variable speech control will be invaluable, not only to the gifted child, who becomes bored if he is held to the rate of absorption of his average fellow-students, but also to the slow learner, who will be able to have the benefit of individual instruction."

The Cambridge Group estimates an early demand for over 12 million units a year, growing to double that in the long term.

## Wescon planning a consumer show

Wescon has announced plans for a new exhibition of electronic products and systems for the home and office. Known as "Expo Electronica," the show will be held in the new Los Angeles Convention Center early in September of 1972.

According to Donald E. Larsen, general manager of Wescon, the new show will precede the traditional Western Electronic Show and Convention by a week or more, but final dates are still to be confirmed.

Present plans call for a five-day show, open to the public, and featuring such products as entertainment electronics (high-fidelity components and systems, television, audio and video tape equipment, musical instruments, and citizens

band and amateur radio equipment), electronics for home security and time-sharing terminals. There will be public hours every afternoon and evening. In addition certain hours will be reserved for wholesale and retail dealers only.

## Intelsat is getting advanced modem

A solid-state communications satellite modem being developed for Intelsat will have advanced features: It will transmit and receive at a 1 gigabit per second rate, will have a bandwidth to bit-rate ratio of 1.5 or less, and will operate in the time-division, or burst, mode.

It is being developed by the Nippon Electric Co., Ltd., of Tokyo, on a \$162,000 contract from Comsat (Communications Satellite Corp.), the interim manager for the International Telecommunications Satellite consortium.

The modem is intended to aid in evaluating the operation of future high-capacity, time-division, multiple-access satellite systems. Andrew Werth, manager of the Modulation Techniques Branch of Comsat Laboratories, Clarksburg, Md., notes that no present Intelsat satellite transponder had the bandwidth capable of using the new modem.

He expects to see it in service in about five years on future Intelsat systems. Delivery by Nippon is scheduled to be within the next 15 months.

Land-based modems have been designed for continuous operation at 1 gigabit rates, Werth says, but this has been between fixed, "hard-wired" stations. Operation in the burst mode poses technical problems because the modem must be able to communicate at random with one station, and then another, recovering the different carrier signals and bit timing from each of the stations as they are acquired in sequence.

## Digital data 'hitchhiking' suggested on MW band

The use of existing microwave radio systems to meet the increasing demand for digital data service through 1977 has been proposed by H. I. Romnes, chairman of the

board of American Telephone and Telegraph Co.

In an address in New York City, Romnes said that a technique developed by Bell Telephone Laboratories would permit data signals to "hitchhike" on existing microwave radio systems by using the lower end of the frequency band of each carrier channel. Known as "data under voice," or DUV, the technique transmits digital data over the lower 500 kHz of the microwave channel, where oscillator noise is normally too high for voice transmission.

Interfacing between the digital signal and the microwave systems would be accomplished by specially designed terminal equipment that would process a 1.5-megabit signal for each working channel in the microwave system.

In the case of a normally operating channel, Bell spokesmen say that the error rate would be practically zero. Should severe signal fading occur however, the data signal would be switched to a standby channel. The error rate of this signal during the switching period would be significantly better than one bit for every 10 million bits transmitted, according to Bell.

A field trial of the new system is to be made in early 1972, and operation in some parts of the country is to begin by early 1974.

## GE halt in IC output laid to profit squeeze

General Electric's decision to halt production of integrated circuits was taken because an "extremely large investment" would have been needed to capture a major share of the market and the profitability of the operation was "doubtful."

The explanation was given by Dr. Thomas A. Vanderslice, vice president and general manager of GE's Electronic Components Div. in Syracuse, N.Y.

The GE move, made as of Oct. 11, followed similar IC shutdowns by Westinghouse in 1969 and Sylvania in 1970.

GE's Integrated Circuit Center, which is part of the Corporate Research and Development Center in Syracuse, remains intact and will retain its proprietary processes.





**THEY'RE MOLEX EDGE CONNECTORS. "Straight-on" or "right-angle" types for printed circuit boards. Terminals crimped to wires automatically. Reliable? And how! Connector terminals are bifurcated. Provide a really solid contact. Yet you can slip the connector on and off time after time without any damage to the printed circuits. And it's not a preload unit. Carries only contacts required. From six to twenty-four. Comes in white or six other colors. Terminals available in tin-plated brass with gold plating or selec-**

**tive gold plating. ■ A good example of how Molex helps create high-speed low-cost devices that simplify circuitry. If you want to save assembly time, steps and money, take a close look at these Molex edge connectors. For free samples write: Molex Incorporated, Downers Grove, Illinois 60515. Or you can make connections by calling (312) 969-4550.**

*...creating components that simplify circuitry*





# New electronics to make ICBMs more blastproof and easier to aim

The keystone of America's nuclear defense—the venerable Minuteman ICBM—is being updated to give it increased resistance to nuclear blasts and a new system for changing its programmed destination in a hurry.

In addition to a lot of extra concrete and shock mounting, system hardness against nuclear blast is being improved by redesign of the electronics.

The new system for more flexible retargeting will allow the change to be made immediately, via computer, at the launching site instead of a wait for the arrival of computer tapes from Strategic Air Command headquarters. The system includes a powerful processor and a magnetic drum bulk store that can hold more than seven million bits of information.

## 2 kinds of nuclear perils

Nuclear blasts create two types of hazards for electronic circuitry. They are electromagnetic pulse

David N. Kaye  
West Coast Editor

(EMP) and radiation. EMP shows up in the electronics as a transient pulse of fairly high level that can burn out unprotected active devices. Therefore the circuits in both the Minuteman systems and the launch-control facility are being redesigned to withstand much higher voltages than they normally would face. In addition transient suppression is being incorporated in the form of input filtering on each circuit board.

Earl G. Foote, chief of electronic design for Minuteman at Boeing in Seattle, also points to extensive use of input decoupling throughout the system to restrict the passage of dc pulses from circuit board to circuit board.

With the redesign of the electronics, more up-to-date technology is being incorporated. Whereas most of the circuitry used to be discretely, it is now being converted to ICs. Col. Allie B. White Jr., deputy chief of engineering on Minuteman at Norton Air Force Base, San Bernardino, Calif., notes:

"The new launch-site systems are the first in Minuteman to use TTL logic."

He says further: "The modifica-

tions being made on one of the Minuteman wings [a wing contains 150 to 200 missiles] will reduce three racks of equipment at the launch site containing discrete components to one rack containing ICs."

Foote admits that ICs are less resistant to EMP and radiation than discretely, but he points out that a "hardness budget," the amount of radiation and EMP resistance of each circuit is being calculated clear down to the IC level. This allows for better prediction of failure modes. He says that previously hardness was only figured to the subsystem level.

J. Michael Gorman, manager of Weapons Systems Engineering on Minuteman for TRW Systems at Norton AFB, notes: "What you really have to consider is just how much radiation you allow to get to the ICs." With this in mind, the designers are using more sophisticated radiation-suppression techniques to shield the ICs.

## Dielectric isolation helps

Two primary mechanisms of radiation damage in ICs are displacement effects of atoms from their proper lattice sites, resulting from fast neutron irradiation and causing a reduction in transistor current gain, and ionization effects caused by short pulses composed of X-rays and gamma rays. According to Dr. George C. Messenger of the Northrop Corp. in Newbury Park, Calif.: "Ionization effects in monolithic p-n junction isolated microcircuits are usually about an order of magnitude larger than in comparable discrete element circuits."

The nature of these ionization effects gives rise to parasitic diode and transistor elements. Primary and secondary photocurrents in



Boeing-built mockup of the Air Force Minuteman III, newest version of the three-stage solid fueled ICBM, shows its bullet shaped shroud, which covers its re-entry system.



these parasitics tend to dominate the over-all response of the microcircuit. Messenger points out that "these parasitics and their photocurrents are essentially eliminated by the use of dielectric isolation."

Since dielectric isolation is effective in reducing radiation damage, the first step in introducing LSI to the Minuteman program is development of a dielectrically isolated bipolar programmable read-only memory. It is being supplied by Harris Semiconductor at Melbourne, Fla.

As for displacement damage, it is primarily prevented by neutron shielding.

### More flexibility in targeting

In the past mission data for eight targets were stored on a magnetic disc in the missile. If a different target was desired, target tapes had to be generated at SAC headquarters and transported to the launch facility for insertion into the missile and storage on discs.

With the new systems configuration, a disc memory will be placed on the missile with about twice the capacity of the old discs. In de-

scribing this new disc, Colonel White says: "In Minuteman III we store three targets instead of eight. However, we store much more information concerning each target than before. The missions are now more sophisticated."

At the launch-control facility a new digital processor, being built by Univac in Minneapolis, and a magnetic drum bulk store will have all the information to reprogram the missile rapidly to any of an almost infinite number of targets. Retargeting will be done at the launch-control facility instead of at SAC.

Most unique of the features of the new processor, according to Joseph C. Daruty, manager of Minuteman communications and command for TRW, is a half-turn wordstrap plated wire memory. He notes that this new memory will yield savings in cost, volume and drive power. The power requirements of the half-turn wordstrap memory are about 20% less than that of a full-turn plated wire memory.

Hardness was also a major consideration in the choice of the memory. The key features of plated wire in this application are nondestructive readout and non-

volatility as well as speed.

Such information as climatology and gravity models are stored on the drum. These data are necessary for missile trajectory calculations. After new target constants are calculated, the data are communicated by cable to the missile.

Other primary areas that will be improved in Minuteman include status monitoring, the interface electronics at the launch-control facility, the security system and a "cancel launch in progress" feature.

More status information will be made possible by an expanded word length on the message. New interface electronics and a new security system will be tied together with more sophisticated coding for communications between the launch-control facility and the missile.

Cancellation of a missile launch once it has been started will require a cooperative effort between two launch-control facilities. If only one such facility is left on the ground, cancellation will require a cooperative effort between it and the airborne launch control. If no launch-control facilities are left on the ground, it will be possible to cancel a missile launching from the air. ■■

---

## Laser rangefinder built in binocular form

It looks like ordinary Army field binoculars. But it can measure distances to targets up to four miles away, and with an accuracy of less than 30 feet. It is, in fact, the latest laser rangefinder for infantrymen.

The rangefinder, undergoing tests at the Army Electronics Command, Fort Monmouth, N. J., measures the time it takes the laser pulse to reach the target and to be reflected and returned to the sender. A light-emitting-diode digital display next to the eyepiece shows the range in meters. The entire process, including transmission, return and readout, takes less than a second.

According to an Army spokesman, if the rangefinder is approved by Combat Developments Command, a developmental model could

go through engineering and field-testing within two years and be in the field shortly thereafter.

Powered by a rechargeable nickel cadmium battery, the entire unit weighs 4 pounds 12 ounces and can be used 250 times without recharging.



Laser rangefinder being tested by the Army. The small, rectangular display to the right of the eyepiece shows the range in meters in light-emitting-diode digits.

The rangefinder employs a yttrium aluminum garnet transmitter with a lithium niobate Q-switch to obtain a nominal peak power of 1.5 MW. The receiver, a silicon avalanche detector with a matched, low-noise, wide-bandwidth, hybridized preamplifier, is capable of detecting a signal as low as 10 nW. False signal returns from such things as moving foliage between the operator and the actual target are eliminated by a continuously variable range gate, shown below the digital display.

The Army has suggested that in addition to its military applications, the new instrument could be of use to civilian surveyors and others who need portable equipment to make quick and accurate measurements of visible objects at a distance. ■■



# Holography system proposed to detect airline hijackers

A harmless-looking woman shows her boarding pass to an airline attendant and starts out to the plane. She is carrying a small bag and a purse. Seconds later a millimeter-wave holographic imaging device reveals that she is also carrying a gun. Although carefully wrapped in cloth and tucked away inside her plastic purse, the metallic object shows up in an unmistakable image on a CRT display.

Hopefully that's the way it will happen in a real-life situation when engineers perfect the concept of real-time holography. In experiments thus far, the gun has been only a toy, its bearer a laboratory assistant, and the time needed to detect the metallic object has been an unrealistic 10 minutes. But the results have proved to two engineers that the holographic detector they have developed might be the

**John F. Mason**  
News Editor

answer to airline hijacking.

Nabil H. Farhat, professor of electrical engineering, and an engineering student, Wayne R. Guard, developed the holographic system at the University of Pennsylvania's Moore School of Electrical Engineering in Philadelphia.

The problem, says Farhat, is to cut the 10 minutes down to seconds—"to develop a real-time detector." The reason the project is warranted, he adds, is that the detector would be safe. "X-ray radiation used in some detectors now has a cumulatively harmful effect," he notes. "Millimeter waves don't."

In the experiments carried out by Farhat and Guard, the toy gun was wrapped in cloth and concealed in an imitation leather bag. It was illuminated with 70-GHz radiation produced by a reflex klystron that had been phase-locked to the local oscillator of a coherent receiver. The klystron was operating in a cw mode with an output of 750 mW.

The illuminator was a parabolic antenna that produced nearly uniform irradiance of  $0.2 \text{ mW/cm}^2$ . The phase distribution of the scattered field was detected by scanning mechanically with a pyramidal horn. The horn, which had a 1-by-0.77-cm aperture over a 5-cm-diameter circular recording aperture, scanned spirally.

A flexible coaxial cable was used to carry a 3.89-GHz local oscillator signal to a harmonic mixer and to convey the resultant i-f signal to the stationary receiver assembly.

After i-f amplification, limiting and phase detection, an output voltage was obtained with a value that was proportional to the phase of the detected object field. This phase signal was then added to a constant dc voltage of sufficient magnitude to allow both positive and negative phase excursions to be represented as a positive voltage. This positive phase signal was used to amplitude-modulate a 1-kHz carrier voltage, which in turn was used to intensity-modulate a CRT light spot.

The minimum detectable power of the detection system was  $-45 \text{ dBm}$  (for a bandwidth of 1 MHz), and the dynamic range was 40 dB.

A photographic reproduction of the object field phase distribution over the hologram aperture was obtained by causing the intensity-modulated light spot on the faceplate of a CRT to duplicate the spiral motion of the scanned receiver horn. Since the intensity of the moving light spot is proportional to the phase signal provided at the output of the receiver, a time exposure of the CRT, using Polaroid (ASA 3000) black and white positive film, produced a hologram whose density was everywhere proportional to the phase of the object field. ■■

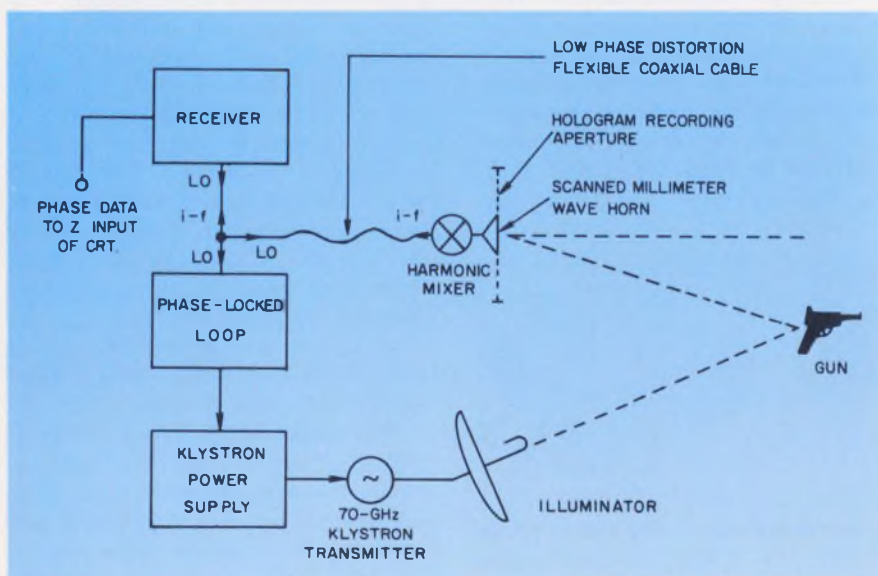

This holographic imaging system demonstrates the feasibility of using millimeter waves to detect weapons carried by airline passengers.

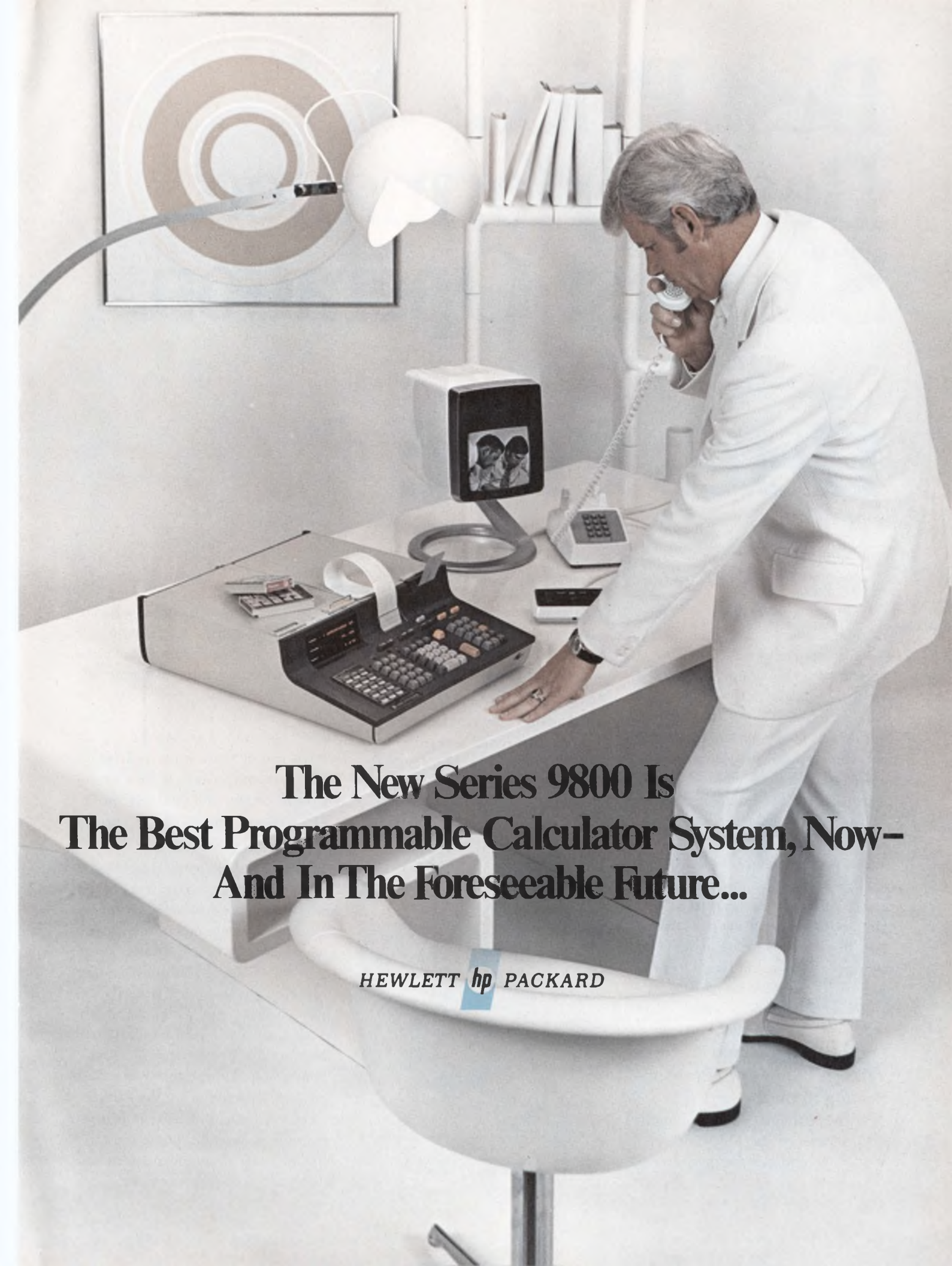

A black and white photograph of a man in a white suit standing at a desk, talking on a telephone. On the desk is a large Hewlett-Packard calculator system with a keyboard and a small screen displaying a photo of two children. A lamp is positioned over the desk, and a framed picture hangs on the wall. The man's hand is resting on the desk near the calculator system.

**The New Series 9800 Is  
The Best Programmable Calculator System, Now—  
And In The Foreseeable Future...**

HEWLETT *hp* PACKARD



# Best Price. Best Performance. Simplest Operation.

## Here's Proof:

The best way to check our claim is to try the new Series 9800/Model 10 for yourself. Call your local Hewlett-Packard Sales Office and we'll be glad to let you get your hands on the Model 10—right at your desk or in your lab. Run some of your typical problems. Check prices—be sure to include all the capability you need and want. You're in for a pleasant surprise. At last, here's a maxi-calculator that can solve your problems—quickly and easily—at a price you can afford.

The Model 10 starts at just \$2975. (If previous experiences have taught you that basic is synonymous with stripped, think about this. The *basic* Model 10 can solve up to 10 simultaneous equations. Need more proof?

### **Only HP Allows You To "Design" Your Own Problem-Solving System.**

With the unique modular-plug-in architecture of the Model 10, you specify — and pay for — only the capability you need. And if your needs change? No problem. You

can expand the memory, add peripherals, or change the keyboard of your existing Model 10, at any time, *without costly modifications.*

### **Only HP Allows You To Customize the Keyboard**

...with interchangeable plug-in blocks. You have a choice of *Statistics* or *Mathematics* functions under single keystroke command. These



function blocks include separate (ROM) memories so they *do not* draw on the main calculator memory, leaving it fully available for further problem-solving power. A third keyboard plug-in option, the *User Definable Function* block, allows you to customize individual keys for operations uniquely important to you and your discipline.

### **HP Offers The Widest Range Of Memory Sizes**

In basic configuration, your Model 10 can perform a complete regression analysis or solve a system of 10 simultaneous equations. If you need more power initially, or if growing demand warrants a larger capacity, the memory is easily expanded with simple plug-in modules. You can expand your Model 10 up to enough power for 17 simultaneous equations (clearly the most powerful calculator on the market). Between basic and maximum configurations, you can choose the combinations of program memory *and* data storage registers to match your needs.





## Only HP Gives You Simple Programming and Editing.

Symbolic addressing, indirect and register arithmetic, added subroutine capability, special editing keys for software debugging, true "Do-Loop" ability—when you get your hands on the Model 10 you'll quick-

ly see that the mechanics of problem solving need no longer stand between you and your great ideas. You can store often used programs on handy magnetic cards for instant entry into your Model 10. These cards may be linked for automatic call by the calculator so there is no limit to the size or complexity of the problems the Model 10 will solve.

## Only HP Gives You Alphanumeric Print-Out

...right on the printer tape. Standard equipment on the Model 10 is the bright, three register LED display. For hard copy you can add (with a modular plug-in) the quiet, low-cost strip printer. For the ultimate in operating simplicity, add the *exclusive Printer Alpha ROM* and you can automatically generate labels, program instructions, and messages—complete with symbols and punctuation—right on the printer tape.

## Only HP Offers You a Host of Peripherals

...to build a system suited to your procedures. The integral I/O bus of the Model 10 lets you plug in such work saving Series 9800

peripherals as a Marked Card Reader, Paper Tape Reader, Digitizer, Typewriter, or the exclusive HP X-Y Plotter that plots linear, log-log, semi-log, or polar plots—and writes alphanumeric.

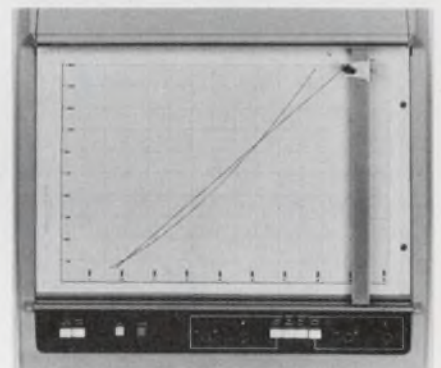

Price. Performance. Simplicity. The Series 9800 is the best desktop computing system now, and in the foreseeable future. But don't take our word for it; ask our competitors. Or write for more information or a "hands-on" demonstration. Hewlett-Packard, P.O. Box 301, Loveland, Colo. 80537. In Europe: 1217 Meyrin-Geneva, Switzerland.

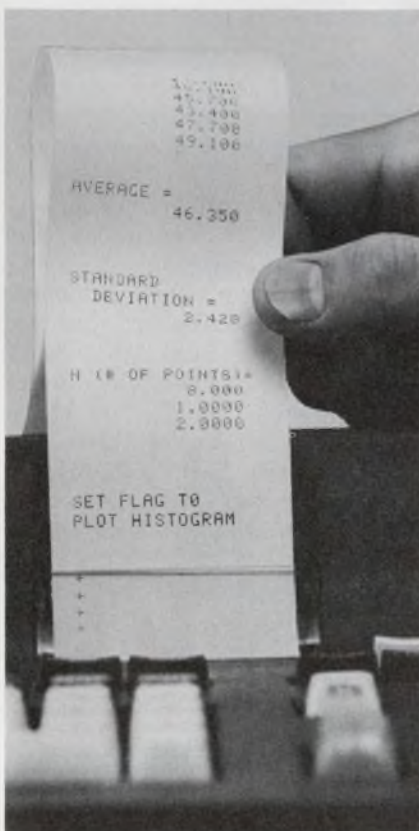

CD114

**HEWLETT *hp* PACKARD**  
CALCULATOR PRODUCTS



# EIA sees civionics spending doubling in next five years

The Electronic Industries Association is projecting very slight growth in Defense Dept. and NASA electronics spending between 1972 and 1985. However, Government spending for electronics in the civilian, or civionics sector is expected to at least double in the next five years.

The projections were made at the EIA's Fall Conference in Los Angeles. The Defense Dept. and NASA forecasts were made by the EIA Requirements Committee, based on a survey of the market expectations of EIA members. The civionics spending projections were made by Dr. Launor F. Carter, vice president and general manager of the Public Systems Div. of Systems Development Corp., Santa Monica, Calif.

Most of the EIA members do most of their business with the Defense Dept. and NASA and are expected to have a tough time breaking into the civionics markets, Carter says. He noted some of the problems:

"There are 27,000 school districts in this country, and you must market to each one individually. I'm not sure that aerospace companies know how to market to this type of organization.

"In all civil systems marketing the lead times required and political frustrations are immense. It often takes over a year to cut through the red tape. The most frustrating thing of all is that it often takes a very long time between the culmination of a design study and the initiation of an implementation phase. You usually can't keep a design team together from one phase to the next."

Total Defense Dept. procurement (Fig. 1) will hardly vary at all from the \$20-billion level, the EIA says. In the case of one key market

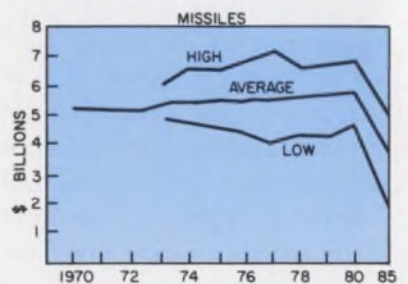
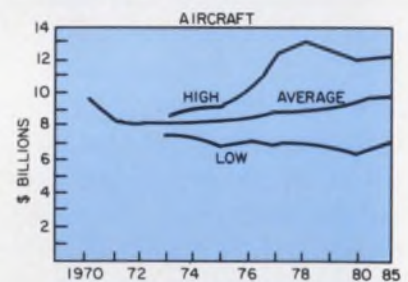
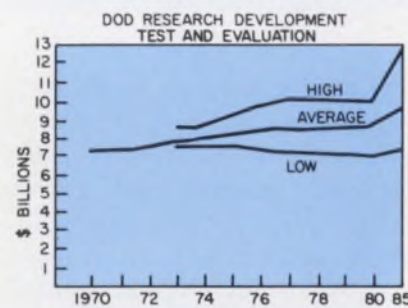
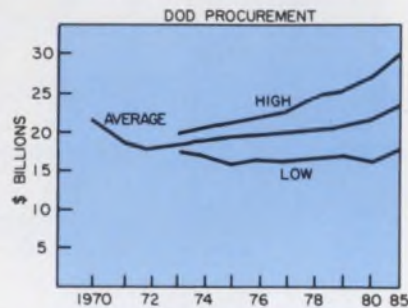

—Research Development, Test & Evaluation—modest growth is expected, from about \$7-billion to about \$9-billion over 15 years (Fig. 2). Aircraft, a second major market, shows a level curve in the \$8-billion to \$9-billion range (Fig. 3). Missiles, the third key market, are

expected to stay in the \$5-billion to \$6-billion range (Fig. 4).

An encouraging area of growth is expected to be shipbuilding. Spending is expected to grow from its current level of about \$2.5-billion to somewhat over \$3.5-billion in 15 years.

When just the electronics content of Defense Dept. spending is broken out, growth of from about \$12-billion to about \$18-billion is projected to 1985 (Fig. 5).

NASA electronics spending is expected to grow from \$1.2-billion to \$1.4-billion over the same time period. (Fig. 6). These totals assume that the space-shuttle program will proceed at full speed. Without that program, the outlook for NASA is bleak, the EIA says.

## Civionics looks good

Carter made projections of Government spending for civionics electronics in these areas:

- Automatic train control systems.
- Vehicular traffic control.
- Justice communications and information processing.

His forecasts for automatic train control spending was for \$126-million in fiscal 1972, \$240-million in '73, \$360-million in '74 and \$480-million in '75.

For vehicular traffic control, including urban and state traffic control and state freeway surveillance, the projections were: \$120-million in fiscal 1972, \$138-million in '73, \$158-million in '74 and \$182-million in '75.

For justice communications and information processing: \$400-million in fiscal 1972, \$500-million in '73, \$625-million in '74, \$780-million in '75 and \$800-million in '76.

Although these figures seem small compared with the combined



# The RAM built by hindsight.

Being the first 1024-bit MOS RAM, the 1103 was quickly designed into many systems. (A big reason we wasted little time second sourcing it.)

At the same time, we (along with many others) felt that there was plenty of room for improvement in terms of cost and performance on an overall system level.

Hence, we're now building our very own 1024-bit MOS RAM, the vastly superior MM5260.

Like the 1103, our MM5260 comes with chip-select.

*Unlike* the 1103, the thoughtfully designed MM5260 features a Tri-State logic common data I/O structure with TTL-compatible on-chip decoding and an internal sense amplifier. Plus precharge decoding to reduce system power dissipation significantly.

On a *system* level, the results speak for themselves: A power dissipation savings of almost 66% (two standard supplies versus three supplies); a 100% reduction in the number of overhead

circuits; and a 200% savings in overhead costs. All without sacrificing system speed or performance.

Finally, the new MM5260 comes in a 16-pin dual in-line package and is available for immediate delivery.

(Realizing the hard-core realities of phasing out an existing format, we will also continue to act as a volume supplier of the MM1103.)

All of which means that there's now only one place you need to write, phone, TWX or cable when it comes to 1024-bit MOS RAMs:

National Semiconductor Corp.,  
2900 Semiconductor Dr., Santa Clara,  
California 95051. Phone (408) 732-5000.  
TWX: (910) 339-9240. Cable: NATSEMICON.

(Hot-off-the-drawingboard Dept.:  
In a blatant attempt to become the most respected name in RAMs, we will soon announce a couple of highly interesting 2048-bit MOS RAMs.)

## National



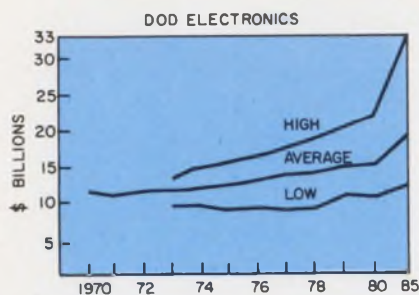

defense and NASA electronics figures, their growth is phenomenal by comparison. Also, these are but three of the civionics areas for electronics manufacturers to consider. When other segments of the civionics market are included, the total dollar picture starts to shift even more in their direction, Carter notes. ■■

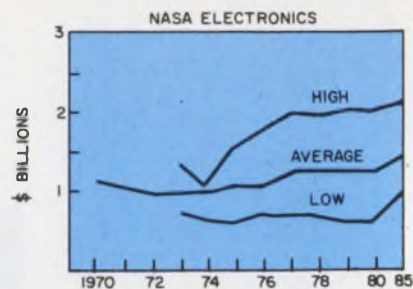

## Mechanical arm can even thread needles

A newly developed mechanical arm that duplicates the motions of its human operator is so sensitive it can thread a needle, stack eggs, pour liquid from one glass to another or assemble electronic circuit boards. And it can work under water.

The operator may stand alongside the robot and be connected to it by wire, or he may be miles away communicating with the arm by radio. A television camera attached to the structure that supports the mechanical arm shows the operator what to do.

The robot limb can also be controlled for repetitive work by a computer.

Called NAT, for Naval Anthropomorphic Teleoperator, the device was developed by MBAssociates in San Ramon, Calif., under a joint arrangement with the Navy, the National Aeronautics and Space Administration and the Atomic Energy Commission. The Navy funded the project to give the Naval Explosive Ordnance Disposal Facility a low-cost robot to dispose of armed explosives. These hazardous jobs are now handled by teams of specially trained Navy personnel.

NASA and the AEC are interested in using such a robot device outside spacecraft, or on the moon or planets to help man explore.

To control the mechanical arm, the operator wears an exo-skeleton device, built like the robot limb (see photo). The exo-skeleton device is equipped with potentiometers at nine strategic places, and they measure any movement the operator makes with his arm. This movement is converted to voltage, which is transmitted to potentiometers

at identical places on the robot arm. When the voltage reading differs on corresponding potentiometers on the slave, the "error" is corrected to agree with the master station—the operator—by a hybrid electro/mechanical/hydraulic/pneumatic system. The slave arm thus continuously imitates the movement of the master arm.

The design also incorporates force feedback, which allows the operator to sense the weight of objects that he commands the slave to handle, as well as to control the gripping force of the slave. The force feedback is obtained by a pneumatic pressure control servo valve developed by MBAssociates.

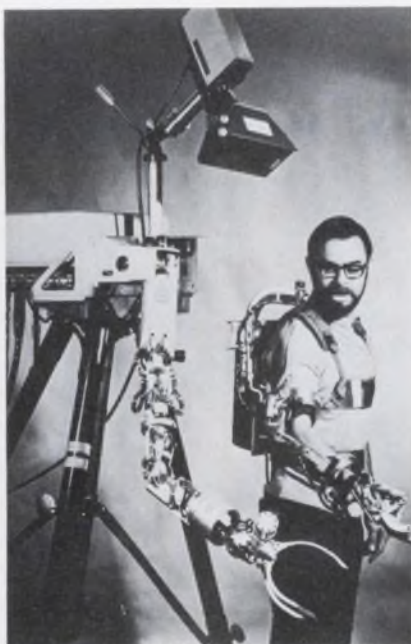

Slave arm imitates motions made by master arm on the operator by equalizing potentiometer readings on both.

Besides its ability to handle sensitive tasks, the robot device can pick up heavy objects—up to 20 pounds and seven inches in diameter—at arm's length.

Data on a two-way link are transmitted over wire or radio.

While NAT was tested under water only last month, it passed two of its more intricate tests—threading a needle and assembling circuit boards—in the laboratory last summer. These tasks had never been performed by a teleoperator system before, according to the developers.

The NAT grip device is more versatile than the hook type of claw currently used by hand amputees and could readily be adapted to their needs, says MBA's senior vice president, David L. Cochran.

Other potential applications include the handling and detoxification of chemical warfare and biological warfare weapons; high-speed, low-cost mining and tunneling in hard-rock formations; search and rescue in hazardous situations, such as fires or mining accidents; salvage of wrecked ships and aircraft in very deep or cold water; unmanned operation, inspection and repair of remotely located control stations, beacons and observation points; rapid industrial production-line assembly; inspection, repair and reactivation of "dead" or obsolete satellites; space-station assembly, cargo transfer and space-shuttle docking.

To aid law-enforcement, the device could disarm dangerous suspects who are carrying weapons, and it could search for hidden bombs and even disarm them if found. ■■



# Surface-Wave Delay Lines

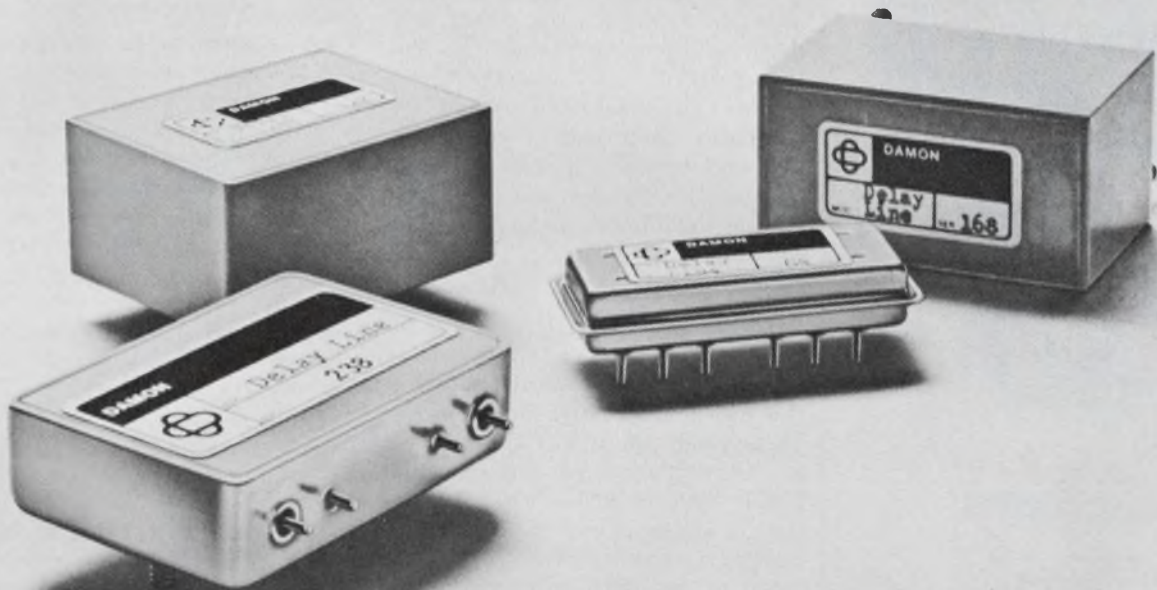

## ...a new state-of-the-art development.

By transferring the signal across the surface instead of through the body, the new Surface-Wave concept results in substantially smaller packages, lower cost in production quantities and superior performance over a 20 MHz to 200 MHz range.

Damon Surface-Wave Delay Lines consist of coupled transducer arrays accurately spaced on a lithium niobate or quartz substrate, using precision photo-etching techniques. The delay of signal propagation is controlled by varying the distance between the interdigital structures. The devices are ideal for use in radar, communications and sonar and have potential use as i-f filters for color television and acoustic logic for computers. Delivery in evaluation quantities in 6-8 weeks. For complete information or evaluation samples write Damon Electronics Division, 115 Fourth Avenue, Needham Heights, Mass. 02194.

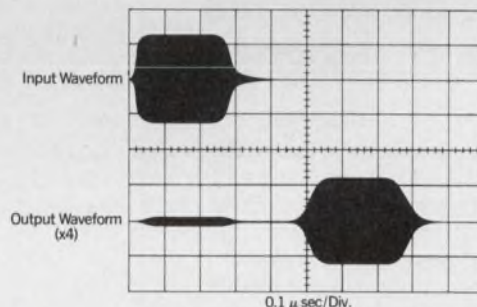

Typical waveforms for a 0.5 microsecond delay line driven by a 0.25 microsecond pulsed carrier at 60 MHz.

### RANGE OF PARAMETERS

Frequency Range:	20 MHz – 200 MHz
Time Delay Range:	0.5 microseconds. – 10 microseconds.
Bandwidth at -3dB:	3% – 30% of center frequency
Insertion Loss:	10 – 20 dB
Spurious Responses:	25 – 30 dB below desired response
Environment:	Full military temp., shock, vibration available
Typical Size:	Less than one cubic inch



**DAMON/ELECTRONICS DIVISION**

INFORMATION RETRIEVAL NUMBER 18



Five of our 16 edgewise meter models:  
 1. Model 2150, ruggedized 5"-scale type in 22% the space of a 6" rectangular type. 2. Model 1140, 4"-scale, greater sensitivity. 3. Model 2520, shielded dual movements, interchangeable scales. 4. Model 1122, 1.24" scale, 26 std. ranges. 5. Model 1136, 2"-scale, 1/5 the space of 3 1/2" meters.

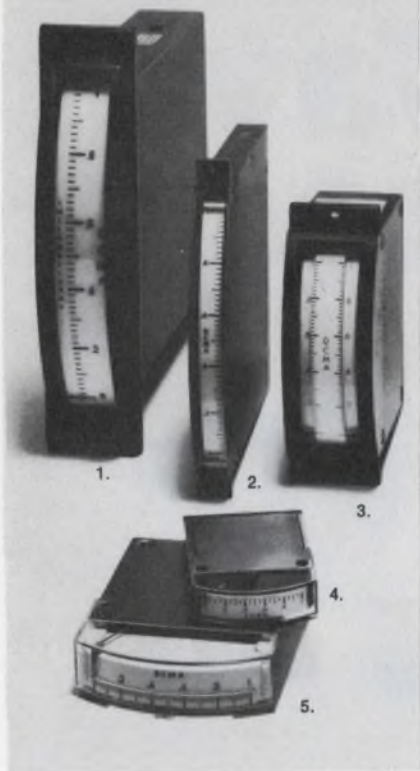

## Edgewise meters:

- most sizes
- dual movements
- custom designs

The patented, pivot-jewel flat movement used in these integrally-shielded meters not only allows maximum space economy by flush stacking, but provides higher vibration immunity and greater ruggedness as well. Unique dual-movement models save even more space, simplify comparison of two variables, have optional interchangeable slide-in scales. Ruggedized 5"-scale models are ideal for adverse military and production/process environments. Write for data on any of 16 models in 40 standard ranges . . . or movements custom-designed for your needs.



**INTERNATIONAL  
INSTRUMENTS**

DIVISION OF SIGMA INSTRUMENTS, INC.  
 88 MARSH HILL RD., ORANGE, CONN. 06477.

INFORMATION RETRIEVAL NUMBER 19

# technology abroad

A contract to develop an anti-collision flight system has been awarded to the French firms L'Onera and Crouzet. The companies plan to produce a time-frequency system compatible with proposed American equipment. Planes equipped with such a system are each allotted a 1.5-millisecond time slot in a three-second cycle. In that slot the plane transmits its altitude in a coded format. Neighboring planes use the transmission to pinpoint the sender's position and speed. A computer then checks to see if any converging courses are dangerous. If they are, the computer issues avoidance instructions to the pilot.

CIRCLE NO. 451

Circuits developed specifically for the watch and clock industry are being produced by ITT-Intermetall of Germany. One circuit, the S.A.J. 190, is a 14-stage divider that reduces a quartz-crystal oscillator frequency from 16,384 Hz down to one pulse a second. This drives a small watch motor. The circuit operating voltage is 1.35 V, and the current drain 6 mA. For low cost, the circuit is packaged in plastic. The company has also developed a seven-stage divider that can accept quartz-crystal frequencies up to 100 kHz.

CIRCLE NO. 452

A new 1024-bit bipolar random-access memory on a single chip has a 50-ns access time. Rivaling the cost of slower MOS devices, the memory is being developed by Ferranti, the British IC manufacturer. The company has completed tests on a 64-bit prototype to determine the lowest-cost layout for a memory cell based on Bell Laboratories' revolutionary collector-diffused isolation process. The Ferranti engineers, introducing newer techniques, have produced a single-transistor mem-

ory cell with a standby dissipation of 5  $\mu$ W per bit and an access dissipation of 300  $\mu$ W per bit.

CIRCLE NO. 453

Alloys like nickel-titanium, which can be deformed and then restored to their original shape by heating above a critical temperature, make "shape memories" that may be useful in the design of relays, according to Philips of The Netherlands. The company, which is pursuing a research program on this material, has demonstrated that the effect occurs when the alloy matrix is asymmetrical. Atoms in the cooling metal seek their original pattern instead of settling into the nearest of a number of symmetrical sites. It has been found that other alloys also have this property, and Philips is investigating them for future application.

CIRCLE NO. 454

Advanced thin-film techniques have been applied to thermopile radiation detectors by engineers at the French Electronics and Applied Physics Laboratory. The detectors—448 junction pairs deposited on an insulating substrate 4 mm by 5.8 mm square—will be used in the Symphonie satellite project. Detector sensitivity, measured in vacuum in the visible spectrum, is 1.35 V/W. In the infrared spectrum it is 1.65 V/W. Thermocouple metals are deposited on the insulator substrate, then photo-etched to the desired configuration. The substrate is bonded to a thermally conductive base, so that even-numbered junctions are in good thermal contact, while odd-numbered junctions are insulated. When the thermocouple array is exposed to radiation, a temperature gradient results.

CIRCLE NO. 455

**Don't miss an issue of Electronic Design; return your renewal card today.**



# Whiskers are out.

## The new military standard for 1.5 watt power zeners is Unitrode's double pin bonded design.

The 1N4461-89 series from Unitrode is available off-the-shelf as JAN and JANTX zeners to MIL-S-19500/406 in most voltages from 6.8V to 100V. They offer greater reliability and improved electrical characteristics at no more cost than conventional 1 watt whisker-type metal can zeners. The reliability of the double pin design is further increased by bonding the silicon chip directly between terminal pins and then fusing a hard glass to the exposed silicon surface and pins.

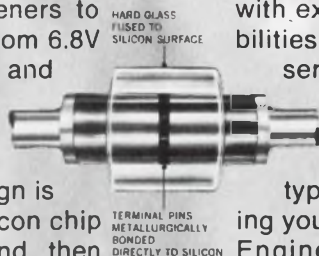

This results in a voidless, monolithic structure with exceptional zener stability. Surge capabilities are 5 times greater than the 1N3016B series. Zener impedances are improved and reverse currents are two orders of magnitude lower. The point is, now you can switch from whisker-type to double slug design without shaving your standards. For fast action, call Sales Engineering collect at (617) 926-0404, Unitrode Corporation, Dept. 11B, 580 Pleasant Street, Watertown, Mass. 02172.



**UNITRODE**

INFORMATION RETRIEVAL NUMBER 20



# Smooth Application Sailing With GE's Fleet of 150-Grid Relays

Here's Why.

**Easy to Evaluate and Select** — Physical and operating characteristics of all five 150-grid relays are very similar. If you are familiar with one, you know them all.

**Wide Application Capability** — For your electronic circuit needs . . . 2-pole, 4-pole, latching, sensitive, AND-logic. Also, a wide choice of coil ratings, mounting forms, and headers to match your exact requirements.

**Top Quality and Reliability** — The GE 150-grid relays have been proven in a great many severe equipment applications the past 4 years. These include the Apollo space vehicle and other major aerospace programs.

**Quantity Discounts** — Apply to the total number of GE 150-grid relays purchased of all types.

Sail through your work load with this time-saving, money-saving, problem-solving GE 150-grid sealed relay fleet. Call your nearest GE Electronic Components Sales office or distributor, or write Section 792-46, General Electric Co., Schenectady, New York 12305.





# washington report

DON BYRNE, WASHINGTON BUREAU

## **Navy studys new hull for ASW platform**

The Navy is studying a radically new hull form for possible use as a highly stable helicopter or antisubmarine warfare electronics platform in rough seas. Called the Stable Semi-submerged Platform — SSP — it consists of two parallel, deeply submerged, torpedo-like hulls attached to hydrofoil struts to a platform well above the water surface. The Naval Undersea Research and Development Center notes that SSP “will provide great seaworthiness at all speeds including zero speed, higher speed and greater maneuverability, and level rides in most sea states by using dynamic control surfaces.” The top deck will contain a central well through which ASW detectors may be lowered into the ocean.

Meanwhile, the Navy’s A-New program continues to be one of the major electronic procurements, and sources predict it will not slack off in the next fiscal year. A-New is a computerized sensor system that will go into the Navy’s P-3C antisubmarine warfare aircraft. There has been no R&D money for A-New since 1969 but procurement totalled \$59.3-million in FY 1970, \$49.4-million in 1971 and \$75-million is requested for the current fiscal year. Navy sources point out that the first production of the Lockheed S-3A carrier-based ASW aircraft is planned for this fiscal year. The S-3As will carry a smaller version of the A-New, but there will be more of them built than P-3Cs.

## **Satellite / cable ratio changed by FCC**

The Federal Communications Commission has issued a new order on the proportionate ratio for satellite and cable international traffic. The five-to-one ratio set in May — five satellite circuits for each cable circuit until the number of satellite and cable circuits were equal — has been replaced by a one-to-one ratio. This means that now for every new satellite telephone circuit one circuit will have to go by cable. Telegraph circuits will not be affected. Meanwhile Clay T. Whitehead, director of the Office of Telecommunications Policy, said that an Administration policy on international communications should be forthcoming from the White House early next year. Whitehead said he plans to meet with communications industry officials on the matter in the near future.

## **Airlines hit satellite plan as too costly**

The scheduled airlines are asking the Government to give up its plan to launch four aeronautical communications satellites over the Atlantic and Pacific oceans. The program, they say, is “too much, too costly and too soon.” A spokesman for the Air Transport Association called the program “completely unjustified because it proposes to use four preoperational



satellites to obtain information that can be gathered for less than half the cost with one satellite under U.S. control." The Department of Transportation, NASA and State Department, in cooperation with the European Space Research Organization, plans to launch the satellites early in 1974 at a cost of roughly \$140-million. ATA said the U.S. share of \$70-million actually amounted to a "down payment on a program that is ultimately expected to range from \$500-million to \$1-billion." ATA called for more research before the program starts. The Federal Aviation Administration said it would have no comment on the ATA charge adding that it was maintaining its schedule for the program.

## **Air Force seeking new "mini" gunship**

The Air Force has embarked on development of a fleet of "mini" warplanes to be used by Southeast Asia allies after the U.S. forces withdraw from Vietnam. Work is now concentrating on a small gunship for the Vietnamese air force which will stress simplified, highly compact electronics for limited night and all-weather capability. The Air Force wants \$14.5-million this year to buy 15 of Helio Aircraft Co.'s Stallion aircraft and Fairchild Industries' Peacemaker.

## **NASA selecting experiments for ERTS satellites**

NASA is still considering more than 400 proposals on how to analyze ecology data supplied by the first Earth Resources Technology Satellite — ERTS-A — and the manned Skylab which will carry an Earth Resources' experiment package aboard. ERTS, a 2100-pound automated satellite, is due to be launched next spring while the Skylab, a 190,000-pound manned spacecraft, is due the next year, also in the spring.

## **First specialized microwave net authorized**

The first specialized microwave common carrier system has been authorized under the FCC's new open competition policy. The grant went to Interdata Communications, Inc., for a New York-to-Washington trunk for voice and data. Interdata was the first to file after Microwave Communications Inc., was granted its Chicago-St. Louis net, which was approved before the new FCC policy was stated in May.

**Capital Capsules:** FCC Commissioner Robert Wells, as expected, has resigned from the commission to seek the governorship of his native Kansas on the Republican ticket. A successor to the commissioner may well come from the commission staff, say reliable sources . . . **The Philippine Communications Satellite Corp. has opposed a proposed cable between the U.S., Guam and the Philippines.** U.S. Comsat took a similar position several years ago against trans-Atlantic cables and lost . . . **NASA has extended for six months its study contracts on the space shuttle.** New target date for selection of sites and definition of the program itself is now April 30 . . . **The third annual Lunar Science Conference will be held at the Manned Space Center in Houston Jan. 10-13.** Apollo 14 and 15 scientific results will be discussed. About 800 scientists are expected . . . **Mariner 9 is expected to go into orbit around Mars next week for a 90-day close-up study of the red planet.**



# TEKTRONIX® GRAPHING TERMINAL *shatters*

the  
price  
barrier

TIME  
SHARING

MINI'S

360/370'S

\$3950  
or less



**NEW 4010**—The new Tektronix 4010 Terminal is an engineering and business oriented computer display terminal with interactive graphing and alphanumeric capabilities. It is hardware and software operational with a host of popular mini-computers, with IBM 360/370 systems and presently with over 20 timesharing systems.

**NEW LOW-COST**—Scientific, engineering and business managers will find the TEKTRONIX 4010 Terminal the best price/performance answer for single and multiple interactive graphing terminal needs. The price of a 4010 is only \$3950, or it may be leased for \$190/month including maintenance. Quantity discounts tumble costs to as LOW as \$3358 each for 20 or more.

**NEW PLOT-10**—This new package provides extensive software capabilities in graphing and application interface routines. It provides you with a series of modules from which you can select elements best suited to your particular operating environment and application. New PLOT-10 lets your computer display more information in less time at much lower cost than ever before.

**NEW 4610**—The new 4610 Hard Copy Unit produces fast, inexpensive, high-resolution, high-contrast, permanent copies of the graphic and alphanumeric information displayed on the 4010-1. The easy-to-handle 8½ x 11-inch DRY copies are most convenient for documentation, communication, recording and filing uses.





# How can Philips **guarantee** the performance of its RF power transistors for mobile transmitters?



Yes...the word is **guarantee.**

## No more wondering "50 watt is 50 what?"

With Philips RF power transistors for mobile transmitters, you know precisely what you're ordering. You get precisely what you order. If used as specified, it will not fail... or your money back!

How is this possible? Not as difficult as it seems.

It starts, of course, with a product of superior reliability. But the real secret is in the specifying.

We provide you with a set of SOAR (Safe Operating Area) curves setting forth, in detail, at exactly what combination of VSWR, temperature and supply voltage variations the transistor will operate correctly. When we say "25 watt", we mean, for example, "25 watt performance, with a 70°C heat sink, withstanding a VSWR of 50, 20% overvoltage and an increase of 20% drive power". Rather than forcing you to build in your own safety margin... with the probability you will over-specify and over-spend to be on the safe side... we determine all the derating parameters for you. The specification is part of the product... and we stand behind it.

The full range of Philips RF power

transistors for mobile transmitting equipment...civil, military, aerospace or maritime... is shown in the accompanying table. Write for full specifications.



electronic components and materials

N.V. Philips' Gloeilampenfabrieken  
Electronic Components and Materials  
Division Eindhoven, The Netherlands.  
Distributed and sold in the U.S. by:  
Amperex Electronic Corporation  
Semiconductor and Microcircuits division  
Providence Pike, SLATERSVILLE R.I. 02876  
In Canada: Philips Electron Devices  
a division of Philips Electronics  
Industries Ltd. 116, Vanderhoof Avenue  
TORONTO 17 - Ontario

Pout (Watt)	SSB		VHF		UHF	
	30 MHz	28 V	175 MHz FM	28 V	470 MHz FM	28 V
0.5					2N4427	
1.0			2N4427			
1.5				2N3866		
2.0					BLX65	
2.5				2N3553	BLX66	
3.0			2N3924		BLX67	BLX92
4.0			BFS22A	BFS23A		
6.0				2N3375		
7.0			2N3926		BLX68	BLX93
8.0	BLX13		BLY87A	BLY91A		
12.0			2N3927			
13.0				2N3632		
15.0			BLY88A	BLY92A		
20.0					BLX69	BLX94
25.0			BLY89A	BLY93A		
40.0						BLX95
50.0	BLX14		BLY90	BLY94		
100.0	BLX15					

# PHILIPS

INFORMATION RETRIEVAL NUMBER 23



# NEW! "THE SWITCH."

A unique high-performance C/MOS analog switch offering multiple configurations on one chip.

## HI-1800

Now, for many analog switching applications all you need is "The Switch." With this single monolithic device you can implement at least five switch configurations. Additional advantages are lower leakage at high temperatures and an excellent power-speed ratio. To order, contact your Harris representative or distributor.

### Features:

**Monolithic C/MOS**

**Low leakage** < 50nA. @ +125°C

**High speed** 250 ns.

**Low power dissipation** 5 mW.

### Type

**R<sub>on</sub>**

Dual DPST 125Ω

Single DPDT 125Ω

Single SPDT 60Ω

Dual SPST 60Ω

Single SPST 30Ω

100-999 units

## HI-1800

0°C to +75°C \$ 9.35  
-55°C to +125°C \$ 13.75

## HI-1800A

0°C to +75°C \$ 11.55  
-55°C to +125°C \$ 17.05

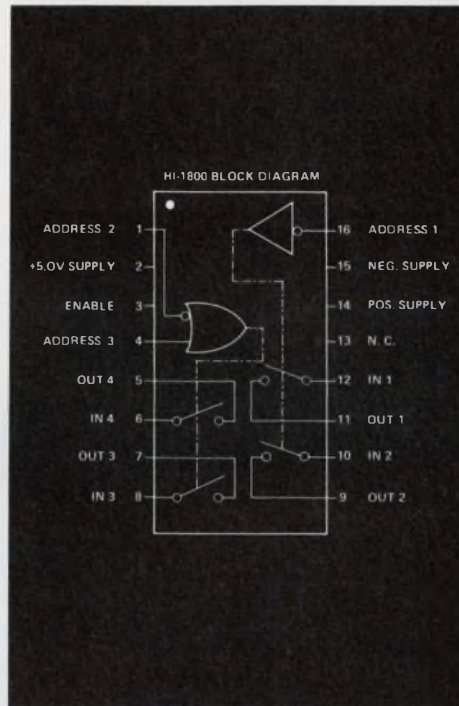

TRUTH TABLE

INPUT ADDRESS				SWITCH CHANNELS			
1	2	3	EN	1	2	3	
L	X	X	L	ON	ON		
H	X	X	L	OFF	OFF		
X	L	X	L			ON	ON
X	X	H	L			ON	ON
X	H	L	L			OFF	OFF
X	X	X	H	OFF	OFF	OFF	OFF

H ≥ +4.0V      LS ≤ +0.4V



**HARRIS**  
**SEMICONDUCTOR**

A DIVISION OF HARRIS-INTERTYPE CORPORATION

P.O. Box 883, Melbourne, Florida 32901  
(305) 727-5430

**DISTRIBUTORS:** Schweber Electronics: Westbury, New York (516) 334-7474; Rockville, Maryland (301) 881-2970, Hollywood, Florida (305) 927-0511  
Harvey/R & D Electronics: Lexington, Massachusetts (617) 861-9200/Semiconductor Specialists, Inc.: Chicago (312) 279-1000; Detroit (313) 255-0300;  
Minneapolis (612) 884-8132, Kansas City (816) 452-3900; St. Louis (314) 428-6100; Dallas (214) 358-5211, Indianapolis (317) 243-8271;  
Pittsburgh (412) 781-8120, Dayton (513) 278-9455 / R.V. Weatherford Co.: Albuquerque (505) 265-5671; Anaheim (714) 547-0891;  
Austin (512) Enterprise 1443; Dallas (214) 231-6051; Denver (303) 427-3736; Glendale (213) 849-3451; Houston (713) Enterprise 1443;  
Palo Alto (415) 321-5373; Phoenix (602) 272-7144; Pomona (714) 623-1261; San Diego (714) 278-7400; Seattle (206) 762-4200.



# Take the price you'd normally pay to measure one nanosecond and 550 MHz.

## Now divide by two.

Now for less than half the price of alternative solutions you can measure frequencies up to 550 MHz and time intervals from 0.15 nanoseconds to  $10^9$  seconds. You get the best resolution too, <50 picoseconds. Only HP's unique type of time interval averaging permits these measurements with such economy.

And you get all the other functions you expect in universal timer/counters. Features such as totalizing, period, ratio and conventional time interval measurements. They're the most programmable counters of their type as well.

This series also includes the only counters with built-in digital voltmeters.

So you can set trigger levels digitally and better than an oscilloscope can for accurate time interval measurements. Use the DVM to check out dc voltages too, or add an HP 11096 probe for ac.

For more accurate measurements you can option for a high stability time base of 5 parts in  $10^{10}$ /day. Or to measure low level signals, we can offer input sensitivities as high as 25 mV.

The HP 5327 Series is ideal for testing logic timing, cable delays, low-power circuits, and crystal oscillators—as well as calibrating frequency and pulse generators. Prices of the three models in the HP 5327 Series range from only \$1495 to \$2150. Or, if a 50 MHz will do your job, there's the companion 5326 Series from just \$950 to \$1595.

Sound too good to be true? Ask your local HP field engineer about these outstanding counter values. Or for more information, write to Hewlett-Packard, Palo Alto, California 94304; Europe: 1217 Meyrin-Geneva, Switzerland.

02117



HEWLETT  PACKARD

ELECTRONIC COUNTERS

# editorial

## Wanted: 20 years' experience. Older men need not apply

Older engineers are washed up. That's the grim conclusion of two professors, Dalton and Thompson, who wrote "Accelerating Obsolescence of Older Engineers" in the September-October issue of *Harvard Business Review*.

Engineers over 40, they say, either can't or don't keep up with technology. So they're given, and they passively accept, routine assignments based on existing—that is, old—technology. And sure enough, they don't keep up with advancing technology. And because they've reached salary levels of around \$18,000 and can't switch jobs easily, they live scared. They lose interest in their work, and their work shows it.

That's pretty scary. That older engineer is you and me—soon, if not now. According to the Harvard article, we're getting older quicker. We now reach our performance peak in our middle to late 30s. But our peak performance years are shifting lower—and shrinking. We reach our peak—and leave it—sooner. That's grim.

Is it any wonder, then, that many engineers no longer are urging their sons to study engineering? Go for law, they counsel, or medicine, or accountancy, or shoe sales—anything but engineering.

What are we to do now? What do we do with our bachelor's and master's degrees and doctorates? What do we do with our 10 or 15 or 20 years of experience? Scrap them?

We've got to work harder. We've got to reject those soft assignments and go after the tough, challenging jobs that involve the newest technology. That's where we can shine. Chasing new technology is always risky because new technologies, like shooting stars, are often brilliant but short-lived.

Our experience, maturity and judgment can help us select the new technologies worth pursuing. Younger engineers don't have that acumen yet. But we can't be complacent. They'll be older very soon.



We know you have more important things to do with your time than filling out forms. But once a year we're required to re-verify the qualifications of every man who wants to continue his free subscription. Please take a moment now to fill out the form tucked inside the front cover. We promise we won't bother you again until next year.

A handwritten signature in dark ink that reads "George Rostky". The signature is fluid and cursive, written in a professional style.

GEORGE ROSTKY  
Editor



## Make sampled-signal analysis easier

with this program for the calculation of power spectra. It will run on almost any machine that accepts XBASIC.

In designing such equipment as a pulse-code modulation (PCM) system or a sampled-data feedback network, it's often necessary to calculate the power spectrum of a periodically sampled signal. The computer program presented here (see box), written in XBASIC, calculates, prints out and plots the power spectrum generated by any specified signal and sampling function.

Note that the program is designed for the theoretical analysis of mathematically described signals, not the real-time processing of experimental data. Thus, while it is ideal for predicting the power spectra that will be produced by PCM systems, a/d converters and other sampling systems, it is not meant to measure the spectrum in an operating system.

### Convolution is the key

A sampled signal can be considered as a product of a periodic sampling function and the signal being sampled. The sampling function can be described in two ways: In the time domain it is a periodic gate function of period  $T$ , sample time  $t$ , and amplitude factor  $A$  (usually equal to one). In the frequency domain it is a series of spectral lines under a  $[(\sin x)/x]^2$  envelope (in power units) (Fig. 1).

Since time-domain multiplication is equivalent to frequency-domain convolution, it's possible to calculate the desired power spectrum by convolving the power spectrum of the sampling function with the spectrum of the signal to be sampled. This is the approach taken in the program.

### Using the program

Although computers differ slightly in the commands they can accept, only minor changes, if any, should be needed for the program to run. One important requirement is that the computer must accept the TAB function that is incorporated in the plot routine.

**Larry J. Meeker**, Associate Engineer, Westinghouse Electric Corp., Advanced Technology Laboratories, P.O. Box 1521, Baltimore, Md. 21203.

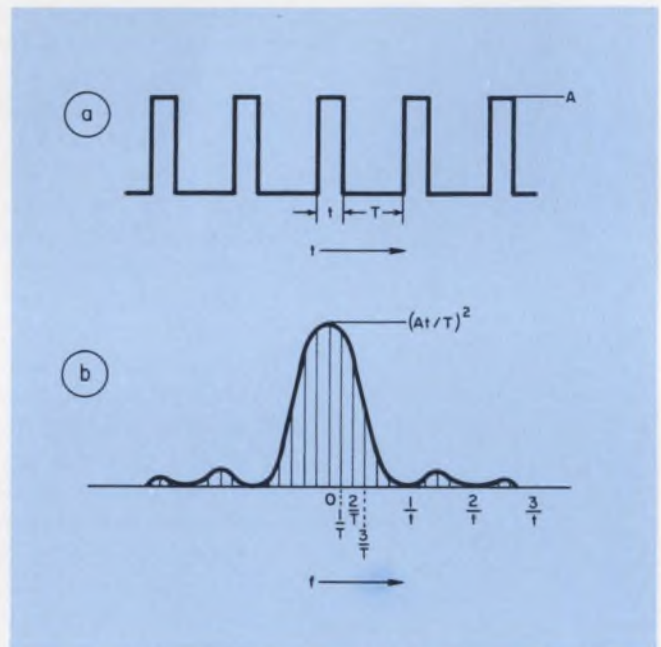

1. The sampling function can be described in two ways: In the time domain, it is a periodic gate function (a), while in the frequency domain, it is a series of spectral lines under a  $[(\sin x)/x]^2$  envelope (b).

The signal to be sampled should be described between lines 400 and 499 of the program. The description should define the spectrum of the signal as a function of  $F$  (frequency), with the final value at each frequency defined to be equal to  $Y$ —that is,  $Y = f(F)$ .

As the program is run, three entries are needed:

ENTER Y-AXIS: MINIMUM, MAXIMUM

?

ENTER X-AXIS: MINIMUM, MAXIMUM  
(IN HERTZ)

?

ENTER: SAMPLE TIME, PERIOD (IN SECONDS) AMPLITUDE FACTOR

?

Input parameters are entered after the question marks and are followed by a carriage return. The first two entries refer to the plotting routine, in which the y axis is broken into 50 increments between the two values chosen for minimum and

## This program samples, convolves and plots power spectra

```
100 REM-LJ MEEKER-SAMPLING FUNCTION-CONVOLUTION AND PLOT
110 LET H4=50
115 LET Ø=20
120 LET P1=3.14159265
130 LET Z2=0
140 PRINT "ENTER Y-AXIS:  MINIMUM,  MAXIMUM"
150 INPUT H1,H2
160 PRINT "ENTER X-AXIS:  MINIMUM,  MAXIMUM,  INCREMENT (IN HERTZ)"
170 INPUT U2,U3,U4
180 PRINT "ENTER:  SAMPLE TIME,  PERIOD (IN SECONDS),  AMPLITUDE FACTOR"
190 INPUT T1,T2,A1
196 PRINT " "
200 PRINT TAB(Ø+15);"RELATIVE POWER"
210 PRINT TAB(Ø+2);"SAMPLE TIME =" ;T1;"SEC,  PERIOD =" ;T2;"SEC"
220 LET H3=(H2-H1)/H4
230 FOR I=0 TO 4
240 PRINT TAB(I*10+Ø);I*10*H3+H1;
250 NEXT I
255 PRINT " "
260 PRINT TAB(Ø+1);"!";
270 FOR I=1 TO H4
280 IF I/10=INT(I/10) THEN 310
290 PRINT ". ";
300 GOTO 320
310 PRINT "!";
320 NEXT I
330 PRINT " "
340 FOR W2=U2 TO U3 STEP U4
350 LET Z1=0
360 FOR W1=-5/T1 TO 5/T1+1/T2 STEP 1/T2
370 LET F=ABS(W2-W1)
400 REM      LINES 400 THROUGH 499 ARE TO BE USED TO DEFINE
499 REM      THE POWER SPECTRUM OF THE SIGNAL TO BE SAMPLED.
500 IF ABS(W1)<1/(2*T2) THEN 570
550 LET S1=(A1*T1/T2)*SIN(W1*P1*T1)/(W1*P1*T1)
560 GOTO 600
570 LET S1=A1*T1/T2
600 LET Y1=Y*S1^2
610 LET Z1=Z1+Y1
620 IF W1<5/T1 THEN 780
650 PRINT Z1;TAB(Ø-8);W2;TAB(Ø);"+ ";
660 LET Y2=INT((Z1-H1)/H3 +.5*H3)
670 FOR I=0 TO H4
680 IF I=Y2 THEN 740
700 PRINT " ";
710 GOTO 770
740 PRINT "**"
750 LET Z2=Z2+Z1
760 GOTO 790
770 NEXT I
780 NEXT W1
790 NEXT W2
800 PRINT "TOTAL POWER TO" ;U3;"HZ =" ;U4*Z2
999 END
```



(a)

Definition of signal to be sampled

```

400 IF F<=1 THEN 403
401 LET Y=0
402 GOTO 500
403 LET Y=1
404 GOTO 500

```

Definition of plot routine and sample function

```

ENTER Y-AXIS: MINIMUM, MAXIMUM
? 0,04
ENTER X-AXIS: MINIMUM, MAXIMUM, INCREMENT (IN HERTZ)
? -2500,2500,100
ENTER: SAMPLE TIME, PERIOD (IN SECONDS), AMPLITUDE FACTOR
? 1E-3,5E-3,1

```

Printout →

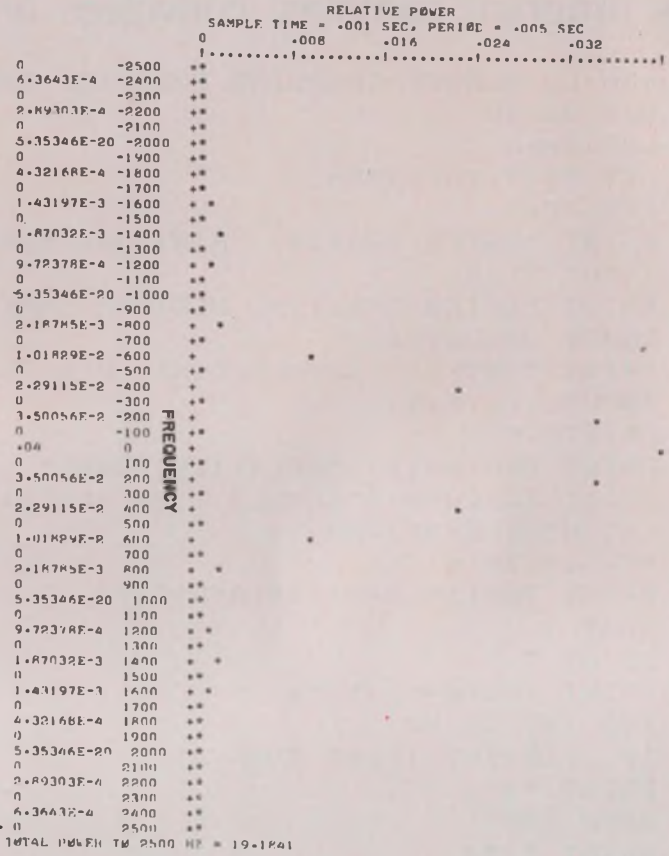

(b)

Definition of signal to be sampled

```

400 IF F>400 THEN 406
401 IF F<100 THEN 404
402 LET Y=(400-F)/300
403 GOTO 500
404 LET Y=F^2/1E4
405 GOTO 500
406 LET Y=0
407 GOTO 500

```

Definition of plot routine and sample function

```

ENTER Y-AXIS: MINIMUM, MAXIMUM
? 0,1.25
ENTER X-AXIS: MINIMUM, MAXIMUM, INCREMENT (IN HERTZ)
? 0,500,10
ENTER: SAMPLE TIME, PERIOD (IN SECONDS), AMPLITUDE FACTOR
? 1,1,1

```

Printout →



2. Test the program: If the signals and sampling functions of Tests 1 and 2 are read into it, the printouts shown here should result. Note that the graphs should

be held sideways to have the frequency axis along the bottom and the relative-power axis in its traditional position along the left-hand side of the plot.

maximum. Any number, positive or negative, may be used to define the y axis. Likewise any number may be chosen to define the x axis, only here a choice of the number and size of increments is given. The last entry defines the sampling function.

### Checking out the program

To check if the program is working properly, it's wise to run two simple tests. For the first, the signal to be sampled is the mathematical description of an ideal, low-pass filter with a cut-off frequency of 0.1 Hz. Convolving the sampled function with the filter function will produce a function identical to that of the sampling function, except that at every spectral line a bandwidth of 0.2 Hz will exist.

Run the program as shown in Fig. 2a. This test determines if the dc term of the sampling function spectrum is correct (it should be equal to  $(t/T)^2$ ), ascertains that the negative frequencies are a mirror image of the positive frequencies and determines if the  $[(\sin x)/x]^2$  spectrum is being calculated properly. The envelope should be zero (or approach zero) at every  $1/t$  Hz. A spike (actually a 0.2-Hz band) should exist at every  $1/T$  hertz.

The second test (Fig. 2b) determines if the defined signal to be sampled has the correct values and shape. This is done by defining the sample function to be an infinite sample by setting  $t = 1$ ,  $T = 1$  and  $A = 1$ . For this test, define the signal spectrum to be used, starting with line 400. The plot should be what has been numerically defined, as in the spectrum plotted in Fig. 2b.

If the results of either test are not as expected, check for errors in inputting the program or in commands to the computer that vary from those used here.

### Several modifications are possible

There are many ways to alter the program to obtain a more desirable output. You can, for example:

1. Do voltage or current convolution. To convolve in voltage (or current), two lines need to be altered to read

```
200 PRINT TAB(I*10+0);"RELATIVE
      VOLTAGE"
```

```
600 LET Y1=Y*S1
```

Make certain the signal to be sampled is then defined in voltage terms.

2. Expand y-axis range. The y axis may be lengthened to include 60 increments, with the elimination of the printout of the y-axis level. The line changes are as follows:

```
110 LET H4=60
```

```
115 LET 0=10
```

## More bandwidth gives more accuracy

Number of sidebands	Increase in power (%)	Total power relative to that of 10 sidebands (%)
1	—	91.20
2	4.96	95.96
3	1.71	97.63
4	0.86	98.47
5	0.51	98.98
6	0.34	99.32
7	0.24	99.56
8	0.18	99.74
9	0.14	99.88
10	0.11	100.00

```
230 FOR I=0 TO 5
```

```
650 PRINT TAB(0-8); W2;TAB(0);"+";
```

3. Simulate an RCL filter situated after the sampling switch in an equivalent circuit by inputting:

```
619 LET Z3=Z1*Z4
```

```
650 PRINT Z3;TAB(0-8);W2;TAB(0);"+";
```

```
750 LET Z2=Z2+Z3
```

where Z4 is the RCL function that is to be mathematically defined on lines 611 through 618.

The total power printout at the end of the plot routine is an approximation of the total power of the frequency range plotted. It is the sum of the power values at each point multiplied by the x-axis increment value. This printout may be eliminated by removing line 800.

To increase or decrease the range of the sampling-function frequencies in the convolution process, and therefore the accuracy, line number 360 may be changed. The  $-5/T1$  to  $5/T1$  identified the limits as  $-5/t$  to  $5/t$ , in other words it includes the fifth  $[(\sin x)/x]^2$  lobe in both positive and negative frequencies. The advantages of increasing the "bandwidth" of the program are illustrated in the table. It should be mentioned that as the limits are increased, computation time also increases and may be an important factor in some calculations.

It should be noted that the  $-5/T1$  to  $5/T1$  limits on the  $[(\sin x)/x]^2$  spectrum are also the limits for calculating values of the signal to be sampled. Another possible discrepancy: The calculated values of the  $[(\sin x)/x]^2$  spectrum may not reach zero but only approach that value as a result of the computer's capacity to deal with only finite values.

The graph title may be altered by changing line 200, and the positioning may be changed by changing the tab function value. In the plotting routine everything is positioned from point "0", whose value is set on line 115. ■■



# Signetics has the broadest line-up of ROMs in the industry.

## **BIPOLAR**

1024 Bit Field Programmable ROM (256 x 4) Open Collector Outputs 8226\*  
1024 Bit Field Programmable ROM (256 x 4) tri-state Outputs 8229\*  
256 Bit Field Programmable ROM (32 x 8) Open Collector Outputs 8223  
256 Bit Mask Programmable ROM (32 x 8) Open Collector Outputs 8224  
4096 Bit Mask Programmable ROM (1024 x 4) Totem Pole Outputs 8228  
2048 Bit Mask Programmable ROM (256 x 8) tri-state Outputs 8204  
4096 Bit Mask Programmable ROM (512 x 8) tri-state Outputs 8205

\*AVAILABLE IN JANUARY

## **MOS**

### **METAL GATE**

1024 Bit Static ROM (256 x 4) Bare Drain or MOS Pull-Down 2410  
1024 Bit Static ROM (128 x 8 or 256 x 4) Bare Drain or MOS Pull-Down 2420  
4096 Bit Static ROM (256 x 8) Bare Drain or MOS Pull-Down 2430

### **SILICON GATE**

3072 Bit Static Character Generator (64 x 8 x 5) tri-state Outputs 2513  
2560 Bit Static ROM (512 x 5) tri-state Outputs 2514  
3072 Bit Static Character Generator (64 x 6 x 8) tri-state Outputs 2516  
6400 Bit Static Character Generator (64 x 10 x 10 or 640 x 10) tri-state Outputs 2526

# And we make them easy to use.

With our fantastic line-up, we can put you on the air in breadboard and keep you there all the way into production. From design desk to shipping dock your ROM designs will be fully functioning at system operating speeds. In breadboard you'll be using field programmable FROMs or simulators. Through prototype you'll be working on FROMs, ROMs, or simulator. In production you'll be working with FROMs and ROMs — taking advantage of field programming or the Signetics quick turn around ROM mask generation and mask verification capability.

Designs will be de-bugged and into production in weeks or even months less time. And at savings you can measure in thousands of dollars per unit type. No one knows more about ROMs than Signetics. And we help make them easy to use. In addition to what you've already seen, here's the deal we offer.



**5 separate fusers for 3 new FROMs.** 3 new FROMs with 5 separate fusers to custom develop your fused ROMs: for laboratory and prototype use or pre-production through mass production.



**De-bug your design before you build it.** With the fantastic ROM simulator, you can simulate up to sixteen fully operational ROMs simultaneously, each up to 4096 bits either Bipolar or MOS. Each operating completely independent of the others. Or use our FROMs which are designed for both prototyping and production usage. Your choice.



**Support.** Application notes, 2 complete manuals covering both MOS and Bipolar, 2 operating programs and a wealth of descriptive data sheets. We put it in writing. Send for it.

Please send me a full literature package.

Name \_\_\_\_\_

Address \_\_\_\_\_

City \_\_\_\_\_ State \_\_\_\_\_ Zip \_\_\_\_\_

**signetics**

811 E. Arques Ave, Sunnyvale, California 94086  
A subsidiary of Corning Glass Works.



# If back intermodulation is a problem in your transmitter, here's a class D (switched type) design that can give you 40 to 50 dB of headache relief.

Any time two transmitters are operated close together in both space and frequency, the problem of back intermodulation may arise. Modern communications equipment, with its broadband transmitters and low-distortion receivers, is particularly sensitive to this problem. And the use of highly nonlinear class C and class D amplifiers doesn't help matters.

In theory, at least, back intermodulation can be completely eliminated in class D amplifiers if the impedance seen by an interference source (looking into the output of a switched amplifier) does not vary over time.

Briefly, back intermodulation results when the output of one transmitter enters a second transmitter, mixes with the second transmitter's second harmonic and is retransmitted. For example, transmitter A can be transmitting on 50 MHz and transmitter B on 51 MHz. The signal from B can enter A, mix with A's second harmonic (100 MHz) and be retransmitted at 49 MHz ( $100 - 51 = 49$ ).

This back intermodulation should be suppressed because it can cause interference in nearby receivers.

A measure of a transmitter's ability to suppress back intermodulation is the attenuation,  $b$ , given by  $b = 10 \log_{10} (P_1/P_2)$  where  $P_1$  is the power from transmitter B at the antenna of A, and  $P_2$  is the third-order interference power at the antenna of A.

## Class D can cut back intermodulation

A properly designed class D (switching) amplifier can reduce back intermodulation, as the following analysis indicates. The amplifier under consideration (Fig. 1) consists of a battery with a voltage of  $V_b$  and switches  $S_1$  and  $S_2$ , which are switched periodically at the carrier frequency,  $\Omega$ . The load resistance,  $R_L$ , represents the antenna. Voltage source  $V_i$  and resistance  $R_i$  represent

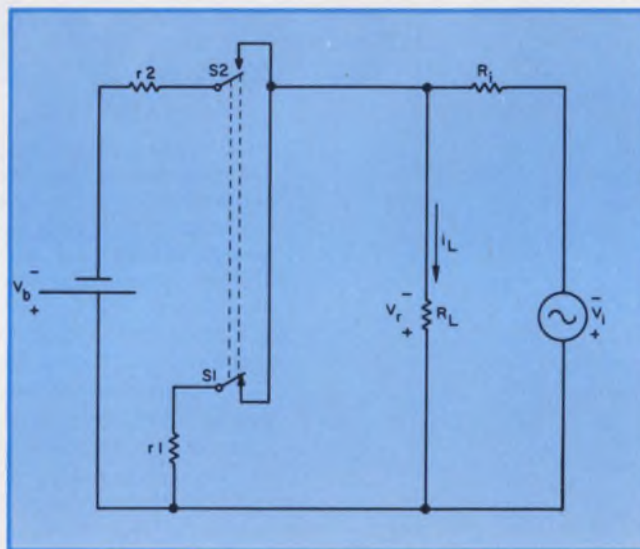

1. Switching can reduce back intermodulation, provided that resistances  $r_1$  and  $r_2$  are equal. In this model,  $V_i$  and  $R_i$  represent an interference source.

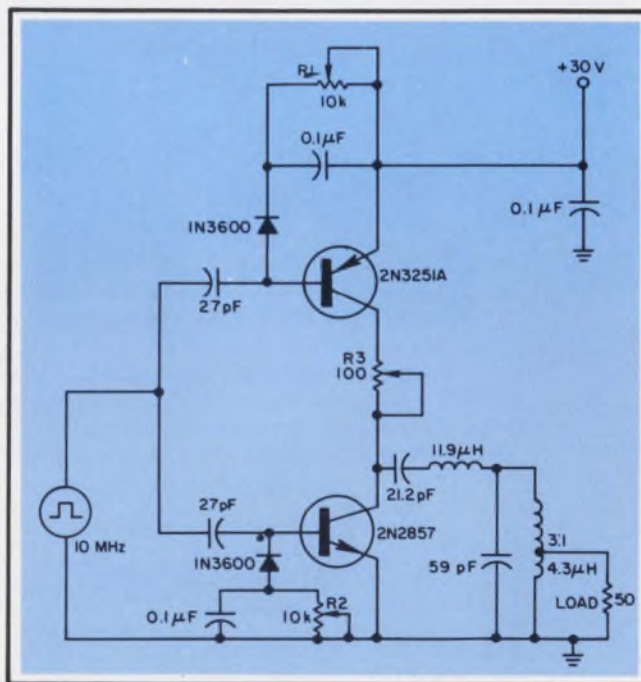

2. This experimental switched amplifier has enough bandwidth to pass both the interference and intermodulation frequencies. To reduce the amount of back intermodulation, resistor  $R_3$  is adjusted to equalize the ON resistances of the two transistors.

Dieter R. Lohrmann, Electronics Engineer, and Lt. James P. Hubert, Electronics Engineer, U.S. Army Electronics Command, AMSEL-NL-R6, Fort Monmouth, N.J. 07703.



the source of an interfering signal. This signal is a sinusoid with a frequency of  $\omega_i$ .

To calculate  $i_L$ —the current through  $R_L$ —we must consider two situations:  $S_1$  closed and  $S_2$  open, and  $S_1$  open and  $S_2$  closed. For the first case, the current through  $R_L$  is given by:

$$i_L = \left( \frac{V_i \cos \omega_i t}{R_L} \right) \left( \frac{1}{1 + R_i \left[ \left( \frac{1}{R_L} \right) + \left( \frac{1}{r_1} \right) \right]} \right),$$

and for the second case, it is:

$$i_L = \left( \frac{V_i \cos \omega_i t}{R_L} \right) \left( \frac{1}{1 + R_i \left[ \left( \frac{1}{R_L} \right) + \left( \frac{1}{r_2} \right) \right]} \right) + \left( \frac{V_b}{R_L} \right) \left( \frac{1}{1 + r_2 \left[ \left( \frac{1}{R_L} \right) + \left( \frac{1}{R_i} \right) \right]} \right)$$

Now, if  $r_1 = r_2$ , then Eqs. 1 and 2 can be interpreted as the sum of a continuous sinusoid of frequency  $\omega_i$  and a rectangular voltage wave of frequency  $\Omega$ —that is:

$$i_L = \frac{V_i \cos \omega_i t}{R_L + R_i (1 + R_L/r_1)} + \left( \frac{2}{\pi R_L} \right) \left( \frac{V_b}{1 + r_2 \left[ \left( \frac{1}{R_L} \right) + \left( \frac{1}{R_i} \right) \right]} \right) \left( \frac{\pi}{4} + \cos \Omega t - \frac{1}{3} \cos 3 \Omega t + \frac{1}{5} \cos 5 \Omega t + \dots \right)$$

This shows that no intermodulation products at  $2\Omega \pm \omega_i$  are present in the antenna current, provided that  $r_1 = r_2$ . In other words, if the interference source looking into the output of the switched amplifier sees a load that does not vary over time, no back intermodulation will be created. It is clear that this result will also hold

true for all ON/OFF ratios of switches  $S_1$  and  $S_2$ .

Further, it is clear that if  $S_2$  is replaced by an inductor, mixing products will occur.

### How well does it really work?

To check the effectiveness of this approach for reducing back intermodulation, the switched amplifier of Fig. 2 was built and tested. The amplifier has a power gain of 8.3 dB, and the band-pass filter at the output was designed to have sufficient bandwidth to pass the interference and intermodulation frequencies.

Resistors  $R_1$  and  $R_2$  are adjusted for proper crossover, and  $R_3$  equalizes the ON resistances of the transistors.

A spectrum analysis of the output (Fig. 3) shows that the intermodulation products are from 40 to 50 dB below the interfacing signal input. (Because of the 6 dB loss in the three-way pad, Fig. 3 shows intermodulation products 6 dB below their actual levels.)

To see how this new approach compares with more conventional designs, the graph of Fig. 4 was prepared. Note that the experimental test circuit offers more than 30 dB of improvement over the AN/VRC-12.

Unfortunately the technique cannot yet be used above the hf region, because complementary pairs of power transistors—bipolar or MOS—that will permit efficient switching at vhf and beyond are not yet available. ■■

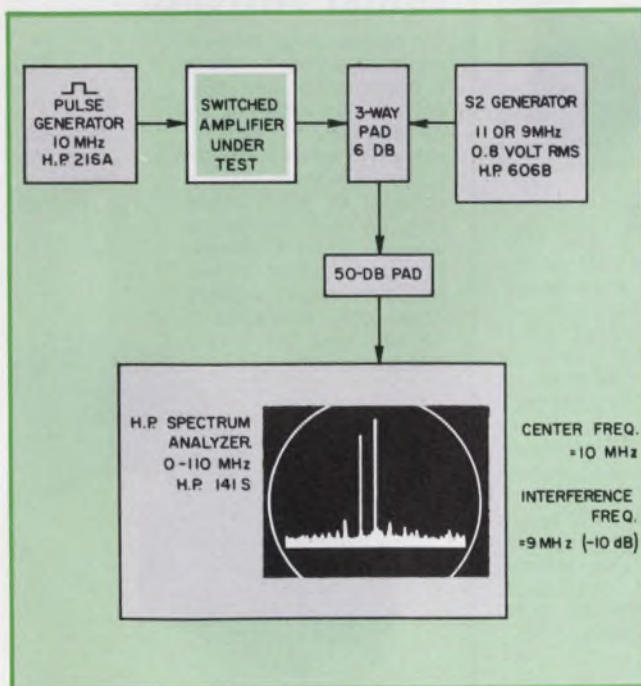

3. Testing a switched amplifier is easy. Just use the illustrated test setup; the results are then displayed on the spectrum analyzer. Note that the three-way pad causes the intermodulation products displayed on the CRT to appear 6 dB below their actual levels.

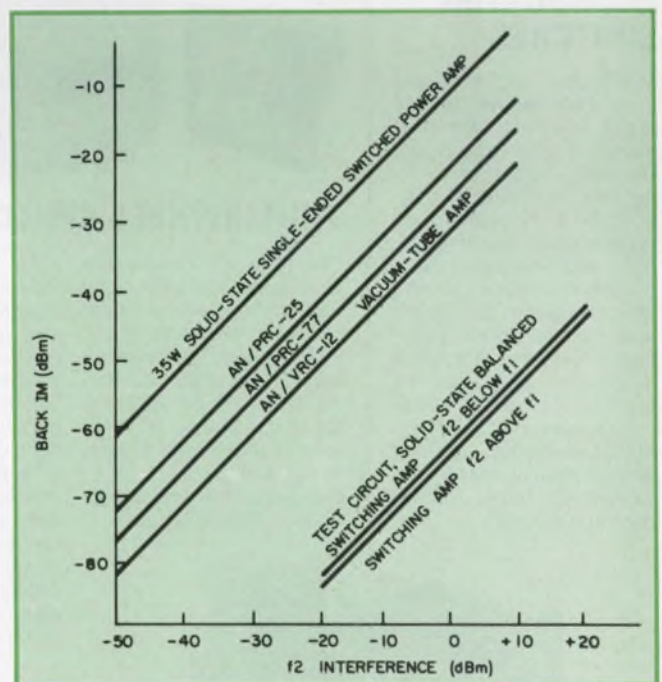

4. The new technique offers more than 30 dB of improvement over the AN/VRC-12, and more than 50 dB when compared with a single-ended solid-state switched power amplifier. This graph plots the amount of intermodulation as a function of the level of the interference signal.



# Thermostats in any shape.



H. A. Wilson thermostatic bi-metals are being used in literally thousands of different configurations.

The many varieties of thermometal available, coupled with Engelhard's engineering expertise and experience in customer applications makes the uses of these metals almost limitless.

These metals change shape with temperature and, when constrained, build up force with temperature change. They can be rolled to any thickness, formed into almost any shape, plated, brazed or welded.

Our engineering know-how and manufacturing facilities surpass those of anyone in the field. For information and/or technical assistance call or write the H. A. Wilson Technical Service Department (201) 686-6600.



ENGELHARD INDUSTRIES DIVISION  
ENGELHARD MINERALS & CHEMICALS CORPORATION  
2655 U. S. ROUTE 22, UNION, NEW JERSEY 07083  
An Equal Opportunity Employer

191 B

INFORMATION RETRIEVAL NUMBER 29

## SWITCHES THAT SAVE YOU SPACE • EFFORT • TIME • MONEY

### PUSHBUTTON SWITCHES

Miniature add/subtract units (left below) retrofit most minithumbwheel switch panel openings. Decades mount on 1/2-in. centers. Standard 10-position, 8- & 12-position on special order. Decimal, binary, and binary with complement outputs. Series PSB (at right in cut) binary and decimal rotary push-button switches are 10 & 12-position units; require but one inch panel space per module. All CDI push-button switches are fully sealed against hostile environments, impervious to dust and liquids.

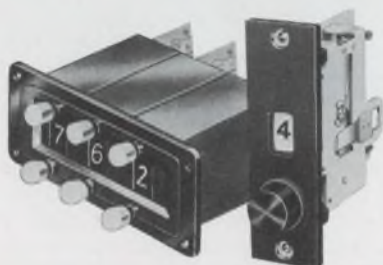

### THUMBWHEEL SWITCHES

CDI turns off hostile environment, turns on total protection—sealing both switching area and panel. Positive, long, trouble-free service operation is characteristic. PS Series (center in cut above) is available in digital and binary, meets MIL-S-22710. E.E. style bezels have no screws visible when mounted.

New Series TSM (at extreme right in cut above) mounts on 1/2-inch centers and retrofits most panel openings for miniature thumbwheel switches. It can be furnished with decimal, binary, and binary with complement outputs, or specified code readout characters; is available with extended PC boards for additional component mountings; also features easily-read characters, positive detent, 10- & 12-position capability.

### ROTARY SWITCHES

Cut maintenance requirements to seconds—where it might otherwise take days. No unsoldering, no disassembly, no wire removal! RS series in lengths up to 36 wafers; manual, solenoid, or motor operation; up to 32-positions; sizes 2", 3", or 4" square. Change programs, configurations, circuits quickly. These units meet MIL-S-22710. Tabet Pat. 2,841,660 and others.

Snap-in, snap-out modules in seconds.

### RS SERIES



## CHICAGO DYNAMIC INDUSTRIES, Inc.

Precision Products Division

1725 Diversey Blvd., Chicago, Ill 60614 • phone (312)543-4600

INFORMATION RETRIEVAL NUMBER 30

# We have a big story on little connectors. This one is about SMB and SMC types.

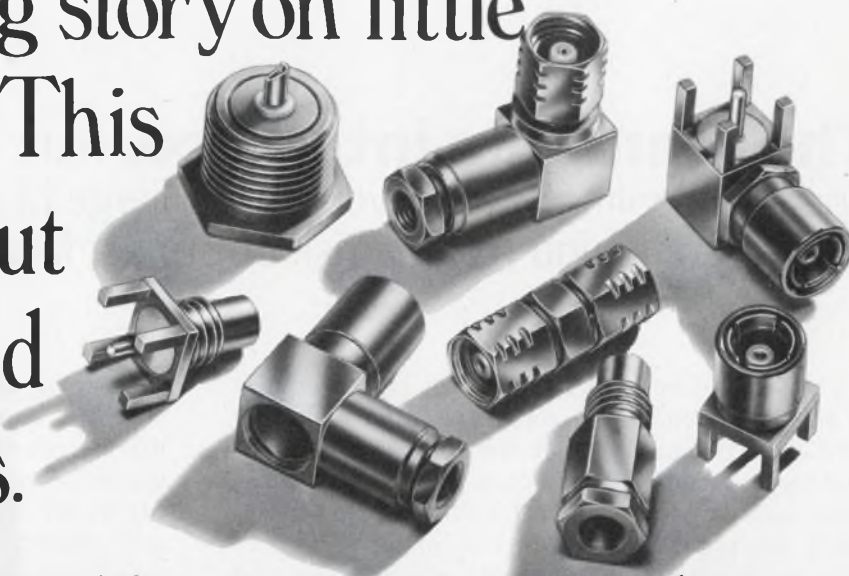

Our story is big and it's important to anyone interested in miniature connectors.

Call them SMB, SMC, type MIL C 22557's or just plain RF type, whatever you call them, we have them, in full range of sizes and interfaces for both semi-rigid and braided cable.

What's more, you'll find them fully compatible with all competitive types; Conhex\*, Subminax-27\* and others. You'll also find them available from in-depth inventories in Boston, North Haven, New York, Philadelphia, Washington, Orlando, Chicago, Dallas, Los Angeles and San Francisco.

And, don't forget our special edge. We give you the choice of conventional crimp type or proprietary Emlock® compression type connectors.

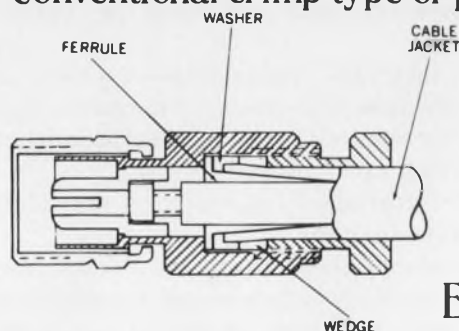

This Emlock® cable grip of ours is all metal and offers the advantages of compression back ends with assembly time equal to crimp. As a clincher, it's impossible to pull the cable out of an Emlock® connector. Disengagement will be caused only by failure of the braid, not pull-out of the compression.

Interesting? Let us tell you more. Write: Miniature Connectors, Phelps Dodge Communications Company, 60 Dodge Avenue, North Haven, Connecticut 06473.

**phelps  
dodge**  
Communications Company

\*Trademark of others

INFORMATION RETRIEVAL NUMBER 31



## The man-man interface. Here's a review on "people dealing" when you're in-charge of a project. Fail here and you run the risk of project failure.

Few actions establish confidence in a company as firmly as completing contracts on time and according to promises. When the company's project engineer is pulling the troika of deadline, technical quality and cost effectiveness, he sometimes forgets the basic function of all managers—to get people to work together toward an end that is beneficial to all.

In other words, he forgets to interface with the other project members whom we shall call interfacers. And although this may seem like common sense, as Voltaire once said: "Common sense isn't so common."

For review, we'll discuss three key areas of interfacing: the over-all responsibility of a good interfacers, the interface elements and their implementation and the impact of engineering changes on interfaces.

### Be prepared—a good interfacers's motto

Turning an engineer into an effective project manager requires conscientious effort. The preparation needed is:

- Clear and specific goals for himself and his interfacers.
- An overview of assignment requirements, including nontechnical ones.
- A thorough knowledge of company operations, capabilities and products.
- Interest in and understanding of other people's work and responsibilities, including their limitations, capabilities and problems.
- A systematic approach to technical and non-technical efforts: maintaining a current awareness program by keeping interfacers informed of new developments, slipped schedules, a reduced budget and new technical requirements.
- Early sensitivity to weak interfacers and other problems to avoid serious cost overruns or delays.

Depending on the assignment, the project en-

gineer will deal with people in management, procurement, quality assurance, publications and marketing. If, for example, his boss tells him to design a breadboard circuit, the interface personnel would include only his manager, a technician and possibly a purchasing agent. However, if the assignment involves development and production of a product for commercial use, an array of persons (see table p. 54) may have to be included in the project engineer's plans.

The key factors in evaluating each interfacers in a project include:

- Who is he?
- Where is he?
- What does he need from the project engineer to do this job? And when?
- How critical is his output?
- How and when does he fit into the project engineer's assignment?

To carry out a successful program, the project engineer should:

1. Start planning interface requirements early. Plan for likely problems and formulate preliminary solutions.
2. Identify the necessary interfacers and their relative importance to the over-all assignment.
3. Meet with the interfacers and make sure that they understand the key aspects of their jobs; that they know their lead-times for completion of work.
4. Prepare interface documents—a chart or checklist, a schedule and checkpoint chart, or a tickler file for reminding each interfacers when important actions are required by him.
5. Keep all interfacers informed of any technical or schedule changes.
6. Coordinate and check progress. Periodically review the status with informal get-togethers or by phone to make sure that no problems are developing or have been overlooked.
7. Ask for record-keeping if this is important. The boss or the customer may have special requirements.
8. Require the interfacers to plan also.
9. Take rapid and positive action when problems occur.

In implementing these steps, most of the proj-

---

Thomas T. Samaras, Configuration Management Consultant, Universal Monitor, 2361 E. Foothill Blvd., Pasadena, Calif. 91107.

## Why change designs?

Here are 12 questions a project engineer should ask himself before deciding on a change in an approved design:

1. Will procurement be able to get the new part on time?
2. If the part doesn't live up to its specification, how much lost time and money will result?
3. What will be the impact on an interfacers' motivation? Will he do his best on a job he has already done?
4. How many assemblies, components and spare parts will have to be reworked or scrapped?
5. How much retesting will be required?
6. Will new manufacturing and test fixtures have to be made?
7. Will test equipment have to be redesigned?
8. What will be the over-all impact on the schedule and budget?
9. How will marketing be affected by the delay?
10. Will specification sheets, advertisement bulletins and manuals have to be revised?
11. Does your boss think it's worth it?
12. How much additional drafting and re-packaging time will be needed? Will printed-circuit boards already ordered or delivered have to be scrapped?

ect engineer's effort will be spent in planning and meetings during the early part of his assignment. Following up with his interfacers will then require only small segments of his time, spread out over the project effort. Of course, emergencies may soak up quite a bit of his time when they occur.

### What to ask in case of a change

The ability to assess the impact of engineering changes on interfaces is vital. For example, suppose that the production design for the product has been completed and parts procurement, manufacturing and testing operations are in full swing. However the project engineer finds that a new semiconductor device has just been put on the market and that it will improve the performance of his product considerably. (After some circuit design, of course.)

Before he decides to make any changes, he should ask himself some searching questions (see box). He'll have to consider the effects that his change will have on other operations.

Before he makes a decision, he has a responsibility to his interfacers. They may be affected so seriously that the assignment or project may overrun its budget and schedule. He must get to-

gether with each affected to determine the ramifications of his change, and once he's collected feedback and data, he can assess the results and present them to his boss for review and approval.

Once work has left the final engineering stage, the project engineer should always get approval from his boss before changing a design that has proved suitable and consistent with the original goals and requirements.

Although a formal interface system isn't always necessary, its principles must be understood and its ground rules followed to complete the assignment on time and within the budget. The project engineer should keep in mind that it's nearly impossible for most people to remember all the interconnections and interdependent elements that exist on a project and to make all the right connections when they are most needed. So, a formal interface system can help do this effectively by setting down firm guidelines and requirements.

If the project engineer does that, he'll avoid serious omissions—parts not ordered in time, runaway costs, (etc.) be on schedule—and improve morale. Everyone will know what he's doing and where to go should trouble arise. ■■

*(Continued on page 54)*



# Table of interface responsibilities and needs

Interface personnel	Responsibilities	Needs
Manager/Boss	Gives over-all view of product concept and use. Sets key goals. Provides resources. Approves expenditures and major actions. Solves major problems. Notifies of changes in plans/goals/requirements. Approves major changes in design.	Notification of problems. Status reports. New or urgent needs. Early notification of expected schedule slippage, failure to meet technical requirements or to stay within budget. Notice of exceptional achievements/progress.
Designer/Draftsman	Prepares schematics, layouts, assembly drawings, parts lists, etc. Identifies documents and assigns part numbers. Follows change control system and procedures. Informs of design simplification and improvement possibilities, weak design areas and potential problems. Meets schedule and budget and reports on status. Meets standards for drawing quality and format. Gets proper approval of design documents before release to manufacturing.	Product requirements. Design goals and potential problems. Special features and potential problems. Schedule and budget. Notification of changes in requirements/design. Special processes or specifications that must be used and test procedure numbers. Parts selection criteria. Manufacturing restraints/considerations. Names of specialists who can help on critical design areas. Test and checkout considerations. Maintenance and repair considerations.
Test Engineer	Designs test setups and gets test equipment and facilities ready. Obtains test fixtures. Schedules testing. Writes test procedures. Detects potential problems. Informs of design changes for simpler testing and checkout. Reports status. Determines environmental test conditions.	Configuration and description of product and usage. Test requirements. Special design features. Mounting orientation, limitations and method. Potential danger areas. Schedule and budget. Notification of changes in requirements/plans.
Quality-Assurance and Reliability Engineers	Ensure that product meets minimum quality and reliability standards/requirements. Notify of design/manufacturing/testing weaknesses and problems. Provide adequate inspection and documentation of incoming parts, material control and hardware. Monitor special processes. Review and approve all documents.	Technical goals and requirements. Budget and schedule. Description of product. Design data. Special features and quality/reliability standards. Applicable specifications. Notification of changes in requirements or plans.
Sales/Marketing Representative	Analyzes market potential and sales strategy. Produces sales literature. Helps set price for product. Informs of problems or needs.	Description of product, especially new or outstanding features. Product specifications. Scheduled availability of product for distribution. Cost of product.
Procurement Representative	Purchase parts and materials at minimum cost. Notifies vendors of changes in requirements. Notifies of delays/problems. Ensures timely delivery.	General and special parts requirements. Identification of long-lead-time parts. Names of desired suppliers. Specification control documents. Quality and reliability requirements. Priority of cost, quality and delivery time. Clear-cut notification when substitute parts cannot be used.
Technician	Builds and tests prototype. Evaluates operation and trouble-shoots. Recommends design improvements. Keeps laboratory notebook up to date.	Performance requirements and criteria. Schedule and budget. Special features/problems. Notification of changes in requirements or plans.
Manufacturing Engineer	Provides tooling and fixtures. Acquires special skills. Meets schedule and budget and quality requirements. Informs of methods for improving productivity of hardware. (Productivity refers to accessibility of parts and realistic tolerances and tooling needs).	Clear-cut goals. Accurate, complete and clear production documents. Special product features and needs. Production document release schedule. All materials needed. Identification of special processes or materials to be used—may require special training program. Changes in plans/design. Schedule and budget.
Facilities Engineer	Provides work areas and equipment when needed. Modifies work areas for special needs.	Exact facility and equipment needs. Special environmental conditions. Scheduled need of facilities and equipment. Changes in plans.
Accountant	Issues job numbers. Provides weekly expenditure reports. Processes time cards. Provides cumulative expenditure reports. Notifies management of dangerous budget trends.	Description of work. Budget control and reporting needs. Subtask budgets. Changes in budgets. Expenditure alert levels requiring notifications.
Publications Engineer	Provides documents on time and in budget. Meets document specs. Distributes documents to staff. Informs of problems or needs.	Document requirements, schedule and budget. Description of product and project activities. Special features of product. Changes in design, schedule or other requirements. Specifications to be followed.
Configuration Manager	Sets up system for ensuring that product meets all requirements and for controlling changes to its configuration. Keeps records of changes and approvals. Reports status of changes.	Product description and requirements. Schedule and budget. Special requirements related to form, fit and function. Notification of all proposed changes.





## Introducing the little counter that can.

It can become four different systems.

It can go anywhere you do.

It can protect you against obsolescence.

It can make buying and maintaining a counter less expensive than ever before.

Meet the Hewlett-Packard 5300, the snap-together counter that's not much bigger than the palm of your hand. It has six digit accuracy, solid state display and autoranging. It'll make period, frequency, time interval and ratio measurements, operate on its optional snap-on battery pack and drive a printer. Rugged dust-proof aluminum case resists almost any bumps it might get in the field. Prices start at only \$520 for one of the most amazing counters you've ever owned.

Start with the basic mainframe (\$395). Then snap on any of the following modules (more on the way) to make just the counter you need, and avoid obsolescence, too:

10 MHz frequency module. Model 5301A, \$125.

50 MHz all-purpose module includes period, time interval. Model 5302A, \$250.

500 MHz module with both 50 $\Omega$  and 1 M $\Omega$  inputs. Model 5303A, \$750.

100 ns time interval module with: unique "time holdoff" feature, dc coupling, slope and trigger level controls, and period and frequency measurements to 10 MHz. All the functions you'd pay \$1200 for in a universal counter. Model 5304A, \$300.

Rechargeable battery pack module works with any of the other modules for cord-free operation. Model 5310A, \$175.

The 5300 is one system you have to use to appreciate. If you've ever needed to accurately measure frequency or time interval, you owe it to yourself to call your nearby HP field engineer for further information. Or write Hewlett-Packard, Palo Alto, California 94304; Europe: 1217 Meyrin-Geneva, Switzerland.

Counters that promise a lot and deliver it all.

02109

**HEWLETT**  **PACKARD**

ELECTRONIC COUNTERS





## Want one-stop shopping in solid-state (LED) indicators?

Dialight's DIODE-LITE™ visual indicator line offers you the industry's broadest choice. Dialco gives you complete design flexibility with a wide choice of LED solid state lamps and indicator lights (which can be retro-fitted to present incandescent units)...illuminated pushbutton switches... digital readouts. Supermarket pricing and availability too. Only Dialight "got it all together" in LED solid state displays. Write today for our Data File on DIODE-LITES.

# DIALIGHT

DIALIGHT CORPORATION, A NORTH AMERICAN PHILIPS COMPANY  
60 STEWART AVENUE, BROOKLYN, N.Y. 11237 • (212) 497-7600

INFORMATION RETRIEVAL NUMBER 33

## The heart of our gaussmeter is so good, even our competitors use it.

The Hall generators that we make for our own gaussmeters are so accurate and dependable, our competitors even use them. But that's where the similarity ends. We have other special features like internal calibration, temperature stable probes, and many more items that are covered in our gaussmeter brochure. Write to: 4949 Freeway Drive East, Columbus, Ohio 43229.

**F.W. Bell Inc.**

A subsidiary of The Arnold Engineering Co.

INFORMATION RETRIEVAL NUMBER 34

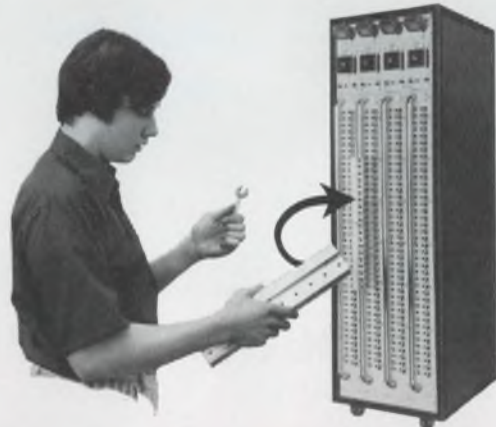

## Power Burn-In System with Heat Sinks interchangeable to any case style in 30 minutes!

- ✓ Demountable heat sink bars hold constant temperature for Burn-Ins, HTRB, Life Testing, Product Evaluation.
- ✓ Versatile System never becomes obsolete.
- ✓ Complete System or Modules available.

Write or call for Standard Burn-In Literature.

**WAKEFIELD ENGINEERING, INC.**

Systems Div. Wakefield, Mass. 01880 • Phone: 617-245-5900

INFORMATION RETRIEVAL NUMBER 35



**AN  
ELECTRONIC  
DESIGN  
SPECIAL  
REPORT**

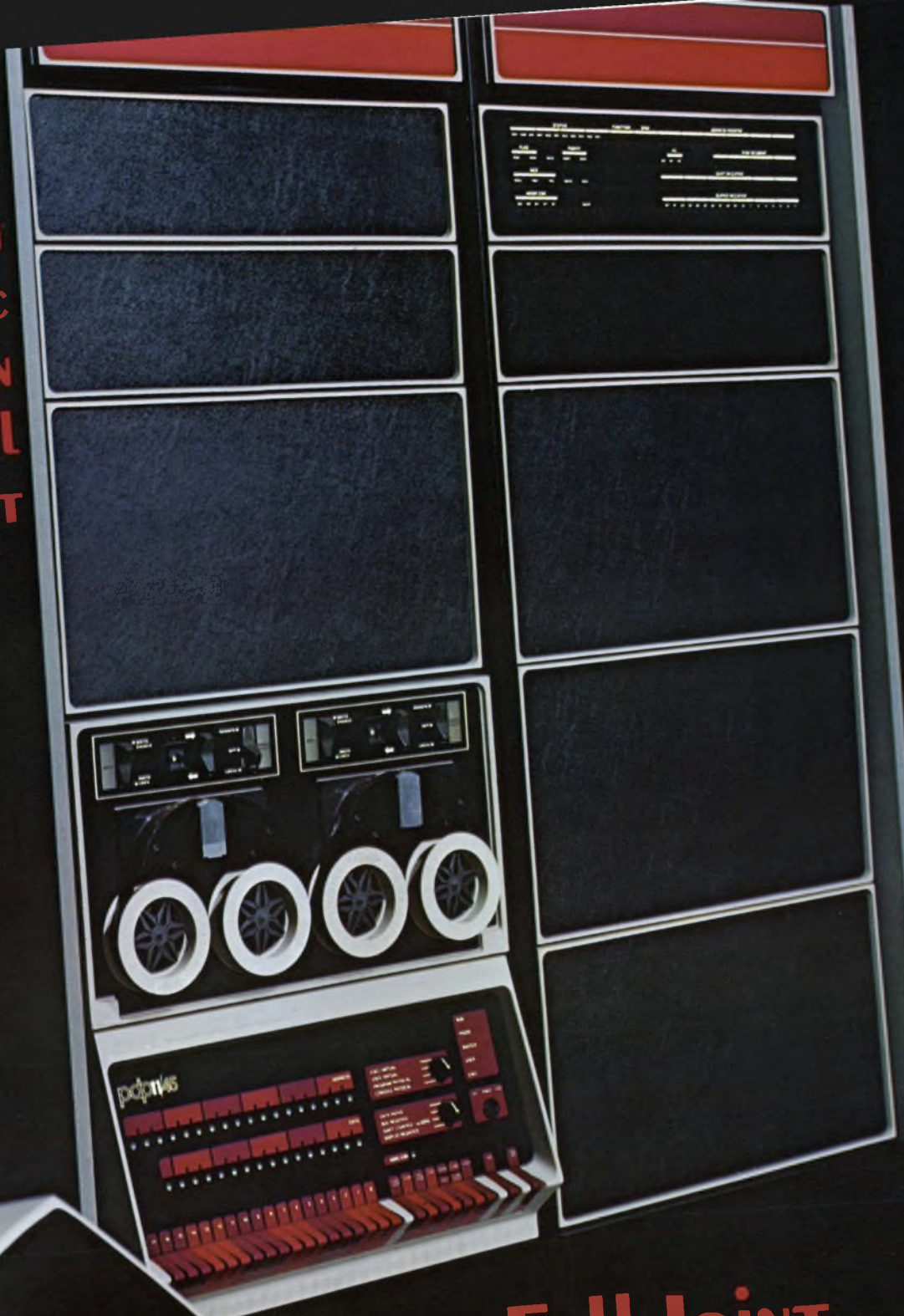

**FALL JOINT  
COMPUTER  
CONFERENCE  
1971**





# We're ready to talk price! Are you ready to talk Rotron®?

When was the last time you checked our prices? If you haven't done so lately, you're in for a pleasant surprise.

Our design and production people have been successfully waging all out war on the inflationary pressures that have driven manufacturing costs up. Innovative product designs... cost analysis programs... new automated manufacturing lines and production techniques... they've used most every method in the book to keep our costs down and your purchase price lower.

All of this was achieved without any sacrifice of the traditional Rotron quality—the quality that has set the standards for the industry for over two decades.

Rotron's nationwide distributor system of 50 stocking locations provides off-the-shelf delivery of standard units and our network of factory representatives provide on-the-spot technical assistance and service.



## ROTRON INC.

Woodstock, N.Y. 12498 ☐ 914 • 679-2401 ☐ Telex 510-247-9033

PACIFIC DIVISION Burbank, Calif. 91506 ☐ 213 • 849-7871

ROTRON N.V. Breda, Netherlands



*Why settle for less when the best costs no more?*

# 1971 Fall Joint COMPUTER CONFERENCE

## SPECIAL REPORT

- For buyers of computing equipment: More power at less cost . . . . . C8
- Minicomputers: Faster and microprogrammable . . . . . C8
- Peripherals for minis: Cheaper, more reliable . . . . . C10
- Programmed calculators are stronger than ever . . . . . C12
- New software packages for circuit analysis . . . . . C13

## TECHNICAL ARTICLE

- Convert your scope to a display terminal. For less than \$200, you get a computer readout with up to 250 characters, and with faster speeds than most teleprinters give . . . . . C20

## PRODUCTS

- An ultra-fast computer system and a low-cost CRT terminal with graphics and alphanumeric capability dominates the equipment exhibition. The computer is Digital Equipment Corp.'s PDP-11/45 which permits the mixing of three types of memory and has an operating speed of 295 ns. The graphics/alphanumeric terminal from Tektronix can be purchased for only \$3400 . . . . . C30

Cover photo courtesy of Digital Equipment Corp., Maynard, Mass.

**Free copies available**  
A limited number of copies of this report are available free. To obtain yours, circle No. 300.



**BOURNS**

**BOLD NEW**

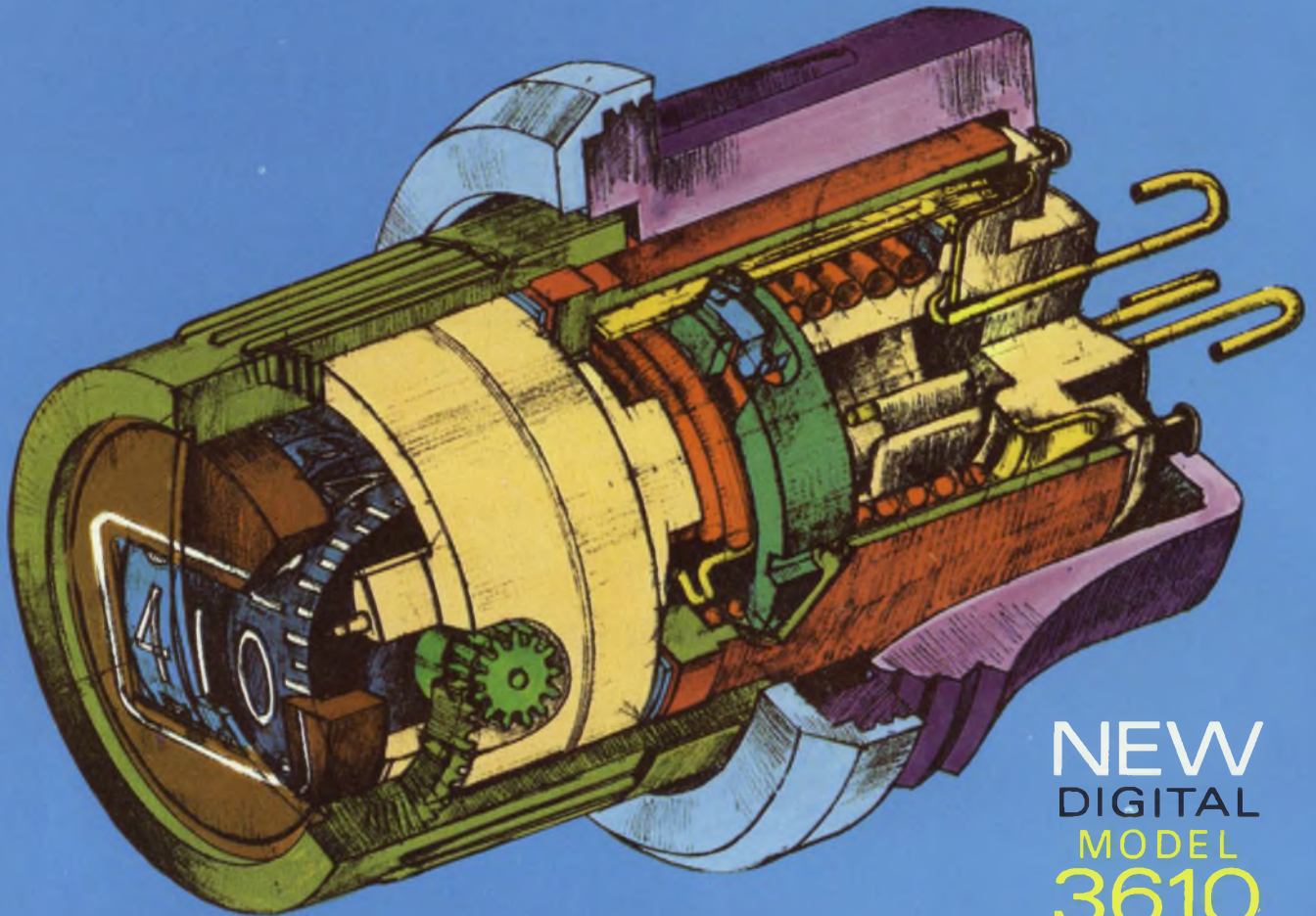

**NEW**  
**DIGITAL**  
**MODEL**  
**3610**

**KNOBPOT<sup>®</sup>**  
**POTENTIOMETER**

**FACTORY - PHASED TO  $\pm 0.5\%$  ACCURACY ...**

**... AT LESS COST\* THAN MOST SEPARATE  
DIAL / POTENTIOMETER COMBINATIONS**

\*SAVES HIDDEN COSTS OF PHASING AND INSTALLATION TIME NOT REFLECTED IN COMPETITIVE PRICES.



# CONCEPT!

A DIAL AND POTENTIOMETER  
IN A SINGLE INTEGRAL UNIT—

... AT NEW REDUCED PRICES!

## NO DIALS TO ASSEMBLE!

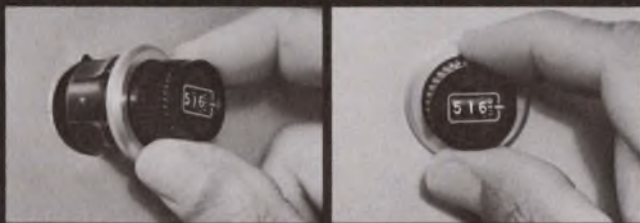

Unlike SEPARATE Digital dial and potentiometer combinations . . . the dial and pot are INTEGRAL IN ONE, 7/8" DIAMETER UNIT. No screws, nuts, or bushing to mess with . . . JUST SNAP UNIT INTO PANEL AND CONNECT TERMINALS.

## NO PHASING REQUIRED

Model 3610 is prephased at the factory to a GUARANTEED ACCURACY OF  $\pm 0.5\%$  BETWEEN ELECTRICAL OUTPUT AND DIAL (This is equivalent to BETTER THAN 0.5% terminal base linearity).



IF YOU PREFER A  
CLOCKFACE READOUT . . .

. . . ask about the Model 3600;  
clockface brother of the Model 3610.  
Also an INTEGRAL DIAL/POTENTIOMETER,  
it's only 3/4 inches in diameter and PRICED EVEN  
LOWER THAN MOST SEPARATE DIAL/POTEN-  
TIOMETER COMBINATIONS.

## COMPARE PRICES . . .

With the labor-savings factored-in, Models 3610 and 3600 cost less than separate dial and potentiometer combinations.

Model 3610

Model 3600

\$15.30\*

\$14.42\*



\*In 500-999 quantities.

7/8" DIAMETER

3/4" DIAMETER

TEN-TURN

**NOW CHECK THE SPECS!**

ACCURACY:  $\pm 0.5\%$  (Maximum error between electrical output and dial reading.)

REPEATABILITY: 0.1%

POWER RATING: 1.5 watts

RESISTANCE RANGE: 100 to 250,000 ohms

RESISTANCE TOLERANCE:  $\pm 5\%$

TEMPERATURE COEFFICIENT OF RESISTANCE WIRE:  
20ppm/ $^{\circ}\text{C}$

TEMPERATURE RANGE

Model 3610  
-25 to +85 $^{\circ}\text{C}$

Model 3600  
-65 to +85 $^{\circ}\text{C}$

For details, contact your local Bourns Distributor,  
Representative, or Bourns Sales Office.





# Introducing the

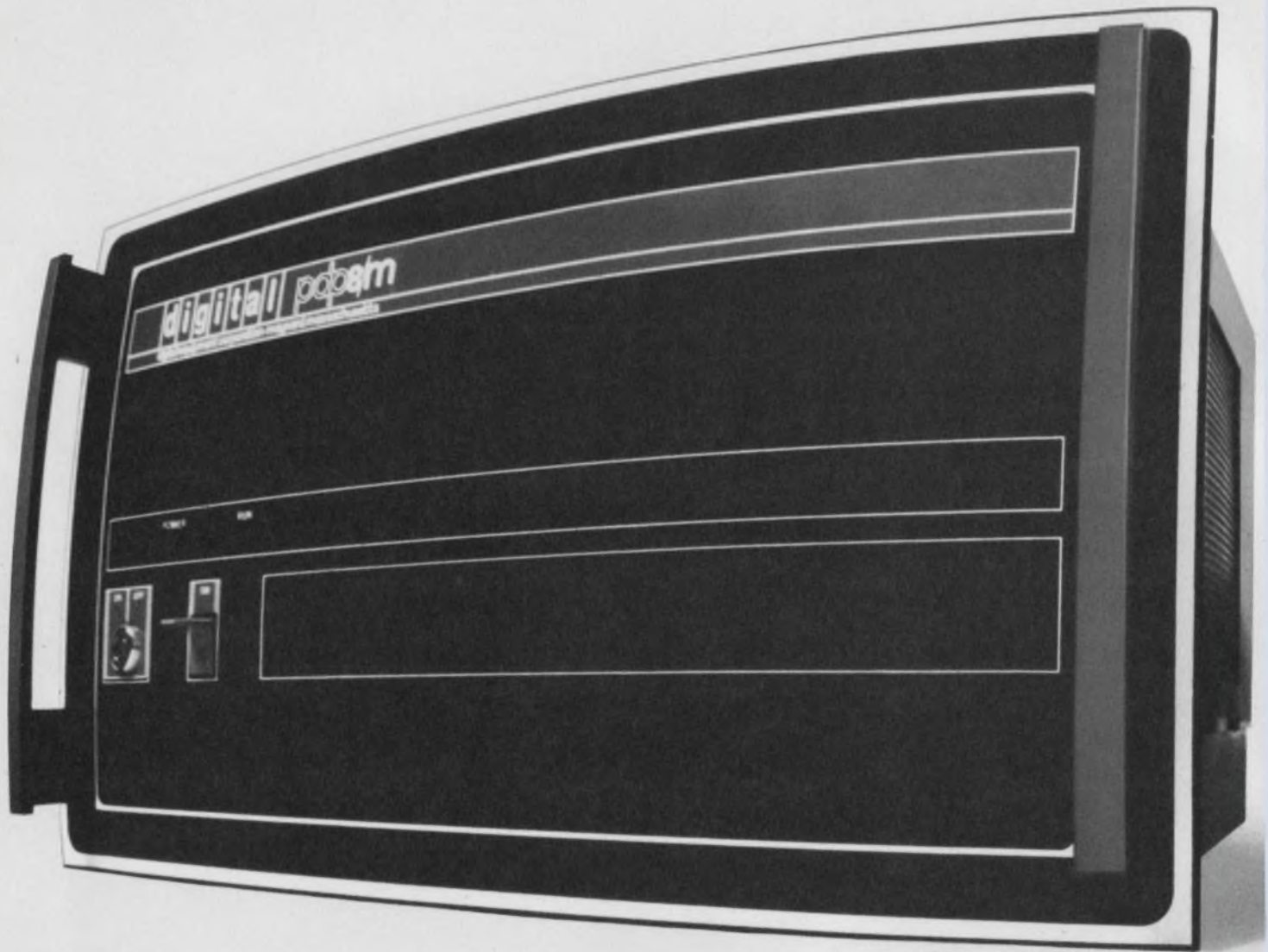

On your left, the 12-bit PDP-8/M. On your right, the 16-bit PDP-11/05. Our brand new additions to the world's most popular families of minicomputers.

Complete computers — at incredibly low prices. Like \$3,069 for the 11/05, and \$2,362 for the 8/M in quantities of 100. Even the dis-

count schedule is new. Very attractive.

In addition, they're compatible with the rest of the family members. Their options. Their peripherals.

They have the features of their bigger brothers. And, a full instruction set. OEM-oriented architecture. Both

the UNIBUS™ architecture of the 11/05 and the OM-NIBUS™ architecture of the 8/M permit easy, flexible configuring and interfacing. Real pluses for the OEM.

They're built with the kind of reliability that comes easy after delivering over 11,000 minicomputers.

# OEM Yardsticks

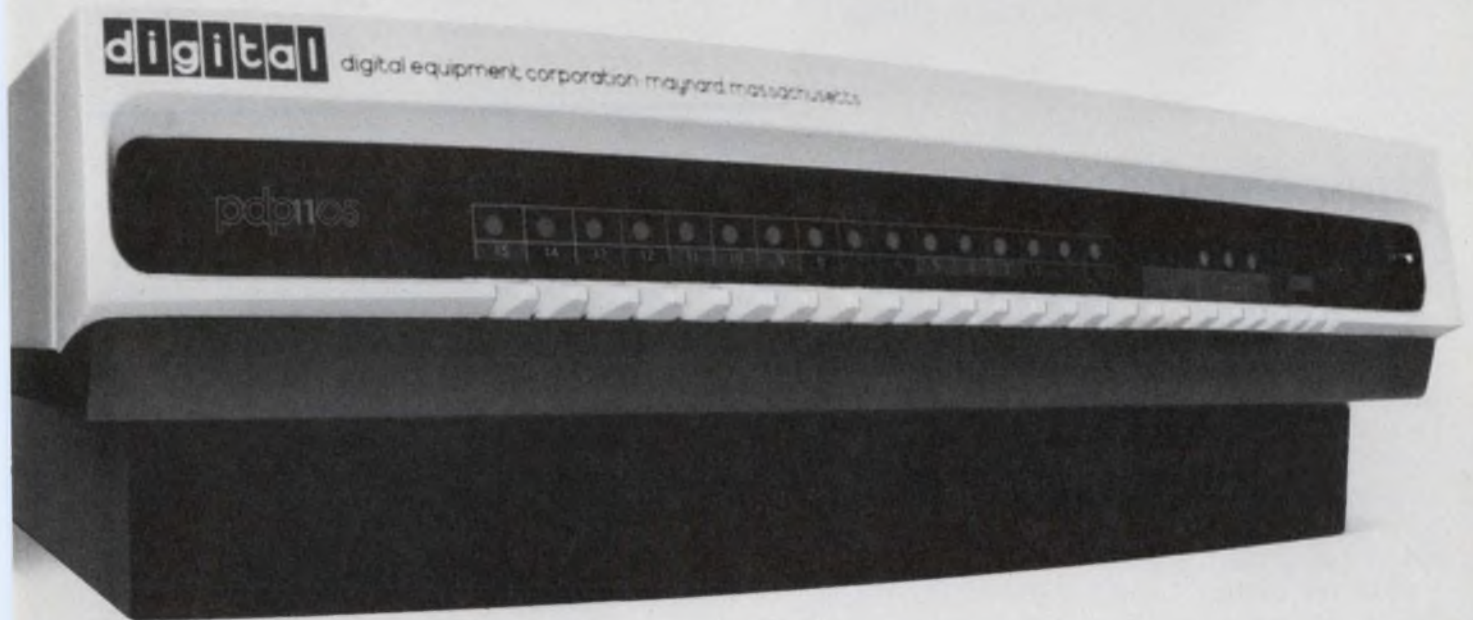

And, they're supported with more field backup than you can get anywhere else. Worldwide.

PDP-11/05. PDP-8/M. Designed for the OEM. Priced for the OEM. Choice for the OEM. From the leader in OEM computer applications.

Now there's a whole new set of standards to measure up to.

Write for more information. Digital Equipment Corporation, Main Street, Maynard, Massachusetts 01754, (617) 897-5111.

**digital**



# FOR BUYERS OF COMPUTING EQUIPMENT: MORE POWER AT LESS COST

DAVID N. KAYE  
WEST COAST EDITOR

Evolution rather than revolution. In a word, that's the story of minicomputers, peripherals for minis, programmable scientific calculators and circuit-analysis software packages. Instead of new technologies emerging in the last year, the existing technologies are being improved. The buyer is getting more for his dollar.

Minicomputers are showing up with more and more semiconductor memory. Microprogramming is becoming a desirable feature in minis. Peripherals designed specifically for minis are continuing to proliferate.

Strides have been made in minidisks, minidrums and cassettes as a convenient bulk storage medium for minis. Most other mini peripherals have changed little technically, but many work better and come with a lower price tag.

Programmable scientific calculators have really come into wide use, with more and better peripherals, more memory and more flexibility in programming.

Three important new circuit-analysis software packages have appeared. The design engineer now has powerful tools with which to attack non-linear circuits.

## MINICOMPUTERS: FASTER AND MICROPROGRAMMABLE

Until fairly recently semiconductor random-access memory (RAM) in minicomputers was the exclusive domain of IBM and Data General. IBM in Boca Raton, Fla., recently delivered its first System 7 to American Motors for use in an exhaust-emission test set. Data General in Southboro, Mass., has been delivering SuperNova computers for several months.

Both the System 7 and SuperNova use bipolar RAMs for main memory. Both manufacturers quote 300-to-400-ns execution times, compared with 1 to 1.6  $\mu$ s on machines that use core main memory.

Allen Z. Kluchman, director of marketing at Data General, considers the emergence of semiconductor memory in minis the most important event in the minicomputer industry in the last year.

But Nick Mazzaresse, vice president and group manager of Digital Equipment Corp., Maynard, Mass., says: "The most significant event in the last 12 months was IBM's statement of intention to pursue this market."

Digital Equipment doesn't down-grade semiconductor memory for minis. It will be introducing at the Fall Joint Computer Conference the

PDP11/45, including both semiconductor RAMs and ROMs (read-only memories). The machine has been designed to use MOS ROMs and either bipolar or MOS RAMs. Access time will be specified at 300 to 850 ns, to allow use of whichever technology is most available (see p. C32).

Kluchman notes that Data General's SuperNova series has been designed to use either technology as well. "When MOS comes up to speed at the right price," he says, "we might switch."

As for IBM, it's well known that it is working very hard on n-channel, self-aligned gate MOS memory technology. Industry sources say this technology may show up when IBM brings out a "little brother" to the System 7.

Many other companies are also expected to show semiconductor main memory for the first time at the Fall Joint Computer Conference. One company that has already announced its intention is MicroData of Santa Ana, Calif.

Although semiconductor RAMs have been used in only a few machines, semiconductor ROMs have found their way into many. The most prevalent use of semiconductor ROMs has been in microprogrammable minicomputers. Along with the rise of semiconductor memory in minis, the trend toward microprogramming must rank as very significant the last year.

Microprogramming is not new. It has been used for a long time in large machines and even





**CF 16A minicomputer** from Xerox Data Systems is a 16-bit, 1.6- $\mu$ s machine designed for system applications.

for a few years in minis. Interdata of Oceanport, N. J., has been working hard for years to popularize the concept, and MicroData formed a company to exploit it. In the last year Hewlett-Packard in Cupertino, Calif., Digital Equipment, Varian Data Machines in Irvine, Calif., and a host of other companies have joined the action.

Microprogramming means that instead of building a general-purpose central processing unit from random combinational logic and implementing the instruction set through software, the instruction set is hard-wired into the machine in the form of a set of ROMs. Each ROM contains a table of information that constitutes one or more micro-instructions. The micro-instructions are then carried out in a particular order. This ordered set is the instruction set of the machine.

### Two basic approaches to microprogramming

Microprogramming can be used for two purposes: to make the machine faster and more flexible. Digital Equipment has taken the flexibility approach. Only enough ROM is included in its machine to implement the basic instruction set. As far as the user is concerned, the machine is a general-purpose cpu. This technique has been used, according to Mazzarese, in the PDP 11 series of computers because they could be built at a lower cost with it. The recently introduced PDP

11/05 sells (in quantities of 100) for \$3069 with 4-k words of memory.

Most of the other entries use the speed approach to microprogramming. They provide more than enough ROM for the basic order code of the machine. The extra ROM is available to implement special instructions. Using this capability, the user can turn a general-purpose computer into a faster special-purpose computer. This is particularly desirable in process-control situations where the computer performs the same task over and over. The group of ROMs used for microprogramming is called the control memory of the computer. In addition to this the computer has a main memory used for normal data storage. In process-control applications, the main memory will most often be core or plated wire. This is because process control requires nonvolatility. If the power fails, the computer must not lose track of what went before. Although techniques are being developed to provide semiconductor RAMs with a least temporary nonvolatility, it is still too expensive to go that route.

What has held back user microprogramming from becoming very popular? It used to be very difficult to do. Kluchman of Data General says: "Not many users are sufficiently competent to develop the microprograms.

Hewlett-Packard and MicroData have taken great strides towards making it easy for the user. HP's entry into the microprogramming mini field is the HP2100. "The HP2100," says Fred Coury, minicomputer section manager, "contains a writable control store. This device is built into the computer and it allows the user to try the microprogrammed instruction set in the machine, to see if it works, before writing it into permanent ROM. There are 1024 24-bit words of ROM in the control memory. Only 256 words are used for the basic instruction set of the machine. The rest is user programmable."

Coury notes that a microprogrammed instruction runs about 20 times faster than the same instruction implemented in random logic. Therefore once a microprogrammed instruction is entered into the machine, the more often that particular instruction is called for in a program, the faster the computer will execute the program. The HP2100 is a 16-bit machine that sells for \$6900 with 4 k of main memory.

MicroData uses a technique somewhat similar to HP's. According to Robert Oakley, product line manager: "To create the microprogram, we provide an assembler, a simulator and a dynamically alterable control memory. The assembler and simulator help in creating the microprogram,





Alpha 16 minicomputer from Computer Automation is a dressed-up version of the Naked Mini 16. The machine is the same in all respects, except that it comes with a control panel and is not meant to be taken apart.

and the alterable control store allows the user to try out the microprogram before permanently introducing it into ROM."

MicroData uses bipolar pROMs and will be announcing an MOS main memory.

Opinion is split in the minicomputer industry as to whether more emphasis should be put on selling to OEMs or to end-users. IBM, as always, takes the end-user approach. Digital Equipment, which has long emphasized the end-user, is now pushing for OEM sales. A consensus of opinion seems to be forming that the OEM market is far larger than anyone had thought.

Computer Automation of Newport Beach, Calif., has made an important move in the OEM direction. Early this year it announced its Naked Mini 8 and Naked Mini 16 (8-bit and 16-bit). These were fairly conventional machines (core memory, 1.6- $\mu$ s access time) that were packaged in an unconventional way and sold at a very low price. David Methvin, president of Computer Automation, says:

"We came to the realization that the OEM does not necessarily want a whole computer. He may want the cpu without power supplies, or he may want to use his own chassis. The Naked Mini machines are constructed in a modular fashion so that they can be sold in pieces very readily."

Going along with the modular approach to computer design is Data General's Kluchman, who notes that there is a "move towards larger circuit boards and fewer interconnections for more reliability."

"Wire-wrap," he notes, "is rarely done any

more. Now multi-layer mother boards are used, that the other boards just plug into."

## PERIPHERALS FOR MINIS: CHEAPER, MORE RELIABLE

About two years ago many companies rushed to get a piece of the minicomputer peripheral market. They came up with poorly designed equipment that was often just a scaled-down version of a peripheral formerly marketed for use with maxi computers. But the needs were not the same. The peripherals no longer merely needed to survive the well-scrubbed environment of the computer room; they now were being sent out into the world of the factory floor or even the engineering laboratory. The use was rougher, the environment was dirtier, and the operators were not always well-trained.

One of the first casualties was the moving-head cartridge disc memory. Since it is not a sealed unit, these 40-to-80-million-bit versions of the more-than-200-million-bit computer-room machines got dirt into them. They got scratched, the head started colliding with the disc, and untold other problems befell them. Now that the glamour has worn off and engineers have had a chance to design the equipment properly, moving-head mini discs have found a substantial market. IBM led the way with a unit designed for the System 7. It had an average access time of 256 ms and about 40 million bits of storage. The 14-inch cartridge designed by IBM has become the standard in the field. But such companies as Iomec in Santa Clara, Calif., Diablo Systems, Hayward, Calif., and Pertec, Glendale, Ariz., have made great strides.

Oakley of MicroData calls for development of a 40-million-bit disc at about \$10,000 with 60-to-100-ms access time and 60-k to 100-k bytes/sec transfer rate. He feels that such a product should be available before the next year is out.

Although the cost per bit is less for the moving-head disc memory, a great deal of interest has been focused on the fixed-head-per-track mini-disc memory. About a year ago the state of the art was a 3-million bit mini disc. At this year's Spring Joint Computer Conference the Librascope Div. of Singer in Glendale, Calif., introduced a 7-million bit memory, the L107A. It sold in small quantities for about \$6000. Since then several manufacturers have come out with comparable units. The bit density on this type of memory is a little over 2000 bits/inch. Access time is 8.5 ms when the disc is rotated at 3600 rpm, and 17 ms when rotated at 1800 rpm.

These heads fly at a height of only 50 micro-inches or so above the disc. Joseph W. Taylor,



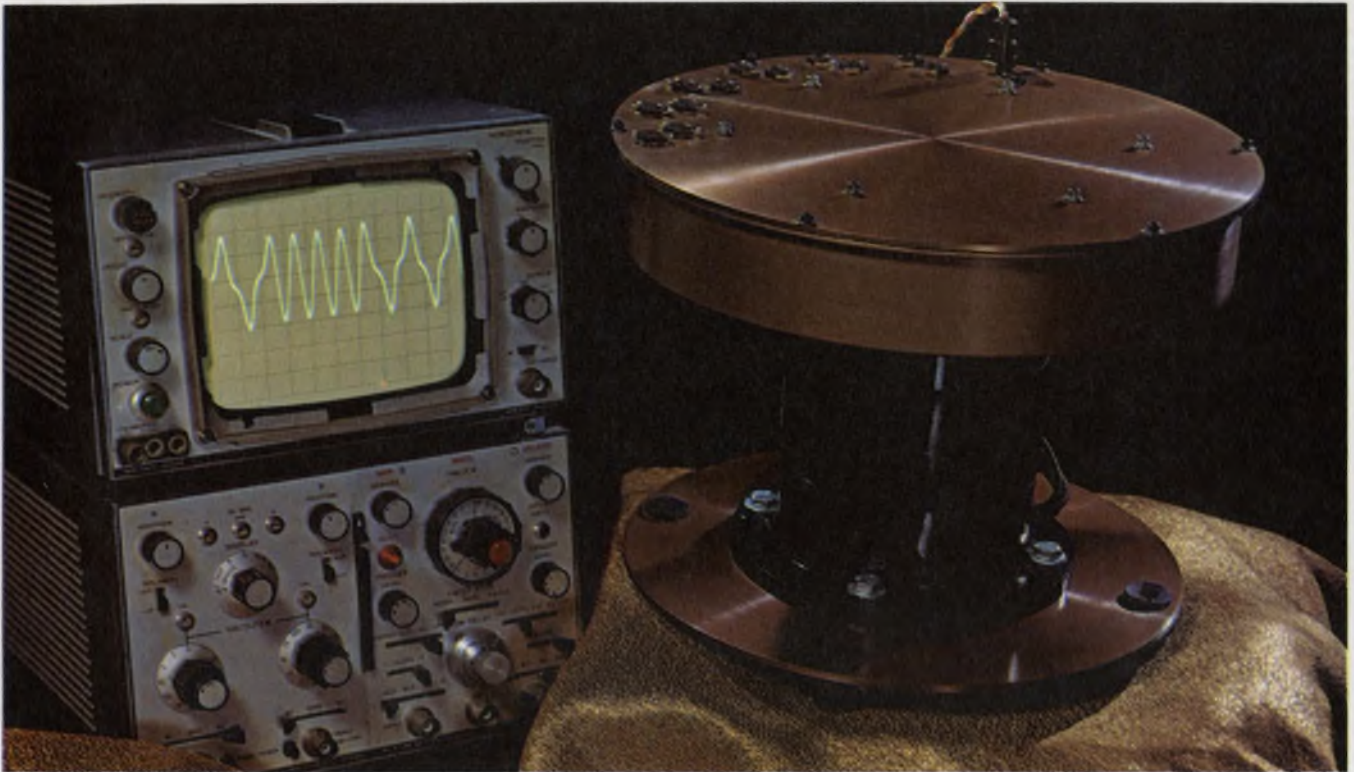

California Electro Mechanisms' DR6E minidrum memory displays a 2000-flux change/inch data pattern.

marketing manager for system products at Xerox Data Systems in El Segundo, Calif., says this is "like flying a 747 jetliner a tenth of an inch off the surface of the earth."

Most of the mini discs on the market today use two flux reversals per bit when recording. Taylor notes that there is a wide move toward single-flux reversal per bit recording, with its automatic doubling of bit density. Librascope, however, is staying with double-flux reversal recording and will be introducing at the fall conference an 18-million-bit mini-disc system called the L107B.

According to Robert J. Fuchiek, product manager for disc memories at Librascope, the new disc will not have a higher bit density; it will merely be a larger disc with more tracks. The 7-million-bit disc was 9 inches in diameter, and the new one is 14.7 inches. The new disc has 256 tracks against 100 for the old one. The L107B will have an average access time of 17 ms at 1800 rpm, and it will sell in small quantities for about \$11,000. As a rotating speed increases, the voltage output of the recording head decreases rapidly. When magnetic head technology makes it possible to go at higher speeds, the access time will really come down dramatically.

Taylor of Xerox Data Systems expects the cost per bit of fixed-head-per-track mini-disc memories to come down about 30% in the next year.

Direct competition for the smaller fixed-head discs are the fixed-head-per-track minidrum

memories. Chief proponent of minidrums is Datum in Anaheim, Calif. New on the scene, but with a very interesting new product, is California Electro Mechanisms in Torrance, Calif. It has just introduced the DR6E mini-drum memory. In its largest configuration, the memory has 2.16 million bits of storage and sells in large quantities for about \$750. It has a density of 60,000 bits per track and uses single-flux change per bit recording.

In addition to discs and drums, where fairly fast access times are desired, magnetic tape still provides the most economical means of storing millions of bits of data when the access time is not important. IBM compatible tape drives have long been a staple in the market. Technology hasn't changed much in the last year, according to Stuart P. Mabon, vice president and general manager of the Peripheral Equipment Div. of Pertec Corp., Chatsworth, Calif. He notes that price erosion is the key element in the business. Tape drives now cost about \$3000, and the price is coming down at the rate of about 10% a year.

Cassette magnetic tape memories are a bright star on the horizon. Technical difficulties with the Norelco cassette have been the chief cause of grief to date. Dale Spencer, chief engineer at Cipher Data Corp., in San Diego, says: "Most problems have been due to the fact that cassettes are designed to be audio devices and not digital devices."

Several advances in the last year point toward more reliable cassette drives. Two different ap-





**Fixed-head-per-track minidisc memories**, such as this Singer Librascope L 107A, with 7 million bits of memory, have become quite popular for use with minis.

proaches are being used. One involves pulling the tape away from the cassette in the vicinity of the magnetic recording head and guiding the tape more precisely past the head. This technique is being used by Bell & Howell in Pasadena, Calif., in its new Model 240 (\$500 in OEM quantities).

Dicom Industries in Sunnyvale, Calif., uses a vacuum column to isolate the tape from the cassette before transporting it past the head in its new model 440 (\$400 in OEM quantities).

Only small technical improvements have found their way into paper-tape punches and readers in the last year. William O. Fordiani, director of marketing at the Electronic Engineering Co. of California in Santa Ana, notes: "We now use stepping motor drives instead of capstan drives. We also now use LEDs and phototransistors for reading. Speeds are now up to 750 characters per second but nobody really needs more than 500 characters per second. Fordiani believes that prices will come down a bit from the current level of about \$1000 per unit, but he doesn't expect any major changes to take place in the equipment in the next year.

Dynamic refresh CRT alphanumeric terminals made great strides about 18 months ago, but they haven't changed much in the last year.

Full graphic CRT terminals are a different story. One of the most significant developments of the last year was the announcement of the Tektronix 4010 graphic terminal at just under \$4000. This is the first interactive, graphic terminal at a price compatible with the cost of minicomputers. According to Morgan E. Howells, marketing manager for information display

terminals at Tektronix in Beaverton, Ore.: "Not only are we providing the terminal, but we also have a new hard-copy printer that can be multiplexed off up to 4-4010's."

In the ever-present search for a replacement for the ASR-33 Teletype, many new printers have come on the market. Saviers at Digital Equipment reports: "We introduced the DEC-writer. It is a 5 x 7 matrix printer that is very quiet. It prints at 30 characters per second, as compared to the ASR-33's 10 characters per second. However, it does cost more at \$2995." An ASR-33 costs between \$650 and \$1000 depending upon its features.

Joseph Cornyn, vice president of OEM marketing at Data Products Corp. in Woodland Hills, Calif., notes that his company is working on a line printer that would print 100 to 150 lines a minute and sell in the range of \$3500 to \$4000.

At Xerox Data Systems, Taylor says: "We're working on a nonimpacting, electrographic printer. The process is the same as in the Xerox copiers, only much faster. We expect to be introducing 40, 80 and 130-column versions this year."

And the search goes on and on.

## PROGRAMMED CALCULATORS ARE STRONGER THAN EVER

Important new products and companies have shown up in the programmable scientific calculator field. The most significant new products have come from Hewlett-Packard and Wang Laboratories. They have introduced units with a great deal of capability at very reasonable prices. Among the new companies on the scene is Compucorp Calculators of Santa Monica, Calif., which produces its own line of products as well as an OEM line for Monroe.

Tektronix bought out Cintra of Mountain View, Calif., and is now upgrading the line to be more competitive with HP and Wang. Looming on the horizon is the threat of Japanese calculator companies expanding out of the low-cost market and into larger, more complex machines.

The first of two important new products has come from the Hewlett-Packard Calculator Div. in Loveland, Colo. It is the Model 10 programmable calculator. Selling for only \$2975 (basic unit), the machine uses all MOS semiconductor memory. The basic unit has 51 registers and storage for 500 program steps. This is expandable with an optional add-on memory. A section of the keyboard is set aside for special function keys. The user can buy one of three plug-in, read-only memory modules that define the func-



tions. One provides mathematical functions, one statistical functions, and one is user-definable. The user-definable block allows the user to set each key in the special-function section of the keyboard to perform any calculation he desires. Programming is performed with magnetic cards.

Wang Laboratories in Tewksbury, Mass., has just introduced the 600 series. These calculators are priced at \$2600 to \$3500 and are also fully MOS memory. They also have user-definable function keys. Up to 1848 program steps can be stored in the largest model, in 247 registers. The basic model has 16 registers and stores up to 312 program steps. Programming is by magnetic-tape cassette.

Both of these calculators have a full range of peripherals, including printers, plotters, additional memory and card readers.

John Dunn, product manager for the HP Calculator Div., sees the next year bringing better and more flexible peripherals for the new calculators. He also sees a widespread move to cassettes for bulk storage.

John Cunningham, manager of marketing services at Wang, thinks the major move will be to more memory. "With the use of MOS," he says, "you'll see calculators with 4-k and 8-k memories, just like minicomputers."

Both Dunn and Cunningham agree that better interfaces for the peripherals will be developed that will enable the calculators to output information in its most useful form. They feel that more special function keys will be needed for a wider range of users. Better printers are also on tap, so data can be outputted in a more useful form.

## NEW SOFTWARE PACKAGES FOR CIRCUIT ANALYSIS

Three important new circuit-analysis software packages have been introduced in the last year. They include CIRC from Xerox Data Systems, ECAP II from IBM in White Plains, N. Y., and AEDCAP from Softech in Waltham, Mass.

All three of these packages have extensive capabilities in nonlinear circuit analysis. CIRC is the most complete at present. It performs ac, dc, transient, worst-case dc and ac stability analysis. According to Richard McNair, computer scientist at Xerox Data Systems:

"CIRC operates in either a conversational mode at a terminal or in a batch mode. It contains a full library of models of devices and ICs that is constantly being updated as the semiconductor industry introduces new products."

CIRC has a capacity of circuits with 30 or more nodes for the on-line conversational user, and up to 300 nodes for the batch user. Output



**Hewlett-Packard's Model 10 calculator** packs a lot of computing power in a fairly small package. The modules included with the calculator allow the user to set a group of special function keys to perform a variety of calculations at the push of a button.

data will either print or plot. CIRC operates only on Xerox's Sigma computers and is sold as a program product.

ECAP II (Electronic Circuit Analysis Program) contains at present only dc and transient analysis. The model library is not as complete as with CIRC, and much of the modeling is left up to the designer. The model library permits one circuit to be imbedded within another. Integrated circuit chips, for example, can be stored in the same library that contains TTL circuits.

ECAP II is designed to be used primarily in the batch mode. It does have a conversational feature when used on an IBM 1130. In the 1130 with 16k of core, the program will handle up to about 100 nodes. With more memory, it can handle more nodes, using a technique called dynamic storage. This storage is similar to virtual memory, in that it moves information around in memory to gain efficiency and make the memory appear to be larger than it actually is. Output data will either print or plot. ECAP II does not do worst-case analysis automatically.

AEDCAP (Automated Engineering Design Circuit Analysis Program) offers ac, dc, transient and stability analysis. It does not yet offer automatic worst-case analysis, but it will, according to Ronald Rohrer, design automation engineer at Softech. The model library is being built up at present, but it is not nearly as extensive as Xerox's.

AEDCAP also uses dynamic-storage allocation, and it can handle 100 nodes for every 25 k of memory. It can be used in either conversational or batch modes and will either print or plot. At the moment the package operates only on IBM 360 and 370 machines, but Rohrer says it will be later implemented on other computers.

Looking into next year, Rohrer sees circuit-analysis packages with reliability and failure analysis. ■■



Your Guardian Angel presents a.



Bestseller

Everything you  
always wanted to  
know about

RELAYS  
SOLENOIDS  
SWITCHES \*

\* AND WE'RE GLAD YOU ASKED



**GUARDIAN**<sup>®</sup>  
GUARDIAN ELECTRIC MANUFACTURING COMPANY  
1572 West Carroll Avenue, Chicago, Illinois 60607

In a hurry? Call your Guardian Distributor.



# .LIBRARY full of MIRACLES



**RELAYS** 24 PAGE FACT BOOK full of dimensional drawings, specifications and application data on the comprehensive line of Guardian relays... including general purpose, special purpose, power, solid state and interlock.

CIRCLE NO. 201 FOR YOUR COPY



**SWITCHES** A PORTFOLIO OF TECHNICAL DATA describing the complete line of Guardian switches: Molded, stacked and the miraculous lever switch with snap-in cam inserts so you change actuator functions instantly!

CIRCLE NO. 203 FOR YOUR COPY

**SOLENOIDS** 44 PAGE MANUAL reveals everything you need to know to spec a Guardian solenoid. Includes specs, pull/stroke graphs and dimensional drawings on frame, laminated and tubular types—dozens of basic solenoids with more than 61,000 variations!

CIRCLE NO. 202 FOR YOUR COPY

**STEPPERS** STEPPING RELAY FACT BOOK with 32 pages of catalog and application data on stepper types ranging from counting, sequence selecting and automatic resetting to pulse multiplying, slave and master, and *more*.

CIRCLE NO. 204 FOR YOUR COPY





# The NAKED MINI™

## \$1450

### The bare maximum.

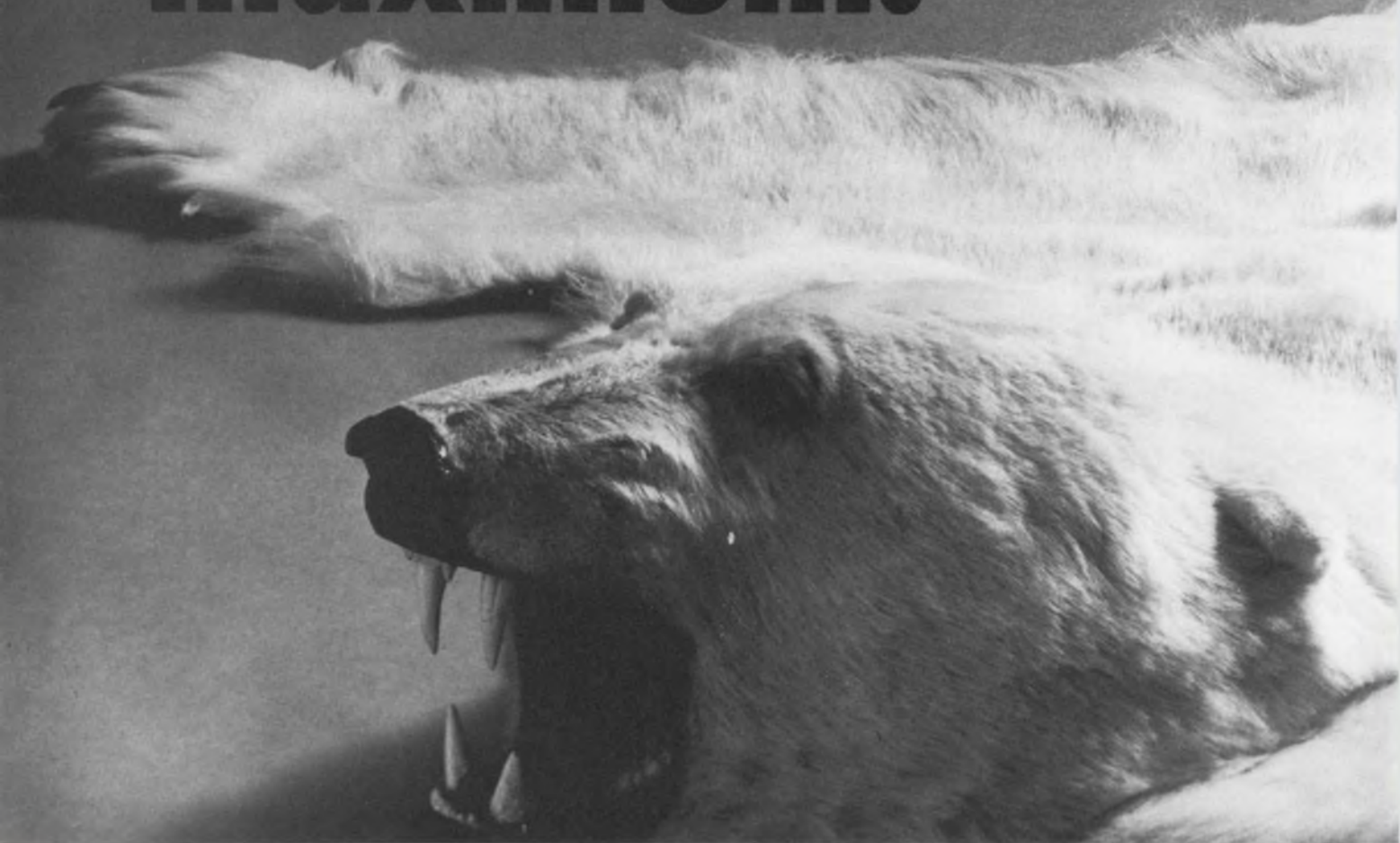

The Computer Automation NAKED MINI™ is naked. But it's not stripped. And that's an important difference.

To us, if a minicomputer is stripped, it's not even a computer. It's only a limited controller. Loose cards and components without even a memory. Sort of a do-it-yourself kit. That's not what you get from us.

The NAKED MINI is a fully-operational, general purpose computer with 4K of expandable memory.

With our NAKED MINI 8-bit and 16-bit computers, the only things missing are the power supply, console, and chassis. That's all.

No, the NAKED MINI is not a stripped computer. Far from it.

It has the complete power of a stand-alone system. It's an integral unit, designed for maximum useability and interface-

ability. It's fully tested and warranted. And it comes with a complete line of standard software.

In fact, you get a lot of features that costlier stand-alone computers don't even have. Standard items like our 145 basic instructions (76 with the 8-bit), the most powerful instruction sets on the market. Three direct memory channels. Vectored priority interrupts. Hardware arithmetic features. And 32K of core. Plus hardware multiply/divide and full byte operations on our 16-bit machines.

Even though our NAKED MINI's have all this horsepower and flexibility, think of them as a component. A component ready to be thoroughly buried inside your OEM product.

Because of its low price tag, the NAKED MINI makes it economically feasible to design your product with a mini-

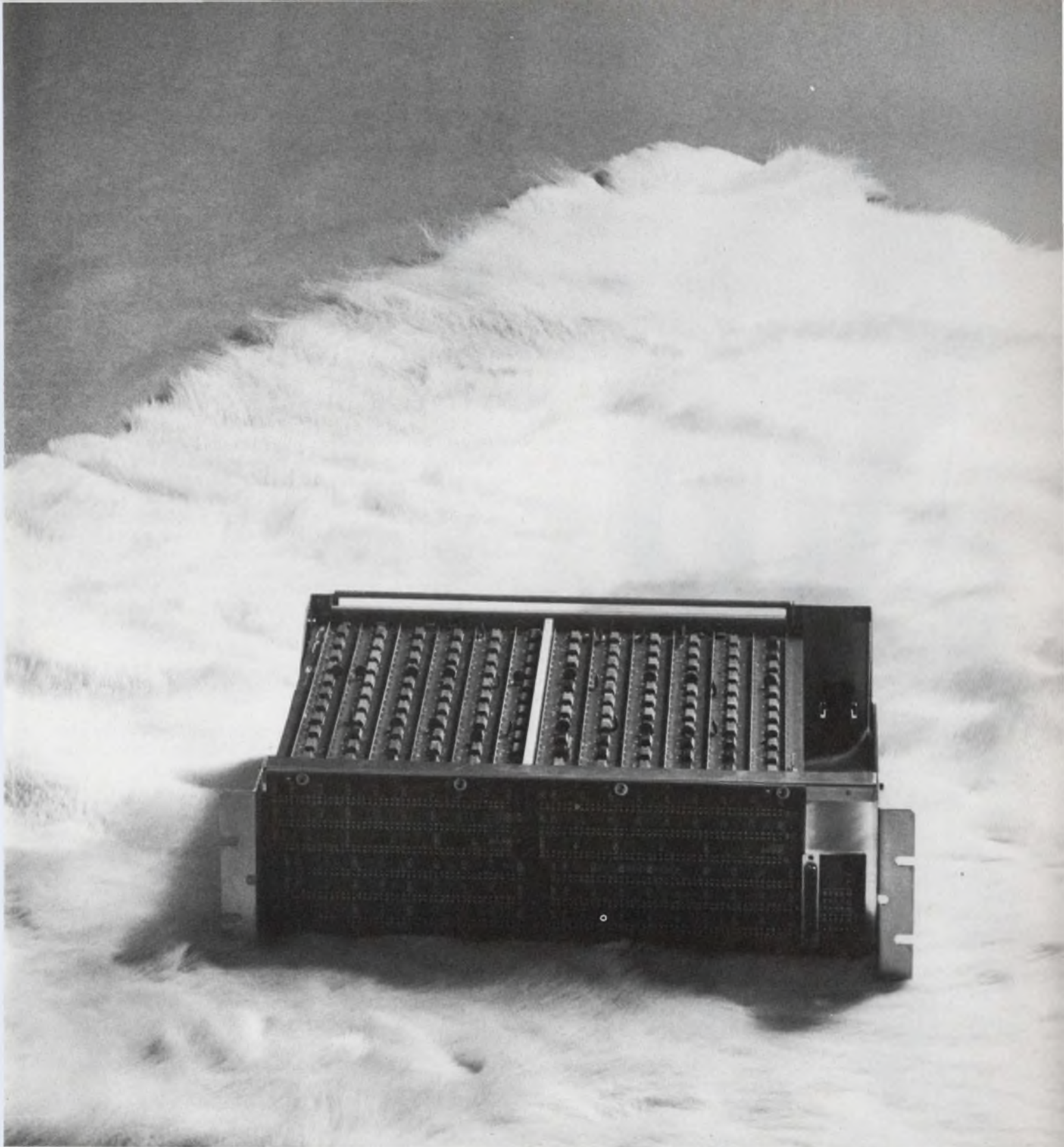

computer, rather than hardwired circuitry. This enhances your system performance, while reducing system costs considerably.

For the systems designer, the NAKED MINI concept means an opportunity to get the full computer power of our packaged machines. But at the price of a component. Take a look at our quantity pricing list. We think you'll agree.

We'll be glad to send you full specification details, including a complete listing of the standard instruction set and software. Just write or call us.

The NAKED MINI has nothing to hide.

#### Naked Mini Quantity Pricing

	10-19	20-49	50-99	100-199	200 plus
NAKED MINI-16					
4K	\$2500.	\$2400.	\$2300.	\$2200.	\$1995.
2K	2200.	2100.	2000.	1900.	1725.
NAKED MINI-8					
8K	\$2275.	\$2125.	\$2000.	\$1925.	\$1730.
4K	1975.	1825.	1700.	1600.	1450.

(NAKED MINI's are sold on firm purchase orders in minimum quantities of 10 units.)

**COMPUTER AUTOMATION, INC.**  
 895 West 16th Street • Newport Beach, California  
 92660 • Phone (714) 642-9630 • TWX 910-596-1377





When it's **POWER** switching you need...



**our relays  
come on STRONG!**

Now Magnecraft offers a complete line of Mercury Displacement Power Relays with liquid mercury-to-mercury contacts. These new Power Relays are available from stock with coil voltage of 120 VAC, however, all other coil voltages are available. In addition to the HI-POWER steel encapsulated version a complete line of glass tube relays are offered. These low cost, tempered glass relays are frictionless, non-corrosive and non-conducting. Contact configurations are SPST, DPST, and 3PST; NO or NC units rated at 20, 25, 35, 50, 60, and 100 amperes @ 115 VAC are on the shelf awaiting your order. Temperature control, sensitive, and time delay solid state hybrid units are also offered.

④



① The MR-11 miniature type is a glass tube DPST relay with 20 ampere switching capability. CSA listed. Also available SPST and 3PST.

② The EM-1 standard type is a glass tube SPST relay with 35 ampere switching capability. UL and CSA listed. Also available DPST and 3PST.

The HD heavy duty type is a glass tube relay similar to the EM type but features 60 ampere switching capability. UL and CSA listed.

⑤



①



③ The "100" relay is an encapsulated glass tube relay with 100 ampere switching capability. CSA listed.

④ The A-11 HI-POWER is an armored steel-encapsulated DPST relay with 25 ampere switching capability. Also available SPST and 3PST.

The "B" series HI-POWER relays are similar to "A" type but feature 50 ampere switching capability.

⑤ The H-1 HI-POWER is an armored steel-encapsulated SPST relay with 100 ampere switching capability. Also available in DPST and 3PST.

③

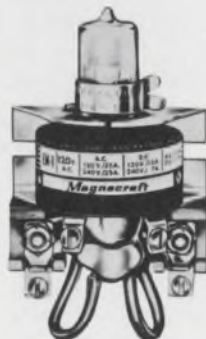

②

**Magnecraft** ELECTRIC COMPANY

5575 NORTH LYNCH AVENUE • CHICAGO, ILLINOIS 60630 • 312 • 282 5500 • TWX 910 221 5221

**FREE CATALOG**

Send for our complete catalog of Mercury Displacement Power Relays describing how they operate, the many features available and giving complete specifications on over 60 types. Prices are also included.





# For built-in reliability, design with "Scotchflex" Flat Cable/Connector Systems.

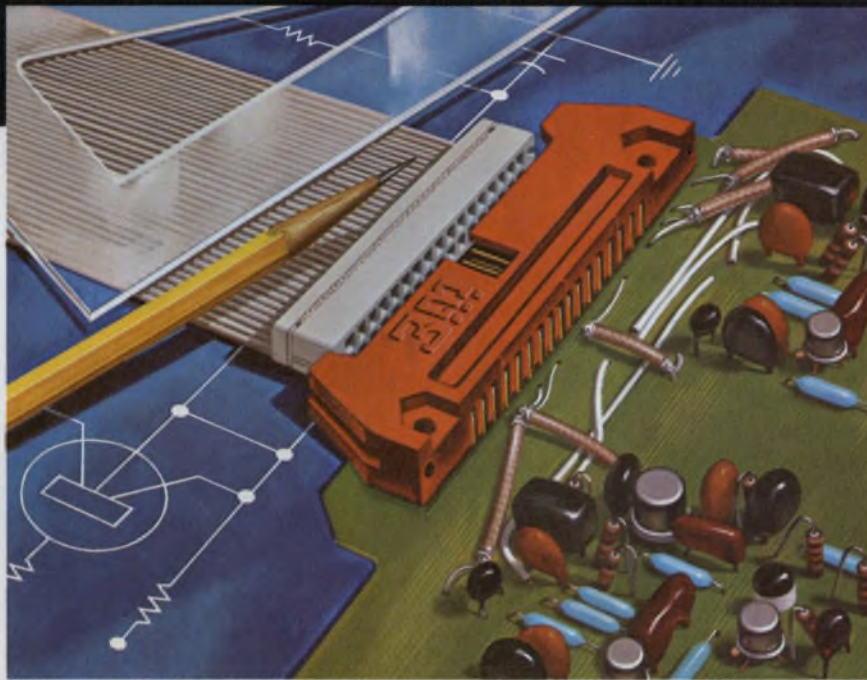

"SCOTCHFLEX" IS A REGISTERED TRADEMARK OF 3M CO.

"Scotchflex" Flat Cable and Connectors can offer you trouble-free packaging for your next generation equipment.

There's built-in reliability for your circuit inter-connects. Our flat, flexible PVC Cable has up to 50 precisely spaced conductors. The gold plated U-contacts are set into a plastic body to provide positive alignment. They strip through the insulation, capture the conductor, and provide a gas-tight pressure connection.

Assembly cost reductions are built-in, too. "Scotchflex" Connectors make up to 50 simultaneous connections without stripping or soldering. No special training or

costly assembly equipment is needed.

Off-the-shelf stock offers you flat cable in a choice of lengths and number of conductors from 14 to 50. Connector models interface with standard DIP sockets, wrap posts on .100 x .100 in. grid, or printed circuit boards. Headers are available to provide a de-pluggable inter-connection between cable jumpers and printed circuit boards (as shown). Custom assemblies are also available on request.

For full information on the "Scotchflex" systems approach to circuitry, write to Dept. EAH-1, 3M Center, St. Paul, Minn. 55101.

**3M**  
COMPANY

INFORMATION RETRIEVAL NUMBER 126



# Convert your scope to a display terminal.

For less than \$200, you get a computer readout with up to 250 characters, and with faster speeds than most teleprinters give.

How often have you wanted a quick look at what's happening within a computer system—at faster speeds than the average teleprinter provides? And without spending thousands of dollars for a video display terminal?

Here's a way to convert a general-purpose oscilloscope into a character display at mini cost. For less than \$200 in parts, a display can be developed that, typically, shows 250 characters and still allows the computer to spend a high percentage of its time in problem solving. The characters (Fig. 1) can be read in a fully lighted room.

## Use a starburst pattern

Characters (and pictures) are drawn on the CRT face by applying appropriate sequences of voltages to the scope x and y axis inputs and turning the scope beam OFF and ON. Early display systems required an external command for each change in x and y voltage (called a stroke), but it was quickly recognized that many of the commands were repetitious.

Many schemes were developed to separate these repeated aspects from the commands to the display terminal, one such being starburst pattern generation. In this method (Fig. 2), digital logic and analog circuitry draw the same starburst pattern for every character. A control command to the display system specifies which portions of the pattern are to be blanked (beam gated OFF).

The basic starburst pattern is shown in Fig. 3, with the x and y deflection voltages required to generate it. Also shown are four digital signals (XPS, XMS, YPS, YMS), which are generated by the timing logic and then summed and integrated by amps to yield the x and y deflection voltages. The numbers on the various strokes of the starburst pattern correspond to stroke times shown on the voltage timing diagram.

The timing and control section of the logic consists of a 22-bit shift register. The first stage of this register is set at the beginning of the star-

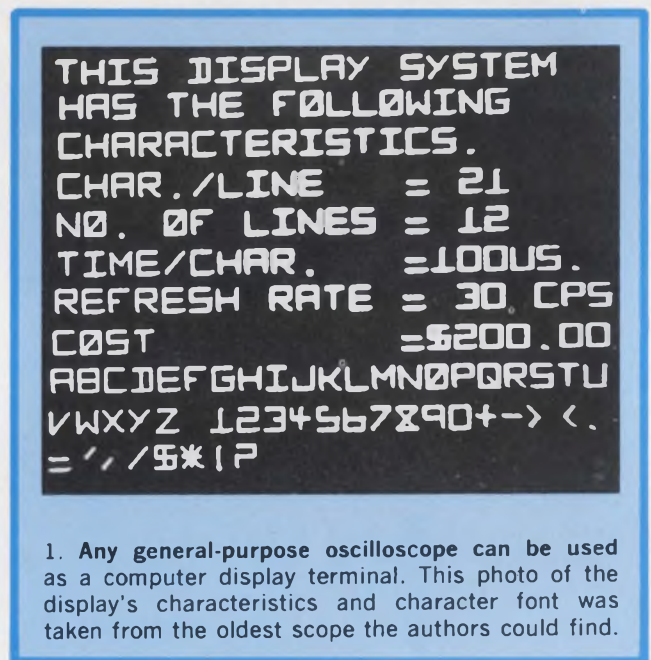

1. Any general-purpose oscilloscope can be used as a computer display terminal. This photo of the display's characteristics and character font was taken from the oldest scope the authors could find.

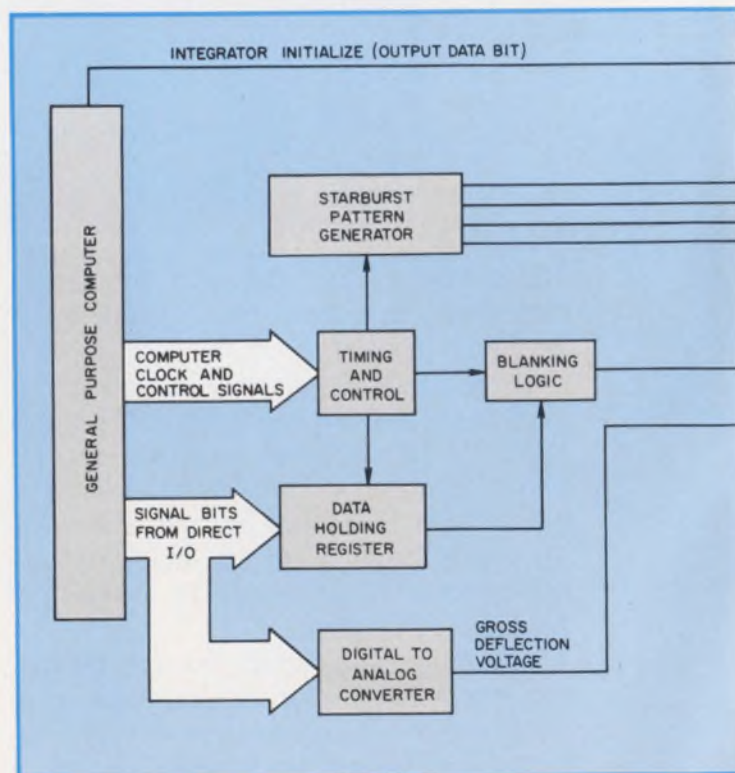

James R. Armstrong and C. Lynn Hern, Dept. of Electrical Engineering, Marquette University, Milwaukee, Wis. 53233.



burst cycle (all others are reset). This ONE is shifted down the register at clock rate, generating the 22 stroke times. (The register can be connected as a ring counter and the display run continuously, but synchronization with the external commands becomes more difficult.)

The starburst-pattern generator logic block (Fig. 2) consists of logic gating that ORs appropriate stages of the 22-bit timing register to generate the signals XPS, XMS, YPS, and YMS. Although there are 22 stroke times, only 18 control bits are required, since four strokes are used merely for positioning and are always blanked.

The character-holding register receives the 18-bit control work. Each stage of the register is ANDed with a stroke time. All of these ANDs are then ORd to produce the blanking control signal. For the character font used, all 18 strokes did not have to be controlled (blanked) independently. Therefore the character-holding register was mechanized so that three data bits each controlled two strokes. Thus only 15 data bits were needed to specify a character.

Figure 4 gives the logic diagram for the mechanization of the digital logic. All flip-flops are D type.

The primary purpose of the analog circuits is to convert outputs XPS, XMS, YPS and YMS from pulses to ramps of various slopes. These ramps (x and y deflection voltages) are then used to draw the starburst pattern.

XPS and XMS are connected to the plus and minus inputs, respectively, of an op amp that is wired as a summer integrator (Fig. 5). The out-

put from this amp is then connected to the negative input of a second op amp to invert the integrated signal. Finally the inverted signal is connected to the x-axis input of an oscilloscope. In a similar manner YPS and YMS are connected to a summer integrator and an inverter.

The op amp used to invert the integrated Y-signal also has an input connected to its non-inverting input terminal. The purpose of this signal, called the gross-deflection voltage, is to move the starburst pattern vertically down the oscilloscope screen, so more than one line of characters can be drawn without overlapping the previous character.

For the system shown, the gross-deflection voltage was produced from a digital to analog converter. The output of the converter is connected to another op amp. This amp is wired so that its output is biased at  $-12\text{ V}$ , when the converter's output is  $0\text{ V}$ . The converter output can be varied from  $0\text{ V}$  to  $+5\text{ V}$ . With the gain of the op amp set at 4.7, the output voltage varies from  $-12\text{ V}$  to  $+11.5\text{ V}$ .

Transistor switches wired across the capacitors on each integrator are used to short out the integrators before each row of characters is drawn. This repositions the CRT beam back to the left side of the tube face.

One transistor is used as a switch to control the z-axis modulation or blanking of the electron beam. When the blanking signal (BLKS) is low ( $0\text{ V}$ ), this transistor is OFF and  $17\text{ V}$  is applied to the z-axis input of the oscilloscope. The voltage turns the beam OFF. When BLKS is high ( $+4$

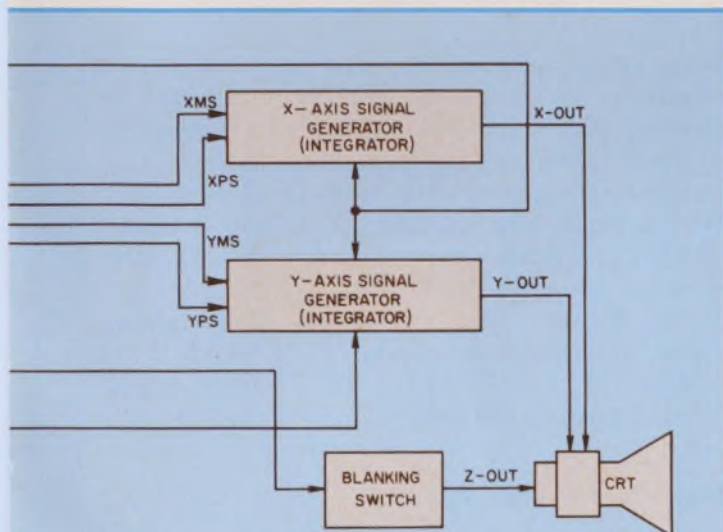

2. Both digital and analog circuits are needed to interface the scope to a computer. The character-pattern pulses and timing signals are generated in digital form using shift registers and then converted to analog deflection voltages.

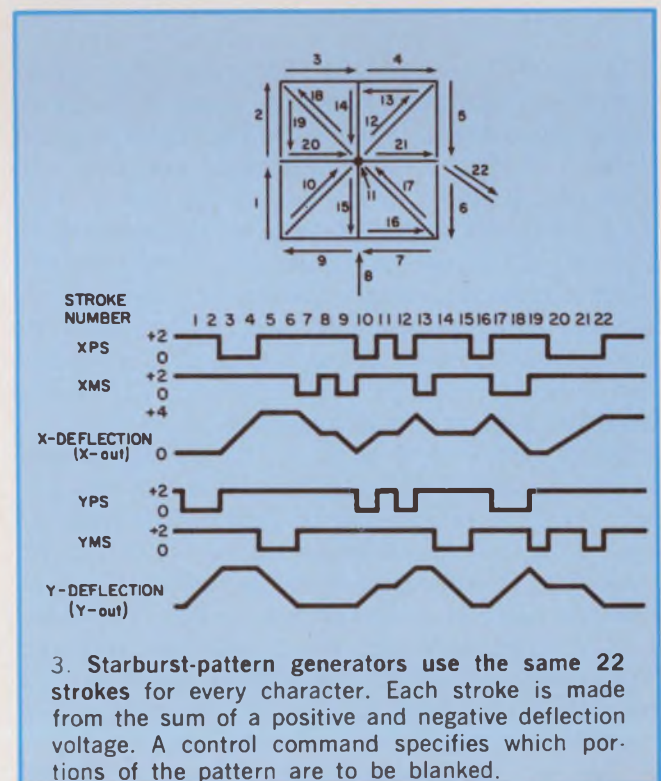

3. Starburst-pattern generators use the same 22 strokes for every character. Each stroke is made from the sum of a positive and negative deflection voltage. A control command specifies which portions of the pattern are to be blanked.



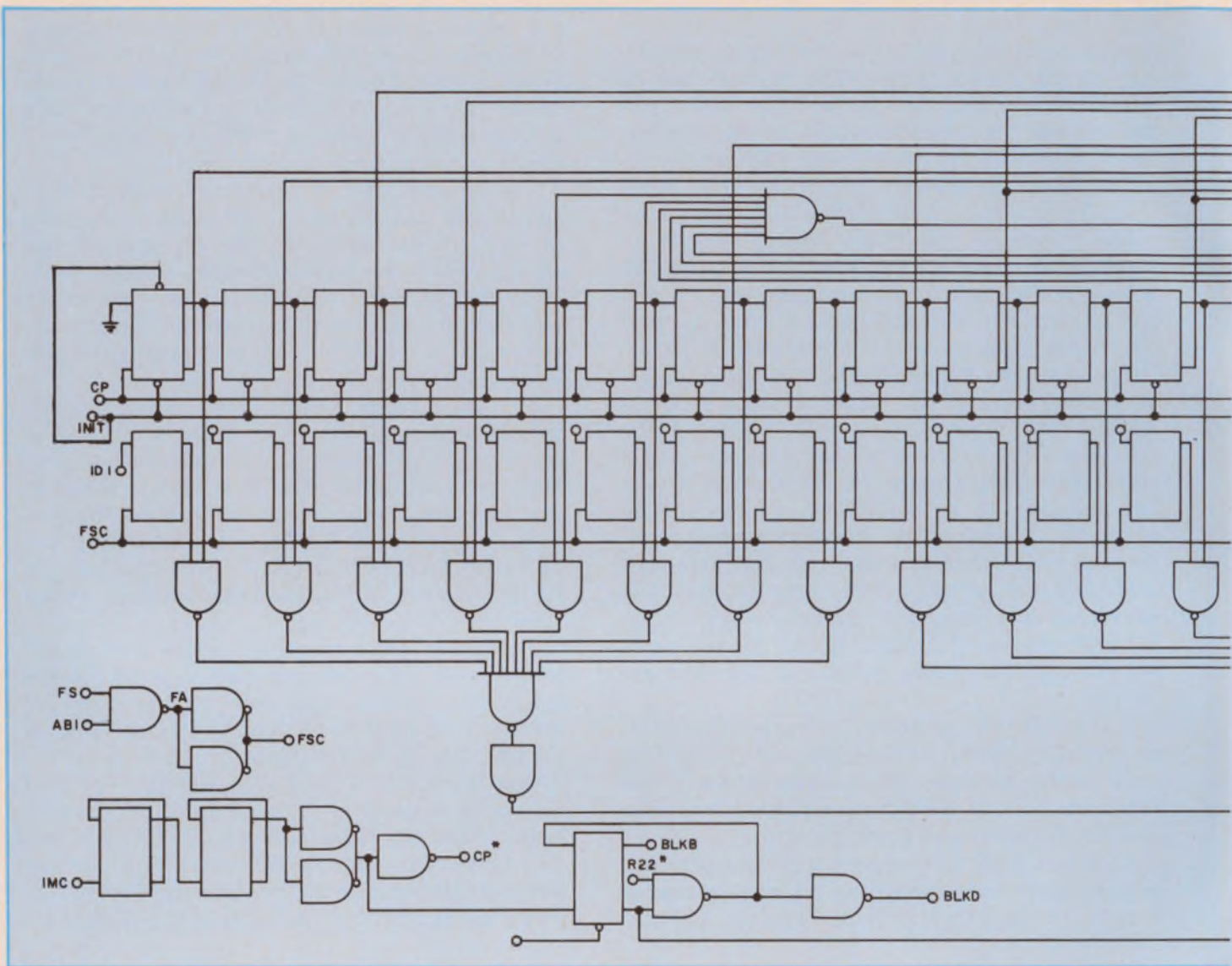

V), then 0 V is applied to the scope z-axis input.

There are six potentiometers in the analog circuits. These are used to insure that the starburst pattern is square and undistorted and that the lines of patterns are horizontal.  $R_1$  and  $R_2$  balance the inputs to the integrators. Potentiometers  $R_3$  and  $R_4$  are used to adjust the x and y amplitudes so the starburst pattern will be square. Finally potentiometers  $R_5$  and  $R_6$  are used to minimize integrator output bias drift. This keeps the lines of patterns horizontal and also helps keep the patterns undistorted.

None of the parts used in the analog circuits is critical. Any moderately fast high gain op amp, such as a 709 or 741, can be used for the integrators. All fixed-bias resistors can be 1/8 or 1/4 W, with 5% tolerance, and the adjustment potentiometers are 10-turn trimmer types. The integration capacitors can be of ordinary ceramic. The switches used for integrator shorting and the blanking output can be any medium-power transistor with reasonable breakdown voltages.

The integrator shorting transistors, 2N2946,

were chosen because they are fast and have a relatively low saturation emitter-to-collector resistance. A low saturation resistance is desirable so the RC time constant of the transistor and the integrating capacitor will be as small as possible. With a small time constant, less time is needed to reset the integrators between lines. All other resistors are type 2N2193.

The display system requires three power-supply voltages: logic power of +4 to +5 V and supplies of +18 V and -18 V. Each supply draws less than 100 mA.

#### Tradeoff: characters vs speed

Choosing the optimal value for the integrating capacitors is one of the few places where performance tradeoffs must be considered. For any given operating frequency, larger integrating capacitors will allow more characters per line to be drawn. However, larger capacitors require a longer shorting time to reset the integrators. This slows the speed of the display system. Thus,



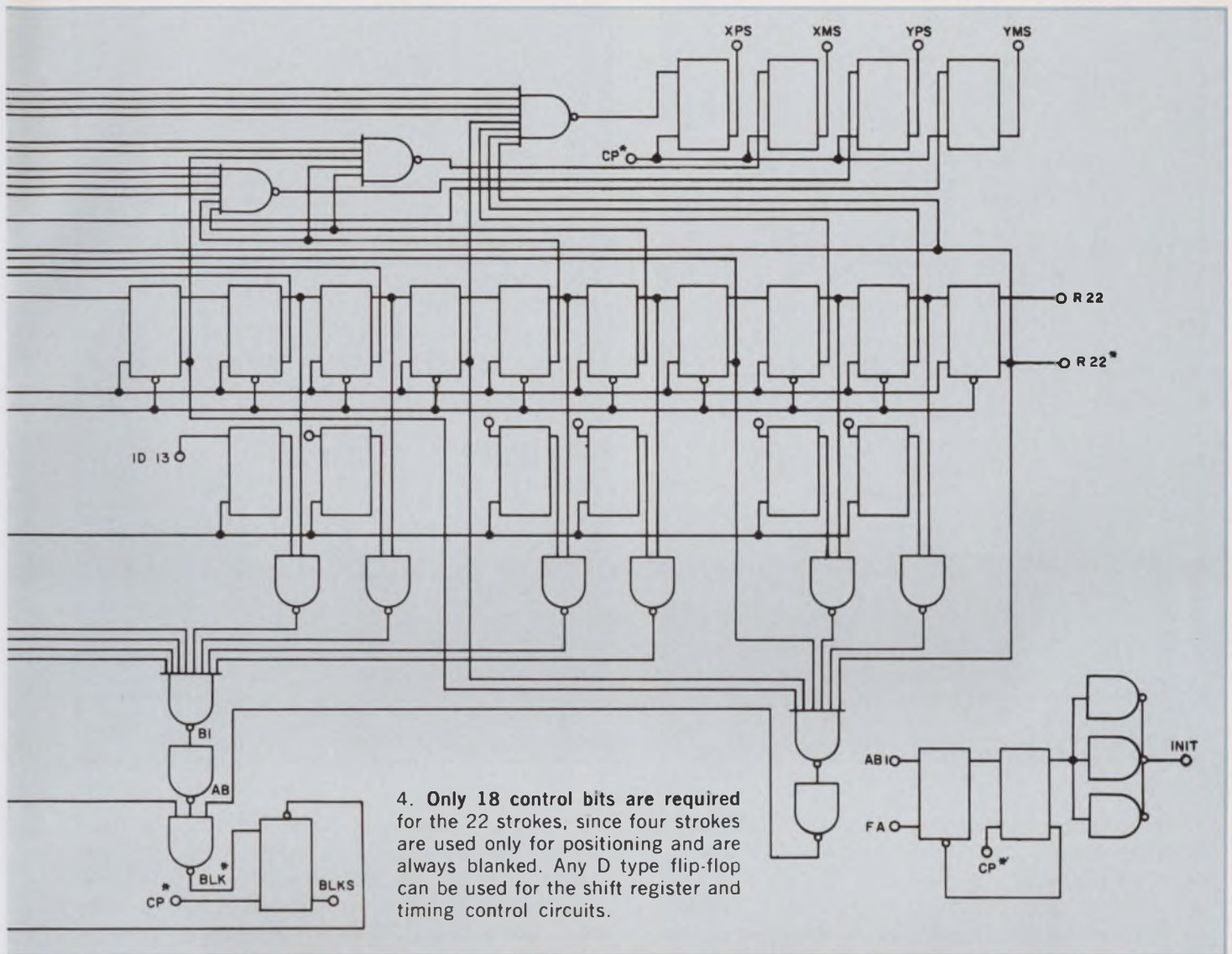

4. Only 18 control bits are required for the 22 strokes, since four strokes are used only for positioning and are always blanked. Any D type flip-flop can be used for the shift register and timing control circuits.

once the clock frequency of the starburst pattern generator is established and the maximum number of characters per line is decided upon, the integrating capacitor should be chosen so that only the required number of characters per line can be written before the integrators saturate. In this way the minimum value for the capacitors will be chosen. With a minimum capacitance, the integrator reset time is kept to a minimum.

The choice of clock frequency depends on many things: how many characters must be displayed in a given amount of time; the refresh rate that is needed; the bandwidth of the x and y-axis inputs of the scope; how persistent the phosphor on the CRT is. Also, most scopes can position the beam fast enough to draw the pattern undistorted. At the higher frequency, the patterns become faint and tend to flicker at any refresh rate under 60 cps. In addition, many scopes with built-in calibrated horizontal inputs cannot position the beam fast enough to handle the drastic changes in direction needed to draw the pattern. A formula that relates these variables can be

stated as follows:

$$V = \frac{1}{RC} vWSC_n, \text{ where}$$

- R= integrator input resistance
  - C= capacitance of integrating capacitor
  - v= output pulse height in volts from the starburst-pattern generator
  - W= output pulse width in seconds from the starburst-pattern generator
  - S= width from pattern to pattern (horizontally) in strokes (=3)
  - C<sub>n</sub>= maximum characters per line
  - V= integrator supply voltage.
- For the system shown:
- C<sub>n</sub>= 20 characters per line
  - C= 0.0034 μF
  - R= 10K ohms
  - v= 2.4 volts
  - W= 4 μs
  - S= 3 (a constant)
  - V= 17 volts.

The software to control the display system will vary from application to application and



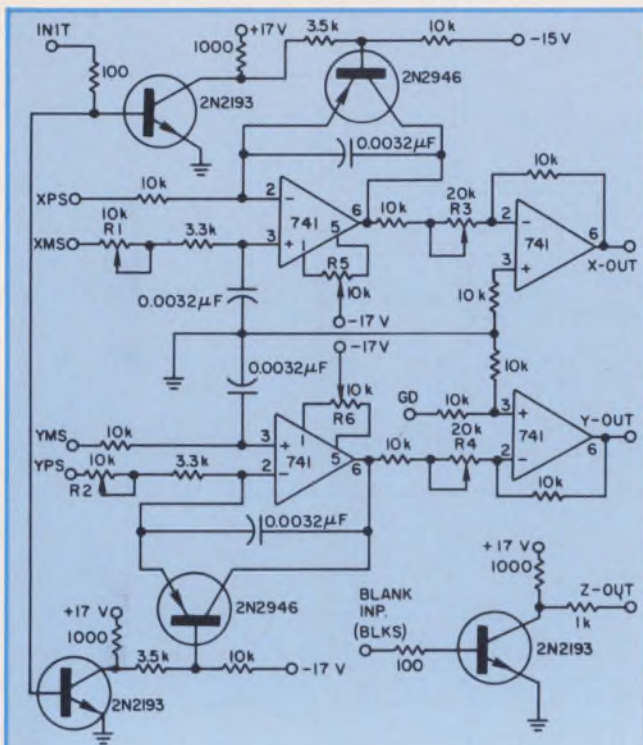

5. The x and y deflection voltages are produced by summing and integrating the deflection voltages. The gross-deflection input to the second Y amplifier moves the starburst pattern vertically so more than one line of characters can be displayed.

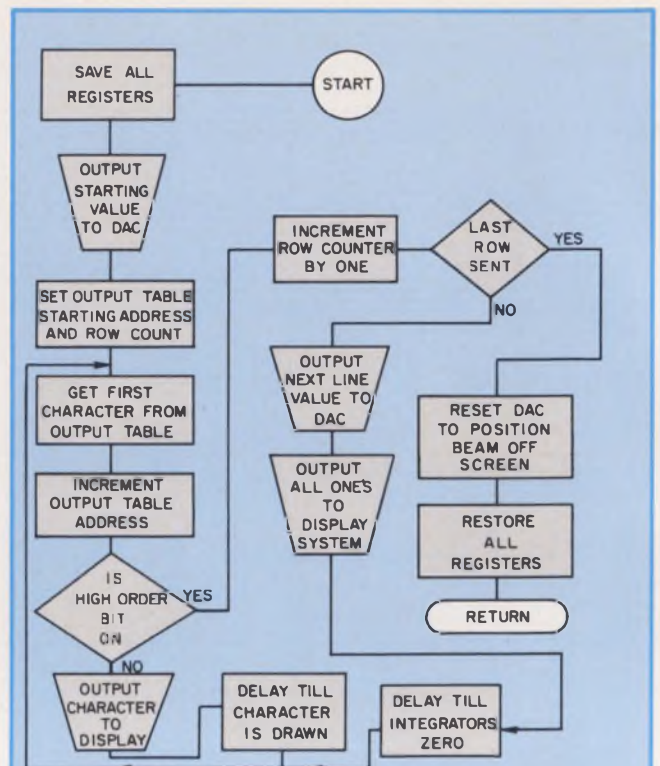

6. An interrupt program is needed to output the characters displayed by the scope. After the last row of characters has been displayed, the interrupt program returns to the main computational program.

from computer to computer. In general, an interrupt program (Fig. 6) is needed to output a table of characters periodically for display, and a table lookup program or subroutine is needed to decode internally generated information to the display character codes. Of course, a main program is also needed to specify what data is to be displayed and to format the data into characters per line and lines of characters.

If it is assumed that no more than 250 characters will ever be displayed, the entire software package (interrupt program, table look-up subroutine and output character table) can be written to use no more than 410 core locations. If all 250 characters are displayed and a 30 cps refresh rate is used, between 750 ms/s (250-kHz clock rate) and 375 ms/s (500-kHz clock rate) are needed to drive the display system.

The interrupt program sets the digital-to-analog converter to a specified starting value. Next, the first character in the output table is sent to the display system. The data is gated from the computer output-holding register into the starburst-pattern generator's holding register. The bits just put into the starburst-generator holding register are used to specify which strokes of the starburst pattern are to be blanked.

While the first pattern or character is being generated and displayed, the interrupt program hangs up in a short delay loop to allow time for

the first character to be displayed. After a fixed period, the delay loop is exited, and the next character in the output table is sent to the display system. This process is repeated until a character code with a ONE in the high-order bit position of the output word is detected.

A ONE in the high-order bit position of an output character code signifies the end of a line of characters. At this time a new value is sent to the digital-to-analog converter to position the scope beam down for the next row of characters. A character code word with all bits set to ONE is sent to the starburst-pattern generator. This word specifies that all strokes in the starburst pattern are to be blanked. In this way the stray traces are blanked out when the CRT beam is positioned for a new line. Also, the high-order bit of the word is used to turn on the integrator shorting transistors.

Next, a row counter is decremented by the interrupt program. If the counter is not zero, the program enters another delay loop, to allow time for the integrator capacitors to discharge. After exiting this delay loop, the process is repeated for the next row of characters.

When the counter reaches zero, the last row of characters has been displayed. After this, the digital-to-analog converter is set so that the beam is positioned off the face of the CRT. The program then returns to the main program. ■■





# Try our straightforward method of reducing fixed resistor costs.

You can't blame engineers or purchasing agents for trying to save every last penny on resistors these days. But lowest price doesn't necessarily mean lowest cost. For example, most manufacturer's color bands won't stand up to the cleaning methods used to remove excess flux. Or they darken and become illegible from the heat

produced in normal usage. This can mean costly identification errors on your production line. The unnecessary expense of rework. Our solution? A-B quality. Bright, crisp identification of Allen-Bradley's specially formulated paints. Baked on to stay on. Designed to resist aging. Discover the other ways to save money. Ask your nearest

A-B distributor for our free booklet "7 ways to tell the difference in fixed resistors." Or write Allen-Bradley Electronics Division, 1201 South Second Street, Milwaukee, Wisconsin 53204. Export: Bloomfield, New Jersey 07003. Canada: Galt, Ontario. United Kingdom: Bletchley, Bucks.

NEW DIMENSION ELECTRONICS  
**ALLEN-BRADLEY**







Right! It's a new  
low-cost, wide-platen  
data terminal

It's the Teletype® model 38. And its capabilities go far beyond the wide format aspect of operation.



The new model 38 line design incorporates many of the things that made the Teletype model 33 so popular: It's a modular line. Exceptionally reliable. Extremely economical; costs very little for all of its capabilities. It's really a logical extension of the model 33 design concept and is system compatible with it.

**... the important differences**



The model 38 prints 132 characters per line at 10 characters per inch. This wide format enables you to send and receive data using the same fan-fold computer paper stock used in your computer room. So you can move the data generated by your computer to any number of remote locations across the nation without time-consuming reformatting problems.

The model 38 generates *all 128 ASCII code combinations*. You can print the full complement of 94 standard graphics, including upper and lower case alphabet characters. And it provides all the functional control necessary for easier operation.

If you would like to input computer data in red and receive output data

in black, or vice versa, the Teletype 38 terminal has this capability, too.

As you can see, the 38's format flexibility makes it easier to get your data in and out of the computer. And it broadens your on-line capabilities as well.

**... the line is complete**

The Teletype 38 terminal is available in receive-only, keyboard send-receive and automatic send-receive configurations. Which means all of the reports, forms, and tabular material you generate can be moved *instantly* to all office, plant, warehouse, and sales locations that need the data using a terminal that best fits system requirements. Saving valuable time, and providing more efficient and profitable operation.

**... plug to plug compatibility**

The model 38 is available with several interface options, operating at 10 characters per second (110 baud).

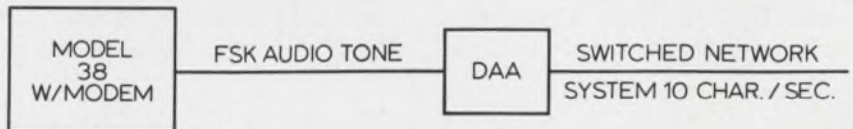

The terminal can be equipped with a built-in modem with simple two-wire, audio tone output which connects directly to the data access arrangement.

# DATA COMMUNICATIONS

equipment for on-line, real-time processing

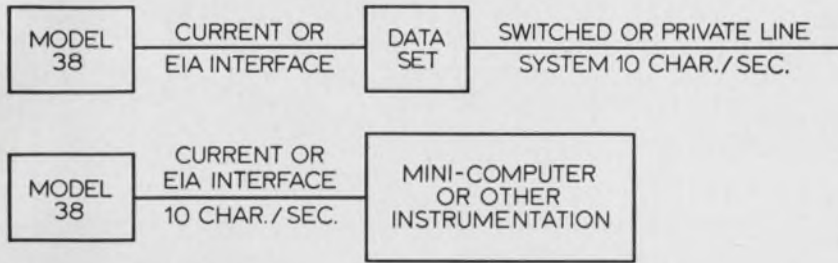

A second interface option is really two options in one. The set is equipped with both a voltage interface that conforms with EIA Standard RS-232-C and a current interface of 20 or 60 ma.

This means you can readily fit the model 38 into just about any switched network, private line or time-sharing system going without special "black box" engineering. Or use it to add maximum input/output capabilities to your mini-computer at a realistic price.

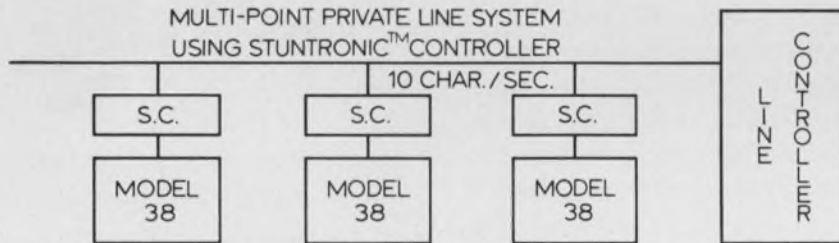

You can even use the model 38 in multi-point "selective calling" systems by adding a Teletype Stuntronic™ station controller.



... automatic send-receive operation up to 2400 words per minute

For systems requiring higher speed capabilities, the model 38 can be used with the Teletype 4210 magnetic tape data terminal. This combination provides on-line speeds up to 240 characters per second. The 4210 uses compact 3" x 3" x 1" magnetic tape cartridges that hold up to 150,000 characters of data. Tape recording, editing, and correction functions are extremely simple.



If you are generating heavy-data loads in a teleprocessing or remote batch processing system, the on-line time saving aspects of this terminal combination are exceptionally dramatic. It is also possible to send or receive data on-line with the model 38 at 100 wpm using the optional built-in modem, if required.



So take a close look at this new wide-platen terminal offering. If you would like more information on the model 38, or any other part of the total line of Teletype data communications equipment, write: Teletype Corporation, 5555 Touhy Ave., Dept. 89-29, Skokie, Illinois 60076.

We would like to be of service.

*machines that make data move*



Teletype is a trademark registered in the U. S. Pat. Office

INFORMATION RETRIEVAL NUMBER 128



# Imagination and Stackpole ferrites can cut a power supply down to size

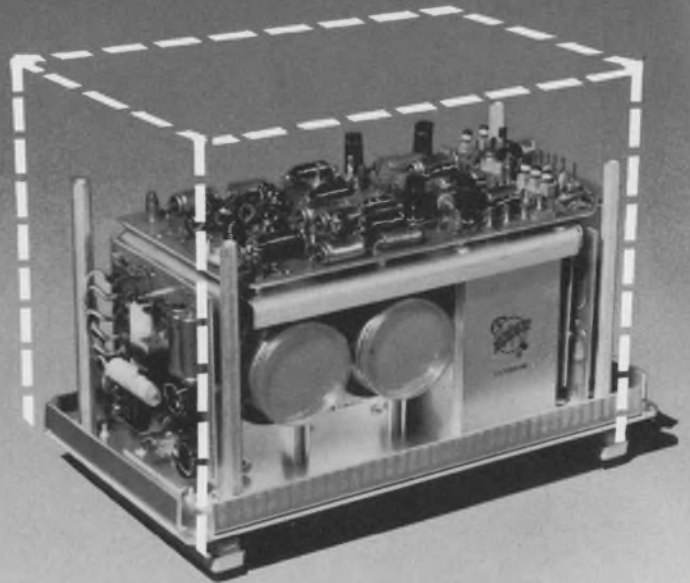

**Tektronix, Inc. uses Ceramag® ferrite materials to achieve efficiency and significant savings.**

Conventional power supplies are bulky, heavy and inefficient. Tektronix, Inc. changed all that. With ferrites and a fresh idea.

By rectifying line voltage, converting it to 25kHz and rectifying it again, Tektronix, Inc. engineers produced a power supply that was 50% lighter, over 25% smaller and consumed 1/3 less power. And the overall operating efficiency of 70% is a big improvement over the 50% typical of conventional power supplies.

Ferrites can offer the unique advantages, design freedoms and electronic characteristics that produce exciting new ideas. Stackpole Ceramag ferrites were used throughout the power supply design. Because Stackpole has a wide variety of materials and configurations, designers can unleash their imaginations.

**Ceramag 24B**



Tektronix, Inc. selected 24B for their "U" and "E" cores. This proven material has seen years of service in flybacks for television. Ideal for power applications, it can be operated at higher frequencies than laminated steel. It is cool running, due to low losses under power conditions and controlled power permeability. Tooling is available for a wide range of "U", "E" and "I" configurations.

**Ceramag 24**



Toroids of Ceramag 24 were used by Tektronix, Inc. for transformer cores. Again, this is a proven material, widely used by the computer industry for pulse transformer cores. It has a tightly controlled initial permeability, and tooling for a variety of sizes is also available.

**Ceramag 7D and 27A**

Multiple material selection for coil forms allowed Tektronix, Inc. maximum flexibility and design freedom. Proper inductance values could be achieved in the allotted amount of room. In addition, the high resistance of 7D



material prevents accidental shorting on printed circuit boards.

Great new designs happen when you start with the idea of ferrites. Particularly Stackpole Ceramag ferrite components. Why? Because Stackpole offers the variety of materials, numerous tooled configurations and the technical back-up you need. Twenty-four years of television and computer experience makes Stackpole one of the largest and most experienced domestic suppliers of quality ferrites.

Consider ferrites on your next prototype or redesign. But give us a call when you start. Perhaps we (and some Ceramag® ferrites) can help you cut a problem down to size. Stackpole Carbon Company, Electronic Components Division, St. Marys, Pa. 15857. Phone: 814-781-8521. TWX: 510-693-4511.



# Ring up a savings on keyboard switches.

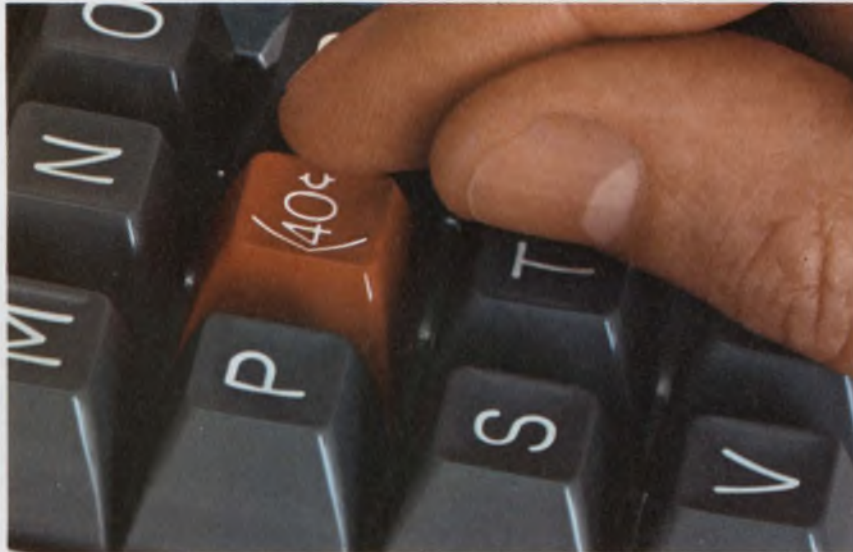

As much as **40%**  
[savings per key]



## The new Oak Series 400.

Get Oak-engineered quality in keyboard switches with the inherent reliability of electro-mechanical operation. Ideal for peripheral data-processing equipment. Contact bounce is less than 3 milliseconds. Long life, up to 20 million operations per key. Designed with self-cleaning crossbar-wiping contacts.



**Under 40¢ each.**

For SPST/NO in production quantities. Other versions comparably priced. Keytop button and snap-in mounting extra.



## A feather touch.

We kept the operator in mind. Standard operating force is approximately 85 grams (3 oz.).



## The configurations you want.

The Series 400 is available in limitless arrangements, including standard 10, 12, and 16-button keyboards. And you can specify any of six different contact circuitries. Choose snap-in or plug-in P.C. mounting. Compact—only 1/2" x 1/2" x 1".

Write today for our Series 400 brochure.

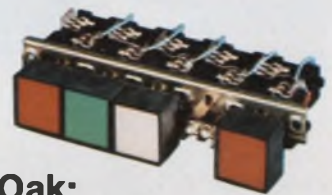

## Also from Oak: Series 300 Lighted Pushbutton Switches.

Featuring Oak's exclusive twin-lamp lighting. If one lamp goes out, the other stays on. Double-wiping contact clips. Short stroke. Smooth, quiet operation. Unlimited combinations. Request our Series 300 brochure.

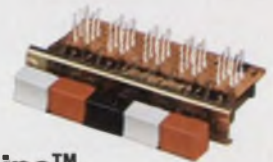

## And our Series 800 Econo-Line™ Pushbutton Switches.

Compact—more buttons and more contacts in less space: 1 PST to 8 PDT per button. Your choice of mechanical actuation. Colored buttons, legend engraving to your specifications. Request our Series 800 brochure.



**OAK MANUFACTURING CO.**

CRYSTAL LAKE, ILLINOIS 60014 • A DIVISION OF OAK ELECTRO/NETICS CORP

Telephone: 815-459-5000

TWX: 910-634-3353

TELEX: 722-447

INFORMATION RETRIEVAL NUMBER 130



## FJCC Products

# Graphics/alphanumerics display terminal costs as low \$3400



*Tektronix, Inc., P. O. Box 500, Beaverton, Ore. Phone: (503) 644-0161. P&A: see text; Nov. 1971.*

For users of computer-display terminals with both graphics and alphanumeric capabilities, Tektronix Inc., introduces a very low-cost business-oriented system.

Called the model 4010 computer display terminal, it costs only \$3950 in single quantities. The price goes down to \$3400 for quantities of 20 or more. The terminal may also be leased for \$200 a month, which includes maintenance service.

The 4010 is a stand-alone storage CRT computer terminal. Alphanumeric input to the computer is via a 33-style keyboard. The graphic input is made by a dual thumbwheel arrangement located on the keyboard. The computer returns information to the 4010 terminal where it is displayed on an 11-in.-diagonal direct-view storage tube.

The output alphanumeric data is in 5-by-7 dot-matrix characters. The CRT screen displays up to 72 characters/line and 35 lines—up to

2500 characters/screen area.

Graphic output data consists of 1024-by-1024 addressable points and 1024-by-780 viewable points. Graphics are drawn into the terminal with a thumbwheel-controlled cross-hair cursor—up to 1020 horizontal-direction and 780 vertical-directional points. Total vector drawing time is only 2.6 ms.

The terminal uses a software system known as PLOT-10 for extensive capabilities in graphing and application-interface routines.

The standard 4010 terminal is arranged in a pedestal configuration. The display section is detachable for desktop installation and it may be located as far as five feet away from the pedestal. The pedestal contains the support circuitry for the display section, the low-voltage power supply, logic storage circuitry, deflection amplifiers and auxiliary board area.

A standard serial data-communications interface—a subset of EIA Standard RS-232-C—plugs into the auxiliary area and comes with the terminal.

An optional interface is available to provide switch-selectable baud rates of 110, 150, 300, 600, 1200, 2400, 4800 and 9600 bits/s. Transmit and receive rates are independent of each other—each switch has two positions. Local-echo and full or half-duplex modes are also switch-selectable.

Additional interfaces are available for TTY ports for such popular minicomputers as DEC's PDP-8, 8E, 9, 11, 12 and 15, Data General's Nova and SuperNova, Hewlett-Packard's 2114, 2116 and 2100A, Varian's 620I, F, L and R, Honeywell's H316, and DDP516, Interdata's 3 and 4 and Raytheon's 703 and 706.

The new 4010 terminal is also completely compatible with over 20 timesharing systems and IBM 360/370 computer systems.

*Booth No. 2602      Circle No. 295*



**A new low-cost CRT terminal with both graphics and alphanumeric capabilities comes in a pedestal configuration. Its top display section can be detached for desktop viewing.**



# GOODBYE SOLID STATE.

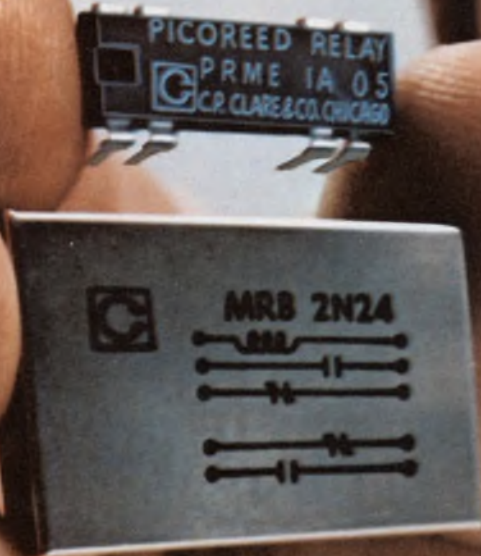

## Hello better switching alternatives.

Have problems achieving isolation at reasonable cost?

Does your logic have to communicate to a noisy outside world?

Have an interface problem requiring complex interconnection and the capability of handling a wide range of signal levels in a bilateral mode?

No need to attempt a complicated solid-state design. Clare's complete line of reed relays solve these problems economically and reliably!

The classic interface between computer-controlled, automated test equipment and a module under test is accomplished easiest with a reed relay matrix. Reeds can switch signal and power levels simultaneously, with bandwidth from dc to MHz.

Open signal-path capacitance less than 0.1 pF, with 4-terminal control-to-signal-path isolation, have made reeds ideal for communication matrixing through RF. Multiplex common mode isolation is a normal characteristic of reed relays.

### THREE TYPES

The Picoreed® is available in a standard TO-116 DIP package called the PRME, or a 0.7" x 0.1" grid-pattern relay called the PRB providing from one to six contacts. Both mount on 0.375" PCB centers.

Clare's MicroClareed® MRB 1.0" x 0.1" grid is an economical relay with U.L. recognition. It provides 10 watt switching capability, mounts on 0.5" PCB centers and is available with one to five contacts.

Clareed® CRU relays offer power handling to 15 watts, low millisecond switching speed, up to twelve contacts and U.L. recognition. Like *all* Clare reed relays, they're immune to false operation and insensitive to overload transients that affect solid state devices.

### RELIABLE

Clare reed relays are rated for millions of operations, because we make every part ourselves . . .

including the hermetically sealed capsules! We manufacture our reed capsules on automated machines in a white-room environment, and we inspect every capsule for physical and electrical characteristics.

### FAST DELIVERY

Clare standard reed relays are available from stock through our national distributor network. And, if you can't find what you need on the shelf, Clare can come up with a design for your requirements.

For more information on our reed relays than you could cover at one coffee break, write C. P. Clare and Company, 3101 Pratt Avenue, Chicago, Illinois 60645.



a GENERAL INSTRUMENT company



# Ultra-fast 16-bit computer has 300-ns operating speed



*Digital Equipment Corp., 148 Main St., Maynard, Mass. Phone: (617) 897-5111. P&A: see text; 1972.*

Newest addition to the DEC PDP family of computers is a powerful new 16-bit model known as the PDP-11/45. Seven times faster than its predecessor PDP-11/20, it features an operating speed for its central processor unit of 300 ns (register-to-register instructions).

Because it allows a mixture of three types of memories—bipolar, MOS and core—its users can mix and match memories to suit their requirements up to a maximum memory capacity of 124k words.

For example, 8k words of bipolar memory can be mixed with 116k words of core; or 32k words of MOS with 92k words of core.

Designed for scientific-computation and environmental-simulation applications, the computer includes standard hardware multiply and divide functions.

The entire range of data types (bit, byte, word and multiple-word) can easily be handled by the multiply and divide integer instruction set. A complete set of conditional branches and condition codes provide the hardware to handle both signed and unsigned integers.

A multi-base architecture for the PDP-11/45 includes not only a standard Unibus data bus but also

a second Unibus and a dedicated high-speed data path. This path connects the dual-port semiconductor memory system to the central processor unit. Because communications between the central processor and the solid-state memory involves one of two controls, the second is free to handle external data requests to 40 megabit/s.

Seven levels of priority interrupts—four for hardware or software and an extra three for software only—and a second set of general-purpose registers enhance the computer's versatility. The second set of registers reduce interrupt service times by as much as 50% and protect executive registers during multi-programming.

A memory segmentation unit is available to provide a mechanism by which a system supervisory program can control allocation of active storage in time-sharing situations through a set of relocation and protection registers.

Hardware floating-point units are available as options to allow the user to use such languages as BASIC and FORTRAN. Other options include byte parity and power-retention systems.

Depending on complexity, the PDP-11/45 ranges in costs from \$15,000 to \$100,000.

*Booth No. 2001 Circle No. 294*

## MOS RAM of 73 kbits is housed on a PC card

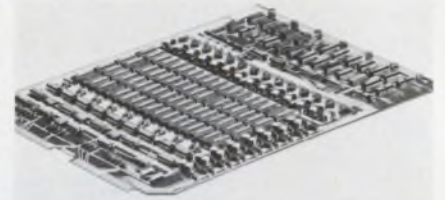

*Signal Galaxies, Inc., 6955 Hayvenhurst Ave., Van Nuys, Calif. Phone: (213) 988-1570. P&A: 2.5¢/bit; 30 days.*

A complete 72-chip MOS RAM memory card contains 73,728 bits of memory and all the electronics for address and data registers, refresh and timing controls. The SG418 card is available in bit/word configurations of 4096 by 18, 4096 by 16, 8192 by 9 and 8192 by 8. Full cycle time is 650 ns and maximum access time is 500 ns. The memory can also operate in a split-cycle (read-then-write) mode. *Booth No. 1613 Circle No. 252*

## Universal tape reader handles most tapes



*Kennedy Co., 127 N. Madison Ave., Pasadena, Calif. Phone: (213) 798-0953. P&A: \$8300; 45 to 60 days.*

Model 8197 universal tape reader is a read-only system for offline operations capable of reading any IBM-compatible tape—9-track 800/1600 characters/in. or 7-track 200/556/800 characters/in., NRZI or phase encoded. All outputs of the model 8197 are de-skewed and buffered and all recording densities are switch-selectable.

*Booth No. 1603 Circle No. 289*





# Bodine helps data devices tell it like it is...

Bodine fractional horsepower drives. Small. Quiet. A complete line designed to power information-handling devices precisely, accurately, dependably. Motors built with all the integrity you've designed into your product—that deliver as specified with fewer callbacks and service problems. If this is the kind of power you're looking for, you'll find no better source.

Over 3,500 standard specifications to choose from. Bodine also builds custom fhp motors to meet design requirements. Our engineers will be happy to help you pinpoint the right one for your particular application need. Computers, business machines, instrumentation, copiers—whatever your product, specify Bodine fhp drives. We've been the power behind the leading products for some 63 years. Write for bulletin. Bodine Electric Company, 2500 W. Bradley Place, Chicago, Illinois 60618.



*Bodine Motors Wear Out—It Just Takes Longer*

**BODINE MOTORS/CONTROLS**

Ask about Bodine SCR motor speed controls



A year ago we introduced 7 new JCM miniature RF coaxial connectors that "do the job for a fraction of SMA prices."

Here, by popular demand, are 8 more.



If you don't require all the electrical performance built into SMA type connectors, why pay for it? Up to 3 GHz for flexible cable assembly and even beyond 6 GHz for semi-rigid assembly, our new JCM series gives you the same electrical performance as the far more expensive SMA types. The series includes connectors for both panel and PC mounting. All are interchangeable and intermateable with the standard, expensive SMA connectors. So you can use them without making any changes . . . and without compromising required performance. There are JCM connectors to accept virtually any miniature size cable, so you don't have to stock a big variety. It's worth looking into, isn't it? All it costs is a stamp.

E. F. JOHNSON COMPANY / Waseca, Minnesota 56093

Dept. ED-11

Please check for technical information or test samples of our new low-cost series 142-0200-001 JCM connectors.

- Please send technical information.  
 I desire test samples. Please call me at \_\_\_\_\_

NAME \_\_\_\_\_

FIRM \_\_\_\_\_

TITLE \_\_\_\_\_

ADDRESS \_\_\_\_\_

CITY \_\_\_\_\_

STATE \_\_\_\_\_

ZIP \_\_\_\_\_



**E. F. JOHNSON COMPANY**

INFORMATION RETRIEVAL NUMBER 133

## FJCC PRODUCTS

### Two-color 14-in. CRT displays 2k characters



GTE Sylvania, Inc., 100 First Ave., Waltham, Mass. Phone: (617) 893-9200. P&A: \$20 (100 quantities) 8 wks.

A new 14-in. two-color high-resolution shadow-mask CRT provides more than 118 square inches of viewable screen area with resolution far superior to standard three-color home-entertainment tubes. The 14VSP-5110 displays 80 characters/line of alphanumeric data legibly across the width of the screen. 2000 or more characters can be displayed at once.

Booth No. 1704 Circle No. 258

### Three recording heads serve computer OEMS

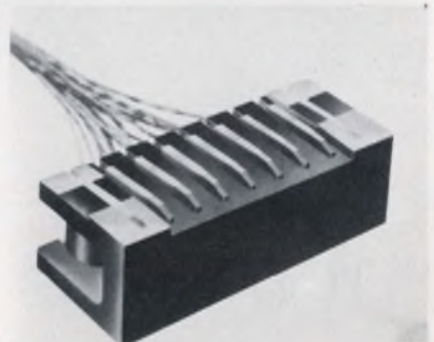

Lipps Inc., 1630 Euclid St., Santa Monica, Calif. Phone: (213) EX3-0449. P&A: see text; 3 to 4 wks.

Three new recording heads are available to serve the computer OEM market. A 9-channel flying disc head assembly using high-density barium-titanate pads is available and costs \$6/track. Another is a magnetic drum single-channel head that is priced at \$7. The third head is an IBM-compatible dual-gap digital tape head costing \$247.

Booth No. 1101 Circle No. 282



# Centralab offers immediate delivery on functional modules

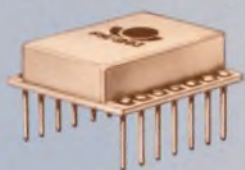

Centralab, the industry leader in thick film microcircuitry, now has combined its recent advances in packaging and chip hybrid technology to bring you five new functional modules available for immediate delivery from stock. These modules are sealed in ceramic packages with 14 swaged terminal pins universally spaced .600" row-to-row and .100" apart to facilitate printed circuit board mounting.

Module	Function	Rating	Suggested Applications
FM-1110	Power driver	1 amp @ 60v steady state	Interfacing with relay/solenoid coils, magnetic cores, lamps, etc. in computers, control consoles, test equipment, digital systems, etc.
FM-1203	Dual driver	300 ma @ 28v steady state	
FM-1403	Quad driver	300 ma @ 28v steady state	
FM-2100	MOS clock driver	200 ma with up to 30v shifts	To drive all popular MOS circuitry in calculators, computers and other digital systems.
FM-3110	Programmable multivibrator	Output pulse widths 200 ns to 12 $\mu$ s	Delay, timing and pulse shaping in computers, control circuits, test equipment and other digital systems.
*FM-4110	RC clock oscillator	500 kHz to 6 MHz	Time base, square wave generators and tone signalling controls for computers, test equipment, etc.
*FM-5110	Overvoltage crowbar	Trip voltage 4.5 to 12.5v, < 1 $\mu$ sec response	To protect voltage sensitive devices such as IC's, MOS devices, etc.
*FM-5111	Overvoltage crowbar	Trip voltage 12.5 to 20.5v, < 1 $\mu$ sec response	
*FM-5120	Electronic fuse	Trip current 1 amp @ 40v, < 1 $\mu$ sec response	DC electronic equipment and systems where precise, fast current disconnect is required.
*FM-6110	Power operational amplifier	250 ma peak output current with supply voltages $\pm$ 15 vdc	Servo systems, test equipment, power supplies, etc.

## DESCRIPTION

**FM-1110, 1203, 1403: Single, dual and quad drivers**  
Designed to accept standard DTL and TTL logic levels and to drive loads which require high power. Consist of single or multiple NAND/NOR gates and high gain amplifiers.

**FM-2100: MOS clock driver**  
Designed to accept standard DTL and TTL logic levels and universally drive MOS circuitry. Consists of a three input AND function followed by a power inverter.

**FM-3110: Programmable monostable multivibrator**  
A flip-flop which, when triggered by an input pulse, generates an output pulse of prescribed width, with control through interconnection of appropriate package pins.

**\*FM-4110: RC clock oscillator**  
An RC astable multivibrator and an output buffer stage capable of providing a square wave output at a predetermined fixed frequency. It can operate down to 5 Hz with the addition of external capacitors.

**\*FM-5110, 5111: Overvoltage crowbar**  
A high speed electronic voltage sensing element and switch designed to protect voltage sensitive electronic devices by shunting out the supply voltage when high transients or other overvoltage conditions are experienced on the supply line.

**\*FM-5120: Electronic fuse**  
The electronic equivalent of a fuse which features accurate threshold levels, high speed and reset capabilities. Available in a variety of current threshold levels.

**\*FM-6110: Power operational amplifier**  
An operational amplifier designed to provide output capabilities far beyond those obtainable with equivalent monolithic IC's.

**\*These modules are scheduled for introduction in 1971.**

We welcome inquiries on any variation of the above modules and can provide rapid turnaround on samples and production quantities of custom modules. For design assistance or other information, write Sales Manager, Microcircuits, Centralab. Standard modules are also available through Centralab Distributors.



**CENTRALAB**

Electronics Division  
GLOBE-UNION INC.

5757 NORTH GREEN BAY AVENUE  
MILWAUKEE, WISCONSIN 53201

M-7115



# 20% - 30%

## MORE PERFORMANCE IN STANDARD BRIDGE PACKAGES

The packages are standard size. It's the current ratings and forward surge ratings that are larger. They give you added performance reliability—and at no additional cost!



**B-10 series**

DC rating — 30A @ 55°C.  
Forward surge rating—400A @ rated load. B-10 series replace similar bridges rated from 8 to 25A and from 50 to 1,000 PRV per leg.



**B-20 series**

DC rating — 35A @ 55°C.  
Forward surge rating—400A @ rated load. B-20 series replace similar bridges rated up to 25A and from 50 to 1,000 PRV per leg.

### SILICON POWER RECTIFIERS

**Tung-Sol makes a complete line of high reliability silicon power rectifiers in the DO-4, 5, 8, 9 and 21 configurations.**

WRITE FOR TECHNICAL INFORMATION.  
SPECIFY BRIDGES, OR POWER RECTIFIERS.

SILICON PRODUCTS SECTION  
**TUNG-SOL DIVISION**  
**WAGNER ELECTRIC CORPORATION**

630 West Mt Pleasant Ave. Livingston, N.J. 07039  
TWX: 710-994-4865 PHONE: (201) 992-1100  
(212) 732-5426

Trademark TUNG-SOL Reg. U. S. Pat. Off. and  
Marcas Registradas

### FJCC PRODUCTS

## Cassette tape controller is EIA/TTY compatible

*Sykes Datatronics, Inc., 375 Orchard St., Rochester, N. Y. Phone: (716) 458-8000. P&A: under \$1500; 90 days.*

A new cassette tape controller is designed to interface one or two Sykes model TT120 transports to a variety of interfaces in a modular fashion. Both the EIA (RS232C) compatible and TTY current-loop interfaces are standard, with other optional interfaces available. When used in conjunction with the EIA-compatible interface, the controller allows the system to receive data from a modem or terminal and write the information on tape. Or it can read from tape and transmit the data to a terminal or modem. The unit is plug-to-plug compatible with all EIA-compatible terminals and modems within 110, 150, 300, 600, 1200, 2000 or 2400 switch-selectable baud rates. When used in conjunction with the TTY current-loop interface, the system is capable of accepting data asynchronously from a teletype, clocking the data and writing it on tape. The unit can then read the batched data and transmit it to an EIA-compatible modem. Features include code-independent operation, variable-length records, simultaneous operations on both transports, high-speed rewind/search and asynchronous or synchronous operation. *Booth No. 1508 Circle No. 291*

## Optional built-in modems complement Teletypes

*Teletype Corp., 5555 Touhy Ave., Skokie, Ill. Phone: (312) 982-3133. P&A: \$200; 3rd quarter, 1971.*

Optional built-in manual originate answer modems are available with lower-speed 33, 35 and 38 (wide-platen) Teletype terminals. The new modems are compatible with the Bell System's 101, 103 and 113 data sets. No extra power supplies, wiring or hardware are necessary as each modem is built into each terminal at Teletype's plant. *Booth No. 1544 Circle No. 262*



## UL Recognized RFI/EMI Filters for Data Processing Equipment

RtroN has developed 14 stock filter types (U.L. specification 478), for the RFI/EMI suppression requirements of data processing equipment. Terminal and bracket variations cover virtually every mounting need.

Custom designed multi-circuit RFI/EMI Filters in square, rectangular, bathtub and other enclosures are available.

Whatever your filtering needs may be, RtroN can design, produce, and deliver high reliability filters on time.

Phone or write for complete details.

**RtroN**  
P.O. Box 743, Skokie, Ill. 60076  
312 • 327-4020



If you need more accuracy and resolution than a 2½-digit V-O-M, but don't want to pay the price of 3½-digits ...

Buy Triplet's new 6028

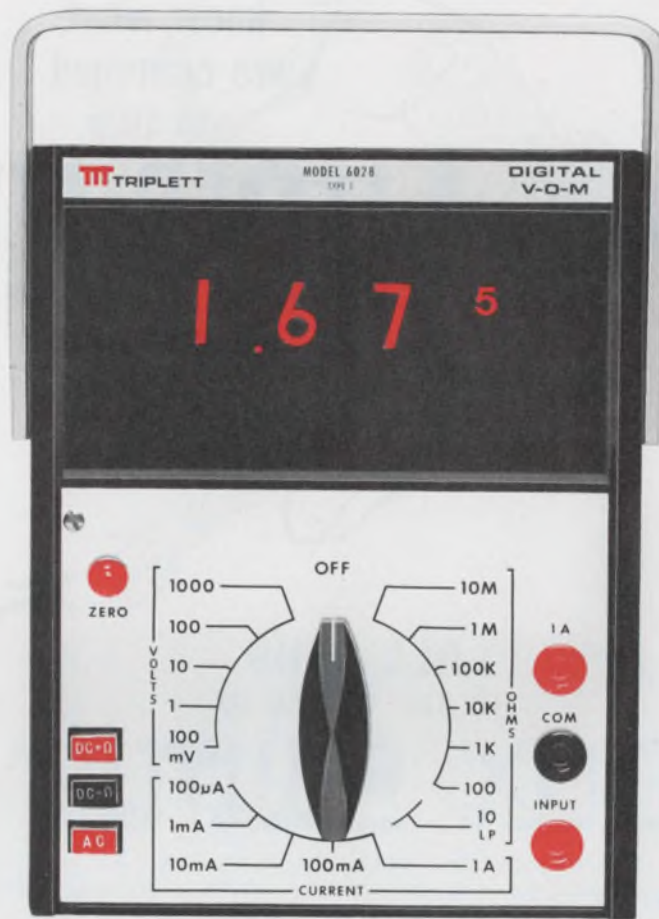

Model 6028 \$275

1. 2¾ DIGITS— Provides high accuracy with resolution to 500 Microvolts.
2. 10 OHMS TO 10 MEGOHMS — 7 Ohms ranges with zero adjust to null lead resistance.
3. LOW CIRCUIT LOADING — Greater measurement accuracy with 10 megohm input resistance for all AC and DC voltage ranges.

Its exclusive 2¾ digit readout lets you read to the nearest "0" or "5" one decimal place beyond the capability of 2½ digit instruments. And at accuracies of  $\pm 0.35\%$  of reading  $\pm 1/2$  digit on DC voltage ( $\pm 0.50\%$  of reading  $\pm 1/2$  digit, DC current), AC voltage  $\pm 0.50\%$  (current 1.0%) of reading  $\pm 1/2$  digit, and resistance to  $\pm 0.5\%$  of reading  $\pm 1/2$  digit. It also offers (among its 27 ranges) a 10

Ohm range and a front-panel zero adjust to zero out the test-lead resistance. Add to those advantages 100% overrange capability, positive out-of-range and reverse polarity indication, and the familiar single range-switch feature of Triplet's famous analog V-O-M'S . . . so that no retraining is necessary to switch to digital accuracy and readability . . . and you have just a few of the many reasons for

buying Triplet's new Model 6028 Digital V-O-M.

Designed for R&D, production, quality control, maintenance and classroom use, the Model 6028 is priced at \$275. See it at your local Triplet distributor or, for more information or for a free demonstration of all of its great features, call him or your Triplet representative. Triplet Corporation, Bluffton, Ohio 45817.

**TRIPLET**

BLUFFTON, OHIO 45817

The World's most complete line of V-O-M's choose the one that's just right for you





ALL THIS  
IN THE SERIES BX  
**BOX SWITCH**

- **UP TO 4 POLES OF SWITCHING**  
1-A, 1-C, 2-C & 2-A in this MOMENTARY ACTION pushbutton Switch (or D, F or G contact forms on special order).
- **INTEGRAL SLIDE CONTACTS**  
Silver-plated spring-tempered phosphor bronze contacts rated 250 ma., 30 watts max., A.C. non-inductive load.
- **ADJUSTO-CLIP® PUSH-IN MOUNTING**  
Instantly adjustable clips for front-of-panel "snap-lock" mounting; for panels 3/64" to 17/64" thick.
- **BEST LOOKING BEZEL IN THE BUSINESS**  
Low silhouette bezel pleasingly frames switch button; acts as an attractive escutcheon plate.
- **SUPER SPACE SAVING SIZE**  
Mounts in matrixes on 11/16" centers in either of two planes. Takes only 1 3/8" behind panel depth.
- **CYBERNETICALLY DESIGNED BUTTONS**  
Handsome finger-fitted concave design: choice of white, black, red, green — other colors and/or identifying legends on special order. 7/64" button stroke.
- **MOLDED BODY ENCLOSES CONTACTS**  
Protects against dust and dirt . . . prevents bending or disfiguring contacts caused by excessive handling. Terminal identification molded into case.
- **AND INCOMPARABLE QUALITY, TOO!**  
Built with the very finest materials manufactured in perfectly matched molds . . . with the "solid" feeling action you expect only from the most precisely engineered switches! Ideal for computers, data processors, telephones and telephone equipment, etc. \* Patent applied for

WRITE FOR BULLETIN 169



5529 N. Elston Avenue Chicago, Illinois 60630

INFORMATION RETRIEVAL NUMBER 138

FJCC PRODUCTS

**Nondestructive memory is infinitely alterable**

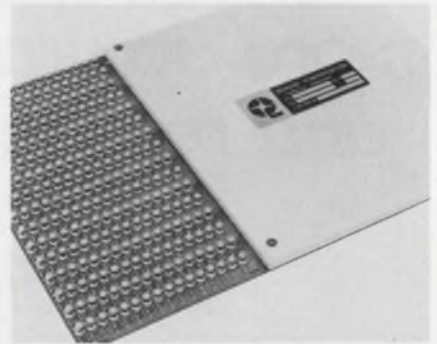

Quadri Corp., 2950 W. Fairmont, Phoenix, Ariz. Phone: (602) 263-9555. P&A: from 5¢/bit; 8 wks.

A new electrically alterable non-destructive read-out memory known as the EANDRO utilizes a low-threshold square-loop core arrayed in a 2-core/bit mode and features infinite alterability. The writing function is accomplished by coincident current selection of the desired cores. A linear high-speed mode is used for the nondestructive read-out operation. The memory stack is a plug-in type.

Booth No. 1648 Circle No. 281

**Low-cost storage system replaces two 2314s**

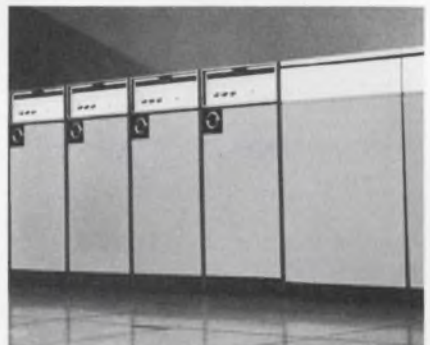

Marshall Data Systems, 2065 Huntington Dr., San Marino, Calif. Phone: (213) 684-1530. Price: \$5545/month (includes controller with 9 drives).

The M2900 dual-density direct-access system features large storage capability of 466 million 8-bit bytes and small space requirement of 150 square feet. It can start and stop in 24 s. A plug-for-plug replacement for the IBM 2314, it can offer the data-storage equivalent of two IBM 2314 systems.

Booth No. 1105 Circle No. 266





# Good as gold.

Burndy has developed, for a substrate chip manufacturer, a printed circuit connector with contacts that are tin-plated over nickel. For a non-critical, low-voltage application such as a desk top calculator, tin is as good as gold, and costs considerably less.

Conversely, for a computer manufacturer, Burndy clad the springs with an unusually thick gold coating of .000500". Yet the price was held down by keeping the concentration only at point of contact.

A two-piece PC connector solved shock and vibration problems in another sophisticated airborne computer. One piece is fastened by

dip solder, the other by wire wrap effecting a firm, precise mating and a connection of highest reliability.

Whatever your needs—or your problems—Burndy can advise you. And with the greatest objectivity. Ours is the broadest line of printed circuit connectors made—with every type of termination: crimp, wire wrap and solder. And we can give you delivery as fast as you need it.

So come to Burndy right at the outset. We can make your designing job easier, and your product more reliable.

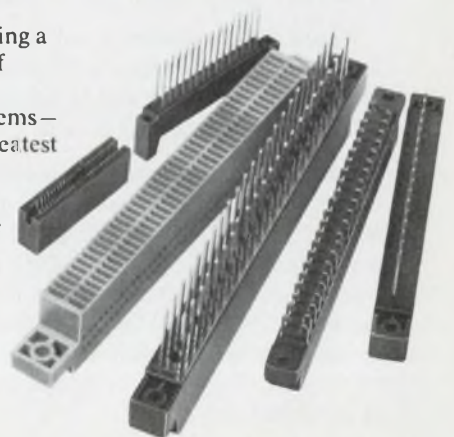

 **BURNDY**  
Norwalk, Connecticut 06856



# Kurz-Kasch Digital Logic Instruments\*



See the  
all new G-S-M  
options

... complete logic systems analysis through the logic-probe concept

Rugged, all solid-state, Kurz-Kasch logic probes are designed for fast, accurate testing of logic levels in all types of integrated circuit systems. A simple readout system indicates "true", "zero", or "pulse" readings precisely through color-coded visual electronic readouts in the probe tip. Absence of logic levels is indicated by all readouts remaining OFF.

**Applications** Logic levels can be accurately tested in virtually any (DTL, TTL, RTL) IC system including desk calculators, business machines, N/C devices, computers or telephone systems. Power is derived from the unit under test allowing use in the field or in the lab.

<b>Specifications</b>	High input impedance prevents loading of circuit under test.
Readout Light Red=Logic "1"	Size $\frac{5}{16}$ " dia., 6" long, 26 $\frac{3}{4}$ " leads with pin terminals
Readout Light White=Logic "0"	
No Readout Light="infinity"	

A pulse detection feature is available on most models of logic probe. A third readout is provided to display high speed pulse trains or a single cycle pulse of less than 50 nanoseconds on the standard Model LP-520. Overload protection to +50, -20 volts DC is also available.

**Standard Probes** Logic probes are presently available in five standard models. MODEL LP-500 for use in testing 4.75-5.0 V DC logic systems. MODEL LP-510 for testing 4.75-5.0 V DC systems . . . includes overload protection to +50, -20 V DC. MODEL LP-520 . . . for 4.75-5.0 V DC logic systems . . . includes overload protection and pulse detection features. MODEL LP-530 for testing of 12-15 V DC logic systems . . . includes overload protection to +50, -20 V DC. MODEL LP-540 . . . for 12-15 V DC systems . . . includes overload protection and pulse detection features.

**Kurz-Kasch shrinks square wave generator to logic probe size** Model LG-580 is a new shirt pocket size, all solid-state logic (square wave) generator for trouble-shooting, testing, or inspection of digital circuitry. Use it to . . . set flip-flops . . . run counters . . . perform clock functions. A unique one-shot mode plus 100 Hz, 1 K Hz, 100 K Hz, and 1 M Hz signals are injected through the probe tip. The Model LG-580 is power lead reversal protected and is priced at \$79.95. The Model LG-580 is for all 4.75-5 V DC systems. Also available is Model LG-581, same as Model LG-580 above, except for use with 12-15 V DC systems —\$89.95.

**Special Probes** As a routine service, Kurz-Kasch will custom design logic probes to user specifications. Custom designs can include: both positive and negative logic levels from 50 to 30 volts . . . special pulse detection characteristics . . . floating or grounded cases . . . custom power supply requirements . . . power lead reversal protection . . . and your choice of logic crossover parameters.

Kurz-Kasch logic probes provide all the information you need to quickly and accurately evaluate all logic systems . . . and they are the most economical logic testing instruments available. Standard Models range in price from \$39.95 to \$69.95. Write today for complete details on all standard and special logic probes.

\*Patent #3,525,939 applies, others pending.



**Kurz-Kasch, Inc.**

Electronics Division  
1421 S. Broadway  
Dayton, Ohio 45401  
Telephone(513)223-8161





## 3 new options for Kurz-Kasch logic probes\*

### LOOK AT THESE NEW FEATURES

**Basic Model LP-520** — Provides the color coded (red, white & blue) visual readout system at the probe tip that indicates logic "1", "0" and "pulse" (50 nano-seconds or greater) conditions in any 5v digital logic system. Absence of logic levels is indicated by all readouts remaining off. The Model LP-520 is priced at \$69.95.

**ADD THESE FEATURES: G-S-M Gating Feature(-G)** — Pulse indicator displays only when probe tip and gate/gates inputs are in coincidence. (see diagram above.) Example: **A.** Gate 1 input **B.** Probe tip input; pulse indicator displays. Moving probe tip to **C.** pulse indicator does not display. Add \$10.00 and suffix G.

**Memory & Stretch(-M)** — Push-Pull switch for selecting stretch or latch mode. Stretch mode detects high speed pulse and displays blue "P" lamp for 200 mS. Latch mode captures high speed pulse/trains and latches blue "P" display on until reset. Add \$10.00 and suffix M.

**5 Nano-Second Capability(-S)** — This allows detection of pulses up to 10 x faster than standard probes. Add \$10.00 and suffix S.

**Free Trial Offer** — Keep abreast of the state of the art. Kurz-Kasch offers a 15 day free trial period. Select the Kurz-Kasch logic probe model above (or any combination of features) that fit your requirements. At the end of 15 days, you may return the probe, or, send us your check. All the features you ever needed for testing digital logic now available in one economical probe unit; 3 input channels, 5 nano-second pulse width detection, pulse latching.

Kurz-Kasch offers a complete line of digital logic testing instruments. Want to talk about your instrumentation requirements? Call Tom Barth, or Dick Pitner, now, at (513) 223-8161.

\*Patent #3,525,939 applies, others pending



**Kurz-Kasch, Inc.**

Electronics Division  
1421 S. Broadway  
Dayton, Ohio 45401  
Telephone(513)223-8161

INFORMATION RETRIEVAL NUMBER 141

ELECTRONIC DESIGN 23, November 11, 1971

### FJCC PRODUCTS

## Computerized system tests core planes



*E-H Research Laboratories, Inc., Box 1289, Oakland, Calif. Phone: (415) 834-3030. P&A: approx. \$130,000 (with computer controller); 30 days.*

Model 8400 core memory test system offers the high-speed testing rate and economy of hard-wired systems with the versatility of a rapid, accurate and repeatable plane or stack set up, coupled with online data acquisition and manipulation of a computer-controlled tester. It measures and displays drive-current waveforms into the device under test.

Booth No. 1007 Circle No. 257

## Rack-mount MOS RAM provides 147,456 bits

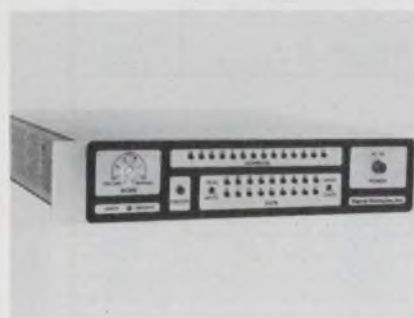

*Signal Galaxies, Inc., 6955 Hayvenhurst, Van Nuys, Calif. Phone: (213) 988-1570. P&A: from \$2209; 45 days.*

A low-cost MOS memory system provides up to 147,456 bits of random-access memory, an optional memory tester card, a test panel and a power supply in a compact chassis which occupies only 3-1/2 in. of rack height. The memory tester allows the optional card to be used to convert the memory into a special-purpose controller or a minicomputer.

Booth No. 1609 Circle No. 290

# NEW

## from BULOVA...

### DC Servo Amps 2.5w to 2,500w

Here's a line of servo amps packaged for flexibility and priced for system saving. It's another example of Bulova's unique capability in producing quality servo products at a price lower than you can make or buy.

Available from 2.5 w to 2.5 Kw —  
Styled in flat pack, modular or  
rack mount — to meet industrial  
or mil-spec — able to operate from  
AC or DC — to include power supply  
when required.

#### FEATURES:

- Adjustable Gain
- Current Limiting
- Voltage or Current Feedback
- Wide Bandwidth
- Low Cost



DCA Series

#### DESIGNED TO DRIVE:

- DC Torque Motors
- Low Inertia Motors
- DC Servo Motors
- Servo Valves
- Deflection Coils

DCAR Series



Don't miss out on this Bulova Servo Special. For new applications or old . . . for help in planning new servo systems . . . for the lowest price on DC Servo Amps . . . Look to Bulova!

Call (212) 335-6000, or write —



**BULOVA**  
SERVO  
PRODUCTS

Electronic Division of Bulova Watch Company, Inc.  
61-20 Woodside Avenue  
Woodside, N. Y. 11377

(212) 335-6000

Bulova also offers a complete line of AC servo products, including servo amplifiers, modulators and demodulators, plus a line of power supplies.

INFORMATION RETRIEVAL NUMBER 142

C41



# NEW VACTEC VACTROLS

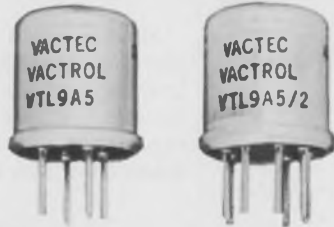

## GENERAL PURPOSE PHOTON ISOLATORS

Both single and dual cell units are available in combinations with incandescent or neon lamps in a low cost aluminum case.

New Vactec Vactrols provide a wide range of control in the on-off mode or in proportional control circuits. Applications include photochoppers, DC isolators, noiseless switching, automatic gain controls, audio limiting and compression, SCR and Triac firing, audio effects, computer interfacing, and others.

## MAXIMUM RATINGS

Maximum case dissipation (5)	400 mW — derate 10 mW/°C above 35°C — case
Maximum cell power	200 mW — derate 4 mW/°C above 25°C — case
Isolation voltage	500V
Thermal resistance — case to ambient	40°C/W
Ambient temperature	-40°C to + 75°C

## SPECIFICATIONS @ 25°C

Part Number	LAMP		PHOTOCELL RESISTANCE — OHMS (3)		Cell Volts (max)
	Volts	mA	ON	OFF	
			Light Adapted (max)	(min)	
<b>INCANDESCENT TYPES</b>					
VTL9A1	1.5	50	400	10 <sup>7</sup>	100
VTL9A2	6.0	40	60	10 <sup>7</sup>	100
VTL9A3	10	14	250	10 <sup>7</sup>	100
VTL9A4	10	22	300	10 <sup>7</sup>	100
VTL9A5	10	22	1500	10 <sup>7</sup>	200
VTL9A9	6.0	40	200	10 <sup>7</sup>	300
VTL9A10	10	14	800	10 <sup>7</sup>	300
VTL9A11	12	25	600	10 <sup>7</sup>	300
<b>NEON TYPES EXTERNAL RESISTOR REQUIRED</b>					
VTL9B6	125 VDC*	1.5	300	10 <sup>6</sup>	200
VTL9B7	125 VDC*	1.5	800	10 <sup>7</sup>	300
VTL9B8	80 VDC*	.3	2000	10 <sup>7</sup>	300

\*Breakdown V.

For complete details and specifications, write for new Bulletin VTL 9 today!

Vactec manufactures a complete line of hermetic Vactrols with LED's or standard lamps. ALL Vactec production, including Vactrols, CdS & CdSe cells, and photovoltaic cells is confined entirely within the United States. Advanced mechanized techniques provide highest quality at prices competitive with other manufacturers anywhere in the world.

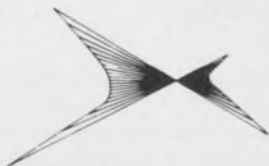

## VACTEC, INC.

2423 Northline Ind. Blvd.  
Maryland Heights, Mo. 63043  
Phone (314) 872-8300

INFORMATION RETRIEVAL NUMBER 143

## FJCC PRODUCTS

### Multi-speed multiplexer sends synchronous data



Codex Corp., 15 Riverdale Ave., Newton, Mass. Phone: (617) 969-0600. P&A: from \$2000; 30 days.

The 880 multiplexer is designed specifically to multiplex multiple synchronous data speeds for transmission on a single communications channel such as that provided by a Codex high-speed modem or an AT&T modem of the 203 and 303 equivalent class. This multiplexer permits channels to be created by the user under the provisions of recent changes to the wideband tariffs.

Booth No. 1128 Circle No. 267

### Talking test set checks data line



International Communications Corp., 7620 N. W. 36th Ave., Miami, Fla. Phone: (305) 691-1220.

Model 220 data transmission test set offers an easy method to isolate problems in all types of data communication systems. It has an audible line monitor which allows the user to hear normal and changing line or data conditions. The test set also shows bit or block error counts on an LED display which eliminates the need for clock watching and calculations to determine error rate.

Booth No. 2404 Circle No. 276



# GENERAL PURPOSE

## BABCOCK RELAYS... A Broad Line for PC Board or Chassis, Dry Circuit to 20 Amps.



### PC Board Subminiature Relays

Ultra low profile with a new flat magnetic system, high sensitivity and a life span to 300,000,000 operations make the Series NF relay unique in application potential. Rated at 2 amps, these DPDT and 4PDT units will switch 6, 12, 24, 48 and 60 VDC, with a (DPDT) pull-in of only 150 MW.

Series HT and HM miniature, open frame, SPDT relays are offered with 2 to 5 amp. ratings. These units feature high sensitivity and long life, and will switch 3, 6, 9, 12, 18, 24, 35, 42 and 60 VDC.

*For more information, circle No. 215.*



### Miniature Relays

A novel "lift-off" card-operated contact system on the Series K relay results in higher speed, with minimal bounce or chatter. UL Recognized, the unit is rated at 2, 3 and 5 amps, in 2, 4 and 6-pole versions, for switching 3, 6, 12, 24, 36, 48, 60 and 115 VDC, and 6 to 220 VAC. Other miniature industrial models, also interchangeable with comparable types, are available in 1, 2 and 4-pole configurations, with ratings of 3, 5 and 7 amps, and voltages of 6 to 110 VDC and 6 to 240 VAC.

*For more information, circle No. 216.*



### AC/DC Power Relays

New Babcock Series HP 10 amp. relays are offered in 2, 3 and 4-pole configurations for use in ac and dc control systems. These units are UL Recognized and are interchangeable with comparable types. They will switch 6, 12, 24, 48 and 110 VDC, and 6, 12, 24, 48, 115, 220 and 240 VAC.

*For more information, circle No. 217.*

Detail technical data on the complete line of Babcock relays is available by writing or calling Babcock Control Products, Babcock Electronics Corp., Subs. of Esterline Corp., 3501 No. Harbor Blvd., Costa Mesa, Calif. 92626; Tel: (714) 540-1234.



### AC Power Relays

Large capacity, compact size and long life are features of UL Recognized Series HG relays. Units are available with ratings to 20 amps (250 VAC) and 1.5KW 3-phase (220 VAC), for switching 6, 12, 24, 48, 115, 220 and 240 VAC, in 2, 3 and 4-pole configurations. These relays are interchangeable with comparable relays.

*For more information, circle No. 218.*



MIL-R-6106



MIL-R-5757



Timers/Sensors



Mercury Wetted



2A Industrial



20A Industrial



ESTERLINE



# New D-C generator simplifies alignment

This new design eliminates the need for a front bearing in the generator. Instead, it utilizes a drive motor shaft and bearing which simplifies alignment resulting in improved performance and longer mechanical life. Ideal for high response motor systems with fast reversals, such as are required in computer applications.

The Model ST-7258A D-C Generator is available with output ranges from 3v to 10v/1000 rpm and approximate rotor inertias of 3.5 gm-cm<sup>2</sup> to 8.5 gm-cm<sup>2</sup>.

SERVO-TEK PRODUCTS COMPANY  
1086 Goffle Road, Hawthorne  
New Jersey 07506  
Phone: 201-427-3100

**SERVO-TEK**  
PRODUCTS COMPANY

Call or write for complete details.

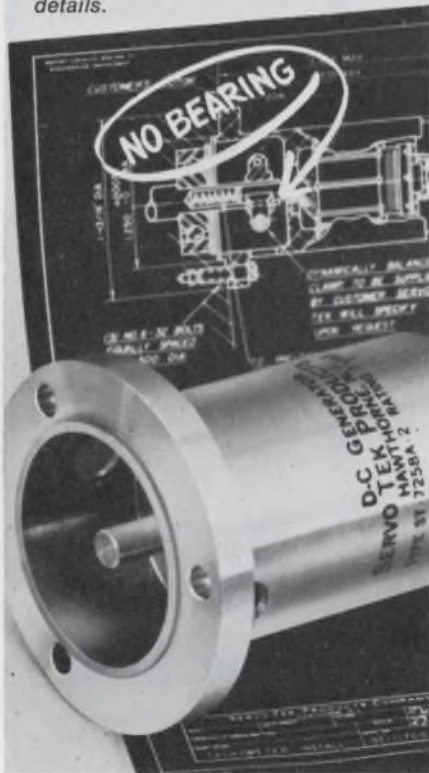

**NEW Rotating Components Catalog**  
Request your personal copy

INFORMATION RETRIEVAL NUMBER 145

## FJCC PRODUCTS

### Core memories expand DEC and IBM computers

Information Control Corp., 9610 Bellanca Ave., Los Angeles, Calif.  
Phone: (213) 641-8520. P&A: see text; stock to 30 days.

Three add-on core memories expand DEC's PDP-8/I and PDP-11 and IBM's 360 computers. The Corpak 8 provides the PDP-8/I with a 28k-by-12-bit memory in a 13 by 16 by 1/2-in. module for \$18,000 (including power supply). The Corpak 11 furnishes the PDP-11 with a 24k-by-16-bit memory in the same size and price. Memories are available for IBM 360/30, 40 and 50 with 32, 65 and 128 kbits at \$36,900, \$54,900 and \$90,100, respectively.

Booth No. 2021 Circle No. 264

### Recording-head line has no external shields

Magnusonic Devices, Inc., 124 Duffy Ave., Hicksville, N. Y. Phone: (516) 938-4700.

A new line of recording heads without external shields includes 200-in./s. 1600-bit/in. and multi-track flying-head models. The 200-in./s heads can be used at 100 in./s as well. The 1600-bit/in. heads are available as standard components. The multitrack flying heads are available in both take-off/land and non-contact versions for use with all types of disc memory systems.

Booth No. 1530 Circle No. 280

### Computer tests digital logic cards functionally

Computer Automation, Inc., 895 W. 16th St., Newport Beach, Calif.  
Phone: (714) 833-3366.

The Capable system functionally tests digital logic cards. It includes a model 216 computer with a 4k-by-16 memory, a 300-character/s tape reader, automatic loading, 63 programmable I/O pins (expandable to 319) and a stand-alone Teletype Corp. ASR-33 terminal. Three new software packages for the Capable system reduce testing time by 80%.

Booth No. 1339 Circle No. 263

# LED 3 DIGIT LED

## PANEL VOLT METER



- L·E·D DISPLAY
- HI SPEED OPERATION — 100 CONVERSIONS/SEC.
- DIGITAL SAMPLING A/D CONVERTER
- BUFFERED BCD OUTPUT — STANDARD
- COMPLETE SYSTEM CONTROL PROVISIONS

*New!* 3 Digit Panel Volt Meter for high speed use with computer controlled systems. Digital sampling technique provides high reliability and improved performance specs in both accuracy and stability; .05% accuracy at room temperature, .1% from 0° C to 50° C operating ambient.

Rugged all aluminum case, polarized lens and L·E·D display... a premium instrument at a moderate price . . . \$180

Design compatibility with all ERC Digital instruments—Counter—Clock—Stop Watch—Calendar Clock—Preset—Remote Display—Comparator—Frequency Meter.

call or write Bob Rush for technical data  
Phone 913, 631-6700



**electronic research co.**

Box 913 • Shawnee Mission, Kansas 66202

INFORMATION RETRIEVAL NUMBER 146



# Save \$15 on our new communications kit and get something special in your system.

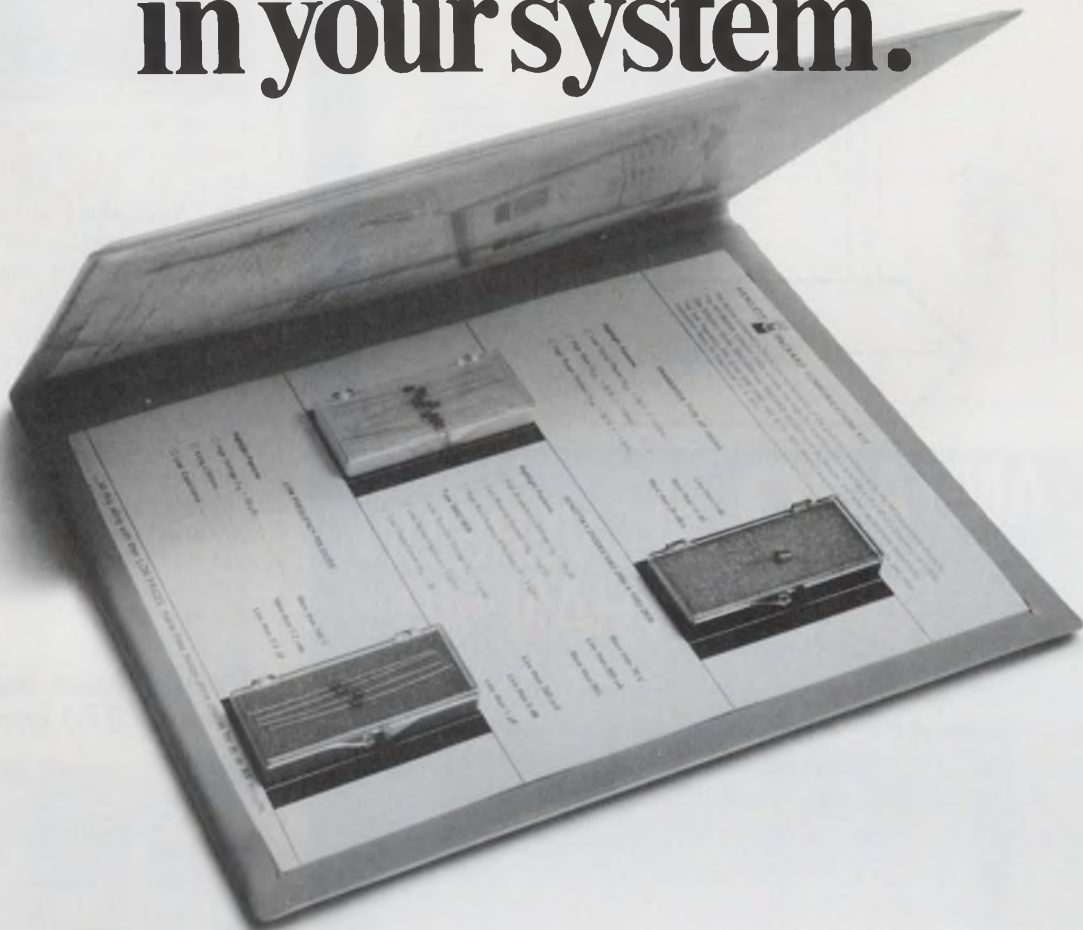

The kit contains 12 Schottky diodes, 4 pin diodes, and one low-noise, high-gain transistor. As well as application notes and data sheets.

If you bought these components separately, it would cost you more than \$34. But right now you can buy the whole kit and kaboodle for \$19.40. We're sure that once you've tried them, you'll come back for more.

Performance like this will bring you back. The HP 2800 Schottky diode is ideally suited for high level detector applications with a breakdown voltage of 70 volts. The HP 2835 Schottky diode, with a breakdown voltage of 5 volts and a forward voltage drop of .33 volts at one mA makes an ideal VHF/UHF mixer.

The HP 3080 pin diode as an AGC element guarantees low cross-modulation and intermodulation

down to frequencies of 5 MHz. The HP 35824A transistor makes an ideal low-noise, high-gain RF amplifier with a noise figure of 3 dB and a 12 dB gain at 1 GHz.

So if you're looking for ways to improve the performance of your RF amplifiers, mixers, detectors or AGC's, tear out the coupon and a check and send them both in.

You may also want one of our very popular Schottky diode kits. For \$8.40, you get eight each of three different Schottky barrier diodes. Try them and see what a difference they make in your circuits.

Clip this coupon and mail with check, money order or P.O. to: Hewlett-Packard Associates, 620 Page Mill Road, Palo Alto, California 94304. Your local HP sales office can also handle the order.

**\$34.00 value for \$19.40!**

(offer expires on January 31, 1972)

- Send me one of your communications kits. (HP 5082-0051)
- Here's \$8.40 for a diode kit. (HP 5082-0050) (California residents add 5% sales tax)

Name \_\_\_\_\_

Company \_\_\_\_\_

City/State/Zip \_\_\_\_\_

- Frequencies  less than 10 MHz  
 10 to 250 MHz  250 to 500 MHz  
 500 to 1000 MHz  greater than 1000 MHz

HEWLETT  PACKARD

COMPONENTS

01109A

INFORMATION RETRIEVAL NUMBER 147



# BUILD THIS 8-BIT A/D CONVERTER FOR UNDER \$30<sup>00</sup> . . .

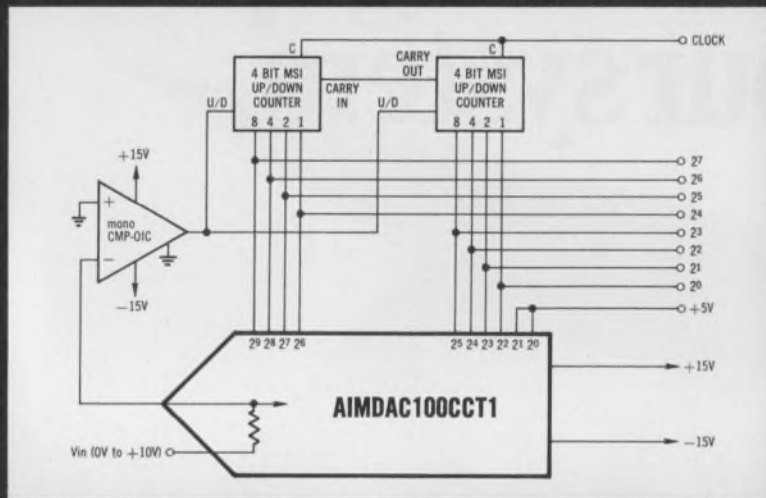

# ... AND A 10-BIT VERSION FOR LESS THAN \$40<sup>00</sup>

**CONVERT TO THE LOWEST COST A/D CONVERSION APPROACH!  
GET THIS PRICE/PERFORMANCE BREAKTHROUGH WITH  
PRECISION MONOLITHICS HIGH-ACCURACY COMPONENTS, NOW!**

Save board space, power consumption, and improve system reliability with this all-IC, minimum package count approach . . . at lowest cost.

At last, you can afford A/D conversion at the signal source.

Full military temperature range devices with MIL-STD-883 processing are available.

### CONVERT WITH THESE OUTSTANDING PMI ANALOG COMPONENTS:

- AimDAC-100ACT1** - .05% Linearity (Max., 0° - 70°C) 10-Bit D/A Converter \$26.00\*
- AimDAC-100CCT1** - .2% Linearity (Max., 0° - 70°C) 10-Bit D/A Converter \$16.00\*
- monoCMP-01CJ** - Fast Precision Voltage Comparator . . . . . \$ 3.25\*

### SAVE AGAIN WITH THESE HIGH-PERFORMANCE PMI OP AMPS:

- monoOP-01CJ** - Low Cost, Fast Slewing/Setting Op Amp.
- monoOP-08CJ** - Pico-Amp Input Current Op Amp.
- SSS 725CJ** - Low-Noise, Low-Drift Instrumentation Op Amp.
- SSS 741CJ** - Improved Performance 741 Op Amp.

\*100 piece price

### SAVE TODAY!

Call 408 246-9225

(TWX 910-338-0528)

for full details.



1500 SPACE PARK DRIVE, SANTA CLARA, CALIF. 95050

A BOURNS Affiliate

INFORMATION RETRIEVAL NUMBER 144

### FJCC PRODUCTS

## Dense disc memories pack in 6000 bits/in.

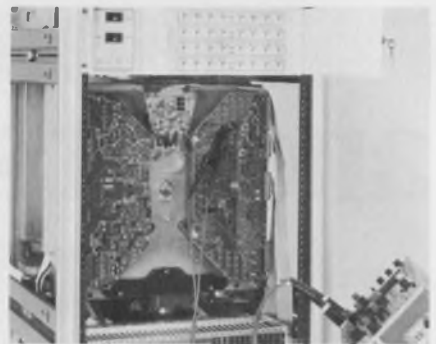

*Pacific Micronetics, Inc., 5037 Ruffner St., San Diego, Calif. Phone: (714) 279-7500. P&A: from 0.02¢/bit; November, 1971.*

A new family of Fastract disc memory systems features packing densities of 6000 bits/in. This high density is achieved without reducing head flying height or head and disc tolerances. Eleven models are available ranging in capacity from 38.4 to 153.6 megabits with an average access time of 16.7 ms (1800 rpm) and data transfer rates of 4, 5, 9, 18 and 36 MHz.

Booth No. 1738 Circle No. 272

## Radial tape subsystem is 360/370 compatible



*Storage Technology Corp., 2270 S. 88th St., Louisville, Colo. Phone: (303) 666-6581. Availability: Nov., 1971.*

The 3400/3800 radial tape subsystem is plug-to-plug compatible with IBM 360 and 370 systems. The 3400 features automatic threading, analog capstan control, linear high-speed rewind and automatic reel hubs. The 3800-III control unit accommodates tape speeds of 75 to 200 in./s and features improved error-correction techniques.

Booth No. 1234 Circle No. 293



# LINEARS FROM RAYTHEON SEMICONDUCTOR.

## OP AMPS

702 Wideband Amplifier  
709 General Purpose  
725 Precision  
741 General Purpose  
747 Dual 741  
748 Uncompensated 741  
4709 Dual 709  
  
101 General Purpose  
107 Compensated 101  
108 Precision\*  
  
4558 Dual 741 (Available in mini-DIP)  
  
4531 High Slew Rate  
4131 Precision  
4132 Micropower

## INTERFACE ELEMENTS

710 High Speed Comparator  
711 Dual High Speed Comparator  
9622 Dual-Line Receiver  
7520 Series Core Memory Sense Amplifiers  
4431 Dual-Line Receiver  
1414 Dual 710 with strobes  
1488 Quad Line Driver / EIA Compatible\*  
1489 Quad Line Receiver / EIA Compatible\*

## VOLTAGE REGULATORS

723 Precision Positive / Negative  
109 +5V Voltage Regulator\*

RAYTHEON LINEARS ARE AVAILABLE  
IN ALL POPULAR PACKAGES:

Plastics — 8-pin mini DIP; 14 and 16-pin DIPs

T Pak — TO-3; 8 and 10-pin TO-5

Ceramic — 14 and 16-pin DIPs; 10 and 14-pin flat packs

When you need a linear IC of any kind, give us a call. We've got what you want. We're stronger than ever in both proprietary and off-the-shelf linear circuits.

And that's not our only strength. Raytheon Semiconductor has changed. Our new technical team is deeply involved in development programs to provide new design tools. New digital analog interfacing that allows active switching and amplifying. Greater integration of external parts in voltage regulators. Super Beta process for precision op amps.

If you haven't been keeping up with us lately you've got a surprise coming. Write for more LIC information and see.

Raytheon Semiconductor, 350 Ellis Street, Mountain View, California 94040. (415) 968-9211.



**RIP THIS PAGE OUT  
AND TACK IT ON YOUR WALL.  
YOU CAN USE IT.**

INFORMATION RETRIEVAL NUMBER 150



\*Available fourth quarter 1971.

**COMPLETE  
PACKAGING  
CAPABILITY**

**+**

**FAST DELIVERY  
FROM  
STOCK**

**INSTANT VERO**

**VEROBOARD**

**D.I.P. BOARD**

**FINGER BOARD**

**VERORACKS**

**MODULE RACK**

**C SERIES VERO CASE**

**D SERIES VERO CASE**

**CARD FRAMES**

**CARD HANDLES**

**FRONT PANELS**

**PANEL HANDLES**

**CONNECTORS**

**DESIGN SERVICE  
NOW AVAILABLE**

**VERO ELECTRONICS inc.**

**171 BRIDGE ROAD**

**HAUPPAUGE, N.Y. 11787**

**TEL. 516 234-0400**

FJCC PRODUCTS

**Flexible line printer  
gives quality printout**



*Digitronics Corp., Albertson, N. Y.  
Phone: (516) 484-1000.*

The model 202 line printer provides quality printout and features extremely simple operation. Its unique design includes a swinging yoke for easy front loading, a flexible font belt and a universal multi-font buffer. With a 64-character font, the new line printer prints at 200 lines/minute and has eight-channel vertical-format control. Its size is only slightly larger than a typewriter.

*Booth No. 1618 Circle No. 260*

**Pen-shaped magnetic  
reader reduces errors**



*Nortronics Co., Inc., 8101 10th  
Ave. North, Minneapolis, Minn.  
Phone: (612) 545-0401.*

The DigiWand is a pencil-sized azimuth-independent magnetic reader for use with point-of-sale digital systems. DigiWand will read encoding formats presently established as standards by the American Bankers Association and the International Airline Transportation Association. Its key feature is a circular gap configuration which sharply reduces digital error rate.

*Booth No. 1203 Circle No. 255*

**TEC LED LITE**

**INDICATORS/SWITCHES**

**IC COMPATIBLE  
INFINITE LIFE**

LED — latest state-of-the-art indicator made practical, readily useable, by TEC-LITE. Brightest LED's made brighter, side viewing by highly efficient lenses. Dozens of body and lens styles and sizes. Terminal options. Fast mounting. Priced from \$1.50.\*

**SWITCH/  
INDICATORS**

TEC-LITE has combined rugged, long life LED with a full range of integral switches — momentary, alternate, and snap action in ratings to 15 amps. Price: \$4.50.\*

**SPECIAL LED DESIGNS**

**ILLUMINATED  
ROCKER  
SWITCHES**



LED's mounted adjacent to each rocker switch provide status indication. Multiple switch assemblies available with a variety of handsome bezel designs. Priced from \$2.00.\*

**LED DISPLAYS**

One or more LED indicators incorporated in easy-to-mount bezels provide a new, attractive method of adding LED's to panels, instruments, etc. Priced from \$1.00.\*

**T-1 1/4 BASED LED-LITE**

Direct LED replacement for flanged base incandescent lamps in 5 to 28 volt models (with internal resistor). Converts all TEC-LITE replaceable lamp devices to LED! Lamps priced from \$1.00.\*

\*100-499 quantities.

See TEC-LITE for the complete line of readouts, indicators, switches, display panels, keyboards, CRT terminals.

TEC, Incorporated; 9800 North Oracle Road, Tucson, Arizona 85704; or phone (602) 297-2203.

**TEC**  
INCORPORATED



If you need panel instruments with **custom** dials, cases, accuracy, tracking, resistance, response time, or practically any combination of unusual specs...

Buy **Triplett's** designed-for-you Panel Instruments

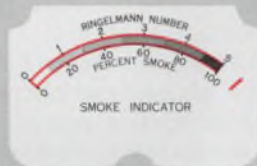
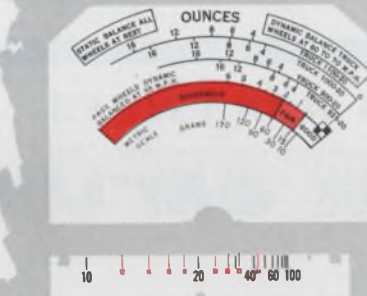
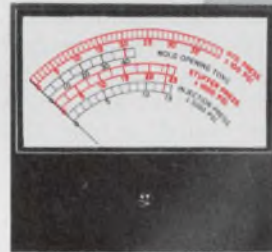
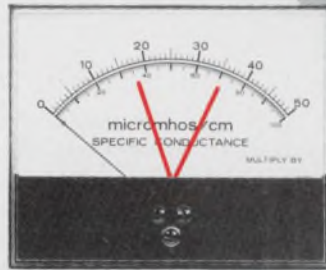
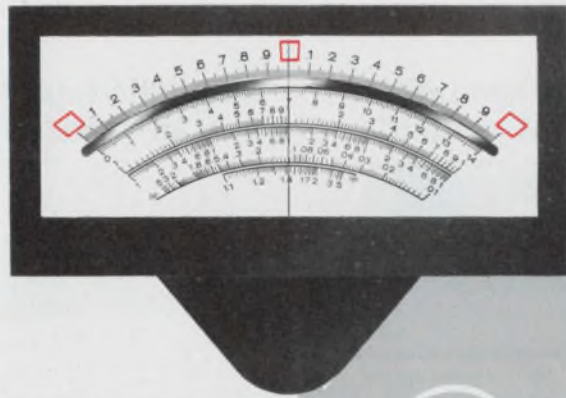

Although we stock some 1369 different styles, sizes and types of standard panel instruments, a very large proportion of our customers buy custom instruments.

Because they need:

**custom dials**

reading in such units as pH, roentgens, mm Hg, rpm, %, inches.

**custom cases**

square, round, rectangular, edge-wise (horizontal and vertical), wide, narrow, shallow.

**custom accuracy**

to within 1/2% with mirror scales and knife-edge pointers.

**custom tracking**

to match the specific needs of existing or new instrument designs.

**custom resistance**

for low circuit loading with tolerances as low as  $\pm 1\%$ .

**custom damping**

to meet stringent electrical and vibration requirements.

For instance, one of our customers had us design and manufacture a custom instrument to replace — in every detail of physical and electrical specifications — one which he was using on a delicate piece of medical instrumentation. Rejects from his previous source had risen to over 20%. He rejected only 3 of the first hundred we shipped — with almost negligible rejections from the many hundreds we've shipped since.

What custom panel instrument specifications do you need to make your

product more reliable, more accurate, more rugged and — in the long run — less expensive? For quick, dependable delivery of small quantities of Triplett's "designed-for-you" panel instruments, contact your Triplett Sales/Service/Modification Center. For prototypes or production quantities, contact your Triplett representative. He'll put you in touch with our Instrument Designers/Engineers who'll help you analyze the problem and suggest the optimum cost/result solution.

**TRIPLETT**  
BLUFFTON, OHIO 45817  
Manufacturers of the World's most complete line of V-O-M's

INFORMATION RETRIEVAL NUMBER 159

**Control storage units modify ROM contents**



*Memory Systems, Inc., 3341 W. El Segundo Blvd., Hawthorne, Calif. Phone: (213) 772-4220. P&A: 5 to 10¢ bit; 30 days.*

A series of writable control storage devices plug-compatible with popular minicomputers provide the user with the ability to modify the contents of his ROM on site, in real time, and under keyboard, console or software control. Omni-ROM units allow ROM-content modification as many times as necessary.

*Booth No. 1127      Circle No. 292*

**Magnetic-tape formatter has all read/write logic**



*Wang Computer Products, Inc., 2400 Broadway, Santa Monica, Calif. Phone: (213) 828-5565.*

A new magnetic-tape formatter provides all the logic necessary for reading and writing IBM-compatible 1600-character/in. phase-encoded and NRZI magnetic tape. The unit can contain either two NRZI formatters and a computer adapter board, or one NRZI formatter and one phase-encoded formatter. Each can control up to four tape drives.

*Booth No. 2425      Circle No. 274*

**4800-bit/s modem works error-free**



*Paradyne Corp., 2040 Calumet St., Clearwater, Fla. Phone: (813) 442-5126. P&A: \$6450; stock.*

A new high-speed online data communications system is the Bisync-48 that can operate error-free on dial-up data circuits with a transmission rate of 4800 bits/s. When connected to a type 2780 terminal, it enables the terminal to operate at two to four times the speed achieved by conventional modems when operating on dial-up data networks.

*Booth No. 1660      Circle No. 287*

**RUBBERIZED ABRASIVES**

**DEBURR SM-O-O-T-H POLISH**



**COMPLETE KIT \$750**

CONTENTS: 8 tapered edge wheels 3/8" dia. x 3/32"; 16 cylinder points 1/4" dia. x 1/8" long; 16 bullet points 3/32" dia. x 1" long; 8 bullet points 1/8" dia. x 3/8" long; 8 straight wheels 1/2" x 1/4" x 1/16" hole; 16 straight wheels 3/4" x 1/2" x 1/16" hole; 8 straight wheels 1" x 3/8" x 1/16" hole; 2 wheel mandrels 1/4" shank; 2 point mandrels 1/8" shank. For use at speeds up to 25,000 RPM.

**\$7.50 BUYS IT ALL** — 80 piece introductory Kit 777 equally assorted in 4 grit textures: coarse, medium, fine and extra fine **TRY IT** — Cratex Rubberized Abrasives improve the surface while preserving critical workpiece dimensions by its unique cushioning action. **FINISH THE JOB** — to your most exacting specifications — often in a single operation. **SEND FOR KIT 777** — or your **FREE SAMPLE** and catalog illustrating the full Cratex product line and its applications.

**CRATEX<sup>®</sup> RUBBERIZED ABRASIVES**

1600 Rollins Road • Burlingame, Calif. 94010  
Sold through leading industrial distributors





# a mos tree grows at Solitron

When it comes to MOS technology, look for the *producers*. Now we've added CMOS to our growing line of highly reliable circuits . . . and our first devices are logic gates, requiring only a 3-volt power supply. Our wide range of both high and low threshold voltage PMOS circuits include RAMS, ROMS, standard shift registers, D/A converters, and character generators. Solitron, a major supplier of calculator circuits, invites custom designs. Our engineering and test equipment is unsurpassed, guaranteeing you components of the highest standards and reliability obtainable . . . and the following are available from stock.

DISCRETES (Circle No. 221)	PMOS (Circle No. 222)	LOW THRESHOLD (Circle No. 223)			CMOS (Circle No. 224)
Singles 3N163/164 3N172/173	Multiplexer UC6410/7410 (6-Channel)	ROMS UC6525/7525 UC6548/7548 UC6596S	Cap. 1024 2048 4096	RAMS UC6550/7550 UC7312 UC7313 UC7316 UC7355	64 x 4 Shift Registers (static) Dual -12 Single -13 Dual -16 Dual -50
Duals 3N165/166 3N188/189 3N190/191	Custom High Threshold Low Threshold	UC7523 UC6572/7572 UC7541	2048 3072 2240	UC7313 UC7316 UC7355	Complete line of 4000 Series. Also Custom Circuits

Give us a quick call today, and test our producibility.



Solitron Devices, Inc., P.O. Box 1416  
San Diego, California 92112

Telephone 714/278-8780  
TWX 910-335-1221

SAN DIEGO, CALIF.  
8808 Balboa Ave.  
CMOS, PMOS Circuits  
Diodes, Rectifiers, &  
Zeners  
FET & Dual FET  
Transistors  
High Voltage Assemblies  
Linear & Monolithic IC's

TAPPAN, N.Y.  
256 Oak Tree Road  
Diodes & Rectifiers  
Ferrite & Ferrite Devices  
High Voltage Assemblies  
Power Rectifiers  
Thick Film Hybrid Circuits

RIVERA BEACH, FLA.  
1177 Blue Heron Blvd  
Hi-Rel Power Hybrids  
Hi-Rel Power Transistors  
PNP-NPN Ind. Transistors  
Si & Ge Power Transistors

JUPITER, FLA.  
1440 W. Indiantown  
Road  
Microwave IC's  
Microwave Semi-  
Conductor  
Microwave Stripline  
Components  
RF Semiconductor

PORT SOLERNO, FLA.  
Cove Road  
Microwave Connectors  
Plaxial (R) Cable  
Precision RF Coaxial  
Conductor  
BEN BAROO, ISRAEL  
AEL Israel, Ltd.  
Full line of Solitron  
devices

KENT, ENGLAND  
London Road, Sevenoaks  
Full line of Solitron devices  
TOKYO 105, JAPAN  
Rm No. 21, Kyodo Bldg.  
No. 4-10, 2 Chome  
Higashi Shinbashi  
Minato-ku  
Full line of Solitron devices

### Mass-memory tape unit stores 128 billion bytes

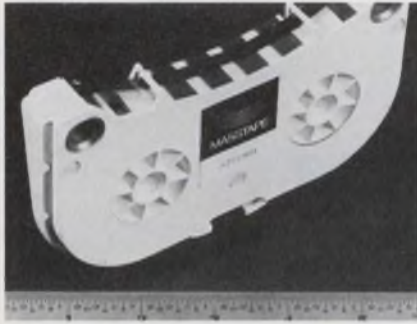

Grumman Data Systems Corp., 711 Stewart Ave., Garden City, N. Y. Phone: (516) 575-3034. Availability: 2nd quarter, 1972.

Masstape is a new high-performance modular mass-memory system with a capacity of 128 billion bytes in increments of 16 billion. A basic system provides six simultaneous accesses with a sustained transfer rate up to 900,000 bytes/s or a burst of one million bytes/s. File access time is 0.6 s. Data is recorded on 260 ft of 1/2-in. tape in cartridges at 8000 bits/in.

Booth No. 1434 Circle No. 278

### Tape drive is compatible with IBM 2420/3420



Bucode, Inc., 175 Engineers Rd., Hauppauge, N. Y. Phone: (516) 273-2100. P&A: \$450 to \$600 (1-year lease range); 30 to 60 days.

Series 3424 tape drive is an automatic-loading plug-for-plug replacement for IBM models 2401, 2420 and 3420 tape drives. Available in models which connect directly to IBM models 2803 and 3803 control units, its single-capstan air-bearing design ensures gentle tape handling. The 3424 features a high-speed controlled rewind cycle.

Booth No. 2520 Circle No. 288

### Ac-line power inverter gives emergency power



Lorain Products Corp., 1122 F St., Lorain, Ohio. Phone: (216) 288-9191. P&A: \$1730; 60 days.

The model 501CP1A1 is a constantly operating 120-V 60-Hz single-phase power inverter system. The system includes a charger, an inverter and a one-hour sealed-cell lead-dioxide battery. During normal operation, commercial ac line power is rectified to power the inverter and maintain the battery. The inverter, in turn, powers the ac load in the event of an ac line failure, drawing its power from the battery.

Booth No. 1119 Circle No. 273

# Introducing the revolutionary new Pertec Buffered Tape Transport. It makes all the incremental tape transports in the world obsolete.



## Printer terminal feeds out 100 lines/minute

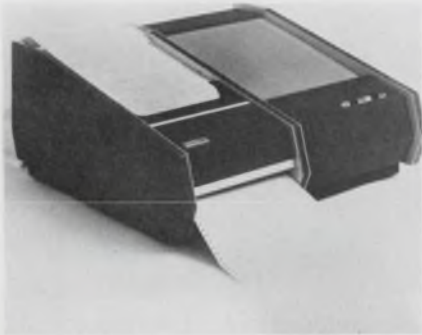

Tally Corp., 8301 S. 180th St., Kent, Wash. Phone: (206) 251-6812. Price: \$195/month rental.

A 100-line/minute data communications printer terminal is designed to replace conventional slow teleprinters. Its multiple-copy printouts can be delivered at 1200 baud over dial-up or leased line networks. Automatic error control routines during transmission assure accurate printout. Standard 80 and 132-column multi-copy continuous-forms paper is used.

Booth No. 1333 Circle No. 250

## Line-voltage regulators protect EDP systems

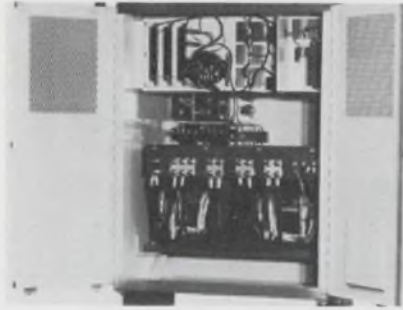

Sola Electric Div. of Sola Basic Industries, 1717 Busse Rd., Elk Grove, Ill. Phone: (312) 439-2800.

A line of Solatron line-voltage regulators has been specifically designed for use in stringent electronic data-processing applications. Each Solatron unit keeps 208-V three-phase lines to within  $\pm 0.25\%$  of the nominal input. The Solatron accepts inputs of  $+10\%$  and  $-20\%$  at a frequency span of 57 to 63 Hz. In addition, the Solatron will filter line noise and clip voltage spikes.

Booth No. 1103 Circle No. 253

## Computer microfilm system is very fast



California Computer Products, Inc., 2411 W. La Palma Ave., Anaheim, Calif. Phone: (714) 821-2541.

Model 1670 computer output microfilm system achieves a print throughput rate of 10,000 to 15,000 lines/minute and a plotting rate of 500,000 increments/s. This offline system consists of the model 900 controller with up to 32,000 bytes of programmable memory, the model 937 magnetic tape unit which can provide a 60,000 byte/s input to the controller and the model 1670 plotter/printer which is the output device.

Booth No. 1548 Circle No. 265

# Yes, even ours.



Pertec Peripheral Equipment introduces a new buffered magnetic tape transport that will revolutionize incremental tape recording.

The Pertec buffered transport is specifically designed for data acquisition, data entry and mini computer applications. It is the first and only transport which provides a true asynchronous read or write operation

in either 7 or 9 track NRZI or 9 track phase encoded tape formats.

A unique asynchronous read mode will transfer data, character by character, on demand for control type systems such as machine tools or plotters. And Pertec's buffered transport can increase the capacity and throughput of mini computer systems by freeing them from the burden of

data and motion control.

The buffered transport uses any of Pertec's 5000-Series (8½ inch reel), 6000-Series (10½ inch reel), or 7000-Series (7 inch reel) tape transports and the new Pertec buffered formatter. Read/write or read-after-write configurations are available. Data is transferred asynchronously at any rate up to 1 MHz. Continuous data can be transferred without any data loss at an average data rate of up to 60 KHz in phase encoded format or up to 40 KHz in NRZI format. And a variable buffer size allows block lengths suitable for most applications.

The new buffered transport is available now from Pertec Peripheral Equipment — the largest independent supplier of digital magnetic tape transports in the world.

For more information on the revolutionary new buffered transport, write or call Pertec Peripheral Equipment, 9600 Irondale Avenue, Chatsworth, California 91311. (213) 882-0030.

**PEC has outgrown its name.  
Our new name is...**

**PERTEC**  
PERIPHERAL EQUIPMENT

**Low-cost line printer types 165 characters/s**



Centronics Data Computer Corp., 1 Wall St., Hudson, N. H. Phone: (603) 883-6505. Price: \$2400.

Utilizing a 5-by-7 dot-matrix character structure, a new line printer provides 165 characters/s or 60 lines (132 characters each) per minute. The model 101 has a clocking system that ensures correct horizontal and vertical character registration. It transmits at 100 to 9600 baud for serial data and up to 75,000 character/s for parallel data.

Booth No. 2434 Circle No. 259

**Versatile tape drive propels tapes 75 in./s.**



Wang Computer Products, Inc., 2400 Broadway, Santa Monica, Calif. Phone: (213) 828-5565.

The Mod 1075 tape drive features a tape velocity of 75 in./s and a vacuum-chamber design which eliminates the need for servo arms. It is IBM-compatible and incorporates IBM head-guide spacing to ensure reliable interchange of IBM and Wang-generated tapes. Data packing densities are up to 800 characters/in. (NRZI) and 1600 characters/in. (phase-encoded).

Booth No. 2425 Circle No. 275

**Digital tape transport has single capstan drive**

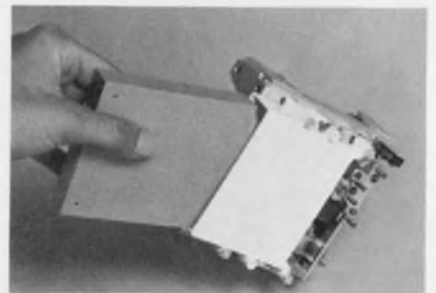

Digitronics Corp., Albertson, N. Y. Phone: (516) 484-1000.

The new MCT-7 mini-cartridge transport is specifically designed for digital use and provides all tape motion by a single dc capstan drive motor. The entire transport consists of only a single or dual-gap head, capstan and optional electronics package. The cartridge allows drop-loading and maintains tape in alignment. The MCT-7 operates at 7 in./s and records 800 flux changes/in.

Booth No. 1618 Circle No. 261

**At 4 cents a terminal, it's easy pin money.**



Cut terminal connection costs with Lear Siegler Pin Bars.<sup>TM</sup>\* Unlike most common connection methods, no soldering is required, so installation time and production costs are significantly reduced. In fact, Pin Bars offer more current-carrying ability, equalized resistance, enhanced terminal contact, and minimum electrical noise — for as low as 3 or 4 cents per terminal.

If you'd like to simplify your bussing operation while increasing your electrical integrity, pin us down for details and a free sample.



LEAR SIEGLER, INC. ELECTRONIC INSTRUMENTATION DIVISION  
714 NORTH BROOKHURST STREET ANAHEIM, CALIFORNIA 92803  
PHONE (714) 724-1010 TWX 910-591 1157

\*Patented



**COILS BY DORMEYER**

Dormeyer coils are carefully built to precision standards and to your exact specifications in any production quantity. Vacuum or vacuum pressure processing assure better impregnation. Request literature.

We will gladly send you quotation on receipt of your specifications.



**DORMEYER INDUSTRIES, Inc.**  
3414 No. Milwaukee Ave., Chicago, Illinois 60641  
WORLD'S LARGEST MANUFACTURER OF SOLENOIDS—COILS—TRANSFORMERS





## **THIS LATCHING RELAY**

**...HAS A LIFETIME OF 100 MILLION BOUNCE-FREE OPERATIONS  
IN ANY MOUNTING POSITION**

It's a Logcell® Mercury Film Relay. It has an inherent contact memory. So no extra parts are needed to make it latch. It needs no holding current, either. The surface tension of a mercury film does it.

The same mercury film assures a bounce-free closure every time. Since it doesn't use a pool of mercury, a Logcell Relay can operate in any mounting position. Even under shock and vibration.

Logcell Latching Relays have been tested to billions

of operating cycles. That's why they can be rated at 100 million operations with a 90% confidence level.

The contacts of a Logcell Relay are self-healing. And produce virtually no contact noise. Contact resistance is constant within a four milliohm range.

For more information about latching and nonlatching Logcell Relays, and Logcell Switches, too, write Fifth Dimension Inc., Box 483, Princeton, New Jersey 08540. Or call (609) 924-5990.



**FIFTH DIMENSION INC.**

**Versatile terminal saves operating costs**



*Novar Corp., Div. of GTE Information Systems, Inc., 2370 Charleston Rd., Mountain View, Calif. Phone: (415) 964-3900. Price: see text.*

The model 5-60 ASCII business data communication terminal includes a Selectric keyboard, a 350-character buffer, and a built-in recorder and modems. Since it inputs data off-line at slow rates and transmits at high rates, phone connect time and charges are minimized. The 5-60 sells for \$6950 and rents for \$199 per month.

*Booth No. 1304 Circle No. 254*

**Cassette transport costs from \$150**

*Dicom Industries, Inc., 715 N. Pastoria Ave., Sunnyvale, Calif. Phone: (408) 732-1060. Price: \$150.*

Low-cost model 171 cassette transport provides bi-directional high-speed search and fast rewind. Using the proposed ANSI/ECMA standard for information interchange via cassettes, the maximum data transfer rate is 1500 8-bit bytes/s. Reliability is two errors in  $2 \times 10^8$  bits. The model 171 is interface compatible with the Dicom model 440 cassette tape transport.

*Booth No. 1748 Circle No. 277*

**Ten easy pieces.**



**For any digital switch or keyboard combination you need.**

You choose your function and your price, for easy, economical interfacing. This family of switches has superior electrical, mechanical, and human factors qualities for high productivity, high thru-put, Data Entry. Available features include true bypass ("n" key-rollover), tactile/audible feedback, and a one millisecond, one-shot output. Your specs select the switch. Magsat Corporation, 7 Sisson Ave., Hartford, Conn. 06106. (203) 233-8513.

Contact Configuration	Prices*
Single Form A	\$ .45
Double Form A	.60
Single Form B	.55
Single Form C	.69
Single Form A (Tactile)	.69
Single Form C (Tactile)	.82
Strobed 2 Form A (Tactile)	.94
Repeat Key	1.05
Push Push Switch	1.05
Solid State	1.15

\*Based on 100,000 piece quantity order.

**magsat** Designed with the operator in mind.

**High-speed terminals are fully portable**

*Computer Transceiver Systems, Inc., 317 Rte. 17, Paramus, N. J. Phone: (201) 261-6800. P&A: \$3000 (1200 RO model), \$3800 (300), \$3190 (300-D); 1st quarter 1971 (1200), 10 days to 2 wks (300, 300-D).*

Two new portable data communications terminals are the Execuport 1200 and 300. The former prints data asynchronously at up to 120 characters/s and has a 132-column-wide carriage with multiple-copy. The latter has selectable speeds of 10, 15 or 30 characters/s and full ASCII. It comes in an integral carrying case. A desktop version (300-D) is available.

*Booth No. 1613 Circle No. 283*

**Data modems are for 19-in. racks**

*Comdata Corp., 7544 W. Oakton St., Niles, Ill. Phone: (312) 692-6107. P&A: \$465 (rack and cabinet), \$195 (modem); stock.*

The series 330 models are designed for 19-in. rack mounts. Each 19-in. rack assembly provides space for up to 16 modems plus a display panel providing indication of the status of four control and two data functions. The modems interface with Data Access Arrangements CBT and CBS for automatic-answering applications or with CDT and private lines for dedicated applications.

*Booth No. 1742 Circle No. 268*



# You get 25 ranges. We only get \$595.

Go ahead. Try to compare the new Weston 1242 with the other good multi-meters. They usually cost \$700 or more with options that add still more cost.

The 1242 is \$595 complete, including a 100-mV range for AC and DC, and a full 100% over-range ( $\pm 1.9999$  display).

The full-scale response speed of  $\frac{1}{2}$  second with input filtering is better than bench-meter performance. But the Weston 1242 measures just 3" x 7" x 7.9" and weighs less than 4 lbs.

What else do you get for \$595? Externally-replaceable fuses. Gold-on-gold contacts. Weston excellence in every detail. (Portable battery pack and leather case are optional.)

If you'd like the additional usefulness of a fully-isolated BCD output compatible with T<sup>2</sup>L logic, get the new Weston 1243. It's only \$100 more than the 1242. Order from Weston distributors, or direct from us. Weston Instruments, Inc., Newark, New Jersey 07114.

**WESTON**<sup>®</sup>

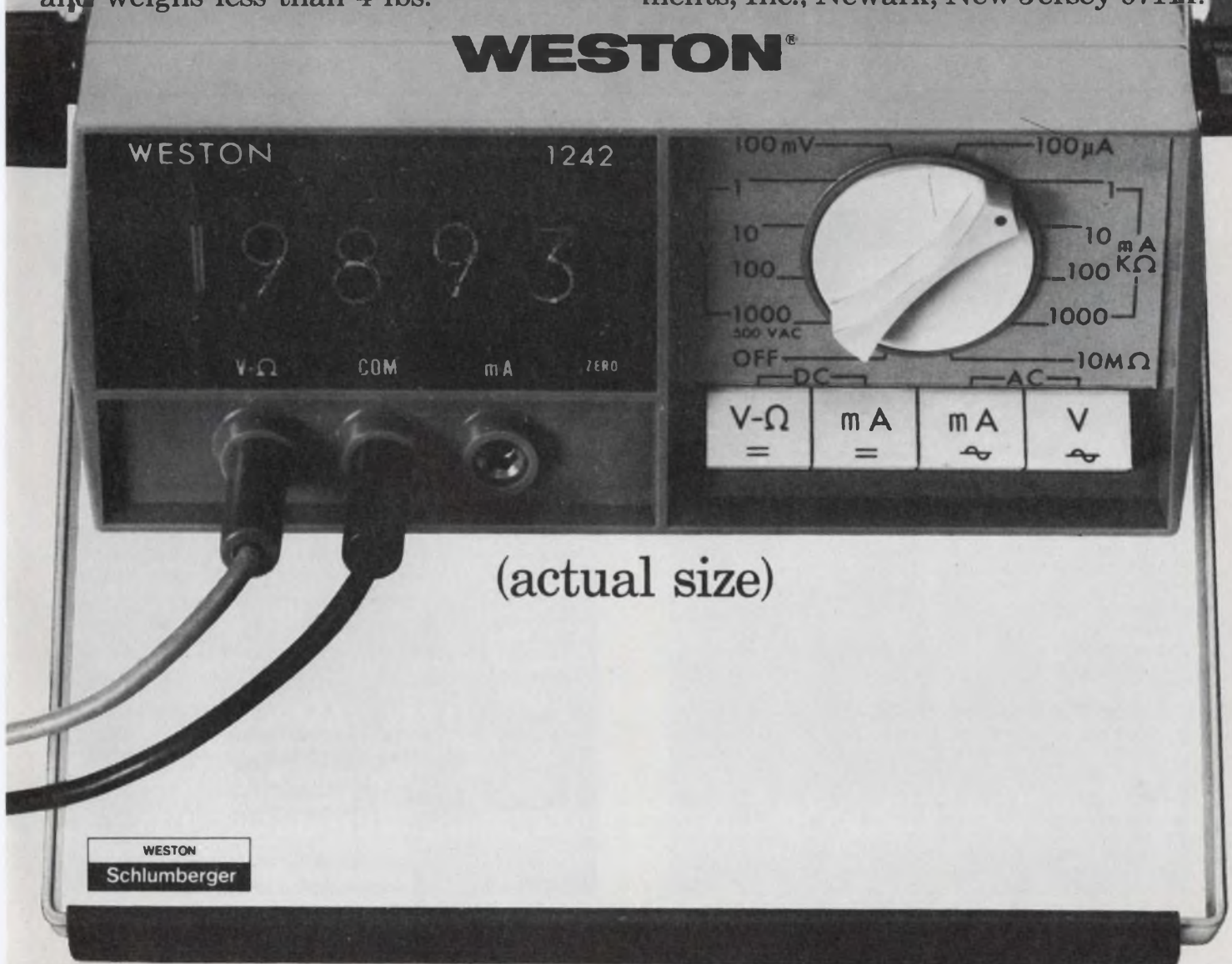

(actual size)

WESTON  
Schlumberger



### Low-cost CRT terminal replaces Teletypes



TEC, Inc., 9800 N. Oracle Rd., Tucson, Ariz. Phone: (602) 297-2203. Price: \$1595 (25 quantities).

A direct plug-for-plug Teletype Corp. terminal replacement is the model 440 Data-Screen CRT terminal which features a 24-line screen of 72-characters/line (or a switch-selectable 1920-character display at 80 characters/line). Its bottom-line data entry and bottom line feed duplicates paper roll-up. An automatic carriage return and an automatic line feed eliminate end-of-line hang ups.

Booth No. 1175 Circle No. 279

### Optical ROM system uses fiber optics

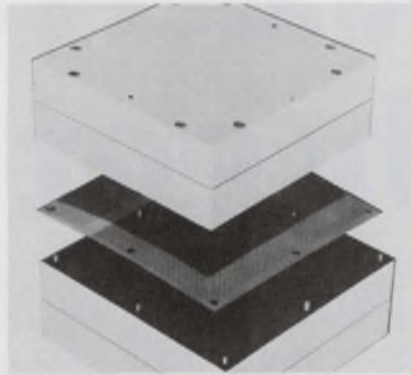

Quadri Corp., 2950 W. Fairmont, Phoenix, Ariz. Phone: (602) 263-9555. P&A: 2¢ to 5¢/bit; 12 weeks.

A new optical ROM memory system, the model 401-22, uses fiber optics rather than a complex and delicate lens system of conventional optical memories. As a result, it requires a relatively simple mask-preparation technique, eliminating the need and expense of peripheral mask-making equipment. The new technique offers user-programmability.

Booth No. 1648 Circle No. 284

### Control system handles multiple data/lines

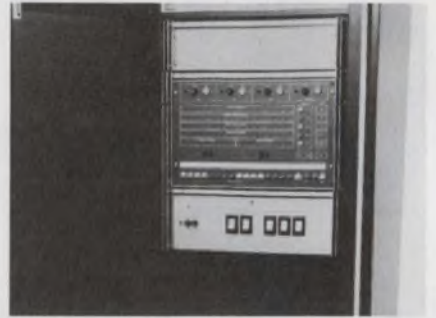

Computer Communications, Inc., 5933 W. Slauson Ave., Culver City, Calif. Phone (213) 390-7777.

The CC-70 is a front-end communications control system which handles multiple communications lines for a central computer. It is controlled by the CC-701, a new communications and control processor, by whose software one model of the CC-70 completely emulates the IBM 2701, 2702 or 2703 transmission control units. It accepts commands from and responds to System/360 or 370 teleprocessing programs.

Booth No. 2610 Circle No. 286

## our mini-digital heads sell data terminals



Nortronics was there when industry first talked about point-of-sale terminals, desk-top calculators, credit-card validators, mini-computers and other peripherals.

Today, we offer a complete line of Mini-Digital .150" cassette and .250" format heads for read/write and read-after-write applications in this 'new breed' of equipment—heads that meet ANSI, ECMA and ISO proposed standards.

Our "Design Digest for Mini-Digital Magnetic Recording" provides application information plus our complete catalog. Write for your copy today! If you don't see the head you need, we can make it in prototype or production quantities—and deliver it anywhere in this world!

world's leader in magnetic heads

**NORTRONICS**  
COMPANY, INC.

8101 Tenth Ave. North • Minneapolis, Minn. 55427 • Tel: 612-545-0401

## For 29¢\* — How Good Can This New Reed Relay Be?

\*Quantity of 1 million

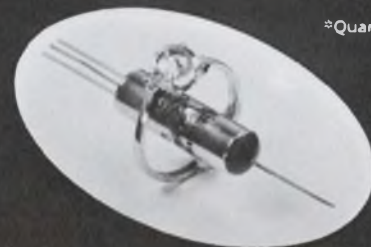

### DAMN GOOD!

Our new 1A Series offers Mil Q 9858A specs at the lowest commercial prices: Hermetically sealed coils —Magnetically shielded for high density packing— Switches 1 amp or 250V @ 20 watts — Coil voltages of 1, 3, 5, 6, 10, 12, & 24 volts—Contact resistance less than 100 milliohms — Micro size .275" OD x .950" long.

How do we do it at that price? Our secret is patent pending.

**FREE SAMPLES**  
to letterhead or phone requests.

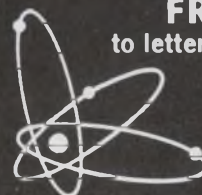

**Electronic Applications Co.**  
2213 Edwards Ave.  
So. El Monte, Calif. 91733  
(213) 442-3212

Known for quality



Everything for making a printed circuit.

ACD offers nothing less than a complete, full-line capability. That means when we finish the artwork, we'll produce and deliver the finished circuitry.

Also, you can depend on ACD for every type of circuitry . . . from conventional single-side boards through exotic multi-layer circuitry (up to 23 layers).

Design through delivery, ACD does it all.



**ADVANCED CIRCUITRY DIVISION**  
**LITTON SYSTEMS, INC.**

4811 West Kearney Street  
Springfield, Missouri 65803 (417) 862-0751

**ACD does  
the whole job.**

# How to save on relays

A quotation from Line Electric includes lots of values that add to the total savings possible.



For instance:

Line makes on-time deliveries to meet your production line schedules.  Line offers excellent engineering help free.  Line maintains the highest manufacturing standards in the industry.

Add these values together and you get all-round savings on your relay purchases. Not to mention the headaches you can avoid.

Won't you check us out and see how much better you can do at Line? Send for free copy of our new 1971 catalogue containing all the most frequently used industrial type relays. We guarantee you'll learn something to your advantage.



In a hurry, call (201) 887-8200 and ask for Relay Sales Manager. We like to do business by phone.

**SINGER**  
LINE ELECTRIC DIV.

Line Electric Division, U.S. Highway 287, Parsippany, N.J. 07054 201/887-8200

INFORMATION RETRIEVAL NUMBER 165

INFORMATION RETRIEVAL NUMBER 164

ELECTRONIC DESIGN 23, November 11, 1971

C59

### Cassette-tape system works as batch terminal



Dicom Industries, Inc., 715 N. Pastoria Ave., Sunnyvale, Calif. Phone: (408) 732-1060. P&A: \$4500; 30 days.

The model 345 batch terminal cassette magnetic tape system expands the power of terminal installations. It is normally configured with a keyboard-CRT and an automatic answer modem (a hardcopy printer is optional). In this configuration, the terminal is a key-to-cassette system with data capture and playback capabilities without using telephone and computer time.

Booth No. 1748      Circle No. 271

### Computer system makes data collection easy



Novar Corp., Div. of GTE Information Systems, Inc., Mountain View, Calif. Phone: (415) 964-3900.

The 7-70 system is designed to serve as a collection station receiving data from Novar terminals via telephone lines or hard wire and recording the information on 1/2-in. tape in a 9-track 800-bit/in. format. It has provisions for fixed or variable record lengths—all fully IBM compatible.

Booth No. 1304      Circle No. 269

### Digitizing systems process graphics



Input Output Computer Services, Inc., 138 Mt. Auburn St., Cambridge, Mass. Phone: (617) 868-5550. P&A: \$17,500, \$22,500, \$31,500; 60 days.

Systems 1, 2 and 3 are general-purpose digitizing and processing systems for graphical and pictorial data such as strip charts, maps, graphs, CRT displays or images on optical viewing screens. Each of the three systems consists of an acoustic tablet and stylus interfaced with a 4-kbit PDP-8/E computer, a Teletype Corp. ASR 33 input and a software package.

Booth No. 2619      Circle No. 256

# FREE

**LAFAYETTE  
1972 Catalog**

Our 51st Year

**468 PAGES**

Your 1st Guide To Everything in Electronics

- Stereo/Hi-Fi Components
- Musical Instruments and Amplifiers
- Photography Equipment
- Ham and CB Gear
- Public Address Systems
- Tools and Test Equipment
- Educational and Optical Equipment
- Black and White/Color Televisions
- Police and Fire Monitor Receivers
- Books and Parts

Plus Thousands of Additional Items

Lafayette Radio Electronics, Dept. 45111  
P.O. Box 10, Syosset, L.I., N.Y. 11791

Send me the FREE 1972 LAFAYETTE Catalog 45111

Name .....

Address .....

City ..... State .....

Zip .....  
(please include your Zip Code No.)

## ACCURACY AND...

# Low Cost\*

There are many other words that describe our complete line of portable standard instruments, too — like rugged, versatile and available. Yokogawa Electric has over 55 years of experience in the manufacture of precision instruments and is now introducing this complete line of taut-band portable standards to the U.S. These instruments are reknown, world-wide, for their quality and precision. Write for our complete technical data and prices today. We're confident that we have a portable AC or DC standard voltmeter, ammeter or wattmeter that will more than meet your requirements at prices that will surprise you.

\* low cost like . . .

AC Ammeter	2/5/10/20 Amps	\$53.00
AC Voltmeter	150/300 Volts	\$44.00
AC/DC Wattmeter	5/25 Amps, 120/240 Volts	\$127.00

Yokogawa Electric  
In the USA, contact:  
Yewtec Corporation • 1995 Palmer Ave  
Larchmont, N.Y. 10538 • 914-834-3550



# Face it.

In panel design, looks are everything.

But, you don't have to sacrifice good looks for the sake of function. Every Rogan control knob and dial is designed to enhance your front panel *and* perform flawlessly.

Rogan offers hundreds of different shapes and sizes and 17 handsome ABS standard colors—with custom colors readily available. So no matter what your application, Rogan control knobs will contribute both functionally *and* aesthetically.

See for yourself. Write for our new "R-71" catalog. Or outline your requirements for quotation. Free samples of particular items will be sent on request.

## Rogan

8019 North Monticello Avenue, Skokie, Illinois 60076  
Phone: (312) 675-1234 • FAX: 910-223-4547



INFORMATION RETRIEVAL NUMBER 168



# LOW-COST

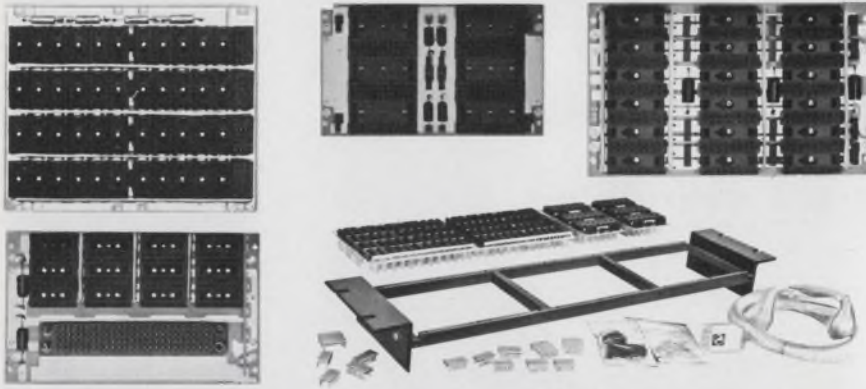

# LOGIC PANELS

Now from EECO, logic hardware and low-cost come together, all you need is your design and you've got it made.

**KITS ...** Take advantage of new low-cost (\$186 up) breadboard kits — everything you need including modular socket boards with more location flexibility from 14, 16, and 28 pin IC assemblies. We'll send you frames, boards, plugs, clips, terminals and enough wire to wrap up the job. Even a wire wrapping tool and power supply, if you like. And EECO provides an advanced power distribution system to knock out high speed switching transients, so you maintain full noise immunity.

**PANELS ...** World's largest selection of sockets, panels, drawers and special assemblies — everything to implement your IC logic design. Low-cost, high density, socket modularity and fast delivery, all combined to give the ultimate in design flexibility. If you want more help from us than that, ask about our computer-aided-design and wire wrap service — from logic diagram to wired hardware in 4 weeks. If you're thinking logic design, EECO's thinking of you.



Send for the latest kit information in the new hardware supplement.  
**ELECTRONIC ENGINEERING COMPANY of California**  
 ELECTRONIC PRODUCTS DIVISION • 1441 E. Chestnut Avenue • Santa Ana, California • Phone: (714) 547-5651  
 TWX 910-595-1550 Telex 67-8420

INFORMATION RETRIEVAL NUMBER 181

## FJCC PRODUCTS

### Cassette recorder controls tape precisely



Bell & Howell Co., Electronics & Instruments Group, 360 Sierra Madre Villa, Pasadena, Calif. Phone: (213) 796-9381. Price: \$1150.

A new digital cassette recorder includes a tape drive that operates entirely external to the cassette. The model 240 incorporates a mechanism that gently extracts a 2-in. loop of tape from the cassette's center opening and automatically loads the tape on an external capstan and precision guide assembly. It operates bi-directionally in synchronous or asynchronous modes in single or double-track models.

Booth No. 1651 Circle No. 251

### Disc RAM system packs 31.5 megabits



Computer Communications, Inc., 5933 W. Slauson Ave., Culver City, Calif. Phone: (213) 390-7777. P & A: \$25,000 (1-million-byte model) 90 days.

The CC-750 fixed-head disc is a random-access memory system with a storage capacity of 31.5 megabits, a data transfer rate of 2.7 megabits/s and an access time of 16.7 ms. Operation of the CC-750 is regulated by the CC-751 disc file controller which interfaces to one or more Computer Communications' communications and control processors.

Booth No. 2610 Circle No. 285

### Attention Advertisers:

Could you use copies of your ad exactly as it appeared in COMPUTER DECISIONS? Then order your reprints directly from us; the minimum unit order is 500 copies.

Please specify if you would like the reprint line omitted on your copies and mail your written order to COMPUTER DECISIONS, Production Dept., 50 Essex Street, Rochelle Park, New Jersey 07662.

500 1,000 Add'l M

#### 8x10 or smaller

1 color, 1 side	\$74.70	82.95	18.15
2 color, 1 side	95.47	108.00	25.28
4 color, 1 side	311.03	342.00	44.33

#### Spreads

1 color	113.66	126.65	25.98
2 color	191.19	205.98	29.58
4 color	354.17	380.76	53.19

Prices FOB Waseca, Minn.

**How long must you keep records**

Write for FREE Record Retention Schedule

Suggested minimum retention periods and when to destroy important papers



the **SHREDMASTER CORPORATION**  
 891 So. Ocean Ave.  
 Freeport, L. I., N. Y. 11520

INFORMATION RETRIEVAL NUMBER 182



## ISOLATED SOLID-STATE AC POWER RELAYS – TO 1000 WATTS

Isolated control by contact closure or TTL compatible logic levels. NO EXTERNAL POWER SUPPLIES REQUIRED. Units weigh 3 oz., are ¾ x 1¾ x 2" in size. 300/1000W, 120/220V, 50/400 Hz operation. Control loop has 1000V isolation, may be left floating or grounded. Contacts close on a 10V circuit. Contact current 20 mA. Units eliminate conduit, copper, utility box at control point, high-voltage switching, and RFI. Hardware for utility box mounting provided. Tie three units together for 3φ control. Prices start from \$8.50.

MODEL TS 100

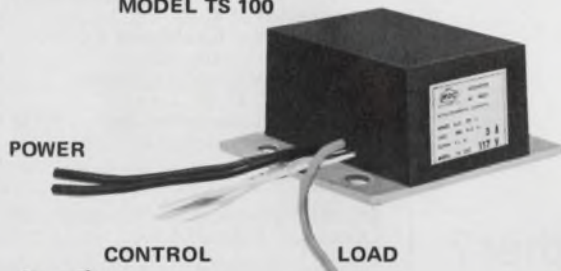

**INSTRUMENTS**  
SANTA FE SPRINGS, CALIF.

INFORMATION RETRIEVAL NUMBER 183

# Celco Yokes for CRT DISPLAYS



CELCO makes YOKES. They make them good. In fact, CELCO has been making the best CRT deflection yokes and focus coils in the industry for the past twenty years. CELCO makes yokes for precision displays when you must have the highest performance available. And CELCO makes yokes for computer terminal displays when you need reliable repetitive scan yokes for commercial purposes, at low cost. Not only does CELCO make good yokes, but they make sure you get the right yoke for your particular CRT display requirements. Call CELCO on your present display problem. A CELCO yoke will solve it. (It might even be one of the standard CELCO yokes listed below.)

#### CELCO PRECISION DISPLAY YOKES:

DN4702 Superfast DYNAMIC  
(2-sec recovery time to 0.1%)  
HD428 Low-Zero Approach  
HDD428 Mini-Spot (CRT/Yoke matched)

#### CELCO COMPUTER TERMINAL DISPLAY YOKES:

PW Position-Write Yokes  
PWM Position-Write, with Pin-cushion Correction  
YA Resonant Drive, Hi-Q

CONSTANTINE ENGINEERING LABORATORIES COMPANY  
MIRAMAR, N. J. 07030 TEL: 908-227-1123 FAX: 732-266-0018  
SPLAND, CAL. 91766 TEL: 714-864-0018 TWX: 910-861-3301

Go ahead and call CELCO. All you've got to lose are your yoke problems.



INFORMATION RETRIEVAL NUMBER 184

ELECTRONIC DESIGN 23, November 11, 1971

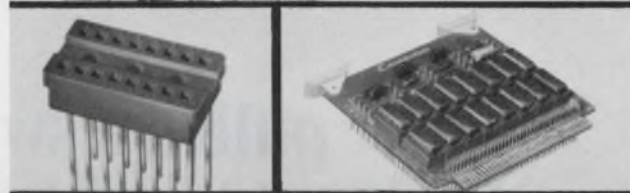
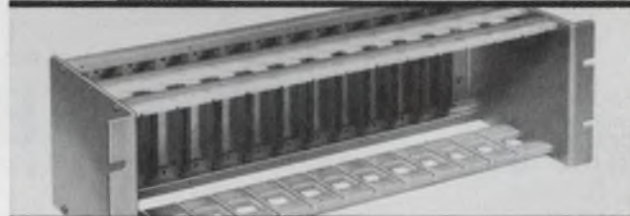
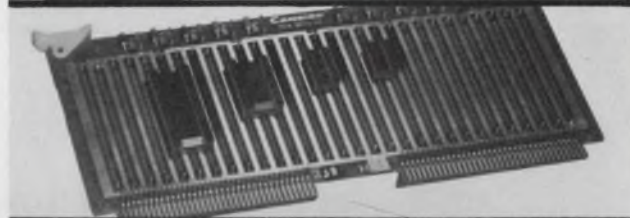
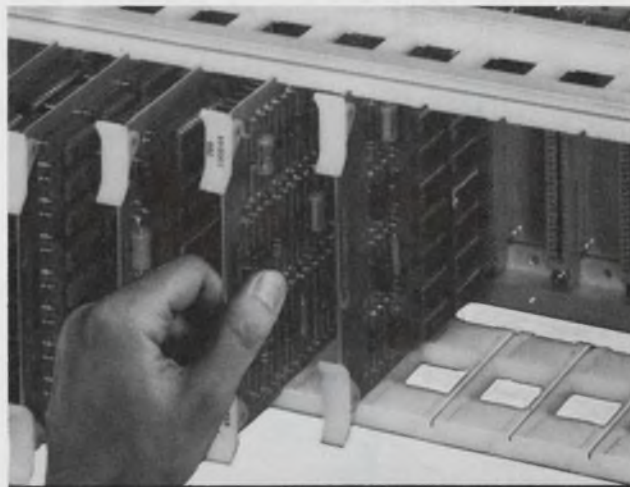

## if you design with ic's Cambion has the "works" for your work

If your digital system is a packaging puzzle, CAMBION can provide the solution.

We have the high density sockets, wire-wrappable Cambi-Cards®, PC logic cards, general purpose and discrete component cards for your functional requirements.

And to complete the picture: card files, power planes, card connectors and extenders, plus a complete numerically controlled Wire-Wrap\* service.

Result: Tightly integrated packaging systems. The "works" for your work.

For details, call us or write for the latest word on IC accessories and wire-wrapping. Cambridge Thermion Corporation, 445ED Concord Avenue, Cambridge, Mass. 02138. Phone: (617) 491-5400. In Los Angeles, 8703 La Tijera Boulevard 90045. Phone: (213) 776-0472.

\*Registered Trade Mark Gardner-Denver Co.

Standardize on

# CAMBION®

The Guaranteed Electronic Components

INFORMATION RETRIEVAL NUMBER 185

If you spec'd an I/O printer that would turn your 'mini' into a 'maxi' accounting system... it would look like this

**Removable Print Wheel**  
48 or 96 character.  
BCD or ASCII

**Wide Carriage**  
Direct Tabbing in two directions (192 print positions) enables operator to simultaneously make entries on invoices, purchase journal and sales journal. A tremendous time-saver.

**Front Form Feed**  
For easy insertion of ledger cards, invoices, passbooks, journal rolls and continuous forms

**Separate Numeric Keyboard**  
Faster entries with less chance of error and ease of operation

**Speed**  
Twice as fast as an IBM Selectric I/O writer. Three times faster (30 cps) than TTY or any other low-cost printer on the market.

**Split Platen**  
Independent feed for simultaneously performing a multiplicity of accounting functions.

**Electric Line Finder (Optional)**

**Reliability**  
Few moving parts. Proven record. Ruggedized.

so, why bother?

We'll also be demonstrating punches and readers At The FJCC, Booth 1624

For more information call Frank Misiewicz OEM Products (201) 935-2200

**LITTON ABS**  
automated business systems

600 WASHINGTON AVENUE, CARLSTADT, NEW JERSEY 07072

INFORMATION RETRIEVAL NUMBER 148



LITTON

## We've pulled a switch. DC input to drive an AC airmover. We call it, "The DC Boxer."

An integrally mounted solid state converter does it. Eliminates brush wear, arcing and attendant noise problems and adds years to service life.

Fan mounts with all the ease of a standard Boxer (4-11/16" sq., 1/2" deep), no extra connections or fasteners required. Eight models deliver up to 120 cfm cooling output.

Available with patented Grand Prix sleeve, or rugged ball bearings, both rated at 10 or more years operating life.

Other airmovers? Of course!

Send for our full-line catalog No. ND4r. It's free, and contains performance data, electrical and mechanical specifications on more than 100 units.

And valuable application information too.



For immediate service, contact us at IMC Magnetics Corp., New Hampshire Division, Route 16B, Rochester, N.H. 03867, tel. 603-332-5300. Or the IMC stocking distributor in your area. There are more than 50 nationwide and overseas.



INFORMATION RETRIEVAL NUMBER 149

## advertiser's index

Advertiser	Page
Allen-Bradley Co. ....	C25
Analog Devices, Inc. ....	C66
Associated Testing Laboratories, Inc. ....	C65
Automated Business Systems, Division of Litton Industries. ....	C64
Babcock Relays, Division of Babcock Electronics Corporation. ....	C43
Bodine Electric Company ....	C33
Bourns, Inc. ....	C4, C5
Bulova Servo Products Electronics Division of Bulova Watch Company ....	C41
Burdny Corporation ....	C39
Cambridge Thermionic Corporation	C63
CELCO (Constantine Engineering Laboratories Co.) ....	C63
Centralab, the Electronics Division of Globe-Union, Inc. ....	C35
Cincinnati Milacron Company ....	C67
Clare & Co., C. P. ....	C31
Computer Automation, Inc. ....	C16, C17
Constantine Engineering Labs. Co. (CELCO) ....	C63
Cratex ....	C50
Digital Equipment Corporation. ....	C6, C7
Dormeyer Industries, Inc. ....	C54
Edmund Scientific Company ....	C65
Electronic Applications Co. ....	C58
Electronic Engineering Company of California ....	C62
Electronic Research Company ....	C44
Fifth Dimension, Inc. ....	C55
Guardian Electric Manufacturing Company ....	C14, C15
Hewlett-Packard ....	C45
IMC Magnetics Corporation ....	C64
Johnson Company, E. F. ....	C34
Kurz-Kasch, Inc. ....	C40, C41
Lafayette Radio Electronics ....	C60
Lambda Electronics Corp. ....	C68
Lear Siegler Inc. ....	C54
Litton Systems, Inc. ....	C59
3M Company ....	C19
MDC Instruments ....	C63
Magnecraft Electric Company ....	C18
Magsat Corporation ....	C64
Nortronics Company, Inc. ....	C58
Oak Manufacturing Co. ....	C29
Pertec Peripheral Equipment ...	C52, C53
Precision Monolithics, Incorporated. ....	C46
Raytheon Company, Semiconductor Operation ....	C47
Rotron, Incorporated ....	C2
Rogan Brothers, Inc. ....	C61
Servo-Tek Products Company ....	C44
Shredmaster Corporation, The ....	C62
Singer, Line Electric Division ....	C59
Singer, Industrial Timer Division. ....	C65
Solitron Devices, Inc. ....	C51
Stackpole Carbon Company ....	C28
Standard Condenser Corporation ...	C36
Switchcraft, Inc. ....	C38
TEC, Incorporated ....	C48
Teletype Corporation ....	C26, C27
Triplett Corporation ....	C37, C49
Tung Sol Division, Wagner Electric Corporation ....	C36
Vactec Inc. ....	C42
Vero Electronics, Inc. ....	C48
Weston Instruments, Inc. ....	C57
Yewtec Corporation ....	C60



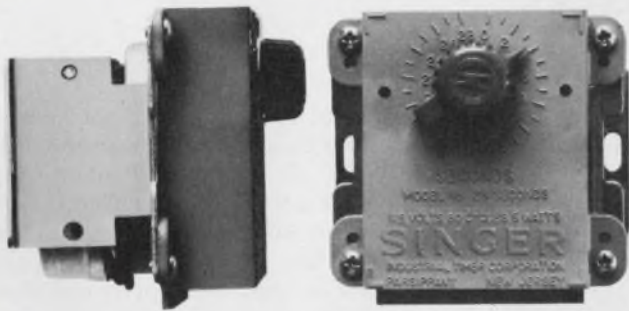

**Viewed from every angle, our new R.B. Delay Timer is a great value at \$8.38\***

To keep manufacturing costs in line and increase dependability, the R.B. is your answer. Has dial adjustability, automatic reset and guaranteed 100% electro-mechanical reliability and accuracy. Replaces cheaper delay devices of questionable performance.

Except for the motor, it is

completely enclosed in G.E. Noryl SE-1† plastic for total insulation and dimensional stability. Repeat accuracy is  $\pm 1\%$  of total time cycle. Load switch capacity is 15 Amps. SPDT-120/240 VAC Non-Ind. snap action.

Choice of 7 time cycles between 5.5 sec. and 4 min.-24 sec. max. Ask for Bul.307.

\*Maximum quantity discount  
†Trademark G.E. Co.

**SINGER**  
INDUSTRIAL TIMER DIV.

Industrial Timer Division, U.S. Highway 287, Parsippany, N.J. 07054 201/887-2200

INFORMATION RETRIEVAL NUMBER 187

**FREE CATALOG!**  
148 PAGES • MORE THAN 4000 UNUSUAL BARGAINS  
OPTICS • SCIENCE • ELECTRONICS



**1000'S OF HARD-TO-FIND BUYS FOR INDUSTRY**

Speed your work! Improve quality! Cut development and production costs! Completely new edition loaded with on-the-job helps, quality control aids, unique items available nowhere else. 148 easy-to-read pages packed with new products, charts, diagrams, illustrations. A treasure house of optical and scientific equipment available direct from stock for industry, research labs, design engineers, experimenters, hobbyists.

**AMERICA'S GREATEST ONE-SOURCE MARKET PLACE**

Hard-to-get surplus bargains. Ingenious scientific tools. Thousands of components: lenses, prisms, wedges, mirrors, mounts, accessories of all descriptions. Hundreds of instruments: lasers, comparators, magnifiers, microscopes, projectors, telescopes, binoculars, photo attachments, black light equipment and the largest selection of unique lighting items in the country.

**ORDER DIRECT WITH ABSOLUTE CONFIDENCE**

Edmund ships more than 5,000 orders monthly to the country's largest industrial. Every item completely guaranteed. You must be satisfied with any purchase or return it in 30 days for your money back. Shop the catalog of America's largest Science-Optics-Space Mart. Send for your free copy today. Absolutely no obligation. No salesman will call. Request FREE catalog "DA".

**EDMUND SCIENTIFIC CO.**  
300 EDSCORP BUILDING  
BARRINGTON, NEW JERSEY 08007

**MAIL COUPON FOR GIANT FREE CATALOG!**

EDMUND SCIENTIFIC CO.  
300 Edscorp Building, Barrington, N. J. 08007  
Please send Free Giant Catalog "DA"

NAME \_\_\_\_\_  
COMPANY \_\_\_\_\_  
ADDRESS \_\_\_\_\_  
CITY \_\_\_\_\_ STATE \_\_\_\_\_ ZIP \_\_\_\_\_



INFORMATION RETRIEVAL NUMBER 188

ELECTRONIC DESIGN 23, November 11, 1971



**LOWEST PRICE CO<sub>2</sub> CHAMBER... \$395**

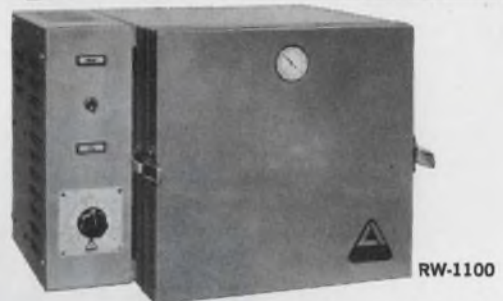

Now you can Go Fail Free without going broke! \$395 buys ATL's Model RW-1100 full range low/high temperature chamber, a compact bench unit lab-engineered specifically for small parts and assembly testing and quality control. ATL hasn't scrimped on quality at your expense either. Look at the full performance features you'll get:  $-100^{\circ}\text{F}$  to  $+350^{\circ}\text{F}$  range ( $3/4^{\circ}$  stability)...half cubic foot work area...door-mounted temperature readout...solid state temperature control...liquid CO<sub>2</sub> cooling.

**LOWEST PRICE MECHANICAL CHAMBER...**

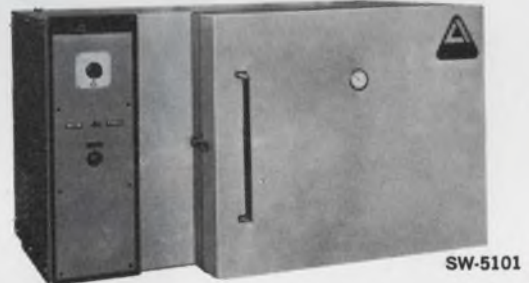

For a full range military testing capability, ATL's benchtop model SW-5101 extends from  $-100^{\circ}\text{F}$  to  $+350^{\circ}\text{F}$  at a phenomenally low cost. Add a host of other advantages such as single compressor design for simplified maintenance...all solid state control...high temperature fail-safe. All for \$970!

Both units are fully presented in the all-new, complete ATL Environmental Equipment Catalog M-7-2. Why not get the whole story today?



**ASSOCIATED TESTING LABORATORIES INC.**

200 ROUTE 46, WAYNE, N.J. 07470 • (201) 256-2800  
NEW ENGLAND DIVISION  
NORTHWEST INDUSTRIAL PARK, BURLINGTON, MASS. 01803 • (617) 272-9050

INFORMATION RETRIEVAL NUMBER 189



# Because it is there.

There, on the top of the largest line of multipliers available, is our 530. It's not quite the fastest: our #422 module slews at 120v/usec. Nor the most accurate: #427 provides 0.1% of full scale. But by jingo, it's the only complete monolithic multiplier - divider - squarer - square rooter on a chip, op amp included. The specs are exhilarating

and the price is right. Why the 530? That and other questions pertaining to multipliers are dealt with at length in a unique document published by us: "Evaluating, Selecting, & Using Multiplier Circuit Modules for Signal Manipulation & Function Generation." Unlike this ad, it's not so commercial as to dwell crassly on the 530. Rather, it is an impartial 16-page booklet that sets forth the theory and applications of multipliers in general. Just ask for "the multipliers booklet." Analog Devices, Inc., Norwood, Mass. 02062. (617) 329-4700.



INFORMATION RETRIEVAL NUMBER 192



a thought about you...

# Anxious

If you're anxious about getting your new OEM system off the drawing board and into production, you need help — and a good general-purpose mini-computer. You can get both at Cincinnati Milacron.

Of course we build reliable hardware; but the product we're proudest of is people. We've got interested, intelligent people anxious to help you choose the system best suited to your needs, build it to exacting specifications, teach you how to use it, and service it promptly.

Give us a call today. We'll send you a reliable mini-computer, plus the kind of people you like to do business with.



**minicomputers**

**CINCINNATI  
MILACRON**

Cincinnati Milacron Company | Cincinnati, Ohio 45209

**Machine Tools  
Process Controls  
Chemicals  
Plastics  
Plastics Processing Machinery  
Abrasives**

Cincinnati area (513) 494-5444 • Chicago area (312) 439-5726 • Los Angeles area (213) 582-8361 • Detroit area (313) 557-2700 • New York area (201) 687-4500

**INFORMATION RETRIEVAL NUMBER 190**

Do you face a make or buy decision on power supplies?

# BUY LAMBDA LX SERIES

Now 7 package sizes...new CC and D



"CC" PACKAGE  
5 volts dc 16 amps  
**\$200**

"D" PACKAGE  
5 volts dc 27.5 amps  
**\$235**

both with overvoltage protection built-in

## Voltage and current ratings

### LXS-CC SINGLE OUTPUT MODELS

4 15/16" x 4 15/16" x 9 3/8"

REGULATION: 0.1%  
RIPPLE: 1.5 mV RMS  
5 mV pk-pk

MODEL	FIXED VOLT. RANGE VDC	MAX. AMPS AT AMBIENT OF:				PRICE
		40°C	50°C	60°C	71°C	
LXS-CC-5-OV	5 ±5%	16.0	14.5	12.7	10.5	\$200
LXS-CC-6	6 ±5%	15.2	13.8	12.1	10.0	200
LXS-CC-12	12 ±5%	10.5	9.4	8.2	5.0	190
LXS-CC-15	15 ±5%	9.5	8.6	7.4	4.8	190
LXS-CC-20	20 ±5%	7.7	7.2	6.5	4.4	190
LXS-CC-24	24 ±5%	6.8	6.4	5.7	4.4	190
LXS-CC-28	28 ±5%	6.0	5.6	5.0	4.3	190

### LXS-D SINGLE OUTPUT MODELS

4 15/16" x 7 1/2" x 9 3/8"

REGULATION: 0.1%  
RIPPLE: 1.5 mV RMS  
5 mV pk-pk

MODEL	FIXED VOLT. RANGE VDC	MAX. AMPS AT AMBIENT OF:				PRICE
		40°C	50°C	60°C	71°C	
LXS-D-5-OV	5 ±5%	27.5	24.2	20.5	16.5	\$235
LXS-D-6	6 ±5%	26.5	23.4	19.8	16.0	235
LXS-D-12	12 ±5%	16.0	14.0	11.9	8.0	235
LXS-D-15	15 ±5%	14.0	12.3	10.4	7.5	235
LXS-D-20	20 ±5%	11.5	10.0	8.6	6.8	235
LXS-D-24	24 ±5%	10.0	8.8	7.5	6.0	235
LXS-D-28	28 ±5%	9.0	8.0	6.8	5.5	235

#### NOTES:

- (1) Current rating applies over entire voltage range. Ratings based upon 57-63Hz operation.  
(2) Prices are U.S.A. list prices only, F.O.B. Melville, N.Y.; North Hollywood, Calif.; Chicago, Ill.; Montreal, Canada. All prices and specifications are subject to change without notice.

The following charges are applicable for shipment from other than Melville, N.Y.

Value of Order	Handling Charges*	Value of Order	Handling Charges*
up to \$50.00	\$1.00	\$301.00 to \$500.00	\$6.00
\$51.00 to \$180.00	\$2.00	\$501.00 and over	F.O.B. Melville, N.Y. only
\$181.00 to \$300.00	\$4.00		

\*Not applicable when shipped from Montreal to Canadian customers.

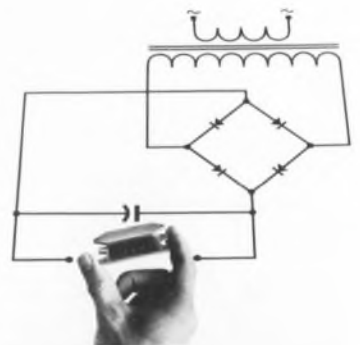

**WHETHER  
YOU MAKE  
OR BUY...**

**LAMBDA  
ELECTRONICS CORP.**

A Company

MELVILLE, NEW YORK 11746 515 Broad Hollow Road Tel. 516-694-4200  
ARLINGTON HEIGHTS, (CHICAGO) ILL. 60005 2420 East Oakton St., Unit Q Tel. 312-593-2550  
NORTH HOLLYWOOD, CALIF. 91605 7316 Varna Ave. Tel. 213-875-2744  
MONTREAL, QUEBEC 100C Hymus Blvd., Pointe-Claire, Quebec-730 Tel. 514-697-6570

INFORMATION RETRIEVAL NUMBER 191



# British engineers read Electronics & Power



... and the world looks on.

**ELECTRONICS & POWER** is a monthly wide-ranging technological magazine designed to record and report, in an easily readable way, the latest advances in electronic and electrical science and technology and their interplay with related technologies, with industrial practice, and with day-to-day life. The coverage is international with a British bias. The magazine includes feature articles specially written by accepted authorities, industrial and technical news, book reviews, editorial

comment and letters to the editor. **E & P** is read by 64 000 members of the Institution of Electrical Engineers, the recognised body for professional electrical and electronics engineers in Great Britain. It therefore accurately reflects British engineering practice. **E & P** is important to you, because it speaks for British electrical and electronics engineering. Free from commercial pressures, **E & P** speaks with authority and integrity to the professional engineer.

**E & P** is published monthly by the Institution of Electrical Engineers, and the annual subscription for 1972 is £13.50 (\$32.40). All subscriptions begin on the 1st January and are accepted for one year only. An annual index is given free to subscribers with every December issue of the journal.

*Please send your subscription orders, with remittances to:*

**The Institution of Electrical Engineers,  
PO Box 8, Southgate House, Stevenage,  
Herts. SG1 1HQ, England**

## Variable-modulus up-down counter is self-reversing with two chips

With only two chips, it's possible to count up and down again in a cyclical, self-reversing fashion (see diagram). And the modulus can be varied, to boot.

The clock input line raises the counter synchronously to its maximum. Further counts bring it back down again. The count modulus is easily changed without logic. Instead you use patch plugs. One chip serves to detect both maximum and minimum count.

Suppose the counter has been cleared to all zeros and we have set MAX COUNT = 3. Terminal  $Q_3$  is connected, via patch 3, to an inverter whose output goes to S. Since all flip-flops are reset,  $Q_3 = 0$  and  $S = 1$ .

The MIN COUNT gate is now activated because  $Q_1 = 0$  and  $\bar{Q}_1 = 1$ . When the clock line is pulsed,  $Q_1$  follows S, and the count is 1. But now  $Q_1 = 1$  and  $\bar{Q}_1 = 0$ , and the MIN COUNT gate is deactivated. On the next clock pulse,  $Q_2 =$

$Q_1 = 1$  and  $Q_3$  is still 0. On the following clock pulse,  $Q_3 = 1$ . Since  $Q_1$  is still 1, the MAX COUNT is activated. The next clock pulse results in  $S = \bar{Q}_3 = 0$  and  $Q_1$  goes low. The count is down to 2, and the MAX COUNT gate is deactivated.

For the detection of R counts, where  $0 < R < M$  and MAX COUNT = M, you use M flip-flops. In the counter—a Johnson type—a count of R is shown when  $[(Q_R)(Q_{R+1}) + (Q_{N-(R+1)})(\bar{Q}_{(N-R)})] = 1$ . Thus detection of an intermediate count requires the use of two-sixths of a hex-inverter package (DM7404) and one-half of an AND-OR-INVERT package (DM7451).

*Richard Percival, Digital Applications Engineer, National Semiconductor Corp., 2900 Semiconductor Drive, Santa Clara, Calif. 95051*

CIRCLE 310

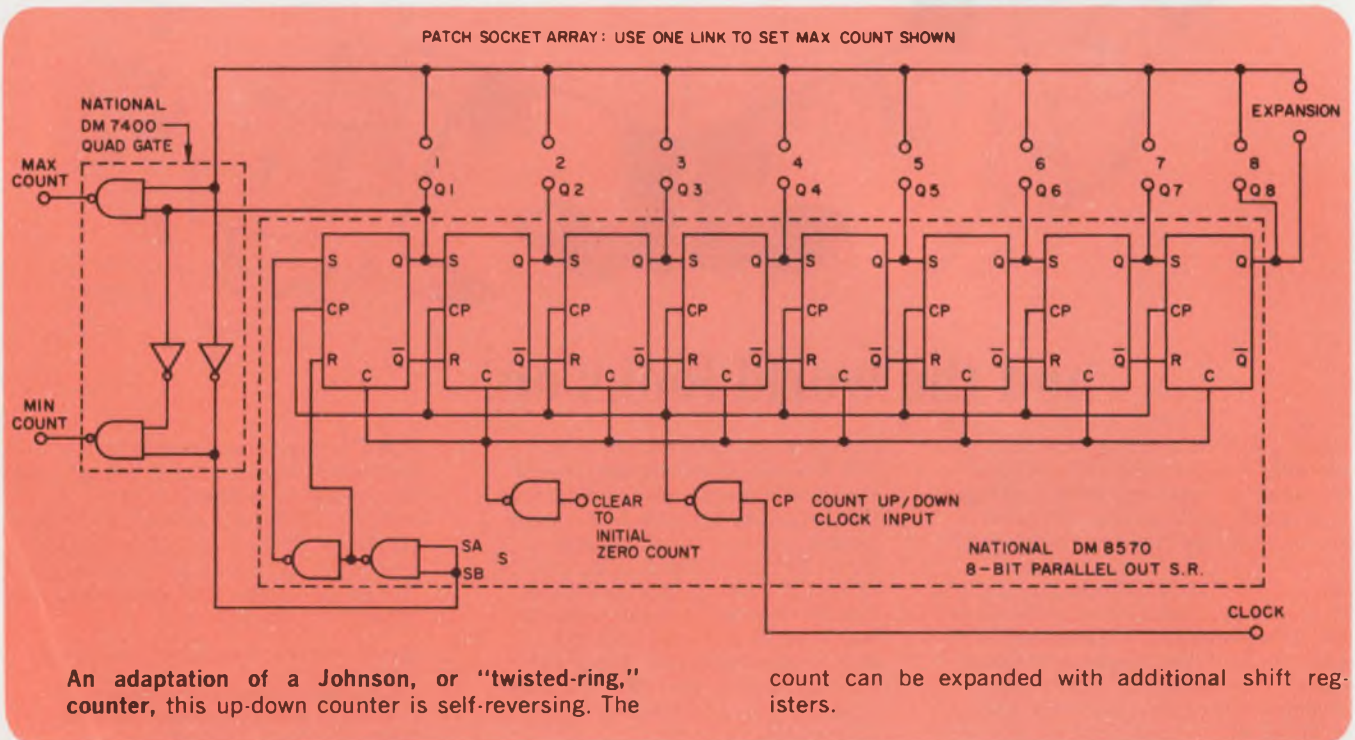



# Look how we widened a credibility gap.

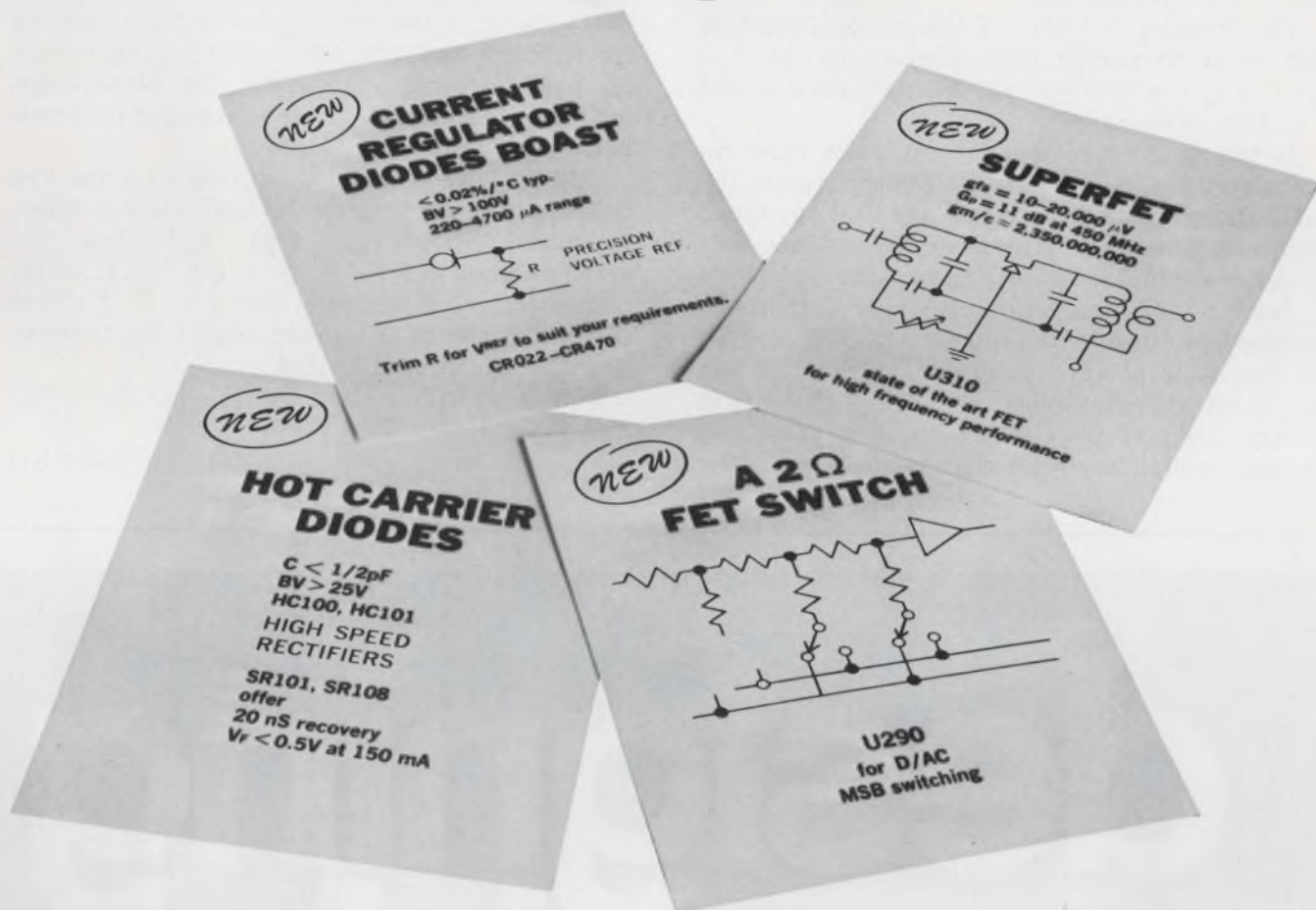

We've done it again — four more times, in fact. We've left our competition blinking in wonder.

Study the four winners above carefully. They have performance characteristics our competition finds hard to believe.

For example, we call U310 "SuperFET" because of its high  $g_{fs}$  and  $g_{fs}/c$ . Our CR Series Current Regulators have  $\approx$  zero temperature coefficient. Our U290 switch has the lowest ON resistance in the industry and the lowest price. Our HC 100/101 Schottky Diodes fea-

ture picosecond switching times and SR108 has  $V_f < 0.5\text{ V}$  at 150 mA.

The point is: we immodestly feel that anybody who can produce these four devices at competitive prices must be leading the field in advanced technology. Best of all, they are only a few samples of our latest talents.

So whether your application calls for something special, or off the shelf, just let us know.

You can believe you'll get the best.



**Siliconix incorporated**

2201 Laurelwood Road • Santa Clara • Calif. 95054  
Phone (408) 246-8000 Ext. 201 • TWX: 910-338-0227

**Siliconix distributors.** Hamilton/AVNET, Semiconductor Specialists, Cramer Electronics, Liberty Electronics, Elmar Electronics, Western Radio, Norelcom. **Siliconix sales offices.** Bethpage, NY (516) 796-4680 / Norwood, MA (617) 769-3780 / St. Louis, MO (314) 291-3616 / Minneapolis, MN (612) 920-4483 / Long Beach, CA (213) 420-1307 / Santa Clara, CA (408) 246-8000 / San Diego, CA ZE 7-1301 / Denver, CO (303) 744-0404 / Phoenix, AZ (602) 947-3183. **Overseas sales offices.** Siliconix Limited, Saunders Way, Sketty, Swansea, Great Britain / Siliconix GmbH, 7024 Bernhausen, Postfach 1340, W. Germany / Siliconix S.A.R.L., 94-Saint-Maur, France, Tel. 283-57-90.

INFORMATION RETRIEVAL NUMBER 36

# Digital filter design can be simplified if binary rate multipliers are used

It's possible for the digital designer to generate transfer functions with the ease formerly reserved for the analog designer. All it takes is the use of binary rate multipliers.

First you design an analog circuit that has the right transfer function. Then you apply the results to the digital case.

The transfer function of the analog circuit in Fig. a—a first-order lag—is given by  $e_o/e_i = 1/(1 + \tau p)$ , where  $p =$  differential operator and  $\tau =$  time constant.

In the digital circuit in Fig. b, pulse rates replace voltages, binary rate multipliers replace the multiplying potentiometers, and an up-down counter replaces the integrator. To see this, let's consider the operation of the circuit.

The SN7497 binary-rate-multiplier output frequency is defined by the equation  $f_{out} = f_{in} \times M/2^n$ , where  $M$  is any six-bit binary number and  $n = 6$  for a single device. The output of the first binary rate multiplier is  $f_c N_i/2^n$ . This pulse rate passes through a circuit that removes a one-bit

oscillation error in the steady-state condition. The pulses are then applied to the up-count input of the up-down counter composed of two SN74193 binary counters. The six least significant bits of the counter ( $N_o$ ) are applied to the second SN-7497 binary rate multiplier. The resultant output rate is  $f_c N_o/2^n$  and is applied to the down-count input of the binary counter, thus closing the feedback loop. Since the counter cannot count up and down simultaneously, the binary-rate-multiplier clock inputs must be supplied by a two-phase nonoverlapping clock.

The up-down counter then integrates the two input rates to produce the binary output number,  $N_o$ , where  $N_o = (f_c N_i/2^n p) - (f_c N_o/2^n p)$ . Rearranging, we get  $N_o/N_i = 1/(\tau p + 1)$ , where  $p =$  differential operator and  $\tau = 2^n/f_c$ . Thus the digital circuit is seen to exhibit the transfer function of a first-order lag.

*Wayne Sefcik, Pinson Associates, Inc., P.O. Box 9648, Austin, Tex. 78757*

CIRCLE 311

# designing solid state inverters?



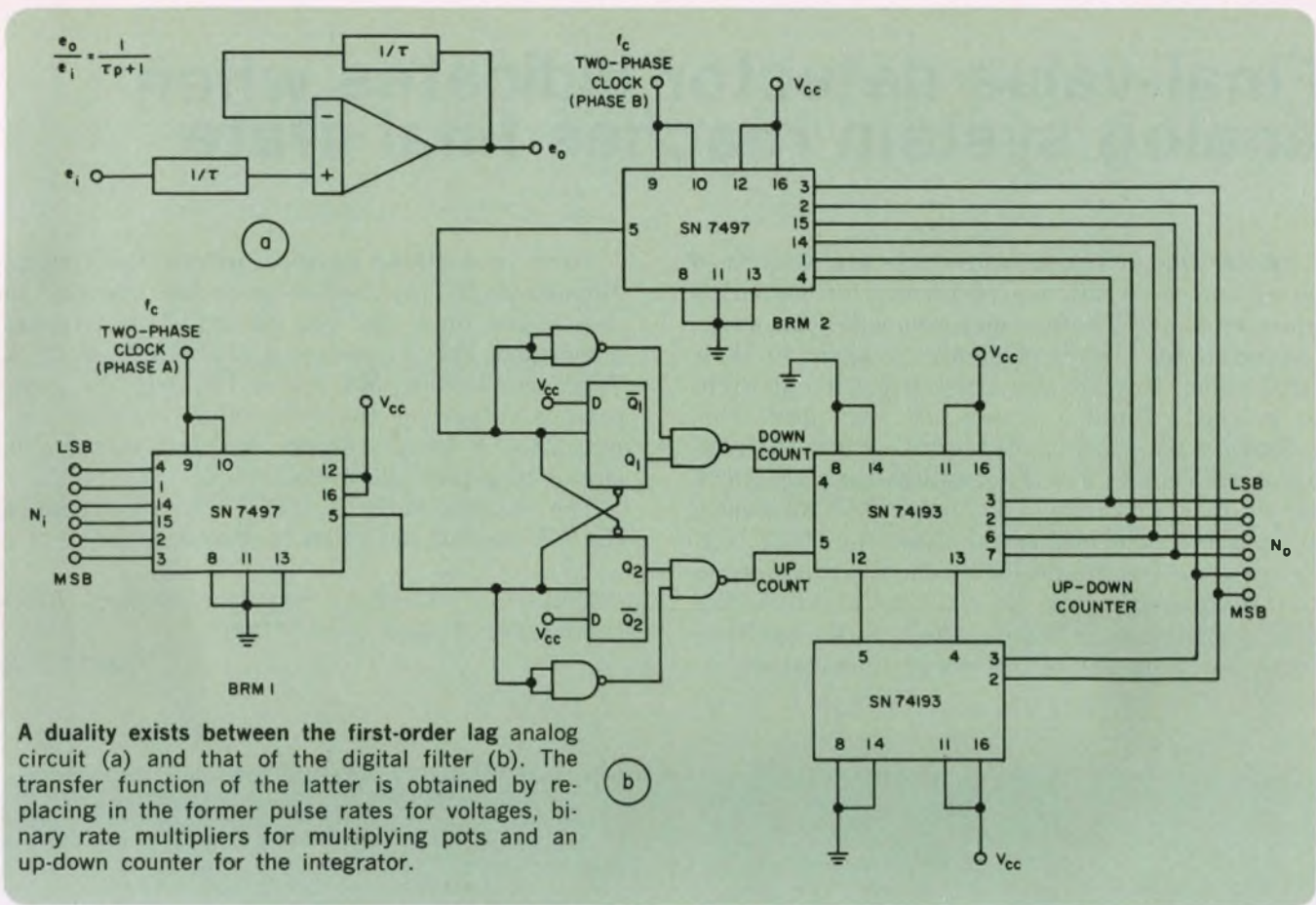

A duality exists between the first-order lag analog circuit (a) and that of the digital filter (b). The transfer function of the latter is obtained by replacing in the former pulse rates for voltages, binary rate multipliers for multiplying pots and an up-down counter for the integrator.

General Electric's new 28F SCR capacitor bulletin can help you select the right capacitor for commutating or filtering applications involving high frequency sinusoidal waveforms and unidirectional or bidirectional square waveforms.



circle  
28

reader service card  
or write General Electric Company  
Section 448-01, 1 River Rd.  
Schenectady, N.Y. 12345



# Final-value detector indicates when analog system reaches final state

When time or temperature tests are performed on an analog circuit, a predetermined time period must be allowed before measurements are made, to permit all circuit elements to settle to their final value. How do you know when it's all right to proceed? Build a circuit that will alert you.

The circuit shown will indicate when the analog input voltage has changed less than 1% for a period of one minute. The circuit uses an analog sample and hold memory to store the input voltage at  $t=0$ . One minute later the stored information is compared with the real-time input. A window comparator indicates whether the real-time input is within 1% of the stored information.

Three monostable circuits provide the timing. Monostable M1 is used to gate the memory to sample the input for one second. This triggers monostable M2 to produce a one-minute wait. A third monostable, M3, gates the window comparator output for the final value detection output. This, in turn, triggers the first monostable circuit to repeat the cycle.

The resistor ratio  $R_b/(R_a + R_b)$  determines the 1% window detection tolerance.

*Richard C. Gerdes, President, Optical Electronics, Inc. Tucson, Ariz. 85706*

CIRCLE 312

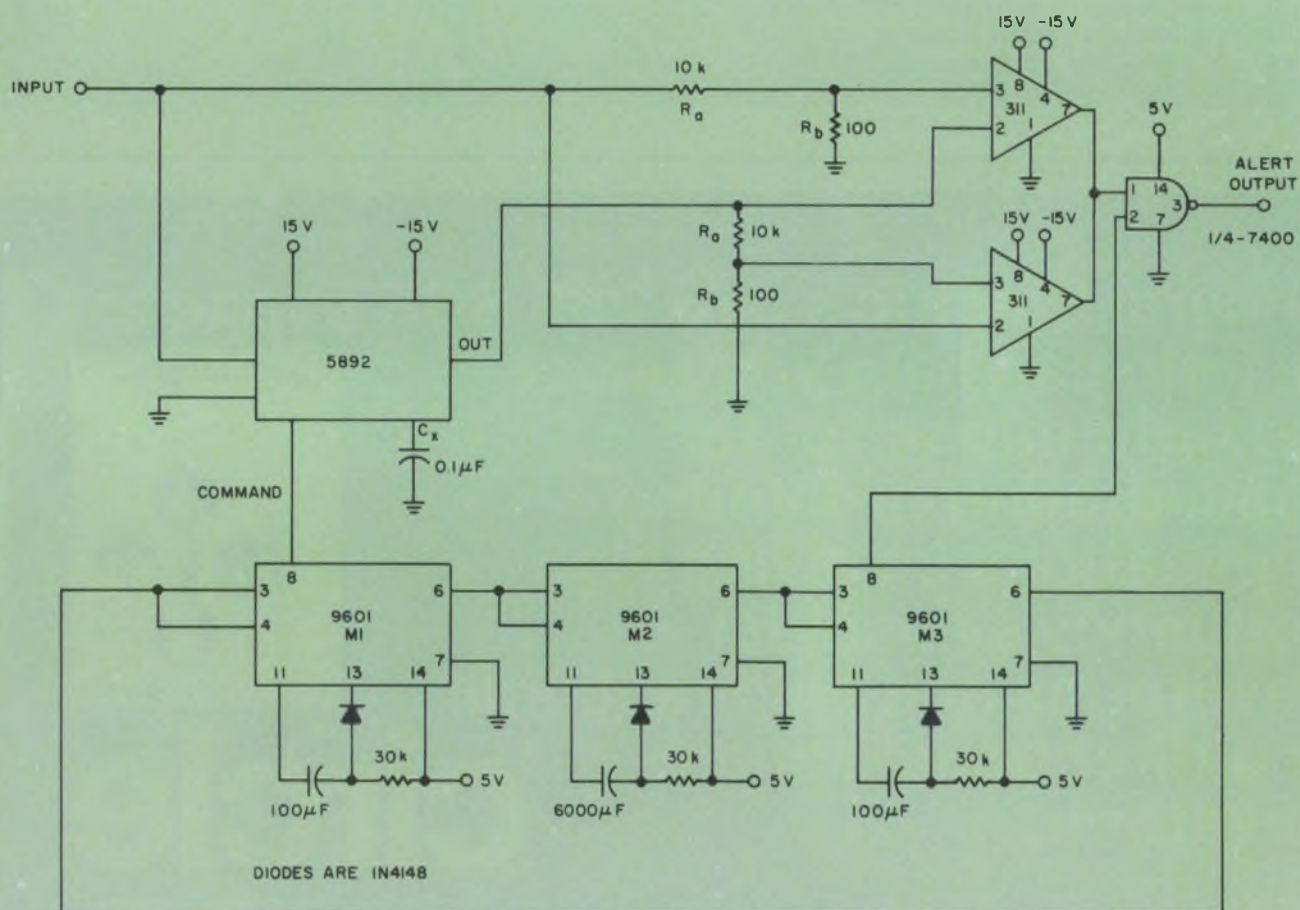

An output of logic ONE indicates a changing input. But when a logic ZERO appears at the output, the

analog input has changed less than 1% for one minute.



13 STANDARD RESISTORS

13 STANDARD RESISTORS

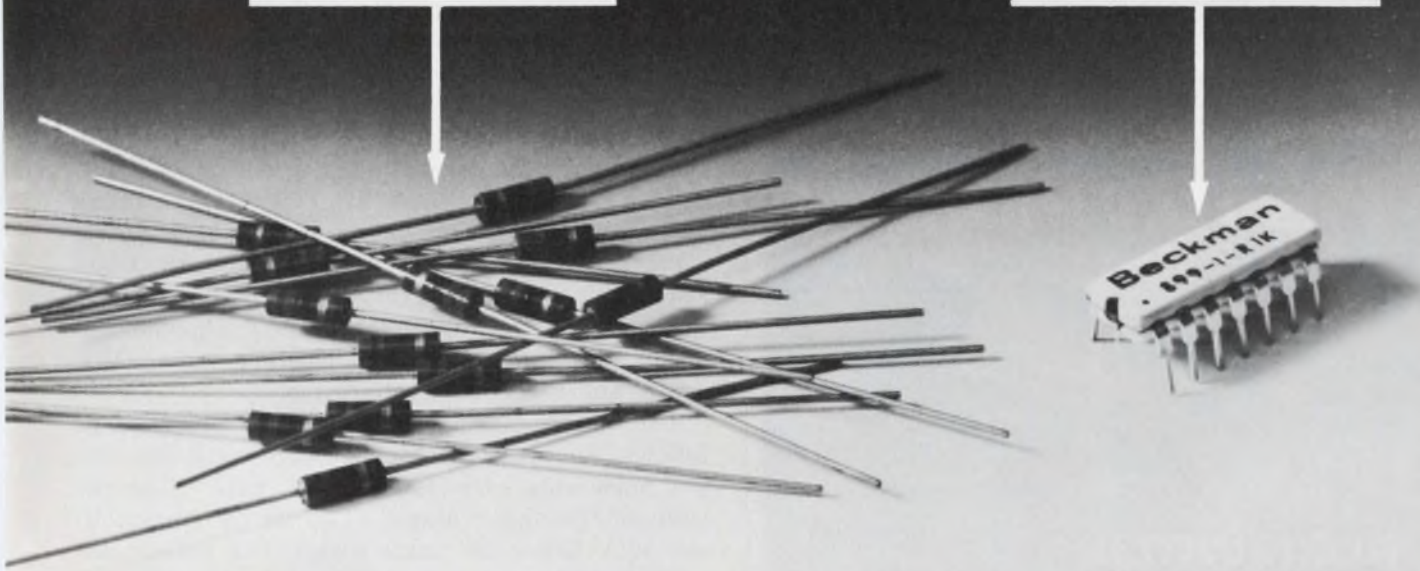

# Helipot's one-piece money saver saves time and space, too.

To keep working with discrete standard resistors just isn't logical. Not when there are ceramic DIPs available that do the same jobs in less space — quicker, easier and cheaper. Whether inserted automatically or by hand.

They're stocked locally for immediate delivery, too. At "on the board" cost-saving prices, in small or large quantities.

**Beckman**  
INSTRUMENTS, INC.  
HELIPOT DIVISION  
Fullerton, California

(Check the specs.) No wasted time while they're "made to order," unless you want custom modifications, which we can do fast.

And remember, ceramic. Ceramic reliability at plastic prices.



Why wait? Call your local Helipot Representative now for applications assistance or more information.

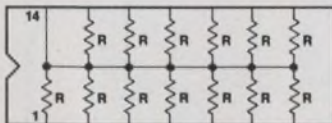

**MODEL SERIES 899-1**

*Resistance Values (ohms):* 100, 150, 220, 330, 470, 680, 1K, 1.5K, 2K, 2.2K, 3.3K, 4.7K, 6K, 6.8K, 10K, 15K, 22K.

*Common Applications:* Digital pulse squaring; MOS/ROM pull-up/pull-down; "wired OR" pull-up; power driver pull-up; open collector pull-up; TTL input pull-down; TTL unused gate pull-up; high-speed parallel pull-up.

*Standard Tolerance:*  $\pm 2.0\%$

<i>Pricing:</i>	1-99	\$1.45
	100-499	1.12
	500-999	0.97

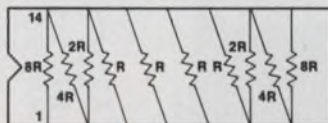

**MODEL SERIES 899-2**

*Resistance Value (ohms):* 10K

*Common Applications:* Inverting operational gain; potentiometric gain; differential gain; noninverting gain; gain adjustment.

*Standard Tolerance:*  $\pm 2\%$

<i>Pricing:</i>	1-99	\$2.75
	100-499	2.15
	500-999	1.86

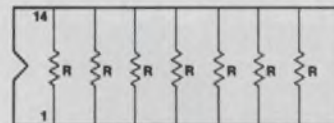

**MODEL SERIES 899-3**

*Resistance Values (ohms):* 68, 100, 110, 150, 220, 330, 470, 680, 1K, 1.5K, 2.2K, 3.3K, 4.7K, 6.8K, 10K, 15K, 22K.

*Common Applications:* Line termination; long-line impedance balancing; power gate pull-up; ECL output pull-down resistors; LED current limiting; power driver pull-up; "wired OR" pull-up; TTL input pull-down.

*Standard Tolerance:*  $\pm 2\%$

<i>Pricing:</i>	1-99	\$1.25
	100-499	0.99
	500-999	0.86



## LOW COST LIGHTED PUSH BUTTON

We have available a variety of lens styles, colors, and switching configurations used with attractive etched plates to make your own low cost lighted Push Button switches. Send for descriptive literature.

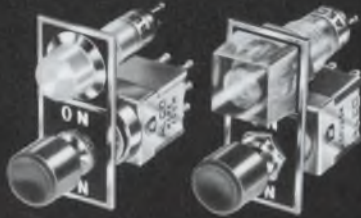

**ALCOSWITCH®**

DIV. OF ALCO ELECTRONIC PRODUCTS, INC., LAWRENCE, MASS.

INFORMATION RETRIEVAL NUMBER 211

## Push ON Push OFF

Exceptionally high current. 6A @ 125 VAC. Snap-action — with fast make & break contacts. SPDT, DPDT & 4PDT — useable either as Norm. Open, or Norm. Closed switch. Silver contacts & terminals. Also available as momentary.

ALTERNATE ACTION



**ALCOSWITCH®**

DIV. OF ALCO ELECTRONIC PRODUCTS, INC., LAWRENCE, MASS.

INFORMATION RETRIEVAL NUMBER 212

## PUSH BUTTON MINIATURES

Mustang series have a standard 15/32 bushing, and ultra-miniature case for rear-panel compactness. Hi-volt barriers inside and out. 6A @ 125 VAC, DPDT. Alternate action or momentary types. Replaceable red or black caps.

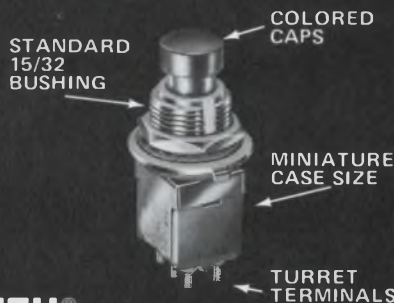

**ALCOSWITCH®**

DIV. OF ALCO ELECTRONIC PRODUCTS, INC., LAWRENCE, MASS.

INFORMATION RETRIEVAL NUMBER 213

## SLIDE SWITCHES

Miniature series offers multiple circuit switching in limited P. C. space. Choice of upright mounting or right-angle mounting. Compact size for P. C. cards. Economically priced.

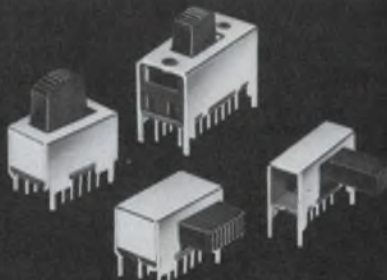

**ALCOSWITCH®**

DIV. OF ALCO ELECTRONIC PRODUCTS, INC., LAWRENCE, MASS.

INFORMATION RETRIEVAL NUMBER 214

# Nanosecond pulser gives a 4-A output

Here's a simple circuit for getting very fast, high-current pulses. The schematic shown provides 4-A pulses with a 4-ns risetime and is capable of 10-kHz repetition rates.

Transistors  $Q_1$  and  $Q_2$  are initially in the OFF condition. The high-voltage supply charges  $C_2$ . Capacitor  $C_3$  charges, through the diode, to about one-half the voltage on  $C_2$ . A clock pulse breaks down  $Q_2$ , thereby applying a near ground voltage to the emitter of  $Q_1$ . With  $Q_2$  in the breakdown condition, the high voltage across  $C_3$  now appears across the base-emitter junction of  $Q_1$ .

This extreme forward bias causes  $Q_1$  to break down. With both transistors now broken down, capacitor  $C_2$  rapidly discharges through the transistors and produces a fast high-current pulse at the output. With  $C_2$  discharged, the avalanche condition terminates. The transistors turn OFF again, and  $C_2$  begins recharging.

The operational procedure of this pulser is as follows: Increase the high voltage until the output pulse rate exceeds the clock rate. Note the value of the high voltage. Then set the high voltage 50 V below the value noted. The pulser output should now be synchronized to the clock.

*Robert D. Morrison, Lawrence Radiation Laboratory, University of California, Livermore, Calif. 94550*

CIRCLE 313

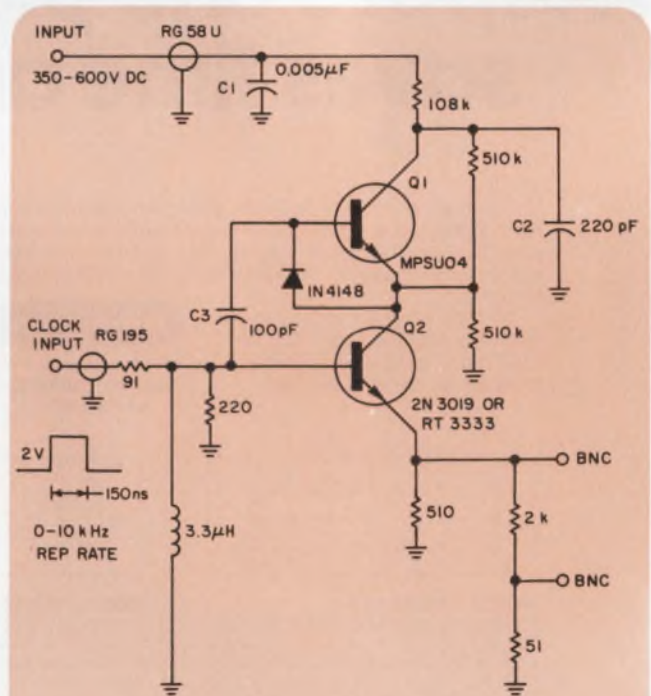

Two transistors in an avalanche mode are used as the basis for this fast, high-current pulser. A clock input provides the means for synchronizing the output pulses. The output load is 50 Ω.



# Clamping varied with transistor

A simple voltage clamp that consists of a transistor circuit can be especially useful when you need between 0.8 V and 1.6 V of clamping.

The equation for  $V_D$  (see diagram) is given by

$$V_D = V_{BE} \left(1 + \frac{R_1}{R_2}\right) + \frac{R_2}{\beta + 1} a_{11} e^{\frac{qV_{BE}}{KT}}, \quad (1)$$

and for  $I_D$ , it is

$$I_D = \frac{V_{BE}}{R_2} + a_{11} e^{\frac{qV_{BE}}{KT}}, \quad (2)$$

where  $q$  = electronic charge,  $K$  = Boltzman's constant,  $T$  = absolute temperature and  $a_{11}$  = reverse saturation current. The clamping voltage  $V_D$  can not be explicitly derived as a function of  $I_D$ , however, Eqs. 1 and 2 can be solved graphically. Design curves, with  $Q_1$  a typical IC transistor, are given for a temperature of 25°C and  $R_2 = 0.93 \text{ k}\Omega$  as a function of  $R_1$ .

The change in temperature of the clamping circuit is given by

$$\frac{dV_D}{dT} \cong \frac{\partial V_{BE}}{\partial T} \left(1 - \frac{R_1}{R_2}\right). \quad (3)$$

Ury Priel, National Semiconductor, 2900 Semiconductor Drive, Santa Clara, Calif. 95051.

CIRCLE 314

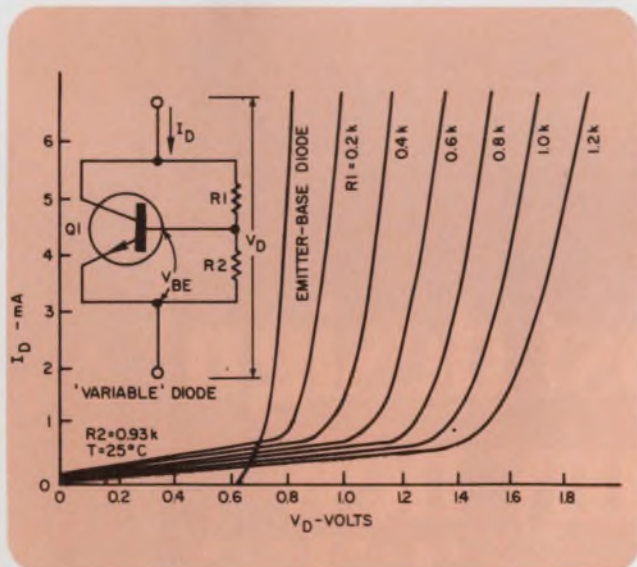

"Variable diode" schematic provides clamping voltages between those that are obtained from one and two common diodes. The curves relate  $I_D$  to  $V_D$ .

Don't forget to mail your renewal card to continue receiving Electronic Design.

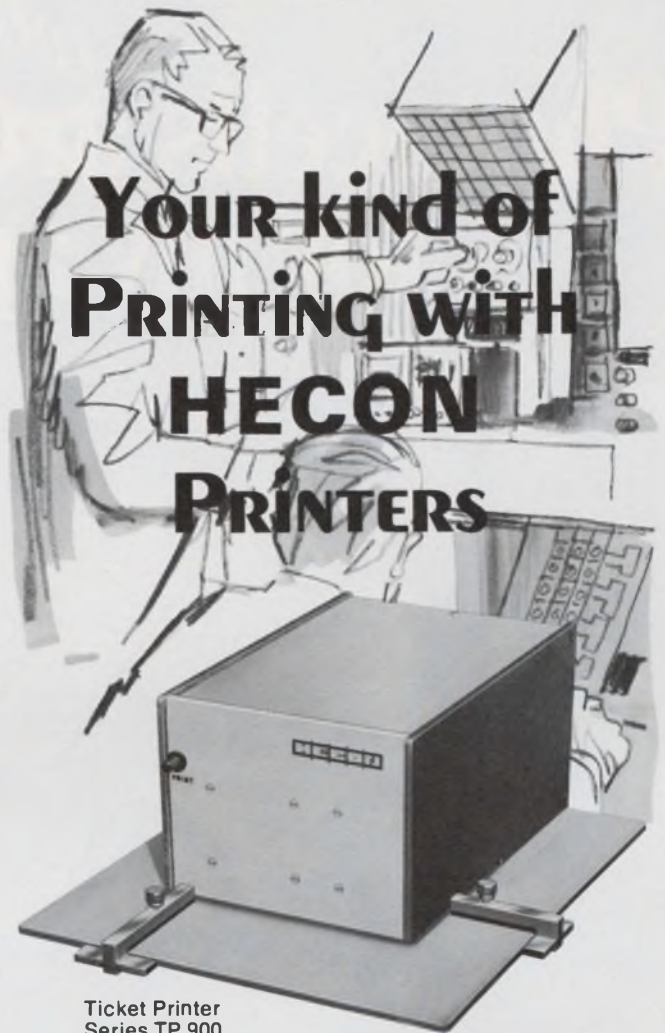

Ticket Printer Series TP 900

- Ticket: 4 to 18 Columns  
Tape: 4 to 12 Columns
- Input: BCD or pulse or combination
- Column Grouping Flexibility
- Time - Date - Data Combination



Tape Printer Series AO 501

Individual Print Modules float with overtravel to assure even, clear print-out. A unique ink cartridge system provides smudge-free print. Adjustable Ticket T-Stops provide accurate positioning for various ticket sizes and print locations. Write today for information describing our full line of printers.

HECON®

Better by Design



HECON CORPORATION

P.O. Box 247, Eatontown, N. J. 07724  
Tel: 201-542-9200; Telex: 132-457

HECON OF CANADA LTD.

80 Galaxy Blvd., Rexdale, Ontario  
Tel: 416-678-2441; Telex: 0622-773

Members of the worldwide Hengstler Group of Companies

INFORMATION RETRIEVAL NUMBER 38



*were*  
Photocells ~~are~~ too expensive  
for my application

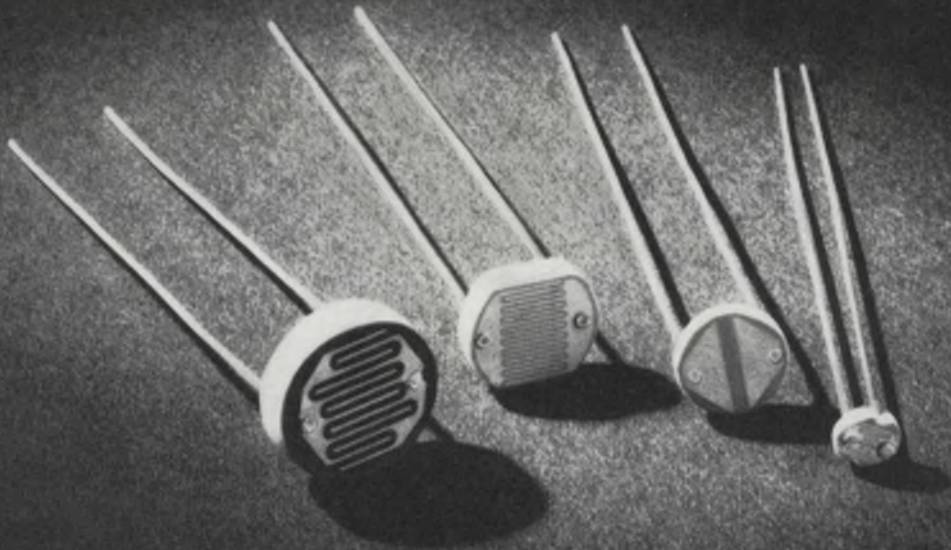

## New low-cost design offers many new application possibilities

Plastic encapsulated cells are now readily available in 4 sizes from .170 inches to .435 inches in diameter... and they're as rugged and nearly as reliable as hermetically sealed cells for many applications.

Look again at the applications where you thought photocells were too expensive. We'll send you free samples if you'll tell us why you need them: Call (914) 664-6602 or write Clairex®, 560 South Third Avenue, Mount Vernon, New York 10550.

### CLAIREX ELECTRONICS

A DIVISION OF CLAIREX CORPORATION



# new products

## Stable $1\text{-}\mu\text{V}/^\circ\text{C}$ FET op amp comes down in price to \$45

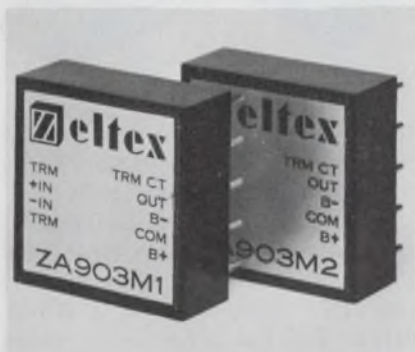

Zeltex, Inc., a sub. of Redcor Corp., 1000 Chalomar Rd., Concord, Calif. Phone: (415) 686-6660. P&A: see text; stock.

Touting high performance at low cost, Zeltex, Inc., has introduced its new ZA903M2 dual-FET-input op amp which features a maximum drift of  $\pm 1\ \mu\text{V}$  over the temperature range of 0 to  $+60^\circ\text{C}$  and costs only \$45 in single quantities. Over the temperature range of  $-25$  to  $+85^\circ\text{C}$  this op amp drifts a maximum of  $2\ \mu\text{V}/^\circ\text{C}$ .

Despite its low cost, the ZA903M2 also includes some impressive features. It utilizes a proprietary circuit design which eliminates drift changes any time an offset voltage adjustment is required. Since it is trimmed to a low level of  $\pm 0.5\ \text{mV}$ , it can be used for many applications without the need for any

offset adjustment potentiometers.

The amplifier's unity gain bandwidth is a wide 4 MHz and full-power response is rated at 100 kHz. Output is  $\pm 10\ \text{V}$  at  $\pm 10\ \text{mA}$ . Typical open-loop dc gain is 115 dB.

A slew rate of  $6\ \text{V}/\mu\text{s}$  can be obtained with this new op amp in both inverter and follower modes. Features also include input current of 10 pA maximum, 90 dB common-mode rejection ratio and very low noise—only  $2\ \mu\text{V}$  pk-pk over 0.01 to 10 Hz.

The low-noise and voltage-drift characteristics of the ZA903M2 combined with its high differential input impedance of  $10^{11}\ \Omega$  and 5 pF make it ideal for use in buffer and amplification applications.

Low-power dissipation and small size are additional features. The unit operates from  $\pm 15\text{-V}$  supplies and draws only 3 mA. And it measures just 1 by 1 by 0.4 in. The leads are 0.04 in. in diameter.

For those who want a FET op amp at an even lower cost with nearly the same characteristics, the economy version ZA902M2 is available at \$35 in single quantities. Except for its  $\pm 3\text{-}\mu\text{V}/^\circ\text{C}$  drift over 0 to  $+60^\circ\text{C}$  and  $5\ \mu\text{V}/^\circ\text{C}$  over  $-25$  to  $+85^\circ\text{C}$ , it is identical to the ZA903M2.

CIRCLE NO. 340

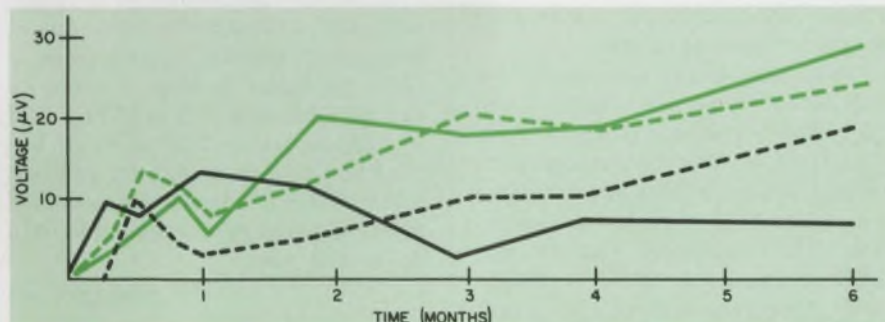

A new low-cost FET op amp features low voltage drift even over long periods of time. Four such model ZA903M2 op amps were tested over

a six-month period for drift-vs-time characteristics. The average voltage drift was  $\pm 10\ \mu\text{V}$ . Corrections were made for temperature variations.

## Hybrid audio agc amp can be programmed



Gulton Industries, Inc., Metuchen, N. J. Phone: (201) 548-2800. P&A: \$9; 6 wks.

An agc audio amplifier in a hybrid thick-film circuit has an externally programmable agc attack and decay response over a 2-to-200-dB/s range. Other advantages include a 1-dB output change over the dynamic range of 50 dB, a low power drain of 1 mA and a power supply range of 10 to 35 V. It is available with FET-input (model GMA9042) and bipolar-input (model GMA9043) stages.

CIRCLE NO. 341

## Remote MOS drivers speed up logic testing

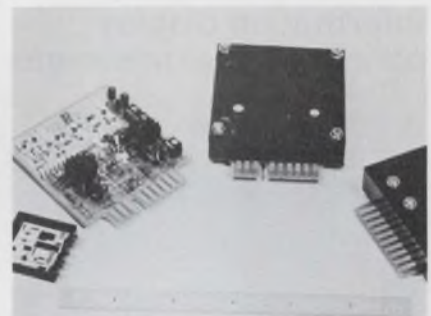

Semiconductor Test Systems, Inc., sub. of Computest Corp., 3 Computer Dr., Cherry Hill, N. J. Phone: (609) 424-2400. P&A: \$80 to \$275; 30 days.

A new line of MOS drivers allows high-speed testing of complex logic devices in real time. The line's thick-film hybrid units are extremely small and can be remote-mounted on a wafer prober or a finished package handler. It offers programmable high and low voltages ( $\pm 30\ \text{V}$ ), fast slew rate (2-V-ns at 50 pF), high-speed inhibit (under 20 ns), high data rate (over 10 MHz), TTL-compatible inputs and output protection.

CIRCLE NO. 342

## Display module with memory handles 20 MHz



Tronix, Inc., Box 349, Phillipsburg, N. J. Phone: (201) 859-3944. P&A: \$20/digit; stock.

The new TR-510 series digital display module allows displayed data to be stored on external command and enables visual monitoring of all significant digits even at a 20-MHz input data rate. Utilizing an automatic internal latch clock, the TR-510 samples incoming data within the normal human visual-response frequency thereby eliminating the blurred "8" display of seven-segment readouts.

CIRCLE NO. 343

## Information display panels conceal messages

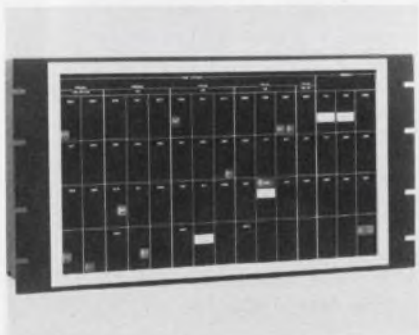

Stacoswitch, Inc., 1139 Baker St., Costa Mesa, Calif. Phone: (714) 549-3041. P&A: from \$8, 4 to 6 wks.

Concealed message information display panels are available for applications in computerized data displays, automated machinery control, vending machines and utility command and control. The panels allow the choice of message, message color, background color, or the background color together with concealed message before illumination.

CIRCLE NO. 344

## Power amplifier gives 50 W rms into 8 Ω

Epitek Electronics Ltd., 19 Grenfell Crescent, Ottawa, Ontario, Canada. Phone: (613) 825-3911.

A new power amplifier module is capable of delivering 50 W of rms power into an 8 Ω load. The 5070 module includes a heatsink permitting operation at ambient temperatures up to 50°C and has built-in short-circuit protection. It operates from a supply voltage of 70 V at a flat frequency response to 50 kHz with 0.5% distortion at full output.

CIRCLE NO. 345

## Hybrid i-f amplifier has 2.5 dB noise figure

Optimax, Inc., Colmar, Pa. Phone: (215) 822-1311.

The model AL-1014 thick-film hybrid i-f amplifier operates at a center frequency of 440 MHz and at a maximum noise figure of 2.5 dB. The new amplifier has maximum input VSWR of 1.5:1 and a maximum output VSWR of 1.7:1. Its minimum gain is 25 dB across a 120-MHz bandwidth with gain stability across the band of ±0.5 dB. Input and output impedance is 50 Ω.

CIRCLE NO. 346

## Low-power converters are DTL/TTL compatible

Progressive Technology, Inc., 1019 Westminister Ave., Dix Hills, N. Y. Phone: (516) 586-6382. P&A: \$450 to \$675; stock to 2 wks.

New low-power s/d converters will accept reference voltages from 20 to 140 V rms and produce 12-bit TTL/DTL-compatible outputs. Both 60 and 400-Hz models are available for either 11.8 or 90 V rms line-to-line. The converters feature ±1-LSB accuracies at 25°C. A 16-line BCD converter will also be available. Power requirements are +15 V at 40 mA, -15 V at 50 mA and +5 V at 150 mA.

CIRCLE NO. 347

## DIP crystal oscillator is TTL IC compatible

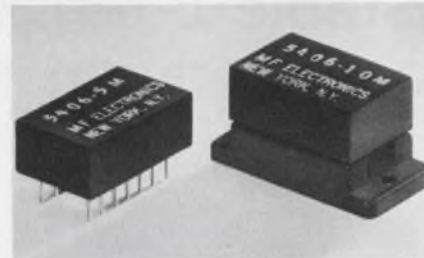

MF Electronics Corp., 118 E. 25th St., New York, N. Y. Phone: (212) OR 4-5360. P&A: \$35; stock.

A new crystal clock oscillator is voltage-level compatible with 7400 TTL ICs. The 5406 plugs directly into DIP sockets with a 0.3-in. height and has a frequency range of 4 to 35 MHz. Frequency stability is ±50 ppm or ±25 ppm over the temperature range of 0 to 65°C.

CIRCLE NO. 348

## Multiple capacitors come in a single DIP

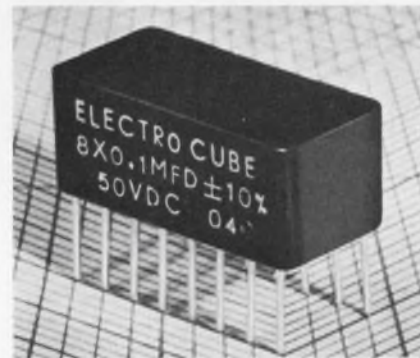

Electrocube, Inc., 1710 S. Del Mar Ave., San Gabriel, Calif. Phone: (213) 283-0511.

Multiple capacitors in a single DIP are available to save space, component handling and assembly time. As many as eight capacitors can be packaged in a 0.385 by 0.34 by 0.82-in. case. The package has 16 leads spaced on 0.1-in. centers. Eight 0.068 μF 100 V dc metalized mylar capacitors, for example, will fit in the case.

CIRCLE NO. 349

This issue has your renewal card, inside front cover. Mail it today.



## Decoder/driver IC has counter and latch

Texas Instruments, Inc., 13500 N. Central Expway., Dallas Tex. Phone: (214) 238-2011. P&A: \$3.65 (100 quantities); 6 to 8 wks.

A new MSI/TTL function in a 16-pin DIP replaces three popular MSI functions. The SN74142 consists of a decade counter, a 4-bit latch and a 1-of-10 decoder/decimal display tube driver on a single monolithic chip. Functionally, the SN74142 will accept input count frequencies of up to 25 MHz, convert and store as four BCD bits, then decode and provide an output designed specifically to drive Nixie display tubes.

CIRCLE NO. 350

## 64-bit bipolar RAM drains but 35 mA

Advanced Micro Devices, Inc., 901 Thompson Pl., Sunnyvale, Calif. Phone: (408) 732-2400. P&A: \$12.80 (100 quantities); stock.

The Am31L01 64-bit bipolar RAM features current drain of only 35 mA and an access time of 70 ns. This Schottky-diode memory, organized as 16 words by 4 bits, is suited for scratch-pad and high-speed buffer memory applications. Available in military and commercial temperature ranges, it is designed with a special guard ring around the Schottky device to obtain high breakdown voltages at the output pins.

CIRCLE NO. 351

## 10-bit shift registers transmit parallel data

Signetics, 811 E. Arques Ave., Sunnyvale, Calif. Phone: (408) 739-7700. P&A: \$3.34 (100 quantities); stock.

Two new MSI 10-bit shift register ICs are the 8274 10-bit parallel-in serial-out unit and 8273 serial-in, parallel-out version. The two can operate together. The 8274 converts data from a computer's parallel form to a serial form that permits transmission to the 8273, which changes the data back into parallel form for further handling.

CIRCLE NO. 352

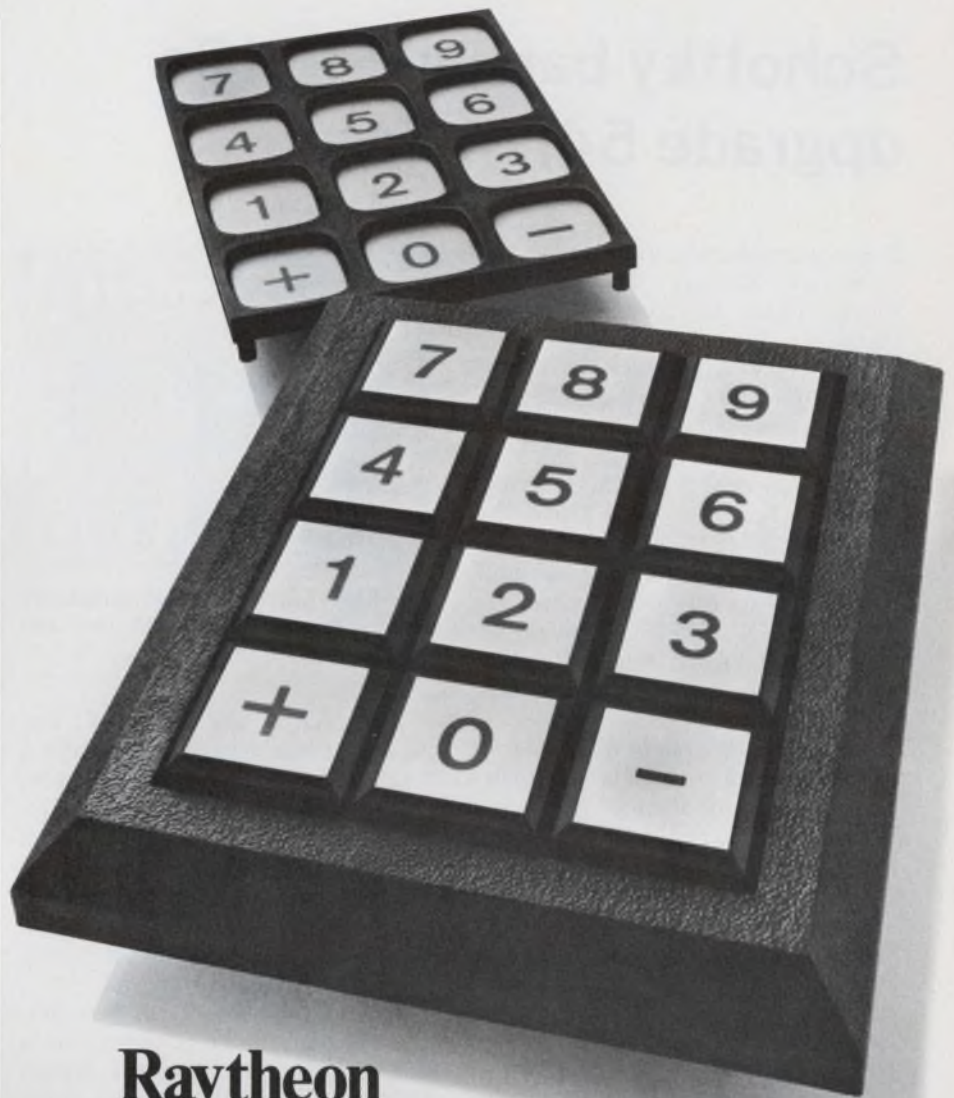

## Raytheon puts design simplicity at your fingertips.

Low profile. Low cost. Reliable conductivity. That's the design convenience offered by Raytheon's new elastomer-contact keyboards.

Our new encoded switch arrays combine conductive plastic technology with a totally integrated keyboard design to provide compact, reliable outputs that do not require diodes or external logic circuitry. Unlike other low profile keyboards, Raytheon offers snap-action keys with positive feel. Standard, custom or multiple codes are available.

Our numeric keyboards are the most economical, most reliable elastomer-contact keyboards available. The unique and patented silver-filled silicone elastomer contacts provide extremely fast, clean contact closure. Both 12-key and 16-key versions are available, with single pole or touch contact configurations.

Put our keyboards to use in your next panel design. They're perfect for use in the computer, communications and control industries.

To put more information at your fingertips, write Raytheon Company, Fourth Ave., Burlington, Massachusetts 01803.





## Schottky barrier TTL ICs upgrade 54/74 line

Texas Instruments, Inc., 13500 N. Central Expwy, Dallas, Tex. Phone: (214) 238-2011. P&A: see text.

Three new high-speed Schottky TTL ICs—two high-complexity MSI circuits and a new flip-flop circuit—have been introduced by Texas Instruments in their series 54/74 IC family.

- The SN54S/74S181 arithmetic logic unit which offers typical add times of 20 ns for 16-bit words.

- The SN54S/74S153 dual 4-line-to-1-line data selector/multiplexer which has equivalent gate delays of only 2.8 ns.

- The SN54S/74S74 dual D-type flip-flop which responds to input clock frequencies of up to 110 MHz.

Featuring 75 equivalent gates on a single chip, the SN54S/74S181 arithmetic logic unit performs 16 binary arithmetic manipulations on two 4-bit words including add, subtract, decrement and direct transfer. Typical addition/subtraction time is 15 ns. Power dissipation is 700 mW.

The device also performs 16 logic functions of two Boolean variables such as NAND, AND, OR and Exclusive OR functions.

The SN54S/74S181 is functionally identical to and pin-for-pin replaceable with the SN54/74181. This means that existing systems can be upgraded by specifying the new Schottky IC.

The second Schottky device is the versatile SN54S/74S153 multiplexer which can be used in ultra-high-speed applications to convert parallel data to serial data or to randomly select information from a number of sources.

Functionally it is identical to and pin-for-pin equivalent to the older SN54/74153. It can be plugged into existing designs providing improvement in data-transmission frequencies. Typical delay times are 6, 12 and 10 ns from the data, select and strobe inputs, respectively, compared to 14, 22 and 17 ns for the SN54/74153.

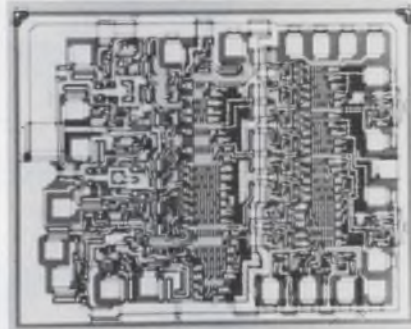

The SN54S/74S181 high-complexity MSI arithmetic logic unit can add 16-bit words in only 20 ns.

All inputs are buffered and represent one 54S/74S normalized load. Power dissipation is 225 mW.

The SN54S/74S74 D-type flip-flop will accept input clock frequencies up to 110 MHz and demonstrates delay times averaging 7 ns. It is positive-edge triggered and has direct clear and preset inputs and complementary outputs.

Clock triggering occurs at a voltage level of the clock pulse and is not directly related to the transition time of the positive-going pulse. After the clock input threshold voltage has been passed, the data on input D is locked out.

Functionally and mechanically interchangeable with the standard SN54/7474 and the high-speed SN54H/74H74, the Schottky TTL version can be used as a plug-in to upgrade existing designs. Power dissipation is 75 mW/flip-flop.

All three circuits are offered in plastic (N suffix) and ceramic (J suffix) dual-in-line or ceramic (W suffix) flat packages. Full-temperature military versions (prefix SN-54) and industrial versions (prefix SN74) are available.

Prices in quantities of 100 to 999, range from \$3.01 to \$32.50 for plastic DIPs; from \$7.45 to \$88 for ceramic DIPs; and from \$9.03 to \$106.10 for ceramic flatpacks. Availability is 2 to 4 wks for plastic DIPs, and 6 to 8 wks for ceramic DIPs and flatpacks.

CIRCLE NO. 353

## MOS character generator offers 5x7 dot matrix

Harris Semiconductor, Melbourne, Fla. Phone: (305) 727-5407. P&A: \$28.60 (100 quantities); stock.

A new p-channel MOS fully decoded character generator for ASCII programs provides a 5-by-7 dot matrix pattern. Designated the HROM-2561, the monolithic device is suited for horizontal-scanning systems such as CRT and other visual displays, including LED readouts. The HROM-2561 operates over  $-55$  to  $+125^{\circ}\text{C}$  and is designed with protection against static charges. Power dissipation is 50 mW at a clock rate of 1 MHz.

CIRCLE NO. 354

## Dual monolithic FETs improve tracking

Solitron Devices, Inc., 8808 Balboa Ave., San Diego, Calif. Phone: (714) 278-8780.

A family of n-channel dual monolithic FETs, the SMF3954, SMF-3955, SMF3956 and SMF3958 are a direct replacement for the 2N3954 and the 2N5452 series but offer improved thermal tracking characteristics. Features include low noise and output admittance, square-law transfer characteristics and a constant tracking coefficient. The devices are available in 6-lead, hermetically sealed TO-71 cans.

CIRCLE NO. 355

## Digital multiplexers handle data selection

Signetics, 811 E. Arques Ave., Sunnyvale, Calif. Phone: (408) 739-7700. Price: from \$2.20 (100 quantities).

Three versions of a 2-input 4-bit MSI digital multiplexer IC are available for use in general-purpose data-selection applications. Data paths in the 8233 multiplexer are non-inverting while those in the 8234 are inverting. The 8235 version is designed for input to adders, registers and parallel data handling. All three are available with operating-temperature ranges from  $-55$  to  $+125^{\circ}\text{C}$  or 0 to  $+75^{\circ}\text{C}$ .

CIRCLE NO. 356



## IC audio amplifiers deliver up to 2 W



Motorola Semiconductor Products, Inc., Box 20912, Phoenix, Ariz. Phone: (602) 273-6900. Price: \$1.56, 95¢ (100 quantities).

Two new inexpensive audio power amplifier ICs for the radio/TV/phonograph market are rated at 1 and 2 W of output power. The MFC9020 (2 W) is housed in an 8-pin stagger-lead plastic package with two heat-dissipating tabs. The MFC6070 (1 W) is supplied in a smaller 6-pin stagger-lead case. Input impedance is in the order of 1 MΩ. Only a 200-mV input is required for full output.

CIRCLE NO. 357

## Plastic HV transistors dissipate up to 20 W

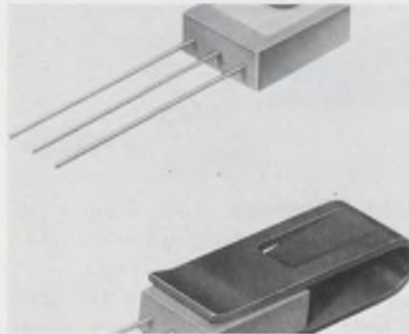

RCA Solid State Div., Rte. 202, Somerville, N. J. Phone: (201) 722-3200. P&A: from 49¢ to 72¢ (1000 quantities); stock.

A family of plastic high-voltage transistors includes TO-5 types 2N6175, 2N6176 and 2N6177 which dissipate 20 W at case temperatures up to 25°C. Types 40885, 40886 and 40887 are the same as the 2N6175, 2N6176 and 2N6177, respectively, except that they are supplied with factory-attached heat clips. They dissipate 1.4 W at 25°C ambients.

CIRCLE NO. 358

## Field-erasable ROM can be reprogrammed



Intel Corp., 3065 Bowers Ave., Santa Clara, Calif. Phone: (408) 246-7501. P&A: \$200, \$184; stock.

A new 2048-bit MOS ROM can be erased and reprogrammed in the field. Designated as the E-ROM, it is programmed electrically using a manual or an automatic tape-actuated programmer. It is erased by shining light from a UV lamp through a transparent quartz lid on the 24-pin ceramic DIP package. Ambient light such as sunlight or indoor illumination will not affect the stored program.

CIRCLE NO. 359

Have you sent us your subscription renewal card?

# free probe catalog

United Sensor probes are used to accurately measure temperature, total and static pressure, velocity and flow direction of fluids, gases, and liquids at any point in a flow stream.

Catalog S-7 provides design and application data for over 200 Pitot-Static, Temperature/Thermocouple, Kiel, and Directional Probes — plus special equipment such as Probe Positioning Units, Pressure and Temperature Rakes, and many special-purpose Probes. Most units are in stock.

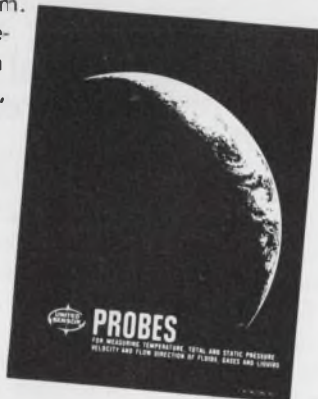

**& CONTROL CORPORATION**  
A Subsidiary of UNITED ELECTRIC CONTROLS CO  
85 SCHOOL STREET  
WATERTOWN, MASS. 02172  
Telephone 617 926-1000

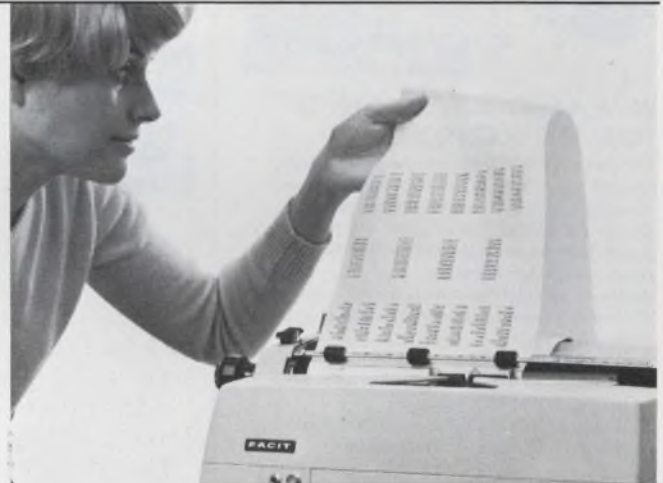

## The Facit 3851 input/output typewriter is provided with remote controlled tabulation.

The tab stops can be set and cleared by remote control. This permits changing the column configuration while the machine is in operation.

There is further interesting information on the new Facit 3851 in this publication.

### Facit 3851 - the conventional typewriter with input/output

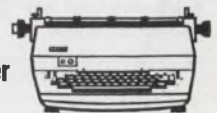

For further information, contact  
in US: Facit-Odhner Inc., 501 Winsor Drive, SECAUCUS, New Jersey  
outside US: Facit AB, Albygatan 102, 171 84 Solna, Sweden

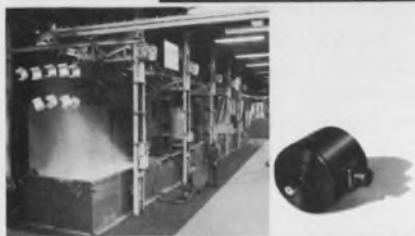
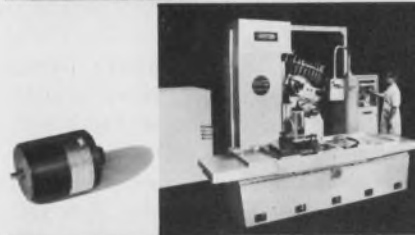

### WE'VE ALREADY SOLVED MANY OF YOUR ENCODER PROBLEMS.

For over ten years, Data Tech has been solving industry's problems in precision measurement, numerical control feedback, instrumentation, design and display. Our solutions are technically sound, economical and offer years of reliable repetitive system operation.

Wherever encoder technology makes good sense our technical skills and years of experience are available to you.

Typical **OPTECON**<sup>™</sup> Encoder Applications -

1. Measurement Laboratory Digitizing
2. N/C Machines and Readouts
3. Severe Industrial Environment Operations
4. Machining Center and Numerous Others



New **SUPERCON**<sup>™</sup> Offers High Performance:  
Frequency: 125 KHz Max.  
Accuracy: 3 arc min.  
Resolution: to 2500 cycles/turn  
Speed: up to 3000 RPM  
Drive Capability: up to 400 feet  
WRITE FOR PUBLICATION  
1-700 for complete information.

Write for **OPTECON**<sup>™</sup>  
Publication 1-601 and  
Application Notes.



<sup>™</sup> - Trade Names describing Data Technology, Inc., series of Optical Encoders



DATA TEChnology, inc.

65 Grove Street, Watertown, Massachusetts 02172/617 : 924-1773

INFORMATION RETRIEVAL NUMBER 43

## MICROWAVES & LASERS

### Silicon impatts deliver up to 1.5 W at 8 GHz



Hewlett-Packard, 1501 Page Mill Rd., Palo Alto, Calif. Phone: (415) 493-1501. P&A: \$150; stock.

New impatt diodes are the first to achieve microwave power levels higher than 1 W. Types 5082-0424, 5082-0425 and 5082-0426 cover 5.3 to 8, 8 to 10 and 10 to 13.5 GHz with minimum cw output power levels of 1.5, 1.25 and 1 W, respectively. Operating voltages are 125, 100 and 80 V, operating currents are 220, 210 and 200 mA and efficiencies are 6.5%, 7% and 7%, respectively.

CIRCLE NO. 360

### S-band amplifier has only 6-dB noise figure

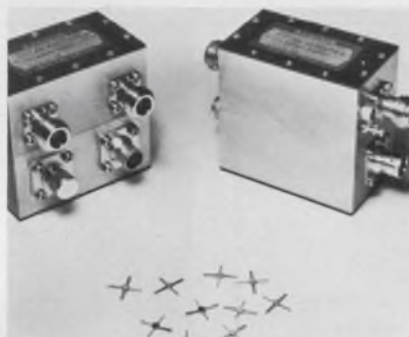

Avantek, Inc., 2981 Copper Rd., Santa Clara, Calif. Phone: (408) 739-6170. P&A: \$3000; stock to 60 days.

The new low-noise AM-4070N amplifier covers the 2-to-4 GHz frequency range with a 6-dB maximum noise figure. The new microstrip amplifier utilizes a new series of bipolar small-signal silicon transistors with high-frequency gain, low noise figure, high  $f_T$  and low-parasitic capacitance. The amplifier is available with in-line or front-mounted TWT-replacement connectors. Size is 3 by 1.75 by 1.25 in.

CIRCLE NO. 361

Don't forget to mail your renewal card to continue receiving Electronic Design.

### YIG 4-stage filter tracks over 1 to 18 GHz

Ryka Scientific, Inc., 641 N. Pastoria Ave., Sunnyvale, Calif. Phone: (408) 738-0930. Availability: 30 days.

The model 412M is a multi-octave 1-to-18-GHz 4-stage YIG-tuned filter that can be tracked linearly over the entire spectrum of L through Ku-band. Its off-resonance isolation is 80 dB minimum. Typical 3-dB bandwidth is 30 to 70 MHz while insertion loss is 4 dB. Off-resonance spurious response is 70 dB down and selectivity is 24 dB/octave. Supplied with SMA connectors, the filter measures 1.4 by 1.4 by 2.75 in.

CIRCLE NO. 362

### X-band power amplifiers deliver up to 500 mW

Hughes Aircraft Co., Electron Dynamics Div., 3100 W. Lomita Blvd., Torrance, Calif. Phone: (213) 534-2121.

Four new impatt-diode amplifiers cover the frequency range of 7 to 11.5 GHz and provide output powers of up to 500 mW minimum. Model numbers 46603H through 46606H have noise figures of 30 dB and group delay of 1 ns over a typical communications channel bandwidth. Gain flatness is  $-0 +1.5$  dB and dynamic range is 3 dB minimum. The amplifiers include current regulators and limiters for transient protection of the impatt diodes.

CIRCLE NO. 363

### Optical lenses have high resolution

Optical Sciences Group, Inc., 24 Tiburon St., San Rafael, Calif. Phone: (415) 453-8980.

New Fresnel II lenses feature grooves 5- $\mu$ m. smooth, 100- $\mu$ m. edge sharpness and angles controlled to seconds of an arc. An optimum groove density has been calculated for each lens, giving increased resolution by taking into account both geometrical optics and diffraction effects. A line of standard lenses is available from 1/2 to 15 in. in dia and 0.4 to 24 in. in focal length.

CIRCLE NO. 364



COMPONENTS

**Potentiometer assembly includes digital readout**



Bourns, Inc., 1200 Columbia Ave., Riverside, Calif. Phone: (714) 684-1700. P&A: \$15.30 (500 quantities); stock.

Model 3610 digital Knobpot potentiometer combines a digital readout and a potentiometer into a single 7/8-in.-dia integral assembly with a guaranteed accuracy. The unit is factory-phased to an accuracy of  $\pm 0.5\%$  between electrical output and dial reading—the equivalent of better than  $\pm 0.5\%$  terminal base linearity. Snap-in mounting takes only seconds.

CIRCLE NO. 365

**Bandpass filters span 1 to 100 kHz**



Beukers Laboratories, Inc., 1324 Motor Pkwy, Hauppauge, N. Y. Phone: (516) 234-2200. P&A: \$65; 7 days.

New low-cost passive bandpass filters are computer designed for operation from 1 to 100 kHz. Designated as series BPF, they provide center-frequency stability of  $\pm 0.5\%$  over the temperature range of  $-40$  to  $+70^\circ\text{C}$ . Standard types are specified at 2% bandwidth and at 5 k $\Omega$  source and load impedances. Bandwidths of 1% to 10% and additional impedance levels are also available.

CIRCLE NO. 366

**Plug-in +5-V DIP supplies MOS voltages**

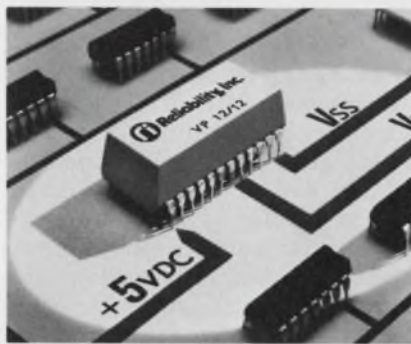

Reliability, Inc., 5510 Greenbriar, Houston, Tex. Phone: (713) 529-5817. P&A: \$36; 2 wks.

A new DIP which may be plugged into IC sockets, or flow-soldered using conventional techniques, derives its power from +5-V  $V_{CC}$  bipolar lines and provides the proper  $V_{KG}$  and  $V_{RS}$  voltages required by MOS units. Called the V-PAC it includes side-exiting pins which facilitate in-circuit testing, a 3/8-in.-high body and a turn-on voltage that tracks the +5-V supply.

CIRCLE NO. 367

**Miniature reed relays measure 0.02 cubic in.**



Wheelock Signals, Inc., 273 Branchport Ave., Long Branch, N. J. Phone: (201) 222-6880.

A complete line of ultra-miniature needle reed relays occupy a volume of 0.02 in.<sup>3</sup> and measure 0.19 in. in dia. Series 372 relays weigh only 1.1 grams and are offered in seven versions with the option of straight or preformed leads, depending on application. Contact rating is 7 W dc at 150 V or 250 mA. Contact resistance is 100 m $\Omega$  and release time is 0.06 ms at rated voltage.

CIRCLE NO. 368

**HIGH POWER VOLTAGE REGULATORS**  
**2 1/2" x 1 5/8" x 3/4"**



**\$18**  
EACH

Now, there's a second source for high power voltage regulators. Tecnetics offers the new VR03 Series. High powered, low cost, little packages. \$18 each in quantities of 100.

The VR03 Series offers:

- Short circuit and overload protection
- Increased current output when used as a driver for series regulating transistors
- Increased power handling capability with external regulation transistor
- Dual connection and negative regulator connection with transformer isolation
- Positive regulator
- Remote programming
- Up to 5 Amperes D.C. output
- Up to 28 Volts D.C. output
- Up to 70 Watts dissipation
- 0.2% Regulation, line or load
- 0.007%/°C temperature coefficient
- Remote sensing
- Electrically isolated case

Manufactured to your specifications

**tecnetics inc.**

P.O.Box 910, Boulder Industrial Park, Boulder, Colorado 80302  
(303) 442-3837 TWX 910-940-3246

INFORMATION RETRIEVAL NUMBER 44

## Wirewound 10-turn pots cost from as low as \$5



Amphenol Controls Div., Bunker Ramo Corp., 120 S. Main St., Janesville, Wis. Phone: (608) 754-2211.

Wirewound 10-turn potentiometers for industrial/commercial applications are available in 1-13/16-in.-dia (series 4400) and 7/8-in.-dia (series 4300) economy versions—under \$5 in production quantities. They range in values from 25  $\Omega$  to 100 k $\Omega$  at  $\pm 5\%$  tolerance. Each model has a 0.25% independent linearity tolerance. Power rating is 5 W at 40°C for the 4400 series and 3 W at 40°C for the 4300 series.

CIRCLE NO. 369

## Radial-lead resistors lower OEM cost to 22¢

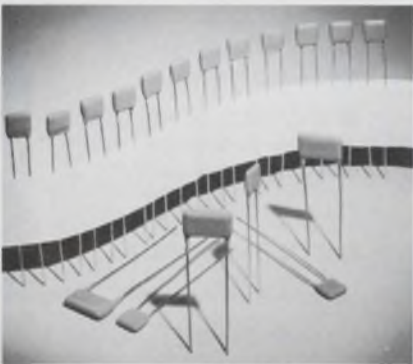

Pyrofilm Corp., 60 Jefferson Rd., Whippany, N. J. Phone: (201) 887-8100. P&A: see text; 3 to 4 wks.

A new low-cost thick-film resistor called the Flatso comes with radial leads and is encapsulated in a fluid bed. For 1000-quantity ranges of 50 to 1 M $\Omega$  and 1 k to 25 M $\Omega$ , 1% 1/4-W resistors cost 22¢ each and 1% 1/2-W resistors 24¢ each. 2%, 5% and 10% tolerance units are also available. The Flatso is only 0.1 and 0.125-in. thin for 1/4 and 1/2-W units, respectively.

CIRCLE NO. 370

## Wafer thermistors can be interchanged

Gulton Industries, Inc., Metuchen, N. J. Phone: (201) 548-2800. P&A: \$4.75; stock.

A complete line of interchangeable wafer thermistors are precisely calibrated to standardized resistance curves. Having the same resistance value at 25°C, these interchangeable wafer thermistors will exhibit identical resistance-vs-temperature characteristics over the usable temperature range of -55 to +150°C. The accuracy in sensing temperature is typically  $\pm 0.2^\circ\text{C}$ . Units are epoxy coated and measure from 0.07-in.<sup>2</sup> square to 0.18-in.<sup>2</sup>.

CIRCLE NO. 371

## Microfilm-recording CRT resolves 0.002-in. spots

Litton Industries, Electron Tube Div., 960 Industrial Rd., San Carlos, Calif. Phone: (415) 591-8411.

A new CRT designed for microfilm recording and scanning applications is available. The L-4249 CRT features a 0.002-in. spot size and a 26-degree deflection angle for enhanced scan speed and linearity. The tube has a flat face with a nominal outside diameter of 5 in. It is available with most standard phosphor materials.

CIRCLE NO. 372

## Rotary switches drop costs to \$3.06

Grayhill, Inc., 565 Hillgrove Ave., La Grange, Ill. Phone: (312) 354-1040. Price: \$3.06 (100 quantities of one-deck models).

A new low-priced enclosed rotary switch line is the series 71. The series offers a choice of standard 0.125 or 0.25-in.-dia shafts. Its switches are small in size—only 0.7 in. in diameter with 0.761 to 3.439 in. of behind-the-panel depth for a 1 to 12-deck switch. Gold-plated contacts are designed to operate at low current requirements. Terminals are molded in position.

CIRCLE NO. 373

This issue has your renewal card, inside front cover. Mail it today.

## Illuminated switches eliminate pitting

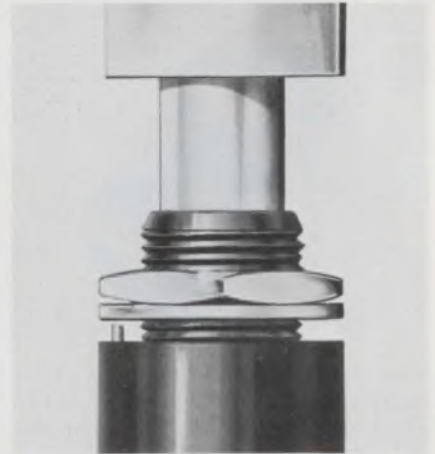

Switchcraft, Inc., 5555 N. Elston Ave., Chicago, Ill. Phone: (312) 792-2700. Price \$4.50 to \$12.50.

A new series of compact fully enclosed illuminated pushbutton switches have been introduced. The snap-slide switch action of the series Orcon switches provides lifting and wiping action. This combination completely eliminates gold migration, pitting, burning and contamination of the contacts. The transfer contacts lift through an air gap, drop onto stationary contacts, then slide with a wiping action.

CIRCLE NO. 374

## Single-turn 1-W pot costs only \$1

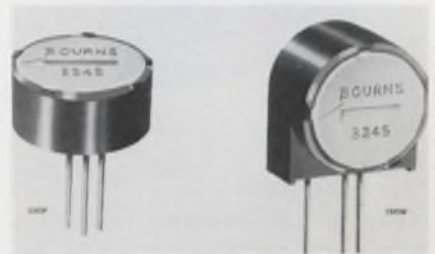

Bourns, Inc., 1200 Columbia Ave., Riverside, Calif. Phone: (714) 684-1700. Price: see text.

Model 3345 0.45-in.-dia wirewound single-turn 1-W potentiometer costs only \$1 (5000 quantities). This Trimpot unit is available in a standard resistance range of 10 to 50,000  $\Omega$  at a tolerance of  $\pm 5\%$  and a temperature coefficient of 70 ppm/ $^\circ\text{C}$ . Maximum height is 1/4 in. The 3345 is rated to operate over the temperature range of -55 to +150°C.

CIRCLE NO. 375



INSTRUMENTATION

**Frequency synthesizer covers 1 to 18 GHz**

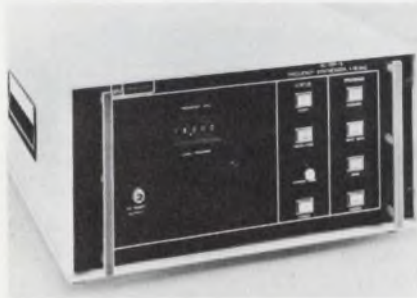

Watkins-Johnson Co., 3333 Hillview Ave., Palo Alto, Calif. Phone: (415) 326-8830.

A solid-state frequency synthesizer provides continuous coverage in the 1-to-18 GHz range. Other specifications of the WJ-1154-5 include frequency steps of 100 kHz (smaller steps available), frequency stability of 1 part in  $10^9$ /day and +10 mW of output power across the entire band. The instrument can be swept or frequency modulated and features local and remote digital programming (BCD).

CIRCLE NO. 376

**Bench-top dc supplies deliver 100 V at 0.1 mA**



Hewlett-Packard, 1501 Page Mill Rd., Palo Alto, Calif. Phone: (415) 493-1501. P&A: \$105, \$130; stock.

Two new general-purpose laboratory dc power supplies designated models 6211A and 6212A are both rated at 0 to 100 V and 0 to 100 mA. Model 6211A is a constant-voltage and current-limited supply. The 6212A is a constant-voltage and constant-current unit. Standard features include 0.01% load and line regulation, 200- $\mu$ V rms/1-mV pk-pk ripple and noise (dc to 20 MHz) and a switchable front-panel meter.

CIRCLE NO. 377

**Low-cost  $\pm 3999$  DPM offers many features**



Newport Laboratories, Inc., 630 E. Young St., Santa Ana, Calif. Phone: (714) 540-4914. P&A: \$189; stock to 3 wks.

A new low-cost digital panel meter with a  $\pm 3999$  count includes as standard features display blanking, autopolarity, buffered, gated and isolated BCD outputs, remote hold command, read rate control, overload and plus-minus indicators and true differential inputs. The 400A's accuracy of 0.05% is maintained with digitizing rates of 0 to 60 readings/s.

CIRCLE NO. 378

**The price of spacers comes tumbling**



**Steel-Aluminum**

Speedy shipment from stock of over 1000 different sizes.

SEND FOR LITERATURE AND FREE SAMPLES!

**CEM COMPANY, INC.**

114 SCHOOL STREET, DANIELSON, CONN. 06239

INFORMATION RETRIEVAL NUMBER 45

ELECTRONIC DESIGN 23, November 11, 1971

**relays...** general purpose, sensitive, miniature, mechanical and magnetic latching



**stepping switches...**



**accessories...**

plugs, sockets and dust covers

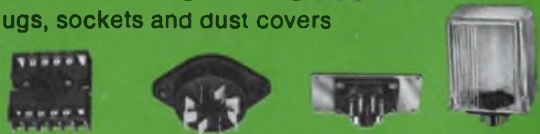

HIGH QUALITY • LOW COST • IMMEDIATE DELIVERY

SEND FOR FREE CATALOGS

**SCHRACK** ELECTRICAL SALES CORP.

1140 Broadway, New York, New York 10001 Tel: (212) 683-0790

INFORMATION RETRIEVAL NUMBER 46



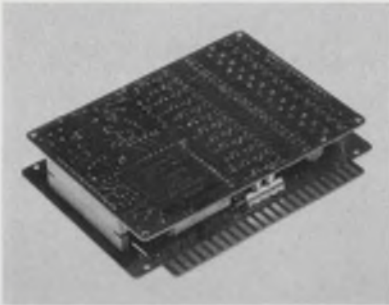

**ADC 700 Series Converters.** Convert 12 binary bits in 6.5  $\mu$ sec and 8 binary bits in 3.5  $\mu$ sec with up to 0.025% full range accuracy and  $\pm 10$  ppm/ $^{\circ}$ C stability. Voltage switching attains high conversion speed without sacrificing accuracy, while maintaining linearity. A reference generator circuit allows the units to meet their specified accuracy with  $\pm 5\%$  regulation of the power supplies. Saturated bipolar switches help to provide low temperature coefficient. Series includes six fully-repairable models. Prices start at \$375 each. Phoenix Data, Inc., 3384 W. Osborn Rd., Phoenix, AZ 85017. Phone 602/278-8528. TWX 910-951-1364.

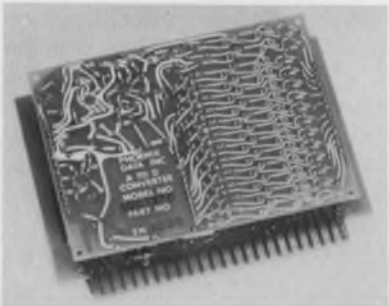

**ADC 1370 Series Converters.** Capable of encoding  $\pm 10$ V full range inputs into 13 binary bits of data with a minimum thrupt time of 14  $\mu$ sec. Provides a resolution of 1 part in 8,191 with an accuracy of  $\pm 0.015\%$  of full range. Features a low temperature coefficient of  $\pm 5$  ppm/ $^{\circ}$ C; full range input of  $\pm 10$ V, 0 to +10V, 0 to +5V, or  $\pm 5$ V standard; with optional 100 megohms input impedance amplifier; serial and parallel outputs; 71,428 conversions on command or continuous. Prices start at \$875 in 1 to 5 quantities. Phoenix Data, Inc., 3384 W. Osborn Rd., Phoenix, AZ 85017. Phone 602/278-8528. TWX 910-951-1364.

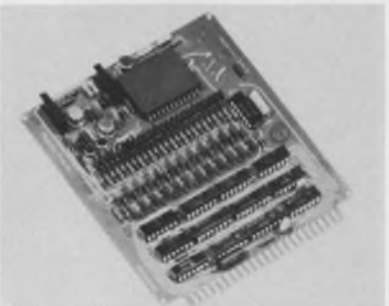

**ADC 300 Series Converters.** Complete, fully-assembled, plug-in modules incorporate all of the functions necessary to perform conversions except for power supplies. Accurate to within  $\pm 0.025\%$ . Single card open construction facilitates field repair and low profile permits units to mount on 0.5" centers. Price of the ADC 312 (12 bit) unit in 1 to 5 quantities is \$300. Phoenix Data, Inc., 3384 W. Osborn Rd., Phoenix, AZ 85017. Phone 602/278-8528. TWX 910-951-1364.

INFORMATION RETRIEVAL NUMBER 47

## INSTRUMENTATION

## Rapid tester checks all ICs in-circuit



*Amex Electronic Systems, Inc., 5319 W. 146th St., Lawndale, Calif. Phone: (213) 279-8525. P&A: \$850, 30 days.*

A new IC test instrument provides rapid in-circuit evaluation of all IC families from RTL, DTL, TTL through MOS and PC boards and any cable harness. Designed to scan a 30-gate Wired-OR output in 30 s, the new CL-2 IC fault locator takes over where the diagnostic computer leaves off. Transistors and ICs can be tested for shorts or leakage without disconnection from the circuit.

CIRCLE NO. 379

## Temperature controller can be set to 0.01 $^{\circ}$ C



*Yellow Spring Instruments Co., Box 279, Yellow Springs, Ohio. Phone: (513) 767-7242. P&A: \$245; stock.*

Control temperature can be set as close as 0.01 $^{\circ}$ C over  $-10$  to +120 $^{\circ}$ C on the model 71A temperature controller which has three easy-to-read dials. With optimum probe placement, temperature can be held closer than the  $\pm 0.03^{\circ}$ C sensitivity zone. The instrument operates with a thermistor probe that serves as one leg of an ac bridge.

CIRCLE NO. 380

## 4-1/2-digit DMM doubles as a counter



*California Instruments Co., 5150 Convoy St., San Diego, Calif. Phone: (714) 279-8620. P&A: \$695; stock.*

A new 4-1/2-digit multimeter doubles as a 10-MHz frequency counter complete with a sensitivity control. Designated as the model 8420, this 0.01%-resolution instrument (on all ranges) can measure ac and dc voltages and resistance values. Its ohmmeter section is designed to withstand up to 115 V rms without any damage.

CIRCLE NO. 381

## Portable probe tests analog/digital circuits



*Custom Electronics (Poole Ltd.), 14 High Street, Poole, Dorset, England.*

Originally designed to enable digital systems to be tested without an expensive scope, the PBI can be used for setting up and testing analog and digital equipment—from an audio amplifier to a computer. The instrument is self-powered by re-chargeable batteries, or can be line powered when the batteries are automatically re-charged. The control unit may be clipped onto a belt, which makes the unit very portable.

CIRCLE NO. 382

**Don't miss an issue of Electronic Design; return your renewal card today.**



## Touch-Tone keyboard provides decimal data



Bashore Co., 840 Sungrove Pl., Brea, Calif. Phone: (714) 529-1887. P&A: \$29.50 (100 quantities); 30 to 60 days.

In addition to generating the standard telephone control tones, a new keyset is provided with an auxiliary contact at each pushbutton to facilitate the generation of serial decimal data for direct entry into electronic equipment without decoding. A common contact which makes after and breaks before the pushbutton contacts provides the unit with a 1-A capacity when wired in series.

CIRCLE NO. 383

## 98-kbit PC-board ROM dissipates 150 $\mu$ W/bit

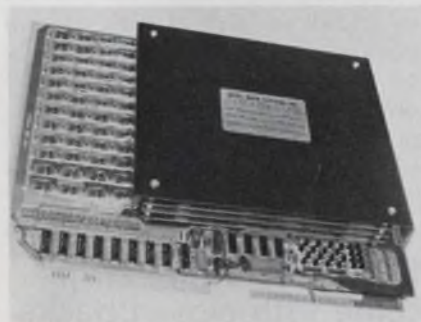

Aztec Data Systems, Inc., Box CR, Irvine, Calif. Phone: (714) 540-8445. P&A: from 1¢/bit; 30 days.

The Romtec 450-B ROM has a full cycle time of 450 ns, maximum access time of 180 ns and dissipates only 150  $\mu$ W/bit. The ROM packs up to 98,304 bits on one 13 by 11 by 1.7-in. PC board. The ROM is typically represented as 2048 words by 48 bits or in any combination specified by the customer. It is available in sizes up to 196,000 bits on special price quotations.

CIRCLE NO. 384

## Compact 38-lb computer packs density and speed

General Electric Co., Aircraft Equipment Div., Utica, N. Y. Phone: (518) 374-2211.

Weighing just 38 lbs and occupying less than 0.7 cubic feet of space, the new CP-32A aerospace computer has a memory access time of 0.387  $\mu$ s. Its plated-wire nondestructive-readout memory of 8k by 32 bits (standard) can be expanded to 16k by 32 bits within the standard casing. The CP-32A has a 0.8- $\mu$ s add time and 32 individually enabled interrupt priority levels.

CIRCLE NO. 385

## 16-track flying head has 25 $\mu$ in. height

Applied Magnetics Corp., 75 Robin Hill Rd., Goleta, Calif. Phone: (805) 964-4881.

A low-cost 16-track flying magnetic head for head-per-track disc memories features a ceramic housing with computer-designed flight characteristics. By altering inputs in the computer design program, flying height can be adjusted to as low as 25  $\mu$ in. Track width of the RW-306916 is 0.007 in. spaced on 0.06-in. centers. Its inductance is 12  $\mu$ H per winding leg and gap length is 110  $\mu$ in.

CIRCLE NO. 386

## 80-column card reader designed for System/3

Bridge Data Products, Inc., 738 S. 42nd St., Philadelphia, Pa. Phone: (215) EV2-8700. Price: see text.

Model 8063 80-column card reader has been designed for IBM System/3 computers. Priced at less than \$5000, or leasing at about \$200/month for a 36-month period with service, the 8063 reads 80-column cards and their stub varieties at 500 characters/minute. System/3 users who currently have only a 96-column capability can easily incorporate the model 8063 into their systems by plugging it directly into the System/3 without program modifications or changes.

CIRCLE NO. 387

# Par-Metal

## ENCLOSURES



engineered efficiency

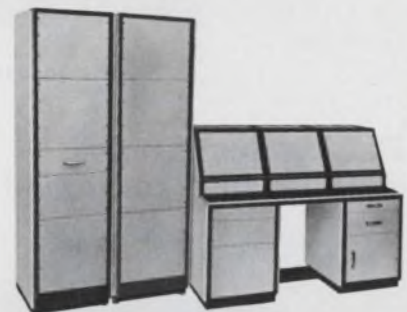

modular flexibility



ruggedly functional



**RESERVE YOUR NEW PAR-METAL CATALOG NOW!**

It's your shopping center and planning guide. Off the press soon. Reserve yours now.

**Par-Metal Products**

DIVISION OF EON CORPORATION  
1260 Atlantic Ave., Brooklyn, N.Y. 11216

INFORMATION RETRIEVAL NUMBER 48



## Rack/panel connectors increase contact density



*Amphenol Industrial Div. of Bunker-Ramo Corp., 1830 S. 54th Ave., Chicago, Ill. Phone: (312) 242-1000.*

Four new microminiature rectangular rack-and-panel connectors are designed with circular spring-type socket contacts for high contact pressure, low contact resistance and firm wiping action. The series 126 connectors provide 10, 16, 28 or 34-contact positions. A unique socket contact exerts firm pressure on six points along the pin to insure a positive electrical connection.

CIRCLE NO. 391

## Flat conductor cable is impedance controlled

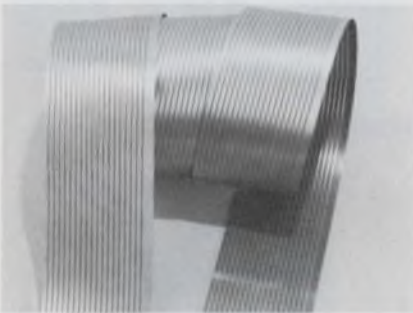

*Amp, Inc., Harrisburg, Pa. Phone: (717) 564-0101.*

Continuous lengths of flat conductor transmission cable with controlled impedance throughout the entire length are available. Such cable assemblies in any length up to 50 feet with impedances from 50 to 100  $\Omega$  can be supplied. Cable construction holds signal-to-signal crosstalk to 2%. Cable-to-cable crosstalk as low as 2-1/2% is possible. Where necessary, transmission cables may be stacked without affecting impedance.

CIRCLE NO. 392

Have you sent us your subscription renewal card?

## PC artwork protectors are simple to use

*Service & Technology Unlimited, Box 66, Commack, N. Y. Phone: (516) 543-1061. P&A: \$1.01 to \$4.57; stock to 4 wks.*

The Carry Art series of inexpensive reusable moisture-resistant PC artwork protectors is made of specially coated rigid board to allow easy insertion and extraction of tape ups, artwork and negatives without snagging or catching. Available in five basic sizes scaled for A, B, C, D and E-size drafting papers with ample room for over-size sheets, the series allows contents to be packed flat.

CIRCLE NO. 388

## Flexible woven cable folds to small size

*Woven Electronics, Box 189, Mauldin, S. C. Phone: (803) 288-4411.*

Space requirements for woven cables in special applications may be reduced to closely defined areas by use of a woven cable with loomed-in folds. The accordion-fold cable spans out to full lengths or flattens neatly to fit small spaces. Designed to interconnect drawers and back panels, the permanently prefolded cable has strain-relief threads at each fold to prevent conductor fatigue due to flexing. Protection from movement wear is provided by reinforcing threads.

CIRCLE NO. 389

## 2-part high-temperature epoxy has high strength

*Epoxy Technology, Inc., 65 Grove St., Watertown, Mass. Phone: (617) 926-0136. P&A: \$16/1-lb kit; stock.*

A wide variety of materials with high-temperature applications can now be rigidly bonded and sealed with a new two-part epoxy, Epo-Tek 380. The epoxy will bond metals, ceramics, glass and plastics of most types and possesses a lap-shear-strength of 500 lb/in.<sup>2</sup> at 300° F, 1300 at 200° F and 1600 at 80° F. Water-absorption property is 0.01%/24 hours at 75° C.

CIRCLE NO. 390

## Paper-tape splice kit makes tape repair easy

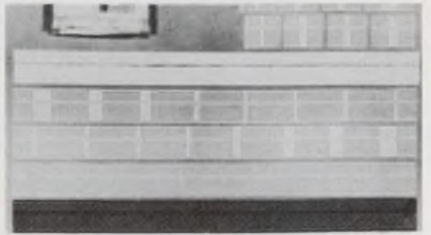

*Data-Link Corp., 7330 Convoy Court, San Diego, Calif. Phone: (714) 279-5430.*

A line of complete splicing tapes and patches can be obtained in a kit for repairing, splicing and correcting all perforated tapes, including mylar. Splicing tapes and patches are available in paper, mylar clear and mylar opaque (black) materials. All splicing tapes and patches are available in 5, 6-7 and 8-channel modes. Free sample kits are also available.

CIRCLE NO. 393

## 3-1/2-in.-high air blower saves on space

*McLean Engineering Laboratories, Princeton Junction, N. J. Phone: (609) 799-0100.*

A new concept in airflow configurations is featured in the new "Slot Formation" blower. The unit delivers air in a single continuous stream (a 12-1/2 in. slot of air). It features a low panel height of only 3-1/2 in. and a velocity and pressure adequate to cool densely packed cabinets. The blower is rated at 150 cubic feet/minute and has a low audible noise level.

CIRCLE NO. 394

## Barrier terminal strips come with closed backs

*Beau Products Div. of Vernitron Electrical Components, Laconia, N.H. Phone: (603) 524-5101.*

Three new closed-back barrier terminal strips are the series 15000, 19000 and 22000. The 7/8-in. wide 15-A 3500-V-rms series 15000 has up to 31 sections. The 1-1/8-in.-wide 20-A 3000-V-rms series 19000 has up to 30 sections and the 1-5/16-in.-wide 30-A 3300-V-rms series 22000 has up to 26 sections. Knockout holes in each section can be readily removed for feed-through terminations.

CIRCLE NO. 395



# application notes



## Temperature measurement

A 144-page temperature measurement handbook and catalog is available. The handbook section contains the complete edition of the just released N.B.S. calibration tables for thermocouples which supersede the thermocouple reference tables listed in N.B.S. circular #561 which has been the standard since 1955. The handbook section also contains much useful temperature measurement data, facts, statistics and material properties on thermocouples, thermistors and thermometers. The catalog section describes hundreds of temperature measurement devices, instruments and accessories of many types, sizes and application from micro-miniature probes as small as 0.0005 in. in diameter to large industrial type thermocouples. Omega Engineering, Inc., Stamford, Conn.

CIRCLE NO. 396

## COS/MOS radiation effects

A new 16-page application note describes the effects of radiation on RCA COS/MOS devices based on conducted studies which are abstracted in three reports. This note serves as a guide that will prove useful in the design of COS/MOS circuits into systems that will be exposed to various radiation environments. RCA Solid State Div., Somerville, N. J.

CIRCLE NO. 397

## regulates to 150 watts...

New Ledex LMR-4  
thick film voltage regulator

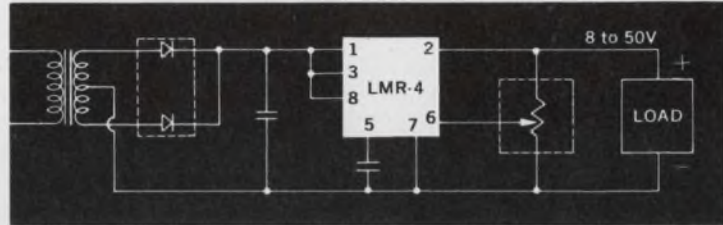

Typical application and connection diagram. Also available with built-in rectification and pre-set output voltage from 8 to 50 VDC.

### Typical Specifications ( $T_a = 25^\circ\text{C}$ )

Parameter	Typical	Maximum
Input voltage	—	60V
Output voltage	8 to 50V	
Load current	1 amp	3 amp
Line regulation, basic mode	0.02%	0.2%
Load regulation, basic mode	0.2%	0.5%
Power dissipation	10 watts	25 watts

Here's a 1 ampere precision regulator with a 0.02% load regulation tolerance. You can go all the way up to 25 amperes with it by simply adding pass transistors... and still hold a respectable 2% variation.

The new LMR-4 comes with a built-in FET current source, so you get excellent ripple rejection (40 db minimum). And you can put your whole regulator circuit on one tiny board, because its design simplicity lets you get by with small and inexpensive capacitors.

Maybe you already know Ledex as the company with the positioning and switching technology people. We're also the people to see when it comes to blending microelectronic miniaturization and low logic levels with the higher current and voltage levels you need to drive electromechanical products.

For more information on Ledex standard and custom pulsers, drivers and regulators, ask for Catalog E-6000. Or, give us a call and let's talk about your application.

**LEDEX** *the total technology people*

**LEDEX INC.**  
123 Webster Street  
Dayton, Ohio 45401  
(513) 224-9891

POSITIONING • SWITCHING • MICROELECTRONICS

INFORMATION RETRIEVAL NUMBER 50

# new literature



## Digital multimeters

A new 16-page catalog contains complete specifications on the unique low-cost auto-ranging 5-1/2-digit 2500 series and 4-1/2-digit 2400 series Tri-Phasic digital multimeters. The catalog also describes the three new circuit techniques utilized in these DMMs—Tri-Phasic conversion, Rathohmic resistance and Isopolar reference. Data Precision Co., Wakefield, Mass.

CIRCLE NO. 398

## Military surplus

A 16-page catalog lists and describes army, navy and air force surplus electronic equipment available for sale. Listed are transmitters, receivers, transceivers, direction finders, sonar, radar and IFF equipment, rescue equipment, controls, ECM and IR equipment and many other items. Military Electronics Corp., Upper Saddle River, N. J.

CIRCLE NO. 399

## Knobs

An eight-page catalog offers complete descriptions of hand-crafted machined aluminum control knobs. Also represented is an expanded line of plastic knobs, all with spun aluminum inlay tops. Alcocnob Div. of Alco Electronic Products, Inc., Lawrence, Mass.

CIRCLE NO. 400

## Active filters

A data sheet describes active frequency filters and functional modules. Electronic Associates, Inc., W. Long Branch, N.J.

CIRCLE NO. 401

## Digital printer

The model 1454 digital printer designed for recording digital data from a variety of program sources is featured in a new publication. Beckman Instruments, Inc., Schiller Park, Ill.

CIRCLE NO. 402

## Instrument rental

A 60-page catalog on rental instruments covers general-purpose test equipment such as analyzers, bridges, power supplies, generators, amplifiers, oscilloscopes, counters and meters. Rental Electronics, Inc., Gaithersburg, Md.

CIRCLE NO. 403

## Active filters

A new line of active filters for use in audio and sub-audio ranges is shown in a brochure. Polyphase Instrument Co., Bridgeport, Pa.

CIRCLE NO. 404

## Rf connectors

A new 68-page catalog describes over 800 ConneX subminiature rf connectors. Seaelectro Corp., Mamaroneck, N. Y.

CIRCLE NO. 405

## Hybrid relay

The Clarac solid-state (hybrid) relay is detailed in a catalog with design specifications. C.P. Clare & Co., Chicago, Ill.

CIRCLE NO. 406

## Real-time peripherals

A 16-page pricing and configuration guide for the RTP7400 series real-time peripheral devices has been released. The series offers an economical and flexible approach to real-time systems implementation and plug compatibility with most popular minicomputers. Computer Products, Fort Lauderdale, Fla.

CIRCLE NO. 407

## Programming panels

Programming panels for test equipment, automatic machinery and digital and analog computers are featured in a new catalog. Virginia Panel Corp., Waynesboro, Va.

CIRCLE NO. 408

## Fault indicators

A bulletin details a line of industrial miniature ball-type "Bite" (built-in-test equipment) indicators designed to monitor the performance of electrical/electronic systems and components and to provide an automatic warning when operation falls outside design parameters. A.W. Haydon Co., Waterbury, Conn.

CIRCLE NO. 409

## DPMs

A four-page brochure describes a series of 35 digital panel meters. Gralex Industries, Farmingdale, N. Y.

CIRCLE NO. 410

## Panel meters

A four-page brochure features new-style glass-windowed rectangular-shaped panel meters. Triplett Corp., Bluffton, Ohio.

CIRCLE NO. 411

## Analog/digital counters

A 16-page catalog covers a complete line of digital and analog instruments including counter-timers, variable time-base counters, time-interval counters and calculating counters. Anadex Instruments Inc., Van Nuys, Calif.

CIRCLE NO. 412

## Standoffs/spacers

A new manual covers a complete line of standoffs and spacers. Universal Components Corp., S. Orange, N.J.

CIRCLE NO. 413



### Allied catalog

Allied Electronics' 1972 616-page catalog is available. Specifications, descriptions, illustrations and prices cover IC and discrete devices, tubes, relays, timers, potentiometers, resistors, controls and transformers. Also included are capacitors, connectors, coils, chokes, sockets, plugs, jacks, switches, fuses, wire and cable. Allied Electronics, Chicago, Ill.

CIRCLE NO. 414

### Shaft angle encoders

A new eight-page catalog describes shaft angle encoder systems which utilize resolvers as the transducers. Astrosystems, Inc., Lake Success, N.Y.

CIRCLE NO. 415

### Digital computers

A revised 16-page brochure describes the Comp-16 and Comp-18 digital minicomputers and peripheral equipment. UniComp, Inc., Northridge, Calif.

CIRCLE NO. 416

### Ferroresonance

A six-page brochure provides OEM designers with a guide to the ferroresonant technique of voltage stabilization. Kepco, Inc., Flushing, N.Y.

CIRCLE NO. 417

### Career placement

For those who are interested in maximizing their techniques in obtaining a new job, a four-cassette-tape program entitled "Successful Job Search Strategy" is available at a cost of \$49.50. The tapes show career seekers how to effectively counter typical employment turn-downs. E. E. Grazda, Westlake Village, Calif.

CIRCLE NO. 418

**Don't miss an issue of Electronic Design; return your renewal card today.**

# ITHACO's precision variable electronic band-pass filters are designed for multi-channel applications requiring close phase and amplitude matching between channels in the frequency range of .01Hz to 100KHz



If your problem is analyzing a variety of signals in the presence of noise, then Ithaco's 4100 series of low-pass, high-pass and band-pass filters will provide a filter setting for optimum signal enhancement. For instance, filter cutoff, bandwidth and noise bandwidth are precisely controlled in convenient  $\frac{1}{3}$  octave settings. Multi-channel applications are served by three and seven channel racks, with close phase ( $\pm 3^\circ$ ) and amplitude ( $\pm .1$  db) tracking between channels. A maximum signal handling capability of 10 volts and a noise floor of less than  $50\mu$  volts results in unmatched performance.

The 4100 series is ideal for most acoustic, environmental test, geophysical, EW and general research applications. Ithaco also provides amplifiers, racks, power supplies . . . right on up to custom engineered data acquisition systems.

Write to Ithaco, Inc., 735 W. Clinton Street, Ithaca, New York 14850, for complete price and product information. Or call Don Chandler at 607-272-7640 to discuss your specific application.

## ITHACO

735 W. CLINTON STREET, ITHACA, NEW YORK 14850  
INFORMATION RETRIEVAL NUMBER 51

## FREE EMI/RFI FILTER CATALOG FROM USCC/CENTRALAB



A new 20-page catalog of EMI/RFI Filters is now available from USCC/CENTRALAB.

The catalog includes: Button, Subminiature, Miniature, and Feed-thru types, which meet or exceed all applicable requirements of MIL-F-15733; and a new line of filters designed to meet all UL and European requirements for electronic data processing units and systems.

Listed are all mechanical and environmental specifications, typical insertion loss curves and complete ordering information.

For your free copy write:  
USCC/CENTRALAB, 2151 N. Lincoln St., Burbank, California 91504.  
(213) 843-4222 — or circle the information retrieval number below.



U. S. CAPACITOR CORPORATION



CENTRALAB Electronics Division • GLOBE-UNION INC.

INFORMATION RETRIEVAL NUMBER 52

## A complete line of CUSTOMIZED ROTARY CERAMIC SWITCHES ...

For RF and POWER APPLICATIONS

RSC switches are available in a variety of switching models. RSC high precision, quality built units are designed for applications requiring long life maintenance-free service. Types include shorting and non-shorting, single and multi-deck, up to 18 pole positions. Features include, 10 to 100 amp current carrying capacity, 20° to 90° detents, 2000 to 24000 volts flashover and corrosion-proof construction.

Write for catalog no. 960 and complete information.



**RADIO SWITCH CORPORATION**

Rt. 79, Marlboro, N. J. 07746



## NEW LITERATURE

### Displays/controls

A 20-page brochure describes electroluminescent and LED displays and controls. Display devices include digital indicators, event timers, mission clocks, helium temperature and pressure indicators, propellant quantity displays and metabolic readout units. Singer Co., Kearfott Div., Little Falls, N.J.

CIRCLE NO. 430

### Emi/rfi gaskets

An up-dated folder on Eccoshield emi/rfi conductive plastic gaskets is available. Emerson & Cuming, Inc., Canton, Mass.

CIRCLE NO. 431

### PC-board process

A four-page illustrated data sheet describes Honeywell's process for producing PC boards. The process features solid-post multi-layer circuitry for critical applications and ordering information. Honeywell Information Systems, Goleta, Calif.

CIRCLE NO. 432

### Dc power supplies

A new catalog describes electrical and mechanical parameters for more than 80 dc power supplies. Electrostatics, Inc., San Diego, Calif.

CIRCLE NO. 433

### Cable ties

A catalog sheet describes Pan-Ty lashing ties for wire and cable. Panduit Corp., Tinley Park, Ill.

CIRCLE NO. 434

### Printers and plotters

A data sheet describing a new line of low-cost printers and printer/plotters has been released. Potter Instrument Co., Inc., Melville, N.Y.

CIRCLE NO. 435

### Rf capacitors

A revised new bulletin covers solid-dielectric rf capacitors. Polyflon Corp., New Rochelle, N.Y.

CIRCLE NO. 436

INFORMATION RETRIEVAL NUMBER 53



# bulletin board

of product news and development

Two disk drive subsystems designed to provide high-capacity information storage at a lower cost on Series 200 computer systems have been introduced to the U.S. and Canadian markets by Honeywell Information Systems. The subsystems are the Type 276 disc drive for the small-scale model 115 and model 115/2 computer systems, and the type 277 disc drive for the medium-to-large-scale models 1015, 2015, 3200, 4200 and 8200 computer systems.

CIRCLE NO. 437

Pacific Applied Systems, Encino, Calif., has developed a software system of test-program automation which assures 100% fault detection and is available on either a lease or service basis. Cost and turnaround time are said to be drastically reduced when compared with conventional methods of test-pattern generation.

CIRCLE NO. 438

Grayhill, Inc., La Grange, Ill., is making available free samples of cable and wire ties and clamps. The cable and wire ties are available in permanent-installation strap types for one-time installation, or in beaded-chain wire ties which can be refastened to allow repair or addition of wires to a bundle.

CIRCLE NO. 439

An innovative national maintenance program for data terminals was announced by Western Union Data Services Co. The unique service called Termicare is a new national health-care program for Western Union Data Service Co.'s terminals in customer service.

CIRCLE NO. 440

Have you sent us your subscription renewal card?

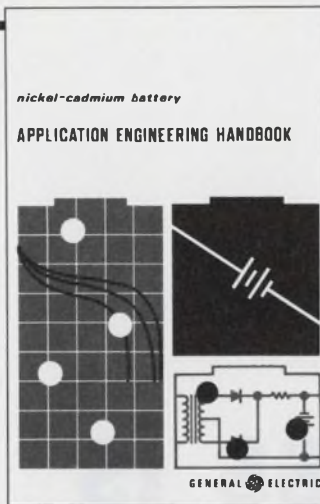

Here's a new, comprehensive manual of interest to all designers—200 pages of application information. To find out how you can order this unique engineering handbook, circle the number below on the reader service card. Or write—General Electric Company, P. O. Box 114, Gainesville, Florida 32601.

GENERAL  ELECTRIC

## all you need to know about nickel-cadmium rechargeable batteries

INFORMATION RETRIEVAL NUMBER 54

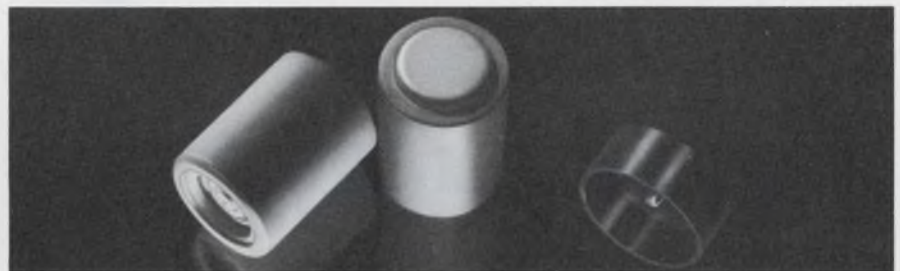

### NEW LONG LIFE LITHIUM BATTERY

The G2600-B1 battery (1 and 3/8" long x 1.0" diameter) provides a nominal 3.2 volts over the temperature range of -40°F to +165°F. Hermetic sealing and glass ampule electrolyte storage make possible a shelf life of 10 years or more. In addition, the G2600-B1 is ideal for low drain, long life applications. This battery demonstrates our advanced state-of-the-art capability in solving your battery problems.

The performance tables below tell the G2600-B1 story the best way possible:

For more complete information on this new power source, call or write Marketing Manager, Honeywell Power Sources Center, Route 309, Montgomeryville, Pa. 18936. (215-699-3585)

Current	AVERAGE VOLTAGE			LIFE TO 2.5 VOLTS (HOURS)		
	-40°F	+75°F	+165°F	-40°F	+75°F	+165°F
250 ma	2.2	2.3		0.5 <sup>a</sup>	0.6 <sup>a</sup>	
200 ma	2.5	2.6		0.7 <sup>a</sup>	0.8 <sup>a</sup>	
110 ma	2.7	2.8		3.5	3.7	
50 ma	2.6	3.1	3.2	8	12	12
20 ma	2.7	3.1	3.2	20	27	29
10 ma	3.1	3.1	3.2	55	55	55
1 ma	3.2	3.2	3.2	500	500	400
.5 ma	3.2	3.2	3.2	1100	1000	900
25 ma	3.2	3.2	3.2	2200	1700	1200

<sup>a</sup>Cut-off to 2.0 volts

**Honeywell** The Automation Company

INFORMATION RETRIEVAL NUMBER 55

**Happiness is  
employees  
who show up  
every day.**

**Hire the Handicapped**



## **Electronic Design**

ELECTRONIC DESIGN's function is:

- To aid progress in the electronics manufacturing industry by promoting good design.
- To give the electronic design engineer concepts and ideas that make his job easier and more productive.
- To provide a central source of timely electronics information.
- To promote two-way communication between manufacturer and engineer.

**Want a subscription?** ELECTRONIC DESIGN is sent free to qualified engineers and engineering managers doing design work, supervising design or setting standards in the United States and Western Europe. For a free subscription, use the postfree application form inside the back cover. If none is included, write to us direct for an application form.

If you do not qualify, you may take out a paid subscription for \$25 a year in the U.S.A., \$35 a year elsewhere. Single copies are \$1.50 each.

**If you change your address,** send us an old mailing label and your new address; there is generally a prepaid postcard for this inside the back cover. You will have to requalify to continue receiving ELECTRONIC DESIGN free.

**The accuracy policy of ELECTRONIC DESIGN is:**

- To make reasonable efforts to ensure the accuracy of editorial matter.
- To publish prompt corrections whenever inaccuracies are brought to our attention. Corrections appear at the end of the Letters column.
- To refuse any advertisement deemed to be misleading or fraudulent.

Microfilm copies are available of complete volumes of ELECTRONIC DESIGN at \$19.00 per volume, beginning with Volume 9, 1961. Work is now in process to complete the microfilm edition of Volumes 1-8. Reprints of individual articles may be obtained for \$2.00 each, prepaid (\$.50 for each additional copy of the same article) no matter how long the article. For further details and to place orders, contact the Customer Services Department, University Microfilms, 300 North Zeeb Road, Ann Arbor, Michigan 48106; telephone (313) 761-4700.

**Want to contact us?** If you have any comments or wish to submit a manuscript or article outline, address your correspondence to:

Editor  
ELECTRONIC DESIGN,  
50 Essex Street,  
Rochelle Park, N.J. 07662



# Electronic Design

## Advertising Sales Staff

Bryce Gray  
Sales Manager

### Rochelle Park, N.J. 07662

Robert W. Gascoigne  
Daniel J. Rowland  
50 Essex Street  
(201) 843-0550  
TWX: 710-990-5071

### Philadelphia

Thomas P. Barth  
50 Essex Street  
Rochelle Park, N. J. 07662  
(201) 843-0550

### Boston 02154

Joseph F. Palmer  
1268 Main Street  
Waltham, Mass.  
(617) 894-2700

### Chicago 60611

Thomas P. Kavooras  
Berry Conner, Jr.  
200 East Ontario  
(312) 337-0588

### Cleveland

Thomas P. Kavooras  
(Chicago)  
(312) 337-0588  
(call collect)

### Los Angeles 90303

Stanley I. Ehrenclou  
Burt Underwood  
2930 Imperial Highway  
Inglewood, Calif  
(213) 757-0183

### San Francisco 94022

Jerry D. Latta  
95 Main Street  
Los Altos, Calif.  
(415) 941-3084

### London W. 1

For United Kingdom and Holland  
Brayton C. Nichols

### For Eastern Europe

Peter Kehr

### The American Magazine Group

27 Maddox Street  
London, W. 1, England  
Phone: 499-0180  
Cable: Ammagnic, London

### Verviers, Belgium

### For Continental Europe

Andre Jamar  
1, Ru Mallar, 1  
087) 253.83 Telex 41563

### Tokyo

Haruki Hirayama  
Electronic Media Service  
5th Floor, Lila Bldg.,  
4-9-8 Roppongi  
Minato-ku  
Phone: 402-4556  
Cable: Electronicmedia, Tokyo



# Design Data from Manufacturers

Advertisements of booklets, brochures, catalogs and data sheets. To order use Reader-Service Card.  
(Advertisement)

## PC Drafting Aids Catalog

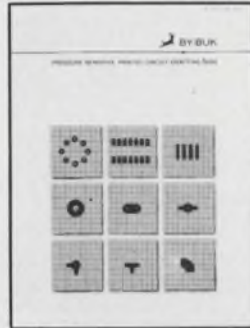

Thousands of time saving, cost saving artwork ideas are found in the By-Buk P-50 catalog of pressure sensitive printed circuit drafting aids. With the most practical artwork patterns for: TO cans, multi-pads, dual-inlines and flat packs featured. Donuts, connector strips, teardrops, ovals, tapes, tees, elbows, etc., by the hundreds are included in the most comprehensive list of sizes. Opaque black, transparent red and transparent blue materials for one and two-sided board designs. For a free copy and samples, write today.

### By-Buk Company

Subsidiary of Webtek Corp.  
4326 W. Pico Blvd.  
Los Angeles, California 90019  
(213) 937-3511

CIRCLE NO. 175

## New Brochure Describes Low-Cost Power Supply Systems



A new brochure by Transistor Devices offers designers and engineers technical data on its expanded range, multiple output, X-L Series of power supplies. Such features as short circuit protection, remote sensing, adjustable outputs and 0.25% regulation, with outputs of 1-30V and current levels of 0.7 to 8 amps give designers a wide selection of models priced from \$48.50 to \$115.00.

CIRCLE NO. 172

### Transistor Devices, Inc.

85 Horsehill Road, Cedar Knolls, N. J. 07927  
Tel. (201) 267-1900

## 1972 Electronic Components Drafting Aids Catalog



**Free Catalog! Free Samples!** Exciting innovations in pressure-sensitive electronic component drafting aids and methods are detailed in the new 1972 edition of the combined Bishop Technical Manual and Catalog 105.

84 illustrated pages of over 15,000 multi-pad configurations, symbols, tapes, sequential reference designations plus hundreds of time-and-money saving hints in making artwork for PC boards. Includes instructions for using the industry's only red and blue tape system for making two-sided boards in perfect registration.

Send now for free Catalog 105 and free samples.

### Bishop Graphics, Inc.

7300 Radford Avenue  
North Hollywood, California 91605  
(213) 982-2000 Telex: 674672

CIRCLE NO. 173

# Less than 1 $\mu$ V Offset!



## New Ultra-Low Thermal emf Reed Relays!

- Unique new method (pat. pend.) virtually eliminates thermal offsets, permits use of almost any type reed switch... Hg wet, dry, high voltage.
- Remarkably independent of ambient temperature, environment.
- Many contact forms, pin configurations available.
- Units also available at less than 500 nanovolts per switch, or less than 1 $\mu$ V differentially between switches.
- Greater than 10<sup>11</sup> ohms isolation resistance.
- Rugged molded package. Moderate price.

Write for Complete New Catalog MR-6.1



**COTO-COIL COMPANY, INC.**  
59 Pavilion Avenue, Providence, R. I. 02905  
Tel: (401) 941-3355

INFORMATION RETRIEVAL NUMBER 56

**put your components**

**through**

**environmental**

**test**

**quickly**



The INRECO static handling system is a must for testing I.C.'s, diodes, transistors, resistors, etc. Devices are clipped to special test P.C. cards which are inserted into inner door mounted connectors. With the door in place and the required temperature in the chamber, all the devices may be powered and/or sensed individually by the scanner plugged into connectors on the door exterior.

# INRECO

INDUSTRIAL REFRIGERATION CO., INC.

8940 Ellis Ave., Los Angeles, Calif. 90034  
Telephone Area Code (213) 870-6664

INFORMATION RETRIEVAL NUMBER 57

# advertiser's index

Abbott Transistor Laboratories Incorporated .....	6
Alco Electronic Products, Inc. ....	64
Allen-Bradley Co. ....	C25
Amphenol Components Group .....	12
Analog Devices, Inc. ....	C66
Associated Testing Laboratories, Inc. ....	C65
Automated Business Systems, Division of Litton Industries .....	C64
Babcock Relays, Division of Babcock Electronics Corporation..	C43
Beckman Instruments, Inc., Helipot Division .....	63
Belden Corporation .....	4, 5
Bell Inc., F. W. ....	56
Bishop Graphics, Inc. ....	85
Bodine Electric Company .....	C33
Bourns, Inc. ....	C4, C5
Bulova Servo Products Electronics Division of Bulova Watch Company .....	C41
Burdny Corporation .....	C39
By-Buk Company .....	85
CEM Company, Inc. ....	75
Cambridge Thermionic Corporation	C63
CELCO (Constantine Engineering Laboratories Co.) .....	C63
Centralab, the Electronics Division of Globe-Union, Inc. ....	C35
Chicago Dynamics Industries, Inc. ....	50
Cincinnati Milacron Company .....	C67
Clare & Co., C. P. ....	C31
Clairex Electronics, A Division of Clairex Corporation .....	66
Computer Automation, Inc. ....	C16, C17
Constantine Engineering Labs. Co. (CELCO) .....	C63
Coto Coil Company, Inc. ....	86
Cratex .....	C50
Cutler-Hammer .....	2
Damon/Electronics Division .....	31
Dale Electronics, Inc. ....	Cover II
Dana Laboratories, Inc. ....	15
Data Technology Corporation .....	72
Dialight Corporation .....	56
Digital Equipment Corporation .....	C6, C7
Dormeyer Industries, Inc. ....	C54
Dow Corning Corporation .....	10, 11, 13
Edmund Scientific Company .....	C65
Electronic Applications Co. ....	C58
Electronic Engineering Company of California .....	C62
Electronic Research Associates, Inc. ....	C44
Engelhard Industries Division, Engelhard Minerals & Chemicals Corporation .....	50
Facit-Odhner .....	71
Fairchild Semiconductor, A Division Fairchild Camera and Instrument Corporation .....	8, 9
Fifth Dimension, Inc. ....	C55
General Electric Company .....	34, 60, 61, 83
Guardian Electric Manufacturing Company .....	C14, C15
Harris Semiconductor, A Division of Harris Intertype Corporation .....	39
Heath Company .....	87
Hecon Corporation .....	65
Hewlett-Packard .....	1, 25, 26, 27, 40, C45, 55
Honeywell Power Sources Center .....	83
IMC Magnetics Corporation .....	C64
Industrial Refrigeration Co. Inc. ....	86
Institute of Electrical Engineers, The	57
International Instruments, Division of Sigman Instruments, Inc. ....	32
Ithaco .....	81
Johnson Company, E. F. ....	C34
Kurz-Kasch, Inc. ....	C40, C41
Lafayette Radio Electronics .....	C60
Lambda Electronics Corp. ....	C68
Lear Siegler Inc. ....	C54
Ledex, Inc. ....	79
Litton Systems, Inc., Advanced Circuitry Division .....	C59
3M Company .....	C19
MDC Instruments .....	C63
Magsat Corporation .....	C56
Magnecraft Electric Company .....	C18
Mason, F. G., Engineering .....	7
Molex, Incorporated .....	21
Motorola Component Products Dept. ....	14
Motorola Semiconductor Products, Inc. ....	17
National Semiconductor Corporation .....	29
North Atlantic Industries, Inc. ....	88
Nortronics Company, Inc. ....	C58
Oak Manufacturing Co. ....	C29



# Control



Controlled impedance cable, flat ribbon style. Loom-made by Woven Electronics, like nobody else can make it, to meet your requirements in precise detail. Test it!

**Reliable Control**—within plus-minus 10% tolerance

**High Density**—more signal line, less space

**Programmed Lead Exposure**—easy termination

**Flexible**—folds, twists, stacks, without interference

**Clear Transmission**—minimum crosstalk

## WOVEN ELECTRONICS

A Division of Southern Weaving Company  
P.O. Box 189 Mauldin, South Carolina 29662 (803) 288-4411

Represented nationally by Zippertubing

INFORMATION RETRIEVAL NUMBER 58

ParMetal Products, Division of EON Corporation	77
Peripheral Equipment Corporation	C52, 53
Phelps Dodge Communications Company	51
Philips Electronic Components and Materials	16A, 38
Phoenix Data, Inc.	76
Precision Monolithics, Incorporated	C46
RCA Solid State Division	Cover IV
Radio Switch Corporation	82
Raytheon Company	69
Raytheon Company, Semiconductor Operation	C47
RtrON Corporation	C36
Rotron, Incorporated	C2
Rogan Brothers, Inc.	C61
Rogers Corporation	Cover III

Schrack Electrical Sales Corp.	75
Servo Tek Products Company	C44
Shredmaster Corporation	C62
Signetics Corporation	46, 47
Siliconix Incorporated	59
Singer, Industrial Timer Division	C65
Singer Line Electric Division	C59
Solitron Devices, Inc.	C51
Stackpole Carbon Company	C28
Switchcraft, Inc.	C38

TEC, Incorporated	C48
TRW Electronic Components, IRC Boone Division	18
Tecnetics, Inc.	73
Tektronix, Inc.	37
Teledyne Electro-Mechanisms	16
Teletype Corporation	C26, C27
Transistor Devices, Inc.	85
Triplet Corporation	C37, C49
Tung Sol Division, Wagner Electric Corporation	C36

United Sensor Corporation	71
U. S. Capacitor Corporation	82
Unitrode Corporation	33

Vactec, Inc.	C42
Vero Electronics, Inc.	C48

Wakefield Engineering, Inc.	56
Weston Instruments, Inc.	C57
Woven Electronics	87
Yewtec Corporation	C60

## New lab-quality instrumentation at famous HEATHKIT do-it-yourself savings!

(A) New Heathkit solid-state digital multimeter. A true lab-grade digital multimeter at about half the cost of comparable DMMs! 5 overlapping DC voltage ranges, 100  $\mu$ V to 1000 V; AC ranges, 100  $\mu$ V to 500 V; 10 ranges measure 100 nanoamperes to 2 amperes on AC or DC; 6 resistance ranges, 0.1 ohm to 20 megohms. Automatic polarity indicators. Automatic decimal point, over-range light. Precision DC calibrator furnished plus transfer method for AC calibration. Solid-state with cold cathode readout tubes & "memory" circuit for stable, non-blinking operation. Assembles in about 10 hours. Kit 1M-102, 9 lbs. ... 229.95\*

New Heathkit 175 MHz scaler & counter combo... for less than \$300! (B) The Heathkit IB-101 counts from 1 Hz to over 15 MHz. Hz/kHz ranges & over-range indicator let you make an 8-digit measurement down to the last Hz. 5-digit cold-cathode readout; extremely low input triggering... less than 30 mV at 100 MHz; all solid-state with 26 ICs, 8 transistors. (C) Heathkit IB-102 scaler extends capability well into the VHF range at a price far below a 175 MHz counter. Compatible with virtually any counter. 10:1 & 100:1 scaling ratios give resolution down to 10 Hz... 1:1 ratio provides straight-through counting. Solid-state, fully regulated supplies. Carrying handle/tilt stand. Kit IB-101, 7 lbs. ... 199.95\* Kit IB-102, 7 lbs. ... 99.95\*

(D) New Heathkit DC-15 MHz dual trace solid-state oscilloscope... \$399.95\* Features rock-solid triggered sweep; full bandwidth in both automatic & normal modes; complete dual trace capability - Ch. 1, Ch. 2, chop, alternate; X-Y mode with 5% or less phase shift; 24 nsec rise time; 9-position 1, 2, 5 sequence vertical attenuator; 8 x 10 cm rectangular flat-face CRT with mu-metal shield. Kit 10-105, 35 lbs. ... 399.95\*

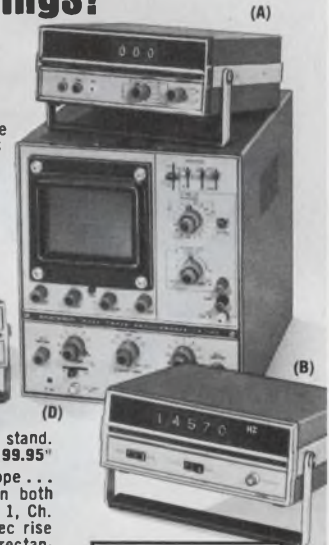

Exciting '72 Catalog Yours FREE for the Asking

HEATH COMPANY, Dept. 520-26  
Benton Harbor, Michigan 49022

Rush my new Heathkit Catalog  
 Enclosed is \$ \_\_\_\_\_, plus shipping.

Please send model(s) \_\_\_\_\_

Name \_\_\_\_\_

Address \_\_\_\_\_

City \_\_\_\_\_ State \_\_\_\_\_ Zip \_\_\_\_\_

Prices & specifications subject to change without notice.

\*Mail order prices; F.O.B. factory.

TE-249

INFORMATION RETRIEVAL NUMBER 59

# OUR ANGLE: Modular D/S and S/D Converters



Do Low Cost  
Repairable  
Circuit Cards  
Make Sense  
from Your Angle?

North Atlantic's new 701 D/S and 711 S/D Converters offer unmatched advantages for the digital/analog interface at low-low cost . . . typically \$1000. Open-card construction is easily and economically maintained. Adaptable to systems needs, interchangeable converter cards are compatible with your automatic test, simulation or digital control systems.

Compared to 19" panel designs, these units provide a choice of accuracy, frequency, resolution, and systems customization without the extra bulk and expense of unnecessary power supplies and other panel controls. They are ideal for multi-channel applications where a converter is assigned to a specific function.

These new converters are available to meet a wide range of systems needs. The 701 D/S has selectable accuracies of 9 or 12 bits with resolution of 8 through 14 bits, transformer output isolation and short circuit protection, operation at 60 Hz or 400 Hz with 1VA or 10VA output. The 711 S/D has 0.05° accuracy, 13 bit resolution with input transformer isolation, and continuously tracks 400 Hz synchro data to 1000°/second.

Don't these converters make sense from any angle? Talk it over with your North Atlantic sales engineering representative today.

**NORTH ATLANTIC**  
*industries, inc.*

200 TERMINAL DRIVE, PLAINVIEW, NEW YORK 11803  
cable: noatlantic / twx: 510-221-1879 / phone: (516) 681-8600



alongside or under  
the D.I.P.

one Rogers  
MINI⚡BUS =



The evidence is accumulating. You may eliminate *all* discrete by-pass capacitors — and get a lower-noise printed circuit board at frequencies where it counts — with a single Rogers Mini/Bus.

**DELIVERY:** Standard configurations are available on short notice. **Telephone:**  
**EAST: (203) 774-9605**  
**WEST: (602) 963-4584**  
to know where we stand today on your requirements. Ask for our Mini/Bus brochure, showing standard parts.

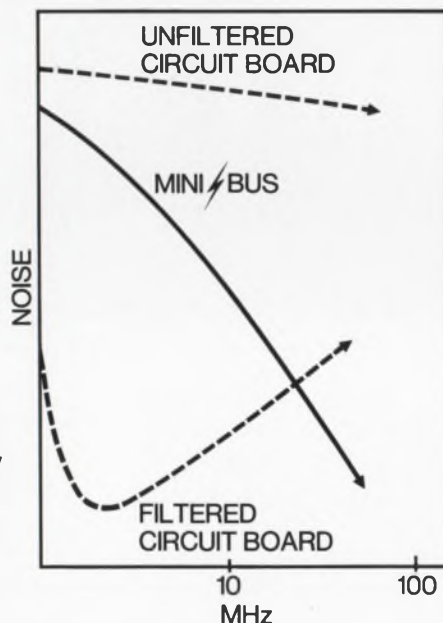

Rogers Corporation Rogers, Connecticut 06263 (203) 774-9605

INFORMATION RETRIEVAL NUMBER 243



If your 200-400 V requirement  
in 8-Amp Triacs includes

# availability

Specify RCA-40668 and 40669

Right now, in whatever quantity satisfies your need, RCA 8-amp silicon triacs are in stock. These 200-V and 400-V units, employing a glass-passivated chip, have proved themselves in circuits throughout the world.

Gate controlled in all four modes, RCA-40668 and 40669 are packaged in plastic — RCA's own VERSAWATT configuration (TO-220AB). You select your choice in regular or formed leads for small size, light weight, and high efficiency in a broad range of applications — from dc-to-dc converters to circuitry for aircraft.

Today's emphasis is fast delivery at common sense prices. Call RCA. While you are at it, ask about RCA-40868 and 40869, new 8-amp SCR's also available in VERSAWATT packaging.

For more information on RCA Triacs and SCR's, consult your local RCA Representative or your RCA Distributor. For technical data, write: RCA Solid State Division, Section 57K11/UR13, Box 3200, Somerville, N. J. 08876. International: RCA, Sunbury-on-Thames, U. K., or P. O. Box 112, Hong Kong. In Canada: RCA Limited, Ste. Anne de Bellevue, 810 Quebec.

**RCA** Solid State  
products that make products pay off

INFORMATION RETRIEVAL NUMBER 244