

# Electronic Design 18

VOL. 19 NO.

FOR ENGINEERS AND ENGINEERING MANAGERS

SEPT. 2, 1971

**The swing is to quadrasonics** as a successor to stereo. There is disagreement, however, over standardizing on four discrete channels of an electronic mixing

matrix. The discrete approach is thought best but problems appear in broadcasting techniques and disc recording. Matrix proponents argue over circuit design. p. 22

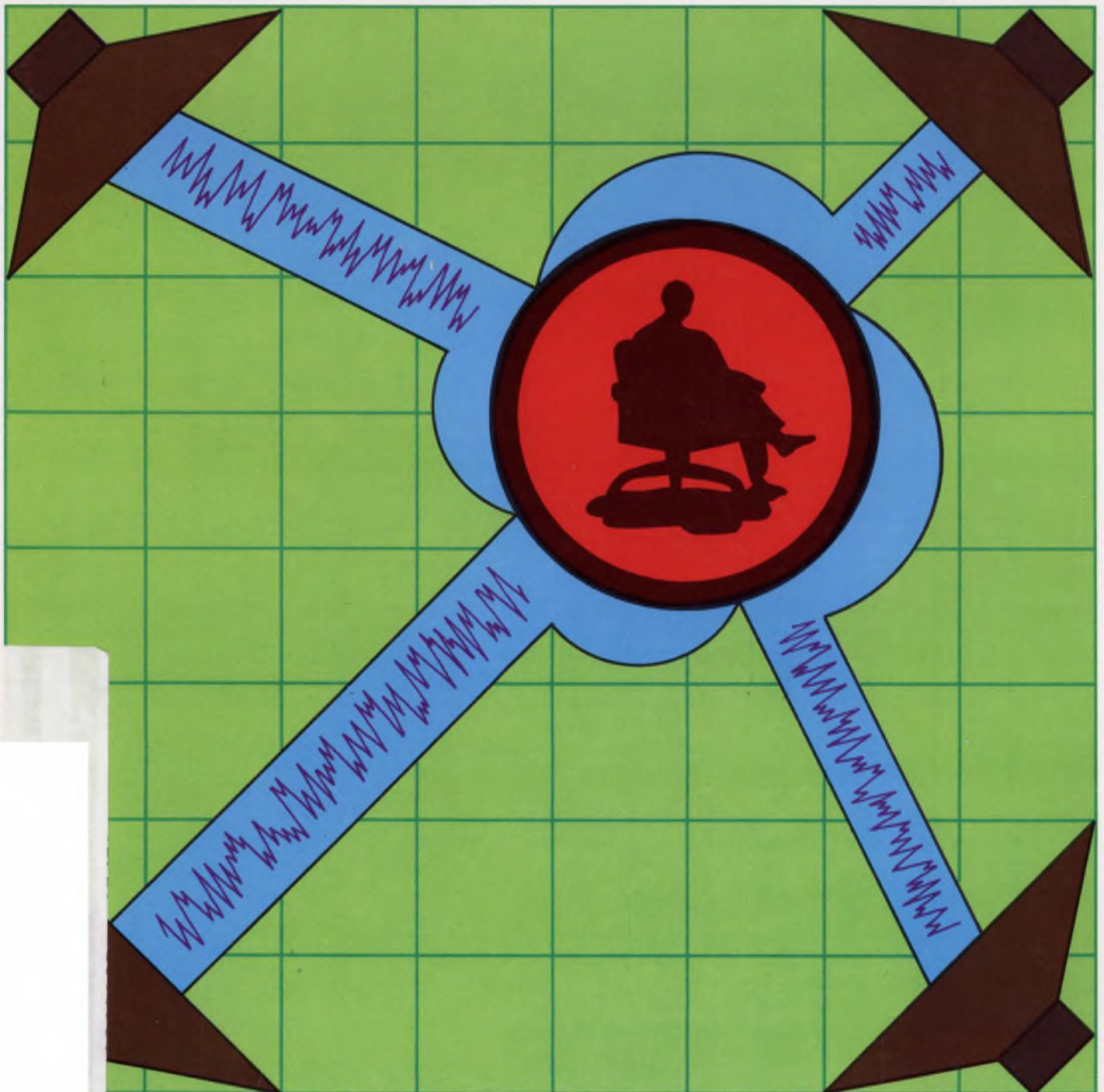

# Introducing: "The Portables" from HP



## The 1707A – Fastest in Its Class

If you're looking for speed in a \$2000 portable scope, then the new dual-channel HP 1707A is your baby. It gives you 75 MHz bandwidth (<4.7 ns risetime)—more than any other scope in its class. And you get 10 ns/div sweep speed, delayed sweep, and 10 mV/div over the full bandwidth. With this capability, you can measure T<sup>2</sup>L or ECL pulse timing and propagation delay. Yet the 1707A costs only \$1925.

And, you get this performance in a truly portable scope. The 1707A weighs only 24 lbs. And it can be powered from an internal, rechargeable battery pack (\$200)—or from any dc source from 11.5 V to 36 V, as well as any standard ac outlet.

Its low power requirement not only allows battery operation—but also eliminates the need for fans, or even dust-admitting vent holes. And although the 1707A is small and light, you still get a large 6 x 10 cm CRT

viewing area—larger than competitive scopes. Compare the display brightness, too!

If you need even more measurement capability, a \$125 option gives you our "lab package" which includes mixed sweep, calibrated delay, and external trigger input for delayed sweep. It also includes external horizontal input, and cascading capability at reduced bandwidth. (How's that for a bargain?)

Our new 1700 Series of portable scopes begins as low as \$1680—for the dual-channel, 35 MHz 1700A (<10 ns risetime). Add delayed sweep, and you've got our 1701A, for only \$1800.

The philosophy behind the 1700 Series is simple—providing the maximum in useful capability per dollar. The 1700A, 1701A, and 1707A offer wide flexibility, giving you everything you need for digital field service work. And they won't cost you a for-

tune. Compare them with anyone's competitive models—prove to yourself that the HP 1700's are the best values in portable scopes today.

For further information on "The Portables"—HP's new 1700 Series scopes—contact your local HP field engineer. Or write Hewlett-Packard, Palo Alto, California 94304. In Europe: 1217 Meyrin-Geneva, Switzerland. \*Option 020 Shown. HP's lab version of the 1707A. \$2050.

Scopes are changing.  
Are you?

081/12A  
**HEWLETT  PACKARD**

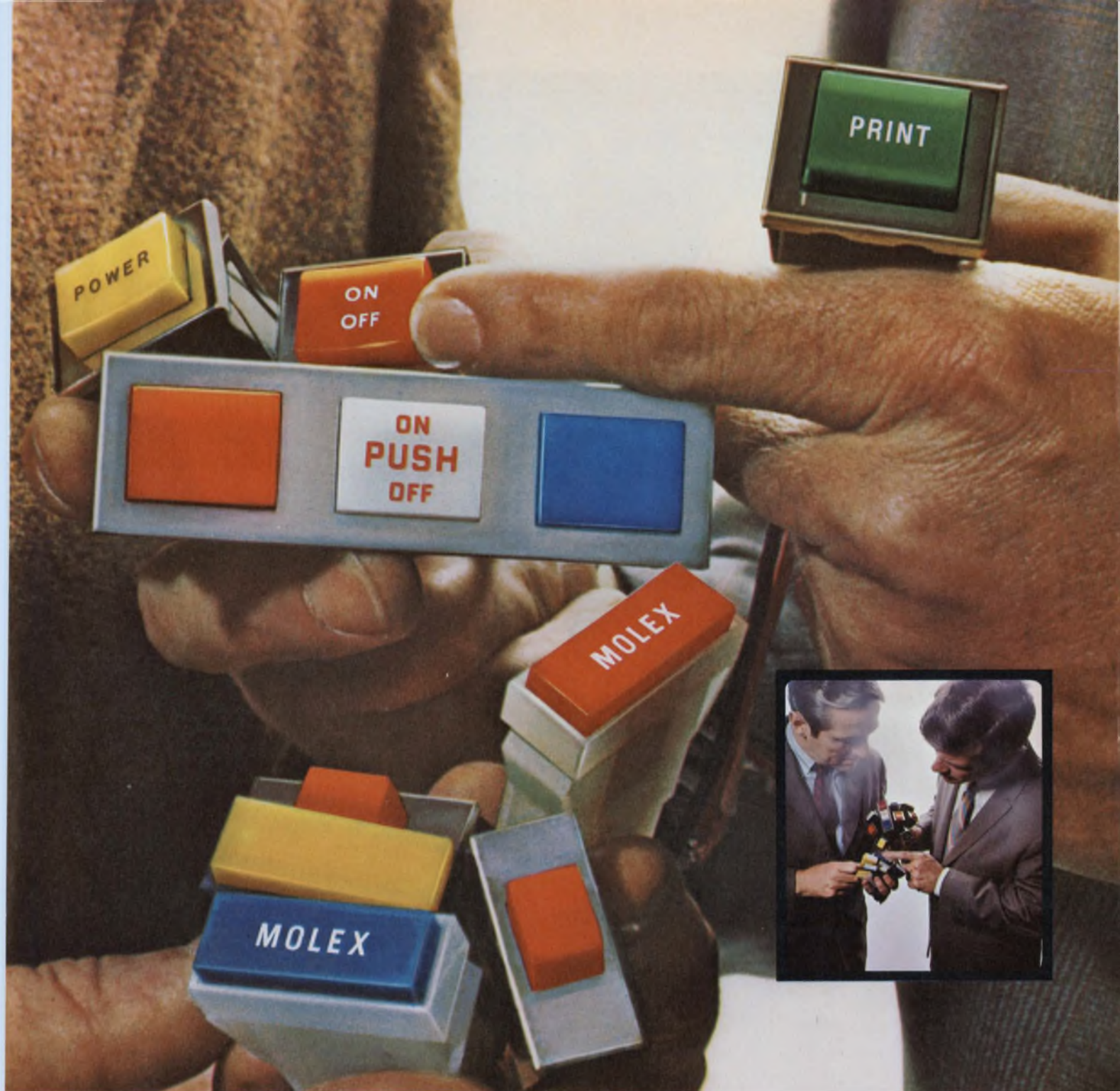

**HERE ARE TWO EASY WAYS TO SOLVE LIGHTED PUSH BUTTON SWITCH PROBLEMS. Economically. Reliably. Fast. The Molex 1175 snap mounts. Offers spade or wire terminals for fast, easy assembly. A choice of nine colors, 500 variations. And look at the Molex 1820. You can use one, or a gang of them, for an infinite variety of applications. Lighted push button can be wired to light independently of the switch. And it's available in colors galore. Best of all . . . both switches are priced considerably under one**

**dollar in quantity. ■ These components are good examples of the Molex creative approach to design problems. And we have the ability to design reliability and ease of assembly into a product without letting costs run wild due to over-engineering. ■ If this makes sense, and you would like a *free sample* of either the 1175 or 1820 switch, write: Molex Incorporated, Downers Grove, Illinois 60515. Or phone (312) 969-4550.**

*... creating components that simplify circuitry*





**When TRW X440 capacitors get together, it's all small talk.**

Since we introduced the X440 precision film capacitor it's been showing up in all the tight places. The X440 features a precision epoxy case with accurately located leads, and is ideal for use on densely populated printed circuit boards.

TRW pioneering in metallized polycarbonate film assures rigid

stability and reliability in these tiny capacitors. Environmental and electrical performance of the X440 will help you meet your toughest specifications. And being the smallest film capacitors on the market, they're often the only answer to a tight packaging problem.

Voltage...50VDC; capacitance...

.001 to .10 mfd; tolerance to  $\pm 1\%$ .

For samples, detailed data and applications assistance, contact TRW Capacitor Division, Box 1000, Ogallala, Nebraska 69153. Phone (308) 284-3611. TWX 910-620-0321.

**TRW**<sup>®</sup>

# Electronic Design 18

FOR ENGINEERS AND ENGINEERING MANAGERS

VOL. 19 NO.  
SEPT. 2, 1971

---

## NEWS

- 19 **News Scope**
- 22 **Four-channel quadrasonic systems**—stereo's successor  
—are giving the consumer industry a new sound to sell.
- 26 **Fighter pilots in training** will be flying an all-electronic combat  
maneuvering range with results being viewed on 3-D displays.
- 28 **Coast-to-coast TV** to present MOS course.
- 30 **Technology Abroad**
- 33 **Washington Report**

---

## TECHNOLOGY

- 40 **Use time-sharing to program your mini.** Available services can help  
you increase your machine's capabilities, save time and save money.
- 46 **Need a good sweep circuit?** Here's one that won't change frequency when you  
vary its output amplitude and vice versa. And it can be built inexpensively.
- 50 **Low-speed modems are easy to design** with ICs. They can perform all of  
the necessary functions, from tone generation to signal conversion.
- 54 **Help yourself to jobs and retraining,** engineers are advised at this conference.  
Attitude, adaptability and self-evaluation are seen as important assets.
- 60 **Ideas for Design**

---

## PRODUCTS

- 69 **ICs & Semiconductors:** Micro-power IC op amp can be totally programmed.
- 74 **Modules & Subassemblies:** Plug-in module power supply spans —300 to  
+25,000 V.
- 76 **Instrumentation:** New 50-MHz counter is designed for panel mounting.
- 73 Data Processing
- 75 Packaging & Materials
- 78 Components
- 79 Microwaves & Lasers
- 88 Product Index

---

## Departments

- 39 **Editorial:** Our R & D slip may be showing soon
- 7 Letters
- 12 Designer's Calendar
- 80 Evaluation Samples
- 80 Design Aids
- 80 Application Notes
- 82 New Literature
- 84 Bulletin Board
- 86 Advertisers' Index
- 88 Information Retrieval Card

**Cover:** Designed by Art Director Bill Kelly

---

ELECTRONIC DESIGN is published biweekly by Hayden Publishing Company, Inc., 50 Essex St., Rochelle Park, N.J. 07662. James S. Mulholland, Jr., President. Printed at Brown Printing Co., Inc., Waseca, Minn. Controlled circulation postage paid at Waseca, Minn., and New York, N.Y. Copyright © 1971, Hayden Publishing Company, Inc. 82501 copies this issue.

**Reliability is six things we do  
that nobody else does.**

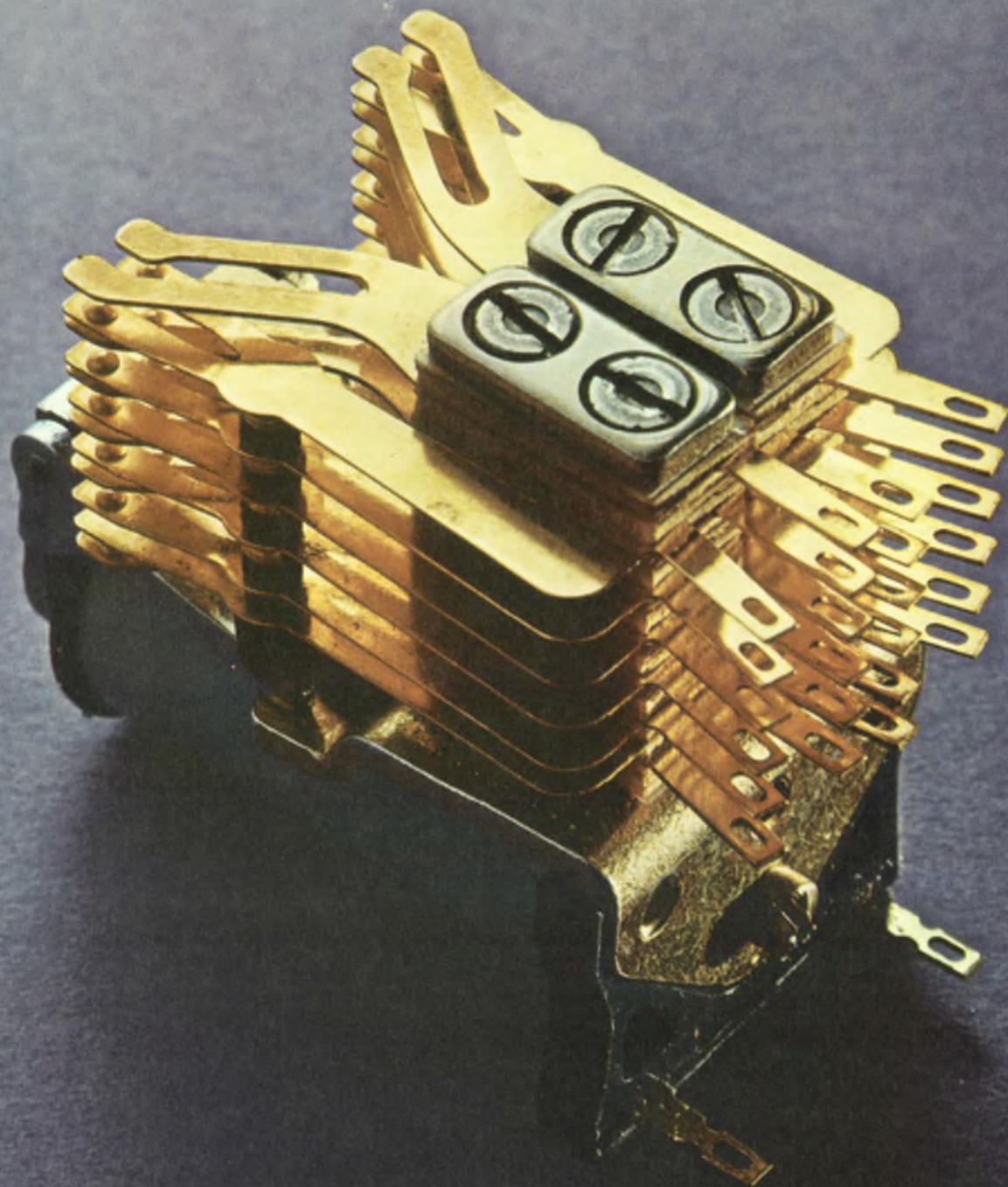



### **We're fanatics.**

We build our relays stronger than we have to. That way, they last lots longer than they ever have to. Our Class E relay (shown on the opposite page) is a good example of our way of thinking.

### **The industry's strongest heelpiece.**

We make the strongest heelpiece in the industry. A gigantic machine bangs them out extra fat and extra flat.

Extra fat to carry a maximum of flux. To handle big loads. Extra flat so that once an AE relay is adjusted, it stays adjusted.

Since our backstop is part of the heelpiece, it's just as thick and flat. But, tough as it is, the slightest wear here would throw the entire contact assembly out of whack. So, to be safe, we weld two tiny, non-magnetic pads where the armature arms meet the backstop. You might say we created the no-stop backstop.

### **Three parts that'll wear like crazy.**

When you build a relay like a small tank, you have to think of everything. We try. Right down to the tiniest part. For example, we make our armature arms and bearing yoke extra thick.



Thicker than years of testing and use say they have to be. Then, to make sure they don't cause wear problems, we insert a hardened shim between the hinge pin and the frame. The pin rides on the shim, instead of wearing into the heelpiece. (You can forget the bearing, it's permanently lubricated.)

### **Buffers with lots of muscle.**

We make our buffers of a special tough phenolic material that lasts. And lasts. And lasts. All without wear or distortion. Another reason why our relays stay in whack.

To make sure our buffers stay in place, we weld the buffer cups to the armature arms. We weld, instead of using rivets, because our lab found that rivets have a habit of falling out.

For the very same reason, we weld buffer cups to the contact springs. And also use the same special tough phenolic buffers.



### **No, we didn't forget the contact springs.**

We have some strong feelings as to what makes a contact spring reliable. Our sentiment is that two contacts are better than one. So, we bifurcate all the springs, not just the make and break. This slotting and the addition of another contact to each spring means you get a completed circuit every time.

We make each set of contact points self-cleaning. The bad stuff doesn't have a chance to build up.

### **Now, what's different about our bobbin?**

Our bobbin is one piece—molded of glass-filled nylon. This provides the maximum in insulation resistance.

Because our bobbin is nylon, we don't have to impregnate with varnish. Moisture and humidity have no effect on the stubborn nylon material. No effect means no malfunctions for you to worry about.



### **What all this means to you.**

What this all adds up to is reliability. The kind of toughness no one else can give you. It means an AE relay works when it's supposed to, longer than it has to. Isn't this the kind of reliability you really need? GTE Automatic Electric, Industrial Sales Division, Northlake, Illinois 60164.

**GTE AUTOMATIC ELECTRIC**

# WHY DO KEITHLEY ELECTROMETERS WIN ALL THE KUDOS?

Simple—they outperform all others.

We offer more sensitivity, stability and versatility, in more models and accessories, to make sure you get the most for your money.

Take our solid-state 610C. For an economical \$645, it measures 200  $\mu\text{V}$  to 100 V with  $10^{14}$  ohms input resistance, currents as small as  $6 \times 10^{-15}$  ampere, resistance to  $10^{14}$  ohms and charge from  $10^{-13}$  to  $10^{-5}$  coulomb. Our battery operated 602 goes for \$695, operates at 1500 volts off ground and provides performance similar to the 610C. Both models are available from stock.

For your digital needs, the systems-compatible 615 gives unparalleled accuracy and convenience, including optional BCD output. Other Keithley Electrometers and Picoammeters offer you many choices of performance and price. We've been innovating electrometer values like these for over 20 years. They've created an industry-wide reputation for kudos-winning performance. Win some kudos yourself. Call your Keithley Sales Engineer for technical literature and demonstrations. Or contact us direct. Keithley Instruments, Inc., 28775 Aurora Road, Cleveland, Ohio 44139. Telephone: 216/248-0400. In Europe: 14, Ave. Villardin, 1009 Pully, Suisse.

Prices slightly higher outside the U.S.A.

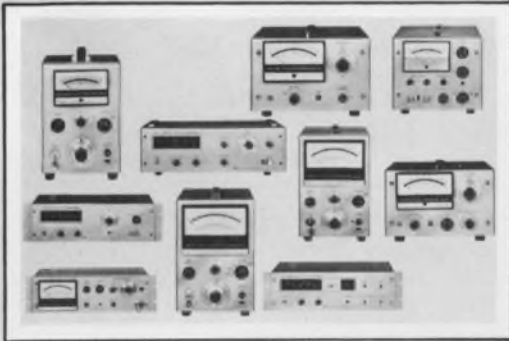

KEITHLEY



## Publisher

Peter Coley

## Editors

Editorial Offices  
50 Essex St.  
Rochelle Park, N.J. 07662  
(201) 843-0550  
TWX: 710-990-5071  
Cable: Haydenpubs Rochellepark

**Editor:** Frank Egan  
**Managing Editor:** Ralph Dobriner  
**Managing Editor:** Raymond D. Speer  
**Microelectronics,** Steven A. Erenburg  
**Computers,** Raymond D. Speer  
**Microwaves,** Michael J. Riezenman  
**Circuits,** Edward A. Torrero  
**Special Projects,** George Rostky  
**Management,** Richard L. Turmail  
**Military-Aerospace,** John F. Mason  
**News,** Michael P. London  
**New Products,** Roger Allan

## Field Offices

### Massachusetts

Jim McDermott  
P.O. Box 272  
Easthampton, Mass. 01027  
(413) 527-3632

### West Coast

David Kaye  
2930 Imperial Highway  
Inglewood, Calif. 90303  
(213) 757-0183

### Washington

Don Byrne  
1111 S. Army Navy Drive  
Arlington, Va. 22202  
(202) 296-8982

## Editorial Production

Dollie S. Viebig

## Art

**Art Director,** William Kelly  
Richard Luce  
Anthony J. Fischetto

## Production

**Manager,** Thomas V. Sedita  
Helen De Polo  
Kathleen McConkey  
Maxine Correal

## Circulation

**Manager,** Nancy L. Merritt

## Information Retrieval

Peggy Long



# letters

## A call to protect the title "engineer"

I certainly agree with the June 10 editorial ["All You 'Train Drivers,' Better Start Talking," ED 12, p. 45] that "engineers have a serious identity problem." However, the fact that the word "engineer" is tagged on a train driver is just a trivial example. This is a simple peculiarity of the English language, to be compared to the term "conductor," which is applied to the collector of fares in a public conveyance or to the leader of a musical ensemble. This is far from the main aspect of the problem.

As you pointed out, "becoming an engineer is not easy." But it does not always seem that way. What about the proliferation of people who refer to themselves as "engineers" when they are holding

some technical job? Actually you can become an engineer (or be called one) through "on-the-job training," without any academic background. This is a great disservice to the engineering profession.

I am not contesting the merit of excellent technical workers, some of whom would probably make outstanding engineers if they would take the time to acquire the basic education in an engineering school. I propose that the term "engineer" be protected and be applied only to an individual who has earned an engineering degree. That way the word may begin to mean something, just as the terms "doctor," "lawyer" or "plumber" do.

*Senior Engineer*  
(Name withheld  
on request)

Escondido, Calif.

## Laser cloth cutter defended as a gain

Joseph B. Wible's objections to the laser cloth cutter because it would eliminate jobs (see Letters, ED 14, July 8, 1971, p. 7) indicates that he doesn't understand why cost-saving advances benefit everyone in the long run, although they may cause short-run problems for some people. The shortest explanation of this can be given by the following example:

Assume sweaters cost \$10. If one factory, through a technological breakthrough, starts selling sweaters for \$5, there might be layoffs in other factories. However, the consumer, who previously had a sweater for his \$10, now can have his sweater for \$5 and still have \$5 to spend elsewhere. That \$5 will provide in time the employment for

the unemployed. But the most important point to be made is that the standard of living of the consumer has gone up because of the increased efficiency of that manufacturer. This is the same process that has enabled individuals to progress to where they can now work eight hours a day at one of thousands of jobs instead of 12 hours a day on the farm.

Those who argue against labor-saving ideas are asking that the standard of living be static; they are asking that each person labor harder than necessary to support himself. In the case of the sweater, they are asking a man who earns \$5 an hour to labor two hours to earn a sweater when he could do it in one.

*Richard J. Savadel*

11 Clifford Blvd.  
Hauppauge, N. Y. 11787

Electronic Design welcomes the opinions of its readers on the issues raised in the magazine's editorial columns. Address letters to Managing Editor, Electronic Design, 50 Essex St., Rochelle Park, N. J. 07662. Try to keep letters under 200 words. Letters must be signed. Names will be withheld on request.

# NEW!

FROM



## LM 345

## CHANNEL AMPLIFIER

The LM345 linear integrated circuit is ideally suited for use as a channel amplifier in FDM and PCM telephone systems. Features include:

- Low quiescent power consumption (typically 20 mW)
- Low distortion (typically 1.5%)
- High voltage gain (typically 100 dB)
- Short circuit protection
- Offset null capability

### OTHER SPECIFICATIONS: (typ.)

Input offset voltage:  $\pm 1.5$  mV  
Input bias current: 100 nA  
Input resistance: 2 megohms  
Output resistance: 75 ohms  
Operating temperature:  $-20^{\circ}\text{C}$  to  $+85^{\circ}\text{C}$

Package type: TO-99 metal can

### PRICE

1-24	25 up	100 up
\$5.25	\$4.70	\$3.50

8-page applications bulletin furnished with each order.

Delivery: From stock. Order from:

 **EUROPEAN  
ELECTRONIC  
PRODUCTS**  
CORPORATION

10150 W. Jefferson Blvd.,  
Culver City, California 90230  
(213) 838-1912

INFORMATION RETRIEVAL NUMBER 6

# A better way to get quick delivery on monolithic filters.

The better way is you. You tell us when you need the filters. It's that simple. And it's the best way to prevent a supplier from saying one week delivery when he means one month.

Seven standard models are available in ranges from 5MHz to 26MHz. Insertion losses are a nominal 2 to 4db. Each filter is shock protected and hermetically sealed. Other frequencies developed to your order. Specs available from Motorola Component Products Dept., 4545 W. Augusta Blvd., Chicago, Illinois 60651.

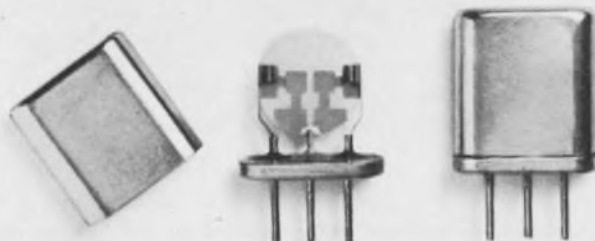



## I.C./D.I.P./M.S.I./L.S.I./P.C.-For sockets with initials MAKE CINCH YOUR INITIAL CHOICE

For standard or custom multiple contact sockets, Cinch has—  
or will design—a high reliability device for your application.

P.C. sockets, with only .130" profile, use a new, unique miniature terminal, with wiping contacts, for 0.016"-0.019" diameter pins. Socket configurations, up to 100 contacts, for MSI, LSI, DIP or read-out tube use can be produced.

DIP sockets, for 14, 16 or 24 pin DIPs with pins as short as .100", in a variety of insulations and platings are available as standard units. Cinch industrial distributors stock many styles for immediate delivery.

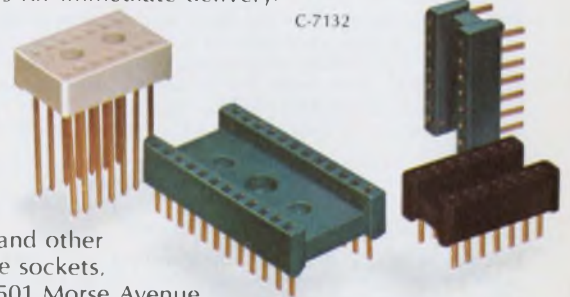
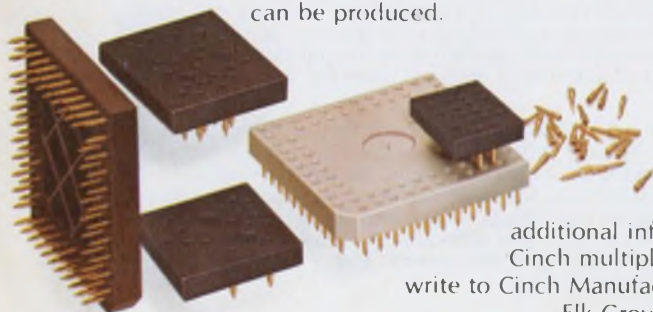

For  
additional information on these and other  
Cinch multiple contact, miniature sockets,  
write to Cinch Manufacturing Company, 1501 Morse Avenue,  
Elk Grove Village, Illinois 60007.

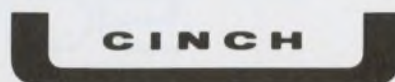

# When you're known for Rolls-Royces,

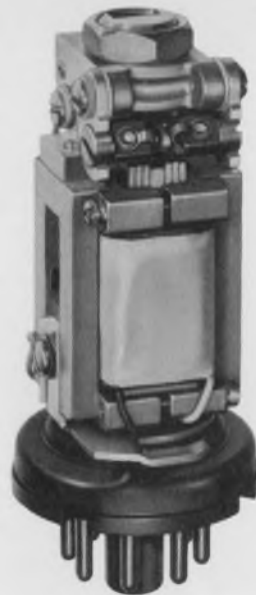

Series 72 Pulse and Telegraph Polar Relay  
... pulse repetition to 400/sec., life in hundreds of millions of operations

# it's hard to get Volkswagen buyers to think of you.



Series 67  
General purpose  
AC & DC, 4PDT, 5A

**SIGMA has 2000 good, different general-purpose relays— many for 50¢/pole.**

If you think of Sigma as a sensitive, close-differential relay house, you're partly correct. We're also a low-priced, general purpose relay house — as a substantial number of vending machine, alarm system, industrial control, copier and communications equipment manufacturers will attest.

For demanding applications such as computer peripherals, you can have one-cubic-inch 4PDT switching, on AC or DC coil signals, of low-level to 5-amp. loads at least 100,000 times with the Series 67. Fast wiring, mounting and interchangeability results from PC or solder terminals, or in sockets with PC or solder terminals.



Single-, two- or three-pole switching of loads up to 10 amps, for one million operations at 28 VDC or one-half million at 115VAC, is provided by the versatile and quickly-installed Series 68.

For up to 6PDT switching of low-level to 5 amp. loads by voltage adjustment, or 1-amp. loads on sensitive current adjustment, the Series 62 combines long life (up to 50 million operations with bifurcated contacts) with moderate cost.



For positive response to coil signals as low as 50 mw, at a cost of under 75¢/relay in quantity, the Series 65 is well-suited to TV channel selectors, slide projectors, vending machines and similar uses involving SPDT switching of 1-amp. loads.

Up to 3PDT switching of 5- or 10-amp. loads, on AC or DC voltages, is available in the compact and low-cost Series 50; wide application in automated equipment, switching small motors, solenoids and other relays.



We'll be glad to supply detailed technical data on any of the general-purpose relays mentioned, with complete price and delivery information on standards. Better yet, tell us your requirements (load, life, cost, driving signal, operating speed and environment) and let us recommend the relay best suited to the job. We can save you time, disappointment and perhaps some money as well. Sigma Instruments, Inc., 170 Pearl St., Braintree, Massachusetts 02185.

## SIGMA

INSTRUMENTS INC

# An electrolytic capacitor with **zero defects?**

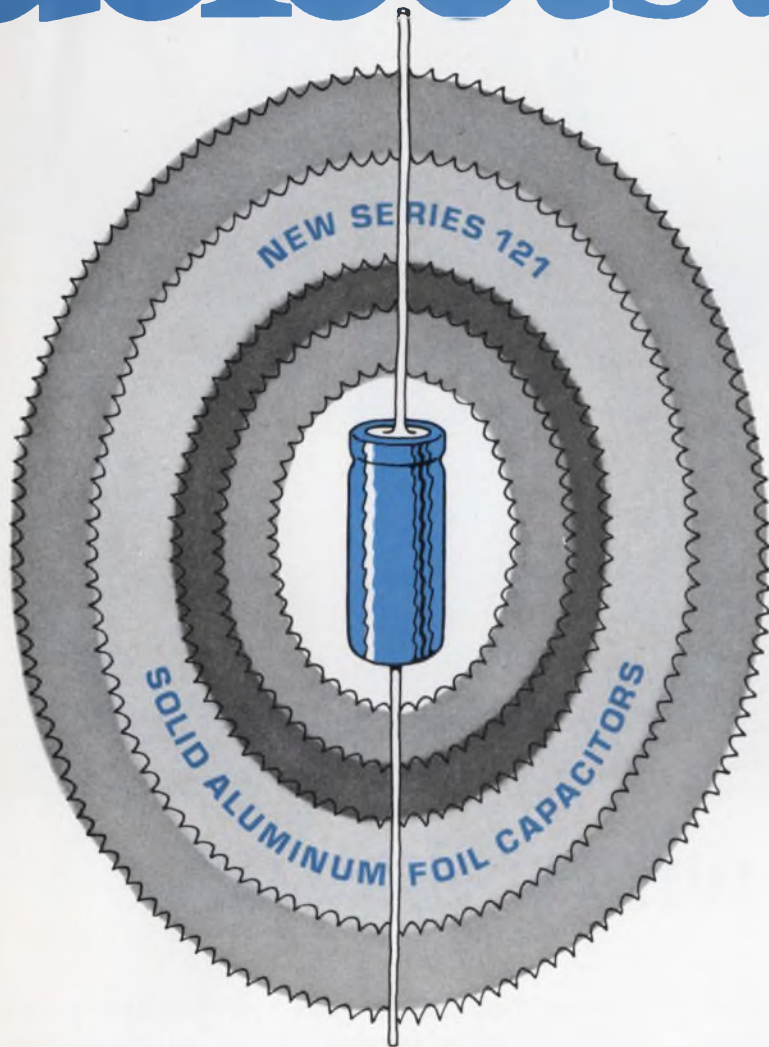

**After 26 million component hours of testing without a single catastrophic failure and 400 million hours of actual field testing,** Amperex announces a solid electrolyte aluminum foil capacitor. This new capacitor fills the gap between dry aluminum and solid tantalum electrolytics where long life, high reliability and stability over a wide range of temperatures are critical design factors. With electrical characteristics similar to solid tantalum types, the new Series 121 capacitors offer higher reliability than either dry aluminum or solid tantalum.

Unlike solid tantalum or dry aluminum types, Series 121 capacitors can tolerate substantial reverse voltages continuously. For short durations, they can withstand reverse voltage equal to the rated voltage. In addition, the special construction results in very high ripple current capability. With no limit on the magnitude of discharge current that can flow, the need for protective series resistance in associated circuits is eliminated.

The new Series 121 solid aluminum capacitors are available in six standard case sizes with values from 2.2 to 330 microfarads and ratings from 6.3 to 40.0 volts. Priced competitively with solid tantalum electrolytics, they offer new design flexibility and increased reliability in high quality professional and consumer products.

For technical data and evaluation samples, contact: Amperex Electronic Corporation, Component Division, Hauppauge, New York 11787. Telephone: 516-234-7000.

#### Outstanding advantages include:

- Reliability
- Reverse Voltage Capability
- Almost Unlimited Discharge Current
- High Ripple Current
- Low Self-Inductance
- Unlimited Storage Without Reforming
- Operating Temperature Range:  
-80°C to +125°C

## Amperex®

TOMORROW'S THINKING IN TODAY'S PRODUCTS

A NORTH AMERICAN PHILIPS COMPANY

# A new cost-saver...

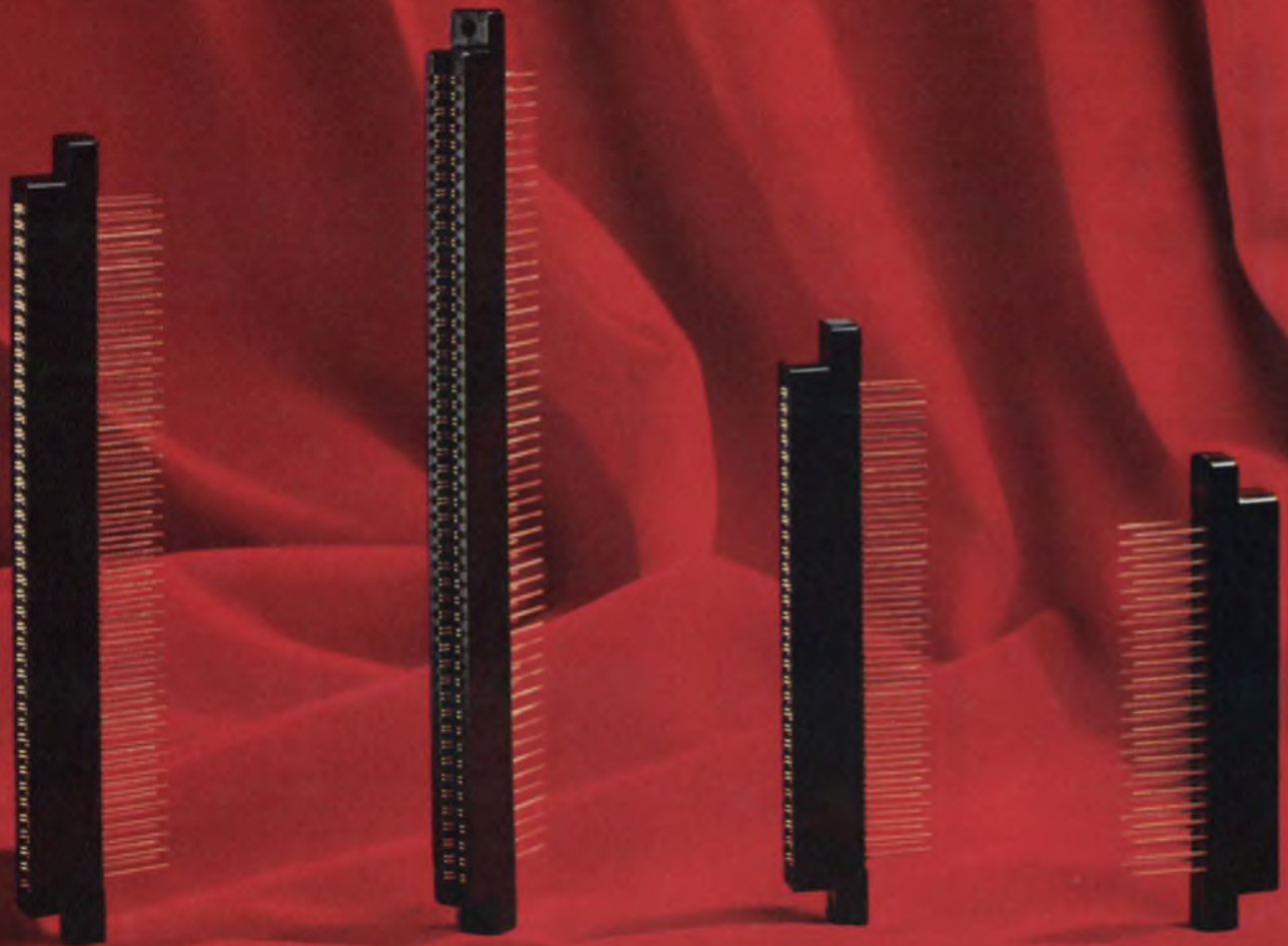

## to wrap your wires around.

Here's a new family of miniature pc connectors from Amphenol for wire wrapping applications. They cost you less because we've engineered new industrial grade materials into these connectors, yet retained all the same features found in military connectors.

Contact spacing is on a .100 X .200, or .125 X .250 grid and the connectors are available in 22-, 30-, 43- and 50-position models with either grid spacing.

These new 225 Series connectors have bifurcated bellows contacts for smooth, positive, 2-point mating action no matter how irregular the board

surface. The bellows exert firm pressure on the pads even under extreme vibration and shock conditions. You get thousands of insertions and withdrawals without a failure.

We can also give you this new low-cost connector with solder terminations on .156 centers. And there's a QPL version to MIL-C-21097B, too.

Call your Amphenol salesman or distributor; he'll show how inexpensive it is to wrap your wires around a great connector. Or write us. Amphenol Industrial Division, The Bunker-Ramo Corporation, 1830 South 54th Avenue, Chicago, Illinois 60650.

**BUNKER  
RAMO** AMPHENOL

# designer's calendar

**Oct. 4-5**

**Joint Engineering Management Conference** (Los Angeles) Sponsor: IEEE et al, L. D. Chipman, Western Electric Corp., 218 Lynn Lane, Westfield, N. J. 07090

CIRCLE NO. 409

**Oct. 11-13**

**International Microelectronics Symposium** (Chicago) Sponsor: International Society for Hybrid Microelectronics, 1410 Higgins Road, Park Ridge, Illinois 60068

CIRCLE NO. 410

## OCTOBER 1971

S	M	T	W	T	F	S
					1	2
3	4	5	6	7	8	9
10	11	12	13	14	15	16
17	18	19	20	21	22	23
24	25	26	27	28	29	30
31						

**Oct. 11-13**

**International Electron Devices Meeting**, (Washington, D. C.) Sponsors: IEEE, G-ED, D. P. Kennedy, IBM Corp., E. Fishkill, Rte. 52, Hopewell Jct., N. Y. 12533

CIRCLE NO. 411

**Oct. 18-20**

**National Electronics Conference** (Chicago) Sponsors: IEEE, Region IV, et al, J. B. Kreer, Michigan State Univ., E. Lansing, Mich. 28823

CIRCLE NO. 412

**Oct. 31-Nov. 4**

**Engineering in Medicine & Biology Conference** (Las Vegas) IEEE, John Hanley, Brain Research Inst., Univ. of Calif., Los Angeles, Calif. 90024

CIRCLE NO. 413

*nickel-cadmium battery*

APPLICATION ENGINEERING HANDBOOK

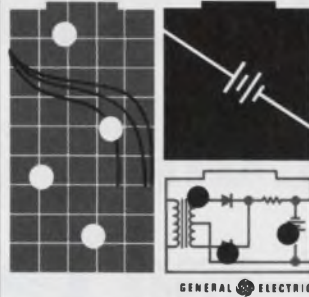

Here's a new, comprehensive manual of interest to all designers—200 pages of application information.

To find out how you can order this unique engineering handbook, circle the number below on the reader service card. Or write—General Electric Company, P. O. Box 114, Gainesville, Florida 32601.

GENERAL  ELECTRIC

# all you need to know about nickel-cadmium rechargeable batteries

INFORMATION RETRIEVAL NUMBER 12

## Perfect mate for integrateds— Micro-Vectorbord® Tenth-Tenth Pattern "P"

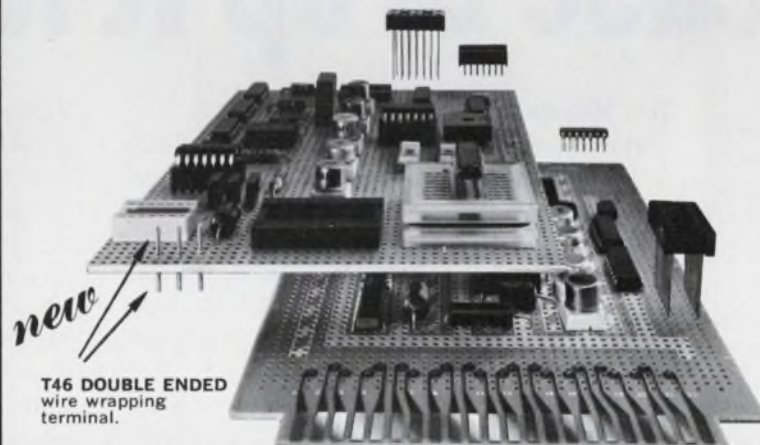

**T46 DOUBLE ENDED**  
wire wrapping  
terminal.

Precision punched .042" holes spaced .1" x .1" available in sheets of various sizes up to 8½" wide by 35" long, 1/16" thick Epoxy Glass, Epoxy Paper, Phenolic.

Copper Clad and Non-Clad. Also available in Plugboards with etched or Elco Varicon contacts, buses, ground planes.

MINIATURE PUSH IN TERMINALS FOR .042" HOLES.



**T44 MINIWRAP** .025" Square, for wire-wrapping.



**K27** .042" Diameter



**T42-1 Micro-Klip**

**Vector**

Send for complete literature

**ELECTRONIC CO., INC.**

12460 Gladstone Ave., Sylmar, California 91342

Phone (213) 365-9661 • TWX (910) 496-1539



INFORMATION RETRIEVAL NUMBER 13

# Will The Designer Who Ordered Plastic Silicon Power In More Than One Package Size, Power Rating and Lead Form,

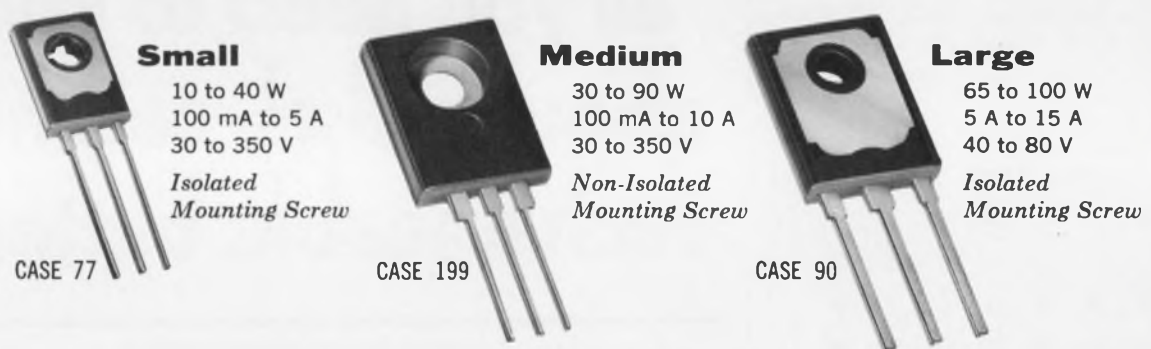

## Please Drop It Right Into

### It's Ready!

Thermopad\* plastic power — now available in just about any size, power rating and lead configuration you require . . . for immediate drop-in into any metal-device socket you might have: TO-66, TO-5 or PCB, for flat or flag-mounting, with or without heat sinks . . . in high voltage, complementary EpiBase\* and Darlington technology!

And you've got over 120 types to do it with: 33 registered and 90 house-numbered units that ensure your getting exactly what you need . . . eliminating over or under-design . . . without costing more than you want to pay!

You have your choice of 40 "small" case 77 types offering the most compact design possibilities . . . available in either E-C-B or B-C-E pin styles . . . readily replacing TO-66 units and furnished in 10 different lead forms.

Use the newest, "medium-sized," case 199 to directly replace TO-66s and other plastic types with unformed leads where

direct, metal-to-metal mounting screw attachment is desired. Like the case 77 and case 90, the 199 provides the most intimate heatsink-to-header contact seal in the industry and offers superior hermetic case integrity in high humidity environments. Power dissipation is also greater because of its 60% bigger heatsink area.

"Large" in every way, the case 90's minimum, .032" thermal path length provides essentially the same  $\theta_{JC}$  as a copper TO-3 in spite of the fact it has only one-fourth the heatsink surface area! You also get Darlington/complementary capability and up-to-100 W performance!

Get the whole story on Motorola plastic silicon power — write Box 20912, Phoenix, AZ 85036 and receive data sheets plus a copy of the new LEADFORMS brochure . . . it details dimensions, styles and applications of Motorola's unique capability to fit plastic power devices to any of your sockets. It's right now!



CASE 77



Standard Straight Pin  
E-C-B Pin Style

CASE 77



Standard Straight Pin  
B-C-E Pin Style

CASE 77



TO-5 PCB Pin Circles  
(Heatsink Optional)  
Collector Bent  
Away From Heatsink Surface

CASE 77



TO-5 PCB Pin Circles  
(Heatsink Optional)  
Collector Bent Toward  
Heatsink Surface

CASE 77



TO-66 Sockets  
Standard Lead Length

CASE 77



TO-66 Sockets  
Long Lead Length

CASE 77



PCB Mounting  
Trimmed Leads

CASE 77



PCB Mounting  
Heatsink Surface Down

CASE 90



Standard Straight Pin  
E-C-B Pin Style

CASE 90

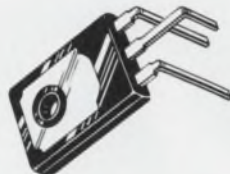

Flat Mounting On Heatsink

CASE 90



PCB Or Heatsink Mounting  
Long Collector Lead

CASE 90

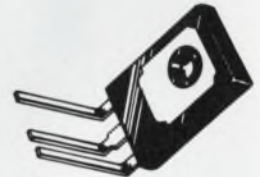

PCB Or Heatsink Mounting  
Short Collector Lead

# His Sockets.

CASE 199

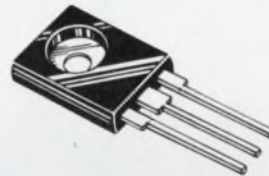

Standard Straight Pin  
B-C-E Pin Style

CASE 199

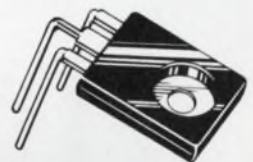

TO-66 Sockets  
Electrically Integral Collector

CASE 199



TO-66 Sockets  
Trimmed Collector

CASE 199

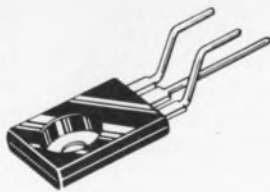

Popular Plastic  
Flag Mounting

CASE 199



PCB Sockets  
Flag-Mounting,  
Trimmed Collector

CASE 199

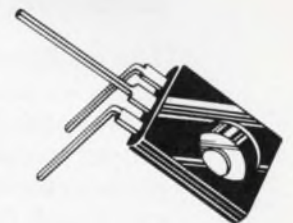

TO-66 Sockets  
Optional Center Lead Connection

CASE 199



PCB Sockets  
Flat Mounting  
Without Heatsink

**3 Different Sizes,  
19 Different Lead Forms To Choose From!**



**MOTOROLA POWER**  
*In The First Place, It's Easy.*

# General Electric Company selects Dacron.<sup>®</sup>



**“The quality of the electrical relays we make depends on many control factors, from proper temperature to proper employee clothing,” says Frank Cutadean, Manager of Shop Operations, Power Systems Management Dept.**

“When our employees wore regular street clothing in our shop, we had problems and so did they. When we switched to rental uniforms made of 65% Dacron\* polyester, 35% cotton, production efficiency was increased, and employee morale was boosted. And at an extremely reasonable cost to us.

“Everybody likes the lightweight comfort of ‘Dacron’, and the way these uniforms stay fresh-looking and neat all week long. Our employees especially appreciate the savings on their personal-clothing costs.

“When we saw how economical rental service was and how much it was appreciated, we extended the service to personnel operating duplicating machines. The same fabric with Du Pont ‘Dacron’ was selected on the basis of good performance in the shop,” says Mr. Cutadean.

Find out what “Dacron” can do for you. Contact the Du Pont Company for more information or assistance in locating suppliers for your requirements. Write: 31J6 Centre Road Building, Wilmington, Delaware 19898. Or call (302) 999-3457.

\*Du Pont registered trademark.



There's a world of things we're doing something about.

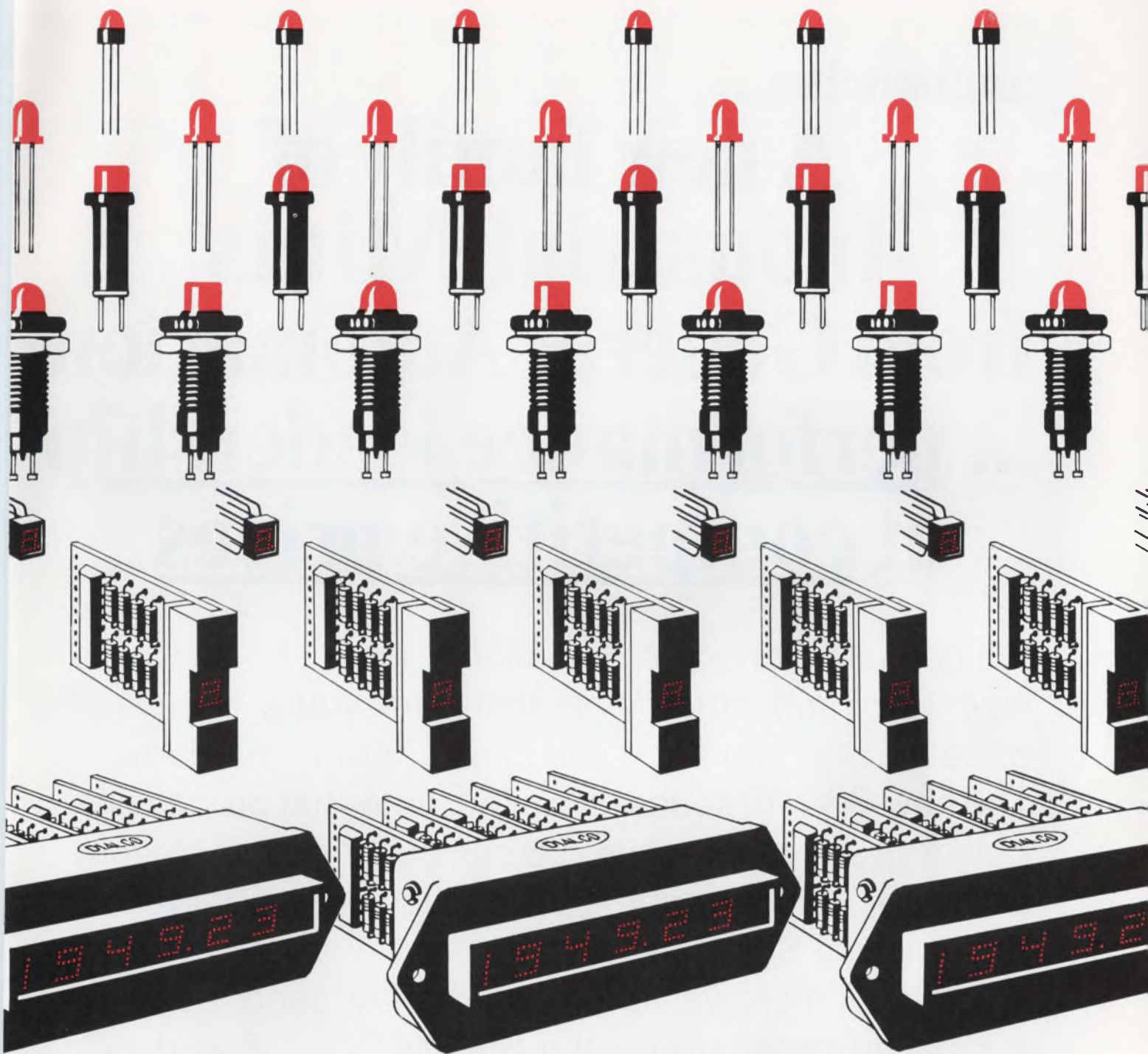

## Just what you'd expect from Dialight... the industry's broadest line of LED light sources, indicator lights and readouts.

Here is every component or package you might need to capitalize on the long life and reliability of LEDs: DIODE-LITE<sup>®</sup> light sources . . . indicator lights utilizing DIODE-LITES in cartridges and complete assemblies . . . illuminated pushbutton switches . . . readout modules in .125", .205" and .625" character heights . . . these modules incorporated in readout packages complete with decoder/drivers . . . and finally, display assemblies of 2 to 10 read-

out packages mounted in a bezel frame with window. All are attractively priced. All are available off-the-shelf from Dialight or through selected distributors.

No one else offers you one-stop shopping in LED visual display. And no one has more experience in the visual display field. That's important too. Write today for our Data File on DIODE-LITES and compare it with anybody else's.

<sup>®</sup> TRADEMARK

# DIALIGHT

DIALIGHT CORPORATION, A NORTH AMERICAN PHILIPS COMPANY • 60 STEWART AVENUE, BROOKLYN, N.Y. 11237 • (212) 497-7600

INFORMATION RETRIEVAL NUMBER 141

announcing...

**A new family of  
Industrial-Minis  
from General Automation  
... performance leadership  
at competitive prices**

Welcome to General Automation's newest family: three new 16-bit *Industrial-Minis* that offer you a choice of price and performance you can't afford to overlook. The new SPC-16 series offers four times the processing power of any other minis you can buy. And they're fully software, input/output, and mechanically compatible with present SPC-16's.

If you want more value for your money, send today for a detailed brochure on the SPC-16/30, /50 and /70. And welcome yourself to the General Automation family!

Write or call for details.



**GENERAL AUTOMATION, INC.**

1055 So. East Street, Anaheim, Calif. 92805  
(714) 778-4800 TWX 910-595-1780

Sales & Service Offices: Nationwide U.S.A. / Belgium / Denmark / England / France / Germany

# Top Value...Let us prove it

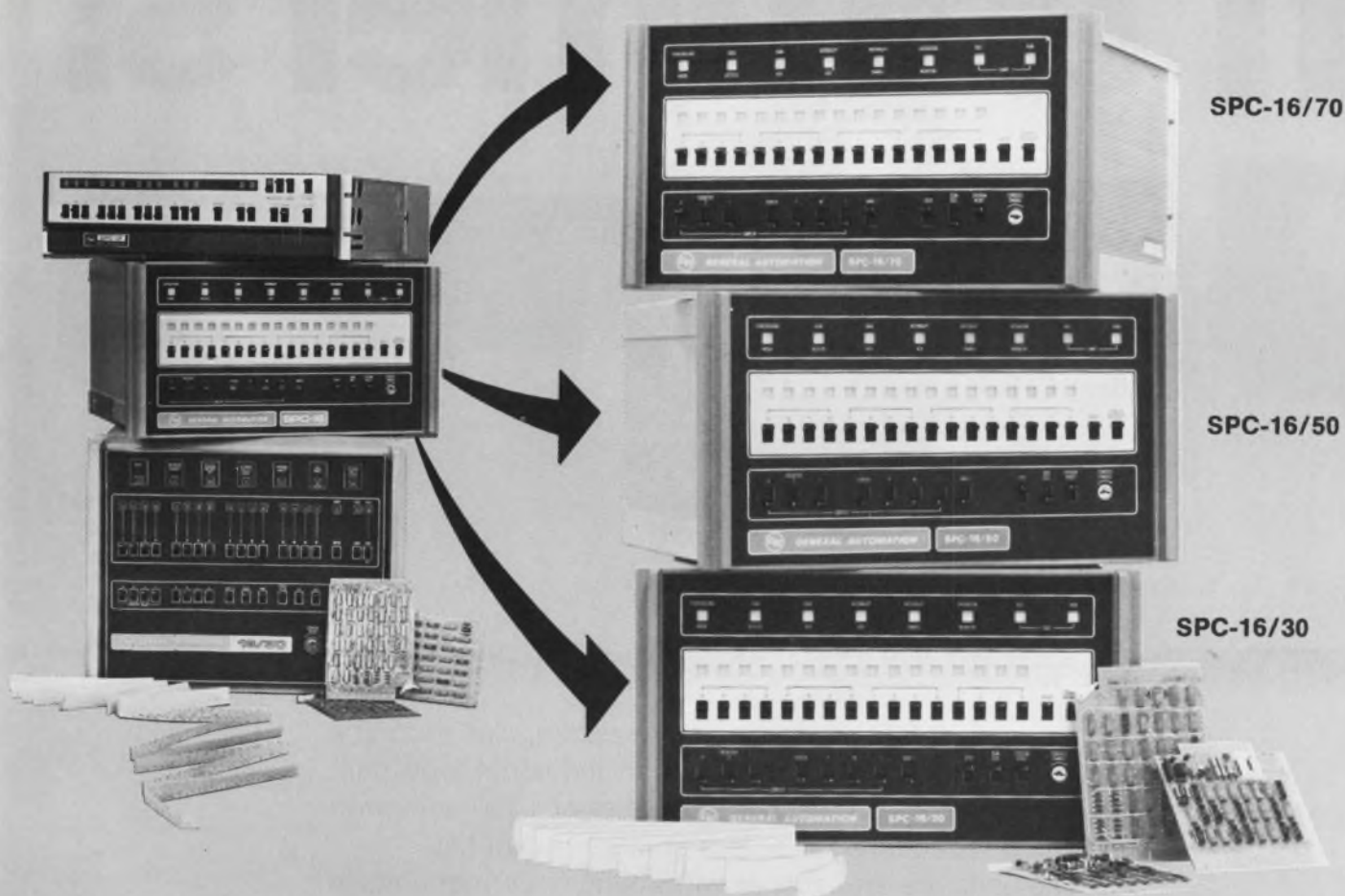

Prices Start at Under \$3000 in Quantity — including 4K Memory

## INDUSTRIAL MINIS FOR COMPUTER-BASED AUTOMATION

# Best buy in trimmers!

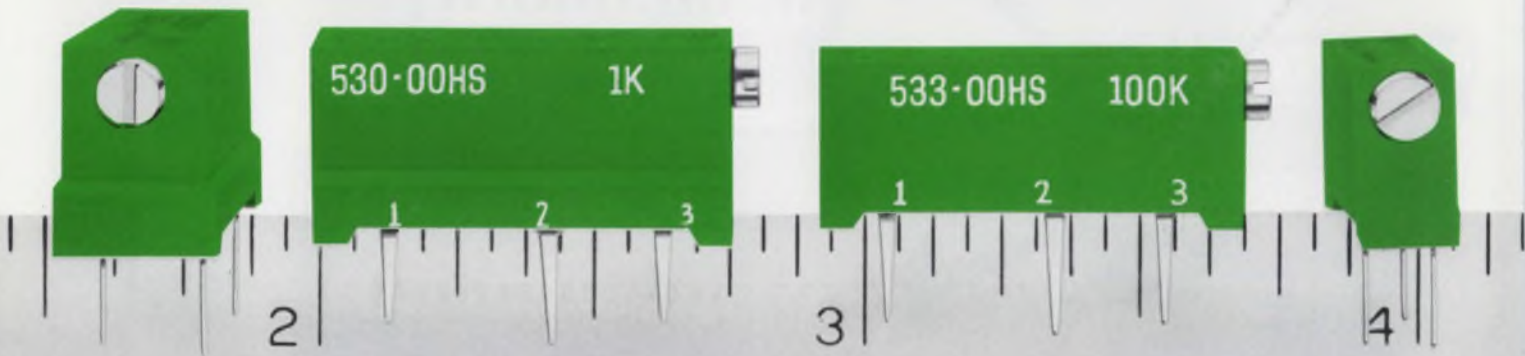

The Weston 530-533 series of  $\frac{3}{4}$  inch rectangular trimming potentiometers is your best buy in an industrial type unit. Prices are under \$1.00 each in quantities of 1000 units with substantial reductions for orders of larger quantities.

The units are available as wirewound or cermet units in both the wide base and narrow base models.

MODEL	BASE	RESISTANCE ELEMENT	TEMPERATURE COEFFICIENT	RESISTANCE RANGE	NO. TURNS
530	Wide	Wire wound	$\pm 70\text{ppm}/^\circ\text{c}$	$10\Omega\text{-}35\text{k}\Omega$	15
531	Narrow	Wire wound	$\pm 70\text{ppm}/^\circ\text{c}$	$10\Omega\text{-}35\text{k}\Omega$	15
532	Wide	Cermet	$\pm 100\text{ppm}/^\circ\text{c}$	$10\Omega\text{-}1\text{ Meg.}$	15
533	Narrow	Cermet	$\pm 100\text{ppm}/^\circ\text{c}$	$10\Omega\text{-}1\text{ Meg.}$	15

For Samples or complete details on these units, call 717-876-1500 or write Weston Components Div., Archbald, Pa. 18403, a Schlumberger company.

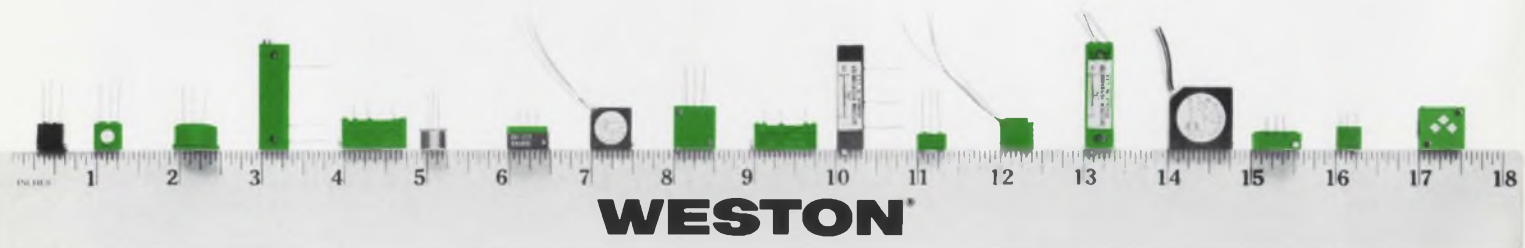

**a good rule to follow...**

**when ordering pots.**

# Announcing a new panel savings plan.



## Big dividends from small pushbuttons.

It doesn't take much to reduce the size of your control panels and cabinet fronts.

All it takes is compact miniature pushbuttons. Like the new MICRO SWITCH illuminated DS.

Two sizes are available ( $\frac{3}{4}$ " x  $\frac{3}{4}$ " for our 1-unit and  $1\frac{1}{8}$ " x  $\frac{3}{4}$ " for our  $1\frac{1}{2}$ -unit). And

both can be matrix mounted on  $\frac{3}{4}$ " or  $1\frac{1}{8}$ " centers. So there's no need for spacers or barriers.

## A long-term investment.

A rugged metal housing encloses each switch and protects against the bumps and bangs of military and commercial use.

The housing also helps provide our DS pushbuttons with exceptional RFI attenuation capability. Incorporated into the housing are welded skirts that assure positive metal-to-metal grounding between the switch and adjacent units. And also between the switch and our rigid, box-girder matrix frame.

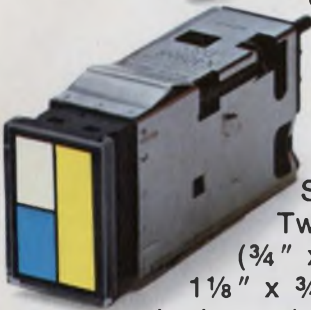

## Your choice of options.

Pick the mounting that best fits your application. Either individually mounted switches (meet the requirements of MIL-S-22885) or custom matrix configurations featuring plug-in switches that are best for remote stations or indicating functions.

You can have up to four lamps in every switch. And either one, two, three or four-way split section screens. (The  $1\frac{1}{2}$ -unit provides more than one-third additional legend area.) Full guards are available for single-unit switches.

Then save even more space by combining both 1-unit and  $1\frac{1}{2}$ -unit switches in the same matrix. A single frame will handle up to sixteen 1-unit switches or up to ten  $1\frac{1}{2}$ -units.

## Who can participate in the plan.

MICRO SWITCH DS pushbuttons meet both commercial and military requirements. So they can be used in almost any panel from power plant control to tactical ground support equipment.

For more information, call your MICRO SWITCH Branch Office or Distributor (in the Yellow Pages under "Switches, Electric"). He'll show you how little it takes to participate in our savings plan.

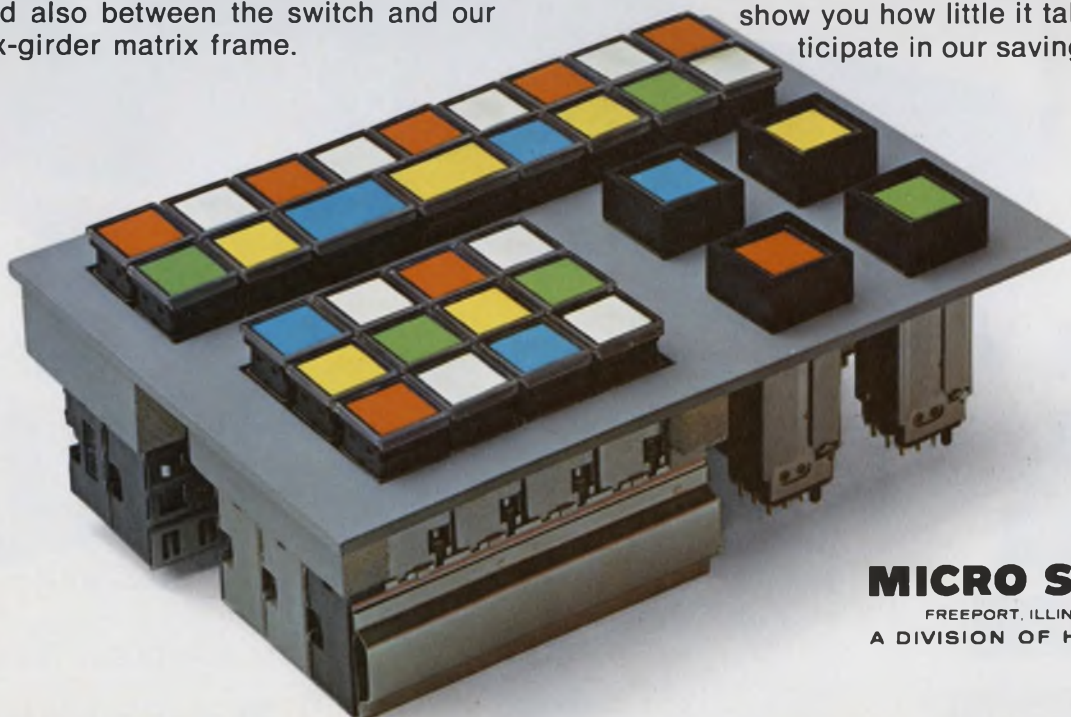

**MICRO SWITCH**

FREEPORT, ILLINOIS 61032

A DIVISION OF HONEYWELL

**DOWN WITH CONNECTIONS... OUT WITH WELDS**

# 8-16 DIGITS YOUR ONLY CHOICE IS **PANAPLEX™** NUMERIC PANEL DISPLAY

Burroughs leads today's display revolution with a whole new way of looking at numeric displays — a total cost savings package designed to eliminate all your display problems. Check these advantages:

**LOW COST** — Your initial investment is lower because PANAPLEX panels are the lowest cost panel displays available. Your circuitry costs go down because PANAPLEX panels are specifically designed for time sharing from low cost MOS, LSI circuitry.

**HIGH RELIABILITY** — Your instrument will be more reliable because PANAPLEX panels are one-piece construction and contain NO internal welds. PANAPLEX panels are impervious to shock and vibration. No other multiple digit device has this proven life and failure free operation.

**CUSTOMER DESIGNED PACKAGING** — Your installation costs are lowered because PANAPLEX panels are supplied in packaged units containing your complete display —

prealigned and ready to be plugged into, or soldered onto a mating board. No individual digit alignment required and only two connections per digit.

**HUMAN ENGINEERED READOUT** — Your selling costs go down because of the PANAPLEX panel's esthetic selling features, including large (0.4") easily read characters in perfect alignment; superior brightness characteristics; a 150° viewing angle; and a nine segment format that permits a centered digit "1". The thin package allows you design freedom — a must in today's competitive market.

**AVAILABILITY NOW** — Production quantities are being shipped now and we can respond to your volume requirements faster than any other source.

*For additional information, call or write:  
Burroughs Corporation, Electronic Components Division,  
P.O. Box 1226, Plainfield, New Jersey 07061.  
Tel: (201) 757-3400.*

**\$156\***  
PER DIGIT

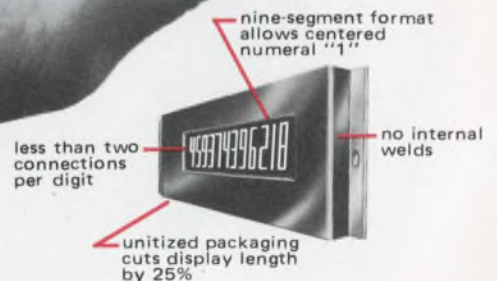
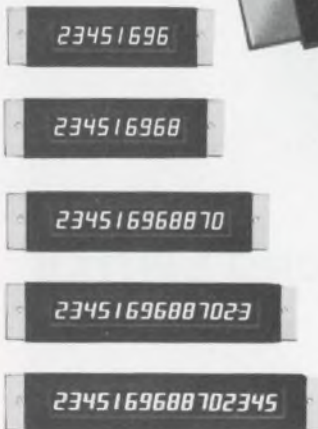

— CALL BURROUGHS TODAY

**Burroughs**



See us at Wescon Show Booths 1732-35

INFORMATION RETRIEVAL NUMBER 17

\*16 digit unit, 1000 quantity.



## U.S. concerns step up sales pitch to Soviet

U.S. electronics manufacturers are moving to increase their sales to Soviet-bloc countries. An increasing number are participating in Eastern European trade fairs, the U.S. Dept. of Commerce reports.

Typical of the exhibitions is one planned in Moscow next April for the makers of computers and computer related data equipment. It's being organized by International Media and Exhibits, Inc., of Newark, N.J., and while any American manufacturer may apply to display his goods, not everyone may be allowed to set up a booth. Only companies specifically invited by "the responsible central purchasing organization" in the Soviet Union will be permitted to exhibit. But to these elite, there are virtually guaranteed benefits.

"The countries of Eastern Europe place a great deal of importance on trade shows," says Melville Morris, vice president of International Media and Exhibits. "These shows are considered so important a means of disseminating technical information that participation in them is almost tantamount to success in terms of potential sales."

Products to be shown at the Moscow fair are:

- General purpose digital computers.
- Data communications, terminals, facilities and processing equipment.
- Graphic data systems.
- Hybrid and analog computers.
- Internal memory systems.
- Peripheral systems.
- Semiconductor and MSI devices.

market. The world market for small-signal transistors has dropped approximately \$100-million since last year, "but it will still hit \$480-million in 1971."

Motorola Semiconductor Products, Inc., sees U.S. factory sales of small-signal silicon transistors at \$165-million this year, down from \$180-million to \$188-million in 1970. Small-signal germanium transistors, a company spokesman in Phoenix, Ariz., says, should drop from \$31-million in 1970 to \$23-million this year. Motorola will stay in the market, he adds.

Fairchild Semiconductor, Mountain View, Calif. says it plans to continue production of small-signal silicon transistors as usual. It never has produced germanium. It foresees no drop in the market.

## Better use of spectrum urged by EIA chairman

The potential demand for two-way radios is such that manufacturing could double and possibly even triple the number of units operating in the U. S. by 1980, says an Electronics Industries Association chairman. But expansion like this will never be realized, he adds, because of a lack of frequency space and poor spectrum management.

In giving this view, Glenn R. Petersen, chairman of the EIA's Land Mobile Communications Section and general manager of the General Electric Mobile Radio Dept., Lynchburg, Va., said the industry was "far short of having the spectrum required to supply the need that exists."

Addressing the national convention of the Associated Public Safety Communications Officers in San Francisco, Petersen urged:

- Significant improvements in the use of the spectrum.
- More advanced concepts in spectrum management.
- More frequencies for mobile radio users.

"In spectrum planning," the EIA chairman said, "the FCC should not try to use just history to forecast spectrum requirements. Also, our own industry must look for new system techniques to get maximum use from both the presently allocated and newly as-

## RCA transistor cutback doesn't faze competitors

RCA's decision to stop manufacturing 100 types of discrete transistors isn't deterring major competitors from continuing to make them, even though nearly all concede that sales are down.

Texas Instruments, Motorola and Fairchild plan to continue production of the transistors.

The RCA move, scheduled to take effect during the first half of 1972, was attributed to increasing demand for integrated circuits and falling demand for discrete transistors. Over the years the small-signal transistors represented a large business for RCA, but now they constitute less than 5% of the sales of the Solid State Div. in Somerville, N.J.

"We saw a continuing shrinkage in small-signal transistors and decided that now was the time to get out," an RCA spokesman said. Most of the abandoned transistors are of the germanium type.

RCA will continue to produce and market a limited number of silicon signal transistors, where the demand is still high. These are mainly for rf amplifiers and high-speed current switches.

Texas Instruments predicts that sales of small-signal transistors will drop to 10% of total semiconductor sales in the United States by 1980 (they amounted to 75% in 1960). But Al Stein, manager of silicon small-signal products in TI's Components Group in Dallas, adds:

"As long as there is a market for small-signal transistors, germanium or silicon, TI intends to serve that

signed spectrum."

Some projections of future mobile radio use range as high as seven million units by 1980, compared with something over 2.1 million in current use.

Looking at specific geographic areas, Petersen observed that even with recent Federal Communication Commission rules giving more spectrum to land mobile radio services, channel crowding would remain as heavy as it is today in New York City and Los Angeles by the mid-1970s.

Among ways for improving channel use, Petersen cited two: an Interconnected Cellular System and a Computer-Controlled Multiple Access System.

The cellular system improves spectral efficiency through space division multiplexing, in which simultaneous transmissions are made on the same channel. The multiple access approach involves a trunking concept, employing computer-control of the mobile radio system to reduce waiting time.

## A TV link to Red China foreseen with Nixon visit

A new TV communications link with Red China may be one by-product of President Nixon's planned trip there, although it probably would be only a temporary link. It appears likely that the portable ground station used to cover Apollo splash-downs will be flown to China to provide live, satellite coverage of the President's visit.

The sudden thaw between the two countries has also stimulated a demand for renewal of regular telephone and telegraph service with the Chinese mainland service that was broken by the Chinese in November, 1968.

AT&T, IT&T World Communications, Inc., and Western Union International have all expressed interest in re-establishing communications. Previously there had been telephone service via AT&T from Dixon, Calif., to China, and via IT&T from Manila to Peking. Both services used high-frequency radio transmissions.

Telegraph service formerly was by RCA Global Communications and Western Union International between San Francisco and Shang-

hai. Since November, 1968, messages have been sent through Japan, the Soviet Union and other countries that maintain diplomatic ties with Red China.

Some communications specialists in this country say the Chinese, utilizing experience gained from launching their own experimental satellites, could set up their own ground stations and link up with Intelsat's global satellite networks.

## Computer shows output visually and by touch

In an effort to make more vivid to students the concept of the physics of force fields, researchers at the University of North Carolina have developed what may be the first "tactile" computer.

As described by the researchers, James Batter and Fred Brooks, before last week's meeting of the International Federation for Information Processing in Ljubljana, Yugoslavia, the user moves a handle around in a small plane area. He sees the position of the handle as a point on a graphic display. This point might represent an electron in an electric force field, a spaceship in the gravitational fields of the earth and moon, and so on.

The computer calculates the force on the object and transmits a proportional force to the handle via motors. Thus, the student experiences forces with his hands, as well as seeing them on the visual display.

According to the researchers, "Experiments have shown that many students learn better with the force-feeling display than with visual display alone."

## FAA presses research on new landing system

The Federal Aviation Administration has awarded the first major contract in its proposed 10-year, \$200-million effort to develop a new microwave landing system to Cornell Aeronautical Laboratory, Buffalo, N. Y.

The \$630,000 contract is for analysis by the laboratory of proto-

type hardware data and recommendations submitted the FAA and other Government agencies. The laboratory will study two areas.

The first embraces recommendations made by the Radio Technical Commission for Aeronautics. The commission has submitted to the FAA the results of a three-year study for a new instrument landing system, compiled from the opinions of some 465 experts around the world.

A second laboratory task will be to evaluate some 50 requests for proposals, to be submitted by manufacturers on Sept. 21 for the first-stage development of the microwave landing system.

## FM radio pager can store beeps

An FM radio-paging transceiver on its way to market contains a memory for storing signals while the user is busy with another call.

It's a third the size of a predecessor (4 1/2 inches high, 4/5ths of an inch thick and 1 1/3 inches wide). It has a three-to-four-week battery life, a soft and more private alert signal and call signals for an entire group as well as individuals. It will cost about the same as its predecessor, approximately \$300.

The improvements resulted from the use of microelectronics, says Martin Cooper, vice president and director of product operations of Motorola Communications and Electronics, Inc., Schaumburg, Ill., where the unit was developed. The basic transceiver contains 80 components, whereas previous units had 210.

"It uses more hybrid technology than any commercial communications product to date," Cooper says, "including eight proprietary thick-film hybrid modules designed exclusively for the unit by the Motorola Semiconductor Div. in Phoenix."

Called Pageboy II, the unit is being built in Motorola's new plant in Plantation, Fla., a suburb of Fort Lauderdale.

When a user's seven-digit call number is dialed, he is alerted by a simple tone, the signal either to go to the nearest telephone or to listen to a one-way voice message

# this power/mate laboratory power supply got bent out of shape,,,



but our  
customer didn't !

He never got it. Just as well.

When you ship as many power supplies as we do . . . day after day . . . to almost as many places . . . day-in-day out, these things are bound to happen. But, we put this power supply through a complete electrical performance test . . . just like we do with each and every power/Mate Power Supply that leaves our plant.

If you know anything about Power/Mate . . . you know the answer.

This power supply meets every electrical performance specifications, except for the meters . . .

We confess, we weren't surprised.

Because, we at Power/Mate know what goes into each and every power supply . . . and what's more, they are built by people who *care!*

(P.S. we shipped the customer another power supply  
the same day . . . . from stock . . . after all,  
90% of our power supplies are in  
stock for same day shipment.)

WRITE FOR FREE CATALOG . . . 26,500 MODELS



**PIMIC**

**POWER/MATE CORP.**

514 S. RIVER STREET, HACKENSACK, N. J. 07601  
Phone (201) 343-6294 / TWX 710-990-5023

INFORMATION RETRIEVAL NUMBER 18

# Quadrasonics giving consumer industry a new sound to sell

In consumer electronics, the swing is to stereo sound's successor: quadrasonic sound.

Quadrasonics is to stereo what stereo was to monaural sound. With four speakers, it permits the listener to surround himself with sound. In so doing, it provides all kinds of new artistic possibilities—and the prospect of millions in sales.

At the Consumer Electronics Show in Chicago, more than 90% of the products shown by 300 exhibitors were sound entertainment units, with various forms of four-channel sound stirring the most

interest. One exhibitor—Koss Electronics, Inc., of Milwaukee—introduced the industry's first four-channel headphones, designed with four separate driver elements—two in each ear.

But manufacturers of quadrasonic equipment face a perplexing choice. The market, and the development to go along with it, is divided between proponents of discrete four-channel systems—systems in which four channels of recorded music feed four amplifiers and loudspeakers—and those who are soundly behind matrixed systems.

In matrixed systems, portions of the sound are electronically mixed and fed to the four speakers in the proper magnitudes, and with speak-

er signals at the proper phase angles, to produce varying effects, such that as shown in Fig. 1.

There is universal agreement that discrete systems give the best quadrasonic performance. Infinite isolation, or separation, between the sound in individual speakers is possible. But they require special four-channel recordings, available now only on tape. And costs for the systems are relatively high.

In addition, four-channel records are not yet available in the U.S., because of the technical problems in putting the four channels on the two channels of a stereo record.

Matrix systems can provide a simulated four-channel effect from records being made by a number of companies that use matrix encoders. With matrix decoders, listeners can play regular stereo records and tapes or hear stereo FM broadcasts with a feeling of being surrounded by sound.

Expensive matrix systems are available today that produce four-channel effects that are remarkably like those of discrete systems. Even \$30 or \$40 decoders are being widely distributed throughout the country through radio chain stores. And more than 50 radio stations in the country are playing the specially encoded records.

But discrete-system backers point out that the matrix setup does not give separation of sound between the speakers. Also, there is a lack of standardization among matrix systems, and a committee of the Electronic Industries Association is seeking to come up with a standard configuration.

In any case—no matter what quadrasonics system emerges as tops—the consumer electronics industry expects to reap a bonanza in sales. Any new sound system like this is bound to stir wide new sales and replacement of obsolete equipment, both hardware and records. With the list-price value of records sold in the U.S. estimated at \$1.2-billion alone last year—an off-year because of the general business recession—the economic potential of quadrasonics is heady.

**Jim McDermott**  
East Coast Editor



Discrete four-channel sound is now available in tape equipment only, such as in this Motorola eight-track, four-channel system. Room sound is balanced by moving the red dot around the green grid, using front-panel controls.

## Discrete technique demonstrated

One company, JVC America, Inc., Maspeth, N.Y., a subsidiary of the Victor Co. of Japan, based in

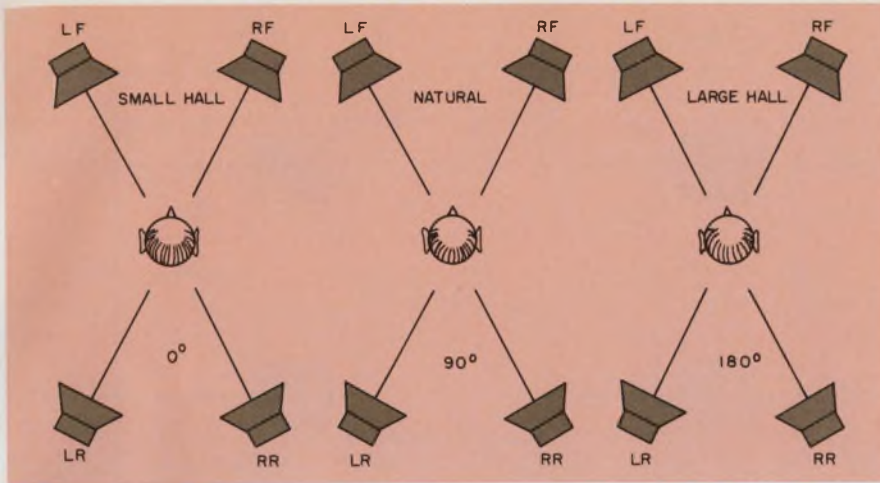

1. Different types of quadrasonic effects are obtained by varying the phase of the signals between the two rear speakers.

Tokyo, has demonstrated a four-channel discrete recording technique that uses multiplexing techniques to put two additional channels on a standard 33-1/3-rpm stereo record. But the bandwidth required is 45 kHz, which is pushing the state of the recording art.

The system works like this: The conventional stereo system has its left and right channels recorded on lefthand and righthand sides of the record groove. The sides are at a 45° angle to the record surface.

The frequency response of the conventional stereo record ranges from about 20 Hz to 15 kHz, and these signals for the left front and left rear speakers are added together and cut into one side of the

groove. Signals for the right front and right rear are added and cut into the other side.

However, these signals cannot be split into their four components—LF, LR, RF, RR—in their present form. To recover them, it is necessary to have channel difference-information recorded at the same time. This difference is then added to the sum signals, giving the separate front and back components.

The channel difference-information needed is that between the left front and left rear speaker signals (LF-LR) and that between the right front and right rear (RF-RR). The minus signals (—LR, —RR) are obtained by inverting the electrical connections in the matrix 180°.

To impress the difference signals on the record so they can be recovered separately, the JVC system modulates a 30-kHz carrier (Fig. 2). The total bandwidth required on the record is 45 kHz.

Difference-signal frequencies of less than 800 Hz and higher than 6 kHz are frequently-modulated while the range between these frequencies is phase-modulated.

To cover the 45-kHz frequency range in cutting a record, the turntable speed is reduced from 33-1/3 rpm by a ratio of 1 to 2.7. This is done, first of all, by slowing the tape recorder from which the record is made. The multiplex signals thus modulate a 11.1-kHz oscillator carrier during the recording process, but in the playback equipment, the turntable is speeded up to give a playback carrier of 30 kHz.

The result of the lowered recording speed is that the direct signal occupies a bandwidth of 11 Hz to 5.6 kHz (it is 30 Hz to 15 kHz in playback), and the modulated signal occupies a bandwidth of 7.4 to 17 kHz (20 to 46 kHz).

To avoid mutual interference between the two modulated signals, the sum signals are delayed in recording by 108 μs with respect to the difference signals (this amounts to 40 μs during playback).

The advantages of this delay, JVC says, are:

- No beats are caused by mutual interference between the modulated signals.
- Distortion of the detected output of the modulated signal, caused by cross-talk between the two modulated signals, is minimized.
- There is increased dynamic range with reduced distortion.
- Separation between the signals that are recovered from the sum signal and the detected difference signal is maximized.
- Frequency response is improved.

### Recording is compensated

In playback the complicated sound groove contains distortion. Also, the amplitude of the difference signals is modulated by the sum-signal swing. To reduce this distortion, the cutter input sum-signal and the carrier modulation are both modified before they are applied to the cutter.

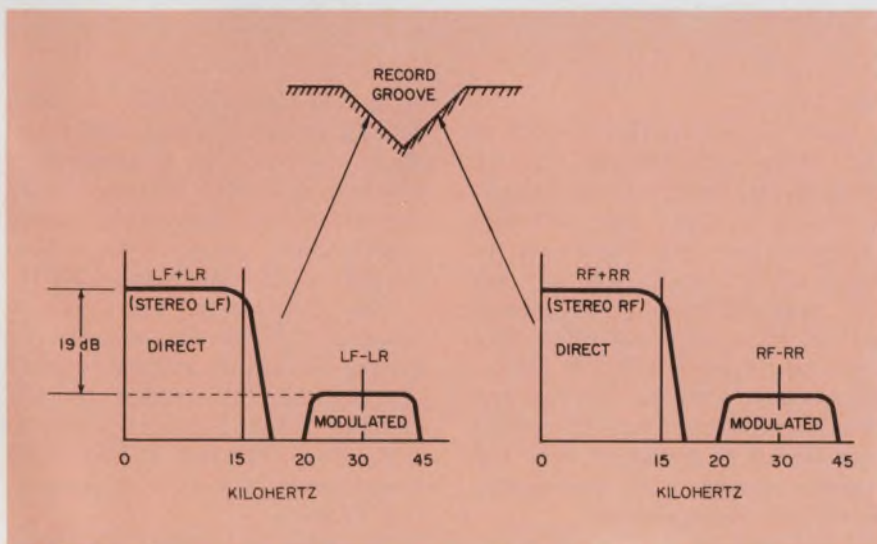

2. The JVC discrete four-channel system records two sum-signals "as is" and multiplexes two difference signals on a 30-kHz carrier. A total bandwidth of 45 kHz is required. The groove is a standard stereo cut.

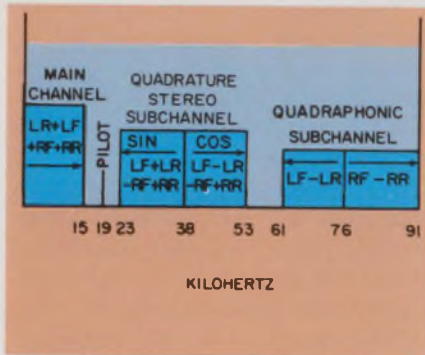

3. The Dorren system transmits four discrete channels over an FM station, using increased bandwidth.

Because the difference signal is recorded between 20 kHz and 45 kHz, its recorded wavelength is very short, and consequently the record groove is subject to a substantially higher noise level than the lower frequencies. To reduce this noise, an automatic noise reduction system is used—but only for the difference signal.

The JVC system requires a special decoder to recover the signals during playback. The right and left sum-signals are obtained directly, as with a conventional stereo playback. The difference signals are passed through discriminators and demodulated.

When these four signals are applied to an algebraic matrix, and are added and subtracted, the four speaker signals are recovered.

For example:

$$\begin{aligned} (LF+RR) - (LF-LR) &= 2 LR \\ (LF+LR) + (LF-LR) &= 2 LF \\ (RF+LR) - (RF-RR) &= 2 RR \\ (RF+RR) + (RF-RR) &= 2 RF \end{aligned}$$

At present JVC hardware and records are not being manufactured in the U.S., although Gerald Orbach, the company's marketing manager, says that 3000 systems a month are being sold in Japan. JVC is also pressing all its own records there.

A principal objection to the system here is the use of a pickup that can respond to a 45-kHz signal.

"Right now," says Howard M. Durbin Sr., vice president of Electro-Voice, Inc., Buchanan, Mich., a cartridge and stereo matrix manufacturer, "the JVC system demands an extremely deluxe—and high-priced—cartridge."

But Orbach says the problem is being studied and a reasonably priced one should be available by

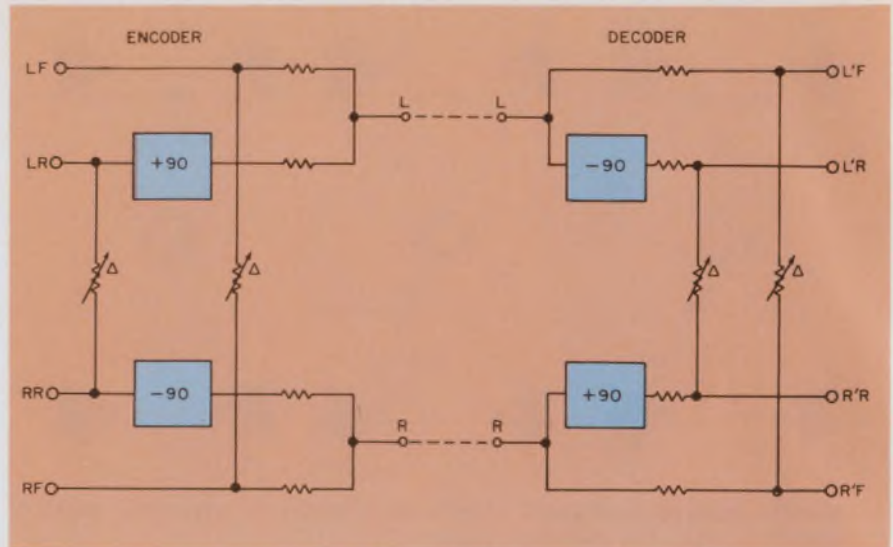

4. Encoding matrices, like this one by Sansui, combine four channels into two. The signal phase is varied between the rear speakers for optimum quadrasonic effect. The decoders reconstitute the four channels.

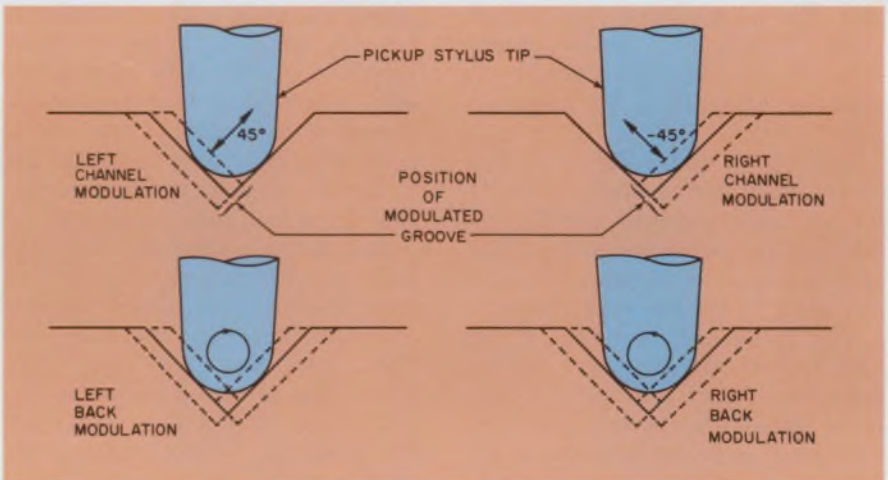

5. The CBS Stereo/Quadrasonic encoder puts left and right front channels on the record by conventional stereo techniques. The left back and right back channels are impressed by circular movement of the cutter.

next March.

Some engineers interviewed at the Chicago show felt that the tiny 20 to 45-kHz grooves would be subject to fairly rapid wear, although Orbach noted that experience in Japan didn't seem to bear this out.

A valid objection to the system is that it is not compatible with home tape machines or FM radios, since none of these has the required 45-kHz response. Also, the recordings cannot be broadcast over FM stations because of the special bandwidth requirements.

A possible solution to broadcasting is in an experimental Quadraplex system for FM transmission and reception of all types of dis-

crete four-channel sound. Invented by Lou Dorren, vice president and director of research at Quadracast Systems, Inc., San Mateo, Calif., the system has successfully passed experimental testing over a San Francisco FM radio station, KIOI.

With JVC looking for a way to broadcast its records and Dorren looking for help in getting eventual approval of his system by the Federal Communications Commission, both JVC and Dorren have joined forces and formed Quadracast Systems.

The composite signal broadcast by the Dorren system over an FM station contains components for the reception of stereo and monaural

sound, and consequently it is compatible with either.

The Dorren system uses the two channels currently used in FM stereo broadcasting—namely, the main channel that contains the left-plus-right signals and the subchannel that carries the left-minus-right information (Fig. 3).

The extra signals needed are LF — LR and RF — RL, and are centered in the added Quadraphonic subchannel 75 kHz from the assigned band edge.

Dorren says that no special conversion of the FM stereo receiver is necessary, other than to add an additional output to the discriminator. This output feeds a Dorren decoder.

In production quantities, Dorren estimates, a Quadraplex decoder could be built for less than \$10.

To broadcast records of the JVC system, the records would first be decoded into their discrete channels at the station and then re-encoded through the Quadraplex encoding system.

Dorren recently filed with the FCC a report on the experimental broadcasts. He says KIOI will file a petition for formal approval of the new Quadraplex standards.

### Matrix systems here and abroad

Competing with the discrete four-channel approach to quadraphonics are a variety of matrix systems, developed by both U.S. and Japanese manufacturers. The systems are comprised of an encoder — usually expensive recording or radio studio equipment — and a small decoder that is either separate or designed into the user's equipment.

From the four recording channels, corresponding to the four speaker positions, the encoder synthesizes a two-channel signal for stereo recording or broadcast. From the two-channel signal, the decoder reconstitutes the original four signals with the proper magnitudes and phase relationships (Fig. 4).

The differences between the various matrices lie in differing levels of separation of sound in the speakers.

This juggling of the speaker signal magnitudes and phases produces the feeling of being variously in a small room, a small hall, a

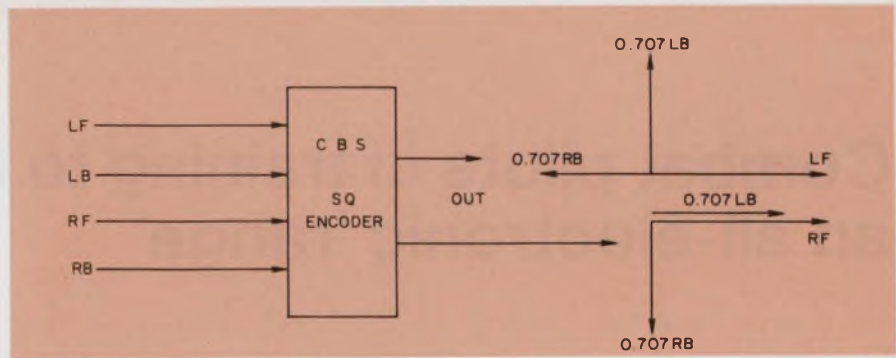

6. The CBS encoder combines the four channels and produces two that have both front and back information. Helical modulation of the left and right back channels is produced by those signals in quadrature.

large concert hall, or in the middle of recording band (Fig. 1). These signals can also be carried in a time sequence from loudspeaker to loudspeaker, to give the impression of a sound source moving across or around the room.

At the very least, these systems have demonstrated the property of enhancing regular stereo broadcasts, while at best—in the more complex and costly matrices — they closely simulate true four-channel sound, down to isolating sound to an individual speaker.

But discrete-system backers like Dorren say there is a degradation in apparent acoustic separation between speakers. As an example, he points out that the usual separation present in stereo recordings is 20 to 30 dB. But, he adds, listing to stereo through a matrix decoder reduces this separation to about 11 dB.

Electro-Voice's Durbin agrees in theory. But in practice, he stresses, this separation is seldom attained, because the speakers are placed too close together in stereo consoles.

Durbin points out that proponents of discrete systems make much of the fact that one sound can be isolated to one speaker. But except for unique recording situations, this occurs only infrequently, he notes. Consequently, he says, the effectiveness of the matrix is, as a practical matter, very good.

Most important, Durbin emphasizes, the use of matrices allow the development of low-cost systems for a mass audience, in contrast with the expensive systems needed for four-channel reception.

More than 50 FM stations and a number of recording companies are now using Electro-Voice encoders,

Durbin says. The Allied Radio Shack chain is marketing Electro-Voice decoders for \$39.95, while Lafayette Radio is selling Dynaco's decoder for \$29.95.

Concurrent with EIA attempts at matrix-system standardization, Sansui Electric in Japan, which introduced the first four-channel encoder-decoder system in the world in May of 1970, is attempting to standardize matrix designs among Japanese companies. At least 12 Japanese firms are producing their own systems.

Though not standardized, matrix systems are all compatible with each other, except for one — that is, they can play back recordings made with other encoders without too great a difference in effect.

The lone dissenter is the new Stereo Quadraphonic recording system developed by CBS Laboratories, Stamford, Conn., for Columbia Records. CBS is apparently determined to establish its own system and standards—as it did some years ago with 33-1/3-rpm recordings. Sony will manufacture the consumer equipment.

The CBS system is unique in that it impresses the four-channel signals on the stereo record by using conventional stereo needle movement for two of the channels and helical clockwise and counter-clockwise movements for the other two. (Fig. 5).

Electro-Voice's Durbin believes CBS made a mistake in its choice of a separate matrix. He says: "When their records are played through our decoders, the back channels will not decode in the direction you want, and you end up coming out with almost equal levels in all speakers." ■ ■

# Combat pilots in training to fly an all-electronic 'range'

The military's system of training fighter pilots for combat is about to change radically, thanks to electronics. Under the new system, instructors can stay on the ground. Pilots won't fire missiles. And when the training exercise is over, pilots and instructors will be able to sit down, play back the maneuvers on a screen and discuss the results.

It will be made possible by an all-electronic system called an air combat maneuvering range, being developed by Cubic Corp. of San Diego. The system will track the aerial maneuvers in real time in moving line drawings on a 3-D display,

play, score the accuracy of simulated missile firings and save all the data for later playback. An instructor, sitting at the display console, will keep in touch with the pilot trainees and be able to advise them instantly of errors they may be making or of ways to improve their performance. Both air-to-air and air-to-ground tactics will be covered by the system.

## Training is limited today

Present displays, largely radar, aren't precise enough to permit such observation of training exercises. And there is no playback feature. Instructors in chase planes accompany the pilot trainees aloft

and observe as they fire live missiles at drones or ground targets. The instructors rely on memory to go over the maneuvers in a debriefing session on the ground.

The first of the new air combat maneuvering ranges will be installed at the Marine Air Station, Yuma, Ariz., and should be operational by November, 1973.

Hubert Kohnin, senior staff engineer at Cubic, notes that the \$7.4-million system will compute accurate attitudes, positions, accelerations, closing rates between planes and targets, ranges between aircraft and airspeeds. The resulting data will be integrated into a real-time simulation on a three-dimensional indicator, so the instructor pilot can observe the action on the range at all times. He will be able to assess immediately the results of simulated missile firings.

As described by Kohnin, the range will consist of four major subsystems. The training aircraft will carry (1) an airborne instrumentation subsystem—contained in a pod that is 27-feet long and five inches wide—which will telemeter essential aircraft performance and weapons data to (2) a tracking instrumentation subsystem on the ground. This subsystem consists of six unmanned remote stations tied to a master station. This network measures range to the aircraft, communicates with the plane and sends all the data it receives to (3) a control and computation subsystem, which digests the information for real-time display in (4) the debriefing and display subsystem.

The airborne instrumentation subsystem provides the interface between the aircraft and the rest of the air combat maneuvering range. Key elements are an air data sensor, transponder, weapons moni-

David Kaye  
West Coast Editor

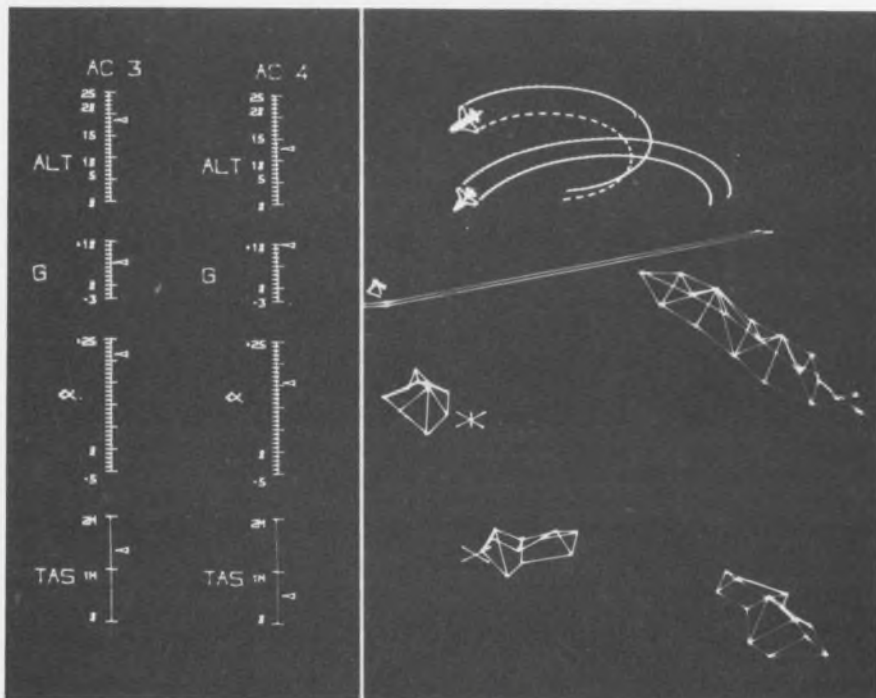

**Dynamic display** (left) presents data on altitude, g force, angle of attack and true air speed for two aircraft engaged in training maneuvers. Up to four planes can be monitored. **3-D display** of two tactical fighters (right) gives a ground instructor up to 10 seconds of time track behind each aircraft. Structures at the bottom are mountains. Two crosses on the ground illustrate the ground positions of each aircraft in real time. The CRT displays are produced by Adage, Inc., Boston.



A-B breakthrough  
will change your thinking  
about photo resistors.



Allen-Bradley's unique electroding process gives new material and surface topography improvements. And superior photodetector response and speed. It means a whole new generation of miniaturized cadmium sulfide and cadmium sulfoselenide photodetectors for hybrid applications. Custom styles to fit

your needs. Chips. Bars. Arrays. And leaded devices for circuit board applications. Temperature limit 85°C. Response as fast as 10 milliseconds at 10 footcandles. Three spectral sensitivities. Standards available as PHOTOCHIPS, multi-cell PHOTOCHIP ARRAYS or single-channel PHOTOBAR detectors, and PHOT-

CHIPS in TO-18 metal or TO-98 plastic packages. All with traditional A-B quality and service. Large-area custom devices are our specialty. Request Publication 5910. Write: Allen-Bradley Electronics Division, 1201 South Second Street, Milwaukee, WI 53204. Export: Bloomfield, N.J. 07003. Canada: Galt, Ontario.



Actual  
size

NEW DIMENSION ELECTRONICS  
**ALLEN-BRADLEY**



tor and a unique attitude heading reference system. The latter is a strapdown unit in which two accelerometers and three gyros are mounted at 45° off the main acceleration plane, Kohnin says: "This configuration allows great precision, due to the fact that acceleration components can now be shared in a high-roll rate environment."

Telemetry of data to the track instrumentation subsystem on the ground is by frequency-shift keying. The data rate is 100 kbits/s.

Three ground stations are needed to pinpoint an aircraft in motion. Since there are seven ground stations, at least three will be in position to track each aircraft at all times, regardless of aircraft attitude. Kohnin points out:

"Ranging from each ground station is done by cw phase comparison. A signal is sent to the aircraft from the ground station. The aircraft acquires the signal and sends it right back to the ground station. The return is compared in phase with a reference, and the phase shift determines the distance. For ranging accuracies of  $\pm 4$  feet, we use a three-tone system. Phase shift is measured at three different frequencies and compared. Maximum range measurement of the system is 100 miles. The lowest frequency tone used is 256 kHz."

Errors caused by changes in atmospheric conditions are accounted for by calibrating the distance between each ground station and the

master station once every 300 ms. Each remote ground station has a 1-W ground-to-ground transmitter and a 5-W ground-to-air transmitter. Both are powered by solar cells and batteries.

Once the ranging is done from three ground stations, position is determined by trilateration and prediction.

Three XDS Sigma 5 computers are at the master ground station. One does missile simulations, another computes navigation and safety parameters, and the third is an executive computer that controls the various peripherals in the system. Kohnin notes: "A three cpu design was chosen so that parallel operations can occur in three computers. In addition the system is capable of automatically detecting a fault in one of the cpu's."

Three CRT displays produced by Adage, Inc., of Boston make up the debriefing and display subsystem. The first and third displays are Adage AGT-110 units. One is a static information display that reads out such information as the name of the pilot, type of aircraft, name of exercise, hazards, mistakes and evaluation of test results. The other is a dynamic display (see photo) that presents data on up to four aircraft. Normally this display will show altitude, g force, angle of attack and true airspeed for each aircraft. In addition the time and some hazard indications will often flash on the screen.

Most interesting of the displays is the center one. This is an Adage AGT-150 interactive 3-D graphics console (see photo). It gives a three-dimensional representation of the action in the air.

### A time track provided

Behind each of the aircraft displayed on the scope is a time track of where the plane has been. This track is variable from 0 to 10 seconds. To aid in aircraft and altitude identification, the right wing track shows up as a solid line. The left wing track shows up as a dotted line, and the bottom of the aircraft is cross-hatched. Other features of the display include zoom, coordinate rotation (so as to look at the sequence from any vantage point), size and intensity variation for perspective, and a view out of the pilot's window, if the ground instructor wants to see what motivated the trainee to perform some maneuver.

All data is recorded on magnetic tape, so the trainee can see a replay of the exercise in normal or stop action. Hard copy can also be called for at any time.

Initially the range will be programmed to accept the following aircraft: F4B-J, F8J, F8K, TA4-F, A7 and F-14.

Besides Adage, the major subcontractors to Cubic include the Lear Siegler Corp., Grand Rapids, Mich., and SDC, Santa Monica, Calif. ■■

---

## Coast-to-coast TV to present MOS course

In what is described as the most ambitious use of closed-circuit, big-screen television for industrial education, Texas Instruments will televise from Dallas lecture sessions on MOS/LSI technology to "more than 1000" engineers in 17 cities around the nation. The videotaped course will be presented Sept. 22-24.

The sessions have been prepared in conjunction with the Electronic Sciences Dept. of Southern Methodist University. Live question-and-answer sessions will follow each of

the lectures.

The three-day, 10-hour course will be shown over the General Electric Command Performance Network—a big-screen video network that employs high-brightness projectors.

According to Don Scharringhausen, TI's manager of market communication: "The course is specifically designed to give electronics-equipment designers the information necessary to evaluate MOS for their projects and to choose from among the myriad

MOS product options.

The course will be presented at central sites in the following cities: Baltimore-Washington, Boston, Chicago, Cleveland, Dallas, Dayton, Denver, Detroit, Indianapolis, Los Angeles, Minneapolis, New York, Palo Alto, Philadelphia, Phoenix, Rochester and San Diego.

Engineers can enroll by sending a check or money order for \$195 to Frank Walters, MOS/LSI Learning Center Director, Mail Station 84, Texas Instruments, Inc., P. O. Box 5012, Dallas, Tex. ■■

# Ring up a savings on keyboard switches.

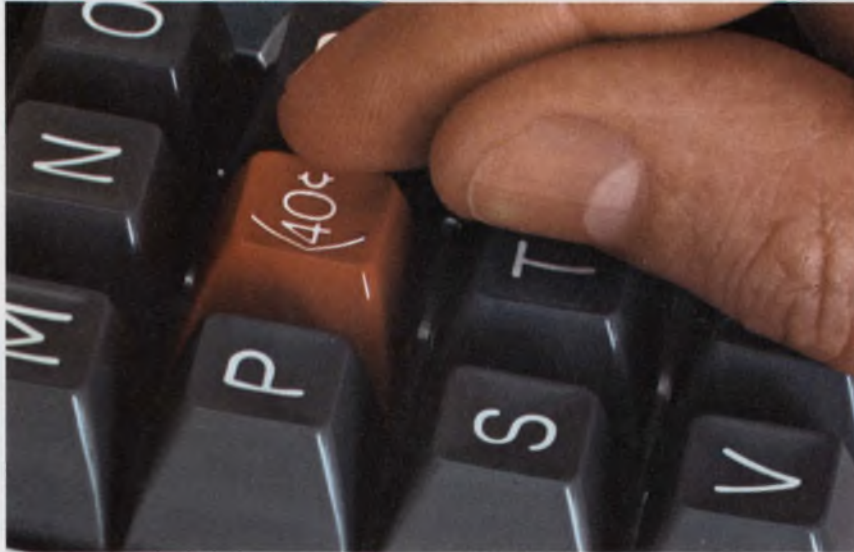

As much as **40%**  
(savings per key)

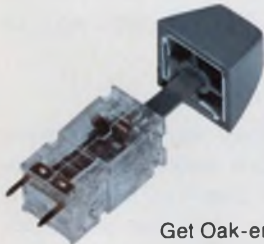

## The new Oak Series 400.

Get Oak-engineered quality in keyboard switches with the inherent reliability of electro-mechanical operation. Ideal for peripheral data-processing equipment. Contact bounce is less than 3 milliseconds. Long life, up to 20 million operations per key. Designed with self-cleaning crossbar-wiping contacts.



**Under 40¢ each.**

For SPST/NO in production quantities. Other versions comparably priced. Keypoint button and snap-in mounting extra.



## A feather touch.

We kept the operator in mind. Standard operating force is approximately 85 grams (3 oz.).



## The configurations you want.

The Series 400 is available in limitless arrangements, including standard 10, 12, and 16-button keyboards. And you can specify any of six different contact circuitries. Choose snap-in or plug-in P.C. mounting. Compact—only 1/2" x 1/2" x 1".

Write today for our Series 400 brochure.

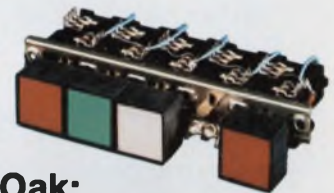

## Also from Oak: Series 300 Lighted Pushbutton Switches.

Featuring Oak's exclusive twin-lamp lighting. If one lamp goes out, the other stays on. Double-wiping contact clips. Short stroke. Smooth, quiet operation. Unlimited combinations. Request our Series 300 brochure.



## And our Series 800 Econo-Line™ Pushbutton Switches.

Compact—more buttons and more contacts in less space: 1 PST to 8 PDT per button. Your choice of mechanical actuation. Colored buttons, legend engraving to your specifications. Request our Series 800 brochure.



**OAK MANUFACTURING CO.**

CRYSTAL LAKE, ILLINOIS 60014 • A DIVISION OF OAK ELECTRO/NETICS CORP

Telephone: 815-459-5000

TWX: 910-634-3353

TELEX: 722-447

INFORMATION RETRIEVAL NUMBER 20

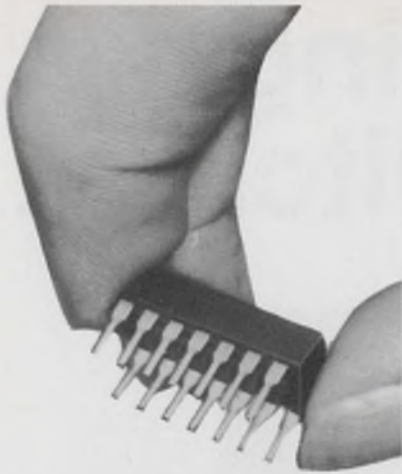

## can one LATCHING RELAY offer all this?

- High Reliability  
( $100 \times 10^6$  operations)
- Inherent Contact Memory
- Bounce-Free Operation
- Self-Healing Contacts
- Operation in Any Mounting Position
- Miniature Size
- No Latching Current
- Virtually No Noise
- Shock and Vibration Resistance
- For Signals from DC to 120 MHz

## Yes... if it's a LOGCELL<sup>®</sup> Mercury Film Relay

Both latching and nonlatching Logcell Relays are available. For more information about Logcell Relays, and Logcell Switches, too, write Fifth Dimension Inc., Box 483, Princeton, New Jersey 08540. Or call (609) 924-5990.



FIFTH DIMENSION INC.

INFORMATION RETRIEVAL NUMBER 21

## technology abroad

A novel type of large-area display that utilizes the electroluminescent panel and a glassy switch is being developed by GEC's Hirst Research Laboratories at Wembley, England, and the Royal Radar Establishment at Malvern. Previously, electroluminescent panels with zinc sulphide-based materials had been restricted to use with ac voltages. But recent work has shown that when dc is passed directly through these displays, large areas light up with a brightness comparable to that of a gallium-arsenide-sulphide display. GEC researchers are now working on a system in which individual phosphor elements can be addressed by an orthogonal set of electrodes laid on the front and back of the panel. To provide the panel with a memory, the electroluminescent phosphor incorporates Ovonic glassy material. A dc bias is permanently applied, so the phosphor will be switched only at those points where pulses applied to the electrodes intersect. The panel emits yellow light of up to 100 ft-L brightness. Operating voltages can be varied between 20 to 100 V, depending on the brightness and efficiency desired. Lifetimes of between 500 and 1000 hours at 50 ft-L have been achieved so far. The panel is reported close to the point where it can be considered for practical applications.

CIRCLE NO. 450

A microwave instrument landing system has been developed by Omera-Segid, the French electronics and avionics company. The system, called Microwave Aircraft Digital Guidance Equipment, is effective to a minimum range of 15 nautical miles. The manufacturers say it is the first portable equipment of its type. The instrument system employs solid-state digital microwave interferometer techniques to measure azimuth and elevation angles and slant

range. On-board controls, a data-link transceiver and an omni-antenna are designed for installation in aircraft. Ground equipment is deployable in less than 10 minutes. The system meets NATO specs for an unattended portable approach system.

CIRCLE NO. 451

The effective temperature range over which negative temperature coefficient thermistors can operate has been more than doubled by ITT engineers at Taunton, England. The new thermistors can be used up to 1000 C, whereas previously these components operated between  $-100$  and  $+300$  C. This development means that thermistors can replace gas and liquid in metal thermometers and thermocouples in applications ranging from flame detection in gas heating systems to industrial furnaces.

CIRCLE NO. 452

A high-accuracy tachometer generator with low noise components down to zero rpm has been developed by J.M. Stephenson, a lecturer at Leeds University, England. The generator employs two serrated discs mounted on a common axis. One is driven at a constant 3000 rpm. The other, a variable speed disc, is mounted to the shaft being timed. Two sets of photocells detect the relative motion of the two discs whenever the light beam is interrupted by a disc serration. There are 180 slits or serrations on each disc; consequently a pulse train is produced when the variable speed disc runs at 3000 rpm. Electronic circuitry transforms this signal into dc voltage plus a component directly proportional to speed. Inherent noise frequency can be above the required bandpass frequency, and can thus be removed.

CIRCLE NO. 453

# GOODBYE SOLID STATE.



## Hello better switching alternatives.

Until now, you considered solid state the only approach to multiplexing low-level, sensor-based analog information or to matrixing both analog and digital stimuli/response signals. High common mode or handling signal and power levels with the same switching device still causes you problems. But no more! Clare developed two mercury-wetted relays that do a better job. We call them the HGJ and the HQQ. And only Clare has anything like them. The "J" and the "Q" give you a direct, reliable and economical solution to switching problems in process control, data logging/acquisition, and automatic component/system testing.

### A PROVEN APPROACH

Clare is already supplying these new relays in quantity to manufacturers of computer control systems and automated test equipment. Names like IBM, Teradyne, Westinghouse,

SEL, G.E., and Honeywell. If our new mercury-wetted relays are used in their advanced systems, they can work for you, too.

### ECONOMICAL

Why? "J" two-pole version designed specifically for capacitor-transfer switching applications and the "Q" is designed for direct three-wire multiplexing. You don't need *any* other components for timing-sequencing or to protect solid-state devices from CMV.

### RELIABLE

Like all Clare mercury-wetted relays, the heart of the "J" and the "Q" is a hermetically sealed glass capsule. Contact switching is mercury-to-mercury. So there's *no* contact wear, *no* contact bounce, constant ON and OFF impedances—*every* operation. Clare "J" and "Q" mercury-wetted relays are rated for *billions* of operations.

### GREATER VERSATILITY

Clare "J" and "Q" mercury-wetted relays can switch wide ranges of signals simultaneously . . . from microvolt to 500 volt levels, from nanoamperes to 2 amps, from dc to megahertz frequencies, and handle common mode to 1500 vac. The "J" can be driven to 250 Hz, the "Q" to 400 Hz. And they both mount on 0.5" PCB centers.

For enough information on C. P. Clare & Company, and all mercury-wetted relays (including the new "J" and "Q") to fill a coffee break, circle our reader service number or write to us. C. P. Clare & Co., 3101 Pratt Avenue, Chicago, Ill. 60645.



a GENERAL INSTRUMENT company

# Siemens

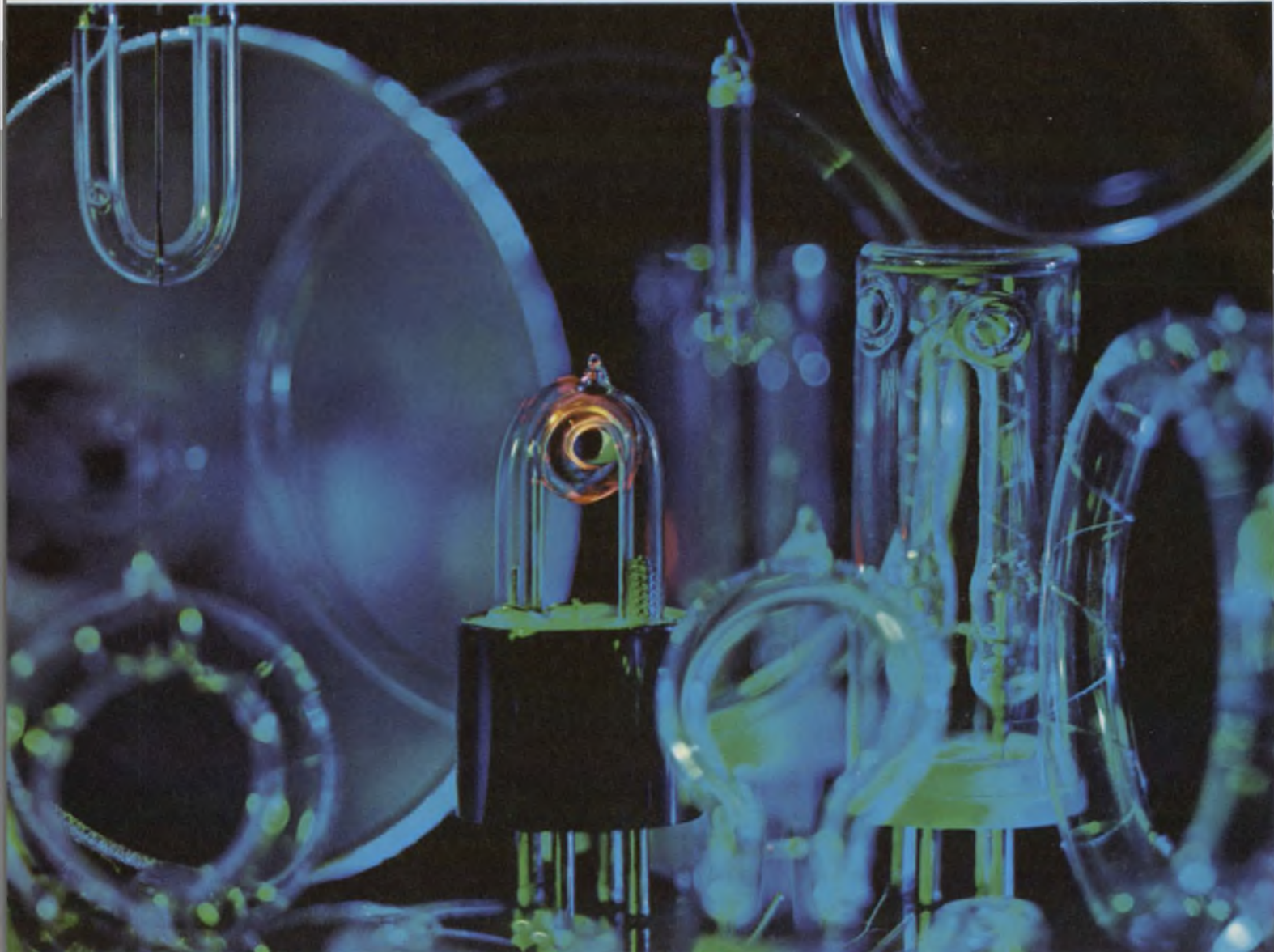

## **These flash tubes produce bursts of sunlight from small amounts of power. We can put them to work for you.**

Our xenon flash tubes produce high intensity light covering wavelengths from the ultraviolet to the near infrared. And they can be pulsed thousands of times as fast as incandescent lamps.

These characteristics plus a very high efficiency make them ideal for laser stimulation, aircraft anti-

collision lights, beacons, timing devices, high-speed inspection systems and photographic lights.

We turn out these tubes by the millions in sizes and shapes to meet many different requirements. Some are low-cost units produced in high volume. Others, sophisticated, one-of-a-kind designs.

There's an answer to your problem in our files or experience. Tell Larry Boone about your needs.

Siemens Corporation, 186 Wood Avenue South, Iselin, N.J., 08830. (201) 494-1000. Siemens. A three billion dollar name in quality products.  **SIEMENS**

# washington report

DON BYRNE, WASHINGTON BUREAU

## **Japan-U. S. talks on exports could affect electronics**

Cabinet level talks between U. S. and Japanese officials, scheduled for two days here next week, could have a heavy impact on the American electronics industry. The U. S. Treasury Dept. and Commerce Dept. want the Japanese to be told flatly that they must abolish quotas on U. S.-made imports, such as computers and integrated circuits, and at the same time direct more of their exports towards the Common Market countries in Europe instead of the U. S.

In addition, the Treasury Dept. wants the U. S. to press Japan for a revaluation of the yen, which Treasury sources say is greatly underpriced. Upward revaluation of the yen would mean that the cost of Japanese imports would go up here, while the price of U. S. exports would decline in Japan. Financial experts, however, are not optimistic over the possibilities of the Japanese voluntarily bringing their currency into line with the dollar and the pound.

But while the Treasury and Commerce Depts. are pushing the hard line, the State Dept. is reluctant to worsen the present trade picture between the two countries. President Nixon's stress on a limitation of Japanese textile imports has created bad feeling, and State Dept. officials don't want the picture to darken any more than it already has.

## **FAA to test computer-directed weapons detection system**

The Federal Aviation Administration is installing a computer-directed weapons detection system at Dulles International Airport, near Washington, D. C. The system was designed by the Westinghouse Corp. and it screens 20 boarding passengers a minute as they pass down a four-foot-long passageway that contains an electromagnetic field. If the passenger is carrying any metal, it causes the field to change. This triggers into action the computer, which is capable of discriminating between a gun, a set of keys or a pen. If an excess amount of metal is detected, an alarm goes off. If a gun is detected, a second alarm goes off. The system will not interfere with pacemakers used by heart patients, the FAA says.

## **Battle looms as FCC sends CATV plans to Congress**

The Federal Communications Commission has filed a "letter of intent" on the future of cable television with Congress, but a bitter fight is expected before that "future" becomes a reality. In essence, the letter sent by FCC Chairman Dean Burch would allow CATV operators in the nation's top 50 markets to import two distant channels if they also offered three network and three independent local channels. If they could not meet these minimums from local stations, they would be allowed to import two distant channels. In the smaller markets CATV operators could import distant channels to provide one independent and three network

channels. In addition, CATV systems would have to provide one nonbroadcast channel for every broadcast channel, a free "public access" channel and one for local government, and it would have to have two-way capacity.

The battle is expected to be joined when Congress reconvenes this week after a month-long summer recess. Lobbyists from the broadcast industry, which has generally opposed CATV expansion, will be running head to head with CATV enthusiasts, while the Government could find itself at odds internally. The White House Office of Telecommunications Policy is still working on a determination of just how much regulation the CATV industry should have and may act before the March 1, 1972 deadline that Burch set as a target date for implementation of the new rules.

## **Advanced helicopter avionics being tested by Army**

The Army's new test division at Fort Hood, Tex., is conducting field studies of advanced helicopter avionics systems. Called Masster (Modern Army Selected Systems Test, Evaluation and Review), the project is looking at the Cobra's Smash (Southeast Asia Multi-Sensor Armament System), Confics (Cobra Night Fire-Control System) and Helms (Helicopter Multifunction System).

Smash, a gimballed, forward-looking infrared sensor and a moving-target-indicating radar in a pod, made by Bell Aerospace under an \$8.9-million contract, is to be field-tested in Vietnam after the Fort Hood evaluation. Confic, a 447-pound, low-light-level TV system, now mounted in the nose turret of a Cobra helicopter, is being made by RCA under a \$1.6-million award. Helms, developed by Bell under an \$1.8-million contract, employs a microwave radar antenna in the main rotor blade of the helicopter for all-weather navigation, remote-area landings and terrain warning.

## **B-1 to get new 'interface contractor' for avionics development**

The Air Force will select a unique "avionics subsystem interface contractor" soon for the B-1 bomber. The contractor will put together the avionics package, each of which will weigh an estimated 3900 pounds and cost \$4.3-million. The "interface contractor," something new to the military, will receive off-the-shelf equipment wherever possible but will also have the authority to develop, or subcontract for, equipment specifically needed for the new strategic bomber. In the interest of saving money there will be no attempt to make technological breakthroughs.

The Air Force says that later this year it will issue requests for proposals for "associate subcontractor" to develop electronic counter measures and infrared surveillance subsystems.

**Capital Capsules:** You can now buy a copy of the "Business Machine Market Information Services Directory" which contains references to sources of information within the department, the trade press and professional associations; it also has market research reports and production and trade statistics. Special emphasis is on electronic data processing. Copies can be obtained for 50 cents each from Sales and Distribution, NTIS, U. S. Dept. of Commerce, Washington, D. C. 20230 . . . **The Navy has let a contract to the University of New Hampshire to study techniques for mooring a subsurface buoy in the deep ocean that would periodically release and retract a submarine sensing buoy to the surface.**



*Ever been away from home  
and missed your storage scope?*

**NEXT TRIP  
take one  
with you**

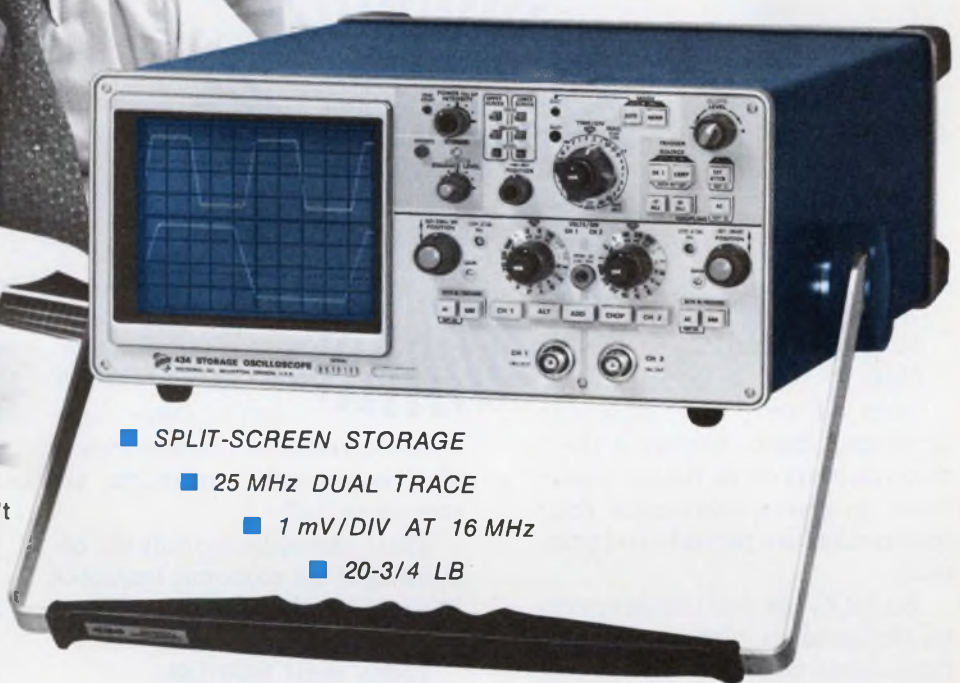
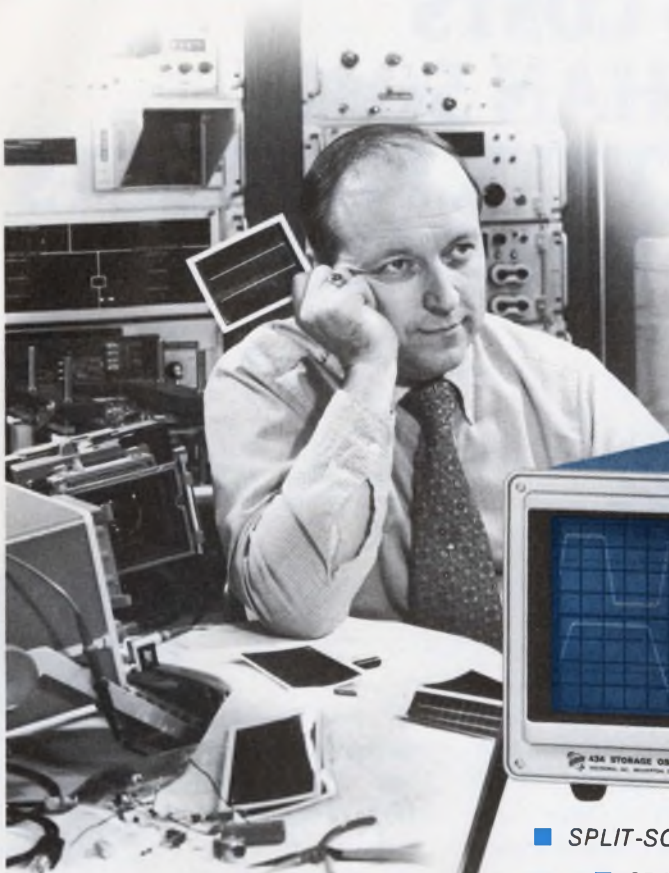

Storage isn't new. Portables aren't either. But storage in a portable oscilloscope certainly is. Now, they're together for the first time in the new TEKTRONIX portable 434 Storage Oscilloscope. It's virtually two instruments in one, offering you all the advantages of bistable split-screen storage, plus those of a portable oscilloscope with a conventional CRT.

How often have you had difficulty making measurements in applications where signals are single event or low rep rate, aperiodic or random? Storage provides you with an easy solution to many of these measurements. And, the portable 434 solves the problem of getting storage to the application.

To save your time, operating the 434 in a storage mode is as simple as pushing a front panel control. You just set the 434 to store a single sweep. When the event occurs, it's stored at writ-

■ SPLIT-SCREEN STORAGE

■ 25 MHz DUAL TRACE

■ 1 mV/DIV AT 16 MHz

■ 20-3/4 LB

ing rates up to 400 cm/ms and retained in a continuous view mode for as long as four hours. The bright, high-contrast display is clearly discernible even when you make the measurement in high ambient light. Another 434 feature you'll like is the CRT's high resistance to burns. It requires no more care than you give a conventional CRT.

The companion model 432 is a nonstorage model of the 434. Otherwise they're identical. Cabinet height is only 5-3/4 inches and rack height is 5-1/4 inches. Even so, there's room for a big 8 x 10-cm CRT. Bandwidth to 25 MHz, and sweep rates to 20 ns/div cover a wide spectrum of measurement needs. Deflection fac-

tors extend to 1 mV/div dual trace and are read out by lighted knob skirts even when you use the included 10X probes. Carrying weight is a very reasonable 20-3/4 pounds.

Before selecting your next portable, you'll want to see what's really new. Your field engineer will arrange a demo of the 432 and 434 at your convenience. Prices are: 432 Oscilloscope, \$1585. 434 Storage Oscilloscope, \$2150. U.S. Sales Prices FOB Beaverton, Oregon.



**TEKTRONIX®**

committed to  
technical excellence

INFORMATION RETRIEVAL NUMBER 24

# HOW TO CUT SYSTEMS COSTS BY MORE THAN 50% AND MARKET BETTER PRODUCTS IN THE BARGAIN.

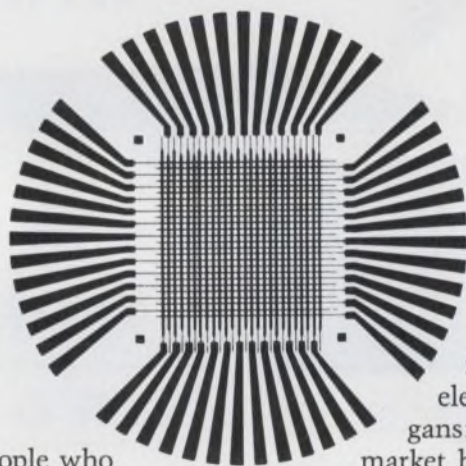

Use MOS/LSIs.  
Not just anybody's.  
Ours.

After all we're the people who developed them, nurtured them through years of the nation's aerospace programs, then made their commercial use possible and practical.

An MOS/LSI arithmetic system we designed enabled a calculator manufacturer to reduce the cost of his 1969 models by 25% versus the going prices for comparable machines. And, in 1971, he was able to drop his prices another 15%.

An MOS/LSI control system is one-half the cost and one-tenth the size of conventional systems.

Because we designed an MOS/LSI musical computer for one organ manu-

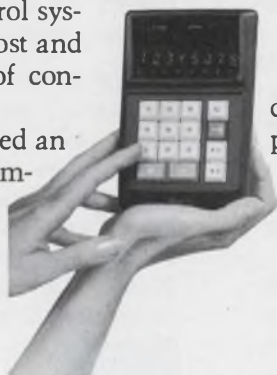

facturer, electronic organs now on the market have thou-

sands of times the musical variety of conventional instruments, yet cost about half.

These examples are only the beginning of the economic impact of MOS/LSI technology on product development.

**Today most MOS/LSIs are in commercial use.**

Manufacturers of electric appliances, automobiles, calculators, business machines, data transmission and telecommunication equipment, minicomputers, computer peripherals, industrial control systems—even pipe organs without pipes—are learning fast. (Mostly from us.) The biggest sellers are getting smaller.

For our customers throughout

the world we have designed hundreds and delivered millions of MOS/LSI circuits. Our deliveries have been on time and our reliability has been proven.

**Building blocks that last for generations.**

Because of our systems design capability, we're able to give our large-scale integrated (LSI) circuits building-block capabilities. When you have so many electronic functions available in a single circuit, it's good business to design so that the same circuits can be used in a number of different systems.

Our exclusive custom-layout, computer-aided design enables us



to provide more electronic functions on a smaller circuit with building-block capability. This minimizes cost—lower circuit cost and lower total systems cost.

These building-block systems perform data reduction functions for everything from simple calculators through business and accounting machines to programmable equipment. They also provide digital functions for data transmission and telecommunication systems.

Best of all, our building-block designs can be adapted and used in successive models of your product as well as in various current models. This permits minimum capital expenditure in developing new products and product lines. Cost per circuit is minimized—and reduced even more over large runs.



ahead.

We've also reduced the cost per bit by applying the building-block approach to the development of MOS/LSI memory systems and circuits.

For prototype evaluation, we have SOS memories in 128 by 40 diode arrays with 20 ns access time encoded on a custom basis within 24 hours at two cents per bit in unit quantities.

**MOS/LSI beats the high cost of electronics.**

Mastery of MOS/LSI design and high-volume production has

enabled us to produce commercial electronic systems at an all-time low cost per function. Less than 1/4 the cost of conventional systems. And they can be packaged so that non-electronic manufacturers can assemble electronics into their equipment without additional labor skills.

For example, you can buy our MOS/LSI digital filter circuits in small quantities and fabricate a plug-in digital filter for less than \$1,000 to do many of the functions that today are performed with black boxes selling for about \$20,000.

Or, you can buy



our MOS/LSI MODEMS, completely assembled, at a fraction of the prices you're paying for conventional units.

**A joint product commitment.**

We're ready to share



with you the long-term commitment required for new product design, testing and development.

Even more.

We'll join with you in product planning, so that you may share in the progress of current research and the advancing technologies of North American Rockwell.

**The state-of-the-art—by its innovators.**

At the point to which it is presently developed, MOS/LSI technology provides digital systems and circuit functions that include logic, memory, switching, counting, driving, multiplexing, digital-analog and analog-digital conversion, frequency generation, discrimination, filtering, modulation and demodulation.

Right now we're developing future generations of microelectronics: new MOS processes; advanced packaging methods; multi-layer ceramic substrates; nitride passivation; silicon on sapphire; bubble memories; liquid crystal displays and more.

Drop us a line on your company letterhead for a copy of our new brochure, "The Economics of Change," or for specific data sheets on circuits you require. Write: C. D. Chambers, P.O. Box 3669, Anaheim, Calif. 92803. Or phone us at 714/632-2231.



**North American Rockwell  
Microelectronics Company**

# No ceramic capacitor should be permitted to enter this world with a birth defect.

Because Union Carbide now has a way to manufacture reliability into KEMET® ceramics, rather than just test it in.

This all started when we examined ceramic capacitors that had failed at the tender age of 10 or 20 thousand hours. Even after they'd passed the burn-in, temperature cycling, and testing requirements of Mil-C-39014.

We found that the failures were not wear-out mechanisms, but were process irregularities common to popular manufacturing techniques. Such as minute dielectric faults, microscopic contaminates, slight misalignment of electrodes, and silver leaching or migration. All revealed themselves as potential problems affecting long-term reliability.

So we developed a high-speed

manufacturing process that gives predictable, uniform results. With new formulation techniques that provide the smallest possible particle size and eliminate contamination. With a continuous-belt casting system for controlled density and quality. With automated equipment for electrode printing and lamination to insure precision assembly. With the exclusive KEMET "Solder-Guard" process to prevent end-metallizing problems.

With all that, KEMET ceramic capacitors are now the most reliable ones you can get.

If you use any ceramic capacitor up to 3.3 microfarads, specify reliable KEMET ceramics.

Write us for complete information at Box 5928, Greenville, South Carolina 29606.

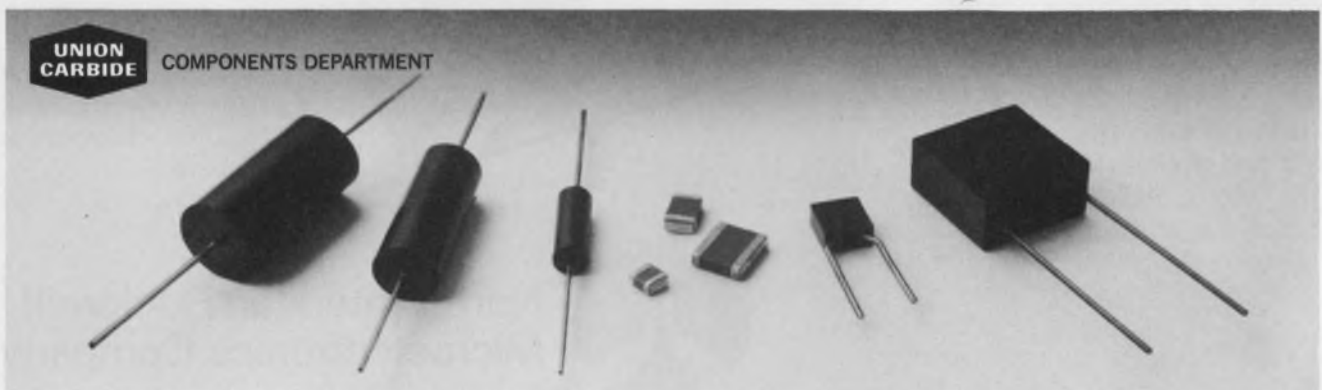

**SUPPORT HEALTHY CAPACITORS. WITH A CHECK.**

# editorial

## Our R&D slip may be showing soon

Government-sponsored R&D in the electronics field is in danger of becoming a shadow of what it once was. And isn't that a shame.

In an article we read recently on automation, it was pointed out that numerical control of machine tools was first developed in 1952 under a contract sponsored by the U. S. Air Force.

This immediately brought to mind the fact that much of the initial development of the integrated circuit in the late 1950s was also accomplished under Air Force sponsorship. And adaptive control, with its revolutionary promise for control systems of all types, was largely spawned under military and aerospace funding.

All such Government sponsored R&D, of course, hasn't been equally productive. That's the nature of R&D, though. At best it's unpredictable, with the wait for results painfully long in some cases and surprisingly short in others. It isn't unusual, either, for the fruits of an R&D program to be only peripherally related to the initial goal.

The fact remains that military-and-aerospace-sponsored R&D over the last 20 or so years has contributed heavily to many areas of electronics technology. And now with the across-the-board cutbacks in Government-funded R&D and the shift in federal priorities to pollution, housing, transportation, etc., electronics R&D is facing economic starvation.

Private industry can take up some but not all of the slack, since its R&D is mostly concerned with specific product development and improvement.

The answer, whether one likes it or not, is that the Government must begin to play a decisive role in R&D. Maybe not as all-pervasive as in Japan, where the Government and industry cooperate to an unusual degree in carrying out R&D programs in the national interest—but decisive nevertheless.

A step in this direction, hopefully, is a bill now in Congress that would establish an Office of Technology Assessment. (See News Scope, ED 17, Aug. 16, 1971.) The function of the office would be to give Congress objective and current information on the immediate and long-range physical, economic, social and political impact of technology.

With a Congress so informed, R&D in general, and electronics-oriented R&D in particular, could be evaluated, planned and executed on a smooth, continuing basis without devastating interruptions of the type we are now experiencing.



*Frank Egan*

FRANK EGAN

# Use time-sharing to program your mini.

Available services can help you increase your machine's capabilities, save time and save money.

The price and size advantages of minicomputers are sometimes offset by the money spent and time consumed in programming. This is where a time-sharing computer service can be extremely helpful. Assembly of minicomputer programs on a time-shared computer is very attractive economically when any of the following conditions are met:

- The source program to be assembled is generated by other programs.
- The minicomputer to be programmed has no high-speed I/O devices for loading and storing programs.
- The minicomputer has not yet been received.
- The minicomputer is engaged in the control of a process and cannot be interrupted to be used to develop software.

The greatest advantage of the time-shared technique lies in the excellent on-line editors provided, as well as their flexible file structure. The mini program is created in the editor, then assembled and errors detected. The errors are then corrected in the editor and the program reassembled. Then the final binary tape is punched.

## Cut time, effort and cost

The figure shows the assembly of a routine provided by Tymshare, Inc., for a Varian 620/i computer. The source program was first written and then punched on paper tape. The tape was then read into the Tymshare system, and the Tymshare editor was used to make corrections.

After it was read into the system and edited, the corrected program was written onto a disc file. It was then assembled, and more errors were found. This process took less than two minutes. The editor was used to correct these errors, and a final assembly was produced. Since the source program was now on a disc file, it could be modified and assembled at any time; there was no need to read the paper tape again.

If this program, a 23,880-character telecom-

munications code, had been assembled on a minicomputer, over two hours would have been required for one assembly with a Teletype Model 33 ASR as the I/O device (see box). But each assembly on the Tymshare system of a source code of this size costs about \$3.

The assemblers in time-sharing computers are not restricted by small core size or a lack of large disc files. This allows the implementation of conditional assemblies, macros, repeat functions, free form input and other aids found in assemblers for large machines but not normally available in minicomputers.

An extra benefit results from assembling software on a time-sharing system that has higher-level languages, such as FORTRAN and BASIC. These can be used to generate complex tables that can then be used by the assembler.

Storing a large number of ASCII messages in a small core is one problem that this technique can solve. For example, one of Tymshare's customers used to store messages this way:

```
MES1 ASC 'ALTERNATING PATTERN ER-  
ROR';0  
MES2 ASC 'INCREMENTING PATTERN ER-  
ROR';0
```

These were two of many messages in a circuit-board test station that had a 4096-word memory with 16 bits per word. The result was 14 words of core were used for the first message and 15 words for the second. Since such a test stand usually contains over 50 such messages, the amount of core consumed was 645 words. The considerable repetition in the messages made vocabulary storage a better solution. In this method a vocabulary of all words to be used is stored in a table. The messages are then composed of table addresses. For example, the two previous messages can now be contained in two words:

```
MES1 04/27  
15/377
```

```
MES2 20/27  
15/377
```

Now each message of N words in length takes

## Glossary of terms

Here's a glossary of computer terms used in this article:

**Assembler**—A computer program that translates a symbolic language program into a machine language program.

**Assembly language**—The symbolic language that the assembler recognizes and translates.

**Binary tape**—A paper or magnetic tape that contains the machine-language instructions in a format that can be read by the loader.

**Bootstrap**—A machine-language program usually loaded into a computer with the use of the computer console. Large computers generally have hardware to eliminate this procedure.

**Compiler**—A computer program that produces

a machine-language program from a higher-level language, such as a FORTRAN IV compiler or a COBOL compiler.

**Higher level language**—A programming language that closely resembles natural language. A statement in a higher-level language will produce many machine-language instructions. The higher-level languages are usually independent of the computer.

**Source program**—A program written in a source language—that is, a language designed for operator ease and convenience of expression.

**Symbolic**—The set of letters, numbers and symbols used for communications between computers and people.

**Word**—The number of bits stored together in a single address. The longer word length provides greater precision.

```

-bAB ←----- ①
INPUT FILE: 1PROG2
B3 1 MULTIPLY DEFINED SYMBOL IMB 0
B4 1 MULTIPLY DEFINED SYMBOL INB R 1*

-EDITOR ←----- ②
*READ PROG2
23880 CHARACTERS
*SUBSTITUTE
"BEGIN" FOR "L22R" ←----- ③
WAIT ? NO
12
*255,267/
STA RLA; STA RNG1; STA 1RNG1; STA TAM; STA TAM2; STA TIMMIN ←----- ④
IF 1; LDA =17; OAR 77; DAR; JAP *-2; LDB =7
EN JBZ SEN; DBR; LDA LINES,6; JAN EN; TBA; LRLA 1
ORA 4MASK; OAR 77; ORA MASK; OAR 77; JMP EN
ELSEIF 4
SEN LDA =36; OAR 77; EXC 76; EXC 276; LDA EN2; STA ENABLE; ENDIF
LDA =600; STA BF+40BUFFERS; ADD 6MASK; STA BF+106BUFFERS
ADD 6MASK; STA BF+107BUFFERS
LDA =177; LDX =STATB2+177; TZB; DAR; DXR; STB 0,5; JAP *-3
LDA =IN2A; STA INAA+1; LDA =IM2A; STA IMAA+1
LDA MINUTE; ADD HRS; JAZ *+4; JMP INIT9; LDA =MSG4; LDX =BUFFERS
JMPM MESSAGE; JMPM DEND
INIT9 LDX =BUFFERS; JMPM DEND
*84 EDIT ←----- ⑤
INB R 1*; ENDIF
XXXXXXXXXX ENDIF
*83 EDIT ←----- ⑥
IMB 0 ←----- ⑦
*83DELETE
*WRITE ←----- ⑦
TO: PROG2
OLD FILE
*QUIT
-bAB
INPUT FILE: 1PROG2
LITERAL 32 INDIRECT 1
PUNCH? ←----- ⑧
-LOGOUT

```

1. After the source program was loaded on the disc file PROG2, the Varian 620/i assembler 6A8 was called and two errors were found. One error was in line 83 and one in line 84.
2. The Editor was then used to make the corrections.
3. The address BEGIN was substituted for the address L22R. Twelve occurrences were found in the entire program.
4. Lines 255 to 267 were printed to point out some of the details of the assembler, such as i-f switches being allowed for conditional assemblies and long variable names.
5. The user now edits line 84. Since cell INB has been served twice, the user types Z control; and deletes the line up to the ";". D control then copies the remainder of the line.
6. The same problem exists for the label IMB. Since this is the only statement on that line, the line is deleted.
7. After writing the corrected program to a disc file, the assembler is called to assemble the file.
8. Because the program assembled without error, the question PUNCH? is asked. The user could then punch a binary tape at his remote teleprinter that will load into the Varian Data 620/i at this point.

The assembly of a large program is fast and easy with a large, time-shared computer. This 23,880-character

program was assembled in just two minutes. The colored portion of the printout shows the user's inputs.

## The long method

Assembling a code with the minicomputer and a teleprinter I/O is time-consuming.

The assembler must first enter a bootstrap by hand, then load the assembler via the teleprinter paper-tape reader and finally read the source code to be assembled.

The Varian 620/i assembler is a good example of a minicomputer assembler. It requires 20 minutes to load with a Teletype Model 33 ASR. The source code must be loaded either two or three times, depending upon whether the assembler is a two-pass or a three-pass. The entire process takes at least an hour. If errors are encountered, subsequent assemblies are required.

To correct errors in the source code, the user must copy the tape up to the error, insert the correction and copy the remainder of the source tape. This process of copying and re-assembling is done for each correction of the source code. During the initial debugging of a program many assemblies are required.

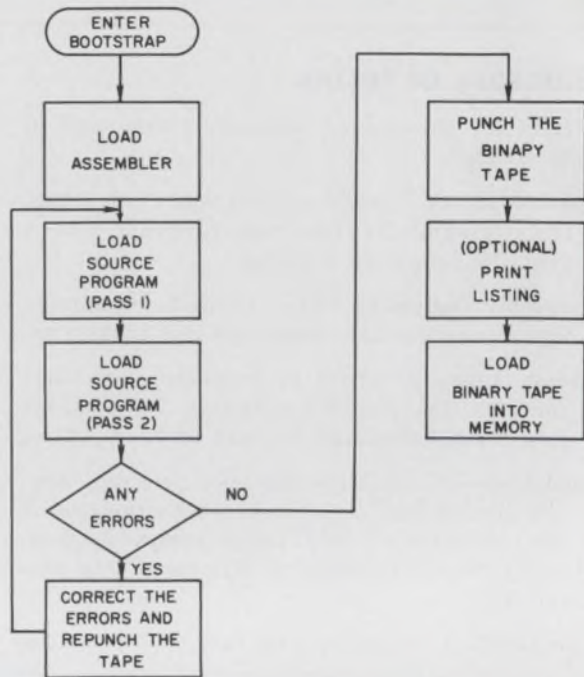

only  $(N/2) + 1$  words of core, plus the vocabulary. Note that in the first message there are two bytes per word, with the 4th word followed by the 27th word followed by the 15th word of the vocabulary. 377 is end of message. All numbers are octal.

Although this technique is helpful, the construction of a vocabulary and the development of the messages is very tedious.

A program in Super Basic has been developed to translate the first format into the second automatically. For further information about this vocabulary generator, circle Reader Information Retrieval No. 474.

A close relationship can exist between the time-sharing computer and the minicomputer. The time-sharing computer provides a large core for a short time, to allow faster program development with a conversational compiler and to produce efficient code to run on the mini. The mini, in turn, provides the good cost performance and efficiency of a small core dedicated to a specific use.

### Use the mini's memory efficiently

The Fortran compilers that are available on minicomputers are usually only of very simple implementation and do not produce a binary code that makes efficient use of core. If these compilers were developed to run in the large core generally available on time-sharing systems, they

could produce a binary object code that would be very efficient in its use of core on the minicomputer.

For example, the Fortran statement  $I=I+1$  in a normal Fortran compiler produces the following machine language code:

```
LDA I      (Load A register with I)
ADD = 1    (Add the number 1)
STA I      (Store A register in location I).
```

A larger, more sophisticated compiler would produce the single instruction:

```
INR I      (Increment memory location I).
```

### Before the minicomputer arrives

If your minicomputer has not yet arrived and you want to start programming, or if it is being used for process-control operations and cannot be interrupted for program development, time-sharing may provide a way to program without the mini. Some time-sharing systems also provide simulators for minicomputers that allow debugging to be done.

Check with your computer manufacturer to determine if an assembler is available for his computer on a time-sharing system. The Digital Equipment Corp. PDP-8 and PDP-11, the Varian Data Machine 620/i, 620/L and 620/f, the Micro Systems Micro 800 and the Data General Corp. Nova 800 and Nova 1200 are some of the minicomputers that have these assemblers. ■■



# Never before So much MOS/FET for so few pennies! RCA-40841 41¢ (1000-unit level)

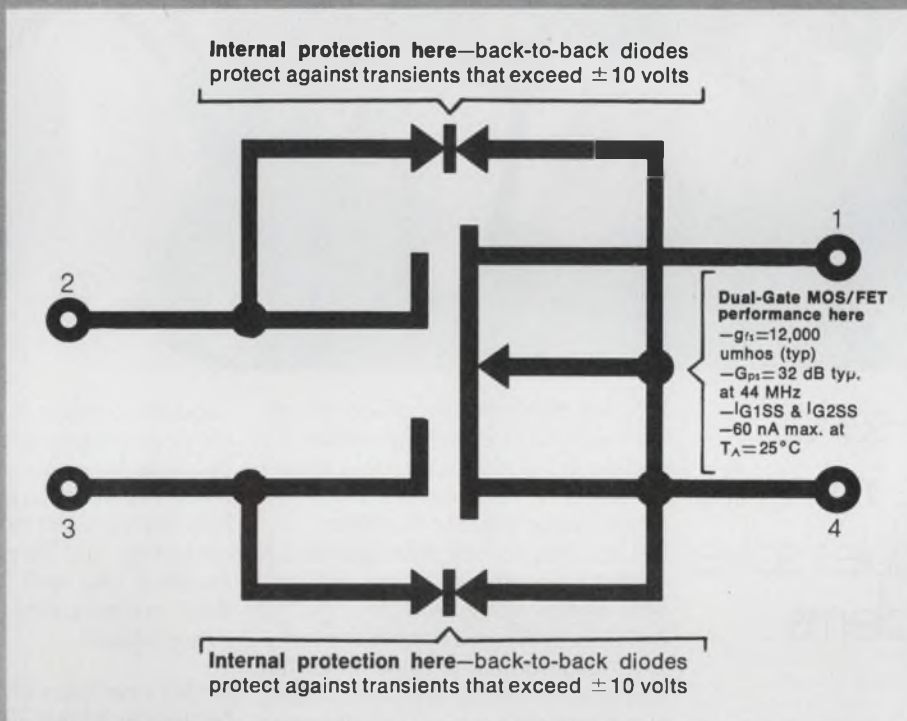

## RCA-40841 general-purpose dual-insulated-gate MOS/FET specified for single- or dual-gate applications from dc to 500 MHz

Here's another important performance/price breakthrough from RCA—the 40841, dual-insulated-gate MOS Field-Effect Transistor for general purpose applications from dc to 500 MHz, featuring:

- superior cross-modulation performance and greater dynamic range than bipolar and many Field Effect Transistors

- wide dynamic range permits large signal handling before overloading

- dual-gate simplifies agc circuitry
- virtually no agc power required

For economy, for performance—in dc amplifiers, RF, IF, and video amplifiers, differential amplifiers, frequency multipliers, choppers, voltage regulators, telemetry and multi-

plex circuits, and servo amplifiers—look into the RCA-40841.

For information on the 40841, see your local RCA Representative or RCA Distributor. For technical data write to: RCA Commercial Engineering, Section 5712/ZT5, Harrison, N.J. 07029. International: RCA, Sunbury-on-Thames, U.K., or P.O. Box 112, Hong Kong.

# RCA Solid State

INFORMATION RETRIEVAL NUMBER 27

# What's all this noise about noise?

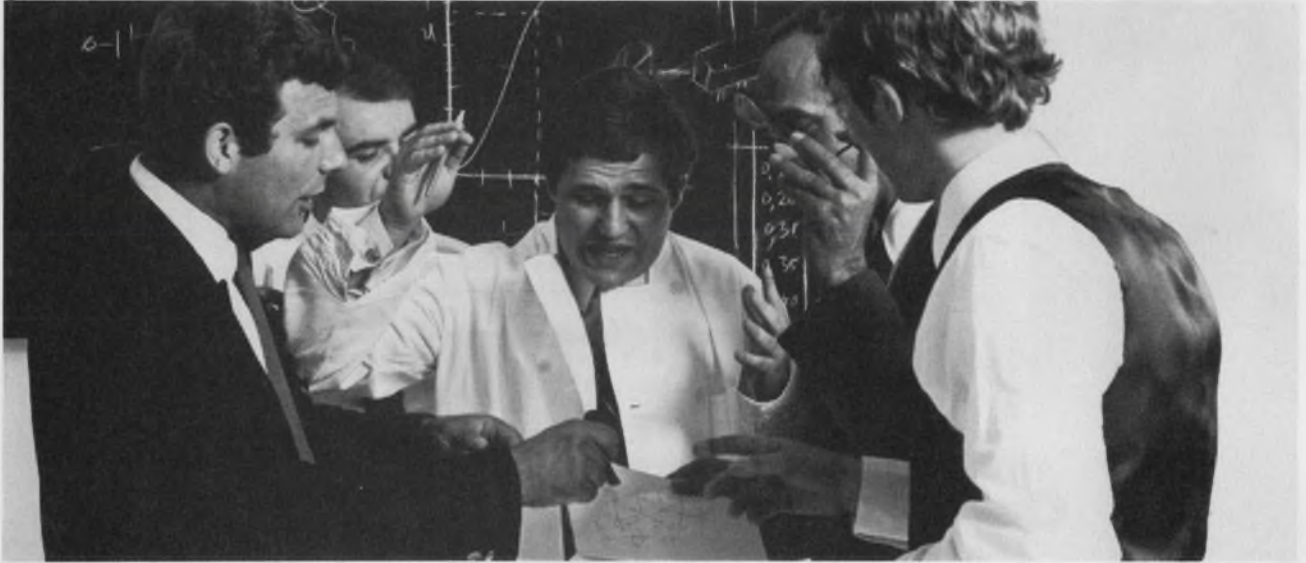

Philips' 30-series high noise-immunity logic modules solve noise problems instantly, right on the circuit design.

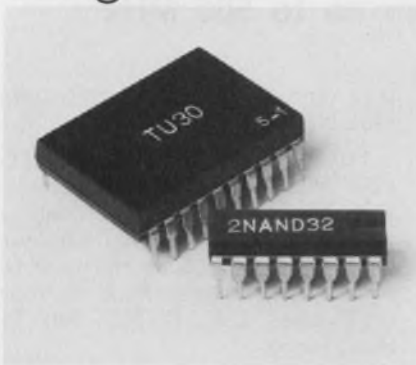

How to eliminate the effects of self-induced and externally generated a.c. and d.c. noise in logic circuits... there's a subject to keep earnest circuit designers debating into the night. But it's time to call time, gentlemen. All this noise about noise is just valuable energy going to waste. Philips' new 30-series high noise-immunity logic modules provide an instant solution, not only to problems caused by so-called d.c. noise, but to the more troublesome spurious a.c. pulses that can cause a logic system to go all illogical.

The trick is in matching up the relationship between noise-immunity and speed-of-system response. With a 30-series module you simply add, where necessary, a slow-down capacitor in the circuit... selected, of course, to fit the situation... and there's no more noise problem left to talk about! Don't leave yet. The 30-series includes not only logic elements, but timers, power amplifiers, lamp/relay drivers, interface modules, p.c. boards, connectors, mounting racks... everything you need to build a complete system.

Modules come in 16 and 20 pin dual-in-line packages ready to insert. Philips provides full application support... we'll even design a prototype for you. Not that we want to take all the noise out of life... just the part that costs you needless time and money. After all, there are still plenty of other things to argue about...

Order your copy of "Noise behaviour of the 30-series".

N.V. Philips' Gloeilampenfabrieken  
Electronic Components and  
Materials Division  
Eindhoven - The Netherlands

Distributed and sold in the U.S. by:  
AMPEREX Electronic Corporation,  
230 Duffy Avenue, HICKSVILLE L.I. N.Y.

In Canada: Philips Electron Devices  
a division of Philips Electronics  
Industries Ltd. 116, Vanderhoof Avenue  
TORONTO 17 - Ontario



electronic components  
and materials

# PHILIPS

INFORMATION RETRIEVAL NUMBER 28

# Quality

is what the brand new NJE RS line of power supplies is all about. From components to transformers, from workmanship to appearance, from durability to serviceability, no other line of power supplies packs so much quality per square inch!

# Interchangeability

of the RS line means just that. Wherever the other guy's LM-LX is now located, you can slip ours right in at no additional cost.

# Performance

translates into something this simple: you can upgrade from .1% or .5% to .01% line and load regulation, with even better stability and temperature coefficient.

# Price

starts at an astonishing \$104 for 5 volts at 6 amps with OVP and cover. And the prices range up to \$850 in 10 model sizes up to 24 volts at 52 amps.



Check these typical NJE RS Power Supply prices, then write or call for detailed specs:

Model	5V	Amps	12V	Amps	15V	Amps	24V	Amps
RSB	\$104	6	\$104	3.6	\$104	3.0	\$104	2
RSC	125	9	125	5.5	125	5	125	3.6
RSCC	146	12	146	8.0	146	7	146	5
RSD	199	15	199	11	199	10	199	7.5
RSE	235	22	235	16	235	15	235	12
RSEE	275	34	275	23	275	21	275	15
RSF	395	60	395	34	395	30	395	24
RSG	495	100	495	56	495	50	495	36
RSH	850	140	850	80	850	72	850	52

Prices effective Aug. 15, 1971

**NJE CORPORATION**  
*Electronic Development and Manufacture*

Kenilworth, New Jersey 07033 / (201) 272-6000 / TELEFAX: FFP • TWX: (710) 996-5967

See complete line at Booth #1021-1022. Wescon Show

INFORMATION RETRIEVAL NUMBER 29

# Need a good sweep circuit? Here's one that won't change frequency when you vary its output amplitude, and vice versa. And it can be built inexpensively.

Designing a sweep oscillator circuit whose output voltage and frequency are variable is easy. What's not quite so easy is to make these quantities independently variable, so that changing one does not affect the other.

One good way to do this is to use a pair of pnpn diodes across the timing capacitor, as in the circuit of Fig. 1. In this inexpensive circuit  $Q_1$  is a silicon pnp transistor operated as a current source; it therefore provides linear charging of the timing capacitor,  $C$ . Diodes  $D_1$  and  $D_2$  are a series pnpn pair.

To understand how the circuit works, recall that a pnpn diode acts as a switch with a very low ON resistance and a very high OFF resistance (Fig. 2). The diode is in its OFF state as the voltage across it is increased along line AB from zero toward the forward breakdown voltage,  $BV_f$ . When  $BV_f$  is exceeded, the diode turns ON and settles into the low-impedance state along line CD in the diagram.<sup>1</sup>

To get the diode back into the OFF state, the current through it must be reduced below  $I_h$ , the holding current. For the M4L3052 diodes used in this circuit,  $I_h$  can vary from 1 to 20 mA.

Briefly the circuit operates as follows: The timing capacitor,  $C$ , is charged by the constant current  $I_c$  so that the output voltage,  $V_o$ , rises linearly with time, in accordance with the formula  $V_o(t) = I_c t / C$ . When  $V_o$  exceeds the composite forward breakdown voltage of the series pair of diodes,  $BV_{fc}$ , the diode pair will turn ON. This provides a low-impedance path through which the timing capacitor can quickly discharge.

When  $V_o$  falls below the composite sustaining voltage,  $V_{sc}$ , of the diode combination (thus letting the diode current drop below  $I_h$ ), the diodes will turn OFF. This allows the whole cycle to be repeated, producing a linear voltage sweep with an amplitude  $V_{oa} = BV_{fc} - V_{sc}$ .

Note that the charging current,  $I_c$ , must be less than the holding current,  $I_h$ , if the circuit is to

work properly. If  $I_c$  exceeds  $I_h$ , then even if the capacitor discharges to  $V_{sc}$ , the diodes will not turn OFF, because  $I_c$  is holding them ON.  $I_c$  must, therefore be less than the minimum specified value of  $I_h$  for the pnpn diodes being used (1 mA in the present case).

## $R_3$ varies both amplitude and frequency

If the switch  $S$  of Fig. 1 is closed, then voltage  $V_a$  can be adjusted by varying  $R_3$  (with  $V_2$  and  $R_2$  fixed). Suppose  $V_a$  can be varied from 1 to 7 V. Diode  $D_1$  will fire for values of  $V_o$  between 9 and 15 V (because  $BV_f \cong 8$  V). As soon as  $D_1$  fires,  $D_2$  will do the same provided that  $D_1$  stays ON until  $D_2$  can fire.

To satisfy this last requirement, the equivalent resistance between point A and ground, with  $D_2$  OFF, must be low enough to allow the current through  $D_1$  to exceed the maximum specified value of  $I_h$  (20 mA in the present case). This equivalent resistance is the parallel combination of  $R_2$  and  $R_3$ .

Since the output amplitude  $V_{oa} = BV_{fc} - V_{sc} = I_c t_r / C$ , the ratio  $V_{oa} / t_r$  is constant for a fixed value of  $I_c / C$ . (The quantity  $t_r$  is the rise time of the linear sweep—the time it takes to rise from  $V_{sc}$  to  $BV_{fc}$ .)

If  $V_a$  is increased by an adjustment of  $R_3$ , then  $BV_{fc}$  and  $V_{oa}$  will also increase. For a constant  $I_c / C$  ratio,  $t_r$  will increase by the same factor.

The frequency of oscillation is given by  $f = 1 / (t_r + t_f)$ , where  $t_f$  is the fall time. Since  $t_r \gg t_f$ , we can safely write that  $f \cong 1 / t_r$ . Thus the adjustment of  $R_3$  that increased the amplitude,  $V_{oa}$ , will decrease the frequency by the same factor. The range over which the frequency can vary may be changed by changing the  $I_c / C$  ratio.

## $R_1$ affects the frequency only

If  $V_2$ ,  $R_2$  and  $R_3$  are fixed and the switch is closed, then  $V_a$  will be a constant. This means that  $BV_{fc}$ , and hence  $V_{oa}$ , are fixed, yielding a constant-amplitude signal.

Now, if  $R_1$  is varied, it will change  $I_c$ , which, in turn, will produce a change in the frequency

Dr. W. V. Subbarao, Assistant Professor, and John H. Champlin, Graduate Assistant, Electrical and Electronics Engineering Dept., North Dakota State University, Fargo, N. D. 58102.

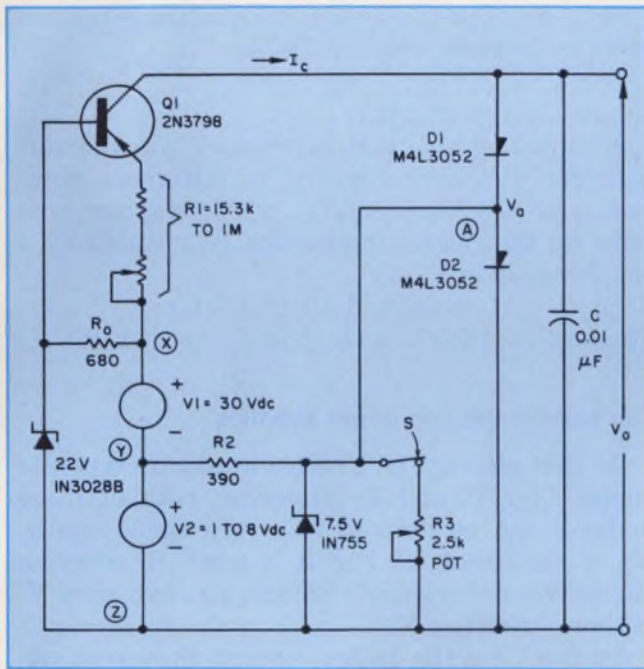

1. Varying  $R_1$  will vary the frequency of this sweep oscillator without affecting its output amplitude. Similarly if the switch  $S$  is opened, variations in voltage  $V_2$  can be used to change the output amplitude without changing the oscillator's frequency.

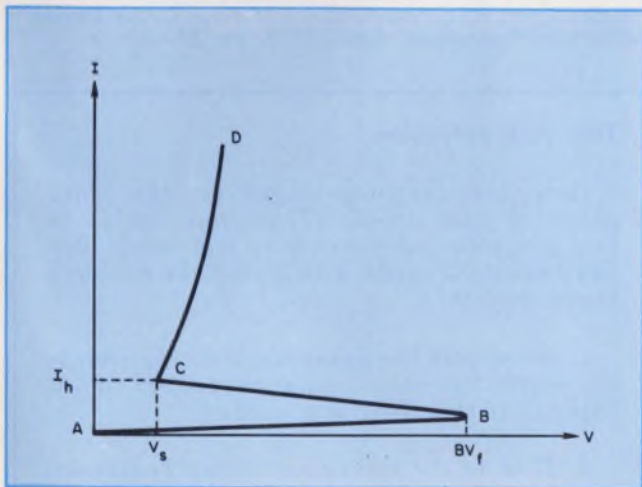

2. A pnpn diode is an excellent solid-state switch. When it operates between points  $A$  and  $B$  on its characteristic, the diode is in its high-impedance OFF state. Exceeding  $BV_f$  causes the diode to switch to its low-impedance ON state, defined by points  $C$  and  $D$  on the curve.

of the oscillator because

$$I_c t_r = V_{oa} C = \text{constant}$$

for given values of  $V_2$ ,  $R_2$  and  $R_3$ . An increase in  $R_1$  will cause a decrease in  $I_c$ , which, in turn, will increase  $t_r$  and lower the oscillator frequency by the same factor.

To see what range of frequency variation is possible, let's consider an extreme case with  $V_{on} = 13$  V (see next section),  $R_1$  set at  $1$  M $\Omega$  and  $C = 0.1$   $\mu$ F. This will result in a low-frequency limit of about 20 Hz.

With  $R_1 = 15.3$  k $\Omega$ ,  $C = 0.001$   $\mu$ F and  $V_{on} = 7$  V, the highest obtainable frequency is 143 kHz for  $I_h = 1$  mA. However, if we make a more realistic assumption about the holding current, say,  $I_h = 4$  mA, then  $f_{max}$  will be four times higher, or 572 kHz.

To change the amplitude only, vary  $V_2$

With this circuit, the frequency can be kept constant while the amplitude is changed by using the amplitude change to stabilize the frequency.

If switch  $S$  is open, then  $V_b$  will rise to approximately  $V_2$  before  $D_2$  fires. Increasing  $V_2$  will increase the output amplitude,  $V_{oa}$ . It will also, however, increase  $I_c$  by the same proportion, so that the time required to charge the capacitor to its new higher level remains constant.

The range of amplitude variation that can be obtained without clamping the output to an external source is determined by  $V_{sc}$  and the range over which  $BV_{fc}$  can be varied. For the pair of M4L3052 diodes of Fig. 1,  $BV_{fc}$  can be varied from 9 to 15 V as  $V_b$  goes from 1 to 7 V, if we assume that the  $BV_f$  for each diode is taken at its lowest limit of 8 V.  $V_o$  can thus be varied from 9 to 15 V when the diodes are OFF.

When they are ON, the lower limit on  $V_o$  is set by  $V_{sc}$ . This is 2 V if we allow 1 V for each diode. Therefore  $V_{oa}$  can vary from  $9 - 2 = 7$  V to  $15 - 2 = 13$  V for the circuit under consideration.

To see what the stable frequency is, recall that  $V_{oa} = I_c t_r / C$ . Differentiating this equation yields

$$dV_{oa} = (1/C) (t_r dI_c + I_c dt_r),$$

which is related to the change in  $V_2$  by the ex-

## our mini-digital heads sell data terminals

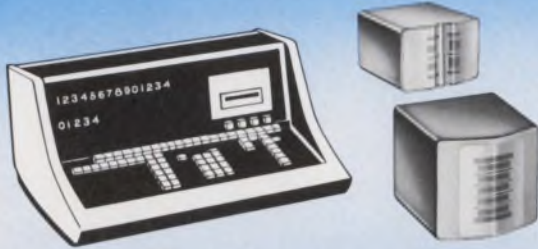

Nortronics was there when industry first talked about **point-of-sale terminals, desk-top calculators, credit-card validators, mini-computers** and other peripherals.

Today, we offer a complete line of Mini-Digital .150" cassette and .250" format heads for read/write and read-after-write applications in this 'new breed' of equipment—heads that meet ANSI, ECMA and ISO proposed standards.

Our "Design Digest for Mini-Digital Magnetic Recording" provides application information plus our complete catalog. Write for your copy today! If you don't see the head you need, we can make it in prototype or production quantities—and deliver it anywhere in this world!



world's leader in magnetic heads

**NORTRONICS**  
COMPANY, INC.

8101 Tenth Ave. North • Minneapolis, Minn. 55427 • Tel: 612-545-0401

INFORMATION RETRIEVAL NUMBER 30

## A few words to those who design circuits without a gaussmeter.

### Good luck.

If you design or work with magnetic circuits, a gaussmeter can save you a lot of time. It converts flux density into voltage for measurement. So, you can check faults both magnetically and electrically to track down any trouble as quickly as possible. Our gaussmeter brochures are the place to start. Write. 4949 Freeway Drive East, Columbus, Ohio 43229

**E.W. Bell Inc.**

A subsidiary of The Arnold Engineering Co.

INFORMATION RETRIEVAL NUMBER 31

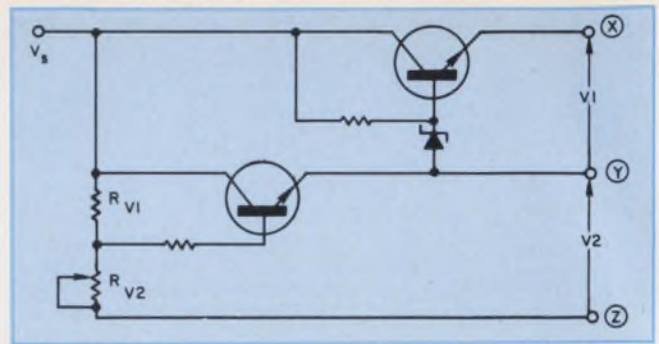

3. Voltage  $V_2$  can be varied without affecting  $V_1$ , by adjusting resistor  $R_{v2}$  in this power supply. Outputs X, Y and Z should be connected to the similarly designated points in the sweep circuit of Fig. 1.

pression  $dI_c = dV_2/R_1$ .

Substituting this last expression into the formula for  $dV_{or}$  and changing to difference notation, and considering  $\Delta V_{or} = \Delta V_2$  we can now solve for the change in risetime,  $\Delta t_r$ , caused by a small change in  $V_2$ ,  $\Delta V_2$ :

$$\Delta t_r = (\Delta V_2/R_1 I_c) (R_1 C - t_r).$$

Thus  $\Delta t_r = 0$  for  $t_r = R_1 C$ , or  $f_{stable} = 1/R_1 C$ .

### You needn't use two power supplies

At first glance, Fig. 1 seems to require separate supplies for  $V_1$  and  $V_2$ . However, both of these voltages can be derived from the same supply,  $V_s$ , if the circuit of Fig. 3 is used. By varying  $R_{v2}$  in this power-supply circuit, you can vary  $V_2$  without affecting  $V_1$ .

To check out the design concept, the sweep circuit described was built and tested in the laboratory. As expected, the frequency was variable from a few tens of hertz up to a few hundred kHz, and  $BV_{fc}$  was variable from 9 to 15 V. ■■

### Reference

1. Starliper, R.L., "Applications of Four Layer Diodes," *Solid-State Technology*, Sept., 1970, pp. 39-42.

### Test your retention

*Here are questions based on the main points of this article. Their purpose is to help you make sure you have not overlooked any important ideas. You'll find the answers in the article.*

1. What sets the upper limit on the charging current for the timing capacitor? What happens if this limit is exceeded?

2. How is the maximum sweep frequency related to the holding current?

3. What is the stable frequency of the circuit in its fixed-frequency, variable-amplitude mode?

a thought about you...

# ANGRY

Do minicomputer failures make you fume? Are disgruntled customers raising your blood pressure? OEM users, take heart! Cincinnati Milacron has a soothing solution for you — the CIP/2100 general purpose minicomputer.

We can't say that a CIP/2100 never fails, but it is built for reliability. For instance, it's rugged enough to take a temperature variation of 0° - 50°C. And it's simple enough that we can teach you to maintain or program it in only one week!

Tell us your application. We'll show you how the CIP/2100 can help you keep your cool — and your customers.



**minicomputers**

**CINCINNATI  
MILACRON**

Cincinnati Milacron Company | Cincinnati, Ohio 45209

**Machine Tools  
Process Controls  
Chemicals  
Plastics  
Plastics Processing Machinery  
Abrasives**

Cincinnati area (513) 494-5444 • Chicago area (312) 439-5726 • Los Angeles area (213) 582-8361 • Detroit area (313) 557-2700 • New York area (201) 687-4500

**INFORMATION RETRIEVAL NUMBER 32**

# Low-speed modems are easy to design with ICs. They can perform all of the necessary functions, from tone generation to signal conversion.

For some engineers, the design of a data modem (modulator/demodulator) is still a major project. But in low-speed applications, in which simple frequency-shift keying (FSK) suffices, all of the blocks in the modem block diagram can be realized by using one or more ICs (Fig. 1).

Line drivers and receivers that conform to EIA specification RS-232 (see box) are available in quad ICs (four drivers or receivers per package). The control logic and signal-converter circuitry usually consist of an assortment of standard digital ICs, with perhaps an op amp included in the signal converter to provide it with a frequency-discrimination capability. And the main components in the tone generator and the active filters are usually a bunch of IC op amps.

## Hysteresis needed in line receiver

Since the line receiver will usually be purchased as a single component, it is more important to know how to buy one than how to build one.

One important fact to bear in mind is that most modems have eight to 16 lines connecting them with the computer terminal. To save space, therefore, it is desirable to use line-receiver chips that contain several complete receivers per package.

A second important characteristic to look for is high input hysteresis. Without it the line receiver will be too susceptible to input noise. This point is so important that the Motorola MC1489A line driver (Fig. 2) has been designed to have more than four times as much hysteresis as its predecessor, the MC1489. The later model has a typical turn-on threshold of 2 V, but it doesn't turn-off until the input voltage falls below 0.8 V. The earlier units had only 250 mV of hysteresis.

The entire hysteresis loop is above ground, so that the receiver meets the fail-safe requirements of RS-232-C. This means the receiver output always goes to a mark condition when the input sees an open circuit.

A third desirable characteristic is a provision

**Clay Tatom**, Manager, Communications Marketing, Motorola Semiconductor Products, Inc., P.O. Box 20906, Phoenix, Ariz. 85036

## What is EIA spec RS-232?

The Electronic Industries Association (EIA) has standardized a specification to which the voltage and the impedance levels of the ONES and ZEROS on the computer side of the modem must conform so that any modem can talk to any computer with which it might be mated. So, the RS-232 specification standardizes the voltage and impedance levels at the computer-modem interface (not at the modem-telephone interface). Two different versions of this specification exist: the older RS-232-B spec and the newer RS-232-C. Most modems being designed today for industrial use conform to the RS-232-C spec. The most important features of this specification are given below.

### Electrical Specifications

Driver output logic levels with 3k to 7k load	$15\text{ V} > V_{OH} > 5\text{ V}$ $-5\text{ V} > V_{OL} > -15\text{ V}$
Driver output voltage with open circuit	$ V_o  < 25\text{ V}$
Driver output impedance with power off	$Z_o > 300\text{ ohms}$
Output short circuit current	$ I_o  < .5\text{ A}$
Driver slew rate	$dv/dt < 30\text{ V}/\mu\text{s}$
Receiver input impedance	$7\text{k ohms} > R_{in} > 3\text{k ohms}$
Receiver input voltage	$\pm 25\text{ V}$ compatible with driver
Receiver output with open circuit input	mark
Receiver output with 300 ohms to ground on input	mark
Receiver output with +3 V input	space
Receiver output with -3 V input	mark

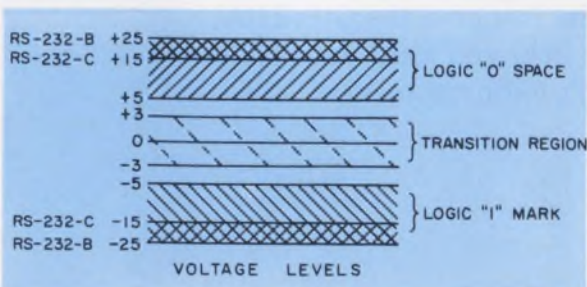



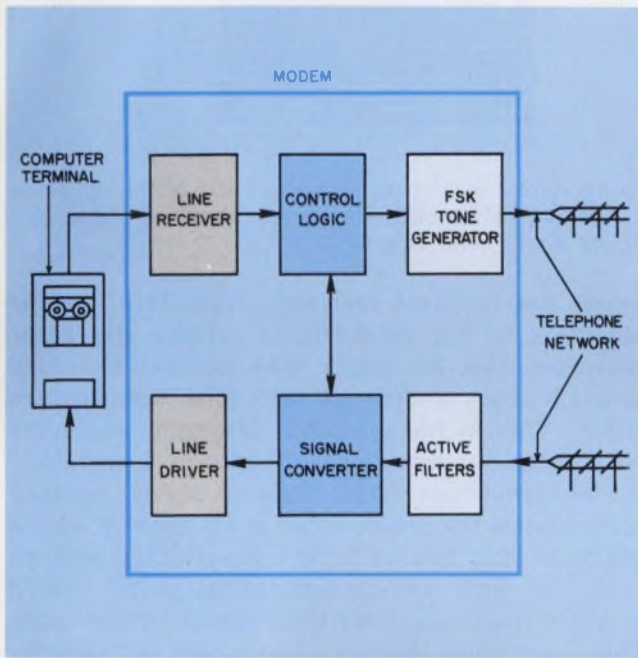

1. Each of the blocks in this modem can be realized with one or more ICs. Only the tone generator and filters will need some passive components. When working with the switched telephone network, a Data Access Arrangement must connect the modem with the network.

for threshold shifting. This enables the unit to be used in the control-logic circuitry as a level translator between MOS devices and TTL or DTL circuits.

The control logic itself is usually a section of TTL, DTL or MOS logic circuits that control the tone generator, FSK, and/or signal-conversion stages of the modem. The actual logic varies with the modem manufacturer, but most use this control section to gate the FSK switches on or off and to drive the inputs of the line drivers.

### This FSK unit uses four op amps

Although highly sophisticated modulation techniques are needed for high-speed data transmission, most low-speed systems being built today use simple FSK tone generators, such as the one shown in Fig. 3. The circuit features an integrator/Schmitt-trigger loop with fourth-order filter-

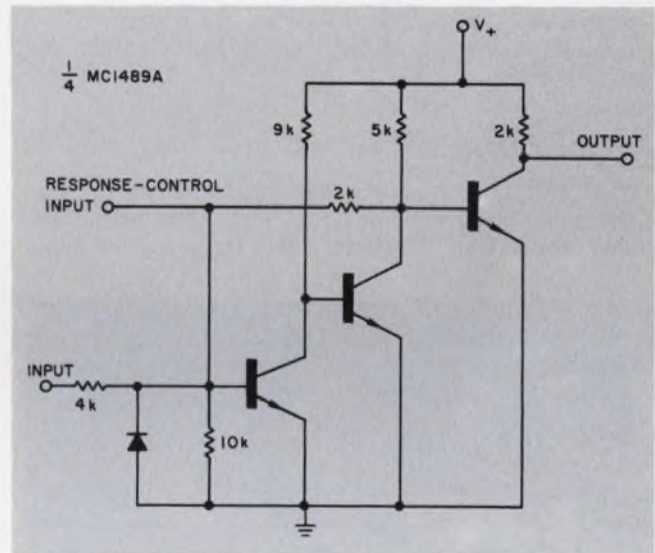

2. This line receiver has over a volt of hysteresis. The response-control input can be used to shift the input threshold by returning it to an auxiliary supply voltage through an external resistor; it can be used to provide extra noise filtering by returning it to ground through an external capacitor; or it can be used to connect two receivers in parallel to the same input line by tying the line to them through 8-k $\Omega$  resistors.

ing for the output signal. A pair of dual op amps is used to minimize the parts count. Good stability is ensured by the zener clipping at the trigger input.

Variable frequencies are generated by changing the input transconductance to the integrator through a Tee network. Shunt switches may then be used to frequency shift from 1070 Hz to 1270 Hz, for the example shown. The integrator amplitude is constant with this approach, and its harmonics are easily filtered.

The filter employed is a modified double-section, second-order Butterworth type, with slightly more peaking than normal to equalize the signal amplitudes and still retain maximum harmonic suppression. Ordinary Sallen-Key type low-pass filters are used since the corner frequencies are not critical and the relative Q is 1.

The active-filter section of the modem is probably the most controversial of all the blocks.

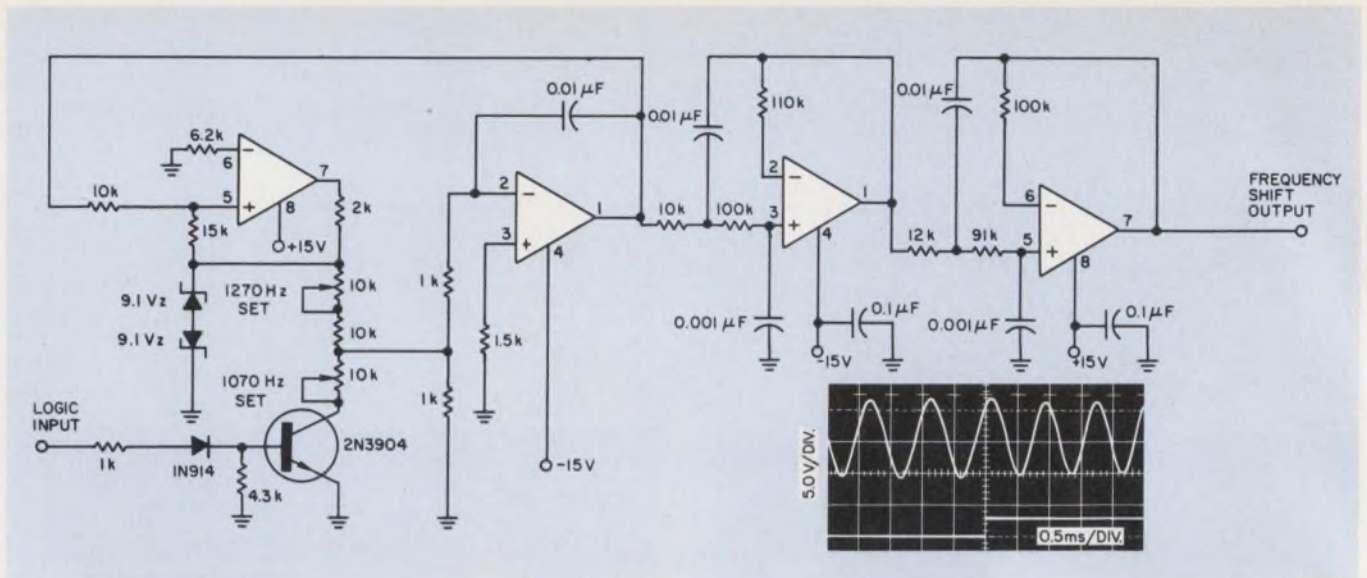

3. This FSK tone generator has good stability because of the zener-diode clipping at its input. The output frequency shifts from 1070 to 1270 Hz when the input

changes from a mark to a space. Each of the op amps is half of an MC1458G. The waveform shows phase continuity during tone switching.

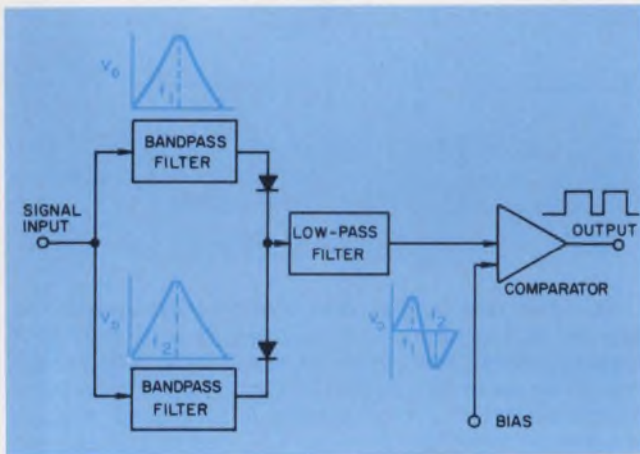

4. Here's one way to build a low-speed signal converter. This circuit is essentially the opposite of a tone generator—its output changes logic levels when its input frequency changes.

longer has to select resistors, capacitors, and/or inductors to 1% or 0.1% to achieve his filter characteristics. No longer does he have to worry so much about component drift with temperature either. This is the approach Motorola engineers recommend for most active filters in a modem.'

The signal-conversion block is almost as controversial as the active-filter block. Most modems are built with TTL or DTL logic circuits perhaps combined with an operational amplifier which provides frequency-discrimination characteristics. This stage takes the audio tones coming from the active filter and demodulates them to give either a ONE or a ZERO depending upon which frequency tone is present. Usually the output is at TTL logic levels. Like the active-filter section, designs are so varied that no standard circuit exists for this block of the modem, although a typical circuit might look like that of Fig. 4.

Designers of active filters usually have their own preferred technique. So long as it works for them, they are often not inclined to explore the advantages of other approaches.

Motorola has worked with several techniques. One is the Sallen-Key method shown in the tone generator. Another is the "bi-quadratic" technique, which has been around Bell Telephone Laboratories a long time but has become popular only recently, because the low-cost IC op amp made it economically feasible. This technique requires several active elements instead of only one, but this trade-off today usually results in production-cost savings as well as other advantages.

The big advantage of the "bi-quadratic" filter is that when the designer uses the several active op-amp elements that the design requires, he no

#### Don't let the driver slew too fast

The last block of Fig. 1 that remains to be discussed is the RS-232 line driver. As with the line receiver, quad packaging is desirable since eight to 16 lines usually have to meet the RS-232-C interface specification.

A point worth noting is that RS-232-C specifies a maximum slew rate of  $30 \text{ V}/\mu\text{s}$ . Some drivers, such as the Motorola MC1488, will exceed this rate if they are made to work into less than 330 pF of capacitance. For very short lines, therefore, an external capacitor may be needed to roll the slew rate down to the  $30 \text{ V}/\mu\text{s}$  maximum. ■■

#### Reference:

1. Motorola Integrated Circuits for Modem and Terminal Systems, 1970.

If you need panel instruments with **custom** dials, cases, accuracy, tracking, resistance, response time, or practically any combination of unusual specs...

Buy **Triplett's** designed-for-you Panel Instruments

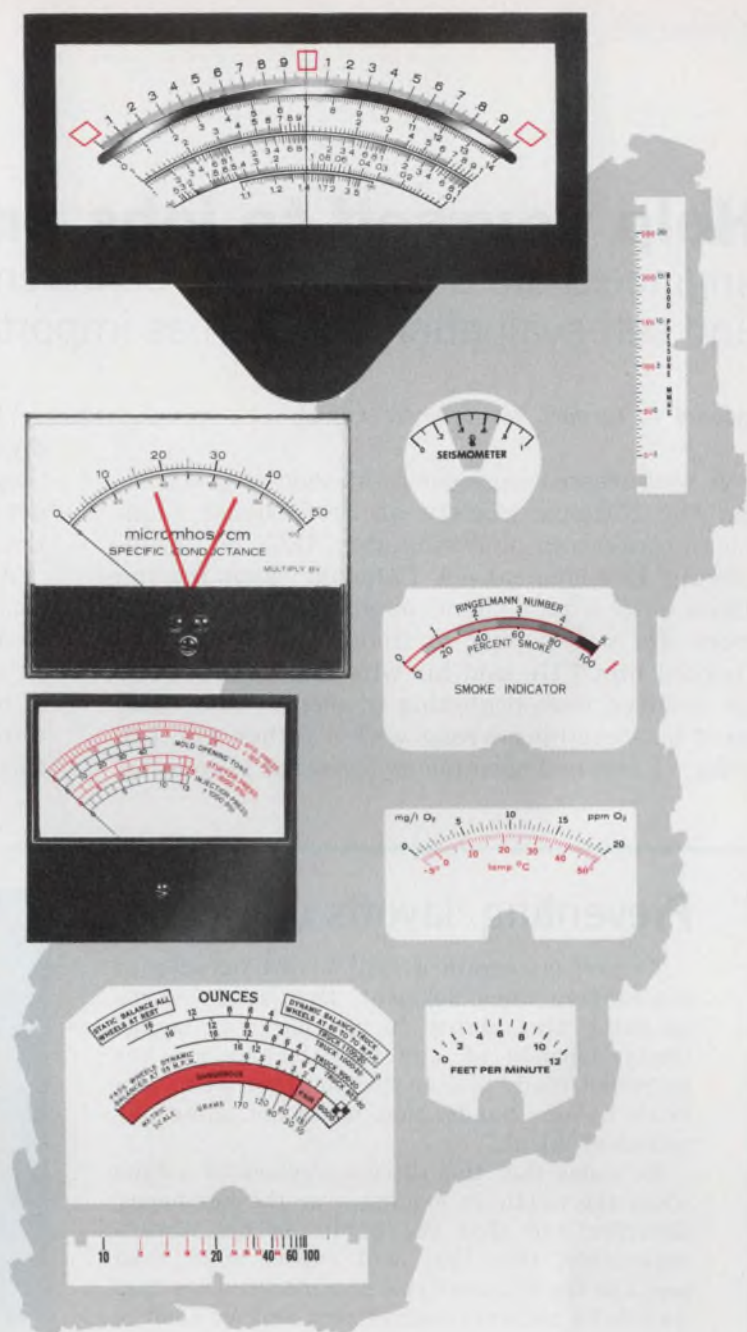

Although we stock some 1369 different styles, sizes and types of standard panel instruments, a very large proportion of our customers buy custom instruments.

Because they need:

**custom dials**

reading in such units as pH, roentgens, mm Hg, rpm, %, inches.

**custom cases**

square, round, rectangular, edge-wise (horizontal and vertical), wide, narrow, shallow.

**custom accuracy**

to within 1/2% with mirror scales and knife-edge pointers.

**custom tracking**

to match the specific needs of existing or new instrument designs.

**custom resistance**

for low circuit loading with tolerances as low as  $\pm 1\%$ .

**custom damping**

to meet stringent electrical and vibration requirements.

For instance, one of our customers had us design and manufacture a custom instrument to replace — in every detail of physical and electrical specifications — one which he was using on a delicate piece of medical instrumentation. Rejects from his previous source had risen to over 20%. He rejected only 3 of the first hundred we shipped—with almost negligible rejections from the many hundreds we've shipped since.

What custom panel instrument specifications do you need to make your

product more reliable, more accurate, more rugged and — in the long run — less expensive? For quick, dependable delivery of small quantities of Triplett's "designed-for-you" panel instruments, contact your Triplett Sales/Service/Modification Center. For prototypes or production quantities, contact your Triplett representative. He'll put you in touch with our Instrument Designers/Engineers who'll help you analyze the problem and suggest the optimum cost/result solution.

**TRIPLETT**  
BLUFFTON, OHIO 45817  
Manufacturers of the World's most complete line of V-O-M's

INFORMATION RETRIEVAL NUMBER 33

## Help yourself to jobs and re-training, engineers are advised at this conference. Attitude, adaptability and self evaluation are seen as important assets for employment.

Richard L. Turmail, Management Editor

A well-dressed engineer in his mid-40s, attending the National Society of Professional Engineer's conference in Washington, D.C., on "Engineering Employment—A Paradox," kept feeding dimes into a pay phone outside the conference room. He was hoping to find an employer who "needed him." He said his wife had left him and his children were beginning to suspect that there must be something wrong with a father who had a degree and had been unemployed for 17 months.

"I've got the clothes on my back, my car and my credit cards," he said, adding: "That is until they catch up with me next month. I can't even get a job as a ditch-digger—they keep telling me I'm over-qualified."

Asked what the future held, he said that he'd considered either ending it all or using the card with the most credit to fly to Europe and get lost. In spite of it all, he maintained a certain degree of humor. "Just wait," he said "until NSPE tries to cash the check I gave them for registration to this conference."

### Preventing 'layoffs unlimited'

To prevent a return visit to the paradox of engineering unemployment, Dr. Tribus warns us that, "Our ability to pay our way in the world depends on our high technology, but we're not ready to face the fact that we have a crisis on our hands, that we're not using our technical talent."

He notes that this dilemma comes at a time when the public is looking over the engineers' shoulder and that the public is not always reasonable, that they will expect more than perhaps the engineer can provide. He says that we need a national commitment and we need to develop new forms of cooperation between business and government. He proposed the following steps that government, education, and the private sector ought to take:

- The creation of special staff positions as legislative advisors.
- The creation of forums by the NSPE or the National Academy of Engineering in which, under control of technically qualified men, responsible debates may be waged over public issues involving technology.
- Develop a new generation of engineers by changing and expanding the engineering college curricula to include the humanities and the social sciences.
- Coordinate standards-making between the Federal Government and industry.
- Encouragement of technology through tax credits, subsidies, loans, development of mar-



**Senator Edward Kennedy:** "Although economic conversion poses extremely difficult technical challenges, they are the sort of challenges on which engineers and scientists have always thrived."



Conference sponsors expected upwards to 300 corporate engineering managers, educators, and government and industrial engineers in attendance. Reportedly due to

the recession, only 75 attendees responded as empty chairs (above) attest. Nominee for IEEE presidency, Robert Tanner, (L) takes notes during presentations.

kets, use of purchasing power, financing of risky ventures, underwriting research or development of prototypes. One plan would be to give a tax credit for any increase over last year's R&D budget until the total R&D outlay exceeds 5 per cent of sales.

Bringing hope to a beleaguered profession is the possible passage of "The Research and Assistance Act." The bill is sponsored by Senator Edward M. Kennedy, who outlined it in his conference luncheon address.

It boils down to the establishment of three policies in the areas of economic conversion:

1. Scientists and engineers should have continuing opportunities for employment in a position commensurate with their professional and technical skill.

2. Federal spending for civilian research and engineering should be raised to parity with defense-related research and engineering, and kept at or above that level in the future.

3. The total Federal investment in science and technology must continue to grow annually in proportion to increases in the G.N.P.

Senator Kennedy asserted that although economic conversion poses extremely difficult technical challenges, they are the sort of challenges on which scientists and engineers have always thrived.

"I firmly believe," he said, "in the capacity of the nation's engineers to tackle these problems with the same degree of energy, imagination and success which have characterized their accomplishments in the past."



Dr. Myron Tribus: "Our ability to pay our way in the world depends on our high technology, but we're not ready to face the fact that we're not using our technical talent."

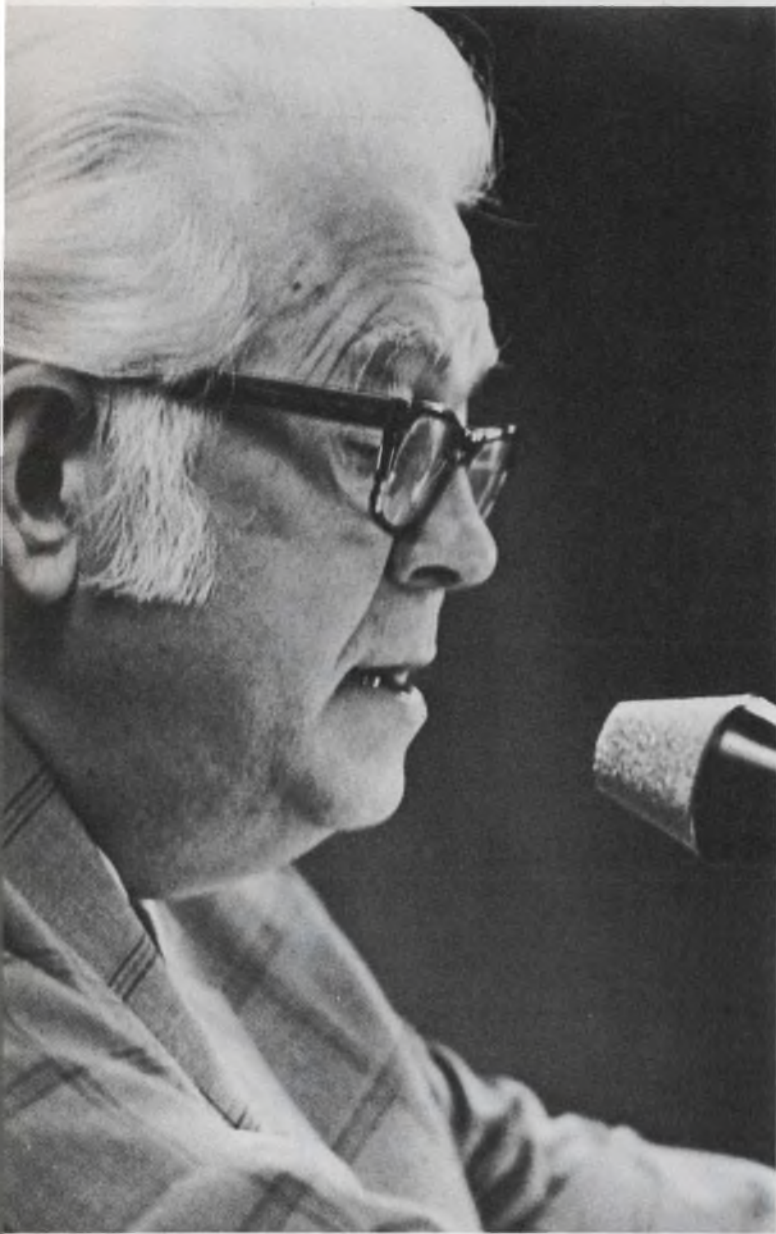

**Dr. Charles E. Goshen:** "It seems more likely that the greater self-resourcefulness demonstrated by those (engineers) in need, the greater will be the cooperation from other segments of the society."

Granted, his misfortune is extreme; there are still thousands of other unemployed engineers who are experiencing somewhat similar problems. But even though the engineering sector of the economy has been hit hard by unemployment as a result of the national recession, no one at the June 17-18 gathering in Washington suggested that engineers should expect something for nothing.

#### **Self-help suggested**

According to the conference organizers, the prime problem is to redirect unemployed engineers into areas that will use their technological expertise to meet human needs. And though the panelists weren't able to present neatly packaged em-

ployment kits to the corporate engineering managers, educators and government and industrial engineers at the conference, they did point out ways that the jobless engineer could improve his chances. The suggestions include:

- Developing a positive attitude and using personality to sell yourself.
- Being prepared to convert from one job area to another—from military to commercial engineering, for example.
- Facing up to critical self-evaluation. Don't demand a "position" when a good job is available.
- Being motivated.
- Being persistent.

#### **Accenting the positive**

Panelist Kaye Kiddoo, corporate director for manpower resources, Lockheed Aircraft Corp., Burbank, Calif., said: "Our industry is like Charlie Brown who gets the ball taken away from him just when he's ready to kick it. We've been blamed for not knowing when Lucy is going to pull the ball away. Unfortunately, the image of the industry has rubbed off on the engineer."

Overcoming a negative attitude isn't easy, especially when chances for unemployment seem slim. But to overcome it the jobless engineer must, the conferees agreed. Dr. Merl Baker, chancellor of the University of Missouri-Rolla, noted: "A positive attitude can be the deciding factor that gets the engineer the job."

Acknowledging that engineers who had been unemployed for a long time would disagree with him, Dr. Baker asserted: "There is no job shortage for college-degree engineers if they have a positive attitude and have personalities to sell themselves."

But no one could say with any conviction how an unemployed engineer in his mid-40s, with a growing family and financial problems, could adopt a winning attitude.

#### **Can you shift gears?**

Assuming that the unemployed engineer can use his personality to advantage, can he also mold himself into a new-discipline engineer? In other words, can an engineer trained in the arts of aerospace adapt his talents to medical electronics, urban engineering and the other emerging fields in the marketplace of the 70s?

Nathaniel Robbins Jr., a director of engineering in the Residential Div. of Honeywell, Inc., Minneapolis, said that the engineer's knowledge was transferrable if he had in his kit at least a four-year engineering degree, varied experience and attributes that separated him from others, such as curiosity, creativity, analytical ability and an aptitude for solving problems.

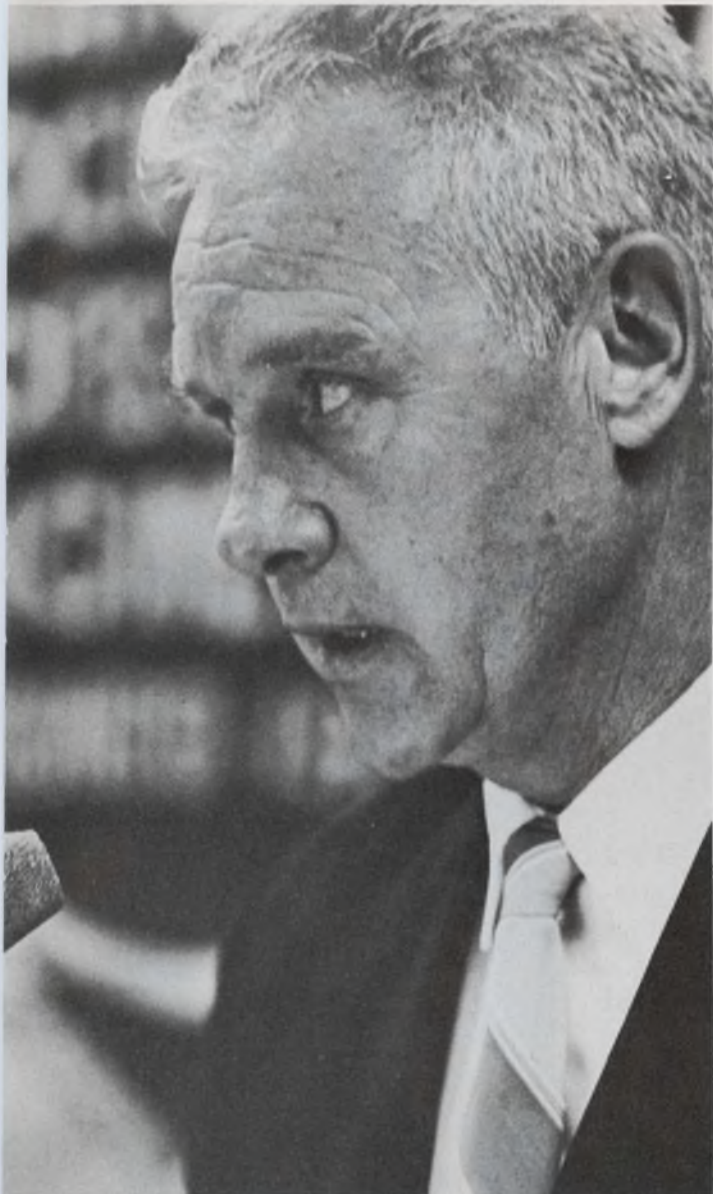

Finlay L. Petrie, chief, Division of Placement, U. S. Training and Employment Service, Department of Labor, told conferees that scientists and engineers don't want to be trained unless there's a job at the finish.

One panel keynoter, Dr. Charles E. Goshen, professor of engineering management and associate professor of psychiatry, Vanderbilt University, noted that spot checks of engineers now in the process of finding new jobs, new careers, outside of the military-industrial economy indicate that the change being forced upon them is more damaging to their pride than to their pocket book.

Ernest L. Buckley, technical administrative supervisor with the General Dynamics Co., Fort Worth, Tex., suggested that engineers direct their training efforts toward the following:

- A brief technical refresher.
- Introduction to their selected new area of specialization.
- A review of the state of the art of the se-

lected area of specialization.

■ Thorough exposure to the "jargon" of that specialty and the peculiarities of the business environment that relates to it.

#### Some training aid available

Who pays for the retraining? It appears that the unemployed engineer does unless he can qualify for the Federal Government program designed to cope with engineering employment problems. Administered by the U.S. Dept. of Labor, the current program is budgeted at \$42-million, \$25-million of which will be used to finance retraining. The guidelines for qualification are restrictive, open only to aerospace project engineers. It is a very modest beginning.

---

The U.S. Department of Labor is neither a trainer nor an employment agency—it has an administrative function. To apply for re-training or employment, the engineer should contact the technical placement office of the Division of Employment Service of his state. These are the offices that have been given Federal grants for employment programs. Inquiries on how to register for the National Registry can also be made there. If the service does not have up-to-date information, the engineer should contact his local regional Office of Information, U.S. Labor Department.

---

Buckley cited three types of unemployed engineers who were having the most trouble vying for positions:

*The unadaptable:* those who resist change and wait in vain for the next wave of mobilization.

*The manager:* those who want a position instead of a job.

*The unqualified:* those without degrees who were "made" engineers by company personnel departments during the peak demand and who cannot compete with bonafide degree holders.

Beyond the present job crisis, which economists widely view as temporary, the Washington conference foresaw a new era of engineering, in which engineers could assume responsibility not only for what they design but also for its effects on society.

The conference keynoter, Myron Tribus, senior vice president of the Xerox Corp. and former Assistant Secretary of Commerce for Science and Technology, summed up the hope this way:

"This responsibility demands a special kind of man—indeed, a special kind of engineer—an engineer who is broadly educated, both in the humanities, the social sciences and the physical sciences, who is deeply motivated to assume both the responsibility for designing tomorrow's technology and for monitoring its effects on society." ■■

# end your signal pollution problems

## Beldfoil® ISO-Shielded™ Cable

It's the cable with virtually perfect shielding. It's a Belden exclusive. Beldfoil ISO-Shield is like a continuous metal tube enclosing each pair of conductors in a cable. It locks out crosstalk or interference . . . whether from outside sources or between shielded elements in the cable.

Beldfoil is a layer of aluminum foil bonded to a tough polyester film (for insulation and added strength.) To form an ISO-Shield, we apply it in any one of several unique ways to meet the requirements of different applications. (See Figures 1 and 2, for example). Each gives more physical shield coverage than braided wire or spiral wrapped (served) shields. And greater shield effectiveness . . . even after repeated flexing.

Beldfoil ISO-Shielded Cables are small, lightweight. They terminate easily. They're modest in price. Your Belden Distributor stocks a wide variety of standard Beldfoil shielded cables as listed in the "Belden Electronic Wire and Cable Catalog" (ask him for the latest edition). And, should you have specifications no standard product can meet, ask him to quote on a specially engineered design. Or, if you choose, contact: Electronic Sales Service Dept., Belden Corporation, Richmond, Indiana 47374.

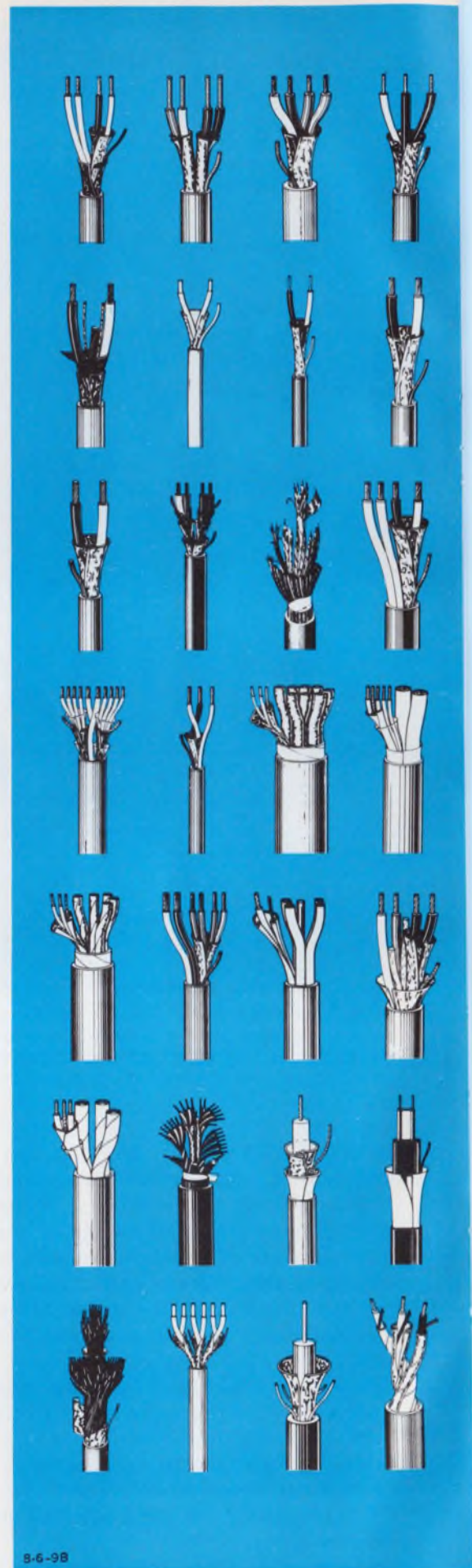

9-6-98





Metal (shield) foil, folded to assure metal-to-metal contact.

FIGURE 1

Polyester insulating layer folded to assure isolation between shields.

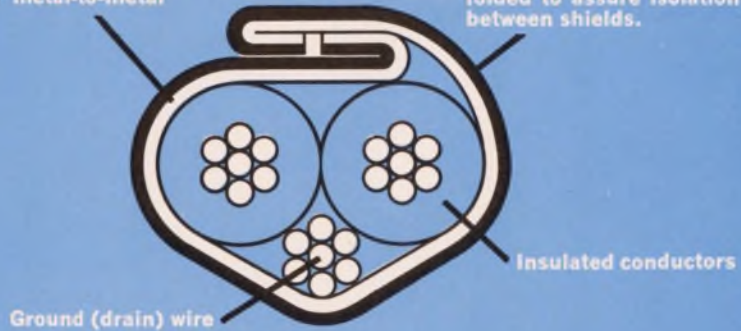

### Beldfoil Multiple Pair Individually Shielded Cable

The Figure 1 cross-section shows Belden's exclusive Z-folded Beldfoil ISO-Shield. Note the metal-to-metal contact between the two edges of the aluminum foil. In essence, you have a continuous aluminum tube. And the polyester layer on the outside of the fold assures the isolation between shields so necessary for best performance in the field.

#### Technical Data

Nominal values for multiple pair individually shielded cables containing 3 to 27 pairs (including 8769 and 8773 through 8778 Series cables)

Suggested working voltage: 300 volts rms max.

Working voltage between adjacent shields: 50 volts rms max.

Capacitance between conductors in a pair: 30 pf per ft. nom.

Capacitance between one conductor and other conductor connected to shield: 55 pf per ft. nom.

Capacitance between shields on adjacent pairs: 115 pf per ft. nom.

Insulation resistance between shields on adjacent pairs: 100 megohms per 1000 ft. nom.

Metal (shield) foil, folded to assure metal-to-metal contact.

FIGURE 2

Polyester insulation layer folded to provide bonus insulation between conductors and shield.

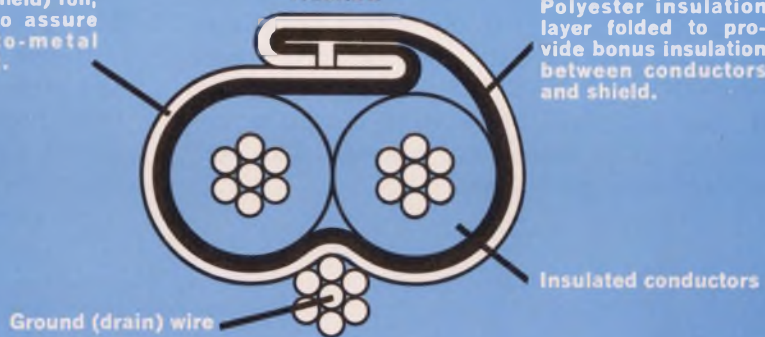

### Beldfoil Shielded Single Pair Cable

The Figure 2 cross-section shows the exclusive Belden Z-fold with the polyester insulating layer inward. This makes use of the high dielectric strength of the polyester film as bonus insulation between the conductors and the shield. (The cable jacket provides the primary insulation of the shield from outside objects or adjacent cables.)

#### Technical Data

Nominal values for 8451 Shielded Pair Cable

Suggested working voltage: 200 volts rms max.

Capacitance between conductors: 34 pf per ft. nom.

Capacitance between one conductor and other conductor connected to shield: 67 pf per ft. nom.

**BELDEN** 

*new ideas for moving electrical energy*

## Demultiplexer uses minimum pulse width

Here's a method of demultiplexing, based on minimum pulse width, that checks the integrity of input data. It does this by allowing extraction of data only after a fixed time delay,  $\Delta$ , from a logic-level transition.

In minimum pulse-width demultiplexing, data is extracted in parallel from a single input channel when the data logic levels exceed a minimum pulse width, be it positive (logic ONE) or negative (logic ZERO). A minimum pulse width is defined for each output channel.

A single minimum pulse width demultiplexing circuit for one output channel is shown in Fig. 1. Logic ONE or logic ZERO signal inputs that exceed the minimum pulse-width requirement,  $\Delta$ , of the circuit are shifted to the output of the circuit as slightly delayed data. Narrow noise spikes and logic ONE or logic ZERO inputs that do not exceed the minimum pulse-width duration requirements of the circuit are ignored. The output data remains unchanged.

The block diagram suggests a complex circuit, but this is not the case (see Fig. 2). In operation, any signal input that does not have sufficient energy to overcome the capacitive effect of C1 or C2 are suppressed. Otherwise transistors Q1 and Q2, respectively, are turned ON. Transistor Q1 inverts logic ZERO inputs, and transistor Q2 logic ONE inputs.

If we assume a positive transition input from logic ZERO to logic ONE for  $t > \Delta$ , where  $t$  is the duration of logic level ONE, the data integrity check delay,  $\Delta$ , is formed when Q2 is saturated by the logic level ONE input (approximately 5 V). The transition of the collector of transistor Q2 from +5 V to its saturation voltage passes, via capacitor C4, to the base of transistor Q4. Transistor Q4 is biased off until capacitor C4 can recharge to a positive value high enough to bias Q4 ON via charge resistor R4.

If the noise suppression delay effects of C2 and other circuit delays are negligible, the time from turn-off of Q4 to turn-on of Q4 by  $R4C4$  is the data integrity check delay,  $\Delta$ , and the minimum demultiplexing pulse duration constant.

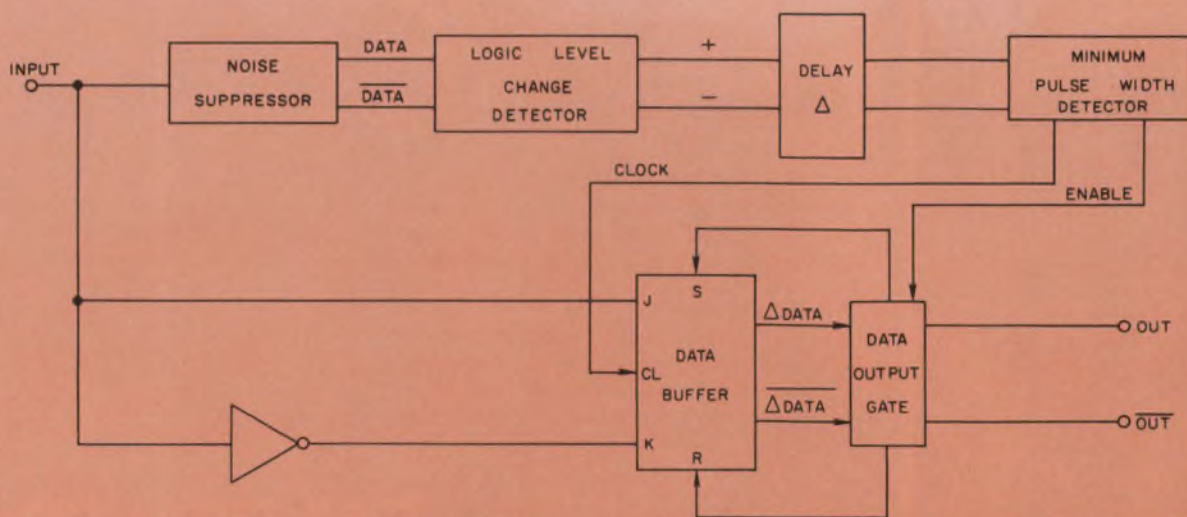

1. Demultiplexer block diagram, based on minimum pulse width, is shown here for a single output channel. Narrow noise spikes or logic ONE and

logic ZERO inputs of too short a pulse width are ignored. For N-channels, N such circuits are required.

## Line noise can be both generated and measured with Beckman's Model 3020.

To be specific, the 3020 can generate a controlled transient similar to the noise encountered in an industrial environment. Or it can measure line noise up to 1KW peak. Or it can simulate power line interference up to 10 KW peak power. □ In each case, noise amplitude and position (phase) are continuously adjustable. And a sweep mode is provided for scanning the noise pulse over a full 360° line cycle. □ This

versatility makes the 3020 ideal for use in R & D departments, in testing and reliability labs, as well as in electronic repair, service and installation companies. □ It can be used for

most everything from troubleshooting noise conditions to serving as a design tool for filtering or shielding of electronic equipment. □ Contact your Beckman representative for the entire story. Or call us direct at (312) 671-3300. □ For information on our complete product line, send for a copy of our new Electronic Instrumentation Digest.



**Beckman**  
INSTRUMENTS, INC.  
ELECTRONIC INSTRUMENTS DIVISION  
3900 North River Road  
Schiller Park, Illinois 60176

Helping science and industry improve the quality of life.

INFORMATION RETRIEVAL NUMBER 35 ►

# W S I O N

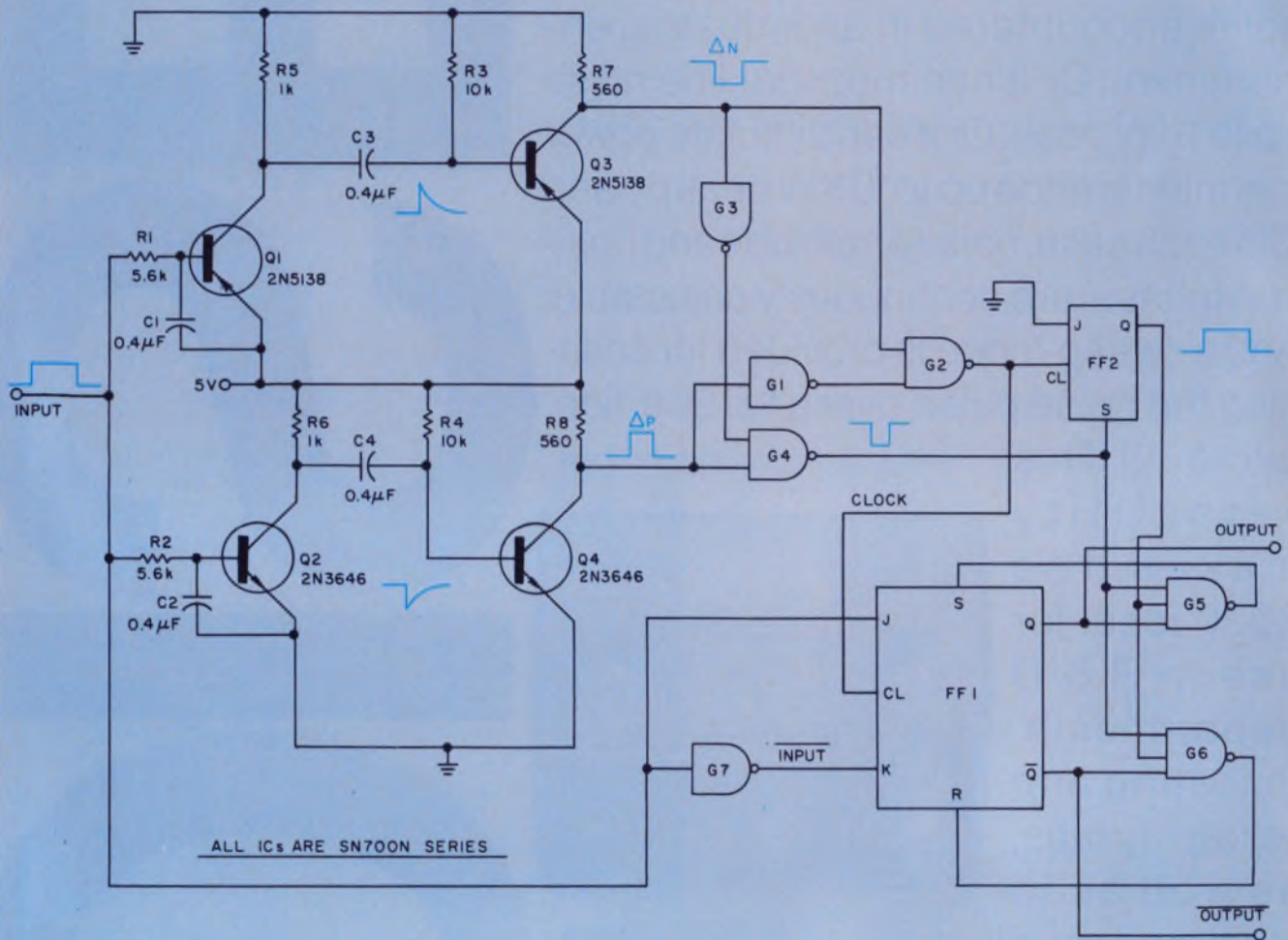

2. The minimum pulse-width,  $\Delta$ , is determined by R4C4 (R3C3) and represents the turn-off time of Q4 (Q3) for a positive (negative) pulse. Flip-flop

FF2 forces FF1 to retain its earlier status for pulses whose width is less than  $\Delta$ . Gate G2 clocks valid data to the output terminal.

Similarly, for a negative transition input from logic ONE to logic ZERO for  $t > \Delta$ , Q1, C3, Q3 and R3 perform as Q2, C4, Q4, and R4, respectively, but with opposite polarity.

The positive pulse output of the collector of Q4, of width  $\Delta$ , is inverted by gate G1. The output of Q3 is saturated to 5 V, and NAND gate G2 produces a positive pulse output of duration  $\Delta$ . Since the input signal and its inverse appear at the J-K terminals of flip-flop FF1, the falling edge of the output of gate G2 clocks the valid data to the circuit output.

Now let's consider a signal input of a duration too long to be rejected as noise, but less than the  $\Delta$  requirements of the demultiplexing circuit. What happens here is that both edges or transitions of the input signal get detected, and the  $\Delta$  for the positive input transition,  $\Delta P$ , and the

$\Delta$  for the negative input transition,  $\Delta N$ , overlap. Both Q3 and Q4 will be saturated for a time ( $\Delta P - \Delta N$ ). When this occurs, both inputs to the NAND gate G4 are high, thus setting flip-flop FF2.

The ONE output (Q) of flip-flop FF2 allows the previous data output of FF1 to force FF1 to retain that status by master set or master reset terminal inputs. Flip-flop FF2 is clocked reset by gate G2 when the trailing edge of the last pulse from Q3 or Q4 is felt. If TTL logic circuits are used, this technique also eliminates the problem of J-K input data levels changing state while the clock input to FF1 is high.

*Alphonso H. Marsh Jr., Senior Engineer, Raytheon Co., 111 Horse Pond Rd., Sudbury, Mass.*

VOTE FOR 311

A breakthrough in printed circuit board lighting technology—T-1 $\frac{3}{4}$  Tu-Pin lamps with PC Board Pin Sockets already installed. Pin socket lamps are stuffed as readily as soldered in lamps with no second operation of lamping. These lamps can be instantly removed from the sockets at any time. The gold-plated Pin Sockets remain in the board, ready to receive a replacement.

An added plus: the lamps and sockets cost only pennies more than lamps alone, and considerably less than competitive products. They offer an honest low-cost way to eliminate the desoldering,



resoldering cycle, and cut component shutdown. And they make re-lamping in the field a simple, easy exercise.

Available in a wide range of electrical ratings from 1.35 to 28V, Hudson Pin Socket lamps can be supplied with straight leads, or with leads bent at right angles for positioning perpendicular or parallel to the board.

Make these convenient lamps your beginning, too. Call your local Hudson representative, or write to Hudson Lamp Company, 528 Elm Street, Kearny, New Jersey 07032. (201) 997-1850

**The end of desoldering.  
The beginning of  
instant replacement.**

## Compute the arctangent for any argument with BASIC

The arctangent trigonometric function of an argument ratio ( $B/A$ ) is a built-in function,  $ATN(B/A)$ , of the BASIC language<sup>1</sup>, but the function is valid only for angles from  $0^\circ$  to less than  $90^\circ$ . It's possible, however, to write a flow chart in BASIC (a), using some FORTRAN function logic, and to use this to compute and print out the arctangent of ( $B/A$ ) for any quadrant (b).

This modified program overcomes the limitation of the BASIC  $ATN(B/A)$  by permitting the conditions  $B=0$ ,  $A=-1$  (180 degrees),  $B=1$ ,  $A=0$  (90 degrees),  $B=-1$ ,  $A=0$  (270 degrees), or  $A=0$ ,  $B=0$  (undefined angle), which are not allowed in  $ATN(B/A)$ . And it avoids the problems of the FORTRAN language<sup>2</sup>, in which the function  $ATN(B/A)$  does not permit the conditions  $B=0$ ,  $A=-1$  (180 degrees) or  $B=0$ ,  $A=0$  (undefined angle).

### References

1. Kiewit Computation Center Dartmouth College: BASIC Fifth Edition, September, 1970, p. 31
2. IBM Corp.: IBM System/360 Fortran IV Library Subprograms, IBM Pub. No. GC28-6596-5, Fifth Edition, October, 1968, p. 33.

*Robert J. Ertman, President, Scientronics, Inc., 55 Dunrovin Lane, Rochester, N.Y. 14618.*

VOTE FOR 312

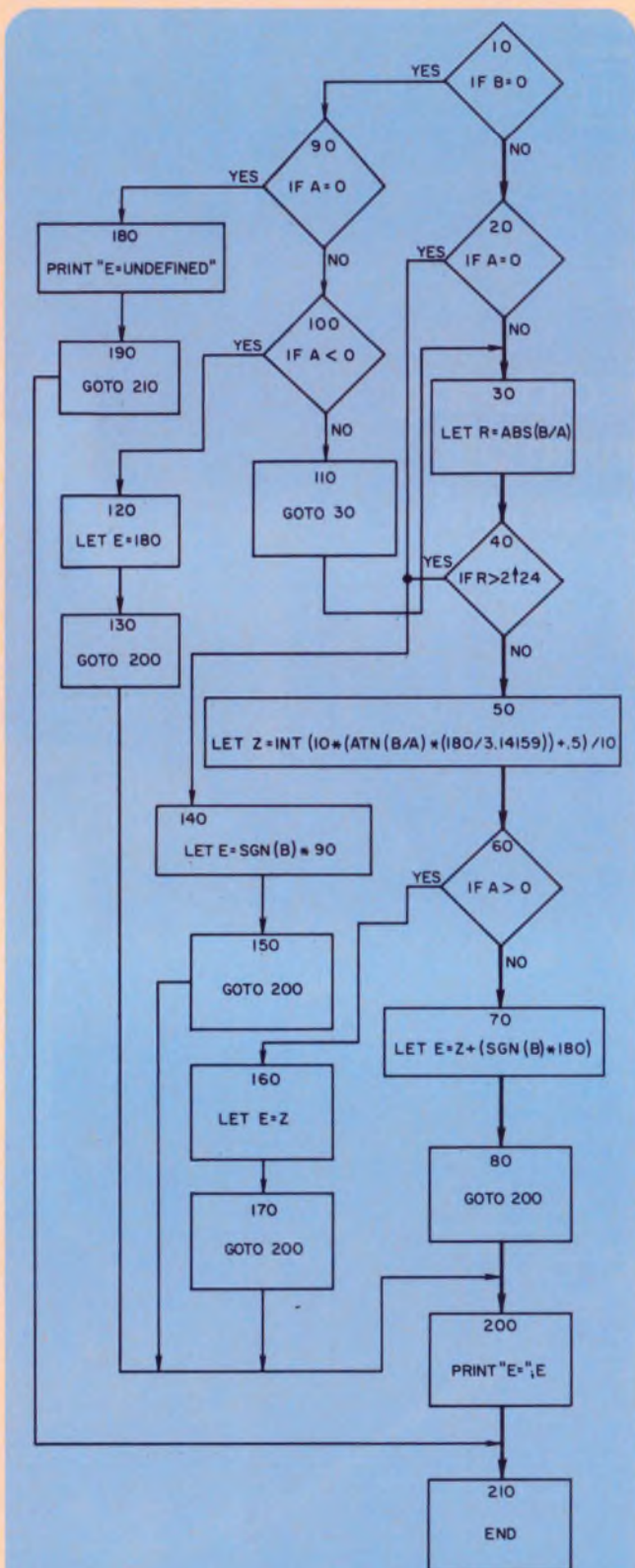

A modified BASIC program allows continuous calculation of the arctangent of the argument ratio ( $B/A$ ) from  $0^\circ$  up to  $360^\circ$ . With  $E$  the angle in degrees,  $A$  and  $B$  are, respectively, the  $X$  and  $Y$  projections of  $E$ .

```

10 IF B=0 THEN 90
20 IF A=0 THEN 140
30 LET R=ABS(B/A)
40 IF R>2+24 THEN 140
50 LET Z=INT(10*(ATN(B/A)*(180/3.14159))+.5)/10
60 IF A>0 THEN 160
70 LET E=Z+(SGN(B)*180)
80 GOTO 200
90 IF A=0 THEN 180
100 IF A<0 THEN 120
110 GOTO 30
120 LET E=180
130 GOTO 200
140 LET E=SGN(B)*90
150 GOTO 200
160 LET E=Z
170 GOTO 200
180 PRINT "E=UNDEFINED"
190 GOTO 210
200 PRINT "E=";E
210 END

```

(b)

# You probably need a programming system unlike any other ever built.

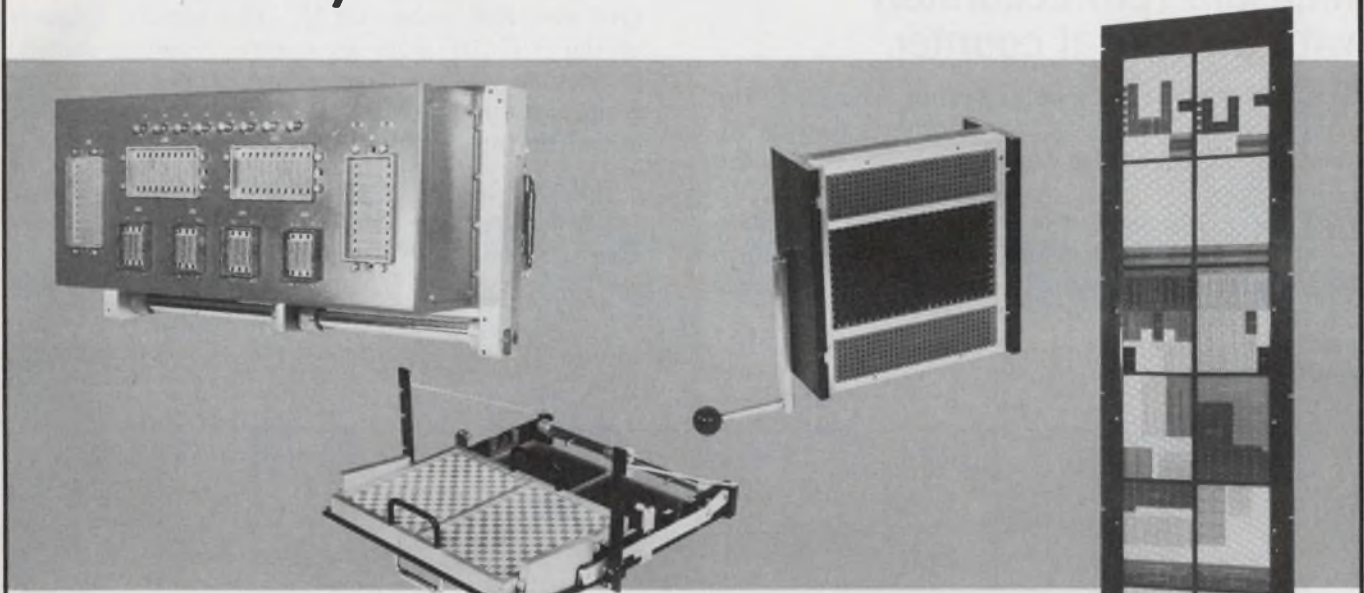

## So did the men we built these for.

Specialty patchboard programming systems have been Virginia Panel Corporation's business for nearly a decade. We create giants like the Fixed System on the right with nearly 10,000 contacts; or the first True-Through Shielded Coaxial Cable programming system next to it; the "System-in-a-Drawer" for space-saving consoles; or the 2,560-contact Roll Cam system that terminates in only 13 quick-change connectors.

And we stock more than 80 standard models.

Helping people like you make rapid or frequent changes in wiring sequences is what our designers and engineers do for a living. VPC systems can be found all over the world in analog computers, aerospace, communications, and specialized electronic test equipment.

You can rely on VPC for all accessory products, for complete service, and for special training if necessary. Our experienced marketing and technical men are based in every major city.

Let us mail you our 40-page catalog today. If you prefer, telephone (703) 942-8376 and a VPC programming systems specialist will be in your office whenever you say. We want to start working with you.



Virginia Panel Corporation  
1400 New Hope Road  
Waynesboro, Virginia 22980  
TWX 710-839-0406

## Measure rpm accurately with an optical counter

Here's a circuit for determining accurately the rpm of a disc, drum, wheel or other rotating object, by utilizing the light modulations of the object itself.

With this system, the train of optical pulses received at the phototransistor is converted into electrical pulses at  $V_1$ . These pulses are differ-

entiated by the first channel of the SN75107 to give modified pulses at  $V_2$ . The second channel of the SN75107 acts as a zero crossing switch, to provide clean square pulses at  $V_3$ . The meter is operated by the dc voltage at  $V_4$ , which is obtained by integrating  $V_3$ .

*Dale Pippenger, Applications Engineer, Texas Instruments, Inc., 13500 North Central Expressway, P.O. Box 5012, Dallas, Tex. 75222*

VOTE FOR 313

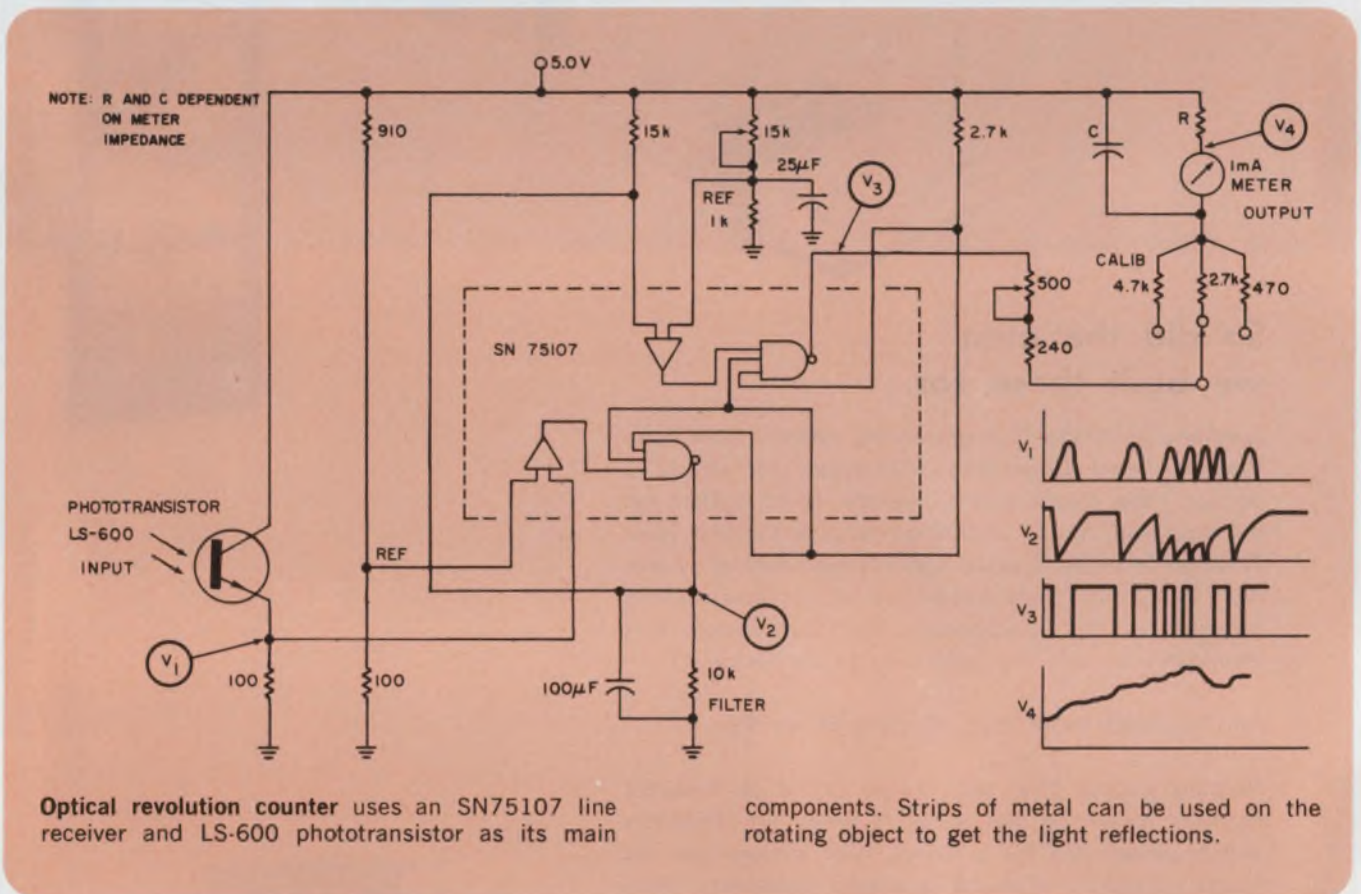

### IFD Winner for May 13, 1971

**John A. DeFalco**, Principal Engineer, Honeywell Information Systems, Framingham, Mass. 01701. His idea "TTL-compatible crystal oscillator operates from 5-V power supply" has been voted the Most Valuable of Issue award.

**Vote for the Best Idea in this Issue.**

**VOTE!** Go through all Idea-for-Design entries, select the best, and circle the appropriate number on the Reader-Service-Card.

**SEND US YOUR IDEAS FOR DESIGN.** You may win a grand total of \$1050 (cash)! Here's how. Submit your IFD describing a new or important circuit or design technique, the clever use of a new component or test equipment, packaging tips, cost-saving ideas to our Ideas-for-Design editor. You will receive \$20 for each accepted idea, \$30 more if it is voted best-of-issue by our readers. The best-of-issue winners become eligible for the Idea Of the Year award of \$1000.



# GIGA-TRIM

trimmer capacitors  
for Microwave Designers

**VARACTOR  
DIODES**



Some companies make their Microwave variable capacitors like this. (Voltage tuneable capacitors).

**GIGA-TRIM**

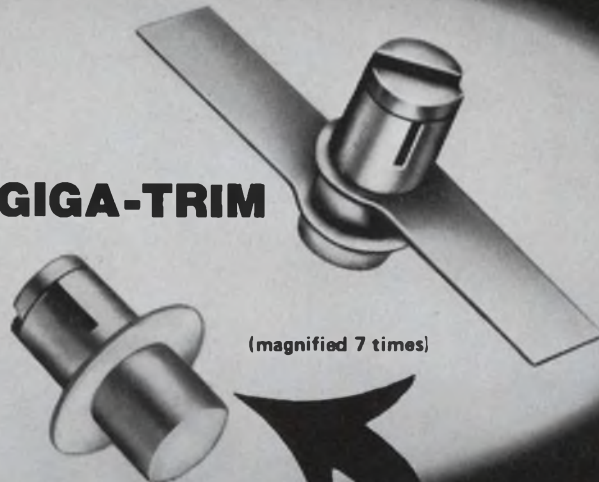

(magnified 7 times)

We, at TEKELEC AIRTRONIC make our Microwave variable capacitors like this (Mechanically tuneable capacitors).

**Q as high as 4000 at 100 MHz**  
**19 models available. For special models refer to factory.**  
**Reactive tuning into K band.**

## APPLICATION IDEAS

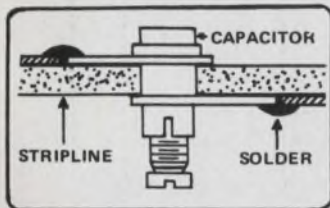

Mounting configuration ideally suited for parallel tuning of striplines.

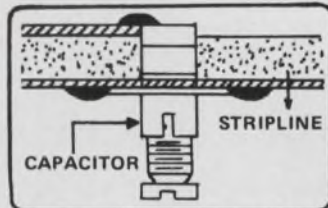

Mounting configuration ideally suited for parallel tuning of striplines.

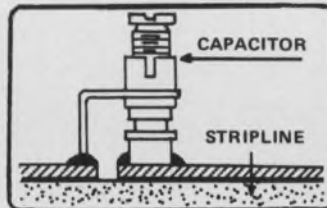

Mounting configuration for striplines. Permits "series" tuning.



actual size

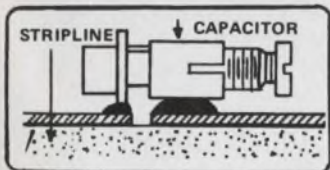

Mounting configuration ideally suited for strip lines or hybrid circuits.

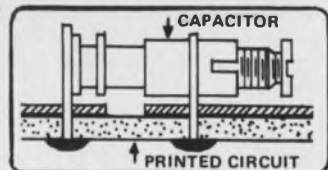

Mounting configuration for printed circuits. Microminiature sizes.

## OTHER PRODUCTS

- Microwave capacitive tuning screws for high Q variable tuning through K band of microwave cavities, filters and other resonant structures.
- High Q air trimmer capacitors.
- Miniature glass trimmer capacitors for microcircuitry.
- Hardware.

For full details contact :

**TEKELEC TA AIRTRONIC**

*Johanson* LICENSEE

273 TP

FRANCE : ■ PARIS (Head Office) : TEKELEC AIRTRONIC Cité des Bruyères - Rue Carle Vernet - 92. SEVRES - FRANCE - Tél. : 626.02.35 et 626.24.38 - Télex 25 997.

BELGIUM : ■ AVIELEC nv. av. Ed. Mesens laan, 73 1040 BRUSSELS - Tél. : (02) 33-96-00 ■ GERMANY (Northern) : HEK gmbh Kaninchenborn 28 - 24. LUBECK ■ GERMANY (Central & Southern) : Tekelec Airtronic GmbH Heinrich Wieland str. 170 - 800 Munich 83 - Tél. : (0811) 40.50.01 ■ ITALY : Tekelec Airtronic SpA Viale Romagna 14, 20133 Milan - Tél. : 73.85.674 ■ HOLLAND : Tekelec Airtronic NV Kruislaan 235 Amsterdam 0 Tél. : (020) 92.87.66 ■ ENGLAND : MCP ELECTRONICS Ltd Alperton, Wembley, Middx ■ SWITZERLAND : FABRIMEX Kirchenweg 5.8032 ZURICH ■ SWEDEN : AB GOSTA P.O.B. 12089 Stockholm 12 ■ NORWAY : A.F. ULRICHSEN Hasleveien 28 - OSLO 5 ■ DENMARK : Ev JOHANSEN A/S Scherfigsvej 1 - 2100 Copenhagen Ø ■ FINLAND : HAVULINNA OY Vuorikatu 16 - HELSINKI 10 ■ SPAIN : UNITRONICS Torre de Madrid Princesa 1 Plaza de Espana - Madrid 8 ■ OTHER COUNTRIES : Please consult Paris Head Office.

INFORMATION RETRIEVAL NUMBER 38



BETTER QUALITY AND RELIABILITY THROUGH CONTROL

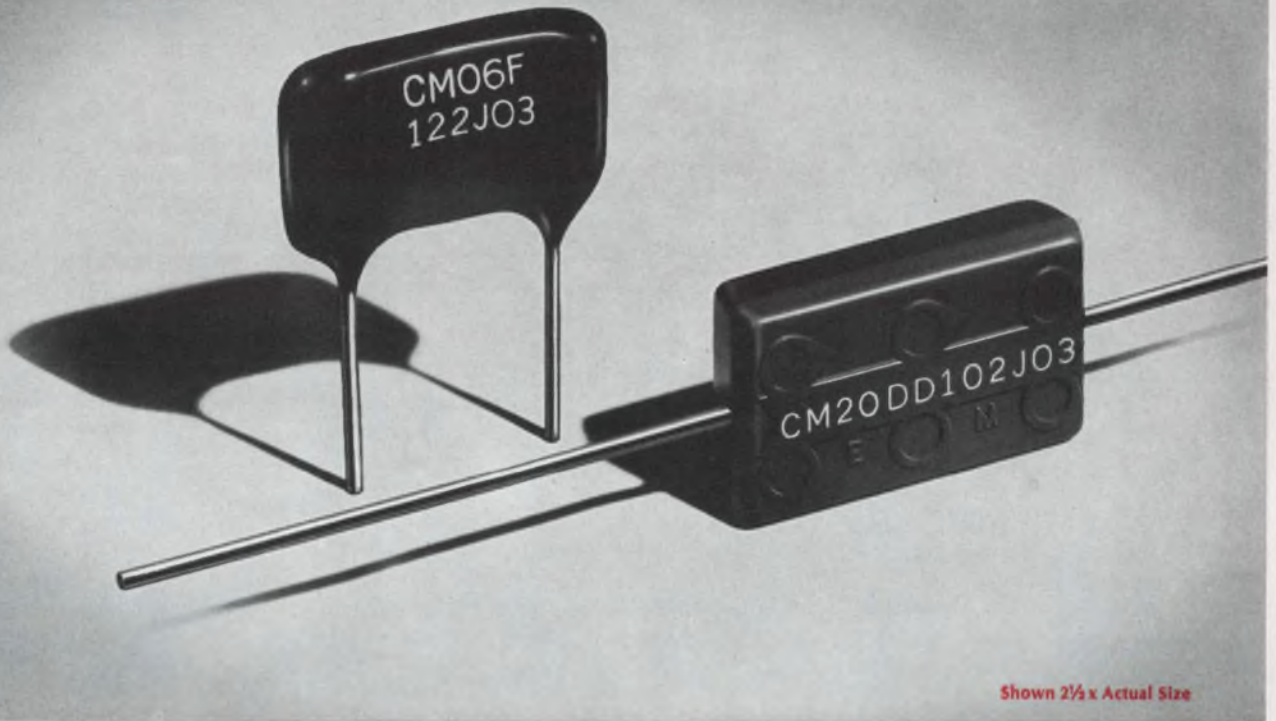

## Capacitor Problems That Require A Lot Of Self-Control...Chemically Speaking

**Problem 1:** How to make sure the silver paste composition used for electrodes provides the best results for each electrical parameter in a given capacitor design?

**Problem 2:** How to improve the recognized moisture reliability of our dipped mica capacitors without adversely affecting life reliability?

**Problem 3:** How to upgrade the reliability of molded mica capacitors to equal that of dipped mica capacitors so designers can take advantage of body uniformity and axial lead design?

**Solution: Chemical self-control!** To do this we operate our own chemical manufacturing plant where we formulate silver pastes, phenolic dipping compounds, and epoxy molding compounds — all under strict controls.

**Result:** Dipped mica capacitors and molded mica capacitors of equally high reliability that operate up to 150°C. Send for technical literature and always insist on El-Menco brand capacitors . . . your assurance of better quality and reliability through control.

### THE ELECTRO MOTIVE MFG. CO., INC.

WILLIMANTIC, CONNECTICUT 06226

Dipped Mica • Molded Mica • Silvered Mica Films • Mica Trimmers & Padders  
Mylar-Paper Dipped • Paper Dipped • Mylar Dipped • Tubular Paper

West Coast Manufacturers contact: COLLINS & HYDECO., 900 N. San Antonio Rd., Los Altos, California 94022  
5380 Whittier Blvd., Los Angeles, California 90022

ALSO SOLD NATIONALLY THROUGH ELECTRONIC PARTS DISTRIBUTORS

INFORMATION RETRIEVAL NUMBER 39

# new products

## Low-power monolithic op amp is completely programmable

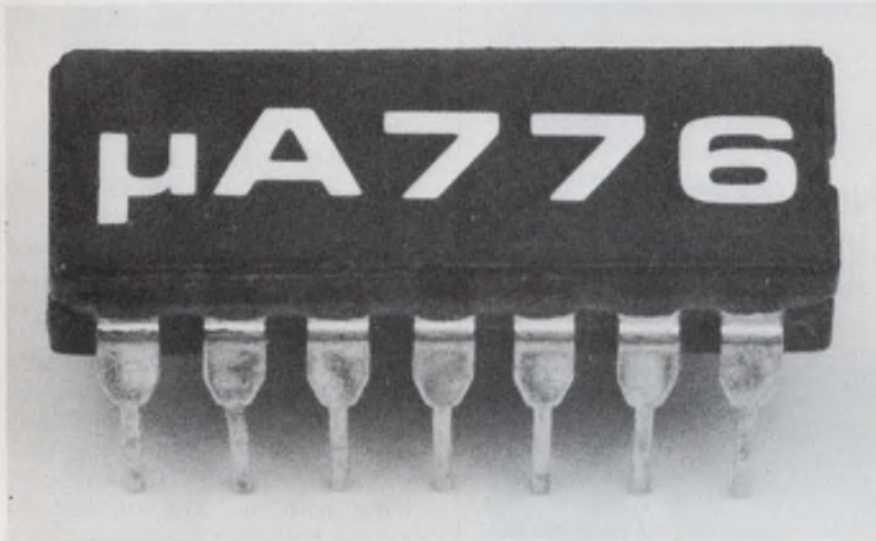

Fairchild Semiconductor, 315 Fairchild Dr., Mountain View, Calif. Phone: (415) 962-5011. P&A: see text; stock.

With only one external resistor, a new micro-power monolithic op amp can be programmed for a wide range of characteristics—gain, bandwidth, slew rate and power dissipation.

Designated as the  $\mu A776$ , it allows a circuit designer to tailor an op amp's characteristics to his needs.

An external programming resistor sets the current level in a master current source that powers the op amp. This current in turn biases all of the op amp's circuitry and determines its operating characteristics. The resistor can be set to currents from 1 nA to 100  $\mu A$ .

At a low set current, the  $\mu A776$  exhibits very low input current, noise current and power dissipation. For example, at a set current of 0.05  $\mu A$ , input offset current and voltage are 0.05 nA and 2 mV, and input current and voltage noise are 0.02 pA/ $\sqrt{Hz}$  and 270 nV/ $\sqrt{Hz}$ , respectively. Quiescent supply current is down to 0.4  $\mu A$ . Open-loop gain is  $10^4$ , slew rate is 0.006 V/ $\mu s$

and unity-gain bandwidth is 10 kHz. The op amp's bias current is a mere 0.15 nA.

At 50  $\mu A$  of set current, the  $\mu A776$  has input offset current and voltage of 12 nA and 2 mV, and input current and voltage noise of 0.15 pA/ $\sqrt{Hz}$  and 20 nV/ $\sqrt{Hz}$ , respectively. Quiescent current is 350  $\mu A$ . However, open-loop gain increases to  $2.5 \times 10^6$ , slew rate becomes 2 V/ $\mu s$  and unity-gain bandwidth is expanded to 2 MHz. The bias current is only 40 nA.

An important feature of the  $\mu A776$  is the fact that it can operate from any voltage as low as  $\pm 1.2$  to as high as  $\pm 18$  V. This means that it can be operated off two battery cells. And with the proper set resistor, the total power drain of the device will be lower than the battery leakage.

The op amp is internally compensated and protected against latch-up and short-circuits.

Unit prices for 1 to 24 quantities are \$11.04 for a metal-can TO-5 version rated to operate  $-55$  to  $+125^\circ C$ ; and \$4.10 for a TO-5 or plastic DIP unit operating over 0 to  $+70^\circ C$ .

CIRCLE NO. 250

## Single TV IC includes complete audio section

Societa Generale Semiconduttori; Via C. Olivetti, 1, 20041-Agate Br., Milan, Italy.

A new 16-pin DIP monolithic IC is expected to revolutionize the design of the sound section of TV receivers. Designated TBA631, it includes the following circuit functions: a 3-stage limiting amplifier, an FM coincidence detector, an audio separator and pre-amp, a self-balancing system and driver and a power output stage. Thus it forms the complete sound section from video driver to loud-speaker.

CIRCLE NO. 251

## Mixer/modulator ICs respond to 175 MHz

Lithic Systems, Inc., 10010 Imperial Ave., Cupertino, Calif. Phone: (408) 257-2004. Price: \$4.80 for LS2596 (100 quantities).

The LS1496/LS1596 double-balanced mixer/modulators are improved versions of the older MC-1596 IC with double the useful frequency range to 175 MHz. They feature low power drain and high internal carrier suppression of 65 dB. The LS1496 operates at 0 to  $+70^\circ C$  and the LS1596 at  $-55$  to  $+125^\circ C$ . DIP and TO-100 packages are available.

CIRCLE NO. 252

## Static shift register has dual 50-bit sections

Solitron Devices, Inc., 8808 Balboa Ave., San Diego, Calif. Phone: (714) 278-8780.

The UC7355 is a dual 50-bit static shift register. It consists of p-channel MOS devices integrated on a monolithic chip. Input, clock data, and output lines are DTL/TTL compatible without external circuitry. The registry is completely static for either state of the clock. Features include a single clock input and input static-charge protection.

CIRCLE NO. 253

EVALUATE  
**BOURNS**  
**LOW COST**  
**FAMILY** OF TRIMPOT® POTENTIOMETERS  
CALL ANY OF THE DISTRIBUTORS LISTED BELOW FOR A

...KIT!

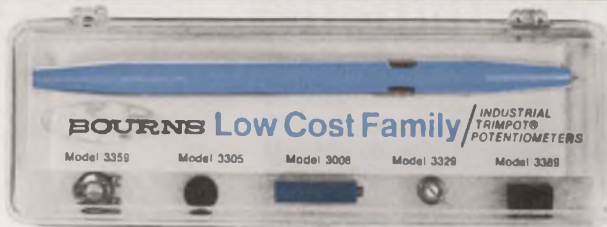

A \$7.75 VALUE FOR ONLY

**\$3.00**

PROVE TO YOURSELF THAT  
BOURNS QUALITY AND LOW-COST  
HAVE BEEN COMBINED

**ALABAMA**

Cramer/E.W., Inc.  
Huntsville, 205 539-5722

**ARIZONA**

Kierulff Electronics  
Phoenix, 602 273-7331

**CALIFORNIA**

Westates Electronics Corp.  
Chatsworth, 213 341-4411  
Hamilton Electro Sales  
Culver City, 213 870-7171  
Liberty Electronics Corp.  
El Segundo, 213 776-6252

Elmar Electronics, Inc.  
Mountain View, 415 961-3611  
Hamilton/Avnet  
Mountain View,  
415 961-7000

Kierulff Electronics  
Palo Alto, 415 968-6292  
Electronic Supply Corp.  
Riverside, 714 683-8110  
Western Radio  
San Diego, 714 239-0361

**COLORADO**

Hamilton/Avnet  
Denver, 303 433-8551  
Kierulff Electronics  
Denver, 303 343-7090

**CONNECTICUT**

Connecticut Electro Sales  
Hamden, 203 288-8266  
Cramer Electronics, Inc.  
North Haven, 203 239-5641

**FLORIDA**

Cramer/E. W. Inc.  
Hollywood, 305 923-8181  
Gulf Electronics  
Miami, 305 887-6541  
Hamilton/Avnet  
Hollywood, 305 925-5401  
Hammond Electronics, Inc.  
Orlando, 305 241-6601

**GEORGIA**

Jackson Electronics Co.  
Atlanta, 404 355-2223

**ILLINOIS**

Allied Electronics Corp.  
Chicago, 312 421-6800  
Newark Electronics  
Chicago, 312 421-2400  
Hamilton/Avnet  
Schiller Park, 312 678-6310

**INDIANA**

Fort Wayne Electronics  
Supply, Inc.  
Fort Wayne, 219 742-4346

Graham Electronics Supply, Inc.  
Indianapolis, 317 634-8486

**KANSAS**

Hall-Mark Electronics, Inc.  
Kansas City, 913 236-4343

**MARYLAND**

Pytronic Industries, Inc.  
Baltimore, 301 539-6525  
Hamilton/Avnet  
Baltimore, 301 796-5000  
Washington, 202 935-5600  
Schweber Electronics  
Rockville, 301 427-4977

**MASSACHUSETTS**

Electrical Supply Corp.  
Cambridge, 617 491-3300  
Cramer Electronics, Inc.  
Newton, 617 969-7700

**MICHIGAN**

Harvey-Michigan  
Romulus, 313 729-5500

**MINNESOTA**

Lew Bonn Co.  
Edina, 612 941-2770

**MISSISSIPPI**

Ellington Electronic Supply, Inc.  
Jackson, 601 355-0561

**MISSOURI**

Hamilton/Avnet  
Hazelwood, 314 731-1144  
Hall-Mark Electronics Corp.  
St. Louis, 314 521-3800

**NEW JERSEY**

General Radio Supply Co., Inc.  
Camden, 609 964-8560  
Hamilton/Avnet  
Cherry Hill, 609 662-9337  
Eastern Radio Corp.  
Clifton, 201 471-6600

**NEW MEXICO**

Electronic Parts Co., Inc.  
Albuquerque, 505 265-8401

**NEW YORK**

Standard Electronics, Inc.  
Cheektowaga, 716 685-4220  
Cramer/Esco, Inc.  
Hauppauge, 516 231-5600  
Milo Electronics Corporation  
Syosset, 516 364-1111  
Cramer-Eastern  
East Syracuse, 315 437-6671  
Hamilton/Avnet  
Syracuse, 315 437-2641  
Federal Electronics, Inc.  
Vestal, 607 748-8211  
Schweber Electronics  
Westbury, L. I., 516 334-7474

Harvey Radio Company, Inc.  
Woodbury, L. I., 516 921-8700

**NORTH CAROLINA**

Cramer/E.W., Inc.  
Winston-Salem, 919 725-8711

**OHIO**

Hughes-Peters, Inc.  
Cincinnati, 513 351-2000  
Pioneer Standard Electronics, Inc.  
Cleveland, 216 432-0010  
Hughes-Peters, Inc.  
Columbus, 614 294-5351

Pioneer/Dayton  
Dayton, 513 236-9900

**OKLAHOMA**

Hall-Mark Electronics  
Tulsa, 918 835-8458

**PENNSYLVANIA**

Pytronic Industries, Inc.  
Montgomeryville, 215 242-6700  
Powell Electronics  
Philadelphia, 215 724-1900  
Cameradio Company  
Pittsburgh, 412 391-7400

**RHODE ISLAND**

Wm. Dandreta & Co.  
Providence, 401 861-2800

**TEXAS**

Hall-Mark Electronics Corp.  
Dallas, 214 231-6111  
Hamilton/Avnet  
Dallas, 214 638-0900  
Harrison Equipment Co., Inc.  
Houston, 713 224-9131

**UTAH**

Standard Supply Co.  
Salt Lake City, 801 355-2971

**WASHINGTON**

Liberty Electronics/Northwest  
Seattle, 206 763-8200

**WISCONSIN**

Taylor Electric Co.  
Mequon, 414 241-4321

**CANADA**

Cesco Electronics Ltd.  
Montreal, Que., 514 735-5511

Cesco Electronics  
Ottawa, Ont., 613 729-5118

Cesco Electronics  
Quebec City, Que.  
418 524-4641

Zentronics Ltd.  
Toronto 19, Ont., 416 781-6651

Varatronics Industries, Ltd.  
Vancouver, B.C., 604 736-9252

ICs & SEMICONDUCTORS

Monolithic FET drivers  
switch on in 100 ns

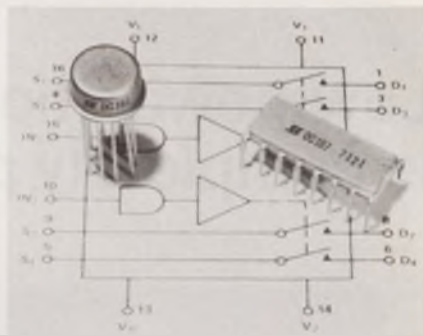

Siliconix, Inc., 2201 Laurelwood Rd., Santa Clara, Calif. Phone: (408) 246-8000. P&A: \$17.50, \$8.75 (100 quantities); stock.

Two new families of high-speed drivers with JFET switches feature 100 ns typical switching times and break-before-make action. The DG181 family of n-channel FETs and associated monolithic drivers is available in two-channel versions with both spst and dpst configurations. The DG187 series includes both one and two-channel devices, with spdt functions.

CIRCLE NO. 254

Dual monolithic op amps  
increase circuit density

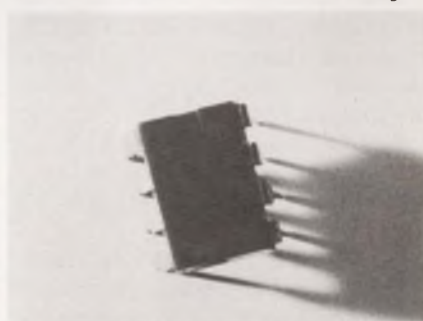

Raytheon Semiconductor, 350 Ellis St., Mountain View, Calif. Phone: (415) 968-9211. Availability: stock to 4 wks.

Two new dual high-gain monolithic op amps, RM4558 and RC4558, feature offset-voltage null capability, no latchup, continuous short-circuit protection, low-power consumption of 100 mW and internal frequency compensation on a single chip. Their excellent channel separation allows them to be used in all single type 741 op amp applications.

CIRCLE NO. 255

**YOUR BOURNS TRIMPOT PRODUCTS DISTRIBUTOR**  
INFORMATION RETRIEVAL NUMBER 40

# BOURNS

# LOW COST FAMILY

## OF INDUSTRIAL TRIMPOT<sup>®</sup> POTENTIOMETERS

# OFF THE SHELF AS LOW AS... 49¢\*



Model  
3305



Model  
3359



Model  
3369



Model  
3389

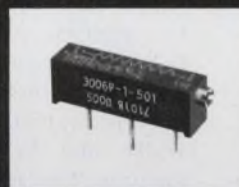

Model  
3006



Model  
3329



Model  
3009

### POWER:

1/2 WATT (or better) AT 70°C.

### TEMPCO:

AS LOW AS 100PPM/°C OVER ENTIRE  
-55° TO +125°C TEMPERATURE RANGE.

Bourns LOW-COST FAMILY was designed specifically to fill the requirements of cost-conscious industrial users — so were the prices! Imagine how they reduce on large production-run quantities. As a bonus, you get Bourns TRIMPOT potentiometer quality, reliability and performance.

### AVAILABILITY

All models shown are stocked in depth RIGHT NOW, so delivery is off-the-shelf from the factory or your local Bourns distributor.

Complete data on all models of the LOW-COST FAMILY is available upon request. Just write, or call, your local Bourns Sales office, representative, or distributor.

\*1000-piece price Model 3389



BOURNS, INC., TRIMPOT PRODUCTS DIVISION • 1200 COLUMBIA AVE., RIVERSIDE, CALIF. 92507

INFORMATION RETRIEVAL NUMBER 41

## Duplex receiver/transmitter occupies a single DIP IC



American Micro-systems, Inc., 3300 Homestead Rd., Santa Clara, Calif. Phone: (408) 246-0330. P&A: \$58.50 (1 to 24), \$45.50 (24 to 99), \$36.40 (100 to 999); stock.

The UART\* (Universal Asynchronous Receiver/Transmitter) is an MOS/LSI IC that functions as a full duplex receiver and transmitter for use in a wide variety of data communications applications.

Designated as the model S1757, the UART IC converts asynchronous serial binary characters to parallel format. Simultaneously, it converts parallel binary characters to a serial asynchronous output with start and stop bits added.

All characters contain a start bit, 5, 6, 7 or 8 data bits, an odd or even parity bit (or no parity bit) and one or two stop bits.

This TTL/compatible chip, packaged in a 40-pin dual-in-line case, functionally replaces approximately 25 TTL/MSI packages, including shift registers, latches and counters.

It can be universally programmed through five available control pins and a control enable input which can be strobed or hard-wired.

This programming feature allows for interface with a wide

variety of communication devices such as Teletype Corp.'s model 28, 32, 33, 37 and Inktronic Teletypes, IBM's 2741 communications terminal, all popular CRT terminals and many other peripherals.

The IC's receiver section includes an input data buffer register to eliminate precise external timing of the loading of parallel input data, and synchronizing circuits to prevent variations in start pulse width due to asynchronous data loading. The receiver also includes parity bit generation circuitry and end-of-transmission and buffer-empty flag outputs.

The receiver section incorporates a start-bit detection scheme which rejects input noise pulses and allows for errorless capture of data with up to 42% of input distortion. Error checking features include parity, framing and overrun.

Flag outputs are provided when an error condition is detected. Received-data and flag outputs are stored by the chip until it receives the next character. These outputs can be wire-OR'd and are provided with separate enable inputs for use in bus-organized applications.

The new UART IC will operate at transmission rates ranging from dc to 10,000 baud. It includes separate TTL-compatible clock inputs for the receiver and transmitter.

\*Trademark pending.

CIRCLE NO. 256

## TV signal-processor IC includes 4 functions

Motorola Semiconductor Products, Inc., Box 20924, Phoenix, Ariz. Phone: (602) 273-6900. Price: 95¢ (1000 to 4999 quantities).

The new MC1345 TV signal processor IC provides sync separation, noise inversion, age keying and amplification and adjustable rf age delay for monochrome or color sets. It replaces at least four transistors and the passive components associated with them. The device provides a 10-V range of positive or negative-going age voltage to a tuner and a 16-V pk-to-pk sync output.

CIRCLE NO. 257

## Low-noise IC compares 4-bit binary pairs

Teledyne Semiconductor, 1300 Terra Bella Ave., Mountain View, Calif. Phone: (415) 968-9241. P&A: \$6 (100 quantities); stock.

A new high-noise-immunity device is the 343 comparator which compares any pair of four-bit binary numbers. Designed for use in industrial applications, the 343 has three active-high outputs: "equal to," "less than" and "greater than." The "equal to" and "greater than" inputs can be tied to the corresponding outputs of a second 343 to provide cascaded operation.

CIRCLE NO. 258

## Switching transistors are for power supplies

RCA Solid State Div., Route 202, Somerville, N.J. Phone: (201) 485-3900. P&A: from \$2.51 to \$9.95 (100 quantities); stock.

Five new 450-V npn power switching transistors for off-line power-supply applications are available. Types 40850 through 40854 are for 5-V supplies with ratings of 25, 50, 100 or 200 A, and for 30-V supplies with ratings of 5, 10, 20, or 40 A. Types 40850 and 40851 have collector ratings of 2 and 7 A, respectively. Types 40852, 40853, and 40854 have ratings of 7, 10 and 15 A, respectively.

CIRCLE NO. 259

## OCR terminal system costs \$250/month



*Input Business Machines, Inc., 12111 Park Lawn Dr., Rockville, Md. Phone: (301) 881-0661.*

A low price, uncomplicated, true optical-character recognition terminal is being offered as an alternative to keypunch and key-to-tape devices. In a system configuration, the system's price is as low as \$250/month. The remote intelligence terminal, RIT 200 OCR reader permits gradual changeover to full-blown OCR source document automation. It makes on-line data entry easily accessible to non-equipment operators.

CIRCLE NO. 260

## High-resolution video disc uses phone lines



*Infotechnics, Inc., 15730 Stagg St., Van Nuys, Calif. Phone: (213) 780-3615. P&A: from \$3000; 2 wks.*

A new magnetic disc recorder with a 14-in.-dia disc, known as Teledisc, can record up to 500 television frames with a resolution of at least 300 horizontal lines. By means of an acoustic coupler attachment, information recorded on the disc is transmitted from a Teledisc in one location to an identical machine in another location in 84 seconds via ordinary telephone lines.

CIRCLE NO. 261

## Analog modem optimizes video transmissions

*Phonocopy, Inc., 120 Long Ridge Rd., Stamford, Conn. Phone: (203) 356-3069. Price: \$500 to \$750.*

The PH-4000A wide-bandwidth, analog data modem has been designed specifically to fill the performance and cost requirements of redundant pictorial data transmission in systems such as Slow-Scan TV, scan-type CRT terminals and facsimile. It is linear in phase and has a frequency response extending beyond 2000 Hz. Equalization for the Direct Distance Dialing network is available.

CIRCLE NO. 262

## EDP interface makes typewriters I/O devices

*Hypertech Corp., 7343 W. Wilson Ave., Harwood Heights, Ill. Phone: (312) 867-4200. P&A: under \$1000; 45 days.*

A new stand-alone, self-contained interface unit enables EDP users to incorporate an IBM I/O Selectric typewriter into their system, as either an output printer or an input station. Called the HyperTyper, it interacts with the Selectric 731 or 735 in a closed-loop mode, and provides all the interface circuitry required to convert ASCII to Selectric or correspondence code.

CIRCLE NO. 263

## Manual programmer tests many linear ICs

*Signetics Measurement/Data, 341 Moffett Blvd., Mountain View, Calif. Phone: (415) 961-9384. P&A: \$980; 60 days.*

The 450 manual programmer is designed to operate as an accessory to the model 1420 linear IC tester. The programmer provides its user with capability of testing different device types using a single program board. Sense amplifiers, voltage regulators, comparators, op amps, voltage followers and video amplifiers can all be tested.

CIRCLE NO. 264

# NEW Mini-Module Regulated dc POWER SUPPLIES



Now you can save space and improve reliability by mounting an Acopian mini-module power supply directly into a printed circuit board. Sizes start at 2.32" x 1.82" x 1". Both single and dual outputs are available. And the duals can be used to power op amps or for unbalanced loads. Other features include:

- Choice of 58 different single output modules ranging from 1 to 28 volts, 40 ma to 500 ma
- 406 combinations of dual output modules with electrically independent, like or different outputs in each section
- 0.02 to 0.1% load and line regulation, depending on model
- 0.5 mv RMS ripple
- Prices as low as \$39 for singles, \$58 for duals

Do you have the latest Acopian catalog? It lists over 82,000 AC to DC power modules for industrial or MIL-spec applications. For your copy, write Acopian Corp., Easton, Pa. 18042, or call (215) 258-5441. And remember, every Acopian power module is shipped with this tag...



# Building-block power supply covers -300 to +25,000 V dc

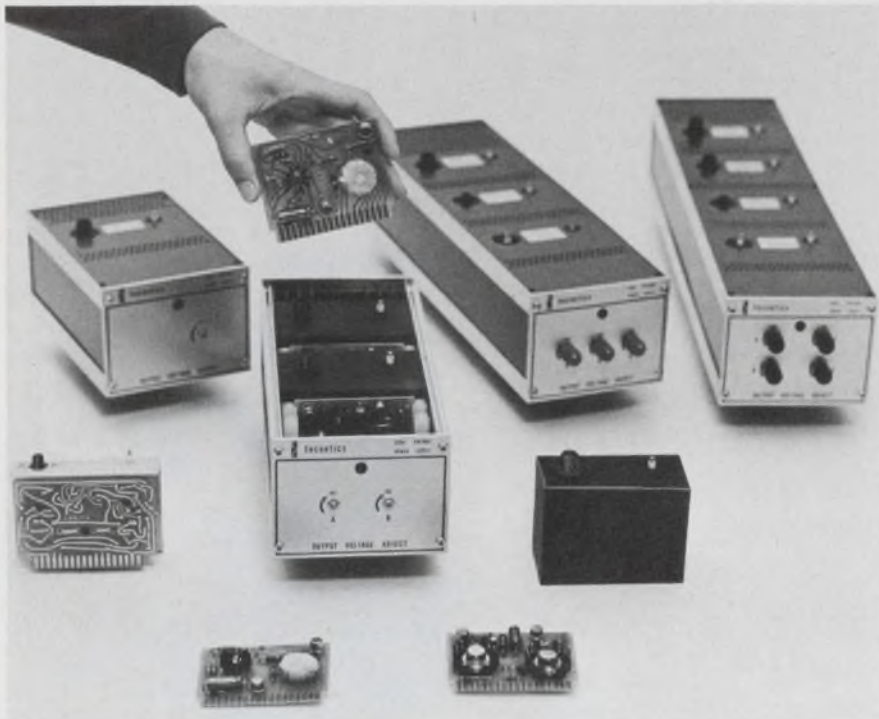

*Tecnetics, Inc., Boulder Industrial Park, Boulder, Colo. Phone: (303) 442-3837. P&A: from \$250; stock to 2 wks.*

A new high-voltage power supply consists of a variable-length frame into which various output-voltage modules, each an off-the-shelf item, can be plugged, to give an output voltage span of -300 to +25,000 V dc, in nine adjustable ranges.

Designated the HV series, the power supply system provides the designer a wide voltage range with standard building-block modules. It was designed for all high-voltage applications and is particularly useful for CRT display systems where multiple voltage outputs are required.

Each of the HV series' voltage ranges can be purchased with either standard or precision regulation. Typically, a standard 16 to 25-kV output module would have 3% load regulation at 25 kV for 1/2 to full-load conditions. This regulation can be improved to 0.3% if a precision regulator module is used to replace the standard one.

Line regulation, which is typically 0.35% for the above-mentioned voltage range (rated over 25 to 32 V), can likewise be improved with a precision regulator to 0.04%.

The basic parts of the HV series supply are the frame, clock assembly, regulator and voltage outputs. The standard and precision regulators and output-voltage circuits are all on plug-in cards.

Four standard frame lengths are available, designated the HV01 to HV04, to accommodate one to four output voltage modules. Nine standard modules supply voltage ranges from 0 to 1 kV dc to 16 to 25 kV dc. Most can be obtained with either standard or precision regulation. A 6.3 V ac output module is also available.

The HV series supply exhibits pk-pk ripple ranging from 0.2% to 0.3%, including spikes. Temperature coefficient is 0.035%/°C.

Frames are available either fully enclosed in blue vinyl finish or open. If rack-mounting is desired, flanges can be supplied for this purpose.

CIRCLE NO. 265

# 6-digit numeric display includes decimals

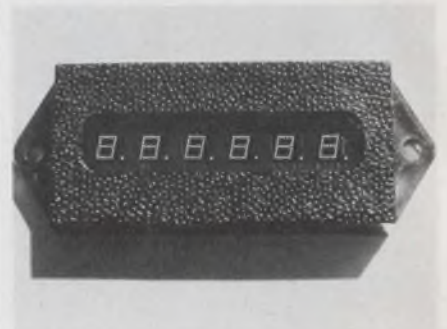

*Fairchild Microwave and Optoelectronics, 3500 Deer Creek Rd., Palo Alto, Calif. Phone: (415) 493-3100. P&A: \$7.95/digit; stock.*

The FND21 six-digit (0.122-in. high) numeric display features bright red numerals and individual monolithic digits, each with following decimals on a common ceramic substrate. Digits are brightness-matched for consistent light output. The units, encapsulated in a molded red plastic package, can be plugged into standard DIP sockets or soldered to a PC board.

CIRCLE NO. 266

# 10-MHz a/d converters start from \$5900



*Computer Labs, 1109 S. Chapman St., Greensboro, N.C. Phone: (919) 292-6427. P&A: see text; 4 to 6 wks.*

A new line of high-speed a/d converters are some 20% cheaper in cost than predecessor models. Models 5610, 5710 and 5810 are capable of 10-MHz word conversion rates with resolutions of 6, 7 and 8 bits, and cost only \$5900, \$6300 and \$6900, respectively. Electrical characteristics are comparable or improved over predecessor models 610, 710 and 810.

CIRCLE NO. 267



### Card edge connector fits 0.156-in. centers

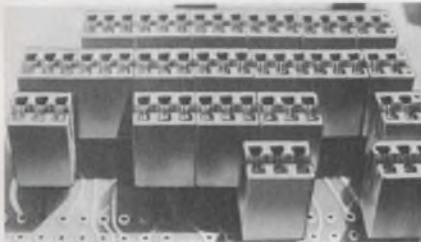

Elco Corp., Willow Grove, Pa. Phone: (215) 659-7000.

A new modular card edge connector provides a means to update connection systems, without the need to redesign existing PC cards, with its 0.156-in. center contact traces. Called the series 6318, it comes in modules of four and six contacts. The modules can be ganged together to custom design connectors to fit existing PC cards without soldering.

CIRCLE NO. 268

### DIP 24-pin sockets use replaceable contacts

Scanbe Manufacturing Corp., 3445 Fletcher Ave., El Monte, Calif. Phone: (213) 579-2300. P&A: \$1 to \$2; stock to 1 wk.

New 24-pin DIP sockets are available in both solderless wrap or solder-in types with replaceable contacts. Their gold-over-nickel, phosphor-bronze contacts are of a high reliability double-wiping design which affords good electrical and mechanical characteristics. The contacts will accept 0.008 to 0.023-in. round or flat leads with a contact resistance of 8 to 10 mΩ.

CIRCLE NO. 269

### Silicone elastomer varies in conductivity

Technical Wire Products, Inc., 129 Dermody St., Cranford, N.J. Phone: (201) 272-5500.

SC-Consil is a new conductive silicone elastomer formulated to provide high to moderate electrical conductivity. Generally described as semi-conductive, the standard compound has a nominal volume resistivity of 1.0 ohm-cm. This basic elastomer can be modified to produce parts with volume resistivities from 10 to 100,000-ohm cm.

CIRCLE NO. 270

### Dual-in-line heat sinks fit 14 and 16-pin units

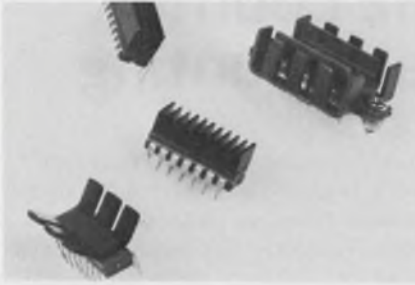

Thermalloy Co., 8717 Diplomacy Row, Dallas, Tex. Phone: (214) 637-3333. Price: 8¢ to 60¢.

Four new heat sinks are specifically designed for 14 and 16-pin DIP packages. They operate with reduced thermal resistance in a forced-air environment. The 6007A is a two-piece, hard-anodize heat sink providing heat removal from both top and bottom surfaces. The 6010, 6011 and 6012 are one-piece heat sinks available in black anodize or gold chromate finishes.

CIRCLE NO. 271

### Conductive coatings are used on displays

Optical Coating Laboratory, Inc., 2789 Giffen Ave., Santa Rosa, Calif. Phone: (707) 545-6440.

A complete family of transparent conductive thin films for use in liquid-crystal and gas discharge display devices is available. The new coatings provide the display device manufacturer with a choice of resistances (100 to 10,000 Ω/square) and allow the use of either curved or flat substrates. They also eliminate confusing reflections from the face of the display panel.

CIRCLE NO. 272

### High-alumina ceramic takes on dark colors

Diamonite Products Mfg. Co., Shreve, Ohio. Phone: (216) 567-4211.

A new dark-brown high-alumina ceramic is designed primarily for parts used in electronic packages containing light-sensitive semiconductor materials. The new material is a highly uniform, sapphire-hard, 95% alumina-grade ceramic.

CIRCLE NO. 273

# Exactly your speed.

Servo-Tek's Speed Indicating System takes the precise rotational speed of your application and displays it on an easy-to-read meter. And it tells you repeatedly and accurately even on the most delicate machinery. A temperature-compensated low torque d-c generator and a taut-band meter movement assure a maximum error of less than 1% of full scale reading. Use it as a watchdog on any industrial application where sensitive speed indication is necessary. The attractive design of our Model ST-926 modernizes any application and comes in a standard version or tailor-made with bi-directional indication, special scales and ranges, and with color coding for multiple readouts.

SERVO-TEK PRODUCTS COMPANY  
1086 Goffle Road, Hawthorne,  
New Jersey 07506.

## SERVO-TEK

PRODUCTS COMPANY

For complete specifications write for our colorful technical sheets.



## Five-digit 50-MHz counter is made for panel mounting



Newport Laboratories, Inc., 630 E. Young St., Santa Ana, Calif. Phone: (714) 540-4914. P&A: see text; 30 days.

Designed for OEM and systems applications where panel mounting is desirable, a new five-digit, programmable, 50-MHz frequency counter is especially compact—just 2.5-in. high, 6.75-in. deep and only 4-in. wide.

Designated the model 6100, this

small counter has good sensitivity, with triggering levels that can be preset from as low as 100 mV. Better sensitivities can be obtained with an option: down to 10 mV rms and to 35 mV pk-pk, for pulses that are at least 10-ns wide.

The 6100 has ac and dc input coupling and is rated for a frequency range of dc to 50 MHz for the dc input and 10 Hz to 50 MHz for the ac input. Its input impedance is 1 M $\Omega$  shunted by 27 pF, and maximum input is 375 V peak from dc to 400 Hz, derated to 10 V peak up to 50 MHz.

Programming of the new frequency counter is achieved via a rear connector, either with contact closures to ground or with DTL and TTL logic level signals.

Three selectable reading rates are available: 0.1, 1 and 10 readings/s. The instrument has five programmable gate times of 1, 10 and 100 ms, and 1 and 10 s.

Additional features include an external TTL gated clock input, a TTL inhibit input that holds readings and inhibits print commands, and a TTL print command output (0.5  $\mu$ s nominal).

Cost of the basic five-digit counter is \$350. This includes a 1-MHz internal crystal oscillator whose stability is 2 parts in 10<sup>6</sup>/month. Temperature coefficient is 4 parts in 10<sup>7</sup>/°C.

An optional 1-MHz crystal is available with a stability of 3 parts in 10<sup>7</sup>/month and a temperature coefficient of 2 parts in 10<sup>7</sup>/°C. It costs \$40.

Additional options include a sixth digit for \$30, \$10 for the BCD output and \$80 for the 10-mV sensitivity feature.

CIRCLE NO. 274

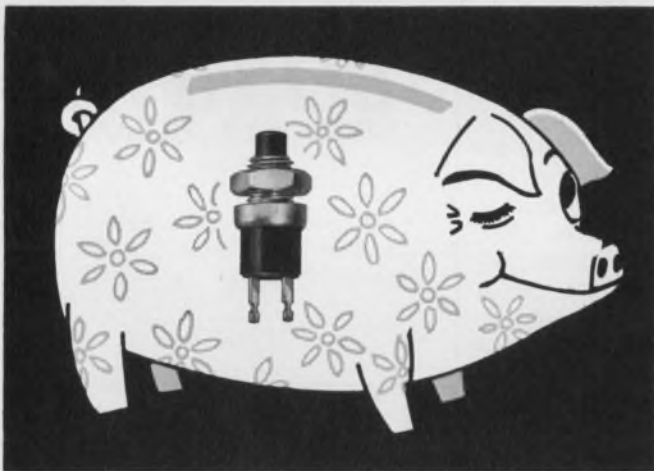

## Push now—save later

Grayhill push button switches are designed so they cost less to USE.

They're engineered to be more reliable, durable—rugged enough to last under a full gamut of rough operating conditions. (Up to 1,000,000 cycles for 1 amp. butt contact switches.)

Cheapness can be very expensive—if it's connected with critical circuitry. That's why a long

list of users prefer real switch economy by specifying Grayhill.

Like to know more? Write or phone for our latest general engineering catalog. Grayhill, Inc., 565 Hillgrove Ave., La Grange, Ill. 60525, (312) 354-1040.

## Grayhill

pioneers in miniaturization

INFORMATION RETRIEVAL NUMBER 44

# QUIK BUS

by ROGERS

Custom-designed laminated bus bars at off-the-shelf prices delivered in three weeks!

Prototypes, short-runs or large production orders — MEKTRON QUIK/BUS can save time and money on all of them. Our new design manual is the key. It permits you to work with a range of standard options, "customizing" voltage-distributing assemblies to fit your needs. No tooling charge. Write for your QUIK/BUS manual today . . . or call (203) 774-9605.



Rogers Corporation / Rogers, Conn. 06263



INFORMATION RETRIEVAL NUMBER 45

ELECTRONIC DESIGN 18, September 2, 1971

## Five-digit multimeter takes 30 readings/s

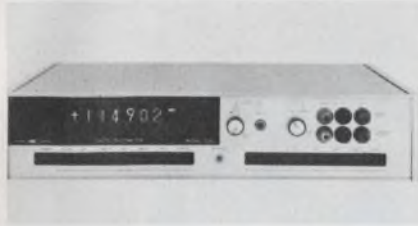

Systron-Donner Corp., 888 Galindo St., Concord, Calif. Phone: (415) 682-6161. P&A: \$1695 (basic unit); 45 days.

New 5-digit, fully guarded model 7110 digital multimeter with high noise rejection provides reading speeds at full accuracy of 30/s without use of a built-in switchable filter. It has all-range auto-ranging from  $\pm 1$  mV to  $\pm 1100$  V dc, including ratio. It also auto-ranges all ranges of ac volts and four-wire resistance options. Other options include isolated BCD output and remote programming, all on plug-in cards.

CIRCLE NO. 275

## 60-MHz counter/timer is quite versatile



G&E Bradley, Ltd., Neasden Lane, London, England.

All types of time measurement and a wide range of other measurements can be carried out with a new counter/timer which has dual channel trigger facilities and a timebase range extending from 1  $\mu$ s to 100 s. The 187 is a lightweight instrument designed to provide full counter-timer facilities over the frequency range of dc to 60 MHz. It can measure frequency, period—single or multiple, and time interval.

CIRCLE NO. 276

## 25-MHz, 10-mV/div. scope costs \$595

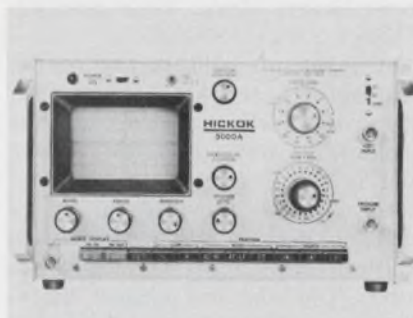

Hickok Electrical Instrument Co., 10514 Dupont Ave., Cleveland, Ohio. Phone: (216) 541-8060. P&A: see text; 15 days.

The low-cost 25-MHz 5000A scope offers 10-mV/division sensitivity and stable triggering beyond 50 MHz. A built-in vertical delay line provides 50 ns of display prior to the trigger point on the input waveform. The 5000A has 3% calibrated vertical sensitivities from 10 mV to 50 V/division. Input impedance is 1 M $\Omega$  and 30 pF. Sweep speeds range from 50 ns to 2 s/division.

CIRCLE NO. 277

## Spectrum analyzer spans 20 Hz to 40 GHz



Hewlett-Packard Co., 1501 Page Mill Rd., Palo Alto, Calif. Phone: (415) 493-1501. P&A: \$1690 (8556A), \$2900 (8552B); 8 weeks.

Absolute amplitude calibration from 20 Hz to 40 GHz with one system is what a new spectrum analyzer allows. The system includes a CRT-equipped mainframe, plug-in i-f sections (8552B), and plug-in swept tuning sections. The 8556A tuning section which scans the 20-Hz to 300-kHz range, extends the analyzer's capability.

CIRCLE NO. 278

AMERICAN MADE

# Tolerance SCHAUER 1-Watt ZENERS

## Immediate Shipment Low Prices

ANY voltage from 2.0 to 18.0

Quantity	Price each
1-99	\$1.07
100-499	.97
500-999	.91
1000-4999	.86
5000 up	.82



All welded and brazed assembly

No fragile nail heads

Gold plated leads

Write for complete rating data and other tolerance prices.

## Buy the kit— Save a lot



Kit contains a 51-piece assortment of SCHAUER 1% tolerance 1-watt zeners covering the voltage range of 2.7 to 16.0. Three diodes of each voltage packaged in reusable poly bags. Stored in a handy file box. Contact your distributor or order direct.

A \$54.57 value for  
ONLY \$24.50

Semiconductor Division  
**SCHAUER**  
Manufacturing Corp.

4511 Alpine Ave. Cincinnati, Ohio 45242  
Telephone: 513/791-3030

INFORMATION RETRIEVAL NUMBER 46

## Johnson-coded switch mates IC counters



Grayhill, Inc., 561 Hillgrove Ave., La Grange, Ill. Phone: (312) 354-1040. Price: from \$4.92 (100 quantities).

A Johnson-coded 1/2-in.-rotary switch for use with COS/MOS divide-by-N counters is available. This type of circuitry, in conjunction with the controlling switch, has application in frequency synthesizer communication systems and program counter controls. The Johnson-coded switch is available in one or two-pole versions of the series 50 switches.

CIRCLE NO. 279

## HV ceramic capacitors are corona-free

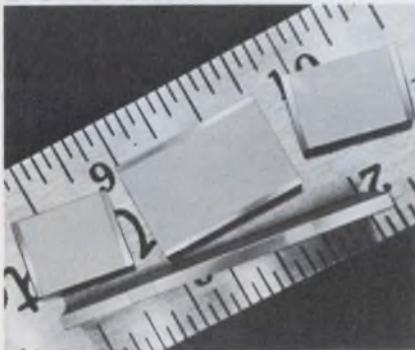

Semtech Ceramic, 652 Mitchell Rd., Newbury Park, Calif. Phone: (805) 498-2111.

A newly developed line of 400 to 1600-V monolithic ceramic capacitors features high-density and low-mass applications. These new energy-storage capacitors are essentially corona-free. They are multi-layered and utilize building-block techniques for various values and terminations. Standard units are chips with palladium-silver terminations.

CIRCLE NO. 280

## Keyboard key switch uses a gold layer

Cherry Electrical Products Corp., 3600 Sunset Ave., Waukegan, Ill. Phone: (312) 689-7600.

A layer of gold is the design feature of a new key for use with electronic keyboards. The key has contacts of 69% gold, 25% silver and 6% platinum. This mix renders contact interfaces inert to chemical action, with resultant low contact resistance (typically 25 m $\Omega$ ). The contacts' crossed knife-edge configuration concentrates closure force at a single crosspoint.

CIRCLE NO. 281

## Low/bandpass filters are miniaturized

Texscan Corp., 2446 N. Shadeland Ave., Indianapolis, Ind. Phone: (317) 357-8781. P&A: \$55 to \$175; 2 to 3 wks.

A new line of miniature (1 by 1 by 2-3/8 in.) lumped-component filters are available in lowpass or bandpass configuration and accommodate a broad range of connector and solder-lug pin combinations. The frequency range for both the low and bandpass filters is 5 to 100 MHz, with a 3-dB bandwidth range of 2 to 8% for the bandpass filters. Impedances of 50 or 75  $\Omega$  are available.

CIRCLE NO. 282

## Solid-state time-delay repeats to 2% accuracy

Omnetics, Inc., Box 113, Syracuse, N.Y. Phone: (315) 455-5731. P&A: \$8.91; 2 wks.

The new series MMS solid-state time-delay relay operates resistive or inductive loads such as relays, contactors, solenoids, and heaters with a repeat accuracy of  $\pm 2\%$ . The series comes in three time tolerances:  $\pm 20\%$ ,  $\pm 10\%$ , and  $\pm 5\%$ , and in any factory-fixed time delay from 0.1 to 480 s or in any adjustable time range desired by the customer.

CIRCLE NO. 283

## Pushbutton switches mount on PC boards

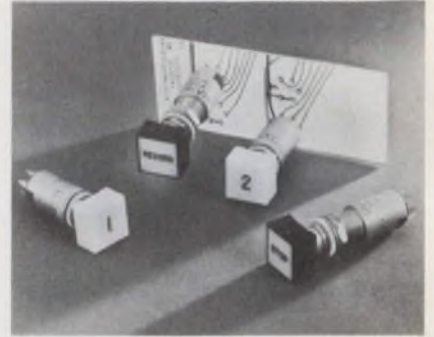

Marco-Oak, sub. of Oak Electro/Netics Corp., 207 S. Helena St., Anaheim, Calif. Phone: (714) 535-6111. Availability: stock.

Both solder and PC-board terminations are offered in a new series of Presslite single-lamp, lighted, pushbutton switches. The new types 545, 562 and 567 feature linear-action contact arrangements which eliminate damage due to excessive operating force and arcing due to insufficient pressure.

CIRCLE NO. 284

## Optical sensor cube delivers a pulse output



Encoder Products Co., 1240 Logan Ave., Costa Mesa, Calif. Phone: (714) 545-5112. Price: \$29.

A new device known as the Pulse Cube contains an IR emitting diode that produces a very narrow, high-intensity beam across a sensing slot. The beam is detected by a phototransistor that activates built-in squaring circuitry which produces a high-amplitude, square-wave output pulse, when any opaque object is passed through the slot.

CIRCLE NO. 285

### Thin-film attenuators span 5 to 1000 MHz



Avantek, Inc., 2981 Copper Rd., Santa Clara, Calif. Phone: (408) 739-6170. P&A: \$150 to \$250; 30 days.

New UTF-015 and UTF-040 series MIC-amp thin-film attenuators feature flat attenuation and low VSWRs from 5 to 1000 MHz. They can be inserted at any point in a cascade of amplifier modules for gain control. The TO-8 devices provide flat attenuation over a 7-octave rf bandwidth. The UTF-015 units attenuate 15 dB min. The UTF-040 units attenuate from 30 to 40 dB.

CIRCLE NO. 286

### Multiplexer arrays have 10<sup>4</sup> current gain



Varian Assoc., Palo Alto Tube Div., 611 Hansen Way, Palo Alto, Calif. Phone: (415) 326-4000. P&A: \$250; 30 to 60 days.

New channel multiplier arrays are available featuring current gains of 5000 to 10,000. The new devices—called the VUW-8960—consist of 1 or 2-in.-dia arrays of glass channels connected electrically in parallel by means of metal electrodes on both surfaces of a disc.

CIRCLE NO. 287

### Detector-op amp combos replace photomultipliers

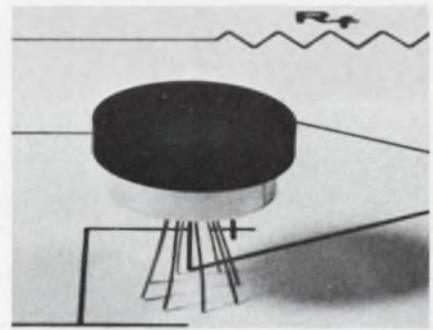

United Detector Technology, 1732 21st St., Santa Monica, Calif. Phone: (213) 829-3357.

A series of new photodetector-op-amp combinations offer a challenge to the photomultiplier tube. The UDT-400, 500, 600 hybrid photodetector op amps solve interfacing problems of low-noise photodiodes and preamplifiers. The three devices operate over a range of 10<sup>-12</sup> to 10<sup>-2</sup> W of light energy input with a linearity of 1%.

CIRCLE NO. 288

Who ever heard of a line of Plug-in delay/interval Timers that is reliable, economical and interchangeable for as low as

**\$27.90?**



You just did.

It's our new Series GP which is completely interchangeable with over 80% of today's most widely used plug-in delay/interval timers. The GP is designed for easy installation in stan-

dard 3-inch diameter panel holes.

Delivery is stock to 6 weeks, depending upon quantity. Consult us for further information and the GP Bulletin 310. Call 201-887-2200.

**SINGER**  
INDUSTRIAL TIMER DIV.

Industrial Timer Division, U.S. Highway 287, Parsippany, N.J. 07054 201/887-2200

**relays...** general purpose, sensitive, miniature, mechanical and magnetic latching



**stepping switches...**



**accessories...** plugs, sockets and dust covers



HIGH QUALITY • LOW COST • IMMEDIATE DELIVERY  
SEND FOR FREE CATALOGS

**SCHRACK** ELECTRICAL SALES CORP.

1140 Broadway, New York, New York 10001 Tel: (212) 683-0790

# evaluation samples



## Pushbutton wire ties

A new heavy duty (series PT200) one-piece pushbutton wire tie allows harnessing wire and cable without screws or time-consuming stringtying. The conical head of the tie is simply pressed into a 1/4-in.-dia hole in any panel 0.031 to 0.14-in. thick. A beaded plastic tie is wrapped tightly around the harness and inserted into a slotted strap, where it locks securely into position. Wires may be substituted, added or removed by loosening the tie and relocking it. The strap is extruded at an angle to stand-off from the panel for easy insertion of the beaded tie. Free samples and information are available. Richco Plastic.

CIRCLE NO. 289

## Tape splices/patches

A complete line of splicing tapes and patches can be obtained for repairing, splicing and correcting all perforated magnetic tapes, including mylar. Splicing tapes and patches are available in paper, mylar clear and mylar opaque (black) materials. Mylar tapes and patches are supplied with pressure-sensitive adhesive and include easy, peel-off backing paper. Paper tapes and patches are available with pressure-sensitive adhesive or moisture-activated (gummed) backing. All splicing tapes and patches are available in 5, 6, 7 and 8-channel modes. Free samples of splicing tapes and patches are available. Data-link Corp.

CIRCLE NO. 290

# design aids



## Multi-layer PC boards

Anyone interested in knowing about design problems for multi-layer PC boards will find a poster-size wall chart and an accompanying booklet invaluable sources of information. The chart shows various board conductors and their thicknesses, layout tolerances and dimensions, hole locations and laminates. The booklet goes through a step-by-step process of how a PC multi-layer board is manufactured, each step clearly illustrated. Lockheed Electronics.

CIRCLE NO. 291

## Recording-head selector

A new digital head selector for datum-series, 1/2-in., IBM-compatible recording heads is available free. Designed in the form of a circular slide rule, the new design aid provides technical data on an extensive line of 7 and 9-channel read-after-write heads, 7 and 9-channel read/write heads, 7 and 9-channel read/read heads and 1/2-in. write and erase heads. Nortronics Co., Inc.

CIRCLE NO. 292

## Epoxy insulation chart

A free epoxy insulation systems wall chart selector is available. This wall chart is designed to help in selecting the standard liquid system best suited to one's electrical or electronic insulation requirements. It shows systems offering a wide choice of characteristics such as pot life and cure, as well as a broad range of electrical and physical properties of the cured material. These include density, tensile strength electric constant and resistivity. Hysol Div. of the Dexter Corp.

CIRCLE NO. 293

# application notes

## Stepper motor principles

Of particular interest to designers of computer peripherals and instrumentation controls is a newly published 28-page "Stepper Motor Handbook." The manual covers the design, application and selection of permanent-magnet stepper motors. Four-phase and eight-phase designs are discussed with special emphasis placed on the eight-phase construction. Also included are mechanical and performance specifications for a line of stepper motors, with both servo and standard flange mounts. Two-phase pulse steppers are also described. A. W. Haydon Co.

CIRCLE NO. 294

## Torque-motor fundamentals

Fundamentals of induction type torque motors are reviewed in an article. Torque motors are first examined in general—their uses and types. Further discussion is then concentrated on the induction type torque motor because of its greatly increased use in magnetic-tape and film-handling equipment. Bodine Electric Co.

CIRCLE NO. 295

## High-noise-immunity logic

A complete series of seven application briefs show design engineers how to apply high-noise-immunity digital logic devices in their circuits. Topics covered by the briefs are: eliminating internally generated noise, implementing collector ORing, second-level gating, quad 60-mA flip-flops and driving lines with 300 series logic. Also covered are the 380 and 381 BCD-to-decade decoders, and the 311 master-slave flip-flops. Each brief is a self-contained discussion of the topic, and is illustrated with many schematics and logic diagrams. Teledyne Semiconductor.

CIRCLE NO. 296

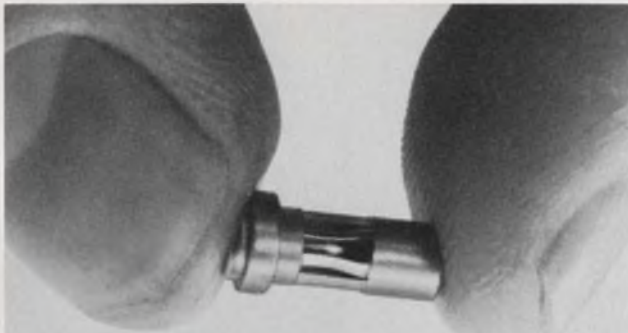

## it takes guts to be a good connector

The kind that can hold without appreciable change in contact resistance through 50,000 cycles and more. And that's the kind of guts you get with CAMBION cage jacks. Permanently swaged inside a precisely machined brass body, these beryllium copper cages come in jacks ranging from .016"-.080" in a wide variety of shapes and types for mounting components, patching, plugging. Complete range of mating pins also available. Our latest catalog has a complete selection - it's free for the asking.

The next time a salesman tries to sell you a connector, ask to see the insides - if it isn't caged, it's not a CAMBION.

Cambridge Thermionic Corporation, 445 Concord Ave., Cambridge, Mass. 02138. Phone: (617) 491-5400. In Los Angeles, 8703 La Tijera Blvd. 90045. Phone: (213) 776-0472.

Standardize on

**CAMBION**  
The Guaranteed Electronic Components

INFORMATION RETRIEVAL NUMBER 50

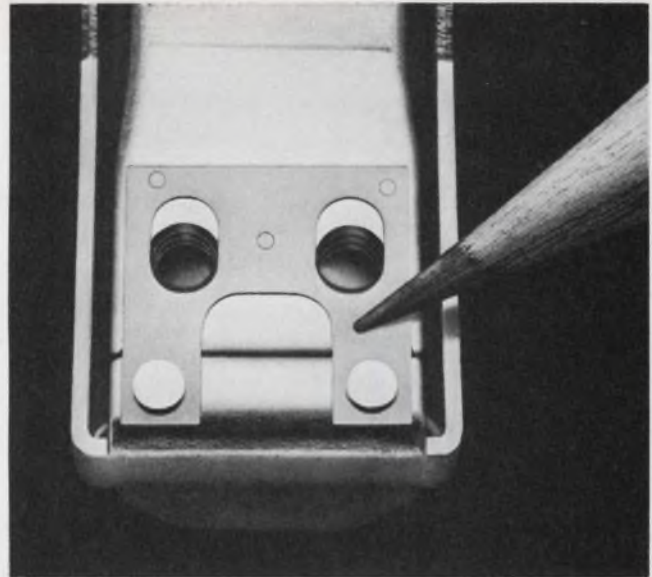

# A new type relay hinge eliminates mechanical wear entirely.

It's called a reed hinge and we've substituted it for the conventional rocker type assembly in our imported JMR Miniature 5 Amp. Cradle Relay. The blade (reed) reduces 4 parts to 1. Simple, lastingly dependable and entirely free of mechanical wear. It's a Line Electric exclusive.

Other significant improvements are in the housing: Pure polycarbonate plastic which has 48% higher heat and 31% greater fracture resistance than nylon, styrene or butyrate. And gold-diffused silver contacts to ensure even greater reliability at low power levels while retaining full load switching capabilities. Also outgassing of all phenolic parts to prevent contact contamination.

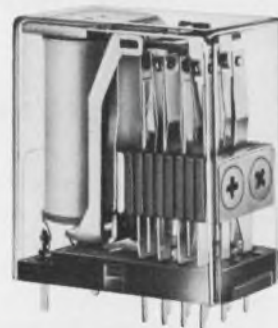

Available in 2PDT, 4PDT, 6-12-24-48 or 110 VDC. Priced as low as \$1.40 (5000 or more per year). You can't buy better. Write or call us at 201-887-8200.

**SINGER**  
LINE ELECTRIC DIVISION

Line Electric Division, U.S. Highway 287, Parsippany, N.J. 07054 201/887-8200

INFORMATION RETRIEVAL NUMBER 52

## THE EXTREMELY ACCURATE WAY TO REDUCE DRAFTING COSTS



### VEMCO V-TRACK DRAFTING MACHINES

They're America's most popular drafting machines—with good reason. VEMCO V-Track machines provide effortless, exceptionally precise tracking. They meet the growing demand for high-angle drafting on steeply inclined boards. Straight line accuracy is exceptional—.003" in 6 feet. VEMCO V-Tracks are the only drafting machines available with new VERSAGRAPHIC heads—the most advanced protractor heads ever developed. It all adds up to faster, more accurate drafting—at less cost. Write for Catalog DM-371 or use reader service card. VEMCO, 766 South Fair Oaks Avenue, Pasadena, California 91105.



**VEMCO** DRAFTING MACHINES

71-2

INFORMATION RETRIEVAL NUMBER 51

ELECTRONIC DESIGN 18, September 2, 1971

# new literature



## Capacitor products

Covering a wide range of capacitors, filters and microcircuits, a new 228-page catalog contains detailed product information on multi-layer ceramic, paper, film mica, oil-filled, high-voltage, SCR, feed-thru, disc and high-voltage multiplier capacitors. Also featured in the catalog are rfi/emi filters and active and passive-wave filters. Aerovox Corp.

CIRCLE NO. 340

## Relays/contactors

A new catalog lists over 450 electrical/electronic relays and contactors. Essex International, Inc., Controls Div.

CIRCLE NO. 341

## PC frames

A new 16-page catalog contains complete data on a line of three-card PC frame systems and accessories. Vero Electronics, Inc.

CIRCLE NO. 342

## Terminal blocks

A new 24-page terminal-block selector catalog is available. Curtis Development & Mfg. Co.

CIRCLE NO. 343

## Power supplies

An eight-page short-form catalog describing precision dc power supplies and power-supply module systems is available. Trygon Electronics, Inc.

CIRCLE NO. 344

## Computer handbook

The Varian 620/L computer handbook, designed to provide all the basic information necessary for programming, operation, and system interfacing of the 620/L computer, is available free. Varian Data Machines.

CIRCLE NO. 345

## Instrument enclosures

A catalog is available describing the Optima line of instrument enclosures in 72 standard sizes, 16 basic colors and hundreds of combinations. Scientific-Atlanta, Inc.

CIRCLE NO. 346

## Voltage standards

Application literature and data sheets on six different types of precision constant-voltage standards known as Certavolts are available. Codi Semiconductor.

CIRCLE NO. 347

## Pollution instruments

"Air Quality Instrumentation" is the title of a new, comprehensive, 16-page bulletin which describes instruments used for air-pollution monitoring. Beckman Instruments, Inc.

CIRCLE NO. 348

## Microwave instrumentation

A 20-page catalog describes a new line of spectrum analyzers, sweep generators, programmable attenuators, and lumped-component miniature lowpass and bandpass filters. Texscan Corp.

CIRCLE NO. 349

## Sweeper/signal generator

The Narda Probe, Vol. 5 No. 1., a quarterly technical journal, describes the design principles, features, options and applications of a new sweeper/signal generator for measurements from 1 to 18 GHz. Narda Microwave Corp.

CIRCLE NO. 350

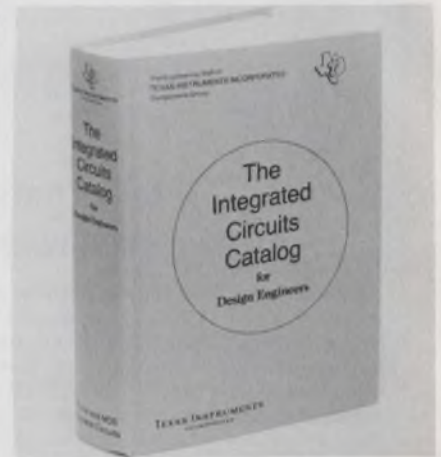

## IC catalog

A new 1616-page catalog entitled "The Integrated Circuits Catalog for Design Engineers" is available from Texas Instruments at \$4.95 a copy. Comprehensive circuit specifications augmented by applications data and schematics are given in this voluminous publication. Information is given on lines of low-power, standard, high-speed and Schottky TTL, including MSI, MOS/LSI, linear, ECL, and DTL ICs. Send check or money order to Texas Instruments Inc., P.O. Box 5012, MS/84D, Dallas, Tex. 75222.

## Telemetry equipment

An illustrated 15-page catalog describes a comprehensive line of dynamic and static measurement telemetry transmitters for temperature, strain and electrical parameters in severe environments. Inmet, Inc.

CIRCLE NO. 351

## Miniature transformers

Miniature transformers in several series are detailed with characteristics and dimensions in a 24-page catalog. Pico Electronics, Inc.

CIRCLE NO. 352

## Alphanumeric displays

Alphanumeric tubes and digital display applications information are contained in a 12-page brochure. General Electric Co.

CIRCLE NO. 353



## Microwave products

A new short-form catalog presents information on more than a dozen standard microwave product groups. Included are high-frequency receivers, mixers, electronic switches, amplifiers, attenuators, doublers and hybrid junctions. Also included are transformers, directional couplers, bandpass and low-pass filters and power splitters. Lorch Electronics Corp.

CIRCLE NO. 354

## PC contacts/terminals

A new 12-page catalog describes how a series of new contacts, staked and dip-soldered to PC boards, produce high-reliability at low cost in connection systems. Elco Corp.

CIRCLE NO. 355

## Digital instruments

A set of data sheets is available with information on digital counters, panel meters, clocks, comparators, stop watches, scalars and displays for panel-mounting applications. Electronic Research Co.

CIRCLE NO. 356

## AM tone telemetry systems

Fundamental design concepts for building remote tone control and monitoring systems are discussed in a new 12-page AM tone telemetry systems catalog. Bramco Controls Div. of Ledex, Inc.

CIRCLE NO. 357

## DIP plastic packages

A new bulletin discusses the high reliability of plastic dual-in-line packages for MOS/LSI ICs. Texas Instruments, Inc.

CIRCLE NO. 358

## Stepping motors

High-torque stepping motors designed to position loads in increments of 10, 20, 30, or 36 degrees are described in an eight-page catalog. Ledex, Inc.

CIRCLE NO. 359



## Switches

A complete line of subminiature toggle, rocker, and paddle-handle switches is shown in an illustrated 12-page catalog. It includes engineering drawings, detailed specifications and pricing. C & K Components, Inc.

CIRCLE NO. 360

## Logic panels

A new brochure describes a complete line of modular logic panels for low-cost, high-density packaging. Stanford Applied Engineering.

CIRCLE NO. 361

## Laboratory magnets

A comprehensive 24-page booklet covers terminology, selection procedures and advantages of using a broad range of laboratory magnets, power supplies and accessories. O.S. Walker Co., Inc. MSI Div.

CIRCLE NO. 362

## Patch cords

A new series of miniature patch cords and replacement cords are described in a product bulletin. Switchcraft, Inc.

CIRCLE NO. 363

## ROMs

A brochure describes a line of U-core ROMs. Datapac, Inc.

CIRCLE NO. 364

## Cassette drives

A four-page brochure covers digital cassette drives. Auricord Div. of Scovill.

CIRCLE NO. 365

# THE WIDEST LINE OF IC TESTERS

DIGITAL • LINEAR  
MANUAL • AUTOMATIC

### Model 824



Functional test of all digital IC's with up to 24 leads including RTL, DTL, and TTL devices. Worst case test time 2.1 seconds. Single card programming provides go or no-go status. \$945

### Model 716A



A simultaneous D.C. and functional test of digital or linear devices. Manual mode for device failure analysis. Semi-automatic mode for production or Q.C. testing. \$2,990

### Model 735



Linear circuit tester for all standard plus a wide variety of custom circuits, either monolithic, hybrid or discrete. Ideally suited for QA testing and parameter analysis. \$7,850

### System 1200



A computer-operated system performing D.C. and low frequency dynamic tests and measurements for all common linear circuit parameters. Force and measurement circuitry at each test station provides flexibility and large volume throughput. Factory price quotation.

### Series 720



Designed to perform complete truth table verification and D.C. parameter test on all digital circuit families. Interfaces to handlers, probers, environmental chambers, and used as a pretester for computer-controlled systems. Model 721A, up to 16 lead devices, \$4,850. Model 724A, up to 24 lead devices, \$8,850

Write for our free brochures describing Microdyne products or call our Applications Department if you have an immediate problem.

Tel: (617) 272-5691



MICRODYNE INSTRUMENTS, INC.  
A COMPUTEST SUBSIDIARY

203 Middlesex Turnpike, Burlington, Massachusetts 01803

INFORMATION RETRIEVAL NUMBER 53

**COMPLETE  
PACKAGING  
CAPABILITY**

**+**

**FAST DELIVERY  
FROM  
STOCK**

**INSTANT VERO**

**VEROBOARD**

**D.I.P. BOARD**

**FINGER BOARD**

**VERORACKS**

**MODULE RACK**

**C SERIES VERO CASE**

**D SERIES VERO CASE**

**CARD FRAMES**

**CARD HANDLES**

**FRONT PANELS**

**PANEL HANDLES**

**CONNECTORS**

**DESIGN SERVICE  
NOW AVAILABLE**

**VERO ELECTRONICS inc.**

**171 BRIDGE ROAD**

**HAUPPAUGE, N.Y. 11787**

**TEL. 516 234-0400**

INFORMATION RETRIEVAL NUMBER 54

## bulletin board

of product news  
and development

AMCAP\* is a new and powerful CAD (computer-aided design) program specifically for use by microwave engineers. It can analyze any circuit from a simple network to a complex phased array antenna feed system, giving such performance characteristics as VSWR and transmission loss. The program is a product of Computility, Inc. of Boston, Mass.

CIRCLE NO. 366

Interdata, Inc. announced that its **Real-Time Operating System (RTOS)** software is now available for immediate delivery. The RTOS software is used with the Interdata model 5 computer with a minimum memory of 24 kbits.

CIRCLE NO. 367

Audio Magnetics Corp. is introducing a 1/2-in. **helical-scan video tape**. The Gardena, Calif., company says its new HP-100 tape is coated by a special process which gives it brighter color definition, more contrast and clarity and fewer dropouts than existing video tapes. The tape is available in 1 and 1/2-hour lengths on 5 and 7-in. reels.

CIRCLE NO. 368

Hazeltine Corp. is reducing rental prices of its 2000 CRT terminal from \$108 per month to \$88 per month, effective immediately.

CIRCLE NO. 369

Price reductions as high as 46% have been announced by Cherry Electrical Products Corp. for its **thumbwheel and leverwheel switch lines**. The average price reduction on the various switch models is reported to be 24%. In addition, 20% price discounts are offered on quantities of fifty switches, with discounts jumping to 25% for 100-piece levels.

CIRCLE NO. 370

\*Trademark of Environmental Computing, Inc.

## Electronic Design

ELECTRONIC DESIGN's function is:

- To aid progress in the electronics manufacturing industry by promoting good design.
- To give the electronic design engineer concepts and ideas that make his job easier and more productive.
- To provide a central source of timely electronics information.
- To promote two-way communication between manufacturer and engineer.

**Want a subscription?** ELECTRONIC DESIGN is sent free to qualified engineers and engineering managers doing design work, supervising design or setting standards in the United States and Western Europe. For a free subscription, use the postfree application form inside the back cover. If none is included, write to us direct for an application form.

If you do not qualify, you may take out a paid subscription for \$25 a year in the U.S.A., \$35 a year elsewhere. Single copies are \$1.50 each.

**If you change your address**, send us an old mailing label and your new address; there is generally a prepaid postcard for this inside the back cover. You will have to requalify to continue receiving ELECTRONIC DESIGN free.

**The accuracy policy of ELECTRONIC DESIGN is:**

- To make reasonable efforts to ensure the accuracy of editorial matter.
- To publish prompt corrections whenever inaccuracies are brought to our attention. Corrections appear at the end of the Letters column.
- To refuse any advertisement deemed to be misleading or fraudulent.

Microfilm copies are available of complete volumes of ELECTRONIC DESIGN at \$19.00 per volume, beginning with Volume 9, 1961. Work is now in process to complete the microfilm edition of Volumes 1-8. Reprints of individual articles may be obtained for \$2.00 each, prepaid (\$.50 for each additional copy of the same article) no matter how long the article. For further details and to place orders, contact the Customer Services Department, University Microfilms, 300 North Zeeb Road, Ann Arbor, Michigan 48106; telephone (313) 761-4700.

**Want to contact us?** If you have any comments or wish to submit a manuscript or article outline, address your correspondence to:

Editor  
ELECTRONIC DESIGN,  
50 Essex Street,  
Rochelle Park, N.J. 07662

## Advertising Sales Staff

Bryce Gray, Jr.  
Sales Manager

### Rochelle Park, N.J. 07662

Robert W. Gascoigne  
Samuel M. Deitch  
Daniel J. Rowland  
50 Essex Street  
TWX: 710-990-5071

### Philadelphia 19025

Mort Sullivan  
P.O. Box 126  
Dresher, Pa.  
(215) 884-6880

### Boston 02154

Joseph F. Palmer  
1268 Main Street  
Waltham, Mass.  
(617) 894-2700

### Chicago 60611

Thomas P. Kavooras  
Berry Conner, Jr.  
200 East Ontario  
(312) 337-0588

### Cleveland

Thomas P. Kavooras  
(Chicago)  
(312) 337-0588  
(call collect)

### Los Angeles 90303

Stanley I. Ehrenclou  
Burt Underwood  
2930 Imperial Highway  
Inglewood, Calif.  
(213) 757-0183

### San Francisco 94022

Jerry D. Latta  
95 Main Street  
Los Altos, Calif.  
(415) 941-3084

### London W. 1

For United Kingdom and Holland  
Brayton C. Nichols

For Eastern Europe  
Peter Kehr

### The American Magazine Group

27 Maddox Street  
London, W. 1, England  
Phone: 499-0180  
Cable: Ammagnic, London

### Verviers, Belgium

For Continental Europe  
Andre Jamar  
1, Ru Mallar, 1  
087) 253.83 Telex 41563

### Tokyo

Haruki Hirayama  
Electronic Media Service  
5th Floor, Lila Bldg.,  
4-9-8 Roppongi  
Minato-ku  
Phone: 402-4556  
Cable: Electronicmedia, Tokyo



Advertisements of booklets, brochures, catalogs and data sheets. To order use Reader-Service Card.  
(Advertisement)

## Fight Fuzziness with New Real-Time 256-point Correlator

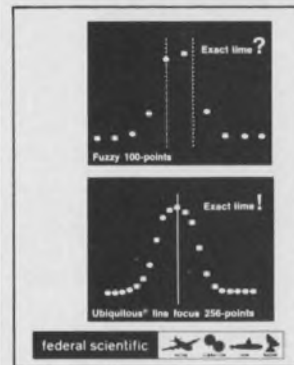

UC-201A Ubiquitous® Correlator is a complete time-domain measurement lab for real-time auto & cross-correlation, signal enhancement, & probability. For underwater acoustics, fluid dynamics, medical research, vibration analysis, noise source identification. Features: exact time measurements with digital dial; computes integral & differential of any stored function (converts probability density to cumulative distribution without rerunning data); pre-computational delay built-in (256 samples); sampling increments from 1/2 usec to 2 sec; complete ext. (computer) control plus digital outputs; built-in test signals for all modes; small, portable, easy to use; reasonably priced. Many options.

CIRCLE NO. 171

## Federal Scientific Corporation

a subsidiary of Elgin National Industries, Inc.  
615 West 131st Street, New York, N. Y. 10027

## WORLD'S SMALLEST 5VDC/100 AMP POWER SUPPLY



Now you can squeeze your power supply down to fit your microcircuitry with our complete line of off-the-shelf 100 watt to 500 watt supplies. All offer small size, lightweight, high efficiency, cool operation, low cost.

630 Series 5V/100 Amp supply has volume under 500 cubic inches! (8 1/2" x 6 3/4" x 8 3/4"); weighs under 20 lbs; 65% efficiency even with light load conditions; no forced air or external cooling for full rated output to 55°C; priced lower than large conventional supplies.

The 100 watt series come in single, dual, triple outputs; 5VDC to 30VDC; commercial, Military, and export models available.

CIRCLE NO. 172

## Trio Laboratories, Inc.

80 Dupont Street  
Plainview, Long Island, N. Y. 11803

## New Testing and Design Techniques



Mr. A. D. Friedman and P. R. Menon of Bell Telephone Labs provide you with step-by-step methods for deriving tests for all types of logic circuits in any digital computer, including testing the new iterative arrays and the checking sequence approach for testing sequential circuits. Clear-cut diagrams show you the simplest ways of pin-pointing faults in AND, OR, NOT, NAND, and other circuits. You'll have techniques for simultaneously simulating faulty and normal circuits, factoring, eliminating redundancy, designing more easily tested circuits, as well as procedures for improving the reliability of all your digital systems. Pub. Aug. '71, 256 pp., illus., 6 x 9", \$15.00. Circle the reader service number for a FREE 15-day examination copy. If payment accompanies your order, we pay postage and handling. Same return privilege, refund guaranteed.

CIRCLE NO. 173

## Prentice-Hall, Inc.

Englewood Cliffs, N. J. 07632

# DPMs

Actual Size



**In 2½, 3½ or 4½-digit models.  
We've got them all.  
Just ask us.**

## GRALEX INDUSTRIES

DIV. OF GENERAL MICROWAVE CORP. • 155 MARINE ST., FARMINGDALE, N. Y. • 516-694-3600  
INFORMATION RETRIEVAL NUMBER 55

**HEAT REACTIVE VINYL  
ZIPPERTUBING®**

TYPE HRV

*best for skin-tight jacketing of cables and wire bundles in minutes!*

HRV is made from material that shrinks when heat is applied. (Also available to meet military specifications.)

for full information on specialized, high-performance jacketing, contact

**THE ZIPPERTUBING®**

13000 S. BROADWAY, LOS ANGELES, CALIF. 90061  
Los Angeles Phone: (213) 321-3901



BALTIMORE • BOSTON • CHICAGO • CLEVELAND  
DALLAS • NEW YORK • ORLANDO • PHOENIX  
SAN FRANCISCO • WEST GERMANY

INFORMATION RETRIEVAL NUMBER 56

# advertiser's index

Advertiser	Page
Acopian Corp. ....	73
Allen-Bradley Co. ....	27
Amperex Electronic Corporation.....	11
Amphenol Components Group .....	12
Beckman Instruments, Inc., Electrical Instruments Division .....	61
Belden Corporation .....	58, 59
Bell, Inc., F. W.....	48
Bourns, Inc. ....	70, 71
Burroughs Corporation .....	18
Cambridge Thermionic Corporation..	81
Cinch Manufacturing Company.....	9
Cincinnati Milacron Company.....	49
Clare & Co., C. P.....	31
Dale Electronics, Inc.....	Cover IV
Dialight Corporation .....	16A
Du Pont Company .....	16
Edmund Scientific Company.....	87
Electro-Motive Mfg. Co., Inc., The..	68
European Electronic Products Corporation .....	7, 84
Federal Scientific Corporation .....	85
Fifth Dimension, Inc.....	30
GTE Automatic Electric .....	4, 5
General Automation, Inc. ....	16B, 16C
General Electric Company .....	13
Grayhill, Inc. ....	76
Graylex Industries .....	86
Hewlett-Packard .....	Cover II
Hudson Lamp Company.....	63
Imperial Travel Service .....	87
Industrial Timer Corporation.....	79, 81
Janco Corporation .....	87
Keithley Instruments, Inc.....	6
Microdyne Instruments, Inc. ....	83
MicroSwitch, A Division of Honeywell .....	17
Molex, Incorporated .....	1
Motorola Component Products Dept. ....	8
Motorola Semiconductor Products, Inc. ....	14, 15
NJE Corporation .....	45
North American Rockwell Microelectronics Company .....	36, 37
Nortronics Company, Inc.....	48
Oak Manufacturing Co. ....	29
Philips Electronic Components and Materials Division .....	32, 44
Power/Mate Corp. ....	21
Prentice-Hall, Inc. ....	85
RCA Solid State Division... ..	43, Cover IV
Rogers Corporation .....	76
Schauer Manufacturing Corp. ....	77
Schrack Electrical Sales Corp. ....	79
Servo-Tek Products Company .....	75
Siemens Corporation .....	32
Sigma Instruments, Inc. ....	10
TRW, Inc., Capacitor Division.....	2
Tekelec Airtronic .....	67
Tektronix, Inc. ....	35
Trio Laboratories, Inc. ....	85
Triplett Corporation .....	53
Union Carbide, Components Division .....	38
Vector Electronic Company Inc.....	13
Vemco Drafting Machines .....	81
Vero Electronics, Inc. ....	88
Virginia Panel Corporation .....	65
Weston Instruments, Inc.....	16D
Zippertubing Corp., The .....	86

### Attention Advertisers:

Could you use copies of your ad exactly as it appeared in ELECTRONIC DESIGN? Then order your reprints directly from us; the minimum unit order is 500 copies.

Please specify if you would like the reprint line omitted on your copies and mail your written order to ELECTRONIC DESIGN, Production Dept., 50 Essex Street, Rochelle Park, New Jersey 07662.

	500	1,000	Add'l M
<b>8x10 or smaller</b>			
1 color, 1 side	\$74.70	82.95	18.15
2 color, 1 side	95.47	108.00	25.28
4 color, 1 side	311.03	342.00	44.33
<b>Spreads</b>			
1 color	113.66	126.65	25.98
2 color	191.19	205.98	29.58
4 color	354.17	380.76	53.19

Prices FOB Waseca, Minn.

**UNUSUAL BARGAINS** FREE! GIANT CATALOG  
... MANY U. S. GOV'T SURPLUS



**NEW! ELECTRONIC DIGITAL COMPUTER KIT!**  
Solve problems, play games, predict weather with this actual working model of giant electronic brains. Amazing new fun way to learn all about computer programming... logic, decimal, binary systems. Laws of Sets—even do your own programming after completing simplified 116 page instructive booklet. Includes step-by-step assembly diagrams. Circuits easily changed. Readout from illuminated control panel. Req. 2 "D" batt. (not incl.). Best model we've seen—for home, school, industry.  
No. 71.434DA (11"x12½"x14") \$31.50 Ppd.



**AMAZING NEW WANKEL ENGINE KIT!**  
Thrill to the fun of building your own see-through motorized model of revolutionary pistonless type engine, rights for which (GM) recently paid \$50 million! Only engine experts think economically modifiable to meet new pollution standards. Replaces piston, cylinder, crank assemblies with rotating discs (sections removed for firing chambers). Smaller than conventional; fewer parts, greater reliability, same speed w/less horsepower. Feat: flashing plugs, rubber fan belt, stick-shift on-off switch. Req. 2-1.5V batt. (not incl.).  
No. 71.424DA (4½" 5"x9") \$6.75 Ppd.

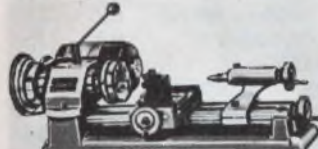

**UNIMAT "MINI MACHINE SHOP"**  
Compact, power tool for metal, plastics, wood with full capabilities of precision machine shop. Works as lathe or vertical drill press. Complete with motor. 1 of a kind for industrial miniaturization, home workshop, model shops, labs, etc. Use basic tool to turn, face, bore, recess, polish. Converts in 1 minute to vertical machine to mill drill, jig-bore, surface grind. 40-p. instr. booklet.  
No. 85.175DA (33 lbs.) \$148.50 F.O.B.



**GIANT FREE CATALOG**  
Completely new 1972 edition—148 pages. Bargains galore! New categories, items, illustrations. 1,000's of buys for industry — Optics, Science, Math. On-the-job helps, quality control aids. Optics for research labs, design engineers experimenters. Instruments for checking, measuring... to speed work. Improve quality, cut costs. Huge selection of telescopes, microscopes, and other hard-to-get war surplus bargains. Write for Catalog DA.

**EDMUND SCIENTIFIC CO.** 300 EDSCORP BLDG., BARRINGTON, NEW JERSEY 08007  
ORDER BY STOCK NUMBER • OPEN ACCOUNT TO RATED FIRMS • MONEY-BACK GUARANTEE

INFORMATION RETRIEVAL NUMBER 57

**Janco Rotary Switches have the guts to prove they are BEST!!!**

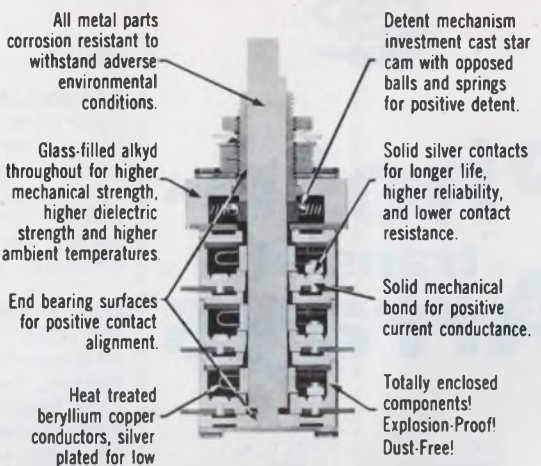

**WRITE FOR FREE CATALOG**

**JANCO CORPORATION**

3111 Winona Ave., Burbank, Calif. 91504  
Phone 213-845-7473 • TWX 910-498-2701

INFORMATION RETRIEVAL NUMBER 58



Be there — tour the  
**1971 Japan Electronics Show**  
In Osaka, Japan, October 1-7

**It's easy**—let Imperial Travel Service arrange your complete itinerary, including flights, accommodations, ground transportation, interpreters and sightseeing tours;

**at a special low cost**—only \$600 air fare to Japan and return, plus \$385 for complete accommodations, all breakfasts, some luncheons, land transportation, admissions, sightseeing and interpreter for 16 days;

**and you can plan your own itinerary**—you can purchase air flights, flights plus land accommodations, add special sightseeing tours and even extend your trip to Hong Kong (\$173 extra air fare) or both Hong Kong and Bangkok (\$270 extra air fare).

- Tours are prepared with the full cooperation of the:
- Electronics Section of the Japan Trade Center and the
  - Electronic Industries Association of Japan.

**CHECK THIS OUT TODAY!**

CALL (212) 581-6350 OR CABLE IMPETRAVEL, NEW YORK

Japan Air Lines tour flight leaves Saturday, Sept. 25th

*Imperial* TRAVEL SERVICE / 680 FIFTH AVENUE, NEW YORK, N.Y. 10019

# NEW!



## Photo-transistor Arrays



EEP's new EPX81 to EPX89 arrays are available in lines of one, two, three, six and nine phototransistors. Each transistor is electrically isolated and is mounted on .100 inch centers. A small apex-angle prevents optical crosstalk between nearby systems. Standard plastic package is easily incorporated in optoelectronic systems for card/tape reading, character recognition, industrial process and control, shaft encoding, sorting, switching and in many other light detection and sensing requirements.

Collector-emitter voltage  $V_{CE}$  25V  
 Photo current  $I_C$  0.6-2.5 mA  
 ( $V_{CE} = 5V$ ;  $B = 1000$  lux)  
 Collector-emitter cutoff current ( $V_{CE} = 25V$ ,  $B = 0$  lux)  $I_{CE} < 200$  mA

### PRICES

Type*	1-24	25 up	100 up	1000 up
EPX81	\$ 1.70	\$ 1.50	\$ 1.20	\$ .79
EPX82	3.50	3.15	2.50	1.75
EPX83	5.70	5.20	4.20	2.96
EPX86	13.60	12.00	9.60	6.70
EPX89	22.00	19.80	15.80	10.90

\*Second digit in type number designates number of transistors in array.  
 Minimum order: \$15.00 per line item

Delivery: From stock. Order from:



10150 W. Jefferson Blvd.,  
 Culver City, California 90230  
 (213) 838-1912

INFORMATION RETRIEVAL NUMBER 59

# product index

Information Retrieval Service. New Products, Evaluation Samples (ES), Design Aids (DA), Application Notes (AN), and New Literature (NL) in this issue are listed here with page and Information Retrieval numbers. Reader requests will be promptly processed by computer and mailed to the manufacturer within three days.

Category	Page	IRN	Category	Page	IRN
<b>Components</b>			capacitors	82	340
capacitors, HV ceramic	78	280	computer handbook	82	345
filters, low/bandpass	78	282	contacts, PC	83	355
relay, time-delay	78	283	contactors	82	341
sensor, optical	78	285	cords, patch	83	363
switch, keyboard	78	281	counters, digital	83	356
switch, preset	78	279	couplers, microwave	83	354
switches, pushbutton	78	284	DIP packages	83	358
			displays, alphanumeric	82	353
<b>Data Processing</b>			doublers, microwave	83	354
computer handbook (NL)	82	345	drives, cassette	83	365
interface unit, EDP	73	263	enclosures, instrument	82	346
modem, analog data	73	262	filters, low/bandpass	82	349
OCR terminal system	73	260	filters, low/bandpass	83	354
programmer, manual	73	264	filters, passive wave	82	340
recorder, video disc	73	261	filters, rfi/emi	82	340
recording heads (DA)	80	292	generator, sweep	82	350
tape splices (ES)	80	289	generators, sweep	82	349
			instruments, pollution	82	348
<b>ICs &amp; Semiconductors</b>			junctions, hybrid	83	354
comparator, 4-bit	72	258	magnets, laboratory	83	362
drivers, JFET	70	254	mixers, microwave	83	354
IC, TV audio	69	251	motors, stepping	83	359
IC, TV processor	72	257	panels, logic	83	361
mixer/modulators, IC	69	252	panel meters, digital	83	356
op amp, monolithic	69	250	PC frames	82	342
op amps, monolithic	70	255	power supplies, modular	82	344
receiver/transmitter, IC	72	256	receivers, microwave	83	354
shift register, static	69	253	relays	82	341
transistors, switching	72	259	ROMs	83	364
			spectrum analyzers	82	349
<b>Instrumentation</b>			splitters, microwave	83	354
counter, frequency	76	274	standards, voltage	82	347
counter/timer	77	276	switches	83	360
DMM, 5-digit	77	275	switches, microwave	83	354
scope, 25-MHz	77	277	telemetry equipment	82	351
spectrum analyzer	77	278	telemetry systems, AM	83	357
			terminals, PC	83	355
<b>Microwaves &amp; Lasers</b>			terminal blocks	82	343
attenuators, thin-film	79	286	transformers	82	352
multiplier arrays	79	287	transformers	83	354
photodetector-op amps	79	288			
			<b>application notes</b>		
<b>Modules &amp; Subassemblies</b>			insulation, epoxy	80	293
converters, a/d	74	267	PC boards	80	291
display, six-digit	74	266	recording heads	80	292
power supply system	74	265			
			<b>design aids</b>		
<b>Packaging &amp; Materials</b>			ICs, high-noise-immunity	80	296
ceramic, dark alumina	75	273	motors, stepper	80	294
coatings, optical	75	272	motors, torque	80	295
connector, card edge	75	268			
elastomer, silicone	75	270	<b>evaluation samples</b>		
heat sinks, DIP	75	271	tape splices	80	290
insulation, epoxy (DA)	80	293	wire ties	80	289
PC boards (DA)	80	291			
sockets DIP	75	269			
wire ties (ES)	80	290			
			<b>new literature</b>		
			amplifiers, microwave	83	354
			attenuators, microwave	82	349
			attenuators, microwave	83	354

Dale RH and RS resistors are used in Burroughs' popular TC 500 on-line terminal computer.



The  
everywhere  
resistors  
...and why.

**DALE WIREWOUNDS:**

Found wherever power must be precisely dissipated. Why? Because of these unequalled advantages:

**SELECTION**—Dale's new resistor catalog gives you the industry's widest choice of standard precision power models—most of them ready to ship from your nearby distributor.

**VERSATILITY**—Your requirements for variations in configuration and function can be quickly matched from a design bank of more than 4000 pre-engineered specials.

**DELIVERY**—2-3 weeks on 1 watt MIL-R-26E models. Comparable fast times on all other popular styles.

*If you think there's no difference in wirewounds—you haven't dealt with Dale. PHONE 402-564-3131 or write for our new expanded Resistor Catalog.*



**DALE ELECTRONICS, INC.,** 1300 28th Ave., Columbus, Nebr. 68601  
In Canada: Dale Electronics Canada, Ltd. • A subsidiary of The Lionel Corporation

INFORMATION RETRIEVAL NUMBER 181

# Grow with RCA's COS/MOS IC line and make your logic systems even more cost-effective

RCA expands its broad line of COS/MOS IC's again to bring the circuit designer nine new opportunities to save space, weight, power, as well as cost, in his new and existing logic circuit designs. The nine new types shown here now widen the number of COS/MOS functions to a total of 43.

- Dual-in-line ceramic and flat-pack packaged COS/MOS IC's (AD and AK series) enable the designer to plan cost-effectiveness into demanding military and aerospace systems. Operating tem-

perature range of these devices is  $-55^{\circ}$  to  $+125^{\circ}\text{C}$ .

- Dual-in-line plastic packaged COS/MOS IC's (AE series) that open up many new application areas in industrial and commercial logic systems. Their operating temperature range is  $-40^{\circ}$  to  $+85^{\circ}\text{C}$ .

Designers prefer RCA COS/MOS for these significant design advantages: extremely low power dissipation - Gates,  $P_T = 10 \text{ nW}$  (typ) at  $V_{DD} = 10 \text{ V}$  (50 nW for AE series); MSI circuits,  $P_T = 10$

$\mu\text{W}$  (typ) at  $V_{DD} = 10 \text{ V}$ . Noise immunity is 45% of the applied voltage over the entire 3 to 15 volts operating range.

See your local RCA Representative or RCA Distributor for price and delivery information on RCA's full line of COS/MOS Product Guide COS-278A write: RCA, Commercial Engineering, Section 5712/CDC65, Harrison, N.J. 07029. International: RCA, Sunbury-on-Thames, U.K., or P.O. Box 112, Hong Kong or, RCA Limited, St. Anne de Bellevue, 810 Quebec, Canada.

## RCA Solid State

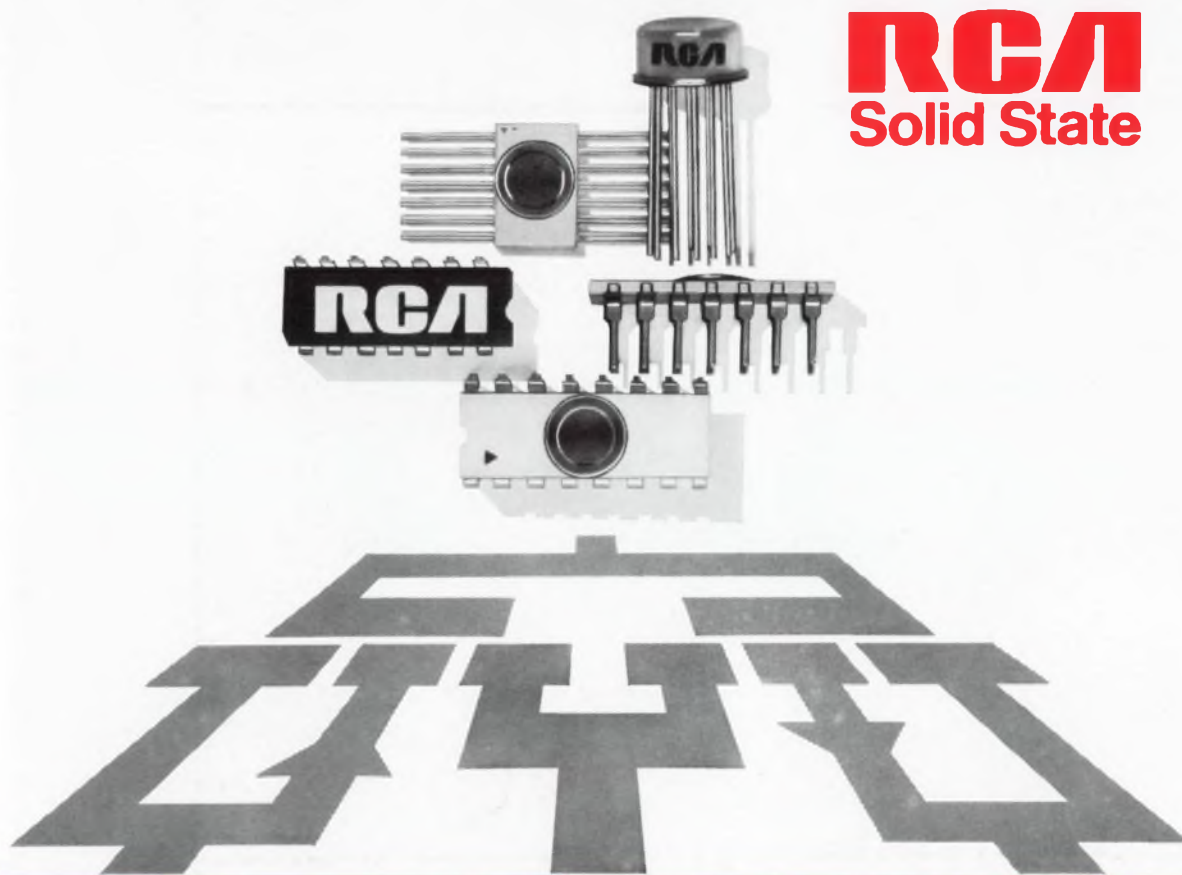

Formerly Dev. No.	Circuit Description	Commercial Type No.	Package	Price 1000-unit level	Formerly Dev. No.	Circuit Description	Commercial Type No.	Package	Price 1000-unit level			
TA5385C	7 Stage Ripple Carry Binary Counter w/Buffered Reset (CD4004A Replacement)	CD4024AD	14 pin DIL	\$ 7.50	TA5925W	Presettable, up/down Counter, Binary or BCD Decade	CD4029AD	16 pin DIL	\$11.95			
		CD4024AE	14 pin DIP	3.35			CD4029AE	16 pin DIP	5.75			
		CD4024AK	14 pin F.P.	8.20			CD4029AK	16 pin F.P.	12.60			
		CD4024AT	12 pin TO-5	7.50			TA5940W	Quad Exclusive OR Gate	CD4030AD	14 pin DIL	3.95	
TA6018W	Decade Counter/Divider with 7 Segment Display Outputs (Display Enable Input)	CD4026AD	16 pin DIL	12.50	CD4030AE	14 pin DIP	1.55	TA5963W	Triple Serial Adder (Positive Logic Version)	CD4032AD	16 pin DIL	7.20
		CD4026AE	16 pin DIP	5.95	CD4032AE	16 pin DIP	4.25					
		CD4026AK	16 pin F.P.	13.15	CD4032AK	16 pin F.P.	7.85					
TA5872W	Dual J/K F-F with Set/Reset	CD4027AD	16 pin DIL	5.50	TA5677W	Decade Counter/Divider with 7 Segment Display Outputs (Ripple Blanking)	CD4033AD	16 pin DIL	12.50			
		CD4027AE	16 pin DIP	2.65			CD4033AE	16 pin DIP	5.95			
		CD4027AK	16 pin F.P.	6.15			CD4033AK	16 pin F.P.	13.15			
TA5873W	BCD to Decimal Decoder	CD4028AD	16 pin DIL	8.25	TA5951	Triple Serial Adder (Negative Logic Version)	CD4038AD	16 pin DIL	7.20			
		CD4028AE	16 pin DIP	4.10			CD4038AE	16 pin DIP	4.25			
		CD4028AK	16 pin F.P.	8.90			CD4038AK	16 pin F.P.	7.86			