

Electronic Design 15

VOL. 19 NO.

FOR ENGINEERS AND ENGINEERING MANAGERS

JULY 22, 1971

Controlling automobile traffic flow on today's streets and highways is no longer a simple engineering job. Game theory is used to plan signal switching strategies.

Computers, data communication systems as well as closed-circuit television are becoming common tools. Automated highways? The work has started. See page 49.





Square trimmers go automatic with new Dale *Fastpack* styling

New from Dale: The first square, film-element trimmers really designed for your high-volume, high-density automatic packaging operations. Our new 87 and 85 **Fastpack** Series combine DIP pin spacing with ½-watt power dissipation and the tough, sealed construction it takes to function reliably after automatic insertion, washing and soldering. Setting stability is excellent—and you have your choice of adjustability. The multi-turn 85 **Fastpack** and the single-turn 87 **Fastpack** fit most industrial/commercial needs as well as many military applications.

SPECIFICATIONS

Power Rating: ½ watt at room temperature

Resistance Range: 10 ohms to 1 Megohm

Tolerance: ±20% standard,
closer tolerances available

Temp. Coefficient: ±150 PPM/° C standard

Operating Temp.: -55° C to +125° C

Resolution: Essentially infinite

Adjustment: 87 = 1 turn; 85 = 12 turns nominal

Construction: Sealed case permits cleaning in common solvents. Standoffs permit board washing.

Dimensions: .265" wide x .280" long x .190" high.
Pin spacing: .300" x .200" grid. Machine insertable models .355" x .200" prior to insertion.

*Gear up for faster production and lower costs with
Dale **Fastpack** trimmers—Phone 402-564-3131 today!*

DALE ELECTRONICS, INC.
1300 28th Ave., Columbus, Nebr. 68601
In Canada: Dale Electronics Canada, Ltd.
A subsidiary of The Lionel Corporation

INFORMATION RETRIEVAL NUMBER 121

DALE®

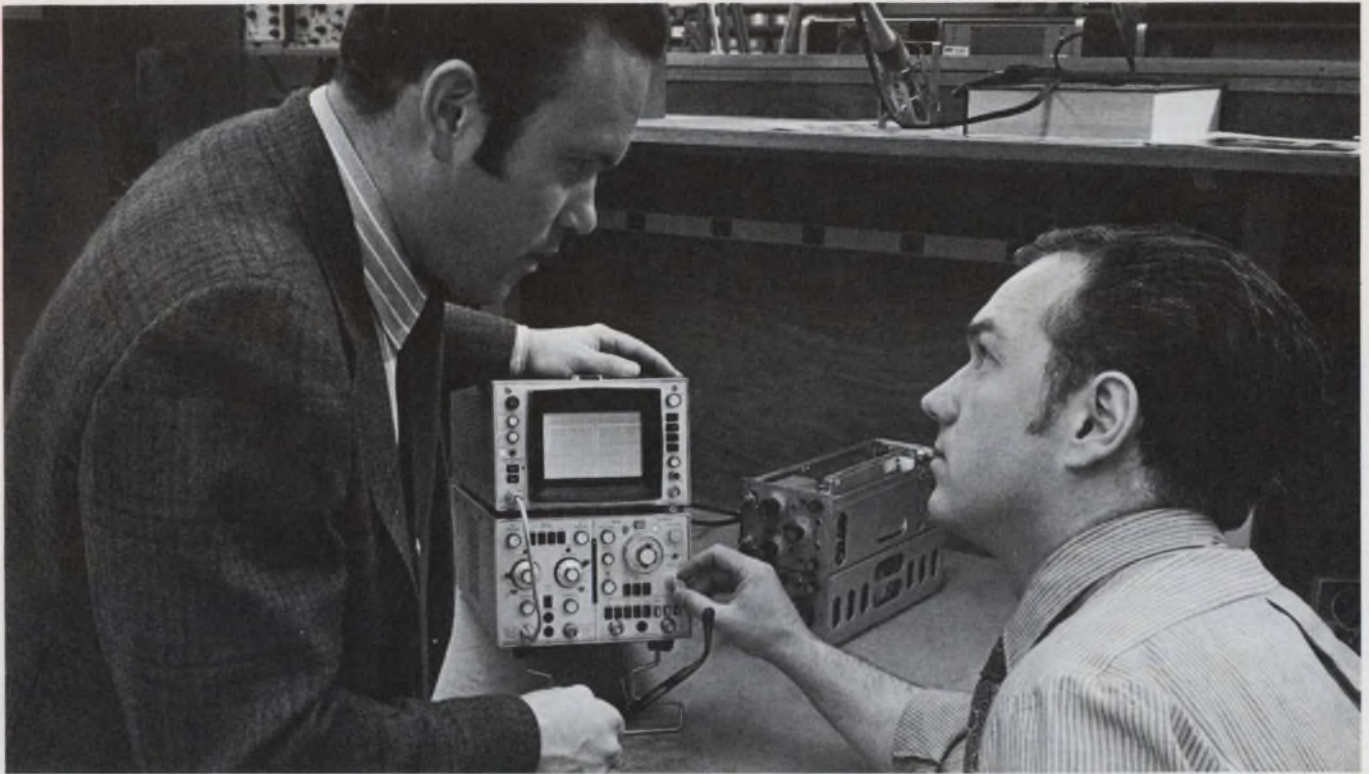

HP's 250 MHz 183: Still The Performance Champ! Ask For A Demo.

If you want to look at waveforms in high-speed logic circuits, or to photograph ultra-fast transients—there's still only one general purpose, lab oscilloscope that gives you a real-time window from DC to VHF. It is HP's 183, the 250 MHz 10 mV/div scope (to 600 MHz with direct access plug-in)—**now available for demos on your bench.**

HP pioneered in the development of the first useful, usable high-frequency scope to give you these features: 10 mV sensitivity, 1.5 ns rise time, 4 cm/ns writing speed, negligible distortion from input capacitance. **Balancing price and performance the 183A system is a bargain**—with delayed sweep, \$3900; without delayed sweep, \$3400 (available in either cabinet or 5¼" rack-height versions).

HP's technical leadership, covering a wide area of disciplines, made it all possible. An in-house IC capability produced monolithic transistor arrays for the vertical amplifier—

key factor in achieving good transient response with 250 MHz bandwidth and high-fidelity reproduction of waveforms.

HP's step-ahead CRT technology produced a unique CRT to display fast signals. The CRT uses two transmission lines for the vertical deflection system, to provide distributed deflection of the electron beam and to give the CRT a **cutoff frequency well beyond present IC technology.**

Since the 183A mainframe is not limited by hard-wired, internal amplifiers, you have freedom to take advantage of any existing HP 180 Series plug-ins, plus any HP high frequency innovations, as they become available—and higher bandwidth amplifiers are now in HP development labs.

Meanwhile, the HP 183 250 MHz Scope is a deliverable system, **capable of making your measurements, now.** And it's backed by almost two years of successful, in-the-field performance on customer workbenches.

The same step-ahead thinking
INFORMATION RETRIEVAL NUMBER 2

exemplified in the HP 250 MHz scope also exists in all HP scopes. To find out all about the most exciting new developments in the rapidly changing world of oscilloscopes, ask your HP field engineer to show you the whole HP 180 scope family, including sampling and storage. Or write, Hewlett-Packard, Palo Alto, California 94304. Europe: 1217 Meyrin-Geneva, Switzerland.

Scopes are
changing.
Are you?

081/13

HEWLETT  PACKARD

Siemens

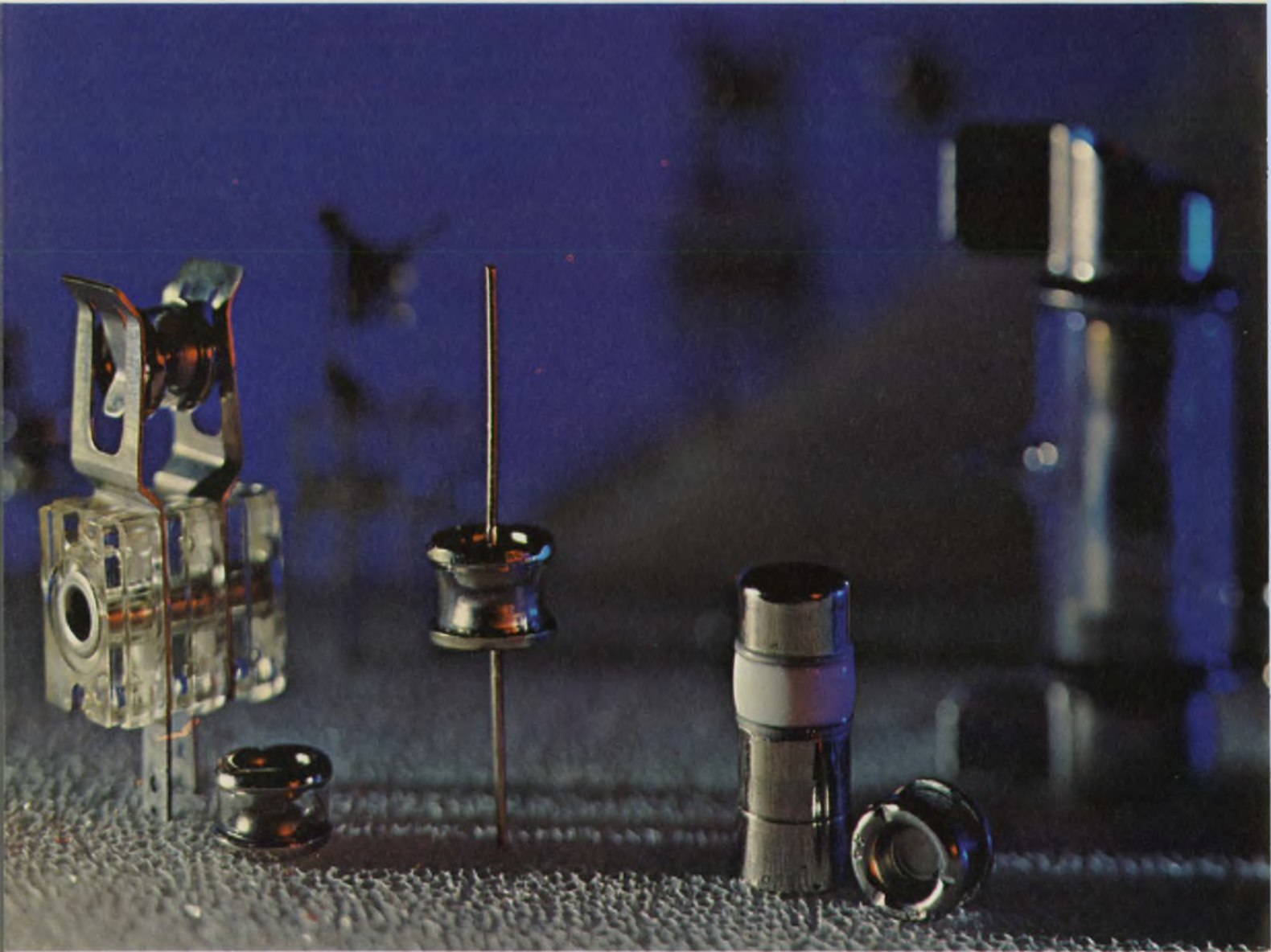

Low-cost SVP™ devices can save your valuable equipment from destruction by voltage transients.

You can no longer overlook the need for protecting your circuits. New sources of transients are cropping up every day. And any one of them might cause operational failure of your equipment.

Now there is an easy low-cost way to protect your circuitry from these transients. It's a simple little

gas-filled surge voltage protector. We call it an SVP. Only this Siemens SVP offers high-current capability (up to 50 kiloamps) in such a small package and a high impedance when not conducting (10^{10} ohms, 1 to 6.8 pF depending on model).

Siemens is the world's largest manufacturer of surge voltage

protectors. More engineers are using them every day. You can benefit by doing the same.

Siemens Corporation, 186 Wood Avenue South, Iselin, N.J., 08830. (201) 494-1000. Siemens. A three billion dollar name in quality products.



SIEMENS

NEWS

- 19 **News Scope**
- 22 **In consumer packaging it's modules, modules everywhere**, along with the trend to solid state.
- 24 **Acoustic holography, a new medical electronics tool**, picks up where medical X-rays leave off.
- 26 **Lf quartz crystal size cut drastically**.
- 28 **A holographic display that can be updated in real time** is now moving from a dream to a development.
- 32 **Technology Abroad**
- 39 **Washington Report**

TECHNOLOGY

- 49 **A chance to banish the traffic nightmare**—A civionics report on untangling traffic with sensors and computer cops.
- 58 **Improve wideband FM recordings** by reducing noise and distortion. Just insert three types of signal-processing circuits in the basic system.
- 62 **Baluns cut ground noise** between interfacing circuits when they are used as common-mode chokes. And they're not common-mode limited.
- 66 **This voltage-controlled rf attenuator** replaces the ganged potentiometers of a standard bridged-Tee attenuator with a pair of p-i-n diodes.
- 70 **For a higher yield from exhibit visits**, check these five pointers. They should help to make your next convention trip more productive.
- 72 **Ideas for Design**

PRODUCTS

- 79 **Instrumentation:** Input DPM circuit allows displays of nonlinear data.
- 83 **ICs & Semiconductors:** Tri-state, 256-bit RAM has 12-ns chip-select speed.
- 86 **Components:** A new solid-state switching device eliminates contact bounce.
- | | | | |
|----|----------------------|----|-------------------------|
| 80 | Microwaves & Lasers | 88 | Modules & Subassemblies |
| 82 | ICs & Semiconductors | 89 | Data Processing |
| 85 | Components | 91 | Packaging & Materials |

Departments

- 47 **Editorial:** Blow the whistle on fraudulent claims
- | | | | |
|----|---------------------|-----|----------------------------|
| 7 | Letters | 94 | New Literature |
| 13 | Designer's Calendar | 98 | Bulletin Board |
| 92 | Evaluation Samples | 102 | Advertisers' Index |
| 92 | Design Aids | 104 | Information Retrieval Card |
| 93 | Application Notes | | |

Cover: Designed and photographed by Art Director Bill Kelly

Fight noise pollution

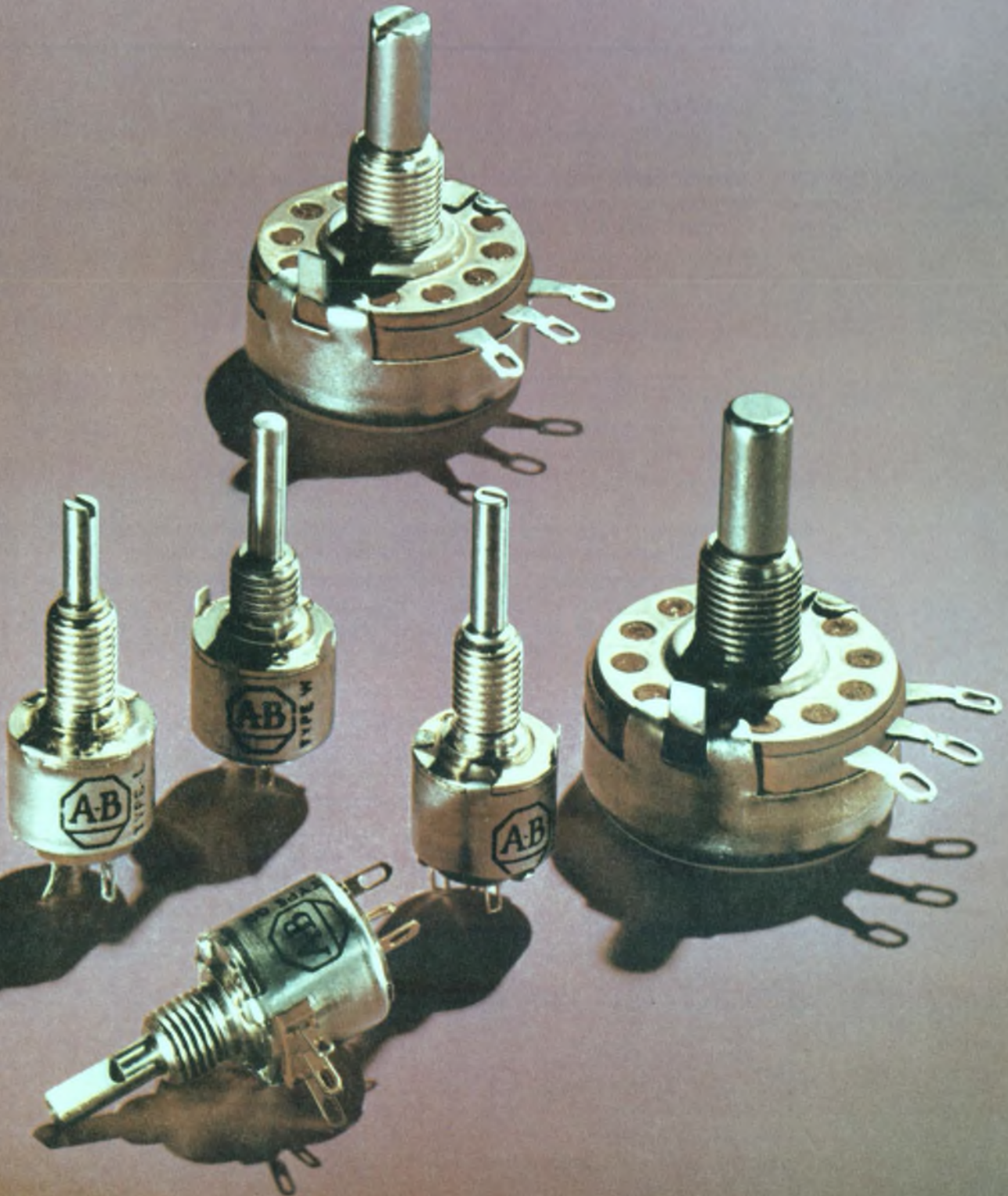

with this quiet family.

Hot Molding with Allen-Bradley's exclusive technique, gives these composition variable resistors an unusually low noise level. And importantly, this low noise level actually decreases in use. Under tremendous heat and pressure the resistance track is molded into place. A solid element with a large cross-section is produced.

This important Allen-Bradley difference means better short-time overload capacity and a long operating life. Control is smooth, resolution almost infinite. These variable resistors are ideal for high frequency circuits. Why should you trust the performance of

your designs or your reputation to anything less than Allen-Bradley quality? Use the most thoroughly "field tested" (over 20 years) variable resistors available today. Quantity stocks of popular types J, G, W and GD available for immediate delivery from your appointed A-B industrial electronics distributor.

For information write: Marketing Department, Electronics Division, Allen-Bradley Co., 1201 South Second Street, Milwaukee, Wisconsin 53204. Export office: 1293 Broad Street, Bloomfield, N. J. 07003, U.S.A. In Canada: Allen-Bradley, Canada Ltd., 135 Dundas Street, Galt, Ontario.

SPECIFICATIONS

	TYPE J— STYLE RV4	TYPE K	TYPE G— STYLE RV6	TYPE L	TYPE W	TYPE GD
CASE DIMENSIONS	5/8" deep x 1-5/32" dia. (single section)	5/8" deep x 1-5/32" dia. (single section)	15/32" deep x 1/2" dia.	15/32" deep x 1/2" dia.	15/32" deep x 1/2" dia.	35/64" deep x 1/2" dia.
POWER at + 70°C	2.25 W	3 W	0.5 W	0.8 W	0.5 W	0.5 W
TEMPERATURE RANGE	-55°C to +120°C	-55°C to +150°C	-55°C to +120°C	-55°C to +150°C	-55°C to +120°C	-55°C to +120°C
RESISTANCE RANGE (Tolerances: ±10 and 20%)	50 ohms to 5.0 megs	50 ohms to 5.0 megs	100 ohms to 5.0 megs	100 ohms to 5.0 megs	100 ohms to 5.0 megs	100 ohms to 5.0 megs
TAPERS	Linear (U), Modified Linear (S), Clockwise Modified Log (A), Counter-Clockwise Modified Log (B), Clockwise Exact Log (DB). (Special tapers available from factory)					
FEATURES (Many electrical and mechanical options available from factory)	Single, dual, and triple versions available. Long rotational life. Ideal for attenuator applications. Snap switches can be attached to single and dual.	Single, dual, and triple versions available. Long rotational life.	Miniature size. Immersion-proof. SPST switch can be attached.	Miniature size. Immersion-proof.	Commercial version of type G. Immersion-proof.	DUAL section version of type G. Ideal for attenuator applications. Immersion-proof.

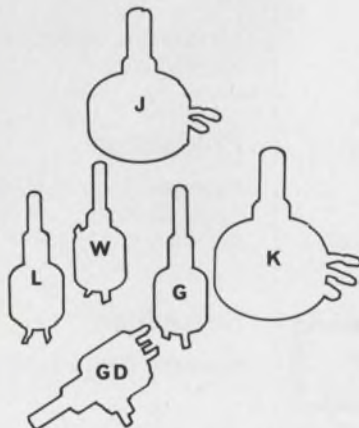

NEW DIMENSION ELECTRONICS
ALLEN-BRADLEY

INFORMATION RETRIEVAL NUMBER 5





How to Buy a Good Power Supply Without Spending a Bundle...

Take a long look at the Abbott line of over three thousand standard models **with their prices listed**. The unit shown above, for instance, is the Abbott Model R5S, a 60 Hz to DC converter which puts out 5 volts of regulated DC at 0.15 amps and sells for only \$83. Other power outputs from 2 to 240 watts are available with **any output voltage from 5 volts to 3,650 volts**, all listed as standard models in our catalog. These power supplies feature close regulation, short circuit protection, and the latest state of the art specifications for solid state modules.

If you really want to save money in buying your power supply, why spend many hours writing a complicated specification? And why order a special custom-built unit which will cost a bundle—and may

bring a bundle of headaches. As soon as your power requirements are firmed up, check the Abbott Catalog or EEM (see below) and you may be pleasantly surprised to find that Abbott already has standard power supplies to meet your requirements — **and the prices are listed**. Merely phone, wire, or write to Abbott for an immediate delivery quotation. Many units are carried in stock.

Abbott manufactures a wide variety of different types of power supply modules including:

- 60A to DC, Regulated
- 400A to DC, Regulated
- 28 VDC to DC, Regulated
- 28 VDC to 400A, 1 ϕ or 3 ϕ
- 24 VDC to 60A, 1 ϕ

Please see pages 930 to 949 of your 1970-71 EEM (ELECTRONIC ENGINEERS MASTER Catalog) for complete information on Abbott modules.

Send for our new 68 page FREE catalog.

abbott transistor

LABORATORIES, INCORPORATED
5200 W. Jefferson Blvd./Los Angeles 90016 (213) 936-8185
1224 Anderson Ave./Fort Lee, N.J. 07024 (201) 224-6900
Cable ABTLABS

INFORMATION RETRIEVAL NUMBER 6

Publisher

Peter Coley

Editors

Editorial Offices
50 Essex St.
Rochelle Park, N.J. 07662
(201) 843-0550
TWX: 710-581-2874
Cable: Haydenpubs Rochellepark

Editor: Frank Egan
Managing Editor: Ralph Dobriner
Managing Editor: Raymond D. Speer
Microelectronics, Steven A. Erenburg
Computers, Raymond D. Speer
Microwaves, Michael J. Riezenman
Circuits, Edward A. Torrero
Special Projects, George Rostky
Management, Richard L. Turmail
Military-Aerospace, John F. Mason
News, Michael P. London
New Products, Roger Allan

Field Offices

Massachusetts
Jim McDermott
P.O. Box 272
Easthampton, Mass. 01027
(413) 527-3632

West Coast
David Kaye
2930 Imperial Highway
Inglewood, Calif. 90303
(213) 757-0183

Washington
Don Byrne
1111 S. Army Navy Drive
Arlington, Va. 22202
(202) 296-8982

Editorial Production

Dollie S. Viebig

Art

Art Director, William Kelly
Richard Luce

Production

Manager, Thomas V. Sedita
Helen De Polo
Kathleen McConkey

Circulation

Manager, Nancy L. Merritt

Information Retrieval

Peggy Long

letters

Training of teachers defended as essential

I had intended to reply sooner to your editorial by Mr. Dobriner in ED 5, March 4, 1971 regarding placement of EE's in the classroom but time slipped away. However, after reading the two letters in ED 9, April 29, 1971, I feel that someone should point out a few facts on the other side of the issue.

First, Mr. Dobriner's proposal of placing engineers in the classroom certainly has some merit if they intend to stay there and gain teaching experience and would not hastily leave after "this year of the engineering crunch" is over. If the engineer's attitude toward teaching is simply "any port in a storm," then one must ask if this half-hearted attitude might not have a similar effect on his teaching performance.

Second, Mr. Yurescko is quite accurate in saying that one can teach teachers if he possesses a Ph.D. but is not allowed to teach in public schools. How many of us have had to suffer through a "prof" who knew all there was to know about his subject, but couldn't teach it worth a damn! No, simple possession of knowledge on the part of an individual does not make him a teacher. Education classes are criticized as a waste of time—many rightly so. But many are invaluable in showing a prospective teacher how to motivate a child and present material in a manner which will make the child want to learn. Few of us realize the enormous differences involved in teaching a college student and a student in the secondary school. Sure, there are bumbling teachers and ineffective school administrators (which is true for engineers and managers, too), but I have grave doubts about Mr. Yurescko's

prediction of "How wonderful it would be, if everyone had the right to teach." Teaching is a lot more than just: "Read the text, answer the question, and a test!"

Third, I confess that several years ago I thought my math background obtained via a BS in physics plus five years of engineering experience at Vandenberg AFB was adequate preparation for teaching math in public schools. How wrong I was! Sure, engineers are heavy in math: calculus, differential equations, Laplace transforms, etc. But how many of these same individuals would be able to handle the kind of math that is being taught in schools today? I won't go into a debate on the good or evil of so-called modern math—I will say that it is very different from what was taught to most of us just five to 10 years ago!

M. Cermack

Let's keep engineers working as engineers

Sir:

Re: Your editorial "Don't waste our EE's—Put Them in Classrooms" (ED 5, March 4, 1971), you gotta be kidding! Isn't an EE who is not EE-ing being wasted? The fact that the IEEE endorses this thinking is only a further indication that it is not concerned about the plight of our profession.

I would suggest that you and the IEEE try to find ways to help the engineering profession rather than supplant it with a new one.

Neil Schleifman

Group Leader
Intertype Co.
360 Furman St.
Brooklvn. N. Y. 11201

Accuracy is our policy

In the May 13, 1971 issue, p. 54, "Designing for the pollution-free industrial era," the sentence containing the words: ". . . as many as 3 distinct bands" should read: ". . . as many as 32 distinct bands."

Electronic Design welcomes the opinions of its readers on the issues raised in the magazine's editorial columns. Address letters to Managing Editor, Electronic Design, 50 Essex St., Rochelle Park, N. J. 07662. Try to keep letters under 200 words. Letters must be signed. Names will be withheld on request.

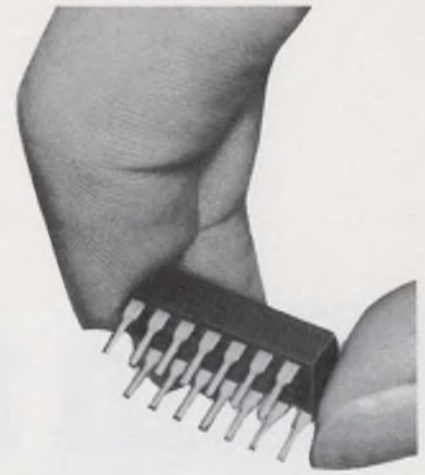

can one LATCHING RELAY offer all this?

- High Reliability
(100 x 10⁶ operations)
- Inherent Contact Memory
- Bounce-Free Operation
- Self-Healing Contacts
- Operation in Any Mounting Position
- Miniature Size
- No Latching Current
- Virtually No Noise
- Shock and Vibration Resistance
- For Signals from DC to 120 MHz

Yes... if it's a LOGCELL[®] Mercury Film Relay

Both latching and nonlatching Logcell Relays are available. For more information about Logcell Relays, and Logcell Switches, too, write Fifth Dimension Inc., Box 483, Princeton, New Jersey 08540. Or call (609) 924-5990.



FIFTH DIMENSION INC.

INFORMATION RETRIEVAL NUMBER 7

**Main memories
get 45,000,000 bits
of 1103 MOS RAM.**

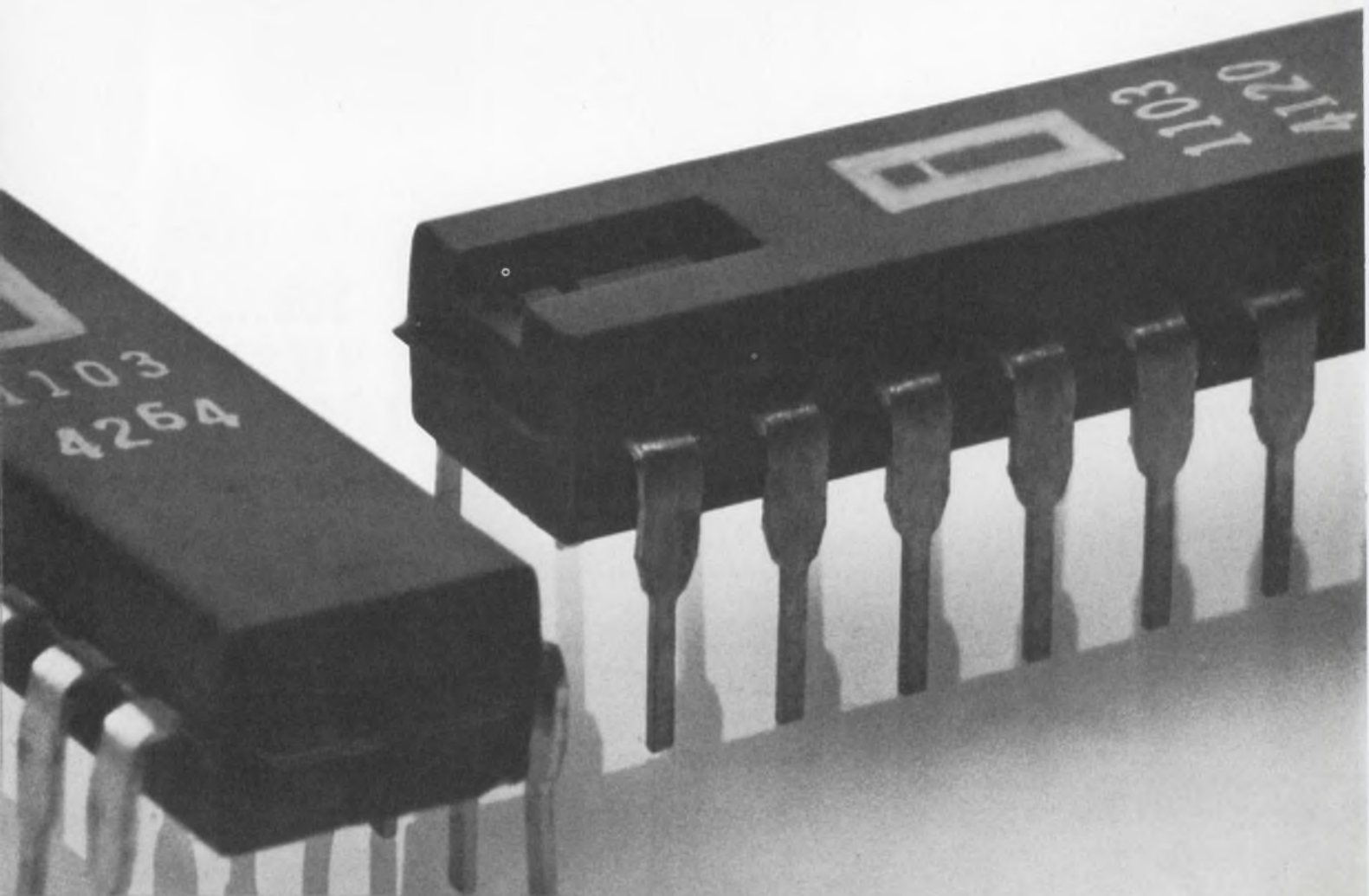

As of June 21 Intel has delivered 45,000,000 bits of the 1103 MOS RAM for use in main frames, mini-computers, data terminals, controllers and scientific calculators.

We can't reveal the buyers as yet, but when you hear their names (perhaps at FJCC) you'll recognize some of the leading figures in the computer industry.

And the RAM they have tested and selected is Intel's 1103, the 1024-bit silicon-gate MOS RAM that's in production in a big way. Deliveries of the 1103 in June alone will total 17,000,000 bits. So if you're thinking of designing with semiconductor memory, don't overlook Intel's 1103. It's the RAM to reckon with.

The 1103's specifications have improved recently. Read cycle time is 480 ns, down from 540 ns. Pre-charge to data out has improved from 390 nsec to 310 nsec. As before, all AC and DC parameters are guaranteed from 0°C to 70°C.

For immediate delivery of the 1103 call your local Intel distributor, Cramer Electronics, Hamilton Electro Sales, Industrial Components, or Electronic Marketing. In Europe contact Intel at Avenue Louise 216, B 1050 Bruxelles, Belgium. Phone 492003. In Japan contact Nippon IC, Inc., Parkside Flat Bldg. No. 4-2-2, Sendagaya, Shibuya-Ku, Tokyo 151. Phone 03-403-4747.

Intel Corporation is in a brand-new production facility at 3065 Bowers Ave., Santa Clara, California 95051. Phone (408) 246-7501.

INFORMATION RETRIEVAL NUMBER 8

intel™
delivers.

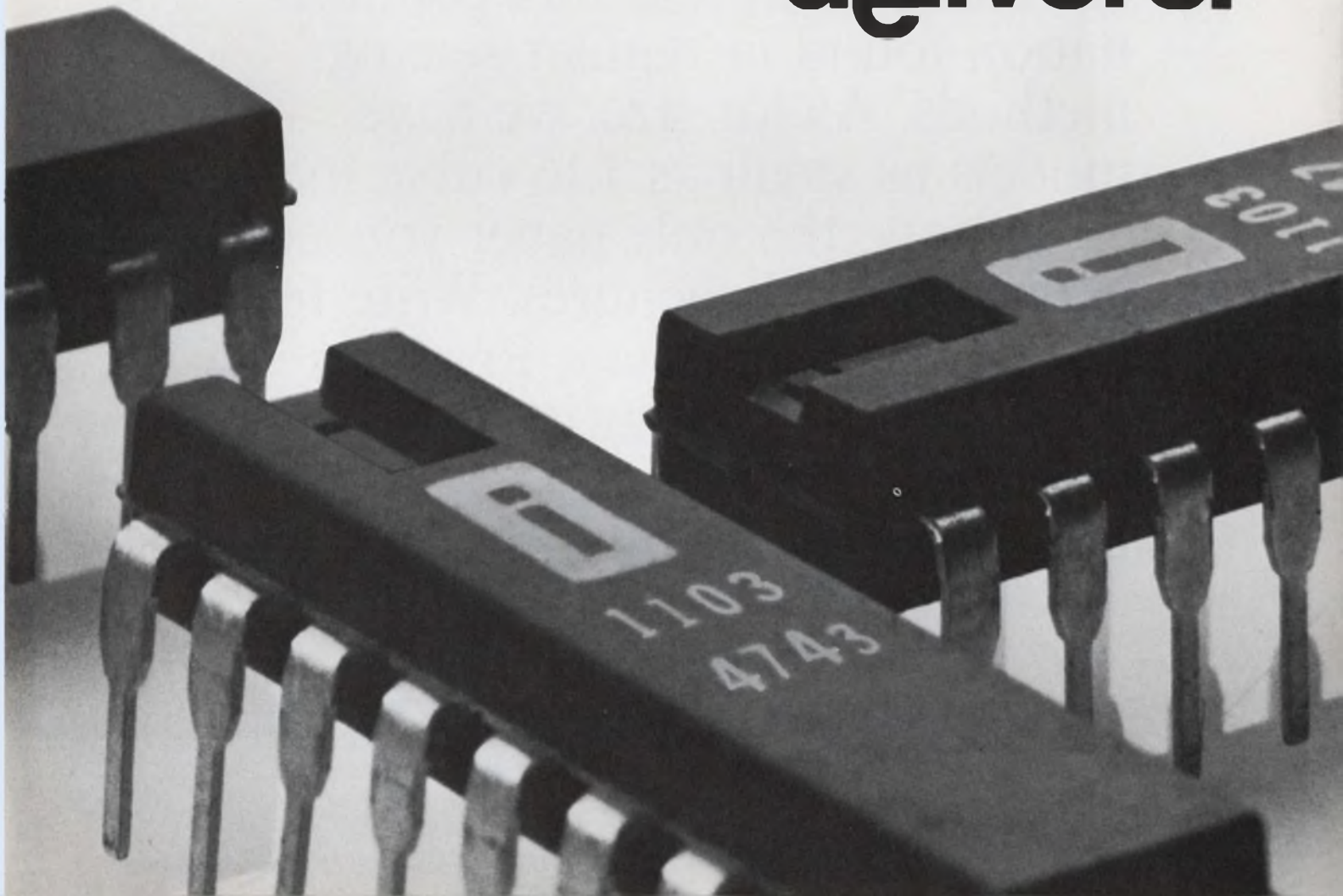

A better way to specify oscillators.

We have a special coding sheet that lets you specify one or more models from over 700 different temperature compensated and clock oscillators.

Our oscillators are made with a unique cold weld crystal which eliminates heat and flux contamination found in regular sealing methods. As for size, we have models as small as 1.16 cubic inch.

So now, the only paper you need is one of our brochures. Write to Motorola Component Products Dept., 4545 W. Augusta Blvd., Chicago, Illinois 60651



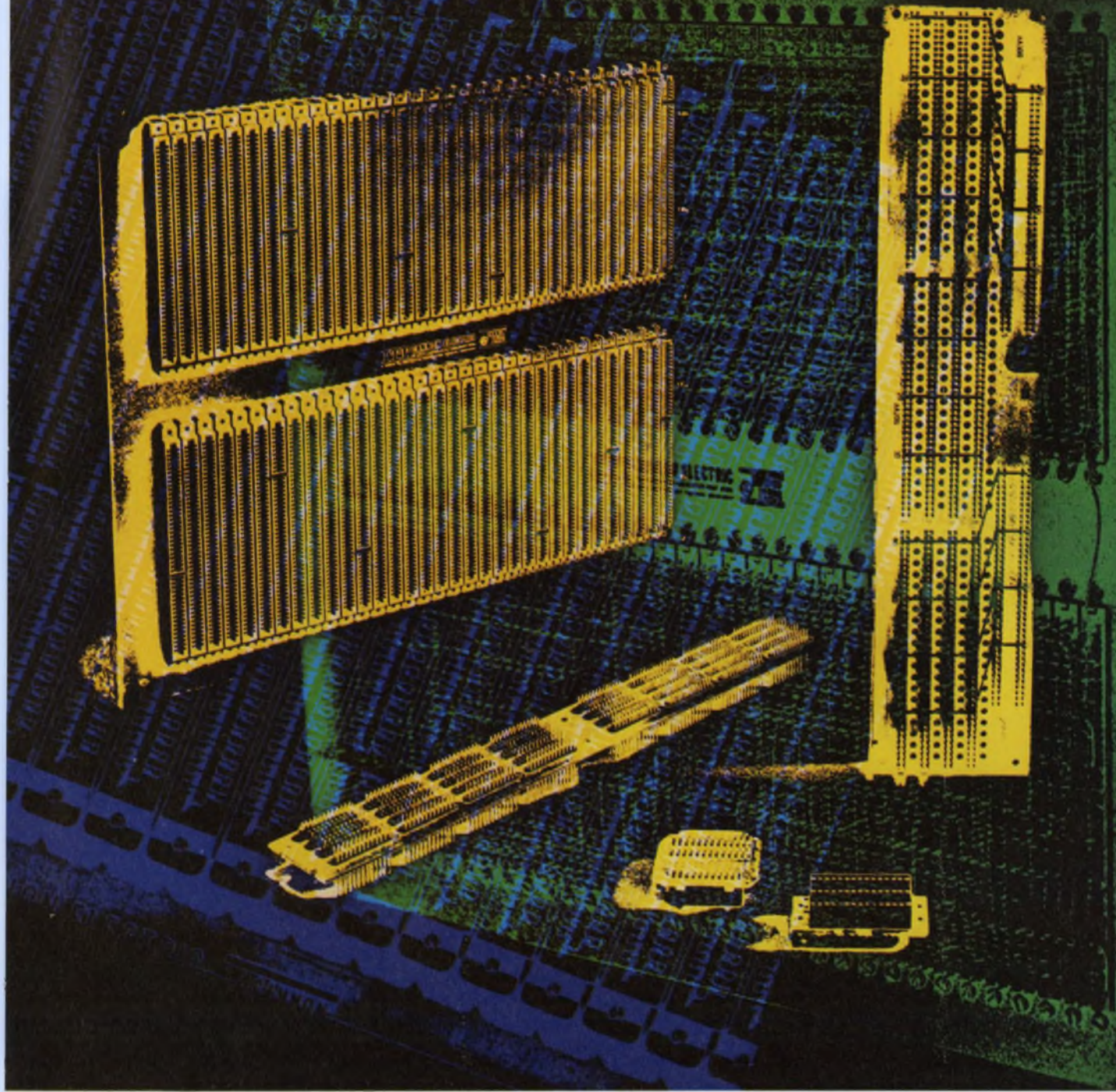

Bottom preloading means better backplanes from Cannon.

When you buy ITT Cannon backplane assemblies you get more dependability, versatility and safety because of the exclusive bottom preload design of our single-beam contact plate connectors.

In most backplane connectors the contacts are "hooked" behind small shoulders of the insulator. Not so with Cannon ECS series connectors. The whole main body of the insulator acts as the bearing surface against the contact's full width.

That means better backplane assemblies because contacts cannot become dislodged causing loss of preload, contacts cannot short against one another, and printed circuit boards, when being inserted, cannot crush contacts.

And there's more insulator material and better material between the contacts, UL approved NORYL, for maxi-

mum safety. Polarizing keys have deeper slots and withstand the most rugged abuse, and can't be jarred loose.

Whatever

your space and configuration requirements, we can deliver backplane assemblies using connectors of practically any length from our basic building block sizes. Connectors can be as close as .250" on center with contacts .125" x .125", or connectors

on .300" centers with contacts on .100" x .100". The base plate may be used as common ground, or laminated voltage planes can be added and connected to specified pins.

Set yourself up for the best backplanes available by contacting ITT Cannon Electric, International Telephone and Telegraph Corporation, 666 East Dyer Road, Santa Ana, California 92702. (714) 557-4700.

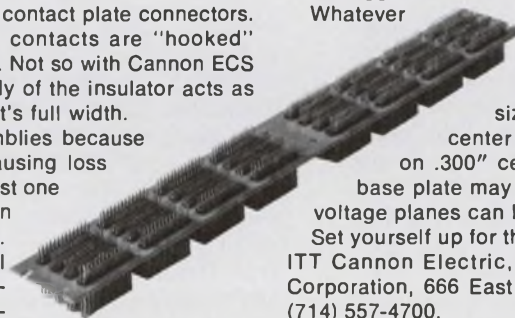

CANNON ITT

Look at it from every angle.

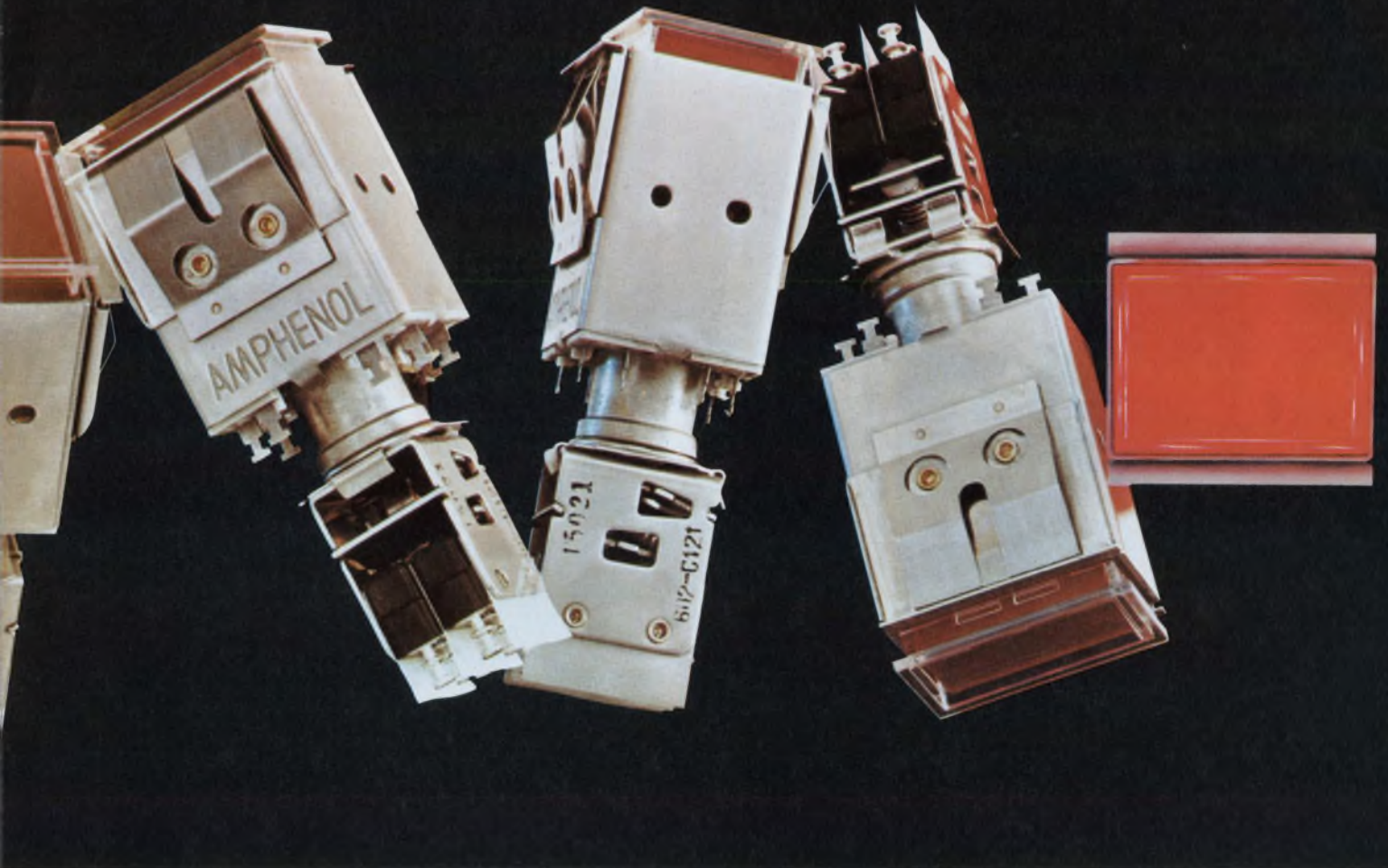

You can't beat the quality or the price.

This switch is from Amphenol's new line of four-lamp push-button panel controls and matching indicator lights. Examine it thoroughly. Notice the careful attention given to its construction.

And each module in the Series 602 line gives you complete freedom of design in circuitry and display. Mounting is quickly accomplished from the front of the panel. Operator indicator module permits independent lamp illumination and provides for momentary or alternate action.

Display possibilities? Lateral, longitudinal;

single-, three-, and four-section screens with a wide variety of color arrangements. Also, a wide variety of mounting options are awaiting your specifications. Long and short barriers, long and short side flange mounts, and optional spacing barriers.

Take another close look at the new Amphenol Series 602, then ask us about the price. That's really worth looking at—from any angle. We'll send you a full line catalog too. Amphenol Controls Division, Bunker Ramo Corporation, 120 South Main Street, Janesville, Wisconsin 53545.

**BUNKER
RAMO**

AMPHENOL

designer's calendar

AUGUST 1971

S	M	T	W	T	F	S
1	2	3	4	5	6	7
8	9	10	11	12	13	14
15	16	17	18	19	20	21
22	23	24	25	26	27	28
29	30	31				

Aug. 17 - 19

Conference on High Frequency Generation and Amplification—Devices and Applications (Ithaca, N. Y.) Sponsors: Cornell Univ. et al. Joseph L. Rosson, Cornell Univ., Phillips Hall, Ithaca, N. Y. 14850.

CIRCLE NO. 418

Aug. 24 - 27

Western Electronic Show & Convention (San Francisco) Sponsors: IEEE, WEMA. WESCON Office, 3600 Wilshire Blvd., Los Angeles, Calif. 90005.

CIRCLE NO. 419

Aug. 25-27

International- Geoscience Electronics Symposium (Washington, D. C.) Sponsor: IEEE. M. T. Miyasaki, Johns Hopkins Univ., 8621 Georgia Ave., Silver Spring, Md. 20910.

CIRCLE NO. 420

SEPTEMBER 1971

S	M	T	W	T	F	S
			1	2	3	4
5	6	7	8	9	10	11
12	13	14	15	16	17	18
19	20	21	22	23	24	25
26	27	28	29	30		

Sept. 8-10

International Conference on Urban Transportation (Pittsburgh, Pa.) Sponsors: U. S. Dept. of Transportation et al. Arthur V. Harris, P.O. Box 2149, Pittsburgh, Pa. 15230.

CIRCLE NO. 421

Nytronics Inductors. Nytronics Capacitors. Off-The-Shelf Service.

Just one big, happy sub-miniature family.

If you buy Nytronics inductors, you should know about our little capacitors,

because we're getting to be pretty big in the capacitor field, with an extremely wide variety of film, paper, tantalum and ceramic units for commercial, industrial and military applications. Capacitance ranges are available from 5,000 μ f at 15 volts to 4.7 pf at 200 volts in sizes down to sub-miniature chips.

And the same precision construction and rigid quality that have made Nytronics inductors the industry standard go into our capacitors as well. Next time you call for Nytronics inductors, ask to see samples of Nytronics capacitors in the sizes and types you use. We're sure you'll be pleased.

If you buy Nytronics capacitors, you should know about our little inductors,

because Nytronics is one of the nation's largest suppliers of miniature RF inductors. We offer MIL-Spec shielded, unshielded, chip and variable inductors in hundreds of off-the-shelf stock values with inductance ranges from .025 μ H to 12H and sizes ranging from the world's smallest shielded inductor to the most complex variable inductors. And Nytronics maintains rigid in-line quality assurance systems to meet or exceed the most demanding industrial and MIL-Spec requirements.

Whatever your capacitor or inductor requirements, it will be worth your while to check with Nytronics or our Local Distributor.



Nytronics, Inc.

Orange Street, Darlington, S.C. 29532 • (803) 393-5421 • TWX 810-665-2182

With the Xerox MD40 you get a bit more.

0101
1101
0010
1



For starters, when you buy the MD40, you get 13-bit resolution for the price of 12. But that's not all.

You also get an instrument you can use as an A-to-D converter, as a high level multiplexer-digitizer with up to 256 channels, as a digitizer-controller for up to 1024 low-level channels, or as a combination high-and-low level digitizer. All without

changing wiring or documentation, simply by plugging in different modules.

And you get the MD40 in standard 19" rack mounting, with your choice of two types of digital I/O connections, and any of six different output formats: 1's complement, serial or parallel; or BCD, parallel. Input can be single-ended or differential, gain programmable. And a list of other options.

And even though the MD40 is a 13-bit instrument, with double the resolution of com-

parably priced units, you can also get it with 8, 9, 10, 11, or 12-bit resolution, to get the perfect match for your application.

Finally, you get compatibility with our full line of 15-bit instruments.

To sum it up, with the MD40 you get not only one more bit, but quite a bit more.

To get more information call (213) 679-4511, ext. 1147 or 3392, or write to Xerox Data Systems, M1-63, 701 South Aviation Blvd., El Segundo, California 90245.

Xerox Data Systems

XEROX®

TO WRAP OR NOT TO WRAP

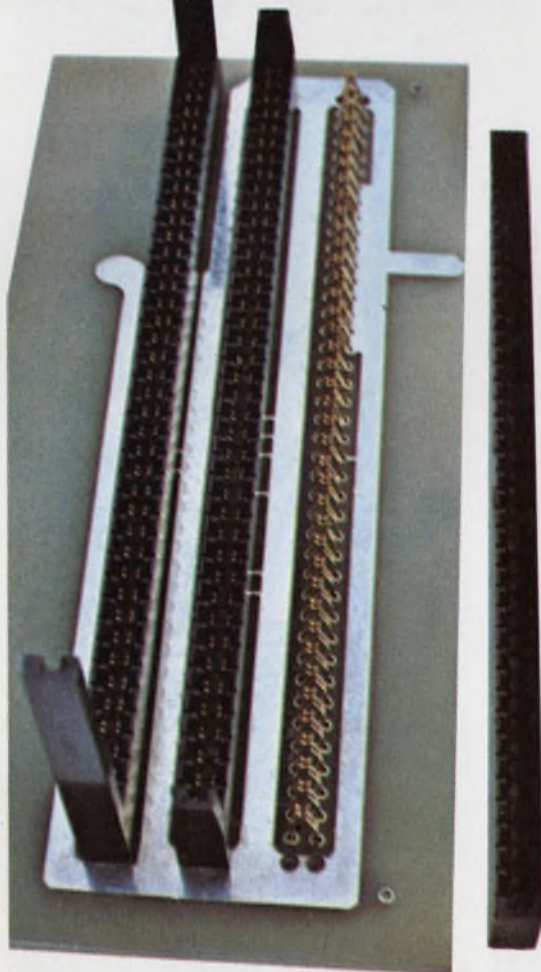
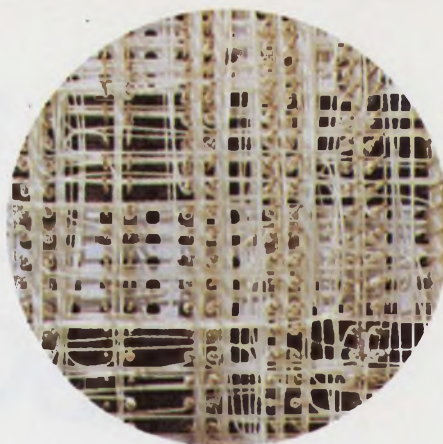

That is the question that invariably arises when you're designing a new circuit. You can either take the wire-wrapping route for design flexibility. Or you can choose p.c. wiring for manufacturing economy. Either way, you have to accept trade-offs.

Wire wrapping lets you make circuit changes throughout the life of your equipment. But, at roughly 10¢ for each pair of terminations, a densely wrapped board can be expensive. On the other hand, p.c. wiring is the less costly alternative, but you're married to the circuit on your multi-layer board. So when a design change is called for, you have to discard the board and design anew.

That is, up until now.

Because Elco has taken the wraps off a new card edge connector that gives you the best of both systems.

You're free to use p.c. wiring in lieu of your first level of wire wrapping, and thus cut as much as 75% from your overall wrapping costs. And you can make your remaining connections by press-fitting the contacts of our new connector through the plated-through holes of the board, and wire wrapping the appropriate contacts.

So you now have the ability to make circuit changes and repairs right on the board. Even replace damaged contacts without disturbing or removing the insulator or adjacent contacts. And you needn't worry about the integrity of the press-fit connection because it's mechanically stronger and electrically more reliable than the best soldered connection.

And Elco will go you even two better.

Give us your p.c. back panel laid out to our hole specs (.125" x .125"), and we'll fill the board with our Series 6317* "Economist" connector. Or send us your specifications, and we'll even supply the board.

Just two more services in keeping with CONNECTRONICS, Elco's Total Connector Capability.

For full details and specifications on the "Economist," contact:

Elco, Willow Grove Division,
Willow Grove, Pa. 19090
(215) 659-7000

Elco, Huntingdon Division,
Huntingdon, Pa. 16652
(215) 659-7000

Elco, Pacific Division, 2200 Park Place,
El Segundo, Calif. 90245
(213) 675-3311



Operations in USA, Australia, Belgium, Canada, Denmark, England, France, Germany, Israel and Japan. Sales offices throughout the world.

*Pat Pending

Copyright © 1971 Elco Corp. All rights reserved.

INFORMATION RETRIEVAL NUMBER 14

WHAT'S REALLY HAPPENING AT WESCON?

Seven-great-shows-in-one for you in the heart of San Francisco – everybody's favorite city. Your kind of first-rate, key-subject program. All together at once by the Golden Gate August 24 through 27

Wescon's got it all together for you in San Francisco. All the new electronics you *need* to see – components and micro devices; everything that measures; solid-state production techniques; new ways to package; new manufacturing gear; computers for engineering; and communications systems galore. Seven "departments" that save your time and help you compare.

32 well-organized and well-chosen professional sessions that talk about what you can do and what you can use—now!

All of it presented to your advantage, in one modern, air-conditioned conven-

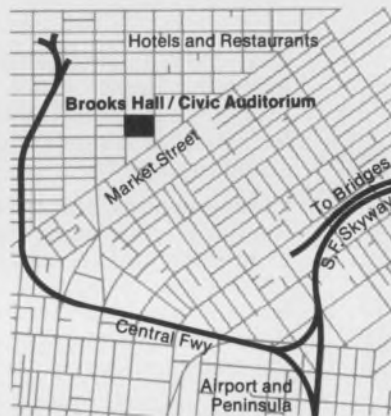

tion center in the heart of a great city (great market, too). Wescon is all about good new ideas. Hundreds of them, waiting for you to take back to the plant. Just one of them repays your time and travel over and over.

We make it easy for you to win: Low-cost registration covers all activities all week. Fast-response product inquiry system. Continuous shuttlebus service. Complete conference preprints, session by session. And much more.

Come to Wescon by the Golden Gate, and take some good ideas home!

Technical Program Sessions

- 1) Choosing a Minicomputer—The User's Viewpoint
- 2) Trends in Vacuum Deposition Technology
- 3) Automatic Testing of MOS ICs
- 4) Gearing Up for New Electronic Markets
- 5) Peripherals for Minis
- 6) Direct Detection Laser Communications
- 7) Engineer's Role in Economic World
- 8) Current Trends in Inductorless Filters
- 9) Computer Programs in Circuit Design
- 10) Future Medical Information Systems
- 11) Employee Loyalty: A Two-Way Street
- 12) Microwave Point-to-Point Communications
- 13) Needs and Trends in Medical Electronics
- 14) Future of Automatic Test Languages
- 15) Data Communications Networks
- 16) Turnaround '71, Strategy for the 70s
- 17) Instrumentation for ATS
- 18) Automatic Manufacturing
- 19) Tomorrow's Programmable Calculators
- 20) Beam-Lead Technology: Here and Now
- 21) Commercial Applications of ATS
- 22) Computer-Aided Manufacturing
- 23) Computer-Aided Design of H-F Circuits
- 24) Optoelectronics
- 25) Hybrid Manufacturing
- 26) Microwave Solid-State Devices
- 27) Mobile Radio in the 70s
- 28) Ion-Implantation Technology
- 29) Micropower Microelectronics
- 30) Computer-Aided Translation
- 31) Electronic Memory, Storage and Display
- 32) Air Pollution Control: Where We Are and Where We Are Going

Brooks Hall/Civic Auditorium Plan

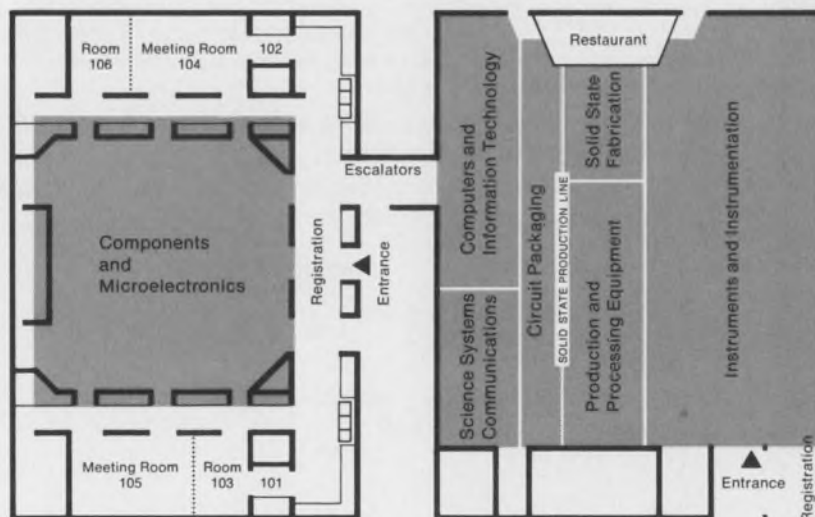

Wescon Schedule at a Glance

	Exhibit Hours	Sessions
Tuesday August 24	9:30am-5pm	10am-12:30pm 2pm-4:30pm
Wed'sday August 25	9:30am-9pm	10am-12:30pm 2pm-4:30pm
Thursday August 26	9:30am-5pm	10am-12:30pm 2pm-4:30pm
Friday August 27	9:30am-4pm	10am-12:30pm 2pm-4:30pm



Co-Sponsors:
Region 6, IEEE,
and WEMA

wescon

San Francisco, August 24-27, 1971

For more information: Western Electronic Show and Convention, 3600 Wilshire Blvd., Los Angeles 90010 (213) 381-2871

Centralab offers immediate delivery on functional modules

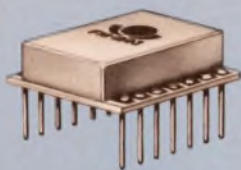

Centralab, the industry leader in thick film microcircuitry, now has combined its recent advances in packaging and chip hybrid technology to bring you five new functional modules available for immediate delivery from stock. These modules are sealed in ceramic packages with 14 swaged terminal pins universally spaced .600" row-to-row and .100" apart to facilitate printed circuit board mounting.

Module	Function	Rating	Suggested Applications
FM-1110	Power driver	1 amp @ 60v steady state	Interfacing with relay/solenoid coils, magnetic cores, lamps, etc. in computers, control consoles, test equipment, digital systems, etc.
FM-1203	Dual driver	300 ma @ 28v steady state	
FM-1403	Quad driver	300 ma @ 28v steady state	
FM-2100	MOS clock driver	200 ma with up to 30v shifts	
FM-3100	Programmable multivibrator	Output pulse widths 200 ns to 12 μ s	To drive all popular MOS circuitry in calculators, computers and other digital systems. Delay, timing and pulse shaping in computers, control circuits, test equipment and other digital systems.
*FM-4100	RC clock oscillator	500 kHz to 6 MHz	Time base, square wave generators and tone signalling controls for computers, test equipment, etc.
*FM-5100	Overvoltage crowbar	Trip voltage 4.5 to 12.5v, < 1 μ sec response	To protect voltage sensitive devices such as IC's, MOS devices, etc.
*FM-5111	Overvoltage crowbar	Trip voltage 12.5 to 20.5v, < 1 μ sec response	
*FM-5120	Electronic fuse	Trip current 1 amp @ 40v, < 1 μ sec response	
*FM-6110	Power operational amplifier	250 ma peak output current with supply voltages \pm 15 vdc	DC electronic equipment and systems where precise, fast current disconnect is required. Servo systems, test equipment, power supplies, etc.

DESCRIPTION

FM-1110, 1203, 1403: Single, dual and quad drivers
Designed to accept standard DTL and TTL logic levels and to drive loads which require high power. Consist of single or multiple NAND/NOR gates and high gain amplifiers.

FM-2100: MOS clock driver
Designed to accept standard DTL and TTL logic levels and universally drive MOS circuitry. Consists of a three input AND function followed by a power inverter.

FM-3100: Programmable monostable multivibrator
A flip-flop which, when triggered by an input pulse, generates an output pulse of prescribed width, with control through interconnection of appropriate package pins.

***FM-4100: RC clock oscillator**
An RC astable multivibrator and an output buffer stage capable of providing a square wave output at a predetermined fixed frequency. It can operate down to 5 Hz with the addition of external capacitors.

***FM-5100, 5111: Overvoltage crowbar**
A high speed electronic voltage sensing element and switch designed to protect voltage sensitive electronic devices by shunting out the supply voltage when high transients or other overvoltage conditions are experienced on the supply line.

***FM-5120: Electronic fuse**
The electronic equivalent of a fuse which features accurate threshold levels, high speed and reset capabilities. Available in a variety of current threshold levels.

***FM-6110: Power operational amplifier**
An operational amplifier designed to provide output capabilities far beyond those obtainable with equivalent monolithic IC's.

***These modules are scheduled for introduction in 1971.**

We welcome inquiries on any variation of the above modules and can provide rapid turnaround on samples and production quantities of custom modules. For design assistance or other information, write Sales Manager, Microcircuits, Centralab. Standard modules are also available through Centralab Distributors.



CENTRALAB

Electronics Division
GLOBE-UNION INC.

5757 NORTH GREEN BAY AVENUE
MILWAUKEE, WISCONSIN 53201

M-7115

Take a turn for the better in rotary switches.

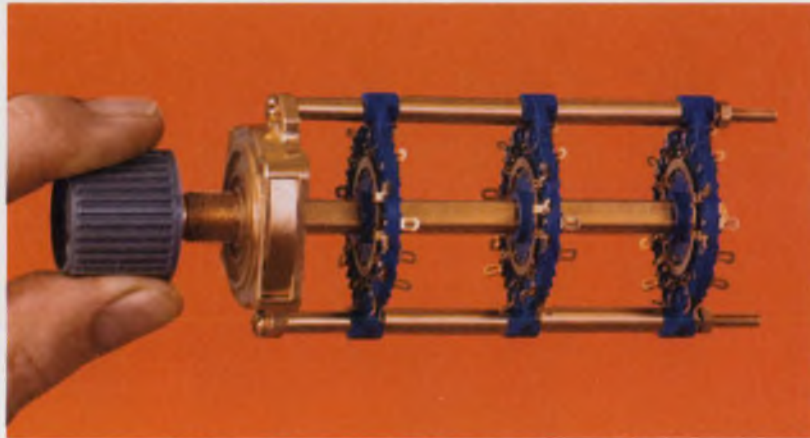

Oak continues to market the broadest line of rotary switches in sizes and configurations to fit your applications.

For example:



Our 1/2-inch subminiature rotary switch.

Ultra-compact, yet provides superior insulating qualities and dimensional stability in demanding environments at lowest competitive price.

A new 12-position Acorn rotary for printed circuits.



A size-saving design. Crisp, uniform detenting with Oak's patented Unidex™ indexing. Has glass epoxy wafer and tinned PC terminals ready for soldering.

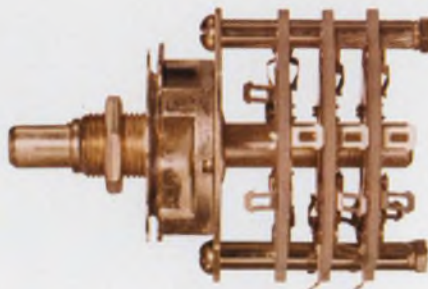

Rotary switches with Unidex indexing, too.

Our F and JKN series. Versatile, economical. And Unidex detent means uniform torque, crisp feel.



And our Multidex® rotary: the almost-universal switch.

Versatile enough to replace 7 old-style rotary designs. Thousands of variations available. With Unidex detent for sure switching time after time. Multidex cuts the cost of engineering design.

There's more.

Miniaturized lever switch: Type 184. Improved dielectric properties plus more clips per stator.



Miniature rotary trim switch. For SPDT trim switching in tight PC-board locations. Long life. Low cost.



Stepping switches: Compact, lightweight. Subminiature to extra-heavy-duty types. Fast response.

Now: order Moduline™ Switches from your distributor.

Choose from 2-million possible switch combinations. 72-hour delivery. Write for the Moduline Catalog.



OAK MANUFACTURING CO.

CRYSTAL LAKE, ILLINOIS 60014 • A DIVISION OF OAK ELECTRO/NETICS CORP

Telephone: 815-459-5000

TWX: 910-634-3353

TELEX: 722-447

INFORMATION RETRIEVAL NUMBER 17

Air industry assailed on its medical efforts

It's one thing to send a man to the moon; it's another to treat him medically on earth. That, in essence, is what critics are saying about aerospace industry efforts to crack the medical-equipment market.

One of the more critical, Dr. Philip G. Drew of the Arthur D. Little Health Care Group in Cambridge, Mass., says that the aerospace industry has "oversold its capability and gotten mud all over its face." So far as medical equipment is concerned, he says, the aerospace image is now "a kiss of death."

His criticism and that of others in the medical field surfaced during two days of seminars for biomedical executives conducted first in New York and then in Chicago by Advanced Management Research, Inc.

Arthur B. Hale, editor-publisher of *Bio-Medical Insight* and program chairman for the seminars, pointed to Martin-Marietta and said it "threw in the towel" on its multi-phasic testing work.

"The Aerospace industry can get you from coast to coast in four hours but can't get you your luggage in 10 minutes," Hale scoffed.

Alexander Sarros, a senior biomedical engineer with the Stanford Research Institute, Menlo Park, Calif., said that medical equipment designed by the aerospace industry was costly to maintain—about 10 to 15% if initial-equipment costs go for maintenance every year, he charged.

"Hospitals are horrified when asked to spend this much money on support of equipment," Sarros said.

There was a general belief among the executives present at the seminars that the problems of selling and servicing medical equipment are more difficult than de-

signing and building it. Electronics companies are not sufficiently knowledgeable about the needs of medical customers, the executives felt. This view is now so widespread that some pharmaceutical companies—Charles Pfizer & Co. is one—are exploring the possibility of making and marketing their own electronics equipment.

Some investment analysts attending the seminars said they, too, believed medical companies gearing up to supply electronic equipment would be more successful than electronics concerns. They attributed this to the better understanding that medical companies had of the complexities of the medical market.

Land mobile gets piece of uhf spectrum

Land mobile radio stations and uhf broadcasters in the 10 largest urbanized areas of the U.S. will begin sharing uhf TV channels, 14 through 20, in the 470 to 512-MHz band, according to a ruling adopted by the Federal Communications Commission.

The action divides each television channel into 120 land mobile channels, each to be made up of two 25 kHz frequencies—one for base station use and one for mobile unit use—for a total of 240 land mobile channels. All eligible land mobile users would have access to both TV channels.

Army is developing new vhf-FM radio

The Army is developing a new-generation, multi-purpose, vhf-FM radio that can be carried by troops or mounted in a vehicle or in an aircraft.

Eventually the new radio could replace a dozen or so now being used, many of which were new during the early days of the Vietnam War. They include five or more AN/VRC-12 series radios for vehicles; manpack radios, such as the PRC-25 and PRC-77; and four airborne radios—the ARC-44, 54, 121 and 122.

The new radio, designated the AN/URC-78, will be a third the size of its predecessor (3-1/2 by 5 by 8-1/2 inches, counting the battery box) and half its weight (8 to 10 pounds). It is completely solid state, using ICs, LSI and hybrid film circuits. Its predecessor, the PRC-25, had one transmitter tube and no ICs or LSI.

The URC-78 will provide 2000 channels, twice the number available in former radios in this class, and it will be designed to be far more reliable than any radio of its kind, with an MTBF of up to 10,000 hours. The MTBF will depend on the cost, weight and power-drain tradeoffs that have to be made during development.

The radio will operate from 30 to 80 MHz.

Development of a prototype of the radio will be competitive. The Army Electronics Command, Fort Monmouth, N.J., has awarded a \$1.7-million contract to the Avco Electronics Div. in Evendale, Ohio, for six engineering prototypes to be delivered over the next 26 months. A \$1.99-million contract has gone to RCA's Communications Systems Div., Camden, N.J., for six prototypes.

NASA's earth research stirring wide interest

NASA doesn't plan to launch its first Earth Resources Technology Satellite (ERTS) until next year, but already it is being besieged by applicants who want access to the data that the satellite will collect.

More than 600 applications have been received so far for data about the earth that will be gathered by research instruments aboard ERTS and an Earth Resources Experiment Package to be carried on the manned orbiting laboratory Skylab. This is the greatest response NASA has ever had for data from its experiments, the space agency says.

The information from space will consist of televised pictures from two return-beam vidicon cameras covering the visible spectrum (blue-green, red and near infrared) and four multispectral scanners sensitive in three visible bands and one band in the near infrared (see "We Interrupt This Magazine for a Live Preview of ERTS," ED 11, May 27, 1971, p. 23). A fifth channel in the thermal IR band will be added to the scanner that goes into a second ERTS satellite.

The applicants are from government, universities and industry, both domestic and foreign, and they are interested in data involving agriculture, forestry, geography, demography, cartography, geology, hydrology, oceanography, meteorology, environmental quality, ecology and the techniques required to convert sensor data into usable information.

ERTS-A is to be launched next spring, and ERTS-B in 1973. The first Skylab carrying the earth resources package is to go up in 1973.

Meanwhile NASA and other organizations are watching the earth from aircraft: NASA and the Dept. of Agriculture continue to carry out the "Corn Blight Watch Experiment," using infrared and color photography cameras flown at 65,000 feet in an RB-57F. And the University of Michigan, under contract to NASA, is flying a multispectral scanner over Indiana at about 5000 feet in a C-47.

High power laser for aerial recon studied

A compact, 100-watt, sealed-off, carbon dioxide laser to be used in low-flying, high-performance aircraft is under development for the Air Force. The laser will illuminate the ground for a line scanner and display in the cockpit.

The Honeywell Systems and Research Center in Minneapolis is developing the laser under contract with the Avionics Laboratory at Wright-Patterson Air Force Base in Dayton.

According to Honeywell's laser scientist, Hans W. Mocker, the laser will be three feet wide, eight and 10 inches wide, and weigh 50

pounds—"a third the size of lasers with comparable power."

The gas mixture to operate the laser will recirculate itself in a sealed-off unit.

Plessey out to capture U.S. memory market

Why did Plessey Memory Products move from Maynard, Mass., to Santa Ana, Calif. last spring? Answer: To occupy a new plant with a new management and to open a drive to capture a large portion of the domestic core stack and memory systems market.

The effort is being guided by a new manufacturing team headed by Arthur F. Webber, general manager of Plessey's North American operations. Webber was a founder of Standard Memories, Inc., of Santa Ana but has sold his interests in the company. He's hired Melvin Lamph, formerly with Electronic Memories in Hawthorne, Calif., to head sales.

Webber forecasts "substantial growth over last year's sales—by a factor of at least four or five."

Magnavox cuts its buying of Japanese components

Magnavox—one of the first U.S. companies to import Japanese consumer electronic devices and components—has done a surprising about-face. According to its president, Robert Platt, the company has established a policy against buying Japanese electronic components for use in Magnavox products.

The reason is somewhat clouded. Some in the industry say Magnavox merely wants to avoid trouble with American labor. The company says it is concerned over this country's unfavorable balance of trade and wants to set an example for the rest of the industry.

Small-screen color TVs that Magnavox formerly purchased in Japan are now being manufactured in a plant in Greenville, Tenn. Small transistor radios are being bought in Singapore instead of Japan. In addition Magnavox plans to manufacture in Nogales, N.M., other items that it used to buy in Japan, including subassemblies for

black-and-white portable TVs and for audio equipment.

Magnavox says it must still depend on Japan for some items, such as cassette recorders. But Platt points out that some Japanese concerns might fight back by refusing to fill Magnavox's present remaining orders.

At the Consumer Electronic Show in Chicago, competitors interviewed by ELECTRONIC DESIGN refused to comment for publication. The main off-the-record comment was: "A surprising move."

Pollution analyzer uses 2nd-derivative technique

"Second-derivative spectroscopy" has hit the market as a new technique for detecting several different types of air pollutants.

The analyzer, which represents a departure from others available (see "Designing for the Pollution-Free Industrial Era," ED 10, May 13, 1971), uses an ultra-violet beam of light that passes through a monochrometer.

As the ultraviolet beam passes through a sample of the unknown pollutant, the second derivative of intensity with respect to wavelength of the beam is taken optically. The spectral signature of the unknown gas is displayed on a chart. The amplitude of the signature is proportional to concentration.

Developed by Spectrometrics of Florida in Pinillas Park, the new analyzer can detect sulphur dioxide, nitric oxide, nitrogen oxide and ozone. It detects concentrations as small as "a few parts per billion," according to Forrest C. Douglas, marketing manager.

Telecast of surgery originates in body

A miniature color TV camera, developed by CBS Laboratories, Stamford, Conn., and an image fiberscope, has been used to televise a neurosurgical operation from inside the human body. Live pictures were beamed to a network of closed-circuit television monitors throughout the Columbia Presbyterian Medical Center in New York City, where the operation was performed.

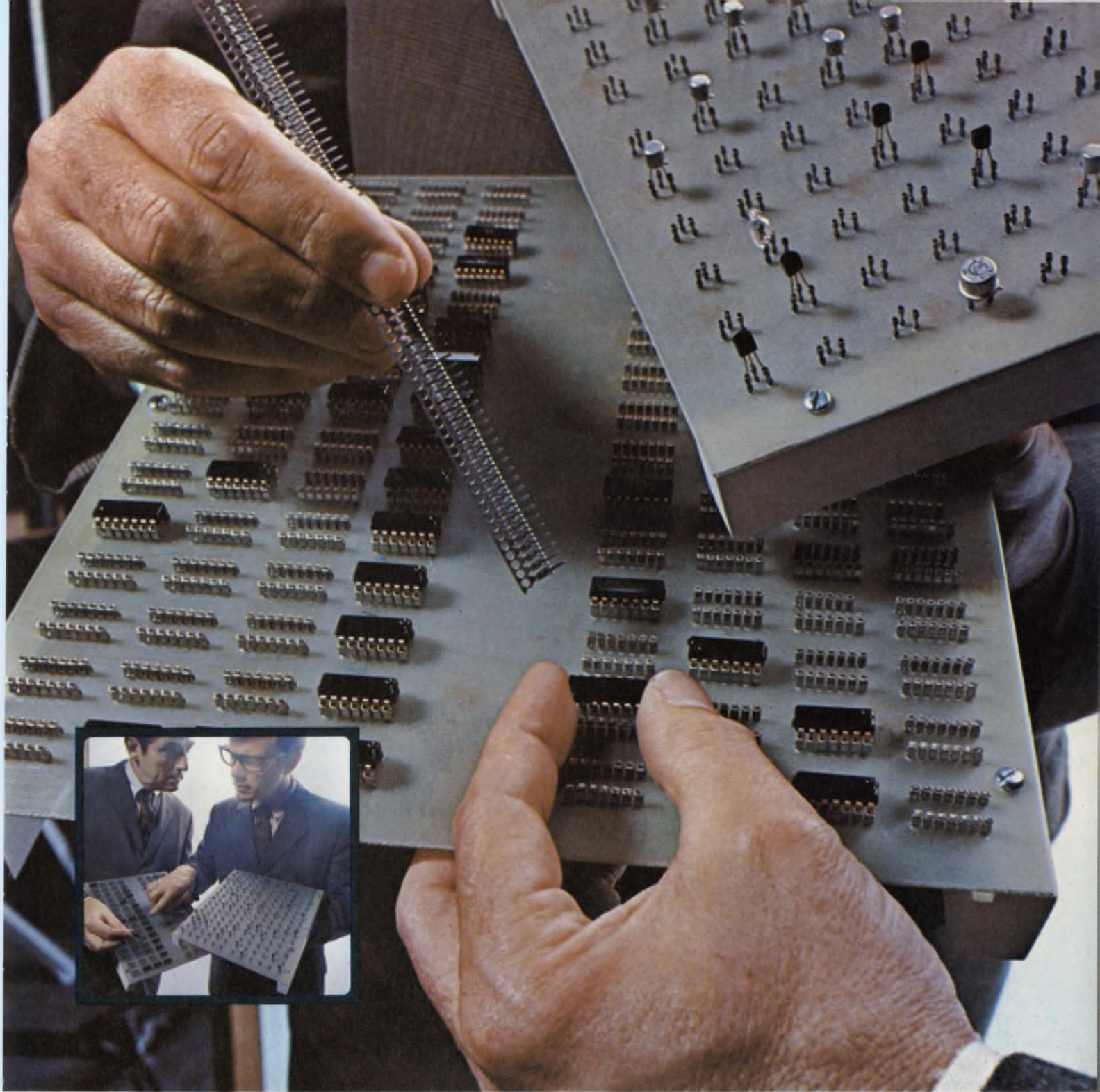

HERE'S A NEW AND BETTER WAY: To make printed circuit board connections. Reliably. At low, low cost. They're Molex Soldercon[®] terminals. Integrated circuit and transistor terminals. Offering the convenience of plug-in I.C.'s and transistors *without* the cost of insulators. They fit directly on the board. And there is equipment available to do the job *automatically*. Fast! Soldercon terminals save time. Money. Speed installation. Make

testing easier, too. And simplify service problems. It's another example of Molex ingenuity . . . in creating components that simplify circuitry. Molex has the know-how and facilities to provide the interconnecting system you need. You can make connections by calling (312) 969-4550. Or write . . . Molex Incorporated, Downers Grove, Illinois 60515.

*... creating components that
simplify circuitry*



In consumer packaging, it's modules, modules everywhere

Modular packaging of electronic circuitry, once found only in military equipment, is being adopted on a widespread basis by the consumer electronics industry.

Led by television manufacturers, consumer designers are swinging over to modular forms for the same reason that the military did: to make it possible for technicians with limited skills to service complex equipment rapidly. The complexity has been brought about by the conversion of circuitry with tubes to all-solid-state versions.

Even today, says Morris Broyles, manager of quality and service for General Electric's Television Receiver Div. at Portsmouth, Va., the servicing of transistor TV equipment presents a formidable problem to the typical service man, who

is used to making simple voltage and resistance measurements for tube equipment.

Other influences that are affecting packaging in consumer electronics today include demands to reduce costs by simplifying equipment through packaging and the tailoring of equipment to solve particular problems, such as theft.

Assemblies being subdivided

The modular packaging concept subdivides a large electronic assembly into smaller, independent functional chassis — printed-circuit boards or cards, or other plug-in elements.

The advantages include easier assembly and disassembly of the equipment and rapid servicing, by simply replacing a suspected module. Equipment can also be readily updated by replacing an old module with a new one.

The functional units, or modules, are electrically interconnected by cable harnesses or some other connector system. As a result, the system has more connectors than equipment with the simple, all-in-one chassis.

Until recently, consumer use of the modular principal was limited because of the cost of the extra connector system. But specialized, low-cost connector systems are now available — systems that have been developed by joint effort between equipment and connector manufacturers. Donald Springer, marketing manager for AMP, Inc., Harrisburg, Pa., notes that these newer systems are characterized by design simplicity and compatibility with automated assembly.

The success of the plug-in replaceable modular concept has been proved according to Richard Kraft, video products manager of the Motorola Consumer Products Div.,

Jim McDermott
East Coast Editor

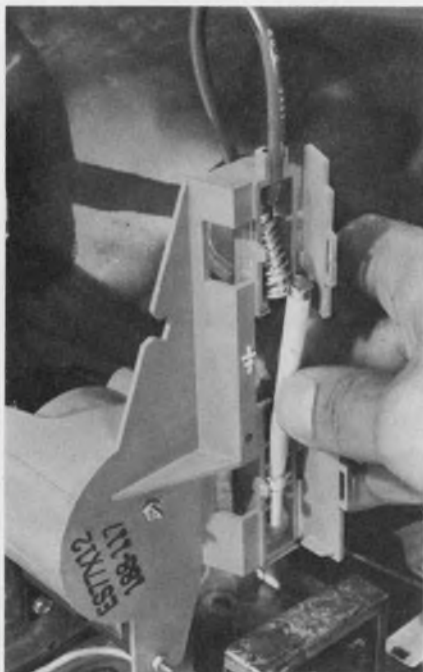

1. A snap-in, solid-state HV rectifier is housed in the molded case of this GE high-voltage TV transformer.

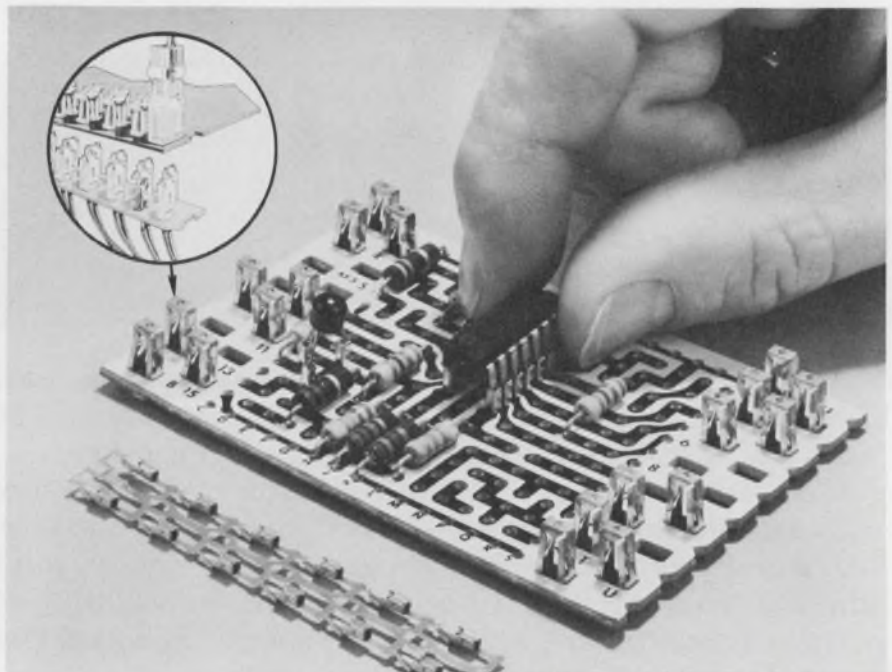

2. Zenith's Dura-Modules have identical conductor patterns, except for those carrying ICs. The special connector system for the modules and related chassis wiring was jointly developed with AMP, Inc.

Franklin Park, Ill. Motorola pioneered modular construction with its Quasar color television sets. One Motorola dealer, Kraft points out, guarantees his customers that he will service all Quasar sets in the home or pay his customer a bonus.

Modular approaches differ

The approach to consumer modular packaging varies from manufacturer to manufacturer, depending on the design philosophy of each.

For example, Motorola's Quasar line, with the "works in a drawer," has essentially all of its circuitry on 11 easily replaced panels, each of which is physically different from the others. The connector system is a low-cost version developed in cooperation with AMP, Inc.

General Electric, on the other hand, is introducing modularization in a simpler way in its new U-1 solid-state chassis for 19-inch black and white TV.

GE's Broyle points out that the U-1 chassis is segmented into three main sub-chassis and also has components, which ordinarily mounted separately, are combined in one package (Fig. 1).

Even Zenith Radio Corp., Chicago, which for years has marketed hand-wired TVs as easy to service,

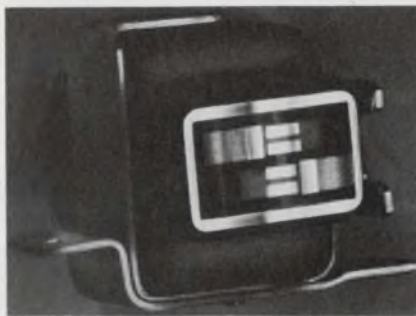

4. Two vertical magnets for tape bias are used in this four-track record/playback head by Ampex.

is converting to solid state and modular packaging. Developed by Darwin E. Inman, assistant chief engineer of the Mechanical Div., the Zenith system uses a universal type of printed-circuit "carrier" that is basically identical in size and shape to every other modular printed-circuit card used by Zenith. These modules are called Dura-Modules, and with few exceptions, the conductor patterns are identical (Fig. 2).

Only the component placement and the electrical circuits are different on Dura-Modules performing different functions. For plug-in connections to the main chassis of the Zenith YV receiver, up to 15 U-shaped receptacle contacts can be selectively inserted in rectangular holes in each end of the

module. Other "outside world" leads that are to be connected to the module have pre-insulated terminals crimped to their ends (see insert in Fig. 2).

Because of the high standardization of the Dura-Modules, optimum component layout for any given circuit can be made by computer.

Phonographs going modular

Modularized design is also being adopted by phonograph makers. For example, a combination phonograph and AM/FM tuner by KLH Research and Development, Cambridge, Mass., is modular (Fig. 3). This unit is assembled with a special interconnection system developed by Molex, Inc., Downer's Grove, Ill.

Robert Murphy, printed-circuit designer for KLH, says that production of the modular phono/tuner solved these problems:

- It reduced assembly labor, since all printed-circuit cards and assemblies simply plug into a main interconnect board.

- It eliminated lead-dress problems that frequently prove troublesome in regular wiring that carries audio signals near high-gain circuits.

- It simplified servicing greatly in contrast with the older units, in which a maze of wires had to be tracked down and unsoldered before repairs could be made. Now a defective board is simply unplugged, and the trouble is isolated.

Packages are getting smaller

Competition frequently forces designers to reduce costs by shrinking circuit elements. In the volume normally occupied by a single two-track head, Ampex has packaged two three-element record/playback heads (really two heads in one) for use in a four-track, automatically reversing stereo cassette player (Fig. 4).

E. Peter Larner, vice president and general manager of the company's Consumer Equipment Div. in Elk Grove Village, Ill., says that the newly developed head avoids alignment problems associated with systems that have separate erase heads or that mechanically move a single head up or down for bi-directional playing. ■■

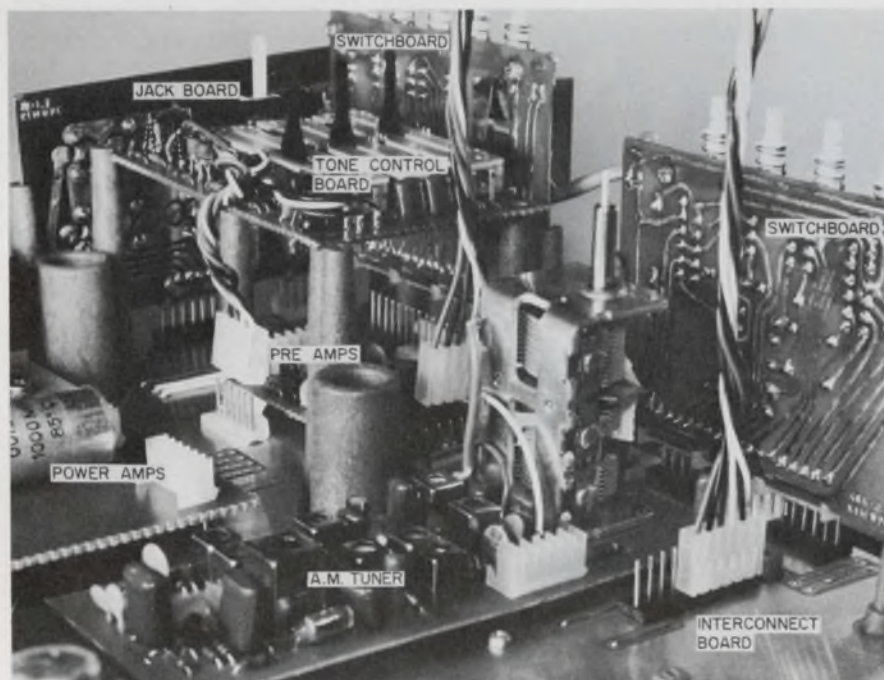

3. Rapid assembly and easy servicing are features of this KLM tuner and phonograph combination using a Molex connection system. Control knobs mount on switchboards and turntable mounts on the large plastic supports.

Acoustic holography picks up where medical X-rays leave off

The limitations of X-rays have frustrated some doctors for decades. X-rays can penetrate soft tissue and give revealing pictures of bone and other solid masses. But suppose the doctor wants to view the soft tissue — the tendons, blood vessels and other matter below the surface of the skin? X-rays usually can't help without elaborate tissue-coloring techniques. But acoustic holography can, researchers are finding.

Acoustic holography has been in use for a few years as a medium for nondestructive testing of welds, honeycomb structures and stripline bonds. Now it is emerging as a new medical tool.

David Kaye
West Coast Editor

Using a system developed by Holosonics of Richland, Wash., researchers have observed in real time on a television screen the motion of human muscles and tendons. Most interesting of the possible applications is the detection of cancer. Victor I. Neeley, vice president for technical development at Holosonics, says that one of the company's units is being used for breast cancer research at the University of Oregon Medical Center in Portland. With acoustic holography, the interior of the breast can be scanned and tumors can be seen.

To image soft tissue with acoustic holography, the tissue must be submerged in a tank of water. Inside the tank are two acoustic transducers. These transducers emit ultrasound or pressure waves

10 MHz. The frequency and intensity of the ultrasound waves determines the depth of penetration of the waves in the subject.

Both of the transducers are focused on a particular area of the surface of the tank where the water meets the air. When an object is inserted in the path of one of the transducers, but not in the path of the other, a ripple pattern is set up in the surface area that both transducers are focused upon. This is a phase interference pattern — actually a hologram, or three-dimensional representation of the object in the tank.

Imaging the hologram

Since the acoustic waves penetrate the object in the tank, Neeley notes, it is possible to focus on any plane inside the object. For example, researchers can look at the tissue 3 cm below skin level, or 5 cm below by refocussing the optics.

Since, as Neeley points out, "the interface between the air and the water is the square law detector that corresponds to the photographic plate in an optical hologram," all that is needed is a means of visually imaging the hologram. This is done by shining laser light on the hologram at the surface of the water and reflecting the hologram image through a lens system into a television camera. The hologram is then displayed on a television monitor.

About $1/2 \text{ mW/cm}^2$ of power density is necessary for ultrasonic imaging. With further improvement in the sensitivity of the optical system, Neeley anticipates considerable reduction in the power density required.

Resolution of the hologram is one wavelength. In water, 3 MHz ultrasound gives a resolution of about 0.018 inches. ■■

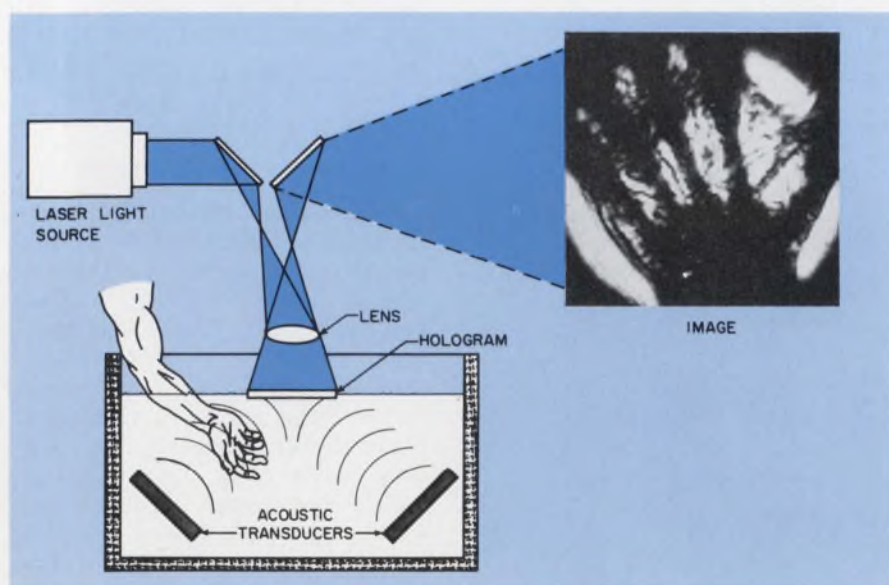

Acoustic holography of soft tissue is possible with this system developed by Holosonics, Richland, Wash. The acoustic transducers produce a hologram at the interface of the water and the air. A laser is used to illuminate the hologram and to reflect the image into a television monitoring system. In the example shown here, the tendons in the hand can be seen, as well as the bones. Since the system views in real time, motion of the hand would show motion of the tendons.

Belden the Special "Specials" specialist

Here's what to do when cable catalog specs just won't do the job: Dial Area Code 317 ■
Then dial 966-6681 ■ You'll get action ■ From a man who devotes full time to solving
engineered cable problems ■ A Belden specialist that "lives"
with your design parameters from engineering through the
actual production run ■ Cables for underwater-under-
ground devices . . . extra-high voltage and pulse ap-
plications . . . medical instrumentation . . . low-level
signal interference problems . . . unusual environ-
mental conditions . . . he's tackled them all ■
Phone now.

8-5-0

DIAL (317) 966-6681

BELDEN



... new ideas for moving electrical energy

Lf quartz crystal size cut drastically

An IC processing technique has made it possible to construct low-frequency quartz crystals that are 10 times smaller in area and 1000 times smaller in volume than present crystals with comparable frequency.

Developed at Statek Corp., Orange, Calif., the tiny crystal is made in the form of a one-mil-thick tuning fork instead of the conventional rectangular shape. Juergen H. Staudte, president of the company, notes that the crystals are so small that an entire crystal oscillator or filter can be packaged inside a TO-5 transistor can or an IC flatpack.

A tuning fork affords an automatic 2π reduction in length as compared to a free-floating rectangular quartz crystal for oscillation at a given frequency. If a rectangular crystal were perfectly clamped at one end, it would afford the same length reduction. However, perfect clamping of a rectangular crystal is not possible. If a rectangular crystal is imperfectly clamped at one end, it greatly degrades the Q of the crystal.

Since a tuning fork structure has 2 tines oscillating in different directions, there is a cancellation node at the junction of the 2 tines. The tuning fork can therefore be perfectly clamped at this node with no reduction in the Q of the crystal.

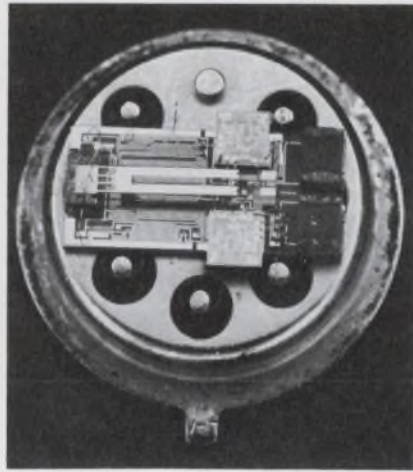

Quartz crystal tuning fork and two monolithic op amps are mounted on a thin-film hybrid circuit and connected in a quartz crystal oscillator configuration. The whole circuit is contained in a TO-5 transistor can.

The integrated circuit techniques used to produce the tuning fork allow a very narrow tine to be produced. This effects a further reduction in the size of the crystal for a given frequency of oscillation.

Processing of the crystals consists of polishing a quartz crystal blank down to a very flat 1 mil thickness, masking the blank with an IC photomask, chemical-etching through the mask and then depositing ohmic contacts. The process is automated and has a high yield. Therefore low-cost, high-volume production is a reality.

The first high-volume customer for the crystals could be the watch industry, Statek says. With an entire oscillator packaged in an IC flatpack and the rest of the electronics on an LSI chip, a very small wristwatch could be produced. Other applications envisioned for the crystals include military timers, radio controls, calculators, tone telemetry for automatic meter reading, clock drivers for data transmission and alarm systems.

Statek's present oscillators can be produced in the frequency range of 10 to 100 kHz with stabilities of 1 to 10 ppm/°C. Because of the small size and the ruggedness of the assembly, these oscillators can stand shock of 100,000 gs, according to Statek. The oscillator package consists of an input op amp feeding into the quartz crystal and outputting into another op amp. The output is then fed back to the input to complete the oscillator. If the feedback is deleted, the circuit becomes a quartz crystal filter. The tuning fork, both op amps and the necessary thin-film resistors are assembled into a hybrid circuit.

The frequency of the tuning fork can be preset to within 10 ppm. If it is necessary to adjust the Q of the tuning fork for filter applications, it can be done by variation of the degree of vacuum in the package. Q variation can be achieved of from 2 to 40,000. ■■

Solid-state film transport developed

The expansion that occurs in piezoelectric material when voltage is applied has been harnessed to advance film in high-quality image recorders. The film is now advanced less precisely by rotary mechanisms.

Developed by Teledyne Ryan Aeronautical in San Diego for the Air Force, the device moves film with two pieces of piezoelectric



Project engineer Charles Davis watches piezoelectric material advance film.

material (lead zirconate-lead titanate). The pieces are clamped against the film, one slightly ahead of the other. When one expands, it moves the film with it; while it is contracting, the other one expands.

The film moves in discrete steps 1 to 10 microns long with speeds of 10 to 100 steps per second, or continuously from 1 to 100 mm/s. ■■

C-LINE PROGRAMMABLE UNIUNCTION TRANSISTORS



guaranteed stability
from -55°C to $+125^{\circ}\text{C}$...

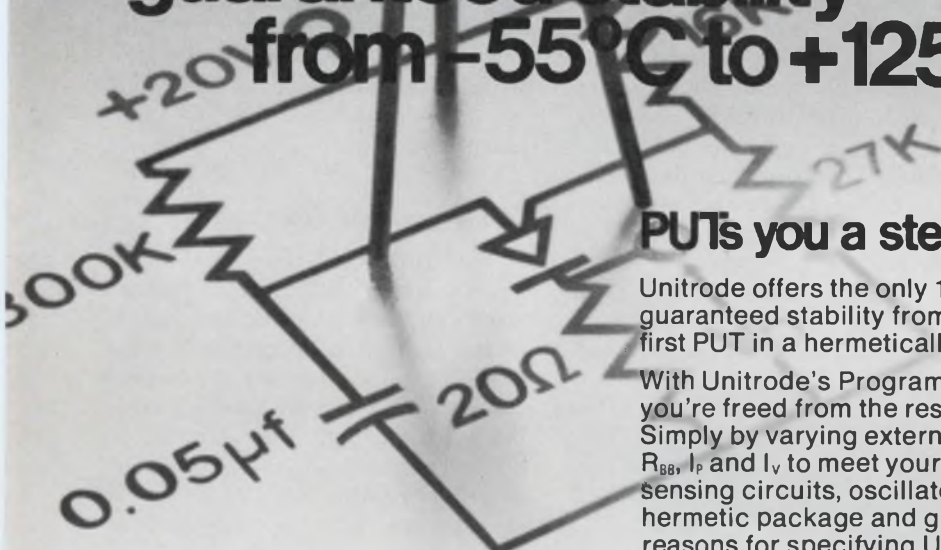

PUTs you a step ahead in design flexibility.

Unitrode offers the only 100V PUT type and the only type with guaranteed stability from -55°C to $+125^{\circ}\text{C}$. We also offered the first PUT in a hermetically sealed TO-18.

With Unitrode's Programmable Unijunction Transistors (PUTs), you're freed from the restricting fixed values of conventional UJTs. Simply by varying external resistor values, you can program E_{ta} , R_{BB} , I_p and I_v to meet your particular needs in timing, pulse, sweep and sensing circuits, oscillators and SCR triggers. The highest voltage, hermetic package and greatest temperature stability are three good reasons for specifying Unitrode PUTs. Three more are nano-amp leakage for long interval timing, low cost, and a strong applications engineering staff ready to help. PUT more design freedom at your fingertips; order any of six types directly off the shelf.

For fast action, call Sales Engineering collect at (617) 926-0404
Unitrode Corporation, 580 Pleasant St., Watertown, Mass. 02172.



UNITRODE quality takes the worry out of paying less.

Unitrode Corporation, Inquiry Processing Dept. 7B
37 Newbury Street, Boston, Massachusetts 02116

Please send free samples of PUT checked below (including data sheet).

Check for Sample	Unitrode Type No.	Forward Voltage Rating Volts max.	Peak Point Current μA max.	Valley Point Current μA min.	Check for Sample	Unitrode Type No.	Forward Voltage Rating Volts max.	Peak Point Current μA max.	Valley Point Current μA min.
<input type="checkbox"/>	2N6119 ¹	40	2.0@10V ³	70@10V ⁴	<input type="checkbox"/>	2N6138	100	10@10V ⁵	40@10V ⁶
<input type="checkbox"/>	2N6120 ²	40	0.15@10V ³	25@10V ⁴	<input type="checkbox"/>	U13T3	100	2.0@10V ⁵	70@10V ⁶
<input type="checkbox"/>	2N6137	40	10@10V ⁵	40@10V ⁶	<input type="checkbox"/>	U13T4	100	0.15@10V ⁵	25@10V ⁶

1. Formerly U13T1 2. Formerly U13T2 3. $R_C=1\text{M}\Omega$ 4. $R_C=10\text{K}\Omega$ 5. $T=-55^{\circ}\text{C}$, $R_C=10\text{K}$ 6. $T=+125^{\circ}\text{C}$, $R_C=10\text{K}$

NAME _____ TITLE _____
 COMPANY _____
 ADDRESS _____
 CITY _____ STATE _____ ZIP _____

Holographic displays in real time move from dream to development

A true three-dimensional holographic display that can be updated in real time—the dream of air-traffic-control and military-information display designers—has been moved nearer realization.

A new system under development at Bendix Research Laboratories, Southfield, Mich., takes the X, Y and Z coordinates of simple, three-dimensional images stored in a computer, and reproduces them in a hologram that can be developed rapidly and viewed.

One aspect of the design is more or less conventional. The X and Y coordinates of images are impressed on the holographic recording medium by deflection of a laser

beam in the X and Y plane.

But a breakthrough came, according to William G. Wolber, acting head of the Bendix Photoelectronics Dept. and one of the designers of the system, when it was realized that depth along the Z axis could be introduced by deflecting the reference beam along the axis, approximately at right angles to the X, Y planes. (Strictly speaking the deflection occurs along the Z' axis, since the object-point displacement of Z is, to a first order, effectively replaced by a reference-point displacement in the opposite direction.) By contrast, the reference beam in conventional systems is fixed.

At present, Wolber explains, the speed with which the holograms may be exposed, developed and

viewed depends on the materials available. In a quasi-dynamic display, the recording medium can be a fast, self-developing film. The film strip is advanced from the recording to display position, frame by frame, as in a motion picture. An update time of one to 10 seconds appears reasonable. Or the hologram may be written as a charge pattern on an electro-optic crystal. The crystal would be coated with a photoplastic material that could be developed rapidly and erased with heat.

Display system explained

The functional elements of a quasi-dynamic 3-D image synthesizer and display system are shown in the figure. In operation, the recording laser beam is passed through the beam-amplitude modulator, which turns the beam on or off or controls its brightness in accordance with the brightness of the points of the synthesized image.

Each position of the beam in the X, Y and Z axes corresponds to a point on the display. The holographic recording medium, which may be a film or other device, is illuminated by the two point sources—X and Y, on the one hand, and Z on the other—in a succession of steps. The position and intensity at each step is controlled by the display element computer, which performs the required coordinate transformations and also inserts corrections for errors caused by the interaction of the beam-deflector driving frequencies with the laser beams.

After the individual frame is developed, it is advanced and illuminated for viewing with a second laser. The viewer sees a virtual image of the display. ■■

Jim McDermott
East Coast Editor

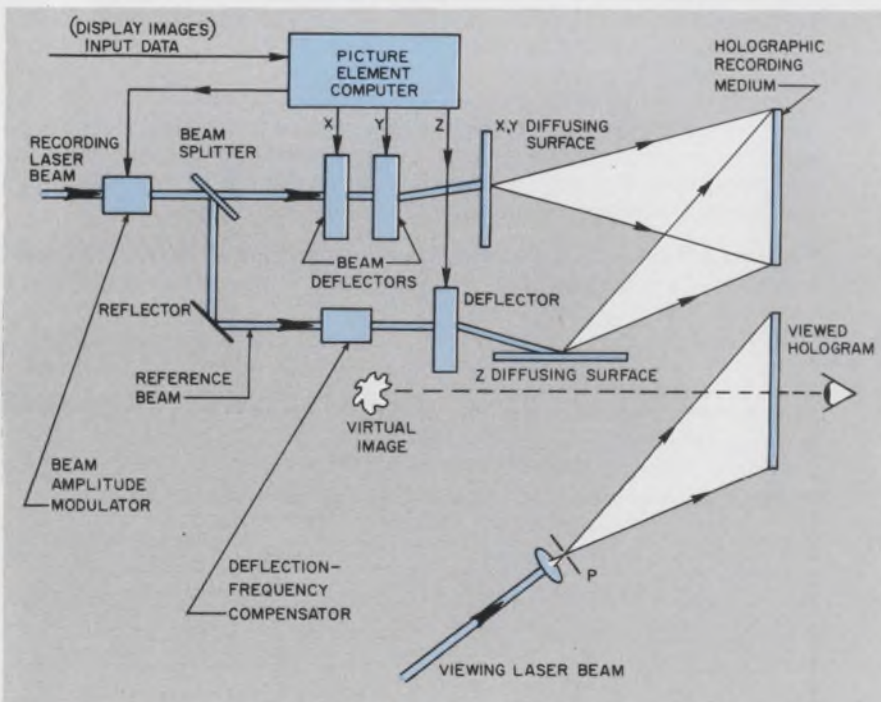

A 3-D holographic display is synthesized by this system. The computer controls the laser-beam intensity and also moves the beams in the X, Y and Z directions to provide a holographic image with perspective.

When you're already on top in linear IC's, you might as well rub it in.

Herewith, the LM216.

Designed for use in high impedance applications, the new LM216 series uses supergain bipolar transistors in a Darlington input stage instead of FETs, which results in exceptionally low offset voltage and input current errors.

Specifically, you'll get input offset currents of 0.00000000010A, typical. With bias currents as low as 50pA and maximum offset current down to 15pA.

The new LM216 also features internal frequency compensation and has provision for offset adjustment with a single 100k-Ohm potentiometer.

Moreover, the LM216 will operate on supply voltages from $\pm 3V$ to $\pm 20V$, drawing a quiescent current of only $300\mu A$. (If you'd like,

the LM216 can even be run from a single power supply like the 5V used for digital circuits.)

That pretty much covers the outstanding features of the new LM216 series op amps.

Which leaves only prices and where to get more information.

Prices (100 up) are as follows:

LM216, \$19.50; LM216A (high performance version), \$40.00; LM316, \$9.95; LM316A, \$20.00.

Where to get more information is National Semiconductor Corporation, 2900 Semiconductor Drive, Santa Clara, California 95051. Phone (408) 732-5000.

TWX: (910) 339-9240. Cable: NATSEMICON.

National

Low cost computer microcircuitry is here. Dow Corning's silicone technology paved the way.

SILICONE PACKAGED MOS RAM DEVICES USED IN NEW, ADVANCED COMPUTERS.

A DOW CORNING SILICONE MOLDING COMPOUND IS CONTRIBUTING TO THE LOW COST AND HIGH PERFORMANCE RELIABILITY OF INTEL CORPORATION'S MOS AND BIPOLAR RAM PRODUCT LINE USED IN TODAY'S ADVANCED COMPUTER HARDWARE. THE TYPE 1101 16-PIN MOS RAM INCORPORATES A MOISTURE-PROOF SEAL OF SILICONE AROUND A SMALLER, HIGHER-YIELD CHIP. IT COSTS 50X LESS THAN THE EARLIER CERAMIC ENCAPSULATED DEVICE. TO DATE, SILICONE ENCAPSULATED DEVICES INCLUDING TYPE 1101 HAVE UNDERGONE A MILLION HOURS OF SYSTEM LIFE TESTS AT INTEL WITH ONLY ONE FAILURE-- AN INPUT SHORT. INCLUDED WERE APPROXIMATELY 200 DEVICES OPERATED OVER 1100 HOURS EACH AT 125 C AMBIENT AND 175 C JUNCTION TEMPERATURE. THE RELIABILITY OF THE SILICONE ENCAPSULANT IS CLOSELY RELATED TO ITS PURITY AND RESISTANCE TO THERMAL DEGRADATION. DOW CORNING SILICONE MOLDING COMPOUNDS DO NOT CONTAMINATE DEVICE SURFACES AND ARE INHERENTLY SELF-EXTINGUISHING. THEY CONTRIBUTE TO THE LONG LIFE AND RELIABILITY OF SEMICONDUCTORS. CIRCLE INFORMATION RETRIEVAL NUMBER 851.



Evolving electronic technology is constantly mastering new industry problems. And silicones are helping to pave the way. Advanced silicone technology can expand your performance parameters. If it's miniaturization, thermal cycling or thermal shock—look to Dow Corning silicones. If it's nonburning safety, vibration damping or corrosion protection—there's a silicone protector to do the job better. Dow Corning silicones bond, seal, insulate, dissipate heat or encapsulate—in environments that no organic material could take.

Get acquainted with Dow Corning's silicone performance improvers. Write today for the complete story. Dow Corning Corporation, Dept. B-1222, Midland, Michigan 48640.

Electrical / electronic materials from

DOW CORNING

DOW CORNING

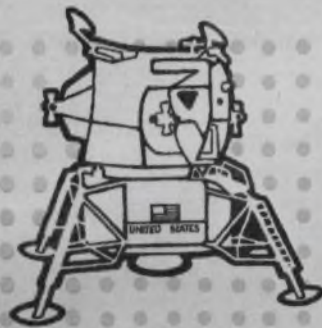
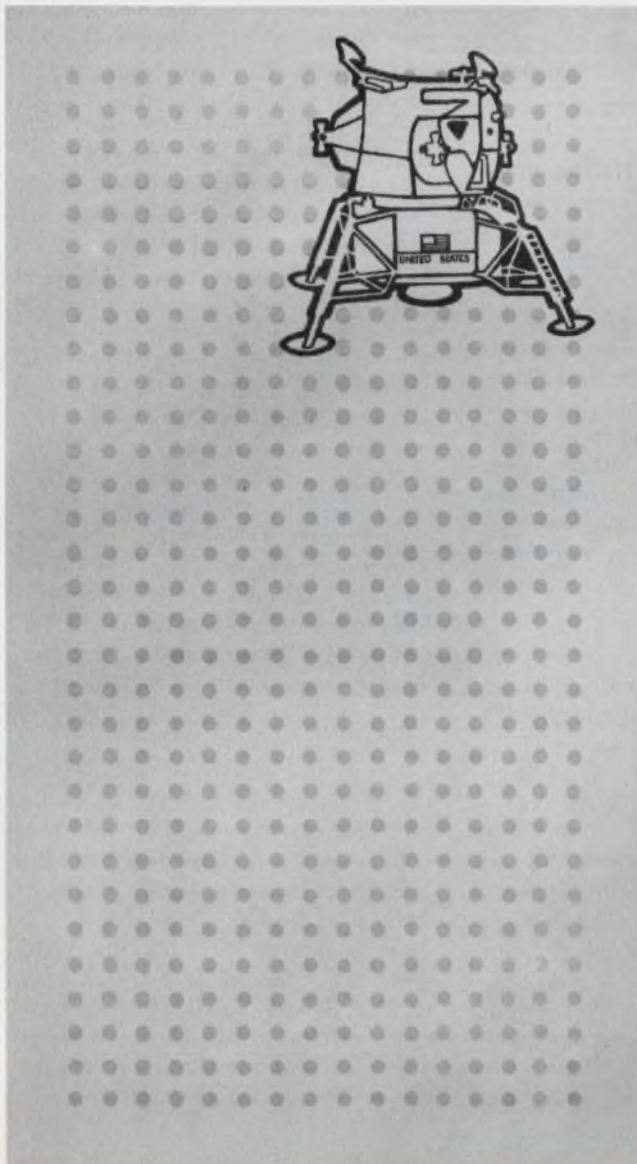

Silicone structural materials withstand even lunar environments. Instruments and wiring are protected from environmental damage inside the Apollo LM with nonflammable silicone laminated wall panels. Components such as coil bobbins, circuit boards and switch decks are also made from silicone laminates or structural molding compounds. These silicone materials provide excellent dielectric properties, strength and protection against tough environments. Write for a list of specialty fabricators that can help you evaluate these engineering materials.

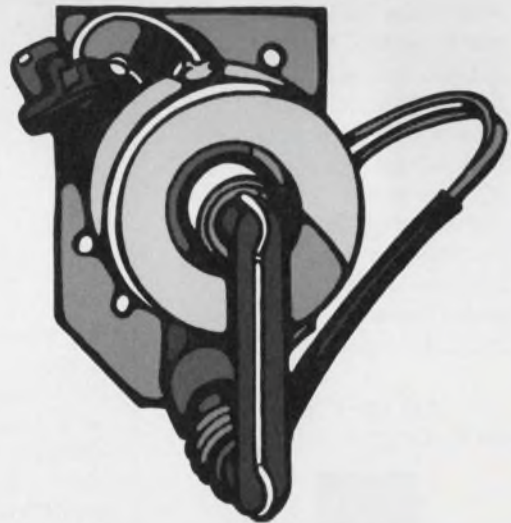

Silicones decrease fire hazard in color TV. Silicones are eliminating costly callbacks and helping to protect the reputations of color TV manufacturers. Flyback transformers impregnated and encapsulated with Sylgard® resin help eliminate fire hazards that result from abnormally high temperatures produced by set malfunctions. For the ultimate in TV safety, Dow Corning also recommends high-voltage wire insulated with silicone rubber and connections sealed with a silicone sealant. Circle Information Retrieval Number 852.

Buying Power?

technology abroad



Here's the new, single source for all your power needs.

- Mil Spec DC Modules
- Wide Range DC Modules
- Slot Voltage DC Modules
- IC Logic Modules
- Full-Range Lab Supplies
- Inverters, Frequency Changers
- High-Voltage Supplies
- AC Regulators
- Full Technical Data
- Full Specifications
- Mechanical Data
- Model Types
- Prices & Availability

Ask for Your Free Catalog #157 Today!



ERA TRANSPAC CORPORATION

67 Sand Park Road, Cedar Grove, N. J. 07009
(201) 239-3000

*A subsidiary of
Electronic Research Associates, Inc.*

A dc contactless capacitor-potentiometer for use in severe environments has been developed by Salford Electrical Instruments of Eccles, England. The device was initially produced for coal-cutting equipment, where conventional potentiometers failed within weeks. The Salford potentiometer has performed satisfactorily for up to a year. It has a dc input, and it produces a dc output whose magnitude is varied in accordance with shaft movement. The primary quantity is sensed as a change in capacitance between two electrodes, one of which is fixed. This capacitor is part of a multivibrator circuit, whose signal is processed by transistor circuitry to yield a dc output proportional to the potentiometer shaft movement.

A new 15-Hz to 1-MHz low-noise amplifier has been produced by the Philips Research Laboratories, Eindhoven, The Netherlands. The new device has an equivalent noise resistance of 100 ohms. The amplifier has a low internal impedance, but circuits have been devised for matching it to high-impedance devices. An emitter-follower circuit has also been devised for driving recording apparatus. Among possible applications, it's expected the amplifier will be used in the preamplifier for a voltmeter.

The first European manufacturer to offer a range of fast Schottky TTL circuits is Britain's Ferranti Ltd., Gem Mill, Chadderton, Oldham, Lancashire. This range, which is pin-for-pin compatible with Texas Instruments' 74-S series, cuts typical switching speeds from 10 ns to 3 ns. These devices are aimed at the computer mainframe and instrument markets. Though the initial series—comprising six basic gate packages and a dual flip-flop circuit—is new, Ferranti has been using the

technology for some time in custom-built circuits. Normally digital and linear processing techniques are incompatible, for gold doping is used to obtain high digital speeds, and this normally degrades linearity. However, by using Schottky techniques for speed, Ferranti has produced custom circuits that combine digital and linear elements on the same chip.

A molybdenum-gate technology that can significantly boost the performance of MOS microcircuits has been developed by research workers at Southampton University, England. To demonstrate the usefulness of the technology they have produced extremely small propagation delays per stage, in the order of 10 ns. This MOS technology, which was only recently announced by General Electric in the U.S., increases MOS speeds by allowing the gate area in a MOS transistor to be more accurately defined. The molybdenum gate can withstand the high temperatures in the diffusion furnace and can thus be used as a target on which to diffuse the source and drain areas.

A fail-safe thermocouple-based temperature transmitter that can provide inputs to a number of recording or control circuits has been developed by Rosemount Engineering Co. in Sussex, England. The system, Model E32025, operates on 110 or 230 V and provides either a 0 to 10 mA or 4 to 20 mA signal. Several alternative thermocouple types are available, and provision is made for inherent cold-junction compensation. Relays can actuate alarms if temperatures exceed selected limits. In case of power failure, the relay coils are de-energized and the contacts close. Variations of ambient temperatures from -20 to 55°C will change the output by no more than 5 μ V per °C.

Digitally Controlled Power Sources Include Added Systems-Oriented Functions

Digitally Controlled Power Sources (DCPS's) are complete digital-to-analog links between a computer (or other digital source) and any application requiring a fast, accurately settable source of dc or low frequency ac power. Such applications generally require more than a programmable power supply or D/A converter with a power amplifier — the DCPS's include these added functions in a single compact trouble-free package:

INTERFACE Customized plug-in interface cards match the Digitally Controlled Power Source to the computer (8421 BCD or Binary).

ISOLATION All digital inputs are floating and isolated from the floating analog output, thus avoiding troublesome loops between the output ground and computer ground.

STORAGE Inputs from all digital data lines are stored upon receipt of a gate signal from the computer. Output levels are maintained until a new gate signal is received — thus, the computer is free to perform other tasks in the interval between voltage level changes.

FUNCTION SELECTION Selects the output voltage range, and isolates the three input bits to the current limit D/A converter.

OUTPUT VOLTAGE D/A CONVERTER Converts one polarity bit plus 16 BCD voltage bits or 15 binary voltage bits to an analog voltage for input to the power amplifier. Thus, resolution is 0.5mV for straight binary and 1mV for BCD operation.

REFERENCES Provide voltage for the Output Voltage and Current D/A Converters.

CURRENT LIMIT D/A CONVERTER Sets current limit of power amplifier to one of eight values.

CIRCUIT POWER SUPPLIES Provide all the necessary dc power — no external power supplies are required.

FEEDBACK Informs the computer when each programming operation is completed and when the output current is overloaded.

BIPOLAR POWER AMPLIFIER Programs either side of zero or through zero without output polarity switches or "notch" effects, with an accuracy of 1mV, 5mV, or 10mV depending on range and model. Outputs now available include $\pm 50V @ 1A$, $\pm 50V @ 5A$, and $\pm 100V @ 0.5A$.

all this

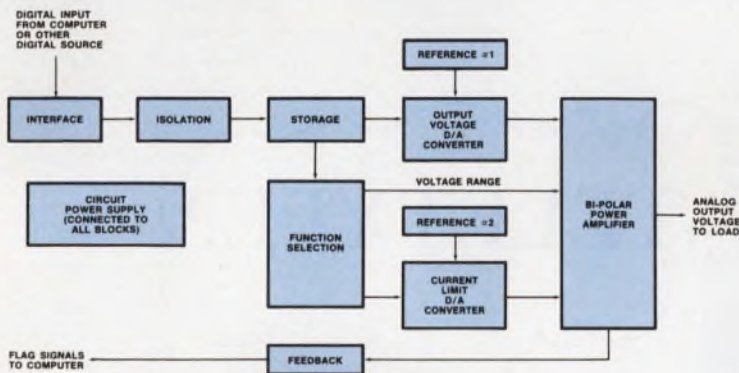

in one
compact package

Write for Technical Data Sheet.

HEWLETT  PACKARD

21105

100 Locust Avenue, Berkeley Heights
New Jersey 07922 • (201) 464-1234

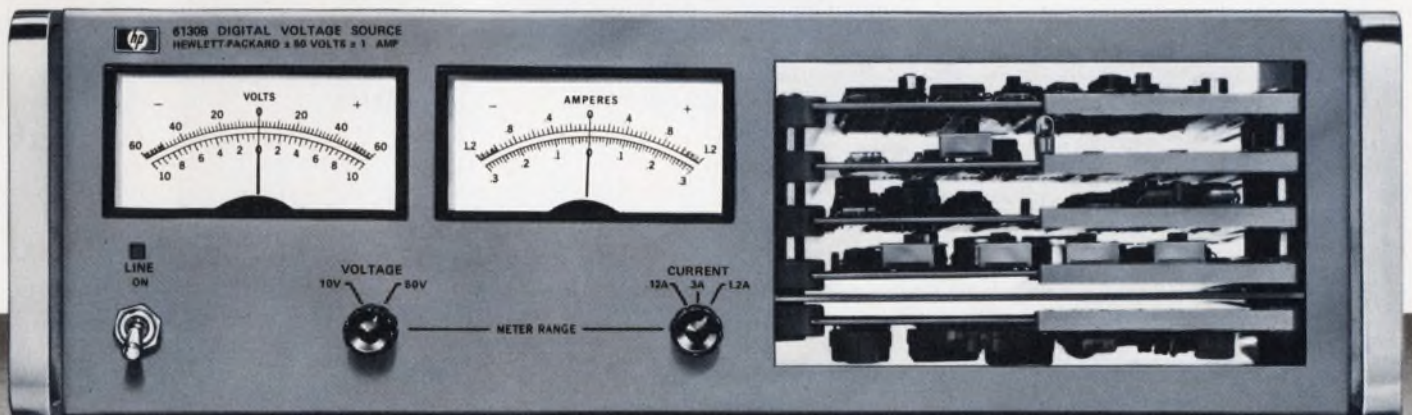

what!



really!



yes, mag
tape
terminals



TELETYPE?

It's true.

After helping a jillion feet of paper tape wind and unwind its way through communications systems everywhere, Teletype announces the addition of magnetic tape data terminals.

There are some basic advantages in both mediums. But as you are well aware, the medium that's right for a system depends a lot on the application criteria.

The new magnetic tape data terminals have many operational features that make life less complicated for the operator.



New, modular line of Teletype® 4210 magnetic tape data terminals.

For example, take a look at the tape cartridge, which was specifically designed for reliability required for data transmission.

Its vital statistics are: 3" x 3" x 1".

It contains 100 feet of 1/2" precision magnetic tape.

It will hold 150,000 characters of data, recorded at a density of 125 characters per inch. The equivalent of a 1000 foot roll of paper tape.

This means that your data is easier to store, easier to handle, easier to work with than ever before. And it's reusable.

DATA COMMUNICATIONS

equipment for on-line, real-time processing

The units have a "fast access" switch which will move tape forward or reverse at a speed of 33 inches per second. A digit counter provides a reference point to help locate various areas of the tape.

Four ASCII control code characters can be recorded in the data format to aid character search operations. When the terminal's "search" button is pressed, tape moves at the rate of 400 characters per second

Also magnetic tape adds high speed on-line capability to low speed data terminals.

You can zip data along the line at up to 2400 words per minute. For example: Take a standard speed Teletype keyboard send-receive set, and a typical typist. Add a new magnetic tape unit to this combination and the on-line time savings can pay for the magnetic tape terminal in short order.

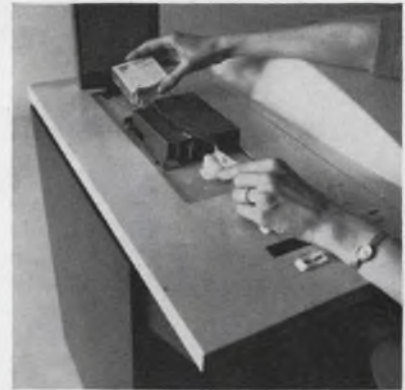

Straight-through threading makes tape loading and unloading exceptionally easy.

They can send or receive at high or low speed. Or can be used independently as stand-alone terminals on-line.

If you would like to know more about this new line of Teletype magnetic tape data terminals, please write Teletype Corporation, Dept. 89-15, 5555 Touhy Avenue, Skokie, Illinois 60076.



until the control code selected is detected. Then the terminal stops the tape automatically.

A "single step" switch is also provided which enables you to move the tape forward or backward one character at a time. In editing or correcting tape, you can send a single character using this feature.

You can take better advantage of voice grade line speed capabilities.

An operator can prepare data for magnetic tape transmission using the keyboard terminal in local mode. Then send it on-line via the magnetic tape terminal up to 2400 words per minute.

These new modular magnetic tape data terminals offered by Teletype are perfectly compatible with model 33, model 35, model 37 and Inktronic® keyboard send-receive equipment.



Teletype 4210 magnetic tape data terminal with 37 keyboard send-receive set.

machines that make data move

ELECTRONIC DESIGN 15, July 22, 1971

INFORMATION RETRIEVAL NUMBER 25



POWERTEC WINS POWER RACE

**With Record Low Prices For New,
High Performance OEM Series**

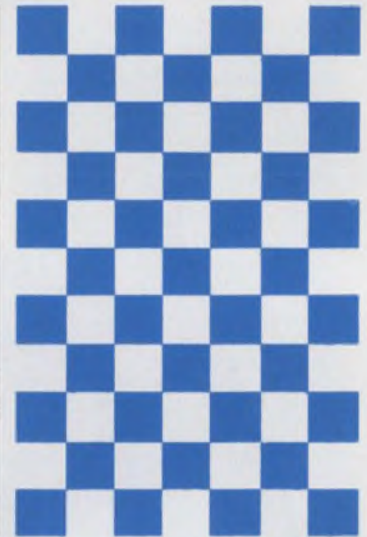
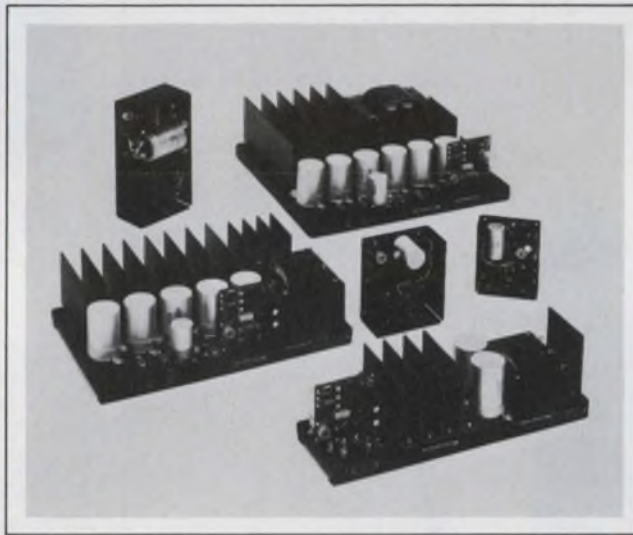
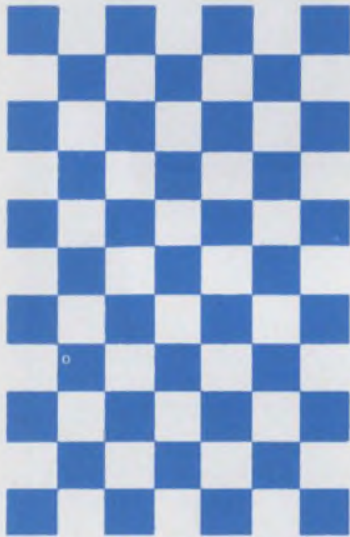

ALL MODELS DELIVERABLE FROM STOCK IN 24 HOURS

Leading the power supply industry with new low prices, top performance and reliability, Powertec's new OEM Series offers 7 popular voltages, in six basic sizes, with 42 power output combinations and is main frame, peripheral and instrument rated.

Available from stock, the OEM Series is a "no frills" fundamental new design — not a price cut, loss leader! Don't take a chance on an also-ran! Get a winner from THE power people at THE power house — Powertec. Request free application data and catalog.

Model Number	*(5)		*(15)		*(24)			Unit Price
	5V	6V	12V	15V	18V	20V	24V	
2B(*)	3A	2.5A	1.5A	1.3A	1.0A	1.0A	1.0A	\$24.95
2C(*)	6A	5A	3.0A	2.8A	2.0A	2.3A	2.3A	\$44.00
2D(*)	12A	10A	6.5A	6.0A	4.5A	5.0A	5.0A	\$75.00
2E(*)	25A	23A	15A	14A	10A	12A	11A	\$129.00
2F(*)	50A	46A	30A	28A	20A	24A	22A	\$219.00
2G(*)	75A	68A	45A	42A	30A	36A	33A	\$299.00

- REGULATION: Line $\pm .05\%$, Load $\pm .05\%$
- INPUT: 115 VAC $\pm 10V$ 47-63Hz
- RIPPLE: 1mv RMS (5 & 15V), 3mv RMS (24V)

- O.L. PROTECTION: Current limit/foldback
- RESPONSE: 50 μ sec typical
- TEMPERATURE: 0°C to 40°C derated to 71°C

POWERTEC INC. an Airtronics subsidiary
9168 De Soto Ave., Chatsworth, California 91311 (213) 882-0004 TWX 910-494-2092

INFORMATION RETRIEVAL NUMBER 26

The General Electric Glass Menagerie

For decades, General Electric has explored the possibilities of glass as it relates to industry's engineers and designers.

Would you like to know what we've learned? What we can make? We'll be pleased to inform you with a captivating new folder now in preparation.

You'll read how vast quantities of glass parts are supplied to meet needs in the Electronic Industry. Where miniature bulb blanks in over one hundred shapes and sizes and many colors of glass beads for sealing to Dumet wire, are manufactured by the millions. How electronic glass is made available for electronic tubes and television picture tube necks. Where tubing is supplied in both long length and cut pieces to meet the exacting requirements of the Electronic Industry.

How we press borosilicate glass into shapes weighing from less than an ounce to as much as ten pounds. How we press parts with dimensional accuracy so that in many instances the cost of grinding or polishing is eliminated.

Though countless standard glass products from lime or low lead or high lead glass are manufactured we also make something special, whenever anyone needs it, such as a high X-ray absorption glass.

For interesting reading, and spectacular photography, just ask us to send you a copy of **Glass in the Twentieth Century**. Available soon. Write: Lamp Glass Department, General Electric Company, 24400 Highland Road, Richmond Heights, Ohio 44143.



GENERAL  ELECTRIC

DATAPAC BUILDS AND SELLS MORE ROMS FOR MORE APPLICATIONS THAN ANYONE ELSE IN THE WORLD

Datapac Read-Only Memory Systems are unique in their design to let you easily change individual bits, words or an entire memory in the field. Datapac ROMs are available in a wide choice of models, sizes and configurations. Capacities from 1K to 1 Megabit. Word lengths to 80 bits. Speeds as fast as 200 Nsec Cycle and 75 Nsec Access. Off the shelf delivery — 50,000 hrs. MTBF. Mil Spec compatible. And 1.5¢ per bit. Write today for our FREE brochure containing the complete Datapac story.

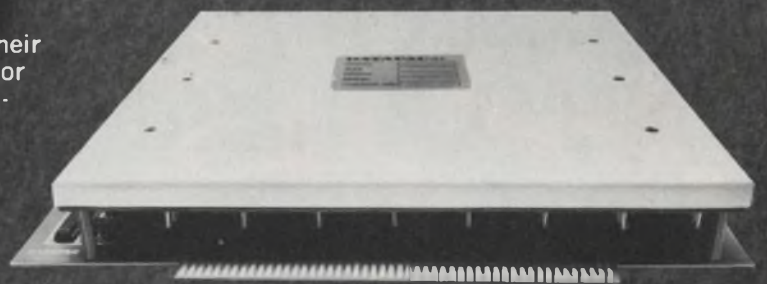

DATAPAC INCORPORATED

3839 S. Main St., Santa Ana, Calif. 92702, Tel. (714) 546-7781

"#1 in the field"

washington report

DON BYRNE, WASHINGTON BUREAU

CATV: A fight over its future?

The Federal Communications Commission says it will ease its regulations on CATV in August, as planned, despite the recent announcement by the White House of a committee to develop a national policy for cable TV. The announcement, which named the chief of the Office of Telecommunications Policy, Clay Whitehead, to head the policy committee, followed testimony by FCC Chairman Dean Burch before the Senate Commerce Committee. In that testimony, Burch said the FCC intended to allow CATV operators to offer subscribers two TV channels not seen on local TV. The broadcast industry has opposed such "importing" of distant signals by CATV operators and a court fight will probably result from the FCC move.

The eased FCC rules are planned to go into effect sometime next month. The White House committee is expected to take at least six months to determine what kind of regulation of the CATV industry, if any, is needed in the national interest.

Lockheed loan possibility brightened by new legislation

Proponents of legislation to provide federal guarantees on loans made to the financially troubled Lockheed Corp. have been heartened by a new plan that would broaden the legislation to include virtually any large company. As it stood, the proposal to aid Lockheed solely had little or no chance of passing, with its fate most likely that of death by filibuster in the Senate. Lockheed needs the help before the summer ends and it would have been a simple matter for the Senate to keep talking until the month-long summer recess arrived next month.

The new plan calls for the Government to guarantee a loan to any company whose failure might deal a serious blow to the nation's economy. Such a measure has support of the Treasury and appropriate committees in the House and Senate. Lockheed boosters in the Senate believe the broadened bill may pass. But both sides warn that passage is a long way from assured and that a filibuster still could take place in the Senate.

Aerospace industry eyes new NASA project

The ailing aerospace industry is eagerly awaiting the healthy infusion of business that NASA's proposed tracking and data-relay satellite system is expected to bring. The \$100-million-plus program may revive some companies heavy in sophisticated communications, telemetry, data acquisition and satellite tracking. Responses to about 90 requests for proposals sent out by NASA are expected soon from companies interested in bidding on the development of the system. The major elements include: two satellites, a user telecommunications system, a ground station, a network scheduling and operations control system.

The study requested by NASA will be in two parts, the first covers

the design and cost of the satellites, the tracking and telemetry command system, the telecommunications system and a ground station. Part 2 will cover the steps necessary to improve telecommunications service to data users.

Alternating-current transit system to be tested

The Dept. of Transportation has granted \$1.3-million to the Cleveland Transit System for testing an electronic propulsion system on rapid-transit cars. The cars will draw 600 V of direct current from a third rail and convert it through on-board inverters to alternating current. The alternating current will drive ac traction motors on the cars. In braking, the motors will act as generators and send current back into the third rail, instead of dissipating it as waste heat.

The department says the system will provide an extremely smooth ride, eliminating the jerks experienced now in rapid-transit cars when they slow down or accelerate. Westinghouse Air Brake Co. will supply the solid-state control systems.

Capital Capsules: Defense Secretary Melvin R. Laird's comments on what would happen if Congress cut \$7-billion from the defense budget, as Sen. William Proxmire (D-Wis.) and others wanted, didn't do too much to bridge the credibility gap. **Laird said the cut would mean the firing of at least 600,000 government civilian workers and a 40% cutback in defense contracts.** But no one seriously believed that the Administration would even toy with the idea of firing that many employees—the job market being what it is and an election coming up next year McDonnell Douglas, in winning over General Dynamics in the contest to build the Navy's anti-ship Harpoon missile, may have won one of the fattest plums of all time. **The initial development contract is for \$60-million over two years, with an announced production award of around \$600-million.** But the contract may go far beyond that, for the Navy feels that eventually it may equip just about everything that floats with the missile. Thousands of missiles may eventually be bought. The Navy wants a missile that can be fired from a ship or aircraft and hit a ship 50 miles away **Senate debate on NASA's budget has revealed that the proposed space shuttle will have defense applications.** Sen. Stuart Symington (D-Mo.) told the Senate that the shuttle would carry aloft photographic and nuclear-detecting satellites and that almost half of the missions of the spacecraft will be for the Defense Dept. Northrop Corp. has set up the Northrop Airport Development Corp. to enter the field of planning, building, and managing airports all over the world. The new organization will be headquartered in Vienna, Va., a Washington suburb. **Northrop estimates the airport market to be about \$80-billion over the next 10 years** U.S. representatives will meet with nine European and five Asian delegates in Madrid on Aug. 3 to attempt to set up a system of international collaboration for the use of aeronautical satellites. The representatives met late last month in Washington as the first step in getting international agreement on the use of the satellites for aircraft communication, navigation and identification **The Federal Aviation Administration held a briefing on its microwave landing system plans for interested industry parties on July 20.** Requests for proposals for development of the system were mailed late last month to about 50 companies. Closing date for response is Sept. 21. The schedule calls for a five-year development program and another five years of procurement and installation.

THE GROWING 7000 SERIES



7904 Oscilloscope

From 500 MHz at 10 mV
with 1-GHz at 5-V direct access

For those who have requirements in between 500 MHz and 50 MHz there's the 150-MHz 7704 (R7704 rackmount), 90-MHz 7504 (7514 storage), all with 4 plug-in compartments; 90-MHz 7503 with 3 plug-in compartments.

Exclusive to the 7000 Series is:

CRT READOUT—

Deflection factors and sweep speeds, the DMM and counter outputs, invert and uncalibrated symbols, etc., are automatically displayed on the CRT—where you look for information. CRT Readout can be ordered initially or as a conversion kit that is easily installed. In each case the cost is only \$400. And it is available in all scopes except the 7403N.

MULTIPLE-PLUG-IN MAINFRAMES

Three or four-plug-in mainframes allow up to twenty combinations of vertical and horizontal operating modes. You can now use plug-ins with widely different

features . . . simultaneously. If you wish, start with only one horizontal and one vertical plug-in and add more as your measurement requirements change.

22 PLUG-INS—

Plug-ins are available to make virtually any measurement desired. Here are some examples: single-trace (dual-trace with two units) • dual-trace (use two for 4-trace) • 10 μ V/div differential • 1 mA/div current amplifier • differential comparator • sampling to 14 GHz • 45-ps risetime TDR • dual time-bases with calibrated mixed sweep • 525-MHz direct counter • digital multimeter • All 22 are compatible with all mainframes (Readout required for DMM and counter).

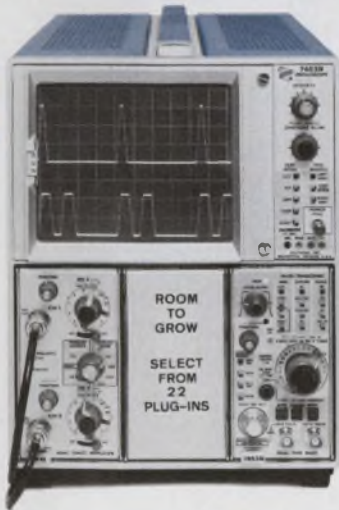

7403N Oscilloscope
(R7403N 5 1/4-inch rackmount)

U.S. Sales Prices FOB Beaverton, Oregon

Tektronix lease and rental programs are available in the U.S.

to 50 MHz at 5 mV

dual-trace, 6 1/2-inch CRT and de-laying sweep for only \$2200

7000-Series Scopes, complete with plug-ins, start as low as \$1650. Call your nearby Tektronix field engineer today for a demonstration of the scopes that make more measurements easier and quicker.



TEKTRONIX®

committed to
technical excellence

Everything's subminiature except their capacity.

Our subminiature switches may be tiny, but there's nothing small about their electrical capacity, long life expectancy, or application versatility.



Shown actual size.

Our SM series, for example, has a switching capability to 10 amps, bifurcated gold contacts for high reliability and a wide choice of integral or auxiliary actuators. Available are several terminal styles, including new flat quick-connects. To meet your other design needs, there's now a sealed version of the SM.

And if that's not enough, our smallest snap-action switch—the 1SX series—combines precision operation and long life in a 1 gram package. Plus it offers most of the features found in the SM.

For more information, call your MICRO SWITCH Branch Office or Authorized Distributor (Yellow Pages, "Switches, Electric"). Or write for Catalog 50.

MICRO SWITCH

FREEPORT, ILLINOIS 61032

A DIVISION OF HONEYWELL

MICRO SWITCH products are available worldwide through Honeywell International.

INFORMATION RETRIEVAL NUMBER 30

5 AMP molded Plastic

NPN SILICON POWER TRANSISTORS

SOLITRON'S "PILL" IS JUST WHAT THE DOCTOR ORDERED FOR YOUR HYBRID APPLICATIONS.



FEATURES INCLUDE:

- Small, compact size (0.105" high by 0.27" diameter)
- Power Dissipation: 25W @ $V_{CE} = 10V$,
 $I_C = 2.5A$ and $T_C = 100^\circ C$
- Tin plated leads provide optimum solderability
- Low price



BHN0001-5
Regulator

Actual
Size

Soltron's new series of 5 Amp plastic power, junction passivated silicon mesa NPN transistors are now available for immediate delivery. Volume production enables us to supply these devices at the lowest prices in the industry. These small "pills" give fast, fast relief from a number of different hybrid application problems. Proven reliability is their extensive use in Solitron's power integrated circuits, regulators and amplifiers.

TYPE NUMBER	Rated Breakdown Voltages	PERFORMANCE SPECIFICATIONS			
		h_{FE}		V_{BE} VOLTS	V_{CE} (Sat) VOLTS
X-53 Case	V_{CEO} (Sus) @ $I_C = 0.2A$	@ $V_{CE} = 10V$, $I_C = 0.5A$		@ $V_{CE} = 10V$, $I_C = 0.5A$	@ $I_C = 1.0A$, $I_B = 50mA$
		Min.	Max.	Max.	Max.
S 4000	40V	20	50	1.2V	1.2V
S 4001	40V	50	150	1.2V	1.2V
S 4002	40V	>150	—	1.2V	1.2V
S 6000	60V	20	50	1.2V	1.2V
S 6001	60V	50	150	1.2V	1.2V
S 6002	60V	>150	—	1.2V	1.2V
S 8000	80V	20	50	1.2V	1.2V
S 8001	80V	50	150	1.2V	1.2V
S 8002	80V	>150	—	1.2V	1.2V

For complete information, prices and engineering application assistance, dial toll-free 1-800-327-3243. Or write:

Soliton

DEVICES, INC.

1177 BLUE HERON BLVD. / RIVIERA BEACH, FLORIDA / (305) 848-4311
TWX: (510) 952-7610

SAN DIEGO, CAL
8808 Balboa Avenue
FET & Dual FET
Transistors
MOS/FET Devices
MOS Memory Arrays
Shift Registers
Monolithic IC's
Small Signal
Transistors

RIVIERA BEACH, FLA.
1177 Blue Heron Blvd.
Hi-Rel Power Transistors
Si & Ge Power
Transistors
Hi-Rel Power Hybrids
PNP-NPN Industrial
Transistors

PORT SALERNO, FLA
Cove Road
Microwave Connectors
Plaxial (RI) Cable
Precision RF Coaxial

JUPITER, FLA
1440 W. Indiantown Rd.
Microwave Stripline
Components
Microwave Semiconductor
RF Semiconductor
Microwave Integrated
Circuits

TAPPAN, N. Y.
256 Oak Tree Road
Diodes & Rectifiers
Zeners
High Voltage
Assemblies
Power Rectifiers
Thick Film Hybrid
Circuits
Ferrite & Ferrite Devices

KENT, ENGLAND
Tubbs Hill House
London Road.
Sevenoaks
Solidev, Ltd
Full line of
Solitron devices

BEN BARAQ, ISRAEL
51 Hayarkon Street
AEL Israel, Ltd
Full line of
Solitron devices

TOKYO 105, JAPAN
No. 5, 3-Chome
Shibahamamatsu-Cho
Minato-Ku
Matsushita Electric
Trading
Full line of
Solitron devices

INFORMATION RETRIEVAL NUMBER 31

CAN YOU REALLY AFFORD TO MAKE YOUR OWN CUSTOM ASSEMBLIES?

P&B's free check list will give you the answer.

We make thousands of custom assemblies each year which include relays and electronic components. We're geared for this work. We have the know-how, the people, the test gear, the necessary production equipment. We normally purchase the components we do not make—diodes, resistors, capacitor, transistors—at maximum discounts.

When we supply your electronic assemblies you do not have to (1) buy and inventory the components, (2) set up a special production line, (3) acquire unusual test equipment, (4) train and pay the necessary produc-

tion and supervisory personnel. The opportunities for savings are obvious.

Ask for our Custom Assemblies Check List, which simplifies the make or buy decision. Better yet, ask us for a quotation on assemblies that incorporate relays. Chances are, we will save you money.

Call your local P&B representative or Potter & Brumfield Division of AMF Incorporated, Princeton, Indiana 47670. 812 385 5251

AMF | POTTER & BRUMFIELD

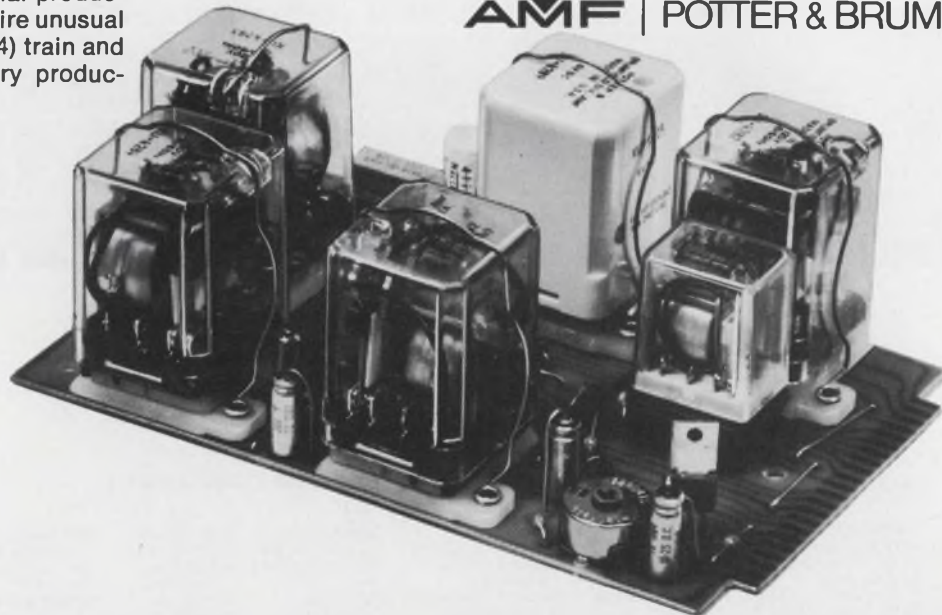

P&B performance. Nothing else comes close.

Compare Against All Other Secondary DC Voltage Standards .

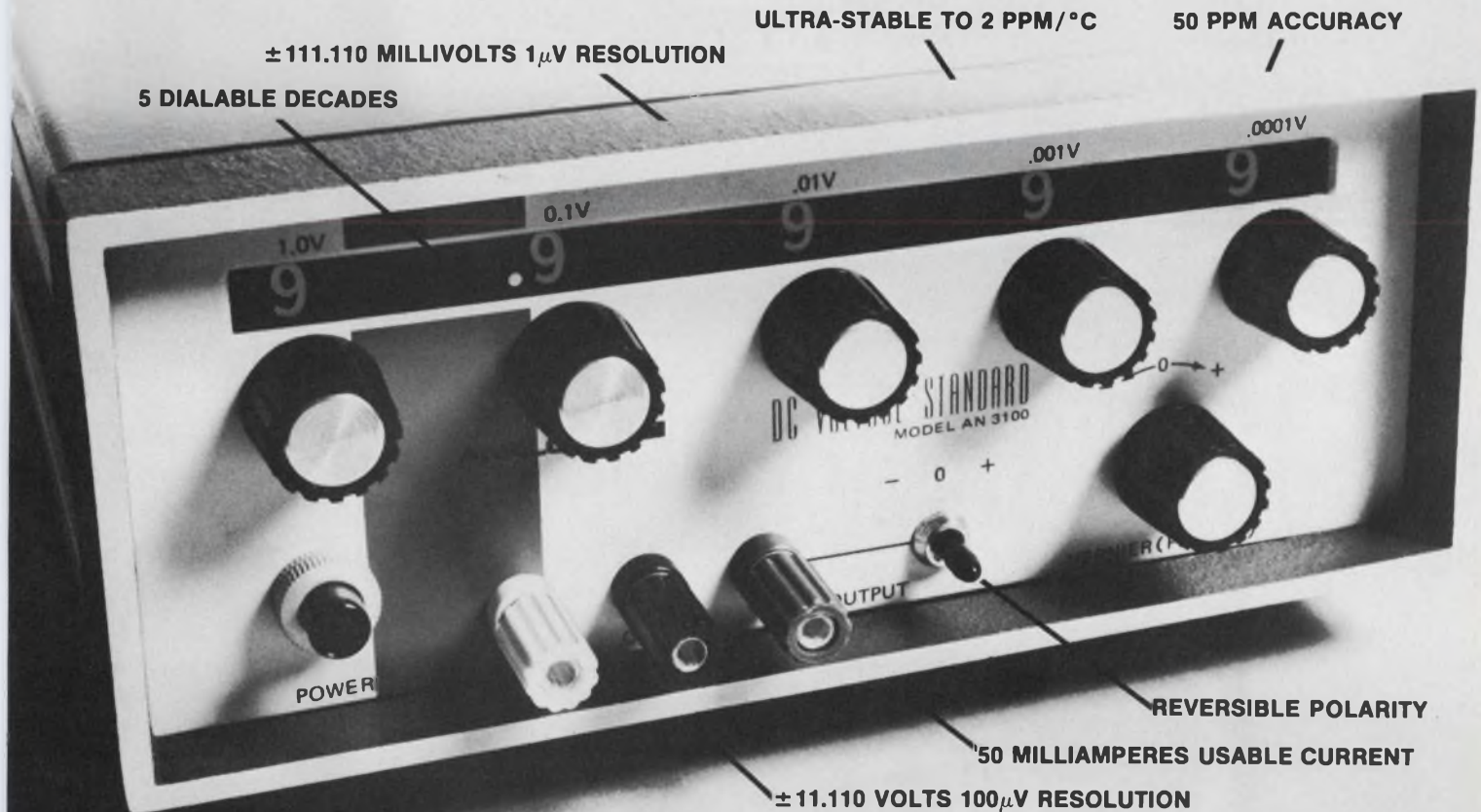

Then Compare the Price of \$595.00

Before you buy any DC Voltage Standard, compare specifications . . . compare cost. Hundreds of operational AN3100's have established proven price/performance criteria for you to act upon.

The AN3100 delivers a unique combination of high accuracy, ultra-stability, wide range and reliability at a price to please the most cost conscious engineer.

\$595.00 goes a long way.

Use the AN3100 to ■ transfer primary-standard reference values ■ perform rapid, accurate calibration ■ provide a standardizing reference in measurement instrumentation ■ and as a base reference in analog computation. Use it as a High Precision DC Power Supply with an accuracy measured in PPM.

The AN3100 is factory calibrated, traceable to NBS primary standard for a certified absolute accuracy of 50 PPM of reading ± 50 microvolts for six months. A built-in divider provides a simultaneous second range up to ± 111.110 millivolts with $\pm 1 \mu\text{V}$ resolution. Outputs are

ungrounded and may be floated up to 500 VDC above or below ground. The main output has a constant 10 milliohm impedance. A front panel vernier control permits fine adjustment of the output level.

Need portability? The AN3100 weighs only 7 pounds, is housed in a compact half-rack enclosure measuring $3\frac{1}{2}$ "H x $8\frac{1}{2}$ "W x 12"D and comes equipped with a handy carrying strap. A tilt-up stand is provided for easy viewing in bench use and a 19" rack mounting adapter is available as an option.

By all measurements, the AN3100 is the most versatile and economical secondary standard available. Send for complete technical data and compare.

ANALOGIC CORPORATION, Audubon Road, Wakefield, Massachusetts 01880.

ANALOGIC ■

...The Digitizers[®]

We took the Boeing 747's panel out of limbo.

Without soft background lighting around aircraft panel instruments, lighted dials can "swim" in a sea of darkness under night conditions. Boeing determined that the forward panels in its 747 cockpit needed frosted bulbs for the proper diffusion of this light, and contacted us.

Our #1309 IF inside frosted bulbs now take the 747's instruments out of a limbo condition and give them the 3-dimensional stability needed for easier pilot readings.

Hudson offers a variety of lamps for practically every



inboard airborne use. And we supply miniature and sub-miniature lamps in any number of bulb and base configurations for other electrical/electronic applications, including automotive. Specials, like the Boeing request, get special attention. In minimum turnaround time, at minimum cost.

LAMP COMPANY
Hudson

We've got a whole book of bright ideas for your illumination. Write for Catalog 106. Hudson Lamp Company, 528 Elm Street, Kearny, New Jersey 07032.

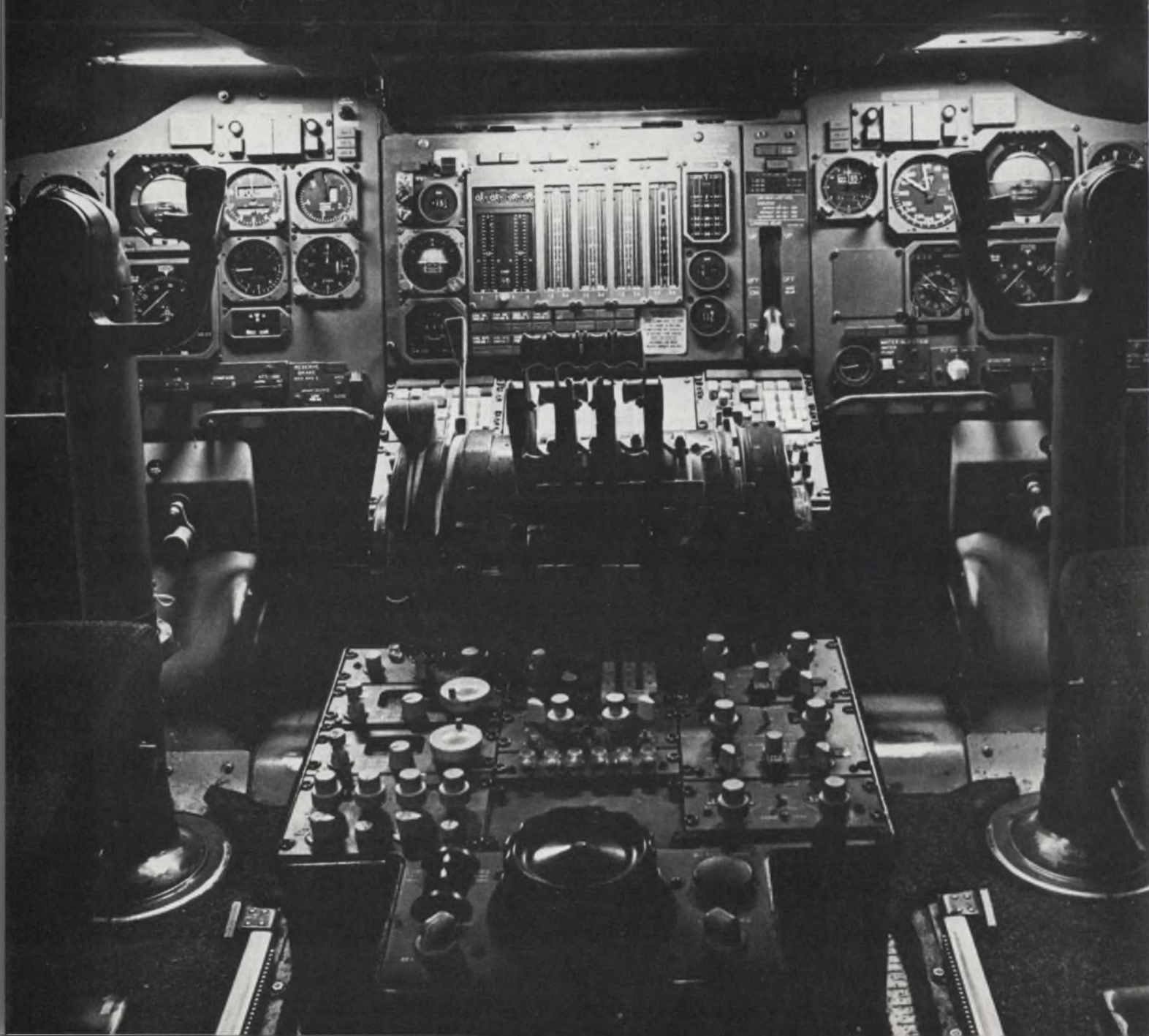

Let's blow the whistle on fraudulent claims

The Federal Trade Commission's decision to police advertising claims could have a significant effect on consumer advertising as we know it today.

Basically the decision calls for the FTC to order companies to submit proof of their ad claims relating to performance, quality, comparative prices, etc. Since the commission's findings will be made public, advertisers who make inaccurate or misleading claims will expose themselves to extremely bad publicity.

As a result, there are those who feel that consumer advertising will now concentrate on creating a good feeling, or image, for a product rather than making specific claims. Others, though, think that consumers will be more confident about ad claims, since factual back-up data will be on file with the FTC. Either way, the FTC's decision is a step in the direction of consumer protection.

A logical question at this point would be: "What connection does the FTC decision have with the electronics industry or the design engineer?" The answer, of course, is that engineers are users and specifiers of a never-ending array of products—from components and instruments, to materials and systems. And these products are advertised extensively by their manufacturers, with the emphasis in most ads on performance and specifications.

Fortunately the large majority of claims made in technical ads are legitimate. A few, though, would not stand up too well under proof to the FTC or any other regulating agency. But pinpointing these is not easy, because of the complexity of today's products and technology.

Often a product's inability to live up to its maker's claims becomes apparent only after a potential user has spent time and money evaluating it—time and money that are irretrievably lost. What can the engineer who finds himself trapped like this do, besides turn to another manufacturer's product, which hopefully will do the job? For one thing, he can and should notify the manufacturer and let him know that he misrepresented his product.

He should also notify all media that carry advertising for that particular product. The media have a stake in the integrity of their advertising. That is why ELECTRONIC DESIGN, as one example, has a policy of refusing any advertisement that it deems misleading or fraudulent. To exercise this policy fully, though, we need your help.



Frank Egan

FRANK EGAN

RAYTHEON SEMICONDUCTOR. OUR RAY III IS THE FASTEST FULL LINE OF TTL PRODUCTS YOU CAN GET.

RAY III has 33 logic functions for superfast TTL circuit designs in both industrial and military applications. There are 22 gates with speeds down to 4 nanoseconds. There are 8 flip-flops with speeds down to 10 nanoseconds. And there are complex MSI arrays that add, decode, generate and check parity.

RAY III is available off-the-shelf. It provides the functions, the speed, the power savings, and the flexibility necessary for fast circuit design.

We've got the process nailed down. DC and AC specs are tight over the entire operating temperature range. We pro-

vide the guaranteed specs you need for no-guesswork system design. And RAY III is compatible with all DTL and TTL logic levels, power supplies, and design rules. RAY III saves power. Up to 20% per gate at high operating frequencies.

RAY III has proven acceptance. In computer central processors and airborne computers. In digital tests and measurement instruments. In minicomputers, multiplexers, computer graphics, and peripheral logic.

We're continuing to expand our broad line of superfast TTL products. We have a new technical team. And new develop-

ment programs providing new design tools. We're the first source for SUHL. We have 57 functions in RAY I and 42 functions in RAY II TTL products. Available in all standard industry packages. And there are more RAY III MSI arrays and logic functions being developed.

Get more information on the fastest complete line of TTL available. Ask your nearest Raytheon Semiconductor franchised distributor for the "RAY III" design manual. Or stop by Raytheon Semiconductor, 350 Ellis Street, Mountain View, California 94040. (415) 982-9211.



PERIOD.

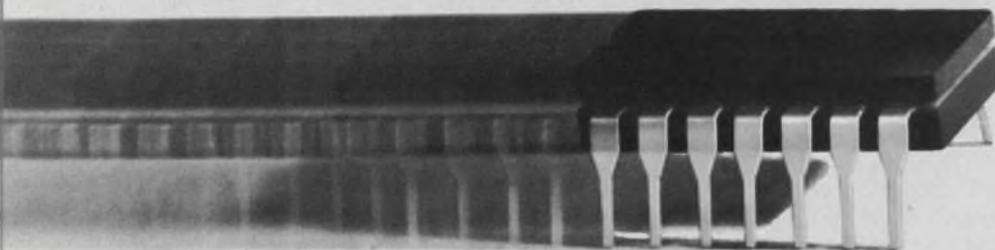

A chance to banish the traffic nightmare

An Electronic Design Special Report

Contrary to popular belief, traffic congestion didn't begin with the automobile. Historians tell us that even ancient Rome had traffic tieups. Some of the solutions tried then included these: one-way streets, off street parking and the banning of chariots from downtown areas at certain times. Sound familiar?

Civionics

It's been said that the United States is a nation on wheels. Americans own 49% of the world's passenger cars. There are over 3.5 million miles of streets and highways in the country. On the average, Americans make 80% of all their trips by car. Before our city streets become completely clogged, before our highways become saturated and before the dream of automated transportation becomes reality, some firm steps must be taken to control traffic. There is an agonizing need for traffic-responsive computer traffic systems. And here the eyes of the nation are on the design engineer. Because there are no off-the-shelf computer traffic control systems for Phoenix, Salina, Concord and the thousands of other big and little cities in the nation. Each demands the individual touch of a designer.

Traffic-control systems require sensors to detect the presence of vehicles . . . computers to correlate the information and make decisions . . . controllers to give motorists red lights, green lights and other information . . . communications systems.

The sensors must be more reliable and have better sensitivity than those now on the shelf. The controllers must be fail-safe. The entire system must be relatively cheap.

So it isn't a simple job. But it can be rewarding. If time is money, effective traffic control will save motorists billions. And more—it will also reduce air pollution and preserve human life. For it's a fact that this year more slaughter will occur on the roads of America than on all the battlefields of Vietnam in the last decade. We kill about 50,000 Americans a year with what has become our most dangerous weapon—the automobile.

Take more than 100 million motor vehicles traveling more than a trillion miles a year, add to that the fact that these vehicles are increasing at a rate of 4% a year, and you begin to get a picture of the monster problem confronting engineers and other traffic experts in the United States.

What's the solution to the traffic mess? The specialists agree that it's not more roads but more effective use of existing streets and highways. This is especially true in the central business districts of cities, where new and wider streets can't be built without prohibitive costs.

Electronics has started to offer remedies. In Albany, N.Y., the city has installed a relatively inexpensive traffic-control system that employs a mini-computer. The flow of vehicles past busy intersections has been speeded from 1000 cars an hour to 5000.

New York City has taken seven arterial roads with 440 intersections and put them under computer control. The result: Trip times along the arterials have been cut by as much as 40% and the number of intersection stops from 15 to 3.

In Houston, Tex., a surveillance and control system placed in operation on the Gulf Freeway raised the average speed during rush-hour jams by 50%—from 22 miles an hour to 34—and reduced accidents 25%.

But the surface has only been scratched. Before electronics can do more, it must overcome problems like these:

- **Costs.** Sophisticated equipment can be built with all the necessary compensation to operate in the severe environments of city streets and highways. But it must also be cheap.

- **Reliability.** Not only must electronic equipment have a high MTBF, but it must also fail in a safe manner.

- **Communications.** Efficient and reliable systems must be developed to handle the flow of data and command signals between centralized control centers and remote signal controllers.

- **Customers.** Electronics companies must learn to deal with customers who want to solve complex problems but who are not familiar with the capabilities and limitations of electronic equipment. And in most cases, they will not pay for hardware development. They want off-the-shelf items.

The stress is on control

Addressing a recent district meeting of the Institute of Traffic Engineers, New York City's Traffic Commissioner T. Karagheuzoff said:

"Every morning of our lives we hear from some new source that our highway system is not equal to the transportation crises resulting from peak-hour commuter demand. If we, as traffic engineers, have a function in allaying this so-called

Untangling traffic with sensors and computer cops

Steven A. Erenburg
Microelectronics Editor

crisis, it lies not as much in the area of new construction in urban areas as in better utilization of existing highways and streets."

Richard K. Boyd, assistant project manager for high-speed ground transportation at TRW, Maclean, Va., says: "Whatever the solution, there are two elements bound to exist: There will be a high degree of automation and a fair degree of restriction on personnel activity."

Most of the new work in street and highway traffic control involves the use of a real-time digital computer system. According to Dr. H. Nathan Yagoda, president of Computran Systems Corp., Hackensack, N.J., such a system "offers the most modern, reliable, flexible, fail-safe type of service."

"It has been proven capable of providing lower transit time, fewer avoidable delays and fewer accidents," he continues. "In addition traffic engineers and maintenance staffs are provided with data-collection capabilities and maintenance aids."

A good example of the improvements brought by a computer-controlled, traffic-responsive system is the increase in traffic flow in downtown Albany after the installation of a minicomputer-controlled network system by Computran. Accord-



The strong role electronics plays in modern traffic control systems is evident in this view of the Sperry Rand System Management Div. Traffic and Transportation

Control Center in Great Neck, N.Y. The center is used by the company to demonstrate, develop and test automated computer-based traffic control systems.

ing to Yagoda, it was the first such system to use a minicomputer.

New York City provides another example of the traffic improvements possible with the use of computer-controlled systems. New York's situation is probably unique, because of its size, says E. Vinson Hoddinott, chief of the city's Bureau of Signals and Communications. Within New York's five boroughs there are 9000 intersections with signal lights.

Hoddinott reports that New York City has an on-going modernization program that is designed to put 500 intersections a year under computer control. "Eventually," he says, "7000 to 7500 intersections will be placed under computer control."

In Houston a 6.5-mile section of the Gulf Freeway was selected as the site for a traffic surveillance and control study program.

The original installation used analog controllers manufactured by the Automatic Signal Div. of Laboratory for Electronics, Inc., to control traffic entering the freeway at eight different ramps. An IBM 1800 computer is now being used as an alternate and also to perform data analysis.

To aid in the study, a closed-circuit TV system, with 14 pole-mounted cameras, provides visual

coverage for operators at the control center.

The system uses what is known as "gap-acceptance" to control traffic entering the freeway. Loop detectors in the right lane of the freeway provide a computer with data that is analyzed to determine when another vehicle may safely enter the highway. When an acceptable gap in traffic is found, the controller sends a command to the signal light at the ramp approach. This directs vehicles onto the freeway in patterns that will least interfere with oncoming traffic.

System has two major parts

There are two parts to any traffic-control system: One is the control system strategy, and the other is the control system implementation. Both must be specified to define a system. Control strategy is what the traffic engineer wants the system to do. System implementation is how the traffic engineer chooses to accomplish the task.

All real-time, traffic-responsive control systems need four basic subsystems for implementation:

1. A sensor subsystem to collect traffic flow data.
2. A computer subsystem to evaluate the incoming traffic data and determine the optimum combination of signal timing parameters.

How one city eased its traffic crisis with a minicomputer

What's the ideal traffic-control system for Middletown, U.S.A.? It could easily be similar to the system installed by Computran Systems Corp. in Albany, N. Y.

The Albany central business district is plagued with most of the traffic problems common to older cities. The streets are narrow and irregular. There is heavy pedestrian and vehicular traffic. Illegal parking occurs too frequently, and during the winter heavy snow is common.

Downtown Albany was hard-pressed to handle the 10,000 motorists who filled the streets on an average day. And then, to compound the problem, construction of a new bridge across the Hudson River was expected to funnel 45,000 more motorists through the business area — most of them transients not headed for downtown Albany. When a new highway is completed, this flood of traffic will largely bypass the business area, but in the meantime it was apparent that traffic on some of the links in the network would increase up to 500%.

A study was conducted to identify present and future traffic flow patterns in the central business district. It was found that a minimum of 20 signal intersections around the Albany terminus of the new bridge would be handling more traffic. The flow was broken down into four major patterns: a.m. peak, midday shopper circulations, p.m. peak and evening through-flow. The traffic routings and intensities for each were different.

In each instance, there was a need to provide for two-way movement of traffic around corners and through short links with inadequate storage capacity. If average length groups of cars moving through the area were required to stop along some of these roadways, there would be a high risk of blocking upstream intersections, with resulting area-wide traffic congestion.

To accommodate the projected demands, a centralized traffic surveillance and control system

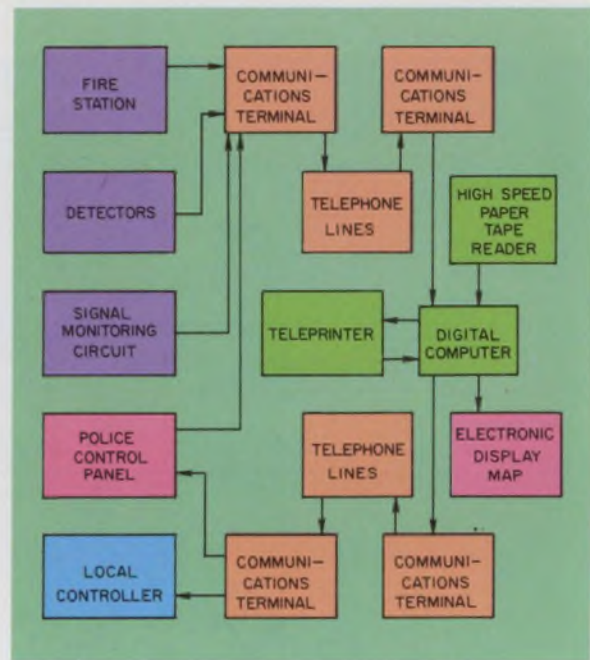

1. The automatic traffic control system developed by Computran Systems Corp. for Albany, N.Y. provides the police and fire departments with override capabilities in case of emergencies.

was designed, built and installed. This system (Fig. 1), which has been in operation for one year, centers on a Varian 620/i minicomputer, which receives inputs from 65 magnetic loop detectors placed throughout the central business area. With this information, the computer exercises demand-responsive control through individual signal controllers placed at the intersections in the network.

Information transmission between the central computer and the individual intersections is accomplished by use of Quindar tone-shift transmitters and receivers. This equipment operates

3. A controller subsystem to carry out the computer's instructions by controlling individual traffic signal lights.

4. A communication subsystem to link the sensors and controllers to the central computer.

Each of these hardware subsystems provides a challenge and opportunity for the electronics industry. But the problems, as we shall see, are not always a matter of meeting the hardware performance specifications.

Versatile sensors sought

Consider sensors. Traffic engineers would like vehicle sensors to provide a variety of informa-

tion, including volume, speed and lane occupancy. Some of the detectors used provide this information directly, some do it by inference and some require multiple detectors.

Most of the vehicle detectors in present use leave something to be desired in either performance, cost, reliability or ease of maintenance. The types include loops, ultrasonic, radar, magnetometer, pressure switches and photocells.

Loop detectors are the most commonly used, primarily because of cost considerations. One type uses a crystal-controlled oscillator and a loop containing four turns of No. 14 wire. The loop, imbedded in the roadway, is tuned to the crystal's frequency, usually 100 kHz. An auto passing near the loop short-circuits part of the magnetic field,

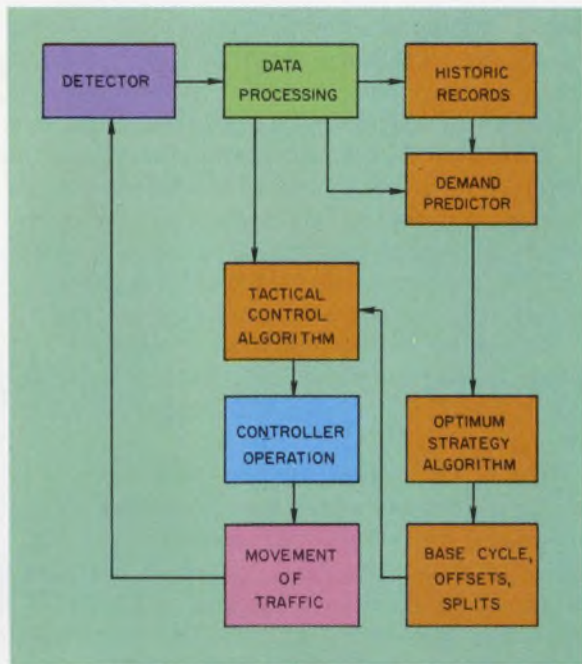

2. A second-generation approach is used to generate the optimum strategy algorithm in the Albany traffic control system. With a first-generation approach the algorithm is developed off-line.

in the audio band, and it uses a land-line network comprised of both owned and leased lines.

Peripheral equipment is limited to a teleprinter, a high-speed paper tape reader and an electronic display map. The teleprinter provides the primary communication channel between the system and the traffic engineer. It provides a hard-copy output for summary reports generated by the system, and its keyboard is used to input system commands.

An electronic map serves as the primary status display, exhibiting information on the assignment of right-of-way at each intersection

and the presence or absence of vehicles at detector stations throughout the area.

Secondary inputs are supplied to the computer from various sources. For example, the firemen at a station in the central business district preempt the system's normal operational sequence, to permit the fire apparatus to maneuver rapidly through the area.

The police can inform the computer as to changes in roadway and weather conditions, and, if needed, a manual system override can be exercised to force the central system to relinquish control.

Monitor circuits permit the computer to detect failures within the control loop. Feedback is obtained from circuits that check the operation of the signal system at each local controller.

The control structure of the system uses a second-generation approach (Fig. 2). In this configuration, detector inputs are processed to generate historic and real-time data. With this information, a prediction algorithm generates the projected traffic demands. The projections are used by the optimum-strategy algorithm to generate nominal cycle lengths, offsets and splits for each intersection.

Real-time data is also used by the tactical control algorithm, which modifies the nominal signal timing in accordance with actual short-term variation. The resultant desired timing is then enforced through the local controllers.

The system is designed to use a simplified optimization algorithm that reflects historic data obtained from the detectors. As protection against detector malfunctions and failures (perhaps the most vulnerable components), the system can be modified by breaking the link between the prediction and the optimization algorithm. When this is done, the optimization algorithm is run off-line and is called a first-generation system.

causing a reduction in the loop's inductance. This, in turn, causes a phase shift in the loop's current, which is detected and closes a relay.

One problem with loop detectors is stability over wide temperature ranges, unless expensive compensation techniques are used. Also, since the loop detector and relay combination is basically a presence detector, speed and occupancy must be calculated with average values for the car's length and inductive effects.

Ultrasonic sensors do not require any alteration to the roadway or disruption of traffic flow during installation or maintenance. The transmitter-receiver is pole-mounted and uses a moving-coil type of loudspeaker to transmit a 20-kHz signal toward the road. During installation the

sensor is adjusted to eliminate ground returns. Pulse repetition frequencies vary from 8 to 21 pps, depending on resolution requirements.

Once again, temperature compensation is a problem. Variations in the speed of sound in air approximate 0.1%/°F over the normal operating range. Also, false returns are another major source of trouble.

Despite their limitation, loop detectors have had much wider acceptance than the other types. Radar detectors have had little success, because of cost and maintenance problems.

Magnetometers and pressure switches have been used primarily for measuring presence and do not have the sensitivity of loop detectors.

Photocell detectors have not had much success,

except under controlled environments like tunnels.

Pressure-activated switches are low in cost but are placed in, not under, the roadway. This can lead to expensive installation and maintenance costs.

The choice of detector is not always made on purely technical grounds. Robert L. Gordon, head of the Research Dept. at the Sperry Systems Management Div., Great Neck, N.Y., describes how it chose detectors for the Federal Highway Administration's Urban Traffic Control System in Washington, D.C.

"Inductive loop detectors were selected as the basic instrumentation to generate data for the control parameters," he reports. "Since the Fine Arts Commission of the District of Columbia prohibits permanently installed devices requiring mast arms of greater than six feet, normal overhead-mounted detectors could not be used. Loop detectors were chosen over magnetic units because magnetic types have been used most often only to roughly measure presence. Because of the ill-defined and variable character of the magnetic detector's sensitivity, quantitative accuracy of occupancy measurement was not considered high enough for Urban Traffic Control System purposes."

In New York City the opposite approach has been taken. Some years ago a decision was made not to put anything in the roadway. This immediately eliminated all but ultrasonic and radar detectors from consideration.

Computers usually provide an easier choice. The basic choice is between analog and digital. Analog computers for traffic control have been around for about 20 years and provide a real-time, traffic-responsive capability. Their major disadvantages are that they are not easily expandable and are costly to modify as control strategies change.

With digital computers, the choice is primarily determined by the number of intersections controlled, the control strategy and the operations (such as record-keeping) not directly related to the traffic-control problem. In general, computational speed is not a major consideration.

According to Carl Sukowski, director of computer control for New York City's Traffic Department, "Almost any process-control computer will do."

The basic system used in New York City has an IBM 1800 computer and is similar to systems originally developed for San Jose, Calif., and Wichita Falls, Tex. The computer contains 32 K words of internal core storage and a 512-K word disc. This allows the machine to control up to 500 intersections by analyzing the traffic flow data from sensors and then picking one of up to 325 different signal-timing schedules.

By using a system that had been previously developed, New York was able to go on-line much more rapidly, according to Sukowski. At present, the city has two 1800 computers and several more on order. Eventually it will need 14 of these computers for full control of traffic. In addition a

The ultimate: automated highway systems

There are experts who say that the ability of our streets and highways to handle increasing traffic will eventually reach a saturation point with present control techniques. The problem is particularly severe in commuter traffic.

An obvious solution to part of the problem is improved mass transit. Not so obvious is how to persuade commuters in the nation's suburbs to leave their cars home. Two approaches that are presently being tested may eventually lead to a real solution to the commuting problem, says TRW's Boyd.

For the last 22 months several lanes of the Shirley Highway in northern Virginia have been reserved strictly for bus use, to determine if congestion can be reduced by luring commuters from their cars. According to the Northern Virginia Transportation Commission, bus riding has increased substantially — as much as 80 per cent on one line — and commuting time has been reduced by 15 minutes for some commuters. At the same time the growth in automobile traffic during the morning rush hours has slowed 50%.

Another concept being tested in several cities

is known as the "Dial-a-Ride" system. It is essentially a personal bus service, similar in operation to a private taxi service. Service is requested from either the home or a bus stop over telephone lines to a central dispatch and control center. The vehicle nearest the call is rerouted by two-way radio command to pick up the passenger. One system, designed by the Boeing Surface Transportation System in Philadelphia, enables a single dispatcher to handle 120 dispatches an hour.

The next logical step, according to Boyd, is to combine the two operations: Pick up passengers in suburban areas, enter a reserved high-speed roadway, drive to a downtown area, leave the highway and disperse the passengers.

Even this will lead to saturation. Tests have shown that the maximum capacity achieved on highways is approximately 2000 vehicles an hour in each lane at a speed of approximately 35 mph. Below this speed, the road can accept more vehicles. Above this speed, drivers increase the spacing between vehicles, so that the capacity of the road actually decreases. At 60 mph the capacity drops to approximately 700 cars an hour.



A new concept in traffic surveillance, ORBIS III, (left) automatically identifies a car, license number and driver and records vehicle speed, location, time and date on a



single 35mm movie frame (right). The device, developed by LTV's Missile and Space Div. uses an illumination system operating in the near IR.

separate computer will be required to act as a master control and to coordinate the activities of the individual computers. New York has chosen and purchased an IBM 360 50 that is being phased in and is operating with the two 1800s.

For Washington's Urban Traffic Control System, Sperry is using an XDS Sigma 5 with 65 K words of main memory. One reason for the large computer is because the system is to be used as a test-bed for different control strategies. For the first phase of the program, 123 intersections with 517 loop detectors will be instrumented.

More typical of the size of installation that will be in use in most cities in the U.S. is the system

installed by Computran Systems Corp. in Albany. Here a Varian 620/i minicomputer with 4 K words of memory was used to control 20 intersections, with information supplied by 65 sensors (see box on p. 52).

Control of signal lights

As for the controller subsystem, the standard signal lights used in U.S. are controlled by a pre-determined set of timing patterns. Signal timing is essentially defined by three parameters: the cycle length, the split and the offset.

The cycle length is the total time in seconds from the beginning of green on a main street to the next beginning of green on the main. The split is the percentage of the cycle assigned to the major street movement. Increasing the cycle length results in longer red periods and therefore longer stops. It also increases the number of vehicles or volume that can pass through the intersection in a given time. This effectively increases the capacity of the intersection. The objective therefore is to have a cycle length long enough for the volume of traffic arriving to pass through the intersection without stopping, but also short enough so that any vehicles stopped do not have long to wait.

The offset is the time delay as green lights flash on at successive intersections. It is this offset relationship that allows a vehicle to proceed from signal to signal without encountering red lights.

Cams on a timing motor are used to set the cycle, split and offset. The cams are used to drive a stepper motor, which switches the actual signal-light circuits. The controllers usually provide between 12 and 18 timing intervals per cycle and can control up to 27 circuits, says Cyrille Dodge, director of signal operations for New York City. Some of the more sophisticated controllers contain three separate timers: one for the morning rush

By automating the highway portion of the trip, Boyd feels that the dial-a-ride system can handle the same number of people as rail rapid-transit systems. At 60 mph an automated highway can handle 5000 vehicles an hour in each lane. Using mini buses carrying 10 to 12 people each, this system could carry over 50,000 people an hour in each lane at less expense than building new rail systems, Boyd contends.

Private autos can also be equipped to travel on automated highways. Initially they would be allowed access on a space-available basis, according to Boyd. Eventually all cars and all inter-city traffic would roll on automated highways.

When asked how long this would take, Boyd told ELECTRONIC DESIGN that he estimates approximately 20 years. He expects to see it begin during the seventies. The technology is here.

One objective of a study recently completed by TRW for the Office of High Speed Ground Transportation, U. S. Dept. of Transportation, was to define a complete intercity, high-speed automated highway system. The system envisioned by TRW would allow cruising speeds in the range of 75 to 150 mph.

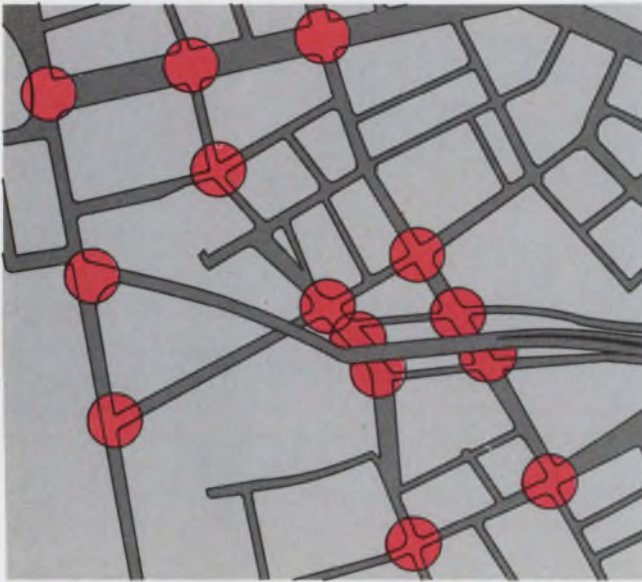

Traffic flow studies must be conducted to identify the major traffic patterns and the sites of critical intersections. Only then can the size of the traffic-control system and the number of vehicle detectors be determined.

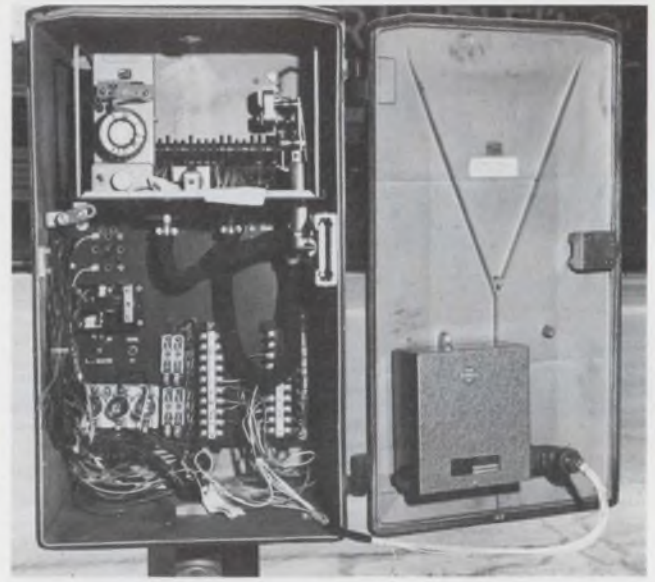

Standard signal controllers are used in New York City's computerized systems. With a simple modification, the action of the fixed-cycle timer (upper left) is interrupted, and the signal timing is placed under computer control.

hour, one for the evening rush hour and one for off-peak periods. The controllers are placed in metal boxes near the signal light. When a computer system is to be installed, all that is required is an adapter that will switch control of the stepper from the timer to the computer.

Communications between a central computer and the various sensors and controllers in the street are usually accomplished by hardwire transmission, primarily for economic reasons. It is cheaper and requires less maintenance than radio communications.

Either leased telephone lines or privately owned lines are used. Here again, the choice is based on economics, including initial cost, installation and maintenance and yearly operating costs. In New York City leased signal-grade telephone lines are used, with one pair of lines for each controller and one pair for each sensor. The signals on these lines are restricted to dc or pulses with a prf of less than 18 per second. New York uses switched dc for communications.

Other types of communications used in conjunction with voice-grade (or better) telephone lines are amplitude modulated frequency-division multiplex, frequency-division multiplex and time-division multiplex.

Nontechnical problems, too

Aside from technical problems, there are other considerations that electronics manufacturers must take note of if they would crack the traffic-control market.

The people most concerned today with present and future traffic problems are the traffic engi-

neers working for municipalities, states and the Federal Government. Traffic engineers are usually civil engineers by education. But they are learning how electronics can be used to solve many traffic-control problems.

"There is a need for a completely new group of people for traffic-control operations. Highway departments have to become transportation departments," says W.R. McCasland, research engineer at the Texas Transportation Institute and director of the Gulf Freeway Surveillance and Control Project in Houston.

According to New York City's Commissioner Karagheuzoff, "The traffic engineer of the future will require a professional knowledge of computers and their capabilities."

In the meantime traffic engineers are responsible for the purchase and installation of control equipment. Most traffic department staffs are not very large, however, and must rely on outside firms to do their systems work.

With the exception of the Federal Government, research and development work must be done by the electronics manufacturer. The Federal Government, through the Dept. of Transportation, does its own research and supports development programs by outside contractors.

When it comes to buying hardware, traffic-control customers are largely interested in price. The low bidder for a contract wins. And when city and state governments purchase something, the contractor doesn't get his money until the equipment is installed and accepted. This differs from practices in the defense and aerospace industries, where contracts are negotiated and a contractor receives progress payments. ■■

More "snaps" at less cost



The Licon® Basic Switch Line offers a full selection of sizes, actuators, ratings and price ranges. Switches actual size.

Today's constant demand in circuit design is "Make 'em smaller, cheaper and more reliable!" So you need better basic switches than ever before. And Licon builds them. With no sacrifice in size, rating or price. For example, the Type 10 series provides precise operation, hefty current rating, high vibration resistance and Mil Spec conformance. The Type 11 is a miniature, general purpose version of the incredibly reliable Licon Butterfly® double-break switch. The switch tested

up to 20 million mechanical cycles without failing. And only Licon has it. The Type 25 is an SPDT switch for broad use in narrow places. It's just 9/32" thick. But because it is similar to the Butterfly, it offers utmost reliability at low cost. And the newly designed Type 19 subminiature SPDT switch packs big reliability and load capacity into really tiny volume. There are a lot more types—from the sub-subminiature Type 18 to the rugged 20-Amp Type 14. Available in single

pole to triple pole designs at prices that you'll like. Send for the book, or have a Licon man bring in the demo kit so you can snap a few yourself. Call or write Licon, Division Illinois Tool Works Inc., 6615 W. Irving Park Road, Chicago, Ill. 60634. Phone (312) 282-4040.



i t LICON

The Innovating Electronic Group of ITW... LICON ■ ELECTRO MATERIALS ■ PAKTRON

Improve wideband FM recordings

by reducing noise and distortion. Just insert three types of signal-processing circuits in the basic system.

Wideband FM recording has many virtues. The incoming signal can be almost anything, from the data on a communications line to the demodulated output from a telemetry receiver. It can have any frequency from dc to the upper cutoff frequency of the reproduce demodulator. But there's an ominous cloud in this sunny picture: Most wideband FM recording systems distort the recorded signals and add noise.

Variations in the magnetic coating on the tape add some form of noise to the modulated carrier, for example, and the nonlinear frequency response of wideband record/reproduce heads is an additional source of distortion. But there are ways to reduce both noise and distortion markedly.

Compensate the basic system

A system that significantly reduces noise and distortion is shown in Fig. 1. In it each data input signal is converted to an FM carrier that combines with a high-frequency (bias) sine wave. Conversion to magnetic flux for recording is accomplished by the record head.

During playback the reproduce-head output goes to a preamplifier and on to a limiter. The last part of the reproduce system is a demodulator that converts the limiter's square-wave frequency into the original data signal.

To this basic system is added, between the preamplifier and the limiter, three signal processing circuits that take out much of the noise and distortion. First, a bandpass filter reduces noise and spurious signals by restricting the bandwidth of the limiter's input to those frequencies that are essential to information transmission.

Second, an amplitude equalizer linearizes the record/reproduce system's gain vs frequency response, to minimize distortion caused by unsymmetrical sideband distribution.

And third, a delay equalizer linearizes the sys-

tem group-delay characteristics, which means that it makes the delay time of the system a more nearly constant function of frequency.

Typical signal processing circuits are shown in Figs. 2-4.

Let's examine more closely now the sources of noise and distortion and how the three signal-processing circuits counteract their effects.

Distortion, caused by nonlinear gain and nonlinear group delay, is minimized by the amplitude and delay equalizers. The chief source of distortion is the reproduce head/tape process, which has a nonlinear gain characteristic over the system passband, as well as a nonlinear transmission time with frequency. As a result, both the gain and the group delay of the whole system change with frequency, thereby distorting the carrier and sideband distribution.

The effect of the nonlinear amplitude vs frequency response on an FM signal is seen in Fig. 5. This waveform is the output of the FM demodulator when nonsymmetrical AM sidebands have been introduced.

A typical amplitude vs frequency curve from a reproduce head that is reading a tape recorded with a constant flux density is shown in Fig. 6. If this curve were flat, there would be no problem. In that case, any amplitude modulation caused by frequency-dependent gain would be linear. The AM sidebands would then be symmetrical and could be taken out by a limiter.

The AM distortion is eliminated by making the system response linear—that is, designing the amplitude equalizer to have a frequency response that is the difference between a linear curve and the nonlinear frequency response curve of the head and tape.

As for nonlinear group delay distortion, it causes a shifting in time of various points on a sine-wave modulation, because the corresponding instantaneous carrier frequencies for each point are unequally delayed in time (Fig. 7).

This type of distortion is eliminated by the delay equalizer, which adds delays at the proper frequencies so all passband frequencies are delayed by approximately the same amount.

A significant difference between the two forms

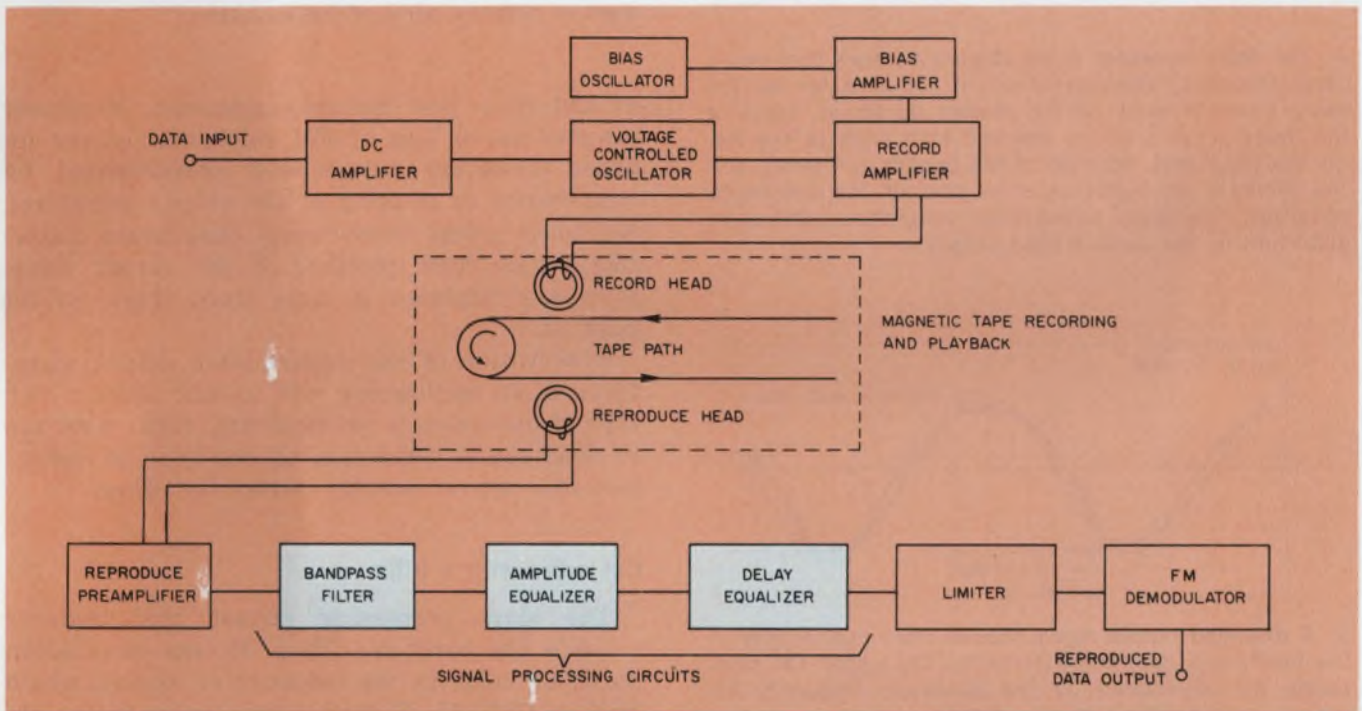

1. A basic wideband FM recording system is modified by the inclusion of three signal-processing circuits between the reproduce preamplifier and the limiter. Re-

produced signal distortion and noise, introduced by the record/reproduce processes, is thereby minimized through filtering and system linearizing.

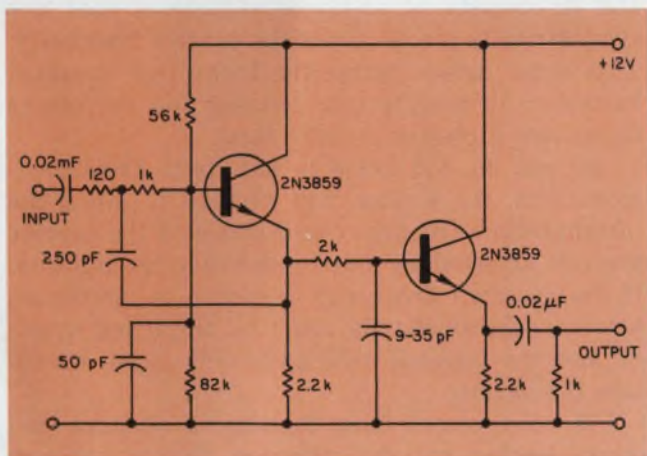

2. The active bandpass filter sets the upper frequency of the passband at about 1700 kHz. The lowest passband frequency, about 100 kHz, is determined by the inter-stage RC coupling networks. Out-of-band noise is rejected, improving the FM carrier-to-noise ratio at the limiter input.

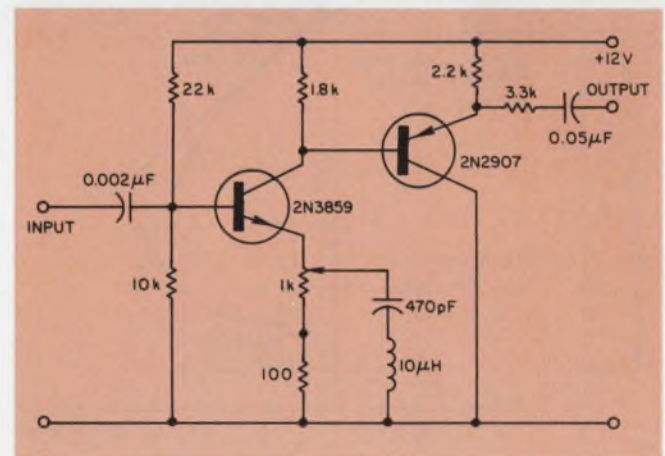

3. The amplitude equalizer is an amplifier stage with an adjustable series-tuned LC circuit that resonates around the top end of the band. A rising gain characteristic, with increasing frequency, restores the linear slope of the system frequency response for AM sidebands, which are removed by the limiter.

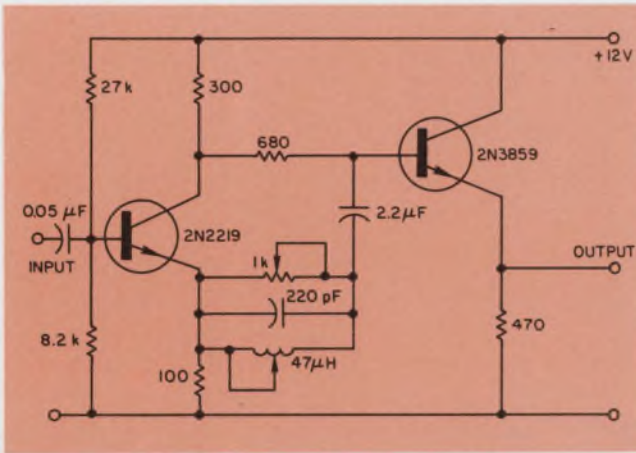

4. The delay equalizer is an all-pass network that has a delay/frequency characteristic that compensates for the delay characteristics of the system passband. Most of the delay error is at the low and high ends of the frequency passband, because of the bandpass filtering and the increase in high-frequency gain of the amplitude equalizer. The delay equalization minimizes quadrature distortion in the demodulated output.

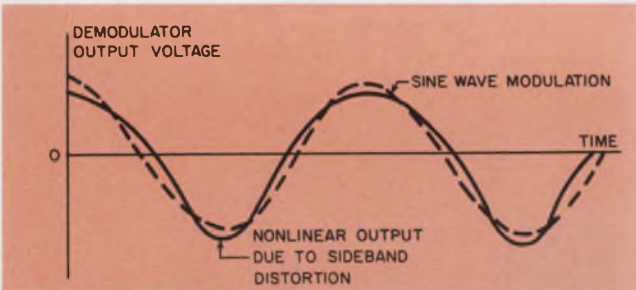

5. A distorted output signal results from nonlinearity in the head/tape gain characteristics. The upper FM sidebands are attenuated by the nonlinear frequency response, causing the output to distort.

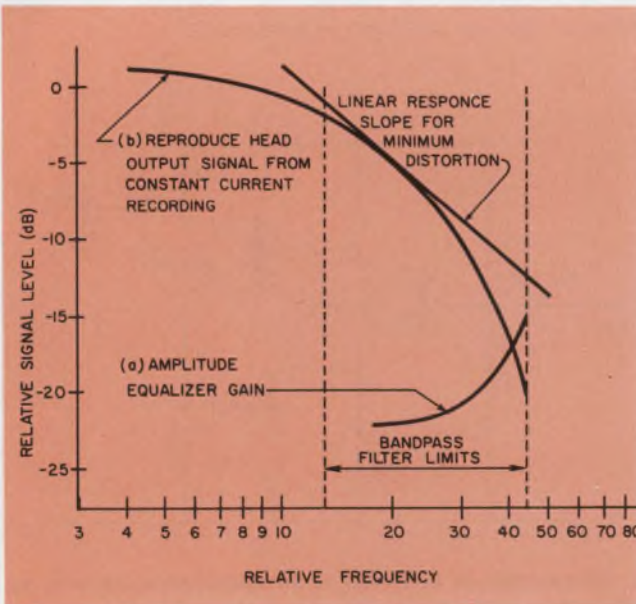

6. The response of the amplitude equalizer (a) is calculated to compensate for the nonlinear response of the reproduce head (b). The resulting curve is linear for minimum distortion.

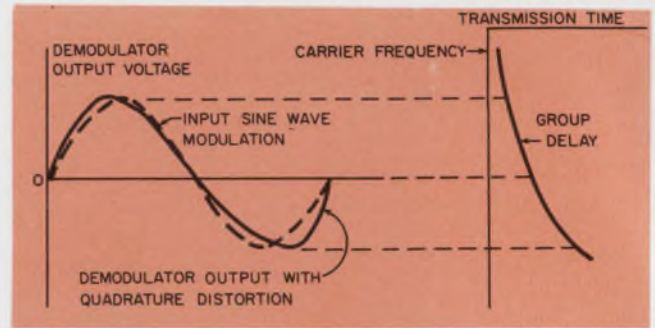

7. A varying system transmission time causes quadrature distortion. As the instantaneous FM frequency changes, the nonlinear group delay results in a displacement of different parts of the waveform.

of distortion now becomes apparent. Nonlinear attenuation, or loss of FM sidebands, causes in-phase distortion components, characterized by compression or peaking of the output waveform. Nonlinear group delay causes quadrature distortion, where some portions of the output waveform are displaced in time from their correct position.

Observation of the demodulator output waveform on an oscilloscope will usually show which type of distortion is predominant. Since both are in quadrature, correction of one type of distortion does not necessarily correct the other.

Cut noise with a filter

The signal-processing circuit that reduces noise is the bandpass filter. It cuts modulation noise, or noise in the presence of signal, which may be 10 to 15 dB higher than noise in the absence of signal.

There are two types of modulation noise: AM and FM. AM noise comes from the spurious amplitude modulation of the reproduced carrier, and it consists of in-phase sidebands that are symmetrically placed about the carrier frequency. This noise arises primarily from two sources: variations in head-to-tape spacing and variations in magnetic coating on the tape.

As long as AM noise is not itself frequency-modulated, the limiter will remove it, since the instantaneous frequency and phase of the carrier are not affected by pure amplitude modulation. If the system's frequency response is nonlinear, however, the sidebands won't be amplified equally, and the unequal sidebands will phase modulate the carrier.

FM noise comes from tape-speed changes and other mechanical disturbances that frequency modulate the recorded carrier. Since the sidebands produced in this way are nonsymmetrical to begin with, FM noise cannot be distinguished from the original modulation and cannot be taken out by the limiter. ■■

No sooner did we bring out the broadest and best line of multipliers in the industry than we dared to publish a comprehensive guide for the curious. Step by step explanations of theory and operation, ten how-to examples with actual circuit diagrams, and a selection

guide for the highly motivated. But not one word of hard sell. The hard sell is here, in this ad. We offer the highest performance multipliers in the business (slewing rates to 120v/usec. accuracies to 0.1% full scale, offset drifts to 0.2mv/°C) as well as the widest selection, including an economy model for only \$39 and the first monolithic—for even less. Don't be modest. Be a multiplier authority. Ask for your free copy of

"Evaluating, Selecting, & Using Multiplier Circuit Modules for Signal Manipulation & Function Generation." Mailed in a plain brown wrapper, if desired. Analog Devices, Inc., Norwood, Mass. 02062. (617) 329-4700.



 **ANALOG
DEVICES**



**Everything
you've wanted to know
about multipliers
but were afraid to ask.**

Baluns cut ground noise between interfacing circuits when they are used as common-mode chokes. And unlike differential amplifiers, they're not common-mode limited.

Ask an electronics engineer to name his biggest technical headache, and there's a good chance that his answer will be "noise." If the noise is caused by circulating ground-noise currents—as is often the case when circuits, subassemblies or racks of equipment are interconnected—then a properly applied balun may be the answer to his problem.

Although baluns (for *balancing units*) have been widely used by rf designers to connect balanced transmission lines with unbalanced lines or devices, their ability to suppress noise in digital and analog circuits is not nearly as well recognized.

Getting inductance when you want it

A balun, or common-mode choke, is a bifilar-wound, broadband transformer that allows equal and opposite currents to flow through its windings, while suppressing unequal and opposite currents, such as those due to ground noise. Because of the bifilar windings, no net flux is generated in the balun when its two currents are balanced; therefore, balanced signals encounter no inductance when passing through the balun. For unbalanced currents, however, the device acts as an inductance, and effectively breaks up the ground-current path.

They're not common-mode limited

Unlike differential amplifiers, which can also be used to suppress ground noise, baluns are not common-mode limited and, of course, they do not require expensive power supplies. Other advantages that they enjoy over differential amplifiers are lower cost, smaller size, less distortion and vastly greater reliability.

Baluns can be applied at either the driving or receiving end of a transmission line. Among the driving-end applications (Fig. 1) are ground iso-

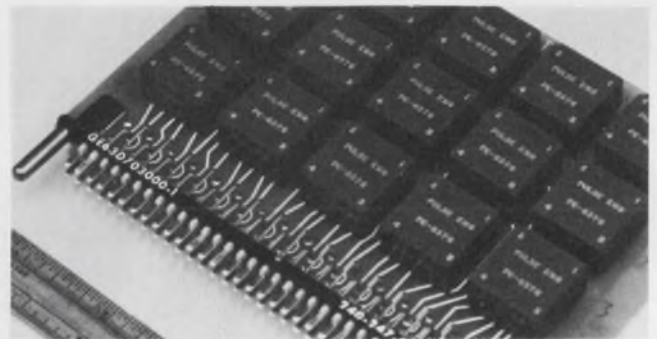

Baluns needn't take up much room. This small printed-circuit board contains 15 units, each of which can handle 2 W of cw power. Lower-power units are available with four baluns per package. The board shown here is used by GE's Apollo Systems Department to break up ground loops in cabinet-to-cabinet interfacing circuits. The baluns are made by Pulse Engineering of San Diego.

lation, current balancing and the protection of critical analog circuitry. In the current-balancing application (Fig. 1b), for example, one side of a two-wire transmission line may pick up an unbalanced noise signal through its distributed capacitance to a noisy ground. By effectively putting an inductance in series with this noise signal, the balun suppresses it without affecting the desired signal.

In receiver applications (Fig. 2) a balun can provide isolation for digital-circuit grounds, perform noise balancing or reduce the noise associated with single-wire transmission. When used as a receiver for a single-ended line (Fig. 2c) the balun allows the line to be converted into a balanced line without picking up any ground noise.

Baluns can cut distortion too

Even when shielded cable is used, baluns can sometimes be employed to advantage. For example, if a cable is used to transmit a clock signal from a clock driver to a load, the signal will actually reach the load through two different transmission lines. One is the coaxial cable; the other is the line consisting of the cable's inner conductor and the ground shared by the clock

Gilbert P. Condon, EMI Engineer, General Electric Co., Missile and Space Div., Apollo Systems Dept., Bldg. 4, Rm. 4620, Apollo Park, Daytona Beach, Fla. 32015.

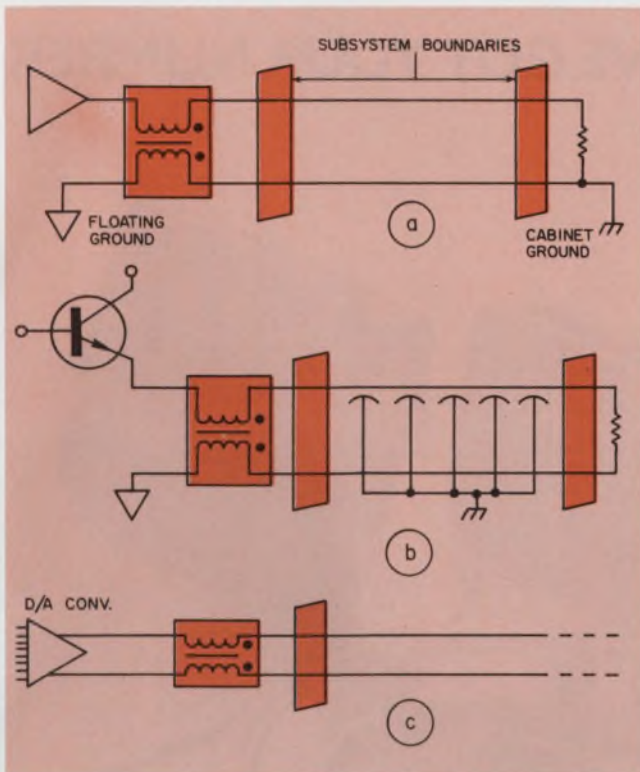

1. A balun can fight noise at the driving end of a transmission line by providing ground isolation (a), current balancing (b) or critical-circuit protection (c). Note that the rake symbols represent facility or cabinet grounds, while the grounds represented by the spade symbols are floating. The subsystem boundaries may be PC board edges, cabinet walls, etc.

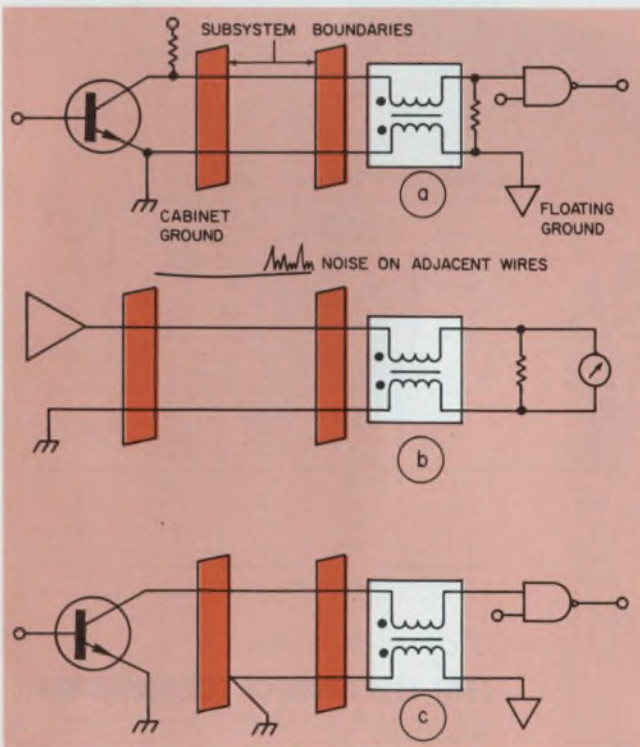

2. A balun can be used at the receiving end of a transmission line for isolating digital-circuit grounds (a), balancing out noise that has been picked up from adjacent wires (b) or providing a termination for a single-wire (unbalanced) transmission line (c).

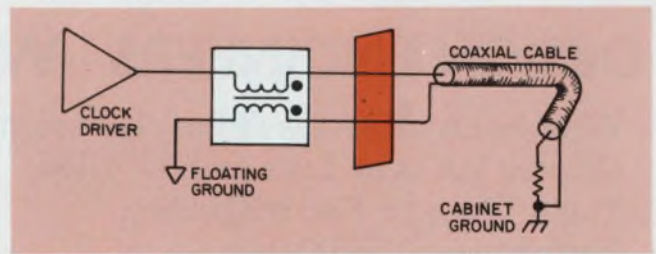

3. Clock-pulse distortion is reduced by the balun because it isolates the clock-driver ground from the system ground. This eliminates the race problems that would arise if each clock pulse reached the load through two different paths with different electrical lengths.

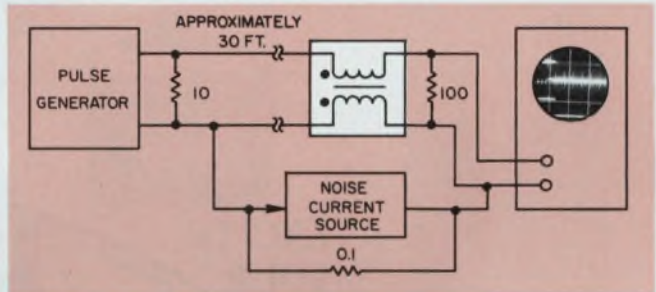

4. A noisy ground is simulated by the noise source in parallel with a $0.1\text{-}\Omega$ resistor in this laboratory test of a balun's noise-reduction performance. As can be seen in the oscilloscope photo, the spikes generated by the noise source are very evident in the upper trace (no balun) and are not noticeable at all in the lower trace (balun in place).

driver and the load.

If these two transmission lines do not have identical propagation velocities, the received clock pulses will be distorted. One way to eliminate this distortion is to use a balun to isolate the clock-driver ground from the rest of the system (Fig. 3).

Effectiveness depends on ground resistance

To experimentally determine the effectiveness of baluns in actually reducing ground noise, the digital-ground isolation concept of Fig. 2a was simulated in the laboratory (Fig. 4). A train of 30-V spikes was put out by the noise source and the amplitudes of the received spikes were measured. With no balun in place, the received amplitude was 0.8 V. With the balun-inserted, the amplitude dropped to about 0.09 V—more than an 8:1 reduction.

Lowering the resistance in parallel with the noise source from $0.1\ \Omega$ to $0.01\ \Omega$, raised the noise-reduction factor to 50:1. Raising it to $1.0\ \Omega$, however, lowered the noise-reduction factor to only 2:1, indicating that baluns will not prove very effective at reducing noise on inter-building cables, or in other situations in which long wire lengths lead to high ground resistances. ■■

DESIGN ENGINEERS—WE'VE GOT YOUR NUMBER

Whether It's Eye-easy Phosphorescent Display Tubes or Crt's and It'll Show You a Thing or Two in Quality, Performance, and Other Important Advantages That Constitute a Big Seeing-Is-Believing Difference

EXCITE
YOUR
CREATIVE
APPETITE



Variety is the spice of life — and here it is on a silver platter. Legi variety comes big so you can design big, and it comes small so you can design small. The choice is yours. But the latitude in physical size isn't all you get with Legi. You also get important quality and performance advantages. Legi phosphorescent display tubes meet portable and circuit-board mounting requirements, have a readout as bright as day, and a dynamic life of 100,000 hrs; 'Multi-Legi' is our special package deal for display electronics system designers; Legi compact decoders and drivers are more designer specials in separate, composite, and Bipolar MOS types; and Legi picture perfect picture tubes let you design from 9" to 5-1/2" down to pocket-size 3" spec. There's a lot more you should know about Legi, if you don't know already. Write today for full particulars, and we'll show you how it pays to think Legi when you're thinking new systems. The spice of life is yours. Now.

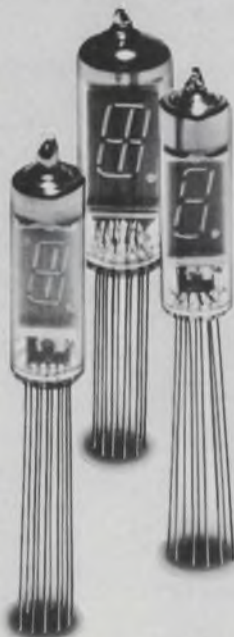

SPECIFICATIONS (pulse operation)

TYPE	Filament Current #1	Filament Voltage #1	Phosphor Segment Voltage #2	Control Grid Voltage #2	Phosphor Segment Current #2
DG12M	85	#1 0.8 ± 10%	50	#2 50	4
DG12H	85	#1 0.8 ± 10%	50	#2 50	3
DG19E	95	#1 1.7 ± 10%	55	#2 55	4
Unit	mA	V _{a.c.}	V _{d.c.}	V _{p-p}	mAp-p

TYPE	Control Grid Current #2	Phosphor Segment Cut-off Voltage #2 (MAX.)	Control Grid Cut-off Voltage #2 (MIN.)	Brightness
DG12M	19	0	-4	150
DG12H	18	0	-4	150
DG19E	22	0	-4	150
Unit	mAp-p	V	V	Ft-L

#1 Effective Value at 50 or 60 Hz A.C.
#2 Pulse condition—Duty Factor 1/16 pulse width 60μsec.

Legi Sole U.S. Agent

LEGI ELECTRONICS CORPORATION

3118A, West Jefferson Blvd. Los Angeles, California 90018, U.S.A.
Tel: (213) 733-9105



The Brighter Side of Electronics

ISE ELECTRONICS CORPORATION

P.O. Box 46, Ise City, Mie Pref., Japan
Phone: Mie (05963) 2-4944, (05963) 5-2121

Solitron eliminates memory headaches with no buffering



Complete Compatibility.

The UC7355 Dual 50 Bit Static Shift Register is DTL/TTL compatible. That means you don't need a special buffer interface between the TTL input lines and the TTL output lines. Simple.

And you can stop worrying about lost information when you use the Soli-

tron Shift Register. No matter what the clock's state is—"0" or "1"—all the data is retained for future use.

When you use the UC7355 only one DTL/TTL clock is needed at any frequency from DC to 2MHz. And all data inputs are protected against static shock.

Contact your Solitron representative. He'll cure your memory headaches—and he'll be glad to tell you about our whole line of MOS devices. Remember, Solitron means reliability.

Solitron Devices, Inc., P.O. Box 1416, San Diego, California 92112
Telephone: (714) 278-8780, TWX 910-335-1221.

Solitron DEVICES, INC.

For custom designs or standards, contact Solitron, leader in semiconductors:

SAN DIEGO, CAL.
8808 Balboa Avenue
FET & Dual FET Transistors
MOS/FET Devices
MOS Memory Arrays
Shift Registers
Monolithic IC's

RIVIERA BEACH, FLA.
1177 Blue Heron Blvd.
Hi Rel Power Transistors

SI & Ge. Power Transistors
RF & small Signal Transistors
PNP-NPN Industrial Transistors

LONG ISLAND CITY, N. Y.
37-11 47th Ave.
Microwave Components
Bolometer Elements
Ferrite & Ferrite Devices
Microwave Semicond.
Plaxial (R) Cable

Precision RF Coax.

PORT SALERNO, FLA.
Cove Road
Microwave Connectors

TAPPAN, N. Y.
256 Oak Tree Road
Diodes & Rectifiers
Zeners
High Voltage Assemblies

Power Rectifiers
Thick Film Hybrid Circuits

TOKYO 105, JAPAN
NO. 5, 3-Chome
Shibahamamatsu-cho
Minato-ku
Matsushita Electric Trading

KENT, ENGLAND
Tubs Hill House

London Road, Sevenoaks
Solidev, Ltd.
Full line of
Solitron devices

BEN BAROQ, ISRAEL
51 Hayarkon Street
AEL Israel, Ltd.
Full line of
Solitron devices

This voltage-controlled rf attenuator

replaces the ganged potentiometers of a standard bridged-Tee attenuator with a pair of p-i-n diodes.

Manually operated bridged-Tee attenuators have long been used as gain controls for rf and i-f signals. In modern equipment, such as automatic communications gear or programmable test instrumentation, however, manually operated controls are not sufficient. For these applications, the variable resistors in the manually operated attenuator (Fig. 1a) can be replaced by p-i-n diodes, yielding a continuously variable, voltage-controlled, bridged-Tee attenuator (Fig. 1b).

In rf and i-f work it is usually important to keep the input and output impedances of the attenuator fixed at some value, Z , independent of the attenuator setting. To keep the impedances constant, the relationships,

$$R_1 = Z(K-1) \quad (1)$$

and

$$R_2 = Z/(K-1), \quad (2)$$

must hold, where $K = \text{antilog}^{10}(A/20)$, and A is the attenuation setting in decibels. Combining Eqs. 1 and 2, we get the relationship

$$R_1 R_2 = Z^2 = \text{constant}. \quad (3)$$

This condition can easily be met if R_1 and R_2 are a pair of ganged potentiometers with R_1 counter-clockwise logarithmic and R_2 clockwise logarithmic.

What are the bias constraints?

Since the electronic version of the attenuator uses p-i-n diodes instead of pots, the condition of Eq. 3 must be translated into terms involving the bias voltages or currents on the diodes. The forward resistance of a p-i-n diode is given by

$$R = r/I^n \quad (4)$$

where I is the forward bias current, r is the diode resistance at $I = 1.0$ mA and n is a constant.

Plugging Eq. 4 into Eq. 3, and making the assumption that a pair of identical diodes is being used, we get the result

$$I_1 I_2 = (r/Z)^{2/n} = \text{constant}. \quad (5)$$

If the constants r and n are not supplied by the

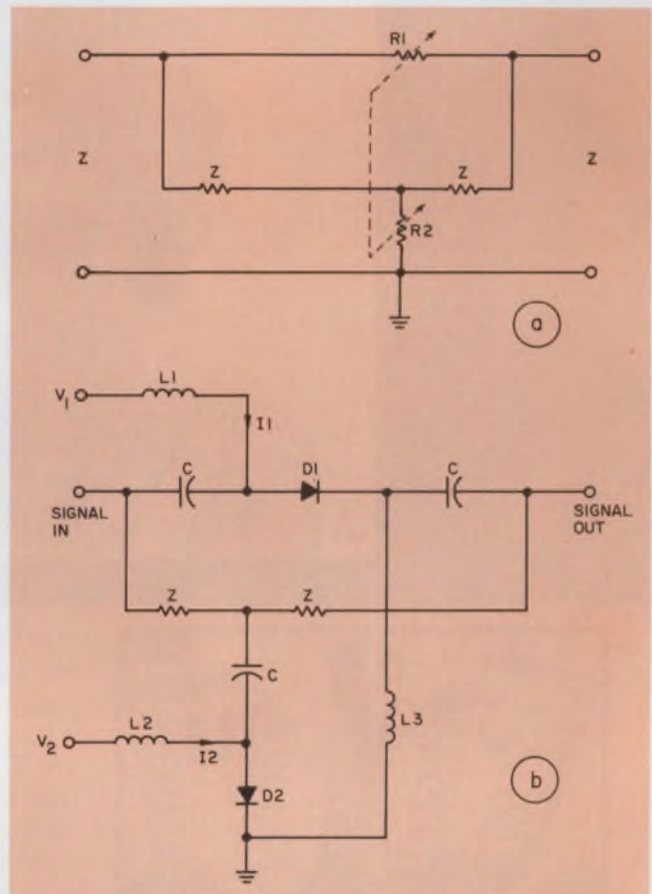

1. The bridged-Tee attenuator (a) maintains a constant impedance, Z , across its entire attenuation range as long as $R_1 R_2 = Z^2$. The electronically variable version (b) uses p-i-n diodes D_1 and D_2 to replace R_1 and R_2 , respectively. Chokes L_1 and L_3 carry bias current I_1 for diode D_1 ; while L_2 supplies D_2 . For effective rf decoupling, the inductors must be chosen so that $\omega L \gg Z$. Similarly, the coupling capacitors should be chosen so that $(1/\omega C) \ll Z$. The product of the diode currents and the sum of the diode voltages must be constant.

diode manufacturer, they can be determined by measuring the forward resistance, R , of the diode as a function of the bias current, I , and plotting the result on log-log paper (Fig. 2).

The resulting curve will be a straight line with slope = n and a 1.0-mA value of $R = r$. The curve of Fig. 2 is for an HP 5082-3039 p-i-n

Nicholas Kadar, Sr. Engineer, Singer Co., Instrumentation Div., 3211 S. La Cienega Blvd., Los Angeles, Calif. 90016.

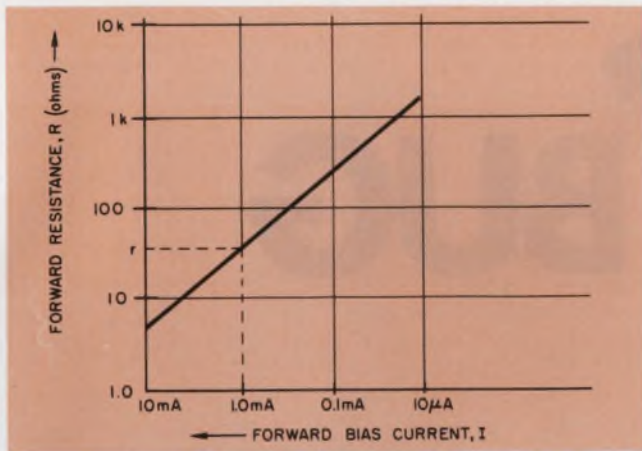

2. Plot the diode's resistance as a function of its forward bias current to find the constants r and n . This curve is for an HP 5082-3039 diode. (Note that the current decreases as you move to the right along the x-axis.) For this diode, $r=28$ ohms and $n=0.93$.

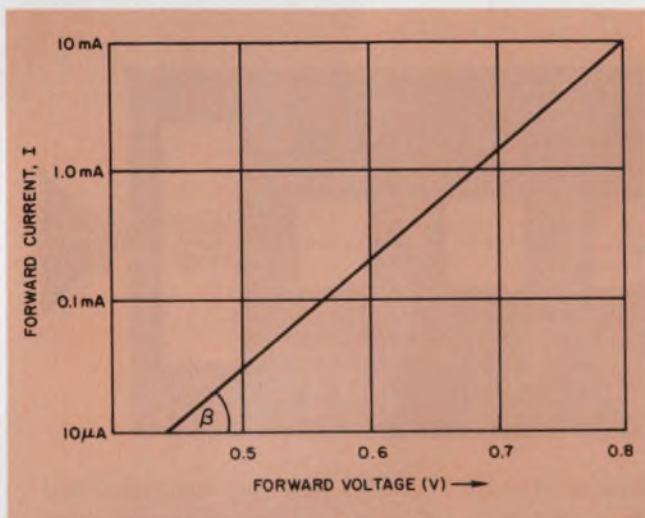

3. To find constants i and k , plot the diode's current as a function of its forward voltage, on semi-log paper. Plug the constants into Eq. 7 to find the sum V_1+V_2 .

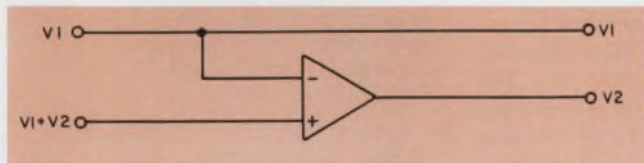

4. The sum V_1+V_2 is automatically kept constant by this differential amplifier circuit. By subtracting V_1 from the reference sum voltage, the circuit automatically generates the proper value of V_2 .

diode. (Note that the current decreases as you move to the right along the x-axis.) The diode constants are $r = 28$ ohms, $n = 0.93$ and $I_1 I_2 = 0.29$ mA².

Since it is often desirable to use voltages, rather than currents, as control signals, it is a good idea to convert the current-product con-

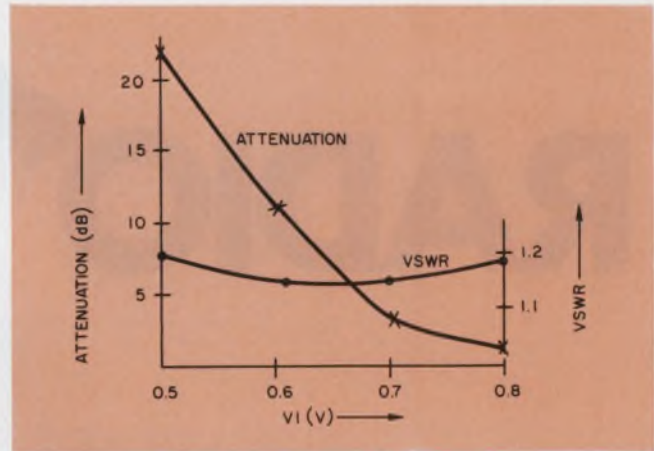

5. The maximum VSWR of the test circuit is below 1.2:1 across the full 21-dB attenuation range. This data was taken from a 50-ohm attenuator with a 20.5-MHz signal. The constant V_1+V_2 was 1.3 V for the HP diodes. Both diodes covered a 0.3-V range, from 0.5 to 0.8 V.

straint of Eq. 5 to an equivalent voltage constraint. The forward bias current through a p-i-n diode is related to the forward voltage, V , by the following mathematical relationship:

$$I = i \exp(kV) \quad (6)$$

where i is the zero-voltage current and k is a constant. The requirement $I_1 I_2 = \text{constant}$, therefore becomes

$$V_1 + V_2 = (1/k) \log_e(I_1 I_2 / i^2) = \text{constant} \quad (7)$$

If the diode constants i and k are not specified by the manufacturer, they can be determined experimentally by measuring and plotting I as a function of V on semi-log graph paper (Fig. 3). The resulting curve will be a straight line with slope $= k$ and zero-voltage current $= i$. For the diode of Fig. 3, $i = 2.26$ nA, $k = 19.2$ and $V_1 + V_2 = 1.3$ V.

Use one control voltage instead of two

In most applications only a single voltage is available for controlling the attenuator. If this voltage is used as V_1 , then a differential amplifier can be employed to generate V_2 by subtracting V_1 from the constant reference V_1+V_2 (Fig. 4).

A bridged-Tee attenuator using HP 5082-3039 p-i-n diodes has been built according to the plan of Fig. 1b. The unit has a characteristic impedance of $Z=50$ ohms, and was driven by a circuit like that of Fig. 4.

The attenuation and VSWR were measured as functions of V_1 at a frequency of 20.5 MHz (Fig. 5). The device has an attenuation range of 21 dB for a control voltage swing of 0.3 V (0.5 to 0.8 V). The measured value of VSWR was always less than 1.2:1. ■■

Bibliography

Hewlett-Packard Co., *Application Note No. 912*.
International Telephone and Telegraph Corp., *Reference Data for Radio Engineers*, Fifth Edition. Howard W. Sams and Co., Inc., New York, 1968.

RADIO BUG

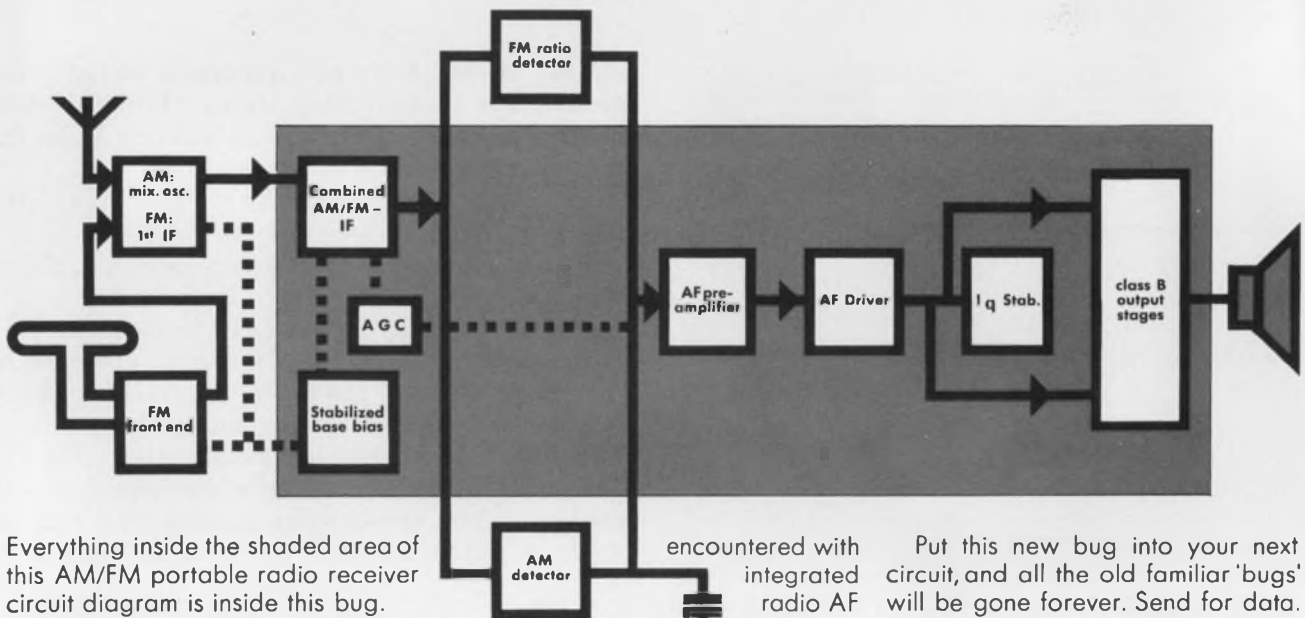
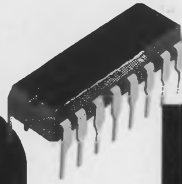

Everything inside the shaded area of this AM/FM portable radio receiver circuit diagram is inside this bug.

Philips' new TBA690 integrated circuit.

It has a voracious appetite for labour costs. Now instead of inspecting, installing and re-checking forty or fifty individual components, you insert just this one, with performance guaranteed.

The TBA690 contains everything in a 1/2 watt* AM/FM receiver that should be integrated, including output stage and quiescent current stabilisation. The unique design of its output stage and bias stabilisation overcomes all problems normally

* 1 watt version TBA700 soon available.

encountered with integrated radio AF amplifiers. There is no loss of sensitivity, and no cross over distortion over the entire supply voltage range from 2.7V to 11.4V. The IC can be used for both FM and AM... even short wave.

Not included are the combined AM/FM input stage and the FM front end... so you have full freedom of circuit layout. Either conventional distributed or lumped IF filters can be used.

The cost of this plastic-encapsulated bug is no more than you would pay if you were using discrete components.

Put this new bug into your next circuit, and all the old familiar 'bugs' will be gone forever. Send for data.

N.V. Philips' Gloeilampenfabrieken
Electronic Components and
Materials Division
Eindhoven - The Netherlands

Distributed and sold in the U.S. by:
Amperex Electronic Corporation
Integrated Circuits Division
CRANSTON R.I. 02920

In Canada: Philips Electron Devices
a division of Philips Electronics
Industries Ltd. 116, Vanderhoof Avenue
TORONTO 17 - Ontario



electronic components
and materials

PHILIPS

AIRPAX

TYPE 203

ELECTROMAGNETIC CIRCUIT PROTECTORS



Type 203 front panel mount electromagnetic circuit protectors are designed for use in computers, computer peripherals, copying machines, air conditioners, marine controls, and other high-quality industrial and military equipment where accurate, reliable protection is demanded.

FEATURES

- Snap-in front panel mounting for fast, economical installation
 - Optional flush mounting available
- Single rocker actuator for 1, 2 or 3-pole assemblies
 - Selection of color combinations
 - 50V DC and 250V AC (50/60 or 400 Hz)
 - Current ratings from 0.020 to 20 amperes
 - Choice of inverse time delay or instant trip

Trip Time vs Percent Rated Current @ 25°C

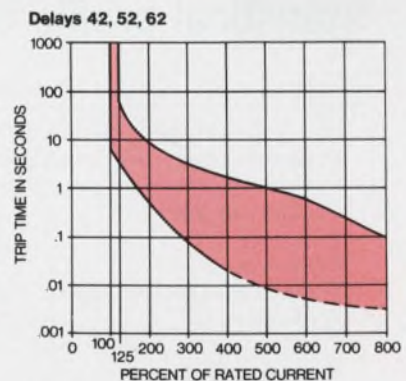
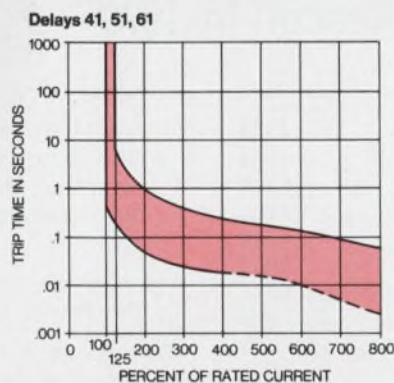
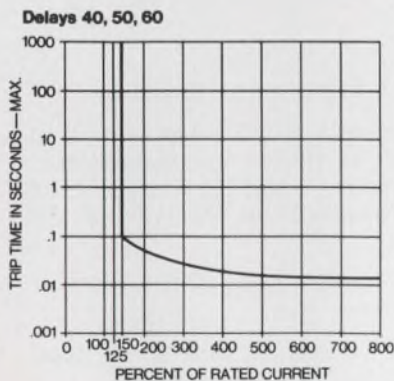

Delays 40, 41 and 42 are for use in 400 Hz systems; delays 50, 51 and 52 are for use in DC systems; and delays 60, 61 and 62 are for use in 60 Hz systems.

For complete details, specifications and application examples, call or write:

AIRPAX™

AIRPAX ELECTRONICS / CAMBRIDGE DIVISION / Cambridge, Maryland 21613 / Phone (301) 228-4600 / TELEX 8-7715 / TWX 710 865-9655

INFORMATION RETRIEVAL NUMBER 41

For a higher yield from exhibit visits, check these five pointers. They should help to make your next convention trip more productive, says this trade show official.

Richard L. Turmail, Management Editor

What electronics company isn't trying to improve its yield on expenses these days? But can it be done on employee visits to trade shows?

It certainly can, says Don E. Larson, general manager of Wescon. Surveys conducted over the last four years by the West Coast trade exhibition indicate, he notes, that four of five engineers visit Wescon for one of these reasons:

- One out of two comes to see new products as they affect his job assignment.
- One out of six comes to get new ideas.
- One out of seven comes to attend particular technical sessions.

"We've found," Larson says, "that engineers could accomplish these objectives more easily if they improved their approach in attending the show in five basic ways." He lists the following pointers:

1. **Scheduling**—In general, an engineer is overly optimistic about the amount of time he has to spend at a show. He believes he can see what he expects to see in the time he has allotted.

In reality he often becomes interested in one of the exhibits, overstays his schedule, and leaves no time for other exhibits he had planned on seeing.

A side effect of "underscheduling" is that the engineer may miss a particular technical session that was one of his main reasons for going to the show. Although the papers given in most sessions are available in print before the session is held, the engineer misses the chance to question the author in person.

Many companies have solved the problem of underscheduling by organizing teams of engineers and giving each an assignment to survey company needs and competitors. Later the engineers will discuss what they've seen. Often each will write a report on his findings, to be distributed to everyone back at the plant. This way the whole show gets covered, and everybody in the company knows what was there.

2. **Homework**—Showgoers should always read in depth about the show *before* going. Since business journals like ELECTRONIC DESIGN publish the schedules of trade-show sessions plus details

Statistical profile of Wescon in 1970

Breakdown of attendance, including exhibitors:

Executive or general manager	4749
Director; dept. head; section head	3994
Project engineer or group leader	3492
Design engineer	3793
Engineer	5041
Technicians	2252
Sales & marketing (up to 1/2 engineers)	6477
Professors	495
Purchasing or procurement	923
Not specified	5595
Total	36,811

Average age: Survey average of past four years indicates 75% are between 28 and 40.

Member of professional societies: Besides being members of IEEE, most were either members of the Instrument Society of America or Na-

tional Society of Professional Engineers.

Hours spent at the show: Six to seven, compared with 4-1/2 hours in 1967. Show management says that the increase may be explained by the expanding complexity of the state of the art.

Number of booths visited: 16 to 22 for a stay of 15 minutes or more.

Number of sessions attended: 15% of the total attendance averaged 1.8 sessions apiece.

Most popular sessions: Applications-oriented sessions—how to do it better and cheaper.

Was show useful: 79% Yes, 21% No, compared with 92% Yes and 8% No in 1969. The fall-off may have been because of the business slump and limits on innovation.



Many engineers attend electronics shows like Wescon to exchange ideas. Some shy from a sales pitch, while

others are so busy telling the booth attendant what they know, they don't learn anything.

of the show highlights, there is ample opportunity for the engineer to familiarize himself with the subjects he's most interested in. If he doesn't read up in advance, he may find that the technical session on medical electronics, for example, is not what he thought it would be.

3. Awareness—It's been said that the engineer doesn't know how to read and absorb information. The question he asks most often at a show, for example, is "Where's the men's room?" though ample indicators usually are posted. Often he doesn't take advantage of the many services a show provides, such as the inquiry card at Wescon. The engineer could get more out of a show if he read the program thoroughly when he first arrived, to find out what was being offered.

4. Shyness—The average engineer's penchant for not wanting to appear ignorant can make him shy to the point of withdrawal. Many hesitate to speak up and ask the booth attendant questions that will help them understand the display. Engineers shy from a sales pitch. They'd rather stand back and eavesdrop on a conversation between another visitor and the exhibitor.

The trouble with that approach, however, is that the other visitors may never ask the pertinent questions.

5. Know-it-all—There are times when the engineer doesn't take the refresher course that the exhibitor offers. He's too busy telling the booth attendant what he knows, instead of finding out what's new. This attitude may be especially prevalent among those engineers who are 40 years and older, who appear to think they're too sophisticated to attend trade shows. The fact is that the older they get, the more they need to know.

"All in all," Larson says, "engineers do a fairly good job of covering our show, but today every bit of pickup in efficiency helps."

Larson says, too, that engineers could do an even better job of viewing the show if the show's exhibitors would do a better job of displaying.

"Exhibitors," Larson says, "should give up their pretty backgrounds aimed at selling themselves institutionally. The name of the game is demonstration. Visitors don't want a static display—they come to see a live demonstration in operation." ■■

ideas for design

Counter tester checks critical parameters

It's often necessary to screen counter circuits before you wire them into a system—to avoid costly troubleshooting later on. Here's a simple tester that offers a complete functional screening of toggle rate, reset time and data strobe time and that indicates failures by lighting lamps. IC counters such as the 8280-1, 8290-3 or equivalents may be tested.

Gates G1, G2 and G3 form a low-frequency oscillator with the frequency adjusted by C1. This frequency then clocks the 8821 J-K flip-flop, which, along with gates G4, G5 and G6, forms a one-of-three decoder. Gates G7 and G8 form a

one-shot, with C2 adjusting the pulse width. Gates G9 and G10 also form a one-shot and gates G12 and G13 make up a high-frequency oscillator that is gated on and off by gate G6.

All functional inputs to the standard and the device under test are wired together. All outputs are compared by means of an 8242 four-bit comparator. If there is a failure, the 8242 will enable fail gates G14, G15 and G16.

As the tester cycles through, three tests occur in sequence: first, the reset; second, the data strobe; and third, a toggle test, initiated when the oscillator is enabled. If any of these tests fail, one of three fail indicators will light.

Ron Siebert, Senior Electronics Tech, Digital Applications, Signetics Corp., 811 E. Arques Ave., Sunnyvale, Calif.

VOTE FOR 311

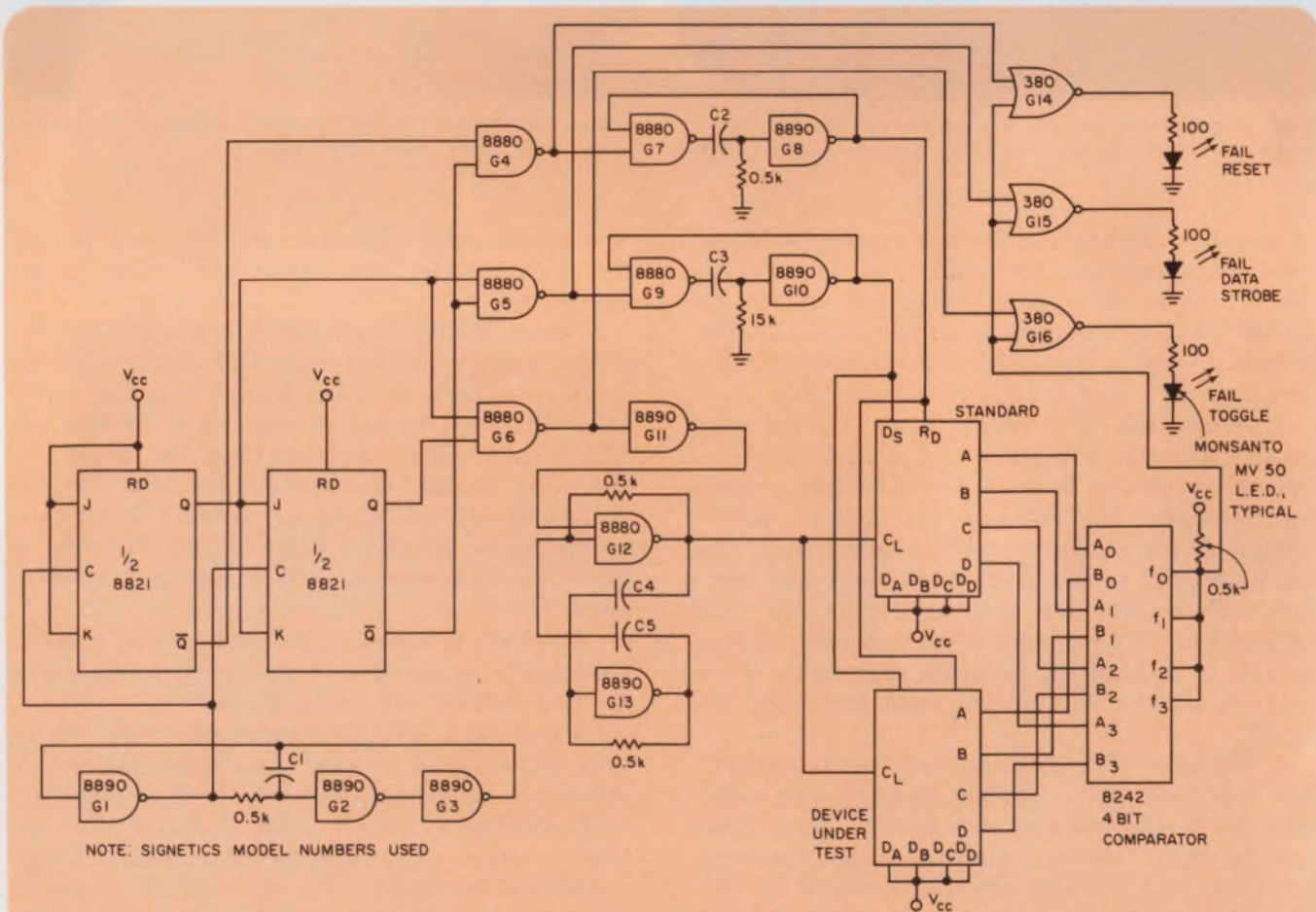

Simple counter tester provides automatic check of critical design parameters. Fail lights are enabled

for insufficient toggle rate, reset time and/or data strobe time.

Siliconix explains the CMOS Seesaw Effect

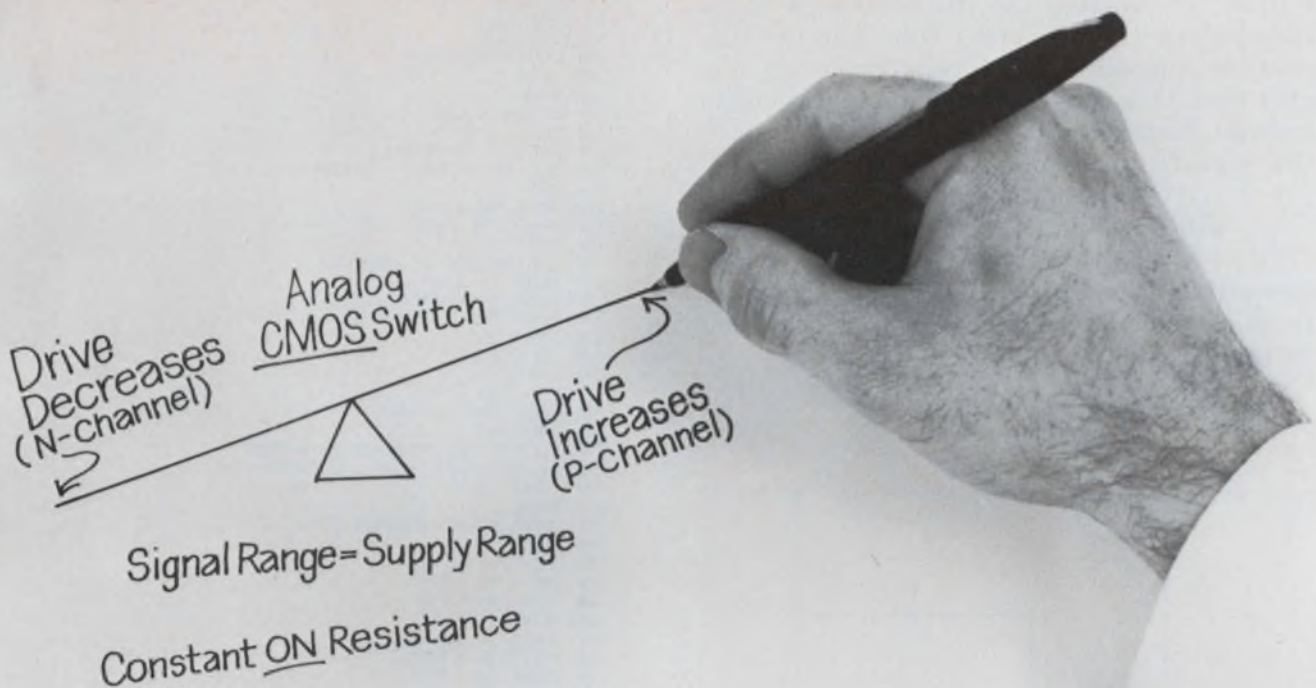

Or "Why Siliconix can deliver fast CMOS switches that handle a ± 10 volt analog signal with a ± 10 volt supply, yet maintain a constant ON resistance."

It goes like this.

With a conventional MOS switch, the analog input voltage is limited to 5–10 volts less than the supply voltage and the ON resistance is known to vary greatly with the analog signal.

Using complementary n- and p-channel MOS transistors on a single chip, Siliconix has created a nearly perfect CMOS switch.

The CMOS seesaw effect is simply this. When the switch transistors turn on (with opposite polarity signals from a built-in inverter), the drive to one increases while the drive to

the other decreases as the analog signal varies. Then, when the ON resistance of one transistor goes up, the ON resistance of the other goes down, leaving the parallel combination nearly constant (typically 60

ohms $\pm 10\%$ with a ± 10 volt supply).

The signal voltage, therefore, can be as large as the supply voltage in either direction!

What's more, Siliconix CMOS switches feature 50–80ns switching times, microwatt standby power and very low capacitance feedthrough.

Want to find out what Siliconix CMOS circuits can do for your applications? Call or write for information on our CMOS line, including the G150 complementary switch, DM110 16-channel digital multiplexer and DG506 16-channel analog multiplexer.

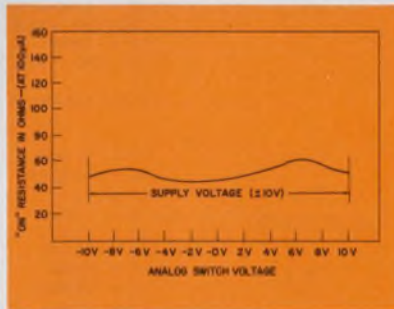

Siliconix incorporated

2201 Laurelwood Road • Santa Clara • Calif. 95054
Phone (408) 246-8000 Ext. 201 • TWX: 910-338-0227

New York: Sy Levine (516) 796-4680 New England: Al La Croix (617) 769-3780 St. Louis: Jim Spicer (314) 291-3616 Minneapolis: Ed Koelfgen (612) 920-4483 Southern California: Dave Ferran (213) 420-1307 Northern California: Chuck Brush (408) 246-8000 In Europe: Siliconix Limited, Saunders Way, Sketty, Swansea, Great Britain. Siliconix GmbH, 7024 Bernhausen, Postfach 1340, W. Germany. Siliconix S.A.R.L., 94-Saint-Maur, France. Tel. 263-57.90.

BASIC helps you trade off active-filter gain and phase

A BASIC program can simplify calculating the parameter values for an active low-pass transitional Butterworth-Thompson filter. In general, the filter compromises the characteristics of the flat-amplitude (Butterworth) filter and the flat-time-delay (linear-phase) filter. The design presented here (Fig. 1a) has several applications in industrial electronics.

The transfer function of the circuit is

$$H(s) = - [R_3/R_1] / [s^2 R_2 R_3 C_1 C_2 + s R_2 C_2 (1 + R_3/R_1 + R_3/R_2) + 1]$$

$$= -A / (s^2 T^2 + sT \sqrt{2 + \mu} + 1),$$

where s is the complex frequency variable, $T = 1/\omega_c$, $\omega_c = 2\pi f_c$, f_c is the corner frequency, and A is the dc gain.

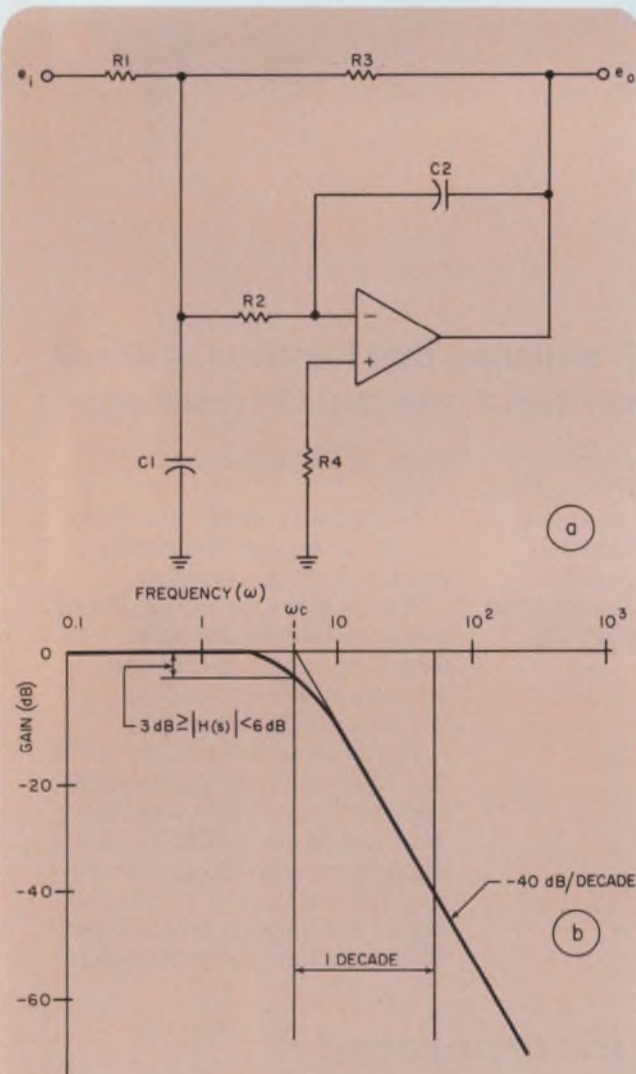

1. An active filter with a second-order transfer function (a) uses only one IC op amp and an RC network. The design, called a transitional Butterworth-Thompson filter, optimizes the trade-offs between amplitude and phase response. Its response is described by the Bode diagram (b).

```

LIST
10 PRINT "PARAMETERS OF ACTIVE TBT LOW-PASS FILTER"
20 PRINT
30 PRINT "RESISTANCES ARE IN OHMS, CAPACITANCES IN FARADS,"
31 PRINT "FREQUENCY IN CPS."
40 PRINT "WHAT ARE THE VALUES OF DC GAIN, CORNER FREQUENCY,"
41 PRINT "AND MU."
50 INPUT A,F,M
60 LET F1=6.28318*F
65 PRINT
70 PRINT "R1 DEPENDS ON THE SPECIFIED DC INPUT IMPEDANCE."
71 PRINT "R1 = ";R1
80 INPUT R1
90 LET R3=A*R1
100 LET C=(1+A)/F1/R3
105 PRINT
110 PRINT "C = ";C
120 PRINT "TAKE C1 > C. C1 = "
130 INPUT C1
140 LET R=R1*R3/(R1+R3)
150 LET R2=R/(F1*R*C1*SQR(2+M)-1)
155 PRINT
160 PRINT "R2 = ";R2
170 PRINT "THE FINAL VALUE OF R2 = "
180 INPUT R2
190 LET C2=1/(R2*R3*C1*(F1+2))
192 PRINT
195 PRINT "C2 = ";C2
200 PRINT "THE FINAL VALUE OF C2 = "
210 INPUT C2
220 LET R4=R2+R
225 PRINT
227 PRINT "R4 = ";R4
230 PRINT "THE FINAL VALUE OF R4 = "
240 INPUT R4
250 LET F=1/SQR(R2*R3*C1*C2)/6.28318
260 LET M=(R2*C2/R3/C1)*((1+A+R3/R2)+2)-2
270 PRINT
271 PRINT
280 PRINT "FINAL PARAMETER LIST:"
290 PRINT
300 PRINT "A = ";A
310 PRINT "FC = ";F
320 PRINT "MU = ";M
330 PRINT
340 PRINT "R1 = ";R1
350 PRINT "R2 = ";R2
360 PRINT "R3 = ";R3
370 PRINT "R4 = ";R4
380 PRINT "C1 = ";C1
390 PRINT "C2 = ";C2
400 END
    
```

```

RUN
PARAMETERS OF ACTIVE TBT LOW-PASS FILTER

RESISTANCES ARE IN OHMS, CAPACITANCES IN FARADS,
FREQUENCY IN CPS.
WHAT ARE THE VALUES OF DC GAIN, CORNER FREQUENCY,
AND MU.
? 1? 5.18? 0.47
R1 DEPENDS ON THE SPECIFIED DC INPUT IMPEDANCE.
R1 = ? 15000
C = 4.16092E-6
TAKE C1 > C. C1 = ? 10E-6
R2 = 2700.65
THE FINAL VALUE OF R2 = ? 2700
C2 = 2.40462E-6
THE FINAL VALUE OF C2 = ? 2.40E-6
R4 = 10200
THE FINAL VALUE OF R4 = ? 10000

FINAL PARAMETER LIST:

A = 1
FC = 5.1849
MU = .466115

R1 = 15000
R2 = 2700
R3 = 15000
R4 = 10000
C1 = .000001
C2 = 2.4E-6
    
```

2. This BASIC program for an active low-pass Butterworth-Thompson filter (a) gives your slide rule a rest. Parameter values are determined once you specify desired dc gain, cut-off frequency and amplitude and phase characteristics. A sample calculation (b) demonstrates the computer's response to a problem.

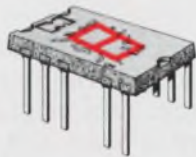

NOW, the MAN 1 with built-in red lens.

The MAN 1A features the same brightness and reliability as our "standard of the industry" MAN 1. It has a .270" high character capable of all digits and nine distinct letters.

CALL YOUR DISTRIBUTOR TODAY FOR 'OFF-THE-SHELF' DELIVERY

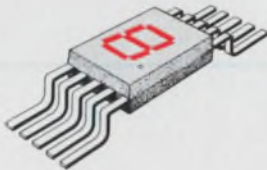

And, if you need a smaller readout with the same reliability, try our MAN 3A.

It is a .115" seven segment numeric with a red epoxy lens.

Pack them in at 5 characters per inch on your calculator, counter or any other piece of equipment where size, weight and low power are essentials.

Available from any of the Monsanto Distributors listed to the right.



The happy medium, for those applications requiring a larger character than the MAN 3 but smaller than the MAN 1. The MAN 4, .190 inch character size in a dual in-line package.

IC compatible and able to be mounted on .35 inch centers for high density display. The MAN 4 is ideal for film annotation, instrument readouts and portable equipment. Phone your distributor NOW for off-the-shelf delivery.

GaAsLITE Update

The AVAILABLE Display and Display Module line

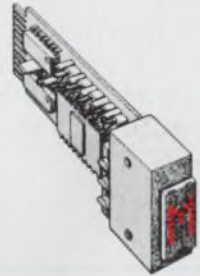

For that man/machine interface where ease of recognition and high reliability is a must - the Monsanto MDA111 Alpha-numeric is a natural. This module display contains all circuitry needed for immediate readout in all 64 ASCII characters. Just supply a six-bit binary word and +5 volts/-12 volts to the input terminals and you're in business.

Priced right for keyboard verifiers, avionic displays or computer terminal readouts.

MONSANTO DISTRIBUTORS.

the on-the-shelf source for GaAsLITE products from Monsanto. Call today to order or to discuss product applications.

**Elmar Electronics
Kierulff Electronics
K-T/Wesco
Liberty Electronics
Schweber Electronics
Semiconductor Specialists
Western Radio**

Monsanto

For additional technical information write
Monsanto Electronic Special Products
10131 Bubb Road, Cupertino, California 95014
(408) 257-2140

The parameter μ varies between 0 and 1. When $\mu = 0$, the design corresponds to a Butterworth filter; for $\mu = 1$, we have a linear-phase Thompson filter.

Resistor R_1 depends on the specified minimum input impedance. Thus $R_1 = (R_{in})_{dc}$, and $R_3 = A R_1$.

Usually the dc gain, A , must have an accurate value. Therefore it is best to use a fixed-value resistor in series with a potentiometer for R_3 to allow adjustment of A .

C_1 must be selected so that $C_1 > (1 + A) / \omega_c R_3$. R_2 can be determined after selecting C_1 , such that

$$R_2 = [R_1 R_3 / (R_1 + R_3)] / [\omega_c C_1 \sqrt{2 + \mu} \cdot R_1 R_3 / (R_1 + R_3) - 1]$$

Now C_2 and R_1 can be found; R_1 is needed only for dc balance. Thus $C_2 = 1 / (R_2 R_3 C_1 \omega_c^2)$, and

$$R_1 = R_2 + [R_1 R_3 / (R_1 + R_3)]$$

The values of ω_c and μ are the last to be calculated.

The BASIC program in Fig. 2a greatly simplifies the task of determining the parameter values. The program was originally written for Data General Corp.'s Nova and Supernova computers, but it can be adapted to all computers that use BASIC. Figure 2b gives a sample calculation for the program list.

Bibliography

Melsheimer, R., "If You Need Active Filters . . ." ED 8, April 12, 1967, p. 78.

M. J. Lounila, Design Engineer, and K. A. Vahajarvi, Nova/Supernova Systems Engineer, Oyj Stroemberg Ab, Electronics Dept., Helsinki, Finland. VOTE FOR 312

Reconnect this IC multiplexer and get a flip-flop circuit

A readily available IC multiplexer—such as the RCA COS/MOS CD 4019 2-input, 4-bit circuit (a)—can be used as a resettable, gated-input quad flip-flop circuit.

The flip-flop circuit (b) is formed by feedback reconnections in the first circuit, as indicated by the dashed lines. The numbers designate the 16-lead DIP pins, with pin 8 to ground and pin 16 to V_{DD} (10 V).

The input signals (a) are four A-channel bits, four B-channel bits and two selection bits. The output signals are four D-channel bits. The A-channel (B-channel) input signals are selected by enabling the KA (KB) selection input terminal, so that the A-channel (B-channel) input bits appear on the D-channel output terminals.

In the flip-flop circuit (b), a negative-going pulse on the KB selection terminal (pin 14) resets the flip-flops D1 through D4. A positive-going pulse on the KA selection terminal (pin 9) enables the AND gates, so that the data on the A-channel input terminals will be stored in the corresponding flip-flops.

The functions of the KA and KB terminals can be reversed by connecting pin 6 to pin 10, pin 4 to pin 11, pin 2 to pin 12, and pin 15 to pin 13. The data on the B-channel input terminals will then be stored in the corresponding flip-flops. This alternate arrangement provides flexibility for optimizing printed-circuit layouts.

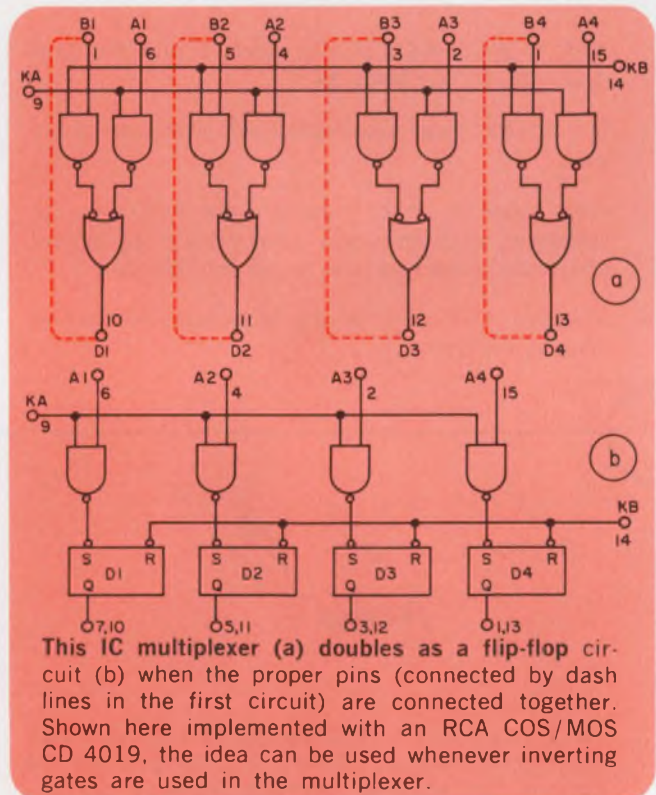

This idea can be used with any logic configuration similar to that in Fig. a if the gates used are inverting gates.

Carl M. Wright, Staff Member, RCA Patent Operations, David Sarnoff Research Center, Princeton, N.J. 08540.

VOTE FOR 313

OUR ANGLE: four frequency phase angle voltmeters

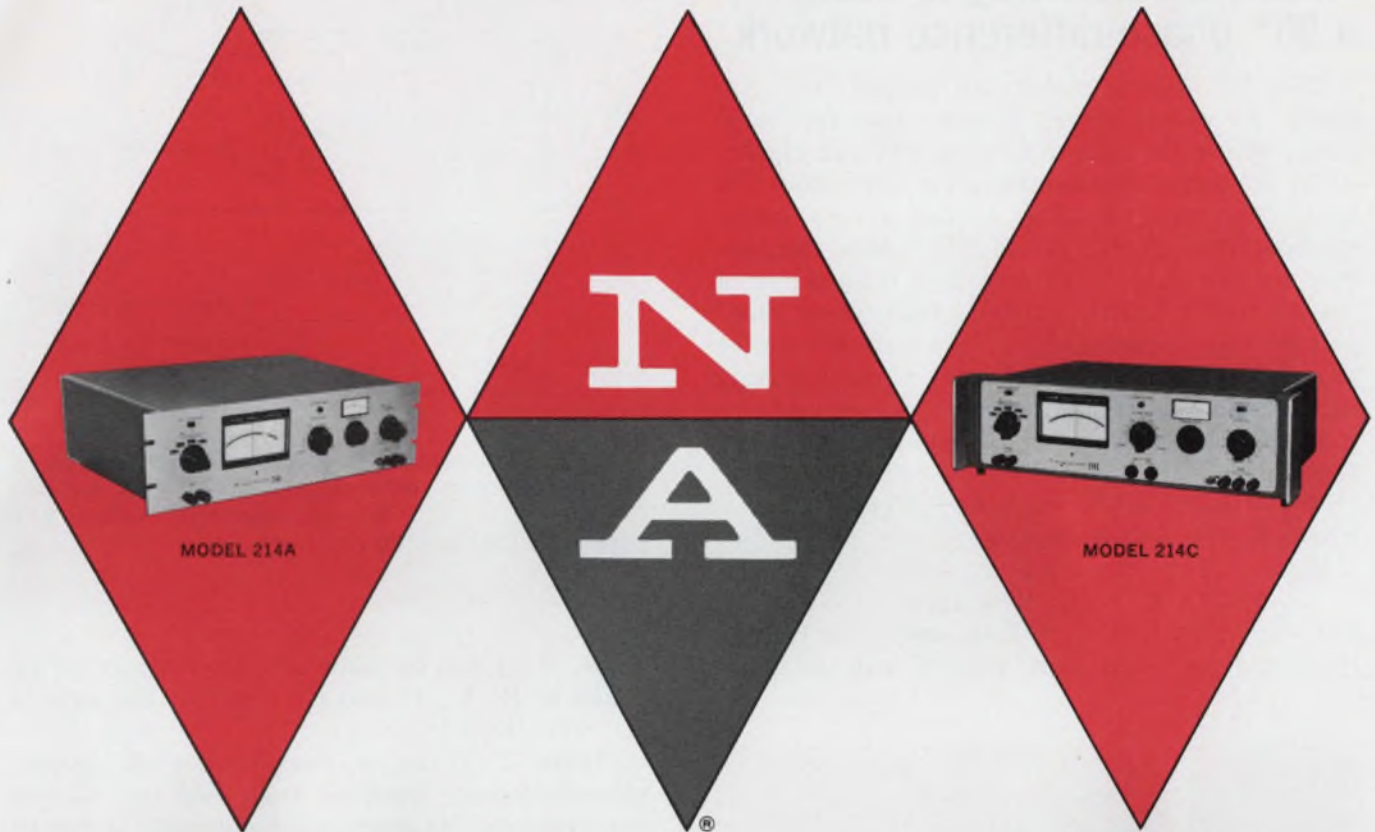

CAN YOU THINK OF A BETTER ANGLE TO AVOID OBSOLESCENCE?

North Atlantic's 214 FOUR-FREQUENCY PHASE ANGLE VOLTMETER introduces a new flexibility in AC voltage measurements. It enables direct reading of null balance, total voltage, fundamental voltage, in-phase voltage, quadrature voltage, and phase angle.

It's also pre-wired to handle four operating frequencies from 30Hz to 20kHz, which means extended longevity and broader application. Even if you only need one frequency, there are three extra spots to add other frequencies later. Frequency changes can be made rapidly and conveniently in the field with plug-in modules. The 214 can be completely recalibrated at the installation site by a single rear-panel adjustment.

Harmonic rejection and high signal overload design of the unit screens out conventional distortion and errors in measurement and calibration. The all solid-state Model 214 offers full accuracy over $\pm 5\%$ bandwidth, 1° phase measurement, adjustable meter scaling for go/no-go testing, and $300 \mu\text{V}$ full-scale sensitivity. Priced from \$1215.00.

Options? Other models offer 0.25° phase accuracy, lower-cost single frequency operation, broadband phase-sensitive performance from 10Hz to 100kHz.

Whether your AC measurements are large or small, contact your North Atlantic sales engineering representative today. He'll show you a new angle to your AC voltage measurements.

NORTH ATLANTIC
industries, inc.

200 TERMINAL DRIVE, PLAINVIEW, NEW YORK 11803
cable: noatlantic / twx: 510-221-1879 / phone: (516) 681-8600

INFORMATION RETRIEVAL NUMBER 44

Here's a better way to design a 90° phase-difference network

This RC op-amp circuit can simplify the synthesis of second-order, all-pass transfer functions, which are used to form fourth and higher-order 90-degree-phase-difference networks. The basic configuration (Fig. 1) has a very useful mathematical property—its RC radian frequencies are identical to the zero/pole frequencies of the over-all transfer function. Once these zero/pole frequencies are known¹, it is a simple matter to calculate the various R and C values from them using only a slide rule.

In factored form, the second-order all-pass function is

$$H(s) = K(s - \alpha_1)(s - \alpha_2)/(s + \alpha_1)(s + \alpha_2),$$

where K, the circuit gain, is

$$K = \alpha_3 / (2\alpha_1 + 2\alpha_2 + \alpha_3) \\ = 1 / (2C_2/C_1 + 2R_1/R_2 + 1),$$

and $\alpha_1 = 1/R_1C_1$, $\alpha_2 = 1/R_2C_2$, and $\alpha_3 = 1/R_1C_2$. It should be noted that with K calculated as

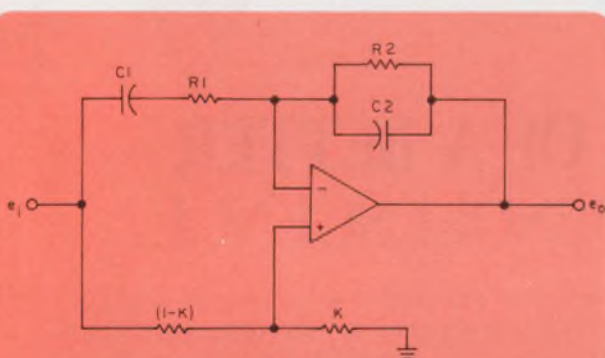

1. This basic circuit lets you synthesize second-order all-pass network functions by using independent, factored, zero/pole pairs. For practical element values, $(\alpha_1 = 1/R_1C_1)$ should be less than or equal to $(\alpha_2 = 1/R_2C_2)$. The circuit gain, K, is determined by impedance ratios.

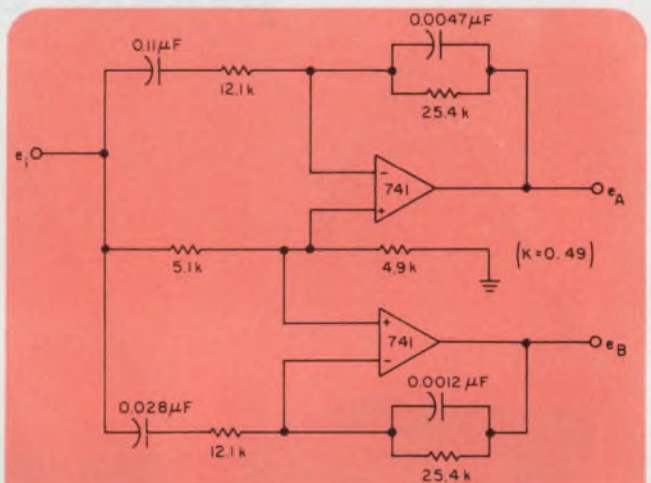

2. The realization of a fourth-order 90-degree-phase-difference network consists of two basic (Fig. 1) circuits. Network operating frequency range is 250 to 2500 Hz.

above, $H(s)$ can be made all-pass for any set of values of R_1 , C_1 , R_2 and C_2 , and that the gain is $|H| = K < 1$.

Figure 2 shows a fourth-order 90-degree-phase-difference network that uses two of the basic circuits. Its operating bandwidth is 250 to 2500 Hz; the zero/pole frequencies are 120, 472, 1325 and 5222 Hz; and the phase tolerance is ± 1.08 degrees. Since individual circuit gain, K, (which equals 0.49) is the same for both networks, a common K-divider is used for both amplifiers. Impedance levels, which are arbitrary, are chosen primarily to provide convenient element values and equal gain.

Allan G. Lloyd, Holobeam, Inc., 560 Winters Ave., Paramus, N.J.

Reference

1. Shirley, Frederick R., "Shift phase independent of frequency," *Electronic Design*, Sept. 1, 1970, p. 62.

VOTE FOR 314

IFD Winner for April 1971

Jerry Graeme, Manager, Monolithic Engineering, Burr-Brown Research Corp., International Airport Industrial Park, Tucson, Ariz. 85706. His idea "Check op-amp open-loop dc gain in one cycle of the test signal" has been voted the Most Valuable of Issue award.

Vote for the Best Idea in this Issue

VOTE! Go through all Idea-for-Design entries, select the best, and circle the appropriate number on the Reader-Service-Card.

SEND US YOUR IDEAS FOR DESIGN. You may win a grand total of \$1050 (cash)! Here's how. Submit your IFD describing a new or important circuit or design technique, the clever use of a new component or test equipment, packaging tips, cost-saving ideas to our Ideas-for-Design editor. You will receive \$20 for each accepted idea, \$30 more if it is voted best-of-issue by our readers. The best-of-issue winners become eligible for the Idea Of the Year award of \$1000.

new products

DPM circuit allows direct display of nonlinear data

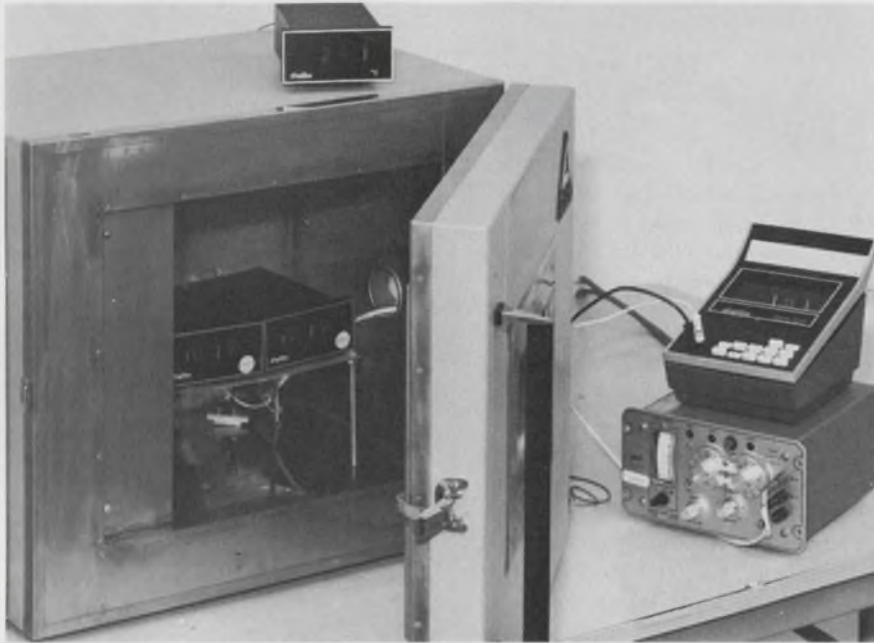

Digilin, Inc., 1007 Air Way, Glendale, Calif. Phone: (213) 240-1200. Availability: approx. 3 wks.

A new circuit technique developed by Digilin, Inc., has been incorporated into its type 2330 DPM for a/d conversion of nonlinear input signals without any prior signal conditioning.

The new processing circuit divides the operating range of the nonlinear analog input signal into ten segments and alters the range of a/d conversion independently during each segment, to yield a ten-point piece-wise linear approximation of the input signal.

The new nonlinear converter will be especially useful with thermocouples, resistance thermometers and strain gauges for process control and medical applications, where most parameters are nonlinear in nature and require some conditioning prior to display.

In linearizing a thermistor output, the current source used to generate the voltage comparator ramp is adjusted at discrete intervals during the conversion period. Since the intervals are determined from the digital output, excellent

repeatability is obtained.

By incorporating this new technique in a DPM, direct signal linearization and display can be obtained at low costs.

For nonlinear functions up to 10% deviation, accuracies of $\pm 0.1\% \pm 1$ digit of the ten-point piece-wise linear approximation can be obtained.

Functions having slope changes as great as 40 dB can be linearized at reduced accuracy.

The DPM provides a BCD output that is DTL/TTL compatible and can be used to drive any data-logging device, such as a printer, dataphone terminal or a computer input terminal.

Most applications of the technique will require custom adjustment of the circuit to fit the specific requirements. This is easily done with ten available manual adjustments in the circuit.

Custom designs are also available within a few weeks.

In unit quantities, a linearized display for a type J or K thermocouple sells for \$295. The price drops to \$220 for OEM quantities.

CIRCLE NO. 250

5-MHz, triggered-sweep scope retails at \$356

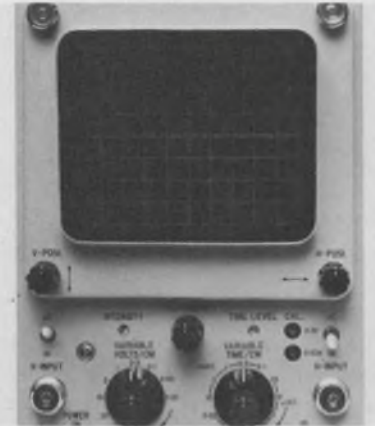

Megura Denpa, Sokki K.K., No. 5, 1, 2 - chome, Chuo-Cho, Meguro-Ku, Tokyo, Japan. Availability: 20 days.

Featuring a dc to 5-MHz bandwidth, the new low-cost MO-190 scope includes triggered sweep, an 8-by-10-cm CRT and sensitivity of 10 mV to 30 V/cm pk-pk. Its time base is calibrated from 1 μ s to 10 ms/cm. Other features include an input impedance of 10 M Ω and 35 pF (direct) or 10 M Ω and 15 pF (with a probe), and suitability for X-Y measurements.

CIRCLE NO. 251

Digital barometer interfaces computers



Bell & Howell, Electronics & Instruments Group, 360 Sierra Madre Villa, Pasadena, Calif. Phone: (213) 796-9381.

A new portable digital barometer can be linked to a computer. Type 4-461 provides users with a five-digit visual readout of barometric pressures with an accuracy of 0.025%. Simultaneously, it is equipped to send BCD directly to a computer or data recorders. It is available in portable or rack-mounted models and measures 6 by 6 by 12 in.

CIRCLE NO. 252

Impedance probe sweeps 0.5 to 110 MHz



Hewlett-Packard, 1501 Page Mill Rd., Palo Alto, Calif. Phone: (415) 493-1501. P&A: \$750; June 1971.

Giving direct readout of both impedance magnitude and phase with swept-frequency display over 0.5 to 110 MHz, the 11655A accessory probe converts the model 8047A network analyzer into a swept-frequency vector impedance meter. With an alternative display model, impedance is presented on cartesian coordinates as $R \pm jX$. Measuring range of the probe is from 0.1 to 10 k Ω .

CIRCLE NO. 253

1-mV-to-100-V chart recorder costs \$295



Linear Instruments Corp., 2930E Grace Lane, Costa Mesa, Calif. Phone: (714) 546-6706. Availability: 2 weeks.

The model 112 true-potentiometric null-balance recorder is available with full-scale spans from 1 mV to 100 V. It features a wide selection of chart speeds including a 12-speed drive with a 1920:1 ratio and a disposable nylon-tip pen whose response is 20 in./s. Error limit is 0.5%. A \$495 model is available with many options.

CIRCLE NO. 254

Photo-Darlington unit has high sensitivity

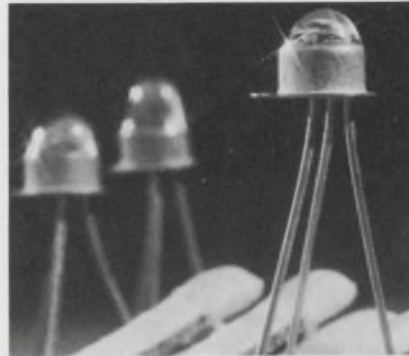

Quantum Sensing, Inc., 1650 Locust Ave., Bohemia, N.Y. Phone: (516) 589-0456. P&A: 85¢ (1000 quantities); stock.

A high-sensitivity (QS506) photo-Darlington unit provides light current of 5 mA with irradiance of only 0.2 mW/cm². This device was designed for applications requiring sensitivities of 100 to 200 times those of conventional photo-transistors at low irradiance. It is sensitive to both visible and near-IR illumination. Its package is a TO-18 header with an epoxy dome.

CIRCLE NO. 255

Light-sensitive FETs cost down to \$4



Teledyne Crystalonics, 147 Sherman St., Cambridge, Mass. Phone: (617) 491-1670. Availability: stock.

A line of industrial light-sensitive FETs are priced for industrial/commercial applications and feature inherent advantages of high sensitivity and high noise immunity. They exhibit low dark current (0.05 nA), fast response (rise time is 30 ns), and broad spectral response (from near IR through visible blue).

CIRCLE NO. 256

Silicon amplifiers offer 10 W at 2.3 GHz



TRW Semiconductor Div., 14520 Aviation Blvd., Lawndale, Calif. Phone: (213) 679-4561. P&A: \$100 to \$240; stock.

A series of silicon amplifiers, designated MICRoAMP, offers power levels of 6 to 12 W in four increments of 1 to 2.3 GHz. Power gain is from 6 to 10 dB depending on the power level and bandwidth. These devices are packaged in hermetic flange or pill configurations and have 30% bandwidths with 50- Ω input VSWRs of less than 2:1.

CIRCLE NO. 257

Low-value capacitor kit is for 3-GHz use



American Technical Ceramics, 1 Norden Lane, Huntington Station, N.Y. Phone: (516) 271-9600. P&A: \$59.95; 1 wk.

A capacitor kit is available for use through 3 GHz. All the capacitors in the kit are manufactured from low-loss fused porcelain, with a Q of 10,000 at 100 MHz being typical for a 10-pF capacitor. Kit L consists of 33 50-mil-cube capacitors in values from 0.1 to 15 pF. Tolerances included are ± 0.1 , ± 0.25 , ± 0.5 and $\pm 5\%$.

CIRCLE NO. 258

What you don't see really counts

And, what you don't see is a large, cumbersome display device that uses too much critical housing space in readout equipment. What you do see is a clear, sharp, highly legible Sperry display† contained in a compact, thin, planar package. This gives the engineer a lot more latitude in developing new designs not to mention the improvement possibilities in existing equipment. The advantages don't stop there — take a close look at these other important Sperry display extras.

Lower Cost —

Sperry displays are priced right; \$2.30 per digit in quantities of 5,000. In larger quantities, the price is even lower — as low as the most inexpensive displays on the market today.

Greater clarity and brightness —

Sperry displays are bright, crisp, and easy to read. The attractive orange glow provides excellent character definition and is strong enough for easy reading in direct sunlight

... as well as under all types of indoor lighting conditions. And, they're the only segmented devices on the market that appear as solid unbroken figures.

Preferred character size and spacing —

Offering a character height of 0.33" with 0.375" centers, Sperry displays have the appearance of printed figures. Uniform spacing is maintained even when stacked end-to-end.

Wider viewing angle —

Advanced planar Sperry displays can be read accurately within a 150° viewing angle. Characters are housed on a flat plane so all figures are displayed equally bright and clear regardless of combination.

Multiplex capability —

A single decoder/driver may be used to multiplex several decades without impairing the appearance of the display. In standard applications a decoder/driver can be used for each digit.

Reduced current requirements —

Sperry devices rank among the lowest. Typical current drain is only 200 μ A per

segment or 1.4mA for a figure 8. The power dissipation is just 200mW. Displays operate on 170 volts DC so they can be used in existing equipment without redesigning the power supply.

Proven reliability —

The cold cathode, gas discharge principle utilized in Sperry display devices has proven reliable in thousands of applications including cockpit instrumentation aboard the Boeing 747. Sperry displays have a useful life expectancy in excess of 100,000 hours.

For complete technical information on Sperry displays use this publications reader service card or phone or write:

Sperry Information Displays Division
P.O. BOX 3579, Scottsdale, Arizona 85257
Telephone (602) 947-8371

SPERRY

INFORMATION DISPLAYS

It's a whole new ball game in display devices!



Shown here is the Sperry SP-733, a 3 digit model. Also available are 2 and 1½ (7 segment character with + and -) digit models.

IC character generator interfaces LEDs/CRTs

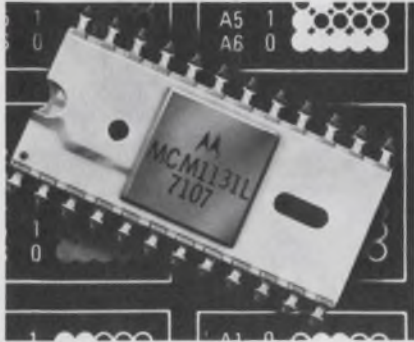

Motorola Semiconductor Products, Inc., Box 20912, Phoenix, Ariz. Phone: (602) 273-6900. P&A: \$22; stock.

A new MOS IC character generator generates voltage patterns needed to form numbers, letters, and symbols on visual displays such as LED arrays or CRTs. The device is normally driven by address codes originating in a computer or other data sources. The new column-select generator, MCM 1131L, can supply 2 mA of output current and accesses in only 500 ns max.

CIRCLE NO. 259

Dual clock driver works 35-kbit MOS arrays

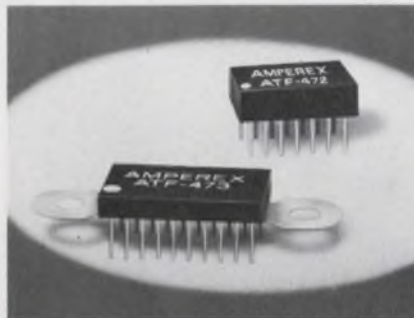

Amperex Electronic Corp., Cranston, R.I. Phone: (401) 737-3200. Price: \$16.50.

A new dual hybrid IC clock driver drives the two phase clock lines for 35,000-bit MOS arrays at 1 MHz. Intended for driving circulating memories or multiples of large MOS arrays, the ATF473 can source and sink up to ± 2 A in each circuit at output swings up to ± 30 V. Switching is fast and symmetrical: max rise or fall time into a 7000-pF load is only 40 ns, and delay time is only 10 ns.

CIRCLE NO. 260

IC-memory decoder has max delay of 18 ns



Intel Corp., 365 Middlefield Rd., Mountain View, Calif. Phone: (415) 969-1670. Price: \$4.35 (100 quantities).

A new high-speed 1-of-8 decoder is available for selecting bipolar memory chips, such as Intel's 3101A 64-bit RAM or 3202 256-bit RAM. The type 3205 decoder converts a binary code at three inputs to a signal on 1 of 8 output leads with input-to-output delay of only 18 ns max. The decoder may be driven directly by TTL and DTL logic.

CIRCLE NO. 261

MOS clock generator has 4 phases in a TO-5

Societa Generale Semiconduttori, Via C. Olivetti, 1, Agrate, Milan, Italy.

A new four-phase MOS clock generator, designated M002, is available in a single TO-5 can. The new device offers three different, selectable modes of operation: major-major, major-minor and minor-minor. Operating with a standard supply voltage of -27 V, the M002 has high frequency (500 kHz) and high output-voltage swing (26 V) without external components.

CIRCLE NO. 262

Premium IC op amps slew at 30 V/ μ s

Raytheon Semiconductor, 350 Ellis Street, Mountain View, Calif. Phone: (415) 968-9211. Availability: stock.

Two new high-slew-rate op amps, the RM4531 and RC4531, provide the dc performance of popular 741 op amps plus 30 V/ μ s slew rates. Their input stages retain small-signal characteristics even when subjected to large differential input signals. Both feature offset null capacity, high gain and can be unity-gain compensated.

CIRCLE NO. 263

Low-offset IC op amp slews at 20 V/ μ s

Precision Monolithics, Inc., 1500 Space Park Dr., Santa Clara, Calif. Phone: (408) 246-9222. P&A: \$14.35 (100 quantities); 4 to 6 wks.

The monoOP-01 monolithic op amp features a 20-V/ μ s slew rate and low voltage and current offsets -0.7 mV and 2 nA, respectively. The internally compensated op amp is a direct pin-for-pin replacement for the popular 2600 series of amplifiers and it performs a similar function to the μ A715 high-slew-rate amplifier. It is available in a TO-99 package.

CIRCLE NO. 264

TTL NAND gate has dual five inputs

National Semiconductor Corp., 2900 Semiconductor Dr., Santa Clara, Calif. Phone: (408) 732-5000. Price: see text.

A new TTL NAND gate is the DM7092/DM8092 dual 5-input gate that is completely compatible with standard TTL. The new device is supplied in three versions: the DM7092D with a cavity DIP package, the DM7092N molded DIP for operation at -55 to $+125^\circ\text{C}$, and the DM8092N molded DIP for 0 to $+70^\circ\text{C}$ use. Prices are: DM-7092D (\$6.75), DM7092N (\$2.91), DM8092N (\$2.04).

CIRCLE NO. 265

Bipolar 2048-bit ROM is field programmable

Monolithic Memories, Inc., 1165 E. Arques Ave., Sunnyvale, Calif. Phone: (408) 739-3535. Price: \$195.

The MM 6305/5305 is a 2048-bit field-programmable bipolar ROM. It uses the fusible-link technology which requires only 90 mA and no special equipment for programming. Programming is achieved in minutes by the user, either in his own facility or in the field, by any test equipment or a field programmer supplied by the manufacturer.

CIRCLE NO. 266

Tri-state 256-bit RAM chip selects in 12 ns

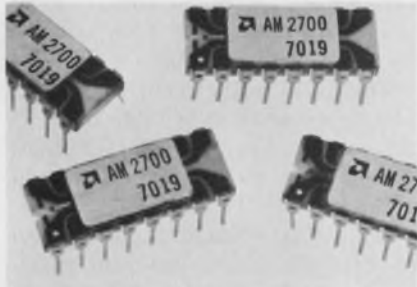

Advanced Micro Devices, Inc., 901 Thompson Pl., Sunnyvale, Calif. Phone: (408) 732-2400. P&A: \$27 (100 quantities); stock.

Organized as 256 words by 1 bit, a new bipolar static random-access memory with a tri-state output—ON, OFF and high-impedance—offers typical chip-select speeds of only 12 ns and read access speeds of 60 ns.

The high-impedance output state allows increased fan-out without loss of speed, either in a system or in any single memory device. The 'AM2700 memory is fully decoded on the chip, and can be addressed and read without the use of external logic.

Three chip-select inputs are available to allow the building of large memory systems with few external decoders. They reduce the amount of peripheral decoding logic by allowing the memory to be organized in a three-dimensional matrix.

An additional feature of the 'AM2700 is low power dissipation in the active state—only 1-1/2 mW per bit. It is rated to operate over the ambient temperature range of 0 to +75°C and is packaged in a hermetically sealed and 100% tested metal-ceramic 16-pin dual-in-line case. The memory can be driven from standard TTL MSI decoder devices.

The new random-access memory unit is processed to conform to Military Standard, 883, Level C. Units are also available, as an option, to conform to Military Standard 883, Level B.

Applications include high-speed buffer memories and small mainframes where speed is a critical factor.

CIRCLE NO. 267

Prevent semiconductor failures . . . with a circuit breaker?

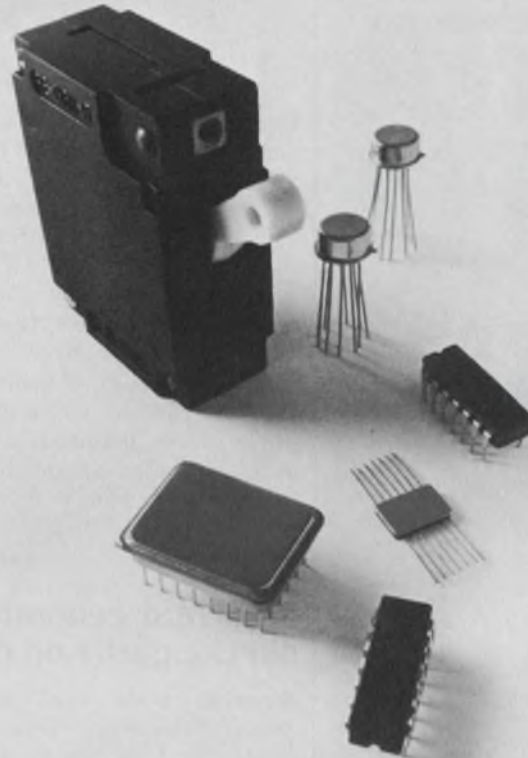

Send us \$20 and see for yourself.

What you'll get back is a sample of our JA/Q® electronics protector, which is no ordinary circuit breaker.

It's a circuit breaker with a built-in hybrid microcircuit crowbar. And that's where the failure prevention comes in.

When a dangerous transient or overvoltage occurs, the crowbar fires and shunts the load within 500 nanosec. Vulnerable semiconductors are never exposed to a condition which might destroy them.

The circuit breaker sees the shunted load as a dead short, and electromechanically disconnects the equipment within 10 millisecc, thus providing protection for the crowbar.

Normal overcurrent protection is in no way affected by the presence

of the crowbar. You can still order precision current ratings, job-matched time delays, and all the other options normally offered with our standard Series JA breakers.

The whole protection package is remarkably economical. In fact, we can provide the crowbar for less than you can build an equivalent circuit in-house. And there are related savings in space, and in the ability to use lower-rated semiconductors.

To evaluate the performance of the JA/Q for yourself, send a check for \$20, along with your name, department, and company letterhead to: Richard Kurtz, Heine-mann Electric Company, 2616 Brunswick Pike, Trenton, N.J. 08602. Please specify 6.5, 14, 17, 26, 32, or 38-volt firing level; and 2, 5, or 10-amp current rating.



HEINEMANN

4775

INFORMATION RETRIEVAL NUMBER 46

Introducing the high-low POWER SUPPLY



(high
performance—
low profile)

Acopian's new low profile power supply offers outstanding performance. Line and load regulation is .005% or 2 mv. Ripple is 250 microvolts. Prolonged short circuits or overloads won't damage it. And built-in over-voltage protection is available as an option.

Yet, it's the thinnest, flattest, most "placeable" 4.0 amp series regulated power supply ever offered . . . just 1.68" low. This low profile makes it perfect for mounting on a 1¾" high panel, or vertically in a narrow space.

Standard models include both wide and narrow voltage ranges. Outputs from 0 to 48 volts. Current ratings from 1 to 4 amp. Prices are low, too, starting at \$80.

For the full low-down on the new low-down power supply, write or call Acopian Corp., Easton, Pa. 18042. Telephone: 215-258-5441. And remember, Acopian offers 82,000 other power supplies, each shipped with this tag . . .



INFORMATION RETRIEVAL NUMBER 47

ICs & SEMICONDUCTORS

IC op amp has low input bias of 3 nA



Burr-Brown Research Corp., International Airport Industrial Park, Tucson, Ariz. Phone: (602) 294-1431. P&A: \$15; stock.

The 3501 IC op amp features low input bias current of ± 3 nA which is achieved by a new current cancellation technique. Its input impedance is $5 \times 10^7 \Omega$ (differential) and $10^{10} \Omega$ (common mode). Internal current levels of the amplifier are maintained constant over the range of supply voltages from ± 3 to ± 20 V dc. Quiescent power drain is 750 μ A.

CIRCLE NO. 268

9-bit MSI generator checks parity on data

Signetics Corp., 811 E. Arques Ave., Sunnyvale, Calif. Phone: (408) 739-7700. P&A: \$3.62 (100 quantities); stock.

A new MSI IC designed to make parity checks on nine data inputs is available. Designated as the 8262 9-bit parity generator and checker, it supplies a parity bit which is transmitted as part of a data word. At the receiving end, the 8262 indicates either that the data has been received correctly or with an error.

CIRCLE NO. 269

Decade counter display driver comes in a DIP

Hughes Aircraft Co., Microelectronic Products Div., 500 Superior Ave., Newport Beach, Calif. Phone: (714) 548-0671. P&A: \$6 (1000 quantities); stock.

A universal decade counter display driver is available in a low-cost 24-pin DIP. The new MOS IC, type HCTRO107D, includes an up-down decade counter which can be preset, four latches for BCD data storage, buffered BCD outputs, and BCD-to-seven-segment decoding with 30 voltage switches.

CIRCLE NO. 270

Dual voltage regulator spans ± 10 to ± 28 V

Silicon General, 7382 Bolsa Ave., Westminster, Calif. Phone: (714) 839-6200. P&A: \$4.45 (100 quantities); stock to 30 days.

Simplified adjustment of output voltage levels from ± 10 to ± 28 V, and current limit inputs for fold-back current limiting are featured in the new SG1502/2502/3502 adjustable dual-voltage regulator. In the SG1502 series, external resistor dividers are used to provide low temperature coefficients. Each output may be adjusted independently (± 10 to ± 23 V for SG3502).

CIRCLE NO. 271

MOS/LSI ICs interface bipolar/DTL/TTL levels

ITT Semiconductor, West Palm Beach, Fla. Phone: (305) 842-2411. P&A: \$11.50, \$4.90, \$13 (100 quantities).

Three new LSI/MOS ICs are the 1056 up/down counter/decoder driver, the 3329 512-bit dynamic shift register and the 3708 eight-channel multiplex switch. All are bipolar compatible needing no special interface devices. The 1056 is a p-channel, enhancement-mode IC. The 3329 and 3708 are silicon-gate, p-channel, enhancement-mode ICs that are DTL/TTL compatible.

CIRCLE NO. 272

14-MHz 8-bit register dissipates but 30 mW

National Semiconductor Corp., 2900 Semiconductor Dr., Santa Clara, Calif. Phone: (408) 732-5000. P&A: from \$12.50; stock.

The DM76L70/DM86L70 low-power 8-bit TTL shift register that replaces two 4-bit registers has a shift frequency of 14 MHz and low power consumption of only 30 mW. In a DIP package, the serial-in-parallel-out device is pin-compatible with the DM7570/DM8570, which typically operates at 20 MHz and dissipates 180 mW.

CIRCLE NO. 273

Tiny indicator tubes are ideal for strobing

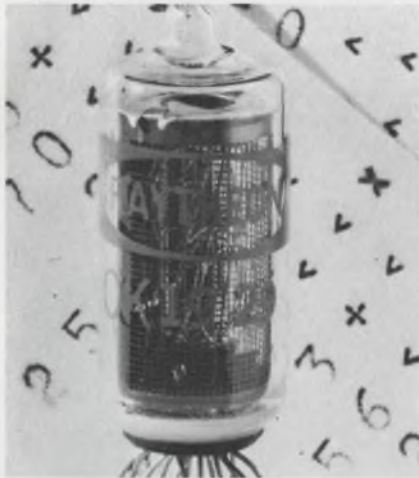

Raytheon Co., 465 Centre St., Quincy, Mass. Phone: (617) 479-5300. P&A: \$3.95 (1000 quantities), 60 days.

Subminiature side-viewing numerical indicator tubes for strobed/time-sharing applications are offered in a new series. These cold-cathode tubes are supplied with numerals 0 to 9 with right and left-hand independently operated decimal points. A companion tube presents plus and minus signs. Each tube has a dia of 0.53 in. Seated height is 1.414 in. and character height is 0.5 in.

CIRCLE NO. 274

Synchronous motor is only 1/4-in. thick

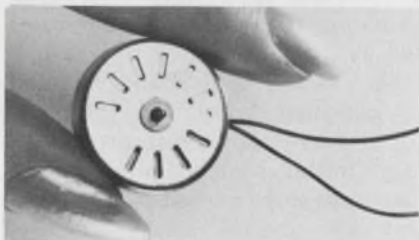

Landis & Gyr, Inc., 4 Westchester Plaza, Elmsford, N.Y. Phone: (914) 592-4400.

A new subminiature synchronous motor is the AMY6 which is approximately 1/4-in. thick and 7/8-in. in dia. It was developed for inclusion in miniature control devices as well as in compact electronic equipment for consumer and industrial products. Its shaft speed is 300 rpm with a 24-V ac, 60-Hz input. Power consumption does not exceed 0.3 VA.

CIRCLE NO. 275

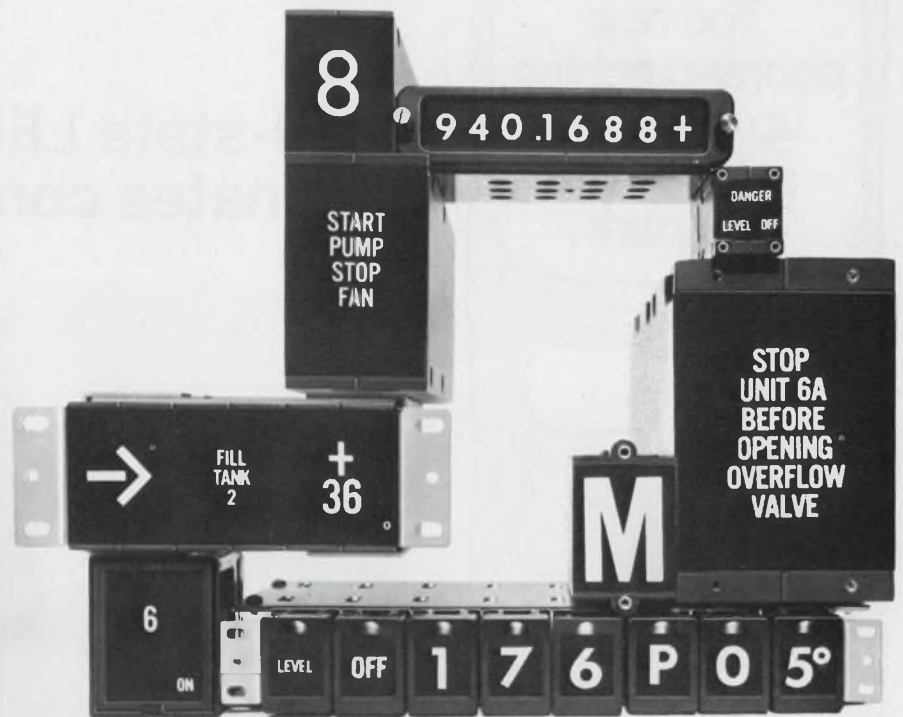

These versatile building blocks give you absolute display control

IEE rear projection readouts let you display everything from single alphanumeric to complex multiword, multiline messages in any type font or style, in your choice of colors, in any language from hieroglyphics to Sanskrit, using any set of symbols known to man, in all sorts of combinations, on a variable brilliance, single-plane viewing surface, all in a variety of sizes from 3/8-inch up to a huge 3 3/8-inch-high characters readable from 100 feet away, and you can get up to 64 different messages, numbers, letters, symbols, or combinations thereof in one single readout.

Be The Master Of Your Display

You can even change messages or characters right in the field to conform the display to programming changes in your system.

That's what we call absolute display control, an order of versatility unapproached by any other display system.

Where To Get Your Building Blocks

And you can get all the rear projection readout building blocks you need to configure a display system that will say just about anything you want it to from IEE.

For instance, we have big 3 3/8-inch by

2 3/4-inch viewing area readouts that let you display such things as 12 different 70- to 80-character messages or giant alphanumeric.

Also handy little fit-anywhere readouts about 1/2" by 3/4" that display 0.37 inch-high characters.

We have readouts that display 11, 12, 24, 48, or 64 different things, like a complete 64-step operator prompter program. And readouts that snap in from the front panel and readouts that display 2-inch characters on compact 2-inch centers.

New Can-Do Driver/Decoder

Now we have a nifty little low-cost hybrid driver/decoder that will drive any one of them, too. It's DTL and TTL-compatible, it puts out a big 300 ma at 30 volts from a .7" by 1.2" 24-pin DIP package, and you can get it separate or attached to the readout.

Ask for the Series 7610. Or information on our wide variety of other driver/decoders.

Our Short-Form Catalog Tells All

Get all the details on our rear projection readout building blocks. Send for our short-form catalog today.

IEE rear projection readouts. For machines with more to say.

Industrial Electronic Engineers, Inc.

7740 Lemona Ave., Van Nuys, California 91405
Telephone: (213) 787-0311 • TWX 910-495-1707



You're a penny-pinching, up-tight, li'l switch with no spark.

True.

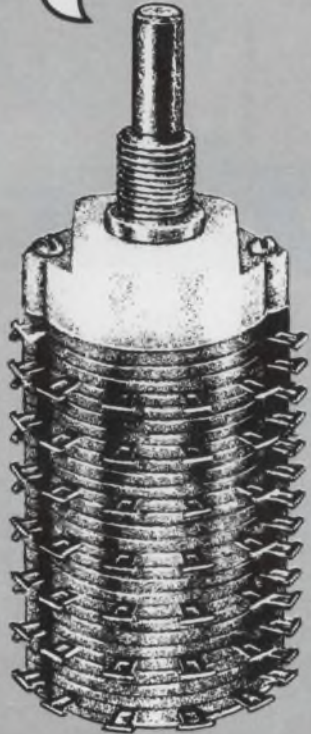

There's no better value than a Stackpole rotary switch. Fast delivery and quality features, but at a price you can afford. Unique design achieves a totally enclosed rotary, without sacrificing complex switching capability. Rigid construction and molded terminals produce a switch so tight it's explosion proof. Samples immediately. Production quantities in 1 to 2 weeks. Including switches with PC mounting. For details, send for Bulletin 73-103.

STACKPOLE
COMPONENTS COMPANY
Raleigh, N. C. 27610

COMPONENTS

Solid-state LED switch eliminates contact bounce

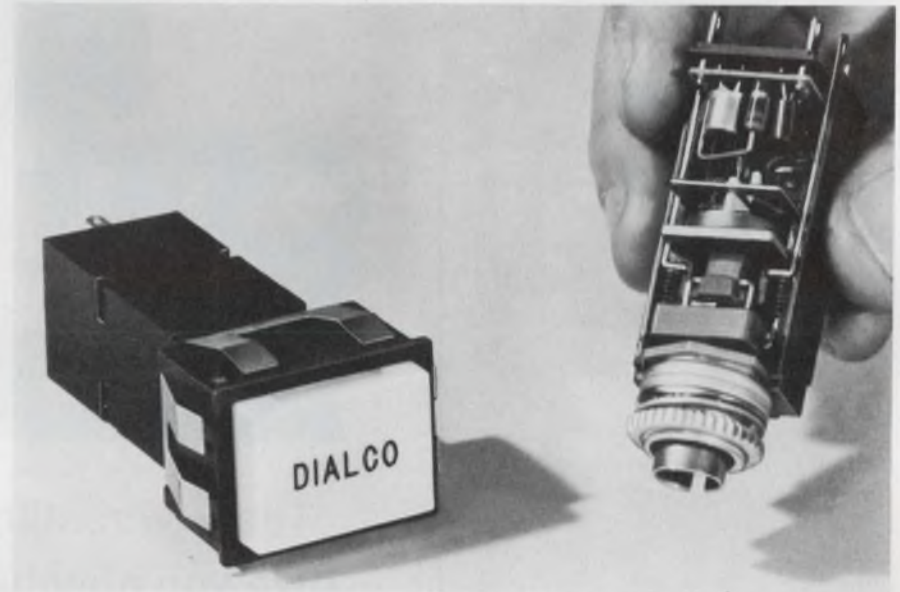

Dialight Corp., 60 Stewart Ave., Brooklyn, N.Y. Phone: (212) 497-7600. P&A: \$6.82 (1 to 9), \$4.03 (1000); stock.

Incorporating an LED, a photo-Darlington amplifier and a Schmitt trigger, a new solid-state pushbutton switch provides contactless, and therefore contamination-free operation and a minimum life of 10 million operations.

Energy from the light-emitting diode, which is always ON, falls on the photo-Darlington amplifier and causes current to flow. When

the pushbutton is activated, the light from the diode is blocked, current ceases to flow and the Schmitt trigger changes state, providing a digital output signal.

The output of the new switch is an open-collector transistor that can be interfaced to levels up to 16 V at 50 mA. It is directly interfaced with RTL, DTL, TTL and HTL logic levels. Typical switching rise and fall times are 100 ns.

The switch is available in snap or non-snap action. In the snap form, a moving magnet provides a high initial pushbutton operating force when the switch is depressed and an audible click indicates switch activation. In the non-snap model, there is a gradual increase in operating force until the switch plunger is bottomed.

Switches are available in spst normally open, spst normally closed and spdt versions.

For interfacing with discrete circuits as well as digital ICs, one or two external resistors must be used with the switch, depending on the switch version, to tie the open-collector output to an external supply line.

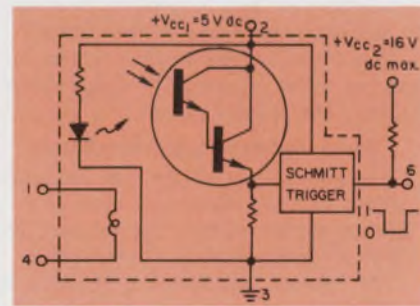

Contactless and clean switching is achieved with a new solid-state device. Activating its pushbutton blocks, the LED's current, which turns off the photo-Darlington amplifier, and causes the Schmitt trigger to change state.

CIRCLE NO. 276

Scott "T" transformers come in tiny packages

Magnetics, 6 Richter Court, E. Northport, N.Y. Phone: (516) 261-4502. P&A: \$19; stock to 3 wks.

A series of new 60-Hz Scott "T" transformers are available in small 1.1 by 2.1 by 1.1-in. packages. The new devices convert 3-wire synchro inputs into 2-wire resolver outputs. They are designed to mount on PC boards, can be used at 400 Hz and will meet the requirements of MIL-T-27B. Specifications include 90 V line-to-line input and 6 V output.

CIRCLE NO. 277

Double-gun rectangular CRT has 8-by-10-cm face

M-O Valve Co., Ltd., Brook Green Works, Longon, England.

A new double-gun rectangular-faced instrument CRT features an 8-by-10-cm display and 6-cm overlap. The 1400D has a post-deflection acceleration voltage of 5 kV and is aluminized. Independent control of brightness and focus is achieved by dual construction of triode, focusing and astigmatism systems. Deflection blanking is compensated for inexpensive dc-coupled operation.

CIRCLE NO. 278

Servo system provides 150:1 speed range

TRW, Inc., Globe Div., 2275 Stanley Ave., Dayton, Ohio. Phone: (513) 227-3171. P&A: \$640; 3 to 4 wks.

A new electronically controlled loop velocity servo package provides a 150:1 speed range. Its speed and direction are directly proportional to the magnitude and polarity of the input command signal. It uses an integral analog tachometer and a solid-state control package. The system provides constant torque output up to 10 oz-in. over 60 to 9000 rpm in either direction.

CIRCLE NO. 279

Flat-face CRT is 13.78 in. long

AEG-Telefunken Corp., 570 Sylvan Ave., Englewood Cliffs, N.J. Phone: (201) 568-8570.

A new short-length (13.78 in.) CRT is the model D14-131 with a 4 by 5-in. flat face. It uses electrostatic deflection and focusing and offers deflection sensitivities of 5 V/cm vertical and 8 V/cm horizontal. Other features include an aluminized screen, blanking, a mesh post-deflection acceleration electrode and a post-acceleration voltage ratio of 10:1 max.

CIRCLE NO. 280

Ballistic accelerometers measure 50,000 g

Columbia Research Labs., Inc., MacDade Blvd. & Bullens Lane, Woodlyn, Pa. Phone: (215) 532-9464. Availability: 2 to 4 wks.

A line of accelerometers and associated solid state miniature amplifiers provide the measurement of ballistic impact of 50,000 g in one, two or three directions, respectively. The 400 series devices are made in single, bi-axial or tri-axial configurations. The accelerometers with single-conditioning amplifiers are self-contained.

CIRCLE NO. 281

Solid-state cartridges include LED lights

Drake Mfg. Co., 4626 N. Olcott Ave., Harwood Heights, Ill. Phone: (312) 876-7227. P&A: approx. \$2; 3 to 4 wks.

The new solid-state Astrolite cartridge is a combination General Electric LED and a housing with either wire leads or terminals. Both versions mount on 0.19-in.-dia holes and are available without or with a cylindrical lens. The housings also include rectifying diodes and resistors for operation from 2.8 to 28 V, ac or dc.

CIRCLE NO. 282

For five cents, I'd start something.

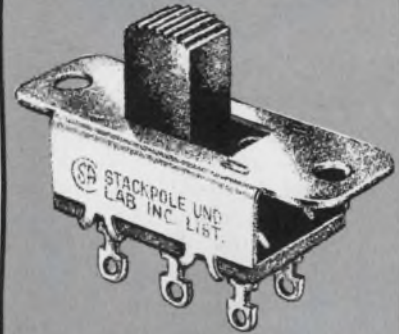

me too.

Turn on with a Stackpole slide switch. Prices start at 5¢ for this field proven standard of the industry. Available in two sizes, Regular and the new 50% smaller Miniature Series. Fully UL and CSA approved. Rated from 1 to 10 amps @ 125 and 250 volts (Miniature Series rated at 3 amps @ 125 V). Over 23 basic types, 7960 variations of slide and rocker switch adaptations. For complete details, send for Bulletin 78/79-100.



STACKPOLE
COMPONENTS COMPANY
Raleigh, N. C. 27610

Tiny 6-digit counter prices under \$30/digit

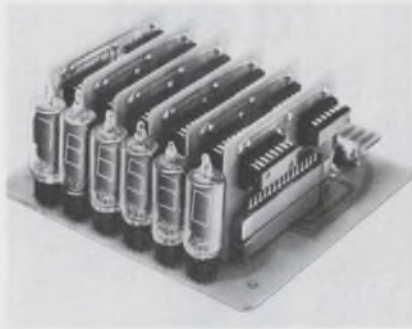

Tronix, Inc., Box 349, Phillipsburg, N.J. Phone: (201) 859-3944.

Designed to meet OEM requirements for low cost, the new TC-5 series electronic counter packs 6 digits of counting into a 4-1/8 by 1-3/4 by 4-3/8-in. plug-in module that is priced under \$30/digit. The TC-5 offers counting speeds up to 20 MHz, compatibility with standard PC edge connectors and 0.4-in.-high visual displays. It operates from an external 5-V supply.

CIRCLE NO. 283

Does everybody make Philbricks?

Sure, there are a lot of imitations, but only one Philbrick.

* FOR EXAMPLE, YOU CAN SPOT A GENUINE PHILBRICK BY THE WAY IT MEETS ITS SPECS. A REALLY TOUGH TEST!

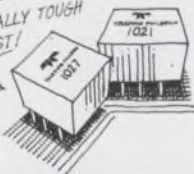

The state-of-the-art standard in Circuit Modules

TELEDYNE PHILBRICK
Allied Drive at Route 128,
Dedham, Mass. 02026

INFORMATION RETRIEVAL NUMBER 51

Economy FET op amps price down to \$10

Polytron Devices, Inc., Box 398, Paterson, N.J. Phone: (201) 523-5000.

A new inexpensive series of FET op amps include models P201C, P201CA, P201C-7 and P201C-7A, with the last two being priced at \$10 and \$14.50, respectively. These internally compensated op amps are particularly useful in applications requiring high input impedance ($10^{12} \Omega$) and low bias current (5 pA). Output voltages are ± 11 V. Other features are voltage gain of 500,000, offset of 5 pA and output of ± 11 V. The P201C-7 provides an output current of ± 5.5 mA, while the P201C-7A provides ± 20 mA.

CIRCLE NO. 284

Anti-log amplifier widens bandwidth

Optical Electronics, Inc., Box 11140, Tucson, Ariz. Phone: (602) 624-8358. P&A: \$100; stock.

Model 396 anti-logarithmic amplifier provides data expansion and, when used with the model 2531 logarithmic amplifier provides wideband and dynamic-range non-linear function generation. Features include 80 dB min dynamic range, $\pm 1\%$ anti-log error and dc to 1 MHz signal bandwidth. The output is 10 V full scale.

CIRCLE NO. 285

Sample/hold module tracks 10 V in 100 ns

Varadyne Systems, 1020 Turnpike St., Canton, Mass. Phone: (617) 828-6395. P&A: \$149; stock.

Model SHM-2 sample-and-hold module can track a full-scale ± 10 -V input in less than 100 ns to within $\pm 0.1\%$ accuracy. Its aperture time is 10 ns and over-all bandwidth is dc to 500 kHz. Slew rate is 30 V/ μ s, output is 10 V at 5 mA and settling to $\pm 0.1\%$ is in 1 μ s. The SHM-2 has a temperature coefficient of ± 20 ppm/ $^{\circ}$ C and operates from ± 15 V dc at ± 35 mA.

CIRCLE NO. 286

Oscillator unit accepts 80 to 110-MHz crystals



McCoy Electronics Co., Mt. Holly Springs, Pa. Phone: (717) 486-3411.

The inconvenience and expense of using a new crystal oscillator for each discrete frequency has been eliminated from 80 to 110 MHz with the new model MC308X1 crystal oscillator. It comes in a case that accepts any insertable TO-5 crystal unit in any discrete frequency in its specified range. Frequency is adjustable to within ± 1 ppm of the desired nominal value at room ambient. Operating from an input voltage of +12 V dc, the new MC308X1 oscillator provides output power of 7 mW into a 50- Ω load.

CIRCLE NO. 287

Digital display mounts easily

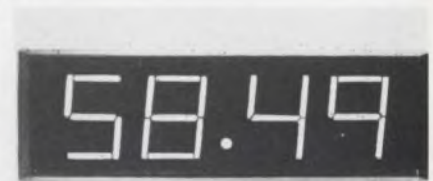

Discon Corp., 2820 N.E. 4th Ave., Pompano Beach, Fla. Phone: (305) 781-0440. Price: \$1.98/digit (100,000 quantities).

New series 40 Digicator display is designed as a complete ready-to-mount assembly. The assembly, including bezel and color filter, mounts easily to the front of any panel by two screws. Lamps are replaceable from the front. The Digicator is available with seven-segment numeric, hexadecimal and alphanumeric characters.

CIRCLE NO. 288

Midget 2-lb calculator has printing output



Monroe Div. of Litton Industries, Orange, N.J. Phone: (201) 673-6680. Price: \$379.

An electronic mini-calculator that prints has been introduced by Litton's Monroe Div. Weighing less than 2 lbs, the pocket-sized calculator, which can easily be held in the palm of the hand, operates on its own batteries or directly from ac voltage. The model 10 "Shrimp" can operate 4 to 5 hours on its own batteries without recharging.

CIRCLE NO. 289

Printing calculator doubles as computer

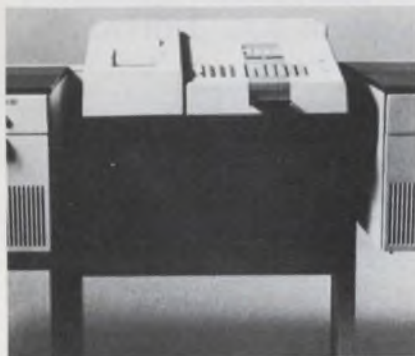

Olivetti Corp. of America, 500 Park Ave., New York, N.Y. Phone (212) 371-5500. Price: \$3980.

The P602 is a self-contained desktop printing computer that can be operated in a manual mode as an electronic calculator and in a program mode as an automatic digital computer, with the ability to follow stored instructions. Programs can be written on its keyboard and can be stored externally on magnetic cards. The main memory is composed of 16 registers.

CIRCLE NO. 290

**NOW
THE SMALLEST
IS ALSO
THE LARGEST.**

The world's smallest power supplies for microelectronics are now available in the world's largest line of high power density, high efficiency supplies: 54 off-the-shelf models.

From 100W to 500W; from 3VDC to 30VDC; single, dual, triple outputs; commercial, military, and export models.

Now in use by such leaders as Burroughs, Control Data, Honeywell, IBM, Litton, NCR, RCA, Univac, and many Government installations. We also custom develop/produce to specific needs.

Write for complete literature.

Trio Laboratories, Inc., 80 Dupont St., Plainview, L.I., N.Y. 11803. Tel.: (516) 681-0400. TWX: 510-221-1861.

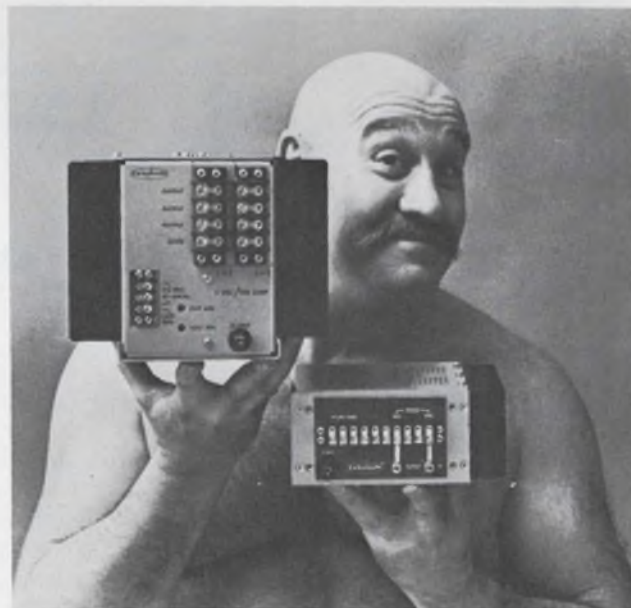

Model SP631
5VDC/100A
Typical efficiency 70%
8.50" x 6.81" x 8.75"
21.5 lbs.
\$695.

Model SP601
5VDC/20A
Typical efficiency 65%
3.25" x 6.50" x 7.50"
6 lbs.
\$400.

Incremental cassette recorders cost from \$99

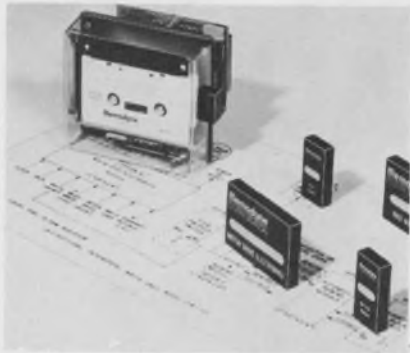

Memodyne Corp., 49 Pollard St., N. Billerica, Mass. Phone: (617) 933-4867. Availability: Sept. 1971.

A new line of low-cost digital cassette recorders achieve true bit-by-bit incremental recording. Their low prices of \$99 include all electronics for unidirectional write-only models in OEM quantities. A complete bidirectional model with write/read electronics costs \$299, in OEM quantities. Electronic functions are on plug-in plastic modules on the transport rear.

CIRCLE NO. 299

Is a Philbrick a black box?

It's whatever you want it to be.

FOR EXAMPLE, PHILBRICK MODELS 4350/4351 LOG OPERATORS MEASURE LOG CURRENT, LOG VOLTAGE OR ANTI-LOGS. A PAIR COMPUTES SQUARES, CUBE ROOTS, INVERSE SQUARES AND CUBES, INTEGRAL AND FRACTIONAL POWERS AND ROOTS. IN LOTS OF 100—ONLY \$73.



The state-of-the-art standard in Circuit Modules

TELEDYNE PHILBRICK
Allied Drive at Route 128,
Dedham, Mass. 02026

INFORMATION RETRIEVAL NUMBER 53

Adjustment gauge aligns cassette drives

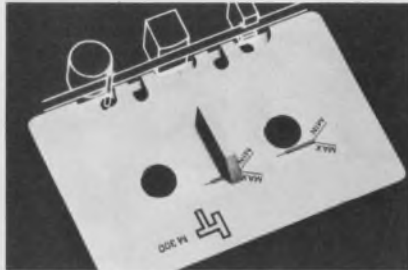

Information Terminals Corp., 1160 Terra Bella Ave., Mountain View, Calif. Phone: (415) 964-3600.

A new gauge permits users of cassette drives to accurately position guides, heads, and pinch rollers. The M-300 head and guide gauge gives maximum performance from digital and audio cassettes and drives. It accurately locates the tape path in a drive with reference to mid-point dimensions of all cassettes meeting ANSI, ECMA and audio standards.

CIRCLE NO. 300

Equalized modem operates at 4800 bits/s

Paradyne Corp., 2040 Calumet St., Clearwater, Fla. (813) 442-5126. P&A: \$4250; 60 days.

The M-48 is a new 4800-bit/s equalized modem with excellent performance on poor-quality unconditioned circuits. Although it was designed to operate on four-wire dedicated unconditioned lines, it also offers a very low error rate using dial-up connections as back-up service.

CIRCLE NO. 301

Alterable 131-kbit ROM cycles down to 125 ns

Integrated Memories, Inc., 260 Fordham Rd., Wilmington, Mass. Phone: (617) 658-5073. Price: under 2¢/bit.

A capacitive ROM system with an alterable 131-kbit density features a cycle time down to 125 ns. The series 1000 ROM uses four storage boards each having 32,768 bits of memory. The stored data pattern is a capacitive matrix etched on a low-cost mask, affixed to a PC board, with 16,384 bits of storage/side.

CIRCLE NO. 302

Video processing system enhances pictures



Spatial Systems, Inc., 132 Aero Camino, Goleta, Calif. Phone: (805) 968-3594.

A new picture-enhancement technique is incorporated in the model 401 Edge Enhancer. Using a combination of TV and analog computer techniques, the system produces an enhanced picture of photographic transparencies wherein the edges, lines and fine structures are emphasized. The 401 consists of a bright-light table to illuminate the photograph, a precision TV camera to pick up the image, and an edge enhanced unit with TV monitor.

CIRCLE NO. 303

Cassette-tape transport system has 3 drives



Canberra Industries, Inc., 45 Gracey Ave., Meriden, Conn. Phone: (203) 238-2351. P&A: \$6900; August, 1971.

The model 2020 cassette tape transport system provides the minicomputer user with three independent cassette-loaded magnetic tape drives, a tape drive controller, a complete interface and software support—all in a single package. It features simultaneous reading and writing on separate decks, back-space recording, and high-speed bi-directional search for addressable files.

CIRCLE NO. 304

Silver/silicone grease is highly conductive



Technical Wire Products, Inc., 129 Dermody St., Cranford, N.J. Phone: (201) 272-5500. Availability: stock.

A new grease is a highly conductive silver/silicone lubricant and is carbon and graphite-free. The grease maintains its electrical and lubricating properties over -65 to +450°F, resists moisture, humidity, many chemicals and ozone. It is a light paste used on the contacting surfaces of mechanical circuit breakers and knife blade switches.

CIRCLE NO. 305

Miniature connectors perform up to 2.3 GHz



Microdot, Inc., Connector Div., 220 Pasadena Ave., S. Pasadena, Calif. Phone: (213) MU2-3351.

A line of microminiature connectors features excellent performance at rf. Called Combonates, they operate from dc to 2.3 GHz with VSWRs of 1.01 to 1.10. They will accommodate up to 17 RG-196A/U or RG-178B/U coax cables in an area less than 0.225 in.². Mixed layouts with coaxial terminations and standard AWG 24, 26 and 28 wires are available.

CIRCLE NO. 306

for ... \$10,000.00 WANG sells the lowest cost calculator ... in the WORLD



When you judge the cost of a calculator you can't just look at the price tag. You must first consider how much it costs to have someone operate your calculator. The lowest cost calculator is the one that does the most work with the least amount of operator time. That's where we come in.

Our Wang calculators out-perform anything in their class. And we make more different electronic calculators than anybody else. Our \$10,000 system can do some jobs that even a similarly priced computer can't handle. And our calculator doesn't require special operators that a computer needs. Any of our models, even for under \$1,000 has the best price/performance ratio in its price range. That's how we got to be the largest United States' manufacturer of electronic calculators.

And there are even more reasons why our calculators cost so little to own; like the fact that they never become obsolete. We designed every Wang calculator to be expanded right in your office when your requirements increase. And factory direct sales and service organization assures you that every Wang calculator you own keeps working for you.



Find out how low cost our calculators are. Call any of our offices or call, collect, Mr. Courtney at 617-851-7211.

WANG LABORATORIES, INC. DEPT. ED-7
836 NORTH STREET, TEWKSBURY, MASSACHUSETTS 01876,
TEL. (617) 851-7311, TWX 710 343-6769, TELEX 94-7421

INFORMATION RETRIEVAL NUMBER 54

Does a Philbrick come only in one size?

Are you kidding?



The state-of-the-art standard
in Circuit Modules

TELEDYNE PHILBRICK
Allied Drive at Route 128,
Dedham, Mass. 02026

INFORMATION RETRIEVAL NUMBER 55

We're getting to be known as rounders.

We invented the BULLS-EYE Connector and created a reputation as circular subminiature specialists. Goes to show you what a little concentration can do. (Like 102 contacts in a #18 shell.)

HUGHES
HUGHES AIRCRAFT COMPANY
CONNECTING DEVICES

INFORMATION RETRIEVAL NUMBER 56

evaluation samples



Wire clips

For controlling wires in electrical components, new wire clips snap easily into punched or drilled holes 0.187-in. in diameter in metal panels or PC boards 0.15 to 0.07-in. thick. Made of self-extinguishing nylon, they are available in two styles: top loading or side loading—with over-riding arms that provide easy wire or cable entry and excellent clip retention. Easily installed by hand, they may be mounted horizontally or vertically with no danger of wires dropping loose. Free samples are available. Lorain Tool & Mfg. Co.

CIRCLE NO. 291

Marking discs

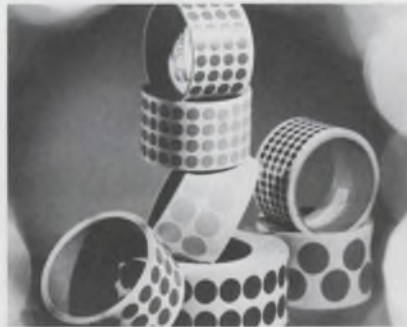

Colored marking discs that can convey information at a glance, be stamped or written on, adhere to any surface and last indefinitely, are offered as samples. The brightly colored, pressure-sensitive discs are die cut out of paper or vinyl and come in six standard colors. Four fluorescent colors are offered in paper only. Five standard sizes are available: 1/8, 1/4, 3/8, 1/2 and 3/4 in. All are individually die cut and packaged in rolls on an easy release protective backing paper. By-Buk Co.

CIRCLE NO. 292

design aids



Master template

A variety of the most widely used symbols, usually found on several different templates, have been incorporated in a single master general-purpose template. Template no. 18 is designed primarily for draftsmen and designers and contains such symbols as circles, squares, hexagons, arrows, deltas and 3 sizes and 2 styles of brackets. It also has 30, 60, 90 and 45-degree triangles and features a 3-in. protractor and an inch scale on the bottom edge. Size of the template is 10-1/4 by 5-1/2 by 0.3 in. Rapidesign Inc.

CIRCLE NO. 293

Drafting tools holder

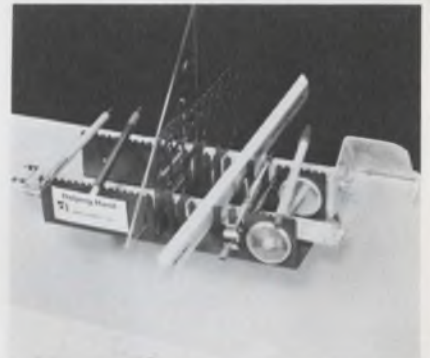

The Helping Hand holds drawing instruments at any board angle from horizontal to vertical with no rolling or sliding. A bracket mounts on either the top edge or side edge of the board. Triangles, templates, compasses, erasers, scales, pencils and knives drop into slots in a plastic holder. The holder is clamped to the bracket at an adjustable angle. Up to 17 instruments can be kept. Cost of the Helping Hand holder is \$12.50. Devonics, Inc.

CIRCLE NO. 294

application notes



Using vector voltmeters

A concise and detailed 13-page application report shows how to make the most of measurement techniques employing vector voltmeters. It explains such measurements as scattering parameter, attenuation, phase, gain and harmonic inspection. It also details power and group-delay measurements. Each measurement discussion is accompanied with neat block-diagram setups. PRD Electronics, Inc.

CIRCLE NO. 295

60-W supply design

The operation and construction of a compact 20-V 3-A regulated power supply that uses ICs and a single pass transistor are described in a 12-page application note. RCA.

CIRCLE NO. 296

Magnetic circuit breakers

The third edition of the Airpax Technical Journal titled "Choice of Protection" is available. The 20-page edition is an informative and well-illustrated journal containing design criteria for magnetic circuit breakers. Airpax Electronics.

CIRCLE NO. 297

Universal active filters

A booklet entitled, "Universal Active Filter Theory and Application," is available. It outlines the operating characteristics and performance advantages of the universal active filter. Also included in the 54-page book is extensive information on using the filter's multi-functional abilities in specific applications. Kinetic Technology, Inc.

CIRCLE NO. 298

ANNOUNCEMENT

4000 SERIES CMOS

(micropower logic)



SOLID STATE SCIENTIFIC HAS THEM ALL!

The Solid State People...



SOLID STATE SCIENTIFIC INC.

MONTGOMERYVILLE, PENNA. 18936
215-855-8400

What's a Philbrick?

The best functional circuit module you can buy.

FOR EXAMPLE, PHILBRICK MODEL 1027 DIFFERENTIAL OPERATIONAL AMPLIFIER SLEWS AT 60 V/ μ SEC, SETTLES TO .01% IN 1 μ SEC, YET IN LOTS OF 100 IT'S ONLY \$29.50

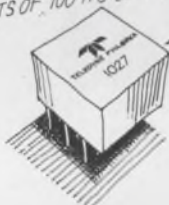

The state-of-the-art standard in Circuit Modules

TELEDYNE PHILBRICK

Allied Drive at Route 128,
Dedham, Mass. 02026

INFORMATION RETRIEVAL NUMBER 58

Less than 1 μ V Offset!

New Ultra-Low Thermal emf Reed Relays!



- Unique new method (pat. pend.) virtually eliminates thermal offsets, permits use of almost any type reed switch... Hg wet, dry, high voltage.
- Remarkably independent of ambient temperature, environment.
- Many contact forms, pin configurations available.
- Units also available at less than 500 nanovolts per switch, or less than 1 μ V differentially between switches.
- Greater than 10¹¹ ohms isolation resistance.
- Rugged molded package. Moderate price.

Write for Complete New Catalog MR-6.1



COTO-COIL COMPANY, INC.
75 Pavilion Avenue, Providence, R. I. 02905
Tel: (401) 941-3355

INFORMATION RETRIEVAL NUMBER 59

new literature



Edmund Scientific catalog

The new 1971 edition of Edmund Scientific's catalog is available. This 148-page booklet is crammed full of thousands of hard-to-find bargains in optical and scientific equipment for industry, research labs, design engineers, experimenters and hobbyists. Edmund Scientific Co.

CIRCLE NO. 340

Conductive coatings

A brochure is available with design information on Electrodag conductive coatings for use on CRTs, resistors, capacitors and crystals. Acheson Colloids Co.

CIRCLE NO. 341

Variacs

The choice and application of Variac adjustable autotransformers are simplified in a new 24-page catalog and applications handbook. General Radio.

CIRCLE NO. 342

Rotary switches

An eight-page bulletin provides design information on rotary switches for commercial, industrial and military applications. Oak Manufacturing Co., Div. of Oak Electro/Netics Corp.

CIRCLE NO. 343



Instrumentation handbook

A hard-bound 395-page instrumentation systems handbook is available. This complete engineering guide is divided into two parts. One is an authoritative textbook on the theory, application, calibration and maintenance of DVMs, computer and pressure systems and MOS/LSI device testing. The other part is a catalog of Non-Linear Systems' equipment and instruments. Free copies are available to qualified readers who should write to R. D. Rockwell, Non-Linear Systems, Inc., Box N, Del Mar, Calif. 92014.

Magnetic laminations

A new electrical lamination catalog includes dimensioned illustrations of standard laminations—single-phase, three-phase and cruciform. Thomas & Skinner, Inc.

CIRCLE NO. 345

Pressure sensor

An eight-page catalog gives complete specifications and prices on six new lines of industrial pressure sensors. Standard Controls, Inc.

CIRCLE NO. 346

Precision tools

Precision tools of all types are shown in a new 36-page catalog. Included in the catalog are tools for adjusting and cleaning equipment, component-extraction and insertion tools, gauges, soldering tools, hand tools, wrenches, telecommunications tools and tool kits. Jonard Industries Corp.

CIRCLE NO. 347

PC laminates

New PC board laminate products are introduced in a six-page brochure. U. S. Polymeric.

CIRCLE NO. 348

Knobs

Standard calibrated knobs for instruments are shown in a new catalog. Radial Controls, Inc.

CIRCLE NO. 349

Emergency power systems

A 20-page book discusses automated emergency systems for handling power failures. Automatic Switch Co.

CIRCLE NO. 350

Glass-to-metal seals

A four-page brochure describes a range of glass-to-metal hermetic seals. Astro Seal, Inc.

CIRCLE NO. 351

Ecology instruments

A 128-page ecology catalog shows instruments and apparatus used in environmental investigation and control. Horizon Ecology Co.

CIRCLE NO. 352

Silicon solar cells

A new four-page bulletin contains information on silicon photovoltaic converters (solar cells). M7, Inc.

CIRCLE NO. 353

Displays and servos

A new 122-page illustrated catalog is filled with application and engineering information on altitude reporting displays, solid-state data converters, servo systems and indicators, digital transducers and displays, encoders, commutators and switch assemblies. Northern Precision Laboratories, Inc.

CIRCLE NO. 354

MODULAR TYPE

MULTIPLES OF 30 PATTERN
SECTIONS UP TO 180
PATTERNS, STANDARD
CATALOG ITEMS

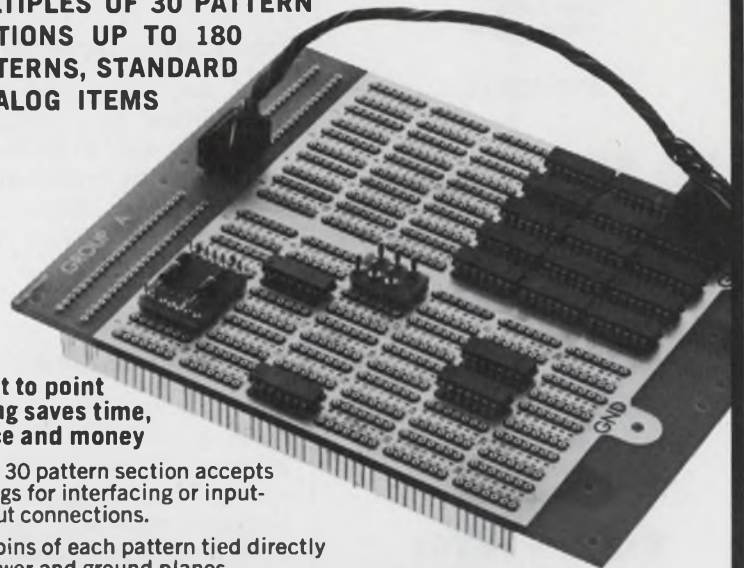

**Point to point
wiring saves time,
space and money**

Each 30 pattern section accepts
3 plugs for interfacing or input-
output connections.

Two pins of each pattern tied directly
to power and ground planes.

Changes and replacement made at component level.

Complete wire wrap service.

IC PACKAGING PANELS

Request Catalog 266

AUGAT

INC. TEL: 617-222-2202
31 PERRY AVE., ATTLEBORO, MASS. 02703

INFORMATION RETRIEVAL NUMBER 60

the grabber.

**Our plunger action Mini-Test Clip
is designed specifically for reaching
into densely packaged miniaturized
circuitry to make rapid, reliable tests.**

- Gold plated copper contact hook makes positive connection, and won't damage lead wires.
- Specially designed tip slides down over square wire-wrap pins for solid contact.
- Integrally molded wire assures greater reliability and eliminates time-consuming assembly.
- Molded nylon probe provides complete insulation to point of connection.
- Four models offer widest selection of connecting plugs. Write for complete information and prices.



POMONA ELECTRONICS

1500 E. Ninth St., Pomona, Calif. 91766 • Telephone: (714) 623-3463

INFORMATION RETRIEVAL NUMBER 61



PRESENTS

Mini-TRANSISTORS

For thick & thin film circuits

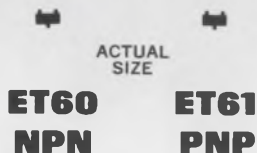

EEP's new ET60 (NPN) and ET61 (PNP) miniature transistors are ideal for use in general purpose amplifiers. All have base-emitter voltages of 5 volts, output capacitance of 8 pF and power dissipation ratings of 150 mW.

$V_{CEO} - 32V$ $I_C - 100 mA$

$f_T - ET60$ 250 MHz
 $f_T - ET61$ 180 MHz

	h_{FE}	
ET60A	120-220	ET61A
ET60B	180-310	ET61B
ET60C	250-460	ET61C
ET60D	380-630	ET61D

Price	1-99	100 up	500 up	1000 up
ET60A	\$.75	\$.50	\$.45	\$.42
ET60B	.77	.51	.47	.43
ET60C	.80	.53	.49	.44
ET60D	.85	.55	.50	.45
ET61A	.90	.58	.54	.49
ET61B	.93	.59	.55	.50
ET61C	.96	.61	.56	.51
ET61D	1.00	.63	.57	.52

Delivery: From Stock. Order From:



10150 W. Jefferson Blvd.,
Culver City, California 90230
(213) 838-1912

INFORMATION RETRIEVAL NUMBER 62

NEW LITERATURE

Electrolytic capacitors

An expanded and up-to-date new edition of a comprehensive Twist-Lok and Print-Lok electrolytic capacitor replacement manual is available. Sprague Products Co., Distributor Div. of Sprague Electric Co.

CIRCLE NO. 355

Tab books catalog

The Spring, 1971 catalog of Tab Books is available. The illustrated 20-page catalog covers books for such subject areas as schematic/servicing manuals, broadcasting, CATV, electric motors, electronic engineering and computers. Tab Books.

CIRCLE NO. 356

Data-acquisition systems

A four-page catalog describes a new line of modular data-acquisition systems designed to interface with minicomputers. Varadyne Systems Div. of Varadyne, Inc.

CIRCLE NO. 357

Voltage-regulator tubes

Several new data sheets are available on high-voltage, high-resistance, and low-current glow-discharge voltage-regulator tubes. Victoreen Instrument Division.

CIRCLE NO. 358

MOS/bipolar memories

A new 20-page catalog describes 21 semiconductor memory devices employing silicon—gate MOS and Schottky bipolar technologies. Intel Corp.

CIRCLE NO. 359

Synchro/resolver bridges

Synchro and resolver bridges are detailed in a six-page bulletin. Theta Instrument Corp.

CIRCLE NO. 360

Data converters

A new six-page bulletin details data converters and related accessories. ILC Data Device Corp.

CIRCLE NO. 361

Planar triodes

An eight-page note discusses operating instructions and characteristics of the entire family of Eimac planar triodes. Varian.

CIRCLE NO. 362

Thermocouples

A new 18-page catalog gives comprehensive application data on thermocouples. Thermo Electric.

CIRCLE NO. 363

DTL ICs

A new brochure shows the many applications and uses of a line of ultra-low-power DTL devices. Teledyne Semiconductor.

CIRCLE NO. 364

Limit switches

A new 28-page publication describes a complete selection of track-type switches. General Electric Co.

CIRCLE NO. 365

Microwave film resistors

A six-page brochure describes and illustrates a series of microwave film resistors. Pyrofilm Corp.

CIRCLE NO. 366

Lasers

A new series of data sheets is available for industrial laser products. American Optical Corp.

CIRCLE NO. 367

Phased-locked generator

A new bulletin describes a triggered/phase-locked waveform generator. Microdot Inc.

CIRCLE NO. 368

Components

A fully illustrated catalog lists fuseholders, fuseboxes, fuse links, thermostats, thermal delay devices, circuit breakers, rf connectors, terminals and sockets. Ercona Corp.

CIRCLE NO. 369



Potentiometric Recorder with basic sensitivity of 100MV ($\pm 0.5\%$). Continuous, inkless writing. Input impedance, $1M\Omega$, min. Plug-in modules and amplifiers available for DC/AC voltage and current, temperature, other functions. Only \$239. Rustrak Instrument Division, Manchester, N. H. 03103. (603) 623-3591.

INFORMATION RETRIEVAL NUMBER 181



LOW CURRENT DRAIN OSCILLATOR, Series 162, draws 800 microamps at 1 Hz to MHz. Frequency stabilities of $\pm 0.001\%$ from 0° to 60° C are standard with outputs compatible with all types of logic. Size $1.5 \times 1.5 \times 0.62$ " high. Accutronics/G.M.R.C., Geneva, Illinois 312-232-2600

INFORMATION RETRIEVAL NUMBER 182

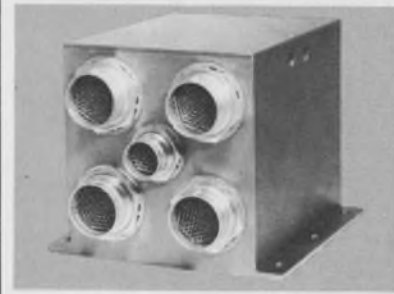

Rely on Fifth Dimension's telemetry experience for your multiplexing and encoding requirements. The 180 channel programmable PCM Multiplexer above is one of thousands of devices supplied for Aerospace, Industrial and Commercial applications. Fifth Dimension Inc., Princeton, N. J. (609-924-5990).

INFORMATION RETRIEVAL NUMBER 183



Power/Mates' New HEV/HEW HIGH EFFICIENCY power supply series is ideally suited for use with INTEGRATED CIRCUITS and MOS/LSI logic. The new series is offered in a wide range of voltages up to 150 VDC with current ratings up to 200 amps. Power/Mate Corp., 514 South River Street, Hackensack, N. J., 07601. (201) 343-6294.

INFORMATION RETRIEVAL NUMBER 184

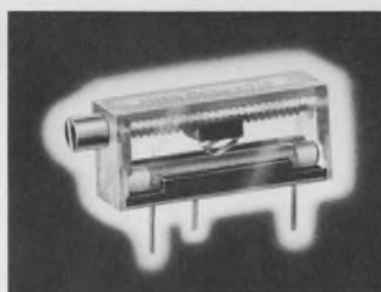

"SEE THROUGH" case of Diplomatic Model 121 wirewound trimmer reveals wiper position, exposes all internal mechanism to visual inspection through assembly, test and field service. Standard terminal arrangement. Quantity price under \$1. Write for specs, samples. Harry Levinson Co., 1211 E. Denny Way, Seattle, Wash. 98122. (206) 323-5100.

INFORMATION RETRIEVAL NUMBER 185



TERMINAL AND CHASSIS MARKING KIT. Prototype chassis, PC-boards, terminal strips, even TO-18 and 1/4 watt resistors are rapidly marked with this handy set. All standard component identification letters and letter combinations are included in ratios according to frequency of use. the DATAK Corporation — 85 Highland Avenue — Passaic, N.J.

INFORMATION RETRIEVAL NUMBER 186



New MR Series AC-DC Regulated Power Supply. Input 115/230 VAC $\pm 10\%$, 57-440 Hz. Output ± 15 VDC and 5VDC, 5VDC or ± 15 VDC. Load 3W, 5W and 8W. Short circuit protected. Prices start at \$45.00 each. Delivery — from stock to 2 weeks ARO. Tecnetics, Inc., Boulder, Colorado. (303) 442-3837.

INFORMATION RETRIEVAL NUMBER 187



UNIVERSAL TIMING CIRCUIT: TA-6030 23-stage array, providing customer specified metalization, operates from 1.3-volt mercury cell to 15-volt battery. For wrist watches, wall, automobile, or digital clocks, etc. COS/MOS achieves low power, high noise immunity. RCA Solid State Division, Somerville, N.J. Phone (201) 722-3200, ext. 2323.

INFORMATION RETRIEVAL NUMBER 188



Heathkit IB-101 Frequency Counter has 1 Hz - 15 MHz range; triggers from less than 100mV to more than 200 V.; Kit only \$199.95. New IB-102 Scaler kit gives any 50 ohm input counter 175 MHz range; just \$99.95 Heath Company, Dept. 520-76, Benton Harbor, Michigan 49022.

INFORMATION RETRIEVAL NUMBER 189

at prices from \$40
**Hipotronics offers you
 immediate delivery
 on over 800 standard
 models of**
**regulated &
 unregulated**
**hv dc
 power
 supplies**

... with output voltages
 from 1 to 1000 KV and
 current outputs from
 0.1 ma to 50 amperes



7.5 KV, 130 ma,
 air-insulated unit,
 with HV section included in control box.

- Standard regulation ranges:**
 Unregulated 10-18%
 Regulated:
 Electromechanical
 (M Series) 0.5%
 Electronic (R Series) 0.01%

HV components: — transformers, capacitors, rectification assemblies, tanks, etc. — designed and manufactured under our roof.

Custom design units: for wide range of applications — electrostatics, accelerators, lasers, high power radars, high voltage testing, and more.

For more information call Keith Reed at (914) 279-8091, or send for our 24-page catalog, which lists complete specifications: "High Voltage DC Power Supplies and Components."

High Potential Technology ®



HIPOTRONICS, INC.
 Brewster, N. Y. 10509 / (914) 279-8091

bulletin
 board
 of product news
 and development

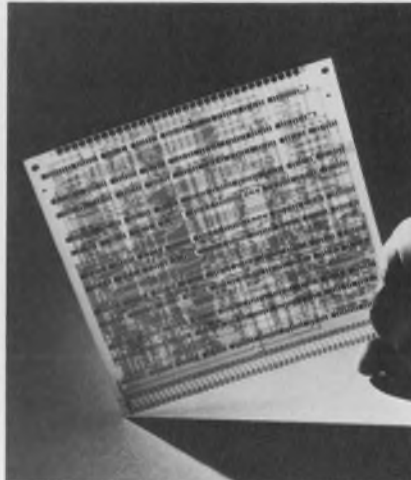

Methode Electronics, Inc. of Chicago, Ill., has announced the development by their Graphic Research Div. of 0.01-in.-dia PC board plated holes, with line widths and spaces 0.005 in.

CIRCLE NO. 370



A new technique for plating brazed assemblies at high temperatures has been developed by Consolidated Reactive Metals, Mamaroneck, N.Y. The method provides an excellent-adhesion nickel coating on small complex parts, without variation across brazed joints or dissimilar metals. Plated parts can be brazed up to 850° C.

CIRCLE NO. 371

Nineteen MOS digital ICs have been introduced by Signetics. These include static and dynamic shift registers, two character generators and a ROM.

CIRCLE NO. 372

Eight new CMOS products have been introduced by Motorola Semiconductor. They include a 64-bit fully decoded RAM, a quad 2-input and a dual 4-input NOR gate, a quad 2-input and a dual 4-input NAND gate, a quad 2-input and a dual 4-input NOR gate, a quad Exclusive OR gate, a dual D flip-flop and a dual 4-bit register.

CIRCLE NO. 373

Price reductions

Self-Scan alphanumeric panel displays have been cut in price by as much as 30%. According to Burroughs Corp., type SSD 1000-0010 16-digit numeric panels without memory can now be bought for \$135 (1 to 9) or \$90 (100). Type SSD 1000-0030 16 and 18-digit alphanumeric panels without memory now cost \$155 (1 to 9) and \$99 (100). Type SSD 1000-0040 16-digit alphanumeric panels with memory cost \$240 (1 to 9) and \$160 (100).

CIRCLE NO. 374

Astro Space Labs of Huntsville, Ala., has reduced the price of its RR-115 reed relay from \$12 to \$8 (single units) and from \$10.80 to \$4.25 (1000 quantities).

CIRCLE NO. 375

Teledyne Semiconductor has announced the following price cuts on FET-input op amps: their model 2404BG has been reduced in price from \$58.50 to \$38.80 each; and the model 2741CF from \$17.50 to \$10.80. Price reductions apply for 100 to 999-unit orders.

CIRCLE NO. 376

Data Technology, Inc., Watertown, Mass., has reduced the price of its model CMA five-digit, dual-axis, bidirectional display counter from a previous price of \$1193 to only \$858, for quantities of 5 units.

CIRCLE NO. 377

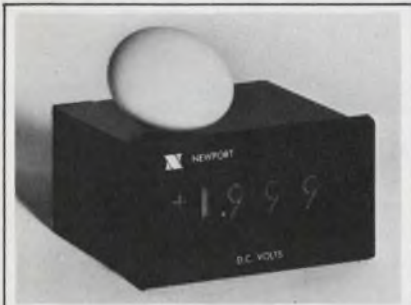

±1,999 count DPM, \$139 single quantity, Series 200A. 5 ranges of DC voltage and current. Automatic polarity, accuracy 0.05% FS ±0.1% R, standard isolated BCD outputs with remote control, up to 60 rdgs./sec. Display blanking, +, - and OL display, aluminum shield-case, 3 mounting styles. Newport Labs, Santa Ana, Ca., (714) 540-4914.

Information Retrieval Number 110



Series 2000 high performance, ±19,999 count DPM, 0.01% accuracy, integral guard-shield, bipolar input, isolated BCD outputs. Ratio option for external reference, 3-pole active filter, 40,000 counts optional, 30 readings/sec. Ranges from 20.000mv DC and 200.00mv AC, \$385. Newport Labs, Santa Ana, Ca., (714) 540-4914.

Information Retrieval Number 111



Series 400A: Low cost ±3,999-count DPM with automatic polarity, 5 ranges of DC voltage and current; accuracy 0.05% FS ±.1% R, resolution 0.025% FS. Isolated and buffered BCD outputs, up to 60 readings/sec, with external control. Display blanking, aluminum shield-case, 3 mounting styles, \$169. Newport Labs, Santa Ana, Ca., (714) 540-4914.

Information Retrieval Number 112



Model 650 Counter eliminates ±1 count ambiguity (Syncrostart). DC to 20MHz Counter-Timer with automatic sensitivity control measures frequency, period, multiple period, time interval, ratio, multiple ratio, totals, cumulative totals, events/gate, cumulative events/gate; 2X10⁻⁶ crystal. 5, 6, and 7 decades \$545. Itron Corp., San Diego, Ca., (714) 540-4914.

Information Retrieval Number 113



Model 800 Digital Data Printer, compact 5¼"H x 8½"W, up to 21 columns, 2.8 lines/sec., programmable 2-color printing and format, controlled decimal points for ranging, column inhibit. Optional digital clock, digital accumulator, input storage, fan-fold or roll paper, \$895 for 7 BCD input columns. Newport Labs, Santa Ana, Ca., (714) 540-4914.

Information Retrieval Number 114



DC to 200 MHz Counter-Times \$895. Model 680 measures frequency, period, multiple period, time interval, ratio, multiple ratios, totals, events per gate, divides, 2X10⁻⁶ crystal. Automatic sensitivity control obviates manual adjustments of trigger sensitivity and Syncrostart (eliminates ±1 count ambiguity). Itron Corp., San Diego, Ca., (714) 540-4914.

Information Retrieval Number 115



Digital Comparators, \$135, Series 270 for instantaneous warning or control feedback. Limits to ±99999 selectable by thumbwheel switches or remote inputs. Compares in 1μSec. Interfaces to BCD or binary digital sources. Contact closure, Hi-Lo lamps and IC-level outputs. Multiple comparators interconnect for batching, sorting. Newport Labs, Santa Ana, Ca., (714) 540-4914.

Information Retrieval Number 116

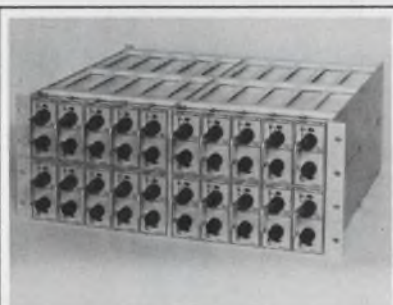

Series 60/70 Data Amplifiers measure DC to 100KHz with gains of 1 to 5000; 133db rejection of 300V common mode, integral AC power supply, 10 units per 3.5" H rack, optional 4-pole filters, input calibration switching, dual outputs, MUX switch, galvo-driver output, zero suppression, oscillograph calibrator. Newport Laboratories, Santa Ana, Ca., (714) 540-4914.

Information Retrieval Number 117



New Series 2600 Precision Digital Thermometers for type J, K, T, S, R and E Thermocouples. Display ±°F or ±°C up to 3800.0 Covers entire thermocouple range. Integral reference junction, 58-segment digital linearization, automatic zero, isolated BCD outputs, break detection and overdrive protection, \$750. Newport Laboratories, Santa Ana, Ca., (714) 540-4914.

Information Retrieval Number 118

Advertiser Specs—Supply glossy photo of product and approximately 40 words which will set no more than 10 lines of 34 characters each AFTER SUBMISSION NO COPY CHANGES CAN BE ACCEPTED. Quick Ads cost only \$300 per insertion, less for frequency advertisers.

Electronic Design

ELECTRONIC DESIGN'S function is:

- To aid progress in the electronics manufacturing industry by promoting good design.
- To give the electronic design engineer concepts and ideas that make his job easier and more productive.
- To provide a central source of timely electronics information.
- To promote two-way communication between manufacturer and engineer.

Want a subscription? ELECTRONIC DESIGN is sent free to qualified engineers and engineering managers doing design work, supervising design or setting standards in the United States and Western Europe. For a free subscription, use the postfree application form inside the back cover. If none is included, write to us direct for an application form.

If you do not qualify, you may take out a paid subscription for \$25 a year in the U.S.A., \$35 a year elsewhere. Single copies are \$1.50 each.

If you change your address, send us an old mailing label and your new address; there is generally a prepaid postcard for this inside the back cover. You will have to requalify to continue receiving ELECTRONIC DESIGN free.

The accuracy policy of ELECTRONIC DESIGN is:

- To make reasonable efforts to ensure the accuracy of editorial matter.
- To publish prompt corrections whenever inaccuracies are brought to our attention. Corrections appear at the end of the Letters column.
- To refuse any advertisement deemed to be misleading or fraudulent.

Microfilm copies are available of complete volumes of ELECTRONIC DESIGN at \$19.00 per volume, beginning with Volume 9, 1961. Work is now in process to complete the microfilm edition of Volumes 1-8. Reprints of individual articles may be obtained for \$2.00 each, prepaid (\$.50 for each additional copy of the same article) no matter how long the article. For further details and to place orders, contact the Customer Services Department, University Microfilms, 300 North Zeeb Road, Ann Arbor, Michigan 48106; telephone (313) 761-4700.

Want to contact us? If you have any comments or wish to submit a manuscript or article outline, address your correspondence to:

Editor
ELECTRONIC DESIGN,
850 Third Avenue,
New York, N.Y. 10022.

Design Data from

PC Drafting Aids Catalog

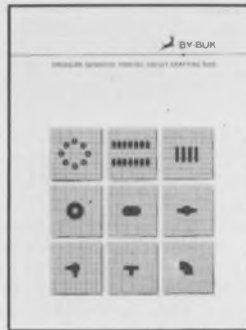

By-Buk Company
Subsidiary of Webtek Corp.
4326 W. Pico Blvd.
Los Angeles, California 90019
(213) 937-3511

Thousands of time saving, cost saving artwork ideas are found in the By-Buk P-50 catalog of pressure sensitive printed circuit drafting aids. With the most practical artwork patterns for: TO cans, multi-pads, dual-inlines and flat packs featured. Donuts, connector strips, teardrops, ovals, tapes, tees, elbows, etc., by the hundreds are included in the most comprehensive list of sizes. Opaque black, transparent red and transparent blue materials for one and two-sided board designs. For a free copy and samples, write today.

CIRCLE NO. 171

How To Write Technical Articles



Electronic Design
850 Third Avenue
New York, N.Y. 10022

A guide for the engineer-author, "How to Write Articles for Electronic Design" shows how easy it is to write for publication—once the engineer knows what to write and how to write it. The Author's Guide includes a complete run-down of the types of articles published by Electronic Design—plus detailed instructions on how to prepare technical articles and short special features. A MUST for every "would-be-writer" in the electronics industry. Send for your complimentary copy by circling the number to the right.

CIRCLE NO. 172

FUNDAMENTALS OF INTEGRATED CIRCUITS

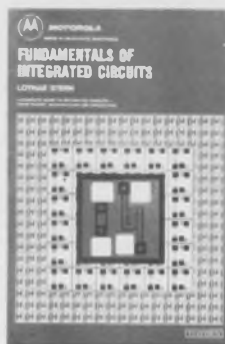

Hayden Book Company, Inc.
116 West 14th Street
New York, N.Y. 10011

A practical guide to integrated circuits, their theory, manufacture, and applications. This new guide by Lothar Stern offers complete, highly readable coverage of the various techniques of circuit fabrication, and their effect on circuit design and performance. As to marketing considerations, it compares the characteristics of the numerous IC structures devised to date in terms of economics and logistics. A volume in the **Motorola Series in Solid-State Electronics**. 198 pages, 7 x 10, illustrated. \$8.95, clothbound. Circle the reader-service number below for 15-day examination copies.

CIRCLE NO. 173

Manufacturers

Advertisements of booklets, brochures, catalogs and data sheets. To order use Reader-ServiceCard (Advertisement)

Get Detailed Analysis Of Spectra To 0.02 Hz Bandwidth

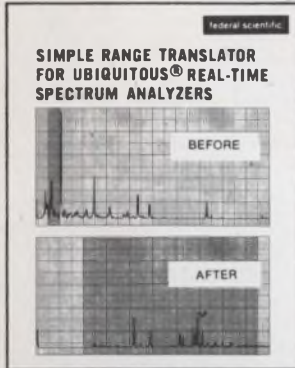

New 30A Range Translator selects narrow bands of frequency, translates them down so they can be analyzed by a Ubiquitous® Low Frequency Real-Time Spectrum Analyzer. (Special version feeds FFT computer inputs, etc.) Selects bands with widths of 20 kHz, 10 kHz, 2 kHz, 1 kHz. Up to 7 ranges supplied, the lowest 10 Hz. Ideal for expansion of small sections of spectrum for detailed analysis. With 500-line UA-6B Analyzer on 10 Hz scale, nominal bandwidth is 0.02 Hz. Customize: you can order even one range. Inexpensive low frequency oscillator can be used; or up to 10 precision oscillator steps can be integral to 30A.

CIRCLE NO. 174

Federal Scientific Corporation
a subsidiary of Elgin National Industries, Inc.
615 West 131st Street, New York, N. Y. 10027

Circuit Zaps® for Instant PC Boards



Circuit Zaps® are 1 ounce copper circuit component patterns, pads, and conductor paths, precision-etched on 5 mil (.005") glass epoxy base material, backed by a special pressure-sensitive adhesive. Circuit Zaps® completely eliminate the artwork, photography, photoprinting, touch up, etching, stripping, and other time-consuming steps in PC board development.

Write today for the FREE TECHNICAL BULLETIN 1003 with FREE SAMPLE.

CIRCLE NO. 175

Bishop Graphics, Inc.
7300 Radford Avenue (ED)
North Hollywood, California 91605
(213) 982-2000 Telex 674672

Dynaload – Solid State Electrical Load



A new technical bulletin presents valuable engineering suggestions to save many dollars and hours in special or production testing of power supplies, servo systems, DC generators and similar power equipment, through the substitution of a single inexpensive test instrument to replace a multitude of specially designed test equipment. The Dynaload offers resistance current or voltage loads over wide dynamic ranges. The brochure illustrates typical setups for testing power supplies, batteries, circuit breakers, etc., and gives specifications for units ranging from 100 to 3000 watts, 0 to 400 volts and 0 to 150 Amps. For your copy, please write:

CIRCLE NO. 176

Transistor Devices, Inc.
85 Horsehill Road, Cedar Knolls, N. J. 07927
Tel. (201) 267-1900

Electronic Design

Advertising Sales Staff

Keith Aldrich
Sales Manager

New York 10022

Robert W. Gascoigne
Samuel M. Deitch
Daniel J. Rowland
850 Third Avenue
(212) Plaza 1-5530
TWX: 710-581-2874

Philadelphia 19025

Mort Sullivan
P.O. Box 126
Dresher, Pa.
(215) 884-6880

Boston 02154

Joseph F. Palmer
1268 Main Street
Waltham, Mass.
(617) 894-2700

Chicago 60611

Thomas P. Kavooras
Berry Conner, Jr.
200 East Ontario
(312) 337-0588

Cleveland

Thomas P. Kavooras
(Chicago)
(312) 337-0588
(call collect)

Los Angeles 90303

Stanley I. Ehrenclo
Burt Underwood
2930 Imperial Highway
Inglewood, Calif.
(213) 757-0183

San Francisco 94022

Jerry D. Latta
95 Main Street
Los Altos, Calif.
(415) 941-3084

London W. 1

For United Kingdom and Holland
Brayton C. Nichols

For Eastern Europe

Peter Kehrer

The American Magazine Group

27 Maddox Street
London, W. 1, England
Phone: 499-0180

Cable: Ammagnic, London

Verviers, Belgium

For Continental Europe

Andre Jamar
1, Ru Mallar, 1
087) 253.83 Telex 41563

Tokyo

Haruki Hirayama
Electronic Media Service
5th Floor, Lila Bldg.,
4-9-8 Roppongi
Minato-ku
Phone: 402-4556
Cable: Electronicmedia, Tokyo

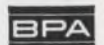

THINK DIGITAL

Brite, new 7-segment fiber-optic readout features compact size & low-current drain. Digits are 0.350" high. A 5-Digit display dissipates about 1-watt; stays cool. 2.5V, 20 mA/segment. Accessories available.

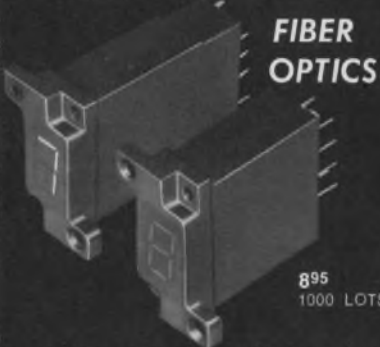

ALCO® ELECTRONIC PRODUCTS, LAWRENCE, MASS.

INFORMATION RETRIEVAL NUMBER 64

7-SEGMENT NEON

New series of single plane 7-segment neon readouts for brighter & wider angle viewing. Only .41" dia. Displays 0-9, some alpha & decimal. Long-life operation. 4.95 each or 2.69 in 1000 lots.



ALCO® ELECTRONIC PRODUCTS, LAWRENCE, MASS.

INFORMATION RETRIEVAL NUMBER 65

WORLD'S NO. 1 MINIATURES

The original miniature switch is available with standard, flat, long and plastic toggles. Normally supplied with silver contacts. Gold-plating or P.C. terminals are available on request. Common 1/2" case size. Rate 5A @ 115VAC.



ALCOSWITCH® 124 STYLES ON THE SHELF FOR IMMEDIATE DELIVERIES. DIV. OF ALCO ELECTRONIC PRODUCTS, INC., LAWRENCE, MASS.

INFORMATION RETRIEVAL NUMBER 66

ROCKER SWITCH U/L RATED

Low-cost rocker switch has high current in 1/2" case. 100,000 on-off operations. Low-silhouette rocker. U/L approved. Choice of SPST on-off @ 85¢ ea., SPDT on-on @ 95¢ ea.



ALCOSWITCH® 10A @ 125 VAC. DIV. OF ALCO ELECTRONIC PRODUCTS, INC., LAWRENCE, MASS.

INFORMATION RETRIEVAL NUMBER 67

advertiser's index

Advertiser	Page
Abbott Transistor Laboratories Incorporated	6
Accutronics, Inc.	97
Acopian Corp.	84
Airpax Electronics, Cambridge Division	69
Alco Electronic Products, Inc.	102
Allen-Bradley Co.	4, 5
Amphenol Components Group	12
Analog Devices, Inc.	61
Analogic Corporation	45
Arnold Magnetics Corporation	103
Astro-Optics, Inc.	104
Augat, Inc.	95
Belden Corporation	25
Bell, Inc., F. W.	103
Bishop Graphics, Inc.	101
By-Buk Company	100
Centralab, the Electronics Division of Globe-Union, Inc.	17
Cincinnati Milacron Company	Cover III
Coto Coil Company, Inc.	94
Dale Electronics, Inc.	Cover II
Datak Corporation, The	97
Datapac Incorporated	38
Dow Corning Corporation	30, 31
ERA Transpac Corporation	32
Elco Corporation	15
Electronic Design	103
European Electronic Products Corporation	96
Federal Scientific Corporation	101
Fifth Dimension, Inc.	7, 97
General Electric Company, Lamp Glass Dept.	37
Hayden Book Company, Inc.	100
Heath Company	97
Heinemann Electric Company	83
Hewlett-Packard	1
Hewlett-Packard, New Jersey	33
Hipotronics, Inc.	98
Hudson Lamp Company	46
Hughes Aircraft Company	92
ISE Electronics Corporation	64
ITT Cannon Electric, A division of International Telephone and Telegraph Corp.	11
Industrial Electronic Engineers, Inc.	85
Intel Corporation	8, 9
Itron Corporation	99
Levinson, Harry	97
Licon, Division Illinois Tool Works, Inc.	57
MicroSwitch, A Division of Honeywell	42
Microwave Filter Company, Inc.	104
Molex, Incorporated	21
Monsanto Electronic Special Products	75
Motorola Component Products Dept.	10
National Semiconductor Corporation	29
North Atlantic Industries, Inc.	77
Nytronics, Inc.	13
Oak Manufacturing Co.	18
Philips Electronic Components and Materials Division	2, 68
Pomona Electronics Co., Inc.	95
Potter & Brumfield Division of AMF Incorporated	44
Power/Mate Corporation	97
Power-Tec, Inc.	36
RCA Electronic Components and Devices	Cover IV
RCA Solid State Division	97
Raytheon Company, Semiconductor Operation	48
Rustrak Instrument Division	97
Siemens Corporation	2
Siliconix Incorporated	73
Solid State Scientific, Inc.	93
Solitron Devices, Inc.	43, 65
Sperry Information Displays Division	81
Stackpole Components Company	86, 87
Tecnetics	97
Technical Wire Products, Inc.	104
Tektronix, Inc.	41
Teledyne Philbrick	88, 90, 92, 94
Teletype Corporation	34, 35
Transistor Devices, Inc.	101
Trio Laboratories, Inc.	89
Unitrode Corporation	27
Wang Laboratories, Inc.	91
Wescon	16
Xerox Data Systems	14

**The heart of
our gaussmeter is
so good, even our
competitors use it.**

The Hall generators that we make for our own gaussmeters are so accurate and dependable, our competitors even use them. But that's where the similarity ends. We have other special features like internal calibration, temperature stable probes, and many more items that are covered in our gaussmeter brochure. Write to: 4949 Freeway Drive East, Columbus, Ohio 43229.

E.W. Bell Inc. A member company
A subsidiary of The Arnold Engineering Co.

INFORMATION RETRIEVAL NUMBER 68

OP AMP & LOGIC POWER

The PHV-30 CT-5 provides regulated ± 15 VDC @ 500 ma and 5 VDC @ 2 amps in one 21 cubic inch package ($1\frac{1}{8} \times 3\frac{5}{8} \times 3\frac{1}{2}$). Weight is only 27 oz. Input: 115 Vrms, 50-500 Hz



ARNOLD MAGNETICS CORPORATION

11520 W. JEFFERSON BLVD. · CULVER CITY, CA 90230 · (213) 870-7014

VOL. 51

INFORMATION RETRIEVAL NUMBER 69

2800 STANDARD

POWER CONVERTERS

YOU SPECIFY:

Input: 5 thru 150 volts, AC or DC

Output:

Single, dual or triple

2 thru 5000 VDC

1.5 thru 150 watts

0.1%, 1.0% or unregulated

Options: Crowbar overvoltage, remote adjust, input voltage alteration, etc. . . .



ARNOLD MAGNETICS CORPORATION

11520 W. JEFFERSON BLVD. · CULVER CITY, CA 90230 · (213) 870-7014

V2Z-61

INFORMATION RETRIEVAL NUMBER 70

Reprints available

Individual or multiple copies of the following

ELECTRONIC DESIGN special features are available:

Report	Per copy cost
A. Civionics report: High-speed ground transportation (8 pages)	\$1.00
B. Optoelectronic components and system design (20 pages)	\$3.00
C. Focus on instrumentation—where it's at and where it's going (13 pages)	\$2.00
D. Civionics report: Ground traffic control (8 pages)	\$1.00
E. The minicomputer and the engineer (40 pages)	\$3.75

Please send me the following:

_____ copies of report A

_____ copies of report B

_____ copies of report C

_____ copies of report D

_____ copies of report E

NAME _____

ADDRESS _____

-MAIL TO-

William E. Smith
Hayden Publishing Co.
50 Essex St.
Rochelle Park, New Jersey 07662

NOTE: Payment must accompany order.

SOMETHING'S HAPPENED TO FIBER OPTICS TECHNOLOGY



Paul Fyfe

...renowned father of synthetic fiber optics

AND



4718 Pennypack Street Philadelphia, Penna. 19136
(215) DE 8-5713

... a new leader in the field of synthetic fiber optics, offering fast delivery on high quality optical fibers from 3 mils to 60 mils with tolerances to $\pm .0001$.

WATCH THEM BOTH!

INFORMATION RETRIEVAL NUMBER 71

MICROWAVE ABSORBER STOCK



Catalog & Application Data

IMFC MICROWAVE
FILTER
COMPANY, INC.

135 WEST MANLIUS STREET
EAST SYRACUSE, NEW YORK 13057
(315) 437-4529

INFORMATION RETRIEVAL NUMBER 72

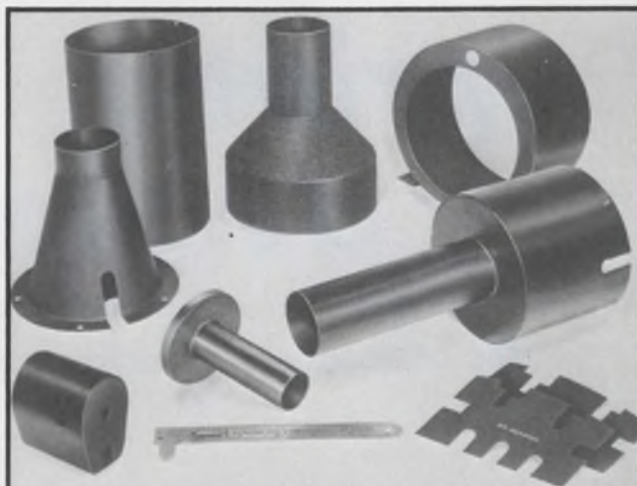

MAGNETIC SHIELDS AND MATERIALS

PRIMAG 90 ■ High permeability ■ For low to medium coercive forces
PRIMAG 40 ■ High saturation ■ Suitable for high coercive forces
LAMINATED 40/90 ■ For high and low level shielding
■ Ductile materials ■ Strain and shock resistant
■ Low retentivities ■ No periodic annealing
Shields for cathode ray, photomultiplier, scan conversion and traveling wave tubes, and recording heads
■ Standard sheets and foils ■ Write for Data #680.

TECKNIT TECHNICAL WIRE PRODUCTS, INC.

East Division • 129 Dermody St., Cranford, N. J. 07016 (201) 272-5500
West Division • 427 Olive St., Santa Barbara, Calif. 93101 (805) 963-1867

INFORMATION RETRIEVAL NUMBER 73

a thought about you...

Neglected

Truly a sad situation. But it's not sympathy the OEM user needs, it's help. We at Cincinnati Milacron can offer you that help — and minicomputers that are in perfect harmony with your application.

When you order minis from Cincinnati, you get not only reliable, general-purpose computers, but our personal, expert attention. We feel that good hardware delivered on time is just not enough, so we make sure our minis are custom-fitted to your system. Then we teach you how to use and maintain them for top efficiency. And no matter where you are, we have a Cincinnati Milacron field service man stationed nearby so that your system will always make beautiful music.

Give us a call. We won't neglect you.



minicomputers

**CINCINNATI
MILACRON**

Cincinnati Milacron Company | Cincinnati, Ohio 45209

**Machine Tools
Process Controls
Chemicals
Plastics
Plastics Processing Machinery
Abrasives**

Cincinnati area (513) 494-5444 • Chicago area (312) 439-5726 • Los Angeles area (213) 582-8361 • Detroit area (313) 557-2700 • New York area (201) 687-4500

INFORMATION RETRIEVAL NUMBER 122

Now 3 zero-voltage switches to trigger your thyristors

Here's new flexibility and economy for your zero-crossing Thyristor trigger application—3 RCA zero-voltage switches give you the exact combination of price and performance your application demands.

RCA Zero-Voltage Switches offer:

- Thyristor triggering at zero-voltage crossing for minimum RFI in 50, 60, and 400 Hz applications.
- Self-contained dc power supply

with provision for supply of dc bias current to external components.

- Built-in protection against sensor failure (in CA3058 and CA3059).
- External provision for zero-current switching with inductive loads. Provision for adding hysteresis or proportional control.
- Recommended for use with RCA's 2.5-40 amp., 100-600 volt series triacs, types 40693-40734. These RCA triacs

are rated for operation with the CA3058, CA3059 and CA3079.

For further information see your local RCA Representative or RCA Distributor. For technical data bulletin file Nos. 406 and 490 and Application Notes ICAN-6158 and ICAN-6268, write: RCA, Commercial Engineering, Harrison, N.J. 07029. International: RCA, Sunbury-on-Thames, U.K., or P.O. Box 112, Hong Kong, or Ste. Anne de Bellevue, 810 Quebec.



FULL-FEATURE PERFORMANCE PLUS ECONOMY
CA3059 in 14-LEAD DIP
Built-in protection,
-40°C to +85°C operation
\$1.95 (1000-UNIT LEVEL)

NEW ECONOMY TYPE
CA3079 in 14-LEAD DIP
-40°C to +85°C operation
\$.99 (1000-UNIT LEVEL)



NEW FOR FULL MILITARY TEMPERATURE RANGE
CA3058 in 14-LEAD DIC
Premium performance,
-55°C to +125°C operation
\$3.50 (1000-UNIT LEVEL)

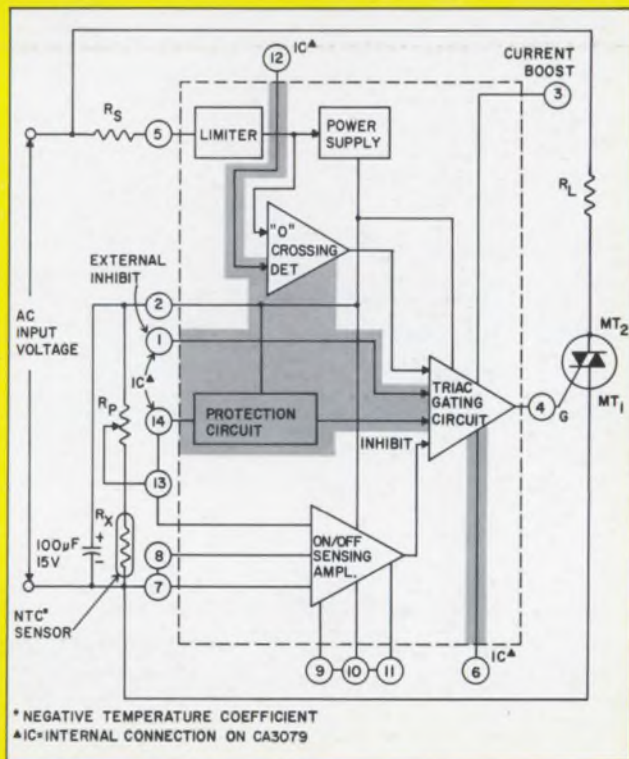

Features

- 24V, 120V, 208/230V, 277V at 50, 60, or 400 Hz operation
- Differential Input
- Low Balance Input Current (max.)- μ A
- Built-in Protection Circuit (Fail-Safe) for opened or shorted sensor (Term. 14)
- Sensor Range (R_x)- $k\Omega$
- DC Mode (Term. 12)
- External trigger & inhibit (Terms. 6 & 1)
- DC Supply Volts (max.)

	CA3058	CA3059	CA3079
24V, 120V, 208/230V, 277V at 50, 60, or 400 Hz operation	✓	✓	✓
Differential Input	✓	✓	✓
Low Balance Input Current (max.)- μ A	1	1	2
Built-in Protection Circuit (Fail-Safe) for opened or shorted sensor (Term. 14)	✓	✓	✓
Sensor Range (R_x)- $k\Omega$	2 to 100	2 to 100	2 to 50
DC Mode (Term. 12)	✓	✓	✓
External trigger & inhibit (Terms. 6 & 1)	✓	✓	10
DC Supply Volts (max.)	14	14	10

RCA Solid State