

# Electronic Design 15

VOL. 18 NO.

FOR ENGINEERS AND ENGINEERING MANAGERS

JULY 19, 1970

**Semiconductor memories** are in—most experts will agree. They can be tailored for speed, size or low cost, and are already widely used in read-only applications.

But for random-access, read-write use, core memories are still king, and plated wire is making strides. How, then, can a designer best choose a memory? See page 70.

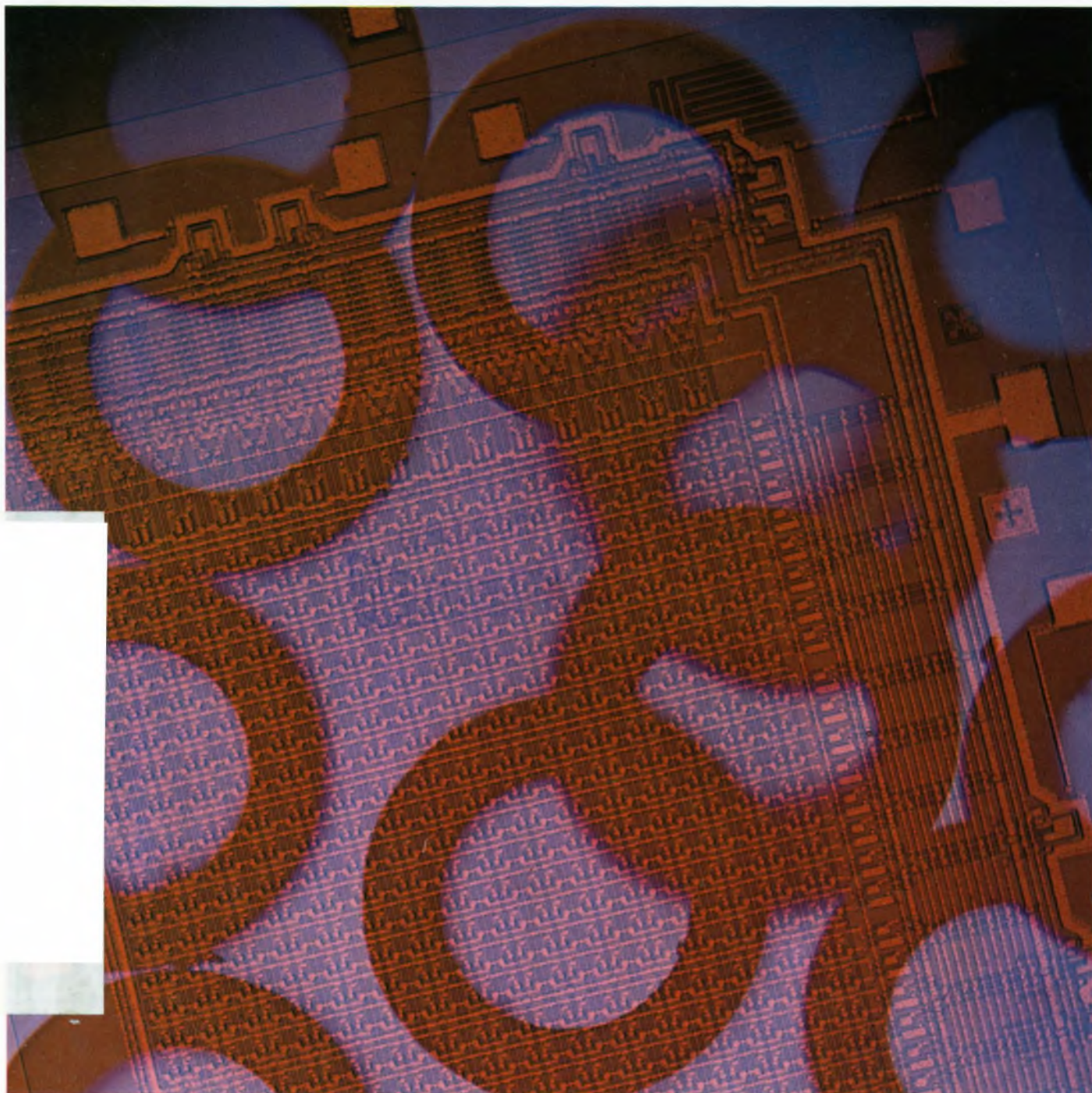



## Trounce trimmer troubles with Dale Industrial and Commercial T-Pots

RCA's widely-used Spectra 70 computer is a good example of Dale Trimmers' year-in, year-out dependability. The models shown here are from Dale's 2100 wirewound series...sealed to meet tough RCA immersion requirements. Used in a number of Spectra 70 control and voltage reference applications, they're part of Dale's workhorse line of industrial and commercial trimmers. Nothing fancy...but you get what you need, when you need it—and you can use all you receive. Dale trimmers have a record of less than 1% customer rejection for *all* causes. Join the growing number of trimmer users who've found there's less trouble when you specify Dale.

**Call 402-564-3131 for complete information or write for Catalog B.**



### DALE ELECTRONICS, INC.

1300 28th Ave., Columbus, Nebr. 68601  
In Canada: Dale Electronics Canada, Ltd.  
A subsidiary of The Lionel Corporation

#### COMMERCIAL GRADE ECONO-TRIM T-POTS



##### WIREWOUND ELEMENT

**2300 Series:** Sealed/Unsealed; 10Ω to 50KΩ, ±10%; 0.5 watt at 25°C, derated to 0 at 105°C; .36 H x .28 W x 1.00 L.

**2400 Series:** Sealed/Unsealed; 10Ω to 50KΩ, ±10%; 1 watt at 40°C, derated to 0 at 125°C; .31 H x .16 W x .75 L.

##### FILM ELEMENT

**8300 Series:** Sealed/Unsealed; 10Ω to 2 Meg., ±10% 100Ω thru 500K, ±20% all other values; .75 watt at 25°C, derated to 0 at 105°C; .36 H x .28 W x 1.00 L.

#### INDUSTRIAL GRADE T-POTS



##### WIREWOUND ELEMENT

**100, 200, 300 Series:** 10Ω to 100KΩ.

100 Series: ±5%; 0.8 watt at 70°C, derated to 0 at 135°C.

200 Series: ±10%; 0.5 watt at 70°C, derated to 0 at 105°C.

300 Series: ±15%; .25 watt at 70°C, derated to 0 at 85°C.  
Dimensions: .22 H x .31 W x 1.25 L (also 1.32 L for 100, 200).

**1100 Series:** 10Ω to 100KΩ, ±10%; 1 watt at 70°C, derated to 0 at 175°C; .28 H x .31 W x 1.25 L.

**2100 Series:** Industrial counterpart RT-11; 10Ω to 100KΩ, ±10%; 1 watt at 70°C, derated to 0 at 125°C; .28 H x .31 W x 1.25 L.

**2200 Series:** Industrial counterpart RT-10; 10Ω to 100KΩ, ±10%; 1 watt at 70°C, derated to 0 at 125°C; .18 H x .32 W x 1.00 L.

##### FILM ELEMENT

**8100 Series:** Industrial counterpart RJ-11; 10Ω to 2 Meg., ±10% 100Ω to 500K, ±20% other values; .75 watt at 70°C, derated to 0 at 125°C; .28 H x .31 W x 1.25 L.

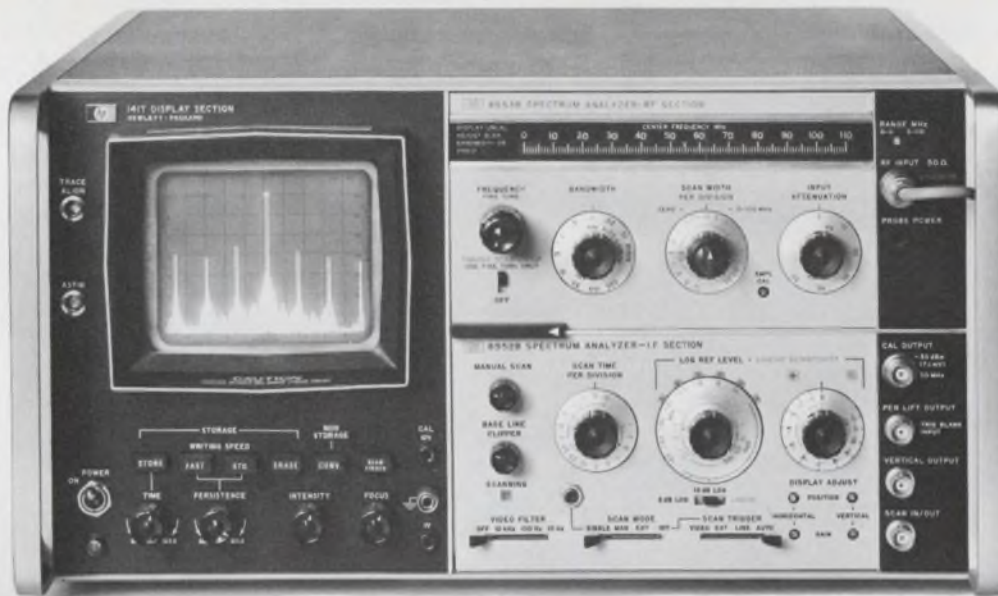

## How do you improve the world's best spectrum analyzer?



## Add counter accuracy and a tracking signal source.

Combine HP's new 8443A Tracking Generator/Counter with the HP 110 MHz Spectrum Analyzer and you can make the most precise, complete frequency-domain measurements ever. The 8443A produces a visible marker that you can place anywhere on the spectrum analyzer display and immediately get 10 Hz resolution digital measurement of that point. The 8443A is more, too: a precision signal source that will make swept measurements over a 120 dB range and still produce the marker to determine any specific frequency with counter accuracy.

The 8553B/8552B Analyzer itself covers 1 kHz to 110 MHz with scans as wide as 100 MHz and as narrow as 200 Hz. It provides absolute amplitude calibration, better than -130 dBm sensitivity, over 70 dB dynamic range, 10 Hz resolution, plus exceptional stability (<1Hz FM) and flatness. The 8443A capitalizes on all the qualities of the analyzer to function both as an accurate frequency counter and as a precision source for complete swept frequency measurements.

With the system you can make much more precise design and production

line measurements of filters, mixers, modulators, oscillators, amplifiers and RF systems. For example, you can now:

- measure to 10 Hz the frequency of nanovolt signals in the presence of much larger ones. Use the tuneable marker to find the signal and measure its frequency on the 8443A counter readout. You can easily identify IM distortion products, hum sidebands, spurious signals, and the like, because the 8443A is a frequency-selective counter with the analyzer's incredible sensitivity.
- completely characterize devices such as narrowband, high Q devices with simple, quick measurements. Use the tracking generator to sweep the spectrum and measure the frequency of any point on the response curve to 10 Hz. You can precisely measure passband flatness and shape factor on filters as narrow as 20 Hz, and make swept-reflection or return loss measurements. In other words, the tracking generator combines with the analyzer to provide a complete swept test system.

- test and align RF communications systems with unprecedented ease, thoroughness and precision. The high resolution and stability of the analyzer lets you see each and every signal, and the 8443A measures their frequency to 10 Hz. The system is also a natural for surveillance applications since you can scan broad and narrow ranges, resolve all signals of interest and count their frequency.

Call us for a demonstration. The system is easy to set up and you'll find it simple to use as an oscilloscope. If you've already got an HP 110 MHz spectrum analyzer, you can add the tracking generator/counter for \$3500. The high-resolution 8553B/8552B with variable persistence display costs \$6750. Ask your HP field engineer for details. Or write Hewlett-Packard, Palo Alto, California 94304; Europe: 1217 Meyrin-Geneva, Switzerland.

04015

**HEWLETT  PACKARD**  
SIGNAL ANALYZERS

INFORMATION RETRIEVAL NUMBER 2

# We've made our cable line bigger, so you can make things smaller.

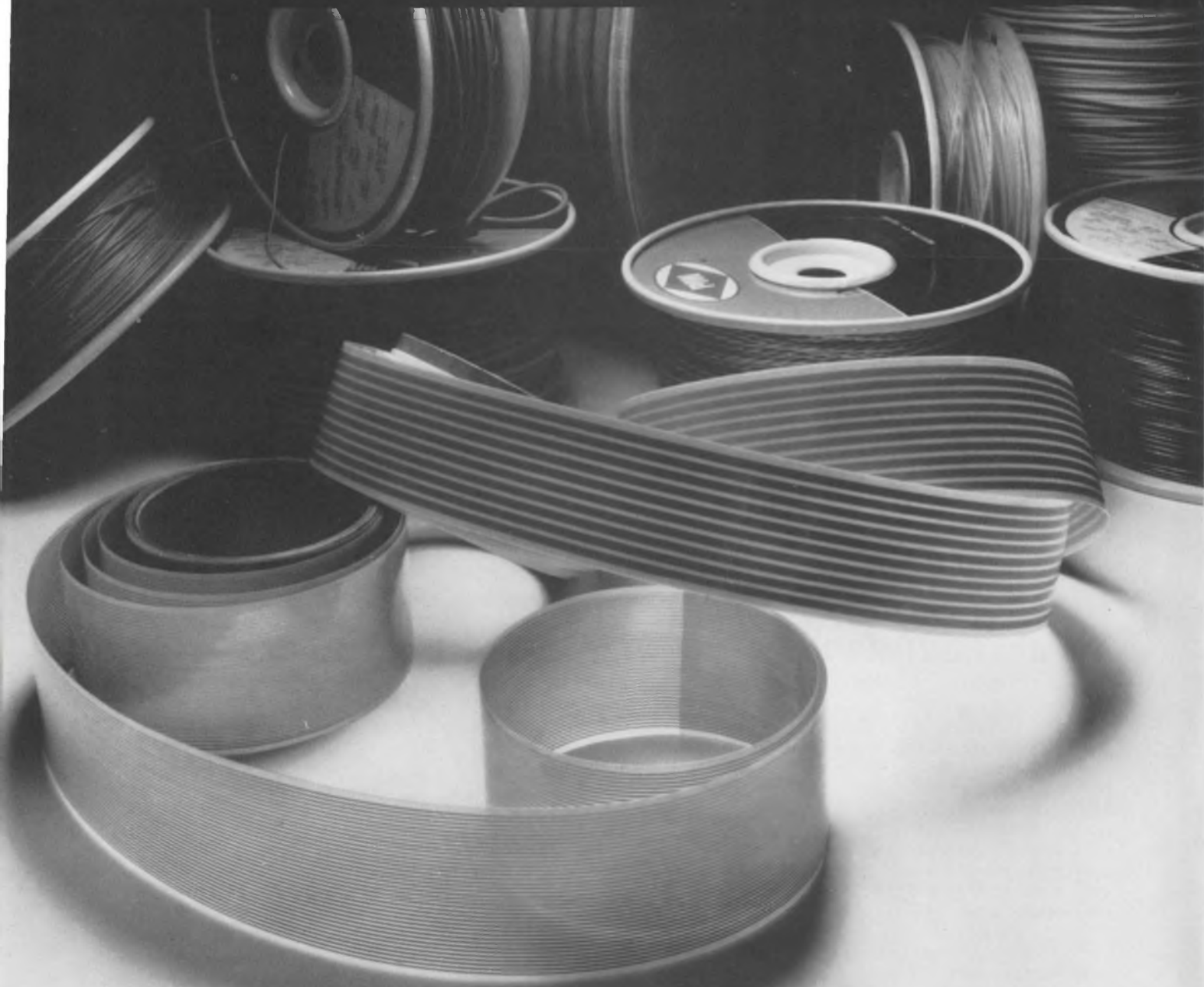

Flat-wire cable can help you make equipment smaller, lighter and lower in cost.

That's nothing new.

What's new is that now you can buy it from Sylvania.

What's more, we've also developed an "instant capability" in flexible insulated wire and cable products.

If you are wondering how we achieved this capability overnight, the answer is simple: We integrated Philadelphia Insulated Wire Co. into our Parts Division.

PIW is one of the oldest wire companies in the country. Although they are old, their capabilities are brand new. Their product line includes wires insulated with Kynar,\* and Teflon.†

Recently, PIW engineers perfected a technique for overcoating Teflon with polyimide enamels to meet the needs of the aircraft industry.

In development operations, they are working with a brand new material, Tefzel.† This resin combines the excellent electrical properties of Teflon with mechanical properties similar to Kynar.

Your Sylvania sales representative now has one of the broadest lines of wire and cable products in the industry. He's the man to talk to when you've got wiring problems.

Sylvania Precision Materials, Parts Division, 12 Second Ave., Warren, Pa. 16365

\*-Trademark of Pennwalt Chemical Company.  
†-Trademark of DuPont.

**SYLVANIA**  
GENERAL TELEPHONE & ELECTRONICS

---

## NEWS

- 21 **News Scope**
- 25 **The 'impossible' communications system**  
Transmitter and receiver operate together on the same channel without interface.
- 28 **Terminals: The big future in computer market**  
But one speaker at IEEE exposition warns of need to improve their performance and to reduce costs
- 30 **Outlook for European electronics: No slump**  
Exhibitors at Mesucora Automation Show in Paris see 10-to-40% general increase in sales this year.
- 33 **Wheatstone bridge adapted to fish counting**
- 36 **Back-panel interconnections go hybrid**
- 44 **Technology Abroad**
- 47 **Washington Report**
- 

## TECHNOLOGY

- 70 **The big memory battle: Semis take on cores.** New challenger has only 0.1% of the random-access memory market today, but in 10 years, some experts say, it will have 90%.
- 80 **For design flexibility, go hybrid.** You can frequently improve circuit performance by mixing monolithic and discrete components.
- 86 **Program your minicomputer in FOCAL.** This conversational language conserves memory and is adaptable to many applications.
- 92 **Watch your specs!** Get the most from instrument transformer vendors by defining performance, not design.
- 98 **Contracts aren't won by accident**—they are captured by outlines that are planned to win, says this proposal manager.
- 104 **Ideas for Design**
- 113 **Product Source Directory:** Semiconductor Memories
- 118 **Desk-top Calculators**
- 

## PRODUCTS

- 123 **Modules & Subassemblies:** Pin-programmable op amps can vary their gain.
- 131 **Data Processing:** Ultra-stable plated-wire memories use epoxy fiber.
- 134 **Instrumentation:** Pulse generator for \$395 gives 5-V output at 50 MHz.
- |                           |                              |
|---------------------------|------------------------------|
| 125 ICs & Semiconductors  | 137 Microwaves & Lasers      |
| 129D Components           | 138 Tools & Engineering Aids |
| 136 Packaging & Materials | 156 Product Index            |
- 

## Departments

- 69 **Editorial:** Can we afford the price of engineering unemployment?
- |                        |                        |
|------------------------|------------------------|
| 13 Designer's Calendar | 144 Application Notes  |
| 52 Sidelights          | 146 New Literature     |
| 140 Evaluation Samples | 150 Bulletin Board     |
| 141 Design Aids        | 154 Advertisers' Index |
- 142 Annual Reports

Information Retrieval Service Card inside back cover

**Cover:** Cores superimposed over semiconductor memory. Photo by Richard Steinheimer.

---

ELECTRONIC DESIGN is published biweekly by Hayden Publishing Company, Inc., 850 Third Avenue, New York, N.Y. 10022. James S. Mulholland, Jr., President. Printed at Brown Printing Co., Inc., Waseca, Minn. Controlled circulation postage paid at Waseca, Minn., and New York, N.Y. Copyright © 1970, Hayden Publishing Company, Inc. 82,501 copies this issue.

# Fight noise pollution

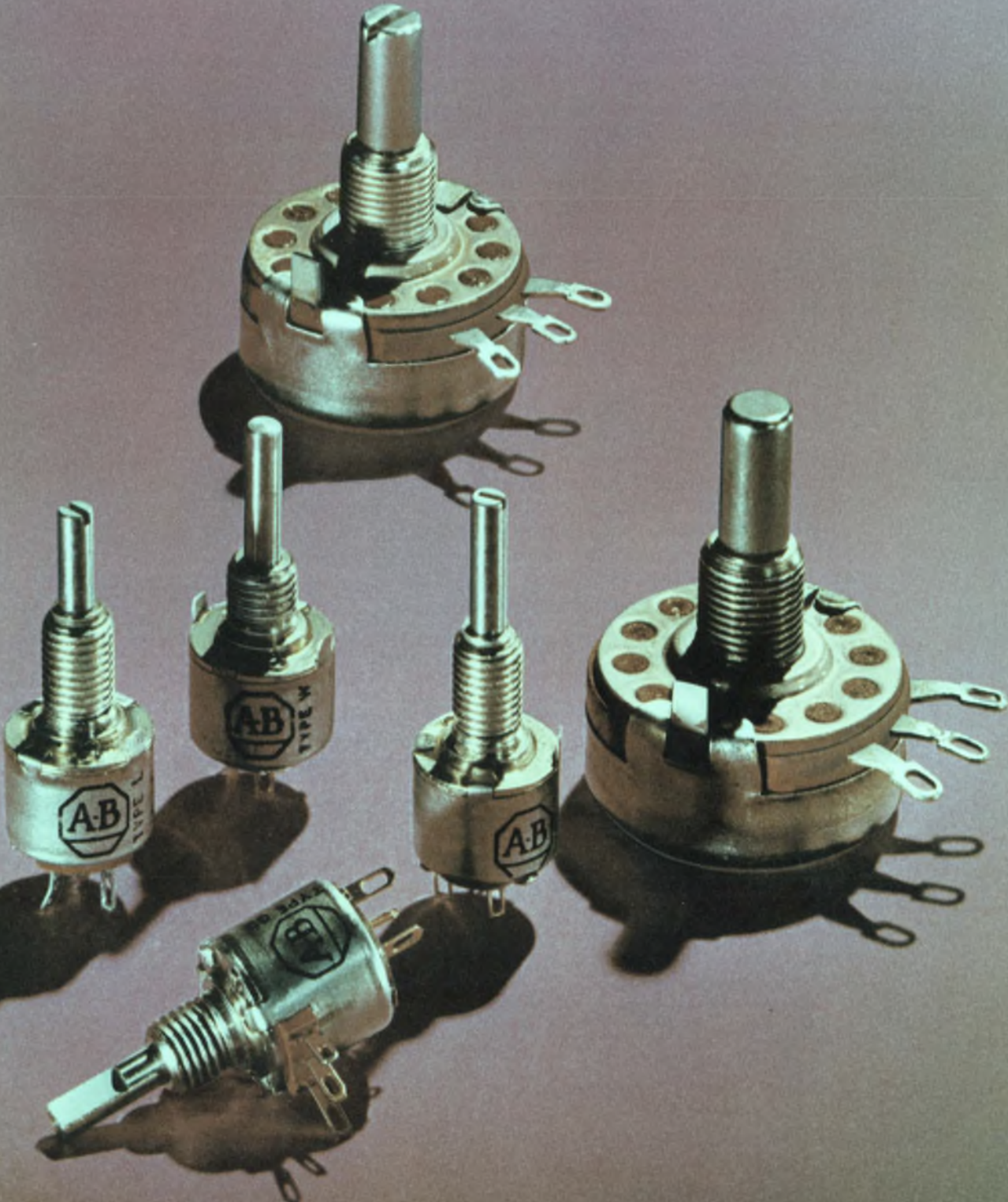

# with this quiet family.

Hot Molding with Allen-Bradley's exclusive technique, gives these composition variable resistors an unusually low noise level. And importantly, this low noise level actually decreases in use. Under tremendous heat and pressure the resistance track is molded into place. A solid element with a large cross-section is produced.

This important Allen-Bradley difference means better short-time overload capacity and a long operating life. Control is smooth, resolution almost infinite. These variable resistors are ideal for high frequency circuits. Why should you trust the performance of

your designs or your reputation to anything less than Allen-Bradley quality? Use the most thoroughly "field tested" (over 20 years) variable resistors available today. Quantity stocks of popular types J, G, W and GD available for immediate delivery from your appointed A-B industrial electronics distributor.

For information write: Marketing Department, Electronics Division, Allen-Bradley Co., 1201 South Second Street, Milwaukee, Wisconsin 53204. Export office: 1293 Broad Street, Bloomfield, N. J. 07003, U.S.A. In Canada: Allen-Bradley, Canada Ltd., 135 Dundas Street, Galt, Ontario.

## SPECIFICATIONS

	TYPE J— STYLE RV4	TYPE K	TYPE G— STYLE RV6	TYPE L	TYPE W	TYPE GD
CASE DIMENSIONS	5/8" deep x 1-5/32" dia (single section)	5/8" deep x 1-5/32" dia (single section)	15/32" deep x 1/2" dia.	15/32" deep x 1/2" dia	15/32" deep x 1/2" dia.	35/64" deep x 1/2" dia.
POWER at + 70°C	2.25 W	3 W	0.5 W	0.8 W	0.5 W	0.5 W
TEMPERATURE RANGE	-55°C to +120°C	-55°C to +150°C	-55°C to +120°C	-55°C to +150°C	-55°C to +120°C	-55°C to +120°C
RESISTANCE RANGE (Tolerances: ±10 and 20%)	50 ohms to 5.0 megs	50 ohms to 5.0 megs	100 ohms to 5.0 megs	100 ohms to 5.0 megs	100 ohms to 5.0 megs	100 ohms to 5.0 megs
TAPERS	Linear (U), Modified Linear (S), Clockwise Modified Log (A), Counter-Clockwise Modified Log (B), Clockwise Exact Log (DB). (Special tapers available from factory)					
FEATURES (Many electrical and mechanical options available from factory)	Single, dual, and triple versions available. Long rotational life. Ideal for attenuator applications. Snap switches can be attached to single and dual.	Single, dual, and triple versions available. Long rotational life.	Miniature size. Immersion-proof. SPST switch can be attached.	Miniature size. Immersion-proof.	Commercial version of type G. Immersion-proof.	DUAL section version of type G. Ideal for attenuator applications. Immersion-proof.

## ALLEN-BRADLEY

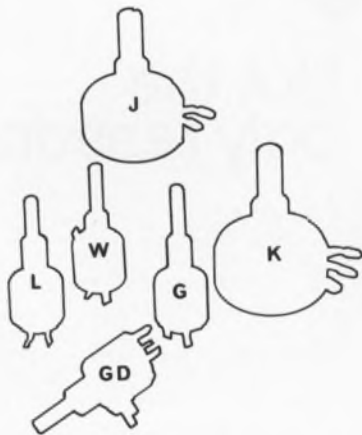

INFORMATION RETRIEVAL NUMBER 4

NEW  
DIMENSION  
ELECTRONICS

Program reliability is the key to a successful minicomputer. And microprogrammed firmware is the lock. Firmware gives the CIP/2000 a memory that can't forget and a program that can't change unless the firmware package is altered.

Firmware makes the computer program reliable. Cincinnati

makes the computer reliable. Sensitive production operations are done in dust-free rooms separated from other air conditioned manufacturing areas by air locks and air showers. We designed and built our own computer controlled testing equipment to check component assemblies and finished computers.

And we do our testing in different temperatures and humidities because systems-oriented computer applications often require operation under hostile conditions.

These are some reasons our mini is the most reliable on the market. For complete information on the minicomputer that starts at less than \$3,100, write to Cincinnati Milacron, Dept. R-54, Lebanon, Ohio 45036. For immediate action, call (513) 494-5444.

# Is Cincinnati firmware the only reason our minicomputer is so reliable?



**Not the only reason.**



**CINCINNATI MILACRON**

Machine Tools/Process Controls/  
Chemicals/Plastics/  
Plastics Processing Machinery/Abrasives

INFORMATION RETRIEVAL NUMBER 5

ELECTRONIC DESIGN 15, July 19, 1970





## Need a function generator? Don't waste your money!

Make sure you get the function generator that best fits your needs... in both price and capability. It's that simple.

Or at least it sounds simple. Then you sit down to make a list of all your technical requirements... present and future. Next you try to match those requirements against all of the instruments available. Finally, you make trade-offs of specific performance features versus X dollars saved.

When you are all done, hopefully you wind up with a function generator that has the best performance/price ratio for your particular needs and budget.

### **But there is an easier way!**

HP manufactures, sells and services a complete line of function generators with a long history of proven performance. Even the newest function generators take advantage of HP's experience and conform to the high quality standards you have come to expect in any HP instrument.

To get all the information you need to determine exactly what you want in a function generator... just turn to page 267 of your 1970 HP catalog. You get more than just a list of products, you get the background information you want to determine your specific needs.

If you need a low-cost general purpose function generator, pay special attention to the HP 3310A. This one does so much that it's actually more than just a function generator.

You not only get the usual sine, square and triangle functions—but both positive and negative going pulses and ramps. Add dc offset, a frequency range of 0.0005 Hz to 5 MHz, all solid-state reliability and a price tag of only \$575 and you will see why we say this one is more than just an ordinary function generator. You save both money and space.

With the HP 3310A you can test and demonstrate the response of differentiator and integrator circuits. Use the triangle output to show how a

sine wave may be synthesized. Use the ramps to demonstrate the action of a comparator circuit.

You can even use a combination of pulses and ramps to simulate the action of a mechanical function to an analog computer. This is a function generator with such potential that you'll be using it for more applications than any other signal source you now own.

If you need more information, just call your local HP field engineer. He will be glad to help you solve any measurement problem you may have. Or, write to Hewlett-Packard, Palo Alto, California 94304. Europe: 1217 Meyrin-Geneva, Switzerland.

090/4

HEWLETT  PACKARD  
S I G N A L S O U R C E S

# To make Decoders that can drive every major display device,

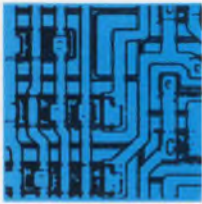

Three Fairchild MSI decoder/drivers cover the requirements of every major military and industrial display device on the market. The 9315. The 9317. And the brand new 9327. Each device has a built-in driver stage—an important feature that means smaller, lower-cost systems with higher reliability.

**NIXIE**—The 9315 One-of-Ten Decoder/Driver accepts decimal inputs and provides ten mutually exclusive outputs which directly drive NIXIE\* tubes. Stable high-voltage output characteristics also make the 9315 ideal for driving relays, lamps and similar devices.

**SEVEN-SEGMENT**—Fairchild's 9317 and 9327 Seven-Segment Decoder/Drivers convert 4 inputs in 8421 BCD code into appropriate outputs for driving seven-segment numerical displays. The 9317 is designed for use with incandescent lamps, neon, electroluminescent and CRT displays, as well as light emitting diode indicators. The 9327 is used for DIGIVAC S/G\*\* vacuum fluorescent readouts. Both devices feature automatic ripple blanking, lamp intensity modulation, lamp test facility, and blanking output. Outputs are disabled by codes in excess of binary 9. Flags are removed on the 6 and 9, which reduces the number of ambiguous states.

\*NIXIE is a registered Trademark of Burroughs Corporation.  
\*\*DIGIVAC S/G is a registered Trademark of Wagner Electric Corporation.

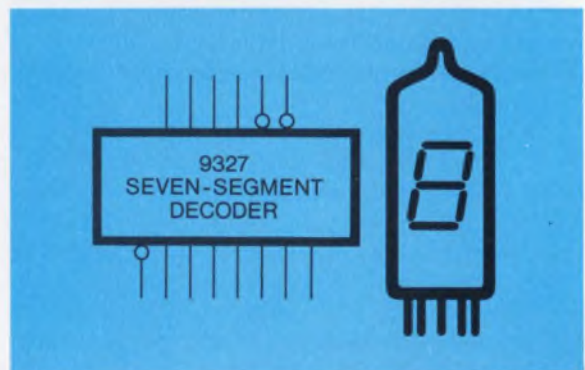
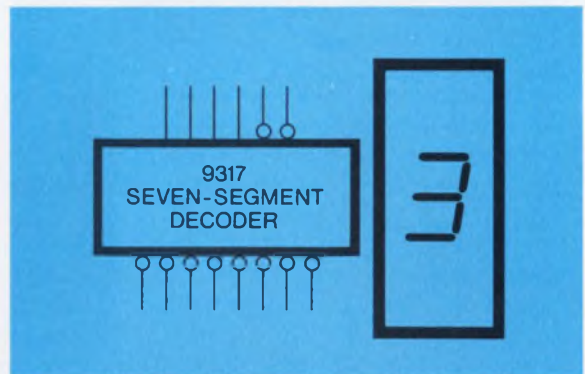
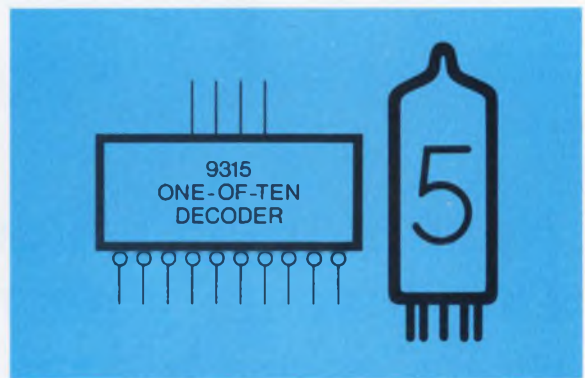

To order these Decoder/Drivers, call your Fairchild Distributor or ask for:

PART NUMBER	PACKAGE	TEMPERATURE RANGE	(1-24)	PRICE (25-99)	(100-999)
U4L931551X	Flat	-55°C to +125°C	\$22.00	\$17.60	\$14.65
U4L931559X	Flat	0°C to +75°C	11.00	8.80	7.30
U6B931551X	DIP	-55°C to +125°C	20.00	16.00	13.30
U6B931559X	DIP	0°C to +75°C	10.00	8.00	6.65
U4L9317513	Flat	-55°C to +125°C	28.00	22.40	18.70
U4L9317593	Flat	0°C to +75°C	14.00	11.20	9.35
U7B9317513	DIP	-55°C to +125°C	25.40	20.30	17.00
U7B9317593	DIP	0°C to +75°C	12.70	10.15	8.50
U4L9327591	Flat	0°C to +75°C	13.05	10.50	8.80
U7B9327591	DIP	0°C to +75°C	11.90	9.55	8.00

# you have to get serious about MSI family planning.

We put together a family plan by taking systems apart. All kinds of digital systems. Thousands of them.

First we looked for functional categories. We found them. Time after time, in a clear and recurrent pattern, seven basic categories popped up: Registers. Decoders and demultiplexers. Counters. Multiplexers. Encoders. Operators. Latches.

Inside each of the seven categories, we sifted by application. We wanted to design the minimum number of devices that could do the maximum number of things. That's why, for example, Fairchild MSI registers can be used in storage, in shifting, in counting and in conversion applications. And you'll find this sort of versatility throughout our entire MSI line.

Finally, we studied ancillary logic requirements and packed, wherever possible, our MSI devices with input and output decoding, buffering and complementing functions. That's why Fairchild MSI reduces—in many cases eliminates—the need for additional logic packages.

The Fairchild MSI family plan. A new approach to MSI that's as old as the industrial revolution. It started with functional simplicity, extended through multi-use component parts, and concluded with a sharp reduction in add-ons. Simplicity. Versatility. Compatibility. Available now. In military or industrial temperature ranges. In hermetic DIPs and Flatpaks. From any Fairchild Distributor.



**OPERATORS**  
9304 - Dual Full Adder/Parity Generator



**LATCHES**  
9308 - Dual 4-Bit Latch  
9314 - Quad Latch



**REGISTERS**  
9300 - 4-Bit Shift Register  
9328 - Dual 8-Bit Shift Register



**MULTIPLEXERS**  
9309 - Dual 4-Input Digital Multiplexer  
9312 - 8-Input Digital Multiplexer

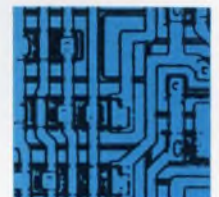

**DECODERS AND DEMULTIPLEXERS**  
9301 - One-Of-Ten Decoder  
9315 - One-Of-Ten Decoder/Driver  
9307 - Seven-Segment Decoder  
9311 - One-Of-16 Decoder  
9317 - Seven-Segment Decoder/Driver  
9327 - Seven-Segment Decoder/Driver



**COUNTERS**  
9306 - Decade Up/Down Counter  
9310 - Decade Counter  
9316 - Hexadecimal Counter



**ENCODERS**  
9318 - Priority 8-Input Encoder

**FAIRCHILD**  
SEMICONDUCTOR

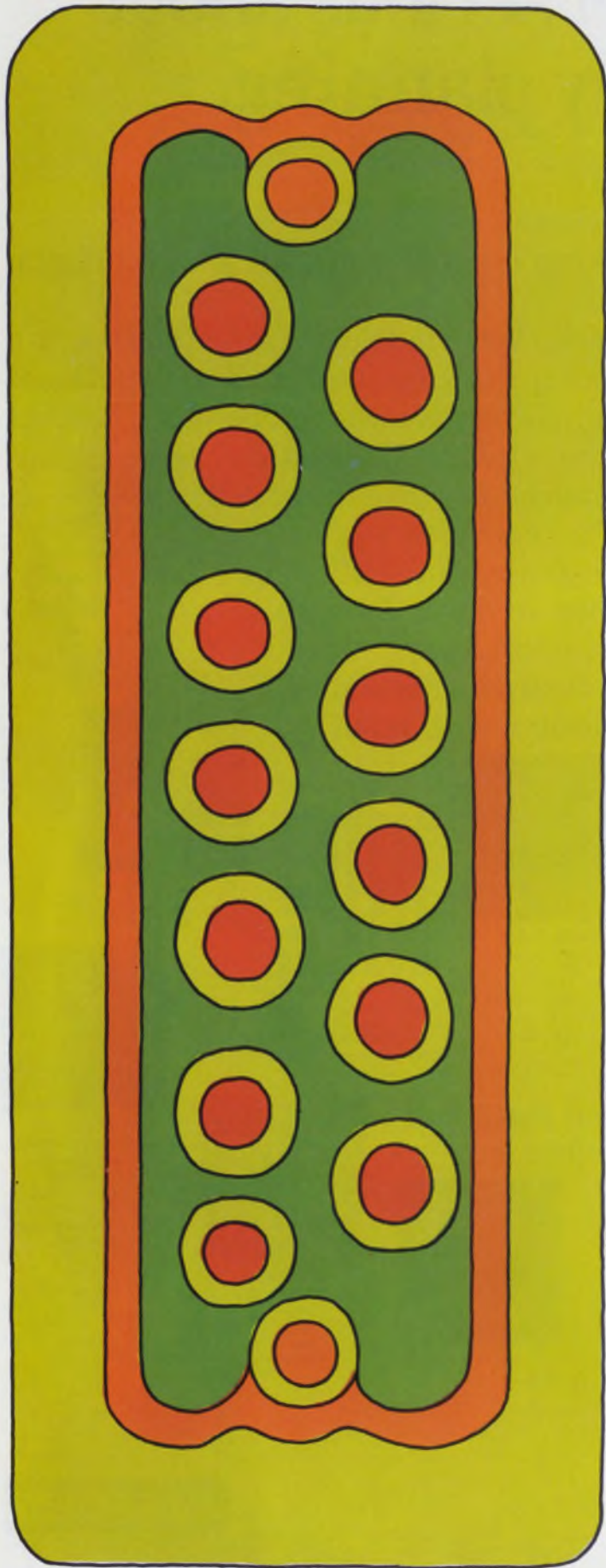

# Winchester Electronics

the  
innovative thinking  
needed to solve  
today's  
problems.

Looking for a quick solution to a particularly knotty connector problem? Look to Winchester Electronics first.

We've got a reputation for producing answers to problems before they exist. So there's always a chance yours might not be a problem after all. For example, we produced our MRE series of miniature rectangular connectors before any specs existed. They've since become the standard for mil spec MIL-C008384. Our MRAC crimp-contact connectors set the standard for MIL-C-22857.

So you see, it's a good idea to contact Winchester Electronics first before you call a problem a problem. With our pioneering spirit, we may have solved your problem years ago. To find out, write or call Winchester Electronics, Main Street and Hillside Avenue, Oakville, Conn. 06779.

 **WINCHESTER  
ELECTRONICS**  
DIVISION OF LITTON INDUSTRIES



YT19 system cabinet, holds all the equipment shown (except teletypewriter) with room to spare.

CD51 controller-digitizer with programmable gain, controls 1024 channels, 10ns aperture time.

TE33 teletypewriter with paper tape reader and punch. (Includes controller.)

CF16 minicomputer with a 4K x 16-bit memory (expandable to 24K) and four different I/O modes. (Includes software.)

Optionally available: MR50 high-level multiplexer and associated channels (approximately \$2400 extra), if you want to mix high and low level signals. Also 10, 12 or 15-bit D to A converters for closed loop systems, and a variety of other off-the-shelf instruments and options to solve virtually any data acquisition problem.

PE20 peripheral controller for CD51/DM40 combination.

OP50 multiplexer switch card contains 8 switches with screw terminals. Each DM40 accommodates up to 16 such cards. Switch cards with other terminal types also available.

OP59 power supply for up to eight DM40s.

DM40 low-level differential multiplexer accepts up to 128 input signals (optionally expandable to 1024) in the range  $\pm 2.5\text{mV}$  to  $\pm 10\text{V}$  full scale, at a rate up to 20kHz, and with a CMR of 120db at DC.

All instruments and interfaces will be cabinet mounted and functionally tested together prior to delivery. If you're in a hurry, call (213) 679-4511, ext. 3668 or 3391.

**XDS**  
Xerox Data Systems  
El Segundo, California

**The last reason you should buy our data acquisition system is the price: \$21,600.**



# MOS keyboards NOW!

Start your own protest about keyboard vendor promises. Clare-Pendar *delivers* MOS Keyboards, not just promises. Production quantity MOS Keyboards NOW, not next year.

MOS Keyboards in stock, too: Teletype Model 37 format, or Model 33/35 format. Or we'll build to your layout—keypunch, CRT display, interactive, portable—you name it.

Choose from the industry's broadest selection of keyboard ROMs. And if we don't have the code you need, a simple mask change can produce any code

you want—bit or non-bit compatible, up to 9 bits/word.

Reliability? Consider this: A fully encoded trimode ASCII Keyboard with 3 major components—an LSI/MOS circuit, reed keyboard switches, and a printed circuit board. How can a keyboard be more simple? And how can a keyboard be more reliable?

You can learn more about super smooth space bars, lighted keytops, 12 and 16 station small keyboards from your nearby Clare Sales Engineer. Call him for a demonstration or call us in

Post Falls for MOS Keyboard action. Clare-Pendar Co., Post Falls, Idaho 83854. Phone 208-773-4541



**CP CLARE-PENDAR™**

The Other Keyboard Company!

# Designer's Calendar

## AUGUST 1970

S	M	T	W	T	F	S
						1
2	3	4	5	6	7	8
9	10	11	12	13	14	15
16	17	18	19	20	21	22
23	24	25	26	27	28	29
30	31					

For further information on meetings, use Information Retrieval Card.

Aug. 25-28

Western Electronic Show & Convention (WESCON) (Los Angeles). Sponsors: IEEE, WEMA. WESCON Office, 600 Wilshire Blvd., Los Angeles, Calif. 90005.

CIRCLE NO. 401

## SEPTEMBER 1970

S	M	T	W	T	F	S
		1	2	3	4	5
6	7	8	9	10	11	12
13	14	15	16	17	18	19
20	21	22	23	24	25	26
27	28	29	30			

Sept. 1-3

Association for Computing Machinery Conference (New York City). Sponsor: ACM. ACM 70, 1133 Ave. of the Americas, N.Y., N.Y. 10036.

CIRCLE NO. 402

Sept. 21-24

International Conference on Engineering in the Ocean Environment (Panama City, Fla.). Sponsor: IEEE. Lewis Winner, 152 W. 42nd St., New York, N. Y. 10036.

CIRCLE NO. 403

Sept. 23-24

Electron Device Techniques Conference (New York City). Sponsor: IEEE. Mayden Gallagher, Hughes Res. Labs., 3011 Malibu Canyon Rd., Malibu, Calif. 90265.

CIRCLE NO. 404



## How to Buy a Good Power Supply

### Without Spending a Bundle . . .

Take a long look at the Abbott line of over three thousand standard models *with their prices listed*. The unit shown above, for instance, is the Abbott Model AL6D-27.6A, a DC to DC converter which puts out 28 volts of regulated DC at two amps and sells for only \$220.00. Other power outputs from 5 to 240 watts are available with *any output voltage from 5 volts to 10,000 volts*, all listed as standard models in our catalog. These converters feature close regulation, short circuit protection, and hermetic sealing for rugged application found in military environment.

If you really want to save money in buying your power supply, why spend many hours writing a complicated specification? And why order a special custom-built unit which will cost a bundle — and may

bring a bundle of headaches. As soon as your power requirements are firmed up, check the Abbott Catalog or EEM (see below) and you may be pleasantly surprised to find that Abbott already has standard power supplies to meet your requirements — *and the prices are listed*. Merely phone, wire, or write to Abbott for an immediate delivery quotation. Many units are carried in stock.

Abbott manufactures a wide variety of different types of power supply modules including:

- 60 $\infty$  to DC, Regulated
- 400 $\infty$  to DC, Regulated
- 28 VDC to DC, Regulated
- 28 VDC to 400 $\infty$ , 1 $\phi$  or 3 $\phi$
- 60 $\infty$  to 400 $\infty$ , 1 $\phi$  or 3 $\phi$

Please write for your FREE copy of this new catalog or see EEM (1968-69 ELECTRONIC ENGINEERS MASTER Directory), Pages 1727 to 1740.

**abbott transistor**

LABORATORIES, INCORPORATED

5200 W. Jefferson Blvd./ Los Angeles 90016  
(213) WEBster 6-8185 Cable ABTLABS

TO: Abbott Transistor Labs., Inc., Dept. 87  
5200 West Jefferson Blvd.  
Los Angeles, California 90016

Sir:  
Please send me your latest catalog on power supply modules:

NAME \_\_\_\_\_ DEPT. \_\_\_\_\_

COMPANY \_\_\_\_\_

ADDRESS \_\_\_\_\_

CITY & STATE \_\_\_\_\_

INFORMATION RETRIEVAL NUMBER 11

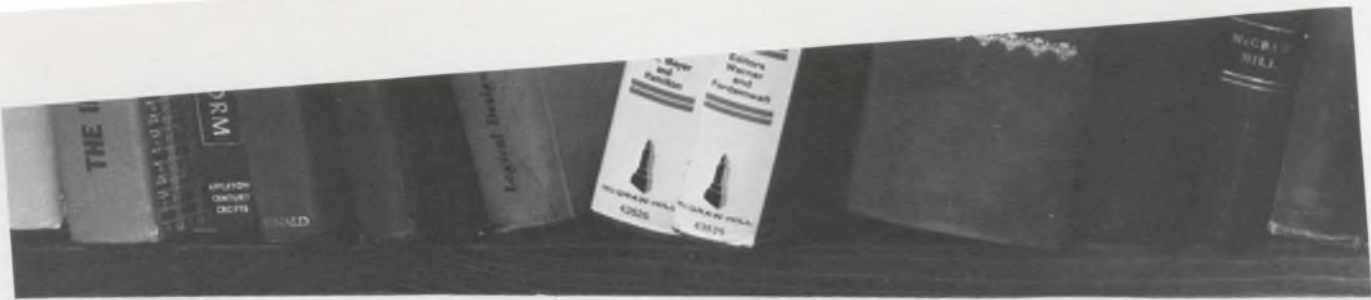

## Buy a library for your computer

Subroutines, micro-programs, functions, encoders and decoders, log tables and logic tables, now you can get any or all of them for your computer. All it takes is a Datapac read-only-memory.

With a Datapac U-core ROM you can change your data contents in minutes, simply by plugging in a new data board. You can even modify or change the data on any given data board right in your own facility. Nothing in a Datapac ROM is engraved in stone. Or etched in silicon.

Datapac memories come in various models and sizes to accommodate anywhere from 1000 to 983,040 bits. They're fast, reliable, and reasonably priced.

And if that's not enough, send for our new brochure. It's full of descriptions and diagrams and specs. It's free. And it may start you on the road to a lot of beautiful memories. DATAPAC Incorporated, 3839 South Main Street, Santa Ana, California 92702. (714) 546-7781.





# The beauty of this connector...



## it saves you a pretty penny.

Sure, Amphenol's new Excellite audio/electronic connector is beautiful. It's strong and light weight, too. Made from the same tough, molded ABS plastic used in pro football helmets and golf club heads. The lustrous nickel plating enhances the look and value of your product.

But where it really sparkles is on the money it saves you. First off, it costs less to buy. The savings from new, lower cost materials are passed on to you. Secondly, it saves you time in termination. Excellite cable connectors come completely assembled, not as a bag of parts. Your production people aren't

burdened with assembly or bothered with parts that don't fit or are missing. We do all that.

The Excellite line provides a full complement of distinctive 3, 4 and 5 contact connectors that are completely interchangeable and intermateable with all latch-lock type audio connectors.

For complete information on Excellite audio/electronic connectors, send for your free copy of Catalog EX-1. Amphenol Industrial Division, The Bunker-Ramo Corporation, 1830 South 54th Avenue, Chicago, Illinois 60650.



**AMPHENOL**  
THE BUNKER-RAMO CORPORATION

# Brazen Offer!

If you can come up with a  
PC fork and blade plate connector system  
that's more versatile than our 5420 system  
we'll make your "special"  
for the price of our "standard".

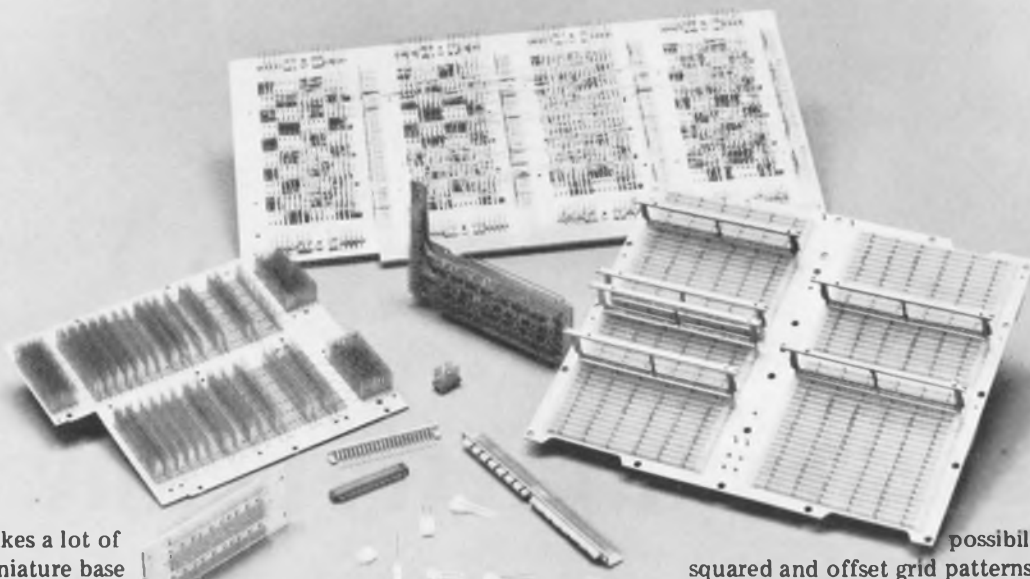

A bid like this takes a lot of guts and/or a miniature base plate connector system that's so versatile we're fairly sure we've got ourselves covered.

Our 5420 system has that kind of universality.

First off, consider the 5420's base plate components. Singles. Doubles. Males. Females. .025 square post. All of which can be spaced on .100", .125", or .150" centers. Okay?

Then there're the header components: 5420 has 50 contact headers for IC packages; heat sinked 40 contact headers standardized for SHP's; and modular headers for any other size.

And all the 5420's components provide the metal-to-metal contact required by MIL-E-5400. (No relation.)

If that's still not enough, multiply by the added

possibilities of both squared and offset grid patterns.

Now you're beginning to see what makes us so sure that our 5420 system will do the job even for the most cunning applications up with which you can come.

They're very much in step with NAFT's standard packaging concept, and versatile enough to take hundreds (make that thousands) of non-standard jobs neatly in their stride.

What we haven't said here we say in our catalog. Write for it. You'll find the 5420 specs on Page 14. Elco Corporation, Willow Grove, Pennsylvania, 19090, (215) 659-7000, TWX 510-665-5573. Or 2200 Park Place, El Segundo, California, 90245, (213) 675-3311, TWX 910-325-6602.



**ELCO** Plate  
Connectors



# meet your production schedules with Cinch-Graphik precision PC boards

When we expanded our plant to 125,000 square feet, we didn't just add space! We tripled our plating facilities, added two 4-headed and two 6-headed N/C drilling machines, quadrupled our multilayer press capacity and added enough trained people to assure that Cinch-Graphik quality will be maintained.

These increased capabilities of the world's largest independent producer of precision circuit boards are available for your volume requirements now. Contact Cinch-Graphik, a Division of TRW Inc., 200 South Turnbull Canyon Road, City of Industry, California 91744, telephone (213) 333-1201 or your nearest Cinch District Office.

**CINCH-GRAPHIK**



# SIZE & COST: NO BIG THING.

EASIER THAN EVER TO FIT  
YOUR BOARD & BUDGET.

BROAD LINE GETS BROADER.  
8 LOWER CAPACITANCE VALUES  
(100 pF thru 390 pF @ 200 V).

Type 192P Pacer<sup>®</sup> Polyester Film Capacitors are mass-produced to beat the space/cost squeeze in commercial and industrial applications. Extended-foil PETP film sections with metal end caps provide best possible non-inductive construction. End caps also act as moisture barriers. Ideal for automatic insertion on printed wiring boards. Expanded line includes capacitance values from 100 pF to .47  $\mu$ F. Voltage range, 80 to 600vdc. Write for Bulletin 2066C.

Technical Literature Service  
Sprague Electric Company  
347 Marshall Street  
North Adams, Mass. 01247

**SPRAGUE**<sup>®</sup>

THE MARK OF RELIABILITY

**THE BROAD-LINE PRODUCER OF ELECTRONIC PARTS**

INFORMATION RETRIEVAL NUMBER 16

45M-0143

# Highlighting

THE ISSUE



Where hands-free communications are needed—for policemen, fire-fighting teams and others—there's nothing quite like the new Bendix locked-oscillator communications system.

With it, multiple conversations can be held on the same vhf channel at the same time. Although the transmitter and receiver of each set are both permanently connected to a single antenna, the transmitter operates continuously without interfering with reception.

The inventor, a former ELECTRONIC DESIGN "Ideas for Design" winner, is John M. Tewksbury, principal engineer at the Bendix Communications Div., Towson, Md. He is shown wearing the device.

**Page 25**

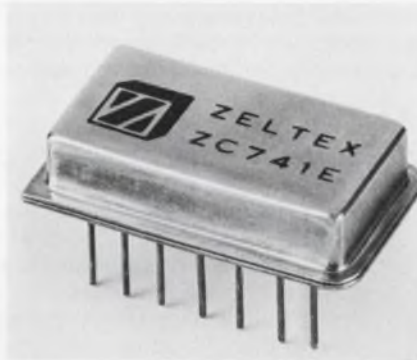

Two new pin-programmable operational amplifiers make possible over 500 combinations of gain, from 0.004 to 250. Both devices also feature selectable-mode operation—they can be used in follower, inverter or summing configurations.

These hermetic DIP devices use integral thick-film input/feedback resistor networks for temperature stability.

**Page 123**

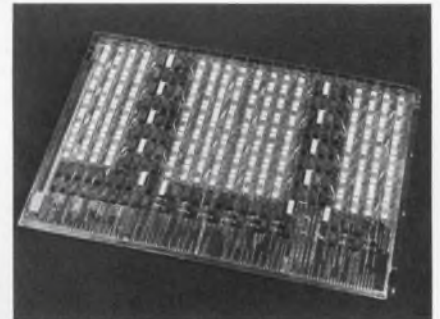

For 15 years, cores have reigned supreme in the commercial random-access, read-write memory market. In this time their price has continued to fall rapidly and their speed has doubled every two and a half years. They have "buried" at least two challengers—cryogenics and planar thin films. Now suddenly a new challenger has appeared—semiconductor memory.

"In 10 years," says Wally Raisanen, operations manager for IC memory and MOS products, Motorola Semiconductor Products Div., Phoenix, Ariz., "semiconductor memories will have the whole business—to a first approximation."

**Page 70**

# Some switches are enough to change your mind.

We don't make any other kind. No carbon copies of what you've already seen, or possibly even used. Because it was time for somebody to pull the switch on switches. And so, we've made improvements. Took out things that weren't necessary. Put in things you said you needed.



For instance, take our Rotary Matrix Switch. It's functional. It's rugged, easy to operate, positions with positive detent action, and it's the smallest available programming device of its kind. Because it's out of sight, beauty is not our intent. It's designed for behind-panel installations in semi-permanent programming applications. And because it's changed so infrequently, we've built in a life span that's as long as you'll need, probably longer than the equipment for which it is intended.

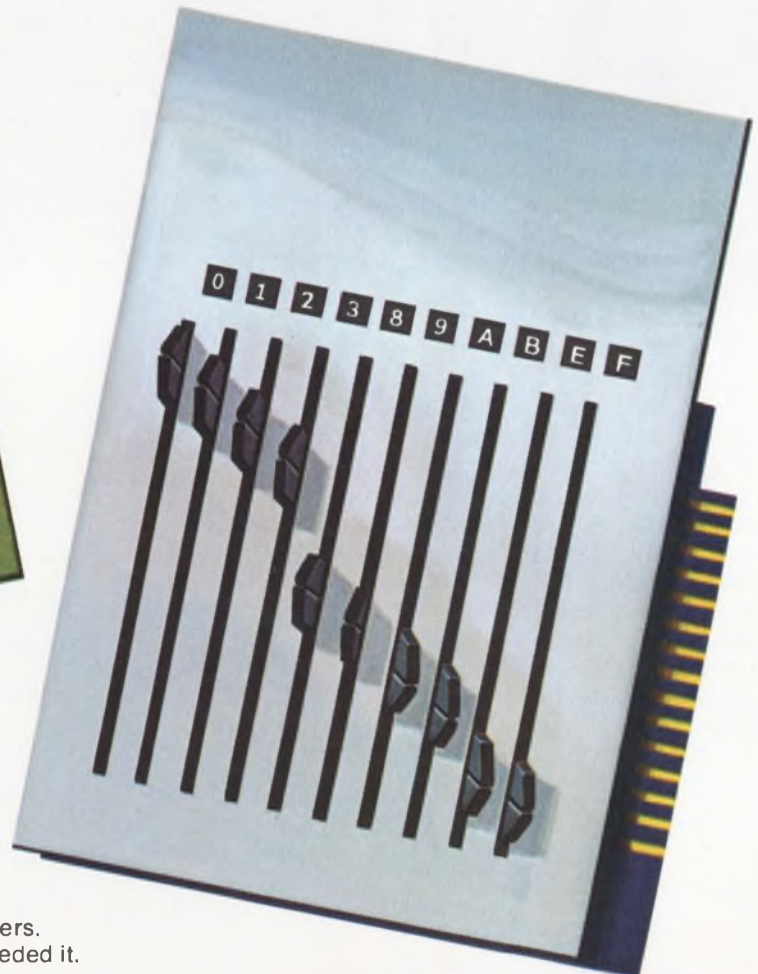

Our Slide Switch is a different story. Because it's seen, we've made it handsome . . . covered it with wipe-clean stainless steel and designed the inside sandwich style so no dust or dirt gets in to foul contacts. And because it is used frequently, we've built in a life-span to bridge a generation gap among engineers.

All because you said you needed it.

Because of the need for design flexibility, configurations to suit special applications are available in both models.

We've got facts, data, specifications and everything else needed to prove that it pays to switch switches. Just write:

Industrial Division, AMP Incorporated, Harrisburg, Pa. 17105.

**AMP**  
INCORPORATED

## IBM unveils System 370 with accent on speed

The first elements of a new line of computers to succeed the System 360 have been announced by IBM. At first glance, the greater potential seems to be in the auxiliary equipment, which includes a new high-speed line printer.

The new computers, models 155 and 165 in a line called System 370, are aimed at replacing the System 360/50 and the 360/65, respectively. The new disc drive (Model 3330) makes use of a 12-disc pack that can store 200 million 8-bit bytes with an access time to a random bit of 30 ms. Up to four such disc drives can be used to provide up to 800 million bytes or 1.6 billion decimal digits of storage. The increased storage is achieved by doubling the number of tracks on each disc and doubling the bit density per track.

The line printer (Model 3211) can turn out 2000 lines per minute of a 48-character set or 2500 lines per minute of a 36-character set. This is twice the rate of previous IBM line printers.

The 370 computers are said to operate at three to five times the speed of the 360 models. The memory cycle time of the 370/165 is 80 ns. Conventional ferrite core memory is used. The fast cycle times result from placing an 8000-bit MSI semiconductor buffer memory between the core memory and the central processing unit. The CPU also contains a high proportion of integrated circuits. There are 72 functions per chip in the buffer and 2 to 8 functions per chip in the CPU. This use of integrated circuitry is a departure from previous practice by IBM.

Rentals for the new computers range from \$50,000 to \$100,000 a month; the purchase prices run from \$2.25-million to \$4.7-million. Deliveries will begin next spring.

Spokesmen for IBM declined to characterize the 370 line as the

long-awaited fourth generation. They said that the new computers were evolutionary rather than revolutionary.

## 55-lb weather stations can be air-dropped

Expendable remote weather stations — known as Erows — are being built for the Air Force to air-drop in otherwise inaccessible places. They are designed to implant themselves in the ground on a spear-like tip and make a variety of meteorological measurements, which are then telemetered to a master station approximately 50 miles away. The battery lasts at least 10 days.

Designed and built by Honeywell's Aerospace Div., St. Petersburg, Fla., under a contract from the Air Force Cambridge Research Laboratories, Bedford, Mass., the small weather stations use frequency-modulated, frequency shift keying (FM-FSK) in the uhf band for telemetry.

The master station, designed for one-man operation, includes a digital recording system for read-out of telemetered data, an interrogation module to display the exact status of the remote station being interrogated, and the built-in self-test equipment. The control station is able to interrogate up to 31 remote stations with coding isolation to prevent site confusion.

Each weather station is 104 inches long and 6 inches in diameter, and it weighs approximately 55 pounds.

"There are many applications for this droppable system," according to John W. Anderson, division vice president at Honeywell. "It could be used by the Army, the Weather Bureau or any number of agencies."

## No follow-the-leader 'yet' on HP cutback

Hewlett-Packard's recent announcement that it planned to give its employees—including corporate officers—a day off every second week and a corresponding reduction in salary has evoked little response from other instrument manufacturers. Companies contacted by *ELECTRONIC DESIGN* either said they had no plans for following HP's lead or refused comment.

Frank Marble, vice president of administration for Systron-Donner Corp. Concord, Calif., says his company does not plan to give its employees uncompensated time off. Systron-Donner had a 5 to 10% layoff as a result of a normal staff review at midyear, he says, but he foresaw no further changes at the moment.

William Thurston, vice president of marketing for General Radio Co., West Concord, Mass., says domestic business is down right now but overseas business is better than expected. The company says it has no plans to reduce either work-days and/or pay. In fact, at the moment they have some paid overtime and have had no general layoffs, he noted.

## IEEE alters handling of CAD information

The IEEE has disbanded its Committee on Computer Aided Design, Analysis and Realizability. The reason: Information on computer-aided design [CAD] should be handled by each discipline area in which it is being used and should not be considered as a separate discipline, the IEEE says.

The move, announced in the final issue of the committee's publication, *CADAR Newsletter*, carried a statement by John A. Dumanian, editor, in which he asserted: "Computer-aided design will play a lasting role in all fields of electronic and electrical engineering. But it is being retarded by the short-sightedness of IEEE group leaders who have failed to detect the importance of CAD."

The IEEE will handle CAD in the future under the auspices of the group using it. Computer-aided design of circuits, for example, will

be covered by the Circuit Theory Group; of electron devices, by the Electron Devices Group, and so on.

## Air Force will test laser reconnaissance

Airborne laser reconnaissance devices have reached the flying stage, and the sensor test range at Eglin Air Force Base, Fla., is preparing for them.

Large oblong panels, ranging in shade from black to white, are being laid out on the range to test the sensitivity of various laser-sensor combinations. These will be mixed among the existing targets—"Vietnamese" villages, trucks, missile sites and tunnels that are spread throughout the 64-square-mile range. These targets are used for testing airborne radar, infrared and low-light-level television.

Some of the lasers soon to be tested will be used to illuminate ground targets for an aircraft's low-light-level TV. Others will use a plain cathode-ray tube and film. For storing the data, some lasers will be equipped with video tape.

All have the advantage of providing a real-time reconnaissance readout. They operate at night, and they're not as big and bulky as radar.

In the area of foliage-penetrating radar, the Air Force is shying away from low-frequency radar that transmits long wavelengths that spill between leaves to detect enemy movements underneath. The low-frequency equipment is reported to be too big. The Air Force is now hoping to get through leaves with side-looking radar equipped with moving-target indicators. The logic goes that a movement detector will "see through" foliage because the radar scans from so many angles as a plane flies over it that some of the pulses are bound to get through.

An Air Force spokesman noted the following trends in reconnaissance aircraft: multi-sensor systems rather than a single sensor; sensors that operate at night; and

real-time readouts to provide "kill" as well as "hunt" capability. This rules out those infrared and side-looking radar systems that must be processed on the ground, he said.

## New company announces large-scale computers

A new computer manufacturer—Computer Operations, Inc., of Costa Mesa, Calif.—has announced a new line of large-scale computers called the Gemini generation. The computers, while more powerful than the IBM 360 series, will be entirely software-compatible with them.

David Stein, vice president of marketing for Computer Operations, notes further that all IBM peripherals can be driven by the new systems.

The logic in the Gemini computers will be all MSI and LSI on laminated, multilayer printed-circuit boards.

Up to 1024 time-shared users at 9600 baud or 16,384 users at 300 baud will be able to communicate with the largest system simultaneously, Computer Operations says. This compares with 16 users at 300 baud on the IBM 360/65.

Stein contends that the Gemini system will be "10 times more cost effective" than the 360/65 and "two to five times more cost effective" than the new 370/165. The Gemini system can execute programs at speeds exceeding two million instructions a second, Stein says. He adds that "while the 360/65 has a maximum of 2 million bytes of directly addressable core and the 370/165 has a maximum of 3 million bytes, the Gemini system has a maximum of 16 million bytes."

Prices for the Gemini systems start at \$3-million without peripherals. According to Peter Warkenton, president and chief executive officer.

Initial shipments are to begin in the fourth quarter of 1971.

## Laboratory pacemaker doesn't need batteries

A biological feedback loop may someday eliminate the need for

batteries in pacemakers. An experimental pacemaker uses piezoelectric disks to convert variations in blood pressure to electricity.

Today's pacemakers are powered by batteries that are implanted, along with the device, in the body. These batteries must be replaced about every year and a half, and a patient must undergo minor surgery for this.

With the experimental design, a small plastic tube is inserted through a vein into the right ventricle of the heart, following the same path as the electrode in a conventional pacemaker. At the end of this tube inside the heart is a small balloon filled with water. As the heart contracts, there is a change in blood pressure, the water is squeezed up the tube, and this produces a mechanical strain in the piezoelectric disks.

The disks convert the mechanical energy to electricity, which is stored in a small capacitor in the pacemaker. The pacemaker, in turn, emits impulses that stimulate the heart muscle, and the loop is closed.

The new pacemaker was devised by Donald L. White and Michael R. Rocchi of Bell Telephone Laboratories in Murray Hill, N. J., and by Dr. Peter J. K. Starek and Dr. C. Wilton Lillehei of the New York Hospital-Cornell Medical Center.



Experimental pacemaker uses biological feedback loop that eliminates the need for battery power.





**This is our Molex 1175. A lighted push button switch. Snap mounts. Spade or wire terminals make assembly easy. In quantity, costs about sixty cents.**

**You could pay more, but that's the point. Men who use switches have told us, "enough is enough". We take that seriously. By creating switches that do the job right, yet aren't over-engineered to the point that costs wind up in left field.**

**So this switch is available in nine colors, 500 variations, and is built to go on and off—and on and on. For about sixty cents.**

**If that makes sense to you, and you would like a free sample of our 1175 switch, write or phone (312) 969-4550.**





## Bodine drives packaging and labeling machines dependably

Compact. Rugged. There's an extra measure of stamina in Bodine fractional horsepower motors for packaging and labeling machines. Stamina that measures up to the reliability and performance you've designed into your product. Bodine fhp drive systems are more than the latest state of the art. There's Bodine craftsmanship and realistic ratings. These spell dependability for you—and your customers.

Whether your field is packaging or labeling—or both—you can do no better than to specify Bodine fhp drives and controls. Over 3500 standard specifications to choose from. Bodine also builds custom fhp drives and controls to meet design requirements. Our engineers will be happy to help you pinpoint the right one for your application.

Write for bulletin. Bodine Electric Company, 2500 W. Bradley Place, Chicago, Illinois 60618.

*Bodine Motors Wear Out—It just Takes Longer*

**BODINE MOTORS/GEARMOTORS  
SPEED CONTROLS**



# The 'impossible' communications system

## Transmitter and receiver operate simultaneously on the same channel without interference

Jim McDermott  
East Coast Editor

Where hands-free communication is needed—for policemen during emergencies, for fire-fighting teams and others—there's nothing quite like the new Bendix locked-oscillator communications system.

With it, multiple conversations can be held on the same vhf channel at the same time. Although the transmitter and receiver of each set are both permanently connected to a single antenna, the transmitter operates continuously without interfering with reception.

It sounds almost impossible, but ELECTRONIC DESIGN received a convincing demonstration that the system really works. No push-to-talk buttons or electronic voice-operated controls are needed.

Invented by a former ELECTRONIC DESIGN "Idea for Design" winner who merited an "Idea of the Year Award"—John M. Tewksbury, principal engineer at the Bendix Communications Div., Towson, Md.—the system employs two principles in operation: the use of a variable-repetition-rate pulse train for voice transmission and the use of a frequency-modulated master oscillator (operating at 12 kHz) that is phase-locked to both transmitted and received pulses.

### FM pulse modulation used

The voice information is transmitted as a string of constant-amplitude, 20- $\mu$ s pulses on which the modulation has been impressed by varying the time between pulses—in essence, FM pulse modulation.

These pulses can be transmitted as 20- $\mu$ s bursts of an rf carrier. The present system, designed for short-range communications—up to 200 feet—operates in the 450-to-500-MHz band with an average power output of 5 mW.

The uniqueness of the system

lies in the fact that the pulses not only contain the voice modulation, but are also used for both local and remote phase-lock control of the 12-kHz sawtooth oscillators—which themselves generate 20- $\mu$ s pulses in step with the local or received modulation.

For each cycle of the 12-kHz oscillator, a 20- $\mu$ s pulse is generated (Fig. 1) and applied to a diode switch, which gates the output of a vhf crystal oscillator. The diode switch output is a 20- $\mu$ s burst of rf that is applied to the transmitter amplifiers, which apply the burst to the antenna.

The transmitted pulse rate, with no modulation, is determined by the free-running frequency of the 12-kHz oscillator. When not receiving pulses from another transmitter, the set feeds its own pulses back through its receiver and around a closed loop to the 12-kHz oscillator input to establish a stable oscillator rate.

Each station's own transmitted pulses are always present at its receiver input, but this does not interfere with reception of pulses that are ahead of or behind it, be-

cause the receiver has been especially designed with a recovery time of about 0.020  $\mu$ s.

When a second station is operating in the vicinity, it transmits its own string of 20- $\mu$ s pulses. The receivers in both stations detect early or late arrivals of the incoming pulses with respect to their own pulses, applying a correcting signal to their own oscillators that tends to correct the error. The signals from both transmitters lock into synchronism and the 12-kHz oscillators in both sets become phase-locked at some frequency that is a compromise between the free-running rates of both. When more stations are added to the loop, they all synchronize their pulse transmissions at some common, compromise frequency.

When anyone speaks into the microphone, the 20- $\mu$ s time-varied pulses are generated in step with the modulation frequencies. When the pulse train passes through a triple integrator, the voice signal is recovered. This signal is amplified and applied to the earphones.

These same pulses are also transmitted as rf bursts, which are received and locked onto by the other sets in the vicinity. The outputs of the receivers are applied

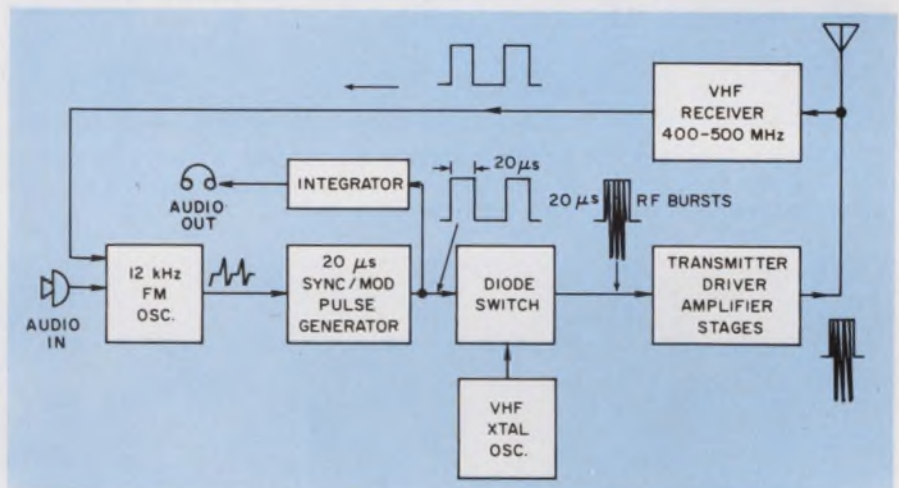

1. In the new Bendix vhf transceiver, the 12-kHz oscillator is frequency-modulated by local voice or received signals, producing a time-varied string of 20- $\mu$ s pulses that are demodulated by an integrator.

(Bendix, continued)

to their 12-kHz oscillators, causing them also to lock in step and produce pulse trains identical to that in the transmitting set.

One of the really new features of the Bendix system is the manner in which the 12-kHz FM oscillator produces the 20- $\mu$ s pulse stream while simultaneously responding to the phase lock signals in the receiver output (Fig. 2). The 12-kHz oscillator is a unijunction transistor with an RC circuit in its base circuit. A sawtooth wave appears across the capacitor, and as the voltage reaches about 50% of  $V_{cc}$ , it abruptly discharges as the unijunction conducts. During this fall-time period, a 20- $\mu$ s, one-shot delay circuit is activated.

At the end of 20  $\mu$ s, the delay circuit output triggers the 20- $\mu$ s pulse generator, which gates the diode switch, causing a 20- $\mu$ s rf burst to be transmitted. This is picked up by the set's own receiver, and the collector of the output stage  $Q_2$  is driven to ground, thus reducing the voltage at point A to  $1/2 V_{cc}$ .

For the next 20  $\mu$ s, the sawtooth voltage remains constant (Fig. 3a), and when the 20- $\mu$ s pulse is finished, the sawtooth voltage continues to rise to the conduction level of  $Q_1$ , which fires and starts the cycle over again.

Any audio input voltage appears in series with the capacitor voltage; so that for a positive ac voltage, the sawtooth will trigger faster, while for a negative voltage, it will take longer to reach conduction. In this manner the

frequency is either increased or decreased. At present, the maximum excursion is  $12 \pm 1.5$  kHz.

**Tracking the pulses**

When an incoming signal is received, and is retarded with respect to the local 20- $\mu$ s pulse, the local receiver "sees" both pulses as a single one that is longer by the duration of the overlap (Fig. 3b). The widened pulse then is applied to the sawtooth as a delay that increases the time between the 20- $\mu$ s sync/modulator pulses and causes these pulses to catch and track the incoming pulses.

The output of the 20- $\mu$ s keyer is also fed to the integrator/amplifier, and when the local pulses accurately track the incoming ones, the demodulated signal is heard.

When the incoming pulse leads the local pulse, an AND gate comes into play. The output of the 20- $\mu$ s, one-shot delay and the output at the  $Q_2$  collector are applied to the AND gate to produce a positive voltage for the duration of the leading pulse overlap.

If the incoming pulse leads the keying pulse, it falls into the first 20  $\mu$ s of the rising sawtooth. But the AND gate is now open for the first 20  $\mu$ s, and a positive voltage is applied to point A (Fig. 2), thereby sharply increasing the voltage at that point and driving it higher than normal.

When the AND gate is turned off at the end of the first 20  $\mu$ s, the local 20- $\mu$ s pulse is applied to point A, which then remains at a higher than normal voltage for the remainder of the second 20  $\mu$ s. The voltage then rises again but reaches the conduction point earlier than it normally would, shortening the time between the local 20- $\mu$ s keyer pulses and causing the local pulses to track incoming ones. ■■

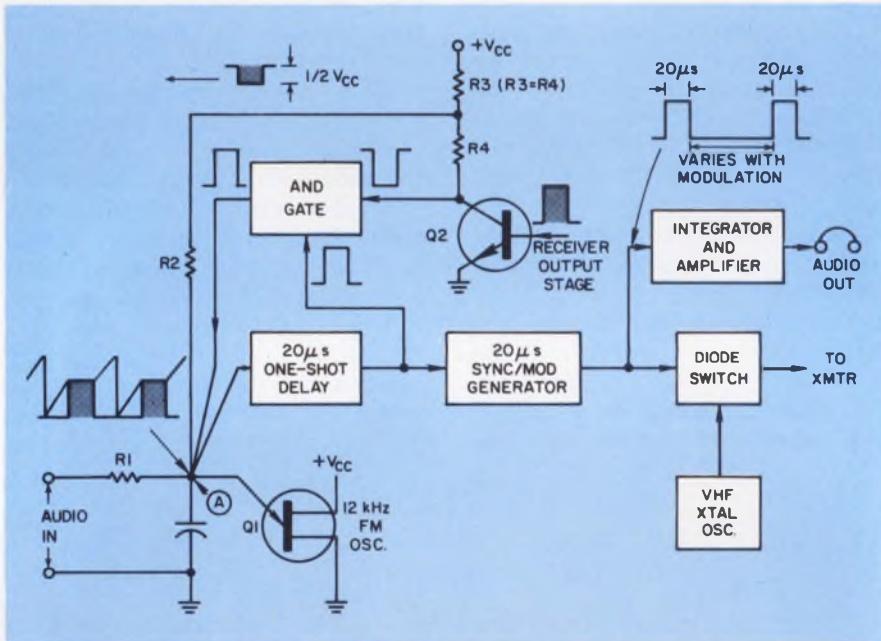

2. A unique feature of the Bendix system is the manner in which the 12-kHz FM oscillator is synchronized with its own transmitter pulses or with received pulses by feeding back the receiver's output to  $Q_1$ .

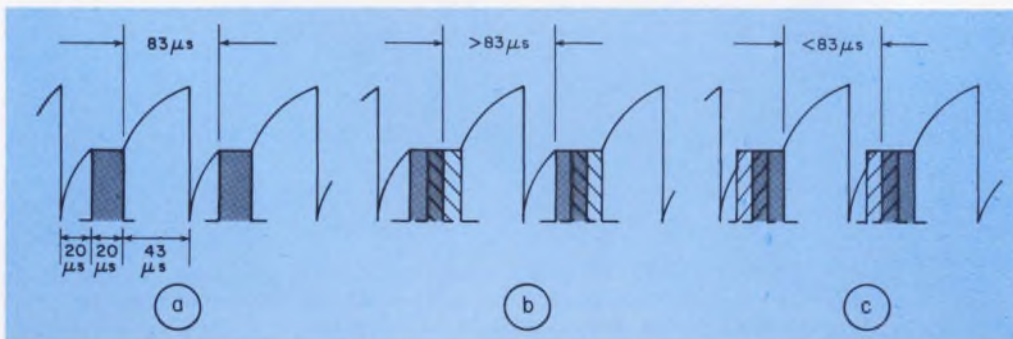

3. The waveforms shown appear at the 12-kHz oscillator base (Fig. 2) for (a) Free running conditions; (b) A late received pulse; and (c) An early received pulse. The overlaps have been exaggerated for purposes of illustration.

TI's quiet  
revolution in  
TTL/MSI

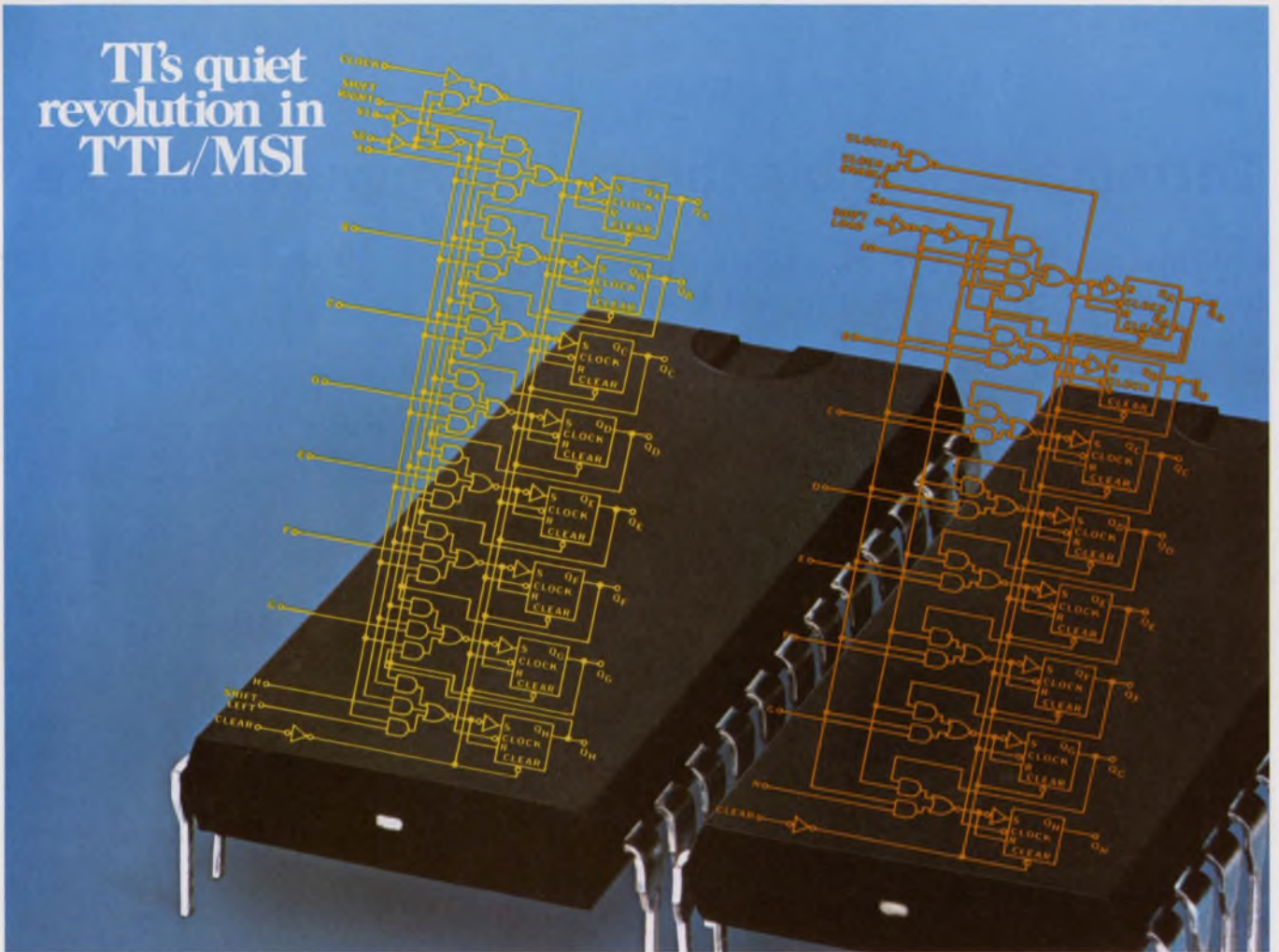

## Either one of TI's new 8-bit shift registers outperforms any two 4-bit SRs—for two-thirds the cost.

Combine any two 4-bit shift registers—you still can't match the flexibility, performance and economy of one of TI's new 8-bit TTL/MSI universal SRs. The SN54/74198 and SN54/74199 each offers twice the complexity (87 equivalent gates) at only two-thirds the cost.

At less than 9¢ per gate, they are excellent buys. The SN54/74198 and SN54/74199 each cost \$7.32 (100-999 quantities) in 24-pin plastic DIP.

What's more, they are fast (20 ns typical propagation delay) and operate at input clock frequencies up

to 32MHz...yet require only 360 mW, or a little more than a 4-bit shift register.

As for logic flexibility, the bidirectional SN54/74198 shifts left or right without external connections, and has full parallel access to each of 8 flip-flops. No need to turn off system clock, either, since a "do-nothing" state is also provided. Try the SN54/74198 as a shift register, parallel-to-serial converter, serial-to-parallel converter or in an accumulator. Inputs are buffered for a fan-in load of 1, including clock.

If your needs dictate, consider the SN54/74199. It shifts left, loads parallel data, inhibits clock, and has important J and K serial steering inputs. Use it also as a Johnson counter, a code converter, a ring counter and a shift register generator counter. Both registers have a direct clear which overrides all other inputs.

For data sheets, write on your letterhead to Texas Instruments Incorporated, P.O. Box 5012, M.S. 308, Dallas, Texas 75222. Or ask your authorized TI Distributor.

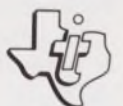

TEXAS INSTRUMENTS  
INCORPORATED

# Terminals: The big future in computer market

## But one speaker at IEEE exposition warns of need to improve their performance and to reduce costs

**Milton J. Lowenstein**  
Computer Editor

Terminals stole the show at the International Computer Group Conference and Exposition, held in Washington, D.C., under the sponsorship of the IEEE Computer Group. CRT displays and intelligent input-output devices predominated, both in the technical papers and the exhibit booths.

All forecasts at the convention indicated that terminal manufacturers would increase their share of the market while computer mainframe builders would encounter a decrease. But at least one speaker warned that present terminal equipment had serious shortcomings in performance and was unduly expensive. He called for improvements and lowered costs to capitalize on the growing market opportunities.

### New memories announced

Two new memory developments were announced at the conference.

Hughes Aircraft disclosed that its magnetic-domain memory had been licensed for production by Digital Development Corp., San Diego. This memory is a mass-storage type that can replace disc, drum and tape.

Honeywell Aerospace Div. told of its 2-mil plated wire memory, which is compatible with MSI drive circuits.

Many of the reasons for growth in the terminal market were discussed by Lowell D. Amdahl, president of Compdata, Inc., Tarzana, Calif., in a paper, "Tomorrow's Technology." He said:

"Technology improvements will be concentrated on serving the user on his terms. This will include a strong trend to place I/O devices, primarily terminals near him."

In addition, Amdahl continued, there will have to be improvements

in software, because "the user will want to use his computer system directly with his data and in his language."

More and better terminals are on the way, Amdahl said.

"Central processors are showing an increase in performance to price ratio of from 40% to 70% per year," he reported. "This has resulted primarily from increases in performance rather than reductions in price. The only exception is in the low end of the range, where minicomputers have been decreasing in price at 30% to 35% per year."

The conclusion is inescapable that relatively more money will go into terminals, Amdahl asserted.

He also touched on auxiliary memories. "Disc memory systems are expected to evolve to higher performance through higher recording densities and greater emphasis on head-per-track organization," he said. Manufacturers showing head-per-track disc systems at the show added that access time had been significantly reduced by this design.



Terminals must be designed for the convenience of the user. This injunction from the IEEE Computer Group conference is here carried out by Ultronic System's new Videomaster terminal, intended for use by stockbrokers.

Strong criticism of terminal performance and cost was sounded by L. C. Hobbs, president of Hobbs Associates, Corona Del Mar, Calif. He said:

"While the cost of the central processor is decreasing rapidly, and software and operating costs are assuming larger roles, peripheral equipments are rapidly dominating the system hardware costs."

### A call for static devices

Hobbs called for new approaches and new technologies to provide higher performance and lower costs. He indicated that it was particularly desirable to divorce mass storage from such electromechanical components as drums, discs and tape drives. A better approach, he said, is to go to static devices—magnetics and semiconductors. But he added that he did not expect to see this goal easily achieved.

Hobbs also pointed out that on-line usage was growing very rapidly. He was supported in this observation by J. Peter Ross of Quantum Science Corp., New York City, who said that dispersed remote computing would dominate the domestic market in the 70s.

### Intelligent terminals on the way

"Among the features to be expected," Ross said, are "more intelligent, job-oriented terminals, central processors optimized by new architectures and improved software, immense mass memories—originally disc but giving way to MOS and LSI technology—and increased communication costs."

Ross added: "The foreign markets are growing 50% faster than those in the U.S., and so is foreign competition. Right now, foreign markets are more profitable than domestic ones. Without their world trade profits, International Business Machines' 1969 net would have been below that of 1968." ■■

# We'll stop adapting our KHP relay when you run out of new applications.

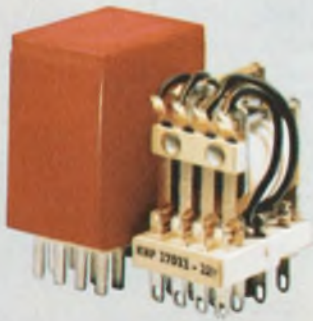

You have a tough relay requirement, right? You need a relay with the reliability of bifurcated contacts. Must have U/L Component recognition. Need .078 taper tab terminals and 400 milli-watts sensitivity. Color coded cases.

No problem. Just call us. We are all tooled and in production. Probably no other manufacturers of our KHP design can say the same.

You see, we've been making this relay longer than anyone because we designed it. We've made it for more different applications than anyone else. That's why we

have more combinations of contact materials, terminals, sockets, and mountings than anyone else.

Available in 2 Form C, 4 Form C or Form Z contact arrangements. Contacts rated 3-amps at 30V DC or 120V AC resistive. Choice of 8 different mountings and 8 contact materials. Coil voltages from 6 to 120 volts.

Complete specifications and ordering information are in our new 194-page Catalog '70. Ask your P&B representative for a copy today. Or write us direct: Potter & Brumfield Division of AMF Incorporated, Princeton, Indiana 47570. Or call 812 385 5251.

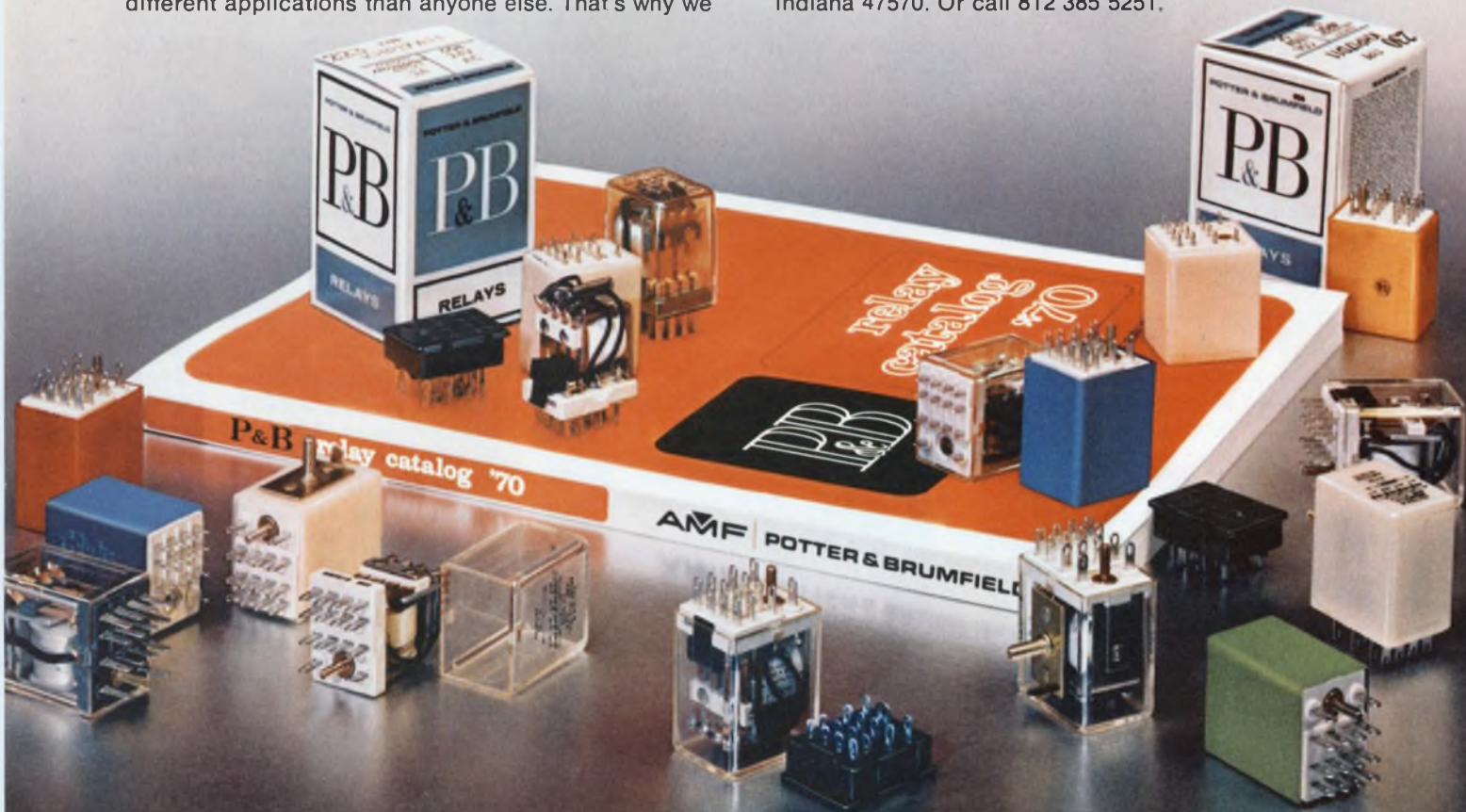

# Outlook for European electronics: No slump

## Exhibitors at Mesucora Automation Show see 10-to-40% general increase in sales this year

Raymond D. Speer  
Managing Editor

### PARIS

In spite of the slowdown in the U.S. economy, it's "business as usual in Europe." This was the view of many of the exhibitors at the giant Mesucora Automation Show here. Their projections were for sales of their products to grow at a rate of 10 to 40% this year.

And computer and peripheral-gear sales are expected to grow the fastest. Representatives of Systems Engineering Laboratories in Rueil-Malmaison and of Mohawk Data Systems, Aéromaritime Electronique, and Viatron-France, all of Paris, were very optimistic. All of these companies represented American firms at the Paris Show, which ran from May 27 through June 4.

There were some, however, who saw faint clouds on the economic horizon. Sales will grow, they said, but not as fast as many expect.

Jean Desplanches, sales engineer for Packard Instrument S. A., Paris, for example, was happy, but not deliriously so.

"Business is not going down," he said, "our sales are increasing slowly in France and throughout the Common Market. But we don't expect large increases.

"One of the reasons," he continued, "is that our products are used largely in research and medicine. Our sales are dependent on budgets allotted to research, and in Europe there isn't much money available for research projects."

Bernard Hauseux, ingénieur électronique E.S.E. with AFE Manufacturing and Sales, Inc., Paris, saw a moderately good market for Hickok instruments, which his company handles.

"In France," he said, "money has been extremely tight; the level of credit has been lowered drastically by the government in the last few years. But now business is

on the increase, and with France's recent devaluation, it is easier to export French products. The result has been a stimulation of business in France."

Pierre Forgeas, ingénieur technico-commercial with Hewlett Packard, France, saw a "so-so" market, with "a growth in HP sales of 15% in 1970—certainly not more."

"This is much slower than last year," he noted.

Forgeas expected HP's growth to come largely from the industrial and automation markets, and he listed also the telecommunications area as a likely market.

"In France," he said, "there has been a great motivation to buy French products first. Since de Gaulle this has been changing, and engineers are becoming primarily concerned with finding solutions to their technical problems. They're getting more interested all the time in buying imports—instru-



Exhibitors were optimistic at the huge Mesucora automation show in Paris. Most predict sales increases in their product lines of 10% to 40% for 1970.

ments and systems, as well as components.

At least one company, though—Ceta Electronics, Ltd., Dorset, England, a firm with no U.S. ties—saw its brightest sales future in the U.S., even though the American electronics business has been relatively poor in recent months. Ceta's sales director, Peter H. Bowker, explained:

"We feel that there's a considerable market for our products in Europe, too, and we're having a go at Western Europe. But we feel the U.S. will be our best market in the future, even though things aren't going too well now."

Up to now, Ceta has limited its sales efforts to Britain.

### Show considered a success

The exhibitors at Mesucora were basing the forecasts for electronics growth in Europe largely on their success at the show, and that success was considerable.

Among the more optimistic, James Baconnet, director of international operations for Systems Engineering, said he definitely expected growth in the European economy this year. Systems Engineering is a supplier of real-time computer systems, both hardware and software. In the process-control, scientific and industrial-computer markets, industry growth should be 17 to 35% in 1970. Baconnet said. Business machines, he added, will grow less swiftly.

Mohawk Data Systems' Pierre Zambaux, director of the Original Equipment Market Div., noted that there was a dip in computer and data-processing sales in February, but he said he expected vigorous growth from now on. Mohawk is selling peripheral equipment—card punches and readers, paper-tape punches, magnetic data recorders and tapes, and high-speed printers.

Zambaux said that, to date, in its first two and a half years of operation, Mohawk had sold over 2000 machines in France alone.

He saw sales to the Soviet-bloc





"The U. S. is four to five years ahead of Europe; and Europe is four or five years ahead of the Soviet"—Pierre Zambaux, ingénieur E. S. E. and division director at Mohawk Data Systems, Paris.

countries as a good possibility, although he hadn't sold any machines there yet. And he observed that the gap between Soviet and American technology was very wide.

"The U.S. is four to five years ahead of Europe," he said, "and Europe is four to five years ahead of the Soviet."

Representatives of Aéromaritime Electronique (AEREL), who sell calculators and minicomputers for Wang Laboratories, Digi-Data Corp., Optronics, Vector and others, predict sales exceeding \$1-million in 1970 for Wang products alone. The market for calculators is widening, they observed, and they see strong growth through 1970 and 1971.

Since the French labor troubles of two years ago, business in general has been growing steadily, according to AEREL's Philippe Clouard, ingénieur technico-commercial. He noted that the calculators and computers that AEREL sells will be used in France for scientific, construction, surveying and business applications. But the largest field of use will be scientific—scientific and statistical calculation

# HIGH PERFORMANCE MOSFETs TO 500 MHz

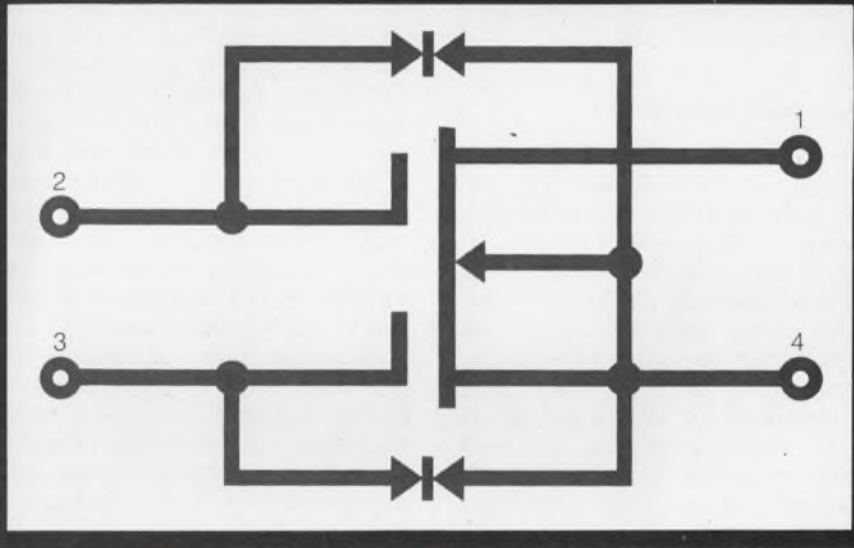

## Another RCA breakthrough: dual-gate-protected MOSFETs for 300 and 500 MHz

You bet it's a breakthrough! The electronics industry, communications in particular, has been waiting a long time for an exceptionally high-performance, VHF MOSFET. Now RCA has two of them—the 3N187 dual-gate MOSFET for space, military, and industrial applications up to 300 MHz, and the 3N200 dual-gate MOSFET for similar applications up to 500 MHz.

RCA dual-insulated-gate MOSFETs are protected by special back-to-back diodes diffused directly into the MOS pellet. These diodes protect against voltage transients encountered in normal handling and usage.

Here are two more bonus features:

Low VHF noise figure

3N187—3.5 dB (typ) at 200 MHz

3N200 { 3.0 dB (typ) at 200 MHz  
4.5 dB (typ) at 400 MHz

High RF power gain—Gps—(No neutralization required)

3N187—18.0 dB (typ) at 200 MHz

3N200 { 12.5 dB (typ) at 400 MHz  
19.0 dB (typ) at 200 MHz

For further information, see your local RCA

Representative or your RCA Distributor, or write:  
RCA, Commercial Engineering, Section 57G-19/ZT3,  
Harrison, New Jersey 07029. International: RCA,  
2-4 rue du Lièvre, 1227 Geneva, Switzerland,  
or P. O. Box 112, Hong Kong.

# RCA

INFORMATION RETRIEVAL NUMBER 22

(no slump, continued)

in research centers and universities. This will account for 60% of their business, Clouard said.

And Gilbert Derbyshire, public relations manager for Viatron France, saw a demand for 2000 System 21's in France alone in 1970. "The problem," he said, "will be delivery. If we can deliver, we'll sell \$5-million in 1970."

### Many seek French reps

Bowker of Ceta Electronics, gauged as "reasonable" the response at the show to his company's products. Ceta manufactures IC testers and considers Teradyne its chief competition in Europe. "One of the things we wanted to accomplish here," the sales director reported, "was to find a good agent to represent us. We've met about 20 interested companies, and we'll select one in the next few days."

Many of the U.S. companies that exhibited at Mesucora were looking for European business partners, and many found them. Bruce Strong, director of business rela-

tions for the U.S. exhibition area at Mesucora, reported that of the area's 39 exhibitors, nine were new to the French market and were looking for representatives. All concluded agreements or were negotiating with French companies by the end of the show.

### Warm greeting to Americans

U.S. participation in the show was greeted warmly by European engineers. AFE Manufacturing and Sales had two booths, for instance—one in the U.S. exhibition area and one on a different floor. It reported its U.S.-affiliated exhibit had more visitors.

Mohawk's Zambaux saw it this way: "European engineers are interested in U.S. companies because that's where they expect to find high-performance, state-of-the-art products. But U.S. companies producing run-of-the-mill items don't command any special attention."

Less advanced products are produced well, and cheaply, in Europe, Zambaux observed.

Bernard Hauseux, ingénieur électronique E.S.E. with AFE, noted that the typical French manufac-



"... Now business is on the increase, and with France's recent devaluation, it is easier to export French products. The result has been a stimulation of business in France"—Bernard Hauseux (left), ingénieur électronique E. S. E. with AFE Manufacturing and Sales, Paris, chats with ELECTRONIC DESIGN's managing editor, Raymond D. Speer, at the Paris Show.

turer could produce test instruments that were the equivalent of those of U.S. manufacturers. But they are more expensive, he added. "Engineering costs are very high," he said, "and European companies can't produce in high enough volume to support extensive development efforts." ■■

## When in Europe, do as Europeans do

Interviews by ELECTRONIC DESIGN among exhibitors at the Mesucora Automation Show in Paris produced these tips for American electronics companies that want to sell in Europe:

Marketing U.S. products in Europe involves considerably more than hanging out a sign. The prestige of the U.S. electronics technology will take you far—but often not far enough to close a sale. You must demonstrate a commitment to the European market.

You must be prepared to talk over with the customer, in his own language, the technical problems that you are offering to solve. And you must provide adequate, visible technical support for your products in Europe.

How do you demonstrate a commitment? By having a good, respected European agent or representative, or by forming a subsidiary in a European coun-

try. It's best to have a permanent agent in each country in which you plan to do business.

One exhibitor at the show, Ceta Electronics of Dorset, England, spent much of its time in Paris hunting for a good French company to represent it in the future. Ceta's sales director, Peter H. Bowker, noted: "In France, people aren't prepared to buy direct from an overseas manufacturer unless he is well-established in France."

A typical French businessman's comment, he said, was: "Your equipment looks very good. As soon as you have an agent established in France, let us know."

The need to speak the customer's language was emphasized by Arturo Krüger, director of technical services in Europe for Motorola Semiconductor Products, Inc. He said that his application engineers must speak four languages—English, French,

German and Italian—to operate effectively from their Geneva base.

James Baconnet, director of international operations for Systems Engineering Laboratories, Rueil-Malmaison, France, observed:

"Europe is 15 nations with at least nine languages, and though the prestige of U.S. electronics makes selling easier, it's much better to use the native tongue when you deal with a customer. The subtleties of negotiations in contracts, for instance, may escape you completely if you don't know the language intimately."

As for technical support for the product, Pierre Zambaux, director of the Original Equipment Market Div., for Mohawk Data Systems, Paris, said it was utterly essential. It takes too long to communicate with the American parent firm on routine problems, he stressed. The customer won't wait.

**Component and  
Circuit Design**

# IDEAS

FROM  
**SYLVANIA**

## CUSTOM ASSEMBLIES

**From circuit boards to complete assemblies,  
we've got the capabilities.**

Before you get to final design, talk to us. We'll show you the best and least expensive way to produce your system.

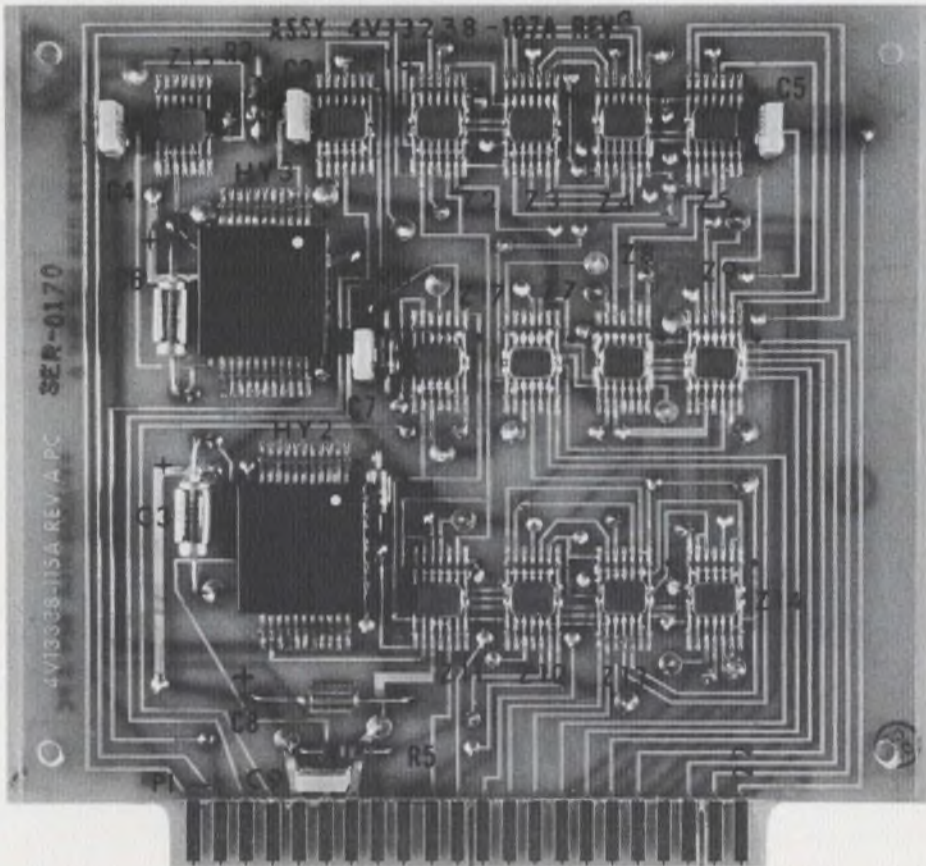

Circuit board assembly for avionics system made and tested at our Muncy, Pa. facility.

Because we've got the experts, we are willing to accept any challenge on the design and assembly of printed-circuit cards. First of all, we make our own circuit boards—single-sided, double-sided and multilayer. We also have the equipment to insert components on the board. And we are experienced at designing specialized equipment to test out the finished assembly.

The result? A completely integrated facility that can take care of all of your circuit assembly headaches. And we have the production facilities to produce your assemblies in volume.

Because of our wide range of capabilities, we can start with you at any point in the design/production schedule. We'll sit down with you at the beginning of design, or we'll make the board that you designed. We'll insert components, if you want, or give you the finished board for component insertion in your own plant.

Talk to our engineers right at the beginning of your design. They'll show you where to relax tolerances to get a better yield and lower cost. They'll analyze thermal conductivity to give you a layout with better heat dissipation. In

fact, they will even run a temperature profile of the entire board and give you a prediction of its reliability. In short, they can cancel out potential problems long before your equipment gets to the production stage.

If you have your board already designed, we'll take over from there and produce them in any volume you require. At that point, we can either deliver the boards to you or turn them over to our component insertion people. They'll set up a production line that will turn out your completed circuit board assemblies at high speed.

And again, at the end of that production line our test equipment people will take over and set up specialized test equipment to make sure that each assembly meets your specifications.

In short, we have the capability to pick up at any point in your design cycle, and drop out wherever you wish.

What more can we offer?

CIRCLE NUMBER 300

---

## **This issue in capsule**

### **Microwaves**

Better step-recovery diodes improve multiplier design.

---

### **Hybrid Microelectronics**

Flexibility is the key to hybrid packaging.

---

### **ICs**

Take advantage of Gray code in your counter designs.

---

### **CRT Modules**

Integrated display module fills computer terminal needs.

---

### **Diodes**

Diode arrays contribute to low-cost, high-speed computers.

---

### **Television**

We've done it again! A brighter color tube.

---

### **Manager's Corner**

Hybrid microcircuits: a packaging concept.

## MICROWAVES

### Better step-recovery diodes improve multiplier design.

Multiplier efficiency is increased by diodes having minimum transition times and lower thermal resistance.

Our new step-recovery diode family is designed for use in both low- and high-order multipliers. The devices are oxide-passivated, mesa epitaxial silicon diodes mounted in the 023 package. Modern bonding techniques have been used in attaching the chip to the package to obtain low thermal resistance. Minimum transition times are obtained by careful control of the intrinsic layer thickness and resistivity.

In multiplier applications, the diode stores charge and appears as a low impedance when driven into forward conduction by one half of the RF signal. On the second half of the cycle, the diode conducts until the stored charge is removed. It then switches off very rapidly at a speed determined by the transition time. Ideally, in multiplier design, the transition time should be less than the period of the output frequency.

Another important factor in multiplier design is the minority carrier lifetime. It is desirable that this lifetime be greater than the period of the input frequency. This lifetime is the time required for all charge stored on both sides of the PN junction during the forward biased state to be returned across the junction when the RF signal reverses phase.

Figures 1 and 2 show the relationship of minority carrier lifetime and maximum transition time to frequency. With these charts and the table of data on our new step-recovery diodes you can see exactly what our diode family can do for you in your next design.

The chart in Fig. 3 shows the junction capacitance variation with bias voltage for three types of microwave diode: microwave tuning varactors (MTV), punch-through varactors (PTV) and the step-recovery diode (SRD). These curves show the step-recovery diode characteristics in comparison to the other types. CIRCLE NUMBER 301

Step-recovery diode characteristics

Type	V <sub>B</sub> (1) Volts min	C <sub>J-6</sub> (2) pf min max		τ(3) ns min	T <sub>t</sub> (4) ps max	θ <sub>th</sub> °C/watt typical	C <sub>jo</sub> /C <sub>J-6</sub> max	f <sub>c-6</sub> (5) GHz min
DVB-6101	30	0.3	0.5	10	100	30	1.6	400
DVB-6102	45	0.5	1.0	25	250	20	1.6	300
DVB-6103	60	1.5	2.5	60	400	15	1.6	200

Test Conditions:

- (1) I<sub>R</sub> = 10 μA
- (2) 1 MHz and V<sub>R</sub> = 6 volts
- (3) I<sub>F</sub> = 10 mA and I<sub>R</sub> = 6 mA
- (4) V<sub>R</sub> = 10 volts and I<sub>F</sub> = 10 mA
- (5) 1 GHz and V<sub>R</sub> = 6 volts

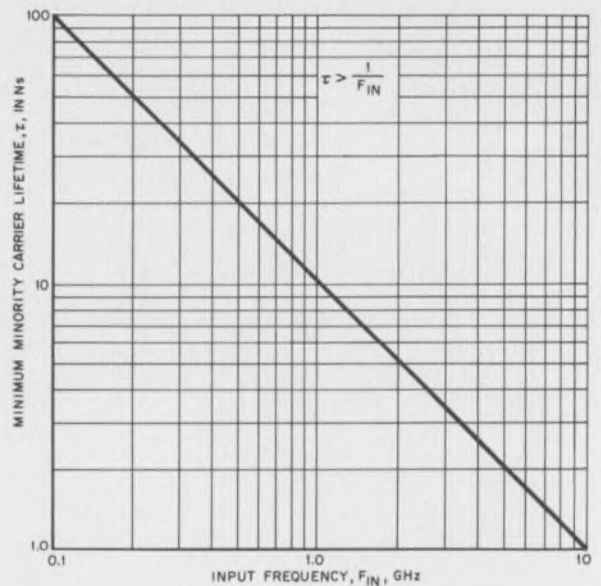

Fig. 1. Minimum minority carrier lifetime compared to multiplier input frequency.

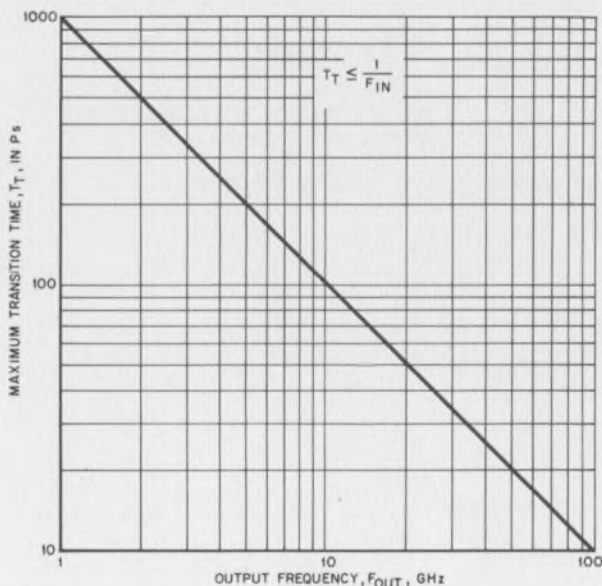

Fig. 2. Maximum diode transition time compared to output frequency of multiplier.

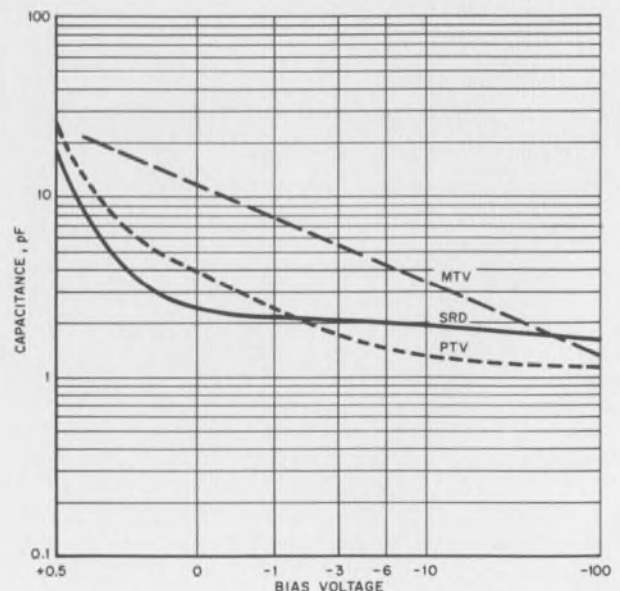

Fig. 3. Capacitance characteristics of three types of microwave diodes.

## HYBRID MICROELECTRONICS

### Flexibility is the key to hybrid packaging.

Trying to force everything into a "standard" package can destroy the advantages of hybrid circuit design.

There is no such thing as a "standard" hybrid microelectronics package. In fact, to impose such restrictions on a designer would defeat one of the most important features of this technology. Design and packaging flexibility is one of the key advantages of the hybrid approach.

The trick is to let your environmental and system parameters dictate what would be the optimum package. Then talk to our hybrid circuit engineers to develop the most efficient and least expensive approach to meeting your requirements.

The design flexibility we can provide is illustrated in the photographs. The first example is a character generator. This is one of a family of devices in a stroke type display system. Over 100 different types of circuit are used in a single display system, and each device differs in the values of the input, or summing, resistors. The general circuit is shown in Fig. 1.

As an additional requirement the amplifier had to be hermetically sealed and replaceable within the module. The amplifier also had to be set at a level to match the other amplifiers in the system. This required dynamic trim of the finished device.

Because of our long experience in this field we have the equipment to do this resistor trimming quickly, accurately and easily and—perhaps most important—at minimum cost.

A final, and important, requirement of the design was that, due to system packaging constraints, the entire module had to be in a dual in-line configuration.

Because of the large number of differing precision resistors required for the range of modules, our engineers designed a substrate that would accommodate more than one module type. This approach had many economic benefits.

The amplifier is constructed using a hermetically sealed TO-5 can for the semiconductor elements of the amplifier. This package is entirely replaceable. After the amplifier is mounted on the substrate containing the precision resistors the amplifier output is adjusted. This is done by monitoring the amplifier output while trimming one of the resistors on the substrate. When the proper output value is reached, the character generator is ready for mounting in custom-designed header. The final product is shown in Fig. 2.

A second example of the flexibility of hybrid packaging is shown in Fig. 3. Here, the requirement was for a hybrid module that would identically replace the discrete component assembly shown.

The hybrid assembly could, of course, be made much smaller, but because of the direct replacement requirement, the hybrid circuit is designed into the same package. In addition to being more economical, the hybrid circuit also offers advantages in size, weight and system reliability.

These are only two examples of how we can apply our hybrid packaging technology to design problems. Do you have a design right now that might be improved by the use of hybrids? Talk to our engineers. You'll be surprised at what they can save you in both work and money.

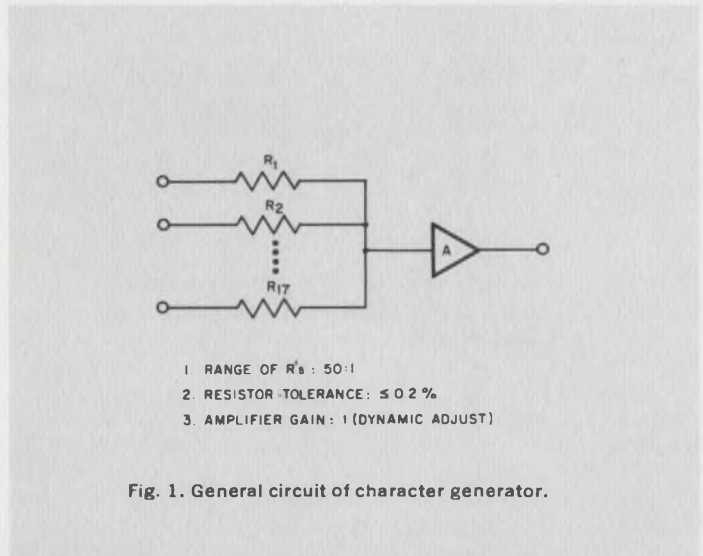

Fig. 1. General circuit of character generator.

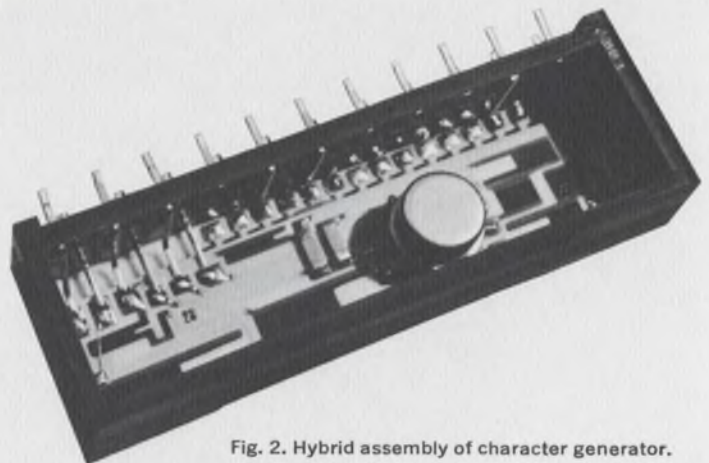

Fig. 2. Hybrid assembly of character generator.

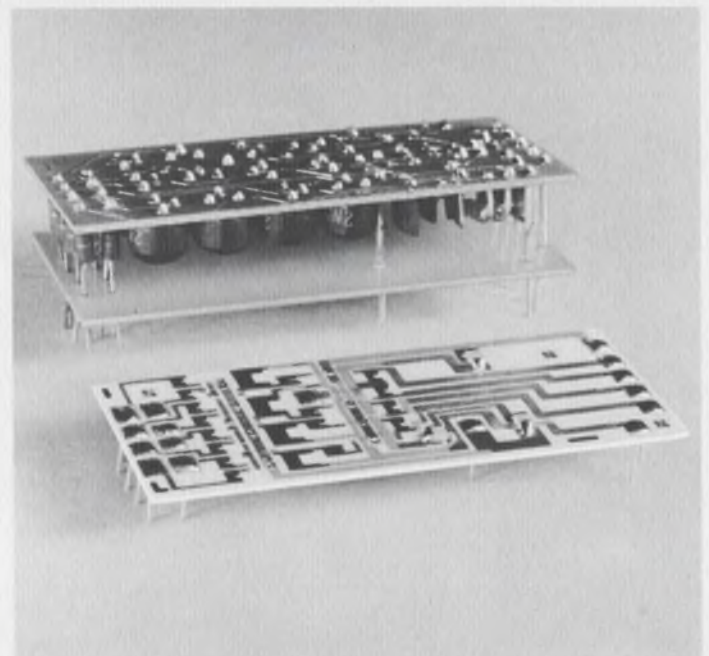

Fig. 3. Discrete component assembly and its equivalent hybrid circuit.

## INTEGRATED CIRCUITS

### Take advantage of Gray code in your counter designs.

Use of Gray code for counters offers some desirable features that you can't get from binary systems.

If you want up/down counters that give you ease of construction, reduced noise, reduced errors in reading, and a system that won't overflow, you should think about using Gray code.

The key advantage of Gray code is that only one bit can change at a time. Thus, if the clock pulse should occur while the counter is being read, the maximum error in the reading is only "one". Noise on the power line caused by flip-flops changing state is also reduced. This decreases power drain in high-frequency operation.

In addition, you can't generate "sliver" pulses with

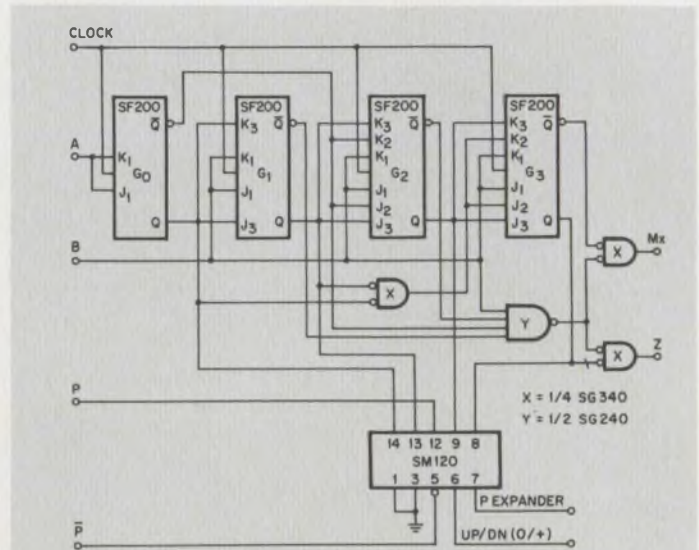

Fig. 1. Four-bit Gray-code up/down counter.

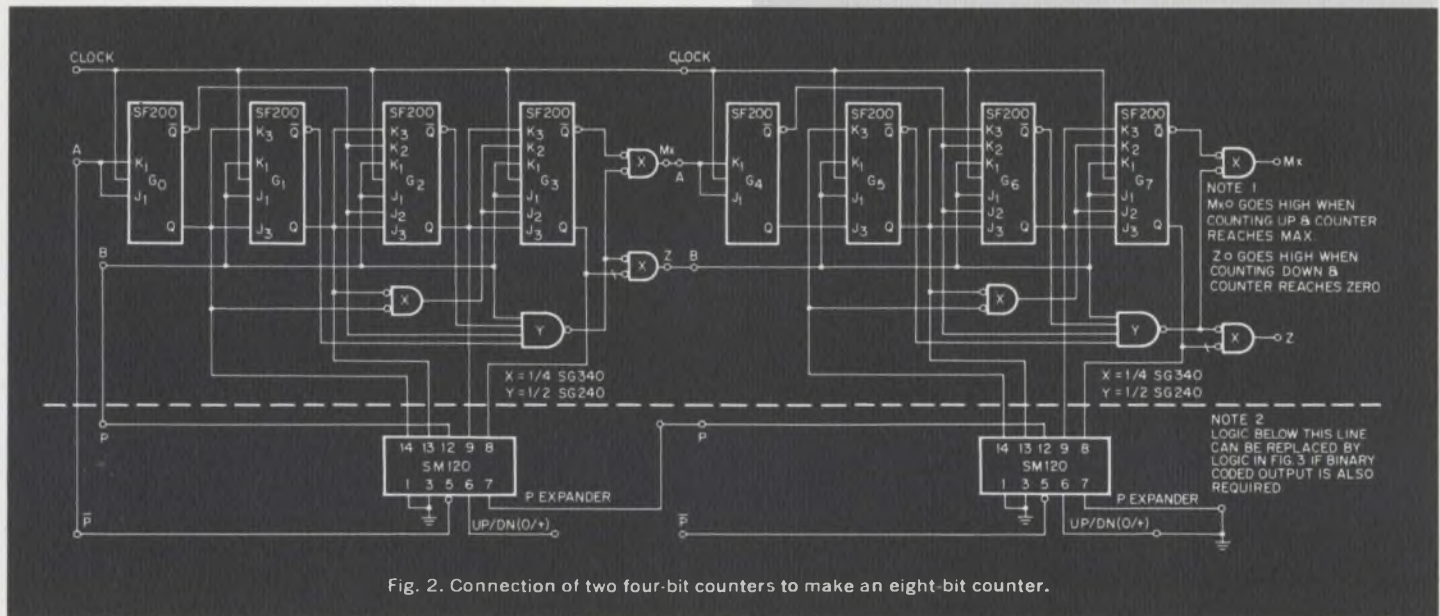

Fig. 2. Connection of two four-bit counters to make an eight-bit counter.

Gray code as is the case in binary operations. It is also very easy to change the direction of counting in a Gray-code counter. You simply invert parity. Another advantage is that the Gray-code counter stops counting when it reaches its maximum value, whether it is counting up or counting down. If this doesn't happen to be a valuable feature in your design, simple logic can be provided to eliminate it.

The logic diagram of a four-bit Gray-code up/down counter is shown in Fig. 1. Parity of the number is generated in an SM-120 parity generator. The parity generator outputs can be inverted by adding a "1" at pin 6 of the SM-120. The maximum value and zero are decoded at pins M<sub>x</sub> and Z, respectively. These signals can be used as enable inputs for additional stages of Gray-code counters, or as controls at the input of the first stage to eliminate the hang-up at maximum or zero.

Figure 2 shows how two Gray-code up/down counters can be connected to produce an eight-bit counter. If pins M<sub>x</sub> and Z of the last stage are logically "ORed" with pins P and P-bar of the first stage before they are connected to pins

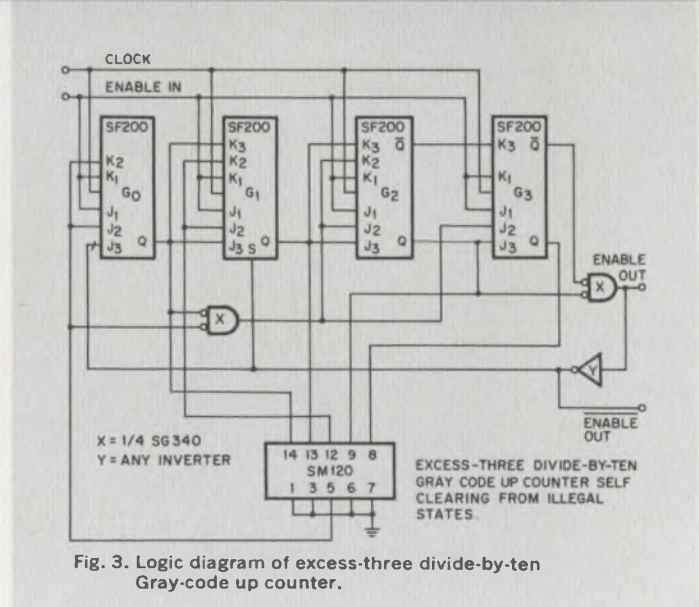

Fig. 3. Logic diagram of excess-three divide-by-ten Gray-code up counter.

A and B, the counter will not hang up at the maximum or zero values.

An excess-three divide-by-ten Gray-code up counter is shown in Fig. 3. This counter will not hang up at its maximum value of 12, but will go to the minimum value of three. The last stage of this counter has a square-wave output. An important point in this design is that all illegal states in this design are self-clearing.

This Gray-code excess-three counter can be very useful in logic systems using decimal notation where the excess-

three code is desired. Also, when used in conjunction with excess-three Gray-code to ten-line decoders, this counter has many advantages over straight binary systems.

If it is necessary to clear the counter to a Gray-code three (binary zero) a negative pulse applied to the clear inputs of  $G_0$ ,  $G_2$ ,  $G_3$  and to preset input of the flip-flop  $G_1$  will do the job.

Our application note #24 covers the design of Gray-code counters in greater detail. If you are interested we will be glad to send you a copy. **CIRCLE NUMBER 303**

## CRT MODULES

### Integrated display module fills computer terminal needs.

Our 12-inch display package fits in nicely with Infoton's system for local or remote computer time-sharing.

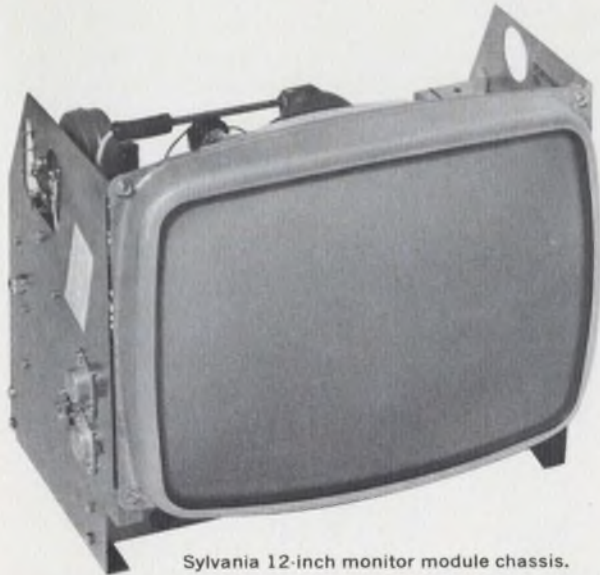

Sylvania 12-inch monitor module chassis.



Infoton Vista 1 Computer display terminal.

Infoton needed a CRT display for their Vista 1 and Vista 2 computer display terminals. They came to us and picked out our off-the-shelf 12-inch CRT module. By doing this, they saved themselves a lot of design time because our module comes complete with all-solid-state power supplies, video and blanking amplifiers. They also saved a lot of money, too, because we build these modules at a lower cost than most people can.

These advantages, combined with Infoton's expertise and design know-how enabled them to offer a reliable, flexible unit at a highly competitive price. In fact, the low cost of Vista 1 and 2 will

make display terminals available to educational institutions that previously could not afford them for computer aided instruction.

The Infoton units are designed for time-sharing applications in such places as brokerage houses, airline reservation systems and medical information systems.

Because Infoton designed their own cabinet, they used our 12-inch monitor in the chassis form shown in the photograph. However, if you need it, we can supply the monitor complete with its own attractive cabinet.

We can also custom tailor display modules to your needs. Because we

build CRTs, we know their characteristics and can pick the best one for your job. And because we know CRTs, it doesn't take our design engineers long to come up with the proper drive circuitry. The result is fast turnaround, flexibility and lower cost for you. In addition, you get exactly the right display system for your application.

In fact, about all you have to do is give us the X, Y and Z input voltages and any special requirements you have, and we will get right back to you with the specifics on design and cost for the exact display module you need.

## DIODES

### Diode arrays contribute to low-cost, high-speed computers.

New family of computers use 16-diode arrays to cut assembly time and increase memory switching speed.

Two new medium-size computers, introduced by Systems Engineering Laboratories, use from 600 to 800 Sylvania 16-diode arrays as core selectors in their memory system. The advantage to SEL was lower assembly cost, higher speed and greater reliability. In addition, these high-speed computers use Sylvania-developed SUHL logic throughout.

Both of these 32-bit computers have a high throughput. The input/output transfer rate is 1.66 million words per second. Because of the modular design and task orientation, these computers are equally suited to real-time, patch processing and general purpose scientific applications. In most cases, they can handle all three at the same time.

The core memory, where the 16-diode arrays are used, can be obtained in capacities from 8,192 to 131,072 words. The arrays are mounted in dual in-line packages.

The arrays, which are available in both common anode and common cath-

ode configurations are shown in Fig. 1. Their typical characteristics are shown in Fig. 2. They provide high forward conductance, fast recovery, low capacitance and tight tolerances. These units have a forward current rating of 300 mA and a power rating of 300 mW per diode.

Reverse recovery time of the diode arrays is a maximum of 60 ns, even under extreme switching conditions with a forward current of 300mA and an  $I_R$  of 30 mA. Typical recovery times under the same conditions are in the 35 ns range.

Because of the manufacturing process used to produce these arrays, electrical characteristics are closely matched over a wide temperature range.

In addition, units are available with 2 to 16 diodes. All of these arrays are available in 10 or 14 lead dual in-line packs or in flat-pack configurations. They all meet MIL-S-19500 standards.

CIRCLE NUMBER 305

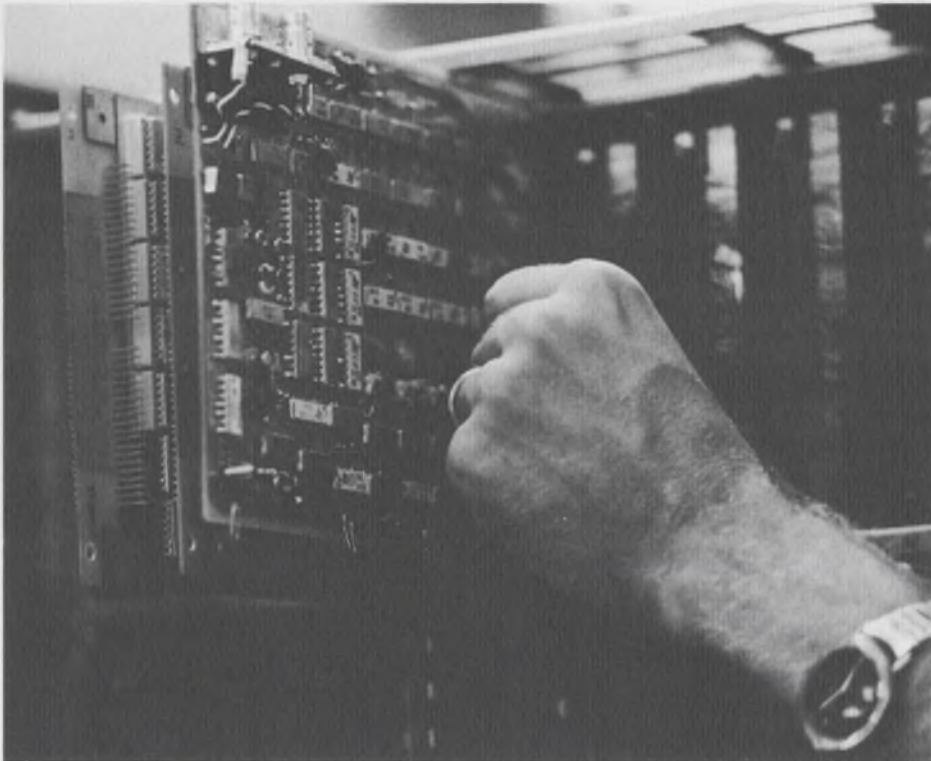

Sixteen-diode array packages are used as memory core selectors in SEL's new high-speed, low-cost, medium-size computer.

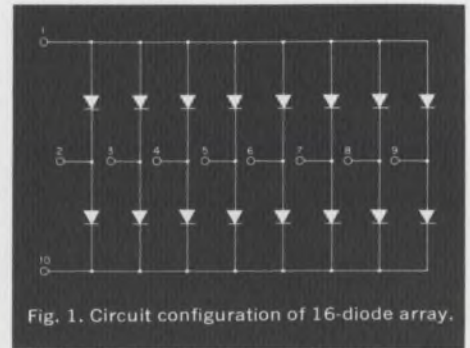

Fig. 1. Circuit configuration of 16-diode array.

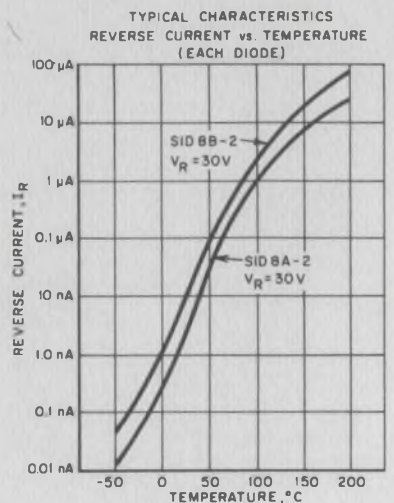
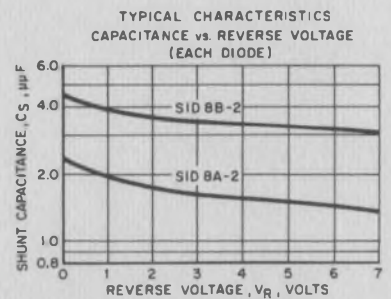
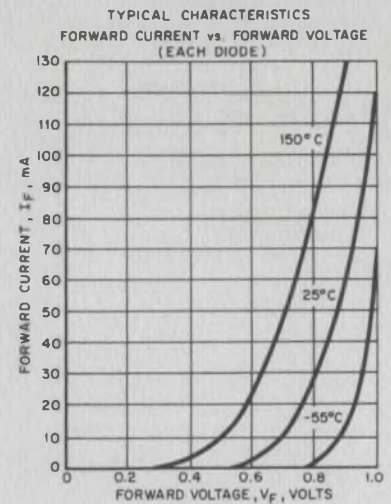

Fig. 2. Typical characteristics of diode arrays.



## TELEVISION

### We've done it again! A brighter color tube.

Using a brighter phosphor and a black mask, we've got a new tube that gives sharper contrast and 103% more brightness than our 1968 tube.

Sylvania has been the traditional leader in color tube brightness and contrast. The reason is simple: we have better phosphors and better methods of deposition. Recently, we introduced a new phosphor system that was competitive with other manufacturers' tubes which use "black" systems to improve brightness without loss of contrast.

Now, we have developed an entirely new *color bright 85*® "Black Mask" picture tube which combines our superior phosphor system with a new black masking technique. The result is a picture tube that combines the best of all possible worlds: a 103% increase in brightness over our 1968 tube, improved color purity and the highest contrast in the industry.

We've always held the edge in phosphor brightness because of the inherent advantages of our phosphor production techniques and our patented phosphor dusting system. The "black" systems, on the other hand, enabled other manufacturers to approach the brightness and contrast of our tubes because the black systems reduced reflectants and allowed the electron beam to cover the entire phosphor dot without splash-over.

When you combine our phosphors with the advantages of a black mask, you get a tube that's 103% brighter than the tube we introduced in February 1968. You also get vastly improved contrast with greater color purity than ever before.

To give you an idea of why Sylvania's *color bright 85* line has traditionally led the brightness race, take a look at the graph. Sylvania developed the first rare earth europium phosphor screen system in 1964. The whole industry followed. And until the development of the black-mask system, they couldn't come near us.

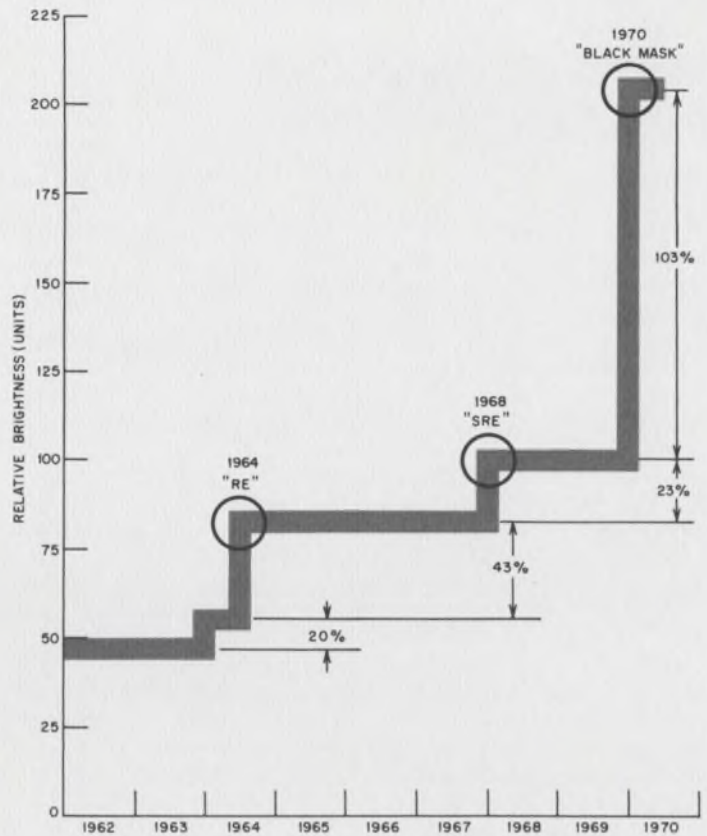

Sylvania brightness increases through the years.

Now, by combining our high brightness MV phosphors with Sylvania's Black Mask technique, we're in front again with the highest contrast in the industry.

Other picture tube manufacturers are using black system methods to reduce the reflectivity of the color tube. Our approach has been to increase the light emitted from the phosphor screen by the development of better phosphors. Both approaches work. But, what do you get when you combine them? The best tube. And Sylvania has it.

CIRCLE NUMBER 306



Use Sylvania's "Hot Line" inquiry service, especially if you require full particulars on any item in a hurry. It's easy and it's free. Circle the reader service number(s) you're most interested in; then fill in your name, title, company and address. We'll do the rest and see you get further information by return mail.

### BUSINESS REPLY CARD

No Postage Stamp Necessary if Mailed in the United States

FIRST CLASS  
Permit No. 2833  
Buffalo, N.Y.

POSTAGE WILL BE PAID BY

Sylvania Electric Products Inc.  
Sylvania Electronic Components  
1100 Main Street  
Buffalo, New York 14209

Dept. E 4 4 4 4

---

---

---

---

---

---

---

---

## MANAGER'S CORNER

### Hybrid Microcircuits: A packaging concept

Too often, design engineers think of hybrid microcircuits as just another component to plug into their system. If they do, they are wrong. Properly designed and applied, a hybrid circuit is a complete subsystem. To think of it in any other way is to lose many of the advantages of this design approach.

Basically, the hybrid microcircuit is a packaging concept that employs thick- or thin-film passive components coupled with either discrete or chip active devices mounted on a ceramic base. The hybrid module is packaged in either a hermetic or non-hermetic enclosure or a combination of both. There are an endless number of package forms that can be employed. This packaging flexibility is a primary advantage of the technology. In addition to size, weight and reliability advantages inherent in hybrids, they are now economically comparable to a discrete version when volume is significant.

In general, any electronic circuitry that cannot justify a monolithic approach is a potential hybrid application. Hybrid packaging complements monolithic designs as a second level of system integration. We see the emergence of the film passive substrates as the next generation of PC board. This, coupled with low-cost chip placement, such as beam-lead devices, will further broaden the economic justification for the use of hybrids.

Sylvania now offers standard off-the-shelf modules ranging from IF amplifiers to digital high-speed networks and power drivers. These modules are packaged in commonly used forms such as flat packs and TO-5 cans. It makes sense to examine these standard devices first in a new design. However, a custom hybrid can make economic sense if the usage can justify the tooling. As a guide, hybrid prototypes charges generally are of the same magnitude as the fabrication of a discrete module with PC board layout.

One area which is becoming increasingly important is hybrid MSI—or multichip digital modules employing TTL devices and a film interconnect pattern. Sylvania believes that multichip modules or hybrid MSI will allow the designer a new dimension in system design.

As a leading supplier of all types of TTL devices, Sylvania will be able to provide economical hybrid MSI modules for a wide variety of applications.

Our long experience in the design and production of hybrid circuits will enable us to offer the designer MSI and LSI arrays in hybrid form. But, perhaps most important, we can offer him RSI—Right Scale Integration. And we can give it to him today.

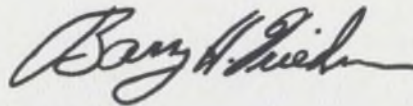

Barry Friedman  
Product Sales Manager, Hybrid Microelectronics

This information in Sylvania ideas is furnished without assuming any obligations.

# SYLVANIA

## GENERAL TELEPHONE & ELECTRONICS

NEW CAPABILITIES IN: ELECTRONIC TUBES • SEMICONDUCTORS • MICROWAVE DEVICES • SPECIAL COMPONENTS • DISPLAY DEVICES

E4

NAME \_\_\_\_\_

PLEASE PRINT

TITLE \_\_\_\_\_

COMPANY \_\_\_\_\_

ADDRESS \_\_\_\_\_

CITY \_\_\_\_\_ STATE \_\_\_\_\_ ZIP \_\_\_\_\_

#### Circle Numbers Corresponding to Product Item

300    301    302    303    304    305    306

Please have a Sales Engineer contact me.

Visit    Phone... Phone No. \_\_\_\_\_ Area Code \_\_\_\_\_



#### HOT LINE INQUIRY SERVICE

Need information in a hurry? Clip the card and mail it. Be sure to fill in all information requested. We'll rush you full particulars on any item indicated.

You can also get information using the publication's card elsewhere in this issue. Use of the card shown here will simplify handling and save time.

## Wheatstone bridge used to count and photograph fish

Automatic fish counting has been initiated at Willamette Falls in Oregon. The new counter has been set up on the fishway to eliminate the round-the-clock manual count used on other fishways.

Fishways are steps that rise, on the average, 1 foot for every 10 feet of horizontal travel. They allow fish such as chinook and coho salmon and steelhead trout to migrate up rivers past waterfalls and dams in order to spawn in the headwaters.

Integral to the system are a TV camera, a video tape recorder, a TV monitor, two detection chambers and a logic-control unit. Each detection chamber is a tunnel 14 inches wide and 2 feet high through which the fish must swim. The chambers are in series, and the fish must swim through both. An electric field is set up in each chamber so that if a fish more than 14 inches long swims through, the field will be grossly disturbed.

The two chambers are arranged in the arms of a Wheatstone-bridge type of circuit. Thus, when the field is disturbed in the lead arm of the bridge, the automatic counter is triggered. Burton E. Carnegie, project engineer for the fishway from the State of Oregon Fish

Commission, told ELECTRONIC DESIGN, "Once a fish triggers the counter, a video tape recorder starts and runs for about three seconds. The fish swimming through is then photographed through a viewing window and a digit counter indexes them."

Video recording is necessary since the automatic counter cannot yet differentiate between the various species of fish. However, a person need not sit for 24 hours in front of a viewing window; he can wait for the count to reach a certain point and then merely turn on the tape recorder, play back the fish passage, and quickly note the proportion of one species of fish to another.

Occasionally, fish drift downstream through the fish ladder rather than swimming upstream. The system can also count fish going downstream since it is the second chamber that will be disturbed first. In the downstream case, the recorder turns on for about 7 seconds. The logic-control unit can adjust the upstream and downstream viewing times to suit current conditions.

The automatic counting system was developed by David Smith of Smith, Root, Inc., of Seattle. ■■



Salmon passes viewing window at the Willamette Falls, Ore., automatic counting station. A closed-circuit TV camera relays the picture to a video tape recorder later used in fish identification.

## the GIANT KILLERS

One Stop Shopping  
from  
The Performance **LEADER**  
in  
Potted Module DC  
Power Supplies



3.6V DC	@	250mA	\$39.95*
5V DC	@	250mA	\$34.95*
		500mA	\$43.95*
		1 Amp	\$63.95*
10V DC	@	120mA	\$26.95*
±10V DC	@	120mA	\$54.95*
12V DC	@	100mA	\$26.95*
±12V DC	@	100mA	\$54.95*
15V DC	@	100mA	\$25.95*
±15V DC	@	25mA	\$19.95*
		65mA	\$36.95*
		100mA	\$41.95*
		200mA	\$72.95*
18V DC	@	65mA	\$26.95*
24V DC	@	50mA	\$26.95*
28V DC	@	40mA	\$26.95*
180V DC	@	10mA	\$41.95*

And more ... 3.6 to 180V DC

1 - 5 day shipment guaranteed.

\*unit qty. prices

CALL: 305-933-5561  
WRITE: P.O. Box 23849  
Ft. Lauderdale, Fla. 33307



**COMPUTER  
PRODUCTS®**

FORT LAUDERDALE

# Reliability is staggered steps and a hunk of DAP.

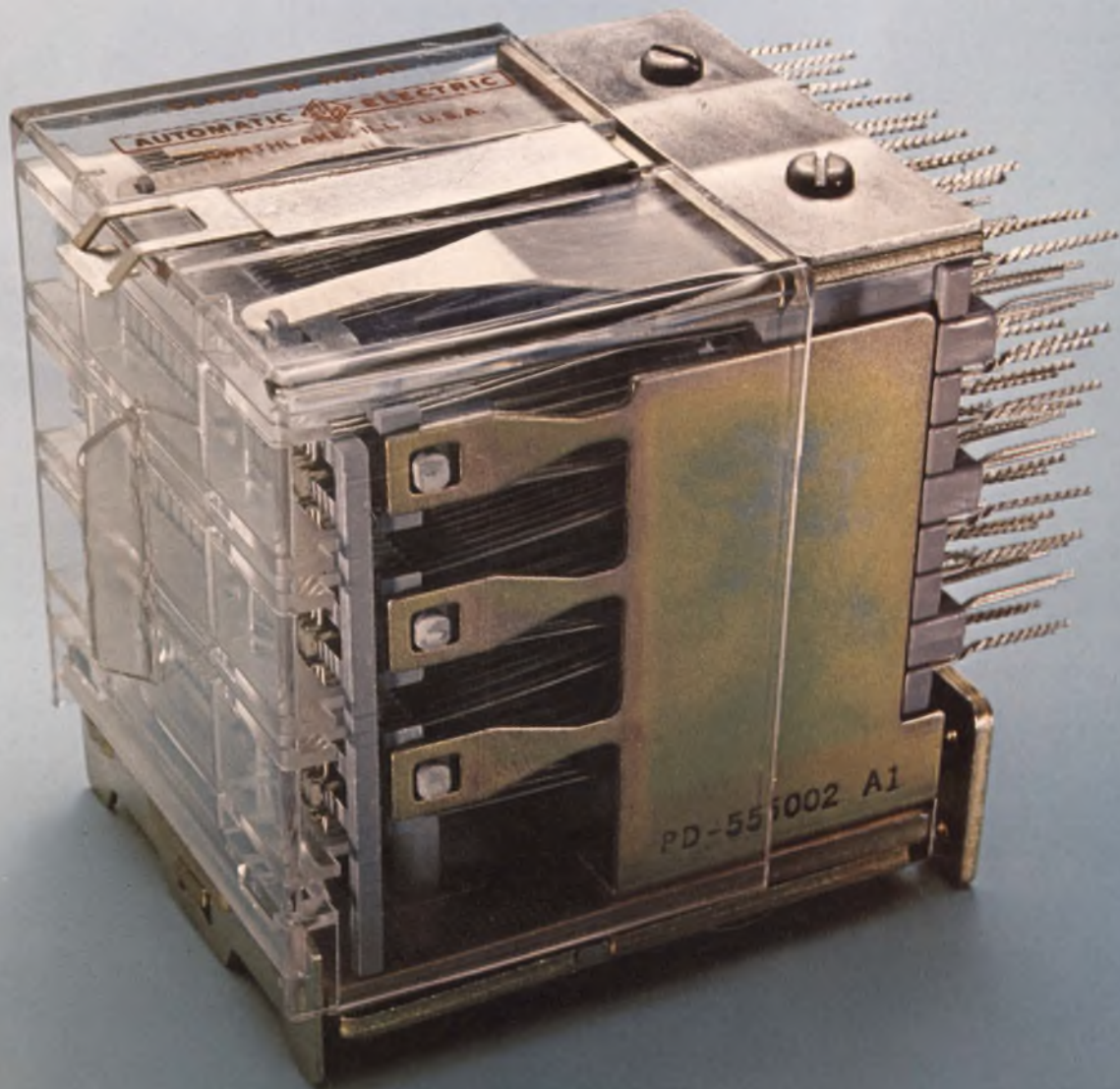

### **Expect over a billion operations.**

Our Class W wire-spring relay is different. In fact, there's nothing like it in the entire industry. Where else can you find a relay with lots of contacts and a mechanical life of more than a billion operations! That's about two and a half times the life of the best conventional relay around.

Another nice thing about our Class W is that it takes up a lot less space and costs less than using a bunch of other relays. That's because we build our Class W relay with one, two or three levels of contact assemblies, with 17 form C combinations per level. By the way, they're available with gold contacts for low-level switching.

### **Making it tough on creepage.**

All those staggered steps you see on the side were put in to raise the breakdown voltage between terminals. These molded steps add extra creepage distance between the terminals. This really counts for high voltage testing, or when using our Class W in unfavorable ambient conditions.

These steps, and all the molding compound used for insulating the contact springs, are made from

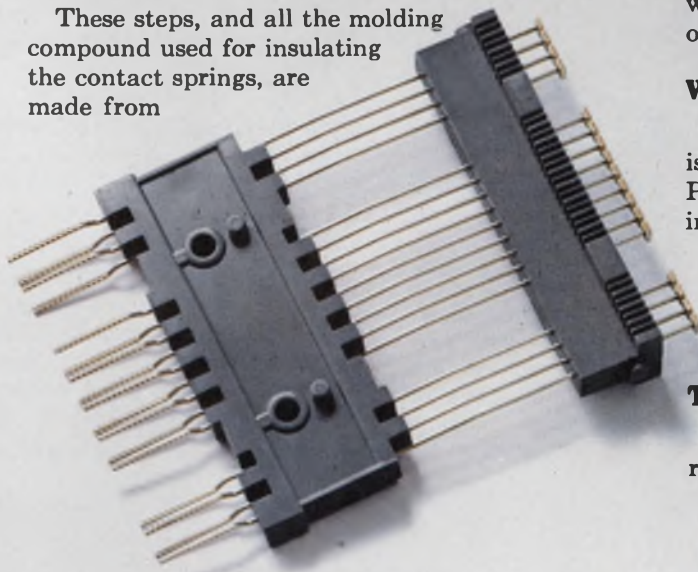

diallyl phthalate. (They call it DAP for short.) It has great insulating properties and it wears like iron. Even if the humidity is high, you have excellent protection.

### **Redundancy—two springs are better than one.**

Each of our long wire-spring contacts has an independent twin with the same function. One tiny particle of dust could prevent contact on other relays. Not with our Class W. You can be sure one of the twins will function. That's back-up reliability.

The twin contacts are twisted together at the terminal end. Then we give them a spanking (you might call it swedging) to provide solderless wrap.



### **We're for independence.**

Our springs are longer, because the longer the spring, the more independent they get. And the better contact they make. Don't forget, the wire-spring relay is the most reliable way to get a permissive make or break contact. You can rely on it.

The middle contact springs have to be stationary. To make sure they stay that way forever, we actually mold them between two thick pieces of DAP on both ends. Just try to move one.

### **When we say flat, it's flat.**

Each frame, banged out by a gigantic machine is extra thick and extra flat. Then they're planished. Planishing is another step we go through in forming the frame to add strength and stability by relieving surface strain.

We've made our spring-loaded pile-up clamp extra thick, too. Once it's tightened down, the whole pile-up is nice and tight, and stays tight.

### **There's more.**

We could tell you a lot more about our Class W relays. Like how the tough high-temp molded

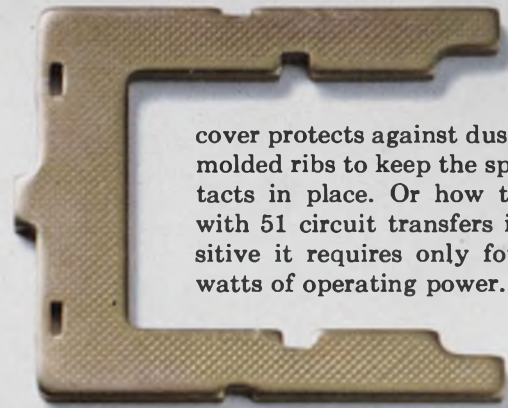

cover protects against dust and has molded ribs to keep the spring contacts in place. Or how this relay with 51 circuit transfers is so sensitive it requires only four to six watts of operating power.

But why don't you let us prove how much reliability we put into our Class W? We'll be waiting to hear from you. Industrial Sales Division, Automatic Electric Company, Northlake, Ill. 60164.

**AUTOMATIC ELECTRIC**  
GENERAL TELEPHONE & ELECTRONICS

# Back-panel interconnections go hybrid

## New approach does away with soldering problems while maintaining cost and flexibility advantages

Back-panel interconnections in much electronic equipment are taking on a different look as designers turn to hybrid interconnection techniques. These hybrid methods combine the technologies of automatic point-to-point wiring and printed circuit wiring in order to maximize cost and flexibility.

A common type of hybrid assembly consists of a double-sided printed-circuit board with connectors mounted on one side and the contact tails, suitable for automatic wiring, protruding through the other side of the board. All fixed connections, such as signal grounds and power, are made to the connectors by printed-circuit wiring. Signal paths that vary depending on individual circuit configuration or that may be subject to later design changes are provided by point-to-point wiring between contact tails.

Thus, the economy of printed-circuit wiring is combined with the flexibility of automatic point-to-point wiring.

The newest hybrid approach, pioneered by Elco Corp. of Willow Grove, Pa., eliminates a major problem associated with other hybrid techniques—namely, connecting the contact tails of the connectors to the printed circuit lines.

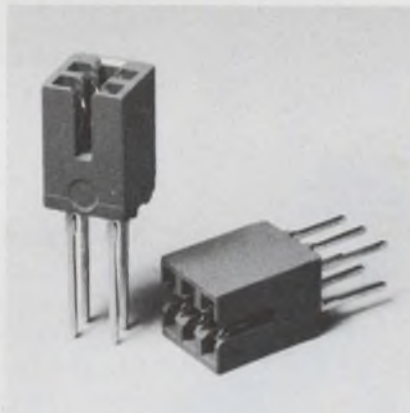

There are two types of MOJO contact modules: an end module with four contacts and a center module with six contacts. With combinations of these modules, most sizes of double read-out connectors can be formed.

Hand-soldering these connections is extremely slow, while automatic soldering methods are expensive and often pose heat problems.

The Elco system does away with soldering. Instead, special modular connectors are used that, when press-fitted into the printed-circuit back panel, form gas-tight connections between the connector contact tails and the plated-through holes in the printed-circuit board.

According to Dr. Herbert E. Ruehlemann, vice president of engineering at Elco, "the gas-tight connections are immune to corrosion, vibration and extremes of temperature, and equal or surpass the soldered joints they replace."

The modular connectors are basically card-edge types with state-of-the-art specifications. There are two module sizes: four contacts and six contacts. This allows a build-up to practically any size.

The maximum module size of six contacts was chosen from the standpoint of field repair. This was the maximum number of contacts, it was felt, that could be pushed out of the board without the strain causing damage to the board. ■■

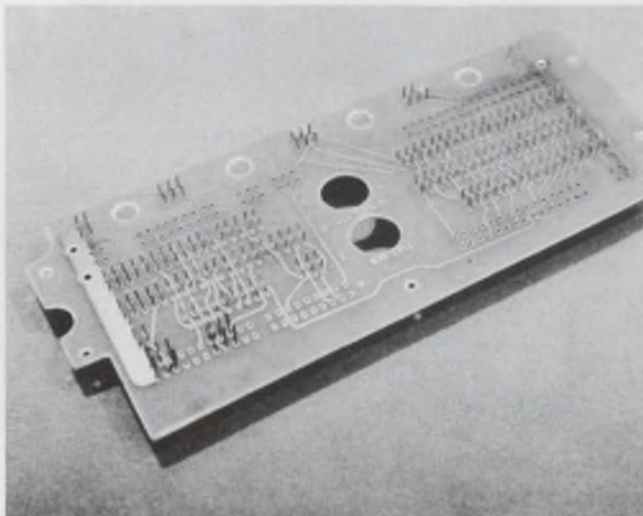

The latest hybrid back-panel interconnection technique establishes the frozen interconnections with the use of a relatively low-cost, double-sided printed circuit board, thereby omitting repetitive automatic wiring cost. The wire-wrap tails of the Elco Corp. connector, called MOJO, permit use of efficient programmed wiring for

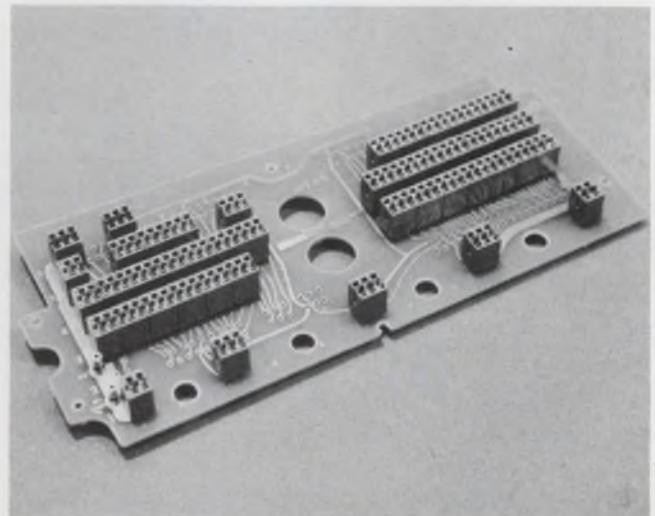

variable and complex back-panel interconnections (left photo). The MOJO connector (right photo) makes this hybrid application attractive, because the contact tails are press-fitted into plated-through holes of the printed circuit board, creating gas-tight joints and omitting costly solder operations.

*over 50% more  
device area  
in these  
14 and 16 lead*

**Al Si Pak<sup>®</sup>**  
ALL CERAMIC  
**PACKAGES**

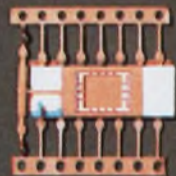

AlSiPak<sup>®</sup>  
No. SZ-80107-AB  
14 lead package  
with device area  
.170 x .200

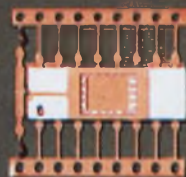

AlSiPak<sup>®</sup>  
No. SZ-80108-AC  
16 lead package  
with device area  
.170 x .220

SHOWN ACTUAL SIZE.  
LEADS ON .300 ROW CENTERS.

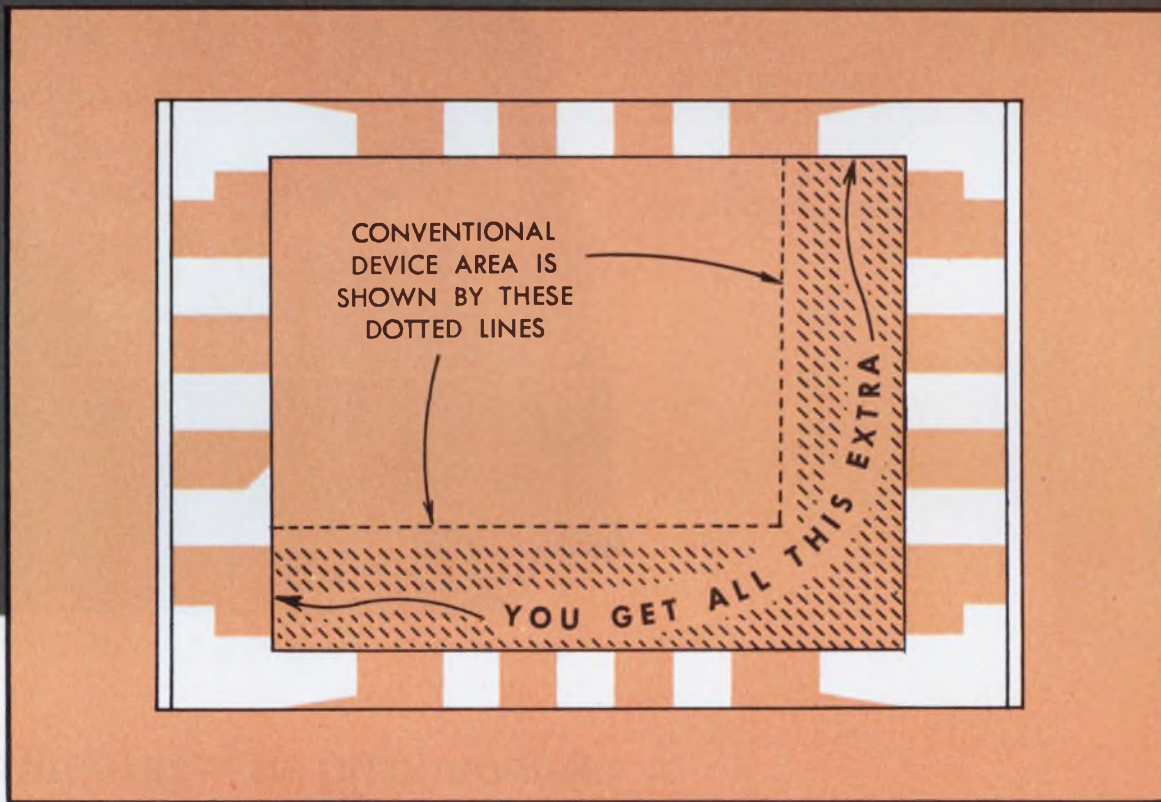

THIS 15X MOCK-UP SHOWS THE ***BIG DIFFERENCE!***

Prices and Detailed Specifications on Request

CODE IDENT. NO. 70371

PHONE 615 265-3411 • CHATTANOOGA, TENNESSEE 37405, U.S.A.

**American Lava Corporation** **3M**  
A SUBSIDIARY OF COMPANY

For service, contact American Lava representatives in Offices of Minnesota Mining and Manufacturing Company in these cities (see your local telephone directory): Boston: Needham Heights, Mass. • Chagrin Falls, Ohio • Chicago: Elmhurst, Ill. • Dallas, Tex. Indianapolis, Ind. • Laurens, S. C. • Los Angeles, Calif. • Metropolitan New York: Ridgefield, N. J. • Up-State New York and Canada: Phoenix, New York • Orange, Conn. • Philadelphia, Penna. • Roanoke, Virginia • St. Louis: Lee's Summit, Mo. South San Francisco, Calif. • International: c/o American Lava Corporation, Chattanooga, Tenn. 37405, U.S.A., TELEX 558432.

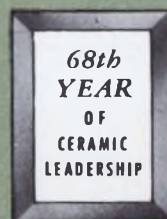

Decimals: Autopoint and scientific notation.

Automatic entry of  $e$  and  $\pi$ .

Ten directly addressable storage registers

Programming: Up to 128 steps. Conditional branching and automatic entry of programs with card reader.



Model 1655. Size: 13" x 13½" x 6½".

**Announcing an important breakthrough for engineers and scientists. Calculators based on the latest MOS/LSI technology. In both printing and display models. Available in over 350 cities coast to coast. And supported by more than 3,300 sales and service technicians.**



Dynamic range:  $10^{-99}$  to  $10^{+99}$



Automatic special functions:  
 $a^x$ ,  $\text{Log}_{10}/\text{Log}_e$ , SIN/COS,  
 $\text{SIN}^{-1}/\text{COS}^{-1}$ ,  $x!$ ,  $\frac{1}{x}$ ,  
Radians to Degrees,  
Single key  $\Sigma x$ ,  $\Sigma x^2$ , N,  
Rectangular to Polar Conversion.

Just plug in  
and put it to work.

Weight: Twelve pounds.

**Monroe men who provide  
the most complete technical  
hardware and software support.  
Because calculators are their only business.  
And our only business too.  
That's how we got our name.  
Monroe. The Calculator Company**

A DIVISION OF LITTON INDUSTRIES

550 Central Avenue, Orange, New Jersey 07050

INFORMATION RETRIEVAL NUMBER 26

# New airborne unit planned for tactical loran

## Air Force wants more programmable computer for variety of missions made possible with loran C/D

**John F. Mason**  
Military-Aerospace Editor

Several mornings a week, an F-105 pilot takes off from Eglin Air Force Base, Fla., climbs several thousand feet and feeds the coordinates of his target into a computer. In moments, a needle points the way, and two rows of eight alphanumeric gas-tube displays light up. On these he reads the distance, the bearing, track error, ground speed, true air speed, and estimated time en route.

Responsible for all this instant information is a test version of a receiver-computer unit—called AN/ARN-92—in the aircraft that takes signals from ground-based loran radio navigation transmitters and uses them to accomplish far more than simple navigation.

With data from loran, plus the other airborne sensors and navigation instruments, the computer guides the plane to its bomb run and turns it over to the toss-bomb computer. It also enables the pilot to pinpoint reconnaissance targets

and to drop air cargo at night and through clouds. All are capabilities never contemplated with earlier loran.

The tests are run with a loran C network at Eglin and its tactical offspring, loran D. The D network is lightweight and movable by air, and can be set up for operation in less than two days. Loran C and its predecessors, A and B, are permanently based and take months to construct.

Tests with the airborne unit over the past three months have been so successful that a tactical loran system is being pushed, according to a spokesman for the Loran Program Office of the Aeronautical Systems Div., Wright-Patterson Air Force Base, Ohio. The Air Force will soon buy several ground-based transmitter networks. And contracts will be awarded to develop an even better version of an airborne receiver-computer unit.

The present airborne unit has done a good job, the Loran Office

spokesman says: "But technology has advanced—such as the availability of more flexible computer software—and we can now make some significant improvements," he adds.

ITT Avionics in Nutley, N. J., built the unit's receiver and Lear-Siegler, Grand Rapids, Mich., the computer. Sperry Gyroscope, Great Neck, N. Y., built the ground transmitter networks and auxiliary equipment.

Loran C and D work on the same principle that was used by the World War II loran A and B series. A master station transmits its pulse along base lines to two slave stations, which, after a slight delay, retransmit the signal to the airborne receiver. The time difference in the arrival of the signals at the receiver is then translated into a position on the earth.

### Goal is variety of missions

Besides the successful bomb runs with the F-105, other tests are under way at Eglin with an RF-4C reconnaissance plane. When the pilot finds his target he takes a photograph. Printed on the film are the loran's special coordinates—the time-difference measurements from the master transmitter and its slaves. These time differences can be fed into a loran-equipped attack plane's computer, which guides the plane to the target.

The next test at Eglin will use an F-4D attack plane that can bomb, without radar, by the ARN-92 alone.

The ARN-92's computer is a 30-bit serial, digital machine. It converts time-difference readings into geographic coordinates. The computer uses a 4096-word read-only memory. Program changes are mechanical and time-consuming.

"The new computer must be electronically programmable for different missions. It must be capable of working out the bomb trajectory equation itself. And it must be easily integrated with other airborne sensors," an officer says. ■■

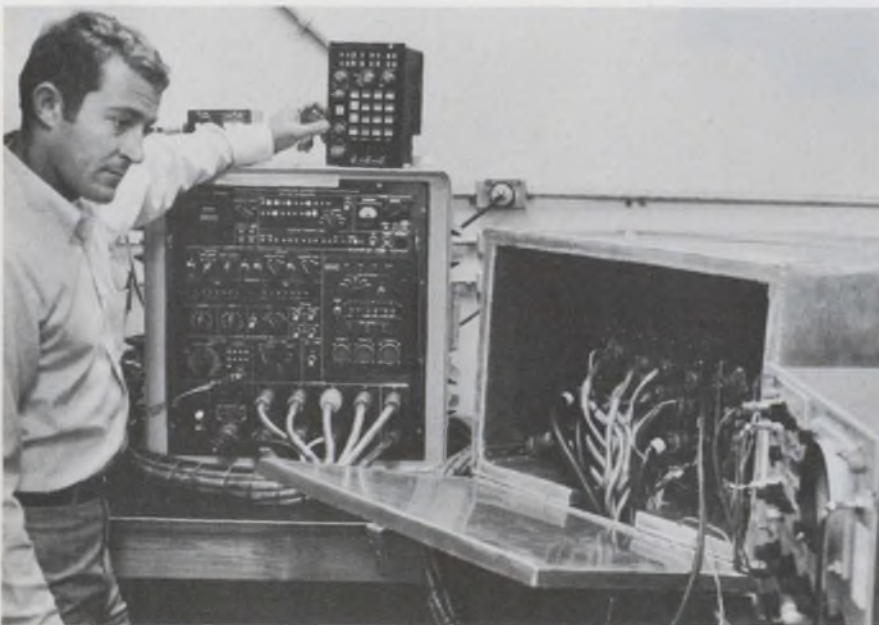

ITT field engineer Randy Smith, at Eglin Air Force Base, Fla., checks an AN/ARN-92 receiver-computer unit before it goes into an F-105.

# 4096 bit memory ...in stock

You can order from local stock the prototype quantities you need in a number of configurations, such as, 1024 x 4, 2048 x 2 and 4096 x 1. What do you need? The Computer Microtechnology Inc. CM2400 series of 4096 bit read/write IC memories are available now at your local Kieruff, K-Tronics, F-J-R or Schley distributor. Call him today.

The CM2400 series features . . . MOS and bipolar technologies . . . TTL inputs and outputs . . . access time 400 ns max . . . cycle time 600 ns max . . . low power of 0.4 mw/bit typ . . . input clamp diodes to minimize line reflections. How about that?

You could be designing in the CM2400 series 4096 bit read/write memory. Lead the pack, don't follow it.



Computer Microtechnology Inc.  
610 Pastoria Avenue  
Sunnyvale, Calif. 94086  
(408) 736-0300



## General Electric helps you solve the tough ones

GE has the broadest line of electronic components in the industry. From the tiniest integrated circuits to powerful high performance motors, GE components help you solve your tough problems . . . in design, in performance, in economy. Take a look at these GE problem solvers.

**p.s.1** New GE computer-grade capacitor offers 50% greater ripple current capability. GE's new 92F provides 30 to 50% lower ESR for better frequency capability. High efficiency permits reduction in size and weight over conventional units.

This newly-developed GE capacitor has a life expectancy of up to 3000 hours at 85C. Temperature capability up to 120C gives increased reliability or eliminates derating or additional cooling. Get complete specifications on this new GE capacitor. Circle 211.

**p.s.2** Replace 200 different SCR's with GE's versatile C103. This rugged epoxy encapsulated low-current SCR comes in the TO-18 plastic package and is ideal for tough military and industrial uses as well as many consumer applications.

The C103 is available in peak reverse voltage ratings from 30 to 200 volts. It combines an extremely sensitive gate (200  $\mu$ A) with a high surge capability (8 amp) and a low forward blocking current (1  $\mu$ A). Get full details. Circle 212.

**p.s.3** GE Sintered Alnico magnets give you high energy products with superior temperature stability and physical characteristics. And only GE can provide a complete line of Sintered Alnico materials.

Sintered Alnico has its greatest advantage in applications where mechanical work is required in small complex shapes. GE materials offer up to 12000 gauss induction and 1550 oersted coercive forces. For complete data or application help, circle 213.

**p.s.4** New Hi-TECH ceramic metal components . . . custom-designed problem solvers. GE's Hi-TECH line offers a variety of alumina, forsterite and other special ceramic materials . . . sealed to virtually any metal . . . and custom-engineered to meet your toughest operational requirements.

Use in severe environments, for example, to withstand ultra-high tempera-

tures and hyperactive chemicals. Ideal for vacuum or gas-filled devices, electrical equipment or machine parts. Find out how GE can custom design the ceramic component you need. Circle 214.

**p.s.5** Get long-life portable power with rechargeable GE nickel-cadmium batteries. Nominal ratings range from 0.1 amp-hours to 4.0 amp-hours in sealed cells and up to 160 amp-hours in vented types at the one-hour rate. And GE batteries are rechargeable for longer operating life.

Get details on how to put longer battery life into your application. Circle 215 for complete information.

**p.s.6** Get more magnetic performance per size and weight with GE cast Alnico 5-7 and 9 permanent magnets. GE's columnar grain cast Alnico 5-7 provides high inductions at 7.5 million energy products. Cast Alnico 9 couples high coercive forces with 9 million energy capabilities.

Complete directionality of grain growth permits design freedoms which were impractical before. Check with GE's application experts. Or for complete details, circle 216.

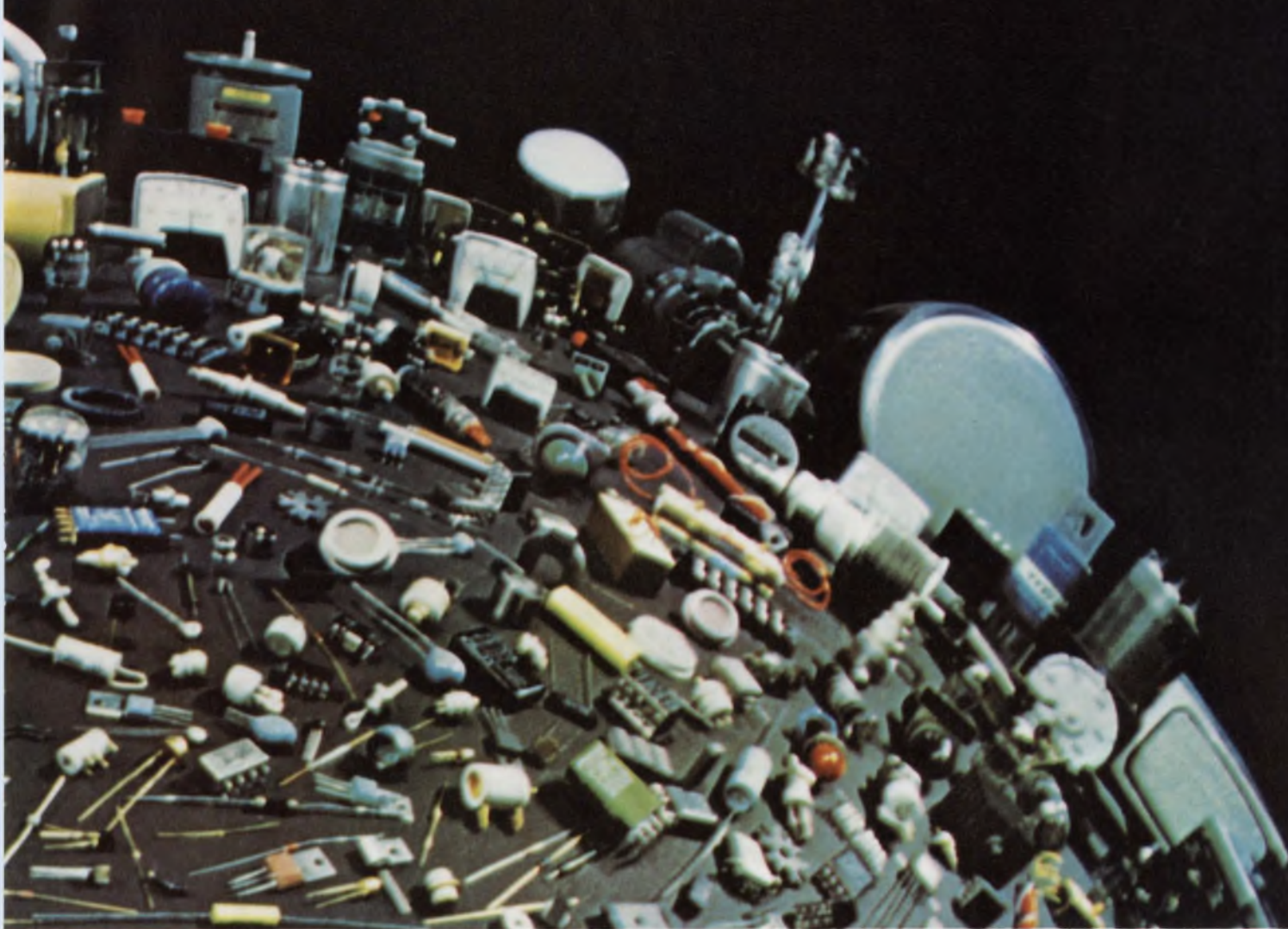

## with the broadest line of electronic components

**p.s.7** Select your indicating instruments from industry's most complete line. For measurement and control of electrical quantities, get GE Panel Meters and Meter Relays in the popular BIG LOOK® and HORIZON LINE® styles. 1½" edgewise instruments are ideal for compact display problems.

And the new BIG LOOK Frequency Meters in three ranges . . . 45-55Hz, 55-65Hz and 380-420Hz . . . are now available for engine generator sets, panel boards and inverters. For complete catalog, circle 217.

**p.s.8** New complementary power transistors are color coded for easy identification. GE's 4-amp NPN/-PNP power transistors (D44C/D45C) are molded in plastic packages to provide tough pellet protection in the most demanding applications. Three round leads fit the standard JEDEC TO-66 configuration.

These color-molded transistors feature low collector saturation voltage, excellent gain linearity and fast switching. Apply them in countless industrial and consumer circuits. For details, circle number 218.

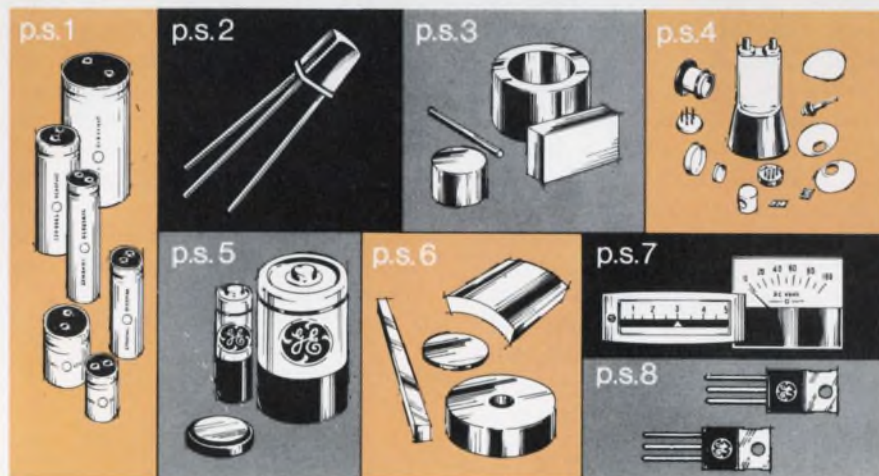

Let General Electric help solve your component problems. Call your nearest Electronic Components Sales Operation Office. Or check with one of the many authorized GE distributors. P.S. Problems? General Electric has solutions.

285-65

GENERAL  ELECTRIC

# Technology Abroad

## 210-foot space antenna to rise near Madrid

Ground has been broken about 40 miles west of Madrid, Spain, for construction of a 210-foot space tracking antenna—a duplicate of the steerable antenna at Goldstone, Calif. When it begins operating in 1973, the new facility will be the third and final link of a new worldwide tracking system which, according to NASA, will more than triple the tracking distance of spacecraft in deep-space missions. A second 210-foot unit is being built at Tidbinbilla, near Canberra, Australia.

## English firm develops new interconnect method

A new method of interconnecting integrated-circuit chips—a possible alternative to the beam-lead process—is reported by Logic Designs Ltd. of Ringwood, Hampshire, England.

Although extremely guarded at this time because of pending patent application, the company did reveal that an interconnection pattern is printed on a dielectric. As one company official noted: "The conductors can be persuaded to come through to the other side of the dielectric at any desired point." One drawing shows the conductors in the center of a dielectric sheet with connection pads on both sides of the sheet.

## Fuel cells power navigation beacon

A navigation beacon powered by fuel cells has been put into operation at Stora Hogarn in the Stock-

holm archipelago.

The cells in the automatic beacon are refueled once a year with a mixture of formate and potassium hydroxide by means of a hose from a boat. Buffer batteries are charged by the fuel cells to cope with peak loads. The fuel cells are automatically shut down when the beacon is shut off during the day.

The beacon is one of several prototypes developed by the Swedish Administration of Shipping and Navigation and ASF, a Swedish electrical engineering group for applications where low average power is required for long time periods. One prototype is being developed as a power source for telecommunications systems.

A solution to the shortage of trained computer personnel may have been found by Siemens AG of Munich, Germany. The company has opened up one of the largest data-processing schools ever founded by a computer manufacturer. The new school contains 30 instruction rooms, one lecture hall, two computer training centers and a dozen computers. Nearly 100 lecturers train about 800 Siemens' staff and customers at a time.

An inexpensive and compact closed-circuit television system designed for home and industrial plant use has been introduced by Tokyo Shibaura Electric Co., Ltd. (Toshiba). The system sells for about \$395 and comes with one camera and one monitor. The monitor has a 4-inch screen. It turns itself off automatically.

## From 31 components you can make over 25,000 different switches or indicators

Flexible, building block concept means low inventory investment. Arrow-Hart's name means top quality. And Authorized Specialty Switch Distributors (below) mean ready availability.

### Arizona Telephone

ELECTRO COMPONENTS  
DISTRIBUTORS 602/258-2665  
1641 E. McDowell  
Phoenix, Arizona

### California

R. V. WEATHERFORD 213/849-3451  
6921 San Fernando Road  
Glendale, California

ELECTRO COMPONENTS  
DISTRIBUTORS 213/264-7100  
122 So. Mission Road  
Los Angeles, California

FISHER SWITCHES, INC. 408/244-6182  
3381 Edward Avenue  
Santa Clara, California

FISHER SWITCHES, INC. 213/746-3740  
3400 S. Broadway  
Los Angeles, California

ELECTRO COMPONENTS  
DISTRIBUTORS, INC. 415/592-3030  
1667 Industrial Road  
San Carlos, California

CONSOLIDATED PARTS 408/294-2302  
180 E. Gish Road  
San Jose, California

ZACK ELECTRONICS 415/626-1444  
1422 Market Street  
San Francisco, California

### Colorado

ELECTRONICS PARTS  
COMPANY 303/266-3755  
1277 Broadway  
Denver, Colorado

 ARROW-HART, INC.  
HARTFORD, CONN.

A grid of various colored push-button switches on a dark background. The switches are arranged in rows and columns, with colors including blue, yellow, orange, and green. Some switches are rectangular, while others are circular. The lighting is dramatic, highlighting the colors of the buttons against the dark background.

Meanwhile, back on earth.

Arrow-Hart scores a breakthrough in lighted push-button switches. Snap-on contact blocks make up to 4-pole double throw form Z switches. 31 stock components = 25,344 different variations. Six colored lenses in three shapes. Is your imagination beginning to run away with you? Write or wire for folder. We call all this Adapt-a-Switch. You'll call it ingenious.

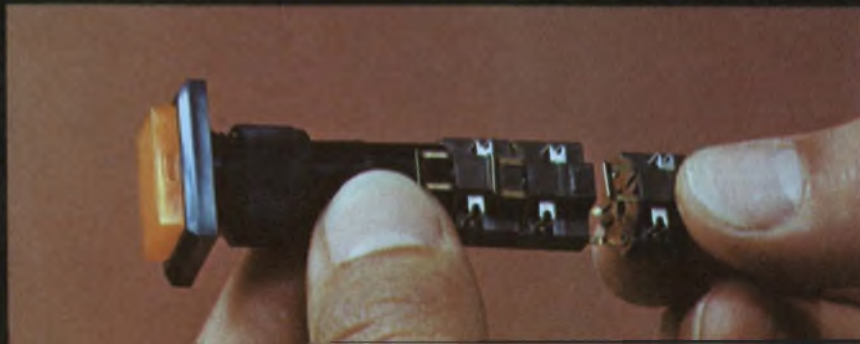

**ARROW  
HART**

ARROW-HART, INC.  
HARTFORD, CONN.



When you can't afford a "wrong number"...

Symbolic representation of the TV, voice, ranging data and biomedical telemetry signals from the moon. Photograph courtesy of NASA.

## bring ERIE in early.

Where are they? How are they? What do they see... and say? NASA and the world want to know. And, the *only* way to find out is over the special Motorola S-band equipment on both the Command and Lunar Modules. Once the Apollo Astronauts are over 30,000 miles out, it's their *only* communications link with Earth. It simply can't fail. That's why Motorola called on ERIE TECHNOLOGICAL to develop the EMI filters and Monobloc capacitors that would help this equipment perform flawlessly on every Apollo mission since Motorola has been involved. Proof, once again, that it pays to bring ERIE in early.

**ERIE TECHNOLOGICAL PRODUCTS, INC.**  
644 West 12th Street, Erie, Pennsylvania 16512  
(814) 453-5611



# Washington Report

DON BYRNE, WASHINGTON BUREAU

## **Litton contract to require \$600-million in electronics**

The Government's \$2.1-billion order for 30 new destroyers, which Litton Industries will build over the next 10 years, will generate about \$600-million in business for electronics manufacturers. Each DD963-class destroyer will carry \$20-million in electronic gear, exclusive of Government-furnished equipment, Litton estimates. In addition the company's yard in Pascagoula, Miss., expects to hire approximately 700 engineers for work on the ship's electronics. In all, some 4000 jobs will be created by the decade-long contract at the shipyard.

Final selection of the subcontractors is under way now, Litton told ELECTRONIC DESIGN. Meanwhile, with the ink on the contract barely dry, Sen. Margaret Chase Smith, Republican of Maine, took to the floor of the Senate to demand an investigation by the General Accounting Office of the award. She also asked that further action on the contract requiring allocation of Government funds be halted until the investigation is complete. Bath Iron Works of Maine was a losing bidder on the contract, the Navy's biggest for shipbuilding.

## **House committee backs \$5-billion mass-transit aid**

Urban mass-transit plans have received a big boost from the House Banking and Currency Committee, which has approved a \$5-billion air program for cities over the next five years. The committee has backed a bill that would allow the Department of Transportation to sign long-term contracts with cities, enabling them for the first time to lay out complete programs and not rely on year-to-year Congressional appropriations. A similar bill has already passed the Senate. The House is expected to pass the legislation when it comes to the floor later in the summer. The money would be used to buy rolling stock and updated electronic equipment to help existing, but badly overcrowded mass-transit systems.

## **FAA to spend millions on electronics in the 70's**

The Federal Aviation Administration will spend about \$600-million in the 70s for improvements to the air traffic control system, and the bulk of the money will be spent on electronic equipment. Administrator John M. Shaffer says his agency expects to spend \$290-million to equip domestic air traffic control centers with automatic flight data processing equipment (basically computers), alphanumeric radar displays and collision prediction and resolution equipment. A total of \$120-million more will be spent on terminal approach radars and \$36-million on long-range radars. In addition, Shaffer says, 100 or so airport surveillance radars will be purchased at a cost of \$152-million.

## **Environment-technology clearinghouse sought**

Sen. Warren G. Magnuson, chairman of the Senate Commerce Committee, is calling for establishment of a Federal agency that would be, among other things, a clearinghouse for data that related technology to environment. Magnuson has promised that his committee will hold ex-

tensive hearings on his bill, which would establish an Independent Technology Assessment and Environmental Data Collection Commission. The commission would study proposed technological advances and their effect on the earth's environment. It would then issue recommendations for the implementation of curbing of the technological advance and at the same time collect and make public all the data that led to its recommendations. Chances of completing action on the proposal this year appear slim because of the Senate's work load.

Similar, but less comprehensive, legislation has already been introduced in the house.

## Senate unit restores cut communications funds

The Senate Appropriations Committee has restored funds cut by the House from budgets for the new Office of Telecommunications Policy and the Federal Communications Commission. The committee put back \$3.3-million cut from the Office of Telecommunications Policy and \$175,000 cut from the FCC. In another action, the White House named Dr. Clay T. Whitehead, a special assistant to the President for communications matters, to head the Office of Telecommunications Policy. For three months, Dr. William Niskanen was assumed to be in line to head the new office, but industry sources were unhappy with his lack of telecommunications experience. Dr. Whitehead, too, lacks industry experience, but he did run the White House study that resulted in the reorganization plan that created the Office of Telecommunications Policy.

## Standardization of telephone computer terminals urged

The National Academy of Sciences has called for enforced standardization of customer-owned computer terminal equipment designed for link-up to the nation's telephone network. A study panel found that "various kinds of harm can occur" from uncontrolled interconnections and that technical limits on the equipment are needed to protect the telephone system. The report called for a "properly authorized" program of standardization, certification, installation and maintenance of the terminal equipment. Such a program, it said, would not interfere with innovation or the improvement of equipment.

## Capital Capsules:

AWACS (the Air Force's Airborne Warning and Control System), which earlier this year fell victim to a Government-wide economy move, may once again be alive and kicking—thanks to a sagging economy. Sources indicate that the contract may be awarded soon to jack up the badly hurt aerospace industry . . . . The Dept. of Transportation has let contracts totaling \$7,767,501 for construction of a car that hopefully will be safer than anything around today. American Machine and Foundry of Santa Barbara received a \$3,240,000 contract; Fairchild Hiller of Farmingdale, N. Y., \$4,547,500, and General Motors, \$1-million. Delivery is to start in 15 months . . . . Is the B-1 bomber, for which a developmental contract was recently awarded to North American, a "paper" airplane? Speculation is widespread in Washington that the plane will never be built and that its chief function will be to serve as a negotiating tool at the Strategic Arms Limitation Talks now going on with the Russians.

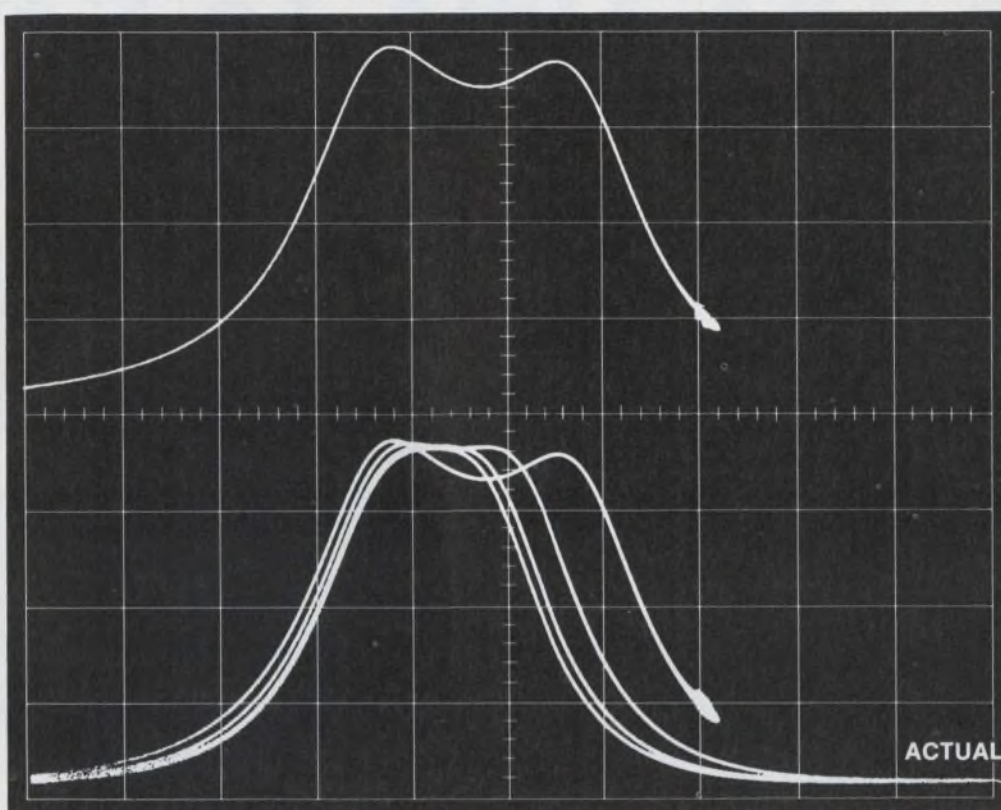

CH1  
> 100  
mV

CH2  
> 100  
mV

HORIZ  
200  
mS

ACTUAL SCREEN SIZE

# A DUAL-BEAM FAMILY

Performance in a Configuration to fit YOUR individual application

Big performance . . . in a compact size! Performance characteristics of this dual-beam oscilloscope family include high-gain, wide-bandwidth amplifiers with 19 calibrated deflection factors from  $10 \mu\text{V}/\text{div}$  to  $10 \text{V}/\text{div}$ . The voltage inputs (differential or single ended) have a bandwidth of DC to 1 MHz at all deflection factors. Current probe inputs are also provided for each beam with 10 Hz to 1 MHz bandwidth and eight calibrated deflection factors ranging from 1 mA to 200 mA/div. A wide sweep range is provided in 21 steps from  $1 \mu\text{s}/\text{div}$  to 5 s/div. The convenient direct reading magnifier provides sweep magnification ratios of up to 50 times. Bright fiber-optics automatically read out scale-factors adjacent to the extra large 8 x 10 div ( $1.27 \text{ cm}/\text{div}$ ) CRT.

This big display area is available in a  $6\frac{1}{2}$ " conventional or rugged bistable storage CRT; both have internal graticules. Three instrument configurations are available, each at the same price. They are: a  $5\frac{1}{4}$ " high rackmount, a 6" high x  $17\frac{3}{4}$ " wide low-profile cabinet and a 10" wide upright cabinet. Save space without compromising your measurements!

Ask your Tektronix Field Engineer for a demonstration. For complete specifications consult your 1970 Tektronix Catalog or write: P.O. Box 500, Beaverton, Oregon 97005.

5031 (Storage) . . . . . \$2500    5030 (Conventional) . . . . . \$1850

These oscilloscopes are available through our new Leasing Plan.  
U.S. Sales Prices FOB Beaverton, Oregon



**Tektronix, Inc.**



committed to progress  
in waveform measurement

# Now's The Time To Get

## Two Ways:

First, get a free evaluation unit of any of six different, popular Motorola unijunction transistors from now through December from your Motorola distributor . . . plus — and a BIG plus — purchase up to 999 of any Motorola UJT at 10% off his regular, published price!

Example: Send the July coupon to your favorite distributor — he'll furnish you a free MPU131, newest of our all-inclusive UJT line. It offers you "programmable" parameters ( $R_{BB}$ ,  $\tau$ ,  $I_V$  and  $I_P$ ) in your timing, sensing, pulsing and oscillator circuits simply by varying the external resistor values. You can make your own specs with it, so to speak.

And, during July, you can also buy up to 999 of any Motorola UJT currently offered from your distributor's inventory at 10% off his regular, 1-999 price.

Same thing in August, September, etc.

Sound like a good deal?

Then understand this: whenever you choose Motorola unijunction transistors you choose

preferred, state-of-the-art leadership in technology and performance.

. . . because the Annular process furnishes fast-response, long-time-delay advantages as well as superior reliability and stability in all applications.

. . . because there are over 20 different metal and plastic Motorola UJT's to meet your top-performance needs in most any design from consumer to military.

. . . because computerized testing ensures uniform results, faster deliveries and user confidence.

. . . because ready availability meets any demand.

. . . because applications assistance is yours for the asking, like AN294, "Unijunction Transistor Timers and Oscillators," a valuable application note we'll send you if you send to Box 20912, Phoenix 85036.

. . . because, almost always, they cost less. So you see, we do offer you a great deal in UJT's. Anytime.

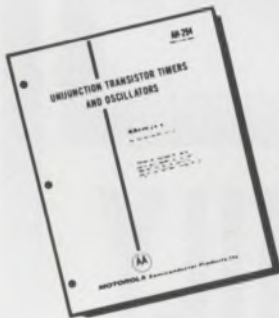

### GREAT UJT DEAL JULY

FREE MPU131  
The Programmable One!

Name \_\_\_\_\_  
Title \_\_\_\_\_  
Company \_\_\_\_\_  
Div. \_\_\_\_\_  
Address \_\_\_\_\_  
City \_\_\_\_\_ State \_\_\_\_\_ Zip \_\_\_\_\_

My favorite Motorola distributor is:

Signature \_\_\_\_\_

### GREAT UJT DEAL AUGUST

FREE 2N2646  
The Available Industry Standard!

Name \_\_\_\_\_  
Title \_\_\_\_\_  
Company \_\_\_\_\_  
Div. \_\_\_\_\_  
Address \_\_\_\_\_  
City \_\_\_\_\_ State \_\_\_\_\_ Zip \_\_\_\_\_

My favorite Motorola distributor is:

Signature \_\_\_\_\_

### GREAT UJT DEAL SEPTEMBER



FREE 2N4870  
The 43¢ Plastic Performer!

Name \_\_\_\_\_  
Title \_\_\_\_\_  
Company \_\_\_\_\_  
Div. \_\_\_\_\_  
Address \_\_\_\_\_  
City \_\_\_\_\_ State \_\_\_\_\_ Zip \_\_\_\_\_

My favorite Motorola distributor is:

Signature \_\_\_\_\_

# A Great Deal In UJT's

	Unijunction	Peak Point Current @ $V_{B2B1}$ $\mu A$ (max)	Valley Point Current mA(min)	Intrinsic Standoff Ratio		Emitter Reverse Current (max)	Interbase Resistance kohms	
				Min	Max		Min	Max
	2N2646	5 @ 25V	4	56	75	12 $\mu A$	4.7	9.1
	2N2647	2 @ 25V	8	68	82	200nA	4.7	9.1
	2N3980	2 @ 25V	1	68	82	10nA	4.0	8.0
	2N4851	2 @ 25V	2	56	75	100nA	4.7	9.1
	2N4852	2 @ 25V	4	70	85	100nA	4.7	9.1
	2N4853	0.4 @ 25V	6	70	85	50nA	4.7	9.1
	2N4948	2 @ 25V	2	55	82	10 $\mu A$	4.0	12.0
	2N4949	1 @ 25V	2	74	86	10nA	4.0	12.0
	JAN2N4948**	2 @ 25V	2	55	82	10nA	4.0	12.0
	JAN2N4949**	1 @ 25V	2	74	86	10nA	4.0	12.0
	2N5431	0.4 @ 4V	2	72	80	10nA	6.0	8.5
	2N4870	5 @ 25V	2	56	78	1 $\mu A$	4.0	9.1
	2N4871	5 @ 25V	4	70	85	1 $\mu A$	4.0	9.1
	MU4891	5 @ 25V	2	55	82	10nA	4.0	9.1
	MU4892	2 @ 25V	2	51	69	10nA	4.0	9.1
	MU4893	2 @ 25V	2	55	82	10nA	4.0	12.0
	MU4894	1 @ 25V	2	74	86	10nA	4.0	12.0
	MPU131	2 @ 10V†		(Programmable)		5nA	(Programmable)	
	MPU132	0.4 @ 10V†		(Programmable)		5nA	(Programmable)	
	MPU133	0.15 @ 10V†		(Programmable)		5nA	(Programmable)	
	MU851	2 @ 25V	2	60	80	100nA	4.7	9.1
	MU852	2 @ 25V	4	70	85	100nA	4.7	9.1
	MU853	0.4 @ 25V	4	70	85	100nA	4.7	9.1

\*\*Conforms to Mil-S-19500/388

† $R_G = 1 M\Omega$

- where the priceless ingredient is care!

## MOTOROLA

Unijunction Transistors



### GREAT UJT DEAL OCTOBER

FREE 2N4852  
The Minutes-TO-Microseconds  
Timer!

Name \_\_\_\_\_  
Title \_\_\_\_\_  
Company \_\_\_\_\_  
Div. \_\_\_\_\_  
Address \_\_\_\_\_  
City \_\_\_\_\_ State \_\_\_\_\_ Zip \_\_\_\_\_

My favorite Motorola distributor is:  
\_\_\_\_\_  
Signature \_\_\_\_\_

### GREAT UJT DEAL NOVEMBER

FREE MU851  
The High-Frequency Micro-T!

Name \_\_\_\_\_  
Title \_\_\_\_\_  
Company \_\_\_\_\_  
Div. \_\_\_\_\_  
Address \_\_\_\_\_  
City \_\_\_\_\_ State \_\_\_\_\_ Zip \_\_\_\_\_

My favorite Motorola distributor is:  
\_\_\_\_\_  
Signature \_\_\_\_\_

### GREAT UJT DEAL DECEMBER

FREE 2N5431  
The Only Low-Voltage UJT!

Name \_\_\_\_\_  
Title \_\_\_\_\_  
Company \_\_\_\_\_  
Div. \_\_\_\_\_  
Address \_\_\_\_\_  
City \_\_\_\_\_ State \_\_\_\_\_ Zip \_\_\_\_\_

My favorite Motorola distributor is:  
\_\_\_\_\_  
Signature \_\_\_\_\_

INFORMATION RETRIEVAL NUMBER 31

## How emotional can memory people get?

"I was amazed," said West Coast Editor Elizabeth de Atley, after a recent tour of the memory industry, "to find how emotional people get about 'their' memory technology—whether core, plated-wire, or semiconductor. I commented on this to a noted memory specialist, Reese Brown, manager of memory techniques, Burroughs Corp., Piscataway, N. J., and he agreed."

Brown said that people become so involved with a particular memory technology that they tend to forget they are all in the memory business. "This attitude," he said, "has led to disaster in the past—for example, when people who worked for the railroads forgot they were really in the transportation business." They lost to competition when they forgot the passengers.

Not all semiconductor manufacturers are quite as bullish as Wally Raisanen, operations manager for IC memory and MOS products, Motorola Semiconductor Products Div., Phoenix, who said, "In ten years, semiconductor memories will have the whole business—to a first approximation." But the others are optimistic, too.

The magnetics manufacturers are none too happy about the threatening noises from the semiconductor industry. A core manufacturer called it psychological warfare. "By making wild predictions about how cheap semiconductors are going to get," he said, "they're trying to swing everybody over their way—because unless they can get the business their prices certainly won't come down." He added, "It's a lot harder for us to make projections about next year's costs because we've had a product for years. We've got to extrapolate from there."

A semiconductor manufacturer replied, "We've got a past, too—ICs. Prices on those have been dropping for years—usually a lot faster than we thought they would. The staid magnetics industry just doesn't know what's hit it yet."

Elizabeth's special report begins on p. 70.



Why is he optimistic about semiconductor memories? Wally Raisanen of Motorola Semiconductor Products Div. tells his reasons to Electronic Design's Elizabeth de Atley.

## Sales Representatives

### ALABAMA

Compar Southern  
Huntsville, Ala. 35801  
(205) 539-8476

### ARIZONA

Compar Rocky Mountain  
Scottsdale, Arizona 85252  
(602) 947-4336

### CALIFORNIA — Northern

Compar San Francisco  
Burlingame, Calif. 94010  
(415) 347-5411

### CALIFORNIA — Southern

Compar Los Angeles  
Burbank, Calif. 91504  
(213) 843-3884  
San Diego, Calif. 92111  
(714) 279-9280

### COLORADO

Compar Rocky Mountain  
Englewood, Colo. 80110  
(303) 781-0912

### FLORIDA

Tech-Rep Associates, Inc.  
Melbourne, Fla. 32901  
(305) 723-9140

Tech-Rep Associates, Inc.  
Indian Rocks Beach, Fla. 33535  
(813) 595-2834

### ILLINOIS

Compar Midwest  
Des Plaines, Ill. 60018  
(312) 775-0170

### INDIANA

Compar Midwest  
Indianapolis, Ind. 46205  
(317) 251-6729

### MARYLAND

Compar Chesapeake  
Baltimore, Md. 21208  
(301) 484-5400

### MASSACHUSETTS

Contact Sales, Inc.  
Lexington, Mass. 02173  
(617) 861-8544

### MICHIGAN

Compar Midwest  
Southfield, Mich. 48075  
(313) 357-5369

### MINNESOTA

Compar Twin Cities  
Minneapolis, Minn. 55416  
(612) 922-7011

### MISSOURI

Compar Midwest  
St. Louis, Missouri 63141  
(314) 542-3399

### NEW JERSEY — Northern

Compar New York  
Clifton, N.J. 07011  
(201) 473-2660

### NEW JERSEY — Southern

Sunday-O'Brien  
Haddonfield, N.J. 08033  
(609) 429-1526

### NEW MEXICO

Compar  
Albuquerque, N.M. 87110  
(505) 265-1020

### NEW YORK — Upstate

Compar Albany  
Albany, New York 12205  
(518) 489-7408

### NEW YORK — New York

Endwell, New York 13760  
(607) 723-8743  
Liverpool, N.Y. 13088  
(315) 471-3356  
Fairport (Rochester), N.Y. 14450  
(716) 271-2230

### NEW YORK — Metro. & L.I.

Compar New York  
Clifton, New Jersey 07011  
(201) 473-2660

### NORTH CAROLINA

Compar Southern  
Winston-Salem, N.C. 27101  
(919) 723-1002

### OHIO

Compar Ohio  
Cleveland, Ohio 44126  
(216) 333-4120  
Fairborn, Ohio 45324  
(513) 878-2631

### TEXAS

Compar Southwest, Inc.  
Dallas, Texas 75225  
(214) 363-1526  
Houston Division  
Houston, Texas 77036  
(713) 667-3420

### UTAH

Compar  
Salt Lake City, Utah 84103  
(801) 364-1163

### WASHINGTON

19-Compar Northwest  
Kirkland, Washington 98033  
(206) 822-4191



**Qualidyne Corporation**

3699 Tahoe Way, Santa Clara,  
California 95051 • 408/738-0120



## This seal is worth money.

You've never seen this symbol before.

But if you're interested in buying interface and memory components for less, yet retaining high quality manufacturing processes, you won't forget it.

This seal is the symbol for Tailored Wafer Fabrication, a unique Qualidyne innovation in semiconductor manufacturing.

This proprietary process makes possible a wafer yield nearly twice the industry average.

That in itself is only part of the story. Quality hasn't been sacrificed for price. The process lets us produce components of unusually high quality.

Hard to believe? Just for comparison's sake, see if your present dual transistors match these monolithic NPN and PNP specs and prices:

**The NPN-QD-100 Series** (in TO-71, 78, 78 epoxy cans) exhibit DC current gains ( $h_{FE}$ ) of 200 min. from 10  $\mu$ A to 1 mA with the Base-Emitter Voltage (VBE1-VBE2) of 5 mV, 3 mV and 1.5 mV. The 100 piece price is \$1.00 to \$3.68, depending upon the package and model you choose.

**The PNP-QD400 Series** (in TO-71, 78, 78 epoxy cans) have DC current gains ( $h_{FE}$ ) of 100 min. from 10  $\mu$ A to 1 mA with Base-Emitter Voltage (VBE1-VBE2) of 5 mV, 3 mV and 1.5 mV. The 100 piece price is \$1.10 to \$4.05, depending upon the package and model you choose.

**The NPN 2N Series** in TO-71 and TO-78 cans.  
 2N2913-2N2920—General Purpose—\$1.75 to \$5.50  
 2N3423-2N3424—High Frequency—\$5.00 to \$7.30  
 2N4044-2N4880—Dielectric Isolation—\$3.00 to \$8.00

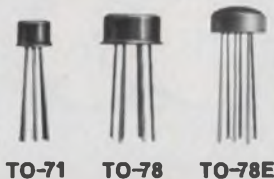

**Qualidyne  
Corporation**

Demonstration, not conversation, sells Qualidyne TWF components. For information on our line of diode arrays, monolithic duals, linear ICs, drivers/receivers and custom semiconductor memories, contact your Qualidyne representative, or contact us directly.  
**Qualidyne Corporation, 3699 Tahoe Way, Santa Clara, Calif. 95051. (408) 738-0120.**

# Feel Free To Flex

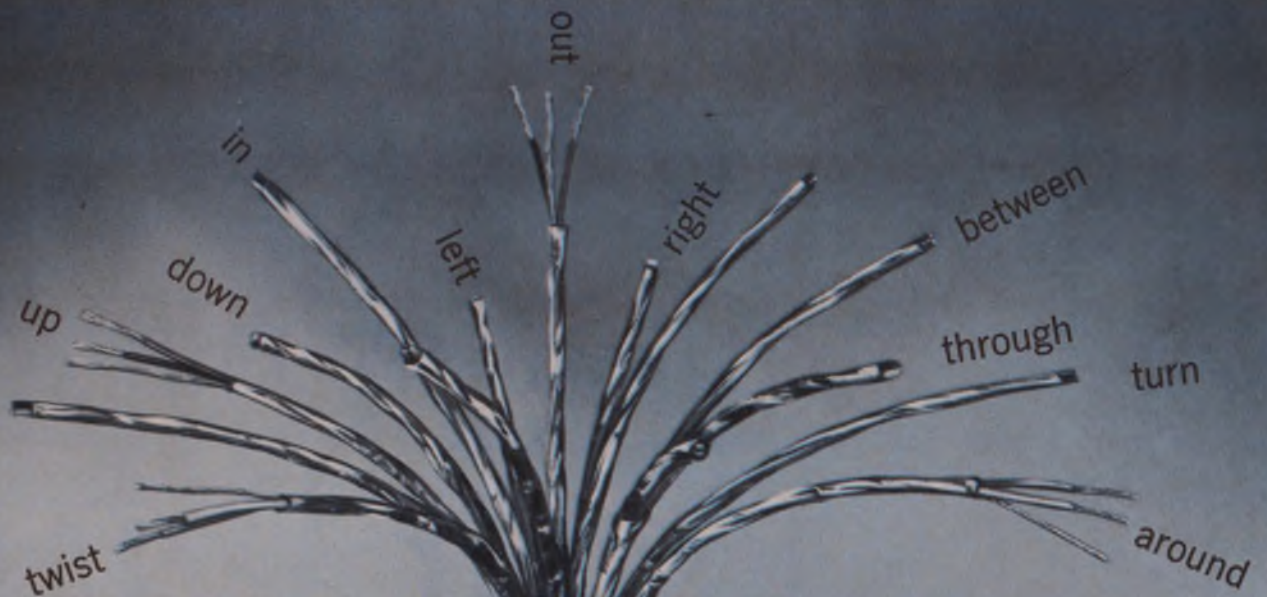

Yes, we know . . . we used to recommend Beldfoil Shielded Cable only for fixed applications. We were too modest. Extended testing proves Beldfoil, even after repeated flexing, provides more physical shield coverage than braided wire or spiral wrapped (served) shields. And greater shield effectiveness. □ Beldfoil is a layer of aluminum foil bonded to a tough polyester film (for insulation and added strength). A Belden invention. We apply it in different ways for different applications. We can even form a unique shield that's like a continuous aluminum tube. This we call ISO-Shield™. □ When new (or in fixed applications) Beldfoil ISO-Shield is extremely effective in limiting crosstalk or interference . . . whether from outside sources or between shielded elements in the same cable. □ Under frequent flexing minor separations may occur in the foil. But special Beldfoil construction features prevent performance from becoming seriously affected. We do, however, recommend that you tell us if cable flexing is to be extreme. We have special designs available to meet severe flexing requirements. □ Beldfoil makes possible a small, lightweight cable that terminates easily and is modest in

price. Your Belden distributor stocks or can quickly obtain just about any size or type you need . . . from single conductor audio and sound cable up to data cable having 27 individually shielded pairs (more pairs available on special order). Ask him for the latest "Belden Electronic Wire and Cable Catalog." Or for technical information, contact Belden Corporation, P. O. Box 5070-A, Chicago, Illinois 60680; phone (312) 378-1000.

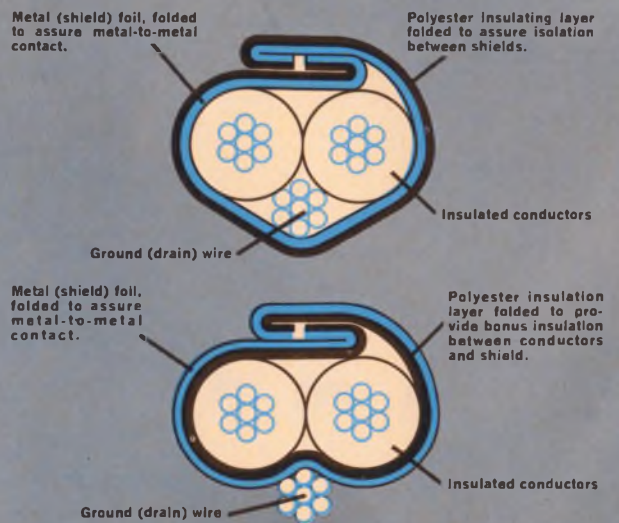



# Beldfoil® Shielded Cable

-shield effectiveness remains outstanding

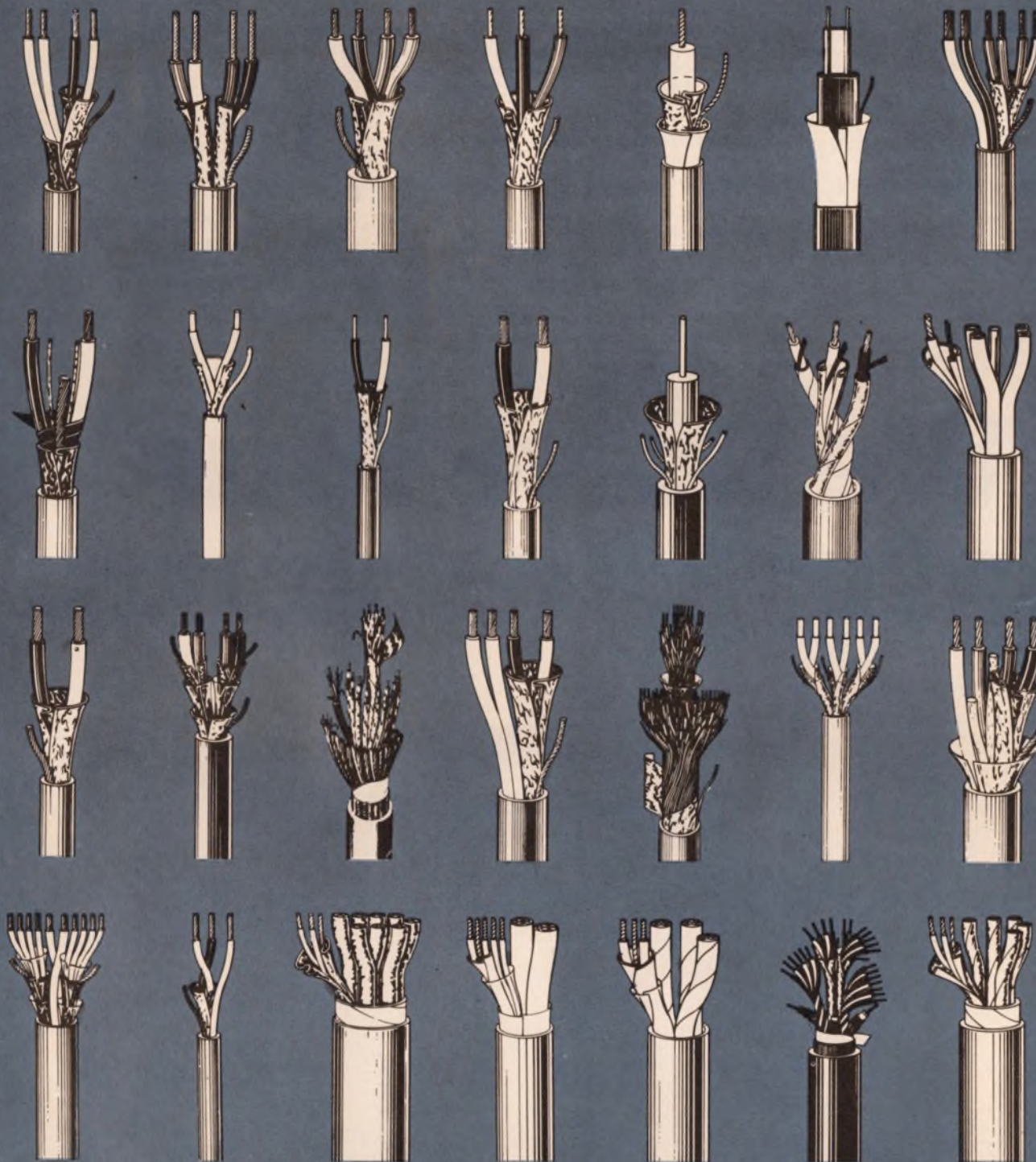

**BELDEN**



8-5-9A

*new ideas for moving electrical energy*

INFORMATION RETRIEVAL NUMBER 33

The Malco reputation wasn't built on dating and marriage counseling. But it was built on broad product lines of precision mating, interconnecting techniques with virtually unlimited tooled parts for superior circuit distribution regardless of your electronic packaging application.

This unique system has been named —

**MALCO/MATES.** However, it does more than supply you with the highest-quality and quick delivery of parts and equipment you need. It was designed to bring your organization and the Malco people together in a mutually satisfying relationship. You'll be surprised how much easier our sales and engineering staff can make your job. Consult us today.

**AUTO/MATES** (Automatically Applied)

**Crimp Type Wire Connectors**

Tabons® (flat blade receptacles)

Pinons (pin receptacles)

Wrapons (wrapost receptacles—  
for .045" or .025" square or .030"  
x .060" or .020" x .030"  
rectangular wraptails)

Rings & Spades

**Printed Circuit Hardware**

Pins

Wraposts

**PLATE/MATES** (Hi Reliability, Logic  
Distribution Plate Connectors)

**Fork and Blade Interconnection  
Systems**

Wasp®

Mini-Wasp®

**CARD/MATES** (Plate Type and  
Standard P.C. Edge Connectors)

Cardec

Card Receptacles

**RACK/MATES** (Accessory Rack and  
Panel Products)

Rack & Panel I/O Connectors

Flat Cable Connectors

Power Buss Strips &

Jumper Clips

Card Guide Systems

**MOD-MATES** (Modular Interconnection  
Designs)

Modu-Con

Dip Mate



**MALCO**®

**MALCO MFG. COMPANY INC**

5150 W. ROOSEVELT RD.

CHICAGO, ILLINOIS 60650

PHONE (312) 287-8700

# We Solve Your Mating Problems.





# Rugged Reliability is only one great feature of the new SPC-16 computer for your industrial automation

SPC-16 also performs like two computers in one... hardware features accommodate real-time dedicated control in the foreground, while performing background batch processing.

SPC-16 blends an unmatched combination of fast response time and powerful computing capability with fail safe features and rugged industrial reliability.

And more importantly, SPC-16 can increase your productivity and profits with a minimum initial investment... with fast pay back.

Ask about the reliability of SPC-16 today... it's backed by a full range of software packages, technical services and maintenance support.

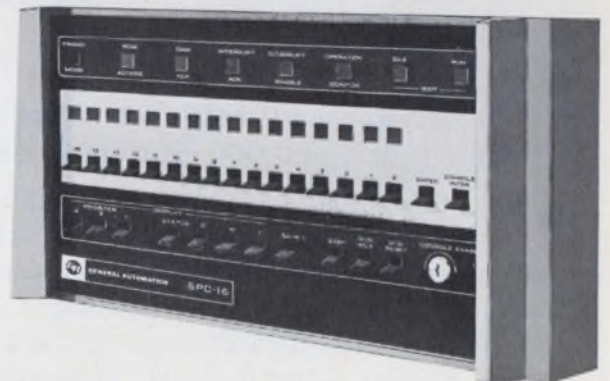

Ask about other automation computers in the GA family. The SPC-12 for less than \$5000. System 18/30 for under \$20,000.



**GENERAL AUTOMATION, INC.**

1402 East Chestnut, Santa Ana, California 92701  
(714) 835-4804 TWX (910) 595-1780

CALIFORNIA  
Los Altos, (415) 941-5966  
Orange, (714) 633-0680

TEXAS  
Dallas, (214) 358-0271  
Houston, (713) 774-8716

ILLINOIS  
Des Plaines, (312) 298-4650  
(California G.A. Corp.)

OHIO  
Cleveland, (216) 351-2275

GEORGIA  
Atlanta, (404) 261-6203

PENNSYLVANIA  
King of Prussia, (215) 265-6525

MARYLAND  
Silver Spring, (301) 587-7090

CONNECTICUT  
Stamford, (203) 325-3883

MASSACHUSETTS  
Waltham, (617) 899-6170

INTERNATIONAL  
BELGIUM  
G.A. 1 24 Blvd de l'Empereur  
Brussels, 13 78 03

ENGLAND  
G.A. Ltd. Wren House  
Portsmouth Road, Esher, Surrey  
Esher 65764

GERMANY  
ERA Elektronische Rechenanlagen  
51 Aschen, Postfach 465  
Werk: Verlautenheide  
Lindenweg 23  
02405 4444

G.A. GmbH  
6200 Wiesbaden  
Frauenlobstr. 9  
06121 83073

**The newest,  
fastest and easiest  
way to specify  
indicator lights,  
push button switches  
and readouts.**



**Dialco's new 56-page product  
selector guide helps you select  
from over 1,500,000 visual indicators**

This book is the result of an all-out effort to provide you with fingertip data on all Dialight components and to make it very easy for you to locate the detailed specs and information you desire. Designers and engineers will find the "Product Selector Guide" invaluable in their work. Send for your copy today. Dialight Corp. 60 Stewart Ave., Brooklyn, N.Y. 11237.



**DIALIGHT**  
A North American Phillips Company

INFORMATION RETRIEVAL NUMBER 36

Hi-Ho **ASTROplate**<sup>®</sup>

"Now we use-um  
ASTROplate bullets!  
Much harder  
than silver!"



ASTROplate<sup>®</sup> is AMAZINGLY RUGGED. ASTROplated RF connectors take abrasion and constant handling without wear-off or finish deterioration to keep a factory-new appearance. To demonstrate ASTROplate's ruggedness we tested silver and ASTROplate on a Vickers hardness tester. ASTROplate is rated at 200 to 350 on the Vickers scale—silver rates at only 70 to 155.

And—you can mix or match ASTROplate<sup>®</sup> anywhere in your system (old or new) with silver or any other finish with *no galvanic reaction*. Solderability performance meets MIL Spec. QQ-S-365.

Ask your Amphenol Distributor for ASTROplate<sup>®</sup>—the PERMANENT FINISH for RF connectors.



INFORMATION RETRIEVAL NUMBER 37

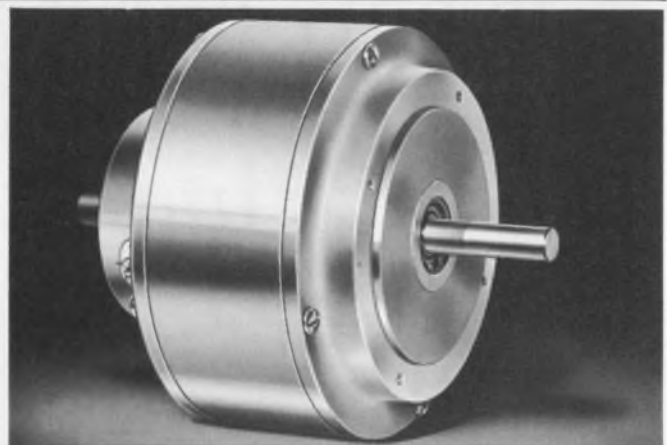

**Stops on a dime . . .**

High Performance DC Motor jumps to full speed faster . . . stops quicker . . . than others its size because it has lower inertia. Produces pulse torques up to 10 times rated torque. For either open or closed loop systems.

Options: Tachometers, special shaft lengths and shapes, forced air cooling adaptations.

Get the complete story from your MICRO SWITCH Branch Office.

Or write: **MICRO SWITCH**

FREEMONT, ILLINOIS 61032  
A DIVISION OF HONEYWELL

INFORMATION RETRIEVAL NUMBER 38

INFORMATION RETRIEVAL NUMBER 39 ►

# CELANESE NYLON IS MADE IN A TOTALLY CONTINUOUS PROCESS. THAT'S ADVANTAGE NO. 1.

Whiteness. We make Celanese nylon in a continuous, patented process—so it has a shorter heat history. That's why it's whiter in the pellet. Whiter in your products. And it's whiter through successive regrinds.

It's one advantage that Buchanan Electrical Products Corporation gets by using Celanese nylon for terminal blocks, connectors—some 30 other electrical parts.

Other reasons for using Celanese nylon include high



dielectric properties, which allow thinner walls, more compact units. Great mechanical strength and toughness. Resilience, for parts that have to snap-fit. Hold. Celanese nylon is self-extin-

guishing. And it has U/L rating on electrical properties of 105°C.

In fact, Celanese nylon has all the best properties you expect in nylon. Without the yellow. Write for a copy of our brochure on electrical applications of Celanese nylon. Also a U/L Yellow Card. Celanese Plastics Company, Dept. N-500, 1090 Lousons Rd., Union, New Jersey 07083.



Celanese Plastics Company is a division of Celanese Corporation. Canadian Affiliate: Chemcell Resources, Ltd. Export: Amcel Co., Inc., and Pan Amcel Co., Inc., 522 Fifth Ave., New York 10036

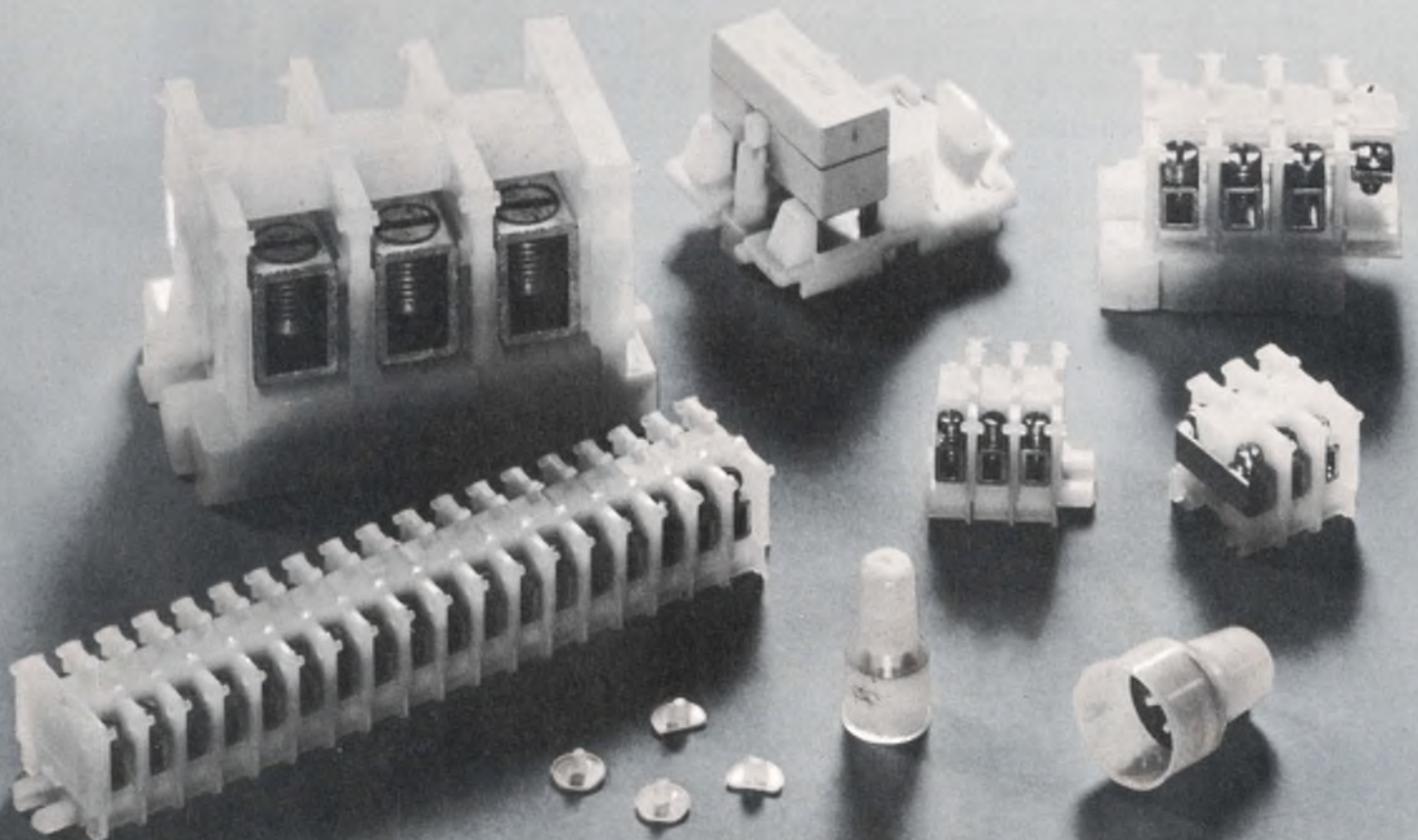

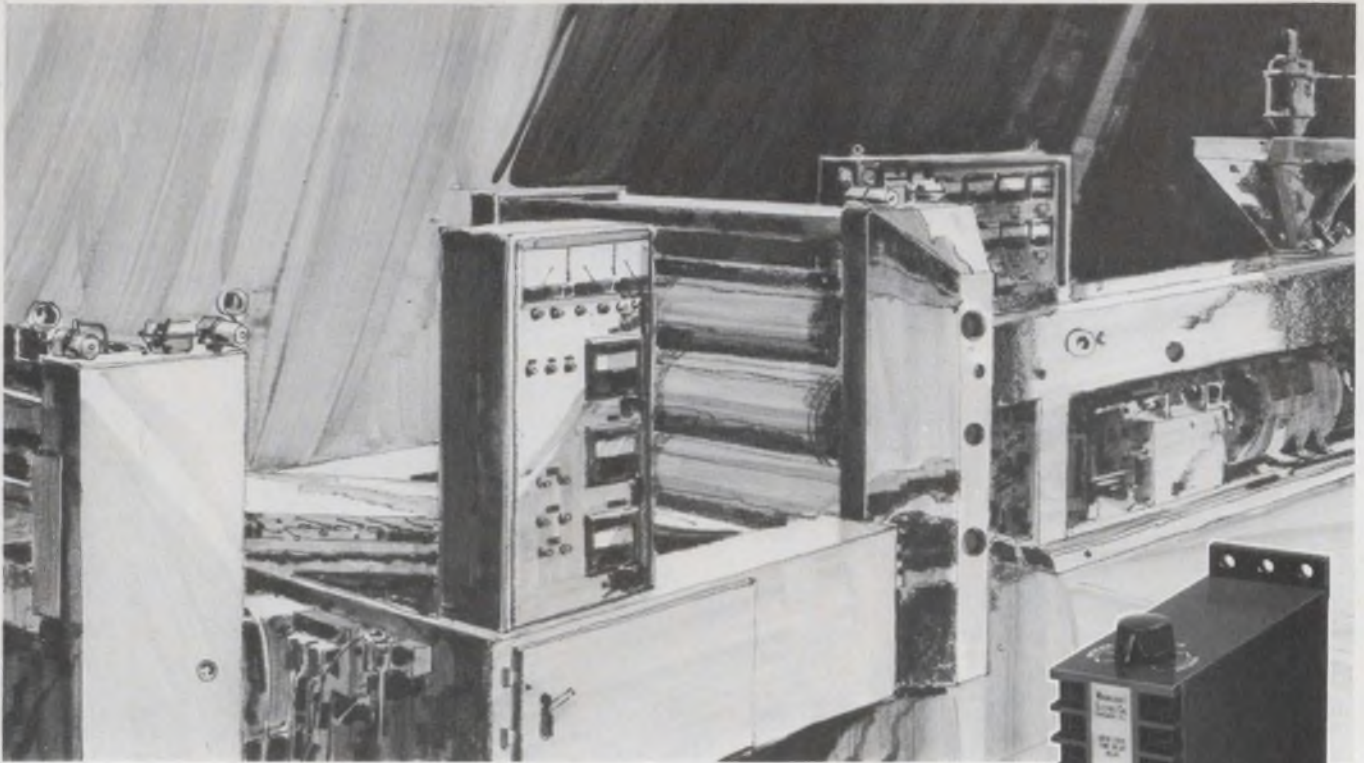

## **MAGNECRAFT THE CONTROLLER**

**Heavy duty time delay and power relays  
for rugged industrial applications**

The Solid State (hybrid) Class 211M time delay relay is designed for heavy duty service requiring accurate time delay control with  $\pm 5\%$  repeatability. This time delay relay makes use of hybrid technology combining solid state circuitry for the timing function with an electromechanical relay for DPDT 10 ampere output switching. This highly reliable relay operates on AC or DC, has an adjustable delay for either operate time or release time. The surface mounted molded plastic enclosure incorporates screw terminals. In stock for immediate delivery, this new relay costs less than \$29.00 in single quantities.

The Electromechanical Class 112M time delay relay comes in a package similar to the 211M. However, it utilizes a highly reliable precision air dashpot for the timing function, and an electromechanical relay for the 10 amp DPDT output switch. The designer will quickly recognize the inherent quality and simplicity in the design. Also in stock for immediate delivery, this time delay relay costs less than \$29.00 in single quantities.

The Class 99 is ideal for heavy duty industrial power relay applications. Occupies less than  $2\frac{1}{2}'' \times 2\frac{1}{2}'' \times 2\frac{1}{8}''$  of space. Yet, it's capable of switching 115 volts at up to 50 amps. Available with a "Magnetic-Blowout" for greater arc suppression and increased DC switching. Class 99 power relays can be supplied with contact combinations from SPST to DPDT at ratings up to 50 amps and in Underwriters Laboratories Listings. In stock for immediate delivery and priced as low as \$5.66 in single quantities.

For your source of 512 different stock relays, write for Magnecraft's Catalog No. 271.



Class 211M  
Class 112M  
Time Delay  
Relay

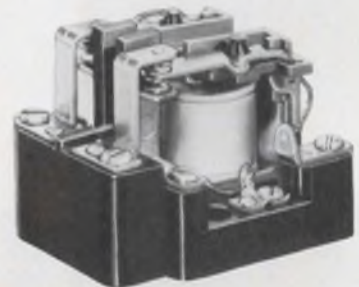

Class 99 Heavy  
Duty Power Relay



# **Magnecraft<sup>®</sup> ELECTRIC CO.**

5575 NORTH LYNCH AVENUE • CHICAGO, ILLINOIS 60630 • 312 282-5500 • TWX-910-221-5221

See us in Booth #1216 at WESCON.

INFORMATION RETRIEVAL NUMBER 40

# SPERRY HAS A COUPLE OF LASER SURPRISES:

## LOWER CURRENT AT LOWER PRICES.

## THE HIGHEST POWER DENSITY AVAILABLE.



# GAAs LASER DIODES

New, smaller, stud-mounted single diodes, and higher-power arrays in dual and radial configurations. All are manufactured with the new low threshold process and emit at 9,000 Å. Send for data sheet—Electro-Optics, Sperry Gyroscope Division, Great Neck, N.Y. 11020; Telephone (516) 574-2598.

### PERFORMANCE CHARACTERISTICS

MODEL #	PEAK POWER WATTS	PEAK CURRENT AMPS.	SOURCE SIZE MILS
003-SC*	3	10	3
008-SC	8	25	6
013-SC	13	40	9
023-SC	23	75	15
040-DC	40	75	15 x 15
100-RC	100	40	45 DIAM.
150-RC	150	75	55 DIAM.
200-RC	200	75	55 DIAM.
500-FC*	500	75	—
1,000-FC*	1,000	75	—

\* Available in late summer, 1970

**SPERRY**  
GYROSCOPE DIVISION  
**ELECTRO-OPTICS**

 SPERRY RAND

# target/radar alignment



MODEL 345C

The Vega C-Band Transponder Model 345C features a single-knob tuning control which simultaneously tunes both receiver and transmitter from the front panel. This eliminates the need for support equipment for tuning to the tracking radar frequency. Even untrained personnel can tune to radar frequency in 5 minutes in the field or aboard ship. The 345C is extremely useful in airborne applications where the exact tracking frequency is not specified prior to the operation. This unit is compact (43 cu. in.), lightweight (43 oz.) and maintains the electrical and environmental characteristics required of superheterodyne transponders in missile, satellite, drone and target applications.

**Vega Precision Laboratories, Inc.,**  
239 Maple Avenue W., Vienna, Virginia 22180  
Phone: (703) 938-6300



INFORMATION RETRIEVAL NUMBER 42



## all the logic that fits, in print

Yet we call it a "Condensed" catalog, because we've packed into relatively few pages the complete and new CAMBION line of TTL integrated circuit logic assemblies.

General purpose cards, Counters, Timing Circuits, Registers, Decoders, Analog Circuits, Interface cards and more . . . you'll find them all incorporating the popular 74/54 IC families. In addition to detailed data on each card, the catalog contains operating specs and general descriptive text for the design engineer developing his own subsystem.

No matter how many catalogs you already have, this one will extend your capabilities, without overextending your bookshelf. Send us your name, we'll send you a copy. Cambridge Thermionic Corporation, 463 Concord Avenue, Cambridge, Massachusetts 02138.

Standardize on

**CAMBION**  
The Guaranteed Logic Assemblies

INFORMATION RETRIEVAL NUMBER 43

## VSI Color Display High Voltage Power Supply

Designed For Use With Multi-Color Beam Penetration Cathode Ray Tubes.

**Remotely Programmable For 5-Color Operation**



Typical Color Control:  
Red 6KV Yellow 9KV Green 12KV

MODEL CS-14

- output — 5 steps random select 6KV-14KV
- switching control — low level DC logic
- all solid state
- DC load — 4.5W
- regulation  $\pm .5\%$  ripple 0.1% PP
- short circuit protected

VSI manufactures a complete line of high voltage Power Supplies for Image Intensifiers, Photomultiplier and Cathode Ray Tubes. Send for brochure today.

**VENUS SCIENTIFIC INC.**  
399 SMITH STREET, FARMINGDALE, NEW YORK 11735 • (516) 293-4100

INFORMATION RETRIEVAL NUMBER 44



# Who provides 99.98% microcircuit reliability? Centralab!



Thick film microcircuit reliability depends on quality control at every stage . . . from design and manufacturing through application and use. At Centralab we have established a single Quality Assurance System that includes some 89 quality and reliability control procedures. This System, which meets MIL-STD-883 requirements, is applied to everything we produce, whether for military, consumer or industrial use. A total of 45 procedures control quality at the design and development stage; 24 during fabrication and assembly; and 20 are applied to verification during application and use. The procedures include use of our DESC-approved environmental test laboratory, one of the few such facilities in the Midwest.

By strictly adhering to these standards and procedures, we've been able to greatly minimize failures. Predicted failure rates for a typical Centralab module average 0.2 failures per million hours.

If quality and reliability aren't enough, we are the leading manufacturer of microcircuits. We've been in the thick of it for 25 years. We've produced more than 500,000,000 thick film circuits in some 5,000 designs. With this kind of manufacturing experience, we can provide product samples in three weeks; production quantities 8 weeks from prototype approval.

At Centralab, we're geared for quality and service. To find out how you can put both to work for you, write for a copy of our new Thick Film Microcircuit brochure.



**CENTRALAB**

Electronics Division  
GLOBE-UNION INC.

5757 NORTH GREEN BAY AVENUE  
MILWAUKEE, WISCONSIN 53201



**CENTRALAB PRODUCTS  
ARE MARKETED INTERNATIONALLY THROUGH  
GLOBE-UNION INC. - INTERNATIONAL DIVISION**

M-7016

# An indispensable design tool...

the inaugural volume in the Hayden Series in  
Materials for Electrical and Electronics Design!

## MATERIALS FOR CONDUCTIVE AND RESISTIVE FUNCTIONS

G. W. A. DUMMER, Formerly Superintendent Applied Physics  
Royal Radar Establishment, British Ministry of Technology

Written by an internationally recognized authority, this volume satisfies the need for a comprehensive, applications-oriented reference on conductive, superconductive, contacting, and resistive functions. It is exceptionally broad and detailed in coverage, setting forth the basic phenomena for each specific function, describing how the materials for each are used in component parts, and providing sufficient basic data to prepare the reader for problems which may be met in specific applications.

In cases where combined materials are part of the design, such as cables and wires, brief data is given of dielectrics, etc. in order that reasonably complete coverage is available. More than one-hundred-forty charts, tables, and diagrams provide rapid access to properties of materials for a specific requirement. Extensive references are included to facilitate further study.

Thorough descriptive coverage... more than 140 charts, tables, and diagrams.

**Conductive Functions.** Introduction to the Principles of Conduction in Low- and High-Resistivity Metals. Tables of Physical Properties of Conducting Materials. Materials, Applications, and Characteristics of Hook-up Wires, Covered Wires, Bus Bars, Transmission Cable, and Microwires. Materials, Applications, and Characteristics of Magnet Wires. Materials, Applications, and Characteristics of RF Cables, Materials Applications, and Characteristics of Printed Wiring Conductors. Materials, Applications, and Characteristics of Integrated Circuit Conductors. **Superconductive Functions.** Phenomena and Environments Associated with Superconductivity. Superconducting Switching Devices. Materials with High Field Superconducting Capabilities. **Contacting Functions.** Contact Functions and the Physics of Contact Phenomena. Contact Materials, Applications, and Tables of Properties. Basic Connection Methods in Electronics. Make and Break Contacts, Plug and Socket Functions, Switching Functions. Relay Functions. Sliding Contacts, Wear, and Noise Phenomena. **Resistive Functions.** Conductivity, Resistivity, Resistance, and Temperature Coefficient of Resistance. Materials, Applications, and Characteristics of Fixed and Variable Resistors. Materials, Applications, and Characteristics of Resistive Films. Index.

G. W. A. Dummer, author and co-author of scores of books on all aspects of electronics, presently devotes all his time to writing and consulting activities. A pioneer in reliability, thin-film circuits, and semiconductor integrated circuits, he initiated much of the British Government's research in microelectronics. His earlier contribution to the development of radar and radar synthetic trainers earned him Britain's award, Member of the British Empire, and America's Medal of Freedom. Mr. Dummer is a Fellow of the I. E. E., the I. E. E., and the I. E. R. E.

Subscribe at 15% savings, or order individual volumes  
on 15-day free examination... mail this coupon today!

- Subscription terms: Please enter my subscription to the Hayden Series in Materials for Electrical and Electronics Design. Each title will be automatically shipped as published, and billed at 15% discount. This subscription may be cancelled at any time.
- Single volume order: 15-day Free Examination. Please send #5636, Materials for Conductive and Resistive Functions, \$13.95, on a 15-day Free Examination basis. At the end of that time I will remit payment, plus postage, or return the book without further obligation. Payment enclosed. (Hayden pays postage with same return guarantee).
- Ship and bill as published those checked:
- #5638    #5635    #5639    #5637    #5634    #5640
- Send further information on the series.

On all overseas orders payment in U.S. dollars must be enclosed.



HAYDEN BOOK COMPANY, INC., 116 W. 14th St., N. Y., N. Y. 10011



326 pages,  
6" x 9", illustrated,  
clothbound, #5636, \$13.95

Save 15% on this volume!  
Enter your subscription to this  
valuable new series today!

### Hayden Series in Materials for Electrical and Electronics Design

Alex E. Javitz, Editor-in-Chief  
A series of integrated engineering books designed to meet the practical needs of all who design electrical and electronic components, devices, equipment, and systems. Offering a unified approach which treats materials according to functional classes, the books provide an essential background in fundamental principles, combined with immediately workable data and techniques for both conventional and advanced applications. Each volume also discusses the relationship between the fundamental nature of materials (microscopic properties) and their functional performance (macroscopic properties).

Forthcoming volumes in the series:

Materials for Semiconductor Functions, #5638,

E. G. Bylander

Materials for Structural and Mechanical Functions,  
#5637, G. Koves

Materials for Magnetic Functions, #5635, F. N. Bradley

Materials for Electrical Insulating and Dielectric

Functions, #5634, H. L. Saums and W. W. Pendleton

Materials for Combined Functions, #5639, E. Scala

An interdisciplinary volume in the series, **Materials Science and Technology for Design Engineers**, #5640, edited by Alex. E. Javitz, provides an advanced exposition of the basic structure and molecular behavior of all relevant materials. Approximate price of each forthcoming volume, \$18.00.

Alex. E. Javitz, Editor-in-Chief of this series, is currently a technical consultant to industry. Formerly an editor of electrical and electronics magazines, Mr. Javitz is widely known in materials and related fields.

Add these valuable references to  
your library automatically —  
enter your subscription today!



## Get Bright, Flicker-Free Displays and Storage with HP's New, Half-Rack Systems Monitor

**"Freeze" your displays, vary their fade rate.** Here, is the first systems monitor using HP's mesh-storage CRT — that eliminates low rep-rate flickering, and eye-fatiguing erase-flashes... the HP 1331A.

**Storage Capability** — Waveforms can be stored for up to 15 minutes, just by pressing a button. An important advantage of the HP mesh-type storage tube is that writing rate and trace brightness do not deteriorate. Also, with mesh storage, stored traces "dissolve" off the screen, rather than being "flashed" off.

**Variable Persistence** — Trace persistence can be varied from 0.2 seconds to more than a minute. This enables you to quickly and accurately compare traces, analyze trends, determine the effects of input variables, eliminate flicker of low rep-rate information.

**High-Intensity Display** — For systems operators, traces can be ob-

served in high ambient light, without having to sit "glued to the screen," because traces are displayed at a brightness of 100 ft-lamberts. This is many times the intensity of displays on other storage monitors.

**Wide Bandwidth** — Utilizing electrostatic deflection, the HP 1331A is capable of handling signals ranging from dc to 1 MHz. This provides fast, 1  $\mu$ s settling time, which reduces computer waiting time when generating rasters, alpha numeric, X-Y or other fast-changing displays.

**Z-Axis Gray Scale** — The exclusive ability of the CRT to display varying trace intensities, gives the HP 1331A a capability to show "shades of gray" — for added realism in 3-D displays, and added clarity in two-dimensional displays or photos.

**Compactness** — Measuring only 7 $\frac{3}{4}$ " wide by 6 $\frac{1}{2}$ " high by 16" deep, the HP 1331A takes up only half of a standard systems rack width.

**Choice of Standard or Programmable Models** — Model 1331A has front panel operating controls, to allow easy manual control. Model 1331C is designed for remote programming operation in system applications of computer displays—alpha numeric or graphic. It has the operating controls and programming input connector mounted on its rear panel.

For the complete story on the 1331A or 1331C, contact your HP field engineer. Or, write to Hewlett-Packard, Palo Alto, California 94304. In Europe: 1217 Meyrin-Geneva, Switzerland. Price: \$1575; OEM discounts available.

080/13

**HEWLETT  PACKARD**  
OSCILLOSCOPE SYSTEMS

INFORMATION RETRIEVAL NUMBER 47

# For automated manufacturing you need

**NEMS**

# DNC1500



## Because...

we supply a complete system operable by:



1. Computer Control
2. Manual Control
3. Paper Tape
4. Magnetic Tape

The NEMS DNC1500 is actually a specially designed mini-computer. It is especially valuable when used with computer control, because it frees the main computer for other duties during repetitive

operations. X-Y positioning of production equipment for insertion operations, drilling, milling, plotting, etc. is performed under the digital control of the mini-computer.

The DNC1500 slews heavy loads at speeds of up to 600 inches per minute. We guarantee accuracy at full speed! Standard resolution of the DNC1500 is 500 micro-inches, assured by the use of 8 BCD digits. Optional resolutions of 100 or 10 micro-inches are available.

For complete information on the NEMS DNC1500, contact: C. G. Chapel, Product Manager

**NEMS**

**National Electro-Mechanical Systems, Inc.**  
Box Q, 32 Broad Ave., Binghamton, N.Y. 13904 • Phone 607 723-9561

INFORMATION RETRIEVAL NUMBER 48

## Until our new Unipulser II<sup>®</sup> came along,



## single decade counters were pretty much alike.

Compare it with any competitor on these points: 1. **Variety.** 22 models, 4 voltages. Predetermined adding or subtracting units. Electrical or pushbutton reset. Available with BCD readout. 2. **Modular.** Complete with its own drive input, transfer and reset circuit and 11-line output for control or electrical readout. Combine them in series for wide range of jobs. 3. **Compact size.** Fits 1/2" by 2-1/16" panel cutout. Die cast frame supports self from front—simplifies installation. 4. **Price.** Begins at \$18 and moves down fast on quantity buys. Pushbutton reset model begins at \$19. You won't find another decade that does so much for so little. 5. **Durability.** Mechanical and electrical transfer life—100 million counts. Write for Unipulser II catalog. 622 N. Cass St., Milwaukee, Wisconsin 53202.



INFORMATION RETRIEVAL NUMBER 49

## THE WORLD'S MOST ACCURATE FREQUENCY SWITCH

FASTER DATA TRANSMISSION

New, GO-NO-GO Audio Switches which fire whenever the input frequency goes above, below, or is within certain definite frequency limits are now available. Accuracies as close as 1 cycle per thousand can be maintained. Maximum response time is the length of two input cycles. All units are completely solid state.

The input frequency can be in the form of a sine or square wave. Or even in pulses in which case it measures the length of time between pulses. Frequencies from 1 hz to 40,000 hz can be handled easily and directly. Higher frequencies can be handled if dividers and/or mixers are incorporated.

Highpass, lowpass, and band-pass functions are all available.

**NEW**  
TELEMETERING  
FREQUENCY  
SWITCHES  
1 hz to 40,000 hz  
RESPONSE LIKE  
THIS

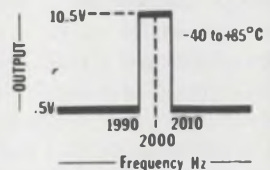

from  
**\$99<sup>50</sup>**  
Single piece

Evaluation  
Sample Available

**GOSH instruments inc**

1252 Berlin Tpke., Wethersfield, Conn. 06109 • (203) 527-4794

INFORMATION RETRIEVAL NUMBER 50



## Honeywell's personalized X-Y recorders are designed with you in mind.

On the surface, Honeywell's X-Y recorders may look alike. But, look closer. They're designed for maximum flexibility so each one can be personalized to meet your particular needs.

For instance, we can supply the recorder with only one input range instead of many. Or we can furnish the front panel in almost any configuration you require. And add special artwork or your company logo at minimum cost.

Or, if your needs are standard, we can provide "off-the-shelf" delivery . . . fast!

No matter what your requirements, all Honeywell recorders accept a wide range of input voltages and exhibit accuracy greater than 0.2% as well as providing high input impedance and a full-scale response time of less than 0.75 seconds.

Since our X-Y recorders look something alike, you may also think that they cost something alike. Not so.

The cost will depend on the configuration you require and the number of recorders you need. Which, in a way, means the cost is up to you!

For more personalized information on your personalized recorder, write or call Don Anderson, MS 222, Honeywell, Test Instruments Division, 303-771-4700, P.O. Box 5227, Denver, Colorado 80217.

### **Honeywell**

Honeywell engineers sell solutions

HONEYWELL INTERNATIONAL Sales and Service offices in all principal cities. Manufacturing in Australia, Canada, Finland, France, Germany, Japan, Mexico, Netherlands, Spain, Taiwan, U.K. and U.S.A.

INFORMATION RETRIEVAL NUMBER 51

# Two simple facts make this diode the best current-controlled resistor you can buy.



**Performance.** HP's PIN diode offers better cross-modulation and second order distortion performance than FETs or other conventional techniques. Our current-controlled resistors have an effective minority carrier lifetime of  $1.3 \mu\text{s}$  with extremely low distortion over the 1 MHz to 1 GHz range. They also have tight resistance tracking between units, and the RF resistance limits are fully specified.

**Price.** You get all this for 99¢ each in 10,000 lots, the lowest priced PIN diode anywhere! Even lower costs in larger quantities. Which now moves true high performance within the price range of low-frequency designers.

Before you design your next equipment with current-controlled attenuators, constant-impedance AGC,

levelling and switching circuits, talk to us about specs and prices and immediate delivery on the 5082-3080 PIN diodes.

**HEWLETT  PACKARD**

SOLID STATE DEVICES

01009

INFORMATION RETRIEVAL NUMBER 52

## Publisher

Hugh R. Roome

## Editors

New York Office  
850 Third Ave.  
New York, N. Y. 10022  
(212) 751-5530

Editor: Frank Egan  
Managing Editor: Ralph Dobriner  
Managing Editor: Raymond D. Speer  
Microelectronics, Steven A. Erenburg  
Computers, Milton J. Lowenstein  
Circuits, Don Mennie  
Microwaves, Michael J. Riezenman  
Management, Richard L. Turmail  
News, John N. Kessler  
Military-Aerospace, John F. Mason  
New Products, Roger Allan  
New Products, Lucinda Mattera  
Directory Manager, Greg Guercio  
Copy, Marion Allen

## Field Offices

### Massachusetts

Jim McDermott  
P. O. Box 272  
Easthampton, Mass. 01027  
(413) 527-3632

### San Francisco

Elizabeth de Atley  
2051 Wellesley St. (Suite D)  
Palo Alto, Calif. 94306  
(415) 321-7348

### Los Angeles

David Kaye  
2930 Imperial Highway  
Inglewood, Calif. 90303  
(213) 757-0183

### Washington

Don Byrne  
1425 N St. NW  
Washington D. C. 20005  
(202) 667-6568

## Editorial Production

Dollie S. Viebig  
Richard D. Grissom

## Art

Art Director, Clifford M. Gardiner  
Assistant, William Kelly  
Rita Jendrzewski  
JoJo Miskimmon  
Jack Weissman

## Production

Manager, Thomas V. Sedlta  
Helen De Polo  
Kathleen McConkey  
Leslie Stein

## Circulation

Manager Nancy L. Merritt

## Information Retrieval

Peggy Long

## EDITORIAL



## Can we afford the price of engineering unemployment?

Our country has become the greatest throw-away culture in the history of civilization. Never before has any one nation discarded so many billions of tons of refuse, including no-rust aluminum cans, no-return bottles and used cars. We toss technical talent aside with nearly as much ease, and we can't afford to.

We not only toss aside an experienced engineer, but we exhibit little concern for his welfare after he's gone. We were glad to use his abilities and knowledge, but in the end, we find no way to keep him, so we throw him away as if he were an aluminum can.

Because of increasing job insecurity in engineering, more and more engineers are forsaking it for other livelihoods. Add to that the report that students are entering engineering school each year at a decreasing rate, and you've got the makings of a shortage of technical talent at a time when the rest of the world is expanding in its technical knowledge.

If we can't afford to discourage talent from working in technology, what can be done to assure that we have enough on tap?

The answer depends, of course, on the Government, and on industry.

Not much can be done about Government spending habits, since cutbacks and contracts are usually the pawns of world affairs. But the electronics industry could help the engineer find work. Some firms lay off experienced engineers with no intention of rehiring them. Management would rather invest in a recent college graduate who has boned up on the latest technology, and who can be hired at a lower salary than his older counterpart.

But some companies do attempt to help their engineers during periods of layoff. Lockheed in California, for example, started an employee referral program some time ago called LEND (Lockheed Employees for National Deployment), by which aerospace companies that use the same kind of engineering talent, can agree on reciprocal temporary trade-offs of personnel while still keeping the talent on the payroll. Other firms might well look into establishing similar agreements.

It's vitally important that the industry does all it can to stimulate engineering employment. As Deutsch, Shea and Evans, Inc., a technical advertising agency, said recently, "Without a sufficient supply of engineering talent, we would rapidly become one of the backward nations of the world."

RICHARD L. TURMAIL

# The big memory battle: Semis

Elizabeth de Atley  
West Coast Editor

For 15 years, cores have reigned supreme in the commercial random-access, read-write memory market. In this time their price has continued to fall rapidly and their speed has doubled every two and a half years. They have "buried" at least two challengers—cryogenics and planar thin film. Now suddenly a new challenger has appeared—semiconductor memory.

"In 10 years," says Wally Raisanen, operations manager for IC memory and MOS products, Motorola Semiconductor Products Div., Phoenix, Ariz., "semiconductor memories will have the whole business—to a first approximation. Of course, anybody can hang onto 10% of anything one way or another."

That's a tall order. Today semiconductors probably constitute less than 0.1% of the total dollar

volume of the random-access memory market. They are used only where core is most vulnerable—that is, where high speed or very small size (a few thousand bits) is required. In large memories core is cheap and hard to beat. Yet Dr. Robert Noyce, president of Intel Corp., Mountain View, Calif., predicts semiconductors will constitute half the dollar volume of the memory market by 1975 (Fig. 1).

To do this, semiconductor memory must take over not only in the mainframe of the small mini or midi computer, in sizes up to 200 K to 300 K bits, but also in the larger mainframe memories of a million bits or more.

What qualifications must they offer to gain entry into these markets?

The smaller computers generally do not require high-speed memories, because they are used with peripheral equipment that has relatively low speed. Therefore to enter this market, semicon-

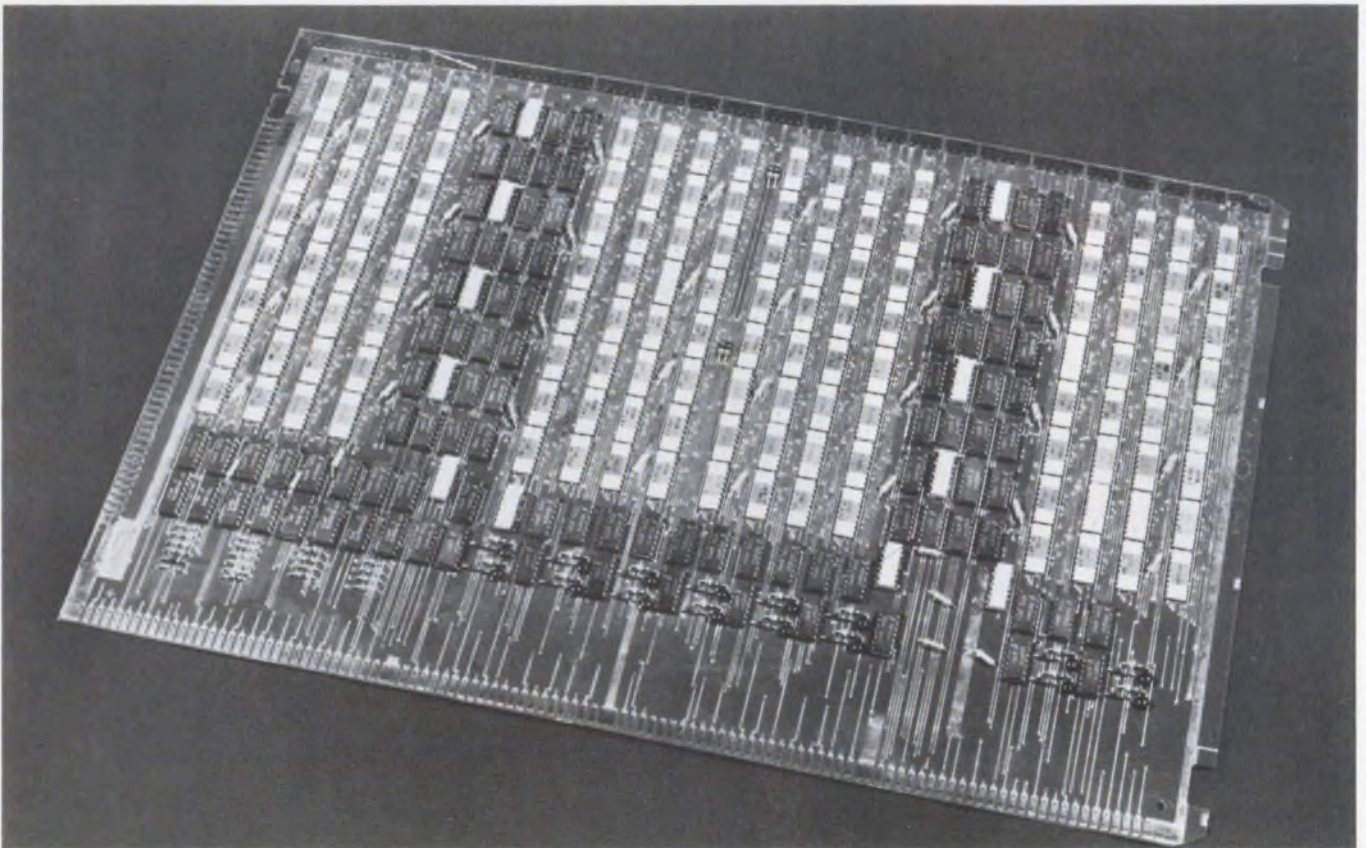

One of four memory boards, each containing 2 K words x 16 bits, is used in the Illiac IV memory system designed and manufactured by Fairchild Semiconductor for

Burroughs Corp. The Illiac IV memory, which is in full production, is a 2-K word x 64-bit system with a full system cycle time of less than 200 ns.



# take on cores

ductor memories will have to be cheaper than core but not necessarily faster—500 ns to 2  $\mu$ s in a system is adequate. The large machines, on the other hand, will require high speed because they are used to perform rapid calculations. Reese Brown, manager of memory techniques, Burroughs Corp., Piscataway, N. J., estimates that large machines being designed this year and next will require memory cycle times in the range of 200 to 500 ns. To enter this market, semiconductor memories must be lower in cost than their magnetic competition. But in this speed range, the competition probably won't be core. In production systems core can be manufactured economically only up to speeds of about 500 ns. Some magnetics manufacturers think plated wire will be the competition semiconductor memories must meet in the high-speed mainframe market.

But regardless of how semiconductor memories edge into the market—whether through extra

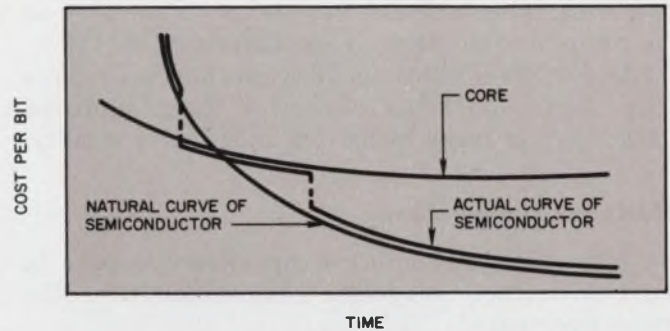

1. The natural curve of semiconductor memory cost per bit vs time will be distorted by competitive manufacturing pressures as it gets close to the price of core, Intel Corp.'s Dr. Robert Noyce points out. "It will then come down to meet the core price earlier than it should," he says, "but then it will remain at the core price a little longer than it normally would have to, just because of the competitive pressures in the market."

## Who's who, in mainframe RAMS?

*Semiconductor companies are climbing onto the mainframe RAM bandwagon fast. As of June, 1970, the following companies told ELECTRONIC DESIGN that they were or would be in the market by January, 1971:*

- Advanced Memory Systems, Inc.
- American Micro-Systems, Inc.
- Cogar Corp.
- Computer Microtechnology, Inc.
- Electronic Arrays, Inc.
- Fairchild Semiconductor
- General Instruments.
- Intel Corp.
- Intersil, Inc.
- Mostek Corp.
- MOS Technology.
- Motorola, Inc., Semiconductor Products Div.
- Philco-Ford Corp.
- Raytheon Semiconductor
- Semiconductor Electronic Memories, Inc.
- Signetics Corp.
- Solid State Scientific Ind.
- Solitron Devices, Inc.
- Texas Instruments, Inc.

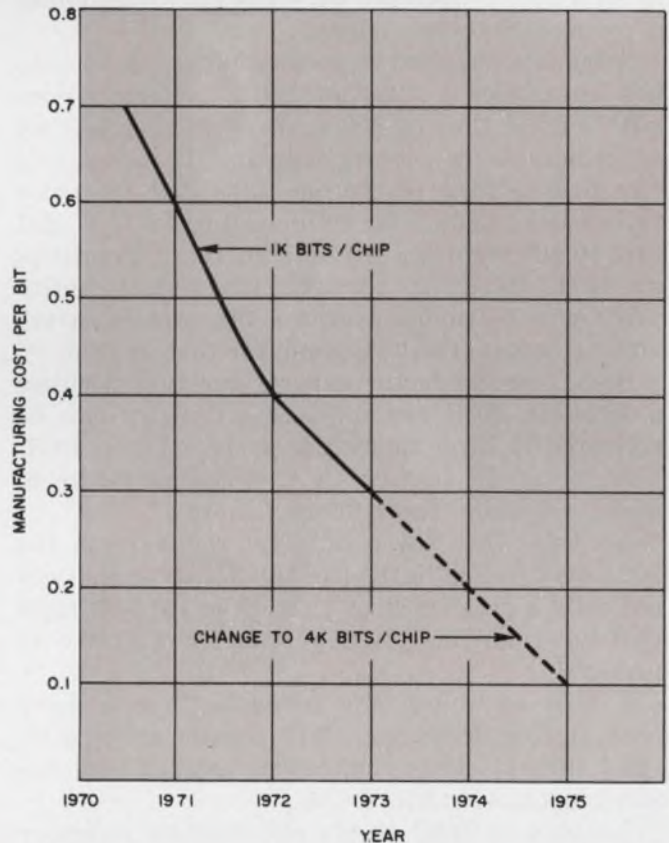

2. Manufacturing costs for a dynamic MOS chip with a cycle time of 0.5 to 2  $\mu$ s can fall to 0.1¢ per bit by 1975, according to a projection by Lee Boysel, president of Four-Phase Systems, Inc., Cupertino, Calif. He is projecting a change in chip density from 1 K bits today to 4 K bits in 1973. Boysel points out that if he were a semiconductor vendor, he would have to multiply these manufacturing costs by a factor of 4 to cover overhead and profit.

speed or lower cost—they will offer one big advantage over their magnetic competitors: organizational flexibility. Because they require less in the way of supplementary electronics than core, they can be cost-effective in much smaller modular sizes. The user can buy as much memory as he needs and no more. (See Directory, p. 113.)

As for the limitations of semiconductor memories, their opponents cite two: their unproved reliability in large memories and their volatility.

### Costs are coming down

How will semiconductor memories compare in cost with their magnetic competition over the next five years?

Robert Graham, director of marketing at Intel Corp., says that MOS products will soon be economical enough to undercut low-cost core even into the megabit sizes. "By early 1971," he says, "MOS dynamic memory will be going for a cent a bit in 100-K quantities."

Intel is taking orders now for a 1024-bit dynamic MOS device with a cycle time of 350 to 400 ns. It would have a system cycle time of around 500 ns (see box on tradeoffs in designing a semiconductor memory).

Advanced Memory Systems, Sunnyvale, Calif., has announced a 1024-bit MOS dynamic device with a cycle time of 800 ns (a system cycle time of around 1  $\mu$ s.). Jerry Larkin, the company's vice president of marketing, says that the price this year is 1.83¢ a bit in quantities of 10 K and that it will be down to 1.47¢ in those quantities by 1971. By 1972, he says, the 10-K quantity price will be under a cent a bit, and in large-volume orders it will be going for that in 1971.

Some semiconductor experts question whether a 1024-bit MOS random-access memory can be delivered in large quantities at 1¢ a bit in 1971. They point out that it is a troublesome device to make, requiring tight process control.

To this, Dr. Noyce of Intel replies that the 1024-bit dynamic MOS random-access memory is basically a simpler circuit than the 1024-bit shift register that Intel is delivering in quantity at present.

Brown of Burroughs concurs. "People have been getting delivery on shift registers," he says, "and that gives us confidence that the random-access memories will follow."

Graham of Intel points out that his company has already delivered between 200 and 300 prototype 1024-bit random-access memories.

Lee Boysel, president of Four-Phase Systems, Cupertino, Calif., notes that his company's manufacturing costs on a similar device are already below 1¢ a bit. Boysel and his associates have designed a 1024-bit dynamic MOS memory with a cycle time of about 2  $\mu$ s and are using it as

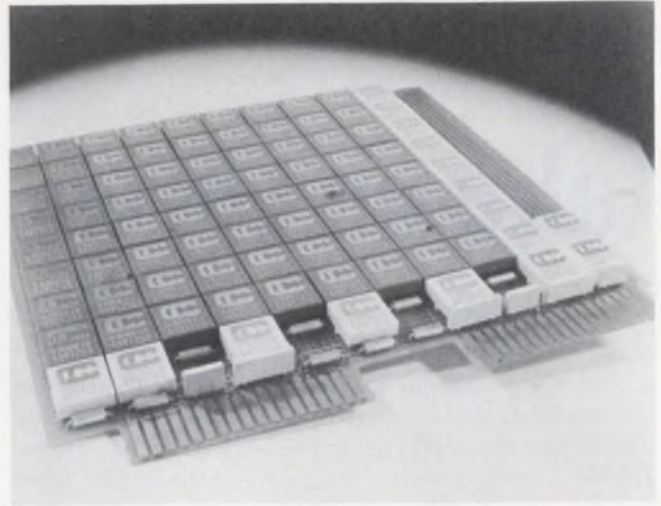

This 1-K word x 9-bit memory card has a full cycle time of 80 ns. Manufactured by Cogar Corp., it is one of three performance levels offered by the company: (1) The "high-performance" level, with 80-ns cycle time and using bipolar technology; (2) The "medium performance" level, with 150-ns cycle time and also using bipolar technology, and (3) The "cost-performance" level, with cycle time of 300 ns and using n-channel MOS technology.

the basic building block for the mainframe memory of their midcomputer. The manufacturing cost with today's yields, Boysel says, is about 0.7¢ per bit. However, he points out, a semiconductor manufacturer with the same manufacturing costs would have to multiply them by a factor of four to cover overhead and profit, bringing the cost per bit to 2.8¢ this year. By putting more bits on a chip, using larger wafers and improving the yields, Boysel expects his manufacturing costs on a 500-ns-to-2- $\mu$ s MOS dynamic chip to fall to .1¢ per bit by 1975 (Fig. 2).

Semiconductor manufacturers say there will be a number of candidates for the high-speed market (200 to 500 ns). Melvyn Snyder, vice president of Intersil Memory Corp., Cupertino, Calif., predicts that it will be N-channel MOS for the 200-to-400-ns range and P-channel MOS above 400 ns (Fig. 3). Cogar Corp. is using N-channel MOS in an 8-K word by 18-bit memory system with a cycle time of 300 ns.

Bipolar memories will be in the running for cycle times of 200 ns or faster. Fairchild Semiconductor's Illiac IV memory is a good example. This 131 K bit system has a cycle time of 188 ns.

David C. Conrad, vice president of marketing, Computer Microtechnology, Inc., Sunnyvale, Calif., says his company's hybrid MOS/bipolar 4-K bit module has a cycle time of 400 ns at present (Fig. 4), but he expects improvements to bring it down to a 325-ns cycle time by the end of this year. Motorola's 8-K hybrid MOS/bipolar module is considerably faster—around 125 ns.

Graham says Intel has a silicon-gate MOS de-

## What causes semiconductor prices to fall?

Most semiconductor experts agree that the prices of semiconductor products fall for three reasons: (1) Increased yields; (2) Greater chip density, and (3) Volume. How will these factors work in the case of semiconductor memory? Harry Neil, director of semiconductor subsystems marketing of Fairchild, puts it this way:

"Obviously if we knew how to get the yields up right now, we would lower the costs in 1970. So the question is, since we don't know how right now, how long is it going to take us to learn? In the past, prices have dropped about 30% a year with any IC, just due to increasing yields.

"Then, in addition, you have an even greater cost reduction when you put more function on a chip. I think a \$5 cost on a package is a reasonable bottomed-out cost for any type of chip. In a 256-bit chip that works out to 2¢ a bit—which is probably two to three years away for bipolar. Right now in the 256-bit bipolar, we're running in the \$20 range [8¢ per bit], and I think it takes about three years to go from \$20

to \$5. If we take a 512-bit chip, that would be 1¢ per bit."

Neil cautions, however, that these time estimates depend upon large-volume production. And that may not be so easy to achieve in the case of random-access memories, which must dislodge well-established competition.

"People bought ICs," he says, "regardless of price because they were the cheapest thing around. So we were able to get our volume up—which automatically brought the price down. The manufacturing costs of semiconductors are very volume-dependent—much more so than core—because of the batch processing and mass production techniques."

But—and it's a big but—how can you get high volume at high prices when you've got competition?

"It gets to be a chicken-and-egg kind of thing," says Neil. "Are you going to commit the capital to building up that kind of production, force the price down and then catch up with it later—in other words, sell at less than cost?"

vice with a component cycle time of 225 ns (access time of 150 ns).

### Competition at low cost: Core

In the low-speed, low-cost market, core is the only competition semiconductors face, but it is formidable competition—particularly in sizes of 100 K bits or above. In general, the larger the core system, the lower the cost per bit, since the peripheral electronics are amortized over many bits. For example, a core memory 1 K words by 8 bits would cost about 5¢ today, whereas a system of 10 million bits would cost as little as 1.5¢, including the power supply.

The size/cost trade-off is reversed for semiconductor memories. In general, semiconductors require much less in the way of peripheral electronics than cores, and therefore are less expensive in small sizes than they are in large. Thus there is a crossover point below which semiconductor memories are definitely cheaper than core, even in today's low-cost systems. Most semiconductor manufacturers set this crossover point at about 4 to 8 K bits today—where, they say, both technologies cost around 6¢ to 7¢ a bit. But at least one core manufacturer hotly denies this. He says, "I'd be happy to buy semiconductors at this price range, but I haven't been able to—even for a large-volume order."

Whatever the crossover point, there is no doubt that large core systems are cheap—and getting cheaper all the time. Dr. Karl Hinrichs, director of engineering, Lockheed Electronics Co., Data

Products Div., Los Angeles, estimates that the cost of manufacturing a core system is coming down at a rate of about 10% a year (Fig. 5). This is due, he says, to two principal factors:

(1) Increased volume of production, thanks to the burgeoning memory market. As a result, he says, core manufacturers continue to improve production techniques—the development of more automatic machinery, for example—so that the cost of the product continues to fall despite increasing labor costs. "We are making 10 times as many cores today as we did five years ago with the same number of people," Hinrichs points out.

(2) Continued cost reduction of semiconductors used in the peripheral electronics of a core system—that is, the TTL medium-scale integration circuits, diodes, etc. The cost of these semiconductors is coming down at a rate of about 20% a year, says Hinrichs, and he expects it to continue to fall at about this rate for some time.

"This last year," he says, "we had a quantum drop in total system cost of about 23%, largely reflecting the fact that we had learned how to design with the new medium-scale integration—integrated sense amplifiers, diodes and drive transistors."

### Competition at high speed: Plated wire

At cycle times very much faster than 500 ns, the competition to semiconductor memory is not core but plated wire. Although core systems with cycle times as fast as 250 ns have been produced,

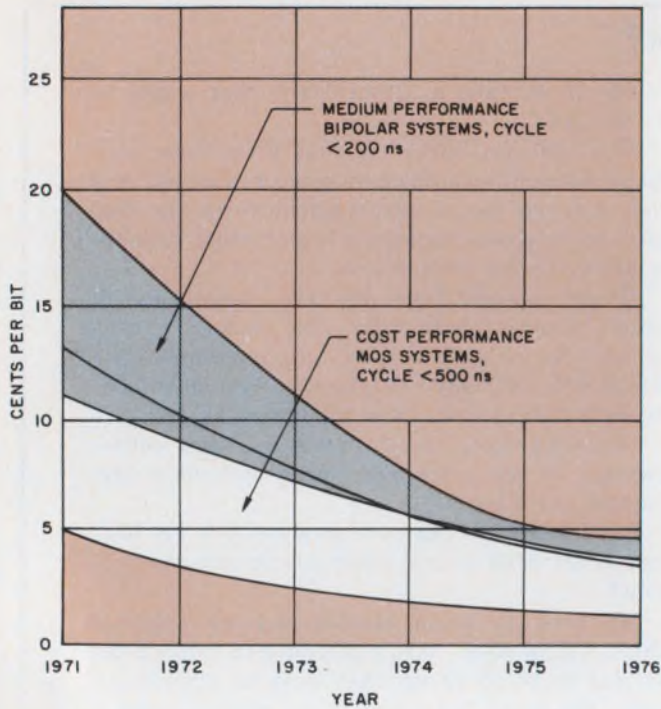

3. Cost projections for two of Cogar Corp.'s memory cards: a medium-performance bipolar card, 1 K x 18, with a cycle time of 150 ns at a cost per bit in 1971 of 12¢, and a "cost performance" n-channel MOS card, 8 K x 18, with a cycle time of 300 ns at a cost per bit in 1971 of 5¢. The low end of the band in each curve represents the cost of a card that is fully loaded and thus makes maximum use of support circuitry on the card.

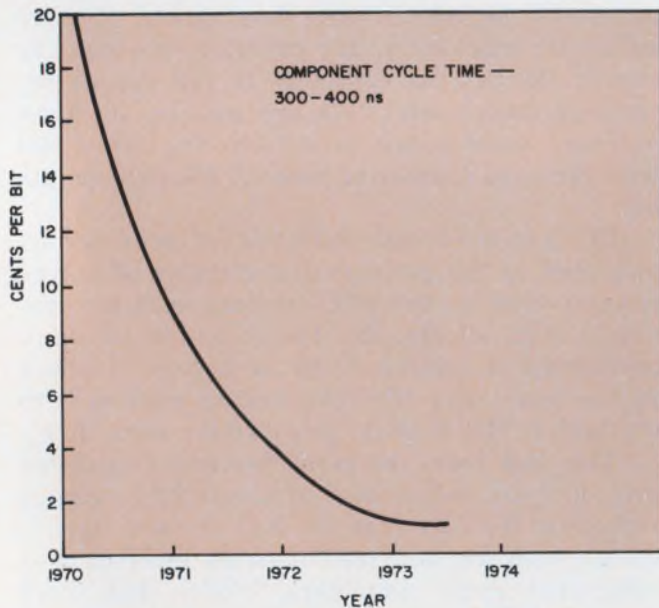

4. Cost projections for Computer Microtechnology's 4 K bit hybrid module, containing MOS for storage and bipolar for sense and decode. David Conrad, vice president of marketing, says that increased manufacturing efficiencies will bring the cost to 2¢ a bit. By 1972-73, he anticipates that "we will be putting more bits on a chip, using larger wafers and a nonhermetic form of packaging, which will easily bring the cost down to 1.5¢ or less."

they are costlier than most computer manufacturers are willing to pay. Dr. Hinrichs points out that the fastest production system Lockheed makes has a cycle time of 500 ns.

In general, he says, going to higher speeds in a core system means using smaller cores, which produce a smaller output signal when they change state, and thus require more expensive drive electronics and sense amplifiers.

Lockheed is turning to plated wire for speeds above 500 ns, Hinrichs says, because it can be manufactured largely by automated techniques and therefore offers the potential for lower cost at high speed. It is inherently faster than core, he says, because the element that is analogous to the core is merely a magnetic coating on the surface of a wire about the size of a human hair. Like the core in a small diameter core system, the very fine plated wire requires expensive drive and sense electronics because its signal level is low. But, says Dr. Hinrichs, the high cost of the electronics is offset by plated wire's potential for low-cost automated production.

George A. Fedde, manager of data processing at the Univac Data Processing Div., Philadelphia, says that plated wire has a potential for a cycle time of less than 100 ns but that production systems today are typically 250 to 300 ns.

In general, plated wire, like core, requires considerable peripheral electronics that must be amortized over many bits to get the cost per bit of the system low. Thus, just as in the case of core, there is a crossover point below which a plated-wire system could not compete with a semiconductor system at any given time. Dr. Jerry Sallo, manager of magnetic films, Lockheed Electronics Co., Data Products Div., puts this crossover point at 10 K bits today. James P. McAllister, manager of Univac's solid-state memory research section, puts it at around 30 K bits and expects it to remain there for the next four years (Fig. 6).

Brown of Burroughs disagrees. He says that by 1972 the crossover point will be over 250,000 bits—"if plated wire ever gets into real production." He adds that today "you can't draw a valid comparison, since neither technology is being widely produced for the open market."

The big advantage that semiconductor memories have over core—organizational flexibility—is only beginning to be exploited by the computer industry. Brown of Burroughs points out that if the memory can be made in small modules instead of one big piece, the user can purchase only as much as he needs.

Robert D. Miller, director of business and market development, Lockheed Electronics Co., Data Products Div., cautions, however, that if a large memory is built from small modular pieces of high-speed technology, the performance of the

# Trade-offs in designing a semiconductor memory

Semiconductor memories generally require much less in the way of drive electronics than cores, because most of the decode and sense circuitry is on the chip. Even when the chips are completely undecoded, the drive circuitry required is less expensive than that of a core system, because lower energies are involved.

In a bipolar or a static MOS memory, the basic element is a flip-flop. Thus if the drive, sense and decode circuitry are included on the chip, small amounts of memory can be mixed directly with the logic. As the memory grows in size, however, peripheral decode and drive circuitry must be added. Thus the cost per bit remains fairly linear over a range of sizes.

In dynamic MOS, the storage element is not a flip-flop but a capacitor with charge stored on it, which must be continually refreshed because of the leakage. Thus a dynamic MOS system requires special refreshing circuitry. In addition it runs off a clock or set of clocks. Just as in the case of a core system, this peripheral circuitry is less costly per bit if it can be amortized over a large number of bits. Thus the optimum modular size for such a system is the number of bits that can be driven with one set of MOS interface circuits.

According to Reese Brown, manager of memory techniques for Burroughs Corp., Piscataway, N. J., the optimum modular size for a memory system made from 1024-bit MOS packages, with drive and decode on the chip, is on the order of 30 K to 60 K bits. A larger memory would normally be made by adding multiples of that modular size. In addition, he says, there is some logic that is slight and can be ignored.

Brown points out that because the peripheral electronics in a static MOS system increase fairly linearly with the number of bits in the system, there is a crossover point in system size above which a dynamic MOS memory system

would be cheaper than a static system. This crossover point, he says, is about 20 K bits. Below 10 K bits, he says, it would not be practical to use a dynamic MOS memory.

Brown points out that it is impossible to make a general statement on the cost of putting a semiconductor array into a system since it depends on the system organization, speed, chip complexity and other factors. However, as a rough rule of thumb he estimates that in a medium-speed (350-to-500-ns) semiconductor system that has more than 250,000 bits, anywhere from 40% to 75% of the total system cost may relate to the array. The remainder represents the cost of building the system. He cautions that this estimate applies to the leveled-off production cost of the system. Whether the cost of putting a particular array into a system is at the high or the low end of the range, he says, depends on the system speed and the type of chip. For example, he says, an MOS dynamic array requires refreshing circuitry and clocks. Furthermore, if a number of such arrays are placed in parallel, supplementary drivers are required, and thus the system cost would be at the high end of the scale. A package like Computer Microtechnology's hybrid module, or a static MOS or a low-speed (of greater than 500 ns) MOS dynamic chip would be at the low end of the scale.

## Estimating system speed

Brown points out that as a rule of thumb for estimating the speed of a semiconductor component in a practical production system of 100 K bits or more, one would add to the component speeds the amounts shown in the table below.

Brown cautions that these estimates are for a practical production system rather than for a laboratory prototype, which does not have to be designed with production tolerances.

Type of Component	Component Speed*	Estimated increment to obtain system speed
Dynamic MOS	Access time Cycle time	Add 50% Add 25%
Static MOS, bipolar, or hybrid MOS/bipolar array, such as the Computer Microtechnology module	Access time Cycle time	Add 20 - 25% Add 10 - 15%

Exception: In a very high-speed system (total cycle time under 100 nsec), where the logic circuits are being pushed to the limits of their speed capabilities, the system access time might approach one and a half to two times the component access time. The cycle time would be only slightly longer than the access time.

\*Throughout this report, speed has been given as cycle time, which is defined as the time between successive requests for memory access. The worst-case cycle time is the cycle time of a read that follows a write. To write information into a location in memory creates transients that must have time to die down before it is possible to

read. Thus a read cycle time that follows a write is longer than a read cycle time that follows another read. Access time is defined as the time required to obtain information from memory after it has been addressed. The time is determined by the number of stages of delay through which the information must travel.

## The magnetics viewpoint

What do magnetics experts say about semiconductor memories?

H. Frederick Koehler, chief engineer for core and semiconductor memory products, Ampex Computer Products Div., Culver City, Calif., believes that as much as 40% of the memory market may go to semiconductors by 1975. "It will be in the area of mainframe memory," he says, "and will be in sizes up to a million bits. But I think that over a million bits, core will still have the market in 1975."

Richard J. Bravo, director of marketing for systems products, Electronic Memories, Inc., Hawthorne, Calif., says: "You can pretty well forecast the future of magnetic memories by envisioning what semiconductor memories are likely to achieve in any specific time period. In our view, they will take over the 4 K x 18 memory size—which is more or less the heart of the minicomputer market—within another 18 to 24 months. The next size you might consider is the half-million-bit memory. Our best estimate at this time is that within three to four years, semiconductor memories will be in production and have their production costs low enough to effectively eliminate the magnetic competition in that capacity."

Dr. Karl Hinrichs, director of engineering, Lockheed Electronics Co., Data Products Div., Los Angeles, agrees that semiconductor memories have great potential, but he cautions that that's all they have right now. "We haven't been able to buy them from anybody at a price that would make them competitive with core in a memory bigger than 1 K bits," he says.



"I think it will be 1975 before we really see the impact of semiconductors on the memory market. Most of the computers that are being designed between now and 1972 won't go into production until 1975"—Dr. Robert Noyce.

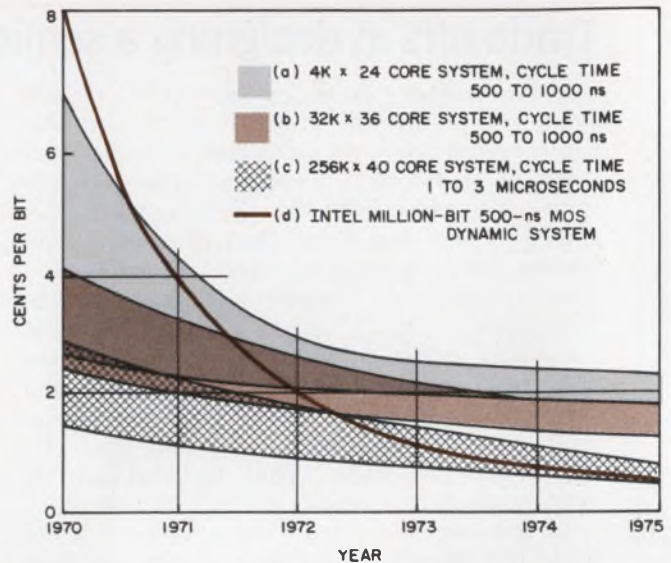

5. The price of a million-bit dynamic MOS system (d) crosses both the 100-K-bit (a) and the million-bit (b) core price bands in 1972 and approaches the lower edge of the 10-million-bit core price band (c) in 1975. The MOS projections are based on the component cost of an Intel 1024-bit dynamic device, doubled to estimate the cost of the complete system, and including refresh circuitry and clocks. The projections assume no increase in chip density that would lower the cost per bit still further between now and 1975. All core estimates were supplied by Lockheed Electronics Co., Data Products Div., Los Angeles. They include the power supply and are based on a minimum sustained production rate of 50 million bits a year.

system is likely to be slower than that of the individual pieces because of "real-world problems, such as extra line lengths."

Yet the small modularity of semiconductors can greatly increase the throughput of a well-designed system, Boysel of Four-Phase Systems points out. The Four-Phase computer has a mainframe memory that consists of up to 32 cards, each containing 1024 24-bit words.

"Since core comes in 4 K solid blocks," says Boysel, "you can only address one location out of 4 K words. Ours comes in 1 K solid blocks, so we can access each one independently. So even though the elemental MOS gates are slower than core, the data interaction rate is much faster."

### Are semiconductor memories reliable?

The question of the reliability of semiconductors in large memories is debated vigorously in the industry.

Richard J. Bravo, director of engineering Electronic Memories, Inc., says that "in memories above a half million bits, the memory market is still somewhat suspicious of semiconductors as reliable storage, primarily because the failures that occur in core memories now are usually semiconductor failures."

Raisanen of Motorola answers this argument

by asking: "What causes semiconductors to fail? High temperatures, high levels of electrical stress, high currents, high voltages. What kind of environment does a core memory provide for semiconductors? High temperatures, high levels of electrical stress, high currents, high voltages. Core people drive the stuff to its very limit. The reason semiconductors fail in core memories is not because they are poor semiconductors; it's because they're poorly used. Now, what do you find in a semiconductor memory? Extremely low power dissipation—like 1/4 mW per bit—low voltages, conservative design. They'll last forever!"

However, Raisanen agrees that "nobody knows if these memories are reliable enough to use in large sizes or not, because it takes a long time and a lot of money to find out; you have to build a lot of memories and put them on test and see how long they last."

Brown of Burroughs believes reliability could be a problem in modular sizes of over a million bits, but he says there should be no big problem at or below that size.

### The problem of volatility

In a semiconductor memory, when the power goes off, the contents of the memory disappear. Proponents of magnetic memories argue that this volatility will preclude the widespread use of semiconductor memories. They concede that a core memory may also lose information during a power failure but point out that this is due to the volatile semiconductor registers in it. If the power fails while any data is stored in these registers, that data will be lost. But, they point out, core memories can be designed to dump the contents of the registers back into the nonvolatile core if the power starts to fail.

Semiconductor proponents reply that if the problem can be solved in cores, it can also be solved in a semiconductor memory. The solution, they say, is battery back-up. Cloyd Marvin, vice president of marketing for Four-Phase Systems, puts it this way: "We haven't run into an application yet that has said 'no' to a volatile memory. If we do, we will hang a battery on the system, and the memory will dump itself onto a disc when there is a power failure. We can unload the whole memory in around 100 ms."

William F. Jordan Jr., manager of memory products engineering, Honeywell Computer Control Div., Framingham, Mass., thinks volatility has been greatly overstressed. "Personally, I think the prime motive for using battery back-up is so we can sell semiconductor memory computers on an equal basis," he says. "If we don't have battery backup, the core memory people will keep stressing the volatility of the semiconductor

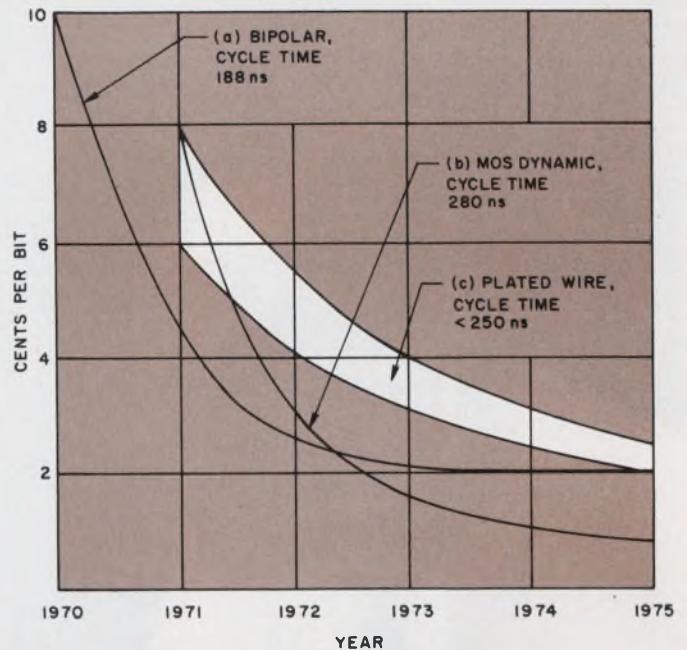

6. A 100-K-to-1-million-bit bipolar system (a) is expected to cost less than a million-bit plated wire system (c) until 1975. A million-bit dynamic MOS system (b) crosses over the low edge of the plated wire price band in the middle of 1971 and continues to fall. Curve "a" is based on an Iliac IV type of system manufactured by Fairchild Semiconductor. The cycle time of the system is 188 ns. The projection assumes a change in chip density from 256 bits today to 512 bits in 1972-73. Curve "b" from Intel Corp. was obtained by taking cost projections for a high-speed dynamic MOS 1024-bit device and doubling it to obtain the estimated cost of building the system. The device cycle time is 225 ns, and the system cycle time is assumed to be 280 ns. No change in bit density is assumed. Curve "c" represents cost projections from Lockheed Electronics Co. on a 32 K x 36 plated-wire system with a cycle time of less than 250 ns.

memory and the salesman will have a hard time selling it."

Nonetheless there are applications in which even battery backup would not solve the problem in a semiconductor memory—for example, on-line applications such as process control or satellite tracking, as well as storage of permanent data.

One interesting example of such an application is the storage of a permanent but alterable program for a point-of-sale terminal. Anar Asbow, manager of terminal development for Singer's Friden Div., San Leandro, Calif., says he could not use semiconductor random-access memories in this application because of their volatility. The terminal, which is a kind of "smart cash register," contains a program that guides the sales clerk through the steps of the sales transaction. This program must be permanent, but it must also be alterable, since the sales procedure varies from store to store. Thus, Asbow says, he could not use read-only memories; the best solution was a core memory. ■■







# Computer downtime could cost this user his share of a multi-billion dollar market.

## That's why he depends on Gerber Scientific and Hewlett-Packard.

In the automotive market, being second with a hot new body design just doesn't make it. That's why car manufacturers are turning to computerized drafting systems, like those made by The Gerber Scientific Instrument Company, South Windsor, Connecticut.

The auto industry knows that computers can mean the margin of difference—when they're working. But when they're not, you just might be "last under the checkered flag." That's why trouble-free performance was a key factor in Gerber Scientific's computer selection for its Series 1200 and 700 controls. These drafting systems make it possible to bring fresh new auto design concepts to market in record time. Gerber's systems are also slashing design time and costs in electronics, aircraft, garments, maps and other detailed work that used to take weeks of manual effort.

Sure Gerber Scientific chose our 2114 computer because they knew it could do the job. And was priced right. But more important, they knew they could count on superb reliability—and depend on world-wide HP service and support back-up—if and when needed. We have 141 service centers in the United States and around the world. For an OEM, this can be a very reassuring fact.

There are other reassuring facts about our small computers. Like Direct Memory Access, a feature now available with the new HP 2114B. The DMA option gives you the flexibility to use high-speed peripherals. And it makes possible the acquisition of very high-speed data. Yet this computer's base price is only \$8500. If you're looking for something a bit more powerful, try the HP 2116B. It's the heart of our popular time-share, real-time executive and disc operating systems. Cost: \$24,000.

Get the full story on computers you can depend on. Call your nearest HP sales office or write to Hewlett-Packard, Palo Alto, California 94304; Europe: 1217 Meyrin-Geneva, Switzerland.

HEWLETT  PACKARD

DIGITAL COMPUTERS

INFORMATION RETRIEVAL NUMBER 125

22942

# For design flexibility, go hybrid!

You can frequently improve circuit performance by mixing monolithic and discrete components.

Hybrid microcircuits may not be your first choice in designing for high performance and small size, but they may well be the best. They offer design flexibility in choosing circuit components not available with monolithics alone. They give some circuit functions that may not be obtained with monolithics. And they sometimes do the job at less cost.

The hybrid approach can be thought of as a packaging technique in which monolithics and discretes are used as components (Fig. 1).

The major emphasis in hybrid microcircuitry has been in military applications, but cost reduction has been so great that industrial and consumer applications are now being considered by manufacturers.

It is a simple matter for a circuit engineer with no knowledge of semiconductor processing to have his breadboard transformed into a production hybrid circuit in as short as four to six weeks.

Let's examine some of the characteristics of hybrids and monolithics and why hybrids may be better:

## Resistors

The diffusion process associated with monolithic circuits results in resistors that are limited in value and exhibit relatively poor tolerance and temperature coefficients when compared with thin-film and trimmed thick-film resistors. They also are characterized by parasitic effects that limit their use in high-frequency and high-voltage applications. The high sheet resistivities of cermet material are particularly useful in low-power circuits requiring resistors above 100,000 ohms. To exceed this value within a monolithic circuit would require too much chip area.

## Capacitors

The maximum practical value for MOS capacitors used in monolithic circuits is typically 100

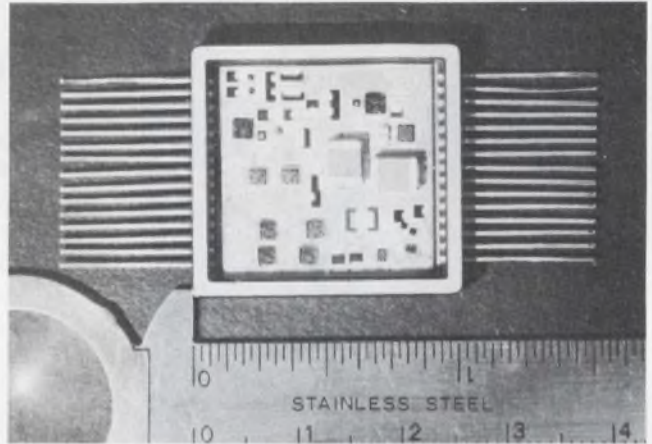

1. Hybrid technology as a packaging technique for monolithic chips is demonstrated by this one-inch-square ceramic flat pack. The circuit contains 10 monolithic chips five diode chips, four capacitors and two high-performance transistor chips.

pF. Here again, higher values are limited by the available real estate. Hybrid circuits use both MOS and multilayer ceramic chip capacitors to achieve values above  $0.1 \mu\text{F}$ .

## Transistor Device Parameters

The necessity for a top-side collector contact, geometry considerations and compatible materials and diffusion schedules to yield both resistors and transistors in monolithic circuits limits certain transistor parameters. In particular, the  $V_{\text{CE SAT}}$  of a monolithic transistor is seldom below 200mV. Breakdown voltages exceeding 25 V are difficult to obtain, and high-frequency performance (above 200 MHz) is limited by the relatively high  $R_0 C_0$  product. Power-handling capabilities are limited by available chip area, and it is not, in general, practical to integrate power transistors with small signal devices.

## Device Flexibility

Perhaps the most serious limitation of monolithic ICs in high-performance circuits is the difficulty in integrating a variety of components on one silicon chip. Circuits requiring complemen-

---

Paul Schwartz, Division Manager, Integrated Circuits Div., General Instrument Corp., Hicksville, N.Y.

tary transistors, zener diodes, resistors, capacitors and field-effect transistors would be difficult, if not impossible, to produce because of the large number of processing steps necessary. High-performance pnp transistors are very difficult to achieve in monolithic ICs. Hybrid technology, by definition, allows the use of all of these devices.

### Typical hybrid applications

Hybrids have potential application in linear circuits, power-supply regulators, logic and interface circuits and analog switches.

In operational amplifiers, for example, hybrids offer lower input voltage and current offset than is possible with monolithics. Adjustable thick-film resistors can be used with monolithic ICs to balance out offsets. Low-input currents can be achieved in monolithic amplifiers that incorporate junction FETs. However, offset voltage must be sacrificed because adjacent FETs from the same wafer give typical offsets of 25 to 50 mV. The hybrid approach of using individually matched FETs and adjustable thick-film resistors provides the required performance.

The circuit of Fig. 2 is a wideband op amp that uses complementary high frequency transistors. Proper selection of components results in a typical gain bandwidth product of over 1 GHz, with open loop gain of 50 dB at 10 MHz. The slewing rate is typically 100 V per microsecond. Slew rates of this order are difficult to achieve in monolithic circuits because of the necessity to use low-gain lateral pnp devices. Composite devices used in monolithics to provide high-gain pnp transistor action are limited in speed by the Miller effect of the associated capacitors.

In the circuit of Fig. 2, the input npn transistor pair consisting of  $Q_1$  and  $Q_2$  is a single chip, with dielectric isolation providing low-input voltage offset.

One of the first applications of hybrid techniques was in dc voltage regulators. In the last year several companies have introduced some rather impressive monolithic regulators. The question naturally arises: Why do hybrid manufacturers continue to introduce new regulators

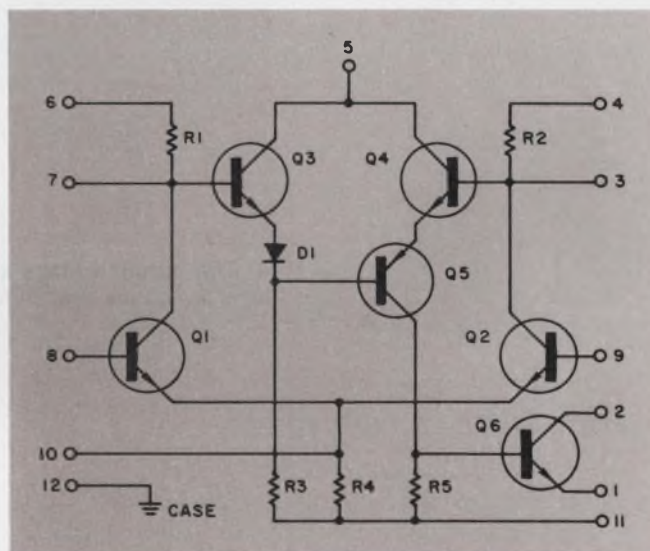

2. This wideband operational amplifier has a slew rate of 100 V per microsecond, which is difficult to obtain with monolithic op amps.

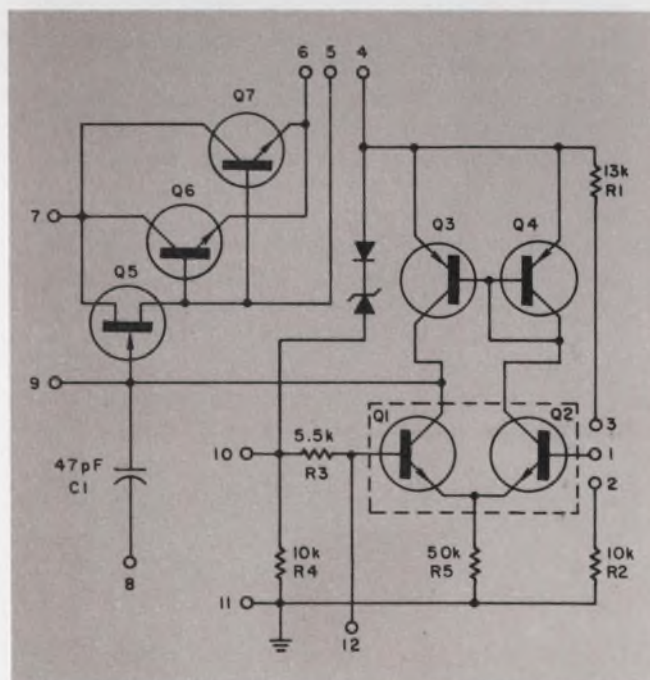

3. Resistor trimming techniques are used to set the output voltage of this 12-V regulator. The external compensation that monolithics require is not necessary.

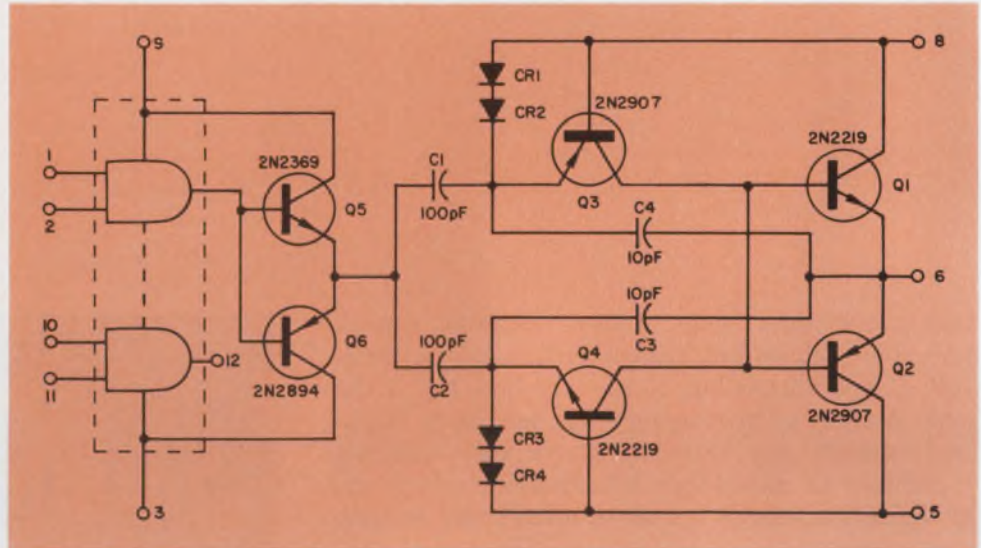

4. The output voltage swing of this hybrid clock driver circuit is above 28 V. Input logic functions are performed with a monolithic dual gate.

## How hybrids are made

In the manufacture of hybrid circuits, a conductor pattern is fired onto a ceramic substrate. Cermet resistors are then screened and fired, and other components, such as semiconductors and capacitor chips, are applied by conventional microcircuit assembly techniques.

Resistors can be adjusted in value either by abrasion to increase the value or by a high-voltage pulsing technique that decreases the value. The advantage of voltage trimming is that circuit functional performance can be adjusted in the testing process after final sealing.

The range of values, tolerances and ratings available for passive components is adequate for the requirements of most circuits. Almost any semiconductor or monolithic IC device can be used in hybrid circuits.

It is true that almost any breadboard can be manufactured in hybrid form. However, the ultimate cost is dependent on the yield, and a judicious choice of components and tolerances is obviously needed.

into their product line? The answer: performance. You can build high power hybrid regulators that can't be made from monolithics.

The main advantage of hybrid regulators is that hybrid trimming techniques can be used to preset the output voltage; thus no external resistors are required. And no additional compensation elements are needed, as in monolithic regulators. Because of monolithic limitations, the hybrid versions can be operated at substantially higher output voltages and currents.

In high-power monolithic regulators, the temperature rise must be minimized to avoid drift of the control and reference circuits. The component layout of hybrid regulators can be optimized from a thermal viewpoint.

For normal operation of the hybrid voltage regulator (Fig. 3), no external components are required. Typical of hybrid regulators, this circuit is thermally and electrically more efficient than an equivalent monolithic version because of the use of parallel pass transistors  $Q_6$  and  $Q_7$ , which have low saturation resistances. The control amplifier uses high-gain npn and pnp transistors for both high open-loop gain and minimum standby current. A junction FET supplies a constant current independent of input voltage to the reference element. The reference element is compensated to provide excellent temperature characteristics for this regulator.

In the digital world, the economics of using monolithic circuits is unquestionable. However, the system designer is faced with the problem of interfacing these devices with other equipment. Interface circuits are required between

low-voltage bipolar devices and relatively high-voltage MOS devices. Hybrid circuits are successfully finding applications as voltage translators, high-speed clock drivers, lamp drivers, memory-core drivers, low-power logic circuits and a variety of other circuits.

### Interfacing digital circuits

Typical of the interface circuits is the hybrid clock driver output stage shown in Fig. 4. The MOS logic that this circuit drives is equal to a 1000-pf capacitive load that must be driven at rates exceeding 5 megacycles. The use of a monolithic TTL dual gate at the input allows logic functions to be performed. AC coupling, complementary transistors and positive feedback result in a high-efficiency driver stage. The output voltage swing of the driver is above 28 V.

Circuits for both d/a and a/d converters require the performance characteristics of hybrid circuits. High-slew-rate operational amplifiers with low offsets are used in conjunction with very-high-performance analog switches and resistive networks. For high-speed d/a conversion, a parallel approach is used in which one analog switch is necessary for each bit. The response of the converter is limited by the speed of the switch, the parasitics of the resistors and the slew rate of the summing amplifier.

A series-shunt switch using bipolar devices is preferred to connect the reference voltage to the resistors. This is because the switch offsets in the ON and OFF conditions are similar and can therefore be partially compensated. In addition the source impedance at the summing-amplifier input remains constant. Figure 5 is a schematic of a dual series-shunt switch designed for a d/a converter. The hybrid circuit was assembled in a 1/4-by-3/8-inch ceramic flat package.

In this circuit a reference voltage is connected to Pin 7, and Pin 5 is grounded. The resistor network is connected to Pin 6. Standard digital logic levels of 0 to 5 V are fed into the base of  $Q_1$  to operate the switch.  $Q_3$  and  $Q_5$ , the actual switching transistors, are operated in the inverse mode to obtain less than 1 mV offset from either the reference or ground. For highest-speed operation, some compromise must be made between ON resistance and speed. Low ON resistance requires considerable base drive, which in turn increases the storage time of the output switches.

In the layout of this circuit it is critical that the output transistors be die-bonded with extreme care. Even though gold-backed chips are used, silicon-gold preforms are required to lower

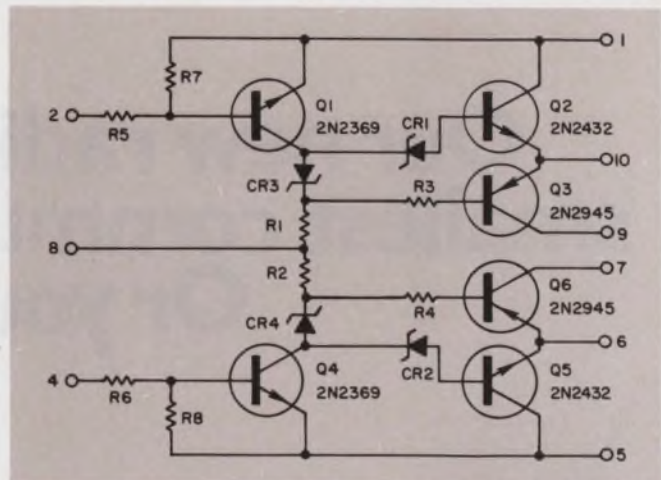

5. Parallel switching for each bit is required for high-speed d/a conversion. This hybrid 2-bit switch combines both high speed with low offset voltage. The response time is limited by the speed of the switch.

the saturation resistance. The geometry and conductivity of the conductors is an important consideration in maintaining low offset.

In a straightforward d/a converter, the analog switches operate only on constant voltages. However, if the analog output is ac, the characteristics of the switch required are somewhat different. Bipolar transistor switches should not be used for ac operations because their offsets change as a function of the input-signal level. The ON resistance of a MOSFET switch varies hyperbolically with the gate-source voltage,  $V_{GS}$ . With positive input signals,  $V_{GS}$  is large and  $R_{ON}$  is small; for negative input signals,  $V_{GS}$  is small and  $R_{ON}$  large. Therefore both MOSFET and bipolar switches distort the ac signal, and system errors are introduced. ■■

### Bibliography

- Davis, E. M., et al, "Solid Logic Technology: Versatile, High Performance Microelectronics," *IBM Journal*, April, 1964.
- Early, C., "Thick Films: Setting up a Prototype Facility," *Electronic Packaging and Production*, December, 1967, pp. 13-17.
- Hayes, W., and Van Hise, J., "How to Design Thick Film Hybrid IC's," *The Electronic Engineer*, August, 1967, pp. 70-74.
- Layer, E. H., "Cermet Microelectronics," Proceedings of the National Electronics Conference, Chicago, 1964.
- O'Connel, Dr. J., and Zaratkiewicz, E., "Thick-Film Technology," *Electronic Packaging and Production*, December, 1967, pp. 13-17.
- Solid-State Technology*, Special thick-film issues, June, 1966; June, 1967; June, 1968; June, 1969.
- Thun, R. F., "Thick Films or Thin?," *IEEE Spectrum*, October, 1969, pp. 73-79.
- Western Periodicals Co., *Proceedings, 1968 Hybrid Microelectronics Symposium*, North Hollywood, Calif.

**Our new radio. It'll solve your  
smallest communications problem.  
Or your largest.**





You have a small radio for your small communications job. You have a big radio for big jobs.

In fact, for every communications job between, you seem to need a different radio.

With all those radios around, you've still got communications problems. Because you've got all those different kinds of radios. Which led our Electronics division to think there must be a way to solve this problem.

We have. We've created a systems concept which uses the same basic radio unit at any command level in the field.

The concept is called FOR, Family of Radios. The basic transceiver is a man-packed unit.

Since it must work in your smallest command, it must be small. Ours is. In fact, it's about the size of two cigar boxes. The closest thing to it is twice its size.

Our radio's weight: 5 pounds. And with batteries: about 10 pounds. The closest thing to it is about twice its weight.

The basic transceiver is available with HF/SSB at 20 watts or VHF/FM at 10 watts.

Because of its size and weight, the radioman can now be as mobile as his fellow squad members.

For company use, a standard power amplifier is added to the basic transceiver. Both units can be mounted on and powered by any type of vehicle by using standard mounts and various input power adapters.

For larger jobs all the way up to brigade, for artillery or air support, the basic unit is combined with a number of standard power amplifiers to provide the required higher power outputs.

The basic unit features modular interchangeability—batteries, amplifiers and circuit components. Add-on units are standard from one system to another—vehicular mounts, speaker systems, input power adapters, power amplifiers.

How we came to make a radio unit this small, this interchangeable, this versatile, points up something about us.

At General Dynamics, we put technology to work solving problems from the bottom of the sea to outer space ...and a good bit in between.

## **GENERAL DYNAMICS**

Additional technical information is available on the Family of Radios on request. Write: General Dynamics, Dept. 850, 1 Rockefeller Plaza, New York, New York 10020

INFORMATION RETRIEVAL NUMBER 53

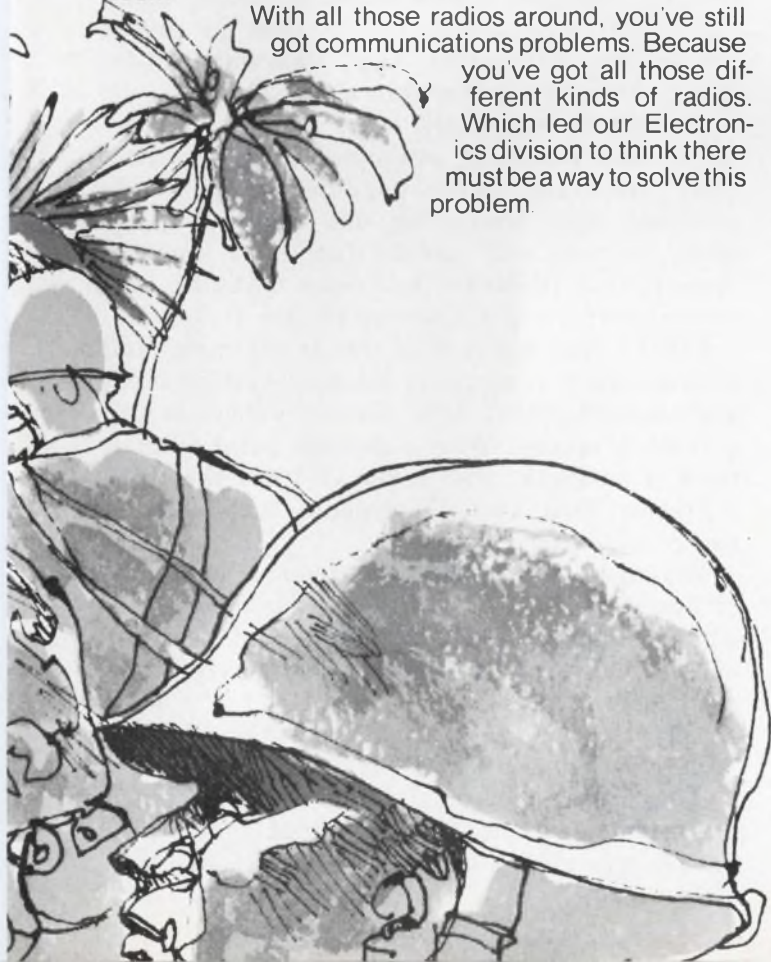

# Program your minicomputer in FOCAL.

This conversational language conserves memory and is adaptable to a wide variety of applications.

Small, general-purpose, digital computers are being used increasingly. But what about an easy-to-use computer language for machines with small core memories? FOCAL\* (FORMula CALculator) was developed to meet this need. No programming experience is necessary to understand it, and it permits a minicomputer to perform many operations formerly restricted to a remote terminal on a time-shared computer.

A high-level language for small computers should have two basic design objectives: It must operate effectively within 4000 words of core memory and it should have complete editing capability and interpretive execution. It should also have a high degree of user orientation that is compatible with engineering needs.

## Commands described to save memory

It is desirable for clarity that commands (Fig. 1) be spelled out completely to avoid ambiguity. However, abbreviations are often desired for speed and economy of core-memory space, since all text is resident in core. The FOCAL compromise is to choose commands so that each has full mnemonic value, while beginning with a different letter. By ignoring extra letters, the language accepts either abbreviations or expanded forms.

Many of the user-oriented features of FOCAL come from the concepts of RAND Corp's JOSS language. One of these is the line-number, group-number structure, which allows use of a set of lines as a subroutine for repeat computations. It also is possible to execute a single line as a subroutine. These subroutines are even recursive—they permit computation involving successive approximations.

The language has a natural format and readable structure with a minimum of arbitrary formats and few cryptic character codes. Finally, the program is a left-right, top-down interpreter,

which makes it easily understood. This, too, makes it adaptable to re-entrant time-sharing.

## The diagnostics are flexible

FOCAL has been provided with a large set of precise error diagnostics that describe and locate programming mistakes (Fig. 2). They provide immediate and accurate indication of errors. The error diagnostic is accompanied by the line number in which the error occurs. If further debugging facilities are required, a trace feature is provided that allows the user to pinpoint his error to the offending character. A question mark in the command text causes succeeding letters to be typed until an error or another question mark is encountered.

Most important is the ability to make corrections within seconds. Recognizing that many users will not be skilled typists, the developers of FOCAL have let the user correct single and multiple character errors within a line by using the "modify" command. This is done by giving positioning information, then inserting or deleting at a given spot within a text string.

Another feature is the large number of operations and functions available, (Fig. 1). And there are input/output facilities that include real-time data acquisition and analysis, large array storage and update functions, complex scope control functions, an analog-to-digital converter control and a Calcomp plotter function.

FOCAL also has a wide numerical range and good accuracy. It normally has a seven-digit input and six-digit output with roundoff. There is also a 10-digit version. With a floating point format, there is an exponential range of 10 to the  $\pm 616$ —greater than that conveniently available on nearly any other computer.

The input/output features provide a great deal of flexibility and utility in creating meaningful output. For example, a print-plot can be made on the teletype with a single interactive statement (Fig. 3):

```
FOR Y=0, 5, 15; TYPE!; FOR X=0,
FSIN (Y) + 12; TYPE"***".
```

Histograms, line functions, multiple axes and non-monotonic values can be plotted. Plotting on the Teletype gives qualitative as well as quantita-

---

\* TM Digital Equipment Corp.



## Focal Commands

Command	Abbreviation	Example of Form	Explanation	Command	Abbreviation	Example of Form	Explanation
ASK	A	ASK X, Y, Z	FOCAL types a colon for each variable; the user types a value to define each variable.	LIBRARY CALL	L C	LIBRARY CALL name	Calls stored program from the disk.
COMMENT	C	COMMENT	If a line begins with the letter C, the remainder of the line will be ignored.	LIBRARY DELETE	L D	LIBRARY DELETE name	Removes program from the disk.
CONTINUE	C	C	Dummy lines.	LIBRARY LIST	L L	LIBRARY LIST	Types directory of stored program names.
DO	D	DO 4.1  DD 4.0 DO ALL	Execute line 4.1; return to command following DO command. Execute all group 4 lines. Return to command following DO command, or when a RETURN is encountered.	LIBRARY SAVE	L S	LIBRARY SAVE name	Saves program on the disk.
ERASE	E	ERASE ERASE 2.0 ERASE 2.1 ERASE ALL	Erases the symbol table. Erases all group 2 lines. Deletes line 2.1. Deletes all user input.	LINK	L	L	For disk monitor system; FOCAL types 4 locations indicating start and end of text area, end of variable list and bottom of push-down list.
FOR	F	For i=x,y,z; (commands) FOR i=x,z; (commands)	Where the command following is executed at each new value. x=initial value of i y=value added to i until i is greater than z.	LOCATIONS	L	L	For paper-tape system; types same locations as LINK.
GO	G	GO	Starts indirect program at lowest numbered line number.	MODIFY	M	MODIFY 1.15	Enables editing of any character on line 1.15 (see below).
GO?	G?	GO?	Starts at lowest numbered line number and traces entire indirect program until another? is encountered, until an error is encountered, or until completion of program.	QUIT	Q	QUIT	Returns control to the user.
GOTO	G	GOTO 3.4	Starts indirect program (transfers control to line 3.4) Must have argument.	RETURN	R	RETURN	Terminates DO subroutines, returning to the original sequence.
IF	I	IF (X) Ln, Ln, Ln IF (X) Ln, Ln; (commands) IF (X) Ln; (commands)	Where X is a defined identifier, a value, or an expression, followed by one to three line numbers. If X is less than zero, control is transferred to the first line number, if X is equal to zero, control is to the second line	SET	S	SET A = 5/B*C;	Defines identifiers in the symbol table.
				TYPE	T	TYPE A + B - C;  TYPE A - B, C/E;  TYPE "TEXT STRING"	Evaluates expression and types out = and result in current output format. Computes and types each expression separated by commas. Types test. May be followed by ! to generate carriage return-line feed, or # to generate carriage return.
				WRITE	W	WRITE WRITE ALL WRITE 1.0  WRITE 1.1	FOCAL types out the entire indirect program. FOCAL types out all group 1 lines. FOCAL types out line 1.1.

(a)

## Focal's Functions

FSOT( )	Square Root
FABS( )	Absolute Value
FSGN( )	Sign Part of the Expression
FITR( )	Integer Part of the Expression
FRAN( )	A noise Generator (.5 - .9)
FEXP( )	Natural Base to the Power
FSIN( )	Sine
FCOS( )	Cosine
FATN( )	Arctangent
FLOG( )	Naperian Log
FDIS( )	Scope Functions
FADC( )	Analog to Digital Input Function
FNEW( )	User Function
FCOM( )	Storage Function

(b)

## Focal Operations and Their Symbols

### Mathematical operators:

↑	Exponentiation
*	Multiplication
/	Division
+	Addition
-	Subtraction

### Control Characters:

%	Output format delimiter
!	Carriage return and line feed
#	Carriage return
\$	Type symbol table contents
( )	Parentheses
[ ]	Square brackets (mathematics)
< >	Angle brackets
" "	Quotation marks (text string)
? ?	Question marks (trace feature)
*	Asterisk (high-speed reader input)

### Terminators:

SPACE key (names)	
RETURN key (lines)	(nonprinting)
ALT MODE key (with ASK statement)	
Comma (expressions)	
Semicolon (compounds and statements)	

(c)

1. This is the FOCAL language, which includes commands (a), functions (b) and operations (c). With these instructions, a complete program can be written.

tive information. This is possible because one can cause the carriage to return without a line feed and can give a carriage return/line feed wherever desired.

### FOCAL is handy in the laboratory

Among other I/O capabilities are some real-time interactions. Thus FOCAL can be used in the laboratory with devices controlled through an output bus by means of FOCAL functions. Where suitable FOCAL functions do not exist, the user can write his own in machine language and access them via a special FOCAL function that he sets up. This function can be used as any other. It can be imbedded within a set of computations, have any number of arguments and allow complex control functions to be performed in conversational language. The computer system is fast enough to allow interaction with devices that need servicing 10 times a second.

FOCAL is one of the first standard programs for the small computer to run asynchronously. It buffers data to and from the Teletype—a distinct advantage when running FOCAL on slower computers, because it allows data to be fed into the computer at a higher speed than the computational cycle. An enormous decrease in the re-

sponse time of the program is possible and operation of the keyboard is smoother.

Another advantage of the interrupt system is that it permits the ending of program loops—for example, from the keyboard, by typing "Control-C." The recovery routine will then go into reset mode, type out the message code "?01.00" and return to command mode. Manual restart via the console switches, as well as all error diagnostics, also go to the recovery routine.

Error printing is withheld until prior printing is complete. Otherwise an error message could be printed prematurely, and the result might be misleading when attempting to trace specific errors within a character string.

### Data formats are varied

There are several powerful output formats: floating point, fixed point and automatic right-shifting of the decimal point if numbers are larger than the allowed integer field. Any desired format can be specified by giving the total number of digits in the field and the number of digits to be allocated initially to the decimal field. Many input formats are acceptable: leading signs, leading blanks, E format, decimal format. Any reasonable specification of an input number is accepted by the machine. The program can accept alphanumeric strings, which it promptly compresses into a single code number. Thus an interactive program may accept the answers "YES," or "NO," or "MAYBE," etc. Such responses are recognized by comparison with "numbers" that begin with the digit zero—for example: IF (REPLY - 0YES) 2.1. In this example REPLY is a variable name and 0YES is a constant.

The compromise used to overcome the size limitation and still gain power is a sacrifice of speed and compatibility with other languages. The objective was to achieve maximum utility within the space allowed and still have enough user storage left to do fairly complex jobs.

### User determines memory configuration

Since even the best intentioned design doesn't satisfy everyone, a good language lets the user establish the limits of the system. When FOCAL is first loaded into core from the tape on which it is supplied, it goes through an initial dialogue, which is actually an interactive FOCAL program whose variables are assessed by machine language. The dialogue requires no extra space, since it occupies the initially "blank" program tape area; it enhances user compatibility by causing changes in the structure of the program itself. In this way FOCAL asks the user whether he wishes to use certain of the extended functions, such as arctangent, logarithm and expo-

### Focal's Error Diagnostics

Code	Meaning
?00.00	Manual start given from console.
?01.00	Interrupt from keyboard via CTRL/C.
?01.40	Illegal step or line number used.
?01.78	Group number is too large.
?01.96	Double periods found in a line number.
?01.:5	Line number is too large.
?01.:4	Group zero is an illegal line number.
?02.32	Nonexistent group referenced by 'DO'.
?02.52	Nonexistent line referenced by 'DO'.
?02.79	Storage was filled by push-down-list.
?03.05	Nonexistent line used after 'GOTO' or 'IF'.
?03.28	Illegal command used.
?04.39	Left of " = " in error in 'FOR' or 'SET'.
?04.52	Excess right terminators encountered.
?04.60	Illegal terminator in 'FOR' command.
?04.:3	Missing argument in display command.
?05.48	Bad argument to 'MODIFY'.
?06.06	Illegal use of function or number.
?06.54	Storage is filled by variables.
?07.22	Operator missing in expression or double 'E'.
?07.38	No operator used before parenthesis.
?07.:9	No argument given after function call.
?07.:6	Illegal function name or double operators.
?08.47	Parentheses do not match.
?09.11	Bad argument in 'ERASE'.
?10.:5	Storage was filled by text.
?11.35	Input buffer has overflowed.
?20.34	Logarithm of zero requested.
?23.36	Literal number is too large.
?26.99	Exponent is too large or negative.
?28.73	Division by zero requested.
?30.05	Imaginary square roots required.
?31.:<7	Illegal character, unavailable command, or unavailable function used.

2. Error diagnostics are of great help in debugging a program, and FOCAL's diagnostics are extensive, in spite of its small core requirements.

nential. Users who do not need these can recover the unused memory space, create larger arrays or use the space as program text storage.

Size limitations place serious burdens on the core layout and on implementation of the program. However, the program is easily expandable to 8000 words. The 4000-word version accommodates a typical program of 20 lines and 40 variables, or about 1000 working cells. A dynamic allocation of resources is supplied in addition to the selection of configuration.

A user is not restricted to 20 lines, 40 variables, a fixed depth of subroutine calls or a fixed depth

of nested expressions. The 1000 words of working space can be allocated to whatever purpose is required in a program: a short program with many variables or a long program with few variable assignments.

### Punctuation conserves memory

A special character can terminate a command string. Thus by using a semicolon to connect two commands, a user saves the data overhead associated with a line pointer, line number and carriage return; a semicolon saves three locations in the text buffer. This convention also fits naturally with the "FOR" command format:

FOR A = b,c,d; . . . This reads: "For the variable A, equal initially to the value of the expression b, incremented by c until A exceeds d, do the command string that follows the semicolon."

The command string can contain other commands and semicolons giving the language a powerful and easily understood iterative statement implemented in minimum core.

The IF command also was improved by the semicolon. The normal form, similar to that of FORTRAN is:

IF (expression) a, b, c; where a, b, c, are line numbers to go to if the result of the expression in parentheses is negative, zero, or positive, respectively.

The semicolon can shorten the IF command, and execution continues along the same line:

IF (exp) 1.45, 3.2; TYPE "GREATER THAN ZERO."

There is one other unique feature of FOCAL. It is possible to convert the computer operation into a desk calculator mode. Simple arithmetic calculations can be made, and the utility of the computer is enhanced for those who have no need for more elaborate programming. ■■

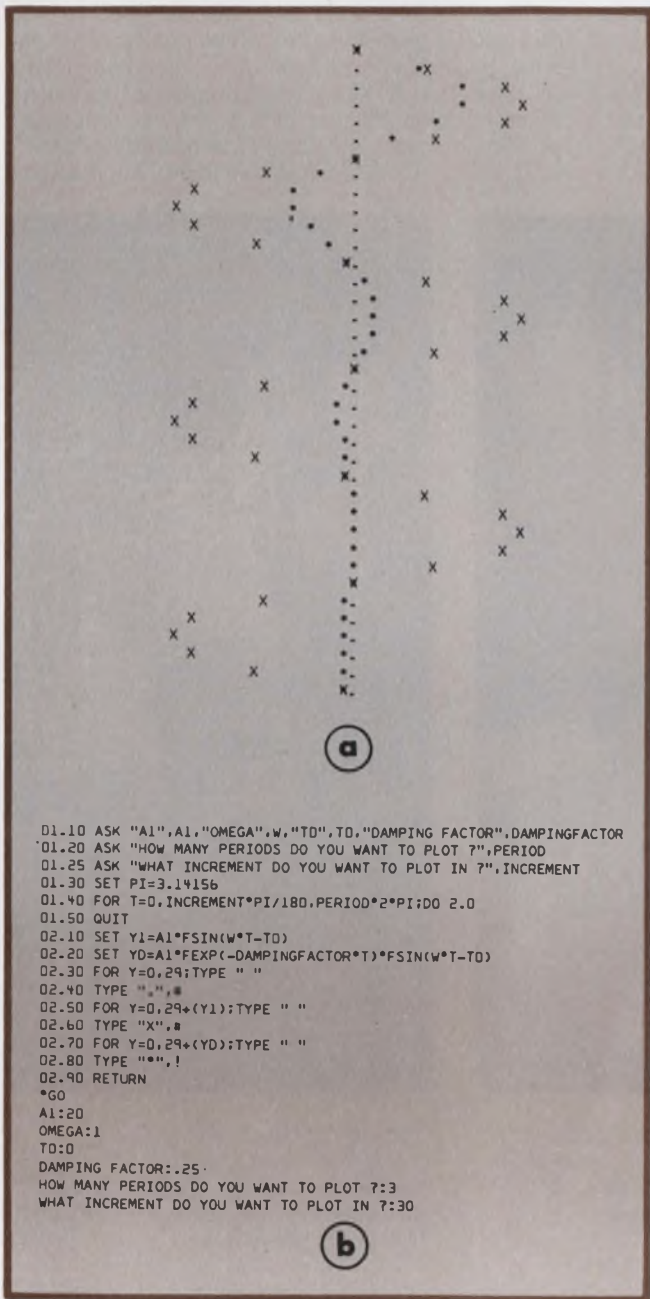

3. This simultaneous print-plot of a damped and undamped sinusoid (a) results from the program (b) shown, and is a typical example of FOCAL problem-solving. By contrast, FORTRAN requires many more statements for the same results.

### Test your retention

Here are questions based on the main points of this article. Their purpose is to help you make sure you have not overlooked any important ideas. You'll find the answers in the article.

1. What are the requirements for a language to be used with small computers?
2. Is asynchronous operation desirable in a conversational language?
3. Why are abbreviations desirable?
4. What is the trace feature?



What happened  
to the  
model 19?

You're looking at some of the Teletype® basics used in building a data communications system. Printer, keyboard, tape sending and receiving combinations in a variety of speed capabilities. Teletype's modular design concept gives you the opportunity to extract the best terminal combination for system

needs today, and refine, add to, subtract and adapt as system modifications are called for. Just as important as the basics, are some of the things not obvious in the photos below. The logic devices, options and accessories that add almost limitless possibilities for making things happen exactly as

your system requires. We have some solid state logic devices that provide precise control of data traffic. That enable your computer to automatically poll data from a number of terminals and feed each terminal with processed data. There are error detection, correction and signal regeneration options to



**model 33 series:** An extremely economical 100 wpm terminal line. Has 4-row keyboard, uses 8-level ASCII code. The most widely used terminal in time-sharing systems today.



**model 35 series:** A rugged, heavy-duty line of 100 wpm terminals. Uses ASCII. Units in foreground are self-contained paper tape punch and paper tape reader.



**Telespeed™ equipment:** A line of high-speed tape-to-tape terminals capable of sending and receiving at speeds of 750, 1050 (shown above), or 1200 words per minute.

# DATA COMMUNICATIONS

equipment for on-line, real-time processing

keep data flowing faultlessly. Options such as pin-feed platens and form feed controls that make it possible to fill multiple copy business forms on-line. And many, many more. What did happen to the model 19? Believe it or not, there are still some of these old, die-hard terminals around. And that's

another advantage your data communications dollar buys when you specify Teletype equipment. It lasts. Moves data reliably, economically, for a long time. On a price/performance basis, Teletype equipment is in a class by itself.

Teletype data communications equipment is available in send-receive capabilities of up to 2400 words per minute. If you would like specific information about any of the equipment described here, write: Teletype Corporation, Dept. 89-17, 5555 Touhy Ave., Skokie, Ill. 60076.



*model 37 series: One of the most versatile heavy-duty terminal lines going. Generates all 128 characters of ASCII. Operates at 150 wpm. Prints in upper and lower case.*



*Inktronic® data terminals: A unique electronic, solid state terminal. Prints up to 1200 wpm. Forms characters through electrostatic deflection (no typebox). ASCII compatible.*



*magnetic tape data terminals: Use compact reusable tape cartridges. Operate on-line at up to 2400 wpm, and connect "locally" to lower speed Teletype terminals using ASCII code.*

# Watch your specs!

Get the most from instrument transformer vendors by defining performance, not design.

Engineers who specify instrument transformers can easily saddle themselves with poorly designed units, and get limited over-all system performance. Such transformers have some characteristics that exceed requirements—resulting in unnecessary cost—while other equally important parameters are degraded.

But there exists a well-tested system for defining instrument transformer requirements so that the optimum cost/performance ratio may be realized. Using this technique results in a possible 30% size reduction and 10% cost saving, with simultaneous performance improvement in such areas as common-mode rejection and reduction of microphonics.

## Specify results, not design

The transformer design expert cannot use his knowledge effectively unless the customer specifies desired performance rather than dictates design. Proper specifications should communicate desirable vs acceptable performance to the designer. Unnecessary customer involvement with the details of construction is a primary reason for poor cost/performance ratios.

This is illustrated by the various schemes used to define the important transformer characteristic—magnetic pickup. Many specifications call out the number of shield cans, while some go even farther and name the material (Mumetal, high nickel, etc). Others dictate the nested shield-can attenuation in decibels. Not specified is the really significant item: the pickup in microvolts or nanovolts for a given magnetic field intensity. And other factors besides shield cans may also affect the pickup level.

## Stray field interference defined

External magnetic field interference is defined as the total stray voltage induced into the trans-

Prepared by the Engineering Dept., Stevens-Arnold, Inc., South Boston, Mass. For further information, contact **G. M. Karon**, Project Engineer.

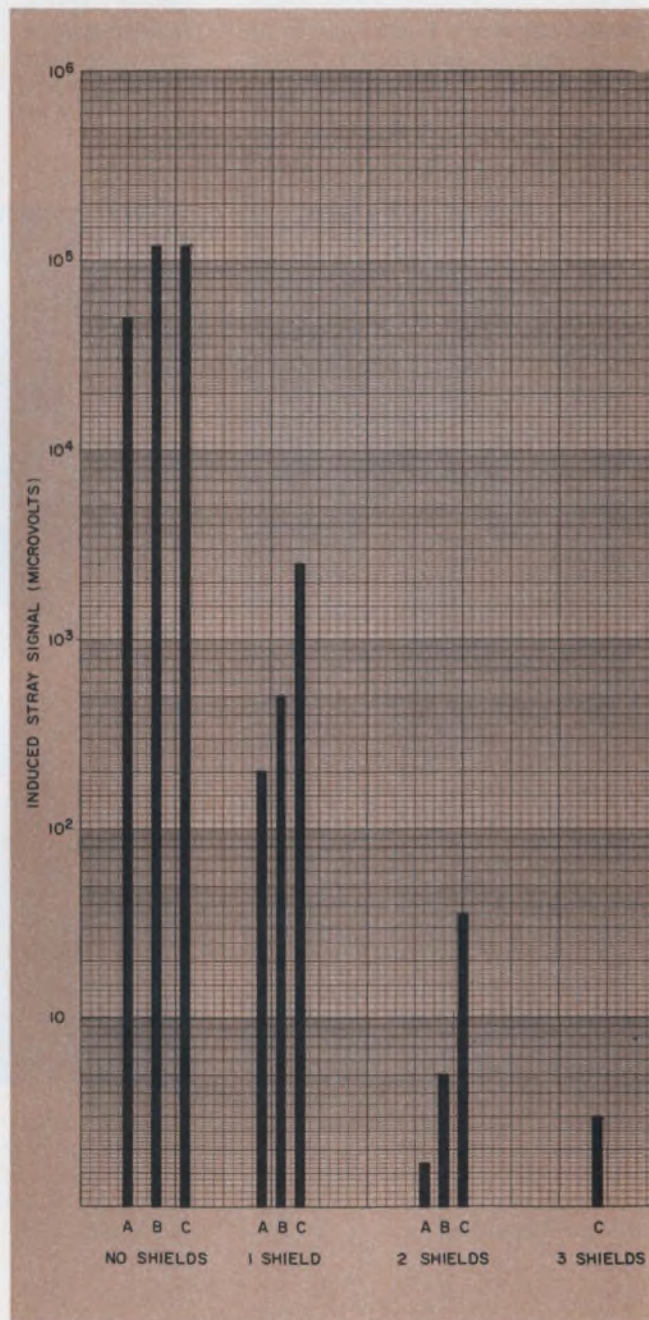

1. Shields help cut stray signal pickup, but it's not the whole solution. Superior core-coil construction makes unit A least sensitive to external fields, while unit C suffers from poor shield design.

former by such fields. Normally, this stray voltage is referred to the transformer primary for uniformity. A proper description of transformer requirements will state the permissible level of the stray signal, together with the external magnetic field strength in which the device is expected to operate.

The following design parameters determine the stray induced signal magnitude:

- Core-coil design.
- Mechanical shielding design—drawn, fabricated, or welded.
- Number, spacing and thickness of shields.
- Shield material used and annealing quality.
- Transformer/external-field orientation.

These factors and their relative importance are shown in Fig. 1. The data is based on a magnetic field having an effective value of 5 gauss at 60 Hz and shows the induced magnetic voltage for three transformer constructions. Concurrent with the four illustrated variations in shield quantity, examples A and B have different corecoil construction with similar shielding, while B and C have identical corecoils but use different magnetic shield designs. Shield-can material is deep-drawn Mu-metal for all examples.

When two shields are used on identical core coil assemblies B and C, note that one set of shield cans is approximately five times as effective as the other in reducing magnetic influence. Also observe that core-coil assembly A with two shield cans is far superior to core-coil assembly C having three shield cans. This data demonstrates that optimum design results from accurate specification of the permissible induced voltage level and anticipated field strength.

When the exact external field strength is not known, a good estimate is 5 gauss at 60 Hz. Experience shows that this approximation holds for most electronic and laboratory equipment applications. In abnormal cases, where the external field exceeds 5 gauss, the exact value can be measured and inserted in the specification.

### Vibration voltages accounted for

Shock and vibration generate unwanted voltages within transformers. Figure 2 gives data on two transformers that are identical except for their susceptibility to shock. If the minimum input signal level should exceed  $50 \mu\text{V}$ , it would be unreasonable to spend extra for the improved unit with a  $1 \mu\text{V}$  generation level.

Stray voltages caused by shock and vibration are produced both inside the transformer and along the connecting leads. Generation of this voltage is attributed to piezoelectric effects, contact potentials, mechanically varied interwinding capacitances and shielded leads vibrating in a magnetic field.

Again, as with magnetic interference, proper procedure is to specify a cause and effect relationship. A clear statement is needed regarding maximum permissible stray signal in microvolts at the anticipated level of vibration. Under non-mobile conditions, the nominal value is 1 g. For mobile or other high-shock applications, the actual vibration level must be measured and used. Shock-mounting the transformer is not recommended because any advantage gained by reduced generation inside the transformer is offset by increased generation along the connecting cable.

### Common-mode rejection improved

Other unwanted voltages can develop within the transformer between a primary winding or the input and common. The transformer's ability to suppress such voltage is called common-mode rejection. The best transformer designs are pres-

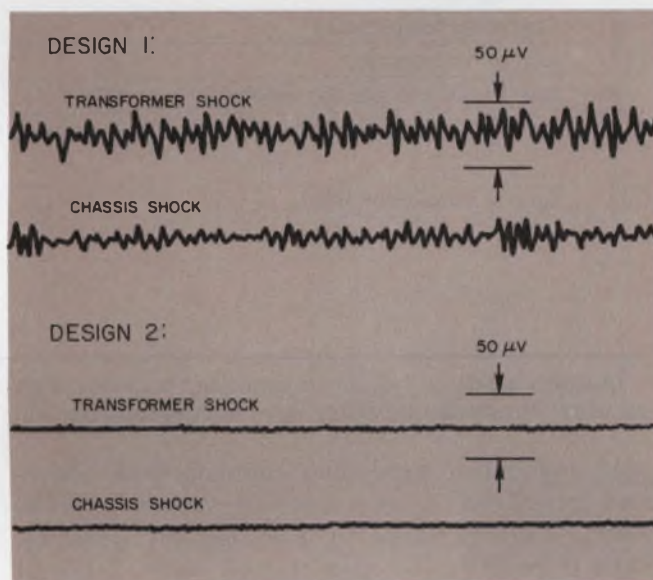

2. Shock and vibration can generate unwanted signals inside the transformer or along the leads. Vibration voltage is a problem under severe environments or when the transformer input voltage is small and easily masked by noise.

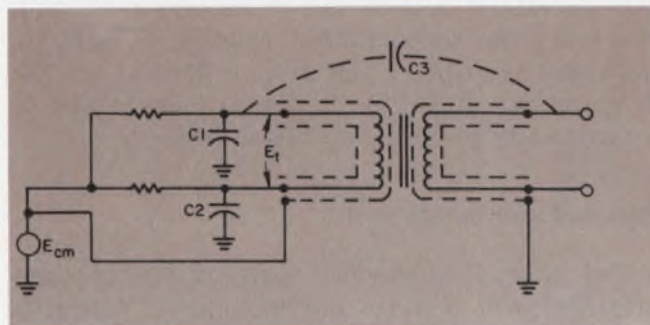

3. External wiring capacitance can defeat the best shielding design. Error voltage  $E_1$  appears across the primary unless all leads are routed and terminated properly.

	Acceptable	Desirable
1. Turns ratio		
2. Primary inductance open circuit _____ V. _____ Hz		
3. Primary resistance		
4. Primary impedance open circuit _____ V. _____ Hz		
5. Size		
6. Maximum permissible stray signal referred to primary due to:	* * * *	* * * *
(a) Magnetic influence 5 gauss or _____ gauss		
(b) Maximum common mode voltage of _____ volts at _____ Hz		
(c) Shock of 1 g or _____ g's		
7. Operating frequency		
8. Secondary load impedance		
9. Source impedance		
10. Bandwidth		
11. Cost		
12. Input voltage range		
13. Secondary resistance		
14. Working voltage rms		
(a) Coils to ground		
(b) Coil to coil		
15. Voltage unbalance		
16. Operating temperature		
17. Insulation resistance		
18. Breakdown voltage (dc or rms _____ Hz)		
19. General application: (lab use, industrial, airborne, mobil, etc.)		
20. Special considerations:		

4. Use this guide to tell the transformer engineer what you need. For design flexibility, give both acceptable and

desirable values for all items. Be sure to include any special considerations.

ently capable of producing common-mode rejections in excess of most over-all system requirements. New methods of electrostatic shielding make it practical to operate well below 1  $\mu$ V in the presence of 500 V common-mode voltages when proper attention is given to lead terminations and their location.

Figure 3 shows how transformer shielding can be defeated by external causes. First, there is capacity  $C_s$  that couples the primary winding to the secondary outside the transformer. Second, there are the unbalanced capacities,  $C_1$  and  $C_2$ , between the primary and ground. This unbalance produces a voltage,  $E_1$ , in the primary which is magnetically coupled into the secondary.

#### Reduced size boosts cost

For every transformer there is an optimum size that will produce minimum cost. Attempts to reduce size below this point boosts the price very rapidly. Since cost is important to most projects, it is important to specify maximum ac-

ceptable transformer dimensions. The designer will then have the most favorable opportunity to provide economy.

#### Describe your application

When potential usage is given as one of the design parameters, it guides the transformer designer in arriving at lowest over-all cost. When only a few pieces are required, the most economical approach is to select a unit that has already been constructed but may be overbuilt in some respects. On the other hand, if a large number of transformers is required, making exactly what is needed can well justify custom design.

All the preceding remarks are tied together on the convenient check list in Fig. 4. Note that it is set up in terms of results rather than design. Transmitting customer requirements in this form allows the transformer expert to produce the best performance balance. This concept pays generous dividends to component engineers and system designers, who are responsible for total system operation. ■■



# HERE'S HOW THE V-O-M SPECIALISTS GO DIGITAL

The principal problem with digital V-O-M's is that circuitry (rather than readability) limits their accuracy. Triplett has attacked that problem with characteristic thoroughness. The result . . . a totally new circuit (patent pending) in which there is virtually no internally-generated current from the V-O-M input circuit to affect measuring accuracy.

Triplett's Model 8000 digital V-O-M . . . the only V-O-M with this newly-developed circuit . . . offers a true DC accuracy of 0.1% of the reading  $\pm 1$  digit and an AC accuracy of 0.2%  $\pm 1$  digit. Triplett calls this "true accuracy" because it's the same accuracy you can achieve day-in and day-out, test-after-test, on any kind of circuit.

Quality-minded buyers will appreciate, too, the other job-matching features of Triplett's new digital V-O-M. Like . . . AC and DC voltage measurements from 1 mV to 1000 V in 5 ranges at 10 megohms input resistance; AC and DC currents from 0.1  $\mu$ A to 1000 mA in 6 ranges; 0.1 ohm to 100 megohms in 6 ranges.

Sounds like it was worth waiting for, doesn't it? It's ready for immediate delivery from your Triplett distributor at \$575 suggested USA user net. If you'd like the added convenience of an instant replay circuit that displays a previously-stored reading for on-demand comparison with an existing reading, ask for the Triplett Model 8000-A at \$630 suggested USA user net. For more information, or for a free, no-obligation demonstration, call your local Triplett distributor or sales representative. Triplett Corporation, Bluffton, Ohio 45817.



*The World's most complete line of V-O-M's . . . choose the one that's just right for you*

1. True 0.1% DC accuracy. Virtually no kickback current\*. Allows voltage measurements in high resistance circuits at stated accuracy.
  2. High AC accuracy with nearly perfect AC linearity and 10 megohm input resistance.
  3. Low profile design in shielded case with modular construction for ease in use and maintenance.
- \*There is virtually no internally generated current from the V-O-M input circuit to affect measuring accuracy. (Patent pending on this feature).



INFORMATION RETRIEVAL NUMBER 55

# If you're reed-switching 5-10 V, 5-10 ma loads

(as in keyboards and IC packages),

there's a good, small but growing company  
making good, small reed switches  
you should know about:

## GENERAL REED

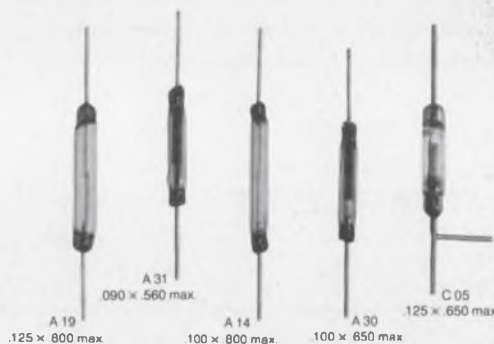

In the last seven years, General Reed has designed and produced many millions of high-quality, miniature magnetic reed switches of Form A and Form C types. Expansion of our manufacturing, including the installation of over 1000 sq. ft. of Class 3-4 clean room facility, has now increased our capacity to deliver *highly reliable* snap-action reed switches *in quantity*, at competitive prices, to meet your requirements. Many standards can be shipped immediately from stock, specials in as little as three days depending on the characteristics you need. General Reed quality assurance techniques include on-line testing of electrical characteristics . . . production in controlled clean room areas . . . heat-treating in controlled atmospheres for precise control of magnetic and mechanical properties . . . mechanical run-in of at least 100,000 operations for all switches . . . microscopic inspection for all Form C switches.

To achieve low and *stable* contact resistance throughout the operating life, General Reed selects from over 50 different combinations of noble contact plating materials specially developed to match a wide variety of specific load requirements. This capability alone offers significant advantages in difficult minimum-current switching applications, such as keyboards and other solid-state circuit interfaces, where erratic contact resistance has been a frequent problem.

Low bounce, long life and relatively high immunity to vibration, shock and temperature extremes are characteristic trademarks of General Reed switches. Call or write the Sigma stocking distributor near you for full details - or contact General Reed Division, Sigma Instruments, Inc., 19 Walnut Avenue, Clark, N.J. 07066. Tel. (201) 382-7373.

**GENERAL REED**  
DIVISION OF SIGMA INSTRUMENTS INC.

INFORMATION RETRIEVAL NUMBER 56

□ OPERATING LIFE OF 10 YEARS □ PROVIDES 107 CFM AT FREE DELIVERY □ LOWEST NOISE LEVEL OF ANY 100 CFM FAN □ COMPACT - JUST 1½" DEEP □ IMPEDANCE PROTECTED □ U.L. YELLOW CARD RECOGNITION □ AVAILABLE FROM STOCK.

**Compare it!  
Install it!  
Forget it!**

# The Rotron MUFFIN<sup>®</sup> FAN

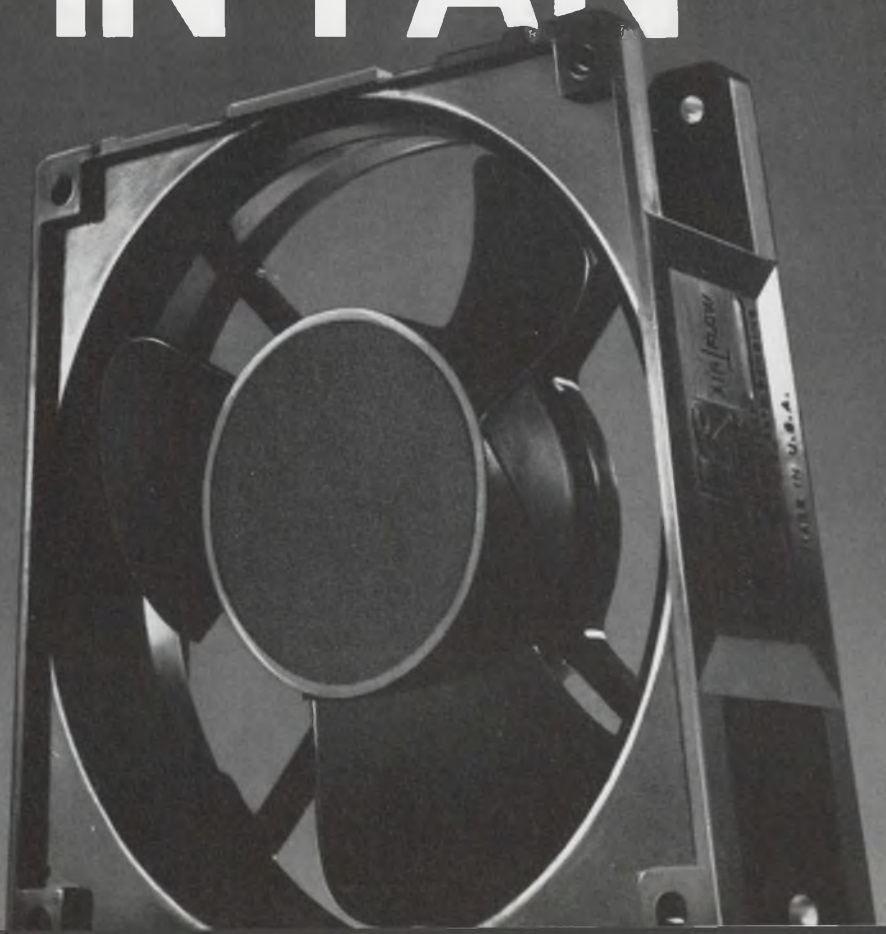

*Need price, delivery or other information? Call 914-679-2401 for immediate service, or write Rotron Incorporated, Woodstock, N.Y. 12498*

## Contracts aren't won by accident!

They are captured by outlines that are planned to win, says this proposal manager.

If your contract proposals are falling flat on their typeface, compare a recent loser with its outline. If they don't match up, you're probably committing marketing suicide. For the proposal that wins is the one that has been planned to win.

To improve our company's proposal approach, we decided to produce an outline that would integrate capture strategy, specification and technical proposal requirements (TPR) into a coherent presentation that would include personnel assignments, topic coverage, and estimated number of text pages and illustrations in the published edition.

Specifically, this outline had to:

1. Establish the minimum contents to be responsive to the request for proposals (RFP).
2. Add to the minimum requirements those additional factors needed to effectively present the capture strategy.
3. Organize the proposal contents so that the precise objectives of the engineering design phase could be clearly established.
4. Direct and implement the activities of the proposal team and indicate assignments, schedules and work to be accomplished.
5. Serve as the vehicle for keeping the plan up to date.

### The medium was the message

We recognized that planning had to be a continuing process throughout the proposal preparation period, and up dating the outline was the best means for keeping everyone informed of changes and their impact on the plan.

What, then, were the ingredients that made the outline acceptable as a dynamic over-all proposal plan? We designed one that consisted of four different elements, including the operations schedule; form of the proposal outline; the assignment summary; and the schedule summary.

The proposal manager first used the operations schedule (Fig. 1) to assign initial start and

finish dates and major milestones to each phase.

As partially shown in Fig. 2, the form of the outline indicated the contents and organization of the proposal, writing assignments, estimated number of text and illustration pages for each assignment, and due dates for submittal of manuscript and artwork sketches to the proposal editor.

So that everyone understood his responsibility in the over-all plan, an assignment summary (Fig. 3) was prepared for each person to show in proposal paragraph number order his specific assignments.

Similarly, the schedule summary (Fig. 4) was listed, in due-date order, when each person's assignments were to be turned in. With these two summaries in hand, each proposal team member knew exactly what his assigned talks were and when they were due.

### Preparing the proposal outline

By analysis of these summaries, problem areas could be spotted before trouble arose. The summaries also enabled the publications department to plot the day-to-day flow of text and illustrations, permitting it to project its manpower requirements more realistically.

Determining the exact contents of the proposal and organizing an effective content outline requires several steps, each tied to a major event in the planning and engineering design phase. In our outline, only section titles and major paragraph headings were identified; assignments only considered the first wave of personnel allotted to the effort; page quantity estimated and due dates roughly established.

Though certainly far from being a polished program plan, the first issue of the outline served to get up a head of steam.

One effective technique used to determine the contents of the proposal was to make a survey of the hardware specifications and TPR (technical proposal requirements) by first outlining them and indenting secondary topics under major headings.

A point of caution about TPR's: Of any part

### PROPOSAL OPERATIONS SCHEDULE

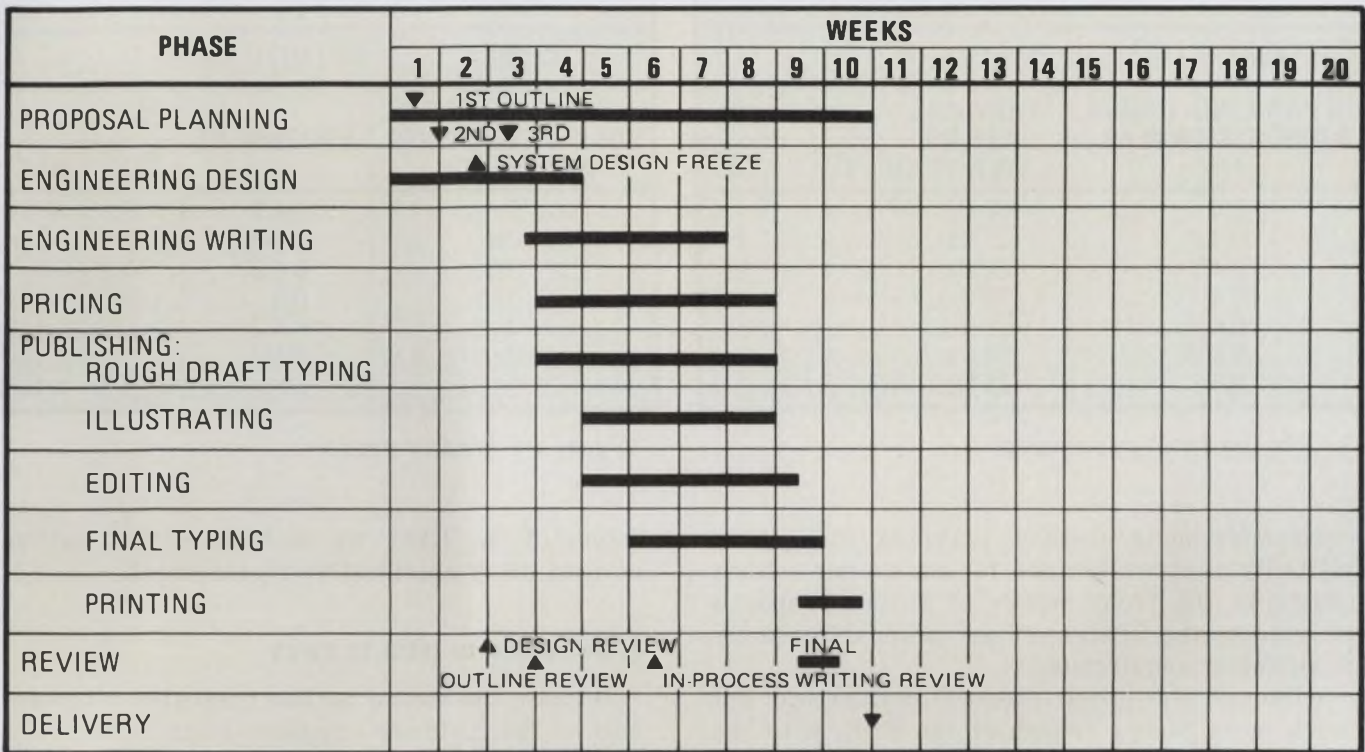

1. **Dual-purpose schedule** is used to assign due-dates and to track phases.

of a request for proposals, the TPR is usually the most vaguely written. It, therefore, requires an extremely careful analysis to determine its explicit and implicit requirements.

Outlining the specification in an indented format furnished an over-all view of hardware requirements and enabled an easy transition when converting them into proposal outline topics.

After the first outline was issued, and while the engineering staff sweated over developing a design approach, the proposal editor studied all

parts of the RFP before preparing the second issue of the outline. The objective of the second outline was to marry the TPR and the specification, and to put into the perspective of an integrated outline the total requirements of the RFP.

To assist in this TPR/specification integration task, we prepared a set of matrix charts. The first matrix plotted the TPR to the proposal outline (see example: Fig. 5); the second plotted the TPR to the specification; and the third plotted the specification to the proposal outline. This

#### Proposal Outline, Issue No. 3, 9 October 1969, Page 6 of 9

CONTENTS	ASSIGNED TO	EST. PAGES		DATE DUE
		TEXT	ART	
SECTION 6 DESCRIPTION OF FUNCTIONAL SYSTEMS				
6.1 Section Summary	F. Thomas	1	0	31 Oct.
6.2 Review of Functional Requirements of Spec.	F. Thomas	2	0	20 Oct.
6.3 Allocation of Functions and Description of Overall Systems Approach	B. Forrest	2	1	21 Oct.
6.4 Description of Computer System Functions	C. Hartmann	4	1	30 Oct.
6.4.1 General Functional Description	C. Hartmann	2	1	22 Oct.
6.4.2 Computer Requirements	C. Hartmann	1	0	23 Oct.
6.4.3 Computer Selection and Rationale	L. Materson	3	0	24 Oct.
6.4.4 Input/Output Requirements	K. Royal	2	1	24 Oct.
6.4.5 I/O Devices: Selection/Rationale	K. Royal	2	0	27 Oct.
6.4.6 Programming	L. Materson	10	4	27 Oct.
6.4.7 Method of Modifying Emitters	C. Hartmann	3	1	28 Oct.
6.4.8 Method of Modifying Aircraft Parameters	C. Hartmann	2	1	29 Oct.
6.4.9 Features Not Dependent on Digital Computation, Justification for and Description of Proposed Method of Obtaining Required Effect	C. Hartmann	4	1	24 Oct.
6.5 Description of Emitter Generation System	C. Hartmann	5	2	25 Oct.
6.6 Description of Antenna Simulation System	K. Royal	4	1	23 Oct.

2. **This outline format is designed** to highlight proposal content and organization.

ASSIGNMENT SUMMARY FOR PROPOSAL				
NAME: C. HARTMANN				
IN PARA. NO. ORDER, YOUR ASSIGNMENTS ARE:	THEY ARE DUE NO LATER THAN	EST. PAGES		
		TEXT	ART	
6.4	30 Oct.	4	1	
6.4.1	22 Oct.	2	1	
6.4.2	23 Oct.	1	0	
6.4.7	28 Oct.	3	1	
6.4.8	29 Oct.	2	1	
6.4.9	24 Oct.	4	1	
6.5	25 Oct.	5	2	

3. Jobs are listed by paragraph.

cross-referencing method provided such great visibility that we decided to use similar matrix charts in the front matter of future proposals to indicate the location of our proposal response to customer requirements.

Although the initial proposal outline was not much more than a rehash of the TPR, with the addition of certain standard proposal elements, the first matrix chart (the TPR-to-proposal outline chart) served to verify that all TPR items did, in fact, find a home in the proposal outline. It also helped show where TPR requirements were redundant or unclear.

The function of the specification-to-TPR matrix was to determine the relationship of a single TPR requirement to a variety of specification requirements and vice versa. When completed, this matrix indicated what portions of the specification the customer emphasized and which areas seemingly did not require a proposal response.

Since good proposal practice is to at least touch on each specification requirement, regardless of TPR limitations, to ensure responsiveness to the

**CROSS-REFERENCE MATRIX  
TPR TO PROPOSAL  
(Management Volume)**

**TECHNICAL PROPOSAL REQUIREMENTS**

PROPOSAL PARA.	a.							c.						
	b. (1) (a)	b. (1) (b)	b. (1) (c)	b. (1) (d)	b. (1) (e)	b. (1) (f)	b. (1) (g)	c. (1) (a)	c. (1) (b)	c. (1) (c)	c. (1) (d)	c. (1) (e)	c. (1) (f)	
Abstract														
Foreword														
Section 1														
Section 2														
2.1														
2.2														
2.2.1														
2.2.2														
2.2.3														
2.2.4														
2.3														

5. It re-checks the requirements.

ASSIGNMENT SUMMARY FOR PROPOSAL				
NAME: C. HARTMANN				
IN DUE DATE ORDER, YOUR ASSIGNMENTS ARE DUE ON	ASSIGNMENT	EST. PAGES		
		TEXT	ART	
22 Oct.	6.4.1	2	1	
23 Oct.	6.4.2	1	0	
24 Oct.	6.4.9	4	1	
25 Oct.	6.5	5	2	
28 Oct.	6.4.7	3	1	
29 Oct.	6.4.8	2	1	
30 Oct.	6.4	4	1	

4. Jobs are listed by due-date.

intent of the RFP, we made sure that outline covered every specification requirement.

**From second to third to home**

Because the second outline presented a picture only of the customer's requirements, further improvement was needed to include all our planning factors.

It was the third outline that really began to shape the proposal. It was prepared after the over-all diagram of the system and a general picture of the over-all physical configuration of the hardware were firm. After this third outline edition was accepted by the proposal manager, the chief systems engineer and the proposal editor, it was validated by using a new set of matrix charts and then presented to the proposal review committee for approval.

The next step was to update the assignments, due dates and page estimates, and to revamp the operations schedule and the assignment and schedule summaries. Each individual's assignments and schedules were carefully examined, using the summaries, and an analysis was made of the activities vs time remaining.

Tradeoffs in scheduling vs resources were now accomplished. For example, the number of pages and the time involved to describe a unique approach to a major technical problem had to be increased significantly; therefore, the impact on the publishing and review phases had to be measured and resolved.

Now that our plan was complete we were ready to build our winning proposal from this foundation. In vying for contract awards, it's best to remember that, in this day of complex technology, *how* something is said is often just as important as *what* is being said. So if you want the brilliance of your engineering approach to glitter when you submit your proposal, plan it that way with your technical proposal outline. ■■

- Five full digits plus "1" for 20% overranging
- Basic unit measures 0 to 1100 volts dc in three ranges
- Auto ranging and polarity with active 3-pole switchable filter
- 25 millisecond sampling speed
- Full systems capability with timing signals and ready indicator
- Low cost options include ac voltage, millivolt-ohms, external reference (ratio) and fully isolated remote programming and data output.

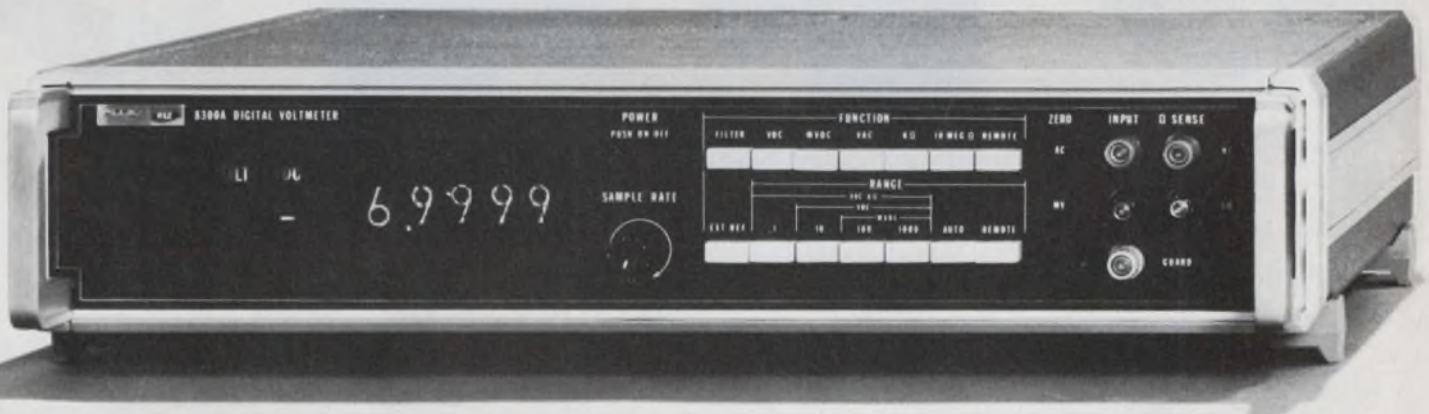

## The first really new DVM in a decade

**Announcing the Fluke 8300A, a 0.005% digital voltmeter with full systems capability for \$1395**

There are a lot of good DVM's around. All but one share a common set of faults—overwhelming complexity and high cost. And as you might guess, the DVM that beats the others cold is the new Fluke 8300A.

Why?

Because Fluke uses a new A to D technique which reduces componentry by up to 500 percent. Obviously, when components are eliminated, good things happen. Power requirements go down, reliability goes up, circuitry is simplified, troubleshooting is speeded and reduced. Most important to the system

designer, lowered costs mean we can invest some of the savings in features you need in a DVM.

With all its features and accuracy, the Fluke 5-digit DVM sells for less than many 4-digit units. We price the options low, too. A fully loaded Fluke 8300A sells for \$3095. Comparable but not equal competitive instruments cost as much as \$5000.

And when the Fluke name goes on the front you know you're getting quality instrumentation... in keeping with the Fluke philosophy of bringing you standards lab performance in portable instrumentation.

Fluke, Box 7428, Seattle, Washington 98133. Phone: (206) 774-2211. TWX: 910-449-2850. In Europe, address Fluke Nederland (N.V.), P.O. Box 5053, Tilburg, Holland. Phone: (04250) 70130. Telex: 884-50237. In the U.K., address Fluke International Corp., Garnett Close, Watford, WD2 4TT. Phone: Watford, 27769. Telex: 934583



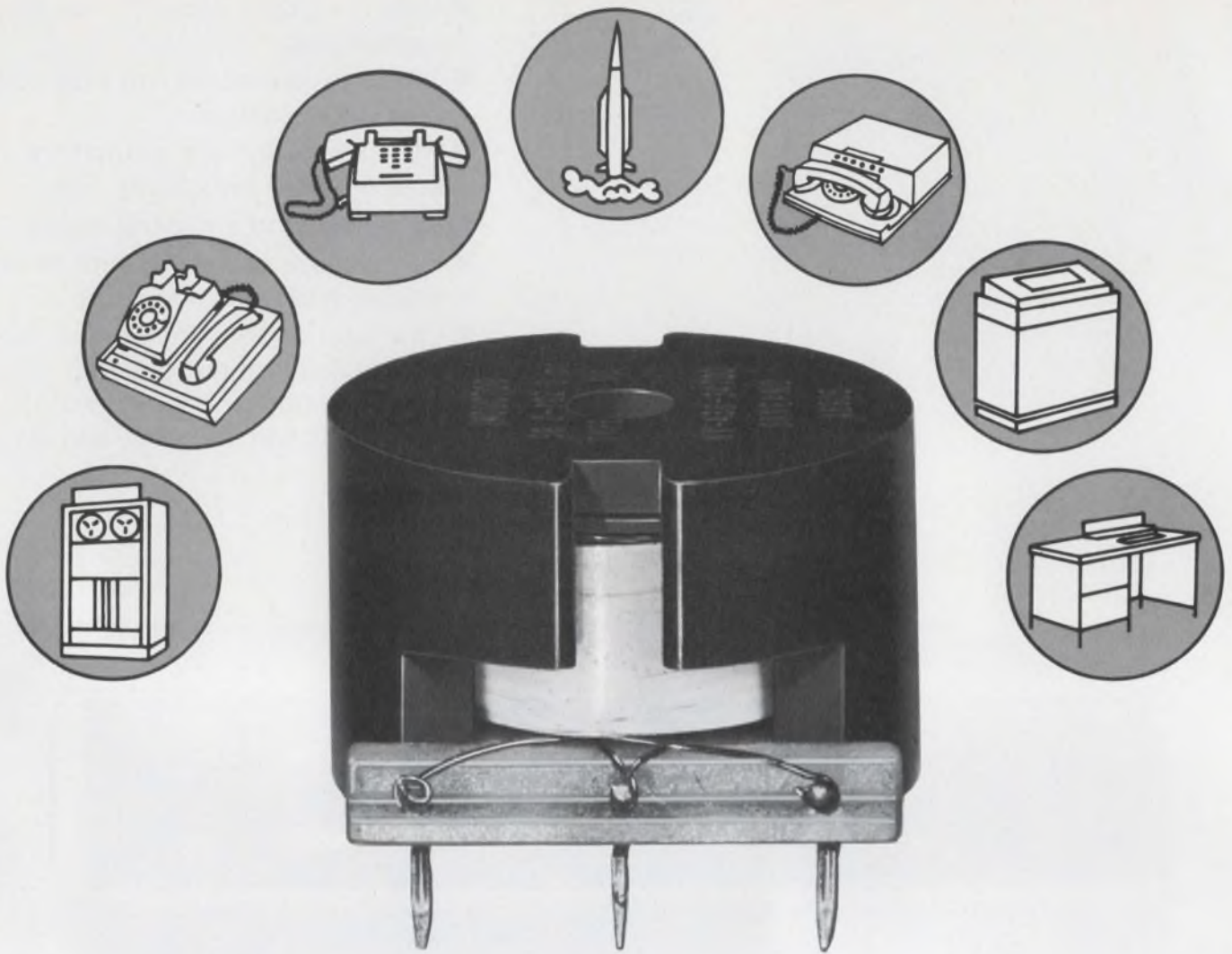

# From custom designs to volume delivery... Sangamo's precision line of communications grade inductor/transformers.

We've been designing and manufacturing communications grade inductor/transformers for years to the most rigid specifications in the data communication industry—*ours*. That's why we guarantee the high quality and reliability of our inductor/transformers. Custom designs are no problem for Sangamo's fully equipped and computerized lab. And our automated facilities make it possible to supply you with as many as you need, military or telephone grade, with the same high reliability. At a reasonable price, too. Sangamo inductors and transformers feature plug-in mountings, high Q and are available in a frequency range of 200 Hz to 500 kHz. For more information, write:



## **SANGAMO** **ELECTRIC COMPANY**

Communication Systems  
P.O. Box 3347  
Springfield, Illinois 62708

T7022



# The hybrid circuit: if you don't like what we make, we'll make what you like.

We're not proud.

We've designed many different standard hybrid microelectronic modules in what we think is the optimum package type for each one.

But, if they don't suit your system, we'll gladly change the package or the circuit to suit your needs.

Our off-the-shelf line spans the spectrum from digital to video. It includes a video amplifier, memory and clock drivers and translators, gated high-power drivers and a 30-MHz IF amplifier.

All of them are our own design and if they meet your needs, we are both ahead of the game.

If they don't, that's where our experience and advanced hybrid techniques come into play. We can translate your design into a hybrid microelectronic module quickly, easily, *and* economically, because we don't have to waste time getting familiar with the problems.

Show us your system requirements. We'll come up with the right hybrid circuit to fill the bill.

That way we'll have a circuit we both like.

*For more information, see your local representative. Sylvania Electronic Components, Hybrid Microelectronics, Waltham, Mass. (617) 893-9200, ext.*

2400. **SYLVANIA**  
GENERAL TELEPHONE & ELECTRONICS

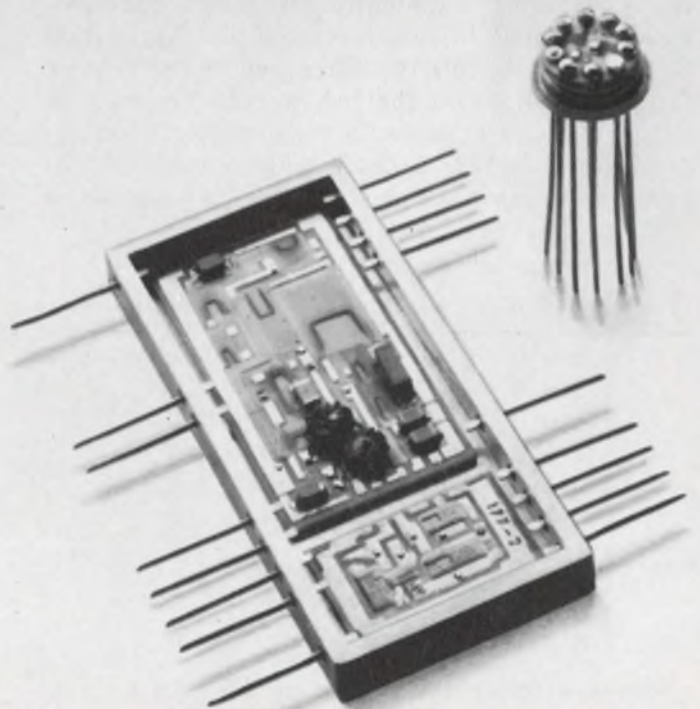

# Ideas For Design

## Improved digital converter offers speed and simplicity

In data processing it is often necessary to convert binary-coded decimal (BCD) signals into a train of serial pulses. This design offers advantages over conventional techniques in terms of simplicity and speed of operation.

The timing circuit controls the output pulse duration from a TTL monostable by using four timing capacitors to provide nine different capacitor combinations. The resulting coded-width output pulse controls an astable circuit. The astable produces serial pulses, which correspond numerically to the BCD input signal.

Connection of the timing circuit for normal operation is shown in the figure. The values of resistance (between pins 11 and 14) and capacitance (between pins 10 and 11) set the duration of the pulse appearing at outputs Q (pin 6 positive) and  $\bar{Q}$  (pin 1 negative). In the quiescent state, the dc voltage at pin 10 is +4.5 V with respect to ground (pin 7), while the dc voltage at pin 11 is +0.8 V with respect to ground. The output pulse is available only when one of the three trigger inputs (pins 3, 4, 5) receives an enable pulse.

In the absence of any BCD signals (in this case the code is 1248) the potential of the 1248 lines is zero and the four diodes are reverse biased, isolating capacitors  $C_1$ ,  $C_2$ ,  $C_4$  and  $C_8$  from pin 10. When information appears on any of the 1248 lines, a potential of +5 V forward-biases the diode(s) and connects the appropriate capacitor(s) to pin 10. When one of the trigger inputs (3, 4, 5) is enabled, a pulse appears at outputs Q and  $\bar{Q}$ , the width depending upon capacitance selected. A truth table giving the capacitor combinations against the 1248 signals is shown.

BCD	Capacitors	Number
1 2 4 8	selected	of pulses
0 0 0 0	0	0
1 0 0 0	$C_1$	1
0 1 0 0	$C_2$	2
1 1 0 0	$C_1 + C_2$	3
0 0 1 0	$C_4$	4
1 0 1 0	$C_1 + C_4$	5
0 1 1 0	$C_2 + C_4$	6
1 1 1 0	$C_1 + C_2 + C_4$	7
0 0 0 1	$C_8$	8
1 0 0 1	$C_1 + C_8$	9

The variable resistor,  $R_v$ , provides a fine con-

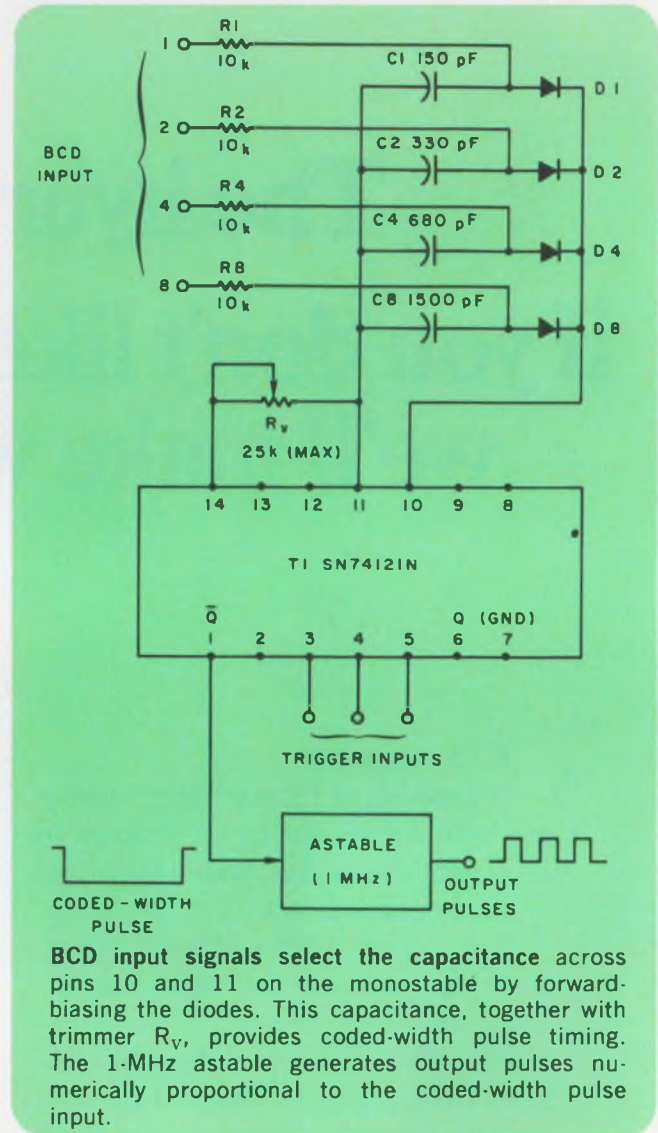

BCD input signals select the capacitance across pins 10 and 11 on the monostable by forward-biasing the diodes. This capacitance, together with trimmer  $R_v$ , provides coded-width pulse timing. The 1-MHz astable generates output pulses numerically proportional to the coded-width pulse input.

control for final adjustment of the output pulse length. The component values shown produce pulse widths in the 0.5-9- $\mu$ s range and control the 1-MHz astable circuit.

Where this coded monostable is used as a converter in large digital systems, a considerable reduction in components and in complexity over conventional conversion techniques is achieved. Astable speeds from 10 Hz to 10 MHz and monostable pulse widths from 100 ns to 1 second are possible. Input codes other than 1248 can be decoded and serialized.

*P. B. Roberts, Electronics Group, Radiological Protection Service, Dept. of Health & Social Security & Medical Research Council, Belmont, Sutton, Surrey, England.*

VOTE FOR 311

## Helipot Trims Price & Profile



89PR100K

The new Helipot Series 89 industrial cermet trimmers feature:

**Low Cost:**

\$1.35 each in 1-9 quantities;  
less than \$1.00  
in quantities over 1,000.

**Low Profile:**

Maximum height of .250 inches  
allows for closer p-c board stacking.

Series 89 trimmers with two different pin spacings  
are available "off-the-shelf"  
from 17 locations across the country.

**Beckman\***

INSTRUMENTS, INC.  
HELIPOT DIVISION  
FULLERTON, CALIFORNIA

INTERNATIONAL SUBSIDIARIES: AMSTERDAM; CAPE TOWN; GENEVA; GLENROTHES,  
SCOTLAND; LONDON; MEXICO CITY; MUNICH; PARIS; STOCKHOLM; TOKYO; VIENNA.

## Transformerless converter yields plus/minus voltages

Using both positive and negative power supplies often simplifies circuit design, but unfortunately it complicates the power-supply problem. In mobile equipment, it is usually impossible to fit another battery into the package. These circuits will serve as a voltage multiplier or as a symmetrical supply.

As a multiplier, the circuits will deliver 20 V at 70 mA from a 12-V 170-mA source. As a symmetrical supply, they will deliver minus 10 V at 40 mA from a plus 12-V 90-mA source.

In operation,  $C_1$  and  $C_2$  charge to the supply voltage through diodes  $D_1$  and  $D_2$ . The multivibrator ( $Q_1$  and  $Q_2$ ) switches  $Q_3$  on and  $Q_4$  off, bringing the bottom end of  $D_1$  to the supply voltage. This

reverse biases  $D_1$  and dumps the charge across  $C_1$  through  $D_2$  and into  $C_2$ , bringing the charge on  $C_2$  to twice the supply voltage. This action is repeated at multivibrator repetition rate.

The unit can be made to operate from positive or negative grounds by simply reversing the polarity of the diodes and reconnecting the doubler as shown in the diagram. By adding power transistors in a Darlington configuration to the output transistors,  $Q_3$  and  $Q_4$ , the current capabilities can be increased to several amperes, enough for most 24-V mobile equipment.

*Ray Kauffman, President, Electronics Engineering Group, Seabrook, Md.*

VOTE FOR 312

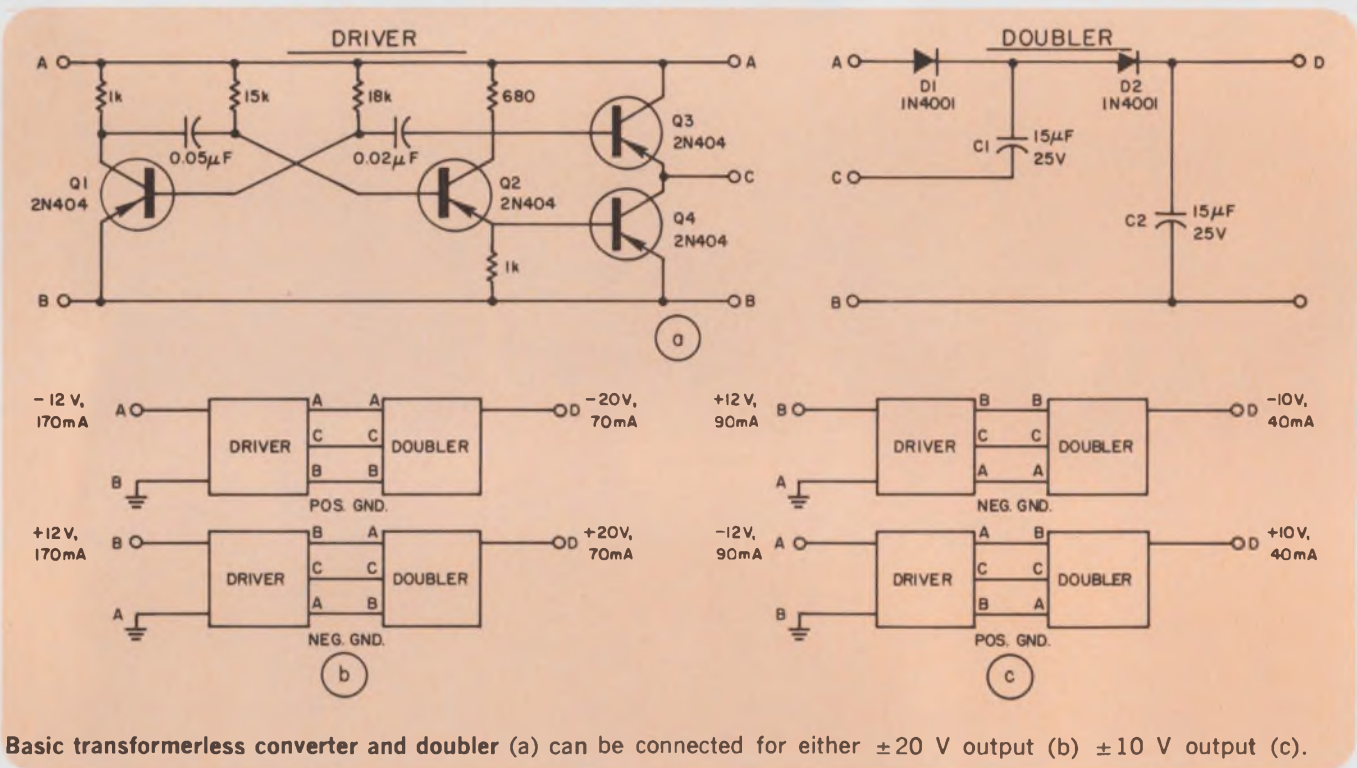

Basic transformerless converter and doubler (a) can be connected for either  $\pm 20$  V output (b)  $\pm 10$  V output (c).

## Inexpensive Schmitt trigger operates above 100 MHz

The low-cost Schmitt circuit is capable of switching speeds in excess of 100 MHz. Hysteresis at 100 MHz is about 1 V, which provides excellent noise immunity and "snap." Output risetime is 2 ns or less.

Standard collector-coupled Schmitt circuits use

a resistor of several kilohms as the regenerative coupling element between collector and base. For high-speed circuits, coupling resistors of several hundred ohms must be used to minimize the effect of collector and base capacitances.

Ideally, the feedback element should have zero impedance to take full advantage of the regenerative current switched between the transistors.

To understand circuit operation, consider that initially  $V_{in} = 0$  V,  $Q_1$  is off and  $Q_2$  is on, con-



Miniature  
price  
tags.

## KMC announces the biggest technical breakthrough in the history of high quality semiconductors.

KMC has just cut prices, on all products, by up to sixty percent.

**A triumph of miniaturization.**

These price cuts mean that you can now get the same high quality semi-conductors you expect from KMC, at prices you wouldn't.

**No cutting corners.**

About a year ago, KMC was purchased by Harvard Industries. Among other things, Harvard brought in highly sophisticated production machinery, substantially increasing yields and reducing many of the operations which had held our prices up. Result: We realized vast reductions in our costs with no reduction in our quality. We now pass these savings along to you.

**The cynics asked why.**

Outsiders asked us: "But engineers have always bought your products. They were *willing* to pay high prices for high quality. Business is booming. Why knock a good thing like your prices?"

**We were steadfast.**

The highest quality is now available at competitive prices. We think this move will result in a general upgrading of all semiconductor applications.

**Write us about your application.**

If you're designing with semiconductors, write us about it. You can now get the cream of semiconductors at prices that won't milk you dry.



**KMC SEMICONDUCTOR CORPORATION**

a subsidiary of Harvard Industries, Inc.



Parker Road, Long Valley, New Jersey 07853.  
(201) 876-3811, TWX (510) 235-3350

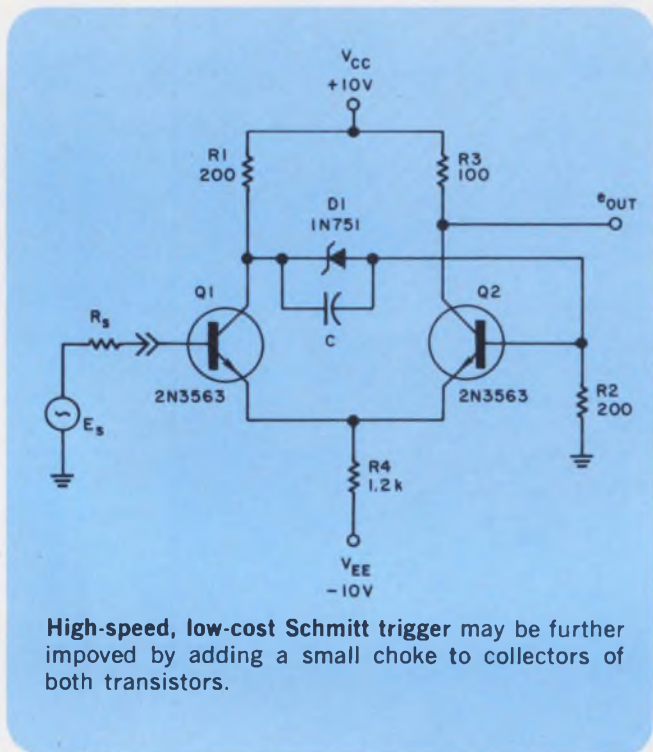

ducting 10 mA. When  $V_{in}$  goes above  $Q_2$ 's base voltage, regeneration takes place.  $Q_1$  starts to turn on, and the  $Q_1$  collector voltage drops. The  $Q_2$  base voltage also drops because of the zener-diode coupling. This tends to cut off  $Q_2$ , turning  $Q_1$  on harder, and further dropping  $Q_1$ 's collector voltage. Regeneration continues until  $Q_2$  is off and  $Q_1$  is on.

The base of  $Q_2$  is now 1 V below its previous value. The Schmitt will not switch back until the input voltage goes below the new  $Q_2$  base voltage, when regeneration again takes place.  $Q_1$  and  $Q_2$  switch approximately the same current as long as the hysteresis is small compared to  $V_{EE}$ .

Feedback element  $D_1$  is a 5-V zener diode that

provides a low impedance feedback path and good temperature stability.  $D_1$  is never switched off, and therefore its impedance remains relatively constant, regardless of the circuit's state. Capacitor  $C$  provides a low impedance path during switching, thus enhancing circuit speed. The capacitor's value is not critical, but a glass or ceramic unit of good quality should be used.

For  $V_{EE} = -10$  V and  $V_{CC} = +10$  V the initial voltage at  $Q_2$  base is

$$(V_{CC} - V_{D1}) [R_2 / (R_1 + R_2)] = +2.5 \text{ V.}$$

For a bias current of 10 mA,

$$R_4 = \frac{2.5 - (V_{BE2} - V_{EE})}{10 \text{ mA}} = 1.2 \text{ k.}$$

Hysteresis is the product of the  $Q_2$  emitter current and the impedance looking into the base, which is

$$R_2 \parallel (R_1 + Z_{D1}) \approx R_2 \parallel R_1 = 100 \text{ ohms.}$$

Hysteresis is therefore (10 mA)(100 ohms) = 1 V. In the quiescent state,  $Q_2$  is conducting 10 mA, with 12.5 mA flowing through  $R_1$ ,  $D_1$  and  $R_2$ . When  $Q_1$  and  $Q_2$  switch,  $Q_1$  draws 10 mA,  $Q_2$  is off, and 7.5 mA flow through  $D_1$  and  $R_2$ . This current maintains good zener regulation and low zener impedance ( $\approx 30$  ohms).

The circuit configuration will work for negative input waveforms by replacing  $Q_1$  and  $Q_2$  with pnp transistors and reversing the polarity of  $D_1$ . The same thing may be accomplished by returning the base of  $Q_2$  to  $V_{EE}$  through an appropriate resistor to give the base of  $Q_2$  a negative bias.

Speed may be improved by adding a small choke in the collectors of  $Q_1$  and  $Q_2$ . With this addition, the circuit will operate at speeds from dc to greater than 140 MHz. Cost of the circuit is under \$2.

*Stephen Kreinik, Senior Electrical Engineer, CBS Laboratories, Stamford, Conn.*

VOTE FOR 313

## FET current source linearizes multivibrator

This voltage-controlled one-shot multivibrator generates an output pulse whose duration is a linear function of the applied control voltage. Deviation from linearity is less than 1% over a 25:1 pulse-duration output range. The essential modification over conventional one-shots is replacement of transistor  $Q_2$ 's base-charging re-

sistor with an FET,  $Q_1$ , operating in the pinch-off region (Fig. 1).

By utilizing the constant-current characteristics of  $Q_1$  to supply the charging current for timing capacitor  $C_1$ , the duration of the pulse provided by  $Q_2$  is dependent only on the size of  $C_1$ , collector voltage at  $Q_2$ , and capacitor-charge-

# Calibrated frequency AND time measurements

... with Tektronix 1L5 and 3L5 Spectrum Analyzers

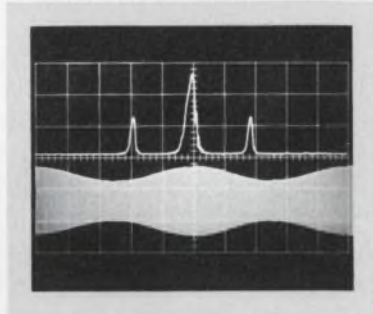

Stored time and frequency display of an AM signal using the 549 Storage Oscilloscope and 1L5 Analyzer.

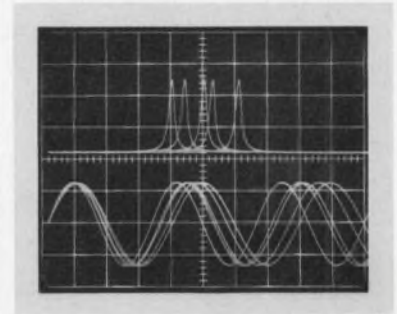

Stored time and frequency display showing oscillator drift using the 564B Storage Oscilloscope and 3L5 Analyzer.

The 1L5 and 3L5 Spectrum Analyzers display the 10 Hz to 1 MHz frequency content of a wide range of electromagnetic waveforms and events such as pressure, vibration and noise. Center frequency range is 50 Hz to 1 MHz. Dispersion is calibrated from 10 Hz/cm to 100 kHz/cm. At 100 kHz/cm dispersion, you can view the entire 10 Hz to 1 MHz spectrum in one display, at sensitivities to 10  $\mu$ V/cm RMS.

MEASUREMENT EASE is a feature of both units. The difference between frequency components is simply the distance in CRT divisions between the components, times the calibrated dispersion. You measure the component amplitude of frequency-based displays just as easily: component amplitude in CRT divisions times the calibrated volts/cm setting.

After completing your frequency measurements, you conveniently go to a time-base measurement. There's no plug-in changing to do — there's no new test setup to do. Change one switch position and the spectrum analyzer is a voltage amplifier. Bandwidth is 10 Hz to 1 MHz. The deflection factors are 1 mV/cm to 100 V/cm.

When your measurements call for IN DEPTH frequency and time analysis in the 10 Hz to 1 MHz range, choose a 1L5 or 3L5. You'll have calibrated frequency-based displays, AND calibrated time-based displays, AND measurement ease — ALL in the same unit.

Other Tektronix spectrum analyzers are available for frequency analysis to 40 GHz.

- 1L5 Spectrum Analyzer Plug-In Unit ..... \$1025
- 3L5 Spectrum Analyzer Plug-In Unit ..... \$1125

Available in U.S. through the Tektronix lease plan.  
U.S. Sales Prices FOB Beaverton, Oregon



Price of Instruments Shown ..... \$2610

Spectral and time analysis using the Tektronix 564B Oscilloscope with rugged bistable storage. View time is as long as one hour.

For a demonstration call your local Field Engineer. For technical information consult your current Tektronix catalog or write Tektronix, Inc., P.O. Box 500, Beaverton, Oregon 97005.

**Tektronix, Inc.**



committed to progress  
in waveform measurement

ing current supplied by  $Q_1$ . The collector voltage of  $Q_2$  is varied by the control-voltage amplifier,  $Q_1$ . When one-shot action is initiated by a negative-going trigger at  $C_2$ , a corresponding pulse-width variation occurs at the output of  $Q_3$ .

Ignoring collector saturation voltages, the output pulse duration is given by

$$t_p = (C_1 V_{ce2}) / I_D$$

where  $C_1$  = timing capacitor value,  $V_{ce2}$  = collector voltage of  $Q_2$  just prior to triggering and  $I_D$  = drain current of  $Q_1$ .

Expressing the variation in output pulse duration in terms of the control voltage,  $E_c$ , and other circuit parameters yields

$$\Delta t_p = \Delta E_c (-h_{fc} R_L C_1) / (I_D R_1)$$

Figure 2 illustrates the variation in output pulse duration obtained for different control voltages. Coarse changes in the duration of the output pulse may be accomplished by varying either  $C_1$  or the drain current of  $Q_1$ . Variation of the latter is easily achieved by altering the FET gate source bias by means of  $R_1$ .

*Phil M. Salomon, Instructor in Engineering, Pasadena City College, Pasadena, Calif.*

VOTE FOR 314

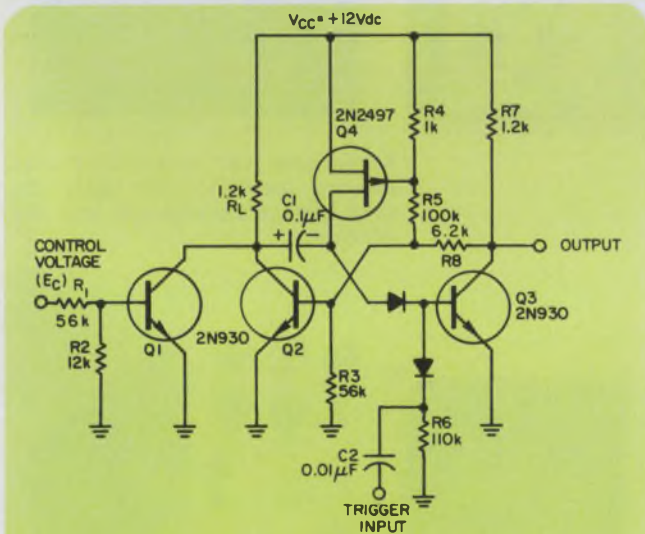

1. Replacement of  $Q_3$ 's base charging resistor by FET  $Q_1$  allows the multivibrator to generate an output whose duration is a linear function of the control voltage.

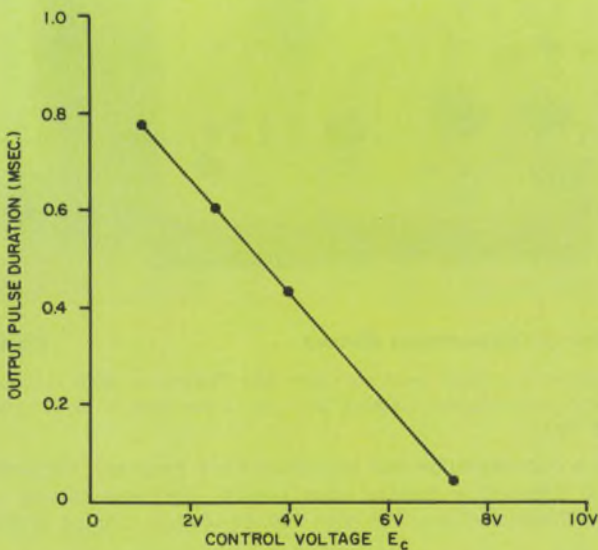

2. With  $C_1$  equal to  $0.1 \mu F$  and the trigger rate at 1 kHz, the output pulse duration is adjustable between 0.04 and 0.78 ms. Coarse changes are possible by varying  $C_1$  or  $R_4$ .

**VOTE!** Go through all Idea-for-Design entries, select the best, and circle the appropriate number on the Reader-Service-Card.

**SEND US YOUR IDEAS FOR DESIGN.** You may win a grand total of \$1050 (cash)! Here's how. Submit your IFD describing a new or important circuit or design technique, the clever use of a new component or test equipment, packaging tips, cost-saving ideas to our Ideas-for-Design editor. You will receive \$20 for each accepted idea, \$30 more if it is voted best-of-issue by our readers. The best-of-issue winners become eligible for the Idea Of the Year award of \$1000.

**IFD Winner for March 1, 1970**

**Harold Minuskin**, Senior Engineer, California Computer Products, Inc., Anaheim, Calif. His Idea "Active Filter Design Uses BASIC Language" has been voted the Most Valuable of Issue Award.

**Vote for the Best Idea in this Issue.**

**IFD Winner for March 15, 1970**

**William E. Peterson**, Associate Engineer, ITL Research Corp., Northridge, Calif. His Idea "Inexpensive Generator Produces Tri-angle and Square Waves" has been voted the Most Valuable of Issue Award.

**Vote for the Best Idea in this Issue.**



# Room for improvement

General Electric's TO-5<sup>2</sup> transistor-size sealed relays give you more room for increased power, improved performance

We didn't cut any corners on this high-reliability, transistor-size sealed relay. We left them on so there'd be more room for a more powerful magnet—2½ times more powerful.

This added power means this type 3SBS, 2PDT, 1 amp relay gives you higher contact forces, larger contact gaps, and greater overtravel to minimize mechanical shifts. Shifts which usually increase early-in-life failures.

Though there's more room inside to give you all these advantages, the outside dimensions—top-to-bottom (.275") and side-to-side (.370")—are the same as any transistor-size relay.

So don't cut corners on your next transistor-size relay application. Specify GE's square Type 3SBS, now qualified to MIL-R-5757E/40. For full details, write General Electric, Section 792-45, Schenectady, New York 12305.



ACTUAL SIZE

GENERAL  ELECTRIC

INFORMATION RETRIEVAL NUMBER 68

# when will MOS read/write memory be less expensive than core?

## right now!

With AMS's 1024-word by 1-bit random access memory

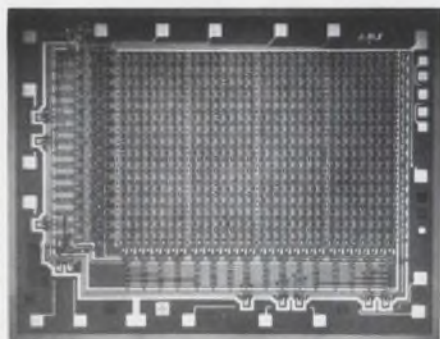

AMS 1K1

PRICES			FEATURES
Quantity	Price	¢/Bit	
1-24	\$102	10	■ Monolithic, fully decoded
25-99	82	8	■ 400 ns access time
100-499	53	5.2	■ 800 ns cycle time
500-999	37	3.6	■ 50 $\mu$ W/bit dissipation
1K to 9.99K	24	2.3	■ 24-lead DIP
10K and up	19	1.84	

For complete information, contact your nearest AMS Representative or write the factory

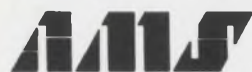

**ADVANCED MEMORY SYSTEMS, INC., 1276 HAMMERWOOD AVENUE  
SUNNYVALE, CALIFORNIA 94086 • TELEPHONE 408-734-4330**

**Texas, Oklahoma, Nevada** Norvell Associates, Inc., 10210 Monroe Drive, P.O. Box 20279, Dallas, Texas 75220. Tel: 214-357-6451

**Norvell Associates**, 6440 Hillcroft Avenue, Houston, Texas 77036. Tel: 713-774-2568

**Minnesota, Wisconsin, Iowa** Special Electronic Sales, 8053 Bloomington Freeway, Suite 121, Bloomington, Minn. 55420. Tel: 612-884-4317

**New England States** Victor Associates, 12 Mercer Rd., Natick, Mass. 01760. Tel: 617-655-4143

**Metropolitan New York/New Jersey** Central Associates, 44 N. Dean Street, Englewood, New Jersey 07631. Tel: 201-568-0808

**Central Associates**, 11 Commercial Street, Plainview, Long Island, N.Y. 11803. Tel: 516-433-0808

**Southeast (Florida, Georgia, Alabama)** Atlantic Components Corporation, 1331 Harbor Lake Drive, Largo, Fla. 33540. Tel: 813-584-8257

**Rockies (Colorado, Utah, Arizona, New Mexico, Wyoming, Idaho, Montana, North Dakota, South Dakota, Kansas, Nebraska)** Elcom Electronic Components Sales, Inc., 209 San Pablo, S.E., Albuquerque, New Mexico 87108. Tel: 505-256-3663

**Elcom Electronic Components Sales, Inc.**, 4783 S. Quebec, Denver, Colo. 80222. Tel: 303-771-6200

**Elcom Electronic Components Sales, Inc.**, 445 East Second South, Salt Lake City, Utah 84115. Tel: 801-355-5327

**Elcom Electronic Components Sales, Inc.**, P.O. Box 27348, Tempe, Arizona 85281. Tel: 602-967-8809

**Eastern Sales Office** Advanced Memory Systems, Inc., P.O. Box 493, Randolph, Mass. 02368. Tel: 617-828-2181

**Western Sales Office** Advanced Memory Systems, Inc., 1276 Hammerwood Ave., Sunnyvale, California 94086. Tel: 408-734-4330

# Product Source Directory

## Semiconductor Memories

This Product Source Directory covers Semiconductor Memories.

Units covered are separated into two categories: Random Access and Read Only Memories. For each table, units are listed in ascending order of one major parameter. The column containing this parameter is color-coded white.

The following abbreviations apply to all semiconductor memories listed:

ina—information not available

n/a—not applicable

req—request

Manufacturers are identified by abbreviation. The complete name of each manufacturer can be found in the Master Cross Index below.

For a complete analysis of semiconductor memories see: The big memory battle: Semis take on cores, pg. 70.

Abbrev.	Company	Information Retrieval No.
American	American Microsystems 3800 Homestead Rd. Santa Clara, Calif. 95051 (408) 246-0330	439
AMS	Advanced Memory Systems 1276 Hammerwood Ave. Sunnyvale, Calif. 94086 (408) 734-4330	440
Cogar	Cogar Corp. All Angels Rd. Wappingers Fall, N.Y. 12590 (914) 297-4323	441
Comp	Computer Microtechnology 610 Pastoria Sunnyvale, Calif. 94086 (408) 736-0300	442
EI Arrays	Electronic Arrays Inc. 501 Ellis St. Mountain View, Calif. 94040 (415) 964-4321	443
Fairchild	Fairchild Semiconductor 313 Fairchild Drive Mountain View, Calif. 94040 (415) 962-5011	444
GI	General Instrument Corp. 600 West John St. Hicksville, N.Y. 11802 (516) 733-3000	445
Intel	Intel Corp. 365 Middlefield Rd. Mountain View, Calif. 94040 (415) 961-8080	446
Intersil	Intersil Inc. 10900 Tantau Ave. Cupertino, Calif. 95014 (408) 257-5450	447
Mostek	Mostek Corp. 1104 Expressway Tower Dallas, Tex. 75205 (214) 526-8050	448
Motorola	Motorola Semiconductor Corp. 5005 E. McDowell Rd. Phoenix, Ariz. 85008 (602) 273-6900	449

Abbrev.	Company	Information Retrieval No.
National	National Semiconductor Corp. 2900 Semiconductor Drive Santa Clara, Calif. 95051 (408) 732-5000	450
Philco	Philco-Ford Microelectronics Div. 1400 Union Meeting Rd. Blue Bell, Pa. 19422 (215) MI 6-9100	451
Radiation	Radiation Inc. Microelectronics Div. P.O. Box 67 Melbourne, Fla. 32901 (305) 727-5412	452
Raytheon	Raytheon Semiconductor 350 Ellis St. Mountain View, Calif. 94040 (415) 968-9211	453
RCA	RCA 415 S. 5th St. Harrison, N.J. 07029 (201) 485-3900	454
SEM	Semiconductor Electronic Memories Inc. 3883 N. 28th Ave. Phoenix, Ariz. 85017 (602) 263-0202	455
Signetics	Signetics Corp. 811 E. Arques Ave. Sunnyvale, Calif. 94086 (408) 739-7700	456
Sylvania	Sylvania Electronic Components 100 First Ave. Waltham, Mass. 02154 (617) 893-9200	457
TI	Texas Instruments Inc. Components Group Box 66207/MS 333 Houston, Tex. 77006 (713) 522-9871	458
Transitron	Transitron Corp. 168 Albion St. Wakefield, Mass. 01880 (617) 245-4500	459

# Random-Access Memories (bipolar)

101

Manufacturer	Model	Size (Words x Bits)	Access Time (ns)	Cycle Time (ns)	Supply Voltage (V)	Power Dissipation (mW)	Temperature Range (°C)	Notes	Price/ Bit \$
RCA	CD2155D	16 x 1	6.5	25	-5	250	-55 to +125	r	1.00
AMS	AMS0161	16 x 1	8	8	-5	400	0 to 70	p	1.00
AMS	AMS0329	32 x 9	15	10	-5	8.8 W	0 to 70	p	1.75
AMS	AMS0328	32 x 8	15	10	-5	8 W	0 to 70	p	1.75
AMS	AMS1289	128 x 9	17	15	-5	9.5 W	0 to 70	p	0.85
AMS	AMS1288	128 x 8	17	15	-5	8.6 W	0 to 70	p	0.85
Motorola	MC1037P	16 x 1	17	50	-5.2	250	0 to 75		0.62
Motorola	MC1036P	16 x 1	17	50	-5.2	250	0 to 75		0.62
TI	SN54/74170	4 x 4	19	45	5	500	-55 to +125	wx	0.37
Fairchild	9033	16 x 1	20	n/a	5	11/bit	-55 to +125		0.44
Fairchild	9030	4 x 2	20	n/a	4.5	44/bit	0 to 70		1.31
Intersil	IM5502C	16 x 1	20	30	5	300	0 to 75		req
Intersil	IM5502M	16 x 1	20	30	5	300	-55 to +125		req
Raytheon	RL80	16 x 1	20	100	5	250	-55 to +125	r	0.50
Transitron	TMC3162	4 x 4	20	60	5	300	-55 to +125		req
Transitron	TMC3163	4 x 4	20	60	5	300	0 to 70		req
Transitron	TMC3164	4 x 4	20	60	5	300	-55 to +125	y	req
TI	SN54/7484	16 x 1	20	n/a	5	275	-55 to +125	wx	0.29
TI	SN54/7481	16 x 1	20	n/a	5	275	-55 to +125	wx	0.285
AMS	AMS40961	4096 x 1	25	30	-5	35 W	0 to 70	p	0.80
Signetics	8220	4 x 2	25	n/a	5	400	0 to 70	u	1.00
Sylvania	SM80	16 x 1	30	30	5	300	-55 to 125		req
Fairchild	9035	16 x 4	35	n/a	5	7/bit	-55 to +125		0.656
Fairchild	4102 Assoc.	4 x 4	35	n/a	5	31/bit	-55 to +125	km	3.125
Motorola	MC4004F	16 x 1	35	100	5	250	0 to 75		1.10
Motorola	MC4005F	16 x 1	35	100	5	250	0 to 75		0.79
Motorola	MC4004L	16 x 1	35	100	5	250	0 to 75		0.74
Motorola	MC4005L	16 x 1	35	100	5	250	0 to 75		0.56
Motorola	MC4084P	16 x 1	35	100	5	250	0 to 75		0.54
Motorola	MC4005P	16 x 1	35	100	5	250	0 to 75		0.41
Cogar	08C09	128 x 18	40	80	-5.2	6.5	0 to 50	ab	0.45
Cogar	08C05	512 x 18	40	80	-5.2	5.6	0 to 50	ab	0.30
Signetics	8222	4 x 2	40	n/a	5	200	0 to 70	u	1.00
Cogar	08CA5	1024 x 75	45	80	-5.2	5.6	0 to 50	ab	0.33
Raytheon	RR5100	16 x 4	45	100	5	350	-55 to +125	r	0.45
Raytheon	RR6100	16 x 4	45	100	5	35	0 to 70	r	0.35
Sylvania	SM283	16 x 4	50	50	5	350	0 to 75		0.20
Comp	CM2100	16 x 4	60	60	ina	400	0 to 75		0.62
Fairchild	4103	16 x 4	60	n/a	5	5/bit	-55 to +125	k	0.375
Intel	31013	16 x 4	60	60	5	500	-55 to +85	p	0.50
Intel	3101	16 x 4	60	60	5	500	0 to 85	p	0.40
Intersil	IM5501M	16 x 4	60	60	5	500	-55 to +125		req
Intersil	IM5501C	16 x 4	60	60	5	500	0 to 75		req
Raytheon	RR6110	64 x 4	60	100	5	450	0 to 70	s	0.40
Raytheon	RR5110	64 x 4	60	100	5	450	-55 to +125	s	0.50
Transitron	TMC6464	16 x 4	60	65	5	500	-55 to +125	y	req
Signetics	1283	8 x 1	80	100	4	160	0 to 70		0.10
Fairchild	4100	256 x 1	85	n/a	5	2.2/bit	0 to 75	k	0.25
Intersil	IM5503M	256 x 1	100	100	5	600	-55 to +125		req
Intersil	IM5503C	256 x 1	100	100	5	600	0 to 75		req
Cogar	15C23	256 x 18	125	150	+5	3.3	0 to 50	ab	0.15
Cogar	15CA1	4096 x 36	125	150	+5	2.4	0 to 50	ab	0.115
Cogar	15C07	1024 x 18	125	150	+5	2.4	0 to 50	ab	0.115
SEM	RAM18A	128 x 8	180	200	+5, -5	2 W	0 to 85		0.30
SEM	RAM28A	256 x 8	180	200	+5, -5	2 W	0 to 85		0.23
SEM	RAM48A	512 x 8	180	200	-5, +5	3.4 W	0 to 85		0.16
SEM	RAM88B	1024 x 8	180	200	-5, +5	5.28 W	0 to 85		0.15
SEM	RAM29A	256 x 9	180	200	-5, +5	2.51 W	0 to 85		0.23
SEM	RAM49A	512 x 9	180	200	-5, +5	4.23 W	0 to 85		0.18
SEM	RAM89B	1024 x 9	180	200	-5, +5	6.1 W	0 to 85		0.15
SEM	RAM418A	256 x 18	180	200	-5, +5	ina	0 to 85		0.21
SEM	RAM50A	512 x 10	180	200	-5, +5	4.23 W	0 to 85		0.18

# Random-Access Memories (hybrid)

102

Manufacturer	Model	Size (Words x Bits)	Access Time (ns)	Cycle Time (ns)	Supply Voltage (V)	Power Dissipation (mW)	Temperature Range (°C)	Notes	Price/ Bit \$
Cogar	30CA1	32,768 x 36	250	300	5, 10, -7	0.38	0 to 50	ab	0.054
Cogar	30C06	8192 x 18	250	300	5, 10, -7	0.38	0 to 50	abde	0.05
Cogar	30C04	2048 x 18	250	300	5, 10, -7	0.54	0 to 50	ab	0.07
Comp	CM2400-5	1024 x 1, 2, 4	250	400	5, 10	1.6 W	0 to 70	ef	0.30

# MEET OUR

# MONO<sup>TM</sup>DAC-01 D/A CONVERTER

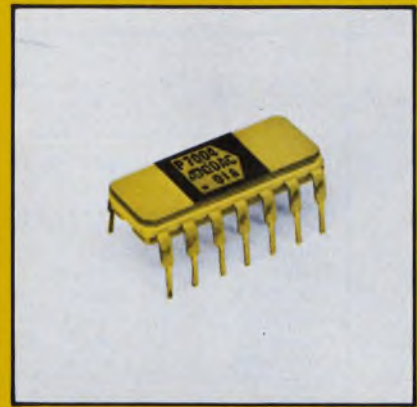

**THE WORLD'S SMALLEST!  
THE WORLD'S LEAST EXPENSIVE!  
THE WORLD'S FIRST ON A SINGLE CHIP!**

**IT HAS HAPPENED! . . .** A complete 6-bit digital-to-analog converter on a single chip! It's the monoDAC-01! It operates from  $\pm 15$  volt supplies and delivers  $+10$  volts full-scale output into a 2K ohm load and fully settles to better than  $\frac{1}{2}$  LSB in 3 microseconds! And — it works from standard T<sup>2</sup>L or DTL levels.

Everything you need is "on the chip" including reference, current switches, resistor ladder and compensated amplifier. You'll be astounded at the performance over the full Mil-Temp range of  $-55^{\circ}\text{C}$  to  $+125^{\circ}\text{C}$ . It comes in the popular dual in-line package. Price? Let us surprise you!

## VERY SPECIAL-BUT STANDARD-SPECIFICATIONS

Resolution:	6 Bits
Accuracy:	$\pm \frac{1}{2}$ LSB from $-55$ to $+125^{\circ}\text{C}$
Output:	0 to $+10\text{V}$
6 Bit Settling Time:	3 Microseconds
Input Logic Levels:	0 to $+3\text{V}$
Power Supply:	$\pm 12\text{V}$ to $\pm 18\text{V}$
Power Supply Rejection:	0.15% FS/V
Power Consumption:	250mW

**That's the monoDAC-01:**

**The world's first commercial, completely self-contained monolithic, 6-bit D/A Converter.**

**Write for more information and/or contact the representative in your area given below!**



**PRECISION  
MONOLITHICS**  
INCORPORATED

1500 SPACE PARK DRIVE, SANTA CLARA, CALIFORNIA 95050  
TEL. (408) 246-9222 • TWX 910-338-0528 • CABLE MONO

For further information, call: ALBUQUERQUE (505) 256-1749; ALEXANDRIA (703) 548-7818; ATLANTA (404) 876-2260; BALTIMORE (301) 944-8262; BURBANK (213) 846-9631; CHERRY HILL (609) 966-4070; COCHITUATE, MASS. (617) 653-8229; DALLAS (214) 348-6660; DAYTON (513) 298-9897; DENVER (303) 744-2821; FT. LAUDERDALE (305) 564-8000; HOUSTON (713) 782-5406; HUNTSVILLE (205) 539-4411; NEW YORK (212) 343-4630; ORLANDO (305) 425-5505; PALO ALTO (415) 326-6400; PAOLI (215) 644-3477; SALT LAKE CITY (801) 278-5022; SAN DIEGO (714) 222-1121; TULSA (918) 939-2848; WILLOUGHBY, OHIO (216) 946-6080; WINSTON-SALEM (919) 725-5384.

INFORMATION RETRIEVAL NUMBER 70

# Random-Access Memories (MOS)

103

Manufacturer	Model	Size (Words x Bits)	Access Time (ns)	Cycle Time (ns)	Supply Voltage (V)	Power Dissipation (mW)	Temperature Range (°C)	Notes	Price/Bit \$
Fairchild	3530	64 x 1	n/a	3500	-13, -27	500	-55 to +85		0.35
RCA	CD4005D	16 x 1	15	65	6 - 15	0.1	-55 to +125	rt	0.62
RCA	CD4005	16 x 1	15	65	6 - 15	0.1	-55 to +125	rt	0.69
Mostek	MK4001	256 x 1	50	70	-18	250	-55 to +85		0.10
TI	TMX4008JC	256 x 1	120	n/a	-12	200	-55 to +85		req
American	S1495	512 x 1	150	350	+5, -10	30 at 1 MHz	-55 to +125	ry	0.10
TI	TMS4003JC	256 x 1	150	n/a	-18	200	-55 to +85		0.075
AMS	AMS10241	1024 x 1	400	800	±15	50	0 to 70	p	0.052
Philco	pLR16x4C	16 x 4	400	ina	-15, -27	250	0 to 70	z	req
GI	RA-6-4803	32 x 1	500	500	5	90	-55 to +125		0.48
Motorola	MC1170L	16 x 4	500	1200	-30	250	0 to 75		0.215
Intel	11011	256 x 1	800	800	+5, -8	400	-55 to +85	p	0.12
Mostek	MK4002	64 x 4	800	1000	+5, -12	350	0 to 75		0.09
American	S1605	128 x 1	1000	1400	+5, -12	350	-55 to +125	ry	0.20
		64 x 2							
		32 x 4							
El Arrays	EA1400	64 x 2	1000	1000	-26	135	-55 to +85	i	0.15
Philco	pRW256x1C	256 x 1	1000	1200	-10, -25	250	0 to 70	pz	0.20
Intel	1101	256 x 1	1100	1100	+5, -8	400	-55 to +85	p	0.10

# Read-Only Memories (bipolar)

104

Manufacturer	Model	Size (Words x Bits)	Access Time (ns)	Cycle Time (ns)	Supply Voltage (V)	Power Dissipation (mW)	Temperature Range (°C)	Notes	Price/Bit \$
Signetics	8224	32 x 8	35	n/a	5	270	0 to 70		0.049
Sylvania	SM323	32 x 8	35	35	5	300	0 to 75		0.05
Cogar	06P07	512 x 32	40	60	-5.2	0.67	0 to 50	abc	0.08
TI	SN7488	32 x 8	40	n/a	5	240	0 to 70	wx	0.03
Motorola	XC171P	16 x 8	45	n/a	5	240	0 to 75		0.078
Motorola	XC170P	16 x 8	45	n/a	5	240	0 to 75	v	0.078
Fairchild	9034	32 x 8	50	n/a	5	0.8/bit	-55 to +125		0.058
Intersil	IM5601M	32 x 8	50	50	5	400	-55 to +125	req	
Intersil	IM5601C	32 x 8	50	50	5	400	0 to 75	req	
Fairchild	4104	128 x 4	60	n/a	5	0.8/bit	-55 to +125	k	0.68
Intel	Std 3301	256 x 4	60	60	5	500	0 to 85	p	0.05
Intersil	IM5602M	256 x 4	60	60	5	650	-55 to +125	req	
Intersil	IM5602C	256 x 4	60	60	5	650	0 to 75	req	
Radiation	PROM	64 x 8	65	ina	ina	400	-55 to +125	x	0.12
							0 to 75		0.09
Fairchild	4003	64 x 16	70	n/a	5	0.8/bit	0 to 70	k	0.073
Motorola	XC270P	32 x 8	100	n/a	5	250	0 to 75		0.078
Motorola	XC271P	32 x 8	100	n/a	5	250	0 to 75		0.078
Cogar	15P06	1024 x 32	125	150	+5	0.34	0 to 50	abd	0.04
Cogar	30P06	4096 x 32	250	300	5, 10, -7	0.1	0 to 50	abde	0.013

- a. Prices are for quantities of 10 or more.
- b. Other organizations are available.
- c. There is a one time mask charge of \$8000.
- d. There is a one time mask charge of \$16,000.
- e. Technology, MOS, bipolar.
- f. Uses 21 or 22 IC chips, (16 MOS and 5-6 bipolar)
- g. Standard pattern available, EA3101 - ASC11 to selectric and selectric to ASC11 code conversion.
- h. Standard pattern available, EA3501, row scan dot code matrix character generator, 64 ASC11 characters.
- i. Standard pattern available, EA3307, ASC11 to Ebdic and EBDIC to ASC11 code converter.
- j. Includes all decoding and output buffers on the chip.
- k. Access time, maximum.

- m. Access time is match time.
- n. There is a masking charge of \$1000.
- p. 100 piece price.
- q.
- r. 1000 piece price.
- s. 250 piece price.
- t. Model CD4005D, 14 lead dual inline ceramic package, CD4005 14 lead ceramic flat pack.
- u. Content addressable memory.
- v. Character generator.
- w. Series 54TTL, -55 to +125°C, Series 74TTL, 0 to 70°C.
- x. 100-999 piece price.
- y. Also 0 to 70°C temperature range available.
- z. Dual inline package.

# Read-Only Memories (MOS)

Manufacturer	Model	Size (Words x Bits)	Access Time (ns)	Cycle Time (ns)	Supply Voltage (V)	Power Dissipation (mW)	Temperature Range (°C)	Notes	Price/Bit \$
TI	TMS4500JC	128 x 6	100	n/a	-20	200	-25 to +85		0.012
TI	TMS4600JC	256 x 8	100	n/a	-20	200	-25 to +85		0.01
GI	RO-1-2240	5 x 7	500	500	25	250	0 to 70	nv	0.96
TI	TMS4100JC	64 x 7 x 5	500	n/a	-14, -25	350	-25 to +85	v	0.0075
TI	TMS2400JC	64 x 5 x 7 32 x 5 x 14	500	n/a	-14, -28	250	-25 to +85	v	0.0075
Intersil	IM7601C	256 x 4	600	600	±12	250	0 to 75		req
Intersil	IM7602M	128 x 8	600	600	±12	250	-55 to +125		req
Intersil	IM7601M	256 x 4	600	600	±12	250	-55 to +125		req
Intersil	IM7602C	128 x 8	600	600	±12	250	0 to 75		req
National	MM4240	512 x 5 64 (5 x 8)	600	n/a	±12	ina	-55 to +125	v	3.00
National	MM521	256 x 4	600	n/a	±12	ina	-25 to +70	v	2.00
National	MM421	256 x 4	600	n/a	±12	ina	-55 to +125	v	4.00
National	MM522	128 x 8	600	n/a	±12	ina	-25 to +70	v	2.00
National	MM5240	512 x 5, 64 (5 x 8)	600	n/a	±12	ina	-25 to +70	v	1.50
National	MM422	128 x 8	600	n/a	±12	ina	-55 to +125	v	4.00
TI	TMS2600JC	256 x 8	600	n/a	-12	200	-55 to +85		0.0075
TI	TMS2800JC	512 x 4 256 x 4	600	n/a	-12, -24	200	-55 to +85		0.006
Mostek	MK2400	256 x 10	700	1000	+5, -12	350	-55 to +85		0.014
Philco	pMS2240C	64 x 7 x 5	700	1000	-13, -27	300	0 to 70	pz	req
Intersil	IM7603M	256 x 8	750	750	±12	350	-55 to +125		req
Intersil	IM7605C	256 x 10	750	750	±12	400	0 to 75		req
Intersil	IM7603C	256 x 8	750	750	±12	350	0 to 75		req
Intersil	IM7604M	512 x 5	750	750	±12	400	-55 to +125		req
Intersil	IM7605M	256 x 10	750	750	±12	400	-55 to +125		req
Intersil	IM7604C	512 x 5	750	750	±12	400	0 to 75		req
American	MA51	256 x 10	800	700	+5, -12	350	-55 to +125	ry	0.015
Mostek	MK2000	64 x 5 x 7	800	800	-14, -18	350	-55 to +85	v	0.012
Mostek	MK2100	64 x 7 x 5	800	800	-12, -24	350	-55 to +85	v	0.012
Philco	pMS2048C	256 x 8 512 x 4 1024 x 2 2048 x 1	800	1000	-13, -27	250	0 to 70	pz	0.017
TI	TMS4300JC	512 x 8 1024 x 4 2048 x 2 4096 x 1	800	n/a	-14, -28	300	-25 to +85		0.011
El Arrays	EA3500	4096 x 1 512 x 5	850	850	-24	90	-55 to +85	h	0.01
National	MM423	256 x 8	850		±12 vdc		-55 to +125	v	3.00
National	MM523	256 x 8	850	n/a	±12	ina	-25 to +70	v	1.50
American	MB51	248 x 1	1000	1000	-15, -27	ina	-55 to +125	ry	0.01
El Arrays	EA3100	256 x 10	1000	1000	-24	90	-55 to +85	g	0.01
GI	MEM 2048	64 x 32	1000	ina	-24 to -28	120	-55 to +85	an	0.05
Mostek	MK2200	16 x 5 x 7	1000	5000	+5, -12	250	0 to 75		0.025
Mostek	MK2300	64 x 5 x 7	1000	5000	+5, -12	350	0 to 75		0.013
El Arrays	EA3300	512 x 8	1500	1500	-24	90	-55 to +85	i	0.008
American	512 x 4	512 x 4	2000	2000	-15, -27	300	-55 to +125	ry	0.01
American	256 x 4	256 x 4	2000	2000	-15, -27	300	-55 to +125	ry	0.01
Philco	pMS1024C	128 x 8 256 x 4	2000	2200	-25, -30	150	0 to 70	pz	0.02
Philco	pM1024C	128 x 8 256 x 4	2000	4000	-25, -30	100	0 to 70	pz	0.02
Fairchild	3501	128 x 8	2500	n/a	-13, -27	250	-55 to +85		0.03

# Product Source Directory

## Electronic Desk Top Calculators

This product Source Directory covers Electronic Desk Top Calculators.

Units covered are separated into two categories: Non-programmable and programmable calculators. Programmable calculators are listed in ascending order of addressable registers. Non-programmable calculators are listed in alphabetical order by manufacturers name.

Unless otherwise noted in the tables, all cal-

culators have input requirements of 95-135 Vac, single phase. The following abbreviations apply to all instruments listed.

ina—information not available

n/a—not applicable

req—request

Manufacturers are identified by abbreviation. The complete name of each manufacturer can be found in the Master Cross Index below.

Abbrev.	Company	Information Retrieval No.
Canon	Canon 64-10 Queens Blvd. Woodside, N.Y. 11377 (212) 478-5600	460
Cintra	Cintra 440 Logue Ave. Mountain View, Calif. 94040 (415) 969-9230	461
Comm	Commodore 390 Reed St. Santa Clara, Calif. 95050 (408) 538-7900	462
Dicta	Dictaphone Corp. 267 Broadway New York, N.Y. 10007 (212) 233-0510	463
Friden	Friden Inc. 2350 Washington Ave. San Leandro, Calif. 94577 (415) 357-6800	464
H-P	Hewlett-Packard Co. 1501 Page Mill Rd. Palo Alto, Calif. 94304 (415) 326-7000	Contact local sales office
IME	IME, Inc. One IME Plaza N. Bergen, N.J. 07047 (201) 861-3900	465
Math	Mathatronics 241 Crescent St. Waltham, Mass. 02154 (617) 893-1630	466

Abbrev.	Company	Information Retrieval No.
Monroe	Monroe Int'l Div. Litton Industries 550 Central Ave. Orange, N.J. 07051 (201) 673-6600	467
NCR	National Cash Register Dayton, Ohio 45409 (513) 449-2000	468
Olivetti	Olivetti Underwood Corp. One Park Ave. New York, N.Y. 10016 (212) 679-3400	469
Remington	Remington Rand Office Equip. 333 Wilson Ave. Norwalk, Conn. 06856 (203) 838-4301	470
SCM	SCM, Inc. 299 Park Ave. New York, N.Y. 10017 (212) PL 2-2700	471
Sharp	Sharp Electronics 178 Commerce St. Carlstadt, N.J. 07072 (201) 933-4200	472
Toshiba	Toshiba America, Inc. 447 Madison Ave. New York, N.Y. 10022 (212) 758-8161	473
Wang	Wang Labs, Inc. 836 North St. Tewksbury, Mass. 01876 (617) 851-7311	474



# SHARP HELPS BUILD STRONG COMPANIES

# 13 WAYS . . .



**1&2** Sharp MICRO. 3 pound genius. Subtracts, adds, divides, multiplies. Mixed calculations. Floating decimal. Sharp QT-8D. Sharp MICRO II. With built-in, rechargeable batteries, charger, AC plug. 3½ lbs. QT-8B.



**3** Sharp MINI II. At a mini price. Performs successive multiplication and division automatically and by constant. Automatic decimal. 2 working registers. 7.9 lbs. Sharp CS-121.



**4** Sharp MIDI II. Newest "Midi." Full memory bank. 2 working registers. Constant key. High visibility display. 7.9 lbs. Sharp CS-221.



**5** Sharp MIDI. 14 digit capacity. 2 working registers. Round-off capability. Memory light. Function light. Recall key. Automatic decimal. Chain calculation.

Meet the efficiency experts. All from Sharp, world's largest maker of electronic calculators.

With the world's most complete line. So you can single out the calculator with the precise capabilities your business needs. (Why pay for capabilities you'll never use?)

Think about that. Every company's calculating problems differ. The Sharp you need for simple bookkeeping isn't the Sharp you'd want for relativity-type math.

But every Sharp has this in common: each is precision engineered to simplify your operation. Advanced circuits—miniaturized I.C.'s—make it possible. Sharp pioneered them. Just as Sharp pioneered the electronic calculator.

And we're first again with circuits a hundred times smaller—ELSI (Extra Large Scale Integrated).

These go into our "Micro." The world's smallest calculator—the 3 pound electronic genius!

Quick to operate, Sharp Calculators are equally quick to master. In a matter of minutes. What's more, our keyboards are all basically the same. Your staff can move from one Sharp to another without retraining.

Trouble-free too. So few movable parts, virtually nothing can go wrong. But if service is needed, our national service network is only a 'phone call away.

No wonder 82% of Fortune's top hundred companies choose Sharp. There's one that custom-fits your operation too.

There is a national network of Sharp representatives ready to serve you. Please check the yellow pages or send in the coupon.



**6** Sharp MAXI. 16 digit capacity. Automatic drop-off. Pre-set or floating decimals. Dual decimal systems for memory and display. Automatic squaring. Round-off, up



**7** Sharp MAXI II. With 2 memory banks. Full 16 digit capacity. Pre-set decimal. Memory light. Function light. Round-off capability. Chain calculation. Automatic squaring. 8½ lbs. Sharp CS-362.



**8** Sharp MAXI III. Extracts 8 square roots instantly. 3 working registers. 2 memories. Pre-set and floating dual decimal systems. Chain calculation. Zero suppression. 14.5 lbs. Sharp CS-361R.



**9&10** Sharp MAGNI. 6 memory banks. Square root capacity. Automatic accumulation of multiplicands. Automatic item count. 16.9 lbs. Sharp CS-361M. Sharp MAGNI II. All the sophistication of the "Magni" plus programming. 16.5 lbs. Sharp CS-361P.



**11** Sharp PRINT-RONIC. Prints electronically. Silent. Speedy. Trouble-free—only 1 moving part. 16 digits. 2 working registers, memory bank, memory light. Pre-set decimal. Recall key.



**12&13** Sharp PRINTMASTER. Electronic mechanical printer. 16 digits. 2 working registers and memory. Round off/down. Pre-set decimal. Recall key. 26.4 lbs. Sharp CS-661. Sharp PRINTMASTER II. Same features as "Printmaster" plus 2 memory banks. 26.4 lbs. Sharp CS-761.



Sharp Electronics Corporation  
Dept. ED-1, Carlstadt, N. J. 07072  
Gentlemen: Please provide me full information on the full Sharp line.

Name \_\_\_\_\_  
Company \_\_\_\_\_  
Street \_\_\_\_\_  
City \_\_\_\_\_  
State \_\_\_\_\_ Zip \_\_\_\_\_

# Non-Programmable Calculators

Manufacturer	Model	Number of Input Digits	Number of Output Digits	Keyboard Functions	Display Type	Hard Copy (yes, no)	Weight	Notes	Price \$
Canon	120	12	12	+ - x ÷	neon	no	8.82		req
Canon	121	12	12	+ - x ÷	neon	no	8.82	(14)	req
Canon	163	16	16	+ - x ÷	neon	no	13.89	(7)(14)	req
Canon	162	16	16	+ - x ÷	neon	no	13.67	(7)(14)	req
Comm	1121	12	12	m	nixie	no	10.6	m	845
Comm	1161	16	16	m	nixie	no	10.6	m	995
Comm	512	12	12	m	nixie	no	ina	m	499
Comm	612	12	12	m	mosaic	no	6.58		599
Dicta	1401	14	14	+ - x ÷	mosaic	no	9.7		695
Dicta	1412	14	14	n	mosaic	no	9.7	n	875
Dicta	1620	16	16	p	mosaic	no	16.1	p	1075
Dicta	1630	16	16	p	printer	yes	33		1295
Friden	1154	13	13	+ - x ÷	printer	yes	42	q	1095
Friden	1166	13	13	+ - x ÷	crt	no	24	q	935
Friden	1162	14	14	+ - x ÷	crt	no	24	r	1095
Friden	1114	14	14	+ - x ÷	nixie	no	12	q	895
Friden	1115	12	12	+ - x ÷	nixie	no	10		695
Friden	1116	16	16	+ - x ÷	nixie	no	12	r	1195
IME	120	12	12	m	nixie	no	14	ms	745
IME	121	12	12	m	nixie	no	14	mst	845
IME	122	12	12	m	nixie	no	14	msu	945
IME	122S	12	12	m	nixie	no	14	mrsu	1045
IME	86-2B	16	16	m	nixie	yes	35	mst	1195
IME	86S	16	16	m	nixie	no	35	msv	1395
IME	86SR	16	16	m	nixie	no	35	mrsv	1495
Monroe	1650	13	10	+ - x ÷	nixie	no	12	jy	2750
Monroe	1660	13	10	+ - x ÷	printer	yes	22	ly	3450
Monroe	1260	14	14	+ - x ÷ % change, %+, %-	printer	yes	22		1395
Monroe	820A	14	14	+ - x ÷	crt	no	14.5		895
Monroe	920	12	12	+ - x ÷	nixie	no	8.8		595
Monroe	925	13	13	+ - x ÷	nixie	no	8.8		req
Monroe	950	16	16	+ - x ÷	nixie	no	15	(1)	950
Monroe	990	16	16	+ - x ÷	nixie	no	15	(1)	1150
NCR	18-2	16	16	+ - x ÷	nixie	no	15.4	(2)	1095
NCR	18-3	16	16	+ - x ÷	nixie	no	15.4	(3)	1275
NCR	18-1	14	14	+ - x ÷	digitron	no	8.8		875
NCR	18-12	12	12	+ - x ÷	itron	no	6.6		595
Olivetti	Logos 270	22	22	+ - x ÷	printer	yes	34	(3)	1195
Olivetti	Logos 250	22	22	+ - x ÷	printer	yes	34		995
Olivetti	Logos 328	22	22	+ - x ÷	printer	yes	55	(3)	995
Remington	EDC-1D	13	13	+ - x ÷	nixie	no	18		695
Remington	EDC-J	13	13	+ - x ÷	nixie	no	18		600
Remington	EDC III	20	20	+ - x ÷	nixie	no	18		970
Remington	EDC-3A	20	20	+ - x ÷	nixie	no	18		895
SCM	414	14	14	+ - x ÷	nixie	no	6	q(4)	895
SCM	516	14	14	+ - x ÷	printer	yes	35	(5)	985
SCM	616	14	14	+ - x ÷	printer	yes	35	q(5)	1150
Sharp	QT8D	8	8	+ - x ÷	digitron	no	3.5		395
Sharp	QT8B	8	8	+ - x ÷	digitron	no	3.5	(8)	495
Sharp	121	12	12	+ - x ÷	digitron	no	8.14	(9)	575
Sharp	221	12	12	+ - x ÷	digitron	no	8.14	(9)	675
Sharp	241	14	14	+ - x ÷	nixie	no	8	(5)(9)(10)	795
Sharp	361R	16	16	+ - x ÷	nixie	no	16.5	(3)(7)(9)	1145
Sharp	361M	16	16	+ - x ÷	nixie	no	16.5	(3)(7)(9)(11)	1245
Sharp	662	16	17	+ - x ÷	printer	yes	17	(5)(9)(12)	895
Sharp	661	16	17	+ - x ÷	printer	yes	26.4	(5)(13)	1095
Sharp	761	16	17	+ - x ÷	printer	yes	26.4	(5)(7)(13)	1195
Toshiba	1612	16	16	+ - x ÷	nixie	no	11.8	(14)	895
Toshiba	1211S	15	15	+ - x ÷	nixie	no	6	(14)	395
Toshiba	1202	15	15	+ - x ÷	nixie	no	6	(14)	495
Toshiba	1623	16	16	+ - x ÷	nixie	no	11.8	(3)(7)(15)	1195
Toshiba	1624	16	16	+ - x ÷	nixie	no	11.8	(3)(7)	1095
Toshiba	1212	15	15	+ - x ÷	nixie	no	6		595

Manufacturer	Model	Number of Input Digits	Number of Output Digits	Number of Addressable Registers	Display Type	Number of Program Statements	Method of Preprogramming	Input/Outputs Available	Hard Copy (yes, no)	Notes	Weight	Price
Wang	320	14	10	2	nixie	320	(19)	printer	yes		5	1282
Sharp	361P	16	16	2	nixie	64	learn	none	no	(3)(7)	16.5	1395
Canon	162P	16	16	2	neon	32	(19)	ina	no		13.89	req
Toshiba	1623G	16	16	3	nixie	17	manual	yes	no	(16)	11.8	1395
Friden	1151	13	13	4	printer	30	keyboard	keyboard	yes	q	42	1395
Camm	AL-1000	14	14	4	nixie	30	keyboard	no	no		23	1495
SCM	566PR	16	16	5	printer	66	keyboard	no	yes	(7)	65	1795
IME	86-28 DG-408	16	16	5	nixie	512	x	bg	yes		59	2890
IME	86-28 DG-308/D	16	16	5	nixie	1024	x	bg	yes		68	3545
Friden	1152	13	13	5	printer	30	keyboard	keyboard	yes	r	42	1495
IME	86-28 DG-308	16	16	5	nixie	512	x	bg	yes	bgwx	59	2540
Wang	360	14	10	6	nixie	320	(19)	printer	yes		5	1497
SCM	1016PR	14	14	7	printer	100	(6)	yes	yes		35	2495
IME	86SRDG-408	16	16	7	nixie	512	x	bg	yes	bgwx	59	3190
IME	86SRDG-308/D	16	16	7	nixie	1024	x	bg	yes	bgwx	68	3845
IME	86SRDG-308	16	16	7	nixie	512	x	bg	yes	bgwx	59	2840
IME	865 DG-408	16	16	7	nixie	512	x	bg	yes	bgwx	59	3090
IME	865 DG-308/D	16	16	7	nixie	1024	x	bg	yes	bgwx	68	3745
IME	865 DG-308/D	16	16	7	nixie	1024	x	bg	yes	bgwx	68	3745
IME	865 DG-308	16	16	7	nixie	512	x	bg	yes	bgwx	59	2740
Manroe	1265	14	14	8	printer	128,256	punched cards	card reader	yes	o	22.5	2495
Olivetti	P101	22	22	10	printer	120	mag cards	yes	yes			3850
Manroe	1665	13	10	10	printer	128,256	punched cards	card reader	yes	y	22.5	3950
Manroe	1655	13	10	10	nixie	128	punched cards	card reader	no	y	12.5	3250
H-P	9100A	12	12	16	crt	196	z	z	yes	yz	40	4400
Wang	362	14	10	24	nixie	32	(19)	printer	yes		5	2395
Cintra	909-00	10	10	26	nixie	85	bcd	efghij	yes	ak	24	3780
Cintra	909-01	10	10	26	nixie	256	bcd	cefghi	yes	ak	24	4030
H-P	9100B	12	12	32	crt	392	z	z	yes	yz	40	4900
Cintra	909-02	10	10	100	nixie	85	bcd	cefghi	yes	ak	24	4570
Cintra	909-03	10	10	100	nixie	256	bcd	cefghi	yes	ak	24	4820
Wang	700	12	12-24	122	nixie	960	care, mag tape	(17)	yes		38	4900
Math	111	9	9	128	printer	L	manual b	bhx		bhxy	ina	L
Wang	720A	12	12-24	248	nixie	1984	care, mag tape	(17)	yes		38	6700
Wang	380	14	10	268	nixie	1280	mag tape	gh	yes		18	3395
Wang	370	14	10	268	nixie	960	(18)	(18)	yes		18	3095

a. Input/output plus 2 guard digits and 2 digit exponent of 10.

b. Paper tape

c. Optical card reader

d. 937 programmer, magnetic tape

e. x-y platter

f. Column printer

g. I-O selective

h. ASR33 teletype

i. A-D/D-A

j. Keyboard functions include,  $a^x$ ,  $\log_{10}$   $\log_e$  sine/cosine,  $\sin^{-1}$ ,  $\cosine^{-1}$ , square root,  $\times 1$ ,  $1/4$ , rad to degree

k. 25,600 program statements with 927 programmer

l. 4K memory, up to 2816 steps. Price, 5 systems from \$10,920

m. Keyboard functions,  $\times$ ,  $\div$ ,  $+$ ,  $-$ , constant, grand total

n. Keyboard functions,  $\times$ ,  $\div$ ,  $+$ ,  $-$ ,  $\Sigma$ , RC, K,  $M_1$ .

o. Options, extra 128 steps, \$300, card reader \$250

p. Keyboard functions,  $\times$ ,  $\div$ ,  $+$ ,  $-$ ,  $\Sigma$ , RC, K,  $M_1$ ,  $M_2$ .

q. Keyboard functions include grand total

r. Keyboard functions include grand total and automatic square root.

s. Keyboard functions A, B, T accessible working registers for recall of 3 multiplication factors

t. Keyboard functions include complete calculation and store or accumulate answer to memory I., clear register I, display total in register I

u. Keyboard functions include complete calculation and store or accumulate answer in memory I, clear memory I, display total in register I, complete calculation and store or accumulate in memory II, display total in register II

v. Same as note u with the addition of memory III, IV, and register III, IV.

w. Additional registers can be added in 60 register increments.

x. Punch card or keyboard.

y. Input/output digits plus 2 digit exponent

z. Method of preprogramming, magnetic card, manual, marked sense card. Input/outputs available, x-y platter, printer, typewriter, teletype, inputs-marked sense card, keyboard.

(1) Separate memory

(2) Automatic constant multipliers, two memories, floating and preset decimal system.

(3) Keyboard functions include square root.

(4) MOS, LSI

(5) 1 memory

(6) Method of preprogramming, keyboard or magnetic tape cartridge.

(7) Two memories

(8) Battery operated

(9) Keyboard function includes constant

(10) Automatic chain multiplication

(11) Six memories

(12) Hard copy is chemically treated paper

(13) Printer is mechanical

(14) Other keyboard functions available check with manufacturer

(15) Contains 31 outputs, displays 16

(16) Contains 32 outputs, displays 16

(17) Input/outputs available, output writer, plotting output writer, punch paper tape input, on line input/output

(18) Preprogrammed by IBM prescored card. input/outputs available, output writer, teletype, storage display, punched tape input, on line input.

(19) Paper punched IBM card

Nixie is a registered trademark of the Burroughs Corp.

# Most engineers know ADC Products builds custom ferro-resonant transformers for constant-voltage power supplies.

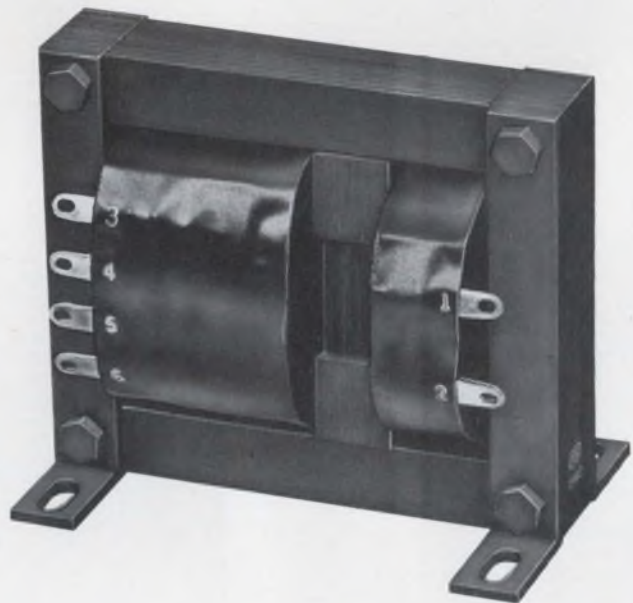

But do you know... ADC Products also builds "Blue-Chip" transformers for P.C. applications, special filters and chokes, tape head and solenoid coils, plus complete power supply assemblies?



ADC Products has hundreds of stock, off-the-shelf components for computer applications. But we also design special transformers—custom designs for your particular problem—with the help of our computer. For example, if you need a special ferro-resonant transformer for a constant voltage power supply, we have a special computer program that can help our design team analyze your parameters and establish the optimum design. The background of 19,897 other designs helped us establish the program—and if we need to, we have any of these prior designs at our fingertips.

Our computer is an important part of our design team . . . How about using ADC Products for real-time reliability in your computer system? Write today for complete information.



**ADC PRODUCTS**  
A DIVISION OF MAGNETIC CONTROLS CO.

4900 West 78th Street, Minneapolis, Minnesota 55435  
(612) 929-7881

# New Products

## Pin-programmable op amps vary gain from 0.004 to 250

Zeltex Inc., sub. of Redcor Corp., 1000 Chalomar Rd., Concord, Calif. Phone: (415) 686-6660. P&A: \$25; August, 1970.

Offering over 500 selectable gain configurations in a single package, two new Zel-Cell pin-programmable operational amplifiers provide gains ranging from 0.004 to 250. Both devices also feature selectable-mode operation—they can be used in follower, inverter or summing configurations.

The two models are the ZC741E with a bipolar monolithic input circuit, and the ZC801E with FET-input hybrid circuitry. Both units are hermetically sealed in 14-pin dual-in-line packages.

Each amplifier incorporates a precision input/feedback resistor network to eliminate the need for external resistors. This feature saves time not only in design and manufacturing, but also in test

and procurement.

The resistor network employs thick films applied to an alumina substrate. It has an over-all network tolerance of 0.1% and a temperature coefficient of 10 ppm/°C.

Conductor paths between resistors and tie points are made of thick-film gold. The network is then over-glazed with thick-film screenable glass. All resistors are screened simultaneously for reliable temperature tracking characteristics.

Dc gain for both models is 100,000, while gain-bandwidth product is 1 MHz for the ZC741E and 4 MHz for the ZC801E. Minimum rated output is  $\pm 10$  V at 5 or 7 mA, respectively.

The ZC741E slews 0.5 V/ $\mu$ s; the ZC801E slews 6 V/ $\mu$ s. Operating temperature range is  $-25$  to  $+85^\circ\text{C}$  for both units.

CIRCLE NO. 250

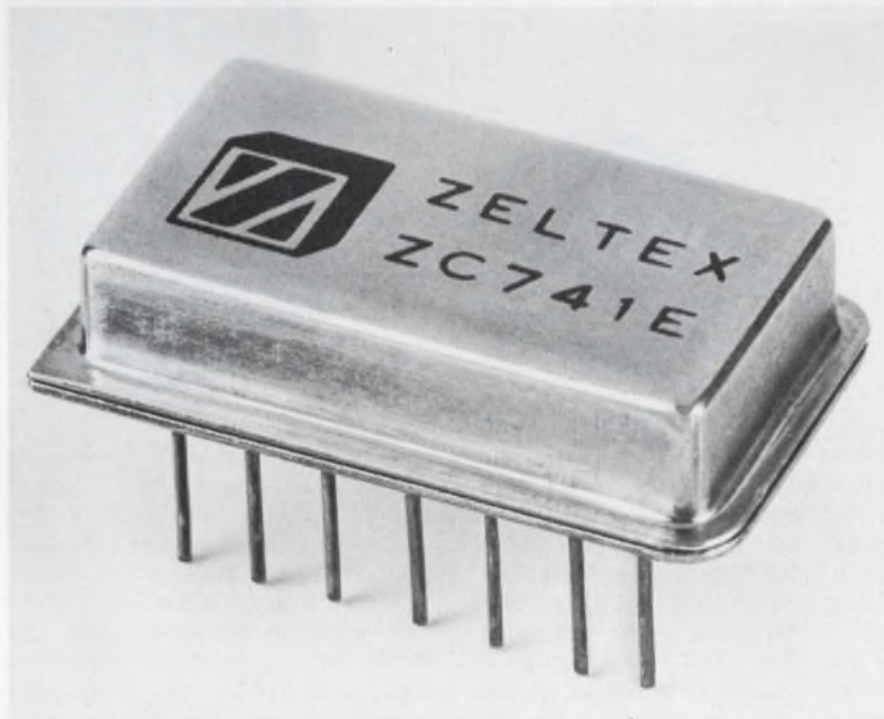

Pin-programmable operational amplifiers make possible over 500 combinations of gain, from 0.004 to 250. These hermetic DIP devices use integral thick-film input/feedback resistor networks for temperature stability.

## 7-output decoder/driver has quad-latch memory



Fabri-Tek Micro-Systems, Inc., 1150 N. W. 70 St., Fort Lauderdale, Fla. Phone: (305) 933-9351. Price: \$13.75.

The FTD-1022 is a BCD-to-7-segment decoder/driver featuring quad-latch memory. The quad latch allows continuous transfer of 4-bit BCD input data to the decoder when the memory strobe is high. When the strobe is low, data is retained until another strobe transition takes place.

CIRCLE NO. 251

## Operational amplifiers reach 0.01% in 0.6 $\mu$ s

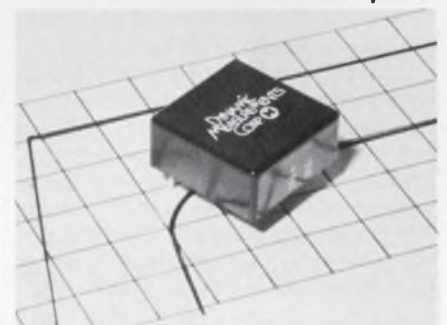

Dynamic Measurement Corp., 108 Summer St., Arlington, Mass. Phone: (617) 648-3610. P&A: \$52, \$62; stock.

Featuring input impedance of  $10^5$  M $\Omega$ , common-mode rejection of 40,000, gain of 250,000 and slew rate of 100 V/ $\mu$ s, model FST-151A,B operational amplifiers settle to 0.01% in 0.6  $\mu$ s. Stability is 35 mV/°C for the 151A and 15 mV/°C for the 151B. Input bias is 0.1 nA for the 151A and 0.05 nA for the 151B.

CIRCLE NO. 252

# THE QUIET LAMP



The design of this lamp makes it ideal for all audio-related applications where freedom from noise is desirable. There are no anchors, a principal source of noise. The lamp has no soldered connections and no soldered-on base. The clip-type mounting bracket is inexpensive and provides a low silhouette that conserves space. Can be supplied in 6 v. and 12 v. types. Write for catalog A-21. Tung-Sol Division, Wagner Electric Corporation, 630 W. Mt. Pleasant Avenue, Livingston, N.J. 07039; TWX: 710-994-4865, Phone: (201) 992-1100; (212) 732-5426.

## TUNG-SOL® BASELESS CARTRIDGE LAMP

TUNG-SOL—WHERE BIG THINGS  
ARE DONE WITH SMALL LAMPS

© Trademark TUNG-SOL Reg. U.S. Pat. Off.  
and Marcas Registradas

INFORMATION RETRIEVAL NUMBER 73

## MODULES & SUBASSEMBLIES

### Thick-film hybrid slashes down costs

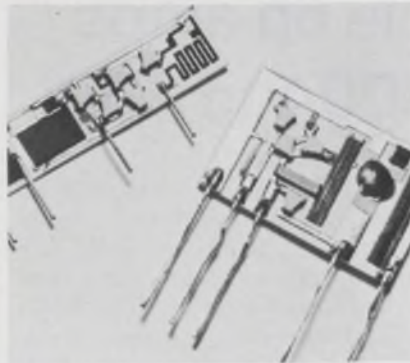

*Circa Tran, Inc., P.O. Box 832, Wheaton, Ill. Phone: (312) 858-3727.*

Known as the Circa-Film Alpha, a new custom-engineered thick-film hybrid microcircuit offers low-cost advantages through the use of mechanized assembly methods which eliminate costly hand assembly. Advantages include improved temperature stability, higher power levels and increased circuit density over comparable PC boards.

CIRCLE NO. 253

### FET-input op amp slews at 8 V/μs



*Philbrick/Nexus Research, a Teledyne Co., Allied Dr. at Route 128, Dedham, Mass. Phone: (617) 329-1600. P&A: \$72 or \$80; stock.*

Supplied in a low-profile TO-8 metal can, the model 1407/14070 FET-input operational amplifier features a gain-bandwidth product of 30 MHz and a slew rate of 8 V/μs. The unit's common-mode rejection ratio is 10,000 at ±10 V, and its input impedance is 10<sup>5</sup> MΩ. The output is protected against short circuits to ground.

CIRCLE NO. 254

### Synchro converter resolves 14 bits

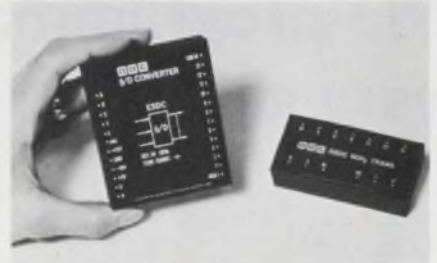

*DDC, 100 Tec St., Hicksville, N. Y. Phone: (516) 433-5330. P&A: \$795 or \$895; stock to 4 wks.*

Designed for 50-to-60-Hz operation, the ESDC-6 converts synchro-angle input information to continuously available digital output data with 14-bit resolution. Accuracy over its entire operating temperature range is ±4 minutes ±0.9 the least significant bit. Synchro input is 90 V rms into 4 MΩ and reference input is 115 V rms at 2.5 mA.

CIRCLE NO. 255

### Double balanced mixer drops cost to \$6

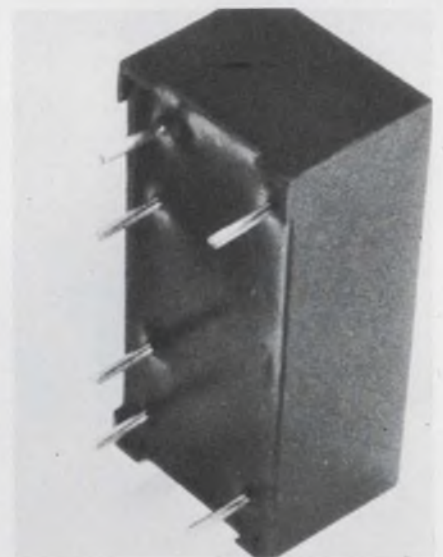

*Andus Engineering, P.O. Box 8, Arlington, Mass. Phone: (617) 646-2121. P&A: \$6 to \$8.50; 2 wks.*

Covering a frequency band of 150 kHz to 200 MHz, a new double balanced mixer slashes costs to \$6 per mixer in 1000-piece lots, and \$8.50 in single-piece quantities. The model DBM-1 has a midband conversion loss of 5 dB and midband balance of 50 dB. It will accept inputs of up to 0.5 W.

CIRCLE NO. 256

**Wideband op amp  
has 2-nA offset**

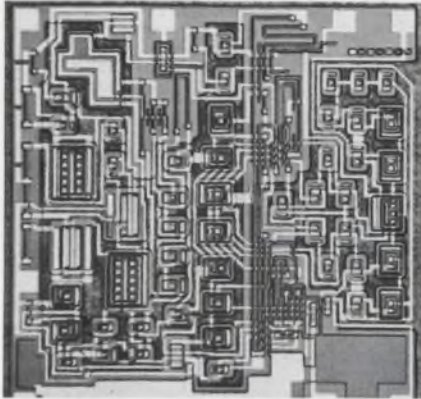

Radiation Inc., Microelectronics Div., P.O. Box 37, Melbourne, Fla. Phone: (305) 727-5430. P&A: \$10.70 or \$17.85; stock.

Offering typical bias and offset currents of 2 nA, a new operational amplifier provides a gain-bandwidth product of 60 MHz at 20-dB closed-loop gain and 100 MHz for 40 to 100 dB of gain. Model RA-2620 is internally compensated for closed-loop gains of greater than three with a unity-gain cross-over frequency at 35 MHz.

CIRCLE NO. 257

**Plastic transistor  
dissipates 25 W**



RCA/Electronic Components, 415 S. Fifth St., Harrison, N.J. Phone: (201) 485-3900.

Said to offer the advantages of a TO-5 metal-can-packaged device, a new plastic power transistor can furnish up to 25 W of dissipation (with a single screw mount to its heat sink) or can be lead-mounted (similar to a standard TO-5 can). After a double insulating overcoat, the transistor chip is mounted on a copper slug for direct contact with any available heat sink.

CIRCLE NO. 258

IMMEDIATELY AVAILABLE

NEW  
**HIGH POWER**  
dc Series Voltage Regulators



Solitron has expanded its high power dc voltage regulator line with three circuits each for positive (+) and negative (-) applications. The HCCA 103 (+) and 104 (-) have current limiter; the HCAA 105 (+) and 106 (-) provide current limiter with a FET constant current source; the HCAA 100 (+) and 102 (-) are the same circuits without limiting and internal current source.

The regulators offer a wide variety of applications from distributed power systems to D.C. motor supplies. Features include:

- Regulation of 5% max. .05% typical, no load to 1.0 Amp
- Temperature coefficient less than .005%/°C
- Line Regulation: Output voltage variations less than .001% @ 1.0 Amp, ± 20% input voltage
- 40 Watts dissipation with heat sink
- Hermetically sealed low profile case (.240 max. ht.) for high density packaging

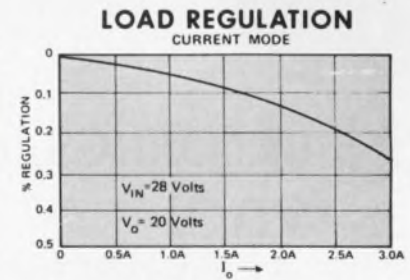
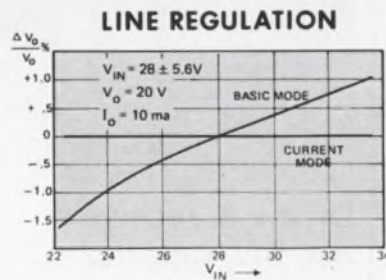

Dial 1-800-327-3243 for a "No Charge" telephone call and further information.

**Solitron**  
DEVICES, INC.

1177 BLUE HERON BLVD. / RIVIERA BEACH, FLORIDA  
(305) 848-4311 / TWX: (510) 952-6676

INFORMATION RETRIEVAL NUMBER 74

who  
maintains  
precision  
tolerances  
in the mass  
production of  
digital  
heads?

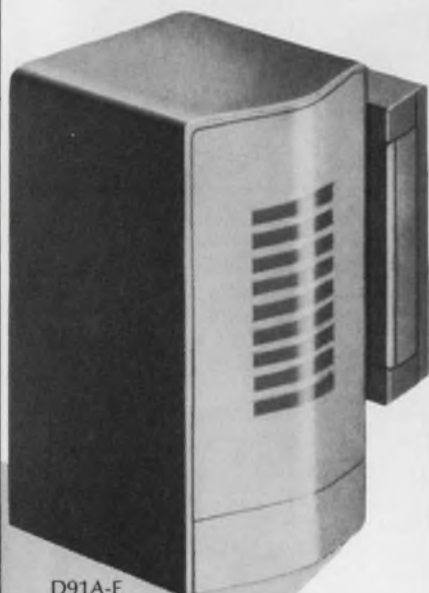

**D91A-E**  
Nine track Read/Write,  
Piggyback Erase  
800 fci, 11 ma  
Saturation Current,  
16.5 ma Operating  
Current. Write  
for complete  
specs.

## Nortronics is who!

- Wide range of IBM-Compatible Heads, 7 and 9-track, single and dual gap, read/write and read after-write
- Industry's largest selection of card-reader and mini-digital heads for cassette and 1/4" formats
- For every application, head first for the world's most experienced manufacturer of magnetic recording heads



**NORTRONICS  
COMPANY, INC.**

8101 Tenth Avenue North  
Minneapolis, Minnesota 55427  
(612) 545-0401

### ICs & SEMICONDUCTORS

#### Decoder/drivers operate from 5 V

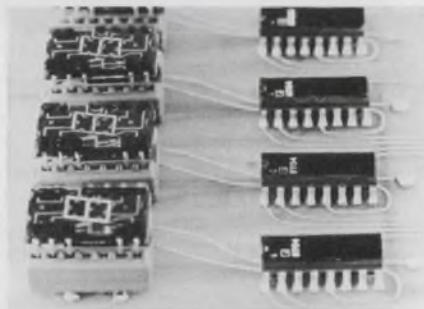

*Signetics Corp., 811 E. Arques Ave., Sunnyvale, Calif. Phone: (408) 739-7700. P&A: \$4.84 or \$5.62; stock.*

Two new seven-segment decoder/drivers, which feature high output sink currents, can operate directly from 5-V sources. Model N8TO4B decoder/lamp-driver has a current-sinking capability of 40 mA per segment. Model N8TO5B decoder/transistor-driver provides a resistive pull-out output circuit.

CIRCLE NO. 259

#### Power transistors switch in 35 ns



*Kerton Inc., 7516 Central Industrial Dr., Riviera Beach, Fla. Phone: (305) 848-9606. P&A: \$2 to \$30; stock to 1 wk.*

A new series of power transistors can switch operating currents as high as 0.25 to 20 A with typical on and off times of 35 and 85 ns, respectively. Operating voltages for these units range from 20 to 100 V. Packages vary from a TO-39 housing for low-current devices to a TO-3 can for currents above 5 A.

CIRCLE NO. 260

#### Half-size op amp is eight-pin DIP

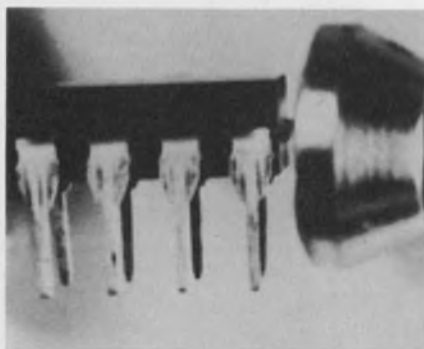

*National Semiconductor Corp., 2900 Semiconductor Dr., Santa Clara, Calif. Phone: (408) 732-5000. P&A: \$4.85; stock.*

Housed in a new type of package, an eight-pin mini-DIP, the LM301-AN operational amplifier doubles the capacity of standard 16-pin dual-in-line sockets—two of these op amps can fit in the same socket. A unique molding process and special lead-frame construction assure moisture resistance, reliability and environmental resistance.

CIRCLE NO. 261

#### Driver & receiver use 5-V supplies

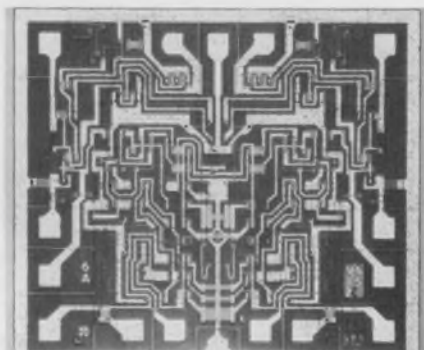

*Fairchild Semiconductor, 313 Fairchild Dr., Mountain View, Calif. Phone: (415) 962-3563. Price: \$11.40 to \$22.80.*

Able to operate directly from 5-V supplies, a new dual differential line driver and a new dual differential line receiver provide uncommitted collector outputs. The model 9614 driver features a current sinking capability of 40 mA, while the model 9615 receiver features a common-mode rejection of 15 V.

CIRCLE NO. 262



## Frequency divider is a single chip

*International Telephone and Telegraph Corp., 3301 Elex Way, West Palm Beach, Fla. Phone: (303) 842-2411. P&A: \$3.60; stock.*

A complete seven-stage frequency divider circuit is now available in a package measuring just 3/4 by 1/2 in. Reportedly, the circuitry necessary for a seven-stage divider of this complexity would require at least one printed circuit board of 5 by 10 in. Although primarily designed for use in electronic organs, the model SAJ110 frequency divider is useful in various sequential circuits.

CIRCLE NO. 263

## Bright red LEDs need only 10 mA

*Plessey Co. Ltd., Microelectronics Div., Optoelectronic and Microwave Unit, Wood Burcote Way, Towcester, Northants, England.*

Guaranteeing an optical power of 120 or 40  $\mu$ W, two new red light-emitting diodes give a typical brightness of 225 foot-lamberts (the GPL 2) or 90 foot-lamberts (the GPL 1) with only 10 mA of operating current. Continuous operation is possible up to 25 mA with increased brightness. Both diodes can be pulsed at operating currents as large as 1 A.

CIRCLE NO. 264

## Tiny infrared LED mounts on PC boards

*Monsanto Electronic Special Products, 10131 Bubb Rd., Cupertino, Calif. Phone: (408) 257-2140. Price: \$2.30.*

Housed in a double-ended flat-lead package for PC-board mounting, a new infrared light-emitting diode is subminiature in size for use in array applications requiring center-to-center spacings as small as 0.087 in. Model ME60 delivers a 550- $\mu$ W total irradiated power at a forward current of 50 mA. In addition, its novel molded lens design results in a highly directional radiation pattern, thus eliminating crosstalk in dense-array applications.

CIRCLE NO. 265

# It took a new generation to bridge the gap

## Delevan's Micro-i<sup>®</sup> Series 155



A new generation of low-cost, miniaturized inductors that is the long-sought transition between discrete and monolithic IC circuits.

### HIGH RELIABILITY AND VERSATILITY

Originally designed to meet the rigorous standards of DOD and NASA specifications, Micro-i Series 155 inductors are perfect for communications applications and the computer field where performance is critical and ownership costs are a consideration. Proven successful for choke and filter applications.

### SUPERIOR FEATURES

Ruggedly constructed with internal connections, thermo-compression bonded for high temperature processing.

RF Inductor Epoxy-molded to meet MIL-C-15305, Rev. D, Grade 1, Class A.

Miniaturization and low profile give improved compatibility with hybrid ICs.

Four separate leads are readily adaptable for solder reflow connections. Eliminates costly body tie-down, reduces lead fatigue caused by vibration and is easily adaptable to tuned circuits by means of outboard chip capacitor.

Write for complete technical data.

**Delevan**  
Division



**AMERICAN  
PRECISION  
INDUSTRIES INC.**

270 QUAKER RD. / EAST AURORA, N. Y. 14052  
TELEPHONE 716/852-3600 TELEEX 091-293

OTHER DIVISIONS OF AMERICAN PRECISION INDUSTRIES INC.: BASCO • DUSTEX •  
MOELLER INSTRUMENT CO. • OXFORD CORP. • TRUCK EQUIPMENT CO.



# Rent-a-Trace

Sometimes the purchasing of new electronic test and measurement equipment can be difficult. Selecting instruments that will meet both short- and long-term needs, getting authorization of funds, waiting out the manufacturer's delivery schedule. There are times when it just isn't worth it.

Let's say you have use for an ultra-high frequency, high-precision scope, but only for a month or two; or maybe you need half a dozen units to handle a peak development load; or maybe you were planning to buy a high-powered model complete with plug-ins but your controller is clamping down on capital expenditures. In situations like these, renting, instead of buying, can be the perfect solution.

R.E.I. can give you the fastest service, the widest selection and the lowest rates of any rental firm in the country. One of our inventory centers is located near you, wherever you are, for instant delivery. Let us tell you more about the many advantages of renting vs. buying. Send today for your free copy of the new R.E.I. Instrument Rental Handbook.

Amplifiers	Filters	Power Supplies
Analyzers	Generators	Recorders
Attenuators	Meters	Sources
Bridges	Oscillators	Stroboscopes
Cameras	Oscilloscopes	Synthesizers
Counters	Plug-In Units	Test Chambers
Detectors	Generator/Synchronizer	

## INSTANT INSTRUMENTS FROM THESE INVENTORY CENTERS:

**Waltham, Mass. 02154**  
69 Hickory Drive  
(617) 891-7610—Telex 923472

**Anaheim, Calif. 92801**  
159 East Freedom Ave  
(714) 879-0561—Telex 655473

**Gaithersburg, Md. 20760**  
16600 Oakmont Ave  
(301) 948-0620—Telex 898446

**Rosemont, Ill. 60018**  
5607 Pearl St.  
(312) 671-2464—Telex 726488

**Fl. Lauderdale, Fla. 33308**  
4808 N.E. 10th Ave.  
(305) 771-3500—Telex 51-4467



**Dallas, Texas 75207**  
1341 Crampton St.  
(214) 638-4180—Telex 732617

MORE INVENTORY CENTERS COMING SOON

# Rental Electronics inc.

A PEPSICO LEASING COMPANY

INFORMATION RETRIEVAL NUMBER 77

## ICs & SEMICONDUCTORS

### 1024-bit registers can clock to 5 MHz



Intel Corp., 365 Middlefield Rd., Mountain View, Calif. Phone: (415) 969-1670. P&A: \$25.60; stock.

Three monolithic LSI shift registers, which handle 1024 bits, have a power dissipation of only 500 mW at 5-MHz clock rates, dropping to 200 mW at 1 MHz. Model 1402 is a 16-lead DIP with four 256-bit registers; model 1403 is a TO-5 package with two 512-bit registers; and model 1404 is also a TO-5 can with a single 1024-bit register. They all are DTL/TTL compatible.

CIRCLE NO. 266

### Interface circuits meet EIA and MIL specs

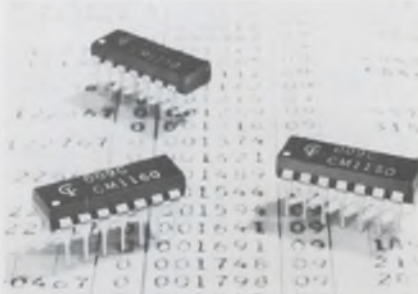

Cermetek, Inc., 660 National Ave., Mountain View, Calif. Phone: (415) 969-9433. P&A: \$8.45; stock.

Dual transmitter and receiver interface circuits are said to be the first monolithic devices capable of meeting both B and C revisions of the EIA (Electronic Industries Association) specification RS232 and MIL-STD-188B. The CM1150 dual transmitter and the CM1160 dual receiver offer the designer of computer equipment flexibility in input/output interface design.

CIRCLE NO. 267

### Photo-transistor works at 150 $\mu$ A



Siemens Corp., Components Div., 186 Wood Ave., South Iselin, N. J. Phone: (201) 494-1000. P&A: \$3.80; 4 to 6 wks.

A new npn-type photo-transistor features a typical photo-current of 150  $\mu$ A for an illumination of 1000 lux. The unit, which is designated as model BP 101, is packaged in a TO-18 case with a translucent epoxy cover. Initial applications include automatic electronic flash-light units and electronic toys.

CIRCLE NO. 268

### IC display drivers block up to 400 V



Unitrode Corp., 580 Pleasant St., Watertown, Mass. Phone: (617) 926-0404. P&A: \$1.85; 2 to 3 wks.

Series EL20 and EL200 solid-state switches are specially designed drivers for electroluminescent displays. They have forward and reverse blocking voltages from 200 to 400 V with high reverse gain for minimum power consumption. All units can be driven directly from low-level ICs. They are available in standard TO metal cans.

CIRCLE NO. 269

**LINEAR**

## *The best of Linear*

*For the past several months, we've presented a profusion of facts, specs and applications on Linear Integrated Circuits.*

*It's time for a recap. Just in case anybody missed something they shouldn't have.*

*The following two pages contain the most significant product information we've presented in this ad series. Not that everything else wasn't important.*

*But, if we only had one ad to run this year, this is the ad we'd run.*

# Introducing the World's First Monolithic J-FET Input Op Amp

Punch-through op amps are solete. Fairchild's new  $\mu$ A740 now ers 150 pA (max.) current into her input. While some manu- turers are talking about super ta or punch-through transistors th current gains of 1000, irchild technology now makes ssible J-FET devices with uivalent betas of over 15,000. nd, they're completely compat- e with standard monolithic ocessing. The  $\mu$ A740 is a simple two- age design similar to the  $\mu$ A741, t employs J-FET input tran- sors to obtain extremely low out currents.

- 740 Electrical Performance**
- Output Current . . . . . 150pA max. (either input)
  - Unity Gain Slew Rate . . . . . 6V/ $\mu$ S
  - Output Resistance . . . . .  $10^{12}$  Ohms
  - Voltage Gain . . . . . 120dB
  - Output Offset Current . . . . . 30pA

The new linear has all the convenience of the  $\mu$ A741: internal frequency compensation for unity gain, input over-voltage protection to either supply, output short circuit protection to ground or either supply, and the absence of "latch-up."

Balanced offset null is easily obtained with a 10K $\Omega$  potentiometer and does not affect other parameters.

Other  $\mu$ A740 features include a wide common mode range of  $\pm 12$  volts, high differential voltage range of  $\pm 30$  volts, and wide operating supply range of  $\pm 5$  V to  $\pm 22$ V.

The  $\mu$ A740 is directly interchangeable with the  $\mu$ A741,  $\mu$ A748 or  $\mu$ A709.

The new Fairchild device provides circuit designers with superior performance in such

applications as active filters, voltage followers, integrators, summing amplifiers, sample and holds, transducer amplifiers and other general-purpose feedback applications.

The  $\mu$ A740 is now available in TO-99 packages (both military and industrial temperature ranges) from any Fairchild Distributor.

Reader Service Number 63

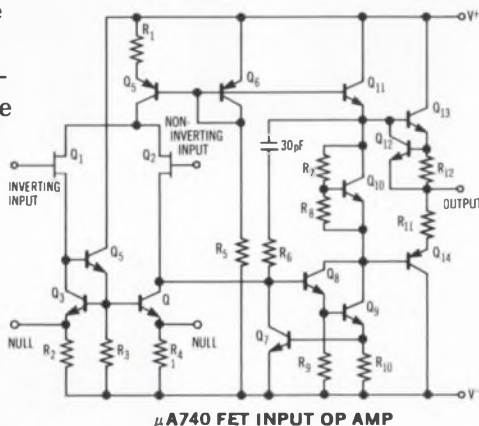

## The New $\mu$ A796:

### We Knew It Was Going To Be Versatile, But We Didn't Know How Versatile.

The new low-cost  $\mu$ A796 Doubly Balanced Modulator/Demodulator is finding its way into an amazing variety of systems. Communications-gear engineers are taking advantage of its great versatility and high carrier suppression in modulators and demodulators for single sideband, suppressed carrier and phase shift key transceivers. It's also being used as a synchronous AM modulator, a quadrature FM modulator, and as a phase comparator for phase locked loop receivers. Digital tape/disc memory designers are utilizing the  $\mu$ A796's unique properties in fast differentiators and phase correcting

circuits for NRZ or phase encoding systems, while remote D.C. R-G-B gain controls, color shade and keystone corrections are practical for color TV broadcast equipment use. Other possibilities lie in signal chopping, frequency changing, linear mixing and more.

**Here Are The Specs:**

- Carrier Suppression . . . . . 65dB
- Transmittance Bandwidth . . . . .
- Carrier Port . . . . . 300MHz
- Signal Port . . . . . 80MHz
- Signal Gain . . . . . 3.5V/V
- Input Impedance . . . . .
- (signal port) . . . . . 200K $\Omega$
- Input Offset Current . . . . . 0.7 $\mu$ A
- Differential Output Swing . . . . . 8.0 volts p-p

**Here Are The Prices:**

- U5F7796312 . . . . .
- 55°C to +125°C . . . . . \$4.80 @ 100 pcs.
- U5F7796393 . . . . .
- 0°C to 70°C . . . . . \$2.25 @ 100 pcs.

**$\mu$ A796 DOUBLY BALANCED MODULATOR/DEMULATOR**

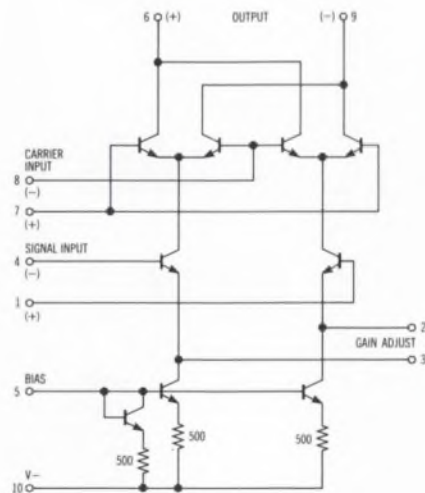

Reader Service Number 64



# New Op Amp has Gain of 3,000,000.

Fairchild's new  $\mu A725$  Instrumentation Operational Amplifier can do the same jobs that used to require expensive chopper-stabilized or complex discrete component amplifiers. The  $\mu A725$  is ideally suited for use in Low Level Signal Conditioners, Instrumentation Amplifiers, Precision Measuring Equipment, Process Control Systems and Data Acquisition Equipment.

### Electrical Performance/Features

- Low Input Noise Current . . . 0.6pA/Hz
- High Open Loop Gain . . . . . 3,000,000
- Low Input Offset Current . . . . . 3nA
- Low Input Offset Voltage Drift . . . . . 0.5 $\mu$ V/ $^{\circ}$ C
- High Common Mode Rejection . . 120dB

One of the many applications for the  $\mu A725$  is in Linear photo-detection systems. Use of a PIN Photodiode with the  $\mu A725$  provides the user with a low noise linear detection system which operates from low voltage supplies and has none of the inherent disadvantages of photomultiplier tubes (high voltage supplies, aging effects, large physical size, high power dissipation).

Reader Service Number 61

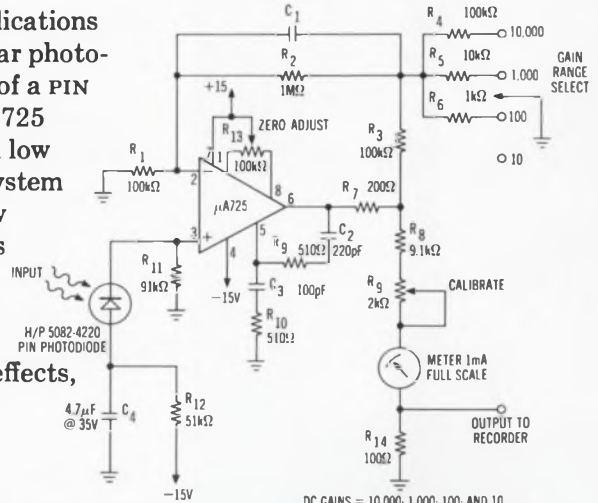

DC GAINS = 10,000; 1,000; 100; AND 10  
BANDWIDTH = DETERMINED BY VALUE OF  $C_1$   
GAIN ACCURACY  $\times$  1000 0.03%

$\mu A725$  PIN PHOTODIODE AMPLIFIER

## Micropower Exists- $\mu A735$

*Minimizing power drain, weight and space gives design engineers ulcers (how come the system power supply designer is the last one to know you've overrun the allotted system power consumption?).*

Here's good news. Relief exists: The  $\mu A735$  micropower operational amplifier uses only 100 $\mu$ W at  $\pm$  3.0 volts.

Systems such as space vehicles, aircraft, and portable medical equipment will benefit from the use of the  $\mu A735$  by shrinking bulky batteries. It gives you low quiescent currents. It also gives you versatile, accurate and cool operation without the customary design tradeoffs.

In addition, the  $\mu A735$  simplifies design of high impedance instrumentation circuits due to its extremely low input currents.

Here are some typical device specifications:

- input offset current . . . . . 500 pA
- input bias current . . . . . 5.0 nA
- input offset voltage . . . . . 1.0 mV
- supply voltage range . . . . .  $\pm$  3 volts to  $\pm$  18 volts
- power consumption . . . . . 100  $\mu$ W
- open loop voltage gain . . . . . 20,000
- input impedance . . . . . 10 m $\Omega$
- noise . . . . . .5 pA /  $\sqrt$  Hz

Smart engineers who like to minimize component count can now take advantage of a new simplified frequency compensation scheme that applies over the entire supply voltage range of the  $\mu A735$ .

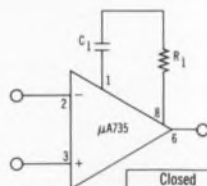

Closed Loop Gain	$C_1$	$R_1$
1	20nF	110k $\Omega$
10	2nF	1.1k $\Omega$
100	680pF	11k $\Omega$

Most engineers like to eliminate those large, expensive, hard-to-find capacitors that hog space and dollars. Here's a nifty little application which will avoid large capacitors in low frequency, active filter design. And with very low supply current drain!

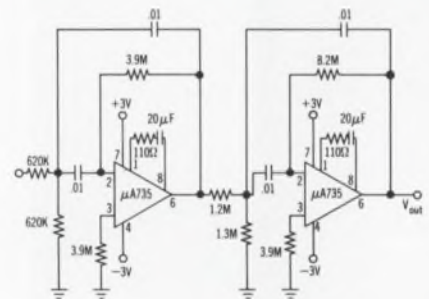

This circuit has a center frequency at 10 Hz, 12 dB rolloff with -3 dB points at 6.5 Hz and 14 Hz. The  $\mu A735$  lets you use small capacitor values and large resistors for frequency shaping at a few Hz, due to the  $\mu A735$ 's low input offset current.

The new price is low, too —

- $\mu A735$  -55 $^{\circ}$ C to +125 $^{\circ}$ C \$37.50 @ 100
- $\mu A735B$  -20 $^{\circ}$ C to +85 $^{\circ}$ C \$22.50 @ 100
- $\mu A735C$  0 $^{\circ}$ C to +70 $^{\circ}$ C \$15.00 @ 100

See? Micropower does exist; alive and in quantity at your Fairchild distributor.

Reader Service Number 62

# 1.0 to 2.5 GHz MIXER

## LUMPED-CONSTANT TECHNIQUE MAKES FOR LOW COST

In fact, the lowest! Thanks to RELCOM's ability to extend lumped-constant manufacturing methods past 1.0 GHz.

Result: A single-balanced mixer with double-balanced performance. A modulator that combines "built-in" filters with a carefully balanced input for 20 dB of isolation at all ports!

Other features: A noise figure typically less than 6.0 dB. And, a dc to 500 MHz output bandwidth.

Write us. We'll send you complete M2F data. Or, better yet, ask us for applications assistance and an evaluation unit by calling us collect.

Price: \$140.00 ea. 1-4 units.

**RELCOM**



2329 Charleston Road  
Mountain View • California 94040  
Telephone (415) 961-6265  
TWX (910) 379-6979

### COMPONENTS

#### Miniature indicators fit 16 to a square in.

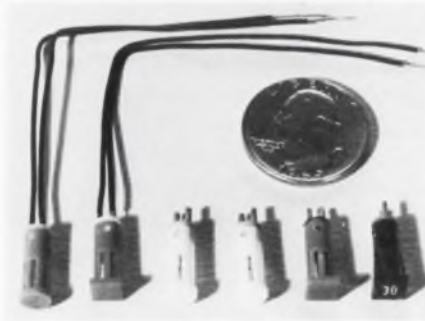

*Nucleonic Products Co., 6660 Varied Ave., Canoga Park, Calif. Phone: (213) 887-1010.*

Extending only 0.039 in. from the front of a mounting panel and 0.649 in. from the back of the panel, series 1.69508 indicator lights are so tiny that 16 of them require one square in. of panel space. Connection to these built-in 6, 12 or 24-V bulbs can be in the form of solder pins or with 4-in. wire leads. Housings mount into 0.197-in.-dia. holes.

CIRCLE NO. 270

#### Tiny indicators clip into place



*Oak Electro-/Netics Corp., Marco-Oak Industries Div., P.O. Box 4011, Anaheim, Calif. Phone: (815) 459-5000.*

Series QT miniature indicator lights now come with a special retaining clip to ease installation and ensure positive retention. The clip, which fits over the light's base behind the panel, eliminates installation difficulties caused by drilling or stamping oversize mounting holes. The lamps are 7/32 in. in diameter.

CIRCLE NO. 271

#### Alphanumeric readout is about 0.175-in. deep



*Pinlites Inc., 1275 Bloomfield Ave., Fairfield, N. J. Phone: (201) 226-7724. Price: \$7.95.*

Maxi-Lite series 10-50 is a digital and alphanumeric readout with an incandescent filament, featuring 5/8-in.-high characters at an overall depth of 0.175 in. It also has a 120-degree viewing angle, variable brightness, and low operating voltage and current of 5 V and 20 mA, respectively. A matching connector and a decoder/driver are available.

CIRCLE NO. 272

#### IC-compatible relay comes in a 14-pin DIP



*C. P. Clare International N. V., Gen.-Graty 102-1040, Brussels, Belgium. Availability: August, 1970.*

The Picoreed is a subminiature sealed-contact 14-pin DIP relay that is fully compatible with ICs. It can be driven by series 54/74 TTL without a buffer or an amplifier, and is available for 6, 12 and 24-V dc operation. Sensitivity is 35 mW with ICs, and 45 to 130 mW with other types of circuits. It operates within 500  $\mu$ s and releases within 100  $\mu$ s.

CIRCLE NO. 273

### Optical isolators withstand 5000 V

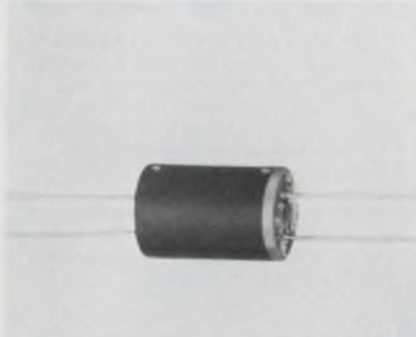

*Optron, Inc., 1201 Tappan Circle, Carrollton, Tex. Phone: (214) 242-6571. P&A: \$11.73 or \$13.49; stock.*

Designed for interfacing data, a new series of optically coupled isolators provide input/output isolation of up to 5000 V. Each isolator consists of a GaAs input diode driving a silicon photodetector. The OP1060 has a minimum output of 0.25 mA. The OP1020 offers fast response while the OP1030 offers high gains. The OP1090 is a photodiode detector.

CIRCLE NO. 274

### Plastic photocells span 0.45 to 166 kΩ

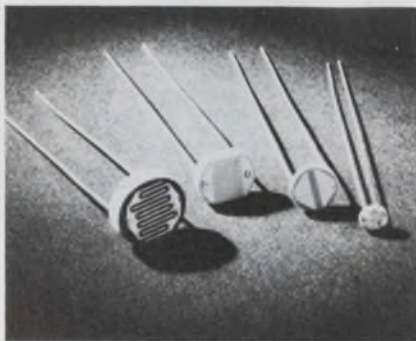

*Clairex Electronics Div. of Clairex Corp., 560 S. Third Ave., Mount Vernon, N.Y. Availability: stock.*

Available in plastic-encapsulated cases, a new line of low-cost CdS and CdSe photoconductive cells range in resistances from 450 to 166,000 Ω at two foot-candles of light. They are available in four sizes ranging from 0.07 to 0.435 in. in diameter. Custom tailoring of sensitivity and slope characteristics is possible.

CIRCLE NO. 275

# Heat problems? Give 'em the air...

**Condor.** A new high performance high reliability propeller fan providing up to 575 cfm for a wide range of cooling applications. The compact design (10-inch diameter, 3.5-inch depth) and light weight make it easy to install in a variety of equipments. 6 models with different connectors add to its versatility.



The Super boxer's exclusive new aerodynamic impeller design provides exceptional output characteristics at high back pressures. Super dependability. 2 patented bearing designs are rated at 10 years life under normal conditions. Super versatility. Compact (4.687-inch square, 1.5-inch depth), mountable inside or outside an enclosure, to intake or exhaust. Accepts all standard Boxer accessories.



**DC Boxer.** The small module mounted integrally on the Boxer frame accepts DC and converts it to drive the Boxer's AC motor. Does away with usual DC motor problems, such as brush wear, arcing contacts, short life, and RF noise. 8 models span the range of 12 to 38 VDC input. Cools heat sensitive equipment such as, TV cameras, sound systems, telephone equipment, etc. Accepts all standard Boxer accessories.



**DC**

## with 3 new air-givers from IMC.

Distributor stocked nationwide for immediate delivery. As are standard Boxers, MiniBoxers, Tandem Boxers, IMCair fans and IMCair centrifugal blowers.

A new 16-page catalog provides drawings, performance parameters and complete specifications for all our airmovers. It's available from IMC Magnetix Corp., New Hampshire Division, Route 16B, Rochester, N. H. 03867, Tel. (603) 332-5300. 

# CUSTOM KEYBOARDS

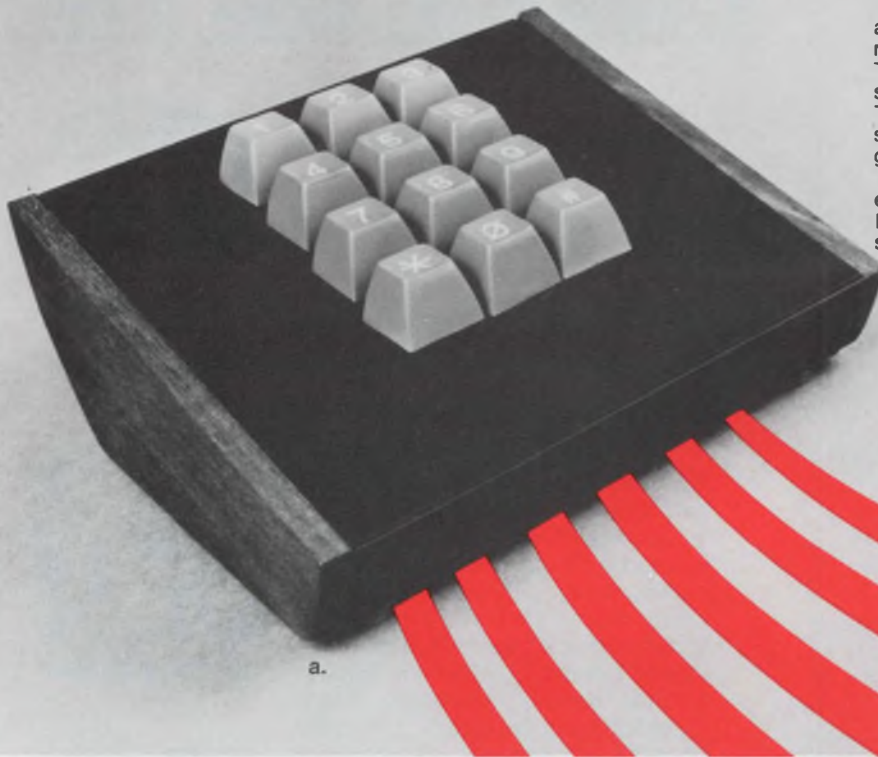

Our Mercutronic Coding Keyboards are unique, using the award-winning mercury tube switching principle. They eliminate printed circuit boards, soldered connections and bounce. The keyboards' coded output will switch IC logic directly, with no gating or delay required.

Individual keys can be easily extracted for replacement, life testing has exceeded 50,000,000 cycles. No standby power is required.

## COMPONENTS

### IC crystal oscillator comes in a 14-pin DIP

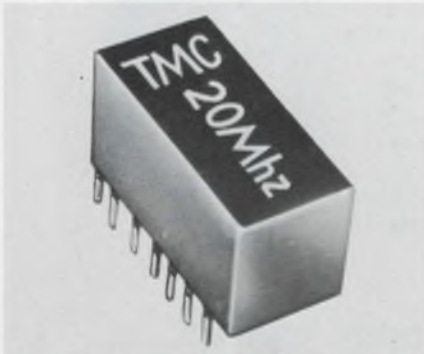

*TMC Systems, Inc., 930 W. 23 St., Tempe, Ariz. P&A: from \$18.45; 2 to 10 wks.*

Covering the frequency range of 18 to 25 MHz, the XO-2007 IC crystal oscillator features a 14-pin dual-in-line package configuration. Stability is  $\pm 50$  ppm over 0 to 50°C. Input power is 5 V dc  $\pm 10\%$  at 22 to 30 mA. Output is a square-wave which drives TTL loads. Special ranges of 10 to 18 MHz and 26 to 30 MHz are available.

CIRCLE NO. 276

### Tantalum capacitors reach 100 $\mu$ F at 35 V

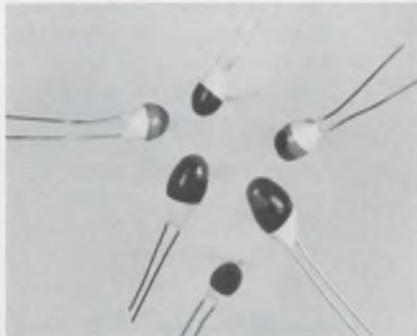

*Siemens Corp., Components Div., 186 Wood Ave. South, Iselin, N.J. Phone: (201) 494-1000.*

A line of miniature tantalum capacitors come with capacitance values of 0.1 to 100  $\mu$ F, and in voltage ratings from 3 to 35 V dc. Reportedly priced competitively with miniature aluminum electrolytics, series B45134 units can operate over a temperature range of  $-55$  to  $+85^\circ\text{C}$  without derating. These epoxy-coated devices have radial leads.

CIRCLE NO. 277

### Miniature transformer has 0.4- $\mu$ s rise time



*Bourns Pacific Magnetics Corp., 28151 Highway 74, Romoland, Calif. Phone: (714) 657-5195*

Designed to operate over the full temperature range of  $-55$  to  $+125^\circ\text{C}$ , the model 4210-1627 miniature high-voltage blocking oscillator transformer has rise and fall times of 0.4 and 1  $\mu$ s, respectively. Specifications include insulation resistance of  $10^4$  M $\Omega$ , rated power of 1500 mW at a 30% duty cycle, and dielectric strength of 1120 V ac.

CIRCLE NO. 278



### Security terminal contains computer



*Saber Laboratories, Inc., 1150 Bryant St., San Francisco, Calif. Phone: (415) 431-4707.*

As easy to use as a typewriter and packaged in a standard attache case, the Mark IV data terminal may be used for business communications and messages of a high-security nature. It has a computer, a keyboard and an alphanumeric tape printer. The built-in computer generates the programs necessary to encipher (code) and decipher (decode) messages.

CIRCLE NO. 279

### Portable terminal prints alphanumeric



*Electronic Arrays, Inc., 9060 Winnetka Ave., Northridge, Calif. Phone: (213) 882-9610.*

A new portable computer terminal can accept and printout either fixed or variable alphanumeric data and/or query/responses with simultaneous printout of the alphanumeric data. Model CT-100 communicates with the computer in ASCII code and format. It contains a 12-pushbutton keyboard, a reader for plastic punched cards, a strip printer, and a coupler.

CIRCLE NO. 280

### CRT display terminals sell for only \$1280



*TEC, Inc., 6700 S. Washington Ave., Eden Prairie, Minn. Phone: (612) 941-1100. Price: \$1280.*

Priced from \$1280 in quantities of 100, a new line of CRT display terminals offers a repertoire of 68 dot-matrix characters available in a variety of formats—up to 1536 characters per page—displayed on a standard TV monitor. Series 400 Data-Screen terminals are available in single or multi-station configurations. They are self-contained with a detachable keyboard.

CIRCLE NO. 281

# ANY CODE ANY CONFIGURATION



Incidentally, we deliver in two to six weeks. All this might lead you to believe that our prices are way up there. Not true. Our keyboards actually cost less. Much less. Regardless of what quantity you require. Curious? We figured you might be. For more information about what our custom Mercutronic Coding Keyboards can mean to you, write to us. You'll receive a no-nonsense reply by return mail.

- a. 12-key numeric (enclosed)  
Custom 5-bit code. \$25.00\*
- b. 12-key telephone array Custom  
4-bit code. \$17.00\*
- c. 19-key calculator array  
Custom 6-bit code. \$27.00\*
- d. 5-key strip  
BCD code. \$7.00\*
- e. 45-key alphanumeric block  
ASCII code. \$57.00\*
- f. 63-key alphanumeric with shift and  
strobe inhibit (stepped) ASCII code,  
modified. \$94.00\*
- g. 10-key numeric  
BCD code. \$15.00\*
- h. 16-key double strip  
Custom 5-bit code. \$22.00\*

\* All prices shown are for lots of 1,000.

#### Mercutronic Division

**Mechanical Enterprises, Inc.**  
5249 Duke St.  
Alexandria, Va. 22304  
(703) 751-3030

## FAULT ISOLATION PROCEDURES ARE NOW A REALITY

**QED SYSTEMS'** Fault Analysis and Simulation Technique, **FAST**, generates fault diagnostics from your logic diagrams in your test systems language. This automatic test generation technique avoids the errors, omissions and redundancies that inevitably result from manually written test procedures.

The computer generated procedure is a comprehensive test of digital logic. The minimum number of test steps are generated to fault isolate to the module level.

Automatic fault isolation at a computer controlled test station means increased productivity. Major portions of the manual diagnosis and repair time can be eliminated by the utilization of these test procedures.

For detailed information contact



SYSTEMS, INC.

Pleasantville, New York 10570

Telephone 914 769-2900

### Rack-mount controller links minicomputers

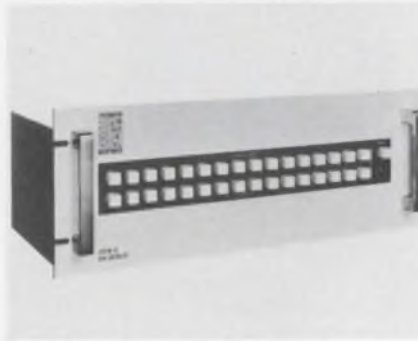

*Cybermation Inc., River Rd., Washington Crossing, Pa. Phone: (215) 493-3686. P&A: \$10,000; 8 to 12 wks.*

A self-contained rack-mounted random-access-memory controller permits direct communication between any minicomputer and moving-head, removable disc, bulk-data storage devices. Called System 23, the unit is a full I/O processor/selector channel controller, and is capable of connecting a minicomputer with up to eight drives.

CIRCLE NO. 282

### Sealed keyboards have thin profile



*Flex Key Corp., 1277 Main St., Waltham, Mass. Phone: (617) 891-1320. P&A: \$9.95 or \$12.95; stock.*

With a total thickness of 1/8 in. (model DK-1L) or 1/4 in. (model DK-1M), two new sealed-construction keyboards occupy no behind-the-panel space beyond their 1/8-in.-long terminations. Pressing a key moves a conductive membrane through a thin aperture film and into contact with a PC board. Each key is effectively a single-pole momentary-closure switch.

CIRCLE NO. 283

### On-line data terminal types 17 characters/s



*Anderson Jacobson, Inc. 1065 Morse Ave., Sunnyvale, Calif. Phone: (408) 734-4030.*

Model AJ 841 on-line conversational terminal can handle typing speed bursts of up to 17 characters per second, so that a fast typist cannot cause a misprint, even on computer log-in. The unit can be connected to any computer providing 2741 Selectric software, and it features the Selectric heavy-duty I/O keyboard-printer. A built-in modem is included.

CIRCLE NO. 284

### Family of modems is truly modular



*General DataComm Industries, 537 Newton Ave., Norwalk, Conn. Phone: (203) 847-2445.*

Featuring ServiSnap construction, Multimodem data sets completely snap-apart and all their printed circuit cards, their card nests, and their power supplies are removable without using any tools. Series 103 units transmit serial asynchronous data, while series GDC-202 modems handle asynchronous binary data. Series 402C models are simplex (transmit-only) data sets.

CIRCLE NO. 285

## Stable wire memory uses epoxy-fiber

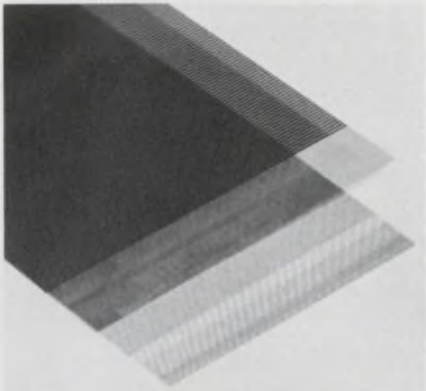

Memory Systems, Inc., 3341 El Segundo Blvd., Hawthorne, Calif. Phone: (213) 772-4220. P&A: 35¢/square in. (0.025-in. wire centers); stock to 2 wks.

A new family of tunnel structures using epoxy-fiber materials allows plated-wire memory planes exceptional dimensional uniformity, freedom from cold flow and improved mechanical strength.

The structures use a combination of epoxy and a randomly-oriented polysaccharide fiber material supported in a urethane medium.

The material contains no abrasive glass fibers and withstands processing temperatures to 350°F. It is bondable with a wide variety of adhesives, and is insensitive to most cleaning solvents, thus allowing conventional handling.

The use of epoxy-fiber material results in superior plated-wire memory mechanical properties and low costs, compared to the use of conventional Kapton/Teflon laminates which cost more and have cold flow problems.

Tightly controlled spacing of the tunnels assures the precise alignment to PC mounting pads without artwork compensation.

Tunnel structures are available with plated-wire memory plane and stack assemblies, or as separate items, forming wires that are still in position.

A standard line is available with lengths up to 16 in. and widths up to 12 in. Center-to-center spacings range from 10 to 50 mils, and tunnel diameters range from 3 to 10 mils.

CIRCLE NO. 286

# If you'd like to make your FM radio 20 times smaller, we've got just the filter for you.

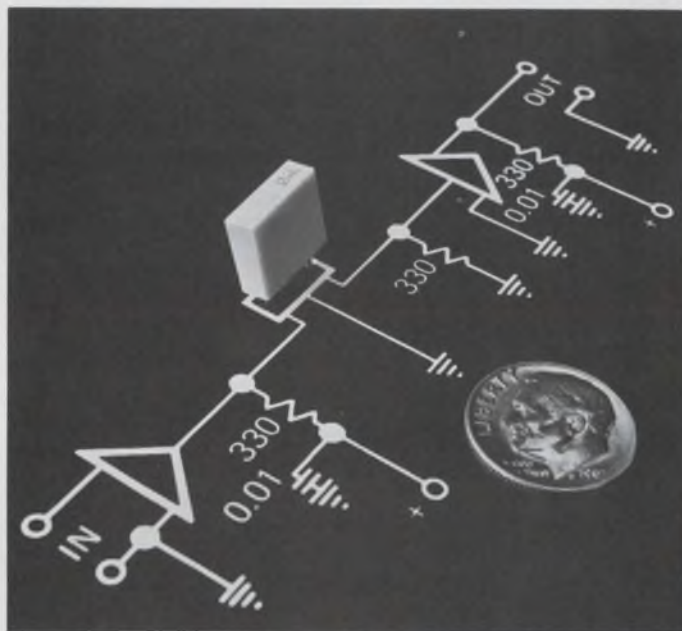

Our new 10.7 megahertz FM filter — the FM-4 — measures only 0.016 cubic inches in volume. But it replaces four tuned circuits more than twenty times its size. Price is competitive with IF cans, and it saves additional dollars by reducing the number of components and interconnections in your IF strip. It's fixed-tuned, too, so it eliminates all those sticky problems of circuit alignment.

The FM-4 is based on the coupled-mode monolithic technique developed for our quartz filters. Result is a new level of performance — higher adjacent channel rejection, distortion less than ½ percent, bandwidths characteristically 235 kHz at 3 dB and 825 kHz at 40 dB. Insertion loss about 3.5 dB. It's just a sample of what we can do in piezoelectric filters — in which we've done the lion's share of development.

So, if you're on a size-reduction kick — or a cost reduction kick — our neat little FM-4 is a good place to start. In fact, for high-quality filters for almost any kind of communication equipment — military, commercial or consumer — get in touch.

Gould Clevite Piezoelectric Division, 232 Forbes Road, Bedford, Ohio 44146. Or: Brush Clevite Company, Limited, Southampton, England.

## GOULD CLEVITE

INFORMATION RETRIEVAL NUMBER 83

## Portable low-cost VOM has 50-k $\Omega$ /V impedance



Unimetrics, Inc., 23 West Mall, Plainview, N. Y. Phone: (516) 694-9171. P&A: \$27.95; stock.

The Omnimeter-50K is a 50-k $\Omega$ /V portable low-cost volt-ohmmeter that measures dc voltages up to 1 kV in 12 ranges and ac voltages up to 1 kV in 10 ranges. It also measures resistances up to 1000 $\times$  in 4 range with 65 k $\Omega$  at center scale. Dc currents and decibels can also be measured. The meter includes a mirror scale, and a diode-protected meter movement.

CIRCLE NO. 287

## True-rms voltmeter checks many waveforms



Scientific-Atlanta, Inc., Box 13654, Atlanta, Ga. Phone: (404) 938-2930. P&A: \$3600; 4 wks.

Measuring true rms or peak values of continuous waveforms, or bursts of complex waveforms, is the 1166 sampling digital voltmeter. Its square-law detector can measure a waveform over an interval of 10  $\mu$ s with a sample period of 3.3 ms. It reads out in linear and logarithmic scales with accuracies of 3% of reading and 0.25 dB, respectively.

CIRCLE NO. 288

## 10-MHz pulse generator has 3-ns rise time

Dytech Research Corp., Box 162, Santa Clara, Calif. Phone: (408) 241-4333. P&A: \$160; stock.

The model 701 is a low-cost pulse generator that features pulse rise and fall times of under 3 ns from 10 Hz to 8 MHz. Output amplitude is variable from 0 to +5 V into a 50- $\Omega$  load. Pulse width is adjustable from 80 ns to 100 ms. Maximum duty factor is over 90% and minimum duty factor is 85%.

CIRCLE NO. 289

## DVM with 5-1/2 digits is accurate to $\pm 0.005\%$

Systron Donner Corp., 888 Galindo St., Concord, Calif. Phone: (415) 682-6161. Price: \$1295.

Retailing at \$1295, the 7005 digital voltmeter features a 5-1/2-digit readout, 10- $\mu$ V resolution (optional to 1  $\mu$ V) and an accuracy of  $\pm 0.005\%$  of reading. Measurements are made at a rate of 5 samples per second, and readings include an autopositioned decimal point, a polarity sign, and an annunciator. Overrange factor is 20%. The meter uses a combination of a dual-slope integrating technique and a high-speed active filter for measurements.

CIRCLE NO. 290

## 200-MHz counter-timer retails at only \$895

Itron Corp., 11675 Sorrento Valley Rd., San Diego, Calif. Phone: (714) 453-5300. P&A: \$895; stock.

Reading frequencies from dc to 200 MHz, and period and time intervals from 1  $\mu$ s to 2000 s, the model 680 counter-timer retails for only \$895. Its circuitry is composed of TTL ICs mounted on plug-in sockets for easy maintainability. Sensitivity is 50 mV up to 2 MHz and 100 mV up to 200 MHz.

CIRCLE NO. 291

## What's the difference?

Some typical squirrel cage photomultipliers. All similar in shape. But the one in the foreground, the new EMI Type 9781B, is different. Take a look at these typical performance figures:

- Photocathode sensitivity... 55 $\mu$ A/L
- Overall gain at 1000V...  $2 \times 10^7$
- Overall voltage at gain of  $10^6$ ... 650V
- Dark current at gain of  $10^6$ ... 1.2nA

The 9781B, a 9 stage tube with UV transmitting glass envelope, is designed for use with low level UV and visible radiation in spectrometer and similar applications. The B11A (B11-88) base means the 9781B will replace other tubes of this design to improve system performance.

For details of the complete EMI P.M. tube range contact:

**GENCOM DIVISION**  
varian/EMI

80 EXPRESS STREET, PLAINVIEW, N. Y. 11803  
TELEPHONE (516) 433 5900

INFORMATION RETRIEVAL NUMBER 84

**\$395 pulse generator  
delivers 5 V at 50 MHz**



*E-H Research Laboratories, Inc.,  
515 11th St., Oakland, Calif.  
Phone: (415) 834-3030. P&A:  
\$395; stock.*

Satisfying performance requirements without straining budget allocations, a new pulse generator provides a repetition rate of 50 MHz at an amplitude of  $\pm 5$  V for only \$395. The model G 710 is the first instrument in a new series of Generation 70 equipment, a completely innovative line for this decade.

No calibration adjustments and standard non-selected parts are inherent features of the new generator. All replacement parts are available from local dealers. The manual provided with the G 710 is all that is needed to trouble-shoot the instrument.

Since the G 710 has internal 50- $\Omega$  terminations for driving non-50- $\Omega$  lines, it eliminates mismatch effects and reflections. Rise and fall times for the new instrument are less than 5 ns, and pulse duty factor is greater than 50%.

Pulse delay and pulse width are controlled from the front panel and are variable from 10 ns to 50 ms. Waveform distortion is less than 5% pk-pk.

External triggering, single-cycle operation, and either single or double-pulse modes are other features. The G 710 is a human-engineered product—all its front-panel controls are color coded for simple operation.

CIRCLE NO. 292

## NEED A **10,000 VOLT ZENER DIODE?**

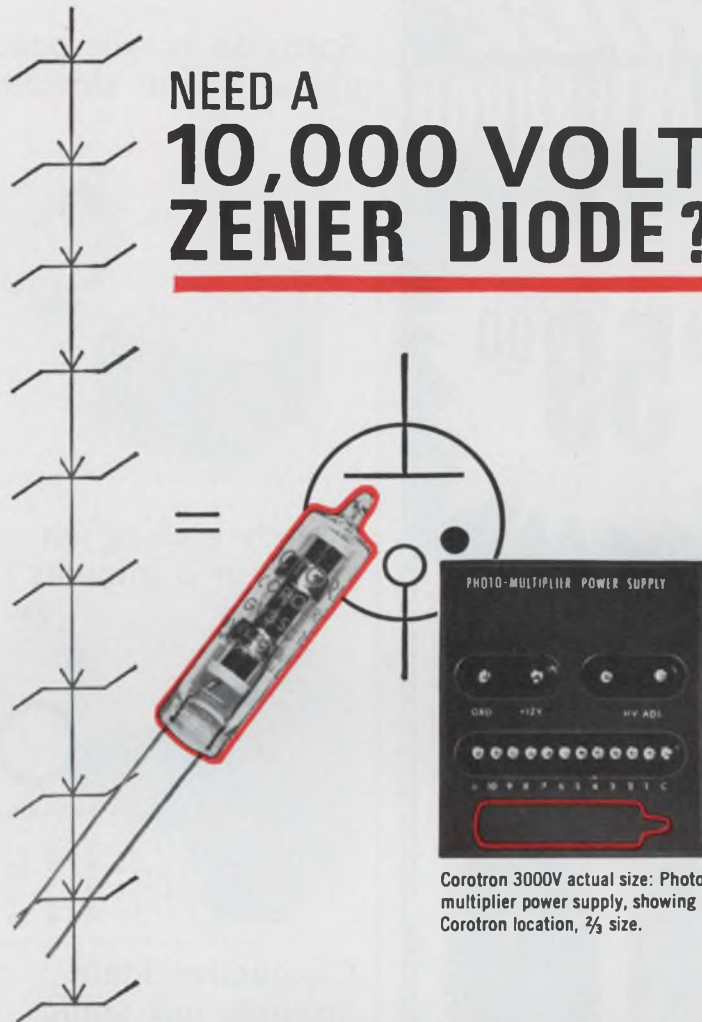

Corotron 3000V actual size: Photo-multiplier power supply, showing Corotron location,  $\frac{2}{3}$  size.

You could string together several hundred zeners. Or you could specify one Victoreen Corotron. It is the gaseous equivalent of the zener with all the advantages of an ideal HV zener diode.

For space research and other rugged applications requiring absolute power supply stability, GV3S Series, shown, provide the ideal reference voltage anywhere in the range of 400 to 3000 volts. They enable circuitry to maintain constant high voltage regardless of battery source voltage or load current variations. Cubage and weight (GV3S Corotron weighs only 4 gm.) are important considerations. So is temperature variation (Corotrons operate from 200°C down to -65°C). Ruggedized versions withstand shock to 2000 G, vibration 10 to 2000 cps.

If you're trying to simplify circuits . . . to cut cost, size and weight . . . to upgrade performance—you need Corotron high voltage regulators. Models are available now from 400 to 30,000 volts. A consultation with our Applications Engineering Dept. will speed up the countdown.

DMA 525



**VICTOREEN INSTRUMENT DIV. of VLN**  
10101 WOODLAND AVENUE • CLEVELAND, OHIO 44104  
EUROPE: ARNDALE HOUSE, THE PRECINCT, EGHAM, SURREY, ENGLAND • TEL: EGHAM 4887

INFORMATION RETRIEVAL NUMBER 85

# PRICE BREAKTHROUGH

**\$59<sup>00</sup>**

## military quality MODULAR POWER SUPPLIES



**Deltron**  
**GUARANTEED 3-day shipment**

- Ideal for IC's—Crowbar protected
- 0.05% regulation . . 500  $\mu$ v ripple
- All silicon—71°C operation
- 10 microsecond recovery time
- Adjustable current limiting
- Plug/wire in—connector supplied

### RATINGS AVAILABLE

Model	Volts	Amps	Price
B10-.6	1-10	0-.6	\$59.
B10-1.2	1-10	0-1.2	\$69.
B20-.35	1-20	0-.35	\$59.
B20-.7	1-20	0-.7	\$69.
B40-.2	1-40	0-.2	\$59.
B40-.4	1-40	0-.4	\$69.

REQUEST TECHNICAL BULLETIN

D 105

# Deltron

WISSAHICKON AVE., NORTH WALES, PA. 19454  
PHONE: (215) 699-9261 • TWX: (510) 661-8061

INFORMATION RETRIEVAL NUMBER 86

## PACKAGING & MATERIALS

### Spray-on acrylic paint gives rfi/emi shielding



Chomerics, Inc., 77 Dragon Court, Woburn, Mass. Phone: (617) 935-4850. Price: \$45/lb or \$16.20/6-oz. can.

Called 4900, a new spray-on one-component air-drying conductive coating provides emi/rfi shielding on plastic or other nonconductive enclosures. When applied in a 1-mil thickness, it exhibits a surface resistivity of 0.05  $\Omega$ /square. Resistivity decreases as thickness increases. It is available in bulk quantities and in six-ounce aerosol cans.

CIRCLE NO. 293

### Speedy etching kit works in 3 minutes



Houle Manufacturing Co., P. O. Box 276, Santa Susana, Calif. Phone: (805) 526-8118.

A fast-acting etching kit consisting of a 1/4-lb package of ammonium persulfate and a bottle of catalyst allows PC-board etching in 3 to 5 minutes. Over 25 square inches of a one-sided copper board as well as a roll of 0.062-in. black tape and strips of 0.25 and 0.312-in.-diameter donuts and teardrops are included.

CIRCLE NO. 294

### Conductive foam grounds out static



Emerson & Cuming, Microwave Products Div., Canton, Mass. Phone: (617) 828-3300. Price: \$12 to \$15.75.

Eccosorb MOS-FET is an electrically-conductive semi-rigid foam material with a low volume resistivity. It is used to prevent electrical overloads of solid-state devices such as MOSFETs, and LSI and MSI circuits. It can be used as a grounding medium for any device susceptible to damage by static electricity.

CIRCLE NO. 295

### IC/component carrier is a plug-in 14-pin DIP

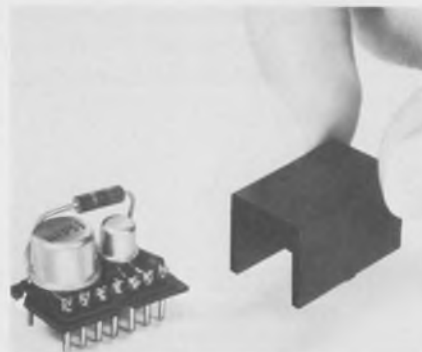

Design & Production Assoc., 1600 N. Arrowhead, San Bernadino, Calif. Phone: (714) 886-8612. P&A: 75¢ to \$1; stock.

A new component carrier for mounting subminiature components and IC packages features a 14-pin dual-in-line plug-in configuration. The DIC-14 may be used as a simple carrier or with any of three sizes of detachable caps. It plugs directly into standard dual-in-line sockets or into 0.1-by-0.3-in. grid patterns in PC boards.

CIRCLE NO. 296

### Plug-in-free generator sweeps out to 12.4 GHz



SpaceKom, Inc., P.O. Box 10, Goleta, Calif. Phone: (805) 967-7114. P&A: \$5500 to \$6800; 60 days.

Without any plug-ins, the model 103 sweep generator covers the frequency range from 10 to 12,400 MHz. This range is divided into three bands (0.01 to 4.2 GHz, 4.2 to 8 GHz and 8 to 12.4 GHz), and is selected by a front-panel control. Continuous sweeping is possible up to 4200 MHz, including the 10-to-4200-MHz range.

CIRCLE NO. 297

### Balanced mixers reach 2500 MHz



Relcom, 2329 Charleston Rd., Mountain View, Calif. Phone: (415) 961-6265. P&A: \$30 or \$60; stock.

Designed for low-noise applications, the M7B and the M7C high-frequency balanced mixers have upper frequency ranges of 2500 and 800 MHz, respectively. At 1500 MHz, the noise figure for the model M7B is typically 6 dB. Both mixers are packaged in a hermetically sealed TO-5 metal can.

CIRCLE NO. 298

### Miniature circulators reach out to 40 GHz



Sonoma Engineering & Research, 760 Montecito Center, Santa Rosa, Calif. Phone: (707) 539-2702.

Operating over the frequency range of 26 to 40 GHz, a new family of miniature circulators offers bandwidths from 100 to 400 MHz with 20 to 30 dB of isolation. A typical unit is the model S-4812 with a 200-MHz bandwidth, centered at 40 GHz, providing 20-dB isolation, 0.3-dB insertion loss and a maximum VSWR of 1.25. The unit measures 1.25 by 0.65 by 0.75 in.

CIRCLE NO. 299

## Now read this...



Actual Size

## 14 digits in 14 centimetres with the new Philips PANDICON\*!

Putting numbers into electronic calculators, computers and data terminals isn't so difficult these days. But getting numbers out — legibly and economically — can be another matter.

Unless, of course, you've heard about Philips' new PANDICON fourteen-decade integrated readout tube, type ZM 1200.

Its legibility you can see for yourself. No more unnatural spaces between digits. Decimal points and punctuation marks where you expect them to be. Coherent numbers instead of 14 separate digits — all in a

space less than the width of this page.

But there are other advantages too. Economy, for example. All 14 digits in one and the same tube. To provide this display with ordinary single tubes, somebody would have to make 168 external connections. The PANDICON needs only 27. Interconnections are inside — protected from damage. You save on drive components because only one decoder-driver is needed for the full 14-digit display. You save on power too — it consumes only 1.5 to 2 W.

Best of all is the reliability. We're not ready to quote Mean-Time-Between-Failure figures yet, because after hundreds of thousands of life-test hours, we haven't had enough failures to make statistically significant conclusions. It may take some time yet, as we anticipate an MTBF of 500,000 hours. Meanwhile, we've given you a full one-year guarantee on this tube — with the strong suspicion it will live 10 times as long! After all we have over 60 years experience in gasdischarge physics.

If 14 digits are too much, we can offer you 8, 10 and 12 digit tubes soon.

Our engineers have also developed a Dynamic Drive Module type DDM 14 to go along with the PANDICON. Everything is described in our new PANDICON data file, which is yours for the asking.

Philips Electronic Components and Materials Division, Eindhoven, the Netherlands.

Distributed and sold in the U. S. by: Amperex Electronic Corporation, Providence Pike, Slatersville, R. I. 02876.

\* Registered trade-mark of N. V. Philips' Gloeilampenfabrieken, Eindhoven, the Netherlands.

ANNOUNCING:

# Cool power

Model CP-5-5  
Price: \$152.00



## for IC logic

These new power modules from ERA provide cool performance, total protection for specialized use in IC, computer, telemetry, strain gauge and transistor applications.

The Transpac CP series is equipped with unique heat sinking for cool (71°C, free air) operation at high currents, protects itself and your equipment through built-in short circuit protection with instant recovery, adjustable current limiting and overvoltage protection.

A special burn-in test program at the factory assures reliability while compact silicon design saves space.

Send for catalog. Write today — before you design.

### STANDARD MODELS

Output Voltage VDC	Current @				Model	Price
	50°C	60°C	71°C			
3.6	3.2	2.8	2.5	CP-3P6-2P5	\$131.00	
5	3.2	2.8	2.5	CP-5-2P5	\$131.00	
3.6	6.5	5.7	5.0	CP-3P6-5	\$152.00	
5	6.5	5.7	5.0	CP-5-5	\$152.00	
3.6	13.0	11.4	10.0	CP-3P6-10	\$194.00	
5	13.0	11.4	10.0	CP-5-10	\$194.00	
3.6	22.0	19.5	17.0	CP-3P6-17	\$241.00	
5	22.0	19.5	17.0	CP-5-17	\$241.00	
3.6	32.0	28.5	25.0	CP-3P6-25	\$325.00	
5	32.0	28.5	25.0	CP-5-25	\$325.00	



**ERA TRANSPAC CORPORATION**

A Subsidiary of  
Electronic Research Associates, Inc.  
67 Sand Park Road, Cedar Grove, N.J. 07009  
(201) 239-3000

INFORMATION RETRIEVAL NUMBER 88

## TOOLS & ENGINEERING AIDS

### Easy-to-use extractor removes connectors

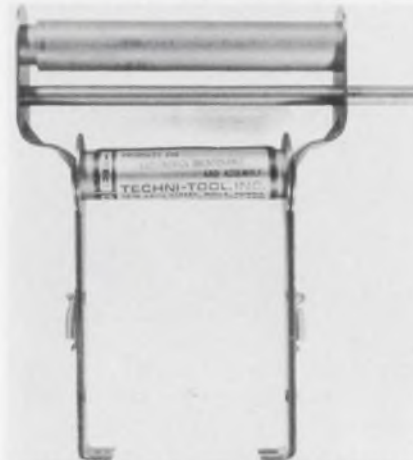

Techni-Tool, Inc., 1216 Arch St., Philadelphia, Pa. Phone: (215) 568-4457.

Designed to eliminate the struggle of disengaging 25 to 50-pin connectors, a new connector extractor, the model 4925, exerts an even pressure to eliminate the chance of damaging individual connector pins. A slight pressure of the fingers easily separates connectors. The tool is made of stainless steel.

CIRCLE NO. 335

### Solder-iron holder prolongs tip life

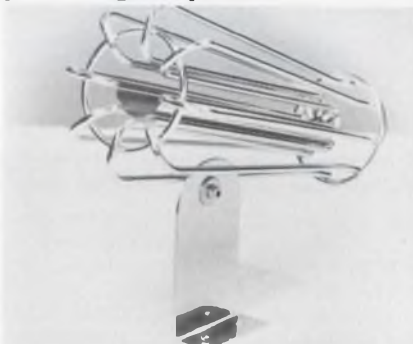

E. H. Titchener & Co., 1 Titchener Pl., Binghamton, N. Y. Phone: (607) 772-1161.

A new welded-wire soldering-iron holder provides easy access for soldering irons, when hot or cold. The unit's design is said to prolong element life since it allows for free passage of air around the soldering iron. An integral shield and cup prevent solder from dripping through the holder. The airy wire design speeds heat dissipation.

CIRCLE NO. 336

### Single-hand gun auto-feeds solder



Ernest Spirig Consulting Engineers, P.O. Box 131, Zurich, Switzerland.

Able to be manipulated with just one hand, the L200 soldering gun features an automatic solder feed to its tip, thereby allowing the other hand to move the work-piece. This automatic solder feed is controlled by pressure on the actuating button. Plug-in heating elements are interchangeable and have ratings from 20 to 60 W.

CIRCLE NO. 337

### Compact tool kit eases servicing



Jonard Industries Corp., Precision Tools Div., 3047 Tibbet Ave., Bronx, N. Y. Phone: (212) 549-7600.

A new 20-piece precision tool kit is specifically designed for servicing of business and central-office equipment. Kit K-77 includes dielectric tools that allow adjusting and repair on live equipment. It is supplied in a leather zippered case. Some tools are a pocket burnisher, a lamp extractor, and a thickness gauge.

CIRCLE NO. 338



## PC-board tool shears and drills

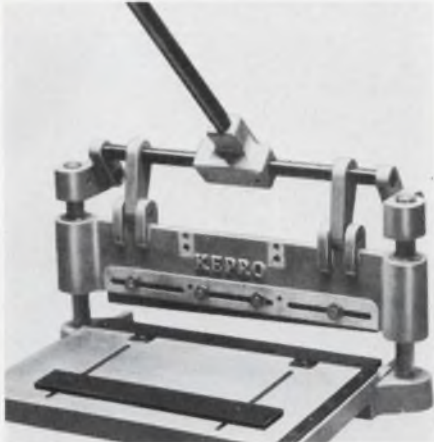

*Kepro Circuit Systems, Inc., 3630  
Scarlet Oak Blvd., St. Louis, Mo.  
Phone: (314) 225-5166.*

With appropriate attachments, a new benchtop tool can perform almost every mechanical process required in the production of etched circuit boards. The model MS-6 Multi-6 can shear, punch, notch and drill PC boards. The unit is basically a 12-in. shearing tool for precision cutting of clad or unclad plastic materials and sheet metals.

CIRCLE NO. 339

## Work positioner holds connectors

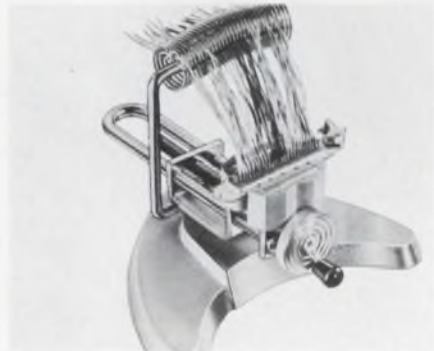

*Line-Master Products, Div. of  
Sandefur Engineering Co., Inc.,  
14507 S. Hawthorne Blvd., Lawndale,  
Calif. Phone: (213) 772-5255.*

The LM 204B connector work positioner holds electrical connectors and lead wires in position so that solder flows down into the joint during wiring. The lead-wire holder keeps the wires separated and positions them vertically for maximum assembly efficiency and accuracy. The vise has reversible jaw pads.

CIRCLE NO. 340

# GIANT PERFORMANCE

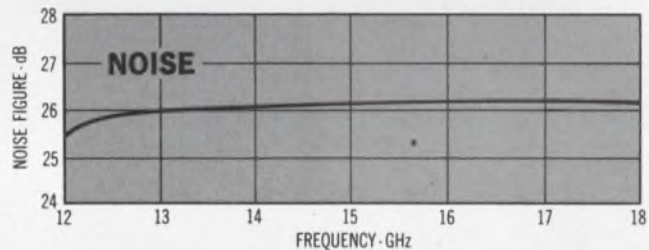
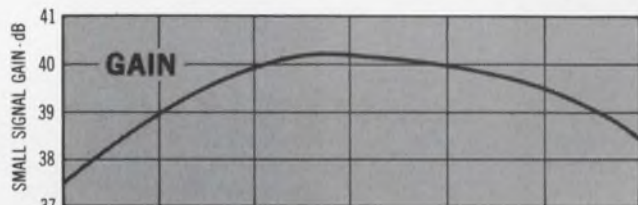
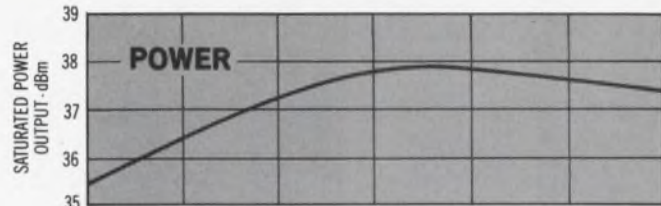

## from a Compact TWT

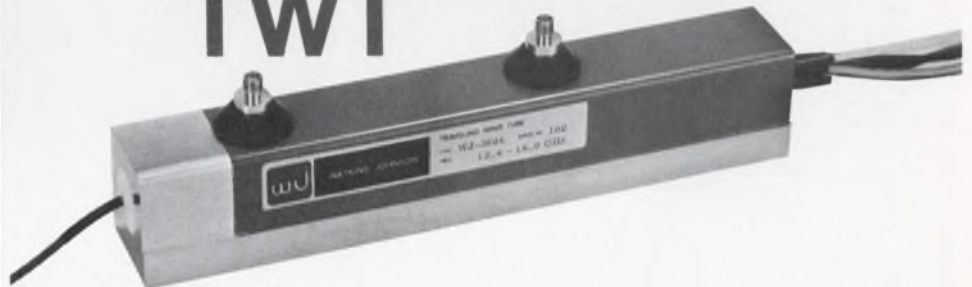

The WJ-3604 is a medium-power low-noise traveling-wave tube designed for use in airborne and shipboard applications. It is particularly suitable for applications where gain variation and noise figure are important (the tube provides fine structure gain variation of  $\pm 0.75$  dB across K-band).

The use of Periodic-Permanent-Magnet (PPM) focusing and metal-ceramic construction results in a compact, lightweight configuration. Alnico-8 magnets are used in the PPM-focusing system, making it relatively insensitive to temperature variations over the operating range.

Operating efficiency of the WJ-3604 can be improved by depressing the collector voltage below the helix voltage. The tube may also be supplied with an integral power supply, resulting in a fully integrated TWT amplifier.

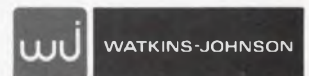

3333 HILLVIEW AVE., STANFORD INDUSTRIAL PARK, PALO ALTO, CALIF. 94304 • (415) 326-8830

INFORMATION RETRIEVAL NUMBER 89

# YOKE SPECIALISTS

FOR INFORMATION DISPLAYS



Syntronic's devotion to precision and attention to detail assure skillfully engineered deflection yokes in prototype or full production quantities. A complete line of value engineered yokes offer cost saving solutions to your CRT projects. Consult scientifically oriented Syntronic Yoke Specialists for the right yoke for your display.



***Syntronic*** INSTRUMENTS, INC.  
100 Industrial Road, Addison, Ill.  
Phone: Area 312, 543-6444

INFORMATION RETRIEVAL NUMBER 90

## Evaluation Samples

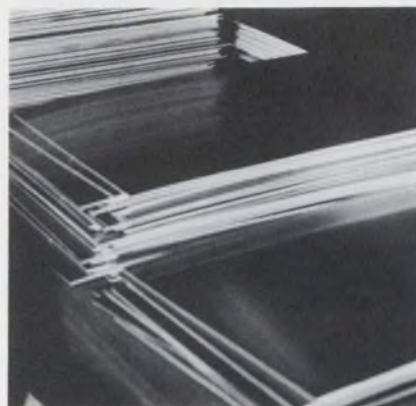

### Copper-clad laminates

Samples are available of two new glass epoxy copper-clad laminates with exceptionally good-drilling and measles-resistance characteristics in printed-circuit board materials. The new laminates are 65M27 and 65M28. Both are warp-free, have a high impact strength and high insulation resistance glass epoxy copper-clads which can be drilled or punched as easily as ordinary G-10 and FR-4 laminates. Westinghouse Electric Corp.

CIRCLE NO. 341

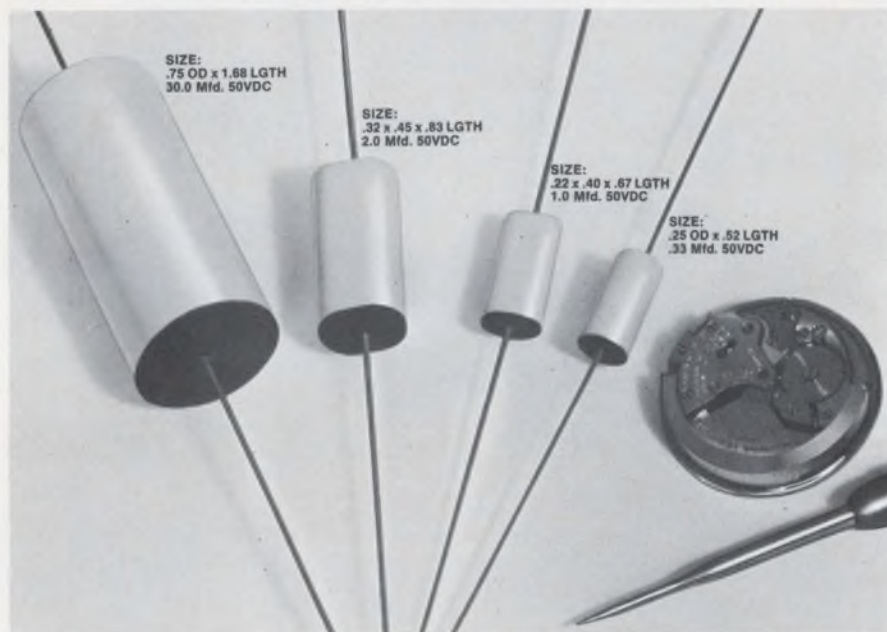

### NEW 50VDC CAPACITORS WITH SPACE SAVING SIZES

Size check these min-miniature wrap and fill, metalized polycarbonate capacitors. They're compact, and made especially for volumetric utilization. With this major breakthrough in size reduction, S & E I capacitors still maintain superior electrical characteristics of thin film metalized polycarbonate dielectrics. They are designated as the 22W, oval shaped series and the 22R round series. S & E I also produces 50VDC and 100VDC capacitors, in a variety of other space saving encasements. Write for a condensed data sheet, or call factory direct for prompt up-to-date information.

**S&E I** Manufacturing/Capacitors

18800 Parthenia Street, Northridge, California 91324 • (213) 349-4111 • TWX 910-493-1252

INFORMATION RETRIEVAL NUMBER 91



### Spirally wound tubing

A sample of a new spirally wound thin-wall tubing made of copper, mu metal, or metal/plastic-film combination is available. It offers designers effective space-saving and cost-saving shielding for reed relays and other application where rfi or emi must be contained. Tubing is available with inside diameters from 0.09 to 1 in., with wall thicknesses from 1/2 mil, and in lengths of 36 in. Niemand Bros. Inc.

CIRCLE NO. 342

# Design Aids



## Data chatter platter

Sung by that famous duo of Randy Z and Bongo Jack, a new 33-1/3-rpm record honoring data processing makes its entry in the hit-record field. This stereo recording has six songs on both sides with titles such as "Push The Magic Button," "When I Was A Bachelor" and "Memory D'Amour," put to the tunes of such oldies-but-goodies as "Puff The Magic Dragon," "Foggy Foggy Dew" and "Melody D'Amour." Versatec, Inc.

CIRCLE NO. 345

## Dielectric materials

Two unique and useful full-color charts show the dielectric constant and loss tangent at microwave frequencies of over 300 materials. Values for dielectric constants are given on an ordinate axis, while an abscissa axis lists loss tangent values. Density and heat capabilities for each material are also shown. Photographs illustrate physical characteristics and uses. Definitions of commonly used terms are also presented with helpful dielectric formulas. Emerson & Cuming, Inc.

CIRCLE NO. 344

## Decimal equivalents

Equivalents of common fractions, expressed in decimals for inches and millimeters, are contained on a handy pocket-sized card. It treats fractions that range from 1/64 in. to 1 in. in 1/64-in. steps. Equivalents are given for each fraction, in decimal form, for both inches and millimeters. Industrial Electronic Engineers, Inc.

CIRCLE NO. 343

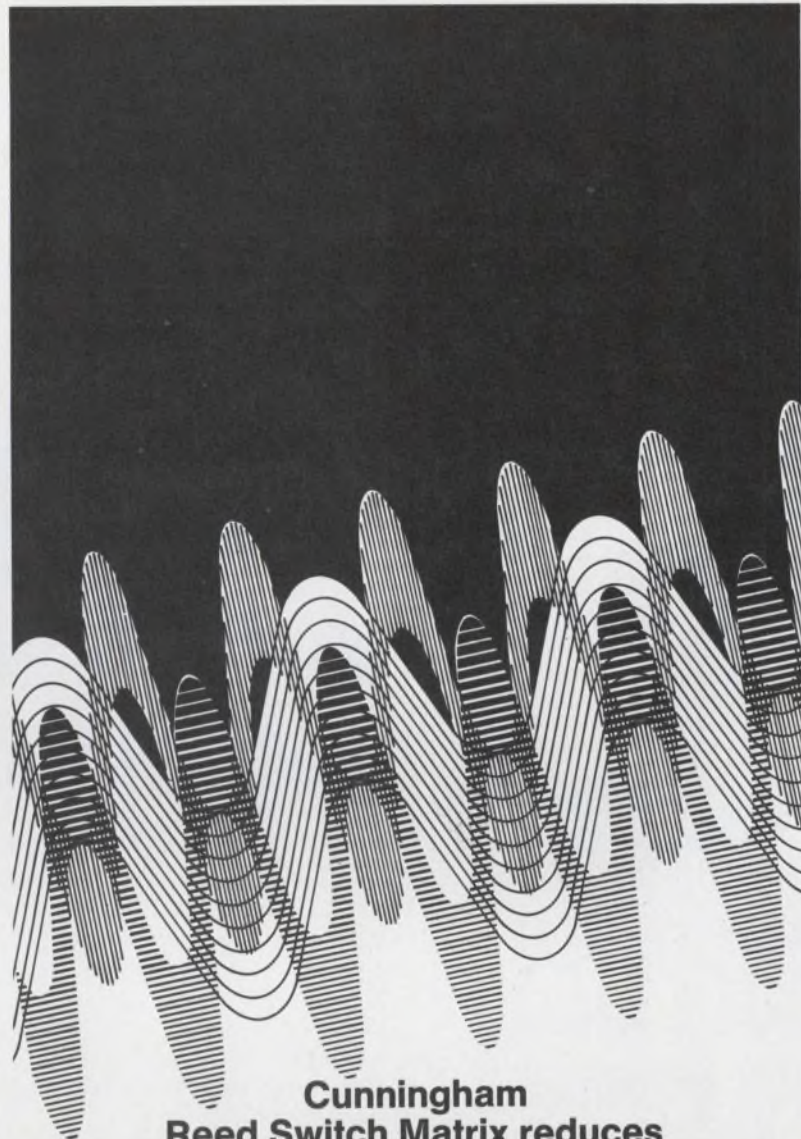

## Cunningham Reed Switch Matrix reduces high-frequency crosstalk to a new low.

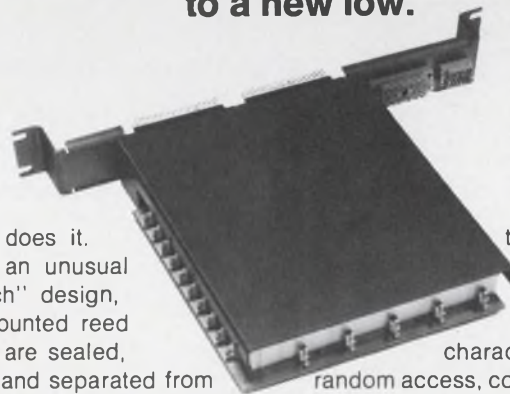

Isolation does it. Through an unusual "sandwich" design, matrix-mounted reed switches are sealed, shielded and separated from their controls, achieving maximum open circuit isolation and negligible crosstalk.

The matrix is ideal for interconnecting video channels, broadband data switching, test systems for nano-second digital pulses, telemetry equipment for multiple data channels, antenna switching, and medical data monitoring. Proven reliability up to 100 million operations. The whole story about

the Cunningham Reed Switch Matrix's excellent signal characteristics, 100% random access, computer compatibility, single package design and dual coaxial connectors for multiple expansion is told in Data Sheet No. 500. Write or phone Cunningham Corporation, 10 Carriage St., Honeoye Falls, New York 14472. Phone (716) 624-2000.

## Cunningham Corporation

SUBSIDIARY OF GLEASON WORKS

INFORMATION RETRIEVAL NUMBER 92



# MIL-SPEC POWER SUPPLIES

*with guaranteed  
3-day shipment*

In the design of MIL-spec equipment, you want power supplies that meet MIL-specs—and you probably want them in a hurry. Acopian can help on both counts.

Acopian offers over 4,000 AC to DC power modules that meet requirements of MIL-STD-810B, MIL-E-5272C and MIL-I-6181D. You'll find full details in our catalog.

And you can depend on Acopian for quick availability, too. Like all Acopian power supplies, your MIL-spec units will be on their way to you 3 days after receipt of your order. We guarantee it.

Do you have the latest Acopian catalog? To get your copy, write Acopian Corp., Easton, Pa. 18042 or call (215) 258-5441. And remember, every Acopian power module is shipped with this tag...



INFORMATION RETRIEVAL NUMBER 93

## Annual Reports

**American Electronic Laboratories, Inc.**, Richardson Rd., Colmar, Pa.  
Broadcasting equipment, CATV, microwave components, electronic countermeasure systems.

1969: net sales, \$21,484,741; net income (loss), (\$849,623).

1968: net sales, \$24,989,897; net income, \$492,555.

CIRCLE NO. 346

**AMP Inc.**, Eisenhower Blvd., Harrisburg, Pa.

Terminals and splices, connectors and interconnection systems, tooling, programming systems.

1969: net sales, \$211,256,000; net income, \$24,280,000.

1968: net sales, \$167,172,000; net income, \$16,227,000.

CIRCLE NO. 347

**Burroughs Corp.**, Detroit, Mich.

Small, medium and large-scale computers, peripheral devices, on-line data systems, data encoders, calculators.

1969: revenue, \$759,335,910; net income, \$55,198,755.

1968: revenue, \$655,560,491; net income, \$43,301,352.

CIRCLE NO. 348

**Dearborn Computer & Marine Corp.**, 6 N. Michigan Ave., Chicago, Ill.

Computer leasing, offshore petroleum drilling, marine services.

1969: total revenue, \$38,335,000; net income, \$2,727,000.

1968: total revenue, \$10,613,000; net income, \$1,250,000.

CIRCLE NO. 349

**Electronic Memories & Magnetics Corp.**, 3435 Wilshire Blvd., Los Angeles, Calif.

Semiconductor, core and disc memories, magnets and PC boards.

1969: net sales, \$84,440,000; net income, \$4,983,000.

1968: net sales, \$66,168,000; net income, \$3,792,000.

CIRCLE NO. 350

**The Electron Machine Corp.**, P.O. Box M, Umatilla, Fla.

Liquid-blending instruments, refractometers, gauging instruments, flaw detectors.

1969: sales and other income, \$873,584; net income, \$66,984.

1968: sales and other income, \$718,292; net income, \$40,503.

CIRCLE NO. 351

**High Voltage Engineering Corp.,**  
Burlington, Mass.

Shunt reactors, electrical insulation and plastics.

1969: net sales, \$23,654,625; net income (loss), (\$534,236).

1968: net sales, \$21,308,668; net income, \$1,434,402.

CIRCLE NO. 352

**Polarad Electronics Corp.,** 5 Delaware Dr., Lake Success, N. Y.

High-frequency instrumentation, spectrum analyzers.

1969: net sales, \$8,747,086; net income (loss), (\$408,330).

1968: net sales, \$8,627,497; net income (loss), (\$1,500,130).

CIRCLE NO. 353

**Sybron Corp.,** 1100 Midtown Tower, Rochester, N. Y.

Medical, process, control and water and waste-treatment equipment, chemicals.

1969: net sales, \$299,757,000; net income, \$16,735,000.

1968: net sales, \$267,523,000; net income, \$14,920,000.

CIRCLE NO. 354

**Texscan Corp.,** 5330 E. 38th St., Indianapolis, Ind.

Sweep generators, oscilloscopes, medical and television test equipment, microwave components.

1969: net sales, \$1,758,800; net income, \$197,791.

1968: net sales, \$1,376,367; net income, \$111,404.

CIRCLE NO. 355

**The Wheelabrator Corp.,** Mishawaka, Ind.

Air-pollution control, metals cleaning, aircraft assemblies and components, lubrication systems.

1969: net sales, \$87,848,930; net income, \$4,183,417.

1968: net sales, \$81,434,494; net income, \$3,957,314.

CIRCLE NO. 356



We make it possible by harnessing the space-saving advantages of the switching regulator—but have pulled its RFI fangs (input and output meet MIL-I-6181).

When you read our data sheet carefully, you'll also find it full of hidden features that other manufacturers would loudly acclaim.

Such as an IC regulating amplifier, automatic overvoltage crowbar, self-resetting automatic overload and short circuit protection, and even 30 ms full-load storage after the input voltage disappears.

Efficiency is so high that the very hottest spot on the heat sink has a rise of only 25°C.

You can actually hold our unit after hours of full-load bench operation without smelling burning flesh!

And is there any other unit you've heard about that will continue to deliver full-load at 71°C.—without derating, heat sinking or forced air cooling.

Single, dual, or triple outputs at voltage levels of 3V to 30V can be provided to your specific needs.

By the way, if you think our \$400 price is high, try adding the "optional extras" to anybody else's standard you had in mind.

Trio Laboratories, Inc., 80 Dupont Street, Plainview, L. I., N. Y. 11803. Tel.: (516) 681-0400.

TWX: (510) 221-1861.



# Now you can squeeze your 5V/20A power supply down to fit your microcircuitry.

INFORMATION RETRIEVAL NUMBER 94

# SHIELDED BOXES

Take  
your  
pick.

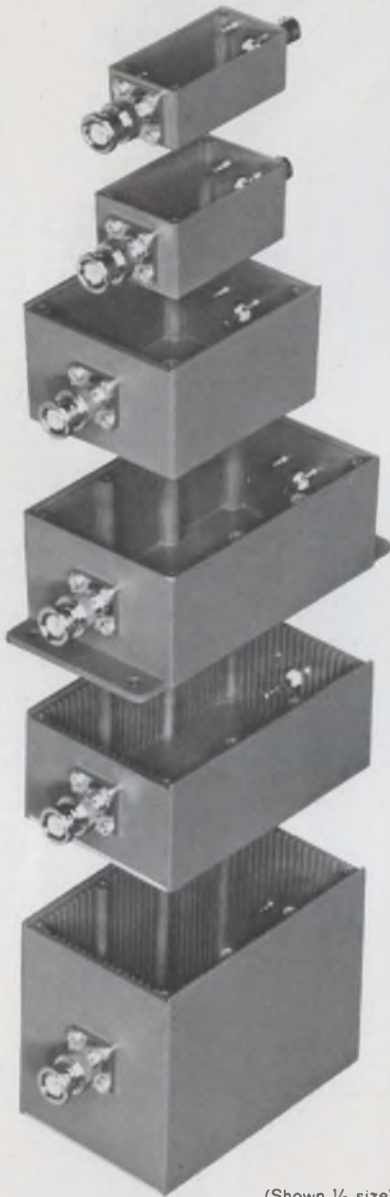

(Shown 1/3 size)

The newly expanded line of Pomona Shielded "Black Boxes" now comes in six different sizes; in cast or extruded aluminum; some slotted to accept circuit boards; in a broad choice of connector combinations or no connectors. There's bound to be one to meet your requirement. Write for complete information in our General Catalog.

**POMONA  
ELECTRONICS**

1500 E. Ninth Street • Pomona, California 91766

# Application Notes



## Cable design guide

A 24-page design guide shows packaging and cable designers how to use flexible etched cables in their component and system designs. It shows many graphic examples of good high-density low-volume interconnection and cable designs. Of interest to managerial personnel is the substantial cost reduction shown that can be achieved using flexible etched cable. Electro-Mechanism.

CIRCLE NO. 357

## Packaging specifications

A technical paper titled "General Specifications for Composite Packages" states all the standards which apply to ceramic composite packages. These include physical, dimensional, visual, hermetic, electrical, plating, environmental and mechanical standards. Insert sheets for standard operating procedures on such processes as etching and cleaning are included. American Lava Corp.

CIRCLE NO. 358

## MOSFETs and static

A technical article deals with the phenomenon of static electricity and its role in damaging sensitive electronic devices such as MOSFETs. It describes the basic concepts of static electricity, and shows in detail a method of offsetting it. Also included are specific handling precautions used by manufacturers of MOSFET devices. Custom Materials, Inc.

CIRCLE NO. 359

## Converter principles

The principles underlying the advanced performance of modern resolver/synchro-to-digital converters are described in a four-page article. Besides discussing the basic principles of the conversion technique, it highlights some of the inherent advantages. Specifically shown is the closed-loop servo which automatically minimizes the error effects caused by noise, harmonics, and quadrature that are inevitably superimposed on the data signal. North Atlantic Industries, Inc.

CIRCLE NO. 360

## IC pocket dictionary

Integrated-circuit terminology is completely listed in a handy pocket dictionary. It includes all IC terms from A to Z with definitions, an appendix of abbreviation standardizations, semiconductor symbols, multiple and submultiple prefixes, waveform notations and logic symbols. Sylvania

CIRCLE NO. 361

## Solenoids

A general discussion on solenoids, what they are, and how to use them, is contained in a new booklet. It includes a general discussion of the various types of solenoids, their operation, and installation problems to be avoided. Dormeyer Industries, Inc.

CIRCLE NO. 362

## Composite metals

"Designing Electrical Parts With Composite Metals" is a report that deals with the problem of conserving precious metals, and proposes the multimetal system, or cladding as it is sometimes called, as one solution. Discussions on cladding vs plating, the selection of base metals, and how to join composites, plus a detailed section of five forms of cladding techniques are included. Texas Instruments Inc.

CIRCLE NO. 363

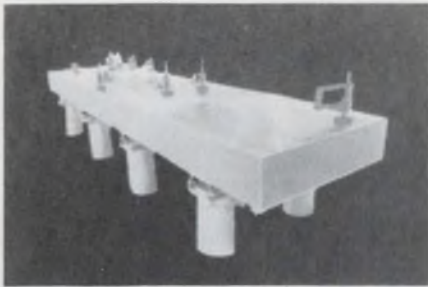

### Optical surfaces

A booklet entitled "Deflection of Optical Working Surfaces" discusses optical deflection, methods of making measurements and computations relative to deflection, and the advantageous nature of ferro-magnetic metalclad honeycomb optical table tops. Illustrations and equations are included. Modern Optics.

CIRCLE NO. 364

### Standards

A new 128-page standards catalog lists 4000 American National Standards and 1700 international recommendations approved through January 15, 1970. International standards are from the International Organization for Standardization (ISO), the International Electrotechnical Commission (IEC), the International Commission for Rules for the Approval of Electrical Equipment (CEE), and the Pan American Standards Commission (COPANT). American National Standards Institute, Inc.

CIRCLE NO. 365

### Fluidic governors

Application notes on fluidic governors for air motors are contained in a new brochure. It discusses the advantages that air motors have over other types of drive systems. Included is a block diagram of a fluidic governor system layout. Also included are torque-versus-speed and horsepower-versus-speed percent charts. Typical applications include automated drilling, explosive mixing, precision hand-held drills and constant-speed drives. General Electric Co., Specialty Fluidics Operation.

CIRCLE NO. 366

# clip this.

if you clip-mount components

Atlee Corporation, 2 Lowell Ave., Winchester, Mass. 01890  
Gentlemen: Please send me the new Atlee catalog featuring component holders and clips, tube shields and inserts.

NAME \_\_\_\_\_

TITLE \_\_\_\_\_

COMPANY \_\_\_\_\_

STREET \_\_\_\_\_

CITY \_\_\_\_\_

STATE \_\_\_\_\_

ZIP \_\_\_\_\_

Atlee component holders and clips are made of spring steel, beryllium copper, phosphor bronze, brass, or aluminum to provide the characteristics you require. Catalog C70 helps you select the holder or clip in the right size, shape, material and finish for your particular application. Send for it today.

INFORMATION RETRIEVAL NUMBER 96

# New Literature



## PC-board process

A new technical bulletin gives full-color step-by-step illustrations of a new PC-board process. The process eliminates artwork, photography, photoprinting, touch up, etching, stripping, and other time-consuming steps in PC-board development. Bishop Graphics.

CIRCLE NO. 367

## Computer manual

A compact 40-page user's manual and a trim catalog of library programs describing the Honeywell 1648 computer system are available. Programming languages include FORTRAN, BASIC, SOLVE, and TEACH. The library catalog groups by applications area: management sciences, engineering, education, games and demonstrations, information and advanced uses. Honeywell Information Services Division.

CIRCLE NO. 368

## Tekscope

The June 1970 Issue of Tektronix's Tekscope is available. It contains articles on pulse and general-purpose signal sources, the use of oscilloscopes as signal sources, and oscilloscope versatility with the use of plug-ins. A "Service Scope" section contains helpful troubleshooting and servicing hints for instrument servicing. Tektronix, Inc.

CIRCLE NO. 369

## Filters

Low-pass, high-pass, bandpass, telegraph tone channel and custom-designed filters are described in a new brochure. Custom designs include notch, noise-weighting, constant-delay, and constant-phase networks. BG Electronics, Inc.

CIRCLE NO. 370

## Coaxial cables

Bulletin 470-1 gives features, typical applications and choice of materials for center conductors, dielectrics, shields and jackets to meet specifications and requirements in the use of microminiature coaxial cables. The cables are ideal for use in interconnecting electronic systems of reduced size and for keeping crosstalk down to a minimum. Berk-Tek, Inc.

CIRCLE NO. 371

## Microelectronics

"Hybrid Microelectronics Review" is a new monthly technical news letter that condenses thin/thick-film microcircuit information. It is designed to assist personnel involved in the hybrid microelectronics field. A scanning service, under the direction of a technical review board, summarizes current technical, marketing, financial and production information concerning thin/thick-film technology. Hybrid Microelectronics Review

CIRCLE NO. 372

## Time-sharing

"The Changing Costs of Time-Sharing" is the title of a special report that focuses on the price changes of five time-sharing vendors. These vendors are Allen-Babcock Computing, Applied Logic Corp., Com-Share, Inc., General Electric and Tymshare, Inc. The report quotes comments from a cross section of time-sharing vendors and users. Time-Sharing Enterprises, Inc.

CIRCLE NO. 373



## Heathkit catalog

The 1970 issue of the Heathkit catalog is now available. It is crammed with 116 pages of consumer electronic equipment, electronic test instruments, hobbyist items, Citizen's-Band equipment and electronic devices for marine applications. Heath Co.

CIRCLE NO. 374

## Zener diodes

A full line of zener diodes is shown in a quick-reference six-page guide. It covers power ranges from 400 mW through 75 W in units with 5% tolerance. The line includes 183 types available from stock, and brief data on pertinent characteristics for each diode, plus dimensional outlines. Mullard Inc.

CIRCLE NO. 375

## Computer plots

Samples of a unique data terminal's X-Y plots known as Typagrams are shown in a new 36-page scrapbook. It contains Typagram plots of voltage and phase angle vs frequency and undamped transient response. Other plots include power level and impedance vs frequency and polynomial and cycloid patterns. Most Typagrams shown were produced in less than 3 minutes by conversing with a remote time-shared computer. Typagraph Corp.

CIRCLE NO. 376





### Wire and cable

A new illustrated 35-page catalog contains specifications for a line of cable, wire, insulating materials and irradiated shrinkable tubing. Products featured are structurally designed for power, communications, military and industrial applications. Coleman Cable Electronic Products Div.

CIRCLE NO. 377

### Delay lines

Fourteen standard electromagnetic delay lines for digital circuitry applications are described in an eight-page brochure. Delays range from 7 to 1000 ns and the smallest delay line measures 0.49 by 0.49 by 0.37 in. Impedances are 100  $\Omega$  and all units meet applicable portions of MIL-D-23859A. The brochure contains detailed physical and electrical schematics for all units. ESC Electronics, a div. of General Laboratory Associates.

CIRCLE NO. 378

### Pulsed rf measurements

A new technique for instantaneous frequency measurement and its application to measuring the frequencies of pulsed rf signals is described in a 16-page application note. It tells how to use a computing counter to make these measurements easily and accurately. Hewlett-Packard.

CIRCLE NO. 379

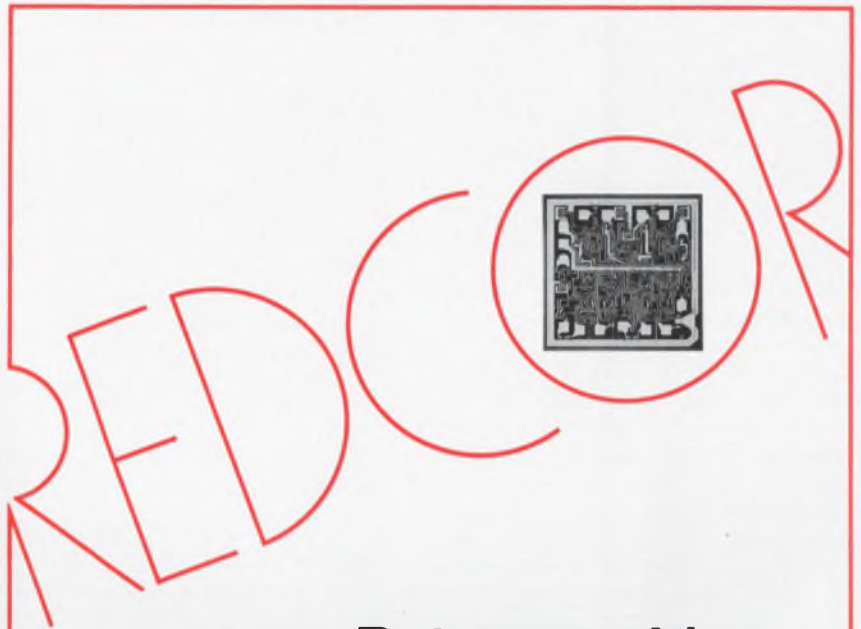

## Bet your chips on a sure thing

The REDCOR PAFT II takes the gamble out of chip testing. It's the MOS/LSI Tester using REDCOR's systems-proven analog and digital components plus the field-proven RC 70 Computer. The Systems Pros at REDCOR have put it all together in a total system for high speed production testing of MOS/LSI devices. And it's been hard at work in the field for a year and a half.

PAFT II is a shoo-in to use. The TEST software package lets technicians write testing routines in an easy-to-use, problem-oriented language. All tests are completely under control of the computer program. Both parametric and functional testing.

When your chips are down for testing, don't gamble. Take the sure bet: come to REDCOR and PAFT II. We're delivering. Call us collect for more information.

**R** REDCOR CORPORATION  
**C** Telephone: (213) 348-5892

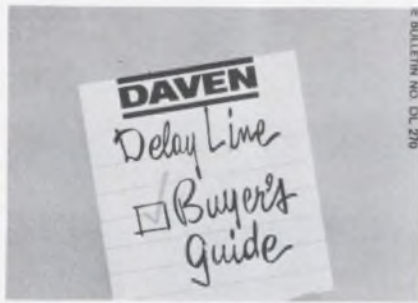

### Delay line guide

Delay lines are the subject of a four-page two-color buyer's guide. It discusses in detail seven prime parameters that must be considered in specifying a delay line. These are: delay time, rise time, attenuation, impedance, distortion, temperature coefficient and package design. These factors are then related to determine varying delay line complexities and costs. Daven Div., McGraw-Edison Co.

CIRCLE NO. 380

### Variable filters

Three notes on the use of a line of variable filters are available. Filters include active, general-purpose, laboratory instrument, operational and high-pass/low-pass types. Rockland Systems Corp.

CIRCLE NO. 381

### Microwave tubes

A condensed 48-page catalog describing a line of microwave tubes gives specifications on more than 200 magnetrons, klystrons, crossed-field amplifiers, traveling-wave tubes, and backward-wave oscillators operating at various frequency bands and power levels. Much of the information is illustrated and cross referenced. Raytheon Co.

CIRCLE NO. 382

### Coaxial connectors

The latest mechanical and electrical data on stainless-steel SAM connectors per MIL-C-39012 is shown in a new nine-page catalog. Included in the catalog are miniature connectors for semi-rigid and flexible cable, striplines, solder pots, printed circuits and tees. Applied Engineering Products Div. of Samarius, Inc.

CIRCLE NO. 383

### Rf connectors

Covering all major rf connector classifications and subtypes is a 161-page fully illustrated catalog. It includes comprehensive part number cross-reference tables, cable data and cable assembly instructions. Dimensions and engineering data for each connector, adapters, terminations and diagrams of mounting holes and plates are included. Bendix Corp.

CIRCLE NO. 384

### Interconnections

A comprehensive line of industrial connectors, plugs and sockets is presented in a 32-page catalog. This full-color publication contains photographs, line drawings, electrical characteristics and mechanical specifications. A selection guide completes the information needed to find the right component for any equipment or circuit application. Amphenol Industrial Div., The Bunker-Ramo Corp.

CIRCLE NO. 385

### Packaging parts

Standard industry packaging for integrated circuits, photodiodes, phototransistors, and crystal frequency and crystal filter devices is detailed in a 12-page brochure. Both window and lens-type photo-covers plus subminiature photo-device housings are shown. Cold-weld packages for crystals include flatpacks for monolithic filters and larger transistor-type packages. GTI Corp., Saegertown Products Div.

CIRCLE NO. 386

### Silicones

"Ideas" is the title of a 32-page, four-color booklet describing the basic functions performed by silicones, fluorosilicones, semiconductor-grade silicon and solid-film lubricants. It includes sections on bonding, sealing, adhering, encapsulating, potting and molding. Dow Corning.

CIRCLE NO. 387



### Pollution control

"Pollution Control, a Kit for Concerned Citizens," is the title of a general information packet on water pollution and the means available for its solution. Included in the packet is a general statement of concern about the environment, a glossary of terms used to describe the water pollution problem and a regional analysis of water pollution problems. Rex Resource Bureau.

CIRCLE NO. 388

### High-voltage capacitors

Information on a new line of high-voltage, fixed and variable gas dielectric capacitors, with voltage ratings to 20 kV peak and capacitances to 3000 pF is provided in a 48-page catalog. Included in the catalog is a chart giving type numbers which are fully interchangeable with vacuum-type capacitors. Energy Laboratories, Inc.

CIRCLE NO. 389

### Transmission lines

A new rigid 800 coaxial transmission-line catalog contains complete electrical and mechanical specifications on a full line of copper and aluminum transmission lines. It also includes a complete listing of accessory items. Prodelin

CIRCLE NO. 390

### High-Q capacitors

High-Q variable capacitors are featured in a new catalog. It details miniature, subminiature, air, general-purpose, microcircuit-trimmer, PC, high-voltage and rf quartz types. Johanson Manufacturing Corp.

CIRCLE NO. 391



### Coaxial relays

A new line of vacuum coaxial relays is listed in a 20-page general catalog. It contains detailed electrical and mechanical specifications that are completely indexed for ready reference. Dow-Key Co.

CIRCLE NO. 392

### Ac/dc converter

The design evolution of a precision ac/dc converter is described in an eight-page application note. The design starts with a precision rectifier using two chopper-stabilized operational amplifiers. Measurements of conversion linearity, output ripple and step response are described and the results are graphed. The converter output filter is then changed in steps with the performance changes illustrated on the graphs. The final circuit uses an active three-pole Butterworth low-pass filter with a 0.25-Hz cutoff frequency. Testronic Development Laboratory.

CIRCLE NO. 393

### Computer plots

A series of very informative booklets entitled "Easy Plotting Procedures" is available. The booklets give a simple step-by-step description of how all types of X-Y plots can be produced automatically using software packages now available through major time-sharing services. Anyone who can use a teleprinter can produce single or multiple X-Y plots from computer lists by merely following the procedures outlined in these booklets. Typagraph Corp.

CIRCLE NO. 394

# LED

## New low cost LED Vactrol photon isolator

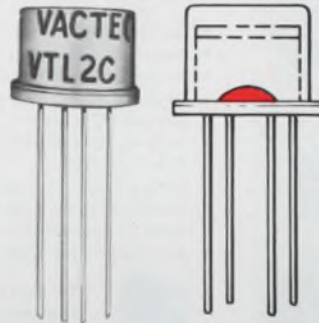

as low as \$4.20 each in 1,000 quantities

- all solid state
- 4 types of photoconductors combined with LEDs
- hermetically sealed TO-5 enclosure
- unlimited life—no filaments
- ideal for environments where shock and vibration are a problem
- applications include photochoppers, linear isolators, noiseless switching, SCR and triac turn-on, audio level controls, etc.

Part Number	LED	PHOTOCELL		
	Current (ma) (1.65v typ.)	Max. Cell Resistance	Typical Rise Time (ms)*	Decay
VTL2C1	40	10 KΩ	.5	3.5 ms **
VTL2C2	40	500 Ω	3.5	500 ms †
VTL2C3	40	2 KΩ	2.5	35 ms †
VTL2C4	40	75 Ω	6.0	1.5 sec †

\* To 63% conductance

\*\* To 1 meg

† To 100 KΩ

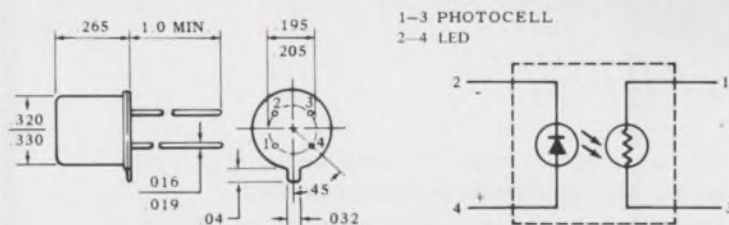

Vactec confines its production activities entirely within the United States. Advanced mechanized techniques provide highest quality at prices competitive with other manufacturers anywhere in the world.



## VACTEC, INC.

2423 Northline Ind. Blvd.  
Maryland Heights, Mo. 63043  
Phone: (314) 872-8300  
Write for Bulletin VTL2C

Specializing in standard Cds, Cdse, and Se sells; custom engineering for every photocell need.

Listed in EBG under "Semi-Conductors" and in EEM Sec. 3700.

INFORMATION RETRIEVAL NUMBER 98

# FOR EXCELLENCE IN ROTARY SWITCHES

## SPECIFY GRAYHILL



- 15°, 30°, 36°, 45°, 60° or 90° Angle Of Throw
- 2 To 24 Positions Per Pole
- Ratings Up To 15 Amps.
- 1 To 6 Poles Per Deck
- 1 To 12 Decks
- Diameters 1/2" To 2 1/4"
- Shorting Or Non-shorting Contacts
- Explosion Proof
- Military Or Commercial Styles
- Single Or Concentric Shafts
- Solder Lug Or Printed Circuit Terminals
- Switch And Potentiometer Combinations
- Key Lock Option
- Homing Rotor (Bridging And Shorting) Option
- Spring Return Option
- Power or Signal Switching
- Isolated Position (Pull-To-Turn) Option
- Adjustable Stop Option



For your Grayhill  
Engineering Catalog  
offering complete technical  
data—contact

565 Hillgrove Avenue  
LaGrange, Illinois 60525  
Area Code 312, Phone 354-1040



... the Difference Between Excellent and Adequate

INFORMATION RETRIEVAL NUMBER 101

# WIRE WRAP BUILDING BLOCK

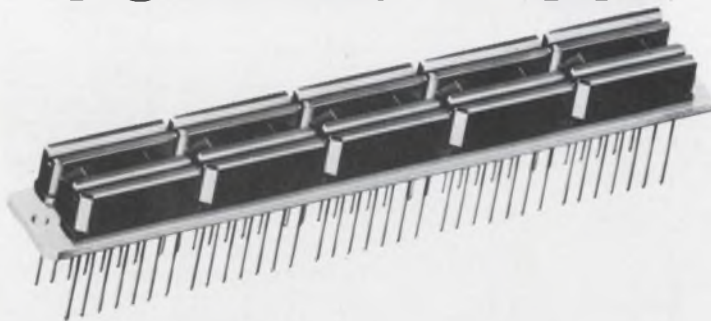

- New approach permits fast breadboarding or prototyping. May be chassis or board mounted.
- Socket groups are positioned with pins on .100 inch grid spacing, suitable for automatic wire wrapping.
- Mounting saddle is furnished with power and ground planes, also available without circuitry.
- Power and ground planes on either side of board are tied directly into mounting holes, permitting bussing together for groud construction.

**AUGAT**  
INC.

Request complete I. C. folder.  
TEL: 617-222-2202  
31 PERRY AVE., ATTLEBORO, MASS. 02703

INFORMATION RETRIEVAL NUMBER 102

## Bulletin board

of product news  
and developments

A frequency synthesizer that covers the 1 to 12.4-GHz range in a single band (1-MHz steps) is now in the breadboard stage at Watkins-Johnson. Tentative specifications include an accuracy of five parts in 10<sup>7</sup> (using the internal standard) and a leveled output of 1 mW ±2 dB across the full band. Unleveled outputs are expected to vary greatly—from 25 mW at 2 GHz to 1 mW minimum at 12.4 GHz.

Integrated color processing circuitry for color television receivers has been developed by the Zenith Radio Corp. for use in its 1971 line. Heart of the new system is three matched ICs: a chroma amplifier, a subcarrier regenerator and a color demodulator circuit.

Second-source pin-for-pin replacement rf power transistors are now available for users of mobile, maritime and military communications equipment. The manufacturer, Solid State Scientific, Inc., of Montgomery, Pa., says the new devices will be cost-competitive with those supplied by Motorola, TRW, and RCA. The transistors will cover the 100 to 500-MHz frequency range with power ratings of 5 mW to 50 W.

CIRCLE NO. 395

Assuring telephone privacy, a new device called Phone-Censor allows the user to talk with another person in the same room without interrupting the party on the line. Pressing a small button on the device cuts off the phone transmitter, but does not affect audio reception. Phone-Censor can be easily installed in the mouthpiece of any standard telephone in a matter of minutes. Suggested retail price is \$2.95. The manufacturer is Multimanufacturing Inc., El Segundo, Calif.

CIRCLE NO. 396

# New! Zenith's colorful two gun CRT

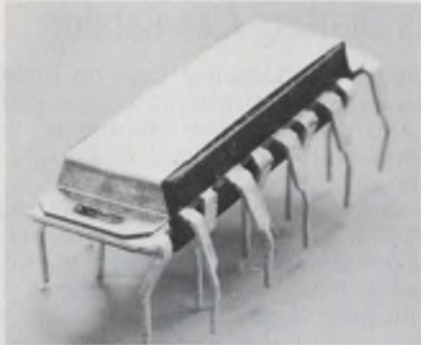

Three developmental linear ICs have been introduced by the RCA Solid State Div. for the video and chroma sections of color television receivers. One circuit, the TA5914, is a complete television video i-f system that performs ten separate functions on a single monolithic chip. The other two circuits form a complete chroma system—the TA5625 is a chroma control system, and the TA5752 is a chroma demodulator. Evaluation quantities are available now, while production quantities will be ready the first quarter of 1971.

CIRCLE NO. 397

Called ALICE, a program for the simulation of digital logic networks can be used to verify the behavior of a logic network or to analyze network timing problems. ALICE can simulate circuits implemented in any form, from completely asynchronous designs to synchronous two and four-phase MOS designs. Network input is simplified by the program's catalogs of standard logic families. Originated by Applicon Inc., Burlington, Mass., ALICE is intended for remote-access and remote-batch use from a Teletype or similar terminal.

CIRCLE NO. 398

Price reductions of about 50% are now in effect for the EDAC series of d/a converter modules from DDC, a div. of Solid State Scientific Devices Corp. Costs, which were \$150 to \$400, range from \$79 to \$189 for accuracies of 8 to 11 bits.

CIRCLE NO. 399

Where precise, high resolution color displays are essential, Zenith Dual Neck, Flat-Face Two Color CRTs offer the best answer. Independent operation of two guns allows different scan formats and rates without the need of complex switching circuits . . . assuring excellent color purity from edge to edge. Details are easily separated by variations of vivid color. For specifications, write for Zenith's new Dual Neck product file.

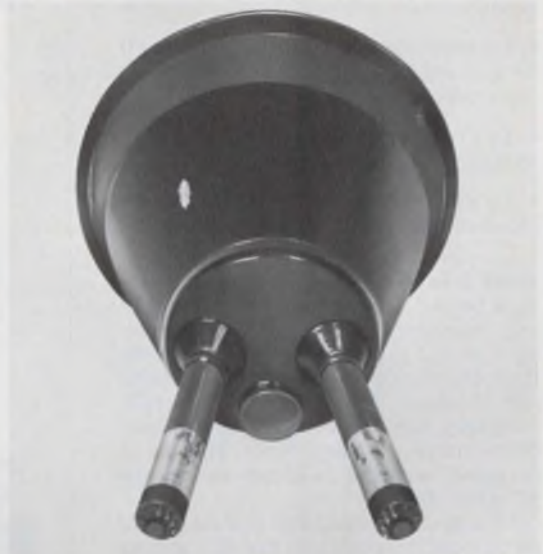

**ZENITH RADIO CORPORATION**  
THE RAULAND DIVISION

5616 W. JARVIS AVE. • CHICAGO, ILL. 60648 • 312-647-8000

INFORMATION RETRIEVAL NUMBER 103



## LIQUID RIVET

One drop bonds almost anything to almost anything for almost forever. We call it Eastman 910<sup>®</sup> Adhesive. It works with metals. With plastics. With rubber. With glass. With bonds that are often stronger than the materials being bonded. It works without heat. Without solvents. Without pressure. Without catalysts. And without a lot of waiting. Philco-Ford uses Eastman 910 to bond aluminum to aluminum. Cessna uses it to bond rubber to acrylic plastic. Bendix uses it to bond steel to brass. For more information, call your Eastman representative. Or write Eastman Chemical Products, Inc. Kingsport, Tennessee.

You may find that Eastman 910 bonding is a lot easier than what you're doing now. More economical. Maybe even quieter.

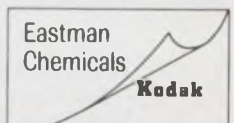

INFORMATION RETRIEVAL NUMBER 104

# Electronic Design

ELECTRONIC DESIGN's function is:

- To aid progress in the electronics manufacturing industry by promoting good design.
- To give the electronic design engineer concepts and ideas that make his job easier and more productive.
- To provide a central source of timely electronics information.
- To promote two-way communication between manufacturer and engineer.

**Want a subscription?** ELECTRONIC DESIGN is sent free to qualified engineers and engineering managers doing design work, supervising design or setting standards in the United States and Western Europe. For a free subscription, use the postfree application form inside the back cover. If none is included, write to us direct for an application form.

If you do not qualify, you may take out a paid subscription for \$25 a year in the U.S.A., \$35 a year elsewhere. Single copies are \$1.50 each.

**If you change your address,** send us an old mailing label and your new address; there is generally a prepaid postcard for this inside the back cover. You will have to requalify to continue receiving ELECTRONIC DESIGN free.

**The accuracy policy of ELECTRONIC DESIGN is:**

- To make reasonable efforts to ensure the accuracy of editorial matter.
- To publish prompt corrections whenever inaccuracies are brought to our attention. Corrections appear at the end of the Letters column.
- To refuse any advertisement deemed to be misleading or fraudulent.

Microfilm copies are available of complete volumes of ELECTRONIC DESIGN at \$19.00 per volume, beginning with Volume 9, 1961. Work is now in process to complete the microfilm edition of Volumes 1-8. Reprints of individual articles may be obtained for \$2.00 each, prepaid (\$.50 for each additional copy of the same article) no matter how long the article. For further details and to place orders, contact the Customer Services Department, University Microfilms, 300 North Zeeb Road, Ann Arbor, Michigan 48106; telephone (313) 761-4700.

**Want to contact us?** If you have any comments or wish to submit a manuscript or article outline, address your correspondence to:

Editor  
ELECTRONIC DESIGN,  
850 Third Avenue,  
New York, N.Y. 10022.

# Design Data from

## 1970 Electronic Components Drafting Aids Catalog



**Free Catalog! Free Samples!** Exciting innovations in pressure-sensitive electronic component drafting aids and methods are detailed in the new 1970 edition of the combined Bishop Technical Manual and Catalog 104A.

68 illustrated pages of over 15,000 multi-pad configurations, symbols, tapes, sequential reference designations plus hundreds of time-and-money-saving hints in making artwork for PC boards. Includes instructions for using the industry's only red and blue tape system for making two-sided boards in perfect registration.

Send now for free Catalog 104A and free samples.

**Bishop Graphics, Inc.**  
7300 Radford Avenue  
North Hollywood, California 91605  
(213) 982-2000 Telex: 674672

171

## An Engineering "Answer" Manual For Circuit Designers: "Selecting, Specifying, Optimizing Modern Crystal Filters"



Prepared by network designers who have pioneered the evolution of the modern crystal filter, this Bulova Answer Manual contains all of what you need to know to Select, Specify and Optimize Modern Crystal Filters. Each step to optimization is graphically evaluated, simple to follow and easy to understand. It's 28 pages includes material on Filter Theory; Parametric Interdependence; Practical Considerations of Packaging vs Performance; Specifying for Optimum Design and Design Tradeoffs for Maximum Performance/Minimum Cost. The manual is FREE upon letterhead-request to anyone involved in the application, specification or purchasing of crystal filters.

**Bulova Watch Company Inc.**  
Electronics Division  
61-20 Woodside Avenue  
Woodside, New York 11377

172

## NEW RELAY SOCKET ASSEMBLIES CATALOG

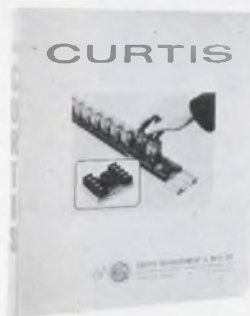

The new Curtis line of printed circuit snap-in track-mounted relay socket assemblies is completely illustrated in this new 2-color, 6 page catalog. Variations include RS8 octal relay sockets, as well as RS11 and RS15 with eleven and fifteen pin relay sockets. Complete dimensional drawings and list prices are included. All units snap in or pop out vertically from prepunched vinyl track and feature Curtis barrier terminal blocks. CSA approved. Send today for your free copy.

SEE US AT WESCON - BOOTH 1018

**Curtis Development & Mfg. Co.**  
3236 North 33rd Street  
Milwaukee, Wisconsin 53216

173

# Manufacturers

Advertisements of booklets, brochures, catalogs and data sheets. To order use Reader-ServiceCard (Advertisement)

## Bus Bars For Noise Reduction

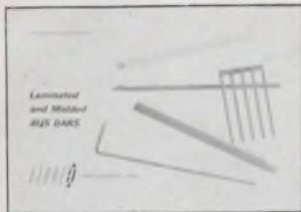

A 16 page Technical Bulletin is now available, describing a new concept in power or signal distribution. Basic mechanical and electrical design principles, along with descriptive pictures and diagrams, are included in this bulletin. These compact buses can replace bulky cable harnesses and repetitive wiring for computer or modular application. This method of construction satisfies the demanding requirements of low inductance and resistance of high speed, solid state systems, while controlling electrical noises.

Send For Free Sample

**Eldre Components, Inc.**  
1239 University Avenue  
Rochester, New York 14607

174

## FREE APPLICATION NOTES ON 12 BIT MONOLITHIC IC D/A CONVERTER CIRCUITS



A multipage application note is offered free by Analog Devices on the new  $\mu$ DAC monolithic IC D/A converter circuits. Both theory of operation and practical applications data is supplied for up to 12 bit ( $\pm 1/2$ LSB) converters through the use of circuit diagrams, photographs and comprehensive text. Descriptions of circuit applications for new monolithic current and voltage switches in DIP and flatpacks are included. Reply card offering evaluation samples is included with the application note.

**ANALOG DEVICES**  
221 FIFTH ST., CAMBRIDGE, MASS. 02142  
TEL: 617/492-6000

175

## NEW Integrated Circuit Techniques



A new problem-solving handbook from **Westinghouse Defense and Space Center** on both digital signal processing and linear integrated circuits. Stresses **systems applications** of integrated circuit devices and techniques to radar signal processing, indicator-display symbol generation, UHF communications, and TV camera developments. Extensively uses examples to help you select the optimum design to realize your specific system requirements. Pub. March 1970, 448 pp., 300 illus., 7x9 1/4", \$16.95. Circle the reader-service number below for a 15-day examination copy.

**Prentice-Hall, Inc.**  
Englewood Cliffs, N.J. 07632

176

# Electronic Design

**Advertising Sales Staff**  
Keith Aldrich  
Sales Manager

**New York 10022**  
Robert W. Gascoigne  
Samuel M. Deitch  
850 Third Avenue  
(212) Plaza 1-5530  
TWX: 867-7866

**Philadelphia 19066**  
William C. Repetto  
P. O. Box 206  
Merion Station, Pa.  
(215) MA-3-5888

**Boston 01945**  
Joseph F. Palmer  
14 Peter Hobart Drive  
Hingham, Mass.  
(617) 742-0252

**Chicago 60611**  
Thomas P. Kavooras  
Berry Conner, Jr.  
200 East Ontario  
(312) 337-0588

**Cleveland**  
Thomas P. Kavooras  
(Chicago)  
(312) 337-0588  
(call collect)

**Los Angeles 90303**  
Stanley I. Ehrenclou  
W. James Bischof  
2930 Imperial Highway  
Inglewood, Calif.  
(213) 757-0183

**San Francisco 94022**  
Arthur R. Shields, Jr.  
95 Main Street  
Los Altos, Calif.  
(415) 941-3084

**London W. 1**  
For United Kingdom and Holland  
Brayton C. Nichols  
44 Conduit Street  
Tel: REGent 4714

**Verviers, Belgium**  
For Continental Europe  
Andre Jamar  
1, Rue Mallar, 1  
087) 253.83 Telex 41563

**Tokyo**  
Haruki Hirayama  
Electronic Media Service  
5th Floor, Lila Bldg.,  
4-9-8 Roppongi  
Minato-ku  
Phone: 402-4556  
Cable: Electronicmedia, Tokyo



**AMERICAN BUSINESS PRESS, INC.**

## STABILITY & QUALITY

High quality capacitors unrivalled in the precision, dependability and compactness. Quality is recognized by ever wider use in measurement equipment, computers, and automatic controllers. "LEAF" the matter of capacitors to MATSUO ELECTRIC CO.

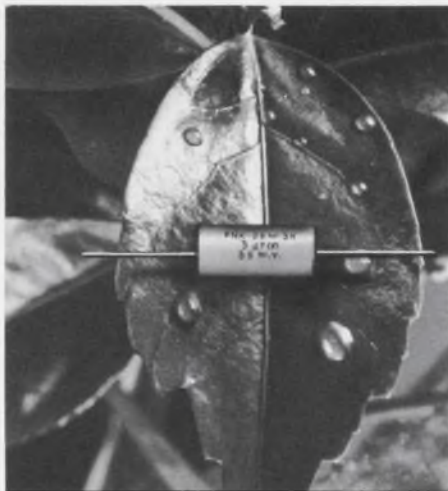

# MATSUO

## METALLIZED POLYESTER FILM CAPACITOR - "TYPE FNX-H"

### Specifications:

Operating Temperature Range:  $-40^{\circ}\text{C}$  to  $+85^{\circ}\text{C}$   
 Standard Voltage Rating: 100, 200, 400, 600 VDC  
 Standard Capacitance Value: .1 MFD to 10 MFD.  
 Standard Capacitance Tolerance:  $\pm 20\%$  (available  $\pm 10\%$ )

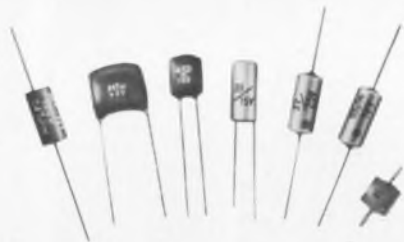

MATSUO'S other capacitors include:

**Solid Tantalum Capacitors:** MICRO-CAP for hybrid ICs, Type TAX hermetically sealed in metallic case, Type TSX encased in metallic case and sealed with epoxy resin, Type TSL encased in metallic case and sealed with epoxy resin. **Polyester Film Capacitors:** Type MFL epoxy dipped, Type MFK epoxy dipped, non inductive, Type MXT encased in plastic tube, non inductive.

For further information, Please write to  
 Manufacturers and Exporters

### MATSUO ELECTRIC CO., LTD.

Head Office: 3-5, 3-chome, Sennari-cho, Toyonaka-shi, Osaka, Japan  
 Cable: "NCCMATSUO" OSAKA Telex: 523-4164 OSA  
 Tokyo Office: 7, 3-chome, Nishi-Gotanda, Shinagawa-ku, Tokyo

INFORMATION RETRIEVAL NUMBER 105

# Advertisers' Index

Advertiser	Page	Advertiser	Page
ADC Products, A Division of Magnetic Controls Co.	122	IMC Magnetics Corp.	129
AMF, Incorporated, Potter & Brumfield Division	29	KMC Semiconductor Corporation	107
AMP, Incorporated	20	Magnecraft Electric Company	60
Abbott Transistor Laboratories Incorporated	13	Malco Manufacturing Company, Inc.	56
Acopian Corp.	142	Matsuo Electric Co., Ltd.	154
Advanced Memory Systems, Inc.	112	Mechanical Enterprises, Inc.	130, 131
Allen-Bradley Co.	4, 5	MicroSwitch, A Division of Honeywell	58
American Lava Corporation	37	Molex Products Company	23
Amphenol, The Bunker-Ramo Corporation	15, 58	Monsanto Company	Cover III
Analog Devices, Inc.	153	Monroe, A Division of Litton Industries	38, 39
Arrow-Hart, Inc.	44, 45	Motorola Semiconductor Products, Inc.	50, 51
Atlee Corporation	145	National Electro Mechanical Systems, Inc.	66
Augat, Inc.	151	Nortronics Company, Inc.	126
Automatic Electric Company	34, 35	Philips Electronic Components and Materials Division	137
Beckman Instruments, Inc., Helipot Division	105	Pomona Electronics Co., Inc.	144
Belden Corporation	54, 55	Potter & Brumfield Division of American Machine & Foundry Company	29
Bishop Graphics, Inc.	152	Precision Monolithics, Incorporated	115
Bodine Electric Company	24	Prentice-Hall, Inc.	153
Bulova Watch Company, Electronics Division	152	QED Systems Inc.	132
Cambridge Thermionic Corporation	62	Qualidyne Corporation	52, 53
Celanese Plastics Company	59	RCA Electronic Components and Devices	31, Cover IV
Centralab, the Electronics Division of Globe-Union, Inc.	63	Redcor Corporation	147
Cinch-Graphik, A Division of TRW Inc.	17	Relcom	128D
Cincinnati Milacron, Inc., Information Products Group	6	Rental Electronics, Inc.	128
Clare-Pendar	12	Rotron, Incorporated	97
Computer Microtechnology, Inc.	41	S & EI Corp.	140
Computer Products	33	Sangamo Electric Company	102
Cunningham Corporation, Subsidiary of Gleason Works	141	Sharp Electronics Corporation	119
Curtis Development & Mfg. Co.	152	Solitron Devices, Inc.	125
Dale Electronics, Inc.	Cover II	Sperry Gyroscope Division, Electro Optics	61
Datapac Incorporated	14	Sprague Electric Company	18
Delevan Electronics A Division of American Precision Industries, Inc.	127	Sylvania Electronic Components Microelectronics	103
Deltron, Inc.	136	Sylvania Precision Materials Parts Division	2
Dialight Corporation	58	Sylvania Electric Products Inc., Electronic Components Group	32A-H
Durant Digital Instruments, A Cutler-Hammer Company	66	Syntronic Instruments, Inc.	140
ERA Transpac Corporation	138	Tektronix, Inc.	49, 109
Eastman Chemical Products, Inc.	150	Teletype Corporation	90, 91
Elco Corporation	16	Texas Instruments Incorporated, Components Group	27
Eldre Components, Inc.	153	Trio Laboratories, Inc.	143
Electronic Design	155	Triplet Corporation	95
Erie Technological Products, Inc.	46	Tung Sol Division, Wagner Electric Corporation	124
Fairchild Semiconductor, A Division Fairchild Camera and Instrument Corporation	8, 9, 128 A-B-C	Vactec Inc.	149
Fluke Mfg. Co., Inc., John	101	Vega Precision Laboratories, Inc.	62
Gencom Division, Varian/EMI	134	Venus Scientific, Inc.	62
General Automation, Inc.	57	Victoreen Instrument Division	135
General Dynamics	84, 85	Watkins-Johnson	139
General Electric Company	111	Winchester Electronics, Division of Litton Industries	10
General Electric Company, Electronic Components	42, 43	Xerox Data Systems	11
General Reed Division of Sigma Instruments, Inc.	96	Zenith Radio Corporation	151
Gosh Instruments, Inc.	66	Hayden Book Company, Inc.	64
Gould Clevite Piezoelectric Division	133	Hewlett-Packard	1, 7, 65, 68, 78, 79
Grayhill, Inc.	150	Honeywell Test Instruments Division	67



now you can reach  
more engineers  
and reach them  
faster...

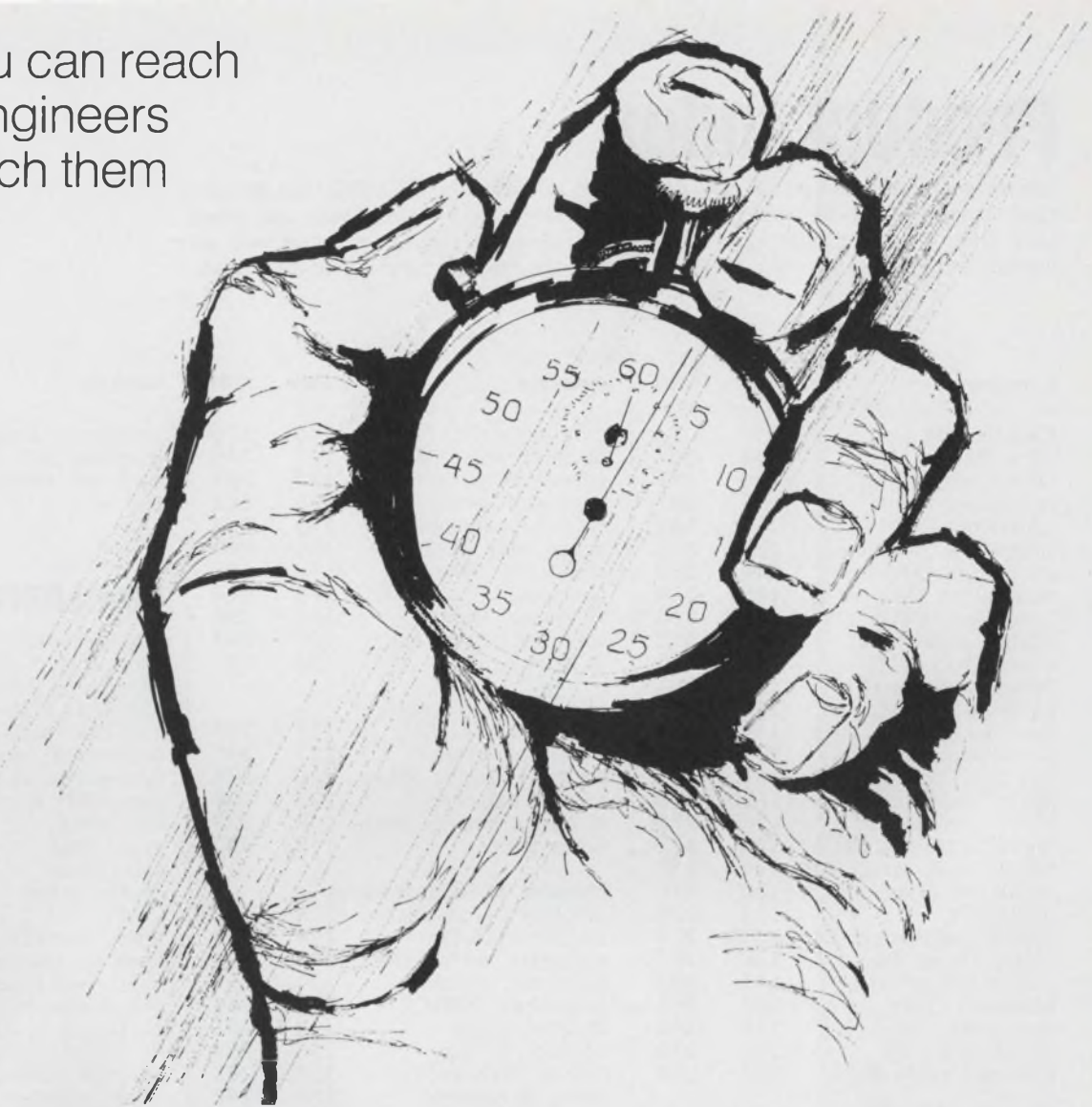

Electronic Design's *NEW*

# FAST CLOSE FORM

Marketing and salespeople can't specify your products... engineers can. Products don't move through distributors until they are specified by engineers. Now there's a way to reach *more*\* EOEM engineers and reach them *faster*. It's Electronic Design's new FAST CLOSE FORM—right up front in the News Section. You can get out your new product story, your price announcements or delivery and distribution information, quickly, while they're still hot. Closing date for film positives is only 24 hours before press time... 48 hours before the issue mails. You save 3 full weeks over normal closing. The form will accept full pages or spreads in b&w or 2-color; premium is only \$150 per insertion. Call your Electronic Design representative today for complete information.

\*Electronic Design has 72,271 EOEM engineers and engineering managers—53,372 more than Electronic News... 37,998 more than Electronics. Source: December, 1969 BPA and ABC Publisher's Statements.

## ELECTRONIC DESIGN FAST CLOSE SCHEDULE

(Post on your production bulletin board.)

ISSUE DATE	REGULAR CLOSING	FAST CLOSE		ISSUE DATE	REGULAR CLOSING	FAST CLOSE	
		ORDER IN N.Y. OFFICE	FILM POS. AT PRINTER			ORDER IN N.Y. OFFICE	FILM POS. AT PRINTER
June 7	May 4	May 22	May 25	Sept. 27	Aug. 24	Sept. 11	Sept. 14
June 21	May 18	June 5	June 8	Oct. 11	Sept. 8	Sept. 25	Sept. 28
July 5	June 1	June 19	June 22	Oct. 25	Sept. 21	Oct. 9	Oct. 12
July 19	June 15	July 3	July 6	Nov. 8	Oct. 5	Oct. 23	Oct. 26
Aug. 2	June 29	July 17	July 20	Nov. 22	Oct. 19	Nov. 6	Nov. 9
Aug. 16	July 13	July 31	Aug. 3	Dec. 6	Nov. 2	Nov. 20	Nov. 23
Sept. 1	July 27	Aug. 14	Aug. 17	Dec. 20	Nov. 16	Dec. 4	Dec. 7
Sept. 13	Aug. 10	Aug. 28	Aug. 31				

# Product Index

**Information Retrieval Service.** New Products, Evaluation Samples (ES), Design Aids (DA), Application Notes (AN), and New Literature (NL) in this issue are listed here with page and Information Retrieval numbers. Reader requests will be promptly processed by computer and mailed to the manufacturer within three days.

Category	Page	IRN	Category	Page	IRN	Category	Page	IRN
<b>Components</b>			data plots (NL)	146	<b>376</b>	positioner, work	139	<b>340</b>
cable design (AN)	144	<b>357</b>	decimal table (DA)	141	<b>345</b>	soldering gun	138	<b>337</b>
cables, coaxial (NL)	146	<b>371</b>	generator, pulse	134	<b>289</b>	surfaces, optical (AN)	145	<b>364</b>
capacitors (NL)	148	<b>391</b>	generator, pulse	135	<b>292</b>	tool kit	138	<b>338</b>
capacitors, HV (NL)	148	<b>389</b>	Heathkit catalog (NL)	146	<b>374</b>			
capacitors, tantalum	130	<b>277</b>	scope news (NL)	146	<b>369</b>			
converters (AN)	144	<b>360</b>	standards (AN)	145	<b>365</b>			
delay lines (NL)	147	<b>378</b>	surfaces, optical (AN)	145	<b>364</b>			
delay lines (NL)	148	<b>380</b>	voltmeter, digital	134	<b>290</b>			
diodes, zener (NL)	146	<b>375</b>	voltmeter, sampling	134	<b>288</b>			
filters (NL)	146	<b>370</b>	VOM, low-cost	134	<b>287</b>			
filters, variable (NL)	148	<b>381</b>						
governors (AN)	145	<b>366</b>	<b>Microwaves &amp; Lasers</b>					
Heathkit catalog (NL)	146	<b>374</b>	circulators, 40-GHz	137	<b>299</b>	<b>New Literature</b>		
IC dictionary (AN)	144	<b>361</b>	generator, sweep	137	<b>297</b>	cables, coaxial	146	<b>371</b>
isolators, optical	129	<b>274</b>	Heathkit catalog (NL)	146	<b>374</b>	capacitors, high-Q	148	<b>391</b>
lights, indicator	128D	<b>270</b>	mixers, balanced	137	<b>298</b>	capacitors, HV	148	<b>389</b>
lights, indicator	128D	<b>271</b>	rf measurements (NL)	147	<b>379</b>	computer manual	146	<b>368</b>
microelectronics (NL)	146	<b>372</b>	tubes (NL)	148	<b>382</b>	computer plots	149	<b>394</b>
MOSFETs & static (AN)	144	<b>359</b>				connectors, coaxial	148	<b>383</b>
oscillator, IC crystal	130	<b>276</b>	<b>Modules &amp; Subassemblies</b>			connectors, rf	148	<b>384</b>
photocells	129	<b>275</b>	amplifiers, operational	123	<b>252</b>	converter, ac/dc	149	<b>393</b>
readout, alphanumeric	128D	<b>272</b>	circuit, thick-film	124	<b>253</b>	data plots	146	<b>376</b>
relay, 14-pin DIP	128D	<b>273</b>	converter, ac/dc (NL)	149	<b>393</b>	delay lines	147	<b>378</b>
relays, coaxial (NL)	149	<b>392</b>	converter, synchro	124	<b>255</b>	delay lines	148	<b>380</b>
solenoids (AN)	144	<b>361</b>	converters (AN)	144	<b>360</b>	diodes, zener	146	<b>375</b>
standards (AN)	145	<b>365</b>	decoder/driver	123	<b>251</b>	filters	146	<b>370</b>
transformer, HV	130	<b>278</b>	decoder/drivers	126	<b>259</b>	filters, variable	148	<b>381</b>
wire and cable (NL)	147	<b>377</b>	divider, frequency	127	<b>263</b>	Heathkit catalog	146	<b>374</b>
			driver & receiver	126	<b>262</b>	interconnections	148	<b>385</b>
<b>Data Processing</b>			filters (NL)	146	<b>370</b>	microelectronics	146	<b>372</b>
computer manual (NL)	146	<b>368</b>	Heathkit catalog (NL)	146	<b>374</b>	packaging parts	148	<b>386</b>
computer plots (NL)	149	<b>394</b>	interface circuits	128	<b>267</b>	PC-board process	146	<b>367</b>
computer terminal	131	<b>280</b>	microelectronics (NL)	146	<b>372</b>	pollution control	148	<b>388</b>
controller	132	<b>282</b>	mixer, double balanced	124	<b>256</b>	relays, coaxial	149	<b>392</b>
data record (DA)	141	<b>343</b>	op amp	126	<b>261</b>	rf measurements	147	<b>379</b>
data terminal	131	<b>279</b>	op amp, FET	124	<b>254</b>	scope news	146	<b>369</b>
display terminal	131	<b>281</b>	op amp, programmable	123	<b>250</b>	silicones	148	<b>387</b>
keyboards	132	<b>283</b>	op amp, wideband	125	<b>257</b>	time sharing	146	<b>373</b>
memory, plated-wire	133	<b>286</b>				transmission lines	148	<b>390</b>
modems, data	132	<b>285</b>	<b>Packaging &amp; Materials</b>			tubes, microwave	148	<b>382</b>
terminal, on-line	132	<b>284</b>	cable design (AN)	144	<b>357</b>	wire and cable	147	<b>377</b>
time sharing (NL)	146	<b>373</b>	cables, coaxial (NL)	146	<b>371</b>			
			carrier, component	136	<b>296</b>	<b>Application Notes</b>		
<b>ICs &amp; Semiconductors</b>			connectors, coax (NL)	148	<b>383</b>	cable design	144	<b>357</b>
decoder/drivers	126	<b>259</b>	connectors, rf (NL)	148	<b>384</b>	converters	144	<b>360</b>
diodes, zener (NL)	146	<b>375</b>	dielectrics chart (DA)	141	<b>344</b>	governors, fluidic	145	<b>366</b>
divider, frequency	127	<b>263</b>	etching kit	136	<b>294</b>	IC dictionary	144	<b>361</b>
driver & receiver	126	<b>262</b>	foam, electrical	136	<b>295</b>	metals, composite	144	<b>363</b>
drivers, display	128	<b>269</b>	interconnections (NL)	148	<b>385</b>	MOSFETs & static	144	<b>359</b>
IC dictionary (AN)	144	<b>361</b>	laminates (ES)	140	<b>341</b>	packaging	144	<b>358</b>
interface circuits	128	<b>267</b>	metals, composite (AN)	144	<b>363</b>	solenoids	144	<b>362</b>
LED, infrared	127	<b>265</b>	packaging (AN)	144	<b>358</b>	standards	145	<b>365</b>
LEDs, red	127	<b>264</b>	packaging parts (NL)	148	<b>386</b>	surfaces, optical	145	<b>364</b>
microelectronics (NL)	146	<b>372</b>	PC-board process (NL)	146	<b>367</b>			
MOSFETs & static (AN)	144	<b>359</b>	silicones (NL)	148	<b>387</b>	<b>Design Aids</b>		
op amp	126	<b>261</b>	spray, rfi/emf	136	<b>293</b>	data record	141	<b>343</b>
op amp, wideband	125	<b>257</b>	transmission lines (NL)	148	<b>390</b>	decimal equivalents	141	<b>345</b>
photo-transistor	128	<b>268</b>	tubing (ES)	140	<b>342</b>			
shift registers, LSI	128	<b>266</b>	wire and cable (NL)	147	<b>377</b>			
transistor, power	125	<b>258</b>				<b>Evaluation Samples</b>		
transistor, power	126	<b>260</b>	<b>Tools &amp; Engineering Aids</b>			laminates	140	<b>341</b>
			connector remover	138	<b>335</b>	tubing	140	<b>342</b>
<b>Instrumentation</b>			decimal table (DA)	181	<b>345</b>			
converters (AN)	144	<b>360</b>	holder, solderer	138	<b>336</b>			
counter-timer	134	<b>291</b>	PC-board tool	139	<b>339</b>			

# The counter of the future— here today.

If headlines like that underwhelm you, think of the most rigorous counting requirement you are likely to encounter in the next few years. Then set these features of our new Model 120A Counter beside it:

Frequency range to 512 MHz • Time base autoranging for optimum resolution (manual selection too, of course) • Monsanto solid-state numerics, the display that makes all others obsolete • Over 60% MSI construction for maximum dependability and function density • Extensive use of plug-in ICs for ease of servicing, minimum downtime • All functions digitally programmable for maximum system compatibility • BCD output, TTL compatible • Full complement of universal counter/timer functions, including "Burst Mode"

In terms of original investment, performance and long-range "Cost of Usership," the Model 120A has no equal. Because it's the counter of the future. Prices? They begin at just \$1775. Write Monsanto Electronic Instruments, West Caldwell, New Jersey 07006.

## Monsanto

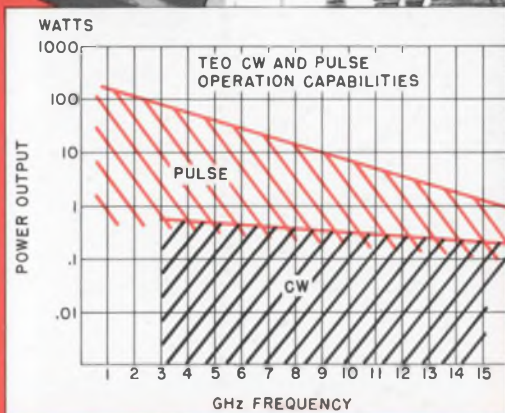
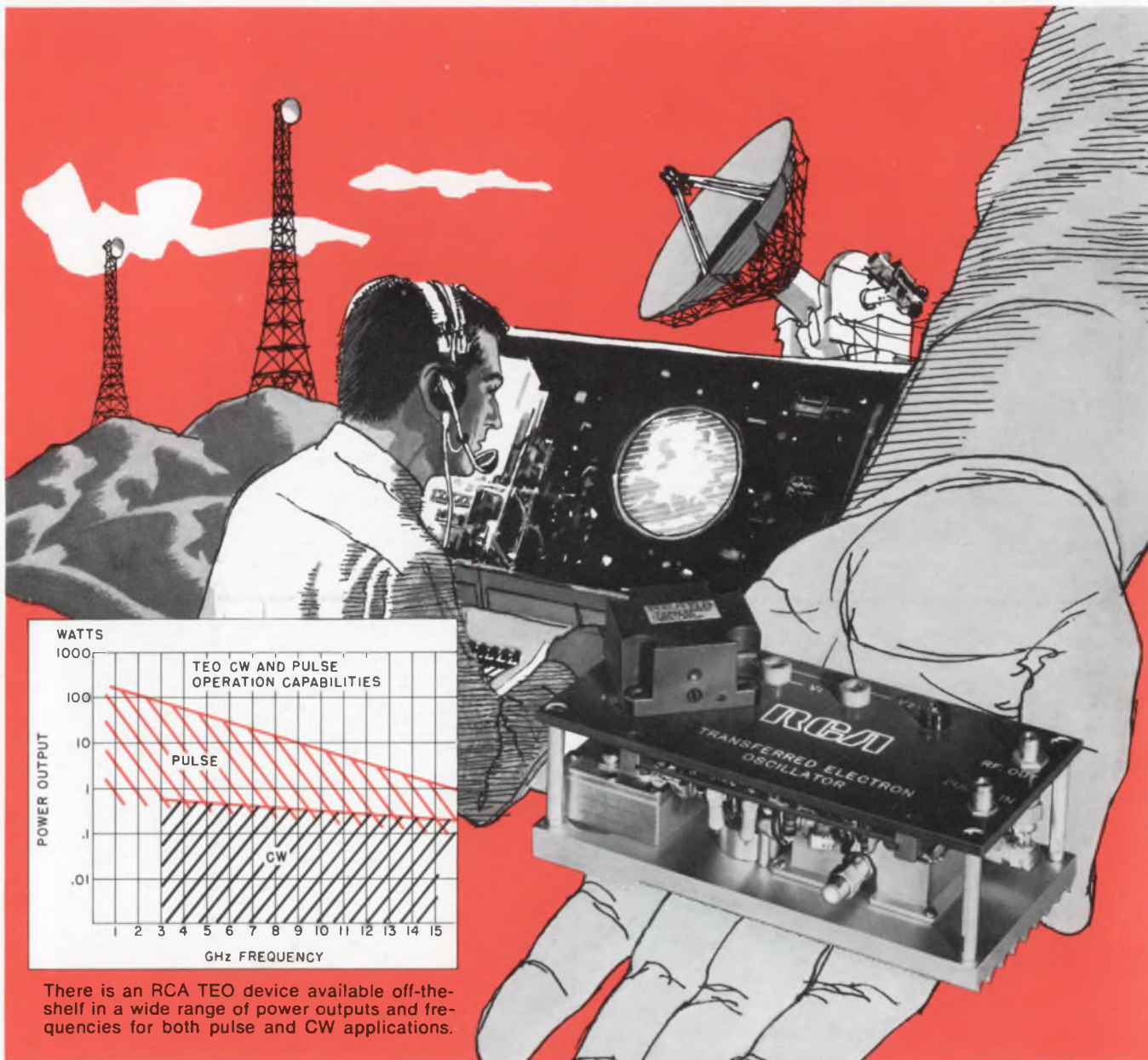

There is an RCA TEO device available off-the-shelf in a wide range of power outputs and frequencies for both pulse and CW applications.

## RCA TEO's—Oscillators and Subsystems for your new microwave designs

Now, the advanced technology of the Transferred Electron Oscillator (TEO) is available for your new microwave designs. RCA announces immediate delivery of standard-line oscillators and subsystems for pulsed and CW applications from L-band to Ku-band.

The TEO is another major RCA contribution to commercial and military microwave systems. RCA pulsed units range in power outputs up to 100 watts; CW devices are available in powers of hundreds of milliwatts over the most widely used microwave frequencies.

These RCA TEO's are ideally suited as power sources and local oscillators in a variety of radar, intrusion alarm, telemetry, transponder, and communications systems. They can be free-running or stabilized. Their frequency can be fixed, mechanically, or electronically tuned. In short, these new devices offer you the reliability of rugged solid-state units in place of tubes or such devices as varactor multiplier chains.

For more information on RCA subsystems and standard-line or custom TEO's, see your local RCA Representative or call Microwave Marketing, (201) 485-3900, TWX 710-995-4474. For technical data, write: RCA, Commercial Engineering, Section 57G-19/ZM8, Harrison, N.J. 07029. In Europe: RCA International Marketing S.A., 2-4 rue du Lievre, 1227 Geneva, Switzerland.

**RCA**