

Electronic Design 11

VOL. 18 NO.

FOR ENGINEERS AND ENGINEERING MANAGERS

MAY 24, 1970

Electronics is invading sports. From scuba diving to ski racing, engineers are rolling up points. But their biggest gains are in computer-operated scoreboards.

The giant animated displays of these megabuck marvels have thousands of incandescent lamps that pose stringent problems in solid-state control. See page 36.



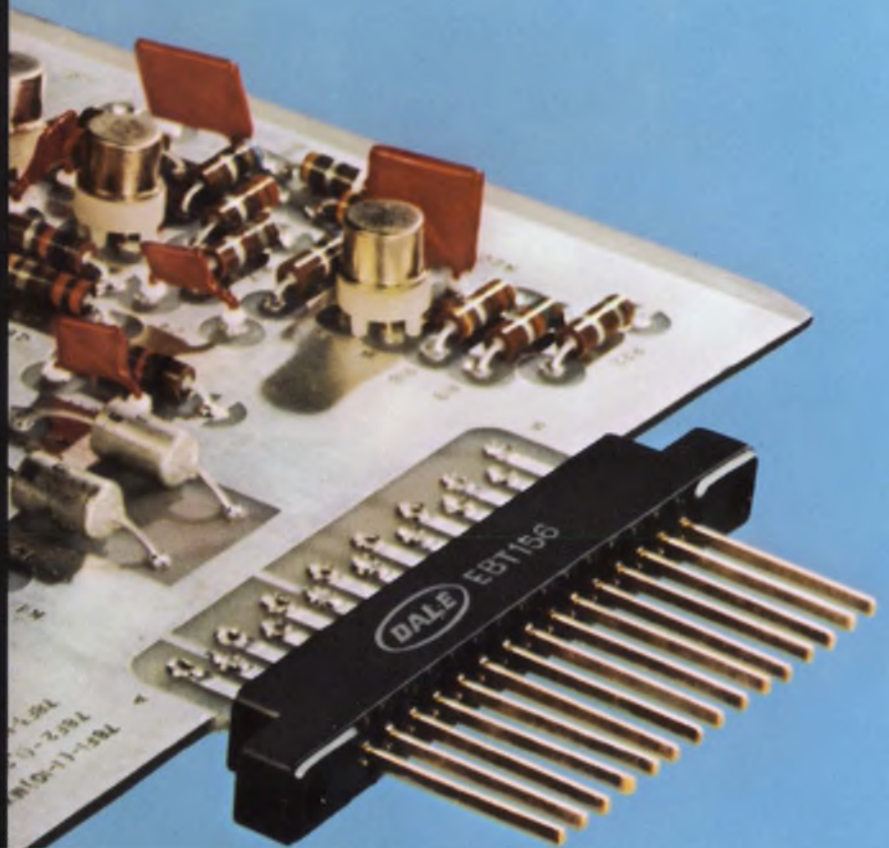
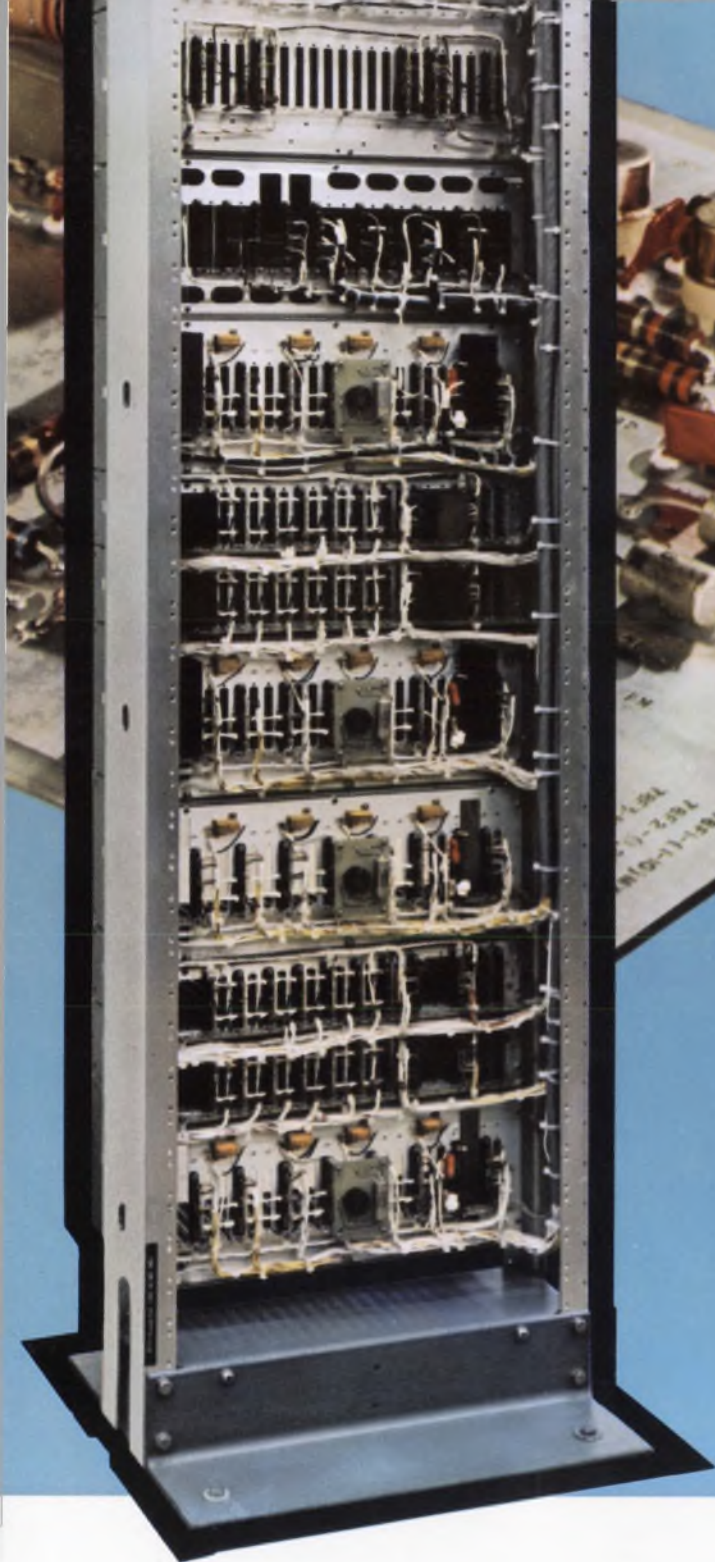

Collins connects with Dale Edgeboards

Here's a better .156" edgeboard. Proven in dozens of applications—including Collins' high performance MX-106 Radio Carrier System shown here. Specify the EBT 156 for single readout 1/16" card applications where you must blend low cost with worry-free performance. Special protected entry aligns and straightens board before contact is made. Prevents contact damage and makes it easier to handle out-of-tolerance boards. Withstands 250 insertion/removal cycles... <math><1 \mu\text{sec}</math> discontinuity during vibration and shock tests per MIL-C-21097B. Dale's EBT 156 is available in six models—8 to 22 contacts. Wirewrap, eyelet or dip solder terminals. Need higher densities? Check Dale's .050" *Thinline* series. They're both in our complete new catalog.

PHONE 605—665-9301 OR WRITE TODAY!



DALE ELECTRONICS, INC.

Box 180, Yankton, South Dakota 57078 A subsidiary of The Lionel Corporation



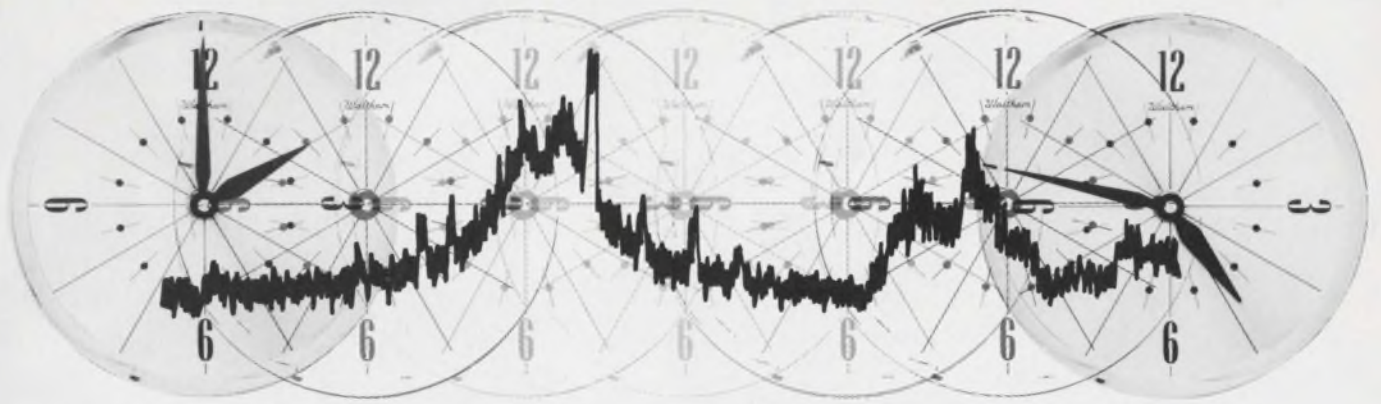

A wave analyzer with a 10,000-second sweep time? Why?

090/6

...because, in low-frequency spectrum analysis work, you need to use a narrow-bandwidth window. The narrower the window you use, the slower you must sweep it across the frequency range to be analyzed. And the slower you sweep, the smaller a frequency range you can cover in any given time. Thus, until now, your choice has been either accuracy or range but not both.

The new HP 3590A/3595A system solves that dilemma. The HP 3595A plug-in is a sweeping local oscillator

with 10,000 seconds of sweep time available. By using it with the HP 3590A Wave Analyzer mainframe, you can scan the entire three-decade audio frequency range at 2 Hz per second, in one sweep. And, by adding an HP X-Y recorder, you can see the results on a single 11 x 17-inch graph.

In addition to extended sweep time, the 3590A/3595A combination also gives you a choice of five sweep rates (from 1 Hz to 1,000 Hz per second) and four filter bandwidths (from 10 Hz to 3,100 Hz), an 85 dB dynamic range

over either of two frequency ranges (20 Hz to 62 kHz and 200 Hz to 620 kHz), 3 μ V to 30 V sensitivity, and built-in autoranging for ease of operation.

The result is a systems-analysis tool ideally suited for work in the lower frequency ranges, with the capability to work in higher frequency ranges as well!

The 3590A Wave Analyzer mainframe is \$3200; the new 3595A plug-in with the 10,000-second sweep time is \$1250. Other plug-ins available for the 3590A are: the 3592A slave and program unit, for use with a second mainframe, \$80; the 3593A with 3-digit mechanical display and 620-second maximum sweep time, \$1100; and the 3594A with 5-digit electronic counter frequency display and 620-second maximum sweep time, \$1600.

To get complete information on the HP 3590A and the various plug-ins, contact your local HP field engineer. Or, write to Hewlett-Packard, Palo Alto, California 94304. In Europe: 1217 Meyrin-Geneva, Switzerland.

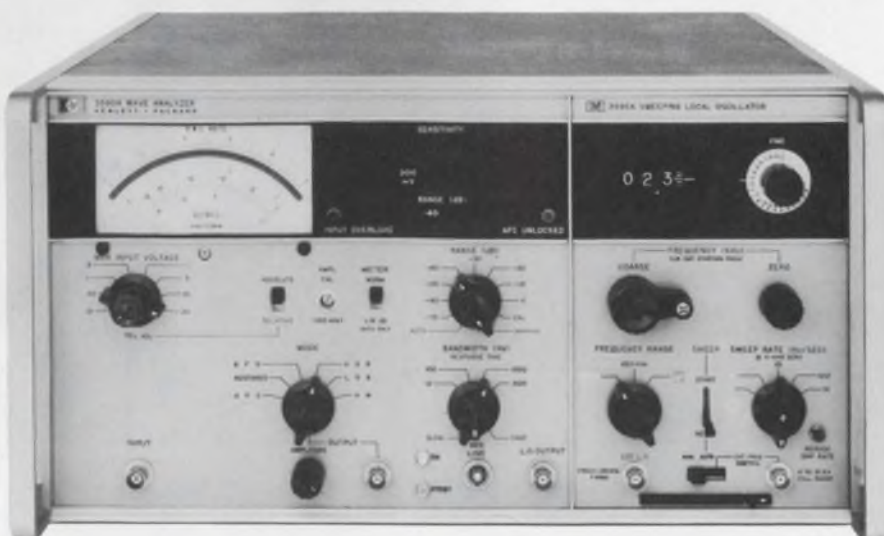

HEWLETT  PACKARD
SIGNAL ANALYZERS

INFORMATION RETRIEVAL NUMBER 2



**Allen-Bradley Type G
variable resistors
help seal Sylvania's
rescue transceivers against**

**ocean
dunkings**

Built primarily for aiding in the location and recovery of downed airmen, Sylvania's emergency rescue transceiver must be reliable under extremely adverse conditions. It is lightweight and compact enough to be carried in the pocket of a flight jacket. It must withstand impact and immersion in salt water without damage.

Essential to meeting these requirements is Allen-Bradley's Type G variable resistor. It's rugged. It's compact. And it provides the necessary seal against water. This particular Type G has two "O" rings—one between the bushing and shaft, and one between the bushing and mounting panel. This dual seal prevents water entering the enclosure, as well as the control.

The Type G variable resistor features the Allen-Bradley solid, hot-molded resistance track. It gives long life—less than 10% resistance change after 50,000 complete cycles. The noise level is extremely low, and the smooth adjustment provides virtually infinite resolution. Low inductance permits operation across a broad frequency spectrum.

For complete details and immediate delivery on this 1/2-inch diameter Type G 1/2-watt variable resistor, call your authorized A-B industrial electronics distributor. Or write: Marketing Dept., Electronics Div., Allen-Bradley Co., 1201 South Second Street, Milwaukee, Wis. 53204. Export Office: 1293 Broad St., Bloomfield, N. J., U.S.A. 07003. In Canada: Allen-Bradley Canada Limited.



Type G
variable
resistor
shown
actual size

Sylvania AN/PRC-90 dual channel rescue transceiver permits two-way voice communication, the transmission of Morse code or the sending of a homing beacon.



ALLEN-BRADLEY
QUALITY ELECTRONIC COMPONENTS

Decimals: Autopoint and scientific notation.

Automatic entry of e and π .

Ten directly addressable storage registers

Programming: Up to 128 steps. Conditional branching and automatic entry of programs with card reader.

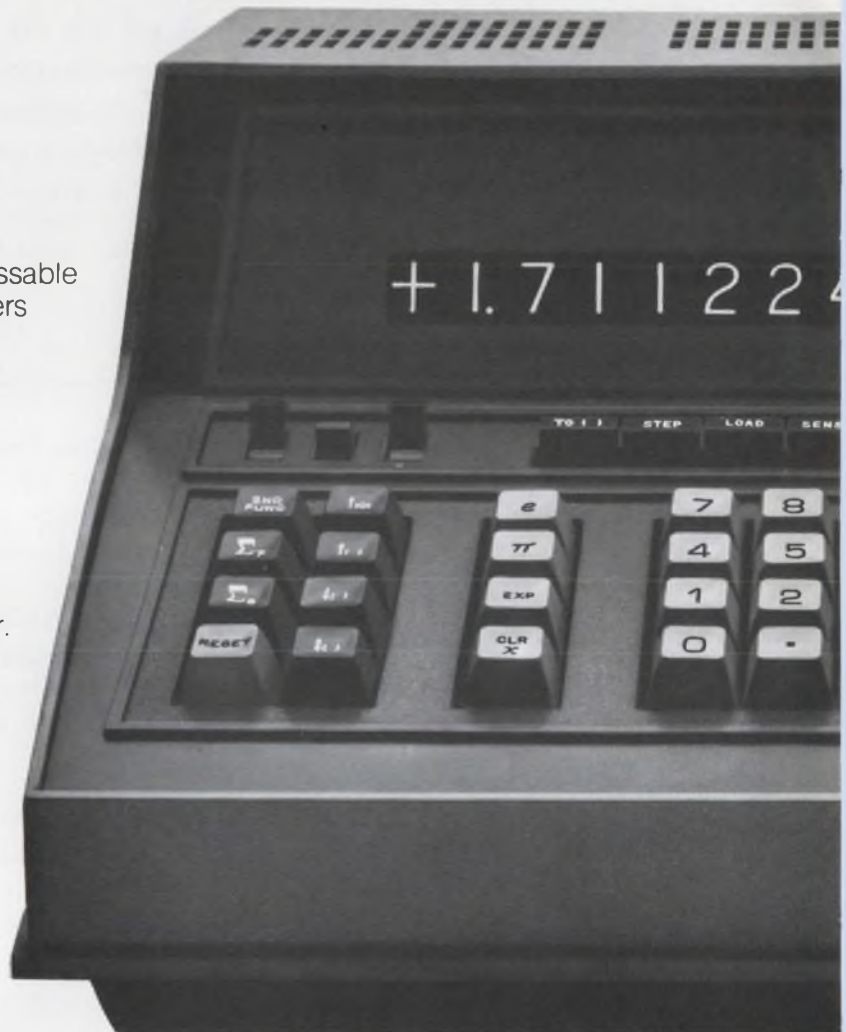

Model 1655. Size: 13" x 13½" x 6½".

Announcing an important breakthrough for engineers and scientists. Calculators based on the latest MOS/LSI technology. In both printing and display models. Available in over 350 cities coast to coast. Supported by more than 3,300

Dynamic range: 10^{-99} to 10^{+99}



Automatic special functions:
 a^x , $\text{Log}_{10}/\text{Log}_e$, SIN/COS,
 $\text{SIN}^{-1}/\text{COS}^{-1}$, $x!$, $\frac{1}{x}$,
Radians to Degrees,
Single key Σx , Σx^2 , N,
Rectangular to Polar Conversion.

Just plug in
and put it to work.

Weight: Twelve pounds.

**sales and service technicians.
Monroe men who know everything
there is to know about calculators.
Because calculators are our only business.
That's how we got our name.
Monroe. The Calculator Company**

A DIVISION OF LITTON INDUSTRIES

550 Central Avenue, Orange, New Jersey 07050

INFORMATION RETRIEVAL NUMBER 4

HOW'S YOUR OP AMP I.Q.?

Q. When you need a high-performance operational amplifier that combines low input current and high slew rate, and is internally compensated, what's your first choice?

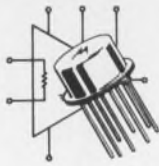

- A. MC1556G**
- 2.0 nA (max) input offset current.
 - 15.0 nA (max) input bias current.
 - 4.0 mV (max) input offset voltage.
 - 40 kHz (typ) Power Bandwidth
 - 2.5V/ μ S (typ)[UnityGain]slew rate

Q. When your design calls for an op amp with maximum slew-rate capability plus other high-performance characteristics; and, a hermetic package at a realistic cost, what would you choose?

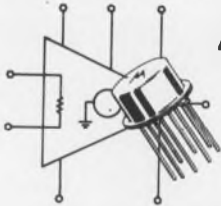

- A. MC1539/MC1439G**
- Slew Rate — 34 V/ μ S (typ) at $A_v = 100$
 - Class AB output for excellent linearity.
 - 20V p-p output swing at 10 kHz (min).
 - 2.0 mV (typ) input offset voltage.

Q. What's the best all-around, internally-compensated, general-purpose op amp available today? *Hint: Same pin configuration as the MC1709.*

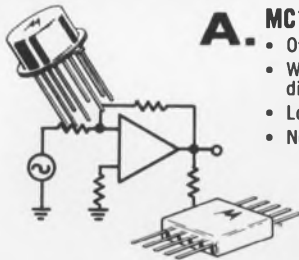

- A. MC1741/MC1741C**
- Offset voltage-null capability.
 - Wide common-mode and differential voltage ranges.
 - Low-power consumption.
 - No latch-up problems.

Q. For optimum economy — where high gain is required with excellent stability — what's your ideal op amp choice?

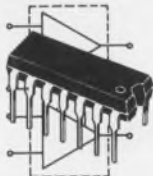

- A. MC1437**
- Two op amps on one chip (Dual MC1709) — for very little more than the cost of one.
 - High-performance open-loop gain.
 - Low temperature drift.

Q. Suppose you want to avoid cascading packages and have some rather severe economic restrictions in addition to high-performance specifications. Obviously, a dual op amp is the answer. What's your best bet?

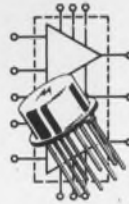

- A. The NEW MC1558G/MC1458G**
- Internal frequency compensation.
 - Short-Circuit protection.
 - Dual MC1741
 - Only \$4.50 (100-up) MC1458 G

Q. What is the "industry-standard", general-purpose op amp? Probably, the one that has been specified more often than any other.

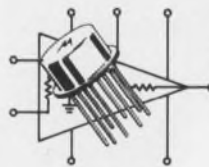

- A. MC1709/MC1709C**
- 150 ohms (typ) output impedance.
 - Large output-voltage swing.
 - Low Temperature drift.
 - High open-loop gain.

Q. If none of these op amps fit your specific application, what do you do next?

A. Select one of the others from Motorola's "broadest of all" op amp lineup:

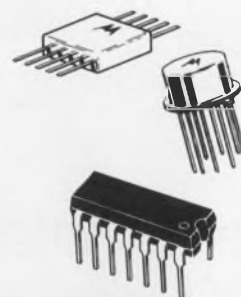

- MC1520**
differential output/wide bandwidth
- MC1530/1430**
uncompensated
- MC1531/1431**
low input currents
- MC1533/1433**
 V_{io} adjustable
- MC1535/1435**
Dual Op Amp
- MC1712**
Wide Bandwidth

If you scored 100%, it's probable that you are already benefitting from Motorola's wide range of op amp types. If not, you should write for our Application Selector Guide — to P.O. Box 20912, Phoenix, Arizona 85036.

We may ask more questions, later!

— where the priceless ingredient is care!



MOTOROLA
INTEGRATED CIRCUITS

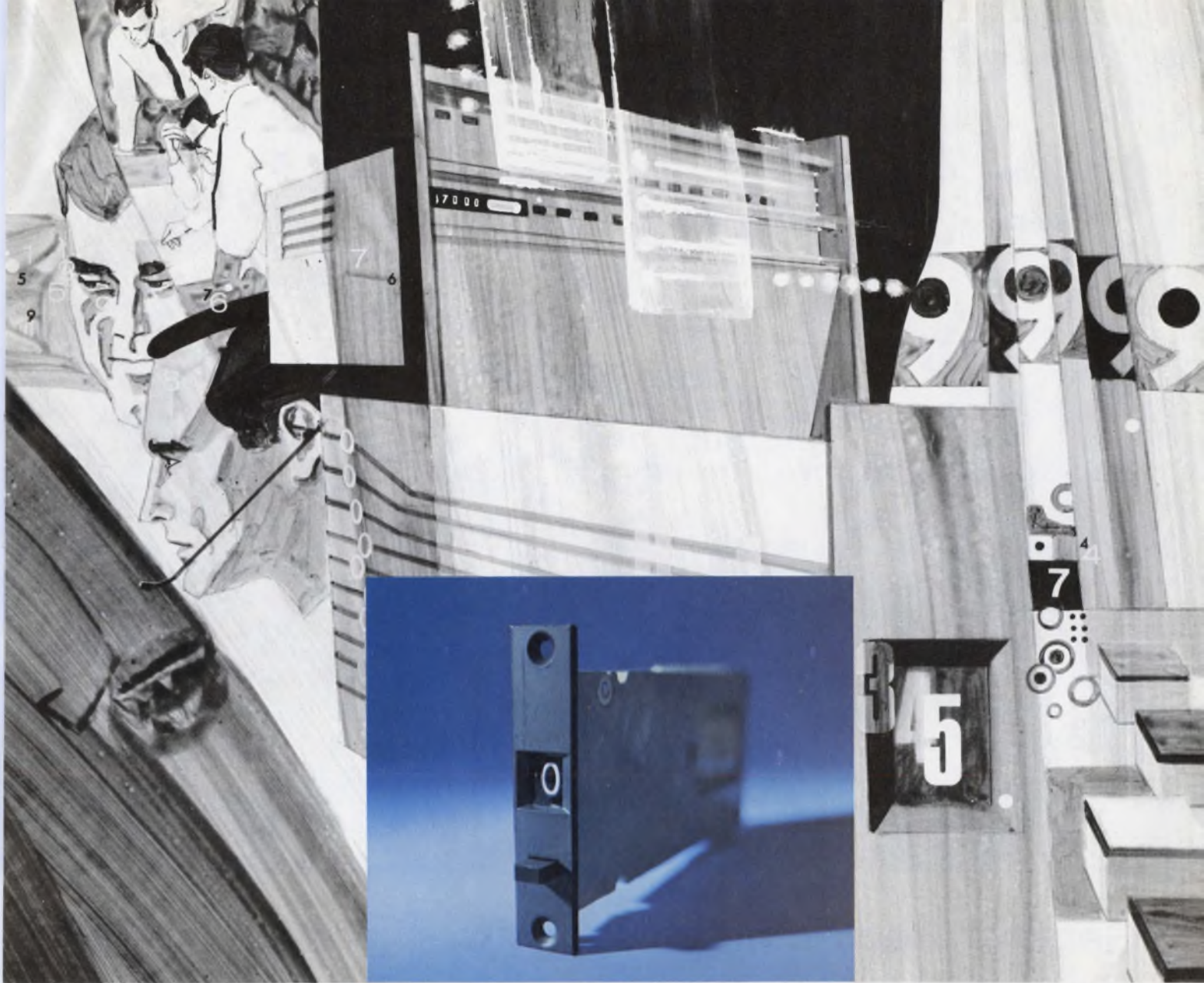

the decade and its capability

1969: Application of the versatile Veeder Decade is limited only by the designer's imagination, and . . .

you'll find that its tremendous flexibility produces ever-widening vistas of possibility. A module that's easily stacked into a compact, multi-digit counter package, the Decade is the ideal unit for high-speed count accumulation, storage and transfer in data processing, control equipment systems, and . . . well, about the only thing we *can't count* is the number of applications for this unique product. The Series 1969 is a single wheel electric counter with electric read-out (BCD or decimal), transfer and reset, and 2400 cpm speed. It combines large figure readability with

narrow width for space economy. Another Decade model, the Series 7266, offers wheel configurations for recording time and counting dozens and denominations of money. The 1969 is only one of the many performers in Veeder-Root's total capability lineup of counting, recording, and controlling instruments—mechanical, electrical, electronic. For information about our complete line, write: Veeder-Root, 70 Sargeant St., Hartford, Conn. 06102. (203) 527-7201.

V E E D E R - R O O T

INNOVATORS IN NUMERICS: COUNTING/RECORDING/CONTROLLING





General Electric helps you solve the tough ones

GE has the broadest line of electronic components in the industry. From the tiniest integrated circuits to powerful high performance motors, GE components help you solve your tough problems . . . in design, in performance, in economy. Take a look at these GE problem solvers.

p.s.1 General Electric delivers 19 new epoxy TO-18 transistors for demanding applications. GE's encapsulated devices are performance-proved, reliable. And they cost less than metal-case devices.

The new epoxy transistors include PNP types, PNP/NPN complementary pairs, and low level amplifiers. They offer breakdown voltages as high as 60V with excellent beta linearity and dissipate up to 500 mW. They handle collector currents up to 1 amp. Get spec sheets on GE's new epoxy transistor lineup. Circle number 211.

p.s.2 GE meter relays put accurate dependability into critical new medical systems. A new heartbeat monitor, for instance, uses GE meter relays to indicate the heart beat visually. And they have the added capability to sound an alarm when preset limits are reached.

Either the easy-reading BIG LOOK® or the low profile HORIZON LINE® styles feature solid state control for precise accuracy. Put GE dependability into your critical circuits. Circle 212 for details.

p.s.3 Forget capacitor leakage problems with GE military-type tantalum wet slugs. The special GE design incorporates a double elastomer seal that maintains performance even through the 35 temperature cycles required by MIL-C-3965E. And life tests show a capacitance change of less than 5% in 2000 hours operation.

GE wet slugs come in 4 case sizes for applications up to 125 volts dc; 1.7 to 1200 μ f. GE's 20 years experience is your assurance of dependability. For complete information, circle 213.

p.s.4 GE Microwave Circuit Modules save up to 60% in size and weight for critical communications and radar systems. GE MCM's may be used as oscillators, amplifiers, multipliers, detectors, mixers, integrated isolators and circulators. And they are extremely stable even in adverse environments.

The GE C-2003E, for example, is used in pulsed transponder applications. It operates dependably from -54 to $+125^{\circ}\text{C}$ and withstands vibrations at 15G from 20 to 500 Hz. Frequency stability is $\pm 3\text{MHz}$ with minimum life of 500 hours operation. Get GE's MCM catalog. Circle 214.

p.s.5 New magnetic material gives 6% increase in residual flux density . . . resists demagnetization. GE's new Alnico 8C was developed for applications requiring high resistance to demagnetization plus a higher flux output than other Alnico 8 alloys.

Alnico 8C is the latest development in GE's complete line of Alnico permanent magnets. It's another example of the technical expertise you get when you specify General Electric to solve your magnet problems. For details on the entire GE Alnico family circle 215.

p.s.6 Get more capacitance in less space with GE computer-grade capacitors. These aluminum electrolytic units deliver up to 540,000 μ f at 5 VDC (34,000 μ f at 100 volts) . . . highest capacitance per case size available. They are rated for continuous duty at 65C or at 85C

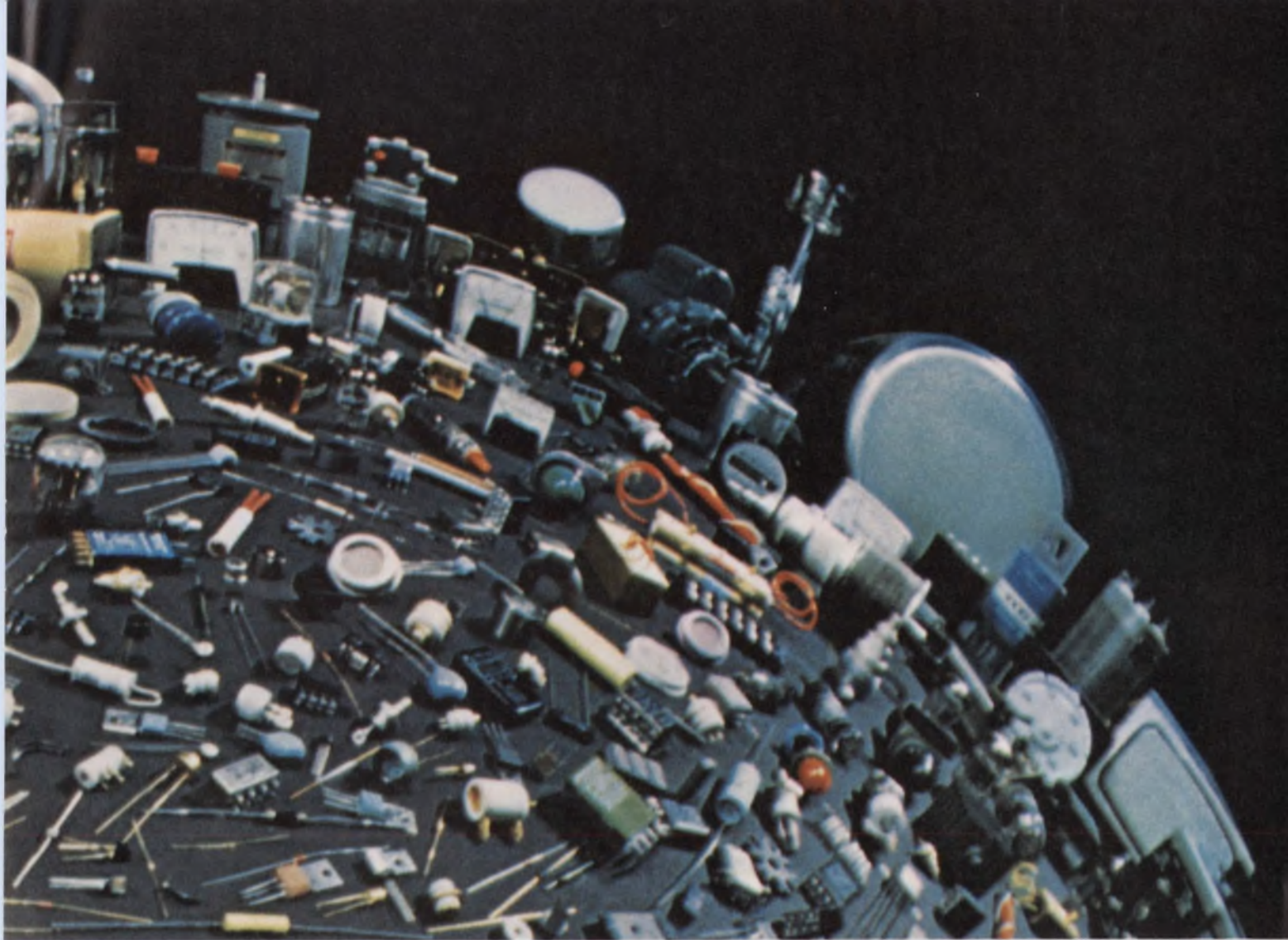

with the broadest line of electronic components

with proper voltage derating.

GE computer grades feature high ripple current capability with low equivalent series resistance. Nine case sizes are available. Circle 216.

p.s.7 Rechargeable GE nickel-cadmium batteries give you longer operating life. Proved GE reliability puts longer battery power into your application at an economical price.

Nominal ratings range from 0.1 amp-hours to 4.0 amp-hours in sealed cells and up to 160 amp-hours in vented types at the one-hour rate. Put dependable GE power in your circuit. Circle reader card number 217.

p.s.8 Programmable UJT lets you control the key parameters with just two resistors. That's right. You control η , R_{BB} , I_p and I_v so that you design your own unijunction as you design the circuit.

Low leakage and peak point currents make GE's D13T programmable UJT a natural for long interval timers. High breakdown voltages, fast trigger pulsing and low voltage operation add versatility. And the plastic TO-98 case helps solve economy problems. Get full details. Circle number 218.

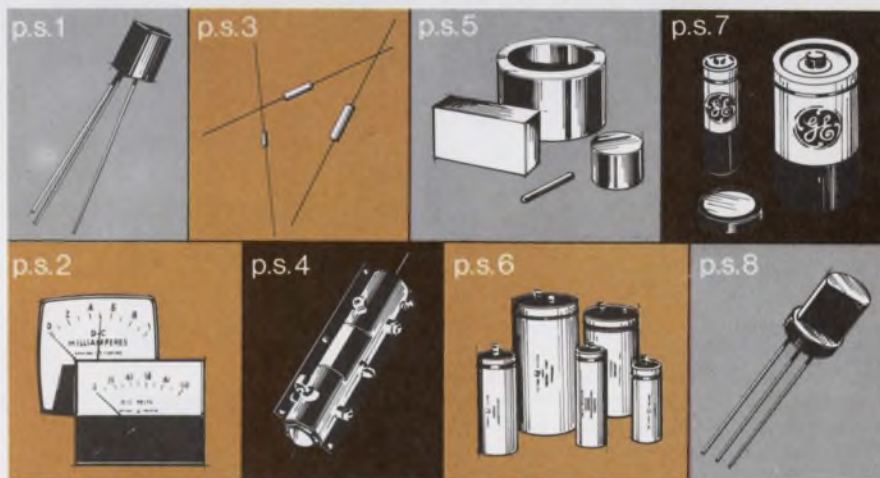

Let General Electric help solve your component problems. Call your nearest Electronic Components Sales Operation Office. Or check with one of the many authorized GE distributors. P.S. Problems? General Electric has solutions.

285-64

GENERAL  ELECTRIC

INTRODUCING NEW RCA SUPERSWITCH:

LIGHT SENSOR AND POWER AMPLIFIER ON ONE IC CHIP!

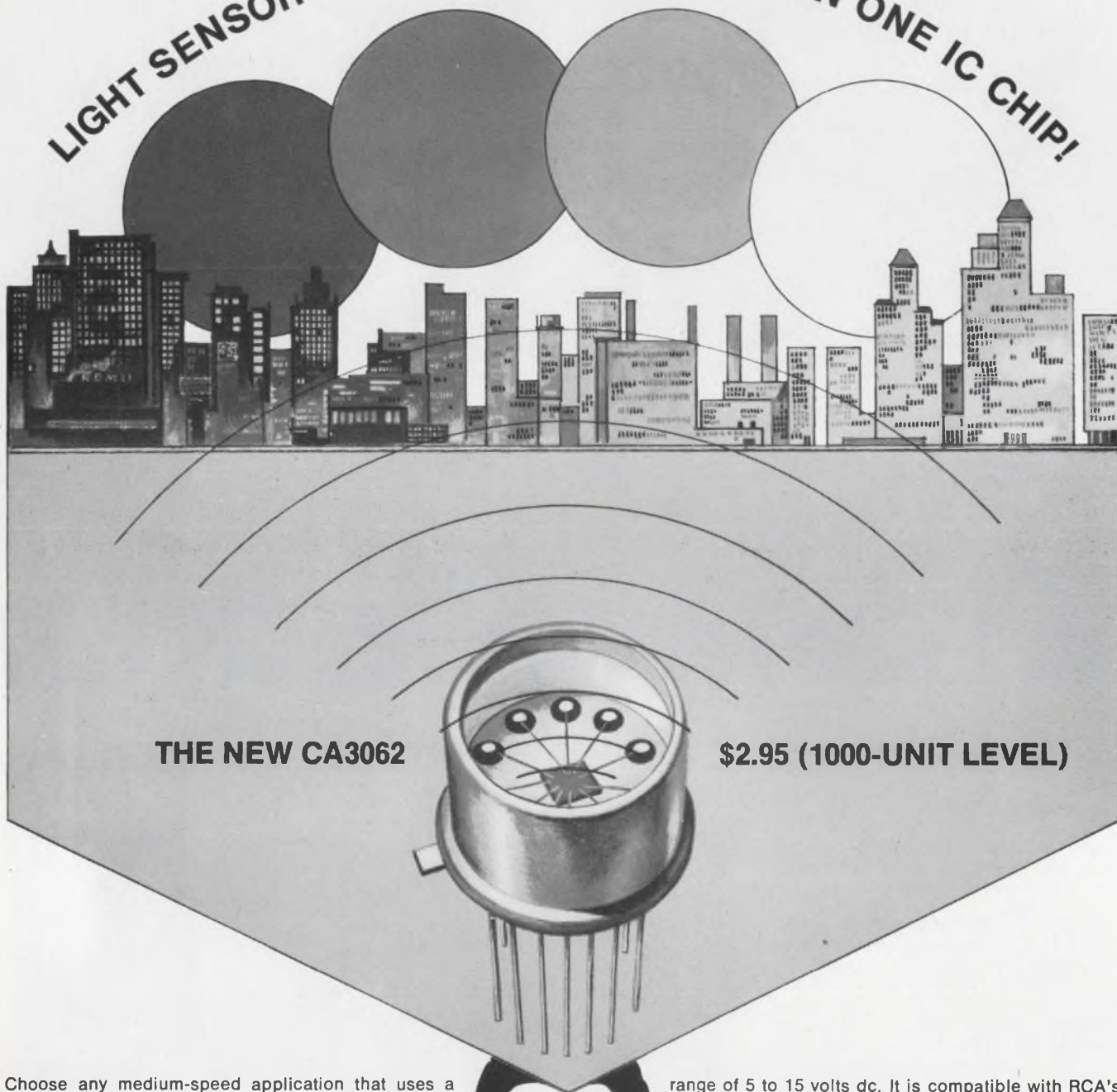

THE NEW CA3062

\$2.95 (1000-UNIT LEVEL)

Choose any medium-speed application that uses a light sensor. You'll find the circuitry easier to design when you use the RCA-CA3062 — because there's less to design. The CA3062 consists of two parallel-connected photosensitive Darlington pairs which drive a differential power amplifier to provide a normally-off and a normally-on output in response to a light input. Turn-on time is typically 38 μ s. Turn-off time is 43 μ s. Available in a compact, window-ended TO-5 style package, the CA3062 has 100 mA output current capability, and can be operated at supply voltages in the

range of 5 to 15 volts dc. It is compatible with RCA's 40736R infrared emitter. Use it for counter and position sensors, optical tachometers, limit detectors, level scanners, paper web sensors, wheel balancers, and similar devices.

For further details, see your local RCA Representative or your RCA Distributor. For technical bulletin, File No. 421, write: RCA Electronic Components, Commercial Engineering, Section E52-2/CA26, Harrison, N. J. 07029. In Europe: RCA International Marketing S.A., 2-4 rue du Lièvre, 1227 Geneva, Switzerland.

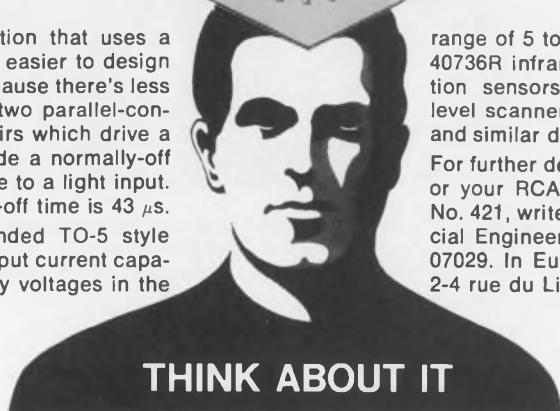

THINK ABOUT IT

RCA Integrated Circuits



Heads: You win.

Tails: You win again.

Elco rack-and-panel connectors give you a better head start.

And a choice of tails.

The head start is the connecting end of an Elco connector: the patented Varicon™ contact that fully meets the requirements of MIL-E-5400. The four mating surfaces of this unique contact are coined to an exceptional hardness and wipe clean with each make. Once the contacts are joined, the inherent springiness of the gold/nickel-plated phosphor bronze and the fork-like design make a superior, gas-tight fit.

Because the contacts are free floating, they align perfectly. A few contacts or 100 or more, all fit precisely together every time, over a long service life. There's no contact chatter. Nobody else gives you a contact head quite like the Varicon.

And nobody else gives you the choice of tails you get with Varicon. You can wire-wrap, crimp, clip, stake, or solder them. Whatever terminating technique or combination of techniques your assembly lines are set up for, we'll furnish the appropriate tail. If staking or crimping is your style, we

can supply the equipment too. Manual or automatic. Purchase or lease.

Elco rack-and-panel connectors come in standard rectangular models, or as miniature connectors, or in modular units. You can have them with 2 Varicon contacts, or up to 140, or anything in between.

In short, our line of Varicon rack-and-panel connectors has a lot going for it. Except price. Though it's a precision component, the Varicon contact is easily produced in high speed progressive dies. There's no expensive machining, no waste. When you can turn out millions of Varicons a week, you don't have to charge a fortune for them.

There's a lot more to be told about Varicon connectors. It's all in our 28-page rack-and-panel connector guide, and we'll be happy to send you a copy. Just write, wire, call, or TWX us. Elco Corporation, Willow Grove, Pa. 19090. (215) 659-7000. TWX 510-665-5573.



.078" Taper Tab



Solder/.098" Taper Tab

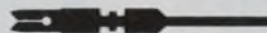

Wire Wrap Tail
.024" x .050" x .567"



Wire Wrap Tail
.024" x .050" x .760"



Crimp (Loose contact)

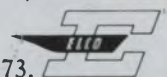



When you want radar as pure and coherent as a laser beam...

Symbolic electronic signal undistorted by EMI —
photographed by Howard Sochurek

bring ERIE in early.

31,000 feet... heavy traffic... ugly weather over the Plains. This isn't the time for "noise" in the radar. But, no sweat! RCA's exciting new AVQ-30X Weather Radar is up front, sweeping the sky... protected from EMI by 39 special ERIE filters. No other airborne radar has ever approached the single or dual system reliability of the AVQ-30. From the start, RCA has called on the outstanding research and component capability of ERIE TECHNOLOGICAL to help in the development of this great new unit. Proof, once again, that it pays to bring ERIE in early.

ERIE TECHNOLOGICAL PRODUCTS, INC.

644 West 12th Street, Erie, Pennsylvania 16512
(814) 456-8592

Designer's Calendar

JUNE 1970

S	M	T	W	T	F	S
	1	2	3	4	5	6
7	8	9	10	11	12	13
14	15	16	17	18	19	20
21	22	23	24	25	26	27
28	29	30				

For further information on meetings, use Information Retrieval Card.

June 24-26

Joint Automatic Control Conference (Atlanta, Ga.) Sponsors: IEEE, et al. D. Lyons, Dept. of Textile Science, Clemson Univ., Clemson, S. C. 29631.

CIRCLE NO. 447

June 28-July 1

Consumer Electronics Show (New York City). Sponsor: Electronic Industries Association. Jack Wayman, EIA, Consumer Products Div., 2001 Eye St., N. W., Washington, D. C. 20006.

CIRCLE NO. 448

JULY 1970

S	M	T	W	T	F	S
			1	2	3	4
5	6	7	8	9	10	11
12	13	14	15	16	17	18
19	20	21	22	23	24	25
26	27	28	29	30	31	

July 14-16

International Electromagnetic Compatibility Symposium (Anaheim, Calif.) Sponsor: IEEE. Jim Senn, Lectro Magnetics, Inc., 6056 W. Jefferson Blvd., Los Angeles, Calif. 90016.

CIRCLE NO. 449

July 21-23

Conference on Nuclear & Space Radiation Effects (San Diego, Calif.) Sponsor: IEEE. Richard Thatcher, Battelle Memorial Inst., 505 King Ave., Columbus, Ohio 43201.

CIRCLE NO. 450

When You Buy a Power Supply, Why Not Get the Best?

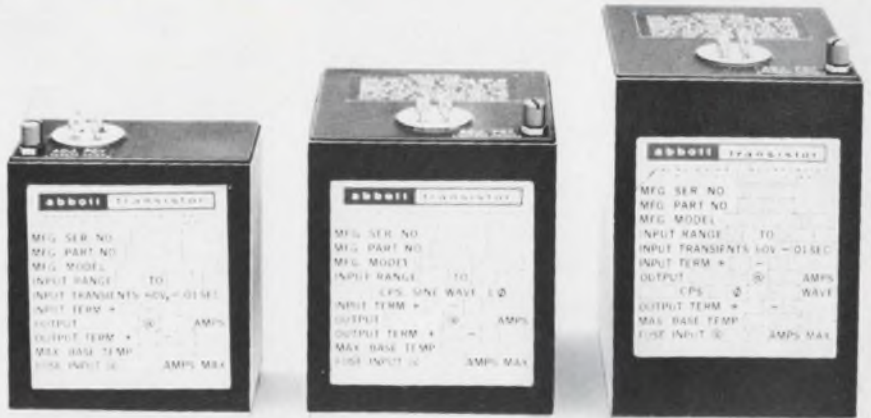

BL1D-27.6A
(109,890 Hrs.)

U2D5-22A
(73,585 Hrs.)

S3D-115A-400
(61,387 Hrs.)

Abbott's New Family of 100°C Units—

are designed to operate in the stringent environment required by military and aerospace systems — (per MIL-E-5400 or MIL-E-5272C) from -54°C to $+100^{\circ}\text{C}$.

RELIABILITY — MTBF (mean time between failures) as calculated in the MIL-HDBK-217 handbook can be expected in excess of 50,000 hours at 100°C for many of our power modules. The hours listed under the photos above are the MTBF figures for each of the models shown. Additional information on typical MTBF's for our other models can be obtained by phoning or writing to us at the address below.

QUALITY CONTROL — High reliability can only be obtained through high quality control. Only the highest quality components are used in the construction of the Abbott power module. Each unit is tested no less than 41 times as it passes through our factory during fabrication — tests which include the scrutinizing of the power module and all of its

component parts by our experienced inspectors.

NEW CATALOG — Useful data is contained in the new Abbott Catalog. It includes a discussion of thermal considerations using heat sinks and air convection, a description of optional features such as short circuit protection and remote output adjustment as well as operating hints for power supplies and a listing of environmental testing costs.

WIDE RANGE OF OUTPUTS — The Abbott line of power modules includes output voltages from 5.0 volts DC to 10,000 volts DC with output currents from 2 milliamperes to 20 amperes. Over 3000 models are listed with prices in the new Abbott Catalog with various inputs:

- 60 ϕ to DC, Regulated
- 400 ϕ to DC, Regulated
- 28 VDC to DC, Regulated
- 28 VDC to 400 ϕ , 1 ϕ or 3 ϕ
- 60 ϕ to 400 ϕ , 1 ϕ or 3 ϕ

Please write for your FREE copy of this new catalog or see EEM (1968-69 ELECTRONIC ENGINEERS MASTER Directory), Pages 1727 to 1740.

abbott transistor
LABORATORIES, INCORPORATED
5200 W. Jefferson Blvd./Los Angeles 90016
(213) WEBster 6-8185 Cable ABTLABS

TO: Abbott Transistor Labs., Inc., Dept. 67
5200 West Jefferson Blvd.
Los Angeles, California 90016

Sir:
Please send me your latest catalog on power supply modules:

NAME _____ DEPT. _____
COMPANY _____
ADDRESS _____
CITY & STATE _____



GOULD 4800

GOULD 4800

This is the fastest printer around.

It also produces both alphanumerics and graphics.

**And printout is 132 columns
wide on an 11 x 8-1/2 format!**

The practical continuous speed of the standard line printer is 600 lines per minute. But the new Gould 4800-II will deliver 4800 lines per minute. And it'll produce both alphanumerics and graphics — simultaneously — directly from any source of digital input as data transmission by telemetry, radio microwave, and/or land line.

There's a new character generator, too. With an ultimate capability of three 128 character fonts with dot matrices up to 15 x 15.* And because it has a 132 character buffer, you don't have to burden your computer's memory banks. The input control lines are built-in, too. Which makes it comparatively simple to interface the 4800 with almost any computer you have in mind.

The 4800 provides programmed control for a

variety of output forms . . . line and letter spacing, paragraphing, columns and so forth. Plus a convenient capability to translate bit mode input into generalized graphics. But speed and versatility are just part of our story. Because it's electrostatic, the 4800 is infinitely quieter than line printers. Because it has fewer moving parts, it's more reliable. And because it's a lot simpler, it's priced well below printers that can't come close to the performance. So there you have it: the Gould 4800 electrostatic hardcopy printer. Isn't it time we talked? Graphics Division, Gould Inc., 3631 Perkins Avenue, Cleveland, Ohio 44114.
*Supplied standard with unit:
One 64 character font with 5 x 7 dot matrix.

GOULD CLEVITE

The Gould 4800. The next generation of high-speed printers.

INFORMATION RETRIEVAL NUMBER 12



A significant advance in silicon rectifier power handling capacity

3 new series of silicon rectifiers from Tung-Sol permit designers to meet extremely high power requirements.

- Reverse voltage ratings to 5000 Volts
- Average forward current to 500 Amperes
- Surge overload ratings up to 8500 Amperes

Controlled avalanche characteristics provide transient handling capability that results in increased reliability.

All units feature ceramic-to-metal seals, mount in any position and are supplied in either polarity.

1511 SERIES

Max. av. forward current at 120° C—420 Amperes

Surge overload rating, 1 cycle—6000 Amperes

Controlled Avalanche Voltage—1250-3500 Volts



1621 SERIES

Max. av. forward current at 120° C—500 Amperes

Surge overload rating, 1 cycle—8500 Amperes

Controlled Avalanche Voltage—1100-2300 Volts



1611 SERIES

Max. av. forward current at 120° C—470 Amperes

Surge overload rating, 1 cycle—5200 Amperes

Controlled Avalanche Voltage—2600-5000 Volts



Write for technical data bulletins—
Tung-Sol Division, Wagner Electric Corporation
630 West Mt. Pleasant Ave., Livingston, N.J. 07039
Twx: 710-994-4865 • Phone: (201) 992-1100; (212) 732-5426

TUNG-SOL High Power Silicon Rectifiers

Trademark TUNG-SOL Reg. U. S. Pat. Off. and Marcas Registradas

INFORMATION RETRIEVAL NUMBER 13



We've just advanced the Q-meter 17 years.

For lab and production-line work, our new Model 4342A Q-meter measures Q faster and easier than its classic predecessor, HP's Boonton 260A.

It measures Q values from 5 to 1000 in a frequency range of 22 kHz to 70 MHz.

- Automatic leveling of oscillator source eliminates need for Q-Multiplier controls.

- Speedy GO/NO-GO selector reduces component testing time.

- High impedance voltmeter virtually

- eliminates frequent zero reset.

- New solid-state circuitry eliminates unreliable thermocouple.

- Pushbutton controls give fast frequency and Q range switching.

- All this means shorter measurement time and a big boost for high-volume testing and lab use.

- It's versatile, too. You can detect extremely small changes in Q. Or measure coil, capacitor and resistor parameters. And the price? Just \$1500.

- Okay. You want to measure up to

peak production. Dial your nearby Hewlett-Packard field engineer. He'll give you all the specs on HP's newest Q-meter in 17 years. Or write: Hewlett-Packard, Palo Alto, California 94304; Europe: 1217 Meyrin-Geneva, Switzerland.

HEWLETT  PACKARD

IMPEDANCE INSTRUMENTS

18002

...want a tantalum capacitor with proven performance?

Buy TYPE 150D TANTALEX[®] SOLID-ELECTROLYTE CAPACITORS



INFORMATION RETRIEVAL NUMBER 884

- Hermetically-sealed in metal cases
- Four case sizes, ranging from 1/4" to 3/4" length
- Value-packed performance characteristics—low impedances at high frequencies, low dissipation factor, minimal capacitance drift with temperature, practically no change in capacitance with life
- Low leakage current limits
- New higher capacitance ratings
- Request Engineering Bulletin 3520F

4SC-9144R3

Now...new, lower capacitance values!

Type 192P PACER[®] FILMITE[®] 'E' CAPACITORS

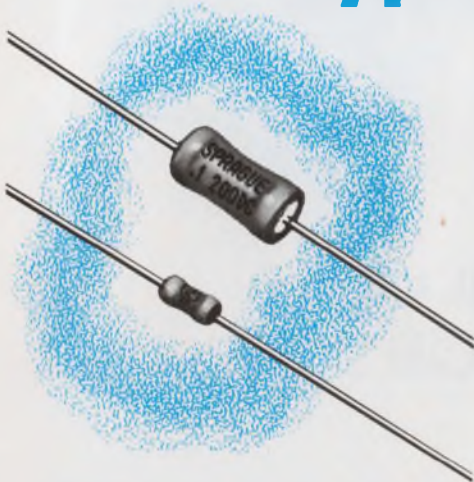

INFORMATION RETRIEVAL NUMBER 885

- Low-cost film capacitors with one-third the size of conventional tubulars
- Eight new low-capacitance values (100 pF thru 390 pF @ 200V) added to broad range of standard ratings
- Special construction—extended foil sections terminated in metal end caps, assuring positive contact with every turn of the electrodes
- End caps are also effective moisture barriers
- Entire assembly protected by special sleeve of high dielectric strength
- Request Engineering Bulletin 2066B

4SC-0105R1

For Engineering Bulletins as noted above, write to:
Technical Literature Service, Sprague Electric Co., 347
Marshall Street, North Adams, Massachusetts 01247.



'Sprague' and '®' are registered trademarks of the Sprague Electric Co.

THE BROAD-LINE PRODUCER OF ELECTRONIC PARTS

Highlighting

THE ISSUE

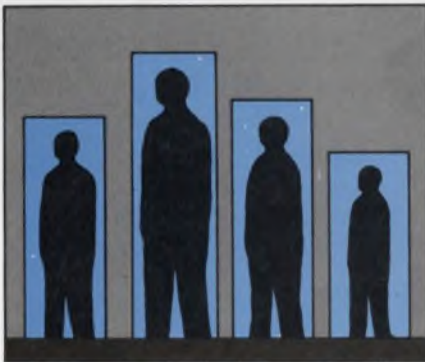

Are you bored with engineering?
Are you in favor of an engineering union?

Would you change your job title to match the work you do?

How much more money do you think you should be earning?

How much responsibility do you think your employer should assume for your continued education in technology?

ELECTRONIC DESIGN has answers to these questions and many others as the result of a management survey conducted among a random sampling of 1000 of the magazine's subscribers.

Page 96



Electronic aids are infiltrating the world of sports—from spectator events like football and horse racing to field and stream activities like fishing and dog training. The most spectacular are the huge stadium scoreboards, ranging from a \$600,000 computer-operated animated football scoreboard for the San Diego Municipal Stadium (see cover photo) to a new \$4-million system now being installed at the Ontario (Calif.) Motor Speedway.

In addition, electronic timing systems have either completely taken over or are being used as backups in many sporting events.

Page 36

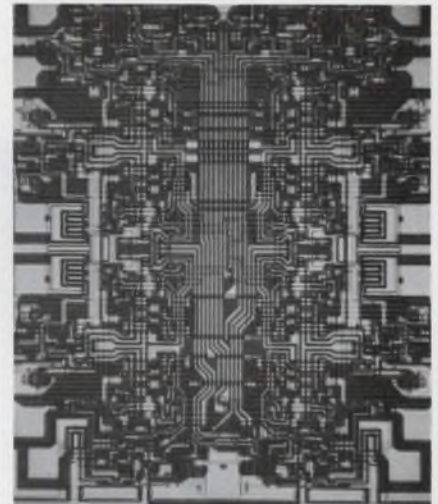

Two new monolithic arrays form a unique family of memory products known as content addressable memories (CAMs).

In content addressable memories data can be associated. That is any data placed at the input of the memory is matched against the memory's stored data. The memory responds with a match or mismatch answer.

With these two new CAMs, data can be written into them just like any other read-write memory and they then provide the association of input to stored data.

Page 117

Why Ragen Semiconductor tests C/MOS with a Teradyne J259

When you're testing complementary-MOS devices with two or three hundred transistors on a chip, you'd better be sure of your test equipment. Ragen Semiconductor, an acknowledged leader in C/MOS, has good reason to believe in its computer-operated test system: With thousands of C/MOS IC's tested and shipped, returns have been virtually nil.

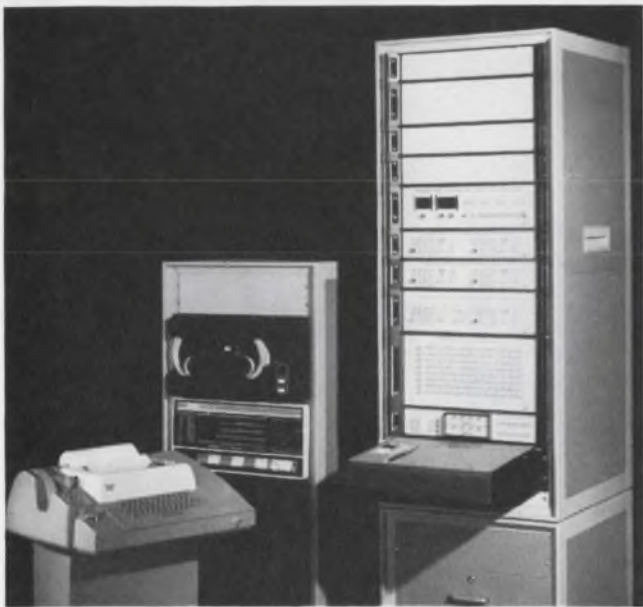

Ragen's test system? A Teradyne J259.

Ask Ragen President Al Medwin what he likes about his J259 and he may tell you that its high-impedance measurement system is perfect for the low-current measurements he has to make. Or he may tell you about the strong software Teradyne supplies with its systems. He may well mention speed because each Ragen device sees 450 parametric tests almost as soon as it's placed in the test socket.

He might also tell you some things the J259 *doesn't* do.

It doesn't force you to stop production once a week for recalibration adjustments.

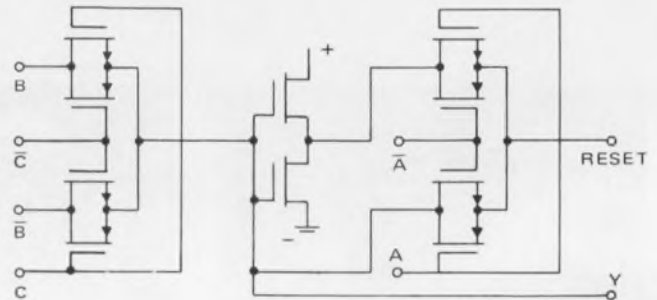

It doesn't break down every time someone insults it. Ragen's J259 downtime has been less than *one percent*.

It doesn't leave you high and dry when your test load changes. When you expand, it expands, through the easy addition of multiplexers, magnetic-tape units, line printers, and all the software you need to go with them.



The J259 makes sense to Ragen Semiconductor. If you're in the business of testing circuits — integrated or otherwise — it makes sense to find out more about Teradyne computer-operated test systems. Just use the reader service card or write Teradyne, 183 Essex St., Boston, Mass. 02111.

Teradyne makes sense.

News Scope

Mini-machines and mini-firms marked this year's SJCC

Minicomputers, minicomputer peripherals, and graphic terminals were conspicuous among exhibits at the 1970 Spring Joint Computer Conference held in Atlantic City, May 5-7. Inexpensive digital cassette tape recorders and magnetic discs were also well represented.

Exhibitors, too, showed a trend to the small in size, according to David T. O'Brien, district manager of General Automation, Inc., Anaheim, Calif.

"The small people," he said, "gain credibility from attending shows. They can demonstrate to a dubious customer that they do, in fact, have working hardware available. The large companies have made their mark and their show expenditures are not returned in increased sales."

Some 360 exhibitors displayed computer hardware in 980 booths at Convention Hall. Among the missing were several manufacturers of large computers: CDC, XDS and Burroughs, for example. And software houses were not as heavily represented as in the past.

An informal survey of exhibitors showed that about 40% of those making inquiries at the booths were from upper levels of management or engineering management. About 20% were computer professionals—engineers and programmers. Fifteen to 20% were university affiliated, and some of the remainder were interested in investing opportunities.

The usual technical recruiting associated with trade shows was evident at the SJCC although at a much reduced rate. Two reasons for this were offered by Dick Wanamaker, who was managing the Career Center.

Wanamaker said, "The job seekers are not here in Atlantic City because it is relatively remote, and

the jobs are not being offered by the employers." He added, "The market for computer professionals has only recently begun to soften. Large companies are now recruiting on a corporation-wide basis instead of the division basis in the past."

Wanamaker had another comment on today's applicants. He said, "They are waiting for agencies to call—they are not dropping in to look for jobs. They were spoiled by the booming demand for their skills in the past."

Some 27,000 attendees paid registration fees of \$20 for sponsor AFIPS (American Federation of Information Processing Societies) members, and \$40 for non-members. The previous \$5 ticket for admission to exhibits only was not offered, thus making attendance comparisons to past joint computer conferences inconclusive.

Growing market seen for test equipment

The \$260-million-a-year Government market for automatic test and checkout equipment will double by 1975, Frost & Sullivan predicts.

The New York market-research company also forecasts that non-computerized systems for testing and checkout, now a \$490-million-a-year Government market, will stay the same.

The biggest buys in automatic equipment will be to support aircraft, Frost & Sullivan reports. The B-1 manned strategic aircraft system will have a central, integrated test system as part of its avionics package. The Air Force's F-15 fighter plane will require from 15 to 20 field shops to maintain it, with \$50-million worth of electronics in the shops.

The Army will buy automated

equipment for the field to reduce personnel. The Navy, which also wants to reduce personnel, needs automated systems on board a ship—not only electronic equipment but everything that operates.

Eventually, the Frost & Sullivan report says, built-in test equipment will monitor each subsystem so it can be repaired with redundant components when something breaks down. The built-in equipment represents only 5% of the market now, but is expected to build up substantially by 1980. Built-in monitoring units for the space agency are expected sooner.

The findings, presented in a 175-page report, are available for \$245 a copy from Frost & Sullivan, 106 Fulton St., New York City.

New ceramic promises to be useful in devices

Practical devices made of ferro-electric ceramics may soon be available, according to two technical papers, presented at last month's meeting of the American Ceramic Society in Philadelphia.

The peculiar electro-optic properties of ferro-electric ceramics have been studied for several years, but their application to specific devices, such as information storage and display systems, has been limited by materials problems.

An improved electro-optic ceramic material—lead lanthanum zirconate titanate (PLZT)—discovered at Sandia Laboratories, Albuquerque, N.M., was described at the Philadelphia meeting by a Sandia researcher, Cecil E. Land.

The ceramic differs from earlier materials in that it is more transparent, producing black-white contrasts of as much as 1000-to-1 and a complete range of colors.

In optical ferro-electric ceramics, voltage is applied across a portion of the plate to establish an electrical polarization vector and align (pole) minute dipoles within the material along this vector. Polarized light directed at the plate is modified as it passes through the ceramic, the degree of modification varying according to the wavelength of the light. The ceramic therefore separates colors much like a prism.

These optical effects remain even

after the electrical field is removed, giving the material a true "memory" capability. The image display may also be viewed directly or projected like a photographic slide.

The second paper, by A. H. Meitzler of Bell Telephone Laboratories, Murray Hill, N.J., described a number of experimental image-storage and display devices using fine-grain ferro-electric ceramics. Thin plates of lead zirconate-lead titanate in combination with transparent conductive and photoconductive films, are used to form device structures capable of storing high-contrast images under the control of electrical voltages.

Meitzler said that experimental devices had demonstrated a resolution of about 50 lines/mm in 50 μm thick ceramic material and had been able to hold the image with no apparent change for several months.

Motorola optimistic about MOS and ECL

"One-half of the ICs used in 1975 will be either MOS memory or ECL devices," according to Milton Lafen, group manager of digital IC product marketing for Motorola Semiconductor Products, Inc.

Speaking at a Motorola seminar on digital ICs, the Phoenix engineer said that emitter-coupled logic would be attractive to designers because of its high speed, while complementary MOS would offer low-power operation. Lafen saw the TTL market continuing to grow until 1972 or 1973, when he expects it to level off at high continued usage.

Another Motorola expert, Michael Callahan, agreed that MOS and ECL were headed for major growth. Callahan, who is operations manager for IC research and development in Phoenix, said that any semiconductor concern that wanted to be a leader would have to be involved in at least nine tech-

nologies. He listed them as follows: complementary MOS, silicon-gate technology, high-frequency bipolar circuits, multilayer metalization, beam-leaded chips, beam-lead laminates, computer-aided design, radiation hardening, and fusible-link ROMs.

Callahan said that future MOS products would have to be low-threshold circuits to be successful. Complementary MOS will give very low quiescent power dissipation, a feature much appreciated by designers, the researcher said, and the silicon-gate technology will yield smaller devices, lower Miller-effect capacitance and higher frequency of operation.

"Multilayer metal will be invaluable in random logic," Callahan said, "where interconnection layout problems are most difficult." And computer aids will be mandatory. "Any vendor that is not willing to invest in CAD will not be in a leadership position in the semiconductor industry of the future," he said.

Callahan predicted that fusible-link ROMs—which are programmed easily by the customer—would offer an easy way around the problem of system design errors. "System designers often make errors," he said, "and are faced with a three-month wait for new ROMs if a mask change is necessary. The new programmable ROMs will make changes in memory programming easy."

And, surprisingly, the IC R&D expert saw a good future for the old RTL logic. "Motorola will introduce new RTL products in 1970," he said.

Laser radar to pinpoint details of moon's surface

Accurate mapping of the moon's topology from a spacecraft will be possible for the first time with a pulsed ruby-laser radar altimeter that measures altitude to within 6.6 feet at 60 nautical miles. The laser transmitter produces a 10-ns, 2-MW peak value. The system, being designed by RCA Aerospace Systems Burlington, Mass., under a \$1.7 million NASA contract, is a special version of RCA's AN/GVS-1 portable Army range finder.

Measurements of the moon's sur-

face using the new altimeter will be made from the orbiting Apollo 16 command and service module.

British urged to merge computer software firms

Within a few years, the expenditure in Britain on software will be twice that of hardware, according to Dr. Ernest Davies, Joint Parliamentary Secretary to Britain's Ministry of Technology.

In addressing the Computer Services and Bureaux Association in London last month, Davies stated that the computer software industry "could be strengthened by some grouping together of software houses to create more viable organizations."

The Ministry of Technology has been responsible for implementing a number of mergers of British firms over the past three years.

Last year in Britain the cost of software was \$72 million while the hardware was worth \$77 million.

Canon and TI develop LSI pocket calculator

A battery-powered calculator, appropriately called "Pocketronic," has been unveiled by Canon, Inc. Aimed for the mass consumer market, the calculator evolved from a joint development program between Canon and Texas Instruments. MOS/LSI helped achieve the small size—4 by 8-3/16 by 1-15/16 inches. The unit weighs 1.8 pounds.

The calculator will be available for sale in Japan later this year, and in the U. S. in January, 1971. Initially, prices are expected to be under \$400, with production starting at 10,000 units per month. Eventually, it is rumored, the price may drop to \$100.

The Pocketronic performs a full range of addition, subtraction, multiplication, division, credit balance and other manipulations of numbers as large as 12 digits.

All calculations are performed by three LSI chips built by TI. Total logic complexity for the three chips is 371 gates (with an average of 4.2 inputs per gate), 203 shift-register bits, and 10 flip-flops. A paper tape is used to provide the readout for the calculator.

Introducing Potter & Brumfield's unique

dual thin-line dry reed relays

An entirely new magnetic structure makes possible an exceptionally low seated height of only 0.275 inch for high density board packaging. Circuit boards employing JDT relays may be spaced on 0.5 inch centers.

This design minimizes magnetic flux dispersion, resulting in a very efficient magnetic circuit. This decreases coil power requirements and often permits direct operation of JDT relays in low-power semi-conductor logic circuits. An interfacing amplifier may be eliminated in many applications.

Terminals are similar to those on IC packages, permitting spot testing on either side of a circuit board. The dual in-line terminals on 0.1 inch centers simplify circuit board design. The reed switches are rated at 10 watts maximum resistive (50V or 0.5A DC maximum) switching.

A solid state time delay circuit may be incorporated in this small package. Or a Darlington amplifier can be included to compensate for low current applications. However, the number of available poles for switching is reduced by the addition of either of these circuits.

The JDT is completely encapsulated in epoxy, giving protection against environmental contamination. The Series is presently available in many combinations of Forms of A, B and C.



Get full information today by calling your local P&B representative or call direct to Potter & Brumfield Division of American Machine & Foundry Company, Princeton, Indiana. 812-385-5251.

Mounted height
is only 0.275"

Power requirements:
only 75mw per pole

Combinations of Forms
A, B and C are available

Single Lot Prices:

JDT 4000 Series (4-pole) \$ 7.65

JDT 8000 Series (8-pole) \$12.95

Quantity discounts apply.

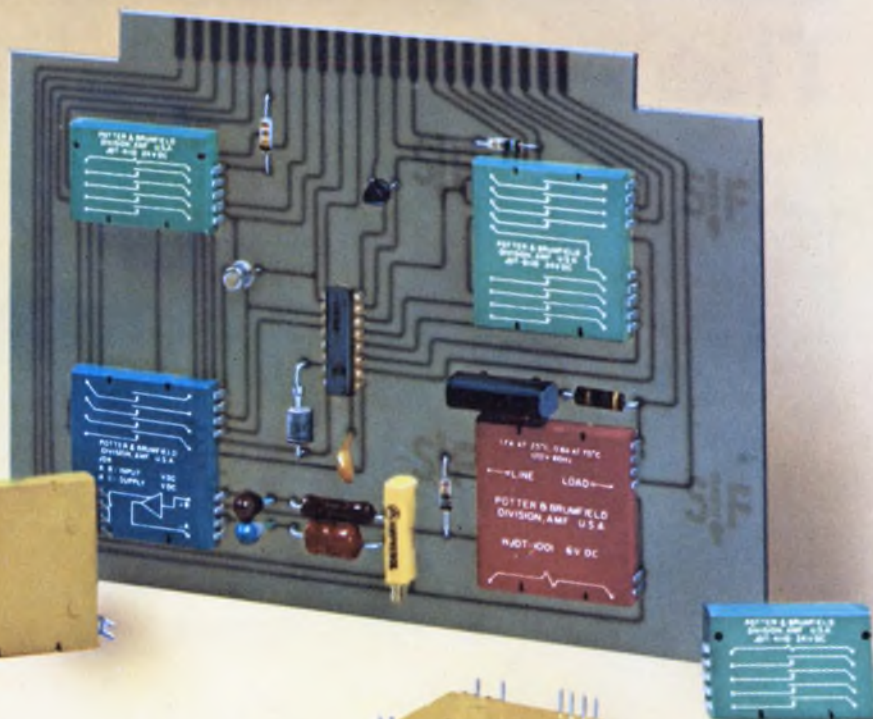

AMF

POTTER & BRUMFIELD

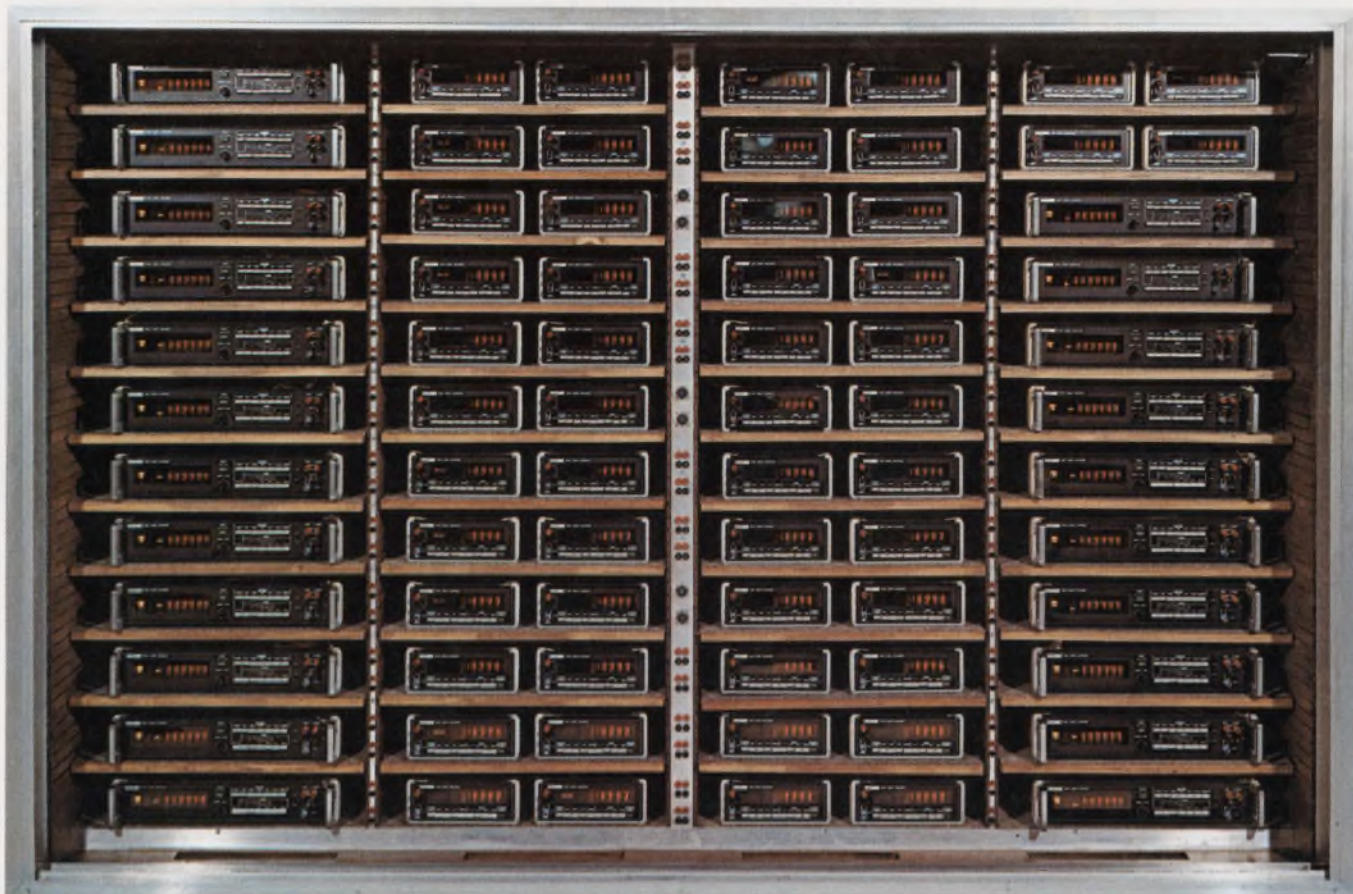

The seven day glitch killer

Every seven days we put another run of new Fluke digital voltmeters in the Fluke "hot box." Here, by continuously cycling the input voltage and "baking in" the instrument at 122°F, we catch the glitches and bugs caused by long term operation in a hot environment.

The "seven day glitch killer" is, of course, only one of the many check-out steps we go through. We control the critical parts by manufacturing all of our own resistors and printed circuit boards and by 100 percent dynamic testing of all active components.

Further, the new Fluke DVM's are designed from the ground up to give you long trouble-free life, low maintenance, and outstanding technical performance. For instance, the Model 8300A has only one-fifth as many components as comparable DVM's. And it's built to work in an 80 percent relative humidity.

In other words, the glitches go before you get the instrument. Another typical Fluke trick.

Model 8100A 0.02% Digital Multimeter with complete portability for only \$695.



Model 8300A Digital Voltmeter with total built-in systems capability for only \$1295.



Fluke, Box 7428, Seattle, Washington 98133. Phone: (206) 774-2211. TWX: 910-449-2850/In Europe, address Fluke Nederland (N.V.), P.O. Box 5053, Tilburg, Holland. Phone: (04250) 70130. Telex: 884-50237/In the U.K., address Fluke International Corp., Garnett Close, Watford, WD2 4TT. Phone: Watford, 27769. Telex: 934583.

Invisible, corner-turning IR detects thieves

Solid-state laser system employs repeaters to ring an industrial area with a beam—for miles, if needed

Jim McDermott
East Coast Editor

Infrared-laser repeaters that can project an invisible beam around a corner and spot a burglar before he gets to work are making it highly unlikely that industrial crime will pay.

The solid-state repeaters—unique combinations of laser receivers/transmitters—are the main elements in a new security system that can wrap a protective beam around a building for miles.

Unlike most laser systems, precise alignment of the transmitter with the receiver is not critical. Also, the beam energy is low enough to be safe for the human eye—less than 10^{-7} joules/cm².

Interruption of the beam at any point sends a coded signal to a monitor station, locating the point where the beam was intercepted.

The transmitters in the system, developed by Holobeam, Inc., Paramus, N.J., use a gallium arsenide (GaAs) laser diode, driven by 30-A, 150-nsec pulses at a 30-Hz rate and radiating in the invisible region at 9050 Å. For maximum sensitivity, the receivers use a silicon photodiode that peaks close to the same wavelength.

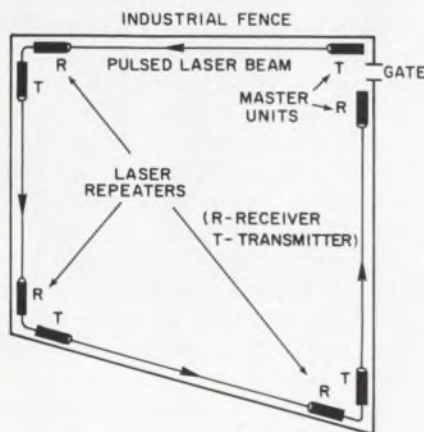

1. Transmitters and receivers of the IR security system are small units—only a few inches long.

For a typical fence system (Fig. 1), a master transmitter is placed at some control point, such as a factory gate. From here, the beam is projected along the fence to the receiver of the first repeater.

The receiver amplifies the pulsed signal and applies it to the repeater transmitter, sending it out at the same power level as from the master transmitter. The beam is thus passed on from repeater to repeater to the master receiver.

The output of the receiver is passed on to a master alarm and display panel, which, upon interruption of the beam, gives an audible or visual alarm and also indicates the interrupted repeater.

The most sensitive system spans 50,000 feet reliably in clear weather. There are also 5000-foot and 500-foot systems. Under heavy fog conditions, the capability of all

systems is reduced.

Brief interruptions of the beam caused by birds or leaves do not trigger the alarm, since the laser pulse rate has been specifically chosen to minimize this. In addition the master receiver signals an alarm only after a preset number of pulses have not been received.

If the beam is interrupted ahead of any receiver, a beam-interrupt detector triggers a local repeater-identification oscillator, which then sends pulses through the remainder of the system at a rate unique to that station. These pulses are decoded by logic that indicates where the interruption has occurred.

The system developed originally for the military, maintains a constant transmitter diode power output from -30° to 130° F through regulation of the laser-diode drive. This is accomplished by feeding back a signal from a subminiature thermistor, mounted on the diode, to the driver-regulator (Fig. 2). ■■

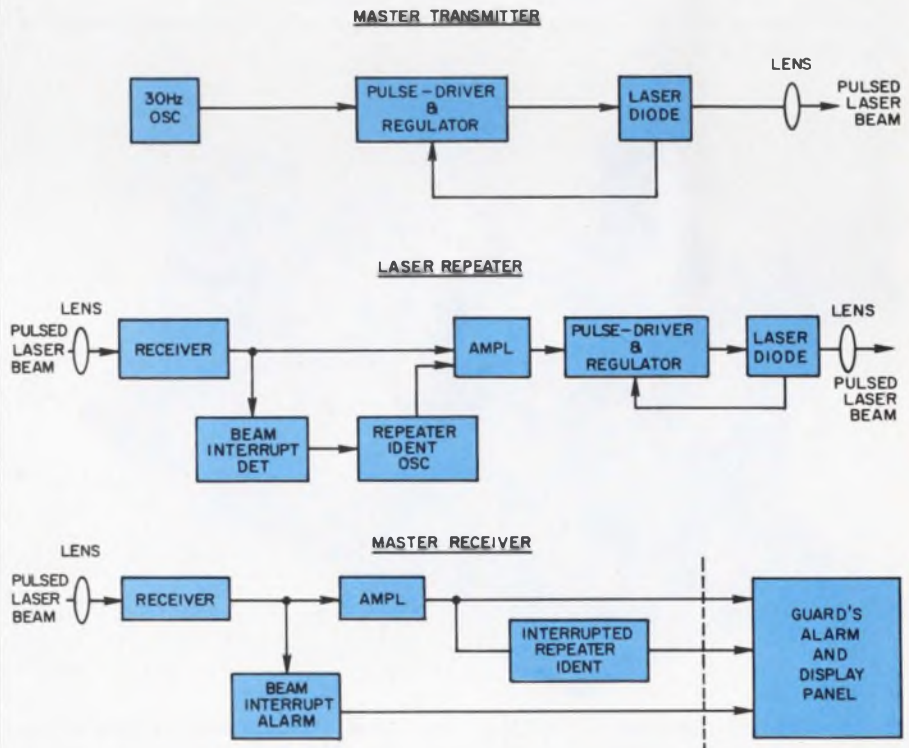

2. Attenuation of the laser beam is overcome in each repeater by amplifying the received signal and projecting the new transmitted beam at the original system level. Receivers and transmitters are separate units.

Process squeezes out wire like toothpaste

The first major change in wire making since jewelers in ancient Egypt began drawing gold wire through drilled stones is reported by Western Electric's Engineering Research Center in Princeton, N.J.

Instead of drawing the wire, as has been done for nearly 4000 years, the new process squeezes it out like toothpaste. Fluid under

high pressure does the squeezing.

Known as continuous hydrostatic extrusion, the new process is said to offer a number of advantages over conventional wire drawing techniques. These include lower equipment costs, cheaper maintenance, greatly reduced space and power requirements, less wire breakage and reduced labor. There

are also indications that wire made by hydrostatic extrusion is stronger than drawn wire of the same gauge, according to Western Electric researcher, Frank Fuchs, Jr.

Fuchs notes that engineers have been intrigued with the idea of using the process to manufacture wire for many years, but until now, nobody knew how to feed wire into a high-pressure chamber on a continuous basis.

Western Electric researchers, headed by Fuchs, solved the problem by "viscous drag feeding"—a method of using a fluid to force wire rod through the high-pressure chamber and out of the die. A fluid, such as warm beeswax, is pumped through the chamber in the direction of the die. Under high pressure, this fluid becomes sufficiently sticky to adhere to the rod and drag it along.

Another fluid is pumped into one end of the chamber under very high pressure to reduce the wire rod's diameter in the "die." Strictly speaking, Fuchs notes, this is not actually a die, since it serves only as a shaped container for the high pressure fluid. There is no metal-to-metal contact as there would be in a true die.

A prototype production machine incorporating all of these features is presently being designed and built by Western Electric for installation in their Atlanta, Ga., facility by the end of the year. The machine is designed to produce aluminum wire at speeds up to 4000 feet-per-minute in sizes as small as 0.02 inch (2 gauge).

Fuchs says that only one pass through a single "die" will be required, regardless of the size of wire being made. Conventional wire making, he notes, requires drawing the wire through as many as 24 dies in tandem on two different machines.

Although the process will initially be restricted to the manufacture of aluminum wire, it is ultimately expected to be used in the production of copper wire as well. ■■

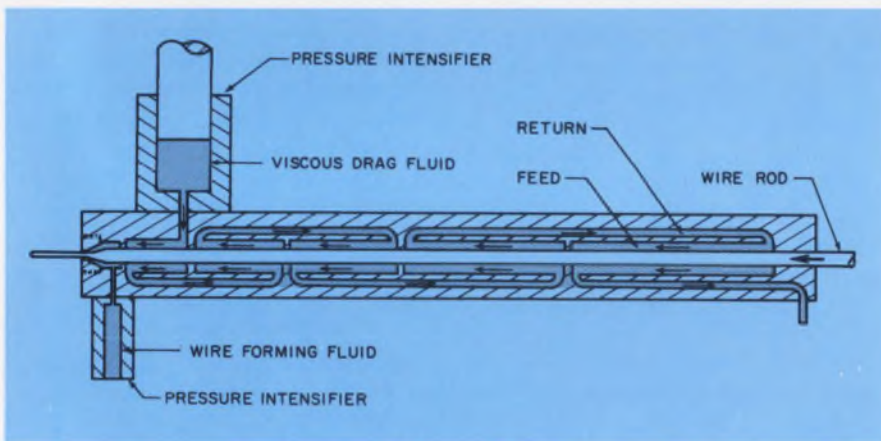

A viscous fluid, such as beeswax, drags the wire rod through the chamber in the direction of the die. There, another fluid under very high pressure reduces the wire rod's diameter.

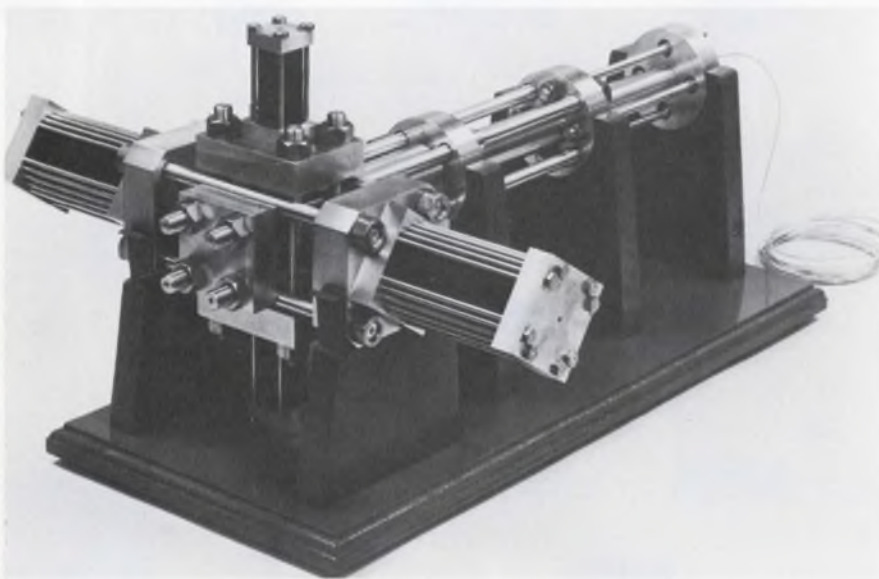

Scale model of continuous hydrostatic extrusion machine will be able to extrude aluminum wire at up to 4000 feet-per-minute in sizes as small as 0.02 inch (24 gauge). The actual machine being built by Western Electric will be about 14 feet long. Wire rod will be continuously fed into the rear of the machine (right) and will emerge from its front end (left) as wire.

BOURNS

bridges the generation gap in...

PANEL CONTROLS



...with **CERMET**

Bourns introduces a new generation of Panel Controls with cermet resistance elements for top performance in high-grade commercial, industrial and RV4, RV5, RV6 type applications.

The hang-up of the hot molded carbon element control (that's the older generation) is it weakens, can't stand the heat.

Bourns found a way to cool it . . . with cermet!

What you get is stability, a better temperature coefficient, a higher power rating in a smaller package.

One 1/2" and two 3/4" diameter units constitute the basic model line which covers all RV4, RV5 and RV6 type applications. Their profiles are the thinnest in the industry. All models show excellent high frequency characteristics, extremely low noise and good setability.

COST? Less than a dollar for Model 3859 in production quantities. Then subtract the price of rejections, complaints and delays common with the older generation. Delivery is off the shelf.

Turn on with Bourns. Send for Data Packet on cermet Panel Controls or call your local Bourns sales office for a sample.

Model 3862, 1/2" dia., 1/4" standard or locking bushing with or without panel seal, 1 watt at 125°C. **Model 3852**, 3/4" dia., standard or locking bushing — 1/4" with or without panel seal for Mil Spec type uses, 3/8" for industry; 2 watts at 70°C. **Model 3859**, 3/4" dia., 3/8" tough plastic bushing; also snap-in version; 2 watts at 70°C.



Coming: portable thermoelectric power

For a long time, the Army has been looking for a quiet, lightweight, high-endurance power source, so its troops on patrol can operate portable radar, communication, data-terminal and other equipment without telltale noise.

Now, with a few modifications, it may have just what it has been waiting for. A manpack thermoelectric generator—a developmental model, temporarily designated PP-6311—has been built by the Minnesota Mining and Manufacturing Co. in Saint Paul, under contract with the Electronic Components Laboratory, U. S. Army Electronics Command, Fort Monmouth, N. J.

The generator was described last week by two Army laboratory men—Joseph P. Angello and Stuart J. Shapiro—at the Power Sources Symposium at Fort Monmouth.

The manpack generator is only 12 inches high, 12 inches long and 5-1/2 inches wide. It weighs 15 pounds without fuel. And it operates 12 hours on one refueling.

Other points the Army likes:

- It starts easily—10 minutes after it's turned on, the system produces rated power.

- It has multi-fuel capability—diesel or jet fuels or combat gasoline can be used.

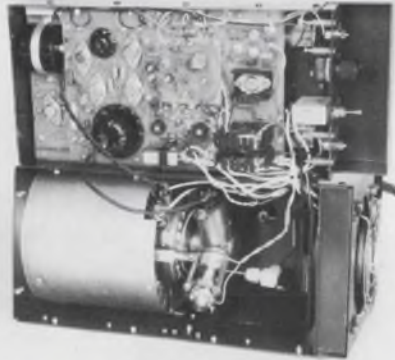

Manpack thermoelectric generator weighs 15 pounds. Top portion contains all electrical and electronic circuits for the power source. Bottom section contains the thermopile, burner, fuel, cooling systems and the battery (not visible).

- It operates quietly. The Army's goal of "inaudibility at 100 feet" hasn't been reached yet, but with more effort it will be, the two laboratory men say.

The generator produces power output by direct conversion of heat energy of the fuels to electrical energy. The process takes place within lead telluride thermoelectric couples that are contained in the

thermopile. Heat is applied to one side of the thermopile by burning liquid fuel in a burner mantle. The other side of the thermopile is kept cool by forcing air, by means of a fan, across a row of heat-dissipating fins.

The fuel is fed to the burner from an internal tank by an electric pump. Fuel is conditioned for combustion by an ultrasonic atomizer.

The airflow necessary for combustion is supplied by a blower in the lower burner assembly.

Ignition is initiated with a glow coil, also in the lower burner assembly. The thermopile provides power for all accessory components as well as the external load.

To get the generator started, battery power is needed. But before three minutes have passed, the thermopile has sufficient power to support the operation alone.

More work on the generator is needed, the Army says. For example, heat from the combustion chamber is so intense it could ignite dry grass, or other flammable materials. Another problem is that the unit's 6-volt level is too low. The Army would like 24 to 28 volts dc, "to be consistent with Army equipment." ■■

Contactless magnetic counter has high accuracy

A magnetically settable counter that will produce any combination of precisely timed electrical pulses on command has been developed at Sandia Laboratories, Albuquerque, N.M.

The device is set without the need for electrical contacts and therefore is said to be more reliable and accurate than similar counters.

The output pulse combinations are set simply by moving a calibrated knob, which moves a magnetic coil, to various positions along a helical winding of nickel-iron

wire. When voltage is applied to the coil, a magnetic reversal (domain) is stored in that particular part of the wire.

When the counter is set therefore, the nickel-iron wire contains one or more domains that may be arranged at linear or logarithmic intervals as binary numbers or as a predetermined code.

The counter's memory is "read" by activating a two-phase clock. The clock applies alternating electrical pulses to a series of paired conductive metal elements, which move the domains along the nickel-

iron wire toward an output coil. The coil senses the arrival of each domain and produces an electrical output pulse.

The inventor of the device, Gordon R. Bachand, supervisor of Sandia's Advanced Test Instrumentation Development Div., says the number and complexity of pulses that can be stored by the counter is limited only by the length of magnetized wire.

Reliability and accuracy are high, he says, because there are no ohmic contacts, whose characteristics would change with time. ■■

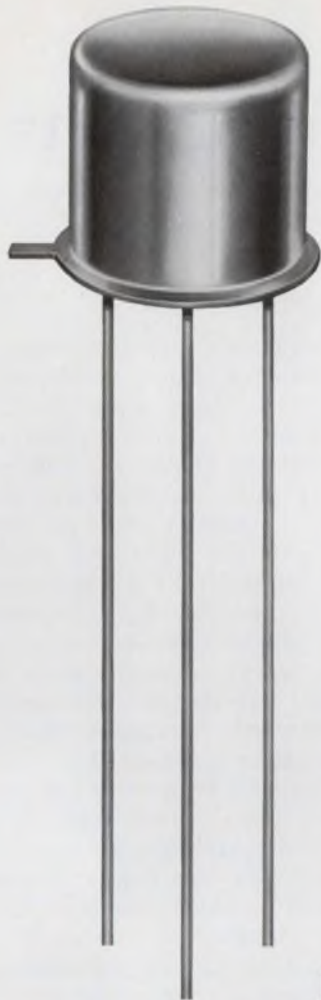

24¢

ID100 and ID200 Series
**INDUSTRIAL
SCR's**



**Only last month
you couldn't touch
an SCR in a
metal package
for anywhere near
the price of plastic**

ID 100 Series

Anode current rating 500mA @ 100°C Case.
Voltage ratings to 200V.
200µa max gate trigger current.
Peak On-Voltage 1.7V max @ 1 Amp.
TO-18 can with 0.5" leads.

(SSPI Product Group)



ID 200 Series

Anode current rating 1.6A @ 70°C Case.
Voltage ratings to 200V.
200µa max gate trigger current.
Peak On-Voltage 2.2V max @ 4 Amps.
TO-5 can with 0.5" leads.

(SSPI Product Group)



Now you can

- Sensing types start at 24c each in 100K lots. Comparably low prices on control types and smaller quantities.
- Typical Unitorde quality . . . from the people who introduced the first lead-mounted SCR's 12 years and millions of SCR's ago.

- Electrically equivalent to most widely used plastic devices.
- Used for lamp or relay driving, sensors, pulse-generators, timing circuits, motor controls, and process controllers.

IN STOCK READY TO DELIVER NOW • SEND FOR YOUR FREE SAMPLES AND COMPLETE SPECS

For Fast Action call Pete Jenner collect . . . today!

A PRODUCT OF THE WIDE RANGING SEMICONDUCTOR TECHNOLOGY OF

UNITRODE



580 Pleasant St., Watertown, Massachusetts 02172 • (617) 926-0404

INFORMATION RETRIEVAL NUMBER 19

The 1971 watch: No hands, no moving parts

John F. Mason
News Editor

Press a button on your all-electronic, solid-state wristwatch, and the time appears on a face that looks like a miniature TV screen. An array of small dots, called the dot matrix, lights up to form the numbers for the hour and minutes.

By touching the button once, the wearer programs the hour and minutes to remain visible for 1 1/4 seconds. If pressure is maintained on the button, the hour and minutes disappear, and seconds appear and continue to count off time for as long as the button is depressed.

Release the button, and your wristwatch screen goes dark.

Prototype models of this watch without hands or moving parts have been developed jointly by the Hamilton Watch Co. of Lancaster, Pa., and Electro/Data, Inc., of Garland, Tex. Production units are scheduled to hit the market next year.

There's no problem about seeing the numbers in poor light. A built-in light sensory mechanism detects ambient light conditions and automatically adjusts the intensity of the dot matrix through four levels of brightness. On a sunny day the light is eight times brighter than

when the time is displayed in a poorly lighted room.

Development of the watch was made possible by the recent availability of ICs that draw only 18 microwatts of power and a high-energy, rechargeable silver zinc battery.

Hamilton's research director, John M. Bergey, alluded to the need for ultra-low-power ICs and the high-energy battery in an interview earlier this year with *ELECTRONIC DESIGN* (see "Time Marches On—but Electronically Now," ED 7, April 1, 1970, p. 25).



Digital display in all-electronic watch that will sell for \$1500.

Hamilton will distribute the new wristwatch for \$1500 retail.

Logic circuitry used

Called Pulsar, the watch computes and displays time electronically utilizing computer logic circuitry and gallium arsenide phosphide light-emitting diodes. The unit consists of three major components: a time computer module with microminiature logic and display circuit substrates, a 3-cell, 4-1/2-V battery and a high-frequency, quartz crystal time base.

The operation begins with the battery stimulating the quartz crystal, which vibrates at precisely 32,768 cycles a second. The vibrations are then reduced to one pulse a second by a multi-stage, integrated circuit binary counter, which passes the pulses through the time computer module to time-display circuitry.

"The high rate of vibration, or frequency, is four times greater than in electro-mechanical quartz crystal watches and enables us to achieve an unprecedented degree of accuracy," says Bergey. "Units we've been wearing have not deviated more than three seconds a month."

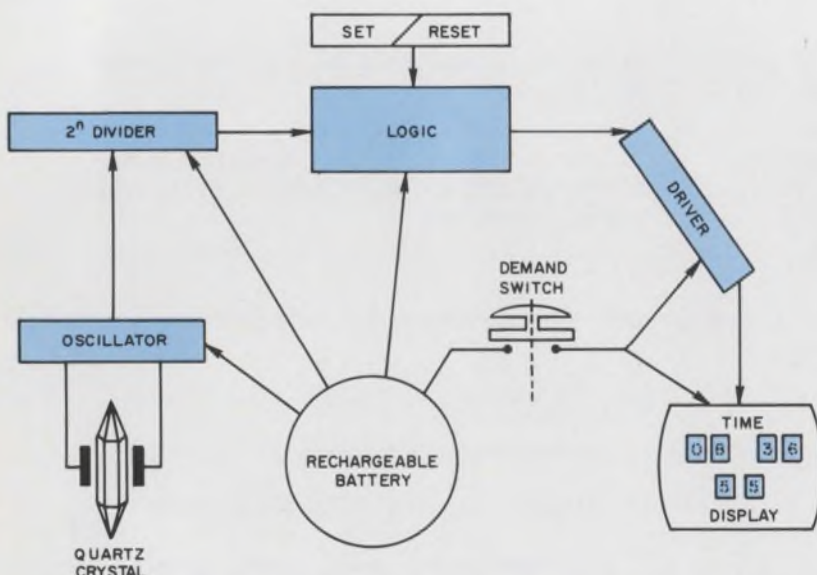

The battery in this solid-state watch stimulates a quartz crystal, which passes pulses through the time-computer module to the time-display stations. Components in photo

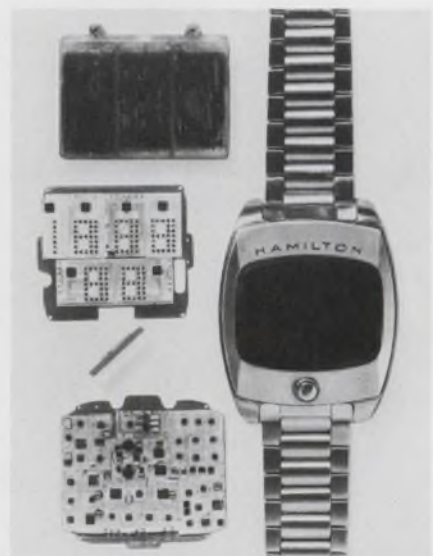

are (from top to bottom): the battery, the display side of the computer module, quartz crystal and the module's logic side.

So far only six of the wrist-watches have been built.

"We not only had to create our own battery," Bergey says, "but to reduce it to operable size, we equipped it with a demand button, so that time would be displayed only on request."

This was done to conserve energy.

Supplying the power

The high-energy main battery, occupying 80% of the volume of the case, performs the dual functions of exciting the quartz crystal and maintaining the charge in a similar, internal sustaining battery—actually a capacitor—that continuously drives the logic circuitry of the computer module. The main battery is 1.035 by 1.4 by 0.196 inches. It operates for six months and can be recharged 50 times.

Spent batteries are replaced by unscrewing the back of the case and inserting a fully charged spare.

"No accuracy is lost during the exchange," explains George Thiess, president of Electro/Data. "We have equipped the timepiece with a second energy source, permanently located on the underside of the logic circuit, to supply sufficient power to operate it during this brief period."

The watch contains 44 complementary-symmetry, metal-oxide semiconductor (MOS) integrated circuits. The circuitry, equivalent to 3474 npn and pnp transistors, is thousands of times more conservative of power than the more conventional bipolar and noncomplementary MOS-ICs, says Hamilton's president, Richard J. Blakinger.

The logic circuitry consists of seven individual hybrid circuits on alumina oxide substrates 0.020-inch thick.

The ICs, the hybrid-circuit logic substrates, display substrates and all wiring are ultrasonically bonded and mounted on separate gold-plated shim plates of 0.015-inch-thick beryllium-copper. The shim plates, with their circuitry, are screwed together back-to-back and constitute a fixed-program computer approximately 1/10-inch thick. The computer and its internal sustaining battery are potted in epoxy and cannot be jarred out of order, Hamilton says. ■■

LINEAR AMPLIFICATION OF LOW LEVEL SIGNALS

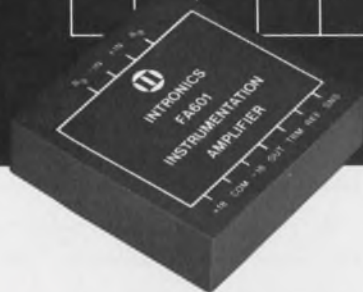
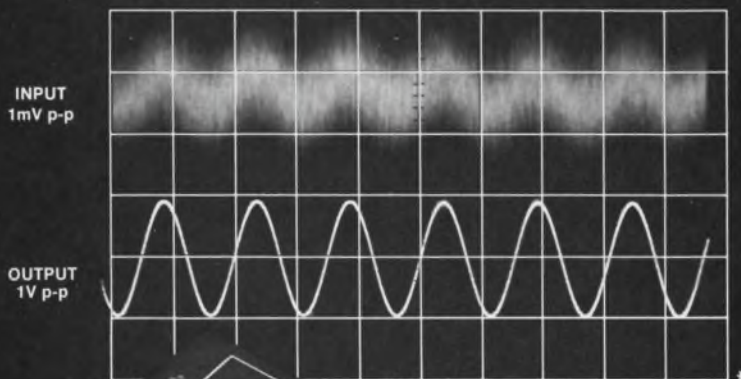

High impedance ($10^{11}\Omega$) FET differential input Adjustable gain of 1 to 1000

Intronics' model FA601 instrumentation amplifier is the optimum selection for transducer applications requiring precision, small size, and economy. Featuring a FET differential input with a high impedance of $10^{11}\Omega$, the FA601 offers programmable gains of 1 to 1000 independent of the input circuit by means of a single resistor, a low input current of 100 pA, and a large unity gain bandwidth of 1 MHz. Special attention has been made to minimize noise generated by the input stage.

The combination of high input impedance, a high CMRR of 86 dB, and low noise make the FA601 ideally suited to:

- biological probes — thermocouples — strain gages
- current sensing
- servo amplifiers
- multiplexer buffering

The FA601's modular package, 2 x 2 x .625 inches, and light weight, 2½ oz., allows convenient location near low level signal sources thereby eliminating cable noise and unwanted signals. The unit operates from ± 15 to ± 18 volt supplies and is easily connected to etched circuit boards or plugged into a mating socket. Price (1-9): \$65.

For technical data or applications assistance on model FA601 or Intronics' broad line of specialized analog products write or call Intronics, 57 Chapel Street, Newton, Mass. 02158, Tel. (617) 332-7350; TWX: 710-335-6835.

* Scope trace demonstrating rejection of common mode noise reproduced from actual Polaroid scope photo.



intronics

Laser makes air visible to aircraft designers

Fog moving past model plane in a wind tunnel at 4000 mph is illuminated to reveal the turbulence

Strange things happen to air rushing past an aircraft at six times the speed of sound. To design aircraft to travel at such speeds, aerodynamic engineers have long needed to "see" the airflow and turbulence clearly.

To help them examine both, wind-tunnel operators have often introduced smoke and water vapor into the air-stream and illuminated the area around the model aircraft with high intensity lights while photographs were taken. The airflow becomes visible under these

conditions because areas of low temperature contain more water particles, which in turn reflect light. Hotter areas contain less water particles and are therefore less visible.

Now, using essentially the same principle—but with the big addition of a laser—engineers are getting better results.

Laser illuminates moisture

A continuous-wave, helium-neon gas laser was installed on one side

of a wind tunnel and a camera on the other. The laser illuminates the natural moisture in the air—which, when the air is pushed to speeds of 4000 mph, turns to fog—and the camera records the whole show.

The results with the laser are superior to those obtained with conventional lights, according to engineers at the Air Force Systems Command's Arnold Engineering Development Center at Tullahoma, Tenn. The work is being carried out by ARO, Inc., for the System Command's Flight Dynamics Laboratory, Wright-Patterson Air Force Base, Ohio.

The laser-painted picture has much more resolution than the one illuminated by the high intensity light, the test engineers say. And, by placing the laser on one side of the tunnel and the camera on the other, they are obtaining a better perspective.

"When the laser looks back at the model aircraft from an angle of less than 90 degrees and the camera on the opposite side does the same, you get an almost three-dimensional effect," one engineer notes.

Portability a feature

The laser is also portable. It can be moved around to provide varying perspectives.

The laser was built by Spectra Physics, Inc., Mountain View, Calif. Using 15 milliwatts of power, it operates at 6328 Å. It is mounted on a swivel arrangement that permits it to beam through a verticle slit and across the test section, scanning the model from nose to tail.

Besides the laser tests, an oil-film technique is also used to study the flow of air over the surface of the model. This involves painting the model with viscous oil. As oil flows over the surface, the oil shapes itself to the airflow.

The oil stays in place even after the model is removed from the air stream. ■■



CW LASER

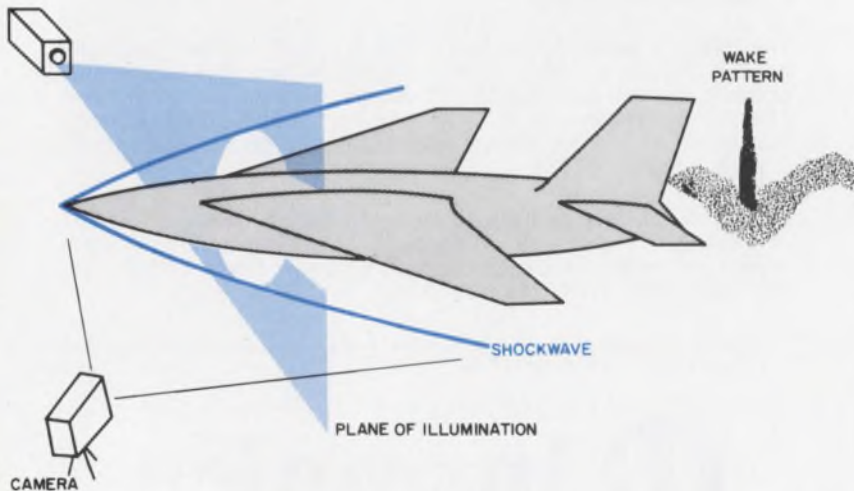

Laser and camera collaborate to show aerodynamic engineers shock waves when wind rushes past a model aircraft at six times the speed of sound. The turbulence behind the tail structure here is so pronounced that it looks like a vertical steel rod emerging from a horizontal layer of smoke.

MICROWAVES

How microstrip designs solve microwave problems.

We've spent over four years in research and development to come up with some very interesting solutions to microwave miniaturization problems.

Our microwave people have spent a lot of time developing techniques for miniaturizing microwave circuitry. They have done microwave projects for both military and commercial applications and have the experience to turn your microwave project into a hybrid package that will fulfill your demands at minimum cost and in minimum size.

We have pioneered the development of beam-lead technology to give us a new and powerful technique for mounting semiconductor devices on microstrip circuitry. For example, we use Sylvania-developed low-noise, beam-lead silicon Schottky diodes in mixer applications, and we use beam-lead PIN diodes for many switch and phase-shifter applications. All of these devices meet the stringent military environmental specification.

To give you an example of our capability, we can list at least three microwave systems that have been developed around our hybrid microwave capability.

These developments include an integrated man-pack radar, an integrated K_u band transceiver and an integrated mixer assembly for a highly specialized application.

For the integrated man-pack radar system we developed a lightweight X-band system almost completely in hybrid integrated circuit form. The radar transmits a pseudo-random phase-coded CW signal. All functions of the radar, including



This issue in capsule

CRTs—Get high speed printouts with these monoscopes.

Hybrid Microelectronics—Diode matrix modules give you design flexibility.

Television—We've squared off the *color bright 85*® tube for 1970.

Microwaves—Millimeter wave source puts out up to 50 mW CW.

ICs—How to use programmable dividers as pulse-train gates.

Diodes—TV high-voltage diodes minimize x-radiation.

Manager's Corner—Will the real Schottky barrier please stand up?

the low-frequency analog and digital circuitry, with the exception of a miniature coaxial avalanche oscillator and the antenna, are made in microstrip integrated form.

These units include an RF phase modulator, high speed RF switches, an oscillator that uses a Sylvania silicon avalanche diode, a balanced mixer using a beam-lead Schottky barrier diode, ferrite circulators and other passive transmission line components.

The hybrid integrated K_u band transceiver is in development under Air Force sponsorship (Contract No. 33616-67-C-1896). In this project we are developing techniques for integrating a large number of functional components on a single alumina substrate at 13.3 GHz. The system, designed to operate as a doppler navigator transceiver, includes: master oscillator using a varactor-tuned avalanche diode that is frequency-stabilized by an integrated phase discriminator; a cascade of avalanche diode power amplifiers producing 100 mW CW output at 13.3 GHz; a frequency shift-key modulator using beam-lead Schottky barrier diodes; T-R switch using beam-lead PIN diodes; a balanced mixer using beam-lead Schottky barrier diodes; and an IF amplifier having a 1.5 dB noise figure at 120 MHz. The third project that demonstrates Sylvania's capability in miniaturized microwave circuitry is an integrated mixer subassembly designed and developed for a highly

specialized military application. The subassembly consists of a bandpass filter, 3 quarterwave contradirectional couplers, and four balanced mixers. All of the units are integrated on four alumina substrates. The individual substrates are interconnected with gold ribbons.

Design goals included minimum cross coupling between mixers, and packaging design that minimizes damage from shock and vibration. Semiconductor devices used in the subassembly include beam-lead Schottky diodes in the mixer circuits.

This integrated subsystem, specially packaged to withstand stringent environmental requirements, is now in volume production.

Among the other components that can be integrated by Sylvania into complex subsystems are limiters, detectors, circulators and isolators.

Circuits can be supplied unpackaged for assembly by the user, or can be packaged by Sylvania in rugged, hermetically sealed enclosures with coaxial connectors or other types of input-output connections.

If you have a microwave design problem, why not talk to our experienced microwave design engineers? You may be surprised at what they can do for you.

CIRCLE NUMBER 300

CRTs

Get high-speed printouts with these monoscopes.

Simple CRT system can generate over 30,000 characters per second from magnetic tape.

A monoscope is simply a cathode-ray tube which converts digitally coded information into video type signals. Because of this, it is a very valuable interface between computers and output display devices. And because we can tailor the target characteristics to the users' specifications, there is no problem in generating special symbols for chart, diagram and map displays as well as alphanumeric characters.

In its simplest form, a monoscope resembles a conventional CRT with electrostatic focus and deflection, with the exception that a solid metal disk replaces the phosphor screen. A typical monoscope of this type is shown in Fig. 1.

The metal disk has a surface which possesses good secondary emission characteristics. The alphanumeric characters or symbols are printed on the disk with a material having poor secondary emission characteristics.

When the electron beam scans a single character in a raster-like pattern, a video signal corresponding to the shape of the character is produced. An identical raster scans the display tube. The beam intensity of the display tube is modulated by the monoscope's video output and the character is produced on the phosphor screen. Used in this manner, the monoscope can produce up to 30,000 symbols per second.

The cathode of the monoscope is generally operated at 1200 to 1800 Volts below ground so that the anode can be run at or near ground potential. This simplifies the design of character selection circuitry from the information source.

A second type of monoscope is shown in Fig. 2. This type uses a stencil-type target where the characters have been chemically etched through the disk. The principle of operation is exactly the same as the first type described.

However, the stencil provides some advantages. Since the beam proceeds unhindered through the stencil openings, it can be displayed on a phosphor screen deposited on the face of the tube. This provides an easy means of visually checking what is being scanned and is very useful in setting up the tube for operation.

The third type of monoscope is shown in Fig. 3. It also makes use of a stencil target, but it is used in a different manner. In this case, surface condition of the stencil is not important. We only use that part of the raster that gets through the stencil and impinges on the front plate. This type of monoscope has many advantages. No target surface preparation is required. It can be mass produced at low cost.

A typical monoscope target format is shown in Fig. 4. An 8 x 8 matrix is fairly standard, but 8 x 12 or 10 x 10 formats can also be used to obtain both upper and lower case characters.

Targets can be custom-designed to meet your requirements and can be fitted to any of the three types of monoscope tubes. Some of the applications for these monoscopes include computer display, airline status boards, stock quotation boards, teaching machines, address label printers, command control center displays, or anywhere that a high-resolution electronic information readout system is required.

CIRCLE NUMBER 301

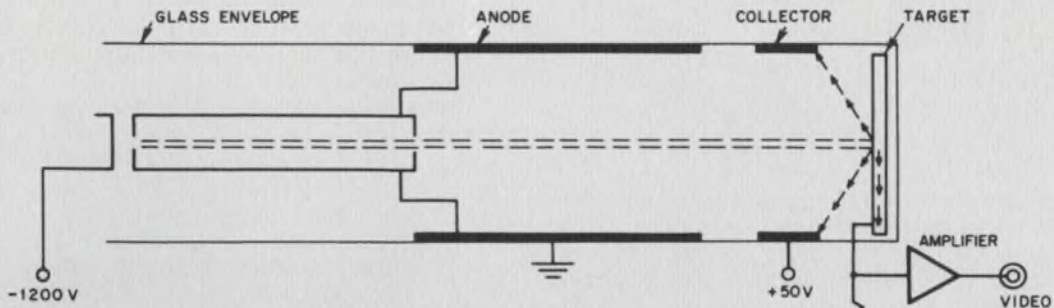

Fig. 1. Basic monoscope using solid target.

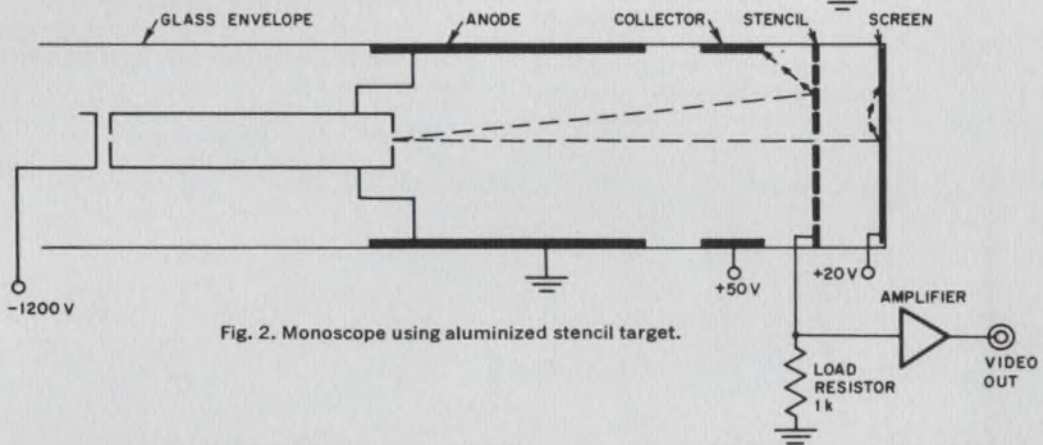

Fig. 2. Monoscope using aluminized stencil target.

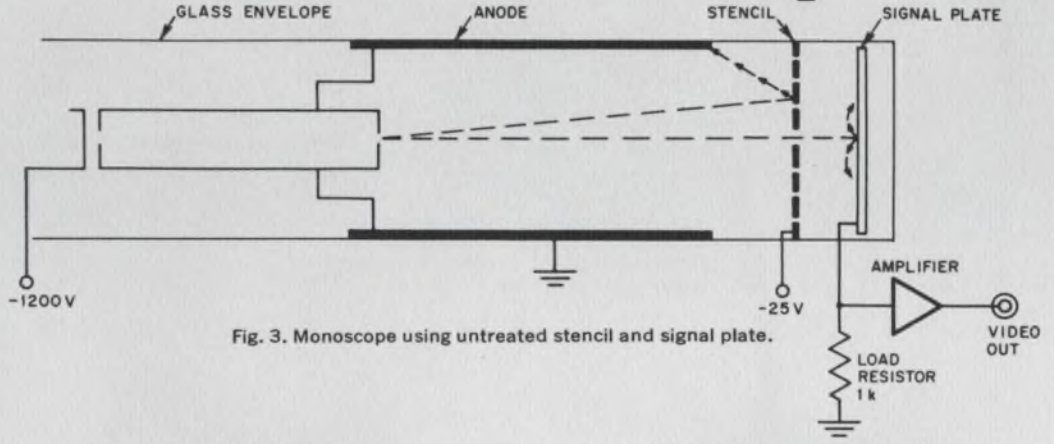

Fig. 3. Monoscope using untreated stencil and signal plate.

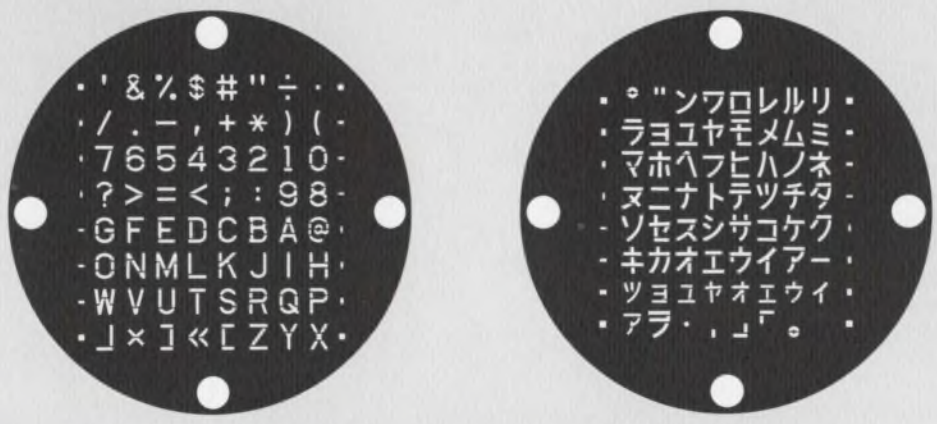

Fig. 4. Typical target stencil for alphanumeric readout.

HYBRID MICROELECTRONICS

Diode matrix modules give you design flexibility.

Our semiconductor and hybrid microelectronics groups team up to offer a wide range of module designs.

Because Sylvania is both a manufacturer of semiconductors and a maker of hybrid microelectronic assemblies, we can offer you a wide range of diode types packaged to your specifications. Using our thick-film packaging approach we can design diode arrays incorporating precision thick-film resistors.

Take, for example, our diode array module. This module is a 13 x 32 diode array containing both pull-up and load resistors. The diodes are high-speed, low-capacitance types. The thick-film resistors are stable cermet elements having low temperature coefficients. These resistors can be trimmed to a tolerance of 0.2% for weighted-network applications.

Other matrix forms are available that will let you in-

crease the efficiency of your logic system design without getting involved in the use of more complex monolithic structures.

Up to 512 diodes can be provided in a single package. The custom matrix design can provide address arrays in 20 x 25, 16 x 32, or in any subcombination that the design might require.

The diode matrix and resistor module can be used in many applications including: code-to-code conversion, multilevel gating structures, AND/OR gating, decoding networks, nondestruct permanent memories, and weighted networks. Some typical applications are shown in the diagrams.

The wide flexibility of our design approach allows us to offer you any combination of diode arrays with or without resistor elements. The final package configuration can be determined by the system application. Flat packs and dual in-line packages can be provided as well as hermetically sealed or encapsulated modules.

You'll be surprised at what our semiconductor hybrid microelectronics teams can come up with to meet your logic system needs.

CIRCLE NUMBER 302

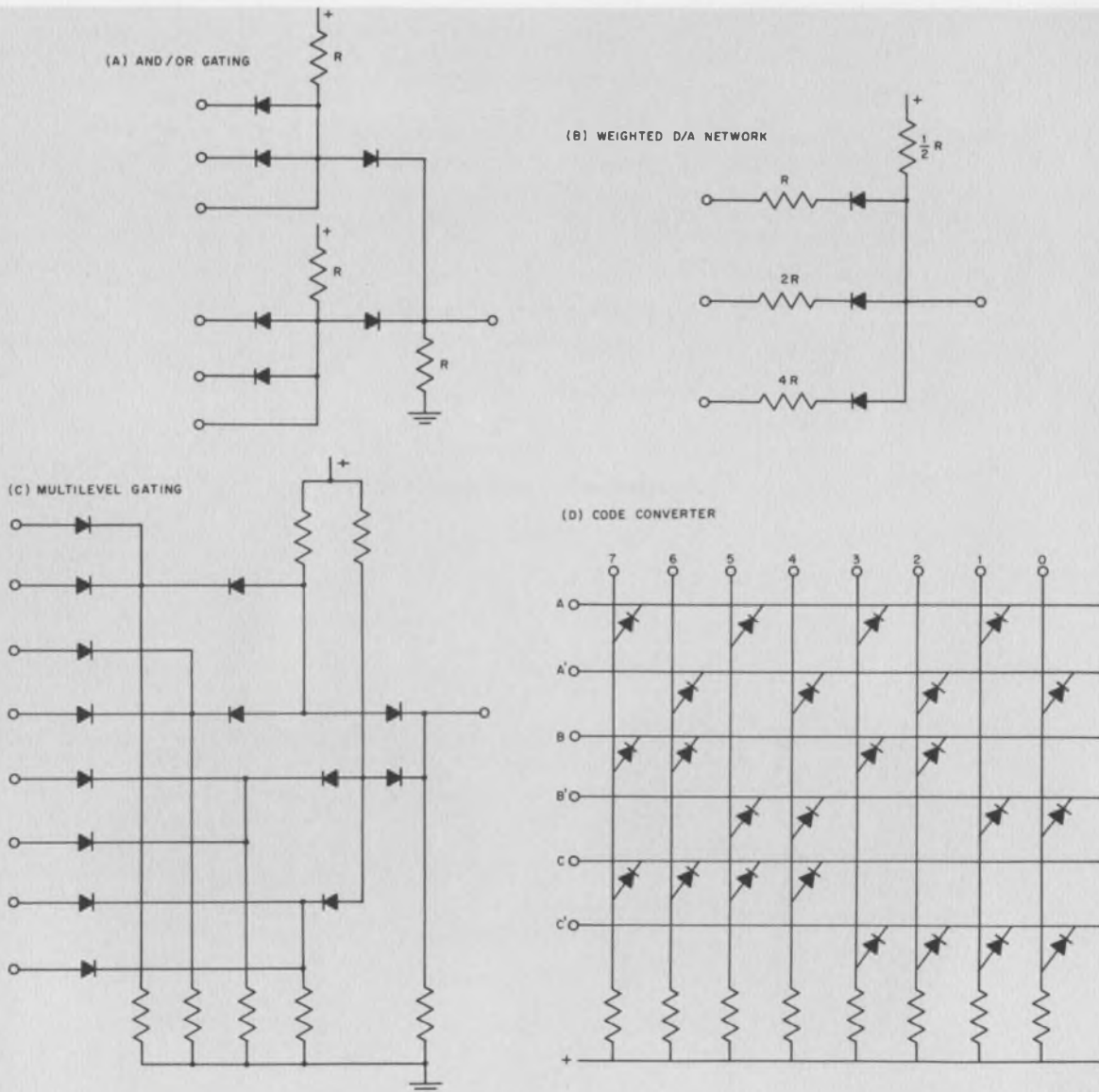

Four examples of how our diode matrix modules can be used.

TELEVISION

We've squared-off the color bright 85® tube for 1970.

New color-tube design gives more usable area with a 3 x 4 aspect ratio.

Here's your chance to become a real "square" in your next color TV set design. We've come up with a new family of *color bright 85* picture tubes that give you squared corners and straighter side lines. The new tubes also feature a 3 x 4 aspect ratio which closely matches the configuration of the transmitted TV signal.

The new tubes are available in 19", 21" and 25" sizes and, of course, all of them feature Sylvania's new improved MV phosphor system that is 30% brighter than previous designs. An outline drawing of our new squared-corner 25" tube is shown in comparison with a conventional 23" tube in the illustration. Note that screen area is increased to 315 sq. in. in the new tube as compared to 295 sq. in. in the conventional design.

As in other *color bright 85* picture tubes, the new squared-off line features an aluminized screen for highest brightness. In addition, these tubes are available with a system light transmittance of 51%. The face panel is a neutral gray filter glass to improve picture contrast.

The new tubes also have a new front panel and funnel design that increases X-ray absorption. When tested in accordance with standard JEDEC procedures, the X-radiation of these tubes does not exceed 0.5 mR/hr. for the

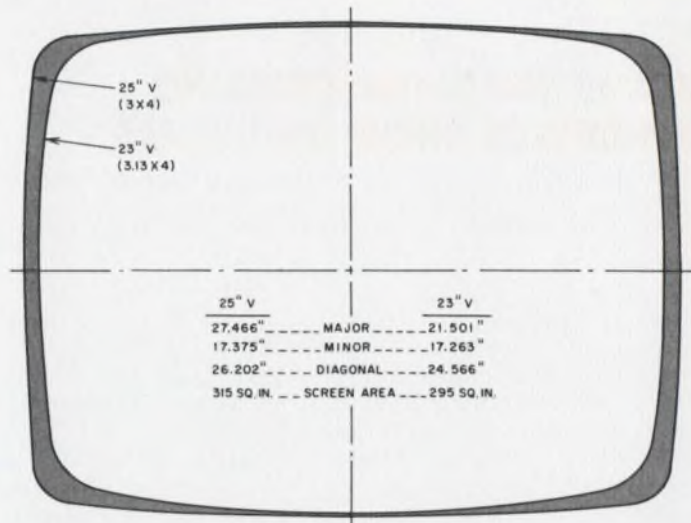

Faceplate outline of new squared-off 25" color picture tube as compared with conventional 23" picture tube.

useful life of the tube even when operated beyond the design-maximum ratings of the tube.

As with all *color bright 85* tubes, a temperature-compensated shadow mask is a standard feature to prevent loss of purity by uncontrolled thermal expansion. A sharp-focus electron gun that achieves tighter beam bundling, and integral kimcode implosion protection are also features that make the new squared-off *color bright 85* the tube to plan your next color set around. CIRCLE NUMBER 303

DIODES

TV high-voltage diodes minimize X-radiation.

Solid-state diode tripler and quadrupler assemblies cut down on radiation from high voltage section of TV sets.

One of the major sources of X-radiation in color TV sets is in the high-voltage cage. You can minimize this radiation by switching over to our high-voltage silicon diode multipliers.

In addition, you'll save money by eliminating the high-voltage cage and its associated hardware. High-voltage regulation is also improved since the loosely-coupled tertiary flyback winding is eliminated.

Since each application of these high-voltage multipliers is unique, we don't offer them as off-the-shelf items. Our engineering staff will work with you to tailor a unit to fit your design needs.

One of our typical designs is shown in the illustration. It's a tripler circuit that takes an 8.5 kV input from the flyback transformer and puts out 25 kV DC to the color tube anode. Loading can be as high as 2.5 mA with minimal drop in output voltage. This circuit also provides a tap for the focus supply voltage.

The diode stacks used in our high-voltage multipliers are all carefully matched. They are then molded into a plastic package along with their associated capacitors. The plastic package will more than meet the environmental requirements of solid-state and hybrid color TV sets.

These requirements include such things as over-voltage

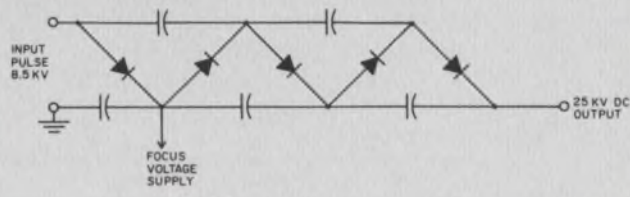
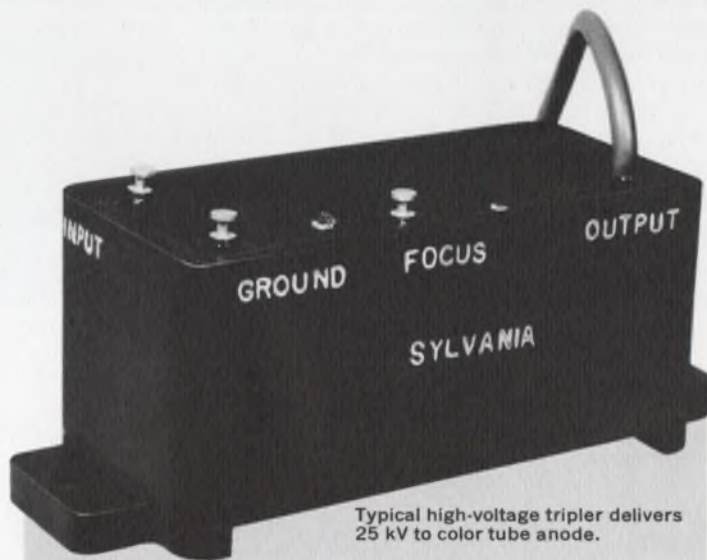

surges, arcing and ambient temperature conditions.

Why not discuss your high-voltage requirements with our diode engineers. They'll show you how to reduce radiation and save money at the same time.

CIRCLE NUMBER 304

INTEGRATED CIRCUITS

How to use programmable dividers as pulse-train gates.

Simple circuit can be programmed to provide N consecutive output pulses on command.

Here is an application of our functional arrays that shows the flexibility of these devices. The SM-143 and SM-153 are both programmable, synchronous down-counters with a built-in decoder that gives a logic "1" output when the counter is in the 0000 state. These programmable dividers are identical in operation except that the SM-143 is programmed by binary numbers and the SM-153 accepts a BCD input.

These dividers are ideal for use as programmable pulse-train gates. The strobed data entry (SET ENABLE) makes it easy to program the counters without adding external logic circuits. The four-input clock gate reduces clock loading and allows logic flexibility. The internal decoder gate and single output cut down on package count and, in addition, power drain is significantly reduced since the four flip-flop outputs are not brought out of the package. A four-bit counter with similar features would use about 100 mW more power.

The circuit diagram and timing waveforms for a programmable pulse-train gate are shown in Fig. 1. For purposes of illustration we are assuming that there is a binary 17 on the input lines.

Grounding the CLEAR input resets the counters to 0000 and causes their decoded outputs (A and B) to go high. (The CLEAR pulse must be at least 150 ns wide.) The high outputs from the counters are applied to the NAND gate (G1) whose "0" output now inhibits the CLOCK input to the system, thus maintaining a static condition.

When the START input is raised to a logic "1", the binary number (in this case, 17) is set into the proper counter flip-flops and decoded outputs A and B go low. The output of G1 now goes high and enables the first SM-143. (The second is still inhibited by decoded output A.) The START pulse must occur when the CLOCK input is low.

The system now allows 17 clock pulses to go through G2 in the following manner: The output of the first SM-143 (output A) goes high as the first clock pulse counts it from 0001 to 0000. This high input enables the clock gate of the second SM-143. The second clock pulse causes the second SM-143 to go from 0001 to 0000 thus setting output B high, at the same time changing the count in the first SM-143 from 0000 to 1111 and causing its output (A) to go low.

The logic "0" at A now inhibits the clock gate of the second SM-143 so that it remains at 0000 while the first SM-143 is counted down from 1111 to 0000 by the next 15 clock pulses (pulses 3 through 17). At this point output A goes high again. Outputs A and B are now both high, forcing the output of G1 to go low inhibiting the entire system. The system is now in the same condition that occurred after the CLEAR pulse. It will remain in this condition until another START pulse occurs.

If an asynchronous START pulse is desired, additional logic can be added as shown in Fig. 2. In the static condition, both counters are at 0000 and their outputs A and B are high, setting the output of G1 low. Gate G1 now inhibits the output gate G2 and the inputs to both counters.

When the start input goes high it allows the programmed number to enter the counters. This will cause the counter outputs A and B to go low. The high START input is inverted by G4 which resets FF1 and disables the J and K

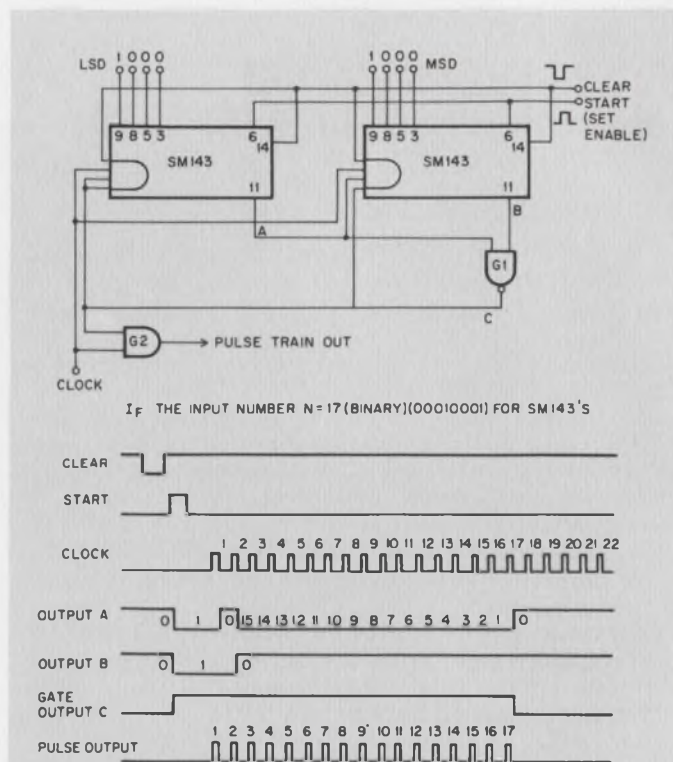

Fig. 1. Programmable pulse-train gate with timing waveforms for a binary 17 input.

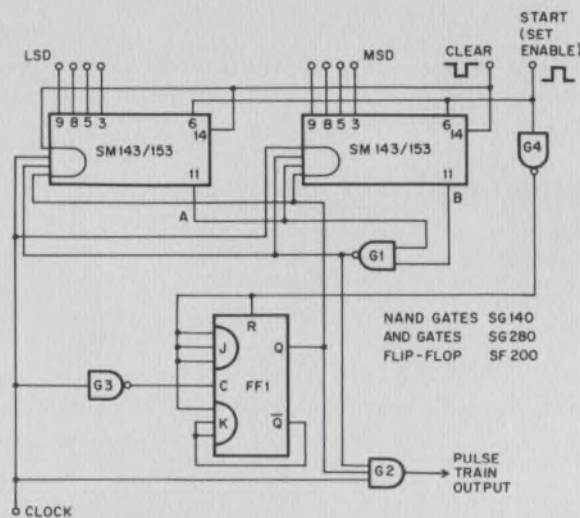

Fig. 2. Circuit of programmable pulse-train gate for use when an asynchronous START pulse is required.

inputs. The Q output of FF1 then maintains the inhibit condition on G2 and both counters. This condition is static as long as the START input remains high.

When the START input goes low, G4 output goes high. This enables FF1. The first positive clock edge to occur, after the START input goes low, is inverted by gate G3 and clocks FF1. The Q output goes high, enabling the output gate G2 and both counters. This and succeeding clock pulses are gated and counted as explained previously, the Q output of FF1 which is now low is connected to the K input, thereby preventing resetting of the flip-flop by the clock pulse output from G3 until the next START pulse re-initializes the cycle.

MICROWAVES

Millimeter-wave source puts out up to 50 mW CW.

Fixed tuned, high efficiency source is available in frequency range from 52 to 70 GHz.

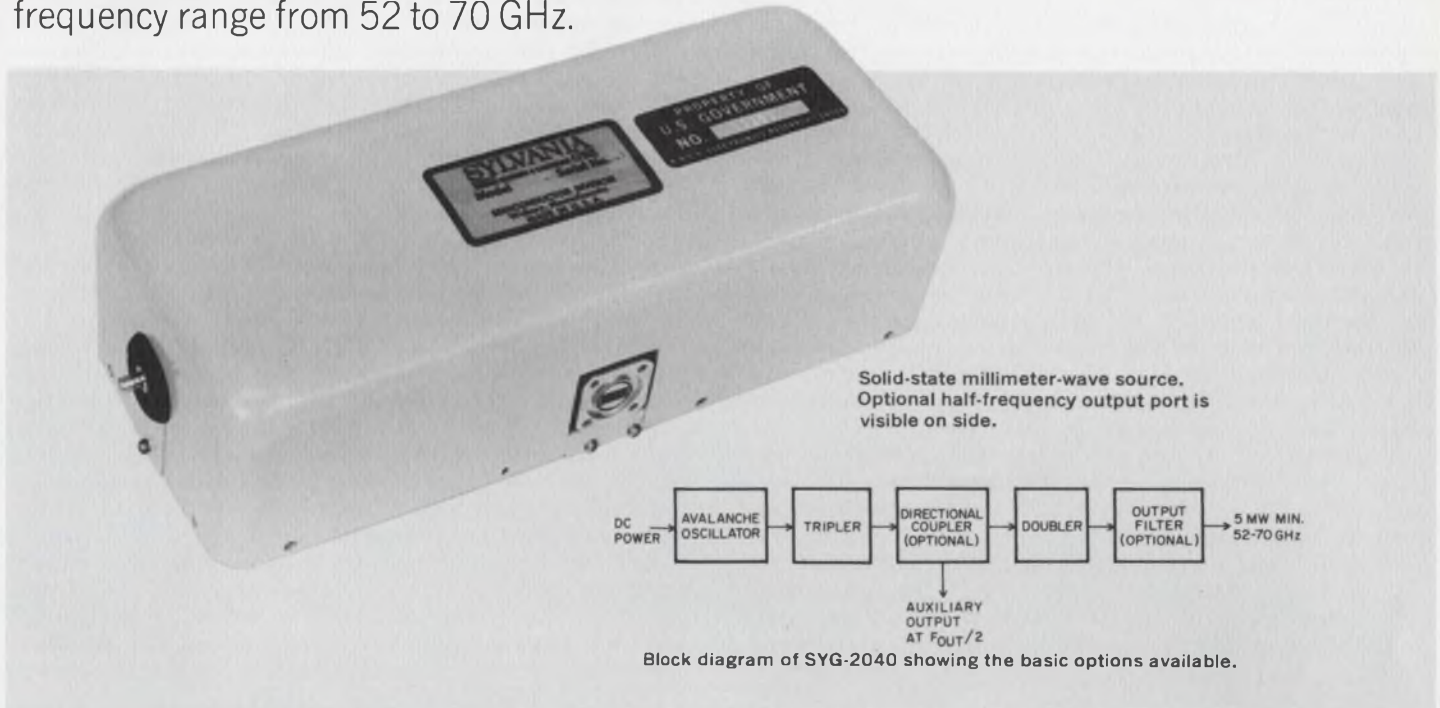

Our SYG-2040 series solid-state millimeter-wave source is a new component that is particularly suited to applications including local oscillators, paramp pumps, and low-power transmitters where long life is required. It also comes with a number of options that make it easy to fit it into a specific system requirement.

Basically, the SYG-2040 uses a high-power avalanche diode oscillator to drive an efficient tripler-doubler multiplier chain. The output frequency may be specified anywhere in the 52 to 70 GHz range.

Among the options available are a low-loss cavity output filter for applications requiring minimum noise sideband

power, and an optional sampling port that provides a 5 mW (min.) signal at half the final output frequency. In addition, the fundamental oscillator can be modified to enable either phase or injection locking techniques to be employed where frequency stability is important.

The basic SYG-2040 solid-state source comes in a 2" x 2" x 6" package. Models with the optional attachments are housed in a slightly larger package. A constant-current DC supply between 70 and 100 V and 60 to 110 mA (10 W max.) is required to drive the avalanche oscillator.

CIRCLE NUMBER 306



Use Sylvania's "Hot Line" inquiry service, especially if you require full particulars on any item in a hurry. It's easy and it's free. Circle the reader service number(s) you're most interested in; then fill in your name, title, company and address. We'll do the rest and see you get further information by return mail.

BUSINESS REPLY CARD

No Postage Stamp Necessary if Mailed in the United States

FIRST CLASS
Permit No. 2833
Buffalo, N.Y.

POSTAGE WILL BE PAID BY

Sylvania Electric Products Inc.
Sylvania Electronic Components
1100 Main Street
Buffalo, New York 14209
Dept. E 3 3 3 3

MANAGER'S CORNER

Will the real Schottky barrier please stand up?

Several years ago, when Schottky barrier diodes using evaporated metal contacts were introduced, many engineers began to call the older point-contact types "the poor man's Schottky". Now that we have had time to compare both types, we wonder if it is entirely fair to use the connotation "poor man's" in referring to point-contact diodes.

Both diode types have really come of age within the past two years. Only now are we really beginning to find out the true differences between them in laboratory circuits and in operating radar systems. And strangely enough, the point-contact mixer/detector, with its tungsten whisker wire and pressure contact to epitaxial silicon, does not always come out as the underdog when compared to the more sophisticated Schottky barrier types. Perhaps even more significant, several distinct advantages and disadvantages of each type of diode can now be clearly seen.

Both types of devices are now made to cover the frequency bands from L to KA. Point-contacts do have a slight edge in being commercially available to meet requirements up to 100 GHz.

Generally speaking, in mixer applications, Schottky barrier diodes are available with up to 0.5 dB improvement in noise figure over equivalent-frequency point-contact types.

Above X-band, however, this advantage disappears and the noise figures are equal. For other important parameters such as RF and IF impedances, somewhat tighter controls can be maintained for Schottky barrier types.

If you consider local oscillator power level degradation with time, or situations where local oscillator power must be varied, you should take a careful look at the Schottky diode. In general, you'll find it is not the better choice of the two. On the other hand, the dynamic range of the Schottky barrier device is better than that of the point-

contact diode, making it the device of choice where this is an important parameter.

Also, in Doppler radar systems using the homodyne principle, the inherent low audio-frequency noise of the Schottky barrier device gives it an advantage over the point-contact diode in noise figure. In addition, microphonics are almost nonexistent in Schottky barrier devices.

Possibly one of the most important criteria to be considered when choosing between Schottky and point-contact diodes is resistance to "burnout" or degradation caused by external pulse power, spike energy, or CW power. Here the data are not sufficient to fit every circuit but, generally speaking, point-contact types are certainly to be favored under these conditions.

With rare exception, point-contact diodes made by the latest fabrication techniques can withstand 3 to 10 dB more incident power than an equivalent Schottky type. On the other hand, where burnout resistance is not a problem, the Schottky device has sufficient advantages to be the leading contender for new circuit designs.

Although it was originally assumed that the Schottky barrier diode would be superior to the point-contact type in environmental tests, such as shock/vibration, this has not proven to be true. Point-contact devices have passed the most stringent MIL-STD tests successfully. Here we have equality but no superiority.

Although we've been working hard to replace the grandfather of all diodes (really, of all semiconductor devices) the point-contact is not yet ready to retire. At the age of 27, he still has many good working years left. The Schottky barrier, by comparison, is still a baby and is just beginning to face the world.

We, as manufacturers, still have a long way to go before we can announce that a choice no longer exists between Schottky and point-contact devices.

Eugene J. Feldman
 Manager, Microwave Products

This information in Sylvania ideas is furnished without assuming any obligations.

SYLVANIA

GENERAL TELEPHONE & ELECTRONICS

NEW CAPABILITIES IN: ELECTRONIC TUBES • SEMICONDUCTORS • MICROWAVE DEVICES • SPECIAL COMPONENTS • DISPLAY DEVICES

E3

NAME _____
PLEASE PRINT

TITLE _____

COMPANY _____

ADDRESS _____

CITY _____ STATE _____ ZIP _____

Circle Numbers Corresponding to Product Item

300 301 302 303 304 305 306

Please have a Sales Engineer contact me.

Visit Phone... Phone No. _____ Area Code _____



HOT LINE INQUIRY SERVICE

Need information in a hurry? Clip the card and mail it. Be sure to fill in all information requested. We'll rush you full particulars on any item indicated.

You can also get information using the publication's card elsewhere in this issue. Use of the card shown here will simplify handling and save time.

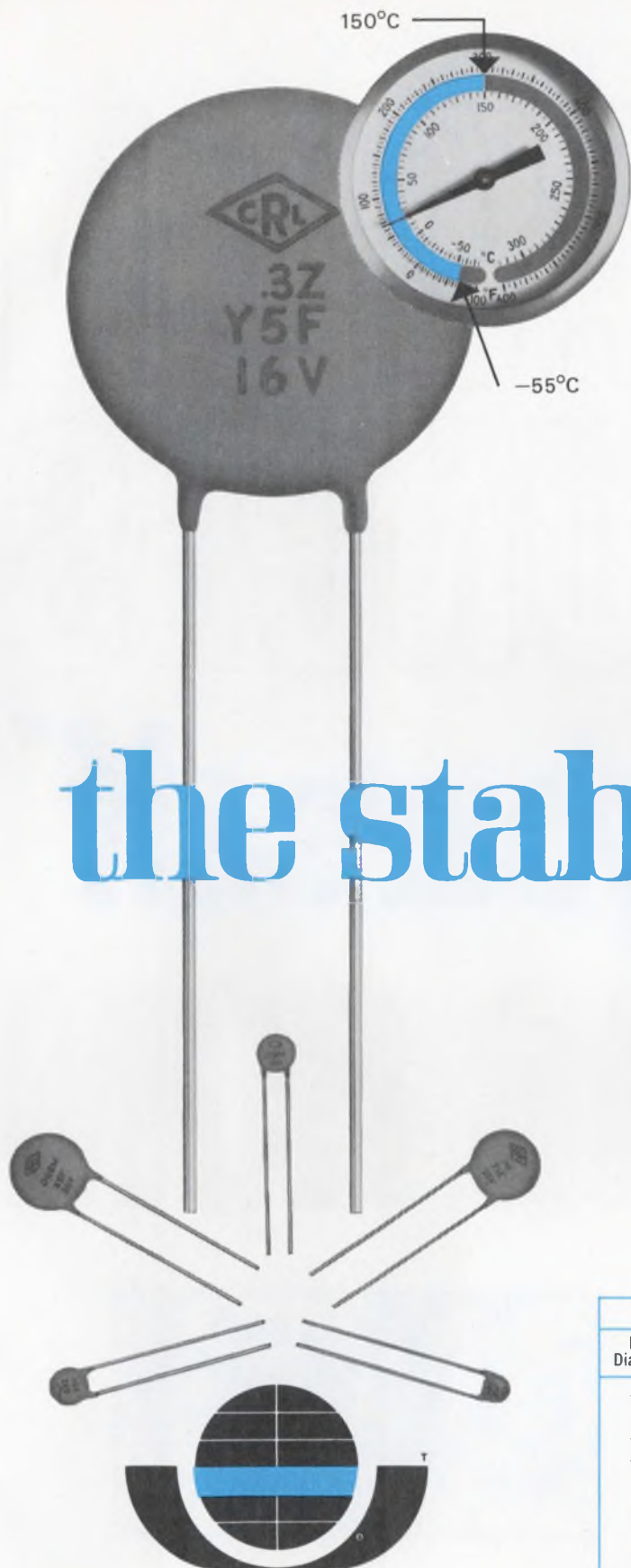

Centralab gives transistor circuits longer, more reliable performance with NEW 16, 25 & 50 volt Ultra-Kaps®

Centralab engineers have achieved a new degree of temperature stability in semiconductor type, low voltage ceramic disc capacitors with their development of temperature-stable Ultra-Kaps. The 16 and 25 volt units can hold a maximum capacitance change of $\pm 4.7\%$; 50 volt units as little as $\pm 7.5\%$.

Ultra-Kaps also exhibit other superior performance characteristics, such as low impedance; high capacitance density; and operation to temperatures as high as 150°C , as low as -55°C . In 50v ratings average dissipation factor is as low as 1.5% ; leakage resistance of 1000 megohms, min.

the stable ones

Ultra-Kaps are ideal for use in transistor circuits because they are operable to a frequency of 1 MHz. And they're still low cost units that replace more expensive mylar and "Hi-K" ceramic capacitors. On quantity orders, they're priced as low as $2\frac{1}{2}$ cents each with delivery as short as 4 to 5 weeks. We can send you samples immediately for your evaluation.

Don't let your design plans melt away because of inferior capacitor performance. Get the ultimate, Centralab's stable Ultra-Kaps.

Max. Diameter	16 volt		25 volt		50 volt	
	Max. Cap. MFD	Min. I.R. Megohms	Max. Cap. MFD	Min. I.R. Megohms	Max. Cap. MFD	Min. I.R. Megohms
.290	.02	5.0	.015	65.0	.01	1000
.390	.033	3.0	.022	45.0	.015	1000
.405	.05	2.0	.033	30.0	—	—
.485	—	—	—	—	.022	1000
.515	.068	1.5	.05	20.0	.033	1000
.590	0.1	1.0	.068	15.0	.047	1000
.690	0.15	0.65	0.1	10.0	.05	1000
.760	—	—	—	—	.068	1000
.820	0.2	0.5	0.15	6.5	—	—
.920	0.3	0.33	0.2	5.0	0.1	1000

*Thickness: .156 inches maximum

Lead spacing: Discs less than .500" diameter, nominal lead spacing is .250"
Discs .500" and larger, nominal lead spacing is .375"

CENTRALAB

Electronics Division
GLOBE-UNION INC.
5757 NORTH GREEN BAY AVENUE
MILWAUKEE, WISCONSIN 53201

M-6901

FOR MORE INFORMATION AND/OR DESIGN ASSISTANCE, WRITE CAPACITOR SALES MANAGER, CENTRALAB.

INFORMATION RETRIEVAL NUMBER 21

RADIATION ANNOUNCES

a "do-it-yourself"

BIPOLAR ROM

512 bits (64 x 8)

65 ns access time

0° to +75°C, \$47.00*

-55° to +125°C, \$61.50*

*** 100 — 999 unit price**

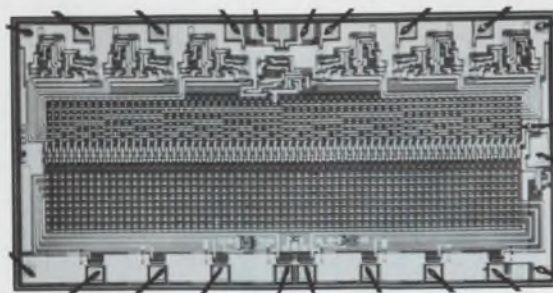

ONE PROM* FOR ALL ROMS

*(Programmable Read-Only Memory)

It's made for a complete range of applications:

- Microprogramming
- Combinational Logic
- Sequential Logic
- Code Conversion

...or any application requiring many ROMS of differing patterns.

HERE'S HOW YOU GET IT!

1. Order the ROM-0512 off the shelf.
2. Generate the truth table.
3. Electronically program each PROM, yourself.
4. Plug it in!

HERE'S WHAT YOU GET!

- Custom programmed ROMS
- 65 ns access time
- DTL/TTL compatibility
- Wired "or" output
- 24-lead dual in-line or 24 lead flat pack

...And we haven't even scratched the surface!

Lexington, Massachusetts (617) 862-1055
Norwalk, Connecticut (203) 853-3648
Frederick, Maryland (301) 682-5400
Oaklawn, Illinois (312) 423-6010
Dallas, Texas (214) 231-9031
Albuquerque, New Mexico (505) 288-3549
Palo Alto, California (415) 321-2280
Long Beach, California (213) 428-7887
P. O. Box 37, Melbourne, Florida 32901 (305) 727-5430



**RADIATION
INCORPORATED**

SUBSIDIARY OF HARRIS INTERTYPE CORPORATION

MICROELECTRONICS DIVISION

EXPORT SALES, DAGE CORPORATION, STAMFORD, CONNECTICUT

INFORMATION RETRIEVAL NUMBER 22

Electronics scores



Ignition noise, corrosion and vibration are enemies of marine electronics. So the electronics on the control bridge of this Christ-Craft Commander Fiberglass yacht has noise-suppression circuitry and water-tight, gold-plated avionics connectors. The equipment includes: a depth sounder, AM (2.5 MHz) and vhf-FM (156-162 MHz) radiotelephones, automatic pilot, automatic direction finder (200-1500 kHz) and radar. Special grounding is also provided.

The newest electronics in small-boat navigation is a space-age version of an aircraft unit, by Radon, Inc., Cos Cob, Conn. It uses vhf (108-118 MHz) Visual OmniRange (VOR) stations for obtaining bearings. Traditionally, boat owners favor 200-kHz-to-1500-kHz direction finders, which are subject to a variety of errors caused by static, interference and propagation-effect fading. Vhf eliminates these, but the signals from coastal VOR stations to boats are usually attenuated by intervening terrain. Borrowing aerospace phase-lock and digital-filtering techniques, Radon has produced a hundred-fold increase in sensitivity over standard VOR receivers. The new equipment reaches down into the noise to extract a useful navigational signal.

Jim McDermott
East Coast Editor

Electronic aids are infiltrating the world of sports—from spectator events like football and horse racing to field and stream activities like fishing and dog training. The most spectacular are the huge stadium scoreboards, ranging from Cubic Corp.'s \$600,000 computer-operated, animated football scoreboard for the San Diego Municipal Stadium (see cover photo) to a new \$4-million system now being installed at the Ontario (Calif.) Motor Speedway. The latter will be the world's first all-electronic timing, scoring and display system for keeping track of up to 50 autos in a 500-mile race.

Cubic's scoreboard, 29 feet high and 80 feet long, has 31,400 lamps, each 40 W and dc-energized. The board is organized in a matrix of 110 rows by 310 columns and employs silicon controlled rectifiers. The design of heat sinking and cooling is critical in these systems, because the fully illuminated board consumes over a million watts. An advantage of the SCRs is that they are essentially a dc memory element, remaining on



in sports

once triggered. But to update information, all conducting SCRs must be cut off and re-energized as new information is inserted.

Electronic timing systems have either completely taken over or are being used as backups in many sporting events traditionally timed by stop watch, such as ski, ice-skate and bobsled racing, track events, swimming competitions, horse and dog racing, and automotive events. These timing systems can be simple or complex versions of a time base operating a mechanical or electronic counter and display. The time-base output is counted down to provide an accuracy of hundredths or thousands of a second.

For the time base, Heuer Time Corp. of New York City uses a 2000-Hz tuning fork, while Bulova Watch Co. depends on its Accutron. The Longines Watch Co.'s equipment for use with TV pickups has a quartz crystal time base with an IC binary countdown. Instead of requiring a separate TV camera to monitor the time display, the Longines system generates the numbers electronically and feeds them into the raster of a camera scanning the sports activity.



Conversation 100 feet down, without earphones and using only milliwatts of power, is like talking on the beach, thanks to a unique speaker-transducer design in Yack/Yack scuba diver communication sets (orange in the photo). The manufacturer, Y Square, Inc., of Santa Ana, Calif., says the transducer is exceptionally efficient because of an oil-filled chamber that produces a very close impedance match between the driving element and the water around it. Sound is transmitted by vibrating the entire case of the unit.



By building a plastic case and then designing the electronics to fit the case, Hartmann, Inc., of Newark, N.J., has cut costs on four products: a fish finder (top), a hand-held direction finder with a compass (center), a wireless tachometer (bottom) and a depth sounder with a meter indicator (not shown). The Cycloc plastic is substantially superior to an aluminum case for withstanding abuse. By using the same case for all four products, Hartmann has reduced packaging costs from \$3 to \$5 for each item to about 75 cents.

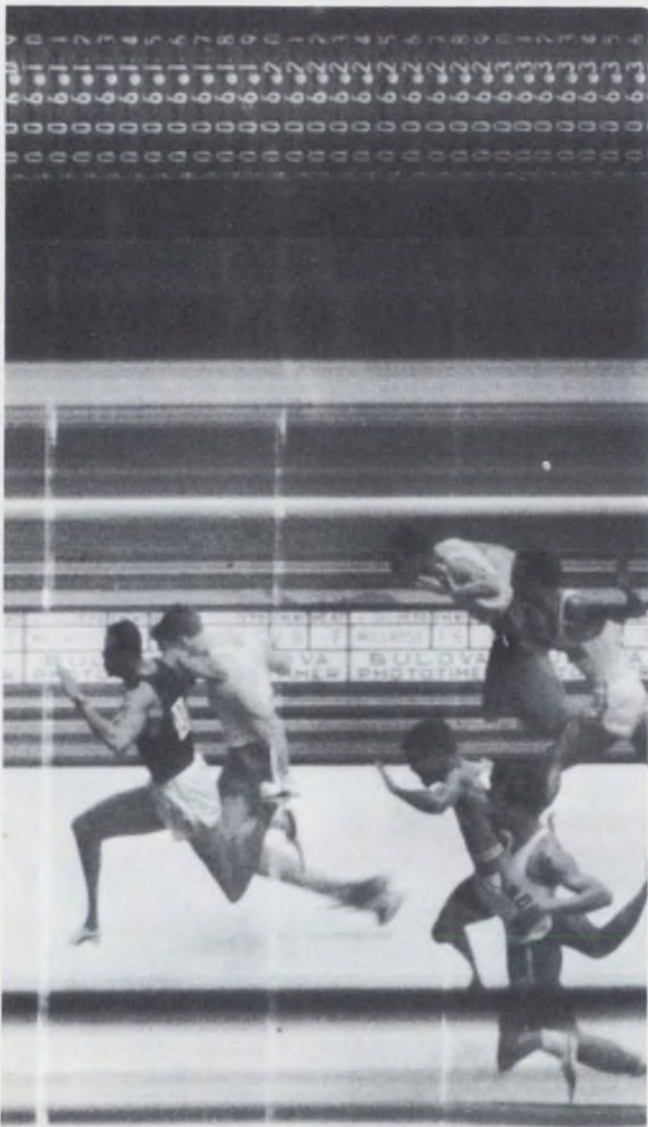

For timing sports events, special systems have been designed. They include the Accutron Phototimer, developed by Bulova Watch Co. for track meets. Above, Bob Richards, Phototimer crew chief, mans a special slit camera at a Madison Square Garden track event. The slit is focused on the finish line, while the film moves by at a speed that freezes the racer's motions. Figures on a digital counter inside the camera are strobed by a flash lamp and exposed on the film, as at left. Digital timing is controlled by a time base driven by an Accutron tuning fork, accurate to 1 part in 10^6 . Timing starts when a photocell transducer attached to the starter's pistol is triggered by the infrared energy of the fired blank. The photocell output is radioed to start the time-base counters at the camera.

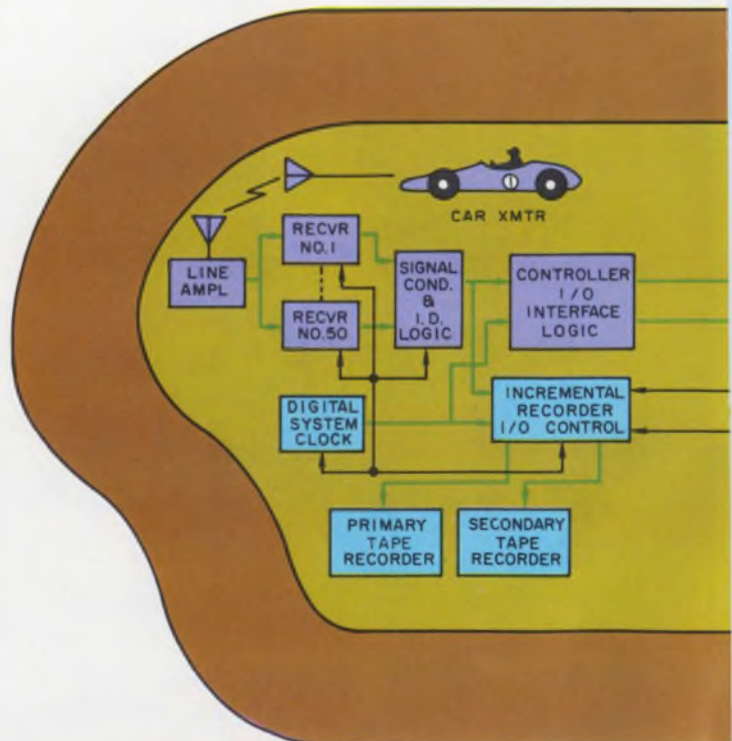

Courtesy ABC TV

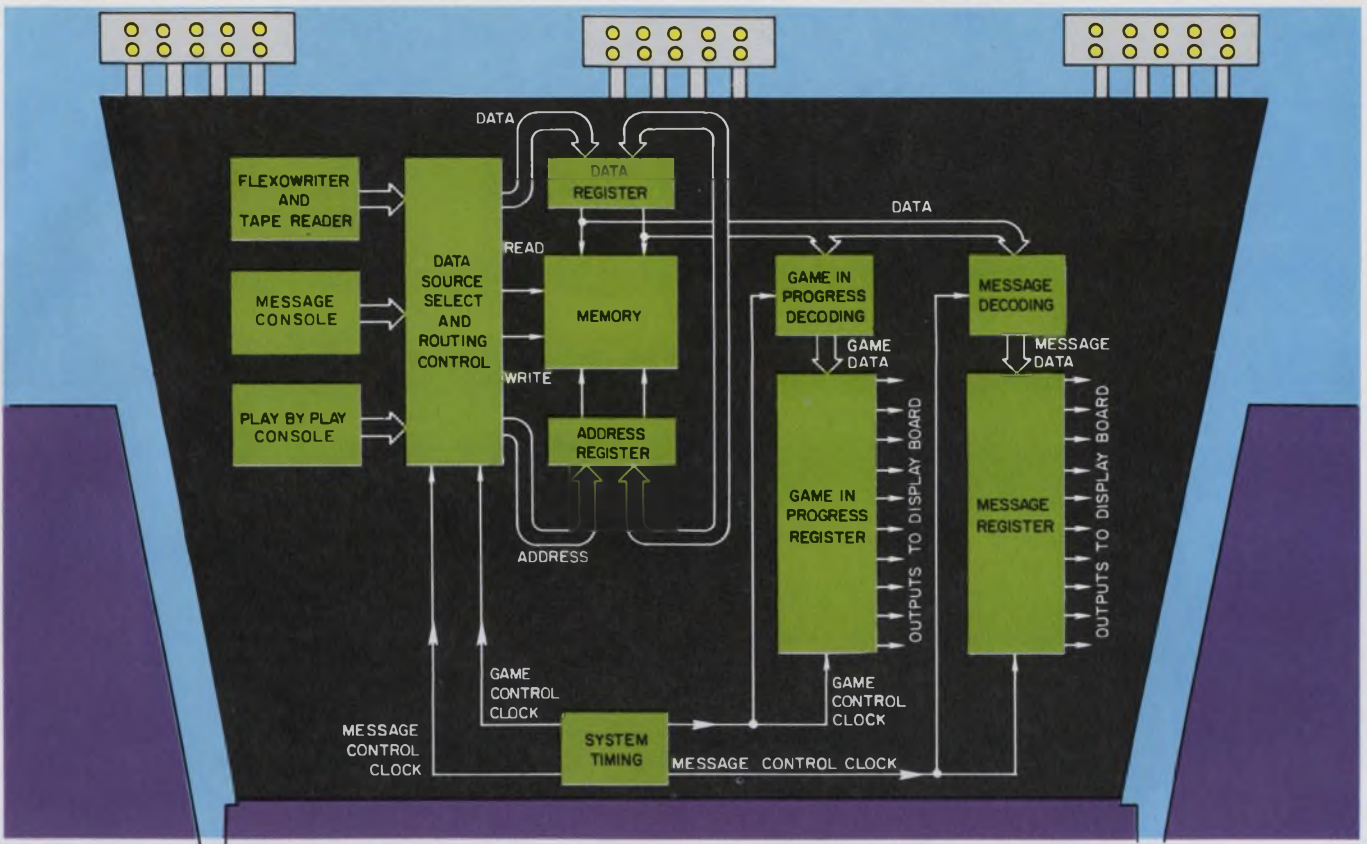

Cubic Corp.'s giant football scoreboard (see cover photo, as well as this block diagram) is divided into three "game-in-progress" areas and an "animation" area. All sections can be controlled either independently or simultaneously by the operator. The system has a special computer with a 4-k, 30-bit word structure and double-addressing for words. Double-addressing allows the updating of informa-

tion on one line while another is held constant. In operation, every location on the board does not correspond to a location in memory. Instead, the information is placed on the board in a column of lights and moved across the board in shift-register fashion. All data that flows through the system goes through the computer main frame, and in this fashion can be constantly up-dated.

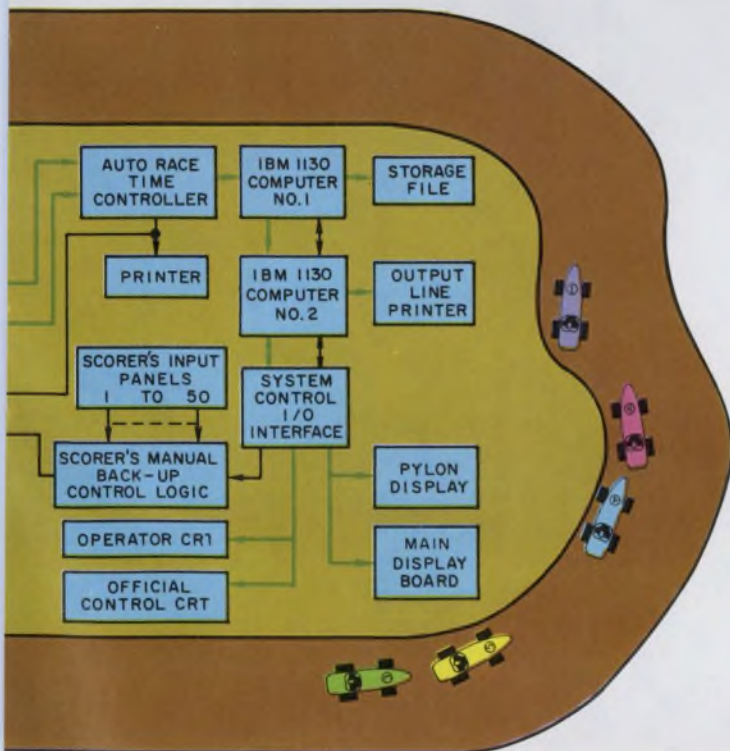

The world's first electronic timing and scoring system for auto racing, complete with a giant display board and four 50-foot pylons that show the numbers of the top 10 cars, is a \$4-million installation now being completed at Ontario (Calif.) Motor Speedway. For timing, radio transmitters are installed in up to 50 cars (compared with the present method at Indianapolis of sending hundreds of timers scrambling over the track with stop watches, eying assigned cars). Loop antenna arrays in the new system are buried at the start/finish line and at the entrances and exits of the pits. As a car passes over the loops, the receiver tuned to its frequency passes a signal to identification logic and to a controller clocking its time to 1/1000th of a second. Two IBM computers control the entire operation. Computer No. 1 receives all the timing data, verifies it and stores it as a complex file, which computer No. 2 then searches to obtain updated race statistics. The statistics are available as a paper printout, on CRT monitors, or on big-board displays in any of a number of formats.



Now race-track fans can watch what once only the racing stewards saw—photo finishes and film playback of races to determine if any fouls were committed. TV monitors are placed in the clubhouse, stands and other points within the parks—like the closed-circuit color TV system shown here at the Aqueduct track in New York City. These systems, engineered and installed at leading tracks throughout the country by Video Projects, Inc., of New Hyde Park, N.Y., use five to 10 cameras. Still photos of close finishes are transmitted directly from the track's photo-finish room to 23-inch TV monitors within 30 seconds after the race is run. The video tape of a race—unlike the camera film, which takes five to 10 minutes to process—can be played back for immediate viewing by the judges and fans. Special-effects equipment allows the system director to add such touches as split screens, lap dissolves and the insertion of text across the bottom of the TV picture.



Color TV coverage of sports brings the thrills home, particularly with close-ups from the backpack camera. But behind the scene, problems are crying for solution, according to LaVerne Pointer, director of broadcast engineering for the American Broadcasting Co. For example, the cables for field color cameras have 82 conductors and weigh a pound a foot. Golf matches require two or three mobile vans with up to 16 cameras and 2000 feet of cable. For field use, the cable is made up in 200-foot sections. Connector reliability is a headache, particularly when the cable lies buried under roads or fairways for days. If it is laid in the open, it is subject to rain, moisture and golf spikes. A much smaller and lighter cable, possibly with use of a multiplexing scheme or some other reliable method of camera-to-van transmission, is needed. ABC uses microwave links between the backpacks and field stations, but only when cable can't be used. The microlinks (12-13 GHz) suffer from multipath interference and random, variable attenuation.

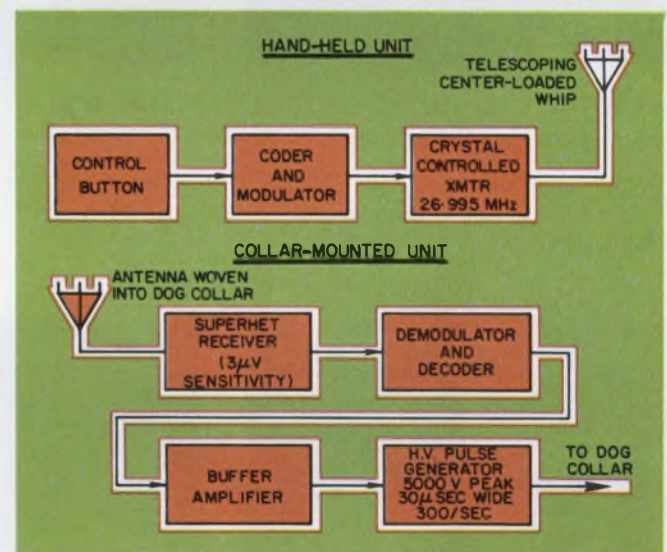

A coded modulation signal is the key to success of a radio-controlled dog trainer, by Tri-Tronics, Inc., Tucson, Ariz. The dog wears a "shock collar" with a woven antenna, plus a receiver and shocking circuits that produce 5000-V pulses across two neck electrodes. In use, the dog is allowed to pursue an undesirable behavior pattern. For example, a setter to be trained for pointing birds may chase a deer, with the trainer observing. When the trainer presses his transmitter button, the shock halts the dog in his tracks. The dog associates the shock with deer and then avoids those animals. The biggest problem with this type of equipment is accidental shocks due to random interference picked up by the dog's receiver from Civilian Band transmitters, auto-ignition systems or power lines. This can ruin a \$500 hunting dog in short order. To avoid this, the Tri-Tronics transmitter is modulated with a coded signal that is decoded in the collar unit.

If you're designing frequency-sensitive circuits, aren't these the measurements you should be making?

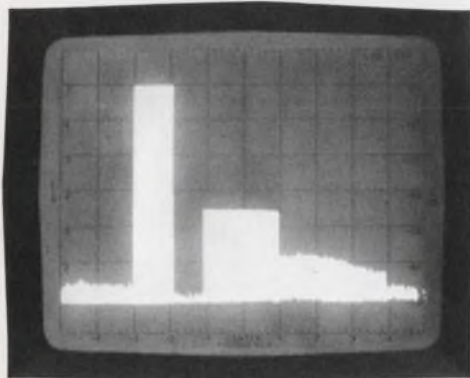

Oscillator Output Spectrum

Frequency scan: 0-100 MHz. Log display (LOG REF = 0 dBm).

Oscillator output is flat at -10 dBm, 20 to 30 MHz. Second harmonic is 35 dB down and flat; third harmonic goes from 50 to 55 dB down.

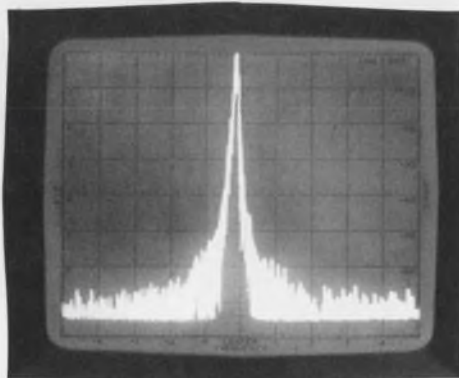

Spectral Purity

Center frequency: 100 MHz. Scan width: 5 kHz/div. IF bandwidth: 300 Hz. Log display (LOG REF = 0 dBm).

Major noise sidebands are approximately 55 dB below carrier.

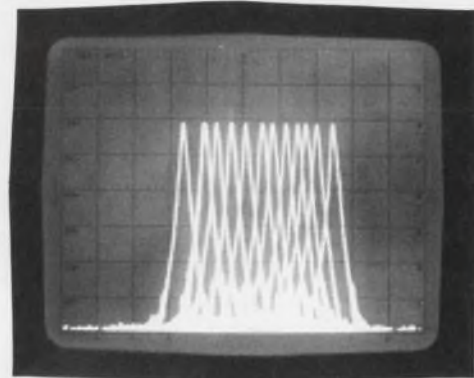

Frequency Drift

Center frequency: 800 MHz. Scan width: 10 kHz/div.

Scans are triggered at 10 second intervals and stored on CRT. Drift = 42 kHz in 2 minutes.

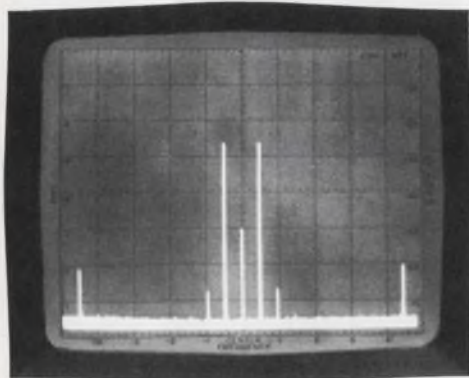

Conversion Efficiency

Center frequency: 50 MHz. Scan width: 5 MHz/div. Log display (LOG REF = -10 dBm).

Double-balanced mixer with 0 dBm drive at 50 MHz and -30 dBm at 5 MHz. Display shows 45 and 55 MHz sidebands at -36 dBm; i.e., 6 dB conversion loss. (Display also shows signal feed-through at 50 MHz and harmonic distortion products at 40 and 60 MHz.)

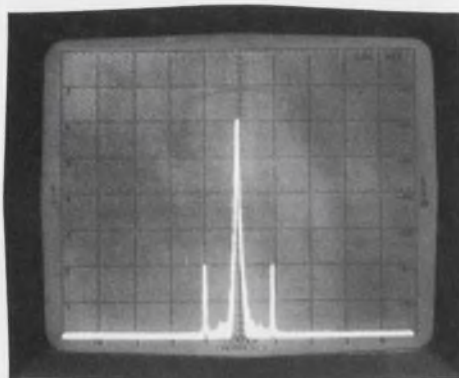

AM Modulation Index

Center frequency: 60 MHz. Scan width: 10 kHz/div. Log display (LOG REF = +10 dBm).

Low level 10 kHz modulation of 60 MHz carrier shows sidebands 40 dB down, i.e., 2% AM. Sidebands as low as -70 dB or 0.06% modulation can be measured.

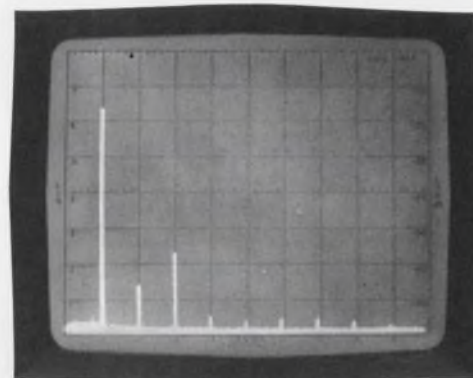

Harmonic Distortion

Frequency scan: 0-50 MHz. Log display (LOG REF = 0 dBm).

Harmonic content of -16 dBm 5 MHz signal is displayed: 2nd harmonic -50 dB, 3rd harmonic -40 dB, others < -60 dB. Harmonic content as a function of absolute fundamental level can be observed.

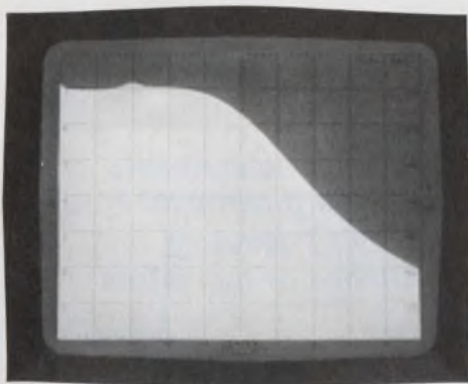

Amplifier Response Frequency scan: 0-500 MHz. Log display (LOG REF = +10 dBm).

With flat input at -20 dBm, gain and frequency response are read directly from CRT (20 dB gain, ± 2 dB to 200 MHz, 0 dB gain at 320 MHz).



Transmission Bandwidth

Center frequency: 800 MHz. Scan width: 0.5 MHz/div. Log display.

Spectrum of pulsed 800 MHz carrier shows 2.2 MHz frequency range between -40 dB lobes, which is bandwidth required to pass 99% of energy.

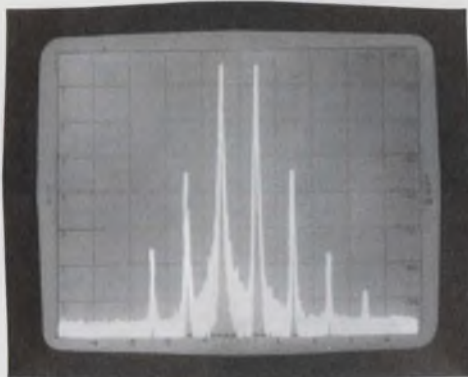

IM Distortion Center frequency: 60 MHz. Scan width: 100 kHz/div. Log display (LOG REF = +10 dBm).

Two-tone test using 59.95 and 60.05 MHz signals at +5 dBm each shows third-order sidebands 30 dB down. Higher order IM products can also be measured.

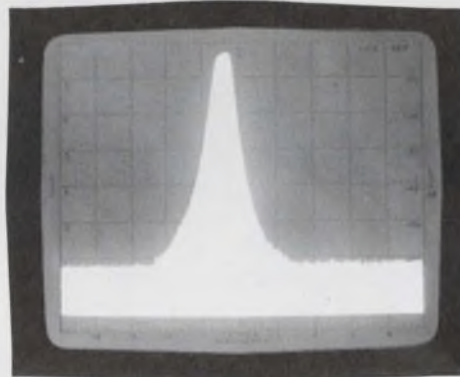

Filter Response Frequency scan: 0-100 MHz. Log display (LOG REF = 0 dBm).

With 0 dBm test signal, passband insertion and stopband rejection of 50 MHz bandpass filter are displayed. Insertion loss is 3 dB, 3 dB bandwidth approximately 4 MHz and 60 dB bandwidth is 36 MHz (Shape factor = 9).

There's only one lab tool that gives you the complete, accurate picture of measurements in the frequency domain: HP's series of fully calibrated spectrum analyzers. One covers 1 kHz to 110 MHz; the other goes from 500 kHz to 1250 MHz. Either is a convenient, easy-to-operate basic instrument for general circuit design that enables you to make all the measurements you see on these pages, plus many more. Use it as a tuned voltmeter, a wave analyzer, distortion meter, frequency meter and power meter. Its absolute amplitude calibration, low distortion, high sensitivity, wide sweep capabilities and wide dynamic range make it a true multi-purpose frequency domain measuring instrument.

The analyzer displays absolute signal levels both in dBm and volts from +10 dBm to < -120 dBm (0.8V to 0.1 μ V). And > 70 dB distortion-free dynamic range permits exceptional accuracy in measuring complex signals.

Sweep the entire frequency range, then reduce the scan width for a closeup view of any portion down to .0002% of the initial sweep. Selectable bandwidths let you get down to 50 Hz resolution with the lower frequency RF unit and to 300 Hz with the 1250 MHz unit. A variable persistence display shows the full trace even at the slow sweeps necessary to achieve high resolution.

You can perform all these measurements as easily as you operate your bench scope. Using HP's lab spectrum analyzers is simple and results are easy to interpret. The cost of the 8553B 110 MHz RF section is \$2100; the 8554L 1250 MHz RF section is \$3300. Either can be used with the basic 8552A IF section (\$2050) and 141T Variable Persistence Display section (\$1700). There's a normal persistence display unit available, too. Your Hewlett-Packard field engineer has the complete details; or write to Hewlett-Packard, Palo Alto, California 94304; Europe: 1217 Meyrin-Geneva, Switzerland.



HEWLETT  PACKARD

SIGNAL ANALYZERS

Letters

You will be the ones out of step—not us

Sir:

Mr. Jack Jones, in Letters, in the March 15, 1970 issue (ED 25), represents the myopic, narrow-minded sort of individual who, I fear, typifies the over-30 engineer. People like this, who can't see beyond the end of their slide rules, are precisely the reason why the engineering community has such a bad reputation among a talented, socially aware younger generation.

The United States is today in the midst of a revolution which must succeed if America or, for that matter, humanity itself is to survive. Whether this revolution is peaceful or violent, orderly or chaotic, will to a large extent depend on how well established institutions respond to the crying need for extensive change. Recent experience, however, indicates that our established institutions—the electronics industry among them—either cannot or will not respond to this need.

Despite the ballyhoo over token efforts to attack real problems, the electronics industry remains heavily committed to weapons development. The reign of terror inflicted upon the Vietnamese people in the name of freedom is a direct result of American technology's eagerness to supply the Pentagon with every conceivable engine of destruction—at a handsome profit, of course. As long as the electronics industry insists on maintaining its current cozy relationship with an arrogant, mindless military establishment, it will become increasingly difficult to recruit talented young people into the engineering profession.

Yes, Mr. Jones, today's youth is idealistic. And, as you suggest, we're also out of step. We are out of step with a war-based economy that squanders billions of dollars annually on useless, unreliable weapons systems for the Pentagon sandbox. We're out of step with so-called professional magazines and societies that glorify this toy-soldier nonsense as being good business, or with the limp excuse

that it furthers scientific and technical "progress." We're out of step with an economic philosophy that recognizes conspicuous consumption as the only valid measure of national success. I could go on, but I think you get the idea.

Gentlemen, the days of "What's good for General Motors is good for the country" are numbered. The revolution is coming, and when it does it will be you who are out of step and not us.

Douglas Abbott

University of California
Berkeley, Calif.

Patent is pending—we hasten to say

Sir:

A minor, though urgent problem, occurred with the release of your feature article in Evaluation Samples, ED 6, March 15, 1970, p. 268, on our new packaging system. Our intent with this article was to go on record that the product was exclusive and that we had patents pending in the United States and many countries outside the U. S. as well.

It would be a great help if you could publish something as soon as possible, making it clear that the product line and product concept are exclusively that of Circuit-Stik, Inc., and that a world-wide marketing line is planned.

Donald E. Harper

Marketing Director
Circuit-Stik, Inc.
Gardena, Calif.

He calls attention to a lack of inversion

Sir:

With regard to the article "Diagram sequential logic on a cube" in the 1 Mar. 1970 issue, page 55, I believe you DID FORGET to include the rear-left "A" CONSTANT in your D cube in Fig. 3.

Wayne E. Snow

Member Technical Staff
North American Aviation
Columbus Division
North American Rockwell Corp.

From 31 components you can make over 25,000 different switches or indicators

Flexible, building block concept means low inventory investment. Arrow-Hart's name means top quality. And Authorized Specialty Switch Distributors (below) mean ready availability.

Arizona	Telephone
ELECTRO COMPONENTS DISTRIBUTORS 1641 E. McDowell Phoenix, Arizona	602/258-2665
California	
T. V. WEATHERFORD 6921 San Fernando Road Glendale, California	213/849-3451
ELECTRO COMPONENTS DISTRIBUTORS 122 So. Mission Road Los Angeles, California	213/386-1611
FISHER SWITCHES, INC. 3381 Edward Avenue Santa Clara, California	408/244-6182
FISHER SWITCHES, INC. 3400 S. Broadway Los Angeles, California	213/746-3740
ELECTRO COMPONENTS DISTRIBUTORS, INC. 1667 Industrial Road San Carlos, California	415/592-3030
CONSOLIDATED PARTS 180 E. Gish Road San Jose, California	408/294-2302
ZACK ELECTRONICS 1422 Market Street San Francisco, California	415/626-1444
Colorado	
ELECTRONICS PARTS COMPANY 1277 Broadway Denver, Colorado	303/266-3755

 ARROW-HART, INC.
HARTFORD, CONN.



Meanwhile, back on earth.

Arrow-Hart scores a breakthrough in lighted push-button switches. Snap-on contact blocks make up to 4-pole double throw form Z switches. 31 stock components = 25,344 different variations. Six colored lenses in three shapes. Is your imagination beginning to run away with you? Write or wire for folder. We call all this Adapt-a-Switch. You'll call it ingenious.

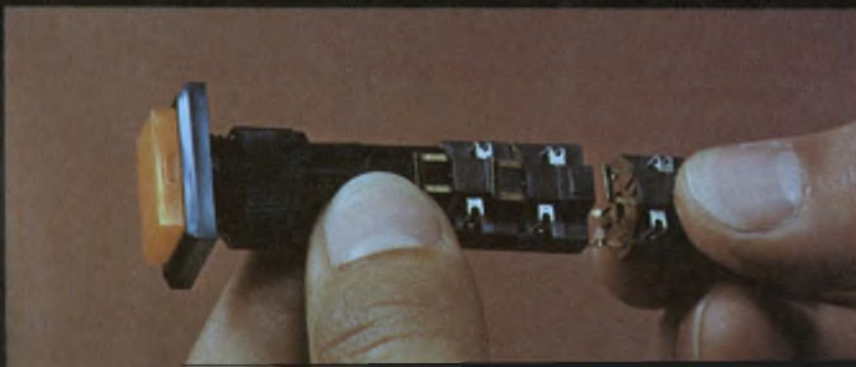

**Arrow
Hart**

ARROW-HART, INC.
HARTFORD, CONN.



THE "INTERMEDIATE" SYNTHESIZER



160 MHz for \$5900

Buying a frequency synthesizer has been something like buying a car. There's a confusion of models, options, and price ranges. Except — there has never been a so-called "intermediate"-model synthesizer. That's because price and performance ranges of synthesizers have tended to cluster just at both ends of the spectrum. The choice was between lower-cost, limited-frequency-range models and those with everything, including a sky-high price tag. So, the buying decision was one based on either trade-off or over-capability.

This is not true any longer! GR has filled the price-capability gap with the new 1165 Frequency Synthesizer. Frequency range is wide, 0.01 to 160 MHz in 100-Hz steps. The price is only \$5900, less than half the price it used to cost to get 160 MHz. If you can furnish your own frequency reference signal (5 or 10 MHz), you can get a model for only \$5300. In the \$5900 model, frequency accuracy is maintained either by an internal precision 10-MHz oscillator (1×10^{-9} per day) or by an external drive or lock source. Output is 0.1 to 1 V into 50 ohms. Both frequency and level can be externally programmed; the 1165 is ideal for applications requiring remotely-programmed local oscillators. Harmonics are typically down 30 dB (at maximum output into 50- Ω load); spurious, discrete non-harmonic signals are typically down 60 dB.

For complete information, write General Radio, West Concord, Mass. 01781; telephone (617) 369-4400. In Europe: Postfach 124, CH 8034, Zurich, Switzerland.

GENERAL RADIO 

Washington Report

DON BYRNE, WASHINGTON BUREAU

Destroyer contract delayed again

Bath Iron Works and Litton Industries, which have been expecting for months to hear that one of them won the award to build six DD-963 class destroyers, may have to wait two more months for their answer.

The House approved \$506.8-million for the ships but a rider was attached to the overall \$20-billion defense authorization bill requiring that the ships be built by two ship yards instead of one. The provision may be removed—as it was last year—by the Senate or later in joint House and Senate sessions. Meanwhile, the rider is holding up the contract award.

Action on the authorization bill may not be completed before late June or July because it includes money for the Safeguard ABM, a program that will undoubtedly be delayed by a filibuster.

House votes \$200-million for Lockheed 'contingency'

The House has approved \$544.4-million for the C-5A program, \$200-million of which is to be used by Lockheed to cover expenditures during the next fiscal year. Lockheed told the Defense Dept. several months ago that it would need \$600-million over the next three years to meet expenses. The House Armed Services Committee recommended the \$200-million for the coming year, stating that it was "doubtful" that Lockheed could cover these expenditures.

Deputy Defense Secretary David Packard told the committee that if the money was not approved, the C-5A program would have to be terminated under confusion and uncertain circumstances, without any clear picture of just what the Government would get for its large investment in the program.

Safeguard streaking toward trouble in Senate

The planned expansion of the Safeguard antiballistic missile system is in deep trouble in the Senate—and perhaps the entire ABM program along with it.

Senate supporters of the ABM system are not sure they can salvage any of the the program, let alone the \$404-million earmarked for extra Safeguard sites. The House passed a \$1,026,000,000 authorization for Safeguard in fiscal 1971, which included \$305-million for construction of a new site at Whiteman AFB, Mo.; \$35-million for additional Sprint missiles at Grand Forks, N. D., and Malmstrom, Mont.; \$40-million for long-lead-time preparation of five additional sites, and \$24-million for related work.

Last year deployment of the ABM squeaked through the Senate on a tie vote. This year proponents feel they will be lucky if they can even get a tie vote. One Senate supporter told ELECTRONIC DESIGN: "If they get us on the run, they'll kill the whole program."

Proponents point out that Sen. Everett Dirksen, a supporter, is dead and that Sen. Karl E. Mundt (R-S.D.), another supporter, is hospitalized and not expected to be on hand for a vote. In addition there is little be-

lief in the Senate that Chinese attack capabilities call for extra ABM spending at this time. The plan within the Senate Armed Services Committee at the moment seems to be to bring out a modified bill that would kill the expansion but keep alive the basic program. Hopefully, say the proponents, this would get through the Senate and give the House a bill that it could live with.

Better planning sought in earth satellite program

The Senate Space Committee has instructed NASA to undertake immediately a study of other Government agency needs in the proposed Earth Resources Technology Satellite Program. The Committee told NASA it would like to see a formal agreement between Government agencies to improve planning and coordination. The recommendation came in the report of the Space Committee on NASA's fiscal 1971 authorization. The committee chopped \$284.9-million from the \$3.6-billion the House had approved. The bulk of the cut was in the manned space program, where the House had added almost \$300-million more than the Administration had requested.

AWACS contractor selection delayed

A contract award for the Airborne Warning and Control System (AWACS), expected in early June, has been postponed four to six months, Defense Dept. sources say. No reason was given for the delay. But it's believed that a contractor for AWACS can't be selected until one is chosen for the B-1 advanced manned strategic aircraft. Announcement of the B-1 contract is imminent, and several of the bidders are involved in both contracts. Boeing and General Electric, for example, are both very much in the running for both contracts, and it's highly unlikely that one company would get both awards.

Capital capsules: The Federal Aviation Administration (FAA) is taking a look at a proximity warning device for general-aviation planes that costs less than \$400 and weighs only two pounds. The device, manufactured by General Aviation Electronics, Inc., of Indianapolis, reacts to the transponders normally installed in military and airline aircraft . . . Adm. Thomas H. Moorer, Chief of Naval Operations, has revealed that two North Vietnamese MIG fighters were knocked down in 1968 by Talos missiles. Both planes were outside the 65-mile range of Talos. News of the downings was held up for security reasons, Moorer said . . . The Australian Parliament has agreed to lease U. S. Phantom F-4E fighters as stand-ins for the 24 F-111C planes it has on order, pending tests on the grounded F-111s. The U. S. Air Force has announced, meanwhile, that the F-111 wing under test at General Dynamic's San Diego facility failed at 3,000 hours—1,000 hours short of its life expectancy. The Air Force says, however, that the test has proved that the aircraft has many years of use during which a fix can be devised . . . The leading candidate for the director of the new Office of Telecommunications Policy is said to be William A. Niskanen, 37-year-old Pentagon economist and former director of program analysis in the Institute of Defense Analysis. His deputy may come from the communications industry.

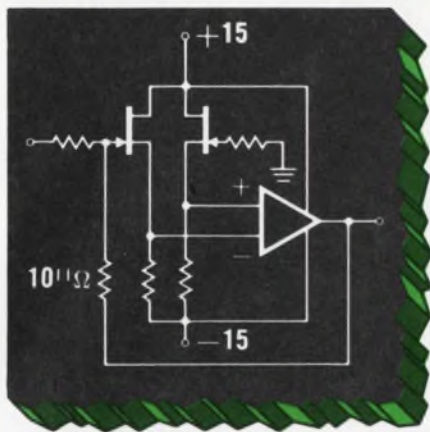

SUB-PICOAMP I_{in} FOR DIFF AMPS WITH FETS

Are these your requirements?— Less than 1 pA I_{in} and low noise (for electrometer, Op Amp, or diff amp) or high slew rate (for sample and hold). Use FETs at the input in either long-tailed pair or differential source follower circuits. Another possibility—the temperature compensated source follower for unbalanced circuits.

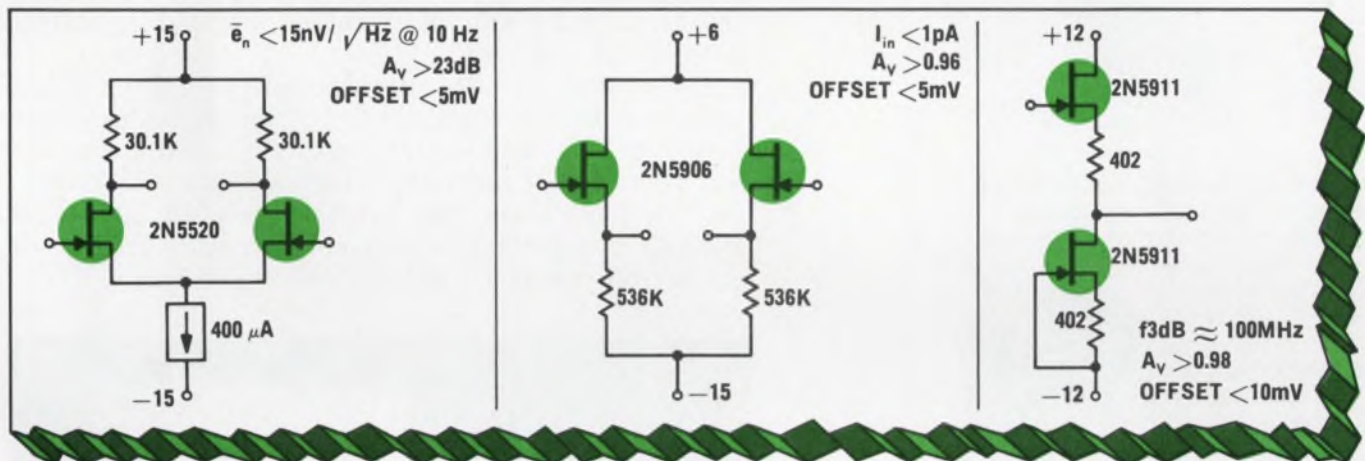

Siliconix assumes no responsibility for circuits shown, nor does it represent or warrant that they do not infringe any patents.

Which FETs to use? ■ General Purpose: 2N5196-99; ■ Low Noise: 2N5515-24; ■ Low Leakage: 2N5902-09; ■ Wide Band and/or High Gain: 2N5911-12.

For more information and applications assistance write or call any of the numbers below.

New York: Sy Levine (516) 796-4680
New England: Al La Croix (617) 762-8114
Ft. Worth/Dallas: Charlie Williams (214) 231-8151
St. Louis: Jim Spicer (314) 291-3616
Minneapolis: Ed Koelgen (612) 920-4483
Southern California: Dave Ferran (213) 420-1307
Northern California: Chuck Brush (408) 246-8000



Siliconix incorporated

2201 Laurelwood Road • Santa Clara • California 95054
 Telephone (408) 246-8000 Extension 201 • TWX: 910-338-0227
 In Europe: Siliconix Limited, Saunders Way, Sketty, Swansea, Great Britain

New Infrared Detectors and Emitters.

Lead-Tin-Telluride Detectors for 8-14 micron radiation. Optimum performance at 77°K. Peak spectral response can be selected. Available in various configurations.



PbSnTe
Detector

Also available — a new family of high power, high efficiency gallium arsenide emitters. 150 milliwatts continuous output at better than 10% efficiency. Substantially higher outputs achievable by cooling the diodes.



GaAs Emitter

Raytheon produces IR detectors covering the spectrum from 2 microns to 8 mm. Both single elements and arrays have been produced.



InSb Array
Dewar
Assembly
and Cryostat

RAYTHEON

Special Microwave
Devices Operation
130 Second Avenue
Waltham, Mass. 02154
(617) 899-8080

Shoot golf with pros — by computer

How'd you like to play an 18-hole round of golf on the famous course of your choice—without leaving your hometown? Our East Coast Editor, Jim McDermott, came across such an invention, called Golf-O-Tron. (Golf-O-Tron Corp., New York, N. Y.) while gathering material for a story on the use of electronics in sports (page 36).

An interesting hybrid—digital/analog—computer is used to control the practice game. The fairway is projected in color on a large screen in front of the player, who drives off the first (and succeeding 17 tees). His ball hits the screen, and from the impact, a computer calculates the trajectory the ball would have taken had our golfer been playing on the real course.

An image of the golf ball following this trajectory is projected on the screen. The computer measures the velocity of the ball and calculates the yardage driven. The projector, controlled by the computer, automatically changes the pictures, as he progresses up the fairway, to correspond with the new position. Once the ball reaches the green, the player putts out on a grasslike surface with the real ball.

Other jobs the computer is undertaking in sports include picking new players for teams. It evaluates the prospects that team scouts report on. And computers are used also for analyzing opponents' games and players. In these cases, the machine makes a statistical analysis of important factors, and the results are printed out for the managers' and coaches' evaluation.

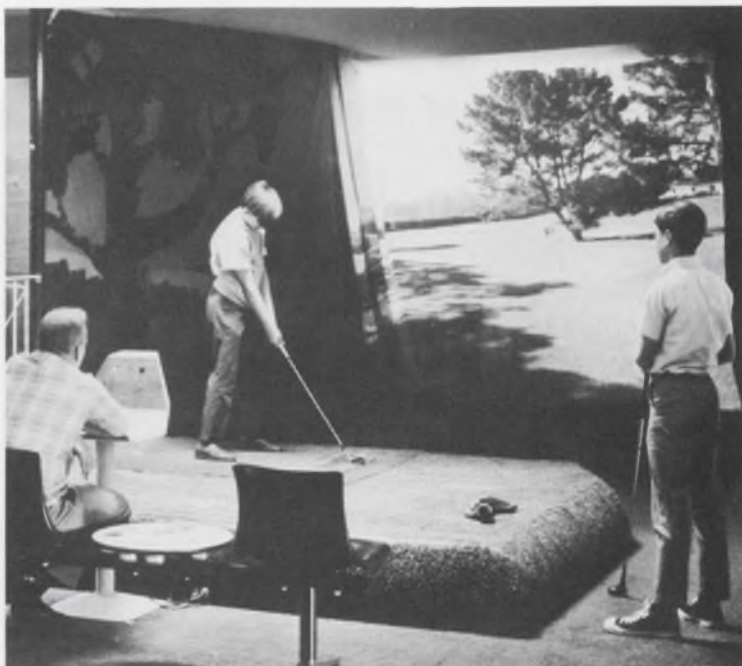

With the Golf-O-Tron practice machine, a player is about to make an iron shot to the hole 50 yards away—on the screen.

TRIAL and ERROR

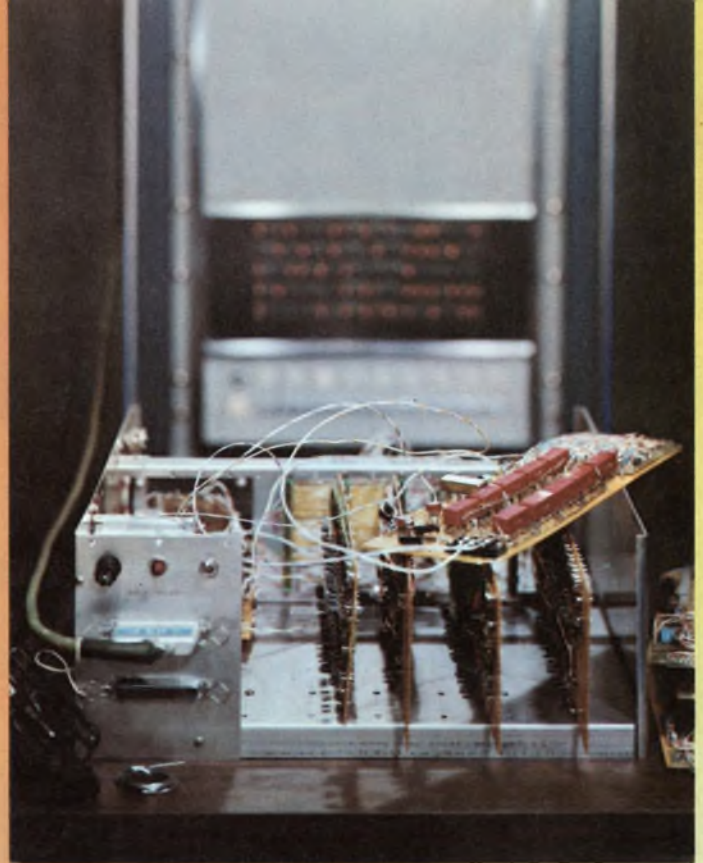

eliminated with digitally controlled power



HEWLETT  PACKARD

POWER SUPPLIES

100 Locust Avenue, Berkeley Heights
New Jersey 07922 • (201) 464-1234

21008

... The most advanced instrument for automatic test systems... designed to save you engineering time and money. HP Digitally Controlled Power Sources are more than digital-to-analog converters with output power capability, they include added "system-oriented" functions... Internal Storage to increase computer operating efficiency; Isolation to break ground loops; Bipolar Amplification for fast up and down programming; Programmable Current Limit to protect sensitive loads; Pre-Interfaced at the factory to match your computer... All this is in a single compact package. Outputs from $-100V$ to $+100V$, currents up to 1A. \$1,800.

Digitally Controlled Power Brochure available upon request.

ELECTRONIC MATERIALS

DOW CORNING®

3140 RTV coating

clear, flowable silicone rubber coating; non-corrosive to copper and other metals
TWO OUNCES

DOW CORNING

ELECTRONIC MATERIALS

DOW CORNING®

3140 RTV coating

clear, flowable silicone rubber coating; non-corrosive to copper and other metals
TWO OUNCES

DOW CORNING®

3141 RTV coating

white, flowable silicone rubber coating; non-corrosive to copper and other metals
NET WT. 2 oz/57 g

DOW CORNING

DOW CORNING®

3141 RTV coating

white, flowable silicone rubber coating; non-corrosive to copper and other metals
NET WT. 2 oz/57 g

DOW CORNING®

3144 RTV adhesive/sealant

translucent, room-temperature-curing silicone rubber adhesive/sealant; non-corrosive to copper and other metals
NET WT. 2 oz/57 g

DOW CORNING

DOW CORNING®

3144 RTV adhesive/sealant

translucent, room-temperature-curing silicone rubber adhesive/sealant; non-corrosive to copper and other metals
NET WT. 2 oz/57 g

ELECTRONIC MATERIALS

DOW CORNING®

3145 RTV adhesive/sealant

grey, non-stump silicone rubber sealant; non-corrosive to copper and other metals
TWO OUNCES

ELECTRONIC MATERIALS

DOW CORNING®

3145 RTV adhesive/sealant

grey, non-stump silicone rubber sealant; non-corrosive to copper and other metals
TWO OUNCES



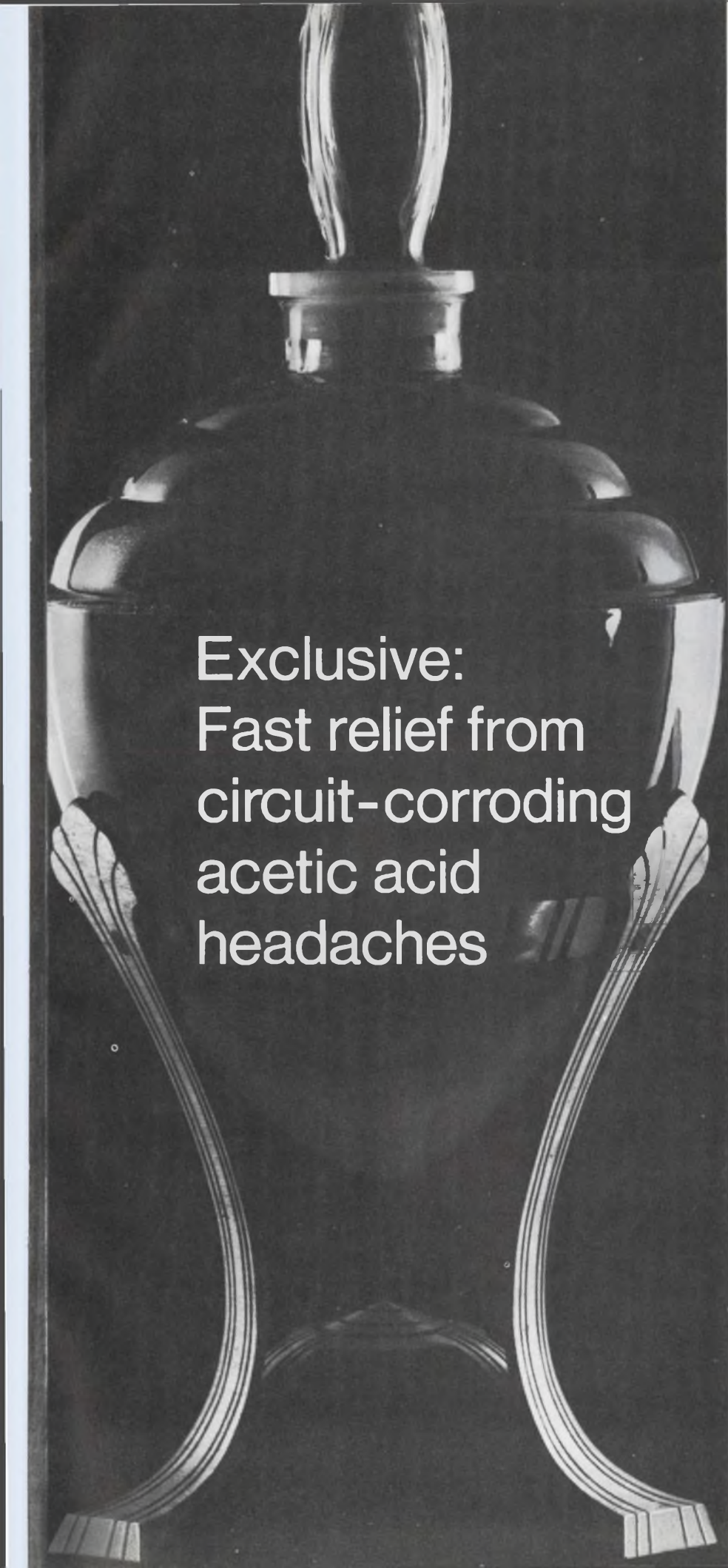

Exclusive:
Fast relief from
circuit-corroding
acetic acid
headaches

Dow Corning® silicone sealants and protective coatings are the only ones that do *not* release acetic acid or other corrosive by-products during cure. They were specifically developed to protect delicate circuit boards and other electronic components from corrosion, dust, dirt, abrasive particles, solvents and chemicals. They are strong, have excellent bond strength, electrical strength; are easy to apply, and cure quickly. There's no "vinegar" smell, either. Dow Corning 3140 (clear) and 3141 (opaque) RTV coatings are ready-to-use silicone rubbers that cure at room temperature. They are ideal for conformal coatings on printed circuit assemblies or for encapsulating small circuits or connectors. Dow Corning 3144 (clear) and 3145 (opaque) RTV adhesive/sealants are high-strength, non-corrosive, nonflowing silicone rubbers used to bond components and seal housings and connectors.

Stop component corrosion with these Dow Corning coatings and sealants. For more information, write Dow Corning Corporation, Dept. B-9342, Midland, Michigan 48640.

*Electrical / Electronic
materials from*

DOW CORNING

DOW CORNING

Process more information faster and cheaper with HP hot carrier diodes.

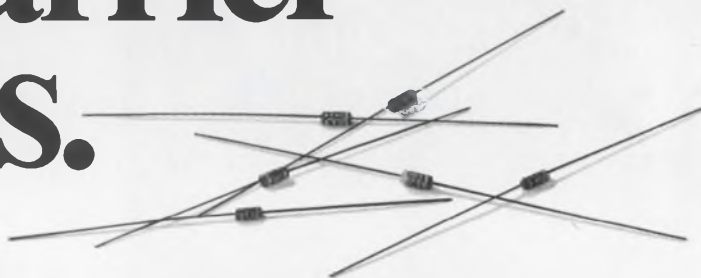

Now you can think about circuit switching speed in terms of picoseconds instead of nanoseconds, for digital logic systems, data handling and peripheral equipment and other applications where you're designing circuits for mixing, clipping, clamping, A/D conversion, gating and sampling.

These low-cost hybrid Schottky diodes are fully passivated, have a 0.4 V threshold voltage, have

100 picosecond switching speed and 1.0 mV/degree C temperature coefficient. They'll withstand temperatures from -55° to 200° C and breakdown voltages up to 70 V. In fact, their near-ideal combination of forward voltage/current characteristics adds up to better-than-PN-junction performance at volume user prices. And they're newly EIA registered.

Check your HP sales office for prices, which are as low as 32¢ each in 100,000 quantities for the HP 5082-2800. Ask about specs and prices on the HP 5082-2810 and 2811, too.

.01008

HEWLETT  PACKARD
SOLID STATE DEVICES

INFORMATION RETRIEVAL NUMBER 29

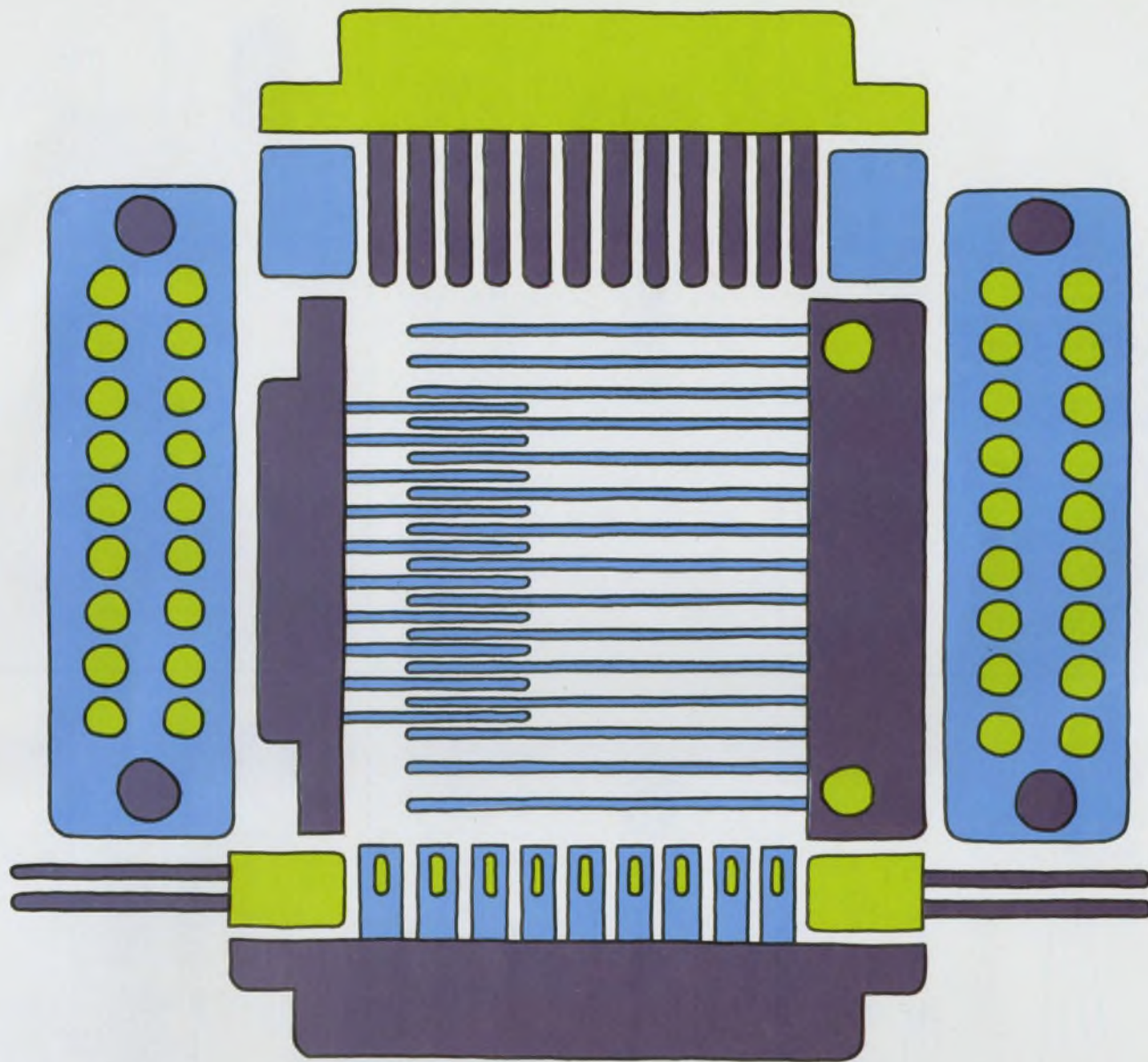

Winchester Electronics

where in-stock printed circuit connectors are closing today's communications gap.

Typical of Winchester Electronics' capabilities in printed circuit connectors are our lines of card edge and board joiners pin and socket connector. And for even more exacting applications, our military approved HB/HBD series.

Available in single and double row terminations, these connectors not only meet

MIL-C-21097 requirements but exceed them in quality and reliability at an economical price.

So, before you go to the expense of ordering a special printed circuit connector, look into the in-stock selection at Winchester Electronics. Just write Winchester Electronics, Main Street and Hillside Ave., Oakville, Conn. 06779.



**WINCHESTER
ELECTRONICS**

DIVISION OF LITTON INDUSTRIES



INFORMATION RETRIEVAL NUMBER 30

5 fast ways to design-in transformers.

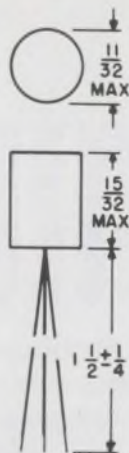

WEIGHT 1/10 OZ

DO-T™ Transistor Transformers & Inductors with frequency response of ± 3 db, 300 Hz to 20 kHz. Primary impedance ranges from 80 CT to 200,000 CT; secondary impedance from 3.2 to 20,000 split. Mw levels from 25 to 500 Inductors from .15 Hys @ 20 maDC to 6 Hys @ 2 maDC.

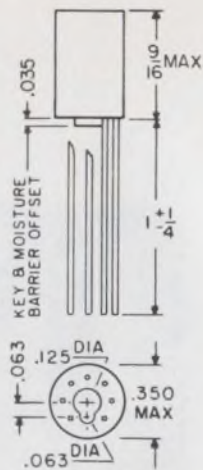

WEIGHT 1/15 OZ

New DO-T200™ Series Transformers & Inductors. Termination patterns conform with TO-5 cased microcircuits. Frequency response: ± 3 db, 300 Hz to 20 kHz. Primary impedance ranges from 1,000 CT to 200,000 CT; secondary impedance from 50 to 12,000 CT. Mw levels from 25 to 100. Also available in all standard DO-T specifications.

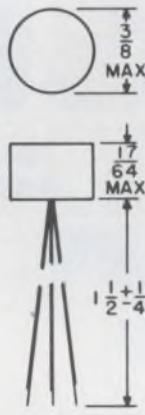

WEIGHT 1/20 OZ

PIL™ Ultraminiature Audio and High-frequency Transformers & Inductors. Frequency response at 1 mw is ± 3 db, 800 Hz to 250 kHz. Primary impedance: 500 CT to 10K CT; Secondary impedance: 500 CT to 2K CT. Max. Mw level: 100. Inductors from .020 Hys @ 10 maDC to .66 Hys @ 0 maDC.

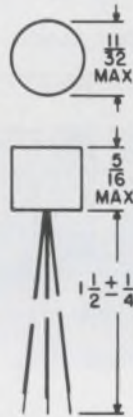

WEIGHT 1/15 OZ

DI-T™ Series Transistor Transformers & Inductors. Frequency response of ± 3 db, 400 Hz to 100 kHz. Primary impedance ranges from 80 CT to 30,000 CT; secondary impedance from 3.2 to 12,000 CT. Mw levels from 50 to 500. Inductors from .08 Hys @ 10 maDC to 4.5 Hys @ 2 maDC.

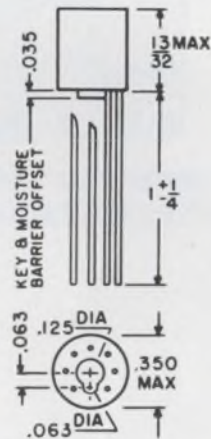

WEIGHT 1/15 OZ

DI-T200™ Transistor Transformers & Inductors. Termination patterns conform with TO-5 cased microcircuits. Frequency response: ± 3 db, 400 Hz to 100 kHz. Primary impedance ranges from 80 to 30,000 CT; secondary impedance from 32 split to 12,000 CT. Mw levels from 50 to 500. Inductors from .02 Hys @ 20 maDC to 4.5 Hys @ 2 maDC. Also available in all standard DI-T specifications.

Here is the entire UTC DO-T family.

Pick any one of these transformers —you'll combine maximum performance characteristics, unusual power handling capability and high reliability in a tiny package. Their parameters greatly exceed those of conventional transformers, making them ideal for a wide range of applications.

All of these transformers have the unique DO-T type construction that UTC developed. The bobbins are

completely rigid, eliminating stress and wire movement. All turns are circular, rather than square, eliminating turn corner stress. All leads and wires are securely anchored to resist strain.

All units are hermetically sealed and are manufactured and guaranteed to MIL-T-27C specifications.

Insist on getting UTC transformers in these five basic series. Simplify your design problems—refer to the UTC catalog, which displays the largest

selection of items in the industry. Standard items are available for immediate delivery—plus custom designs to your specifications.

Contact your local distributor. Or, write for latest catalog to *United Transformer Company, Division of TRW, INC., 150 Varick Street, New York, New York 10013.*



TRW®

SUDDENLY ALL OTHER VOLTAGE REGULATORS ARE SECOND BEST.



HERE'S WHY:

- $\pm 0.01\%$ line & load regulation
- $\pm 0.5\%$ preset output voltage
- Short-circuit proof
- MIL-STD-883 hermetic package
- \$40 (1-9 quantity)
- Model 828 (plus) and Model 838 (minus) from stock
- Many other outstanding features; contact your local Helipot representative.

Beckman

HELIPOT DIVISION

FULLERTON, CALIFORNIA • 92634

INTERNATIONAL SUBSIDIARIES: AMSTERDAM • CAPE TOWN • GENEVA • GLENROTHES,
SCOTLAND • LONDON • MEXICO CITY • MUNICH • PARIS • STOCKHOLM • TOKYO • VIENNA

DUAL TRANSISTORS

THEIRS  \$9⁵⁰
 OURS  \$2⁴⁰

SURE A METAL CAN
 IS HERMETIC.
 BUT IS IT WORTH A
 \$7.00 PRICE DIFFERENTIAL?

Now you can get what you need; the specs. Without paying an arm and a leg for a metal can. Look over the table of types. The specs check. And the price is \$0.92 to \$2.40 at 100-999. So pick up the phone to save a pocketful of dollars.

Sprague thinks not. In 9 out of 10 industrial and instrument applications, it's beta match and V_{BE} tracking that count in a dual transistor. Not the can. That's why we package in plastic. So you can save dollars on your design. With no loss in performance. Just like with ICs, where plastic DIPs are almost the rule. It's just that simple.

Polarity	$ V_{BE1} - V_{BE2} $		$\frac{ V_{BE1} - V_{BE2} }{\Delta T_A}$			Matched Duals	Pinning	
	5mV	10mV	10 μ V/ $^{\circ}$ C	20 μ V/ $^{\circ}$ C	30 μ V/ $^{\circ}$ C		BN E B C O O O	BP O O O E C B
NPN/NPN	TD-100 TD-200 TD-250	TD-101 TD-201	TD-250	TD-100 TD-200	TD-101 TD-201	TD-2219	TD-200 TD-201 TD-202 TD-250	TD-100 TD-101 TD-102 TD-219
PNP/PNP	TD-400 TD-500 TD-550	TD-401 TD-501	TD-550	TD-400 TD-500	TD-401 TD-501	TD-2905	TD-500 TD-501 TD-502 TD-550	TD-400 TD-401 TD-402 TD-2905
PNP/NPN	—	—	—	—	—	TD-600 TD-601 TD-602 TD-700 TD-701 TD-702	TD-700 TD-701 TD-702	TD-600 TD-601 TD-602

PRICE? DELIVERY? LOCAL DISTRIBUTORS? TECHNICAL LITERATURE?
 GET THE ANSWERS AT ANY OF THE NUMBERS LISTED BELOW.

485-9188R3

ALA. Huntsville, no charge call operator, WX4000 ARIZ. Phoenix (602) 279-5435 CALIF. Burlingame (415) 347-7701 Los Angeles, Bell Tel., (213) 870-0161, Gen. Tel., (213) 391-0611 San Diego (714) 278-7640 COLO. Denver (303) 756-3611 CONN. Trumbull (203) 261-2551 DC. Washington (202) 244-6006 FLA. Orlando (305) 831-3636 ILL. Schiller Park (312) 678-2262 IND. Indianapolis (317) 253-4247 MASS. Newton (617) 969-2520 North Adams (413) 664-4411 MICH. Ann Arbor (313) 761-4080 Detroit, no charge call operator, Enterprise 7498 MINN. Minneapolis (612) 335-7734 MD. St. Ann (314) 291-2500 N.J. Cherry Hill (609) 667-4444/(215) 467-5252 Wayne (201) 696-8200 N.M. Albuquerque (505) 265-1579 N.Y. Melville (516) 549-4141 Syracuse (315) 437-7311 N.C. Winston-Salem (919) 722-5151 OHIO Chagrin Falls (216) 247-6488 Dayton (513) 223-9187 Cincinnati, no charge call operator, Enterprise 3-8805 TEX. Richardson (214) 235-1256 WASH. Seattle (206) 632-7761.



YT19 system cabinet, holds all the equipment shown (except teletypewriter) with room to spare.

CD51 controller-digitizer with programmable gain, controls 1024 channels, 10ns aperture time.

TE33 teletypewriter with paper tape reader and punch. (Includes controller.)

CF16 minicomputer with a 4K x 16-bit memory (expandable to 24K) and four different I/O modes. (Includes software.)

Optionally available: MR50 high-level multiplexer and associated channels (approximately \$2400 extra), if you want to mix high and low level signals. Also 10, 12 or 15-bit D to A converters for closed loop systems, and a variety of other off-the-shelf instruments and options to solve virtually any data acquisition problem.

PE20 peripheral controller for CD51/DM40 combination.

OP50 multiplexer switch card contains 8 switches with screw terminals. Each DM40 accommodates up to 16 such cards. Switch cards with other terminal types also available.

OP59 power supply for up to eight DM40s.

DM40 low-level differential multiplexer accepts up to 128 input signals (optionally expandable to 1024) in the range $\pm 2.5\text{mV}$ to $\pm 10\text{V}$ full scale, at a rate up to 20kHz, and with a CMR of 120db at DC.

All instruments and interfaces will be cabinet mounted and functionally tested together prior to delivery. If you're in a hurry, call (213) 679-4511, ext. 3668 or 3391.

XDS
Xerox Data Systems
El Segundo, California

The last reason you should buy our data acquisition system is the price: \$21,600.

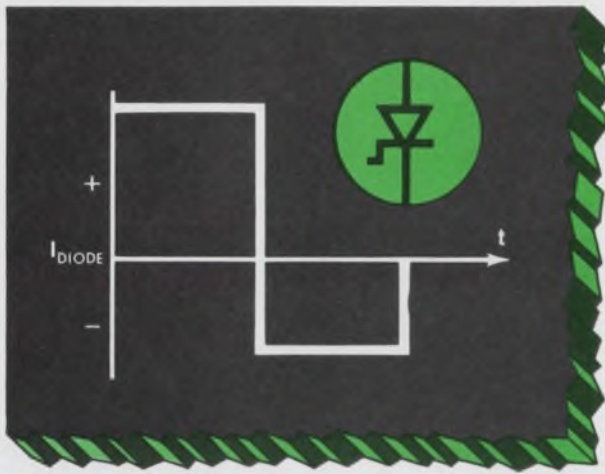

A PULSE SNAP DIODE from SILICONIX. (SILICONIX?)*

Here's a semiconductor diode that can really put a snap in your pulse circuitry. It can handle high amplitudes at picosecond speeds, all with simple, low-cost circuitry.

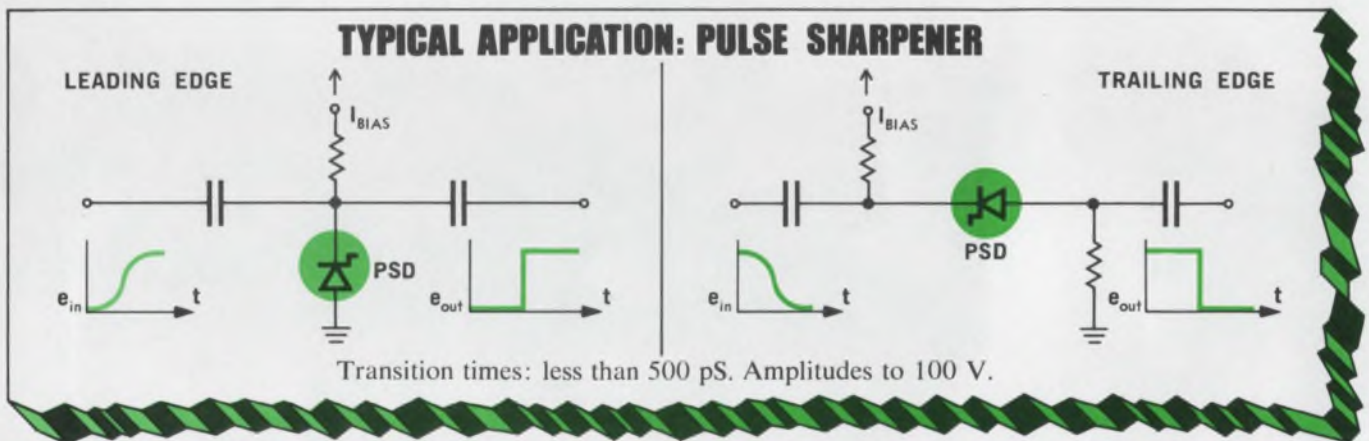

Other uses for this pulse snap diode include

- Pulse Squaring
- Pulse Delaying
- Pulse Area Limiting
- Impulse Generation
- Sine-to-Square Conversion
- Etc.

Instant data and applications information available from any of the offices below. Just write or call.

New York: Sy Levine (516) 796-4680
New England: Al La Croix (617) 762-8114
Ft. Worth/Dallas: Charlie Williams (214) 231-8151
St. Louis: Jim Spicer (314) 291-3616
Minneapolis: Ed Koelfgen (612) 920-4483
Southern California: Dave Ferran (213) 420-1307
Northern California: Chuck Brush (408) 246-8000



*... a new addition to the expanding family of high speed, HF and microwave devices from:

Siliconix incorporated

2201 Laurelwood Road • Santa Clara • California 95054
 Telephone (408) 246-8000 Extension 201 • TWX: 910-338-0227
 In Europe: Siliconix Limited, Saunders Way, Sketty, Swansea, Great Britain

That little black box is a power amplifier with 150 watt output



We said one hundred fifty watts!



This little beauty is the smallest power amplifier capable of 150 watt output and 100 watt internal dissipation at 90°C case temperature. It's uniquely suited and priced to drive industrial control systems using DC torque motors, servo motors or for directly activating loud speakers, actuators, sonar transducers and TV magnetic deflection circuits.

Why try to duplicate Inland's years of experience in designing, specifying and manufacturing control systems from command signal to final drive. We can save you time and money by solving your interface problems before they occur. And you get 2 weeks delivery.

The IC-100 is field repairable and can be configured to meet MIL-E-5400 including MIL-STD-704. For further information including quantity pricing, just give us a call or drop us a line.



**INLAND
CONTROLS**

A DIVISION OF
KOLLMORGEN



*Who ever heard
of a computer
with an*

EPU?

Unlike any other computer you've ever seen, the GRI 909 Computer, a Direct Function Processor, has an expandable instruction set. Starting with the basic configuration of nearly one hundred instructions, it can be expanded with firmware modules to literally thousands of instructions.

Typical units in our standard library of plug-in firmware operators are "Multiply/Divide", "Byte Swap/Pack", "Byte Comparator", and "General Purpose Registers". And, if you prefer, you can make up and plug in your own proprietary operators.

This is a true hardware expansion of the processor unit . . . not merely a read-only memory execution of subroutines. (Although the GRI 909 can handle that too, of course.)

Don't box yourself in. Get the GRI 909. It's a family of computers within a single processor unit.

For more information on the Direct Function Processing technique write:

GRI Computer Corp.

gn 76 Rowe Street,
Newton, Mass. 02166
(617) 969-7346

* EXPANDABLE PROCESSOR UNIT

gn-909
THE NEW BREED

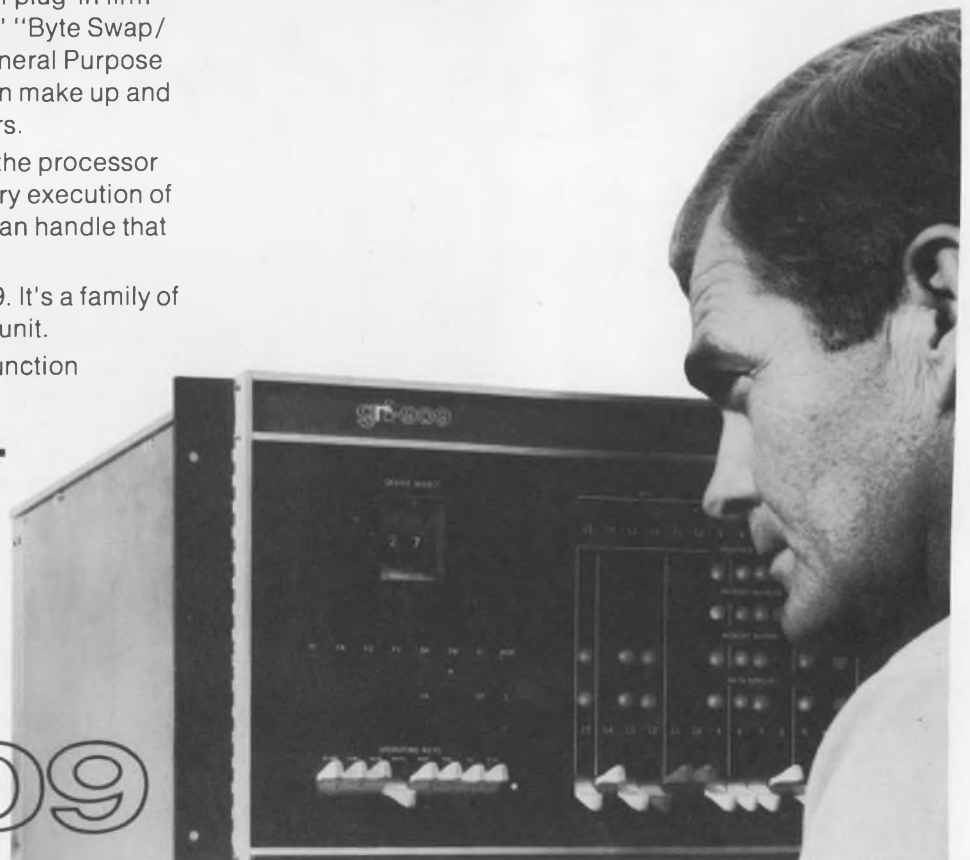

CELANESE NYLON IS MADE IN A TOTALLY CONTINUOUS PROCESS. THAT'S ADVANTAGE NO. 1.

Whiteness. We make Celanese nylon in a continuous, patented process—so it has a shorter heat history. That's why it's whiter in the pellet. Whiter in your products. And it's whiter through successive regrinds.

It's one advantage that Buchanan Electrical Products Corporation gets by using Celanese nylon for terminal blocks, connectors—some 30 other electrical parts.

Other reasons for using Celanese nylon include high



dielectric properties, which allow thinner walls, more compact units. Great mechanical strength and toughness. Resilience, for parts that have to snap-fit. Hold. Celanese nylon is self-extin-

guishing. And it has U/L rating on electrical properties of 105°C.

In fact, Celanese nylon has all the best properties you expect in nylon. Without the yellow. Write for a copy of our brochure on electrical applications of Celanese nylon. Also a U/L Yellow Card. Celanese Plastics Company, Dept. N-500, 1090 Lousons Rd., Union, New Jersey 07083.



Celanese Plastics Company is a division of Celanese Corporation. Canadian Affiliate: Chemcell Resources, Ltd. Export: Amcel Co., Inc., and Pan Amcel Co., Inc., 522 Fifth Ave., New York 10036

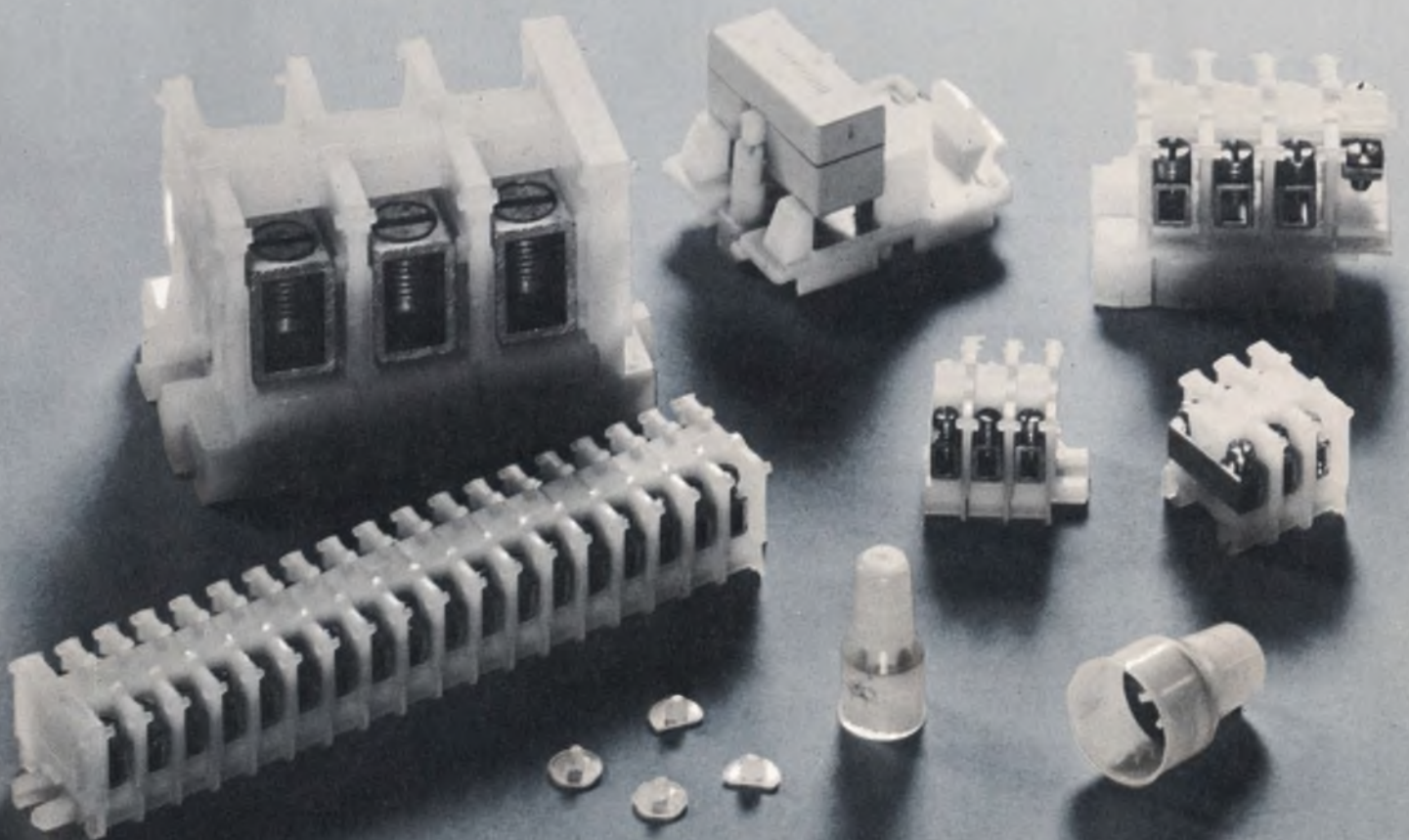

For $\approx 1\text{¢}/\text{bit}$ - production quantities of YOUR CHOICE

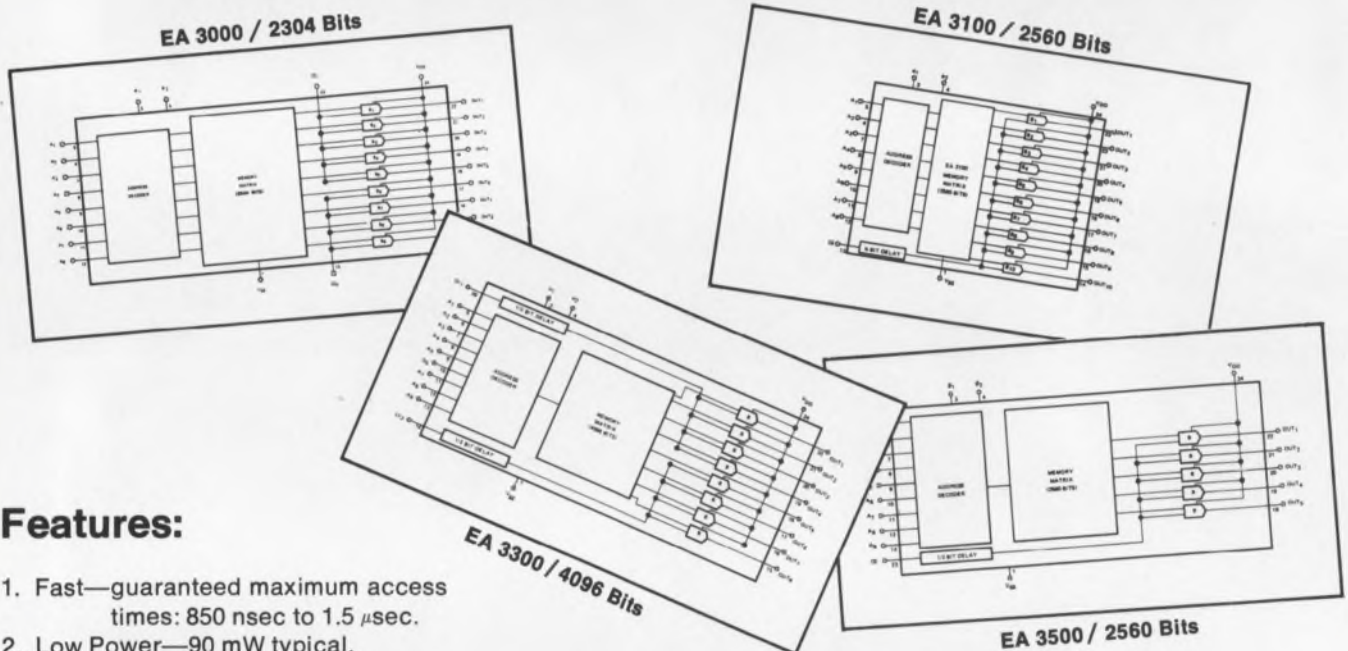

Features:

1. Fast—guaranteed maximum access times: 850 nsec to 1.5 μsec .
2. Low Power—90 mW typical.
3. Complete decoding within each ROM.
4. Wire-OR capability.
5. May be biased to be bipolar compatible.
6. Synchronous and compatible.
7. 24-pin dual-in-line packages.

Standard Patterns

available *today* at EA distributors

1. **EA 3001**—Starburst character generator and Selectric bail to ASCII code converter.
2. **EA 3101**—ASCII to Selectric Line Code and Selectric Line Code to ASCII code converter.
3. **EA 3307**—ASCII to EBCDIC and EBCDIC to ASCII code converter.
4. **EA 3501**—Row Scan Dot Code Matrix Character Generator.
5. **EA 3701**—Column Scan Dot Code Matrix Character Generator.

Custom Patterns

Any EA ROM can be programmed to your specialized bit patterns. Allow 6 to 8 week delivery.

For data sheets and forms for submitting your specialized bit patterns, contact your local representative or write Electronic Arrays, Inc., 501 Ellis Street, Mountain View, California 94040. (415) 964-4321.



electronic
arrays, inc.

PROVEN MOS PRODUCTS DELIVERED IN VOLUME

Reading at a distance made easy...

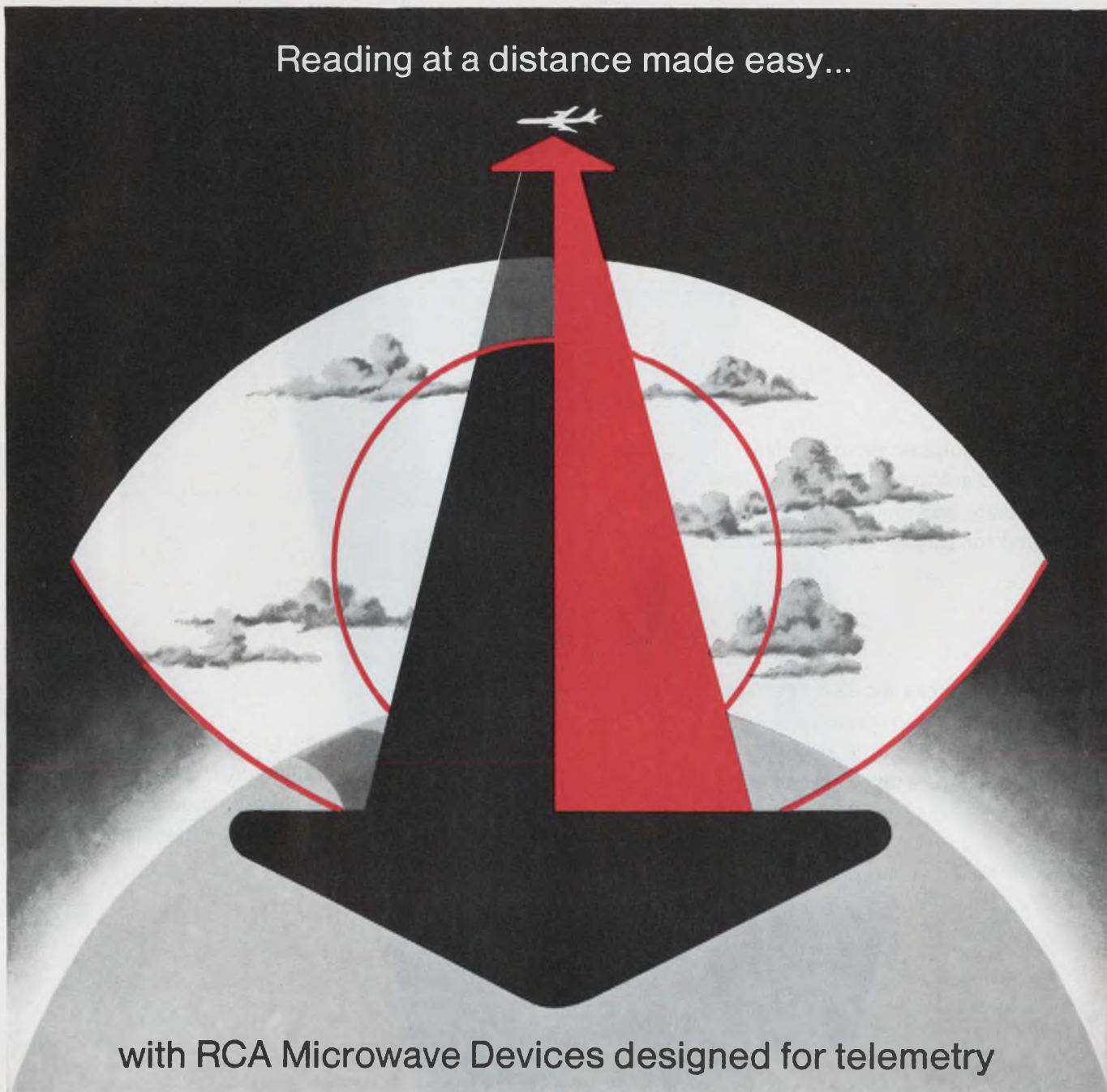

with RCA Microwave Devices designed for telemetry

Build into your telemetry system all the advantages of size, weight, power, economy, and shock capability with products from a single source—RCA.

For more than two decades, RCA has manufactured devices in high volume for use from low L-band all the way to Ku-band.

Today RCA offers products for such diverse applications as: radiosondes, missile guidance, shell telemetry, joint inflight data systems, weather observations, pollution control, and experiments in bio-medical research, stress, environment, pressure, temperature, and mapping with the help of infrared.

In outline, these are some of the RCA devices available for your airborne and ground-based telemetry systems:

L- and S-band—Pencil Tubes and Cavities, Transistor Power Sources, Oscillators, Microwave In-

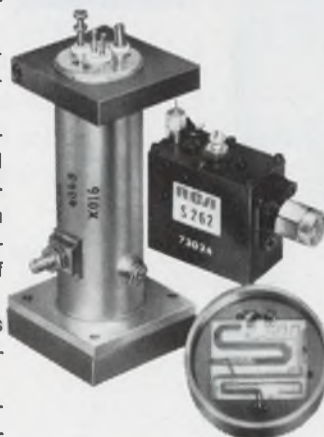

tegrated Circuits—for applications from 250 mW cw to 600 W peak.

S-band—High Power Transistor Amplifiers, Microwave Integrated Circuit Modules—in 5 W to 10 W systems.

C-, X-, and Ku-band—TEO's, Oscillators, Microwave Integrated Circuits—for use in the 100 mW range.

Wideband—Traveling-Wave Tubes for low and medium power applications up to 20 W.

For more information on RCA products available for your telemetry requirements, see your local RCA Representative. For technical data, write: RCA Electronic Components, Commercial Engineering, Section E52-2/ZM7, Harrison, N.J. 07029. In Europe: RCA International Marketing S.A., 2-4 rue du Lièvre, 1227 Geneva, Switzerland.

RCA

So what if Grant Slides save hours of down time?

Is there a quicker, more efficient way to get to a fault location than by immediate and smooth extension of the unit for simple, fast check-out?

Would you guess the savings from being able to keep equipment connected (and in operation) while maintenance takes place?

How great is the value of slides if individual chassis' can be interchanged with similar chassis' in moments?

What's it worth if slides enable equipment to be serviced in half—or less than half the time it ordinarily takes bolting and unbolting, fastening and unfastening?

Virtually every product can use the ready access provided by Grant Slides. There are thousands of types, styles and sizes available. Slides that tilt, lock, extend and lock and perform dozens of other functions. Undoubtedly, there's a Grant Slide that can help make your product better too.

Write for complete data.

GRANT
PULLEY & HARDWARE CORPORATION

EASTERN DIVISION: 21 HIGH STREET, WEST NYACK, NEW YORK 10994
WESTERN DIVISION: 944 LONG BEACH AVE., LOS ANGELES, CALIF. 90021

INFORMATION RETRIEVAL NUMBER 39

INFORMATION RETRIEVAL NUMBER 40 ►

Each Sylvania 7400N package is guaranteed to meet a hermeticity specification of 1×10^{-7} cc/sec, 2% AQL.

We make this guarantee because of the superior construction of our Cerdip package.

And you don't pay anything extra for this added feature; in fact you pay less. The price on our Cerdip 7400N devices is no higher than competing plastic units.

This guarantee of hermeticity applies to all 14 devices in our present off-the-shelf line and will apply to 13 additional 7400N TTL devices we will announce in the near future.

We're pretty proud of this guarantee and we are putting it on our data sheet just as we do with electrical specs.

This is a major commitment to improved reliability.

Sylvania 7400N devices are at your distributor right now. You don't have to worry about problems with plastics when you can get our guaranteed Cerdip packs, and save money, too.

Sylvania Electronic Components, Semiconductor Division, Woburn, Mass. 01801.

SYLVANIA
GENERAL TELEPHONE & ELECTRONICS

Guaranteed* hermeticity in every package.



That's why you need 9th-sourcing in 7400N TTL.

*These integrated circuits are guaranteed to substantially conform to Sylvania's applicable specifications and be delivered free of defects in materials and workmanship. If they are defective in such respects, at Sylvania's election, Sylvania will either repair, replace or grant a credit at invoice prices if defective integrated circuits are returned to the factory pre-paid within one year after shipment. THESE GUARANTEES ARE IN LIEU OF ALL OTHER GUARANTEES EXPRESSED OR IMPLIED. Sylvania shall not be liable for special or consequential damages of any nature.



WE WANT OUR NAME ON THE TIP OF YOUR TONGUE!

Scotchpar 3M
BRAND POLYESTER FILM COMPANY

INFORMATION RETRIEVAL NUMBER 41



small wonders: big news

Denser PC packaging at low cost is now possible . . . thanks to CAMBION's low-profile standard variable inductors. They're wound on new, thin wall coil forms that allow higher Q's and inductance values.

Ultra-reliable as well as miniature, these high performance inductors are built for longer life . . . longer by a factor of ten in tuning torque. They have an operating temperature range of -55° to 125°C and a tuning range of $\pm 20\%$ from the mean inductance.

For total circuit reliability — at a small price — it pays to choose CAMBION inductors. They're available in a wide choice of values, sizes, styles and finishes for immediate delivery.

Cambridge Thermionic Corporation, 445 Concord Ave., Cambridge, Mass. 02138. Phone: (617) 491-5400. CAMBION Electronic Products, Ltd., Castleton, Near Sheffield, England. Phone: Hope 406/407.

Standardize on

CAMBION
The Guaranteed Electronic Components

INFORMATION RETRIEVAL NUMBER 42

SWITCHES for PRINTED CIRCUITS



Grayhill Miniature Push Button or Rotary Switches with PC Terminals

Availability

Push Button PC Switches

- Rated $\frac{1}{4}$ Amp. - 115 VAC Resistive
- 2 Circuits - One NC, One NO - Can Be Wired For SPDT
- Flush Or Stand-Off Mounting

Rotary PC Switches

- 30° , 36° , 45° or 60° Angle Of Throw
- 2 to 12 Positions Per Pole
- 1 to 4 Poles Per Deck
- 1 to 12 Decks
- Totally Enclosed
- Shorting Or Non-shorting
- Commercial Or Military

For your
Grayhill Engineering
Catalog offering complete
technical data—contact



565 Hillgrove Avenue
LaGrange, Illinois 60525
Area Code 312, Phone 354-1040

... the Difference Between Excellent and Adequate

INFORMATION RETRIEVAL NUMBER 43



The MAN 1:

A seven-segment light-emitting all-semiconductor alphanumeric readout.

Put the attention-demanding red light from electrically excited GaAsP to work in your digital displays for industry, computer peripherals, or avionic/marine instrumentation. Our MAN 1 is shock-resistant and long-lived. Offers styling advantages because it's flat, parallax-free and visible within 150°. Reads out all numbers plus A, C, E, F, H, J, L, O, P and U. Available now. Any quantity.

- Brightness: 350 foot-Lamberts @ $I_f=20$ mA, 3.4V, per segment.
- Pulsed forward current=100mA, 10% duty cycle/per segment.
- Compatibility: directly interfaces with off-the-shelf IC decoder/drivers.
- Price: 1,000 quantities, \$11.00 (all prices are suggested resale figures).



The MAN 2:

An alphanumeric display made up of 36 discrete LEDs which can form 64 ASCII characters and a decimal point.

The IC-compatible 5 x 7 X-Y array gives you a bright red (peak emission 6500Å), high contrast display suitable for keyboard verifiers, avionics or computer terminals or other displays. Since the 36 dots can make 2³⁶ bits available, the MAN 2 can be very useful in film annotation work.

- Per-diode brightness: 300 foot-Lamberts @ $I_f=10$ mA, 1.7 volt per diode.
- Pulsed forward current (50 μ sec 20% duty cycle) 100 mA
- Light turn-on and turn-off 5 ns typical
- New reduced price: 1-9 quantities, \$40.00.

GaAsLITEs are in stock world wide.

You know that all of our products are available in the U.S. through Schweber (516) 334-7474; Semiconductor Specialists (312) 279-1000; K-Tronics (213) 685-5888; or Kierulff. You can get them overseas as easily:

- United Kingdom: SEMICONDUCTOR SPECIALISTS, West Drayton 6415
- France: YOUNG ELECTRONIC, 604-10-50
- West Germany: Alfred Neye, ENATECHNIK, (04106) 4022
- Denmark: SCANSUPPLY, AEGIR 5090
- Belgium: TECHMATION, 384078
- Netherlands: TECHMATION, 020-173727
- Norway: ARTHUR F. ULRICHSEN A/S, 21 6510
- Switzerland: OMNI RAY A.G., 051-478200
- Italy: SILVERSTAR LTD., 46.96.551
- Sweden: GP-INGENJOERSFIRMAN, 08/930280
- Japan: NEW METALS AND CHEMICALS LTD. CORP., (201) 6585-7
- Australia: HAWKER DE HAVILLAND AUSTRALIA PTY., LTD., 93-0221
- Israel: MONSEL

GaAsLITE Update

Being a quick and thorough survey of what's available in solid state displays.



The MAN 3:

The world's first commercially available planar monolithic display. Low cost, besides!

The MAN 3 is a small (.125" high) bright red GaAsP seven-segment display that gives you extremely good visibility with high density packing; 16 digits need only 3 inches on your display. And since the MAN 3 interfaces with our standard IC drivers and uses as little as 10 mW per segment, it's simple to design numerical readouts into desk calculators, truly portable battery-operated instruments, even timepieces.

- Brightness: 200 foot-Lamberts @ $I_f=5$ mA, 1.7 volt, per segment.
- Total cont. forward current: 80 mA.
- Pulsed forward current=50 mA, 10% duty cycle per segment.
- Price: 1,000 quantities, \$7.55.



MPC 1 MPC 2 MPC 3

We've mounted the MAN 3 for you

Our MPC-series are simply the new MAN 3 numerics carefully soldered to NEMA-grade G-10 copper-clad glass/epoxy laminate pc boards.

The MPC 1 and MPC 2 boards let you address each segment of the numeric independently. The MPC 3 holds six MAN 3's which are multiplexable (X-Y addressable). There are two major benefits in doing your prototype work with our MPC units:

- 1) they're a heck of a lot easier to breadboard and 2) you can use them for fast turnaround into full production. Send for complete details. Fast! Price, MPC 2: 1 to 9, \$35.80 ea.

Monsanto

For additional technical information write Monsanto Electronic Special Products, 10131 Bubb Road, Cupertino, California 95014. (408) 257-2140.

decoder

It decodes, level shifts and gates! It's in stock! Right now! Order for your requirements now. Computer Microtechnology Inc. is shipping from stock the CM1400 3 bit binary to one of 8 line decoders. It is a bipolar integrated circuit with standard TTL inputs and special output circuitry with high level signals for driving MOS devices.

Many of your system functions can be performed by using the CM1400 decoder. You will find it ideally suited for address decoding and level shifting in MOS memories, gating low level MOS multiplexers and general high speed decoding applications. Two chip inhibit inputs are provided for easy expansion.

Computer Microtechnology Inc. continues to supply products that increase the capability of memory systems. The CM1400 decoder illustrates this with its high speed and other excellent characteristics. Check the specs.

CM1400 3 BIT BINARY TO ONE OF 8 LINE DECODER

Propagation Delay 50 nsec typ,
100 pf load

Power Dissipation,
AC and DC 140 mw typ,
+5 and +10 V

Output High Voltage 9.5 V typ,
-0.1 mA

Packaging 16 lead dual-in-line

Price \$15.25, 1-24

Delivery Stock

Order yours today! They're in stock!



Computer Microtechnology, Inc

CM AREA OFFICES

Plant	East	West
610 Pastoria Sunnyvale, Calif. (408) 736-0300	10 Dale Street Waltham, Mass. 02154 (617) 891-0002	1627 Pontius Avenue Los Angeles, Calif. 90025 (213) 478-1285

INFORMATION RETRIEVAL NUMBER 45

calibration and measurement in one instrument.

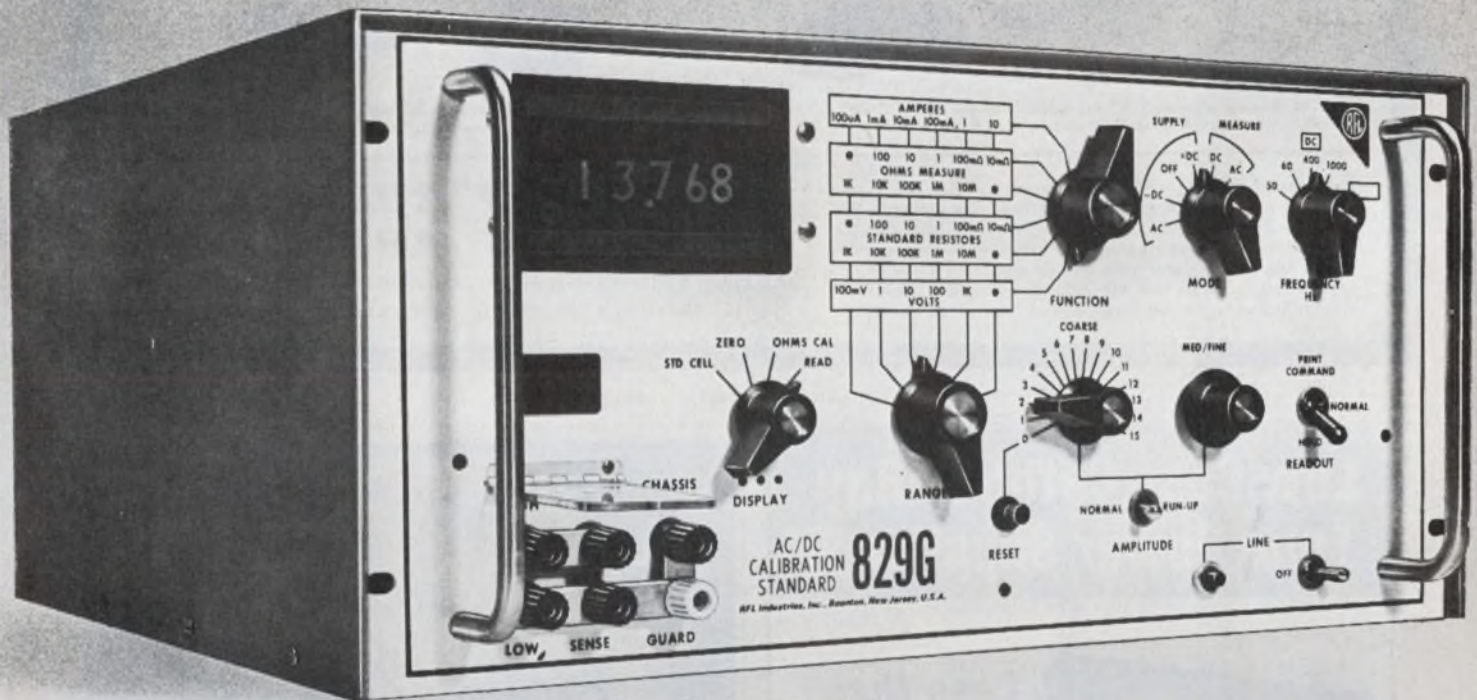

Model 829G The best of both worlds

Now you can take advantage of the unique RFL Model 829G Universal Calibration Standard — a new, doubly useful instrument that provides a precision source of AC and DC volts, amps, ohms, — plus precision measurement of these parameters from external sources . . . with 5-digit read-out.

The new 829G replaces the famous 829 series, for 15 years the industry calibration

standard. Take a look at just some of its capabilities:

AC or DC voltages in 5 ranges, 0.1V to 1000V. Currents in 6 ranges, 100uA to 10A. Ten precision resistance values, 0.01 ohm to 10 meg. AC frequencies: 50,60,400, 1000 Hz and EXT. AC Watts capability when locked to another AC source. Four-terminal sensing in both source and measurement modes, plus high accuracies, high

resolution, and high output regulation. And all this priced at what you'd expect to pay for a calibrator alone. You can't afford not to have it—the cost \$3100.00. Write for complete data today.

RFL Industries, Inc. Instrumentation Div. Boonton, N. J. 07005. Tel.: (201) 334-3100 / TWX: 710-987-8352 / CABLE RADAIRCO, N. J.



RFL Industries, Inc.

RUBBERIZED ABRASIVES

DEBURR SM-O-O-T-H POLISH



COMPLETE KIT \$750

CONTENTS: 8 tapered edge wheels $\frac{1}{8}$ " dia. x $\frac{3}{32}$ "; 16 cylinder points $\frac{1}{8}$ " dia. x $\frac{1}{8}$ " long; 16 bullet points $\frac{3}{32}$ " dia. x 1" long; 8 bullet points $\frac{3}{8}$ " dia. x $\frac{1}{8}$ " long; 8 straight wheels $\frac{1}{2}$ " x $\frac{1}{8}$ " x $\frac{1}{16}$ " hole; 16 straight wheels $\frac{3}{8}$ " x $\frac{1}{8}$ " x $\frac{1}{16}$ " hole; 8 straight wheels 1" x $\frac{3}{16}$ " x $\frac{1}{16}$ " hole; 2 wheel mandrels $\frac{1}{8}$ " shank; 2 point mandrels $\frac{1}{8}$ " shank. For use at speeds up to 25,000 RPM.

\$7.50 BUYS IT ALL — 80 piece introductory Kit 777 equally assorted in 4 grit textures: coarse, medium, fine and extra fine. **TRY IT** — Cratex Rubberized Abrasives improve the surface while preserving critical workpiece dimensions by its unique cushioning action. **FINISH THE JOB** — to your most exacting specifications — often in a single operation. **SEND FOR KIT 777** — or your **FREE SAMPLE** and catalog illustrating the full Cratex product line and its applications.

CRATEX[®] RUBBERIZED ABRASIVES

1600 Rollins Road • Burlingame, California
Sold through leading industrial distributors

INFORMATION RETRIEVAL NUMBER 47

Low Cost Cathode Ray Tube Power Supplies



MODEL L-15

Less than \$30 in Production Quantities

FEATURES:

- Output — 15,000 VDC @ 150 μ A
- Input — 15 VDC
- Short Circuit and Reverse Polarity Protected
- Fully Encapsulated
- Volume only 18 cu. in.

VSI also manufactures a complete line of high voltage Power Supplies for Image Intensifiers and Cathode Ray Tubes. Send for brochure today.

VENUS SCIENTIFIC INC.

399 SMITH STREET, FARMINGDALE, NEW YORK 11735 • (516) 293-4100

See us at Booth 17/SID Show

INFORMATION RETRIEVAL NUMBER 48

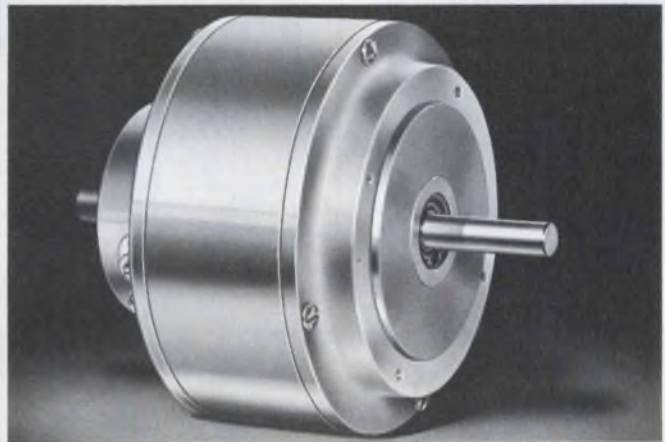

Stops on a dime . . .

High Performance DC Motor jumps to full speed faster . . . stops quicker . . . than others its size because it has lower inertia. Produces pulse torques up to 10 times rated torque. For either open or closed loop systems.

Options: Tachometers, special shaft lengths and shapes, forced air cooling adaptations.

Get the complete story from your MICRO SWITCH Branch Office.

Or write: **MICRO SWITCH**

FREEPORT, ILLINOIS 61032

A DIVISION OF HONEYWELL

INFORMATION RETRIEVAL NUMBER 49

ELECTRONIC DESIGN 11, May 24, 1970

Tackle box

Contains a full line of work-together electronic materials to tackle any job.

The coupon below nets you complete data on the full line of Owens-Illinois vitreous and crystallizing materials . . . basic ingredients for all microcircuit devices.

All from a single source. All job-matched to work together. All high yielding — prepared from high quality materials to assure proper functioning of any microcircuit device you'd like to tackle.

We'll also rush you an Owens-Illinois technical representative. He'll help you select and apply the materials best suited to your needs. Just fill out the coupon.

OWENS-ILLINOIS
ELECTRONIC MATERIALS
Toledo, Ohio 43601

Package Sealants. Ten types. For hermetically sealing micro-electronic packages.



Thick Film Pastes. Three conductor, three dielectric. Lowest K-value, highest Q-factor on market.



Substrate Glazes. Seven types. For glazes or insulating films.

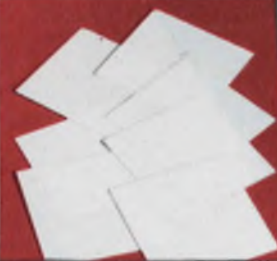

Sputtering Targets. Three types of sputtering target glass. Thin, smooth dielectric films.



Preform Materials. Sintered ground glasses, bead and connector forms. Tailored thermal expansion.



Glazed Package Parts. Custom glazing by Owens-Illinois available for your ceramic package parts.



OWENS-ILLINOIS, INC.,
Electronic Materials, Customer Service Mgr.,
Dept. E-5, P.O. Box 1035, Toledo, Ohio 43601

Please send me literature on:

- | | |
|--|---|
| <input type="checkbox"/> Package Sealants | <input type="checkbox"/> Glazed Package Parts |
| <input type="checkbox"/> Substrate Glazes | <input type="checkbox"/> Thick Film Pastes |
| <input type="checkbox"/> Sputtering Targets | <input type="checkbox"/> Preform Materials |
| <input type="checkbox"/> Have a technical representative call. | |

Name _____ Title _____

Company _____

Address _____

City _____ State _____ Zip _____

"BELLOWFORM" PRINTED CIRCUIT CONNECTORS

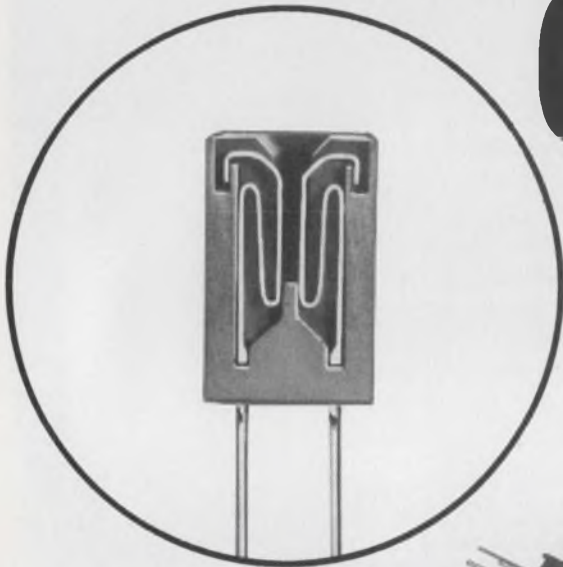

MOLDING
CROSS-SECTION
WITH CONTACT

**.025" Square Terminations
for Solderless Wrap**

**.100" and .125" Contact-
to-Contact Spacing**

CUTAWAY SHOWS
INTERNAL
CONFIGURATION

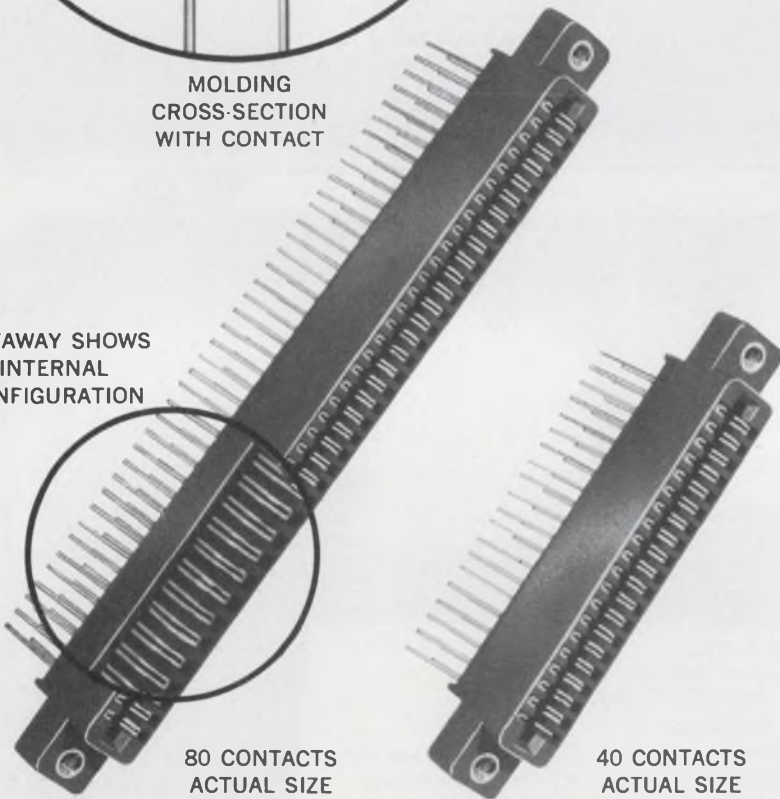

80 CONTACTS
ACTUAL SIZE

40 CONTACTS
ACTUAL SIZE

- 40, 50, 60, 80 or 100 contacts
- Polarizing slots in molding – no loss of contact position
- For 1/16" printed circuit boards

**Write for printed
circuit catalog
on our entire line
of receptacle
type connectors.**

For the Sales Representative Nearest You, See Our Listings in EEM and VSMF Directories.

CONTINENTAL CONNECTORS

CONTINENTAL CONNECTOR CORPORATION □ WOODSIDE, N. Y. 11377 □ TELEPHONE: (212) 899-4422

INFORMATION RETRIEVAL NUMBER 51

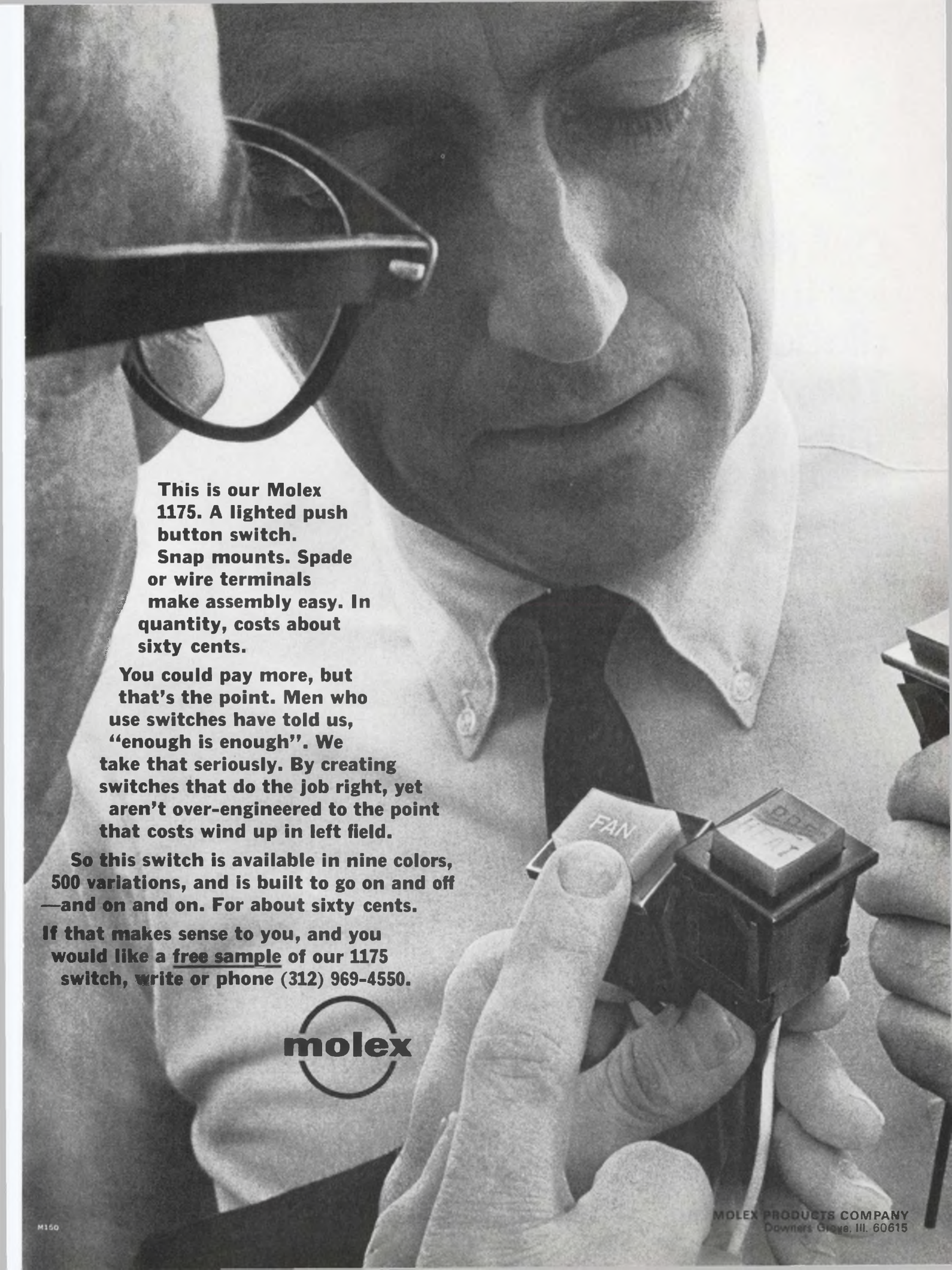

This is our Molex 1175. A lighted push button switch. Snap mounts. Spade or wire terminals make assembly easy. In quantity, costs about sixty cents.

You could pay more, but that's the point. Men who use switches have told us, "enough is enough". We take that seriously. By creating switches that do the job right, yet aren't over-engineered to the point that costs wind up in left field.

So this switch is available in nine colors, 500 variations, and is built to go on and off—and on and on. For about sixty cents.

If that makes sense to you, and you would like a free sample of our 1175 switch, write or phone (312) 969-4550.





Call RCA for tunnel diodes. They're stable, they're available off the shelf.

RCA tunnel diodes offer prime advantages of immediate availability plus remarkable stability proved by over a million device-hours of testing.

Note these outstanding characteristics: low capacitance, high I_p/I_V ratios, mechanical ruggedness, improved thermal resistance, uniformity—all achieved through an RCA process of epitaxially-grown junctions. Check the chart for key parameters.

Added features: the gold-plated leads require no pretinning for soldering efficiency. And the package lends itself well for high-volume PC-board mounting operations. Use RCA tunnel diodes especially in your high-speed switching and high-frequency signal-processing applications.

See your local RCA Representative for more information. Or call your RCA Distributor—he's fully stocked. Special selections are yours if you need them. For technical data on specific types, write: RCA Electronic Components, Commercial Engineering, Sec. 52E-2, Harrison, New Jersey 07029. In Europe: RCA International Marketing S.A., 2-4 rue du Lièvre, 1227 Geneva, Switzerland.

Type	I_p (mA)		I_p/I_V	C (pF)		tr (ps) Typ.
	Min.	Max.		Min.	Max.	
40561	4.5	5.5	6/1	25	1800	
40562	9	11	6/1	25	900	
40563	18	22	6/1	30	600	
40564	45	55	6/1	40	350	
40565	90	110	6/1	40	150	
40566	4.75	5.25	8/1	15	1200	
40567	9.5	10.5	8/1	15	600	
40568	19	21	8/1	20	400	
40569	47.5	52.5	8/1	25	200	
40570	95	105	8/1	25	100	
40571	4.75	5.25	8/1	8	600	
40572	9.5	10.5	8/1	8	300	
40573	19	21	8/1	10	200	
40574	47.5	52.5	8/1	12	100	

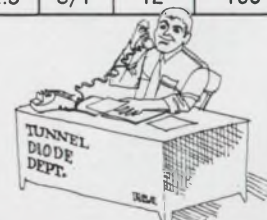

RCA

Publisher

Hugh R. Roome

Editors

New York Office
850 Third Ave.
New York, N.Y., 10022
(212) 751-5530

Editor: Frank Egan
Managing Editor: Ralph Dobriner
Managing Editor: Raymond D. Speer
Microelectronics, Steven A. Erenburg
Computers, Milton J. Lowenstein
Circuits, Don Mennie
Microwaves, Michael J. Riezenman
Management, Richard L. Turmail
News, John N. Kessler
Military-Aerospace, John F. Mason
New Products, Roger Allan
New Products, Lucinda Mattera
Directory Manager, Greg Guercio
Copy, Marion Allen

Field Offices

Massachusetts

Jim McDermott
P.O. Box 272
Easthampton, Mass. 01027
(413) 527-3632

San Francisco

Elizabeth de Atley
2051 Wellesley St. (Suite D)
Palo Alto, Calif. 94306
(415) 321-7348

Los Angeles

David Kaye
2930 Imperial Highway
Inglewood, Calif. 90303
(213) 757-0183

Washington

Don Byrne
1425 N St. NW
Washington, D.C. 20005
(202) 667-6568

Editorial Production

Dollie S. Viebig
Richard D. Grissom

Art

Art Director, Clifford M. Gardiner
Assistant, William Kelly
Rita Jendrzewski
Lynn Thompson
JoJo Miskimmon

Production

Manager, Thomas V. Sedita
Helen De Polo
Kathleen McConkey
Leslie Stein

Circulation

Manager, Nancy L. Merritt

Information Retrieval

Genate Piccinetti

EDITORIAL



Lesson from Apollo: plan for contingencies

When it all works well, everyone is doing a great job. When things go wrong, we find out how competent people really are. Competent designers always design margin into their systems and plan for contingencies. Lesser designers merely try to meet the specs, with little or no margin, and hope that nothing goes wrong.

The true value of contingency planning really showed up during the difficult moments following the explosion on Apollo 13.

It was about two years ago, at the North American Rockwell Corp., that the solution was worked out for the problem of what to do if two of the fuel cells failed aboard the service module of the lunar spacecraft. A remarkable calm prevailed at the Manned Spacecraft Center in Houston, and also on board Apollo 13, when the explosion occurred. These men knew that the situation, while extremely dangerous, had a workable solution that had been practiced for many hours while the astronauts were training for the mission. It was but one of many contingencies for which the astronauts had drilled. And Astronaut Jack Swigert had recently completed the writing of a manual concerned with what to do if any malfunctions occurred in the command module.

What better example of the value of designing in margin than that of Grumman's outstanding lunar module? A vehicle designed to fly merely from an orbit around the moon to the lunar surface and back again actually guided the command and service modules around the moon and all the way back to earth. This vehicle far exceeded the expected demands upon its navigation and life-support systems, its power supplies and its engines.

Yet it wasn't always so in the beginning of the Apollo program. Witness the disastrous fire that cost the lives of three astronauts and the weight problems that the early lunar module had at Grumman. Each of these shortcomings cost the nation heavily. But the final design was excellent.

A lesson must be learned from the extremely competent design engineers who put together the Apollo system. Never fail to plan for major contingencies. Always assume that Murphy (whoever he was) was right when he postulated his law: "If it can fail, it will."

DAVID N. KAYE

Liberate your FET amplifier design from tight device specifications by using this combination bias technique. Transfer curves greatly simplify the job.

Engineers often design FET amplifiers that are unnecessarily sensitive to device characteristics because they may not be familiar with proper biasing methods.

One way to obtain consistent circuit performance in spite of wide device variations is to use a combination of constant-voltage and self biasing. The combined circuit configuration turns out to be the same as that generally used with bipolar transistors, but its operation and design are quite different.

Three basic circuits

Let's examine three basic common-source circuits that can be used to establish a FET's operating point (Q-point) and then see how two of them can be combined to provide greatly improved performance. The three basic biasing schemes are:

- Constant-voltage bias, which is most useful for rf and video amplifiers employing small dc drain resistors.
- Constant-current bias, which is best suited to low-drift dc amplifier applications such as source followers and source-coupled differential pairs.
- Self bias (also called source bias or automatic bias), which is a somewhat universal scheme, particularly valuable for ac amplifiers.

The Q-point established by the intersection of the load line and the $V_{GS} = -0.4$ V output characteristic of Fig. 1 provides a convenient starting point for the circuit comparison. The load line shows that a drain supply voltage, V_{DD} , of 30 V and a drain resistance, R_D , of 39 k Ω are being used.

The quiescent drain-to-source voltage, V_{DSQ} , is 15 V, allowing large signal excursions at the drain. Maximum input signal variations of ± 0.2 V will produce output voltage swings of ± 7.0 V—a voltage gain of 35.

The constant-voltage bias circuit (Fig. 2) is analyzed by superimposing a line for $V_{GS} =$ con-

stant on the transfer characteristic of the FET.

The transfer characteristic is a plot of I_D vs V_{GS} for constant V_{DS} . Since the curve doesn't change much with changes in V_{DS} , it is quite useful in establishing operating bias points. In fact, it is probably more useful than the output characteristics because its curvature clearly warns of the distortion to be expected with large input signals. Furthermore, when a bias load line is superimposed, allowable signal excursions become evident and input voltage, gate-source signal voltage, and output signal current calculations may be made graphically.

The heavy vertical line at $V_{GS} = -0.4$ V establishes the Q-point of Fig. 1. No voltage is dropped across resistor R_G because the gate current is essentially zero. R_G serves mainly to isolate the input signal from the V_{GG} supply.

Excursions of the input signal, e_i , combine in series with V_{GS} so that they add algebraically to the fixed value of -0.4 V. The effect of signal variation is to instantaneously shift the bias line horizontally without changing its slope. The shifting bias line then develops the output signal current as shown in color in Fig. 2.

The constant-current bias approach (Fig. 3) for establishing the Q-point of Fig. 1 requires a 0.39-mA current source. For an ideal constant-current generator, input signal excursions merely shift the bias line horizontally and produce no resultant gate-source voltage excursion. This bias technique is therefore limited to source followers, source-coupled differential amplifiers, and to ac amplifiers where the source terminal is bypassed to ground at the signal frequency.

If an ac ground is provided by a bypass capacitor across the current source, a vertical ac bias line will be established. Input signal variations will then translate the ac bias line horizontally, and signal development will proceed as with constant-voltage biasing (Fig. 3, color).

Should the bypass capacitor not provide a sufficiently small reactance at the signal frequency, the ac bias line will not be vertical. It will still intersect the transfer curve at the Q-point but with a slope equal to $-(1/X_C) = -\omega C$ (Fig. 4). This will lower the gain of the amplifier because of signal degeneration at the source. The input

signal, e_g , is reduced by the drop across the capacitor:

$$v_{gs} = e_g - v_s = e_g - i_s X_c \quad (1)$$

It is clear from Fig. 4 that the input signal only shifts the operating point by an amount equal to v_{gs} , the effective input signal. As the signal frequency is decreased, the slope of the ac bias line decreases, causing the effective input signal to approach zero.

Self bias needs no extra supply

The self-bias circuit (Fig. 5) establishes the Q-point by applying the voltage dropped across the source resistor, R_s , to the gate. Since no voltage is dropped across R_s when $I_D = 0$, the self-bias load line passes through the origin. Its slope is given by $-1/R_s$. Therefore, the desired Q-point is established by setting $-1/R_s = I_{DQ}/V_{GSQ}$.

Signal development is the same as in the case of the partially bypassed constant-current scheme except that the load line is a dc bias line. Signal degeneration is described by Eq. 1 with X_c replaced by R_s . The ac gain of the circuit can be increased by shunting R_s with a bypass capacitor, as in the constant-current case. The ac load line then passes through the Q-point with a slope $-(1/Z_s = -(\omega C + 1/R_s))$.

The circuit is biased automatically at the desired Q-point, requires no extra power supply and provides a degree of current stabilization not possible with constant-voltage biasing.

A fourth biasing method, combining the advantages of constant-current biasing and self

biasing, is obtained by combining the constant-voltage circuit with the self-bias circuit (Fig. 6). A principal advantage of this configuration is that an approximation may be made to constant-current bias without any additional power supply. The bias load line may be drawn through the selected Q-point and given any desired slope by properly choosing V_{GG} . (The bias line intercepts the V_{GS} axis at V_{GG}). The larger V_{GG} is made, the larger R_s will be and the better will be the approximation to constant-current biasing.

All three circuits in Fig. 6 are equivalent. Circuit 6a requires an extra power supply. The need for an additional supply is avoided in 6b by deriving V_{GG} from the drain supply. R_1 and R_2 are simply a voltage divider. To maintain the high input impedance of the FET, R_1 and R_2 must both be very large.

Very large resistors cannot always be found in the exact ratio needed to derive the desired V_{GG} in every circuit application. Circuit 6c overcomes this problem by placing a large R_G between the center point of the divider and the gate. This allows R_1 and R_2 to be small, without lowering the input impedance.

One point of caution worth remembering is that as V_{GG} is increased, V_s increases, and V_{DS} decreases. Therefore with low V_{DD} , there may be a significant decrease in the allowable output voltage swing.

Biasing for device variations

The value of the combination-bias technique becomes apparent when one considers the normal

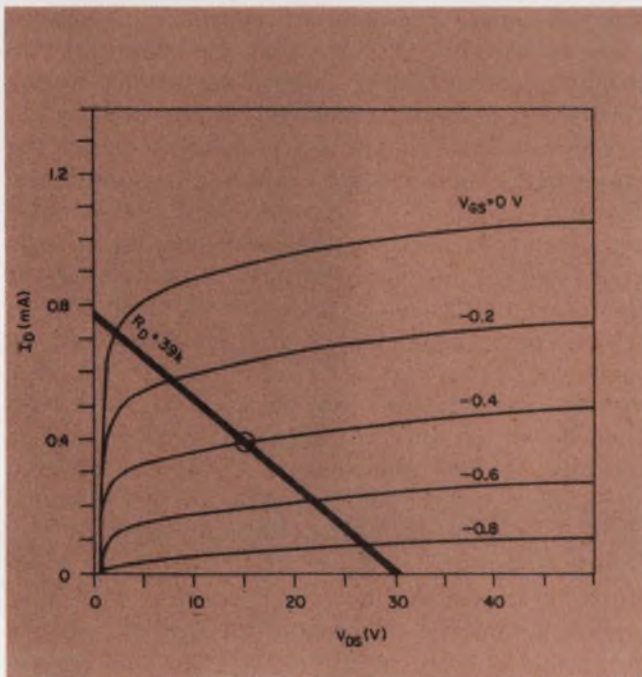

1. A large dynamic range is provided by the operating point at $V_{DSQ} = 15$ V, $I_{DQ} = 0.39$ mA and $V_{GSQ} = -0.4$ V. The output characteristics are for a typical 2N4339.

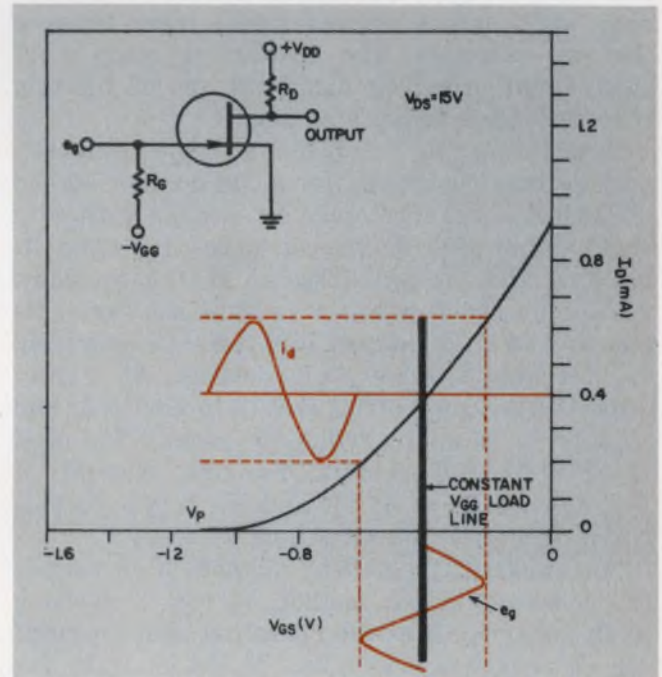

2. Constant-voltage bias is maintained by the V_{GG} supply as shown on this typical 2N4339 transfer curve. Input signal e_g moves the load line horizontally (color).

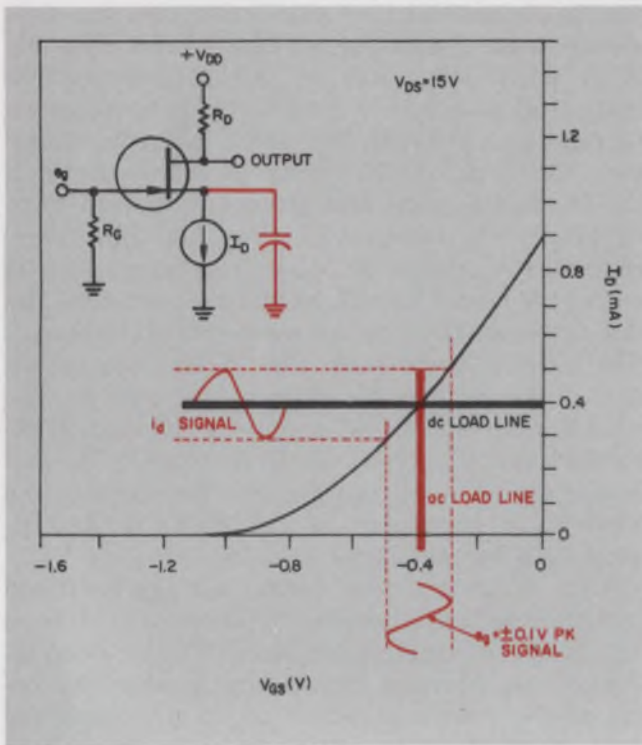

3. Constant-current bias fixes the output voltage for any R_D . Hence, input signals cannot affect the output unless the current source is bypassed (color).

production spread of device characteristics. The problem is illustrated in Fig. 7 where two limiting sets of output characteristics, representing the actual min-max spread of the Siliconix 2N4339, are presented. Limiting characteristics like these are not normally available. Even if they were, however, they'd be of little help in establishing operating points suitable for all devices with output characteristics lying between the two extremes. The problem is much more easily approached by using the set of limiting transfer characteristics of Fig. 8.

Attempting to establish suitable constant-voltage bias conditions for a production spread of devices is practical only for circuits with very small values of dc drain resistance—for example, circuits with inductive loads. As the constant-voltage bias plot of Fig. 8 reveals, constant gate bias causes a significant difference in operating I_{DQ} for the extreme limit devices. At $V_{GS} = -0.4$ V, the range of I_{DQ} is 0.13 to 0.69 mA, and V_{DSQ} for a given R_D will vary greatly for most resistance-loaded circuits. For the example of Fig. 1, with $R_D = 39$ k Ω and $V_{DD} = 30$ V, V_{DSQ} varies from near saturation (5 V) to 25 V.

An apparently excellent method of biasing is the constant-current method of Fig. 3. Biasing in this manner fixes the operating drain current for all devices and sets V_{DSQ} to $V_{DD} - I_{DQ}R_L$ for any device in the production spread. V_{GS} automatically finds a value to set the appropriate $I_{DQ} = \text{constant}$ for all devices. For the constant-

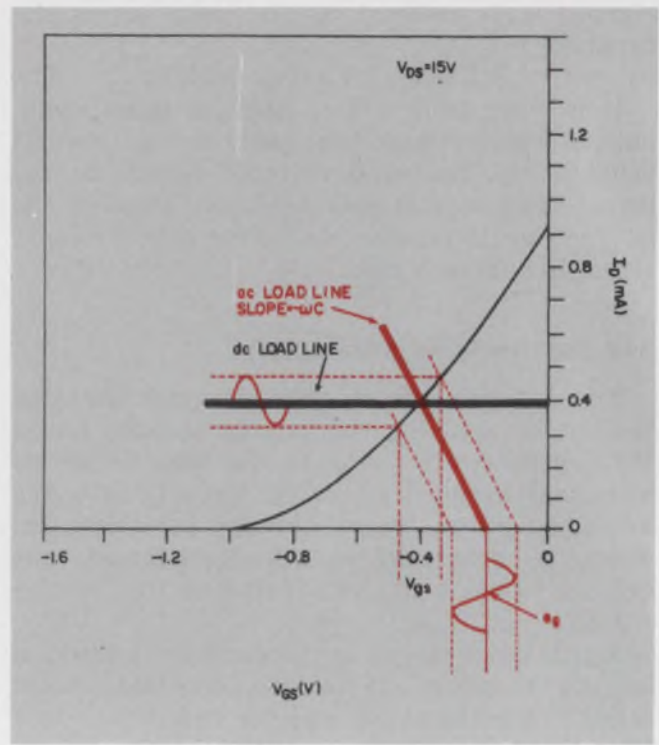

4. Partial bypassing of the current source (Fig. 3) lowers the circuit gain by tilting the ac load line from the vertical. The capacitor drop subtracts from e_v .

current bias plot of Fig. 8, with $I_{DQ} = 0.39$ mA, V_{GS} would range from -0.11 V to -0.67 V.

Output characteristics are not needed as long as I_{DQ} is chosen to be below the minimum I_{DSS} . With $R_D = 39$ k Ω and $V_{DD} = 30$ V, V_{DSQ} is 14.8 V for all devices.

The disadvantages of the constant-current method are that it allows no signal to be developed unless the current source is bypassed and, as we shall see, it lacks the flexibility to provide constant gain despite variations in the forward transconductance, g_{fs} , of the devices.

The self-bias scheme is a reasonable choice for single-ended dc amplifiers and for ac amplifiers. In unbypassed or dc circuits, some compromise must be made between the gain loss due to current feedback degeneration and the advantage of current stabilization achieved with high R_S .

An appropriate choice of I_{DQ} limits can be made by using the pair of limiting transfer curves. For example, for $R_S = 1$ k Ω , the load line shown on the self-bias curve of Fig. 8 is established. The maximum I_D is 0.52 mA, and the minimum I_D is 0.24 mA. The operating range of V_{DSQ} may be calculated for any value of V_{DD} and R_D . Clearly, for $R_D = 39$ k Ω , the maximum-limit device (device B) would operate with $V_{DSQ} = 9.8$ V and the minimum-limit device (device A) would operate with $V_{DSQ} = 20.6$ V. This results in fairly satisfactory operation for all devices. However, such a variation in I_{DQ} imposes severe limitations on the circuit design.

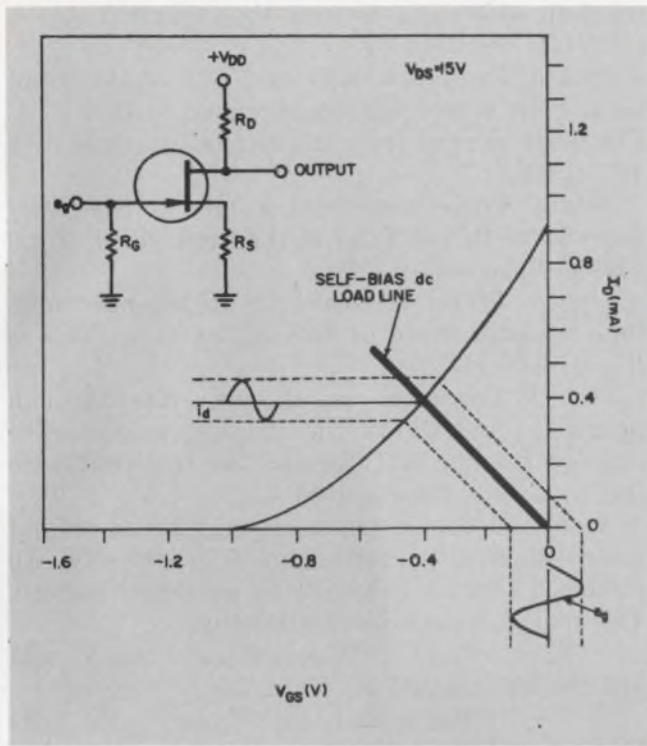

5. The self-bias load line passes through the origin with a slope $-1/R_S$. Bypassing R_S will steepen the slope (color) and increase the gain of the circuit.

A better approach is illustrated by the combination-bias curve of Fig. 8 with $V_{GG} = 1.2$ V. The range of I_{DQ} for this bias condition is 0.25 mA to 0.32 mA. A similar minimum difference in I_{DQ} could be achieved with $R_S = 6$ k Ω and $V_{GG} = 0$, (a self-bias condition) but the operating points would be pushed toward the toe of the transfer characteristics and allowable signal input would be reduced.

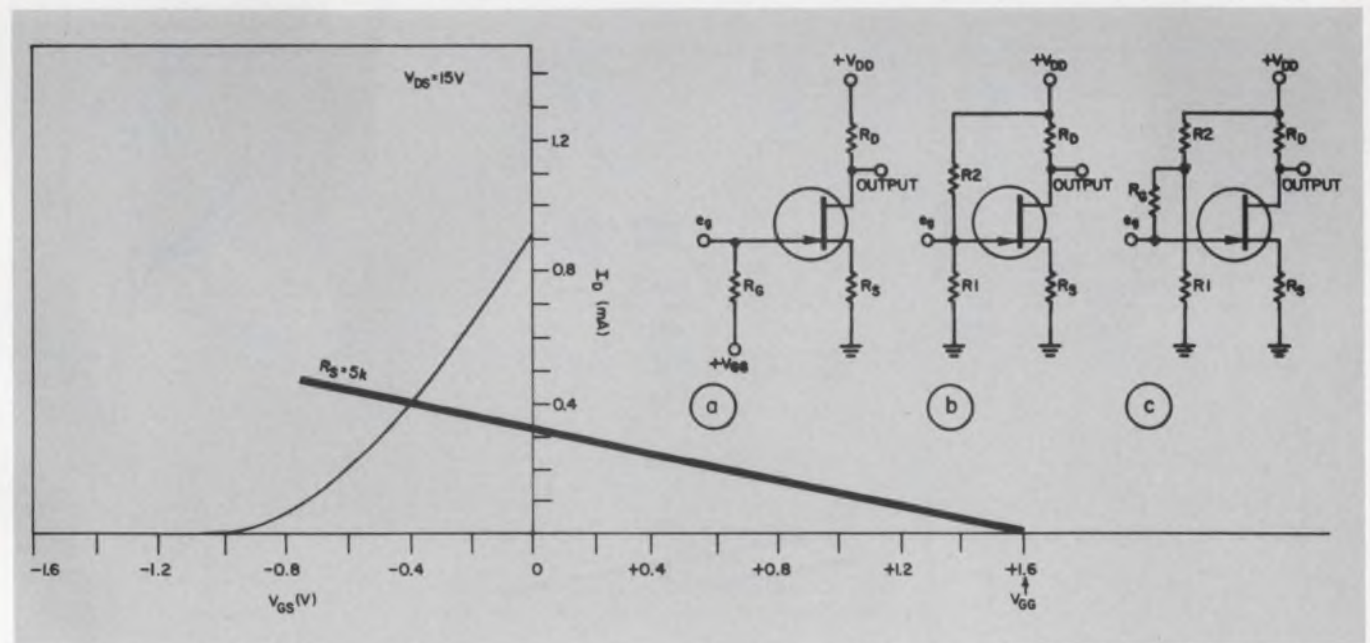

6. All three combination-bias circuits are equivalent. They add constant-voltage biasing to the self-bias circuit

The upper load line allows $v_{rB} = \pm 1.8$ V (limited by I_{DSSA}), while the lower line allows a v_{rS} of only ± 0.7 V (limited by V_{PA}). (The subscript letters A and B refer to the minimum and maximum devices, respectively.) The combination circuit allows almost ideal operation over the full production spread of devices. Even with $R_D = 62$ k Ω , the V_{DSQ} would range only between 10 and 15 V.

For this circuit, R_D should be chosen to allow the largest output signal swing for I_{DQ} midway between the two extremes of 0.25 and 0.32 mA; namely 0.285 mA. Setting the voltage drop across R_D at one-half of $(V_{DD} - 2V_{P typ})$ or 14 V, yields $R_D = (14 \text{ V}/0.285 \text{ mA}) = 49$ k Ω .

It is helpful, in any design, to know the effect of temperature variations on the transfer curves and transconductance characteristics. Ideally, minimum and maximum transfer characteristics would be plotted at three temperatures: above, below, and at room temperature. Then the design would take all types of variation into account.

Minimize the gain variations

Leaving R_S unbypassed helps reduce gain variations from device to device by providing degenerative current feedback. However, this method for minimizing gain variations is only effective when a substantial amount of gain is sacrificed.

A better approach is to use the combination-bias technique with the bias point selected from the transfer and transconductance curves (Fig. 9).

As Fig. 9 shows, it is possible to find an R_S and a V_{GG} that will set I_{DQA} and I_{DQB} to values

to establish a reasonably flat load line without sacrificing dynamic range.

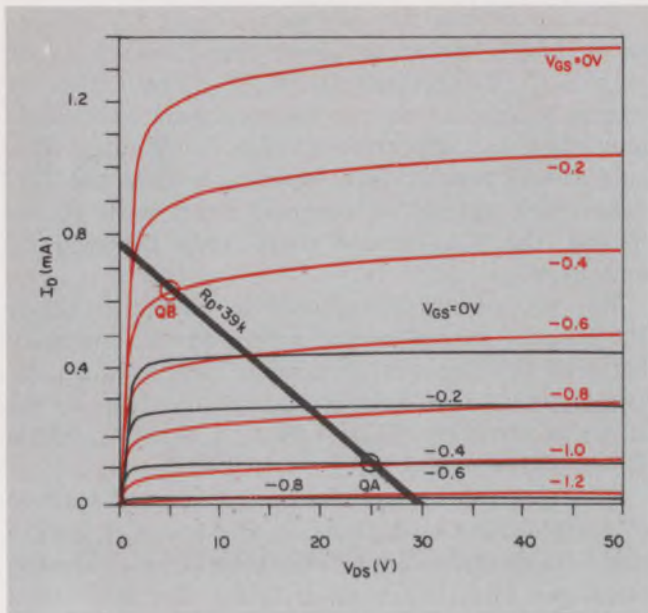

7. The wide variations in device performance shown by this pair of output characteristics make clear the disadvantages of constant-voltage biasing.

so that g_{fsQ} will be the same for both devices. The g_{fsQ} of all intermediate devices will be approximately equal to the limiting values. Thus, a constant, or nearly constant, stage gain is obtained even with a bypass capacitor.

The design procedure is as follows:

Step 1. Select a desired I_{DQA} below I_{DSSA} . A good value, allowing for temperature variations, is 60% of I_{DSSA} . This will allow for decreasing I_{DSS} due to temperature variation and for reasonable signal excursions in load current.

Step 2. Enter the transfer curves at $I_{DQA} \cong$

$0.6 I_{DSSA}$ (0.3 mA) to find V_{GSQA} . This $V_{GSQA} \cong 0.2$ V for the 2N4339.

Step 3. Drop vertically at V_{GSQA} to the minimum limit transconductance curve to find g_{fsQA} . The value as read from the plot is approximately $1000 \mu\text{mho}$.

Step 4. Travel across the g_{fs} plot to the maximum curve to find V_{GSQB} at the same value of g_{fs} . This is $V_{GSQB} \cong -0.7$ V.

Step 5. Travel vertically up to the maximum limit transfer curve to find I_{DQB} at V_{GSQB} . This is $I_{DQB} \cong 0.36$ mA.

Step 6. Construct an R_S bias line through points Q_A and Q_B on the transfer curves. The slope of the line is $1/R_S$, and the intercept with the V_{GS} axis is the required V_{GG} .

As Fig. 9 demonstrates, it may be somewhat inconvenient to perform Step 6 graphically. An algebraic solution can then be employed instead. The source resistance is given by

$$R_S = (V_{GSQA} - V_{GSQB}) / (I_{DQB} - I_{DQA}) \quad (2)$$

and the bias voltage is

$$V_{GG} = R_S I_{DQB} + V_{GSQB} \quad (3)$$

Care should be taken to maintain the proper algebraic signs in Eqs. 2 and 3. (For n-channel FETs, V_{GS} is negative and I_D is positive. For p-channel units, the signs are reversed.)

If the transconductance curves of Fig. 9 are not available, g_{fs} can be determined by simply measuring the slope of the transfer curve at the desired operating point. Just place a straight-edge tangent to the curve at the Q-point and note the points at which it intercepts the I_D and V_{GS} axes. The slope and g_{fs} are given by:

$$\text{slope} = g_{fs} = I_{D(\text{intercept})} / -V_{GS(\text{intercept})} \quad (4)$$

In designing a constant-gain circuit, simply

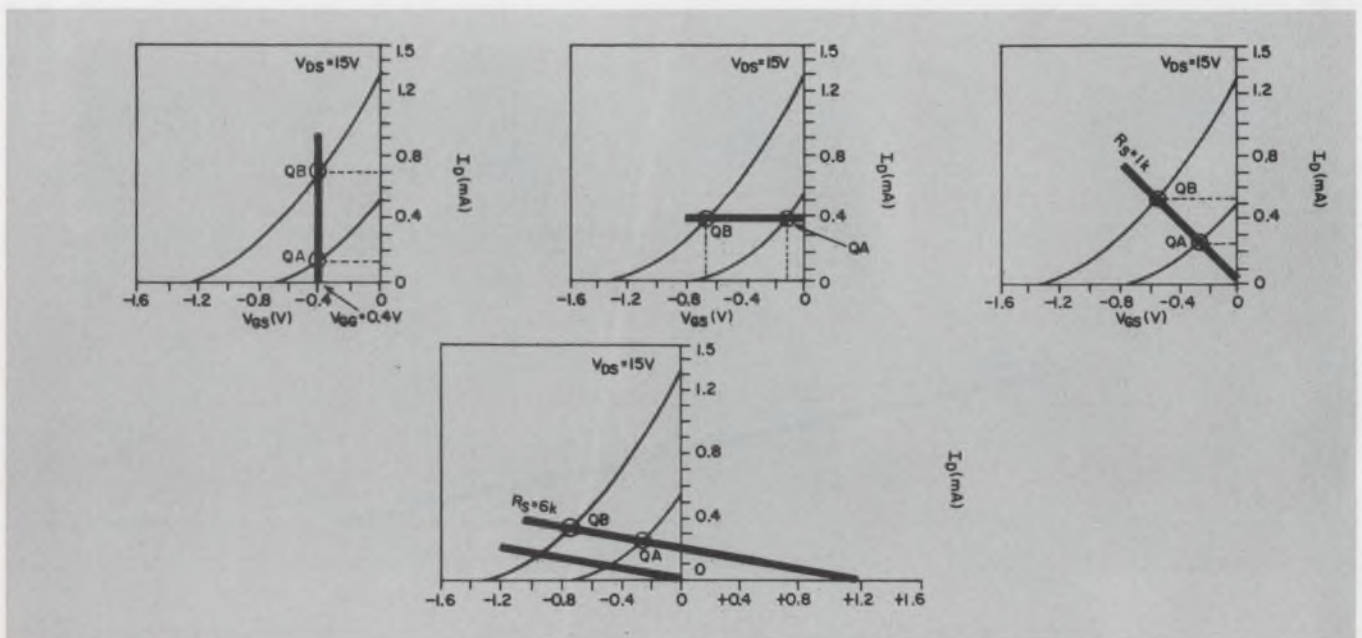

8. The advantages of combination biasing, when one is working with a spread of device characteristics, are

made obvious by plotting the load lines for the various types of biasing on a pair of limiting transfer curves.

set the straightedge tangent to the transfer curve of device A at point Q_A and slide it, without changing its slope, until it is tangent to the curve of device B. The tangency point is Q_B .

Designing without output curves

Although the transfer characteristic has been seen to be extremely valuable in designing a bias circuit, it cannot be used to graphically establish V_{DSQ} . However, if a set of output curves is not available, V_{DSQ} can be determined or selected from the transfer curve by using the following procedure:

Step 1. Establish R_S and limiting values of I_{DQ} , V_{GSQ} and g_{fsQ} from the transfer curve.

Step 2. Establish V_{DD} as available, but in no case greater than BV_{GSS} nor less than several

times V_P . There are special cases where V_{DD} will be below this limit, but in no case should instantaneous v_{dr} be allowed to fall below $2 \times V_P$ if minimum distortion is to be achieved.

Step 3. Set V_{DSQ} approximately midway between V_{DD} and $2 \times V_P$; lower if large output signals will not be handled.

Step 4. Select R_D to give the appropriate V_{DSQ} . The formula is:

$$R_D = [(V_{DD} - V_{DSQ}) / 0.5 (I_{DQA} + I_{DQB})] - R_S \quad (5)$$

In the example of Fig. 8, this procedure would have yielded $V_{DSQ} = (30-3)/2 = 13.5$ V and $R_D = (30 - 13.5) / 0.5 (0.52 + 0.24)$ mA $- 1$ k $\Omega = 42.5$ k Ω .

Step 5. Check to ensure that with this R_D , device B is not in a saturated condition— $V_{DQB} = V_{DD} - I_{DQB} R_D > 2 V_P + R_S I_{DRQ}$. Decrease R_D if this condition is not met.

An alternate method, that selects R_D to provide a specified voltage gain, follows Steps 1 and 2 above and then proceeds as follows:

Step 3. Determine required stage gain, A_v , and set $R_D = A_v / g_{fsQ}$.

Step 4. Calculate V_{DSQ} to ensure that the criteria of Step 2 are not violated:

$$V_{DSQ} = V_{DD} - (R_D + R_S) I_{DQ} \quad (6)$$

Step 5. If necessary, change I_{DQ} , V_{DD} , A_v and/or R_D to obtain an optimum compromise. ■

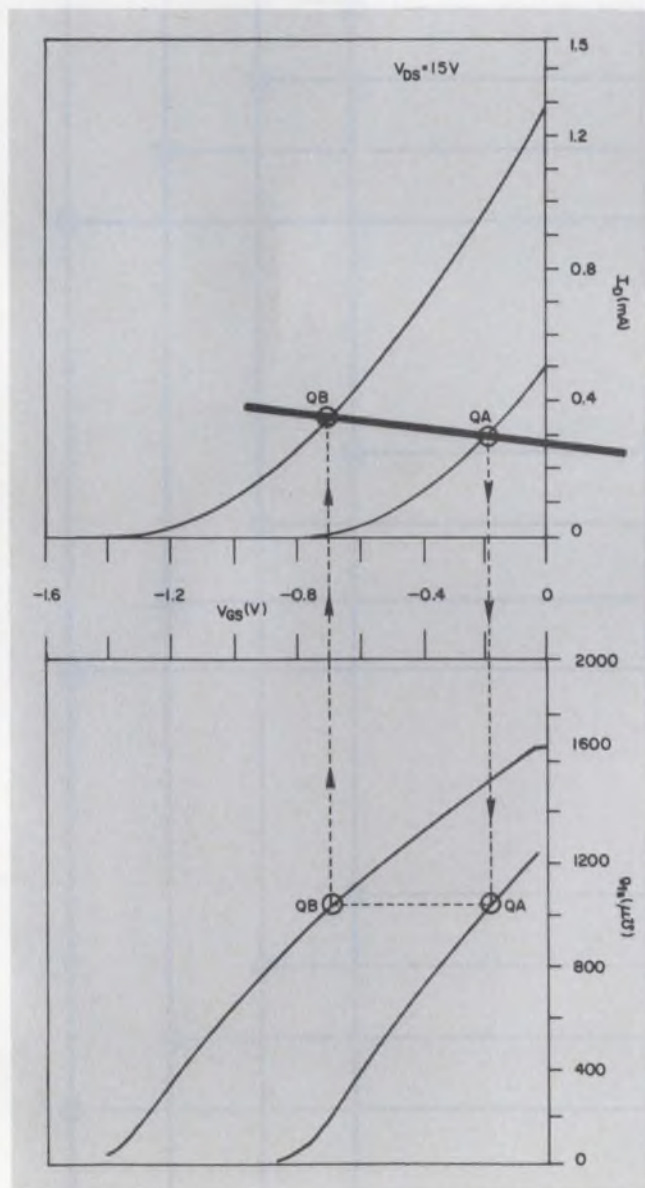

9. Gain variations are minimized when the load line is designed to intersect the pair of limiting transfer curves (top) at points of equal g_{fs} (bottom).

Bibliography

- Sherwin, J. S., "How, Why and Where to Use FETs," *Electronic Design*, May 17, 1966, p. 94.
 Sherwin, J. S., "Knowing the Cause Helps to Cure Distortion in FET Amplifiers," *Electronics*, Dec. 12, 1966, pp. 99-105.

Test your retention

Here are questions based on the main points of this article. Their purpose is to help you make sure you have not overlooked any important ideas. You'll find the answers in the article.

1. Why is constant-current biasing unsuitable for common-source dc amplifiers and unbypassed ac amplifiers?
2. What is combination biasing?
3. How can combination biasing be used to reduce amplifier gain variations when FETs with different transconductances are used?
4. How can a FET transfer characteristic be used to establish the output operating point when output characteristics are not available?

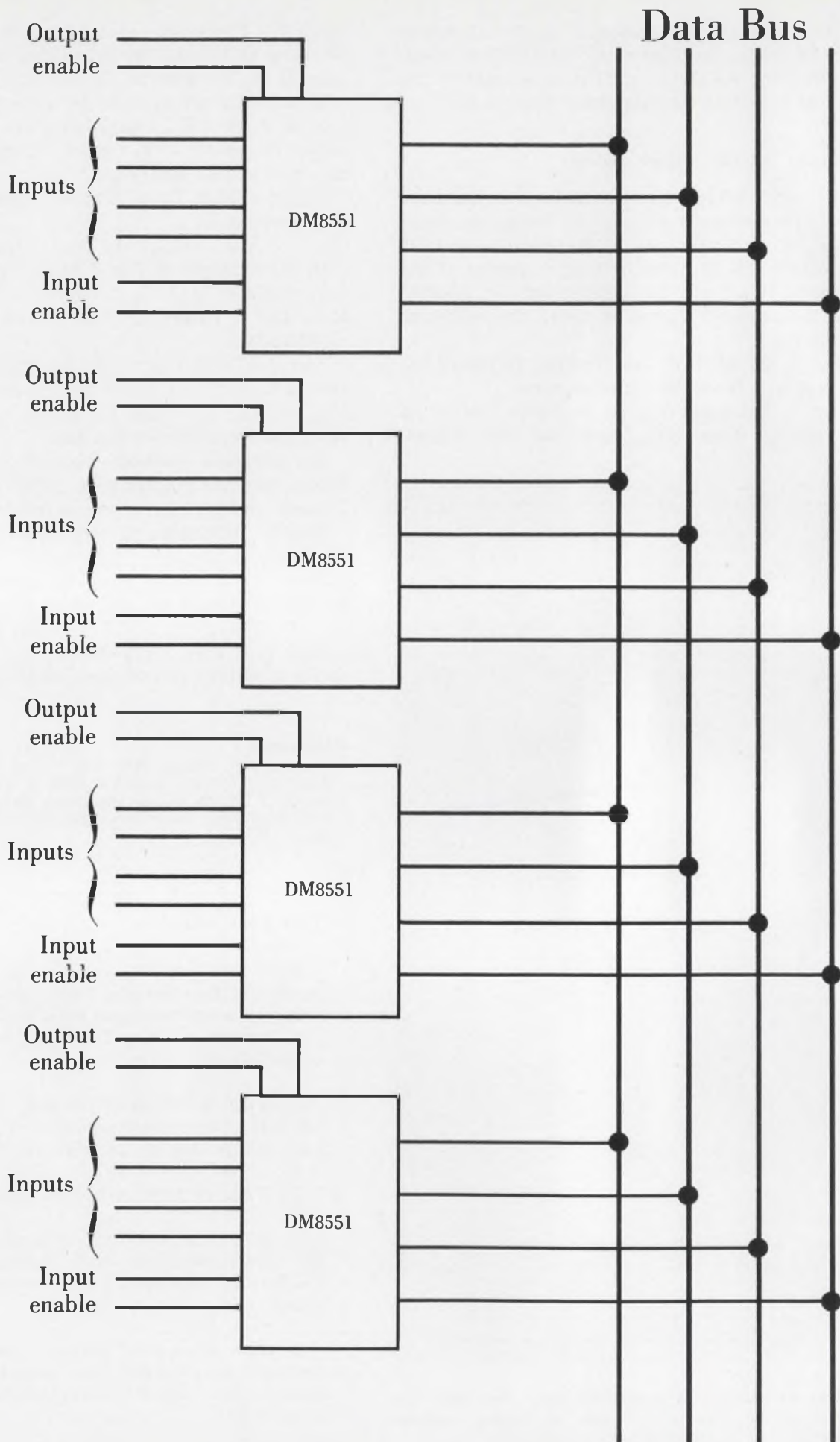

Tri-state Bus-line

There's a third state in a TTL databus with our DM8551. Conventional low impedance logical 1, logical 0 and a high impedance state you can use as a logical "neutral." The 8551 gives you the high impedance characteristics of an open collector output with the high drive of TTL. It makes it possible to design mini-computers as bus-organized systems totally TTL. Direct coupling. Shorter lines. TTL all the way.

DM8551 — Bus-OR'd Quad D — operates synchronously from a common clock. This element has the further advantage of input data acceptance without controlling the clock. Specifically designed for use in bit serial and bit parallel applications. Controlling the third state makes it possible to connect the output of the 8551 directly to the output of other 8551s. You can impede the output of all devices except the one you select, logically.

Take it from National. The 8551 is a new concept in TTL and something else in a databus. TTL/MSI, logically from National Semiconductor. Write for App Notes and specs. 2900 Semiconductor Drive, Santa Clara, California 95051. (408) 732-5000. Telex: 346-353 Cables: NATSEMICON.

National/TTL MSI

Design filters in minutes.

Characterize performance by nondimensional ratios and calculate their values on a computer.

Filter design can be reduced to a simple routine by using a computer program to derive basic relationships, such as capacitance or resistance ratios. A plot of these results is then used to determine filter parameters. The entire process of filter synthesis can be completed in a matter of minutes.

As an example of this approach, two types of filters — an active low-pass and a passive bridged-T — are designed. Coefficients of the filter transfer functions are related to performance specifications, and suitable programs are written for them.

Use dimensionless ratios

The key to the method is to define a set of dimensionless ratios that makes it possible to design the filters without regard to passband gain, corner frequency, damping ratio or impedance levels. Thus all filters can be designed from one set of curves.

For the feedback amplifier of Fig. 1a, for example,

$$E_o/E_i = (R_3/R_1) / (R_3 R_1 C_1 C_2 s^2 + (2/R_1 + 1/R_3) R_1 R_3 C_2 s + 1).$$

This equation is of the form

$$E_o/E_i = (R_3/R_1) / ((s/\omega_o)^2 + (2\zeta s/\omega_o) + 1)$$

where:

$$\omega_o = 1 / \sqrt{R_3 R_1 C_1 C_2}$$

$$\text{or } C_2 = 1 / (R_1 \omega_o \sqrt{(R_3/R_1) (C_1/C_2)})$$

$$\text{and } \zeta = \sqrt{(R_1/R_3) (C_2/C_1) (1 + 2R_3/R_1)} / 2$$

$$\text{or } C_1/C_2 = (1 + 2R_3/R_1)^2 / 4 (R_3/R_1) \zeta^2. \quad (1)$$

The network thus provides adjustable passband gain, R_3/R_1 , damping factor, ζ , and corner frequency, ω_o .

Equation 1 is the relationship to be plotted. Instead of four independent variables, only two need be considered and, since all variables of Eq. 1

are dimensionless, a single plot provides a general solution to a set of specifications.

A BASIC program to compute values for Eq. 1 is given in Fig. 1b. Capacitance ratios to 100 and damping ratios from 0.1 to 1.0 offer realizable results for Butterworth, Chebyshev and other low-pass filters.

Minimum capacitance ratio exists for $R_3/R_1 = 0.5$ and $R_1 = R_2$. The results are plotted in Fig. 2. Only this graph is required for the desired synthesis. For example, a Butterworth 2-pole, low-pass

The figure consists of two parts, (a) and (b), on a light blue background. Part (a) is a circuit diagram of an active low-pass filter. It features an operational amplifier (op-amp) with its non-inverting input (+) connected to a resistor R_1 which is tied to ground. The inverting input (-) is connected to a network of resistors and capacitors. A resistor R_2 connects the inverting input to node A. Node A is also connected to the input E_i through resistor R_1 and to ground through capacitor C_1 . A resistor R_3 connects node A to the output E_o . A capacitor C_2 connects the output E_o back to the inverting input (-). Part (b) is a BASIC program for calculating the filter's response. The program starts with '10 PRINT "R=", "Z=", "C="' and ends with '90 END'. It uses a loop to calculate values for R, Z, and C based on input parameters N and Z.

```

LOPASS

10 PRINT "R=", "Z=", "C="
20 FOR N=1 TO STEP 1
30 LET R = .0625*(2^N)
40 FOR Z=.1 TO 1.1 STEP .2
50 LET C = ((2*R+1)^2)/(4*R*(Z^2))
60 PRINT R,Z,C
70 NEXT Z
80 NEXT N
90 END

RUN
    
```

1. The active low-pass filter is based on a feedback amplifier (a). In the analysis given, $R_2 = R_1$. A BASIC program computes values for the filter response (b).

Benton Bejach, Electronic Development Manager, Borg-Warner Controls, Santa Ana, Calif.

filter is required with a passband gain, R_3/R_1 , of 32 and a corner frequency of 1 kHz. R_1 is chosen to be 10 k Ω and $\zeta = 0.707$. Referring to Fig. 2:

$$C_1/C_2 = 66 \text{ and } C_2 = 1/(10^4 \times 2\pi \times 10^3 \sqrt{32 \times 66}).$$

Thus $C_2 = 347$ pF, $C_1 = 66 \times 347 = 22900$ pF,

$$\text{and } R_2 = 32 \times 10^4 = 320 \text{ k}\Omega.$$

When components with 5% tolerance are used, about 1-dB deviation from the predicted frequency response is observed.

Bridged-T filter is another test

Another analysis treats the passive bridged-T filter (Fig. 3). Its transfer function is of the form:

$$E_o/E_1 = [(s/\omega_o)^2 + 2\zeta_1 s/\omega_o + 1] / [(s/\omega_o)^2 + 2\zeta_2 s/\omega_o + 1].$$

If $s = j\omega_o$, the notch depth is $E_o/E_1 = \zeta_1/\zeta_2$ and the following dimensionless relationships exist:

$$R_1/R_2 = 1/(4\zeta_1^2 (-1 + \zeta_2/\zeta_1) - 1),$$

$$C_2/C_1 = (4\zeta_1^2 (-1 + \zeta_2/\zeta_1)^2) / (4\zeta_1^2 (-1 + \zeta_2/\zeta_1) - 1),$$

$$\omega_o = 1/\sqrt{R_1 C_1 R_2 C_2}. \quad (2)$$

These relationships approach infinity for pairs of ζ_1 and ζ_2/ζ_1 obeying the relation:

$$\zeta_2/\zeta_1 = 1 + (1/4\zeta_1^2)$$

Some values of this set that establish the boundaries of physically realizable networks are as follows:

ζ_1	ζ_2/ζ_1
0.10	26.0
0.15	12.1
0.20	7.25
0.25	5.0
0.30	3.78
0.35	3.05
0.40	2.56
0.50	2.0

The BASIC programs given in Fig. 3b plot the R_1/R_2 and C_2/C_1 ratios. Dummy variables are used as follows: R for the resistance ratio, C for the

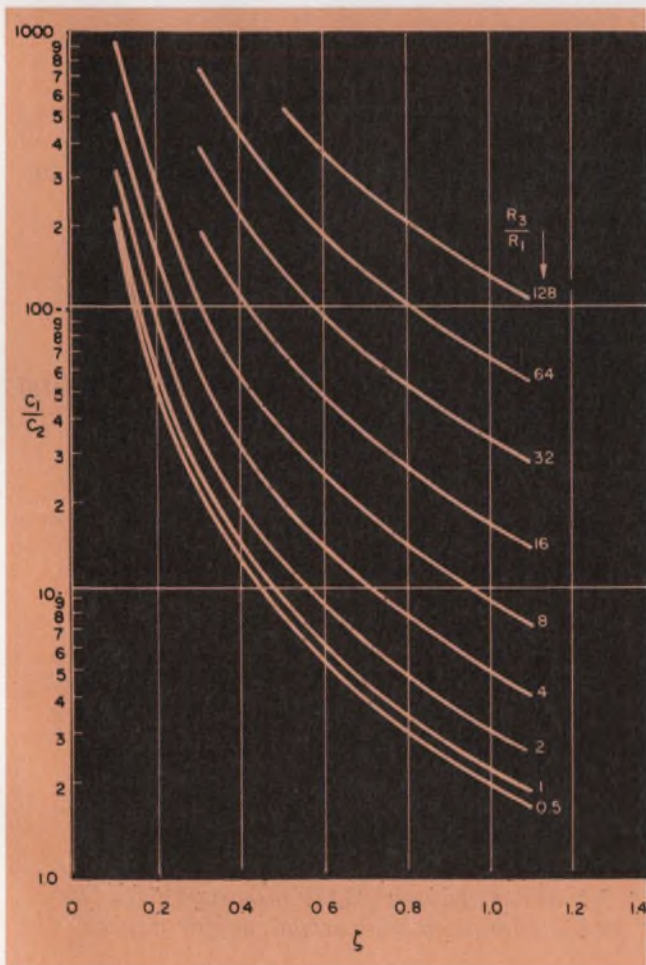

2. A nondimensional plot of low-pass filter response uses C_1/C_2 and the damping factor as variables and R_3/R_1 as a parameter.

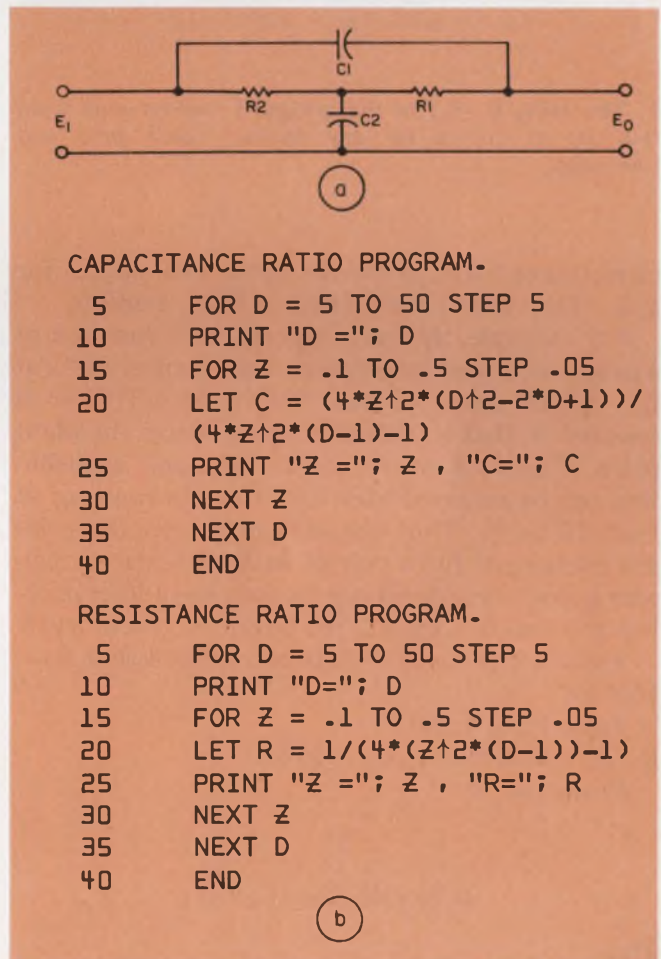

3. The response of the passive bridged-T filter (a) is computed by the BASIC program in (b). Both capacitance ratio and resistance ratio programs are shown.

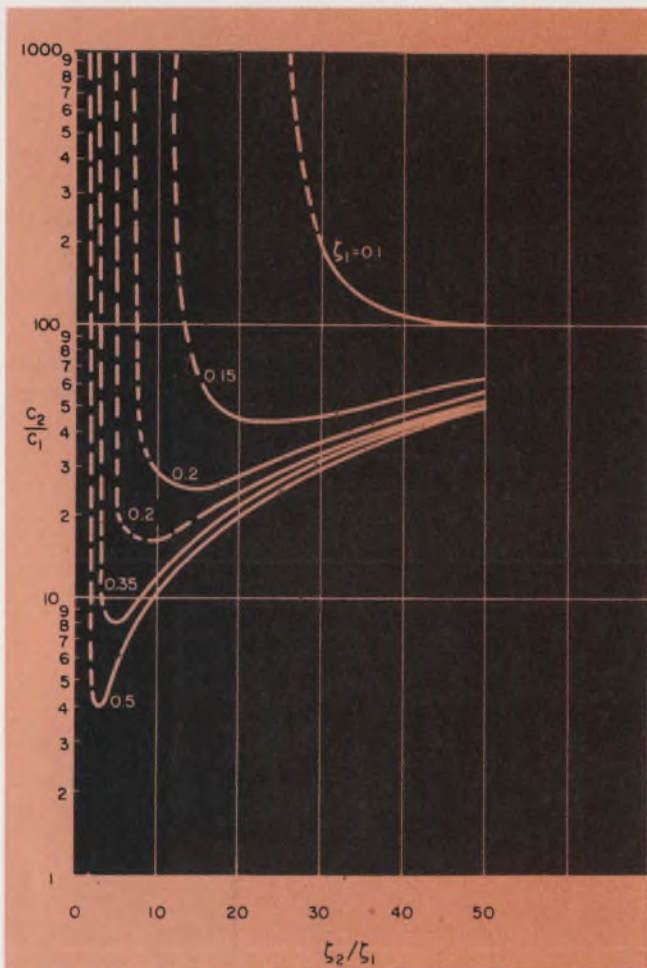

4. The ratio, C_2/C_1 , of the bridged-T can be read from this set of curves for any desired notch ratio and frequency.

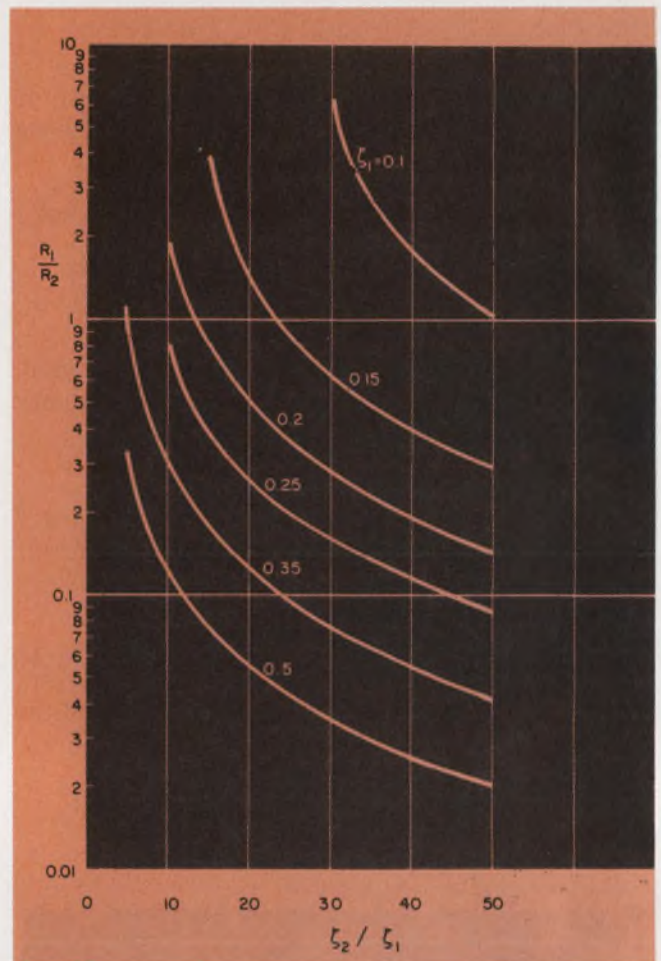

5. The bridged-T resistance ratio, R_1/R_2 , is determined from this family of curves. Both this set and that of Fig. 4 are plotted from the program values of Fig. 3 (b).

capacitance ratio, D for the notch ratio and Z for ζ_2/ζ_1 . The results are plotted in Figs. 4 and 5.

For example, the open-loop transfer function of a proposed closed-loop system has complex roots at $f_0 = 10$ Hz and $\zeta = 0.15$. The bridged-T filter is selected so that its complex zeros cancel the plant poles. Figures 4 and 5 indicate that pole cancellation can be achieved over a notch ratio range of at least 15 to 50. Thus the undesired complex poles are exchanged for a pair of easily calculated real-axis poles. Considerations of the closed-loop problem at hand will dictate the optimum notch depth.

Assume that $\zeta_2/\zeta_1 = 30$ is desired and that $R_2 = 100$ k.

From Figs. 4 and 5:

$$R_1/R_2 = 0.62 \text{ and } C_2/C_1 = 45.5.$$

From Eq. 2:

$$C_1 = \frac{1}{\omega_0 R_2 \sqrt{(R_1/R_2) (C_2/C_1)}}$$

Thus

$$C_1 = \frac{1}{2\pi \times 10 \times 10^5 \sqrt{0.62 \times 45.5}} = 0.03 \mu\text{f},$$

$$C_2 = 45.5 \times 0.03 = 1.37 \mu\text{f},$$

$$\text{and } R_1 = 0.62 \times 10^5 = 62 \text{ k}\Omega,$$

completing the synthesis. Again experimental results closely approach the theoretical. ■ ■

Test your retention

Here are questions based on the main points of this article. Their purpose is to help you make sure you have not overlooked any important ideas. You'll find the answers in the article.

1. What are the advantages of using non-dimensional ratios in filter design?

2. What causes most discrepancies between computed and actual performance?

3. What is the basic configuration of an active filter?

Gate your op amp—and get a powerful new device that simplifies test, control, switching and modulation circuitry.

Adding a gate to an operational amplifier produces a new device that acts as both a switch and an amplifier. It isolates inputs and outputs when a gating signal is applied, and it functions as a conventional op amp when the signal is not present.

The gated op amp can be used to provide variable gain, switch ac and dc signals, perform sample and hold operations and act as a wide-band, phase-sensitive demodulator. And it usually does so with fewer components than conventional circuits require.

The supply voltage, ground or any other convenient source may be used to provide the gating signals. Depending upon the output stage configuration, converting an existing op amp for gated operation may be as simple as adding a single lead. But for most currently available IC op amps several external components will be required.

How to add the gate

A typical example of how to add gating control is shown in Fig. 1 for an amplifier with a Class A output stage using two npn transistors. In this case the addition of two diodes provides the required output isolation.

Assuming a high impedance drive from the preceding portion of the circuit, diode D_1 cuts off the constant current source, Q_1 , when the gating terminal is connected to the negative supply, and diode D_2 protects the reverse base emitter junction of Q_2 .

A similar example, involving only the addition of a lead for the gating signal is accomplished with the Ferranti ZLD2T op amp (Fig. 2).

In this case, with the gating input unconnected the amplifier performs as a normal ZLD2T, allowing the usual op-amp functions. When the gating input is connected to the negative supply line, both Q_3 and Q_6 are cut off. With no current supplied to Q_1 and Q_2 , Q_3 does not conduct. The inverting and noninverting inputs are thus isolated from each other, and from the output.

John M. Morrison, Senior Research Engineer, Ferranti Limited, Edinburgh, Scotland

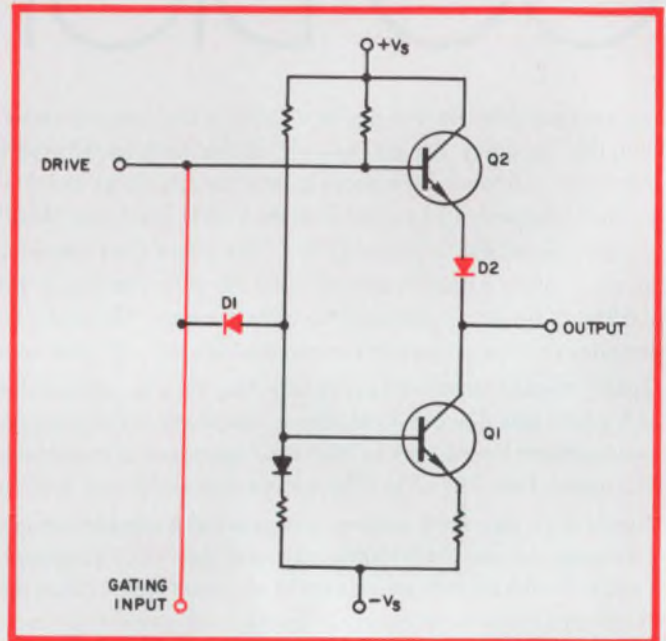

1. Two diodes add gating capability to this Class A output op amp. Similar techniques can be applied for op amps with Class B and emitter-follower output stages.

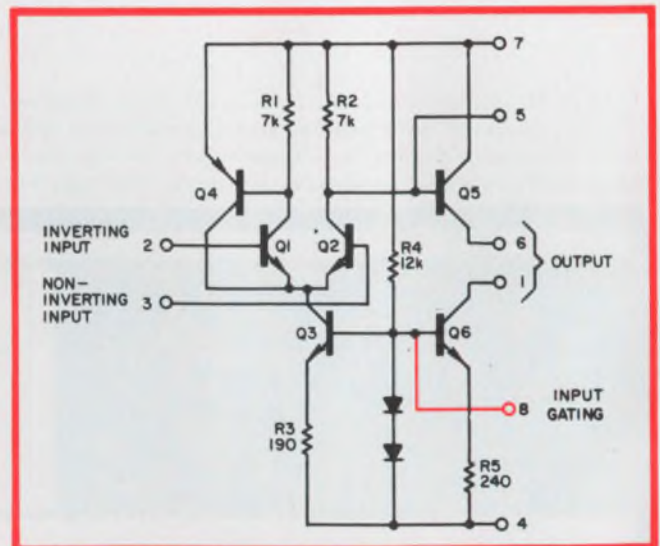

2. One lead is all that is required to convert the ZLD2T operational amplifier for gated operation. External components are required to convert most other existing IC op amps.

Build a pulse train encoder and visual fault indicators.

A simple pulse coding circuit is one application for gated op amps. As shown in Fig. 3, a gated op amp and four resistors will combine three pulse trains into a single signal. The eight possible input combinations produce eight distinct output voltage levels. This circuit is particularly useful in test data recording where the number of inputs exceeds the number of recording channels.

A useful display that provides visual fault indication is a second application for the gated op amp in test instrumentation. In a system where a single input generates multiple ac or dc outputs, all of varying amplitudes or polarities, a simple histogram plot on an oscilloscope screen (Fig. 4) is a time-saving check. For example, if we have a range of dc voltages to be monitored, which bear a specified relationship to each other, these voltages are normalized to some convenient value by a choice of suitable resistor ratios, and sequential selection is obtained by a ring counter synchronized with the time base sweep of the oscilloscope. Instant indication of any deviation is displayed.

4. A ring counter controls the switching of the gated op amps in this histogram display. The oscilloscope alerts an operator to any malfunction. Any deviation from the reference voltage (V_A) is indicated as a change in voltage level on the scope.

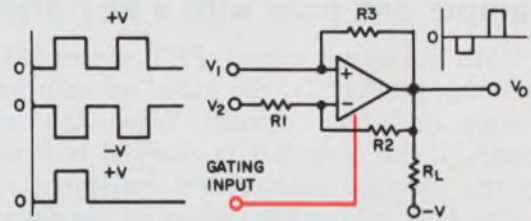

3. A handy coding circuit produces eight distinct and unambiguous output voltage levels for three pulse train inputs. A much more complex circuit would be required if a gated op amp was not used.

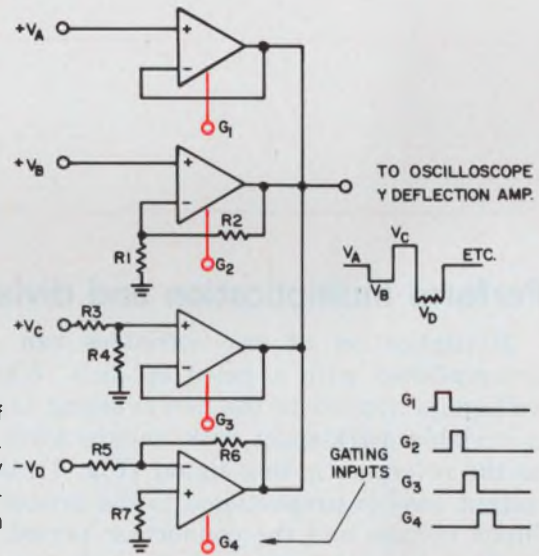

Get variable gain elements or three-state comparators.

Another application is the three-state comparator circuit of Fig. 5. An op amp in an open-loop configuration has two stable states. By adding two transistors to a gated op amp, a third state, with the output level zero, is present when the input voltage allows the extra transistors to conduct, thus cutting off the amplifier. This circuit is useful for limit monitoring.

A variation can be obtained by adding a third transistor (Fig. 6). Applications include a servo gain-change element, a portion of an afc feedback loop, frequency doubler and a special-purpose comparator.

6. Gain varies with input level when a third transistor is added to the circuit of Fig. 5. The circuit is particularly useful in nonlinear control systems.

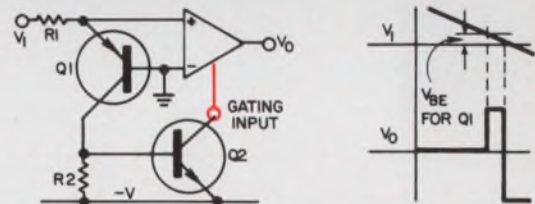

5. Get a three-state comparator by using two transistors with a gated op amp. The circuit is useful for automatic testing and sorting.

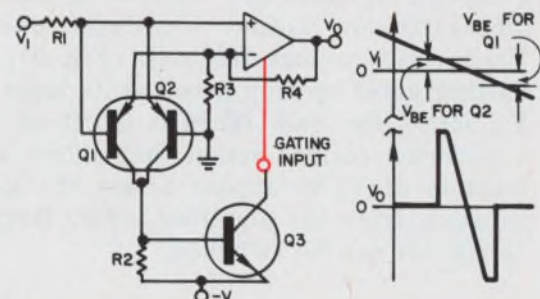

Sample and hold with a FET and a capacitor.

With a capacitor and FET connected across the output (Fig. 7), the gated op amp acts as a sample and hold circuit. When the amplifier conducts, the capacitor is charged to a value set by the external gain-control resistors.

The FET allows the charge on the capacitor to be held for a period that is a function of the FET gate leakage and the cutoff leakage of the op-amp output stage transistors. Since the FET is inside the feedback loop, its gate source voltage is largely irrelevant.

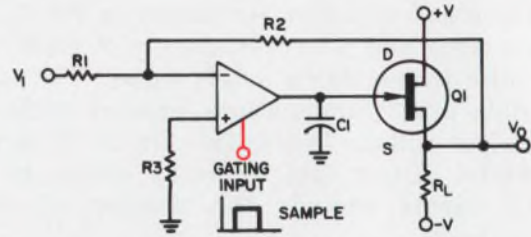

7. Make a sample and hold circuit using a FET and a capacitor with a gated op amp. A feedback capacitor will convert this circuit to an integrating sample and hold circuit.

Perform multiplication and division of two variables.

Multiplication of two variables can also be accomplished with a gated op amp. When a dc voltage is applied to the noninverting input, and a variable mark-space ratio square wave is used as the reference gating signal (Fig. 8), the mean output level is proportional to the product of the input voltage and the conduction period. (Many methods exist for generating a pulse period proportional to a dc voltage.) Division can be accomplished in a similar way.

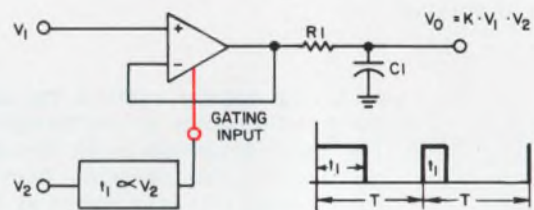

8. A voltage multiplier circuit consists of a gated op amp and a pulse generator. Pulse repetition rate is constant while pulse width is proportional to V_2 .

Use gated op amps to switch both ac and dc.

The gated op amp can also be used in many switching applications. With unity gain and an inherently low output impedance due to the 100% series voltage feedback (Fig. 9), the conducting gated op amp develops its input voltage, V_1 , across the load. When it is cut off, there is a potential divider action that allows a defined fraction of V_2 to appear across the load, with isolation from the amplifier input. Both ac and dc signals can be switched.

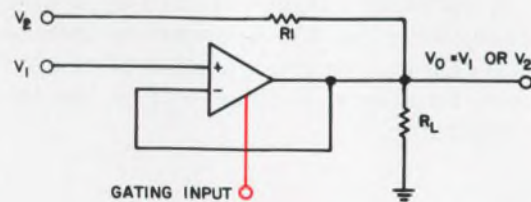

9. Switch both ac and dc signals with the same gated op amp. When the op amp is conducting, output voltage is V_1 .

Modulators are possible, too.

Modulation is also an interesting field of application for the gated op amp. With a dc voltage applied to the input of the noninverting amplifier and a square-wave gating signal (Fig. 10), an output is generated that is synchronous with the gating reference.

With a sinusoidal input and square-wave reference gating signal, a half-wave, phase-sensitive demodulation is produced. This circuit has a number of advantages over conventional demodulators. They include:

- High input impedance.
- A wide range of allowable load impedance.
- Wide range gain.
- No need for special reference transformers.

Full-wave demodulation is made possible by using an inverting amplifier configuration and an input in phase with the switching reference (Fig. 11). In this case one input half cycle is inverted when the amplifier conducts, and the other half cycle is reproduced across the load by the potential divider action of R_1 and R_2 when the amplifier is cut off. Unlike the half-wave demodulator, the output amplitude is load-dependent during one-half cycle. ■■

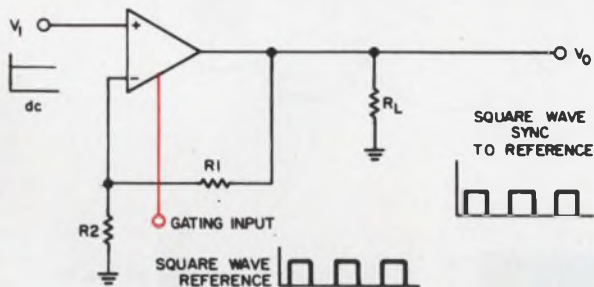

10. Modulate an input voltage signal using a square-wave reference to gate the op amp. Normal op-amp characteristics provide gain for low-level signals.

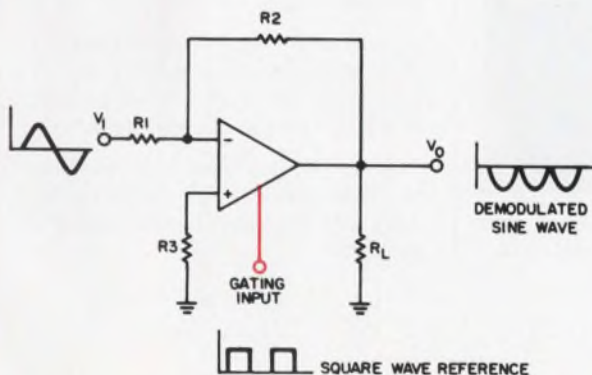

11. Full-wave demodulation without special transformers is accomplished in this gated op-amp circuit. The same circuit can be used for a wide frequency range of signals.

STATE OF THE ART SEMINARS FOR ENGINEERS AND SCIENTISTS

Here's an opportunity to engage in short programs that will review many of the latest advances and engineering techniques in your field . . . presented by RCA Institutes.

LOGIC DESIGN	Minneapolis	5/18-22
	Washington, D. C.	6/1-5
	Chicago	6/15-19
	Albuquerque	7/27-31
	Montreal	8/24-28
	Detroit	8/31-9/4
DIGITAL SYSTEMS ENGINEERING	Cleveland	5/11-15
	Boston	5/18-22
	Montreal	6/1-5
	Denver	6/22-26
	New York	7/6-10
	Washington, D. C.	7/13-17
	San Francisco	7/20-24
	San Diego	7/27-31
	Huntsville, Ala.	8/3-7
	Chicago	8/10-14
	Houston	8/24-28
DIGITAL COMMUNICATIONS	Albuquerque	5/18-22
	Houston	6/1-5
	San Francisco	6/15-19
	Boston	6/22-26
	Los Angeles	6/22-26
	Huntsville, Ala.	7/6-10
	Minneapolis	7/13-17
	Syracuse, N. Y.	7/27-31
	Washington, D. C.	8/10-14
	New York	8/24-28
INTEGRATED CIRCUITS	San Francisco	5/20-22
	San Diego	5/25-27
	Detroit	6/8-10
	Rochester	6/29-7/1
	Montreal	7/6-8
	Houston	7/13-15
	Pittsburgh	7/27-29
	Clark, N. J.	8/3-5
	San Francisco	8/10-14
		Los Angeles

Above schedule subject to change

RCA

RCA Institutes, Inc. Dept. ELD-50
Institute for Professional Development
Central & Terminal Avenues, Clark, N. J. 07066

For free descriptive brochure, please check the seminar in which you are interested.

- Logic Design Integrated Circuits
 Digital Communications Digital Systems Engineering

Name _____ Title _____

Company _____

Address _____

City _____ State _____ Zip _____

what!



really!



yes, mag
tape
terminals



TELETYPE?

It's true.

After helping a jillion feet of paper tape wind and unwind its way through communications systems everywhere, Teletype announces the addition of magnetic tape data terminals.

There are some basic advantages in both mediums. But as you are well aware, the medium that's right for a system depends a lot on the application criteria.

The new magnetic tape data terminals have many operational features that make life less complicated for the operator.



New, modular line of Teletype® 4210 magnetic tape data terminals.

For example, take a look at the tape cartridge, which was specifically designed for reliability required for data transmission.

Its vital statistics are: 3" x 3" x 1".

It contains 100 feet of 1/2" precision magnetic tape.

It will hold 150,000 characters of data, recorded at a density of 125 characters per inch. The equivalent of a 1000 foot roll of paper tape.

This means that your data is easier to store, easier to handle, easier to work with than ever before. And it's reusable.

DATA COMMUNICATIONS

equipment for on-line, real-time processing

The units have a "fast access" switch which will move tape forward or reverse at a speed of 33 inches per second. A digit counter provides a reference point to help locate various areas of the tape.

Four ASCII control code characters can be recorded in the data format to aid character search operations. When the terminal's "search" button is pressed, tape moves at the rate of 400 characters per second

Also magnetic tape adds high speed on-line capability to low speed data terminals.

You can zip data along the line at up to 2400 words per minute. For example: Take a standard speed Teletype keyboard send-receive set, and a typical typist. Add a new magnetic tape unit to this combination and the on-line time savings can pay for the magnetic tape terminal in short order.

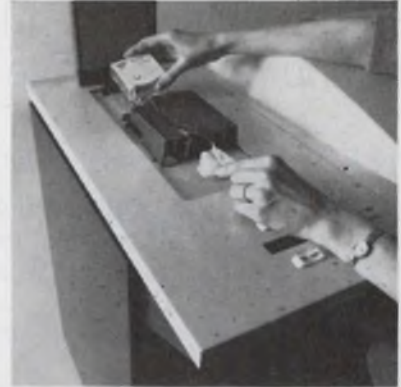

Straight-through threading makes tape loading and unloading exceptionally easy.

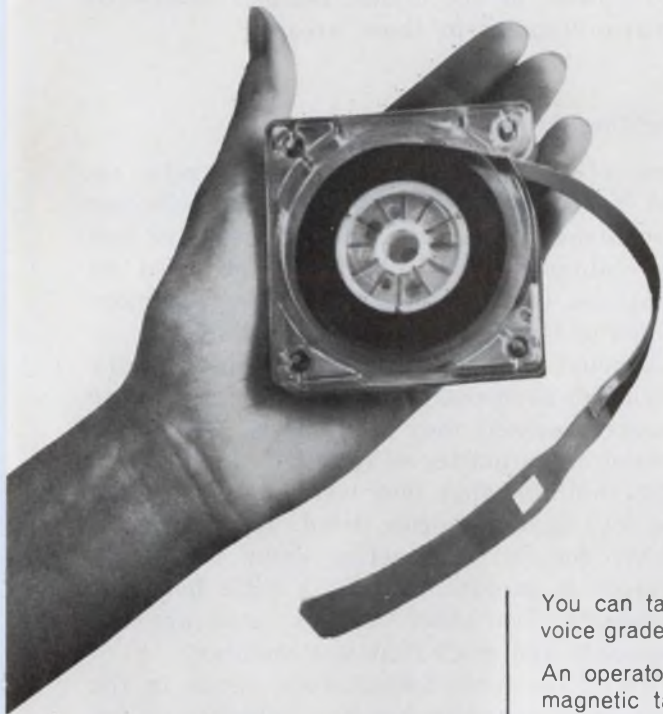

until the control code selected is detected. Then the terminal stops the tape automatically.

A "single step" switch is also provided which enables you to move the tape forward or backward one character at a time. In editing or correcting tape, you can send a single character using this feature.

You can take better advantage of voice grade line speed capabilities.

An operator can prepare data for magnetic tape transmission using the keyboard terminal in local mode. Then send it on-line via the magnetic tape terminal up to 2400 words per minute.

These new modular magnetic tape data terminals offered by Teletype are perfectly compatible with model 33, model 35, model 37 and Inktronic® keyboard send-receive equipment.

They can send or receive at high or low speed. Or can be used independently as stand-alone terminals on-line.

If you would like to know more about this new line of Teletype magnetic tape data terminals, please write Teletype Corporation, Dept. 89-15, 5555 Touhy Avenue, Skokie, Illinois 60076.



Teletype 4210 magnetic tape data terminal with 37 keyboard send-receive set.

machines that make data move

INFORMATION RETRIEVAL NUMBER 57



Engineers want more challenges, according to this attitude survey. Many respondents say they not only become bored but even change jobs because the work is too elementary.

Richard L. Turmail, Management Editor

Are you bored with engineering?

Are you in favor of an engineering union?

Would you change your job title to match the work you do?

How much more money do you think you should be earning?

How much responsibility do you think your employer should assume for your continued education in technology?

ELECTRONIC DESIGN has answers to these questions and many others as the result of a management survey conducted among a random sampling of 1000 of the magazine's subscribers. Of the nationwide sample canvassed, 55 per cent responded to our questionnaire.

A further breakdown of responses by titles reveals that 2 in 3 respondents are engineers; 1 in 4 is a manager; 1 in 19 is a president or vice president; and 1 in 24 is a chief engineer.

Over one-third of those who responded are in their 30s, while those in their 20s and 40s split half the total response.

Survey data

This report reveals the findings of a survey conducted in March, 1970, among subscribers to ELECTRONIC DESIGN. We mailed 1000 questionnaires to a random sample of our subscribers, and 550 replies were returned to us in time for tabulation and analysis. All information was treated anonymously.

The survey was designed to include responses from two engineers for each manager—a job title ratio that adequately reflects our subscription list.

The questionnaire contained 18 items. Engineers were told that the information they supplied on the form would be used in a management survey article designed to inform them how their attitude compares with that of their colleagues concerning their career needs, their complaints and their expectations in the engineering profession.

Nearly 1 in 2 respondents indicated that they lived on either coast, with those of the East Coast having a slight edge in numbers. The Midwest was represented by 1 in 6 engineers. Nearly 4 in 5 engineers like their employment location. Those who would rather live elsewhere would choose, in order of preference, the West Coast, the Southwest or the South, mainly because of the warm climates in those areas.

Spotlighting the survey highlights

Some of the attitudes that are generally assumed to be held by EEs—such as believing they're underpaid, and feeling that they've had a poor education—are generally confirmed by the response. Other responses, however, are more enlightening—and sometimes disturbing:

- Although you may find your present work satisfying or even challenging, 1 in 6 responding engineers admitted they were bored with their profession. As a matter of fact, EEs in their 20s and 30s indicated that they were the most bored of the four age categories listed. The main reason given for this engineering ennui is that an EE career is unrewarding, with little hope for advancement. Two other reasons listed are bad management and work that is elementary.

- One of the most tossed-about issues in the engineering community has been whether or not the engineer should unionize. In this survey, nearly 1 in 8 EEs said that their company is unionized. Asked "Do you favor an engineering union?" 1 out of 4 engineers who responded to the question said they thought a union would promote more benefits and job security for the EE, and more bargaining power with corporate management.

The remaining 3 of 4 responding EEs reported, in many cases angrily, that union affiliation would stifle incentive, degrade the engineering profession, create a barrier between the engineer and his manager, hinder the recruitment of new employees, and foster promotion on a seniority basis rather than on merit.

Engineers from New England and the South reported the greatest number of unionized com-

Profiles in challenges

Age group	20 - 29 27%	30 - 39 38%	40 - 49 26%	50 - 59 9%
Why did you choose an engineering career?				
Like to build things	54%	47%	49%	75%
Other	28%	33%	31%	20%
Best salary	10%	12%	10%	—
Teaches sequence	8%	9%	10%	5%
Did you change jobs in last 2 yrs?				
Yes	50%	28%	24%	14%
Why?				
Unchallenging work	34%	16%	18%	71%
Advancing career	20%	32%	40%	14%
Underpaid	16%	19%	18%	—
Bored with engineering – and Why?				
Yes	22%	22%	11%	4%
Unchallenging	97%	84%	87%	—
Too much time reading	3%	16%	13%	100%
Consideration for career advancement				
Interesting work	44%	29%	40%	39%
Money	29%	27%	23%	37%
Promotion	27%	23%	24%	8%
Socially-conscious work	—	21%	13%	16%

Training that respondents say employer should offer (by age group)

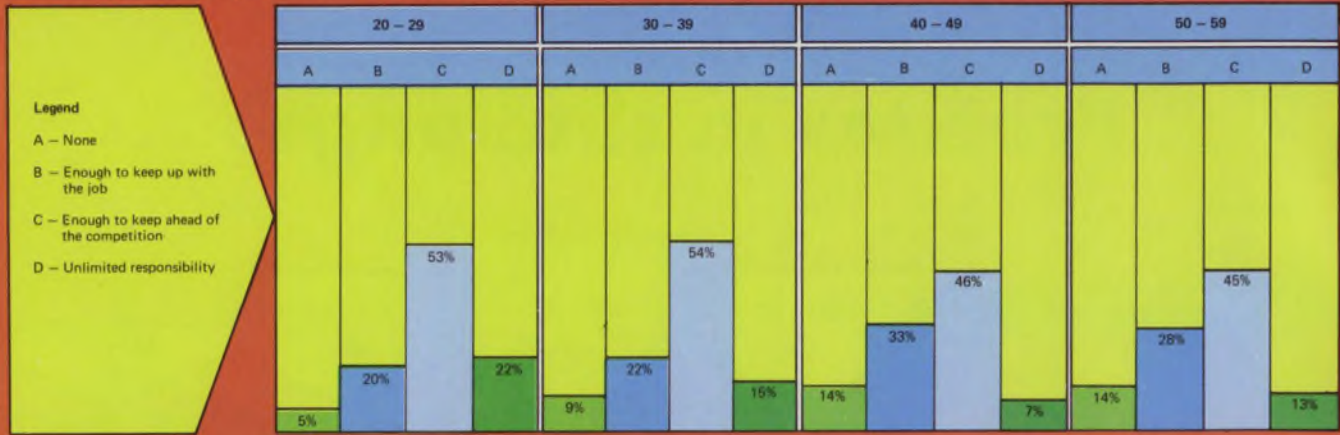

panies, while the least number are reportedly in the Southwest and West Coast.

East Coast engineers favor unionization most, while Southwestern EEs favor it least.

■ What's in a title? "Nothing," say some engineers, while others would upgrade their titles if given the option. Still others report they would have to downgrade their title if it was necessary to describe what it is they actually do.

Of the presidents and vice presidents represented in the survey, only 1 in 8 would change his corporate nomenclature. Of course, the vice presidents would most often change their title to "division president," while many presidents would change theirs to "retired." (So they said.)

Only 1 in 10 chief engineers reporting would change his label to read either "department head" or "engineering manager." Most chiefs are satisfied with their designation—probably because the title of chief is all inclusive.

Of the managers, only 1 in 10 would rather be called "consultant" or "vice president." Very few respondents downgrade their titles at this level.

Engineers, however, apparently feel that they are the most maligned of career men in the matter of titles. One in six of them would change their name plates to read either "clerk" or "assistant technician." Jobs at the engineering level tend to be general in nature, with the usual load of paper work and technician's duties.

■ Regardless of title, however, most responding engineers agree on the amount of additional salary they think they should be earning. One-third, representing a plurality of the respondents in each title category (excepting that of president and vice president) believe that they should be taking home \$2500 more annually than their present salary. Reasons given for the proposed increase are that experience, responsibility, and the high cost of living justify it.

Three of 10 of both managers and engineers

feel that their present wages are satisfactory. Half of the presidents and vice presidents are satisfied with their stipend, because, in most cases, they either receive a liberal bonus or own the company.

■ And if you owned a company, how much of your profits should you invest in the continued technical training of your employees? In our survey, 1 in 2 of all responding EEs feel that their employer should finance enough training to keep them ahead of the company's competition. One in four EEs feel that their company should at least be responsible for keeping them up with the latest developments in their work.

While over 2 in 5 of all companies reported by responding EEs offer enough education to keep their engineers up to date on the job, 1 in 5 companies reported offer no training at all.

There is an interesting parallel between those EEs who are for or against unionization and the amount of company-sponsored training of-

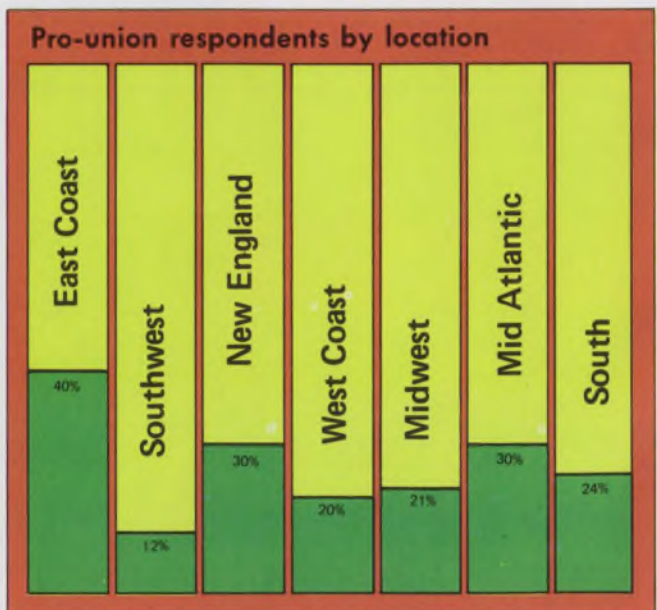

Reported amount of training employers offer (by location)

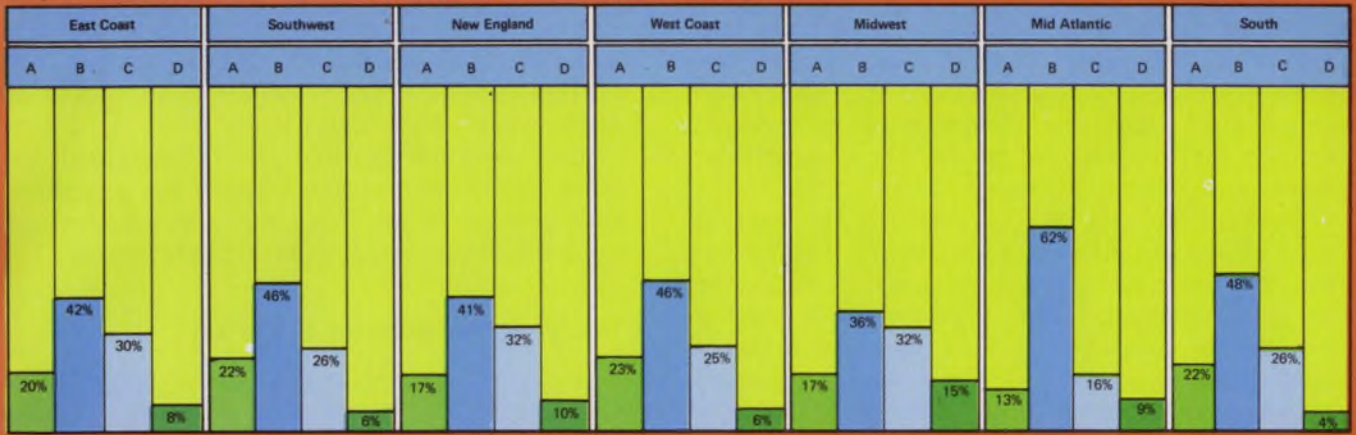

ferred. Seven of ten of those who are pro-union, believe that their non-union companies should keep them ahead of the competition or should take on unlimited educational responsibility. Yet significantly, according to our survey, pro-union EEs work for companies that, in 7 out of 10 cases, offer either only enough training to keep the EE proficient at his job or no education.

Responding engineers who are anti-union tend to believe that their company should not necessarily be responsible for much more than enough training to keep them up with their work. Yet, according to the report, most anti-union engineers work for companies that offer more training than they expect to receive.

Job-hopping by age groups

As might be expected, the survey indicates that the younger the engineer the more likely he is to change jobs. In the past two years such

was the case of half the respondents in the 20-to-29 age category. The reasons most often given for the change were either "unchallenged by the work" or "advancing the career."

According to our survey, the percentage of job-hopping EEs decreases, however, as they grow older. Three out of 10 EEs in their 30s have changed company allegiance in the last two years, stating as their reasons: "to advance their career" or "underpaid." One in five engineers in their 40s switch jobs, usually for purposes of advancement, and only 1 in 7 of those respondents in their 50s had a change of scene, with the excuse of "finding more rewarding work."

What EEs say about higher education

Nearly half of the respondents reported that their engineering training in college did not prepare them properly for contemporary technology, at the time of their graduation. The reason most often listed for this lack of preparation is "not enough practical application of engineering fundamentals in college." "Poor choice of curriculum" is another reason often given. Poor instruction is least noted as a cause.

Over half of those EEs who indicated that their training was satisfactory said that they chose engineering because they like to build things and because the profession teaches them logical sequence.

Two apparent contradictions developed in the areas of job-hopping and career choice when compared with education tabulations. For example: one of the main reasons given by "poorly educated" EEs for choosing an engineering career was that they thought they "could earn the best salary." The second contradiction is the report that while "well-educated" EEs change jobs to advance their careers, "poorly educated" ones say they usually change jobs because they're

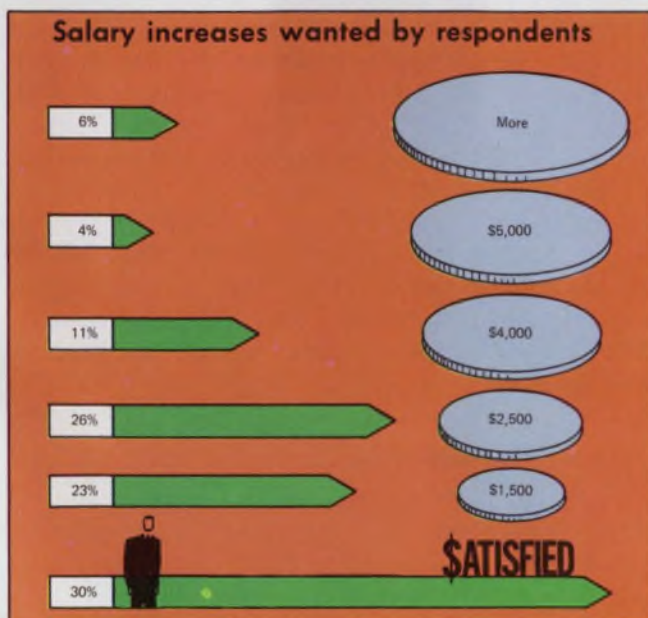

unchallenged by the work.

Interesting also, is the finding that companies, regardless of location, place exactly the same emphasis on the amount of training they offer their employees. They are, in order of preference: enough for the job; enough for the competition; none; and unlimited responsibility.

Perhaps help is on the way for the current crop of student EEs in the matter of insufficient practical engineering application in college. In an article published this year by the American Society for Engineering Education, an industry spokesman suggested, at a conference attended by representatives of both industry and education, that industry update both curriculum and student by creating more part-time employment opportunities for engineering students and faculty members. In reciprocation, the spokesman suggested the schools could create a more practical, industry-related curriculum.

The extracurricular engineer

A few respondents facetiously—perhaps—considered “paying my family’s bills” and “job hunting” to be worthwhile community activities, while others listed such disparate activities as the “third world liberation front,” “underwater rescue team,” and “converting text books to the Braille system” as being worthwhile projects.

One disturbing tabulation is that one engineer in five is not engaged in any community activity at all. Most of those in that category plead that their engineering studies don’t give them time.

One engineer in five, however, has found time to serve his church, and 1 in 7 busies himself in civic affairs, including such diverse activities as the chamber of commerce, law enforcement, conservation, voluntary fire department, parks commission, Red Cross, and the development of human resources. Scouting engages 1 in 10 engineers, and the PTA and other school associations hold the attention of 1 in 20 EEs. Additional activities listed include charities, social work, little league, little theatre, politics, YMCA, and volunteer teaching.

What about that generation gap?

It appears that the so-called generation gap certainly exists, but not on the scale we’ve been told—at least not in the engineering profession.

Of those who considered themselves qualified to answer the question, 1 in 6 engineers under 30 years of age said that he had trouble understanding his boss. The most prevalent reason for the misunderstanding, according to the young EE, is that his supervisor is either “unwilling or unable to make clear-cut decisions.”

Only 1 in 12 managers over 30 years of age

reported having trouble understanding their under-30 subordinates. The reason most often given for this gap was “language” (a failure to express himself) or “attitude” (he thinks the world owes him a living).

Most respondents said they understood each other pretty well, either because the age difference between them was slight, or because most companies have a policy to air grievances.

That great advancement in the sky

Of all respondents, whether by age, title, or location, 2 out of 5 said that the most important consideration in the advancement of their engineering career in the next five years revolves around “more interesting work.” One in four said that “more money” is the most important consideration, while another quarter of them said “promotions” were more important. The least listed consideration was “socially conscious work.”

Sounding board vs the suggestion box

What then is the general mood and attitude of electronic design engineers, according to our survey results?

For one thing, even though some younger EEs are admittedly bored with their work, most respondents are EEs because they like to build things. And even though their working conditions are often undesirable, the vast majority of them still don’t want anything to do with a union, mainly because it would stifle their incentive and degrade them as professionals. Those who are pro-union feel that their company should provide them with more training.

While most respondents feel they should be earning more salary, a surprisingly high percentage of them are satisfied with their pay.

Although the majority of responding engineers say they were “poorly trained,” the reason they most often give for switching jobs is that they were unchallenged by the work.

It may be that the respondents to this survey took advantage of it to register all the opinions and gripes they couldn’t air at work. If so, the survey is a sounding board that should be posted in electronics firms across the country where management, as well as other EEs, can read it. Who knows? It might even replace the suggestion box. ■■

Our thanks . . .

to those 550 engineers and engineering managers who took time out to complete our questionnaire. You have performed a nationwide service for EEs.

Guess the price of HP's new counter



Clues:

it averages time intervals to 10 picoseconds

it has a built-in 0.05% integrating DVM

it's dc to 50 MHz, CW or burst

its counter and DVM are easily programmable

Surprise: \$1550. That modest amount buys a Hewlett-Packard timer/counter that does things universal counters never did before. For example, it averages time intervals as short as 0.15 nanoseconds. So you can resolve to 10 picoseconds on repetitive signals.

That modest sum also buys a counter with a built-in integrating digital voltmeter. So it's the only counter that can measure internal trigger level settings or other inputs with DVM precision. Now you can measure 10 to 90% rise times, half power points and other voltage-dependent time intervals. That means unprecedented simplicity, for example, in propagation

delay measurements. The counter also features four integration times. As a DVM, it provides three voltage ranges, 60 dB noise rejection and 0.05% accuracy.

Even without these exclusive features, the 5326's are real bargains. They count to 50 MHz direct with seven-digit resolution (eight digits optional), measure period and multiple period average and scale input frequencies by any power of 10 up to 10^8 . They measure ratio and they totalize.

With programming and BCD output options, the 5326's fit easily into systems applications. Counter and DVM are DTL programmable through a common connector.

You can get all of these benefits in the 5326B for \$1550, or buy the same counter, less the DVM, in the 5326A for \$1195. Any way you look at the 5326 A or B—either is a great counter value. Your local field engineer has all the facts about HP's new IC counter line. Give him a call or write to Hewlett-Packard, Palo Alto, California 94304; Europe: 1217 Meyrin-Geneva, Switzerland.

HEWLETT  PACKARD

ELECTRONIC COUNTERS

IN 1963, WAVETEK

BEGAT

THE FIRST SOLID-STATE 1 MHz FUNCTION GENERATOR. IN 1964, WAVETEK

BEGAT

THE FIRST VOLTAGE CONTROLLED GENERATOR. IN 1965, WAVETEK

BEGAT

THE FIRST PROGRAMMABLE VOLTAGE CONTROLLED GENERATOR. IN 1966, WAVETEK

BEGAT

THE FIRST SWEEP/TRIGGER VCG. IN 1967, WAVETEK

BEGAT

THE FIRST PUSHBUTTON DIGITAL VCG. IN 1968, WAVETEK

BEGAT

THE FIRST 0.01 % PROGRAMMABLE WAVEFORM GENERATOR. IN 1969, WAVETEK

BEGAT

THE FIRST 2 MHz FUNCTION GENERATORS WITH OSCILLATOR SPECS AND PRICES.

AND, IN 1970, WAVETEK

BEGAT



THE MODEL 142—THE FIRST 10 MHz VOLTAGE CONTROLLED GENERATOR THAT IS ALSO AN OSCILLATOR, A PULSE GENERATOR, AND A SIGNAL GENERATOR THAT SELLS FOR ONLY \$595.

WAVETEK MARCHES ON!

P.O. Box 651, San Diego, Calif. 92112 (714) 279-2200 TWX 910-335-2007

INFORMATION RETRIEVAL NUMBER 59

Product Source Directory

Function Generators Squarewave Generators

This Product Source Directory covers Square-wave and Function Generators.

For each table the instruments are listed in ascending order of one major parameter. The column containing this is color-coded white.

The following abbreviations apply to all instruments listed:

ina—information not available

n/a—not applicable

req—request

Unless otherwise specified, the power requirements for the instruments are 105-125 Vac.

Manufacturers are identified by abbreviation. The complete name of each manufacturer can be found in the Master Cross Index below.

Abbrev.	Company	Function	Square-wave
Argonaut	Argonaut Associates Inc. P.O. Box K Beaverton, Ore. 97005 (503) 292-3149	451	452
Datapulse	Datapulse Div. Systron-Donner Corp. 10150 W. Jefferson Blvd. Culver City, Calif. 90230 (213) 836-6100	453	
EICO	Electronics Instrument Co., Inc. 283 Malta St. Brooklyn, N.Y. 11207 (212) 949-1100		454
EMR	EMR-Hatboro East County Line Road Hatboro, Pa. 19040 (215) 672-1240	455	
Exact	Exact Electronics Inc. 455 Southeast 2nd Ave. Hillsboro, Ore. 97123 (503) 648-6661	456	457
GR	General Radio Co. 22 Baker Ave. W. Concord, Mass. 01781 (617) 369-4400		458
Heath	Heath Co. Benton Harbor, Mich. 49022 (616) 983-3961		459
H-P	Hewlett-Packard Co. 1501 Page Mill Road Palo Alto, Calif. 94304 (415) 326-7000	Contact local sales office	Contact local sales office
IEC	Interstate Electronics Corp. Data Products Div. 707 E. Vermont Ave. Anaheim, Calif. 92803 (714) 772-2811	460	
Krohn-Hite	Krohn-Hite Corp. 580 Massachusetts Ave. Cambridge, Mass. 02139 (617) 491-3211	461	462

Abbrev.	Company	Function	Square-wave
Marconi	Marconi Instruments 111 Cedar Lane Englewood, N.J. 07631 (201) 567-0607		463
Measure	Measurements, McGraw-Edison P.O. Box 180 Boonton, N.J. 07005 (201) 334-2131		464
Microdot	Microdot Instruments 220 Pasadena Ave. S. Pasadena, Calif. 91053 (213) 682-3351	465	
Philips	Philips Electronic Instruments 750 S. Fulton Ave. Mount Vernon, N.Y. 10550 (914) 664-4500	466	
Radiometer	Radiometer The London Co. 811 Sharon Drive Westlake, Ohio 44145 (216) 871-8900		467
RCA	RCA Electronic Components & Devices 415 S. Fifth St. Harrison, N.J. 07029 (201) 485-3900		468
Servo	Servo Corp. of America 111 New South Road Hicksville, N.Y. 11802 (516) 938-9700	469	
Tektronix	Tektronix Inc. P.O. Box 500 Beaverton, Ore. 97005 (503) 644-0161	470	471
Varitron	Varitron Corp. P.O. Box 2594 St. Louis, Mo. 63114 (314) 231-9240	472	
Wavetek	Wavetek 9045 Balboa Ave. San Diego, Calif. 92123 (714) 279-2200	473	474

Manufacturer	Model	FREQUENCY				Function	OUTPUT				Misc. Features	Price \$
		Min. Hz	Max. kHz	Rise μ s	Fall μ s		Min. V	Max. V	Imp. Ω	Atten. dB		
Varitron	WBFG	0.02	0.2	0.3	0.3	a	1	3	600	n/a	a	126
EMR	1641	0.02	0.5	n/a	n/a	c	$\pm 10\mu$ V	± 10	1	n/a	cd	6385
Servo	1999	0.001	1	2	2	b	20	40	500	111		3575
Philips	PM5168	0.005	5	3	ina	b	ina	20	600	ina		550
Argonaut	LRG 051	0.01	10	1	1	square	0	10	100	n/a		275
						ramp	0	100	1000			
						pulse	0	10	100			
						del. pulse	0	10	100			
Tektronix	162	0.1	10	1	ina	pulse	50	n/a	1000	ina		165
						gate	50	n/a	1000			
						sawtooth	25	145	1000			
H-P	203A	0.005	60	0.2	0.2	j	0.3	30	600	40	j	1250
Krohn-Hite	4025	0.001	100	ina	ina	z	ina	10 rms	200/600	ina	z	1950
Krohn-Hite	4024	0.001	100	ina	ina	z	ina	10 rms	200/600	ina	z	1200
H-P	3300A/3301A	0.01	100	0.25	0.25	y	-40 dB	35 p-p	600	40	y	730
H-P	3300A/3302A	0.01	100	0.25	0.25	x	-40 dB	35 p-p	600	40	x	945
H-P	3300A/3304A	0.01	100	0.25	0.25	w	-40 dB	35 p-p	600	40	w	945
Krohn-Hite	4100	0.1	100	ina	ina	l	ina	10 rms	50	ina	l	550
H-P	3300A/3305A	0.1	100	0.25	0.25	u	0.03	24 p-p	600	40	uv	1675
Varitron	WBFG	20	200	0.3	0.3	a	1	3	600	n/a	a	96
Exact	505B	0.0001	1000	0.05	0.05	g	0	28	600	40	gi	645
Exact	5000	0.0001	1000	0.05	0.05	g	0	28	600	40	gh	500-1200
Exact	502	0.0001	1000	0.05	0.05	e	0	10	600	40	e	385
Exact	503B	0.0001	1000	0.05	0.05	e	0	28	600	40	ei	545
Exact	504B	0.0001	1000	0.05	0.05	g	0	28	600	40	gi	565
Exact	500B	0.0001	1000	0.05	0.05	e	0	28	600	40	e	495
Wavetek	116	0.0015	1000	0.01	0.01	u	1	30	50	40	pu	845
Wavetek	115	0.0015	1000	0.01	0.01	u	1	30	50	40	mu	745
Wavetek	111	0.0015	1000	0.01	0.01	u	1	30	50	40	u	545
Wavetek	112	0.0015	1000	0.01	0.01	u	1	30	50	40	trigger	695
Wavetek	114	0.0015	1000	0.01	0.01	s	1	30	50	40	s	795
Wavetek	113	0.001	1000	0.01	0.01	u	0.01	30	50	50	pushbutton	595
Wavetek	110	0.005	1000	0.01	0.01	b	1	30	50	40	6 outputs	445
Microdot	F280A	0.01	1100	0.01	0.01	q	0.01	11 p-p	50	yes	qkr	1545
Microdot	F270A	0.01	1100	0.01	0.01	q	0.01	11 p-p	50	yes	qr	1445
Datapulse	410	0.0002	2000	50	50	a	0.004	40	50/600	40	a	995
Datapulse	401	0.02	2000	40	40	b	0.002	0.02	50/600	40	b	395
Wavetek	130	0.2	2000	0.1	0.1	b	0.01	20	50	40	b	295
Wavetek	131	0.2	2000	0.1	0.1	b	0.01	20	50	40	b	395
Wavetek	134	0.2	2000	0.1	0.1	u	0.01	20	50	40	u	495
Wavetek	135	0.2	2000	0.1	0.1	u	0.01	20	50	40	u	695
Wavetek	136	0.2	2000	0.1	0.1	b	0.0001	20	50	80	b	595
Microdot	F220A	0.005	3000	0.01	0.01	e	n/a	16.25	50/600	yes	ekp	1085
Microdot	F210B	0.005	3000	0.01	0.01	n	n/a	16.25	50/600	yes	nk	785
Microdot	F240A	0.005	3000	0.01	0.01	e	n/a	16.25	50/600	yes	ekm	1105
Microdot	F230B	0.005	3000	0.01	0.01	e	n/a	16.25	50/600	yes	ek	1095
Exact	120	0.1	3000	0.06	0.06	b	0.01	10	50	60	b	295
Exact	123	0.1	3000	0.06	0.06	b	0.01	10	50	60	b	345
Exact	126	0.1	3000	0.06	0.06	e	0.01	10	50	60	ef	495
H-P	3310A	0.0005	5000	0.03	0.03	s	0.03	24 p-p	50	60	st	595
Exact	100	0.001	5000	0.05	0.05	e	0.01	15	50	70	e	445
IEC	F55	0.0005	10000	0.03	0.03	a1	n/a	15	50	yes	a1, a5	1195
IEC	F54	0.0005	10000	0.03	0.03	a1	n/a	15	50	yes	a1, a4	1085
IEC	F53	0.0005	10000	0.03	0.03	a1	n/a	15	50	yes	a1, a3	895
IEC	F52	0.0005	10000	0.03	0.03	a1	n/a	15	50	yes	a1, a2	795
IEC	F51	0.0005	10000	0.03	0.03	a1	n/a	15	50	n/a	a1	595
Wavetek	144	0.001	10000	0.02	0.02	u	0.0001	30	50	80	pu	895
Wavetek	142	0.001	10000	0.02	0.02	u	0.0001	30	50	80	u	595
Tektronix	R116	99.9	10000	0.01-110	0.01-110	a	± 0.02	± 10	50	ina	a	1825
Tektronix	115	100	10000	0.01-100	0.01-100	a	0.02	± 10	50	ina	a	865
Tektronix	284	100k 100M 100k	10000 1 GHz 10000	70×10^{-6}	ina	pulse sine square	0.01 0.1 0.01	1 0.1 1	50 50 50	ina		555

- a. Functions, sine, square, triangle, pulse, sine squared, sawtooth.
- b. Functions, sine, square, triangle.
- c. True arbitrary.
- d. Paper tape programming.
- e. Functions, sine, square, triangle, ramp, pulse, burst.
- f. Internal sweep, dc offset. Pulse variable in width and repetition rate. Gating and triggering.
- g. Functions, sine, square, triangle, ramp, pulse, haversine, haversine, half sine.
- h. Modular construction, price varies with requirement.
- i. VCF 50:1. Gating & triggering. Dc offset. Three output amplifiers.
- j. Functions, sine, square, phase shifted sine and square.
- k. VCF 100:1. Gating & triggering, dc offset, phase shift.
- l. Functions, sine, square pulse. Model 4130 at \$1295, programmable.
- m. Phase lock generator.
- n. Functions, sine, square, triangle, ramp, pulse.

- a. Programmable pulse-paired, burst, gated, delayed & undelayed generator.
- p. Triggered tone burst generator.
- q. Functions, sine, square, triangle, sine squared.
- r. All functions programmable.
- s. Functions, sine, squared, triangle, \pm pulse, \pm ramp.
- t. Programmable frequency within one range. Sync output and dc offset included.
- u. Functions, sine, square, triangle, ramp.
- v. Type 3305A, sweeper plug-in at \$975 included. 0-4 decades log sweep in any one range.
- w. Functions, sine, square, triangle, sawtooth. Type 3304A, sweep/offset plug-in at \$285 included. Programmable frequency within one range. Sync pulse output, dc offset included.
- x. Type 3302A trigger/phase lock plug-in at \$245 included. Programmable single period, multiple period, phase lock &

(continued on pg. 106)

Datapulse is making waves.

Big or little, one channel or two, FM or AM, square, triangular, sine or swept, the new family of Datapulse function generators makes better waves. What's more, we've put a couple of new ideas to work in the design so that you get more  for your \$\$\$.

The little beauty on top, the Datapulse Model 401, sells for only \$395 and gives you a dial accuracy of one percent (that's about twice as good as the competition). Frequency is 0.02 Hz to 2 MHz, and sine distortion is only 0.25 percent in the audio range. Square-wave rise time is a

fast 40 nanoseconds. To handle low levels, we give you 80 db dynamic amplitude range.

You can field calibrate the 401 with a screwdriver, and we give you a calibrated 1V p-p square wave out for scope work. A switchable 40 db attenuator and your choice of 50 or 600 ohms output impedance further simplifies your life. You get 1000:1 voltage control, too.

The other unit, the one with all the buttons, bells and whistles, is the elegant and sophisticated Model 410. It takes up where the 401 leaves off.

Frequency is 0.0002 Hz to 2 MHz. Dial accuracy is 1%. Uniquely among function generators, the 410 allows you to both AM and FM outputs for an extra dimension in wave generation. A built-in triggerable sweep generator gives complete flexibility using either or both of the independently controllable 40V p-p output channels to generate sine, square, triangle, sawtooth, and swept waves. Price is a modest \$995.

To arrange a demonstration or obtain more data, contact your local S-D man. Or address Datapulse Division, Systron-Donner Corporation, 10150 W. Jefferson Blvd., Culver City, California 90230. Phone (213) 836-6100.



DATAPULSE
DIVISION

SYSTRON  DONNER

Manufacturer	Model	FREQUENCY				OUTPUT				Misc. Features	Price \$
		Min. Hz	Max. kHz	Rise μ s	Fall μ s	Min. V	Max. V	Imp. Ω	Atten. dB		
Argonaut	SRS020	0.1	10	0.5	0.5	0.01	150	a	n/a	a	225
EICO	377	60	30	ina	ina	10	10	1000	n/a		60
GR	1313-A	10	50	0.1	ina	n/a	5 p-p	60	0-20	c	350
Heath	IG-18	5	100	0.05	0.05	0	10	52	-62 to +22	g	99
Measure	71	6	100	0.2	0.1	0	75	var	s	s	290
GR	1309-A	10	100	0.1	ina	n/a	5 p-p	600	0-20	c	375
RCA	WA-504A	0.02	200	1	1	n/a	10	ina	n/a	b	95
RCA	WA-44C	0.02	200	ina	ina	n/a	8	100k	n/a		99
EICO	379	20	200	0.1	ina	0	10	ina	n/a	b	95
GR	1210-C	20	500	0.35	ina	0	30 p-p	2.5k	ina	c	255
Exact	500B	0.0001	1000	0.05	0.05	0	28	600	40	ef	495
Krohn-Hite	4100	0.01	1000	ina	ina	ina	10 rms	50	s	s	550
Marconi	2103	10	1000	30	30	0.25	2.5	600	ina	t	135
Tektronix	106	10	1000	0.012	ina	0.5	12.5	ina	ina	x	665
Radiometer	RC011	10	1000	0.05	0.05	0	1	50/600	u	bu	633
Heath	EUW-27	20	1000	0.15	ina	0.1	10	52	n/a	c	100
Tektronix	114	100	1000	0.01	0.01	1	10	50	ina	v	340
Wavetek	130	0.2	2000	0.1	0.1	0.1	20	50	40		295
H-P	209A	4	2000	0.05	0.05	-20 dB	20 p-p	600	26	ch	345
Exact	120	0.1	3000	0.06	0.06	0.01	10	50	60		295
Exact	123	0.1	3000	0.06	0.06	0.01	10	50	60	d	345
Measure	72	5	5000	0.05	0.05	0	12	75/500	s	s	360
Wavetek	142	0.0001	10000	0.02	0.02	0.0001	30	50	80		595
H-P	8005A	0.3	10000	10ns-2s	10ns-2s	0.02	5	50	p	pq	1100
H-P	8003A	0.3	10000	0.005	0.005	0.05	5	50	p	p	470
H-P	8002A	0.3	10000	10ns-2s	10ns-2s	0.05	5	50	p	p	700
H-P	8010A	1	10000	12ns-1s	12ns-1s	0.02	5	50	p	pr	1925
H-P	221A	1	10000	0.015	0.015	0	5	50	j	j	225
H-P	220A	1	10000	0.015	0.015	0	-5	50	i	j	225
H-P	211B	1	10000	0.005	0.005	0.02	5	50	i	i	450
Microdot	F324A	10	10000	0.01	0.01	100 μ V	6.32 p-p	50/600	yes	bz	660
Marconi	1370A	10	10000	0.4	0.4	0.001	73.2 p-p	75-100	-50	c	935
Microdot	F323A	10	10000	0.01	0.01	100 μ V	6.32 p-p	50/600	yes	by	795
H-P	222A	100	10000	0.004	0.004	0.05	10	50	k	k	690
H-P	1900A/1905A/1915A	25	25000	7ns-1ms	7ns-1ms	\pm 1.25	\pm 25	50	n	n	2570
Tektronix	2101	2.5	25000	0.005	0.005	0.5	10	50		w	req
H-P	1901A/1905A/1917A	25	25000	10ns-40ms	10ns-40ms	0.2	10	50	m	m	1195

- a. 50mA maximum current.
- b. Solid State.
- c. Also Sine wave output.
- d. Programmable dc.
- e. Three outputs.
- f. Dc offset.
- g. Output impedance on 0.1V & 1V range, 220 Ω on 10V range.
- h. Programmable sync.
- i. Also 600 Ω unit, 1 Hz-1000 kHz, 70 ns rise & fall time, 0.3-30V output. Attenuator calibrated in volts, 7 steps in 1, 2.5, 5 sequence with vernier.
- j. Remote frequency programming. Attenuation calibrated in volts.
- k. Pulse generator that may be operated as squarewave generator. Attenuation calibrated in volts, 7 steps from 0.1-10V in 1, 2, 5 sequence.
- m. Plug-in pulse generator operated as squarewave generator, programming is optional. Attenuation calibrated in volts, 5 steps. Price includes one blank plug-in.
- n. Plug-in pulse generator operated as squarewave generator, programming is optional. Attenuation calibrated in volts, \pm 2.5 to \pm 50V high Z source and \pm 1.25 to \pm 50V, 50 Ω source.
- p. Pulse generator operated as squarewave generator. Attenuation calibrated in volts, 7 steps in 1, 2.5, 5 sequence with vernier.
- q. Simultaneous + and - outputs.
- r. Two independent channels. Outputs may be combined.
- s. Attenuation calibrated in volts.
- t. Battery or line operated.
- u. Attenuation calibrated in volts, 4 steps, 1, 10, 100mV, 1V.
- v. Continuously variable pulse width period & variable amplitude.
- w. Continuously variable period, duration, delay, amplitude and baseline offset.
- x. \pm fast rise or high amplitude, sync input or trigger output.
- y. Expanded scale. Conversion from rms to p-p available.
- z. Expanded scale.

(continued from pg. 104)

- reference frequency. Sync pulse output included. Functions, sine, square, triangle (2 outputs).
- y. Functions, sine, square, triangle (2 outputs). Type 3301A plug-in at \$30 included. Programmable frequency within one range. Sync output included.
- z. Functions, sine, square, pulse. Model 4024 frequency accuracy 0.5%, model 4025, 0.1% accuracy.

- a1. Functions, sine, square, \pm ramp, triangle, \pm pulse, variable width pulse.
- a2. Gate & triggering included.
- a3. Gate, triggering and phase lock included.
- a4. Gate, triggering and sweep included.
- a5. Gate, triggering, phase lock and sweep included.

Let's face it: We won't knock them out of the ring tomorrow. But Microdot is hereby announcing its entry into the general instrument market. With a full line of solid state waveform generators and test oscillators. So, while the guys at H-P are still yawning with surprise, here are some facts for your consideration.

There are five models in each series. The waveforms cover a frequency spectrum of .005 Hz to 3 MHz. They offer a wide variety of output signals: sine, square, triangle, ramp and sync pulse. Their versatility is evident in one model which offers you six instruments in one: function generator, VCO, sweep generator, sawtooth generator, pulse generator and tone burst generator. Other models provide full digital programming capability that is compatible with system interfaces using standard TTL and DTL positive logic.

The five test oscillators cover a frequency range

from 10 Hz to 10 MHz. Each instrument includes an output signal level monitor, and amplitude is controlled by precision step attenuation.

When Microdot takes on a giant of the instrument business, we don't fool around. These instruments are now in the hands of good reps all across the country, and inventory is available for immediate delivery.

So write. Or give us a call.

We'll offer you complete literature, a demonstration if desired — and, of course, a pair of miniature boxing gloves inscribed with our motto (which might be yours someday): "Sock it to the fat cats." After all, if we're going to get into a fight against these kinds of odds, we need all the friends we can get.



MICRODOT INC. / INSTRUMENTATION
DIVISION

220 Pasadena Ave., South Pasadena, Calif. 91030

Here we were, busily competing with Amphenol on connectors,
Belden on cable products, SPS and Esna on fasteners and
Philco-Ford on RF instrumentation—

and now some wise guy decides to take on Hewlett-Packard.



INFORMATION RETRIEVAL NUMBER 61

Integrated op-amp pulse circuit has 18-second time constant

New-generation low-input current-integrated operational amplifiers lend themselves readily to long-time constant pulse circuits. In the following example, a monostable multivibrator with an 18-second time constant is achieved with a minimum of components, cost and complexity.

To understand circuit operation (Fig. 1), assume the output to be in its quiescent state at the positive saturation level of the LM 107. In that case, the noninverting terminal is at approximately $(V_{sat})(R_3)/(R_2+R_3)$. The inverting terminal is at $V_D (\approx 0.56 \text{ V at room temperature})$.

If a negative spike greater than $[(R_3V_{sat})/(R_2+R_3)] + V_D$ is brought to the noninverting terminal, the amplifier output will reverse states at the slewing rate of the amplifier ($\approx 0.34 \text{ V}/\mu\text{s}$). After this has occurred, the capacitor C_1 will charge through R_1 until the voltage across C_1 is greater than $(-V_{sat})(R_3)/(R_2+R_3)$. At this point the amplifier, acting as a comparator, will return itself to the quiescent state.

However, as shown in Fig. 2, the one problem with this basic circuit is that the reset time is as long as the output pulse. To remedy this, it is

necessary only to add a diode and resistor in the feedback loop (D_2, R_4) in such a direction that the reset time constant is shortened as shown in Fig. 1 where

$$\text{pulse duration} = R_1 C_1 \ln \left(\frac{R_2}{R_2 + R_3} - \frac{V_D}{V_{sat}} \right),$$

assuming that $V_{sat} = -V_{sat}$.

Choose:

- $R_4 \ll R_1$.
- $(V_{sat}R_3)/(R_2+R_3) \gg V_D$ (to minimize effects of V_D changes with temperature).
- $(V_{sat}R_3)/(R_2+R_3) \ll V_{sat}$ (to minimize effects of V_{sat} changes with temperature).

$$\text{Reset time} = R_1 C_1 \ln \left(\frac{R_2}{R_2 + R_3} - \frac{V_D}{V_{sat}} \right)$$

Note that ion-implantation diodes have a lower forward breakdown and a better temperature coefficient than standard silicon junction diodes, and that they result in an even more stable output over temperature.

Peter Berg, Group Supervisor, Dalmo Victor Co., Belmont, Calif.

VOTE FOR 311

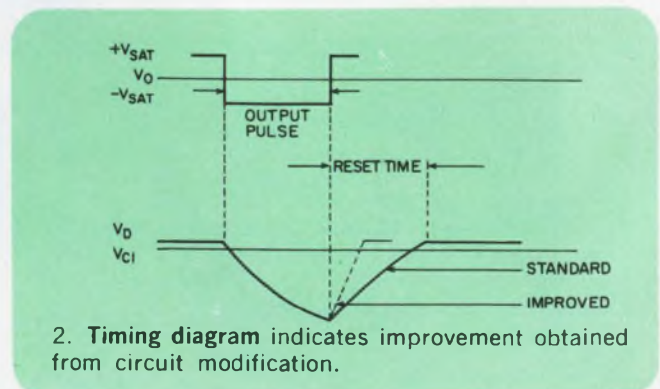
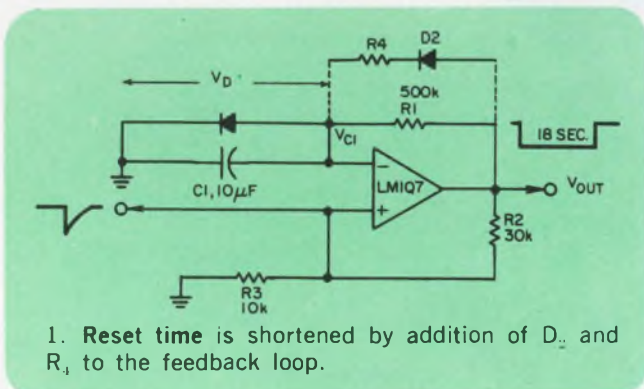

There isn't another like it. A 1/4-inch, single-pole, six position, 28-vdc. Helipot switch for PC boards.

Beckman® INSTRUMENTS, INC.

HELIPOT DIVISION

Fullerton, California 92634

INTERNATIONAL SUBSIDIARIES: AMSTERDAM; CAPE TOWN;
GENEVA; GLENROTHES, SCOTLAND; LONDON; MEXICO CITY;
MUNICH; PARIS; STOCKHOLM; TOKYO; VIENNA



Model 374H \$3.00 (1-9 pieces)

Model 374 \$2.75 (1-9 pieces)

Monolithic circuits provide inexpensive dual regulation

For powering analog circuits, such as op amps, both positive and negative voltages are usually needed. A low-cost approach to the problem of providing dual, regulated voltages is shown in the circuit diagram.

The heart of this design is a low-priced monolithic operational amplifier connected in a unity gain, inverting configuration. The monolithic voltage regulator provides the reference voltage, and the op amp provides negative current.

Because of the circuit arrangement, both output voltages— e_{o1} and e_{o2} —can be controlled by the one regulator. The negative output stability will be dependent upon the positive output stability. This is acceptable because most operational amplifiers that could be powered from this circuit are insensitive to common-mode voltage changes.

The input-output voltage drop is 5 V and the maximum available current is about 25 mA. These two figures indicate a safe margin on power dissipation at maximum load current.

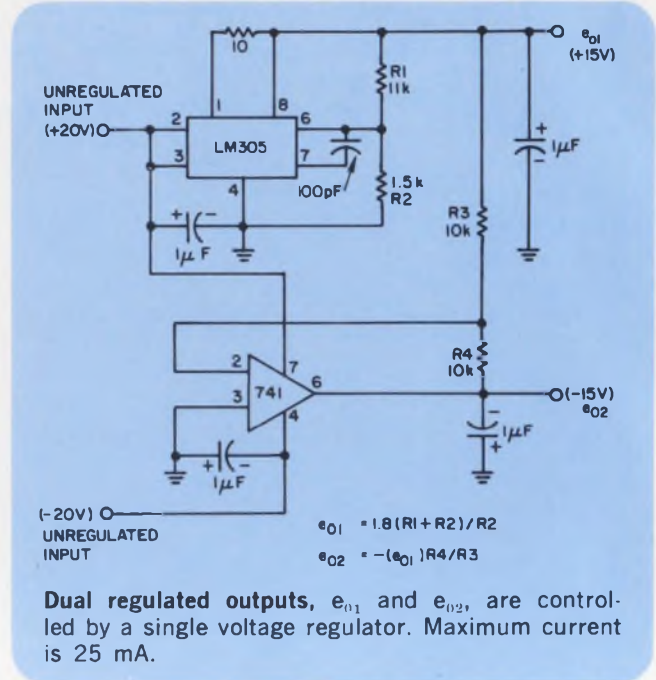

Richard C. Gerdes, President, Optical Electronics, Inc., Tucson, Ariz.

VOTE FOR 312

Low-voltage shunt regulator can power tunnel diodes

A simple circuit that has only three components can provide a low-voltage (0.3-V), low-impedance (0.3 Ω) power supply with a temperature coefficient on the order of 0.1%/°C.

A high-gain general-purpose silicon npn transistor is used in a basic shunt mode, with a forward-biased germanium diode in series with its collector. As shown in Fig. 1 the output voltage V_o is initially the difference between the conduction potentials of the silicon base-emitter voltage (0.6 V) and the germanium-diode drop (0.3 V). The collector-to-emitter saturation voltage of Q_1 must be less than the difference.

It is more convenient, in practice, for improved thermal tracking of the two junctions to employ a diode-connected pnp germanium transistor, Q_2 , rather than a germanium diode. With both transistors in TO-18 cans, and collectors to case, a small heat sink maintains good thermal contact.

Base-emitter voltage of Q_1 decreases by about 2.3 mV/°C, tending to reduce V_o ; but the base-emitter voltage of Q_2 decreases by approximately the same extent and opposes the change in V_o caused by Q_1 . Since the temperature dependent term is a function of junction current, the tem-

perature stability varies with load R_L .

The shunt configuration gives an inherently low output impedance, as shown in Fig. 2, with $R_L = \infty$, $R_1 = 1$ k Ω and $R_L = 220$ Ω , over a range of input voltages. The slope change from negative to positive output impedance is due to the finite current gain of Q_1 . With Q_1 and Q_2 in a

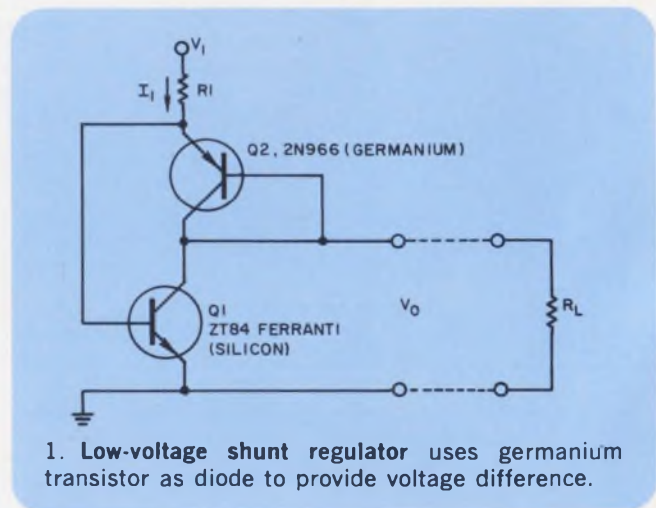

RCA-TA7487 is new.

It offers 2 W with 10 dB gain (min.)
at 2 GHz for solid-state microwave designs.

RCA-TA7487 is a ceramic-metal coaxial unit.

It can do a big job for engineers
designing to achieve minimal space without
sacrificing solid-state power and
performance at UHF/microwave frequencies.

By the nature of its package, TA7487 features
low parasitic capacitances and inductances.

This introduces stability into your designs
for point-to-point microwave relay links,
S-band telemetry, distance measuring equipment,
and collision avoidance systems.

Here's a suggestion:

Use TA7487 as a driver for RCA-TA7205—
another RCA "overlay" transistor
in the industry's champion RF power line.

Ask your local RCA Representative
about TA7487 and other "overlay" units.

For technical data, write:

RCA Electronic Components,
Commercial Engineering,* Harrison, N. J. 07029.
In Europe: RCA International Marketing S.A.,
2-4 rue du Lièvre, 1227 Geneva, Switzerland.

RCA



The Collision-Avoidance Transistor

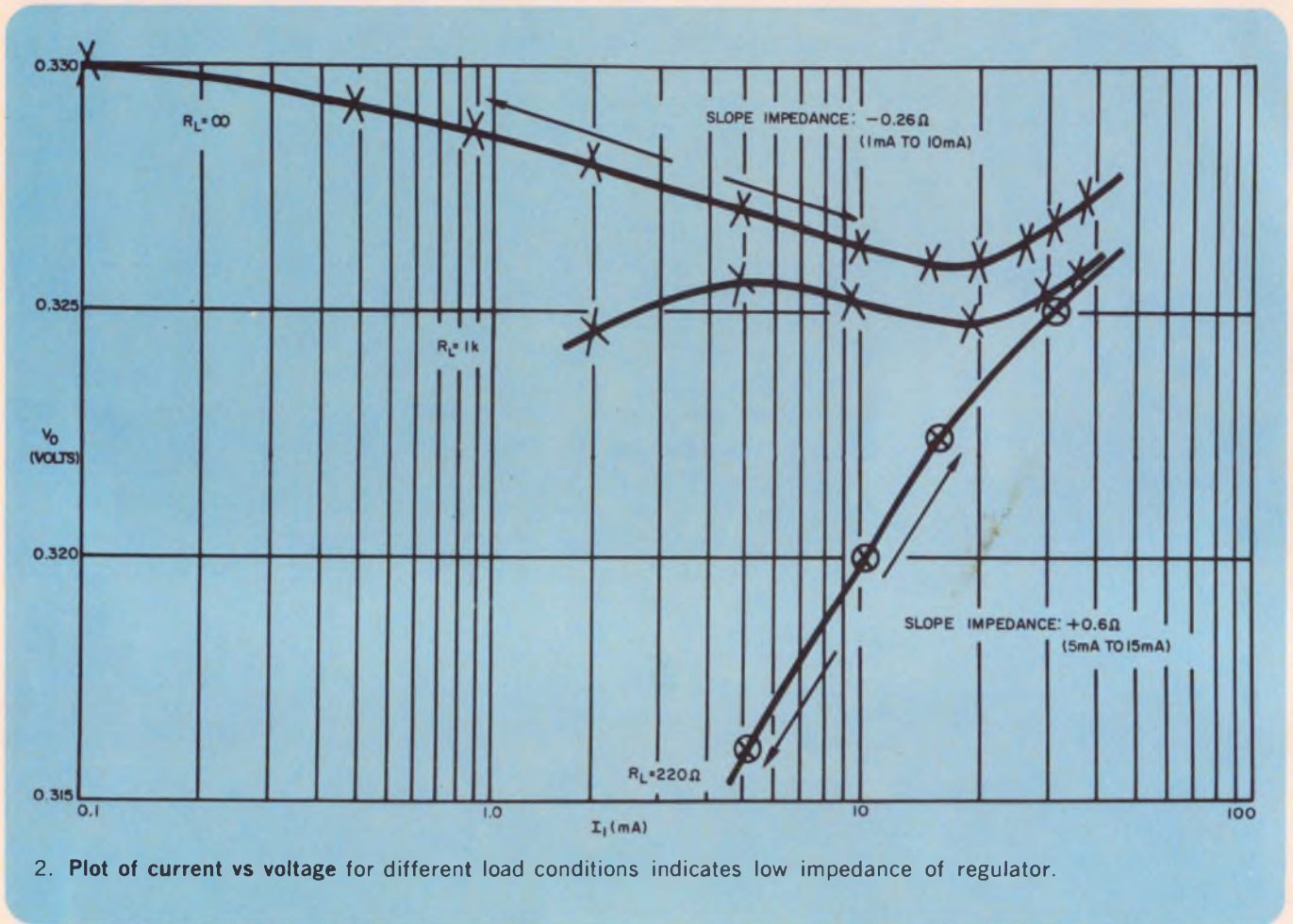

common heat sink and no load, $V_o = 0.326$ V at 25°C and 0.310 V at 75°C , corresponding to 0.32 mV/ $^\circ\text{C}$ change. For $R_L = 220 \Omega$, $V_o = 0.313$ at 25°C and 0.290 V at 75°C , equivalent to 0.42 mV/ $^\circ\text{C}$.

The supply was designed for powering a gallium-arsenide tunnel-diode oscillator where 0.3 V

crosses the negative resistance region. With suitable choice of Q_1 and Q_2 it is also useful as a low-voltage stable reference derived from a widely varying input voltage.

John M. Morrison, Design Engineer, Ferranti, Ltd, Edinburgh, Scotland.

VOTE FOR 313

High-frequency VCO uses TTL gates

One of the problems encountered when constructing high-frequency astable multivibrators from cross-coupled transistors is the shunt capacitance, C_{hp} , of each transistor. This capacitance sets an upper frequency limit on the multivibrator. The input circuit of a TTL gate presents only a small shunt capacitance to the circuit.

The circuit shown utilizes two TTL NAND gates, two capacitors and six resistors to form a voltage-controlled oscillator (VCO). With the

indicated component values and V_{in} at 0 V, the frequency of oscillation is approximately 7 MHz.

The gates are biased at their turnover points (typically $1.4 - 2$ V) by the voltage divider networks R_1 , R_2 and R_3 , R_4 . These networks, together with C_1 and C_2 define the basic operating frequency. The gates are protected from negative-going input pulses by diodes D_1 and D_2 .

R_5 and R_6 provide the input connections for the oscillator control voltage V_{in} . The frequency may be adjusted $\pm 10\%$ by varying V_{in} between

THREE NEW OP AMPS YOU HELPED DESIGN



AVAILABLE FROM STOCK

These new amplifiers represent three of the best design alternatives emerging from today's technology. They have been created as a result of literally thousands of contacts between you, the op amp user, and Analog Devices' applications engineers. Each is designed to maximize *user value...* that is, the best possible performance at the lowest possible cost.

LOW COST FET

\$12 Unit Quantities

At just \$12. in unit quantities, the **Model 40** becomes the FET input op amp recommended in nearly all general purpose applications where high input impedance and low bias current are required. Two versions are offered which differ only in initial offset voltage, input bias and difference current, and price. The encapsulated module measures 1" x 1" x 0.5".

CHOPPERLESS DIFFERENTIAL

0.25 μ V/ $^{\circ}$ C

Newest in a series of low drift chopperless differential op amps, the **Model 184** gives chopper-stabilized-like performance with the application flexibility of differential inputs, coupled with low cost. The 184 is recommended for an extremely wide variety of high performance applications and promises to become the industry standard for low drift requirements. Three versions are available, differing principally in drift characteristics and cost. Package size is 1.5" x 1.5" x 0.4".

FAST SETTLING FET

0.6 μ s to 0.01%

Settling time of just 0.6 μ sec to 0.01% accuracy makes the new **Model 45** applicable to many high speed/fast settling requirements such as A/D and D/A converters, pulse height amplifiers, etc. Input parameters are characteristic of FET differential input amplifiers. Two versions are available with differing offset and drift specifications. Package size is 1.12" x 1.12" x 0.4".

SPECIFICATIONS	MODEL 40 J K	MODEL 184 J K L	MODEL 45 J K
OPEN LOOP GAIN	5 x 10 ⁴	3 x 10 ⁵	10 ⁵
RATED OUTPUT, min	±10V @ 5mA	±10V @ 5mA	±10V @ 20mA
FREQUENCY RESPONSE			
Unity gain, small signal	4MHz	500kHz	10MHz
Full power response, min	100kHz	5kHz	1MHz
Slew rate, min	6V/ μ sec	0.3V/ μ sec	75V/ μ sec
INPUT OFFSET VOLTAGE @ 25 $^{\circ}$ C, max, μ V	Adj to 0	±250 ±100 ±100	Adj to 0
Average vs. temp 10 to 60 $^{\circ}$ C, max, μ V/ $^{\circ}$ C	±50 ±20	±1.5 ±0.5 ±0.25	±50 ±15
INPUT BIAS CURRENT @ 25 $^{\circ}$ C, max	-50pA -20pA	(0,+) 25nA	-50pA -25pA
Average vs. temp 10 to 60 $^{\circ}$ C, max, nA/ $^{\circ}$ C	doubles every 10 $^{\circ}$ C	-0.25	doubles every 10 $^{\circ}$ C
INPUT DIFFERENCE CURRENT @ 25 $^{\circ}$ C	±25pA ±10pA	±2nA	±25pA ±10pA
Average vs. temp 10 to 60 $^{\circ}$ C, nA/ $^{\circ}$ C	doubles every 10 $^{\circ}$ C	±.02	doubles every 10 $^{\circ}$ C
INPUT IMPEDANCE			
Differential	10 ¹¹ Ω 3.5pF	4M Ω	10 ¹¹ Ω 3.5pF
Common mode	10 ¹¹ Ω 3.5pF	1000M Ω	10 ¹¹ Ω 3.5pF
PRICE			
1 - 9	\$12. \$19.50	\$45. \$60. \$75.	\$38. \$48.
10 - 24	\$11.80 \$18.70	\$43. \$57. \$71.	\$36 \$46.

ANALOG DEVICES, INC. • 221 FIFTH STREET • CAMBRIDGE, MASSACHUSETTS 02142 • TEL: 617/492-6000

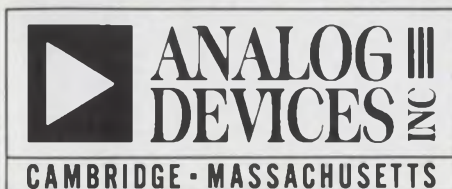

Data on these three amplifiers is contained in a new brochure featuring pre-selected Analog Devices' op amps. The amplifiers outlined in this short form catalog are those recommended for about 85% of the requirements evaluated by Analog Devices' applications engineering department. Available without charge on request.

+5 V and -5 V.

The basic operating frequency may be increased by using smaller values of C_1 and C_2 . By reducing the value of R_5 and R_{in} , the frequency control range may be extended.

The inverting gates are optional, but they provide improved wave shape, and buffer the output from external clock loads.

A. C. Burley, A. V. Aellen, Senior Engineers, Hawker Siddeley Dynamics Ltd., Hertfordshire, England.

VOTE FOR 314

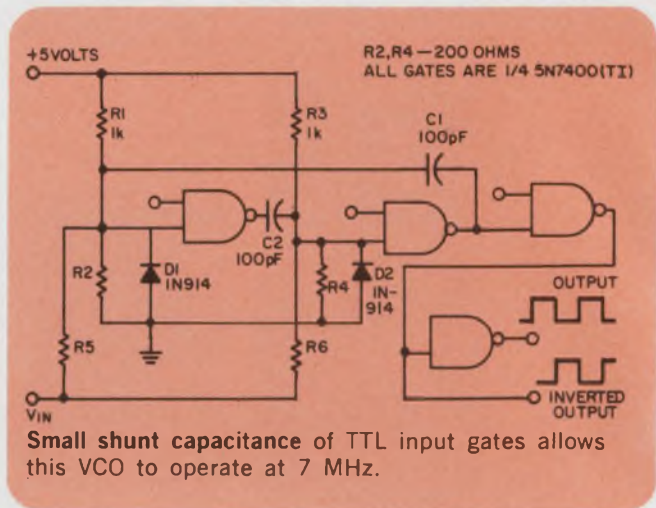

Noise generator simulates radar return-signal 'grass'

Radar return-signal "grass" can be simulated in test setups by the following random-noise generator that operates in the range of 100 kHz to 8 MHz.

The circuit and its output signal are shown in the figure. The design uses one Motorola MC-

1836P hex inverter package that contains three circuits in each of two networks. A variable resistor and fixed capacitor in parallel connection control the network frequency. Each network is adjusted to a different frequency, and the coupling capacitors, C_1 and C_2 , provide interaction between the two circuits. The result is a random noise output signal.

Potentiometers P_1 and P_2 are used to produce various "colors" of noise. P_3 varies the output from 0 to 3.0 V peak to peak. Potentiometers are Spectro model 153-1. The capacitor C_3 is used to couple the noise into a video output amplifier. Fixed resistors could replace the variable potentiometers if only one output level is desired.

Donald D. Lacy, Member of Technical Staff, Logicon, Inc., San Diego, Calif.

VOTE FOR 315

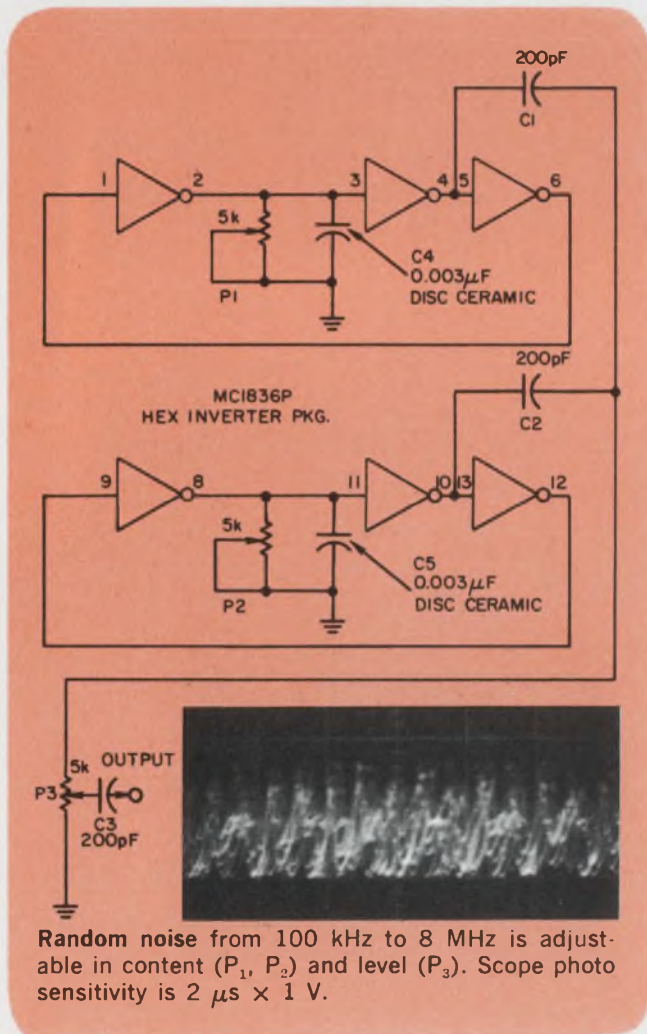

VOTE! Go through all Idea-for-Design entries, select the best, and circle the appropriate number on the Reader-Service-Card.

SEND US YOUR IDEAS FOR DESIGN. You may win a grand total of \$1050 (cash)! Here's how. Submit your IFD describing a new or important circuit or design technique, the clever use of a new component or test equipment, packaging tips, cost-saving ideas to our Ideas-for-Design editor. You will receive \$20 for each accepted idea, \$30 more if it is voted best-of-issue by our readers. The best-of-issue winners become eligible for the Idea Of the Year award of \$1000.

IFD Winner for February 1, 1970
 George S. Oshiro, Design Engineer, Teledyne Systems, Los Angeles, Calif. His Idea "EXCLUSIVE-OR Gates Replace Choppers in Phase-Lock Loop" has been voted the Most Valuable of Issue award.
Vote for the Best Idea in this Issue.



Rugged Reliability is only one great feature of the new SPC-16 computer for your industrial automation

SPC-16 also performs like two computers in one... hardware features accommodate real-time dedicated control in the foreground, while performing background batch processing.

SPC-16 blends an unmatched combination of fast response time and powerful computing capability with fail safe features and rugged industrial reliability.

And more importantly, SPC-16 can increase your productivity and profits with a minimum initial investment... with fast pay back.

Ask about the reliability of SPC-16 today... it's backed by a full range of software packages, technical services and maintenance support.

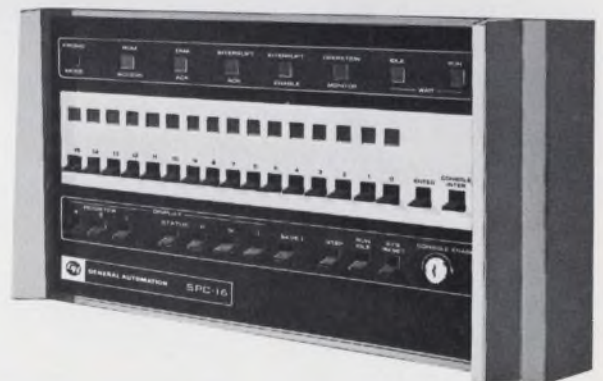

Ask about other automation computers in the GA family. The SPC-12 for less than \$5000. System 18/30 for under \$20,000.



GENERAL AUTOMATION, INC.
1402 East Chestnut, Santa Ana, California 92701
(714) 835-4804 TWX (910) 595-1780

CALIFORNIA
Los Altos, (415) 941-5966
Orange, (714) 633-0680

TEXAS
Dallas, (214) 358-0271
Houston, (713) 774-8716

ILLINOIS
Des Plaines, (312) 298-4650
(California G.A. Corp.)

OHIO
Cleveland, (216) 351-2275

GEORGIA
Atlanta, (404) 261-6203

PENNSYLVANIA
King of Prussia, (215) 265-6525

MARYLAND
Silver Spring, (301) 587-7090

CONNECTICUT
Stamford, (203) 325-3883

MASSACHUSETTS
Waltham, (617) 899-6170

INTERNATIONAL
BELGIUM
G.A.I. 24 Blvd. de l'Empereur
Brussels, 13 78 03

ENGLAND
G.A. Ltd. Wren House
Portsmouth Road, Esher, Surrey
Esher 65764

GERMANY
ERA Elektronische Rechenanlagen
51 Aachen, Postfach 465
Werk. Verlautenheide
Lindenweg 23
02405-4444

G.A. GmbH
6200 Wiesbaden
Frauenlobstr. 9
06121-83073

Hart- Advance Versatility



**Smallest Enclosed Power Relay Available
25 Amp, 250 Volt, 2 Circuit**

U/L and CSA RECOGNIZED—Only 1½ sq. in. x 1⅞" high, ideal for single and two phase switching. Features AMP quick connect terminals with companion U/L recognized socket available. Many, exclusive patented features.

HEAVY DUTY and RUGGED—W Series relays are DPST general purpose relays with 25 amp contact ratings, able to handle 1 and 2 HP motor loads easily.

MOUNT UP!—Optional mounting...choice of panel, side or socket.

APPLICATIONS—For appliances, automation equipment, motor starting, vending machines and panel boards.

For full details, write today for the General Catalog.



HART-ADVANCE RELAY DIVISION
OAK ELECTRO/NETICS CORP • CRYSTAL LAKE, ILL 60014
PHONE: 815-459-5000 TWX: 910-634-3353

INFORMATION RETRIEVAL NUMBER 66



KEPCO TALKS POWER SUPPLY TECHNOLOGY:

HOW TO TEACH AN ANALOG VOLTAGE, DIGITAL TRICKS

The output of a power supply is an infinite continuum of possible settings limited only by the resolution of the control and your steadiness of hand. To subject such an analog continuum to digital control requires that we divide it into digits of information which can be machine-processed (as opposed to your personal tweaking of a control). The digits must be timed and sequenced correctly—stored if necessary—and then used to select command levels for a programmable power supply.

The device to do all this may take one of several forms. It may be a low level D/A employing semiconductor switching with some sort of capacitive or transformer signal isolation—or it might be a high level D/A, operating at the output voltage level, using mechanical means to switch fixed control resistors.

The first method obtains speed at the expense of resolution and stability. The best semiconductor switches exhibit relatively large "on" resistances and a distinctly noninfinite "off" resistance. Moreover, at low levels, noise limits the resolution. Typically, this type of D/A produces a small (under 10V) analog output that must be amplified in a linear manner by the power supply that it controls, noise and all.

Kepeco has chosen the second method. Cycle times don't break any speed records but are in line with the speed of the fastest programmable power supplies. We use reed relays arranged in decades of four each, controlling precision, wirewound, low TC resistors scaled 8-4-2-1.

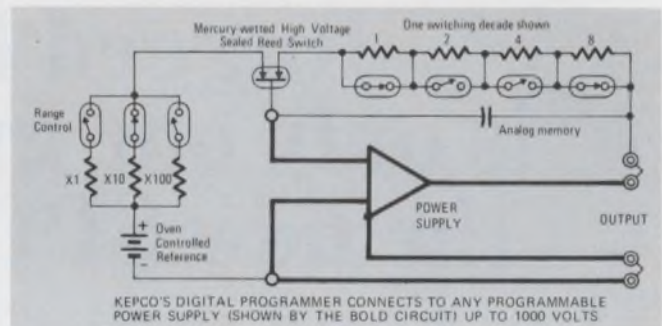

Because the D/A is working right at the output level, controlling voltage 1:1, you can divide voltage into some mighty small pieces. A three-position movable decimal point helps. Model DPD-3, for instance, will control 0-1000.00, 0-100.000 and 10.0000 volts! And, because the reeds firmly connect precision-fixed resistors—with a low "on" resistance—directly to the power supply's control loop, you can leave the setting indefinitely, confident that it will stay right on the nose.

Transients are avoided by a two-stage switching system. A command change is initiated by first opening the mercury-wetted relay to throw the power supply onto an analog memory "hold" capacitor, while the individual decade reed switches open and close in a dry circuit, establishing a new precision command level. The mercury-wetted relay then cycles closed, permitting the supply to slew to its newly established voltage level.

There are seven different D/A's available with separate 3, 4 and 5 digit storage registers, plus a handy keyboard for manual entry. These will teach digital tricks to any of some 102 different programmable power supplies ranging up to 1000 volts.

KEPCO For complete specifications
and applications notes,
write Dept. DB-5

KEPCO, INC. • 131-38 SANFORD AVENUE • FLUSHING, N.Y. 11352
(212) 461-7000 • TWX # 710-582-2631

INFORMATION RETRIEVAL NUMBER 67

ELECTRONIC DESIGN 11, May 24, 1970

New Products

Content addressable memories match input to stored data

Signetics Inc., 811 E. Arques Ave., Sunnyvale, Calif. Phone: (408) 739-7700. P&A: 40¢ to 70¢ per bit, 80¢ to \$1.40 per bit; stock.

Two new monolithic arrays form a unique family of memory products known as content addressable memories (CAMs). They are the high-speed model 8220 and the low-power model 8222 elements.

Content addressable memories are memories in which data can be associated. That is any data placed at the input of the memory is matched against the memory's stored data. The memory responds with a match or mismatch answer.

With these two new CAMs, data can be written into them just like any other read/write memory and they then provide the association of input to stored data. They also give the address location of what word in the memory matches the data presented at its input.

Until now, to use data in a read/write memory, the stored data had to be processed after the input data was read in. The use of computer software was a common technique.

The model 8220 high-speed element can perform an associate function in 25 ns, while the model 8222 low-power element dissipates only 300 mW maximum and 200 mW typical.

Both elements incorporate the necessary addressing logic and contain eight identical memory cells, which are organized as four words, each being two bits long.

With reference to input and stored data, both can be conditioned to perform the following functions: associate, write-in only and read-out only.

Write-in can be done simultaneously to all bits, or to one bit at a time. The readout function of the stored information is performed on one word at a time.

Cell selection for read and write functions is obtained by the proper

addressing of input and output lines.

The cell's output structure for each element is of the "bare collector" variety which allows cells to be mutually connected.

This feature permits the memories to be expanded in two directions—in word length and in the number of words when multiple packages are employed.

Each array contains 100 discrete gates and each has a circuit structure of the familiar TTL type (DCL family) and is fully compatible with TTL and DTL input and output structures. Both memory elements can be used in a computer data processing associative process and in stored comparator applications.

Each element can also be configured as a self-learning memory. In this mode, the memory does not issue a write command for the output if a matching input word is contained in its storage.

If however the input word is not contained in the storage, the memory will "learn" to put the input word into storage for subsequent associative functions.

In the self-learning configuration, the element is always in the associate mode when no word has to be written into storage.

Monitoring the output lines provides a convenient way of decoding an available address.

A clear command totally erases the memory contents. The process of selectively erasing individual words is also a simple one.

The model 8820 is available in 16-pin flatpacks in either temperature range of -55 to $+125^{\circ}\text{C}$ or 0 to $+75^{\circ}\text{C}$. It is also available in a 16-pin dual-in-line case for the temperature range of 0 to $+75^{\circ}\text{C}$.

The model 8222 is available in the following versions: 8222B (0 to $+75^{\circ}\text{C}$) and 8222R (-55 to $+125^{\circ}\text{C}$ and 0 to $+75^{\circ}\text{C}$).

CIRCLE NO. 250

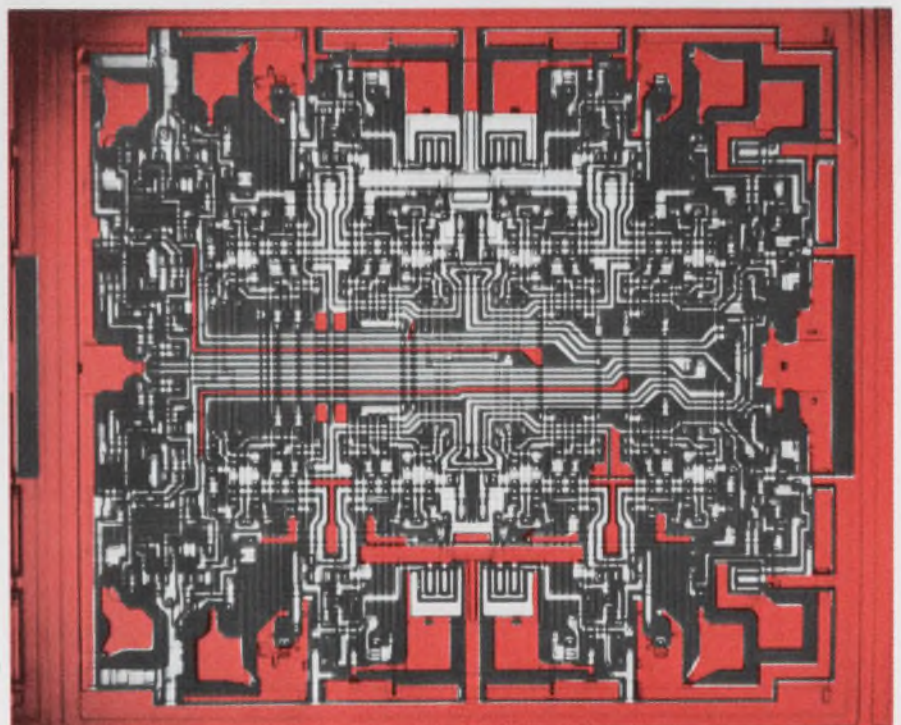

Monolithic op amp has FET inputs

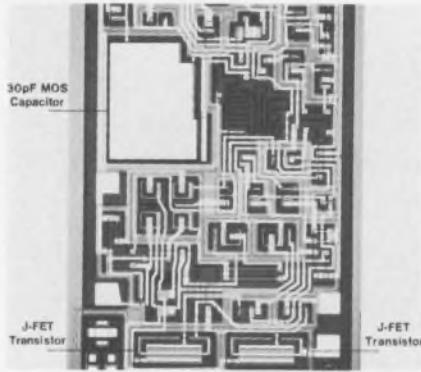

Radiation Inc., Microelectronics Div., sub. of Harris-Intertype Corp., Melbourne, Fla. Phone: (305) 727-5412. Price: \$82.50.

Incorporating an on-chip resistor ladder network, the RI-1080 monolithic digital-to-analog current-mode converter can handle up to eight bits of data at the same time. Depending on the external voltage reference, this new MSI device can operate in three modes: bipolar, unipolar positive or unipolar negative. Operating temperature range is -55 to $+125^{\circ}\text{C}$.

CIRCLE NO. 252

Dual transistor gains up to 1500

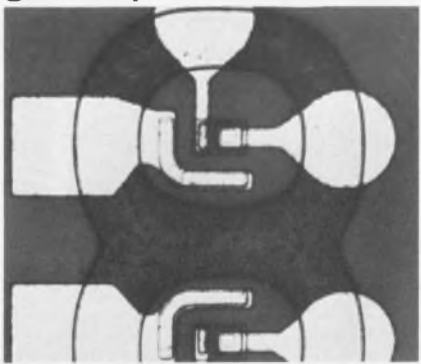

Silicon General Inc., 7382 Bolsa Ave., Westminster, Calif. Phone: (714) 839-6200. P&A: \$5.30; stock.

Permitting fast low-cost fabrication of custom ICs, a new monolithic IC breadboard, the SG3801 QuikChip, contains over 50 separate components of various types and values. These components can be interconnected with a wire bonding machine, allowing the circuit designer to construct prototypes without the customary reliance on the semiconductor manufacturer.

CIRCLE NO. 254

Fairchild Semiconductor, 313 Fairchild Dr., Mountain View, Calif. Phone: (415) 962-3563. Price: \$37.50 or \$73.50.

Hailed as an industry first, the $\mu\text{A}740$ is a monolithic FET-input operational amplifier that operates with 200-pA maximum current into either input. In addition, the device features equivalent betas of more than 15,000 and an input impedance of $10^{12} \Omega$. Unity-gain slew rate is $6 \text{ V}/\mu\text{s}$; voltage gain is 120 dB.

CIRCLE NO. 251

D/a converter chip processes 8 bits

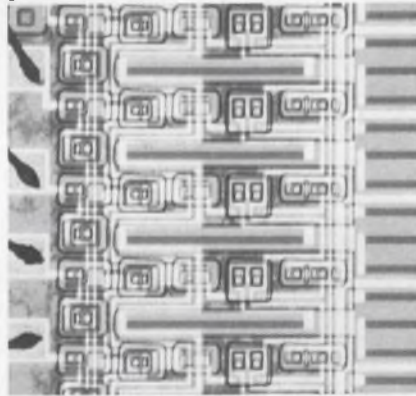

Intersil Inc., 10900 N. Tantau Ave., Cupertino, Calif. Phone: (408) 257-5450. P&A: \$6; stock.

Suited for both radiation-hardened and industrial applications because of its dielectrically isolated construction, a dual monolithic super-beta transistor guarantees a beta of greater than 1500 at a $1\text{-}\mu\text{A}$ base current. Model IT124 also features a capacitance of 0.8 pF and a unity-gain crossover frequency of 100 MHz. Current off-set is 0.5 nA.

CIRCLE NO. 253

Monolithic breadboard allows customized ICs

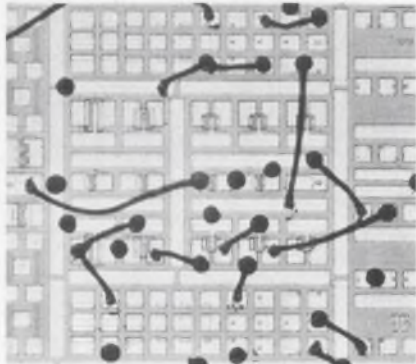

Dual transistors boast 1.5-mV match

Qualidyne Corp., 3699 Tahoe Way, Santa Clara, Calif. Phone: (408) 738-0120. Availability: stock.

A complete line of high-gain npn and pnp dual transistors features a matching specification (base-emitter voltage) as tight as 1.5 mV. These devices cover almost all of the popular dual 2N numbers now in use—over 150 transistors in all. Gains are greater than 200 with a $10\text{-}\mu\text{A}$ base current, and output capacitance is as low as 1 pF. Unity-gain crossover frequency is greater than 200 MHz.

CIRCLE NO. 255

Transistor for 84¢ accommodates 30 W

Power Physics Corp., P.O. Box 626, Eatontown, N.J. Phone: (201) 542-1393. P&A: 84¢; stock.

Selling for 84¢ each in lots of 100 to 999, a new silicon npn power transistor can typically handle collector-emitter voltages of 140 V. Type 2N3054 offers a power capability of 30 W. Peak collector currents range from 3 to 7 A. The unit, which is packaged in a TO-66 metal can, is expected to be used in power supplies, oscillators, voltage regulators and amplifiers.

CIRCLE NO. 256

Digital ICs clamp inputs

Sylvania Electric Products Inc., sub. of General Telephone & Electronics, 1100 Main St., Buffalo, N.Y. Availability: stock.

Now available are 14 new series 7400N TTL integrated circuits offering the advantage of clamping diodes on all inputs for reliable short-circuit protection. Fully interchangeable with competing lines, the new devices come in a standard all-ceramic package with tapered lead ends to facilitate socket insertion. Circuit functions include NAND gates, AND-OR-INVERT gates, and dual D and J-K flip-flops.

CIRCLE NO. 257

Counter/driver IC runs readout tubes

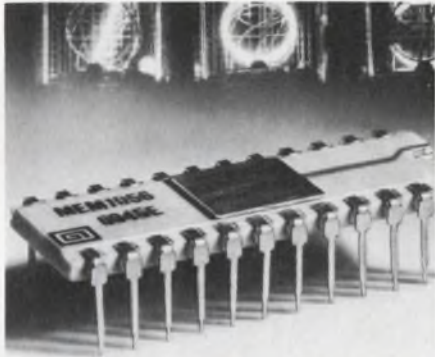

General Instrument Corp., 600 W. John St., Hicksville, N.Y. Phone: (516) 733-3333. Price: \$20.

Said to do the job of three conventional IC packages, a BCD-counter/display-driver can power a single seven-segment numeric indicator by itself. Model 1056 is a MOS IC that contains a single-decade up-down BCD counter, a storage register, a BCD-to-seven-segment decoding matrix, and display drivers. It is supplied in a 24-lead dual-in-line package.

CIRCLE NO. 258

Plastic complements dissipate 15 watts



General Electric Co., Semiconductor Products Dept., 1 River Rd., Schenectady, N.Y. Phone: (315) 456-2396. P&A: 45¢ to 65¢ in quantity; stock.

Offering collector saturation voltages of 0.5 V at 3 A, two new 15-W complementary Power Pac transistors, the D44C and D45C, are rated at 30, 45 and 60 V. These plastic units have typical switching times of less than 600 ns. The D44C is an npn device, while the D45C is a pnp device.

CIRCLE NO. 259

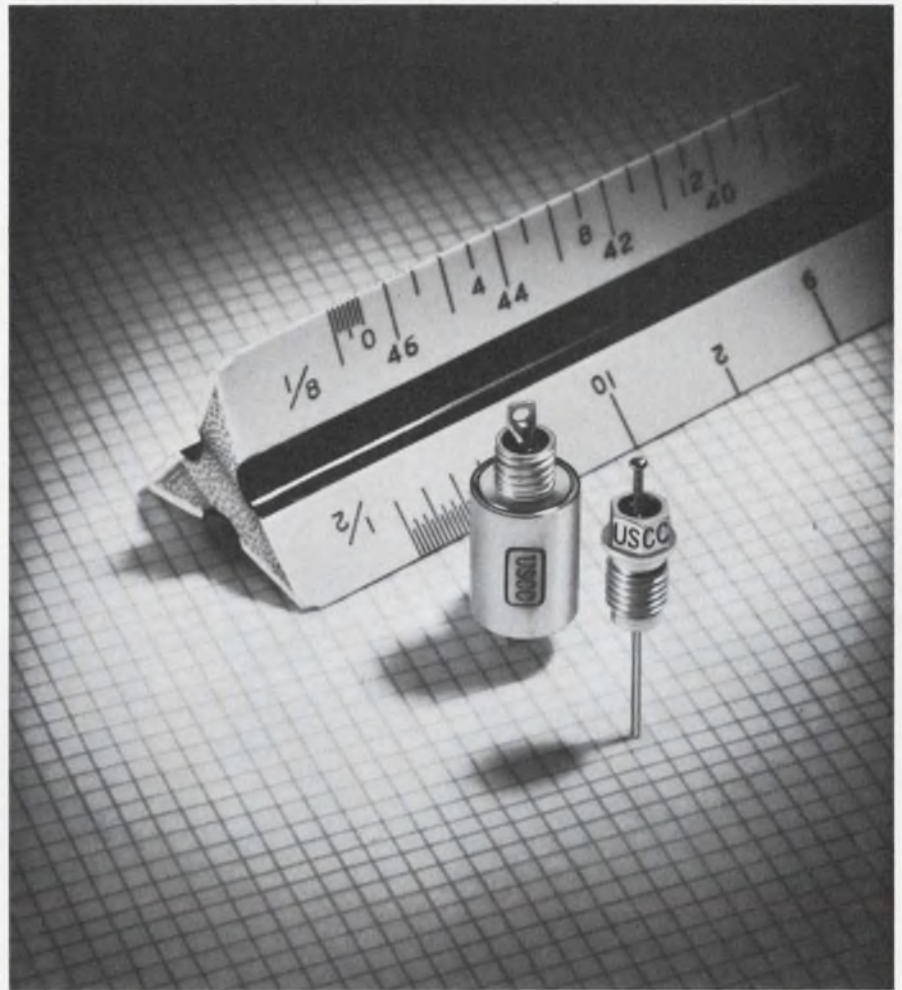

How small are your EMI problems?

An EMI/RFI problem used to be one of the least appealing facts of circuit life. Add the requirements for a small unit with high attenuation characteristics and you were in trouble. Not anymore. Today, you'll find lasting happiness with two proven USCC series of miniature filters. Both provide up to 70 dB of attenuation.

Series 2000 suppresses conducted noise from SCR's, switches, relays, motor commutators, etc., in low voltage dc lines from 10 kHz to 10 GHz. Available in Pi, L or T section units for 50/100/200/300 WVdc and 115/230 Vac in 10 current ratings and 2 thread lengths.

Series 3000 subminiature units are for use where size, weight and reliable performance are critical as in microwaves, communications and airborne equipment. Available in Pi or multi-section units for 50/100/200 WVdc from 10 MHz to 10GHz.

Send for the complete details in a series of technical catalog sheets: U.S. Capacitor Corporation, 2151 No. Lincoln Street, Burbank, California 91504. Phone: (213) 843-4222. TWX: 910-498-2222.



Other reliable USCC EMI/RFI products: general purpose filters, signal line/communications filters, power line filters and cabinet assemblies, data processing filters, and special/custom filters.

INFORMATION RETRIEVAL NUMBER 68



Our Driver Manual.

(It's a free license to control all driving situations.)

Fault-free control of load driving can be yours when the motor matches (or exceeds) your product or system requirements and avoids the performance compromises inherent in common motors.

The Motor Catalog offers you literally thousands of choices — size, type, horsepower, torque, input — to obtain exactly the motor you need. In addition, there's comprehensive theory and applications information.

IMC Magnetics Corp., Eastern Division, 570 Main Street, Westbury, N.Y. 11591, Tel. (516) 334-7070, TWX 510-222-4469



INFORMATION RETRIEVAL NUMBER 69

Arithmetic logic unit adds 16 bits in 42 ns

Fairchild Semiconductor, 313 Fairchild Drive, Mountain View, Calif. Phone: (415) 962-5011. Price: \$14 to \$30.80.

Model 9340 four-bit arithmetic logic unit is a new MSI circuit that can add two 16-bit numbers within 42 ns when connected in multiple. The unit can also perform several other functions like OR, AND, subtraction, and equivalence. Because the device includes carry-look-ahead circuitry, the user can add up to 16 bits with only four 9340s and no other package. It comes in military or commercial versions, either flatpacks or DIPs.

CIRCLE NO. 260

Zener diodes accept 50 W

Electronic Transistors Corp., 153-13 Northern Blvd., Flushing, N.Y. Phone: (212) 539-6700.

Offering tolerances of ± 20 , ± 10 and $\pm 5\%$, a new line of general-purpose zener diodes can dissipate power levels as high as 50 W. This new family of rectifiers comes in JEDEC TO-3 packages or in stud-mounted DO-5 packages. Their operating temperature range is -65 to $+175^\circ\text{C}$; voltage ratings range from 4.7 to 200 V.

CIRCLE NO. 261

Dual sense amplifiers strobe independently

National Semiconductor Corp., 2900 Semiconductor Dr., Santa Clara, Calif. Phone: (408) 732-5000. P&A: \$7 or \$9.10; stock.

Intended for use with small core memories having as many as 4000 words, two new monolithic dual sense amplifiers feature independent strobing. The LM354A and LM354 are functionally identical, but the LM354A has a tighter guaranteed input threshold voltage uncertainty. Typical outputs for the circuits are 3.9 V for a logical 1 and 0.25 V (0.4 V maximum) for a logical 0.

CIRCLE NO. 262

Photosensor chip can drive directly



Dionics Inc., 65 Rushmore St., Westbury, N.Y. Phone: (516) 997-7474.

Dielectrically isolated for good high-frequency response and radiation resistance, a new line of npn silicon matched-pair transistor chips provide a close parameter match, from 10 μA to 1 mA. Types 3423 and 3424 have their collectors isolated from each other and from the bottom of the chip. The chips are gold-backed, permitting conventional eutectic die-bonding.

CIRCLE NO. 264

Tiny thermistors give up to 10k Ω

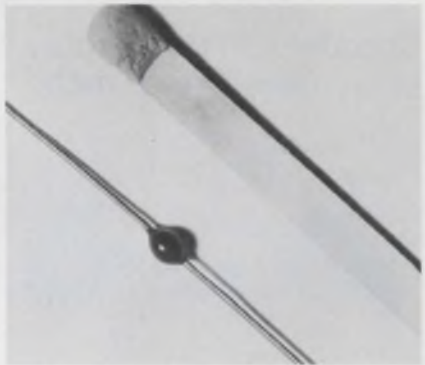

Texas Instruments Inc., Components Group, P.O. Box 5012, Dallas, Tex. Phone: (214) 238-2011. P&A: \$2.68 or \$3.70; stock.

With a power output that is spectrally compatible with silicon sensors, two new pn gallium-arsenide light sources provide a minimum power output of 1 mW (the TIL24) or 0.4 mW (the TIL23). The units cover both the military and industrial temperature ranges. Both light sources have a narrow light beam emission at an angle of 35 degrees.

CIRCLE NO. 266

RCA/Electronic Components, 415 South Fifth St., Harrison, N.J. Phone: (201) 485-3900. P&A: \$2.95; stock.

Combining a photosensitive section, an amplifier and two 100-mA driver transistors on a single chip, the CA3062 monolithic light sensor can drive a lamp, relay or triac without additional amplification. The unit operates either as a normally OFF or normally ON photo-switch. It comes in a hermetic 12-lead TO-5-style package.

CIRCLE NO. 263

Transistor chips match to 10 μA

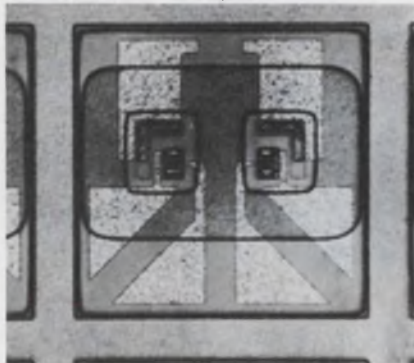

Sensitron Inc., 225 Paularino Ave., Costa Mesa, Calif. Phone: (714) 540-4160.

Called micro-silicon devices, a new line of thermistors, the size of a 0.1-in. sphere, are available with resistances from 10 to 10,000 Ω . Series 125 units are available with radial leads or radial-opposed leads. Maximum operating temperature is 150°C, and nominal temperature coefficient is 0.7%/°C. The devices are designed for semiconductor circuit compensation.

CIRCLE NO. 265

Light sources put out 1 mW



Alone in its class

Johanson products stand alone as a symbol of leadership. Even an unpracticed eye can see the differences between a Johanson capacitor and its counterpart.

Such things as ultra-high Q (useable at microwave frequencies) . . . ultra-high stability (0 ± 15 PPM/°C) . . . and "sizes" for hybrid and microcircuit as well as for conventional applications . . . these and other integral design advances attest



Model 5801
(actual size)

superiority.

Send for a complete Johanson catalog. Let a Johanson product help your product be a leader!

Johanson

Johanson Manufacturing Corporation
Rockaway Valley Road, Boonton, N.J. 07005
(201) 334-2676 • Telex: 13-6432

Fast d/a converters settle down in 25 ns



Datel Systems Corp., 943 Turnpike St., Canton, Mass. Phone: (617) 828-1890. P&A: from \$195; 2 wks.

Containing buffer logic, switches, a ladder and voltage reference in a single package, the DAC-H series of d/a converters feature an output settling time of 25 ns to $\pm 0.1\%$ of final value. This allows for an update word rate of 40 MHz. Output is ± 2.5 mA full scale with a voltage compliance of ± 1.2 V, and output linearity is ± 2.5 μ A with a 5- μ A resolution.

CIRCLE NO. 267

Burr-Brown Research Corp., International Airport Industrial Park, Tucson, Ariz. Phone: (602) 294-1431. P&A: \$110, \$90, \$70; stock to 4 wks.

A line of three new chopper-stabilized low-drift operational amplifiers include differential inputs. Models 3354/25, 3355/25 and 3356/25 drift 0.2, 0.5 and 1 μ V/ $^{\circ}$ C, respectively. Input bias currents are 20, 50 and 50 pA, respectively. Open-loop gain is 140 dB at dc.

CIRCLE NO. 268

Chopper-stable op amps are differential units

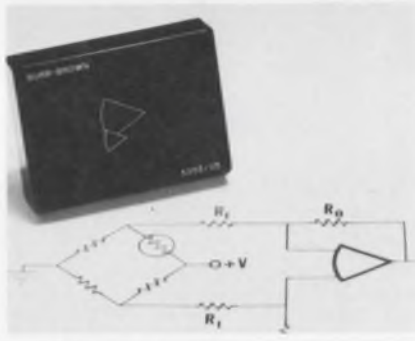

GPS Corp., 14 Burr St., Framingham, Mass. Phone: (617) 875-0607. P&A: \$17; stock.

Including an adjustable input offset voltage of 2 mV and an input bias current of 50 pA, the low-cost model 801 differential FET-input operational amplifier retails at \$17. Other characteristics are an open-loop gain of 100,000, full output frequency of 50 kHz, a slewing rate of 5 V/ μ s and an input drift of 100 μ V/V. The output is ± 10 V at ± 20 mA.

CIRCLE NO. 269

Low-cost FET op amp chops price to \$17



Optical Electronics, Inc., P.O. Box 11140, Tucson, Ariz. Phone: (602) 624-8358. P&A: \$87; stock.

The model 5882 multiplier is a low-cost four-quadrant analog unit with a wide bandwidth of dc to 30 MHz. Its features include a maximum untrimmed offset voltage for both X and Y inputs of ± 2 V. Also featured is a null rejection characteristic of 73 dB at 5 MHz. Both inputs have an impedance of 4 k Ω and a dynamic output range of -10 to $+10$ V.

CIRCLE NO. 270

Wideband multiplier spans dc to 30 MHz



Low-cost multiplier downs price to \$29.50



Teledyne Philbrick/Nexus Research, Allied Dr. at Route 128, Dedham, Mass. Phone: (617) 329-1600. P&A: \$29.50; stock.

Providing an output of ± 10 V at frequencies to 40 kHz, the model 4452 low-cost four-quadrant multiplier/divider retails for only \$29.50. Its voltage range for either X or Y input is ± 10 V and each input's impedance is 30 k Ω . Operation to 400 kHz is possible with derating of parameters. The unit measures 1.5 by 1.5 by 0.6 in.

CIRCLE NO. 271

Decoder/driver display slims depth to 1 inch

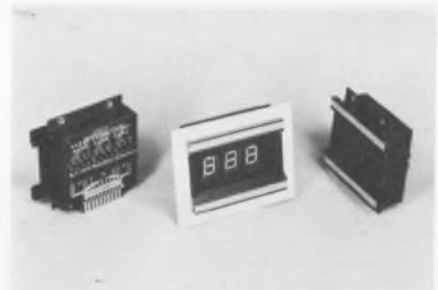

Integrated Circuit Electronics, Inc., 237 Riverview Ave., Newton, Mass. Phone: (617) 891-4311. Price: \$49.50 (3 decades).

The D-4000 series decoder/driver display features behind-the-panel depth of only 1 in. It contains a bezel with filter lens, decoder, driver circuitry and replaceable low-voltage low-power readout tubes. It is IC-compatible and interfaces to four-line BCD levels. The use of a single-connector termination eliminates wiring.

CIRCLE NO. 272

High-voltage supply drives price under \$30



Venus Scientific Inc., 399 Smith St., Farmingdale, N.Y. Phone: (516) 293-4100. Price: under \$30.

Supplying an output of 15 kV at 150 μ A, the new all-silicon L-15 low-cost high-voltage power supply for computer and CRT displays boasts a price of less than \$30. It is a dc-to-dc converter operating from 15 V dc and is short-circuit and arc-over protected. The input is protected against reverse polarity and the output has less than 1% of pk-pk ripple.

CIRCLE NO. 273

Tiny low-cost op amp is priced at \$26

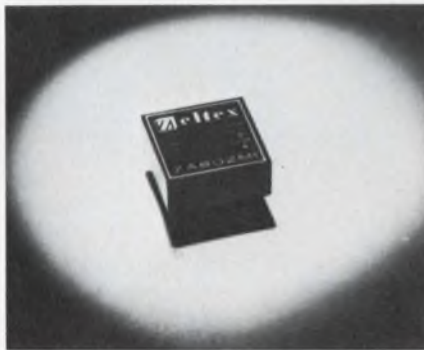

Zeltex, Inc., 100 Chalomer Rd., Concord, Calif. Phone: (415) 686-6660. P&A: \$26; stock.

Featuring 15 pA of input current, a 100,000:1 common-mode rejection ratio and frequency response of 4 MHz at unity gain is the tiny low-cost FET-input ZA-802M1 operational amplifier that measures 1 by 1 by 0.4 in. and costs \$26. Maximum input voltage drift is 50 μ V/ $^{\circ}$ C for the temperature range of -25 to $+85^{\circ}$ C.

CIRCLE NO. 274

LED

New low cost LED Vactrol photon isolator

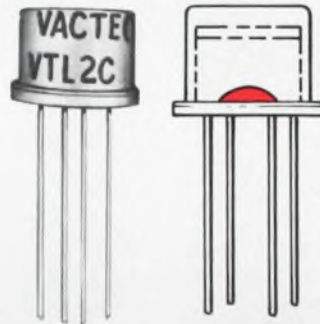

as low as \$4.20 each in 1,000 quantities

- all solid state
- 4 types of photoconductors combined with LEDs
- hermetically sealed TO-5 enclosure
- unlimited life—no filaments
- ideal for environments where shock and vibration are a problem
- applications include photochoppers, linear isolators, noiseless switching, SCR and triac turn-on, audio level controls, etc.

Part Number	LED	PHOTOCELL		
	Current (ma) (1.65v typ.)	Max. Cell Resistance	Typical Rise Time (ms)*	Decay
VTL2C1	40	10 K Ω	.5	3.5 ms **
VTL2C2	40	500 Ω	3.5	500 ms †
VTL2C3	40	2 K Ω	2.5	35 ms †
VTL2C4	40	75 Ω	6.0	1.5 sec †

* To 63% conductance

** To 1 meg

† To 100 K Ω

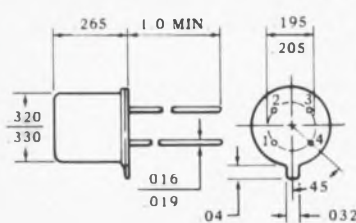

1-3 PHOTOCELL
2-4 LED

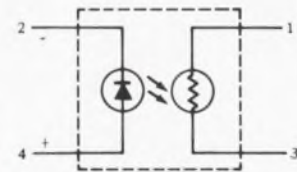

Vactec confines its production activities entirely within the United States. Advanced mechanized techniques provide highest quality at prices competitive with other manufacturers anywhere in the world.



VACTEC, INC.

2423 Northline Ind. Blvd.
Maryland Heights, Mo. 63043
Phone: (314) 872-8300
Write for Bulletin VTL2C

Specializing in standard Cds, Cdse, and Se sells; custom engineering for every photocell need.
Listed in EBG under "Semi-Conductors" and in EEM Sec. 3700.

INFORMATION RETRIEVAL NUMBER 71

**Low-cost LED lamp
sells for only 50¢**

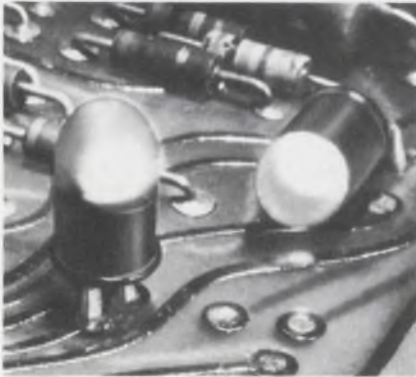

Hewlett-Packard, 1501 Page Mill Rd., Palo Alto, Calif. Phone: (415) 326-7000. P&A: 50¢; 30 days.

Designed to replace miniature incandescent lamps, the 5082-4403 red light-emitting diode features a price of only 50¢ in large quantities. It requires only 1.8 V at 20 mA to operate and provides high visibility over a broad angle. This GaAsP lamp self-mounts in panels or on printed circuit boards and is compatible with most integrated circuits.

CIRCLE NO. 275

**Indicator light for ICs
works from logic levels**



Dialight Corp., 60 Stewart Ave., Brooklyn, N.Y. Phone: (212) 497-7600.

Designed for integrated circuits, a new transistorized indicator light operates directly from TTL, DTL and RTL modules thereby eliminating the need for a special power supply and interface circuitry. It includes all driving circuitry within its housing and accepts wide voltage swings without increases in signal current. Lamps used are T-1-3/4 incandescent types.

CIRCLE NO. 276

**Spdt thumbwheel switch
is but 0.225-in. long**

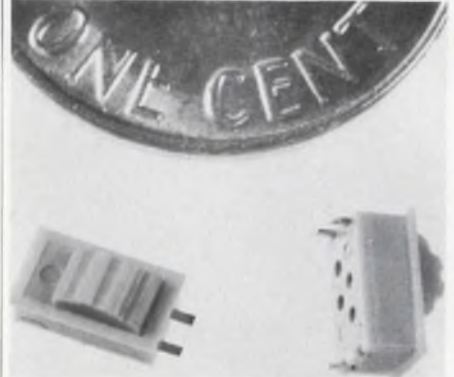

Wilbrecht Electronics, 240 Plato Blvd., St. Paul, Minn.

Only 0.225 inches long, the model 2000 spdt switch sets new standards for ultra electromechanical miniaturization. Its uniquely designed detent produces large-size switch feel. The use of precious metal contacts and wiping action results in low contact resistance. It is enclosed to ensure long life of over 50,000 cycles. For added flexibility it is available in a variety of colors.

CIRCLE NO. 277

**GUARANTEED UNIFORMITY
IN ELECTRICAL, PHYSICAL
CHARACTERISTICS**

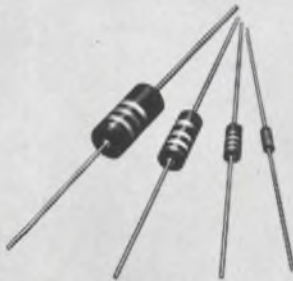

- Available in 2, 1, 1/2 and 1/4 watt sizes.
- Uniform from resistor to resistor, order to order.
- 100% tested for resistance value.
- Solderability, load life and humidity-temperature characteristic checked.
- Impregnated to assure moisture resistance.
- Write for literature.



INFORMATION RETRIEVAL NUMBER 72

**TWO, NEW
POWERFUL CERAMAG®
FERRITE MATERIALS**

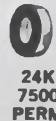
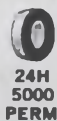

- True 5000 and 7500 permeability ratings.
- Both 24H and 24K stay at designated perm over a wide range of sizes.
- Curie point for 24H and 24K is 175°C, typical.
- Precision engineered materials produced through exact processing, density checks and controls.
- Terrific inductance in a small size.
- Residual magnetism is 850 (24H) and 700 (24K) gauss.
- Write for data about these production materials.



INFORMATION RETRIEVAL NUMBER 73

**ENVIRONMENT PROOF
ROTARY SWITCHES**

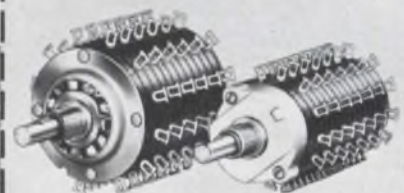

Series 600 1 3/8" Dia. — Series 100 1 1/8" Dia.

- Both index mechanism and electrical sections are completely enclosed.
- Corrosive atmospheres, dust, dirt and moisture are permanently sealed out, lubricants sealed in.
- Solder or quick-connect terminals molded permanently into position minimize production damage.
- Standard index angles include 15°, 30°, 36°, 60° and 90°, special angles available on request.
- Write for engineering bulletin.



INFORMATION RETRIEVAL NUMBER 74
ELECTRONIC DESIGN 11, May 24, 1970

Resistor/capacitors are dual-in-line arrays

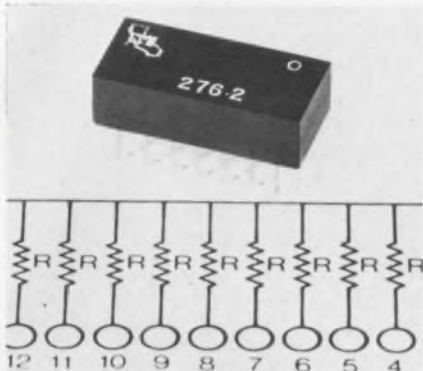

California Microcircuits, Inc. subsidiary of Teller Industries, Inc. Phone: (213) 772-2161.

New arrays containing networks of up to thirteen resistors or capacitors in a single 14-pin dual-in-line package are available. Resistors can have any value ranging from 20Ω to $1 M\Omega$ with a tolerance down to $\pm 0.1\%$. Capacitors can have values ranging up to $0.1 \mu F$. A 15-resistor array is also available in a 16-pin DIP housing.

CIRCLE NO. 278

Pulse transformers handle $500 V\mu s$

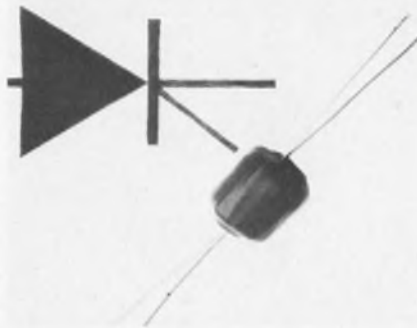

Aries Technology, 1247 El Camino Real, Mountain View, Calif. Phone: (415) 964-1606. Price: \$3.85 to \$4.10.

Two series of pulse transformers feature a product of pulse height times pulse width of $300 V\mu s$ (type BM) and up to $500 V\mu s$ (type BN). They were designed for SCR trigger circuits and general instrumentation where relatively long pulses are required. All units are available in a variety of turns ratios and use self-supporting #24 AWG leads.

CIRCLE NO. 279

Tiny ceramic FM filter measures but 0.016-in.³

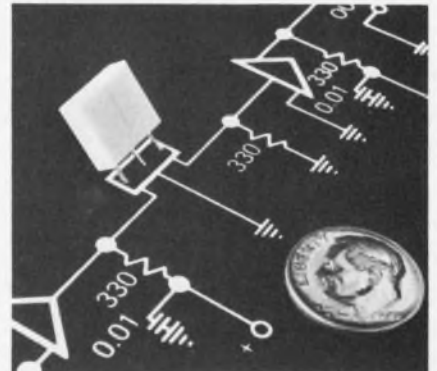

Gould Inc. Piezoelectric Div., 232 Forbes Rd., Bedford, Ohio. Phone: (216) 232-8600. P&A: 50¢ per 100,000; 2 wks.

Combining small size and high selectivity is the new FM-4 10.7-MHz ceramic bandpass FM filter. It is a high-Q piezoelectric ceramic molded in epoxy measuring only 0.415 by 0.38 by 0.1 in. It is distortion-free to a stop-band above 45 dB, with a 3-dB bandwidth of 235 kHz and a 40-dB bandwidth of 825 kHz.

CIRCLE NO. 280

UNEXCELLED QUALITY FOR LESS THAN 5¢

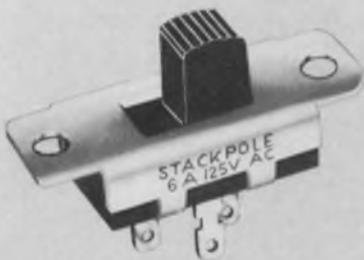

- Listed by UL AND CSA, 1 to 10 amps at 125V AC.
- 7960 slide switch combinations—23 basic types.
- New rugged solder lug terminal, designed for use with quick connectors.
- Uniform quality assured by automated assembly.
- Electro-silver plated terminals and contacts—shorting and non-shorting.
- Phenolic or nylon triggers in a variety of colors.
- Write for engineering literature.

STACKPOLE
COMPONENTS COMPANY
P. O. Box 14466
Raleigh, N. C. 27610

INFORMATION RETRIEVAL NUMBER 75

ELECTRONIC DESIGN 11, May 24, 1970

CERAMIC CAPACITORS WITH SUPERIOR TEMPERATURE COEFFICIENT

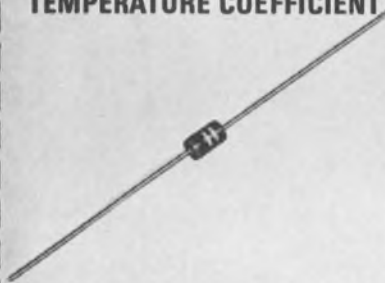

- Available in range of 0.1 to 10 picofarads.
- Tolerances of 5%-10%-20%, at rated working voltage of 500V DC.
- Temperature coefficient is $\pm 2\%$ for values of 0.1 to 5.1 pf over a temperature range of $-55^\circ C$ to $85^\circ C$.
- Only $\pm 3\%$ temperature coefficient for values of 5.1 to 10.0 for temperatures ranging from $-55^\circ C$ to $+85^\circ C$.
- Power factor less than 1% at 1 megacycle at less than 80% RH.
- Write for bulletin.

STACKPOLE
CARBON COMPANY
Electronic Components Division
St. Marys, Pa. 15857

INFORMATION RETRIEVAL NUMBER 76

SLIDE-TROL® — NEW CONCEPT IN POTENTIOMETER DESIGN

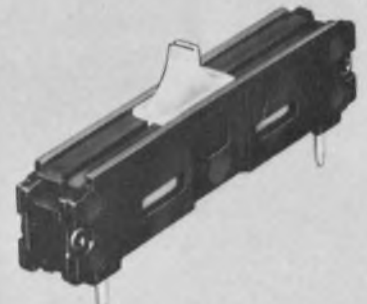

- Mount horizontally, vertically or sideways, either singly or in multiple units.
- Standard solder lug, wire wrap or printed circuit terminals available.
- Low noise and low contact resistance, plus uniform heat distribution.
- Ratings 40-500 Ω 1.5 watts, 500-5K Ω 1.25 watts, 5K Ω and over 1 watt.
- Thermal expansion-contraction and shock hazard problems eliminated.
- Know resistance setting at a glance.
- Compact, lightweight, functional, attractive.
- Write for SLIDE-TROL® Brochure.

STACKPOLE
COMPONENTS COMPANY
P. O. Box 14466
Raleigh, N. C. 27610

INFORMATION RETRIEVAL NUMBER 77



82,000 POWER SUPPLIES

*with guaranteed
3-day shipment*

The Acopian promise of 3-day shipment doesn't apply to just part of our line—or to even 90% of our line. It is your assurance that whenever you order supplies listed in the Acopian catalog, your order will be on its way to you in 3 days. We guarantee it.

Do you have the latest Acopian catalog? It lists AC to DC power modules with both single and dual outputs. Regulated and unregulated. With plug-in, barrier strip or solder lug terminations. For industrial or MIL-spec applications. For your copy, write Acopian Corp., Easton, Pa. 18042 or call (215) 258-5441. And remember, every Acopian power module is shipped with this tag...



INFORMATION RETRIEVAL NUMBER 78

COMPONENTS

Passive LC filters are dual-in-lines

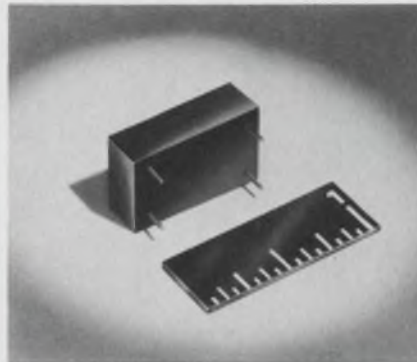

ESC Electronics, 534 Bergen Blvd., Palisades Park, N.J. Phone: (201) 947-0400.

Housed in cases measuring 0.76 by 0.46 by 0.25 in. are several series of passive low-pass LC filters in dual-in-line packages. DIF-L20 units attenuate 20 dB minimum in the stopband beyond cutoff. DIF-L39 units attenuate 39 dB minimum in the stopband beyond cutoff. Insertion loss is 0.5 dB and passband ripple is ± 1 dB. Other filter geometries are available.

CIRCLE NO. 281

Low-noise active filters reach down to 0.001 Hz



Analog Devices, Inc., 221 5th St., Cambridge, Mass. Phone: (617) 492-6000. P&A: \$34 to \$99; 2 wks.

The series 700 low-cost low-pass active filters use ICs and computer-aided design to span the frequency range of a low 0.001 Hz to 20 kHz at cutoff with only 50 μ V of noise. Cutoff-frequency tolerance is 2% and signal amplitude range for a minimum discernible signal to ± 10 V full scale is $10^4:1$. The filters incorporate a two-pole Butterworth design.

CIRCLE NO. 282

Malfunction indicator shows faults in color

A. W. Haydon Co., 232 N. Elm St., Waterbury, Conn. Phone: (203) 756-4481.

A low-cost tiny fault indicator provides an instant visual display of a transient or continuous circuit malfunction by a color transfer of its display mode. This 0.32-in. dia device latches into place magnetically until it is reset. Resetting is done by energizing a reset coil. It was designed for pulse operation and does not need continuous power.

CIRCLE NO. 283

Miniature rotary switch has 9/16-in. diameter

Daven Div. of Thomas A. Edison Industries, Grenier Field, Manchester, N.H. Phone: (603) 669-0940.

With a diameter of only 9/16 in., the new series S compact rotary selector switches offer as many as 10 decks with spacings of 18, 22-1/2, 36 and 45 degrees. One-pole versions are available for 2 to 20 positions and 4-pole versions for 2 to 5 positions. Shorting and non-shorting types are included.

CIRCLE NO. 284

Shielded blower units suppress emi to 24 GHz

McLean Engineering Laboratories, P.O. Box 127, Princeton Junction, N.J. Phone: (609) 799-0100.

Generating no measurable emi noise, the R2EB300 series of blowers are designed with a theoretical attenuation capability for electric fields and plane waves of 109 dB to a frequency of 24 GHz. Tested against MIL STD 280, a shielded blower-enclosure combination provided attenuation of 71 dB to 10 GHz. Airflows range from 150 to 1000 cubic feet per minute.

CIRCLE NO. 285

In-circuit IC checker tests all pins at once



Caltron Industries, 2015 Second St., Berkeley, Calif. Phone: (415) 548-1966. P&A: \$229; 4 wks.

Circuit-Vu 100 portable integrated circuit analyzer speeds the trouble-shooting of digital systems by allowing in-circuit checking of all inputs and outputs of an IC simultaneously. The status of each input and output is displayed through an overlay containing the schematic of the logic element under test. The overlay eliminates checking IC manuals for pin layouts.

CIRCLE NO. 286

Compact IC tester sells for just \$295

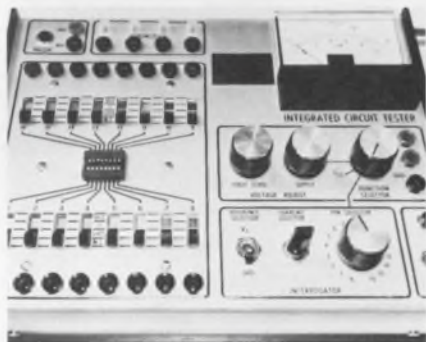

Spectrum Dynamics, P.O. Box 23699, Fort Lauderdale, Fla. Phone: (305) 566-4467. P&A: \$295; stock to 2 wks.

Carrying a price tag of only \$295, a new integrated circuit tester is a compact manually programmed instrument designed for dc and functional testing of most digital ICs. Model 101 has a 4 by 16 program matrix that permits selection of supply voltage, logic level 1, ground, or no connection at each pin. It has a pushbutton pulser.

CIRCLE NO. 287

Oscilloscope for \$300 reaches out to 8 MHz



RCA/Electronic Components, 415 South Fifth St., Harrison, N.J. Phone: (201) 485-3900. Price: \$298.50.

Besides a flat (within ± 1 dB) vertical-amplifier frequency response from dc to 5 MHz, the WO-505A solid-state \$298.50 oscilloscope is usable out to 8 MHz. This high-performance instrument also offers a gain of 15 mV pk-pk per inch on the high-sensitivity range of the vertical amplifier. Another feature is return-trace blanking circuits.

CIRCLE NO. 288

True rms voltmeter reads 1000 times/s



Hewlett-Packard, 1501 Page Mill Rd., Palo Alto, Calif. Phone: (415) 326-7000. P&A: from \$800 or \$900; stock.

Model 3480A/B general-purpose digital voltmeter is a four-digit instrument that can make up to 1000 readings per second for dc voltage or resistance. The unit also offers a true rms ac converter plug-in measuring down to 100 mV full-scale with response from 1 Hz to 1 MHz. The 3480A is a half-rack DVM, while the 3480B is a full-rack one.

CIRCLE NO. 289



**One of the
unique qualities
of Electro Cube
is to produce
non-standard
packages readily**

electro cube
capacitors

We also make 4,000 or more standard capacitors with wound dielectrics. If case style is a problem, ask. We'll help. Electro Cube, Inc., 1710 South Del Mar Road, San Gabriel, California 91776. (213) 283-0511

Face up to the flat one!

The inherent advantages of Zenith Flat-Face CRTs assure the brightest, clearest display of alphanumeric and analog data. Parallax errors are minimized. Provides resolution as high as 2500 TV lines. Design variations include single and dual neck configurations. Optional rear projection ports and laminated implosion shields. For details, write or call (312) 674-8000.



ZENITH RADIO CORPORATION

THE RAULAND DIVISION

5616 W. JARVIS AVE. • CHICAGO, ILL. 60648 • 312-647-8000

INFORMATION RETRIEVAL NUMBER 80

THESE NEW LUMPED



CONSTANT DELAY LINES



ARE AVAILABLE FROM



5 TO 25NS IN ONE-



HALF NANOSECOND



INCREMENTS!

series 25

If you've been looking for lumped constant delay lines in the 5-25NS delay range...with fixed delays at half nanosecond increments, look to ECC's Series 25 Delay Lines. Available in 41 fixed delay versions from 5-25NS, these lines are epoxy encapsulated in Diallyl Phthalate cases ranging in size from .500W x 1.300L x .375D to 1.200W x 1.300L x .375D. All cases feature stand-off feet for PC board mounting. Rise times for this series is from 1NS to 2.25NS. Impedance is 75 ohms and attenuation is .1db max. This series meets applicable portions of MIL-D-23859A and MIL-STD-202C. All units are available from stock to 3 weeks ARO. Contact the factory for complete details.

ECC

ENGINEERED COMPONENTS CO.
2134 West Rosecrans Avenue
Gardena, California 90249
Ph. (213) 321-6565, 321-8294

INFORMATION RETRIEVAL NUMBER 81

INSTRUMENTATION

Digital panel meter measures 17 ranges



Dixon Instruments, P.O. Box 1449, Grand Junction, Colo. Phone: (303) 242-8863. P&A: \$199; stock.

A new 3-1/2-digit panel meter can measure 17 ranges of dc and ac voltage, and dc and ac current by simply switching its interchangeable plug-in cards. Model VT300 features a built-in power supply, automatic zero, overrange indicator, internal calibration reference voltage, BCD output, and an external trigger input. Accuracy is $\pm 0.1\%$ of reading, $\pm 0.1\%$ of full scale.

CIRCLE NO. 290

Pulser for \$390 reps out to 10 MHz

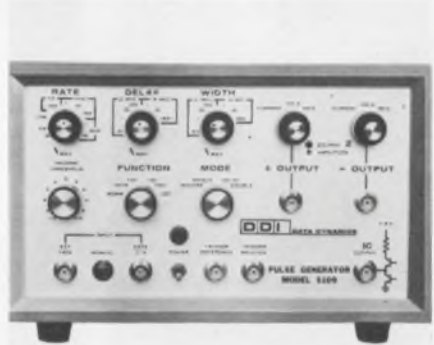

Data Dynamics Div., 240 Humphrey St., Englewood, N.J. Phone: (201) 567-5300. P&A: \$390; stock.

Costing only \$390, a new pulse generator, model 5109, can deliver repetition rates from 10 Hz to 10 MHz. It has three separate outputs, which are always active and are simultaneously available. The three outputs are: positive pulse, negative pulse, and an IC-compatible output specifically designed for TTL, RTL and DTL circuits. Pulse width is adjustable.

CIRCLE NO. 291

Low-cost lead bender retails for \$14.95

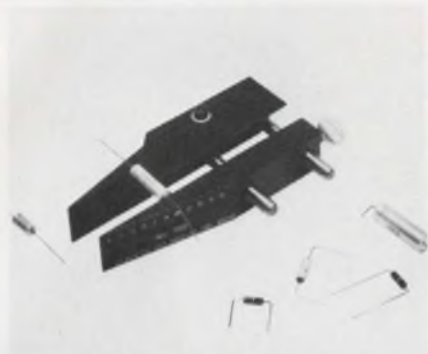

By-Buk Co., 4326 W. Pico Blvd., Los Angeles, Calif. Phone: (213) 937-3511. Price: \$14.95.

A new lightweight component-lead bending block with gauge plate for use in prototyping, testing and product assembly costs only \$14.95. Model 700 is a precision-made banding block which gives neat rounded bends to leads on resistors, diodes, capacitors, transistors and inductors, doing away with nicks, rings and plier damage normally encountered.

CIRCLE NO. 292

Technical pen set streamlines design



J. S. Staedtler, Inc., Box 68, Montville, N.J. Phone: (201) 335-1800.

The Mars-700 S9 is a new technical pen set whose compact design makes it ideal for both desk and board use. The set's case functions as a work stand and is designed to close in such a way that it is easy to store and convenient to carry. Keyholes are provided to hold the cap of each pen in a vertical position so the user can change line width easily.

CIRCLE NO. 293

Universal work station adjusts several ways



Siks Manufacturing, Inc., 143 E. 233 St., Bronx, N.Y. Phone: (212) 892-8566.

Adjustable to accept a wide variety of printed circuit boards, terminal boards, connectors and assemblies is the Uni-Stat work station which can be positioned to allow different types of electronic and mechanical assembly operations. It is adjustable to combinations of height and width within its holding dimensions of 0 to 5-in. wide and 0 to 2-in. high.

CIRCLE NO. 294

Fiber-optic source beams 800 foot-candles

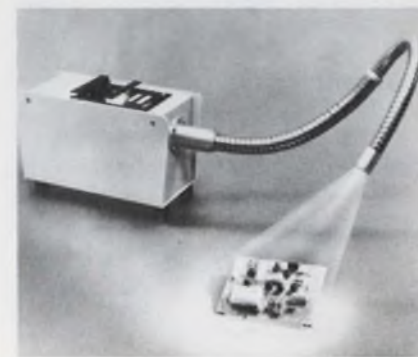

Bausch & Lomb, 635 St. Paul St., Rochester, N.Y. Phone: (716) 232-6000. P&A: \$300; stock.

A new fiber-optics illuminator provides a cool 800-foot-candles spot of light within a 7-in. dia circle up to 6 in. from the end of its probe. The probe is a 1/2-in.-dia fiber-optics bundle and is available in two or three-foot lengths. It is flexible to allow its bending and will retain almost any shape to direct the illumination.

CIRCLE NO. 295

ELFIN
2.99*

think digital

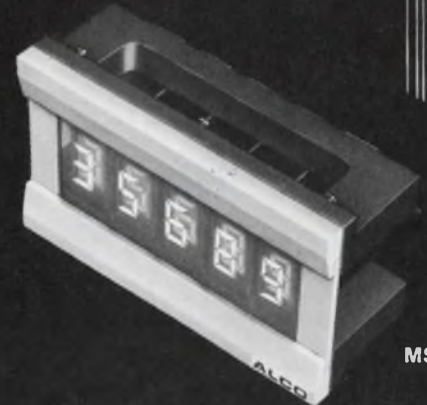

MS-4000
3.85*

Think ELFIN — the new single plane, segmented neon readout indicator that provides brighter displays and wider viewing. Only 0.41" dia. ELFIN display 0-9, + and —, some alpha symbols and decimal.

The MS-4000 Series has new readouts added to include numeric and symbol indications. Each model is a miniature encased readout with the flat single-plane viewing, and uses 100,000 hr. #683 T-1 subminiature lamps. Plug-in feature expedites replacement. Photograph above shows five MS-4000 readouts used with a module mounting and bezel kit.



MS-250
4.97*

ALCO's RK numeric and symbol readouts have a unique in-line design to provide clear displays without focusing problems. The precision machined 1-piece aluminum case also serves as a heat sink.



MS
4.97*

The MS Mosaic numeric segmented indicators are available in 2 sizes and use either 6 14 or 24V lamps for flexibility in design.



MSM-5A
4.97*

SEND FOR
ALCO — NUMERIC
CATALOG

* 1000 Lot Price:

ALCO

ELECTRONIC PRODUCTS, INC.

Lawrence, Massachusetts 01843

who's first
with a
Z-combo
cassette
head for
dictating and
telephone
answering?



MODEL
ZW1R36K

.030* proximity of erase and
r/p gaps allows precision
editing. R/P inductance
200 mhy, 340 ohms
D.C.R., 0.7 RMS
voltage at
1 khz.

Nortronics is who!

- Extended tip version for card reader, drum and belt applications
- Dual channel units available
- Applicable as mini-digital tunnel-write head; request digital specs



**NORTRONICS
COMPANY, INC.**

8101 Tenth Avenue North
Minneapolis, Minnesota 55427
(612) 545-0401

PACKAGING MATERIALS

High-density PC board reduces circuit size

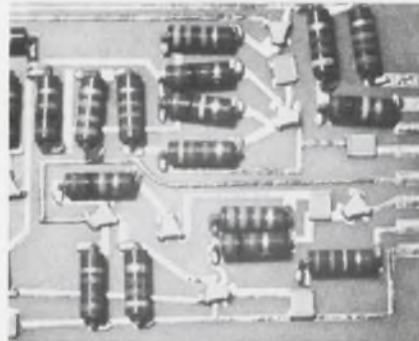

*Circa-Tran, Inc., P.O. Box 832,
Wheaton, Ill. Phone: (312) 858-
3727.*

A new PC board that reduces circuit size features copper conductors that are electroplated rather than etched to the phenolic substrate in thicknesses from 0.1 to 1 mil. Circa-Board's design allows mechanized assembly of all components to the same side as the copper conductors. Mechanized assembly via programmed feeders is made possible by distinctively shaped components.

CIRCLE NO. 296

Custom-woven cable fits any application

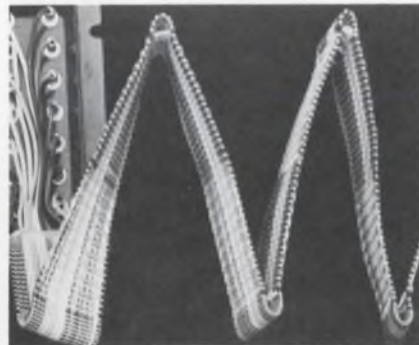

*The Zippertubing Co., 13000 S.
Broadway, Los Angeles, Calif.
Phone: (213) 321-3901.*

In instances when only a certain type of connector will do for a given application, but the cable or harness presents a problem, FRC Fab-Ri-Cable may be the ultimate solution. A low profile allows it to fit into extremely limited spaces, and to fold once or several times. It will bend, spiral, or accordion fold without affecting the performance of the conductors.

CIRCLE NO. 297

Wood-metal cabinets enhance enclosures

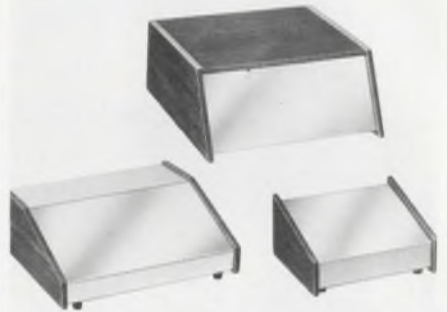

*Javelin Precision, Inc., 116 Toledo
St., Farmingdale, N.Y. Phone:
(516) 293-6443. Availability: stock.*

Slope-front desk panel cabinets, known as the Executive series, provide a unique combination of wood and aluminum. The enclosure's wood panels are constructed of hand-worked solid walnut, deep grained with an attractive luster finish. Metal panels are fabricated of 16-gauge anodized aluminum with a clean natural finish. All cabinets are equipped with rubber feet.

CIRCLE NO. 298

One-system liquid bonds in 60 seconds



*Tescom Corp., Instrument Div.,
2633 S. E. Fourth St., Minneapolis,
Minn.*

Called Zipbond, a new one-system bonding liquid joins most materials to themselves and to each other in just 60 seconds. Because no heat or pressure treatment is needed, it is ideally suited for jobs requiring fast curing time. Its tensile shear strength is 2770 psi. All types of materials can be bonded including rubber, metals, plastics, wood and glass.

CIRCLE NO. 299

Amplifiers for C band lower cost to \$850

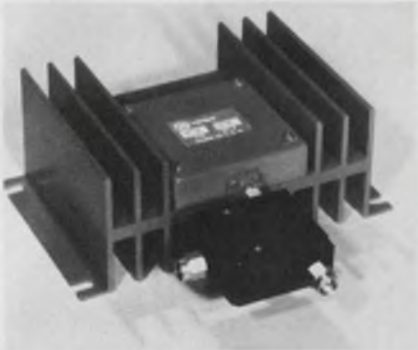

Varian Solid State Div., Beverly, Mass. Phone: (617) 922-6000. P&A: \$850; 60 days.

Covering the frequency band of 3.95 to 8.2 GHz, the model VSC-9650K (3.95 to 5.85 GHz) and VSJ-9650K (5.85 to 8.2 GHz) impatt amplifiers deliver outputs of 100 mW at \$850 per unit including the circulator. Both have two versions: one with a 50-MHz bandwidth and 13-dB gain and one with a 500-MHz bandwidth and 13-dB gain.

CIRCLE NO. 335

Low-noise transistors operate to 2000 MHz

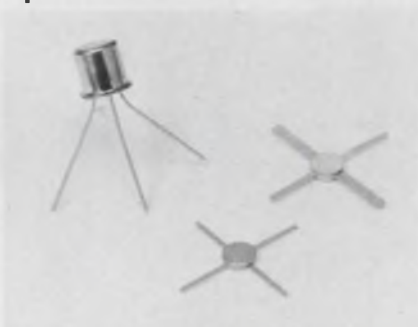

Avantek, Inc., 2981 Cooper Rd., Santa Clara, Calif. Phone: (408) 739-6170. P&A: \$13, \$25; stock.

Two families of silicon npn transistors are the AT-25, 25A and 25B, in TO-72 packages, and the AT-50, 50A, 51, 52 and 55, in stripline packages. The AT-25 series works to 1000 MHz, with a noise figure of 1.5 dB and 14-dB unneutralized gain at 500 MHz (AT-25B). The AT-50 series works to 2000 MHz with a noise figure of 2.5 dB and 14-dB unneutralized gain at 1 GHz (AT-50A).

CIRCLE NO. 336

Pnp power transistors take 40 W at 175 MHz



Motorola Semiconductor Products Inc., Box 20924, Phoenix, Ariz. Phone: (602) 273-3466. P&A: \$6.20, \$15, \$23, \$38; stock.

Four new additions to a line of pnp rf silicon power transistors are types MM4020, MM4021, MM4022 and MM4023. They feature output powers and gains at 175 MHz of 3.5 W at 11.5 dB, 15 W at 7 dB, 25 W at 5.5 dB and 40 W at 4.5 dB, respectively. Each transistor features balanced-emitter construction.

CIRCLE NO. 337

GaAs laser diode line spans 8 to 200-W range

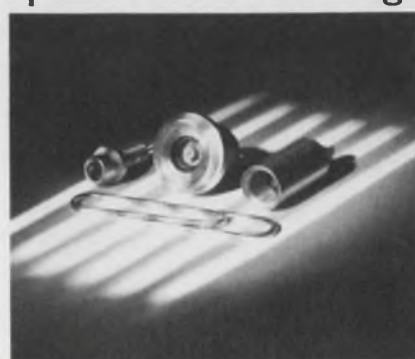

Sperry Gyroscope Electro-Optics Group, Great Neck, N.Y. Phone: (516) 574-2715.

Featuring low threshold currents and low costs at peak power densities is a line of new GaAs laser diodes ranging from 8-W units to 200-W arrays. Single diodes in the 8 to 23-W range are stud mounted. Higher-power units include a 40-W dual diode and 100 to 200-W radial arrays. Units in 500 and 1000-W densities will be available in the future.

CIRCLE NO. 338

the original ALCOSWITCH®

The original miniature ALCOSWITCH® has been the engineer's 1st choice for contemporary front panel designs.

When most every one was working with conventional switches of the 1930's, ALCOSWITCH® introduced the concept of mass-produced switches compatible with the new technology of miniaturization.

Ultra-miniature in size, the original ALCOSWITCH® combines high current capacity and exceedingly long life into a 1/2" size case. Contacts are solid silver and the phenolic body has high voltage barriers between terminals and contacts.

Since its introduction the original ALCOSWITCH® has withstood the test of time, where today it is the "most-asked-for" miniature switch.



This broad line of miniature switches includes toggles, push buttons and rotaries, all available in one, two, three and four pole in a single case construction.

Read all about it in this 20-page catalog!



ALCO®

ELECTRONIC PRODUCTS, INC.
Lawrence, Massachusetts 01843

Low-cost calculator uses mosaic lamps



Spiras Systems, Inc., 332 Second Ave., Waltham, Mass. Price: \$7000 to \$8000.

Introduced as a specialized version of the Irascope CRT data base display terminal, the model DBEC 1000 U/L system features 72 IBM-font upper and lower-case characters. This new terminal provides local and/or remote editing capabilities. It also claims flicker-free characters in a 2000-character field and a bonded safety faceplate etched for minimum glare.

CIRCLE NO. 340

CRT computer displays show black-on-white



Wyle Laboratories, Computer Products Div., 128 Maryland St., El Segundo, Calif. Phone: (213) 322-1763.

Labeled as Computerminal, a new data display terminal offers a display capacity of up to 1024 characters. Model 800 can handle transmission speeds as fast as 2400 bits per second. It provides control disciplines that are equivalent to IBM models 2260 and 2265. Special keyboard configurations permit its use in a variety of applications.

CIRCLE NO. 342

Dictaphone Corp., Business Machines Div., 120 Old Post Rd., Rye, N.Y. Price: \$695.

A 14-digit calculator, which sells for \$695, uses a mosaic-lamp display to eliminate depth perception problems and glimmering effects, and to minimize operator eye fatigue and transposition errors. A principal feature of model 1401 is its zero suppression system, which displays only the actual numbers put into the calculator and the results.

CIRCLE NO. 339

CRT terminal stylizes font



Applied Digital Data Systems, Inc., 89 Marcus Blvd., Hauppauge, N.Y. Phone: (516) 273-7799. P&A: \$2995 to \$3995; 90 to 120 days.

Unlike most computer terminals, the Consul series of CRT displays show black characters on a white display page centered on the screen to ease eyestrain. The page format provides margins that enable the user to anticipate the end of a line or the last of a sequence of text. The units are compatible with teletypewriters.

CIRCLE NO. 341

Data display terminal shows 1024 characters

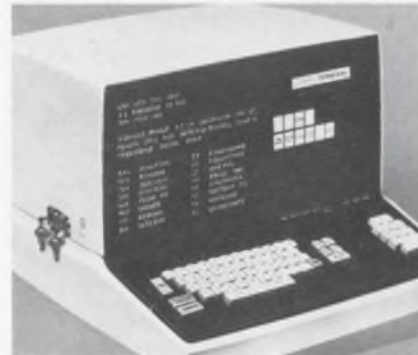

Low-cost minicomputer simplifies programming



Atron Corp., Trapp Rd., St. Paul, Minn. Phone: (612) 454-6150. Price: from \$6000.

The Datamanager 501 is a new low-cost minicomputer that is said to significantly reduce programming time. Its processor is specifically designed to handle data in strings as well as single characters. The basic machine, which costs \$6000 in quantity, includes four high-speed buffered I/O channels with full buffer address control and two direct memory access ports.

CIRCLE NO. 343

Solid-state keyboards cost just \$100 each



Control Devices, Inc., 204 New Boston St., Woburn, Mass. Phone: (617) 935-1105. P&A: \$100; 30 days.

Low-profile solid-state keyboards are said to use a unique switching technique that allows these fully encoded units to sell for less than \$100 in production quantities (1000 units or more). Series CDK keyboards offer two basic formats: one for typical typewriter applications and one for keypunch-type applications. The basic configuration has up to seven rows of keys.

CIRCLE NO. 344

The best power supply
to tuck into impossible spaces
is the one specifically designed
to tuck into impossible spaces.
We make it.
We call it our Impossible Space
Power Supply.
(also known as the JR series)

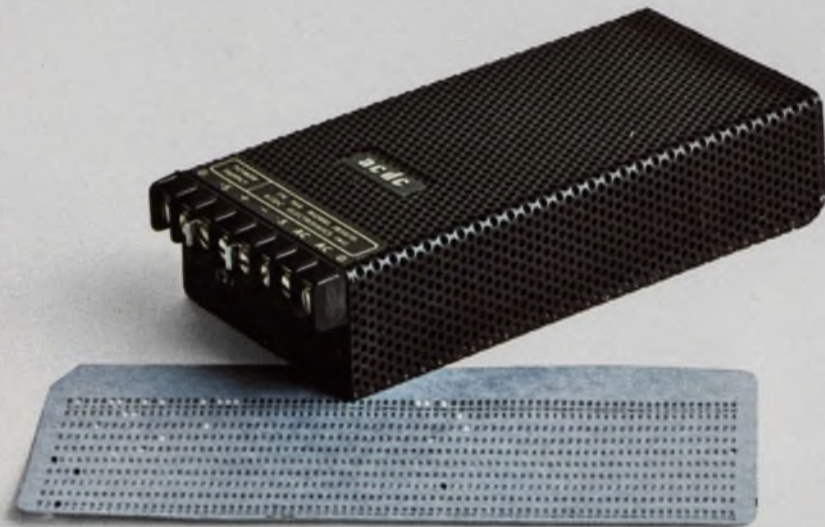

Weighing in at a mere 1.5 pounds and measuring only 1 $\frac{3}{8}$ " x 3 $\frac{1}{8}$ " x 6.5", ACDC's new JR offers more watts per unit volume than any other miniature power supply on the market. It's so small that you can put five of them in the same space normally occupied by one of "theirs" . . . so efficient (80%) that it requires no internal heat sinks . . . and so noise-free that you can use it anywhere.

Three JR models are available in continuously adjustable

output voltage ranges from 3.0 to 30 volts (0.1% regulation) and in current ratings from 2.0 to 10 amps. And most important, it operates from conventional 60 or 400 cycle input.

Of course, the JR costs a little more than conventional power supplies (\$285 in small quantity), but if space and efficiency is your problem, the JR is your only answer.

Get one tomorrow . . . or five . . . or ten . . . or a hundred. They're on the shelf.

acdc electronics inc.

Oceanside Industrial Center, Oceanside, California 92054, (714) 757-1880

JR Miniaturized Power Supply Module Specifications

Nominal Output Voltage (VDC)	Output Voltage Range ^a (VDC)	Maximum Current Rating (Amps)	Maximum Dimensions (inches)			Weight approx. (lbs.)	Case Size	Model (Add -1 for Overvoltage Protection)	Quantity	Price (add \$30 for OVP)
			H	W	L					
5	3.0	10	1.375	3.125	6.5	1.5	K1	JR5K10	1-9	\$298
	5.0	10							10-24	291
	5.5	9							25-49	285
	6.0	8							50-99	280
15	12	4.0	1.375	3.125	6.5	1.5	K1	JR15K4.0	1-9	\$298
	15	4.0							10-24	291
	18	3.0							25-49	285
25	22	2.5	1.375	3.125	6.5	1.5	K1	JR25K2.0	1-9	\$298
	25	2.0							10-24	291
	30	2.0							25-49	285
										50-99

^aContinuously adjustable

Input	105-125VAC, 47-420Hz, single phase.
Output	Voltage range shown in table is continuously variable between limits by externally accessible screwdriver adjustment of multiturn pot. Output is floating — either positive or negative terminal may be grounded. Current: zero to full load as shown in tables.
Regulation	0.1% + 5mV NL-FL ± 0.1% ± 5mV for ± 10% input variation.
Ripple	3mV RMS max (120Hz). 25mV P-P (spikes at 50KHz rep. rate).
Stability	Typical 10mV for eight hour period after initial warmup.
Transient Response	Typically less than 1 msec in response to an NL-FL step.
Remote Sensing	Terminals are provided to maintain regulation at the load, compensating for the DC voltage drop in the load cable.
Remote Voltage Adjustment	Terminals are provided to adjust the output voltage by means of a remote variable resistor.
Ambient Temperature	Unit must be mounted to allow conductive heat-sinking to hold the case temperature below 80°C.
Weight	Approx. 1½ lbs.
Mounting	Mounting surface 3½ x 6½ has threaded mtg. holes.
Dimensions	1¾ x 3½ x 6½.

Overload Protection	Models are inherently protected against overload and short circuits of any duration. Automatic recovery is electronically accomplished.
Overvoltage Protection (Optional)	A complete independent overvoltage protection module is available and straddles the output terminals. This protection does not depend on the regulating circuitry of the supply. Trip voltage adjustable from 5-30 volts.
Connector	Barrier strip termination.
Construction	Black anodized aluminum case. Unit may be removed from case for complete serviceability.
Temperature Coefficient	0.02%/°C max.

TEMPERATURE GRAPH FOR JR SERIES POWER SUPPLIES.

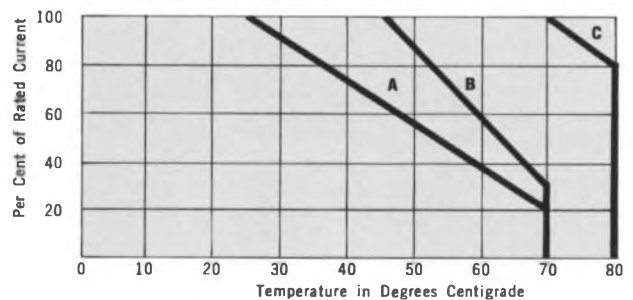

A. Ambient temperature. Unit unmounted. Base plate vertical.
B. Ambient temperature. Unit attached to HS-1 Heatsink. Fins vertical.
C. Base plate temperature of supply.

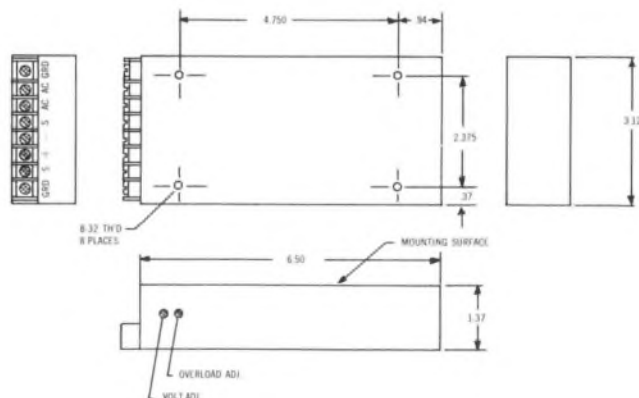

Full-feature display has \$2995 price tag

Hazeltine Corp., Industrial Products Div., Little Neck, N.Y. Phone: (212) 321-2300. P&A: \$2995 or \$88/month; stock.

The model 1760 terminal is a compact stand-alone desktop display that includes a keyboard input and a CRT monitor for only \$2995, not \$500 as previously reported (ED 9, April 26, 1970, page C41, circle no. 265). This new display terminal can present 1760 characters on 32 lines of 55 characters each, or 1998 characters on 27 lines of 74 characters each. In addition, the 1760 offers split-screen capabilities and full editing features.

Characters have a 5 by 7 dot matrix structure, and character generation is by means of ON/OFF control of a standard 525-line TV raster. Nominal transmission rate for the new terminal is 110 baud, adjustable to 2400 baud or to below 110 baud. The unit comes with 9 or 12-in. monitors.

CIRCLE NO. 345

Electronic calculators trim operator time



IME Sales Corp., One IME Plaza, North Bergen, N.J.

Designed for general business use, series 120 electronic calculators feature a simplified keyboard to reduce the number of key depressions, thereby increasing operator efficiency by as much as one-third. Visual recall of both the factors and the total of the previous calculation, automatic rounding, and self-clearing are other advantages. The units are supplied with four, five or six memories.

CIRCLE NO. 346

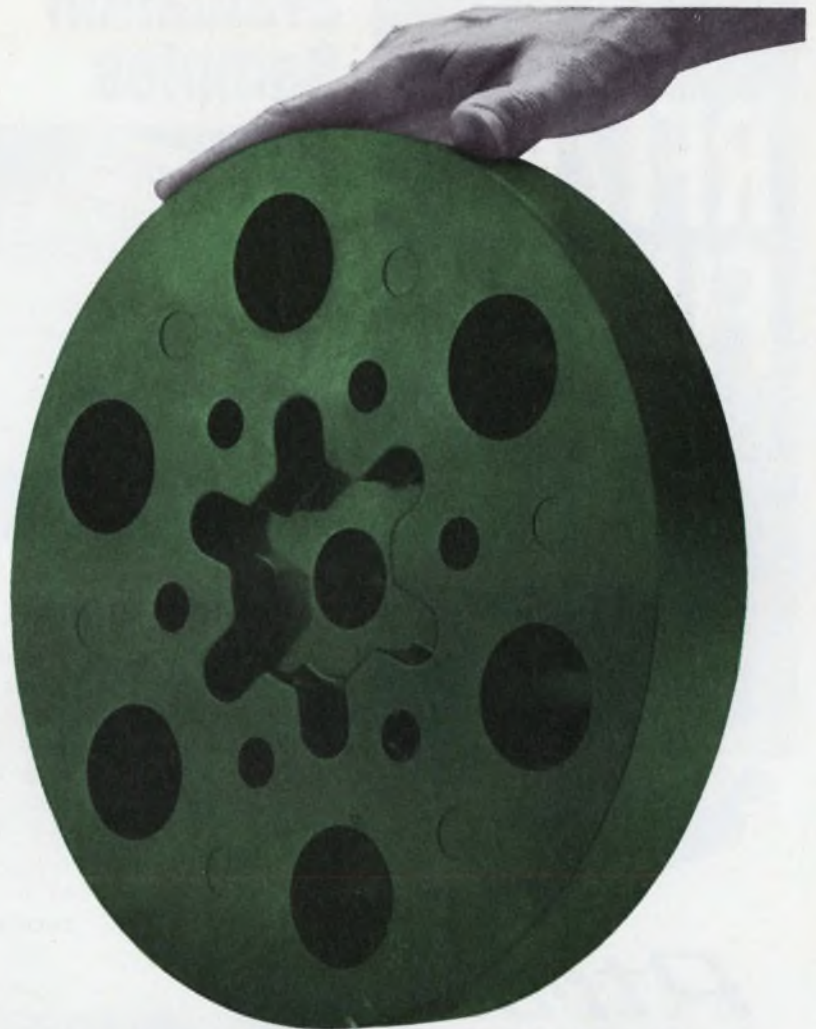

Who says diallyl phthalate is for small parts? Not GE!

GE specified a diallyl phthalate compound for this 8¼-pound molding because of its remarkable insulating properties. It is one of the largest moldings ever made of the material.

FMC's diallyl phthalate* resin has negligible lifetime shrinkage, doesn't lose its electrical insulating properties, and isn't degraded by moisture or aging.

In fact, among thermosetting plastics, it is unsurpassed in the ability to retain its electrical characteristics at high temperature and humidity levels.

This big insulating header, molded with an Acme Resin glass-fiber-filled compound,

is extremely strong. Used in large, high voltage power transformers, it proves that diallyl phthalate has more than just application in small, precision-molded parts.

If you need molded parts that stay on the job, remember a compound based on FMC's diallyl phthalate resin can solve a wider range of tough—and big—problems. Organic Chemicals Division, FMC Corporation, 633 Third Ave., N.Y., N.Y. 10017.



*FMC supplies basic diallyl phthalate and diallyl isophthalate resins under the trade-name DAPON. Write for complete information and a list of companies supplying molding compounds and prepregs based on these resins.

FMC Chemicals

INFORMATION RETRIEVAL NUMBER 85

TUBULAR,
BULKHEAD
MOUNTING TYPE

RFI/EMI FILTERS



Rtron

Cylindrical Style Interference Filters

that reduce or eliminate unwanted noise or signals. Small size, light weight, maximum attenuation. Voltage current or insertion loss characteristics required, determine physical size. Maximum isolation of terminals and high frequency performance are assured by threaded neck design for bulkhead mounting. Feed-thru capacitor circuitry conservatively rated for both military and commercial applications.

Rtron corporation
 P.O. Box 743 Skokie, Illinois 60076
 Phone 312 • 327-4020

- Send catalog and prices.
- Have Representative call.
- Specifications enclosed on Multi-circuit or custom design filters. Send estimate.

Name _____

Firm _____

Address _____

City _____

State _____ Zip _____

INFORMATION RETRIEVAL NUMBER 86

Evaluation Samples



Dry transfer lettering

Free samples of an extensive line of dry transfer letters and symbols are available. The line consists of four type styles (#1200, #9700, #1400, and #5700) in a variety of sizes. Styles include Jason, Computype, Parady and Futura Light in lower-case and capital letters and numerals. Tactype Inc.

CIRCLE NO. 347

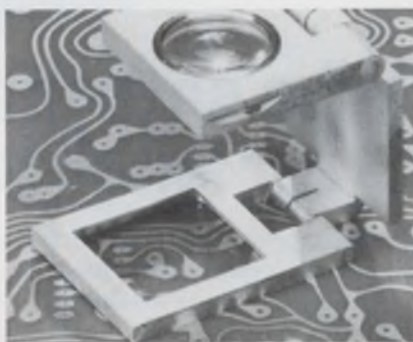

PC board etchant

Phodar is a new photopolymer dry-applied resist that reduces PC board etching to a simplified five-minute process. Preparation time is cut because no special cleaning solutions are required and meticulous care to assure perfect adhesion between film and plate is unnecessary. There is no waiting time between lamination and exposure and Phodar completely eliminates the post-baking cycle after development. Full details and a free test pack are available to qualified readers. Photopolymer Research Corp.

CIRCLE NO. 348



Temperature monitor

A free evaluation sample is available of a self-adhesive miniature 5/16-in. square temperature recorder. The model 200 is a pastel temperature monitor that indicates the temperature attained over the range of 100 to 1100°F by turning black permanently when its rated temperature is reached. Models are available with one to eight different calibrated temperature ratings. The rated temperature is printed below each indicator window. William Wahl Corp.

CIRCLE NO. 349



Drawing board cover

Vyco is a new cover that rejuvenates drawing board surfaces for better protection and longer life. It's vinyl three-ply laminated construction assures crack-free surfaces and consistent line drawing reproductions at high quality. It has two useable surfaces: green and ivory. Compass point holes and hard pencil impressions will not mar its two surfaces. Sample pieces are available for examination. Alvin & Co., Inc.

CIRCLE NO. 350

Design Aids

Resistor curves

A series of three curves and a table of comparison are available to assist engineers in calculating resistor power ratings. The curves are used to approximate how much heat a given resistor will generate under a given condition. One is a derating curve for resistor ambient temperature, another curve shows the resistor's temperature rise vs its power dissipation and the third curve gives the percentage of the resistor's power rating vs its temperature rise. The table gives the amount of heat the resistor will generate under a given circuit and ambient conditions. Ward Leonard Electric Co.

CIRCLE NO. 351

Color selector

A new contemporary color selector for a standard line of metal enclosures for electronic instruments and systems is available. It shows color swatches that are selected to afford the enclosure designer a wide opportunity to create attractive color schemes by coordinating, contrasting or harmonizing the standard colors shown. Premier Metal Products Co.

CIRCLE NO. 352

Frequency chart

A frequency-conversion chart that covers the frequency range of 1 Hz to 10 GHz and directly indicates frequency stabilities of oscillators is available. It gives frequency stabilities in parts-per-million and in per-cent figures. It is designed as a time saver for those engineering groups and manufacturers who are continually working with frequency-control devices. Accutronics/Div. of Gibbs Manufacturing and Research Corp.

CIRCLE NO. 353



Simpson's NEW solid-state VOM with FET-Input

- **HIGH INPUT IMPEDANCE...**
11 Meg Ω DC 10 Meg Ω AC
- **PORTABLE..... battery operated**
- **7-INCH METER..... overload protected**

Simpson's new 313 gives you high input impedance for accurate testing of latest circuit designs . . . free of line cord connections. Over 300 hours operation on inexpensive batteries. And the new 313 is *stable*, which means positive, simplified zero and ohms adjustments. Protected FET-input handles large overloads. DC current ranges to 1000 mA. Sensitive Taut Band movement and 7-inch meter scale provide superior resolution down to 5 millivolts. Write today for complete specifications.

Complete with batteries, 3-way AC-DC-Ohms probe, and operator's manual **\$125.00**

*GET "OFF-THE-SHELF" DELIVERY FROM
YOUR LOCAL ELECTRONIC DISTRIBUTOR*

Simpson

ELECTRIC COMPANY



5200 W. Kinzie Street, Chicago, Illinois 60644 • Phone (312) 379-1121

EXPORT DEPT.: 400 W. Madison Street, Chicago, Illinois 60606. Cable Simelco
IN CANADA: Bach-Simpson Ltd., London, Ontario • IN INDIA: Ruttonsha-Simpson Private Ltd., International House, Bombay-Agra Road, Vikhroli, Bombay

INFORMATION RETRIEVAL NUMBER 87

C-COR AMPLIFIERS

ALL NEW 3230 SERIES SOLID STATE POWER AMPLIFIER LINEAR OUTPUT TO 4 WATTS



C-COR MODEL 3231 Bandpass Power Amplifier

With frequency range from 90 to 500 MHz and bandwidth to 60 MHz, the MODEL 3230 series amplifiers provide excellent transient response, smooth flat bandpass frequency response and wide dynamic range. The new C-COR 3230 Series will find use where several watts of power are required for pulse, FM, AM, or CW signal amplification.

Specifications	Model 3230 Series
Frequency Range MHz	90 to 500
3 dB Bandwidth [Min]	30 to 60
1 dB Bandwidth [Typ]	80% of 3 dB Bandwidth
Gain	20 to 35dB

Power Output
[Min] [dBm] at
1 dB compression

+30 to +36
Package size: 2" H x 3" D x 7" L
(over 325 MHz Units 9" L)

Input/Output Impedance for all models is 50 ohms and power required is +28 Vdc. Operating temperature -40 to +60°C (Air Temperature)

Model 3230 Series are standard catalog units aligned to customer's exact bandpass. Hence they provide a fast, economical answer to a large variety of linear amplifier needs. More difficult requirements can often be met by paralleling or otherwise modifying standard units.

Write or telephone for catalog and technical data on your amplification requirements . . . or check C-COR listing in EEM.

"C-COR Amplifiers . . . Rated First
Where Performance is Rated First."



C-COR

ELECTRONICS, INC.

60 Decibel Road

State College, Pennsylvania 16801

814 238-2461

Application Notes



Logic handbook

The sixth edition of the 1970 Logic Handbook contains 448 pages covering solid-state logic, application notes and descriptions and prices of more than 200 standard logic and accessory items. It describes M-series TTL interface and design circuits, K-series industrial control logic, analog/digital converters, power supplies, mounting hardware, cabinetry, and wire-wrapping services. It also describes earlier R, B and W-series logic modules. Digital Equipment Corp.

CIRCLE NO. 354

Wave analyzer

A number of typical wave analyzer applications are illustrated in a new 20-page booklet. It shows instrument connections on a page that is opposite an X-Y graphical recording of the result. Applications include measuring harmonic amplitudes, determining distortion, comparing filter characteristics and audio frequency-response recording. Hewlett Packard Co.

CIRCLE NO. 355

Ultrasonic delay lines

An illustrated two-color brochure describing new digital delay lines and their applications is available. It covers the basic definitions and measurements of delay, attenuation and spurious signal levels. Characteristic operating curves and tabulated performance data for representative designs are included. Microsonics Division of Sangamo Electric Co.

CIRCLE NO. 356

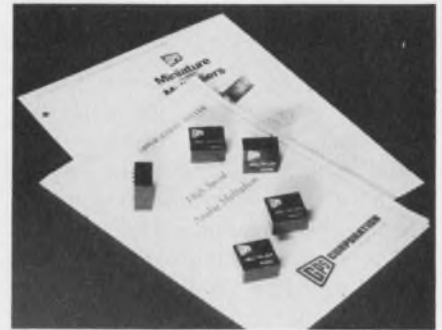

Analog multipliers

Application notes on high-speed analog multipliers are available in a new booklet. It presents a series of block diagrams with simplified technical descriptions of many useful multiplier applications as a systems component. Included are applications in the field of computation, signal conditioning, high-speed switching and modulation/demodulation. Useful background information on types of multipliers and typical sources of error is also presented. GPS Corp.

CIRCLE NO. 357

Data retrieval

"Modulated Time Codes Find Data in Analog Recording Systems" is an illustrated handbook on the theory of time code indexing and automatic data retrieval. It discusses the theory of operation, bandwidth recording on magnetic tape, time error accumulation and synchronization accuracy, weighted digit code recognition and reader-automatic search. CGS Scientific Corp., Datametrics Div.

CIRCLE NO. 358

Signal processing

A new method of signal processing called differential pulse width modulation is discussed in a six-page brochure. The method permits transducers to produce a high-level output signal to overcome the problems of noise and ground loops or power-frequency pickup. The brochure includes basic principles of operation with illustrations. Setra Systems, Inc.

CIRCLE NO. 359

Impatt diodes

A new method for measuring the thermal impedance of impatt diodes is discussed in a new application engineering bulletin. The new method achieves measurement results by the use of the reverse-bias characteristics of the diode's current-voltage curve. Thermal impedance values obtained by this method have been found to be more reliable and more meaningful than values obtained from forward-bias characteristics. Varian, Solid State Div.

CIRCLE NO. 360

Ladder networks

A new 14-page application engineering bulletin surveys the d/a and a/d requirements for networks and describes design principles for ladders. Schematic diagrams show basic converter circuits as well as formulas for calculating transfer functions and binary relationships. Circuit diagrams are also used to describe weighted, current-fed, and voltage switching ladders. Advantages and limitations of various networks for use in a/d and d/a converters are also presented. Vishay Resistor Products, Division of Vishay Intertechnology, Inc.

CIRCLE NO. 361

Neon glow lamp design

An illustrated technical discussion on the design of neon glow lamps, their operational characteristics and applications is available in a 12-page brochure. It starts with a discussion of what a neon lamp is, how it works and why, and what the operational characteristics of the device are. Included are two and three-element lamps showing how light is generated and what the spectral distribution of the light is. Ignition characteristics and methods are discussed with many curves and charts showing how the lamps act under different conditions. Signalite Inc.

CIRCLE NO. 362

You can reduce costs by Improving Reliability

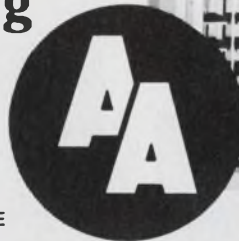

AEROTRONIC ASSOCIATES
CAN HELP YOU KEEP
THE COMPETITIVE EDGE

with Burn-In and Life-Test Systems custom designed to your own specifications. If you are a large user of semiconductor or IC devices, preconditioning can significantly

reduce sub-assembly or system failures. Eliminate costly rework by

preconditioning semiconductor and IC components.

Reduce SUB-ASSEMBLY FAILURES as much as 80 percent

Reduce SYSTEM failures by 40 to 50 percent

Circle our information retrieval number for a copy of, "A Logical Approach to Testing ICs."

Contact
AEROTRONIC ASSOCIATES

CONTOCOOK, NEW HAMPSHIRE 03229

TELEPHONE (603) 746 - 3141

INFORMATION RETRIEVAL NUMBER 89

circuit-stik^{INC.}

INSTANT CIRCUIT BOARDS!

**A NEW ELECTRONIC
PACKAGING
CONCEPT***

From
schematic
drawings to
card cage systems—
IN ONE STEP!

- NO ETCHING
- NO DRILLING
- NO ART WORK

**SEND FOR YOUR
FREE CATALOG
AND SAMPLES.**



All types of circuit-element configurations may be mixed and combined on the same board.

circuit-stik^{INC.}

1518 W. 132nd STREET, GARDENA, CALIFORNIA 90249

*Patent Pending

New Literature

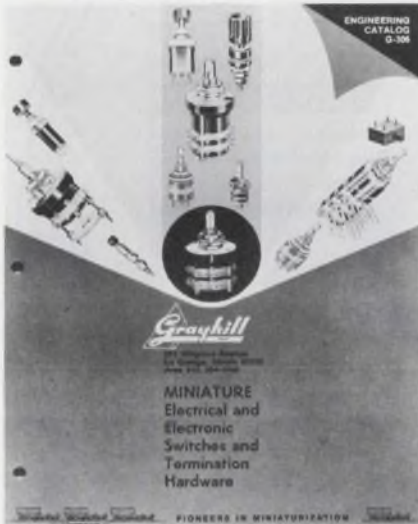

Switches

Miniature electronic switches, terminations, indicator lights, and a multitude of termination hardware are listed in a new comprehensive 88-page catalog. Switches contained include pushbutton, rotary, lighted and printed circuit types. Termination hardware includes binding posts, test jacks and clips, insulators, coil forms, washers, and transistor, lamp and tube sockets. Specifications, outlined dimensions and illustrations are shown. Grayhill Inc.

CIRCLE NO. 363



Indicator lights

Catalog MIL-70 is a quick and handy cross-reference to military numbers of indicator lights, base and cap assemblies. It also covers military products that are qualified and tested to meet requirements of MIL-L-3661B. The two-fold, three-ring-punched catalog details indicator-light specifications and illustrates many military styles. Marco-Oak, a division of Electro/Netics Corp.

CIRCLE NO. 364

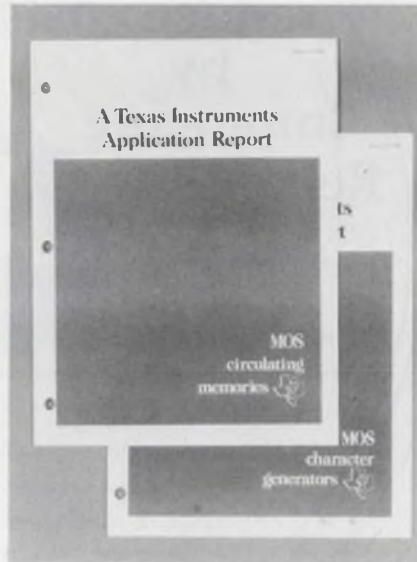

MOS ICs

Two new application reports discuss the use of MOS integrated circuits. One 16-page booklet discusses how MOS shift registers can be combined with TTL ICs to form economical data memories. The three main parts of a circulating memory are discussed in detail. Block diagrams are included to illustrate each of the circulating memory parts. The other report describes MOS read-only memory character generators and how they can be used advantageously in display systems. Covered are fundamentals of character generators and detailed applications. Texas Instruments Inc.

CIRCLE NO. 365

Modules and matrices

Programming modules and matrix boards and accessories are detailed in a four-page two-color condensed catalog. It describes the role of the matrix board as a fundamental programming method for thousands of different instruments and systems. Matrix boards listed are shown with hole patterns and spacing dimensions. Various ways are shown in which appropriate nomenclature, symbols and programming stripes can be added. Interswitch.

CIRCLE NO. 366



Metric tools

A broad line of foreign metric and domestic industrial tools are described in a new illustrated catalog. Tools shown include taps, dies, reamers, wrenches, precision and special instruments and other accessories in metric and non-metric sizes. The catalog is carefully compiled and designed for convenience, ready reference and reading ease. It includes tables of conversions and charts that are useful for practical shop work. Veteran Tool & Supply Co.

CIRCLE NO. 367



Shelf power supplies

A complete line of shelf power supply packages is described and shown in a new 12-page two-color catalog. Supplies shown include six different-sized packages with seven voltage levels ranging from 3.6 to 28 V dc at current ratings from 0.35 to 85 A. General specifications, dimensional data, options, accessories and prices are given. North Electric Co., Electronics Div.

CIRCLE NO. 368



Connectors

A full line of solderless terminations and unique attaching tools are described in a four-color 28-page catalog. Illustrated are insulated and non-insulated terminals to meet every requirement. Also included are special-type terminals for high-temperature applications up to 650°F. Vaco Products Co.

CIRCLE NO. 369

Instruments

Various laboratory and measurement instruments are described in a new 32-page illustrated catalog. It contains information on voltage, current and power measuring equipment. It also includes laboratory standards, ratio transformers, high-voltage dividers and several instrument accessories. Singer Instrumentation Div.

CIRCLE NO. 370

Filter program

A filter program that allows the filter designer or systems analyst to select a given filter transfer function from a program list is described in a new booklet. Selectable transfer functions include Bessel, elliptic, Butterworth-Thompson and ultrashperical, plus others. Selection can be made for the filter's geometry, and frequency and impedance transformations. Systems Associates, Inc.

CIRCLE NO. 371

Why settle for molded composition when you can get the superior quality of Carbon Film Fixed Resistors at even lower prices!



Available in wattages of 1/8, 1/4 and 1/2 ... in resistance ranges from 1 ohm to 10 megohms ... at tolerances of 5% and 10% ... Amperex carbon film resistors offer all the advantages of high stability, low noise level and long life that make them ideal for all applications.

Proven superior to competitive molded composition types and priced (for example) at \$50.00 per thousand for a 1/8 watt resistor with a 5% tolerance, Amperex carbon film resistors are immediately available in unlimited production quantities from our main warehouse in Hauppauge, New York as well as from strategically-located distribution centers all over the U.S.A.

For detailed data and evaluation samples, write: Amperex Electronic Corporation, Component Division, Dept. R, Hauppauge, New York 11787. For even faster service, phone 516-234-7000.

Amperex®

TOMORROW'S THINKING IN TODAY'S PRODUCTS

A NORTH AMERICAN PHILIPS COMPANY

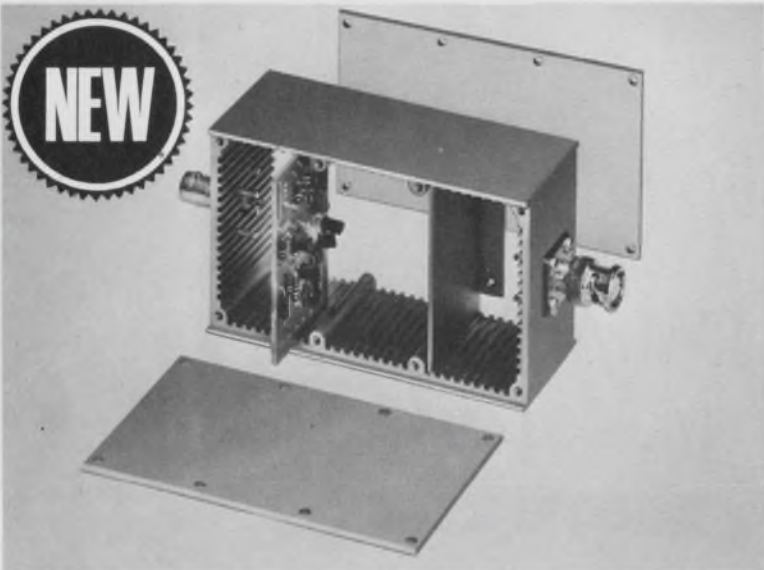

SHIELDED BOXES with CARD GUIDES

Rugged die-cast aluminum boxes, slotted to accept $\frac{1}{4}$ " circuit boards and shielding dividers. Excellent for packaging electronic circuitry. Boxes have removable top and bottom covers. Useable inside space: 4"x2"x1 $\frac{1}{2}$ ". Several models with various connectors.

Write for 1969 Catalog



POMONA ELECTRONICS CO., INC.
1500 E. Ninth Street, Pomona, California 91766

INFORMATION RETRIEVAL NUMBER 92



Instrumentation

The 1970 edition of the Honeywell 276-page hard-cover instrumentation catalog is available to qualified readers. It covers in separate sections technical information on instruments and systems, applications notes on how and why particular instruments are used and descriptions of supporting services. Products shown include recorders, voltmeters, amplifiers, monitor scopes and data-acquisition and bio-medical systems. Other products include medical instruments, transducers, rfi/emi instrumentation, and signal-conditioning equipment. Honeywell Test Instruments Div.

CIRCLE NO. 372



Components

The new 120-page Component Selector contains listings and extensive engineering information on new lines of standard products that are said to cover 98% of industry requirements. These products include SCRs, capacitors, low-pass, L-section and rfi/emi filters, enclosed general-purpose relays, dual temperature-rated tantalum foil capacitors and many other components. Cornell-Dubilier Electronics.

CIRCLE NO. 373

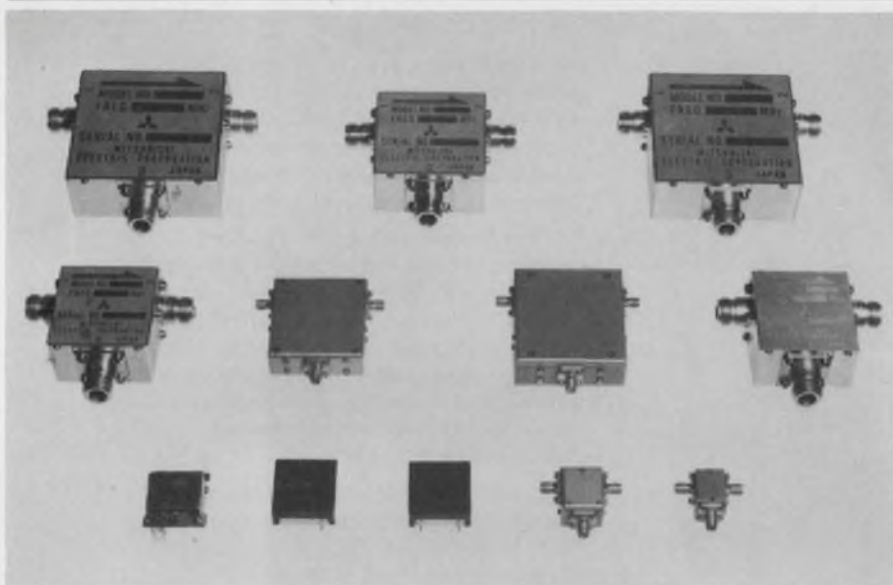

Thanks for Visiting the Mitsubishi Booth

We extend our sincere appreciation to all those IEEE Show visitors who took the time to stop by the Mitsubishi Electric booth. The enthusiastic interest shown in the displays was especially encouraging. We are glad to be able to report that our monolithic ICs and mini circulators—VHF, UHF, and SHF, as well as the 700 MHz type—were all favorably received.

Now that the show is over, we welcome any further inquiries from you about the new research developments and techniques.

ADVANCED AND EVER ADVANCING
MITSUBISHI ELECTRIC

Tokyo, Japan

INFORMATION RETRIEVAL NUMBER 93



Industrial controls

Application notes describing a line of monitors and time-delay relays are included in a revised 12-page catalog. Monitors included are voltage, current, phase-sequence and phase-loss types. These are for single-phase or three-phase delta or wye monitoring. Solid-state time-delay relays include delay-on-operate, interval-on-operate, delay-on-release and single-shot models. Diversified Electronics Inc.

CIRCLE NO. 374

Connectors

A large number of styles and sizes of high-density rack-and-panel connectors are described in a 12-page catalog. Described are military and commercial types with 9 to 51 contacts in plastic and metal shells. Included are detailed engineering drawings, photographs, and exploded parts views that present all physical parameters and contact locations. Microdot Inc., Connector Div.

CIRCLE NO. 375

Lamps and magnifiers

A full line of industrial lamps, magnifiers, and magnifier-lamp combinations are described in a comprehensive eight-page catalog. Lamps covered include high-intensity, balanced-arm engineering, magnetic-base, spotlight and utility lamps. Accessories and prices are also shown. Roxter Corp.

CIRCLE NO. 376

HIGH DENSITY IC PACKAGING PANEL Modular Type

INCREASES FLEXIBILITY
IN PROTOTYPING,
PRODUCTION AND
FIELD SERVICE.

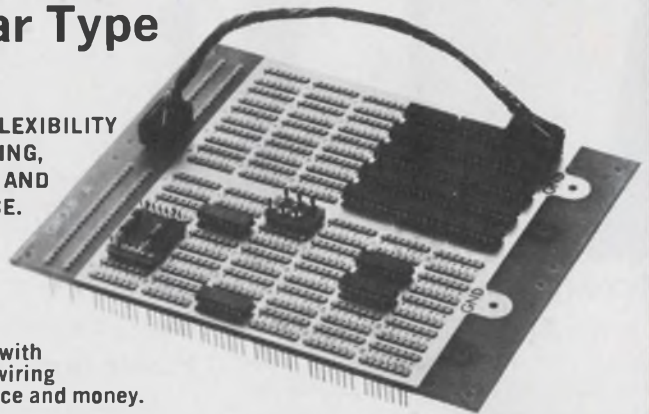

P Series Panel with
Point to Point wiring
saves time, space and money.

- Available in multiples of 30 IC pattern sections up to 180 patterns.
- Two pins of each pattern tied directly to power and ground planes. Different numbers available for different pin assignments.
- IC pattern also accepts I.O. plugs and adaptor plugs for discrete components.
- Excellent contact retention and low contact resistance.
- Wire Wrap terminations with Tri-level connection length.

Request Complete IC Folder

AUGAT

Tel: 617-222-2202

31 Perry Ave., Attleboro, Mass. 02703

INFORMATION RETRIEVAL NUMBER 94

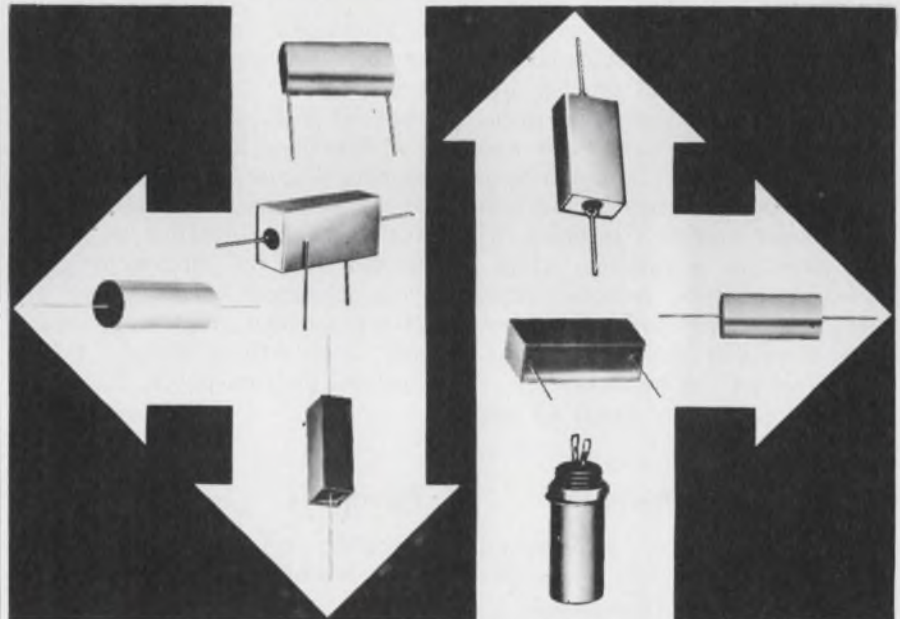

A size breakthrough in metalized polycarbonate capacitors

is now produced by S&E Manufacturing. The new mini-miniature 22 series of 50VDC and 100VDC metalized polycarbonates are available in all standard encasements. They feature an excellent combination of high thermal stability and small size, making them particularly superior for circuits requiring a flat T.C. and low losses. A typical size in our 22R series, of 10.0 mfd. 50VDC, is .58 O.D. x 1.16 in length. A 1.0 mfd. size is .40" x .67". So we invite you to call for any special configuration techniques and sizes, or send for our data catalog sheets.

S&E Manufacturing / Capacitors

18800 Parthenia Street, Northridge, California 91324 • (213) 349-4111 • TWX 910-493-1252

INFORMATION RETRIEVAL NUMBER 95



Microwave products

A line of broadband components for rf, i-f and microwave signal-processing systems is available in a 12-page catalog. It gives descriptive specifications on over 150 devices offered in standard connector and subminiature PC plug-in types. Hybrids, power dividers, combiners, directional couplers, and balanced mixers described cover the frequency range of 0 to 3 GHz in multi-octave bands to permit broadband signal processing. Anzac Electronics division of Adams-Russell Co., Inc.

CIRCLE NO. 377

Dc power supplies

A complete line of regulated and parametric dc power supplies are covered in a new eight-page document. It lists six basic lines and numerous models of dc power supplies for both laboratory and systems requirements. Included is such data as regulation, ripple, noise, attenuation, response time, operating temperature, circuitry, dimensions and delivery information. Wanlass Instruments.

CIRCLE NO. 378

Resistors and rheostats

Various types of wire-wound resistors, rheostats and accessories are featured in an 18-page catalog. Included are fixed, adjustable, non-inductive, axial-lead and lug-ended type resistors with power ratings from 1 to 225 W. Power rheostats with ratings to 300 W are also shown. A discussion on resistor selection and ratings is contained along with resistor temperature-rise curves. Ward Leonard Electric Co.

CIRCLE NO. 379



Power semiconductors

Specifications for a complete line of power transistors, power rectifiers, rectifier assemblies, zener and reference diodes, triacs and SCRs are offered in an 80-page catalog. Individual booklets of different colors separate the catalog into various product families. A listing of JAN and JAN TX military part numbers is also included. Sensitron Semiconductor.

CIRCLE NO. 380

Thermistor probes

Thermistor probes for precise temperature measurement and control in medical, scientific, and industrial applications are illustrated and described in a new eight-page catalog. It contains complete specifications, prices, and ordering data. Included is information on an improved line of probes offering close tolerances. Also included are extremely small, high-temperature, and linear-output probes. Yellow Springs Instrument Co., Inc.

CIRCLE NO. 381

Terminals

Open-barrel terminals for automatic-machine applications are covered in a 32-page catalog. It describes over 825 types that are intended for high-speed automatic installation. The associated automatic machinery is also described. Part numbers, dimensions and material contents are detailed in tabular form. A handy numerical index for locating any part number in the catalog is also included. AMP Incorporated.

CIRCLE NO. 382

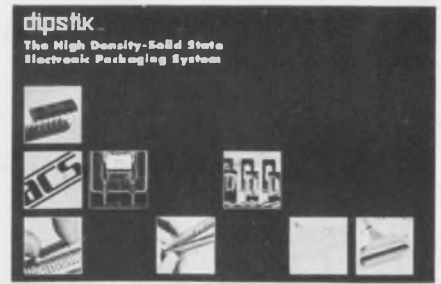

Dual-in-line packaging

How to mount 5 dual-in-lines in a package 1/4 the size of a PC board in 30 seconds without a drop of solder is only one of the features covered in a 16-page catalog. It details how a new high-density IC packaging device eliminates most of the problems associated with PC boards and socket mounting systems while providing high-capacitance and low-impedance ground and power planes. Other areas covered in detail are the device's capability to accommodate dual-in-lines with varying tolerances. ACS Industries.

CIRCLE NO. 383

IC sense amplifiers

A series of high-speed sense amplifiers is fully described in an eight-page booklet. Electrical characteristics, recovery and recycle times and logic diagrams are included. Switching characteristics and schematics are also included. Three output configurations that are widely used in this series are shown. Component values are included on schematics. Silicon General Inc.

CIRCLE NO. 384

SCRs and triacs

Specifications, characteristics, parameters and ratings for the selection and application of SCRs and power logic triacs are contained in a new 112-page catalog. It includes outline drawings, an abundance of characteristic curves, dimensional data and pertinent considerations regarding device use. A separate section contains information on power control assemblies and a discussion on heat exchangers. International Rectifier.

CIRCLE NO. 385

Electronics in Canada

Over 200 Canadian electronics companies are listed in a comprehensive booklet, published by the Canadian Government, to serve as a ready reference for anyone who is interested in Canadian electronic products and services. Listings of electronic equipment and systems, components, consumer products and consultant companies include addresses, products and services. A product index shows you exactly where to look for particular requirements. The booklet also outlines the story of the growth and success of the electronics industry in Canada. Canadian Department of Industry, Trade and Commerce.

CIRCLE NO. 386

Rf coaxial connectors

Miniature SMA 3-mm rf coaxial connectors designed to meet requirements of MIL-C-39012 are described in a 32-page catalog. It also contains a complete line of SMB and SMC subminiature connectors which meet requirements of MIL-C-22557 and MIL-C-39012. The comprehensive catalog contains specifications and mating characteristics typical to each line, plus detailed mechanical drawings of each connector style. Wherever necessary, recommended cable impedances and type numbers are called out. Sealectro Corp.

CIRCLE NO. 387

Lafayette catalog

The new 116-page 1970 Lafayette Radio Electronics catalog 704 is available. It features high-fidelity systems and components, citizen's band equipment, radios, televisions, tape recorders and small home appliances. It also features automobile tape players, musical instruments and amplifiers, camera equipment and special closeout prices on speakers. Lafayette Radio Electronics Corp.

CIRCLE NO. 388



Simpson's new 2700.

Versatile Digital System:

- New, fast warm-up*
- 4½ digits
- 0.05% accuracy
- 5 plug-in function modules

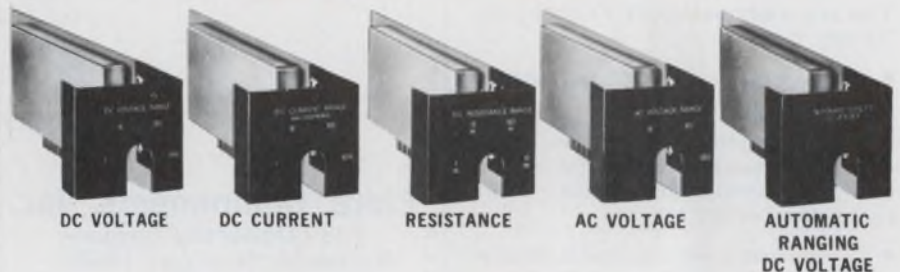

- Automatic Polarity Selection
- Built-in Self Calibration
- 100 Microvolt Resolution
- Optional BCD output
- IC Modular Design for reliability

2700 DIGITAL SYSTEM \$615⁰⁰
complete with DC voltage range module, test leads, and operator's manual

AVAILABLE "OFF-THE-SHELF" AT ELECTRONIC DISTRIBUTORS STOCKING SIMPSON INSTRUMENTATION PRODUCTS.

Simpson ELECTRIC COMPANY



5200 W. Kinzie Street, Chicago, Illinois 60644 • Phone (312) 379-1121
Export Dept: 400 W. Madison Street, Chicago, Illinois 60606. Cable Simelco
IN CANADA: Bach-Simpson Ltd., London, Ontario • IN INDIA: Ruttonsha-Simpson Private Ltd., International House, Bombay-Agra Road, Vikhroli, Bombay

INFORMATION RETRIEVAL NUMBER 96

Electronic Design

ELECTRONIC DESIGN'S function is:

- To aid progress in the electronics manufacturing industry by promoting good design.
- To give the electronic design engineer concepts and ideas that make his job easier and more productive.
- To provide a central source of timely electronics information.
- To promote two-way communication between manufacturer and engineer.

Want a subscription? ELECTRONIC DESIGN is sent free to qualified engineers and engineering managers doing design work, supervising design or setting standards in the United States and Western Europe. For a free subscription, use the postfree application form inside the back cover. If none is included, write to us direct for an application form.

If you do not qualify, you may take out a paid subscription for \$25 a year in the U.S.A., \$35 a year elsewhere. Single copies are \$1.50 each.

If you change your address, send us an old mailing label and your new address; there is generally a prepaid postcard for this inside the back cover. You will have to requalify to continue receiving ELECTRONIC DESIGN free.

The accuracy policy of ELECTRONIC DESIGN is:

- To make reasonable efforts to ensure the accuracy of editorial matter.
- To publish prompt corrections whenever inaccuracies are brought to our attention. Corrections appear at the end of the Letters column.
- To refuse any advertisement deemed to be misleading or fraudulent.

Microfilm copies are available of complete volumes of ELECTRONIC DESIGN at \$19.00 per volume, beginning with Volume 9, 1961. Work is now in process to complete the microfilm edition of Volumes 1-8. Reprints of individual articles may be obtained for \$2.00 each, prepaid (\$.50 for each additional copy of the same article) no matter how long the article. For further details and to place orders, contact the Customer Services Department, University Microfilms, 300 North Zeeb Road, Ann Arbor, Michigan 48106; telephone (313) 761-4700.

Want to contact us? If you have any comments or wish to submit a manuscript or article outline, address your correspondence to:

ELECTRONIC DESIGN,
850 Third Avenue,
New York, N.Y. 10022.

Design Data from

PRECISION CARBON FILM RESISTORS



High Voltage . . . High Frequency . . . High Megohm . . . complete specifications for 120 devices and "The Case for Carbon Film" are presented in this new 1970 resistor catalog. Resistors are offered in 15 basic styles, ranging from .25 to 100 watts, with over 100 special variations available. Resistances range from 10 ohms to 100 Terohms and tolerances from $\pm 1\%$. Applications include those requiring high resistances, voltage capability from 250 to 125,000 V, and high frequency or pulse circuits. Send for free catalog and engineering data.

Resistance Products Company
914 South 13th Street, Harrisburg, Pa. 17104
(717) 236-5081

171

Bus Bars For Noise Reduction

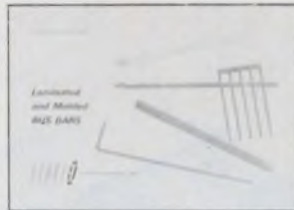

A 16 page Technical Bulletin is now available, describing a new concept in power or signal distribution. Basic mechanical and electrical design principles, along with descriptive pictures and diagrams, are included in this bulletin. These compact buses can replace bulky cable harnesses and repetitive wiring for computer or modular application. This method of construction satisfies the demanding requirements of low inductance and resistance of high speed, solid state systems, while controlling electrical noises.

Send For Free Sample

Eldre Components, Inc.
1239 University Avenue
Rochester, New York 14607

172

Quality Fasteners For All Designs

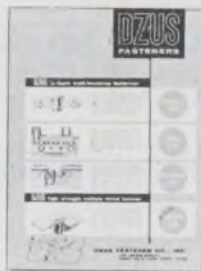

This 8-page catalog provides design data on the complete group of DZUS 1/4-turn self-locking fasteners for standard, high speed and panel applications, as well as universal high strength multiple thread fasteners for high tensile and shear stresses. Dzus stud assemblies, wire forms and receptacles offer an exceptional, wide variety of combinations from stock to fit specific fastening requirements. Diagrams and tables give full details for rapid, unlimited design selection. Condensed or complete Catalog available on request.

Dzus Fastener Co., Inc.
425 Union Boulevard
West Islip, L. I., N. Y. 11795

173

Manufacturers

Advertisements of booklets, brochures, catalogs and data sheets. To order use Reader-ServiceCard (Advertisement)

PORTABLE POWER SPECTRAL DENSITY SYSTEM ANALYZES VIBRATION AND NOISE ON-LINE



For production or field use; can be carried to automotive test tracks, heavy machine installations, aircraft flight lines. Provides, in seconds, a complete picture of the average spectrum, to determine condition of machinery, reveal developing malfunctions, locate source of unwanted noise. System consists of a UA-10 Mini-Ubiq™ Real-Time Spectrum Analyzer and a 1010 Digital Averager; produces 200-point narrow-band spectra in ranges from 10 Hz to 20 kHz wide.

Federal Scientific Corporation
a subsidiary of Elgin National Industries, Inc.
615 West 131st Street, New York, N. Y. 10027

174

Clamp or Tie Wire Bundles In Seconds!



Six-page catalog contains complete ordering information for CAB-L-TITE® clamps and BUND-L-TITE® straps, devices which provide a fast and reliable means of securing wires and wire bundles. Units withstand loadings greater than 50 G's, are removable in seconds for re-routing wires, and are self-locking—no tying, no knots, no hitches to come loose. Lightweight Du Pont Zytel meets MIL-P-17091 and MIL-P-20693. Proved in aircraft and missiles. Photos, dimensional drawings, tables, physical properties, specifications, price list. Request catalog A.

Dakota Engineering, Inc.
4315 Sepulveda Blvd.
Culver City, California 90230

175

DRAFTING AIDS CATALOG



Send today for the By-Buk Printed Circuit Drafting Aids P-45 Catalog featuring the most comprehensive listings of basic pressure sensitive printed circuit drafting shapes, tapes and aids. Contains thousands of pads, tees, elbows, corners, donuts, connectors, fillets, colored tapes, multi-pads for dual in-lines, flat packs, TO cans and more. Here is your guide to better printed circuit drafting. Scores of ideas to speed master artwork preparation time and reduce drafting costs. Send for your free catalog and samples.

By-Buk Company
4326 West Pico Blvd., Los Angeles, Calif. 90019
Phone: (213) 937-3511

176

Electronic Design

Advertising Sales Staff
Keith Aldrich
Sales Manager

New York 10022
Robert W. Gascoigne
Thomas P. Barth
Samuel M. Deitch
850 Third Avenue
(212) Plaza 1-5530
TWX: 867-7866

Philadelphia 19066
William C. Repetto
P. O. Box 206
Merion Station, Pa.
(215) MA-3-5888

Boston 01945
Joseph F. Palmer
14 Peter Hobart Drive
Hingham, Mass.
(617) 742-0252

Chicago 60611
Thomas P. Kavooras
Berry Conner, Jr.
200 East Ontario
(312) 337-0588

Cleveland
Thomas P. Kavooras
(Chicago)
(312) 337-0588
(call collect)

Los Angeles 90303
Stanley I. Ehrenclou
W. James Bischof
2930 Imperial Highway
Inglewood, Calif.
(213) 757-0183

San Francisco 94022
Arthur R. Shields, Jr.
95 Main Street
Los Altos, Calif.
(415) 941-3084

London W. 1
For United Kingdom and Holland
Brayton C. Nichols
44 Conduit Street
Tel: REGent 4714

Verviers, Belgium
For Continental Europe
Andre Jamar
1, Rue Mallar, 1
(087) 253.83 Telex 41563

Tokyo
Haruki Hirayama
Electronic Media Service
Rm. 601, Daini Miyauchi Bldg.
6-8-14, Roppongi,
Minato-ku
Phone: 402-4556
Cable: Electronicmedia, Tokyo



AMERICAN BUSINESS PRESS, INC.



More torque, Less weight in moving coil mechanism

Highly stable, linear and accurate mechanism for indicating, control or recording systems. 18-0-18° linearity is 1%. Coil design with over 75% of winding "working" in high energy, uniform field air gap assures greater accuracy. Coil system weighs 0.85 gm, develops 26.4 mmg of torque; 31:1 T/W. Mechanism offers negligible vibration pivots and jewels — custom damping — wide range of sensitivities.

AMMON

AMMON INSTRUMENTS, INC.
345 Kelley St., Manchester, N.H. 03105

INFORMATION RETRIEVAL NUMBER 98

A mouse has already been saved from leukemia.

Help us save a man.

For years, you've been giving people with leukemia your sympathy. But sympathy can't cure leukemia. Money can. Give us enough of that, and maybe we'll be able to do for a man what has already been done for a mouse.



American Cancer Society

Space Contributed By
Hayden Publishing Company, Inc.

Advertisers' Index

Advertiser	Page	Advertiser	Page
ACDC Electronics	132A-B	3M Company, Scotchpar	68
Abbott Transistor Laboratories Incorporated	13, 16 A-B	MicroSwitch, A Division of Honeywell	72
Acopian Corp	126	Microdot, Inc.	107
Aerotron Associates	137	Mitsubishi Electric	140
Alco Electronic Products, Inc.	129, 131	Molex Products Company	75
Allco	64B	Monsanto Company	69, Cover III
Allen-Bradley Co.	2	Monroe, Division of Litton Industries	4, 5
Ammon Instruments, Inc.	146	Motorola Semiconductor Products, Inc.	6
Amperex Electronic Corporation	139	National Semiconductor Corporation	84, 85
Analog Devices, Inc.	113	Nortronics Company, Inc.	130
Arrow-Hart, Inc.	44, 45	Oak Electro/Netrics Corp.	130
Augat, Inc.	141	Owens-Illinois, Inc.	73
Beckman Instruments, Inc., Helipot Division	57, 109	Philips Electronic Components and Materials Division	64A
Bourns, Inc.	27	Pomona Electronics Co., Inc.	140
By-Buk Company	145	Potter & Brumfield Division of American Machine & Foundry Company	23
C-Cor Electronics, Inc.	136	RCA Electronic Components and Devices	10, 65, 76, 111, Cover IV
Cambridge Thermionic Corporation	68	RCA Institutes, Inc.	93
Celanese Plastics Company	63	RFL Industries, Inc.	71
Centralab, the Electronics Division of Globe-Union, Inc.	33	Radiation, Incorporated	34, 35
Circuit Stik, Inc.	137	Kaytheon Company Special Microwave Devices Operation	50
Computer Technology, Inc.	70	Resistance Products Company	144
Continental Connector Corporation	74	Rtron Corporation	134
Cratex	72	S & EI Corp.	141
Dakota Engineering, Inc.	145	Siliconix Incorporated	49, 60
Dale Electronics, Inc.	Cover II	Simpson Electric Company	135, 143
Dow Corning Corporation	52, 53	Sprague Electric Company	18, 58
Dzus Fastener Co., Inc.	144	Stackpole Carbon Company	124, 125
Elco Corporation	11	Stackpole Components Company	125
Eldre Components, Inc.	144	Electronic Components Group	32A-H
Electro Cuhe, Inc.	127	Sylvania Electric Products, Inc., Sylvania Electric Products, Inc., Electronic Components Semiconductor Dept.	67
Electronic Arrays, Inc.	64	Systron-Donner Corporation, Datapulse Division	105
Electronic Design	147	Teletype Corporation	94, 95
Engineered Components Co.	128	Teradyne	20
Erie Technological Products, Inc.	12	Triplett Corporation	89
FMC Corporation	133	Tung Sol Division, Wagner Electric Corporation	16
Federal Scientific Corp.	145	U. S. Capacitor Corporation	119
Fluke Mfg. Co., Inc., John	24	United Transformer Co., Division of TRW, Inc.	56
GRI Computer Corp.	62	Unirole Corporation	29
General Automation, Inc.	115	Vactec Inc.	123
General Electric Company, Components Sales Operation	8, 9	Veeder-Root	7
General Radio Company	46	Venus Scientific, Inc.	72
Gould, Inc., Graphics Division	14, 15	Wavetek	102
Grant Pulley & Hardware Corporation	66	Winchester Electronics, Division of Litton Industries	55
Grayhill, Inc.	68	Xerox Data Systems	59
Hewlett-Packard	1, 17, 42, 43, 51, 54, 101	Zenith Radio Corporation	128
IMC Magnetics Corp.	120		
Inland Controls, A Division of Kollmorgen	61		
Intronics, Incorporated	31		
Johanson Manufacturing Corp.	121		
Kepeco, Inc.	116		

now you can reach
more engineers
and reach them
faster . . .

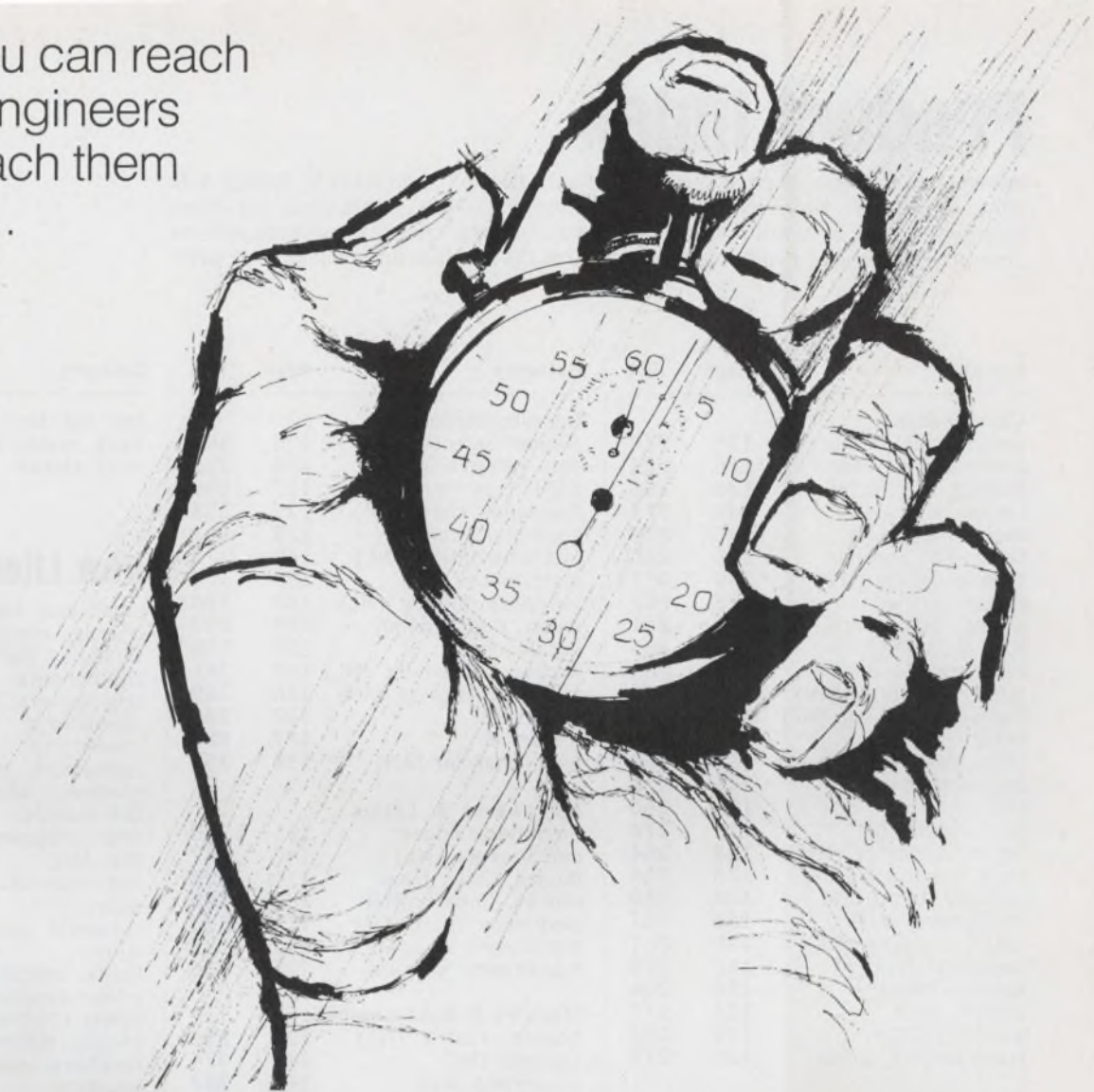

Electronic Design's *NEW*

FAST CLOSE FORM

Marketing and salespeople can't specify your products . . . engineers can. Products don't move through distributors until they are specified by engineers. Now there's a way to reach *more** OEM engineers and reach them *faster*. It's Electronic Design's new FAST CLOSE FORM—right up front in the News Section. You can get out your new product story, your price announcements or delivery and distribution information, quickly, while they're still hot. Closing date for film positives is only *24 hours before press time . . . 48 hours before the issue mails*. You save 3 full weeks over normal closing. The form will accept full pages or spreads in b&w or 2-color; premium is only \$150 per insertion. Call your Electronic Design representative today for complete information.

*Electronic Design has 72,271 OEM engineers and engineering managers—53,372 more than Electronic News . . . 37,998 more than Electronics. Source: December, 1969 BPA and ABC Publisher's Statements.

ELECTRONIC DESIGN FAST CLOSE SCHEDULE

(Post on your production bulletin board.)

ISSUE DATE	REGULAR CLOSING	FAST CLOSE		ISSUE DATE	REGULAR CLOSING	FAST CLOSE	
		ORDER IN N.Y. OFFICE	FILM POS. AT PRINTER			ORDER IN N.Y. OFFICE	FILM POS. AT PRINTER
June 7	May 4	May 22	May 25	Sept. 27	Aug. 24	Sept. 11	Sept. 14
June 21	May 18	June 5	June 8	Oct. 11	Sept. 8	Sept. 25	Sept. 28
July 5	June 1	June 19	June 22	Oct. 25	Sept. 21	Oct. 9	Oct. 12
July 19	June 15	July 3	July 6	Nov. 8	Oct. 5	Oct. 23	Oct. 26
Aug. 2	June 29	July 17	July 20	Nov. 22	Oct. 19	Nov. 6	Nov. 9
Aug. 16	July 13	July 31	Aug. 3	Dec. 6	Nov. 2	Nov. 20	Nov. 23
Sept. 1	July 27	Aug. 14	Aug. 17	Dec. 20	Nov. 16	Dec. 4	Dec. 7
Sept. 13	Aug. 10	Aug. 28	Aug. 31				

from dc to 3 GHz
with only
one plug-in



**This new "4th generation"
I-C plug-in counter/timer
Outperforms all others...**

And will for years to come!

Why compromise for less? The Model 1500A has a main frame counting range from dc to 125 MHz (to 3 GHz with a single plug-in). This instrument is fully programmable, has provision for external time base up to 10 MHz, and many other significant features, including the well recognized advantages of Monsanto's "4th generation" 90% integrated circuit design.

Shown above is the Model 1104B 3 GHz frequency converter plug-in. Also available: Model 1100A uncommitted

plug-in; Model 1101A 500 MHz prescale plug-in; Model 1102A 6-digit preset plug-in; Model 1103A 500 MHz frequency converter plug-in; Model 1107A time interval plug-in; Model 1201A DVM plug-in.

Unparalleled performance plus award-winning design make the Model 1500A the ultimate counter for the no-compromise engineer. The price for the main frame is \$2400.00, FOB West Caldwell, N. J. Other models of the 1500 Series offering a wide selection of fea-

tures and capabilities begin at \$1800.00.

Most engineers take Monsanto's reliability for granted because of our 2-year warranty. But, just in case, we maintain 37 Service Centers located strategically throughout the United States and overseas.

For a demonstration, or for full technical details, call your local Monsanto Field Engineer now or contact us directly at: Monsanto Company, Electronic Instruments, West Caldwell, New Jersey 07006, (201) 228-3800.

Monsanto

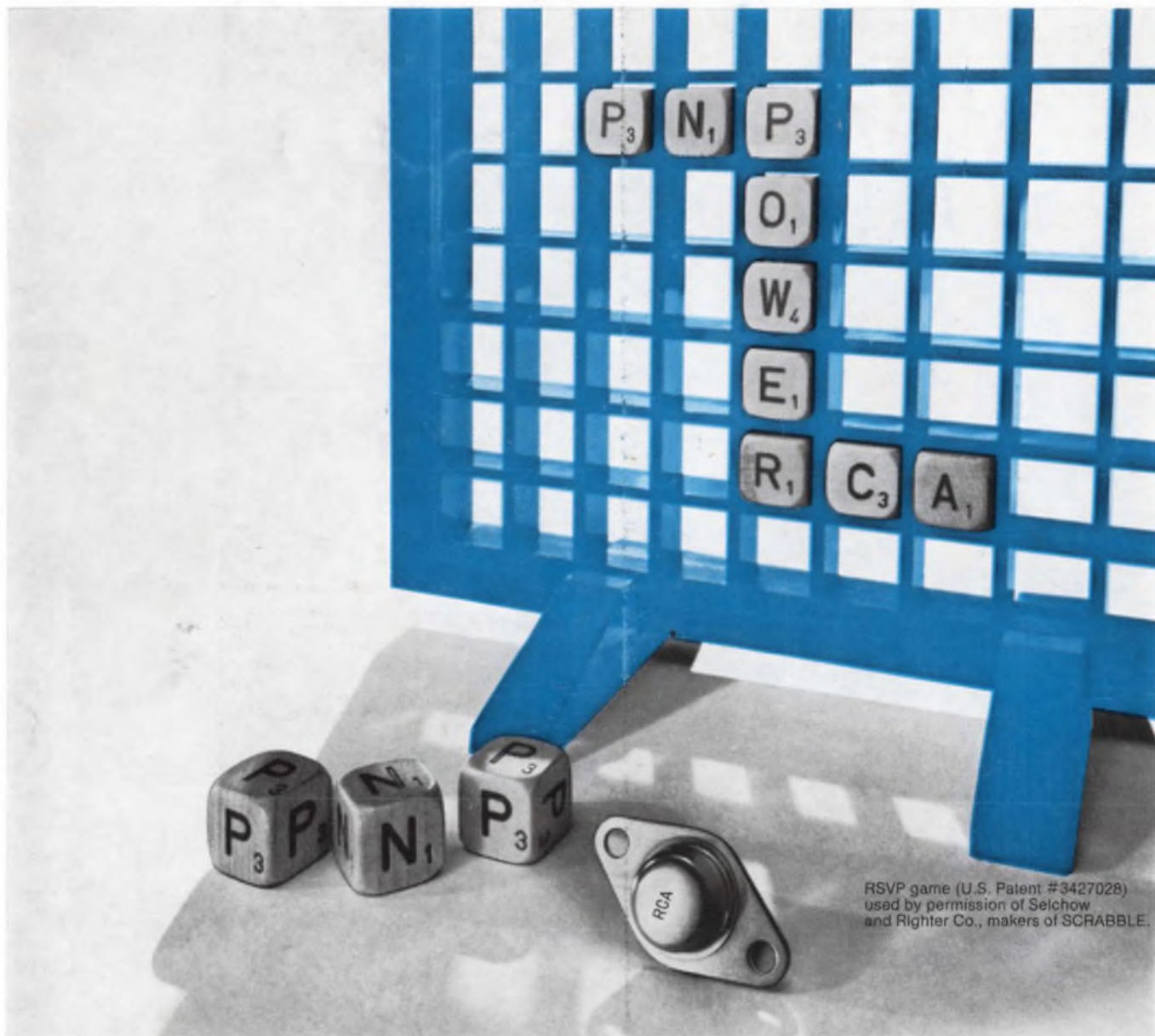

RSVP game (U.S. Patent #3427028) used by permission of Selchow and Righter Co., makers of SCRABBLE.

You Win With RCA P-N-P Power... New 2N5954 Family (2N3054 Complement)

This new RCA p-n-p transistor has the qualifications that can make winners of you and your designs. The 2N5954 is a silicon power unit in a hermetically-sealed TO-66 package. Complementing the 2N3054 (already widely known in sockets in military, industrial, and commercial equipment), the 2N5954 features controlled second-breakdown ratings. To be sure, each transistor is individually tested to meet specified parameters before it is shipped.

The new 2N5954 family with its multiple epitaxial structure and emitter ballasting techniques add up to a traditionally rugged RCA power device...giving you the design capability to achieve high performance levels in your equipment. One of three new RCA p-n-p types now offered for switching and amplifier applications, 2N5954 (or its family types, 2N5955 or 2N5956), together with its n-p-n complement, provide bi-directional control and phase inversion advantages.

P-n-p/n-p-n complements are particularly advantageous if you're trying to cascade four or five stages. In a power supply design, for example, the use of complementary types can eliminate voltage build-up that would be encountered if cascaded n-p-n, or cascaded p-n-p types were employed.

Check the chart on these new types. For more information, consult your local RCA Representative or your RCA Distributor. For technical data, write: RCA Electronic Components, Commercial Engineering, Section 52E-2 /UT8, Harrison, N. J. 07029. In Europe: RCA International Marketing S.A., 2-4 rue du Lièvre, 1227 Geneva, Switzerland.

Type No.	V _{CB0} (V)	V _{CEx} (sus) (V)	V _{CER} (sus) (V)	V _{CE0} (sus) (V)	I _C (A)	P _T (W) @ T _C = 25°C
2N5954	85	85	80	75	-6	40
2N5955	70	70	65	60	-6	40
2N5956	50	50	45	40	-6	40

RCA