

Electronic Design 6

VOL. 18 NO.

FOR ENGINEERS AND ENGINEERING MANAGERS

MARCH 15, 1970

The IEEE show looks ahead toward the next decade and finds engineers will be deeply involved in improving the quality of urban life: computer-run city halls, a revolution in CATV, electronic medicine, traffic-control systems, cleaner air and water—these are just some of the possibilities. For a preview, turn to page U84.



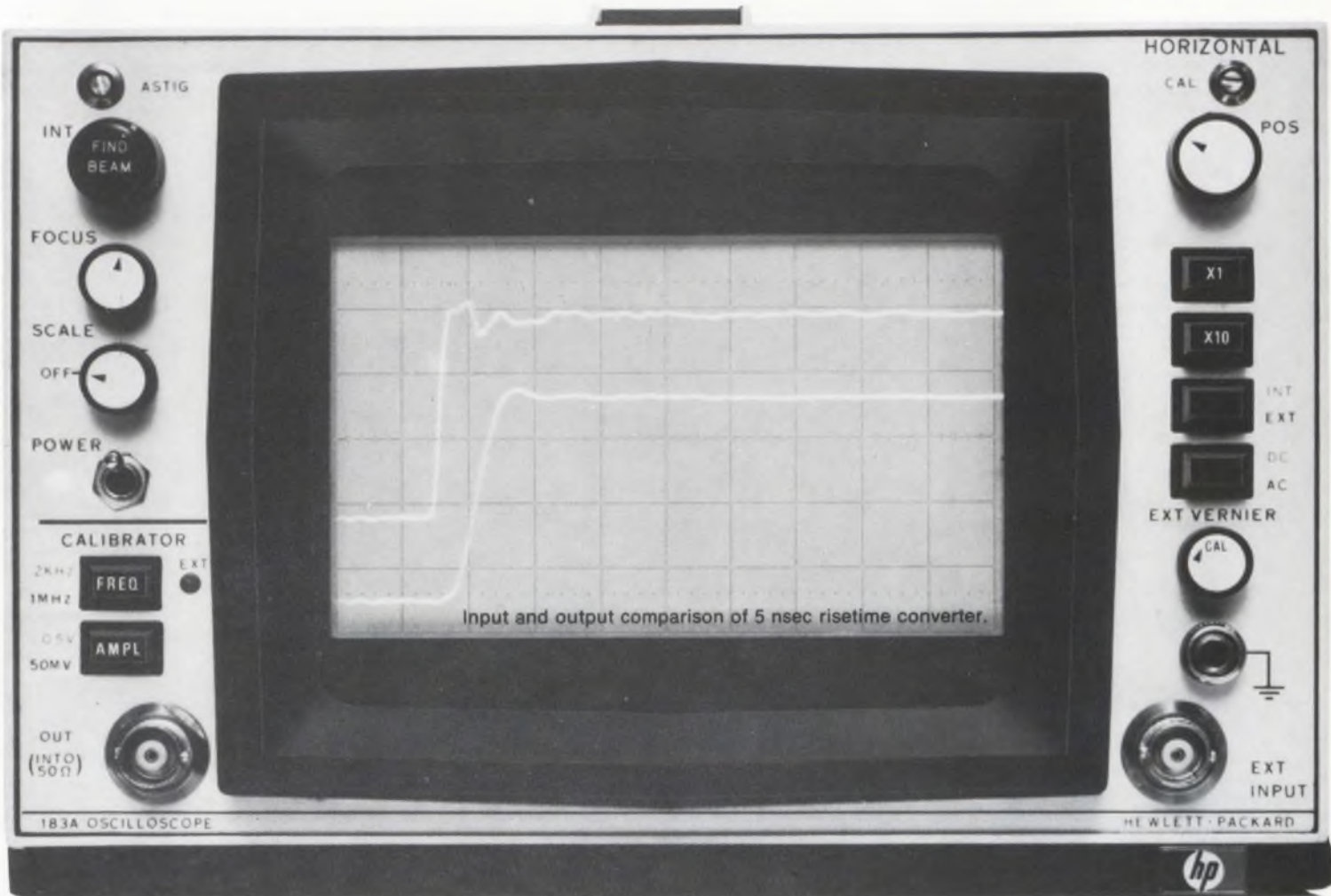

The Performance Champ — world's fastest general-purpose real-time scope!

The HP 183A Oscilloscope system adds one more way that you **see more—do more** with the field-proven 180 scope system.

Now you can measure from dc to 250 MHz — real time! Now you have a vhf scope that also gives you a bright dual-trace with a fast-writing speed of 4 cm/nsec on a big 6 x 10 cm screen. Plus, a sensitivity of 10 mV/div for low-level signal measurements — sweep speeds of up to 1 nsec/div for easier viewing of high frequency signals — and complete compatibility with the entire 180 series of plug-ins.

Sound expensive? Well, the 183A mainframe with a 250 MHz dual-channel vertical amplifier and a > 250 MHz time base costs only \$3150. That's less than some systems that don't even approach this kind of high frequency performance.

The basic 183A mainframe uses the all-new step-ahead technique of a CRT transmission line deflection system to provide real-time bandwidth beyond 500 MHz. And since it contains only the CRT and power supplies,

future, improved plug-ins will give you full performance in the mainframe you buy now. You won't have to worry about built-in mainframe limitations — now or in the future.

If you're interested in maximum scope performance per dollar invested, then the HP 180 system is the answer. From 50 MHz, to 100 MHz, to sampling, to variable persistence and storage scopes, the 180 system has the right combination to meet your requirements. You get more for your dollar today. You get more for your dollar in the future. You get the best performing, most versatile high-frequency scope system available today!

For more information, call your local HP field engineer. Or, write to Hewlett-Packard, Palo Alto, California 94304. Europe: 1217 Meyrin-Geneva, Switzerland.

089/14A

HEWLETT  PACKARD

OSCILLOSCOPE SYSTEMS

ACTUAL SIZE



THE "INTERMEDIATE" SYNTHESIZER

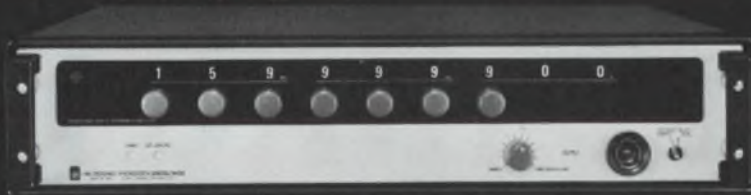

160 MHz for \$5900

Buying a frequency synthesizer has been something like buying a car. There's a confusion of models, options, and price ranges. Except — there has never been a so-called "intermediate"-model synthesizer. That's because price and performance ranges of synthesizers have tended to cluster just at both ends of the spectrum. The choice was between lower-cost, limited-frequency-range models and those with everything, including a sky-high price tag. So, the buying decision was one based on either trade-off or over-capability.

This is not true any longer! GR has filled the price-capability gap with the new 1165 Frequency Synthesizer. Frequency range is wide, 0.01 to 160 MHz in 100-Hz steps. The price is only \$5900, less than half the price it used to cost to get 160 MHz. If you can furnish your own frequency reference signal (5 or 10 MHz), you can get a model for only \$5300. In the \$5900 model, frequency accuracy is maintained either by an internal precision 10-MHz oscillator (1×10^{-9} per day) or by an external drive or lock source. Output is 0.1 to 1 V into 50 ohms. Both frequency and level can be externally programmed; the 1165 is ideal for applications requiring remotely-programmed local oscillators. Harmonics are typically down 30 dB (at maximum output into 50- Ω load); spurious, discrete non-harmonic signals are typically down 60 dB.

For complete information, write General Radio, West Concord, Mass. 01781; telephone (617) 369-4400. In Europe: Postfach 124, CH 8034, Zurich, Switzerland.

GENERAL RADIO



See the 1165 in action at the IEEE show, along with a "showroom" full of other products from GR. Booths 2E26-2E36.

Why are we advertising this Fairchild DVM?



Because it's now a Systron-Donner DVM. Along with its companions, the famous Model 7000A has been combined with S-D DVM's to form one big broad line. In fact, we can now fulfill more DVM needs than anybody else. And with **field-proven, state-of-the-art** instruments to boot!

The new S-D line covers everything from \$245 panel meters to 0.005% guarded multimeters to programmable systems meters. Every DVM uses **dual slope integration**, the best measurement technique yet developed.

What's more, only S-D offers you the true flexibility and economy of **plug-in cards** (not modules). For example, the Model 7000A expands from a basic DC voltmeter to a multimeter simply by slipping cards into already existing slots. You can add AC volts, ohms, current, 100 mv and many other options—at any time.

You get the most performance for the money, too. The proof is in our new catalog. For your copy, write Measurements Products Division, 888 Galindo Street, Concord, California 94520, or call (415) 682-6161.

SYSTRON  DONNER

Another first! One of 157 S-D instruments. Electronic counters/Pulse generators/Microwave frequency indicators/Digital clocks/Memory testers/Analog computers/Time code generators/Data generators/Digital voltmeters/Spectrum analyzers/Digital panel meters/Microwave signal generators/Laboratory magnets/Data acquisition systems/Microwave test sets.

News Scope

CONTINUED

of carbon and a highly ionic conducting solid electrolyte." Its absence of electrical leakage has permitted a device that was energized in June, 1969, to still retain over 96% of its charge.

Oxley has not yet tried to get more than 50 farads, but he says it is possible, "if someone needs it."

A basic limitation on the device is that it can be used as a capacitor only at dc. As frequency is increased, the capacitance falls off drastically. By 2 Hz, it is down to 1/50 of its dc value, says Oxley.

(For details see p. 227).

Demand for engineers declined again in 1969

For the third consecutive year, the demand for the services of engineers and scientists has dropped, according to the Engineer/Scientist Demand Index maintained by Deutsch, Shea & Evans, a New York advertising agency. Reasons for the decline, according to DS&E relate to cuts in Government contracts with defense and aerospace industries.

The average demand level for 1969, according to the index, was 108.5. This is a 6.3 drop from the previous year's average of 114.8 and more than 80 points below the peak demand of 190.3 in 1966.

Monolithic readout challenges Nixies

The first solid-state numeric display to compete in the market place with gas discharge tubes has been announced by Monsanto Electronic Special Products, Cupertino, Calif.

The display is made of gallium arsenide phosphide deposited over a substrate and the diodes are interconnected to form seven-segment numerics. Called the MAN-3, the display requires an external decoder/driver.

For orders in the 20,000-unit range, Monsanto says the costs will

be comparable to those of Nixie tubes.

Optical circuits carry laser light

Nickel-size optical circuits for laser light can be made of lightguides—hairlike, transparent pipes—it was recently announced by Bell Telephone Laboratories, Murray Hill, N.J.

The lightguides, 100 times thinner than a human hair, are deposited (sputtered) as a film on a glass plate. According to Bell Labs, lightguides can be interconnected to form complex optical circuits that perform functions similar to those of electronic circuits in computers and communications equipment.

Such a circuit would be relatively unaffected by heat, noise, or vibrations, says the company. Lightguides can carry laser beams around relatively sharp bends.

Closed-circuit TV sales boom in big-time racing

Horse racing is paying out big money for closed-circuit TV—both black-and-white and color systems. Market potential for racetrack systems throughout the country approaches \$25 million, according to Al Ajar, president of Video Projects, New Hyde Park, N.Y.

Over \$650,000 has recently been awarded to Video for black-and-white installations at Liberty Bell Park, Philadelphia, and for color TV systems for Aqueduct and Belmont tracks in New York City and the Saratoga racetrack in upstate New York.

The closed-circuit systems not only keep the racing fans posted on betting odds, race results, and photo finishes, but provide video playbacks for stewards and judges. Only about 10% of the racetracks in this country have similar systems at present. Most others use cinematography for playbacks.

New gas engines offer computer standby power

Because the data-processing industry is one of the fastest growing markets for standby power systems, the Yardney Electric

Corp., known for its Silvercel batteries, has recently announced a new line of gasoline-engine-powered generators designed to insure power for computers.

Sheldon Keilson, manager of the electronics systems department, pointed out that, as semiconductor memories become more generally employed, the problem of safeguarding information stored in such volatile memories becomes more acute.

Since the company plans to reduce its stake in R&D and increase its emphasis on production, it is transferring its New York City operations to its Pawcatuck plant, Stonington, Conn.

Space-shuttle studies to begin next month

Proposals for a contract for preliminary design of the National Aeronautics and Space Administration's space shuttle are due on March 30. Eight companies were invited to submit proposals, and three will probably win. The parallel studies will last 11 months; then the final contractor will be picked.

The two-stage shuttle carrying 10 passengers will take off in a vertical position. Both stages will be manned and both will return to earth and land horizontally.

The eight competitors are Lockheed, Burbank, Calif.; Chrysler, Detroit; Grumman, Bethpage, N.Y.; General Dynamics, San Diego; North American Rockwell, Downey, Calif.; Martin Marietta, Denver; and McDonnell-Douglas, St. Louis. Monitoring the work will be NASA's Marshall Space Flight Center, Huntsville, Ala., and the Manned Spacecraft Center in Houston.

Ultrasound used to check for heart disease

Rather than passing a catheter (a long thin pipe) into one of the heart chambers to screen patients for suspected heart disease and monitor heart activity, scientists have used ultrasound, a form of sonar.

The ultrasound studies were performed by Stanford University and NASA's Ames Research Center.

U.S. electronics may be hit by European trade agreement

American electronic manufacturers could be disqualified from selling their wares in the European market by regional trade agreements among the Common Market countries and the European Free Trade Association.

According to a spokesman for the Electronic Industries Association (EIA), a tripartite agreement among Britain, France and Germany is on the verge of being signed. This would exclude the sale of electronic components and equipment by nonmember countries. Such U.S. sales total over \$1 billion, according to Leon Podolsky, technical advisor to the U.S. on electronic components for the International Electrotechnical Commission.

The IEC is the worldwide organization for the development of international electrical and electronics standards. Its membership comprises 41 countries, including the Communist bloc nations.

The EIA spokesman said, "We have been told by representatives of the tripartite countries that they intend to invite others to participate, but not for a year or so. But by that time, their procedures and standards may be set in concrete."

The EIA is proposing a self-certification system to be administered by the IEC or some other completely international group. This proposal would be implemented similarly to the qualified product list that is now used in certifying military products.

The nations participating in the tripartite agreement have proposed reliability and quality control certification program through the European Committee for the Standardization of Electronic Components (CENEL). The administration and testing of components would be done by the European

Committee for Quality Assurance, presumably consisting of representatives of the member countries.

At a press conference last month, sponsored by the American National Standards Institute, Inc., Richard O. Simpson, Deputy Assistant Secretary of Commerce, warned that if American representatives don't participate in the formulation of standards by the IEC, U.S. products may not be compatible for both domestic and European markets. The alternative for a manufacturer might be to produce specials for overseas requirements, reducing savings and profits inherent in mass production.

The implications of what happens at the upcoming IEC meeting in Washington, D. C., in May could have a decided bearing not only on electronics sold in Europe, but also on the entire spectrum of household electrical appliances—from blankets and heating pads to washing machines, Simpson said.

Simpson urged support of the American National Standards Institute, which is coordinating this country's participation in IEC work. "Our entire economy is affected," he said. "The job of the average industrial worker may depend on how successful U.S. industry is in selling American products at home and increasing exports to other countries."

Return-beam vidicon proves versatile

A new return-beam vidicon tube, developed by RCA, Lancaster, Pa., will be applied as an ultra-high-resolution device in two different applications. The first is a camera in the NASA Earth Resources Technical Satellite, slated to be launched in the first quarter of

1972; the second is an electron-image scan converter in an Air Force data-conversion system.

The earth satellite camera under development by RCA Astroelectronics Div., Hightstown, N. J., uses a return-beam vidicon with a two-inch-square photosensitive surface. This camera will photograph a 100 × 100-foot swatch of the earth from a proposed orbiting altitude of 5000 miles.

Sponsored by the NASA Goddard Space Flight Center, Wallops Island, Va., the proposed satellite will provide a complete inventory of the entire world every day: Using infrared and multispectral cameras, the satellite could detect blighted areas, check for pollution on land and in the oceans and even relay back the movements of large schools of fish.

In the Air Force data-conversion system under development at the RCA Aerospace Systems Div., Burlington, Mass., and sponsored by the Avionics Laboratory at Wright Patterson Air Force Base, Dayton, Ohio, a return-beam vidicon with a 4.5 inch photosensitive surface is used as a high-resolution scan converter utilizing electrical read-in and read-out. This particular tube, according to John R. McAllister, RCA Div. vice president, has achieved 10,000 TV lines of resolution in the laboratory. This can be compared to 450 effective lines on a good TV set.

Half-dollar-sized disc holds up to 50 farads

Energy-storage devices with 10,000 times more capacity than the best tantalum capacitors have been developed by Gould Ionics, Inc., Canoga Park, Calif. According to James Oxley, technical manager of the company, the "electrochemical device not only has very high-capacity density, but also has orders-of-magnitude better charge retention than an electrolytic capacitor."

The device consists of two electrode wafers separated by an electrolyte wafer. According to Oxley, high capacitance (up to 300 farads/in.³) is "a result of maximization of the electrode/electrolyte interface area in structures consisting of a finely divided blend

Why NIXIE[®] tubes when we just developed SELF-SCAN[™] panel displays?

Now from Burroughs - two great digital readouts, NIXIE tubes and SELF-SCAN panel displays form a bright new team in digital readouts.

NIXIE tubes are your only logical choice for digital readouts containing up to 8 digits. Their long life, uniform brightness (200 ft. lamberts with no chance of partial fadeout) and the wide choice of configurations available help make NIXIE tubes the most economical, reliable, and readable digital readouts on the market for most panel displays.

BUT

When your display requires 8 to 10 or more digits, turn to Burroughs' amazing new SELF-SCAN panel displays.

Designed for larger displays, SELF-SCAN panel displays reduce drive circuitry up to 90%, thereby eliminating a major cost of readout systems. And

you can specify SELF-SCAN panel display systems with or without memory. Flicker-free, comfortably readable in the brightest light or darkest shadows, SELF-SCAN panel displays provide unparalleled savings for readouts with 8 to 400 digits of alphanumeric display.

Regardless of your readout requirements, one of Burroughs team of digital displays - industry standard NIXIE tubes or the outstanding state-of-the-art advance, SELF-SCAN panel display systems - will meet your needs.

For additional information write to Burroughs Corporation, Electronic Components Division, P.O. Box 1226, Plainfield, N.J. 07061. Tel: (201) 757-3400.

It's a matter of

DOLLARS AND DIGITS



More than 8 digits? Choose the new Burroughs SELF-SCAN panel display.



For 8 digits or less, NIXIE tubes are still your most profitable answer for readout displays.

Burroughs



See us at IEEE Booth #2D39-45

Highlighting

THE ISSUE

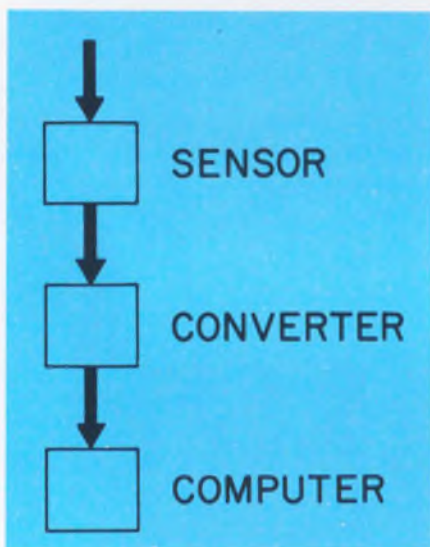

Electromechanical sensors, such as linear transformers, resolvers and synchros, are commonly used in control systems because they provide precision and economy. With the application of digital computers in control systems, simple and accurate methods for converting the ac outputs of these sensors into digital form become vital.

This design guide describes improved techniques leading to efficient, lower-cost synchro-to-digital converters.

Page 178



Called an energy-storage device (ESD), a new electrochemical capacitive component bridges the gap between a conventional capacitor and a secondary battery. About the size of a half-dollar, the 0.5-V ESD attains capacitances of about 50 farads with an approximate internal resistance of 1 to 2 ohms.

The new device is made of pressed powder wafers and is currently intended for straight dc applications.

Page 227

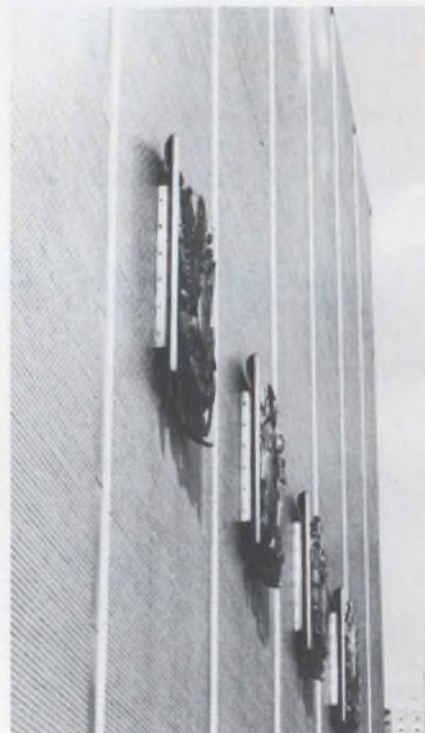

Electronics in the changing world of the seventies is the theme at this year's IEEE International Convention and Exhibition. More than at any previous show, the emphasis is on the peaceful uses of electronics—computer techniques in urban government, community antenna television, air and ground traffic control, medical aids for the handicapped and air and water pollution control.

Page U84

...want a tantalum capacitor with proven performance?

Buy TYPE 150D TANTALEX[®] SOLID-ELECTROLYTE CAPACITORS

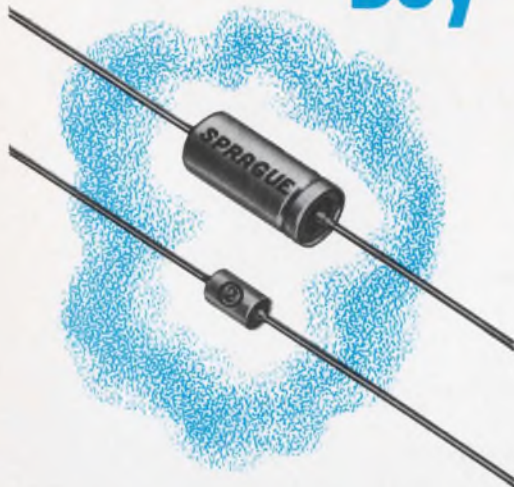

INFORMATION RETRIEVAL NUMBER 821

- Hermetically-sealed in metal cases
- Four case sizes, ranging from 1/4" to 3/4" length
- Value-packed performance characteristics—low impedances at high frequencies, low dissipation factor, minimal capacitance drift with temperature, practically no change in capacitance with life
- Low leakage current limits
- New higher capacitance ratings
- Request Engineering Bulletin 3520F

45C-9144R3

...need a reliable wirewound resistor?

Specify ACRASIL[®] PRECISION/POWER RESISTORS

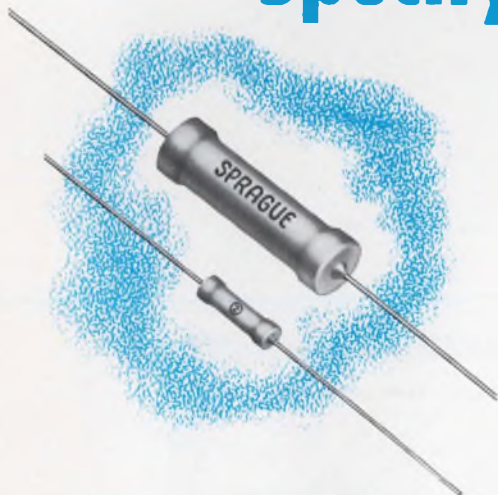

INFORMATION RETRIEVAL NUMBER 822

- Excellent stability and reliability, even under extended load life, extremely high humidity, and other adverse operating conditions
- Expansion coefficient of silicone coating is closely matched to that of ceramic base to insure against damage to resistance winding
- Coating provides exceptional protection against moisture, shock, vibration, fungus
- Available with standard and non-inductive windings
- Resistance tolerances as close as $\pm 0.05\%$
- Request Engineering Bulletins 7450A and 7450.1

45R-B118R2

For Engineering Bulletins as noted above, write to:
Technical Literature Service, Sprague Electric Co., 347
Marshall Street, North Adams, Massachusetts 01247.



"Sprague" and "®" are registered trademarks of the Sprague Electric Co.

THE BROAD-LINE PRODUCER OF ELECTRONIC PARTS

HERE'S HOW THE V-O-M SPECIALISTS GO DIGITAL

The principal problem with digital V-O-M's is that circuitry (rather than readability) limits their accuracy. Triplett has attacked that problem with characteristic thoroughness. The result . . . a totally new circuit (patent pending) in which there is virtually no internally-generated current from the V-O-M input circuit to affect measuring accuracy. Triplett's Model 8000 digital V-O-M . . . the only V-O-M with this newly-developed circuit . . . offers a true DC accuracy of 0.1% of the reading ± 1 digit and an AC accuracy of 0.2% ± 1 digit. Triplett calls this "true accuracy" because it's the same accuracy you can achieve day-in and day-out, test-after-test, on any kind of circuit.

Quality-minded buyers will appreciate, too, the other job-matching features of Triplett's new digital V-O-M. Like . . . AC and DC voltage measurements from 1 mV to 1000 V in 5 ranges at 10 megohms input resistance; AC and DC currents from 0.1 μ A to 1000 mA in 6 ranges; 0.1 ohm to 100 megohms in 6 ranges.

Sounds like it was worth waiting for, doesn't it? It's ready for immediate delivery from your Triplett distributor at \$575 suggested USA user net. If you'd like the added convenience of an instant replay circuit that displays a previously-stored reading for on-demand comparison with an existing reading, ask for the Triplett Model 8000-A at \$630 suggested USA user net. For more information, or for a free, no-obligation demonstration, call your local Triplett distributor or sales representative. Triplett Corporation, Bluffton, Ohio 45817.



The World's most complete line of V-O-M's . . . choose the one that's just right for you

1. True 0.1% DC accuracy. Virtually no kickback current*. Allows voltage measurements in high resistance circuits at stated accuracy.
2. High AC accuracy with nearly perfect AC linearity and 10 megohm input resistance.
3. Low profile design in shielded case with modular construction for ease in use and maintenance.

*There is virtually no internally generated current from the V-O-M input circuit to affect measuring accuracy. (Patent pending on this feature).



INFORMATION RETRIEVAL NUMBER 16

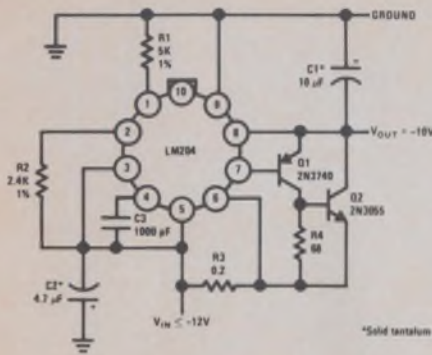

FIGURE 3b. 2A Negative Regulator

sistors increases the output current without increasing the minimum input-output voltage differential. The minimum differential will be 2 to 3V, depending on the drive current required from the integrated circuit and operating temperature. Low input-output voltage differential allows more efficient regulation.

Although the regulators are relatively simple, some precautions must be taken to eliminate possible problems. First, when the regulator is used with boost transistors, a solid tantalum output capacitor is needed. Unlike electrolytics, solid tantalum capacitors have low internal impedance at high frequencies. This suppresses possible high frequency minor loop oscillations as well as providing low output impedance at high frequency. Also, for the LM104, the output capacitor frequency compensates the regulator and must have good frequency characteristics.

The power transistors recommended are single-diffused, wide-base devices. These devices have fewer oscillation problems than double-diffused, planar transistors. Also, they seem less prone to failure under overload conditions. Of course, like the power transistors in any regulator, adequate heat sinking is necessary. The heat sink should keep the transistor junction temperature at an acceptable level for worst case conditions of maximum input voltage, maximum ambient temperature and shorted output. By far, the major cause of regulator failures is inadequate heat sinking.

Good construction techniques are also important for regulator performance. If proper care is not taken, ground loop errors and lead resistance drops can easily become greater than regulator errors. For example, 0.05" wide, 2 oz. printed circuit conductor has a resistance of about 0.007Ω per inch. For a 200 mA, 15V regulator, ten inches of conductor would decrease the regulation by a factor of 2.

Ground loops are worst yet, since voltage drops can be amplified and appear at the regulator's output. In Figure 3, voltage drops between Pin 4 of the LM105 and the bottom of R₃ are amplified by the ratio of R₂/R₃ and appear at the output.

When the regulator is powered from ac that is rectified and filtered, current flowing in the filter can sometimes cause an unusual ground loop problem. For capacitor input filters, the peak charging current is many times the average load current. Even a few milliohms of resistance can cause appreciable voltage drop during the peak of the charging. When the charging current produces a voltage drop between R₃ and Pin 4 of the LM105, it appears as excessive ripple on the output of the regulator.

Of course, single point grounding eliminates these problems, but this is not always possible. Usually it is sufficient to insure that load current does not generate a voltage drop between the ground side of the voltage setting resistor and the ground of the IC.

In most cases, short circuit protection is the only fault protection needed. However, for some regulator circuits, such as positive and negative regulators used together, additional protection is necessary. If the positive and negative supplies are shorted together, it is possible to cause the output voltage of one of the supplies to reverse, blowing the IC. This is especially true if the current capabilities are different, such as a 200 mA negative supply and a 2A positive supply. A clamp diode between the output and ground of each supply will prevent such polarity reversals. Also, clamp diodes should be used to prevent input polarity reversal and input-output voltage differential reversal.

The use of ICs in regulator circuits can enhance power supply performance while minimizing cost and engineering time. Since only one IC is needed for a wide range of outputs, the part cost, board space and purchasing problems are less when compared to discrete designs. Also engineering time is saved since typical and worst case performance data, as well as application data, is available from the manufacturer before design is begun.

REFERENCES:

1. R.J. Widlar, "An Improved Positive Regulator," *National Semiconductor AN-23*, January, 1969.
2. R.J. Widlar, "Designs for Negative Regulators," *National Semiconductor AN-21*, October, 1968.

National Semiconductor Corporation
 2900 Semiconductor Drive, Santa Clara, California 95051
 (408) 732-5000 / TWX (910) 339-9240





IC REGULATORS SIMPLIFY POWER SUPPLY DESIGN

Although power supply requirements vary, IC voltage regulators can fulfill the majority of needs. Power supplies designed with ICs can give predictable regulation better than 0.1% with a minimum of engineering effort. Output voltages between 0 and 40V at currents of 10A are easily achieved. Further, with a minimum of changes, a single regulator circuit can be used for a wide variety of output voltages and currents.

A basic 200 mA positive regulator circuit is shown in Figure 1. The LM105¹ contains the voltage reference and control circuitry while the external

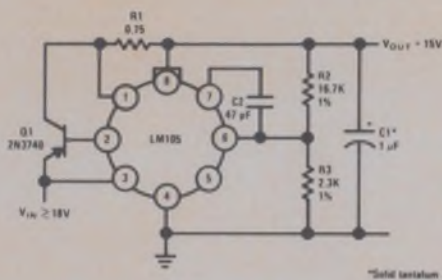

FIGURE 1. 200 mA Positive Regulator

components set the output voltage, current limit and increase power handling capacity of the IC. The output voltage is set by R₂ and R₃. A fraction of the output voltage is compared by an error amplifier with an internal 1.8V reference. Any error is amplified and used to drive the 2N3740 power transistor. Since the open loop gain is large, there is little error and a high degree of regulation.

Current limiting is set by R₁. The voltage drop across R₁ is applied to the emitter base junction of a transistor in the IC. When the transistor is turned on, it removes drive from the series pass transistor; and the regulator output exhibits a constant current characteristic. Since the turn on voltage of a transistor is temperature dependent, so is the current limit. The current limit sense voltage is about 0.4V at 25°C decreasing linearly to 0.3V at 125°C. Therefore, the current limit resistor must be chosen to provide adequate output current at the maximum operating temperature.

To regulate negative voltages, the circuit in Figure 2 is used. An LM104² contains the voltage reference and control circuitry while an external

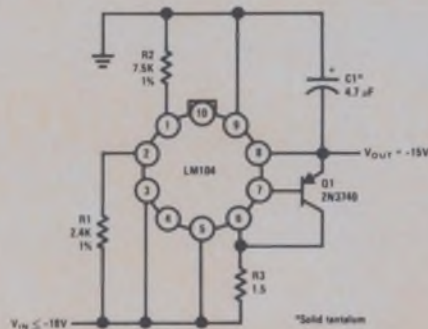

FIGURE 2. 200 mA Negative Regulator

transistor is used to increase the power handling capacity. A reference voltage is generated by driving a constant current, determined by R₁, through R₂. The voltage across this resistor is fed into an error amplifier. The error amplifier controls the output voltage at twice the voltage across R₂. The output voltage is resistor programmable with R₂ and adjustable down to zero.

Current limit in the LM104 is similar to the LM105. Voltage across R₃ turns on an internal transistor that decreases drive to the output transistors. This current limit sense voltage is also temperature dependent, decreasing from 0.65V at 25°C to 0.45V at 125°C.

Boosting the available output current from 200 mA is relatively simple. Figure 3 shows posi-

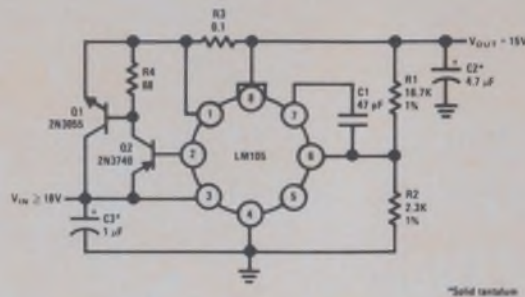

FIGURE 3a. 2A Positive Regulator

tive and negative 2A regulators. An additional power transistor increases the current handling capability of the regulator. Adding the boost tran-

Our 5000 and 7500 permeability Ceramag[®] ferrite materials can pack a terrific amount of inductance into a small size.

And the higher the perm, the fewer turns required. Results. Lower distributed capacity. Material savings. Improved performance.

Ceramag[®] offers the designer a true 5000 permeability. New, Ceramag[®] 24K is also a true 7500 permeability. Both materials hold their permeability over a wide range of sizes.

Ceramag[®] 24H and 24K are production materials, ready for immediate use in your design. Stock available in some sizes.

Precisely engineered, Stackpole ferrite materials are produced by exact processing, density checks, rigid kiln controls and accurate sintering. You get more out of Stackpole Ceramag[®] materials simply because we put more into them.

Study the characteristics of 24H

| | $\frac{L}{N^2}$ (nh) TOROID SIZE: 0.230" O.D. 0.120" I.D. 0.060" L. | MAXIMUM PERMEABILITY | SATURATION FLUX DENSITY @ 1.5 OERSTED | RESIDUAL MAGNETISM | COERCIVE FORCE | CURIE POINT | TEMPERATURE COEFFICIENT OF μ_0 | |
|--------------------------|---|----------------------|---------------------------------------|--------------------|----------------|-------------|------------------------------------|------------------|
| | | | | | | | -25° to 25° C. | 25° C. to 75° C. |
| CERAMAG [®] 24K | 1485 | 9700 | 4100 | 700 | 0.05 | 175 | +1.000 | -0.450 |
| CERAMAG [®] 24H | 990 | 6900 | 3800 | 850 | 0.1 | 175 | +0.700 | -0.450 |
| 2500 PERM REFERENCE | 495 | | | | | | | |

and 24K, then consider how you might use these ferrites.

For more information, samples and applications, contact:

Stackpole Carbon Company,
Electronic Components Division,
St. Marys, Pa. 15857 Ph: 814-834-1521. TWX: 510-693-4511.

Disaccommodation factor for both materials is 1.4×10^{-6} , typical.



STACKPOLE
Electronic Components Division

Producing high quality Ceramag[®] ferrite components for the home entertainment, industrial electronics and computer industries for over twenty-two years.



Designer's Calendar

MARCH 1970

| | | | | | | |
|----|----|----|----|----|----|----|
| S | M | T | W | T | F | S |
| 1 | 2 | 3 | 4 | 5 | 6 | 7 |
| 8 | 9 | 10 | 11 | 12 | 13 | 14 |
| 15 | 16 | 17 | 18 | 19 | 20 | 21 |
| 22 | 23 | 24 | 25 | 26 | 27 | 28 |
| 29 | 30 | 31 | | | | |

For further information on meetings, use Information Retrieval Card.

Mar. 23-26

IEEE Convention and Exhibition (New York City) Sponsor: IEEE. H. L. Nicol, The Institute of Electrical and Electronics Engineers, 345 E. 47th St., New York, N. Y. 10017

CIRCLE NO. 321

APRIL 1970

| | | | | | | |
|----|----|----|----|----|----|----|
| S | M | T | W | T | F | S |
| | | | 1 | 2 | 3 | 4 |
| 5 | 6 | 7 | 8 | 9 | 10 | 11 |
| 12 | 13 | 14 | 15 | 16 | 17 | 18 |
| 19 | 20 | 21 | 22 | 23 | 24 | 25 |
| 26 | 27 | 28 | 29 | 30 | | |

Mar. 31-Apr. 2

International Symposium on Submillimeter Waves (New York City) Sponsor: IEEE et al. J. Fox, Microwave Research Institute, Polytechnic Institute of Brooklyn, 333 Jay St., Brooklyn, N. Y. 11201

CIRCLE NO. 322

Mar. 31-Apr. 2

Symposium on Law Enforcement Science and Technology (Chicago) Sponsor: U.S. Dept. of Justice. IIT Research Institute, Law Enforcement Science & Technology Center, 2024 West St., Annapolis, Md. 21401

CIRCLE NO. 323

Apr. 7-9

Reliability Physics Symposium (Las Vegas) Sponsor: IEEE. K. H. Zaininger, RCA Laboratories, Princeton, N.J. 08540

CIRCLE NO. 324



Simpson's new 2725.

Compare it with the electronic counter you were going to buy:

| SPECIFICATIONS | SIMPSON 2725 | YOUR COMPARISON |
|--------------------------------|---|-----------------|
| Wide frequency range? | YES. 5 Hz to 20 MHz. | |
| Measures frequency ratios? | YES. 1 to 1.99999×10^5 . | |
| Measures time periods? | YES. 300 μ seconds to 0.2 second. | |
| Measures time intervals? | YES. 300 μ seconds to 1.99999×10^5 seconds. | |
| Totalizes? | YES. 0 to 1.99999×10^5 counts. | |
| Crystal controlled time bases? | YES. 6 xtal-controlled bases, switch selected. | |
| Self-test circuitry? | YES. Front panel switch tests logic circuitry. | |
| Dependable solid state design? | YES. Integrated circuits. | |
| Number of full time digits | 5. Plus automatic overrange indication. | |
| Accuracy | $\pm 0.01\%$ ± 1 digit | |
| Price | \$525. complete with probe and operator's manual. | \$ |

4-digit Model 2724 also available: \$450.

GET "OFF-THE-SHELF" DELIVERY OF THE NEW SIMPSON DIGITAL ELECTRONIC COUNTERS AT DISTRIBUTORS STOCKING SIMPSON INSTRUMENTATION PRODUCTS

Simpson

ELECTRIC COMPANY



5200 W. Kinzie Street, Chicago, Illinois 60644 • Phone (312) 379-1121
 Export Dept: 400 W. Madison Street, Chicago, Illinois 60606. Cable Simelco
 IN CANADA: Bach-Simpson Ltd., London, Ontario • IN INDIA: Ruttonsha-Simpson Private Ltd., International House, Bombay-Agra Road, Vikhroli, Bombay

INFORMATION RETRIEVAL NUMBER 13

the 4-day substrate

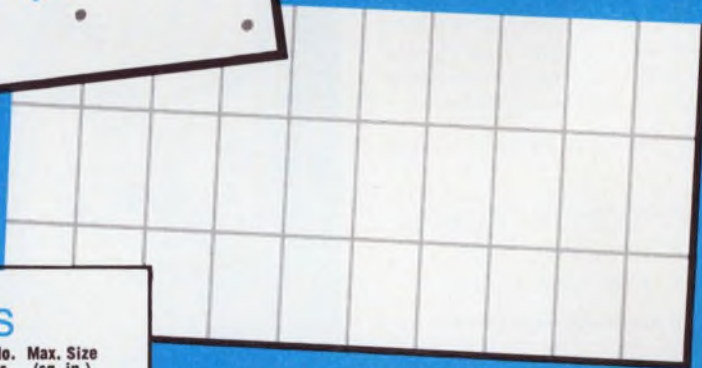

4-DAY SUBSTRATES

| Ceramic (10 or 25 mils thick) | Part Type | Max. No. Pieces | Max. Size (sq. in.) |
|--|---------------------------|--------------------|------------------------|
| ADS-96F (96% Al ₂ O ₃ , as-fired) | Standard- Size Blanks* | 2500 | 4 |
| | | 1500 | 8 |
| | | 500 | 16 |
| ADS-995 (99.5% Al ₂ O ₃ , as-fired) | Custom- Cut Blanks** | 1000 | 4 |
| | | 500 | 8 |
| | | 250 | 16 |
| | Standard- Size Blanks* | 1250 | 4 |
| | | 750 | 8 |
| | | 250 | 16 |
| | Custom- Cut Blanks** | 500 | 4 |
| | | 250 | 8 |
| | | 100 | 16 |

*Available in over 110 shapes and sizes (listed in DS-1402).

**Cut to your specifications.

7-DAY SUBSTRATES

Coors ships the following substrates within 7 calendar days of receipt of order.

Standard-Size Blanks — 15, 20, 25, or 30 mils thick; same quantities and wide choice of sizes as 4-day substrates.

Custom-Cut Blanks — 15, 20, 25, or 30 mils thick; same quantities as 4-day substrates.

Parts With Holes — maximum 250 pieces per order; maximum 50 holes per piece; minimum 15-mil hole diameters; 10, 25, or 35 mils thick.

Strate-Breaks® — maximum 500 pieces per order; maximum 100 segments per piece; 1 to 4 sq. in. total part size; 10 or 25 mils thick. (Sizes listed in DS-1402.)

Why wait 8 to 16 weeks (or more) for ceramic substrates?

Coors ships the parts shown at the left in 4 calendar days (or less).

And the cost is lower than you might think.

For details on part sizes, shapes, tolerances, and materials, send for data sheet 1402.

For prices, mail or phone specifications to:

Coors Porcelain Company
Tape Products Dept.
600 Ninth St.
Golden, Colorado 80401
(303) 279-6565, Ext. 404

Coors/CERAMICS

The better idea people in microelectronics.

PHILCO



PHILCO-FORD CORPORATION • MICROELECTRONICS DIVISION • BLUE BELL, PA. 19422

Announcing a first-class second source for Series 9300 MSI.

Now for the first time you can get 9300 T²L MSI circuits . . . today's high-versatility logic with optimum speed-power product . . . and made by Philco-Ford, the people long identified with high reliability in IC production.

We're bringing you the most wanted MSI types first: registers, counters, decoders, and multiplexers. Versatility is built in; additional logic requirements are pared way down . . . in some cases eliminated. Then there's the packaging. Don't forget it's ceramic DIP with proved hermeticity . . . by the people who know Cerdip.

Here are the first six, with more coming soon:

- pL9300 4-bit universal register
- pL9306 BCD up/down counter
- pL9311 1-of-16 digital decoder
- pL9312 8-bit digital multiplexer
- pL9316 binary hexadecimal counter
- pL9328 dual 8-bit shift register

CIRCLE 38 ON READER SERVICE CARD

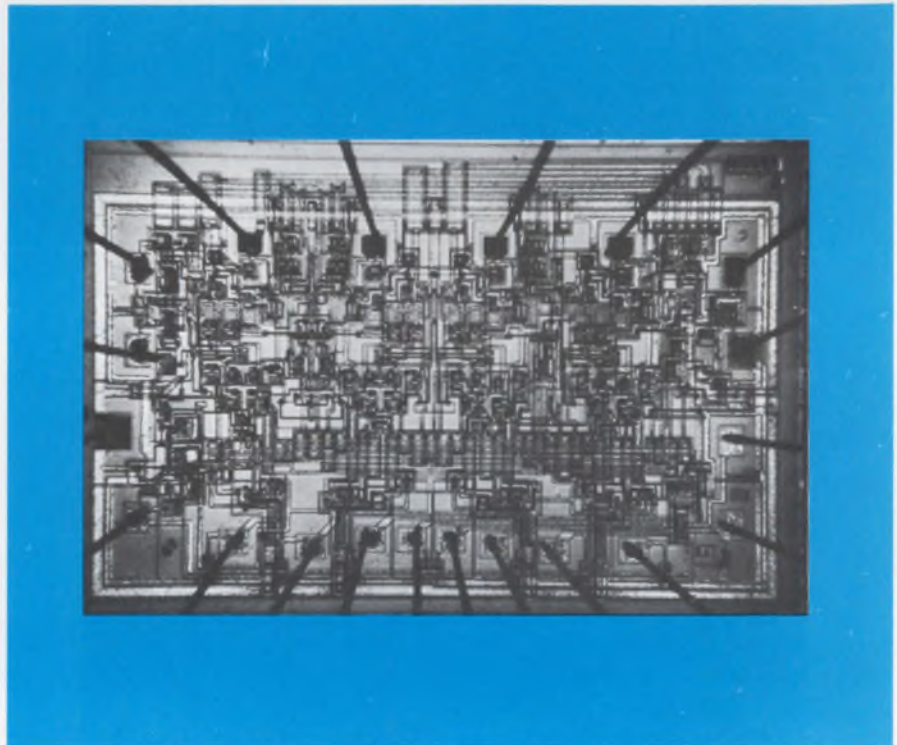

Need analog MSI? Call a Philco Hybrid Hunter.

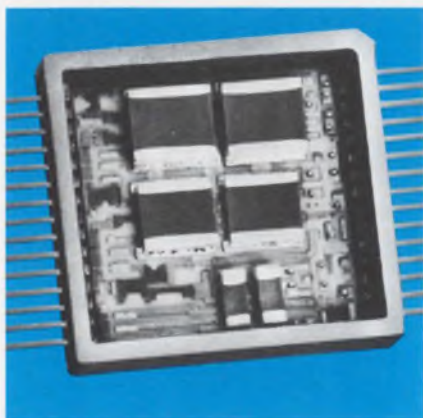

Want to microminaturize a circuit now designed for discrete components? Need more voltage, current, or power capability than you can get from monolithic integrated circuits?

Then you need an AMSI by Philco. Here's an example of an AMSI hybrid circuit now in volume production at our Spring City hybrid facility. It's a triple detector circuit, contained in a 1 x 1-inch all-hermetic flatpack made by Philco-Ford. Look what's inside:

- 13 thick-film resistors, in values from 3.9K to 182K ohms. All resistors are 1% tolerance, low TCR.

- 6 capacitors, in values from .033 to .33 μ fd. All capacitors 1% tracking with temperature.
- 19 active PNP and NPN devices, with V_{be} and V_{ce} matching ± 5 millivolts.

When you need AMSI, call a Philco Hybrid Hunter. Just show us your circuits . . . and give us a month. We'll have prototype hybrid circuits on your desk. They will be ready for production in one of the most experienced hybrid facilities in the country. And they will be priced competitively.

CIRCLE 39 ON READER SERVICE CARD

microtopics

1024-bit static ROM

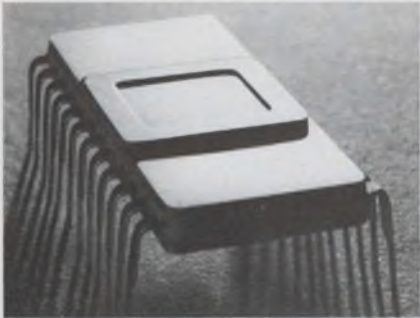

The Philco® MOS 1024-bit read-only memory has a *static* output data level. It remains valid as long as an address is present.

That means you can address it as slowly as necessary to be compatible with your output device, and the extra expense of clock generators and drivers is eliminated.

Bit pattern, 128 8-bit words; access time, typically 2 μ s; cost in 100-piece lots, less than 4 cents per bit.

The pMS1024C static ROM is packaged in a 24-lead hermetic DIP. Samples available now in character generator form.

And for high-speed applications, try our *dynamic* ROM . . . comparable costs and access times less than 1.0 μ s.

CIRCLE 35 ON READER SERVICE CARD

COMING SOON FROM PHILCO-FORD

- New MOS memory products
 - 256-bit RAM
 - 2048-bit static ROM
 - 2240-bit static character generator ROM
- PL7751 Differential wide-band memory sense amplifier
- Schottky-barrier diodes in new packages

Our InSb multi-element IR detectors are all ours.

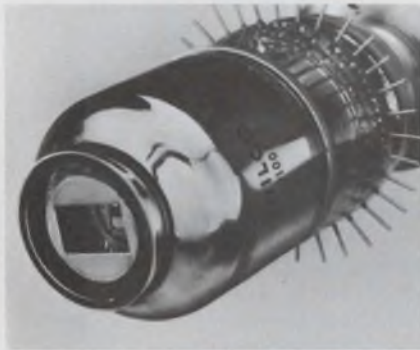

Because Philco® detectors are made entirely in-house. The whole assembly . . . detector array, liquid nitrogen- or cryostat-cooled dewar with cooled filter, and matching current-mode preamp.

What does this mean to you? Your interface problems are eliminated. You also gain from the start-to-finish quality control. By growing our own InSb, for example, we control impurity levels for maximum sensitivity and low noise performance.

And we've been doing these things for over 10 years . . . long enough to have more InSb photovoltaic detectors in the field than anyone else.

Take a look at some of the specs . . . elements as small as .05 mm x .05 mm with element spacing .025 mm for high resolution, detectivity approaching theoretical limits, linear arrays of more than 100 elements, and detector impedance of 10 megohms or more.

CIRCLE 36 ON READER SERVICE CARD

UHF to Ku band. How's that for broadband switching?

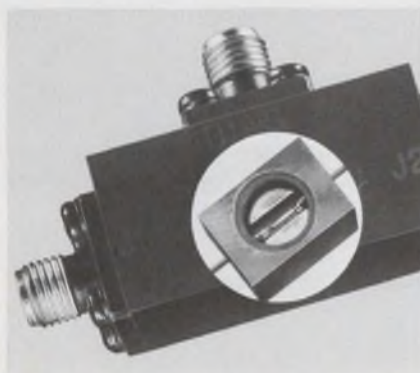

That's what you get with our new Philco® P9800 Series coax switch assemblies.

And switching performance over any part of that range is better than just about any narrow-band switch assembly you can find.

The secret? The P9800 Series employs our new L8370/L8380 Series integrated switch modules. These hermetically sealed modules eliminate the package parasitics which limit the broadband performance of conventional semiconductor diode switches.

These new modules, which are also available separately, permit switching ratios in the order of 50 db over the specified operating frequency range with switching speeds down to 10 nanoseconds.

You can get the new P9800 Series switch assemblies with integral hybrid drivers to solve your control circuit interface problems. In addition, units designed to exhibit linear attenuation or other special characteristics can be supplied as required.

CIRCLE 37 ON READER SERVICE CARD



Heads: You win.

Tails: You win again.

Elco rack-and-panel connectors give you a better head start.

And a choice of tails.

The head start is the connecting end of an Elco connector: the patented Varicon™ contact that fully meets the requirements of MIL-E-5400. The four mating surfaces of this unique contact are coined to an exceptional hardness and wipe clean with each make. Once the contacts are joined, the inherent springiness of the gold/nickel-plated phosphor bronze and the fork-like design make a superior, gas-tight fit.

Because the contacts are free floating, they align perfectly. A few contacts or 100 or more, all fit precisely together every time, over a long service life. There's no contact chatter. Nobody else gives you a contact head quite like the Varicon.

And nobody else gives you the choice of tails you get with Varicon. You can wire-wrap, crimp, clip, stake, or solder them. Whatever terminating technique or combination of techniques your assembly lines are set up for, we'll furnish the appropriate tail. If staking or crimping is your style, we

can supply the equipment too. Manual or automatic. Purchase or lease.

Elco rack-and-panel connectors come in standard rectangular models, or as miniature connectors, or in modular units. You can have them with 2 Varicon contacts, or up to 140, or anything in between.

In short, our line of Varicon rack-and-panel connectors has a lot going for it. Except price. Though it's a precision component, the Varicon contact is easily produced in high speed progressive dies. There's no expensive machining, no waste. When you can turn out millions of Varicons a week, you don't have to charge a fortune for them.

There's a lot more to be told about Varicon connectors. It's all in our 28-page rack-and-panel connector guide, and we'll be happy to send you a copy. Just write, wire, call, or TWX us. Elco Corporation, Willow Grove, Pa. 19090. (215) 659-7000. TWX 510-665-5573.



.078" Taper Tab

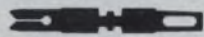

Solder/.098" Taper Tab



Wire Wrap Tail
.024" x .050" x .567"



Wire Wrap Tail
.024" x .050" x .760"

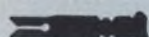

Crimp (Loose contact)

ELCO Rack-and-Panel
Connectors

See us at NEPCON Central Booth 215

The Following Performance Is Brought To You By The Only Manufacturer Of 50 A, Hot Carrier Rectifiers

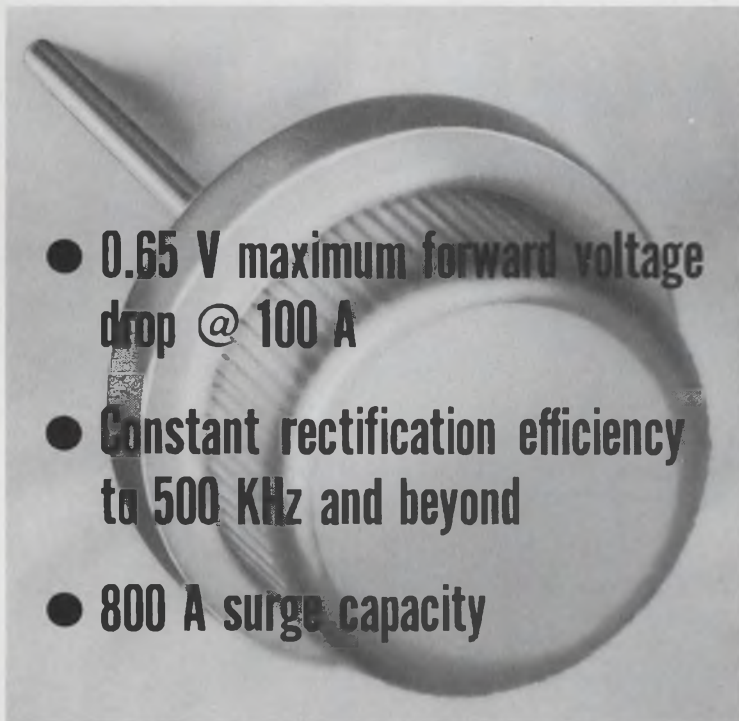

- 0.65 V maximum forward voltage drop @ 100 A
- Constant rectification efficiency to 500 KHz and beyond
- 800 A surge capacity

50% less power loss than conventional alloy or diffused devices!

That's the advantage in efficiency behind the new MBD5500, 50 A (I_o) hot carrier silicon rectifier. And, not only does this unique high-current device cut your power losses through unmatched low forward voltage drop but it trims time and money outlay for required heat sinking through one of the most efficient, low-cost package designs available – the pressfit (DO-21 outline).

Employing Schottky barrier, low resistivity, metal-over-oxide junction techniques in a large area chip, the 20 V ($VRM_{(rep)}$) MBD5500 is perfect for use in low voltage power supplies in computers and other applications where power loss and/or high frequency rectification are prime design considerations.

Its "majority carrier" operation makes it inherently suitable for applications where extremely low stored charge is required or where commutation transients are a problem.

Combine these advantages with top rectification efficiency, excellent surge-handling, low thermal resistance and passivated junctions and you've virtually got the "ideal" diode . . . the MBD5500 – available now for evaluation from your franchised Motorola distributor.

Turn one loose in your circuit design and watch it go – *efficiently!* Write Box 20912, Phoenix 85036 for more data.

—where the priceless ingredient is care!



MOTOROLA
RECTIFIERS

solve temperature control problems

OFFER PRECISE TEMPERATURE CONTROL, RAPID RESPONSE, MINIMAL DIFFERENTIAL . . . *from G-V*

G-V offers a wide selection of electrical thermostats for over and under temperature indication, alarm or cut-off service. They are designed to meet the rugged and precise requirements of both military and commercial applications including missiles, data processing equipment, etc. Both surface sensing and immersion types are available. For surface temperature sensing, crystal can size VE Series features a tolerance of $\pm 3^{\circ}\text{C}$, a differential of $\pm 1.5^{\circ}\text{C}$. Various models cover settings between -55°C and $+150^{\circ}\text{C}$. The C8 Series cartridge immersion or air sensing thermostats are available with a variety of mounting brackets and terminals. They are supplied with a setting tolerance of $\pm 5^{\circ}\text{F}$ ($\pm 3^{\circ}\text{C}$), and repetitive operation within $\pm 1^{\circ}\text{F}$ can be expected. These units will withstand indefinite exposures to temperatures of -65°F to $+300^{\circ}\text{F}$ without damage. The C8 Series can be adjusted without damage to the hermetic seal. Contact ratings: VE Series, up to 3 amps; C8 Series up to 5 amps.



G-V CONTROLS INC.
LIVINGSTON, NEW JERSEY 07039
(201) 992-6200

INFORMATION RETRIEVAL NUMBER 811

*AIR FLOW SENSING SWITCH



A new design concept and technique is utilized to monitor presence of air flow. When air flow drops below a safe level, it operates an alarm or automatic shut-off. Used in electronic equipment, cooling packages, air conditioners, computers, etc.
Features: Operates in any plane, no moving parts. No special adjustments.

*Recognized Under The Components Program Of Underwriter's Laboratories, Inc.

only from 

INFORMATION RETRIEVAL NUMBER 815

*ELECTRICAL THERMOSTATS FOR INDUSTRIAL USE

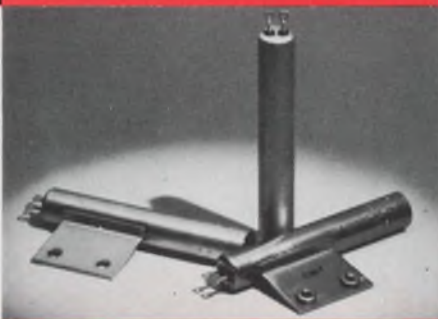

The D8 Series is suitable for a wide range of temperature control applications, offering exceptional stability. Since the encasing shell is the temperature sensing element, response to temperature change is very rapid.
Features: contact ratings up to 5 amps, operating range -65° to $+300^{\circ}\text{F}$.

*Recognized Under The Components Program Of Underwriter's Laboratories, Inc.



INFORMATION RETRIEVAL NUMBER 816

DIRECT-LINE FIELD ENGINEERING SERVICE



G-V assistance is always available to help you design and produce a better product. G-V Regional Field Engineers in your area will assist you and your design group in new applications and proper selection of your controls. G-V Product Engineers will help you with special applications. When you require experience, products and services in electro-mechanical and solid-state controls . . . call your man from G-V.



INFORMATION RETRIEVAL NUMBER 817

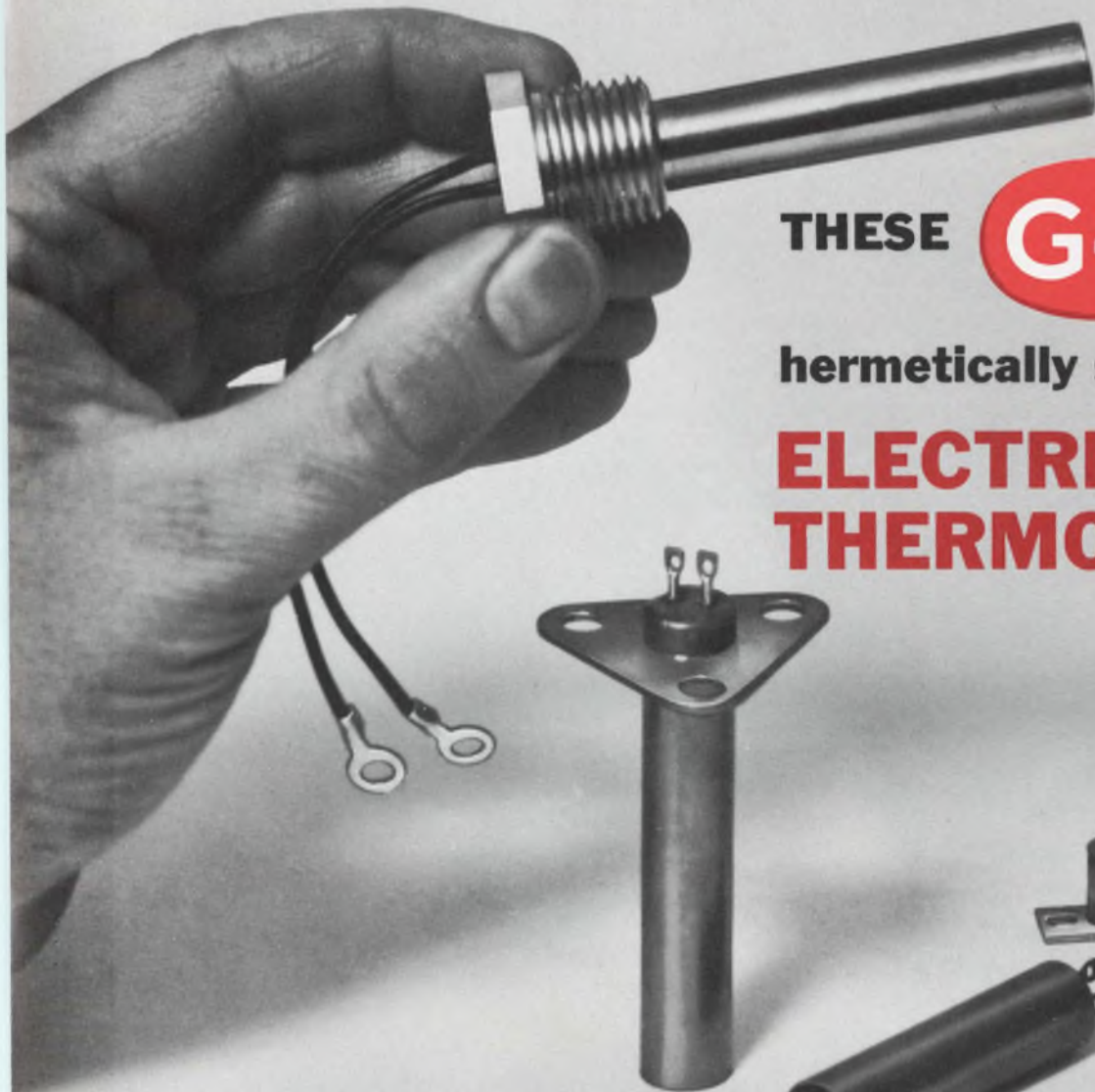

THESE



hermetically sealed

ELECTRICAL THERMOSTATS ...

*QUICK CONNECT TYPE INDUSTRIAL THERMAL RELAY

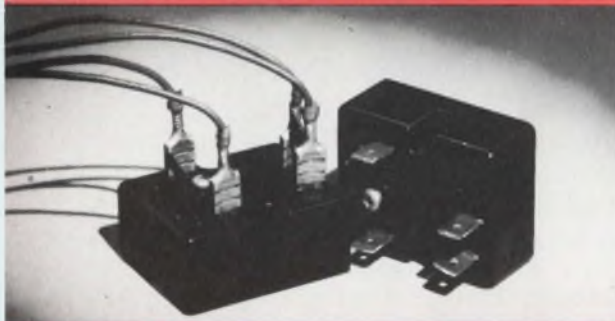

The Quick Connect thermal relays are designed to withstand the most demanding industrial applications. They reduce installation time and cost. Require only two mounting screws. Eliminates need for brackets, sockets, retainers. **Features:** time delays, 2 to 180 sec.; contacts, SPST, NO/NC; heater voltages, 6.3, 26, 115V AC or DC; resistive rating, 2A 115V AC or 1A 28V DC; mounts in any position.

*Recognized Under The Components Program Of Underwriter's Laboratories, Inc.



INFORMATION RETRIEVAL NUMBER 812

*RED LINE INDUSTRIAL THERMAL TIMING DEVICES



Designed to meet the most demanding applications. They are housed in shatter-proof, dust-proof metal enclosures and feature stainless steel mechanisms and encased heaters for reliable, quiet operation in any plane. **Features:** delays up to 3 minutes, operating voltages 6.3 to 115V, AC or DC.

*Recognized Under The Components Program Of Underwriter's Laboratories, Inc.



INFORMATION RETRIEVAL NUMBER 813

*THERMETTE 9 PIN RELAY



Metal enclosed thermal time delay is dust proof and shatter proof — designed for industrial applications requiring reliable operation and long life. **Features:** temp. compensated; time delays, 2 to 180 sec.; heater voltages, 6.3, 26, and 115V. AC or DC; contacts, SPST, NO or NC.

*Recognized Under The Components Program Of Underwriter's Laboratories, Inc.



INFORMATION RETRIEVAL NUMBER 814



This is any digital logic system you can think of.

Gentlemen: I have a design for a digital logic system and I understand you have everything I need to put it together. Please send me complete information on the compatible system elements I checked below:

- J Series logic modules.** A high quality line at moderate prices, using commercially available DTL and TTL circuits with noise-immune packaging.
- T Series logic modules.** Proprietary IC's designed into noise-immune circuits. Highest fan-in and fan-out available.
- Automated wiring services.** Computer generated list-

ing; error-free verified wire-wrapping. Complete documentation provided.

- Mini-computer.** A 16-bit processor with powerful instructions that conserve memory and an I/O structure with four different operating modes.
- Analog instruments.** Low-level and high-level multiplexers, digitizers, D-to-A converters. 10, 12, or 15-bit resolution, choice of high or medium speeds, free-standing or coupled to the mini-computer.
- All of above.**

NAME _____ TITLE _____
 COMPANY _____ PHONE _____
 ADDRESS _____ CITY _____ STATE & ZIP _____

Send to: Xerox Data Systems, Dept. B, 701 South Aviation Blvd., El Segundo, Calif. 90245
 If you can't wait, call (213) 679-4511 ext. 3668 or 3391

XDS
 Xerox Data Systems
 El Segundo, California

A quick guide to magnetic drives: torque transmitters that work when other methods won't.

Magnetic drives offer you some relatively inexpensive solutions to difficult torque transmission problems. For instance, a magnetic drive can transmit torque through a non-magnetic barrier without using any mechanical connection. And because the system completely eliminates seals, it eliminates problems of leakage, maintenance and contamination.

3 basic types of magnetic drives.

1) *Synchronous drives* are equivalent to a shaft connection. Two basic arrangements are axial and radial. Axial drives consist of two Indox magnets or two Alnico side pole rotor magnets. Axial thrust is a maximum at zero load and diminishes as more torque is applied.

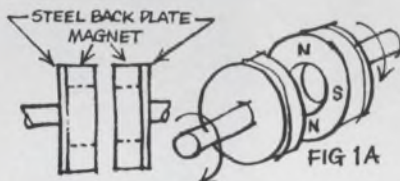

Radial drives consist of two ring magnets and have no axial thrust. Because of starting in-

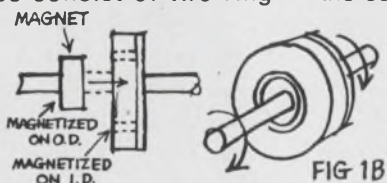

ertia, the outer magnet normally drives the inner one. When the maximum torque of a synchronous drive is exceeded, the driven member stops. This can offer important protection in event of overloading. And you never have to replace shear pins or worn frictional surfaces.

2) *Eddy current drives* use the field of a rotating permanent magnet to induce eddy currents in a conducting material. Interaction between these currents and the magnetic field gives rise to the torque of the coupling. Torque varies with the relative speed of the members. Eddy current drives use driven members of aluminum or copper in the form of cups, tubes or discs depending upon the configuration needed.

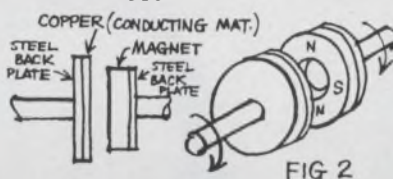

3) *Hysteresis drives* use the magnetic field of a rotating permanent magnet to drive the material of the hysteresis member through its hysteresis loop. The unit is syn-

chronous provided the maximum torque isn't exceeded. Beyond this point the torque is independent of the slip speed and remains constant.

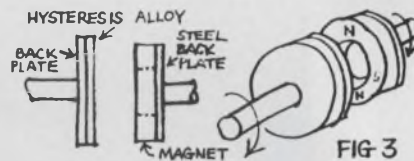

Hysteresis drives operate at close gaps. But unlike eddy current drives, hysteresis drives transmit constant torque.

Design aids available free.

The basic factors to consider in magnetic drive design include:

- radial or axial gap configuration
- relationship of torque to slip speed
- ambient operating temperature
- non-magnetic material through which torque must be transmitted
- maximum torque to be transmitted
- critical nature of the alignment.

We're anxious to help answer your questions. And we would like to send you some useful aids that include graphic presentations of important factors in magnetic drive design. Just write Indiana General, Magnet Products, Valparaiso, Ind. 46383.



indiana general

a division of Electronic Memories & Magnetics Corporation



Advanced Micro Devices has perfected the production technology of complex, mainstream digital and linear monolithic circuits.

James N. Giles collaborated with R. Widlar on the design and frequency-compensation of the first monolithic op amps. He wrote the *Fairchild Linear Circuit Handbook*, the industry's standard reference. He's Director of Engineering, Analog Operations.

Edwin J. Turney has ten years' sales management experience in the semiconductor industry. He's been involved in the growth and service needs of customers like XDS, Burroughs, NCR and many more. That's given him special credentials for his job as Director of Sales and Administration.

R. Lawrence Stenger increased the reproducibility of the UA 709 from 6,000 circuits per month to 400,000! His department produced 22 second-generation LICs in two years. He's Managing Director, Analog Operations.

Frank T. Botte worked on the industry's first linear I.C.s. He developed the first production-reliable MOS monolithic capacitor, making possible the UA741—the industry's first frequency-compensated op amp. Now he's Director of Development, Analog Operations.



W. Jerry Sanders III took eight years getting from sales engineer to chief marketing executive of a \$100 million semiconductor company. Along the way he managed to learn the business from the men who invented it. He's Advanced Micro Devices' President and Chairman of the Board.

Jack F. Gifford led the linear circuit business into the industrial, computer peripheral and instrumentation markets. He's specialized in product definition and planning. That's why he's Director of Marketing and Business Development.

Sven E. Simonsen has more than four years in the development of monolithic complex digital circuits. He designed and developed the 9300 MSI sequential circuit family. He is Director of Engineering, Complex Digital Operations.

D. John Carey was responsible for the development and manufacture of 26 monolithic complex digital circuits in 12 months, including the 9300 MSI family. He's Managing Director of Complex Digital Operations.

**"Why don't we get together
and start a business?"**



NEWS

- 21 **News Scope**
- 24 **At the solid-state circuits conference:**
In data communications, it's LSI
Impatts continue their trip from lab to field
All-IC consumer products edge a little closer
- 30 **Rx for progress in medical electronics: Communicate**
Engineers and doctors at San Francisco conference agree that a clearing house for ideas is needed.
- 36 **Phased arrays: They're great, but . . .**
New applications and component developments look promising, but the costs are still too high.
- 41 **Wanted: Memory for sledding at Mach 7**
- 42 **Extend standard cell design to bipolars**
- 47 **Washington Report**

U81 **IEEE-USA**—A special section devoted to this year's big show

TECHNOLOGY

- 178 **Synchro-to-digital converters**—three major categories are introduced and detailed in Part I of this practical design guide.
- 188 **Program designs active filters** and reduces the engineer's effort by using expanded BASIC and a time-shared terminal.
- 199 **Electromagnetic interference worry you?** It won't if you apply these easy-to-follow suppression recommendations to your equipment.
- 204 **That 'dream' job might be a nightmare**—unless you take preventive measures by getting to know your future boss as he knows you.
- 208 **Ideas for Design**
- 221 **Product Source Director: Random Noise Generators**

PRODUCTS

- 227 **Components: Coin-sized** energy-storage device has capacitance of 50 F.
- 234 **Microwaves & Lasers:** Tiny rf switch handles 10 mW from 10 MHz to 1 GHz.
- 238 **Data Processing:** Semiconductor memories sell for only 1.2¢ per bit.
- 243 **Modules & Subassemblies**
- 248 **ICs & Semiconductors**
- 254 **Instrumentation**
- 258 **Packaging & Materials**
- 262 **Tools & Engineering Aids**

Departments

- 63 **Editorial:** '71 budget will separate the men from the boys
- 13 Designer's Calendar
- 52 Letters
- 60 Sidelights
- 268 Evaluation Samples
- 270 Design Aids
- 272 Annual Reports
- 274 Application Notes
- 276 New Literature
- 286 Advertisers' Index
- 288 Information Retrieval Service

Information Retrieval Service Card inside back cover

Cover: Illustration of the electronic decade to come by Chris Randall

ELECTRONIC DESIGN is published biweekly by Hayden Publishing Company, Inc., 850 Third Avenue, New York, N.Y. 10022. James S. Mulholland, Jr., President. Printed at Brown Printing Co., Inc., Waseca, Minn. Controlled circulation postage paid at Waseca, Minn., and New York, N.Y. Copyright © 1970, Hayden Publishing Company, Inc. 81,801 copies this issue.

Get **sine, square and triangle** functions—and **positive and negative going pulses, positive and negative going ramps**—in the new HP 3310A. And there's more! You'll have these seven functions over a decade of decades—0.0005 Hz to 5 MHz.

All this capability is packed into a package only 7¾" wide, 4½" high, 8" deep! With the 3310A Function Generator performing many of the functions of the pulse generator, ramp

generator, bias box and amplifier on your bench—think about the clutter you eliminate...the instant access you'll have to all these signals.

With the dc offset capability of the 3310A, you can put any of the functions where you want them—easily and without biasing. And, with the choice of high or low level output, you can get clean low level signals without an external attenuator. You get a maximum of 15 V peak-to-peak into 50 Ω—and that's plenty of power to eliminate most needs for external amplification.

Add to this the external frequency control capability which allows you to sweep over a 50 to 1 range or tie the 3310A into a system—the price

of only \$575—solid-state reliability—and you know the HP 3310A is more than a function generator!

Order your HP 3310A today from your nearest HP Sales Office. For full specifications, write to Hewlett-Packard, Palo Alto, California 94304. Europe: 1217 Meyrin-Geneva, Switzerland.

HEWLETT *hp* PACKARD
S I G N A L S O U R C E S

099/9

This One Is More Than A Function Generator!



AT THE SOLID-STATE CIRCUITS CONFERENCE

In data communication, it's LSI

John N. Kessler
News Editor

The impact of LSI in the years 1970 to 1990 will be comparable to that of the transistor since 1950. This was the view of many designers at the 1970 IEEE International Solid-State Circuits Conference, held in Philadelphia last month.

The participants in a session on data communications considered the question, "What must happen when data terminals become something like the telephone?" Many papers described circuits and devices that were smaller, yet more complex than pre-LSI types; that were of larger capacity, yet easier to fabricate and potentially cheaper to manufacture. A megabit bipolar LSI memory system outlined by F. S. Greene Jr. and N. U. Phan of Fairchild Semiconductor, Palo Alto, Calif., epitomizes the trend of the future. It combines LSI with modular memory boards that are expandable to megabit sizes.

Each memory component is a bipolar chip measuring 0.111 inch by 0.159 inch. A coincident X and Y



Tomorrow's teacher? A TV-like terminal may be used one day to educate our young people, according to designers at the 1970 Solid State Circuits Conference. This display was designed by Donald L. Bitzer and H. Gene Slottow of the University of Illinois Coordinated Science Laboratory.

six-variable input (3 out of 6 code) is used for addressing information. A bi-directional data line controlled by a read/write input pin operates at 70-ns read access and 40-ns write. The memory is compatible with DT μ L, TT μ L, and CT μ L and uses a 500-mW power supply.

New variable delay line

A completely new approach to electronic variable delay lines was presented by F. L. J. Sangster of Philips Research Laboratories, Eindhoven, the Netherlands. Although the basic concept of a "bucket brigade" storage capacitor has been described before, this marked the first time the device had been fabricated as an integrated circuit.

Information is stored in an array of capacitors as an amount below a nominal charge level. This permits the use of a simple circuit with only one transistor per storage capacitor.

The megabit memory and the bucket-brigade delay line typify the advances in data-communications hardware that can be expected this year. But an informal panel discussion moderated by Virgil I. Johannes, head T-5 digital line dept., Bell Laboratories, pointed to a proliferation of computers and remote computer terminals that will use such devices and combine them with chips containing 20,000 to 100,000 active elements.

Marvin Silverstein, principal engineer, Honeywell, Inc., St. Petersburg, Fla., said this would give more computer capability at a reduction in cost. But while hardware costs go down, cost increases can be expected in software, memory and displays, he said.

Much of the discussion focused on how "smart" the remote terminal should be to be part of a telephone-like communication system. Brian Warner, principal product planner, Xerox Data Systems, El

Segundo, Calif., said: "The more central systems the terminal can be connected to, the more cost-effective it will be."

Warner emphasized that computers must be able to speak to each other and to various types of terminals. This flexibility will meet a variety of consumer needs. And by consumer needs, members of the discussion panel meant not only research scientists, engineers and airlines but also restaurants, hotels, hospitals and families that will use terminals for inventory control of perishable foods, book-keeping, centralized banking and newspaper information retrieval.

Digital transmission favored

It was generally agreed that digital data transmission would be most effective because it permits the following:

- Conservation of bandwidth, especially with systems such as pulse-code-modulation.
- More error control in a long-haul system because a pulse stream can be regenerated with far greater accuracy than analog signals.
- Greater compatibility for future systems, such as satellites.
- More security—greater privacy—of communications.
- Sharing of the system through use of time-division multiplexing.

Norman Snow, head, wideband data dept., Bell Labs, Holmdel, N. J., noted a major difficulty in going to a digital system: "We are still living with an analog system that took 70 years to build, so we must use modem and stand-alone terminals to squeeze what we can out of the system."

He was, of course, referring to the present telephone system.

It is questionable whether future data communication systems will operate on the voice-band telephone system that has been created. There are political and economic factors that will shape the future of data transmission,

and these do not involve the solid state.

John E. Cox, assistant vice president, Western Union, Mahwah, N. J., pointed out that "the FCC ruling about two weeks ago prohibits common carriers from getting into the CATV field." And some at the conference felt that data systems of the future will ride on the back of CATV. But—assuming that the common carriers will handle future data systems—there will be changes in tariffs that could affect the design of transmission facilities as well as the equipment at both ends.

Some of the questions asked were:

- "How will magnetic tape cassettes change the nature of data transmission?"

- "How will we handle shared data links on a switched system?"

- "What about costs? Will common carriers offer service on a bit and error-performance basis?"

- "If a CATV network is used, how can inquiries be made? How will that system be made bi-directional?"

- "Can a data network be operated by a number of small competing companies, or must we rely on a major common carrier to assure the uniformity and compatibility required for such a large system?"

Cox said that future terminals would be much more complex than present ones. "They will allow a

user to load the terminal and walk away," he said. "The terminal will make sure that transmission takes place."

But what happens in a time-division multiplexed system when an object is rotated to show its three dimensions on a graphic computer terminal? Store-and-forward techniques were suggested by Cox as a possible answer.

Will future data communications transmission use broadband or narrowband systems? Cox said that graphics would be more cost-effective with broadband systems. Warner of Xerox agreed but said that "for alphanumeric systems, you can use narrowband systems to good advantage." And he added:

"Putting the 'smarts' in the terminal will not be cost-effective in the long run. But this will probably be done anyway in the near future."

One member of the audience asked about the cost of coaxial switches. Cox said that he knew of coaxial switches that could switch 50 channels individually and could be mounted on a telephone pole.

A huge potential market was foreseen for data-communication systems in education. Several members of the panel humorously suggested that the cost of education was increasing at a rate that might make education in the home via a TV-like terminal a

necessity in the next decade.

One member of the panel, noting the transportation, pollution and communication problems that the commuter faced in traveling to work in New York City, suggested that the time and energy might be better used working at home and using data-transmission to communicate with the office.

H. Gene Slottow, professor of electrical engineering at the University of Illinois, was in the audience, and he reported the latest advances in that university's computer-based teaching program, called PLATO. (See "Turn on Designs With New Displays," ED 25, Dec. 6, 1969, p. 71). Slottow said that there were plans to develop 4000 student terminals in dormitories, classrooms and even in homes. There are now 20 such terminals in use at Illinois, he said, and courses have been successfully taught for credit in French, Russian and chemistry.

Snow of Bell Laboratories said that the remote reading of utility meters via telephone-line transmission had been studied at the laboratory in Holmdel and that field studies were being made of the effectiveness of the method.

The feasibility of such a system has been established. The economics remain to be worked out. Meters must be modified, Snow said, to incorporate the sensing elements. ■■

Impatts continue their trip from lab to field

Michael J. Riezenman
Technical Editor

High-speed digital communication with millimeter waves has come a step closer to reality with the development of an experimental modulator capable of operating at 300 Mb/s. Developed by a team of researchers from Bell Telephone Laboratories, in both Murray Hill, N. J., and Allentown, Pa., the modulator uses a fixed Impatt-diode oscillator followed by a separate variable path-length modulator (Fig. 1).

By separating the oscillator from the modulator—rather than attempting to modulate the oscillator

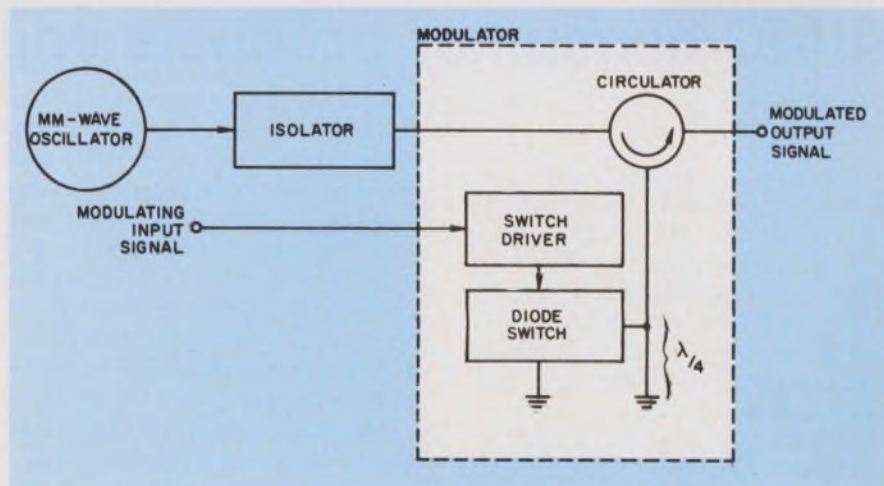

1. By separating the oscillator from the modulator, the designers have obtained high-speed modulation without sacrificing oscillator stability.

(Solid-State, continued)

directly—the design avoids many practical problems, according to Dr. Kaneyaki Kurokawa, supervisor of the group that studied the functional devices and circuits at Bell's Murray Hill laboratory.

Direct modulation schemes, such as varactor tuning, are simple in principle, Dr. Kurokawa told the Solid-State Circuits Conference, but they involve many compromises between conflicting factors—particularly in wideband applications. For example, a low-Q oscillator circuit is desirable for high modulation sensitivity, but noise and stability requirements demand a high-Q circuit.

The scheme that Bell adopted allows the oscillator and modulator to be optimized independently. And it has the additional advantage of flexibility. Should a superior millimeter-wave oscillator be developed at sometime in the future, the whole modulator would not have to be redesigned. It would only be necessary to replace the oscillator portion.

The Impatt-diode oscillator designed for the experimental project produces 85 mW of output power at 56.4 GHz. Its efficiency is 2.2%.

Varying the path length

The modulator itself uses an approach that Dr. Kurokawa calls PLS-DCPSK, for path-length switched, differentially coherent,

phase-shift keying. The modulating input signal drives the diode switch, and thus determines whether the millimeter-wave signal is to be reflected at the diode or a quarter wavelength away. A circulator is used to route the input signal to the diode switch and the reflected signal to the output port.

Signals that are not reflected at the diode switch, have to travel the quarter-wave section twice, and thus are 180° out of phase with the others. At the receiver, a differentially coherent detection technique is used. The rf phases of signals one time slot apart are compared. Zero phase difference yields a ZERO at the output; 180° yields a ONE.

Combining for power

Another development that seems to be paving the way for Impatt diodes to travel from the laboratory to the field was described by Dr. Isamu Tatsuguchi, a member of the technical staff at Bell's Allentown laboratory. He has constructed a power-combining network for phase-locked Impatt-diode oscillators. The network actually consists of three sections: a power splitter for the input locking signal, an array of injection-locked oscillators, and a combiner for the outputs of the oscillators. The network is modular in design so that many identical sections can

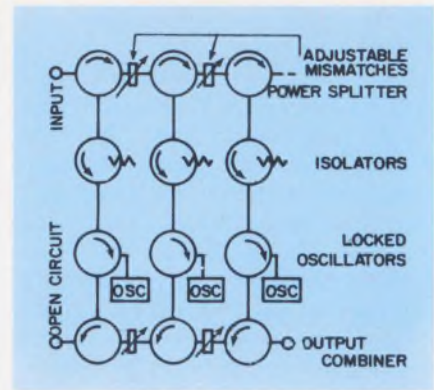

2. All paths from input to output have the same electrical length. Adjustable mismatches in the combiner allow for diode differences.

be bolted together (Fig. 2).

The key characteristic is that all of the paths from input to output have the same electrical length. Thus the oscillators all combine in a phase-coherent manner and are useful in practical fm systems. Adjustments are available to compensate for differences between the individual diodes.

Another important property of the network is that it can combine powers from oscillators operating at different power levels without power-dumping or other problems.

Each oscillator module contains four circulators. Thus, for economy, a thin-film fabrication technique must be used.

In the experimental work, three power modules operating at about 6 GHz were used. The total output power was 32.7 dBm for a locking gain of 16.5 dB over a 160 MHz bandwidth. ■■

All-IC consumer products edge a little closer

Don Mennie
Technical Editor

Two new developments described at the Solid-State Circuits Conference bring the day of fully integrated consumer electronics a step closer. The developments are: a high-gain, 15-W monolithic power amplifier and integrated-circuit realization of the standard a-m radio tuning capacitor.

According to Ernest Long, linear integrated circuits engineer with Motorola, Inc., Phoenix, Ariz., there are no fundamental limitations that prevent construction of

monolithic power amplifiers. His design—a preamplifier, thermal-protection circuit, ripple filter and two npn power transistors, combined on a single 74 × 75-mil chip—supports this. Long said his 15-W, 80-dB closed-loop-gain IC amplifier would be marketed within a year, and he expects rapid acceptance among quadrasonic stereo manufacturers (Fig. 1).

Heat dissipation is a major problem in IC power-amplifier design. Long's solution combines two techniques for thermal control: an efficient heat-sink package plus tem-

perature-sensing circuitry.

The IC package design is sufficient to cool the chip under normal operating conditions. When overloads develop, as would occur with the amplifier output shorted, a normally saturated dc amplifier senses changes in the chip temperature. At 175°C, the output of this amplifier rises sufficiently to bring a transistor into conduction, which disables the power amplifier. This thermal shutdown circuit is an intimate portion of the power-amplifier IC and thus responds immediately to overload conditions.

Whatever turns you on.

Or off.

If you are looking for a faster way to turn on and turn off with TTL, we've got news for you.

Our DCL 8800 series is not only faster than 54/7400, but it gives better overall performance. And if speeds of 13ns suffice, you won't have to pay the premium for 54/74H.

So check yourself and see how the 8800 series works for you.

| | FANOUT | | t_{on} | t_{off} | C_L | \$* |
|----------|--------|-----|----------|-----------|-------|------|
| | "0" | "1" | | | | |
| N8880A | 10 | 20 | 13ns | 13ns | 30pF | .85 |
| SN74H00N | 10 | 10 | 10ns | 10ns | 25pF | 1.58 |

*100-999 per manufacturer's, 1/15/70 Price List.
100-999 Single Type per Signetics Corp. Current Price List.

Interested? Write for your DCL Handbook giving complete details on the 8800 series. Then contact your local distributor for off the shelf delivery.

Of course, if you really need that 3 nano-seconds, we've got 54/74H too.

It's just a matter of what turns you on.

Signetics

Signetics Corporation / 811 E. Arques Ave., Sunnyvale, California 94086 / A subsidiary of Corning Glass Works

INFORMATION RETRIEVAL NUMBER 19

(Solid-State, continued)

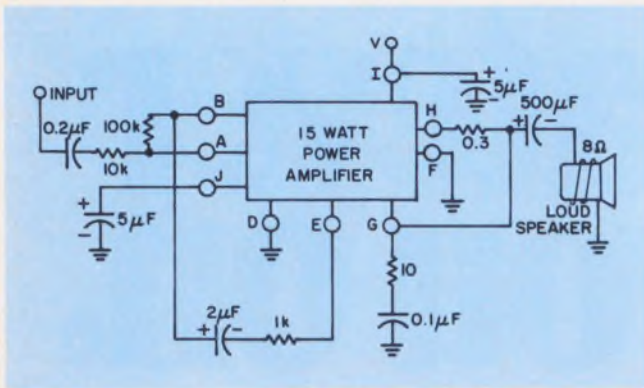

1. Typical connection using a high-power IC in an audio system. Motorola plans to market a 15-W, IC amplifier on a 74×75 -mil chip within a year.

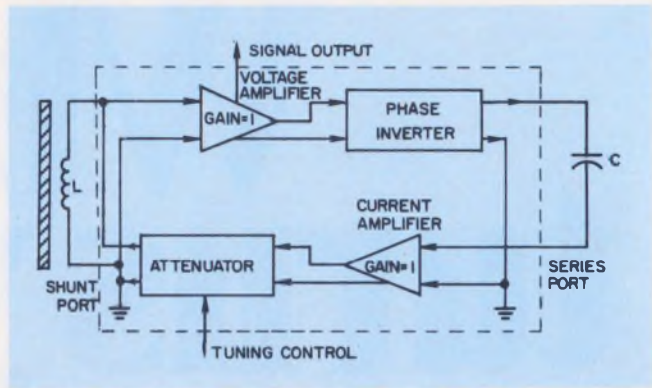

2. Impedance converter allows transformed value of C to appear across L. Two such units—one for the antenna coil, one LO—go into an a-m receiver.

A system to provide an IC equivalent to the a-m radio mechanical tuning capacitor was outlined by Philip Thompson, professor of electrical engineering at the University of Ottawa.

Almost completely integrated receiver systems should be feasible, he said, once tuning is incorporated alongside the LO, detector, i-f stages and amplifier on a single chip.

Thompson's approach uses twin-impedance converters to tune and track the ferrite antenna and local oscillator found in a broadcast-band receiver. Each impedance converter has a variable transformation ratio, which allows the impedance of capacitor C appearing across inductor L (see Fig. 2) to be continuously adjusted. This is the tuning control. The transformation ratio depends on the unity-gain amplifier's common-emitter cascode circuit current ratio. Thompson reported two impedance converters fabricated on the same chip would track with fair accuracy.

When questioned from the floor about dynamic range, out-of-band signal rejection and intermodulation distortion, he commented that experimental designs had performed satisfactorily but that complete data was not yet available. He described his work as experimental and exploratory, not yet ready for consumer use.

Color TV on three chips

A panel session on consumer electronics brought out conflicting opinions between IC vendors and

color-TV manufacturers.

The panel leader, Neil Frihart, manager of advanced TV development at Motorola, Inc., Franklin Park, Ill., predicted that in six years color TV sets would be built with three chips containing 75% of the circuitry. He was confident that ICs would win the consumer's respect by providing economy, size advantages and reliability not available with discrete components.

Taking a more critical view of the relationship between IC vendors and television manufacturers, Norman Doyle, section manager for consumer applications with Fairchild Semiconductor, Mountain View, Calif., pointed to the 15 different monolithic television i-f strips currently available as evidence of noncooperation. Doyle, who was also skeptical of television manufacturers' budget priorities, said that present outlays for cabinets and picture tubes far exceeded the electronic costs. In the light of such spending practices, he believes IC producers deserve support during the early stages of development, regardless of small price differentials that favor discrete component hardware.

On the other hand, Doyle encouraged IC manufacturers to provide product uniformity that would lead to reliable, low-cost consumer electronics.

Another view on the standardization issue was voiced by Donald Ruby, a microelectronics engineering specialist with Zenith Radio, Chicago. He doesn't want to see the innovative designer shackled by restrictions. "Creativity stops,"

Ruby argued, "when standardization sets in."

"Partitioning" was viewed by the panel members as closely related to the touchy question of industry cooperation. Partitioning refers to a needed agreement defining which TV subsystems comprise each chip. The grouping of functions (LOs, sync separators, video amplifiers, etc.) appears far from settled.

Gerald Lunn, development manager for custom linear integrated circuits with Motorola, Phoenix, remarked that at least part of the problem was technical. At present, he contended, the "natural partitions" of color television circuitry are just becoming adaptable to IC technology.

Another opinion on the problems plaguing color-television adaptation to the ICs came from Wim Hetterschied, semiconductor applications engineer with N. V. Philips, the Netherlands. He suggested that technical personnel now responsible for discrete component television design were reacting unfavorably to monolithic circuits, since their jobs were threatened by IC advances. Vulnerable engineers react by downgrading ICs at every opportunity, Hetterschied contended.

Responding to audience questioning about flat solid-state television screens, Doyle of Fairchild remarked that the "25-kV firecracker" (standard television tube) would be around quite a few more years. Panel members agreed that interfacing ICs with high voltage is still a problem to be solved. ■

solid state...up to date

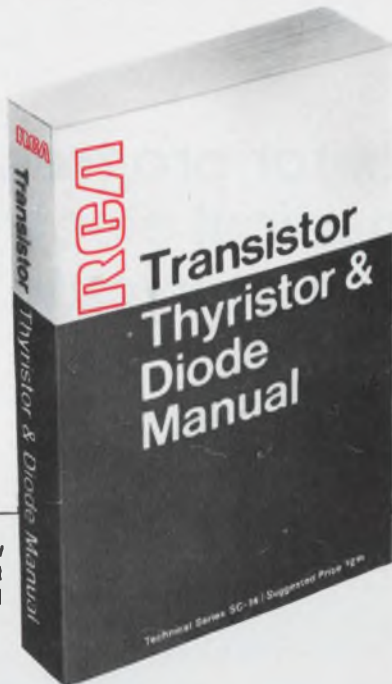

More than 100 new pages of latest information added

Suggested price \$2.50

| CONTENTS | PAGE |
|--|------------|
| MATERIALS, JUNCTIONS, AND DEVICES | 3 |
| Semiconductor Materials, P-N Junctions, Current Flow, Types of Devices | |
| BIPOLAR TRANSISTORS | 11 |
| Design and Fabrication, Basic Circuits, Characteristics, Biasing, Bias Stability, Coupling, High-Frequency Operation, Switching, Transient Effects | |
| MOS FIELD-EFFECT TRANSISTORS | 33 |
| Theory of Operation, Fabrication, Electrical Characteristics, General Circuit Configurations, Handling Considerations | |
| THYRISTORS | 40 |
| Silicon Controlled Rectifiers, Triacs, Diacs, Gate Characteristics, Switching Characteristics, Ratings, Critical Rate of Rise of On-State Current, Holding and Latching Currents, Critical Rate of Rise of Off-State Voltage, Transient Protection, Radio-Frequency Interference | |
| SILICON RECTIFIERS | 59 |
| Thermal Considerations, Characteristics, Ratings, Overload Protection, Series and Parallel Arrangements | |
| OTHER SEMICONDUCTOR DIODES | 65 |
| Tunnel Diodes, Varactor Diodes, Compensating Diodes, Photoconductive Diodes, Light-Emitting Diodes | |
| LINEAR SYSTEM APPLICATIONS | 74 |
| Detection, Amplification, Oscillation, Frequency Conversion, Automatic Frequency Control, Frequency Multiplication | |
| TV DEFLECTION AND COLOR DEMODULATION | 128 |
| Scanning Fundamentals, Sync, Vertical Deflection, Horizontal Deflection, Color Demodulation | |
| POWER SWITCHING AND CONTROL | 144 |
| Nonsinusoidal Oscillators, Switching Regulators, Converters and Inverters, Automobile Ignition System, Pulse Modulators, Light, Heat, and Motor Controls | |
| COMPUTER CIRCUITS | 174 |
| DC POWER SUPPLIES | 183 |
| Rectification, Filtering, Regulators | |
| TESTING AND MOUNTING | 191 |
| SYMBOLS | 211 |
| SELECTION CHARTS | 217 |
| TECHNICAL DATA | 223 |
| OUTLINES | 564 |
| MOUNTING HARDWARE | 576 |
| CIRCUITS | 582 |
| INDEX | 653 |

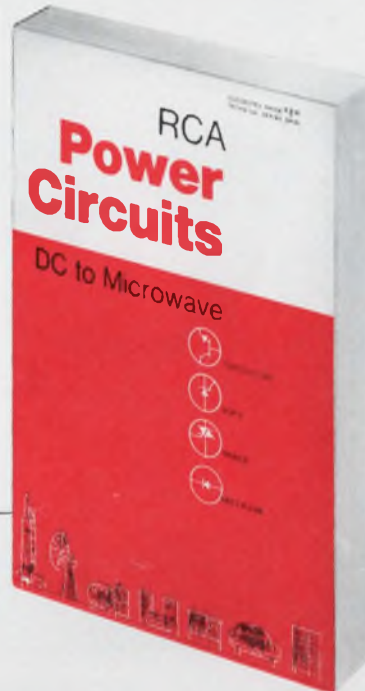

Newly expanded information for the circuit designer

Suggested price \$2.00

| CONTENTS | PAGE |
|---|------------|
| SEMICONDUCTOR MATERIALS, JUNCTIONS, AND DEVICES | 3 |
| Semiconductor Materials, Current Flow, N-P-N and P-N-P Structures, Types of Devices | |
| SILICON RECTIFIERS | 10 |
| Theory of Operation, Characteristics and Ratings, Series and Parallel Rectifier Arrangements, High-Voltage Rectifier Assemblies, Packaging | |
| THYRISTORS | 29 |
| Theory of Operation, Construction, Ratings and Characteristics, Series and Parallel Operation, Transient Protection | |
| SILICON POWER TRANSISTORS | 65 |
| Design and Fabrication, Basic Transistor Parameters, Maximum Ratings, Thermal Considerations, Second Breakdown, Safe-Area Ratings, Small-Signal Analysis, Large-Signal Analysis, Switching Service | |
| RECTIFICATION | 149 |
| POWER CONVERSION | 162 |
| POWER REGULATION | 200 |
| Linear Voltage Regulators, Switching Regulator, General Triggering Considerations, Phase-Control Analysis of SCR's, Motor Controls, Incandescent Lighting Controls | |
| THYRISTOR AC LINE-VOLTAGE CONTROLS | 226 |
| General Considerations, Motor Controls, Heater Controls, Incandescent Lighting Controls | |
| HIGH-FREQUENCY POWER AMPLIFIERS | 262 |
| Design of RF Power Amplifiers, Matching Networks, Marine Radio, Citizens-Band Transmitters, Mobile Radio, SSB Transmitters, Aircraft Radio, Community-Antenna TV, UHF Military Radio, Microwave Amplifiers and Oscillators, Frequency Multipliers | |
| CONTROL AND LOW-FREQUENCY POWER AMPLIFIERS | 379 |
| General Considerations, Audio-Frequency Power Amplifiers, Ultrasonic Power Sources, Servo Amplifiers | |
| BIBLIOGRAPHY | 438 |
| INDEX | 440 |
| RCA TECHNICAL PUBLICATIONS | 444 |

New and indispensable

Order yours today from your RCA Distributor

or RCA Electronic Components,
Commercial Engineering, Section C15-18-SD,
Harrison, N. J. 07029



Dr. Irving
Selikoff

Rx for progress in medical electronics: Communicate!

Elizabeth de Atley
West Coast Editor

"Gentlemen, we hardly know you exist."

In these blunt words, Dr. Irving Selikoff, director of the Environmental Sciences Laboratory at the Mount Sinai School of Medicine in New York City, summed up for engineers last month the major problem that medical electronics must overcome before it can expand dramatically: better communication between physicians and engineers on the design of equipment and the role that electronics should be playing in medicine.

Addressing 450 engineers and physicians in San Francisco at the Second National Conference on Electronics in Medicine, Dr. Selikoff alluded to these counts in an indictment of the present state of medical electronics:

- Although modern hospitals use sophisticated electronic instrumentation to care for the critically ill (see "Where EE and MD Link Up to Prolong Life," ED 4, Feb. 15, 1970, pp. 24-28), the new devices are serving only a small minority of patients. Last Jan. 15 at Mount Sinai Hospital in New York, for example, only 4% of all patients in "that most highly automated university hospital" were being treated with the help of electronic equipment.

- Much of the electronic medical equipment being offered today is "ancient."

- The price of electronic equipment is sometimes too high in proportion to the simple job that it can do.

A physician-engineer work session at the conference concluded that engineers could solve nearly all of the problems of doctors if the designers know what the problems were and if someone was willing to pay for the R&D. The need for some kind of national clearinghouse, where information on medical instrumentation could be collected and disseminated, was mentioned again and again.

A need for expansion

That there is ample room for improvement and expansion in medical electronics was clear to conferees.

Right now, Dr. Selikoff told his audience, "if all the work you engineers have done in the last 20 years were taken out of the hospital, it really would not make very much difference in the health or disease of the patients there."

He might have added "relatively"—because to the handful of patients who owe their lives to electronic aids, it's a big difference.

The promise of medical electronics was abundantly attested at the conference by booths exhibiting pacemakers, coronary and intensive-care equipment and even some

automated medical history-taking systems. One booth advertised the availability of a computer diagnostic system manufactured by Mead Johnson Medical Services, Inc., for pediatricians. But, listening to the speakers and visiting the panel meetings, conference visitors were inclined to agree with Dr. Selikoff that for the vast majority of physicians and patients—both in doctor's office and hospitals—electronic simply doesn't exist yet.

A work session conducted by a private physician and an engineer proved enlightening. The physician, Dr. Lindon Davis, an internist from Williston, Park, N.Y., complained that most of the equipment available to him was as outdated and poorly designed as the wooden tongue depressor. Engineers in the audience countered with complaints that physicians were generally loath to spend the time talking to them about equipment needs, slow to accept new equipment and unwilling to pay a realistic price for it.

The session touched off a lively exchange of ideas between the panelists and the engineers in the audience. But—indicative, perhaps, of another big hurdle that medical electronics faces—only a half dozen physicians showed up for the two afternoons that the session was in progress, against 30 to 40 engineers.

Dr. Davis explained that he uses technicians and instruments to perform as many tests on his patients as possible, but that for many important tests, no equipment is available and he must depend on his own sensitive fingers and eyes to make the diagnosis. For example, he would like to be able to buy instruments that would do the following:

- **Detect blood flow.** In the swollen extremities of some aged patients, he said, it takes him 15 minutes or more to feel with his fingers whether there is any blood flow at all.

- **Detect breast tumors.** Cancerous tissue, said Dr. Davis, is generally a hard, firm nodule buried in the softer surrounding tissue. When the breast is large or contains cysts, it is impossible to tell by touch whether there is cancer or not. In such cases an X-ray of the breast is required, and this takes several days because the X-ray must be interpreted by an expert in mamography. Meantime, says Dr. Davis, "the patient hangs by her thumbs, waiting to find out whether she has cancer or not." To relieve her mind, he would like an instrument that would tell quickly whether cancerous tissue is present.

- **Determine the patient's distribution of weight.** If people do not walk or stand properly, they put an unnatural strain on their bones and therefore stress the muscles and tendons. This condition can be compensated for by having the patient wear the proper corrective shoes, Dr. Davis said. At present most doctors determine the weight distribution of the patient by noting what part of his shoes wears out first. But Dr. Davis would like a more quantitative method of determining the patient's weight distribution.

- **Detect muscle tension.** Doctors use their hands to detect the presence of muscle tension. But an instrument would be useful, Dr. Davis said, in at least two ways: (1) To determine whether an accident patient has a whiplash injury (insurance companies ask proof that the patient is in pain); and (2) To determine whether low back pain and headaches are due to muscle tension or to something more serious. ■■



Why do engineers hate inductors?

Well, primarily because inductors stubbornly resist integration. Nytronics started taming them about 30 years ago, and our R&D boys have been concentrating on improving their quality and performance ever since. Today we think our line of inductors is the most nearly perfect it is possible to make.

WEE-DUCTOR — Magnetically shielded with inductance range 0.1 to 180,000uH, designed to MIL-C-15305, Grade 1, Class B. Encapsulated Envelope: 0.157" diameter x .450" length.

SUPER WEE-DUCTOR/90537 TYPE — Manufactured in accordance with MS90537, Molded Magnetically shielded with inductance range 0.1 to 100,000uH $\pm 10\%$ tolerance. Molded Envelope: 0.163" diameter x 0.410" length.

SUPER WEE-WEE-DUCTOR — Miniature shielded with inductance range 0.1uH to 10,000uH. Designed to MIL-C-15305, Grade 1, Class B. Epoxy-Molded Envelope: 0.125" diameter x 0.335" length.

DECI-DUCTOR — Subminiature with inductance range 0.1 to 1000uH. Designed to MIL-C-15305, Grade 1, Class B. Molded Envelope: 0.100" diameter x 0.250" length.

S-M-L INDUCTORS — Non-shielded with inductance range 0.1 to 10,000uH. Designed to MIL-C-15305, Grade 1, Class B. Molded Envelope: "S" Type — 0.188" diameter x 0.44" length, "M" Type — 0.25" diameter x 0.60" length, "L" Type — 0.31" diameter x 0.90" length.

VARIABLE INDUCTOR — Unshielded with adjustable range 0.1 to 4700uH. Designed to meet MIL-C-15305, Grade 1, Class B. Encapsulated Envelope: 0.400" diameter x 0.500" length. Vertical or Horizontal mounting.

WEE V-L — Magnetically shielded adjustable range 0.1 to 100,000uH. Designed to MIL-C-15305, Grade 1, Class B. Epoxy Molded 0.300" diameter x 0.400" length.

WEE CHIP-INDUCTOR — Magnetically shielded, wrap-around termination permitting contact to either face or ends. Designed to meet MIL-C-15305, Grade 2, Class B. .280" x .195" x .100". Presently available .15uH to 1000uH.

■ Send for our new 44-page catalog with the quality line of standard components.



NYTRONICS, INC.

The quality line of standard components

550 Springfield Ave., Berkeley Heights, N.J. 07922 ■ (201) 464-9300 ■ TWX: 710-984-7977

INFORMATION RETRIEVAL NUMBER 21

Huge market growth forecast for British ICs

English consultant predicts their wide use in the computer industry by the mid 70s

Raymond D. Speer
Managing Editor

Rapid growth of IC markets in Britain—especially in the computer industry—a vast growth in consumer IC sales and an increased use of hybrid circuits are forecast by an English design consultant, Alex K. Godden.

An engineer with the Department of Engineering Science at the University of Oxford, Godden predicts a 1973 IC market of \$72 million. The hybrid circuit market for that year, he says, will be about \$48 million, and the total IC market in Britain and Europe including hybrid circuits, should be \$300 million (see table).

These are miniature markets compared with those in the U. S., Godden says, "but the growth trend is very clear. Moreover, our British industries have been reforming, recapitalizing and putting down firm lines of devices, and 1970 will show another upswing of sales."

Godden feels that the growth rate of the British semiconductor market has been underestimated, to date, by a factor of two.

Computers lead the trend

"It seems that the greatest growth is in the computer central processors," Godden says, "in peripheral equipment and in small office calculators. All of these use ICs, and the trend is toward MSI. The computer segment of the market is now roughly 50% of the total.

"The fields of industrial control, communications, and sub-unit/sub-circuits, too, are fast adopting ICs."

Godden sees a somewhat slower growth of IC use by firms dealing with aircraft and general instrumentation.

Although consumer markets have been lagging, until now, Godden

expects them to be second only to the computer markets by the mid 70s.

"The automotive field is already using a lot of semiconductors in the form of thyristors and rectifiers," he says, "and I expect wide use of ICs in fuel-injection systems, exhaust control, instruments and intercommunication systems by the mid 70s."

IC acceptance is slow

Management in Europe has been very reluctant to commit itself to the use of ICs. "Let me illustrate the type of thinking that is still running through medium and high technology firms," Godden says. "I worked in the aircraft control and missile simulation field in 1963. My group worked out that a discrete-component control amplifier in an aircraft application then cost \$288 over all. An IC version at that time would have cost \$300.

"Our management would not agree to reform production techniques, even though we showed that by November of 1964 the integrated discrete version would cost the same amount. (Actually, this happened earlier, in August, 1964.)"

This kind of reluctance is gradu-

ally being overcome, asserts the English engineer, but it is still holding up the growth of the IC industry.

Godden sees ICs in general as more and more easily used. "Many components used with ICs," he says, "have been redesigned to be compatible with them. Plate-through holes and double-sized boards are now child's play. And from the designer's point of view, the performance of ICs is better than equivalent discrete circuits, providing one knows how to handle these devices."

Major customers are large firms

Who are the major customers of the IC vendors right now? Godden says that these are usually the larger institutions: industrial firms in the computer, aircraft and instrumentation industries. A smaller group consists of the "expertise" firms dealing in controls, and in-house developments of measuring and control circuits.

Godden sees a good rate of growth in hybrid circuits in Britain in the next few years. "If I were back in the instrument industry I should definitely consider custom-designed hybrids on thick or thin-film circuits, particularly for moderately long runs," he says. "There has been a steady growth in this country over the past 6 to 8 years in hybrid devices. ■■"

Table: Predicted growth (in millions of dollars)

| Markets | 1969 | 1973 |
|-------------------------|--------|--------|
| United Kingdom | | |
| ICs (excluding hybrids) | \$28 | \$72 |
| Hybrids | \$3 | \$48 |
| Total ICs and hybrids | \$31 | \$120 |
| Europe | | |
| Total ICs | \$96 | \$300 |
| Total semiconductor | \$420 | \$631 |
| U.S. | | |
| Total semiconductor | \$1300 | \$1752 |
| World | | |
| Total semiconductor | \$2150 | \$2734 |

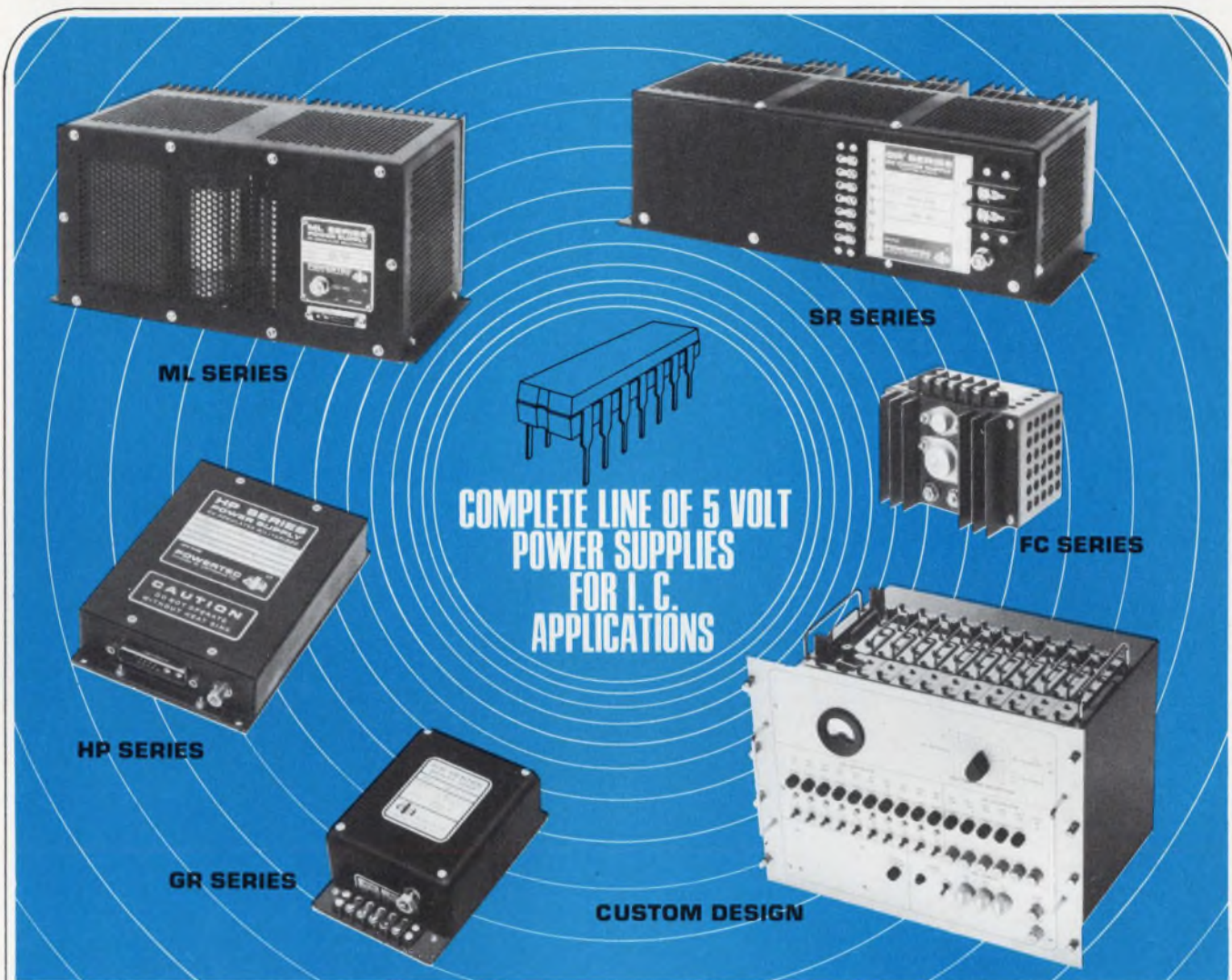

LOGIC POWER

A FEW EXAMPLES OF POWERTEC'S BROAD LINE OF POWER SUPPLIES

GR SERIES 5V-2.5A \$ 49

- 31 STANDARD MODELS • FULL RATING TO 71°C
- 47 TO 440 HZ INPUT • COMPUTER GRADE COMPONENTS

SR SERIES 5V-35A \$249

- 64 MODELS AVAILABLE • OPTIONAL OVP • REMOTE SENSE CAPABILITY • HIGH EFFICIENCY

ML SERIES 5V-20A \$379

- 100% MILITARY • MEETS MIL-E-16400, MIL-T-21200 • ±.00075% REGULATION • DOCUMENTATION PACKAGE

HP SERIES 5V-30A \$789

- MILITARY AIRBORNE TO MIL-E-5400 • 400 HZ, 3 PHASE INPUT • 24 MODELS AVAILABLE • 2 WATTS PER CUBIC INCH

FC SERIES 5V-5A \$179

- 1/5 THE SIZE OF CONVENTIONAL SUPPLIES • HIGH FREQUENCY SWITCHING APPROACH • 20 STANDARD MODELS • OPTIONAL OVP

CUSTOM DESIGN

POWERTEC HAS A COMPLETE FAMILY OF BASIC BUILDING BLOCK CIRCUITS THAT ARE READILY ADAPTABLE TO YOUR CUSTOM SYSTEM SPECIFICATIONS

SEND FOR OUR NEW 1970 CATALOG



POWERTEC DIVISION

9168 DESOTO AVE., CHATSWORTH, CALIF. 91311 • Phone (213) 882-0004

When you're really serious about MSI family planning,

To make a Quad Latch that's both R/S and D compatible,



Fairchild's new MSI 9314 Quad Latch is a versatile, high-speed device that can be used in any application requiring a single-input D-type latch or an R/S-type latch. It has no undefined states in the R/S mode. Its unique multi-function capabilities make it useful in a number of applications: four-bit storage latches, contact bounce eliminators, multi-input active-high set/reset latches, counting and holding display systems, eight-bit addressable latches, A/D conversions, zero and ones catching storage.

The addition of this device to our MSI family gives you everything you need for just about any latching application you could name. Use the new 9314 for maximum function versatility. Or the 9308 Dual Four-Bit Latch when minimum package count is most important. Your Fairchild Distributor has complete specs on both MSI devices.

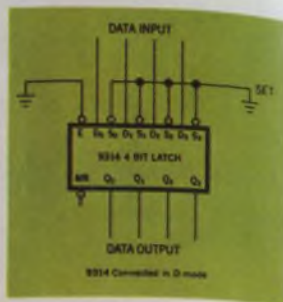

| For only the 9314, see 9314 | | | | For only the 9308, see 9308 | | | |
|-----------------------------|-------------------|---------------|------|-----------------------------|-------------------|---------------|------|
| PART NUMBER | TEMPERATURE RANGE | PRICE (IN \$) | QTY. | PART NUMBER | TEMPERATURE RANGE | PRICE (IN \$) | QTY. |
| 9314-0000 | 0-70°C | 11.00 | 1000 | 9308-0000 | 0-70°C | 11.00 | 1000 |
| 9314-0001 | 0-70°C | 11.00 | 1000 | 9308-0001 | 0-70°C | 11.00 | 1000 |
| 9314-0002 | 0-70°C | 11.00 | 1000 | 9308-0002 | 0-70°C | 11.00 | 1000 |
| 9314-0003 | 0-70°C | 11.00 | 1000 | 9308-0003 | 0-70°C | 11.00 | 1000 |
| 9314-0004 | 0-70°C | 11.00 | 1000 | 9308-0004 | 0-70°C | 11.00 | 1000 |
| 9314-0005 | 0-70°C | 11.00 | 1000 | 9308-0005 | 0-70°C | 11.00 | 1000 |
| 9314-0006 | 0-70°C | 11.00 | 1000 | 9308-0006 | 0-70°C | 11.00 | 1000 |
| 9314-0007 | 0-70°C | 11.00 | 1000 | 9308-0007 | 0-70°C | 11.00 | 1000 |
| 9314-0008 | 0-70°C | 11.00 | 1000 | 9308-0008 | 0-70°C | 11.00 | 1000 |
| 9314-0009 | 0-70°C | 11.00 | 1000 | 9308-0009 | 0-70°C | 11.00 | 1000 |
| 9314-0010 | 0-70°C | 11.00 | 1000 | 9308-0010 | 0-70°C | 11.00 | 1000 |

you have to get serious about MSI family planning.

We put together a family plan by taking systems apart. All kinds of digital systems. Thousands of them.

First we looked for functional categories. We found them. Time after time, in a clear and recurrent pattern, seven basic categories popped up: Registers, Decoders and demultiplexers, Counters, Multiplexers, Encoders, Operators, Latches.

Inside each of the seven categories, we sifted by application. We wanted to design the minimum number of devices that could do the maximum number of things. That's why, for example, Fairchild MSI registers can be used in storage, in shifting, in counting, and in conversion applications. And you'll find this sort of versatility throughout our entire MSI line.

Finally, we studied ancillary logic requirements and packed, wherever possible, our MSI devices with input and output decoding, buffering and complementing functions. That's why Fairchild MSI reduces in many cases eliminates the need for additional logic packages.

The Fairchild MSI family plan. A new approach to MSI that's as old as the industrial revolution. It started with functional simplicity, extended through multi-use component parts, and concluded with a sharp reduction in add-ons. Simplicity. Versatility. Compatibility. Available now. In military or industrial temperature ranges. In hermetic DIPs and Flatpacks. From any Fairchild Distributor.

Nobody makes MSI the way Fairchild does.



Fairchild Semiconductor Corp. A Division of Fairchild Camera and Instrument Corporation. Mountain View, California 94035. (415) 351-8000. Telex: 954 000 0000

Fairchild's MSI family plan started with the 9300 Series. Highly versatile, highly compatible devices in seven functional categories: Registers. Decoders and demultiplexers. Counters. Multiplexers. Encoders. Operators. Latches. A minimum number of devices that do a maximum number of things. (Like a register that shifts, counts, stores and converts.)

you don't stop at one family.

Now Fairchild has a new family. Low power MSI. The 9200 Series. All the versatility of the 9300s at 1/4 the power. But low power doesn't mean low speed. Fairchild's new family operates at 5MHz – ideal for military, avionics and industrial low-power, minimum-space applications.

The 9200 family typically features 2mW/gate with 20nsec/gate delay for the optimum trade-off between speed and power. Devices come in both DIPs and Flatpaks. The first six of the economical low-power devices are already in inventory. You can get them today at any Fairchild Distributor.

Here are the first six:

- 9200 — 4-Bit Register
- 9208 — Dual 4-Bit Latch
- 9209 — Dual 4-Bit Digital Multiplexer
- 9211 — 1-of-16 Decoder
- 9212 — 8-Input Digital Multiplexer
- 9228 — Dual 8-Bit Shift Register



OPERATORS



REGISTERS

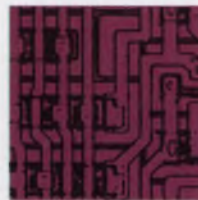

DECODERS AND DEMULTIPLEXERS



MULTIPLEXERS



COUNTERS



ENCODERS



LATCHES

FAIRCHILD
SEMICONDUCTOR

Phased arrays: They're great, but ...

New applications and component developments look promising, but the costs are still too high

Michael J. Riezenman
Microwaves Editor

To a too-casual observer, the age of the phased-array (or electronically scanned) radar may appear to be upon us. But a closer look casts serious doubts on this conclusion.

Among the heralds of the phased-array era—or ESR era, as it's called by specialists—are the following developments:

- RCA has recently announced a series of technical advances that it says can cut the cost and size of phased arrays enough to make possible a new generation of transportable tactical phased-array radars.

- Raytheon is pushing development of ESRs for high-stress airborne applications, where high G-forces make mechanical scanning very difficult.

- The new Aegis shipborne missile system, being developed for the Navy by RCA, will employ a large electronically scanned radar for target detection and tracking.

But this is only half the story. The following facts must also be considered:

- The Navy, although more than pleased with the performance of the phased-array radar on the aircraft carrier *Enterprise*, is not going to put one on its new nuclear-powered carrier, the *Nimitz*. Nor is it planning to install a phased-array system on the two *Nimitz*-class carriers that will follow.

- The computer, which makes possible the effective use of ESRs, has also, in the words of Carl Blake, head of the phased-array group at MIT Lincoln Laboratory, "extended the utility and efficiency of mechanically steered radars, leaving relatively few missions requiring the versatility, capacity and flexibility of the phased array."

- Although the Sperry-built Hapdar at the White Sands Missile

Range in New Mexico and the Bendix-built FPS-85 at Eglin Air Force Base in Florida are operating well, no demand for additional large phased-array systems seems to be materializing.

Expense hinders use

Why the contradiction in trends? Are phased arrays good or aren't they?

Yes, they're good, but they're also awfully expensive. Therefore they can be economically justified only for applications where their special properties give them an advantage over mechanically steered rivals. Phased arrays, it therefore seems, will not come into their own until new applications and reduced costs combine to tip the economic balance in their favor.

In what applications is this likely to happen? There are several areas, each of which exploits a different advantage of the phased array concept.

Probably the single most outstanding advantage of phased arrays is that they have no moving parts. Thus they are well suited for missions in space, where the problem of slewing a dish antenna around is quite formidable: It's tough to tell what's moving—the antenna or the spacecraft. And once you get the antenna moving in space, it's pretty hard to make it stop.

Can handle high data rates

Another important advantage that a phased array brings to a radar system is its ability to cope with high data rates. Because beam steering is not affected by any mechanical constraints, great flexibility is available in scanning and tracking. The scan can be extremely fast, and it need not be at

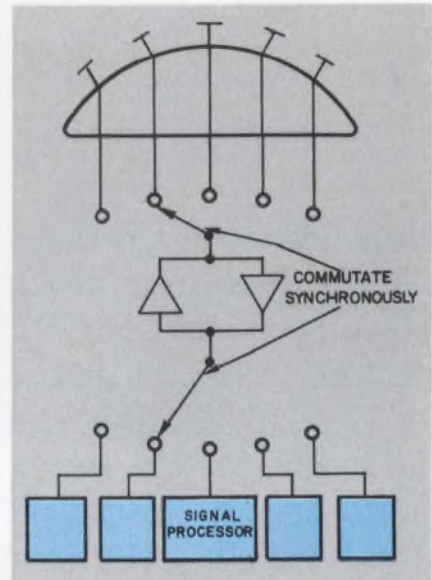

1. Background clutter is reduced with this phased-array setup that can scan 360° without a moving beam. A multiple-beam approach is used. Note that each radiating element in the diagram is a complete beam-forming antenna.

a constant angular velocity. Thus an adaptive phased-array radar can be designed to allocate most of its energy to those sectors of the sky in which interesting or potentially interesting objects have been detected. At the same time it can maintain routine surveillance over the rest of the sky.

By contrast, the inertia of a rotating antenna makes it very difficult to change its angular velocity; it wastes a significant fraction of its resources looking at uninteresting volumes of space.

The array of elements that comprise a phased array antenna can be excited to form many beams and thus can track several objects, each with a different pulse repetition frequency if necessary, while maintaining surveillance over a whole volume of interest.

Versatile air-defense potential

In an air-defense application, if a high-speed object is found to be

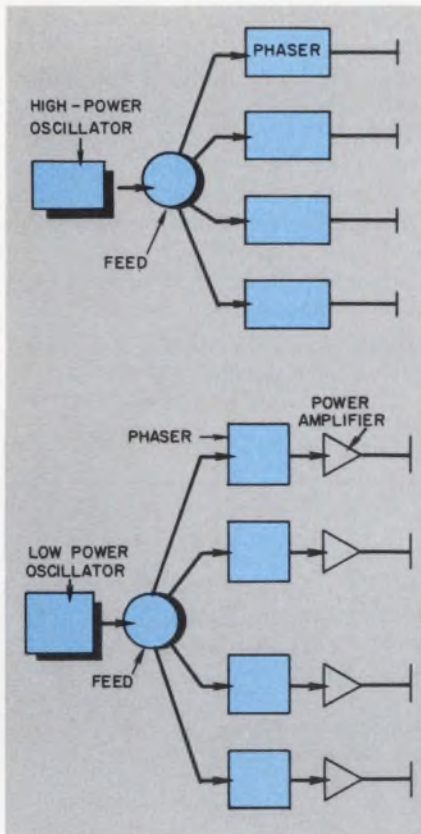

2. Two approaches for generating the power: the "big bottle" approach (top) and the individual-amplifier approach (bottom). The relative costs of high-power phasers and power amplifiers will determine the best way to go.

heading toward the defended area, the radar might be designed to concentrate a lot of its energy on that object. It would update the position data on the object many times a second, to get a precise track on it. Then the system could make a decision about the nature of the object and the appropriate action to be taken, if any.

If the object turned out to be harmless, the radar would immediately cease allocating to it the large amount of power-aperture product needed for a precise track and would merely maintain a coarse track for bookkeeping purposes. Bookkeeping is necessary so that the radar doesn't squander its resources doing a fine track on the same object every time the search beam detects it.

In this type of application the phased-array approach wins out over the mechanically scanned method when the total data rate—which increases with both the number of expected targets and

their speeds—becomes too high for the mechanical system to cope with. It should be noted, of course, that several mechanical systems can be operated together, and so the exact crossover point is not easy to define.

For example, the aircraft carrier Enterprise is outfitted with a phased-array radar system that takes the place of several rotating-dish radars. But the new Nimitz carrier will go back to the old multi-radar approach simply because its four mechanically scanned radars will be cheaper than a single phased-array system.

Eyes on the back of its head

Besides space applications and in very-high-data-rate situations, phased-array techniques can also be helpful in moving-target indicator radars. The multiple beam-forming capability of the phased array makes it possible to use a "searchlight" approach in looking for targets. Many stationary beams are formed, each aimed in a different direction. Scanning is accomplished not by moving the beams but by sequentially examining each beam's return. Since the beams do not move, background clutter is minimized.

Moving-target indicator radars detect only moving targets. But a scanning beam simulates motion, and hence makes even stationary backgrounds show up as clutter. The faster the scan speed, the wider the clutter bandwidth and the bigger the problem. By continually searchlighting an area, a phased-array radar can reduce the stationary-clutter bandwidth almost to zero. And in the words of Dr. John L. Allen, associate head of the Radar Measurements Div. of the Lincoln Laboratory, "that's the finest way in the world to make a moving-target indicator radar."

The radar can be made fairly inexpensively by building only one transmitter and one receiver and time-sharing them between the array elements for each beam (Fig. 1). A signal-processing unit is needed for each beam position. Two synchronized commutating switches connect the signal processors and the beam-forming arrays to the transmitter-receiver combination at a very rapid se-

quential rate.

The beauty of this scheme, Dr. Allen explains, is that each signal processor thinks that it is the only radar in the world and that it's operating at a PRF equal to the system PRF divided by the total number of beams. In a system that he built, Dr. Allen had 32 beam positions and a commutation rate equivalent to a mechanical scan rate of 10,000 rps.

Fighting high G forces

Fast-moving, highly maneuverable aircraft impose stiff mechanical requirements on their radars. If a plane makes a 3-G turn in a dogfight, it better have some hefty motors on its mechanically steered radar antenna, or the dish will simply be pegged to the outside of the turn until the maneuver is completed. Now as David O. Lavoie, Marketing Manager for Advanced Avionics at the Raytheon Co.'s Missile Systems Div., Bedford, Mass., points out, big motors are heavy. And every extra pound of radar can lower the system cost, avionics equipment means about six more pounds of aircraft.

Thus if an over-all systems viewpoint is used—with the aircraft as the system—it may turn out that phased-array radar can lower system cost, even if the ESR is more expensive than its mechanically steered counterpart.

Lavoie also explains that phased arrays can be designed to conform to an airplane's fuselage shape and that they are more reliable than mechanically steered radars. The hydraulic motors have reliability problems, he says, because they are susceptible to failures caused by dirt that gets into their oil lines.

Because they have no moving parts, electronically steered radars can be made much "harder" than conventional radars. The radiating elements can be mounted in cavities in a massive steel plate and protected by concrete. Extensive trusswork—too heavy to be used in a moving system—can be employed for increased strength. Strength, then, is another advantage, especially for fixed military applications, such as Safeguard.

But what price strength? And what price all of the other advantages of phased arrays?

(phased arrays, *continued*)

The high costs of the low-loss, high-power phase shifters and their drivers make the "big bottle" approach (Fig. 2, top) extremely expensive. An oversized oscillator tube must be used to make up for the power lost in the feed and the phasers. This is not only costly in itself, but it also adds to the power and cooling system requirements.

The individual-amplifier

approach (Fig. 2, bottom) avoids the costs associated with the high-power phasers, but it substitutes the costs of a large number of power amplifiers.

What can be done to reduce these costs? Two important approaches stand out:

- Use fewer components.
- Reduce the component costs.

The first approach, quite literally, is to use fewer components in the array. One well known example of this is the thinned-lens Hapdar

(Hard Point Demonstration Array Radar) built by the Sperry Gyroscope Div. of Sperry Rand Corp., Great Neck, N. Y., for the White Sands Missile Range. This radar has a 30-foot-diameter lens aperture with 3750 radiator positions. To save money, however, only 2165 of these positions are occupied by active radiators. The others have been replaced by dummies. The dummies are resistively terminated to maintain proper matching.

By carefully randomizing the

A 90-second primer on phased arrays

Very briefly, a phased array is a collection of simple radiating elements arranged over an area called an aperture. The elements are excited from a common source, so that phase coherence is maintained.

A beam (or beams) can be formed from the superposition of the radiation from all of the elements. By varying the relative phase of the signal applied to each element, or the frequency of the main oscillator, the direction in which the beam is aimed can be adjusted.

The simple idea described above can be implemented in a great many ways. For example, the rf power can be delivered to the aperture through either a space (optical) feed or a constrained feed. The two basic types of space feed are the transmission, or lens type and

the reflection. In both rf energy from a feedhorn illuminates the aperture, much as a conventional parabolic reflector is illuminated.

The reflection array accepts the energy, bounces it off an array of reflective phase shifters and re-radiates it from the same side of the aperture. An advantage of the reflection array is that the aperture thickness is not limited—there's plenty of room for the phase-shifter driver circuitry. A disadvantage is the partial aperture blockage caused by the feedhorn.

The transmission array eliminates the blockage problem by accepting energy on one side, passing it through the array of phasers and re-radiating it on the opposite side. Unfortunately this approach doesn't leave much space for the drivers.

Both types of space feeds have a common problem: They take up a lot of room. Typically, optical considerations make it necessary to have the distance from the feedhorn to the aperture about equal to the aperture diameter.

This large-volume problem can be tackled by going to a constrained feed. This would in most cases be a waveguide arrangement that routes the energy to each phaser in the aperture. The corporate feed (illustrated) is quite common and has the property that all of the path lengths, from the rf input to the radiators, are equal. Corporate feeds are more expensive than optical feeds, and they introduce extra losses.

There are two basic approaches to providing the power in a phased array. In the "big bottle" approach, all of the rf power is generated by a single high-power tube. The competitive approach is to feed all of the phasers with low-power microwave energy and then have a separate power amplifier follow each phaser.

Clearly, the phasers are very important devices in any phased-array system. A key question that comes up at the system design level with every ESR is whether to use diodes or ferrite devices as the phase-shifting elements. Ferrite devices are generally more reliable but also more lossy. Diodes can be switched more rapidly and with less power. Each situation is different, but recent designs tend to employ diodes at the lower frequencies and ferrite phasers at the higher ones.

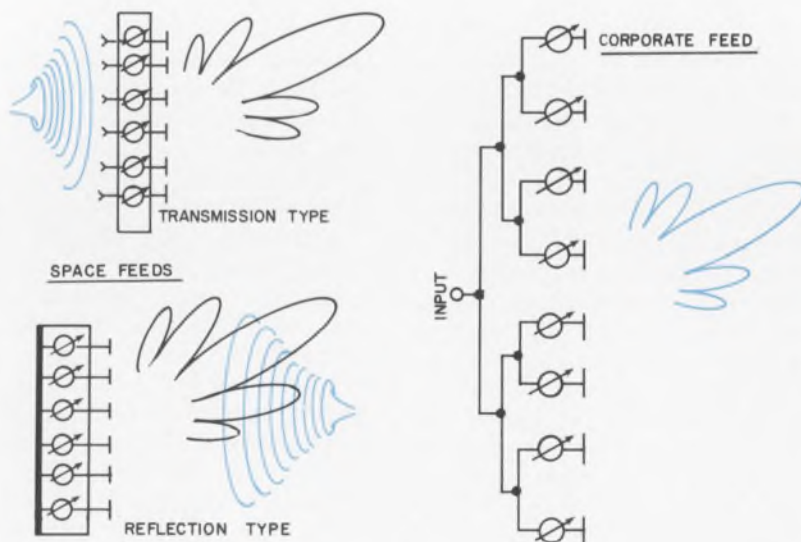

a little *blue* pill for budget blues

BOURNS MODEL 3365

$\frac{1}{2}$ " wirewound adjustment potentiometer

Tense? Wrought with anxiety over lowering the cost on printed circuit board assemblies? Here's the prescription: Bourns Model 3365, a $\frac{1}{2}$ " high-quality single-turn wirewound.

Consider the ingredients: resistance range from 10 to 50,000 ohms, with a $\pm 5\%$ TR tolerance; power rating of 1 watt at 25°C; sealed to withstand fluxing and soldering operations; noise-free operation. Meets MIL-STD-202 for steady-state humidity and MIL-R-27208 for shock, vibration and load life.

It's easy to take: two-way adjustment, by thumb or screwdriver; \$1.21 in 1,000-piece quantity for low profile (.24" high) to adjustment model; \$1.58 for the side adjust.



Actual Size

Additional information on Model 3365 is as close as your phone. Call your local Bourns sales office; or your Bourns distributor... he has it on the shelf.



(phased arrays, continued)

position of the dummy elements, the designers have blocked changes in the antenna beam pattern; the thinned array has the same beam-width as a full 30-foot array. The antenna gain, on the other hand, is reduced, because it is a function of the number of active radiators.

Cutting components costs

Considerable progress is also being made in component cost reduction. For example, RCA recently announced the development of a dielectric-loaded phase shifter that it estimates will reduce phaser costs by 25% over previous designs. Dr. Arthur S. Robinson, manager of systems and advanced technology for RCA's Missile and Surface Radar Div. in Moorestown, N. J., explains that the new phasers are smaller and that this will lower their production cost.

RCA has also developed a reduced-cost driver for the phase shifters. Dr. Robinson explains that the use of hybrid integrated circuits provides the savings in this area.

Despite these developments, component costs remain a big problem. And many experts, such as Daniel R. Stettin, chief engineer at the

Combyte Corp., Farmingdale, N. Y., feel that the problem won't be solved until production volume grows. High-power phase shifters, for example, are simply too expensive in small quantities. But high-volume production might reduce the price of a \$500 phaser to, say, \$100.

Is solid-state the answer?

In the individual-amplifier approach to array design, the key cost element is the amplifier. The hope here is that the costs of transistors (or other solid-state devices) will come down far enough to make the approach competitive with the "big bottle" approach.

Actually no one really seems to think that solid-state power generation can compete with high-power vacuum tubes on a direct dollars-per-watt basis. Rather the argument is that the reliability of solid-state devices will make them cheaper to use over the lifetime of the system, because maintenance and operating costs will be reduced.

Not everyone will buy that argument. Lincoln Laboratory's Carl Blake, for example, observes: "Skeptics argue that the reliability of solid-state devices is far from resolved, especially for the types of semiconductors that

must be used for microwave power generation. They argue further that even if these devices do have extraordinary long life, their high initial cost will never be offset by reduced maintenance costs."

In a further comment on statements hailing the reliability of solid-state devices, Blake says: "Three hundred fifty people man five shifts on the FPS-85 [the big phased-array space tracker at Eglin AFB]. Of these 350, only about 20 are assigned to the transmitter. Other than the transmitter, the FPS-85 is all-solid-state."

Blake isn't too sanguine about solid-state devices for radar power generation for another reason: They are peak-power limited.

Unlike vacuum tubes, which can have peak-power capabilities that are many times larger than their average power ratings, the peak-power and cw-power ratings of transistors are essentially the same. Even the Gunn, Impatt and LSA devices fall into this category for pulses longer than a few nanoseconds.

Because of this peak-power limitation, solid-state radar transmitters must operate with very high duty cycles (20% to 30%) to put enough energy onto their targets for acceptable performance.

This means that expensive pulse-compression processing, either analog or digital, is needed in the receiver to get the range resolution obtainable with low duty-cycle transmitters. This hidden cost is quite real and may often be overlooked in a quick cost comparison, Blake points out.

Another disadvantage associated with high duty cycles is that they create severe scheduling problems. By substantially reducing the available listening time, they make it difficult to parcel out optimally the radar's resources among its various targets. Even with fairly good filters, Blake says, you don't want to listen for a return on one frequency while you're transmitting on an adjacent one.

But perhaps the biggest drawback of the high duty cycle is that by using up a lot of time to transmit energy, it reduces the time available to collect data. And this compromises the greatest strength of the phased array—its ability to handle very high data rates. ■■

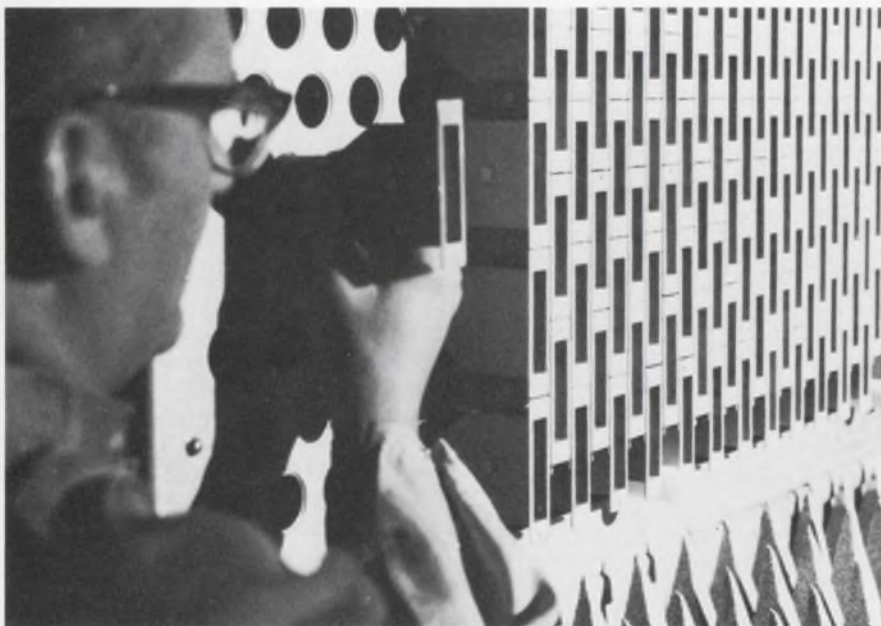

To drive costs down, this advanced phased-array radar employs special dielectric-loaded phase shifters and hybrid IC drivers. The system is under development at RCA's Missile and Surface Radar Div.

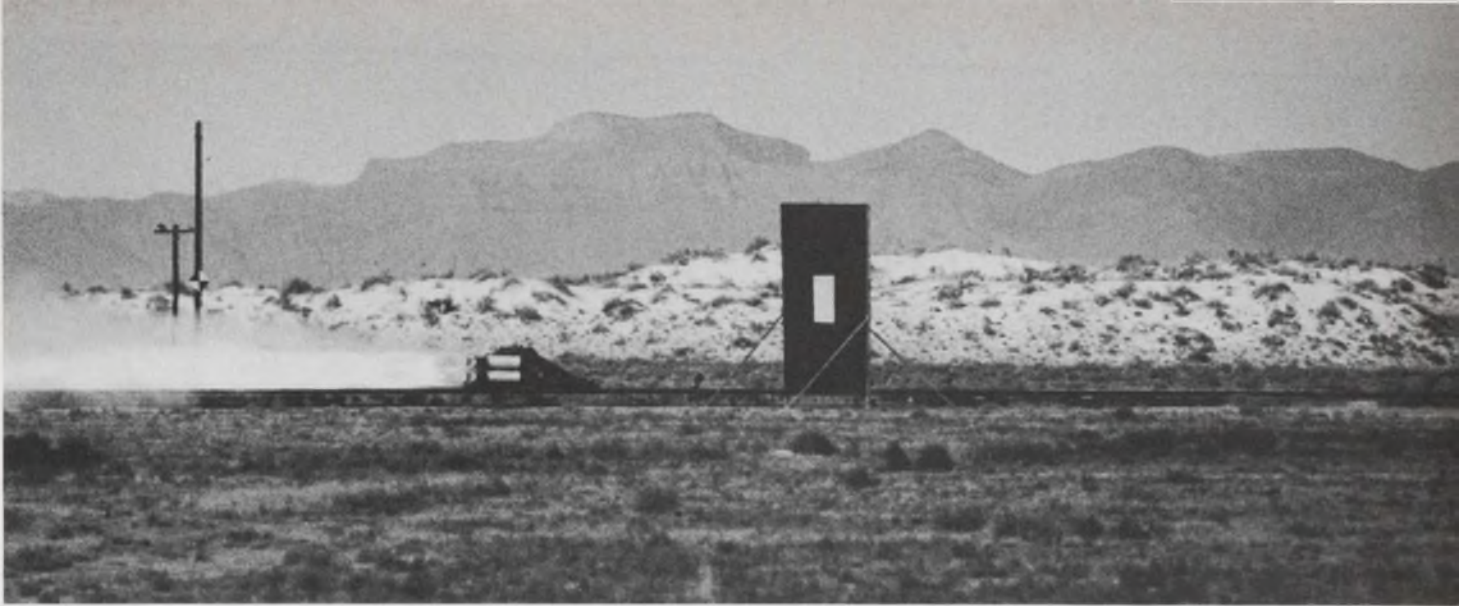

By the time you hear the blast-off, the sled is gone. The new record is 8183 feet per second.

Wanted: Memory for sledding at Mach 7

Story and photographs by John F. Mason, Military-Aerospace Editor

How do you telemeter data from a ground vehicle that's moving at 5580 miles an hour—Mach 7.4?

Answer: You don't.

Mach 7.4 is 8183 feet a second. At 6000 feet a second, metal antennas begin to heat up and erode, and an ionization sheath forms that blocks radio transmission.

Solution: Probably the use of rugged core memories with data-compression circuits, packaged to withstand the punishment at Mach 7.4 and beyond.

The problem has arisen at Holloman Air Force Base in the New Mexico desert, where the military has for years been using rocket-propelled sleds to test what will happen to equipment—anything from spacecraft to small electronic components—during space travel, re-entry and sometimes impact.

Acceleration into and out of space can subject a piece of hardware to 200 g's. Heat is so intense that it melts nose cones or vital parts of a missile or craft. And vibration and shock can disintegrate electronic components and aerodynamic structures alike.

To control and measure these forces is vital. And doing it on the ground is easier than in space.

Recently a Chaparral sled equipped with 15 rocket motors hit the Mach 7.4 speed. And the next goal, says the Chaparral's builder, Lockheed Electronics Co. of Plainfield, N. J., is 9000 feet a second. These

runs must carry instruments and acquire data.

W. M. Sanders, chief of the Instrumentation Div. at Holloman, where the sleds run on both single and double rails, puts the problem simply to designers: "When your telemetry transmitter antennas erode or burn up altogether, you don't get any data."

Even without the higher speeds, telemetry from ground sleds has always been a problem. The signals frequently split up, at any supersonic speed, causing multipaths that can confuse analysts who are trying to piece together data from the test.

To avoid telemetry altogether, Holloman tried putting tape recorders on its high-speed sleds to store the data until the ride was over. But the recorders burned up.

Now, engineers at Holloman are planning to try a new technique: core memories with data-compression circuits. If the memories can be built to hold up under the rigors of the ride, they can pour several million bits of information from each ride into a computer at the test center.

Proposals for the memories are in, and a choice for an industry contractor will be made soon.

Hardware tested at Holloman may be bugged by as many as eight transducers, although the usual number is three. Until the core memories are operational, te-

lemetry will have to be used and the speed of the sleds will have to be held down. Telemetry operates in the 1400 MHz and 2200 MHz regions. The signals are usually fm, using PCM, PAM or PDM modulations. The receiver is halfway down the length of the track ■■



What happens to a pilot ejected from his aircraft at the speed of sound? This transducer-equipped dummy will be blasted off a rocket-propelled sled to find out.

Extend standard cell design to bipolars

Fairchild Micromosaic technique developed for MOS LSI, now applied to LSI bipolar arrays

Elizabeth deAtley
West Coast Editor

Fairchild has extended its standard-cell Micromosaic approach, originally developed for MOS LSI, to bipolar LSI arrays with two and even three layers of metal. In Micromosaic, predesigned cells are laid out on the chip and interconnected by computer. Turnaround times of 12 to 16 weeks from acceptance of the order to shipment of prototype parts are allowed, says Robert F. Wickham, product marketing manager for advanced bipolar digital products, Fairchild Semiconductor, Mountain View, Calif. A complete custom design takes at least twice as long, he notes.

At the present time, the technology is implemented only with standard TTL, he points out, but it will be extended during 1970 to other circuit types, such as low-power TTL. To minimize system

cost, standard packages and standard package techniques will be used, he says.

At least one customer has already ordered a system that uses this new technology in part. The system is a 5-chip military airborne computer, says Wickham.

By the end of March, he says, Fairchild expects to have enough cells in its library to implement 75 to 80% of all customer bipolar designs in Micromosaic, and 95% by the end of the year.

The first standard Micromosaic bipolar product—a 4-bit arithmetic logic unit containing about 60 gates—will be announced in mid-April, says Wickham.

Although a Micromosaic chip may be slightly larger than a completely custom device, he says, this difference is "more than offset by the reduction in engineering costs and the competitive advantage it gives us to get the product on the market faster."

Until recently, Fairchild produced its bipolar arrays either all-custom or by Micromatrix. In the Micromatrix approach, wafers that contain a fixed pattern of standard cells are processed up to the point of metallization and stockpiled. Then when the customer orders a specific array, the cells are interconnected with one or more layers of metal, diced, packaged and shipped. The total turnaround time for Micromatrix is considerably faster than for Micromosaic, says Wickham (8 to 12 weeks compared with 12 to 15), but the technique requires about one-third more silicon area and therefore is not suited to LSI complexities. Fairchild will continue to use this technology, says Wickham, for MSI levels of complexity (30 or 40 gates).

The Micromosaic approach was first developed for MOS, when it reached the LSI levels of complexity that normally require custom design, Wickham says. Because of steadily improving process techniques, the bipolar technology is now reaching these levels of complexity. In fact, says Wickham, it has doubled in complexity in the past year. "Right now," he points out, "we're looking at bipolar designs in the 100-gate area, and by the end of the year, we expect to reach 150 to 175 gates per chip."

In general, Wickham says, a piece of logic that contains 100 gates or more is unique to a single system and therefore must be custom-designed. This is costly and time-consuming. Furthermore, he points out, since a large part of the logic system can be put on a single LSI chip, the design of the chip should be considered during the course of the system design to arrive at an optimum tradeoff between the total number of chips and the area per chip. As a result, customer/manufacturer interface becomes a problem. Micromosaic relieves this problem by helping the customer to design his system for ease of chip layout, testing, and manufacture. ■■

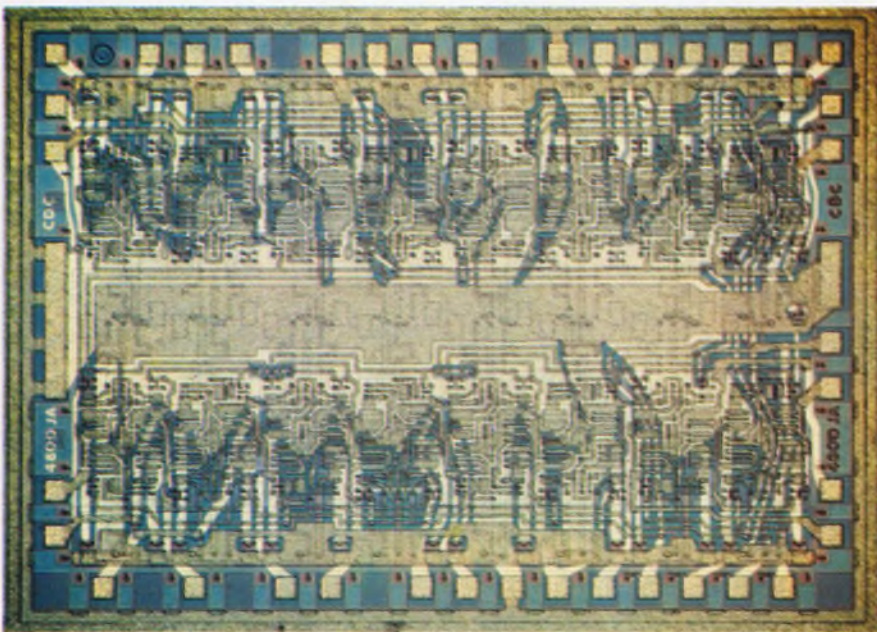

Chip made with standard-cell techniques marks Fairchild's entry into the field of bipolar Micromosaic. By March, the company expects to have enough cells in its library to implement 75 to 80% of all customer designs in Micromosaic, and 95% by the end of the year.

Draw your own conclusions with this new time-share terminal.

Now you can have a time-share terminal that lets you see your data graphically— instantly — as it prints out on your Teletypewriter. Now you can plot for comprehension, for meaningful report illustrations, for permanent records. And do it while the time-share data's coming in.

The HP 7200A Graphic Plotter is the first major advance in time-share flexibility since the Teletypewriter itself. The Graphic Terminal feeds from standard EIA ASCII inputs and automatically plots computer data in points, lines, curves, bar graphs, pie

charts, or any other useful engineering, mathematical or business graphics you need. Plot directly from the Teletype keyboard, too, or silence the Teletype-writer and use the plotter alone.

It's the end of the graphic time lag.

The HP 7200A is easy to use and requires no special operating or programming/language knowledge. It plots smooth lines, not the staircase drawn by the incremental recorder. And it lets you position the graph where you want it on any type or size of graph paper up to 11" x 17".

Talk to your time-share service about

Hewlett-Packard's new 7200A Graphic Plotter. If your service doesn't offer it yet, have them give us a call. The Graphic Terminal. For people who can benefit from a dash of art with their cold hard data.

HEWLETT  **PACKARD**

GRAPHIC RECORDERS

11921

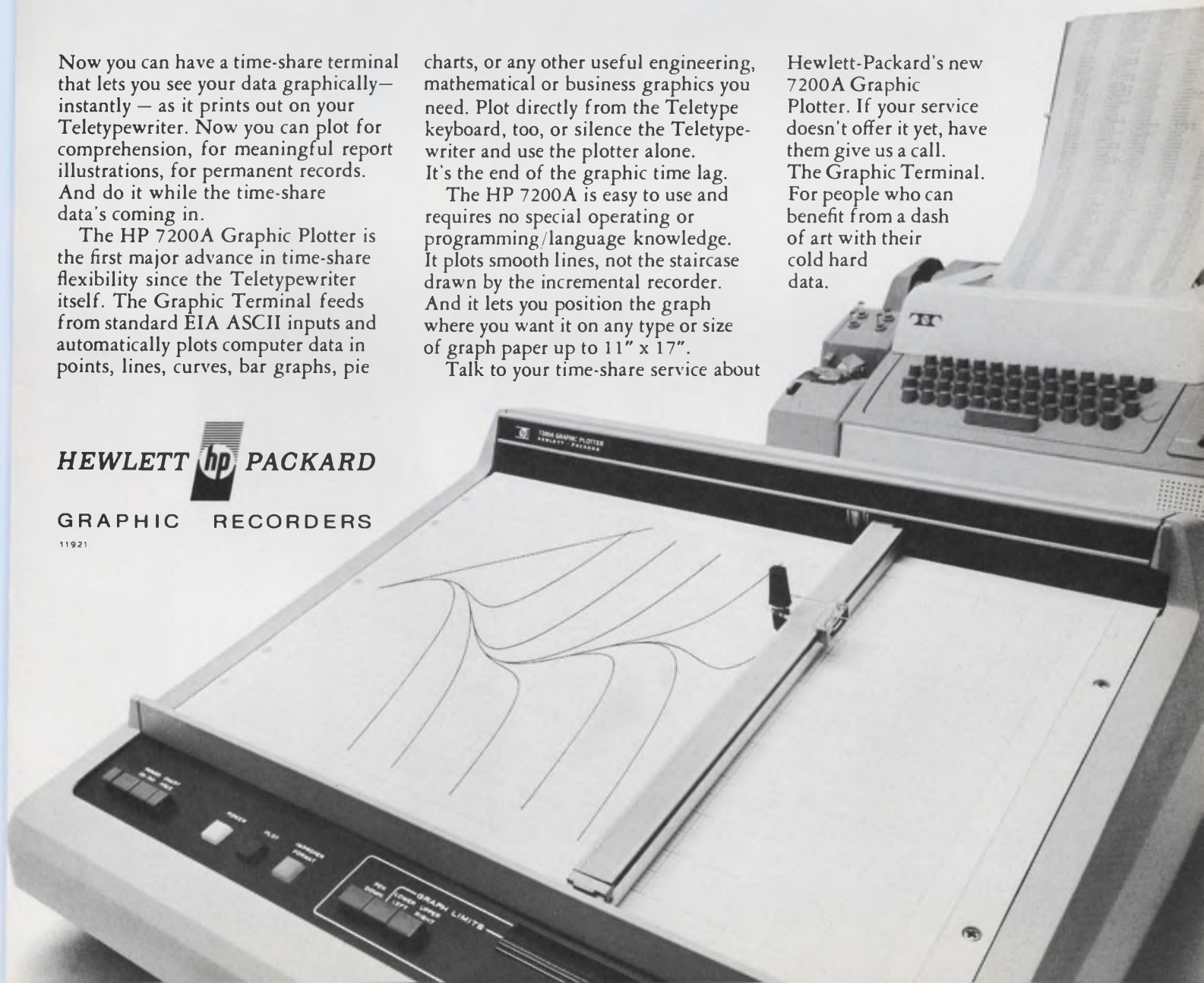

TI's quiet revolution in optoelectronics

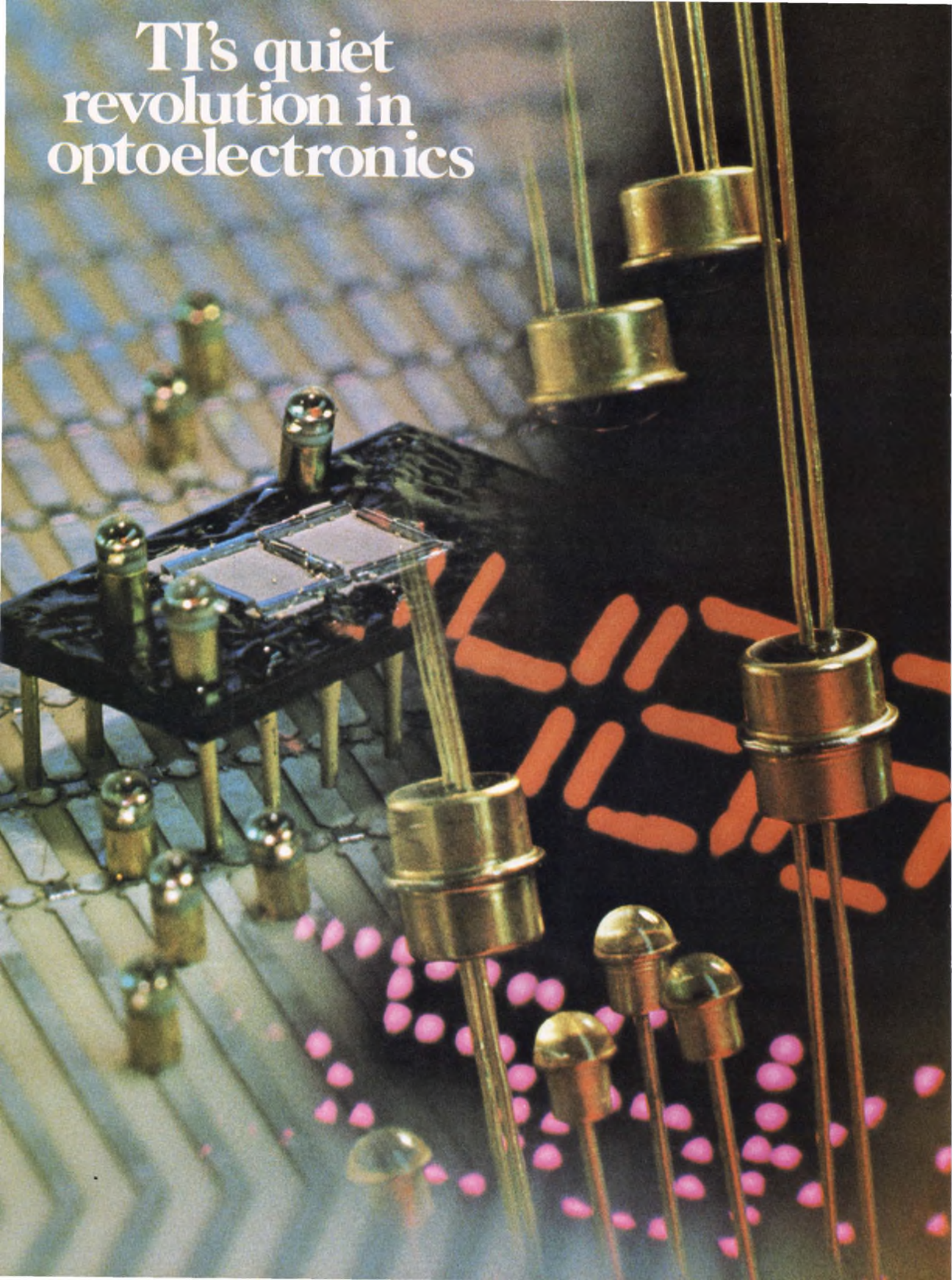

Improve cost/performance ratios with the speed of light.

Start with lower costs.

TI brings optoelectronics prices into line by standardizing to meet the specifications most designers need.

Then compare performance.

TI devices are 20 times more reliable, 1000 times faster than their costly electromechanical counterparts. Simple circuits. Low voltage. Low current. Low cost.

TI is quietly creating new design opportunities for you. Product improvements. The industry's biggest production volume. More choices. Standards. Custom devices, too.

New low cost phototransistors...



with features you'll find in high-priced components.

Exclusive alignment flange. Metal can. Two leads sealed to glass and mated for standard TO-92 sockets.

Rugged. Easy-to-mount.

Yet, priced below comparable 100% epoxy devices. 67¢ in 100s.

And, the new TIL63 through TIL67 phototransistors offer sensitivity ranges from 0.4 to 10 mA and above.

Ideal for reliable controls, switches, recognition equipment.

For detailed specifications, circle number 231.

Visible light emitting diodes...



standardized and in volume production.

So the cost is low. As little as \$1.27 in 1000 lots.

Improved, too. A bright 750 f-L

on about 1/20th of a watt. Immune to shock and vibration. Easy to use.

Coaxial package designed for compact display matrix assemblies. Or single indicators.

And, you can measure TI VLED life by the decade.

For detailed specifications on improved TIL201 and TIL202, VLEDs, circle 232.

New rugged coupler/isolator...



replaces costly, high-voltage hardware.

It could be a tiny pulse transformer. Put it on a high-density PC board. Couple it to 1000 volts. No problem.

Resistant to extreme shock, vibration and temperatures. Rejects noise. Eliminates ground loops.

Increase system flexibility. Replace heavy components in data transfers, system interface, even in motors.

And, cut your system costs.

For more information on the new TIL107 and TIL108 coupler/isolators, circle number 233.

New P-N GaAs emitters...



powered up and priced down.

Up above 1 mW output.

Down to \$2 in 5000s.

New TIL23 and TIL24 emitters offer the performance you need for cost-critical tape readers, velocity indicators and character recognition.

Save space, too.

Small size makes them easy to place at 0.087", center-to-center...

now required for new card readers.

For more information, circle 234.

New x-y hybrid sensor arrays...



the ideal solution: low cost, high performance.

TI's working on it.

The 50¢ channel in large volume. Medium-density arrays that will gain reliability by magnitudes over conventional hybrid techniques.

Standard plug-ins of 50 or more sensor elements. Spaced down to 50 mils, center-to-center. Light current matched to within 50%.

TI is ready to discuss your custom requirements. Write now.

7-bar numeric display...



now in development. In volume production later this year.

The prototype is in the works. It's shown at left with the plastic cover off to reveal rugged construction.

TI solid state numerics for small, low power readouts. Bright red 1/4" character. Long lasting. Cool. Shock resistant. IC compatible. Standard 14-pin.

Talk over your needs. Write TI today. New TI phototransistors, VLEDs, coupler/isolators and emitters are available now. Call your local TI sales office or authorized distributor.

For detailed specifications, circle the reader service numbers. Or write: Texas Instruments Incorporated, PO Box 5012, MS 308, Dallas, Texas 75222.



Prices are manufacturer's suggested list; subject to change without notice.

TEXAS INSTRUMENTS
INCORPORATED



a Dana DVM for \$425

Designed and developed by the same people who build our \$6,000 instrument...and our \$5,000 instrument... and our four, three, two and one thousand dollar instruments. No wonder it's so good.

Dana's new 3800 is the most accurate 3-digit DVM on the market. But it's more than a DVM. It's a full multimeter that will measure dc volts, ac volts, ohms, and dc current — with even a BCD option available. Superimposed power line hum is rejected by 1,000 times. It's so stable that it will run for over 6 months without calibration. So insensitive to temperature and humidity that you can use it anywhere without affecting performance, and its case is made of Cyclocac[®], the same rugged material used in professional football helmets.

Our reputation rides on the 3800. Just as it rides on every other DVM we make... for use on the bench and in systems; militarized models; 4- and 5-digit; from \$350 to over \$8000. There's a lot more to the Dana story, and to the 3800, so write for it. We'll also tell you how you can qualify for a free trial.

**Dc & ohms only:
\$350.00**

DANA[®]

Dana Laboratories, Inc.
2401 Campus Drive, Irvine, California 92664

Cyclocac is a registered trademark of Borg-Warner Corp.



Washington Report

CHARLES D. LA FOND, WASHINGTON BUREAU

DOD prepares Senate for Safeguard fight

To improve chances of getting the Congressional go-ahead on further development of the Safeguard antiballistic-missile system, Defense Secretary Melvin R. Laird devoted an extra day to the subject during his two-day military posture statement to the Senate Armed Services Committee and the Defense Appropriations Subcommittee.

Getting on with the ABM system, Laird told Congressmen, was necessary because of the growing "Soviet threat to our land-based forces and because of the potential Chinese threat."

To counter anti-ABM forces in Congress who say the all-important Safeguard radar is so vulnerable to attack that the system's effectiveness is doubtful, Laird suggests initiation of a program to "develop more survivable radar."

In order not to unsettle anyone with massive whole-program cost figures, Laird talked in terms of a year-to-year approach to advanced weapon development—a point of view that will apparently be used in future Defense thinking.

A new communications market: Yugoslavia

Big news for international electronics suppliers is a \$40-million loan by the World Bank for an expanded telecommunications network in Yugoslavia, which plans a 7-year \$470-million program to improve its total telecommunications services. The \$40-million loan is part of a \$95-million project—the remaining \$55-million to be derived from suppliers' credits. The World Bank, an affiliate of the United Nations, requires that proceeds of its loan be spent outside the borders of the recipient and that bidding be international.

According to a World Bank official, external-circuit facilities required in the over-all program include an Intelsat type of earth station to permit long-range satellite relay, a high-capacity microwave system including eight main links, plus associated branches, new transmission centers in 17 main transit exchanges, and a major coaxial cable. The earth station, he says, will cost more than \$4-million and will use a 30-meter-diameter antenna.

The loan represents the first crack in a wall erected by the Soviet Union preventing Communist-bloc nations from joining the Intelsat consortium.

Navy needs raft of money to survive

"We're watching our seapower go straight down the drain, and I don't think the American people give a damn," declares John R. Blandford, House Armed Services Committee chief counsel. Over \$20 billion is required during the next five years to rebuild the Navy's aged fleet, he told a recent Navy League symposium here.

The Administration is asking \$2.7 billion for new ships and fleet modernization in the fiscal 1971 budget—an increase of \$500 million over the fiscal '70 figure. With that amount, says Blandford, "Anyone who

understands the need for rebuilding our Navy knows it can't be done." To stay abreast with the Soviet Union, Blandford estimates a funding need of \$4 billion a year for the next five years. Extra shipbuilding authorizations will again be sought by the House this year, but industry informants here are not optimistic of Senate approval.

Environmental needs speed Patent Office aid

The urgent need to control our deteriorating environment has become so well accepted that it has penetrated the thick pile of red tape within the U.S. Patent Office. Commissioner William E. Schuyler, Jr., director of the office, says that patent applications related to environmental control will henceforth be processed in "six to eight months" instead of the usual three year waiting period.

Patent officials disclose a normal backlog of well over 200,000 applications pending, with about 5 per cent of this number falling roughly into the environmental category. To obtain higher priority for the environmental type of patent, they ask inventors to identify the nature of their submissions clearly and send them directly to Commissioner Schuyler. The same identification information should also be transmitted to his office for patents pending to obtain earlier processing.

Congress wants wider use of government inventions

A movement is under way in Congress to enable the Government to get more income from inventions derived from Government-supported research by making them more available to industry and charging more.

Now, if a company stumbles on an invention that the Government has paid another company or a university to produce, it and other companies are free to use it for a small fee. Needed, says Sen. Jennings Randolph (D-W. Va.), is a more effective way to disseminate news of inventions and Government-owned patents to industry.

Carrying Congressman Randolph's suggestion a step further, Dr. Harvey Brooks, Chairman of the National Academy's Committee on Science and Public Policy, proposed to Congress that a new Government agency be established to publicize Government-owned patents and to grant exclusive licenses to companies for a limited duration with the Government receiving a negotiated share of the royalties.

Broadcasters to get domestic satellite study

A comprehensive study of ground vs satellite-relay systems for domestic radio and television broadcasting is under way here for the major networks by Page Communications Engineers, Inc., a subsidiary of Northrop Corp. The four-month study will provide ABC, CBS, and NBC with both technical and economic comparisons of the two alternatives.

"The reason for the study," says John Gardella, Page vice president for marketing, "is to determine whether an all-ground microwave system or a satellite system with active repeaters is more economical than the existing systems." The firm will analyze both initial costs and long-term operating costs.



GE 50V .10±10%

COMES WITH EVERY GE
BLACK HAWK CAPACITOR

Unique construction

Molded epoxy encapsulation. Precise dimensions. Mounting feet. Welded leads.

That's what makes the GE Black Hawk unique. What does this mean to your printed circuits? You get built-in "damage resistance" to vibration or shock with an epoxy case that also stands up to any soldering iron. You get the best utilization of circuit board space in grouping or single components with precise dimensions in case and lead location. Mounting feet elevate the body of the unit above the circuit board giving Black Hawk capacitors greater stability during dipping. Secure welding of the leads to the extended foils of the roll gives you a low dissipation factor and a firm electrical as well as an exceptionally strong mechanical connection.

The automatically insertable Black Hawk capacitors are available in

| Voltage Ratings: | Capacitance Ratings: | Temperature Ratings: |
|------------------|------------------------|-------------------------|
| 50V, 200V, | .001uf to 1.0uf (50V) | -55C to +85C (and +125C |
| 400V, 600V | .001uf to .68uf (600V) | with proper derating) |

For further details, call your GE Electronic Distributor or GE ECSO District Sales Manager, or write Section 43041, General Electric Co., 1 River Road, Schenectady, N. Y. 12305.

Electronic Capacitor & Battery Dept., Irmo, S. C.

GENERAL  ELECTRIC

See these new Burr-Brown products at IEEE (BOOTH 3A26-27)



New low cost A/D-D/A Converters

An all-new line of high-speed converters priced from \$119.00. 8, 10, and 12 bit units are available among 14 A/D and 17 D/A models. Modules are self-contained, requiring only input signal and power supply.

New \$27.00 Multiplier

A high-speed multiplier with accuracy adjustable to $\pm 1\%$. Low 100 unit price of only \$27.00.

New Square Rooter

This unique function module will square-root with an accuracy of $\pm 0.5\%$ of full scale with wide dynamic input range of +3 mV to +10V. And, the 100 unit price is only \$39.00.



and over a dozen new amplifiers

- 4 new Electrometer Amplifiers with varactor input. These inverting and non-inverting units have a bias current of only .01 picoamps and a $10^{14}\Omega$ input impedance.
- 5 new Hybrid IC Op Amps including 2 DIP FETS and 3 DIP bipolars.
- Four IC Op Amps to MIL-STD-883.
- A new low power Instrumentation Amplifier.
- New Differential input chopper Op Amp with ultra-low drift and high common mode rejection.
- New Line Drivers offering ultra-fast slew rate and wide bandwidth while driving 50Ω load. Output current ± 100 mA.

Or get your copy of the new 1970 Burr-Brown catalog

by contacting your Burr-Brown Engineering Representative or using this publication's reader service card.

BURR-BROWN

RESEARCH CORPORATION

International Airport Industrial Park • Tucson, Arizona 85706
TELEPHONE: 602-294-1431 • TWX: 910-952-1111 • CABLE: BBRCORP



Operational Amplifiers
Instrumentation Amplifiers
Active Filters
Multiplier/Dividers
A/D-D/A Converters

Is Your Computer Doing Things For You... Or To You?

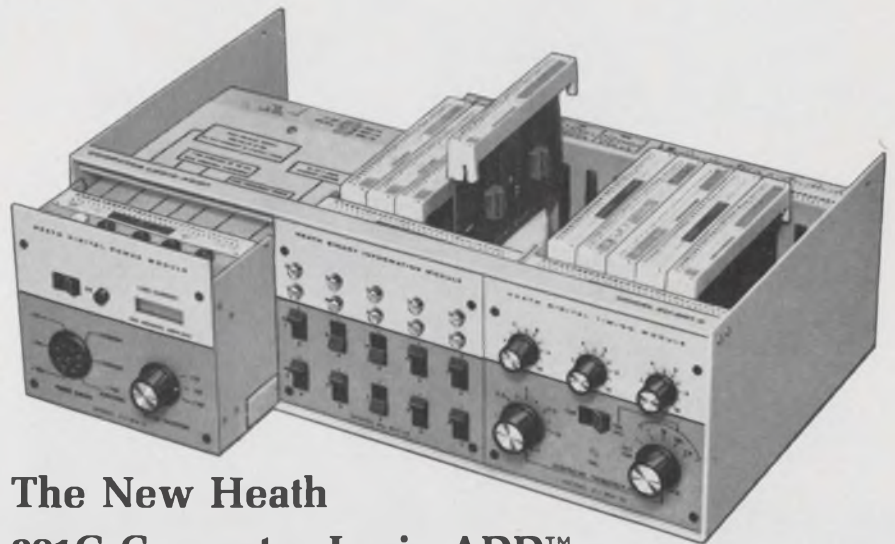

The New Heath 801C Computer Logic ADD™ Broadens Your Understanding

What Is Your General Purpose Computer Doing?

Is it doing things for you in your problem solving that make the job easier, faster, more accurate? Things like analyzing, processing, measuring... working as an integral, active part of your design process? Does your knowledge of how your computer works, and what it can do, enable you to significantly alter your view of the problem... to the point of finding a better solution? Or is your computer, by being something of an enigma, doing things to you... like wasting your valuable time... increasing costs... degrading the accuracy and repeatability of your results? Is your computer doing things for you... or to you? The New Heath 801C System Can Help You Find Out... by broadening your understanding of computer logic. The Computer Logic ADD is designed to give you the basic knowledge of computer logic you need to effectively use the computer as a functional part of your designing and problem solving methods. The 801C System consists of the new EU-801C Computer Logic Analog-Digital Designer (ADD), a pioneering new text, "Digital Electronics For Scientists", by Drs. Malmstadt & Enke, and a Workbook keyed to the text and written to lead the newcomer a step at a time through basic logic functions and methods of manipulating data.

The EU-801C Computer Logic ADD is a precision teaching and design device composed of three Modules... Digital Power, Binary Information and Timing. Plug-in circuit cards in the Modules contain discrete logic functions such as AND, OR, NOR, NAND, INVERT etc., and the solderless connectors on the top of each card allow the user to patch the cards together with ordinary hook-up wire to form logic sub-systems and systems identical to those used in present computers. Standard logic symbology is used throughout the system so the cards can be connected according to common logic diagrams. The ADD is also completely open-ended... more complex circuit cards are available from Heath to provide design & self-teaching capability for computer interfacing, digital instrumentation and control functions.

The Workbook, written by Drs. Malmstadt & Enke, is applicable to anyone interested in learning basic computer logic concepts and functions. The Workbook contains descriptive summaries, textbook references and specific instructions for 50 experiments. The experiments systematically "open up" the computer so that its basic logic functions and data handling methods become clearly understood. The format, experiments and presentations are designed for self-teaching and self-checking of one's comprehension. Table Of Contents by chapter: (1) Gate Logic... the student becomes familiar with logic levels, truth tables, Nand/Nor gate logic, Boolean Algebra, and encoder, adder, subtracter, decoder, multiplexer, comparator, parity and relative magnitude detector circuits and functions. (2) Flip-Flops... one of the most basic logic functions, used in all types of registers, for buffer storage, counting, converting, scaling and many other computation and measurement applications. (3) Counters & Scalers... including BCD counting, decade counters, scalars, variable modulus counters and preset counters. (4) Shift Registers... this set of experiments illustrates all the basic shift register circuits and applications. (5) Counting Measurements... this chapter demonstrates the use of counters to measure frequency, period and time interval. (6) Binary Computation... including serial and parallel addition and subtraction, which are the basis for all types of computation in actual computers.

Text—"Digital Electronics For Scientists" is a complete, up-to-date reference and study text for modern digital logic techniques. Although only the non-electronic portions of this text are used with the 801C System, the complete text offers an invaluable source of information for those interested in probing further into the nature and uses of current digital techniques.

The New Heath 801C System... can be the key to making your small computer an active, functional part of your design process. Order your 801C System now... and discover that your computer can be doing things for you, instead of to you. EU-801C, complete system \$365.00*

FREE Heath Scientific Instrumentation Catalog



Describes these and other precision instruments for laboratory, engineering, education and R & D applications. Send for your FREE copy now... just write on your school or company letterhead.

HEATH COMPANY, Dept. 580-21
Benton Harbor, Michigan 49022

a Schlumberger company

Please send FREE Heath Scientific Instrumentation Catalog

Name _____

Address _____

City _____ State _____ Zip _____

Prices and specifications subject to change without notice.
*Mail Order Prices; F.O.B. Factory

EK-284

step up!



to perfect performance

—with Bodine fhp motors and D.C. Motor Controls Now... precise control of speed, torque and power for every fractional horsepower need. Motor controls perfectly matched to characteristics of Bodine's NSH line of D.C. shunt-wound motors. Or, for just reliable fractional horsepower, Bodine motors available in over 3,500 standard catalogued specifications. Plus numerous specials. Virtually any type, size or rating: 1.45 milli-hp. to ¼ hp., torques from 0.18 oz.-in. to 350 lb.-in., speeds from 0.6 to 10,000 rpm. Also more than 330 stock types and sizes. Write for Bulletin. Bodine Electric Company, 2500 W. Bradley Place, Chicago, Illinois 60618.

Power/controls for office machines
■ machine tools ■ electronic equipment
■ electrical control devices
■ medical apparatus ■ communications equipment
■ data processing equipment ■ laboratory equipment
■ recording instruments
■ inspection and testing equipment
■ musical instruments ■ scientific apparatus ■ many other applications.

Bodine Motors Wear Out—It Just Takes Longer



BODINE MOTORS/CONTROLS

INFORMATION RETRIEVAL NUMBER 29



Letters

Come on, gentlemen! Let's fight anarchy

Sir:

With regard to the article "Design Digital Converters Logically" by Messrs. A. H. Frim and M. M. Miller (ED 24, Nov. 22, 1969, p. 66), I would like to comment that a DTL 930 gate is a "NAND" gate, regardless of what symbol is used to describe it. In Figure 1, the authors erroneously labeled this device a "NOR" gate.

Reference to MIL-STD-806B will readily show that the two top symbols in Figure 1 are identical—that is, if we stick with positive logic for both circuits, which is, I am sure, the intent of the authors. In addition, the expressions

$$\overline{F} = ABC$$

$$F = \overline{ABC}$$

$$F = \overline{A + B + C}$$

are all identical and describe a NAND function. The equivalent expressions for a NOR function would be

$$\overline{F} = A + B + C$$

$$F = \overline{A + B + C}$$

$$F = \overline{ABC}$$

Come on, gentlemen. Let's stick to convention, and let's fight anarchy.

Jeffrey Lowenson

Versatran Division
AMF Thermatool, Inc.

Puts love of work over community obligation

Sir:

During the months of August and September of the past year, I, with others, put in an average of 16 hours a day, seven days a week, on a project that was behind schedule. I did not receive any overtime pay, and I was not working under the influence of promises or any other form of compensation. I was working to get the job finished in the shortest possible time, using the resources available.

I consider myself to be one of those "creative ones" Dr. Ehrlicke refers to in his interview in the December 20, 1969, issue (ED 26, p. 76). However, my drive during that two-month push *did not* come from a "sense of obligation to the community," as Dr. Ehrlicke suggests. It came from my love of my work.

I will not work for the community since the community cannot pay me, and I believe in value given for value gained. I do not recognize any right of a community, society, humanity, or any other alleged consciousness, to my work. My work is for my benefit first, the company's benefit second, and the customer's benefit third. The community benefits from my work as it does from the work of other creative men, but only indirectly. It is not a true motivating factor.

If you and Dr. Ehrlicke think that man truly works for the benefit of the community, look around you. The men who expected the community to pay them quit working a long time ago. The proof of this is in today's great emphasis on having fun. If a man enjoys his work, he does not have to look outside of it for pleasure. And pleasure *is* a motivating factor.

Edward W. Rummel

Senior Project Engineer
Western Reserve Electronics Inc.
Cleveland, Ohio

In response

Sir:

I read Mr. Rummel's comment with interest. In particular, I found it intriguing that my reference to a "sense of obligation to the community" was unreservedly taken as being in opposition to one's "love of work" or to the undeniable fact that "pleasure is a motivating factor." Clearly, these two attitudes are not mutually exclusive. I believe my individualism

to be second to nobody's. Neither, I am sure, did Mr. Rummel, in denying that the community's benefit is a motivating factor while claiming that "My work is for my benefit first," mean to proclaim a man's right to enjoy his work regardless of its effect on the community. Without finding a sense of obligation to community an enjoyable aspect of his work, I am afraid neither individual nor community can flourish in the long run.

K. A. Ehrlicke

Today's youth 'ideal'? He calls them 'fools'

Sir:

I had a rather violent reaction to your editorial "Any of You Evil Engineers Ready to Defend Yourself?" in the Dec. 6, 1969 issue (ED 25).

I can't possibly imagine where you get the idea that today's young people are "idealistic." Do you call it idealism when today's youth smokes pot, sniffs glue, takes the needle, riots in the streets, stones the police, invades the university president's office, runs around in sloppy, dirty clothing with sloppy-looking, dirty, long hair, and generally makes a damn fool of itself before the nation and the entire world?

I, for one do not feel I have to justify engineering to this type of person. I feel that it is not engineering that is out of step but rather today's youth. What are needed are more old-fashioned parents like myself who establish firm rules and deliver good hard spankings when those rules are broken.

I think today's news media—and I am including you in that group—do the nation a disservice when you describe today's youth as idealistic. If it is "idealistic," then its ideals are certainly completely rotten.

You say, "No wonder America's

(continued on p. 56)

**If the world's
largest machine tool
company built a
MINICOMPUTER,**

**what would it
look like?**

Like this.

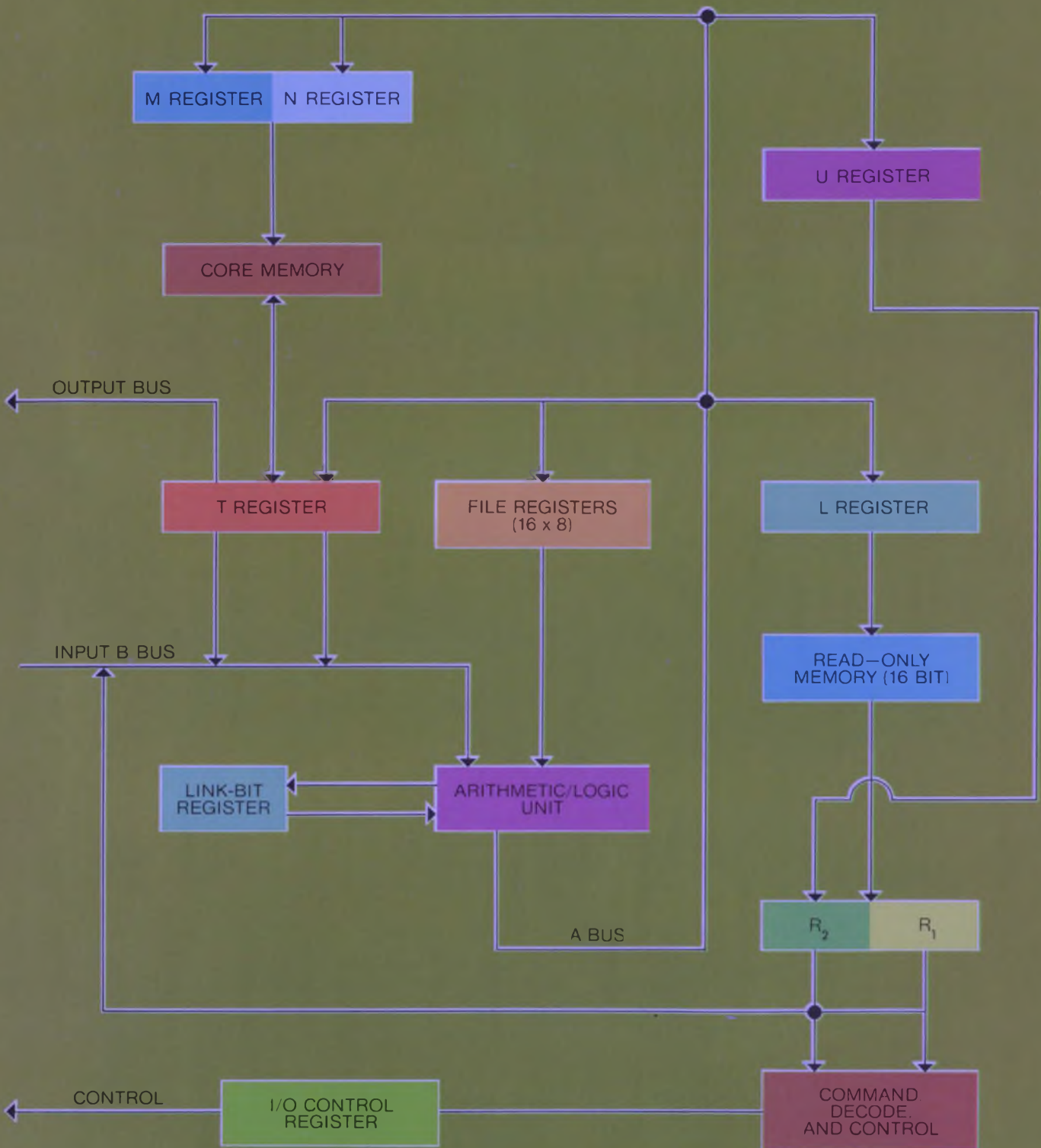

THE CIP/2000 FROM CINCINNATI

A new, low cost, microprogrammable digital computer
for dedicated and general purpose applications.

Now what will it do?

The CIP/2000 operates fastest and most efficiently when specifically produced for a dedicated application. By exploiting its micro-programming capability, you can integrate it into any of your systems for control and/or data processing.

Use it to acquire data, to concentrate and/or perform computations on the data, to monitor operations and processes, to perform continuous automatic testing, to control automated production lines, for in-house time-sharing systems, for medical monitoring, or for laboratory data acquisition and experimentation control. In short, the CIP/2000 offers a low-cost, ultra-reliable

method to apply computer techniques where the high costs of larger computers made such use prohibitive in the past.

For less than \$3,100 you get a computer with 15 general-purpose, 8-bit file registers; 7 dedicated working registers; microprogram control; 16 powerful microinstructions, including logical arithmetic, control and literal data. Its speed is outstanding, with 1.1 microsec memory cycle time and 220 nanosec micro-instruction execution time. The unit has read-only memory space up to 1,024 instructions.

Many optional features and arrangements are available, including a variety of I/O devices, core memory up to 32K, Direct Memory Access, as well as assembler and simulation software.

One application is our model CIP/2100, in which the microprogram converts the basic system into a software-programmable, general-purpose computer. Support software is available for both units, as well as strong program in training, maintenance, and field service.

The Cincinnati Milling Machine Co. has been actively

engaged in the electronics field for over 15 years, manufacturing dependable control systems for real-time hostile environments.

CINCINNATI controls operate sophisticated machines producing critical components for aircraft and space vehicles. The production of the new CIP/2000 computer is a natural outgrowth of this activity.

For full specifications for both the CIP/2000 and CIP/2100 computers, contact The Cincinnati Milling Machine Co., Dept. R-14, Lebanon, Ohio 45036, phone (513) 494-5444.



The CIP/2000

CINCINNATI

The Cincinnati Milling Machine Co.

INFORMATION RETRIEVAL NUMBER 31

(continued from p. 52)

youth is ready to believe only evil about engineering." If you read the newspapers I am sure you are aware that today's youth believes evil about everything, including God, the church, the government, the nation, the flag, the university, the police, their parents, the judiciary, and every other established organization. Again I ask you, are all these things wrong or is it possible that youth is wrong? I think what we need to do is stop glorifying youth, give it a good boxing about the ears when needed, and nip in the bud this marvelous revolution today's youth is promising us which will bring us to the "ideal" society.

Jack Jones

Chief Engineer
J. H. Westerbeke Corp.
Boston, Mass.

Sony challenges parts of Hall Effect story

Our magneto-diode was referred to in detail in the article "The Hall Effect: Success at 90" in the ED 21, Oct. 11, 1969 issue, p. 38. We would very much like to know what sources had convinced the author that "—at about 35°C the bidirectional effect ceases and there remains only a decrease in resistance for either direction field."

Although we admit that the present germanium device is somewhat temperature-sensitive, we firmly believe that the bidirectional behavior subsists irrespective of the temperature, as long as the electric and/or magnetic field(s) are not too high.

The effect of temperature dependence of the zero-field resistance can be compensated considerably by the use of a matched pair. Temperature dependence of the sensitivity of the matched pair can be kept within say ±5% in the temperature range 0°C — 40°C without any compensating means. Therefore, it could be, and actually

is, used for analog applications where such degree of accuracy is useful.

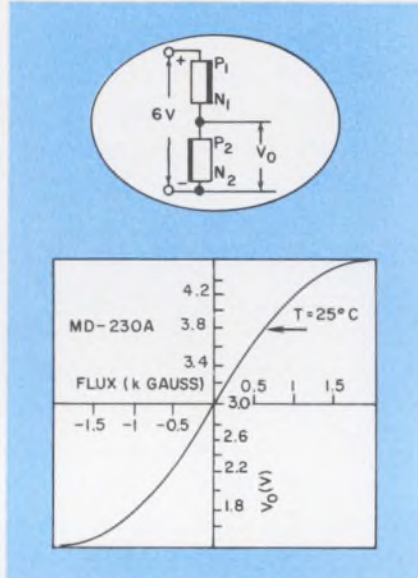

We would also like to point out a misfitting graduation of both horizontal and vertical axes of the figure on p. 44. Each division of the horizontal and vertical axes should correspond to 0.5 k Gauss and 0.2 V, respectively, if the figure is for our product MD-230A.

Toshiyuki Yamada

Research Scientist
Sony Corp.
Yokohama, Japan

Ed's Note: You're right, and we appreciate your eagle-eyed comments.

Elizabeth, I love you

Sir:

Is Elizabeth deAtley married? After reading her editorial, "Be Your Own Boss This Year—" (ED 2, Jan. 18, 1970) I think I'm in love.

On second thought she must be single. A woman who dares to suggest that technical men behave like *men* instead of sanitized, domesticated breadwinners is asking for rejection.

D. A. Berg

Head, Program Development
Hughes Aircraft Co.
Fullerton, Calif.

Accuracy is our policy

In the Ideas for Design item "Multivoltage Monitor Circuit Uses Only a Single Transistor" (ED 26, Dec. 20, 1969, page 81) the following corrections should be noted:

■ Equation (1) should read

$$E_{oc} = \frac{V_1/R_1 + V_2/R_2 \dots + V_n/R_n + V_n/R_n}{1/R_1 + 1/R_2 \dots + 1/R_n + 1/R_n}$$

■ Equation (6) should read

$$E_{oc} = [K + (V_n/R_n)] / (1/R_p) = I_b R_p + V_{BEf}$$

■ Equation (9) should read

$$1/R_p = K/nV_1 + K/nV_2 \dots + K/nV_n + 1/R_a$$

■ R_n (in Fig. 1b) should read R_p ,

■ -12 V reference (in Fig. 2) should read -28 V.

■ $V_a = -12$ V, mentioned in the calculation example below Eq. 9, should read $V_a = -28$ V.

In the article "Design and Match RF Amplifiers" (ED 10, May 10, 1969, p. 106), program statement 193 of Table 1 should read IF(K) 91, 91, 161.

In the Ideas for Design item, "Temperature Stable Power Supply Uses IC As Error Amplifier" (ED 23, Nov. 8, 1969, p. 103) the lower transistor in Figure (a) was incorrectly drawn with the emitter grounded. Actually the upper and lower transistor emitters should be tied together with the lower transistor collector grounded.

The Idea for Design "Simple Crystal Oscillator Uses Monostable Integrated Circuit" featured in ELECTRONIC DESIGN page 85, December 20, 1969 has an error in the schematic. The capacitor labeled 450 pF should be marked 4 to 50 pF as per the accompanying text.

A \$3.00 thumbwheel switch has started a revolution



That's our 1776. It sells for \$3.00 in single quantities and if you think you can get one cheaper, you're right. Prices come down below \$2.00 in quantity.

But don't let the price fool you. Our 1776 has everything you'd expect from a thumbwheel switch that costs a lot more — and then some. You can get them in an unusually wide range of codes. The widest range available anywhere. And delivered in 24 hours or less because of our nationwide sales and distribution system.

Assembly is a snap. You can mount as many

as 15 stations with our snap-on retainer band. And up to 34 of them using mounting rods. They have dust seals and solder tab termination. The dial characters are large and easy to read, and they're protected against dust and moisture by a plastic window.

Join the revolution. Write for our free catalog on thumbwheel switches. That's the spirit.



Electronic Engineering Company of California
1441 East Chestnut Ave. Santa Ana, Calif. 92701

Distributed by G.S. Marshall Company,
Hall-Mark Electronics and Schwebel Electronics.

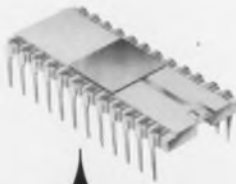

one-package

**MTOS
counter
display
drivers**

available in production quantities

General Instrument's new one-package MOS counter display drivers replace conventional counter decoding and driving systems requiring at least 3 packages

MEM 1056 BLOCK DIAGRAM

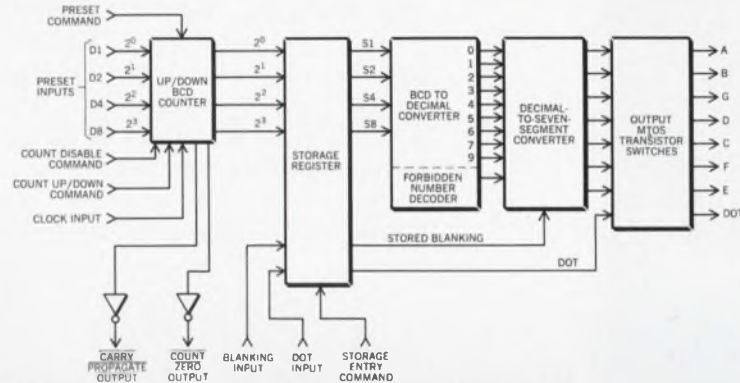

MEM 1056 BCD BLOCK DIAGRAM

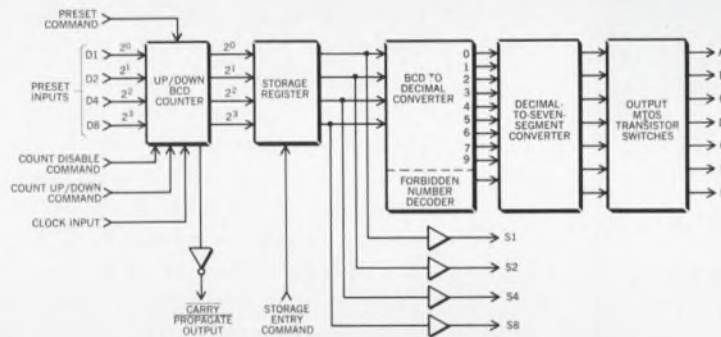

It takes only one MOS MEM 1056 in one 24 lead dual in-line package to drive a seven segment fluorescent readout tube such as the DIGIVAC® S/G.

Conventional IC counter decoder and driving systems require at least 3 packages to do the same job.

The elimination of the need for all but this single package means lower installation costs, lower PC board costs, less assembly and test time and, of course, higher reliability.

The MEM 1056 is an MOS monolithic integrated circuit designed primarily to operate in conjunction with a seven segment fluorescent readout tube for displaying numeric information. It contains a one decade up-down BCD counter, a storage register, a BCD-to-seven segment decoding matrix and display drivers. The device features:

- Direct Display Drive Capability
- Low Power Consumption
- Count Zero Indication
- Decimal Point Indication
- False Code Indication
- Blanking Input

The up-down counter sections of the chips can be cascaded to form synchronous counting chains. Also, by utilizing external elements, asynchronous, one-megacycle, up-down counting can be achieved irrespective of the number of counter stages cascaded.

The description and features of the MEM 1056 BCD are basically the same as those of the MEM 1056 except that the BCD version has four BCD outputs.

Both the MEM 1056 and MEM 1056 BCDs are available from your authorized General Instrument Distributor. For full information write General Instrument Corporation, Dept. 56, 600 West John St., Hicksville, L. I., N. Y. 11802. (In Europe, write to General Instrument Europe S.P.A., Piazza Amendola 9, 20149 Milano, Italy; in the U.K., to General Instrument U.K., Ltd., Stonefield Way, Victoria Rd., South Ruislip, Middlesex, England.)

*DIGIVAC is a registered trademark of Wagner Electric Corporation



GENERAL INSTRUMENT CORPORATION • 600 WEST JOHN STREET, HICKSVILLE, L. I., NEW YORK

INFORMATION RETRIEVAL NUMBER 33

Where accuracy counts...

IDEAL PRECISION METERS ARE FIRST IN QUALITY AND PERFORMANCE!



250° Long Scale Meter for Automotive, Aircraft, Marine and Switchboards

Precision engineered meters to fit any specification or cost requirement.

For special applications or unique design requirements, our Custom Service Department manufactures to fit individual specifications.

- Imperial Series
- Capitol Series
- Ambassador Series
- Edgewise Series
- Statesman Series
- Diplomat Series
- Moving Magnet Indicator Series
- 250° Long Scale Series
- New Rotary Solenoid
- ... plus a complete line of Military & Avionic Meters

For detailed specifications and ranges write for your free illustrated catalog to



IDEAL PRECISION METER CO., INC.

214 Franklin Street, Brooklyn, N.Y. 11222
Telephone: 212-383-6904 • TWX: 710-584-2390

INFORMATION RETRIEVAL NUMBER 44

SIDELIGHTS

A new editor for Electronic Design

Major changes have been made in the editorial department of **ELECTRONIC DESIGN**: Frank T. Egan, managing editor, takes over as editor from Howard Bierman, who moves to **MICROWAVES**, another Hayden publication, and becomes publisher. Two managing editors have been appointed to fill Egan's previous post: Ralph Dobriner, formerly news chief, and Raymond D. Speer, formerly microelectronics editor.

Egan first joined **ELECTRONIC DESIGN** in 1965 as a technical editor and became managing editor last May. In his new post he plans to "keep **ELECTRONIC DESIGN** as responsive to the needs of designers as it has always been."

Welcome to Japan, Mr. Bierman

Drawn by Japan's booming electronics industry and its flurry of development activity in devices and hardware—plus the lure of the mysterious Orient—Howard Bierman, then editor, traveled to the East in mid-January. Several weeks later, after more than 40 plant visits in Tokyo, Osaka, Kyoto and Yokohama, he returned, enthusiastic about the flourishing industry. Weary, too, for between business visits, he had been entertained by geisha girls, whiplashed by excited cab drivers caught in a frenzy of Tokyo traffic, and crammed full of raw fish and rice.

His report, covering Japan's dramatic market growth, recent technical developments, products to be displayed at IEEE, and an interview with a Japanese engineering-manager, starts on p. U161.



The next generation of desk-top calculators is the subject under discussion as Howard Bierman, left, interviews Dr. Tadashi Sasaki, director of Sharp's Industrial Instrument Div.

INFORMATION RETRIEVAL NUMBER 45 ►

The mind easer...



- You never worry about what it's doing to the circuit
- You forget about zero adjusting forever

The Digilin Type 340 Digital Multimeter eliminates the two major causes of multimeter fretting in one low-cost, high-performance meter. First, the exclusive new Digilin Input Amplifier Technique (patent pending) does away with circuit loading *throughout* the test function. Forget about transient noise creeping in when impedance drops during the measurement cycle — a worry that always nags you when such input techniques as dual slope integration and chopper-stabilized ampli-

fiers are used. The 340 never disturbs the circuit ever. And with a 340, you'll never short another lead and adjust for zero again. Before every measurement cycle, the 340 does it for you — automatically, precisely, leaving no doubt about whether it was done right.

Only with Digilin do you get these features, and the 3½-digit, 0.1%-accuracy Digilin 340 gives you lots more: Award winning design (1969 WESCON Industrial Design Competition) • Automatic

polarity • Pushbutton ranging • High visibility, no-blink display • only 3 pounds • Assured reliability by Digilin 100-hour burn-in and factory test. \$345 complete in single units. Need battery-powered flexibility? Digilin 341 with same features plus battery supply at \$395. Digilin Type 340. The mind easer. It's an eye pleaser, too.

Get more information—or no-obligation demonstration. Call or write Digilin today. Digilin Inc., 6533 San Fernando Rd., Glendale, California 91201. Tel. 213-246-8161.

See us at Booth 3A43, IEEE Show

digilin
DIGITAL INSTRUMENTS



Now! A smaller* Digivac S/GTM display with important new features

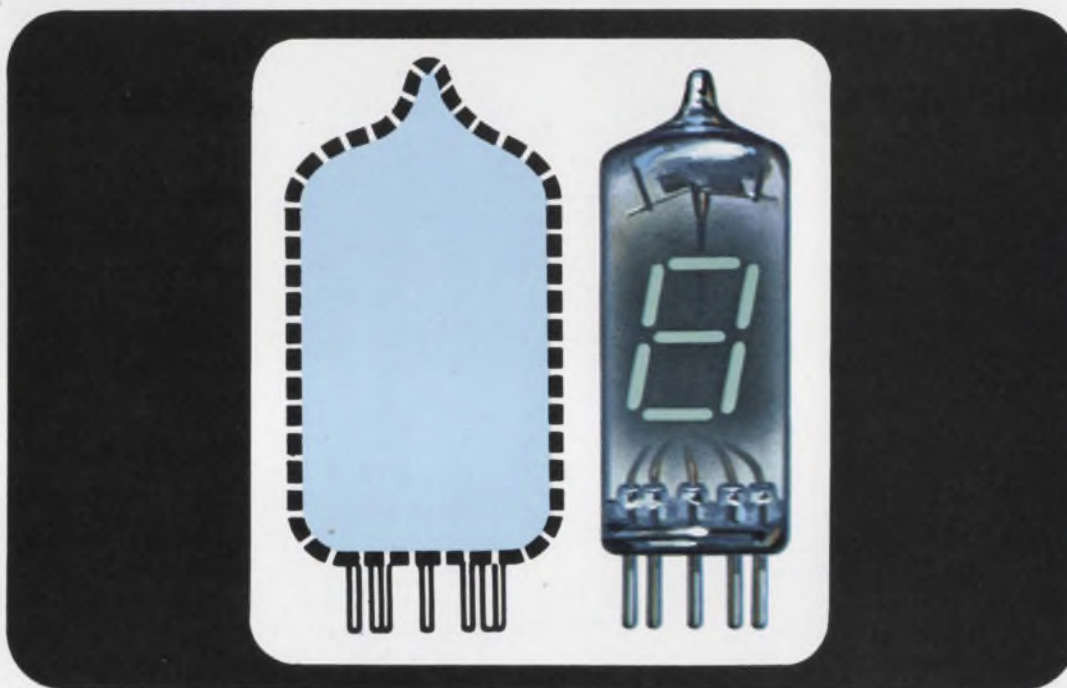

NEW—Requires less space....NEW—MIL spec construction...
NEW—Electrostatically stable....NEW—Solderable leads optional

Electrically and optically identical to and interchangeable with the original types... but substantially smaller. Same driver and low power requirements. Rugged construction meets MIL specs for shock and vibration. Impervious to electrostatic influences. No reduction in size of the single-plane, high-legibility, 7-segment character. Eye-ease green can be filtered to provide unlimited colors. Regular 9-pin miniature basing, or 10-pins where decimal is required. Solder-in leads reduce seated height of Digivac S/G displays.

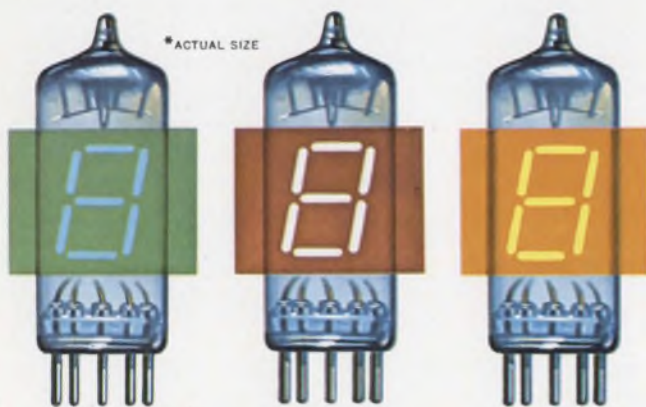

FILTERING PROVIDES COLOR OPTIONS

DIGIVAC S/GTM

VACUUM FLUORESCENT DISPLAY

TUNG-SOL DIVISION
WAGNER ELECTRIC CORPORATION

630 W. Mt. Pleasant Avenue
Livingston, N.J. 07039
TWX: 710-994-4865
Phone: (201) 992-1100; (212) 732-5426

Trademark TUNG-SOL Reg. U.S. Pat. Off.
and Marcas Registradas

Publisher

Hugh R. Roome

Editors

New York Office
850 Third Ave.
New York, N.Y., 10022
(212) 751-5530

Editor: Frank Egan
Managing Editor: Ralph Dobriner
Managing Editor: Raymond D. Speer
Computers, Milton J. Lowenstein
Circuits, Don Mennie
Microwaves, Michael J. Riezenman
Management, Richard L. Turmail
News, John N. Kessler
Military-Aerospace, John F. Mason
New Products, Roger Allan
New Products, Lucinda Mattera
Directory Manager, Greg Guercio
Copy, Marion Allen

Field Offices

Washington

Charles D. LaFond
P.O. Box 138
Burke, Va. 22015
(702) 461-7210

Massachusetts

Jim McDermott
P.O. Box 272
Easthampton, Mass. 01027
(413) 527-3632

San Francisco

Elizabeth de Atley
2051 Wellesley St. (Suite D)
Palo Alto, Calif. 94306
(415) 321-7348

Los Angeles

David Kaye
2930 Imperial Highway
Inglewood, Calif. 90303
(213) 757-0183

Editorial Production

Dollie S. Viebig
Richard D. Grissom

Art

Art Director, Clifford M. Gardiner
Assistant, William Kelly
Rita Jendrzewski
Lynn Thompson
JoJo Miskimmon

Production

Manager, Thomas V. Sedita
Helen De Polo
Kathleen McConkey
Leslie Stein

Circulation

Manager, Nancy L. Merritt

Information Retrieval

Genate Piccinetti

EDITORIAL



'71 budget will separate the men from the boys

Can the electronics industry meet the challenge of the priority changes in the budget for fiscal year 1971? We believe so, if it redirects its considerable resources for the national good, as well as for self-preservation.

Predictably, the first Nixon Administration budget produced an uproar of conflicting reactions in the press and in Congress. But, like it or not, the new budget reflects change, and for industries oriented to defense and aerospace, the prospect is a year of austerity. New goals for the decade are being formulated—programs to fight crime, clear the environment, and lift the underprivileged. In addition, the Nixon approach signals a policy change: every program is subject to annual review and possible elimination or cutback—and then must await the disposition of a socially awakened Congress.

In the 50s, this nation supported without question three concurrent Air Force strategic-missile programs involving simultaneous R&D and production. In the 60s, it also financed fleet ballistic-missile projects for the Navy and carried out a successful moon landing program. All were multibillion-dollar efforts carried out in approved long-term programs.

There are no long-term national programs for defense and space in the 1970s. Strategic weapons are pawns to be played and given away in a U.S.-Soviet game called SALT (Strategic Arms Limitation Talks). The Apollo program is terminal, with death a certainty in 1974.

The impact of these priority changes will be felt by a majority in the electronics industry, over half of whose yearly sales are derived from Government contracts, directly or by subcontract. It enjoys over 40% of the defense dollar and 50% of NASA expenditures. With these markets dwindling, the industry now must adjust and seek out the far lesser portions available to it in new and expanding programs.

Electronic sensors may be adapted for use in environmental surveillance, military radio communications are needed in law enforcement, computer systems and software programs must be scaled down and put to work on medical and social applications.

This country has advanced technology, and it has the necessary designers and engineers. Now it needs to redirect those capabilities to meet new goals.

CHARLES D. LAFOND

Coming for tomorrow's metro areas:
the regionally planned, "expandable-disposable"
rapid transit system that itself creates new
values in, around and outside the city core...
personal transit lines using small family-
sized rail-cars traveling non-stop
on electrified guideways.
IR can help close
the loop.

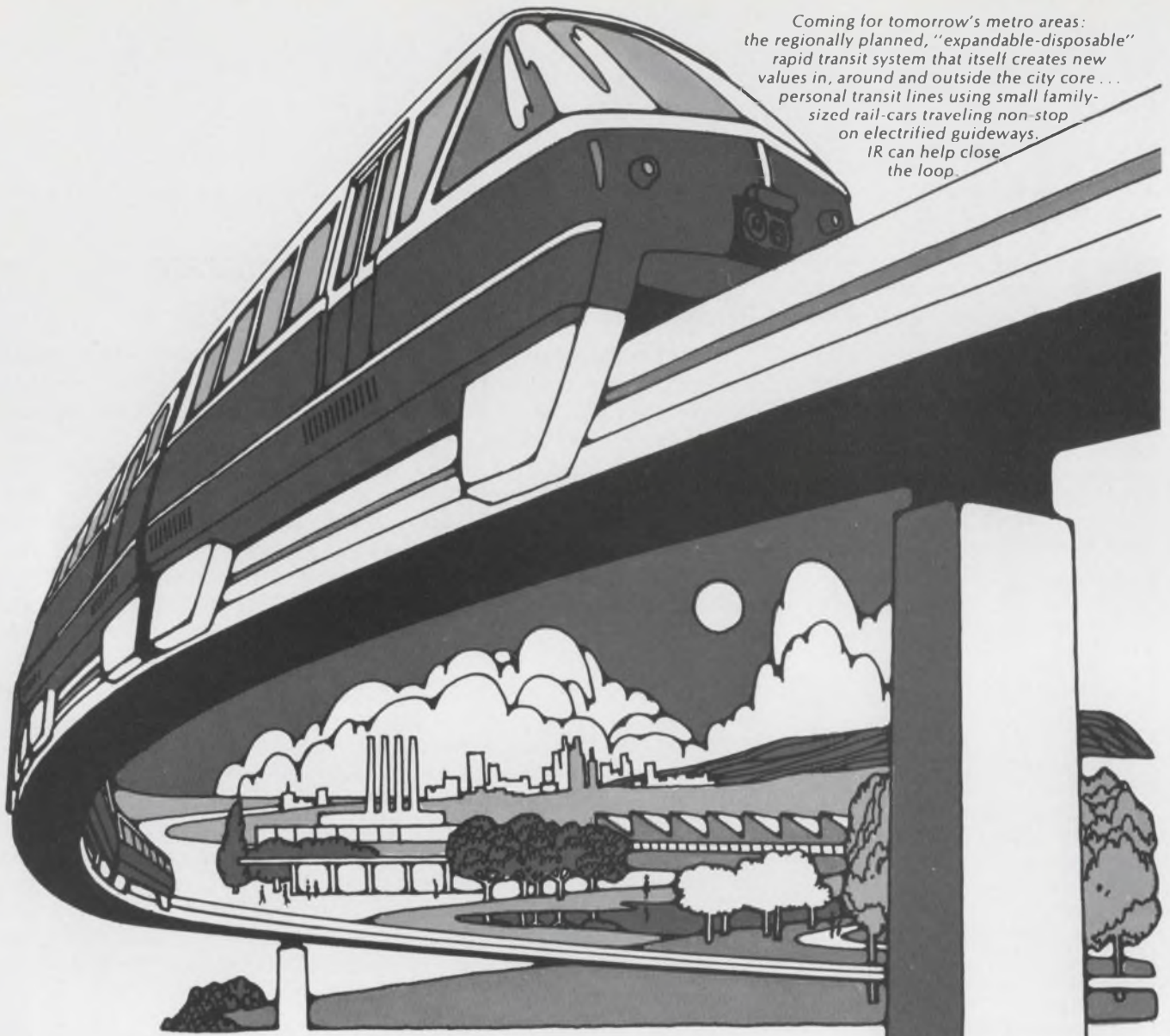

Get aboard IR's 40 Amp diode line. With the best track record for value.

And fast delivery.

International Rectifier's 40HF diodes have been around the circuit for some time. With its rugged case and diffused junction, this diode has become the backbone of medium power rectification. Used in a wide variety of both sophisticated and general purpose applications ranging from dc motor controls to inverter, high frequency applications. It's a top value for less dollars.

The 40HF line, forward or reverse polarity, comes in an all-metal, corrosion-resistant, hermetically sealed DO-5 case. Rated 50-1000 volts in IR numbers, 50-600 volts in JEDEC cross-referenced numbers.

And they're on-the-shelf, ready-to-deliver. At a down-to-earth price. For express-train delivery, call your local IR Authorized Industrial Distributor or IR direct.

Silicon Controlled Rectifiers □ Power Logic-Triacs □ Silicon Power Rectifiers □ Selenium Rectifiers
□ Zener Diodes □ Custom-engineered Sub-assemblies and Systems □ Light Sensitive Devices

INTERNATIONAL RECTIFIER 

Semiconductor Division, 233 Kansas Street, El Segundo, California 90245, Phone (213) 678-6281
MANUFACTURING FACILITIES: UNITED STATES, CANADA, GREAT BRITAIN, INDIA, ITALY, JAPAN, WITH SALES OFFICES AND DISTRIBUTION IN MAJOR CITIES THROUGHOUT THE WORLD



new mil-performance square cermet trimmers from CTS

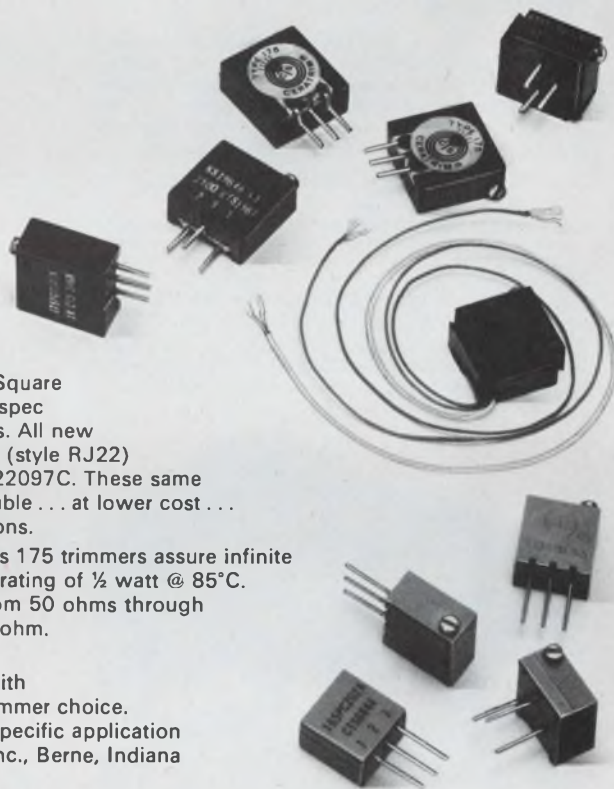

Now . . . with CTS Cermet Multi-Turn Square Trimmers you get Characteristic C Mil-spec performance for all military applications. All new series 165 (style RJ24) and series 175 (style RJ22) meet tough Characteristic C of Mil-R-22097C. These same environmental characteristics are available . . . at lower cost . . . for commercial and industrial applications.

Both small $\frac{3}{8}$ "-square series 165 and compact $\frac{1}{2}$ "-square series 175 trimmers assure infinite resolution over a 20 ohm to 2.5 megohm range . . . and power rating of $\frac{1}{2}$ watt @ 85°C. TC ± 150 ppm/°C for 2k ohms and above. -0 +175 ppm/°C from 50 ohms through 250 ohms and -0 +250 ppm/°C from 500 ohms through 1k ohm. All available at no extra cost.

Low cost*, proven quality, and top performance—combined with **fast distributor delivery**—make CTS your best industrial trimmer choice. Can't use one of our standard series? Ask how we can solve specific application problems. Call or write for complete details to CTS of Berne, Inc., Berne, Indiana 46711. Phone (219) 589-3111.







*Check these prices for 4-6 week production delivery. (Small quantities from stock)

| | Series 165 | | Series 175 | |
|--------------------------------------|--------------|-------------|--------------|-------------|
| | 25-49 (each) | 1000 (each) | 25-49 (each) | 1000 (each) |
| Commercial ($\pm 20\%$ Tol.) | \$4.55 | \$.325 | \$4.20 | \$2.95 |
| MIL-type ($\pm 10\%$ Tol., Char. C) | 5.30 | 3.80 | 5.10 | 3.65 |

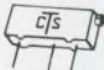

CTS CORPORATION
Elkhart, Indiana

Other CTS Cermet Trimmers include:

| | | | | | | |
|---|---|---|---|--|---|---|
|  |  |  |  |  |  |  |
| Series 185 1- $\frac{1}{4}$ " x .290" x .364" multi-turn | Series 190 $\frac{3}{4}$ " x .160" x .310" multi-turn | Series 340 $\frac{1}{4}$ " x $\frac{1}{4}$ " square x .270" high—single-turn | Series 360 $\frac{7}{16}$ " x $\frac{1}{4}$ " x $\frac{1}{4}$ " x $\frac{2}{16}$ " single-turn | Series 385 $\frac{1}{32}$ " round x .225" high—single-turn | Series 660 $\frac{3}{8}$ " round x $\frac{1}{4}$ " high— single-turn | Series 630 $\frac{1}{2}$ " round x $\frac{1}{32}$ " high— single-turn |

INFORMATION RETRIEVAL NUMBER 48

WATT'S NEW? A 2000 WATT LINEAR POWER AMPLIFIER FOR 10¢ A WATT!

We came through, again!

Our customers have long recognized Control Systems Research as their very best source for low cost, high performance, transistorized DC servo amplifiers. Frankly, they weren't overly surprised when we told them about this exciting new breakthrough. They've come to expect this sort of thing from CSR.

But we wanted *YOU* to know that CSR is introducing the PFM SERIES of DC servo amplifiers for high volume servo applications like tape drives, film drives, machine tool drives, and other servo motor applications. This new generation of amplifiers utilizes a unique combination of pulse width and frequency modulation techniques to achieve a linear bipolar output — at a cost of LESS THAN 10¢ PER WATT.

The new PFM SERIES of amplifiers is available in a variety of continuous voltage and current ratings from ± 60 VDC and ± 40 amps on down. We review your amplifier requirements with the aid of a computer and supply an amplifier with the exact voltage and current you require.

Our OEM customers also like the fact that the PFM SERIES operates from a unipolar, non-regulated power supply and not the old-fashioned bipolar supplies. (That's why we designed it that way.)

You might be wondering how we can get 2000 watts of continuous power out of a $3\frac{1}{8}$ x $3\frac{1}{8}$ x $1\frac{1}{2}$ module at less than 10¢/watt — especially with internal power dissipation and the like. Call us today! We'd like to tell you all about it.

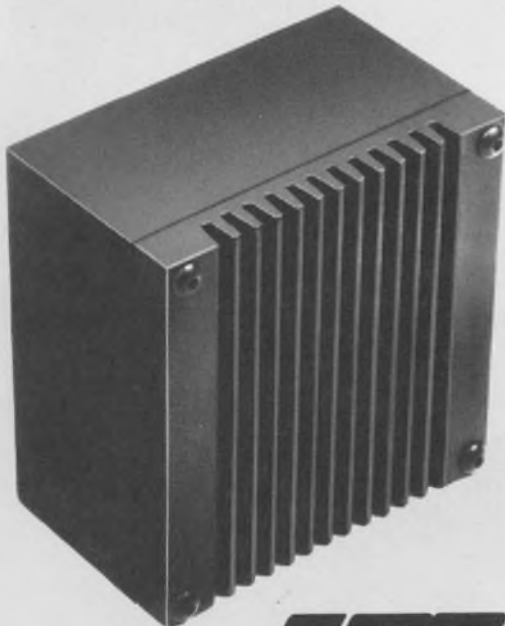

CSR

CONTROL SYSTEMS RESEARCH, INC.
1811 Main Street, Pittsburgh, Pa. 15215
412-781-1887



70SA1

INTRODUCING



The instrument that obsoletes systems.

Simple idea. But someone had to think of it first. We did. We took all the elements of a digital data acquisition system and designed them as plug-in modules. Then we put them all in a box—*one box*. Result: the system became a single instrument.

So what? Cimron's new 8000 Series Digital Data Acquisition System is the first major departure in design concept since the advent of analog-to-digital converters. This new instrument optimizes the digital system. It offers the greatest

range of inputs, speed, and recording capability obtainable—*all at a price no system can match*. Cimron's measuring instruments will meet any accuracy and resolution requirement.

Modules in the single small 50-lb box include scanners, comparators, programmers, serializers, digital clock. No cables. No redundant components. Eliminates noisy ground loop problems. The housing contains a time shared readout, common power supply, and front panel con-

trols. The DAS 8000 is easily expandable and computer compatible.

Cimron *customer concern* again brings you a new instrument for solving the most stringent and complex measurement problems at the lowest cost per channel. For details on the DAS 8000, write: Cimron, Dept. D-130, 1152 Morena, San Diego, California 92110.

CIMRON



CIMRON DIVISION

LEAR SIEGLER, INC.

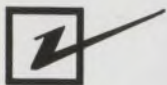

check out

ELECTRO'S New Low Cost *MINI-PROX*

**Compact Proximity Sensing System
for Non-contact, Detection and Control
of Ferrous and Nonferrous Metals**

- LOW COST
- ASSURED SENSING DISTANCE ACCURACY
- TEMPERATURE-STABLE
- NO MOVING PARTS IN ELECTRONIC OUTPUT MODEL
- PLUG-IN CONVENIENCE

MANY MONEY SAVING APPLICATIONS

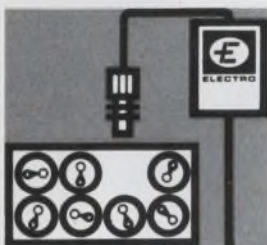

PACKAGING



COUNTING

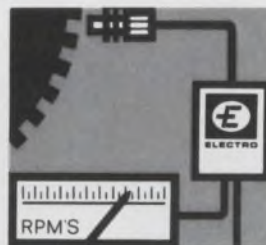

SPEED CONTROL

Conveyor Control • Cut-Off Control • Missing Parts Detection • and many others



Model 55125 Mini-Prox with
Model 41060 plug-in socket
and 4943 sensing head.



Accuracy of sensing distance is often a critical factor in sensing and control applications. Mini-Prox accuracy can be depended upon in any environment; heat to +160°F or cold to -30°F at either probe or control. Line voltage variations from 105 to 130 volts—dust—moisture—vibration, none of these affect its accuracy. You can set it and forget it.

Plug-in design provides for easy wiring. Unitized construction eliminates soldering or wiring of sensitivity controls. Connections for power, sensing head and relays are made to screw-type socket terminals. Operations up to 600 per minute may be controlled or monitored by the Model 55125 illustrated. Electronic output models for higher speeds are also available. Five standard sensing heads are presently available with sensing ranges of .050" to .250", .100" to .500", .300" to 1.000".

ELECTRO with 15 years field experience in proximity switches has designed-in reliability, assuring you of years of trouble-free performance. Compare with others of similar size and price. One look at the quality of construction tells the difference.

ELECTRO representatives are experienced in assisting with proximity switch applications. Most carry local stocks to service your requirements immediately.

Write for bulletin giving complete specifications and the name of your nearest EPL representative.



ELECTRO
PROXIMITY SWITCHES

ELECTRO PRODUCTS LABORATORIES, INC.
6125 West Howard St., Chicago, Ill. 60648 • 312/647-8744

INFORMATION RETRIEVAL NUMBER 55

Before you buy another
16 bit machine



General Automation has a new stand-alone computer for manufacturing automation

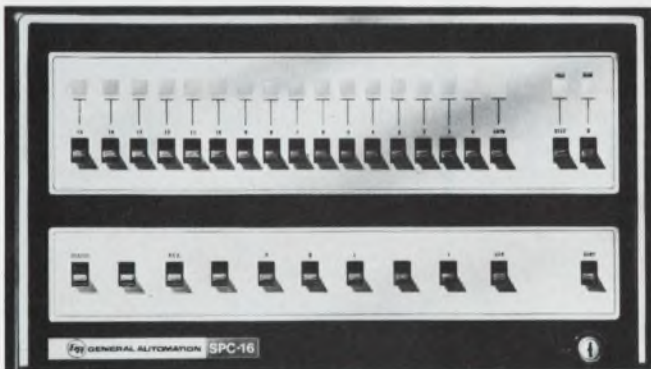

It's the SPC-16... a powerful new industrial automation computer... 960 nanoseconds fast... expandable 4K memory.

It's organized to provide for efficient handling of bits, bytes and words in read/write and macroprogramming in ROM... and ready-to-use GA productized software reduces programming time, effort and cost to a minimum.

SPC-16 gives you big computing power, accuracy, reliability and programming simplicity... and flexibility in interfacing with peripherals through the GA family of mini-controllers... and the SPC-16 is supported by expert consultation, systems engineering, programming and customer training services.

So before you buy another 16-bit machine... ask about the SPC-16 performance... Cost? Less than \$10,000.



Ask about other industrial computers in the GA family. The SPC-12 for less than \$5000. System 18/30 for under \$20,000.
GENERAL AUTOMATION, INC.
Automation Products Division
706 West Katella, Orange, Calif. 92667
(714) 633-0680, TWX 910-593-1601

CALIFORNIA
Los Altos, (415) 941-5966

TEXAS
Dallas, (214) 358-0271
Houston, (713) 774-8716

ILLINOIS
Des Plaines, (312) 298-4650
(California G.A. Corp.)

OHIO
Cleveland, (216) 351-2275

GEORGIA
Atlanta, (404) 261-6203

PENNSYLVANIA
King of Prussia, (215) 265-6525

MARYLAND
Silver Spring, (301) 593-6010

CONNECTICUT
Stamford, (203) 325-3883

MASSACHUSETTS
Waltham, (617) 899-6170

INTERNATIONAL
G. A. I.
24 Blvd. de l'Empereur
Bruxelles, Belgium

G. A. Ltd.
Wren House, Portsmouth Rd.
Esher, Surrey, Esher 65764

INFORMATION RETRIEVAL NUMBER 52

Three *new* reasons to specify

D I G I *▲* E C



Model 262

Digital Multimeter

(AC, DC, Ohms)

A .1% Multimeter for everyday usage. A necessity for design and development, production, quality control, or anywhere that DC volts and current, AC volts, and ohms are measured. Battery pack available.

\$375



Model 311

Precision Calibrator

(Voltage & current source)

A .01% precision voltage and current Calibrator that serves as a working standard. In addition, the high current capability may be used as a lab source for developing those critical circuits so essential in electronics today.

\$650



Model 691

21 Column Printer

(3 lines per second)

A Drum Printer which is expandable from 4 to 21 columns to satisfy your specific requirements. This versatile printer accepts all standard BCD inputs and provides 38 symbols along with "floating" decimal point.

starting at **\$770**

See us at booth
2E 44-46



D I G I *▲* E C

by **UNITED SYSTEMS CORPORATION**

918 Woodley Road • Dayton, Ohio 45403 • (513) 254-6251
Representatives Throughout the world

For complete specifications
request new catalog D69A

Is the 901 counter-timer just too good to be true?



Shown with optional 1.3-GHz plug-in.

NO!

It was...but it's not any more!

Last year, when we introduced the Model 901, we were years ahead of the industry. Here was the first state-of-the-art universal counter-timer that could count directly to 200 MHz without a plug-in, and—with a plug-in—could go right on counting into the gigahertz range. What's more we offered it at the unheard of low price of only \$2475—about \$250 to \$1000 below the nearest competition!

It wasn't long before we knew we had a tiger by the tail. Here was a dream instrument with all the universal counting and measuring functions built into the standard main frame...with gate times of 1 μ s to 100 sec instead of to just 10 sec...with a TIM with a resolution of 10 nsec instead of 100...with an input sensitivity of 10 mV instead of the usual 50 or 100...with 9-decade readout instead of just 8...and with remote control available as an optional extra. With all that going for us we had just one problem: how to get into volume production fast enough to meet demand.

Now cut to 1970. The industry still hasn't caught up with the Model 901, but our production has caught up with demand. You can now buy this state-of-the-art instrument *right off the shelf* for the same low price. What's more, for only \$825 extra, you can also have the Model 931 Heterodyne Converter plug-in that extends the 901 frequency range up to 1.3 GHz.

But why dream on? Why wait to catch up to the times? The 901 is a reality today. For the full facts, circle the reader service card.

COMPUTER MEASUREMENTS



A DIVISION OF NEWELL INDUSTRIES

12970 Bradley/San Fernando, Calif. 91342/(213) 367-2161/TWX 910-496-1487

INFORMATION RETRIEVAL NUMBER 54

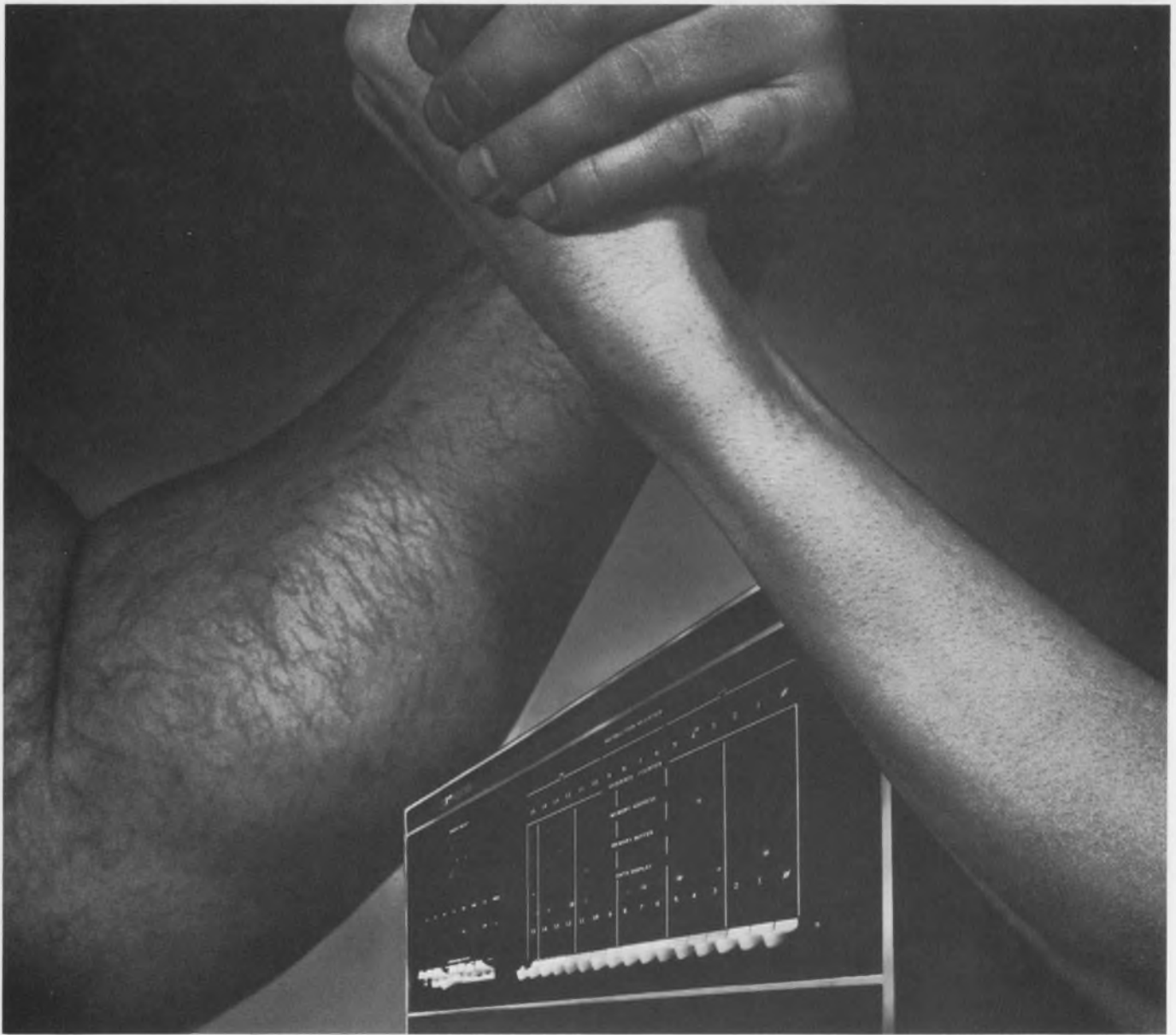

It's the second bus that separates the men from the boys in the new systems computers

The GRI-909 Direct Function Processor — leader of a new breed of powerful, systems-oriented mini-computers — is characterized by a dual, internal/external bus system. No other computer offers such a dual bus approach.

Therefore . . . no other computer can provide all these features:

- 16-bit word device-to-device transfers in a single cycle
- 16-bit word register-to-register transfers, both *internal and external* to the computer
- "On-the-fly" arithmetic operations during transfer
- Unlimited priority interrupt channels
- Unlimited direct memory access channels.

Check out these and the many other exclusive GRI-909 advantages. You'll find that nothing on the market today can touch it.



Write for the
new GRI-909
brochure.

GRI Computer Corporation

76 Rowe Street
Newton, Massachusetts 02166 — (617) 969-7346

INFORMATION RETRIEVAL NUMBER 51

gri-909
THE NEW BREED

the 2-Second Cathode

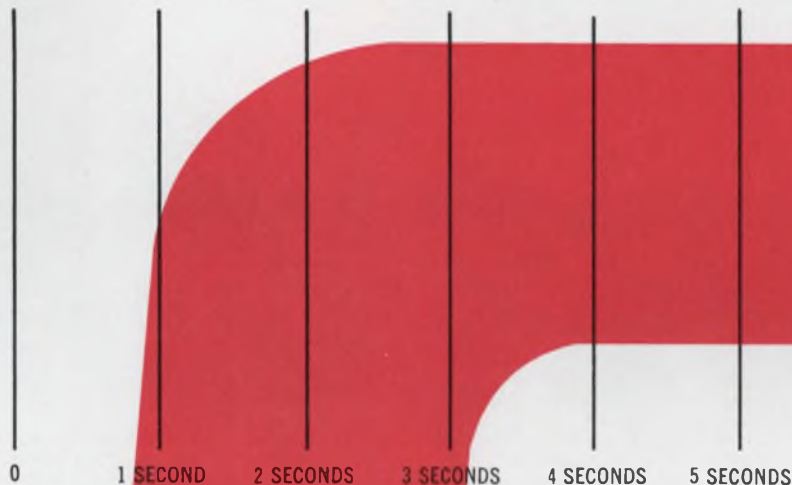

ITT's fast warm-up electron gun.

For its broad line of traveling wave tubes, ITT Electron Tube Division has developed a cathode with the fastest warm-up interval in the industry.

For any TWT that we make, you may now specify this cathode. You'll receive a tube that accommodates all your performance requirements in addition to reaching full power output temperature in TWO SECONDS.

Putting you in a unique position is putting us in a unique position. ITT Electron Tube Division, International Telephone and Telegraph Corporation, P.O. Box 100, Easton, Pa. 18042.

ELECTRON TUBE DIVISION **ITT**

Treat Your System To A Fond Memory...

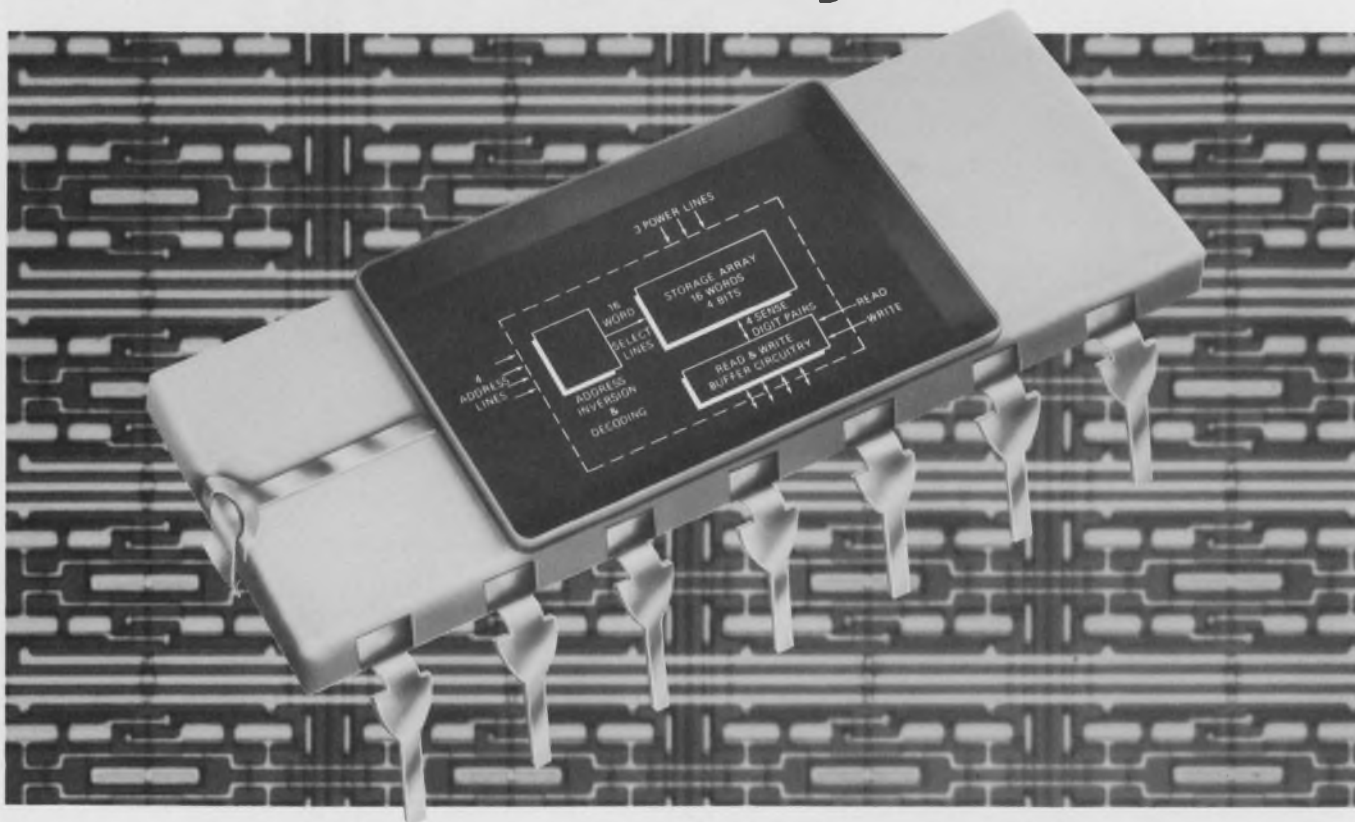

The MC1170L – Fastest MOS Memory Available

High performance and low cost neatly sum up the characteristics of Motorola's MC1170L 64-Bit MOS Random Access Memory. Designed for use in 500 ns or less access time systems, the memory is organized as 16 words of 4 bits each and features a typical access time of 250 ns. Decoding, Read, Write and Storage circuitry are all contained on the 80-mil square chip, thereby minimizing interconnection requirements and fabrication costs. And when cost is a prime consideration the MC1170's production quantity low bit cost overshadows higher 50¢/bit costs for 16-bit bipolar memories and 25-to 50¢/bit costs for magnetic memories (4,000-bit systems).

A word in the memory is addressed by applying the appropriate binary code to the four address lines. Separate read and write inputs control the mode of operation. During operation, four bit lines insert data into the memory in the write mode and sense the stored information in the read mode.

The MC1170L is flexible for expansion to larger memory systems. The binary addressing characteristic, the bit line wired OR capability and the availability of the enable input all aid in expanding the MC1170L to meet larger system requirements.

Use the MC1170L anywhere that low speeds and low data rates are required. Since the readout is nondestructive the MC1170L offers advantages over magnetostrictive delay lines. And, its comparative low-cost/high performance/small-size ratio suggests applications in digital instrumentation, miniaturized data processing equipment and advanced office machines.

Now's the time to start thinking of your system. To help you out we have a new application note (AN-501) which explains the MC1170L in detail. It's yours for the asking — just write to P.O. Box 20912, Phoenix, Arizona 85036. And for immediate evaluation units call your local Motorola distributor. Make this a day you'll remember with fond memories.

— where the priceless ingredient is care!



MOTOROLA
Integrated Circuits

INFORMATION RETRIEVAL NUMBER 57

ELECTRONIC DESIGN 6, March 15, 1970

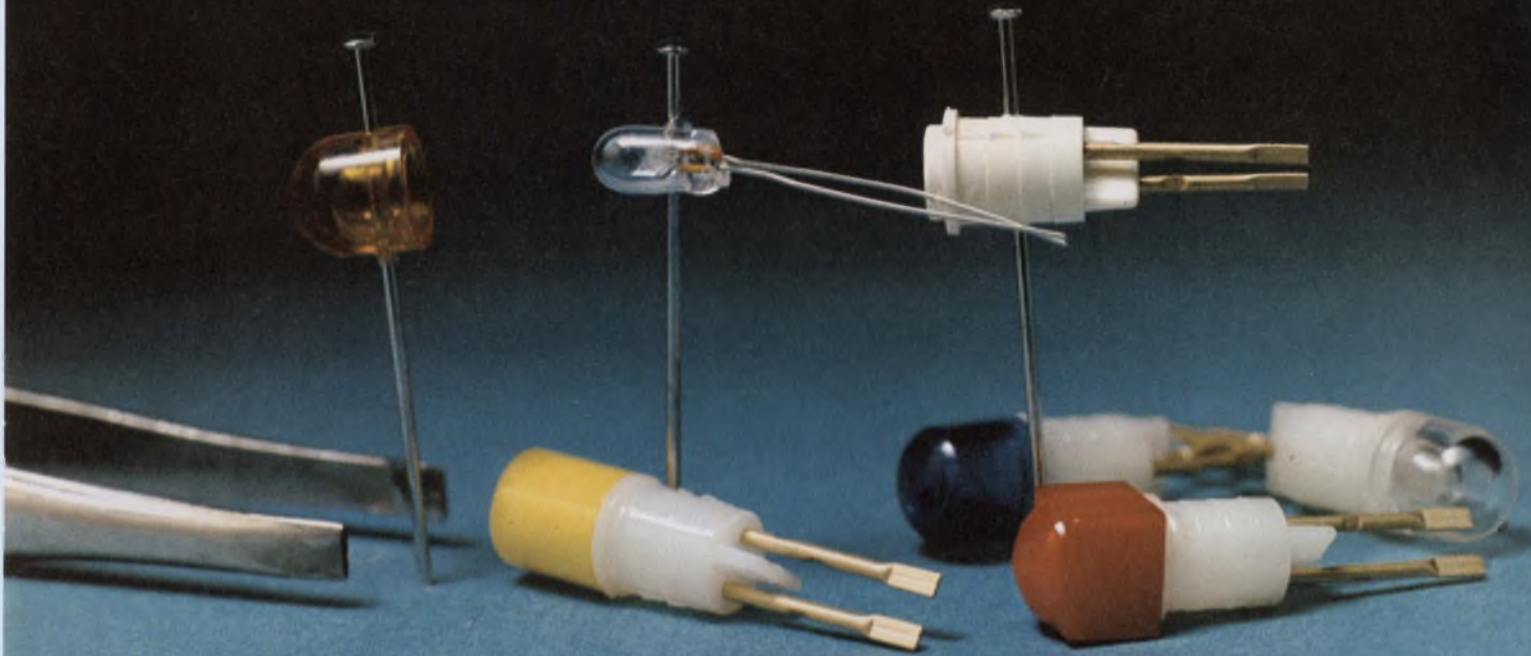

Relamping is simple with Chicago Miniature's CM-25 "Brite-Lites." No tools are required. You merely unsnap the cap and remove the unbased T-1 lamp with your fingers. Our engineers devised an ingenious way to simplify lamp insertion, too. The new lamp easily inserts into internal wire lead guides. The lead guides are indented (patent pending) to assure positive contact with the lamp leads. There's no need for lead soldering. Relamping is all done from the front of the panel, so base removal is unnecessary.

Here's another engineering exclusive close plus and minus tolerances.

Holding light tolerances improves parts interchangeability and panel appearance. Also, "Brite-Lites" are available with cylindrical caps that can be easily hot stamped with legend information.

These "Brite-Lites" mount on .250" centers and have a strong polycarbonate base with leads for panel or printed circuit wiring. You can specify any of six different cap colors in translucent or transparent types.

Our Lited Devices catalog CML-2 gives details on our complete line of quality indicator lamps, just circle the reader service number to receive your copy. Write on your company

letterhead to receive a sample "Brite-Lite" so you can dissect one yourself.

For application assistance contact your Chicago Miniature Sales Representative. For off-the-shelf delivery, contact your local authorized Chicago Miniature Electronic Distributor.



CHICAGO MINIATURE
LAMP WORKS
4433 N. Ravenswood Ave.
Chicago, Illinois 60640
(312) 784-1020

a GENERAL INSTRUMENT company

THE LIGHTING BUGS

How to dissect a lighting bug.

**Most
"miniature"
filters still
cramp your
style.**



**Not ours. They're
20% smaller.
10% more
efficient.
100% ready.**

Nowadays, most "miniature" RFI filters just aren't miniature enough.

Ours are. In A C or D C , these new Mini-Filters[™] are at least 20% smaller in volume than the ones you're using. Now that's miniature.

As for insertion loss, how does 5 to 10 more Db's sound? That's how much more these little giants suppress, despite their smaller size. And, they do it with an even lower DC resistance.

Something else. They're priced a little smaller. That's a big plus.

So quit cramping your style. Go from small filters to Mini-Filters[™]. They're 100% ready for delivery. Right now.

Make the big move.



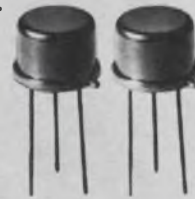

COMPONENTS DIVISION
GENISCO TECHNOLOGY CORPORATION
18435 Susana Road
Compton, California 90221
(213) 774-1850

Depend on RCA
reliability in
complementary
medium-power
transistor
pairs...



hermetically sealed for broader applications.

Now...RCA covers the industrial  spectrum with general-

purpose, p-n-p/n-p-n  transistor complements...and they're all hermet-

ically sealed in TO-5 packaging to give you greater design flexibility and

reliability. Choose any of these broad-spectrum device families – the  p-n-p



2N5781, 2N5782, 2N5783, or the n-p-n 2N5784, 2N5785 and 2N5786.

They can fit a host of switching and amplifier  applications – in com-

puters, for example, as well as in oscilloscopes, radar, missiles, hi-fi equipment,

marine radios and satellite  communications systems. RCA silicon p-n-p

and n-p-n medium-power transistors all feature low saturation voltages, high

breakdown voltages and high h_{FE} (min.) at  high current. And they're

beta controlled to 1.6 A, with collector-to-emitter sustaining voltages (V_{CE}) up

to 80 V available. V_{CE} (sat.) is 1.0 V max. at 1.6 A. For complete  details,

see your local RCA representative or your RCA distributor, or write RCA Elec-

tronic Components,  Commercial Engineering, Section IG3-2/UT5, Harri-

son, N.J. 07029. In Europe: RCA International Marketing S.A., 2-4 rue du Lièvre,

1227 Geneva, Switzerland.

RCA

INFORMATION RETRIEVAL NUMBER 60

Even in power supplies, somebody makes progress once in a while. This is the new NIMS high voltage power supply.

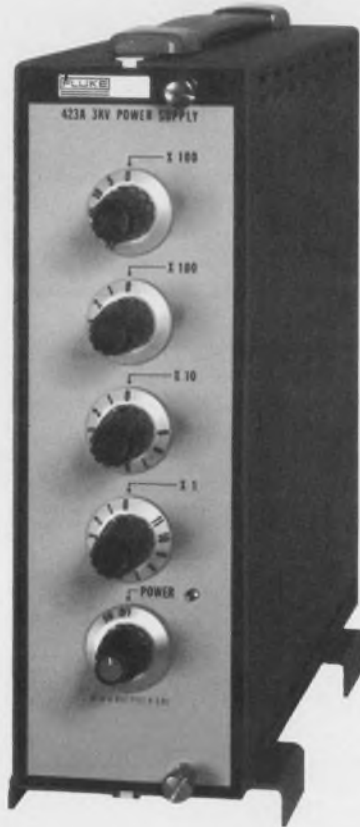

It's a Fluke.

Fluke's new NIMS (nuclear instrument module system) high voltage power supply is priced about the same as the three major competitors, \$460. That's where the similarity ends.

In every other pertinent spec, the new Fluke 423A exceeds or at the very least meets the competition. And, in addition, it offers some exclusive features all its own. Let's go down the list. Only Fluke offers a full 0 to 3000 volts, line and load regulation of 0.001 and 0.002 percent across the board. Only Fluke offers portable bench case or NIMS bin module. Only Fluke offers remote analog slewing of the output or manual operation. Only Fluke offers a current limit of 15 ma. Other specifications are output current, 0 to 10 ma, Resolution, 100 mv. Accuracy, 0.25%. Ripple and noise, 5 mv peak-to-peak (10 Hz to 1 Mhz). Polarity is reversible at the rear panel. Size is 2.7" x 8.7" x 9.7". Price with case is \$495.

For full details, see your Fluke sales engineers or contact us directly.



Fluke, Box 7428, Seattle, Washington 98133. Phone: (206) 774-2211.
TWX: 910-449-2850. In Europe, address Fluke Nederland (N.V.), P.O. Box 5053,
Tilburg, Holland. Phone: (04250) 70130. Telex: 884-50237. In the U.K., address
Fluke International Corp., Garnett Close, Watford, WD2 4TT.
Phone: Watford, 27769. Telex: 934583.

See us at IEEE 2C02-2C04

INFORMATION RETRIEVAL NUMBER 61

Pick of the Crop!



Brand New - The NLS Series MX-2 Multimeter

This is a *PEACH* of a buy. The MX-2 combines multifunction capability with the integrating technique of A/D conversion in a low-cost, versatile, accurate unit with stability unequalled in low-cost digital meters. And you receive all of this without sacrificing the quality feature of plug-in construction. The MX-2 affords 5 DC Ranges, 4 AC Ranges, 5 Ohms Ranges, Auto Ranging and Polarity and Print-out, all at a price so low you'll want to buy a *PEAR*

of them. Send for our brochure which graphically compares the MX-2 to other low-cost 4-digit Multimeters in a factual, easy-to-understand manner. Non-Linear Systems, Inc., P.O. Box N, Del Mar, Calif. 92014, 714/755-1134. TWX 910/322-1132.



NON-LINEAR SYSTEMS, INC.
DEL MAR, CALIFORNIA

Making speed/cost trade-offs in conversion equipment? With Raytheon Computer, you can have it both ways.

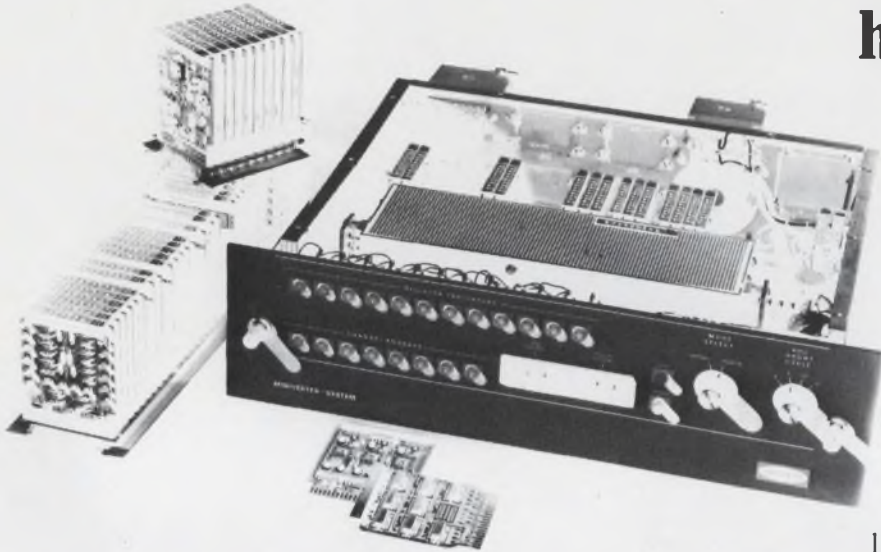

Analog/digital interfaces and conversion can end up costing you more than any other portion of your system.

So we've come up with a system of our own. Instant conversion in a range of prices and performance levels. All with the best price/performance ratio in the industry.

For analog-to-digital conversion, \$1,220 buys you our 10-bit A-to-D converter and a 50kHz word rate. \$1,790 buys our 12-bit high-speed 100kHz Miniverter™. \$4,095 gets our 100kHz, 15-bit Multiverter® III. Each of these analog-to-digital converters has 8 multiplexed channels (expandable to 128) and a short-cycle control for even higher through-puts with shorter words.

And every converter is fully-wired, fully-tested and fully documented with wiring

lists, test results and technical manuals. You get a complete instrument, not just a collection of cards.

The same story holds for our other conversion and interface equipment. DAC's. Multiplexers. Sample-and-holds.

Or even complete computerized systems. We have a family of 16-bit computers that let you make your trade-offs working with a choice of CPU's that range in cycle times from 900ns to 1.75μs and in price from under \$10,000 to \$19,000. And we'll get you on-line faster than anyone else because we have over 400 debugged proven programs available off-the-shelf.

Like we said, we'll give you the best price/performance ratio in the industry. If that's what your systems need, call or write today. Ask for Data File CB-180.

Raytheon Computer, 2700
S. Fairview St., Santa Ana,
Calif. 92704. Phone 714/
546-7160.



The only thing Raytheon Computer does is your job. Better.

If you don't see what you want here



just ask.

Johanson Manufacturing Corporation
Rockaway Valley Road, Boonton, N.J. 07005

Sketch Circuit Application:

Specifications Required:

Capacitance _____

Q @ 100 MHz _____

Temperature Coefficient _____

Voltage _____

ΔC VS Rotation _____

Operating Temperature Range _____

Type of Application _____

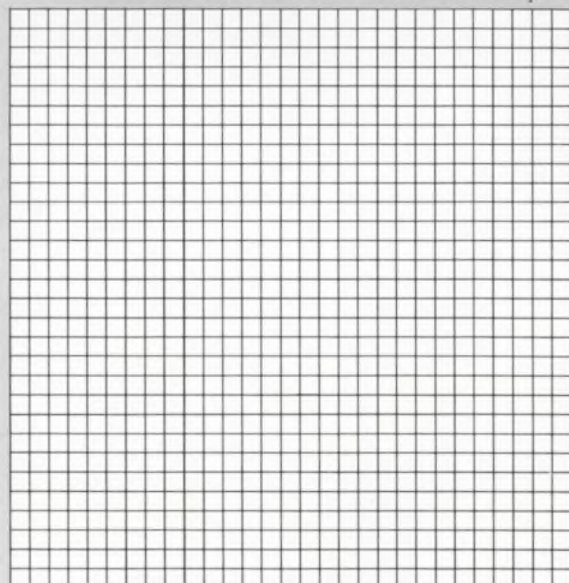

Send today for our catalog on the new 5200 series. It gives important information on Microwave applications.

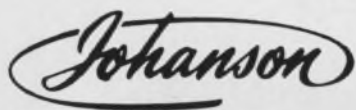

Johanson Manufacturing Corporation
Rockaway Valley Road, Boonton, N. J. 07005 • (201) 334-2676
Electronic Accuracy Through Mechanical Precision

Room for improvement

General Electric's TO-5² transistor-size sealed relays give you more room for increased power, improved performance

We didn't cut any corners on this high-reliability, transistor-size sealed relay. We left them on so there'd be more room for a more powerful magnet—2½ times more powerful.

This added power means this type 3SBS, 2PDT, 1 amp relay gives you higher contact forces, larger contact gaps, and greater overtravel to minimize mechanical shifts. Shifts which usually increase early-in-life failures.

Though there's more room inside to give you all these advantages, the outside dimensions—top-to-bottom (.275") and side-to-side (.370")—are the same as any transistor-size relay.

So don't cut corners on your next transistor-size relay application. Specify GE's square Type 3SBS. For full details, write General Electric, Section 792-45, Schenectady, New York 12305.



GENERAL  **ELECTRIC**

INFORMATION RETRIEVAL NUMBER 68

NCR, Los Angeles, is the largest, fastest-moving commercial computer manufacturing facility in Southern California and one of the most advanced in the world. Here, you can share new fourth-generation challenges with men who have already placed some of the world's most advanced digital systems hardware and software on the market

NOT SOMEDAY NOW

—people who have pioneered high-speed thin-film technology, advanced disc memories, monolithic integrated circuitry and automatic production techniques. NCR means business in 121 countries. The NCR Electronics Division can mean a non-stop, non-defense, no-limit future for you today.



MAGNETIC HEAD DESIGN ENGINEERS

To design and develop flying magnetic recording heads and the required prototype tooling. Positions require BS or MS in EE, ME or physics plus three years of applicable experience. Knowledge of ferrite machining technology and ferrite heads desirable.

ADVANCED DEVELOPMENT ENGINEERS

Positions available for senior MECHANICAL and ELECTRONIC engineers with strong experience in high-speed mechanisms and mechanical, hydraulic and electromechanical systems.

LOGIC DESIGN ENGINEERS

Senior-level positions in logic design for persons with knowledge in MSI and LSI circuitry for fourth-generation computer systems. Also positions in manufacturing engineering for digital test equipment design. Positions require BSME/BSEE and five years' related experience.

CIRCUIT DESIGN ENGINEERS

For design and development of LSI circuitry arrays, including detailed circuit design and extending through integrated fabrication. Will also evaluate LSI packaging con-

BROAD-HORIZON, PRESENT-TENSE, NON-DEFENSE, NON-STOP ENGINEERING AND PROGRAMMING OPPORTUNITIES AT NCR, SOUTHERN CALIFORNIA

cepts and interface with semiconductor vendors. Prefer BSEE and several years of related experience.

SYSTEMS ANALYST ENGINEERS

Junior and senior level positions available for ENGINEERS, ANALYSTS and PROGRAMMERS who have several years' experience in any of the following areas:

Systems analysis and evaluation of business systems. Selected applicants will determine and participate in the establishment of either small processor systems or a large multi-processing system.

Study and development of on-line systems in business data communication environment.

Evaluation of multi-programming, multi-processor time sharing systems using simulation techniques.

SOFTWARE PROGRAMMERS

To design, code, de-bug and document operating systems software or on-line executive software modules. Prefer degree in business or a science discipline and/or experience in systems programming.

DIAGNOSTIC PROGRAMMERS

Positions involve the writing of diagnostic programs for checkout, acceptance test, file maintenance of EDP systems. Requires previous programming experience.

NOW INTERVIEWING

Positions are open at NCR Los Angeles and San Diego facilities. To schedule an interview during the IEEE International Convention in New York City, March 21-24, contact Steve Williams at the New York Hilton Hotel or send resume, including salary history, to the address below.

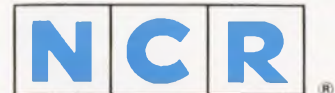

The National Cash Register Company
ELECTRONICS DIVISION
2817 West El Segundo Boulevard,
Hawthorne, California 90250
An equal-opportunity employer

INFORMATION RETRIEVAL NUMBER 903





Tom Daly



YOU CAN'T KEEP A GOOD BUTTERFLY DOWN.

Many years ago, (before cyclamates or even The Pill), the little Licon people tried to invent a completely new kind of switch. It was to be a double-break switch no bigger than a single-break. Oh boy.

But seriously, this meant a lot to them. They wanted a switch with a life expectancy of over 20 million mechanical cycles without alteration of original switch characteristics. Two transfer blades instead of one. And twice as many contact surfaces. Generally speaking, that's double the electrical rating of a single-break switch of equal size. (If you're impressed by this, read on. If not, read on anyway, there's only a little left.)

As the months passed, the Licon people worked on. And off. Until it finally happened—the Butterfly action double-break switch was born. Hallelujah! Yippee! Hurrah! Etc.!

Since it did everything it was supposed to, and according to the custom of the land, those smart little people had it patented. And in no time the Butterfly became a giant among switches. It sort of took off on its own.

To this very day, the Licon people continue to produce the fabulous Butterfly switch. In sizes from sub-subminiature to heavy duty. So, when your children ask you where the Butterfly switch comes from, you can tell them this story. Then again, you might be better off telling them you don't know.

Better yet, tell them to write for a catalog. CIRCLE NO. 65



Licon Division
Illinois Tool Works Inc.
6615 W. Irving Park Road
Chicago, Illinois 60634



**IEEE
USA**

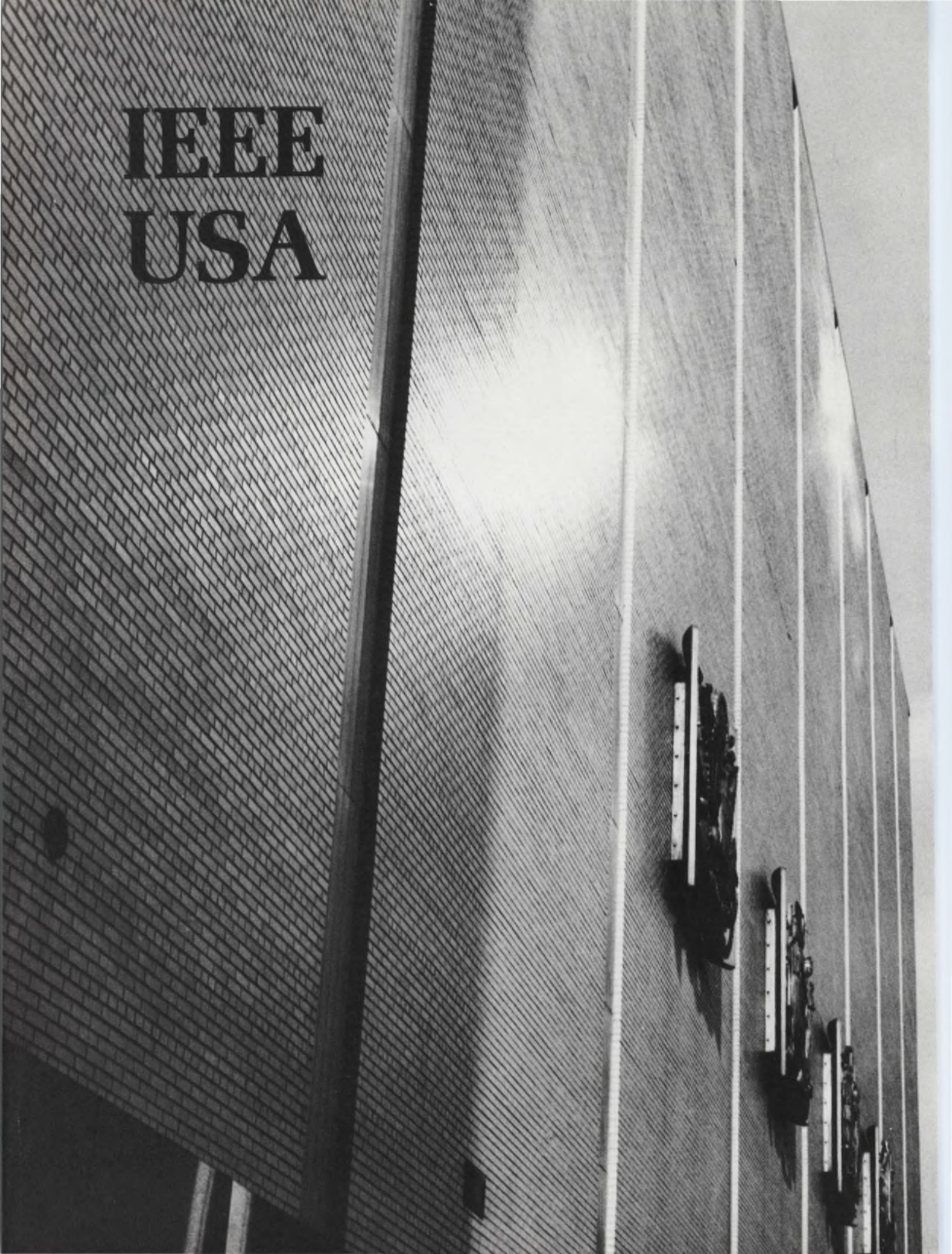

A new show helps launch 'The Spectacular 70s'

A new decade . . . new hopes for the most revolutionary industry in America—electronics. The IEEE International Convention and Exhibition has its sights on target: "Launching the Spectacular 70s in Electrical and Electronics Engineering" is its theme this year. And the emphasis is again on peaceful uses of electronics, only more so—computer techniques in urban government, community antenna television, air and ground traffic control, medical aids for the handicapped, and air and water pollution control.

There are more technical sessions this year—62 in all. Seven are special "how-to-do-it" sessions, dealing with the techniques that experts in the field are using to solve everyday design problems.

In addition, for engineers interested in expanding their education, tutorial seminars are

being held on computers and patient care, programming for industrial-process computers, digital filter design and application, the use of quantum electronics today, monolithic integrated circuits, LSI.

More than 60,000 engineers are expected to attend the show March 23-26. Over 600 companies are displaying products in the four-story Coliseum in midtown New York. The exhibitors include representatives of Japan's booming electronics industry. The new Japanese emphasis is on quality—and the products show it.

But before you join the bustling traffic in the aisles, relax. Take the short tour with **ELECTRONIC DESIGN**—here, right in these pages. You'll get a fast, authoritative look at the highlights without footsore fatigue. The tour starts below:

| | |
|---|------|
| Design trends in major engineering areas, as reflected in the technical papers | U86 |
| Circuits | U86 |
| Communications | U87 |
| Computers | U89 |
| Medical | U92 |
| Microcircuits | U93 |
| Microwaves | U97 |
| Urban Technology | U100 |
| Complete guide to technical papers listed by engineering subject | U110 |

| | |
|---|------|
| Touring the exhibit areas | U130 |
| Outstanding new products | |
| Modules & Subassemblies | U132 |
| Data Processing | U138 |
| Instrumentation | U140 |
| ICs & Semiconductors | U146 |
| Components | U148 |
| Microwaves & Lasers | U152 |
| Packaging & Materials | U158 |
| Tools & Engineering Aids | U159 |
| "Made in Japan"—today it's a sign of quality | U161 |

Technology: Present and future

IEEE convention papers tackle the problems and promises of electronic designing and application

Circuits

Gigabit technology picking up speed

Speed and packaging-density improvements are helping gigabit digital circuits toward wider acceptance among design engineers. Increased speed, in particular, is welcomed by users. It allows real-time processing of very-high frequency signals, important to military applications. And in price-sensitive situations, such as large computer facilities, high speed cuts the cost of each computation.

These and other developments in gigabit digital circuits are discussed in Session 5C. The session chairman, Wayne Cotten, an electronic engineer with the National Security Agency in Fort Meade, Md., explains that gigabit digital circuits are finding major applications in two categories: high-speed signal processing and large-capacity computers. He has selected several technical presentations to demonstrate the circuit advantages over what he terms "mainstream technology."

Cooling trade-off analyzed

Examining digital-circuit packaging and layout, with emphasis on thermal considerations, William Rhoades, senior staff engineer with Hughes Aircraft, Fullerton, Calif., says cooling in high-density circuits calls for a trade-off with speed. Efficient cooling requires considerable physical space, thus increasing the circuit dimensions and slowing performance. On the other hand, fast circuitry dissipates the most heat per unit area and thereby needs a superior cooling system to operate reliably. Rhoades concludes in a paper, "Packaging Aspects of Gigabit Digital Circuits," that with continuing demands for increased digital circuit speed, packaging design will become the chief limiting factor.

Efficient cooling capable of dissipating greater than 20 W per square inch is now possible, he says. His design utilizes a closed system where liquid coolant is first vaporized and then permitted to condense while dissipating heat. The system is maintenance-free, using no pumps or moving parts.

A breakthrough in measuring

From Yohan Cho, president, and John Connolly, vice president, of Tau-Tron, Lowell, Mass., comes a breakthrough in rapid MSI and LSI measurements. Their talk, "Ultra High-Speed Digital Array Testing," outlines a new computer-controlled method that allows exhaustive tests of a 100-pin integrated circuit in a few microseconds. Cho says that other schemes using computers for digital-circuit testing have a built-in delay, because the control and pattern-generation functions are combined. By providing separation of computer control and pattern generation, Cho reports his system accomplishes in microseconds what other equipment needs weeks to perform.

Emery Garth, a member of the technical staff at Texas Instruments, presents interconnection and packaging methods for obtaining high-gate density. Garth has developed packaging advances that allow gate densities that are five times greater than competitive processes. Excellent power dissipation is maintained throughout the improved circuitry.

In his paper, "Interconnection of ECL Circuits for Maximum Gate Density," Garth includes computer-aided design techniques for building high-speed systems. Beginning with a logic design input, the computer-aided capability described by Garth is said to produce art work for the construction of printed-circuit boards. Cost and time savings are realized by eliminating drafting.

Tips on getting fast switching

Feedback current switching circuits, utilizing low threshold voltages to obtain fast switching,



Peering into his upconverter is A. H. Firester of RCA, Princeton, N.J. The device is used to convert infrared

images to visible images. The red streak is an infrared laser beam (Session 1A).

are discussed by Leonard Weiss, advisory engineer, and Keith Mathews, senior associate engineer, both with International Business Machines, Poughkeepsie, N.Y. Their two-part talk, "Feedback Current Switching Circuits," explains negative-feedback circuit theory and then presents practical applications plus schematics. The advantages claimed for this feedback system include subnanosecond speed, tolerance to ac noise signals and increased output capacity for driving mechanical devices.

High-speed converters are discussed by Robert Cotton, Robert Vernot and Joseph Frangipane, members of the technical staff at Philco-Ford, Willow Grove, Pa. Their presentation, "A/D and Multiplexers for Hundreds of Megabits," contains a brief background on a/d converters leading to implementation philosophy and a look at state-of-the-art developments.

Techniques based on State-Variable and Scattering-Parameter formulations have had considerable impact on device, circuit and system design. Session 8D offers the design engineer a chance to review these techniques and use them effectively. ■■

Communications

A new era beckons systems developers

The communications emphasis at this year's IEEE show is definitely on systems concepts—the major trends that are expected to dominate the communications field for the next decade—not on neat solutions to specific little problems. The problems and the future of satellites, cable, waveguide, laser beams and terrestrial radio are treated at separate sessions.

Also being given close scrutiny is the union of the computer and communications. On the one hand, the communication system is a tool that provides a data link between two or more computers. On the other, the computer is a component in a communications system, where it may perform functions as diverse as signal processing and message or circuit switching.

A third, increasingly important, area being covered is electromagnetic compatibility (EMC). The current art and future needs—both military and commercial—are being discussed.

The satellite story

It's estimated that at its present rate of growth, the volume of mail handled by the U.S. Post Office will be so large by the end of this decade that the nation's labor force will be unable to distribute it if today's methods are employed. Problems like this are stimulating great interest in broadband transmission systems, being covered in Sessions 1B, 2B and 3B.

Session 1B, "Satellite Communications for the 70s," will attempt to project current technology over the next 10 years. The technology is expected to have two major effects: It will change the nature of existing services, and it will make new services possible. Existing services, which consist almost exclusively of international telephone communications, will be called upon to handle increasing amounts of data and other traffic, such as TV and telemail. Also, time-division, multiple-access schemes will begin to replace frequency-division, making possible very flexible demand assignment methods of operation. Spot-beam antennas will further improve the flexibility and capacity of future satellite systems.

Among the new services that will become available will be direct broadcast—from a satellite to, say, a home TV receiver—and data relay.

All of these developments are technologically feasible and may become operational in the next decade. Whether they are actually implemented or not will depend upon a variety of technical and economic tradeoffs, the discussion of which should make Session 1B an important one for systems planners, Government officials and communications systems designers.

The 'wired city' concept

Just as satellites can solve a wide variety of long-distance communications problems, cable systems can deal effectively with the perhaps more challenging short-haul cases. Session 2B, "A Broadband Communications Network of the Next Decade—Cable Television," describes what can be done with cables and examines the tradeoffs involved in using cables to provide services that are now supplied by other means.

The "wired city" concept envisions use of a single broadband cable for all of a subscriber's communications needs in the nation's urban areas. Hundreds of educational and instructional TV channels would be available simultaneously over such a system, in addition to regular off-



Picturephone developed by the Bell System can be used to transmit drawings or charts (Session 5B).

the-air TV, electronic mail delivery, data transmission, and other broadband services. Furthermore, there's no reason why a cable-equipped home or office couldn't use its cable for information retrieval, thus effectively putting an entire library at the user's fingertips.

Satellite systems designers may be particularly interested in a paper by Q. B. McClannan and G. P. Herkert of Philco-Ford Corp., Palo Alto, Calif. Entitled "Use of Satellites for CATV," it examines the rather unusual tradeoffs that come up when a satellite is used to feed a group of CATV networks. Existing satellite systems involve only a small number of earth stations, and so the system designers have been freed to specify fairly expensive and sophisticated ground equipment (85-foot antennas, cryogenically cooled receivers, etc.) to make the satellite as simple and reliable as possible. Direct-broadcast satellites go to the opposite extreme; they involve millions of receivers, and hence must keep receiver cost down, even at the expense of tremendously powerful satellites. The CATV case falls in between, and it should be interesting to see how the tradeoffs work out for that application.

Session 3B, "Millimeter Wave and Optical Systems: Superhighways for Telecommunications," describes not only the capabilities of these systems but the manufacturing and installation problems as well. Since the millimeter-wave transmission art has advanced farther than the

optical, it gets most of the detailed attention. Only one paper out of the four—"Optical Transmission Research," by R. Kompfner of Bell Telephone Laboratories, Holmdel, N.J.—deals with optical systems. The paper describes the three approaches to optical transmission that are currently receiving the most attention, mentions their huge potential capacity and compares the present state of their development with that of millimeter-wave systems.

"The Digital Mating Call of Computers and Communications" (Session 6B) is a panel session that aims to focus on the problems that need solving in this area over the next five years. The panelists include representatives of the users of computer communications, suppliers of communications services and the Government.

The use of computers to process analog signals is covered in Session 4B, "Digital Processing of Analog Signals." Two papers are devoted to digital filtering.

The compatibility problem

Electromagnetic compatibility has been growing steadily in importance as the spectrum has become more crowded and electronic systems more complex. Session 4D, "Progress in the Electromagnetic Compatibility Field," is not aimed especially at communications systems designers, but it offers them so much that it cannot be passed up. Some papers describe what needs to be done in EMC in the future, and others suggest the methods for doing it.

A particularly valuable paper on methodology is "Intrasystems Compatibility in Large Aerospace Systems," by Jim Spagon of TRW Systems, Redondo Beach, Calif. It presents a philosophy of design that will probably become universal in the future: the systematic consideration of EMC problems at the beginning of any complex design project.

With this approach, the system is first modeled with such available data as pulse rise times, power levels, receptor susceptibility and the like. Then a computer program is employed to determine the subsystem specification limits that will give the whole system a comfortable operating margin, without over-designing everything. The computer can also help in the selection of critical test points and in the design of cabling.

This approach is not pie in the sky, Spagon points out. It works. The computer program was used during the Apollo program to study potential EMC problems between the lunar module and the command service module in their docked configuration. With the computer-aided approach, NASA saved quite a bit of time and money.

The problems, both legal and technical, of "electromagnetic pollution" are also covered in

Session 4D. Herman Garlan of the Federal Communications Commission is presenting a paper on "Recent Legislation and Future Requirements of the FCC and Industry in EMC." It offers designers a chance to sample the Government's thinking in this area. ■■

Computers

'Cities are the growth industry of the future'

"There are opportunities for engineers in urban government."

So says Dr. E. S. Savas, New York City's First Deputy Administrator who is chairman of Session 1C, "Computer Techniques in Urban Management." This session and 7F, "Trends in Computer Applications for the 70s," deal with some of the social problems facing this country—problems that are opening up new challenges for engineers.

The emphasis of Session 1C, according to Dr. Savas, "is to lay the groundwork for future, more glamorous applications." He says: "Lots of fundamental good stuff has to be done to avoid getting into technological disasters as we reach for more complex systems. It is mandatory that significant upgrading and modernization take place in the cities. Cities are the growth industry of the future."

Richard Golden, Acting Director of Data Processing for the city of Chicago, is presenting "The Chicago Story," a discussion of how Chicago is making use of computers and electronic data processing. This presentation and one by Harry Lipton, Manager of Computer System Planning in the Office of the Mayor, New York City, describe the use of computers and data communications in police and fire departments.

Dispatching problems involved

Automated communication and dispatching are vital to police and fire services. A problem of particular interest arises in Fire Departments in large cities. When a fire company answers an alarm, it leaves behind an empty firehouse. If no plans are made for redeployment of other companies, its local area is unprotected. A scheme must be established to assign priorities to other companies to cover for those that are answering alarms. A computer-controlled program for performing this function can provide more efficient coverage and greater protection.

It is problems like these, which are solved

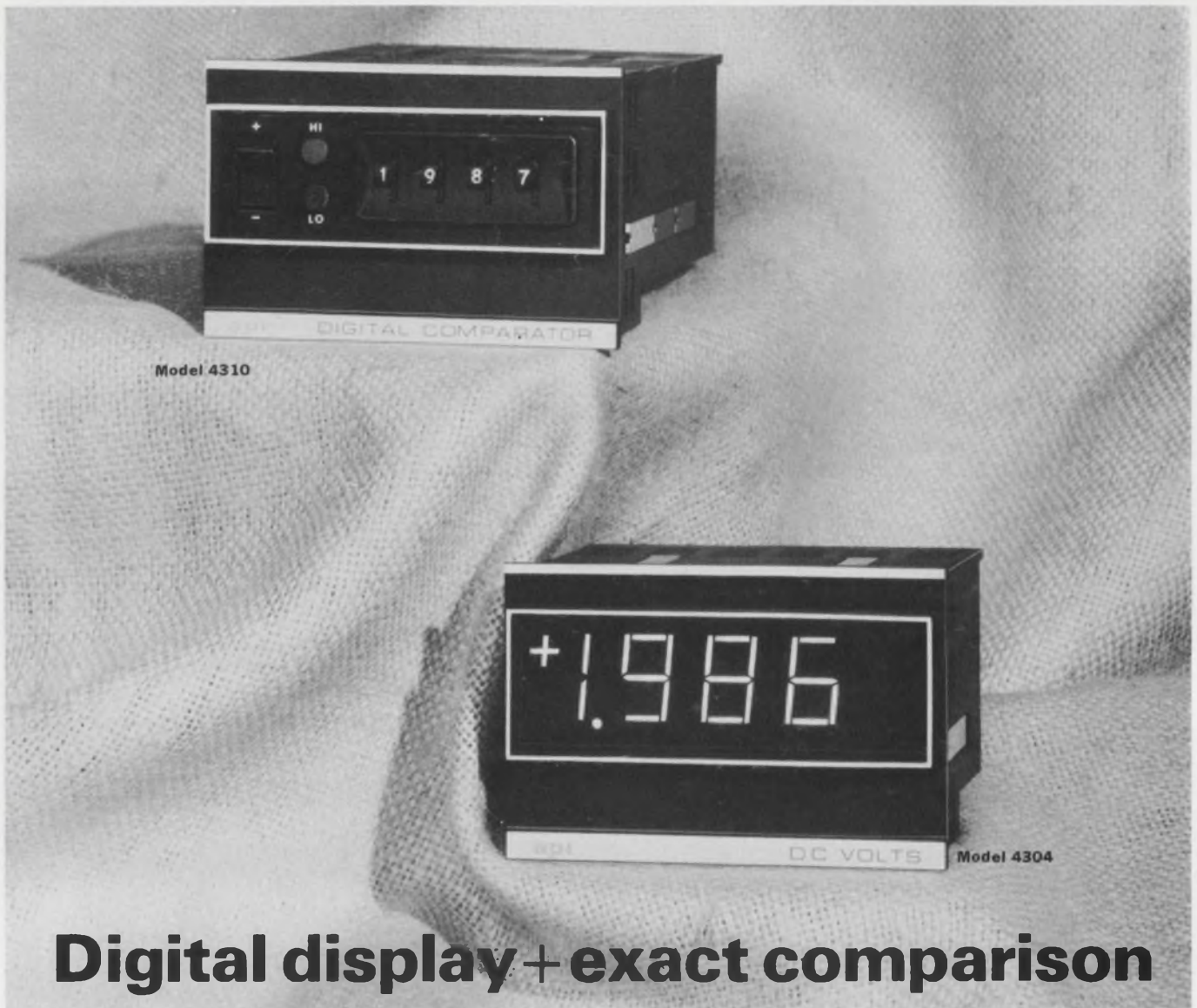

Model 4310

Model 4304

Digital display + exact comparison ...a new team from API

API now teams award-winning digital panel meters with matching digital comparators to bring you large up front display and precise limit control, plus the other quality features you expect in fine digital instruments.

Digital panel meter

Model 4304—Range: 0-199.9 mV to 0-1000 V. Price \$245.

Standard features: • autopolarity • 0.1% accuracy • BCD output • dual slope integration • selectable decimal points • separable power supply

Digital comparator

Model 4310—Four-digit. Price: \$165.

Standard features: • BCD input 1-2-4-8 • algebraic comparison • logic output • 2 amp relay contact • visual lamp indicator • adjustable thumbwheel limit • fixed limit • remote programming

For the full story on what's new in digital instrumentation, ask for *API Digital Products Data*.

IEEE Booth Nos. 2G34-36



For low-cost multi-decade displays, API offers 7-bar segmented displays with counter, storage and decoder-driver. Mounting hardware available.

api

INSTRUMENTS CO.

Chesterland, Ohio 44026 • (216) 729-1611

readily by an engineering approach, that may attract engineers to urban government. Both Golden and Lipton hope to develop interest among their listeners for such service.

Session 7F carries on the theme of computer solutions to current problems. Organized by Harold G. Plant, a supervisor with RCA, Inc., Cherry Hill, N.J., and led by J. N. DiMarino, also of RCA, the papers in this session include "The Evolution of Medical Computing," by M. Kessler of the Hospital-Shared Computer Center, Towson, Md., and "Trends in Transportation Computer Applications," by William P. Ollman of the Chicago and Northwestern Railway, Chicago.

The minicomputer dissected

"The Minicomputer Phenomenon" is the title of Session 5G, with L. C. Hobbs of Hobbs Associates, Inc., Corona del Mar, Calif., the organizer and chairman. The minicomputer is a small computer with a very small price tag. The availability of main frames with 8-to-16-bit words and 4k and up words of memory can do a wide variety of jobs that is not being done well or at all at present. Among the problems encountered in applying minicomputers, however, is that of interface with other equipment.

In a paper entitled "Peripheral Equipments for Minicomputers," Larry W. Vincent of Lockheed Electronics Corp., Los Angeles, discusses the problems of input-output interface standards, the place of the minicomputer in data terminals of larger systems, its role as a black box in control systems and the rapid loading of programs.

The organization of the internal structure of a computer determines how well it operates in a given environment. This internal structure is designed into the machine by its manufacturer. And in "Systems Architecture for Minicomputers," by G. C. Hendrie of Honeywell, Inc., Framingham, Mass., the internal structure of various minicomputers is contrasted with input-output and peripheral connection and addressing schemes, particularly for machines with short word lengths. Hendrie also discusses methods for dynamic relocation of programs and the protection of memory, both of which are important when multi-programming techniques are used.

Panel discussions planned

Several topics of interest to computer-oriented engineers are the subjects of panel discussions. Session 6G, "Prospects for Time Sharing in the 70s," probes an industry that is now undergoing serious stresses resulting from a cost squeeze. The topics to be placed before the panelists include software applications, language services, interaction with large data structures and the

handling of remote batch processing. In addition development of remote terminals and standards for interactive terminals will be considered. T. D. Truitt of Prime Information, Inc., Princeton, N.J., is the organizer and chairman of this session, and the panelists represent time-sharing services and their users.

Session 4R addresses itself to "System Engineering—How Can We Use It Effectively?" The panel moderator is Dr. Robert A. Frosch, Assistant Secretary of the Navy for Research and Development, who has gone on record as a critic of the way in which systems engineering is being applied. He has written that systems management techniques are no substitute for good management practices and that a mystique has grown up around the systems approach that credits it



Automotive systems are designed by computer-aided design techniques at Ford Motor Co.'s Dearborn, Mich., plant (Session 4G).

with more than it can deliver.

Joining Frosch as members of the panel are Dr. Eugene Fubini, a consultant of New Canaan, Conn.; Harold Chestnut of General Electric Co., Schenectady, N. Y.; R. E. Donohue, an R&E specialist with the Dept. of Defense, and J. A. Baird of Bell Telephone Laboratories, Holmdel, N.J.

Many significant questions are being addressed to the panel. Among them: "Why are we faced with accelerating costs and system inadequacies in transportation, communication, weapons, education, health services and other areas while our environment has become increasingly more polluted?" The panel will try to answer the over-all question by considering more specific areas, such as: When should systems engineering be used? How should the computer be used? What can be done to improve existing systems? Is military

systems experience transferable to civilian systems? This discussion could be a highlight of the convention. ■■

Medical

Designers still grope for efficient 'limbs'

Microminiaturization, hydraulic logic systems, portable computers, microminiature electrodes—all aspects of control systems and electronics technology have been brought together. But designers still haven't satisfactorily solved the problem of how an artificial arm and hand are to pick up a glass of water.

This is the theme of Session 2D: "Augmentation for the Severely Handicapped—Mental, Sensory, and Motor." Leon Harmon of Bell Telephone Laboratories, Murray Hill, N.J., chairman and organizer of this session, points out that even the simplest things that people do, think or perceive involve a highly complicated natural system.

The trend in this area, so far as electronics is concerned, lies not in techniques but more in the development of design systems, such as pattern recognition and computer control.

'Understanding the relationship'

The solution to aiding the severely handicapped, says Harmon, "lies in understanding the relationship between physiology and psychophysics." He gives this example:

"From the fingertip to the shoulder, there is something of the order of 40 to 50 degrees of freedom. The best artificial limb systems so far have only two or three degrees of freedom."

Harmon says an artificial-limb system—articulated in every joint, with each joint able to rotate—could be built but for these reasons:

- Failure to produce electromechanical devices that are both small enough and able to operate with the same degree of precision as a natural system.

- Lack of insight into how to go about making the multiple-control signal network required to drive as many as 30 different signals simultaneously and in coordination.

The best that has been done so far, Harmon says, is to implant tiny electrodes in muscle stumps, so that when a person thinks about moving, a detector can pick up a signal from the brain to whatever residue of muscle is left. Such myoelectric pickups in residual muscles can oper-

ate a prosthetic device.

However, Harmon cautions, "the complexity of coordinating such signals is so great that only two or three such signals—or four at most—can be processed simultaneously. The result is a very crude approximation of the real thing."

Artificial elbow developed

An important recent advance in motor prosthesis is an artificial elbow developed by R. W. Mann at the Massachusetts Institute of Technology. Mann uses myoelectric detectors in residual muscles to pick up not only information from the efferent nervous network that transmits from the brain to the limb, but also information from the afferent system that feeds information back to the brain. This feedback indicates to an amputee the position of his elbow without his looking at it.

"Our aim," says Mann, "was to take full advantage of the natural workings of the brain, spinal cord and nervous system, and electronically process information from these sources, to drive the elbow."

To create a skin sensation that moves up and down the muscle stump, Mann places potentiometers in the elbow that drive vibro-stimulators. There are 36 operational amplifiers on two printed-circuit boards in the elbow. This could be boiled down to a couple of tiny silicon wafers, Mann says.

More than 20 such elbows are now being fitted at clinics in the field. But the eventual use of this prosthesis will depend not only on how efficiently it works but also on how well it will be accepted by the independent physician in a field that Mann characterizes as "relatively static."

Harmon agrees that the use of electronics to aid the handicapped is "embryonic in its development," but he adds: "It's developing fast."

Help for mentally deficient

To help the mentally deficient, there are computer systems that enable training to go on repetitively, according to Harmon. But he emphasizes that "people are sometimes deficient in particular ways." For example, it has been found that sometimes a person regarded as mentally deficient because he can't speak or write has been able to typewrite. Harmon compares the opening of communication channels for the mentally deficient with finding substitute "seeing" channels for persons who are blind.

A major point made by Haig Kafafian of the Cybernetics Research Institute in Washington, D.C., is the interrelation of sensory and mental deficiencies. "If a person is blind," says Harmon, "he's already got a mental deficiency of a sort,

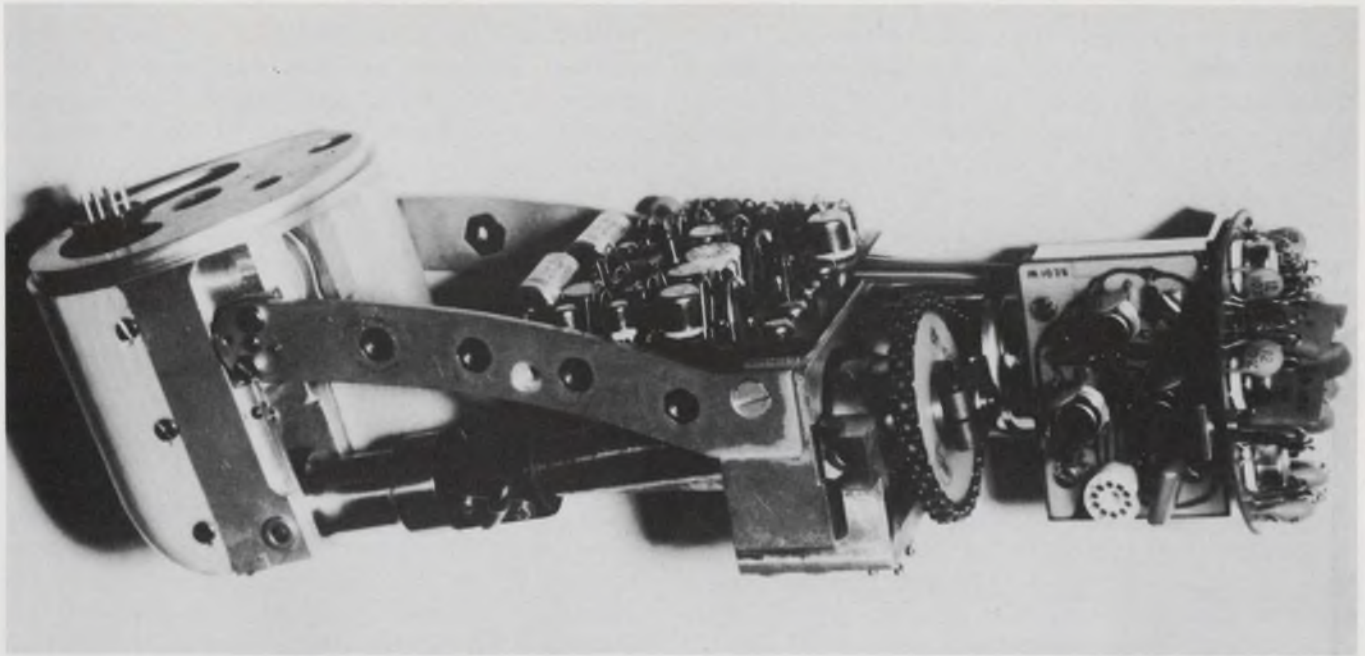

Electronic elbow was developed by a group headed by Prof. Robert W. Mann of MIT. The pivot point (elbow) is

the ball screw to the right of the aluminum casting that attaches to the upper arm.

because that avenue of communication is cut off."

It is difficult to consider any deficiency in isolation, Harmon says. The job of the engineer is to tailor a communication channel to the needs of a particular deficiency. ■■

Microcircuits

IC complexity due to double yearly

Over 12,000 bits of read-only memory on a tiny piece of silicon—that's going to be easy, say industry experts, in the MOS world of 1973. And by that time bipolar random-access chips should reach at least 4096-bit complexity.

Chip complexity in memory and logic circuits is expected to double every year for at least the next five years. The result will be lower costs per function—well under a penny a bit—and the new, fast silicon memories will compete aggressively with core over the next decade.

For designers in the computer industry, the implications are clear: Study the new technology, know its capability and be prepared to use it. And Session 4A, a panel titled "Integrated Silicon Devices—A Projection Through the 70s," offers a chance to learn. The session organizer, Jack Raper, manager of advanced circuits at General Electric, Syracuse, N.Y., has assembled speakers who are known throughout the world

for their expertise in semiconductors.

The panelists include Dr. Robert Noyce, president of Intel Corp., Mountain View, Calif; Jack Kilby, assistant vice president, Texas Instruments, Dallas; Eugene Blanchette, group director of integrated circuits, Fairchild Semiconductor, Mountain View, Calif., and W. S. Boyle, executive director, Semiconductor Components Div., Bell Telephone Laboratories, Murray Hill, N.J.

A look at the future

Attending designers are being treated to a fascinating glimpse of the semiconductor world of the future. While the achievement of 12,000 bits per chip in MOS read-only memories is regarded as a certainty, for instance, bipolar random-access memories will run into serious heat-dissipation problems at about 512 bits per chip.

As Robert Graham, director of marketing of Intel Corp., points out, bipolar read-write memories dissipate at least 2 mW per bit. The 512-bit chip has roughly 1 watt of dissipation, and that's about all you can handle in a regular package. For higher complexity and higher dissipations, the manufacturers will have to go to expensive studded packages that can be attached to suitable heat sinks.

Package cost is going to be important, even for low-dissipation chips, because chip costs are going to drop swiftly, and package costs aren't. Graham sees bipolar memory challenging MOS memory in price in the next few years, and package cost will help this occur. As both bipolar and MOS chips get cheaper, the cost of the packages they're mounted in becomes more important, and

the costs of packaged units will tend to equalize.

There are a few rocks in the road ahead, too. Graham sees two problems: "First, we are reaching the limits of optical resolution in our photolithography. Ultimately the wavelength of the light passing through the optics will limit process accuracy, and we'll reach a plateau of achievement by 1975 or so. Second, design and tooling costs are becoming prohibitive in complex chips. We must use computer aids to keep the cost down."

The Intel executive says that the design of the logic function is easily done now with computer aids, but problems remain with chip-layout design. It costs so much and takes so long to do chip layouts that the progress of complex semiconductor products is being held up. Graham sees a partial solution in replacing random logic designs with read-only memory, though. ROMs are much easier to design and test.

There are problems, too, in deciding on useful products. Texas Instruments' Kilby notes that the industry's ability to build complex IC products has outreached its ability to design catalog items of that complexity. "That's why linear IC sales are so small," he says. "We haven't been able to identify suitable building blocks."

Rise in custom work possible

Production of standard lines of building blocks greatly simplifies the vendors manufacturing op-

Integrated circuits are moving into more and more consumer products, like the TV sets shown in this RCA production line (Session 8A).



eration and the presentation of products to customers. The sales engineer can tuck a catalog under his arm and hit the road. But Kilby sees a possibility of heavily increased custom design work.

The vendors may have to compete with one another for design contracts on each piece of customer equipment—and the emphasis on fast, accurate design will lead to intensive use of computer aids. Sales forces in this case will have to work very closely with the customers' engineering groups. An example of this trend to custom work is the MOS field. "We're doing a large number of custom design programs already," Kilby says.

He warns that the designer of the future, the expert in application of IC products, will have to spend a lot of time studying the function of his designs on a system basis. He'll be forced to relinquish much of his detailed design work—that will be done, in effect, by the designers of the ICs.

The critical compatibility issue

One of the most critical system questions facing designers today, of course, is the compatibility of MOS and bipolar circuits.

Making MOS and bipolar circuits work together is getting easier, but it's still a tricky task. Designers faced with the problem must attend Session 3A, "Achieving MOS-Bipolar Compatibility." Speakers from Bell Telephone Laboratories, MOSTEK, Union Carbide, Motorola and General Electric are examining the problems, reviewing the methods and spelling out the future of interfacing.

For the designer new to the MOS world, the problems are many. He must know, for instance, when to press for custom MOS design, and when to use off-the-shelf MOS and bipolar circuits to build a system.

And it's really a tough problem in economics. Wally Raisanen, manager of MOS and memory products at Motorola Semiconductor, who presents a paper on Motorola's 8000-bit MOS-bipolar LSI memory, points out that there are no uniform cost figures in custom design and that estimates vary widely, depending on design details. He advises potential MOS customers to travel—to talk to the many vendors and to find out what custom design costs and when it can truly be justified. Many problems, though, will be uncovered only during actual detailed design. "A designer has to try custom design once or twice to come to understand the nitty-gritty problems," Raisanen says.

He feels strongly that memory functions are best performed by hybrid technology—whether in one or a group of packages.

Hellava DVM



THE MAXI-RANGER

DC Volts
 μV Sensitivity to 1000 V

Resistance
4 Wire Kelvin Measurements
1 Milliohm to 10 Megohms, F.S.

DC Current
1 nA/digit Sensitivity to 1 Amp

No other DVM offers 6 ranges of DC Volts, 7 ranges of Resistance and 6 ranges of DC Current for as low as \$795. For the same \$795, you get 100% overrange, 100 dB Common Mode Rejection and resolution to 1 μV , 1 nA and 1 milliohm. Current resistance sensing is 10 milliamps on the lowest range. It meets just about all the needs of the design engineer, production and the calibration lab—in a single instrument.

Want more? OK—How about dual-slope conversion, an unbreakable Cicolac[®] cabinet and extensive use of MSI for simplicity, reliability, light weight and compact size?—They're all standard. If additional options are

your style, you can have 6 ranges of AC Current, 5 ranges of AC Volts, autoranging, display storage, BCD Outputs and even Rack Mounting.

Our new color brochure covers other great features and proves the Maxi-Ranger is the DVM of the '70s. We guarantee you'll swear by it—never at it.

INSTRUMENT SYSTEMS DIVISION
DYNASCIENCES

SUBSIDIARY OF **Whittaker**
CORPORATION

9601 Canoga Avenue
Chatsworth, California 91311
Telephone (213) 341-0800

See the Maxi-Ranger at IEEE, Booth 2K-33

"Circuit functions requiring high speed can be filled by bipolar components," he says, "and those requiring low cost with MOS. This is what we do in our 8K-bit memory module.

"We've found it easy to design this structure so that the MOS interface is simple and direct. With low-threshold MOS, we get by with signal swings as low as 4 volts, which are easy to get with DTL. Complicated level shifters and special interface circuits can be avoided completely."

The Motorola expert expects MOS-DTL combinations to be very popular.

"Vendors who had an early position in MOS have built up a big business base around high threshold MOS," he says, "but you can't have direct interfacing and high thresholds, too. Manufacturers who are new in the business, like Motorola, National and Texas Instruments, are making bipolar-compatible, low-threshold MOS, and they're getting all of the new business."

Consumer ICs heading up

Low-threshold MOS isn't the only market segment due for sharp growth. Consumer ICs, which

have been slow getting off the ground, now seem poised for a rapid climb.

At session 8A, "ICs for Consumer Applications," speakers from GE, Delco Radio, RCA, Mullard, and Matsushita examine the current status of ICs in consumer items, the reasons for their introduction and the possibility of future market growth.

Increased performance and reliability are the prime reasons for using ICs in consumer goods, they say. Manufacturers work under a special constraint, however: The improved consumer item can't cost more than its predecessor. This often leads observers to conclude erroneously that low cost is the prime objective.

Dr. Frank Stein, manager of semiconductor research and engineering at Delco Radio, Kokomo, Ind., points out that new integrated circuits must often substantially underprice their discrete counterparts, to cover the cost of tooling up for IC assembly. But he is confident that there is a tremendous potential for consumer ICs, especially in the automotive industry, where their reliability, performance and small size make them ideal.

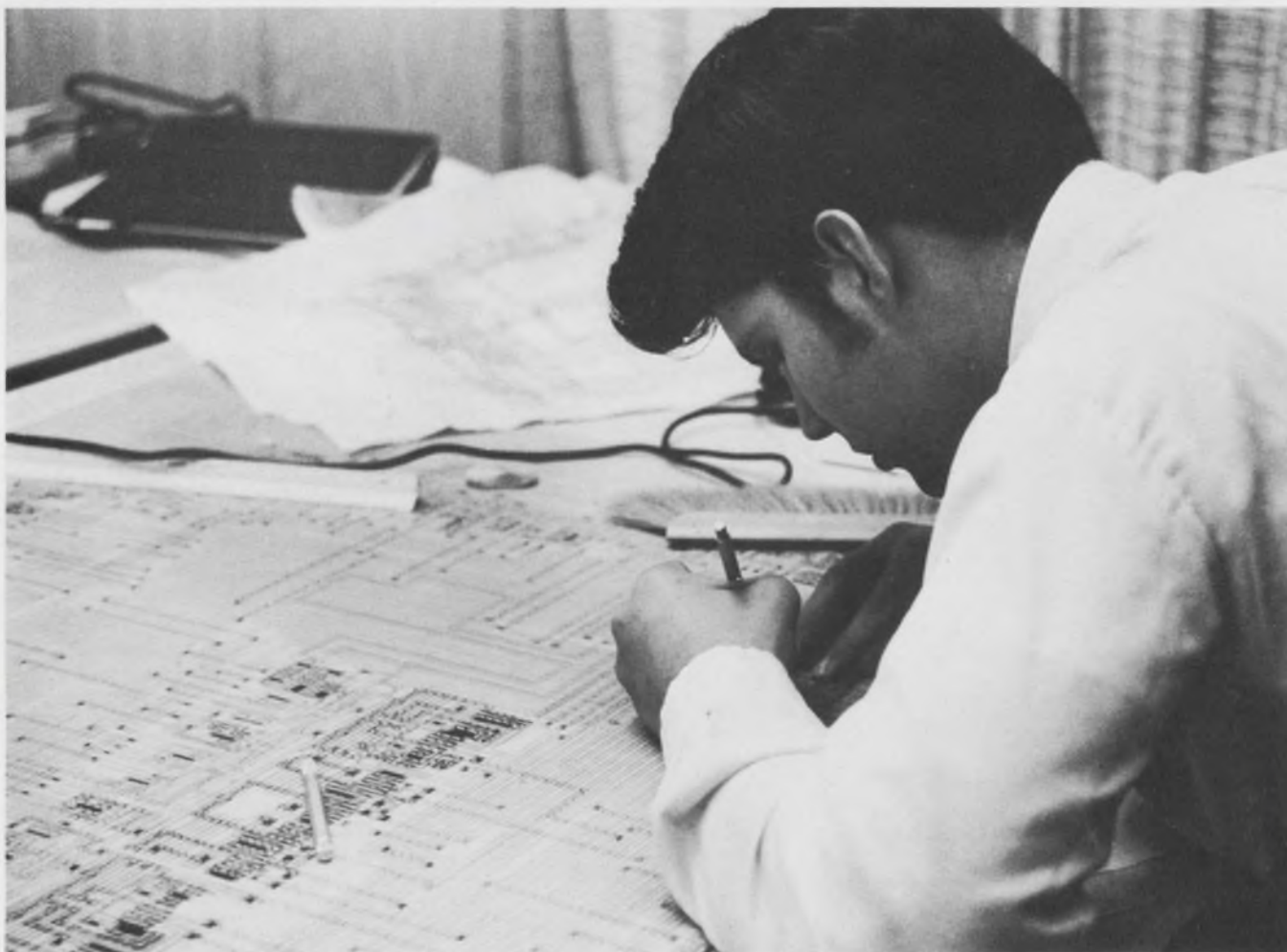

Swiftly increasing chip complexity is forecast by the experts. Here Phil Richards, a draftsman at Intersil, Inc.,

Cupertino, Calif., checks a mask layout sketch for a 200-gate addition-subtraction control circuit chip.

IC reliability leads, of course, to low field-service requirements, and the IC structure lends itself to easy-to-fix modular construction. Service people don't need an in-depth knowledge of the circuits they replace—they can follow easy troubleshooting and replacement directions. Stein believes this will lead to fast service.

But not all semiconductor people share this view. Howard Bonner, applications manager for central marketing, Texas Instruments, feels that service personnel tend to slow innovation in consumer goods by resisting it. Theoretically, he says, IC consumer items are easy to repair, but field servicemen are afraid of them. Bonner contends that some transistor TV sets were pulled out of production because of massive problems with field repair. The service staff simply wasn't ready for the new technology, he says, and attempts at repair often led to ruined sets. ■■

Microwaves

Power tubes making a strong comeback

Despite the inroads of solid-state devices, both thermionic and cold-cathode microwave power tubes have advanced enough to assure their presence on the design scene for some time to come.

Drive and output tubes have been combined in single packages, thereby simplifying high-power-stage design and providing better bandwidths. Modulation power requirements have been slashed, along with pulse and cw drive levels, thus simplifying and, in some cases, eliminating costly circuitry and components.

These and other improvements are discussed in Session 7C, "Recent Trends and Applications of Microwave Power Amplifiers." The session was organized by R. A. Dehn, manager of microwave tube research and development for General Electric, Schenectady, N.Y.

An important accomplishment, Dehn points out, is the integration of essentially two tubes—a driver and output power stages—in the same envelope structure. Two examples are presented at the session.

Coaxitron simplifies application

One is the Coaxitron amplifier, a broadband two-stage, triode-tetrode device of megawatt peak rf output. It has been designed for airborne radar applications by RCA, Lancaster, Pa.

In a paper, "Coaxitron Amplifier," J. A. Eshleman, engineer, and J. B. Pickard, product de-

velopment engineer, say the typical output stage efficiency is 45% at 1.45 MW peak power, with an instantaneous bandwidth of 10% at a center frequency of 428 MHz.

The Coaxitron power stage has a complete rf input and output, along with triode electron interaction circuits, in the same vacuum envelope. Dielectric dissipation and arcing over are minimized as a result.

New light on the Twystron

The Twystron, a hybrid tube combining a klystron driver and TWT output structures, is another example of fabricating driver and output elements in the same tube. Although it was invented six years ago, Dehn notes, developmental applications have been military and classified, and little has been published about the tube.

Used in broadband, high-power radars, the Twystron, according to Richard B. Nelson, chief engineer of the Varian Tube Div. at Palo Alto, Calif., is a pulsed amplifier operating at 5-MW peak level with a 15% maximum bandwidth. The best comparable bandwidth available from TWTs is 10%, he says, while that of the klystron is only 8%. Nelson is delivering a paper, "A Twystron Hybrid Linear Beam Tube."

The narrow, flat-topped bandpass in the Twystron is obtained by stagger-tuning the klystron cavities and by regulating cavity Qs. The relatively broad traveling-wave response is thus compensated for.

The operating frequency range of the Twystron is broad, Nelson points out, ranging from 400 MHz up to the millimeter waves. Tubes produced for use to date have been for C and S bands, simply because high-power radars operate in those regions.

The Twystron operates with about 40% efficiency for pulsed peak power outputs of from 1 to 5 MW. Average power at the peak 5 MW is about 20 kW.

In broadband radars, Nelson indicates, Twystrons are replacing the klystron and TWT and, in fact, have made the 1-MW TWT obsolete. In this sense, they've out-dated their own product, since Varian was the only manufacturer of 1-MW TWTs.

Cw klystrons have dual grids

A recent landmark in medium power cw klystrons has been the introduction of dual grids into the tube, providing a means of automatic frequency control, lowered noise, reduced modulation power requirements and higher efficiency.

These were design goals four or five years ago, according to George Caryotakis, manager of engineering for high-power microwave tubes at

Varian. In discussing these advances in "Applications and Requirements for CW Power Klystrons," Caryotakis says that the improvements were obtained through better tube design by applying electron-optics theory and filter-design theory to the tube elements.

The new tubes, used primarily for military and satellite applications in the high C-band and at X-band, are medium-power cw devices, producing a maximum of 500 kW at 50% efficiency, although they can be used down to 1 kW. In pulsed applications, output power ranges from 2 kW to 100 kW.

Varian is beginning to put grids in a line of klystrons that have heretofore been cathode pulsed. The obvious advantage here is a substantial reduction of pulse driving power due, in part, to increased tube gains—20 to 30, instead of 10 to 20.

A single grid in a klystron is not new, Caryotakis says, but, in general, they have not been reliable because the grid intercepts tube current, overheats and fractures. While some single-grid tubes have been developed to overcome this, Varian's latest development is the use of two grids, one ahead of the other.

The first grid, at cathode potential, shadows the second (control) grid, so that no emission takes place. This permits pulsing the tube with but 1/30th of the plate voltage, in contrast with cathode-pulsing the tube by applying or removing full power.

The reduction in power requirements and modulator circuitry provides a considerable weight saving for airborne applications. But, more important, Caryotakis says that in production quantities, the price of the tube is negligible when the

savings on other components are considered.

Another big plus of the newest tubes is the fact that they can be tuned electromechanically, in contrast with a former complicated and time-consuming procedure that required an oscilloscope and sweep generator. As a result, tuning from a remote location by push-button operation is a possibility. This feature is particularly useful for satellite operation.

Demotron has cold cathode

One of the most interesting papers at the microwave tube session is "Characteristics of an RF-Keyed Cross-field Amplifier," by J. R. M. Vaughn, senior research engineer in the Litton Industries Tube Div., San Carlos, Calif. It describes the development of a cold-cathode crossed-field tube called the Demotron.

The unique feature, as Vaughn explains it, is that it has no thermionic cathode; instead a cold cathode utilizes secondary emission. To obtain an rf output, it is only necessary to apply dc power and an rf input signal.

Developed from the original magnetron, Demotrons are now out of the laboratory and a commercial product. They are well-suited for pulse operation in the more sophisticated radars, which vary the frequency of the rf from pulse to pulse or even during the pulse.

Some of the C-band tubes already have a pulsed output power of 500 kW, with an average dissipation of 1.5 kW. And their instantaneous bandwidth of 10% is about the same as the high-power (100-kW) TWTs.

Whereas the TWTs need a pulsed modulator

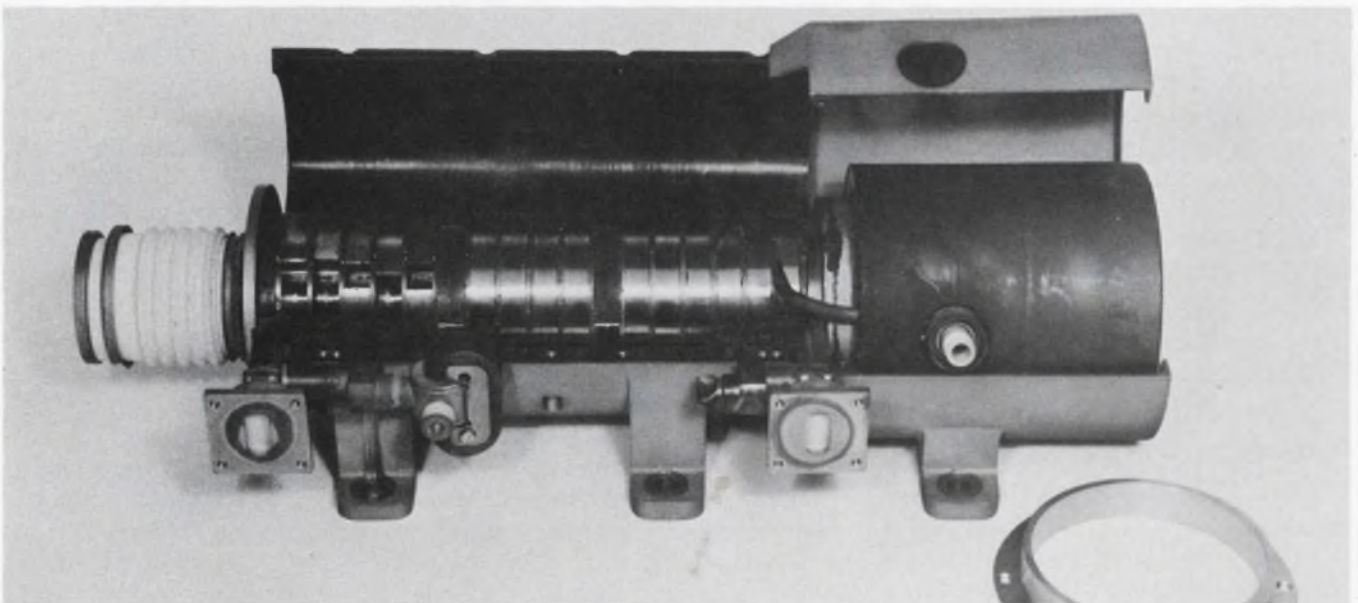

Cutaway view of a high-power, pulsed, X-band TWT by Hughes Aircraft Co. A heat pipe surrounding the tube

provides electromagnetic isolation and environmental protection (Session 7C).



Optima enclosures...

For information, call or write

Optima, Box 13654

Atlanta, Georgia 30324

Telephone 404-939-6340

A product of

Scientific-Atlanta

*See us at IEEE — Booths 1G03 & 1G05

that turns the power to the tube on or off, the Demotrons are simply connected to the operating dc, and, with no drive signal, they draw about 1 microampere in a cut-off condition.

The rf driving pulses are generated at milliwatt levels and are amplified by a chain of TWTs to drive crossed-field tubes in the last one or two power output stages.

The most serious problem in developing the tube was internal arcing, which is typical of many dc-operated microwave tubes. As a result, Vaughn says, Demotrons are invariably used with a "crowbar" on the power supply. But Varian developments have minimized such arcing from one arc every five minutes in the early developmental stages to better than one in four hours today.

The potential of the tube is great, Vaughn feels, and although it is not yet being used in production systems, he believes it will find substantial use in the next generation of radars. ■■

Urban Technology

Environment pollution calls for a team cure

How will environmental pollution be controlled? Hubert Heffner, Deputy Director of the Office of Science and Technology in Washington, D.C., says that "interdisciplinary teamwork" will do it. The efforts of engineers, scientists, politi-

cians and others will be involved.

Cleaning up our environment is an extremely complex issue, says Heffner. "Many aspects of it are social, political and economic," he notes.

Heffner is the keynote speaker at Session 6D, "Environmental Pollution—Today's Engineering Challenge." His talk on the engineer's task for tomorrow considers the importance of physical electronics and the need for a change in the training of engineers as they set out to solve the problems of air and water contamination.

Heffner points out that the atmosphere is accumulating increasing amounts of carbon dioxide and dust. "The CO₂ may imply that we're going to raise the temperature of the earth and melt the arctic oceans," he says. "On the other hand, if dust becomes more prevalent, it may go the other way, and we'll have a colder climate." He feels that environmental engineering will depend heavily on understanding the physical and meteorological implications of problems.

A change in training

Understanding, he continues, requires a change in the training of engineers. "For example," he says, "there may well be a place for another kind of PhD, one which does not concentrate so heavily on the requirement for individual research as a contribution to new knowledge." In addition to physics, Heffner says, a great majority of the environmental tasks require training in the social sciences, economics and other nonengineering subjects.

The chairman of the session, William E. Cory, director of electronic systems at the Southwest

Consolidated Edison's Energy Control Center in New York City makes ample use of computer technology to

improve operating efficiency and lower costs of production (Session 1F).



PIRGO SOLVES YOUR POWER HYBRID CIRCUIT PROBLEMS...

WITH SILICON PLANAR POWER TRANSISTOR CHIPS

Known for consistent high quality and field-proven dependability, all Pirgo chips (dice) are 100% D-C probe tested, and are guaranteed to an LPTD of 10%.

High current NPN and PNP types (up to 30 amps) are available for immediate off-the-shelf delivery. They can also be obtained with gold backing for convenient, easy mounting to ceramic substrates.

There are economic advantages, too. Because no one else has lower prices, PIRGO transistor chips will bring down the cost of your hybrid circuit. You'll get top service...and all the technical advice you ask for. Affiliated with Sprague Electric Company, PIRGO draws upon the full resources and sales staff of that company.

Send directly for a copy of our new catalog and price list. Or call your local Sprague Electric sales engineer.

SILICON PLANAR POWER TRANSISTOR CHIP SPECIFICATIONS

| NPN TYPE NO. | I _C Max. AMPS. | BV _{CEO} VOLTS | BV _{CEO(sus)} VOLTS | BV _{EBO} VOLTS | h _{FE} @ 0.5 AMPS | F _{T(TYP)} MHz | PNP TYPE NO. |
|--------------|---------------------------|-------------------------|------------------------------|-------------------------|----------------------------|-------------------------|--------------|
| PG-3001 | 2 | 80 | 60 | 8 | 50 min | 90 | PG-4001 |
| PG-3002 | 2 | 100 | 80 | 8 | 50 min | 90 | PG-4002 |
| PG-3303 | 2 | 140 | 120 | 8 | 50 min | 90 | PG-4003 |
| PG-3004 | 2 | 160 | 140 | 8 | 50 min | 90 | PG-4004 |
| PG-3005 | 2 | 180 | 160 | 8 | 50 min | 90 | PG-4005 |
| NPN TYPE NO. | I _C Max. AMPS. | BV _{CEO} VOLTS | BV _{CEO(sus)} VOLTS | BV _{EBO} VOLTS | h _{FE} @ 1 AMP | F _{T(TYP)} MHz | PNP TYPE NO. |
| PG-3101 | 5 | 60 | 40 | 8 | 40 min | 70 | PG-4101 |
| PG-3102 | 5 | 80 | 60 | 8 | 40 min | 70 | PG-4102 |
| PG-3103 | 5 | 100 | 80 | 8 | 40 min | 70 | PG-4103 |
| PG-3104 | 5 | 120 | 100 | 8 | 40 min | 70 | PG-4104 |
| PG-3105 | 5 | 140 | 120 | 8 | 40 min | 70 | PG-4105 |
| NPN TYPE NO. | I _C Max. AMPS. | BV _{CEO} VOLTS | BV _{CEO(sus)} VOLTS | BV _{EBO} VOLTS | h _{FE} @ 5 AMPS | F _{T(TYP)} MHz | PNP TYPE NO. |
| PG-3201 | 10 | 60 | 40 | 8 | 40 min | 60 | PG-4201 |
| PG-3202 | 10 | 80 | 60 | 8 | 40 min | 60 | PG-4202 |
| PG-3203 | 10 | 100 | 80 | 8 | 40 min | 60 | PG-4203 |
| PG-3204 | 10 | 150 | 120 | 8 | 40 min | 60 | PG-4204 |
| PG-3205 | 10 | 160 | 140 | 8 | 40 min | 60 | PG-4205 |
| NPN TYPE NO. | I _C Max. AMPS. | BV _{CEO} VOLTS | BV _{CEO(sus)} VOLTS | BV _{EBO} VOLTS | h _{FE} @ 10 AMPS | F _{T(TYP)} MHz | |
| PG-3301 | 30 | 60 | 40 | 8 | 40 min | 40 | |
| PG-3302 | 30 | 80 | 60 | 8 | 40 min | 40 | |
| PG-3303 | 30 | 100 | 80 | 8 | 40 min | 40 | |
| PG-3304 | 30 | 140 | 120 | 8 | 40 min | 40 | |



ELECTRONICS INC.
A SPRAGUE ELECTRIC COMPANY AFFILIATE

130 CENTRAL AVENUE
FARMINGDALE, NEW YORK 11735
Tel: 516-694-9880 • TLX: 96-1498

See PIRGO at the Sprague Booths 3D11 thru 3D18 at the IEEE Show.

INFORMATION RETRIEVAL NUMBER 70

more than a power supply

You get more than a power supply when you specify this or any Hewlett Packard power supply. An international network of 220 sales/service offices are at your disposal . . . the most comprehensive service manuals detailing every aspect of the supply from theory and operation to troubleshooting . . . protection circuitry including an internal overvoltage "crowbar" to safeguard delicate loads, standard on this Low Voltage Rack (LVR) Series. OUTPUTS: 10V @ 20, 50, or 100A; 20V @ 10, 20, or 50A; 40V @ 3, 5, 10, 30, or 50A; 60V @ 3 or 15A. RIPPLE AND NOISE: typically 200 μ V rms, 10mV p-p. Remote Programming and lots more. Prices start at \$350.

and you can customize it with these options...

- 10-Turn Output Voltage and Current Controls
- Chassis Slides
- 3-Digit Graduated Decadial for Voltage or Current
- 115V, 208V, or 230Vac Inputs
- 50Hz Input



HEWLETT  PACKARD

See us at IEEE

POWER SUPPLIES

Over 100 power supplies are described in the 1970 HP Electronics Catalog. Write for your copy.

hp DC POWER

From 10 μ V to 4000V

From 1 μ A to 2000A

From \$90 to \$3,500

From manual to computer controlled.



LOW COST SUPPLIES

Compact laboratory power supplies can be stacked or rack mounted. Choose from 6 well-regulated models: 10V @ 1A; 25V

@ .4A; 50V @ .2A. Three Constant Voltage/Current limiting models — \$90. Three Constant Voltage/Constant Current models — \$115.

Constant Voltage/Constant Current with Automatic Crossover, Remote Programming, Remote Sensing, Auto-Series or Parallel, Optional Internal Over-voltage "Crowbar"



MEDIUM POWER / TRANSISTOR REGULATED

Precisely regulated. Programming speeds as fast as 500 μ s. 20 models: 7.5V @ 3 or 5A; 10V @ 10A; 20V @ 1.5, 3, 5, or 10A; 30V @ 1A; 40V @ .75, 1.5, 3, or 5A; 60V @ 1 or 3A; 100V @ .75A; 160V @ .2A; 320V @ .1A. \$144 to \$395.



MEDIUM POWER / SCR REGULATED

8 models: 20V @ 15 or 45A, 40V @ 10 or 25A; 60V @ 5 or 15A, 120V @ 2.5A; 600V @ 1.5A. \$360 to \$550.

HIGH POWER/SCR REGULATED

12 Models: 4V @ 2000A; 8V @ 1000A; 18V @ 500A; 36V @ 300A; 64V @ 150A; 110V @ 100A; 220V @ 50A; 300V @ 35A; 600V @ 15A. \$1275 to \$3500.



Research Institute, San Antonio, Tex., emphasizes that to control pollution, we must have effective legislation that will punish the polluters.

"I think it's quite obvious to most of the electrical engineers that the basic technology to monitor pollution has been developed," says Cory. "The problem is getting it to a point where it is cheap enough, reliable enough and small enough to be used at collecting sites." For example, instruments that have been developed need to be automated and distributed in the field.

Future monitoring techniques may involve the use of earth satellites, equipped with TV infrared cameras and with sensors to locate areas of contamination.

"We can detect and monitor pollution," says Cory, "but there has been little to actively prevent pollution through the use of electronics that do not create another form of pollution."

The interrelationship of problems and solutions is exemplified by the trend toward nuclear power. This would solve the problem of air contamination by smoke-belching power furnaces but nuclear reactors require large quantities of river or ocean water as a coolant—and this, in turn, is creating a thermal pollution problem.

New instruments sought

Robert S. Burd, Deputy Assistant Commissioner for Operations in the Federal Water Pollution Control Administration, Arlington, Va.,—another speaker at the session—sees a need for new instrumentation to monitor and detect contamination in rivers and oceans.

One project of particular concern to the federal administration is the 800-mile, 4-foot-diameter oil pipeline that will run from the Arctic Ocean at Prudhoe Bay to Valdez Harbor in southern Alaska. The pipe is to carry 500,000 barrels of oil a mile at a temperatures of 160 degrees F across the Yukon River and vast areas of federal land. A combine of oil companies—including Shell, Mobil and British Petroleum—have set mid-1972 as the completion date for the pipeline.

Burd expresses concern about protecting the environment, particularly because "this is an area that is active so far as earthquakes go." Instruments will be needed to detect not only leaks in the pipe but seismic disturbances that could create breaks that could, in turn, affect the ecology of the area.

The federal official says the Water Pollution Control Administration has raised the question of what happens when a hot pipe is placed in the permafrost—a combination of ice and soil that never thaws. He fears the pipe will be inclined to sink deeper into the ground and suggests that placing it on stilts above ground may be the answer. ■■



NEW

...from CLARESEARCH
 ...Ultraminiature
 reed relays

■ Two new lines of Picoreed relays give you a wider choice in sensitivity, contact configurations and space-saving size. For example, note the new low profile of Types PRA and PRB—allows .375" pcb mounting centers. And note the new high sensitivity of Types PRAH and PRBH.

Both lines available in one to five Form A contacts with traditional Clare reliability. 100,000,000 operations at signal levels. 5 volt (must-operate 3.75v), compatible with standard 5 v DTL and TTL logic families. 6, 12 and 24 volt standard relays also available.

For information, circle Reader Service number, or write for Data Sheet 971A. C. P. Clare & Co., Chicago, Illinois 60645...and worldwide.

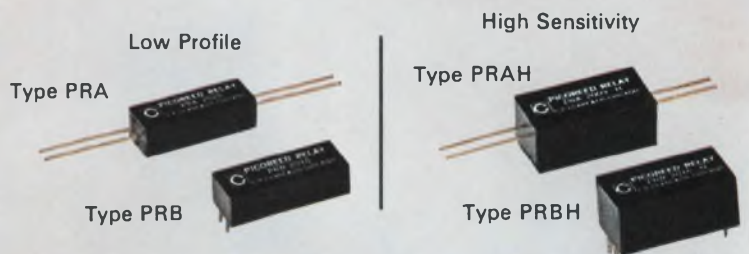

| Electrical and Dimensional Characteristics | Types PRA/PRB—Low Profile | | Types PRAH/PRBH—High Sensitivity | |
|--|---------------------------|-------------|----------------------------------|-------------|
| | Form 1A | Form 5A | Form 1A | Form 5A |
| Operate time, including bounce | 500 μ s | 600 μ s | 600 μ s | 900 μ s |
| Average nominal power for 5 volt units | 65 mw | 250 mw | 46 mw | 140 mw |
| Pcb mounting centers | .375" | .375" | .500" | .500" |
| Length | .781 | .800 | .800 | .800 |
| Width* | .250 | .675 | .400 | .800 |
| Height | .187 | .225 | .350 | .350 |

*Widths vary according to number of switches. One through 5 available.



a GENERAL INSTRUMENT company

Clare-Pendar presents the first LSI/MOS KEYBOARD

... a new concept in

- high reliability
- low power operation
- encoding flexibility
- interface compatibility with TTL/DTL/MOS
- low profile
- custom keyboard design



 **CLARE-PENDAR™**

CLARE-PENDAR CO.
Box 785
Post Falls, Idaho 83854

TOMORROW many systems will use Solid State Relay Hybrids We have them TODAY

These six new devices expand dramatically your range of switching options. Now, you can conveniently interface semiconductor logic circuits with inductive loads such as motors, solenoids, or relays. Inputs as low as 5 microwatts can be used to switch 7 ampere loads, for example. Many millions of times, too.

Input/output isolation normally associated with relays is maintained. Installation is conventional, too . . . direct onto printed circuit boards or in a wide choice of sockets. These new products represent a happy melding of semiconductors and relays to enhance the qualities of both. Here is a look at tomorrow's switching devices. We have them today!

① **SOLID STATE/REED AC SWITCH** Our JDB Series has a height of only .275". It offers the input/output isolation of a reed relay plus the power switching capability and long life of a thyristor. Its 1 Form A contacts will switch loads of 1.7A rms at 25°C ambient for more than 10 million times.

② **AMPLIFIER-DRIVEN JDT RELAYS** Signals as low as 25 microwatts will operate this modified version of our low profile, Thin-line JDT Series. Two dry reed contact forms are available: 2 Form A and 4 Form A. In the 2 Form A configuration, input voltages range from 5 to 24 VDC. In the 4 Form A package, from 12 to 24 VDC. This Series—our JDA—allows for 0.5" centers for printed circuit boards.

③ **ALTERNATE, DIRECT-ACTION, IMPULSE RELAY** This hybrid relay is unique. The DPDT relay employs a permanent magnet in parallel with its normal, single coil, magnetic circuit. Added to this is a solid state flip flop circuit. Thus, our KUR Series has both permanent memory and alternate action features and is controlled from a single, non-polarized, DC source. Contacts are rated 5 or 10 amperes. Because the KUR is designed to transfer its contacts when it receives a specified input pulse and then hold in that mode with or without power, it is recommended for on-off operation or alternate energizing of two loads.

④ **AMPLIFIER-DRIVEN KUP RELAY** The KUA Series significantly expands our family of KUP general purpose relays. Its sensitivity is in the 25 microwatts range . . . and its

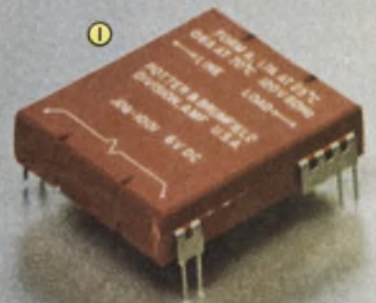

New from P&B! solid state relay/hybrids that advance the art of switching

DPDT contacts will switch 5 amperes at 28 VDC resistive or 120V 60 Hz, 80% P.F. It is designed for continuous duty and to fit the wide choice of KUP sockets and enclosures.

⑤ **SOLID STATE HYBRID RELAY** Our EBT Series is a solid state AC switch controlled by a reed relay. This device will switch 7 amperes rms, 60 Hz at 25°C ambient. It is fast (operate time is approximately 2 milliseconds), and the relay provides input/output isolation. Coil voltages range from 6 to 48 VDC. Convenient octal-type socket mounting is provided. Life greater than 10 million operations can be expected.

⑥ **SENSITIVE SOLID STATE HYBRID RELAY** Our EBA Series is similar to the EBT (above) except considerably more sensitive. It will accept a signal of only 12 microwatts. It, too, will switch a 7 ampere load in 2 milliseconds and, like the EBT, incorporates an RC network for dv/dt suppression. As semiconductors accomplish the switching, it is bounce-free.

These devices widen the dimensions of electromagnetic switching. They are engineered and tooled. They offer a ready solution to going from low power logic sources to work-performing loads. Information is available from your P&B representative or contact the factory.

Potter & Brumfield
Division of American
Machine & Foundry Company,
Princeton, Indiana 47570.
812/385-5251.

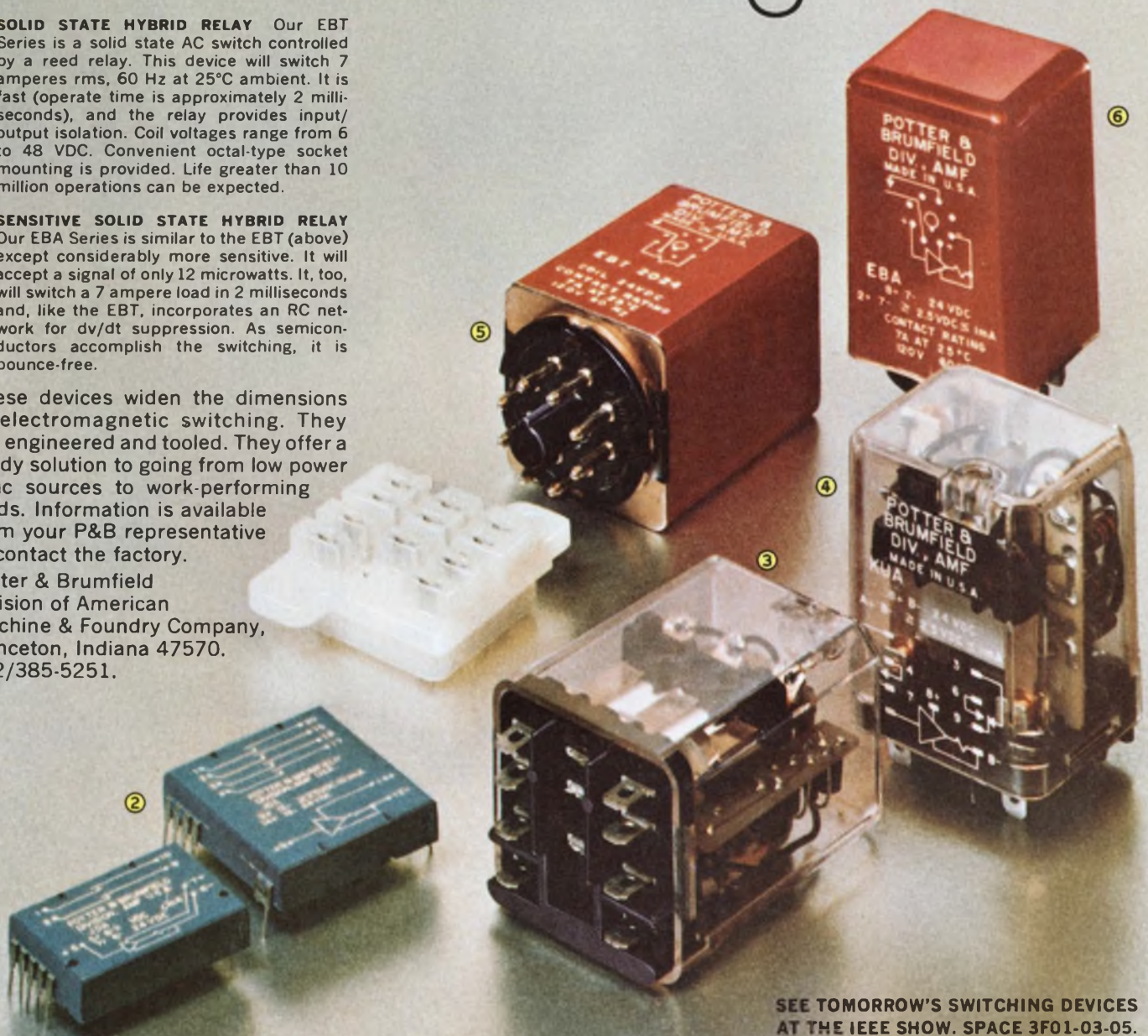

SEE TOMORROW'S SWITCHING DEVICES
AT THE IEEE SHOW. SPACE 3F01-03-05.

AMF | POTTER & BRUMFIELD

**Reliability is a spring, a wheel
and two thingamajigs.**

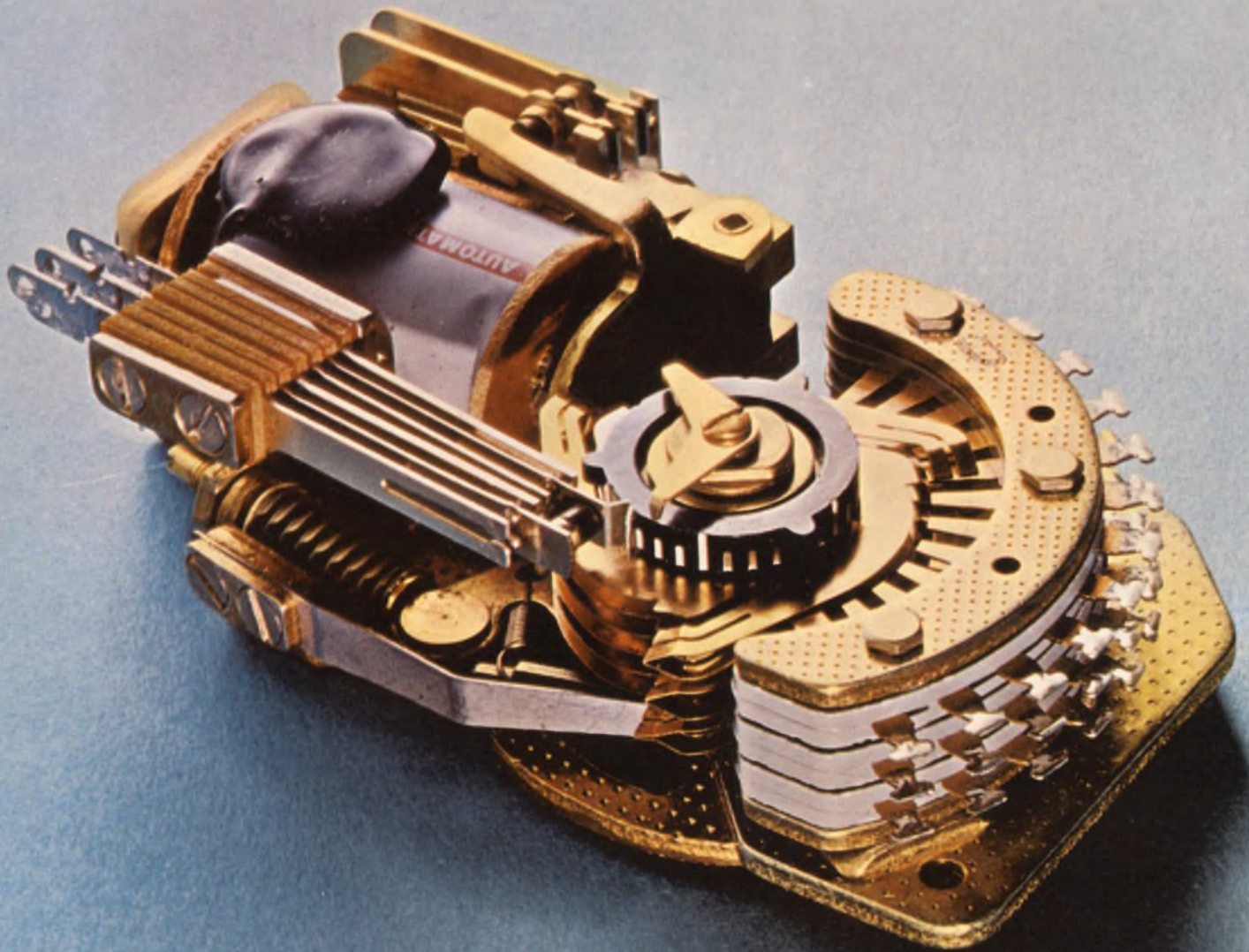



Every AE Type 44 stepping switch comes with them.

One-spring power.

The drive spring is a coil. What it does is store up power. When it comes time to switch, the spring lets loose and moves the wiper assembly forward. Each time using precisely the same pressure.

Notice our spring is tapered at one end. It's designed to perfectly match the power input. That's why you always get the best possible transfer of energy.

At one end of the drive spring is an adjusting screw. We turn it a little this way or a little that way and the tension is always perfect.

Try that with a flat spring.

We re-invented the wheel.

The ratchet wheel is a little different. The way it's made, for one thing. First, we blank it. Next, shave it. And finally, case-harden it. Then it's super strong.

Notice the big, square teeth that always provide a sure bite.

A thingamajig with teeth.

That thingamajig next to the wheel is the armature assembly. When the teeth on the end of it mesh with the teeth on the ratchet wheel, they stop the wiper assembly and position it precisely on the contact bank. Smooth as silk, every time. No jarring, no jamming, no banging.

No adjustments, either. As the teeth wear, they just drop further into the wheel. So nothing ever gets out of whack.



A pawl that floats.

On the end of the armature is the pawl. We made it "free floating" to eliminate the jamming and binding that go with the old style pawl stop block. And while we were at it, we stopped pawl breakage and put an end to double-stepping or overthrow.

Don't bother looking for this special set-up anywhere else. It's patented.

The other thingamajig.

It's called a contact spring. We've got some strong feelings as to what makes a contact spring strong.



In the first place, we believe there's strength in numbers. So we put two sets of contacts on each spring. This means you get a completed circuit every time. Without fail.

But some of the credit for this has to go to our solving the most common cause of contact failure—the build-up of insulating films on the contact points.

We make each set of points self-cleaning. That way, the bad stuff doesn't have a chance to build up.

Finally, take the buffers. We make ours of a special, tough phenolic material that lasts. And lasts. And lasts. All without wear or distortion.

To make sure they stay in place, we weld the buffer cups to the contact springs. We weld, rather than use rivets, because our lab found that rivets have a habit of falling off or wearing out.

Seeing is believing.

We could go on talking reliability and tell you about our testing and run-in room. There's a lot more to tell.

But we'd rather have our Sales Representative show you. And let you see first

hand the reliability that's built into every AE stepping switch.

Just call or write. Automatic Electric Company, Northlake, Illinois 60164.

AUTOMATIC ELECTRIC

SUBSIDIARY OF GENERAL TELEPHONE & ELECTRONICS
INFORMATION RETRIEVAL NUMBER 74

Complete guide to technical papers

Who's talking, what are the subjects and when and where are the sessions being held—it's all here at your fingertips

Avionics and Aerospace

- Space Broadcasting—Where is the Technology; What can it do?—R. W. Hesselbacher, General Electric, Valley Forge Space Center, Philadelphia, Pa. (1B.1/Mon./a.m./M)
- The Canadian Domestic Satellite Communications System—J. Almond, Telesat, Ottawa, Canada. (1B.2/Mon./a.m./M)
- Relay Satellite Systems (TDRS)—R. A. Stampfl, NASA, Goddard Space Flight Center, Greenbelt, Md. (1B.3/Mon./a.m./M)
- International Civil Telecommunications Satellite Systems in the 1970-1980 Decade—F. John D. Taylor, Communications Satellite Corporation, Washington, D.C. (1B.4/Mon./a.m./M)
- Use of Satellites for CATV—Q. B. McClannan, G. P. Herkert, Philco-Ford Corp., Palo Alto, Calif. (2B.1/Mon./p.m./M)
- Aeronautics in the 70's—Session Chairman: The Hon. William Anders, National Aeronautics & Space Council, Washington, D.C. (3C/Tues./a.m./SN)
- IntraSystems Compatibility in Large Aerospace Systems—J. A. Spagon, TRW Systems, Redondo Beach, Calif. (4D.1/Tues./p.m./SS)
- Application of Modern Control Theory to Air Traffic Control—M. Athans, MIT, Cambridge, Mass. (7E.1/Thur./a.m./N)
- Control Application of the Apollo Lunar Module Digital Autopilot—K. J. Cox, NASA, Houston, Tex. (7E.4/Thur./a.m./N)

Aircraft Antennas for Satellite Communications at UHF/SHF—C. A. Linberg, MIT Lincoln Lab., Lexington, Mass. (8B.3/Thur./p.m./M)

Circuits and Circuit Theory

- Bipolar-MOS Tradeoffs in Memory Design—E. Alexander, BTL, Allentown, Pa. (3A.1/Tues./a.m./T)
- Current Directions in MOS-Bipolar Interfacing—R. H. Crawford, MOS-TEK, Dallas, Tex. (3A.2/Tues./a.m./T)
- A Bipolar-Compatible MOS Read-Only Memory—R. Goldin, Union Carbide, San Diego, Calif. (3A.3/Tues./a.m./T)
- MOS-Bipolar LSI Memory—W.R. Raisanen, Motorola, Phoenix, Ariz. (3A.4/Tues./a.m./T)
- Circuit and System Aspects of Variable-Threshold FET's—L. J. Ragonese, General Electric, Syracuse, N.Y. (3A.5/Tues./a.m./T)
- Feedback Current Switching Circuits—General Concepts—Leonard Weiss, K. F. Mathews, IBM, Poughkeepsie, N.Y. (5C.1/Wed./a.m./SN)
- Interconnection of ECL Circuits for Maximum Gate Density—C. Garth, Texas Instruments, Dallas, Tex. (5C.2/Wed./a.m./SN)
- Packaging Aspects of Gigabit Digital Circuits—W. T. Rhoades, Hughes Aircraft, Fullerton, Calif. (5C.3/Wed./a.m./SN)
- A/D and Multiplexers for Hundreds of Megabits—R. V. Cotton, R. D. Ver-

- not, J. R. Galbraith, Philco-Ford, Low Grove, Pa. (5C.4/Wed./a.m./SN)
- Ultra High-Speed Digital Array Testing—J. B. Connolly, Yohn Cho, Tau-Tron, Lowell Mass. (5C.5/Wed./a.m./SN)
- State Variables: What Are They and Why Use Them?—T. A. Bickart, Syracuse University, N.Y. (8D.1/Thurs./p.m./SS)
- State Variables: Modern Computerized Network Analysis—C. Pottle, Cornell University, Ithaca, N.Y. (8D.2/Thurs./p.m./SS)
- The Scattering Matrix from DC to Microwave—H. V. Carlin, Cornell University, Ithaca, N.Y. (8D.3/Thurs./p.m./SS)
- The Application of Scattering Parameters to High Frequency Circuit Design—G. D. Bodway, J. J. Dupre, Hewlett Packard, Palo Alto, Calif. (8D.4/Thurs./p.m./SS)

Communications

- Space Broadcasting—Where is the Technology; What can it do?—R. W. Hesselbacher, General Electric, Valley Forge Space Center, Philadelphia, Pa. (1B.1/Mon./a.m./M)
- The Canadian Domestic Satellite Communications System—J. Almond, Telesat, Ottawa, Canada. (1B.2/Mon./a.m./M)
- Relay Satellite Systems (TDRS)—R. A. Stampfl, NASA, Goddard Space Flight Center, Greenbelt, Md. (1B.3/Mon./a.m./M)
- International Civil Telecommunications Satellite Systems in the 1970-1980 Decade—F. John D. Taylor, Communications Satellite Corporation, Washington, D.C. (1B.4/Mon./a.m./M)
- A Scenario for the Future of Cable Television Distribution—N. E. Feldman, Rand Corporation, Santa Monica, Calif. (2B.2/Mon./p.m./M)
- Distribution of Electronic Mail Over the Broadband Pary Line Communications Network—W. B. Gross, General Electric, Philadelphia, Pa. (2B.3/Mon./p.m./M)
- System Consideration for "More than 12 Channel" CATV—I. Switzer, MacLean-Hunter Cable TV Limited, Toronto, Canada. (2B.4/Mon./p.m./M)
- A Millimeter Waveguide Transmission System—I. Welber, BTL, Holmdel, N.J. (3B.1/Tues./a.m./M)
- The Waveguide Medium: Manufactur-

Technical papers are grouped in these categories

- | | |
|-----------------------------|--------------------------------|
| Avionics and Aerospace | Materials and Packaging |
| Circuits and Circuit Theory | Medical Electronics |
| Communications | Microelectronics |
| Components | Microwaves |
| Computers and | Oceanography |
| Computer-Aided Design | Power Generation and Control |
| Education and Management | Signal Processing |
| Electro-optical | Solid-State Devices and Theory |
| Industrial Electronics | Systems Engineering |
| Lasers and Holography | Urban Engineering |

- ing Challenge—T. Nakahara, Sumitomo Electric Industries, Ltd., Osaka, Japan. (3B.2/Tues./a.m./M)
- Millimeter Waveguides: The Installation and Maintenance Challenge—E. E. Sumner, BTL, Whippany, N.J. (3B.3/Tues./a.m./M)
- Optical Transmission Research—R. Kompfner, BTL, Holmdel, N.J. (3B.4/Tues./a.m./M)
- A Digital Frequency Synthesizer—Joseph Tierney, MIT Lincoln Lab., Lexington, Mass. (4B.1/Tues./p.m./M)
- A Design Technique for Non-recursive Digital Filters—L. R. Rabiner and Bernard Gold, BTL, Murray Hill, N.J. (4B.2/Tues./p.m./M)
- A Method of Generating Gaussian Random Numbers by Computer—C. M. Rader, MIT Lincoln Lab., Lexington, Mass. (4B.3/Tues./p.m./M)
- Applications of Digital Waveform Processing in Radar—H. D. Helms, BTL, Whippany, N.J. (4B.4/Tues./p.m./M)
- Digital Filter Building Blocks from LSI Technology—W. A. Clapp, RCA, Inc., Camden, N.J. (4B.5/Tues./p.m./M)
- Current Telecommunication Opportunities for Compatibility—G. W. Haydon, Institute of Telecommunication Science, Boulder, Colo. (4D.4/Tues./p.m./SS)
- The Tape Revolution in Communication—Frank Siedel, Storycraft, Inc., Lakewood, Ohio. (4F.3/Tues./p.m./MH)
- Picturephone Station Set—W. B. Cagle, BTL, Holmdel, N.J. (5B.1/Wed./a.m./M)
- Picturephone Switching—J. B. Connell, BTL, Holmdel, N.J. (5B.2/Wed./a.m./M)
- Picturephone-Transmission — D. W. Nast, BTL, Holmdel, N.J. (5B.3/Wed./a.m./M)
- A Study of Picture Quality and Video Telephone—K. Nagata, A. Muira, Nippon Electric Company, Tokyo, Japan, (5B.4/Wed./a.m./M)
- Basic Technical and Economical Aspects of Videophone—H. Ebel, Siemens Aktiengesellschaft, Munich, Germany (5B.5/Wed./a.m./M)
- The Digital Mating Call of Computers and Communications — Session Chairman, V. N. Vaughan, Jr., AT&T, New York, N.Y. (6B/Wed./p.m./M)
- Electromagnetic Spectrum Control Programs—W. Dean, Jr., Office of Telecommunications Management, Executive Office of the President, Washington, D.C. (6D.6/Wed./p.m./SS)
- The Coaxitron Amplifier—J. A. Eshleman, J. B. Pickard, RCA, Lancaster, Pa. (7C.1/Thur./a.m./SN)
- Applications and Requirements for CW Power Klystrons—G. Caryotakis, Varian Associates, Palo Alto, Calif. (7C.2/Thur./a.m./SN)
- The Twystron Hybrid Linear Beam Tube—R. B. Nelson, Varian Associates, Palo Alto, Calif. (7C.3/Thur./a.m./SN)
- Characteristics of an RF-Keyed Crossed Field Amplifier—I. M. Vaughan, Litton Industries, San Carlos, Calif. (7C.4/Thur./a.m./SN)
- TWT Versatility Extended by Integral Heat Pipe—L. H. Hershenson, K. G. Wood, Hughes Aircraft Co., Torrance, Calif. (7C.5/Thur./a.m./SN)
- Statistical Pattern Recognition—T. M. Cover, Stanford University, Stanford, Calif. (7D.1/Thur./a.m./SS)
- Can Coding Beat the System?—J. L. Massey, University of Notre Dame, Notre Dame, Ind. (7D.2/Thur./a.m./SS)
- The Evolution of High Speed Digital Data Transmission on Wire Lines—J. L. Holsinger, Codex Corp., Watertown, Mass. (7D.3/Thur./a.m./SS)
- Computer Communication Cooperation CLEAR—A. O. Atkinson, Computer Center for Cincinnati, Ohio. (7F.3/Thur./a.m./MH)
- Short Backfire Antennas—B. C. Reynolds, Radiation Systems, McLean, Va. (8B.1/Thur./p.m./M)
- Feed for Large Dishes—F. A. Lauriente, Rantec Corp., Grenada Hill, Calif. (8B.2/Thur./p.m./M)
- Aircraft Antennas for Satellite Communications at UHF/SHF—C. A. Linberg, MIT Lincoln Lab., Lexington, Mass. (8B.3/Thur./p.m./M)
- Integrated Circuits in Array Design—W. T. Patton, D. Staiman, RCA, Moorestown, N.J. (8B.4/Thurs./p.m./M)
- Electrically Small Active and Passive Antennas—E. M. Turner, Wright-Patterson Air Force Base, Ohio. (8B.5/Thur./p.m./M)

Components

- Performance Characteristics of the New Single-Gun Light Valve Color TV Video Projector—W. E. Good, and T. True, General Electric Co., Syracuse, N.Y. (3D.1/Tues./a.m./SS)
- Flat Panel Display—G. R. Kaelin, Litton Data Systems, Van Nuys, Calif. (3D.2/Tues./a.m./SS)
- High Contrast Cathode Ray Tube—G. Steele, Sigmatron, Inc., Santa Barbara, Calif. (3D.3/Tues./a.m./SS)
- The Lithocon Silicon Storage Tube—F. P. Heiman, S. R. Hofstein and A. Waxman, Princeton Electronic Products, Princeton Junction, N.J. (3D.4/Tues./a.m./SS)

Computers and Computer-Aided Design

- Computer Techniques in Urban Government—S. Simich, Touche Ross Co., New York, N.Y. (1C.1/Mon./a.m./SN)
- The Chicago Story—R. Golden, Civic Center Building, Chicago, Ill. (1C.2/Mon./a.m./SN)
- The New York Story—H. B. Lipton, Office of the Mayor, New York, N.Y. (1C.3/Mon./a.m./SN)
- Computer Output by Electro-Photography—D. A. Ross, RCA, David Sarnoff Research Center, Princeton, N.J. (1E.2/Mon./a.m./N)
- Computer Applications—G. W. Stagg, American Electric Power Service Corp., New York, N.Y. (1F.4/Mon./a.m./MH)
- Techniques and Equipment for LSI Testing—G. C. Padwick, Fairchild Instrumentation, Sunnyvale, Calif. (1G.1/Mon./a.m./G)

- Systems Considerations for Dynamic Testing of LSI—J. G. Salvador, Teradyne Dynamic Systems, Inc., Encino, Calif. (1G.2/Mon./a.m./G)
- Computer Controlled Test Systems for IC Memory—C. W. Green, BTL, Allentown, Pa. (1G.3/Mon./a.m./G)
- Dynamic Test Systems for LSI Arrays—Conrad J. Boisvert, Jr., Cogar Corp., Wappingers Falls, N.Y. (1G.4/Mon./a.m./G)
- A Precision Computer Controlled Step and Repeat Camera—J. W. Elek, BTL/Allentown, Pa. (2C.4/Mon./p.m./SN)
- Computational Aspects of Power System Dynamic Simulation—J. M. Undrill, General Electric, Schenectady, N.Y. (2E.4/Mon./p.m./N)
- Operating Systems: Present and Future—Peter Denning, Princeton University, Princeton, N.J. (2G.1/Mon./p.m./G)
- The Implementation of Operating Systems—R. A. Creech, Burroughs Corp., Pasadena, Calif. (2G.2/Mon./p.m./G)
- Time-Sharing and Its Influence on Computer Software—A. S. Lett, IBM, Yorktown Heights, N.Y. (2G.3/Mon./p.m./G)
- Recent Developments in Programming Languages—Peter Wegner, Brown University, Providence, R.I. (2G.4/Mon./p.m./G)
- Bipolar-MOS Tradeoffs in Memory Design—E. Alexander, BTL, Allentown, Pa. (3A.1/Tues./a.m./T)
- A Bipolar-Compatible MOS Read-Only Memory—R. Goldin, Union Carbide, San Diego, Calif. (3A.3/Tues./a.m./T)
- MOS-Bipolar LSI Memory—W. R. Raisanen, Motorola, Phoenix, Ariz. (3A.4/Tues./a.m./T)
- Standard Touch-Tone Telephone as an Interactive Computer Terminal—F. H. Westervelt, D. B. Smith, University of Michigan, Ann Arbor, Mich. (3G.1/Tues./a.m./G)
- A Magnetic Tape Device for Use with Teletypewriter Terminals—I. S. King, Teletype Corp., Skokie, Ill. (3G.2/Tues./a.m./G)
- A New Computer Driven Display—C. K. Megla, Corning Glass Works, Raleigh, N.C. (3G.3/Tues./a.m./G)
- Design Tradeoffs in a Low-Cost Programmable Graphic Display—E. W. Pugh, Jr., J. E. Cunningham, Imlac Corp., Waltham, Mass. (3G.4/Tues./a.m./G)

Guide to abbreviations

Session locations in the New York Hilton are:

- G—Gramercy Suite
- MH—Murray Hill Suite
- M—Mercury Ballroom
- N—Nassau Suite
- SN—Sutton Ballroom North
- SS—Sutton Ballroom South
- T—Trianon Ballroom

Numerals refer to sessions and to papers in a session—for example, 8F.5 is paper 5 of session 8F.

The hours of the technical sessions, Monday through Thursday are: 9:30 a.m. to 4:30 p.m.

diversified components

*Prices shown are single lot.
Inquire about quantities.

Proximity Switch Assembly

Encased magnet actuates a reed switch to within 1" ctrs. Rated 500 μ A, 60 VDC. RS-24-NO.

Check 160

2.85*



Low-Current Readout

Compact 7-Segment readout features low-drive requirement. Plug-in mount. 2.5V @ 20 ma. per segment. With socket. MS-250A.

Check 161

8.25*

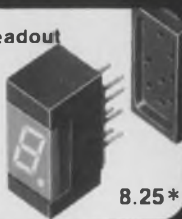

110V Neon Indicator

With built-in NE2H hi-intensity lamp & series resistor for 110V. Unique retainer allows front or rear panel mounting. 6" leads. Plastic housing. 1 1/2" long. BIM-B-3.

Check 162

59¢*

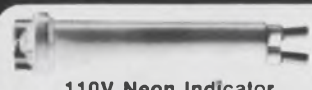

Terminal Strip Kit

Low-loss ceramic strips. 2/56 threaded mounts. Can be resoldered thousands of times. Trial kit 2 each of 6 sizes. MEP Series.

6.00 kit

Check 163



Remote Control Relay

For safe, shock-free remote control circuit operations. Standard octal base plug-in; clear plastic cover. FRP-104.

Check 164

5.45*



Machined Aluminum Knobs



45¢*



55¢*

Check 165

Matched family of natural aluminum knobs featuring anodized satin finish. Has expensive appearance, but priced like plastics. K-Series. 1/2" dia. 45¢, 1" dia. 55¢ ea.

Immediate Deliveries on Above Items

ALCO®

ELECTRONIC PRODUCTS, INC.

Lawrence, Massachusetts 01843

See Us At Alco Booth 46-23

Electromagnetic Compatibility in Modern Computer Systems—W. P. Lohner, IBM Corp., San Jose, Calif. (4D.3/Tues./p.m./SS)

Text-to-Speech Conversion; Giving Clarity and Style to a Talking Computer—C. H. Coker, BTL, Murray Hill, N.J. (4F.1/Tues./p.m./MH)

Computer Graphics at a Small Diversified Research Center—J. B. MacDonald, Western Electric, Princeton, N.J. (4G.1/Tues./p.m./G)

Application of Interactive Graphics at Ford Motor Co.—Gerald Partington, Ford Motor Co., Dearborn, Mich. (4G.2/Tues./p.m./G)

Interactive Display Systems for Management Planning—T. M. Albert, W. E. Workman, Westinghouse Electric Corp., Pittsburgh, Pa. (4G.3/Tues./p.m./G)

Use of Computer Graphics in Computer Aided Design of LSI Equipment—Arnold Spitalny, Solid State Data Sciences, Hauppauge, N.Y. (4G.4/Tues./p.m./G)

Computers in the Classroom: Facts, Faults, Fancies and the Future—L. P. Grayson, National Center for Education R & D, Washington, D.C. (5D.3/Wed./a.m./SS)

System Architecture for Minicomputers—G. C. Hendrie, Honeywell, Framingham, Mass. (5G.1/Wed./a.m./G)

The Software and Softwhen of Minicomputers—D. E. Ferguson, Programmatic, Inc., Los Angeles, Calif. (5G.2/Wed./a.m./G)

Peripheral Equipments for Minicomputers—L. W. Vincent, Lockheed Electronics Corp., Los Angeles, Calif. (5G.3/Wed./a.m./G)

Advanced Applications for Minicomputers—W. H. Davidow, Hewlett Packard, Palo Alto, Calif. (5G.4/Wed./a.m./G)

Impact of LSI on Future Minicomputers—M. E. Hoff, Jr., Intel Corp., Mountain View, Calif. (5G.5/Wed./a.m./G)

Magnet Memories of the '70s—P. A. Harding, Electronic Memories, Inc., Hawthorne, Calif. (6A.1/Wed./p.m./T)

Semiconductor Memory—R. Rice, Fairchild Semiconductor Research, Palo Alto, Calif. (6A.2/Wed./p.m./T)

Disk Files—A. W. O'Sullivan, Digital Development Corporation, San Diego, Calif. (6A.3/Wed./p.m./T)

Optical Memory—J. A. Rajchman, RCA, Princeton, N.J. (6A.4/Wed./p.m./T)

The Digital Mating Call of Computers and Communications—Session Chairman, V. N. Vaughan, Jr., AT&T, New York, N.Y. (6B/Wed./p.m./M)

Design of MIC's by Optimal Seeking Computer Techniques—C. J. Lump, U.S. Army Electronics Command, Fort Monmouth, N.J. (6F.5/Wed./p.m./MH)

Prospects for Timesharing in the 70's—Session Chairman T. D. Truitt, Prime Information, Inc., Princeton, N.J. (6G/Wed./p.m./G)

Holographic Optical Memories for Data Storage—L. K. Anderson, BTL, Murray Hills, N.J. (7B.2/Thur./a.m./M)

Banking Operations in the Last Three Decades of the 20th Century—J. V. Vergari, Federal Reserve Bank of Philadelphia, Pa. (7F.1/Thur./a.m./MH)

The Evolution of Medical Computing—Now a Revolution—M. Kessler, Hospital-Shared Computer Center, Towson, Md. (7F.2/Thur./a.m./MH)

Computer Communication Cooperation CLEAR—A. O. Atkinson, Computer Center for Cincinnati, Ohio. (7F.3/Thur./a.m./MH)

Trends in Transportation Computer Application for the 70's—W. P. Oilman, Chicago and North-Western Railway, Chicago, Ill. (7F.4/Thur./a.m./MH)

Maintenance Planning for a Reliable Process Control Computer—P. K. Mattheiss, Sun Oil Company, Marcus Hook, Pa. (8C.1/Thur./p.m./SN)

Computer Control of an Automated Warehouse—L. P. Christianson, IBM, San Jose, Calif. (8C.2/Thur./p.m./SN)

Education and Management

The Fatal Abstract—A Pedagogical Farce in One Act—Session Chairman, J. M. Lufkin, Honeywell, Inc., Minneapolis, Minn. (1P/Mon./a.m./SS)

Text-to-Speech Conversion; Giving Clarity and Style to a Talking Computer—C. H. Coker, BTL, Murray Hill, N.J. (4F.1/Tues./p.m./MH)

Cross-Fire Lecture Technique—Bradford Daggett and Alfred Peticolas, Institute for Professional Development, RCA, Clark, N.J. (4F.2/Tues./p.m./MH)

The Tape Revolution in Communication—Frank Siedel, Storycraft, Inc., Lakewood, Ohio. (4F.3/Tues./p.m./MH)

Multi-Screen Mixed Media—Victor Jackson, Melandrea, Inc., New York, N.Y. (4F.4/Tues./p.m./MH)

Interactive Display Systems for Management Planning—T. M. Albert, W. E. Workman, Westinghouse Electric Corp., Pittsburgh, Pa. (4G.3/Tues./p.m./G)

CCTV in Graduate Education—The SMU Experiment—C. R. Vail, Southern Methodist University, Dallas, Tex. 5D.1/Wed./a.m./SS)

Technology in Education—Trends in the United Kingdom—R. C. G. Williams, Phillips Electronic & Associated Industries, Ltd., London, England. (5D.2/Wed./a.m./SS)

Computers in the Classroom: Facts, Faults, Fancies and the Future—L. P. Grayson, National Center for Educational R&D, Washington, D.C. (5D.3/Wed./a.m./SS)

Patent Pay for Engineers—Session Chairman: J. A. Reilly, Kenyon & Kenyon, New York, N.Y. (5E/Wed./a.m./N)

Continuing Technical Education at BTL—A Philosophy; Planning and Implementation—E. D. Reed, BTL, Murray Hill, N.J. (6E.1/Wed./p.m./N)

Continuing Education in Industry as a Resource Management Activity—S. E. Moore, IBM, Poughkeepsie, N.Y. (6E.2/Wed./p.m./N)

A Collaborative Self-Education Program between an Electric Utility and a University—W. F. MacKenzie, Pennsylvania Power and Light Company, Hazelton, Pa. (6E.3/Wed./p.m./N)

Get One Free.

Comar now unveils its complete new CR-2 series: The only relays that give you single-pole, double-pole or three-pole specifications.

Undoubtedly, you've seen and heard of our new single-pole relay, (we call it our "one track mind"). That's when you need only one make-and-break. Now Comar initiative makes it even easier than ever. Need two makes-and-breaks? Specify the two-pole relay. Same for our new three-pole relay.

They're all the same compact size: $1\frac{1}{4}'' \times \frac{5}{8}'' \times \frac{59}{64}''$. They're compatible with one another so that two 3-pole relays placed side by side, for example, will give you six poles . . . in less space than you needed before for two 4-pole relays. Less expensive than the 4-pole relay too. Better balanced. Yet built with the same exacting quality that Comar builds into all their relays.



3349 Addison Street/Chicago, Ill. 60618
Phone: (312) JU 8-2410

Send me one free!

Single-Pole Double-Pole Three-Pole
Available to qualifying purchasing agents and engineers. Please fill in completely.

Name _____

Title/Function _____

Company _____ Phone _____

Address _____

City _____ State _____ Zip _____

Your Product Line _____

Mix or match any of the new CR-2 relays to obtain the exact number of functions you need—for five poles combine our 2- and 3-pole relays. For seven poles use our 3- and 4-pole relays.

"Get one free" by mailing the coupon, but, if you have more in mind, just tell us your problems. You'd be amazed at what we have that we *haven't* shown you.

Contact Rating: 4 amps at 120 volts A.C. resistive and 4 amps at 30 volts D.C. resistive.
Coil Voltage Range: Up to 115 Volt D.C.
Complete with dust cover. Socket available.

New! Comar CR-2 Relays • Single-Pole • Double-Pole • Three-Pole



THE CHILLER

Cold. Calculating. Mechanically refrigerated. Yet, at times, warm . . . even hot. Called by those who know . . . Tenney Jr. Inside 1¼ cu. ft. of emptiness waiting for you and yours. Get it. Sit it on your bench-top. Watch it pull down from ambient 75°F to -120°F in 55 minutes. Or, if heat is your hang-up, watch it zoom to +350°F in 35 minutes. Either way with ±¼°F control and no RFI. Write or call us about Tenney Jr. today. We'll see that you get yours.

T Jr: \$1080 — Available immediately from stock. Also ask about the Tenney SST, only \$890.

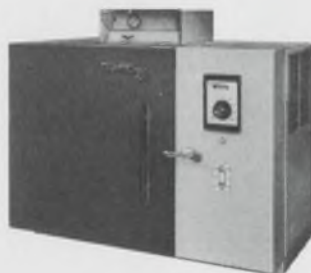

Tenney
ENGINEERING, INC.

1090 Springfield Rd., Union, New Jersey 07083 • (201) 686-7870
Western Division: 15721 Texaco St., Paramount, Calif. 90723



Electro-optical

- Applications of Non-Linear Optics—
I. P. Kaminow, BTL, Holmdel, N.J.
(1A.2/Mon./a.m./T)
- Upconversion: A New Technique for
Infrared to Visible Image Conversion—
A. H. Firester, RCA, Princeton,
N.J. (1A.3/Mon./a.m./T)
- The Evolution in Gallium Arsenide
Phosphide Injection Electroluminescent
Displays—J. C. Barrett, Hewlett
Packard Corporation, Palo Alto,
Calif. (2A.1/Mon./p.m./T)
- Red and Green Light Emission from
Gallium Phosphide Diodes—W. Rosen-
sweig, BTL, Murray Hill, N.J.
2A.2/Mon./p.m./T)
- Visible Light Emission from Gallium
Aluminum Arsenide—M. R. Lorenz,
IBM, Yorktown Heights, N.Y. (2A.3/
Mon./p.m./T)
- Efficient Infrared-Excited Visible Lumi-
nescence in Rare Earth Systems—
R. A. Hewes, General Electric, Nela
Park, Cleveland, Ohio. (2A.4/Mon./
p.m./T)
- DC Gas Discharge Panel Display—W.
J. Harman, Jr., Burroughs Corpora-
tion, Plainfield, N.J. (2A.5/Mon./
p.m./T)
- Optical Transmission Research—R.
Kompfner, BTL, Holmdel, N.J.
(3B.4/Tues./a.m./M)
- Optical Memory—J. A. Rajchman,
RCA, Princeton, N.J. (6A.4/Wed./
p.m./T)

Industrial Electronics

- Application of Interactive Graphics at
Ford Motor Co.—Gerald Partington,
Ford Motor Co., Dearborn, Mich.
(4G.2/Tues./p.m./G)
- State of the Art Laser Applications in
Manufacture—D. Whitehouse, Ray-
theon, Waltham, Mass. (5F.1/Wed./
a.m./MH)
- Recent Advances in CO₂ Laser—Ma-
terials Working Processes—L. Mar-
shall, Coherent Radiation Labora-
tories, Palo Alto, Calif. (5F.2/ Wed./
a.m./MH)
- Semiconductor Wafer Surface Inspec-
tion by Intensity Spatial Filtering—
R. O. De Nicola, Western Electric
Company, Inc., Princeton, N.J.
(5F.3/Wed./a.m./ MH)
- Application of Modern Control Theory
to Air Traffic Control—M. Athans,
MIT, Cambridge, Mass. (7E.1/Thur./
a.m./N)
- Recent Optimization, Estimation, and
Identification Developments in Elec-
tric Power System Operation—J.
Peschon, R. E. Larson, F. G. Rees,
L. P. Hajdu, A. S. Debs, and A. J.
Tether, Systems Control, Inc., Palo
Alto, Calif. (7E.2/Thurs./a.m./N)
- Some Practical Applications of Modern
Control Theory in Steam Power
Plant Control—T. J. Williams and
R. C. Walters, Purdue University,
Lafayette, Ind. (7E.3/Thur./a.m./
N)
- Control Application of the Apollo
Lunar Module Digital Autopilot—K.
J. Cox, NASA, Houston, Tex. (7E.4/
Thur./a.m./N)
- Maintenance Planning for a Reliable
Process Control Computer—P. K.
Mattheiss, Sun Oil Company, Mar-

Techno has 3/8" RTR24 style (MIL-R-39015) wirewound trimmers qualified at the P confidence level for 0.1% FR.

Available for immediate delivery.



Write for Bulletin ER

TECHNO-COMPONENTS CORP.

A SUBSIDIARY OF OAK ELECTRO/NETICS CORP.
7803 LEMONA AVENUE / VAN NUYS, CALIFORNIA 91405
(213) 781-1842 / TWX: 910-495-2015

INFORMATION RETRIEVAL NUMBER 78

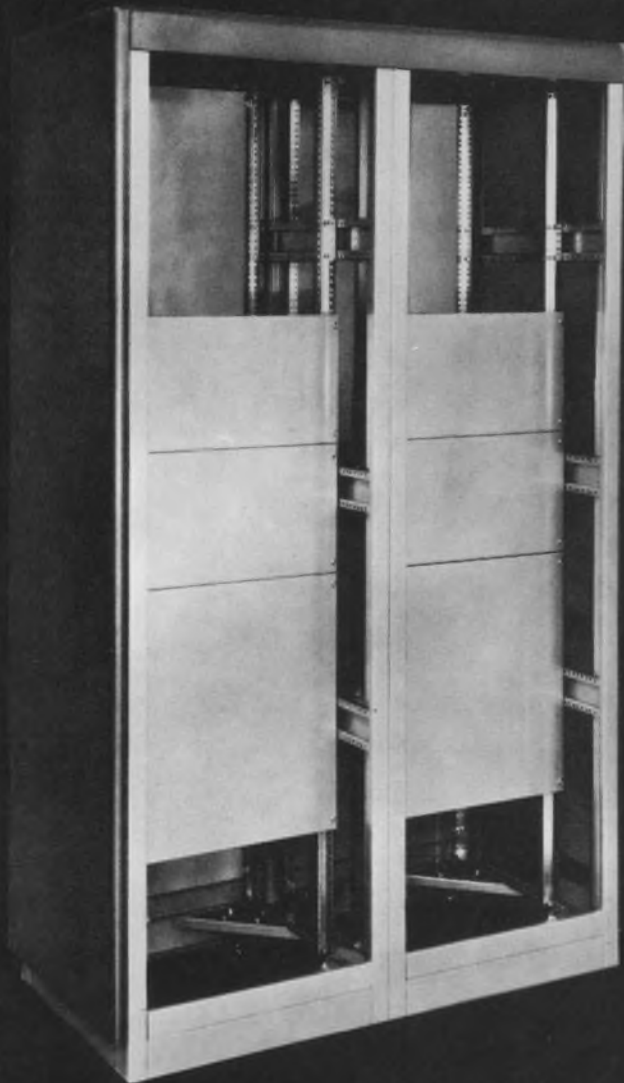

No extra charge for brute strength.

Amco builds enclosures to last. With plenty of muscle like 14 gauge, double welded, 4 formed horizontal and vertical frame members. Full heliarc seam welds on all corners, top and bottom. Sturdy multi-formed mounting channels for flush or recessed panels. Direct floor bearing support with extended vertical frame channels. 12 gauge gusseting that will handle loads in excess of 2000 lbs. Integral lift-eyes. And, all of these are standard construction. That's just for starters. We structurally test our enclosures and publish the certified test results. Here's an example of the brutal military tests these enclosures can take:

SEMI-CUSTOM ENCLOSURES:

MIL-E-5272C Vibration test procedure XII

Shock test—procedure III (MIL-S-901B)

Shock test—procedure V (MIL-S-4456)

E.M.I. ENCLOSURES:

Vibration test—MIL-STD-167 Type I.

Shock test—MIL-S-901C

Electromagnetic interference test—Requirements & test methods MIL-STD 826

Radio Frequency Electric Field Attenuation Measurements for shielded equipment enclosures MSFC-STD-280

Units with 14 ga. C.R.S. components also meet MIL-STD-285

Besides all this, you can have your own computer age cabinet look with Amco's INTERFACE-33 enclosure styling system. These enclosures have all the strength features mentioned above and the cost for styling is only about \$40 per cabinet. Best of all, there's practically no limit to the styling combinations you can choose for single or multiple bay consoles. Add realistic delivery dates, plus competitive pricing and you'll find it's hard to beat Amco quality and service. **Amco Engineering Co.**
7333 W. Ainslie
Chicago, Illinois 60656



See us Booth 27 at Nepcon Central

cus Hook, Pa. (8C.1/Thur./p.m./SN)

Computer Control of an Automated Warehouse—L. P. Christianson, IBM, San Jose, Calif. (8C.2/Thur./p.m./SN)

The Reluctance of Management to Accept its Responsibilities in Automated Factories—R. Fidler, Spiras System, Inc., Whilinsville, Mass. (8C.3/Thur./p.m./SN)

A Cable Production Control and Sequencing System—G. M. Schultz, Western Electric Engineering Research Center, Princeton, N.J. (8C.4/Thur./p.m./SN)

Lasers & Holography

State of the Art Laser Applications in Manufacture—D. Whitehouse, Raytheon, Waltham, Mass. (5F.1/Wed./a.m./MH)

Recent Advances in CO₂ Laser—Materials Working Processes—L. Marshall, Coherent Radiation Laboratories, Palo Alto, Calif. (5F.2/Wed./a.m./MH)

Detectors for Laser Systems: A Review F. D. Shepherd, Air Force Cambridge Research, Bedford, Mass. (6C.1/Wed./p.m./SN)

High Efficiency Optically Pumped Lasers—K. B. Steinbruegge, I. Liberman, T. Henningsen, Westinghouse Research Labs., Churchill, Pa. (6C.2/Wed./p.m./SN)

Efficient Tunable Optical Parametric Oscillators—J. Falk, Stanford University, Stanford, Calif. (6C.3/Wed./p.m./SN)

Desk-Size 1000 Watt CO₂ Laser—W. B. Tiffany, R. Targ, Sylvania Corp., Mountain View, Calif. (6C.4/Wed./p.m./SN)

Holograms as Recorded Interference Patterns—W. E. Kock, The Bendix Corp., Southfield, Mich. (7B.1/Thur./a.m./M)

Holographic Optical Memories for Data Storage—L. K. Anderson, BTL, Murray Hill, N.J. (7B.2/Thur./a.m./M)

Acoustic Holography—R. M. Mueller, Bendix Research Labs., Southfield, Mich. (7B.3/Thur./a.m./M)

Validating Cards by Holography—E. H. Christy, Radiation Lab, Tulane University, New Orleans, La. (7B.4/Thur./a.m./M)

Holographic Image Deblurring Techniques—G. Stroke, State University of N.Y., Stony Brook, N.Y. (7B.5/Thur./a.m./M)

A Holographic Video Playback System—W. J. Hannan, RCA, Princeton, N.J. (7B.6/Thur./a.m./M)

Materials and Packaging

Properties of Magnetic 'Bubble' Domains—A. H. Bobeck, Bell Telephone Laboratories, Murray Hill, N.J. (1A.1/Mon./a.m./T)

Acoustoelectric Interactions—A. R. Moore, RCA Princeton, N.J. (1A.4/Mon./a.m./T)

Recent Advances in CO₂ Laser—Materials Working Processes—L. Marshall, Coherent Radiation Laboratories, Palo Alto, Calif. (5F.2/Wed./a.m./MH)

Medical Electronics

An Introduction to Problems of Aids for the Handicapped—Physiological and Perceptual Aspects—L. D. Harmon, Bell Telephone Laboratories, Murray Hill, N.J. (2D.1/Mon./p.m./SS)

Visual Aids and Substitute Devices—P. W. Nye, Willis H. Booth Computing Center, California Institute of Technology, Pasadena, Calif. (2D.2/Mon./p.m./SS)

Auditory, Aids and Substitute Devices—G. W. Fellendorf, Alexander Graham Bell Assn. for the Deaf, Inc. Washington, D.C. (2D.3/Mon./p.m./SS)

Limb Prostheses and Ortheses—R. W. Mann, MIT, Cambridge, Mass. (2D.4/Mon./p.m./SS)

Man-Machine Systems for Aiding the Learning-Disabled—Haig Kafarian, Cybernetics Research Institute, Washington, D.C. (2D.5/Mon./p.m./SS)

Introduction—Some Comments on the Imaging of Biological Systems, plus film: "Biomedical Applications of the Scanning Electron Microscope"—T. L. Hayes, University of California, at Berkeley. (3E.1/Tues./a.m./N)

Current Biological Investigations Utilizing the Scanning Electron Microscope—Alan Boyde, University College, London, England. (3E.1/Tues./a.m./N)

New Perspectives in Biology Through the Scanning Electron Microscope—T. E. Everhart, E. R. Lewis, University of California at Berkeley, (3E.3/Tues./a.m./N)

Combined Scanning Electron Microscopy and Electron Probe Analysis of Biological Tissue—A. J. Tousimis, Biodynamics Research Corp., Rockville, Md. (3E.4/Tues./a.m./N)

The Evolution of Medical Computing—Now a Revolution—M. Kessler, Hospital-Shared Computer Center, Towson, Md. (7F.2/Thur./a.m./MH)

Microelectronics

Techniques and Equipment for LSI Testing—G. C. Padwick, Fairchild Instrumentation, Sunnyvale, Calif. (1G.1/Mon./a.m./G)

Systems Consideration for Dynamic Testing of LSI—J. G. Salvador, Teradyne Dynamic Systems, Inc., Encino, Calif. (1G.2/Mon./a.m./G)

Computer Controlled Test Systems for IC Memory—C. W. Green, Bell Telephone Laboratories, Allentown, Pa. (1G.3/Mon./a.m./G)

Dynamic Test Systems for LSI Arrays—Conrad J. Boisvert, Jr., Cogar Corp., Wappingers Falls, N.Y. (1G.4/Mon./a.m./G)

Integrated Circuit Design Automation—Jim Narud, Motorola Inc., Phoenix, Ariz. (2C.1/Mon./p.m./SN)

A Rotating Mirror Pattern Generator—K. M. Poole, Bell Telephone Laboratories, Murray Hill, N.J. (2C.2/Mon./p.m./SN)

An Electron Beam Pattern Generator—W. R. Samaroo, J. Raamot, P. D. Parry, Western Electric, Princeton, N.J. (2C.3/Mon./p.m./SN)

If you think
uniquely styled
enclosures have to
cost a bundle...
then take a look at
INTERFACE-33



IT'S A WHOLE NEW
CONCEPT THAT WILL SAVE
UP TO 75% OF YOUR
STYLING COSTS.

READ ABOUT IT... JUST
CHECK THE READER
SERVICE NUMBER BELOW.

AMCO ENGINEERING CO.
7333 West Ainslie Street
Chicago, Illinois 60656



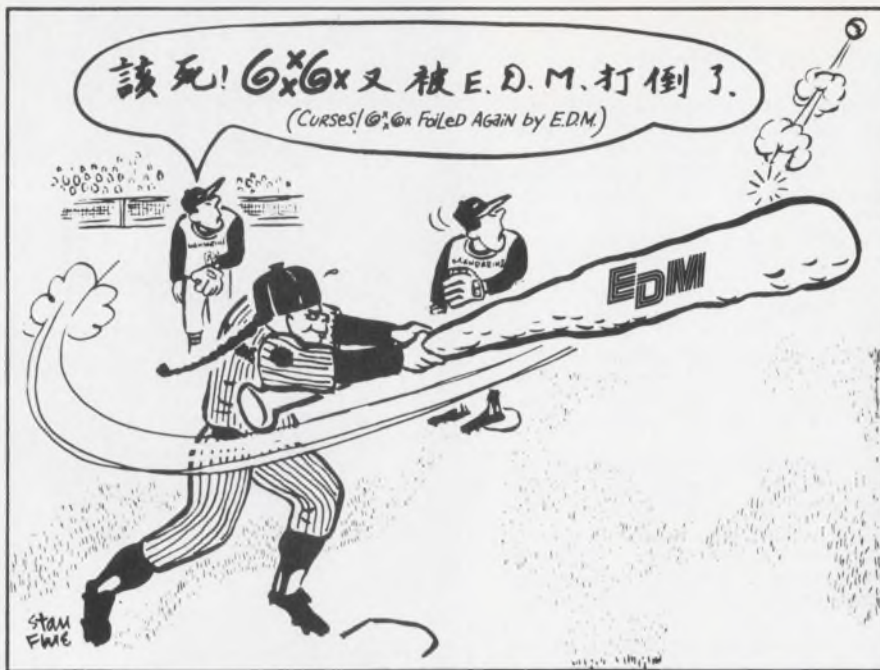

... and only **DELTRON** gives you



in every one of its full line of
standard and custom POWER SUPPLIES

All DELTRON Power Supplies are meticulously engineered with EDM (EXTRA DESIGN MARGIN). This means that every electrical and mechanical part is rated for the extra service that permits each power supply to withstand inadvertent or uncontrollable stresses that would damage or seriously impair the life of competitive units. And we have a track record of some of the most important state-of-the-art developments in the power supply field. *Don't buy another power supply before looking over Deltron's new comprehensive catalog.*



FREE
32-PAGE
POWER SUPPLY
CATALOG

Deltron inc.

Wissahickon Ave., North Wales, Pa. 19454 • Phone: (215) 699-9261 • TWX (510) 661-8061

See us at the IEEE Show Booth 2J39

INFORMATION RETRIEVAL NUMBER 81

- A Precision Computer Controlled Step and Repeat Camera—J. W. Elek, Bell Telephone Laboratories, Allentown, Pa. (2C.4/Mon./p.m./SN)
- Bipolar-MOS Tradeoffs in Memory Design—E. Alexander, Bell Telephone Laboratories, Allentown, Pa. (3A.1/Tues./a.m./T)
- Current Directions in MOS-Bipolar Interfacing—R. H. Crawford, MOSTEK, Dallas, Tex. (3A.2/Tues./a.m./T)
- A Bipolar-Compatible MOS Read-Only Memory—R. Goldin, Union Carbide, San Diego, Calif. (3A.3/Tues./a.m./T)
- MOS-Bipolar LSI Memory—W. R. Raisanen, Motorola, Phoenix, Ariz. (3A.4/Tues./a.m./T)
- Circuit and System Aspects of Variable-Threshold FET's—L. J. Ragnese, General Electric, Syracuse, N.Y. (3A.5/Tues./a.m./T)
- Integrated Silicon Devices—A Projection Through the 70's.—Session Moderator, J. D. Meindl, Stanford University, Stanford, Calif. (4A/Tues./p.m./T)
- Systems Approach to Effect On-Site Immediate Emergency Treatment—Jacob Kline, University of Miami, Coral Gables, Fla. (4E.1/Tues./p.m./N)
- Engineering in Medicine in Vietnam—C. A. Heisterkamp, Lancaster General Hospital, Lancaster, Pa. (4E.2/Tues./p.m./N)
- Biomedical Engineering Study of Shock—S. F. DiZio, Rensselaer Polytechnic Institute, Troy, N.Y. (4E.3/Tues./p.m./N)
- Automated Care of Acutely Ill Cardiac Patients—Alberto Budkin, Miami Heart Institute, Miami Beach, Fla. (4E.4/Tues./p.m./N)
- Telemetry for Emergency Medical Care, Some Systems Considerations—E. L. Nagel, University of Miami, Miami, Fla., H. M. Hanish, Bio-Com, Inc., Culvert City, Calif. (4E.5/Tues./p.m./N)
- Use of Computer Graphics in Computer Aided Design of LSI Equipment—Arnold Spitalny, Solid State Data Sciences Corp., Hauppauge, N.Y. (4G.4/Tues./p.m./G)
- Feedback Current Switching Circuits—General Concepts—Leonard Weiss, K. F. Mathews, IBM, Poughkeepsie, N.Y. (5C.1/Wed./a.m./SN)
- Interconnection of ECL Circuits for Maximum Gate Density—C. Garth, Texas Instruments, Dallas, Tex. (5C.2/Wed./a.m./SN)
- Packaging Aspects of Gigabit Digital Circuits—W. T. Rhoades, Hughes Aircraft, Fullerton, Calif. (5C.3/Wed./a.m./SN)
- A/D and Multiplexers for Hundreds of Megabits—R. V. Cotton, R. D. Vernot, J. R. Gabraith, Philco-Ford, Willow Grove, Pa. (5C.4/Wed./a.m./SN)
- Ultra High-Speed Digital Array Testing—J. B. Connolly, Yohn Cho, Tau-Tron, Lowell, Mass. (5C.5/Wed./a.m./SN)
- Semiconductor Wafer Surface Inspection by Intensity Spatial Filtering—R. O. De Nicola, Western Electric Company, Inc., Princeton, N.J. (5F.3/Wed./a.m./MH)
- Impact of LSI on Future Minicomputers—M. E. Hoff, Jr., Intel Corp., Mountain View, Calif. (5G.5/Wed./a.m./G)

memory

(is our thing)

If memory is your thing, you need Computer Microtechnology memories. The first one is ready, the CM 2100 64 bit bipolar read/write memory. It features the best minimum write pulse width in the industry, 12 nsec typ. This combined with the other specifications gives you superior units for your applications. All decoding, driving and sensing circuitry is on the chip of this self-contained memory. You can achieve memory expansion simply through chip select input and wired-OR capability of outputs. The CM 2100 is ideally suited for high speed scratchpad or buffer memories. Do your thing. Check the specs and then order your CM 2100 memories today. PRODUCT LINE: 64 BIT, 256 BIT, 4096 BIT MEMORIES.

**CM 2100 64 BIT BIPOLAR
READ/WRITE MEMORY:**

Organization 16 words by 4 bits
Read Access Time 40 nsec typ.
60 nsec max.
Minimum Write Pulse Width
12 nsec typ. 25 nsec max.
Compatibility DTL and TTL
Packaging 16 lead dual-in-line
Price \$40.00, 1-24
Delivery Stock



Computer Microtechnology Inc.
610 Pastoria
Sunnyvale, California 94086
(408) 736-0300

DELIVERY FROM STOCK

a series of DUAL OUTPUT POWER SUPPLIES

FROM
\$49.00



for OP AMPS and IC'S

An exceptional value, the new Deltron OS/PS Series are Independent Dual Output Power Supplies for use with operational amplifiers, integrated circuits and digital logic. Check these features—

- 0.02% regulation
- 500 microvolts ripple and noise
- 10 microsecond recovery time
- Master-slave series and parallel
- Built to top quality standards
... MIL P-13949 & MIL A-8625
- Plug/wire in — compact design
- All Silicon ... 71°C operation

OS/PS SERIES—RATINGS AND PRICES

| MODEL | Each Output | | Price |
|-----------|-------------|------|-------|
| | Volts | Amps | |
| OS6-0.2D | 5-6 | 0.2 | \$49 |
| PS6-0.2D | 5-6 | 0.2 | \$69 |
| OS6-0.6D | 5-6 | 0.6 | \$69 |
| PS6-0.6D | 5-6 | 0.6 | \$89 |
| OS15-0.1D | 8-15 | 0.1 | \$49 |
| PS15-0.1D | 8-15 | 0.1 | \$69 |
| OS15-0.3D | 8-15 | 0.3 | \$69 |
| PS15-0.3D | 8-15 | 0.3 | \$89 |

WRITE FOR TECHNICAL BULLETIN

Deltron

WISSAHICKON AVE., NORTH WALES, PA. 19454
PHONE: (215) 699-9261 TWX: (510) 661-8061

D 117

See us at the IEEE show, Booth 2J39

INFORMATION RETRIEVAL NUMBER 83

Semiconductor Memory—R. Rice, Fairchild Semiconductor Research, Palo Alto, Calif. (6A.2/Wed./p.m./T)

Microwave Integrated Circuits for Avalanche Diode Applications—G. Basawapatna, Microstate Electronics Corp., Murray Hill, N.J. (6F.1/Wed./p.m./MH)

Monolithic and Hybrid Technology for Microwave Integrated Circuits—B. Dodson, F. Emery, Texas Instruments, Dallas, Tex. (6F.2/Wed./p.m./MH)

Microstrip Diode Phase Shifters—R. G. Forest, C. Ward, Microwave Associates, Burlington, Mass. (6F.3/Wed./p.m./MH)

Thick vs Thin Film Assembly Techniques for MIC's—J. F. Bunker, Microwave Associates, Burlington, Mass. (6F.4/Wed./p.m./MH)

Design of MIC's by Optimal Seeking Computer Techniques—C. J. Lump, U.S. Army Electronics Command, Fort Monmouth, N.J. (6F.5/Wed./p.m./MH)

The Problems and Promises of Micro-electronic Interconnection Processes—A. S. Rose, RCA, Sommerville, N.J. (7A.1/Thurs./a.m./T)

Beam Lead Chip Interconnection Systems—M. P. Eleftherion, Western Electric Inc., Princeton, N.J. (7A.2/Thurs./a.m./T)

The STD Interconnection Systems—J. P. Dietz, General Electric, Syracuse, N.Y. (7A.3/Thurs./a.m./T)

Flip Chip Interconnection Systems—L. F. Miller, IBM, Hopewell Junction, N.Y. (8A.1/Thurs./p.m./T)

Integrate for Household Appliances After Careful Value Study—C. E. Wellman, General Electric, Syracuse, N.Y. (8A.1/Thurs./p.m./T)

Integrated Circuits in the Automobile Radio—T. E. Endres, GMC, Kokomo, Ind. (8A.2/Thurs./p.m./T)

The Transition of LIC's in Television Receivers—R. A. Santilli, RCA, Somerville, N. J. (8A.3/Thurs./p.m./T)

The United Kingdom Market and Circuit Design—T. Jacobs, Mulard Ltd., London, England. (8A.4/Thurs./p.m./T)

Consumer Integrated Circuits in Japan—Hideo Hozumi, Matsushita Electric Industries, Osaka, Japan. (8A.5/Thurs./p.m./T)

Integrated Circuits in Array Design—W. T. Patton, D. Staiman, RCA, Moorestown, N.J. (8B.4/Thurs./p.m./M)

Microwaves

A Millimeter Waveguide Transmission System—I. Welber, BTL, Holmdel, N.J. (3B.1/Tues./a.m./M)

The Waveguide Medium: Manufacturing Challenge—T. Nakahara, Sumitomo Electric Industries, Ltd., Osaka, Japan, (3B.2/Tues./a.m./M)

Millimeter Waveguides: The Installation and Maintenance Challenge—E. E. Sumner, BTL, Whippany, N.J. (3B.3/Tues./a.m./M)

Optical Transmission Research—R. Kompfner, BTL, Holmdel, N.J. (3B.4/Tues./a.m./M)

Session Topics in Perspective to Other Microwave Power Sources and Amplifiers—B. Hoefflinger, Cornell University, Ithaca, N.Y. (5A.1/Wed./a.m./T)

Gallium Arsenide Transferred-Electron Oscillators and Amplifiers—F. Sterzer, RCA, Princeton, N.J. (5A.2/Wed./a.m./T)

Gallium Arsenide P-N Junction and Schottky Barrier IMPATT diodes—W. G. Mattei, Raytheon, Murray Hill, N.J. (5A.3/Wed./a.m./T)

High-Efficiency Avalanche Diode Microwave Sources—K. K. N. Chang, RCA, Princeton, N.J. (5A.4/Wed./a.m./T)

Power Combination with Diode and Circuit Arrays—J. W. Gewartowski, Bell Telephone Laboratories, Murray Hill, N.J. (5A.5/Wed./a.m./T)

Microwave Integrated Circuits for Avalanche Diode Applications—G. Basawapatna, Microstate Electronics Corp., Murray Hill, N.J. (6F.1/Wed./p.m./MH)

Monolithic and Hybrid Technology for Microwave Integrated Circuits—B. Dodson, F. Emery, Texas Instruments, Dallas, Tex. (6F.2/Wed./p.m./MH)

Microstrip Diode Phase Shifters—R. G. Forest, C. Ward, Microwave Associates, Burlington, Mass. (6F.3/Wed./p.m./MH)

Thick vs. Thin Film Assembly Techniques for MIC's—J. F. Bunker, Microwave Associates, Burlington, Mass. (6F.4/Wed./p.m./MH)

Design of MIC's by Optimal Seeking Computer Techniques—C. J. Lump, U.S. Army Electronics Command, Fort Monmouth, N.J. (6F.5/Wed./p.m./MH)

The Coaxitron Amplifier—J. A. Eshleman, J. B. Pickard, RCA, Lancaster, Pa. (7C.1/Thurs./a.m./SN)

Applications and Requirements for CW Power Klystron—C. Caryotakis, Varian Associates, Palo Alto, Calif. (7C.2/Thurs./a.m./SN)

The Twystron Hybrid Linear Beam Tube—R. B. Nelson, Varian Associates, Palo Alto, Calif. (7C.3/Thurs./a.m./SN)

Characteristics of an RF-Keyed Crossed Field Amplifier—I. M. Vaughan, Litton Industries, San Carlos, Calif. (7C.4/Thurs./a.m./SN)

TWT Versatility Extended by Integral Heat Pipe—L. H. Hershenson, K. G. Wood, Hughes Aircraft Co., Torrance, Calif. (7C.5/Thurs./a.m./SN)

Short Backfire Antennas—B. C. Reynolds, Radiation Systems, McLean, Virginia. (8B.1/Thurs./p.m./M)

Feed for Large Dishes—F. A. Lauriente, Rantec Corp., Grenada Hill, Calif. (8B.2/Thurs./p.m./M)

Aircraft Antennas for Satellite Communications at UHF/SHF—C. A. Linberg, MIT Lincoln Lab., Lexington, Mass. (8B.3/Thurs./p.m./M)

Integrated Circuits in Array Design—W. T. Patton, D. Staiman, RCA, Moorestown, N.J. (8B.4/Thurs./p.m./M)

Oceanography

Deep Ocean Search by Visual and Acoustic Means—C. L. Buchanan, U.S. Naval Research Laboratories, Washington, D.C. (2F.1/Mon./p.m./MH)

Operational Lessons in Deep Ocean Search—F. A. Andrews, Catholic University, Washington, D.C. (2F.2/



an unfair comparison...

The new Cyclohm Fan from Howard vs. "the other fan"

The new Howard tubeaxial fan delivers a larger volume of air over a wider range, runs up to 10 years without service or lubrication, has a rugged cast aluminum frame, yet costs about the same as "the other fan" you're now using. (See why we call the comparison "unfair"?)

In all fairness, we admit the new Howard Cyclohm fan is exactly the same size as "the other fan." They're interchange-

able. But then we come to comparisons like Howard Cyclohm's six-blade impeller (vs. three) which is computer-mated to the famous Howard Unit Bearing Motor with a 5-year warranty based on an engineered lifespan of 10 years (vs. a traditional bearing motor). Then, too, there's 115 CFM air delivery (vs. 100). And cost: The new Howard Cyclohm never costs more than "the other fan" . . . and Howard delivery is overnight!

Be fair to yourself: Send for all the unfair facts.



HOWARD

HOWARD INDUSTRIES
A DIVISION OF MSL INDUSTRIES, INC.
2420 18th STREET, RACINE, WISCONSIN 53403
414-632-2731 TWX 910-271-2387

Introducing
a new range of

NPO

low
pf

CHIP CAPACITORS

For exceptional stability where
performance requirements for
low capacitance are critical!

These tiny, monolithic NPO Chips (VJ0805) offer capacitance values from 1.0 to 9.1 pf in a .080 x .050 size. They have a temperature range from -55°C to $+125^{\circ}\text{C}$ and offer exclusive noble metal terminations—a design feature of all Vitramon "Vee Jem" Chip Capacitors—to assure exceptional bonding capabilities. Immediately available in quantity to meet your production schedule. *For complete specifications, write for Data Sheet C27.*

Vitramon[®]

VITRAMON, INCORPORATED
BOX 544
BRIDGEPORT, CONNECTICUT 06601

Mon./p.m./MH)

Ocean Floor Mapping by Towed Sensors—F. N. Spiess, Scripps Institute of Oceanography, San Diego, Calif. (2F.3/Mon./p.m./MH)

Panel Discussion—Challenges for the Future—with above Speakers. Moderator: J. P. Craven, MIT, Cambridge, Mass. (2F.4/Mon./p.m./MH)

Power Generation and Control

Advances in Nuclear Fusion Research—H. R. Drew, Texas Atomic Energy Research Foundation, Fort Worth, Tex. (1F.1/Mon./a.m./MH)

Power Transmission Advances—L. O. Barthold, Power Technologies, Inc., Schenectady, N.Y. (1F.2/Mon./a.m./MH)

Applications of Cryogenics—H. H. Woodson, MIT, Cambridge, Mass. (1F.3/Mon./a.m./MH)

Computer Applications—G. W. Stagg, American Electric Power Service Corp., New York, N.Y. (1F.4/Mon./a.m./MH)

Modern Control Theory Applied to Load-Frequency Problem—O. I. Elgerd, University of Florida, Gainesville, Fla. (2E.1/Mon./p.m./N)

Introducing Positive Damping Through Discrete Switching—W. A. Mittelstadt, Bonneville Power Administration, Portland, Ore. (2E.2/Mon./p.m./N)

Dynamic Measurements in Power Systems—G. L. Park, Michigan State University, East Lansing, Mich. (2E.3/Mon./p.m./N)

Computational Aspects of Power System Dynamic Simulation—J. M. Undrill, General Electric, Schenectady, N.Y. (2E.4/Mon./p.m./N)

Recent Optimization, Estimation, and Identification Developments in Electric Power System Operation—J. Peschon, R. E. Larson, F. J. Rees, L. P. Hajdu, A. S. Debs, A. J. Tether, Systems Control, Inc., Palo Alto, Calif. (7E.2/Thurs./a.m./N)

Some Practical Applications of Modern Control Theory in Steam Power Plant Control—T. J. Williams, R. C. Walters, Purdue University, Lafayette, Ind. (7E.3/Thurs./a.m./N)

Signal Processing

A Digital Frequency Synthesizer—Joseph Tierney, MIT Lincoln Lab, Lexington, Mass. (4B.1/Tues./p.m./M)

A Design Technique for Nonrecursive Digital Filters—L. R. Rabiner, Bernard Gold, Bell Telephone Laboratories, Murray Hill, N.J. (4B.2/Tues./p.m./M)

A Method of Generating Gaussian Random Numbers by Computer—C. M. Rader, MIT Lincoln-Lab, Lexington, Mass. (4B.3/Tues./p.m./M)

Applications of Digital Waveform Processing in Radar—H. D. Helms, BTL, Whippany, N.J. (4B.4/Tues./p.m./M)

Digital Filter Building Blocks from LSI Technology—W. A. Clapp, RCA, Inc., Camden, N.J. (4B.5/Tues./p.m./M)

There's a one micron difference in these mesh screens magnified 100,000* times

Can you see it?



* estimated

Not likely. You couldn't spot a 25 micron difference in these screens with the human eye, let alone one. We picture the enlarged micro-mesh screens because we regularly produce mesh to micron tolerances, or even millionths of inches.

Buckbee-Mears has all sorts of exotic capabilities in electroforming and the precision etching of metal and glass. We've been making precision parts since we began etching metal fire control reticles for the military in World War II. Today, with our automated computer-plotter system (BMAPS), we can do things 20 times faster than a few years ago. And do them more accurately, too.

For example, we electroform standard stock sieves down to 5 micron hole sizes, guaranteed accurate

within ± 2 microns. In quantity. We can do even better on special orders.

If you need a little less precision—for fewer dollars, of course—check our prices and delivery times for more routine etched metal or glass parts. We can make virtually any part that can be drawn on paper. Our prices are fair, and we think 15 days is long delivery.

Solving problems for people like you is our business. We have a long list of blue chip companies we've helped, and we'd like to add you to the list. Call or write Bill Amundson, Industrial Sales Manager, today. His number is 612-227-6371.

No problem is too small for us.

PRECISION METAL AND GLASS ETCHING • ELECTRO FORMING • AUTOMATED DESIGN

bmc BUCKBEE-MEARS COMPANY
SAINT PAUL, MINNESOTA 55101

INFORMATION RETRIEVAL NUMBER 86

Statistical Pattern Recognition—T. M. Cover, Stanford University, Stanford, Calif. (7D.1/Thurs./a.m./SS)

Can Coding Beat the System?—J. L. Massey, University of Notre Dame, Notre Dame, Ind. (7D.2/Thurs./a.m./SS)

The Evolution of High Speed Digital Data Transmission on Wire Lines—J. L. Holsinger, Codex Corp., Watertown, Mass. (7D.3/Thurs./a.m./SS)

Solid-State Devices and Theory

The Evolution in Gallium Arsenide Phosphide Injection Electroluminescent Displays—J. C. Barrett, Hewlett Packard Corp., Palo Alto, Calif. (2A.1/Mon./p.m./T)

Red and Green Light Emission from the Gallium Phosphide Diodes—W. Rosenzweig, Bell Telephone Laboratories, Murray Hill, N.J. (2A.2/Mon./p.m./T)

Visible Light Emission from Gallium Aluminum Arsenide—M. R. Lorenz, IBM, Yorktown Heights, N.Y. (2A.3/Mon./p.m./T)

Efficient Infrared-Excited Visible Luminescence in Rare Earth Systems—R. A. Hewes, General Electric, Nela Park, Cleveland, Ohio (2A.4/Mon./p.m./T)

DC Gas Discharge Panel Display—W. J. Harman, Jr. Burroughs Corporation, Plainfield, N.J. (2A.5/Mon./p.m./T)

Session Topics in Perspective to Other Microwave Power Sources and Amplifiers—B. Hoefflinger, Cornell University, Ithaca, N.Y. (5A.1/Wed./a.m./T)

Gallium Arsenide Transferred-Electron Oscillators and Amplifiers—F. Sterzer, RCA, Princeton, N.J. (5A.2/Wed./a.m./T)

Gallium Arsenide P-N Junction and Schottky Barrier IMPATT Diodes—W. G. Mattei, Raytheon, Murray Hill, N.J. (5A.3/Wed./a.m./T)

High-Efficiency Avalanche Diode Microwave Sources—K. K. N. Chang, RCA, Princeton, N.J. (5A.4/Wed./a.m./T)

Power Combination with Diode and Circuit Arrays—J. W. Gewartowski, Bell Telephone Laboratories, Murray Hill, N.J. (5A.5/Wed./a.m./T)

Systems Engineering

Systems Engineering—How Can We Use It Effectively?—Session Moderator, The Hon. R. A. Frosch, Assistant Secretary of the Navy (R&D). (3F/Tues./a.m./MH)

IntraSystems Compatibility in Large Aerospace Systems—J. A. Spagon, TRW Systems, Redondo Beach, Calif. (4D.1/Tues./p.m./SS)

Management Techniques for System ElectroMagnetic Compatibility—A. G. Zimbalatti, Grumman Aerospace Corp., Bethpage, L.I. (4D.2/Tues./p.m./SS)

Electromagnetic Compatibility in Modern Computer Systems—W. P. Lohner, IBM Corp., San Jose, Calif. (4D.3/Tues./p.m./SS)



The New York Hilton, where most of the technical program takes place.

Current Telecommunication Opportunities for Compatibility—G. W. Hayden, Institute of Telecommunication Science, Boulder, Colorado. (4D.4/Tues./p.m./SS)

Progress Report and Future Needs of the Dept. of Defense—J. P. Georgi, Electromagnetic Compatibility Analysis Center, North Severn, Annapolis, Maryland. (4D.5/Tues./p.m./SS)

Recent Legislation and Future Requirements of the FCC and Industry in EMC—Herman Garlan, Federal Communications Commission, Washington, D.C. (4D.6/Tues./p.m./SS)

Urban Engineering

Computer Techniques in Urban Government—S. Simich, Touche Ross

SEE IT AT
IEEE
BOOTH 2B32

2nd Son of Ubiquitous[®]

(AND SEE THE REST OF THE
UBIQUITOUS FAMILY, TOO.)

FEDERAL SCIENTIFIC CORP.

IEEE/COLISEUM, N.Y.C.

MAR. 23-26

2nd Son of Ubiquitous[®]

The new lil' Ubiq[®], the smallest real-time spectrum analyzer for on-line frequency measurements of noise, vibration, and underwater signals.

Now there are two basic real-time spectrum analyzers, each designed for a specific job.

The big Ubiquitous UA-6A for the lab is the finest, most flexible and precise instrument, to determine significant parameters during the R&D phase of study.

And now the new lil' Ubiq UA-10 — the smallest, easiest to operate, for use in the field, right at the source of the signals or in production where portability and economy are important, but where the highest speed and resolution are not required.

For special requirements, we make the 1000-line UA-9 with twice-as-fine resolution as the UA-6A; and the 100 kHz UA-8H, which operates five times as fast as the UA-6A.

We also make cross-PSD, correlation, and analyzer-computer systems.

Call us for a real-time solution to your signal processing problems.



| FEATURES | BIG UA-6A | NEW LIL' UA-10 |
|--|----------------------------------|---------------------------|
| Number of frequency points | 500 | 200 |
| Dynamic range | 54 dB | 48 dB |
| Number of analysis ranges | 10 | 7 |
| Narrowest built-in bandwidth | .02 Hz | .1 Hz |
| Widest coverage | 40,000 Hz | 20,000 Hz |
| Provision for machine signatures through external sampling | built-in | built-in |
| Transient capture | automatic built-in | manual (automatic option) |
| Frequency accuracy | digital marker calibrated to .2% | .5% read from display |
| Oscilloscope display, chart recording, and X-Y plotting | yes | yes |
| Single frequency select | with digital switches | with 10 turn dial |
| Companion averager | dual 500-pt. | single 200-pt. |
| Height | 12½" | 7" |
| Rack mounting | yes | yes |

federal scientific



FEDERAL SCIENTIFIC CORPORATION
 ORIGINATORS OF THE UBIQUITOUS[®] SPECTRUM ANALYZER
 SUBSIDIARY OF ©ELGIN NATIONAL INDUSTRIES, INC.
 615 W. 131ST ST., N. Y., N. Y. 10027. TEL: (212) 286-4400.



UNIVERSAL IC PACKAGING PANEL

**INCREASES FLEXIBILITY
IN PROTOTYPING
PRODUCTION AND
FIELD SERVICE**

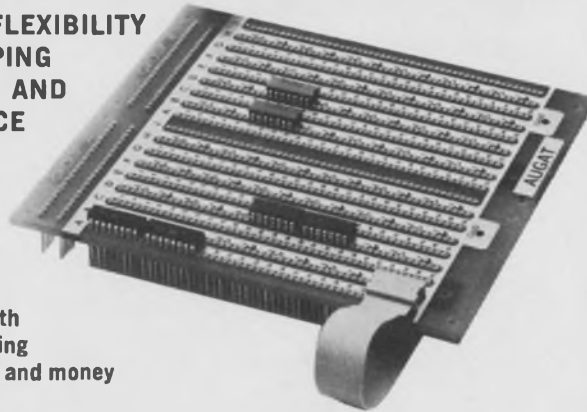

**U Series panel with
point to point wiring
saves time, space and money**

- Available in multiples of 9 row sections up to 54 rows.
- Each 9 row section accepts 3 plugs for interfacing or input-output connections.
- Accepts 14, 16, 24 and 36 lead Dual-in-Line integrated circuits.
- Double sided board with power and ground planes connected to additional wire wrap terminations outside of contact row.
- Wire wrap terminations with tri-level connection length.

Request complete I. C. folder.

AUGAT
INC.

Tel: 617-222-2202
31 Perry Ave., Attleboro, Mass. 02703

INFORMATION RETRIEVAL NUMBER 89

HIGH DENSITY IC PACKAGING PANEL

Increase flexibility — save time, space, money

**HIGH PERFORMANCE
FAST DELIVERY
LOW COST**

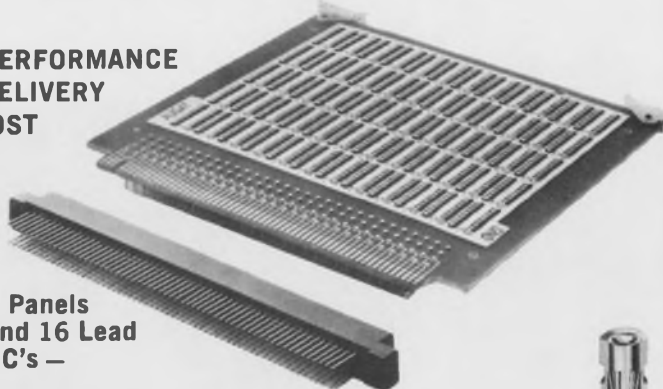

**R-Series Panels
For 14 and 16 Lead
Plug-In IC's —**

- 60 patterns standard
- Mates with Augat's new 120 contact edge connector with Wire Wrap terminations on .100 inch centers. Connector supplied separately.
- 1/8" double-sided board has power and ground planes connected to each IC pattern.
- Machined contacts assure high reliability and retention.
- Wire Wrap terminations on IC patterns.

AUGAT
INC.

Request Complete I. C. Folder
Tel: 617-222-2202
31 Perry Ave., Attleboro, Mass. 02703

INFORMATION RETRIEVAL NUMBER 90

Co., New York, N.Y. (1C.1/Mon./a.m./SN)

The Chicago Story—R. Golden, Civic Center Building, Chicago, Ill. (1C.2/Mon./a.m./SN)

The New York Story—H. B. Lipton Office of the Mayor, New York, N.Y. (1C.3/Mon./a.m./SN)

A Scenario for the Future of Cable Television Distribution—N. E. Feldman, Rand Corporation, Santa Monica, Calif. (2B.2/Mon./p.m./M)

Distribution of Electronic Mail Over the Broadband Party Line Communications Network—W. B. Gross, General Electric, Philadelphia, Pa. (2B.3/Mon./p.m./M)

Electronic Techniques Improve Urban Transportation—Theodore Karageuzoff, New York City Department of Traffic. (4C.1/Tues./p.m./SN)

Advances Toward Highway Automation—R. E. Fenton and K. W. Olson, Ohio State University, Columbus, Ohio. (4C.2/Tues./p.m./SN)

Stochastic Model of a Freeway Entrance Ramp Control System—Richard Wiener, City College of New York. (4C.3/Tues./p.m./SN)

High Speed Rail Vehicles—G. N. Sarma and Frank Kozin, Polytechnic Institute of Brooklyn. (4C.4/Tues./p.m./SN)

A Technique for Space Allocation in a Deterministic Traffic Network—R. K. Boyd and M. P. Lukas, TRW, Inc., Washington, D.C. (4C.5/Tues./p.m./SN)

Systems Approach to Effect On-Site Immediate Emergency Treatment—Jacob Kline, University of Miami, Coral Gables, Fla. (4E.1/Tues./p.m./N)

Automated Care of Acutely Ill Cardiac Patients—Alberto Budkin, Miami Heart, Institute, Miami Beach, Fla. (4E.4/Tues./p.m./N)

Telemetry for Emergency Medical Care, Some Systems Considerations—E. L. Nagel, University of Miami, Miami, Fla., H. M. Hanish, BioCom, Inc. Culver City, Calif. (4E.5/Tues./p.m./N)

Environmental Pollution—The Engineer's Task for Tomorrow—H. H. Heffner, Office of Science and Technology, Executive Office of President, Washington, D.C. (6D.1/Wed./p.m./SS)

Air Pollution Control: Our Problem—J. H. Ludwig, National Air Pollution Control Administration, Arlington, Va. (6D.2/Wed./p.m./SS)

Water Pollution Control Programs—A. Hirsch, Federal Water Pollution Control Administration, Arlington, Va. (6D.3/Wed./p.m./SS)

Land Pollution Control—J. L. Knetsch, The George Washington University, Washington, D.C. (6D.4/Wed./p.m./SS)

Urban Noise Control—K. D. Kryter, Stanford Research Institute, Menlo Park, Calif. (6D.5/Wed./p.m./SS)

Electromagnetic Spectrum Control Programs—W. Dean, Jr., Office of Telecommunications Management, Executive Office of the President, Washington, D.C. (6D.6/Wed./p.m./SS)

Trends in Transportation Computer Application for the 70's—W. P. Oilman, Chicago and North-Western Railway, Chicago, Ill. (7F.4/Thurs./a.m./MH) ■■

9—count 'em—9 resistors in this 1/4" × 1/4" sandwich

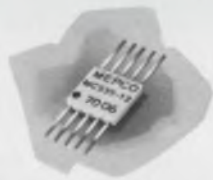

Ceramic resistor flatpacks from MEPCO

In addition to this 1/4"×1/4" package for up to 9 resistors, there's a 1/4"×3/8" size for up to 13 resistors, and a 1/4"×1/2" size for up to 19 resistors. All meet the environmental requirements of MIL-STD 202.

These precision, thick-film networks eliminate stocking of a wide variety of resistors when a pattern of values is used repetitively throughout a system.

Try them as pull-up resistors for IC logic networks, voltage dividers, miniature attenuators and matching networks, ladder networks or precision feedback resistors for operational amplifiers.

MEPCO mass produces these miniature ceramic-enclosed cermet resistor packs sealed with a high temperature polymer. To meet your specifications. At miniature prices. Send for complete data.



MEPCO, INC. Columbia Road, Morristown, N. J. 07960



Are you a forgotten man to everyone except your family -- and Uncle Sam?

If the figures on your Form 1040 reminded you of the job advancement you did *not* get this year, what are you going to do about it?

We believe that advancement may depend as much on being in the right place at the right time as it does on ability. If you agree, you should look into what's happening at NCR.

NCR is now the second largest company in the world in the computer systems business—supplying hardware and software answers for a whole world full of expanding markets. But the more answers we work out, the more questions we stir up.

That's why we are still growing rapidly. Why we need more engineers, of all degrees. More physicists, too. And software people. That's why NCR could be the right place—and *now* the right time—for you to advance your career.

In many positions you would be handling significantly more responsibility than you do now, because our employees advance as fast as they are able to assume additional duties.

Tell us about your background and career objectives. Write:

**T. F. Wade, Executive and Professional Placement
The National Cash Register Company, Dept. ED-3
Dayton, Ohio 45409.**

We are an Equal Opportunity Employer M/F



INFORMATION RETRIEVAL NUMBER 901

one of our advanced subsystems, the opto-hybrid*

detects small changes of input, amplifies and digitizes output • channel-to-channel uniformity of $\pm 10\%$ (important with translucent tape) • digital output DTL or TTL compatible • available with either low or high true level output • amplification right at the detector minimizes influence of noisy electrical environment • cost comparable with discrete component amplifiers and sensing array — a dramatic size/weight advantage • works equally well with LED or incandescent source • fits into existing systems with little or no redesign... any number of detectors in almost any specified package

*Shown — 9 channel tape reader version.

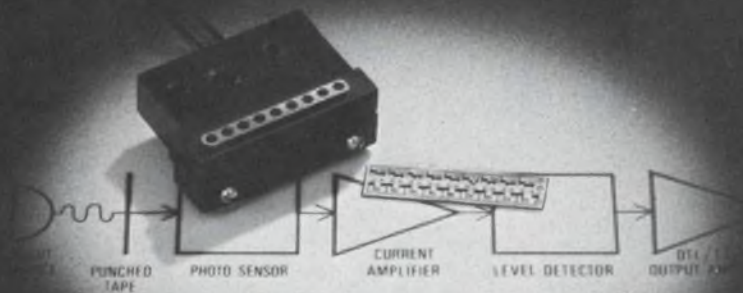

actual size

proof of the benefits of controlled crossbreeding— our new opto-hybrid

We've been making semiconductors a long time. Our list of "firsts" is impressive... particularly so in miniaturization of discrete silicon hi-rel devices. And, our assignment to produce silicon solar cells for the U.S. Space Program (we're #1) has kept us extra sharp in photovoltaics. Add to that our recent high-level R & D and technical work force build-up and you can see why right inside our plant is the best source for solutions to your hybrid circuit problems — whatever they may be. Bring us those problems. We'll solve them quickly and economically!



**CENTRALAB
SEMICONDUCTOR**

Division • GLOBE-UNION INC.
4501 NORTH ARDEN DRIVE
EL MONTE, CALIFORNIA 91734

zeners, temp.-compensated devices, tunnel diodes, rectifiers, scr's, semiconductor chips, hi-rel hybrids and photovoltaic products

INFORMATION RETRIEVAL NUMBER 93

See the product parade at IEEE '70.

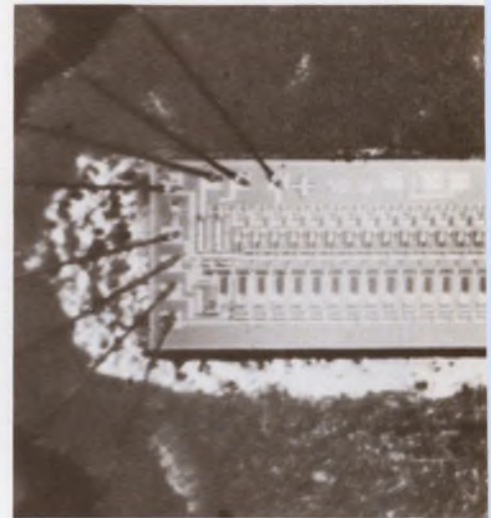

Differential IC operational amplifiers, which are also useful as direct-current amplifiers, can deliver output currents as large as 70 mA. p. U146.

| | | | |
|----------------------------------|------|-----------------------------------|------|
| Modules & subassemblies. | U132 | Components | U148 |
| Data processing. | U138 | Microwaves & lasers. | U152 |
| Instrumentation. | U140 | Packaging & materials. | U158 |
| ICs & semiconductors | U146 | Tools & engineering aids. | U159 |

Four-channel oscilloscope with digital readout and a four-trace display allows simultaneous viewing of inputs and outputs from digital ICs or flip-flops. This new instrument also features a bandwidth of greater than 1 GHz. Waveform voltage measurements can be made on any one channel. See p. U140.

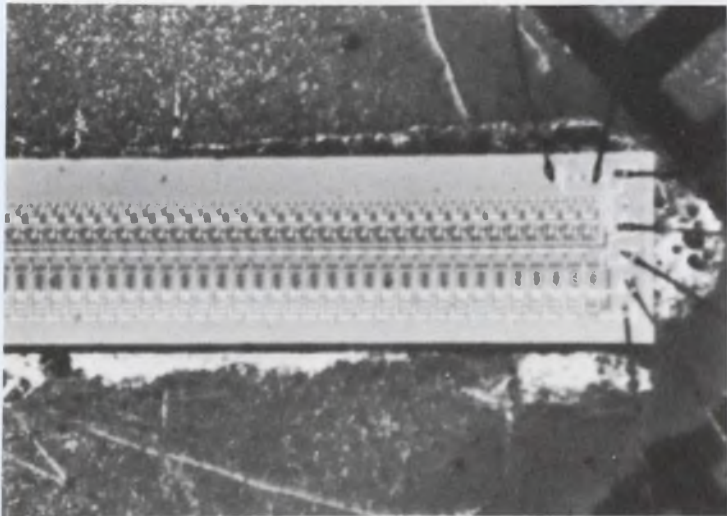

Monolithic photodiode array includes 51-bit on-chip shift register with its 50 photodiodes. p. U146.

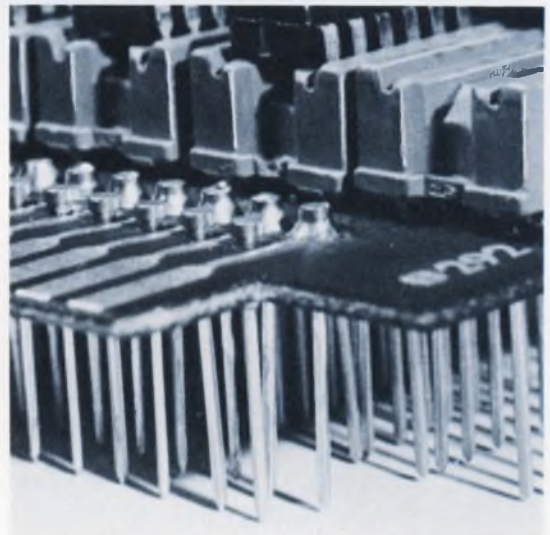

Plug-in modular IC logic-card system extends the do-it-yourself concept to logic designs. Able to choose from over 100 standard off-the-shelf integrated-circuit function logic cards, the designer can now do the simple logic himself. Up to 16 wire-wrap IC sockets can be accepted by a single PC-board module. p. U138.

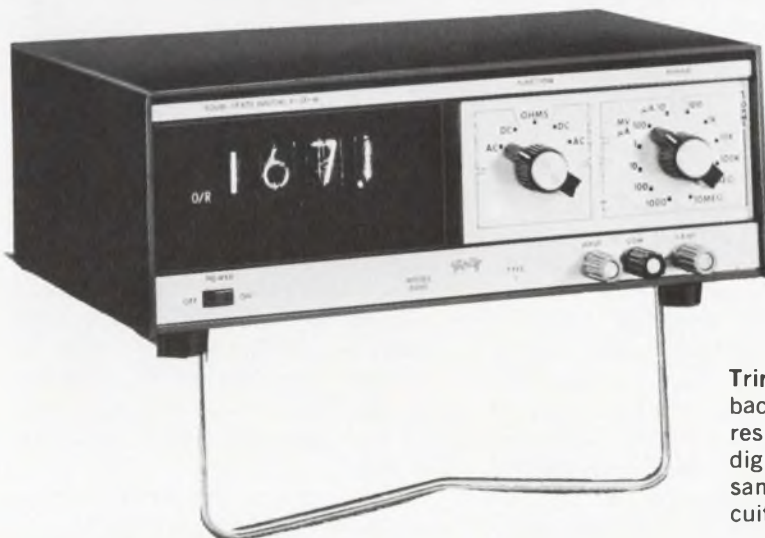

Trim digital multimeter, which virtually eliminates kick-back current, can make voltage measurements in high-resistance circuits at its stated accuracy. This 3-1/2-digit instrument also offers 50% overranging and a sampling rate of six times per second. Protective circuitry allows input voltages as high as 1000 V. p. U140.

Modular a/d and d/a converters boost performance, drop prices



Datel Corp., 943 Turnpike St., Canton, Mass. (617) 828-1890. P&A: see text; 2 weeks.

Making its mark in the highly competitive epoxy module market, Datel Corp., who is exhibiting for the first time at IEEE, is introducing several new lines of a/d converters and d/a converters.

The a/d converters consist of two basic types: series ADC-E which uses a dual-slope-integration conversion technique; and series ADC-L, M and H which use a modified successive-approximation conversion method.

Designed primarily for industrial and process control applications where noisy environments are a common problem, series ADC-E units achieve accuracies of $\pm 0.05\%$ at costs ranging from \$99 to \$149. They can handle 8, 10 or 12 binary bits or 3 BCD bits, and have a maximum conversion word rate of 3 kHz.

Series ADC-L, M and H units offer accuracies of $\pm 0.05\%$, $\pm 0.025\%$ and $\pm 0.1\%$, respectively, with price tags of \$225 to \$900.

Maximum conversion word rates are 25 kHz, 250 kHz or 2.5 MHz. Resolutions are 6, 8, 10, or 12 binary bits or 3 BCD bits.

All of the new converter series accept unipolar or bipolar inputs with voltage ranges up to ± 10 V. In addition, their outputs are compatible with DTL/TTL circuits. Module size is identical for all the units— $2 \times 4 \times 0.4$ in. Available options include a 10-channel MOS-FET analog multiplexer and sample-and-hold modules.

Emphasizing self-sufficiency, the new d/a converters include: input interfacing logic that is DTL/TTL compatible, high-speed electronic switches, a temperature-compensated voltage reference source, precision ladder networks, and an output buffer amplifier.

The HybriDAC series, which sells for \$69 to \$119, provides resolutions of 8, 10 or 12 binary bits to an accuracy of $\pm 0.05\%$. Their output settling time is $5 \mu\text{s}$ to $\pm 0.05\%$ of the final output value. Measuring but $1.5 \times 2 \times 0.4$ in., these units have a temperature coefficient

of 30 ppm/ $^{\circ}\text{C}$.

Series DAC-I units shorten settling time to 150 ns within $\pm 0.025\%$ of the final output value. Their unit costs range from \$115 to \$165, and module size is $1 \times 2 \times 0.4$ in. Like the HybriDAC devices, these converters can handle 8, 10, or 12 binary bits, in addition to 3 BCD bits. Temperature coefficient is 15 ppm/ $^{\circ}\text{C}$.

Offering the same resolutions as the DAC-I series, the DAC-V d/a converters are priced from \$129 to \$189. Their output settling time is $2 \mu\text{s}$ to $\pm 0.05\%$, while output amplitude is ± 10 V at 10 mA. The units, which measure $2 \times 2 \times 0.4$ in., provide a temperature coefficient of 20 ppm/ $^{\circ}\text{C}$.

The fourth series of this new d/a converter line is labeled DAC-H. Featuring an extremely fast output settling time of 30 ns to $\pm 0.1\%$, these devices can handle either 8 or 10 binary bits. Their maximum output voltage is 1 V at 5 mA, while temperature coefficient is 15 ppm/ $^{\circ}\text{C}$. Prices range from \$149 to \$169 for the DAC-H modules, whose sizes are $2 \times 2 \times 0.4$ in.

Also being shown for the first time at the IEEE show are two new power supplies. They are said to be the first line-operated dc power supplies in a package that is less than one cubic inch. Model UPM-5/1A uses an input voltage of 115 V ac to produce an output voltage of 5 V dc. Its output current is 1 A, and load regulation is $\pm 0.05\%$. The unit measures only $2 \times 2 \times 0.4$ in., and costs just \$89.

The model BPM-15/150 power supply also operates with an input voltage of 115 V ac. Its output, however, is ± 15 V dc at 150 mA. Load regulation for this unit is $\pm 0.05\%$. Like the model UPM-5/1A, the BPM-15/150 is a $2 \times 2 \times 0.4$ -in. module that has a price tag of \$89.

Both supplies can drive digital and linear integrated circuits.

Booth No. 3B29 Circle No. 364

Full performance at a price you can afford



You don't have to be a Scotsman to know that you pay more for top performance. So if we told you this new 3-digit DPM was made to sell for less than \$115 in OEM quantities, you'd figure its performance at something less than that delivered by our higher priced models.

But you'd be wrong. And here's why.

First of all, our initial objective was to develop an instrument for OEM measurement needs of the scientific and medical community. Obviously, price was an important factor. But so was performance. The happy solution

was to eliminate a few of the more exotic functions that these users normally don't require. For example, 100% overrange and standard BCD output (an option available on Model 1261).

Secondly, instead of compromising performance, we've actually *improved* it! Model 1261 is a basic 0-99.9 millivolt DC meter with 50% overrange capability, 100 microvolt resolution, long-term stability, 50 megohm input impedance, high rejection characteristics, and Weston's patented dual slope* circuitry. It's packaged in the plug-in case that's common to all our

DPM's, giving you Weston front panel serviceability.

This latest addition to our DPM family brings .1% accuracy within range of practically everyone's budget. Make your own comparisons, spec for spec, with other digital compacts on the market. Write today for complete data and ranges available.

WESTON INSTRUMENTS DIVISION,
Weston Instruments, Inc., Newark, N.J.
07114, a Schlumberger company

WESTON®

Economy 0.1% multiplier spans 100-kHz bandwidth

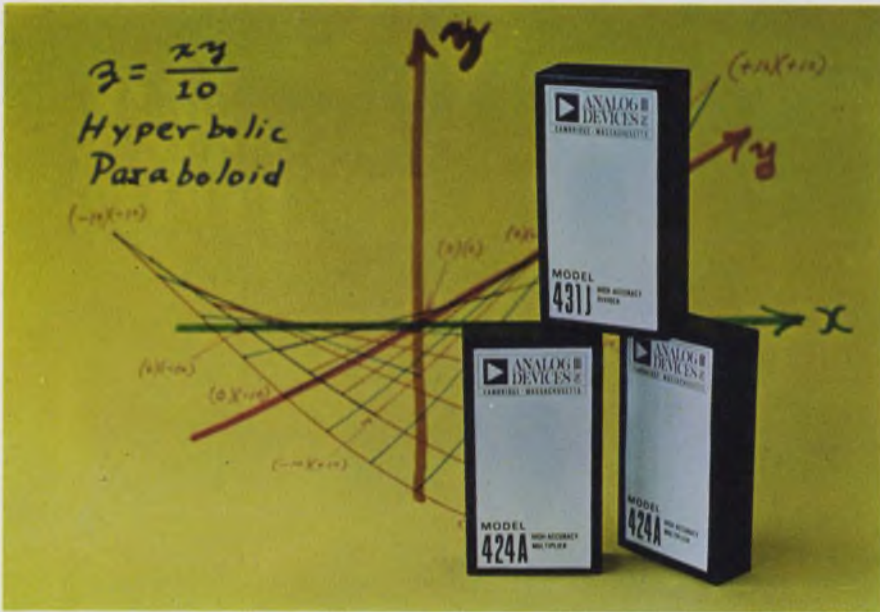

Analog Devices, Inc., 221 Fifth St., Cambridge, Mass. Phone: (617) 492-6000. P&A: \$175 or \$225; May, 1970.

Striking a happy medium in the cost-performance trade-off game, a new analog multiplier module achieves accuracies of $\pm 0.1\%$ and a bandwidth of 100 kHz, while holding price down to \$225. In addition, model 424K features a linearity of $\pm 0.04\%$ and a full-power response of 30 kHz.

For applications that do not require as stringent an accuracy, a second new multiplier, model 424J,

fills the bill. It too has a 100-kHz small-signal bandwidth and a 30-kHz full-power response, but its accuracy is $\pm 0.2\%$ (to 1 kHz) and its linearity is $\pm 0.08\%$. The 424J is also less expensive—only \$175.

Both of these computer-grade multipliers use pulse-height/pulse-width modulation and are, therefore, basically carrier devices. Their X and Y input signals modulate an internally generated multivibrator signal, whose average output is proportional to the product of the input signals. The X input controls the duration of the multivibrator output, while the Y input controls amplitude.

Output information is extracted from the multivibrator signal by low-pass filtering. This produces a signal that is proportional to the instantaneous average value of the carrier pulses.

Filtering removes the carrier harmonics, but gives a net frequency response that is usually only one-tenth the carrier frequency. To attain their 100-kHz bandwidth, the new multipliers use a 3-MHz carrier, instead of the 50-to-100-kHz one employed by previous devices.

Booth No. 3F16 Circle No. 361

Wideband amplifier settles in 80 ns



DDC Div., Solid State Scientific Devices Corp., 100 Tec St., Hicksville, N.Y. Phone: (516) 433-5330. P&A: \$125; stock to 3 wks.

With a minimum slewing rate of 400 V/ μ s, a new wideband amplifier settles to 0.1% in 80 ns maximum, or to 0.1% in 300 ns maximum. The output of model FS-23 is ± 10 V at 30 mA, and its typical voltage drift is 20 μ V/ $^{\circ}$ C. Settling time includes slew-rate limitations, and overshoot and delay. Some applications are d/a converters and pulse amplifiers.

Booth No. 3B11 Circle No. 267

Rack-mount supplies boast 75-A output

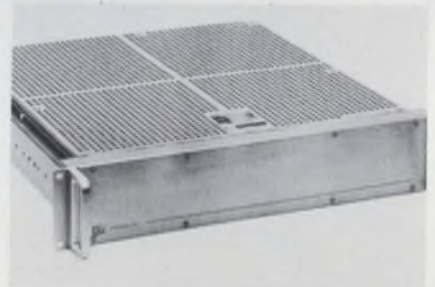

Dynage Inc., 1331 Blue Hills Ave., Bloomfield, Conn. Phone: (203) 243-0315. P&A: \$525 typical; 4 wks.

Initially available in five different case sizes, series L power supplies provide high efficiency and high current outputs with full over-voltage and overcurrent protection. A typical unit has a rating of 5 to 5.5 V at 75 A, and is packaged in a rack-panel configuration just 3-1/2-in. high. Standard voltage ratings for all five case sizes are 5.25-V nominal output, along with 12.5 and 15.5-V units.

Booth No. 2F06 Circle No. 263



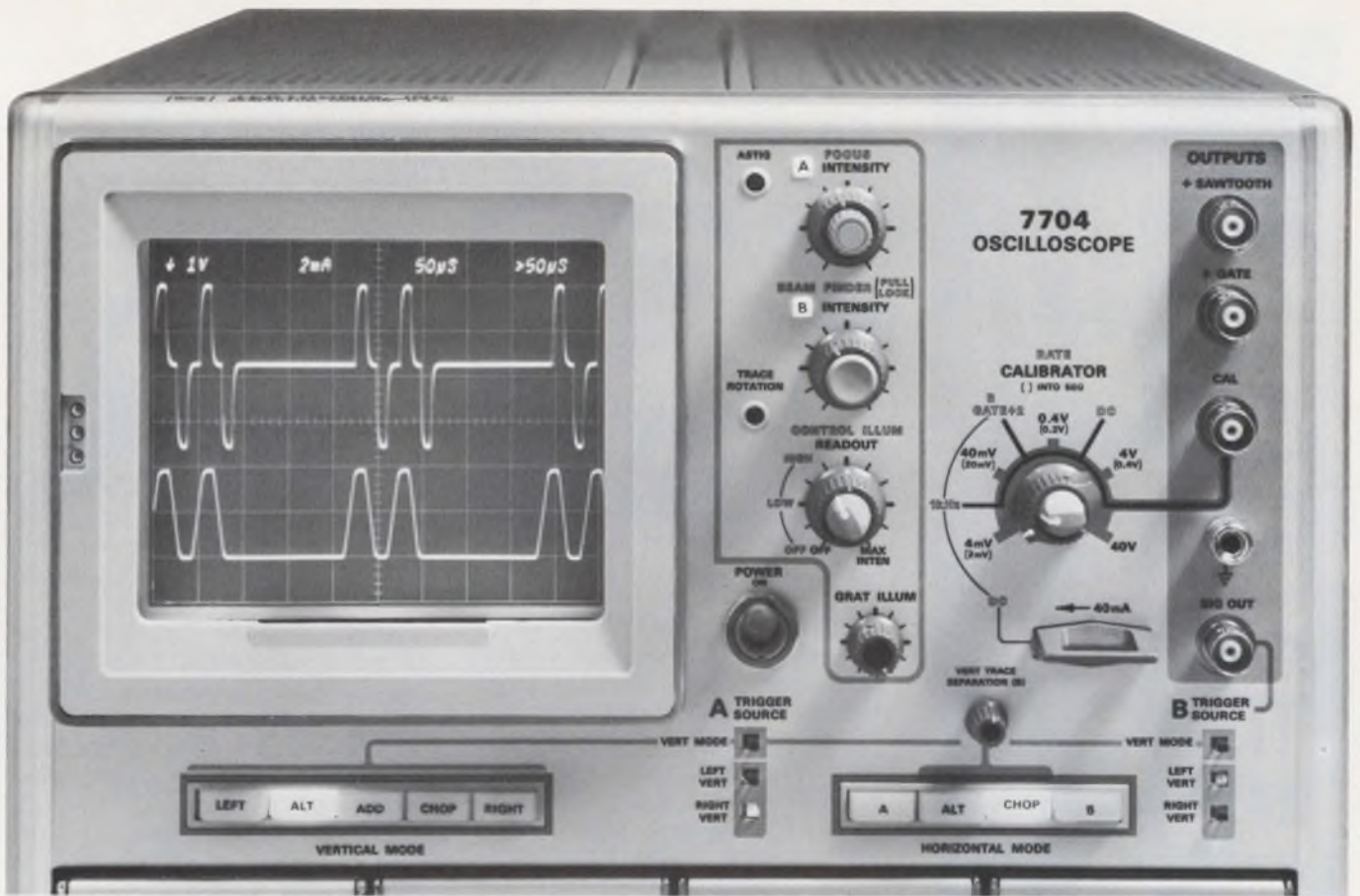

With Tektronix 7000-Series Oscilloscopes
**versatility begins
 with the mainframe**

The New Tektronix 7000-Series Oscilloscopes feature vertical and horizontal amplifiers with dual inputs. This means the mainframe amplifiers can be time shared by up to four plug-ins for unmatched display versatility. Up to 20 combinations of vertical and horizontal operating modes are possible. Simultaneous measurements can be made by multiple plug-ins with widely different features. Voltage and current, real time and sampling, high-gain differential and dual trace, delaying and delayed sweeps are just a few examples. Many applications which formerly required a true dual-beam oscilloscope are now solved by mainframe amplifiers which simulate dual-beam performance.

With mainframe versatility, and four plug-in capability, a wider range of measurement problems can be solved with only one oscilloscope.

Thirteen New plug-ins covering a wide performance spectrum complement the versatility of the new Tektronix four plug-in oscilloscopes. More plug-ins are initially available than in many oscilloscopes even years after introduction. Today, you can choose a New 7704 (150 MHz) or 7504 (90 MHz) Tektronix mainframe with unmatched versatility, confident that plug-ins are ready to solve virtually all of



your multi-trace, differential, sampling, or X-Y measurements.

For measurement ease, Auto Scale-Factor Readout labels the CRT with time/div, volts or amps/div, invert and uncal symbols and corrects for probes and magnifiers. All the data is on the CRT, where you need it to make faster measurements with fewer errors. And, looking into the future, the readout system is designed to meet needs other than those of today's plug-ins. You can solve **more** measurement problems **easier** and **quicker** with an oscilloscope where VERSATILITY begins with the mainframe.

Your Tektronix Field Engineer will gladly discuss with you the complete VERSATILITY of the New Tektronix 7000-Series Oscilloscope System. Contact him locally or write: Tektronix, Inc., P. O. Box 500, Beaverton, Oregon 97005. See your 1970 Tektronix catalog for specifications.

Prices of instruments shown:

| | |
|--|--------|
| 7704 150-MHz Four Plug-In Oscilloscope | \$2500 |
| 7A16 150-MHz Single-Trace Amplifier | \$ 600 |
| 7A14 105-MHz Current Amplifier | \$ 575 |
| 7B71 Delaying Sweep Time Base | \$ 685 |
| 7B70 Delayed Sweep Time Base | \$ 600 |

U.S. Sales Prices FOB Beaverton, Oregon

Tektronix, Inc.

committed to progress in waveform measurement

INFORMATION RETRIEVAL NUMBER 95

IF YOU NEED SOLENOIDS

YOU NEED

DORMEYER INDUSTRIES

**WRITE FOR FREE
TECHNICAL DATA**

Visit Booth #4B16
IEEE Show



DORMEYER INDUSTRIES, Inc.
3414 No. Milwaukee Ave., Chicago, Ill. 60641

MODULES & SUBASSEMBLIES

**Reference ladder switch
lowers offset to 2 mV**

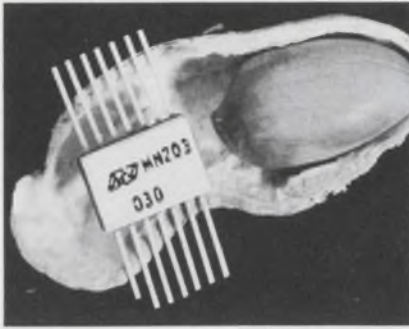

Micro Networks Corp., 5 Barbara Lane, Worcester, Mass. Phone: (617) 756-4635. P&A: \$60; stock.

Featuring a low series resistance of 20 Ω , a new negative-reference ladder switch has a low offset voltage of 2 mV maximum. The MN203 has a pair of spdt switches that drive resistance ladders for d/a circuits. Its input is compatible with monolithic logic circuits and its output delivers ground or -10 V to the ladder. Units are available to drive up to 14-bit d/a circuits.

Booth No. 4G11 Circle No. 342

**Display module
lights up 50 dots**



Cunningham Corp., Honeoye Falls, N.Y. Phone: (716) 624-2000. P&A: \$200; stock.

The Glo-Cator is a new high-density lighted display module that displays the condition of as many as 50 switches in dots of clearly defined light on a matrix pattern. It incorporates its own lamp driver and test circuits and operates from 5-V logic at low currents. Any number of units can be combined in any direction to duplicate a matrix pattern.

Booth No. 3A12 Circle No. 336

**Modular multiplier
boasts 1% accuracy**



Zeltex Inc., 1000 Chalomar Rd., Concord, Calif. Phone: (415) 686-6660. Price: \$43.

Without using external trimming potentiometers, a new multiplier offers an accuracy of 1% maximum. The model 605 modular unit features an output offset drift of only 2 mV/ $^{\circ}$ C and a gain error drift of only 0.03%/ $^{\circ}$ C. Its full-output frequency response is 100 kHz and small-signal response is 500 kHz. It is short-circuit proof and measures only 1.5 \times 1.5 \times 0.625 in.

Booth No. 2H19 Circle No. 338

**Small decade counter
works at 10-MHz rate**

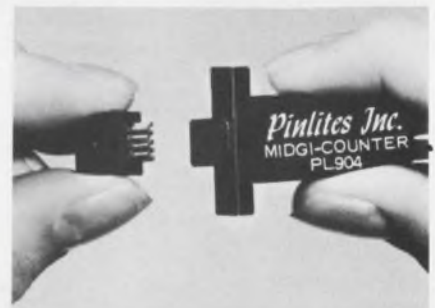

Pinlites Inc., 1275 Bloomfield Ave., Fairfield, N.J. Phone: (201) 226-7724. Availability: stock.

Only one-sixth of a cubic inch in volume, the Midgi-Counter is a miniature decade counter that can operate at rates up to 10 MHz. Compatible with IC circuitry, the unit counts a TTL data pulse and then converts it to a seven-segment code. Both military and commercial versions are available. All models are designed for 5-V operation, and feature automatic zero blanking.

Booth No. 3H01 Circle No. 269

MOST DIVERSIFIED LINE OF 512 STOCK RELAYS FOR CUSTOM APPLICATIONS
general purpose • telephone type • dry reed • mercury-wetted contact • industrial power • plug-in
coaxial • hermetically sealed • time delay • solid state • printed circuit • latching • high voltage

Magnecraft

STOCK RELAYS



**CATALOG
NO. 271**

*Specifying relays? You need our
new catalog of 512 stock relays for
immediate delivery. Send for it!
And see us at IEEE—Booth #3E11.*

MAGNECRAFT ELECTRIC CO. • 5575 N. LYNCH AVE. • CHICAGO, ILL. 60630 • 312 282-5500 • TWX 910-221-5221

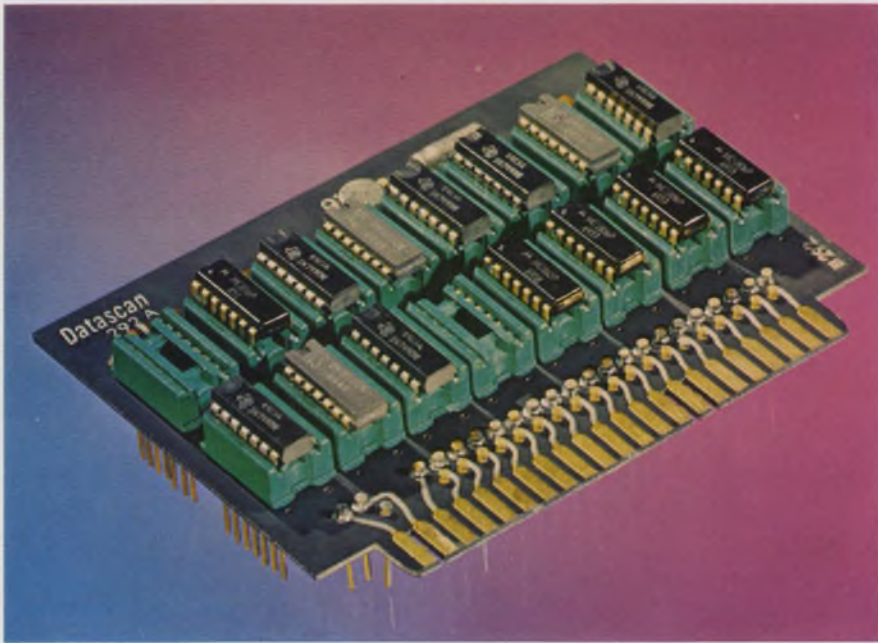

Plug-in IC logic-card system permits customized designs

Datascan, Inc., 1111 Paulison Ave., Clifton, N.J. Phone: (201) 478-2800. P&A: \$47 for basic board, \$4 per socket for wiring, \$2 average per IC; stock.

Extending the do-it-yourself concept to logic circuits, the Wrap-X logic-card system allows the engineer to select the complex function cards he needs and then do the simple logic himself.

Key to this concept is the Wrap-X printed-circuit-board module, which contains 16 wire-wrap sockets for 14-pin ICs and/or 16-pin MSI chips. The true significance of this new Wrap-X card is its mechanical compatibility with over 100 standard off-the-shelf function logic cards—like decimal converters and shift registers.

The Wrap-X card system competes with the large-scale backplane approach. Wrap-X, however, offers an economic advantage for use in small systems or for prototype quantities of large systems. Complex function cards, for example, cannot be economically duplicated with a backplane approach.

In addition, backplane methods require very complex wire-wrap interconnections to replace the func-

tion cards. Therefore, an extensive run list and many hours of engineering time are often necessary. In contrast, most of the interconnections are plated in the Wrap-X system.

Another consideration is that discrete components and semiconductors must be housed on plug-in platforms when the backplane approach is used. Each of these platforms requires a physical design before the run list can be generated. This also frequently entails many hours of design and drafting time. In the Wrap-X standard-card system, the function cards are already designed and laid out.

The wiring for large backplane units is usually more extensive than for the Wrap-X system because all of the plated interconnections on the function cards must be hard wired. In backplane systems then, there is a risk of noise problems because summing junctions and other low-level signal points must be tracked over some distance, and may be mixed with digital wiring.

An additional Wrap-X feature is dynamic decoupling.

Booth No. 2E51 Circle No. 360

Scientific calculators use MOS LSI circuits



Litton Industries, Monroe Div., 550 Central Ave., Orange, N.J. Phone: (201) 673-6600.

Employing MOS LSI technology, four electronic calculators are sophisticated scientific machines that can make decisions, as a computer does, in a portable 12-pound desktop package. Series 1600 units consist of two display models and two printing models. They have 10 data storage registers, and provide standard decimal and scientific decimal notation.

Booth No. 3A23 Circle No. 291

Endless loop cassette leans on single hub



TDK Electronics Corp., 23-73 48th St., Long Island City, N.Y.

Compatible with any cassette machine, a new endless loop cassette uses a novel principle of operation—the tape is fed from and taken up by the same hub. The other hub has a spring to keep the unit firmly in place on the machine. Initially, the unit will be available in 3, 6 and 12-minute packages. Applications include self-learning, industrial training, and use as a message repeater.

Booth No. 4C04 Circle No. 258

In our first act we introduced our precision miniature line of snap-action switches. Now comes a beautiful new addition—the sub subminiature line.

All we ask is a chance to prove our ability to give you real quality at a competitive price. With old-time service and on-time delivery a part of the deal. We invite comparisons.

For example. The unique design of our sub subminiature incorporates a floating contact blade and a low stressed C-spring which provides an overtravel tolerance minimum of .010 inch. Less than half as critical as competition.

And it has a minimum electrical life of 50,000 operations—at rated load.

As you can see, we're making a real play for your next switch order. Sub subminiature or miniature. Let your Cutler-Hammer Sales Engineer or Switch Distributor give you our product/service story. He could bring down the curtain on your old supplier.

CUTLER-HAMMER 

SPECIALTY PRODUCTS DIVISION Milwaukee Wis. 53201

INFORMATION RETRIEVAL NUMBER 98

Our SS10KT40 with gold contacts is one of the many stars in our sub subminiature line.

16 switches, all U.L. listed. 4 terminal variations (single turret, double turret, pin, and quick connect). 6 industry standard external actuators (leaf, reverse leaf, roller leaf, reverse roller leaf, lever, and roller lever). Gold contacts. Switches in stock for immediate delivery.

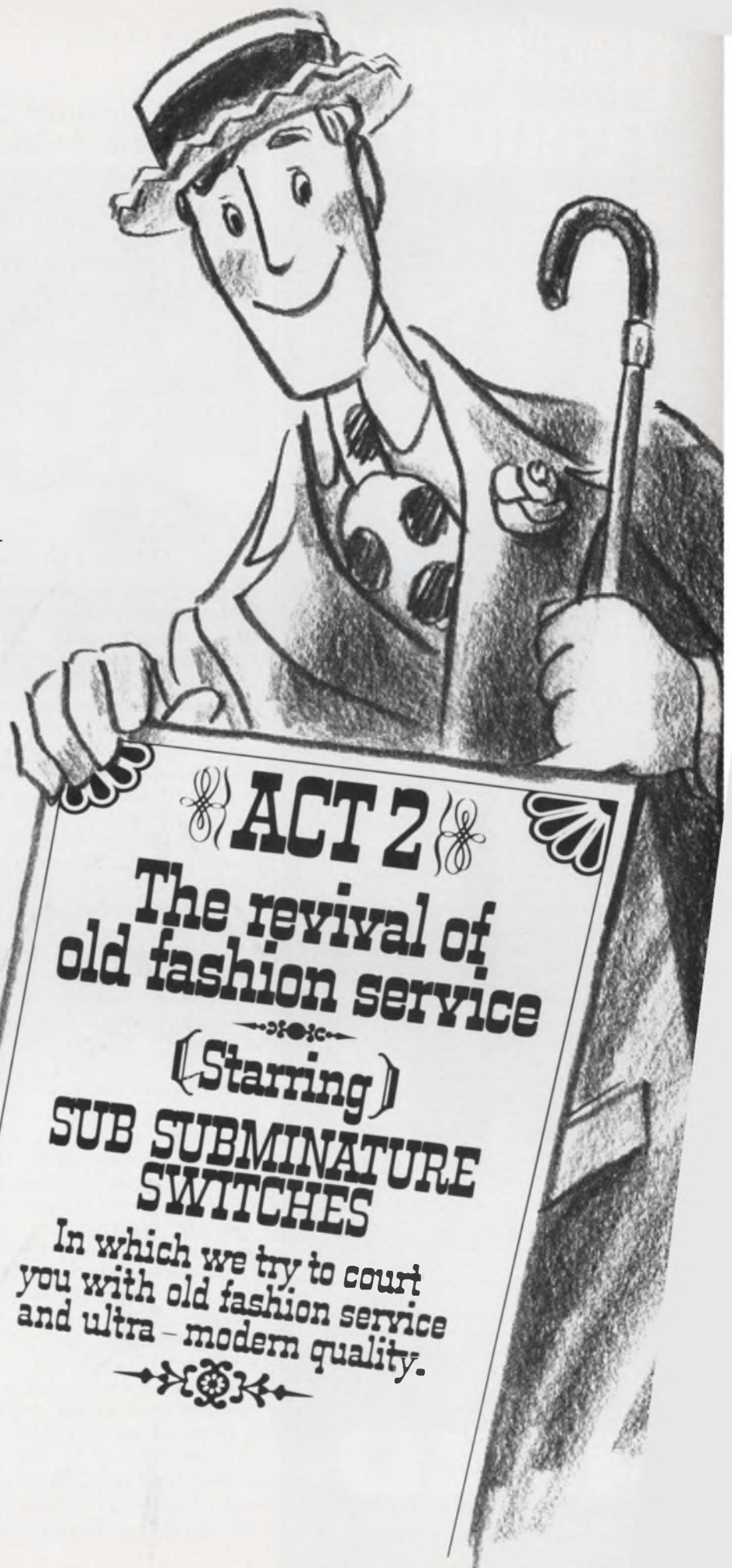
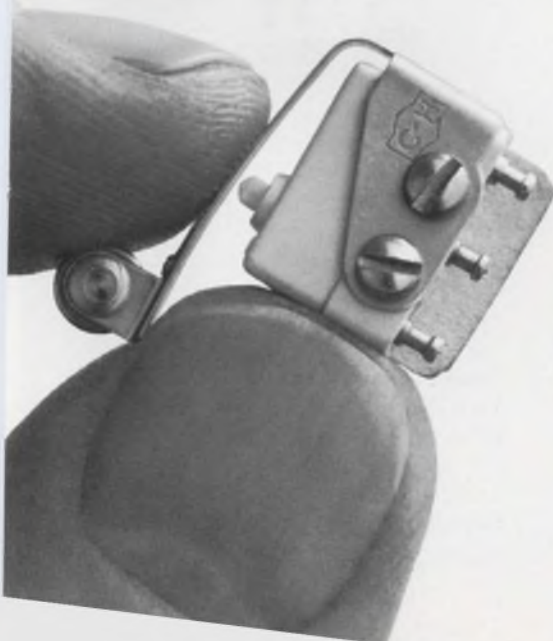

packaged readouts

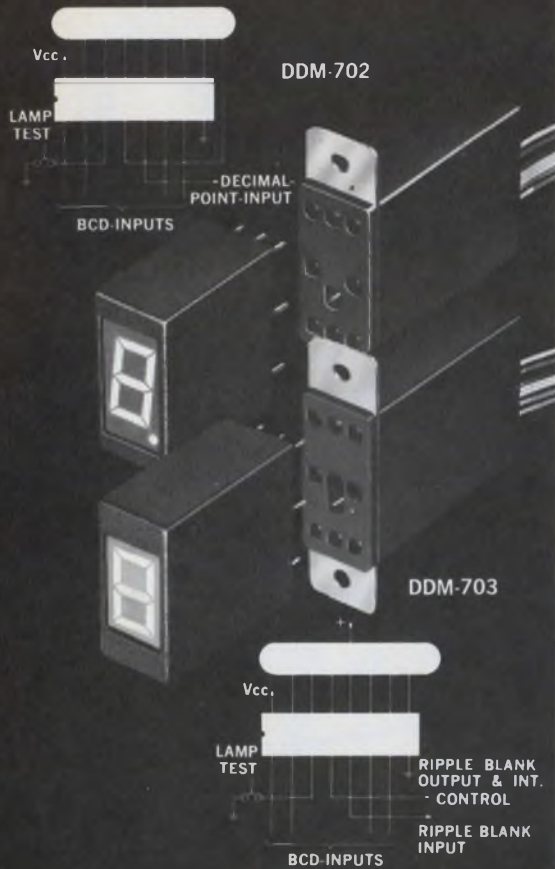

Now you can buy the complete readout and decoder/driver combination rather than assemble your own.

The ALCO "packaged readouts" include the 7-segment incandescent devices ready to plug into its own mating decoder/driver having a BCD input compatible with DTL and TTL circuitry.

Model DDM-702 has an ALCO MS-4100BC seven-segment readout and features an inverter-driver function necessary to energize the decimal point in the display device. Complete Package Price, \$19.95 (100 lot).

Model DDM-703 includes an ALCO MS-4000BC readout having a ripple blanking capability and intensity control input. Both models operate on 5V and have a lamp test provision. Complete Package, \$18.95 (100 lot).

It's more convenient to plan your designs the ALCO way. We provide a cost advantage whether application is for a prototype or in production. We also supply matching bezels and mounts to support up to 8 of the above modules.

Call us now at (617) 686-3887 and ask for one of our readout specialists.

ALCO®

ELECTRONIC PRODUCTS, INC.
Lawrence, Massachusetts 01843

See us at Alco Booth 4G-23

INSTRUMENTATION

Portable low-cost DMM checks five functions



Hickok Electrical Instrument Co., 10514 Dupont Ave., Cleveland, Ohio. Phone: (216) 541-8060. P&A: \$380 (includes battery and probes); April 1970.

Capable of measuring ac and dc voltages, ac and dc currents and resistances, a new low-cost portable multimeter features a 3-1/2-digit readout. It also includes a built-in battery check.

The model 3300 meter has 100% overrange and auto-polarity and operates from a rechargeable nickel-cadmium battery or 115 or 230 V ac.

Dc voltages are measured over 6 ranges from 100 mV to 10 kV with a minimum resolution of 100 μ V. Accuracy extends from 0.1% of reading ± 1 digit to 0.5% of full scale.

Ac voltages are measured over 6 ranges from 100 mV to 10 kV with a minimum resolution of 100 μ V. Accuracy extends from 0.5% to 1% of full scale. Ac frequency response covers 22 Hz to 100 kHz.

Dc and ac currents are measured in 4 ranges each over 1 mA to 1A at a minimum resolution of 1 μ A. Dc current accuracy is 0.2% of reading ± 1 digit and ac current accuracy ranges from $\pm 0.5\%$ to $\pm 1\%$ of full scale.

Resistance measurements range over 100 Ω to 10 M Ω in 7 ranges. Accuracy is 0.3% of full scale. Input resistance is 11 M Ω dc and ac impedance is 10 M Ω and 200 pF.

Booth No. 2C25 Circle No. 252

◀ INFORMATION RETRIEVAL NUMBER 101

Digital multimeter stops kickback current

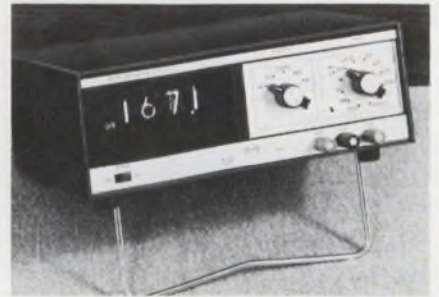

Triplet Corp., 286 Harmon Rd., Bluffton, Ohio. Phone: (419) 358-5012. Price: \$575.

A new 3-1/2-digit multimeter boasts virtually no kickback current, thereby allowing voltage measurements in high-resistance circuits at stated accuracy. Model 8000 also has protective circuitry that prevents damage to the tester when input voltages are as high as 1000 V ac or dc. It has 50% over-ranging, and a sample rate of six times per second.

Booth No. 2D40 Circle No. 299

Digital readout scope offers four channels



E-H Research Laboratories, Inc., 515 11th St., P.O. Box 1289, Oakland, Calif. Phone: (415) 834-3030.

Providing more than 1-GHz bandwidth, a new four-channel four-trace oscilloscope with digital readout allows simultaneous viewing of inputs and OR/NOR outputs from digital ICs or flip-flops. Model 1100 permits time measurements to be made between any two points on one channel's displayed waveform, or between points on any two of the four channels.

Booth No. 2C29 Circle No. 297

INFORMATION RETRIEVAL NUMBER 102 ▶



Trust your Guardian Angel

for the newest 4PDT—5amp miniature relay

Give us a cubic inch on your printed circuit board . . . and we'll fill it with a plug-in relay. The logical relay for logic systems, computers, business machines—any application requiring maximum endurance and reliability in minimum space. Our new 1310, 4PDT-5 amp miniature relay is just a little more than one cubic inch in size, with inductive load contact rating of $\frac{1}{8}$ hp @ 120V 60 Hz. But the small size doesn't limit its mechanical life of 100 million operations DC, 50 million AC. Minimum!



The miniature size doesn't limit its versatility, either. It's available with a choice of solder lug, quick connect .110, or printed circuit terminals—sockets for "plug-in" installation available with PC or solder lug. Other features like AC and DC versions, the Lexan dust enclosure that's standard, plus U/L and CSA recognition make this relay the answer to an engineer's prayers. (And all this time you didn't really believe you had a Guardian Angel!)



**GUARDIAN[®]
ELECTRIC**

MANUFACTURING COMPANY • 1550 West Carroll Avenue, Chicago, Illinois 60607



COMPLETE APPLICATION DATA is yours for the asking. Send for Bulletin B5-1.

Talk to your Guardian Angel at the IEEE Show.

designer's keyboard

SB-033 — INTERLOCK
SB-034 — MOMENTARY



28.50 User Net

The ALCO modular idea is a simple concept for the design engineer to create his own custom push button layouts from "stock" switch modules and assemblies.

The basic modules allow use of up to twelve (shown at right) switches per section. A designer may stack any number of these switch sections in a group by themselves or in conjunction with the ALCO mating 12-segment keyboard assemblies (shown above).

Highly efficient, single pole "normally open" reed switches are used throughout, thus assuring reliability and extremely long life expectancy.

For design-service assistance and price quotations, call (Area 617) 686-3887.

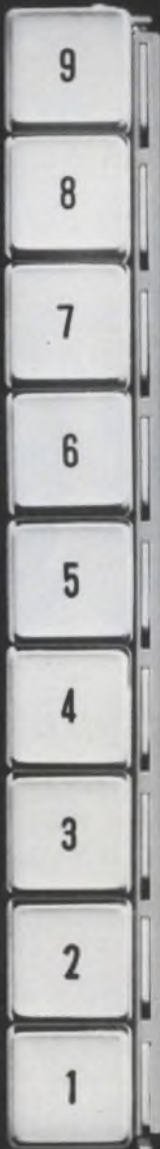
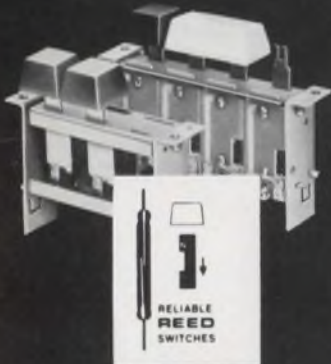

Available as Momentary and Interlock

ALCO

ELECTRONIC PRODUCTS, INC.

Lawrence, Massachusetts 01843

See Us At Alco Booth 4G-23

INSTRUMENTATION

Three-plug-in scope reaches out to 90 MHz



Tektronix, Inc., Box 500, Beaverton, Ore. Phone: (503) 644-0161. P&A: \$1775, \$900; 2 months.

A new addition to the 7000-series of oscilloscopes is the type 7503 three-plug-in scope with a 90-MHz bandwidth. Its mainframe provides electronic switching between two vertical plug-ins. This allows simultaneous measurement of two waveforms. Another new addition to the 7000 series is the 7B52 time base. It has normal, intensified, delayed and mixed sweep modes.

Booth No. 2G25 Circle No. 280

Chronetics, Inc., 500 Nuber Ave., Mt. Vernon, N.Y. Phone: (914) 699-4400. P&A: \$4000; stock.

The model 1012 is a fully programmable pulse generator that is TTL and DTL-interface compatible. It provides all timing generation, output drivers and all digital manual and remote-control functions. It operates up to 20 MHz in a single or double-pulse mode. Featured are pulse delay, width control, control delay, dc offset and external-triggering capabilities.

Booth No. 2F40 Circle No. 354

Pulse generator interfaces TTL/DTL

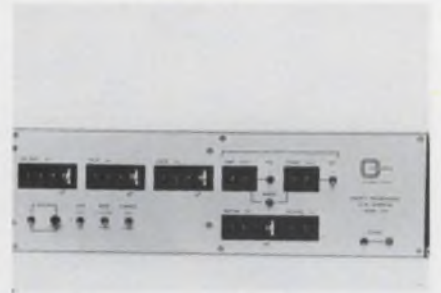

Systron Donner Corp., 888 Galindo St., Concord, Calif. Phone: (415) 682-6161. Price: \$1295.

Displaying a five-digit readout with 20% overrange capability is a new digital voltmeter with a resolution of 1 μ V. The model 7005 digital voltmeter includes a built-in current measuring mode that eliminates the need for external shunts. Adding options to the unit is simplified by the use of plug-in boards which insert into built-in slots on the voltmeter.

Booth No. 2B11 Circle No. 343

Five-digit voltmeter resolves down to 1 μ V



Dana Laboratories Inc., 2401 Campus Dr., Irvine, Calif. Phone: (714) 833-1234. Price: from \$1495.

Five series 8000 universal timer-counters can measure frequency to 120 MHz, in addition to period and multiple period average, and can totalize and do frequency scaling. The model 8035 has a 10-ns time-interval resolution and makes frequency measurements to 500 MHz with a 500- μ V sensitivity. An eight-digit display is standard on all units.

Booth No. 2H39 Circle No. 285

Timer-counters resolve 10 ns



◀ INFORMATION RETRIEVAL NUMBER 103

INFORMATION RETRIEVAL NUMBER 104 ▶

MORE SWITCH FOR THE MONEY.

NOW YOU CAN SPECIFY PRACTICALLY ANY CUSTOM PUSHBUTTONS ON SWITCHCRAFT'S DW "Multi-Switch®"

There's almost no limit to the variety of pushbuttons you can use on this space-saving, multiple-station pushbutton switch. It has a newly designed "Cross-Rib" actuator located on each module



that makes the switch more versatile than ever.

The "Cross-Rib" actuators conform to industry standards and are furnished $\frac{3}{4}$ " and $1\frac{1}{8}$ " long to accommodate different size pushbuttons. They solve many operator-machine interface problems

when used with Switchcraft non-illuminated "Dual," "Showcase," concave or convex face, rectangular, round or square pushbuttons, or the unique "Glo-Button" that achieves simulated illumination.

MORE QUALITY FOR THE MONEY.

In a nutshell, the Series 70000, 71000 DW "Multi-Switch®" is an economical 1 to 18 station switch, that offers up to 4 PDT switching per station; Interlock, All-Lock, Non-lock or Push-lock/ Push-release functions, plus an almost unlimited variety of electromechanical and electrical accessory options. These switches are adaptations of the Switchcraft Series 65000 DW "Multi-Switch®" switches that

are noted for their simplicity, economy and reliability.

SWITCHCRAFT FORUM

Join the SWITCHCRAFT FORUM by sending us a request on your company letterhead. Just give us details

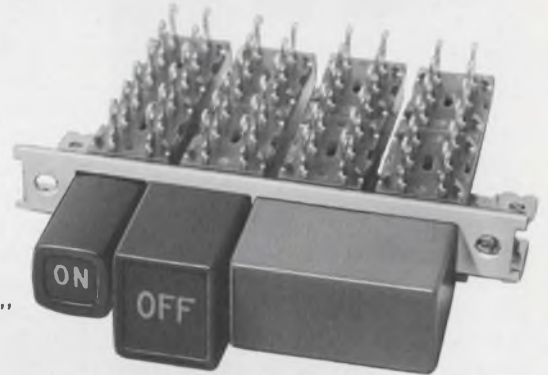

on your application, function and the circuitry required.

We'll forward a free sample of the Series 70000 DW "Multi-Switch®" plus our "FORUM FACTS on 'Multi-Switch®' SWITCHES" handbook that's loaded with specifications and application information. Your name will also be added to our TECH-TOPICS mailing list. Over 12,000 design engineers find the application stories in this technical publication extremely useful in their work.

SEE US AT IEEE—BOOTH 4G30-32
SWITCHCRAFT, INC.
5529 N. Elston Avenue
Chicago, Illinois 60630



SWITCHCRAFT
INC.

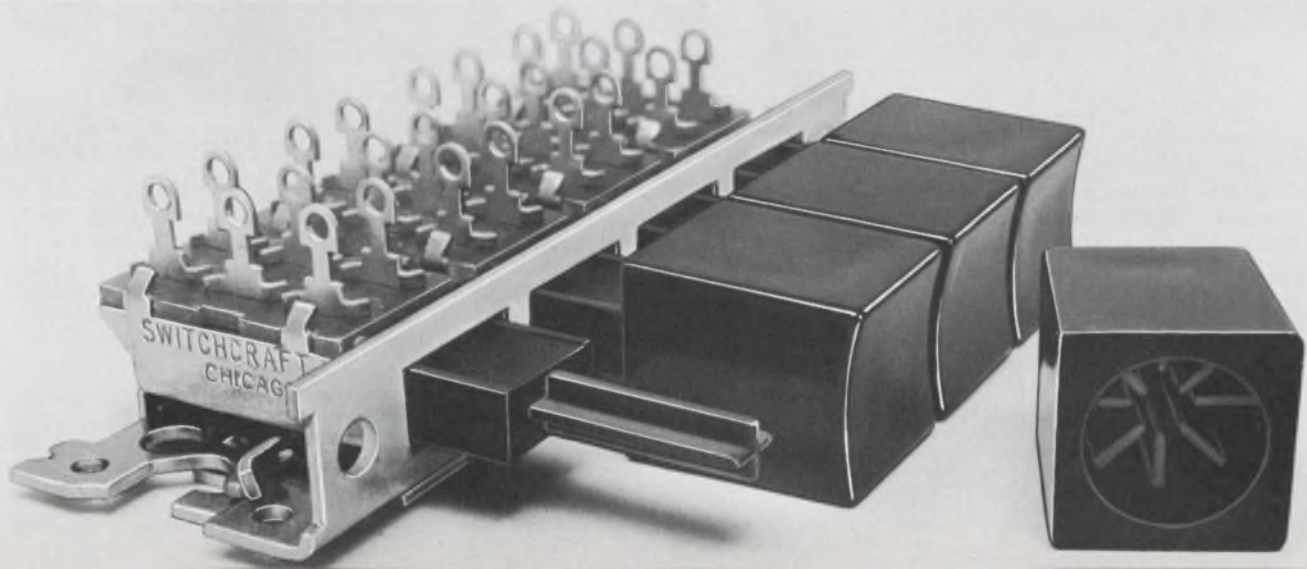

Three-digit panel meter has run or hold modes



Gralex Industries, Inc., 155 Marine St., Farmingdale, N.Y. Phone: (516) 694-3607.

Providing overrange and negative symbols, a new three-digit panel meter features selectable free-run or hold modes. The model DM-30 has five full-scale input ranges: 100 mV, 1, 10, 100 or 1000 V dc. Front-panel gain and slope adjustments are provided. Other features include an isolated BCD output and stored display to eliminate blinking and blanking.

Booth No. 3K20 Circle No. 290

Multifunction generator spans 1 mHz to 10 MHz



Wavetek, 9045 Balboa Ave., San Diego, Calif. Phone: (714) 279-2200. Price: \$595.

Providing positive and negative and manual-controlled generator pulse, sine, square and triangle waveform outputs, a new voltage covers the frequency range of 0.001 Hz to 10 MHz. The model 142 instrument has outputs that can be made symmetrical or asymmetrical by as much as 20 to 1. The output waveform is provided through a six step attenuator in 10-dB steps.

Booth No. 2E45 Circle No. 348

Frequency synthesizer ranges out to 160 MHz

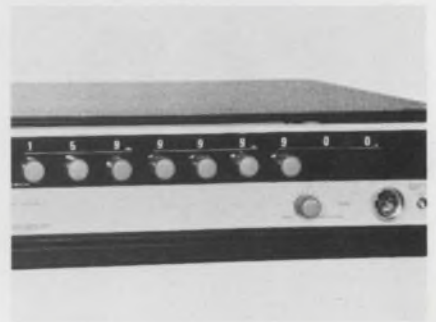

General Radio Co., 300 Baker Ave., W. Concord, Mass. Phone: (617) 369-4400. Price: \$5900, \$5300.

Featuring a stability of 10⁻⁹ parts per day, a new frequency synthesizer spans 10 kHz to 160 MHz in 100-Hz steps. Model 1165 is available in a master version with a precision quartz oscillator. A slave version contains no internal oscillator. It can be driven from an auxiliary 10-MHz output of a master unit, another slave unit or any 5 or 10-MHz source.

Booth No. 2E26 Circle No. 281

- **400 cycle power**
- **1% distortion**
- **.5% frequency and voltage regulation**



The completely transistorized model CRS-100A frequency converter (100VA output) offers all this in only 3 1/2" panel height... and high reliability, too!

Others are available rated at 30 VA to 15 KVA with fixed or adjustable output frequencies. Call or write today for complete details.

CML, Inc.

A subsidiary of Tenney Engineering, Inc.
166 National Road, Edison, N. J. 08817
(201) 287-2810 • TWX 710-998-0560



INFORMATION RETRIEVAL NUMBER 105

TACKLE THOSE BIG JOBS ON MINIATURE PROJECTS!!



FREE CATALOG!

SEND FOR YOUR FREE 128-PAGE TOOL & SUPPLY CATALOG... Contains over 10,000 time-saving tools and supplies including Hand Tools; Measuring Tools; Precision Machinery; Cutting Tools; Magnifiers... plus many other items used in the electronics, instrument making and precision industries... Every industry where precision tools are used!

Ask for Catalog No. 695

HAMMEL, RIGLANDER & CO., INC.
Post Office Box 222 • New York, N. Y. 10014

INFORMATION RETRIEVAL NUMBER 106

programmable FM / AM Modulation Meter...

with...

- 2 MHz to 1000 MHz using external synthesizer
- 10 mV sensitivity
- FM deviation ± 1.5 KHz to ± 500 KHz in six programmable ranges
- AM mod. depth, peak and trough selectable with carrier shift output
- Low distortion demodulated output
- Positive control logic
- Auto/manual operation switch selector and automatic ranging attenuator sets AM carrier level

Write for detailed specifications.

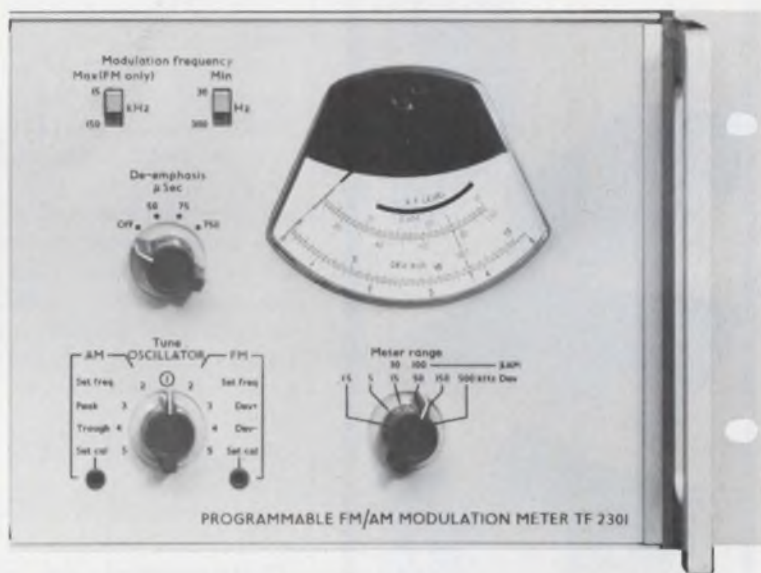

mi MARCONI
INSTRUMENTS
DIVISION OF ENGLISH ELECTRIC CORPORATION

111 CEDAR LANE □ ENGLEWOOD, NEW JERSEY 07631
TELEPHONE: (201) 567-0607

721

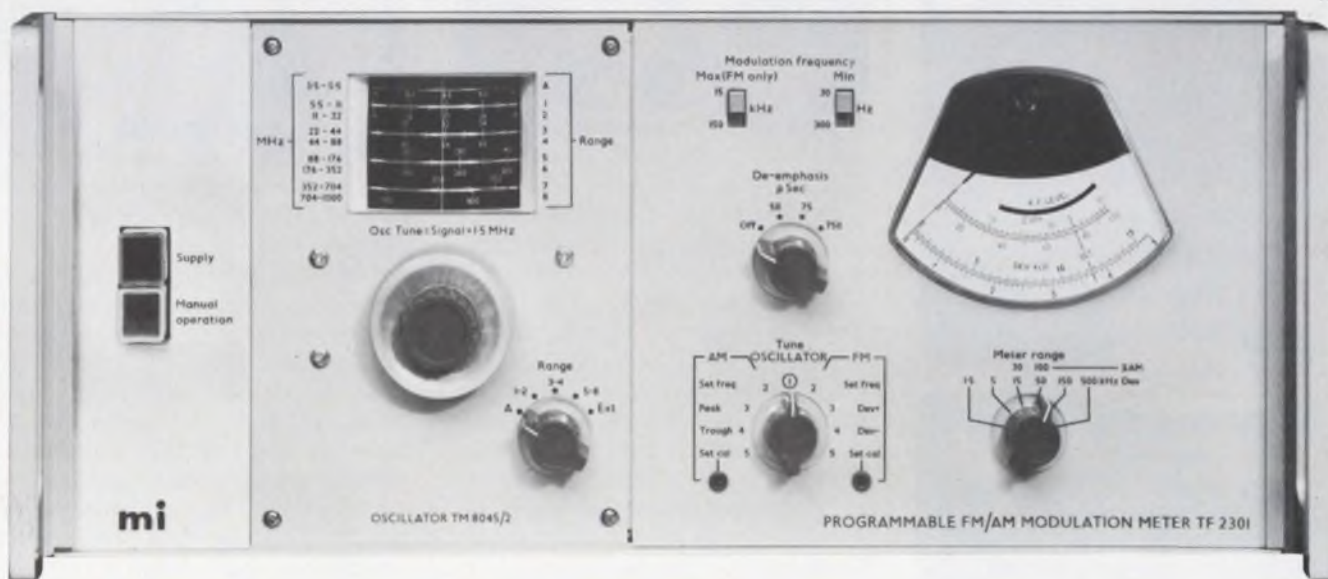

SEE US AT IEEE BOOTH #2D02-8

INFORMATION RETRIEVAL NUMBER 107

NPL

INDICATORS



*When
you need Servo or
Digital Indicators...*

- VERTICAL SCALE
- PRECISE ANGLE
- ROUND DIAL
- DIGITAL TO DIGITAL
- ALTITUDE DISPLAY

check with...

NPL**NORTHERN PRECISION
LABORATORIES INC.**202 FAIRFIELD ROAD
FAIRFIELD, NEW JERSEY 07006

area code (201) 227-4800

TWX 710-734-4301

ICs & SEMICONDUCTORS

Chip photodiode array contains shift register

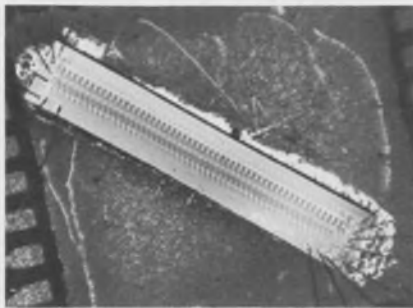

*Teknis Ltd., Teknis House, 31
Stoke Rd., Guildford, Surrey, Eng-
land.*

Model IPL 20 is a linear configuration of 50 silicon planar photodiodes, which are integrated with a 51-bit shift register on a single monolithic chip. The shift register permits multiplexing of the diode sensors at rates governed by an external clock. The chip measures 0.228×0.042 in. and is housed in a 40-lead flatpack with a glass-fronted window lid. Total power consumption is about 100 mW.

Booth No. 3B30 Circle No. 260

Differential op amps deliver 70-mA output

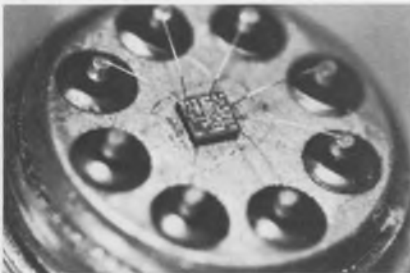

*Siemens Corp., 186 Wood Ave.
South, Iselin, N.J.*

Using directly coupled stages to minimize zero drift, two new integrated differential operational amplifiers can supply output currents as large as 70 mA. Models TAA 861 and TAA 865 can be used as direct-current amplifiers, with and without phase reversal, and with almost any desired gain and any desired input impedance. In addition, their frequency response may be altered via negative feedback.

Booth No. 2H02 Circle No. 259

Light-emitting diode has limiting resistor



*Oxley Developments Company Ltd.,
Priory Park, Ulverston, North
Lancs, England. P&A: \$5; 4 to 6
wks.*

Incorporating its own current-limiting resistor, a new red LED comes in a package measuring only 0.08 inch in diameter and 0.28-inch long. The unit boasts a pitching capability of 0.1 inch, and a current consumption of 4 mA at 6 V. Other versions are available to operate from supply lines of 12 V, and without the internal limiting resistor. Applications include use as circuit and logic status indicators.

Booth No. 3B28 Circle No. 264

Monolithic amplifiers swing out to 100 MHz

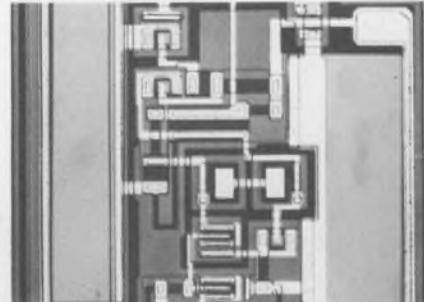

*Plessey Company Ltd., Components
Group, Cheney Manor Swindon,
Wiltshire, England.*

Intended primarily for use in successive detection logarithmic i-f strips, the SL521A, B and C are bipolar monolithic-integrated circuit wideband amplifiers operating at center frequencies between 10 and 100 MHz. The devices provide amplification, limiting and rectification. They are suitable for direct coupling and incorporate supply-line decoupling.

Booth No. 3F06 Circle No. 293

New - Rotron ^{T.M.} **biscuit** blower

.... fits inside 1-3/4" rack mounted instruments

.... provides high pressure blower performance

Now you can have high pressure centrifugal blower performance in a space never before possible! The new Rotron "biscuit" blower provides useful amounts of high velocity cooling air at a pressure that can force or draw air through tight, electronic packages or directed over hot components. Featuring a minimum depth of only 1-9/16", the unique construction of the "biscuit" blower enables it to perform reliably, quietly, and continuously for 10 years **without** any maintenance.

Because the "biscuit" blower is the **only** commercially available 50/60 Hz air moving device delivering up to 25 cfm of cooling air, capable of being packaged inside 1-3/4" rack panel instruments, significant increase in instrument packaging densities utilizing I.C. technologies are now feasible. Its high static pressure capabilities

and its ability to run continuously without air passing through its impeller make the "biscuit" especially suitable for applications where it is desired to hold down paper or film such as office equipments.

The "biscuit" features the same inverted motor construction and resiliently mounted, permanently lubricated sleeve bearing as the famous Muffin Fan. Encapsulated stator construction integrates the electrical portion of the shaded pole motor into the blower housing to provide a monolithic structure impervious to moisture or dust. Three mounting options are provided for easy application and true versatility. Compare the thin profile of the "biscuit" blower with conventional units of similar performance and you can immediately see all the space-saving advantages that are yours.

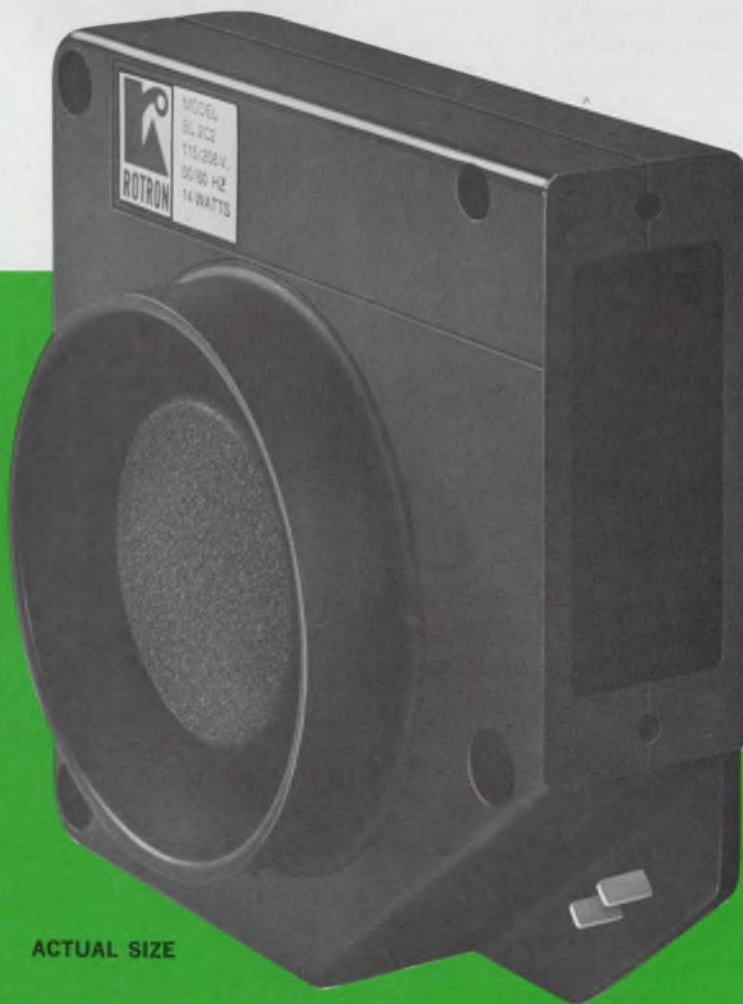

Write today for complete technical information to:
Rotron Incorporated,
Woodstock,
New York 12498.

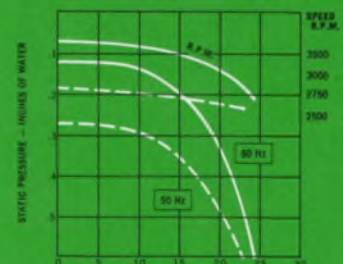
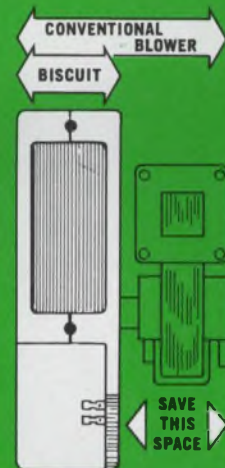

Visit Rotron at IEEE Show, Booths: 3F11, 3F13, 3F15

INFORMATION RETRIEVAL NUMBER 109

NPL

DATA CONVERSION SYSTEMS



when converting...

- analog to digital
- digital to analog
- synchro to digital
- resolver to digital
- digital to synchro
- digital to resolver
- digital to DC
- digital to AC
- DC to digital
- AC to digital

convert to...

NPL

write or call...

**NORTHERN PRECISION
LABORATORIES INC.**

202 FAIRFIELD ROAD
FAIRFIELD, NEW JERSEY 07006
area code (201) 227-4800
TWX 710-734-4301

COMPONENTS

Ten-position switches provide coded outputs

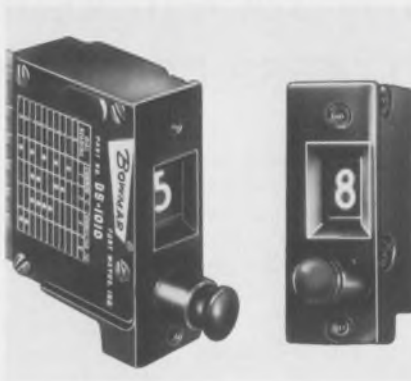

Del Electronics Corp., 250 E. Sanford Blvd., Mt. Vernon, N.Y. Phone: (914) 699-2000.

Constructed of reconstituted mica is the new line of Delmica solid monolithic block capacitors. They offer excellent dielectric characteristics and a low temperature coefficient and dissipation factor. High insulation resistance and corona voltage, and stability are also offered. Units are available in high-voltage and precision types for operation to 150°C.

Booth No. 2C12 Circle No. 345

Thin keyboard switches contain no moving parts



Stevens-Arnold Inc., 7 Elkins St., S. Boston, Mass. Phone: (617) 268-1170. Price: \$42.50.

Featuring a lifetime of over 2 billion operations, a new spdt break-before-make relay offers a thermal offset of only 40 nV. The Micro-level relay shows good isolation between drive and signal circuits. It features no-bounce operation and an off-on switching ratio of 10^{11} to 1. Contacts are rated up to 10 V resistive at up to 1 mA.

Booth No. 4B14 Circle No. 351

Boumar Instrument Corp., 8000 Bluffton Rd., Fort Wayne, Ind. Phone: (219) 747-3121.

With a choice of backlighting, two new push-button 10-position indicator switches provide BCD or decimal outputs for each position. The DS-1010 has the BCD output while the DS-1011 has the decimal output. Both have display windows for switch position indication with contacts rated at 125 mA at 28 V dc or 115 V ac. Lifetimes are well over 1 million operations for both.

Booth No. 2G35 Circle No. 355

Solid mica capacitors form monolithic blocks

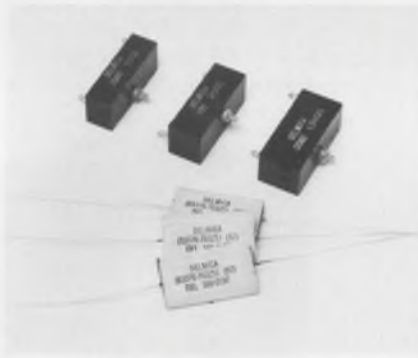

Alco Electronic Products, Inc., Box 1348, Lawrence, Mass. Phone: (617) 686-3887. Price: \$9.95.

A radically new concept in switches is the Flex-key system of PC keyboard switch modules. They have no moving parts and do not require any space behind the mounting panel since they are only 1/4-in. thick. The switches are button keys made up of three parts: a conductive elastomeric element, a thin aperture film and a printed-circuit board.

Booth No. 4G23 Circle No. 254

Low-thermal-emf relay lowers offset to 40 nV



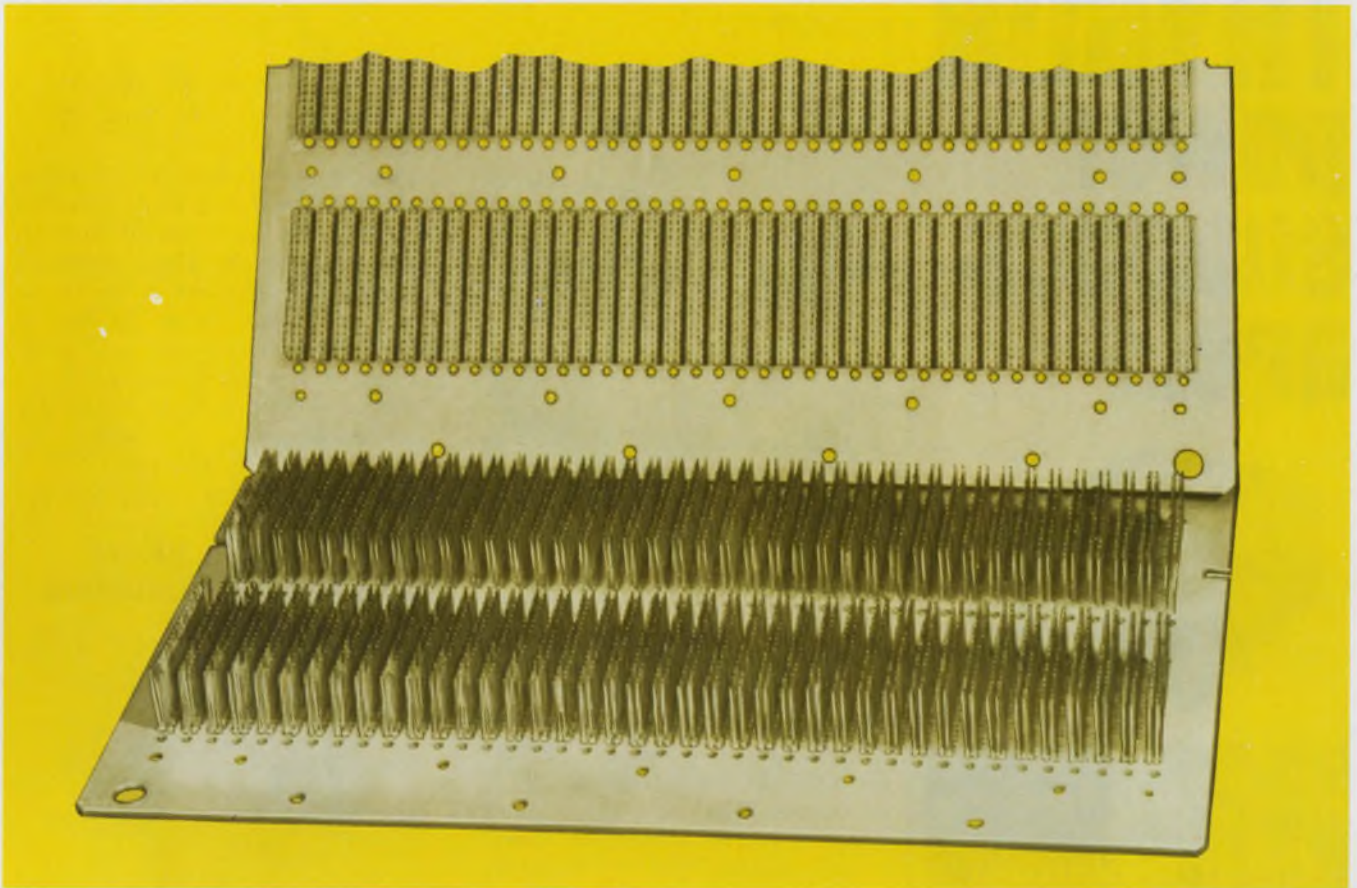

New "Reli-Apanel" Backplane Wiring Plates

- HIGH PACKAGING DENSITY. All grid pattern sizes available, square and offset: .100", .125", .150", and .200": .025" and .045" square or .031" x .062" terminations.
- Customer-engineered back panel requirements for prototypes or production runs. Custom-designed and manufactured by Methode, delivered ready-to-go for your wire-wrapping equipment.
- Card-edge or metal/metal interconnections provided. Rigid metal wiring panels provide precise alignment for connector modules . . . can serve as electrical ground or voltage plane, or for mounting other electronic components.
- Unlimited circuit design versatility — providing backplane wiring flexibility at minimum costs . . . reducing production and assembly costs.
- Ideal for electronic instrumentation, test equipment, computer applications—where components and connectors must be tightly spaced and interconnected.



CONNECTOR DIVISION

Methode Electronics, Inc.

7447 W. Wilson Ave.

Chicago, Illinois 60656 312-867-9600

TRYGON power supplies are...



the triple output space-savers...

- Takes the place of 3 separate power supplies for IC applications, sequencing, data processing, computer peripherals, and OEM applications. Compact size — only 5" x 8" x 10".
- **Multiple Outputs:** +3.2 to +5.5VDC at 6A; +10 to +26VDC at 1.8A; -5 to -16VDC at 1.5A.
- **Special Control Circuits:** "S" option provides internal sequencing, OM501 accessory incorporates full output monitoring.
- **Rapid Delivery:** Standard off-the-shelf delivery solves your lead time problems.
- **High Reliability:** 0.05% Regulation, 2mV Ripple, 0.05% Stability, Overvoltage Protection standard on IC output, optional on other outputs.
- **Low Cost:** Economical — only \$245 in small quantities and very much lower in larger OEM quantities.
- Rack adaptable with other Trygon Systems/OEM power supplies — Liberator Sub-Rack and TPS Series, for full systems versatility.

Write or call today for our new 16-page New Product Supplement S1169 and select your power supplies for immediate delivery.

TRYGON POWER SUPPLIES

111 Pleasant Avenue, Roosevelt, New York 11575
Tel: 516-378-2800 TWX: 510-225-3664
Trygon GmbH 8 München 60, Haidelweg 20, Germany
Prices slightly higher in Europe.

COMPONENTS

Stable resistors to 1% cover 10^4 to 10^{10} Ω



RF Interonics, Inc., Div. of KDI Corp., 100 Pine Aire Dr., Bay Shore, N.Y. Phone: (516) 231-6400. Availability: stock.

Using high-density packaging, two new series of subminiature rfi/emi filters feature units with case diameters of 0.375 in. Filters are available in ratings of 100 V dc (series 2575) and 115 V ac or 200 V dc (series 2550). Six current ratings range from 0.5 to 10 A. Standard circuit configurations include L, Pi and T circuits.

Booth No. 4D09 Circle No. 341

Dc-to-dc transformer shrinks size to 0.9 in.³

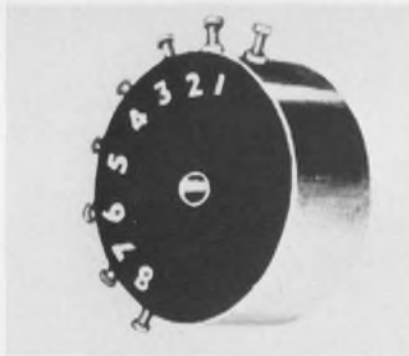

Nanotron, Inc., 8720 Woodley Ave., Sepulveda, Calif. Phone: (213) 893-6325.

A new dpdt relay (break before make) incorporates conventional semiconductor components in a hybrid microelectronic assembly for a true solid-state device. The Nanoswitch miniature high-speed relay requires low driving power. Insulation resistance between all terminals is greater than 10,000 M Ω at 25°C. Mounting is available in TO-5, TO-116 and 1/4-size crystal cases.

Booth No. 4H17 Circle No. 251

Victoreen Instruments Div., 10101 Woodland Ave., Cleveland, Ohio. Phone: (216) 795-8200.

Exhibiting a stability of better than 1% under full loads for 2000 hours is the new line of Mastermox metal oxide glaze resistors. These small resistors range in resistance values from 10 k Ω to 10,000 M Ω and provide over 40 W of power dissipation per cubic in. Accuracies range from 0.5 to 2% and temperature coefficients extend from 200 to 600 ppm.

Booth No. 3B48 Circle No. 344

Tiny rfi/emi filters shrink case diameters



Microtran Co., Inc., 145 E. Mineola Ave., Valley Stream, N.Y. Phone: (516) LO1-6050. P&A: \$12; stock.

A new dc-to-dc converter transformer that switches up to 20 kHz with an output of ± 15 or 30 V at 1 A, reduces its package size down to 1-1/4-in. in diameter by 3/4-in. high. The device is an epoxy-molded unit that operates from an input of 13.8 or 28 V dc. It weighs only 1 oz. and is suitable for use in center-tapped full-wave applications.

Booth No. 3E18 Circle No. 357

Solid-state dpdt relay incorporates discretes

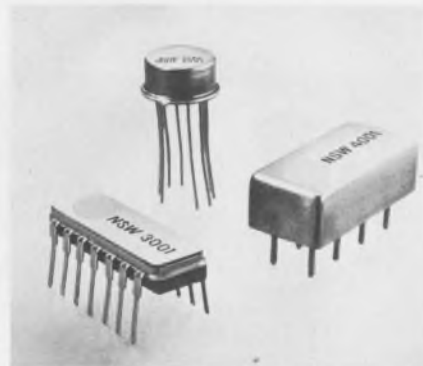

Tight Tolerance T-H Testing



*for labs that are
tight with a buck!*

*Now from Associated—an all-new
temperature-humidity test
chamber that delivers tight
tolerance performance at
low, low prices!*

Series HH-5100 Temperature-Humidity Chambers feature a new precision instrumentation package, new refrigeration and an improved recirculating humidity system that gives weeks of operation on a gallon of water. Specs? Consider these:

- temperature range -100 to $+350^{\circ}\text{F}$ or -65 to $+350^{\circ}\text{F}$
- temperature control accuracy $\pm 1^{\circ}\text{F}$ or better
- humidity range 10 to 98% RH, $\pm 2\%$ or better
- all solid state wet and dry bulb controllers with RFI suppression; dual centigrade and Fahrenheit scales
- two-pen, two-cam programmer, 24-hour recording
- built-in demineralizer with replaceable cartridge

Available with single- or dual-stage cascade refrigeration, in 4, 8 and 27 cubic foot capacities. Write or call for detailed data.



**ASSOCIATED TESTING
LABORATORIES INC.**

200 Route 46, Wayne, New Jersey 07470 • (201) 256-2800

West Coast Office

1304 Seventh St., Santa Monica, Calif. 90401 • (213) 451-8521

whirlybird tracker

Tracking drones is a job that is made to order for the Vega Model 877S Tracking Antenna System. It is designed to provide passive tracking on the 2.2 to 2.3 GHz telemetry link and also an independent output at 1.75 to 1.85 GHz for television information. Among the functions provided by this system are automatic data acquisition and tracking, sector scan and manual slew.

This non-stabilized unit provides tracking information in the azimuth plane. Two narrow beams are used in the azimuth plane and switched at a fixed rate of 60 Hz in order to derive an azimuthal servo error signal. Beam crossover point is 3.0 db down from the peak. Vertical coverage is provided by beam shaping, CSC² to 40° above the horizon. This results in good tracking at short range and maximum altitude.

The equipment used to acquire drone information consists of a modified 4' parabola mounted on a radome covered baseplate with drive pedestal located in the lower center. Three supporting legs are equipped with swivel pads for leveling. Remote Indicator Control Box contains all operating elements as well as remote indicator for azimuth bearing information.

For further details concerning the Vega Model 877S Tracking Antenna System write to:

VEGA PRECISION LABORATORIES, INC.
239 Maple Avenue W., Vienna, Virginia 22180
Phone: (703) 938-6300

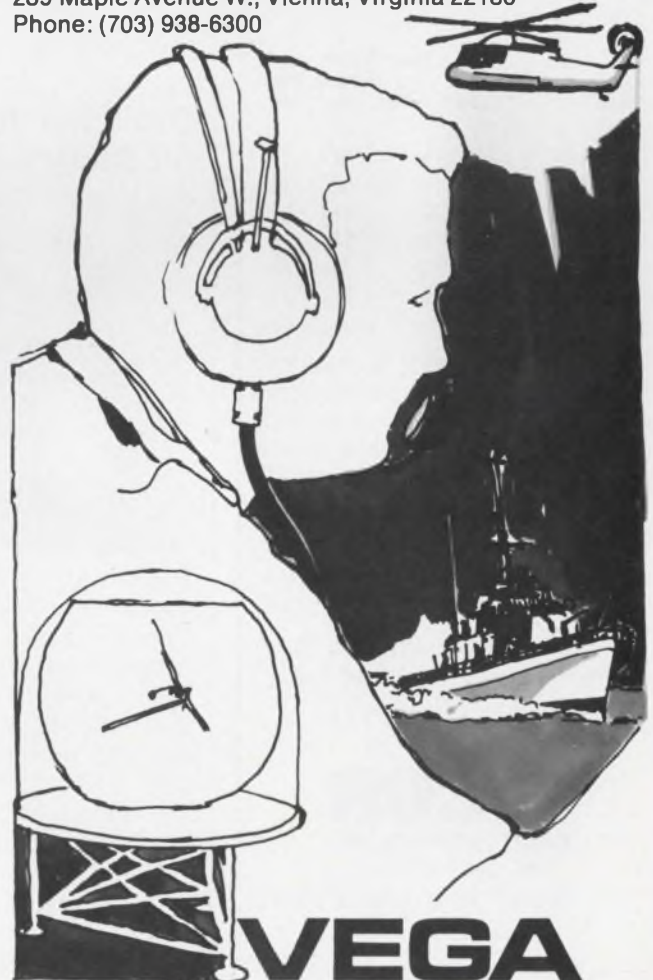

INFORMATION RETRIEVAL NUMBER 124

ELECTRONIC DESIGN 6, March 15, 1970

INFORMATION RETRIEVAL NUMBER 125

U151

C-COR AMPLIFIERS

POWER AMPLIFIERS LINEAR OUTPUT UP TO 63 WATTS

WIDEBAND 1 kHz to 400 MHz
GAIN FROM 8 dB to 30 dB
PRICED FROM
\$1250 to \$4000



Model 1028 illustrated is but one of many Power Amplifiers made by C-COR . . . each designed for a specific use. The chart below indicates a few of C-COR'S power amplifiers and their characteristics.

| Model | Passband 3 dB Nom. | Power Output Gain @ 1 dB Comp. Nom. | |
|--------|-----------------------|--|-----|
| | | Nom. dBm | dB |
| 1029 | 100-300 MHz | +44 | 8 |
| 1029-A | 0.1-250 MHz | +44 | 10 |
| 1029-B | 1-160 MHz | +48 | 16 |
| 1012 | 0.001-185 MHz | +41 | 7.5 |
| 1012-A | 0.1- 60 MHz | +44 | 12 |
| 1028 | 30-300 MHz | +35 | 30 |
| 3002 | 200-400 MHz | +32 | 17 |

Driver Amplifiers available to increase gain

In amplifiers, it is well to turn to C-COR . . . where amplifiers are the main business. If we can't supply you off-the-shelf, our engineers will design and produce the amplifier you need — and do it fast!

Write or telephone for catalog and technical data on your amplification requirements . . . or check C-COR Listings in EEM.

"C-COR Amplifiers . . . Rated First
Where Performance is Rated First."



C-COR

ELECTRONICS, INC.

60 Decibel Road
State College, Pennsylvania 16801
814 238-2461

MICROWAVES & LASERS

Low-cost rf p-i-n diode distorts to 0.05% max



Hewlett-Packard, 1501 Page Mill Rd., Palo Alto, Calif. Phone: (415) 326-7000. Price: \$2.95.

Type 5082-3080 is a low cost p-i-n diode that can attenuate or switch signals from 1 MHz to 1 GHz at a maximum distortion of 0.05%. Its rf resistance is controlled by the dc forward bias and is linearly variable from 5 to 2500 Ω . Breakdown voltage is greater than 100 V and dc power dissipation extends to 250 mW. It is priced at 99¢ per unit at 10,000 to 25,000 quantities.

Booth No. 1E12 Circle No. 273

Oscillator for X band modulates to 200 MHz

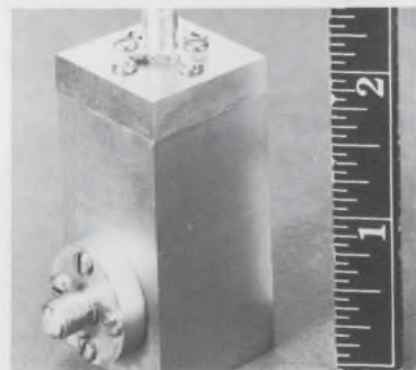

Hughes Aircraft Co., Electron Dynamics Div., 3100 W. Lomita Blvd., Torrance, Calif. P&A: \$720; stock.

Operating in the frequency range of 8 to 12.4 GHz, a new avalanche diode oscillator displays a linear modulation capability of 200 MHz. The device, model 44014H, is an X-band bias-tuned oscillator operating over its full frequency range with a power output of 5 mW. It is tiny and lightweight, measuring only 3 cubic in.

Booth No. 1F29 Circle No. 363

Precision power meter digitizes its readout



General Microwave Corp., 155 Marine St., Farmingdale, N.Y. Phone: (516) 694-3600.

Featuring automatic operation, a new programmable power meter displays its output digitally. The model 471 covers 10 MHz to 40 GHz (when used with the 420 series of power heads). It can measure 10 nW to 3 W in the linear mode, and -39.9 to +35 dBm in the logarithmic mode. Accuracy is 0.5% of reading ± 1 count (linear mode) and ± 0.1 dB (logarithmic mode).

Booth No. 3K20 Circle No. 272

Fm/a-m modulation set is fully programmable



Marconi Instruments Div. of The English Electric Corp., 111 Cedar Lane, Englewood, N.J. Phone: (201) 567-0607. P&A: \$4455; August, 1970.

Covering the carrier frequency range of 2 to 1000 MHz is the model 2301 fm/a-m modulation meter that is fully programmable. It measures full-scale deviation in six ranges from ± 1.5 to ± 500 kHz for the fm frequency range of 30 Hz to 150 kHz. Up to 90% of modulation depth for a-m measurement is possible at carriers from 2 to 350 MHz.

Booth No. 2D02 Circle No. 262

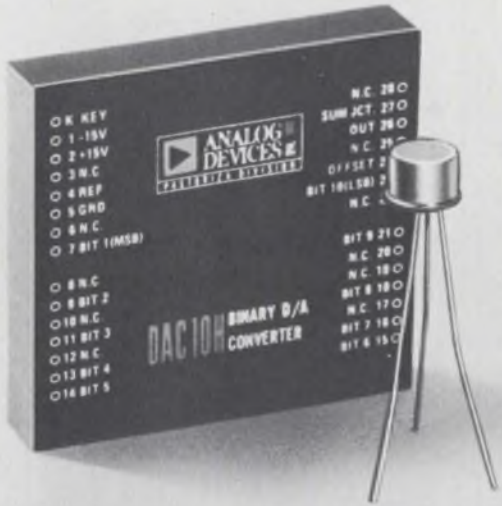

D/A Converters: Make or buy?

Three things to think about...

1

LOW INITIAL COST — \$55

This completely self contained 10 bit D/A converter costs just \$55 in 100 quantities and includes DTL/TTL compatible input switches, resistor ladder network, precision reference and output amplifier* with tracking gain resistors . . . a complete D/A converter in a miniature 0.4"H package for \$55 (100 pieces). The DAC 10-H settles the make/buy question once and for all!

*Model MDA 10-H is also available for 300 ns settling times (does not include output amplifier).

2

GUARANTEED PERFORMANCE

You just unpack the DAC 10-H and plug it in. No external trim pots, output amplifier or other components are required . . . apply $\pm 15V$ power and your input signals. DAC-10 H is ready to go, with performance tested and guaranteed. No debugging, no trimming, no missed deadlines. Speaking of performance, compare the features with the alternative modular converters in the adjacent chart. DAC-10 H is clearly the Best Buy for all applications where up to 10-bit resolution and accuracy, moderate speed, and input logic flexibility are required.

3

INSTANT AVAILABILITY

Delivery is normally from stock. That means no lost circuit design time, no parts inventory, no manufacturing delays, no production slippages. Evaluation samples are instantly available, too . . . just contact the applications engineering staff at Analog Devices or your local sales office. Evaluate the DAC-10-H in your circuit against your requirements. Find out for yourself that the new DAC-10 H is the answer!

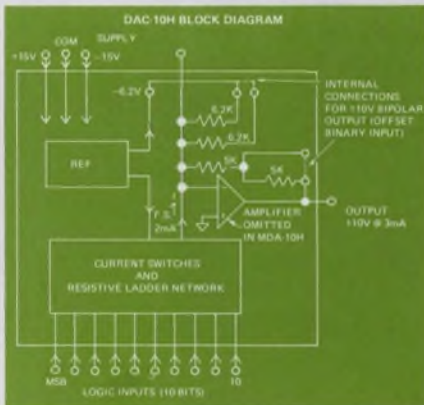

| | ANALOG DEVICES | BECKMAN | FAIRCHILD | SPRAGUE |
|------------------|----------------|-------------|---------------|-------------|
| MODEL | DAC 10-H | 845† | μ A722† | UM1500† |
| BITS | 10 | 8 | 10 | 10 |
| REFERENCE | Yes | Yes | Yes | No |
| OUTPUT AMP | Yes, (741) | Yes, (741) | No | No |
| RESISTOR NETWORK | Yes | Yes | No* | Yes |
| CODE | Binary or BCD | Binary only | Binary or BCD | Binary only |
| POWER SUPPLY | $\pm 15V$ | $\pm 15V$ | $\pm 6V$ | +3V, -20V |
| PRICE (1-9) | \$75. | \$75. | \$75.* | \$79. |

*Plus resistor network @ \$31 in 100 quantity
†Based on published data as of 15 Jan. '70

SPECIFICATIONS

Resolution: 10 bits binary
Accuracy: $\pm 1/2$ LSB (0.05%)
Data Inputs: TTL or DTL Compatible
Output Voltage: Unipolar models: 0V to +10V
Bipolar models: $\pm 5V$; $\pm 10V$

Amplifier Output
Current: 5mA
Settling Time: 20 μ s (MDA - 10H: to .05%: 300 ns)
Linearity: $\pm 1/2$ LSB
Temp. Coefficient: ± 50 ppm/ $^{\circ}C$ (0° to $70^{\circ}C$)
Power Requirement: $\pm 15V$ @ 25mA

Comprehensive data sheets with complete specifications and applications information are available. Evaluation samples may also be arranged. Contact Analog Devices or your local sales office.



| | | | | |
|--------------|--------------|--------------|--------------|--------------|
| 205/536-1969 | 303/781-4967 | 317/846-2593 | 514/683-3621 | 613/224-1221 |
| 206/767-3870 | 305/424-7932 | 412/371-9449 | 516/692-6100 | 617/492-6000 |
| 213/595-1783 | 305/565-7029 | 414/465-1550 | 518/372-6649 | 713/622-2820 |
| 214/231-4846 | 312/774-1452 | 415/941-4874 | 602/274-6682 | 716/695-1001 |
| 215/643-2440 | 313/886-2280 | 416/247-7454 | 604/926-3411 | 913/831-2888 |
| 216/261-5440 | 314/725-5361 | 512/732-7176 | 607/748-0509 | 918/622-3753 |
| 301/588-1595 | 315/454-9314 | 513/426-5551 | 612/881-6386 | 919/924-1971 |



NANOPULSER

the fast rise time,
large amplitude, variable
delay pulse generator



Rise/fall time less than 1ns
Amplitude variable up to $\pm 50v$

The Series 2306 NANOPULSER combines extremely fast rise/fall time and large amplitude with other important performance features:

- REP RATES UP TO 1 MHz
- BIPOLAR OUTPUTS
- GATING CAPABILITY
- SINGLE SHOT OPERATION
- LOW JITTER
- PRE-TRIGGER PULSE
- PROGRAMMING CAPABILITY

TYPICAL APPLICATIONS: Testing high speed switching devices such as semiconductors, IC's, memory elements, etc.; Reflectometer pulse source for discontinuity testing of long or lossy cables via time domain reflectometry. **PRICE:** From \$650

VARIABLE CALIBRATED DELAY UNIT



0 to 60.75ns in
0.25ns increments

Bandpass > 1000 MHz

Series 1200 Delay Units provide discrete values of calibrated delay for applications in RF, pulse and digital systems. Delay steps as small as 0.25ns, continuously variable up to a total of 60.75ns with a built-in 0.3ns vernier. Delay accuracy is better than $\pm 1\%$. Ideal for use with Series 2306 NANOPULSERS to provide calibrated pulse widths. Both manual and remotely programmable models available. **PRICE:** From \$340

GRALEX

INDUSTRIES
155 MARINE ST., FARMINGDALE, N.Y.
516-694-3607

A DIVISION OF
GENERAL MICROWAVE CORPORATION

MICROWAVES & LASERS

Solid-state system single-sweeps 1210 MHz

Wiltron Co., 930 E. Meadow Dr.,
Palo Alto, Calif. Phone: (415) 321-
7428. P&A: \$1390, \$1685; 4 wks.

Featuring an output of 1 V rms (+13 dBm), a new solid-state sweeper covers the entire band of 10 to 1220 MHz in one sweep. The model 610B main frame and 61081 plug-in combine to produce an output that is flat to within ± 0.3 dB over the entire frequency range. Harmonics and spurious signals are kept down 30 dB below the output. Sweeping is achieved with a slide-rule dial with start and stop controls.

Booth No. 2D44 Circle No. 261

Ultra-stable He-Ne laser nears Krypton standard

Siemens Corp., 186 Wood Ave.
South, Iselin, N.J.

A new He-Ne laser provides a frequency stability close to the primary length standard of Krypton 86. By using a Zeeman absorption cell, the LG 65 laser stabilizes at least one power of ten higher than any other comparable laser system. It is fully automatic and is easy to handle. The highly stable frequency is reproducible in only 30 seconds after being switched on.

Booth No. 2H02 Circle No. 257

Rf 500-MHz attenuator dissipates 100 watts

Bird Electronic Corp., 30303 Au-
rora Rd., Cleveland, Ohio. Phone:
(216) 248-1200. Price: \$165.

Covering the frequency band of dc to 500 MHz is the model 8323 30-dB rf attenuator that dissipates up to 100 W of rf power. It includes several harmonic frequencies of the design fundamental. Maximum frequency deviation is 1/2 dB over the entire frequency band. Corrections to within 0.2 dB are possible at six calibration frequencies and at dc, by the use of a table.

Booth No. 2E40 Circle No. 352

ENGINEERS

- Evaluation and Test
- Manufacturing
- Others

Automatic Electric, a leading innovator of computerized electronic switching systems and the largest producer of communications equipment for the independent telephone industry, has numerous entry level and experienced technical positions available in the following areas:

EVALUATION & TESTING Electronic and electrical engineers to initially learn the design of new electronic and computer systems and then perform prototype and/or field evaluation thereon. Entry level requirements — BS degree in EE, ET, or computer science with some knowledge of programming. Higher level positions exist for those with experience in electronic common control systems.

MFG. ENGINEERING Degreed electronic or electrical engineers (new or experienced) initially learn new computerized electronic telephone switching systems, design test equipment and associated test procedures and troubleshoot the mass production of this equipment.

Additional Positions currently available include:

- Component and Circuit Design Engineers
- Automation Engineers
- Chemical Engineers
- Switching System Planning Engineers
- Traffic Analyst

If you are interested in a progressive, growing company that offers well equipped modern facilities, a policy of promotion from within, and a pleasant West suburban location (15 miles from downtown Chicago), send your resume in confidence to:

Bruce Bullock

Professional Employment Representative

AUTOMATIC ELECTRIC

Subsidiary of General Telephone & Electronics
400 North Wolf Rd., Northlake, Ill. 60164

An Equal Opportunity Employer



V-Scan Binary Encoder

Norden Encoders: there's no better way to convert shaft angles to numbers.

Norden offers the broadest line: magnetic, optical and contacting. Plus reliability, verified by 100% testing. Plus competitive pricing. And fast delivery.

For more information and detailed specs, write Norden, Att: Components Dept., Helen Street, Norwalk, Conn. 06856. Phone (203) 838-4471. TWX: 710-468-0788.

Norden DIVISION OF UNITED AIRCRAFT CORPORATION



| | Total Count | Revolutions for Full Count | Diameter" | Model Number |
|---|----------------------|----------------------------|-----------|--------------------|
| NEW! Rugged Industrial Grade Optical Incremental Encoders | | | | |
| All available with quadrature and internal squaring circuit options | 4,000 | 1 | 3.500 | OADC-35/4000/INC |
| | 3,000 | 1 | 3.500 | OADC-35/3000/INC |
| | 2,500 | 1 | 3.500 | OADC-35/2500/INC |
| | 2,000 | 1 | 3.500 | OADC-35/2000/INC |
| | 1,200 | 1 | 3.500 | OADC-35/1200/INC |
| | 1,000 | 1 | 3.500 | OADC-35/1000/INC |
| | 600 | 1 | 3.500 | OADC-35/600/INC |
| | 400 | 1 | 3.500 | OADC-35/400/INC |
| | 200 | 1 | 3.500 | OADC-35/200/INC |
| Optical Incremental Encoders | | | | |
| All available with index marker, quadrature outputs and internal squaring circuit options. Other counts on special order. | 500 | 1 | 2.250 | OADC-23/500/INC |
| | 512 | 1 | 2.250 | OADC-23/512/INC |
| | 1,000 | 1 | 2.250 | OADC-23/1000/INC |
| | 1,024 | 1 | 2.250 | OADC-23/1024/INC |
| | 2,000 | 1 | 2.250 | OADC-23/2000/INC |
| | 2,048 | 1 | 2.250 | OADC-23/2048/INC |
| IC-Compatible Encoders. For direct interface with TTL & DTL circuits | | | | |
| Binary | 128 | 1 | 1.750 | ADC-ST7-BNRY-E/L |
| | 8,192 | 64 | 1.750 | ADC-13-BNRY-E/L |
| | 524,288 | 4,096 | 1.750 | ADC-19-BNRY-E/L |
| Binary-Decimal Code | | | | |
| | 100 | 1 | 2.250 | ADC-ST2-BCD/L |
| | 1,000 | 10 | 2.250 | ADC-3-BCD/L |
| | 10,000 | 100 | 2.250 | ADC-4-BCD/L |
| | 100,000 | 1,000 | 2.250 | ADC-5-BCD/L |
| | 1,000,000 | 10,000 | 2.250 | ADC-6-BCD/L |
| | 360 | 1 | 2.250 | ADC-3-36BCD-E-360L |
| | 3,600 | 10 | 2.250 | ADC-4-36BCD-E-360L |
| | 36,000 | 100 | 2.250 | ADC-5-36BCD-E-360L |
| | 360 | 1 | 3.250 | ADC-ST3-36-BCD/L |
| | 3,600 | 36 | 2.250 | ADC-4-36-BCD/L |
| | 36,000 | 360 | 2.250 | ADC-5-36-BCD/L |
| | 360,000 | 3,600 | 2.250 | ADC-6-36-BCD/L |
| External Logic V-Scan Binary Encoders | | | | |
| | 128 or 256 | 1 | 1.750 | ADC-7/8-BNRY-XB |
| | 8,192 or 16,384 | 64 | 1.750 | ADC-13/14-BNRY-XB |
| | 524,288 or 1,048,576 | 4,096 | 1.750 | ADC-19/20-BNRY-XB |
| Single Turn Gray Code Encoders | | | | |
| Available with various levels of RFI suppression | 256 | 1 | 1.066 | ADC/11/8/GRAY |
| | 256 | 1 | 1.750 | ADC-ST8-GRAY |
| | 512 | 1 | 2.250 | ADC-ST9-GRAY |
| | 1,024 | 1 | 3.062 | ADC-ST10-GRAY |
| Multiturn Gray Code Encoders | | | | |
| Available with various levels of RFI suppression | 1,024 | 4 | 1.062 | ADC-11/10GRAY256 |
| | 1,024 | 16 | 1.062 | ADC-11/10GRAY 64 |
| Low-Cost Magnetic Noncontacting Encoders | | | | |
| Incremental | 128 | 1 | 1.750 | MADC-18/128/INC |
| Binary | 128(V scan) | 1 | 1.750 | MADC-18/7/BV |
| Binary | 8,192(V scan) | 64 | 1.750 | MADC-18/13/BV |
| Binary | 524,288(V scan) | 4,096 | 1.750 | MADC-18/19/BV |

All magnetic encoders are normally furnished with sleeved leads. Terminal header or Cannon connector options are available for all units. Non-standard counts within the capabilities of the encoder are available on special order. **SEE US AT IEEE—BOOTH 4C11**

economical

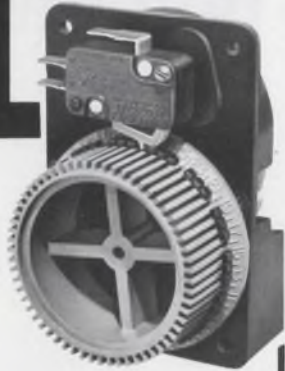

low cost timer...

SEALLECTROTIMER™

- For Process Control • Instrumentation
- Control Timing • Photocopying Machines
- Vending Machines • Displays
- Automated Broadcasting

Here's the answer to those many timer and programming problems. A revolutionary combination of field programming capability, 100% repeatability and either ON/OFF or cam switching in one low cost package. No loose parts. No critical cam adjustments. The LCT SealectroTimer.

A precisely machined 60 position programming drum with sliding contact actuators, driven by a 1 RPM (other speeds available) synchronous motor is the heart of the SealectroTimer. Each actuator corresponds to a 1 second time interval allowing any on/off or camming functions to be set up in increments of 1 second from 1 through 60 seconds. A built in drum position indicator assures 100% repeatability. Contacts (one and two contact models are available) are rated at 15A., 115 VAC resistive and 6A., 115 VAC inductive.

If your control or timing system requires an inexpensive program or time base generator, the LCT SealectroTimer is the answer.

Write for complete technical details.



PROGRAMMING DEVICES DIVISION

SEALLECTRO CORPORATION

MAMARONECK • NEW YORK

PHONE: 914 698-5800 TWX: 710-566-1110

Sealectro Ltd. Portsmouth, Hants, England

Sealectro S.A. Villiers-le-Bel, Paris, France

Visit SEALLECTRO at IEEE Show, Booths 4G04-4G10 & 4H03

INFORMATION RETRIEVAL NUMBER 130

U156

MICROWAVES & LASERS

Leveler for rf power holds levels to $\pm 0.1\%$



Weinschel Engineering Co., Inc., Gaithersburg, Md. Phone: (301) 948-3434. P&A: \$2950; 60 days.

With a minimum control range of 20 dB, a new rf power leveler keeps levels to within $\pm 0.1\%$ +1 μ W with source level variations of ± 3 dB. Model 1805 uses only dc substituted and bias power to eliminate common ac/dc errors. Deviations are indicated on a meter with 0.2- μ W resolution. Selectable dc substituted power levels are 0.5, 1, 5 and 10 mW.

Booth No. 2H42 Circle No. 250

Small power monitors span 10 MHz to 12.4 GHz



PRD Electronics, Inc., 1200 Prospect Ave., Westbury, N.Y. Phone: (516) 334-7810. Price: \$320.

The 6872 series of microwave power monitors provide continuous monitoring in the frequency range of 10 MHz to 12.4 GHz. They maintain stated accuracy with variations in metering circuit resistance. Accuracy is 1% for an amplifier portion and 1 to 2% for a sensor portion. VSWR is a maximum 1.5 and power ranges of 1 and 10 mW full scale are available.

Booth No. 2E48 Circle No. 340

Rf power amplifier supplies up to 8 W



RF Communications Inc., 1680 University Ave., Rochester, N.Y. Phone: (716) 244-5830.

Providing up to 8 W of rf power into a 50- Ω load, a new power amplifier is tunable within six band-switched ranges from 10 to 500 MHz. Model RF-815 supplies about 35 dB of gain over its entire frequency range. Its 3-dB rf bandwidth is 1.5 MHz at the low end of the frequency range, increasing to 3 MHz at 500 MHz. A front meter shows output level.

Booth No. 2C00 Circle No. 278

Self-contained rf load cools 10 kW by itself



Bird Electronic Corp., 30303 Aurora Rd., Solon, Ohio. Phone: (216) 248-1200. Price: \$2300.

Operating under 10 kW of power, a new self-contained self-cooled rf terminating system eliminates the need for external water cooling. The model 8636 occupies three cubic feet of space and operates continuously under 10 kW of power from 5 to 45°C. It terminates into a 50- Ω line with a VSWR of 1.1 from dc to 1000 MHz and 1.15 up to 1400 MHz.

Booth No. 2E40 Circle No. 256

HUDSON N

is never out-drawn...

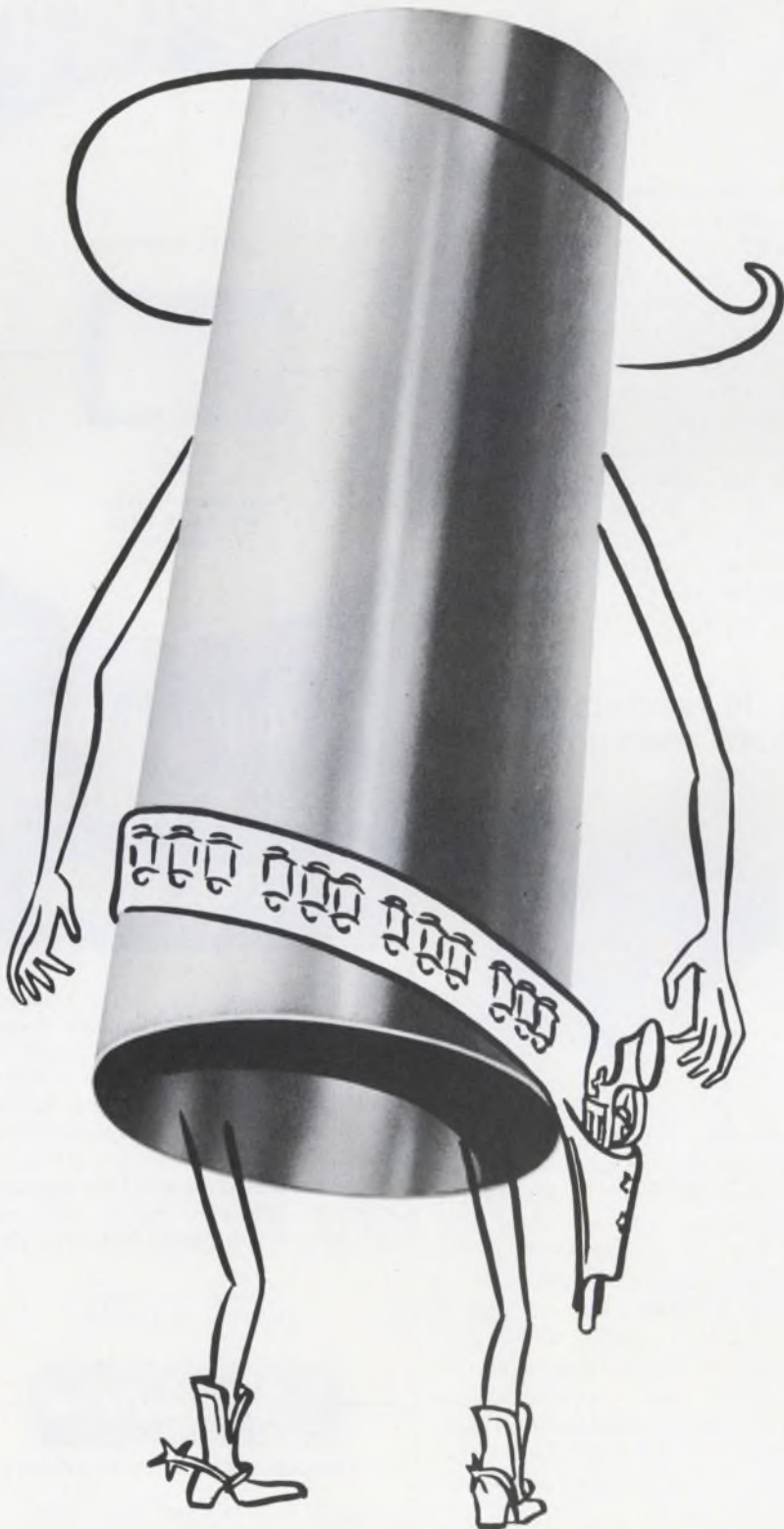

**nor out-stamped . . .
nor out-assembled!!!**

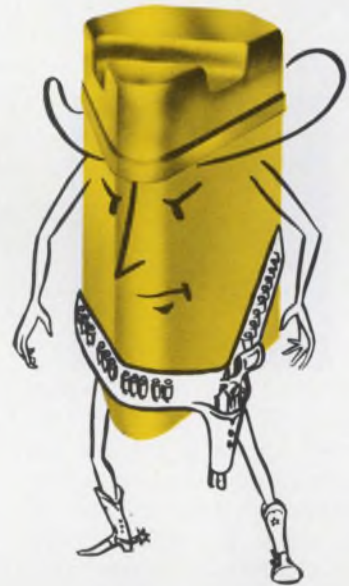

We are actually quite friendly, but get mighty tough when it comes to beating all challengers "to the draw".

See us at the IEEE Show, Booths ID07-ID11, for samples of the many thousands we have already "covered". We think they'll trigger a reaction.



HUDSON TOOL & DIE CO., INC.
Enclosures-Stampings-Assemblies

18 MALVERN STREET
NEWARK, NEW JERSEY 07105



**WHY SHOULD YOU
SPECIFY
MECATORN®
SPUN
REFLECTORS?**



The exclusive Torngren Mecatorm® hydraulically controlled spinning process has produced thousands of spun-to-specification "dishes" in use today by both military and commercial communication networks — at substantial savings over other more costly fabricating methods.

If you have a requirement for parabolic reflectors from 4 inches to 16 feet in diameter call Torngren today for complete details on the cost saving and metallurgical advantages of the Mecatorm® process.



TORNGREN
COMPANY



DIVISION OF
STANDARD INTERNATIONAL CORPORATION

238 PEARL STREET SOMERVILLE, MASS 019 886 3250

INFORMATION RETRIEVAL NUMBER 132

U158

PACKAGING & MATERIALS

**Terminal blocks
get disconnect tabs**

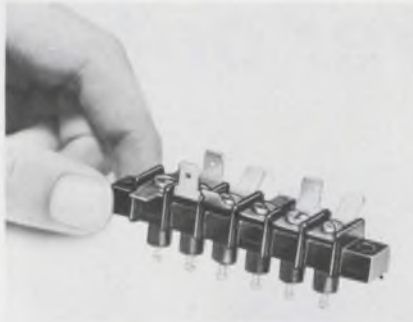

*Curtis Development & Mfg. Co.,
3288 North 33rd Rd., Milwaukee,
Wis. Phone: (414) 445-1817.*

Quick-disconnect tab terminals are now included on a line of fully insulated feed-through terminal blocks. The tin-plated tab terminals, which come in two sizes (0.032×0.25 in. or 0.032×0.187 in.), are available in six styles: single or double-sided versions of horizontal, vertical, or 45-degree configurations. The terminal blocks provide up to 26 poles.

Booth No. 4E11 Circle No. 270

**DIP IC sockets
include ejector**

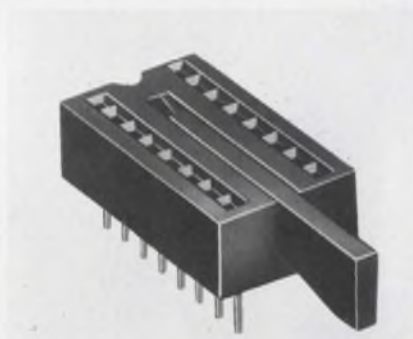

*Jermyn Industries, Vestry Estate,
Sevenoaks, Kent, England.*

A new series of dual-in-line sockets provides from 8 to 50 contacts for IC devices. The 16-pin receptacle has an integral ejector key that simplifies the removal of the integrated circuit. The larger DIP sockets, namely the 24, 28, 36, 40 and 50-contact devices, accommodate most LSI packages and are available in two forms: one for test purposes and the other for production use.

Booth No. 1C22 Circle No. 271

**METALIZED
POLYESTER
CAPACITORS**



**to your exact
specifications...
at stock prices**

Unique, self-healing units that remain in circuit during voltage surges with little or no loss of electrical properties. Use the M2W's where size and weight are limiting factors and long life and dependability are required. The units utilize metalized Polyester Dielectric with film wrap and custom formulated epoxy resin end fill. Available in round and flat styles.

*Samples available on
your letterhead request*



CONDENSER CORPORATION

Dept. ED-3 1065 W. Addison St.,
Chicago, Ill. 60613 • 312-327-5440

INFORMATION RETRIEVAL NUMBER 133

ELECTRONIC DESIGN 6, March 15, 1970

Multi-lead spreader does 2400 parts/h



Edvil Microscience Div., Mill Plain Rd., Danbury, Conn. Phone: (203) 764-1574.

Able to handle as many as 2400 pieces per hour, a new multi-lead spreader provides fast and accurate lead separation for multi-lead TO-5 headers. The MS-15 is available in four models—for 6, 8, 10 and 12-lead headers. It is a portable machine measuring 10-in. wide by 13-1/4-in. deep by 9-5/8-in. high. Header height adjustment ranges from 0.2 to 0.375 in. Booth No. 1J07 Circle No. 265

Ultrasonic solderer works without flux



Electromation Components Corp., 11 Lincoln St., Copiague, N.Y. Phone: (516) 264-0823. Price: \$424.

A new ultrasonic generator and soldering pencil combine to eliminate the use of flux when soldering leads to ceramic and crystal tiles and semiconductor substrates. Ultrasonic soldering is accomplished by vibrating the soldering pencil tip at 25 kHz to a temperature of 750°F. An unheated carbide-tipped tool can also be attached to the generator for trimming microcircuits.

Booth No. 1A31 Circle No. 337

Meet the Best Contacts!

IN BARNES MINIATURE MF SOCKETS FOR TESTING "TO" PACKAGED I.C.'S



Can a small but hard-working "TO" socket speed up your operation? You bet it can! The reliable Barnes Series MFQ sockets have large pyramidal entrances and spring-tempered, wiping type contacts that mean fast insertion and fast withdrawal — as well as positive contact. Their small size, 50,000 insertion life, and easy board-mounting features, have found them ready employment... in test, breadboarding, aging and burn-in applications. Write for details.



Lansdowne, Pa. 19050 • 215/MA2-1525

barnes / THE FIRST WORD IN CARRIERS, CONTACTORS & SOCKETS FOR I.C.'S

INFORMATION RETRIEVAL NUMBER 134

SWITCHING PROBLEM?

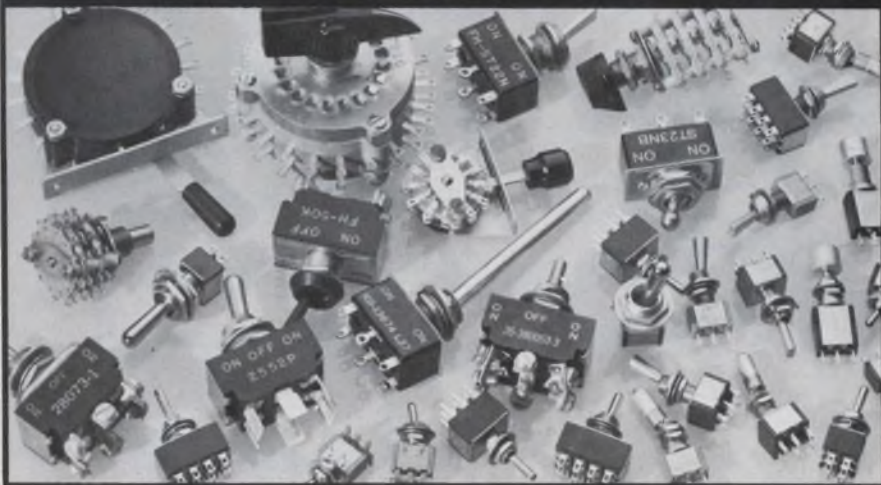

TRY ONE OF THESE FOR SIZE ...

... toggles, rotaries, levers; sub-min and standard sizes; military and general purpose; sealed and not sealed; open and enclosed; 12-, 14-, and 20-position; various finishes, configurations and constructions, standard and special—the works.

See them and operate them at the Show, or if you can't make it to the Show, be sure to get your copy of the new General Catalog 170A and SM-33. And in the meantime, look us up in Radio-Electronic Master.



J-B-T INSTRUMENTS INC.

NEW HAVEN, CONNECTICUT 06508
(203) 772-2220

Booth 4E12 at the IEEE Exposition, March 23-26

INFORMATION RETRIEVAL NUMBER 135

Signal Innovator



Singer has advanced the state-of-the-art with a signal generator so New it almost requires a new name.

The Model SG-1000 obsoletes every other signal generator within its frequency range . . . singly or in combination. Its performance is so superior that no other instrument available can equal or even approach it.

That's why we call it the Innovator.

Here's why you'll call it unbelievable . . .

- Digital readout of frequency.
- Broadband frequency coverage from 61kHz to 512MHz (to 1024MHz with a simple passive doubler) in a small 5¼" high package.

- Exceptional frequency accuracy and resolution . . . typically 0.005% . . . and no human readout errors.

- Full modulation capability AM FM Pulse Video Internal 1,000Hz modulation . . . and combinations of the above.

- Output levels from +20dBm to -146dBm.

- An automatically leveled output . . . within ± 0.5 dB over the entire frequency range.

- Use it as a 2MHz counter for counting modulating signals or rep rates directly.

- A spectrally pure output signal approaching that of a crystal . . . extremely low residual and incidental FM.

- Total elimination of dial tracking errors.

- The availability of BCD frequency output and a

programmable attenuator to assure system integration.

This is only part of the SG-1000 story. A more complete technical description is available in Singer Application/ Data Bulletin SG-10 upon request.

For additional information contact your local Singer Representative, or write or call —

The Singer Company
Instrumentation Division
915 Pembroke Street
Bridgeport, Conn. 06608.
203-366-3201.

In Europe contact: Singer
Sewing Machine Company,
Instrumentation Division, P.O.
Box 301, 8034 Zurich, Switzerland,
Telephone: (051) 47 25 10
TWX 710-453-3483

SINGER
INSTRUMENTATION

'Made in Japan'

— today it's a sign of quality



Photo by Sharp Corp.

By **Howard Bierman**, Editor

Japan's electronics sales
rocket to new heights **U162**

ICs play a heavy role
in Japanese success **U164**

Money isn't everything
to a Japanese engineer **U174**

ニ
ホ
ン
セ
イ
ー
イ
マ
ワ

ヒ
ン
シ
ツ
ヲ
ア
ラ
ワ
ス

に
ほ
ん
せ
い

Japan's electronic sales

Up, up and away is not the slogan of Japan Air Lines — but it certainly could be that of the Japanese electronics industry. Climbing at the dizzying rate of a 44% increase in factory sales in 1969 after a dramatic 32% rise in 1968, the quality-conscious producers of components and consumer and industrial products are reaching for the sky. Factory sales soared to a total of \$7.5-billion in 1969, compared with \$5.25-billion in 1968. Exports rose from \$1.4-billion in 1968 to close to \$2-billion last year — up more than 40%. These statistics were released recently by the Japan Electronic Industry Development Association and the EIA of Japan.

Consumer products were responsible for 46% of last year's factory sales as they rose from \$2.3-billion to almost \$3.5-billion. An overwhelming demand for color TV sets, as well as for compact black-and-white portables, helped account for these significant gains. Factory sales of industrial electronics, including desk-top calculators and computers, rose 27% — up from \$1.6-billion to more than \$2-billion. Components to support these record productions and for replacement gained 53%, surging to \$2-billion in 1969 from \$1.4-billion the year before.

The total electronics market for 1969, therefore, was dominated by consumer electronics production, followed by both industrial equipment and components (each approximately 27% of the total). There is no significant military or space budget in Japan to support research and development.

Consumer production soars

Of the almost \$3.5-billion in consumer products produced in 1969, sales of TV sets increased more than 53% — from \$1.27-billion to \$1.94-billion. Audio equipment — stereo receivers, phonographs, etc. — scored a spectacular rise of more than 63%

as they reached \$1.08-billion in factory sales last year, compared with \$660-million in 1968.

Radios, with considerable competition from Hong Kong and Taiwan manufacturers, gained 26%, moving from \$370-million in 1968 to \$465-million.

Calculators and instruments gain

Of the \$2-billion in industrial electronics production, desk-top calculator output more than doubled, hitting \$148-million in 1969, compared with \$71-million in '68. Test-instrument production rose more than 31% — from \$226-million to \$294-million.

Expansion of fm and uhf TV stations was responsible for a 53.5% increase in broadcasting equipment production — to \$63.6-million from \$41.6-million in 1968. The entire communications segment of the industrial market scored a 22.5% gain, rising from \$730-million to more than \$900-million. Computer production rose to \$535-million, against \$455-million in 1968, an 18% gain. A major rise in computer sales is forecast for the 70s as a myriad of minicomputers roll off assembly lines.

ICs lead rise in components

Total component production rose 52.6% last year, totaling \$2-billion. Tubes and semiconductor devices showed a 40.4% boost, reaching \$827-million in sales, CRTs rose 53% with a \$342-million output to supply the burgeoning TV market, and resistors and capacitor sales rose 50.3% and 44%, respectively, with totals of \$161-million and \$268-million.

Integrated-circuit production, not detailed by the Japan Electronic Industry Development Association, was estimated to have tripled to \$72-million in 1969. This figure is expected to soar to over \$190-million this year and to over \$300-million in 1971, according to a recent survey of eight IC manufacturers. These dramatic production gains are necessary to supply the heavy demands projected

rocket to new heights

for bipolar and MOS devices for the booming consumer and calculator-mini-computer markets.

The survey also reveals that more than 43% of the '69 output of ICs was used for in-house production of desk-top calculators and computers by the systems divisions of eight major IC firms. The remaining 57% was made available to the open market.

The eight IC suppliers estimate that close to 60% of their production was used in desk-top calculators in 1969, while 23% ended up in computers. Only 17% of the '69 production of ICs was used in consumer products, test equipment and industrial equipment other than calculators and computers.

In 1971, the IC companies estimate, calculators and computers will require less than 60% of the total IC output, and the remainder will go to the consumer and industrial markets.

The heavy use of MOS in desk-top calculators resulted in an estimated 50:50 ratio between bipolar and MOS production dollars. MOS/LSI for desk-top calculators accounted for close to \$9-million production in 1969, with a substantial increase expected this year.

Exports spiral to new highs

Total Japanese exports of electronics increased by a substantial 40.8% to a fraction under \$2-billion from the 1968 level of \$1.4-billion. The export gain for consumer products was 40%; it accounted for over \$1.3-billion in sales alone (TV sets and radios were responsible for \$360-million and \$500-million, respectively). Tape recorders, with cassette types receiving wide acceptance, rose more than 44% in export sales—\$330-million, against \$228-million in 1968.

Industrial electronic exports increased to \$268-million, compared with \$183-million in '68—a 46% gain. Computer exports more than doubled, rising from \$51-million to \$103-million. Test-equipment exports rose 20.6%—from \$32-million to about \$39-million.

Component exports were up 41%, with capacitors showing a gain of 59% (to \$54-million), semiconductors rising 45% (to \$27-million), resistors increasing 45% (to \$17.5-million) and electron tubes up 20% (to \$48-million). ■■

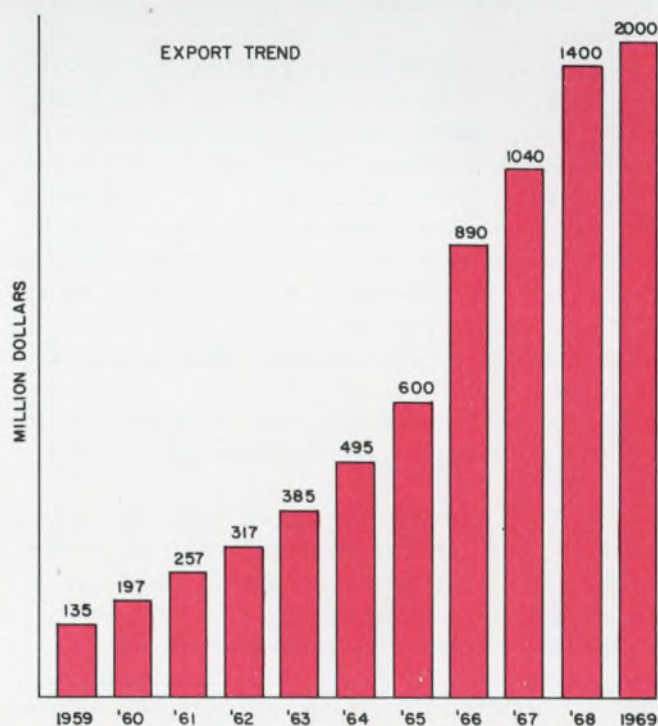
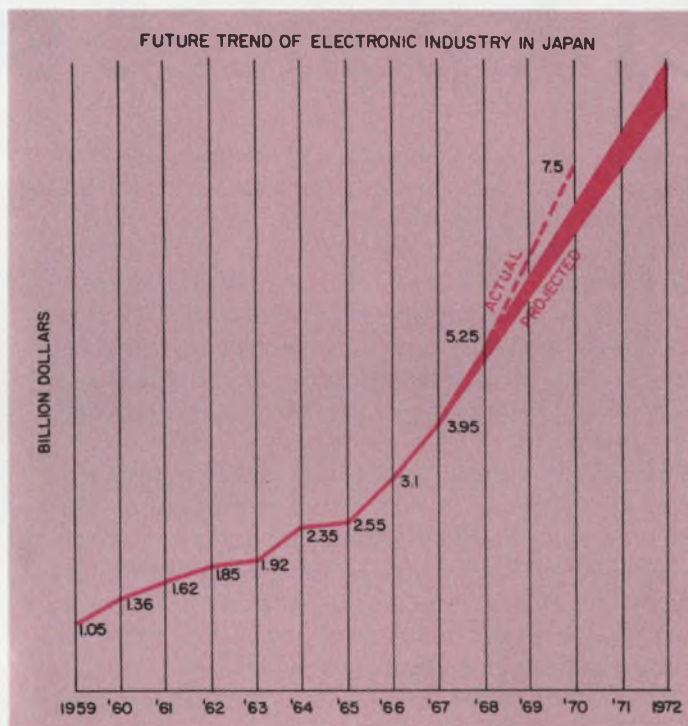



ICs play a heavy role in Japanese success

Power ICs, semiconductors, minicomputers and new consumer products are the pacesetters of the Japanese electronic industry this year.

High-power ICs, reaching the 50-W level for hybrids and 20 W for monolithics, are finding their way into such booming consumer areas as TV sets and stereo systems. Low-noise microwave transistors, made by ion-implantation techniques, are leading the way to more compact communication equipment.

Low-cost minicomputers and desk-top calculators are offering an attractive substitute to the more complex and costly time-sharing installations previously planned for numerous test and process-control applications. And finally, electronic wristwatches and microwave ovens are growing contenders for the consumer's dollars.

High-power packages, both monolithic and hybrid designs, have been developed and are in production for such consumer products as stereophonic amplifiers and receivers, tape recorders, public-address systems and deflection sections of TV sets.

Top power output honors go to Sanken Electric Co., Ltd., of Tokyo for its 25 and 50-W hybrid units. Six transistors and one diode are used, with a single-ended push-pull design in the output stage. Two npn diffused-junction power transistors, with high secondary breakdown resistance characteristics are used in the output stage and are reported to be capable of withstanding a short-circuited output (at full rating) for five seconds without damage. All necessary electrolyte capacitors and resistors, except a single coupling capacitor to the speaker, are contained in an assembly measuring approximately $3 \times 1 \frac{3}{4} \times 3 \frac{1}{4}$ inches.

The 50-W unit sells for \$15 in quantities of less than 100 and for \$10 in quantities of more than 50,000. The 25-W type costs \$10 in small quantities and \$7 in mass quantities.

Toshiba (Tokyo Shibaura Electric Co., Ltd.) has introduced a 20-W hybrid IC that uses a pnp differential input circuit to minimize the effects

of temperature and line voltage fluctuations. The output transformerless design uses seven transistors and requires three external capacitors. The voltage gain is 31.5 dB.

Another supplier of hybrid ICs is Sanyo Electric of Tokyo, which introduced the first high-power hybrid IC (15 W) in Japan two years ago. Its type STK-003 contains seven transistors, including a complementary pair of power transistors. A total of eight external capacitors and resistors are needed to complete the circuitry. With a 40-V supply, a maximum output of 15 W (at 1% distortion) can be achieved. Sanyo also produces a 10-W unit, the STK-015, for 32-V operation and a 5-W unit, STK-011, for 25-V operation.

Undaunted by the prediction of semiconductor engineers that monolithic ICs would remain at 5 W until a significant breakthrough in monolithic fabrication extended the limit to 10 W, Sony Corporation's Research Center in Yokohama has produced a 20-W continuous rms power rating with a single-ended, push-pull configuration. This IC development overshadows the 3-W and 5-W monolithic devices available from other U.S. and Japanese manufacturers.

Three key factors influence the design of a high-power IC. First, breakdown voltage must be high to permit use of a reasonably high supply voltage. Second, collector series resistance must be low to minimize power loss due to high collector current flow. And third, the device must exhibit stable operating characteristics, despite temperature variations caused by the heat generated within the small chip area. Sony's new fabrication technique involves a unique epitaxial process to control selectively the growth of a fine polycrystalline structure and a single crystal on the same substrate. A special process, taking advantage of the difference in diffusion velocities in the single and polycrystalline structures, controls the concentration of impurities during IC fabrication. The polycrystalline structure permits a low resistance connecting lead to be fabricated from the buried collector layer to the surface contact, and it also

IEEE SHOW 1970

Show Place: Coliseum & Hilton Hotel,
New York, N.Y. U.S.A.

Show Period: March 21 - 26th

Booth Number 4C03, 4C04

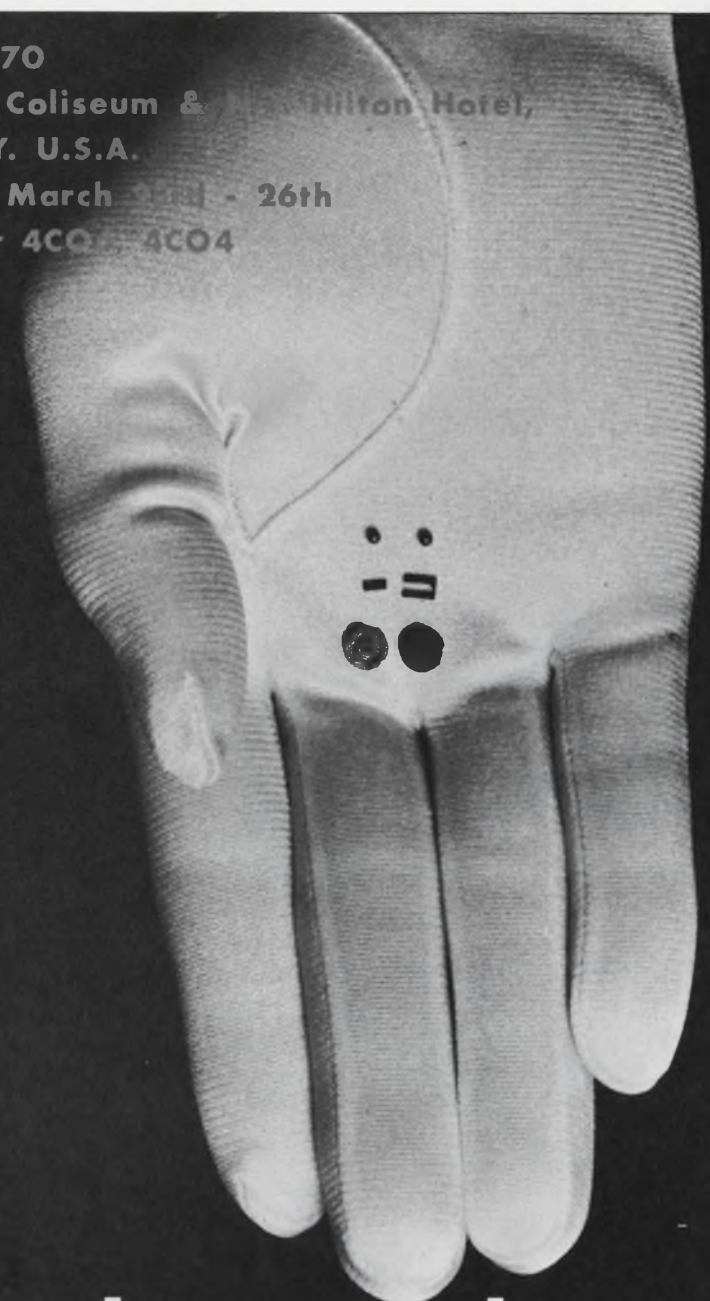

We're here to show you....

TDK presents the highest level of magnetic materials technique at the IEEE Show. Keep your eyes on products from TDK which is devoted to world electronic development.

TDK PRODUCTS

Glass bonded head cores High density ferrite cores Pulse transformer cores Hexalators YIG singles crystals R cores Q cores EP cores 3 type pot cores 5 type pot cores EE cores Microwave materials Circulators Isolators

As always, TDK representatives will be on hand at the New York Plaza Hotel (corner of 5th Ave. and 59th St.) to give first-hand data on the complete line of communication - use ferrite products



Representative in U.S.A. & Canada for Ferrite Core for Communications
**MH&W
INTERNATIONAL
CORPORATION**

INFORMATION RETRIEVAL NUMBER 137



TDK ELECTRONICS CO., LTD.

2-14-6 Uchikanda, Chiyoda-ku, Tokyo, Japan
• For detailed information, write to:

TDK ELECTRONICS CORP.

23-73 48th Street Long Island City, New York 1103
Phone: (212) 721-6881

• **LOS ANGELES Branch**, 6151 W Century Blvd.
Los Angeles, California 90045 Phone (213) 670-5515

• **CHICAGO Branch**, 2906 West Peterson Avenue, Chicago
Illinois 60645 Phone (312) 973-1222

acts as an efficient diffusion canal for the dopant to reach the single crystal regions to form isolation junctions. The process allows npn and pnp transistors of similar vertical structure (nonlateral) to be made on a single substrate with low saturation resistance, high breakdown voltage and stable characteristics, despite temperature variations.

Although the fabrication steps may appear complex, Dr. Shigeo Shima, director of Sony's research center, says the process is highly controllable and high yields are not at all difficult to attain. The initial application for these devices, according to Dr. Shima, will be in the vertical deflection section of Sony TV receivers. Later applications will involve stereo equipment and tape recorders.

A 3-W monolithic IC is being offered by Mitsubishi Electric Corp., Itami City, for lower-voltage (12 V) equipment in cars and boats or portable battery applications. A total of 13 transistors, including three lateral pnp types, are included within the chip, and eight external components are needed. For 3-W output across a 4-ohm load, 50 mV is required for full output. Nippon Electric Co., Tokyo, is also producing a 3-W monolithic amplifier, the μ PC21C, in a 14-lead plastic, dual-in line package.

ICs for color TV applications

Consumer product manufacturers in Japan are like their counterparts in the U.S. when it comes to tight security concerning new product announcements. But the pace to introduce ICs into consumer products appears more pressing in Japan, where there is both a tightening labor market and a major effort among leading producers to raise their output substantially. By 1973, the leading producers

A new fabrication technique by Sony gives 20 W of power from this chip on a TO-5 can.

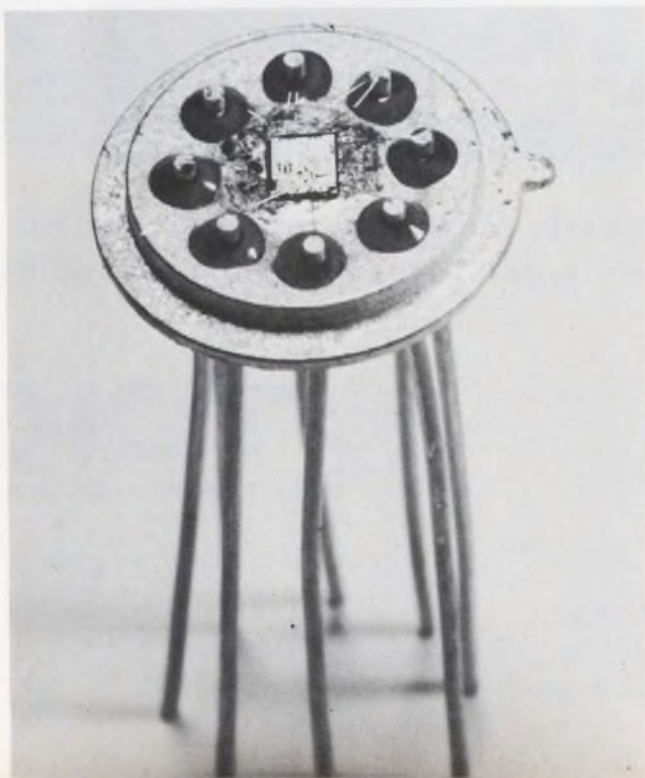

of consumer electronic products expect to double their sales and to add only 10-20% more production help to achieve this. Since wages are on the rise and at the same time increased profits are constantly being sought, the importance of IC applications become apparent.

Several manufacturers, including Sanyo and Matsushita Electric Industrial Co. of Osaka, introduced compact IC monochrome TV sets over a year ago. The Matsushita (Panasonic) pocket-size receiver uses eight thick-film hybrid ICs, rather than monolithic types, to approximate conventional circuit design, which uses discrete components. The eight hybrid IC packages provide the following functions: (1) Sound i-f amplifier and discriminator; (2) Audio and agc; (3) Video i-f amplifiers; (4) Video detector and amplifier; (5) Sync separator and afc; (6) Vertical deflection; (7) Horizontal deflection, and (8) Power-supply filtering. A separate tuner subassembly, using variable capacitance diodes, a flyback transformer and high-voltage rectifier, and a miniature, specially developed 1.5-inch CRT complete the battery-operated set. Four AA nickel-cadmium batteries are reported to give two hours of viewing time. The recharge time is three hours for the 1.5-pound portable, which draws only 1.2 W.

The use of ICs reduces the 280 soldering points needed for a conventional TV receiver design to about 70 in this portable set — a considerable saving in assembly time and cost.

Joint effort pressed with ICs

The use of ICs to reduce cost and improve reliability in color TV receiver design is a major team effort in Japan. Five TV manufacturers, seven component producers, four universities and two institutes in the Osaka area have organized the Kansai Electronic Industry Development Center to develop jointly such a color TV receiver.

A prototype set was recently developed using thin-film, thick-film and monolithic ICs. The circuits not considered for IC implementation were the uhf tuner, video output, horizontal and vertical outputs, high voltage rectifier and power supply. The vhf tuner uses a thin-film hybrid IC for the rf amplifier, and over-all gain is 15 dB for the lower channels and 12 dB for the higher channels. A monolithic IC performs the oscillator mixer function and provides 22 dB gain for the low channels and 16 dB for the high channels.

Monolithic ICs are employed for the chroma bandpass amplifier and chroma demodulators; a thick-film hybrid IC is used for the matrix pre-amplifier. A monolithic IC burst amplifier is biased by a thin-film color killer stage. The 3.58-MHz oscillator and amplifier function is performed by a monolithic IC with a thick-film hybrid assembly as the reactance transistor stage. Both thick and thin-film techniques are used to fabricate the color

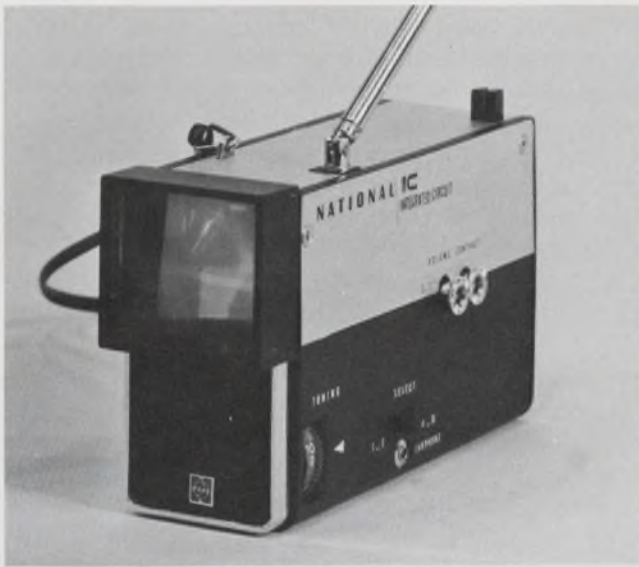

Eight thick-film ICs and a 1.5-inch CRT are features of this Matsushita portable.

phase detector circuit. A 3-W audio monolithic IC amplifier is used to drive a 4-ohm speaker with 50% efficiency from a 50-mV detector signal. A multi-purpose monolithic differential amplifier with R-C feedback is used in the vertical oscillator, and another similar type is used in the horizontal oscillator section.

Watches and microwave ovens produced

New areas for the application of electronics to consumer products are watches and microwave ovens. Several months ago a quartz-crystal wrist-watch, with an accuracy within five seconds a month, was announced by Seiko Watch-K. Hattori & Co., Japan's leading watch manufacturer.

The quartz crystal assembly consists of a 8.192-Hz oscillator, an IC divider to reduce the signal to one pulse a second, an electromechanical transducer to convert these second signals into mechanical rotary movement, a counting mechanism to move the second hand in one-second intervals, and a battery to operate the electronics and step motor continuously for one year.

Microwave ovens that are large enough to handle a chicken but compact enough to be placed on a small table are enjoying overwhelming consumer acceptance in Japan today. More than 250,000 microwave ovens were produced in 1969, according to industry sources, compared with 50,000 the previous year. Manufacturers such as Matsushita and Sharp Corp., Osaka, are reported planning on production of 750,000 ovens this year. Domestic demand is expected to peak during the year, and exports are expected to reach the U.S. market.

According to a Sharp spokesman, the company's microwave ovens have already passed the safety requirement levels for the United States Public Health Service, the Federal Communications Commission and Underwriters Laboratories. The U.S.



She's cooking with microwaves, not gas, to cut food preparation time to about a tenth.

radiation level requirement, according to the spokesman, is 10 mW/sq. cm., while Japan's is 0.3 to 0.5 mW/sq. cm. — a tolerance that is met by all Japanese microwave oven manufacturers. The popular ovens for the home deliver 600 W and are not much larger than a king-size rotisserie. The cooking time with such ovens is reduced to one-eighth to one-twelfth the time that conventional gas ovens take. Retail prices in Japan have dropped below \$300.

On display at IEEE Show

Some of the outstanding achievements of the Japanese electronics industry are on display at the New York IEEE show. For example, the strenuous efforts of Japan's semiconductor firms to supply their domestic consumer and industrial customers are evident.

At the IEEE show, Mitsubishi (Booth 4G17) is exhibiting an extensive line of linear ICs for the consumer market. Stereo demodulators, 1-W and 3-W amplifiers, op amps, voltage regulators, differential voltage comparators and a 300-mW a-m radio chip are just a few of the items in its product line.

Nippon Electric Co. (Booth 3B01) is in pilot production with a 144-bit n-channel MOS-LSI memory having a cycle time of 80 ns. Also in production is a single 64-bit dynamic shift register (μ PD108C) and a dual 64-bit dynamic shift register (μ PD109C); both MOS units are geared for the desk-top calculator market. Nippon is also producing a line of linear ICs for monochrome and color receivers including its μ PC24C for combined service as video amplifier, sync separator, noise suppressor and age keyer.

A line of MOS ICs and LSI devices is being shown by Toshiba (Booth 3B22). In addition to the 4-bit static shift register, 48, 60 and 64-bit dynamic register, as well as a 36-pin ceramic dual

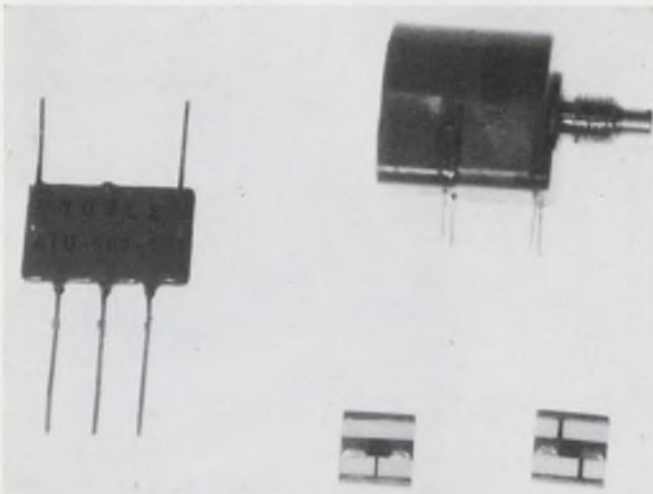

Metal film attenuators, variable and fixed, with long-term temperature stability, are being offered by Teikoku Tsushin Kogyo, Tokyo.

in-line timing pulse generator (T 3019) for generating 27 different control pulses, are on exhibit.

Toshiba is also demonstrating a high-speed IC tester, series 1200, capable of testing 100 ICs a second.

Transistor and diodes shown

High-voltage silicon power transistors for the audio, video and deflection output stages of TV receivers are being shown by Matsushita (Booth 4J11). The type 3SK36 high-frequency MOS transistor includes two protection diodes integrated into the MOS gates.

Sharp Electronics (Booth 4G16) will be showing its GaAs negative-resistance, infrared light-

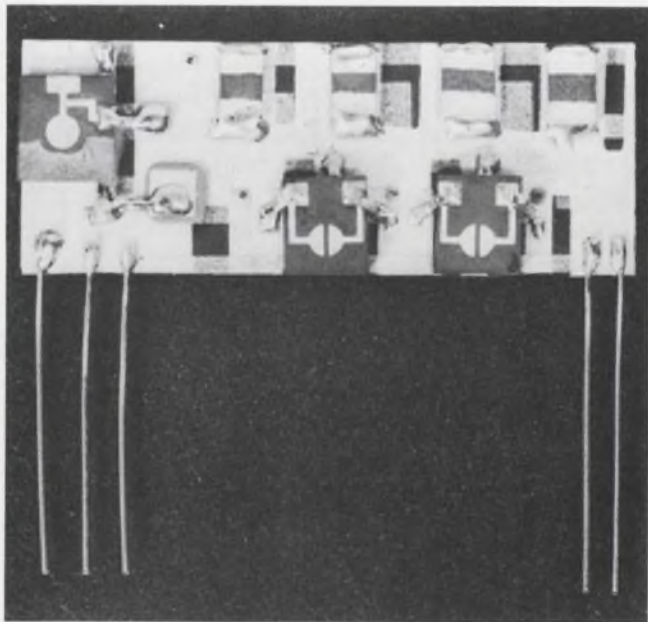

A 4.5-MHz intercarrier sound i-f module, using ceramic filters based on the energy-trapped mode, is being offered to TV manufacturers by Murata Manufacturing Co., Nagaoka. The hybrid offers 40-to-46-dB gain with more than 70-kHz bandwidth.

emitting diodes, developed by the company's Opto-electronics Research Group. The four-layer GND device, discovered by Sharp engineers as production process changes were being investigated, provides a fast-acting switching action and produces light output that is reportedly 50% greater than that of conventional light-emitting diodes. The applications under investigation include amplifiers, logic circuits, optical memory systems, d/a and a/d converters, pattern recognition and optical communications.

In addition, Toshiba is exhibiting its highly publicized silicon low-noise IBT transistors. Designed primarily for low-noise microwave amplifier use, the npn S1072 device offers a 3-dB (typical) noise figure at 2 GHz with 8-dB power gain; at 4 GHz, the noise figure is only 5 dB (typical). Although no definite price figure has been announced, the device is expected to sell for about \$100; production plans will be based on the demand stemming from sample deliveries made before mid-year.

Nippon Electric has developed a 3.4-to-4.4-GHz transistor amplifier with 7-dBm output power, using its V417 transistors. Unit amplifiers of the same design are connected in cascade by short transmission lines. The circuit is fabricated on alumina substrates and isolators are integrated in the input and output parts of the amplifier. The noise figure is 10 dB, and the input and output VSWR is 1.2 maximum.

The company has also developed a 4-GHz Schottky barrier diode mixer-preamplifier, using its SM153 diode. In this mixer, the image frequency is terminated reactively. Thin-film fabrication techniques are used to deposit the circuits on ceramic and glass substrates.

A line of miniature isolators and circulators is being exhibited by Mitsubishi.

A tunable filter, extending 200 MHz on either side of 1 GHz is exhibited by TDK Electronics Co., Tokyo (Booth 4C04). The insertion loss is 4 dB, and the bandwidth is 20 MHz for the YA11G device. TDK is also showing a compact broadband stripline circulator for C-band operation.

5000-MHz scope leads instrument gains

Measurement and test equipment in Japan, including process-control instrumentation, is being manufactured by close to 250 companies. Slightly less than 100 concerns, producing about 90% of the industry volume, belong to the Japan Electric Measuring Instruments Manufacturers Association, according to the group's director, Tsuneji Asami. About \$360-million in factory sales were estimated for the total measurement market in 1969, Asami reports, against less than \$300-million the year before; electronic test instruments account for about 30% of these totals. Growth at a 20% annual rate is expected to continue through

NEW LED



NUMERIC READOUT

Amazing. This new Hitachi LED numeric readout is smaller than a pen point.

But, you can use it to display numerical figures zero to nine.

Brilliantly. On low voltage. Even on dry batteries.

In whatever item you have that requires **Light Emitting Diodes**.

All because Hitachi was technically successful in producing large crystals of gallium arsenide phosphide and a new monolithic integrated structure.

See how it works yourself. Come to the '70 IEEE Show at the New York Coliseum, March 23 to 26. Look for Hitachi booth numbers 3K30-3K35.

Get them down now. Better yet, tear out this page and take it with you to the Show.

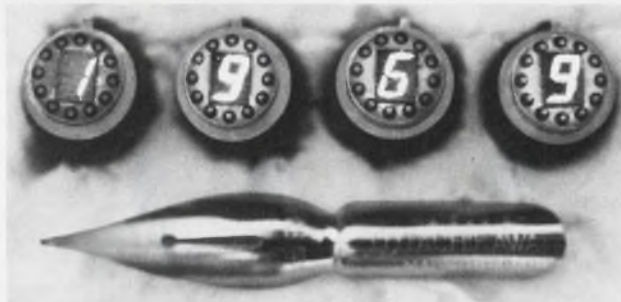

Voltage:
Operable on 1.75 volts
Current:
50 mA per numerical digit
Power Consumption:
85 mW per digit

Spectral Wavelength:
6,300Å to 6,800Å (red)
Responsive Speed:
One nanosecond (one billionth of a second)
Brightness:
More than 120 feet Lambert



See these important developments, too! Ferroelectric-Ferroelastic Crystals / TGS Detectors / MOS LSI / 16 MIL Memory Cores / Scanning Type Electron Microscopes / Laser Ray Tubes / Sound Spectrogram Color Indicators / Millimeter Wave Test Equipment (Gun-Diode) / 110 Polarization TV Tube and TV Sets

INFORMATION RETRIEVAL NUMBER 138

1970. Of the \$360-million total production, only 20 to 25% is exported, Asami explains, since Japanese companies have not resolved the problem of setting up competent, economical service and calibration stations throughout the world. Drastic changes in instrumentation design are common in the U.S., Asami notes further, due to NASA's funding for sophisticated equipment; Japan's industry has no such backing and, as a result, its technical growth in this area is slower and more deliberate.

However, companies such as Iwatsu Electric Co., Tokyo, and Matsushita Communication Industrial Co., Ltd., offer oscilloscopes with 200 and 300-MHz bandwidths. Plug-in counters extending to 12.5 GHz, multi-function digital voltmeters and sophisticated data-acquisition systems are being supplied by Takeda Riken Industry Co., Ltd. These are but a few of the concerns supplying the necessary test hardware for the fast-growing consumer



From dc to 5,000 MHz is the range of this Matsushita Nanoscope, which uses a traveling-wave CRT.

and industrial manufacturers in Japan.

A 5000-MHz, real-time oscilloscope has just been announced by Matsushita for observation of non-recurrent, single-transient waveforms. The instrument, called a Nanoscope, relies on a specially designed traveling-wave CRT with a vertical deflection system made of a coaxial, helical-strip slow-wave structure.

Dominant role due for computers

Computers are expected to play a substantial role in continuing Japan's electric industry growth. The 18% increase in computer factory sales between 1968 and 1969 is only a beginning, industry experts predict. The powerful Ministry of International Trade and Industry has recently announced a priority goal to close the U.S.-Japan computer gap by 1980. Not much more than 10

years ago the first computer installation was placed in operation in Japan. By mid-1969, close to 5000 installations were operating, compared with about 50,000 in the U.S. To accomplish their goal, Japanese computer companies will have to maintain a steady 30% increase each year for the next decade.

Six major computer manufacturers — Nippon Electric Co., Hitachi Ltd, Fujitsu, Toshiba, Oki Electric and Mitsubishi — have been organized to provide equipment sales and rentals through a jointly owned Japan Electronic Computer Co.

Minicomputers growing in number

Much of the effort is directed to the small and minicomputer product lines, which offer considerable potential for export sales. Among the growing number of minicomputer models are Hitachi's HITAC-10, Matsushita's MACC-7/s, Nippon Electric Co.'s NEAC-M14, Oki Electric's OKITAC-4300 and Fujitsu's FACOM-R.

A superfast 300-ns magnetic core memory, using 12 mil cores, is being exhibited by TDK Electronics. The basic memory capacity of the 2 $\frac{1}{2}$ D system is 2k words of 8 bits plus parity. The size of this memory, approximately 4 x 25 x 15 inches, is claimed to be one-fifth the size of the commonly used four-wire, 3 D system (which uses 20 mil cores), and with the same memory capacity.

Desk-top calculators on the rise

Desk-top calculator factory sales more than doubled last year, from \$71-million in 1968 to \$148-million. Sharp Corp., reportedly supplying 23% of the world market and 40% of Japan's output, is preparing its next generation of desk-top machines. Dr. Tadashi Sasaki, director of Sharp's Industrial Instrument div., foresees a pocket-size machine with a built-in electronic printer.

For display, Sharp is working on special mechanical devices that require low power consumption, as well as miniature micropower multi-character, in-line tubes. Also under consideration, according to Dr. Sasaki, are gallium arsenide phosphate solid-state numerical displays. Developments in keyboard design include work on Hall-effect devices, Sharp's patented GND negative-resistance Ga As units and miniature reed relays. In a limited keyboard space, an operator may accidentally depress two keys at the same time; an electromechanical assembly permits the system to ignore the second key that was depressed. The next-generation calculator will have this function served by LSI shift registers, Dr. Sasaki suggests.

To further reduce calculator size, Dr. Sasaki indicates that PC manufacturers are being asked to produce low-cost, highly accurate through-hole boards that will have less than 1.6 mil spacing with less than 0.8 mil line width for conductors.

STABILITY & QUALITY

High quality capacitors unrivalled in the precision, dependability and compactness. Quality is recognized by ever wider use in measurement equipment, computers, and automatic controllers. "LEAF" the matter of capacitors to MATSUO ELECTRIC CO.



MATSUO

SOLID TANTALUM CAPACITORS FOR HYBRID ICs - "MICROCAP".

Specifications:

Operating Temperature Range: -55°C to $+85^{\circ}\text{C}$
 Standard Voltage Rating: 6.3, 10, 16, 20, 25, 35 VDC
 Standard Capacitance Value: .001 to 22MFD (EG series)
 Standard Capacitance Tolerance: $\pm 20\%$ (M)

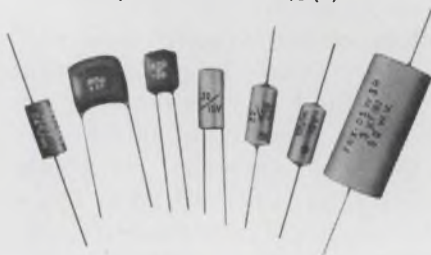

MATSUO'S other capacitors include:

Metallized Polyester Film Capacitor: Type FNX-H mylar wrapped.
Solid Tantalum Capacitors: Type TAX hermetically sealed in metallic case, Type TSX encased in metallic case and sealed with epoxy resin, Type TSL encased in metallic case and sealed with epoxy resin. **Polyester Film Capacitors:** Type MFL epoxy dipped, Type MFK epoxy dipped, non inductive, Type MXT encased in plastic tube, non inductive.

For further information, Please write to
 Manufacturers and Exporters

MATSUO ELECTRIC CO., LTD.

Head Office: 3-5, 3-chome, Sennari-cho, Toyonaka-shi, Osaka, Japan
 Cable: "NCCMATSUO" OSAKA Telox: 523-4164 OSA
 Tokyo Office: 7, 3-chome, Nishi-Gotanda, Shinagawa-ku, Tokyo

INFORMATION RETRIEVAL NUMBER 139
 ELECTRONIC DESIGN 6, March 15, 1970

SMK'S HIGHLY DEPENDABLE PRODUCTS

Over 45-year experience

● Components First Division



From audio equipment for general public's use to industrial equipment.

● Components Second Division



Jacks for earphone, head phone, various types of D.C. power sources.

● Connector Division

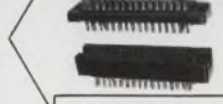

Component parts—connectors and sockets—for industrial and consumer markets.

● Switch Division

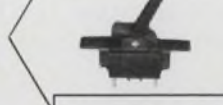

Specifically the quality of slide switches and seesaw switches produced by this division is assured by the U.L. Mark.

● Machinery Division

This Division is responsible for the improvement of product quality and work efficiency through the utilization of new lead machines and continuous job training.

MAIN PRODUCTS:

- Fuse Holders
- Plugs
- Lamp Sockets
- Jacks
- Binding Posts
- Switches
- Connectors
- Other Components



SHOWA MUSEN KOGYO CO., LTD
 New York Office: c/o Kanematsu Goshu (U.S.A.) Inc.
 One Whitehall Street, New York, N.Y. 10004, U.S.A.
 Telephone: (212) 425-2700
 Head Office: No 5-5-6 chome Togoshi, Shinagawa-ku,
 Tokyo, Japan
 Telephone: 785 1111 Cable: SHOWAMUSEN TOK

INFORMATION RETRIEVAL NUMBER 140



Versatile COSMICAR® lenses meet all your purposes

COSMICAR lenses, widely reputed as superlative in reproduction and microfilming applications, are also available for 16mm cine and CCTV cameras.

Please write for further detail to:



COSMICAR OPTICAL CO., LTD.

568, Shimoochiai, 2-chome, Shinjuku-ku,
 Tokyo, Japan

Cable Address: "MOVIEKINO TOKYO"

INFORMATION RETRIEVAL NUMBER 141

U171

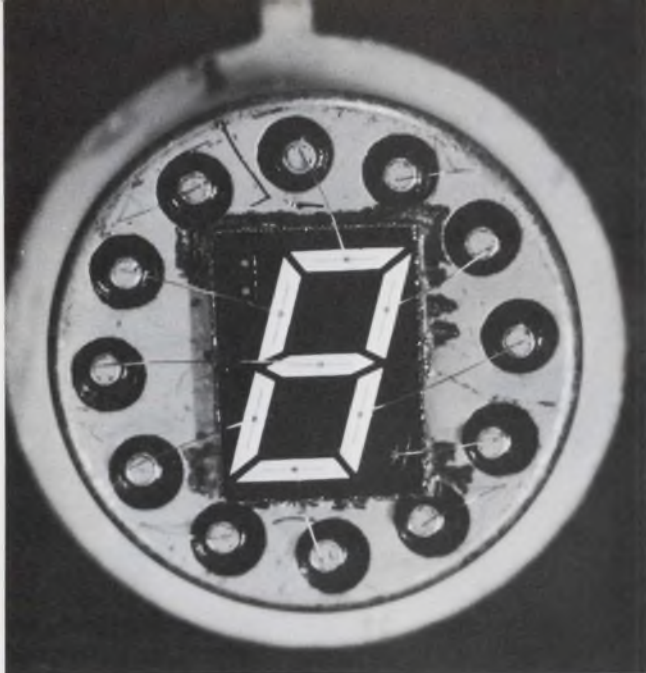

This seven-segment, solid-state GaAsP array by Hitachi requires only 85 mW per digit.

Sharp is actively engaged in designs to reduce the input power demands to less than 800 mW.

When will this pocket-size, battery-powered, eight-digit prototype be ready for marketing and test evaluation? By the end of 1971, Dr. Sasaki believes.

Future of display tubes is bright

Considerable development effort is underway at tube and calculator companies toward smaller, brighter, lower-power-consuming display devices. Prototypes have been announced for solid-state alphanumeric displays and for multi-digit discharge tubes.

Hitachi has announced a seven-segment, GaAsP light-emitting diode array, capable of displaying numerical characters that are less than a half inch high. The device operates at 1.75 V with average current at about 50 mA per digit, for an average input per digit of only 85 mW. The spectral wavelength is in the 6300 to 6800 Å region, and brightness is said to be more than 120 feet lamberts. At present, no price or availability

figures are available.

Multi-digit discharge tubes have already been announced by Philips of the Netherlands, Matsushita and Ise International Corp., Tokyo. A new entrant into the field is Nippon Electric with its LD8008 eight-digit and 8D5005 12-digit development devices.

A low-voltage, low-current incandescent subminiature indicator tube is being prepared for the calculator market by Apollo Corp., Tokyo. Labeled the Atron, the tube is reported capable of brightness levels of 5,000 foot-lamberts (maximum) compared with the 200-foot-lambert levels of competitive fluorescent and glow-discharge types.

Digital display tubes, with character sizes ranging from 8.5 to 19 mm and bulb diameter from 10 to 32 mm, are available from Okaya Electric Industries Co., Tokyo. The display is formed by mosaic combinations of filaments, which result in low-cost assembly, the company reports.

Still another entry in the display tube field is Oshino Electric Lamp Works of Tokyo, reportedly the top producer of subminiature indicator lamps in Japan. According to Hiroshi Oshino, the company's export manager, it will have seven-segment numerical readout tubes ready before mid-year.

To illustrate the pressing pace of display-tube companies, Keiji Aoyago, president of Ise, says his company plans to raise output from the 1969 total of 300,000 units to 4 million this year and 8 million by 1971. Solid-state display devices don't worry Aoyagi right now; he believes they will need more than two years to become price-competitive and will find it difficult to compete on the basis of their small character size.

Planning to visit Japan for Expo '70 this year? Combine business with pleasure by planning your trip between April 10 and 20, the dates of the Japan Electronics Show. More than 300,000 visitors are expected to pass to view the 1500 booths of 350 exhibitors. The show is being held in Tokyo at the Harumi International Trade Fair Grounds. Last year's show at Osaka attracted 160,000. Each year the show alternates between Tokyo and Osaka, in the same manner as the annual Los Angeles-San Francisco Wescon exchange. ■■

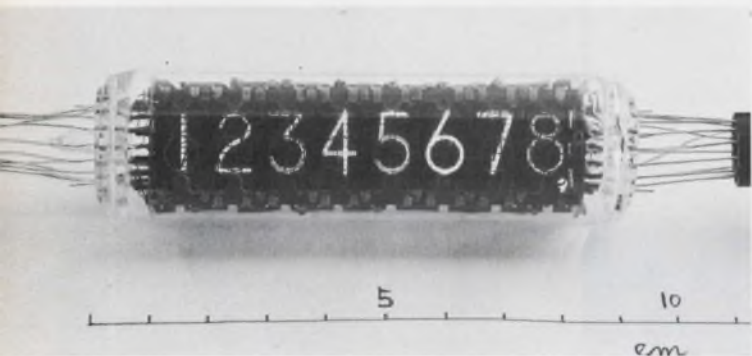

Eight digits in one readout tube. Nippon Electric is also demonstrating a 12-digit model.

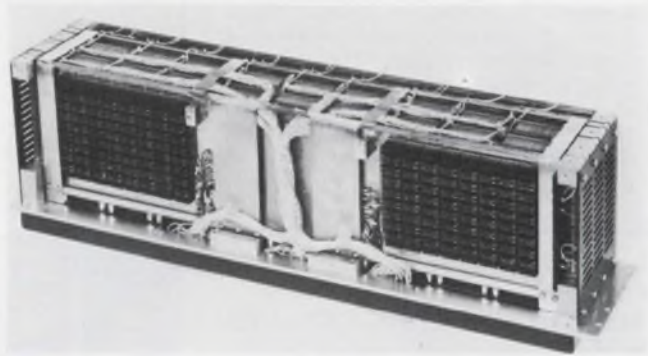

A compact, high speed memory, using 12-mil cores, has been fabricated by TDK Electronics.

NOBLE COMPONENTS

■ SMALL MOLDED CAPACITOR (GIMMICK TYPE)

■ SLIDE VARIABLE RESISTOR
< VJ456 >

- EFFECTIVE SHAFT TRAVEL: 45MM (1.772")
- FOR TINY CONTROL AND VOLUME CONTROL

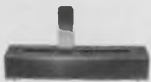

■ WIRE - WOUND VARIABLE RESISTOR
< WR181 - 7K >

- FOR CONVERGENCE CIRCUIT



■ CARBON - COMPOSITION VARIABLE RESISTOR
< V24L5G (PH)N >

- SMALL TRACKING ERROR



MAIN PRODUCTS: VARIABLE RESISTOR ● ELECTRONIC SWITCH ● CAPACITOR ● FIXED RESISTOR ● COIL & IFT

TEIKOKU TSUSHIN KOGYO CO., LTD.

NOBLE 335, NISHINAKA - MACHI, KARIYADO, KAWASAKI, JAPAN
TEL: NAKAHARA (044) 042-3171 TELEX: 3842-155 CABLE ADDRESS: TEITSU
INFORMATION RETRIEVAL NUMBER 142

Soshin's One Finger Speciality Mica Capacitors

The only mica capacitors to pass
evaluation testing by Japanese Government
equivalent to MIL-C-5D

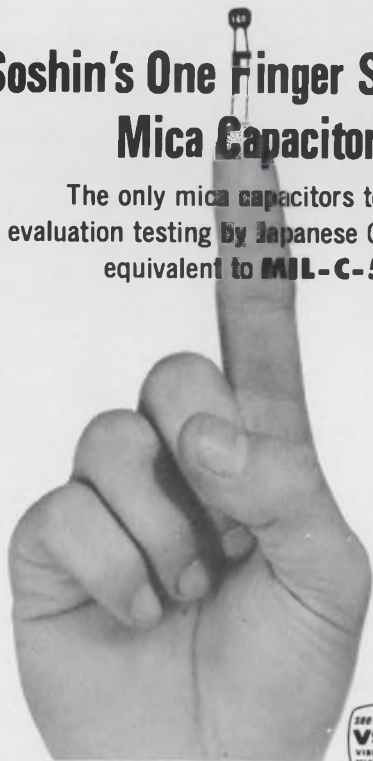

SOSHIN SOSHINELECTRIC CO., LTD.

18-18, Nakamagome 1-chome, Ohta-ku, Tokyo, Japan
Cables: SOSHINCAP TOKYO Telex: 246-6377

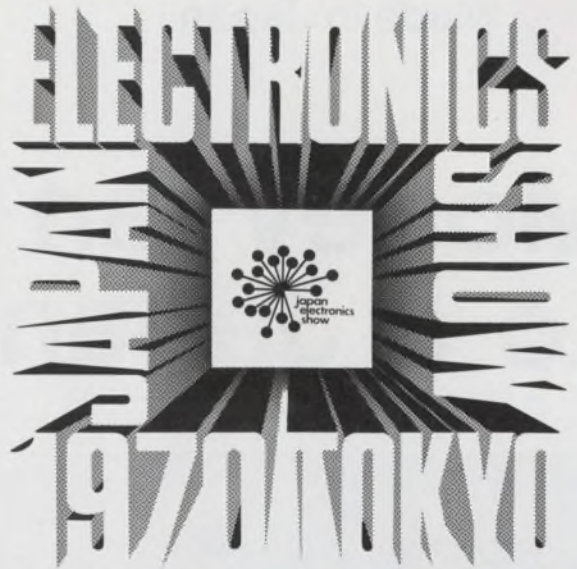

APRIL 10-20 JAPAN ELECTRONICS SHOW (JES)

1970 IS THE YEAR... FOR JES AND EXPO '70

The ninth Japan Electronics Show will open a new decade of brilliant advancement in the everprogressing world of electronics. The year 1970 is also of special significance, in that Japan will host the first world exposition ever to be held in Asia. And JES will be geared to the central theme of Osaka's Expo '70—"Progress and Harmony for Mankind."

Over 400 applications for participation in the JES have already been received from leading international electronics firms in a dozen countries, as well as from their counterparts in Japan.

The JES will again provide an excellent opportunity to inspect the latest electronics technology and products, and to promote business ties on an international scale.

Exhibit areas will be divided by:

- Consumer products—Television, radios, stereo phonographs, tape recorders, etc.
- Industrial products—Communications, testing/measuring equipment, radio apparatus, associated electronics devices, etc.
- Components/Parts—Discrete components (resistors, capacitors, transformers, speakers, semiconductor devices, etc.), integrated circuits, etc.
- Foreign participants from U.S.A., Canada, France, West Germany, Holland, Italy, Sweden, Denmark, Austria, and others.

Sponsored by
ELECTRONIC INDUSTRIES ASSOCIATION OF JAPAN
Managed by
JAPAN ELECTRONICS SHOW ASSOCIATION
Tosho Bldg., 3-2-2, Marunouchi, Chiyoda-ku, Tokyo, Japan
Cable: ELINDASO TOKYO Phone: 211-2765

Overseas Information Offices
Electronic Sec.

JAPAN LIGHT MACHINERY INFORMATION CENTER (JETRO)
U.S.A.: 437, 5th Avenue, New York, N.Y.

West Germany: Duesseldorf, Berliner Allee 32, West Germany

INFORMATION RETRIEVAL NUMBER 143

ELECTRONIC DESIGN 6, March 15, 1970

INFORMATION RETRIEVAL NUMBER 144

U173



Money isn't everything to a Japanese engineer



Kiyokatsu Negishi, on the way up 17 years after graduating from a Japanese engineering school.

"Wages have been skyrocketing each year. Now, for instance, the average eight-year senior high school graduate can earn as much as \$77 to \$85 per month as base salary!"

That's not a typographical error. That's a comment from a recent editorial in a Japanese technical publication, *Japan Electronic Engineering*. Wages in Japan, even for engineers with college degrees, are only a fraction of what they are in the United States. But there are fringe benefits for the security-minded — such as a job for life, without fear of layoffs.

To the typical American engineer, it might seem paternalistic. To the Japanese engineer, the system offers peace of mind and opportunity to advance.

Kiyokatsu Negishi is in charge of the design of industrial measurement equipment at Rikadenki Kogyo Co., Ltd., Tokyo, a concern engaged in the development and manufacture of multi-pen and computing recorders. It took him 15 years to reach this department head level. After joining the company 17 years ago upon graduation from a

senior engineering high school, Negishi spent 10 years as an engineer until he was promoted to section chief. Five years later, he was given his present responsibility.

Negishi is married, has two daughters, 4-years old and six months, and is one of the few engineers in Japan who own a home rather than rent an apartment. He recently bought a home near Yokohama, about 26 miles from the plant. He commutes by train.

Negishi's plant works on an 8:30-4:30 schedule from Monday to Friday, with three-quarters of an hour for lunch each day. In addition the regular schedule includes work on Saturday from 8:30 to 12:30 every other week, except during the months of July and August when employees are expected to work every Saturday for this half-day period.

Overtime during the week draws a 20 per cent bonus after 4:30 p.m. and a 25 per cent bonus after 10 p.m. The average overtime is about 25 hours a month.

Last year Negishi earned approximately 1,800,000 yen or \$5000 (360 yen = \$1). Two-thirds of this sum came from salary and overtime, and the remaining third from the company's bonus program.

Layoffs are a rarity

Don't rush to any conclusions. Salary isn't the most significant factor to a Japanese engineer, according to Rikadenki's Yozo Yasunaga, managing director of Negishi's top engineering boss. First, Yasunaga points out, there is a glaring contrast between a company's responsibility to an employee in Japan and the comparable relationship in the United States.

Both U.S. and Japanese companies use a 90-day trial period to allow the engineer and employee to evaluate each other. If either party feels a wrong decision was made at this early stage and that long-range compatibility is not likely, parting is amiable and no harm to company or career growth has resulted.

After the 90-day period, if both parties are satisfied in a U.S. company, the employee continues to

TOYOCOM COMLINE® INTEGRATED CRYSTAL FILTERS

- The only standard line of integrated 10.7MHz and 21.4MHz crystal filters on the market. These tandem monolithic integrated crystal filters use no inductors or transformers. Don't use an old-fashioned filter in your equipment designs. Take advantage of the reduced cost, small size and improved performance available only with a tandem monolithic integrated crystal filter.
- The smallest standard model 10.7 and 21.4MHz crystal filters on the market. Upright mount or flatpack. Our flatpack 10.7 MHz filters are only 0.20 inches high.

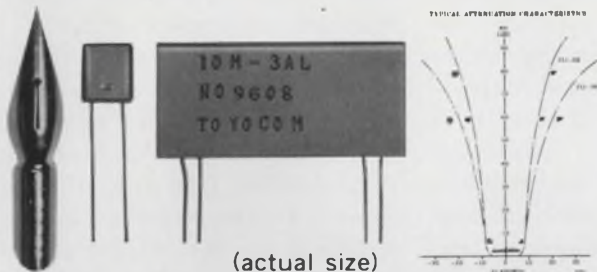

(actual size)

COMLINE filters are manufactured to highest commercial standards by Toyocom, the leading Japanese manufacturer of quartz crystal products—distributed, tested and guaranteed by **PIEZO TECHNOLOGY, INC.** P.O. Box 7877, Orlando, Florida 32804

TOYOCOM
TOYO COMMUNICATION
EQUIPMENT CO., LTD.

EXPORT DEPARTMENT:
TORANOMON BLDG.,
15, SHIBA-TORANOMON,
MINATO-KU, TOKYO, JAPAN.
CABLE: EXPORTOYOCOM TOKYO

INFORMATION RETRIEVAL NUMBER 145

Nitsuko HIGHLY DEPENDABLE PRODUCTS

—over 50-year background of technique—



ALL WELDED CONSTRUCTION
• Miniature Electrolytic Capacitors
• Metallized Polyester Film Capacitors

MH & W International Corp.

280 Midland Avenue, Saddle Brook, N.J.
07662, U.S.A.
Phone: 201-791-6277, 212-244-0695

See us at the
PLAZA HOTEL
during the IEEE SHOW.

• MANUFACTURER:

NTK Nitsuko Ltd. e

260 KITAMIKATA KAWASAKI, JAPAN CABLE: NITSUKO KAWASAKI
TEL: 044-82-5131 TELEX: 3842-177 NITSUKO KAW

Manufacturer of a complete line of capacitors and various kinds of telephone sets.

INFORMATION RETRIEVAL NUMBER 146

ELFIN™ T.M. NEON INDICATORS

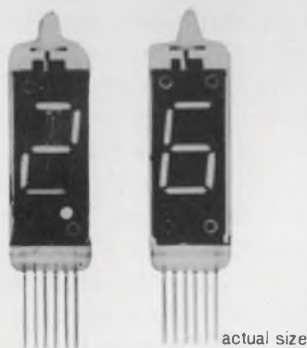

1. Single Plane
2. Brighter Display
3. Wide Viewing Angle
4. Smallest in Size
5. Low Power Consumption

RODAN OKAYA ELECTRIC INDUSTRIES CO., LTD.

Yasuda Bldg., 3-8-1-chome, Shibuya-ku,
Tokyo, Japan

Distributed by: **ALCO ELECTRONIC PRODUCTS, INC.** Lawrence,
Mass 01842 (617)686-3887
Cable Address: Altronics

INFORMATION RETRIEVAL NUMBER 147
ELECTRONIC DESIGN 6, March 15, 1970

Meet Mitsubishi at the Coliseum

The '70 IEEE Show is the time. Booth 4G17, New York Coliseum is the place. And this year Mitsubishi is proud to show the newest results of our research and advanced techniques—Miniature Coaxial Circulators; VHF, UHF, SHF. We urge your special attention to our 700 MHz type. We expect this built-in model to have a big impact on the IC field, making much smaller communication equipment possible.

We are also showing miniaturized broad-band S-band circulators, and monolithic ICs—both digital and linear.

ADVANCED AND EVER ADVANCING
MITSUBISHI ELECTRIC
Marunouchi, Tokyo, Japan

INFORMATION RETRIEVAL NUMBER 148

U175

CREATE A NOISE-FREE AGE



If your business is radios, TV sets, stereo receivers, or transceivers, make sure they are noise-free. An easy check is whether or not they use ceramic filters.

Ceramic filters are now replacing conventional IFTs and the more expensive quartz filters in the products of such well-known manufacturers as Sony, Motorola, Hitachi and Toshiba.

A city in the size range of Los Angeles or New York may have 20 or more FM stations. Only a set using ceramic filters can provide the selectivity, stereo separation, capture ratio and freedom from distortion which are absolute requirements for satisfactory reception of today's FM broadcasts.

Murata today is the only manufacturer in the world capable of marketing ceramic filters for use in FM and TV sets. This is a result of more than 10 years of research and development on this and other useful solid-state devices.

Be sure the next set you design has noise-free Murata ceramic filters. Avoid the ordinary. Help create a noise-free age!

muRata

MURATA MFG. CO., LTD.

Nagaoka, Kyoto, Japan
Telex: 5429-901 MURATA KTN
Cable Address: MURATAKYOTO

**MURATA
CORP. OF AMERICA**

2 Westchester Plaza, Elmsford,
New York 10523
Telex: MURATA EMFD 137332
Phone 914-592-9180

work as long as he is content—provided there is no budget slash or abrupt termination of a project he is involved with. When contracts become tight and budgets are trimmed, engineers may be thrown into a panic in this country, as they await news of who is to be axed until new contracts are won. Or, in times of stability, the American engineer may receive an offer for a more attractive salary from another company; he may resign after due consideration and start anew elsewhere.

It doesn't work that way in Japan. A Japanese employer, Yasunaga explains, enters into a lifelong contract with an employee once the 90-day trial period is over. The employee is expected to remain with the company until retirement age—in most companies, 55 years old for men, 50 for women, though Rikadenki has raised its retirement age for men to 57 because of the increasing labor shortage.

Layoffs, Yasunaga says, are just about nonexistent for permanent Japanese employees (some part-time employees are hired but with full understanding that they join the company for temporary work only). Should a company reach the point where layoffs are necessary—and it happens from time to time—the concern faces considerable disgrace, and the executives responsible for allowing this situation to occur are often replaced. So job security does not gnaw at the Japanese engineer.

What about the engineer who is lazy? Or unhappy? Or incompetent? He is not fired, Yasunaga explains. He is urged to change his work pattern, to study and so update his technical abilities, and to alter his attitude. If he fails to respond, he will be kept at his present position, performing his same tasks with no promotion or significant salary change. He will be fired only if he becomes physically abusive or commits a crime. The problem of the rebellious

employee doesn't often come up, because employees know that if they are discharged by a company, their chances for securing work elsewhere are virtually nil.

Today's engineering graduate in Japan—whether a college or senior high school graduate—starts at about 40,000 yen per month, or about \$110, plus overtime.

In addition to his base salary and overtime, the young bachelor engineer receives about 1,500 yen a month to help pay his rent (a married engineer gets 2,000 yen), plus 1,000 yen a month for lunch, Yasunaga says. Most companies offer free use of beach houses in the summer and ski lodges in the winter for the employee and his immediate family.

Employees also receive two bonus checks a year at companies such as Rikadenki.

Complete medical coverage, including dental bills, is provided by joint contributions from the Japanese Government and the company.

The new engineer at Rikadenki receives two months of on-the-job training.

The managing director himself, Yasunaga notes, takes part in a most important segment of the first month's program. New engineers are taught how to conduct themselves properly in the presence of senior staff members. They learn how to address superiors, how to speak politely and how to bow respectfully. Bowing is not considered demeaning—it is a gesture as courteous as a handshake or a military salute.

Are Japanese engineers satisfied with the system? Kiyokatsu Negishi appears quiet and confident as he discusses his job and its responsibilities. He doesn't own a car, but his earnings have permitted him to buy, besides the house, a washing machine, TV set and other so-called luxuries. His company has been growing at a sound, steady pace, and he appears satisfied as his career progresses. At 35 years old, Negishi has no gray hairs. ■■

INTEL BOMBS THE PRICES ON LSI MEMORIES



Model 1101, a 256-bit MOSRAM with 1.5 μ sec maximum access, drops in price by 60% to 73%. Now competes in price with small core memories.

Industry prices cut more than half

Very high yields at Intel are beginning to realize the long-promised economies of LSI. Using advanced technologies — like the silicon gate for MOS and the Schottky process for bipolars—Intel has achieved yields far greater than the 2% or 3% typical of LSI production.

First major price reductions have been made on two fully-decoded random-access memories, both DTL and TTL compatible. Look at the difference between old and new prices:

| Quantity | Model 1101 (256-bit MOS) | Model 3101 (64-bit bipolar) | Both New |
|-------------|-----------------------------|--------------------------------|-------------|
| | Old | Old | |
| 1 - 9 | \$150 | \$99.50 | \$40.00 |
| 10 - 24 | \$110 | \$74.00 | \$40.00 |
| 25 - 99 | \$ 80 | \$53.00 | \$32.50 |
| 100 - 249 | \$ 65 | \$43.00 | \$26.50 |
| 250 - 999 | — | — | \$26.50 |
| 1000 - 2000 | — | — | \$23.50 |

In stock now at over 40 locations. Phone your local Intel distributor: Cramer Electronics or Hamilton Electro Sales. Or call us collect at (415) 961-8080. Intel Corporation is in production at 365 Middlefield Rd., Mountain View, Calif. 94040.

**Intel delivers.
Try us.**

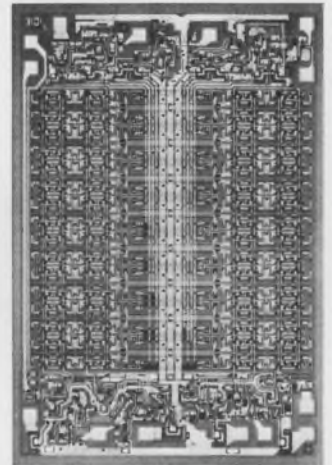

Model 3101, a 64-bit bipolar RAM with 60 ns maximum access, drops in price by 38% to 60%.

intelTM

An Electronic Design practical guide for synchro-to-digital converters

Written by: Hermann Schmid, Senior Engineer, General Electric Co., Binghamton, N.Y.

Edited by: Don Mennie, Circuits Editor

Part I

Electromechanical sensors, such as linear transformers, resolvers and synchros^{1,2}, are commonly used in control systems because they provide precision and economy. With the application of digital computers in control systems, simple and accurate methods for converting the ac outputs of these sensors into digital form become vital.

This design guide briefly reviews conventional methods for making such conversions. It then describes improved techniques leading to efficient, lower-cost hardware.

Methods for encoding ac signals using standard equipment divide into the following areas:

- Single-phase ac-to-digital converters.
- Synchro/resolver-to-digital sine/cosine converters.

Custom circuitry is required for:

- Synchro/resolver-to-digital angle converters.

Single-phase ac-to-digital converters

Three types of ac-to-digital converters occupy the single-phase classification: asynchronous,

sampling and integrating.

1. *Asynchronous single-phase ac-to-digital converters.* This conventional system for encoding ac signals uses one inversion amplifier, one or two phase-sensitive demodulators and a dc-to-digital converter (Fig. 1). One demodulator always converts the ac signal, V_{Xac} , into a dc signal, V_{Xdc} . A second demodulator is needed only when the digital output signal, X_D , must represent the ratio V_{Xac}/V_{Rac} exactly.

V_{Xdc} is a function of signal amplitude and the phase relationship between the signal and the reference. Therefore, both V_{Xac} and V_{Rac} are connected to the demodulator in the signal path. V_{Rdc} , by contrast, is a function of just the reference amplitude. Only V_{Rac} is connected to the demodulator in the reference path. If V_{Xdc} is a bipolar signal, then positive and negative reference potentials are required. A standard operational amplifier, connected as unity gain inverter, provides the negative reference voltage, $-V_{Rdc}$.

Circuit operation depends on the combined performance of the dc-to-digital converter, op amp and demodulator. Over-all conversion error is the demodulator error plus the dc-to-digital converter error, whereas converter bandpass is related to the demodulator low-pass filter time constant and the encoder transport delay.

2. *Single-phase sampling ac-to-digital converter.* This method of ac signal conversion can be used

Adapted from ELECTRONIC ANALOG/DIGITAL CONVERSION by Hermann Schmid, copyright © 1970 by Van Nostrand Reinhold Company, by permission of Van Nostrand Reinhold Company.

with any high-speed a/d converter. The dc-to-digital converter of Fig. 2 will accept ac signals with the addition of two amplifiers and two single-pole switches.

The peak detector generates a control signal for the analog sampling switches, S_1 and S_2 , by comparing the reference signal, V_{Rac} , with a positive threshold voltage, V_{Th} . To provide isolation from ac reference variations, $+V_{Th}$ is generated by rectifying V_{Rac} and loading it so that V_{Th} is always less than the V_{Rac} peak amplitude. The width, t_c , of the control signal (V_C) pulses is set by adjusting the load resistor, R , which in turn determines how much V_{Th} is below the peak value of V_{Rac} . For proper operation, t_c must always be longer than the aperture time of the converter.

The two single-pole switches, S_1 and S_2 , connect V_{Xac} and V_{Rac} to the converter for the duration of t_c . Because the a/d converter digital output always represents the ratio V_X/V_R , simultaneous changes in V_X and V_R are of no consequence provided all variations are proportionally equal. This condition is fulfilled by two sine waves of different amplitudes. The conversion time, T_c , need not be extremely short. A reasonable value for T_c is less than 5% of T_p , the repetition period of the ac signal.

Sampling ac-to-digital converters possess a high noise-rejection capability when identical noise is present on the signal and the reference. (This is the case in most applications.)

The control signal, V_C , is needed to synchronize converter operation with the reference signal peaks. For example, the positive-going edge on V_C can be used to start the conversion.

The inversion amplifier generates the negative reference voltage, which is essential if V_X is a bipolar signal.

The sampling ac-to-digital converter accuracy is essentially the same as that of the dc-to-digital converter, since the peak detector will not introduce discrepancies, and switching errors can be made negligible.

3. *Integrating ac-to-digital converter.* Up/down integration a/d converters can be used to implement an integrating ac encoder (Fig. 3). With such a converter, the ac signal is integrated during the *up* integration period, T_1 , and the dc reference is integrated during the *down* integration period, T_2 (Fig. 4). The up and down integration periods must be exactly one-half the ac signal period.

Figure 3 illustrates that one ac-to-dc converter and two amplifiers must be added to the up/down integration converter to make it accept ac signals. One amplifier is employed as a zero crossing detector and the other as a unity-gain inverter. The ac-to-dc converter may be either a phase-sensitive demodulator or a precision rectifier. It is needed only when a precise ratio of V_{Xac}/V_{Rac}

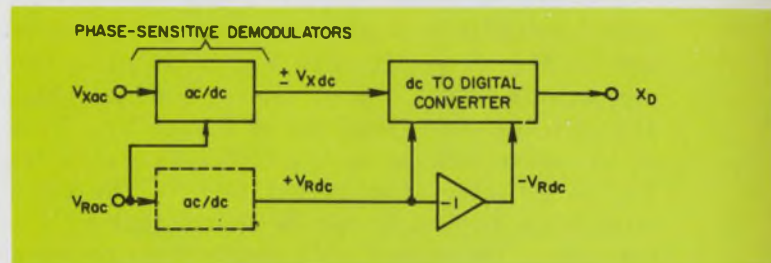

1. **Asynchronous converter** uses off-the-shelf hardware but is relatively slow.

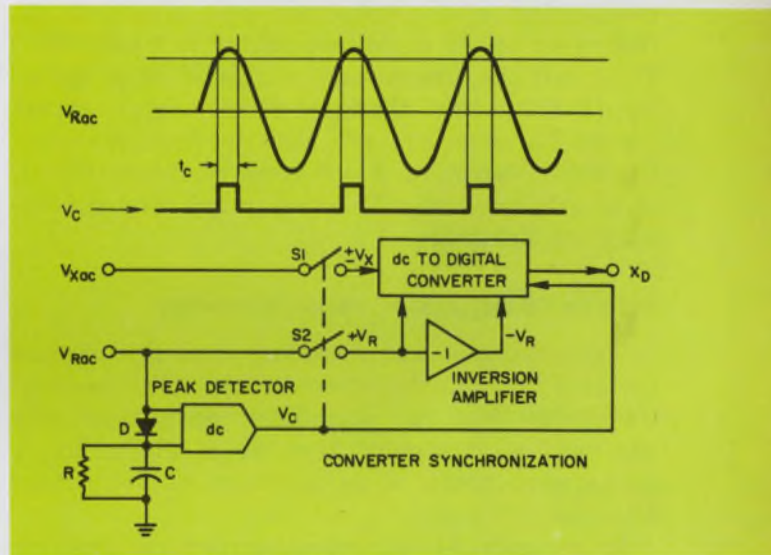

2. **Single-phase sampling converter** provides input signal noise rejection and high speed.

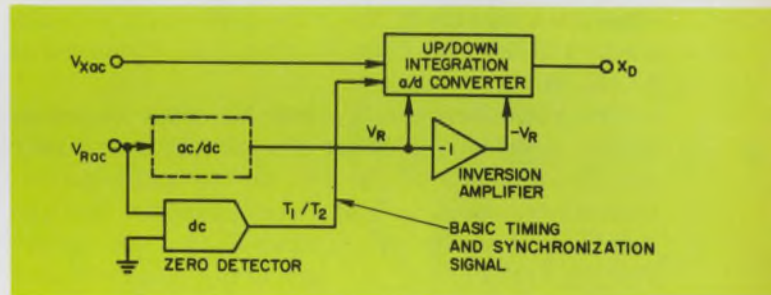

3. **Integrating converter** is sensitive to clock and signal frequency variations.

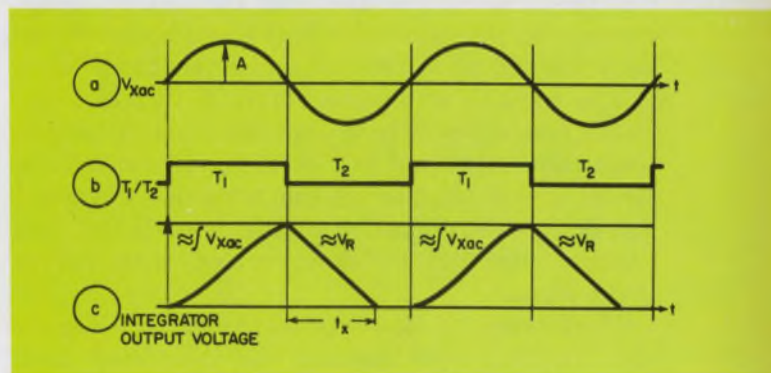

4. **Integrator output (c)** shows ac signal integrated during T_1 , dc reference integrated during T_2 .

must be determined.

The first amplifier can be a comparator that provides HIGH level output when V_{Rac} is positive and LOW level output when V_{Rac} is negative. The comparator output is a square-wave signal (Fig. 4b) with the same frequency as V_{Rac} or V_{Xac} . This square wave defines the two integration periods; T_1 , the *up* integration period, and T_2 , the *down* integration period. It can be shown that t_x is a function of the ratio V_X/V_R , and of the sine-wave period, T_p .

With a dc integrating a/d converter, the period T_1 is constant and the digital output signal is independent of the converter clock frequency, f_c . But in an up/down ac integrating a/d converter, T_1 is half the sine-wave period, and since the ac signal frequency changes widely, large errors result. Large errors are also produced by clock frequency variation, which is not compensated for, as in a dc converter. This design has limited accuracy and flexibility.

Resolver-to-digital sine/cosine converters

Asynchronous and sampling models comprise the sine/cosine converter category. This converter design has one significant advantage over the more sophisticated resolver to digital angle converters; there is no requirement for octant selection circuitry.

In a resolver-to-digital converter, the resolver output signals, $V_X(t)$ and $V_Y(t)$, can be converted into a pair of digital signals, X_D and Y_D , with two ac-to-digital converters. $V_X(t)$ and $V_Y(t)$ are sine-wave signals of the same frequency, ω , (Eq. 2 and 3 in box) with amplitudes of $K_X E_0 \cos \theta$ and $K_Y E_0 \sin \theta$.

The ratio between V_X and V_Y must be maintained precisely. Neither the absolute accuracy nor the linearity of the two ac-to-digital converters is important. It is of critical concern that the gain and linearity of the ac-to-digital converters should track over all operating regions and environments.

Resolver-to-digital sine/cosine converters do not require quadrant or octant selection circuits, but they do require two a/d converters. Sine/cosine converters provide sine θ and cosine θ outputs instead of θ , usually a disadvantage.

The asynchronous resolver-to-digital sine/cosine converter (Fig. 5) is comprised of two ac-to-dc converters and two dc-to-digital converters. Because the outputs of the ac-to-dc converters are dc signals, operation of the dc-to-digital converters need not be synchronized with the ac input signals.

Most types of dc-to-digital converters can be used in this asynchronous converter, but since most ac signals change slowly with time, a high-speed converter is not needed unless it is to be

time-shared between a large number of resolver outputs.

The converter accuracy depends on the gain and linearity match in the dc-to-digital converters, and is a function of their zero offset level.

The sampling resolver-to-digital sine/cosine converter (Fig. 6) consists of two dc-to-digital converters, two sampling switches and one peak detector. Reduction in hardware is obtained at the cost of synchronizing dc-to-digital converter operation with the ac input signal peaks. The output of the peak detector, V_C , operates both sampling switches, S_1 and S_2 , and starts the conversion operation in both dc-to-digital converters.

The signal inputs to the two dc converters are pulsed dc voltages representing the peak amplitudes of $V_X(t)$ and $V_Y(t)$; the reference inputs are the dc reference voltages $+V_R$ and $-V_R$. The outputs X_D and Y_D are binary signals, proportional to the sine and cosine of resolver shaft angle θ . Just as for the asynchronous version, ultra-high-speed a/d converters are not needed unless many resolver signals are to be converted through the same encoder.

Resolver-to-digital angle converters

The synchro/resolver-to-digital angle converter design approach provides the basis for accurate and efficient ac-to-digital converters. Six types (designated Type I through VI) will be considered in detail, beginning with Type I in this installment. The majority of synchro/resolver-to-digital angle converters require octant selection circuits, described in the following paragraphs.

Most resolver-to-digital converters determine the quadrant or the octant of the resolver shaft angle by comparing the magnitudes and polarities of the resolver output signals V_X and V_Y . The criteria for this comparison is as follows:

| Octant | Polarity of V_X | Polarity of V_Y | Magnitudes of V_X and V_Y | Quadrant |
|----------------|-------------------|-------------------|-------------------------------|----------------|
| 0 ₁ | (+) | (+) | $V_X > V_Y$ | Q ₁ |
| 0 ₂ | (+) | (+) | $V_X < V_Y$ | Q ₁ |
| 0 ₃ | (-) | (+) | $V_X < V_Y$ | Q ₂ |
| 0 ₄ | (-) | (+) | $V_X > V_Y$ | Q ₂ |
| 0 ₅ | (-) | (-) | $V_X > V_Y$ | Q ₃ |
| 0 ₆ | (-) | (-) | $V_X < V_Y$ | Q ₃ |
| 0 ₇ | (+) | (-) | $V_X < V_Y$ | Q ₄ |
| 0 ₈ | (+) | (-) | $V_X > V_Y$ | Q ₄ |

The principle and problems are similar, whether resolver-to-digital angle converters select octants or quadrants. Only octant selection circuitry will be described here. (Note: Octant selection circuits

Electromechanical sensor ac signals defined

All information from electromechanical sensors is contained in amplitude modulation of the ac output signal. A single-phase ac signal (from a linear transformer) is defined as

$$V(t) = E \sin(\omega t + \psi) \quad (1)$$

where E is the amplitude, ω is the frequency, t is the time and ψ is the phase angle with respect to some reference.

A two-phase ac signal (from a resolver) is defined as

$$V_X(t) = K_X E_o \cos\theta \sin(\omega t + \psi_X) \quad (2)$$

$$V_Y(t) = K_Y E_o \sin\theta \sin(\omega t + \psi_Y) \quad (3)$$

where $V_X(t)$ and $V_Y(t)$ are sine-wave signals with amplitudes of $K_X E_o \cos\theta$ and $K_Y E_o \sin\theta$, respectively, with a frequency of ω and phase shifts of ψ_X or ψ_Y .

In the expressions for the amplitudes, only $\sin\theta$ and $\cos\theta$ vary; the reference amplitude E_o and the gain factors K_X and K_Y are constant.

A three-phase ac signal (from a synchro) is defined as

$$V_1(t) = K_1 E_o \sin\theta \sin(\omega t + \psi_1) \quad (4)$$

$$V_2(t) = K_2 E_o \sin(\theta + 120^\circ) \sin(\omega t + \psi_2) \quad (5)$$

$$V_3(t) = K_3 E_o \sin(\theta - 120^\circ) \sin(\omega t + \psi_3) \quad (6)$$

where $V_1(t)$, $V_2(t)$ and $V_3(t)$ are sine-wave signals with amplitudes of $K_1 E_o \sin\theta$, $K_2 E_o \sin(\theta + 120^\circ)$ and $K_3 E_o \sin(\theta - 120^\circ)$, respectively, with a frequency of ω , and phase shifts of ψ_1 , ψ_2 , ψ_3 . In the expressions for the amplitudes, only $\sin\theta$, $\sin(\theta + 120^\circ)$ and $\sin(\theta - 120^\circ)$ vary; the reference amplitude E_o and the gain factors K_1 , K_2 and K_3 are constant.

A common misunderstanding holds that transmitted resolver and synchro signals contain data in the phase shift between sine waves. This concept is wrong. A synchro or resolver introduces a spacial, or positional, phase shift, and *not* a phase shift in time. The terms $\sin\theta$, $\cos\theta$, $\sin(\theta + 120^\circ)$ and $\sin(\theta - 120^\circ)$ only modulate the amplitude of the reference sine wave, ($E_o \sin\omega t$). Any

phase shift on these signals is a secondary effect due to parasitic parameters.

It is not the absolute magnitude of the amplitude that carries this information, but the magnitude *ratio* of two or more signals. With a single-phase signal, the amplitude ratio between the signal, V_X , and the reference, V_R , carries the information. With two-phase signals, the ratio V_X/V_Y represents data transmitted (Eq. 2 and 3). Similarly, the relationships between V_1 , V_2 and V_3 (Eq. 4 to 6) transmits three-phase signal intelligence. All ac-to-digital conversions must be such that the digital output signal (X_D) is always the ratio of two ac signal amplitudes. This is easy to accomplish with any a/d converter,³ since $X_D = V_X/V_R$.

Normally, the frequency and amplitude of the reference ac signal can change over wide limits. In an aircraft, the 400-Hz supply voltage may vary between 380 and 420 Hz and $\pm 10\%$ in level. Electromechanical sensors are insensitive to these variations since information is carried as an amplitude ratio. Also, considerable noise is often superimposed on ac signals. A thorough description of ac signal noise is given in MIL-STD-704A.⁴

All known synchro signal encoding methods transform three-phase signals into two-phase signals, which are then converted into digital form. Each synchro-to-digital encoder consists of a three-phase to two-phase converter and a resolver-to-digital encoder. Standard three-phase to two-phase conversion uses two transformers in a classical Scott-T connection. These Scott-T transformers can be built with high accuracy^{5,6} and reasonable cost, but are still large compared to IC packages.

To overcome size incompatibility, electronic Scott-T converters have been developed.⁷ They are small and light but not as accurate as transformer types.

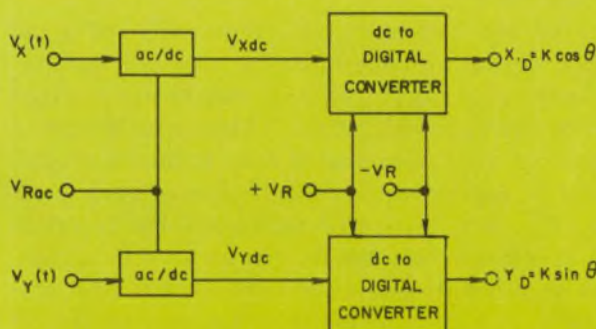

5. Elimination of octant selection circuits is the major advantage this asynchronous sin/cos converter gives.

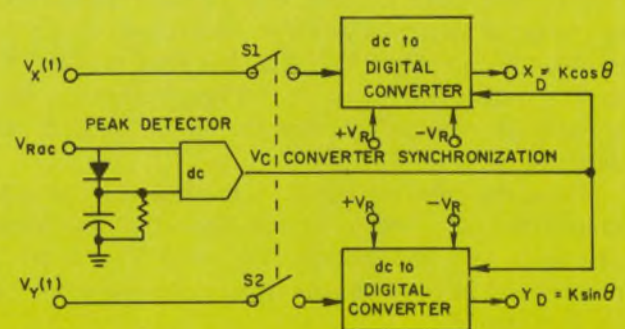

6. Sampling sine/cosine converter design allows a reduction in hardware requirements.

are not used in the Type I converter, which is described in the last portion of this installment.)

Octant selected by comparators

To determine the octant position of a resolver shaft, the output signals, V_{Xac} and V_{Yac} , which are amplitude-modulated ac signals (Eqs. 2 and 3 in box), must be examined for their relative amplitude and polarity. The amplitude and polarity of V_X and V_Y are plotted as a function of the resolver shaft angle θ in Fig. 7a. Most resolver-to-digital angle converters accept input signals only if they lie in the first octant. This means that the amplitude of V_Y is between zero and $+0.707$ of full scale, and the amplitude of V_X is between $+0.707$ of full scale and full scale. The octant selector determines which of the four resolver signals — $+V_X$, $-V_X$, $+V_Y$ or $-V_Y$ — contains first octant information. In the octants listed below, the circuit selects the following resolver output signals, $V_{X'}$ and $V_{Y'}$ (refer to Fig. 7) as inputs to the resolver-to-digital converter.

| For $V_{Y'}$ | For $V_{X'}$ |
|----------------------------|----------------------------|
| $+ V_Y$ in 0_1 and 0_4 | $+ V_X$ in 0_1 and 0_8 |
| $+ V_X$ in 0_2 and 0_7 | $+ V_Y$ in 0_2 and 0_3 |
| $- V_Y$ in 0_5 and 0_8 | $- V_X$ in 0_1 and 0_5 |
| $- V_X$ in 0_3 and 0_6 | $- V_Y$ in 0_6 and 0_7 |

With the Type II converter (shown later) $V_{X'}$ and $V_{Y'}$ are resolver bridge inputs; in other cases $V_{X'}$ becomes the reference input, V_R , and $V_{Y'}$ the signal input, V_S , to a conventional a/d converter.

After the resolver output signals are converted to dc voltages, the octant control signals (Fig. 7b) can be generated by four comparator circuits, CP-1 through CP-4 (in Fig. 8) which identify the octant. The function of the four comparators is as follows: CP-1 detects when V_X is positive
CP-2 detects when V_Y is negative
CP-3 detects when V_X is more positive than V_Y
CP-4 detects when $V_X + V_Y$ is negative

By gating appropriate output combinations of CP-1 through CP-4 and their complements, any two of the eight octants can be addressed. Four of the eight control signals so generated, V_{C1} to V_{C4} , can be used to select $V_{X'}$. Another four signals, V_{C5} to V_{C8} , select $V_{Y'}$ (Fig. 7c). The resulting output signals, $V_{X'}$ and $V_{Y'}$, for the eight octants are depicted in Fig. 7d.

Since the resolver output signals are amplitude-modulated ac signals and differential amplifiers are used as comparators, V_{Xac} and V_{Yac} must be processed before the desired comparisons can be performed.

Figure 8a illustrates a method where the resolver output signals are converted into dc voltages, V_{XdC} and V_{YdC} , with two phase-sensitive demodulators.

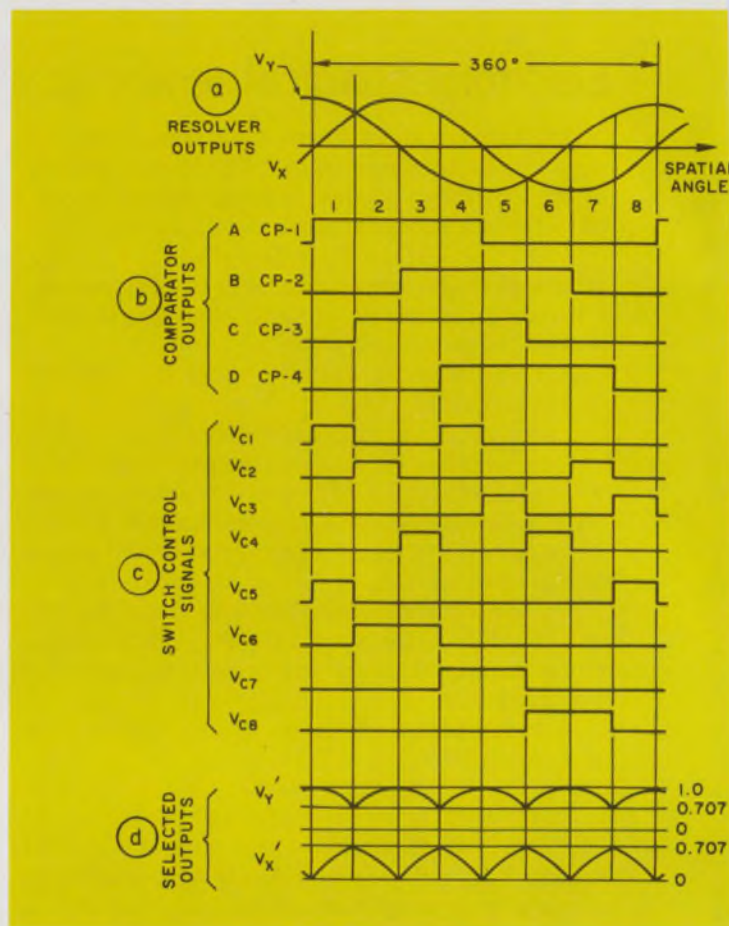

7. Octant selection is the first step in determining resolver shaft position with digital angle converters.

The two sets of selector switches, S_{1X} to S_{4X} and S_{1Y} to S_{4Y} , can then connect ac or dc output signals to the ensuing circuit.

Another solution (Fig. 8b) connects V_{Xac} and V_{Yac} to the comparators only during the peak of the sine wave. The inputs to the comparators become pulsed dc signals. All switching can be performed with a peak detector and two sampling switches (see the sampling ac-to-digital converter of Fig. 2). With the inputs applied during short periods (T_p) the output signals, $V_{X'}$ and $V_{Y'}$, are useful just during T_p . Only a sampling ac-to-digital converter can be used with this octant selection circuit.

For all resolver-to-digital converters using ac bridges, digital storage must be provided so that the comparator output signals can be memorized between any two peak pulses. This can be achieved by shifting each comparator output into a single-stage shift register at the beginning of each peak pulse (Fig. 8c). With this provision, the input to all eight selector switches may be an ac or dc signal.

One significant difference between the first circuit (Fig. 8a) and the last two circuits (Figs. 8b and 8c) is speed. The former incorporates a low-pass filter in the ac-to-dc converter. In contrast, the latter two circuits have no such frequency

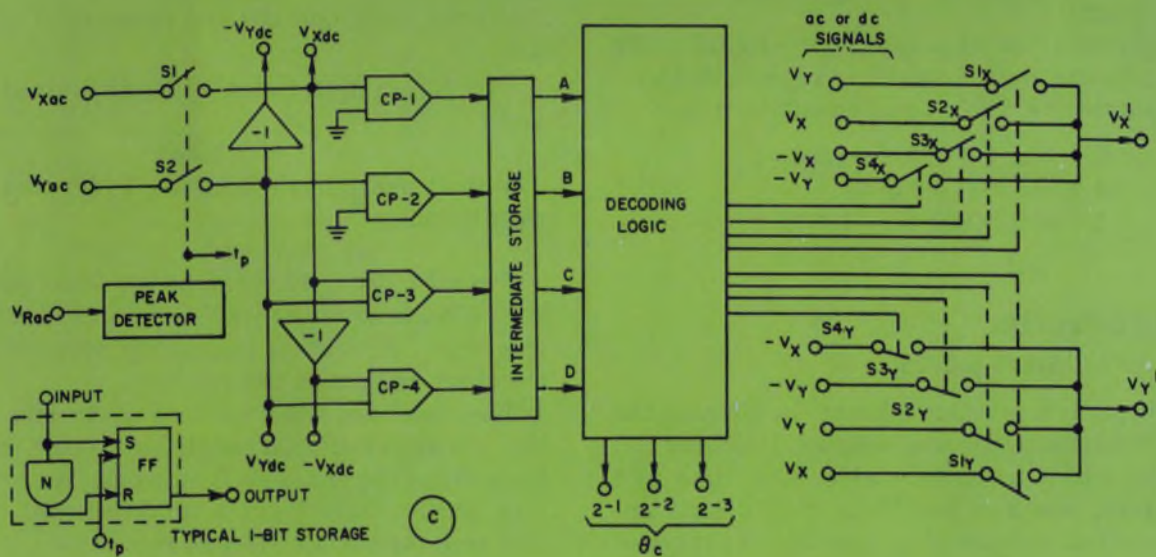
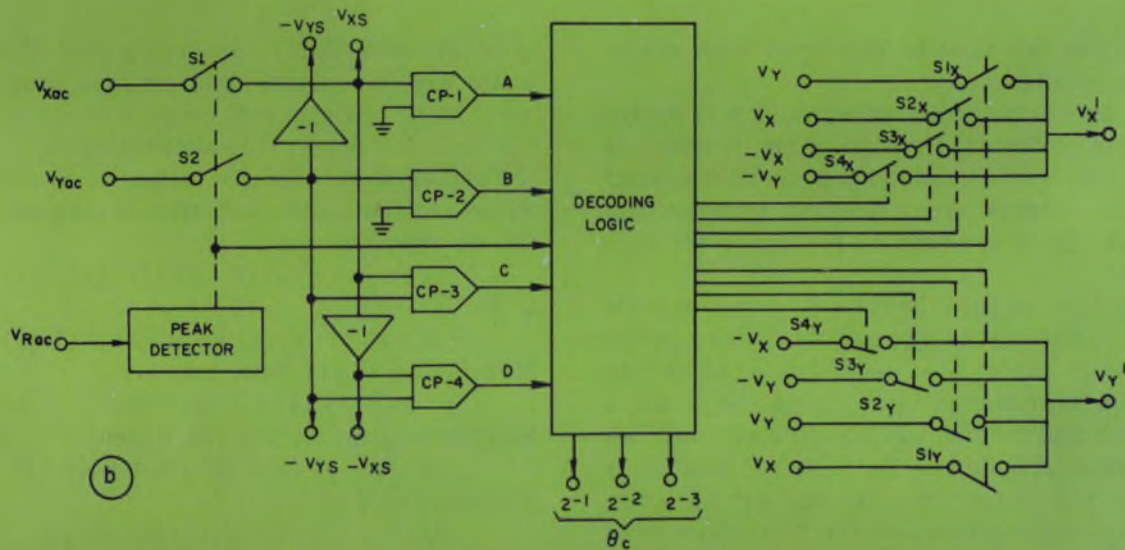
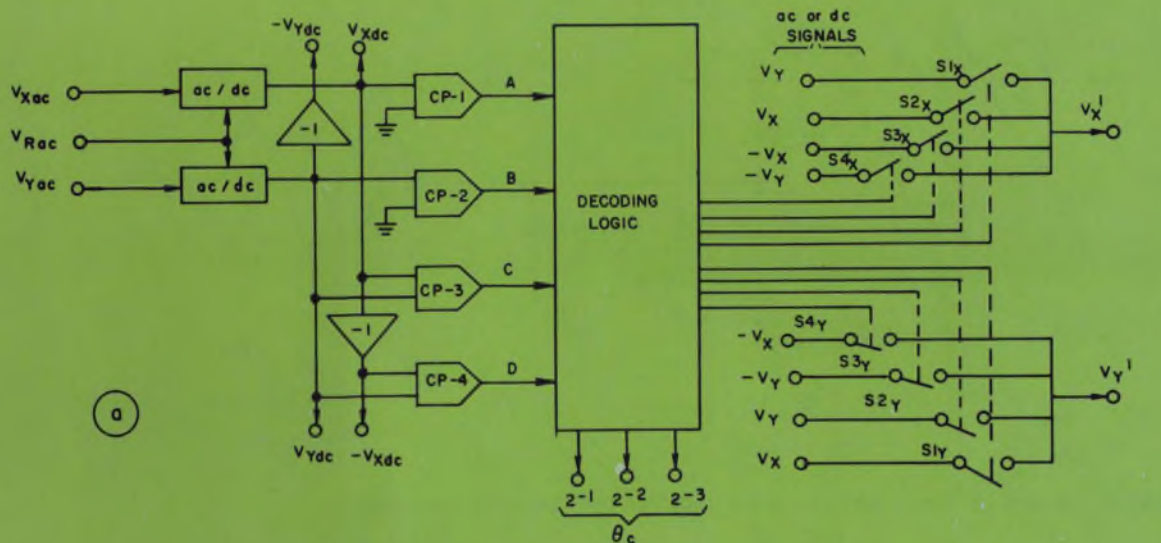

8. Octant selection circuits use phase-sensitive demodulators (a) for converting resolver outputs to dc. Sampling technique (b) provides octant selection with inputs applied

during short periods (T_p). Digital storage (c) allows memorization of comparator outputs between any two peak pulses.

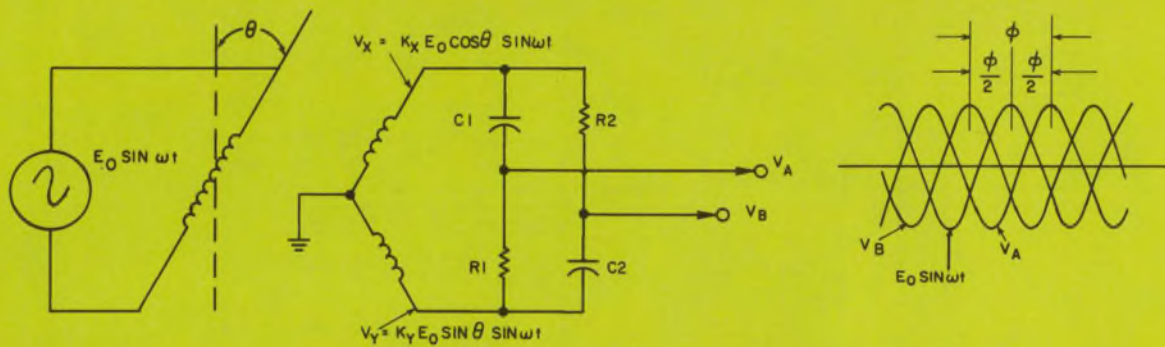

9. Phase-shift network for the Type I converter requires precision RC components.

limitation and can thus be employed with multiplexed converters.

Strictly speaking, octant selection is a three-bit quantization of the analog input signals, which is actually a coarse a/d conversion process. The four comparator outputs are processed to form the three most significant bits of the converter output signal.

Figure 7d shows that the octant-selected signals $V_{X'}$ and $V_{Y'}$ are mirror-symmetrical with respect to the resolver angles $\theta_D = n\pi/4$. This implies that information represented by $V_{X'}$ and $V_{Y'}$ is not a continuous function of θ , but has a discontinuity at $n\pi/4$. Besides, the signals $V_{X'}$ and $V_{Y'}$ produce a complemented output signal during all even octants. A simple correction for this effect is to complement (use 1 instead of 0, or 0 instead of 1) the resolver-to-digital angle converter output in all even octants.

The output signal of a resolver-to-digital angle converter is the angle θ , which is represented as a binary number in two's complement form as:

0 1 1 ... 1 1 1 for $+180^\circ$
 0 0 0 ... 0 0 0 for 0°
 1 0 0 ... 0 0 0 for -180°

Type I converter needs precision parts

The Type I converter concept is simple, but hardware requirements are complex. Precision RC networks, which must be stable with time and temperature, are required.^{8,9} In this design approach, output signals of a resolver, $V_X(t)$ and $V_Y(t)$, are connected across two RC phase-shifting networks (Fig. 9). The voltages V_A and V_B , at the junction of R and C of the two networks, are sine waves whose amplitude and phase are functions

of $V_X(t)$ and $V_Y(t)$. Assuming that $V_X(t)$ and $V_Y(t)$ are the outputs from an ideal resolver;

$$V_X(t) = E_0 \cos \theta \sin \omega t \quad (7)$$

$$V_Y(t) = E_0 \sin \theta \sin \omega t \quad (8)$$

Further assuming the values of R and C are chosen so that $\omega RC = 1$, then $V_A(t)$ and $V_B(t)$ can be expressed as

$$V_A(t) = [V_X(t) - j V_Y(t)] / (1 + j) \quad (9)$$

and

$$V_B(t) = [V_Y(t) - j V_X(t)] / (1 + j). \quad (10)$$

Multiplying $V_X(t)$ with $\tan \theta$ gives

$$V_Y(t) = V_X(t) \tan \theta \quad (11)$$

Substituting Eq. 11 into Eq. 9 yields

$$V_A(t) = V_X(t) [1 - j \tan \theta] / (1 + j). \quad (12)$$

The amplitude of $V_A(t)$ is

$$V_A = \sqrt{1/2(1 + \tan^2 \theta)} E_0 \cos \theta \sin \omega t \quad (13)$$

and the phase shift with respect to $V_X(t)$ is

$$\phi_A = \theta - 45^\circ. \quad (14)$$

Similarly, the amplitude and phase shift of $V_B(t)$ are

$$V_B = \sqrt{1/2(1 + \tan^2 \theta)} E_0 \sin \theta \sin \omega t \quad (15)$$

and

$$\phi = -\theta + 45^\circ. \quad (16)$$

The total phase angle between $V_A(t)$ and $V_B(t)$ then becomes

$$\phi_{A-B} = \phi_A - \phi_B = 2\theta - 90^\circ. \quad (17)$$

From Eq. 14 or 16 it can be seen that the phase shift ϕ between $V_A(t)$ or $V_B(t)$ and the reference sine wave, $E_0 \sin \omega t$, is directly proportional to the shaft angle θ of the resolver.

The simplified diagram in Fig. 10 shows that the resolver-to-digital angle converter consists basically of the phase-shift network, two comparators, pulse gating logic, a unidirectional counter and an intermediate storage register.

The two phase-shift networks (Fig. 9) convert the variable-amplitude signals $V_X(t)$ and $V_Y(t)$ into two variable-phase signals, $V_A(t)$ and $V_B(t)$. The resistors, R_1 and R_2 , and the capacitors, C_1

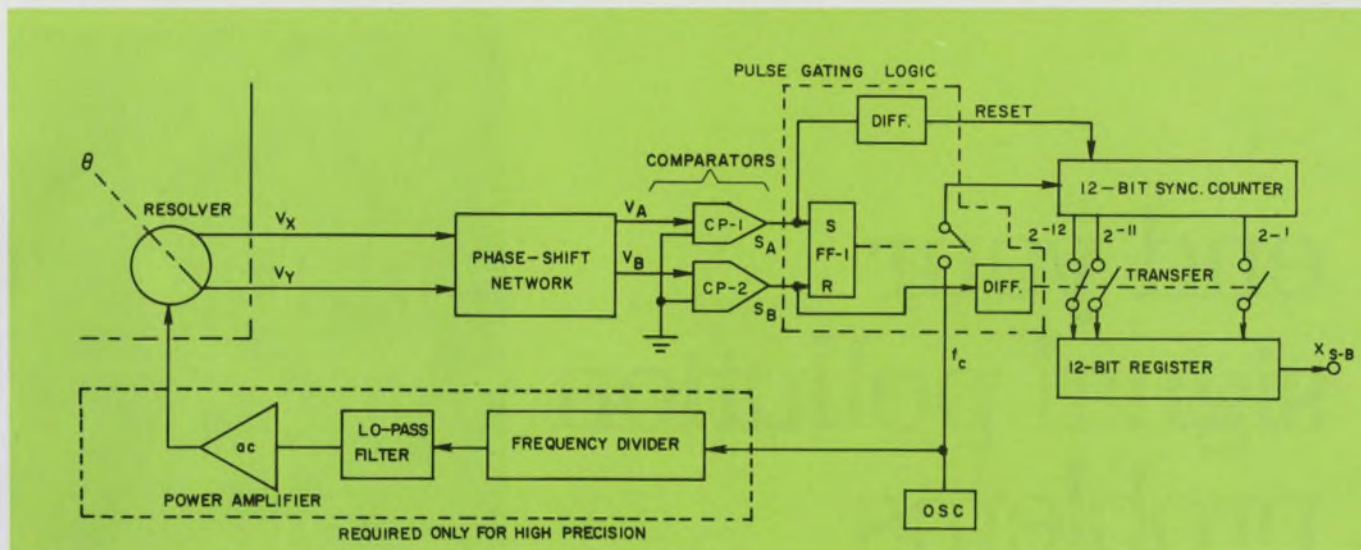

10. Type I converter design provides precision only when resolver ac reference is generated from clock frequency.

and C_2 , must be able to satisfy and maintain the relationship $\omega RC = 1$. This requires precision resistors and capacitors trimmed to the proper value.

The ability to maintain $\omega RC = 1$ over time and temperature after trimming, is mainly a function of capacitor stability. With a temperature coefficient of 25 ppm, available from today's glass or porcelain capacitors, the value of C will vary 0.35% (max) over a -55°C to $+85^\circ\text{C}$ temperature range. Sophisticated compensation networks are used by converter manufacturers for better temperature stability.

The two comparators (Fig. 10) detect the zero crossings of $V_A(t)$ and $V_B(t)$. The output signals of these comparators are square waves with the same frequency as V_A and V_B , but phase-shifted with respect to each other. One of these square waves, S_A , is used to set flip-flop FF-1, and to reset the counter with a narrow pulse. This pulse is generated by differentiating S_A in the digital differentiator D .

The other square wave, S_B , resets FF-1. The output of FF-1 is a pulse-width signal whose ON time is determined by the zero crossing of $V_A(t)$ and $V_B(t)$. This makes the FF-1 output proportional to the angular position of the resolver. Provided the output of FF-1 is ONE, the clock pulses (f_c) are connected to the counter. The content of the counter will increase to a value (N_θ), which is proportional to the resolver shaft angle θ . At some convenient time, N_θ is transferred into a storage register where it can be read out as either a parallel or serial word, X_{S-B} .

To maintain the equation $\omega RC = 1$ requires stable resistors and capacitors, and a stable excitation frequency (ω) for the resolver. In most applications, the resolver is energized from an ac supply with a frequency of 400, 1000, or 1800 Hz. The technique described above cannot be used

with these supplies due to frequency drift. Special supplies are needed that exhibit good frequency stability.

The simplest technique for generating a high-stability ac reference voltage is to count-down the clock frequency (f_c) to a frequency at which the resolver can operate. Next filter and buffer the square-wave signal generated. Note, though, that the buffer amplifier required must be able to handle high power, since the reference winding load of each resolver will consume between 0.5 and 2 W. ■ ■

References:

1. Blackburn, J. F., *Components Handbook*, McGraw Hill Book Co., New York, 1949, Chap. 10.
2. Crow, C. R., *Synchros and Self-Synchronizing Devices*, Scientific Book Publishing Co., Vincennes, Ind., 1953.
3. Schmid, H., "a/d and d/a Converters," Parts 1, 2, and 3, *Electronic Design*, Oct. 24, 1968, pp. 49-72; Dec. 19, 1968, pp. 57-76; Jan. 4, 1969, pp. 97-112.
4. "Electric Power, Aircraft, Characterization and Utilization," *Military Standard*, Dept. of Defense, Wash., D.C.
5. "New Transformer Converts 3-Phase Synchro to 2-Phase Resolver Output," *Technical Specifications*, Magnetics, Inc., Northport, N.Y.
6. "Scott-T Transformers," *Technical Specifications*, Astro-Systems, Mt. Vernon, N.Y.
7. "a/d and d/a Converters," *Capability Brochure C67-1267*, General Precision, Inc., Kearfott Products Division, Little Falls, N. J., 1967, Pg. 9.
8. "Electronic Analog/Digital Conversion Systems," *Capability Brochure EDMDD-105*, General Precision, Inc., Kearfott Division, Little Falls, N. J., 1963.
9. "Solid State Synchro to Digital Converter, Model S3231-11," *Technical Specification*, GAP Instrumentation Corporation, Westbury, L.I., N.Y.

Watch for Part 2

The second part of this Practical Guide for Synchro-to-Digital Converters will appear in our next issue, ED 7, April 1, 1970. This portion will include further synchro/resolver-to-digital angle converter design techniques.

end your signal pollution problems

Beldfoil® ISO-Shielded™ Cable

It's the cable with virtually perfect shielding. □ It's a Belden exclusive. □ Beldfoil ISO-Shield is like a continuous metal tube enclosing each pair of conductors in a cable. □ It locks out crosstalk or interference . . . whether from outside sources or between shielded elements in the cable. □ Beldfoil is a layer of aluminum foil bonded to a tough polyester film (for insulation and added strength.) □ To form an ISO-Shield, we apply it in any one of several unique ways to meet the requirements of different applications. (See Figures 1 and 2, for example.) □ Each gives more physical shield coverage than braided wire or spiral wrapped (served) shields. □ And greater shield effectiveness . . . even after repeated flexing. □ Beldfoil ISO-Shielded Cables are small, lightweight. □ They terminate easily. □ They're modest in price. □ Your Belden Distributor stocks a wide variety of standard Beldfoil shielded cables as listed in the "Belden Electronic Wire and Cable Catalog" (ask him for the latest edition). □ And, should you have specifications no standard product can meet, ask him to quote on a specially engineered design. □ Or, if you choose, contact: Belden Corporation, P. O. Box 5070-A, Chicago, Illinois 60680. Phone (312) 378-1000.

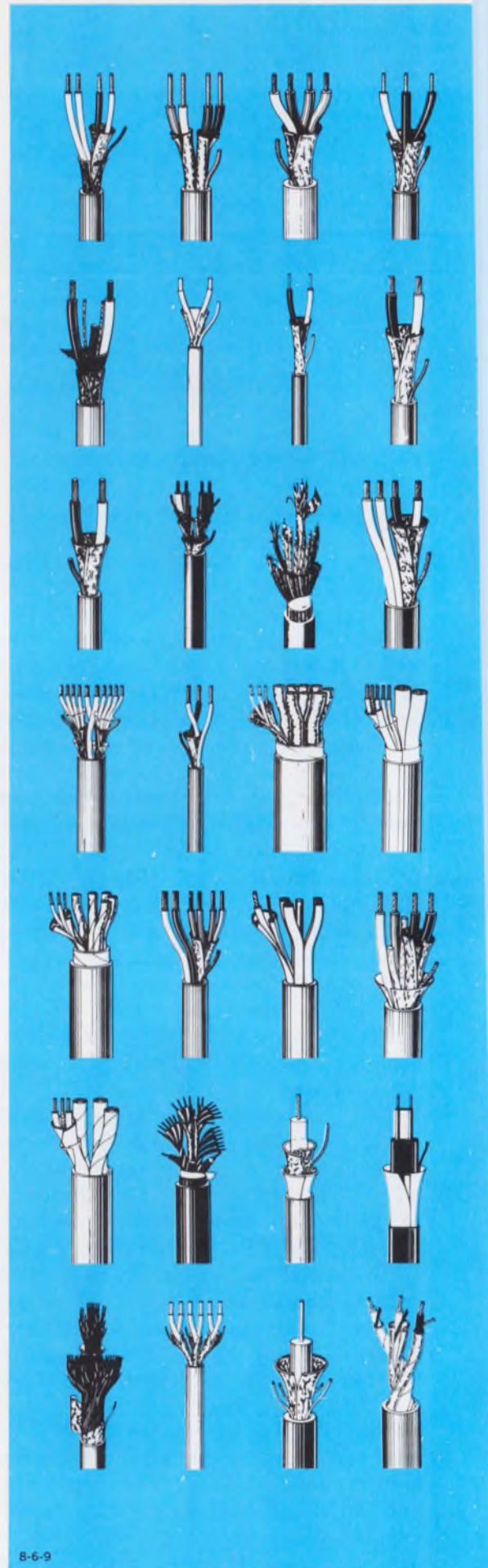

8-6-9

Metal (shield) foil, folded to assure metal-to-metal contact.

FIGURE 1

Polyester insulating layer folded to assure isolation between shields.

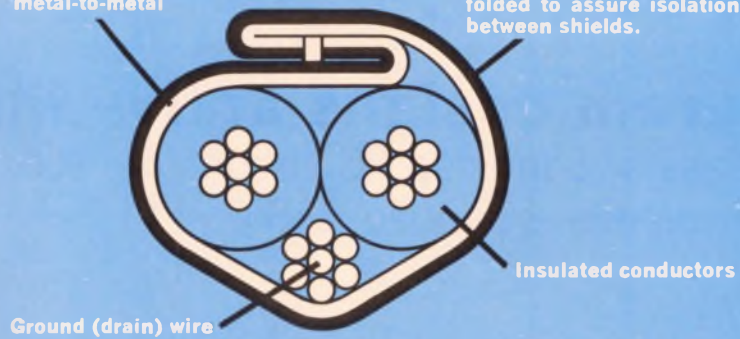

Beldfoil Multiple Pair Individually Shielded Cable

The Figure 1 cross-section shows Belden's exclusive Z-folded Beldfoil ISO-Shield. Note the metal-to-metal contact between the two edges of the aluminum foil. In essence, you have a continuous aluminum tube. And the polyester layer on the outside of the fold assures the isolation between shields so necessary for best performance in the field.

Technical Data

Nominal values for multiple pair individually shielded cables containing 3 to 27 pairs (including 8769 and 8773 through 8778 Series cables)
Suggested working voltage: 300 volts rms max.
Working voltage between adjacent shields: 50 volts rms max.
Capacitance between conductors in a pair: 30 pf per ft. nom.
Capacitance between one conductor and other conductor connected to shield: 55 pf per ft. nom.
Capacitance between shields on adjacent pairs: 115 pf per ft. nom.
Insulation resistance between shields on adjacent pairs: 100 megohms per 1000 ft. nom.

Metal (shield) foil, folded to assure metal-to-metal contact.

FIGURE 2

Polyester insulation layer folded to provide bonus insulation between conductors and shield.

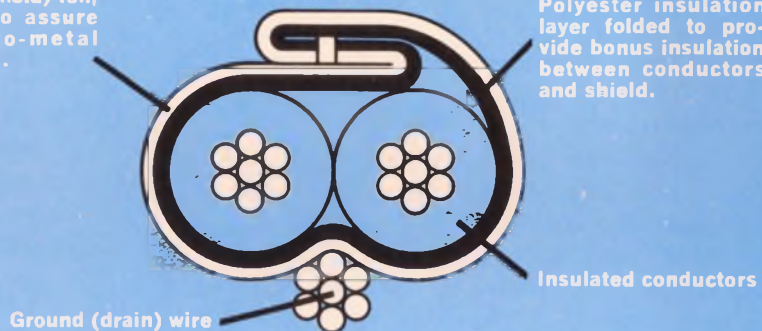

Beldfoil Shielded Single Pair Cable

The Figure 2 cross-section shows the exclusive Belden Z-fold with the polyester insulating layer inward. This makes use of the high dielectric strength of the polyester film as bonus insulation between the conductors and the shield. (The cable jacket provides the primary insulation of the shield from outside objects or adjacent cables.)

Technical Data

Nominal values for 8451 Shielded Pair Cable
Suggested working voltage: 200 volts rms max.
Capacitance between conductors: 34 pf per ft. nom.
Capacitance between one conductor and other conductor connected to shield: 67 pf per ft. nom.

BELDEN

new ideas for moving electrical energy

Program designs active filters.

Bandpass or bandstop RC circuits are specified fully, using versatile expanded BASIC.

Bandpass and bandstop filters are derived by connecting high and low-pass filters in series or in parallel, respectively. A recent article¹ described the methods of designing active high or low-pass filters by using a BASIC² computer program. By extending that program, Butterworth or Chebyshev RC band filters can also be designed by computer.

Low-pass and high-pass filters are formed by cascading one or more of the circuit sections shown in Fig. 1. An even-pole filter uses only 2-pole sections and has Chebyshev ripple with unity-gain minimums.¹ An odd-pole filter uses 2-pole sections, and a single 1-pole section and has Chebyshev ripple with unity-gain maximums.

Bandpass and bandstop filters are formed as shown in Fig. 2. The low-pass filter has N_1 poles and a cutoff frequency of F_1 . The high-pass filter in both cases has N_2 poles and a cutoff frequency of F_2 . With $F_1 > F_2$, the series combination of those two filters is a bandpass filter from F_2 to F_1 . With $F_1 < F_2$ the parallel combination is a bandstop filter from F_1 to F_2 .

In both the bandpass and band-reject cases, the skirt selectivity of the filters is that of the individual low-pass and high-pass filter rather than that of a true band filter. For such filters the asymptotic falloff rate of the skirts is measured in absolute decades of frequency rather than decades of half-bandwidths. This means that these low-pass/high-pass combination filters are better suited to broadband than to narrowband applications.

The program has many features

The BASIC computer program used is called RCFIL (Fig. 3). It includes:

- Design of bandpass and bandstop, as well as low-pass and high-pass filters.
- Design of odd-pole and even-pole filters.
- Graphical and tabular printout of gain and phase vs frequency.

- Optional printout of individual section responses.

- Optional independent choice of the C values in each section.

To execute a filter design, enter the specifications and printout control as DATA in lines 1-4 of the program (Fig. 3a), as follows (using actual numerical values, not the algebraic symbols shown):

```
1 DATA F1, N1, D1
2 DATA F2, N2, D2
3 DATA Z0, C
4 DATA O1, O2, O3
```

where

F1 = low-pass cutoff frequency in kHz.

N1 = low-pass number of poles

D1 = low-pass passband ripple in dB (D1 = 0 for Butterworth)

F2 = high-pass cutoff frequency in kHz

N2 = high-pass number of poles

D2 = high-pass passband ripple in dB (D2 = 0 for Butterworth)

Z0 = filter type (Z0 = 0 for low, high, or bandpass; Z0 = 1 for bandstop)

C = maximum capacitance (nF)

O1 = printout control of component values (O1 = 0 for not printing, 1 for printing)

O2 = printout control of complete filter response (O2 = 0 for no printing, 1 for graph only, 2 for table only, 3 for graph and table)

O3 = printout control of individual section responses (O3 = 0 for no printing, 1 for graphs only, 2 for tables only, 3 for graphs and tables)

For a simple low-pass or high-pass design, the unwanted filter characteristics in lines 2 or 1 must be entered as zeros.

The printout control variables O1, O2, and O3 in line 14 allow the selective deletion of unwanted output from the program. It is desirable to limit the amount of printout to those portions that are useful, because of the relatively slow printing speed (10 characters per second) of the teletype terminal. In normal use, line 4 is entered as 4 DATA 1, 3, 0, which produces a three-page printout—one page with the component

Frederick R. Shirley, Technical Staff, Electronic Design Dept., Sanders Associates, Inc., Nashua, N.H.

values, a second with the graph, and a third with the table. As options, any of these pages could be deleted, or the response of each individual section (graph or table) could be inserted, by re-typing new DATA in line 4.

To satisfy certain specialized applications, the following options are available in the program:

- A log frequency scale may be preselected from F4 to F3 (in kHz) by re-typing lines 15-16. The scale for frequency, which is the independent variable in both the graph and table printouts, is normally chosen to be suited to the filter type and cutoff frequencies. The provision for overriding this automatic frequency scaling is useful for directly comparing the responses of two different filter designs.

- The number of low-pass multiples (Z1) and high-pass multiples (Z2) may be chosen other than unity by re-typing lines 17-18. Butterworth and Chebyshev filters with many poles require high-Q sections, which are less stable¹ than low-

Q sections. The provision for multiple filters allows the design of a lower Q filter composed of, say, three four-pole filters instead of a single 12-pole filter.

- The standard decade list of C values may be revised by re-typing line 20. The first DATA number (in this case 6) tells the computer how many C values are included in the decade list. The following DATA numbers (10, 15 . . . , 68) are the six C values, listed in increasing order from 10 to 99. The value of C2 in the low-pass 2-pole section (Fig. 1) is chosen from this list according to certain design constraints.¹

- The C values may be individually specified by re-typing line 26 with Z = 1 and lines 27—30 with the C data (in nF) in the normal order of printout (see Fig. 4a). This provision allows scaling of the C values either to limit the spread of R values or to find the precise R values required for a measured set of C values. The selection of C values must be consistent with

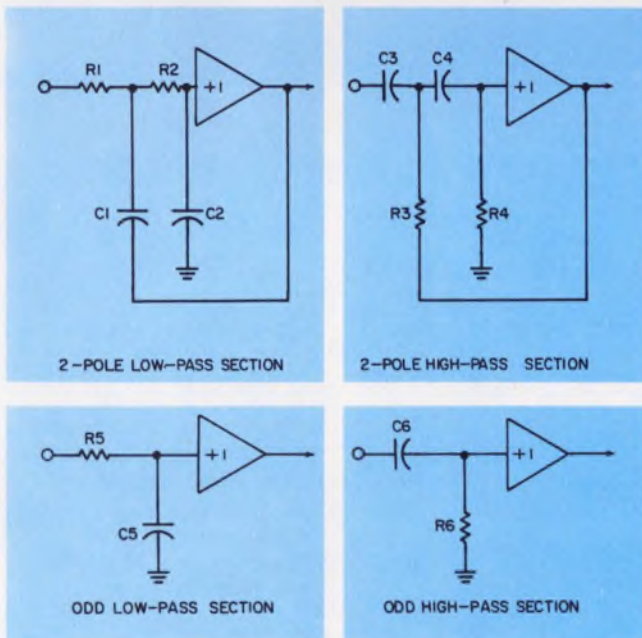

1. One and two-pole sections are cascaded to form multiple pole filters. The computer selects component values to get Butterworth or Chebyshev response.

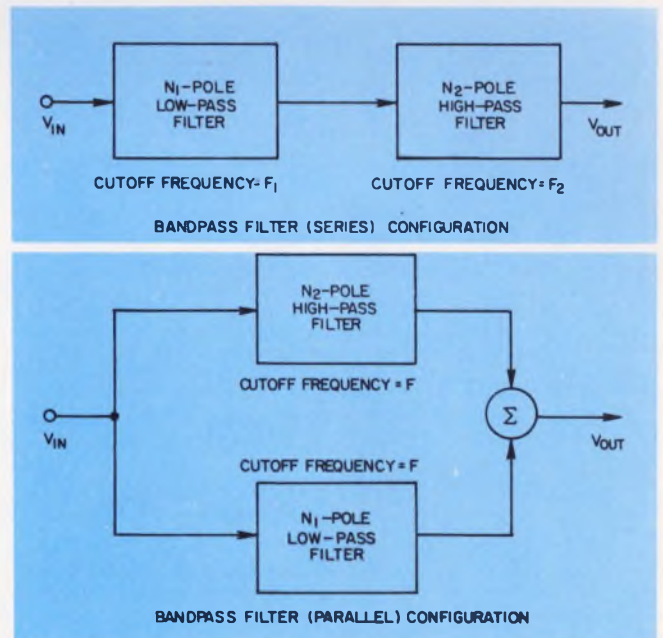

2. Combine low and high-pass filters to get band filters. If $F_2 > F_1$, the filter is bandpass, if $F_1 > F_2$, it is a band-stop filter.

```

1 DATA 10,3,0
2 DATA 1,4,0
3 DATA 0,10
4 DATA 1,3,0
11 READ F1,N1,D1
12 READ F2,N2,D2
13 READ Z0,C
14 READ O1,O2,O3
15 LET F4=0
16 LET F3=0
17 LET Z1=1
18 LET Z2=1
19
20 DATA 6,10,15,22,33,47,68
21 READ Kb
22 DIM C(25)
23 FOR K=1 TO Kb
24 READ C(K)
25 NEXT K
26 LET Z=0
27 DATA
28 DATA
29 DATA
30 DATA
31
100REM MAIN PROGRAM
110 DIM F(1,44),G(3,44),P(3,44),T(44)
120 LET Q0=6.28318531
130 LET Q1=2.30258509
140 GOSUB 630 'FREQ SCALE
150 IF O1<>1 THEN 200
160 GOSUB 1170 'HEADING
170 PRINT " COMPONENT VALUES (R IN KILOHMS, C IN NANOFARADS)"
180 PRINT
190 PRINT " "," LOWPASS VALUES"," HIGHPASS VALUES"
200 LET N=INT(N1/2)
210 IF N2<N1 THEN 230
220 LET N=INT(N2/2)
230 FOR I=N TO 1 STEP -1
240 IF I>N1/2 THEN 290
250 GOSUB 1640 'LOWPASS POLES
260 GOSUB 1850 'LOWPASS
270 IF O1<3 THEN 290
280 GOSUB 3030 'CUM RESPONSE
290 IF I>N2/2 THEN 340
300 GOSUB 1680 'HIGHPASS POLES
310 GOSUB 2190 'HIGHPASS
320 IF O1<3 THEN 340
330 GOSUB 3030 'CUM RESPONSE
340 IF O1<>1 THEN 360
350 GOSUB 3450 'PRINT-OUT
360 NEXT I
370 IF (N1+N2)/2=INT(N1/2)+INT(N2/2) THEN 440
380 GOSUB 2470 'ODD-SECTION
410 IF O1<>1 THEN 510
420 GOSUB 3710 'PRINT-OUT ODD
430 GO TO 480
440 IF O1<>1 THEN 510
450 PRINT
460 PRINT
470 PRINT
480 FOR K=1 TO 46-3*N
490 PRINT
500 NEXT K
510 IF O1>3 THEN 600
520 GOSUB 3030 'CUM RESPONSE
530 IF O3=0 THEN 600
540 LET O1=4
550 LET Z1=1
560 LET Z2=1
570 LET Z=0
580 LET O2=03
590 GO TO 230
600 STOP

```

a

| Subroutine name | Starting line number | What is accomplished | Subroutine name | Starting line number | What is accomplished |
|------------------|----------------------|--|------------------|----------------------|---|
| 1. Freq. scale | 630 | Calculation of the frequency scale | 7. Round-off | 2920 | Round-off of output data to either 3 or 5 decimal places |
| 2. Heading | 1170 | Print-out of page heading | 8. Cum. response | 3030 | Calculation of the cumulative response of combined filters (and use of graph and/or table sub-routines) |
| 3. Pole location | 1640 | Determination of pole locations for Butterworth or Chebyshev response | 9. Print-out | 3450 | Print-out of component values |
| 4. Low-pass | 1850 | Calculation of low-pass, 2-pole section component values and response | 10. Subheading | 3890 | Print-out of subheading to indicate filter portion analyzed |
| 5. High-pass | 2190 | Calculation of high-pass, 2-pole section component values and response | 11. Graph | 4050 | Print-out of gain and phase versus frequency in graphical form |
| 6. Odd-section | 2470 | Calculation of odd-section component values and response | 12. Table | 4580 | Print-out of gain, phase, and time-delay versus frequency in tabular form |

b

the design constraint $C2 < C1$ in the two-pole low-pass section.¹ If this constraint is violated the computer will print nasty comments, such as "square root of negative number," and the resulting in R values will be invalid.

Understand the program

The program RCFIL is written in BASIC.^{1,2} Because of its length (about 12,000 characters) this program must be used on an extended BASIC time-shared computer.

Figure 3a shows the "Main Program" (about 50 lines in length) of the program. The main program calls several specialized subroutines, listed in Fig. 3b. The use of a subroutine structure is particularly advantageous in longer computer programs because it simplifies the writing and debugging procedures, and keeps the program flexible for possible future modifications.

The computer works on each line in the main program sequentially until it reaches line 600, at which point it stops and returns control to the user. This prevents the use of the subroutines except as specifically directed within the main program by GOSUB command. The operation of the main program is indicated in flow-chart form in Fig. 3c.

The "Frequency Scale" subroutine chooses the points of the frequency scale according to the filter type and cutoff frequencies. Low-pass filters use a linear frequency scale, high-pass an inverse linear scale, and combined (bandpass or band-stop) a log scale. The frequency values, which form the independent scale in the graph printout (Fig. 4), are rounded off to three places for convenience.

The frequency-scale subroutine also calculates a series of points that are larger than the primary points by 0.01%. These varied frequency points are required in the "Cum Response" subroutine to compute time delay, which is the instantaneous slope of the filter phase vs frequency curve.

The "Heading" subroutine prints the filter type at the top of each page in order to avoid confusion between printouts for different designs. Each of the pages of printout—component values, graph and table—is adjusted to be 66 lines in length. In this way the heading appears at the same position on each successive 8-1/2-by-11-inch sheet of teletype paper.

The subroutines for the pole locations and the two-pole low-pass and high-pass sections are derived from the equations presented in Reference 1. The phase calculations—based on the use of the arc-tangent function—are derived in a manner similar to that for gain calculations.

The "Odd-Section" subroutine finds the component values and response for the single one-

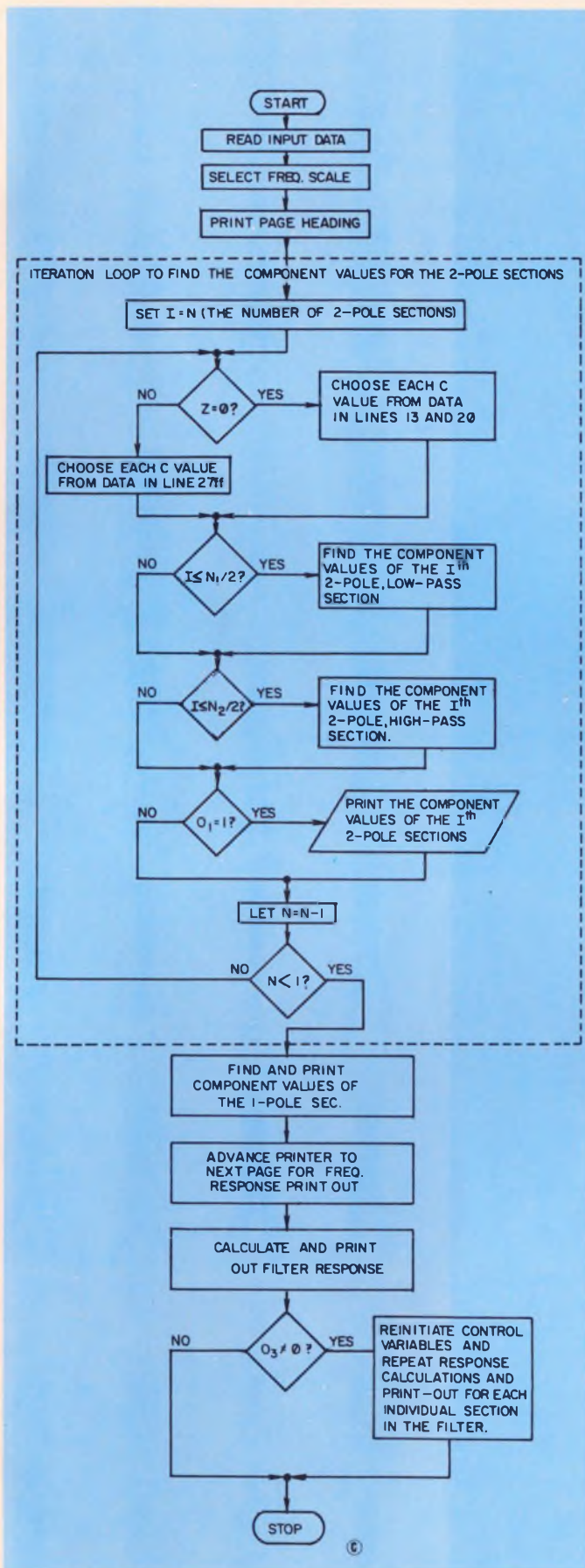

3. Component values are computed by this expanded BASIC program: (a) is the main program; (b) is a list of the subroutines used in the main program; (c) is a flow chart of the complete program.

BUTTERWORTH BANDPASS RC FILTER

| | FREQ (KHZ) | POLES |
|-----------|------------|-------|
| LOWPASS: | 10 | 3 |
| HIGHPASS: | 1 | 4 |

COMPONENT VALUES (R IN KILOHMS, C IN NANOFARADS)

| | LOWPASS VALUES | | HIGHPASS VALUES | |
|-------------|----------------|---------|-----------------|--------|
| SECTION 1 | | | R3= 14.704 | C3= 10 |
| | | | R4= 17.227 | C4= 10 |
| SECTION 2 | R1= 4.8702 | C1= 10 | R3= 6.0906 | C3= 10 |
| | R2= 2.3641 | C2= 2.2 | R4= 41.589 | C4= 10 |
| ODD-SECTION | R5= 1.5915 | C5= 10 | | |

1

BUTTERWORTH BANDPASS RC FILTER

| | FREQ (KHZ) | POLES |
|-----------|------------|-------|
| LOWPASS: | 10 | 3 |
| HIGHPASS: | 1 | 4 |

RESPONSE OF COMPLETE FILTER:

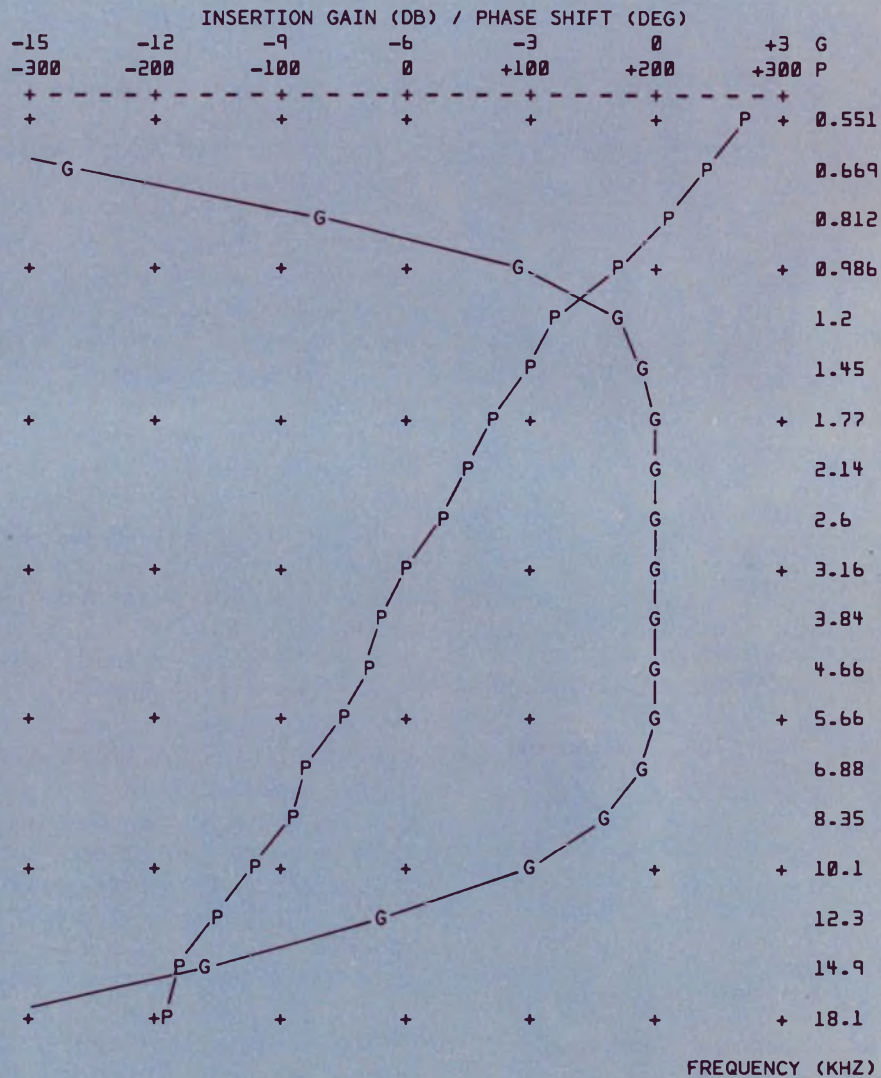

1

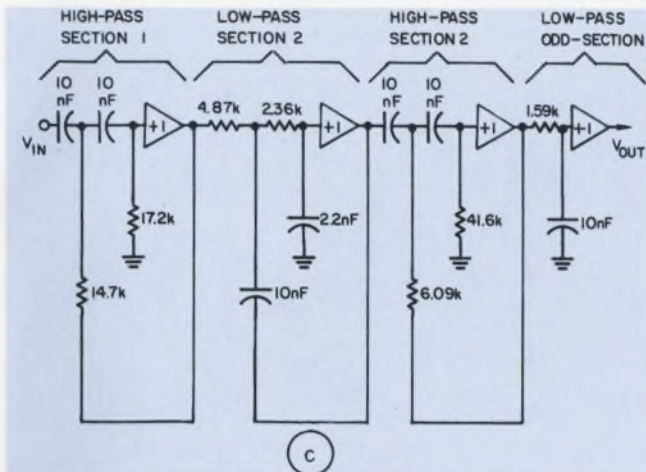

4. A Butterworth bandpass filter is designed by the computer in (a). The response is plotted in (b), and the circuit is drawn in (c).

pole section in an odd-pole low-pass or high-pass filter. In the low-pass section (Fig. 1) the normalized resistor value is $R_5 = 1/(C_5 X_1)$ where X_1 is the minor axis of the Chebyshev ellipse.¹ This value reflects the location of the pole on the real axis of the complex-frequency-plane at a distance $\sigma = X_1$. Similarly, the normalized resistor value in highpass section is $R_6 = X_1/C_6$.

The cum-response subroutine finds the gain and phase responses of a combined filter. The total response of a bandpass filter is the linear sum of its series low-pass and high-pass components. For a low-pass response of +1.0 dB at -10° and a high-pass response of -16 dB at $+80^\circ$ —both at the same frequency—the combined response is -15 dB at $+70^\circ$.

The total response of a bandstop filter is the vector sum of its parallel low-pass and high-pass components. For a low-pass response of +1.0 dB at -10° and a high-pass response of -16 dB at $+80^\circ$, at the same frequency, the combined response is +1.1 dB at -2° .

The print-out subroutines for the component values, subheading and table are straightforward. The data numbers are rounded to present the output in the most meaningful format. There is a graph print-out subroutine.³

Sample designs illustrate technique

Two filter designs using the expanded computer program demonstrate the use of the technique. The first example is a Butterworth bandpass filter (Fig. 4) composed of a 3-pole low-pass section at 10 kHz and a 4-pole high-pass section at 1 kHz. The second is a Chebyshev bandstop filter (Fig. 5) composed of a 2-pole low-pass section at 200 Hz with 1 dB passband ripple, and a 3-pole high-pass section at 5 kHz with 1 dB ripple.

To solve the first design, the filter specifications are entered as DATA in lines 1-3, as shown in the program listing of Fig. 3. Line 1 specifies the low-pass filter, line 2 the high-pass filter, and line 3 a bandpass (series) configuration with a maximum capacitance value of 10 nF. Line 4 specifies print-out of the component values and the response of the complete filter in both graphical and tabular forms. Print-out of the responses of the individual sections is suppressed.

When the program is run, a three-page print-out is generated. Each page begins with a descriptive heading. Figure 4a shows the first page, which gives the component values, and Fig. 4b shows the second page, containing a graph of gain and phase vs frequency. The third page, a table of gain, phase and time delay vs frequency, is not shown here. The table can however give more information than the graph and it should be used for frequencies above and below those

CHEBYSHEV BANDSTOP RC FILTER

| | FREQ (KHZ) | POLES | RIPPLE (DB) |
|-----------|------------|-------|-------------|
| LOWPASS: | 0.2 | 2 | 1 |
| HIGHPASS: | 5 | 3 | 1 |

COMPONENT VALUES (R IN KILOHMS, C IN NANOFARADS)

| | LOWPASS VALUES | | HIGHPASS VALUES | |
|-------------|----------------|---------|-----------------|--------|
| SECTION 1 | R1= 123.66 | C1= 22 | R3= 0.3575 | C3= 22 |
| | R2= 44.921 | C2= 4.7 | R4= 5.8218 | C4= 22 |
| ODD-SECTION | | | R6= 0.715 | C6= 22 |

(a)

CHEBYSHEV BANDSTOP RC FILTER

| | FREQ (KHZ) | POLES | RIPPLE (DB) |
|-----------|------------|-------|-------------|
| LOWPASS: | 0.2 | 2 | 1 |
| HIGHPASS: | 5 | 3 | 1 |

RESPONSE OF COMPLETE FILTER:

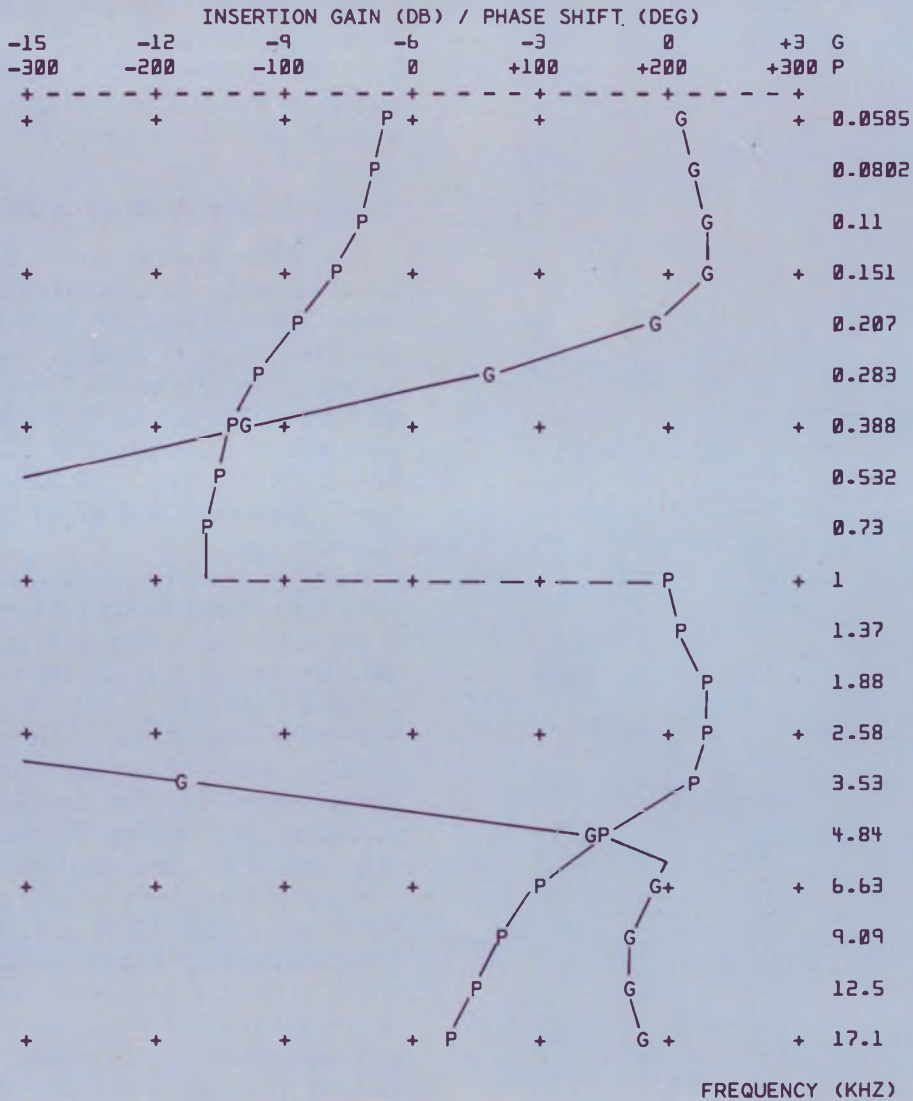

(b)

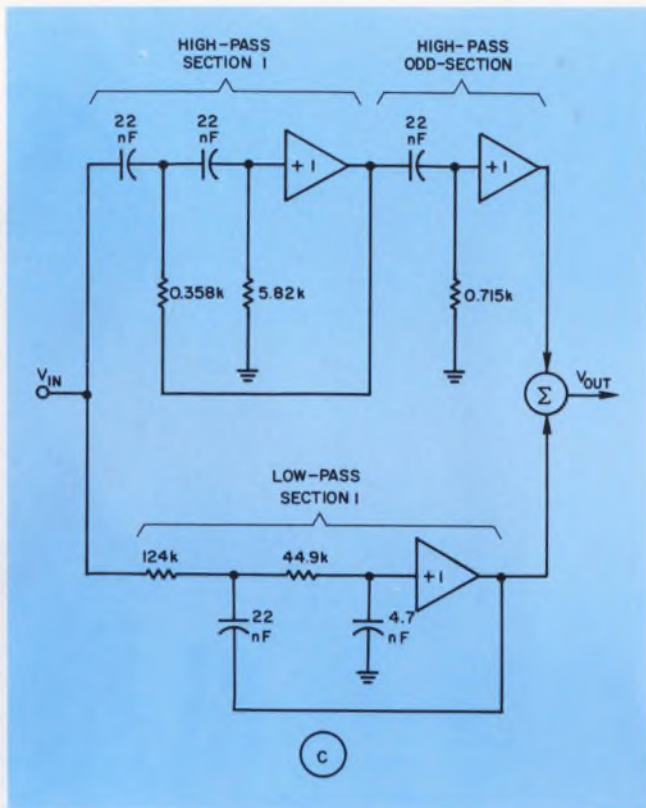

5. A Chebyshev bandstop filter design is computed by the program in (a). The frequency response is given in (b), and the circuit in (c).

plotted.

The gain values in Fig. 4b are plotted with the letter G on a scale of -15 dB to $+3$ dB, and the phase values are plotted with the letter P from -300° to $+300^\circ$. The frequency scale is logarithmic from half the high-pass cutoff frequency to twice the low-pass cutoff frequency.

The resulting filter design, using the circuits of Fig. 1 and the computer-determined component values of Fig. 4a, is shown in Fig. 4c. The individual sections of both the low-pass and high-pass filters are all cascaded in series. A high-pass is used as the first of the cascaded sections in order to get ac coupling at the filter input. The 2-pole sections are ordered from low Q to high Q to avoid amplitude clipping due to the resonant rises in the higher Q sections.

To solve the second design example, the filter specifications must be entered as DATA by re-typing lines 1-3, as shown below:

```
1 DATA 0.2,2,1
2 DATA 5,3,1
3 DATA 1,2,2
```

When the program is run with these DATA lines, the printout of Fig. 5 is generated. Figure 5a gives the component values, while Fig. 5b is a graph of gain and phase vs frequency. The resulting filter design, Fig. 5c, uses the circuits of Fig. 1 and the band-stop configuration of Fig. 2 with the computer-determined component values.

The phase jump of 360° at 1 kHz (Fig. 5b) is an artifact of the bandstop filter realization. In order to obtain 0° phase shift through the low-pass filter at low frequencies, while maintaining 0° through the high-pass filter at high frequencies, a phase jump of an integer multiple of 360° is necessary. Although this phase jump is unreal, it is permissible representation, since phase multiples of 360° are undetectable at a single frequency. To obtain 0° phase extremes with this program, the phase jump is arbitrarily set at the geometric mean frequency.

Because of the Chebyshev realization method,¹ even-pole filters have unity-gain ripple minimums, and odd-pole filters have unity-gain ripple maximums. This effect can be seen in the response of the band-stop Chebyshev filter design (Fig. 5b). The 2-pole low-pass portion of the filter is an even-pole filter and has passband gain between 0 dB and $+1$ dB, while the 3-pole high-pass is an odd-pole filter and has passband gain between -1 dB and 0 dB. ■■

References:

1. Kincaid, R., and Shirley, F., "Get Something Extra in Filter Design," *Electronic Design*, June 21, 1969, pp. 114-121.
2. *BASIC Language Reference Manual*, General Electric Information Service Publication 202026A, April, 1968.
3. Shirley, F., "You Don't Have to be a Programmer," *Electronic Design*, April 13, 1967, pp. 54-60.

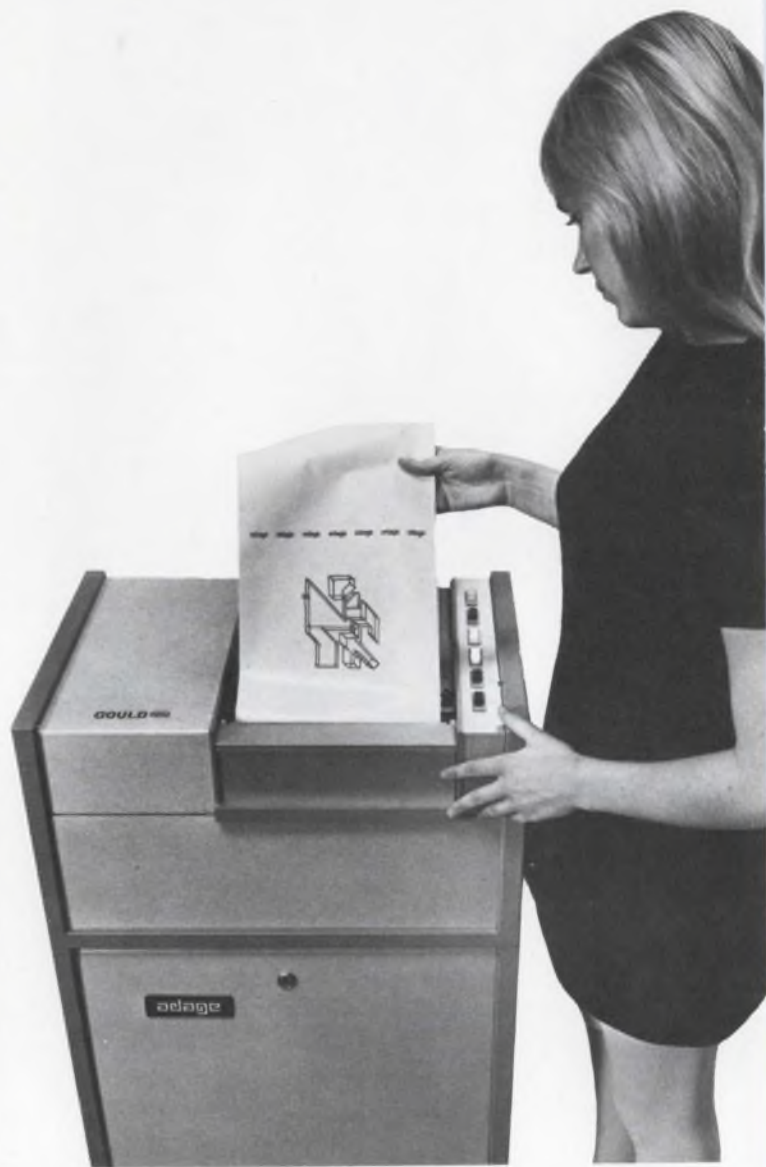
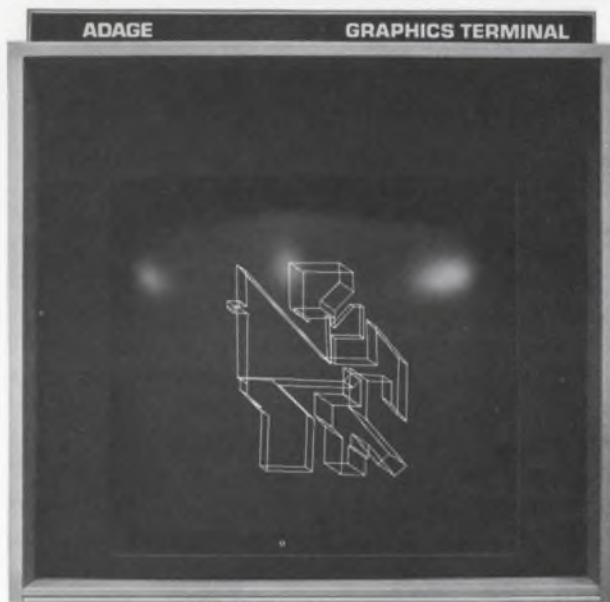

**From CRT display
to hardcopy printout.
In seconds!**

A plotter takes 30 minutes. A dry-silver photographic process makes muddy copies.

But at Adage, Inc. the Gould 4800 Electrostatic Printer puts out clean hard copy in seconds. No wait.

No wonder the 4800 is now a catalogued item for Adage Inc.'s award-winning Graphics Terminal.

The Graphics Terminal is a CRT display computer system with infinite potential for interactive graphics applications in science and engineering. To name a few, cockpit design, mathematical equations and printed circuit cards.

Having the 4800 Electrostatic Printer on line the user can alter his design equation with a light pen and have clean hard copy of any stage within seconds.

Adage officials say their system is further enhanced by the economy of the 4800. It doubles as a printer by putting out both alphanumerics and graphics. It has fewer moving parts to maintain than conventional equipment. And Adage interfaced the

4800 in a matter of days . . . at surprisingly low cost.

More 4800 facts:

At 412,000 characters per minute, the Gould 4800 breaks the old printout bottleneck on your computer. It reproduces signals from any source of digital input or data transmission by telemetry, radio microwave and/or land line, quickly, quietly, accurately and economically.

4800 can probably recap the same benefits for your system as it does for Adage's Graphics Terminal. Write us to see. Don't wait. Graphics Division, Gould Inc., 3631 Perkins Avenue, Cleveland, Ohio 44114.

GOULD CLEVITE

Gould 4800. The next generation of high-speed printers.



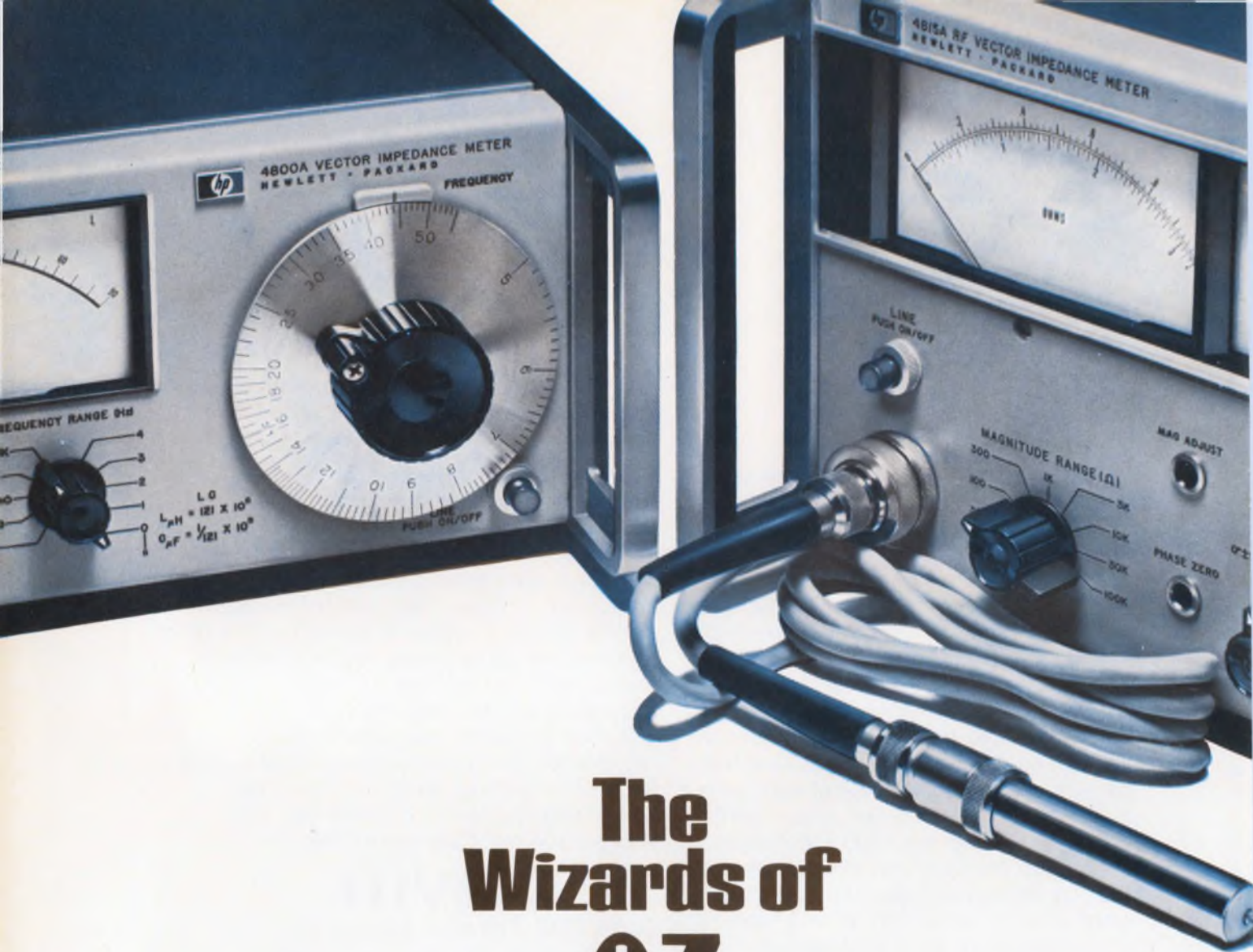

The Wizards of θZ

Like magic . . . vector impedance instruments read out complex impedance in an instant.

With the HP impedance meters, measurements involving impedance magnitude, Z , and phase angle, θ , no longer require tedious test procedures. These measurements are now as easy to make as voltage readings. No nulling . . . no balancing . . . no calculations to make. The wizardry of these HP instruments provides direct readout of Z (in ohms) and θ (in degrees) over a continuous frequency range.

HP 4800A Vector Impedance Meter covers the 5 Hz to 500 kHz range. You set the frequency, select
IEEE Show Visit us at Booth 2F25-2F36

the impedance range and read: Z from 1 ohm to 10 Megohms, and θ from -90° to $+90^\circ$. \$1650.

HP 4815A RF Vector Impedance Meter covers 500 kHz to 108 MHz. Measures, via a probe, active or passive circuits directly in their normal operating environment. Z from 1 ohm to 100 K ohms; θ from 0° to 360° . \$2650.

Application Note 86 describes many applications of the 4800A and the 4815A Vector Impedance Meters including the measurement of Z , R , L , and C . For your copy and complete specifications, contact your local Hewlett-Packard field engineer or write: Hewlett-Packard, Green Pond Road, Rockaway, New Jersey 07866. In Europe: 1217 Meyrin-Geneva, Switzerland.



HEWLETT  PACKARD
IMPEDANCE INSTRUMENTS

Electromagnetic interference worry you?

It won't, if you apply these easy-to-follow suppression recommendations to your equipment.

It's hard to escape unwanted electromagnetic energy in the world. It exists virtually everywhere today and hampers the performance of many sensitive electronic devices. Turn on the radio in your car, and sooner or later you'll encounter static from neon lights, electric power lines, lightning or the ignition system. The television set in your home is vulnerable to spurious energy generated by electric blenders, power tools, vacuum cleaners and other appliances. Most of these electromagnetic interferences are merely objectionable. But they can be catastrophic in such sensitive circuitry as aircraft navigational guidance systems and computers.

Unwanted energy can enter the susceptible circuit along conductive paths, such as power lines and signal cables. Or it can be radiated through the atmosphere around the circuit. Usually the proper installation of metallic radio-frequency bonding, shielding and electrical filtering members interrupts the flow of spurious

John L. Steenburgh, IBM Corp., Technical Associate, EMC Development Group, Systems Development Div., Kingston, N. Y.

energy and causes it to dissipate or to be diverted from the circuit. This protection allows the circuit to perform as intended in its electromagnetic environment.

In addition to protecting the circuit, the properly installed shield tends to contain internally generated energy that could affect the performance of unprotected circuits nearby.

It has been observed that certain areas of electronic equipment are especially vulnerable to electromagnetic interference and that these critical points are found in most equipment. They must be protected by shielding if the interference is to be contained.

Let's examine these vulnerable areas and see how they can be protected. The accompanying photos give the highlights of a step-by-step shielding design for a small computer, without going into specific radio-frequency bonding methods or hardware. Although the computer is used as an example, the recommendations are general in nature and can be applied to other types of electronic circuitry that requires shielding protection.

(continued on next page)

The fundamentals of good shielding design

How effective the shielding configuration is depends largely on the electrical continuity throughout the shield. In general, the areas of prime concern are apertures, such as cooling vent holes, and member interface areas, such as cover-frame seams. Good radio-frequency bonding technique must assure that electrical continuity will be maintained. Because of this, the critical areas must be paint-free and the surface treated with electrically conductive coatings.

The measure of the shield's over-all ability to reduce radiated electromagnetic energy is called shielding effectiveness, or attenuation. It is measured in decibels as a function of frequency.

It is difficult to specify a desired level of circuit protection for electronic products, since there are so many variables. Among these are

the impedance of the circuit, its function and susceptibility to noise, and the anticipated electromagnetic environment at user locations. Specialized measurements of radiated interference or susceptibility levels can help designers estimate the circuit protection needed in accordance with electromagnetic-compatibility standards, whether commercial or military. Regardless of requirements, the design task follows the sequence shown in the accompanying figure.

One technique that is especially useful is the fingerstock closure. These devices, illustrated in Fig. 10, provide the spring-loaded contacts and wiping action for self-cleaning. They may be mounted either on both mating surfaces, to cover at 45°, or on one surface, with a 90° knife edge on the other.

1. A typical computer, with some of the circuit areas that require protection from unwanted electromagnetic energy: the external covers, cabling and the operator's console area.

2. The basic member of the shield system is the metallic frame, assembled so that electrical integrity is maintained throughout. An electrically conductive surface treatment provides a radio-frequency (rf) bonding base for the attachment of covers, panels and internal subassemblies. Electroplated cadmium, zinc or nickel has been used in the past. Electroplated tin over nickel is satisfactory when used with light-pressure rf bonding members, because tin oxides are soft and electrically conductive.

3. Vent panels at the top and bottom of the conductive frame use closely spaced (eight inches maximum) fasteners and provide for shielding and cooling. Rf mesh gasket material may be used to provide additional metal-to-metal contact between the plated surfaces. The geometry of the air passage perforations follows the suggestions of UL safety specifications.

4. The addition of power equipment to the system demands considerations for preventing unwanted energy from entering along the power cables. An electrical filter and the external shield are recommended to provide protection. The input side of the filter should be made electrically continuous with the shield by using paint-free electrically-conductive areas, threaded fasteners and rf mesh gasket material.

5. Externally routed signal cables may be enclosed in suitable shields. It is important to provide adequate termination at the cable entry aperture. A special cable termination bulkhead (shown here with one cable attached) may be used if many cables are involved.

6. Some internal enclosures, such as the power supply in this case, require access panels (lower left) for assembly, inspection or maintenance. These panels may have paint-free conductive mounting surfaces to allow metal-to-metal contact.



1.

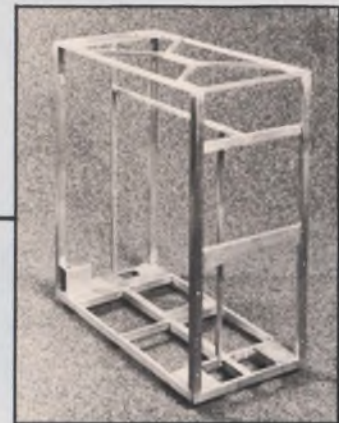

2.

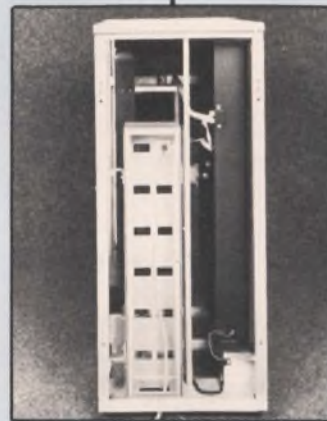

5.

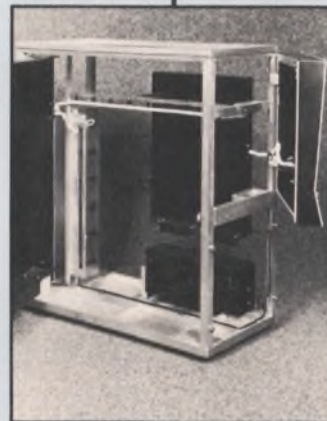

7.

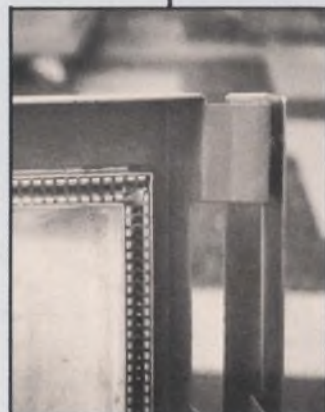

9a.



9b.

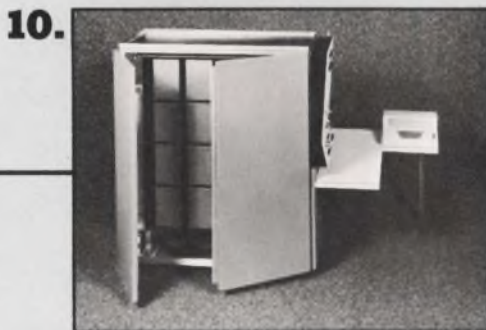
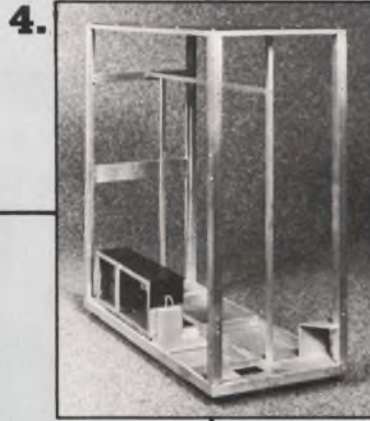

7. Proper routing of cables provides protection at minimal cost. Power cables (black) should be kept close to and parallel with frame members in the lower part of the structure. Control cables, such as those associated with the operator's console (right center), should be similarly treated. Signal cables (white) should be suspended away from frame members with nonconductive supports. Spacings of at least 1.00 inch from frames, at least 12 inches from other cables and routings near the top of the structure should be observed for the signal cables.

8. Each control panel (bottom) should have paint-free electrically conductive mounting surfaces and rf mesh gasket members (behind control panel) may be added for additional metal-to-metal contact area. Controls, such as switches, should be housed in metal and rf bonded to the mounting panel. Back shielding can be used with shielded controls. Indicator lamps should have minimum-sized apertures. Visual access areas, such as meters or displays, may be shielded with fine mesh screen or with metallic-coated glass.

9. Easy attachment and replaceability of covers, in addition to damage protection, is achieved by using an electrically conductive fingerstock mounting channel. The pre-plated channel is an integral part of the cover assembly, attached and masked-off prior to cover-painting operation. Full-cover fingerstock peripheral protection is possible, as in "a". A double row of tin plated fingerstock members are contained in a mounting channel by self-exerted spring pressure, as shown in "b". Short sections of fingerstock may be spotted at random locations or full fingerstock population is possible. A knife edge, attached to the frame, contacts the fingerstock when the cover is closed. Of special interest is the fact that the channels and fingerstock can be attached to a plated sub-plate, as shown, to serve as a shield. This shield can then be attached to any cover, metallic or non-metallic, to provide shielding protection to the circuitry.

10. A conductive flange on the mating cover simplifies the installation of fingerstock (not shown) on the center seam. This technique demands cover sequencing during opening and closing.

ELECTRONIC MATERIALS

DOW CORNING®

3140 RTV coating

clear, flowable silicone rubber coating; non-corrosive to copper and other metals

TWO OUNCES

DOW CORNING

ELECTRONIC MATERIALS

DOW CORNING®

3140 RTV coating

clear, flowable silicone rubber coating; non-corrosive to copper and other metals

TWO OUNCES

DOW CORNING®

3141 RTV coating

white, flowable silicone rubber coating; non-corrosive to copper and other metals

NET WT.

DOW CORNING

DOW CORNING®

3141 RTV coating

white, flowable silicone rubber coating; non-corrosive to copper and other metals

NET WT. 2 oz/57 g

DOW CORNING®

3144 RTV adhesive/sealant

translucent, room-temperature-curing silicone rubber adhesive sealant; non-corrosive to copper and other metals

NET WT.

DOW CORNING

DOW CORNING®

3144 RTV adhesive/sealant

translucent, room-temperature-curing silicone rubber adhesive sealant; non-corrosive to copper and other metals

NET WT. 2 oz/57 g

ELECTRONIC MATERIALS

DOW CORNING®

3145 RTV adhesive sealant

grey, non-slump silicone rubber sealant; non-corrosive to copper and other metals

TWO OUNCES

ELECTRONIC MATERIALS

DOW CORNING®

3145 RTV adhesive sealant

grey, non-slump silicone rubber sealant; non-corrosive to copper and other metals

TWO OUNCES



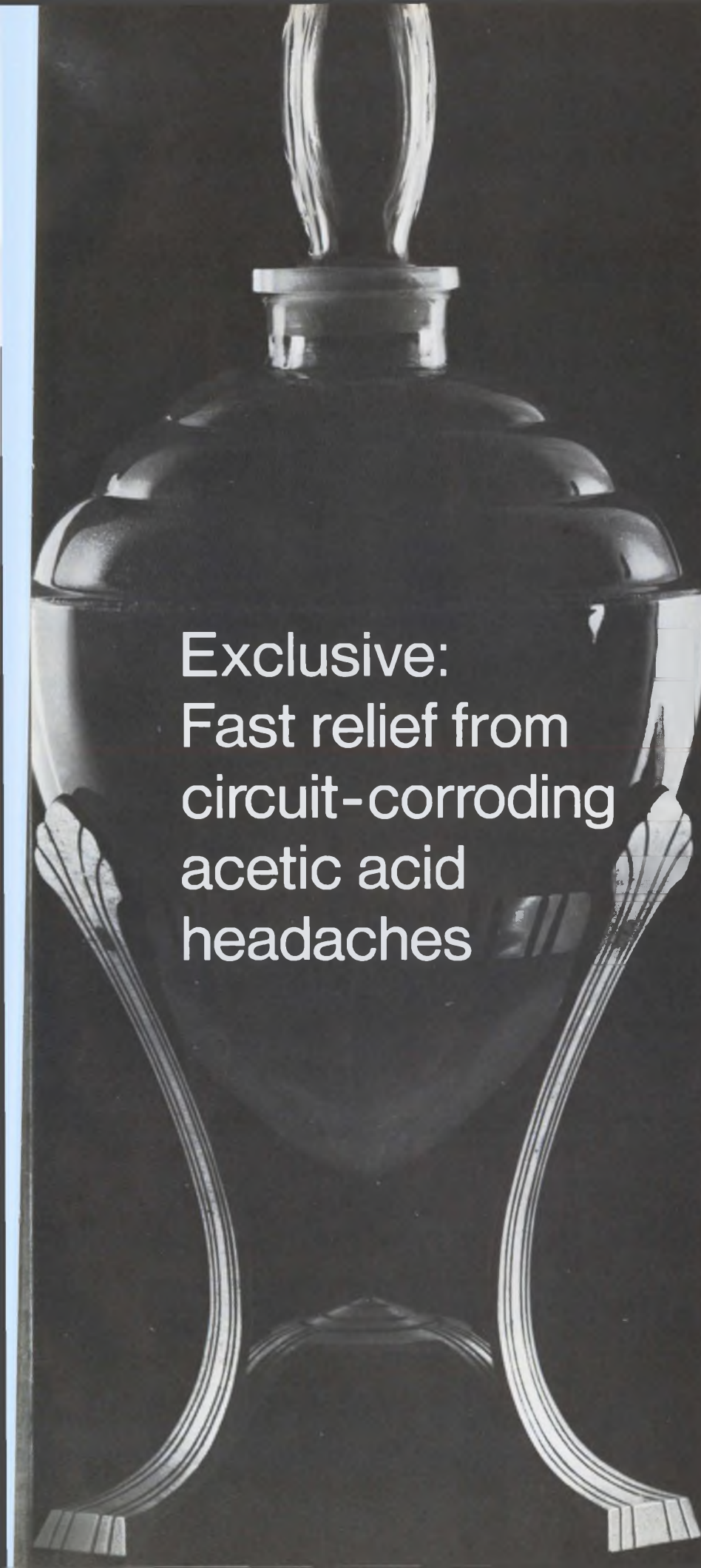

Exclusive:
Fast relief from
circuit-corroding
acetic acid
headaches

Dow Corning® silicone sealants and protective coatings are the only ones that do *not* release acetic acid or other corrosive by-products during cure. They were specifically developed to protect delicate circuit boards and other electronic components from corrosion, dust, dirt, abrasive particles, solvents and chemicals. They are strong, have excellent bond strength, electrical strength; are easy to apply, and cure quickly. There's no "vinegar" smell, either. Dow Corning 3140 (clear) and 3141 (opaque) RTV coatings are ready-to-use silicone rubbers that cure at room temperature. They are ideal for conformal coatings on printed circuit assemblies or for encapsulating small circuits or connectors. Dow Corning 3144 (clear) and 3145 (opaque) RTV adhesive/sealants are high-strength, non-corrosive, nonflowing silicone rubbers used to bond components and seal housings and connectors.

Stop component corrosion with these Dow Corning coatings and sealants. For more information, write Dow Corning Corporation, Dept. B-9342, Midland, Michigan 48640.

*Electrical / Electronic
materials from*

DOW CORNING

DOW CORNING

That 'dream' job might be a nightmare!

To ensure against employment disappointment, get to know your prospective employer as well as he knows you.

Are you in the market for a new job? If so, or if you plan to be, consider how elated you perhaps felt when you were offered your present position. Perhaps you later experienced a vague, dull disappointment when you discovered that the employment package so handsomely wrapped for you proved to be something other than a present. The message should be clear: Before you leave your present position, take a long and thorough look before you leap into a new one.

Even if you are reasonably satisfied in your current position, there is an obvious career advantage in keeping aware of the operations of competitive companies.

Evening the odds

When you hand your resume to a personnel recruiter, the odds are that he has virtually unlimited resources to check it out. And he knows that, if he makes a mistake in hiring you, the mistake is rather easily rectified.

However, if you make a mistake in your evaluation of the position or the company, you can be stuck with your decision, at least temporarily. And the odds are against you, because you probably have a limited knowledge of the company interviewing you. In fact, if you are seeking a position in one of the new growth areas—such as computer peripherals—you may not have even heard of the company that replies to you.

But to make the hiring game a better gamble for you, there are certain sources of information that can help you to learn almost as much about your potential employer as he learns about you.

There are two phases to the investigation you should undertake:

- Determining where the company is going and how fast; what the chances of success are.
- Determining whether or not a particular

company has a future for you, personally; if it is the kind of place where you want to work.

The annual report

Much information about a company's operations is a matter of public record. However, corporate policies, internal procedures, management attitudes, and real working conditions are not published information. Investigation and interpretation are required on your part.

The best place to start finding out about a company is its *annual report*, which will be available if the company's stock is publicly traded. A stockbroker will be able to show you a copy, or a businesslike letter from you to a company officer will usually produce a copy, if you state that you are a potential investor.

A professional financial analyst can read as much information between the lines of an annual report as he can from the published details of operations. Although you can't expect to do as good a job as a professional analyst, your observations will give you a pretty good idea about long range company plans.

A recent ELECTRONIC DESIGN article gave seven major keys to financial analysis, as outlined in a New York Stock Exchange booklet. For maximum benefit, you should study a five-year financial record, if possible, to determine trends and long-range plans. The seven keys to financial evaluation of an annual report are:

1. *Pre-tax Profit Margin*. This is the ratio of operating profit (before interest and taxes) to sales. An upswing in sales usually widens the profit margin.

2. *Current (working capital) Ratio*. A gradual increase in the ratio of current assets to current liabilities means improved financial strength—a company able to take advantage of expansion opportunities.

3. *Liquidity Ratio*. The ratio of cash and marketable securities to current liabilities (sometimes expressed as a percentage) indicates a company's ability to meet current obligations

Anthony W. Whitworth, Marketing Coordinator, Communications, Sangamo Electric Co., Springfield, Ill.

and to pay larger dividends. This ratio is often lower during a period of expansion or rising prices. A protracted decline can indicate that a company will have to raise additional capital to achieve expansion plans or to enter new markets.

4. *Capitalization Ratios.* These are the percentages of the total company investment allotted to each type of debt, stock, and surplus. A higher ratio of surplus to common stock means that the common stock is strong since there are fewer claims on corporate income in the form of debt securities or preferred stock.

5. *Sales to Fixed Assets.* The ratio of annual sales to the value of plant, equipment and land before depreciation and amortization. A sizable expansion in facilities should lead to increased sales.

6. *Sales to Inventories.* (Commonly called "inventory turnover.") This ratio is computed by dividing the year's sales by the year-end inventories. A high ratio indicates good merchandising policies. A sudden lowering indicates the possibility of an inventory tied up in possibly obsolete products.

7. *Net Income to Net Worth.* Derived by dividing net income by the total of preferred stock,

companies that are not publicly traded, because they give key background about the owners, management, and capitalization.

Securing one of these comprehensive reports requires a good contact, such as your banker, and you may be required to pay for the service. However, if you contemplate going to work for a small, new company, organized and managed by people you do not know, consider the fee a good investment.

Would you want to work there?

Having determined whether or not the prospective company is what you are looking for in terms of your career needs, you should then determine what life with that company would be like for you. Besides your own personal questioning of both recruiting and technical people during a company interview, information about the internal policies and operations of a company may be gathered from the following sources:

Professional Colleagues. You probably belong to a professional society. One or more of your colleagues probably has some knowledge about any given company. If possible, also, ask the

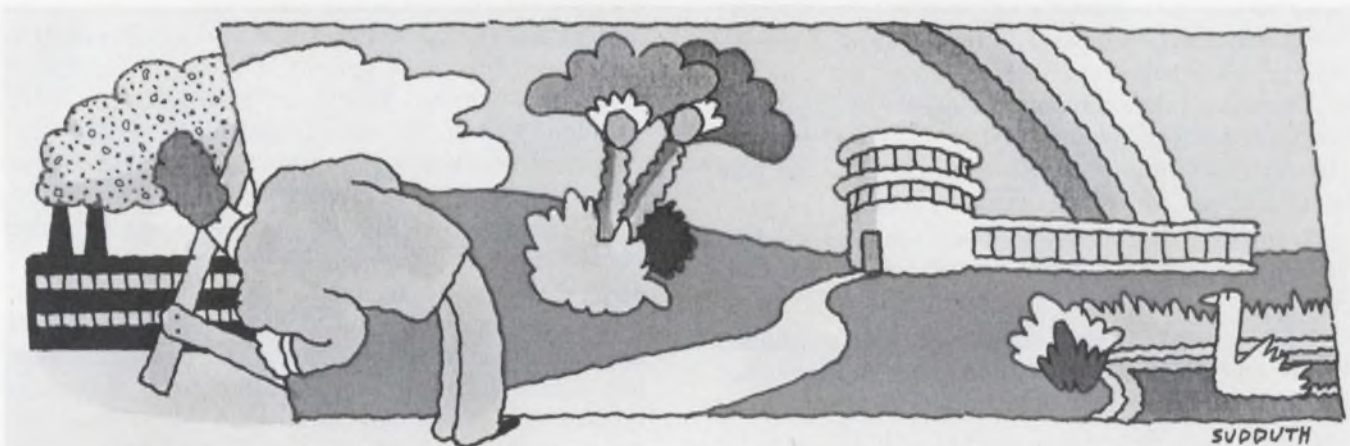

common stock, and surplus accounts. This is an indication of the company's earnings on the stockholder's investment. An increasing ratio trend is favorable.

Complete the analysis

Naturally the figures derived for a particular company must be tempered with several other observations such as: (1) the state of the particular industry in general; (2) the condition of this company's competitors; and (3) your own objectives. For instance, are you more interested in steady, stable employment or in gambling on a rapidly rising company?

Dun & Bradstreet and similar financial reports contain information about the projected financial success of a listed company. These are excellent sources for information about new, small

company's vendors, customers, and competitors how they rate your prospective employer. An even better source is a man who currently works for the company. It's true that a satisfied employee is a company's best recruiting ad.

The Community. Today many electronics companies are located in small towns and suburban areas. When you travel there for an interview, talk to as many non-company people as you can. This includes airport personnel, cab drivers, service-station attendants. If a company has been around for a while, and has a mature, community-minded management, most local people will have a positive opinion about it. Also check the local paper. (You'll need to pick up a copy anyway, to check housing and food prices, and local recreation facilities.) See if the paper carries any mention of the company personnel and their involvement in the community. If the company is

expanding it might be running local ads for recruiting factory personnel. If so, observe what they promise in benefits. Also, contact the local chamber of commerce for literature. This material will tend to tell you how much influence the company has in local affairs and plans.

Your Prospective employer. Some questions are best answered on the spot by the recruiting interviewer (concerning company policy) and by the technical administrators (about working conditions). But that does not always ensure you against receiving incomplete answers. Some recruiters are not very candid. Always keep in mind, however, that you are entitled to ask any pertinent questions.

Exercise your right to inquire

Support Personnel—What is the approximate ratio of nontechnical to technical personnel? A high ratio means that you'll probably have to spend less time on non-engineering work. In other words, count the technicians.

Professional Societies—Does the company encourage participation in professional societies? Do they pay dues and expenses? What is company policy in regard to trade-show attendance? What are travel policies? Is publication of papers and articles encouraged? How many members of engineering management are active in local professional-society leadership? Too many negative answers could mean that the company is not concerned about individual requirements.

Reference Material—Is the company library well organized? Is there a full-time librarian? Are there microfilming and duplicating facilities?

Management Training—Does the company have any formal programs for management training or personnel development?

Continuing Education—What are the policies for continuing education? Time off for classes? Full or partial tuition reimbursement? How many company employees teach at the local college or university?

Internal Communications—What employee communications are available? Are publications designed to keep all employees well informed of the company's over-all goals and accomplishments? Is there an internal engineering newsletter for dissemination of design information?

Physical Conditions—Are normal working conditions better than what you have now? Well lighted? With relatively quiet separate offices, or a large "bullpen"?

Job Potential—It's important to find out how high one can go within a particular company and still practice engineering. In some situations, a man must switch from engineering to management if he desires to advance beyond a certain

point. In other companies, line responsibility for engineering extends into top management. Some companies permit older, competent engineers without desire for management duties to fill specially created "assistant to the chief engineer" or "consultant" positions.

These positions are usually more predominant in companies heavily engaged in R & D activities, and such positions are obviously limited in number. Their presence indicates, however, that the company has recognized design competence enough to reward it. It is also interesting to note the percentage of sales management and top management team members who started with the company as design engineers. Although your planned career path may not include sales or corporate management, it is worthwhile to discover if such career paths exist.

Replacement Policies—Companies in some "cyclical" industries, such as the aerospace industry, cooperate in placement programs when massive layoffs result from contract cancellations. For instance, if an aerospace company loses a large contract (as happens when Congress cancels a defense hardware program) the company is faced with the prospect of laying off a large number of professional, technical, and skilled employees. It then contacts all logical prospective employers for these people and offers assistance in their recruiting. It will set up offices for interviewing within its plant, and will supply employment records and references to meet stated requirements of the recruiting companies.

At first glance, this seems a strange way for competitors to operate; however, in the aerospace industry it seems to work out well. Companies get a chance to hire professional people easily and at reasonable cost; the personnel that are laid off get an opportunity for continuous employment; and the company, of course, assumes that when fortune smiles upon them again, they will be able to rehire the same employees in the same manner.

Switch, don't fight

Today a properly designed engineering career includes an infrequent, but calculated, job change. According to a recent ELECTRONIC DESIGN survey, electronics engineers reported having an average of three jobs per career. In the computer industry, engineers with 16 to 20 years' experience reported having an average of over five positions per career. It's important to prepare yourself psychologically for changing jobs. Other engineers are making changes, too.

And remember—when you decide that your objectives demand a change, consider any job offer you receive as a special evaluation for a most important client: You. ■■

They're new, Molex edge connectors. For printed circuit boards. Terminals crimped to wires automatically. We have straight-in and right-angle types. With and without mounting ears. It's another giant step by Molex in helping create high-speed, low-cost devices that simplify circuitry. Reliable? You bet. The connector has bifurcated terminals that provide solid contacts. Yet you can slip the connector on and off many times without damaging printed circuits. And it's not a preloaded unit. Carries only contacts required. From nine to twenty-two.

If you want to save assembly time, steps and money, take a close look at this new Molex edge connector. For free samples, write or you can make connections by calling (312) 969-4550.



**MOLEX PRODUCTS
COMPANY**
Downers Grove, Ill. 60615

Ideas For Design

Inexpensive generator produces triangle and square waves

The inexpensive function generator shown develops both triangular and square wave outputs. The circuit was designed for maximum efficiency and triangular linearity with a few parts.

The transistors Q_3 and Q_4 form a differential amplifier with a constant-current generator created by the emitter junction of Q_5 . Positive feedback via buffer transistor Q_2 forces the differential amplifier to act as a threshold detector

with a large amount of hysteresis. The lower level sensed is always ground, whereas the upper level ($+V$) is adjusted by R_5 . Q_1 is a gated current source. Q_6 is a constant current sink.

When Q_4 is ON Q_3 is OFF and Q_2 forces the base of Q_1 to sense a $+V$ level. Current source Q_1 supplies sufficient current to charge timing capacitor C_1 linearly toward $+15V$. When this ramp reaches $+V$, Q_3 turns ON, Q_4 turns OFF

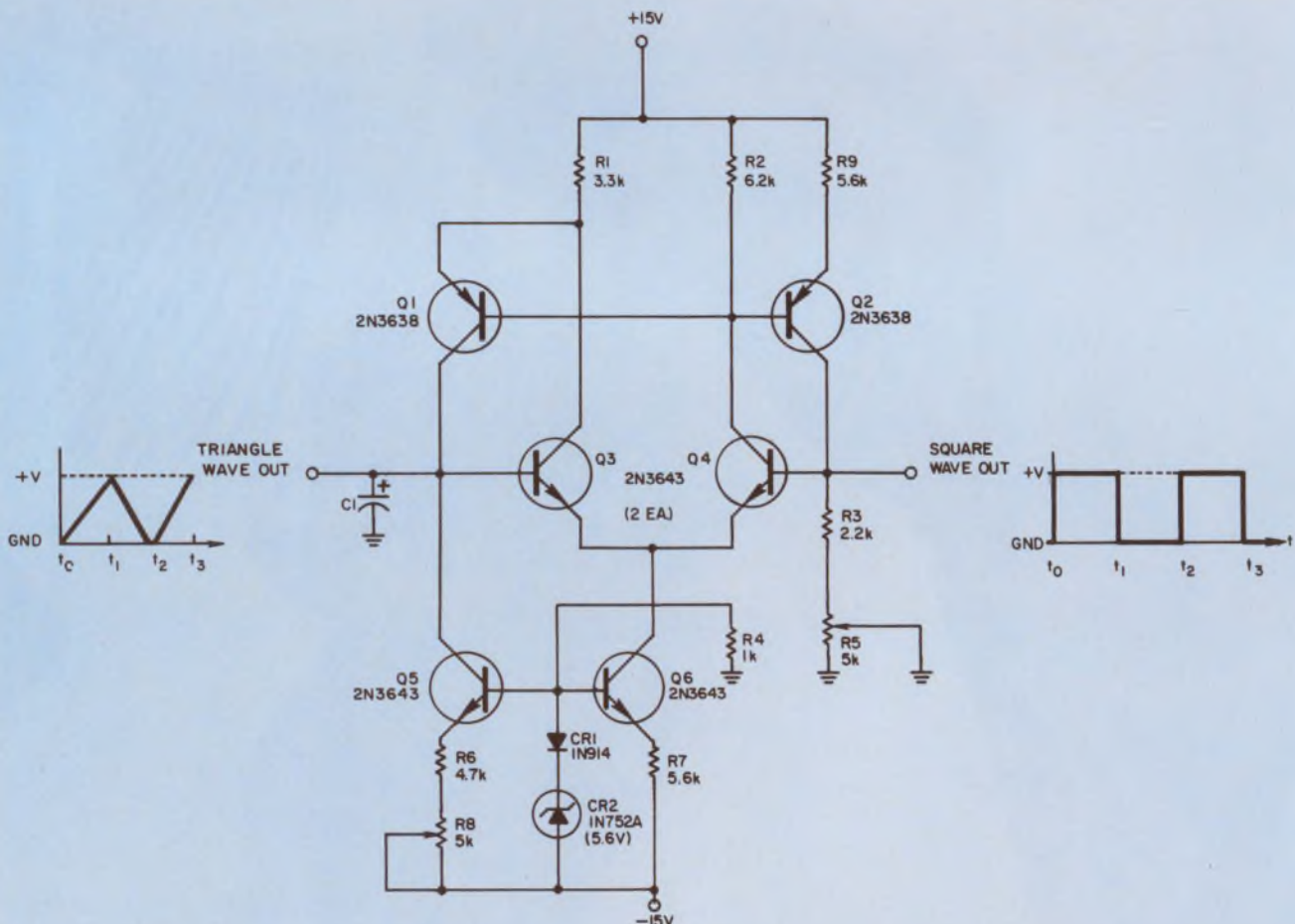

Low component count function generator simultaneously produces triangle and square waves.

Signal and system analysis at a glance.

Compare data streams and records. Characterize noisy, random signals. Detect periodic signals buried in noise. Identify vibration sources in structures and isolate different transmission paths and times. Completely characterize components in complex systems by impulse response measurements and frequency spectral analysis.

You can do all this and more with Hewlett-Packard's new all-digital 3721A Correlator — on-line, and at a price you can afford.

It's a powerful, portable signal analyzer. It offers cross-correlation for comparison of two signals in noise, with a sync pulse. Auto-correlation for

comparison of a signal with itself. Signal recovery. And statistical probability measurement.

And it's as easy to use as an oscilloscope.

The time span across the CRT can be varied from 100 μ S to 100 seconds (to infinity with external clock). Maximum resolution is 1 μ S. An optional delay offset facility enables you to look at up to 1000 points of time scan. And a unique quick look feature gives you an almost immediate indication of the final value of the function being computed.

Remember, HP's 3721A is all digital. This gives you tremendous averaging versatility and power. The averaging time constant is changed at the flick of a

switch — over a range of 36 milliseconds to over 100 days. And for maximum convenience, our new correlator can be interfaced directly to a computer for frequency spectrum analysis and other types of data manipulation.

The price? Just \$8325. For comprehensive signal and systems analysis at a glance, call your Hewlett-Packard representative. Or call or write Hewlett-Packard, Palo Alto, California 94304; Europe: 1217 Meyrin-Geneva, Switzerland.

HEWLETT  PACKARD
SIGNAL ANALYZERS

18911

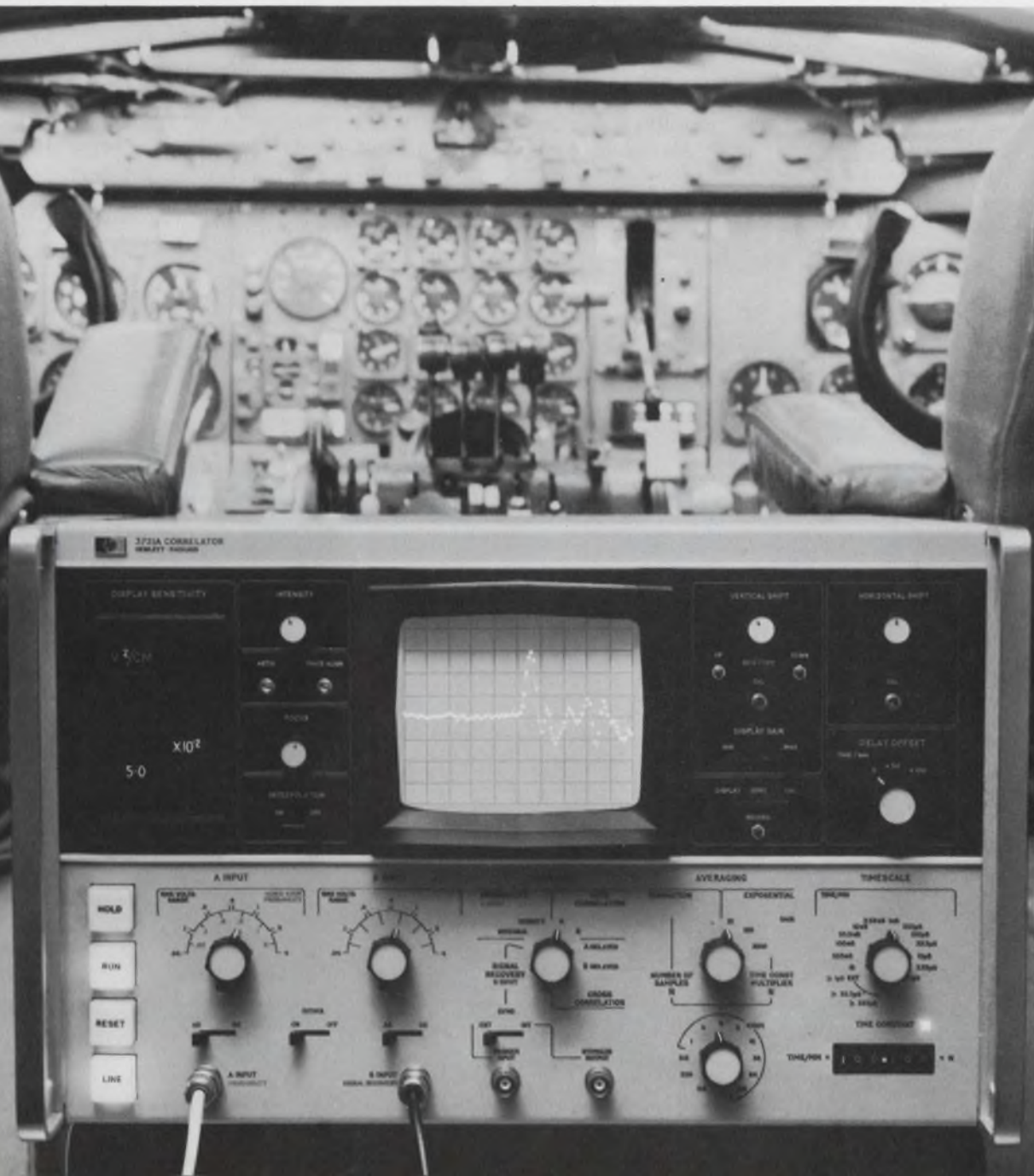

and the current source Q_1 shuts down. The timing capacitor C_1 is now discharged linearly by current sink Q_5 . When the discharge ramp reaches ground the charging cycle repeats, thus forming a triangular output across C_1 , while providing a square wave output at the base of Q_3 . Symmetry adjustment is accomplished by setting

R_5 , which controls the C_1 discharge rate.

Any low-leakage capacitor may be used for C_1 . By changing C_1 , the frequency of the circuit can be adjusted from 0.01 Hz to 200 kHz.

William E. Peterson, Associate Engineer, ITL Research Corp., Northridge, Calif.

VOTE FOR 311

Symmetrical power supply is adjusted with only one control

With the growing use of linear integrated circuits, the need for symmetrical negative and positive power supplies is quite common. The positive and negative supply voltages should track each other precisely, and it is convenient to simultaneously adjust both voltages by using a single control.

The positive supply shown in the figure is conventional. Integrated-circuit amplifier A_1 detects the error voltage and provides compensation with drive to the series transistor Q_2 . Stable, low-noise operation of the zener reference diode D_5 is made possible by the presence of FET Q_1 ,

which acts as a constant current source. Residual zener-diode noise is further reduced by the integrating circuit R_1 and C_3 .

The negative supply is also a series regulator. One input of the operational amplifier A_2 is held at ground potential, and the other input sees the voltage at the summing point of R_5 and R_6 . A_2 acts to maintain this summing point voltage at zero, which results in a symmetrical negative output voltage. If the offset voltage error of A_2 (always less than a few millivolts) is suitably compensated, the output voltage is symmetrical within the precision of the divider R_5 and R_6 .

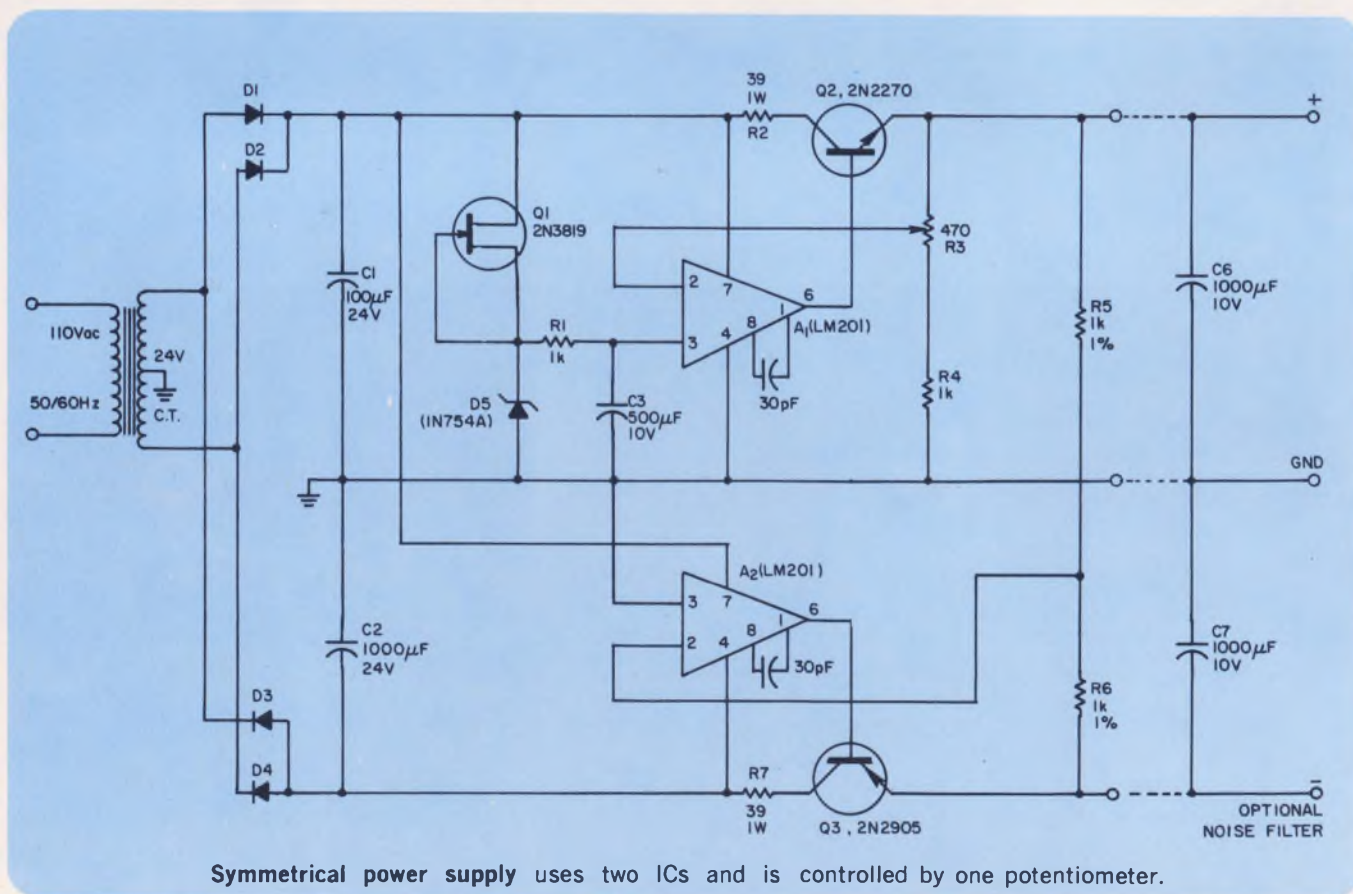

Symmetrical power supply uses two ICs and is controlled by one potentiometer.

For your op amp applications that call for both economy and quality, we've karate chopped prices on three of our most popular devices.

Ch'op amp prices on Bipolars:

ADO47/10 (H6010C) now only \$10.50

5 μ V/ $^{\circ}$ C Drift, Typ

100 nA Input Bias Current

100 dB Common Mode Rejection Ratio

Ch'op amp prices on FETS:

ADO84/10 (H7040C) now only \$11.50

100 dB DC Voltage Gain, Min

100 pA Input Bias Current, Max

60 dB Common Mode Rejection Ratio

6 V/ μ sec Slew Rate, Min

75 μ volts/ $^{\circ}$ C Drift, Max*

* 50 μ V/ $^{\circ}$ C and 25 μ V/ $^{\circ}$ C available on special order

Ch'op amp prices on Chopper

Stabilized Units:

ACS10 only \$53.00

140 dB Open Loop Gain, Min

6 V/ μ sec Slew Rate, Min

0.5 μ V/ $^{\circ}$ C Drift, Max

25 pA Input Bias, Max

Short Circuit Proof

Our monolithics are priced even lower.

For complete specifications and chop-chop delivery, get in touch with your local Fairchild Controls Representative or contact us at 423 National Avenue, Mountain View, California 94040. (415) 962-3833.

FAIRCHILD

CONTROLS

A DIVISION OF FAIRCHILD CAMERA AND INSTRUMENT CORPORATION



NEW CHOP AMPS

This power supply delivers $\pm 8 \text{ V}/\pm 100 \text{ mA}$. Output voltages can be adjusted $\pm 15\%$ from nominal. Although simple and economical, this circuit displays excellent performance. For a simultaneous $\pm 15\%$ input voltage variation and a 0-100% load variation, output voltage remains within $400 \mu\text{V}$ of its nominal value. Output noise (worst case) is less than $15 \mu\text{V rms}$, and dc output impedance is less than 10^{-3} ohm up to 30 Hz. From this frequency upward, it rises 6 dB/oc-

tave.

This supply is unconditionally stable with any kind of reactive load; thus it is possible to parallel both outputs with $1000\text{-}\mu\text{F}$ capacitors. Output noise is then reduced to $5 \mu\text{V rms}$, and output impedance remains less than 0.1 ohm at any frequency.

Jean-Francois Delpuch, MS, DSc, Institut d'Electronique, 91-Orsay, France

VOTE FOR 313

Ordinary 3 x 5 index card makes a handy ruler

A simple way to make approximate measurements when no ruler is handy is to use an ordinary 3 x 5-inch index card folded as shown. With just two folds, 1, 2, 3, 4 and 5-inch measurements can be made. If you make it a habit to carry a few of these cards for note taking, a ruler suitable for making rough estimates is easily constructed.

First, fold the lower left corner on a diagonal so that the left edge coincides with the top. Next, fold the piece on the right in half.

When the card is unfolded, the creased edges will provide five different increments, as shown in the diagram.

Ruby G. Lowenstein, Designer, Hampton Bays, N.Y.

VOTE FOR 312

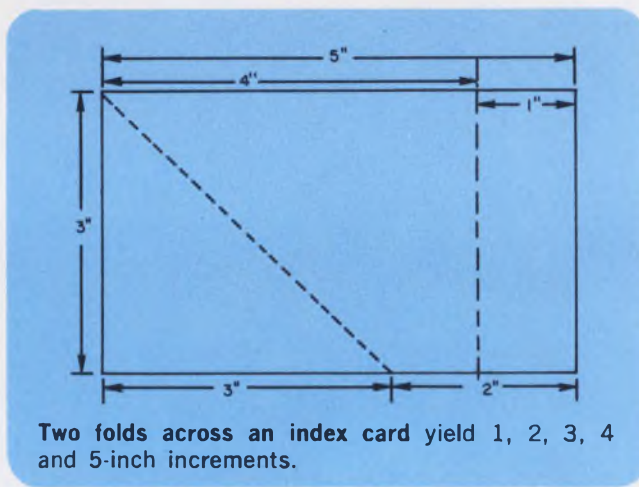

Electronically tuned notch filter uses FET as a resistor

The resonant frequency of a twin-T notch filter can be varied continuously over a selected frequency range with the aid of FET switches in the resistive arms. This results in an electronically tuned notch filter.

The FET switches are driven from a variable-frequency generator with fixed cycle length. Variation in generator duty cycle will change the effective resistance of the notch filter resistive arm so that the effective resistance increases with switching frequency. Unit-to-unit variation between FET ON impedances is about 150Ω . Circuit sensitivity to differences in FET ON impedance is reduced by making the notch filter resistive arm values about 30 times greater than 150Ω . With a view to retaining this same ratio in the upper resistive arm, a paralleled FET combination is used.

The twin-T filter shown in Fig. 1 has a notch frequency that can be varied from 30 to 800 Hz.

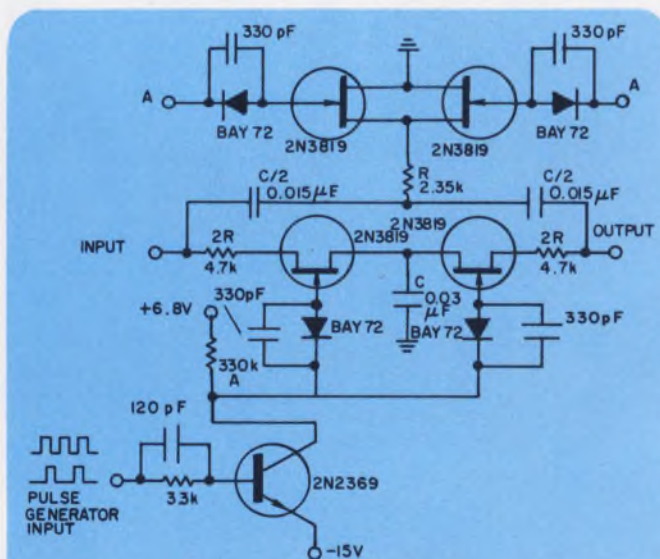

1. Electronic tuning exploits controlled variation in FET ON resistance for this twin-T design.

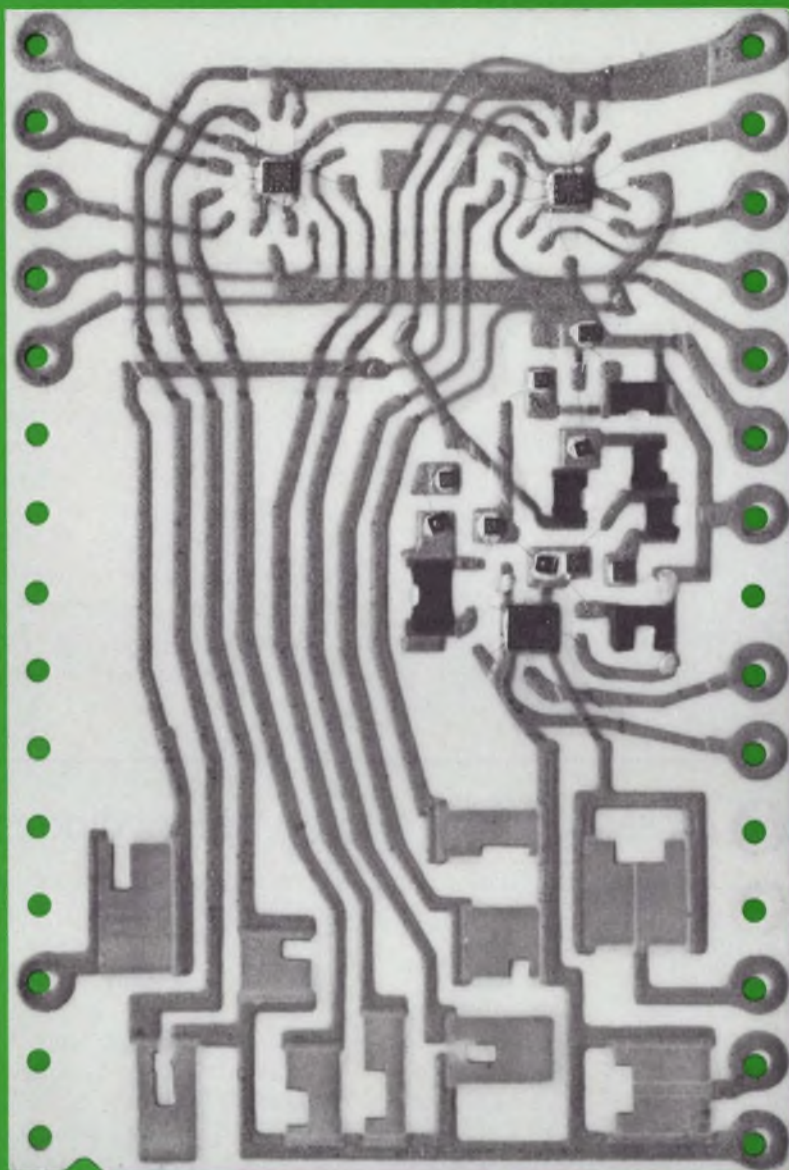

4 X Actual Size.

A complete 8-bit Digital-to-Analog Converter for \$75!

The new Helipot Model 845 is a thick-film, miniaturized hybrid digital-to-analog converter (DAC) that converts an 8-bit binary word into an analog output. The input gates, switches, resistor network, reference voltage, and output amplifier are all in the hybrid module.

Because of its operating temperature range (-20°C to $+85^{\circ}\text{C}$), Model 845 can be used for any industrial digital-to-analog conversion, process control being a typical application. Price is \$75/unit in 1-9

quantities (less in greater numbers). The package size is 1.0 inch x 1.5 inches x 0.170 inch. The unit accepts an 8-bit, parallel, binary word that is TTL- and DTL-compatible, and an enable gate is provided. Four different output-voltage ranges are available as standard models: two unipolar (0 to +5 v, 0 to +10 v) and two bipolar (-5 to +5 v, -10 to +10 v). Power-supply requirements are +15 v at 60 ma and -15 v at 10 ma. The output accuracy is $\pm 1/2$ least-significant bit at $25^{\circ}\text{C} \pm 1$ mv

per percent of supply-voltage variation. The output-current range is 0 to ± 2.5 ma, and the output slew rate is 0.3 v/ μsec .

And, it's available from stock.

Beckman

INSTRUMENTS, INC.

HELIPOT DIVISION

2500 HARBOR BOULEVARD

FULLERTON, CALIFORNIA 92634

INTERNATIONAL SUBSIDIARIES: AMSTERDAM; CAPE TOWN; GENEVA; GLENROTHES, SCOTLAND; LONDON; MEXICO CITY; MUNICH; PARIS; STOCKHOLM; TOKYO; VIENNA

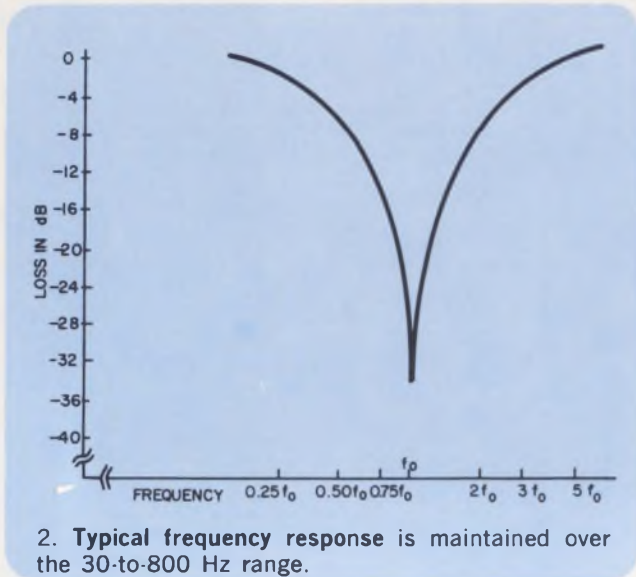

For this particular network the switching pulse length was fixed at $2.5 \mu\text{s}$, and the frequency adjusted over the range 10 to 200 kHz; the lowest switching frequency being more than 10 times greater than that of the highest frequency handled by the filter. The resonant frequency for the filter is given by:

$$f_0 = 1 / (2\pi RC)$$

A low-pass filter can be connected at the network output to remove the effects of the switching frequency. The frequency response of the notch filter is shown in Fig. 2. To obtain a smooth continuous sweep of the notch frequency, the FET switches may be driven from a voltage/frequency converter, which in turn is driven by a voltage ramp generator.

Stanley Summerhill, Design Engineer, Servette, Geneva, Switzerland.

VOTE FOR 314

High-speed zero crossing detector uses tunnel diodes

A tunnel diode and a differential amplifier can form a high-speed zero crossing discriminator with broad dynamic range, high input resistance and high input sensitivity.

For the circuit shown in Fig. 1, the collector currents of Q_1 and Q_2 are equal when the input signal is zero. When a negative input signal is fed to Q_1 , I_{c1} decreases and so does V_d . When $V_d = E_s$ (switching voltage) the tunnel diode switches from the high to the low voltage state. A further increase of negative input signal lowers the tunnel diode voltage. When Q_1 is cut off, V_d is zero.

If two matched emitter-base breakdown protection diodes (D_1 and D_2) are provided, the input signal can exceed the emitter-base junction breakdown voltage of Q_1 but offset will be prevented.

For the trailing edge of the input signal, Q_1 is turned on, and collector current increases. When $I_c R$ equals E_t (threshold voltage) the tunnel diode switches from the low to the high voltage state. This switching corresponds to low-level discrimination.

If both Q_1 and Q_2 have tunnel diodes in their

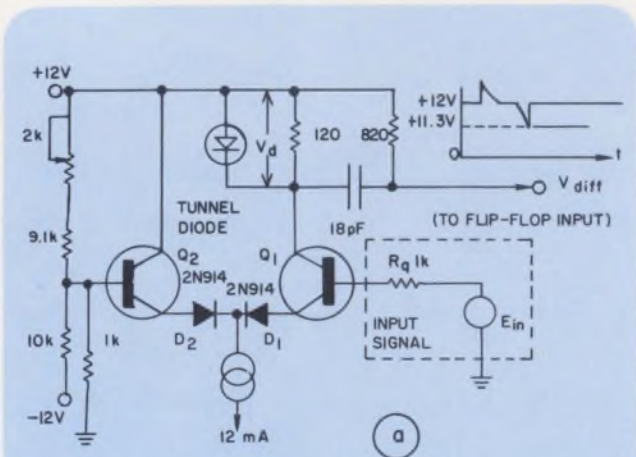

1. Basic zero crossing discriminator uses one tunnel diode.

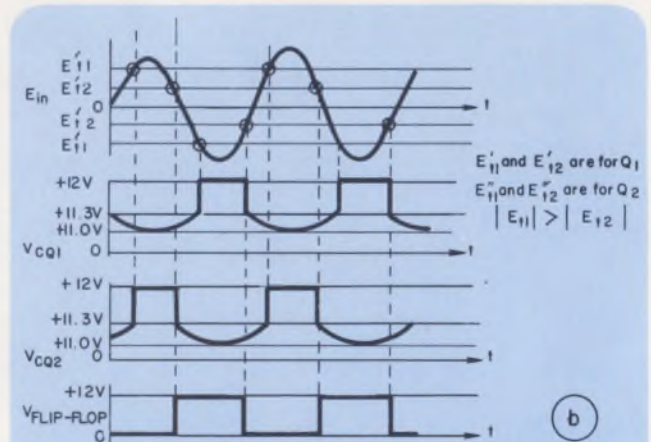

2. Zero crossing detector waveforms produced when tunnel diodes are connected to the collectors of both Q_1 and Q_2 . (Second tunnel diode not shown in figure 1).

FROM THE

WAVE MAKERS:

A NEW SERIES OF SOLID STATE PROGRAMMABLE OSCILLATORS



Krohn-Hite's Series 4100 Rack-Mounted Solid State Programmable Oscillators are the new generation of medium-priced, precision general purpose oscillators. They combine the convenience of automatic programmed frequency and amplitude selection with the outstanding performance characteristics of the popular Model 4100 Push-Button Oscillator. Covering the frequency range of 0.1 Hz to 1 MHz, Series 4100 Programmable Oscillators boast a frequency calibration accuracy as low as 0.1%.

Available in four models, Series 4100 Oscillators are designed for either standard manual operation or automatic programmed frequency or amplitude selection by any one of several commonly available means, such as computer output, punched cards, punched tape or computer mag tape. Programming format is the standard 1-2-4-8 binary coded decimal system. A unique feature of the Series 4100 Programmable Oscillators is the capability to produce both sine and square wave outputs with 1/2 watt of power into 50 ohms with remote or local frequency control. Best of all, Series 4100 provides a degree of frequency stability, low distortion, and amplitude stability that can't be matched by competitive units.

The following chart provides a brief rundown of the important operating parameters of the new generation Series 4100 Solid State Programmable Oscillators. And don't forget the model 4100A non-programmable oscillator is still available at \$550. They're all products of the recognized leader in variable filters who's out to make waves in oscillators, too. For complete technical information on any of these new Krohn-Hite Oscillators, write THE WAVEMAKERS: Krohn-Hite Corporation, 580 Massachusetts Avenue, Cambridge, Massachusetts 02139 U.S.A.

Tel: (617) 491-3211 TWX: 710-320-6583

| SERIES 4100 SOLID STATE PROGRAMMABLE OSCILLATORS | | | | | | | | | |
|--|------------|--------------|------------|------------------|-------|-------------|-----------------|----------------------------|--------|
| Frequency Range | Osc. Model | Freq. Acc. % | Max. Volts | Output Impedance | Dist. | Square Wave | Prog. Amplitude | Approx. Ship. Wt. lbs. kgs | Price |
| 0.1 Hz to 1 MHz | 4131R | 0.1 | 10 RMS | 50 | 0.02% | yes | no | 30/15 | \$1375 |
| 0.1 Hz to 1 MHz | 4141R | 0.1 | 10 RMS | 50 | 0.02% | yes | yes | 30/15 | \$1585 |
| 1 Hz to 1 MHz | 4130R | 0.5 | 10 RMS | 50 | 0.02% | yes | no | 27/13 | \$1075 |
| 1 Hz to 1 MHz | 4140R | 0.5 | 10 RMS | 50 | 0.02% | yes | yes | 27/13 | \$1285 |

KH KROHN-HITE
CORPORATION

OSCILLATORS / FILTERS / AC POWER SUPPLIES / AMPLIFIERS

collectors, the circuit can be used to discriminate zero crossings of an alternating input waveform, as shown in Fig. 2. In this case, the threshold voltages E_{11} and E_{12} can be adjusted independently. After differentiation, the Q_1 and Q_2 collector voltages are fed to the input of a flip-flop.

With a 5 mA Gallium Arsenide tunnel diode, 5 mV sensitivity was obtained.

Marin Sampaleanu, Design Engineer, Institute of Atomic Physics, Bucharest, Romania.

VOTE FOR 315

VOTE! Go through all Idea-for-Design entries, select the best, and circle the appropriate number on the Reader-Service-Card.

SEND US YOUR IDEAS FOR DESIGN. You may win a grand total of \$1050 (cash)! Here's how. Submit your IFD describing a new or important circuit or design technique, the clever use of a new component or test equipment, packaging tips, cost-saving ideas to our Ideas-for-Design editor. You will receive \$20 for each accepted idea, \$30 more if it is voted best-of-issue by our readers. The best-of-issue winners become eligible for the Idea Of the Year award of \$1000.

Chart speeds the design of single-layer air-core coils

The use of a chart simplifies the design of air-core inductors. This is true in cases where the coil radius winding pitch (turns per inch) and required inductance are known. Such cases arise when commercial coil stock is used, or when a coil is to be wound with known pitch (such as close spaced) on a form of known radius.

Use of the chart is most easily accomplished with a pair of dividers. From the calculation of step 1, fix one point of the dividers at x on the X-axis. From vertical intersection with proper radius curve, place the other point at y on the Y-axis. Swing the arc from y around to the X-axis to obtain coil length on the X-axis.

As shown in the figure, the coil length is determined directly from the curves. The length of

the coil is given by

$$\ell = X + \sqrt{X^2 + Y^2},$$

where

$$X = \frac{5L}{r^2 n^2}$$

and

$$Y = \sqrt{1.8 r X}$$

The formula for ℓ is derived from the formula

$$L = \frac{r^2 N^2}{9r + 10\ell}$$

In this case, the total number of turns (N) is simply written as $n\ell$. The original formula for L is accurate within 1% for $\ell \geq 0.8 r$.

Arthur N. Boyars, U. S. Naval Ordnance Laboratory, Silver Spring, Md.

VOTE FOR 316

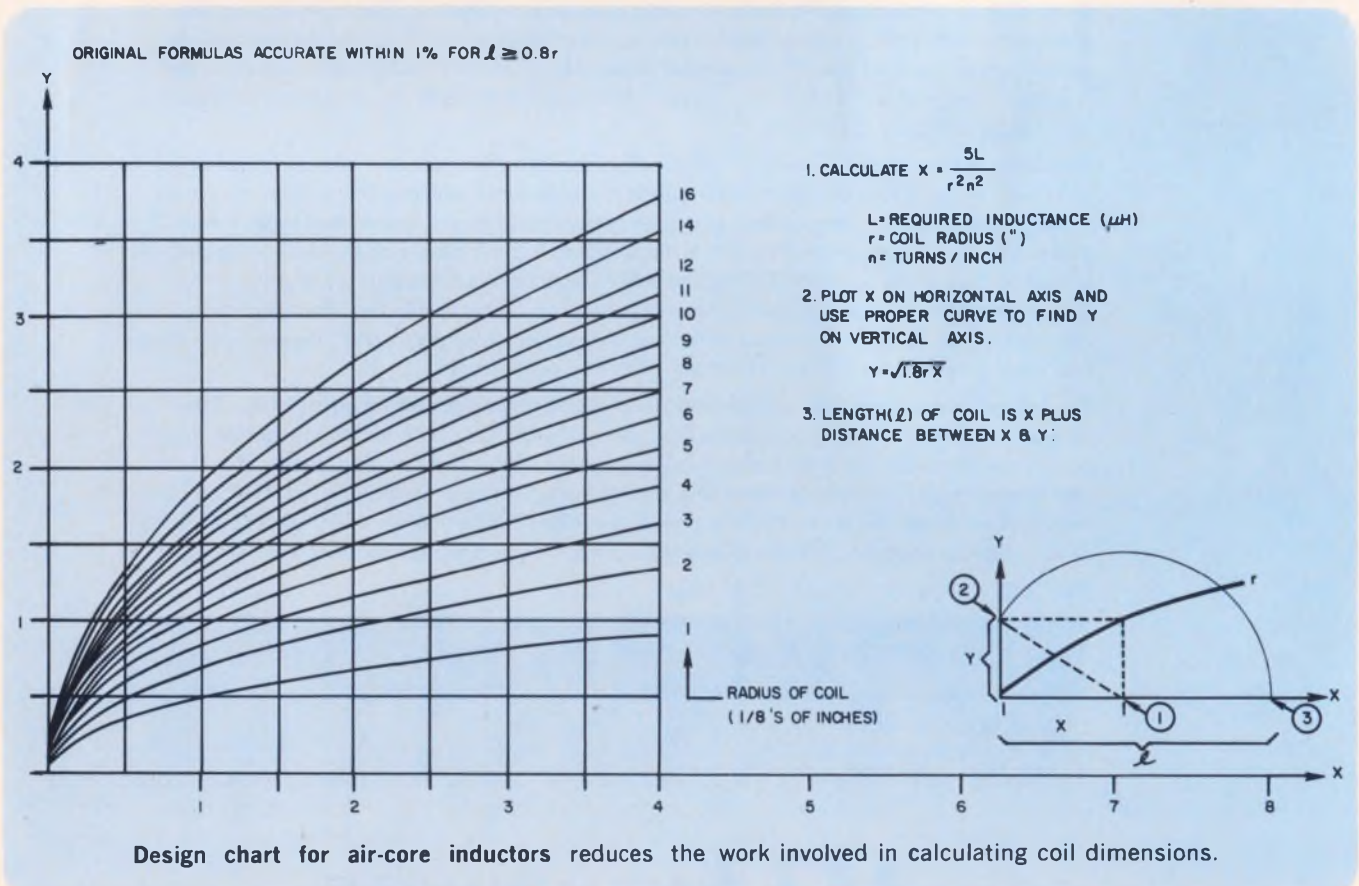

How can such a little guy uphold the family reputation?

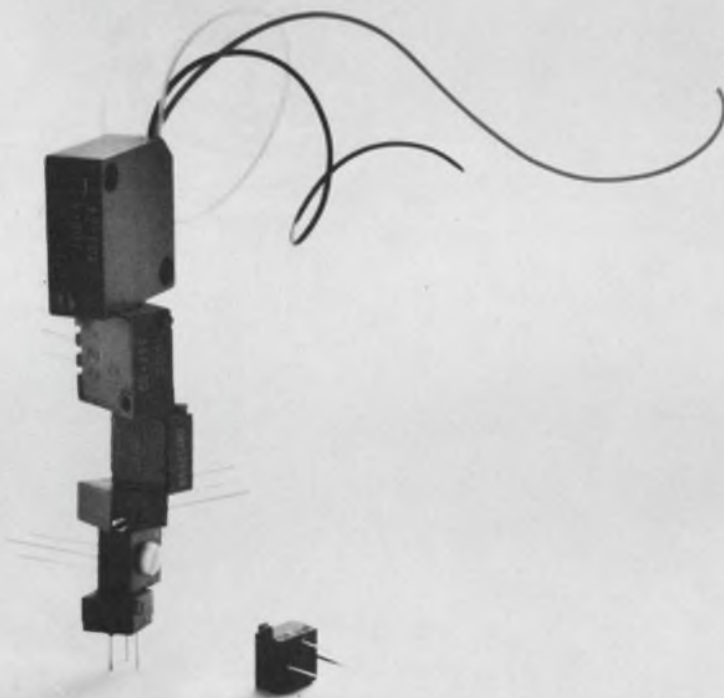

Our new 561/562 series are true Squaretrim® potentiometers down to the last quarter inch. As the smallest members of this distinguished family, they have to live up to a bigger reputation than other pots their size. They do. We made sure.

We gave them the same high quality element that makes our military pots so reliable . . . the same tight $\pm 5\%$ tolerance . . . the same wide 10 ohms to 20K standard resistance range and -55°C to $+150^{\circ}\text{C}$ temperature

range. We even designed them to meet all environmental requirements of MIL-R-27208, like their larger military brothers.

Models 561 and 562 $\frac{1}{4}$ " Squaretrims are available in three configurations, top or side adjustable, and they give you a generous 13:1 adjustment ratio. You wouldn't expect a general-purpose pot to have all these features and still be reasonably priced. But it's just another example of how our Squaretrim family supports its reputa-

tion as the biggest name in value for the smallest thing in pots.

They're in stock now at Weston Potentiometer distributors. Or ask us about special resistance values, data sheets, evaluation samples.

The little guys.

WESTON COMPONENTS DIVISION,
Archbald, Pennsylvania 18403, Weston
Instruments, Inc. a Schlumberger company

WESTON®

new

dimensions

WITH

QMF*

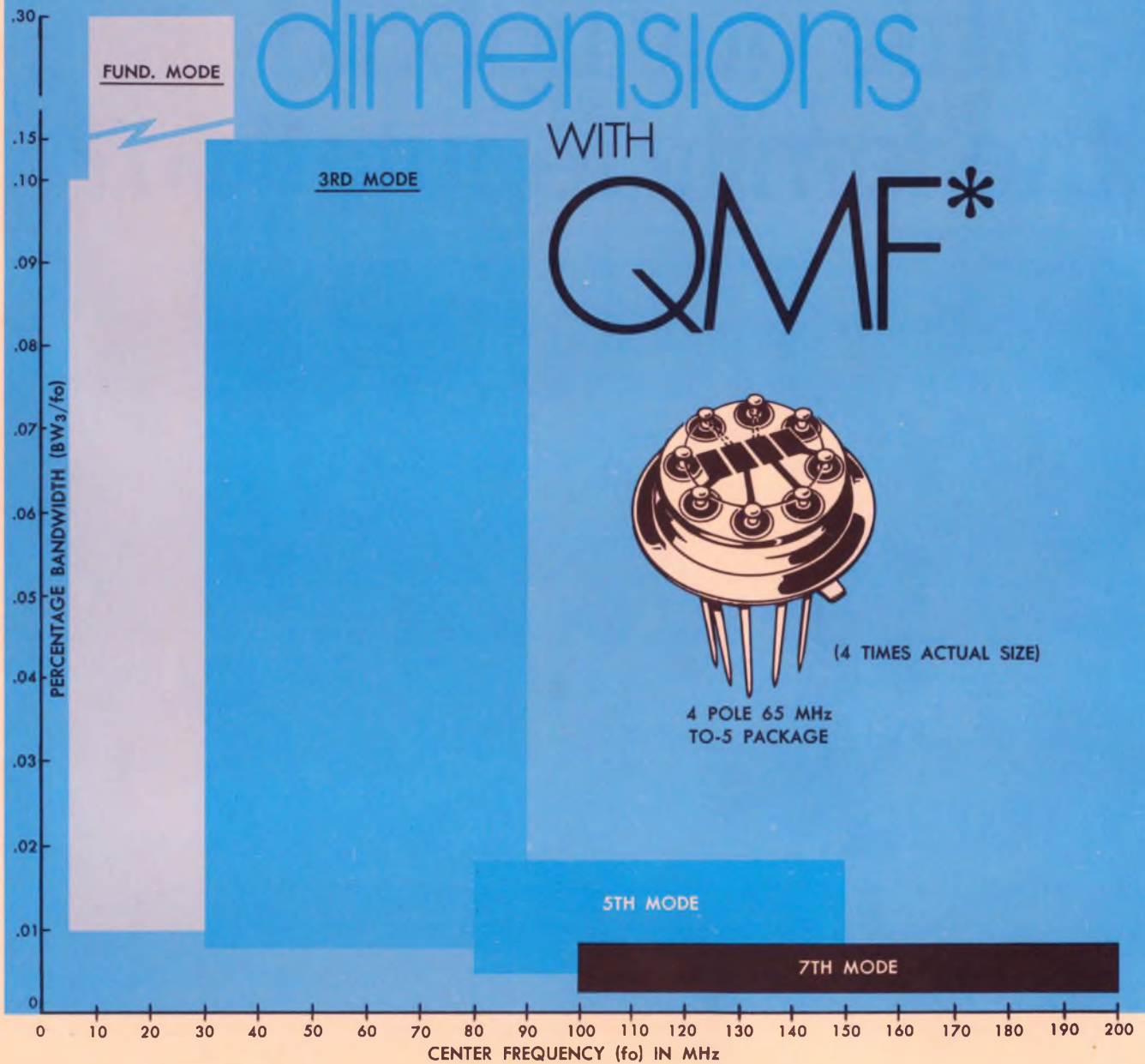

(4 TIMES ACTUAL SIZE)

4 POLE 65 MHz
TO-5 PACKAGE

(here's valuable bandwidth information you'll want to save)

Regardless of what they are called, M^CCoy Electronics Co. makes available the most complete offering of multi-electroded devices in the industry. From 5 to over 200 MHz, both crystal and filter technologies are combined to provide you assurance of competence, quality and reliability. We engineer and fabricate...

***Quartz Mechanical Filters
Uncoupled Filter Devices
Custom Innovations...**



MCCOY ELECTRONICS COMPANY
MT. HOLLY SPRINGS, PENNSYLVANIA 17065
Tel. 717-486-3411 TWX: 510-650-3548
a subsidiary of OAK ELECTRO/NETICS CORP

Put our experience to work for you!

INFORMATION RETRIEVAL NUMBER 99



The MOD Line...

Do you know about the MOD line . . . ? If you are a communications design engineer you need to know. If you are working in the areas of VHF, UHF, microwave on up through light frequencies you need to know. If you are amplifying, transmitting, receiving, oscillating, filtering, measuring or almost anything at these frequencies you need to know. Many engineers are discovering the new MOD line . . . How about you?

The MOD line includes the products and services of the Fairchild Microwave and Optoelectronics Division (MOD). The products you need to know about are:

high frequency transistors, hybrid amplifiers, microwave sources and optoelectronic sensing and emitting devices. Many engineers have found that these products make their design jobs easier and can lower their circuit or system costs.

You, our customer, and your needs make service an important part of the MOD line . . . We have a motto that explains our position on service: "Your requirements come first at Fairchild Microwave and Optoelectronics Division (MOD)." Many engineers have accomplished their design objectives faster and more efficiently because of our service.

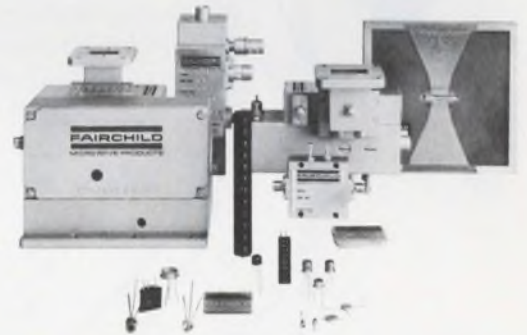

You need to know about the MOD line . . . If you haven't received your copy of the MOD line catalog circle reader service number 1. Keep your eye on number 1 because in future months it will bring you important information about new products. Number 1 is . . . The MOD line . . . circle it today.

FAIRCHILD

MICROWAVE AND OPTOELECTRONICS
A DIVISION OF FAIRCHILD CAMERA AND INSTRUMENT CORPORATION
2513 Charleston Rd., Mt. View, Ca. 94040



It Won't Work!

There's a lot more to making modules than buying a few IC's and slapping them on a board. For one thing, the modules almost never work – the first time. Almost never the second time. Occasionally the third time. And that's only the prototype.

Chances are, Digital already has the optimum design, computer tested, fully debugged, manufactured, and sitting there on the shelf. Frustrating, isn't it?

Digital's M Series is the most complete, fully compatible, high speed, integrated circuit, inexpensive line of modules anywhere. We manufacture several million a year – many for our own computers – and know how.

Send for our new Logic Handbook. It tells you what, why, and how to build logic systems from modules. But, alas, not how to build the modules themselves.

DIGITAL EQUIPMENT CORPORATION, Maynard, Massachusetts 01754. Telephone: (617) 897-5111 / Cambridge, Mass. / New Haven / Washington, D.C. / Parsippany, Palisades Park, N.J. / Princeton, N.J. / Rochester, N.Y. / Long Island, N.Y. / Philadelphia / Pittsburgh / Cleveland / Dayton / Huntsville / Cocoa, Fla. / Chicago / Denver / Ann Arbor / Salt Lake City / Houston / Albuquerque / Los Angeles / Palo Alto / Seattle. INTERNATIONAL, Carleton Place and Toronto, Ont. / Montreal, Quebec / Edmonton, Alberta, Canada / Reading and Manchester, England / Paris, France / Munich and Cologne, Germany / Oslo, Norway / Stockholm, Sweden / Sydney and West Perth, Australia.

digital
MODULES • COMPUTERS

Product Source Directory

Random Noise Generators

This Product Source Directory, covering Random Noise Generators, is the ninth in a continuing series of product selection data that will list comparative specifications and prices for products frequently purchased by design engineers. All categories will be arranged according to some primary parameter so that items having similar functional capabilities can be instantly compared.

How to use the tables

The tables in this section list the specifications for random noise generators. The following abbreviations apply to all instruments listed:

n/a—not applicable

| Name | Company | Reader Service No. |
|-----------|---|--------------------|
| Aerospace | Aerospace Research Inc. 130 Lincoln St. Boston, Mass. 02135 (617) 254-7200 | 465 |
| AIL | Airborne Instrument Labs Comac Road Deer Park, L.I., N.Y. 11735 (516) 595-3215 | 466 |
| B&K | B&K Instruments Inc. 5111 W. 164th St. Cleveland, Ohio 44124 (216) 267-4800 | 467 |
| Elgenco | Elgenco Inc. 1550 Euclid St. Santa Monica, Calif. 90404 (213) 451-1635 | 468 |
| Gen Micro | General Microwave Corp. 155 Marine St. Farmingdale, N.Y. 11735 (516) MY 4-3600 | 469 |
| GR | General Radio Co. 22 Baker Ave. W. Concord, Mass. 01781 (617) 369-4400 | 470 |

ina—information not available

An index of models by manufacturer is included at the end of each table.

For each table, the instruments are listed in ascending order of one major parameter. The column containing this parameter is color-coded white. Manufacturers are identified by abbreviation. The complete name of each manufacturer can be found in the Master Cross Index.

Sweep Generator Addendum

The sweep generator (ED 25, December 6, 1969) product source directory listing Kay Electric products is replaced by this addendum.

| Name | Company | Reader Service No. |
|---------|--|-------------------------------------|
| H-P | Hewlett-Packard Co. 1501 Page Mill Rd. Palo Alto, Calif. 94304 (415) 326-7000 | Contact Local Sales Office |
| Marconi | Marconi Instruments 111 Cedar Lane Englewood, N.J. 07631 (201) 567-0607 | 471 |
| PRD | PRD Electronics Inc. 6801 Jericho Tpke. Syosset, N.Y. 11791 (516) 364-0400 | 472 |
| R-S | Rohde & Schwarz 111 Lexington Ave. Passaic, N.J. 07055 (201) 773-8010 | 473 |
| Scott | Scott Instrument Labs. Div. of H. H. Scott Inc. 111 Powdermill Rd. Maynard, Mass. 01754 (617) 897-8801 | 474 |

Index by Model Number

| Name | Model | Code | Name | Model | Code | Name | Model | Code |
|--------------------------|-----------|------|--------------------------|---------|------|------------------------|---------|------|
| Aerospace | NS-C | NG3 | Gen Micro | 503 | NG3 | | X501D | NG7 |
| Aerospace Research, Inc. | NSLB | NG3 | General Micro-wave Corp. | 504 | NG3 | | X501D-5 | NG7 |
| AIL | 07001 | NG3 | | A501C | NG8 | GR | 1381 | NG2 |
| Airborne | 07009 | NG6 | | C501C | NG6 | General Radio | 1382 | NG2 |
| Instrument Lab. | 07010 | NG4 | | C501C-5 | NG6 | Co. | 1383 | NG3 |
| | 07012 | NG5 | | E501C | NG8 | | 1390-B | NG2 |
| | 07048 | NG5 | | F501C | NG8 | H-P | 343A | NG4 |
| | 07049 | NG5 | | G501C | NG5 | Hewlett-Packard | 345B | NG3 |
| | 07050 | NG6 | | G501C-5 | NG5 | Co. | 349A | NG5 |
| | 07051 | NG6 | | J501C | NG6 | | 3722A | NG2 |
| | 07052 | NG7 | | J501C-5 | NG7 | | 8057A | NG1 |
| | 07053 | NG8 | | K501C | NG8 | | G347A | NG5 |
| | 07091 | NG8 | | M501C | NG8 | | H347A | NG6 |
| | 07096 | NG8 | | N501C | NG4 | | J347A | NG6 |
| B&K | 1024 | NG1 | | N501C-5 | NG4 | | P347A | NG7 |
| B&K | 1042 | NG1 | | N510-1P | NG4 | | X347A | NG7 |
| Instruments | 1402 | NG1 | | N510-2 | NG4 | Marconi | 2091 | NG3 |
| Elgenco | 301A | NG1 | | N510-2P | NG4 | Marconi | 7816 | NG1 |
| Elgenco, Inc. | 311A | NG1 | | N510-3 | NG5 | Instruments | | |
| | 312A | NG1 | | N510-3P | NG5 | PRD | 904-A | NG4 |
| | 321A | NG1 | | N510-4 | NG6 | PRD | | |
| | 331A | NG2 | | N510-4P | NG6 | Electronics | | |
| | 602A-200 | NG2 | | N510-5 | NG7 | R-S | SKTW | NG4 |
| | 602A-1390 | NG2 | | N510-5P | NG7 | Rohde & Schwarz | SUF | NG3 |
| | 603A | NG2 | | N510-6P | NG7 | | | |
| | 610A | NG3 | | S501C | NG4 | Scott | 811BC | NG2 |
| | 624A | NG2 | | S501C-5 | NG5 | Scott Instrument Labs. | | |
| | 632A | NG1 | | U501C | NG7 | | | |
| | | | | U501C-5 | NG8 | | | |



CLIFTON'S new one-inch cube DC MOTOR delivers the torque of units twice its size.

Save space and weight with this DC Motor which offers peak torque of 7.5 oz-in and torque sensitivity of 5.3 oz-in/amp from a one-inch cube. Clifton quality, reliability and long life are built in ingredients.

For further information, write or call your local Clifton Sales Office or 5050 State Rd., Drexel Hill, Pa. 19026. 215 622-1000; TWX 510 669-8217.

CLIFTON 
DIVISION OF LITTON INDUSTRIES

INFORMATION RETRIEVAL NUMBER 166

We'll hybrid thick-film your circuit in our new $\frac{1}{4}$ " x $\frac{3}{4}$ " flat pack, and get you into some tight spots.

Getting you into tight spots is one way of getting you out of them. For now you can design your circuit confident that everything will fit. And we can produce that custom circuit flawlessly.

Our exclusive $\frac{1}{4}$ " x $\frac{3}{4}$ " T3 configuration enables you to do just about anything with the available area. First, because of its unique dimensions. Also, because it comes in 3 basic variations.

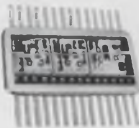

With all 14 leads coming out of one side, it can lay flat or stand. It is also available with leads on both sides. Or, in a dual in-line configuration. Name it. You've got it. Just about.

But we've got more than just a nice new shape for you. We have the facilities to produce prototypes or

large quantities fast. In a high reliability environment.

Our people, materials and equipment conform to the highest standards. For instance, Mil-Std-883. We test, check and counter-check. And our clean rooms provide the optimum production atmosphere.



What's more, if you need it, we'll help you solve design problems.

We can produce your design in our $\frac{1}{4}$ " x $\frac{3}{4}$ " hybrid thick-film flat packs now. Find out how it can fit into your plans. Write or call: Columbia Components Corporation, 60 Madison Avenue, Hempstead, New York 11550 (516) 483-8200. On the West Coast: (213) 272-9525.



COLUMBIA COMPONENTS CORP.

A SUBSIDIARY OF COMPUTER INSTRUMENTS CORP.

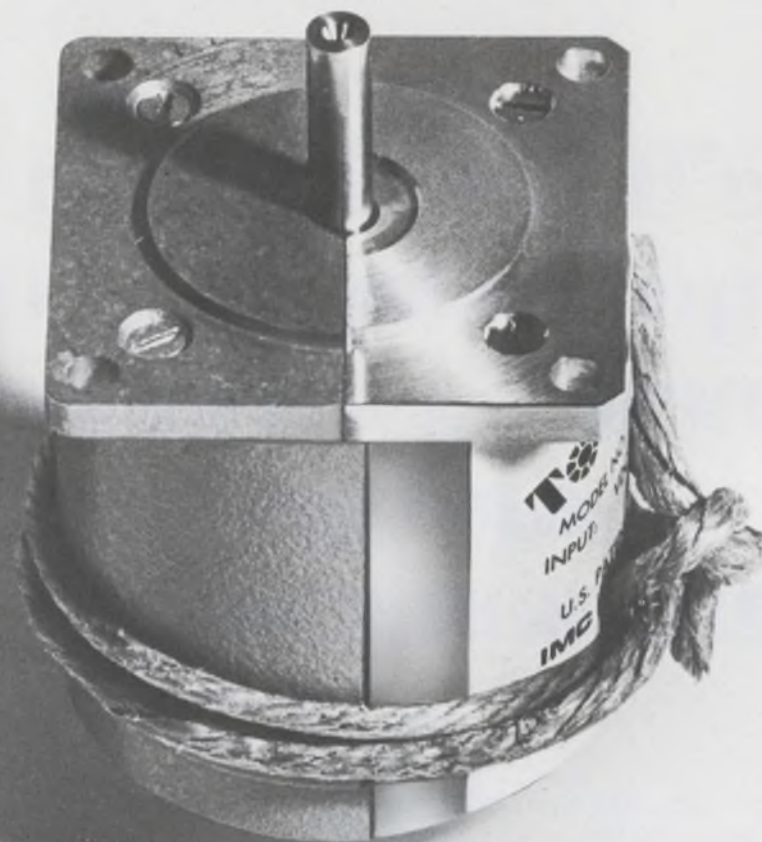

The Better Halves.

Or how to get the best of 2 single source suppliers.

Have the best of choices.

Try IMC's newly patented Tormax 200.

It's directly swappable with the other one.

Steps in 1.8-degree increments at rates up to 550 steps/sec.

Turns at 72 rpm from a 60-Hz input.

Backed by IMC's extensive stepper design and manufacturing capability.

Available immediately in standard models.

A little longer for dual shafts, splines, keyways, different mounts, and so forth.

IMC Magnetics Corp., Western Division, 6058 Walker Avenue, Maywood, California 90270, Tel. (213) 583-4785, TWX 910-321-3089.



New Products

Coin-sized electrochemical storage device gives 50-F capacitance with 0.5-V rating

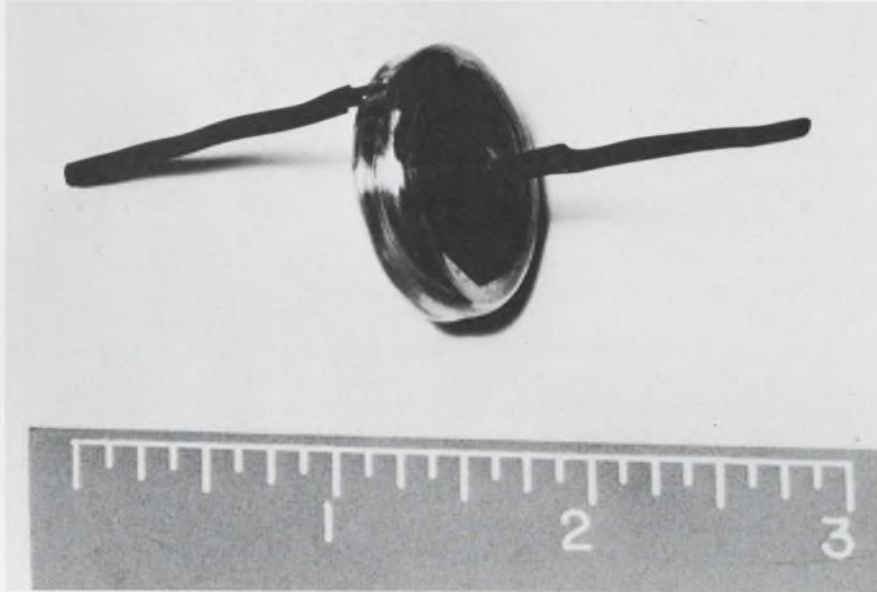

Gould Ionics Inc., P.O. Box 1377, Canoga Park, Calif. Phone: (213) 341-1040. P&A: \$50; 2 to 4 wks.

Called an energy storage device (ESD), a new electrochemical capacitive component bridges the gap between a conventional capacitor and a secondary battery. About the size of a one-half dollar, the ESD attains capacitances of about 50 farads with an approximate internal resistance of 1 to 2 Ω .

The new device is made of pressed powder wafers and is currently intended for straight dc applica-

tions. It makes possible sample-and-hold circuits that can store information for weeks. Other applications include integrators for industrial control and standby power supplies for electrically volatile avionics memories.

Because of the magnitude of its capacitance and internal resistance, this poker-chip-sized component exhibits a very long time constant. This means it can retain charge for long periods of time—one ESD for example, was charged in June, 1969 and still retains over 96% of

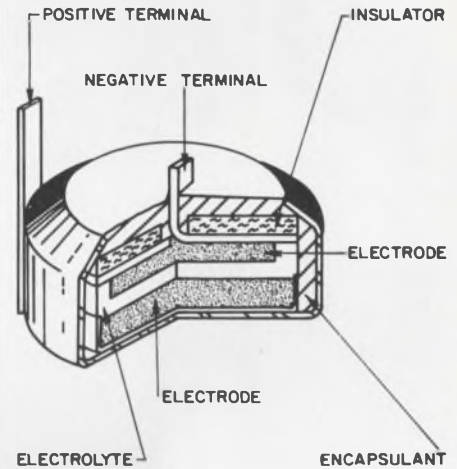

Electrochemical capacitive device, about the size of a poker chip, uses pressed-wafer construction to achieve capacities of 50 F at 0.5 V.

its energy today.

A single ESD, or cell, has a voltage limit of 0.5 V. However, higher voltages can be obtained by stacking the cells in series.

Each cell contains two electrode wafers separated by an electrolyte wafer. The high capacitance is due to the maximization of the electrode electrolyte interface area in structures of a finely divided blend of carbon and the electrolyte.

Evaluation units are available with either a 0.5 or 1-in. dia.

CIRCLE NO. 365

Also in this section:

Ultraminiature rf switch operates at 10-mW power levels from 10 MHz to 1 GHz. p. 234.

High-speed semiconductor memory systems cost as little as 1.2¢ per bit. p. 238.

Precision dc voltage regulator compensates for component thermal drift. p. 243.

Circuit packaging system lets designer go from sketch to same-day prototype. p. 266.

Evaluation Samples, p. 268. Design Aids, p. 270. Annual Reports, p. 272.

Application Notes, p. 274. New Literature, p. 276.

PC-board reed relays squelch thermal emf



Self-Organizing Systems, Inc., P.O. Box 9918, Dallas, Tex. Phone: (214) 276-9487. Availability: stock.

Mounting directly on PC boards, series 545 Chemtron reed relays hold thermal emf to less than $3 \mu\text{V}$ across their contacts at 100% duty cycles. The new units feature electrostatic shielding, magnetic shielding, and IC-driven 4.5-V coils. They are available with one, two or three-pole normally open contacts and 12-V coils for transistor drivers.

CIRCLE NO. 366

Small T-1-3/4 lamp focuses end beam



Lamps, Inc., 17000 South Western Ave., Gardena, Calif. P&A: from 60¢; 4 wks.

Claimed to be an industry first, a new type 253 subminiature lamp projects a critically focused lens-end beam. Its design uses a straight-sided glass envelope—T-1-1/4 from lens-end to base—aligned in a T-1-3/4 base to assure perfect fit. Measuring 0.2 in. in dia and 0.69 in. in length, the new lamp is rated at 2.5 V and 35 A, $\pm 10\%$. Its average life is said to be 10,000 hours.

CIRCLE NO. 367

Subminiature lamps accept low inputs



Chicago Miniature Lamp Works, 4433 N. Ravenswood Ave., Chicago, Ill. Phone: (312) 784-1020.

Designed for applications requiring illumination from low-current sources, a new line of T-1 subminiature lamps offer a maximum rating of 30 mA and an average current range from 20 to 25 mA. These fine-wire-filament units are aged for 16 hours to insure long lamp life and dependable operation. They can be driven directly from low-output integrated circuitry.

CIRCLE NO. 368

Low-voltage neon lamps generate HV internally



Alcolite Div. of Alco Electronic Products, Inc., Box 1348, Lawrence, Mass. Phone: (617) 686-3887. P&A: from \$4.85; stock.

Containing transistorized internal generators, the LVN series of Logilite neon lamps provide the necessary high voltage to excite the neon from a low-voltage source. Each lamp has a normal operating voltage of 5 V dc and a normal current of 30 mA. Maximum and minimum ranges are 6 V at 36 mA and 4 V at 31 mA, respectively.

Booth No. 4G23 Circle No. 253

Chip capacitors come in EIA sizes

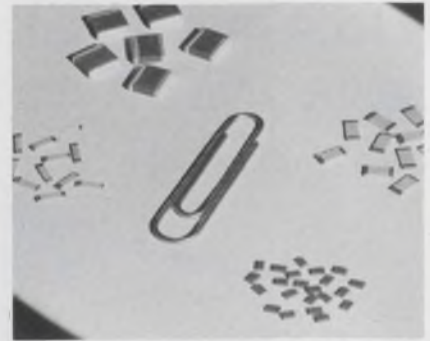

Vitramon, Inc., P.O. Box 544, Bridgeport, Conn. Phone: (203) 268-6261.

A line of EIA-standard-size chip capacitors is now available: the VJ0805 (0.08×0.05 in.), the VJ1805 (0.18×0.05 in.), the VJ1808 (0.18×0.08 in.), and the VJ2224 (0.22×0.24 in.). These chips have a capacitance range of 10 to 470,000 pF in NPO and general-purpose dielectrics. Standard voltage ratings are 50 V dc at 125°C and 100 V dc at 85°C , and capacitance tolerances are ± 5 , ± 10 and $\pm 20\%$.

CIRCLE NO. 369

Cermet chip resistors vary termination type

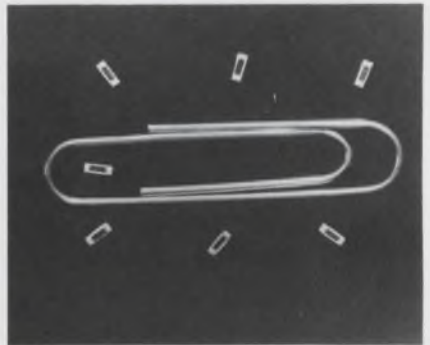

Monolithic Dielectrics Inc., 114 W. Magnolia Blvd., Burbank, Calif. Phone: (213) 848-4465. P&A: from 10¢; stock to 4 wks.

A new line of microminiature cermet chip resistors are now available in a variety of terminations for most bonding methods—including reflow soldering, thermo-compression or ultrasonic bonding, strap reflow soldering, and eutectic chip attachment. Resistances can range from 10Ω to $5 \text{ M}\Omega$, with temperature coefficients of ± 50 , ± 150 or ± 300 ppm/ $^\circ\text{C}$.

CIRCLE NO. 370



**It's not just our
MOS memory tester.
It's our commitment to
the MOS industry.**



**It's not the computers
we build.
It's the problems
we solve.**

REDCOR has delivered, or has on order, more computer-controlled MOS test systems than all other manufacturers combined. In fact, nearly 80% of all MOS LSI/MSI devices produced in the upcoming years will be REDCOR-tested. Surprising, perhaps, but true. Why this vote of confidence from so many industrial giants? One reason is that we design and build, using state-of-the-art techniques, all the system components, including the computers. And we provide the systems engineering, the software, and the field service . . . a "one source, one responsibility" commitment. MOS testing may not be your application, but whatever your systems requirement, let a REDCOR Systems Pro solve it for you.

R REDCOR CORPORATION
C Telephone: (213) 348-5892

See our MOS testers in action at IEEE — Booth 2H 13



28V DTL POWER GATE

Problem: Find 28 volt 4-input DTL power gate immune to 80 volt transients.

Solution: The Siliconix H-100 Dual Power Gate, offers high AC and DC noise rejection and operates directly from 28 volt power supplies.

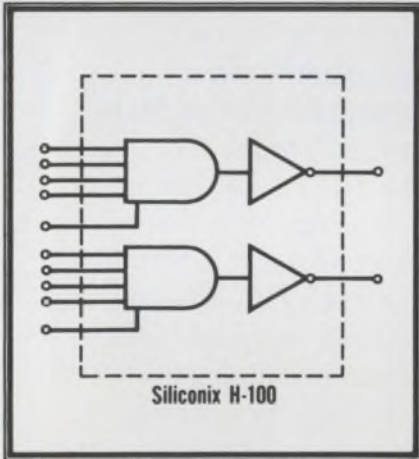

The H-100 was developed for use with noisy aircraft and marine power supplies; output drives 100 mA and sustains 90 volts. Available in TO-86 or TO-116 packages. Write or call today for the data sheet on the Siliconix H-100!

Siliconix
incorporated

2201 Laurelwood Rd. • Santa Clara, Calif. 95054
(408) 246-8000 Ext. 201 • TWX: 910-338-0227

COMPONENTS

Bounce-free switch works in any position

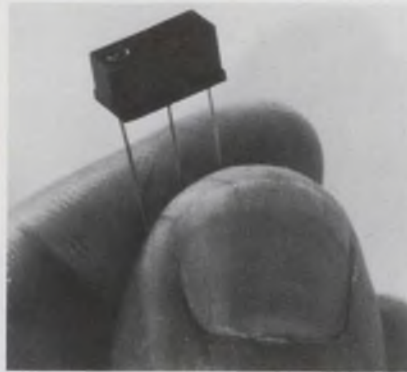

Master Specialties Co., 1640 Monrovia, Costa Mesa, Calif. Phone: (714) 642-2427. P&A: from \$14.27; stock to 3 wks.

Indicating position, a new alternate action push-button switch also serves as a non-electrical indicator of switch position. The series 800 Tellite switch has a lighted indication of switch mode when depressed to the ON position. If power fails, the lighted indication will cease, but the switch will remain in the depressed position.

CIRCLE NO. 372

No-gear servo motor runs cassettes directly



McLean Engineering Laboratories, P.O. Box 127, Princeton Junction, N.J. Phone: (609) 799-0100.

A new blower cuts audible noise to a whisper by using a solid-state motor control and a modulating thermostatic probe. For instance, if the unit senses the outlet air temperature to be 90°F, it operates at full volume to gradually cool the equipment. It then automatically decreases blower speed to maintain a constant cabinet temperature. Blower life is said to improve.

CIRCLE NO. 374

Fifth Dimension Inc., P.O. Box 483, Princeton, N.J. Phone: (609) 924-5990. P&A: \$9; stock to 4 wks.

Able to operate in any mounting position, a miniature magnetically actuated limit switch features bounce-free performance for over 50 million cycles. Designated as model 3100 Logcell, this mercury-film device occupies only 0.015 cubic inch. Its contact resistance is less than 50 mΩ, and thermal noise is less than 1 μV. Load rating is 1 A at 6 V.

CIRCLE NO. 371

Push-button switch has alternate action

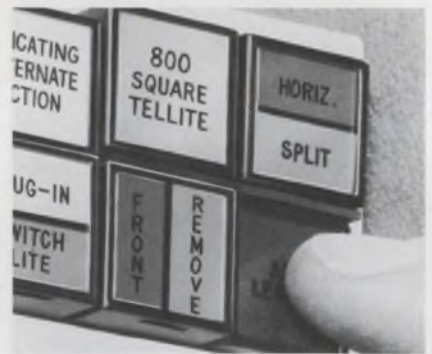

Litton Precision Products, Inc. Clifton Div., Marple at Broadway, Clifton Heights, Pa. Phone: (215) 622-1000.

Without requiring any intervening mechanical gears, a new dc servo motor can directly drive computer tape cassettes for digital data entry at speeds from 2 to 20 inches per second. The speed of this size 13 motor is controlled by the choice of oscillator frequency. Start times range from 3 to 8 ms, and speed control is accurate to ±3%.

CIRCLE NO. 373

Automatic blower senses temperature

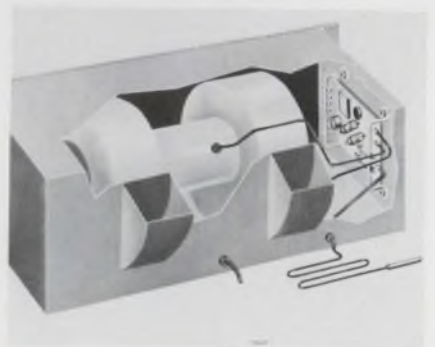

LED numerics slash price 40%

Hewlett-Packard, 1501 Page Mill Rd., Palo Alto, Calif. Phone: (415) 326-7000. P&A: \$25 to \$70; stock.

First introduced in 1968, Hewlett-Packard's 5080-7000 solid-state numeric indicator with integral decoder/driver now reflects price reductions as large as 40%. In quantities of 1000, for example, these LED numerics cost only \$25 each as compared with a previous unit price of \$42. For small quantities of 1 to 9, unit price is now \$70, instead of \$75.

CIRCLE NO. 375

Switch with 1.35-in. dia fits up to 24 positions

Grayhill, Inc., 561 Hillgrove Ave., La Grange, Ill. Phone: (312) 354-1040.

A new miniature 24-position rotary switch has a diameter of only 1.35 in. with a behind-the-panel dimension of 0.916 in. for a single-deck unit; each additional deck adds approximately 0.333 in. Model 53M15 is available with 1 to 12 poles per deck and with as many as 12 decks to a switch; a total of 12 poles is the maximum per switch. Resistive load ratings are 0.25 A at 115 V ac or 6 to 28 V dc.

CIRCLE NO. 376

Chip resistors get beam leads

IGE, P.O. Box 63, Watertown, Mass. Phone: (617) 879-5890.

Intended for hybrid and microwave circuits, new beam-lead chip resistors have tin-plated tabs for easy attachment. These $0.06 \times 0.08 \times 0.01$ -in. devices are available in standard ohmic values from 22 to 510 Ω . The chips withstand temperatures up to 200°C during circuit processing and up to 150°C for continuous operation. Temperature coefficients range from below 25 ppm to approximately 100 ppm.

CIRCLE NO. 377

A single capable source for both lamps and fiber optic light guide systems

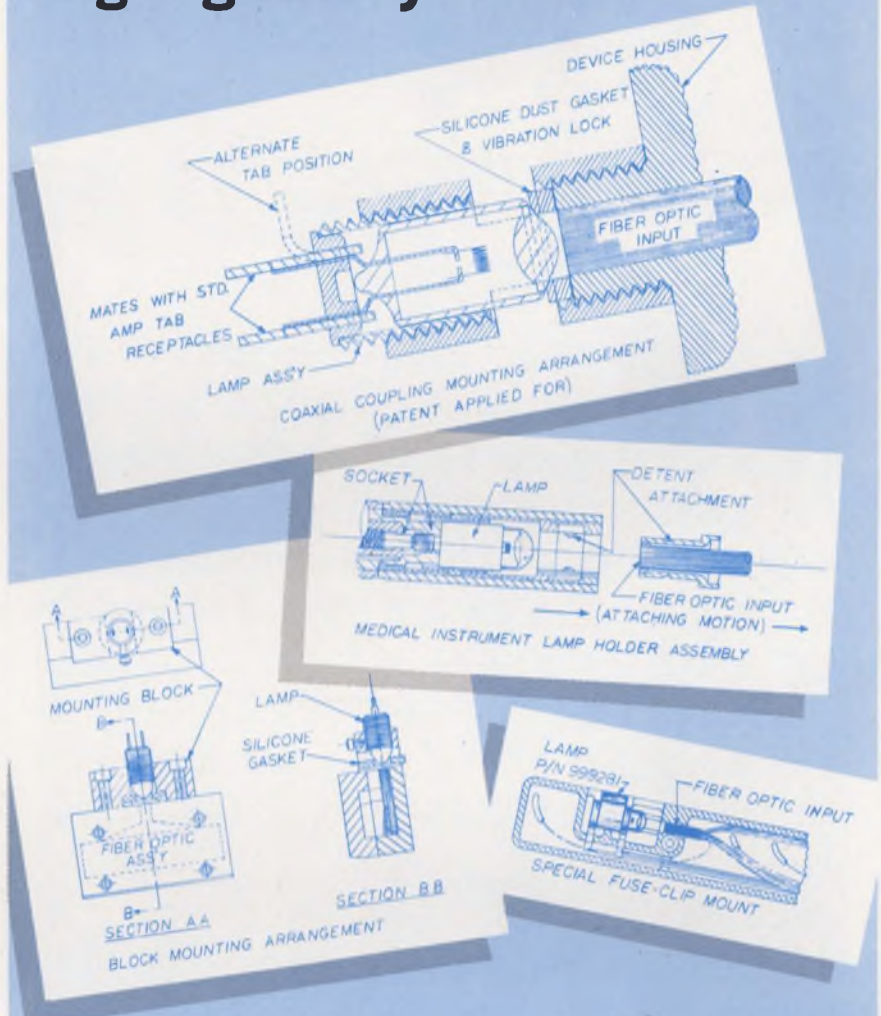

There are obvious advantages in speed, cost and often in efficiency of the ultimate system in having one source produce both miniature lamps and fiber optic assemblies. Welch Allyn has that capability.

We are major suppliers of fiber optics and incandescent illumination sources to principal computer manufacturers and other light guide users.

In addition to our standard lamp designs, we have recently developed a new family of customized miniature vacuum lamps for fiber optic and photo-sensitive device applications with selectable lens-film combinations and basing for optimum utilization of energy.

Our lamp-fiber optic systems are designed for maximum efficiency and are often less costly than standard multiple-lamp systems.

Phone or write for more information

WELCH ALLYN, INC.
Skaneateles Falls, N.Y. 13153
(315) 685-5788



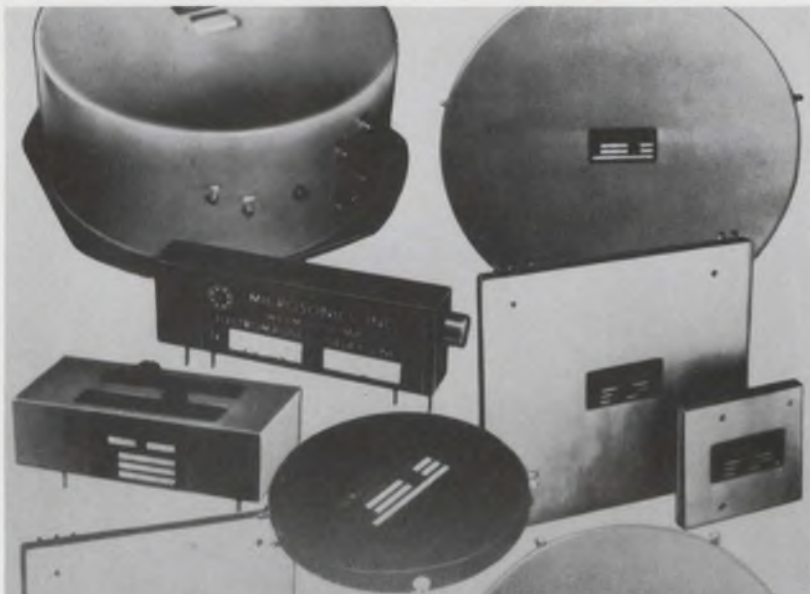

**LC & DC • DISPERSIVE • DIGITAL
MAGNETOSTRICTIVE • QUARTZ
GLASS • VARIABLE • TAPPED
LC & DC • DISPERSIVE • DIGITAL
MAGNETOSTRICTIVE • QUARTZ
GLASS • VARIABLE • TAPPED
LC & DC • DISPERSIVE • DIGITAL
MAGNETOSTRICTIVE • QUARTZ
GLASS • VARIABLE • TAPPED
LC & DC • DISPERSIVE • DIGITAL
MAGNETOSTRICTIVE • QUARTZ
GLASS • VARIABLE • TAPPED
LC & DC • DISPERSIVE • DIGITAL
MAGNETOSTRICTIVE • QUARTZ
GLASS • VARIABLE • TAPPED
LC & DC • DISPERSIVE • DIGITAL**

MICROSONICS

*for proven design, reliability &
performance in*

DELAY LINES

Serial Memories



Write for Bulletins today

MICROSONICS

60 Winter Street, Weymouth, Mass. 02188

Tel: 617 337-4200

A division of the Sangamo Electric Company

COMPONENTS

Coupled-mode filter responds with 6 poles

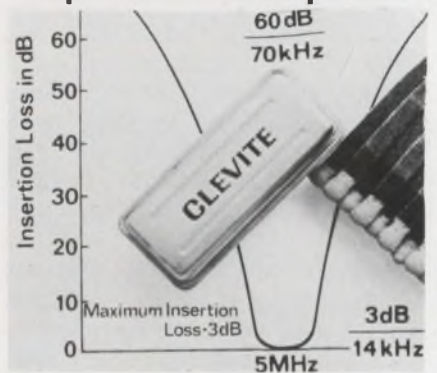

*Gould Inc., Piezoelectric Div., 232
Forbes Rd., Bedford, Ohio.*

Ideal for matching solid-state circuitry in vhf/uhf communications receivers, a new six-pole coupled-mode quartz filter offers a center frequency of 5 MHz. The device has a 3-dB bandwidth of 14 kHz, and a 60-dB bandwidth of 70 kHz. Maximum insertion loss is 4 dB, ultimate attenuation is 100 dB, and spurious mode rejection is 90 dB. Other applications include telemetry, radar and aerospace radio systems.

CIRCLE NO. 378

Triggerable spark gap switches 3000 amperes



*Siemens Corp., 186 Wood Ave. S.,
Iselin, N.J. Availability: stock.*

Designed for fast bipolar switching of high currents, a new miniature triggerable spark gap can switch up to 3000 A. Designated KAT 05-01, it transfers charges of up to five ampere-seconds per discharge and operates from 90 to 450 V. It is triggered by a high voltage pulse as short as 5 μ s and requires only 10^{-6} watt-seconds of trigger energy. It withstands transients without being damaged.

CIRCLE NO. 379

Push-button switches eliminate bounce

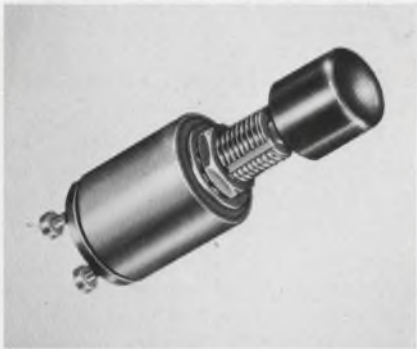

Alcoswitch Div. of Alco Electronic Products, Inc., Box 1348, Lawrence, Mass. Price: \$3.90, \$4.25.

Containing ceramic magnets, a series of new push-button switches allows switching with a light touch and features no bounce. The MSPM series of momentary-contact switches have glass encapsulated contacts and keyed non-rotating plungers. Contact bounce is 1 ms and ratings are 100 mA at 50 V dc. Available are two types: spst normally open and normally closed versions.

CIRCLE NO. 380

Geared cam switches refine indication

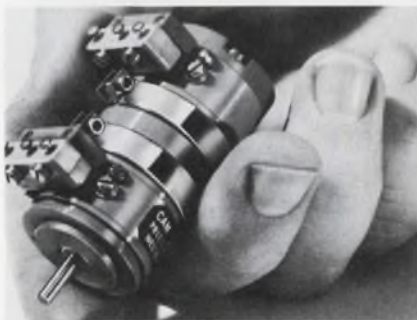

Precision Mechanisms Corp., 44 Brooklyn Ave., Westbury, N.Y. Phone: (516) 334-5955.

Able to be mounted like potentiometers, synchros or other Size-11 rotating components, series GCS100 geared cam switches combine all the features of a conventional plate cam, follower and snap-action switch. They are intended for programming, counting, timing and angle position indication. Scale factors are 1:10, 1:100, 1:36 or 1:60 between independently adjustable switches.

CIRCLE NO. 381

Heat problems? Give 'em the air...

Condor. A new high performance high reliability propeller fan providing up to 575 cfm for a wide range of cooling applications. The compact design (10-inch diameter, 3.5-inch depth) and light weight make it easy to install in a variety of equipments. 6 models with different connectors add to its versatility.



The Super boxer's exclusive new aerodynamic impeller design provides exceptional output characteristics at high back pressures. Super dependability. 2 patented bearing designs are rated at 10 years life under normal conditions. Super versatility. Compact (4.687-inch square, 1.5-inch depth), mountable inside or outside an enclosure, to intake or exhaust. Accepts all standard Boxer accessories.



DC Boxer. The small module mounted integrally on the Boxer frame accepts DC and converts it to drive the Boxer's AC motor. Does away with usual DC motor problems, such as brush wear, arcing contacts, short life, and RF noise. 8 models span the range of 12 to 38 VDC input. Cools heat sensitive equipment such as, TV cameras, sound systems, telephone equipment, etc. Accepts all standard Boxer accessories.



DC

with 3 new air-givers from IMC.

Distributor stocked nationwide for immediate delivery. As are standard Boxers, MiniBoxers, Tandem Boxers, IMCair fans and IMCair centrifugal blowers.

A new 16-page catalog provides drawings, performance parameters and complete specifications for all our airmovers. It's available from IMC Magnetics Corp., New Hampshire Division, Route 16B, Rochester, N. H. 03867, Tel. (603) 332-5300. 

Isolation was the only thing preventing a high-frequency Reed Switch Matrix Until now.



The Cunningham Reed Switch Matrix reduces high-frequency crosstalk and interference to a new low. Unique "sandwich" design seals, shields and separates matrix-mounted reed switches from their controls. Offers:

- **Excellent signal characteristics:** 50-ohm distributed. Broadband handling with top isolation. Low thermal noise.
- **100% Random access:** Any number or combination of crosspoints can be set, any place, any direction without affecting other crosspoints.
- **Computer compatibility:** Can be directly addressed by all computers using +5 volt logic. No added interfacing needed.
- **Proven reliability:** Up to 100 million operations.
- **Easy inspection and maintenance:** Control and signal sections can be separated for easy access.
- **Applications:** Interconnecting video channels; broadband data switching; test systems for nano-second digital pulses; telemetry equipment for multiple data channels; antenna switching; medical data monitoring.

Write or call for Data Sheet No. 603, Cunningham Corporation, 10 Carriage St., Honeoye Falls, New York 14472. Phone: (716) 624-2000.

Cunningham Corporation

SUBSIDIARY OF GLEASON WORKS

INFORMATION RETRIEVAL NUMBER 184

Broadband low-cost rf switch boasts tiny size of 0.025 in.³

Mini-Circuits Laboratory Div. of Scientific Components Corp., 2913 Quentin Rd., Brooklyn, N.Y. Phone: (212) 252-5252. P&A: \$40; stock to 3 wks.

Systems and instrument designers in need of miniaturization can now avail themselves of a new low-cost miniature broadband rf switch in a TO-5 case that measures only 0.025 cubic in.

The model SB-1 50- Ω rf switch, believed to be the smallest unit of its type, is capable of switching 10-mW power levels with a compression of less than 0.2 dB over a

wide frequency range of 10 MHz to 1 GHz.

It requires exceptionally low switching currents. Typical and maximum drive currents are 1 and 5 mA, respectively, over the entire operating frequency range.

Another outstanding feature is its high port-to-port isolation of better than 30 dB. Insertion loss ranges over a maximum of 1.5 to 3 dB for the ON state and 17 to 30 dB for the OFF state.

Specifications for the switching port include 5 mA of drive current, 120 Ω of nominal impedance and a standard positive polarity. Negative polarity is available on request.

Absolute maximum ratings include total input power of 25 mW and total input current of 25 mA to all ports over an operating temperature range of -65 to $+100^{\circ}\text{C}$.

The switch costs \$16 for quantities of 100 to 999 units and \$40 for quantities of 1 to 4 units.

Sockets at a cost of \$1.50 and test fixtures at a cost of \$55 are available.

CIRCLE NO. 382

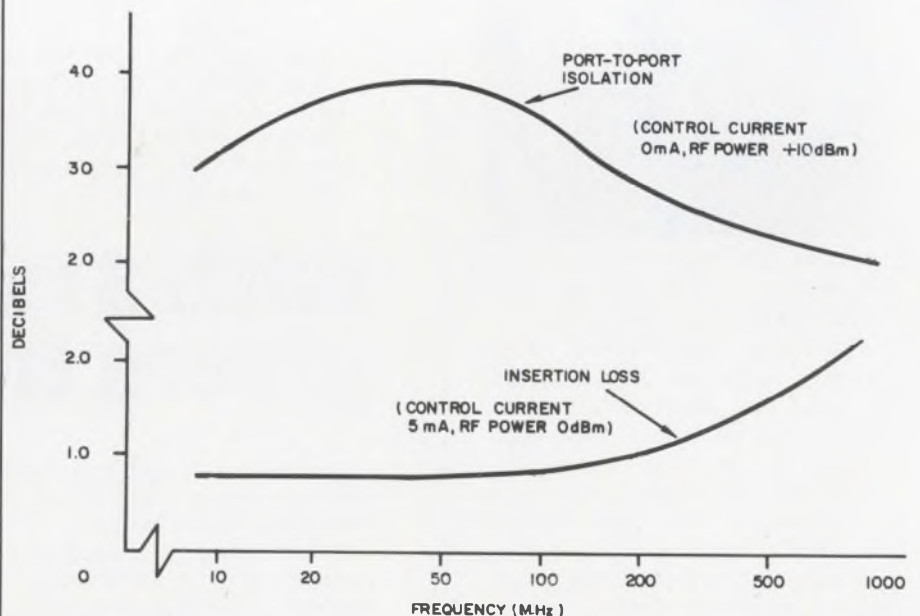
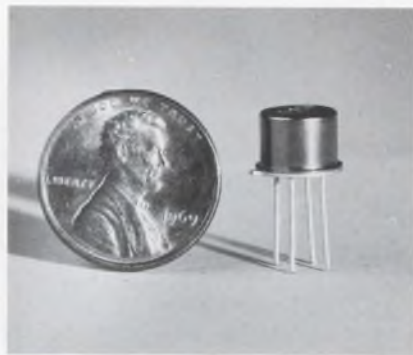

Spanning the frequency range of 10 to 1000 MHz, the model SB-1 low-cost miniature rf switch minimizes its insertion loss (1 dB typical) and maximizes its port-to-port isolation (over 30 dB typical).

Sweep generator shows 4 curves

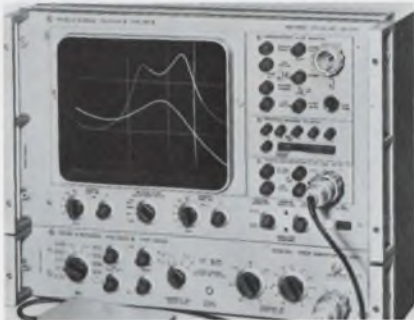

Rohde & Schwarz Sales Co., Inc.,
111 Lexington Ave., Passaic, N.J.
Phone: (201) 773-8010. Availability:
stock.

Spanning 0.1 to 1000 MHz with a harmonic content of less than 1%, the Polyskop III sweep generator can display four curves on its screen at the same time. The unit is suitable for all frequency-response measurements on two-and four-terminal networks within its range. Its output voltage is controlled by two attenuators with six 10-dB and ten 1-dB steps.

CIRCLE NO. 383

Continuous He-Cd laser emits deep-blue wave



University Laboratories Inc., 733
Allston Way, Berkeley, Calif.
Phone: (415) 848-0491.

With an output wavelength in the deep-blue region at 4416 Å, a new internal-mirror continuous helium-cadmium laser develops an output power in excess of 2 mW with a beam diameter of 0.9 mm and a divergence of 1 milliradian. Model 416 operates from a dc plasma discharge containing vaporized metal cadmium in an atmosphere of helium gas. Required input is only 175 W.

CIRCLE NO. 384

LET'S DO SOMETHING EXOTIC AT THE
SHOW THIS YEAR—SOMETHING CLASSY, THAT
SHOWS McLEAN PRECISION INSTRUMENT MOTORS
AND BLOWERS ARE REALLY BUILT!



WE DECIDED TO EMPHASIZE
OUR PERFORMANCE CURVES BOSS—
AND WE'RE KNOCKIN' 'EM DEAD!



McLean's performance curves are something to get excited about just the same. A talented computer resolves Precision Instrument Motor problems that just can't be handled by ordinary motor manufacturers — plotting curves that relate motor RPM to shaft torque, power factor, and percent efficiency. Blowers and Motors are computer-matched and built for highest performance and guaranteed for 25,000 hours of operation. Write or phone for some exotic, but understandable, information.

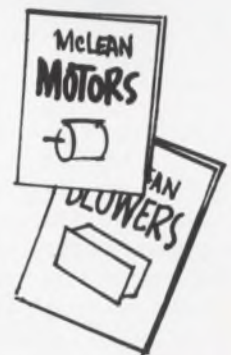

McLEAN
ENGINEERING LABORATORIES mclean®

Princeton Junction, New Jersey 08550 • Phone: 609-799-0100 • Telex: 84-3422

Visit us at the I.E.E.E. Show, Booth 4K12

INFORMATION RETRIEVAL NUMBER 185

S-band transistors gain 3 dB at 5 W

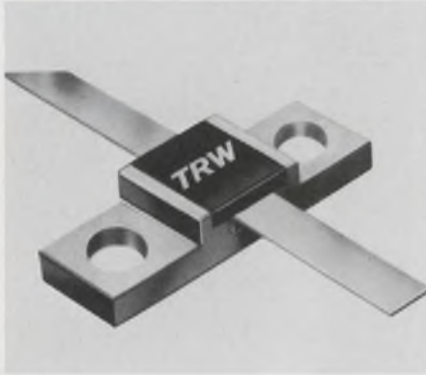

Selectro Corp., RF Components Div., 225 Hoyt St., Mamaroneck, N.Y.

A new Type N dual-channel Y adaptor provides simultaneous two-frequency transmission and reception without crosstalk or rf leakage, from dc to 2 GHz. Designated as ConheX 57-086-0019, the device is a hermetically sealed airborne-type assembly with a maximum VSWR of 1.08:1 through each channel. It meets the requirements of MIL-C-71, MIL-C-22557, and MIL-C-39012.

CIRCLE NO. 386

Varactor-tuned source ends spurious outputs

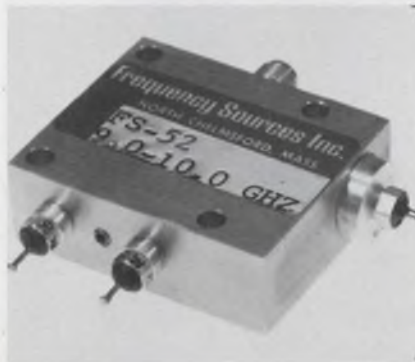

American Technical Ceramics, 1 Norden Lane, Huntington Station, N.Y. Phone: (516) 271-9600.

Designed for use in phased-array radar applications, series ATC-PAC capacitors can handle 20 A of cw power at 175 MHz, 50 A of pulsed rf power at 500 MHz, and 1 kW of power at S band. The devices, which have an rf voltage rating of 1000 V, are composed of dense fused porcelain, rather than sintered ceramic. They are tiny 1/8-in. cubes.

CIRCLE NO. 388

TRW Semiconductors Div., 14520 Aviation Blvd., Laundale, Calif. Phone: (213) 679-4561. Price: \$42 to \$188.

Four new 3-GHz transistors developed for use in S-band equipment offer power outputs ranging from 300 mW and 6-dB gain (the PT6669) to 5 W with 3-dB gain (the PT6636). All the units are common-base devices and require a source voltage of 28 V. In 100-unit quantities, the 300-mW transistor costs \$42, and the 5-W unit is \$188.

CIRCLE NO. 385

Dual-channel adaptor silences crosstalk



Frequency Sources, Inc., Kennedy Dr., P.O. Box 159, N. Chelmsford, Mass. Phone: (617) 251-4921.

Because it does not use frequency multiplication, a new wide-band varactor-tuned Gunn-effect solid-state source eliminates spurious output problems and permits bandwidths of over 12%. Model FS-52 covers the frequency range of 8.5 to 9.6 GHz. Its minimum output power is 3 mW, and typical required input power is -8 V dc at 350 mA. Typical tuning voltage for this oscillator is 0 to -50 V.

CIRCLE NO. 387

Porcelain capacitors sustain 1 kW in S band

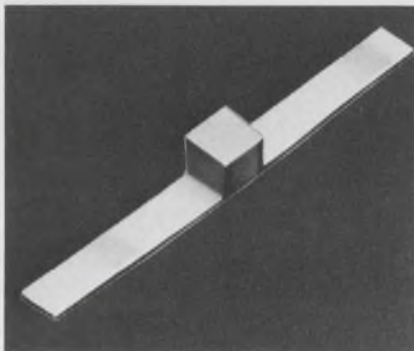

Diode amplifiers take 250 mW cw

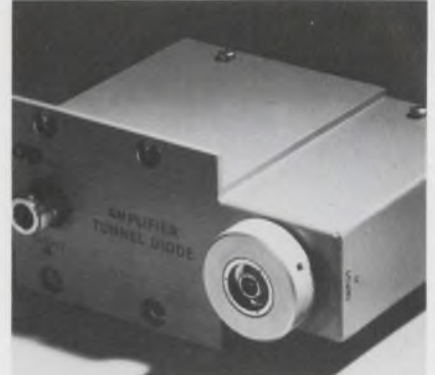

International Microwave Corp., 33 River Rd., Cos Cob, Conn. Phone: (203) 661-6277.

Without sacrificing noise-figure level, a line of microwave tunnel-diode amplifiers can withstand up to 250 mW cw of rf input power with no permanent degradation of performance. A typical unit covers the frequency range of 4.4 to 5 GHz with a gain of 21.5 ± 1.5 dB and a noise figure of 4.2 dB. Gain variation, for temperatures from -32 to +71°C, is +0 dB and -3 dB.

CIRCLE NO. 389

S-band amplifiers are microwave ICs

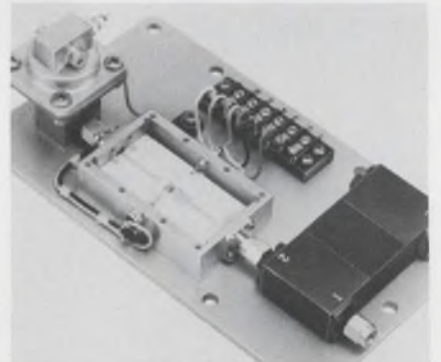

RHG Electronics Laboratory, Inc., 94 Milbar Blvd., Farmingdale, N.Y. Phone: (516) 694-3100.

A new line of uncooled MIC parametric amplifiers feature a noise temperature of 100°K. Known as the PAR series, the units cover frequency ranges from 1 to 8 GHz with bandwidths to 500 MHz. A double-balanced design on an alumina substrate provides high local-oscillator-to-rf isolation from the built-in avalanche-diode pump source. The units weigh under 2 lb.

CIRCLE NO. 390



FAIRCHILD

The company you gave up looking for.

If you're as good as you think you are, we have several dozen new jobs that need doing in semiconductors, controls, graphics, instrumentation, optics, microwaves, chemistry, aerospace research, electrometrics and just about any other corner of tomorrow.

The thing that separates these jobs from all the others is the company you'll keep. Because the company is Fairchild.

The people who work at Fairchild are here because Fairchild has created the kind of organization they almost gave up looking for. An organization that knows its future is directly related to their potential. An organization whose interests span ten interrelated technologies, demanding the uncommon ability to grow rapidly and change direction quickly.

If you possess a sound knowledge in your discipline and an awareness of the practical economics of technical management, we invite your inquiry.

Write to Michael D. Hawkins,

Fairchild Camera and Instrument Corporation, 464 Ellis Street, Mountain View, California. 94040.
An equal opportunity employer.

LET GPS HELP YOU
THINK FUNCTIONS



Miniature Hybrid Multipliers

- Available from stock.
- 6 different models with accuracies from 0.1% to 5%.
- Priced from \$45 in quantity.
- Completely self-contained and buffered inputs.
- Occupies one half cubic inch.
- Applications include modulation - demodulation, voltage controlled amplification, correlation, wattmeters.

Write for descriptive brochure and application notes to:
GPS CORPORATION
14 Burr Street,
Framingham, Mass. 01701
(617) 875-0607



GPS — The Complete Source for
Compatible Operational Elements.

INFORMATION RETRIEVAL NUMBER 187

DATA PROCESSING

Solid-state memories cost less than 2¢/bit



*Advanced Memory Systems, Inc.,
1276 Hammerwood, Sunnyvale,
Calif. Phone: (408) 734-4330.
P&A: from 1.2¢/bit; summer,
1970.*

Cutting costs below that of drums, discs and cores, a new family of memories features block transfer rates as fast as 16 megabytes per second and costs as low as 1.2¢ per bit. The new memories are offered in two packages: the SSU (Semiconductor Storage Unit) line in upright cabinets, and the mini-SSU line in 19-in. racks for free-standing housings.

Storage capacities for the mini-SSUs can be 262,144 bits, 524,288 bits, 1,048,576 bits or 2,097,152 bits. Their respective block transfer rates are 8, 16, 32 or 64 megabits per second, with readout widths of 8, 16, 32 or 64 bits. Prices range between 1.64 to 2¢ per bit and 1.2 to 1.6¢ per bit.

These smaller SSUs are expected to have an impact on the peripheral market for uses like storage, buffering or memory extension. Their access times are said to be 30 to 60 times faster than discs or drums.

There are three full-size SSUs offering storage capacities of 2, 4 or 8 megabytes, at costs ranging from 1.46 to 1.98¢ per bit. They are random-addressible systems with block transfer rates up to 16 megabytes per second and access times in the order of microseconds.

CIRCLE NO. 391

Coated computer tape wards off scratches

*Memorex Corp., 1180 Chulman
Ave., Santa Clara, Calif. Phone:
(408) 247-1000. Availability:
spring, 1970.*

Astron is a new back-coated computer tape that resists scratching and build-up of particle-attracting static charges, thus reducing dropouts, a common source of computer tape errors. There is also a reduction of tape damage caused by the slippage of tape layers when wound on a reel. In addition, the new tape provides consistent start/stop performance on a large number of tape drives.

CIRCLE NO. 392

Compact CRT terminals show all stored data

*Delta Data System Corp., Wood-
haven Industrial Park, Cornwells
Heights, Pa. Phone: (215) 639-
9400. Price: \$90 and \$120 per
month.*

Three new self-contained Tele-Term desktop video display terminals can store more information (over 100 lines) than can be displayed on the screen at one time. The screen actually acts as a window, which can move up or down into the memory and display all the information stored there. Each terminal can display up to 27 lines of 80 characters at one time. They can be supplied with a built-in acoustic coupler.

CIRCLE NO. 393

Desktop mini-computer has \$7500 price tag

*Computer Logic Systems, Inc., 49
Pollard St., N. Billerica, Mass.
Phone: (617) 667-1359. P&A:
\$7500; spring, 1970.*

Carrying an OEM-quantity price tag of \$7500, a new desktop mini-computer offers a general-purpose capability for the small businessman who has been priced out of the large computer field. Model CLS-18 is an 18-bit machine intended for a broad range of uses in business, industry, engineering, and education.

CIRCLE NO. 394

Cassette record head reads after writing

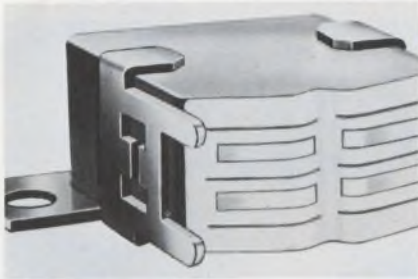

Nortronics Co., Inc., 8101 Tenth Ave. North, Minneapolis, Minn. Phone: (612) 545-0401. P&A: \$150; 8 wks.

A new read-after-write cassette recording head provides immediate verification that the equipment is writing properly. The unit is available in a single-channel (model WR1R) or a dual-channel (model WR2R) version. It permits reduction in core memory storage, provides faster process times, and eliminates the need for ultra-critical precision in tape backup.

CIRCLE NO. 395

Attache-case terminal talks computer lingo



International Business Machines Corp., Data Processing Div., 112 E. Post Rd., White Plains, N.Y. Phone: (914) 949-1900. P&A: \$600, or \$20/month; third quarter, 1970.

Built into an attache case, a new portable audio terminal allows users to enter alphanumeric information into a System/360 computer and get computer-compiled spoken responses to their inquiries. Model 2721 operates for at least eight hours on rechargeable batteries, or can be plugged into any 110-V ac line.

CIRCLE NO. 396

L.E.D. INDICATORS

New! Solid State—Infinite Life!



TEC takes the latest technology and gives it practical application. We've built an easy-mounting line of subminiature indicators and switch-indicators, using the new L.E.D. (light emitting diodes).

They're tough. The red-emitting L.E.D. light source gives infinite life and reliability, resistance to shock and vibration, avoids catastrophic failure.

There are two-terminal models operating from a 5 VDC supply and transistor controlled models—which interface directly with RTL, DTL and TTL microcircuit logic—operating from signal levels of: ON: +2.5 to +10 VDC, OFF: 0 to +0.8 VDC.

All models rear-mount in a 1/4" hole on 3/8" centers. They feature fast switching capability, three lens color choices (transparent red, transparent amber and clear) and the easy installation you expect from all TEC-LITE indicators. As low as \$3.55 in 100-499 quantities.

For full information on the SS Series—or our complete line of display/control products and systems—write: TEC, Incorporated, 6700 So. Washington Avenue, Eden Prairie, Minnesota 55343.

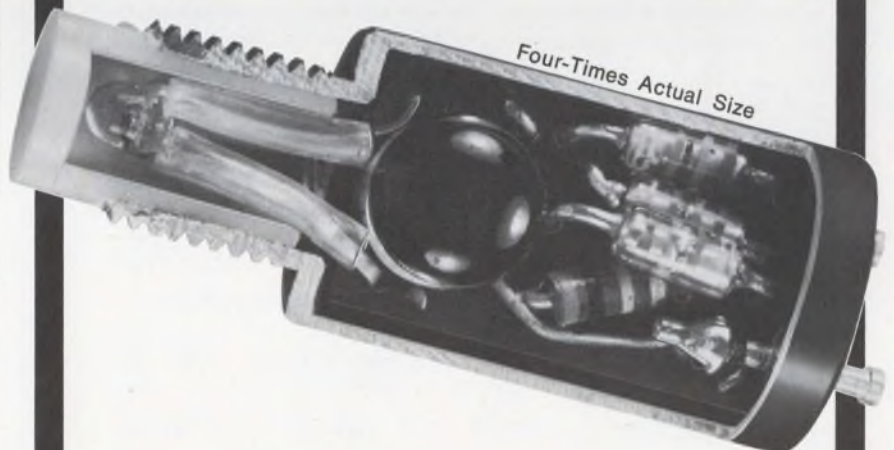

TEC

INCORPORATED

INFORMATION RETRIEVAL NUMBER 188

JFD MICROMINIATURE MODUTRIM

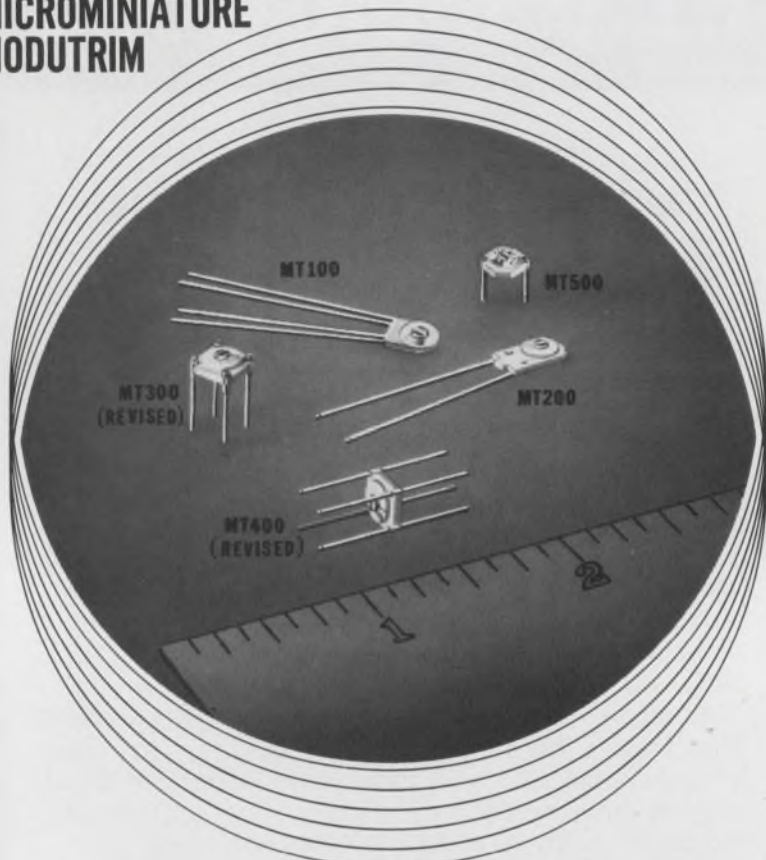

A UNIQUE CERAMIC VARIABLE CAPACITOR

Unique is the word that best defines the Modutrim—microminiature capacitor series. The MT series offers the design engineer superlative stability due to a special rotor designed by JFD. The rotor stability is due to a special proprietary ceramic material in a monolithic structure.

Especially designed for micromodule and hybrid applications, Modutrim is available in a wide range of Δ Cs with electrical characteristics that are outstanding for components of this exceptional small size.

Offered in 5 basic mounting configurations the Modutrim (MT100, 200, 300, 400 and 500) provides an optimum choice for your design applications.

In addition, JFD has modified its MT300 and MT400 series to provide added strength without affecting the mechanical or electrical parameters.

MT capacitors meet or exceed MIL-C-81.
JFD engineers are available to meet your design requirements.

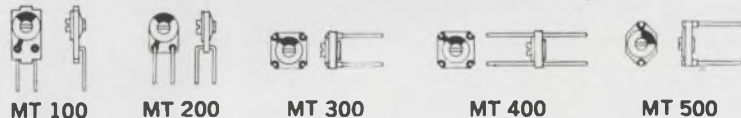

Write for catalog.

Illustrations actual size.



"TODAY'S COMPONENTS BUILT FOR TOMORROW'S CHALLENGES"

JFD ELECTRONICS CORP. / COMPONENTS DIVISION

15th Avenue at 62nd Street / Brooklyn, New York 11219 / Phone 212-331-1000
SUBSIDIARY OF RIKER-MAXSON CORPORATION

See Us At The IEEE Show, Riker-Maxson Components Group Booth #s' 4E03 and 4E05

Also the Paris Components Show April 3rd-8th Allee L Stand #53

INFORMATION RETRIEVAL NUMBER 189

DATA PROCESSING

Parallel data modem takes 8-level inputs



General Data Comm Industries,
537 Newtown Ave., Norwalk, Conn.
Phone: (203) 847-2445.

Designated as the GDC-402C, a parallel-input simplex modem accepts 5, 6, or 8-level tape reader inputs (paper or magnetic) and converts the data to parallel tones for transmission over the public telephone network. The modem transmits nine tone channels in parallel, eight data channels, and one timing channel. Operating speed is 75 characters per second.

CIRCLE NO. 397

Fast graphics plotter prints electrostatically



Info-Max, 470 San Antonio Rd.,
Palo Alto, Calif. Phone: (415)
327-4570. Price: \$8000.

A new high-speed electrostatic computer graphics hard-copy printer, which is also effective for X-Y plotting, facsimile, line printing and automatic drafting, needs only 5 s to place 10^6 fine black dots in a 10-in. square. Each dot is accurately positioned by digital logic to form the desired patterns. It is a self-contained desk-top unit designed for direct computer interface.

CIRCLE NO. 398

Compact data sets
come in card form



Tel-Tech Corp., 9170 Brookville Rd., Silver Spring, Md. Phone: (301) 589-6035.

Two compact medium-speed data modems, the TT-202 and the TT-201, are available in PC-card form, rack mounted, or desk mounted. They are ideal for integral installation in terminals operating at rates of 1800 or 2400 bits per second. The basic cards measure 12 x 6 in.; the tallest component is 1-in. high. The 202 consists of just one card, while the 201 is two cards.

CIRCLE NO. 399

Eight-input multiplexer
shifts 7×10^6 times/s



Computer Labs., 1109 S. Chapman St., Greensboro, N.C. Phone: (919) 292-6427. P&A: \$2400; stock to 30 days.

Designed for high-speed digitizing of analog inputs, the MUX-810 multiplexer accepts eight analog signals and feeds them to a single output at a rate of 6.6 million connections per second. The connections can be made sequentially, with any number of channels in the sequence, or on a random-access basis. Single-channel stepping is via a front-panel push button.

CIRCLE NO. 400

NEW from BULOVA ...DC Servo Amps 2.5w to 2,500w

Here's a line of servo amps packaged for flexibility and priced for system saving. It's another example of Bulova's unique capability in producing quality servo products at a price lower than you can make or buy.

Available from 2.5 w to 2.5 Kw
— Styled in flat pack, modular or rack mount — to meet industrial or mil-spec — able to operate from AC or DC — to include power supply when required.

FEATURES:

- Adjustable Gain
- Current Limiting
- Voltage or Current Feedback
- Wide Bandwidth
- Low Cost

DESIGNED TO DRIVE:

- DC Torque Motors
- Low Inertia Motors
- DC Servo Motors
- Servo Valves
- Deflection Coils



Bulova also offers a complete line of AC servo products, including servo amplifiers, modulators and demodulators, plus a line of power supplies.

Don't miss out on this Bulova Servo Special. For new applications or old . . . for help in planning new servo systems . . . for the lowest price on DC Servo Amps . . . Look to Bulova!

Call (212) 335-6000, or write —

BULOVA **sp** **BULOVA SERVO PRODUCTS**
Electronic Division of Bulova Watch Company, Inc.
61-20 Woodside Ave., Woodside, N. Y. 11377 (212) 335-6000

Go Bulova, and leave the designing to us!

INFORMATION RETRIEVAL NUMBER 190

HANSEN'S NEW 900 SERIES



gives you
standard Synchron[®]
reliability with up
to 98 oz.-in. torque

Now, without sacrificing compact size, you can get high torque even at higher speeds—from 1 to 900 RPM. Synchron[®] 900 Series has thick, wide gears, specially designed to give the added gear strength that makes full use of its power increase. Highest quality instrument gear train for all speeds below 900 RPM.

The new self-starting hysteresis motor has positive direction of rotation—right or left hand. Plus extra heavy phenolic first gear for low noise level. It can be stalled continuously without electrical or mechanical damage.

Added strength in both the rotor and gear train enables 900 Series to handle your toughest timing and control jobs. Because of its compact dimensions, it is often interchangeable with motors of lower torque. To find out what 900 SERIES can do for you, write or phone today to have a representative contact you.



HANSEN MFG. CO., INC.
Princeton, Indiana 47570

HANSEN REPRESENTATIVES: CAREY & ASSOCIATES, Houston and Dallas, Texas; R. S. HOPKINS CO., Sherman Oaks, Calif.; MELCHIOR ASSOCIATES, INC., San Carlos, Calif.; THE FROMM CO., Elmwood Park, Ill.; JOHN ORR ASSOCIATES, Grand Rapids, Mich.; H. C. JOHNSON AGENCY, INC., Rochester, N.Y.; WINSLOW ELECTRIC CO., Essex, Conn.; Villanova, Pa., and New York, N.Y.

EXPORT DEPARTMENT: 2200 Shames Drive, Westbury, N.Y. 11590

INFORMATION RETRIEVAL NUMBER 191

DATA PROCESSING

Data multiplexer links 64 terminals



Nationwide Electronic Systems, Inc., 7N662 Route 53, Itasca, Ill. Phone: (312) 773-0370. P&A: \$750; stock to 6 wks.

Operating with instruments or circuitry having a BCD output, the CC1200 economy code converter translates information into hard-copy printout or computer-compatible punched paper tape. All it needs is a model 33 Teletype to provide the permanent record. With zero suppression, its input capacity is a 10-digit BCD signal.

CIRCLE NO. 402

Dynelec Systems, Inc. 139 Harristown Rd., Glen Rock, N.J. Phone: (201) 447-0900. Availability: 45 days.

DyneCoM 70W is a compact communications multiplexer that can concentrate data from 2 to 64 remote low-speed asynchronous terminals over a single 2400-bit-per-second voice-grade line. The unit automatically intermixes and simultaneously operates each four-speed data circuit from 45.5 to 300 bits per second.

CIRCLE NO. 401

Economy code converter allows hard-copy record



High-speed data modem transmits 3600 bits/s



International Communications Corp., sub. of Milgo Electronic Corp., 7620 N.W. 36th Ave., Miami, Fla. Phone: (305) 691-1220. Price: \$3995.

A new data set is capable of transmitting 3600 bits per second over dial-up telephone lines. Modem 3300/36 also has a 150-bit-per-second reverse channel. This allows maximum throughput by eliminating the line turn-around time normally encountered with high-speed dial-up operation.

CIRCLE NO. 403

Design Elements, Inc., 2074 Arlington Ave., Columbus, Ohio. Phone: (614) 486-7755.

Design-79 acoustic data couplers offer fm data transmission, LC filtering for high noise rejection, and error-free transmission. The units are fully compatible with all standard telephones and may be used with all popular data terminals. They are available in originate only, answer only, and originate/answer models.

CIRCLE NO. 404

Data couplers filter noise



Dc voltage regulator compensates for drift

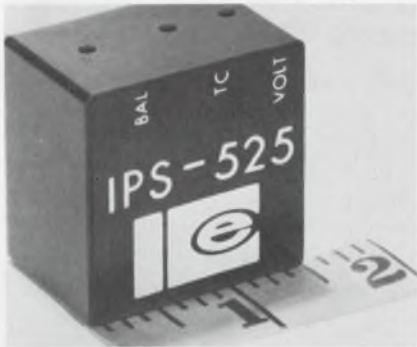

Inter-Computer Electronics, 1213 Walnut St., Lansdale, Pa. P&A: \$105; stock.

A new 0.01% voltage regulator enables users to program the temperature coefficient of the reference supply to accommodate the thermal drift of electronic components. Model IPS-525 provides independent adjustment controls for output voltage and temperature coefficient to produce a regulated output that varies linearly with temperature. The output is 5 to 25 V at 20 mA.

CIRCLE NO. 405

Low-drift FET op amp lowers cost to \$12



Analog Devices, Inc., 221 5th St., Cambridge, Mass. Phone: (617) 492-6000. P&A: \$12; stock.

Costing only \$12, the model 40 FET-input operation amplifier boasts an input impedance of 10^{11} Ω , 50 pA of bias current and 5 pA/ $^{\circ}$ C of bias-current drift. It features a voltage drift of 50 μ V/ $^{\circ}$ C, open-loop dc gain of 200,000 and full-power response of 100 kHz. The rated output is ± 10 V at 5 mA. Another version with 20 μ V/ $^{\circ}$ C of voltage drift costs \$19. Booth No. 3F16 Circle No. 358

Free! Money-Saving Guide

Working with logic modules? Then here's something you should have. It's a Guide for logic design applications.

(For Logic Design Applications)

Free Drafting Aid Symbol More free stuff? You better believe it!

Real handy! The Guide outlines a procedure to assist you, the Systems Engineer, in transposing a logic design into an idealized listing of the logic cards needed to implement the design.

It's simple to use and you can really sock away the money you'll save on reducing the number of cards you need. That's right!

We're helping you to reduce the number of logic cards you have to buy.

But that's okay, sock it to us!

Wyle also has a sample of stick-on logic drafting symbols for you, the only catch is that you have to request this item on your letterhead.

So just drop a line with your name and address on your company letterhead to our Marketing Manager, Gordon Elsner.

He'll sock you a sample logic stick-on drafting symbol right back to you.

And if you're socked in with an immediate application call Gordon direct, Now! (213) 678-4251



WYLE
COMPUTER PRODUCTS
DIVISION OF WYLE LABORATORIES
128 Maryland Street, El Segundo, California 90245

SERVO PACKAGE PROBLEMS?

When it comes to servo packages, we've got the technical considerations licked. That goes for both components and packaging design.

We can give you the "tightest" job at the lowest price and meet your delivery requirements, too.

We have literally thousands of different servo components. Motors: stepper, synchronous, braked, viscous-damped and inertial-damped. Motor generators: rate, damping, integrating and high-signal-to-noise. Synchros and resolvers of all descriptions. Clutches, brakes and gearheads.

We design and build all the associated electronics: servo and buffer amplifiers, stepper-motor logic packages, phase-shifting capacitors, quadrature rejection circuits, electronic choppers and summing, isolation and switching networks.

All you have to do to solve similar problems is call one single source—Kearfott. Write today to: Kearfott Division, Singer-General Precision, Inc., 1150 McBride Avenue, Little Falls, New Jersey 07424.

SINGER
KEARFOTT DIVISION

ANSWER: KEARFOTT'S "ALL-UNDER- ONE-ROOF" SERVICES.

INFORMATION RETRIEVAL NUMBER 193

Hybrid microcircuit boasts 500-W output

TRW Electronics Semiconductors Div., 14520 Aviation Blvd., Lawndale, Calif. Phone: (213) 679-4561. P&A: \$8; 4 wks.

Mounted in a TO-3 case, a new power hybrid microcircuit handles 500 W of output power. The DPS-1000 is a dual-power Darlington switch that delivers currents of 5 A average and 10 A peak, from 50-V power supplies. It has a current gain of 1000 and reverse transient suppression. Total rise time is 150 ns and storage time is 1.5 μ s.

CIRCLE NO. 406

Modular power supply retails at only \$23.50

Zeltex, Inc., 1000 Chalomar Rd., Concord, Calif. Phone: (415) 421-3555. P&A: \$23.50; stock to 2 wks.

Providing a dual output of ± 15 V at 25 mA, a new modular regulated power supply costs only \$23.50. The model ZM 1525 encapsulated module regulates 0.2% for line and load and has 2 mV pk-pk of ripple and noise. It is short-circuit proof and will operate from -25 to $+71^\circ\text{C}$ without temperature derating. Input voltage is 105 to 125 V ac at 50 to 400 Hz.

CIRCLE NO. 407

High-voltage op amp has 10-pA input bias

Intech Inc., 1220 Coleman Ave., Santa Clara, Calif. Phone: (408) 244-0500. P&A: \$85; stock.

With supply voltages up to ± 50 V, the model A-160 high-voltage operational amplifier offers a maximum input bias current of 10 pA. It also features 94 dB of common-mode rejection and 20 $\mu\text{V}/\text{V}$ of supply rejection. Slewing rate is 20 V/ μs and open-loop gain is 200,000. Typical bandwidth is 4 MHz and drift is 25 $\mu\text{V}/^\circ\text{C}$. The unit measures 1.5 \times 1.5 \times 0.4 in.

CIRCLE NO. 408

Video amplifiers slew at 180 V/ μ s

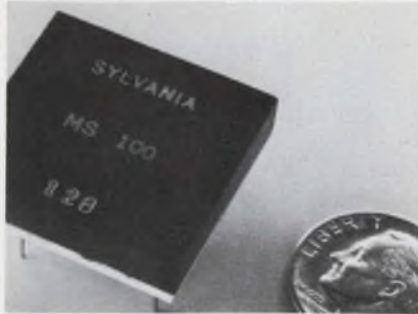

Sylvania Electric Products Inc.,
Microelectronics Operation, Wal-
tham, Mass. P&A: \$52; stock.

Two new high-gain video ampli-
fiers provide slew rates of 100 V/
 μ s (the MS100A). Both units offer
an open-loop gain of 50 dB with a
3-dB bandwidth of 1 MHz. Each
device delivers 700 mW of output
power, and each has an open-loop
output impedance of 33 Ω . Operat-
ing temperatures can range from
-55 to +80°C.

CIRCLE NO. 409

PC-card supply delivers 230 V



Mylee Digital Sciences Inc., 16
Progress Parkway, Maryland
Heights, Mo. Phone: (314) 542-
4525. P&A: \$34.50; stock to 2 wks.

Built on a plug-in printed circuit
card, a new variable high-voltage
power supply provides a minimum
output current of 35 mA with the
output voltage adjustable from 170
to 230 V. Model HVPS-2 has a
regulation of $\pm 1\%$ for line varia-
tions of 10 V, and $\pm 1\%$ for load
variations from zero to full load.
Maximum input power is 225 mA
at 115 V ac.

CIRCLE NO. 410

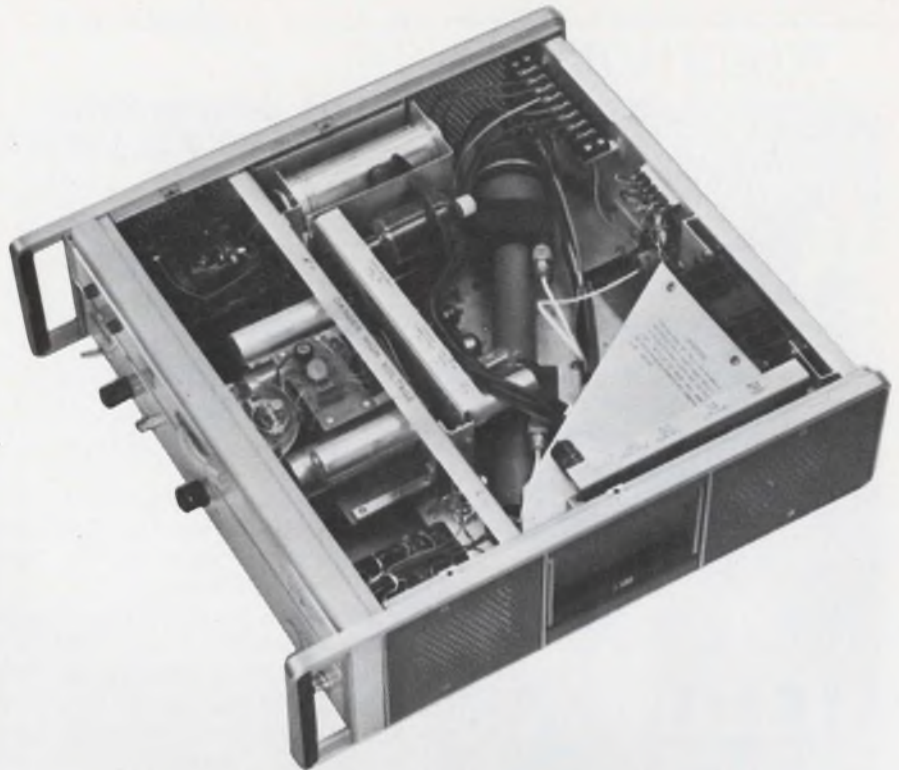

NO 1-WATT POWER AMPLIFIER SHOULD BE WITHOUT ONE...

... One of W-J's 1-Watt Traveling-Wave Tubes

Any one of our L-, S-, C- or X-band tubes will do the job for
you. Designed for use in broadband microwave amplifiers, these
rugged PPM-focused TWTs combine high power and high gain
in a small package. Details:

SPECIFICATIONS

| | Band | Frequency Range | Power Output | Small Signal Gain | Noise Figure |
|---------|------|--------------------|-----------------|----------------------|-----------------|
| WJ-2500 | L | 1 to 2 GHz | 1 watt min. | 30 dB min. | 30 dB max. |
| WJ-2501 | S | 2 to 4 GHz | 1 watt min. | 30 dB min. | 30 dB max. |
| WJ-2502 | C | 4 to 8 GHz | 1 watt min. | 30 dB min. | 30 dB max. |
| WJ-2503 | X | 8 to 12 GHz | 1 watt min. | 30 dB min. | 30 dB max. |

Size and weight for L- and S-band units: 2.7 x 2.85 x 14.5 inches, 3.5 lbs.

Size and weight for C- and X-band units: 2.5 x 2.5 x 12.75 inches, 3.5 lbs.

You can see these and other W-J
products in our Applications Engineering
Suite at the Barbizon-Plaza, Suite G,
during IEEE Week in New York.

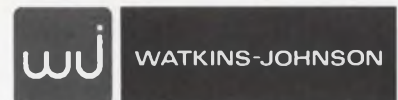

3333 HILLVIEW AVE., STANFORD INDUSTRIAL PARK, PALO ALTO, CALIF. 94304 • (415) 326-8830

INFORMATION RETRIEVAL NUMBER 194

WORKHORSE!



TYPE 9750

Nothing fancy, and not expensive. Just a good old 10 stage photo-multiplier but: It has a superb alkali cathode with excellent collection efficiency (which is fundamental for good S/N ratio), highly stable CsSb dynodes which provide a gain of 10^6 at just over 1,000 volts, and a dark current of 10^{-10} A. at that voltage (50 A/L).

As usual EMI has provided a number of variations: 9750QB with a spectrosil window for UV and low level counting applications, (liquid scintillation) 9750B with Pyrex window for visible applications, and finally 9750KB for those who prefer the B-14A overcapped base. In the "K" configuration, it is directly interchangeable with our 9656KB or a number of competitive types.

The 9750 with its high quantum efficiency and low dark current gives excellent resolution for low energy gamma rays. When used with a thin two inch sodium iodide crystal with a beryllium window, the resolution for Fe^{55} is of the order of 40%.

Flying spot scanners, photometers, thermoluminescent dosimeters, low level scintillation counting are all applications for which the 9750 is highly suitable. Detailed specifications on request from:

GENCOM DIVISION varian/EMI

80 EXPRESS STREET, PLAINVIEW N. Y. 11803
TELEPHONE (516) 433-5900

MODULES & SUBASSEMBLIES

Hybrid decoder/driver puts out 30 V at 120 mA

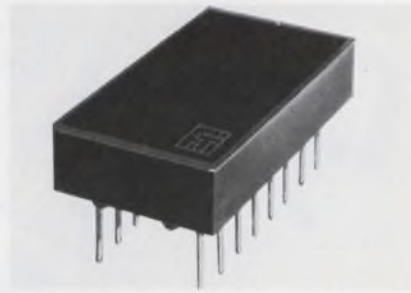

Fabri-Tek Micro-Systems, Inc., 1410 S. W. 3rd St., Pompano Beach, Fla. Phone: (305) 943-9440. Price: \$12.50.

Housed in a plastic 16-pin dual-in-line package, a new BCD-to-seven-output decoder/driver can continuously supply 30 V at 120 mA at each of its outputs. This hybrid device, model FTD-1001, can handle surge currents up to 400 mA and a maximum package power dissipation of 1 W. Nominal power supply requirements are 5 V and 96 mA.

CIRCLE NO. 414

Phase difference module processes SSB signals



Aritech Corp., 130 Lincoln St., Brighton, Mass. Phone: (617) 254-2990. P&A: \$175; stock.

Called a quadrature phase difference module, a new signal processing circuit provides a broadband 90-degree phase shift for precision single-sideband modulator and demodulator applications. Model 6 QPD 2-128/0 accepts one or two input signals and produces two outputs, which are 90 degrees out of phase with respect to each other. The phase difference is kept constant.

CIRCLE NO. 416

Military regulators hold output to 0.01%

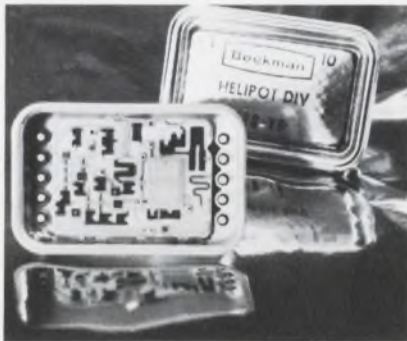

Beckman Instruments, Inc., Helipot Div., 2500 Harbor Blvd., Fullerton, Calif. Phone: (714) 871-4848. Price: \$40.

Models 828 (positive) and 838 (negative) dc voltage regulators are hermetically sealed devices in metal packages that conform to applicable portions of MIL-STD-883 and offer +0.01% maximum line and load regulation. Their output voltage temperature coefficient is 0.01%, while output voltage setting tolerance is $\pm 0.5\%$. Regulated voltages range from 5 to 30 V.

CIRCLE NO. 415

FET-input op amp gains 250×10^3



Philbrick/Nexus Research, a Tele-dyne Co., Allied Dr. at Route 128, Dedham, Mass. Phone: (617) 329-1600. P&A: \$30 to \$35; stock.

Featuring a full-power output response of 100 kHz, a new FET-input operational amplifier guarantees an open-loop gain of 250,000 and offers a minimum unity-gain bandwidth of 2 MHz. Model 1408, which has a slew rate of 6 V/ μ s, is internally trimmed for offset voltage, and includes internal frequency compensation and short-circuit protection.

CIRCLE NO. 417

Wideband op amp has 50-dB gain



Optical Electronics, Inc., P.O. Box 11140, Tucson, Ariz. Phone: (602) 624-8358. P&A: \$58; stock.

Intended for use in video pre-amplifiers, model 9776 FET operational amplifier boasts a minimum open-loop gain of 50 dB and a gain-bandwidth product of 300 MHz. It also offers a slewing rate of ± 250 V/ μ s, and a 175-ns settling time to 0.1% residual error. The unit is packaged in a 1-in. square by 0.31-in. high module. It can satisfy both inverting and non-inverting requirements.

CIRCLE NO. 418

D/a converter module has 50-ns settling time

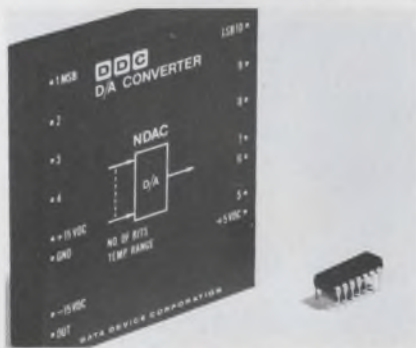

DDC Div., Solid State Scientific Devices Corp., 100 Tec St., Hicksville, N.Y. Phone: (516) 433-5330. P&A: from \$250; stock to 3 wks.

Available in 8 and 10-bit versions, a new series of d/a converters provide settling times as fast as 50 ns. Series Nanodac units come complete with an output amplifier that can supply up to 5 V at 100 mA into loads as heavy as a 50- Ω coaxial line. There are three operating temperature ranges: -55 to $+85^\circ\text{C}$, -25 to $+70^\circ\text{C}$, or 0 to $+50^\circ\text{C}$.

Booth No. 3B11 Circle No. 268



Victoreen's rare specimen!

Our MOX-1125. A rare specimen made only by Victoreen. With rare qualities in the 1-10,000 Megohm range. Rated at 1.00W @70°C. 5,000 volts maximum. Yet it's just .130" in diameter by 1.175" long.

It's one of Victoreen's Mastermox metal oxide glaze resistors. About one-half the size of competitive resistors of similar power handling capacity.

All Mastermox resistors are rare performers. Excellent stability: As little as 1% drift under full load in 2000 hours — with more than 40 watts power dissipation per cubic inch. $\pm 0.5\%$ tolerance. 10K ohms to 10,000 Megohms resistance range. Voltage and temperature cycling leaves no permanent effect. And Mastermox stays potent on the shelf — less than 0.1% drift per year.

Get Mastermox. Rare resistor performance.

| Model | Resistance Range | Power Rating @ 70°C | *Max. Oper. Volts | Length Inches | Diameter Inches |
|----------|------------------|---------------------|-------------------|------------------|-----------------|
| MOX-400 | 1 - 2500 megs | .25W | 1,000V | .420 \pm .050 | .130 \pm .010 |
| MOX-750 | 1 - 5000 megs | .50W | 2,000V | .790 \pm .050 | .130 \pm .010 |
| MOX-1125 | 1 - 10000 megs | 1.00W | 5,000V | 1.175 \pm .060 | .130 \pm .010 |
| MOX-1 | 10K - 500 megs | 2.50W | 7,500V | 1.062 \pm .060 | .284 \pm .010 |
| MOX-2 | 20K - 1000 megs | 5.00W | 15,000V | 2.062 \pm .060 | .284 \pm .010 |
| MOX-3 | 30K - 1500 megs | 7.50W | 22,500V | 3.062 \pm .060 | .284 \pm .010 |
| MOX-4 | 40K - 2000 megs | 10.00W | 30,000V | 4.062 \pm .060 | .284 \pm .010 |
| MOX-5 | 50K - 2500 megs | 12.50W | 37,500V | 5.062 \pm .060 | .284 \pm .010 |

*Applicable above critical resistance. Maximum operating temperature, 220°C. Encapsulation: Si Conformal. Additional technical data in folder form available upon request. Or telephone: (216) 795-8200.



DMA 532

VICTOREEN INSTRUMENT DIVISION
10101 WOODLAND AVENUE • CLEVELAND, OHIO 44104
EUROPE: ARNDAL HOUSE, THE PRECINCT, EGHAM, SURREY, ENGLAND • TEL: EGHAM 4887



INFORMATION RETRIEVAL NUMBER 196

BETA DISPLAYS

BETTER DISPLAYS

Remember. You can't do better than Beta. Here is a full range of high resolution CRT display system modules that have proven themselves in situations ranging from applesauce processing to creating the recently televised Apollo moon pictures. Send for Engineering Data Sheets today.

± 35 VOLT DEFLECTION AMPLIFIERS



The models DA223, DA224 and DA225 are dc-coupled, all-silicon, solid-state modular packages capable of supplying up to ± 2.0 , ± 4.0 and ± 6.0 amperes of deflection current respectively to each axis of a directly-coupled deflection yoke. A unique method of damping optimizes the amplifier for the particular yoke being used by means of an adjustable potentiometer. The amplifiers also feature extremely fast settling time and high bandwidth. The user has the choice of operating the amplifiers Class A for achieving nonlinearities of $\pm 0.02\%$ maximum or Class AB for minimum power consumption.

HIGH & LOW VOLTAGE CRT POWER SUPPLIES



SERIES HV provides regulated high voltage outputs for CRT electrodes - anode, focus grid, G2, and filament.

| Model No. | Anode Output Range |
|-----------|--------------------|
| HV8 | 1-8 kv |
| HV20 | 5-20 kv |
| HV30 | 15-30 kv |

SERIES PAK provides regulated low voltage outputs for Beta modules - ± 35 volts, ± 20 volts, G1, and filament.

| Model No. | ± 35 volt (deflection) Output |
|-----------|-----------------------------------|
| PAK7 | 7 amperes |
| PAK16 | 16 amperes |

MODULAR CRT BUILDING BLOCK COMPONENTS



Individual, compatible plug-in circuits such as: DF2050 Dynamic Focus Generator; DF347 Electromagnetic Dynamic Focus Amplifier; DF2496 Electrostatic Dynamic Focus Amplifier; LC2656/2676 Precision Linearity Correction Circuit; LC916/918 Linearity Correction Circuit; VA2076 Video Amplifier (10 MHz); VA2075 Gamma-Corrected Video Amplifier (10 MHz); VA2769 Video Amplifier (10 MHz, 60 volt output); VA2077 Video Amplifier (30 MHz); SG1190 X-Y Sawtooth Generator; PP529 Phosphor Protection Circuit; DA341 Deflection Amplifier (± 200 ma); DA1340 ($\pm .75$ amperes); EDA800 Electrostatic Deflection Amplifier (350 volts plate-to-plate positive or negative); EDA1504 Electrostatic Deflection Amplifier (500 volts plate-to-plate positive or negative); FR1882 Static Focus Regulator; BA1714 Blank/Unblank Amplifier. All Beta circuitry features silicon semiconductors and temperature stable metal-film resistors throughout.

PRECISION TUBE AND COIL MOUNTS



Flexible combinations of standard assemblies for the precision mounting and alignment of CRTs, yokes and coils: CRTM Basic CRT Mount includes removable bezel, rods and neck end clamps; DSTM Dual Gun Recording Storage Tube Mount, includes rods and neck clamps both ends; MCM Micropositioner Coil Mount allows 6 independent motions and positive lock; FYM Fixed Yoke Mount for application where micropositioning is not required; FYMS Fixed Yoke Mount for servo-type mounted yokes; CCM Centering and/or Alignment Coil Mount; MS983 Magnetic Shield Enclosure.



BETA INSTRUMENT CORPORATION

20 Ossipee Road, Newton Upper Falls, Massachusetts 02164 / Tel. 617 969-6510 / TWX 710-335-6973

ICs & SEMICONDUCTORS

Monolithic regulator goes to 37 V at 150 mA

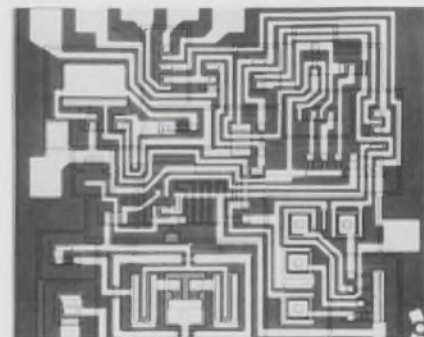

Intersil Inc., 10900 N. Tantau Ave., Cupertino, Calif. Phone: (408) 257-5450. P&A: \$4.85; stock.

A new monolithic voltage regulator, type ICB8723C, features an output voltage that is adjustable from 2 to 37 V, with 0.01% line and load regulation. Npn or pnp pass elements may be added when output currents exceeding 150 mA are required. There are provisions for adjustable current limiting and remote shut-down. The new regulator can operate from positive or negative supplies.

CIRCLE NO. 457

Decoder circuit has level shift

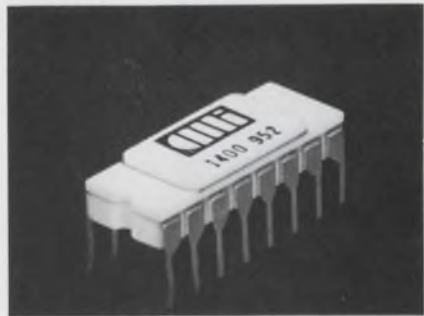

Computer Microtechnology Inc., 610 Pastoria, Sunnyvale, Calif. Phone: (408) 736-0300. P&A: \$15.25; 1 wk.

Accepting TTL inputs and supplying 1-to-9-V outputs to drive low-threshold MOS devices, a new one-of-eight decoder features an integral bipolar-to-MOS level shift. Model 1400 also has two chip-inhibit inputs for ease of expansion, and its output is short-circuit protected. In addition, the output stage is free of current spiking during switching to reduce ac power.

CIRCLE NO. 458

Custom Thick Film Hybrid Microcircuits

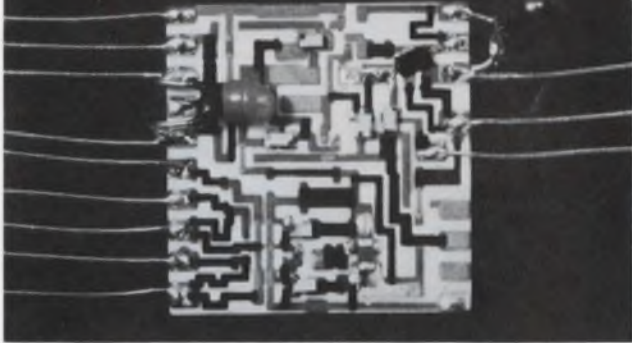

Complete services are offered to repackage and manufacture your discrete circuit in hybrid thick film form or manufacture your thick film design in production quantities.

Printed and fired thick film circuits feature:

- Miniaturization
- High Reliability
- Low Cost

Fast turn around prototype capability allows quick evaluation of your requirement.

Astro-Space Laboratories, Inc.



110 Wynn Drive, N.W. / Huntsville, Alabama 35806
205/837-5830

INFORMATION RETRIEVAL NUMBER 198

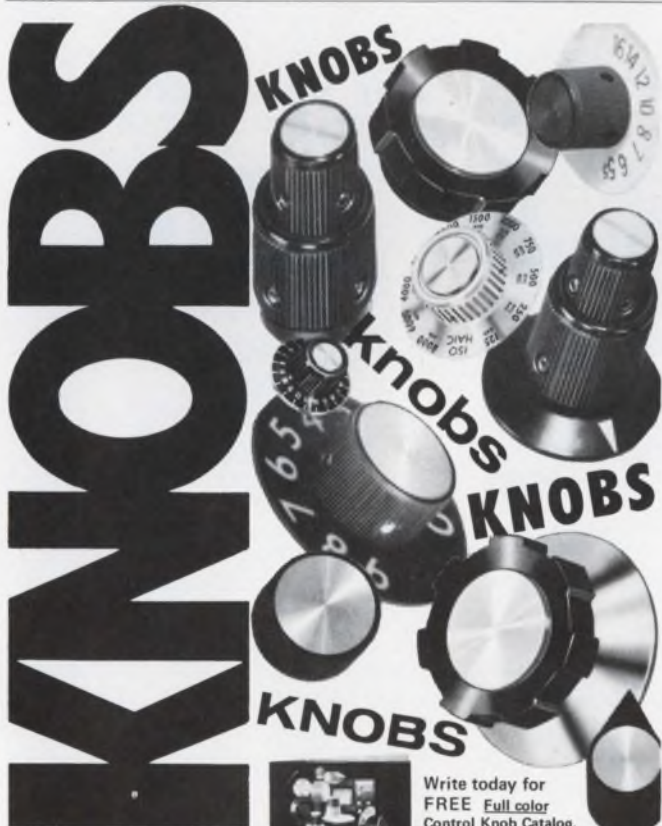

Outline your requirements for quotation and **FREE knob sample**



Write today for **FREE Full color Control Knob Catalog.**

Rogan
BROTHERS, INC.

8031 N. Monticello Ave.
Skokie, Illinois 60076
312/675-1234

INFORMATION RETRIEVAL NUMBER 199

ELECTRONIC DESIGN 6, March 15, 1970

Oak Versatility



Now! One new exclusive switch replaces seven

You can easily eliminate tedious design engineering problems—just use versatile Multidex® switches. They're available in thousands of variations...are smaller than the switches they replace...yet provide more contacts (up to 36) at no additional cost. Crisp Detenting... the patented Unidex™ detent offers uniform "feel" for long life in choices from 10° to 36° throw. Meets MIL-S-3786, SR32 requirements.

Superb Insulation... molded diallyl phthalate meets MIL-M-14 requirements and guarantees electrical continuity between mounting and housing. Glass-alkyd insulation available on request.

Special contacts and clips... Oak-pioneered, double-wiping, self-cleaning contacts assure trouble-free operation. Special AF clips with large windows speed wiring.

What's more, Multidex switches meet commercial and military environmental requirements. Special options available on request. For full details, write today for Bulletin SP-324.



OAK MANUFACTURING CO.

A Division of OAK ELECTRO/NETICS CORP.
Crystal Lake, Illinois 60014
PHONE: 815-459-5000 TWX: 910-634-3353

INFORMATION RETRIEVAL NUMBER 200

DIVERSIFIED Power Supplies ... OUR CAPABILITY SUPPORTS YOUR LINE

From *Diversified Electronics*... low cost, custom-engineered OEM Power Supplies—based on imaginative new ideas in designing Power supplies for particular needs! Design-proven circuits are combined to achieve the power performance you require and the packaging flexibility needed. All this with off-the-shelf cost and delivery advantages plus custom-engineered OEM reliability.



TYPICAL
PRODUCT
DESIGNS

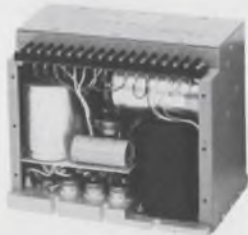

DIVERSIFIED EXPERIENCE ... engineered supplies for: BWO-VTM-TWT • Photomultipliers • Storage and Display Cathode Ray Tubes • Discrete and Integrated Solid State Devices • Swept Power Supplies • Solid State Pulse Modulators.

For answers to all your power conversion needs—call or write:



718 EAST EVELYN AVENUE
SUNNYVALE, CALIFORNIA 94086
(408) 738-3911

ICs & SEMICONDUCTORS

Compensated op amp protects itself

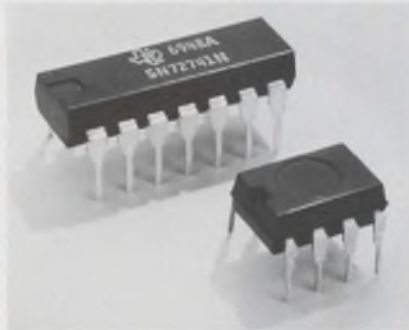

Texas Instruments Inc. Components Group, P.O. Box 5012, Dallas, Tex. Phone: (214) 238-2011. P&A: \$2.40 or \$2.95; 2 wks.

Beside being short-circuit protected, a new linear IC operational amplifier features internal frequency compensation for high stability without the need for external components. Characterized over the temperature range of 0 to 70°C, model SN72741 is offered in both an 8 and 14-pin plastic dual-in-line package. Its power dissipation is 50 mW.

CIRCLE NO 459

Video amplifier chips gain 20 dB at 100 MHz



Silicon General, Inc., 7382 Bolsa Ave., Westminster, Calif. Phone: (714) 839-6200. P&A: \$1.10 to \$2.25; stock.

Requiring only 100 mW of power at 12 V, series 401 high-frequency video amplifiers feature a voltage gain of 20 dB at 100 MHz, 5-ns rise and fall times, and fixed or variable gains. These monolithic circuits also offer single-supply operation and symmetrical limiting. The gain may be varied through the use of integral diodes.

CIRCLE NO. 460

Hybrid drivers supply 250 mA

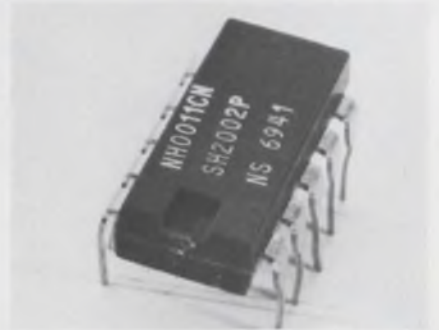

National Semiconductor Corp., 2975 San Ysidro Way, Santa Clara, Calif. Phone: (408) 245-4320. P&A: \$3.40 to \$13.40; stock.

Three new hybrid drivers, the NH0011, NH0011C and NH0011-CN, use an integrated-circuit driver and a high-voltage output transistor to deliver output currents from 150 to 250 mA at up to 40 V. In addition, the units provide logic flexibility by employing a four-input NAND gate, a NOR input and a logic output to give latching capability.

CIRCLE NO. 461

Tiny light sensor generates 10 mA



Optron, Inc., 1201 Tappan Circle, Carrollton, Tex. Phone: (214) 242-6571. P&A: \$3.95; stock.

Suitable for applications where the available light is below normal industry standards, a new extra-sensitive silicon planar Darlington light sensor can generate light currents in excess of 10 mA at an irradiance of 1 mW/cm². With normal light input, the OP 300 photo-transistor supplies an output current that is sufficient to drive IC logic circuits.

CIRCLE NO. 411

Axial-lead zeners boast 5-W rating



International Rectifier Semiconductor Div., 233 Kansas St., El Segundo, Calif. Phone: (213) 678-6281. P&A: \$2; stock.

Costing \$2 each in quantities of 1 to 99, a new family of 5-W axial-lead zener diodes functions as constant-voltage regulators from 3.3 to 100 V, with voltage tolerances of 5, 10 and 20%. Types 1N5333 through 1N5378 come in a molded plastic package that provides good environmental characteristics. The units have 0.04-in. dia leads.

CIRCLE NO. 422

Dual hybrid driver clocks MOS circuits

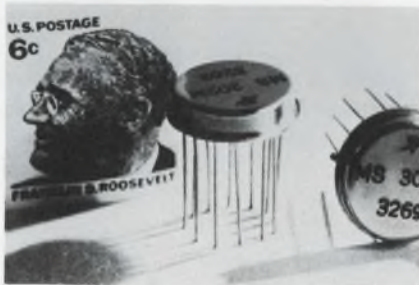

Sylvania Electric Products Inc., Microelectronics Operation, Waltham, Mass. P&A: \$27 or \$38; stock.

Packaged in a standard TO-8 metal case, a new film hybrid microcircuit provides two-phase clock inputs to MOS circuits. Designated the MS302, the industrial version operates over the temperature range of 0 to 70°C; the military version, MS302M, performs over temperatures ranging from -55 to +125°C. Both versions can function as interface circuits between TTL and MOS.

CIRCLE NO. 413

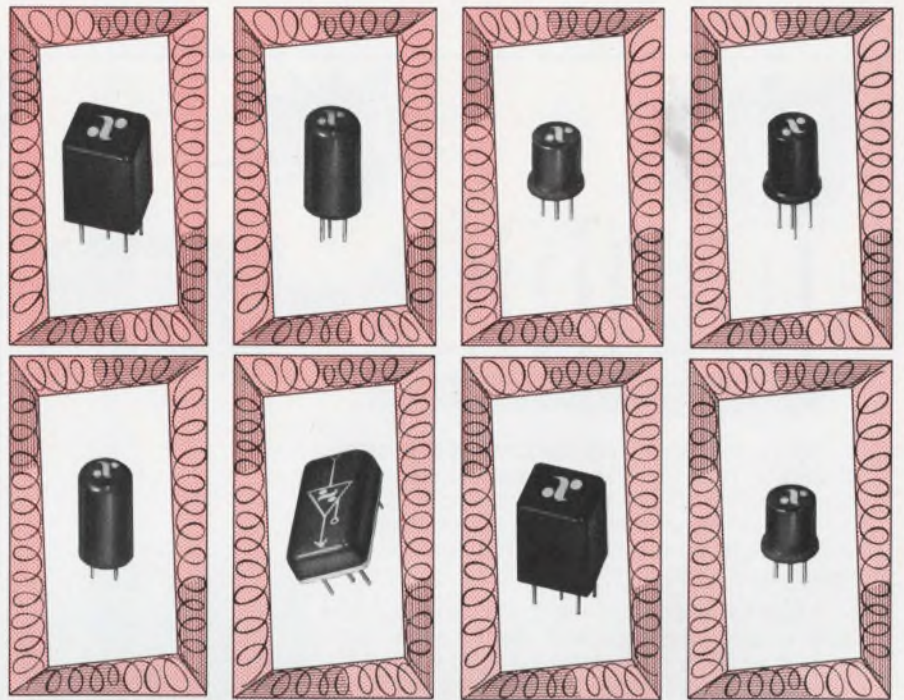

talk about compatibility • look at our

PLUG-IN FAMILY

(20 KHz - 1 GHz)

Over 50 wee relatives have a lot in common. All are broadband devices, frequency and performance compatible for your use in RF, IF and microwave signal processing. They've had on-the-job experience in printed circuits. And all are ready to travel immediately or on 2 to 3 weeks notice.

| | |
|---|---|
| <p>90° HYBRIDS ± 5% of center frequency. Greater than 20 db isolation. VSWRs less than 1.3. Phase 90° ± 2°.</p> | <p>180° HYBRIDS 4-port devices (rat-race equiv.) with decade bandwidths. Loss less than 1 db. Isolation greater than 30 db. VSWRs less than 1.3.</p> |
| <p>BI-DIRECTIONAL COUPLERS Decade bandwidths. Coupling 10-30 db. Loss less than 0.5 db. VSWRs less than 1.3. Directivity greater than 25 db.</p> | <p>DOUBLE-BALANCED MIXERS All use hot carrier diodes. Conversion loss and noise figures less than 6.0 db at 200 MHz and 8.0 db at 400 MHz. All ports isolated and an IF operating to DC.</p> |
| <p>POWER DIVIDERS/COMBINERS 2-way, 3-way devices with decade bandwidths. Less than 0.5 db loss. VSWRs less than 1.3.</p> | <p>MIC AMPLIFIERS VHF integrated circuit amplifiers with stabilized operation. 3 db bandwidth (.5 to 200 MHz). 21 db gain. +12 dbm power output. VSWRs (input-output) 1.5:1 (50 ohms).</p> |
| <p>N-WAY POWER DIVIDERS 4-way plug-ins with Loss less than 1 db. Isolations greater than 25 db. VSWRs less than 1.3.</p> | <p>SOLID-STATE SWITCHES Fast-switching SPST, SPDT and DPDT units with excellent switching signal isolation (over 25 db). Low insertion losses and high on/off ratios.</p> |

our new PLUG-IN FAMILY ALBUM (circa 20 KHz - 1 GHz) includes guaranteed specifications on these and other devices. Write, wire or phone ANZAC, 39 Green Street, Waltham, Massachusetts 02154 • (617) 899-1900.



INFORMATION RETRIEVAL NUMBER 202

the mighty-mini



Schrack's **NEW MINIATURE STEPPING SWITCH**, Type RTM, is the smallest stepping switch available on the market today. Only $\frac{1}{4}$ the size of comparable steppers, it combines high performance with economy of space and cost.

The RTM is equipped with 2 x 10 or 2 x 12 gold-plated contacts and mates with our socket which meets standard printed circuit spacings. Unique hold-down spring enables mounting in any position.

Write for free catalog today. Schrack also manufactures all types of relays, stepping switches and accessories. Catalogs upon request.

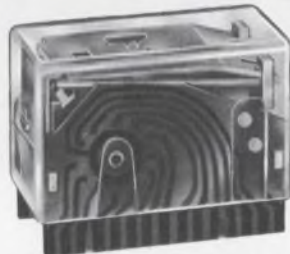

1 41/64" L x 13/16" W x 15/16" H

SCHRACK ELECTRICAL SALES CORP.

1140 Broadway, New York, New York 10001
tel: (212) 683-0790

INFORMATION RETRIEVAL NUMBER 203

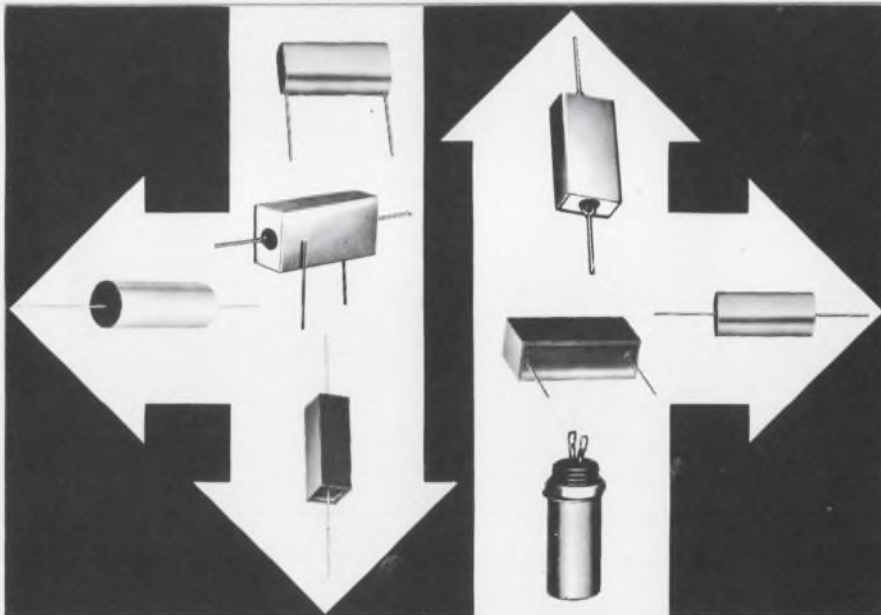

A size breakthrough in metalized polycarbonate capacitors

is now produced by S&E Manufacturing. The new mini-miniature 22 series of 50VDC and 100VDC metalized polycarbonates are available in all standard encasements. They feature an excellent combination of high thermal stability and small size, making them particularly superior for circuits requiring a flat T.C. and low losses. A typical size in our 22R series, of 10.0 mfd. 50VDC, is .58 O.D. x 1.16 in length. A 1.0 mfd. size is .40" x .67". So we invite you to call for any special configuration techniques and sizes, or send for our data catalog sheets.

S&E Manufacturing/Capacitors

18800 Parthenia Street, Northridge, California 91324 • (213) 349-4111 • TWX 910-493-1252

INFORMATION RETRIEVAL NUMBER 204

Rectifiers for 300 A carry 800 to 2500 V

International Rectifier, Semiconductor Div., 233 Kansas St., El Segundo, Calif. Phone: (213) 678-6281. P&A: \$48; stock.

Able to carry up to 300 A, high-voltage silicon rectifiers are now available with repetitive peak reverse voltage ratings of 800 through 2500 V. The new devices can handle a maximum surge current of 6250 A at maximum rated load conditions. Both forward-polarity (series 301U) and reverse-polarity (series 301UR) units are available.

CIRCLE NO. 419

LSI memories drop prices 73%

Intel Corp., 365 Middlefield Rd., Mountain View, Calif. Phone: (415) 969-1670. Price: \$40.

Reflecting price reductions ranging from 38% to 73%, two fully decoded random-access LSI memories now cost only \$40 each in single-unit quantities. Model 1101, which formerly cost \$150, is a 256-bit silicon-gate MOS memory with a 1- μ s maximum access time. Model 3101, which sold for \$99.50, is a 64-bit Schottky-process bipolar memory with a 60-ns maximum access time.

CIRCLE NO. 420

Second-source 7400 ICs sell for 77¢ to \$6.65

Fairchild Semiconductor, 313 Fairchild Drive, Mountain View, Calif. Phone: (415) 962-3563. Price: 77¢ to \$6.65.

Entering the market as a major supplier of series 7400 integrated circuits, Fairchild Semiconductor is now offering 24 of the general-purpose TTL circuits at prices that range from 77¢ to \$6.65 in quantities of 100. These ceramic dual-in-line devices consist of 17 gates, six flip-flops, and a BCD-to-decimal decoder/driver. All the units are exactly equivalent to the originals.

CIRCLE NO. 421

Isolated-stud SCRs carry 35 A continuous



RCA/Electronic Components, Commercial Engineering, 415 South Fifth St., Harrison, N.J. Phone: (201) 485-3900. P&A: \$3.30 to \$6; stock.

Four new 35-A SCRs now come in isolated-stud packages for applications requiring isolation from the chassis or housing. Type 40680 is a 100-V device for low-voltage power supplies; type 40681 handles 120-V lines, while type 40682 is for 240-V lines; type 40683 is a 600-V unit for high-voltage power supplies.

CIRCLE NO. 412

Phototransistors are DIP modules

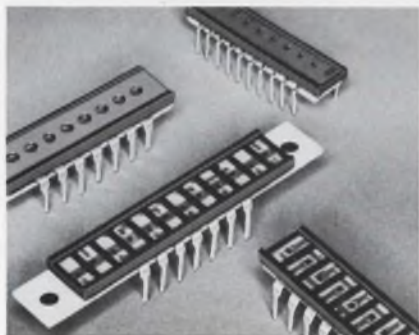

HEI, Inc., Johnathan Industrial Center, Chaska, Minn. Phone: (612) 445-3510.

Packaged like plastic dual-in-line ICs, a new family of standard phototransistor arrays for optical character-recognition applications can be supplied with 5 to 12 phototransistor sensors and in a variety of on-center distances. These commercially available phototransistor chips feature standard positioning tolerances as tight as ± 0.001 in. They can be PC-board mounted.

CIRCLE NO. 423



dc Series Voltage Regulator

from **Solitron**, of course!

Solitron has introduced a new dc voltage regulator which establishes unique regulation characteristics in a hybrid high reliability circuit. Features of the HCCA 100 regulator are:

- ▶ Regulation of .05% max., .01% typical, no load to 1.0 Amp
- ▶ Voltage range 8V to 50V
- ▶ Temperature coefficient less than .005%/°C
- ▶ Maximum output current of 3.0 Amps
- ▶ 25 Watts dissipation with heat sink
- ▶ Hermetically sealed package

Dial 1-800-327-3243 for a "No Charge" telephone call and further information.

Solitron

DEVICES, INC.

1177 BLUE HERON BLVD. / RIVIERA BEACH, FLORIDA
(305) 848-4311 / TWX: (510) 952-6676

INFORMATION RETRIEVAL NUMBER 205

Regulated supplies display output value



NJE Corp., 20 Boright Ave., Kenilworth, N.J. Phone: (201) 272-6000. P&A: \$339 or \$446.

A new line of regulated power supplies allows their output voltage or current to be read on a 3-1/2-digit display. These LVC II/DVM units offer a readout accuracy of 0.1%, automatic decimal-point positioning, and five scale values. Outputs can be as large as 50 W, with voltages of 19.9 or 199.9 V and currents of 0.5, 1, 2 or 4 A. All the supplies include remote sensing.

CIRCLE NO. 424

Storage oscilloscope can vary viewing time



Tektronix, Inc., P.O. Box 500, Beaverton, Ore. Phone: (503) 644-0161. P&A: \$2500; second quarter, 1970.

Loaded with convenience features like illuminated push buttons and novel beamfinders, a new dual-beam, split-screen, bistable, storage oscilloscope offers a variable viewing time system. This system can be directed to automatically erase either or both halves of the display area after a predetermined viewing time. Type 5031 also has a 1-MHz bandwidth.

CIRCLE NO. 425

Economy 3-digit DMMs boast 0.1% accuracy



Dana Laboratories, Inc., 2401 Campus Dr., Irvine, Calif. Phone: (714) 833-1234. Price: \$350 or \$425.

Two new 3-digit multimeters feature a dc accuracy of 0.1% of reading and 0.1% of full scale. Model 3800, which costs \$425, has full multimeter capabilities; it includes five dc and four ac voltage ranges, six resistance ranges, and six dc current ranges. Model 3860 provides dc and resistance measurement capability for only \$350.

CIRCLE NO. 426

Transient recorder converts any scope



Biomation Corp., 1070 E. Meadow Circle, Palo Alto, Calif. Phone: (415) 321-9710. Price: \$1185.

Specifically designed to capture single-shot transients or repetitive signals up to 1 MHz, the new 610 transient recorder converts any oscilloscope to a storage scope with no writing rate limitation. In the single-shot mode, the recorder is triggered by the transient as it occurs; the signal is then captured and held for any length of time.

CIRCLE NO. 427

Power supply for \$199 features triple output



Trygon Electronics, Inc., 111 Pleasant Ave., Roosevelt, N.Y. Phone: (516) 378-2800. P&A: \$199; 4 wks.

Priced at \$199 is the model TL8-3 with three independent adjustable and metered outputs. Outputs are 0 to +8 V dc at 3A, 0 to +32 V dc at 1 A and 0 to -32 V dc at 1 A. Included are automatic current limiting, 0.01% regulation and 0.05% stability. Each output has a dual-scale ammeter/voltmeter and an over-voltage accessory is available.

Booth No. 2B49 Circle No. 346

Digital bridge works like scope



Micro Instrument Co., 12901 Crenshaw Blvd., Hawthorne, Calif. Phone: (213) 679-8237. P&A: \$2495 for mainframe, from \$995 for plug-ins; 6 to 8 wks.

Designed to bring versatility and economy to component testing, a new digital bridge, consists of two basic sections—the mainframe chassis for display and control circuitry, and plug-in test-head circuit modules for specific tests. Making use of the plug-in concept used by oscilloscopes, model 6100 eliminates costly equipment redundancy.

Booth No. 3A50 Circle No. 286

Mid-Eastern's ABC Series power supply system allows you to select the power supplies, panels, and racks which meet the requirements of your system exactly. Now you may buy only the power and options you need. You can select from models with outputs from 3 to 200 volts. You can choose from four panel styles in quarter or half-rack sizes: (1) blank; (2) on/off control with pilot light; (3) metered: volts and amps; or (4) complete with volt and amp meters, on/off control, pilot light, output terminals, and voltage adjust. You can pick a four-module or eight-module rack.

In short, you may create your own custom power supply system at a far lower cost than comparable non-modular units.

Each M-E power supply is series pass regulated with the most advanced integrated circuit control amplifiers and reference voltage circuits. Remote sensing, parallel or series operation, complete repairability, and solid-state overload protection are standard features. Overvoltage crowbar protection is available among the options.

Input: 105-130 VAC, 50-60 Hz
Output: 3V/10A to 200V/1.0A
Regulation: Line: 0.02%
 Load: 0.02%
Ripple: < 500 μ V rms
Load Response: < 50 μ seconds
Operating Temp.: 0-50°C, 71°C derated

Send for tech specs covering all ABC Series models, panels and racks. Or call your nearest M-E representative for fast, personal service.

M Mid-Eastern Industries A Division of Eanco, Inc.
 660 Jerusalem Rd. / Scotch Plains, N.J. 07076 / (201) 233-5900

M-E's new Pick-Your-Power Pack. It's simple as ABC.

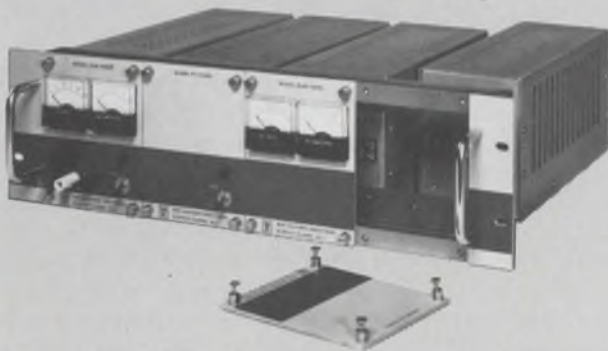

INFORMATION RETRIEVAL NUMBER 206

ELECTRONIC DESIGN 6, March 15, 1970

MINIATURE POWER RESISTORS

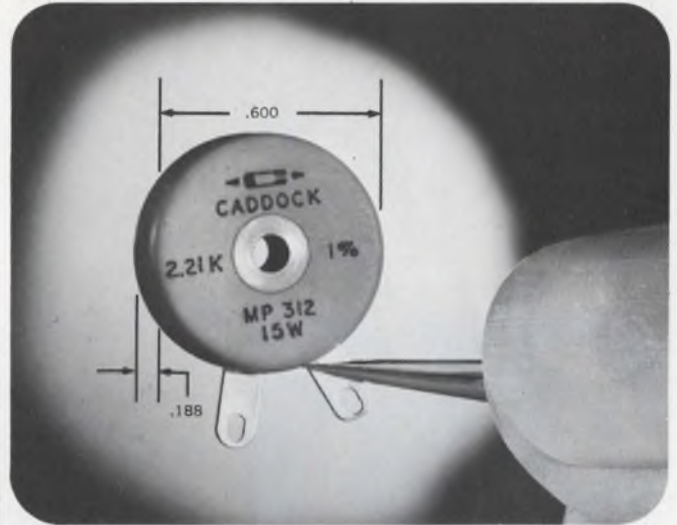

CHASSIS-MOUNT TYPE • NEW LAMINAR DESIGN • LOW PROFILE • 50% REDUCTION IN SIZE AND WEIGHT • COMPLETELY NON-INDUCTIVE • T.C.: 50 PPM/°C • RESISTANCE TOLERANCE: \pm 1%

| Model No. | Power Rating† | Max. Voltage | Diel. Str. | High Temp. TC: | Resistance Range | Terminals |
|-----------|---------------|--------------|------------|----------------|-------------------|------------------------------------|
| MP311 | 15 Watts | 300 | 600 | 50 | 50 Ω -200K | 12" Min Teflon Leads 26AWG 7x34 |
| MP312 | 15 Watts | 300 | 600 | 50 | 10 Ω -200K | Gold Plated Solder Lugs |

†Power rating based on chassis mounting—MP311 and MP312 on 6"x4"x2"x.040 aluminum chassis

‡TC: 50ppm/°C Referenced to 25°C, Δ R taken at +150°C and +275°C. (Low temp. TC will be nominally -85ppm/°C at -55°C. See typical R-T curve.)

Resistance Tolerance: \pm 1% standard (Other tolerances on special order.)

Insulation Resistance: 10,000 Megohms, dry. Method—Mil-R-18546D, para. 4.6.8.

Solderability: Per Mil-R-18546D, para. 3.7, para. 4.6.4.

Terminal Strength: Per Mil-Std-202, Method 211, Cond. A (Pull Test), 5 lbs., and Cond. B (Bend Test), Max. Δ R, .2% or .2 Ω , whichever is greater.

Thermal Shock: Per Mil-R-18546D, para. 4.6.9, max. Δ R, .5% or .2 Ω , whichever is greater.

Momentary Overload: 2 times rated power or 1.5 times max. allowable working voltage, whichever gives the lower power, for 5 seconds. Max. Δ R, .5% or .2 Ω , whichever is greater.

Moisture Resistance: Mil-Std-202, Method 106B, less steps 7a and 7b, max. Δ R, .5% or .2 Ω , whichever is greater.

Life: Per Mil-R-18546D, para. 4.6.12, 1,000 hrs. Max. Δ R, .1% or .2 Ω , whichever is greater.

Shock, Medium Impact: 50G, per Mil-Std-202, Method 205, Cond. C.

Vibration, High Frequency: Per Mil-Std-202, Method 204, Cond. B, Max. Δ R, .2% or .2 Ω , whichever is greater, through shock and vibration sequence.

DERATING CURVE

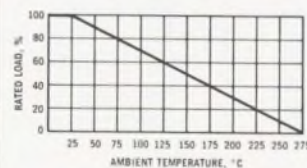

TYPICAL R-T CURVE

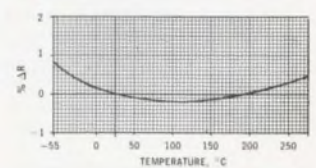

CADDOCK  **ELECTRONICS**

3127 Chicago Ave., Riverside, Calif. 92507 • Telephone: (714) 683-5361

INFORMATION RETRIEVAL NUMBER 207

255

BUY A KIT SAVE A LOT



1% TOLERANCE
SCHAUER
1-WATT ZENERS
A \$54.57 value, just

\$24.50

Kit contains a 51-piece assortment of SCHAUER 1% tolerance 1-watt zeners covering the voltage range of 2.7 to 16.0. Three diodes of each voltage . . . packaged in reusable poly bags. Stored in a handy file box. Rating data sheet included.

Use these Schauer zeners over and over in laboratory prototypes as well as in precision test equipment. Contact your distributor or order direct. Schauer is #2 in the plastic encapsulated diode field, highest quality, the industry's lowest prices!

Semiconductor Division

SCHAUER
MANUFACTURING CORP.

4511 Alpine Ave., Cincinnati, Ohio 45242
Telephone: 513/791-3030

INFORMATION RETRIEVAL NUMBER 208

INSTRUMENTATION

Breadboard kit multiplies uses

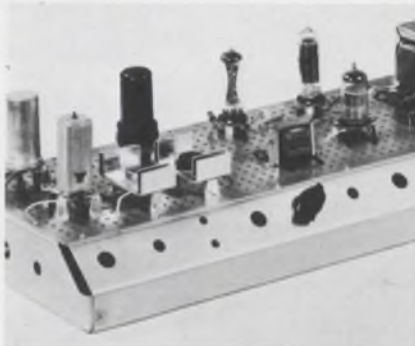

Houle Manufacturing Co., P.O. Box 276, Santa Susana, Calif.

A new prototype breadboard kit with a slanting-front chassis can be used as an rf kit, a conventional R & D laboratory kit, or as a piece of laboratory test equipment. For critical rf circuitry development, the kit has a two-sided copper-clad deck with gold-plated Teflon-insulated feed-through terminals for maximum component shielding. For conventional prototype work, the kit has a phenolic deck and solder-type or solderless connectors.

CIRCLE NO. 428

Logic test probe detects 5-ns pulses



Advanced Digital Research Corp., 608 Vaqueros Ave., Sunnyvale, Calif. Phone: (408) 245-8000. P&A: \$125; stock.

Intended for check-out and fault-isolation of discrete and IC digital logic circuits, a new probe features 5-ns pulse detection and a 50-MHz response. Logic Pen detects and indicates logic levels, single pulses and pulse trains. It has four lamps that indicate "1" and "0" logic levels and "Q" and "Q" changes of state.

CIRCLE NO. 429

Digital counter line senses 10-mV inputs



Anadex Instruments Inc., 7833 Haskell Ave., Van Nuys, Calif. Phone: (213) 782-9527. P&A: from \$460; 3 to 4 wks.

Operating from almost any input wave shape, series CF-600 digital counters feature a 10-mV input sensitivity and remote programmability. This new line includes counter-timers, totalizers, frequency counters, variable-time-base counters, and preset counters. Inherent high noise immunity is provided by dc switching and TTL ICs.

CIRCLE NO. 430

Four-digit voltmeter warms-up in 5 minutes



Simpson Electric Co., div. of American Gage & Machine Co., 5200 W. Kinzie St., Chicago, Ill. Phone: (312) 379-1121.

Featuring a new fast warm-up time, the 2700 dc digital voltmeter requires just one minute to reach an accuracy of $\pm 0.1\%$, ± 1 digit; a five-minute warm-up brings the instrument to its full rated accuracy of $\pm 0.05\%$, ± 1 digit. The unit has four full-time digits and an update rate of five readings per second.

CIRCLE NO. 431

LINEAR

Linear Integrated Circuit technology is happening so fast, it's difficult to determine which development to advertise first. So, we've decided to advertise everything at once. As it happens.

Every month, you'll see this weird-shaped ad in the trade press. It will include new product announcements, applications, marketing decisions, assorted breakthroughs, a design contest, what-have-you. Sort of a something-for-everybody compendium of LIC information. If you see something you like, write us and we'll tell you more about it.

New Product Digest

In addition to the μ A715 and μ A725, Fairchild is introducing the following new Linears:

- μ A731 **Dual Channel Sense Amplifier**
2mV Threshold Accuracy
5nSec Strobe Time Variation
Internal Memory Data Register
Reader Service Number 112
- μ A735 **Micro Power Amplifier**
100 μ W Power Consumption
2nA Offset Current
 \pm 3V to \pm 18V Supply Voltage
10M Ω Input Resistance
Reader Service Number 113
- μ A739 **Dual Low Noise Op Amp**
1 μ V_{rms} Noise (20Hz to 150KHz)
50 μ A Offset Current
20,000 V/V Voltage Gain
Reader Service Number 114
- μ A742 **Zero Crossing AC Trigger**
Operates from AC or DC Supply
2 Amps Peak Output Current
Time Proportioning Operation
Adjustable Hysteresis
Reader Service Number 115
- μ A747 **Dual Internally Compensated Op Amp**
Short Circuit Protected
Latch-up Proof
Offset Voltage Null Capability
 \pm 30V Differential Input Voltage
200,000 V/V Voltage Gain
Reader Service Number 116
- μ A748 **High Performance Op Amp**
Short Circuit Protected
Latch-up Proof
 \pm 30V Differential Input Voltage
200,000 V/V Voltage Gain
Reader Service Number 117
- μ A749 **Dual Op Amp**
92dB Voltage Gain
20MHz Bandwidth
Latch-up Proof
Short Circuit Protected
Reader Service Number 118

EDITORIAL

If We Can't Sell You Ours, We'll Sell You Theirs.

For a long time, Fairchild built only linears designed by Fairchild engineers. We didn't think anything else was worth the effort. People said we had an NIH (Not Invented Here) complex. And, they were right.

However, it's been brought forcefully to our attention that a couple other guys in this business know what they're doing. The competition is coming out with some pretty worthwhile linears. Our customers have noticed too, because they're talking to other manufacturers about linears we don't make. They're even talking to sole sourcers!

To keep things even, we've decided to give our wandering customers something they're going to need if they start dealing with a sole source linear maker: A second source. Us. (Just in case the original supplier's factory blows up or they lose the formula or whatever it is that happens when you can't get delivery.)

Starting now, Fairchild is introducing a new line of linears. We call them IT circuits (Invented There). The first two are available today: The LM101 and the MC1495. Soon we'll add the LM101A, MC1496 and the SN7524. Of course, we've given them Fairchild part numbers.

Here's a conversion chart:

| | | |
|------------|-----------------------|--------|
| μ A795 | Analog Multiplier | MC1495 |
| μ A796 | Modulator | MC1496 |
| μ A748 | Operational Amplifier | LM101 |
| μ A777 | Operational Amplifier | LM101A |
| μ A761 | Sense Amplifier | SN7524 |

There will be other additions to the IT line soon. So be sure you contact your local Fairchild Sales Engineer before you drop a design for lack of a reliable alternate source. Just give him the part number you want and ask him to check the IT line. Farewell NIH.

Reader Service Number 119

Contest

Last year, Fairchild gave a series of seminars on Linear Integrated Circuits in which we introduced 12 new products. One device, the μ A742 TRIGAC Zero-Crossing A.C. Trigger, was so significant we offered a free sample to anyone who came up with an original application for it. We got hundreds of replies. The most ingenious was sent in by Richard M. Burkhart, a graduate student at the University of Illinois. We liked Richard's application so much, we decided to give him \$100. Then, we liked the \$100 idea so much, we decided to make it a contest.

Here's how it works:

- 1) Get all the facts on a Fairchild Linear IC.
- 2) Design the world's greatest application for it.
- 3) Send the application to us.

All entries will be judged by the editors of EEE Magazine. Every

month, they will select the most fantastic application and give us the designer's name. We'll publish the winning design here and give the winner \$100 upon publication.

To give you an idea of what we're looking for, here's Richard Burkhart's design:

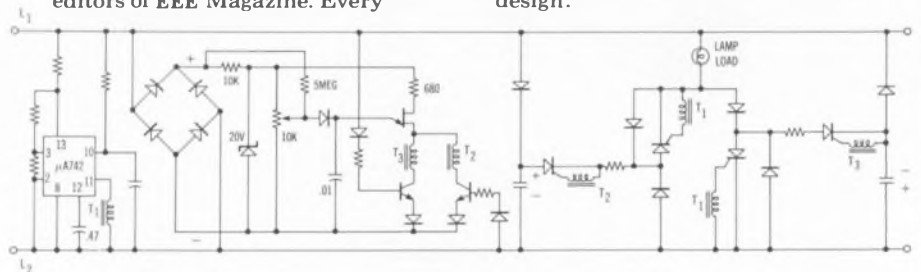

Send all entries to: Fairchild Linear Contest
P.O. Box 880A, Mountain View, California 94040

REVERSE PHASE CONTROL CIRCUIT

ECC CAN SOLVE YOUR OVERSIZE 50 VOLT RADIAL LEAD CAPACITOR PROBLEMS. If you've been looking to buy truly miniature 50-Volt metalized polyester radial lead capacitors, look to ECC. ECC utilizes 17 specific package sizes to package their 50 volt capacitor products, encompassing more than 90 standard values from .001 to 5.0 mfd. Space saving package sizes range from .100W x .285L x .225H to .475W x 1.100L x .650H. Designed for PC board installation, these radial lead capacitors are epoxy encapsulated in Diallyl Phthalate housings; packages incorporate stand-off feet to allow solder fillet formation, inspection and flush cleaning. Lead length is .125(min.) with break-outs on .100 increments. ECC Radial Lead Capacitors meet applicable requirements of MIL-C-18312, MIL-C-27287 and MIL-C-19978. Standard values are available from stock or within 3 weeks ARO. Circle the reader service number for a copy of Catalog C-4/69.

ECC engineered components company

2134 W. Rosecrans Ave., Gardena, Calif. 90249 · (213) 321-6565 / 321-8294



INFORMATION RETRIEVAL NUMBER 211

If your equipment calls for custom-designed protection...

Give us your out-of-the-ordinary container requirement—and we'll meet it. Precisely. In the shortest possible time. Because we have everything it takes to do the job. Sandwich construction materials. Off-the-shelf components. Standard hardware. Over 30 years of experience in the manufacture of cases and containers. The result? Complete equipment protection against shock, vibration, and environmental hazards. Built to all required MIL specifications. We also make custom molded and standard fiberglass and ABS thermoplastic containers and cases. Call or write for our standard price lists and comprehensive design manuals.

Skydyne will "contain" it for you.

Skydyne, Inc.

River Road, Port Jervis, N. Y. 12771 • (914) 856-6655

Subsidiary of **b·p** Brooks & Perkins, Inc.

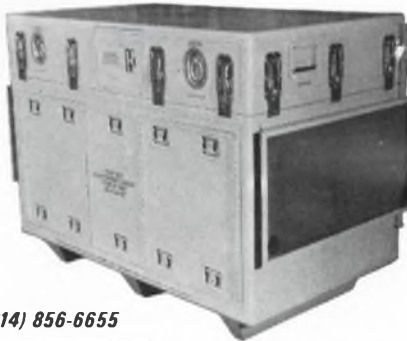

INFORMATION RETRIEVAL NUMBER 212

256D

INSTRUMENTATION

Lab power supplies regulate with ICs



Deltron Inc., Wissahickon Ave., North Wales, Pa. Phone: (215) 699-9261.

With their integrated circuit regulation systems, two new series (RP and SP) of laboratory power supplies can operate with high regulation, stability, and freedom from random thermal transients. For the high-power SP series, a high-performance non-dissipative pre-regulator is included. Both of these power-supply lines incorporate protective and guard circuits.

Booth No. 2J39 Circle No. 275

High-accuracy DPMs resolve 10⁴ counts



Computer Products, 2709 N. Dixie Highway, P.O. Box 23849, Fort Lauderdale, Fla. Phone: (305) 565-9565. P&A: from \$273; 15 to 30 days.

With a resolution of 10,000 counts, series DP400 digital panel meters yield accuracies of $\pm 0.02\%$. ± 1 count. Full-scale input ranges for voltage meters are 1, 10 or 100 V. The units have a self-contained power supply, and operate with a temperature coefficient of 0.003%/°F. Their dimensions are 4.2 × 2.5 × 3 in.

CIRCLE NO. 436

New Op Amp has Gain of 3,000,000.

Fairchild's new $\mu A725$ Instrumentation Operational Amplifier can do the same jobs that used to require expensive chopper-stabilized or complex discrete component amplifiers. The $\mu A725$ is ideally suited for use in Low Level Signal Conditioners, Instrumentation Amplifiers, Precision Measuring Equipment, Process Control Systems and Data Acquisition Equipment.

Electrical Performance/Features

- Low Input Noise Current . . . 0.6pA/ Hz
- High Open Loop Gain 3,000,000
- Low Input Offset Current 3nA
- Low Input Offset
- Voltage Drift 0.5 μ V/ $^{\circ}$ C
- High Common Mode Rejection . 120dB

One of the many applications for the $\mu A725$ is in Linear photo-detection systems. Use of a PIN Photodiode with the $\mu A725$ provides the user with a low noise linear detection system which operates from low voltage supplies and has none of the inherent disadvantages of photo-multiplier tubes (high voltage supplies, aging effects, large physical size, high power dissipation).

Reader Service Number 110

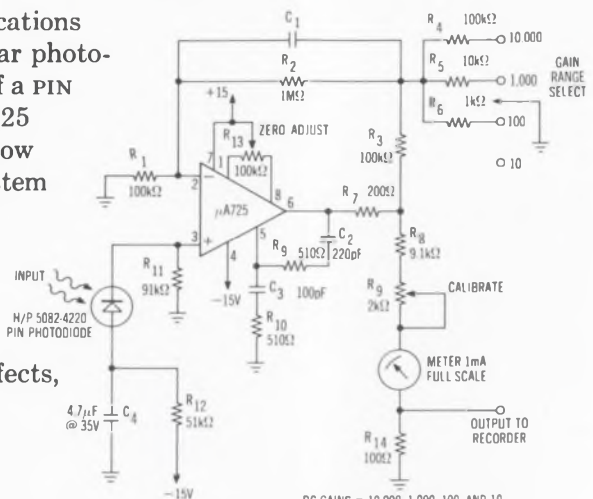

DC GAINS = 10,000; 1,000; 100; AND 10
BANDWIDTH = DETERMINED BY VALUE OF C_1
GAIN ACCURACY \times 1000 0.03%

$\mu A725$ PIN PHOTODIODE AMPLIFIER

$\mu A715$ Basis of Fast Sample/Hold Circuit.

Many data acquisition systems require a sample and hold circuit to improve analog-to-digital conversion accuracy. The requirements of a good S/H circuit are:

1. minimum droop during the hold period
2. high open loop gain for good closed loop gain accuracy
3. high speed
4. minimum temperature drift

A basic sample and hold circuit configuration looks like this:

In the sample mode, the sampling switch Q_1 is turned on and

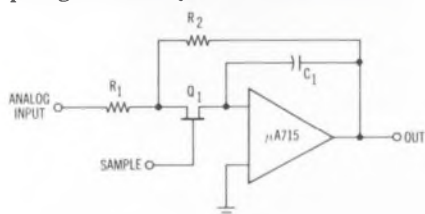

BASIC OPERATIONAL SAMPLE AND HOLD CIRCUIT

the circuit functions as an inverting operational amplifier.

When Q_1 is switched off, the circuit functions as an integrator, holding the output voltage constant at the sampled value.

The acquisition time when going from the hold mode to the sample mode is a function of the time constant R_2C_1 and the required accuracy, and is given by:

$$t_a = R_2C_1 \ln \left(\frac{100}{\% \text{ accuracy}} \right)$$

A complete sample and hold circuit is shown below. It includes the components necessary to compensate for the DC and AC errors inherent to the basic configuration. The DC offset is adjusted to zero by a 50k potentiometer (R_4). C_3 , C_4 , and C_5 provide unity gain frequency compensation.

A junction field effect transistor is used as the sampling switch Q_1 . Because there is some capacity from the gate to the source of Q_1 , a portion of the gate signal to the switch is coupled through the device onto the holding capacitor C_1 causing an offset error which is bucked out by an opposing signal, coupled by C_2 , from the sample pulse input onto the holding capacitor.

Holding Accuracy. During the hold time the output voltage will tend to drift as the holding capacitor integrates the input bias current of the amplifier. This drift is compensated by supplying temperature compensated bias current from a separate source, R_5 , R_6 , R_7 and D_1 .

With a 10 volt step input (± 5 volts to ∓ 5 volts) the settling time to $\pm 0.05\%$ is 10μ sec. This is slightly longer than that given by equation 1 due to the finite "on-resistance" of the sampling switch Q_1 . If C_1 is decreased to 100pF the settling time is about 1μ sec. Temperature drift of the output in the hold mode is approximately 0.001% per degree Centigrade for a hold time of 100μ sec.

Reader Service Number 111

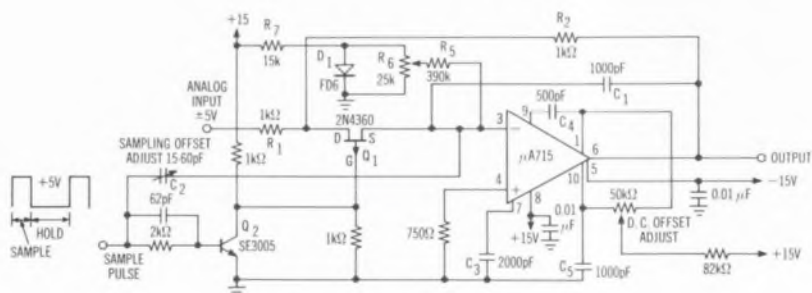

$\mu A715$ SAMPLE AND HOLD CIRCUIT

GOOD BUY, MR. CHIPS

BY MONOLITHIC DIELECTRICS



CHIP KIT NO. 1 consists of 300 monolithic ceramic capacitor chips for hybrid circuits. Browse, examine, and test. There are 10 chips of each standard RETMA values from 1.2 pf to 330 pf in $\pm 10\%$ tolerances at 50 VDCW.

CHIP KIT NO. 2 consists of 300 sample chips, 10 chips each of all standard RETMA values from 390 pf to .1 MFD in $\pm 10\%$ tolerances at 50 VDCW.

KIT NO. 1 or KIT NO. 2—\$49.50 ea. A GOOD BUY! Delivery from stock. Call direct and ask for Jim Waldal.

Monolithic  Inc.

P.O. Box 647, Burbank, Calif. 91503 • (213) 848-4465

INFORMATION RETRIEVAL NUMBER 213

Set an improved *PDQ standard by comparing with

BEAU

Connectors



Series 3300

Visit Booth No. 26
NEPCON CENTRAL, Chicago

April 7, 8, 9

Beau Products Division



Vernitron
Electrical Components
117 Union Avenue, Laconia, N.H. 03246
Tel: (603) 524-5101 TWX: 710-364-1843

*PDQ:

Price — right
Delivery — dependable
Quality — proved

BEAUPUG® Series 3300 electrical connectors, for instance, have been developed to provide a reasonably priced, reliable, versatile connector for chassis, cable and modular use where space is not a prime consideration.

Request PRICE/
CATALOG No. 75-DA

STATE OF THE ART SEMINARS FOR ENGINEERS AND SCIENTISTS

Here's an opportunity to engage in short programs that will review many of the latest advances and engineering techniques in your field ... presented by RCA Institutes.

| | | |
|-----------------------------|-------------------|----------|
| LOGIC DESIGN | San Francisco | 4/6-10 |
| | Los Angeles | 4/13-17 |
| | Syracuse, N. Y. | 4/27-5/1 |
| | Houston | 5/4-8 |
| | Huntsville, Ala. | 5/11-15 |
| | Minneapolis | 5/18-22 |
| | Washington, D. C. | 6/1-5 |
| | Chicago | 6/15-19 |
| Albuquerque | 7/27-31 | |
| DIGITAL SYSTEMS ENGINEERING | Dallas | 4/13-17 |
| | Washington, D. C. | 4/27-5/1 |
| | Cleveland | 5/11-15 |
| | Boston | 5/18-22 |
| | Montreal | 6/1-5 |
| | Denver | 6/22-26 |
| Washington, D. C. | 7/13-17 | |
| DIGITAL COMMUNICATIONS | New York | 4/6-10 |
| | Chicago | 4/20-24 |
| | Albuquerque | 5/18-22 |
| | Houston | 6/1-5 |
| | San Francisco | 6/15-19 |
| | Los Angeles | 6/22-26 |
| | Huntsville, Ala. | 7/6-10 |
| | Minneapolis | 7/13-17 |
| Syracuse | 7/27-31 | |
| INTEGRATED CIRCUITS | Boston | 4/13-15 |
| | Atlanta | 4/20-22 |
| | New York | 5/11-13 |
| | San Francisco | 5/20-22 |
| | San Diego | 5/25-27 |
| | Detroit | 6/8-10 |
| | Rochester | 6/29-7/1 |
| | Montreal | 7/6-8 |
| | Houston | 7/13-15 |
| | Pittsburgh | 7/27-29 |

Above schedule subject to change.

RCA

RCA Institutes, Inc. Dept. ELD-30
Institute for Professional Development
Central & Terminal Avenues, Clark, N. J. 07066

For free descriptive brochure, please check the seminar in which you are interested.

Logic Design Integrated Circuits
 Digital Communications Digital Systems Engineering

Name _____ Title _____

Company _____

Address _____

City _____ State _____ Zip _____

INFORMATION RETRIEVAL NUMBER 215

INFORMATION RETRIEVAL NUMBER 214



Antiques
are fine—
but not for
test instrumentation.

Move up to our Automatic Synchro/Resolver Bridge.

Use your test engineers as they should be used . . . as skilled observers . . . not dial twisters. Complex set ups that require operation of a manual synchro bridge and an error detector are time consuming and frequently error producing.

Our unit features: ■ Completely automatic nulling ■ Accuracy and resolution of .1°, .01° or .001° ■ In-line decimal readout ■ BCD electrical output ■ Accommodates 11.8, 26, and 90 VAC inputs ■ High input impedance ■ Insensitive to quadrature and distortion.

For further information, or a demonstration at your plant, phone or write: astrosystems, inc. 6 Nevada Drive, Lake Success, New York 11040 516/328-1600 TWX 510/233-0411. West Coast Office/4341 Commonwealth Avenue, Fullerton, California 92633 714/523-0820.

astrosystems



See us at the IEEE Show—Booths 2L01 and 2L02

INFORMATION RETRIEVAL NUMBER 216

PACKAGING & MATERIALS

Conductive carriers protect MOS chips

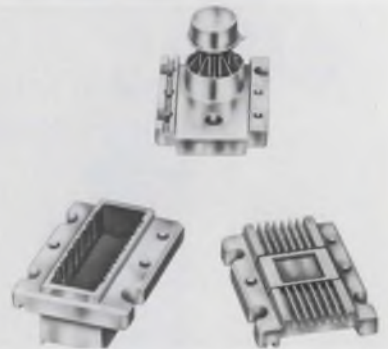

Barnes Corp., 24 N. Lansdowne Ave., Lansdowne, Pa. Phone: (215) 622-1525. P&A: 3¢ to 25¢; 2 to 4 wks.

Aluminum-plated conductive carriers eliminate the static electrical charges that can build-up and ruin MOS IC devices during handling and shipping. Because the carriers are coated with vacuum-deposited aluminum, there is a conductive plating over their entire surface. This coating keeps all leads shorted so that no voltage differential can exist between them.

CIRCLE NO. 437

Cable jacketing goes on with twist



Zippertubing Co., 13000 S. Broadway, Los Angeles, Calif. Phone: (213) 321-3901.

Called Zip-tight, a new cable jacketing comes in pre-zipped spiraled lengths so that its inside diameter is much larger than the wiring or items to be jacketed. Cable is simply inserted in the wide-mouth opening of the jacketing, which is then twisted with a slight wrist action to form a tight and compact finished unit. Length and material type can be specified.

CIRCLE NO. 438

Interface connectors accept 2 cable types

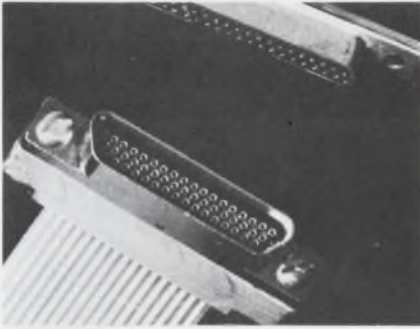

Microdot Inc., Connector Div., 220 Pasadena Ave., S. Pasadena, Calif. Phone: (213) 682-3351.

Designed specifically for use with flat cable, a new connector series will accept round cable, or a combination of flat-conductor and round cables, thus acting as an interface between equipment with different cable types. The connectors' unique design permits users to completely terminate the cable and check circuits before the completed assembly is inserted into the metal housing.

CIRCLE NO. 439

Ribbon cable stays flexible

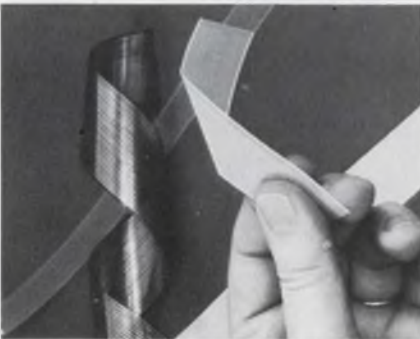

Sylvania Electric Products Inc., Philadelphia Insulated Wire, 333 New Albany Rd., Moorestown, N.J.

Flexible flat-conductor cable is now available for use in military, commercial, industrial and computer applications. A choice of five insulations is offered: polyester; self-extinguishing polyester; total polyimide, for use to 250°C; polyester bonded polyimide, for operation to 150°C; and polyimide Teflon fluorinated ethylene propylene-bonded, for operation to 200°C.

CIRCLE NO. 440

NOW! from RMC



"ACROSS-THE-LINE" U.L. LISTED DISCAPS

| EIA Class | .580 MAX. -AU-RMC 10NPO 5% | .720 MAX. -AU-RMC 5027 20% Z5U | .850 MAX. -AU-RMC 160N1500 10% | 1.050" MAX. -AU-RMC .01 +80-20% |
|-----------|---|--|-----------------------------------|------------------------------------|
| Class II | 330 470 680 | 820 .001 .0015 .0022 .0027 | .0033 .0039 .0047 .005 | .0068 .0082 .01 |
| Class I | NPO 3.9 - 20 N750 15 - 35 N1500 15 - 67 | 21 - 31 36 - 61 68 - 119 | 32 - 47 62 - 82 120 - 180 | |

THICKNESS: .225 Max.

RMC now offers a complete line of ceramic disc capacitors fully approved by Underwriters Laboratories for the NEW "Across-The-Line" capacitor requirements. This approval is required of all capacitors utilized directly or indirectly across the power supply line.

This application is significantly different from the "Antenna Coupling and Line By pass" capacitor requirements of Underwriters Laboratories Subject 492, and the original RMC -U- capacitor type continues to be approved for those applications.

SPECIFICATIONS

CAPACITANCE: Within specified tolerance:
Class I @ 1MC and 25°C
Class II @ 1KC and 25°C

CAPACITANCE TOLERANCES AVAILABLE:
Class I ±5%, ±10% or ±20%
Class II ±20%, +80 - 20%

WORKING VOLTAGE: 150 VRMS @ 60 cycles (210 volts peak AC plus DC)

POWER FACTOR:
Class I .1% max. at 1 MC
.2% max. less than 30 pf
Class II 1.5% max. at 1KC

INSULATION RESISTANCE: Greater than 7500 Megohms @ 500 VDC

TEMPERATURE COEFFICIENT:
Class I NPO N750 N1500
Class II Z5U; Z5F 1500 pfd. And Less.

FLASH TEST:
Per U.L. Sub. 492

LIFE TEST:
Per U.L. Sub. 492

INSULATION RESISTANCE AFTER HUMIDITY:
Greater than 1000 Megohms @ 500 VDC

BODY INSULATION: Durez phenolic—vacuum wax impregnated. Standard coating on leads 1/16" max. measured from tangent

LEAD STYLES AVAILABLE: Long lead—#20 AWG tinned copper

DISCAP
CERAMIC
CAPACITORS



RADIO MATERIALS COMPANY
A DIVISION OF P. R. MALLOY & CO., INC.
GENERAL OFFICE: 4242 W. Bryn Mawr Ave., Chicago, Ill. 60644
Two RMC Plants Devoted Exclusively to Ceramic Capacitors
FACTORIES AT CHICAGO, ILL. AND ATTICA, IND.

INFORMATION RETRIEVAL NUMBER 217

BOURNS

NOW OFFERS A COMPLETE LINE OF
**PASSIVE
MICROELECTRONIC
CIRCUITS**

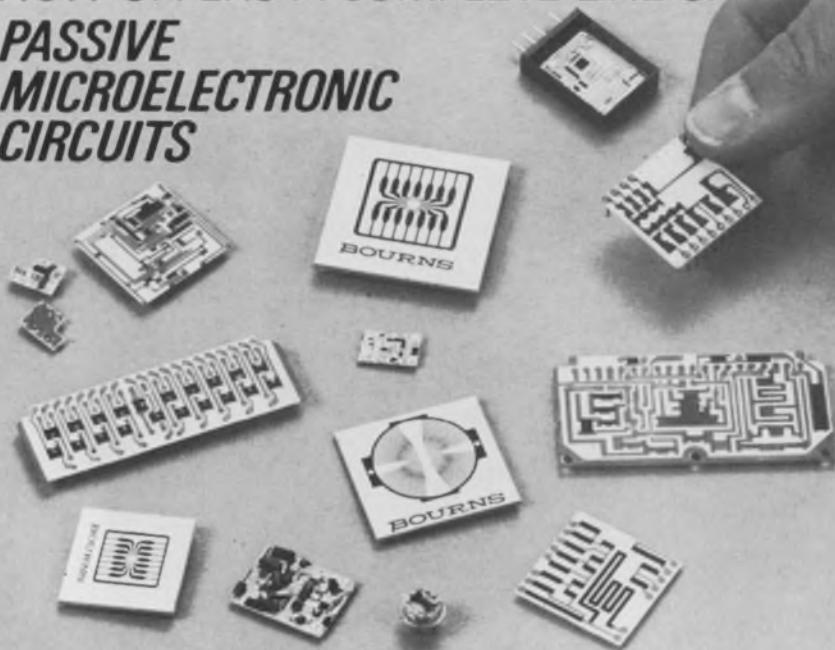

BOURNS
TECHNICAL MATERIALS

TRIMPOT PRODUCTS DIVISION • 1200 COLUMBIA AVE., RIVERSIDE, CALIF. 92507

SEND FOR NEW CAPABILITY BROCHURE. IT SETS FORTH DESIGN PARAMETERS FOR BOURNS THICK FILM RESISTOR AND RESISTOR-CAPACITOR NETWORKS.

INFORMATION RETRIEVAL NUMBER 218



RF and POWER SWITCHES

A complete line of rotary, high voltage and high current ceramic-type switches for RF and low frequency applications.

Write for catalog, containing information on the mechanical and electrical properties of our standard line of switches.

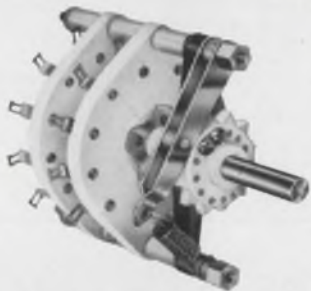

RADIO SWITCH CORPORATION

P.O. Box 79 Marlboro, N.J. 07746

Tel. (201) 462-6100

INFORMATION RETRIEVAL NUMBER 219

LARGEST AND MOST
DIVERSIFIED STOCK OF

RELAYS

IN THE WORLD!

We also stock MICROSWITCHES®

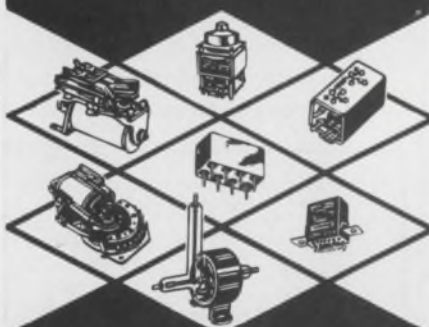

Faster Delivery / Lower Prices
All Types / Most Makes

SEND FOR
CATALOG ED

**Universal
RELAY CORP.**

42 White St., New York, N.Y. 10013
(212) 925-6900 • TWX 710-581-4461

INFORMATION RETRIEVAL NUMBER 220

PACKAGING & MATERIALS

Termination system grounds and shields



Chomerics, Inc., 77 Dragon Court, Woburn, Mass. Phone: (617) 935-4850.

Using a conductive grounding grommet, a new terminating system provides both rfi shielding and shield grounding right at connector terminations. Individual shielded wires are forced through the preformed holes in the grounding grommet, leaving a short length of exposed shield inside the grommet. A ground is achieved by bussing the conductive grommet to the connector backshell with a heat-shrinkable conductive boot.

CIRCLE NO. 441

Cermet pastes hold 50 ppm



Cermet Alloy, Cermet Div. of Bala Electronics, Corp., P.O. Box 465, Bala Cynwyd, Pa. Phone: (215) 828-4650. Availability: stock.

Developed for thick-film microcircuits, a family of thixotropic cermet pastes have a temperature coefficient of 50 ppm for resistance levels from 100 ohms per square to 10 kilohms per square. These new inks are completely blendable over the entire sheet resistivity range, and can be trimmed by a laser. They are batch-to-batch reproducible.

CIRCLE NO. 442

Emerson & Cuming, Inc., Microwave Products Div., Canton, Mass. Phone: (617) 828-3300. Price: \$30/lb.

Eccoshield ES is an electrical-conductive lacquer based on fine silver with good coatability and adherence to almost any clean hard surface. It was developed especially to enhance radio-frequency shielding integrity. One coat of the material gives a surface resistivity of less than one ohm per square; successive coats reduce this to 0.1 ohm per square.

CIRCLE NO. 443

Diamond compounds come as aerosols



Conductive paint boosts shielding



Engis Equipment Co., Hyprez Div., 8035 N. Austin, Morton Grove, Ill. Phone (312) 966-5600.

Available in 5 and 14-ounce aerosol dispensers, a new line of diamond compounds are designed for applications where uniform application is absolutely necessary. The new spray compounds and lubricants are all color-coded for easy and fast identification. Alignment of the spray nozzle for proper and complete emptying of the can is greatly simplified by a directional arrow.

CIRCLE NO. 444

Times Wire & Cable Co., div. of Insilco Corp., 358 Hall Ave., Wallingford, Conn. Phone: (203) 269-3381. Availability: stock.

Primarily intended for use aboard aircraft, a high-temperature lightweight low-loss flexible coaxial cable can operate at temperatures as high as 400°F. The MI-5224 cable consists of a stranded silver-covered copper inner conductor insulated by a taped TFE dielectric. The outer conductor is a double braid of flat silver-covered strips of copper.

CIRCLE NO. 445

PC-card files adjust size

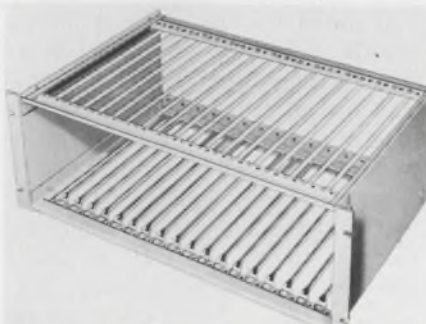

Braided coax cable withstands 400°F

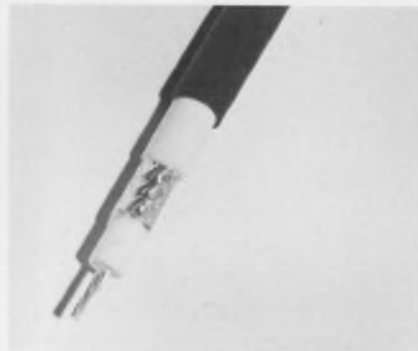

Premier Metal Products Co., div. of Sunshine Mining Co., 337 Manida St., Bronx, N.Y.

A new line of adjustable printed-circuit-card files can accommodate card widths from 2-7/8 to 8 in. and depths to 14-1/2 in. Series PHC units fit standard 19 and 24-in.-wide racks for 5-1/4, 7 and 8-3/4-in. panel heights. The 19-in. frames hold up to 27 cards; the 24-inch frames accept as many as 36 cards. They also have two adjustable rear connector panels.

CIRCLE NO. 446

Test Power Transistors



FAST · ACCURATE · AUTOMATIC

The Lorlin Automatic Transistor Tester Model TB is programmable over a range of 0.1 nanoamps to 10 amps and 10 mV to 600 V. All types of transistors from small signal to high power can be tested for breakdown voltages, leakage, gain and saturation voltages with 1% accuracy.

A complete test sequence can be programmed by the operator in minutes. Since a standard test takes just 16 milliseconds, high daily thruput is possible.

Models are available with up to 24 test positions and 18 sorting classifications. Remote test stations with the same range and accuracy are available to permit several operators to share one tester. All Lorlin testers will interface with automatic probing, handling and classifying equipment.

Lorlin testers are designed for maximum reliability, ease of service, convenience of programming, and simplicity of operation. Their speed, accuracy and reasonable price provide users a substantial return on their capital investment. Write or call for more information and a demonstration in your plant.

SEE THE MODEL TB AT BOOTH 2K37 IEEE
LORLIN
industries inc.

Precision Road, Danbury, Connecticut 06810
 Tel: 203-744-0096

For Literature circle 221
 For Demonstration circle 222

WHEN YOU CHANGE JOBS...



TOOLS & ENGINEERING AIDS

Plastic syringe applies resins

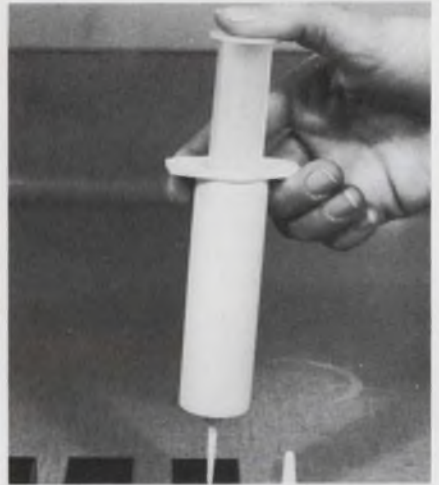

EPD Industries, Inc., Laboratories Div., 2055 E. 223rd St., Long Beach, Calif. Phone: (213) 775-7141. Price: 23¢ to 79¢.

Permitting controlled application of resins without contamination, a new polyethylene syringe provides easy access to otherwise inaccessible areas. The unit has a tapered tip that can be cut back to accommodate high-viscosity resins, and a tapered cap that can be cut to accept steel adaptor needles. Sizes range from 6 to 50 cm³. The barrels are self-venting.

CIRCLE NO. 447

DIP IC inserter is spring-loaded



Hunter Tools, 9851 Alburdis Ave., Santa Fe Springs, Calif. Phone: (213) 692-7281. P&A: \$8.90; stock.

A new spring-loaded hand tool is designed for inserting dual-inline packages into printed circuit boards. Most DIP hole patterns are slightly narrower than the actual lead spread. This holds the circuits firmly in place during handling or wave soldering. The type 52 inserter automatically squeezes the package to fit the hole pattern, and then ejects it when the DIP is firmly placed in the circuit board.

CIRCLE NO. 448

Regulating heat gun adjusts to 900°F



Sigma Systems Corp., 3163 Adams Ave., San Diego, Calif. Phone: (714) 283 3193.

Having precision-resetting capability, a new heat gun yields adjustable temperatures from ambients to 900°F. Excellent regulation is achieved with the model ER900 by phase-angle control of the heater current from 0 to 14 A with a constant-velocity air flow. Product damage from overheating is virtually eliminated since the temperature can be preset and limited by the operator.

CIRCLE NO. 449

Component trimmer cuts parallel leads

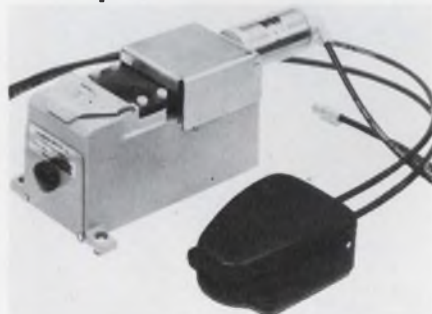

Technical Devices Co., 11242 Playa Court, Culver City, Calif. Phone: (213) 870-3751. P&A: \$275; stock.

Designated the Mark IX, a pneumatic machine trims parallel leads of components such as transistors, disc capacitors, DIP modules, TO cases, and many other packages, within one-square-inch area. Quick-change dies allow the trimming of up to 20 leads on a single module to specified lengths from 0.05 to 0.5 in. A foot control valve is included.

CIRCLE NO. 450

REMEMBER...

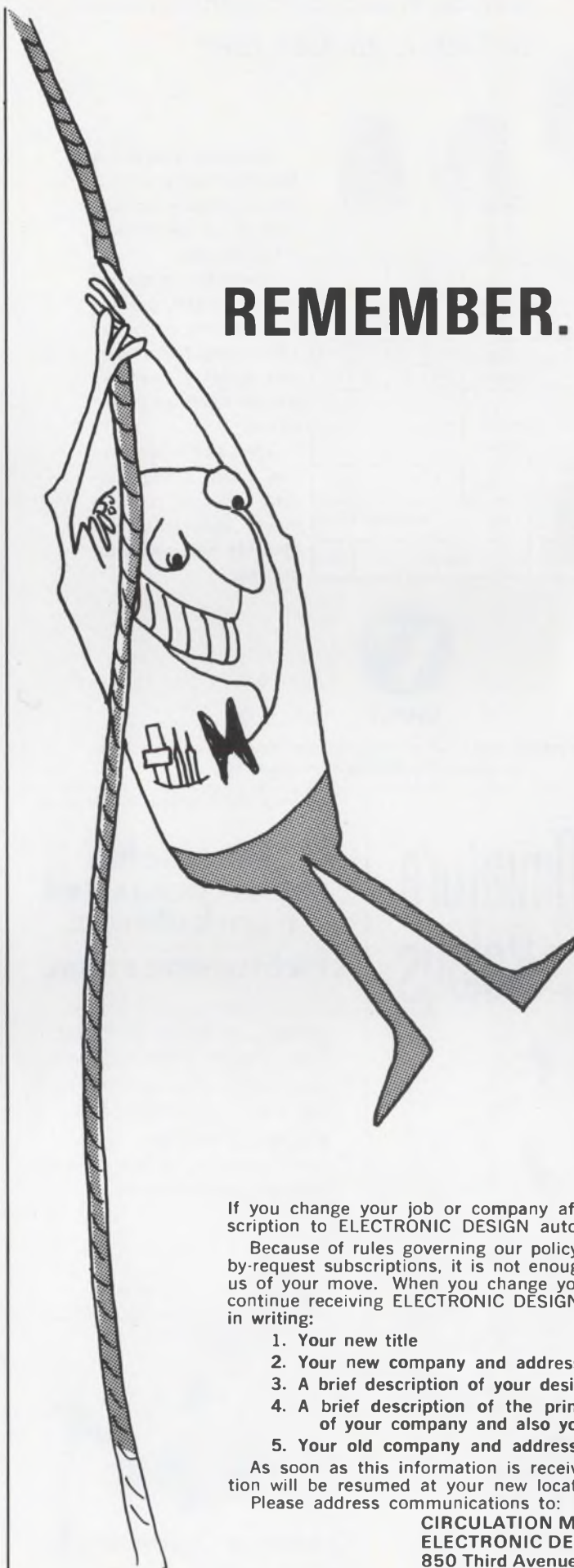

If you change your job or company affiliation, your subscription to ELECTRONIC DESIGN automatically stops.

Because of rules governing our policy of free, qualified-by-request subscriptions, it is not enough to merely notify us of your move. When you change your job, in order to continue receiving ELECTRONIC DESIGN, you must tell us in writing:

1. Your new title
2. Your new company and address
3. A brief description of your design duties
4. A brief description of the primary end products of your company and also your department.
5. Your old company and address

As soon as this information is received, your subscription will be resumed at your new location.

Please address communications to:

**CIRCULATION MANAGER
ELECTRONIC DESIGN
850 Third Avenue, New York 10022**

Available in production quantities now!

10 AMP & 25 AMP IBR®



| ELECTRICAL CHARACTERISTICS at $T_C = 25^\circ\text{C}$ (Unless Otherwise Specified) | SYMBOL | 200V | 400V | 600V | UNIT |
|---|------------------|------------|------|------|---------|
| Minimum Avalanche Voltage | $V_{(BR)}$ | 250 | 450 | 650 | VOLT |
| Maximum Avalanche Voltage | $V_{(BR)}$ | 700 | 900 | 1100 | VOLT |
| RMS Reverse Voltage | $V_{R(RMS)}$ | 140 | 280 | 400 | VOLT |
| Average Rectified Output Current at $T_C = 100^\circ\text{C}$ (Fig. 2) | I | 10 or 25 | | | AMP |
| Nonrepetitive Peak Surge Current (Fig. 3) | I_{FM} (surge) | 100/250 | | | AMP/LEG |
| Max. Surge Current, 1 sec. at 60Hz and $T_C = 100^\circ\text{C}$ (Nonrep.) | $I_{F(RMS)}$ | 30/50 | | | AMP |
| Power Dissipation in $V_{(BR)}$ Region for 100 μ sec., Square Wave (Fig. 4) | PRM | 600/1500 | | | WATT |
| Insulation Strength, Circuit-to-Case | | 2000 (MIN) | | | VDC |

Varo Integrated Bridge Rectifiers offer single-phase full-wave rectification in an electrically insulated case.

Controlled avalanche characteristic permits selection of decreased PRV safety factor without greatly reduced transient voltage vulnerability.

The IBR® is ideal for use where space, current and cost requirements disallow use of discrete semiconductor devices.



VARO

SEMICONDUCTOR DIVISION, 1000 N. SHILOH ROAD, GARLAND, TEXAS 75040 (214) 272-4551
INFORMATION RETRIEVAL NUMBER 223

TOOLS & ENGINEERING AIDS

Long-life flashlight uses 10-year battery



Mallory Battery Co., Broadway & Sunnyside, Tarrytown, N.Y. Phone: (914) 591-7000. Price: \$5.99.

Designed for emergency uses, a new flashlight is equipped with a Duracell battery that lasts 10 years or more until activated. The battery is activated by turning a terminal cap that puts the flashlight into instant service. Until activated, the battery can be stored indefinitely. Placed in use, it lasts more than twice as long as ordinary types.

CIRCLE NO. 451

Stranded-wire cutter improves cable slicing



Brookstone Co., 554R Brookstone Bldg., Peterborough, N.H. Price: \$4.45.

The unusual shape of a new 4-3/8-in. cutter allows neat slicing of insulation and/or stranded conductors. It eliminates the usual messy cuts encountered when slicing stranded conductors. Solid-conductor copper and aluminum wires up to 1/2-in. in dia over the insulation can be neatly cut. The cutter is forged of top-quality hardened and tempered carbon steel, and is chrome-plated.

CIRCLE NO. 452

Micro-Miniature Reed Relays

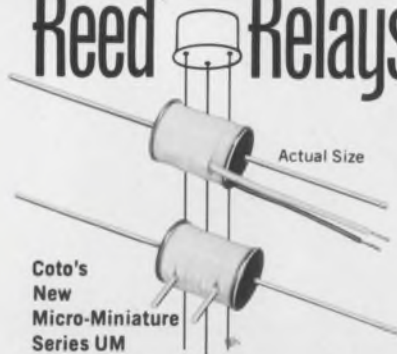

Coto's New Micro-Miniature Series UM

- Extremely small size: .400" x .300" OD
- Occupies less than 0.03 cu. in.
- Ultra-high speed 100 Microseconds operate time excluding bounce
- Stock voltages 3, 6, 12 and 24 volts
- Available with either leads or pins with 0.2" spacing

Special voltages, resistances, electrostatic and/or magnetic shields available. Write for new Data Sheet MR-9.1



COTO-COIL COMPANY, INC.
59 Pavilion Avenue, Providence, R. I. 02905
Tel: (401) 941-3355

INFORMATION RETRIEVAL NUMBER 224

THIS SPACE CONTRIBUTED BY THE PUBLISHER

A mouse has already been saved from leukemia.

Help us save a man.

For years, you've been giving people with leukemia your sympathy. But sympathy can't cure leukemia. Money can. Give us enough of that, and maybe we'll be able to do for a man what has already been done for a mouse.



American Cancer Society

overload proof!



HI-VOLTAGE POWER SUPPLIES

This new power supply is practically indestructible. It contains a unique transformer that shuts itself off when the load exceeds maximum ratings. (see chart) Even a direct short across the output can't hurt it! It eliminates the need for fusing and can be used as a load sensitive power transducer for many applications.

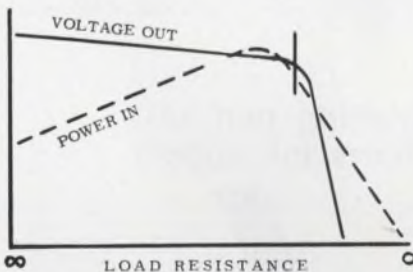

Line regulation is $\pm 3\%$, 105-129 volts (Input 105-129 v. RMS 60 Hz). Load regulation is less than 20%, 0.5 ma., and ripple is less than 2% RMS.

| MODEL | KV | CAN SIZE | PRICE |
|----------|----|--------------|---------|
| HVN 2-5 | 2 | 2½ x 3¾ x 2¾ | \$45.00 |
| HVN 5-5 | 5 | 2½ x 3¾ x 3½ | 57.00 |
| HVN 10-5 | 10 | 3¾ x 4½ x 3½ | 87.00 |
| HVN 15-5 | 15 | 3¾ x 4½ x 5 | 92.00 |

Just check the reader service number below for full details or write:



ENERGY SENTINEL DIVISION
Chicago Condenser Corp.
3255 W. Armitage Ave.
Chicago, Illinois 60647

INFORMATION RETRIEVAL NUMBER 225
ELECTRONIC DESIGN 6, March 15, 1970

Tiny label printer makes numerical codes



W. H. Brady Co., 726 W. Glendale Ave., Milwaukee, Wis. Phone: (414) 332-8100.

Printing repeated numerical codes on self-sticking vinyl cloth labels is a new palm-size label printer called the "mini-labeler." It can be set to print up to six characters across. Depressing a print level feeds pre-cut labels with the desired codes. Labels are pre-cut on a continuous liner in 3/4 or 3/8 in. lengths and 3/4 or 1-1/2-in. widths.

CIRCLE NO. 454

Silver-soldering pot strips and joins wires



Precision Electronics Corp., Coil-O-Matic Div., Marshfield, Mass. Phone: (617) 834-6677.

Eliminating the need for chemical or abrasive removal of film insulation is a new high-temperature silver-soldering pot. By dipping wires into the pot, it simultaneously strips and solders them eliminating the use of soft solder and a soldering iron. The new pot is said to operate ten-times faster than older methods, and it achieves temperatures in excess of 1300° F.

CIRCLE NO. 455

INFORMATION RETRIEVAL NUMBER 226 ►

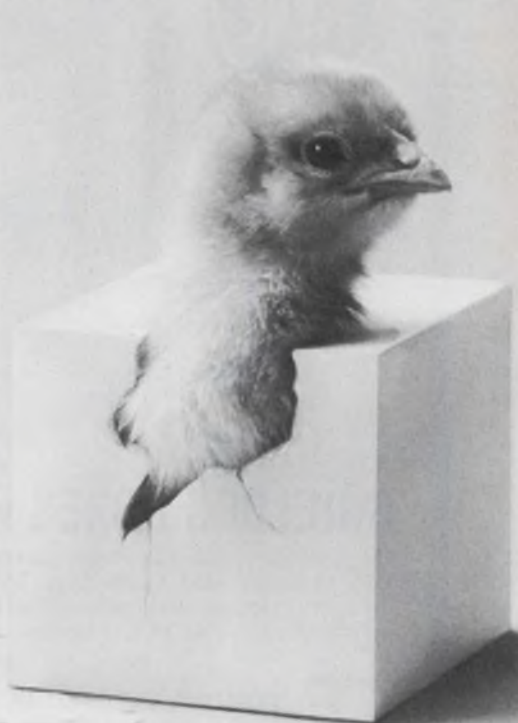

One of the
unique qualities
of Electro Cube
is to produce
non-standard
packages readily

electro cube
capacitors

We also make 4,000 or more standard capacitors with wound dielectrics. If case style is a problem, ask. We'll help. Electro Cube, Inc., 1710 South Del Mar Road, San Gabriel, California 91776. (213) 283-0511

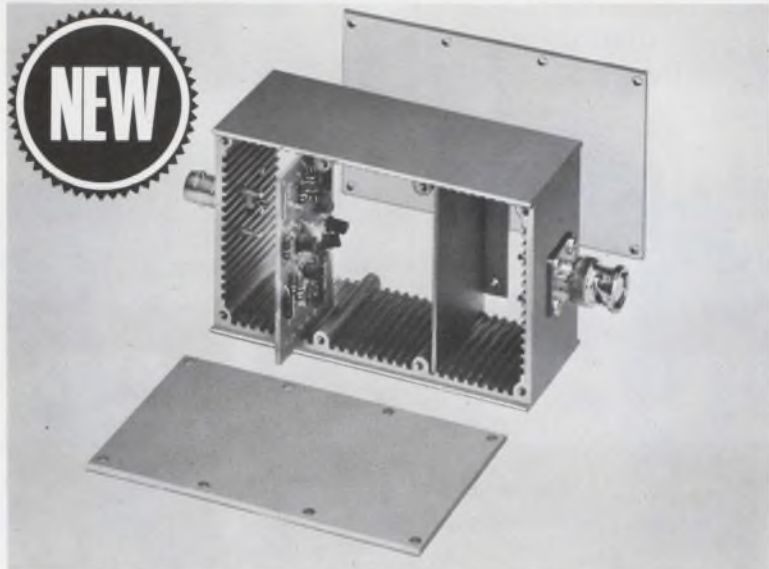

SHIELDED BOXES with CARD GUIDES

Rugged die-cast aluminum boxes, slotted to accept $\frac{1}{8}$ " circuit boards and shielding dividers. Excellent for packaging electronic circuitry. Boxes have removable top and bottom covers. Useable inside space: 4"x2"x1½". Several models with various connectors.

Write for 1969 Catalog



POMONA ELECTRONICS CO., INC.
1500 E. Ninth Street, Pomona, California 91766

INFORMATION RETRIEVAL NUMBER 227

Materials dispenser ejects tiny amounts

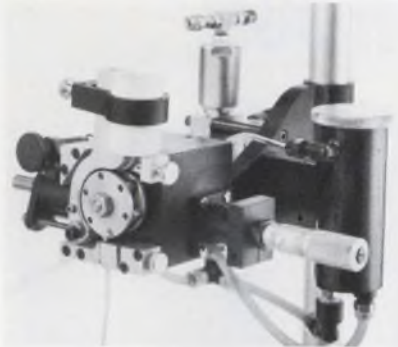

Fluidyne Instrumentation, 3685 Mt. Diablo Blvd., Lafayette, Calif.

The Picoshot is a unique device that can dispense tiny quantities of highly-viscous materials. It dispenses epoxy, urethane and silicone resins for component coating, sealing and bonding. The device is a precision-machined pump that is driven by an air cylinder, and a rack-and-pinion with a one-way over-travel clutch. Individual shot-size adjustments are accomplished by a micrometer.

CIRCLE NO. 453



Soldering irons for every use

Specify Wallbrand for top value — choose from such "firsts" as the IDL (Instant Heat), DH (Duo Heat) and XLS (9 interchangeable elements), plus numerous other pencils, irons and guns for many metal joining jobs. All Wall products are made in U.S.A.

and accessories



HOLDERS



TIPS and DISPENSERS



DESOLDERER

SEND FOR CATALOG I-669A

WALL MANUFACTURING CO.
Dept. ED-30 Box 3349 Kinston, N. C. 28501

INFORMATION RETRIEVAL NUMBER 228



ZIPPERTUBING® R.F.I. SHIELDING JACKETING

for quick application and protection of multi conductor cables!

SHN 3 for R.F.I. shielding and protection. Tinned copper braid, attached to inside overlap provides gasket type seal and solderable termination point.

SHX 4 — of special knitted compounded wire for highly flexible R.F.I. shielding.

CPE conductive polyethylene for electrostatic protection.

MS provides low frequency magnetic shielding.

For full information on specialized, high-performance jacketing, contact

THE **ZIPPERTUBING®** CO.

CORPORATE HEADQUARTERS

13000 S. BROADWAY
LOS ANGELES, CALIF. 90061
Los Angeles Phone: (213) 321-3901
New Jersey Phone: (201) 256-4980



BALTIMORE • BOSTON • CHICAGO • CLEVELAND • DALLAS
NEW YORK • ORLANDO • PHOENIX • SAN FRANCISCO • WEST GERMANY

INFORMATION RETRIEVAL NUMBER 229

Drafting pen set shows ink supply



Alvin & Co., Inc., 611 Palisado Ave., Windsor, Conn.

The P396C Drafttech drawing pen set comes complete in a custom-form plastic case with seven interchangeable nib points. The pen itself features a visible ink supply, an extra-large ink capacity and a precision stylus guide for controlled line widths. This new pen set is suitable for all types of technical drawings and lettering applications. Other sets are available with 10 interchangeable nib points.

CIRCLE NO. 456

now available . . . **STOCK**

BUS BARS

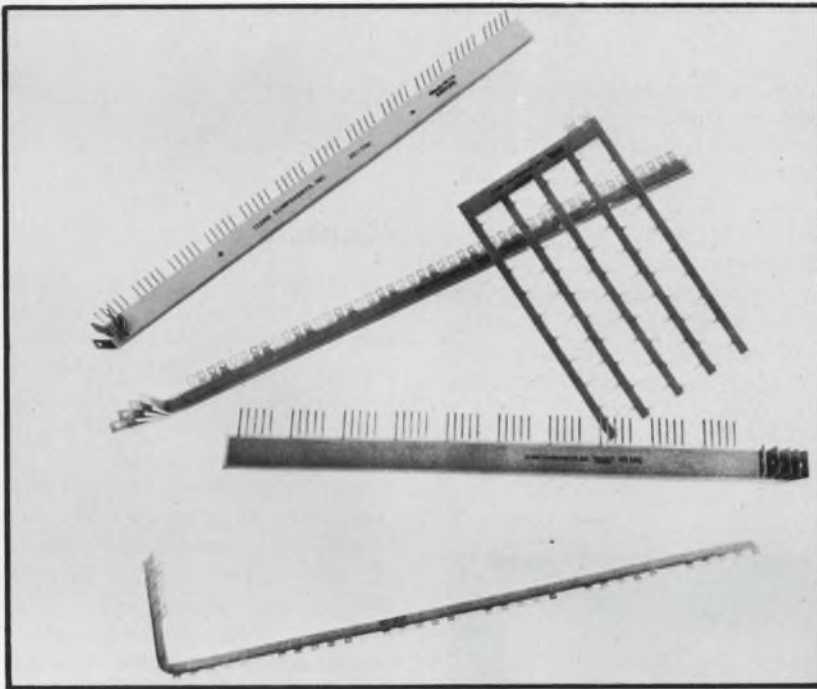

Designed for prototypes,
small quantities and
immediate delivery.

Write for price list and
technical data . . .

ELDRE 

COMPONENTS, INC.

1239 UNIVERSITY AVENUE
ROCHESTER, NEW YORK 14607

IEEE

See us at booths
4G12 & 4G14

INFORMATION RETRIEVAL NUMBER 235



2 informative seminars

**MINICOMPUTERS
& APPLICATIONS**

**TELECOMMUNICATIONS
& MESSAGE SWITCHING**

coming to

april 13-15 NEW YORK AREA june 22-24

april 27-29 WASHINGTON DC june 1-3

Marriott Motor Hotels

for information write or call:

**REGISTRAR
DATA INSTITUTE, INC.**

200 Park Avenue, Suite 303E
New York, New York 10017

(212) 687 2066

in-house presentation available

INFORMATION RETRIEVAL NUMBER 236

ELECTRONIC DESIGN 6, March 15, 1970

A SMALL ROTARY SWITCH



with **TREMENDOUS** features

- 30° Angle of Throw (12 Positions)
- 0.7" Behind Panel, 0.562 Diameter
- One, Two or Four Poles
- Shorting or Non-Shorting
- PC or Solder Lug Terminals
- Sealed or Unsealed
- Adjustable or Preset Stops
- Commercial or Military Styles

To Make and Break 50 MA for 25,000 cycles,
200 MA for 10,000 cycles (rated at 115 VAC resistive)

REQUEST YOUR ENGINEERING DATA SHEET 157



565 Hillgrove Avenue
LaGrange, Illinois 60525
Area Code 312, Phone 354-1040

... the Difference Between Excellent and Adequate

INFORMATION RETRIEVAL NUMBER 237

Evaluation Samples

Breadboard system

A new concept in circuit packaging permits rapid assembly of all prototypes and limited-quantity production systems directly from engineering schematics and logic flow diagrams. The Circuit-Stik packaging system is a complete family of circuit subelements and circuit materials that allows individual circuit boards to be assembled and tested from engineering sketches the same day.

Conductive circuit subelements are supplied on thin substrates with a pressure-sensitive adhesive backing. They can withstand soldering temperatures and can be easily modified with an ordinary pair of scissors. The elements offer good adhesion strength, and yet can be removed when design changes are necessary.

There is a wide variety of patterns available for all commonly used components, including flat-packs, dual-in-lines, and TO-5-packaged integrated circuits, transistors, diodes, resistors, test-point jacks, and plug-in printed-circuit-board connectors.

Also eliminating the need for drilling, series 1000 circuit subelements have preplated copper patterns that are used with 0.1-in. punched board material. When these pressure-sensitive circuit elements are placed on the backing board, the result is a reliable printed circuit board ready for mounting and conventional component soldering.

Prototypes can now be as neat and professional-looking as the final off-the-production-line designs. Gone are the stand-off-mounted components and wobbly terminals. Delays normally encountered for artwork, etching and drilling are also circumvented in just a few minutes.

All types of circuit elements can be mixed and combined on the same board. In addition, special configurations are available for use with wire-wrap systems to reduce the number of sockets and wire-wraps required. Finished circuit boards can easily be expanded — by using

conventional card cages and rack-and-panel hardware.

Prices for the series 1000 off-the-shelf system range from 20¢ to \$2 per subelement. Another group of subelements, series 2000, are for high-density layouts.

Free evaluation samples are available to the readers of *ELECTRONIC DESIGN*. The manufacturer is Circuit-Stik, Inc., 1518 W. 132nd St., Gardena, Calif.



Novel circuit packaging system lets designer go from his sketch to a same-day working prototype.

CIRCLE NO. 612

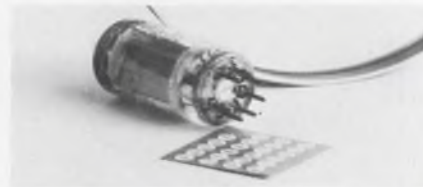

Miniature labels

Developed for precise marking of miniaturized electronic components, tiny pressure-sensitive markers, called Micro Labels, can be die cut in any required shape and size down to 0.025-in. diameters. These miniature labels can also be color coded, imprinted with characters as small as 0.007 in. in height, and consecutively numbered. They adhere readily to ceramics, metal, glass and painted surfaces. Now available as free evaluation samples, the labels are fungus-static, moisture and salt-spray resistant, and meet MIL-specification requirements. Allen Hollander/Kimball Systems.

CIRCLE NO. 613

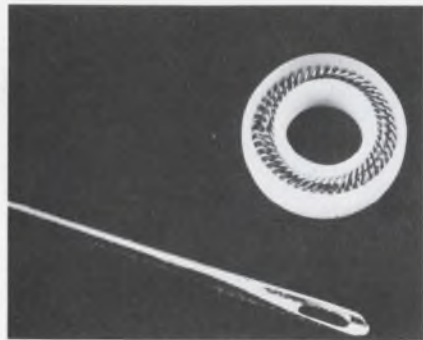

Teeny-weeny seal

Thought to be the world's smallest, a new microminiature spring-loaded Teflon seal is now available for applications requiring very low friction, compact size, long life, chemical inertness, and indefinite shelf life. The seal consists of an elliptical garter spring with canted coils that can deflect over 50% from original size upon loading. This spring provides the required load for positive sealing. Operating temperatures can range from -65 to +550°F at most pressures. The seals, which are available as free evaluation samples, come with inside diameters from 3/32 to 5/8 in. Bal Seal Engineering Co.

CIRCLE NO. 614

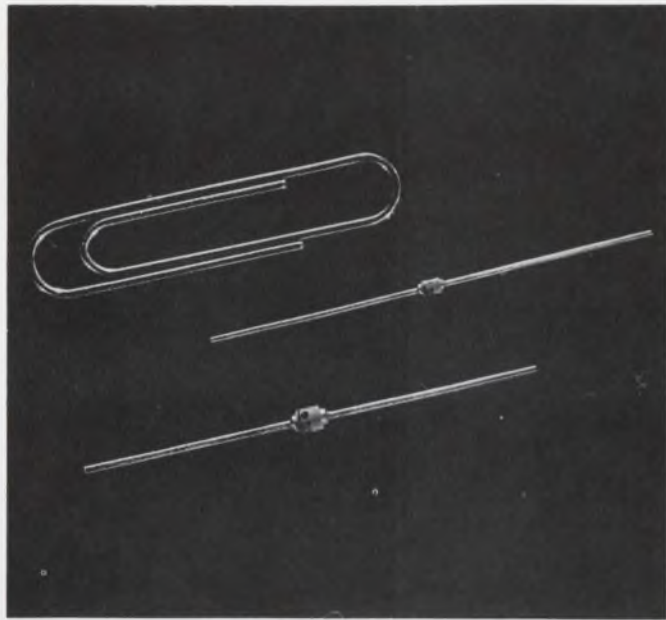

now
IN SERIES
mini-size
power glass zeners
...from COMPONENTS

AVAILABLE NOW!

- 1.5 Watts (1N4461-1N4496)
- 3 Watts (1N5063-1N5104)
- 5 Watts (1N4954-1N4989)

Double stud construction . . . Special fused glass bonding . . .
now make it possible to pack big power in tiny "match head size" cases . . . 1/4 the size of comparable conventional zeners.

- Rugged, reliable Power Glass Zeners from Components mount in any position.
- Operate from -65°C to $+200^{\circ}\text{C}$.
- Surge capability up to 40 amps.
- Leakage current down to 50 nanoamps.
- Order now in voltages from 6.8 to 200.

Write or call today. Data sheets on request.

COMPONENTS 
INCORPORATED

Biddeford, Maine 04005

the best way
to start
designing
a system is to
**SEND FOR
THE LATEST
CATALOG of
PREMIER
STANDARD
METAL
ENCLOSURES**

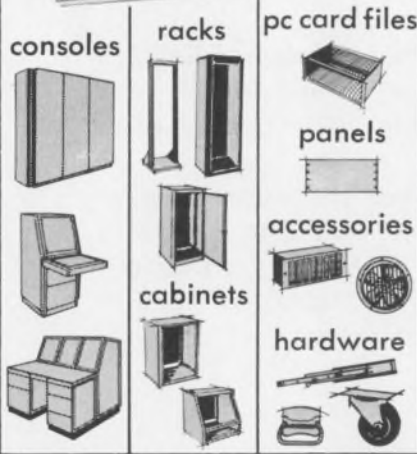
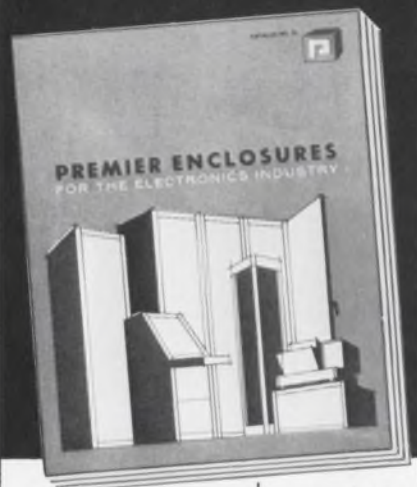

**PREMIER
METAL PRODUCTS CO.**
A Division of Sunshine Mining Company
Pioneers in Metal Housings
for the Electronics Industry Since 1946
337 Manida Street, Bronx, N.Y. 10474
(212) 991-6600



Design Aids



Communications rule

An easy-to-use circular slide rule calculator answers several commonly asked questions about two-way radio communications systems: how far can a given system be expected to communicate; and what affect gain antennas, tower height, transmitter power, or receiver sensitivity have on performance and system cost. The calculator estimates ballpark system costs and ranges in a matter of minutes. Other factors taken into consideration by the new slide rule are receiver sensitivity, frequency of operation, vehicle noise levels, type of coaxial cable and environmental factors. Antenna Specialists Co.

CIRCLE NO. 615

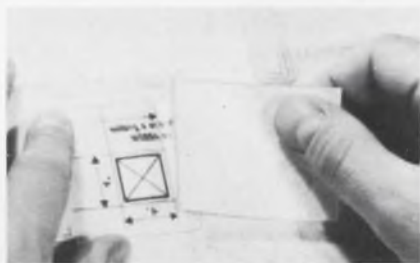

Design sheets

Tri-acetate sheets, pre-printed with custom repetitive symbols, title block, diagrams or any other drawings, can save design time as well as money in many engineering departments. The sheets adhere to drawings in only seconds, and their matte surface almost thrives on erasures. Reproductions are crisp and clean, even when microfilming; there are no ghosts no matter what tracing medium is used. These laminated sheets will not curl and are transparent for easy positioning before application. Stanpat Products Inc.

CIRCLE NO. 616

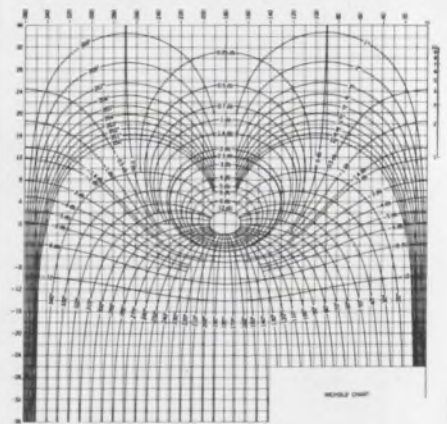

Feedback design

A Nichols-chart oscilloscope CRT overlay can help design engineers to predict the closed-loop behavior of their feedback network designs. The overlay is included in a 17-page application note, "Using the 675A/676A Network Analyzer as an Education Tool." Describing the frequency behavior of electrical networks, the brochure illustrates how frequency-swept transfer and driving-point measurements can be displayed on a conventional oscilloscope. Hewlett-Packard Co.

CIRCLE NO. 617

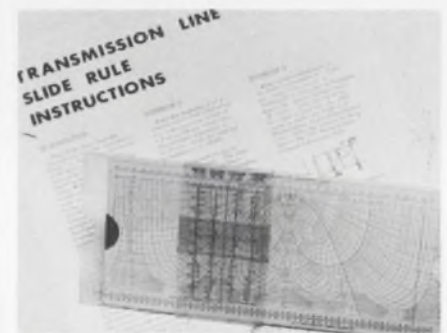

Transmission rule

Extremely useful in solving line wave problems, a transmission line slide rule allows the conversion of a complex impedance to its reflection coefficient. Available in a heavy-plastic case, the slide rule gives an expanding area as VSWR is reduced. For example, for a VSWR of 1.2:1, the new design aid is equivalent to a Smith Chart over 20 inches in diameter, yet this device fits in a shirt pocket. Load impedance is represented at the right end of the rule, with the generator to the left, an appropriate number of wavelengths away. Cost is \$8. Greencastle Electronics.

CIRCLE NO. 618



PASS ME THE AVO!

SIL VOUS PLAIT • POR FAVOR

Worldwide, "Pass the AVO" means someone wants the most accurate, most reliable multimeter... anywhere. Twenty four ranges for AC and DC current, voltage and resistance. Full meter protection includes fuse, velocity actuated mechanical cutout and diode protection for meter movement.



This internationally famous AVO Model 8 has for over 50 years set the highest standard in multimeters. Over a million in use today!

Calibration, parts and service by factory trained personnel are available at our Plainview, N.Y. facility and in most countries throughout the world.

GENCOM DIVISION
varian/EMI

80 EXPRESS STREET, PLAINVIEW, N. Y. 11803
TELEPHONE: (516) 433-5900

INFORMATION RETRIEVAL NUMBER 240

ABSOLUTE SHAFT ENCODERS WITH FAR FEWER BRUSHES

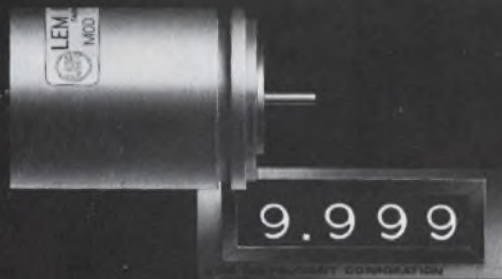

- UNLIMITED CHOICE OF FUNCTION • LOW COST • LOW TORQUE & INERTIA • NON-AMBIGUOUS, CONTINUOUS, PARALLEL OUTPUT • LOW NOISE

The new LEM Shaft Encoders utilize a unique disc, brush assembly and electronic configuration that makes it possible to encode any function in any code with the same basic disc and rotating brush arrangement.

High reliability, low torque and inertia, self-contained logic, low noise and long trouble-free life are a few of the features offered by the new LEM units.

These new shaft encoders are available in all standard and any special codes and functions at low cost. Also available is a complete line of solid state, digital displays compatible with the new encoder line. Request new catalog.

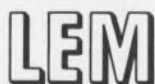

INSTRUMENT CORPORATION
Subsidiary of TWIN DISC, INCORPORATED
20 Sarah Drive, Farmingdale, New York 11735
Phone (516) 293-7240

INFORMATION RETRIEVAL NUMBER 241

ELECTRONIC DESIGN 6, March 15, 1970

Going to IC's? Or Higher IF's?

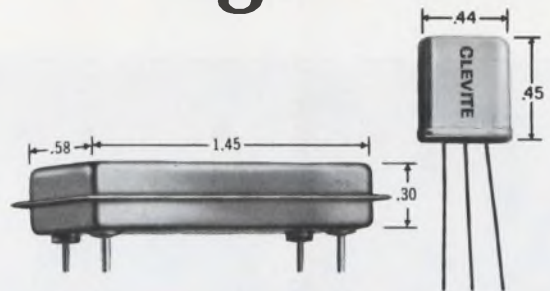

Go with Clevite's off-the-shelf coupled- mode quartz filters.

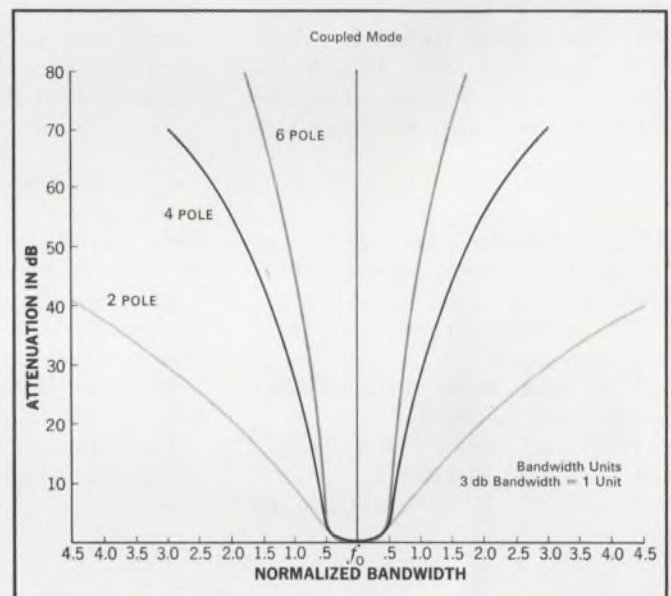

Now you can get *immediate delivery* on Clevite Uni-Wafer® coupled-mode Quartz Filters. Eleven models are available right off-the-shelf—two, four, and six pole; center frequencies of 10.7, 20.5, and 30 MHz; AM or FM bandwidths of 9, 14, and 30 kHz. And they're available in coldweld-sealed flatpacks or solder-sealed HC 18 cans.

Clevite's exclusive Uni-Wafer design uses trapped energy techniques to maximize resonant energy over arrays of resonators on a single quartz wafer. As a result, you get higher performance in a smaller package.

Clevite Uni-Wafer Filters are ideal for matching IC or conventional circuitry in VHF or UHF communications receivers, and radar, telemetry or aerospace systems. They're smaller and more reliable than discrete filters, have steeper skirt ratios, lower insertion losses, and better spurious mode rejection.

If you're going to IC's or higher IF's, Clevite Uni-Wafer coupled-mode Quartz Filters are the best way to go. For more information, including complete specifications, write Piezo-electric Division, Gould Inc., 232 Forbes Road, Bedford, Ohio 44146, or: Brush Clevite Company, Limited, Southampton, England.

GOULD CLEVITE

INFORMATION RETRIEVAL NUMBER 242

Annual Reports



The above artwork appears on the cover of the 1969 annual report for **Capitol Industries, Inc.**, 1750 N. Vine St., Hollywood, Calif., pioneers of audio tape cassettes in the music recording and

Alloys Unlimited, Inc., 320 Long Island Expressway South, Melville, N.Y.

ICs, communications, computers and aerospace.

1969: net sales, \$142,070,570; net earnings, \$7,635,159.

1968: net sales, \$116,104,637; net earnings, \$7,283,473.

CIRCLE NO. 601

Applied Research Inc., 76 S. Bayles Ave., Port Washington, N.Y.

Space and earth communications, machining, sound systems.

1969: net sales, \$7,728,169; net earnings, \$192,922.

1968: net sales, \$7,318,282; net earnings, \$65,907.

CIRCLE NO. 602

Computest Corp., 409 Route 70 E., Cherry Hill, N.J.

Digital instrumentation, computers, test systems, IC testers, binary sequence detectors.

1969: net sales, \$7,743,824; net earnings, \$493,210.

1968: net sales, \$6,081,778; net earnings, \$296,420.

CIRCLE NO. 603

publishing fields. Their net sales for 1969 were \$153,104,000 and net income was \$6,312,000. Net sales for 1968 were \$111,627,000 and net income was \$1,402,000.

CIRCLE NO. 600

Cook Electric Co., 6401 Oakton St., Morton Grove, Ill.

Telephone communications equipment, tape readers, airborne direction finders.

1969: net sales, \$19,791,417; net income, \$1,241,561.

1968: net sales, \$17,498,988; net income, \$1,042,874.

CIRCLE NO. 604

Energy Fund Inc., 8500 Wilshire Blvd., Beverly Hills, Calif.

Mutual fund in electronics, physics, metallurgy, medicine, transportation and computers.

1969: Total net assets, \$125,-757,502; shareholders, 54,357.

1968: Total net assets, \$124,-535,934; shareholders, 46,988.

CIRCLE NO. 605

Milgo Electronic Corp., 7620 N.W. 36th Ave., Miami, Fla.

Radar instrumentation, modem filters, graphic plotters, analog computers, signal processors.

1969: net sales, \$8,267,518; net income, \$766,982.

1968: net sales, \$4,654,153; net income (loss), (\$589,456).

CIRCLE NO. 606

Omni Spectra, Inc., 24600 Hallwood Court, Farmington, Mich.

Microwave components, devices and connectors.

1969: sales, \$5,158,204; net earnings, \$389,587.

1968: sales, \$5,419,959; net earnings, \$471,945.

CIRCLE NO. 607

Orbit Instrument Corp., 131 Eileen Way, Syosset, N.Y.

X-Y ball trackers and single-coordinate joysticks.

1969: net sales, \$1,366,650; net earnings, \$330,492.

1968: net sales, \$1,400,829; net earnings, \$209,980.

CIRCLE NO. 608

Pacific Plantronics, Inc., P.O. Box 635, Santa Cruz, Calif.

Telephone and communications headsets, solid-state data switching systems.

1969: net sales, \$9,016,696; net earnings, \$856,655.

1968: net sales, \$6,765,961; net earnings, \$568,329.

CIRCLE NO. 609

Power/Mate Corp., 514 S. River St., Hackensack, N.J.

Regulated laboratory and rack-mountable power supplies, power supply racks and accessories.

1969: sales, \$1,595,568; net income, \$164,438.

1968: sales, \$1,093,797; net income, \$103,561.

CIRCLE NO. 610

Rochester Instrument Systems, Inc., 275 N. Union St., Rochester, N.Y.

Digital, analog and power conversion equipment, annunciators.

1969: net sales, \$2,920,016; net income, \$118,280.

1968: net sales, \$2,004,772; net income, \$64,769.

CIRCLE NO. 611

**Thermotech
molds
your ideas
into profits**

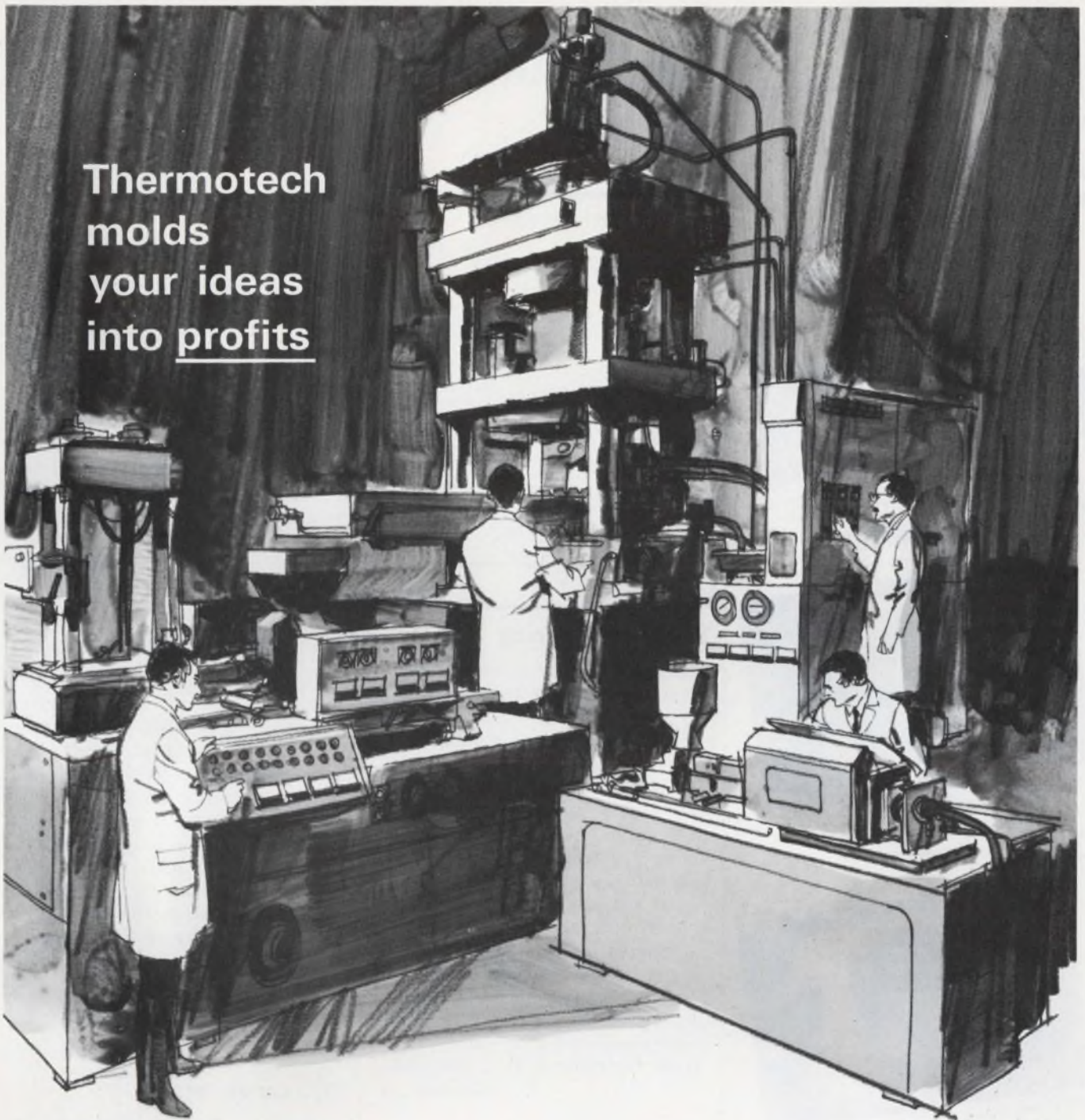

| | |
|--|---|
| | |
| <p>More than 600 stock bobbins for electrical-electronic applications.</p> | <p>Thermoset moldings—shorter cycles with less tooling.</p> |
| | |
| <p>Miniaturized thermoplastic and Fluorocarbon Moldings.</p> | <p>Custom Thermoplastic Moldings to 25 ounces.</p> |

©Thermotech Industries, Inc. 1969

Your design idea may be but a few steps away from economical, efficient production by Thermotech technicians.

That's because Thermotech has always welcomed the difficult in plastic molding—precision work with all moldable materials.

THE REASON: Thermotech has pioneered many innovations in precision molding machinery, tooling, materials and processes.

THE RESULT: Product ideas turned into profitably produced plastic parts.

So, whatever your product idea . . . from switches, buttons, bobbins and relays, to entire housings, covers and assemblies . . . Thermotech can help you produce it *Economically!*

Send sketch, print or mockup for fast, airmail quote. Or, just call, today.

THERMOTECH INDUSTRIES, INC.



"Where New Ideas Take Shape In Plastics".

Dept. , 1202 South Fifth Street
Minneapolis, Minnesota 55343 • (Area 612) 938-7671



FREE BROCHURE
(Over 50 pages, describes facilities and products).

**new...
IN COLOR
SD DATACOLOR**



**FULL COLOR DIGITAL
DISPLAY SYSTEMS**



- COLOR CONTOURS
- COLOR GRAPHICS
- COLOR PICTURES



**COMPATIBLE WITH
DIGITAL COMPUTERS
AND COLOR TELEVISION**

- REAL TIME PICTURE ANALYSIS
- NOISE AVERAGING
- INTERACTIVE OPERATION



SPATIAL DATA SYSTEMS, inc.
132 aero camino
goleta, california 93017

Application Notes

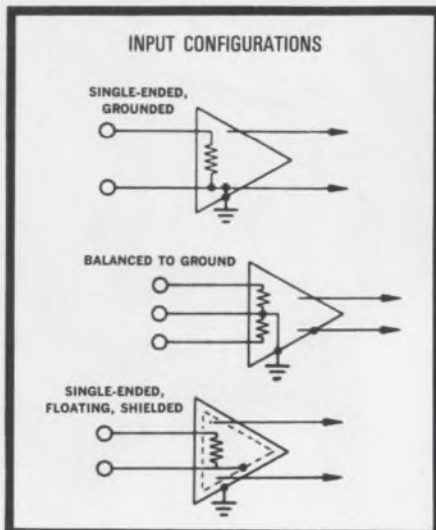

Signal conditioning

Besides proper grounding techniques, a two-color 16-page booklet explains the basic types of signal sources and conventional amplifier input configurations. Illustrations and text deal with amplifier selection and the proper signal cabling methods to subdue electrical noise or ambient conditions. Procedures are outlined for identifying each signal source and detailed figures show proper signal connections to each amplifier type. The problems of signal cable shielding and troublesome ground loops are discussed, along with specific instructions for eliminating these difficulties. Brush Instruments Div., Gould Inc.

CIRCLE NO. 619

SCR systems terms

A glossary of terms for SCR adjustable-speed/torque drive systems is featured in the latest issue of "Motorgram" (Vol. 49, No. 6). This special dictionary includes definitions for avalanche diode, closed-loop feedback, full and half-wave rectification, zener diode, and many other terms. Also in the issue are case histories on two gear-motor applications: one for a single-channel recorder and the other for a barium-solution mixer. Bodine Electric Co.

CIRCLE NO. 620

Computer glossary

The term byte and more than a hundred other esoteric words coined by the computer industry are defined in a new eight-page brochure. This glossary of commonly used computer terms covers the word gamut from access time to zero suppression. Definitions provide cross references, synonyms and/or antonyms, and table illustrations where necessary. In defining abbreviations, root words are given in addition to the explanation. General Automation, Inc.

CIRCLE NO. 621

Computer power

Dealing with data acquisition computer power, an eight-page technical paper discusses the relative advantages of 12, 16, and 18-bit word lengths when used for real-time data acquisition with small computers. The paper tells how speeds, memory-addressing, memory-reference instructions, micro-instructions, and memory sizes are related to the ease of use and practicability of the three different computer word lengths. Vidar Corp.

CIRCLE NO. 622

D/a converters

Entitled "A Dissertation on Specifying, Measuring and Using Very High-Speed Digital-to-Analog Converters," a four-page technical paper gives insight into some of the problems confronting users of today's state-of-the-art d/a converter modules. The paper discusses some of the difficult-to-measure speed characteristics, suggests circuits for measuring dynamic performance, and alerts the user to problems that can arise in high-speed d/a converter applications. Settling time and glitch (output transients) are two of the topics illustrated with schematics. Analog Devices, Inc., Pastoriza Div.

CIRCLE NO. 623

Until our new Unipulser II came along,



single decade counters were pretty much alike.

Compare it with any competitor on these points: 1. **Size.** More compact than any comparable unit. 2. **Modular.** Complete with its own drive input, transfer and reset circuits. And 11-line output for control or electrical readout. This lets you combine them in series for a wide job range. 3. **Price.** Begins at \$18 and goes down just as fast as anyone else's on quantity buys. Push button preset model begins at \$19. You won't find another decade that does so much for so little. 4. **Durability.** Mechanical and electrical transfer life—100 million counts. Each. 5. **Hundreds of uses.** From metering to data processing, to all types of production control. Write for Unipulser II catalog. 622 N. Cass St., Milwaukee, Wis. 53202.



INFORMATION RETRIEVAL NUMBER 792 7083-A

**NOW
PANDUIT
PENNY-TY™
cable tie
at 1¢ each**

THE PANDUIT SST1M PENNY-TY Miniature Cable Tie is now available for 1¢ each in quantities of 50,000* or more.

- Meets Military Standards MS-3367-4, MS-17821-4 and MS-18034-4.
- Harness diameter range 0 to 3/4"; loop tensile strength 18 lbs. minimum.
- Self-locking and releasable prior to final tightening.

*In accordance with standard conditions of PANDUIT Price Sheet effective 12/1/69

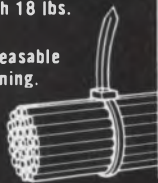

At your PANDUIT Distributor. FREE SAMPLES.

PANDUIT® CORP.

Tinley Park, Ill. 60477 • Phone: 312-532-1800 • Telex 25-4560

VISIT PANDUIT I.E.E.E. SHOW BOOTH 1B-15
INFORMATION RETRIEVAL NUMBER 793

ELECTRONIC DESIGN 6, March 15, 1970

**PROVEN RELIABILITY—
SOLID-STATE POWER INVERTERS,
over 260,000 logged operational hours—
voltage-regulated, frequency-controlled,
for missile, telemeter, ground support,
135°C all-silicon units available now—**

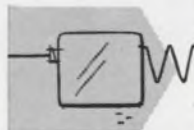
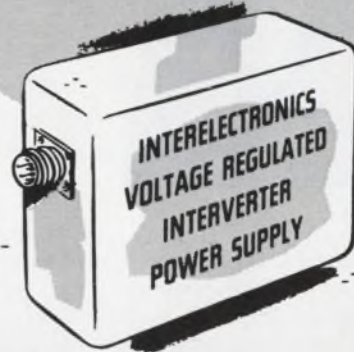

Interelectronics all-silicon thyatron-like gating elements and cubic-grain toroidal magnetic components convert DC to any desired number of AC or DC outputs from 1 to 10,000 watts.

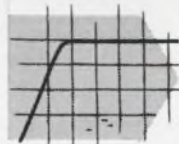

Ultra-reliable in operation (over 260,000 logged hours), no moving parts, unharmed by shorting output or reversing input polarity. High conversion efficiency (to 92%, including voltage regulation by Interelectronics patented reflex high-efficiency magnetic amplifier circuitry.)



Light weight (to 6 watts/oz.), compact (to 8 watts/cu. in.), low ripple (to 0.01 mv. p-p), excellent voltage regulation (to 0.1%), precise frequency control (to 0.2% with Interelectronics extreme environment magnetostrictive standards or to 0.0001% with fork or piezoelectric standards.)

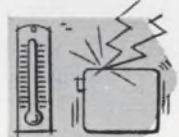

Complies with MIL specs. for shock (100G 11 mlsc.), acceleration (100G 15 min.), vibration (100G 5 to 5,000 cps.), temperature (to 150 degrees C), RF noise (I-26600).



AC single and polyphase units supply sine waveform output (to 2% harmonics), will deliver up to ten times rated line current into a short circuit or actuate MIL type magnetic circuit breakers or fuses, will start gyros and motors with starting current surges up to ten times normal operating line current.



Now in use in major missiles, powering telemeter transmitters, radar beacons, electronic equipment. Single and polyphase units now power airborne and marine missile gyros, synchros, servos, magnetic amplifiers.

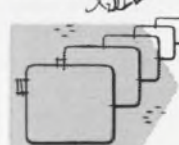

Interelectronics—first and most experienced in the solid-state power supply field produces its own all-silicon solid-state gating elements, all high flux density magnetic components, high temperature ultra-reliable film capacitors and components, has complete facilities and know how—has designed and delivered more working KVA than any other firm!

**INTERELECTRONICS CORPORATION
550 U. S. Route 303, Congers, N. Y.
Telephone: 914 ELmwood 8-8000**

INFORMATION RETRIEVAL NUMBER 794

New Literature



Buyer's guide

Over 500 manufacturers of electronic components plus their industrial distributors and/or sales representatives are conveniently listed in a new buyer's guide. All component distribution outlets are listed geographically with telephone numbers. Covered are such components as semiconductors, capacitors, resistors, connectors and transformers. Also included are tubes, wire, relays, switches and heat sinks. The guide enables buyers to locate a standard component for immediate delivery and assists engineers in locating and obtaining technical information from qualified representatives. Electronic Distributors Tek Publishing Co., Inc.

CIRCLE NO. 624



Templates galore

Pictures and descriptions for nearly 200 standard templates are contained in a 24-page catalog. Included are templates for draftsmen, engineers, architects, designers, programmers and industrial layouts. Templates are grouped according to type, such as lettering and shape. Also included are 30 new metric templates, as well as a section showing customers how to order custom-designed units. RapiDesign, Inc.

CIRCLE NO. 625

Microwave by computer

Filtan, an easy-to-use computer program that eliminates the need for building prototype microwave circuits, is described in a brochure. It allows engineers to pre-test design performance on a computer. The program features microwave engineering language and requires less than two hours of training time to use. It is designed for full interactive use and can analyze nearly all microwave circuits. With it, the user can change circuits at will and run repeated analyses. It is available for most time-sharing and batch processing computers. Sanders Associates, Inc.

CIRCLE NO. 626

Semiconductors

A broad range of semiconductor components is described in a short-form 1970 product catalog. It gives component mechanical and electrical characteristics, maximum ratings and other specifications. Listed are voltage-variable capacitors, low-voltage avalanche zeners, temperature-compensated zener reference diodes, and logarithmic diodes. A section of the new catalog is devoted to miniature devices in chip, pellet, micro-strip and axial-lead packages. CODI Semiconductor div. of Computer Diode Corp.

CIRCLE NO. 627

Connectors

A complete series of subminiature connectors is described in a new 28-page illustrated catalog. The connectors are compact, high contact-density units built to meet or exceed the requirements of military specification MIL-C-8384B. Described and illustrated are connector configurations and insert types with 9, 15, 25, 37 and 50 contacts in both crimp snap-in and solder-pot type terminations. Also listed are combination layouts with provisions for the inclusion of high-voltage and coaxial contacts. Cinch Manufacturing Co.

CIRCLE NO. 628

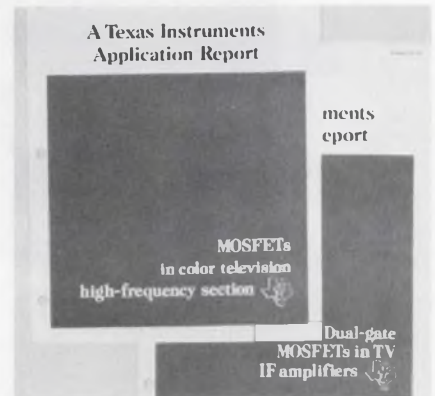

MOSFETs in color TV

Two new brochures evaluate dual-gate MOSFET applications in color television receivers. One eight-page brochure shows how FETS are as effective as vacuum tubes in eliminating cross modulation in tuners. It provides schematics and performance details of the rf amplifier, mixer and local oscillator sections of a MOSFET tuner, and a 45-MHz i-f amplifier. The second brochure contains a 16-page discussion on considerations involved in designing a dual-gate MOSFET i-f amplifier. Texas Instruments Inc.

CIRCLE NO. 629

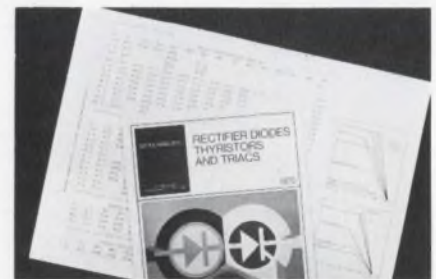

Power semiconductors

Information on a comprehensive range of power semiconductors is contained in a new rectifier diodes, thyristors and triacs catalog. The 12-page multi-colored publication features data on general-purpose, controlled-avalanche and fast-recovery silicon rectifiers. It also has data on high-voltage rectifier stacks, rectifier diodes, triacs, and thyristors. Easy-to-read charts for each item show the performance and temperature curves. Mullard Inc.

CIRCLE NO. 630

Motorola crystal controlled clock oscillators

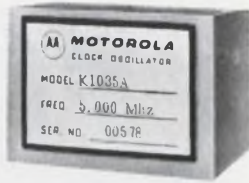

As small as 1.5 cubic inch Ages less than 1×10^{-6} per year

Where rugged construction, small size and instant warm-up are desired, Motorola Clock Oscillators fill the bill for a wide variety of applications.

Wide Frequency Range. 400 KHz to 40 MHz. Extended ranges on special order.

Small Size. As small as 1.5 cubic inch.

Stability. Ranges from ± 5 ppm to 100 ppm from 0°C to $+55^{\circ}\text{C}$. Extended ranges on special order.

Low Power. For voltage of 5v to 15v, 30 mw to 100 mw typical.

Variations in input voltage, frequency, output level and wave shape can be made to special order. Tell us your needs!

For complete information, send for a free copy of Bulletin TIC-3609 today. Write Component Products, Dept. 39-F, Motorola Communications & Electronics, Inc., 4501 W. Augusta Blvd., Chicago, Illinois 60651; or call (312) 772-6500.



INFORMATION RETRIEVAL NUMBER 795

THE WORLD'S MOST ACCURATE FREQUENCY SWITCH FASTER DATA TRANSMISSION

New, GO-NO-GO Audio Switches which fire whenever the input frequency goes above, below, or is within certain definite frequency limits are now available. Accuracies as close as 1 cycle per thousand can be maintained. Maximum response time is the length of two input cycles. All units are completely solid state.

The input frequency can be in the form of a sine or square wave. Or even in pulses in which case it measures the length of time between pulses. Frequencies from 1 hz to 40,000 hz can be handled easily and directly. Higher frequencies can be handled if dividers and/or mixers are incorporated.

Highpass, lowpass, and band-pass functions are all available.

GOSH instruments, inc

P.O. BOX 36 • WETHERSFIELD, CONNECTICUT 06109 • (203) 527-4794

NEW
TELEMETERING
FREQUENCY
SWITCHES
1 hz to 40,000 hz
RESPONSE LIKE
THIS

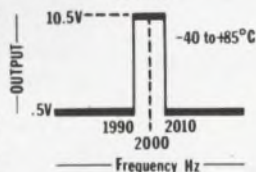

from
\$99⁵⁰
Single piece

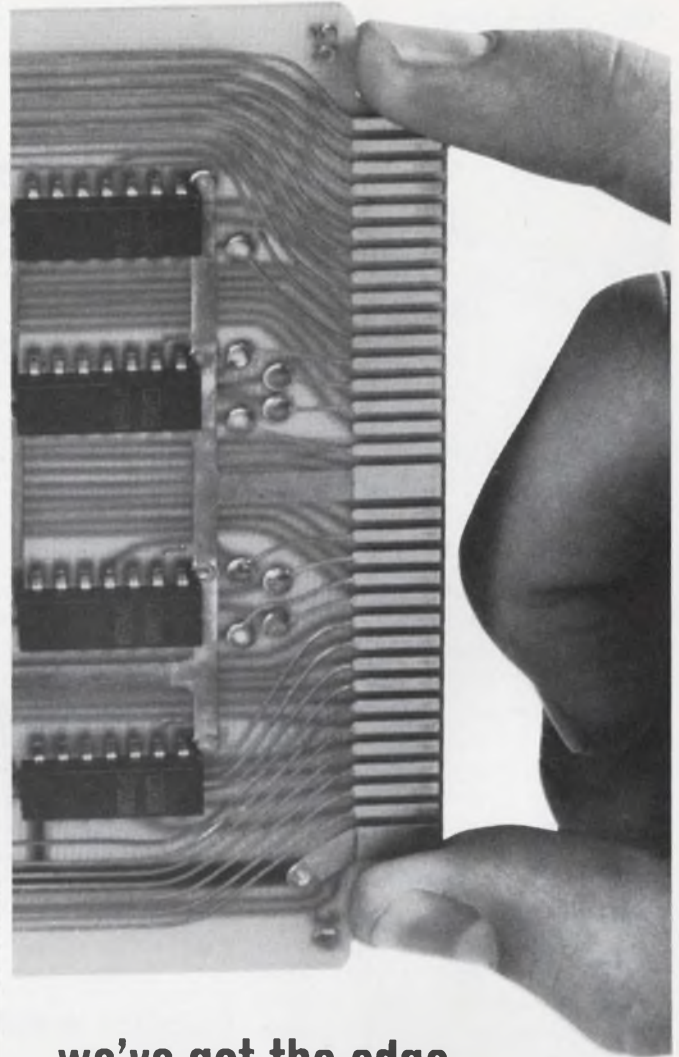

we've got the edge on our logic competition

And it starts with the 70 connection edge of all our logic assemblies. Our design brings more digital functions to the outside world, puts more functions on a card. And the trend toward more complex functions and large scale integration won't obsolete our design - in fact, we're helping make it possible.

Get an edge on your competition, choose from the industry's widest range of logic assemblies - DTL for moderate speeds, TTL for high frequencies, and MSI for low cost through better packaging.

In the Cambion line, you'll find all the logic cards you'd expect to need plus those one-of-a-kind required to complete your system without having to develop the card yourself. You'll also find all the necessary accessories, connectors, card drawers and files and power supplies. In fact, you can start your system design at any level and gain a competitive edge with Cambion logic assemblies and accessories. We've got a manual full of them we'll be glad to send you. Just send us your name. Do it today. Cambridge Thermionic Corporation, 445 Concord Avenue, Cambridge, Mass. 02138.

Standardize on

CAMBION

The Guaranteed Logic Assemblies

INFORMATION RETRIEVAL NUMBER 796

INFORMATION RETRIEVAL NUMBER 797



Ultraminiature supplies

Ultraminiature dc power supplies are described in a new 16-page combination catalog/handbook. It specifies and features a complete line of PC-board-mounting dc power supplies for digital ICs. Supplies for hybrid, linear, LSI and MOS ICs are also shown. A selection guide categorizes supplies according to output (volts and milliamperes). Also included are regulation data, price information and a power supply handbook. A glossary of terms, principles of operation, operating features and detailed specifications are in the handbook. Datel Corp.

CIRCLE NO. 631



Relays

A broad line of 512 relays is listed in a 24-page relay catalog. It contains information about the latest technology in dry-reed, mercury-wetted, time-delay and general-purpose relays. Also discussed are hermetically sealed, power, coaxial and telephone type relays. Complete technical data including functional operating characteristics and dimensional drawings is included. Magnecraft Electric Co.

CIRCLE NO. 632

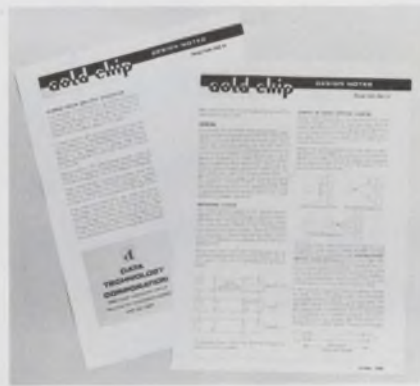

Logic-card design

Two new descriptive technical papers discuss techniques for interconnecting and using Gold Chip high-speed logic cards. Designated Gold Chip Design Notes, they offer engineers helpful hints that can save time, money and effort. Ground screens, length of runs, routing, dynamic loading, and the use of 75-Ω coax cable are topics discussed in the initial monograph. Data Technology Corp.

CIRCLE NO. 633

Emi/rfi shielding

Five fast and effective ways to prevent emi/rfi problems are described in a new eight-page brochure. It features the specifications and descriptions of eleven different shielding products. These materials are available in strip-extrusion, rf strip, wire-mesh, weather-strip and gasket forms. Specifications include dimensions, part numbers and material composition. Metex Corp.

CIRCLE NO. 634

IC sockets

More than 290 test sockets for TO-cased IC and microcircuit packages are listed in a new 20-page catalog. Detailed are 25 different socket styles for packages with 6 to 14 leads. They are designed to meet any test, bread boarding, burn-in and production requirement. A socket-selection table in the front of the book guides the user to the correct socket style. Barnes Corp.

CIRCLE NO. 635



Potentiometer design

The increased flexibility offered to the designer by the use of special potentiometer packages is illustrated in a new potentiometer-design brochure. Applications and special packaging options are cataloged for the designer to use as a reference when considering the use of a precision potentiometer or trimmer. Examples of cost-saving designs and support capabilities highlight an engineering focus on the design and production of special products. Spectrol Electronics Corp.

CIRCLE NO. 636



Wirewound resistors

Five types of low-cost wirewound power resistors are described in a new folder. Produced by a continuous-winding method, the resistors use high-quality resistance wire that is wound over a woven fiberglass core. They are available either in bare or molded styles encased in a ceramic package. Standard and special tolerances included are ±10 and ±5%, respectively, and operating temperature ranges from -55 to +275°C. Dale Electronics, Inc.

CIRCLE NO. 637



Wire and cable materials

A concise new nine-page catalog lists a full line of wire, cable, tubing, sleeving and microwave-dielectric products. Each of these product categories is shown with application data, technical data such as temperature and voltage ratings, dimensional information, and descriptions. The last page discusses dielectric materials used for low-dielectric applications. American Enka Corp., Brand-Rex Div.

CIRCLE NO. 638

Relays

Catalog 170 lists hundreds of different relays with their descriptions, specifications, dimensions and prices. It lists telephone, aircraft, mercury-wetted, differential and polar types. Also included are sensitive, latching, timing, sealed, resonant and stepping models. One part illustrates a line of relay sockets and another contains a table of contents. Universal Relay Corp.

CIRCLE NO. 639

Research materials

A new 104-page catalog/price list contains prices and technical information on 468 research materials. Covered are 50 metals in high and ultra-high purity grades and 18 standard alloys. Ceramic materials including oxides, borides, carbides, nitrides, and silicides are also covered. Sections of the catalog are devoted to a number of useful conversion charts on technical data sheets. General information on analytical techniques used to measure material purity is also presented. Materials Research Corp.

CIRCLE NO. 640



NEW WAY TO GET A HANDLE ON CONSTANT CURRENT ... 0.1 AMPERE TO 1 NANOAMPERE

Now you can keep tight rein on low level currents for materials research, semiconductor testing and for other areas in science and industry where a reliable current source is needed. The Keithley 225 delivers from 0.1 A to 100 nA full scale with 0.02% resolution on most ranges. It keeps them on target with 0.02% stability and low 0.01% rms noise. Variably selectable compliance voltages from 10 to 100 volts and 0.005% load regulation wrap-up this neat source for really constant currents.

Consider convenience features

like bipolar output, the ability to float 500 volts off ground, an output filter to deal with inductive loads. And, protection from overloads with automatic recovery. Now—can you afford to pass up such capability when it's yours for only \$595?

For technical literature and demonstration, contact your Keithley Sales Engineer. Or, Keithley Instruments, Inc., 28775 Aurora Road, Cleveland, Ohio 44139. Telephone: (216) 248-0400. In Europe: 14 Ave. Villardin, 1009 Pully, Suisse. Prices slightly higher outside the U.S.A.



KEITHLEY
INFORMATION RETRIEVAL NUMBER 798

Terminal blocks

A complete line of barrier terminal blocks and accessories is described in a twenty-four page illustrated catalog. It lists over 1200 units, covering 22 basic types. Shown is data on voltage, current and wattage ratings, insulation materials, terminal styles and finish options, types of fanning and marker strips, and other accessories. Complete dimensional specifications and drawings are also included. Featured are blocks with a molded-in barrier between each adjacent terminal. Cinch Manufacturing Co.

CIRCLE NO. 641

Dynamic analysis

Thirty applications for a wide variety of analysis and control systems are described in detail in a new manual. The analysis is performed with a frequency-tuned narrow-band filter instrument. It extracts amplitude, frequency and phase information from raw data signals from 1 to 50,000 Hz. The analysis of random and periodic signals or total response for magnitude and phase data is discussed. Block diagrams show how the instrument performs in many types of analysis systems. Spectral Dynamics Corp. of San Diego.

CIRCLE NO. 642

Socket catalog

A complete line of high-reliability sockets are described and illustrated in a new 16-page guide. The line includes 14 and 16-pin DIP sockets, and transistor, tube, relay and crystal sockets. Included are complete specifications, descriptions, and dimensional drawings. Featured are two types of DIP sockets: a low-profile low-cost model and a versatile heavy-duty type with replaceable contacts. Both incorporate double-leaf contacts for positive wiping action. Elco Corp.

CIRCLE NO. 643



D/a converters

Three sections that are devoted to digital-to-analog converters are included in a comprehensive 28-page handbook. One section provides basic theory on d/a converters including typical circuits and definitions of key parameters. Another section describes a wide variety of applications for such devices. A third section describes a new line of ultraminiature d/a converters. Comprehensive mechanical and electrical specifications on 16 models of four series are included. Datel Corp.

CIRCLE NO. 644

MSI logic

Series 8000 MSI logic is covered in a new handbook with three illustrative sections. One section is devoted to design considerations of temperature ranges, package types and ratings. A second section gives electrical specifications of shift registers and buffers, synchronous and asynchronous counters, adders and arithmetic elements, multiplexers, and arrays and drivers. A third section explains a program designed to assume product specified performance, uniformity and reliability. Signetics Corp.

CIRCLE NO. 645

Nickel cadmium batteries

Three new plastic-container batteries in 320, 350, and 415 ampere-hour capacities and a line of long-rate nickel cadmium storage batteries are described in a new specification catalog. It includes complete performance data for 15 plastic-container batteries and 19 steel-container batteries, ranging from 10 to 1245 ampere-hour capacities. Also included are typical discharge curves, at 1, 3, 5, 8, and 10-hour rates. Dimensions for all cell types and data for long-duration discharges of up to 100 hours are also included. NIFE Inc.

CIRCLE NO. 646

Miniature hand tools

A complete line of miniature hand tools, designed and manufactured to industrial standards, is shown in a 36-page tool catalog. It includes specifications, prices, descriptions and photographs of such tools as pliers, nippers, tweezers, scissors, shears, screwdrivers and nutdrivers. Also included are pin vises and holders, knives, scribers, soldering accessories, hammers, mallets and magnifiers. The catalog contains a complete index, a wire-cutting chart and introductory sections on how to select the right tool. Electronic Tool Co.

CIRCLE NO. 647

Lafayette catalog

Catalog 703, the 1970 spring publication from Lafayette Radio Electronics Corp. is now available. The 116-page book features citizen's band equipment, stereo-fidelity systems and components, portable radios, televisions, speakers, multi-track tape players and stereo headphones. Also featured are intrusion alarm systems, voltohmmeters, auto audio accessories, public-address systems, cameras, musical instruments and experimenter's kits. Lafayette Radio Electronics Corp.

CIRCLE NO. 648



Sample-and-hold circuit

A new sample-and-hold circuit that offers a combination of high speed and accuracy is described in a four-page brochure. The high accuracy of 0.01% is achieved by a unique circuit that compensates for the dielectric absorption losses in the capacitor. The circuit's high input impedance of $10^{11} \Omega$ eliminates errors due to a finite source impedance. Data Technology Corp.

CIRCLE NO. 649

Chip amplifiers

A series of high-speed sense amplifiers in chip form is fully described in an eight-page brochure. Three configurations of the series are shown with their electrical characteristics, recovery and recycle times and logic diagrams. Also shown are schematics that contain component values. Absolute maximum ratings are given and package designs are illustrated. Several typical characteristic operating curves are also shown. Silicon General, Inc.

CIRCLE NO. 650

Potentiometers

Complete information on a new series of potentiometers is available in a 20-page catalog. It provides electrical and mechanical specifications on commercial composition variable resistors. The resistors are 15/16 in. in diameter and range in power ratings from 1/4 to 3/4 W. A special two-page spread on attached power switches includes a choice of five new rotary switches. CTS Corp.

CIRCLE NO. 651

PRINTED CIRCUIT BOARDS

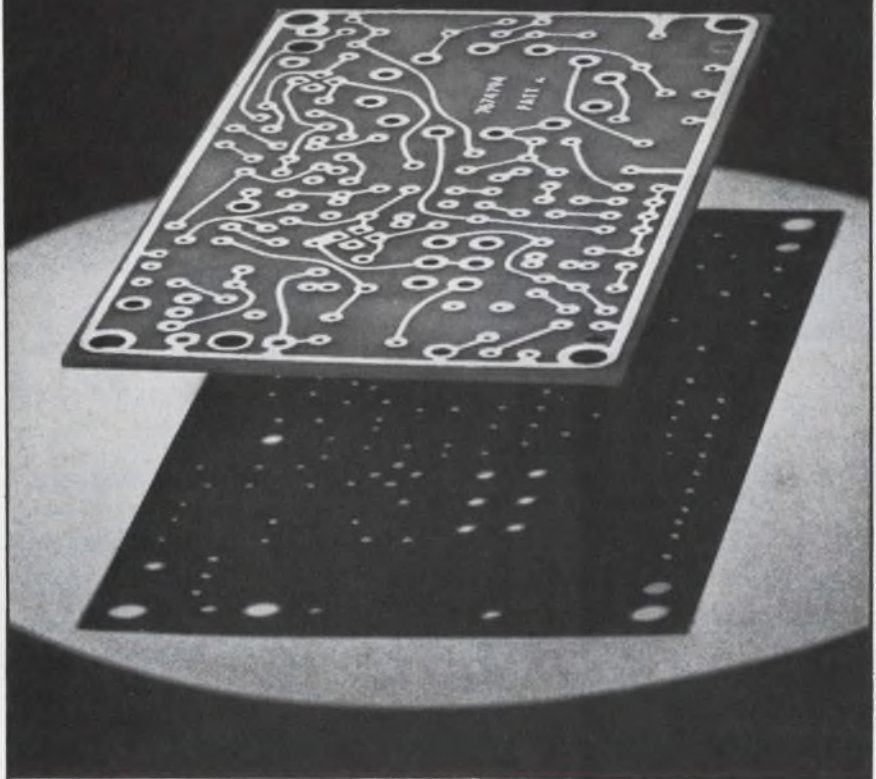

Complete Production Package Tailored to Your Requirements ROBINTECH®

Offers controlled quality printed circuit boards manufactured to your specifications . . . from design to high volume production.

Plated through holes, uniform drilling, consistent production, fabrication to order, and expert assembly . . . all in one complete package.

Uniquely modern facilities for all aspects of printed circuit board manufacture are at your service.

Send sketch and your requirements for design recommendation and quotation.



ROBINTECH electromechanical
division
INCORPORATED

3465 Vestal Road, Vestal, New York 13850
phone: (607) 798-5011

P.O. Box 215, Bodle Hill Road, Owego, N.Y. 13827
phone: (607) 754-0410

Manufacturers of Flexible Shafts and Push-Pull Mechanical Remote Controls; Custom Electromechanical Assemblies and Electric Wiring Harnesses; Printed Circuit Boards; Shock Control and Vibration Isolation Systems.

© ROBINTECH 1970

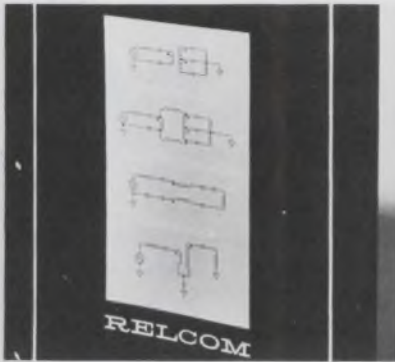

Transformers

Specifications and application material on a new line of miniature transformers are included in a six-page catalog. Transformers featured exhibit a very-low insertion loss over a wide frequency range of 0.1 to 700 MHz. Impedance transformations include 50 Ω . to 12.5, 25, 50, 100, 200 and 800 Ω . Six of the transformers are balanced types and four are single-ended types. Each is packaged in a high-temperature epoxy container or a hermetically sealed TO-5 case. Relcom.

CIRCLE NO. 652

Power supplies

A complete line of standard power supply systems is described and illustrated in a new catalog. Four standard rack sizes accommodating up to 16 single or dual-output power supplies are included. Shown are systems supplied with standard power controls and metering panels. Standard power supplies and accessories allow the selection of over 350 supply models with accessories. Lambda Electronics Corp.

CIRCLE NO. 653

Data processing

Six different data processing services are described in a new 20-page brochure. They include time-sharing, and remote batch and on-site batch data processing services. Also included are contract software, systems consultation and management services. Each of these services is discussed in detail and is offered by data centers located in 16 cities in the United States. Honeywell Information Services Div.

CIRCLE NO. 654



A/d converters

Six different analog-to-digital converters are described in a four-page brochure. Presented are performance details, engineering specifications and inter connection pin assignments. A concise theory of analog-to-digital converter operation is also included. The converters described include 10, 12 and 13-bit binary units, with or without amplifier inputs. Data Technology Corp.

CIRCLE NO. 655

Radar components

Radar modulator components such as pulse forming networks, pulse transformers, modulators, charging reactors, and power supplies are covered in a new 16-page booklet. Physical and electrical characteristics for nearly 30 typical and special-purpose components are described. Effective approaches to interfacing problems associated with modular components are also discussed. Capatron Div. of AMP Inc.

CIRCLE NO. 656

Digital multipliers

A comprehensive eight-page data sheet provides detailed information on the new series of 5400 digital multimeters. Features found in these four-digit instruments include a new computing rms ac measurement technique. In addition, complete specifications, options, modules, and accessories are included. Dana Laboratories, Inc., Measurements Div.

CIRCLE NO. 657

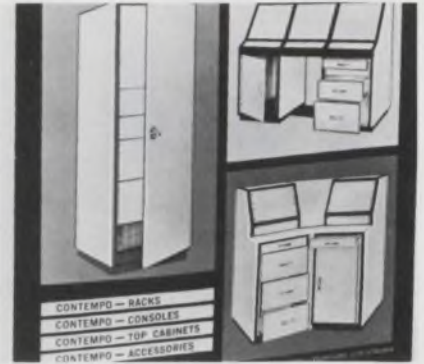

Electronic housings

Completely simplified for easy access to information is a 32-page catalog with an extensive line of metal housings for electronic instruments and systems. It is both graphically and photographically illustrated with dimensions, specifications and exploded views. Included are new modular cabinets, cabinet wedges, pedestals and two-toned textured vinyl-finish assemblies. Par-Metal Products Div. of EON Corp.

CIRCLE NO. 658

Microwave measurements

Valuable technical information on phase, swept-frequency and automatic VSWR measurements is included in a new catalog. It also contains signal-generator background information, and voice-band testing of telephone circuits. Technical information summaries are provided at the beginning of each section of the catalog making it a useful item for technical libraries. Wiltron Co.

CIRCLE NO. 659

Dry-reed switching

Written by a staff engineer in a reliability laboratory, a new 60-page handbook entitled "A Guide to Dry-Reed Switching" details important facts about dry-reed switching. It points out how excellent solutions to specific switching problems can be obtained. Proper solutions can be achieved provided relay characteristics and limitations are recognized, understood, and applied within their specified ratings. Automatic Electric Co.

CIRCLE NO. 660

ECL gates

Applications of ECL (emitter-coupled-logic) basic gates in ultra-high-speed digital systems are covered in a 12-page booklet. It includes seven basic gate modules of the ECL-2500 integrated-circuit series. Contained are several gate module features, including a typical propagation delay of 2.5 ns with a high noise immunity of ± 225 mV at 25°C. The seven modules described contain various combinations of the basic ECL gate. Electrical and typical operating characteristics, parameter measurement information and mechanical data are amply shown. Texas Instruments.

CIRCLE NO. 661

Instrument cases

An extensive line of standard and custom instrument cases, thermoformed from plastics, is described and illustrated in a new catalog. Designed for commercial and military applications, they are available in 35 standard off-the-shelf configurations. Optional features offered to meet custom requirements include special hinges, valves, bumpers, and handles. Custom interiors are detailed, such as flexible foam, mechanical vibration and shock systems. Part numbers, dimensions, illustrations, outline drawings and other specifications are included. Skydyne Inc.

CIRCLE NO. 662

Chemicals and metals

The 1970 edition of Alfa Inorganics catalog contains 424 pages of inorganic, organometallic and ultra-pure chemicals and related materials for research. Five different sections are color-coded for quick and easy reference. This catalog is a handy reference for research scientists in chemistry, electronics, physics optics and related disciplines. New items include 70 different metals and refractory and ceramic discs. Alfa Inorganics, Inc.

CIRCLE NO. 663

VACTEC

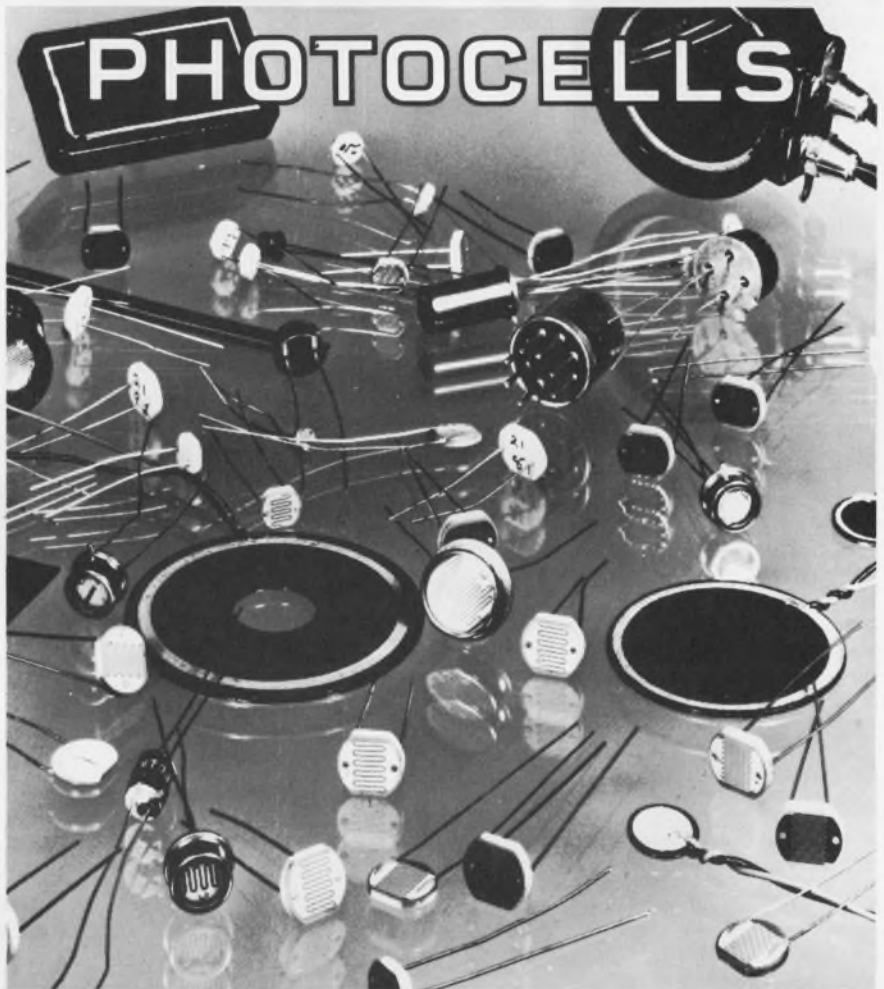

**The world's most un-diversified
company manufactures a
standard or custom size
and type for every
requirement.**

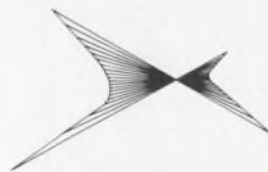

VACTEC, INC.

2423 Northline Ind. Blvd.
Maryland Heights, Mo. 63043
Phone (314) 872-8300

Write for Bulletin PCD-4 describing CdS and CdSe cells; for photocell lamp or LED modules request Vactrol Bulletin SPV-4A for Se types; or see EBG under "Semi-Conductors" or EEM Sec. 3700.

INFORMATION RETRIEVAL NUMBER 780

ELECTRONIC DESIGN'S function is:

- To aid progress in the electronics manufacturing industry by promoting good design.
- To give the electronic design engineer concepts and ideas that make his job easier and more productive.
- To provide a central source of timely electronics information.
- To promote two-way communication between manufacturer and engineer.

Want a subscription? ELECTRONIC DESIGN is sent free to qualified engineers and engineering managers doing design work, supervising design or setting standards in the United States and Western Europe. For a free subscription, use the postfree application form inside the back cover. If none is included, write to us direct for an application form.

If you do not qualify, you may take out a paid subscription for \$25 a year in the U.S.A., \$35 a year elsewhere. Single copies are \$1.50 each.

If you change your address, send us an old mailing label and your new address; there is generally a prepaid postcard for this inside the back cover. You will have to requalify to continue receiving ELECTRONIC DESIGN free.

The accuracy policy of ELECTRONIC DESIGN is:

- To make reasonable efforts to ensure the accuracy of editorial matter.
- To publish prompt corrections whenever inaccuracies are brought to our attention. Corrections appear at the end of the Letters column.
- To refuse any advertisement deemed to be misleading or fraudulent.

Microfilm copies are available of complete volumes of ELECTRONIC DESIGN at \$19.00 per volume, beginning with Volume 9, 1961. Work is now in process to complete the microfilm edition of Volumes 1-8. Reprints of individual articles may be obtained for \$2.00 each, prepaid (\$.50 for each additional copy of the same article) no matter how long the article. For further details and to place orders, contact the Customer Services Department, University Microfilms, 300 North Zeeb Road, Ann Arbor, Michigan 48106; telephone (313) 761-4700.

Want to contact us? If you have any comments or wish to submit a manuscript or article outline, address your correspondence to:

Howard Bierman, Editor,
ELECTRONIC DESIGN,
850 Third Avenue,
New York, N.Y. 10022.

Design Data from

PRECISION CARBON FILM RESISTORS



High Voltage . . . High Frequency . . . High Megohm . . . complete specifications for 120 devices and "The Case for Carbon Film" are presented in this new 1970 resistor catalog. Resistors are offered in 15 basic styles, ranging from .25 to 100 watts, with over 100 special variations available. Resistances range from 10 ohms to 100 Terohms and tolerances from $\pm 1\%$. Applications include those requiring high resistances, voltage capability from 250 to 125,000 V, and high frequency or pulse circuits. Send for free catalog and engineering data.

Resistance Products Company
914 South 13th Street, Harrisburg, Pa. 17104
(717) 236-5081

174

1970 Electronic Components Drafting Aids Catalog



Free Catalog! Free Samples! Exciting innovations in pressure-sensitive electronic component drafting aids and methods are detailed in the new 1970 edition of the combined Bishop Technical Manual and Catalog 104A.

68 illustrated pages of over 15,000 multi-pad configurations, symbols, tapes, sequential reference designations plus hundreds of time-and-money-saving hints in making artwork for PC boards. Includes instructions for using the industry's only red and blue tape system for making two-sided boards in perfect registration.

Send now for free Catalog 104A and free samples.

Bishop Graphics, Inc.
7300 Radford Avenue
North Hollywood, California 91605
(213) 982-2000 Telex: 674672

175

FUNDAMENTALS OF INTEGRATED CIRCUITS

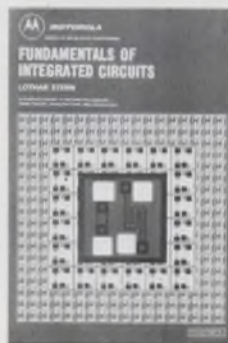

A practical guide to integrated circuits, their theory, manufacture, and applications. This new guide by Lothar Stern offers complete, highly readable coverage of the various techniques of circuit fabrication, and their effect on circuit design and performance. As to marketing considerations, it compares the characteristics of the numerous IC structures devised to date in terms of economics and logistics. A volume in the **Motorola Series in Solid-State Electronics**. 198 pages, 7 x 10, illustrated. \$8.95, clothbound. Circle the reader-service number below for 15-day examination copies.

Hayden Book Company, Inc.
116 West 14th Street
New York, N.Y. 10011

176

Manufacturers

Advertisements of booklets, brochures, catalogs and data sheets. To order use Reader-ServiceCard (Advertisement)

Clamp or Tie Wire Bundles In Seconds!



Six-page catalog contains complete ordering information for CAB-L-TITE® clamps and BUND-L-TITE® straps, devices which provide a fast and reliable means of securing wires and wire bundles. Units withstand loadings greater than 50 G's, are removable in seconds for re-routing wires, and are self-locking—no tying, no knots, no hitches to come loose. Lightweight Du Pont Zytel meets MIL-P-17091 and MIL-P-20693. Proved in aircraft and missiles. Photos, dimensional drawings, tables, physical properties, specifications, price list. Request catalog A.

Dakota Engineering, Inc.
4315 Sepulveda Blvd.
Culver City, California 90230

177

HOW TO SUCCEED WHILE YOU'RE STILL YOUNG



The average engineer — despite a high starting salary — hardly ever reaches \$20,000 a year. Recent surveys indicate that the average engineer earns only \$15,500 at today's salary levels. But middle management engineers expect salaries up to \$30,000 . . . and young middle managers are **still promotable!** The Alexander Hamilton Institute representative can tell you the exciting story. But first, find out how you, too, can qualify for the highest rewards in industry. Send for our **FREE** booklet, "Forging Ahead in Business." Act now. No obligation.

Alexander Hamilton Institute
Department A-975
235 East 42nd Street
New York, N. Y. 10017

178

PEM Preassembled Captive Screw Fasteners

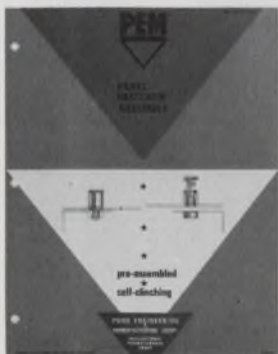

PEM self-clinching panel fasteners are completely preassembled with captive screw, spring and retaining washer in stainless steel retainers ready for permanent mounting in panels as thin as 0.060". Knurled and slotted captive screws with tapered leads can be removed if desired from their permanently mounted retainers. Send for free PEM bulletin describing self-clinching, pre-assembled panel fasteners in thread sizes #4-40 through 1/4"-20. Each thread size is available in three screw lengths.

Penn Engineering & Manufacturing Corp.
Box 311
Doylestown, Pa. 18901

179

Electronic Design

Advertising Sales Staff

Keith Aldrich
Sales Manager

New York 10022

Robert W. Gascoigne
Thomas P. Barth
Samuel M. Deitch
850 Third Avenue
(212) Plaza 1-5530
TWX: 867-7866

Philadelphia 19066

William C. Repetto
P. O. Box 206
Merion Station, Pa.
(215) MA-3-5888

Boston 01945

Joseph F. Palmer
P. O. Box 645
14 Peter Hobart Drive
Hingham, Mass.
(617) 742-0252

Chicago 60611

Thomas P. Kavooras
Berry Conner, Jr.
200 East Ontario
(312) 337-0588

Cleveland

Thomas P. Kavooras
(Chicago)
(312) 337-0588
(call collect)

Los Angeles 90303

Stanley I. Ehrenclou
W. James Bischof
2930 Imperial Highway
Inglewood, Calif.
(213) 757-0183

San Francisco 94022

Arthur R. Shields, Jr.
175 San Antonio Rd., S 243
Los Altos, Calif.
(415) 941-3084

London W. 1

For United Kingdom and Holland
Brayton C. Nichols
44 Conduit Street
Tel: REGent 4714

Verviers, Belgium

For Continental Europe
Andre Jamar
1, Rue Mallar, 1
(087) 253.83 Telex 41563

Tokyo

Haruki Hirayama
Electronic Media Service
Rm. 601, Daini Miyauchi Bldg.
6-8-14, Roppongi,
Minato-ku
Phone: 402-4556
Cable: Electronicmedia, Tokyo



AMERICAN BUSINESS PRESS, INC.

SNOB KNOB



Black

Decorative
metallic
ring

Spun
aluminum
cap

Spun
aluminum
inlay

The first new styling innovation in fifteen years!
900 Series Snob Knobs come in four bright, handsome models. Spun aluminum cap. Spun aluminum inlay. Decorative metallic ring. And Black. From 1/2" to 1 3/4" diameter.
Kurz-Kasch is known as the quality knob source by electronics manufacturers the world over. If you're not familiar with the outstanding Kurz-Kasch line, we'll send you a complete catalog. And if you're just anxious to see the new Snob Knob, we'll send you a free sample.



Kurz-Kasch, Inc.

Standard Parts Division • 1415 S. Broadway
Dayton, Ohio 45401 • Phone 223-8161

INFORMATION RETRIEVAL NUMBER 781

"IT'S GOOD BUSINESS
TO HIRE THE HANDICAPPED."

ISN'T THAT A GREAT IDEA, SNOOPY?



THE PRESIDENT'S COMMITTEE ON EMPLOYMENT
OF THE HANDICAPPED, WASHINGTON, D. C.

CEI has it.
RF TRANSISTORS



CEI has it.
KLYSTRONS

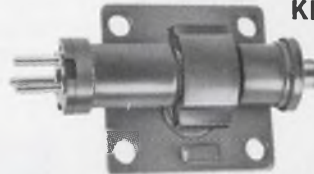

CEI has it.
GUNN DIODES



CEI has it.
MAGNETRONS



Calvert products:

Klystrons, Magnetrons, Gas Flash Tubes,
Semiconductors, Thyratrons, RF Transistors,
Gunn Diodes, SCR's

Write.



Calvert Electronics International, Inc.
220 E. 23rd St., New York, N.Y. 10010
ED-3

- Please send me your catalog.
 Please send information on (product) _____

Name _____ Title _____
Company _____ Tel _____
Address _____
City _____ State _____ Zip _____

Western Div.: 871 E. Hamilton Ave. Campbell, Calif. 95008

INFORMATION RETRIEVAL NUMBER 782

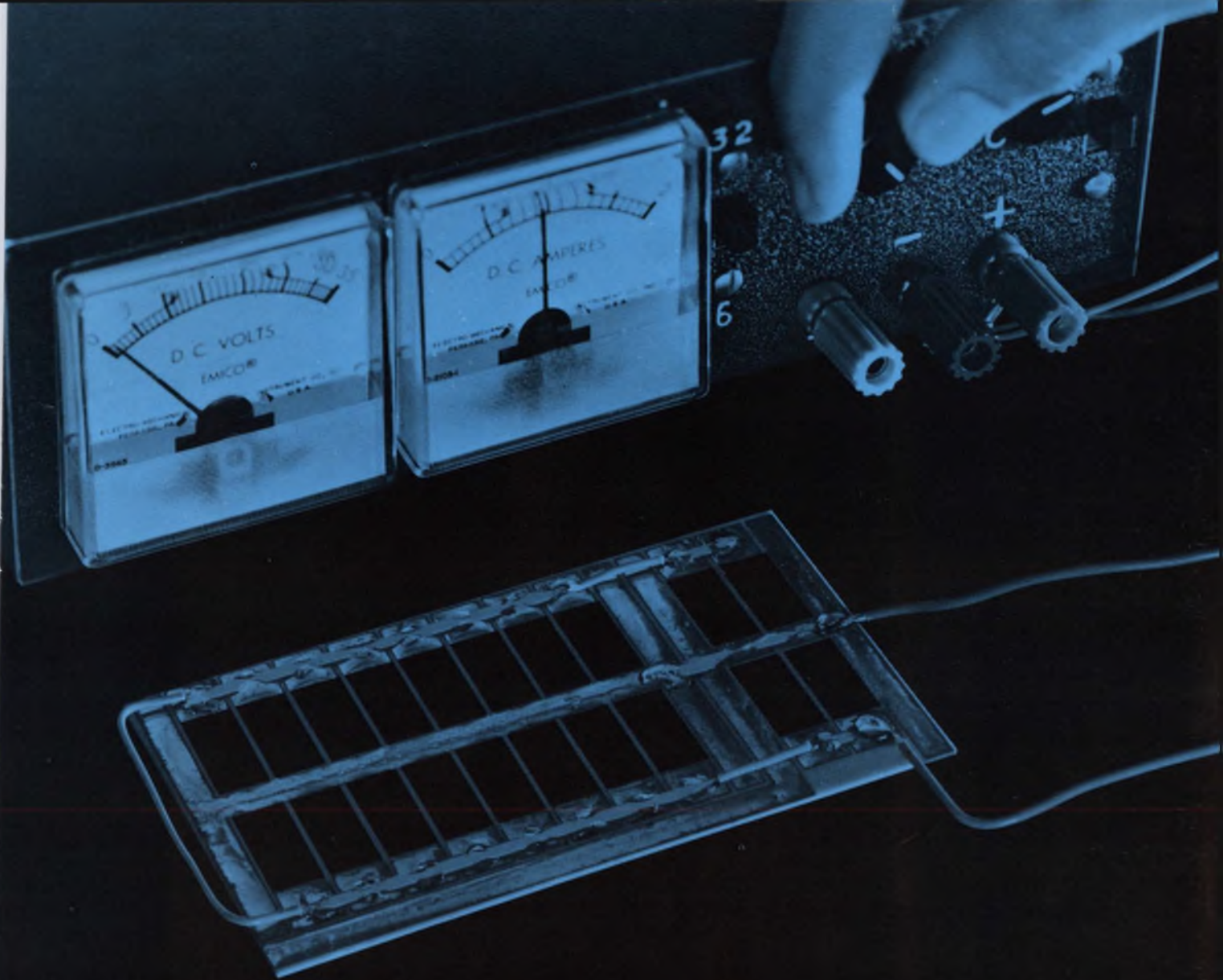

Dale puts the power in thick film networks

Dale makes thick film R-C networks as standard as this dual in-line package and as small as this



1/4-inch square model.

Within this broad capability we've become known as power specialists. Our ability to work with substrate, heat sink, package density and all the other network variables lets us deliver the power you need—in the size you need. "Big" jobs like the one shown above (5" x 2-1/2", 20 resistors, 60 watts) don't scare us a bit. Whether your next network is tremendous or tiny, give us a shot at it.

PROTOTYPES ON MOST DESIGNS IN LESS THAN THREE WEEKS... Call 402-564-3131 for complete details or write for Catalog A.

GENERAL NETWORK SPECIFICATIONS

Temperature Coefficient: ± 250 PPM max. from -55°C to $+150^{\circ}\text{C}$. T.C. as low as ± 50 PPM in limited resistance ranges.

Tolerance: Standard $\pm 10\%$. As low as 1% when required.

Power Loading: 16 watts/in.² standard with aluminum oxide substrate .015"-.040" thick. Substantially higher with heat sinking and beryllia substrates.

Terminations, Conductors and Land Areas: Platinum gold, palladium gold, gold and silver, depending upon application. Crossovers can be made. Lands for attaching active or passive components can be provided.

Moisture Changes: Meet Method 103, MIL-STD-202

Resistor Patterns: Thick film resistive materials with resistivities from 1 ohm/sq. to 1 megohm/sq. can be used. Patterns can be made from 1/10 square to 10 squares.

Capacitors: Screened = $.01 \mu\text{fd}/\text{in.}^2$; Chip = up to $5 \mu\text{fd} \pm 10\%$ to $\pm 20\%$ or GMV. Dissipation Factor = Less than 1.5%. Working Voltage = 50.

Packaging: Dual-in-line packaging can be used with plated Kovar or other types of leads. Also conformal coatings can be applied to modules with wire or ribbon leads. Screened and cured silicone coatings can be used to protect specific areas of the circuit.

DALE ELECTRONICS, INC.

1372 28th Ave., Columbus, Nebr. 68601
In Canada: Dale Electronics Canada, Ltd.
A Subsidiary of The Lionel Corporation



It's time for a change in your digital displays! Increase versatility, decrease costs — with RCA's new NUMITRON Digital Display Devices

Compare these RCA product advantages:

- Sharper, cleaner displays
- Controllable high brightness
- Up-front planar numerals for wider viewing angle
- Unlimited filter-color selection
- Low voltage operation — designed for 4½ V
- Fully compatible with RCA's new Integrated Circuit Decoder/Drivers

- Rugged construction
- Long life—high reliability
- Designed for low-cost 9-pin miniature sockets

Interested? For more information on the new RCA NUMITRON Digital Display Devices, contact your local RCA Representative or write to RCA Electronic Components, Commercial Engineering, Section 018DE-2, Harrison, N.J. 07029. Also ask for

data on the new RCA Integrated Circuit Decoder/Drivers, especially designed for use with RCA's Digital Display Devices. Type Numbers of NUMITRON Digital Display Devices:

RCA-DR-2000—Numerals 0 through 9
RCA-DR-2010—Numerals 0 through 9, with decimal
RCA-DR-2020—Plus-Minus and Numeral 1
RCA-DR-2030—Plus-Minus

Unretouched photograph of operating NUMITRON devices mounted on plastic tubing.

RCA
Digital Display Devices

