

Electronic Design 20

VOL. 17 NO.

FOR ENGINEERS AND ENGINEERING MANAGERS

SEPT. 27, 1969

A U.S. domestic satellite system is on the horizon. But what form will it take? Will it use 4, 6 or 30 GHz? Will it carry telephone calls, television, mail or maybe a

magazine-of-the-air? For a review of the various proposals and a look at problems like interference and power limitations, don't miss the report starting on page 36.

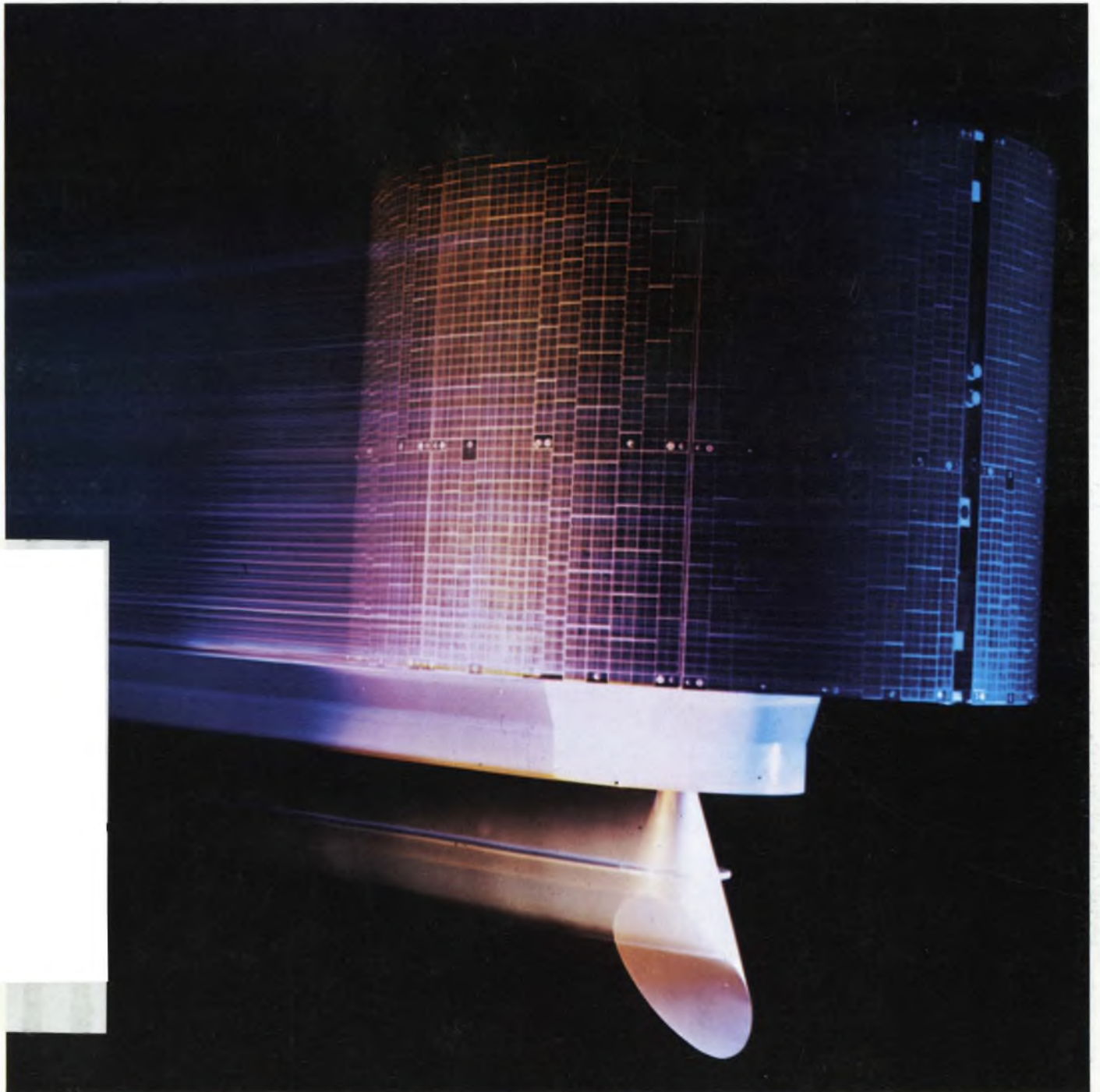

Take A New Look With 3 New CRT's

NEW 8 x 10 div. CRT—140B mainframe has a full 8 x 10 cm rectangular display area for expanded measurement capabilities.

NEW 8 x 10 div. CRT with variable persistence and storage—in the 141B stops, stores, varies display time in the bigger, rectangular format.

NEW 8 x 10 inch CRT—143A has extra-large display area for group viewing or for monitoring at a distance.

These three new mainframes are in addition to the 140A and 141A mainframes with round CRT's, and the five mainframes with either round or rectangular CRT's for spectrum analysis. That makes ten mainframes for better performance in any direction.

Only the HP 140 scope system gives you this combination of capabilities:

Sampling to 12.4 GHz...delayed sweep time base for sampling... 50 $\mu\text{V}/\text{cm}$ sensitivity dc-coupled *with no drift*... four channel amplifier... 100 μV , 100 dB dual trace... plug-ins for direct readout of TDR, swept-frequency, spectrum analysis—with full compatibility between mainframes and all plug-ins.

With 22 plug-ins, three sampling heads and ten mainframes to choose from, you can match your scope to your measurement requirements. Check the selection chart, see page 508 in your 1969 HP catalog, then contact your HP field engineer. Or, write to Hewlett-Packard, Palo Alto, California 94304. Europe: 1217 Meyrin-Geneva, Switzerland. Price: 140 Mainframes, \$640 to \$1500; plug-ins \$250 to \$1900.



HP 140 Scope System PLUG-IN CAPABILITIES	VERTICAL PLUG-INS											COMPATIBLE TIME BASES					SPECIAL PLUG-INS						
	1400B	1401A	1402A	1403A	1404A	1405A	1406A	1407A	1408A	1410A	1411A	1420A	1421A	1422A	1423A	1424A	1425A	1415A	1416A	8552	8553L	8554L	
1. Wide Band			*		*							*	*		*								
2. Sampling										*	*	*	*	*	*	*	*						
3. High Gain Differential	*			*		*	*	*	*	*	*	*	*	*	*	*	*						
4. Dual Trace		*	*	*	*	*	*	*	*	*	*	*	*	*	*	*	*						
5. Four Channel		*	*	*	*	*	*	*	*	*	*	*	*	*	*	*	*						
6. X-Y	*	*	*	*	*	*	*	*	*	*	*	*	*	*	*	*	*						
7. Delayed Sweep												*	*	*	*	*	*						
8. No Drift												*	*	*	*	*	*						
9. High Common Mode Rejection	*			*	*	*	*	*	*	*	*	*	*	*	*	*	*						
10. Algebraic Addition		*	*	*	*	*	*	*	*	*	*	*	*	*	*	*	*						
11. Time Domain Reflectometry										*	*	*	*	*	*	*	*						
12. Wide Band TDR																*	*						
13. Swept Frequency																		*	*	*	*	*	*
14. Spectrum Analysis																			*	*	*	*	*

HEWLETT  PACKARD
OSCILLOSCOPE SYSTEMS

089/17 A



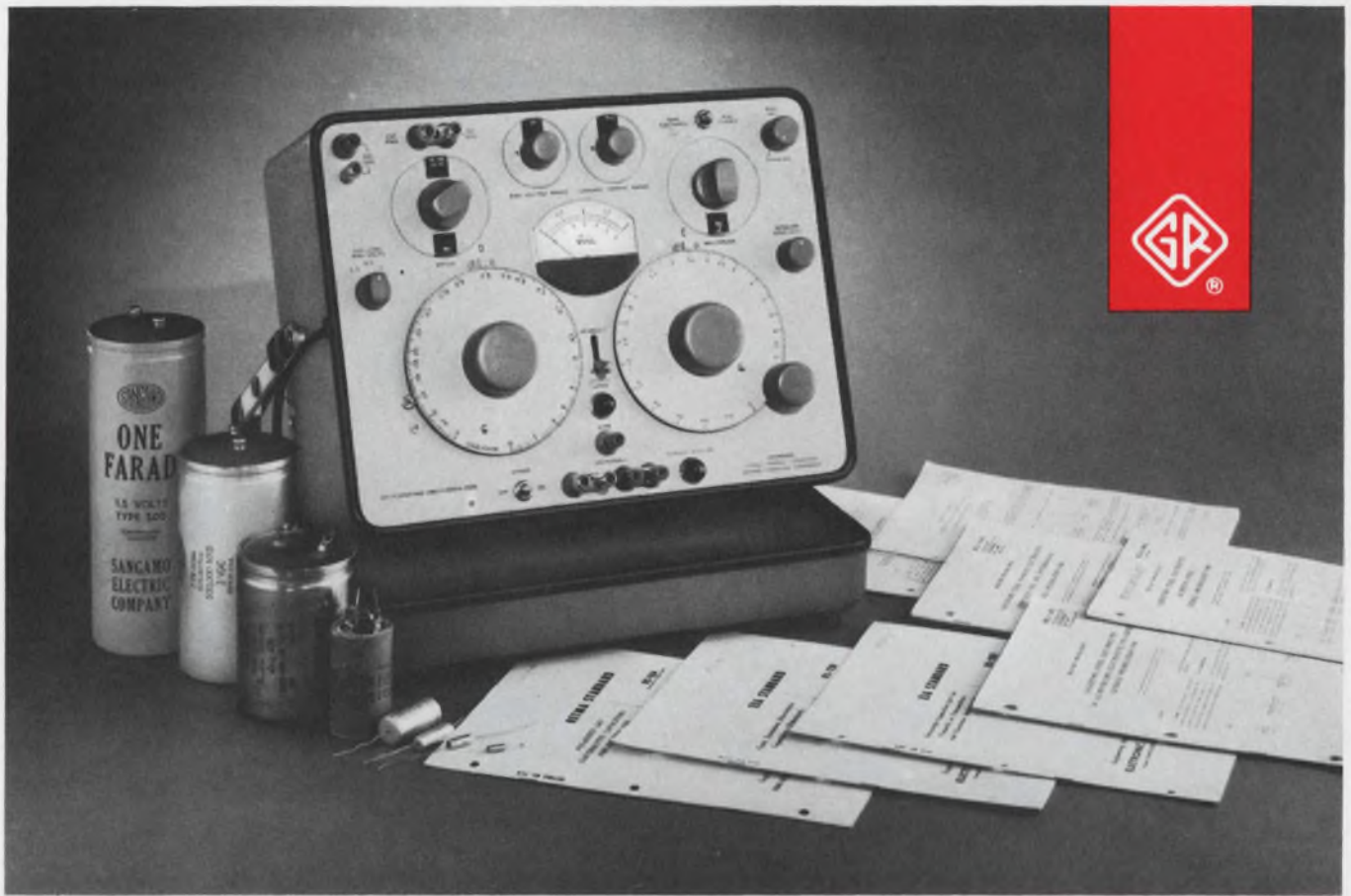

A "system" for testing tantalum and aluminum electrolytics

The Type 1617 Capacitance Bridge is really a system in one package designed specifically to test electrolytic capacitors at 120 Hz per MIL or EIA specifications. However, this 1% bridge can measure any capacitor, including those as large as 1.1 F. Besides having an exceptionally wide C range, the 1617 has many other features that make it an excellent general-purpose bridge for component testing at quality-control and incoming-inspection stations.

WIDE RANGE. C range of 10^{12} , from 1 pF to 1.1 F, with an accuracy of $\pm 1\% \pm 1$ pF and 2% from 0.11 F to 1.1 F. D range from 0 to 10 with an accuracy of approximately $\pm 2\% \pm 0.001$.

CONVENIENCE. The 1617 is completely self-contained; just plug it into a power line and start measuring. It includes a 120-Hz generator, a tuned detector, and an adjustable dc polarizing voltage, all enclosed in a handy, portable, flip-tilt carrying case.

MIL and EIA SPECIFICATIONS. It meets or exceeds the requirements of: MIL-C-39003 (Solid Tantalum), MIL-C-3965C (Tantalum Foil and Sintered Slug), MIL-C-39018 (Aluminum Oxide), (EIA) RS 154B (Dry Aluminum), MIL-C-62C (Polarized Aluminum), (EIA) RS 205 (Electrolytic), MIL-C-26655B (Solid Tantalum), (EIA) RS 228 (Tantalum).

OTHER FEATURES. The 1617 bridge:
has a metered, dc polarizing voltage that is adjustable

from 0 to 600 volts; external bias up to 800 volts may be applied.

- provides for 2-, 3-, 4-, or 5-terminal connections to minimize the effects of residual impedances.
- detects leakage current down to $0.5 \mu\text{A}$.
- can operate at frequencies up to 1000 Hz with an external generator.
- has important safety features, such as warning lights and discharge circuitry, which protect both the operator and the instrument.
- has Orthonull® balance finder to permit rapid bridge balances and eliminate sliding nulls during high-D capacitance measurements.
- has a generator that is phase-reversible to reduce the effects of hum pickup; amplitude is selectable and limited to 0.2 V, 0.5 V, or 2 V.

The 1617 bridge can also measure the capacitance and loss of cables, transformers, insulating materials, and electric motors.

Price: \$1250 in the U.S.A. For complete information, write General Radio, W. Concord, Massachusetts 01781; telephone (617) 369-4400. In Europe: Postfach 124, CH 8034 Zurich 34, Switzerland.

GENERAL RADIO

Input filtering PLUS dual-slope integration form a unique double barrier against noise in these fast-reading DVM's. This new idea from S-D gives you more accuracy for less money than any other .01% DVM.

The portable Model 9200 and the Thin-Line, rack-mounting Model 9300 come with all the popular ranges, functions and interfacing options. Prices start at \$1175.

Send for the complete, proven specs and see for yourself. Contact Measurements Division, Systron-Donner Corporation, 888 Galindo Street, Concord, Calif. 94520. Phone (415) 682-6161.

Newest DVM idea: double noise barrier boosts accuracy!



More firsts. Two of 145 Systron-Donner instruments

Electronic counters	Digital voltmeters
Pulse generators	Spectrum analyzers
Microwave frequency indicators	Digital panel meters
Digital clocks	Microwave signal generators
Memory testers	Laboratory magnets
Analog computers	Data acquisition systems
Time code generators	Microwave test sets
Data generators	

SYSTRON  DONNER

NEWS

- 21 News Scope
- 25 **From 8-1/3 bps to 16,200 bps—Here's how**
New telemetry for Mariner began as experiment and ended with the best pictures yet taken of Mars
- 30 **Computerized 'eye' to shed light on the sun**
16 pre-programed investigations will be available when Air Force puts new solar telescope to work
- 32 **Animal tests to help evaluate TV radiation**
- 36 **What's delaying U.S. satellite communications?**
A special report
- 51 **Washington Report**
- 56 **Sidelights**
- 59 **Editorial: Launch—or get off the pad**

TECHNOLOGY

- 68 **Develop useful general models** of nonlinear devices for computer aided design. The tunnel diode illustrates the curve-fitting approach.
- 74 **Streamline feedback-amplifier design.** It's simple if you analyze forward and reverse transmission paths of your circuit separately.
- 78 **One step ahead of need (never two)** was the over-all managing technique used by this Grumman engineer who directed NASA's assembling and testing program for LM 5.
- 85 **Ideas for Design**

PRODUCTS

- 94 **Instrumentation:** Two new instruments display with LED numerics.
- 100 **Components:** Tiny balanced mixer spans 25 kHz to 500 MHz.
- 97 ICs & Semiconductors
- 103 Data Processing
- 104 Modules & Subassemblies
- 106 Microwaves & Lasers
- 107 Packaging & Materials
- 108 Production

Departments

- | | | | |
|-----|---------------------|-----|-------------------------------|
| 14 | Designer's Datebook | 111 | Application Notes |
| 109 | Evaluation Samples | 112 | New Literature |
| 110 | Design Aids | 118 | Advertisers' Index |
| 110 | Annual Reports | 120 | Information Retrieval Service |

Information Retrieval Service Card inside back cover

Cover Photo: Courtesy of TRW's Systems Group, Redondo Beach, Calif.
The Intelsat III satellite has a mechanically despun antenna.

Put Your New Silicon Power Circuit Designs In The Best Shape Possible Now!

...and vice versa.

Put it this way: there's a Motorola, off-the-shelf, 2N number representing exact, optimized performance, cost and reliability requirements for your silicon power circuit design; and, an alternative to parameter compromise from a limited-line supplier's inventory.

Choose switch or amplifier . . . HV or high current . . . PNP or NPN . . . high or low frequency . . . consumer, industrial, or military – more than 250 standard, preferred devices in 10 different packages and 18 current ratings – or a turn-around-on-a-dime capability that meets unique needs.

Send for our *Silicon Power Selector Guide* and see . . . (Box 20912, Phoenix, Arizona 85036). All the shapes that make any difference are available only from us.

There are no two ways about that.

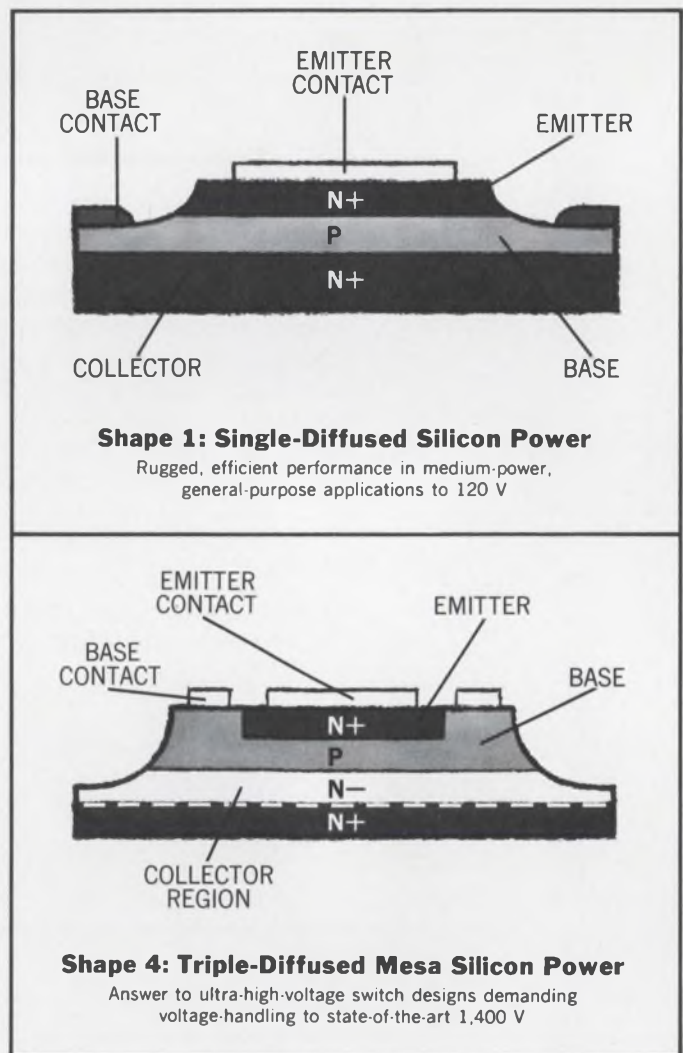

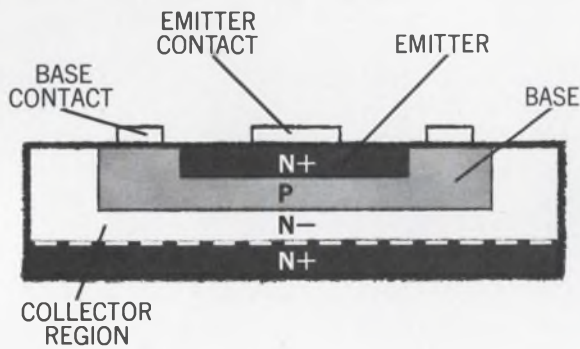

Shape 2: Triple-Diffused Silicon Power

High reliability, high frequency and high current for NPN or PNP switch/amplifier designs to 300 V

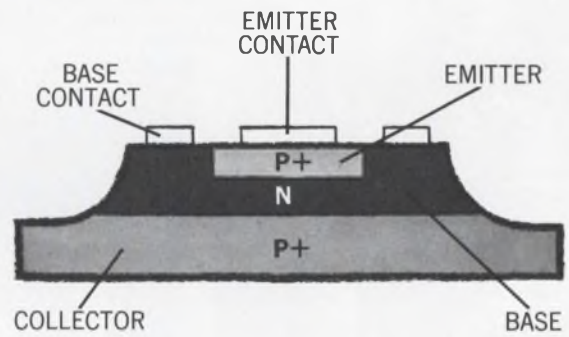

Shape 3: EpiBase* Silicon Power

Efficient, low-cost key to replacement of high-current germanium in PNP and NPN to 140 V

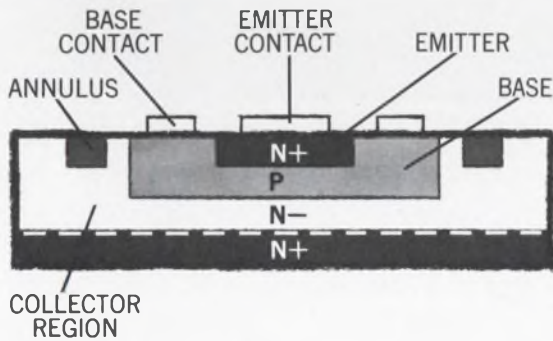

Shape 5: Epitaxial Annular Silicon Power

Double-diffused for high-current reliability and up to 1,000 times less leakage

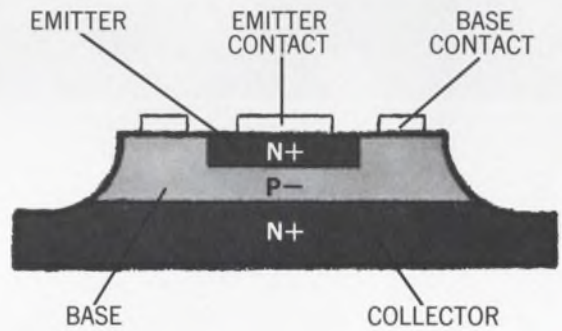

Shape 6: Hybrid Single-Diffused Silicon Power

No. 1 industrial choice for efficient, lower-cost, rugged switching/amplifying to 140 V

MOTOROLA

Silicon Power Transistors

*Trademark Motorola Inc.
†Annular Semiconductors
Patented by Motorola Inc.



The Trend is TTL.

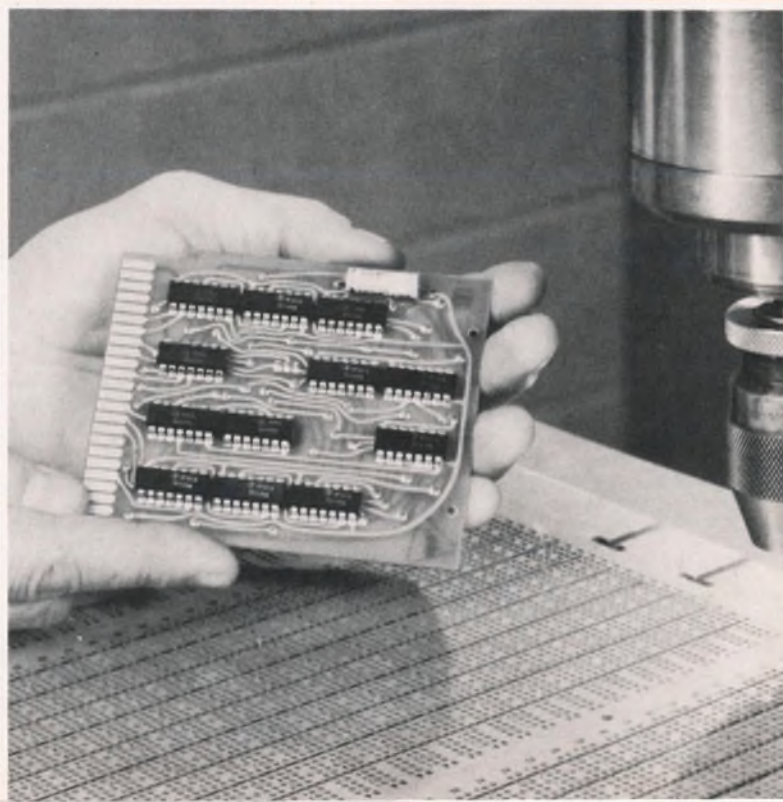

Icon all-digital numerical control helps customer cut costs and downtime.

TI integrated circuits help Icon build reliability and economy into all-digital numerical controls.

Icon Corporations' System 350 all-digital open-loop numerical control is turning in new records for reliability, economy and ease of installation.

The TI Series 74N TTL integrated circuits used in the system are giving flawless performance. About the ICs, Dr. Gordon Baty, Icon president said: "Of the more than 30,000 we have in the field, we've had almost no inexplicable

failures. We think this kind of trouble-free performance is what machine tool users want. We sink or swim on reliability and performance on the machine shop floor."

Icon's open-loop system offers far greater reliability, lower overall costs, and easier retrofit of existing machine tools.

One retrofit example: National Connector purchased a 75-year old vertical mill from a junkyard for \$250. They restored it and installed an Icon System 350 numerical controller.

Total costs ran about \$15,000 (less than one-half the cost of machines with similar capabilities). The restored mill met both tolerance and production-rate demands of National's high-precision interconnection manufacturing facility.

Retrofit went smoothly and quickly. Both mill and controller worked perfectly the first time with normal adjustments. Today, after more than a year, the system is still working perfectly.

Maintenance is simplified. High-density IC design packs instantly recognizable functions onto individual cards—allowing fast diagnosis and easy replacement.

Each Icon System 350 utilizes more than 250 TI Series 74N TTL integrated circuits in low-cost plastic packages. About twenty different types are used—including some of the latest MSI circuits.

New design aid

Integrated circuits from TI are helping many other manufacturers of industrial systems to increase reliability, improve performance, and reduce costs. Find out more from a new 80-page brochure that includes valuable design information on Series 54/74—industry's broadest TTL line. Circle 118 or write Texas Instruments Incorporated, P.O. Box 5012, M.S.308, Dallas, Texas 75222.

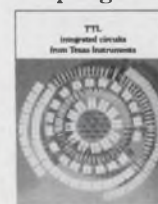

Upper Photo: Earl Johnson, consulting engineer for National Connector, holds one of the Icon boards containing TI TTL integrated circuits.

Lower Left: This vertical mill was purchased from a junkyard for \$250. After clean-up and restoration, an Icon numerical control was fitted smoothly and quickly. The new unit met both tolerance and production rate demands of National Connector.

Lower Right: Series 74N integrated circuits deliver command pulses to hydraulically-assisted stepping motors—positioning the mill to accuracies of ± 0.002 ".

TEXAS INSTRUMENTS
INCORPORATED



Indicator tubes—simple interfacing, limited flexibility, low in cost.



Full-scale terminals—extremely flexible, very expensive.

One way Two way



New kind of CRT Readout—the best of two worlds.

New way

Announcing the SRD-100—a new CRT readout device with simple interfacing. Now it's practical to use CRT readout displays in place of indicator tubes. Without getting into the cost of full-scale terminals. Especially if you need remote or multiple displays. And even if you need only 5-10 digits.

The SRD-100 accepts numeric/symbolic BCD data in parallel form, converts it to a composite video signal and displays it on any 525-line TV monitor.

In any of 160 character positions. Interfacing is as simple as indicator tubes.

And you can display data at remote locations with any number of CRTs—with just a single coaxial cable.

You can blink data off and on four times per second. Use three different sizes of character display. And reverse the character and display background from black on white to white on black. All controlled independently, line by line.

Cost for the basic SRD-100, not including TV monitors, is \$995. Characters in groups of half lines, plus options, are additional.

So if you have a numerical readout problem in any application like automatic testing, process control, automation or data acquisition, you're no longer limited to indicator tubes. Now you have a choice.

From the company that specializes in innovative data communications systems.

ADDS

Applied Digital Data Systems, Inc.



Mr. Richard Kaufman
Marketing Director, Dept. 11
Applied Digital Data Systems, Inc.
89 Marcus Boulevard
Hauppauge, New York 11787

Please send more information about the SRD-100.

Name _____

Title _____

Company _____

Address _____

City _____

State _____ Zip _____

Mini-est mfd's for μ spaces

or: our next series may be invisible

You can still see our new Minitan® W-Series tantalum capacitors . . . but just barely. These extraordinary little solid-electrolyte devices — the industry's smallest — pack up to .47 mfd. into a case about the size of a pin head.

What's more, they do it with a maximum DC leakage (at 25°C) of only 0.5 μ A, standard tolerances to $\pm 5\%$ and a 130% surge voltage rating. Gold-plated solid nickel leads and an operating temperature range of -55°C to +85°C help make this the finest series of microminiature modular capacitors available for hybrid and thick film circuit use.

Considerably smaller than comparably rated CS13 and epoxy filled devices, Minitan® W's have also out-shrunk monolithic ceramics. For example, a typical .22 mfd. ceramic measures .350 x .095 x .070; the Minitan® W case is only .100 x .050 x .040.

Of course, if you like capacitors you can see with scarcely a second glance, Components also has the broadest line of CS13, CSR13, CSR09, subminiature, and microminiature modular, cordwood, and non-polars around. Send for our new general catalog and get the small picture.

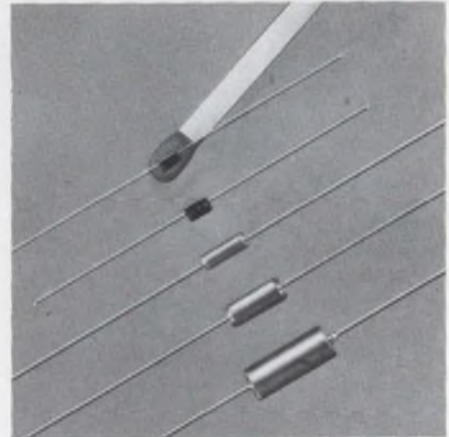

WHAT COMES AFTER MICROMINIATURE? — Looming large in comparison with C.I.'s new "W Series" capacitor (on matchhead) are the following tantalum units: Standard TR Series (CSR13), Miniature TY Series (CSR09), Subminiature Econotan (CT), and Microminiature Minitan® (U case).

PART NUMBER		W CASE SIZE	
AXIAL	RADIAL	CAP. IN MFD @ 25°C. 120 Hz	WVDC @ 85°C
W472A	W472R	.0047	20
W682A	W682R	.0068	20
W103A	W103R	.010	20
W153A	W153R	.015	20
W223A	W223R	.022	20
W333A	W333R	.033	20
W473A	W473R	.047	20
W683A	W683R	.068	20
W104A	W104R	.10	15
W154A	W154R	.15	10
W224A	W224R	.22	6
W334A	W334R	.33	4
W474A	W474R	.47	2

DIMENSIONS INCHES	
A	.100 max.
B	.050 max.
C	.040 max.
D	.030 \pm .015

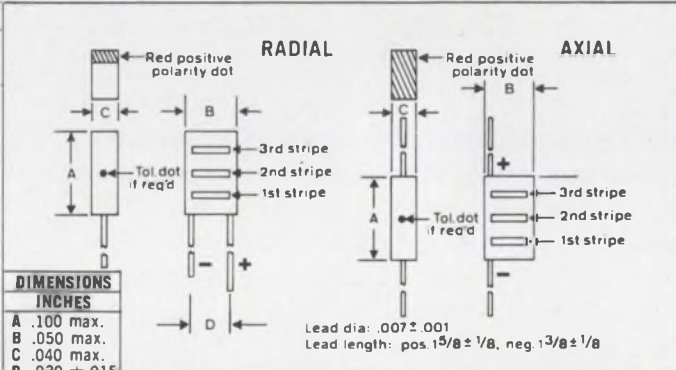

MINITAN® MODULAR (Also available with axial leads)		MINITAN® CORDWOOD	
	U		Y
	F		P
	M		B
	L		A
	S		G
	J		

0.08 MFD @ 20 VDC to 220 MFD @ 3 VDC (Coldwood Series available from 0.1 MFD @ 50 VDC)
0.1 MFD @ 50 VDC to 47 MFD @ 3 VDC (Modular Series available to 220 MFD)

(ACTUAL SIZE) (ACTUAL SIZE)

COMPONENTS, INC.
CAPACITOR PRODUCTS
 BIDDEFORD, MAINE 04005 - TEL (207) 284-5956 - TWX 710-229-1559

Pick your own happy ending.

All good things, including circuit boards, must come to an end.

That's where we come in. We've got the happy ending patented.

Four times. (Pat. nos. 2,248,686; 2,294,056; 3,182,276; 3,208,026.)

In all the configurations you need. Four plug styles. Ten receptacle styles. For direct staking, or with their own insulator. With or without card guides. With or without guide pins. With any number of contacts (up to 135, on one triple-decker receptacle).

Every one meets Mil-E-5400 including the new revision "K", which makes metal-to-metal contacts mandatory.

Our Varicon™ metal-to-metal contacts are patented — and famous, in their quiet way. Because, in millions of operating hours, not one has failed.

The Varicon contacts have a unique fork-like design, with four large, coined, mating surfaces that form a firm gas-tight seal. Even after being mated for years, they remain clean and unoxidized. They have, and

keep, a low contact resistance and high current capacity. And they're exceptionally resistant to shock and vibration.

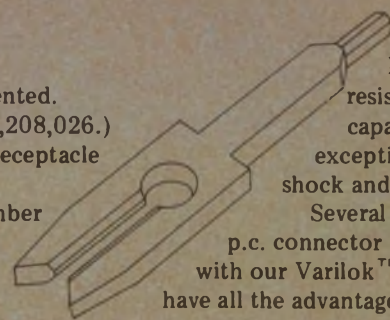

Several members of our p.c. connector family come with our Varilok™ contact. These have all the advantages of the Varicon contacts — except that you can insert and remove them from the receptacle yourself. They're available by the handful for small scale production and on 1800-contact reels for use with automatic crimping equipment.

They're all described in our printed circuit connector guide. To get your copy, write, wire, call or TWX us. Elco Corporation, Willow Grove, Pa. 19090. (215) 659-7000. TWX 510-665-5573.

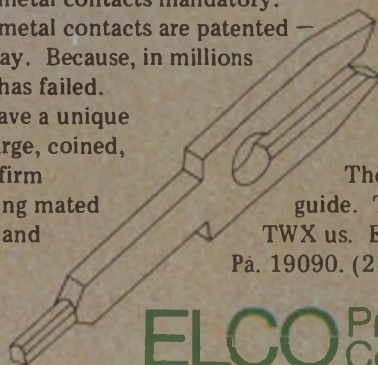

ELCO Printed Circuit
Connectors



Equal

Gates

DM8000N (SN7400N)	Quad 2-Input, NAND gate
DM8001N (SN7401N)	Quad 2-Input, NAND gate (Open Collector)
DM8002N (SN7402N)	Quad 2-Input, NOR gate
DM8003N (SN7403N)	Quad 2-Input, NAND gate (Open Collector)
DM8004N (SN7404N)	Hex inverter
DM8010N (SN7410N)	Triple 3-Input, NAND gate
DM8020N (SN7420N)	Dual 4-Input, NAND gate
DM8030N (SN7430N)	Eight-Input, NAND gate
DM8040N (SN7440N)	Dual 4-Input, Buffer
DM8050N (SN7450N)	Expandable Dual 2-Wide, 2-Input AND-OR-INVERT gate
DM8051N (SN7451N)	Dual 2-Wide, 2-Input AND-OR-INVERT gate
DM8053N (SN7453N)	Expandable 4-Wide, 2-Input AND-OR-INVERT gate
DM8054N (SN7454N)	Four-Wide, 2-Input AND-OR-INVERT gate
DM8060N (SN7460N)	Dual 4-Input expander
DM8086N (SN7486N)	Quad Exclusive-OR-gate

Flip Flops

DM8540N (SN7472N)	MASTER-SLAVE J-K flip flop
DM8501N (SN7473N)	Dual J-K MASTER-SLAVE flip flop
DM8500N (SN7476N)	Dual J-K MASTER-SLAVE flip flop
DM8510N (SN7474N)	Dual D flip flop

Counters

DM8530N (SN7490N)	Decade Counter
DM8532N (SN7492N)	Divide-by-twelve counter
DM8533N (SN7493N)	Four-bit binary counter
DM8560N (SN74192N)	Up-down decade counter
DM8563N (SN74193N)	Up-down binary counter

Decoders

DM8840N (SN7441AN)	BCD to decimal nixie driver
DM8842N (SN7442N)	BCD to decimal decoder

Miscellaneous

DM8550N (SN7475N)	Quad latch
-------------------	------------

Spec-for-spec. Pin-for-pin. Second source on all popular 74N.

Opportunity

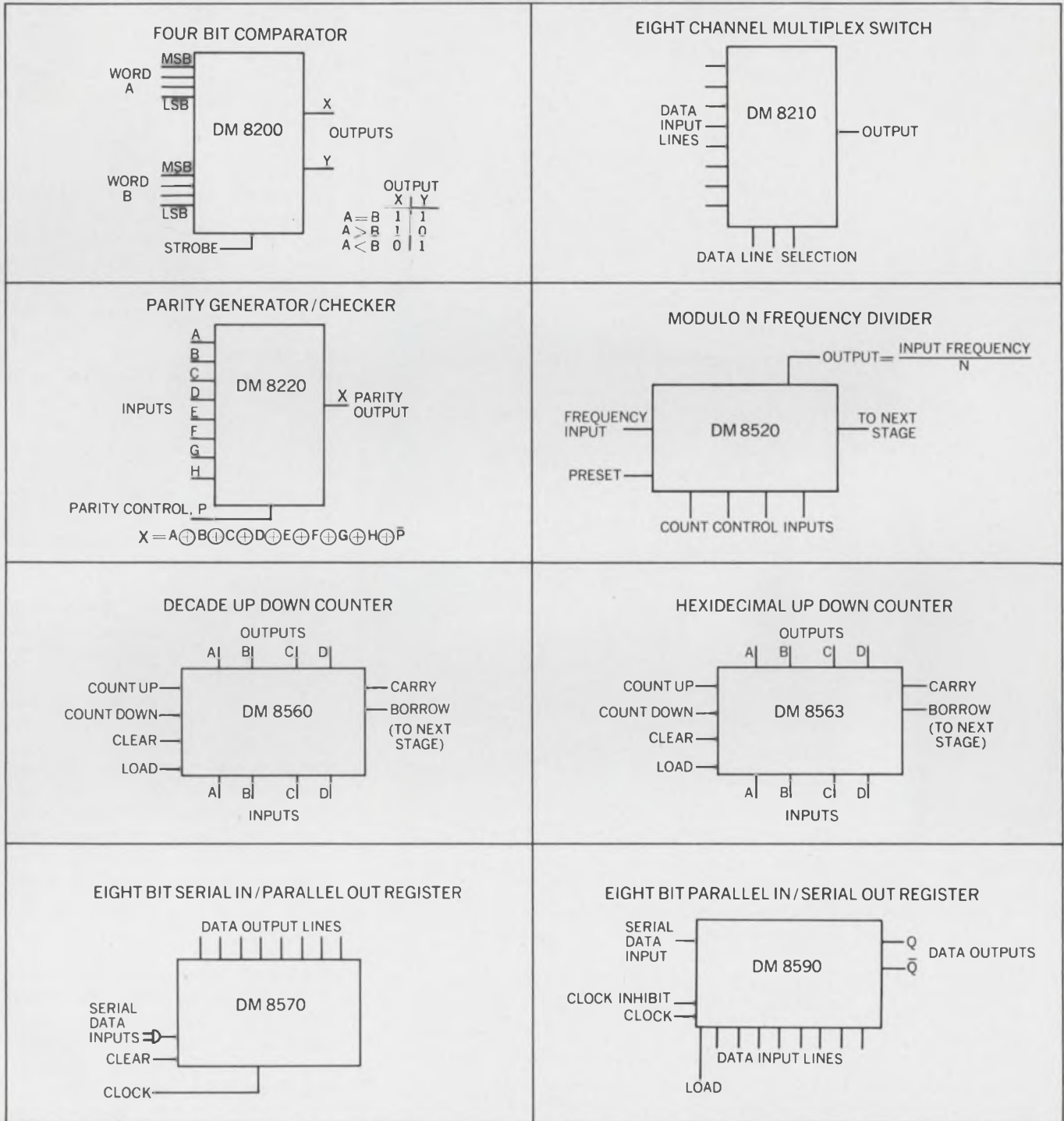

These exclusive National TTL MSI circuits offer designers increased opportunities for circuit savings in design time, board space and costs. Write or call for your free TTL Spec Guide, TTL Cross Reference Guide, and TTL Performance Tables. National Semiconductor, 2975 San Ysidro Way, Santa Clara, California 95051 (408) 245-4320 TWX: 910-339-9240 Cables: NATSEMICON

National/TTL

A single capable source for both lamps and fiber optic light guide systems

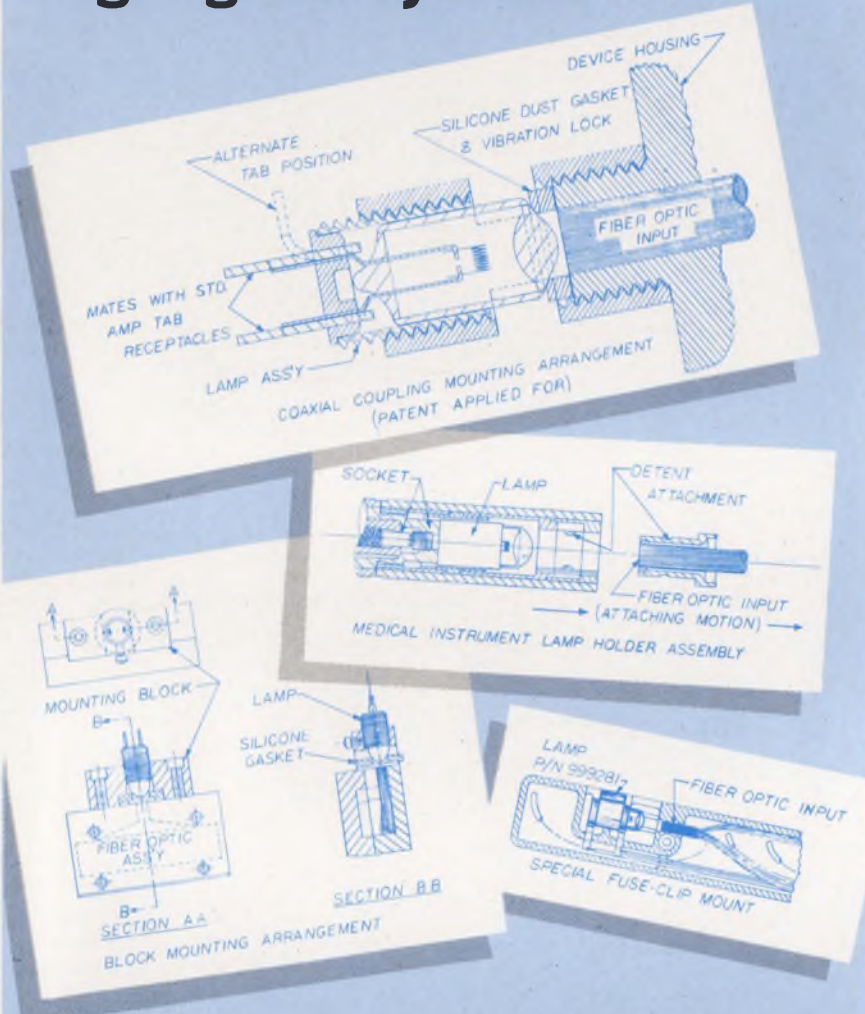

There are obvious advantages in speed, cost and often in efficiency of the ultimate system in having one source produce both miniature lamps and fiber optic assemblies. Welch Allyn has that capability.

We are major suppliers of fiber optics and incandescent illumination sources to principal computer manufacturers and other light guide users.

In addition to our standard lamp designs, we have recently developed a new family of customized miniature vacuum lamps for fiber optic and photo-sensitive device applications with selectable lens-filament combinations and basing for optimum utilization of energy.

Our lamp-fiber optic systems are designed for maximum efficiency and are often less costly than standard multiple-lamp systems.

Phone or write for more information

WELCH ALLYN, INC.
Skaneateles Falls, N.Y. 13153
(315) 685-5788



Designer's Datebook

OCTOBER 1969						
Sun	Mon	Tue	Wed	Thu	Fri	Sat
			1	2	3	4
5	6	7	8	9	10	11
12	13	14	15	16	17	18
19	20	21	22	23	24	25
26	27	28	29	30	31	

NOVEMBER 1969						
Sun	Mon	Tue	Wed	Thu	Fri	Sat
						1
2	3	4	5	6	7	8
9	10	11	12	13	14	15
16	17	18	19	20	21	22
23	24	25	26	27	28	29
30						

For further information on meetings, use Information Retrieval Card. Oct. 6-8

Oct. 21-23
Thermionic Energy Conversion Conference (Carmel, Calif.) Sponsor: IEEE, W. E. Harbaugh, RCA, Electronic Components, Lancaster, Pa. 17604

CIRCLE NO. 401

Oct. 26-30
Mathematical and Computer Aids to Design Conference (Anaheim, Calif.) Sponsor: IEEE, ACM, SIAM, J. F. Traub, Computing Science Research Center, Bell Telephone Laboratories, Murray Hill, N. J. 07974

CIRCLE NO. 402

Oct. 27-29
Southeastern EMC Symposium (Atlanta, Ga.) Sponsor: IEEE, D. Vrooman, P.O. Box 331, Smyrna, Ga. 30080

CIRCLE NO. 403

Oct. 27-29
Electronic & Aerospace Systems Convention (EASCON) (Washington, D.C.) Sponsor: IEEE, H. P. Gates, Jr., Sect. of Army for Southeast Asia Matters, The Pentagon, Washington, D.C. 20310

CIRCLE NO. 404

Nov. 5-7
Northeast Electronics Research and Engineering Meeting (NEREM) (Boston) Sponsor: IEEE, C. J. Peters, Sylvania Electric Products, 40 Sylvan Road, Waltham, Mass. 02154

CIRCLE NO. 405

Nov. 18-20
Fall Joint Computer Conference (Las Vegas) Sponsor: E. Grabbe, TRW Systems Inc., Bldg R3, Room 2070, One Space Park, Redondo Beach, Calif. 90278

CIRCLE NO. 406



Two best sellers with the same silly problem

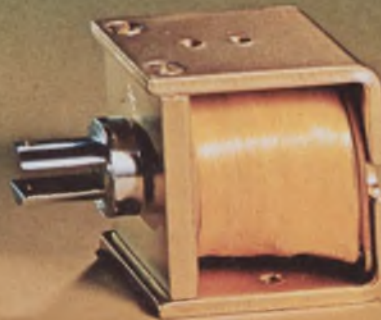

When your 1969 model looks the same as your 1968 model—getting across the engineering advances and improvements that are on the *inside* is a problem.

For instance, in 1966 we started using fully-annealed Armco steel for all Guardian Solenoid plungers... an "inside" improvement. Then, to compound the problem, we covered up this improvement with copper/nickel plating.

In 1968 we did it again. We took those

long-life plungers and started running them in a cavity lined with low-friction phenolic. This alone increases operating life by maybe half a million operations.

And there's more: The new acetate-yarn-sealed coil cover that's standard this year means better protection, complies with U/L construction at no extra cost.

Our "bug" changes. Inside. Where an engineering advance makes for a better solenoid. Write for Bulletin G2, TS.

NEW! TUBULAR SOLENOIDS



Eleven new Guardian Tubular Solenoids to fit every application. Practically install themselves. Just insert threaded bushing through installation hole and tighten furnished nut.



GUARDIAN[®]
ELECTRIC

MANUFACTURING COMPANY 1550 W. Carroll Ave., Chicago, Illinois 60607

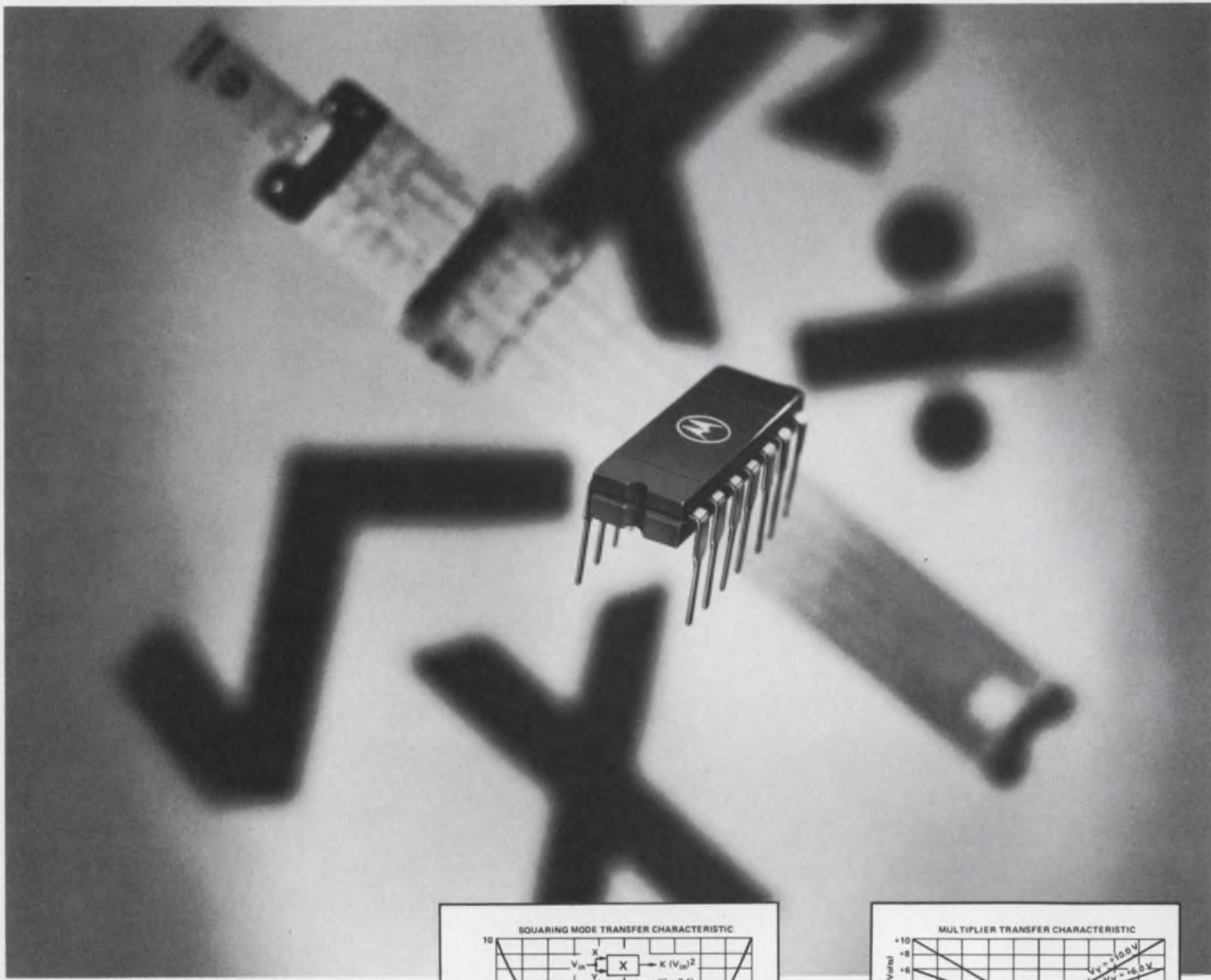

MC1595 is the industry's first true Linear, 4-Quadrant Multiplier IC.

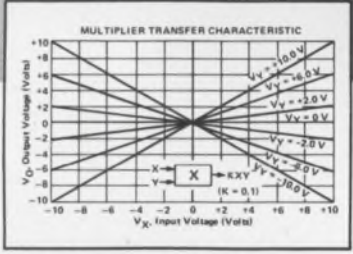
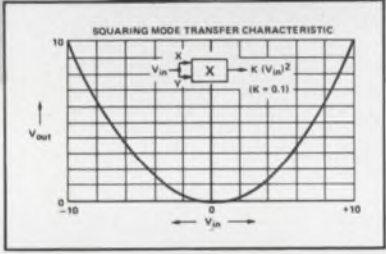

Here is the first element in what promises to be a large family of monolithic, linear multipliers. The MC1595 is designed for uses where the output voltage is a linear product of two input voltages; and, as such, its list of applications is almost limitless, particularly in the control and instrumentation fields.

For example, some of the applications are:

- To Multiply
- To Divide
- To Find Square Root
- To Determine Mean-Square

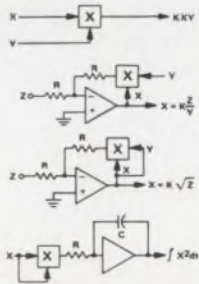

- Frequency Doubling

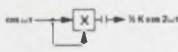

The MC1595 can also be used as a Balanced Modulator/Demodulator, and for Electronic Gain Control among many others. It even has the capability for determining true rms; plus direct power calculations.

Here are some of the features that contribute to the wide versatility of the MC1595:

- Excellent Linearity — 1% max error "X" input; 2% error max "Y" input.

- Wide Bandwidth—Phase Error $\leq 3^\circ$ from DC to 750 kHz.
- Adjustable Scale Factor.
- Large Input Voltage Range ± 10 V.

The MC1595 Multiplier is currently available from distributor stock in the 14-pin dual in-line ceramic package. So is its 0 to 70° temperature-range counterpart, the MC1495. For complete information, including a just-published Application Note, circle the reader service number, or write: P. O. Box 20912, Phoenix, Arizona 85036.

—where the priceless ingredient is care!





NEW

7000 SERIES

Plug-In Oscilloscopes

150 MHz Bandwidth . . .

USABLE performance to 150 MHz or 90 MHz. Combined mainframe and plug-in bandwidths are specified at minimum deflection factors with or without probes. With . . .

MORE Sensitivity

Higher sensitivities are achieved at greater bandwidths than ever before. 5 mV/div at 150 MHz, 1 mV/div at 100 MHz and 10 μ V/div at 1 MHz. With . . .

MORE Flexibility

Each mainframe accepts up to four plug-in units. Thirteen plug-ins are currently available to cover virtually all multi-trace, differential, sampling, and X-Y applications. Plus . . .

NEW Convenience

Greater convenience in all areas of instrument operation. Features such as Auto Scale Factor Readout, lighted push-button switching, and true automatic triggering assure faster, more accurate, less complicated measurements.

Please turn for additional information.



7504

CONTROLS

st "A" sweep, "B" sweep, independently. A single- astigmatism adjustment, nder complete the control

CALIBRATOR

A multi-function generator usable as a "standard" for calibration of voltage and current GAIN, time/div, and probe compensation. The output is DC or AC (1 kHz or variable) voltage or current (fixed at 40 mA). The amplitude accuracy is within 1% and the time accuracy is within 0.5% at 1 kHz.

TRIGGERING

The signals from both vertical plug-ins are coupled through a main-frame logic circuit and made available to each horizontal plug-in, selectable from LEFT channel, RIGHT channel, or slaved to VERTICAL MODE. The latter frees the operator from manual source changes during single-trace operation and, in conjunction with the P-P AUTO TRIGGER MODE in the time-base units, provides true hands-off triggering during routine measurements.

FOUR PLUG-IN CHANNELS

The modular approach is the answer to instrument flexibility. With dual-trace switching in the mainframe amplifiers, each plug-in can be "specialized" in function and operate in combination with other units. Thirteen plug-ins are currently available for the 7000-Series. Together, they represent the widest range of performance options for multi-trace, differential and sampling applications available today.

and Amplifier

MHz (2.4 ns tr) in the ns tr) in the 7504. mV/div at full band-

7A22 High-Gain Differential Amplifier

Bandwidth—DC to 1 MHz with selectable upper and lower —3 dB points. Min deflection factor—10 μ V/div at full bandwidth.

7B51/7B50

Time-Base Units for the 7504

5 ns/div maximum sweep speed. Operable singly or in combination for delaying sweep capability.



7M11 Delay Line Unit

Two 75 ns, 50- Ω delay lines. Trigger selection from either line.



7S11 Sampling Amplifier

Accepts the plug-in sampling heads for bandwidths to 14 GHz (25 ps tr).

7T11 Random Sampling Time Base

10 ps/div to 5 ms/div sweep range, accomplished with equivalent-time and real-time techniques.

Triggering to 12 GHz.



7704

AUTO SCALE FACTOR READOUT

A character generator senses the position of volts/div, amps/div, time/div, polarity, and uncalibrated variable controls, then accounts for probe attenuation and displays the correct scale factors for all channels directly on the CRT.

DISPLAY C

Three intensity controls adjust and READOUT brightness focus control, a screwdriver and a two-position beam focus group.

BRIGHT TRACE

The acceleration potentials are 24 kV for the 7704 and 18 kV for the 7504 for improved trace visibility. Single-shot photographic writing speed is $3300 \text{ cm}/\mu\text{s}$ (7704) measured with the standard P31 phosphor, the new C-51 camera and 10,000 ASA film. The display area is 8 cm x 10 cm with a parallax-free illuminated graticule.

DUAL-TRACE SWITCHING

Both the vertical and horizontal mainframe amplifiers are "dual trace" providing a unique level of flexibility with plug-in combinations. A relatively small number of plug-ins can then meet a wide range of application requirements. The CHOP and ALT modes permit simultaneous displays of delaying and delayed sweep, and, through switching logic, may be "slaved" to provide a functional dual-beam type of display.



7A13 Differential Comparator Amplifier

Bandwidth—DC to 100 MHz (3.5 ns tr) in the 7704; DC to 75 MHz (4.7 ns tr) in the 7504. Min deflection factor—1 mV/div at full bandwidth.

7B71/7B70

Time-Base Units for the 7704

2 ns/div maximum sweep speed. Operable singly or in combination for delaying-sweep capability.

7A16 Wide-Band

Bandwidth—DC to 150 MHz (3.5 ns tr) in the 7704; DC to 90 MHz (3.9 ns tr) in the 7504. Min deflection factor—5 mV/div at full bandwidth.



7A11 Captive FET Probe Amplifier

Bandwidth—DC to 150 MHz (2.4 ns tr) in the 7704; DC to 90 MHz (3.9 ns tr) in the 7504. Min deflection factor—5 mV/div at full bandwidth.

7A12 Dual-Channel Amplifier

Bandwidth—DC to 105 MHz (3.4 ns tr) in the 7704; DC to 75 MHz (4.7 ns tr) in the 7504. Min deflection factor—5 mV/div at full bandwidth.



7A14 AC Current Probe Amplifier

Bandwidth—25 Hz to 105 MHz depending on mainframe and current probe; two probes available. Min deflection factor—1 mA/div at full bandwidth.



C-51/C-50 Trace-Recording Cameras



Two new compact trace-recording cameras have been designed for direct compatibility with the 7000-Series Oscilloscopes. The C-51 and C-50 cameras are basically identical units, differing only in the lens system. The C-51 has an f/1.2, 1:0.5 lens; the C-50 uses an f/1.9, 1:0.7 lens. The C-51 is recommended for single-shot photography at the fastest sweep rates, the C-50 for more general purpose applications. Photographic writing speed of the two 7000-Series mainframes with the C-51 and 10,000 ASA film (without prefogging) is 3300 cm/ μ s (7704) and 2500 cm/ μ s (7504).

The cameras offer a new level of operational convenience for mistake-proof trace photography. The guess work normally associated with selection of f stop and shutter speed to match the ASA index and trace brightness is eliminated. After setting the ASA index, the built-in photometer allows a visual correlation of trace intensity to the correct f stop setting and shutter speed. After initial adjustment, a change of f stop or shutter speed will still maintain the same exposure. Focusing is accomplished by two beams of light projected on the CRT which, when superimposed, indicates optimum focus. The insert shows the photometer spot and the range-finder focusing images.

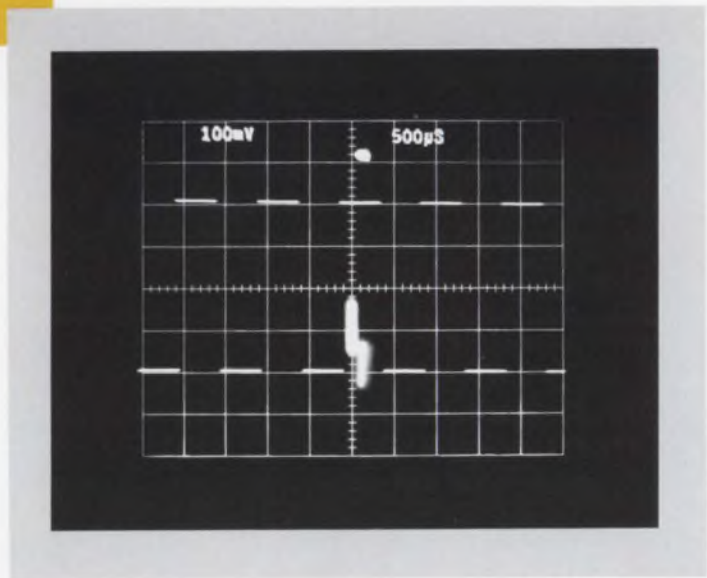

SCOPE-MOBILE® CARTS

The 204-2 Scope-Mobile® Cart is specifically designed for the 7000-Series instruments. It provides a securing mechanism for the oscilloscope, nine positions of selectable tray tilt, a large storage drawer, storage for five 7000-Series plug-ins, and large locking-type wheels.

PROBES

The P6053 is a miniature fast-rise 10X probe designed for full compatibility with the 7000-Series instruments. Input R and C is 10 M Ω , 10.3 pF. Probe risetime is 1.2 ns or less.

The P6052 is a passive dual-attenuation probe designed for measurements below 30 MHz. A sliding collar selects 1X or 10X attenuation. Input R and C is 1 M Ω or 10 M Ω , 100 pF or 13 pF. Risetimes are 60 ns (1X) and 7 ns (10X).



7704 Oscilloscope	\$2500
7504 Oscilloscope	\$2000
7A11 Amplifier Plug-In	\$850
7A12 Amplifier Plug-In	\$700
7A13 Amplifier Plug-In	\$1100
7A14 Amplifier Plug-In	\$575
7A16 Amplifier Plug-In	\$600
7A22 Amplifier Plug-In	\$500
7B71 Time-Base Plug-In	\$685
7B70 Time-Base Plug-In	\$600
7B51 Time-Base Plug-In	\$510
7B50 Time-Base Plug-In	\$450
7S11 Sampling Plug-In	\$450
7T11 Sampling Time-Base Plug-In	\$1100
7M11 Dual Delay Line Unit	\$250
204-2 Scope-Mobile® Cart	\$155
C-51 Trace-Recording Camera	\$900
C-50 Trace-Recording Camera	\$700
P6052 or P6053 Probes	ea \$50

U.S. Sales Prices FOB Beaverton, Oregon

Tektronix, Inc.

For a demonstration, call your local Tektronix field engineer or write: Tektronix, Inc., P.O. Box 500, Beaverton, Oregon 97005.

New ways in digital automation with:

- Shaft Encoders, 34 types
- Synchro-to-Digital Converters, 6 types
- Analog-to-Digital Converters, 10 types
- Solid-State Digital Modules, 136 types

FREE . . . 58 Pages

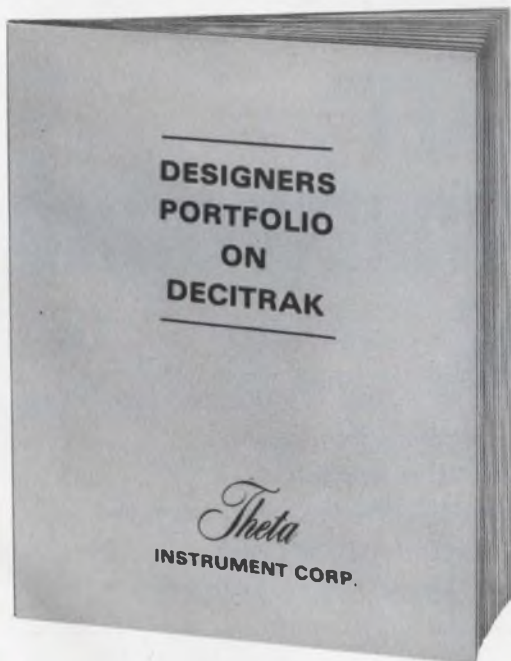

Includes copy of
"A Primer on Shaft Encoders"

We call it the DECITRAK[®] SYSTEM

Selecting from hundreds of off-the-shelf digital transducers and circuits, we assemble a remarkably low-cost, customized digital system for control/display/logging. DECITRAK can perform as simple a job as providing remote digital display of antenna pedestal position. Or, as impressive a task as the precise control of massive prime movers in response to punched-card commands.

Need a computer interface? A code converter? A typewriter driver? Set-point controls? Let a Theta Application Specialist tailor a system to your specific needs from the field-proven line of DECITRAK digital components.

More than 1,000 of these systems are now in use in nuclear installations, satellite tracking stations, wind tunnels, and aboard ships.

Theta

INSTRUMENT CORPORATION

FAIRFIELD, NEW JERSEY 07006 • PHONE: 201 - 227-1700 • TELEX: 138353

INFORMATION RETRIEVAL NUMBER 12

...want a tantalum capacitor with proven performance?

Buy TYPE 150D TANTALEX[®] SOLID-ELECTROLYTE CAPACITORS

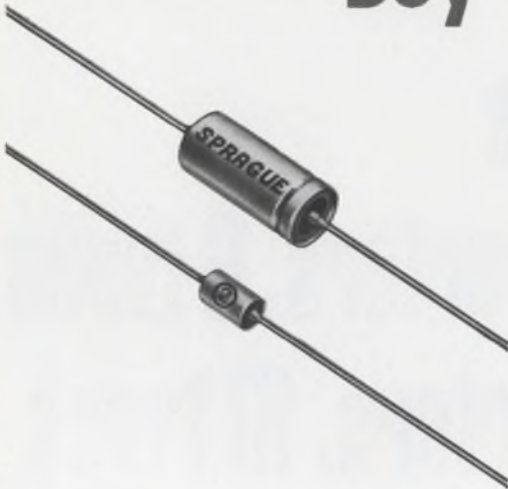

INFORMATION RETRIEVAL NO. 821

Hermetically-sealed in metal cases. Four case sizes, ranging from 1/4" to 3/4" length. Value-packed performance characteristics — low impedances at high frequencies, low dissipation factor, minimal capacitance drift with temperature, practically no change in capacitance with life. Low leakage current limits. Investigate new higher capacitance ratings.

45C-9144R1

Buy resistors with built-in dependability...

Vitreous-enamel BLUE JACKET[®] POWER WIREWOUND RESISTORS



INFORMATION RETRIEVAL NO. 822

All-welded end-cap construction eliminates moisture along the leads, also anchors leads securely to resistor body. Expansion coefficients of vitreous enamel coating, ceramic core, and end caps are closely matched. Standard wattage ratings include 1, 2, 2.5, 3, 5, 7, 10, and 11 watts. Also available with radial tab terminals in ratings from 8 to 230 watts.

For complete technical data on Type 150D Tantalex Capacitors, write for Engineering Bulletin 3520F. For information on Blue Jacket Resistors, request Bulletin 7410D. Write to: Technical Literature Service, Sprague Electric Co., 347 Marshall Street, North Adams, Massachusetts 01247.



[®]'Sprague' and [®]' are registered trademarks of the Sprague Electric Co.

THE BROAD-LINE PRODUCER OF ELECTRONIC PARTS

News

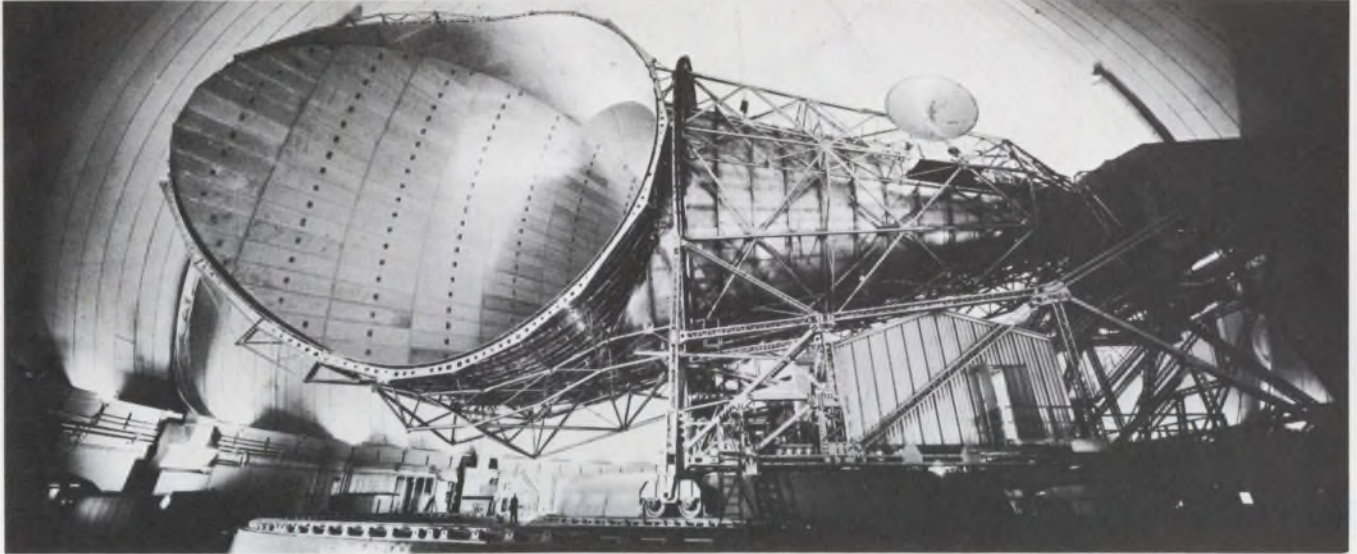

'Big Horn' antenna at Andover, Me., may one day receive and transmit messages from a

domestic satellite system. It's now used as an Intelsat ground station. p. 36.



365-foot solar telescope will attempt to unlock the sun's secrets. p. 30.



Transmission of data from Mars at 16,000 bits per second became feasible when a 210-foot antenna went into operation. The result: best photos yet taken of the planet. p. 25.

Also in this section:

Animal tests to help evaluate TV radiation. p. 32.

News Scope, p. 21 . . . Washington Report, p. 51 . . . Editorial, p. 59.

BURROUGHS DEVELOPS... SELF-SCANTM PANEL DISPLAY

the most significant development in electronic display

Burroughs, the originator of NIXIE[®] tubes, now revolutionizes display technology with the first commercially practical dot matrix display system. It took SELF-SCAN panel display, the remarkable Burroughs invention that takes the electronics out of the present electronic display ... reducing costly drive circuitry up to 90%.

With a minimum number of leads and drivers, Burroughs' system automatically scans data input into in-plane readout characters formed by glowing dots ... making possible a totally new combination of readability, minimal packaging and cost advantages.

The new flat-panel display is basically a matrix of small gas discharge cells hermetically sealed between heavy glass plates in a sandwich configuration. The matrix itself, formed of insulating material, has small grooves on its top surface to allow positioning of information anode wires which intersect each hole. Cathode conductors behind the center sheet intersect at each cavity with a second set of anode wires.



.0123456789+- E.

By utilizing the phenomena of preferential glow transfer and glow shifting, the initial glow caused by cathode ionization in the dot matrix may be moved through selected holes to a visible position on the top surface. A sequential flow of light is thus achieved without separate drivers for individual columns and rows.

Burroughs' alphanumeric SELF-SCAN panel displays are available with or without memory for any application requiring 16 or 18 digit readout.

Write today for descriptive brochure, Burroughs Corporation, Electronic Components Division, P. O. Box 1226, Plainfield, New Jersey 07061. Tel.: (201) 757-5000.

Burroughs 

INFORMATION RETRIEVAL NUMBER 13

Steady growth forecast for electronics in '70s

Despite expected cuts in spending by the Defense Dept., the outlook for the electronics industry in the early 1970s is good, the Electronic Industries Association says.

In a report to be presented at its meeting in Los Angeles Oct. 6-8, the EIA says electronics sales should rise from \$25.1-billion this year to \$26-billion by 1971-72. Total defense spending will be dropping in the same period, the EIA predicts, so that by 1971 military outlays will come to \$75-billion and by 1972 to \$72-billion. But after 1972, the EIA forecasts, defense spending will again rise, reaching \$76-billion in the mid and later 1970s.

No single market continues to dominate electronics sales, according to the association. But it was emphasized that just in what direction and how much should be spent for new market development is entirely up to the individual firms, since the EIA report makes no recommendations.

The projected decrease in defense spending during the next three years is based on a slowdown in the Vietnam war effort, primarily in such nonelectronic areas as ammunition outlays, personnel and operations and maintenance. These decreased costs will be partly offset by inflation and increased spending for strategic systems such as a new aircraft to replace the B-52 intercontinental bombers.

The marketing report gives a comprehensive review, in 13 chapters, of the many areas of interest to various segments of the electronics industry. These include 1-year projected studies for such areas as aerospace, law enforcement, marine sciences, poverty, housing, transportation, and the balance of payments situation.

To those who look for rapid expenditures in such areas as pollu-

tion, crime control, urban reconstruction, transportation and education, the report's predictions will be disappointing. Not before five years, or possibly 10, will the full impact of spending in these problem areas be felt, the EIA says.

An analysis of the market in oceanography indicates that expenditures will stay at the half-billion dollar annual level for the near future, with an upturn to about \$1.8-billion by 1980.

The study invisions: "This turning to the sea and the prospect of a national program directed at fostering civil marine technology have major implications for the aerospace and defense industry."

Compact CO₂ laser developed by Sylvania

Most carbon dioxide lasers are so long that their use has been limited mainly to the laboratory and a few industrial applications. A 1000-watt CO₂ continuous-wave laser, for example, is typically upwards of 60 feet long. Sylvania Electronic Systems, Mountain View, Calif., says it has a better design: It has developed a 1000-

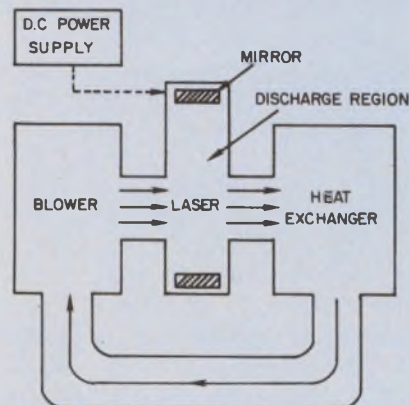

Desk-sized CO₂ laser contains a closed-cycle gas cooling system.

watt CO₂ continuous-wave laser that is about the size of a standard office desk.

The compactness of the Sylvania device—called the Gas-Transport Laser—is made possible by a closed-cycle gas cooling technique. In conventional carbon dioxide lasers, the hot gas mixture (carbon dioxide, nitrogen and helium) is cooled by random diffusion to the walls of the laser tube. Devices of this type are extended in length to handle large amounts of power and to provide the cooling surface required.

In Sylvania's laser (see diagram), the hot gas mixture is excited by an electrical discharge in the laser region. It is then cooled to its original temperature in a self-contained heat exchanger and is recycled by an internal blower back to the active region.

Dr. William Tiffany of the company's electro-optics division says the improved cooling results in high power from a much shorter length. In fact, 1000 watts was generated in one meter of active length—20 times the output power per unit length of conventional gas lasers, according to Dr. Tiffany.

In laboratory tests, the laser is said to have achieved 1000 watts of output power, with a gas flow rate of 6000 cubic feet-per-minute and an efficiency of 10 per cent.

Dr. Tiffany says the company is working on a 5000-watt CO₂ laser in about the same size.

Plans are to market the present model in about five months for about \$50,000.

Town goes it alone—equips own airport

One day the leaders of Latrobe, a small, but well-heeled, community in the rolling hills of Pennsylvania, got tired of watching sleek corporation jets and fancy private planes fly over their airport without landing. The town had much to offer. There was good fishing, hunting, golf clubs—one owned by Arnold Palmer—and industry. But to get there, pilots in jet planes had to land at the Pittsburgh Airport and then drive to Latrobe because the insurance policies they carried would not permit them to land at airports without good communica-

tions, a tower and an instrument landing system.

Latrobe didn't have these and the Federal Aviation Administration couldn't help because the airport didn't have enough landing operations to warrant the government's supplying the equipment.

So, Latrobe bought the equipment itself. The Pennsylvania Aeronautics Commission kicked in half the money, and corporations and private donors provided the rest. They bought an ILS from Cutler-Hammer's AIL Div. in Deer Park, N. Y., for \$79,000. A trailer-like tower, hoisted to the roof of a building was obtained from Air Traffic Control Systems, Inc., in Cleveland for about \$25,000.

Since then monthly operations have jumped from 1500 in October 1968—just before the new equipment was installed—to 8240 in August 1969. The sale of gasoline has increased 67 per cent, and landing fees are rolling in. The airport is so busy that FAA will probably soon take over its operation.

Latrobe airport authorities are happy, and electronics manufacturers are, too. AIL has sold landing systems for non-FAA money to three other towns and is looking optimistically to the 300 additional community airports throughout the country that also might try it alone.

Stock exchange makes automation study

The American Stock Exchange has released a broad-based blueprint for computerizing security-exchange procedures and operations from coast to coast. The study, prepared for AMEX by North American Rockwell Corp., took six months to prepare. It examines the exchange's problems, procedures and operations and recommends what should be automated and what left alone.

"We have task forces looking at hardware," an exchange spokesman

said, "but any selection is a long way off."

Another study, looking farther into the future, is under way by the Rand Corp., under contract jointly with both the American and New York Stock Exchanges. This study will be completed by February, 1970.

New vendor offers line of precision ICs

Unusually precise analog ICs will be manufactured by Precision Monolithics Inc., a new company of Santa Clara, Calif., according to its president, Marvin Rudin.

"One of our first products will be a monolithic 741 op amp with offset currents under 3 nA and offset voltages under 1 mV," says Rudin. "This will be an improvement by a factor of at least 10 in current and 5 in voltage over the best 741 now available from other sources."

The op amp and other circuits will compete directly with the high-performance linear modules produced by a number of vendors, and will include DDAs, op amps, and precision linear amplifiers. The company expects to fill initial orders by the first quarter of 1970.

Precision Monolithics Inc. is 40% owned by Bourns Inc., Riverside, Calif.

RCA plans expansion in time-sharing field

For several years, RCA has been dangling its corporate toes in the soothing, tepid waters of commercial time-sharing without taking the plunge. Now, it has indicated, it may be ready to dive into the market.

The occasion was the dedication earlier this month of RCA's plant in Marlboro, Mass., where it plans to turn out peripheral computer equipment. Robert W. Sarnoff, the company's president, announced at the ceremony the introduction of the RCA Spectra 70/61 computer—an advanced and sophisticated machine designed for use in the time-sharing field. RCA has every intention of using the new computer to go on line with a wide

range of time-sharing services, Sarnoff said.

Both Sarnoff and James R. Bradburn, executive vice president, pointed out that RCA currently offers shared computer time to companies in Wall Street and also has its own internal scientific time-sharing service as a link between RCA plants across the country.

Important features of the new 70/61 computer include the ability to provide local and remote access for over 350 terminal users. It is fully compatible with the earlier and smaller 70/46 and has source-level language compatibility with the IBM System 360. Monthly rental for the 70/61 will be about \$40,000, including maintenance. This price is 30 per cent higher than for the 70/46, but the larger machine is three times faster, RCA says, and also offers a threefold increase in terminal capacity and a fivefold rise in input/output capacity.

Sarnoff said: "During the 1970s we expect RCA's commercial data-processing equipment sales to rise beyond \$1-billion a year." He added:

"By 1975, 80 cents of the average dollar spent on systems will be for the kinds of peripheral equipment to be manufactured at Marlboro."

Weather center adds new computer system

Meteorological data analysis and prediction got a boost with the acquisition, last month, of a second Control Data Corp. model 6600 large-scale digital computer system by the Commerce Dept.'s Environmental Science Services Administration (ESSA). The 6600 was installed at the World Weather Center at Suitland, Md., a suburb of Washington, D. C.

The facility is shared by the National Environmental Satellite Center and the National Meteorological Center. The former agency operates the Tiros Operational Satellite weather system, which continually receives data from the Environmental Survey Satellites in orbit around the earth. The Meteorological Center collects and analyzes data from all global sources.



Fairchild Acquires Union Carbide Modular Products Line.

All standard and special modular op amps formerly offered by Union Carbide are now manufactured and marketed by Fairchild Controls, Mountain View, California.

Fairchild Controls' purchase of these Union Carbide products is part of a continuing planned program of expansion through both internal new product development and acquisition of quality products which complement the Fairchild line.

Fairchild will also continue to produce all special modular op amps that until now have been provided by Union Carbide.

For availability or applications information regarding these products contact Fairchild Controls, Modular Products, 423 National Avenue, Mountain View, California 94040. (415) 962-3833.

Standard Union Carbide operational amplifiers now made and sold by Fairchild Controls include:

Class	Type	Model
Chopper Stabilized	General Purpose	H2000
		H2030
Instrumentation Amplifier	FET Input	H3100
Wide Temperature Range High Performance Types	General Purpose	H6000
	FET Input	H7000
	Wideband	H9000
Commercial Temperature Range Types	General Purpose	H6010
		H6020
		H9010
		H9020
	FET Input	H9030
		H7010
		H7020
	H7030	
	H7040	
	H7050	
Output Current Booster	General Purpose	H6050
Comparator	General Purpose	H8010

FAIRCHILD
CONTROLS

A DIVISION OF FAIRCHILD CAMERA AND INSTRUMENT CORPORATION

Modular Products / 423 National Avenue / Mountain View, CA 94040 / (415) 962-3833

Looking for an All-Around Voltmeter?

Hewlett-Packard gives you a broad choice of multi-function meters that do not have to be pampered. Choose the versatility that fits your needs for ac volts, dc volts, current and resistance measurements. The exclusive individually calibrated taut-band meter used in these voltmeters gives you reliability, repeatability and high accuracy.

Make 90% of your day-to-day ac/dc measurements with laboratory precision using the hp model 410C Voltmeter. Measure dc from 15 mV to 1500 V full scale, current from 1.5 μ A full scale, resistances from 10 Ω to 10 M Ω , and ac volts to 700 MHz. The hp-developed photoconductor chopper amplifier gives the 410C high sensitivity, low drift, and low noise. Price of hp 410C is \$475. Vacuum tube version, hp 410B is \$300.

Low cost fully-portable multi-function meter—that's the all-solid-state, battery-operated hp model 427A Voltmeter. It costs only \$225. Option 01 gives both battery and line operation for an additional \$25. Measure dc voltages from 100 mV to 1 kV full scale; ac voltages from 10 mV to 300 V full scale at frequencies to 1 MHz (to 500 MHz with the 11096A High Frequency Probe, price \$45); resistance from 10 Ω to 10 M Ω . Ac and dc accuracy is $\pm 2\%$. FET's in the input circuit give you 10 M Ω input impedance—minimal circuit loading.

Highly sensitive dc and resistance measurements are made with hp 412A DC Vacuum Tube Voltmeter. With its 1 mV full scale dc voltage sensitivity and 1 Ω midscale ohms sensitivity, and its simplicity of

operation, the 412A is ideal for production line testing. Measure dc with 1% full scale accuracy. Price of 412A is \$450.

Extreme accuracy and hands-free operation distinguish the "Touch and Read" 414A DC Autovoltmeter. Automatic ranging and polarity indication occurs in less than 300 ms. Measuring accuracy for dc voltage is $\pm(0.5\%$ of reading $+0.5\%$ of full scale)—the best available in any analog voltmeter. Resistance accuracy is $\pm(1\%$ of reading $+0.5\%$ of full scale) on an easy-to-read linear scale. Price is \$690.

For full details on these and other Hewlett-Packard Voltmeters, see your hp catalog or contact your nearest hp field engineer. Or, write to Hewlett-Packard, Palo Alto, California 94304. Europe: 1217 Meyrin-Geneva, Switzerland.



HEWLETT *hp* PACKARD
ANALOG VOLTMETERS

098/15

From 8 1/3 bps to 16,200 bps--Here's how

New telemetry for Mariner began as experiment and ended with the best pictures yet taken of Mars

David N. Kaye
West Coast Editor

It began as an experimental high-speed telemetry system that Mariners 6 and 7 were to test as the unmanned spacecraft flew past Mars. But it worked so well in the developmental stage that NASA decided to make it the primary transmission system on the space missions last July.

As a result, data was transmitted back to earth at a speed of 16,200 bits per second instead of the 270 bps originally planned. And NASA obtained TV photos of Mars that were four times better than those obtained in the first Mariner fly-by in 1965 (see ED 17, Aug. 16, 1969, "New Mars Photos Show a Fourfold Gain in Detail," p. 21).

The significance of the new high-speed data-transmission system becomes clear when one considers that the 270-bit-per-second system originally planned for Mariners 6 and 7 was already quite a jump from the 8 1/3-bps system used in 1965. Instead of being the primary system, the 270-bit system was used as a secondary transmission unit.

Recorder is bypassed

With a primary data-transmission speed of 16,200 bps, NASA was able to bypass one of the two on-board tape recorders when the Mars scientific and picture data were sent back to earth. For certain data, both recorders were bypassed. Not only could a greater amount of data be sent back in a shorter time, but increased system reliability was achieved through the elimination of one or both of the tape recorders.

Original plans called for all the data to be stored on board the spacecraft at high speed on an

analog tape recorder, then played back at a lower speed through an analog-to-digital converter, and finally re-recorded on a digital tape recorder. A playback of the digitized tape at a still lower speed was then planned so the data could be transmitted to earth over the 270-bps telemetry channel. Engineers at Jet Propulsion Laboratory in Pasadena, Calif., recognized, however, that the use of two tape recorders in tandem created a potentially unreliable situation. A question was raised as to the feasibility of using a special channel that would transmit the data at the playback rate of the analog tape recorder; this would eliminate one of the tape recorders. At 16,200 bps, it was noted, the analog tape

recorder could play back all of the recorded data in slightly less than three hours. Subsequently it turned out that for certain data, even the analog tape recorder could be eliminated.

According to Mahlon Easterling, project engineer on the high-speed telemetry system in its early stages at JPL, "We could play back scientific data and decimated picture data as it was acquired. Decimated picture data includes every seventh picture element." To get back all the data in real time would have required seven times the speed that was available, or 113,400 bps. And to transmit fast enough for real-time motion TV, the power would have had to be increased a great deal more than seven times. NASA settled for the 16,200-bps system.

"Since the science data and the decimated picture data could by-

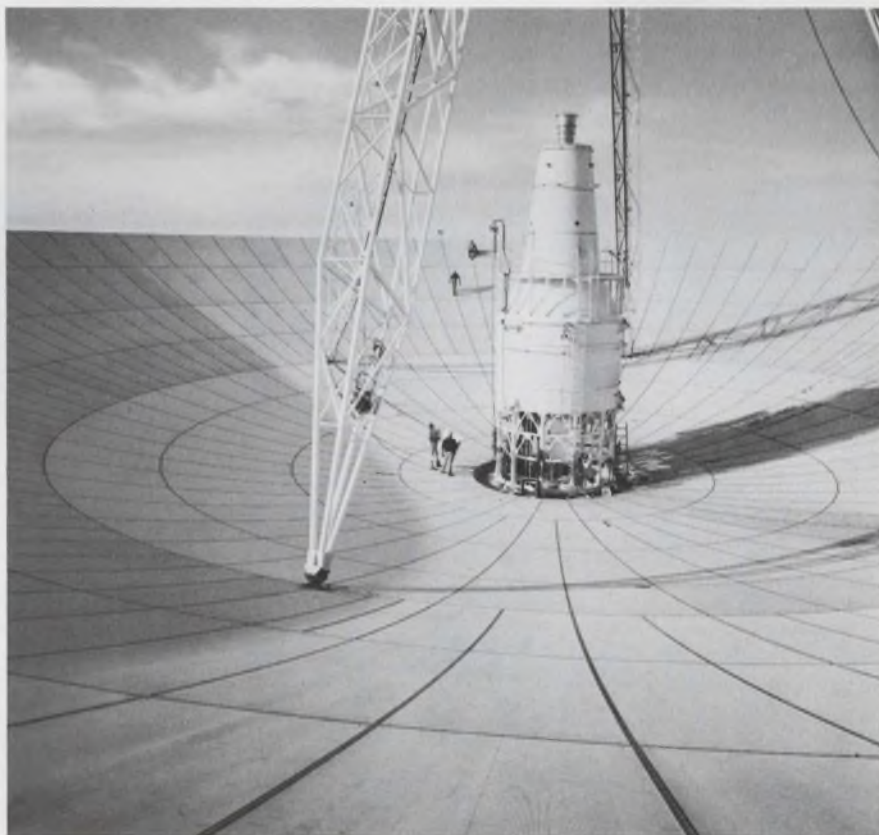

A key ground factor in the success of the Mariner 6 and 7 missions was this 210-foot antenna at Goldstone, Calif. It wasn't available for the 1965 flight.

(Telemetry, continued)

pass the recorders," Easterling observes, "it could come back with a higher quality. Each recorder does degrade the data somewhat."

Several factors contributed to successful increasing of the transmission speed to 16,200 bps. The most important was a switch from an 85-foot antenna on the ground to a 210-foot dish put into service at Goldstone, Calif., in 1966.

Another important move included increasing the spacecraft's transmitter power from 8.9 to 18.2 watts, and transmitting the data in a special code.

Easterling notes: "Each bit requires a specific amount of energy. Since power is energy per unit time, doubling the power, doubles the number of bits per unit time which can be transmitted." But each factor must be related to the total energy received on the ground.

To send 16,200 bps instead of $8\frac{1}{3}$, an increase in power of 32.9 dB had to be provided. Most of this came from the factors that make up the standard communication equation:

$$S = P_T M G_T L_S G_R L_R,$$

in which P_T is the power produced by the spacecraft transmitter; M is the modulation loss (that is, the factor that relates the power in

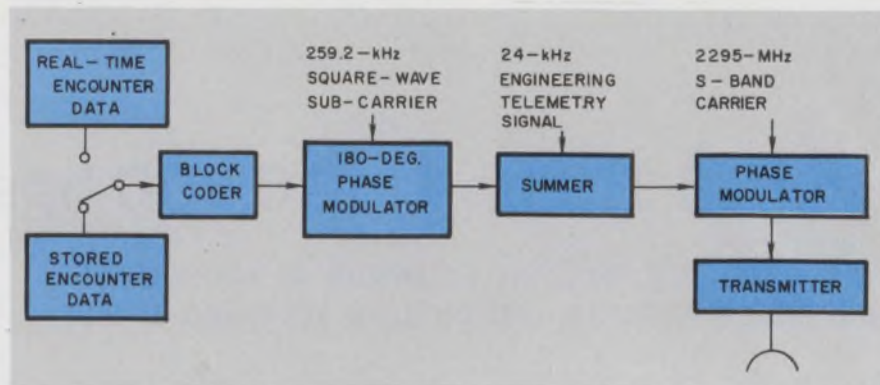

Block diagram of the 16,200-bit-per-second Mariner data-transmission system.

the sidebands to the total power); G_T is the transmitting antenna gain over an isotropic antenna, including both circuit and pointing losses as well as antenna gain; L_S is the free space transmission loss; G_R is the receiving antenna gain; L_R is the receiver loss or efficiency (the difference between how the receiver actually operates and how it would operate if perfect), and S is the received sideband power.

The received sideband power multiplied by the duration of a bit, T_b , gives the received signal energy per bit. The receiver system effective noise temperature multiplied by Boltzmann's constant gives the receiver noise spectral density. Together, these specify the figure of merit, ST_b/N_0 , for a digital communication system. Dividing the achieved figure of merit

by that required for a specified performance, we get the system's margin of performance.

The 32.9 dB of additional signal was obtained in the following way.

- 3.10 dB was due to an increase in the transmitter power, P_T , from 8.9 to 18.2 watts.

- 3.96 dB was due to a change in the modulation index, M , which increased the sideband power from -5.30 to -1.80 dB relative to the total power.

- 0.10 dB was due to an increase in the size of the spacecraft antenna. Although G_T should be substantially larger, a compromise was made in which the antennas on both spacecraft were pointed in the same direction, even though they arrived near Mars on different days.

- 6.84 dB was picked up in L_S



The payoff of a faster telemetry system is readily apparent when these two photos of Mars are compared. Left: A shot by Mariner 4 in 1965, transmitted at $8\frac{1}{3}$

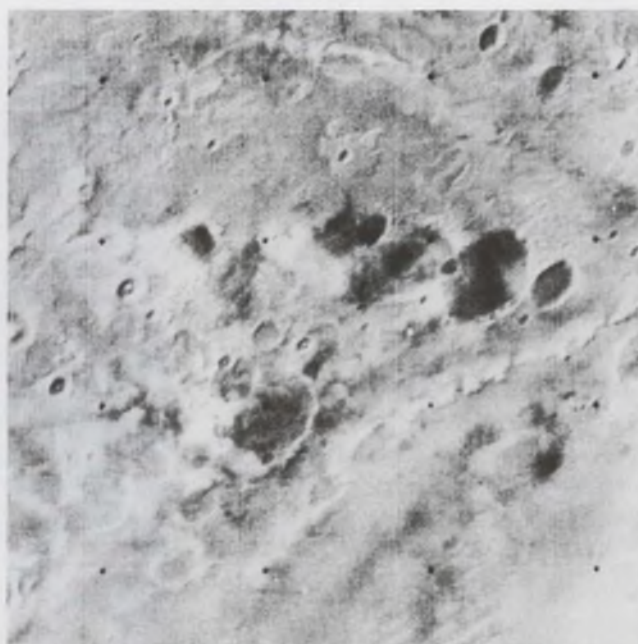

bits per second. Right: A sharper, more detailed photo of the distant planet sent last July by Mariner 7 at 16,200 bits per second.

These guys have got our numbers.

SIGNETICS STOCKING DISTRIBUTORS

ALABAMA

Huntsville 35801: *Compar Corp.*, 904 Bob Wallace Ave., Room 114
Phone: (205) 539-8476

ARIZONA

Scottsdale 85251: *Compar Corp.*, 84 West 1st Street
Phone: (602) 947-4336 TWX: (910) 950-1293

CALIFORNIA

Burlingame 94010: *Compar Corp.*, 828 Airport Blvd.
Phone: (415) 347-9501

Culver City 90230: *Hamilton Electro Sales*, 10912 W. Washington
Phone: (213) 870-7171

Burbank 91504: *Compar Corp.*, 2908 Naomi Avenue
Phone: (213) 843-1772

Los Angeles 90022: *Wesco Electronics, Inc.*, 5650 Jillson Street
Phone: (213) 685-9525 TWX: (910) 580-1980

Palo Alto 94303: *Wesco Electronics, Inc.*, 3973 E. Bayshore Road
Phone: (415) 968-3475

San Diego 92111: *G. S. Marshall*, 7990 Engineer Road, Suite 1
Phone: (714) 278-6350

El Monte 91731: *G. S. Marshall*, 9674 Telstar Avenue
Phone: (213) 579-1500 TWX: (910) 587-1565

CANADA

Downsview, Ontario: *Cesco Electronics, Ltd.*,
24 Martin Ross Avenue
Phone: (416) 638-5250

Montreal, Quebec: *Cesco Electronics, Ltd.*, 4050 Jean Talon West
Phone: (514) 735-5511

Ottawa, Ontario: *Cesco Electronics, Ltd.*, 1300 Carling Avenue
Phone: (613) 729-5118

Quebec: *Cesco Electronics, Ltd.*, 128 West Ballier Street
Phone: (418) 524-3518

COLORADO

Denver 80110: *Compar Corp.*, 300 East Hampden Avenue
Phone: (303) 781-0912 TWX: (910) 933-0183

Denver 80216: *Hamilton Electro Sales*, 1400 West 46th Street
Phone: (303) 931-0580

CONNECTICUT

Hamden 06500: *Compar Corp.*, 2357 Whitney Avenue
Phone: (203) 288-9276 TWX: (203) 772-0439

FLORIDA

Orlando 32805: *Hammond Electronics*, 911 W. Central Blvd.
Phone: (305) 241-6601

ILLINOIS

Elmhurst 60126: *Semiconductor Specialist, Inc.*,
195 Spangler Ave., Elmhurst Industrial Park
Phone: (312) 279-1000 TWX: (910) 254-0169

Addison 60101: *Compar Corp.*, 315 Laura Drive
Phone: (312) 543-8833

MARYLAND

Baltimore 21208: *Compar Corp.*, Pikesville Professional Bldg.,
7 Church Lane
Phone: (301) 484-5400 TWX: (710) 862-0860

Rockville 20850: *Pioneer Washington Electronics, Inc.*, 1037 Taft St.
Phone: (301) 427-3300

MASSACHUSETTS

Burlington 01803: *Avnet Electronics Corp. of Mass.*,
207 Cambridge Street
Phone: (617) 272-3060

Newton Highlands 02161: *Compar Corp.*, 88 Needham Street
Phone: (617) 969-7140 TWX: (710) 335-1686

Watertown 02172: *Schley Electronics Corp.*, 36 Arlington Street
Phone: (617) 926-0235

MICHIGAN

Southfield 48075: *Compar Corp.*, 21250 10½ Mile Road
Phone: (313) 357-5369

Detroit 48240: *Semiconductor Specialists Inc.*,
25127 West Six Mile Road
Phone: (313) 255-0300

MINNESOTA

Minneapolis 55416: *Compar Corp.*, 3925 Monterey Avenue,
P. O. Box 16095
Phone: (612) 922-7011

Minneapolis 55423: *Semiconductor Specialists Inc.*,
7742 Morgan Avenue South
Phone: (612) 866-3434

MISSOURI

St. Louis 63141: *Compar Corp.*, 11734 Lackland Industrial Drive
Phone: (314) 542-3399

NEW JERSEY

Cherry Hill 08034: *Hamilton Electro Sales*,
1608-10 West Marlton Pike
Phone: (609) 662-9337

Haddonfield 08033: *Compar Corp.*, 15 Potter Street
Phone: (609) 429-1526

NEW MEXICO

Albuquerque 87110: *Compar Corp.*, 2129 San Mateo, N.E.
Phone: (505) 265-1020 TWX: (910) 989-1659

NEW YORK

Albany 12205: *Compar Corp.*, 6 Highland Avenue
Phone: (518) 489-7408 TWX: (710) 441-8224

Buffalo 14202: *Summit Distributors Inc.*, 916 Main Street
Phone: (716) 884-3450

New York 10011: *Terminal-Hudson Electronics*, 236 W. 17th St.
Phone: (212) 243-5200 TWX: (710) 581-3962

Woodbury 11797: *Compar Corp.*, 335 Crossways Park Drive
Phone: (516) 921-9393 TWX: (510) 221-2170

NORTH CAROLINA

Winston-Salem 27101: *Compar Corp.*, 1106 Burke Street
Phone: (919) 723-1002 TWX: (510) 931-3101

OHIO

Cleveland 44103: *Pioneer Standard Electronics*,
5403 Prospect Avenue
Phone: (216) 432-0010

Fairborn 45324: *Compar Corp.*, 16 South Broad Street
Phone: (513) 878-2631

Fairview Park 44126: *Compar Corp.*, 19500 Center Ridge,
Rocky River, or P. O. Box 4791
Phone: (216) 333-4120

PENNSYLVANIA

Philadelphia 19132: *Milgray-Delaware Valley, Inc.*,
2532 North Broad Street
Phone: (215) 228-2000 TWX: (710) 670-3400

Dallas 75207: *Hamilton Electro Sales*, 2344 Irving Blvd.
Phone: (214) 638-0900

Houston 77019: *Hamilton Electro Sales*, 1216 West Clay Street
Phone: (713) 526-4661 TWX: (910) 881-3721

WASHINGTON

Kirkland 98033: *Compar Corp.*, 12610 N.E. 104th Street
Phone: (206) 822-4191

Seattle 98108: *Kierulff Electronics*, 5940 6th Avenue, South
Phone: (206) 763-1550

Now you've got theirs. Signetics

Signetics Corporation / 811 E. Arques Ave., Sunnyvale, Calif. 94086 / A subsidiary of Corning Glass Works

INFORMATION RETRIEVAL NUMBER 16

(Telemetry, continued)

due to the decreased distance between Mars and the earth, as compared with the 1965 Mariner voyage. This time around, Mars was less than half the distance from the earth than it was four years ago.

- 8.50 dB was due to the increased antenna gain on the earth. G_R for the 210-foot antenna at Goldstone is +61.00 dB, as opposed to +52.5 dB for the 85-foot antenna used before.

- 2.96 dB was due to improved receiver efficiency, L_R , on the ground. According to Easterling: "The equipment is about 90 per cent efficient—that is, it operates within 10 per cent of what it would if it were all perfect. This is perfect in the ideal, or block-diagram sense."

These factors accounted for 25.46 dB of the required 32.9 dB. Most of the remaining improvement came from two other factors:

- 4.10 dB was due to the fact that Goldstone has a maser that provides a system noise temperature of 25° K instead of the 65° K that the earlier system had. After conversion to noise spectral density, N_o , the new figure became -184.60 dBm/Hz.

- 2.20 dB was due to the block coding used. If bit-by-bit detection were used, as in Mariner 4 in

1965, the required ST_R/N_o would have been 5.20 dB after all losses were considered. But with the data encoded six bits at a time into a biorthogonal code, the required ST_R/N_o was reduced to only 3 dB, for a word-error rate of 10^{-2} . That error rate was equivalent to the error rate on Mariner 4.

With 31.76 of the 32.9 dB now accounted for, the last 1.14 dB came in the form of a reduction in the performance margin—from 3.30 dB on Mariner 4 to 2.16 dB on Mariners 6 and 7.

Reed-Muller code used

The heart of the high-rate telemetry system was the block coder, built for JPL by Texas Instruments in Dallas. It could take a six-bit data word and transform it into a 32-symbol, block-coded word. The result was data-coded with the use of a form of Reed-Muller biorthogonal code.

The final output was also comma-free, so that word sync could be derived on the ground. Comma freedom in a code means that any 32-symbol string composed of the last 32-N symbols of one code word in juxtaposition with the first N symbols of the next code word (that is, an overlap of N symbols) is forbidden as a member of the code dictionary. Therefore from any string of sym-

bols received on the ground, a definitive determination could be made of where one code word ended and the next began.

The block coder took either the real-time data or the stored data, converted it to code and fed it into a 180-degree phase modulator. The phase modulator placed the data on a 259.2-kHz square-wave subcarrier and sent the result into a summing circuit. In the summer, a 24-kHz engineering telemetry signal was added, and the sum was fed into another phase modulator. Here all the information was placed on a 2295-MHz, S-band carrier, and the final signal was sent to the transmitter. The transmitter increased the power to 18.2 watts and fed the signal through a 40-inch, high-gain antenna and back to the earth.

"The major problem in the development of Mariner '69," according to Easterling, "was in the precise testing of the system. For example, how could we establish within a couple of tenths of a dB the precise S-band signal levels at which we had to work."

Test console a big help

James C. Springett, the engineer at JPL in charge of verifying the high-rate telemetry system performance, credits an rf test console built by Westinghouse with solving the most serious problems. This test console is capable of creating a signal source with a known signal-to-noise ratio. Thus the system under test sees the signal-to-noise ratio that it will see in actual performance. The console has a ± 0.1 dB/day stability and a ± 0.05 dB accuracy, for an over-all accuracy of ± 0.15 dB. According to Springett, this is an "order of magnitude better accuracy" than that obtained with normal techniques.

High-data-rate telemetry is also planned for a Mariner probe scheduled in 1971. Two vehicles that year will orbit Mars, taking pictures and sending back scientific data. The basic data rate is to be the same as that for the two recent Mariners.

"The main evolution on Mariner '71," says Easterling, "will be to have multiple data rates available for use." ■■

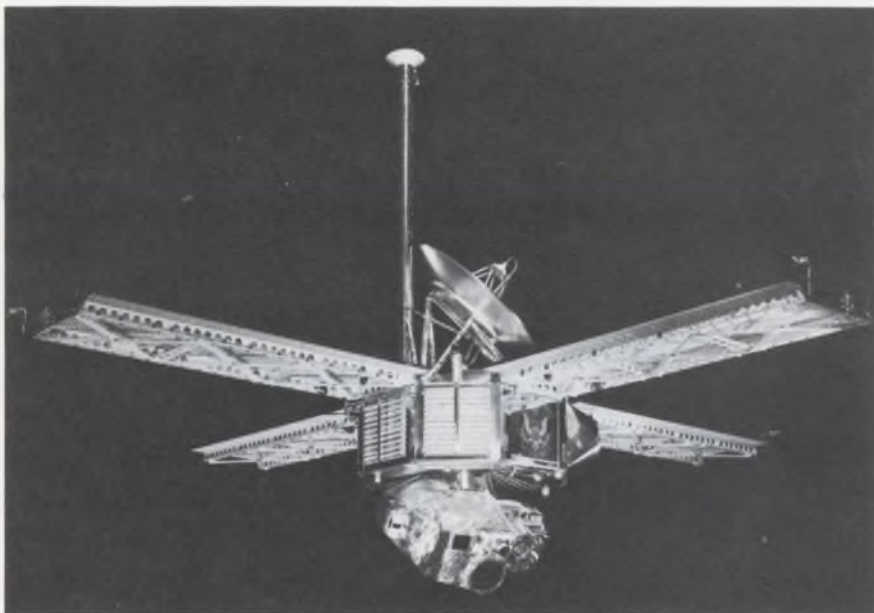

Mariner 6, fully extended, its high-gain antenna on top and its cameras pointed downward at a slant. The spacecraft flew successfully past Mars last July.

2.5 A Triac Versatility from RCA

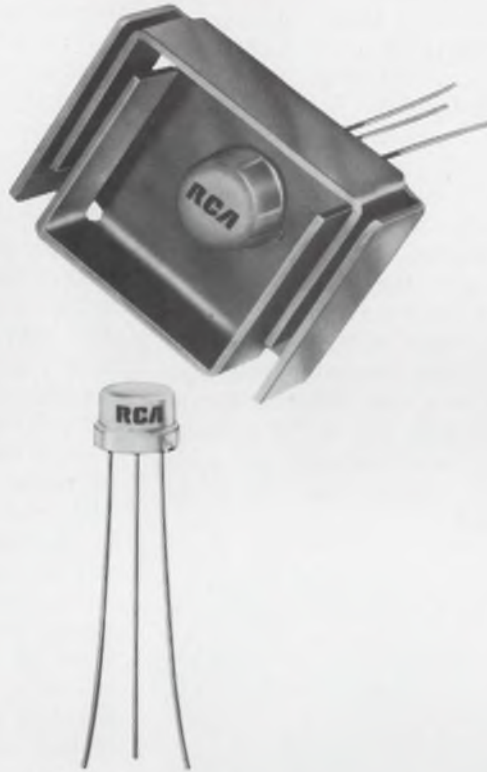

Sensitive-gate Triacs in TO-5 package for low-power phase control and load switching

Here's versatility *plus* in a Triac family! RCA types 2N5754, 2N5755 and 2N5756 are designed for low current circuits of either resistive or inductive loads, and for use in driving high current Triacs. All three devices feature shorted-emitter design and RMS on-state current rating of up to 2.5 A. All have gate characteristics as follows: I_{gr} = 25 mA max. in I^+ , III^- modes and 40 mA max. in I^- , III^+ modes. Repetitive peak off-state voltage ratings of 100, 200 and 400 volts are available to match your needs. And all three Triacs are designed to switch from off-state to on-state for either polarity of applied voltage with positive or negative gate triggering voltages. For PC board installation, you can also obtain the

2N5754, 2N5755 and 2N5756 with factory-attached heat-radiators. Ask for RCA's 40684, 40685 and 40686, respectively.

You can also turn to RCA if you need greater gate sensitivity. The 40530-series Triacs offer you I_{gr} of 3 mA and 10 mA—for driving by integrated circuits, as shown in the following tabulation:

I_{gr}	Low Voltage (100 V)*	120-V Line (200 V)*	240-V Line (400 V)*
3 mA (all modes)	40525/40531	40526/40532	40527/40533
10 mA (all modes)	40528/40534	40529/40535	40530/40536
25 mA (I^+ , III^- modes)	2N5754/40684	2N5755/40685	2N5756/40686
40 mA (I^- , III^+ modes)			

* V_{DROM} (Repetitive peak off-state voltage)

Select the type best suited for your circuit designs. Then see your local RCA Representative or your RCA Distributor for economical pricing details. For technical data, write RCA Electronic Components, Commercial Engineering, Section RG9-4, Harrison, N. J. 07029.

RCA Thyristors

Computerized 'eye' to shed light on the sun

16 pre-programed investigations will be available when Air Force puts new solar telescope to work

John F. Mason
Military-Aerospace Editor

When the world's most sophisticated solar telescope takes its first look at the sun next month, Air Force scientists atop the 9200-foot mountain near Sunspot, N. M., will have little to do but sit back and watch the secrets that the gigantic instrument reveals (see "Giant Telescope to Probe Sun's Secret," ED 19, Sept. 13, 1969, p. 22).

With a resolving power of less than 0.2 seconds of arc, the telescope's acuity matches that of the most powerful telescopes—stellar or solar—in the world.

The new instrument will surpass

the performance of the previous champion—the solar telescope at Kitts Peak, Ariz.—in clarity and resolution. Although the Kitts Peak instrument is longer—500 feet, as opposed to the new telescope's 365 feet—the new instrument is evacuated, thus eliminating air currents that distort the image.

The operation will begin when a sensor tells the telescope's SDS Sigma 2 computer that the sun is out and ready to be observed. On this cue, the computer will take over, putting the 365-foot instrument through one of 16 pre-programed investigations of some aspect of the sun that the scientists select.

The SDS Sigma 2 is built by Scientific Data Systems, a subsidiary of Xerox Corp. at El Segundo, Calif. It is a 24-kilobit, 900-nano-second machine.

The telescope will be used to examine the solar corona—the most difficult region of the sun to observe—as well as flares and prominences, sunspots and the high energy proton showers associated with sunspot activity. Knowledge of these phenomena will help scientists from the Air Force Cambridge Research Laboratories predict severe magnetic and other solar disturbances and develop methods for minimizing their effects. These phenomena have long been a menace to communications on earth, to instruments in satellites, and, now, to man himself as he contemplates traveling deeper into space.

The scientists can select the particular phenomenon they want to watch by flipping one of 16 switches on a hand-held control box. Eight of these boxes will be in the control room.

Computer calls the shots

The computer's first step, after being informed that the sun is out, is to command the telescope's turret to find the sun. When this has been accomplished—roughly within a minute or two of arc—the computer tells the turret's servo control system to switch to its optical error detector mode, to align the turret precisely with the sun and then to track it as it moves.

At the same time the computer starts the coordinate converter, which converts the azimuth and elevation angles of the turret to astro-geometrical data. This information, along with a solar clock, enables the telescope to track the sun while it is obscured by clouds.

Information from the telescope is picked up by a photomultiplier and put on magnetic tape. The first readout appears on microfilm in the



A 321-foot-long vacuum chamber will enable this solar telescope to provide high-resolution, jitter-free pictures of hitherto unseen solar activity.

form of plots and graphs.

Of the telescope's 365-foot length, 227 feet is set in a deep shaft beneath the ground. The above-ground portion is enclosed in a conical tower 138 feet high. The central core of the telescope consists of a cylinder 321 feet long with a maximum diameter of 10 feet. The system's entire optics—from the objective port at the top of the tower to a 64-inch reflecting mirror at the bottom of the shaft—is in an evacuated chamber.

Eliminating distortion

The chamber weighs 250 tons and is evacuated to 250 torr, a pressure that corresponds to that at an altitude of about 180,000 feet. To provide a friction-free bearing for the entire core assembly, the chamber is suspended like a pendulum, floating on an 11-ton pool of mercury. The assembly rotates slowly to follow the sun.

Besides evacuation of the chamber to eliminate distorting internal air currents, additional protection against image-distorting heat currents is provided by embedding water-cooled pipes in the concrete walls of the tower. By control of the temperature of the water flowing in these pipes, the temperature of the tower walls can be maintained at equilibrium with the air temperature inside the tower.

Light from the sun enters the telescope through a 76-cm aperture via a quartz window 10 inches thick and 30 inches in diameter. Two flat mirrors, each 40 inches in diameter, reflect the light—first along a horizontal path, then downward through the 321-foot length of the cylinder to a focusing mirror 183 feet beneath the ground level. This 64-inch focusing mirror has a focal length of 180 feet. It can be tilted to direct light upward again and to form an image of the sun on one of the several selected instruments at ground level.

All of the instruments are clustered about the central shaft and rotate with the shaft. The largest instruments are three evacuated spectrographs, each 68 feet long with diameters of five feet. These are mounted vertically to the central core. ■■

Attention: **HYBRID CIRCUIT ENGINEERS**

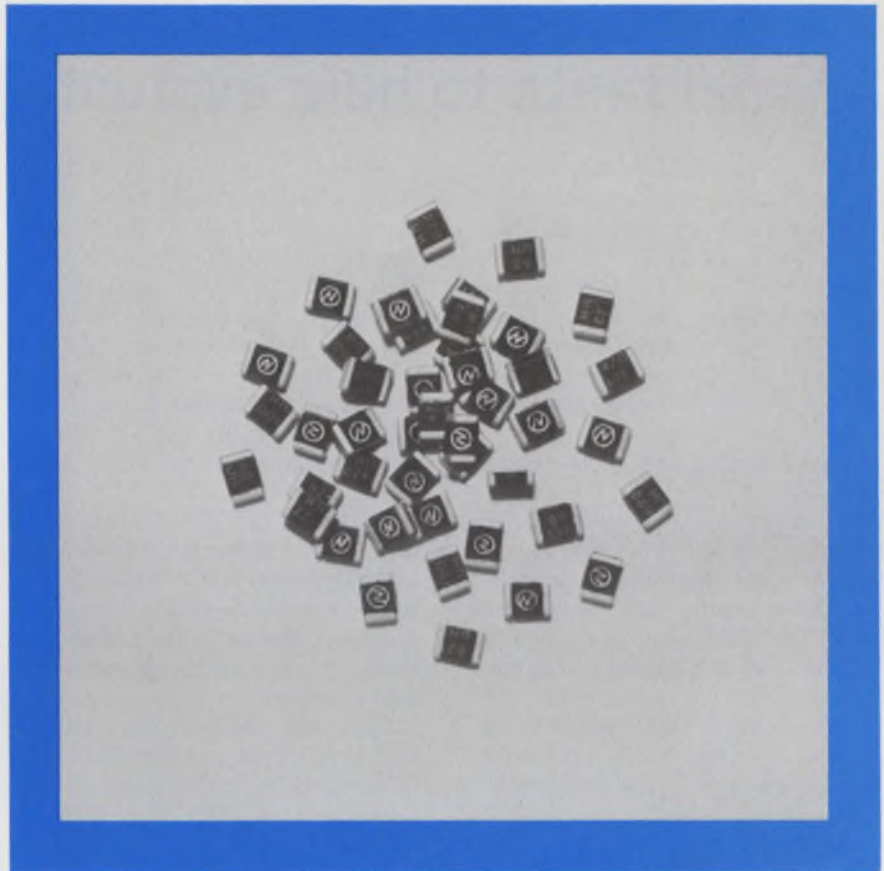

Nytronics announces the first of a family of chip components

WEE-CHIP-INDUCTOR™

A Standard Off-The-Shelf Component

- RF CHIP INDUCTOR
- FULLY (MAGNETICALLY) SHIELDED
- HI Q
- INDUCTANCE RANGE UP TO 1000 μ h
- DESIGNED TO MEET MIL-C-15305, GRADE 2, CLASS B
- STABILITY 100 TO 500 PPM/°C

Write for complete engineering data about our Wee-Chip Inductor



NYTRONICS, INC.

The quality line of standard components

550 Springfield Ave., Berkeley Heights, N.J. 07922 ■ (201) 464-9300 ■ TWX: 710-984-7977

INFORMATION RETRIEVAL NUMBER 18

Animal tests to help evaluate TV radiation

How harmful—if at all—are the effects of radiation from color TV sets? Pigs may provide some clues.

The Dept. of Health, Education and Welfare is conducting a series of experimental studies in which the eyes of swine are being irradiated to compare the effects from color TV radiation with those from high-energy X-rays.

According to a spokesman for the federal department, pigs are being used because, "except for sub-human primates, their optical system is closest to that of humans." The experiments are being conducted at the department's Bureau of Radiological Health in Rockville, Md.

The focus of the research, according to Harry D. Youmans, physics adviser to the bureau, "is to compare known biological effects from 250-kV radiation with 30-kV, color-television-like radiation."

The effects suffered by pigs subjected to 100, 600 and 1000 Rads of 30-kV X-rays cannot be compared directly to the effects on humans, he says, adding: "But these levels are not as far-fetched as they may seem. Information we have received indicates that some children watch TV for as long as five to 15 hours a day. And the total radiation from color TV sets—if the set is defective—can be quite high."

Several surveys of radiation from color TV sets have been conducted by the Public Health Service. In Suffolk County, N.Y., officials from the PHS found that 20 per cent of the sets they examined emitted radiation above the 0.5-mR/hr level. A review of the survey taken in Pinellas County, Fla., shows that about 65 per cent of the sets emitted radiation above 0.40-mR/hr.

Speaking for the TV manufacturers, J. Edward Day, special counsel for the Electronic Industries Association denies that a hazardous situation exists and that there is any justifiable cause for public alarm.

Day told ELECTRONIC DESIGN that the Suffolk and Pinellas County surveys "are unreliable and that the measuring instruments were inaccurate."

Day considers a survey conducted by the PHS in Washington, D.C. to be a better reflection of the true situation. In this survey, about 6 per cent of the sets were found to exceed the 0.5 mR/hr standard. However, two out of the 1128 receivers studied emitted radiation above 12.5 mR/hr—the top of the measuring scale.

The reason for ionizing radiation emissions is the operating voltages for color sets, which is about 10 times greater than the black and

white receivers. Sources of this radiation can be eliminated by going from tube components to solid-state devices.

The Dept. of Health, Education and Welfare has set down the following guidelines for permissible radiation from manufacturer's sets:

- Effective Jan. 1, 1970—when power-line voltages are at the highest level, radiation must not exceed 0.5 milliroentgens per hour at a distance of 5 cm, averaged over an area of 10 cm.

- Also, by Jan. 1, 1970—sets must pass this test with 130-volt input and all user TV controls set to positions producing the maximum radiation.

- By June 1, 1970—sets must pass this test with all service controls set to produce maximum radiation.

- As of Jan. 1, 1971—measurement must meet the 0.5-mR standard, even with defective, shorted or inoperative components.

The 0.5-mR/hr standard adapted by HEW is a figure that has been set by the National Council on Radiation Protection and Measurements. A spokesman for that organization says there has been no definitive study of the physical effects of low-level radiation and that the 0.5-mR/hr standard is conservative—"less radiation than that experienced by persons living in, say, Denver."

George M. Wilkening, head of industrial hygiene and safety at Bell Telephone Laboratories and a member of the Technical Electronic Product Radiation Safety Standards Committee set up by the government, also points out that "while relatively low-level radiation can and should be reduced, there has been no scientific information on the effects such radiation may have on the body."

This is why the research at HEW's Bureau of Radiological Health is important. Their researchers may find some answers to the biological effects of low-level radiation—in a pig's eye. ■■



Solid-state rectifiers to replace tube components for color TV. Such devices eliminate sources of ionizing radiation.

Introducing a little revolution in fail-safe reed switching.

This new Cunningham Hystareed™ Magnetic Latching Relay operates *without permanent biasing magnets* or holding currents. Latches and

stays latched. Won't change its programmed state because of vibration, shock, power interruptions or transients. Needs no adjustment or calibration. Available up to 6 form A's, 4 form C's in a single assembly. Operates as standard relay for scanning.

Ideal for: data acquisition, low-level switching, computer interfacing, logic control, industrial machinery control.

Samples available. For complete facts, request Brochure No. 606B. Write or phone Cunningham Corporation, Carriage St., Honeoye Falls, N. Y. 14472. Phone (716) 624-2000.

Cunningham Corporation

SUBSIDIARY OF GLEASON WORKS

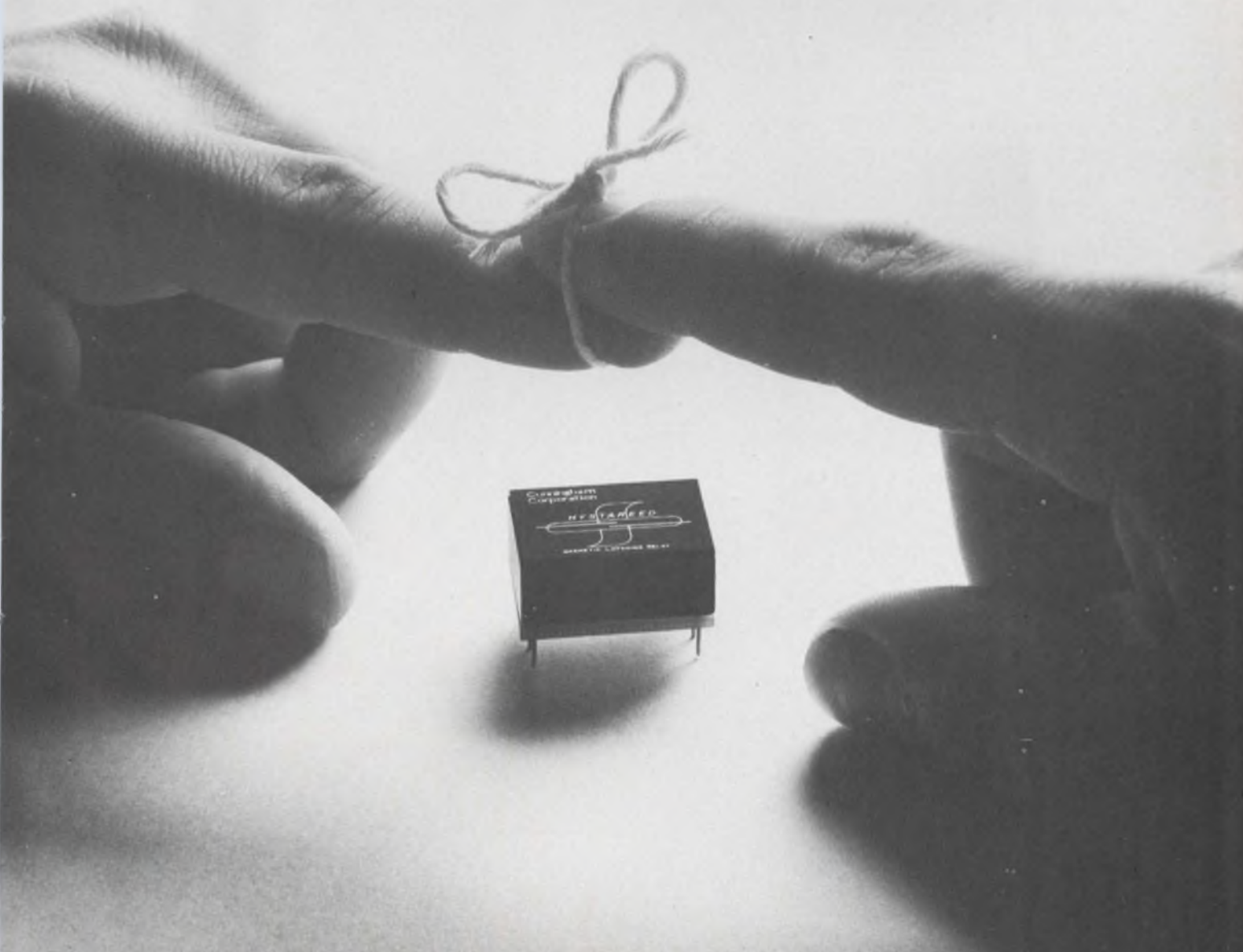



We make components for guys who can't stand failures.

There's no such thing as a little failure to some guys. Either your system will perform as you designed it, or it won't. Either the right answer comes out, or it doesn't. Anything less is too much to bear.

At Corning we make our resistors and capacitors like all your customers were just that demanding. We build in an extra measure of performance into everything we do. Because like you and the guys who use your equipment, we can't stand failures either.

Take our precision tin oxide resistors, for example. They're the best of the metal film class. Because the resistive tin film is completely oxidized and molecularly bonded to the glass substrate, our tin oxide resistors are impervious to moisture and environmental degradation. No other resistor can deliver the same stability and reliability over load life. They offer guaranteed moisture resistance across all ohmic values to set a standard of reliability that can't be matched by metal film, wire wounds, carbon comps or metal glaze resistors.

After a 56-day-long heat test in an environment of extremely high humidity, our tin oxide resistors

showed a resistance change of just 0.2 per cent. And in an ambient temperature test—now in its ninth year—not one of the 600 tin oxide resistors being tested has exceeded a resistance change of 1.5 per cent.

You can get this kind of extra performance in miniature size, too. With our CORNING® C3 Resistors, circuit designers are now reducing the volume and weight of their boards a full 65 per cent.

Our tin oxide resistors represent extremely good value. They offer long-term economy over metal film, precision wire wound and metal glaze resistors. And our miniature C3 resistors compete costwise with carbon comps.

And take our glass capacitors. In an extensive lab test program, the U.S. Air Force has found that our glass capacitors have much better stability and much higher insulation resistance than the ceramic, mica and the other capacitor-types they tested. That's why glass capacitors are being designed into so many major aerospace and missile projects.

Then there's our line of Glass-K™ capacitors that give you the volumetric efficiency and economy of monolithic ceramic

capacitors, but with the much improved stability and reliability that only a glass dielectric can add. They're now being used in a number of computer systems.

We have other developments, too. Like our flame proof resistors. Ideal for circuitry where functions, environments and duty cycles demand low power resistors with excellent frequency characteristics, our flame proof tin oxide resistors can withstand overloads of up to 100 times rated power without any trace of flame. And, because they open under overload, they provide protection for your other, more expensive components.

At Corning, we make components for guys who can't stand failures. Guys like your most important customers. Guys like you.

Next time you're designing a system, reach for your Corning capacitor and resistor catalogs and call your local Corning authorized distributor for off-the-shelf delivery. They'll help you design-in an extra measure of performance.

If you don't have our catalogs, ask your Corning distributor for copies or drop us a line at: Corning Glass Works, Electronic Products Division, Corning, New York 14830.

CORNING
ELECTRONICS

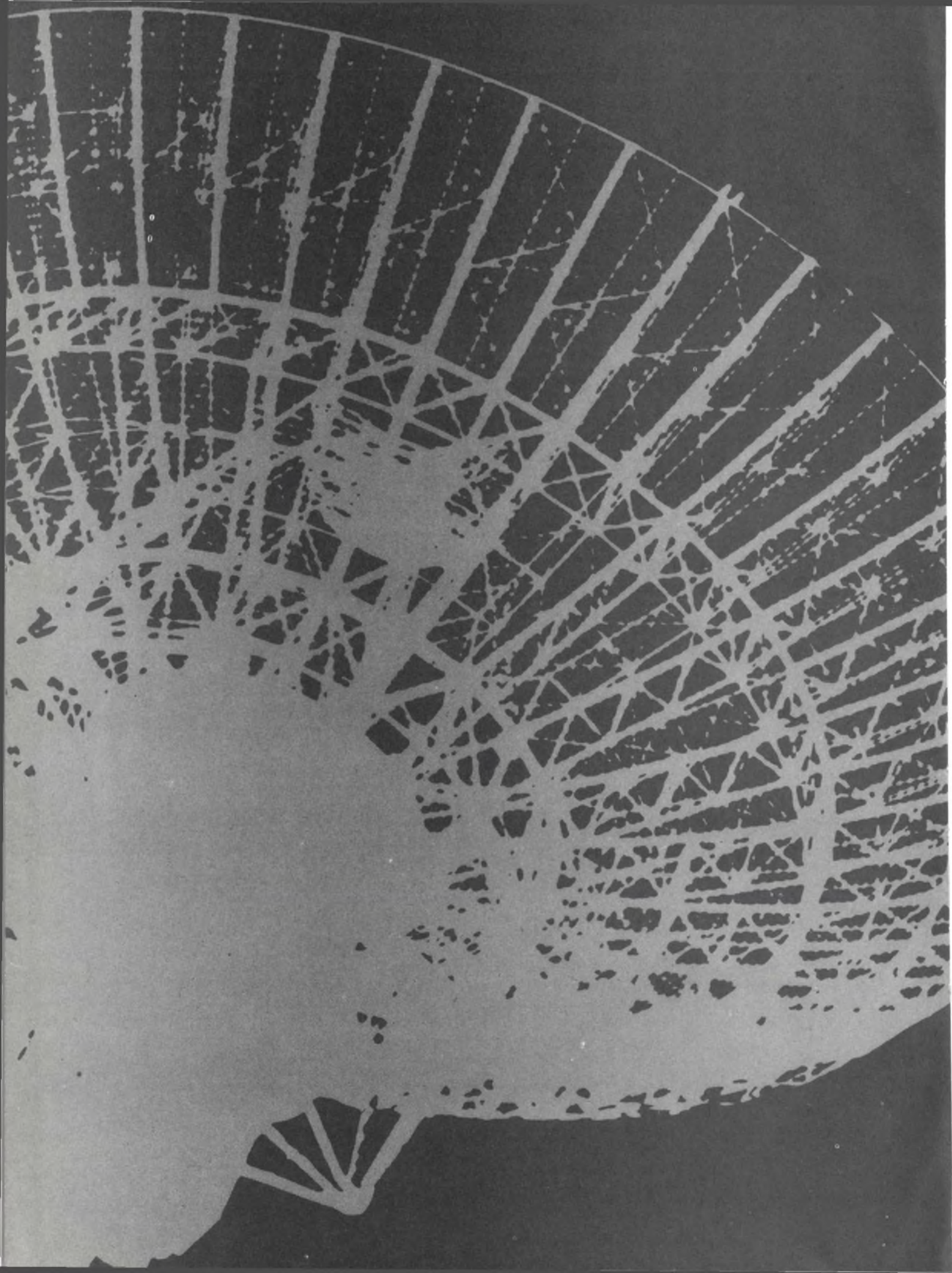



Charles D. LaFond, Chief, Washington News Bureau and
Michael J. Riezenman, Technical Editor

What will be the U.S. policy for domestic communications satellites?

This is a decision long overdue from the Federal Communications Commission in Washington. And, without some policy edict, if only temporary, no progress can be made toward setting up such a system.

The technology is available, drawn from the highly successful developmental and operational efforts of U. S. industry and federal agencies. The nation needs such a system now, potential users insist.

A domestic relay system, if it has a sufficient number of high-capacity, synchronous-relay satellites, can make possible simultaneous live telecasts to all fifty states—a possibility not now achievable with conventional cable or rf links.

A domestic satellite system could complement existing telecommunications networks of the common carriers, by improving traffic routing, expanding capacity and assuring a reliable relay in times of disaster. Hurricane Camille, for example, knocked out cable and microwave links in many southern states last month.

The Soviet Union has a domestic communications system. The French and the English are considering one. Canada has approved one. But the U. S., which leads at least the Western world in communications satellite technology, has been hamstrung by indecision for well over two years.

American industry wants it. Individually many companies and organizations have filed proposals for either multipurpose or specialized domestic satellite systems. And herein lies the difficulty.

The Communications Act of 1962 established the Communications Satellite Corporation (Comsat) as a quasi-

What's delaying U.S. satellite communications?

The technology is ready and able. Only a decision from Washington is needed.



Looming up out of a field of cane at Cayey, Puerto Rico is this 85-foot earth station antenna. The station links the island with the U. S. mainland, Latin America, Europe and other Atlantic Basin points equipped with earth stations.

public-owned utility to develop and operate the U. S. portion of an international satellite telecommunications system. Subsequently Comsat was selected by the Satellite Telecommunications Satellite Consortium (Intelsat) now numbering 68 nations, to manage the global network.

U. S. common carriers and other interested industry groups accept Comsat's role in the international system but deny that it has the automatic right or authority to own and operate all domestic systems. They recognize the vast potential for TV, telecommunications, educational broadcasting and aeronautical communications and navigation support. The clash over who will operate a domestic satellite system is further tangled with future ownership of ground terminals.

Comsat believes it has a Congressional mandate through the act that established it as a "carriers' carrier." James McCormack, Comsat's board chairman, sums up the corporation position this way:

"In Comsat's view, it would be entirely without logic or economic sense to contend that the nation's only presently authorized operator of privately owned satellite facilities was ever intended to be excluded from the nation's first really large market for satellite communications. We are more than willing to provide all needed satellite services to all potential users, foreign and domestic. We have no other reason for being."

AT&T agrees that Comsat should retain control of satellite operations but says it should not own all supporting ground stations. Rather, terminals should be owned and operated, where appropriate, by the common carriers, AT&T says.

Not so, says Comsat's McCormack. Ownership of earth stations is "vital" to Comsat, he declares, since the young corporation "has no interest in any other communications medium and no other means of diversification."

Comsat is not opposed by just the U. S. carriers. Many foreign governments, members of Intelsat, argue that Comsat participation in a U. S. domestic system could constitute a conflict of interest. The reason: Comsat is the U.S. representative in Intelsat and controls the majority vote in all decision-

making processes; also, Comsat is the operational manager for the Intelsat global network.

Meanwhile, to get the system moving, Comsat has offered to begin establishment of an experimental domestic system using its own money. Later, if the FCC should so determine, it would turn the system over to another designated operator (with proper reimbursement).

Congress has held hearings with interested parties in an attempt to better understand the problem and determine whether or not additional legislation is necessary. To date it has found no such need.

President Lyndon B. Johnson established a task force in 1967 to develop recommendations for future U. S. telecommunications policy including satellite techniques. The group's report, completed last year, strongly urged initiation of a pilot or experimental domestic satellite communications system. The report, only recently released to the public by the next Administration, was put out without any endorsement of the findings. The FCC has deferred any decision on domestic satellite policy with the excuse that it would await the task-force report recommendation on future policy and, hopefully, some expression of direction from the President.

Further delays sought

The White House stepped in last month by requesting further delay (at least 60 days) of a decision until Presidential Special Advisor on Communications Dr. Clay T. Whitehead and his staff can review the domestic satellite system problems and industry proposals. It has also requested FCC cooperation and participation in the Whitehead study.

Ultimately, the FCC commissioners must weigh all recommendations and determine some course to follow. Their problem is further muddled, in the opinion of many experts, by the fact that the FCC may not have the legal power to decide the issue. Nevertheless, it is expected that a policy determination will be made shortly, though the real solution may come later in the courts.

On Dec. 16, 1966, Comsat filed

a proposal for a domestic communications satellite system and service with the FCC. It contained a comprehensive outline for an initial or experimental system but involved a two-phase program that included three generations of hardware. In short, the Comsat proposal was based on a long-term building-block approach in which experience can contribute to design improvement as the system grows.

The initial phase, called the Pilot Program, proposed a two-year effort during which up to four high-capacity multipurpose synchronous satellites, each carrying 12 transponders, would be deployed. These would operate in the 5925-to-6425-MHz band for receiving (up-link) and in the 3700-to-4200-MHz band for transmitting (down-link).

A total of 34 ground stations would be needed initially, including two extra-large stations in the New York City and Los Angeles areas. The large terminals would each employ two 85-foot antennas. Two other receive-transmit stations located in the southeastern and northwestern regions of the U.S. would use single 42-foot dishes. The remaining 30 smaller terminals would be for receiving only and would use dishes from 25 to 35 feet in diameter, depending on their locations.

Each satellite would be capable of handling 12 color TV channels, or 21,600 trunk-message channels (through the two 85-foot dishes only), or 9600 multipoint message channels (to 42- and 85-foot dishes only). All stations would support TV receiving.

For the Pilot Program, Comsat estimates a space-segment investment of about \$36 million and an additional \$22 million for the ground segment. It also estimates a two-year operational cost of about \$47 million.

The design of the present Intelsat IV satellite (now in development by Hughes Aircraft) will fit the requirements for the Pilot Program vehicle, in addition to serving the global Intelsat network as fourth-generation hardware.

Comsat emphasizes that, even with the early domestic system, it would be able to provide reliable and efficient 24-hour multi-channel transmissions to all time zones of TV network programs for distribu-

tion to affiliate broadcast stations. Its proposal also asserts that the system will provide other "cultural and educational TV distribution, trunk and point-to-point telephone, telegraph, facsimile, data and other communications."

Ultimately, in its "1970 model" system, four satellites could be employed, each with a five-year lifetime. These would provide a total capacity of 48 color TV channels or up to 84,000 trunk voice-grade channels, or any combination of these. Earth stations would continue to be expanded so that, by the time all four satellites were in service, up to 180 ground stations would be operational. The firm estimates that by about early 1971 90 per cent of the U.S. TV-viewing public could be receiving satellite-relayed programs.

The Comsat technical plan next calls for four "1973 model" satellites, each having double the capacity of the earlier model and each having a six-year design life. This model, too, would operate in the 4- and 6-GHz bands but would also be capable of receiving at frequencies above 10 GHz. The more advanced satellite array, when fully deployed, would be capable of handling 96 color TV channels, or 168,000 telephone channels.

AT&T seeks growth system

Through its subsidiary, Bell Telephone Laboratories, AT&T also proposed in detail, late in 1966, a two-phase domestic system using multipurpose satellites and a very large operational capability.

AT&T noted that it seeks only to own and operate the ground station along with other U. S. common carriers. The satellite portion of the system, says AT&T could be owned and operated by Comsat.

For its initial system, which would cost more than \$290 million, AT&T suggests a concept similar to Comsat's proposed Pilot system. It would use two stationary satellites operating in the 4- and 6-GHz bands, with a capacity of either 12 TV channels or 9600 duplex voice circuits. Two major Earth stations would be needed, using 85-foot dishes—one in the New York area and one in the vicinity of Los Angeles. In addition, 73 TV receiving stations

would be required for national distribution of programs.

The second phase, however, involves new ground stations and highly advanced satellites to come into service in the early 1970's. The satellites would be large, on the order of 3000 pounds and would operate in the bands of about 4, 18 and 30 GHz.

The second-phase system would probably cost more than \$200 million, the firm estimates. This would include four satellites and their launch vehicles, plus extensive modifications to the existing ground facilities. But the firm is anticipating an expected spectrum congestion in the 4- and 6-GHz bands. It further believes that satellites operating at these lower frequencies will not have sufficient traffic-handling capability to meet traffic needs anticipated by the mid-1970's.

The larger satellites each would have forty-five PCM (pulse code modulation) and 12 fm transponders. Each PCM transponder would be capable of handling 1344 simplex telephone circuits or one TV circuit; each fm transponder would handle one TV channel. The fm transponders would operate at the 4-GHz level while the PCM transponders would receive at 30 GHz and transmit down at 18 GHz.

AT&T estimates that 26 ground stations would have to be available for the advanced satellites at a total cost of nearly \$70 million.

Total capacity of the system by the mid-1970's would be 83,000 voice circuits and 27 TV circuits. This should be sufficient, the firm says, until about 1980.

Ford wants educational TV relay

In mid-1966, the Ford Foundation submitted a proposal to the FCC for what it termed a "broadcasting non-profit satellite system." Essentially it would be used as an educational TV relay system to reach all areas of the continental U.S., as well as Alaska, Hawaii, Puerto Rico and the Virgin Islands. The multichannel system would have a high-quality TV color channel for each of 24 satellite microwave repeaters.

In the Ford concept, two satellites would be placed in synchronous orbit, and a third might later



Checking out a satellite isn't simple. This mass of gear at Hughes Aircraft in El Segundo, Calif., is only part of the transportable systems test equipment needed to check out an Intelsat IV.

be considered for increased traffic capacity. The satellite design concept, prepared by Hughes Aircraft and Philco-Ford, calls for a craft weighing in at about 770 pounds and using an electronically despun antenna system.

The ground system would require up to 233 terminals of varying complexity for metropolitan areas, plus 10 mobile stations.

The last of the major proposals submitted to the FCC for consideration in the domestic satellite issue was one by General Electric that outlines a concept for establishment of a nationwide business-to-business communications system. The selling point for the GE approach is a greatly reduced cost

for the transmission of data between business firms or within elements of a widespread organization.

A basic system for use over the U.S., says GE, would require only two satellites; one would be employed in stationary orbit for operational use and the other for backup.

Other plans more specialized

Other proposals for domestic satellites have been filed with the FCC during the last several years, but the majority are for special-purpose relay systems. For example, several of the broadcasting networks presented a joint plan for

NEW



*New Allen-Bradley
hot-molded Type GD
dual variable resistor
shown actual size*

TWO
IN
ONE

Allen-Bradley hot-molded dual variable resistor

Here's the most compact two section variable resistor currently available—the new Allen-Bradley dual Type GD. It's one-half inch in diameter and only a fraction of an inch longer than the popular single section Type G control. The case is dust-tight as well as watertight. ■ Both resistance tracks in the dual Type GD are solid, hot-molded elements, which provide long operating life. As with the single Type G, the noise level is low initially and actually decreases with normal use. Adjustment is smooth at all times with virtually infinite resolution. And low inductance permits operation at frequencies far beyond the usable range of wirewound controls. ■ In addition to standard application, these new dual Type GD controls are ideally suited for use in compact attenuators. ■ Dual Type GD controls are available with nominal resistance values from 100 ohms to 5.0 megohms. For complete specifications on tolerances, tapers, and options, please write Henry G. Rosenkranz, Allen-Bradley Co., 1201 South Second Street, Milwaukee, Wis. 53204. Export Office: 1293 Broad Street, Bloomfield, N.J., U.S.A. 07003. In Canada: Allen-Bradley Canada Limited.



ALLEN - BRADLEY
QUALITY ELECTRONIC COMPONENTS

TV distribution to cut their operating costs.

Aeronautical Radio, Inc., a firm providing communications for most of the commercial air transport firms, has sought an aeronautical satellite system to complement its existing communications network. Numerous other schemes have been submitted by the petroleum and trucking industries.

At least one publisher, McCall Corp., has entered the picture. Last summer the firm requested the FCC for exclusive use of one color TV channel from the Comsat Pilot

Program to be used as a "magazine of the air" for selected audiences. Said Henry E. Bowes, McCall president: "The domestic satellite can have a profound and sweeping impact on our business, commercial and personal lives because of its reliability, flexibility and reduced transmission costs."

In addition to the magazine type of experimental programming, Bowes noted McCall's interest in using the satellite channel for transmitting computer data and for use in its printing processes.

For TV distribution purposes,

American Broadcasting Companies, Inc., was the first to file with the FCC for a domestic satellite system. This was in March, 1966, and although the first filing was intended solely for ABC TV transmissions, the proposal later was modified to become a joint concept including the National Broadcasting Co. and Columbia Broadcasting System.

By the end of 1966, 19 separate proposals had been filed with the FCC for domestic systems. Several more have followed, with the GE proposal among the last. ■■

Power is the big problem

Power is the single most important consideration in a satellite communication system. This one factor strongly affects all others. The reason is simple: Generating electrical energy 22,000 miles above the earth is an expensive proposition.

Solar cells are the only practical devices currently available, although nuclear generators have been flown experimentally. The more power a satellite requires, the larger, heavier and more costly will be the array of solar cells that must be orbited to provide it. And high-payload launch vehicles aren't cheap. Intelsat III, with an orbited weight of only 280 pounds, needed a \$5.7-million Thor-Delta booster to put it where it is. Since the satellite itself cost only \$6-million, the launch cost is a pretty significant fraction of the total.

Another problem with high-power satellites is cooling them. Air and water cooling are a bit difficult in the absence of air and water. All that remains is radiation cooling. This requires large radiators—further adding to the weight problem.

To make the best use of the power available from a satellite (or, putting it another way, to minimize the satellite power needed for a given task) several basic design ideas can be used:

- Extremely large earth station antennas can be employed, together with very low-noise rf amplifiers.

- Directional antennas can be put on the satellite to increase the effective radiated power.

- High modulation-index fm can be used to trade bandwidth for power.

- The satellite's power amplifier can be operated in saturation for better dc-to-rf conversion efficiency.

Unfortunately, each of these ideas has disadvantages as well as advantages, and a trade-off analysis must be made in each case.

Dishing up the power

Perhaps the most straightforward way to increase the information-carrying capability of a satellite system is to use very large antennas and cooled low-noise am-

plifiers on the ground. The larger the earth-station antennas are made, the more satellite power they will intercept and the less satellite power will be required for each channel.

The economic sense behind this approach can best be illustrated by examining what the International Telecommunications Satellite Consortium (Intelsat) charges the users of its satellites. For a user whose station has an antenna-gain/temperature ratio of 40.7 dB or better, Intelsat charges \$20,000 per voice channel per year. A 40.7-dB G/T ratio (G is measured in dB above isotropic, and T is measured in dB above 1°K) requires an earth station with an antenna diameter of approximately 85 feet at the standard down-link frequency of 4 GHz. Such an earth station costs approximately \$3-million to \$4-million.

Now by dropping down to a 42-foot-diameter dish, one can cut the cost of the earth station to \$1-million to \$2-million. However, the G/T ratio is now reduced to about 32 dB, requiring about 8.7 dB more satellite power for the same quality of received signal. Because the small-dish earth stations require more satellite power than do the large ones, Intelsat charges them more. The price difference in this case is about \$110,000 per voice channel per year—a factor of 6.5! It's obvious that an earth station carrying any reasonable amount of traffic will operate more economically over the long term with the

"ALLEN BRADLEY HOT-MOLDED RESISTORS ENHANCE THE QUALITY STANDARD OF OUR DATA-RECORDERS."

Mohawk Data Sciences Corporation

MDS The time reduction achieved by the MDS Data-Recorder method of computer input preparation demands continuously reliable operation. And this in turn demands the highest standards of performance from each and every component.

Allen-Bradley fixed composition resistors were a natural selection. Made by an automatic hot-molding technique—developed and used exclusively by Allen-Bradley—A-B resistors afford the ultimate in uniformity. From resistor to resistor—year in and year out—physical and electrical properties are unvarying. Predictable. Always of the highest order.

Performance records are equally excellent. For example, Allen-Bradley hot-molded resistors meet the requirements of the new MIL-R-39008A Established Reliability Specification at the *highest* level—the S level. And this is true for *all* three ratings—the 1 watt, ½ watt, and ¼ watt—and over the *complete* resistance range from 2.7 ohms to 22 megohms.

For complete specifications on this quality line of hot-molded resistors, please write to Henry G. Rosenkranz, and request a copy of Technical Bulletin 5000. Allen-Bradley Co., 1201 S. Second St., Milwaukee, Wis. 53204. Export Office: 1293 Broad St., Bloomfield, N.J., U.S.A. 07003. In Canada: Allen-Bradley Canada Ltd.

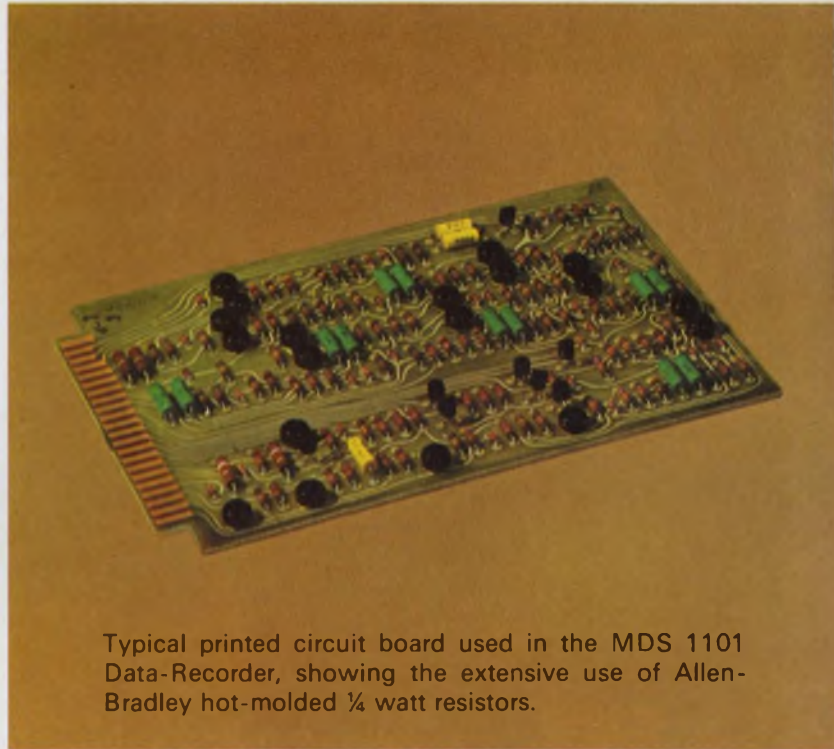

Typical printed circuit board used in the MDS 1101 Data-Recorder, showing the extensive use of Allen-Bradley hot-molded ¼ watt resistors.

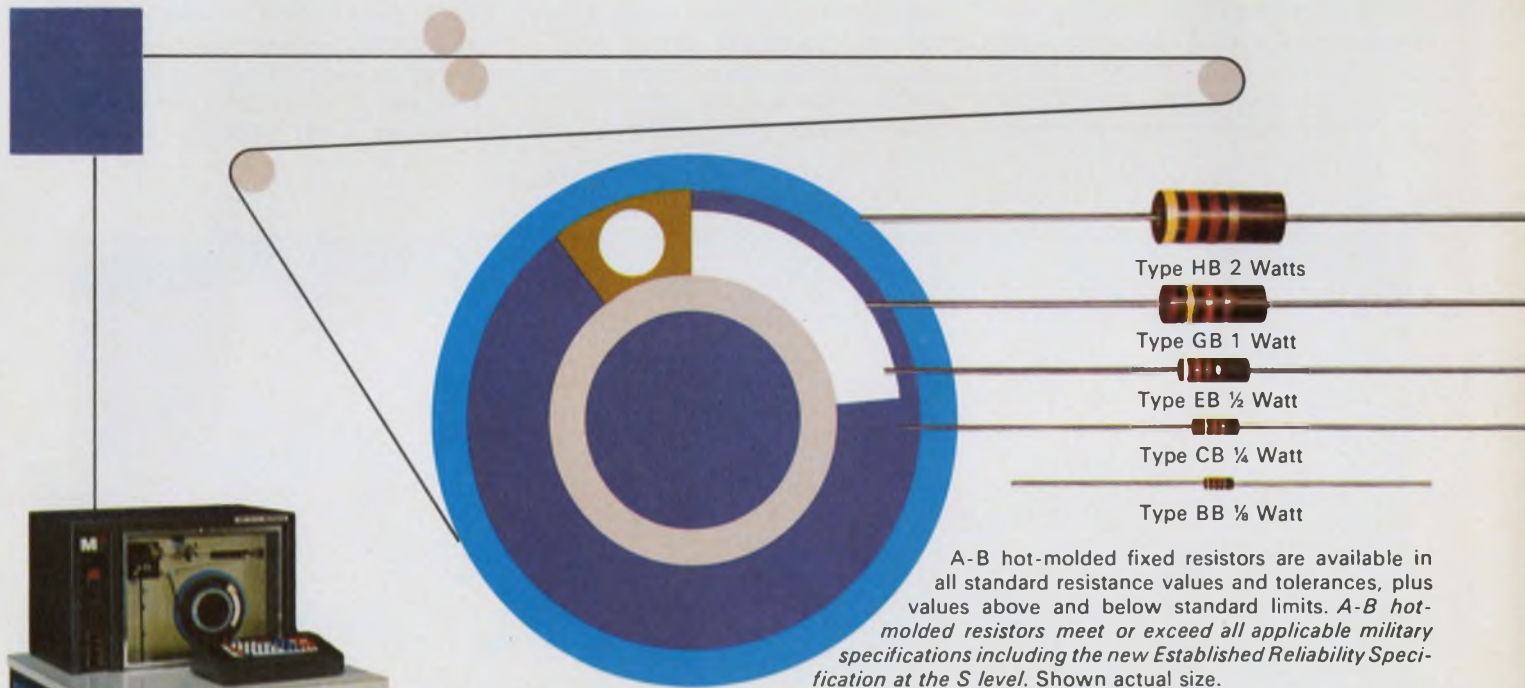

A-B hot-molded fixed resistors are available in all standard resistance values and tolerances, plus values above and below standard limits. A-B hot-molded resistors meet or exceed all applicable military specifications including the new Established Reliability Specification at the S level. Shown actual size.

Mohawk 1101 Data-Recorder permits transcribing of data from source documents direct to ½" computer magnetic tape.



large dish.

It might seem sensible then to use ever larger dishes for more and more economical operation. The rub here is that, at any given frequency, the diameter of the dish must be doubled for every 6-dB increase in antenna gain (Fig. 1). This soon leads to uneconomically large dishes that weigh so much that gravity distorts them from their desired parabolic shape.

85-foot antenna preferred

The 85-foot dish has emerged from trade-off considerations such as these as the more or less standard antenna in international satellite communications. For domestic use, however, some experts feel that a smaller size is best. One reason for this is that domestic earth stations will operate at much higher elevation angles and hence will not need the extremely narrow beamwidths that the big dishes provide to avoid picking up noise from the warm earth. Antenna elevation angles on the order of five degrees are common in international networks when the satellites are placed in orbit above the oceans. But a domestic satellite would, of course, be placed on a longitude line that passes through the U. S., and angles of 30° and more would be typical. This factor will be of great help in preventing interference problems between the satellite's

stations on earth and existing terrestrial microwave relay stations.

The same satellite power limitations that make large ground antennas attractive are obviously making television relay directly to the home impractical at this time. Since it is unreasonable to expect every TV set owner to pay for a large dish on his roof, the only way to get adequate signal strength at the receiver is to boost the satellite power. Power levels on the order of tens of kilowatts would be needed for this application. While nuclear power supplies may make this practical in the future, no present planning envisions such powerful satellites.

Instead, TV relay will probably be done between TV studios. A television broadcasting station in a small city might thus incorporate a receive-only earth station on its grounds. Then the TV station could switch its transmitter between its own studio for locally generated programs and the earth station for network programs originating principally in Los Angeles and New York.

It's interesting to note in this application that although the economic considerations are the same basically as in single-pair-of-users application, the resulting optimum system is different. In the single-pair analysis, based largely on existing international services, it was assumed that relatively few

earth stations would be using each satellite. It was further assumed that each station would carry a fairly heavy load of traffic (say, a hundred channels). This would justify the construction of expensive earth stations to keep down the cost of the satellite.

A rather different picture may well emerge in the case of a broadcast mode of operation, such as TV relay. Here, a great many earth stations will be available to support the satellite financially, and none will want to spend the millions of dollars needed for the big-dish stations. Thus the trend in broadcasting operations will probably be toward smaller earth stations with 15-to-30-foot dishes and toward more powerful satellites.

The extra power can come from increased satellite antenna gain.

Increasing power the easy way

Just as large antennas can be used on the ground to save power, so can they also be used on the satellite itself. There are two major problems to be considered when directional antennas are to be used on a satellite, but both can be solved, as has been proved by Intelsat III and several experimental satellites. The first problem is that of despinning the antenna, and the second is simply that the area of coverage of a satellite and its antenna gain are uniquely related;



A huge 380-ton horn antenna is housed in this radome nestled in the autumn foliage near Andover, Maine. Originally built by Bell Telephone Laboratories for exper-

iments with Telstar, the station is now used by Comsat for commercial transatlantic communications. The horn is equivalent to an 85-foot parabolic dish.

once one is picked, the other is known. Let's look at these problems in order.

To stabilize them in their orbits, satellites are made to spin about an axis parallel to the earth's. The resulting gyroscopic effect maintains their attitude with respect to the earth. It's obvious that for a directional antenna to be kept aimed at the earth, its beam is going to have to move with respect to the satellite. This operation is called despinning the antenna.

Despinning can be done mechanically, by actually rotating the antenna with respect to the satellite at the same rotational velocity that the satellite has. Or it can be done electronically, by means of a phased array. The disadvantage of the mechanical approach is the decrease in reliability: It's generally a good idea to avoid using moving parts in unmanned spacecraft. This point was made clear when a bearing on an Intelsat III froze up last June. Subsequent models of the satellite had to be modified to avoid the problem, which apparently was caused by the extremely cold temperature of the bearing during the time of the year when it was in the satellite's shadow. The cure was installation of a heater.

Unfortunately, the electronic approach to despinning has a worse disadvantage: It wastes power. Phased-array antennas derive their directivity from the interference

between the radiating elements in the array. The beam they form is aimed by changing the relative phase of the signal applied to each radiating element (Fig. 2). The most straightforward way to do this is to insert an electrically variable phase shifter between the rf source and each radiating element. Unfortunately, each phase shifter has a certain insertion loss, and the total rf power loss when many elements are used has been deemed too high by the designers of commercial satellites.

Of course, in the future, small, efficient, reliable solid-state rf sources may be available to allow each radiator to have its own oscillator. Then the phasing could be done before the power output stage (Fig. 3), at which point the phaser losses wouldn't be very important. At present, however, traveling-wave tubes provide the best mixture of bandwidth, power, efficiency and reliability, and to have a separate TWT for each radiator seems to be out of the question.

The problems of electrically despun antennas are worse for domestic satellites than for international ones because of their smaller area of coverage. To cover the entire earth, as international satellites do, a beamwidth of approximately 20 degrees is needed. This is generally conceded to require 16 phase shifters at 4 GHz, the frequency normally used for down-

link transmission. However, if a 2-degree beam is desired—as it would be in some domestic applications—160 phasers would be needed. The losses would increase with the number of phasers making the mechanical approach even more desirable in a domestic satellite.

The gain-coverage problem

Not much can be done about the relationship between coverage area and satellite antenna gain. The beamwidth of an antenna and its gain are uniquely related (Fig. 4). When one is specified, the other is also. This means that the designer of a satellite really has no freedom of choice between raising the antenna gain or the power level of a satellite once the coverage has been fixed. It also means that the designer of the complete system has a very important choice to make when he decides on the coverage areas.

This is just one of the factors complicating the design of a domestic system. Other technical problems, such as interference reduction, along with political and legal considerations, will ultimately combine with the tradeoff between antenna-gain and satellite power to determine the coverage plan.

Substituting bandwidth for power

An entirely different approach to conserving satellite power, which can be pursued independently of the directional-antenna approach, is to substitute bandwidth for power. This is the same idea that forms the basis of conventional fm broadcasting, but in satellite technology the idea is exploited to the fullest.

A single 4-kHz voice channel is often spread out over 750 kHz in satellite communications by use of extremely high-modulation indices. This can be compared to the conventional fm broadcast situation, where a peak deviation of 75 kHz is used and the baseband signal is 15 kHz wide.

Despite this prodigious use of bandwidth, all commercial satellites in operation today are limited by their total power rather than their bandwidths. (The down-link frequency range for communications

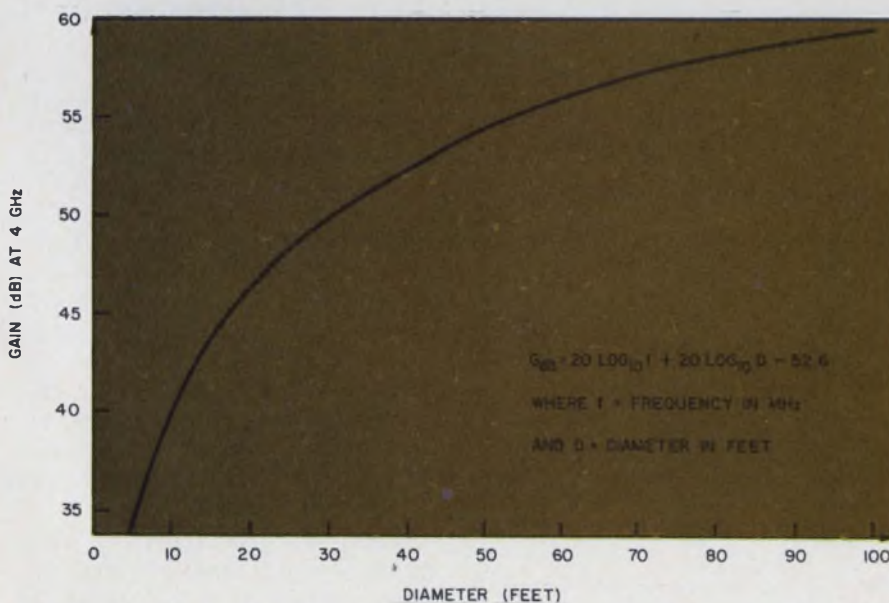

1. The point of diminishing returns is reached when it no longer pays to double the diameter of a parabolic reflector for 6 dB of additional gain. This occurs at about 85 feet for international stations.

satellites is 500 MHz wide—from 3.7 to 4.2 GHz). Future satellites—for example, Intelsat IV, which is now being developed—will run out of bandwidth before they run out of power if they operate with the same high-performance earth stations that are in use today.

As is well known, the price that one pays for the improvement afforded by an fm system is the existence of a threshold (Fig. 5). This is a value—or more accurately, a range of values—of input carrier-to-noise (C/N) ratio above which the fm receiver operates properly, providing an output signal-to-noise ratio that is considerably higher than the input C/N (the exact amount of the improvement depends on the modulation index and other factors and is thoroughly discussed in many books, such as Panter¹). Below the threshold, the system falls apart

completely; it's actually worse than a straight a-m system.

Obviously then, it is necessary to operate fm systems above their thresholds. In satellite work where power is so expensive, any technique that can lower the point at which the threshold occurs is naturally going to get a lot of attention. Two of these threshold extension techniques in common use in earth station receivers are the fmb (fm feedback) and PLL (phaselock loop) approaches.²

In the fmb approach, frequency feedback is employed to reduce the bandwidth of the i-f signal. A variable-frequency oscillator is made to follow the instantaneous frequency of the incoming modulated carrier. This oscillator serves as the receiver's local oscillator and hence yields a very narrowband i-f signal. The bandwidth of the i-f amplifier may then be reduced, lowering the i-f

noise power, and, thus the threshold.

In the PLL approach (Fig. 6) a phase detector replaces the discriminator of the standard fm receiver. The output of the phase detector is low-pass-filtered and used to control the frequency of the reference oscillator of the phase detector. Since the voltage-controlled oscillator is tracking the incoming signal, its control voltage is the output signal. Since the low-pass filter only allows the VCO to track the slowly modulated frequency of the carrier, all of the incoming noise is suppressed except that which falls in a very narrow band around the carrier. Again, this has the effect of lowering the threshold.

The saturation problem

A very obvious way to save power in a power-limited system is to operate all of the high-power devices as efficiently as possible. In the case of satellites, this means operating the output TWT at full power. (The dc power consumption of a TWT is fairly constant over the dynamic range of the tube, so that maximum efficiency occurs at maximum power out.) In addition to providing maximum efficiency, operation of the TWT in a hard-limiting mode has the advantage of making up-link power control unnecessary: The power out of the satellite will be independent of the input power.

As long as a satellite is only going to be used to relay a single carrier, hard limiting is definitely the way to go. Problems arise when you try to use a satellite to relay communications over two separate links at the same time. The highly nonlinear transfer characteristic of the saturated amplifier generates a host of intermodulation products with two deleterious effects: Some of the intermod products fall in the desired signal bands, causing interference, and the others simply eat up a lot of satellite power.

There are essentially two ways out of this dilemma. The first approach, which is in use today, is to back off on the TWT drive power to make the satellite more nearly linear and to continue sending separate messages through the

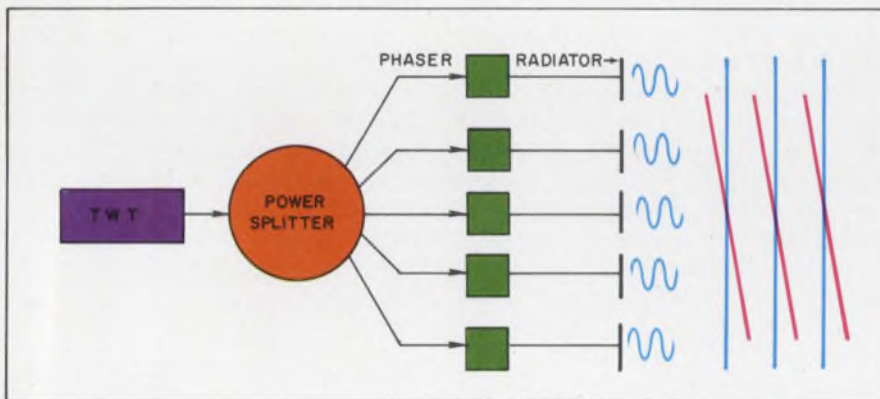

2. A phased-array antenna aims its beam by changing the relative phase of the signal applied to each radiator. When the phases are all the same, the resultant beam moves to the right, as shown by the blue constant-phase lines. By progressive delay of the phase (from top to bottom), the beam can be tilted up, as shown by the red lines.

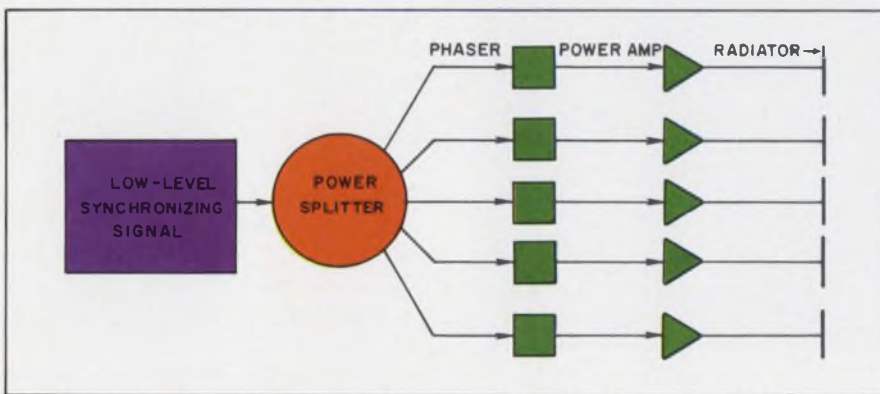

3. Phaser losses can be made unimportant through use of a separate power amplifier for each radiator. The amplifiers can be true amplifiers, or perhaps oscillators that are phase-locked to the input signal. In any event, this approach won't be practical until very lightweight reliable solid-state amplifiers are made available.

Not everyone needs our 5700

Sure it's the most accurate DVM there is — 0.0025%. And the most stable — 0.0065% for a year. But if you don't really need a DVM that's good enough to calibrate other DVMs, don't buy it. Buy one of our 32 others instead.

We make them for labs and production lines, for use on the bench and in systems, militarized models, four digit DVMs and five, from \$1150 to over \$8000. (Actually, with our unique plug-in modules, you can create some 300 different configurations. For every imaginable application. To fit every budget.)

And no matter which of our other 32 you buy, you'll have a DVM made with the same meticulous care as our 5700. With many of the same circuits. By the same people. To give you the confidence you've come to expect from Dana.

Which one suits you best? Ask for the decision maker, our free brochure.

Dana Laboratories, Inc., 2401 Campus Drive, Irvine, California 92664.

DANA



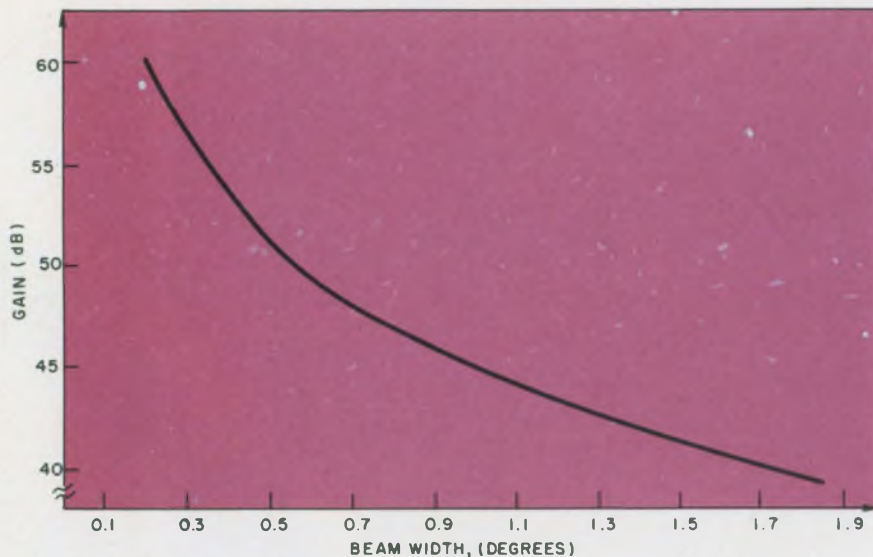

4. No freedom exists to specify the antenna gain once the coverage area is chosen. Here antenna gain is plotted against 3-dB beamwidth at a frequency of 4 GHz. The gain equation is given in Fig. 1, the formula for 3-dB beamwidth is $\Theta = 7 \times 10^4 / fD$, where f is the frequency in MHz, D is the antenna diameter in feet, and Θ is expressed in degrees. (Both formulas are from ITT's "Reference Data for Radio Engineers," fourth edition, p 753).

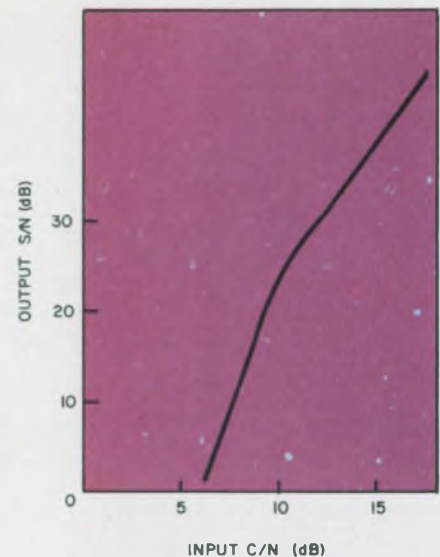

5. The price of fm improvement is the existence of a threshold. In this rather representative system, it occurs in the neighborhood of 10-dB carrier-to-noise ratio. The corresponding S/N is about 25 dB.

satellite on different carriers at the same time. This is the frequency-division, multiple-access (FDMA) approach. The alternative is to use the satellite as a hard-limiter but to time share it among all the users. This is time-division multiple-access (TDMA).³

Proponents of the TDMA approach point out that FDMA wastes power because it requires backing off on the tube drive, makes up-link power control necessary and it is not very flexible because of the need for careful frequency planning. TDMA, on the other hand, while suffering from none of these disadvantages, does require very accurate time synchronization of all of the stations. A certain amount of "overhead" or "housekeeping" data must be sent as a preamble to each message burst to lock up the receiver clock and decoder. For users who want to send only one or two channels, the overhead time may exceed the useful message time. Therefore TDMA is not the universal solution.

Actually, as with most problems, the optimum solution will depend on the details of each particular case. A satellite repeater designed to relay telephone traffic between New York and Los Angeles might well be a hard-limiting type, because the traffic over that link is

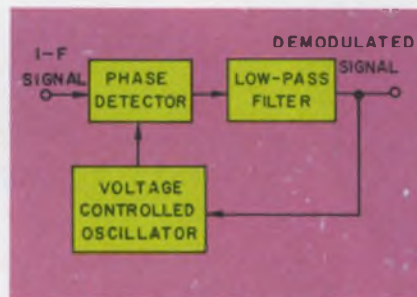

6. A phaselock loop can serve as a threshold extension fm modulator. Since the VCO is made to follow the i-f, its control voltage is the demodulated output.

so heavy that the single carrier would occupy the total capacity of the transponder (a single satellite can have more than one transponder). This would be a single-access situation, and ordinary fm would be used.

In the case of multiple accesses, two distinct situations can be distinguished. In the first case, there would be a fairly small number of users with each station handling a fairly large amount of traffic. In an international situation, this might be a group of countries—like the U.S., Canada, Great Britain, France and Germany. Here is where TDMA is at its best. Changes in traffic flow can be easily and quickly accommodated, and each user can easily support the overhead time costs.

The other case of multiple accessing involves a large number of very small users. Internationally these would be the small, emerging nations of Asia and Africa. These users do not have much traffic to send, but they may want to send it almost anywhere. For this application, the Comsat Corp. of Washington, D. C. has developed the SPADE system. This is an FDMA system in which each channel rides on its own carrier and the carriers are assigned on demand. Each station in the SPADE network would be equipped with a frequency synthesizer for the generation of whatever carrier it is told to use when it demands a channel.

The advantage of this approach is its flexibility. No frequency planning is involved since all of the carriers have the same power and bandwidth. This method would probably not be used in a domestic system since terrestrial facilities are adequate for the low-traffic links. ■■

References:

1. Philip F. Panter, *Modulation, Noise and Spectral Analysis*, McGraw-Hill, New York, 1965, Chap. 14 (pps 427-460).
2. Panter, *op. cit.*, Chap. 16 (pps 478-504).
3. Michael J. Riezenman, "Data Communication: The medium and the message," *Electronic Design* (ED 9), April 26, 1969, p. C8.



Ultramation: the memory that helps you forget.

Ultramation: the ultimate in automation with Honeywell. It means a new core memory system that helps you forget about initial costs – the Honeywell ICM-160. It delivers 4,096 words with 8, 12 or 16 bits per word for under 5¢ per bit and is field expandable.

And you can forget about downtime, too. The ICM-160 has a calculated 40,000 hour MTBF from 0° to 50° C.

You can forget about space and maintenance problems. The ICM-160 is the smallest (2³/₄" x 5" x 9"), fastest (1.6 μsec full cycle time, 550 nsec access time), 4K-word memory in the under \$5K price range. Modular construction makes it

fast and easy to maintain.

No wonder it's a logical choice for use in mainframe applications as well as special systems – digital controllers, computer peripherals, data communication buffers. Delivery? 30 days is standard. And it arrives with complete documentation – the kind of detailed information you'd expect from a supplier who's been designing and producing core memory systems for over 10 years.

Find out about the memory that helps you forget. Write for complete specs. Honeywell, Computer Control Division, Framingham, Mass. 01701.

Honeywell
AUTOMATION

The big plastic switch payoff

NPN					PNP				
	I _c (mA)	t _{on} (ns) (max)	t _{off} (ns) (max)	BV _{CEO}		I _c (mA)	t _{on} (ns) (max)	t _{off} (ns) (max)	BV _{CEO}
MPS3646	300	18	28	15	MPS3638/A	300	75	170	25
2N4409/01	150	35	255	40	2N4402/03	150	35	255	40
2N4264	100	23	35	15	2N5409	100	75*	225*	120
2N4265	100	23	35	12	2N5401	100	75*	225*	150
2N5550	100	105*	355*	140	MPSL51	100	75*	225*	100
2N5551	100	105*	355*	160	MPS3639	50	25	25	6
MPSL01	100	105*	355*	120	MPS3640	50	25	35	12
MPS2369	10	12	18	15	MPSL07	10	20	40	6
MPS2713/14	10	13*	21*	18	MPSL08	10	20	40	12
MPS834	10	16	30	30†	MPS3639	10	60	60	6
2N4264	10	25	35	15	MPS3640	10	60	75	12
2N4265	10	25	35	12	2N3905	10	70	260	40
MPS706/A	10	40	75	15	2N3906	10	70	300	40
2N3903	10	70	225	40	MPS404	10	265*	385*	24
2N3904	10	70	250	40	MPS404A	10	265*	385*	35

NPN					PNP				
	I _c (mA)	t _{on} (ns) (max)	t _{off} (ns) (max)	BV _{CEO}		I _c (mA)	t _{on} (ns) (max)	t _{off} (ns) (max)	BV _{CEO}
MMT2222	150	16*	160*	30					
MMT3014	30	16	25	20					
MMT3960A	20	1.75*	1.95*	8	MMT2907	150	20*	150*	40
MMT2369	10	12	18	15	MMT3546	50	25	35	12
MMT3903/04	10	37*	136*	40	MMT3905/06	10	43*	155*	40

†BV_{CEs} *typical value

You get the big payoff in your switching transistor applications by specifying Motorola plastic switches. Your payoff will be the confidence in delivery and a device selection possible only with a supplier building more than a million plastic small-signal transistors daily and still growing. Your payoff will be in uniformity of performance and reliability inherent in devices produced from long experience with mechanized/automated large-volume lines, and the total economy based on all these factors.

Get in on the payoff now. Specify Motorola plastic switches, or at least send for more information today to P.O. Box 20912, Phoenix, Arizona 85036.

-where the priceless ingredient is care!



MOTOROLA
Plastic Transistors



Electronic pollution feared

Residents of northern Wisconsin, in growing numbers, are registering concern over the Navy's plans to install a super-power, very-low-frequency communications transmitter system in that region. And it appears that their worries may be justified, since the Navy intends to spend \$1.6-million just to determine the effects of such a system on the local environment. Among the worries are these: What effect will the new system have on other electronics equipment? Will it disrupt telephone services? Will it be dangerous electrically to humans and animals?

Called Project Sanguine, the not-so-secret R&D effort is concerned with a massive transmitting complex that would significantly increase the reliability of the Navy's strategic communications, particularly with its ballistic missile submarine force. Most of the information being released on the project is coming from state and national legislators who are concerned over the environmental effect of the effort.

The Navy reportedly is establishing a Sanguine test facility in Wisconsin that will use a scaled-down design with only a 28-mile crossed antenna grid. Voltages averaging less than 64 volts per meter will be present at the extremities of the grid, according to the Navy, but close to the cable a potential of 100,000 volts per meter may be experienced. The test grid is above ground. The Navy is planning at least a year of testing.

Should the system ultimately be approved, it has been estimated that it will require 6000 miles of buried cable and 240 transmitter sites each requiring 10 acres. The buried cable will require 30-foot rights-of-way between the fenced-off transmitter sites. Neither the operating

Washington Report

CHARLES D. LAFOND
WASHINGTON BUREAU

frequency nor power output has yet been revealed.

With the multi-megawatt power believed contemplated in this system, opponents are afraid the Navy station may induce currents in every metallic object in or near the transmitter area. The Navy has admitted transmissions could induce "mild electric shock," but has indicated it plans to insulate at regular intervals everything in the area that needs to be insulated.

A principal opponent of the new system is Democratic Senator Gaylord Nelson. He says Navy figures show that 1000 feet of wire (such as in a farm fence) 100 feet from the underground antenna will carry a potential of 52 volts, and that the same wire at two miles will carry 22 volts. He also notes that a typical farmer's electrified fence carries only 12 volts and that under certain conditions even this has been known to be dangerous.

A principal Navy contractor investigating the effects of the planned facility is Hazelton Laboratories of Falls Church, Va. It has a \$150,000 contract to study such effects. But, based on its original proposal, some critics feel that Hazelton's ultimate report may be somewhat biased toward Navy wishes.

In its proposal, the firm noted that because of the intensity of the transmitter output, many local animals and plants would be exposed to the "field for very long periods of time, unless they are killed by it, are removed or, in the case of free-ranging animals, are driven out by noxious effects." The firm also pointed out a potential hazard to the local ecology resulting from increased temperature effects during transmitter operation. Yet it proposed only to make a limited study of this effect, using plants. It stated further "that such animals as groundhogs are not of sufficient economic value to

Washington Report

CONTINUED

be of concern. Hazelton does plan radiation tests on a variety of domestic animals in its laboratory here.

Other contracts issued by the Navy in the test program included the following:

- Bell Telephone Laboratories, \$200,000 to study station influences on area telephone services.
- Illinois Technical Research Institute, \$400,000 to study ways to minimize interference with other electronic equipment.
- RCA, \$500,000, to look into electrical effects on nearby fencing and railroads.

Military communications study due

The Pentagon's Defense Communications Agency, which directs the strategic military global communications network, has established a study group to investigate problems in linking its system to the tactical communications systems contemplated by the U.S., Australia, Canada and Britain. There is especial concern over the equipment that will be developed in the current four-nation R&D program called Project Mallard.

Mallard was begun in 1965 and is intended to produce by the mid-1970s the designs and basic hardware for a highly advanced digital tactical system for common use by the field forces of the four countries. The system will involve all communications modes, including satellite relay, and will employ automatic switching throughout.

Inertial sensor improved

Northrop Corp. representatives here are eloquent in their praise of an advanced inertial sensor recently developed by the company's Electronics Div. in Norwood, Mass. The unit combines in a single instrument a two-axis gyro and a two-axis accelerometer. Thus, they report, two of these elements can be combined by installing them perpendicularly to one another to create a complete inertial reference, a three-axis system plus one redundant axis.

Called a Multi-Function Sensor, the miniaturized prototype element is 2.1 inches long by 0.7 inch diameter and weighs just under 125 grams. The unit has been under development for seven years, the company says. Specifications for the unit indicate a sensitivity acceptable for an aircraft application, possibly in a strap-down (gimballess) inertial navigation system.

Navy gets new computer controls

The Navy Supply Systems Command here reports that the first of seven new inventory-control computer systems has begun operation at the Jacksonville Naval Air Station in Florida. Six more air stations will be equipped similarly during the next year with the paired IBM System 360 computers, one a Model 50 and the other a Model 25. When the full system is complete, it will control parts for and support over 50 aircraft types in use by the Navy.

Under its contract awarded last June, IBM provides the basic computers for each facility plus all the remote terminals and interconnecting communications equipment to tie in with the central computers. Also, each computer complex employs a magnetic disc storage unit with a 233-million character capacity.

The Navy says that the computers will provide "inventory control of one million aircraft parts valued at \$2 billion." The seven repair centers annually process five million requisitions and two million receipts.

'Brain-drain'—fact or fiction?

A report published by the Population Reference Bureau in Washington, examines the so-called "brain-drain"—the influx of scientists and other highly skilled people to this country from foreign lands. A total of 12 per cent of all recent immigration to the United States consisted of such highly skilled people, the report notes. It says that recent immigration to the U.S. has ranged from 306,000 to 360,000 annually. Of this total 8682 were engineers in 1967.

BLACKBOXING...?

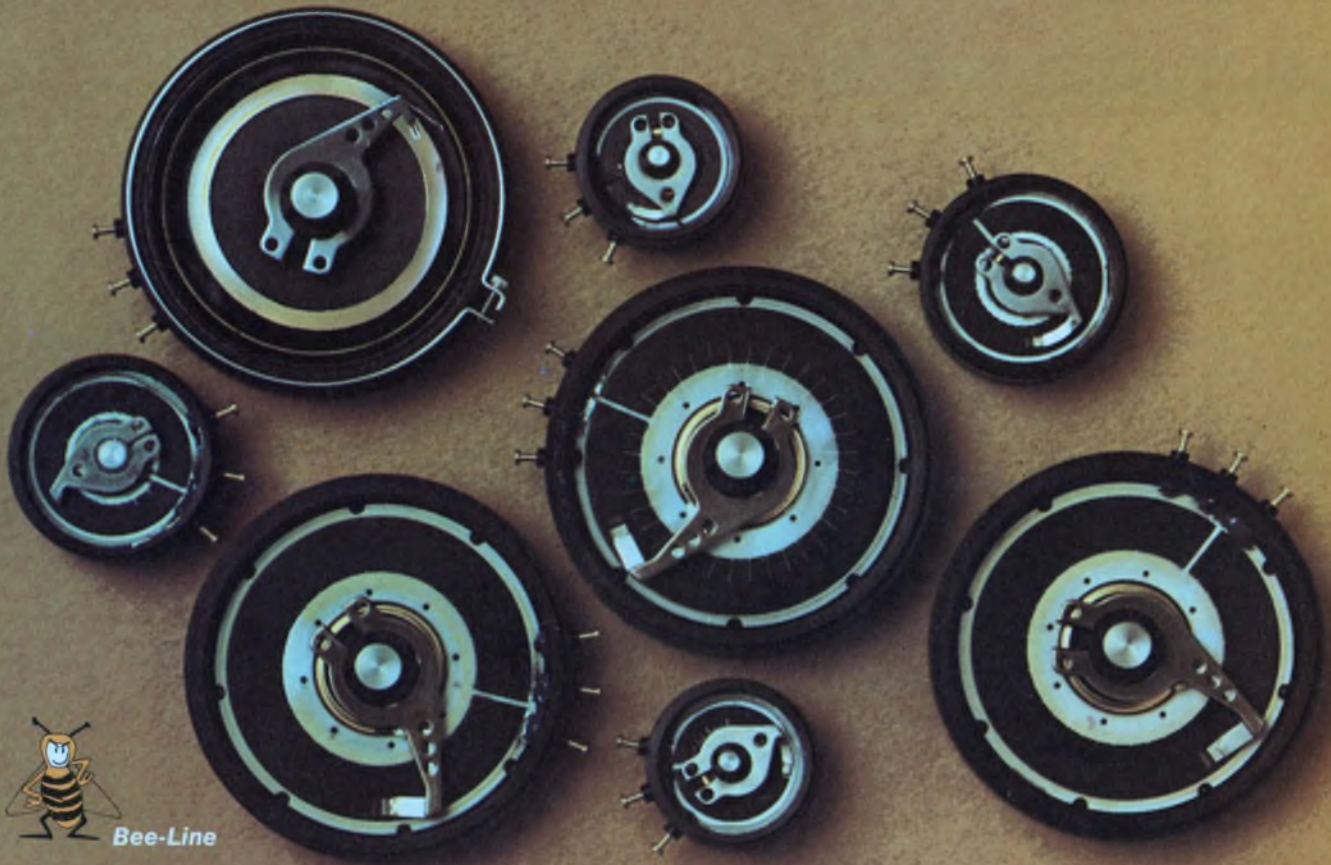

FORGET ABOUT POTENTIOMETER ELEMENT-

... DESIGN FOR SIZE AND DEPTH!

Eliminate size restrictions previously imposed by electrical application! *Bee-Line* does it! Regardless of the type of element—wirewound, conductive plastic, cermet or BiFilm™*... The *Bee-Line* series, in the new standard size and a compact, sturdy package, lets you design your black box before the elements are chosen!

To the packager

Three standard diameters— $\frac{7}{8}$ " , $1\frac{1}{16}$ " , 2". No more "hands-tied" electrical specifications that dictate overall size!

To the buyer

Standard size—0.2" per extra cup—avoid headaches of "almost the same as", "just like", etc.

To you

Whatever your function, the Bourns *Bee-Line* can solve a problem in your responsibility area. It truly provides an answer where no one before has dared to tread!

Get complete details on the versatile, slim, trim *Bee-Line* from the factory, your local Bourns Sales Office or Representative today!

*BiFilm is Bourns new, low TC Conductive Plastic



NPE reed relays are reliable... because we build them that way

All the way from basic reed switch fabrication / to precision-wound coils / to final packaging / we build in reliability at every step . . .

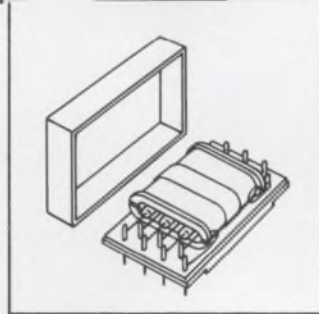
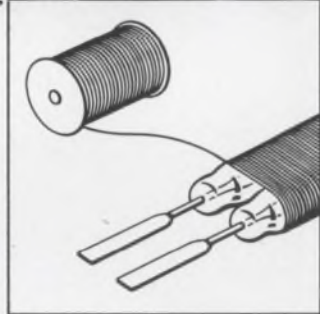
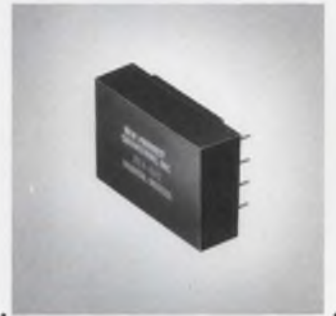

Reliability is exemplified in its highest degree in this miniature 824 Series Reed Relay. Epoxy encased with magnetic shielding standard, NPE's 824 Series is also readily adaptable to electrostatic protection. Other features include: pliable potting of reed switches and coil; welded terminals; standard or magnetic latching. The 824 Series offers superior performance wherever miniature reed relays are used. Other quality NPE relays are described in the chart below and pictured on the facing page.

Series	Contact Combinations	Center-to-Center Pin Spacing	Poles	Construction	Special Features
812 Miniature	Form A, Form B, Form C (A + B)	.150 Inch	Up to 6	Open Type	Economy miniature series
822 Miniature	Form A, Form B, Form C (A + B)	.100 Inch	Up to 4	Open Type	Smallest package using miniature reed switch
823 Miniature	Form A, Form B, Form C (A + B)	.100 inch	Up to 4	Potted in Plated Metal Can	Environmental protection
824 Miniature	Form A, Form B, Form C (A + B)	.100 inch staggered	Up to 6	Epoxy Cased, Potted in Pliable Compound	High reliability version
842 Standard	Form A, Form B, Form C (A + B) and True Form C	.200 or .218	Up to 8	Open Type	Higher power control
843 Standard	Form A, Form B, Form C (A + B) and True Form C	.200 or .218	Up to 8	Potted in Plated Metal Can	Environmental protection
852 Standard	One Form A only	.250 Inch staggered	1 pole only	Open Type	Economy standard relay

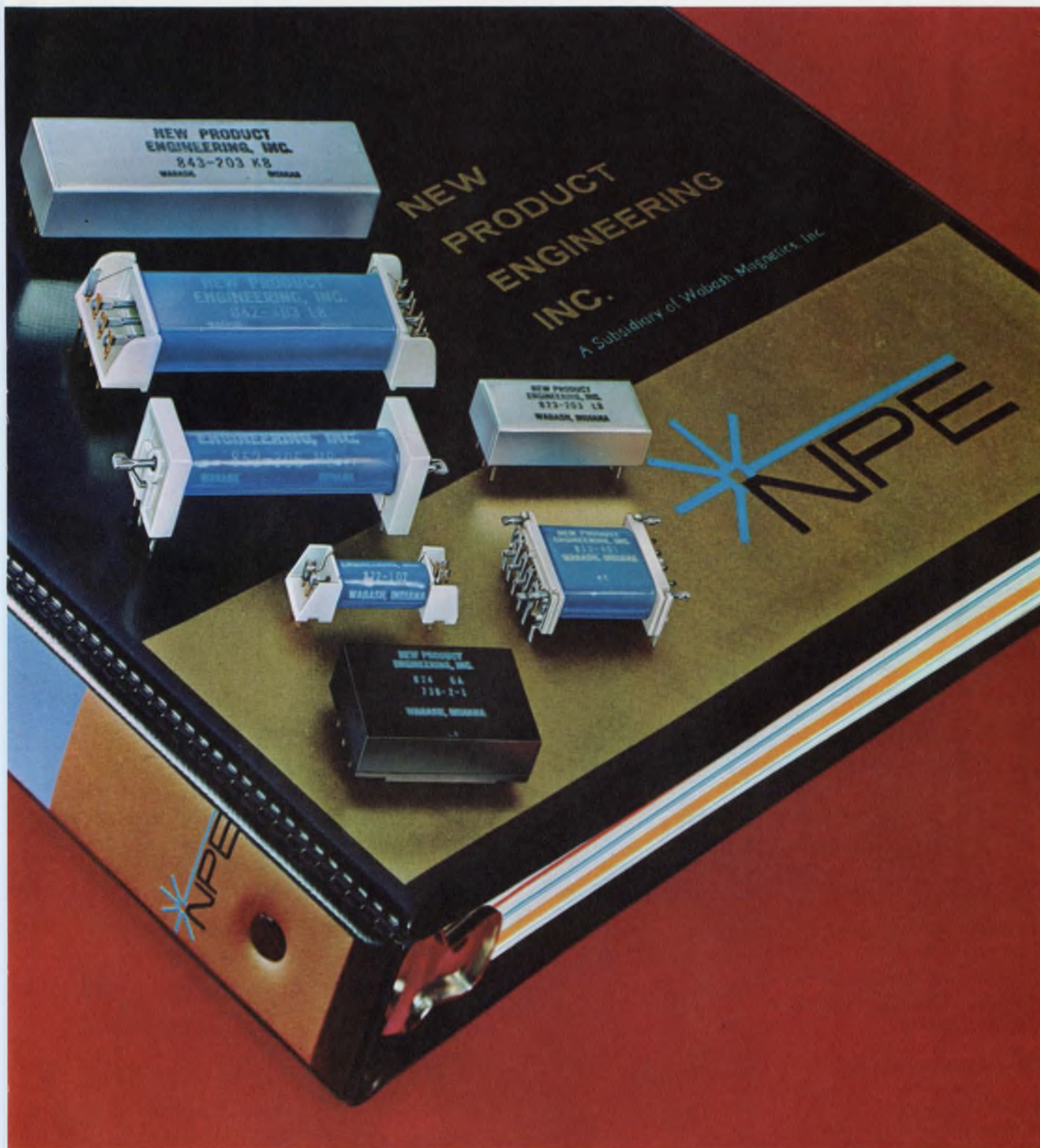

New Product Engineering's recognized mastery of reed switch technology, combined with Wabash Magnetic's unmatched coil manufacturing capabilities, assure a superior line of rugged reed relays to meet industry's most

demanding requirements.

If we don't build a reed relay that meets your specifications, let us know. Our problem-solving engineers are available to help you design one that will.



NEW PRODUCT ENGINEERING, INC.

A Subsidiary of Wabash Magnetics, Inc.

812 Manchester Avenue, Wabash, Indiana 46992
Telephone (219) 563-2191 TWX 810-290-2722

INFORMATION RETRIEVAL NUMBER 27

METERS ARE OUR BUSINESS!



Ambassador with
Taut Band Movement

Ideal Precision has a meter to satisfy every meter need — fit any specification — or cost requirement.

- Imperial Series
- Ambassador Series
- Capitol Series
- Edgewise Series
- Statesman Series
- Diplomat Series
- Moving Magnet Indicator Series
- 250° Long Scale Series
- Plus a full line of Military & Avionic Meters

And if you have special applications or unique design specifications, our *Custom Service* manufactures to fit individual specifications.

For detailed specifications and ranges write for your free catalog to



**IDEAL
PRECISION
METER CO., INC.**

214 Franklin St., Brooklyn, New York 11222
Telephone: 212-383-6904

SIDELIGHTS

Are we overcrowding space?

The last question that concerned ELECTRONIC DESIGN staffers Charlie LaFond and Mike Riezenman while they were writing their stories on prospects for a U. S. domestic satellite program, (pp. 36 to 48), was the crowding of space with flying objects. Charlie and Mike were largely occupied with lessons of the recent past and problems of the immediate future. But several people they interviewed—notably Wilbur L. Pritchard, director of the Comsat Laboratories in Washington, D. C.—were very much concerned with the eventual effect of placing so many satellites in orbit.

At first thought, this problem may seem too remote to cause worry. After all, at the synchronous altitude of approximately 22,000 miles, more than 150,000 miles of orbital space are available for satellites.

But the hard facts are that there are certain preferred orbital positions, and certain minimum separations must be maintained between satellites. If the "birds" get much closer to each other than about two degrees (as seen from the earth) then earth stations will have a tough time trying to get their messages one at a time without interference.

The time to solve this problem, says Pritchard, is now—not after the sky is already crowded and various countries and companies are feverishly competing for the little remaining space.

And just in case anyone still thinks that it's too early to worry about space crowding, Pritchard points out that only 60 years ago, when Bleriot first flew the English Channel, people would have thought you crazy if you'd started planning to avoid major air-traffic tieups over New York City.



Holding an early version of Intelsat III, Mike Riezenman gets briefed on progress. The phone at left is of early French vintage. Who would have thought, back in 1896 . . . ?

Announcing Digitest 500, the \$250 digital multimeter from Honeywell.

No kidding. \$250

This world's smallest multimeter may be inexpensive to buy, but that's the only thing cheap about it.

Take capability. Our Digitest 500 gives you five functions (resistance, AC and DC voltages, AC and DC currents), plus 17 ranges to choose from. And it can be operated from 117V 50-60Hz line or an external 12V source. Or consider accuracy: Digitest 500 is five times as accurate as the conventional VOM.

As you can see, we've made it both compact and lightweight (2½ lbs.) by using a large-scale integrated circuit. So the Digitest 500 is just 2½" x 5" x 9", but has polarity indication, a moving decimal point, an overload indicator and built-in calibration check. Plus overrange up to 100% (on all ranges except 300VAC).

For more details, write Don Anderson, M.S. 206, Honeywell Test Instruments Division, P.O. Box. 5227, Denver, Colorado 80217.

Honeywell



INFORMATION RETRIEVAL NUMBER 29

TRW Announces Ultra-Linear RF Power Transistors... 2 to 150 MHz

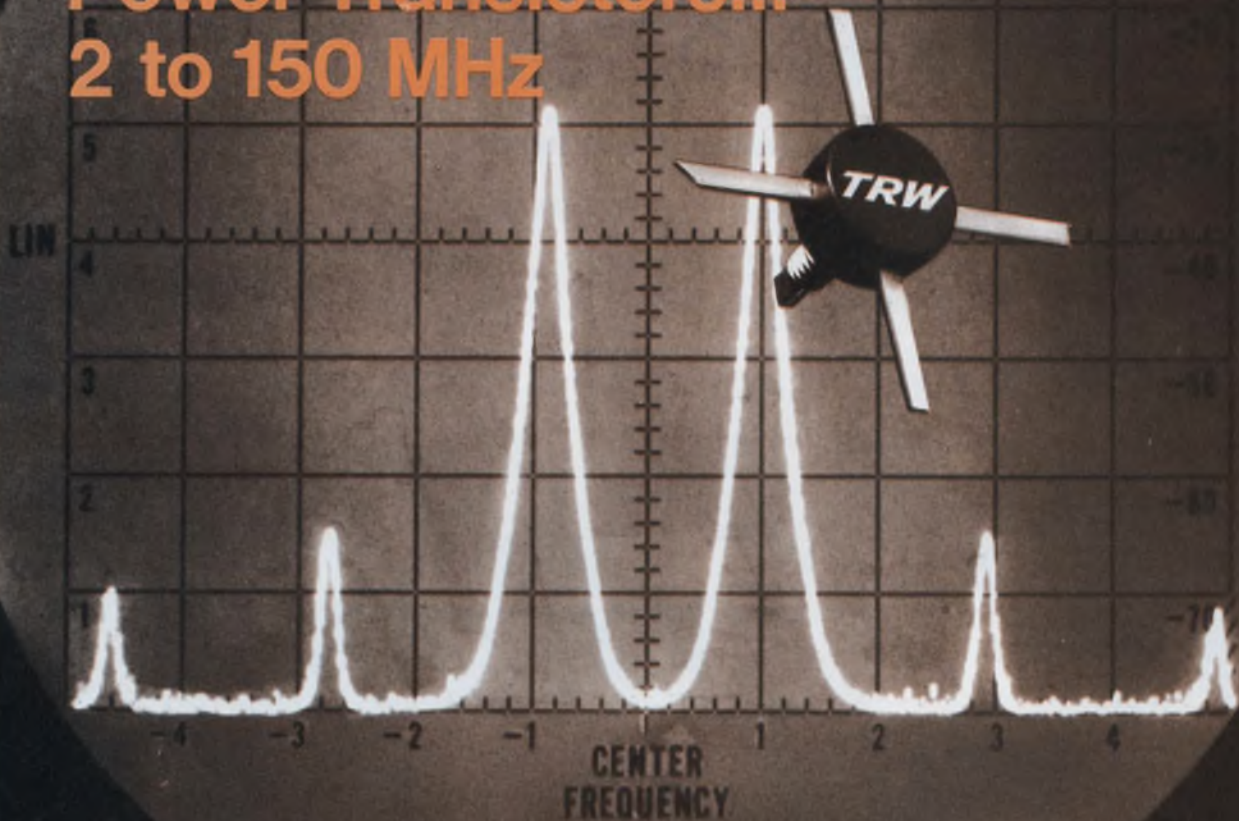

20 to 100 watts...- 32 dB intermodulation guaranteed

TRW offers three new 28-volt RF transistors to meet a range of output power needs in either SSB or CW. All are designed for Class A, Class AB, or Class C operation. All will withstand severe output mismatch. All are available in low profile, strip-line packages.

The 2N5707 provides 20 Watts

P.E.P. in SSB use from 2 to 30 MHz, and 30 Watts CW output to 150 MHz. The 2N5708 provides 40 to 50 Watts respectively over the same frequencies, and the 2N5709 furnishes 80 and 100 Watts in the same operating modes. All three have excellent broadband capabilities.

Contact any TRW Distributor or

TRW Semiconductors, 14520 Aviation Boulevard, Lawndale, California 90260. Phone: (213) 679-4561. TWX 910-325-6206. TRW Semiconductors Inc. is a subsidiary of TRW Inc.

TRW®

INFORMATION RETRIEVAL NUMBER 30

Publisher

Hugh R. Roome

Editor

Howard Bierman

Managing Editor

Frank Egan

Technical EditorsMilton J. Lowenstein
Michael J. Riezenman
Raymond D. Speer
Stella Lawrence**Management and Careers Editor**

Richard L. Turmail

News EditorsRalph Dobriner, Chief
John N. Kessler**Washington News Bureau**

Charles D. LaFond, Chief

Military/Aerospace Editor

John F. Mason

East Coast Editor

Jim McDermott

West Coast EditorsElizabeth deAtley
David N. Kaye**New Products Editors**Lucinda Mattera
Roger Allan**Directory Manager**

Greg Guercio

Copy Editor

Marion Allen

Editorial Production

Dollie S. Viebig

Art Director

Clifford M. Gardiner

Art Assistant

William Kelly

Technical IllustratorsRita Jendrzejewski
Lynn E. Thompson
JoJo Miskimmon**Production Manager**

Thomas V. Sedita

Asst. Production Manager

Helen De Polo

Production AssistantsBernard Wolinsky
Kathleen McConkey**Circulation Manager**

Nancy L. Merritt

Information Retrieval

Genate Piccinetti

EDITORIAL



Launch— or get off the pad

Just about everyone agrees that the United States had better get moving on the establishment of a domestic communication satellite system. Unfortunately, there is something less than full agreement on the form the system should take, the material it should carry and, especially, who should ultimately own and operate it.

Comsat believes it has a Congressional mandate to own and operate such a system. AT&T says no—it is all well and good for Comsat to own and operate the satellite portion of the system, but the ground stations should be the properties of the common carriers. And General Electric, which has also proposed a system, says it doesn't care who owns or operates it.

To make matters worse, there is some speculation that the Federal Communications Commission, which to date has refused to reach a decision without knowing the Administration's position, may not even have the legal power to decide the issue—and that a final solution may have to come from the courts, after the FCC reaches its decision.

The end result is that years will have elapsed between the first serious proposals of Comsat, AT&T and the Ford Foundation and the actual launching of the first satellite in a domestic system.

During this time the rest of the world will not be standing still. As pointed out in the Special Report beginning on page 36 of this issue, four countries as of today are either actively considering or have in operation domestic communication satellite systems. And who knows what other countries will join the ranks within the next two years?

If the FCC commissioners do not soon get their decision off the launching pad, the United States, with its great expertise in communications satellites, may one day find itself akin to the cobbler's children who had no shoes.

We feel the time has come for the FCC to stop procrastinating and waiting for the Administration to make its position known.

A decision should be reached as soon as possible—one based on the present and future communications requirements of the nation. Any changes in that decision can then be left to the courts and/or the Congress.

FRANK EGAN

**Pick
another
winner.**

**We did.
i-1101**

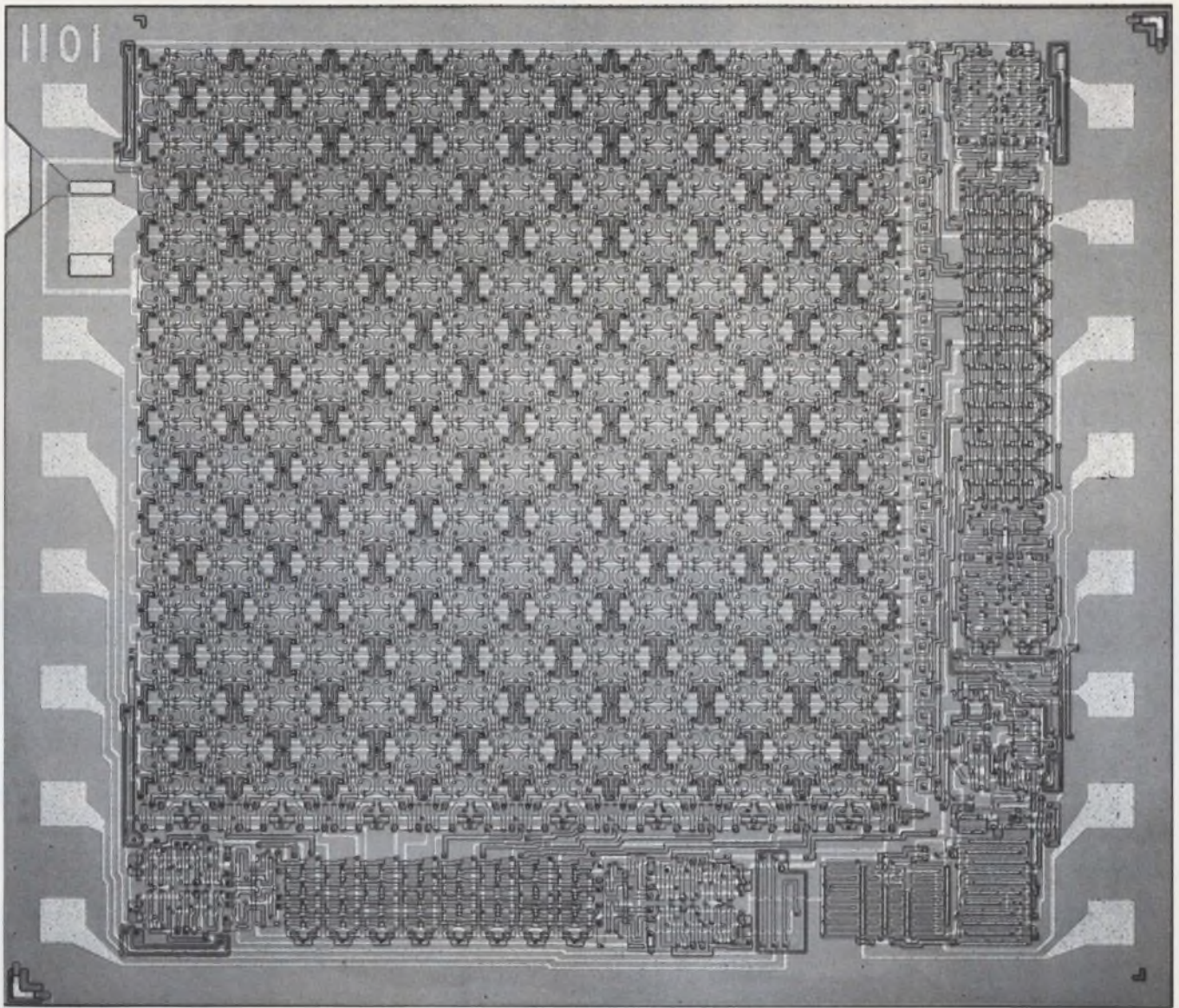

First silicon gate MOS. 256-bit random-access memory. Fully decoded.

Introducing the Intel Model i-1101 static random-access memory
□ 256 x 1 organization □ 0.1 mW per bit standby power □ 2 mW during access □ 800 nsec typical access time □ DTL and TTL compatible □ OR-tie capability □ In a 16-lead hermetic DIP.

Available now in over 40 locations. Phone your local Intel distributor: Cramer Electronics or Hamilton Electro Sales. Or phone us collect at Mountain View, California (415) 961-8080. □ Intel Corporation, 365 Middlefield Road, Mountain View, California 94040. Intel regional offices in Costa Mesa, California □ (714) 545-8541 and in Andover, Mass. (617) 536-0700.

intel

**Now we're in the memory business.
And here's a bipolar scratch pad**

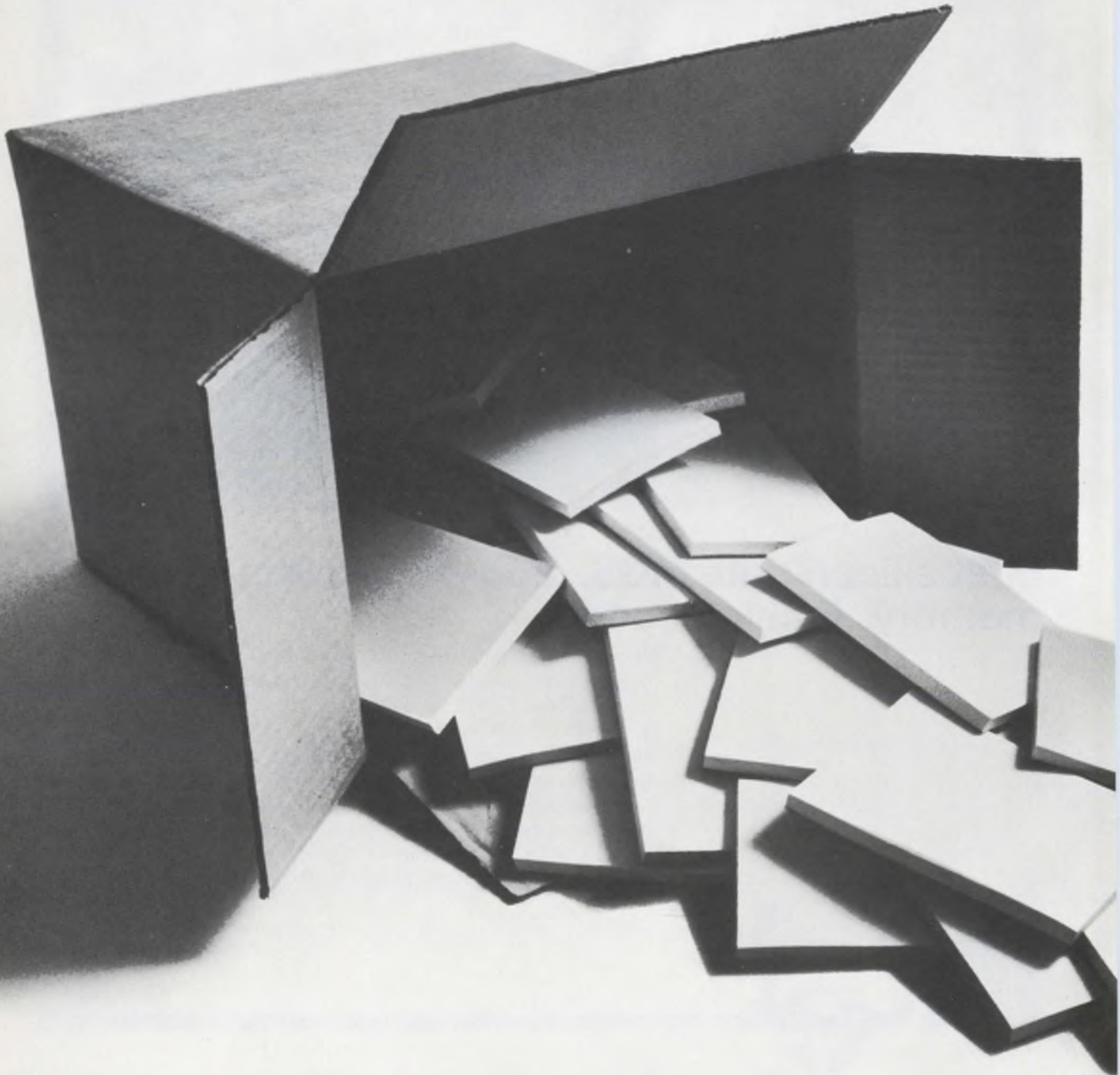

to help you remember.

Anyone with half an eye can see the bright future of the semiconductor memory business. And for months Raytheon's been deploying to nab a lion's slice of that action. We herded up all the processing niceties of our high-rel military components. All the 10th-mil-tolerance magic of our Ray III TTL. All our way-out beam-lead technologies. And now we're in the business.

Leading off with our spanking new 64 bit bipolar RAM. We guarantee a 45 nanosecond read time, but it usually coughs up a word in under 35 ns. And the entire chip, including on-chip address decoding, write and sense circuitry, perks along on only 350 mW. Cost per 100-999 is \$51.50 (-55° to $+125^{\circ}\text{C}$ version) and \$38.00 (0° to $+70^{\circ}\text{C}$). Available now, off distributors' shelves, in a 16-lead DIP. Flatpacks coming up.



What else? Before the end of the year, look for beam-lead 256-bit and 512-bit multi-chip arrays in 24 pin DIP packages.

And by next June, a monolithic beam-lead 256-bit bipolar scratch pad in a 16-pin DIP. With super-quick access times, thanks to far tighter tolerances and new cell designs. Plus Schottky barrier diodes, washed emitters and like that.

Then in 1970 we'll be unveiling a line of IC read-only memories. And after that it's just a little time until we're mainly in the mainframe memory business.

All of which proves you better keep us in mind when you're in the memory market. The company that gets the ideas and delivers the goods. Raytheon Semiconductor, Mountain View, California. (415) 968-9211.



INFORMATION RETRIEVAL NUMBER 32

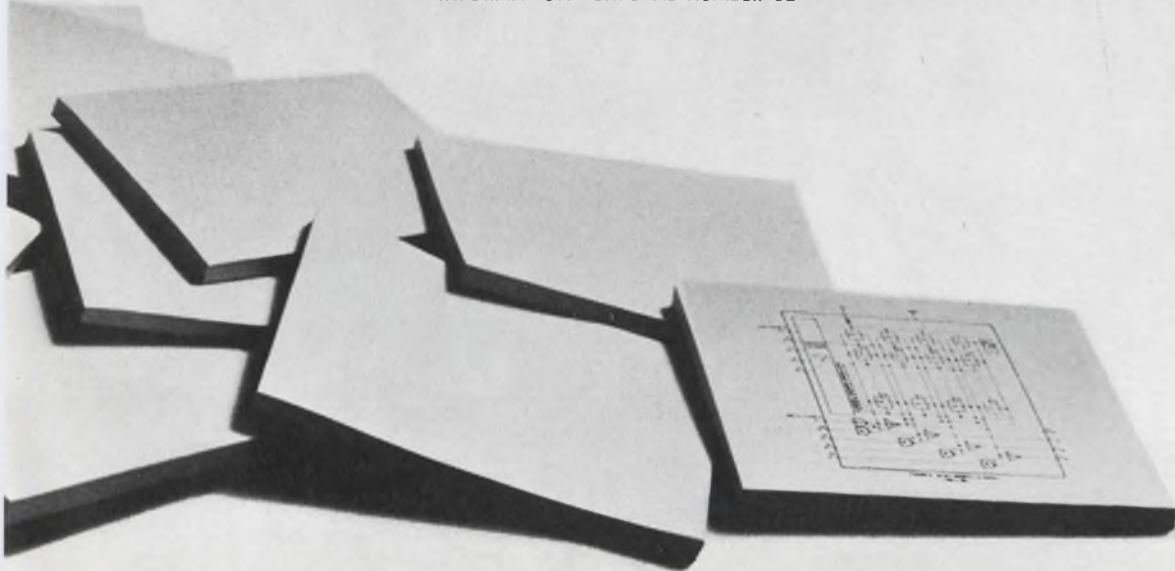

We don't know who'll design it. But we know where he can get the batteries.

At the nearest Burgess Distributor. They're probably somewhere in his stock of batteries.

One's bound to be right for the electric spaghetti windlass. And one's exactly what you need for whatever you're designing. Another thing. Whether it's a standard or special, your Burgess Battery will be power-fresh.

All distributor inventories are checked, rotated, and filled-in according to a systematic schedule.

So the battery you get comes on strong . . . and stays that way.

When you need batteries, check with your Burgess Distributor. He's a great source of power.

And when you need technical information, give us a call. Burgess has a library filled with the latest, most complete engineering data and technical battery material in the business.

Meanwhile, send for our new engineering manual and do a little window shopping. It's got comprehensive listings of all batteries available through Burgess. Clevite Corporation, Burgess Battery Division, Freeport, Illinois 61032.

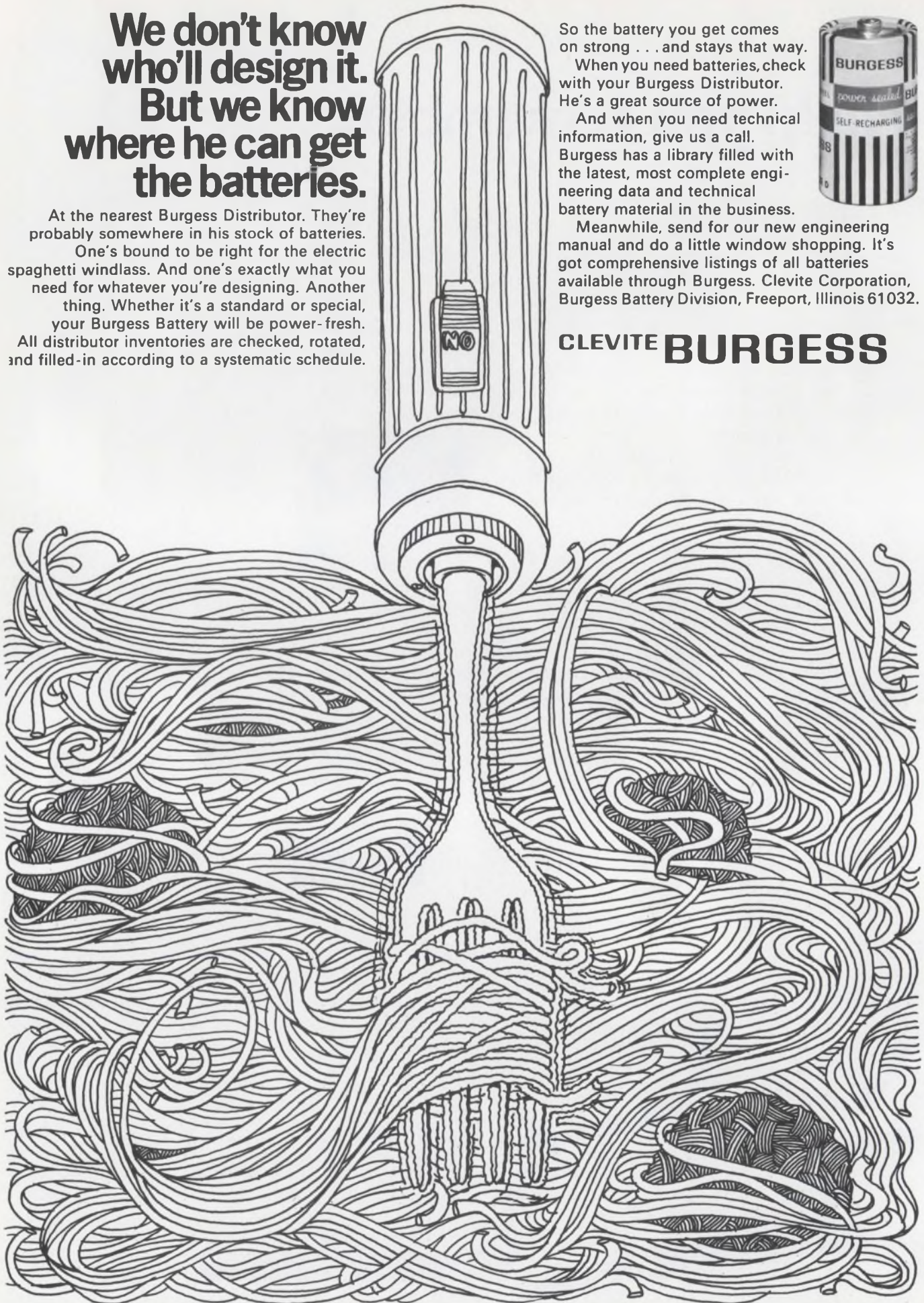

CLEVITE BURGESS

Don't blow a fuse because your semiconductors aren't properly protected.

The new Airpax CEL-GARD® semiconductor fuses make fault-current protection easy for you! Now you can be sure that your rectifiers, thyristors, silicon-controlled rectifiers, and power transistors are properly protected . . . even in the face of short circuit disaster . . .

by using the easy steps outlined in our new catalog.

CEL-GARD® fuses are designed specifically for the semiconductor. The fastest arc-quenching techniques available are used to insure the **shortest possible** total fault-clearing time. In addition, CEL-GARD® fuses offer more mechanical durability when subjected to frequent switching of maximum rated currents. This means **longer CEL-GARD® life and increased circuit reliability.**

Protect your semiconductors properly. Send today for your catalog. Then you can be sure you're safe!

AIRPAX ELECTRONICS

Phone: (301) 228-4600

Telex: 8-7715

TWX: (710) 865-9655

Cambridge Division

Cambridge, Maryland 21613



Send for your AIRPAX CEL-GARD® fuse catalog today!

NAME _____
TITLE _____
COMPANY _____
ADDRESS _____
CITY _____ STATE _____ ZIP _____
PHONE _____

Mail to: AIRPAX ELECTRONICS, Cambridge Division, Cambridge Md. 21613

New from the **SPEC-TROLL!**



A 10-TURN INDUSTRIAL WIREWOUND POT WORTH BLOWING OUR HORN ABOUT!

Selling for only \$4.39 in quantity, our new Model 532 features "designed-in" reliability to give you top pot performance at bargain prices. The 532 offers:

- Longer element for "tighter" resolution.
- Precious metal contacts for minimum noise characteristics.
- Improved vibration-resistant slider design and dual slip ring contacts.
- Rugged mechanical stops for dependability.
- Passivated stainless steel shaft.
- A tough industrial design that can handle most of the requirements associated with MIL-R-12934.

Brief Specs

Size:	3/8" diameter
Resistance Range:	15 ohm to 180K
Resistance Tolerance:	± 5%
Independent Linearity:	+0.25%
Power Rating:	3 watts @ 40°C

The model 532 is available through your local Spectrol distributor. For full specs, circle the reader service number. Qualified respondents may obtain a sample *free of charge* through their Spectrol representative.

Spectrol

SPECTROL ELECTRONICS CORPORATION
A subsidiary of Carrier Corporation
17070 EAST GALE AVENUE
CITY OF INDUSTRY, CALIF. 91745
(213) 964-6565 • TWX: (910) 584-1314

INFORMATION RETRIEVAL NUMBER 43

New from the **SPEC-TROLL!**



A LOW-COST INDUSTRIAL WIREWOUND POT WITH PREMIUM FEATURES

Welded termination—With heavy-duty ribbon taps welded to several turns of wire, the new single-turn Model 132 can better withstand high-level vibrations and short-term overloads.

Unitized design—With only 4 major subassemblies — a stainless-steel shaft and rotor, a coil, a molded housing, and a rear lid — the 132 offers a new simpler design for greater reliability, with rear terminals for better packaging.

Rugged construction—The materials used in the 132 have been selected for their ability to withstand impacts and abrasions during assembly or maintenance to assure the customer a trouble-free, serviceable pot.

Low cost—For less than \$6 (in quantity)—you can buy this precision industrial pot! Also, heavy-duty stops (8 in. lb. static) are optional at no extra cost.

For full specs, circle the reader service card. Qualified respondents requesting a sample will receive a Model 132 *free of charge* from their local Spectrol representative.

Spectrol

SPECTROL ELECTRONICS CORPORATION
A subsidiary of Carrier Corporation
17070 EAST GALE AVENUE
CITY OF INDUSTRY, CALIF. 91745
(213) 964-6565 • TWX: (910) 584-1314

INFORMATION RETRIEVAL NUMBER 44

New from the **SPEC-TROLL!**



NOW CHOOSE BETWEEN THESE NEW LOW-COST INDUSTRIAL CERMET AND CONDUCTIVE PLASTIC POTS!

Need a quality low-cost industrial pot with virtually infinite resolution, high performance, and long reliable service? Then your best choice is Spectrol's new conductive plastic Model 138 or cermet Model 139. Both single-turn models offer excellent linearity, high power rating, and a broad resistance range. But why not check the specs and decide for yourself.

Brief Specs	C.P. Model 138	Cermet Model 139
Size:	1-5/16"	1-5/16"
Resistance Range:	500Ω to 100KΩ	500Ω to 1 Megohm
Independent Linearity:	± 0.5%	± 0.5%
Power Rating:	2 w @ 40°C. 5 w @ 40°C.	

With either choice you get the same "designed in" reliability and rugged construction as with our Model 132 wirewound—and all are priced lower than the competition! For full specs, circle the reader service number. Qualified respondents may obtain a sample *free of charge* through their Spectrol representative.

Spectrol

SPECTROL ELECTRONICS CORPORATION
A subsidiary of Carrier Corporation
17070 EAST GALE AVENUE
CITY OF INDUSTRY, CALIF. 91745
(213) 964-6565 • TWX: (910) 584-1314

INFORMATION RETRIEVAL NUMBER 45

Technology

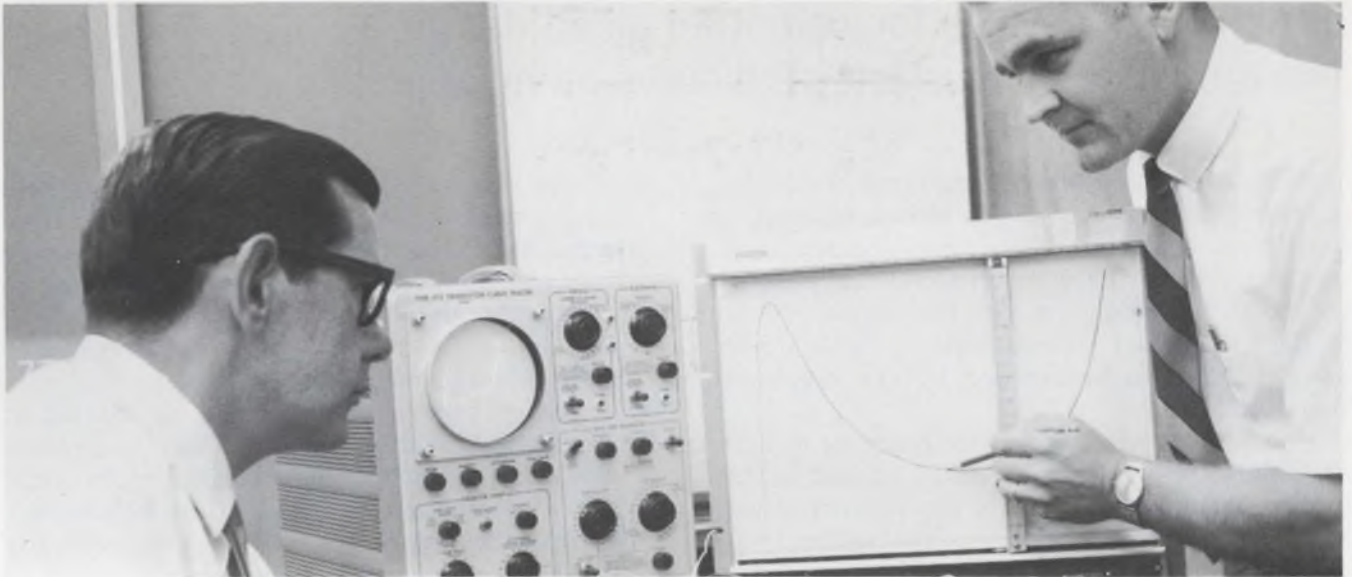

General models of nonlinear devices are proving valuable in computer-aided design. Oscil-

loscope and X-Y plotter curves are key elements in determining a model. p. 68.



Precision management, with bar charts and other aids to keep pace of progress, helped

Grumman engineers assemble and test the LM 5 for its landing on the moon. p. 78.

Also in this section:

Streamline feedback-amplifier design with a simple analysis. p. 74.

Ideas for Design. p. 84.

Develop useful general models

of nonlinear devices for computer-aided design.

The tunnel diode illustrates the curve-fitting approach.

Computer-aided circuit analysis requires a mathematical model for each circuit element. In particular, nonlinear devices must be accurately modeled. Transistor and switching diode models have been well developed and documented,^{1,2,3} but SCRs, UJTs, and tunnel diodes, among others, usually have to be devised by the designers themselves.

Models may be classified by range of validity and complexity. Ideally, a model should be frequency independent, valid for any current or voltage excitation within the device ratings, and have a fixed topology that provides a one-to-one correspondence, with physical processes. It should consist of passive elements (R, L, C and mutual inductance), if possible of fixed value, current sources (I) and voltage sources (V) whose mathematical equations are "well-behaved."

Small-signal, piecewise linear and large-signal models are all nonlinear simulations. A large-signal model, because it can be used over a wide range of operation, is the type best suited for use in general computer circuit analysis. It may be more complex than necessary for many applications, but it is usually safer to simplify a general model than elaborate a simple one. For these reasons the model discussed in this article is of the large-signal variety.⁴

Formulate general device models

But whatever family of semiconductor devices is involved, certain general considerations and requirements must be regarded:

- An understanding of the physical processes that produce the external electrical characteristics is desirable. Although it is possible to use a purely black-box approach, it is helpful to know which phenomena are the result of tunneling, avalanche of the junction, stored charge, conductivity modulation, etc.
- The manufacturing process used in making a given device may be pertinent to the model. For

example, a transistor of planar construction will probably exhibit different transient behavior from a transistor having the same 2N number although of annular construction. The result may need to be two different models or two different sets of model parameters, one for each manufacturer or manufacturing process.

- A major portion of any model is the set of mathematical equations that describes the physical operation. They may be derived in various ways, but two criteria that must be met are an adequate description of device behavior and compatibility with the language of the computer.

- The model topology is the interconnection of the discrete components making up the network that approximates the device. Although not imperative, it is usually desirable to have one element or set of elements to represent each physical phenomenon. In a tunnel diode, for example, one resistor is used for series resistance, and one capacitor represents junction capacitance; but one current source simulates tunnel current and a second represents minority carrier current.

- The development of a model involves a determination of certain defining parameters. These parameters must be obtained from knowledge of the device physics or from operating characteristics. If the operating characteristics are not supplied by the manufacturer, then measurements must be made by the user. Sometimes it is more difficult to determine what measurements to make and how to make them than it is to formulate the equations and the topology.

- Once the model has been formulated, the device parameters must be obtained. Usually it is necessary to extract these parameters from the data measurements, previously mentioned. The data reduction involves curve-fitting data points or other analytical manipulations to get the parameters explicitly.

An important constraint on the mathematical equations is that they must have the same form as the network equations used in the general program. For example, in finding a steady-state solution using the SCEPTRE program,⁵ a current source cannot be a function of the voltage across

Dr. Marvin E. Daniel, Sandia Laboratory, Albuquerque, N. M.

it except for the special case of the diode equation, $I = I_s(e^{\phi_e}-1)$. This constraint only means that, when putting a model into a general program, one should be aware of any unique features of that program.

Tunnel-diode model is examined

A general approach to the modeling of any non-linear device is the technique of curve fitting. A computer can take the tedium out of the job. A tunnel-diode model illustrates the curve-fitting technique. The voltage-current characteristic curve of a typical tunnel diode is shown in Fig. 1 along with some of the important dc parameters.

The unique properties of a tunnel diode that are most often utilized are its negative resistance and its very rapid switching from V_p to a point in the forward conduction region (at a voltage something less than V_{fp}). For voltages greater than V_{fp} , the tunnel diode follows the ordinary diode characteristic.⁶

Most tunnel-diode circuits are designed around the peak point and valley point, so any tunnel-diode model should accurately approximate these points. It is relatively easy to measure the peak point, valley point, and the maximum slope in the negative conductance region ($-G$). Measurement of current at voltages greater than V_{fp} is also quite easily accomplished with automatic test equipment.

There is very little resistance to current flow when reverse bias is applied to the junction — that is, with reverse bias, the tunnel diode is nearly a short circuit. Although the model to be developed is valid for negative bias, accurate modeling of reverse behavior is normally considered of little importance in tunnel-diode applications.

Establish model topology

The topology assumed to represent a tunnel diode with lumped components is shown in Fig. 2. The values of the series resistance, R_s , and the series inductance, L_s , are normally given on manufacturers' specification sheets. The series inductance is usually of the order of 1 to 10 nanohenries (depending on the length of the leads) and must be included because of the high normal operating frequencies.

The junction capacitance, C_j , can be measured on a double-balance rf admittance bridge.

Although no capacitance measurements can be made in the negative resistance region, sufficient data points are available for $V < V_p$ and $V > V_v$ to determine that a typical junction capacitance versus V curve has the general shape shown in Fig. 3. The C_j curve is described by the same relationship used for ordinary diode transition capacitance; namely,

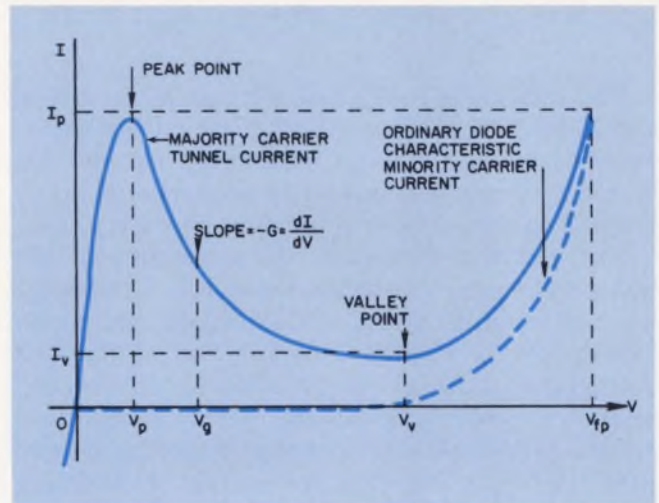

1. Static V-I characteristic of typical tunnel diode defines the curve that must be matched mathematically.

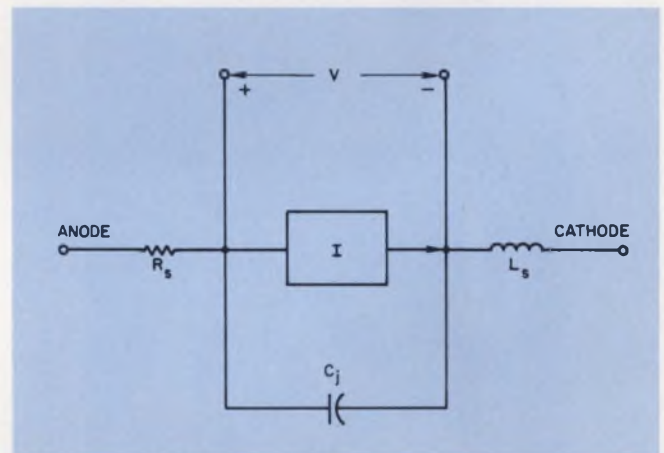

2. Topology of tunnel diode depicts the lumped parameters that must be evaluated.

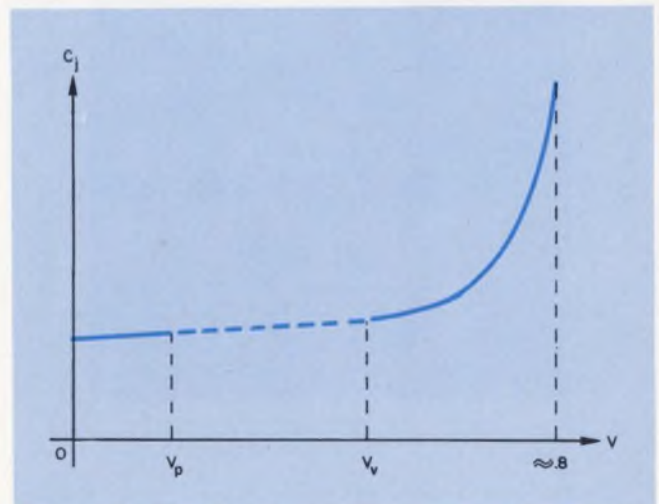

3. Capacitance characteristic of tunnel diode resembles that of an ordinary diode but is difficult to measure within the negative resistance region.

$$C_j = \frac{K}{(V_z - v)^N}$$

The constants K , V_z and N must be evaluated from the plot of C_j vs. v . Typical values are N between 0.3 and 0.5 and V_z between 0.6 and 1.0. K varies more widely and is proportional to C_j since it is dependent on junction geometry.

The current generator, I , approximates the static V-I characteristic shown in Fig. 1. Development of a mathematical model includes finding an expression for current as a function of junction voltage, v . It must be possible to obtain any unknown coefficients in the defining equations from external measurements on the device, or from published data. One effective method of obtaining values for the peak and valley point, and points in the forward conduction region is to photograph

the face of an oscilloscope curve tracer. Measurements are then made from the photographs. Figure 4 shows several examples of this technique.

Write curve-fitting equations

Several different methods for modeling the current generator I have been developed. One⁷ approximates the entire characteristic by an exponential function

$$I(v) = A ve^{-av} + B(e^{b_1 v} - e^{-b_2 v}) + C(e^{cv} - 1) \quad (1)$$

Where $I(v)$ is the current through the diode as a function of the voltage (v) across it and A , a , B , b_1 , b_2 , C and c are constants to be determined.

Equation 1 represents the sum of the tunneling current, the excess current, and the diffusion current, respectively; or $I(v) = I_{tun} + I_{ex} + I_{diff}$.

The entire V-I characteristic might be fitted exactly to Eq. 1, but this is not always feasible. First, the entire curve would have to be known; second, the solution of one equation in seven unknowns can be tedious at best. Without approximations and assumptions to reduce the number of unknowns, a computer search routine to do the job is relatively inefficient.

It seems, however, that with what is known about the unique tunnel-diode curve and some assumptions, a reasonably good approximation can be made without knowing the entire characteristic. A procedure for obtaining the equation coefficients with only a limited amount of information will now be developed.

First, measure four points: the peak point, $[V_p, I_p]$, the valley point, $[V_v, I_v]$, and two points in the forward conduction region, $[V_f, I_f]$ and $[V_m, I_m]$, where $V_m > V_f > V_{fp}$. The last two points are normally chosen so that I_m is near the maximum rated current of the device and I_f is about 1.5 I_p . The value of $-G$ is also needed. It can either be taken from most diode specification sheets or it can be measured.

For $v > V_{fp}$, the last term of equation (1) is dominant, so it can be assumed that

$$I(v) = C(e^{cv} - 1), v > V_{fp}$$

Using the two data points in the forward conduction region, (V_m, I_m) and (V_f, I_f) , and simplifying, the results are:

$$c = \frac{\ln\left(\frac{I_m}{I_f}\right)}{V_m - V_f}$$

and

$$C = \frac{I_f}{(e^{cV_f} - 1)} = \frac{I_m}{(e^{cV_m} - 1)}$$

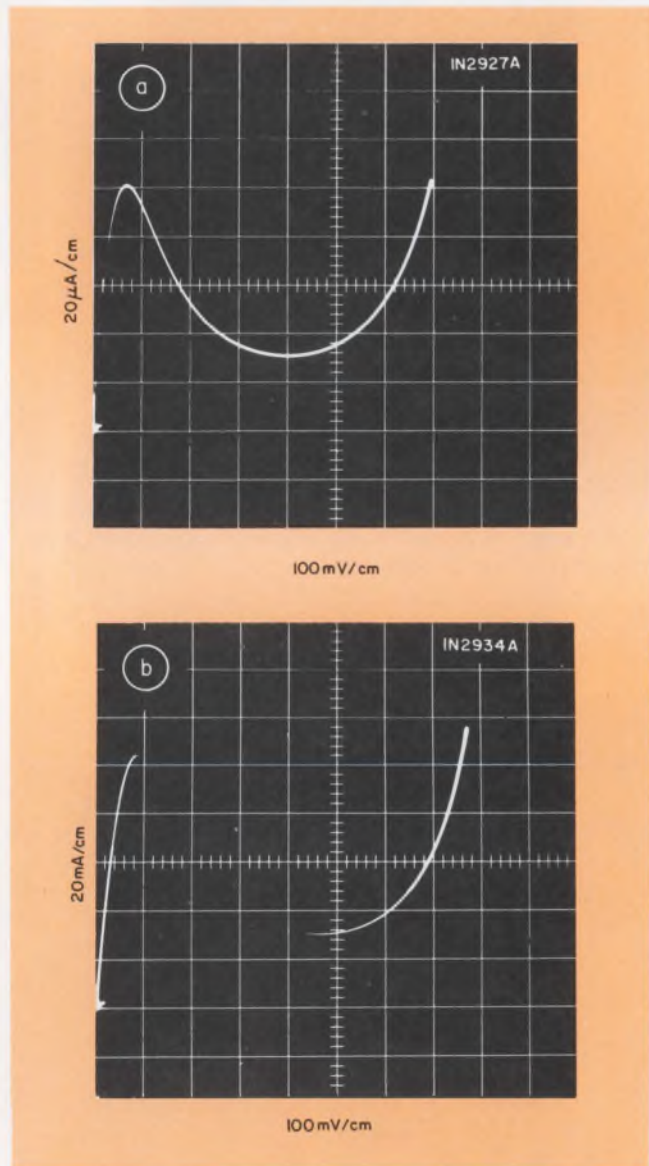

4. Oscilloscope traces of tunnel-diode characteristics facilitate measurement of peak, and valley points. The loss of detail in the negative resistance region of the IN2934A makes measurement of V_g difficult.

Thus c and C are known.

Since the peak point is a relative maximum and the valley point is a relative minimum, the first derivative of $I(v)$ must be zero at these points. For $v < V_p$, it can be shown that the diffusion current is negligible [$C(e^{cv} - 1) \approx 0$]. When $v \approx V_v$, none of the three current expressions is negligible, although I_{ex} , the excess current, is the majority term. Therefore, from Eq. 1 and its first derivative evaluated at (V_p, I_p) and (V_v, I_v) respectively:

$$I_p = AV_p e^{-aV_p} + B(e^{b_1 V_p} - e^{-b_2 V_p}) \quad (2)$$

$$I'(V_p) = 0 = Ae^{-aV_p} (1 - aV_p) + B(b_1 e^{b_1 V_p} + b_2 e^{-b_2 V_p}) \quad (3)$$

$$I_v = AV_v e^{-aV_v} + B(e^{b_1 V_v} - e^{-b_2 V_v}) + C(e^{cV_v} - 1) \quad (4)$$

$$I'(V_v) = 0 = Ae^{-aV_v} (1 - aV_v) + B(b_1 e^{b_1 V_v} + b_2 e^{-b_2 V_v}) + cCe^{cV_v} \quad (5)$$

This gives four equations in five unknowns. One more item of information is known; the maximum negative conductance. Since $-G$ is the maximum slope of the negative conductance region, it is at the point of inflection, V_g , of $I(v)$. However, since V_g is not known, some approximations must be made. The diffusion current has very little effect, and the excess current is nearly linear in this region. Therefore, assuming that the inflection point of $Av e^{-av}$ is also the inflection point of $I(v)$, gives $V_g = \frac{2}{a}$. Then,

$$I'(V_g) = -G = Ae^{-aV_g} (1 - aV_g) + B(b_1 e^{b_1 V_g} + b_2 e^{-b_2 V_g}) \quad (6)$$

Equations 2 through 6 constitute a set of equations that must be solved to obtain A , a , B , b_1 , and b_2 . A method of iteration which can easily be programmed can be used to obtain the solution as follows:

Assume initial values for B , b_1 , b_2 . Using these values, find A and a from Eqs. 2 and 3. Substitute these calculated values of A and a into Eqs. 4, 5 and 6. Eliminate B from this set of equations, and there remain two transcendental equations in b_1 and b_2 .

$$\frac{b_1 e^{b_1 V_v} + b_2 e^{-b_2 V_v}}{e^{b_1 V_p} - e^{-b_2 V_p}} = K_1 \quad (7)$$

$$\frac{b_1 e^{b_1 V_g} + b_2 e^{-b_2 V_g}}{e^{b_1 V_p} - e^{-b_2 V_p}} = K_2 \quad (8)$$

The last two equations provide a definition of

b_1 and b_2 . Several iteration procedures are available for solving such equations. Perhaps the simplest method is the linear iteration. (See Reference 6 for a discussion of other methods that might be used.)

Linear-iteration method is simplest

To apply the linear-iteration method, begin with Eqs. 7 and 8 rearrange them into a form

$$b_1 = g_1(b_1, b_2)$$

$$b_2 = g_2(b_1, b_2)$$

The general iteration formula is then

$$b_1^{(j+1)} = g_1(b_1^j, b_2^j) \quad (9)$$

$$b_2^{(j+1)} = g_2(b_1^j, b_2^j) \quad (10)$$

The iteration described by Eqs. (9) and (10) is

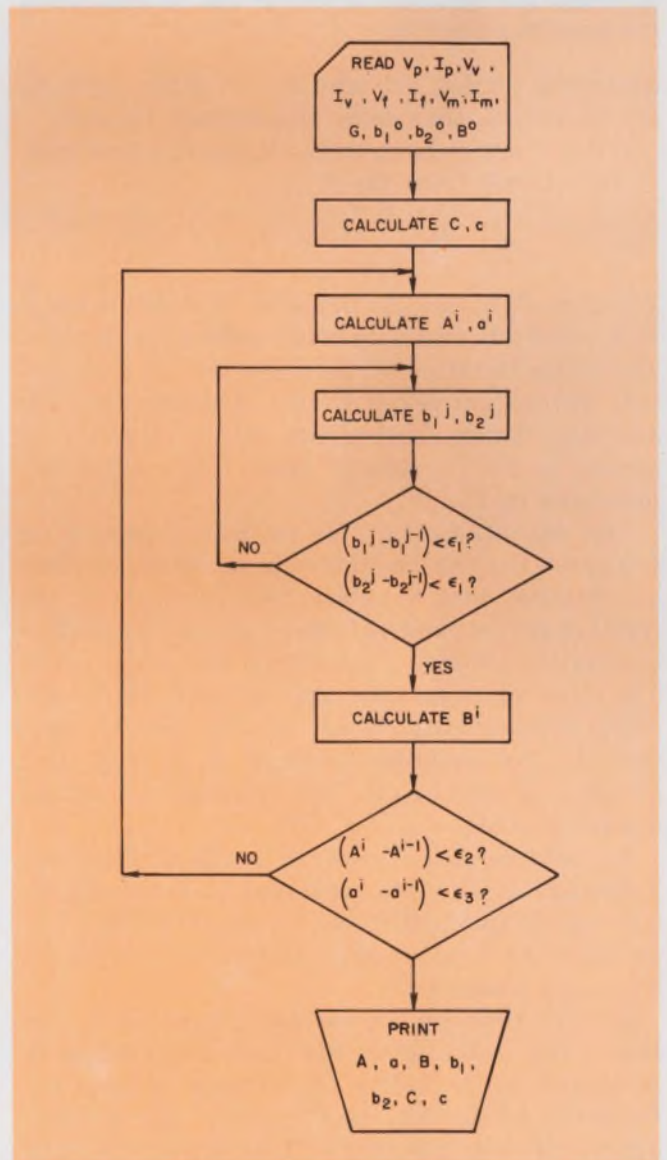

5. Flow chart of computer program shows the steps to be followed in determining parameters of the curve-fitting equation. Note the iteration steps for the a , A , b and B parameters.

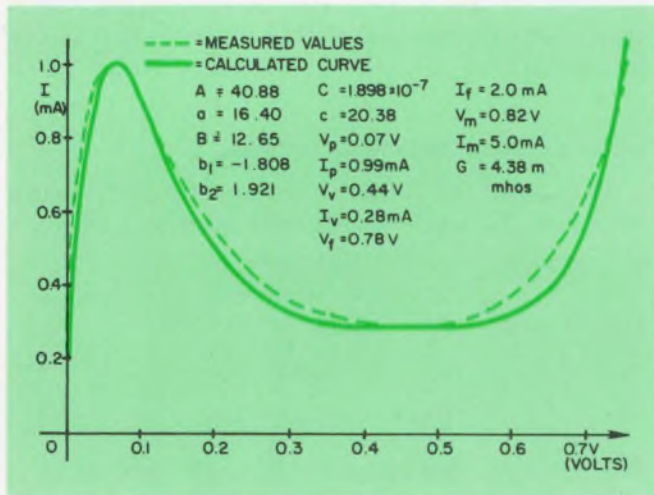

6. Static V-I characteristic for 1N2929 tunnel diode illustrates the closeness to fit that can be obtained by the curve-fitting method.

continued until $b_1^{(j+1)}$ and $b_2^{(j+1)}$ differ from b_1^j and b_2^j by less than some preassigned amount.

After b_1 and b_2 have been calculated, a new value of B is found from Eq. 4.

$$B = \frac{K_3}{e^{b_1 V_p} - e^{-b_2 V_v}}$$

The new B , b_1 , and b_2 found are substituted into Eqs. 2 and 3 to calculate better values for A and a . The entire iteration is continued until the parameter values converge within a predetermined accuracy. A flow chart of the complete iteration is shown in Fig. 5. Results from this method are presented in Fig. 6.

The advantages for this method of describing $I(v)$ are: (a) the need for only specification-sheet information, plus two easy measurements in the forward region; and (b) the fit is exact at the two most critical points — peak point and valley point. The disadvantages are that a good fit to the entire characteristic is not always possible, and that the five equations relating A , a , B , b_1 , and b_2 are difficult to solve; the iteration sometimes doesn't converge.

Another method of curve fitting is to divide the V-I characteristic into zones and fit an n th-degree polynomial function to each zone. The degree of fit can be made as good as desired by using more zones and a larger n .

For the tunnel-diode example, three zones, one below the peak point, one including the peak point and one including the valley point and the forward conduction region, and up to 5th-degree polynomials give a fit to within 3%. The constraints on the polynomials are: all functions and their first derivatives must be continuous, and functions for adjacent zones must have matching values and first derivatives at the zone

boundary.

The advantages of this method are that polynomial functions are well-behaved and easy to manipulate, the polynomial coefficients are easy to extract, and a very close fit can be obtained. The disadvantages are that each polynomial has a limited zone of applicability, and the entire device V-I characteristic must be accurately known.

The key to the successful use of these methods is to use the computer to eliminate the mathematical drudgery. Thus, the computer that created the need for accurate device models is the means by which the models themselves are generated. ■ ■

References

1. M. E. Daniel and C. H. Purdue, "Computer Model Specifications for Non-linear Devices," *Proc. 1967 Annual Symposium on Reliability*, IEEE Catalog No. 7050, January, 1967, pp. 162-166.
2. N. O. Sokal, J. J. Sierakowski, and J. J. Sirota, "Transistor and Diode Models for Computer Analysis of Circuits," *Electronic Design*, ED 12, 13, 14, June and July, 1967.
3. W. G. Sheerer, "Selecting Device Models for Computer-Aided Design," *Electro-Technology*, Vol. 81, No. 5, May 1968, pp. 43-48.
4. F. F. Kuo and W. G. Magnuson, Jr. (editors), *Computer Oriented Circuit Design*, Chapt. 7, Prentice-Hall, Inc., July, 1969.
5. H. W. Mathers, S. R. Sedore, J. R. Sents, "Automated Digital Computer Program for Determining Responses of Electronic Circuits to Transient Nuclear Radiation (SCEPTRE)," *Air Force Weapons Laboratory TR-66-126*, February, 1967.
6. M. E. Daniel, "Development of Mathematical Models of Semiconductor Devices for Computer-Aided Circuit Analysis," *Proc. IEEE*, Vol. 55, November, 1967, pp. 1913-1920.
7. "Analytical Methods and Fundamental Parameters for Predicting Responses of Electronic Circuits to Transient Nuclear Radiations, with Application to Hardened Circuit Design," *Air Force Weapons Laboratory TR-65-105*, July 1965, p. 4.

Test your retention

Here are questions based on the main points of this article. Their purpose is to help you make sure you have not overlooked any important ideas. You'll find the answers in the article.

1. Which type of nonlinear device model is most general?
2. What nonmathematical constraints must be placed on the model equations?
3. How does one obtain the data from which to construct a tunnel-diode model?
4. What three significant currents make up the total tunnel-diode current?

Total light modulation systems

From the Leader in Electro-Optic Devices...

Select a high performance modulator from ISOMET's complete line of longitudinal or transverse mode electro-optic light modulators.

Longitudinal Field Modulators

EOLM Series 101, 201, 301 with KDP or KD*P crystals feature large linear and angular apertures suitable for coherent and non-coherent light sources. Applications include biological and chemical measurements involving interaction of samples with light beams (for example circular dichroism) or in astronomical spectral studies. Moderate electrical bandwidth—audio to 2 MHz. Operating voltages are in the low kilovolt range. Priced from \$488.

EOLM Series 400 KD*P, useable for gas lasers, have intermediate operating voltages from 1 to 2 kV, wide electrical bandwidth, very high contrast ratio and fast response times. Ideal for ranging, data recording, retrieval and transmission applications as well as for research and educational uses. Priced from \$385.

Transverse Field Modulators

TFM Series 510 feature the lowest available drive voltages—as low as 75 V. Suitable for use with lasers. Electrical bandwidth from DC to 100 MHz and beyond. Wide optical bandwidths and negligible piezoelectric resonances. Ideal for high bit data transmission links, atmospheric propagation studies, ultra high speed laser stroboscopy and laser printing, display and ranging systems. Priced from \$2700.



Amplifiers and Drivers

Choose a suitable driver from ISOMET's exceptionally versatile line of solid state amplifiers and drivers designed to amplify low level input signals from audio to 6 MHz and provide up to 100% modulation.

Precision Optics

Add ISOMET precision optical components such as polarizers, wave plates, beam splitters and optical coatings to your modulator and driver selections and you have a total modulation system.

ISOMET's application engineering department is at your service to provide in depth technical assistance to aid you in solving your light modulation problems.

Call or write for more information on electro-optic modulators, drivers, Q-switches, Q-switch pulsers and electro-optic crystals to ISOMET Corporation, 433 Commercial Avenue Palisades Park, New Jersey, 07650. Tel: 201-944-4100

ISOMET

Streamline feedback-amplifier design.

It's simple if you analyze forward and reverse transmission paths of your circuit separately.

In designing feedback amplifiers the forward and reverse transmission paths must be separated. The brute-force approach is to write loop equations and manipulate them into a form that permits isolation of the two paths. This is time-consuming, however, and tends to obscure the dominant parameters. A simpler method is to analyze the paths separately, taking into account the loading effects of the source, load and feedback impedances.

Actually, the impedance levels of the various feedback methods indicate that a different set of equations is best suited to each case. Thus, selection of the proper matrix not only reduces design time but also offers better insight into circuit performance.

Consider the general case

The general feedback amplifier shown in Fig. 1a has the transfer function:

$$G = \frac{\alpha}{1 - \alpha\beta} \quad (1)$$

where α is the forward amplifier gain and β is the feedback function.

Two assumptions are made in the analysis of such an amplifier:

- First, the forward transmission through the feedback path is negligible in comparison with the transmission through the forward amplifier

path;

- Second, the reverse transmission through the forward amplifier path is negligible in comparison with the reverse transmission through the feedback path.

Figures 1b and 1c consider the combination of the closed-loop amplifier and the source impedance as a two-port network. The input parameters are the source voltage (E_s) and the source current (I_s). The output parameters are the load voltage (E_o) and the load current (I_o). I_o is set equal to minus I_L since the two-port analysis defines currents flowing into the positive terminal.

There are four general types of interconnections between the forward and feedback paths to be considered:

- Series-shunt feedback, which provides a high input impedance and a low output impedance.
- Shunt-series feedback, which provides a low input impedance and a high output impedance.
- Shunt-shunt feedback, which provides a low input and output impedance.
- Series-series feedback, which provides a high input and output impedance.

Series-shunt feedback

The series-shunt feedback amplifier shown in Fig. 2 lends itself to an h parameter two-port. In matrix form, its equations are:

$$\begin{bmatrix} E_s \\ -I_o \end{bmatrix} = \begin{bmatrix} h_{11} + Z_s & h_{12} \\ h_{21} & h_{22} \end{bmatrix} \times \begin{bmatrix} I_s \\ E_o \end{bmatrix} \quad (2)$$

Sidney A. Friedman, Electronics Engineer, Cardion Electronics, Woodbury, N. Y.

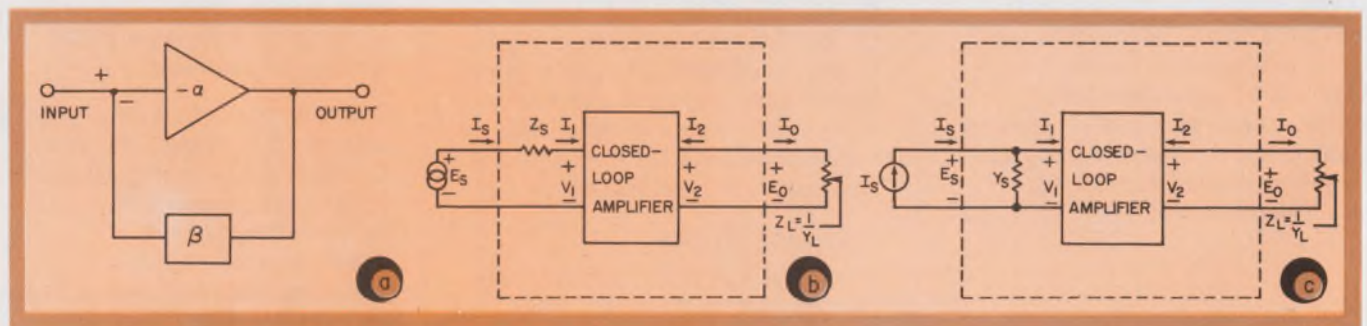

1. The general feedback amplifier (a) may be considered as a two-port network driven from a voltage source (b)

or a current source (c). On this basis, the forward and feedback paths can easily be analyzed separately.

Solving for voltage gain:

$$\frac{E_o}{E_s} = \frac{-h_{21}/(h_{11} + Z_s)(h_{22} + Y_L)}{1 - h_{22}h_{21}/(h_{11} + Z_s)(h_{12} + Y_L)} \quad (3)$$

Comparing Eq. 3 with the general form (Eq. 1) yields:

$$\alpha = \frac{-h_{21}}{(h_{11} + Z_s)(h_{22} + Y_L)} \quad (4)$$

$$\beta = h_{12}$$

Using standard two-port technique, the terms in Eq. 4 can be related to circuit values. The results are summarized in Table 1.

Shunt-series feedback

The shunt-series feedback amplifier shown in Fig. 3 lends itself to a g parameter two-port, whose equations in matrix form are:

$$\begin{bmatrix} I_s \\ E_o \end{bmatrix} = \begin{bmatrix} g_{11} + Y_s & g_{12} \\ g_{21} & g_{22} \end{bmatrix} \times \begin{bmatrix} E_s \\ -I_o \end{bmatrix} \quad (5)$$

Solving for current gain:

$$\frac{I_o}{I_s} = \frac{g_{21}/(g_{11} + Y_s)(g_{22} + Z_L)}{1 - g_{12}g_{21}/(g_{11} + Y_s)(g_{22} + Z_L)} \quad (6)$$

Comparing Eq. 6 with Eq. 1 yields:

$$\alpha = \frac{g_{21}}{(g_{11} + Y_s)(g_{22} + Z_L)} \quad (7)$$

$$\beta = g_{12}$$

The results of these calculations are summarized in Table 1.

Shunt-shunt feedback

The shunt-shunt feedback amplifier shown in Fig. 4 lends itself to the use of a y parameter two-port:

$$\begin{bmatrix} I_s \\ -I_o \end{bmatrix} = \begin{bmatrix} y_{11} + Y_s & y_{12} \\ y_{21} & y_{22} \end{bmatrix} \times \begin{bmatrix} E_s \\ E_o \end{bmatrix} \quad (8)$$

Solving for current gain:

$$\frac{I_o}{I_s} = \frac{-y_{21}Y_L/(y_{11} + Y_s)(y_{22} + Y_L)}{1 - y_{12}y_{21}/(y_{11} + Y_s)(y_{22} + Y_L)} \quad (9)$$

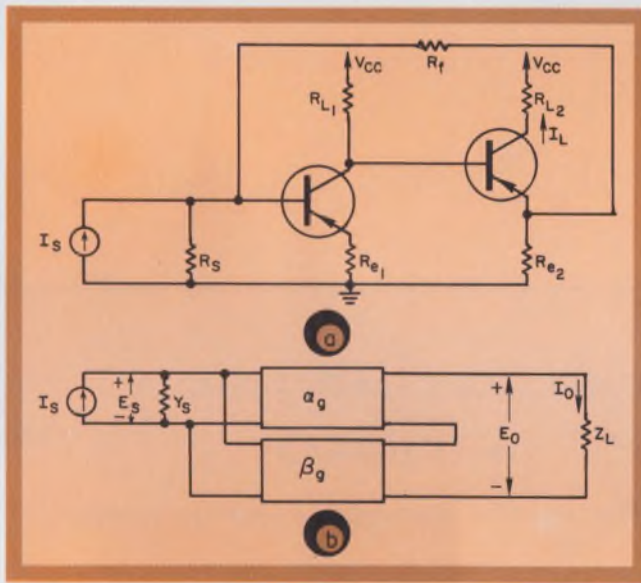

2. Typical series-shunt configuration (a) is best analyzed using h parameters (b) since I_s is common to both the forward and reverse networks and E_o is across both networks.

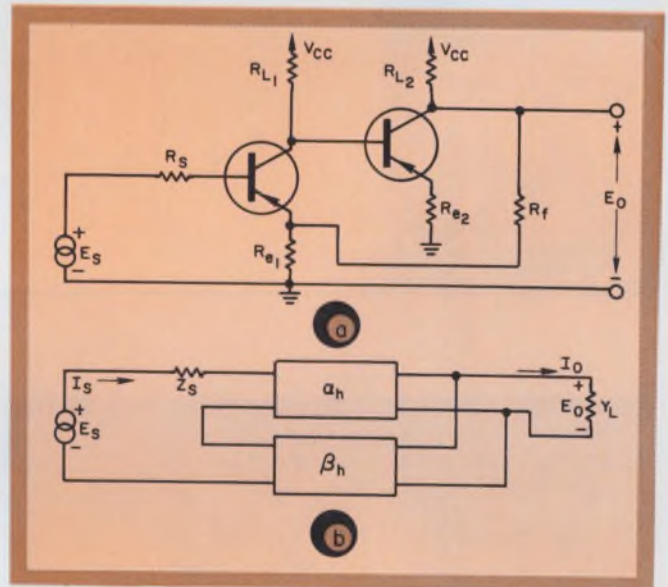

3. Typical shunt-series configuration (a) is best analyzed using g parameters (b) since I_o is common to both the forward and reverse networks and E_s is across both networks.

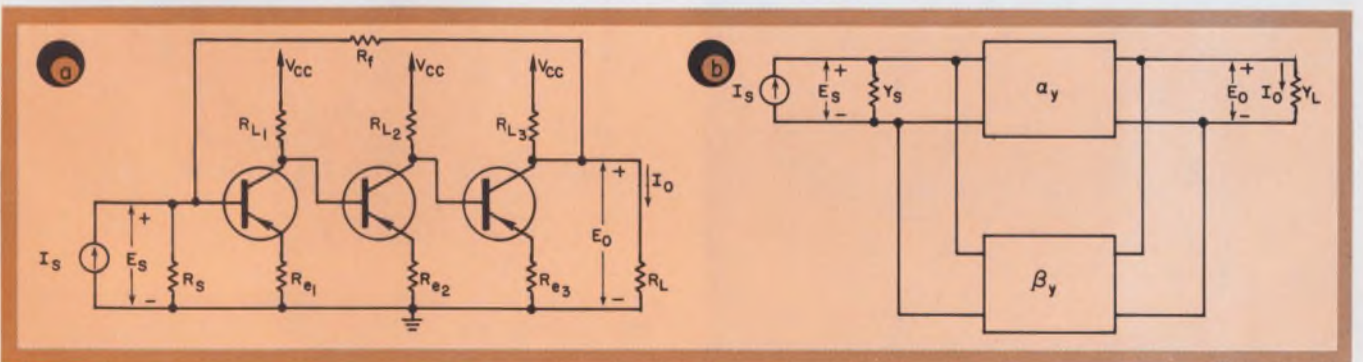

4. Typical shunt-shunt configuration (a) is best analyzed using y parameters (b). This selection of parameters is

based on the fact that E_o and E_s are both across the forward and reverse networks.

Table 1. Design equations

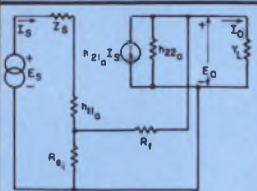
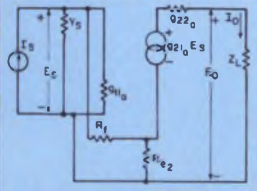
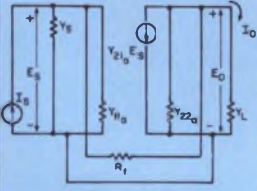
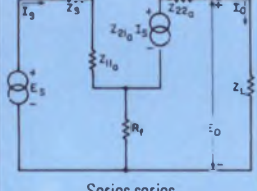
Configuration	Equation	β	α
 <p>Series-shunt</p>	4	$-\frac{R_{e1}}{R_{e1} + R_f}$	$\frac{E_o}{E_s} = \left(\frac{1}{R_s + r_{b'1} + R_{i1}} \right) (h_{fe1}) \left(\frac{R_{L1}}{R_{L1} + r_{b'2} + R_{i2}} \right) (h_{fe2}) (R_o)$
 <p>Shunt-series</p>	7	$-\frac{R_{e2}}{R_{e2} + R_f}$	$\frac{I_o}{I_s} = \left(\frac{R_p}{R_p + r_{b'1} + R_{i1}} \right) (h_{fe1}) \left(\frac{R_{L1}}{R_{L1} + r_{b'2} + R_{i2}} \right) (h_{fe2})$
 <p>Shunt-shunt</p>	10	$\frac{R_L}{R_f}$	$\frac{I_o}{I_s} = \left(\frac{R_1}{R_1 + r_{b'1} + R_{i1}} \right) (h_{fe1}) \left(\frac{R_{L1}}{R_{L1} + r_{b'2} + R_{i2}} \right) (h_{fe2}) \left(\frac{R_{L2}}{R_{L2} + r_{b'3} + R_{i3}} \right) (h_{fe3}) \left(\frac{R_3}{R_3 + R_L} \right)$ or $\frac{E_o}{E_s} = \frac{R_f}{R_s}$ (for the closed-loop amplifier)
 <p>Series-series</p>	13	$\frac{R_f}{R_L}$	$\frac{E_o}{E_s} = \left(\frac{1}{R_s + r_{b'1} + R_{i1}} \right) (h_{fe1}) \left(\frac{R_{L1}}{R_{L1} + r_{b'2} + R_{i2}} \right) (h_{fe2}) \left(\frac{R_{L2}}{R_{L2} + r_{b'3} + R_{i3}} \right) (h_{fe3}) \left(\frac{R_{L3}}{R_{L3} + R_o} \right) (R_o)$

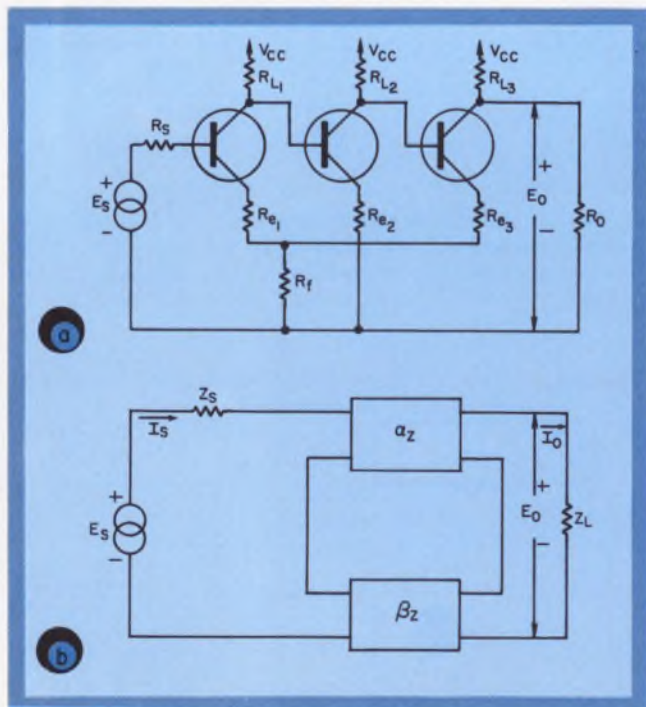

5. Typical series-series configuration (a) is best analyzed using z parameters (b) since I_s and I_o both flow through the forward and reverse networks.

Comparing Eq. 9 with Eq. 1 yields:

$$\alpha = \frac{-y_{21} Y_L}{(y_{11} + Y_s)(y_{22} + Y_L)} \quad (10)$$

$$\beta = -y_{12}/y_L$$

The results of these calculations are summarized in Table 1.

Series-series feedback

The series-series feedback amplifier shown in Fig. 5 lends itself to the use of a z parameter two-port:

$$\begin{bmatrix} E_s \\ E_o \end{bmatrix} = \begin{bmatrix} z_{11} + Z_s & z_{12} \\ z_{21} & z_{22} \end{bmatrix} \times \begin{bmatrix} I_s \\ I_o \end{bmatrix} \quad (11)$$

Solving for voltage gain:

$$\frac{E_o}{E_s} = \frac{z_{21} Z_L / (z_{11} + Z_s)(z_{22} + Z_L)}{1 - z_{12} z_{21} / (z_{11} + Z_s)(z_{22} + Z_L)} \quad (12)$$

Comparing Eq. 12 with Eq. 1 yields:

$$\alpha = \frac{z_{21} Z_L}{(z_{11} + Z_s)(z_{22} + Z_L)} \quad (13)$$

$$\beta = z_{12} / Z_L$$

The results of these calculations are summarized in Table 1. ■■

Reference

Ghausi, Mohammed S. *Principles and Design of Linear Active Circuits*, New York, N. Y., McGraw-Hill, Chap. 14.

For 60¢ you can buy a diode with 100 picosecond switching time, low forward resistance, low reverse current, low stored charge and all the other parameters that add up to better-than-PN junction performance. Hewlett-Packard's 5082-2810/11 Hot Carrier Diodes are the best — coming and going — that you can buy for high-speed switching

at low cost. They're 4½ times faster than any PN junction. Try to beat that combination in a circuit design.

In thousand quantities, the 5082-2811 diodes are 60¢ each and the 5082-2810 diodes are 90¢. So before you order another PN junction diode, or any other high-speed semiconductor, try one of HP's new hot carrier diodes.

Call or write to Hewlett-Packard, Palo Alto, California 94304; Europe: 1217 Meyrin-Geneva, Switzerland.

HEWLETT  PACKARD
SOLID STATE DEVICES

**Hot Carrier Diodes for
Switching
Logic
Clamping
Sampling
Log Conversion
A-D Conversion**

Fastest speed. Lowest price.

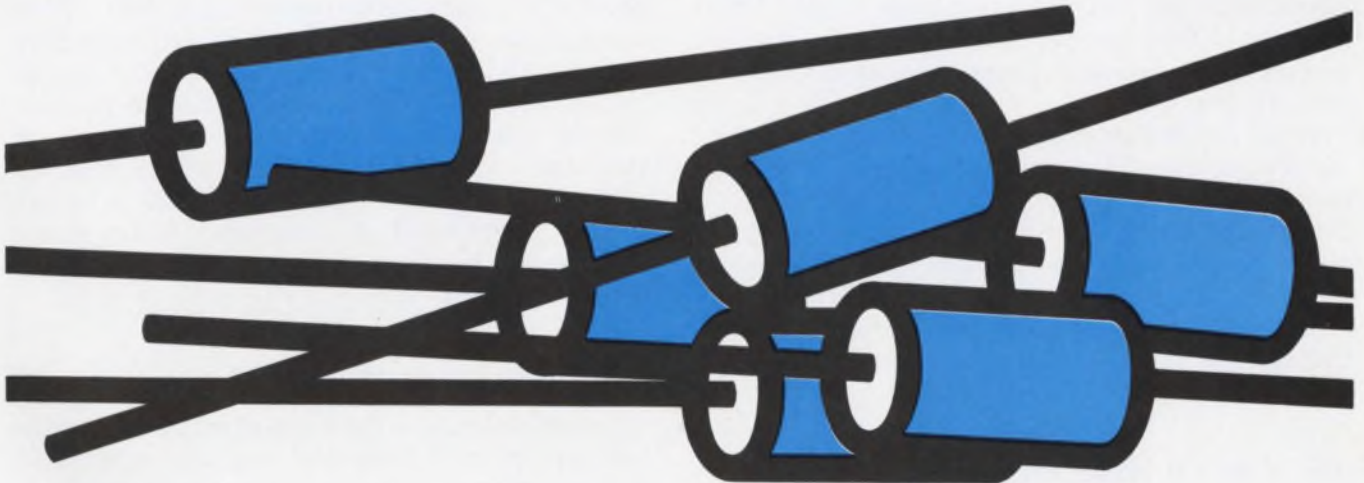

One step ahead of need (never two) was the over-all managing technique used by this Grumman engineer who directed NASA's assembling and testing program for LM 5.

Richard L. Turmail, Management & Careers Editor.

Immediately before Apollo 11's module scored a lunar touchdown, most of us back on earth were huddled around TV screens nervously anticipating all the mechanical and electrical functions that could go wrong. The happy fact that nothing did go wrong is a tribute to NASA's Lunar Module program in general, and to those responsible for the success of the LM assembly and test program in particular.

Because we think our readers are interested in knowing exactly how such a program was managed, we interviewed Paul Butler, Grumman Aerospace Corporation's Assistant LM Program Director for SCAT (spacecraft assembly and test). Mr. Butler is currently working on the company's space station project. NASA awarded the LM contract to Grumman in January, 1963. The company accounted for about 45% of the cost of the project, with over 7000 suppliers accounting for the remaining percentage.

Our questions and Butler's comments follow:

What were your emotions when the LM was approaching a lunar landing?

The landing didn't worry us, especially when Armstrong said that systems were still "go." The alarm light that came on didn't bother us because we knew the astronauts had more than 30 seconds of fuel left.

What worried us most was the launch from the moon's surface. During the landing the astronauts had an abort capability at any given time. Once they were on the moon, however, the engines had to work the first time. It bothered us that a man couldn't take over until the LM engine lit. I guess all of us were mentally going through the things that had to function to allow the ascent stage to leave the moon.

How is the LM project organized?

Dr. Ralph Tripp, LM Program Director, reports to Joe Gavin, Vice President, Space Pro-

grams. Five assistant program directors serve him through (1) engineering; (2) manufacturing; (3) spacecraft assembly and test; (4) ground support equipment; and (5) quality control.

What was SCAT's responsibility?

SCAT's responsibility was to assemble and test the LM to delivery for launch. Manufacturing produced the basic structural shell and wiring harness of the LM, and our job was to install all the black boxes, outfit the cabin, test all the systems, and take it up to the point where it could be flown. When the vehicle left Grumman it was absolutely complete, except for the fuel and the computer programs that were designed for the moon mission.

How did you maintain quality control?

Grumman representatives were present at each vendor's plant. We changed the mix of engineering and quality control constantly; we let it pulse as a function of what we were after. The vendors checked their parts out of their plant, and we checked them into our plant. We ran what we called a PIT-test (pre-installation test) every time we got a new piece of equipment. We'd check every piece before installing it in a vehicle to make sure it had not been damaged in transit.

Every time we broke, say, a connector, before we placed it back in its box we had to go back into the circuitry and exercise every copper path that went through that plug to be sure that the pin mated, and to be sure that when it didn't mate it didn't bend or come loose. Every single wire had to be functioning and have continuity from end to end.

How did you coordinate the work?

Coordination was the most effective key to the entire program. I happen to be a nut on planning and scheduling. Planning, to me, isn't tracking. Tracking just tells me where I am today, and I never want to know just that. What I want to

"You pay a guy a salary to do a professional job. If he does a good job, why do you have to reward him?"

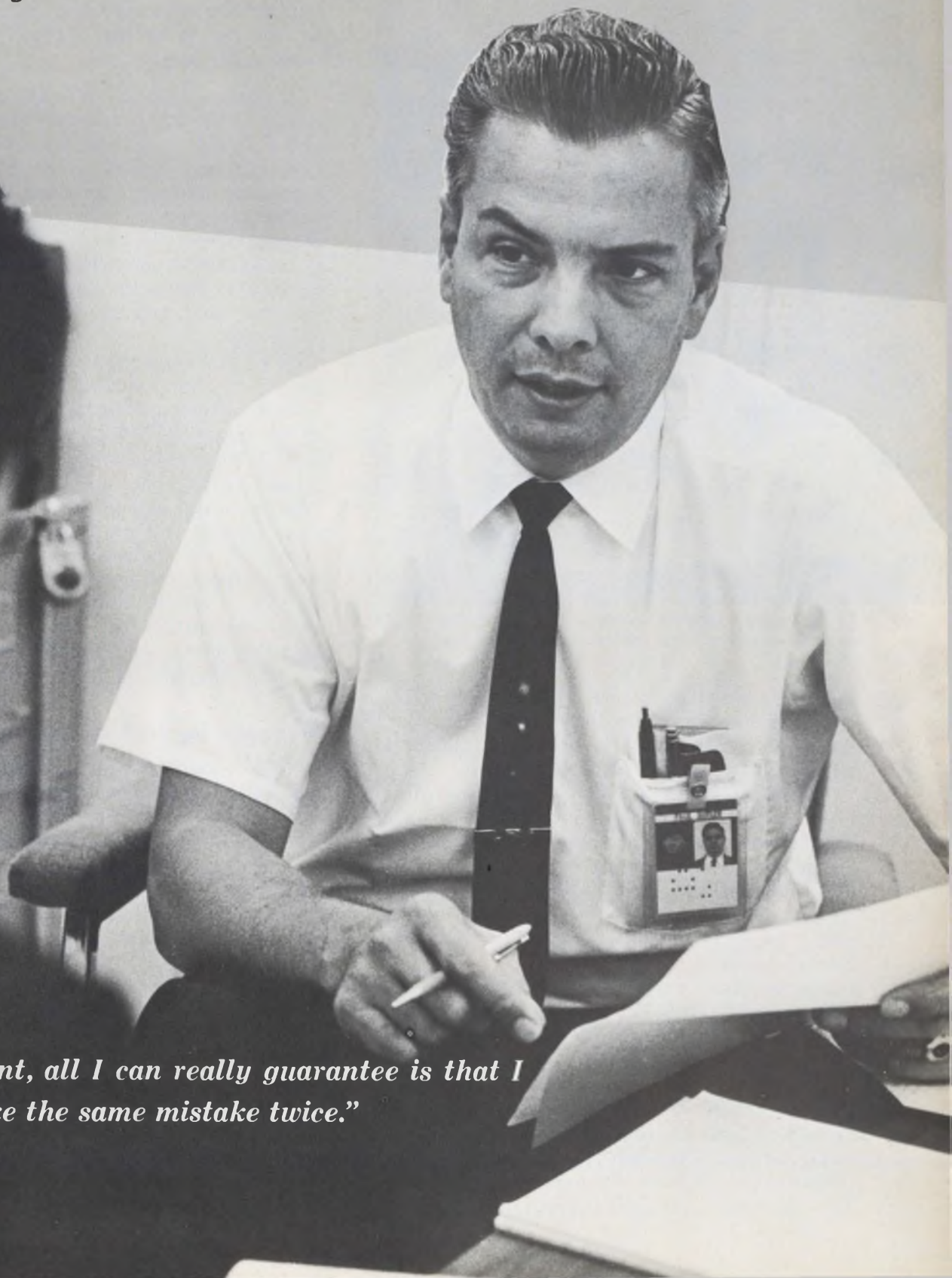

"In development, all I can really guarantee is that I will never make the same mistake twice."



The LM engine ignites! Grumman engineers congratulate each other as the lunar module kicks off the moon.

know is—based on where I am today—what's left, and how do I get there from here. So I denied the 1200 people of SCAT the chance to tell me what they did yesterday.

I think the key is this: I could quiz three group heads, and each head could say that he's one day down (one day behind schedule). One or two of the three might mean they were going to be down only one day three months from now. But one day down for the third man might mean he was going to miss by a month, or cause another group to miss by a month.

We constantly assessed the impact of the current position. LM is not production, it's development in the truest sense of the word; for each LM mission is a stepping-stone to the next one.

Let's consider two philosophies to explain the basic difference between development, and production. I can use the philosophy that says I want parts on the shelf: if something breaks, I can take it off the shelf and put it into play. This indicates a production program. But in de-

velopment, the first time you have an anomaly you want to find out right away what failed, why it failed, and how you can fix it so it doesn't fail again. When you determine the cause of the failure, you then modify all the subsequent boxes . . . And you have to be careful not to overhandle the box because you're likely to destroy its integrity.

How did you work out the timing of the deliveries for subsystems so that related pieces would be ready at the proper time?

A master schedule was the real heart of the timing. I like to pace parts coming in slightly ahead of my needs. One ahead of need—never two, just one. Installing one part triggers the scheduling system to produce the next one, or deliver the next one as the case might be. Of course, we had confidence in some of the hardware, and we'd go ahead and install it. But we couldn't do that with some of the active pieces like the radar, which we'd been working with constantly.

Now where this "one ahead of need" system gets to be significant is if the LM on the pad, with it maximum priority, lays a requirement on us for a part. We'd take it from the last vehicle on the line or, if it wasn't there, from the next vehicle up the line, and so on. We had three vehicles on test here at all times, and there were three vehicles at Cape Kennedy.

Our job, in addition to moving vehicles out, was to support the Cape. I could pull a part from the No. 1 vehicle in Bethpage, figuring that I had more latitude to employ a "work-around" than they had down there. We had 24 hours; at the Cape they had only one hour.

What would you avoid doing again?

Nothing really stands out in my mind. We're constantly improving the system; better management methods were spawned by an evolutionary process. Once we put the LM together we had to hook the ground support equipment to it and check it to see if it was functioning. We're constantly refining this check-out system. When I get smarter I expect to be able to check some major system, knowing full well that if I get certain parameters out of it all systems must be working.

The development program is, by nature, one that teaches us what to avoid doing the next time. For example, we took 80 days of electrical subsystem testing and cut it to 20 through better test logic and experience. If we were going to work on LM for 10 years we could check it out in a short time. Weight is important. If you knew some circuitry in a given component was

required by another one, you'd use that same circuit rather than repeat it.

What is the cost differential between manned and unmanned space vehicles?

The human being can handle emergencies. Neil Armstrong could probably have landed on a rock and got away with it. But he saw it so he came down and moved over away from it. Some of the unmanned Surveyors landed, and some didn't. The cost would depend mostly on what the vehicle is sent for. The cheapest way to go is in a manned LM with no backup system.

What element of chance was there in designing the LM to land and take off from the moon?

We weren't certain how large the landing gear should be. We asked ourselves: Does radar reflect and bounce off the lunar surface, or does it penetrate x amount of feet and then bounce back? Would there be dust on the surface or not? What was the composition of the surface, and how big a footprint did we need to support it? We were extremely conservative. We made the pads three feet plus. We learned later, of course, that the pads penetrated the lunar surface by 1/4 inch.

What was your most serious problem in assembling and testing LM?

Water glycol. How was it used? You have to get rid of heat. On earth you can turn on the fan. But in the vacuum of space you don't have this capability. The thermal characteristics in space are extreme. In the absence of any atmosphere, the sun side of the vehicle gets very hot and the shade side gets very cold.

If I want to cool a piece of hot radio equipment I can suck the heat off through a cold plate. Now I've got the heat in the cold plate, but I still have to get rid of it some way. So I transfer the heat from the cold plate into a hollow tube containing water glycol. Then it passes on through sublimators. I'll boil off some water and pass the heat off into the hard vacuum of space.

The main problem with glycol is that it forms a residue. Many times we'd be working up on top of the LM and break a line. If we spilled the glycol we had to keep washing the LM down with distilled water and wipe the surface with litmus paper to make absolutely sure that the residue was off. If we didn't get it off and the water hit the thermal-shielding blanket it would injure it. Then we'd have to take the blanket off and change it. A water glycol spill was serious because it took time to correct the mistake, and time was our most important commodity.

(continued on next page)

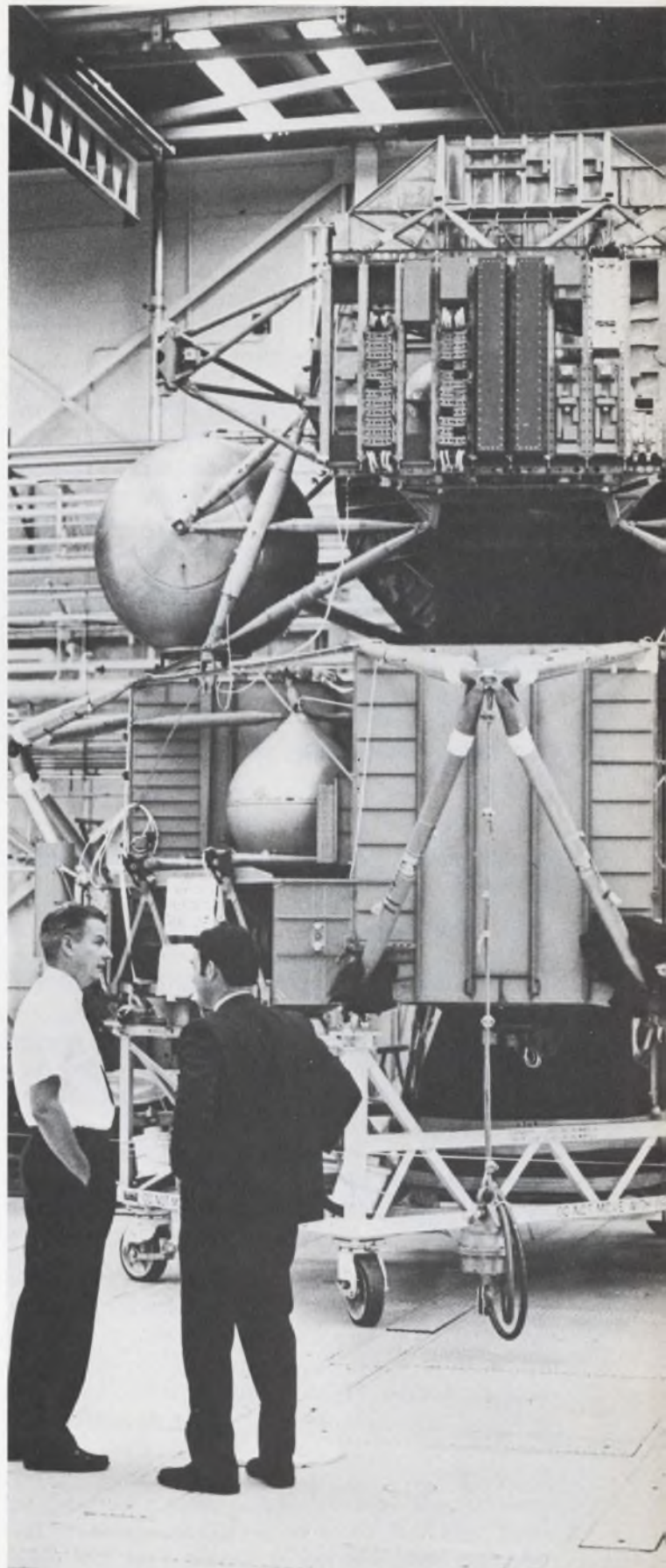

"LM is built inside-out because in outer space the vacuum is on the outside, and the atmosphere is on the inside," Butler tells ELECTRONIC DESIGN editor Dick Turmail at Grumman plant as they inspect a mock-up of the LM innards.

How were employees motivated to maintain the high reliability of the LM?

A staff can build an airplane and watch it fly, and then they can work on it some more and watch it fly again. But after a LM is finished, your staff will never see it again except on TV. This kind of engineering makes it difficult for management to motivate a man to admit he's made a mistake. We overcame this problem through a fortunate selection of people over a long period of time. We chose people who had a human desire to do a good job.

If one of them goofed, I would talk to him and ask him if he had learned something from the mistake. I would ask him what he was going to do the next time. I like to know why people do things. Many will give you "reasons" when they're really only trying to convey a thought. The key to good management is in trying to determine your staff's mental process rather than the words they're using. If you understand the mental process, you can begin to solve their problem.

In development, all I can really guarantee is that I will never make the same mistake twice. That guarantee automatically means that I will keep getting better.

Does Grumman have any incentive bonus program for engineers on the LM project?

No. Everybody says, "What are you going to do for your people?" From my own warped personal point of view—nothing. We already did it. You pay a guy a salary to do a professional job. If he does a good job, why do you have to reward him? I like to think that doing a good job is part of the professionalism of being an engineer.

Some companies believe that the only way to hold onto their best people is to give them a piece of the action.

I don't believe that. The only way to hold onto the best people is to give them a challenge. If you have the moxie it takes to be a good engineer today, you don't want to sit back; you want to create. If an engineer doesn't have a challenge, more money isn't going to help him.

When the LM approached the moon's surface, the alarm light that came on with 30 seconds of fuel remaining was reported as having been the result of an overloaded computer. How do you overload a computer?

Everything that's fed into a computer has a priority. The LM computer was saturated by

low-priority programs. When a computer is programmed, it has a built-in circuit that says, "Hey, I'm so saturated I can do only one program at a time." When the alarm lit up, it simply meant that the low-priority programs were not being interrogated by the computer.

Neil Armstrong wasn't concerned about those programs anyway; the computer still had the capability to match anything he was going to do. We knew we had 90 seconds of overfuel against his time-line; 30 seconds represented one-third of his overfuel left. That's a pretty good margin. You don't want to carry a lot of fuel anyway. For every pound you want to land up there, it takes four pounds on the pad to get it off. From a safety and economy standpoint, you don't want to land something you're not going to bring back with a large safety margin.

Did NASA breathe down your neck?

Sure. Sometimes we expected it—sometimes we didn't. I'll say this: The relationship I enjoyed in SCAT was closer and on a higher technical plane than any I've ever known. The problem we had to solve forced a much closer relationship; we didn't just talk contract ties, we talked technical problems and solutions.

What kind of engineering talent are you interested in for the future?

That depends on the direction the company wants to take in the future. What is the post-Apollo space program?

Whatever it is, it will include an orbiting space station. Most of the cost right now is in getting from earth into orbit. Of course, we'd still have to get up to the station, but I could get there with a bulk of fuel and run back and forth from the moon many, many times before I'd have to go back to earth. I could always send the spacecraft back to an orbiting space station, repair it, and stick it back in orbit.

Three things will drive the space program: Performance, cost and time. Apollo definitely had time as its driver, but it also had to perform. Cost? No one knew how to land on the moon at a lower cost and still do it in this decade. Time? Post-Apollo programs will be willing to let time slide.

Do you have any regrets about the LM program?

One regret I have is that the descent stage is on the moon forever more, and the ascent stage is orbiting the moon. We'll never get them into the Smithsonian Institution for future generations to see. ■■

The
Choice
is **TTL.**

TI introduces an MSI parity generator/checker which has no equal.

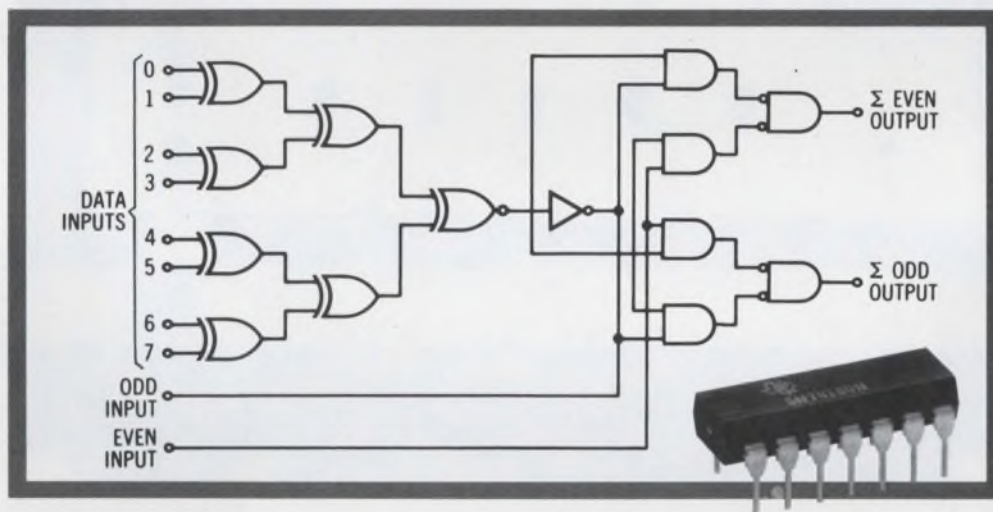

(Peerless speed and economy.)

TI's new SN54180/SN74180 MSI circuits generate ODD/EVEN parity for 8-bit words in only 32 nanoseconds. For longer word lengths, each additional 8-bits requires a mere 10 ns. Thus, parity for a 16-bit word is accomplished in a quick 42 ns.

Power dissipation: typically 170 milliwatts.

As for packages, you have an unparalleled choice of flat packs, ceramic or plastic dual-in-lines.

And you won't find the equivalent function anywhere else for

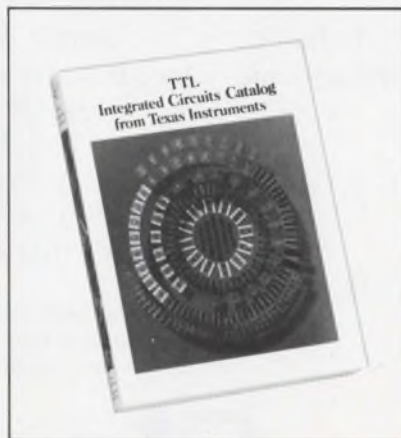

\$7.69 (plastic package, 100-999 quantities). Prompt delivery. Full compatibility with TI's other TTL and DTL circuits.

You'll want more facts, so we've put together a level-headed 424-page catalog containing the data sheets on every Series 54/74 TTL circuit from TI. Circle 113 on the Reader Service card or write Texas Instruments Incorporated, P. O. Box 5012, M.S. 308, Dallas, Texas 75222. Or check with your nearby authorized TI Distributor.



TEXAS INSTRUMENTS
INCORPORATED

This IC tester is simple-minded.

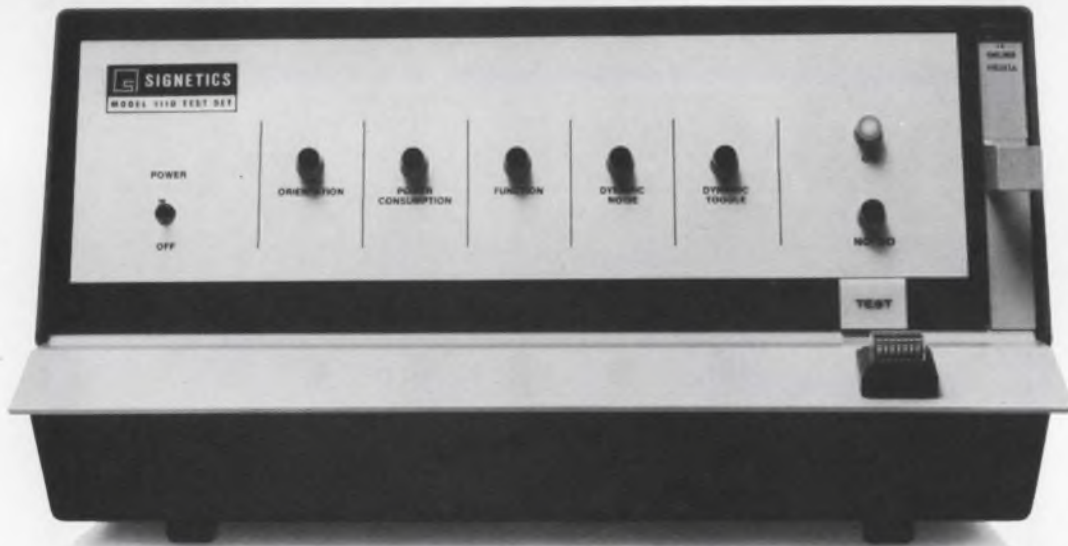

You like things uncomplicated. Streamlined. Functional.

So that's the way we built our Model 1110 Digital IC Tester.

No gauges to twiddle, no knobs to fiddle. In fact, it's so easy even your secretary can handle it.

It takes five steps:

1. Select and insert a single program board.
2. Insert IC in test socket.
3. Push test button—blink, blink, blink.
4. Go—the IC is good.
5. No go—it fails the test.*

And our model has a high accuracy rating of 1% on DC parameter tests which only seems right for a company that has years of experience in the integrated circuit field.

Simple enough? You'll find the price is too. It starts at \$4,500.

Now all you have to do is write us for a sales brochure and data sheets. Or, call Marketing, Signetics, Measurement Data (415) 961-9399 or 961-9384 for a demonstration.

It's that simple.

*Specific tests indicated... 1) orientation test, 2) power consumption test, 3) function test, 4) dynamic noise test, 5) dynamic toggle test.

Signetics

MEASUREMENT / DATA

Signetics, Measurement/Data, 341 Moffett Blvd., Mountain View, Calif. 94040 / A subsidiary of Corning Glass Works

INFORMATION RETRIEVAL NUMBER 48

Generate variable-phase square waves this cheap, easy way

Converting a sine wave into a constant-amplitude square wave with adjustable phase shift is often necessary in such circuits as phase-sensitive detectors. A very satisfactory solution to this need, using inexpensive monolithic operational amplifiers and operating over the full 0° to 180° range, is shown in the figure.

Amplifier *A1* is an inverting sine wave generator, and *A2* is a cosine generator. The outputs are summed together by *A3* with relative weighting controlled by *P1*. The input to *A3* is thus a sinusoid whose amplitude and phase are deter-

mined by the amplitudes of the input sine and cosine waves. Because *A3* is operated open-loop, it acts as a zero-crossing detector generating a constant amplitude square wave whose phase can be adjusted from -90° to $+90^\circ$. The circuit can be used at any frequency from 10 Hz to 1 MHz by setting the reactance of *C* to 10 k Ω at the desired frequency.

John R. Nielsen, Electrical Engineer, Idaho Nuclear Corp., Idaho Falls, Ida.

VOTE FOR 311

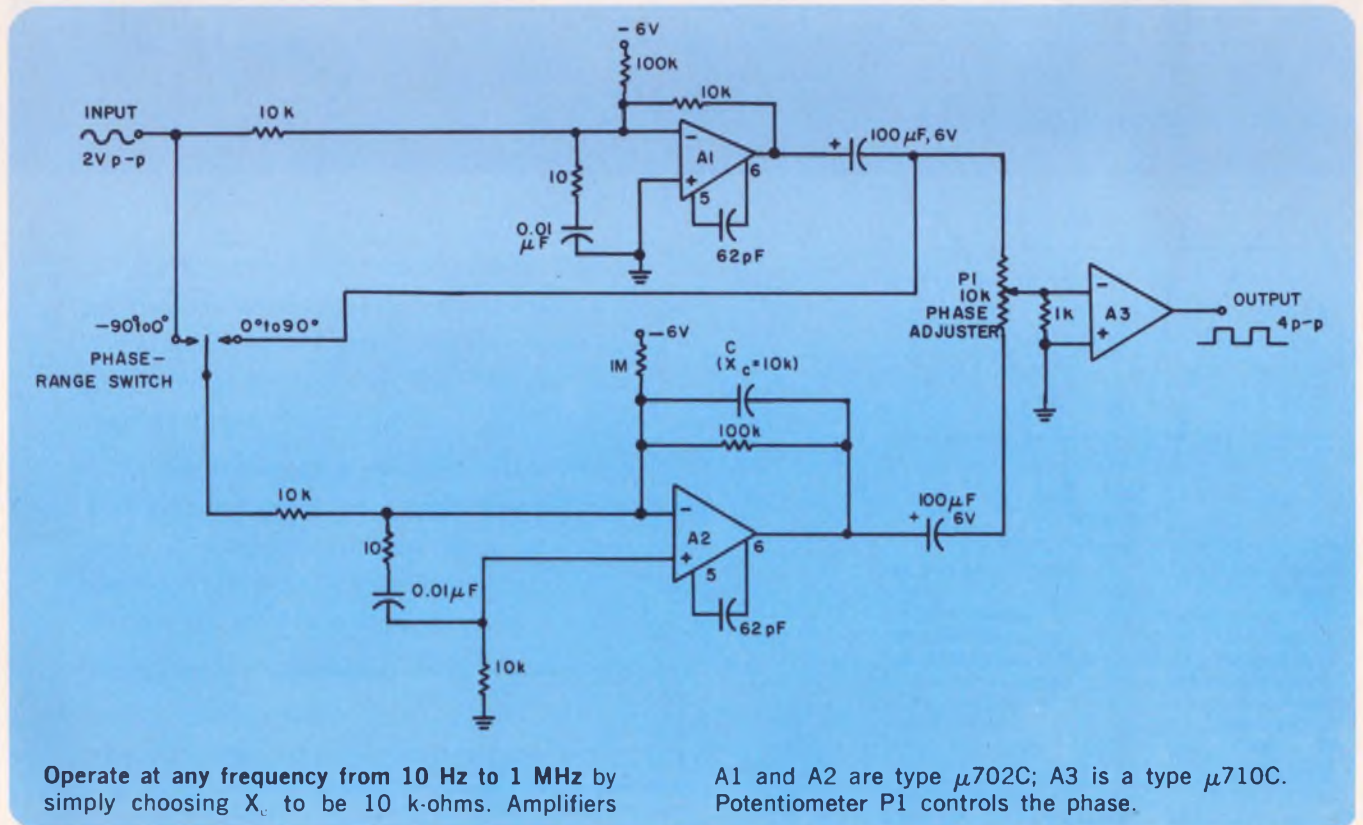

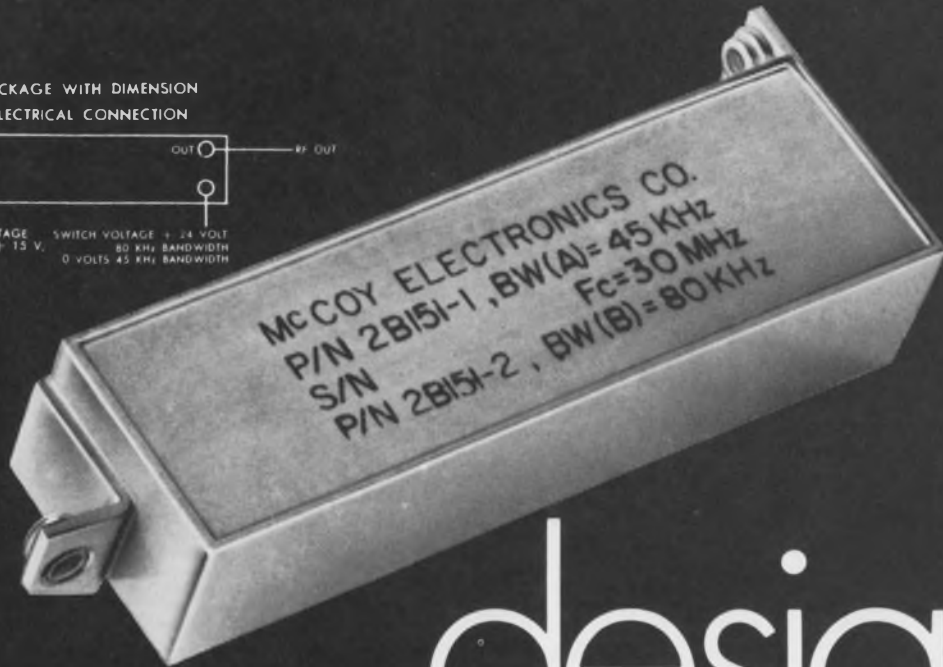
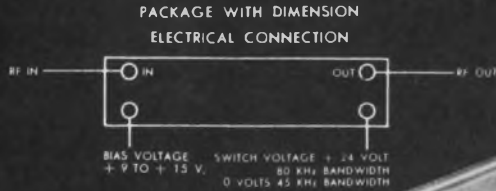

design freedom

yours with the new switchable dual bandwidth
crystal filters

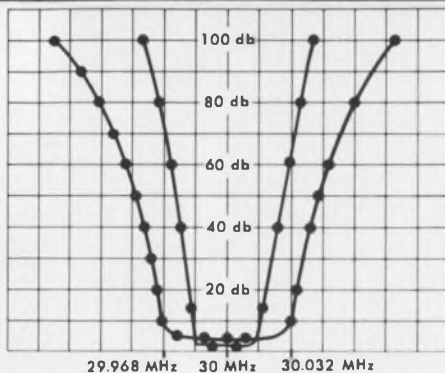

SPECIFICATION	CENTER FREQUENCY 30 MHz
filter (A)	filter (B)
1 db Bandwidth 35 KHz Min.	1 db Bandwidth 64 KHz Min.
6 db Bandwidth 45 KHz Min.	6 db Bandwidth 80 KHz Min.
60 db Bandwidth 90 KHz Max.	60 db Bandwidth 160 KHz Max.
Ultimate Attenuation 80 db	Ultimate Attenuation 80 db
Impedance 50 Ω in & out	Impedance 50 Ω in & out
Ripple 1 db Max.	Ripple 1 db Max.
I.L. \leq 4 db	I.L. \leq 4 db
ENVIRONMENTAL:	Tol.
TR -55°C to 105°C	Center Frequency \pm .005%
Vibration—Mil. Std. 202	Method 204 A Test Cond. D
Shock—Mil. Std. 202	Method 205 C Test Cond. C

For multi-mode communication systems, McCoy has added another technological achievement in expanding applications for crystal filters. The switchable filter is custom-made to your specifications, economically, and in a small package.

At McCoy Electronics, the integration of crystal and filter engineering technology is your assurance of the finest crystal filter performance available today. And we'll be ready for tomorrow with the next dimension in crystal filters to suit your future needs.

Put our experience to work for you!



MCCOY ELECTRONICS COMPANY
MT. HOLLY SPRINGS, PENNSYLVANIA 17065
Tel. 717-486-3411 TWX: 510-650-3548
a subsidiary of OAK ELECTRO/NETICS CORP

INFORMATION RETRIEVAL NUMBER 49

Transformer-less Meacham bridge employs IC op amp

An untuned version of the well-known Meacham Bridge crystal oscillator can easily be built with an IC op amp (Fig. 1). Unlike many other IC crystal "clocks," this one maintains the crystal drive at a constant level, thus improving the circuit's frequency stability.

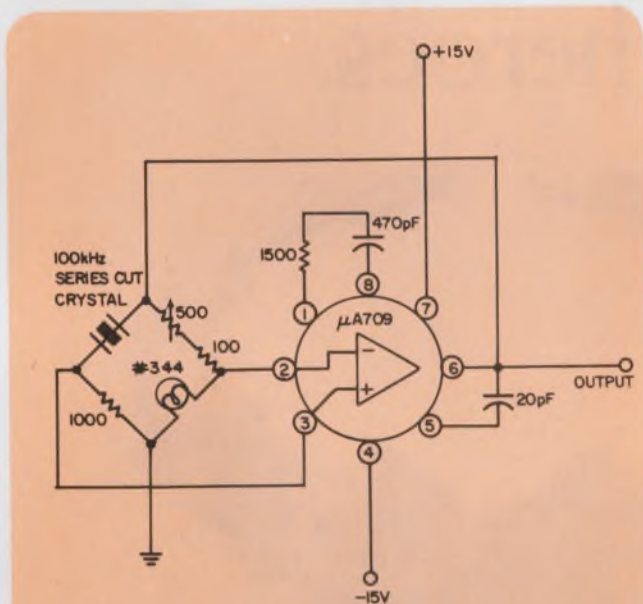

1. No transformer is used in this Meacham Bridge. An IC op amp is combined with a light bulb to keep the crystal drive level fixed.

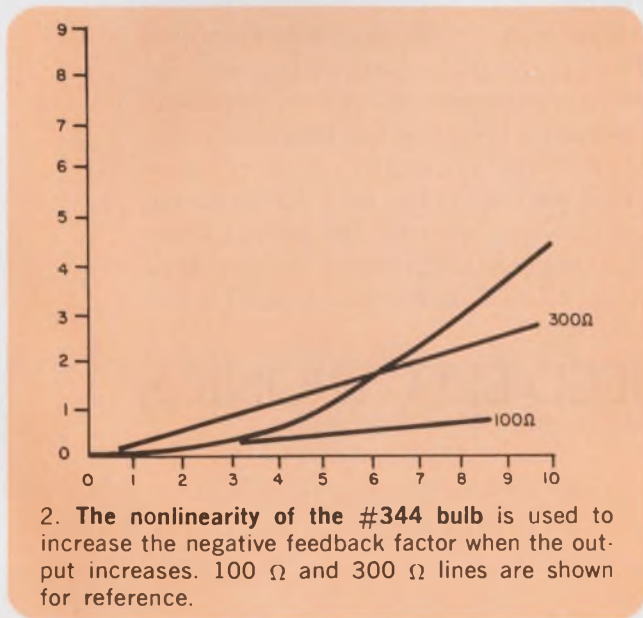

2. The nonlinearity of the #344 bulb is used to increase the negative feedback factor when the output increases. 100 Ω and 300 Ω lines are shown for reference.

A #344 lamp on the negative feedback side of the bridge acts as a nonlinear element (Fig. 2) to cause an increase in the negative feedback factor when the output increases. This operating point stabilization is similar to that used in most RC audio generators.

Since the lamp operates at about 100 Ω and the crystal series resistance at series-resonance is about 1000 Ω, it is not possible to make all of the bridge arms equal. This would improve the stability of the design.

By using a vacuum-mounted crystal, with a lower series resistance, the all-equal-arm aim could be approached. Also, as op amps with higher frequency cutoffs become available, AT-cut crystals above 1 MHz could be used in similar designs. These crystals have about 100 Ω of series resistance near 2.5 MHz and would seem to be naturals for such a Meacham Bridge.

Henry D. Olson, Research Engineer, Stanford Research Institute, Menlo Park, Calif.

VOTE FOR 312

Divide by 3, 5 or 10 with a minimum of hardware

Many digital applications require frequency dividers of factors other than the binary quantities 2, 4, 8, etc. There are several techniques for designing such dividers, and most of them require additional gates or components.

A technique that is more economical in the use of components utilizes the set and clear in-

VOTE

VOTE! Go through all Idea-for-Design entries, select the best, and circle the appropriate number on the Reader-Service-Card.

SEND US YOUR IDEAS FOR DESIGN. You may win a grand total of \$1050 (cash)! Here's how. Submit your IFD describing a new or important circuit or design technique, the clever use of a new component or test equipment, packaging tips, cost-saving ideas to our Ideas-for-Design editor. You will receive \$20 for each accepted idea, \$30 more if it is voted best-of-issue by our readers. The best-of-issue winners become eligible for the Idea Of the Year award of \$1000.

We have a memory that will make design engineers look like heroes.



How about a small to medium size memory with an access time of 250 nanoseconds. Cycle time of 500 nanoseconds. With 4K to 16K words of from 10 to 60 bits. And the lowest price going.

The CE-50 state-of-the-art, $2\frac{1}{2}$ D, three wire memory is available now. That's immediate delivery for the latest and best small to medium size memory you can buy anywhere.

The CE-50's spec sheet is nothing less than heroic. But what else could you expect from the company that's delivered more than 100 million bits of $2\frac{1}{2}$ D memories. The numbers and facts are yours for the asking. Write: Memory Products, Lockheed Electronics Company, Data Products Division, 6201 East Randolph Street, Los Angeles, California 90022.

LOCKHEED ELECTRONICS

A Division of Lockheed Aircraft Corporation

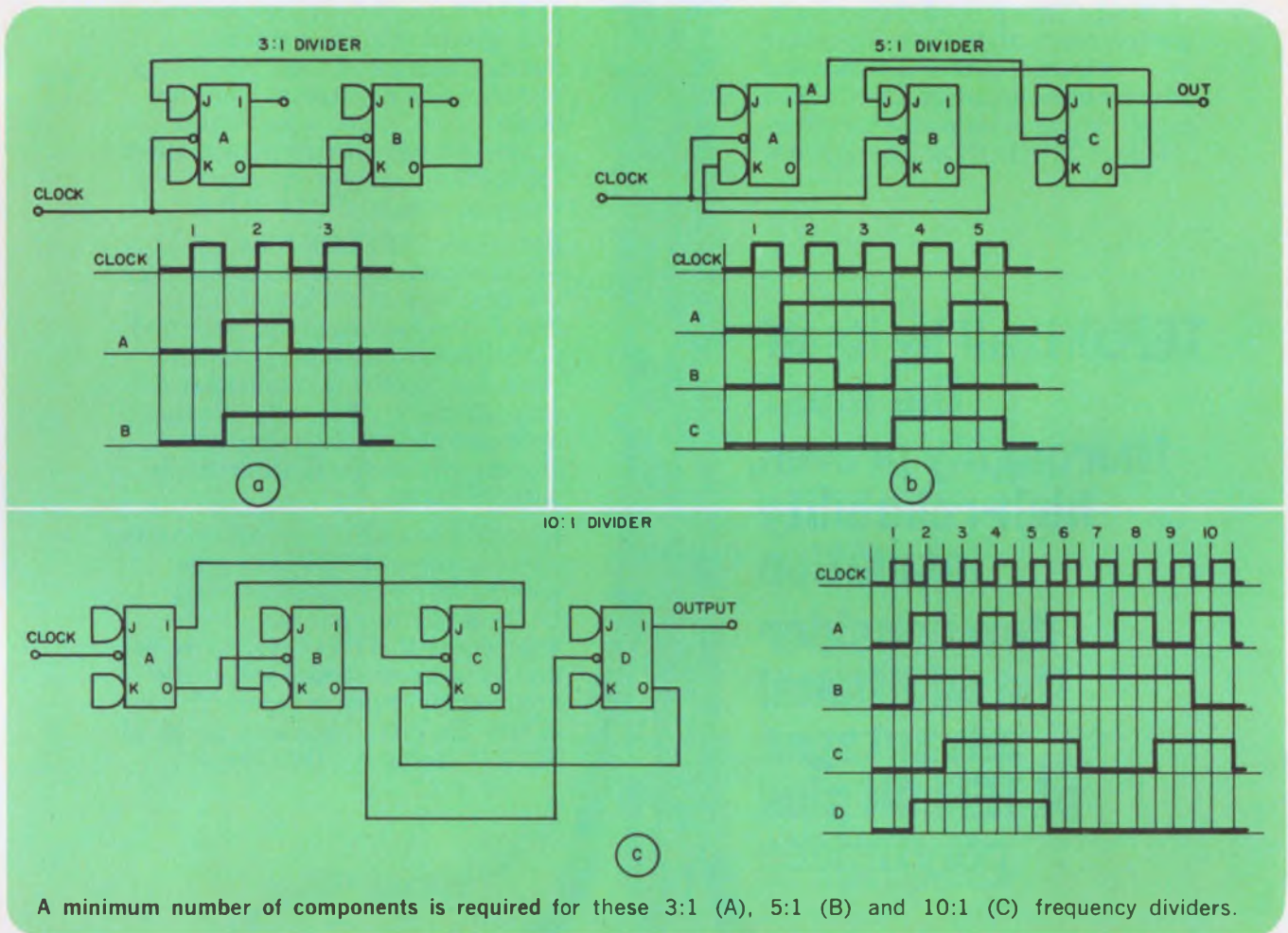

A minimum number of components is required for these 3:1 (A), 5:1 (B) and 10:1 (C) frequency dividers.

puts of J-K flip-flops. Minimum-hardware frequency dividers of this type for factors of 3, 5, and 10 are shown in the illustrations. These arrangements are suitable for either DTL or TTL

J-K flip-flops.

Basil Ioannou and Carl Brunnett, Design Engineers, Picker Instruments, Cleveland, Ohio.

VOTE FOR 313

Send us those programing short cuts

In line with the impact that time-sharing terminals are having on the work of the electronic designer, ELECTRONIC DESIGN will now accept computer programs and subroutines as Ideas for Design. The only requirements are that the program perform some useful design calculation or function, that it be in a recognized computer language, and that it not exceed 60 lines.

So come on—send us those programing short cuts and clever subroutines.

Lumped model improves CAD analysis of transmission lines

Most programs for the computer-aided design (CAD) of electrical circuits are limited to lumped-parameter circuit representations. However, it is often necessary to handle transmission lines with such programs. A lumped-parameter approximation (Fig. 1) is usually used for this purpose.

If the CAD program can handle controlled voltage and current sources, the six-element equivalent circuit of Fig. 2 can be used to advantage. It is an *exact* equivalent of a lossless

For over 20 years, wire insulations of Du Pont TEFLON fluorocarbon resins have provided maximum performance and reliability under extremes of temperature and adverse environments. But did you know there are composite constructions of TEFLON and polyimides

**TEFLON: all by itself
the most
thoroughly proven,
high-reliability
insulation**

**Now consider
the additional
advantages
of TEFLON plus
polyimides**

which offer you extra performance benefits for all wiring applications? TEFLON plus polyimide constructions guard against installation damage because of their toughness and abrasion resistance. They are made in two forms: a polyimide enamel over a primary insulation of TEFLON or a polyimide tape wrapped around the TEFLON.

Both these "TEFLON plus..." constructions are rated for use over a wide temperature range—up to 260°C. They are easily printed and potted, nonflammable, chemical-resistant, lightweight and have a small diameter. They provide the optimum dielectric quality which you expect from insulations made with TEFLON.

If you'd like additional information on composites of TEFLON plus polyimides (or composites using mineral fillers or polyvinylidene fluorides with TEFLON), write us and let us know about the specific application you have in mind.

Write: Du Pont Company, Room H 7297, Wilmington, Del. 19898.

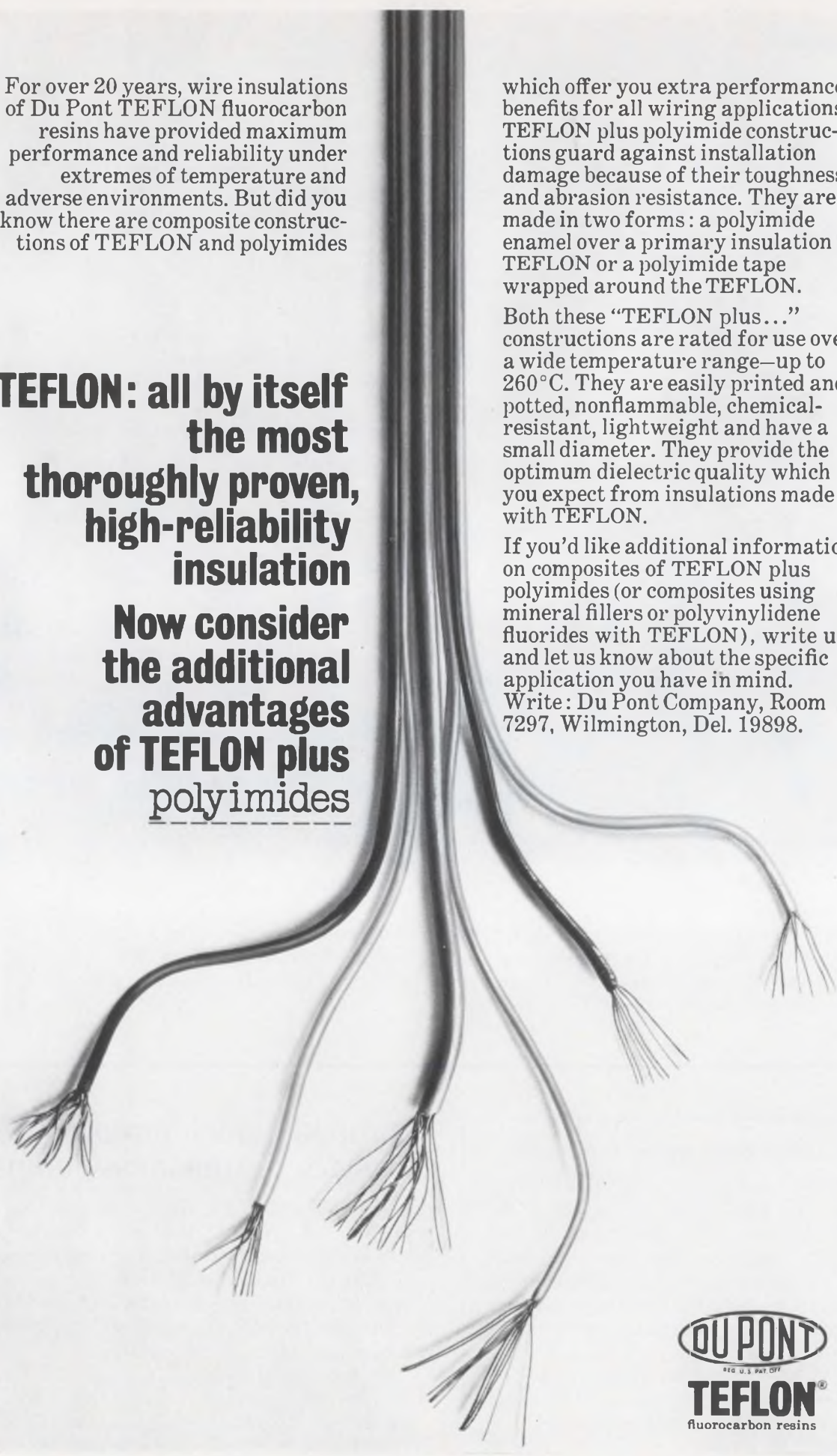

DU PONT
REG. U.S. PAT. OFF.
TEFLON[®]
fluorocarbon resins

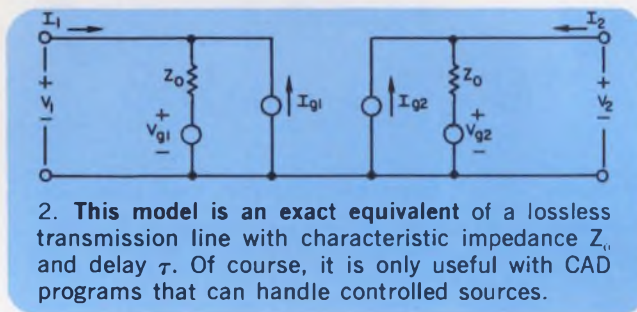
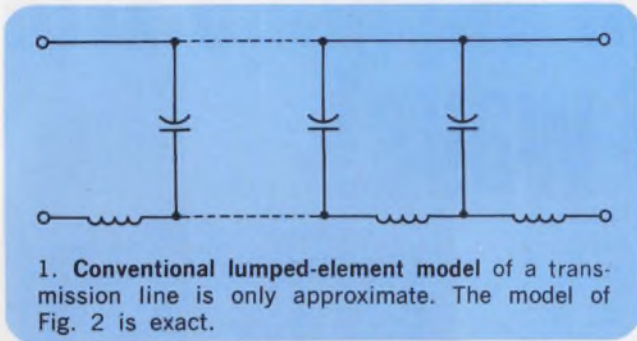

transmission line of characteristic impedance Z_0 and delay τ . The circuit is especially well-suited to steady-state analysis.

The four controlled sources are:

$$\begin{aligned} V_{g1} &= V_2 e^{-i\omega\tau} & V_{g2} &= V_1 e^{-i\omega\tau} \\ I_{g1} &= I_2 e^{-i\omega\tau} & I_{g2} &= I_1 e^{-i\omega\tau} \end{aligned}$$

If it is desired to use the model for a transient analysis, the equations should be replaced by their time-domain forms:

$$\begin{aligned} V_{g1}(t) &= V_2(t-\tau) & V_{g2}(t) &= V_1(t-\tau) \\ I_{g1}(t) &= I_2(t-\tau) & I_{g2}(t) &= I_1(t-\tau) \end{aligned}$$

Of course, for the transient analysis, the computer must remember the histories of I_1 , I_2 , V_1 and V_2 from $t - \tau$ up to the present time, t .

John J. Carroll, *Electrical Engineer, U. S. Naval Avionics Facility, Indianapolis, Indiana.*

VOTE FOR 314

LEDs have advantages as constant brightness sources

A light emitting diode (LED) can replace the incandescent lamp and provide constant brightness references for industrial equipment. The circuit shown combines good stability and control with low cost. Furthermore, there is no need to resort to optical feedback. Control is attained to $\pm 3\%$ of the diode's brightness at ambient temperatures over the range from $+10^\circ$ to

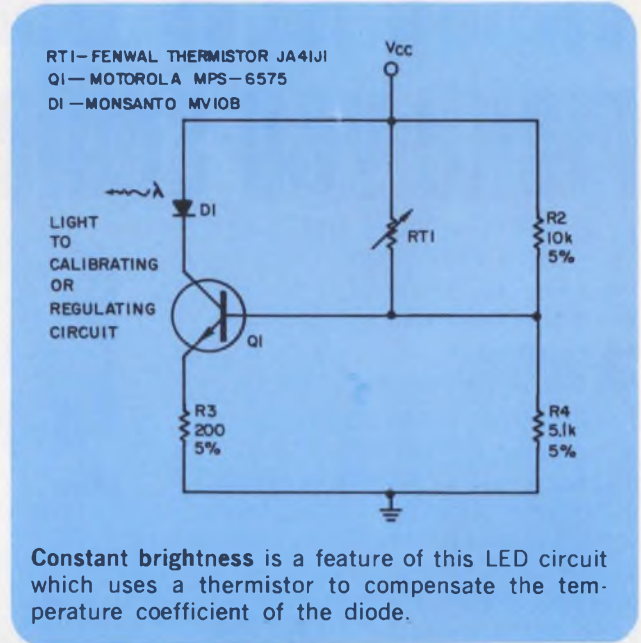

$+50^\circ\text{C}$. Also, there is no need to compensate for aging or blackening as is the case with incandescent lamps.

The circuit relies on the stability inherent in solid state light sources as well as their long life. Unlike incandescent lights, light-emitting diodes do have thermal coefficients but they are predictable.

In the circuit shown, the thermistor, RT1, provides the necessary temperature compensation. The constant brightness circuit is driven from a regulated dc supply providing $+12$ volts. The forward current of diode D1 at ambient temperature is set by resistor R3. Five percent tolerance resistors are sufficient for the 3 percent control this circuit provides.

The temperature characteristic of the light-emitting diode is improved at least one order of magnitude by the thermistor. The LED temperature coefficient is negative, and the diode's light output decreases with increases in temperature. However, increases in temperature also decrease the thermistor's resistance thus increasing the base drive of Q1 and, consequently, the diode current. As a result, the diode's light output remains constant over the temperature range. For falling temperatures, the forward current is lowered by the increase in the thermistor's resistance. In this manner, the current through the diode is reduced as the temperature decreases, and its light output again remains stable with temperature changes.

William Otsuka, *Applications Manager, Monsanto Co., Cupertino, Calif.*

VOTE FOR 315

These NEW Bench Supplies will make you smile 3 ways!

- 1 Excellent regulation .01% and -ripple only 250 mv!
- 2 Same Day Shipment. No annoying wait
- 3 Low Price. You can buy several

The BP-89 and BP-118 both give you a regulation of supply within 0.01% and ripple is 250 microvolts. Silicon differential amplifiers and stable voltage references result in excellent stability. They are short circuit and overload protected, and feature MIL spec performance. At such low prices, you can afford to have several of these fine power supplies available. Stop waiting in line to use the more expensive one, and smile!



BP-89
0-34 volts at 0.5 amps for **\$89**

BP-118
0-34 volts at 1.5 amps for **\$118**

SPECIFICATIONS

OUTPUT: 0-34Vdc, BP-89 — 0-500mA BP-118 1.5Amp
INPUT: 105-125Vac, single phase, 50-400Hz
LOAD REGULATION: Less than $\pm 0.01\%$ plus 1mV output voltage change for a load current change equal to the current rating of the supply.
LINE REGULATION: Less than $\pm 0.01\%$ output voltage change for a change in line voltage from 105 to 125 (or 125 to 105) volts at any output voltage and current within rating.

RIPPLE AND NOISE: Less than 200 μ V RMS/1mV p-p
TEMPERATURE COEFFICIENT: Output voltage change per degree centigrade is less than 0.02% plus 1mV after 30-minutes warmup.
STABILITY: The total drift for 8 hours (after 30 minutes warmup) at a constant ambient is less than 0.1% plus 5mV.
CONSTRUCTION: All metal case with baked enamel finish.



POWER/MATE CORP.

514 S. River St., Hackensack, N.J. 07601
 (201) 343-6294, TWX: (710) 990-5023

SAME DAY SHIPMENT

INFORMATION RETRIEVAL NUMBER 52



Let our ultrasonic switch put silent sound to work.

It counts, sorts, positions, and monitors regardless of environment. Detects without contact; senses through dust, smoke, steam, fog, snow and contamination.

Beam patterns can be reshaped with accessories to perform almost any task. The switch is energized by completion or interruption of the beam. Operates from 40 ft. to .17 in. At speeds up to 500/min. with an electromagnetic relay, 1500/min. with our Reed Switch Relay. NEMA 1 and NEMA 5-12 enclosures.

Get the facts. Call your Cutler-Hammer Distributor or circle Reader Service Number below.



CUTLER-HAMMER

POWER DISTRIBUTION & CONTROL DIVISION, Milwaukee, Wis. 53201



INFORMATION RETRIEVAL NUMBER 53

Products

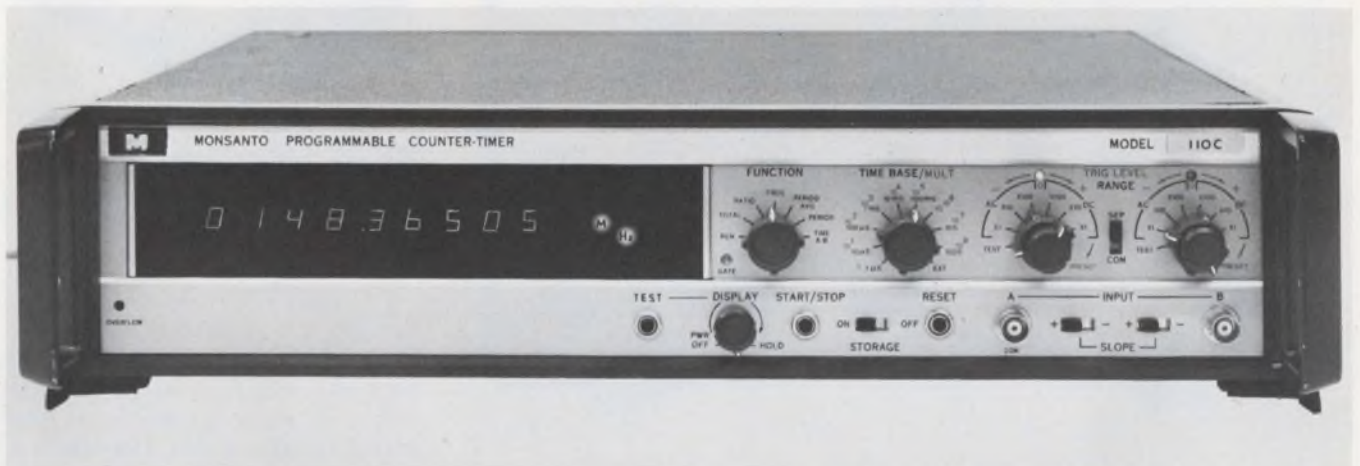

Solid state all the way. Two new instruments, an integrating dc voltmeter and a program-

mable 150-MHz universal counter, readout with numeric LED arrays, p. 94.

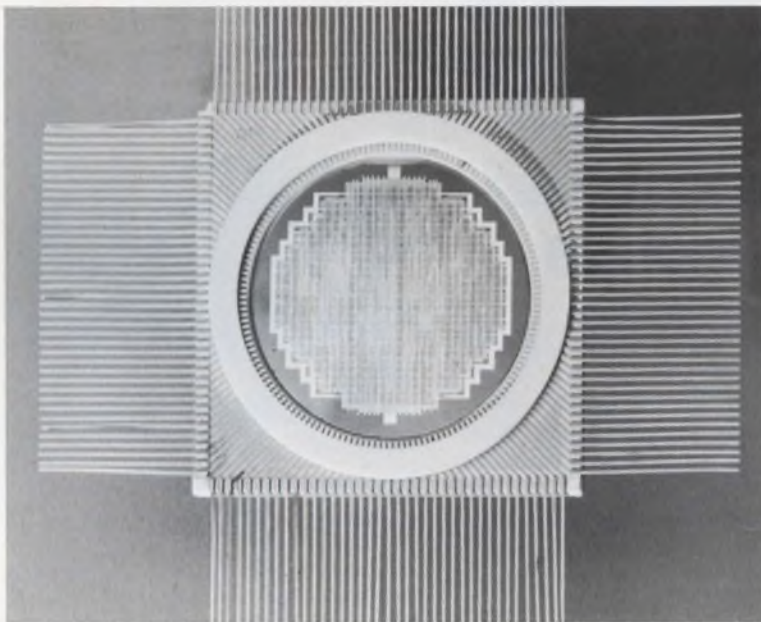

Computer on a chip. New digital LSI analyzer with 253 gates solves differential equations, p. 97.



Power plus. New SCR has 450-A rating and PIV of 1200 V, p. 97.

Also in this section:

Digital \$89 panel meter with 100% overranging is accurate to 1%, p. 94.
Solid-state lamp is bright red LED with 150- μ W 10-mA output, p. 98.
Transistor-sized balanced mixer performs from 25 kHz to 500 MHz, p. 100.
Evaluation Samples, p. 109 . . . **Design Aids**, p. 110 . . . **Annual Reports**, p. 110.
Application Notes, p. 111 . . . **New Literature**, p. 112.



Digital voltmeter and counter readout with LED numerics

Monsanto Electronic Instruments, 620 Passaic Ave., West Caldwell, N. J. Phone: (201) 228-3800. P&A: \$895 (200A), \$1975 (110C); October/1969 (200A), December/1969 (110C).

Founding a unique generation of electronic instruments, a new integrating digital dc voltmeter and a programmable 150-MHz universal counter incorporate solid-state light-emitting numerics for readout display. Establishing a true industry first, both new instruments employ seven-segment LED arrays to form the numeric symbols.

Dispelling the myth that solid-state displays will double instrument costs, model 200A integrating dc voltmeter offers a full five-digit readout for only \$895. Other features include 20% overranging, automatic polarity selection, and remotely programmable pushbut-

ton range selection.

The 200A measures dc voltages to 1000 V in four ranges, with resolutions of 100 μ V to 100 mV. Its accuracy is $\pm 0.01\%$ of full scale, $\pm 0.05\%$ of reading, ± 1 digit, whichever is smaller.

Within its half-rack package, the new voltmeter also provides BCD output, display storage and a floating input capability. This last feature permits scanning both single-ended and balanced signals.

Model 110C nine-digit 150-MHz universal counter-timer offers a full range of functions plus BCD output. It totalizes, can be pre-scaled, and measures frequency ratio, period average, period and time interval.

The new counter can be remotely programed for time base, function, start/stop operation, trigger level, slope and display. It is TTL compatible.

CIRCLE NO. 250



Three-digit \$250 meter trims size with LSI

Honeywell Test Instruments Div., P.O. Box 5227, Denver, Colo. Price: \$250.

Introduced earlier this year in Europe, a new \$250 digital multi-meter is claimed to be the world's smallest such instrument and the first designed with large-scale integrated circuitry. Called Digitest 500, this three-digit instrument can measure 17 ranges of ac and dc voltage, and current and resistance with accuracies ranging from 0.2 to 1.5%. Low-range sensitivities are 100 μ V and 100 nA.

CIRCLE NO. 251



Accurate DPM sells for \$89

Tyco Laboratories, Inc., 16 Hickory Drive, Waltham, Mass. Phone: (617) 899-2440. P&A: \$89; 45 days.

Priced at \$89 in unit quantity, a new 2-1/2-digit panel meter offers a basic voltage range of 0 to 100 mV with 100% overranging and an accuracy of 1% of reading, ± 1 digit. Model TPM-200 has a resolution of 1 mV with a full-scale range of 100 mV. Its input impedance is greater than 100 M Ω and common-mode interference rejection is over 100 dB from dc to 60 Hz.

CIRCLE NO. 252

Motorola Tone Modules



A unique method of selective switching, signaling and control.

Motorola's S-1400 series Tone Modules let you switch, signal and control without the complex circuitry of other methods. These plug-in, solid-state tone devices allow many functions to be controlled over a single voice-grade transmission medium.

"Encoder" and "Decoder" models are offered. Both are self-contained and transistorized, and can be operated in parallel. This unique circuitry has been performance proven, and is used in Motorola communications products.

Direct inquiries for literature to:

Component Products, Sales Department, Motorola Communications & Electronics, Inc., 4501 Augusta Blvd., Chicago, Ill. 60651. Phone (312) 772-6500 TWX (312) 222-0805



MOTOROLA

INFORMATION RETRIEVAL NUMBER 54

Laminar Clean Air

with Tenney Lami-Flow Benches

The most advanced "second generation" design for work bench contamination control. These are self contained units with air circulator, filters, lighting and work space all combined into one integral package. Just plug it in. Tenney benches feature a new patented air-directing, permuting membrane to direct and focus the air while giving it true laminar flow. This enables new design location flexibility for greater filter efficiency, giving you air cleanliness exceeding the requirements of Class 100, Federal Standard 209A.



Write or call for further information.



Tenney
ENGINEERING, INC.

1090 Springfield Rd., Unlon, New Jersey 07083 • (201) 686-7870
Western Division: 15721 Texaco St., Paramount, Calif. 90723

INFORMATION RETRIEVAL NUMBER 55

ELECTRONIC DESIGN 20, September 27, 1969

Oak Versatility



Ultra Compact Rotary Switch 1/2" does a man-sized job

Rugged rotary outperforms its nearest competitors by the widest of margins, gives you man-sized performance at a bargain price. Don't believe it? Compare:

FEATURES	OAK 1/2" SWITCH	BRAND "A" SWITCH	BRAND "B" SWITCH
Double-wiping contacts	Yes	No	No
1/2" Diameter	Yes	Yes	Yes
Multiple Decks	Yes	No	Yes
P. C. Capability	Yes	Yes	Yes
Tri-Ball Detent	Yes	No	No
Adjustable Stops	Yes	No	No
Designed to Meet Mil-S-3786/19	Yes	No	No
Available through Electronic Distributors	Yes	No	No
COMPARE!	OAK LOWEST in Cost	Cost is 60% HIGHER	Cost is 140% HIGHER

GET OAK QUALITY PLUS THE LOWEST PRICE IN THE INDUSTRY

For full details on the sub-miniature switch that does more, write today for Bulletin SP-299.



OAK MANUFACTURING CO.

A Division of OAK ELECTRO/NETICS CORP.
Crystal Lake, Illinois 60014
Phone: 815-459-5000 TWX: 910-634-3353

INFORMATION RETRIEVAL NUMBER 56



Probe lights up to check logic levels in a flash

Make contact with the new Kurz-Kasch Logic Probe ... With the speed of light, you can visually trace pulses or test the logic levels of DTL, TTL and related circuits. Probe flashes "true" and "zero" logic readings by illuminating signal lamps in the end of the instrument. Like having a lab of test equipment at your fingertips. Indicates "infinity" too, identifying improper logic or a disconnection. Displays symmetrical wave forms by illuminating both lamps.

You'll light up at the low user price of \$29.97. The probe is used for testing, inspection, troubleshooting and circuit design. Fits in a shirt pocket; leads attach to unit being tested for power. Responds to systems from 3.75 to 6.5 vdc. Input impedance: 150 k Ω (logic "true"). Logic Probe is available through your local electronic distributor for immediate delivery, or for demonstration upon request. For additional information write Kurz-Kasch, Inc., Logic Instrument Division, 1421 S. Broadway, Dayton, Ohio 45401. (513) 223-8161.



INFORMATION RETRIEVAL NUMBER 57

INSTRUMENTATION

Digital panel meter is 0.05% accurate



Computer Products, Inc., 2709 N. Dixie Highway, P.O. Box 23849, Fort Lauderdale, Fla. Phone: (305) 565-9565. P&A: \$328; 15 to 30 days.

Requiring a panel space of only 2.5 by 3 by 4.2 in., model DP400 digital panel meter can measure dc voltages with an accuracy of 0.05%, $\pm 1/2$ count, and a 4000-count resolution. It offers eight voltage ranges from 200 mV to 400 V and features an internally selectable decimal point position. Its temperature coefficient is 0.005%/°F.

CIRCLE NO. 253

Dual-trace oscilloscope ends flicker and drift



Dumont Oscilloscope Laboratories, Inc., West Caldwell, N.J. Phone: (201) 376-7300. P&A: \$2195; December, 1969.

With a new triggering device that eliminates trace flicker, the 1050 solid-state dual-channel oscilloscope maintains signal synchronization regardless of the vertical positioning of either trace. In addition, the new instrument ends the need to readjust trigger level to maintain the desired reference level after trace repositioning. Bandwidth is dc to 50 MHz.

CIRCLE NO. 254

High-power pulser doubles as supply



Instrument Research Co., P.O. Box 231, Lincoln, Mass. Phone: (617) 897-7647. P&A: \$1175; stock to 4 wks.

Delivering pulse widths of 0.5 μ s to 1 ms, model PM-2 high-power pulse generator can also be used as a dual-output power supply for driving 1-A loads at 0 to 2 kV. Output pulse risetimes range from 160 V/ μ s to 20 kV/ μ s at a repetition rate of 1 to 20,000 pulses per second. Power output is 45 W average or 2.25 kW peak at a duty cycle of 1 to 2%.

CIRCLE NO. 255

Memory voltmeter includes recorder



Micro Instruments Co., 12901 Crenshaw Blvd., Hawthorne, Calif. Phone: (213) 679-8237.

Able to measure transients as small as 50-ns wide, a new memory voltmeter uses a built-in strip-chart recorder to permanently record all readings. Model 5201CR has a dual-shielded cabinet isolated to 1000 V and can measure up to 30 kV with an optional probe. The recorder uses 63-ft dry-process pressure-sensitive paper at a speed of 30 inches per hour. Speeds from 10 to 150 inches per hour are optional.

CIRCLE NO. 256

SCR with 1200-V PIV carries up to 450 A

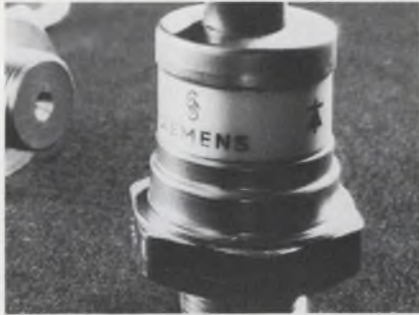

Siemens America Inc., Empire State Building, 350 Fifth Ave., New York City. Phone: (212) 564-7674. P&A: \$165; 6 to 8 wks.

Offering a maximum peak inverse voltage rating of 1200 V, a new silicon controlled rectifier can handle continuous currents as high as 450 A. Type SSi N 20 has a normal PIV of 1000 V that can be increased to 1200 V with the addition of factory-installed pass transistors. Maximum periodic peak reverse voltage is 2000 or 2400 V, depending on the PIV rating.

CIRCLE NO. 257

LSI digital analyzer is on-chip computer

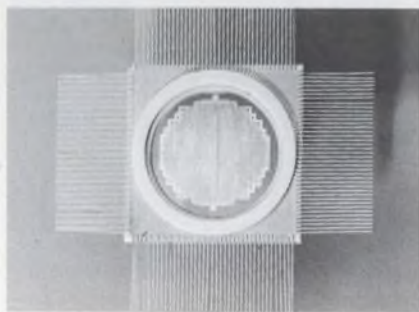

Texas Instruments Inc., Components Group, P.O. Box 5012, Dallas, Tex. Phone: (214) 238-2011. P&A: \$750; 8 wks.

Using large-scale integration techniques to fit 253 equivalent gates on a single slice of silicon, a new digital differential analyzer is a special-purpose incremental computer for the solution of differential equations. Model DRA 1001 employs high-speed TTL parallel logic and can operate with an input clock rate of 2 MHz. Power dissipation is approximately 2.1 W.

CIRCLE NO. 258

Heat problems? Give 'em the air...

Condor. A new high performance high reliability propeller fan providing up to 575 cfm for a wide range of cooling applications. The compact design (10-inch diameter, 3.5-inch depth) and light weight make it easy to install in a variety of equipments. 6 models with different connectors add to its versatility.



The Super boxer's exclusive new aerodynamic impeller design provides exceptional output characteristics at high back pressures. Super dependability. 2 patented bearing designs are rated at 10 years life under normal conditions. Super versatility. Compact (4.687-inch square, 1.5-inch depth), mountable inside or outside an enclosure, to intake or exhaust. Accepts all standard Boxer accessories.



DC Boxer. The small module mounted integrally on the Boxer frame accepts DC and converts it to drive the Boxer's AC motor. Does away with usual DC motor problems, such as brush wear, arcing contacts, short life, and RF noise. 8 models span the range of 12 to 38 VDC input. Cools heat sensitive equipment such as, TV cameras, sound systems, telephone equipment, etc. Accepts all standard Boxer accessories.



DC

with 3 new air-givers from IMC.

Distributor stocked nationwide for immediate delivery. As are standard Boxers, MiniBoxers, Tandem Boxers, IMCair fans and IMCair centrifugal blowers.

A new 16-page catalog provides drawings, performance parameters and complete specifications for all our airmovers. It's available from IMC Magnetics Corp., New Hampshire Division, Route 16B, Rochester, N. H. 03867, Tel. (603) 332-5300.



High Voltage Silicon Rectifiers

Available in production quantities now!

HIGH VOLTAGE RECTIFIERS*							
1000V	I _O	1.99	7000V	I _O	1.99		
VA 10	50mA	1.36	VC 70	1.5A	6.82		
VB 10	100mA	1.41	VF 5-7	5mA	1.71		
1500V			VF 10-7	10mA	1.89		
			VF 25-7	25mA	2.08		
VA 15	50mA	1.44	8000V				
VB 15	100mA	1.51		VC 80	1A	7.15	
2000V			10,000V				
	VA 20	50mA	1.55	VF 5-10	5mA	1.96	
	VB 20	100mA	1.59	VF 10-10	10mA	2.16	
	VC 20	2A	5.20	VF 25-10	25mA	2.38	
2500V			12,000V				
	VA 25	50mA		1.66	VF 5-12	5mA	2.22
	VB 25	100mA		1.72	VF 10-12	10mA	2.44
					VF 25-12	25mA	2.68
3000V			15,000V				
	VA 30	25mA		1.93	VF 5-15	5mA	2.30
	VB 30	50mA		1.88	VF 10-15	10mA	2.54
	VC 30	2A		5.52	VF 25-15	25mA	2.80
3500V			20,000V				
	VA 35	25mA		2.70	VF 5-20	5mA	2.97
					VF 10-20	10mA	3.27
4000V			25,000V				
	VB 40	50mA		2.05	VF 25-20	25mA	3.60
	VC 40	2A		5.85	VF 5-25	5mA	3.72
5000V			30,000V				
	VB 50	50mA		2.40	VF 10-25	10mA	4.09
	VC 50	1.5A		6.18	VF 25-25	25mA	4.51
	VF 5-5	5mA		1.60	40,000V		
VF 10-5	10A	1.77	VF 5-30	5mA		4.46	
VF 25-5	25mA	1.95	VF 10-30	10mA		4.91	
6000V			VF 25-30	25mA	5.39		
	VB 60	50mA		2.62	VF 5-40	5mA	5.95
	VC 60	1.5A		6.50	VF 10-40	10mA	6.54
			VF 25-40	25mA	7.20		



VA SERIES

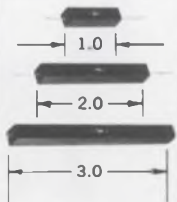

VF SERIES



VC SERIES

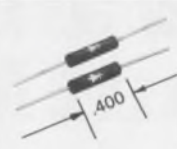

VB SERIES

*Available with fast recovery characteristic.



SEMICONDUCTOR DIVISION, 1000 N. SHILOH ROAD, GARLAND, TEXAS 75040 (214) 272-4551

INFORMATION RETRIEVAL NUMBER 59

ICs & SEMICONDUCTORS

Solid-state lamp beams bright red

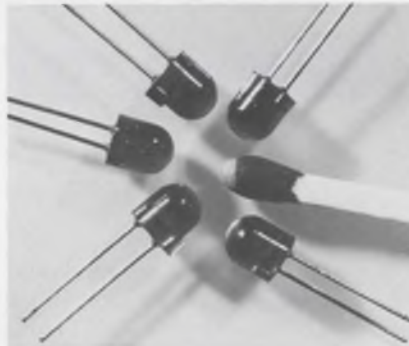

General Electric Co., Miniature Lamp Dept., P.O. Box 2422, Cleveland, Ohio. Phone: (216) 266-2248. Price: \$9.52.

Easily visible in room light, a new bright red solid-state lamp peaks at 700 nm and produces 150 μ W at 10 mA. This gallium-phosphide light-emitting diode, type SSL-22, is a plastic-encapsulated device, one-quarter of an inch in diameter. It has an end-on candlepower of 1.5 millicandela.

CIRCLE NO. 259

MOS memory kits control displays

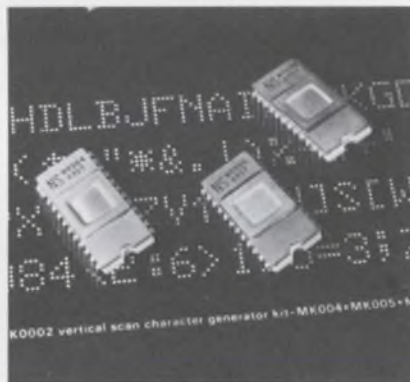

National Semiconductor Corp., 2975 San Ysidro Way, Santa Clara, Calif. Phone: (408) 245-4320. Price: \$120 or \$150.

Designed to generate control signals for digital data displays, two new MOS read-only memory kits (models SK0001 and SK0002) contain three 1024-bit memories that are preprogrammed to convert standard communications code words (ASC11) into raster scan or vertical scan control signals. Each kit stores 64 standard 5 by 7 alphanumeric symbols.

CIRCLE NO. 260

Power transistors turn-on in 10 ns



Solitron Devices, Inc., 1177 Blue Heron Blvd., Riviera Beach, Fla. Phone: (305) 848-4311. Availability: stock.

Packaged in the popular TO-60 case, a new line of fast-switching 10-A power transistors feature turn-on times of less than 10 ns. Series SDT6110-SDT6113 devices have a total switching time of less than 80 ns and a risetime of less than 10 ns. They offer planar construction and a typical unity-gain cross-over frequency of 500 MHz.

CIRCLE NO. 261

Economy MSI circuit decodes and drives

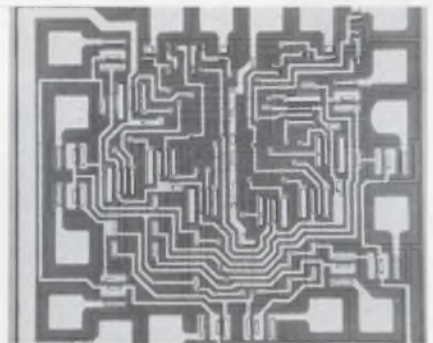

Fairchild Semiconductor, 313 Fairchild Drive, Mountain View, Calif. Phone: (415) 962-3563. P&A: \$10 to \$22; stock.

Able to drive Nixie tubes directly, a new low-cost one-of-ten decoder/driver accepts 8-4-2-1 binary coded decimal (BCD) inputs and provides ten mutually exclusive outputs. Called the MSI 9315, this medium-scale integrated circuit has stable high-voltage output characteristics that also make it ideal for driving miniature lamps, relays and other high-voltage devices.

CIRCLE NO. 262

Power Darlington gain up to 20,000

Motorola Semiconductor Products, Inc., P.O. Box 20924, Phoenix, Ariz. Phone: (602) 273-6900. Price: \$7.95 or \$11.95.

Two new npn silicon power Darlington amplifiers, types MJ-3801 and MJ3802, feature a minimum dc current gain of 20,000 and 2000, respectively. Both monolithic devices have a maximum collector-emitter cutoff current of 10 μ A and a minimum collector emitter breakdown voltage of 80 V. Power dissipation is 40 W and continuous collector current is 10 A.

CIRCLE NO. 263

MOSFET multiplexer has leakage of 200 pA

Union Carbide Corp., Semiconductor Dept., P.O. Box 23017, 8888 Balboa Ave., San Diego, Calif. Phone: (714) 279-4500. Availability: stock.

Consisting of six MOS p-channel enhancement transistors on a single chip, the MULT6 (UC6410) multiplexer holds leakage current to less than 200 pA and capacitance to under 1 pF. Besides a voltage breakdown rating of -40 V, the device offers added gate protection so that it can be handled like any bipolar device with no detrimental static charge accumulation.

CIRCLE NO. 264

IC op amp trio fit on one chip

RCA/Electronic Components, 415 S. Fifth St., Harrison, N.J. Phone: (201) 485-3900. Price: \$5.95.

Designated the CA3060A integrated operational transconductance amplifier, a new IC op amp array consists of three transconductance amplifiers on a single silicon die. The electrical characteristics of each amplifier are a function of the total current of that particular amplifier. The current flow in each amplifier is externally adjustable from 100 nA to 1 mA.

CIRCLE NO. 265

NOW! from RMC

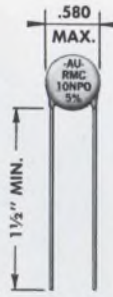
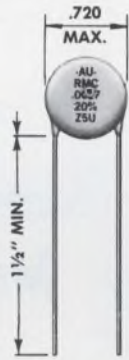
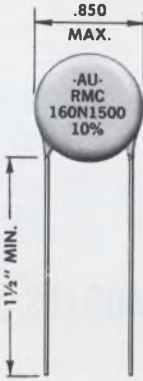
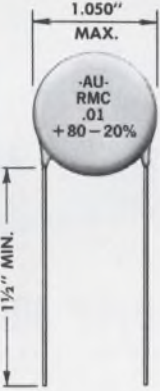

"ACROSS-THE-LINE" U.L. LISTED DISCAPS

				
EIA Class				
Class II	330 470 680	820 .001 .0015 .0022 .0027	.0033 .0039 .0047 .005	.0068 .0082 .01
Class I				
NPO	3.9 - 20	21 - 31	32 - 47	
N750	15 - 35	36 - 61	62 - 82	
N1500	15 - 67	68 - 119	120 - 180	

THICKNESS: .225 Max.

RMC now offers a complete line of ceramic disc capacitors fully approved by Underwriters Laboratories for the NEW "Across-The-Line" capacitor requirements. This approval is required of all capacitors utilized directly or indirectly across the power supply line.

This application is significantly different from the "Antenna Coupling and Line By pass" capacitor requirements of Underwriters Laboratories Subject 492, and the original RMC -U- capacitor type continues to be approved for those applications.

SPECIFICATIONS

CAPACITANCE: Within specified tolerance:
Class I @ 1MC and 25°C
Class II @ 1KC and 25°C

CAPACITANCE TOLERANCES AVAILABLE:
Class I $\pm 5\%$, $\pm 10\%$ or $\pm 20\%$
Class II $\pm 20\%$, $+80 - 20\%$

WORKING VOLTAGE: 150 VRMS @ 60 cycles (210 volts peak AC plus DC)

POWER FACTOR:
Class I .1% max. at 1 MC
.2% max. less than 30 pf
Class II 1.5% max. at 1KC

INSULATION RESISTANCE: Greater than 7500 Megohms @ 500 VDC

TEMPERATURE COEFFICIENT:
Class I NPO N750 N1500
Class II Z5U; Z5F 1500 pfd. And Less.

FLASH TEST:
Per U.L. Sub. 492

LIFE TEST:
Per U.L. Sub. 492

INSULATION RESISTANCE AFTER HUMIDITY:
Greater than 1000 Megohms @ 500 VDC

BODY INSULATION: Durez phenolic—vacuum wax impregnated. Standard coating on leads $\frac{1}{16}$ " max. measured from tangent

LEAD STYLES AVAILABLE: Long lead—#20 AWG tinned copper

DISCAP
CERAMIC
CAPACITORS



RADIO MATERIALS COMPANY
A DIVISION OF P. R. MALLORY & CO., INC.
GENERAL OFFICE: 4242 W. Bryn Mawr Ave., Chicago, Ill. 60646
Two RMC Plants Devoted Exclusively to Ceramic Capacitors
FACTORIES AT CHICAGO, ILL. AND ATTICA, IND.

INFORMATION RETRIEVAL NUMBER 60

JFD PISTON TRIMMERS

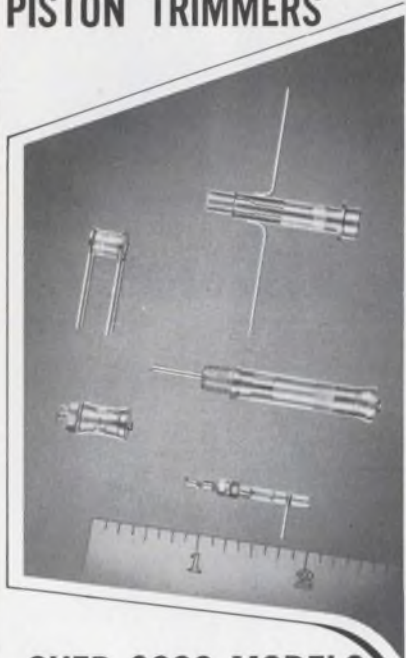

OVER 3000 MODELS

JFD offers the industries largest selection of Piston Trimmer capacitors to meet every circuit requirement. More than 3000 standard and special designs assure exactly the right component for every application.

The Miniature Telescopic Capacitor Series — offers a variety of glass and quartz dielectric materials in a wide range of capacitance values. For example: the VC10GWY is available from .8 to 4.5 pf for printed circuit mounting. Body length is only 5/16". Another example is the NVC 24G panel mount — available in a 1 — 38 pf capacitance range. Body length measures 1.19/32".

The Max-C High Range Miniature Telescopic Capacitor Series — utilizes an embedded electrode for greatly increased capacitance range. Models are available from 10 pf — 250 pf sizes ranging from 17/64" — 1.61/64" in body length. The Max-C series offers a wide variety of sealed and unsealed models.

Beyond this is an immense array of standard and special units covering almost every requirement: from minute diameters for space considerations to heavy walled units for high voltage applications.

More JFD Piston Trimmers meet or exceed present military specifications, than any other brand.



JFD ELECTRONICS CORP. / COMPONENTS DIVISION

15th Avenue at 62nd Street
Brooklyn, New York 11219
Phone 212-331-1000

SUBSIDIARY OF RIKER-MAXSON CORPORATION

Transistor-sized mixer covers audio-to-uhf band

Mini-Circuits Laboratory Div., Scientific Components Corp., 2913 Quentin Rd., Brooklyn, N.Y. Phone: (212) 252-5252. P&A: \$73; stock to 3 wks.

Spanning the frequency range from audio to uhf with a bandwidth of greater than 14 octaves,

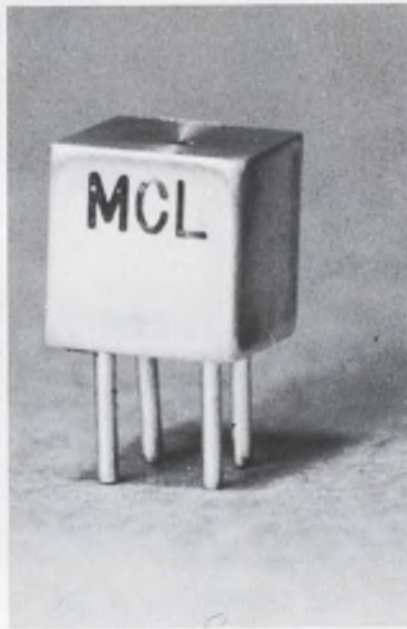

a new microminiature double-balanced mixer operates from 25 kHz to 500 MHz with a typical noise figure of less than 6 dB. This tiny device, model ASK-2, features a volume of only 0.05 cubic inches, occupying approximately the same board space as a TO-5 transistor package.

In addition, the new mixer can perform a variety of functions. It can be used as a very fast switch, a current controlled attenuator, a balanced modulator, a frequency doubler or a phase detector.

Its precision internal components include miniature printed circuit boards, hot-carrier diodes and specially designed transmission-line transformers. The unit is also shielded against emi.

Intended for 50-Ω systems, the ASK-2 has a maximum conversion loss of 7 dB from 200 kHz to 200 MHz and 10 dB from 25 kHz to 500 MHz. Minimum isolation between its local oscillator and rf ports is 30 dB from 25 kHz to 30 MHz and 15 dB from 30 to 500 MHz. Isolation specifications are identical between the local oscillator and i-f ports.

CIRCLE NO. 266

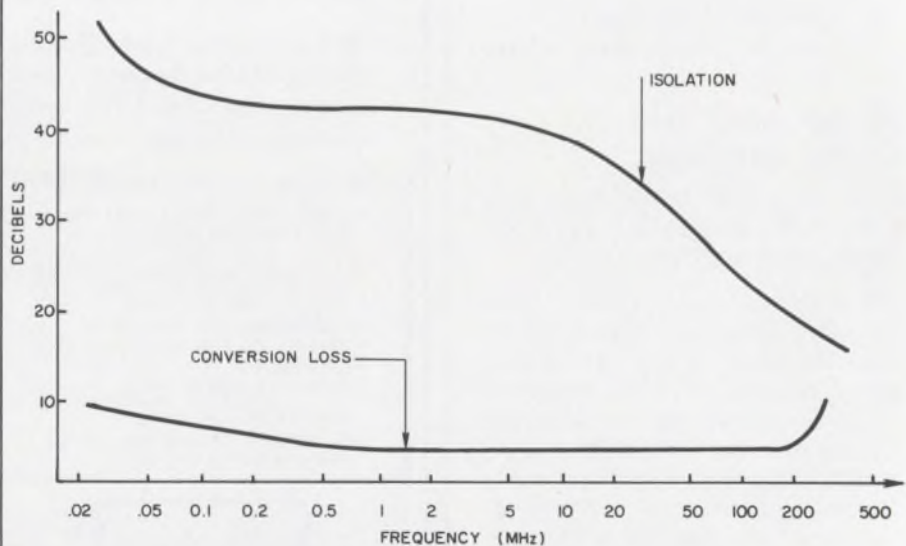

Minimizing conversion loss and maximizing isolation, a new transistor-sized double-balanced mixer spans the frequency band of 25 kHz to 500 MHz. Occupying but 0.05 cubic inches, this microminiature device holds conversion loss to 10 dB maximum and keeps isolation to 15 dB minimum.

High-Q air capacitor trims from both ends

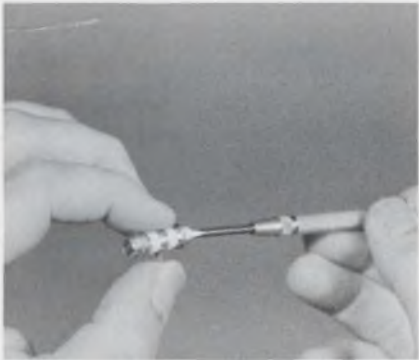

Voltronics Corp., West St., Hanover, N.J. Phone: (201) 887-1517. P&A: \$6.75; stock.

Separately tunable from either end, a new sealed dual air trimmer capacitor has a minimum Q of 4000 at 100 MHz. Capacitance values on both ends range from 0.8 pF to more than 10 pF. Model V3043 has high resolution and completely linear tuning. Its temperature coefficient is 50 ± 50 ppm/ $^{\circ}$ C and operating temperature range is -55 to $+150^{\circ}$ C.

CIRCLE NO. 267

Segmented readout slims down depth



EDP Corp., 1900 North Mills Ave., Orlando, Fla. Phone: (305) 241-5324. Price: \$12.40.

Capable of forming numerals 0 to 9, a new line of seven-segment modular readouts measures only 1.3 in. deep. Series 100 units use incandescent bulbs rated at 150,000 hours for long life. Another feature is a viewing angle of 170° at distances up to 75 feet. Optional lens color variations are available.

CIRCLE NO. 268



World Famous Simpson 260[®] Millions now in use!

Better than ever

with New
Taut Band
Movement
cannot develop
error-causing
friction.



- SELF-SHIELDING, SHOCK PROOF . . . for outstanding accuracy and repeatability.
- VARISTOR PROTECTED against even 200,000% overloads.
- RUGGED DEPENDABILITY that has no equal.

New Taut Band 260[®]-5 complete with test leads, batteries, and 40-page operator's manual . . . \$65.00

New Taut Band 260[®]-5M with anti-parallax mirror scale and knife-edge pointer . . . \$67.00

New Taut Band 260[®]-5P with circuit breaker overload protection of VOM circuitry . . . \$97.00

GET "OFF-THE-SHELF" DELIVERY FROM
YOUR LOCAL ELECTRONIC DISTRIBUTOR

Simpson

ELECTRIC COMPANY



5200 W. Kinzie Street, Chicago, Illinois 60644 • Phone (312) 379-1121
Export Dept: 400 W. Madison Street, Chicago, Illinois 60606. Cable Simelco
IN CANADA: Bach-Simpson Ltd., London, Ontario • IN INDIA: Ruttonsha-Simpson
Private Ltd., International House, Bombay-Agra Road, Vikhroli, Bombay

I N S T R U M E N T S T H A T S T A Y A C C U R A T E
INFORMATION RETRIEVAL NUMBER 62



3 ways to prevent numerals from "spotting" at 55°C.

Fill with freon...
keep in shade...
or specify Datavue*
Indicator Tubes.

All Datavue tubes are rigorously tested to meet commercial and military specifications, produced for 200,000 hours of reliable operation. U.S.-made, they can cost less than \$3.95 each.

Datavue tubes feature: straight, stiff leads for fast insertion; fully formed, high-brightness characters; rated for strobing operation; wide range of alphanumeric, decimals, special characters. More than 40 different sockets, including right-angle types, are available.

Call your Raytheon distributor or sales office. *Raytheon Company, Industrial Components Operation, Quincy, Mass. 02169.*

*Trademark of Raytheon Company



INFORMATION RETRIEVAL NUMBER 63

COMPONENTS

Monolithic capacitors handle 3000 Vdcw

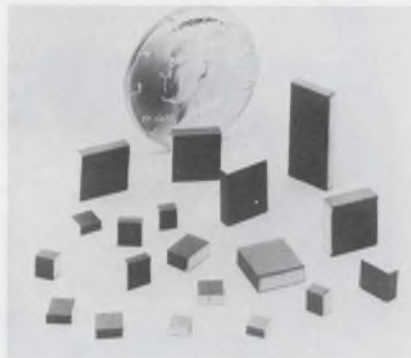

Monolithic Dielectric, Inc., P.O. Box 647, Burbank, Calif. Phone: (213) 848-4465. P&A: from 30¢ stock.

Measuring only 200 by 200 by 80 mils, a new line of monolithic capacitors feature a voltage rating of 3000 Vdcw. With capacitance values as high as 720 μ F, these tiny capacitors have temperature coefficients of +15% maximum and a dissipation factor of less than 1% at 1 kHz. Their operating temperature range is -55 to $+125^{\circ}\text{C}$.

CIRCLE NO. 269

Miniature relays build-in drivers



Whelock Signals, Inc., 273 Branchport Ave., Long Branch, N.J. Phone: (201) 222-6880.

Incorporating built-in solid-state drivers, a new series of miniature reed relays occupy a volume of only 0.05 cubic inches, allowing space savings of up to 50%. Series 442SS units require only microwatts to operate and have a contact rating of 7 W. Models are available with two to four poles.

CIRCLE NO. 270

CdS photocell sandwich senses 10 foot-candles

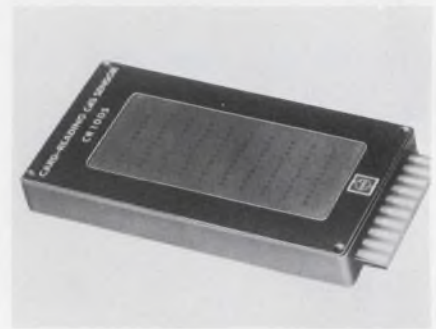

Matsushita Corp. of America, 200 Park Ave., New York City. Phone: (212) 697-6146.

Primarily designed for card reading purposes, a new cadmium-sulfide photocell sensor is energized by a light source of only 10 to 30 foot-candles. This is said to represent a sensitivity improvement ten times greater than conventional cadmium-sulfide cells. Model CR-100S is a 10 by 10 matrix array with a unique sandwich-type construction. It is packaged in a plastic case.

CIRCLE NO. 271

Chip resistors have four taps



Solid State Scientific, Inc., Commerce St., Montgomeryville, Pa. Phone: (215) 855-8400.

Encompassing a wide assortment of standard RETMA values, two new chip resistor kits contain chips that are tapped three or four times. Kit SD2500-17 consists of 25 chips for each of 18 different types, covering values from 4.7 Ω to 1 M Ω . Kit SD2502-15 contains 25 chips for each of 14 different types, with 44 values from 22 Ω to 82 k Ω . Typical chip size is 28 by 38 mils.

CIRCLE NO. 272

CRT display system interfaces easily

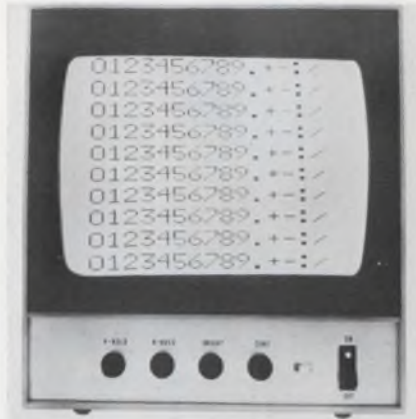

Applied Digital Data Systems, Inc., 89 Marcus Blvd., Hauppauge, N.Y. Phone: (516) 273-7799. Price: from \$995.

Called a static raster display, a new CRT readout offers a design engineer a numeric/symbolic device that can use any standard 525-line TV monitor. Interfacing to any system is as simple as that for indicator tubes. Model SRD-100 accepts direct BCD input signals from any digital data source and converts them into a composite video signal.

CIRCLE NO. 273

Rack-mount memory meets MIL specs

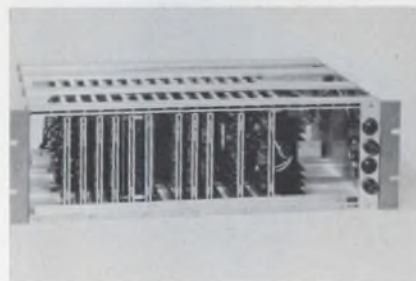

United Telecontrol Electronics, 3500 Sunset Ave., Asbury Park, N.Y. Phone: (201) 988-0400.

Housed in a rack-mount chassis for use in standard 19-in. relay racks, model 2199M core memory system meets MIL-E-16400, Class IV, Type 1 equipment specifications. It is dimensionally compact at 5-1/4 by 19 by 14-1/2 in. overall. Its 1 by 8 core stack plugs into keyed edge connectors, as do its solid-state IC printed-circuit cards.

CIRCLE NO. 274

Read-only memory stores data manually

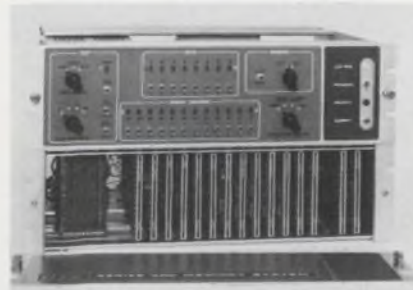

United Telecontrol Electronics, 3500 Sunset Ave., Asbury Park, N.J. Phone: (201) 988-0400.

Adapting a general-purpose random-access memory to simulate read-only memory storage, a new system offers three major features: stored data can be changed (or entered) manually, address and data output binary information is continuously displayed, and access is provided for loading from tape, drum, card or core storage. Complete programs can contain up to 4096 eight-bit words.

CIRCLE NO. 275

Electrostatic copier standardizes printouts



Saxon Business Products, Inc., sub. of Saxon Industries, Inc., 450 7th Ave., New York City. Phone: (212) 524-7932. Price: \$1595.

Specifically designed for the computer industry, the new electrostatic desk-top office copier quickly reduces computer printouts by 25% and makes them standard business-form size. Copystat CR-75 takes an 11 by 14-in. printout original and produces an 8-1/2 by 11-in. copy in order to save filing space and handling time.

CIRCLE NO. 276

push with ALCOSWITCH

These miniature push button switches control heavy currents with outstanding reliability and consistent performance. Snap-action mechanism allows quick make-and-break along with solid silver contacts for efficient switching operations.

LIGHTED MODELS

The illuminated push button Series MSPN have over 50 varied colored buttons and sizes to fit your specific applications. Versatile DPDT model with isolated lamp terminals.

WATERPROOF

The "E" Series is made to rigid specifications exceeding industry standards. Miniature in size, but exceptional in performance. Available as momentary, or Push-ON or Push-OFF, in one, two and 4PDT models.

Whether you need one or one thousand switches you have a greater variety to choose from when you specify an ALCOSWITCH.



SEND FOR COMPLETE ALCOSWITCH CATALOG

ALCO

ELECTRONIC PRODUCTS, INC.

Lawrence, Massachusetts 01843

FAST—10 MHz PRECISION



Analog Multiplier

The new M510 multiplier is a moderately priced, epoxy encapsulated transconductance multiplier featuring very fast operation with excellent linearity and temperature stability. The 5 MHz full output frequency and 10 MHz response suit the M510 to modulation, correlation, display systems, and other applications requiring fast performance.

- 5 MHz Full Output
- DC to 10 MHz
- 1% Accuracy
- 300 V/ μ s Slew Rate
- No Adjustments
- True 4 Quadrant
- 2 x 3 x 0.62 Inches

SPECIFICATIONS (25°C, ± 15 V)

Output functions	XY/10, X ² /10
Linearity X	0.5% max
Linearity Y	0.25% max
Input voltage X, Y	± 10 V to common
Input impedance X, Y	10 k Ω , common
Output (short protected)	± 10 V, 10 mA
Output impedance, dc	1 Ω max
Frequency response	
Small signal (-3 dB)	10 MHz min
Full output (20 V p-p)	5 MHz min
Gain temperature stability	$\pm 0.02\%$ / $^{\circ}$ C max
Offset temperature stability	± 1 mV/ $^{\circ}$ C max
Power requirement	± 15 Vdc, 50 mA
Price (1-9)	\$295



TWX 710-335-6835
(617) 332-7350

57 CHAPEL STREET, NEWTON, MASS 02158
INFORMATION RETRIEVAL NUMBER 65

MODULES & SUBASSEMBLIES

FET hybrid op amp slews at 50 V/ μ s



Philbrick/Nexus Research, a Tele-dyne Co., Allied Drive at Route 128, Dedham, Mass. Phone: (617) 329-1600. P&A: \$55; stock.

Providing full output at 1 MHz and a small-signal bandwidth of 10 MHz, a new FET-input hybrid operational amplifier features a slew rate in excess of 50 V/ μ s and a rolloff of 6 dB/octave. Model 1405 is a differential unit with maximum bias currents of 50 pA and an offset voltage drift of 25 μ V/ $^{\circ}$ C. Open-loop gain is 300,000 typical.

CIRCLE NO. 277

Analog multiplier spans 3-MHz band



Optical Electronics Inc., P.O. Box 11140, Tucson, Ariz. Phone: (602) 624-8358. P&A: \$63; stock.

Providing a total error of 1% when used with four external adjustments, a new four-quadrant analog multiplier boasts a large-signal bandwidth of 1 MHz and a small-signal bandwidth of 3 MHz. Model 5805 has a dynamic range of ± 10 V on both inputs and an input impedance of 10 k Ω . Maximum untrimmed offset voltage is ± 2 V for the inputs and ± 3 V for the output.

CIRCLE NO. 278

Low-cost multipliers eliminate trimming

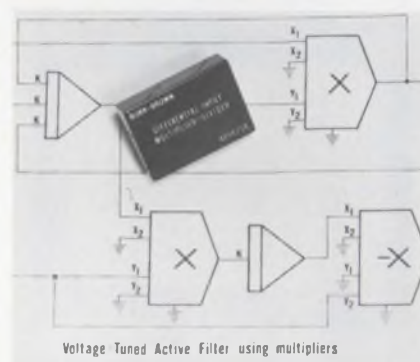

Burr-Brown Research Corp., International Airport Industrial Park, Tucson, Ariz. Phone: (602) 294-1431. P&A: \$45 or \$59; stock to 4 wks.

Performing without the need for external trimming, two new low-cost multipliers work directly from standard ± 15 -V dc supplies. Tailored for general-purpose multiplier applications, models 4095/15 and 4096/15 exhibit less than a $\pm 0.1\%$ error with a 1% variation in either power supply. Accuracy is ± 2 and $\pm 1\%$, respectively, including all errors.

CIRCLE NO. 279

Modular \$35 multiplier delivers 1% accuracy



Intronics Inc., 57 Chapel St., Newton, Mass. Phone: (617) 332-7350. P&A: \$35; stock.

Selling for \$29 in 100-unit quantities and \$35 in small quantities, a new low-profile multiplier with an accuracy of 1% gives a full-output frequency of 100 kHz. Model M420 is an encapsulated module measuring only 0.4 in. high. Its operating temperature range is -25 to $+85^{\circ}$ C.

CIRCLE NO. 280

STABILITY & QUALITY

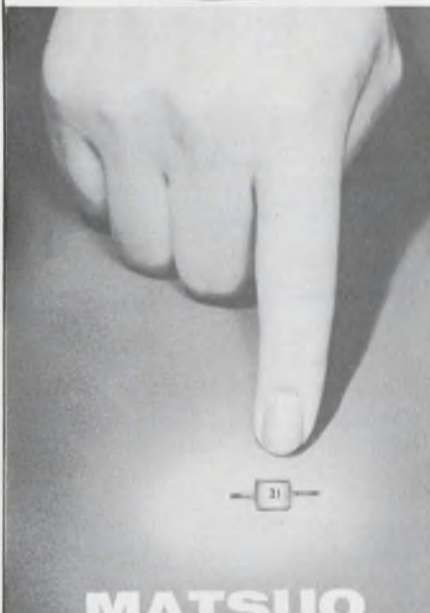

MATSUO

SOLID TANTALUM CAPACITORS FOR HYBRID ICs - "MICROCAP".

Capacitance exceeding 10,000 picofarads obtained despite miniature size. "MICROCAP" features excellent heat resistance, solderability and mechanical strength comparable to conventional discrete components, for easy use in hybrid integrated circuits.

Specifications:

- Operating Temperature Range: -55°C to $+85^{\circ}\text{C}$
- Standard Voltage Rating: 6.3, 10, 16, 20, 25, 35 VDC
- Standard Capacitance Value: .001 to 22MFD (E6 series)
- Standard Capacitance Tolerance: $\pm 20\%$ (M)

MATSUO'S other capacitors include:
Metallized Polyester Film Capacitor:

Type FNX-H mylar wrapped.

Solid Tantalum Capacitors: Type TAX hermetically sealed in metallic case, Type TSX encased in metallic case and sealed with epoxy resin, Type TSL encased in metallic case and sealed with epoxy resin. **Polyester Film Capacitors:**

Type MFL epoxy dipped,

Type MFK epoxy dipped, non inductive, Type MXT encased in plastic tube, non inductive.

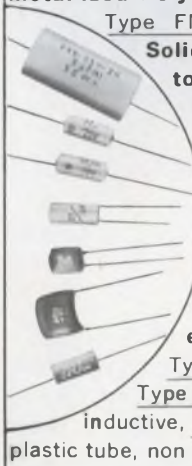

For further information, please write to:

MATSUO ELECTRIC CO., LTD.

Head Office: 3-5, 3-chome, Sennari-cho, Toyonaka-shi, Osaka, Japan
Cable: "NCCMATSUO" OSAKA Telex: 523-4164 OSA
Tokyo Office: 7, 3-chome, Nishi-Gotanda, Shinagawa-ku, Tokyo

INFORMATION RETRIEVAL NUMBER 66

Inexpensive op amp drifts only $50 \mu\text{V}/^{\circ}\text{C}$



Zeltex, Inc., 1000 Chalomar Rd., Concord, Calif. Phone: (415) 686-6660. P&A: \$16; stock.

Useful for differential, inverting and non-inverting circuits, a new \$16 differential FET op amp features a typical voltage drift of $50 \mu\text{V}/^{\circ}\text{C}$ and a typical input bias current of 50 pA. The initial off-set voltage of model 134D can be adjusted to zero with an external potentiometer. Its dc gain is 50,000 and gain-bandwidth product is 1.3 MHz.

CIRCLE NO. 281

Hand-sized supply powers 500 gates



Semiconductor Circuits, Inc., 163 Merrimac St., Woburn, Mass. Phone: (617) 935-5200. P&A: \$49.95; stock.

Mounting directly on PC boards, a new small power supply puts out 5 V at 500 mA to drive as many as 500 logic gates. Model P1.5.500, an encapsulated unit measuring 2.5 by 3.5 by 0.875 in., operates from an ac source of 105 to 125 V, 50 to 400 Hz. Its line regulation is 0.05% maximum, and ripple and noise are less than 1 mV rms.

CIRCLE NO. 282

brite glo[®] ALCOLITE

Alco's new Brite Glo[®] miniature lamp series is achieved through painstaking workmanship that assures the best pilot assembly on the market.

The new T-1 3/8 MNE neon series has an exclusive ring electrode construction that glows on the entire surface with direct current. Available as individual lamps or as miniature panel assemblies.

All our miniature incandescent pilot assemblies contain the most popular and long-life MIL-grade T-1 5 volt lamps. Choice of domed or cylindrical assemblies, in a variety of colors.

Our standard neon series are all equipped with NE2 lamps and are available in many lens styles and colors, with or without built-in series resistors.

For design-service assistance and price quotations, call (Area 617) 686-3887.

SEND FOR COMPLETE
ALCOLITE
CATALOG



ALCO

ELECTRONIC PRODUCTS, INC.
Lawrence, Massachusetts 01843



SCHAUER

1%

tolerance

1 WATT ZENERS ARE A REAL BUY!

ANY voltage from 2.0 to 16.0 at the industry's **LOWEST PRICES!**

Quantity	Price each
1-99	\$1.07
100-499	.97
500-999	.91
1000-4999	.86
5000 up	.82



THE HI-RELIABLE!

No fragile nail heads.
Silicon junction aligned between two, parallel, offset tantalum heat sinks . . . great lead tension strength.
All welded and brazed assembly.
High pressure molded package.
Gold plated nickel-clad copper leads.
Write or phone for Form 68-4 for complete rating data and other tolerance prices.

Semiconductor Division

**SCHAUER
MANUFACTURING
CORP.** 4511 Alpine Avenue
Cincinnati, O. 45242
Ph. (513) 791-3030

MICROWAVES & LASERS

S-band transistors boast 5-W output



TRW Semiconductors Inc., 14520 Aviation Blvd., Lawndale, Calif. Phone: (213) 679-4561. P&A: \$100 to \$290; stock.

Three new microwave transistors operate at 2 GHz with a source voltage of only 28 V. Type 2N5766, which has a 1-W output, can withstand an infinite VSWR at any phase angle. Type 2N5767 supplies a 2.5-W output and can withstand a 3:1 VSWR at any phase angle. Type 2N5768 with a 5-W output can also withstand a 3:1 VSWR at any phase angle.

CIRCLE NO. 283

Solid-state oscillator gives 10 mW at 5 GHz

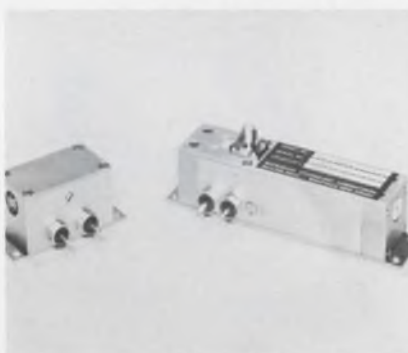

Engelmann Microwave Co., Skyline Drive, Montville, N.J. Phone: (201) 334-5700.

Mechanically tunable over ± 50 MHz of the center frequency with $\pm 1\%$ electronic tunability, a new miniature solid-state microwave oscillator develops an output power in excess of 10 milliwatts in the 5-GHz region. The unit has a frequency stability of 0.1% over a temperature range of 0 to 60°C and 0.4% over the range of -30 to +70°C.

CIRCLE NO. 284

Nine-digit counter spans 20 Hz to 3 GHz



Eldorado Electrodata Corp., 601 Chalomar Rd., Concord, Calif. Phone: (415) 686-4200. P&A: \$2250; 2 wks.

Able to service the new communication and telemetry bands, a microwave frequency counter provides complete coverage from 20 Hz to 3 GHz on a single input. Model 970, which sells for \$2250, offers a full nine-digit readout. This new microwave instrument also features a resolution of 0.1 Hz and a sensitivity of -7 dBm.

CIRCLE NO. 285

Activity monitor sees out to 12 GHz



Watkins-Johnson Co., 3333 Hillview Ave., Stanford Industrial Park, Palo Alto, Calif. Phone: (415) 326-8830.

Intended for a quick-look analysis of spectrum activity, the WJ-1140 microwave monitor provides a CRT display of signal activity in the frequency band from 1 to 12 GHz. Readily installed for airborne, shipboard or van applications, the new compact solid-state system is ideal for situations involving restricted volume.

CIRCLE NO. 286

Modular rfi enclosures protect out to 18 GHz

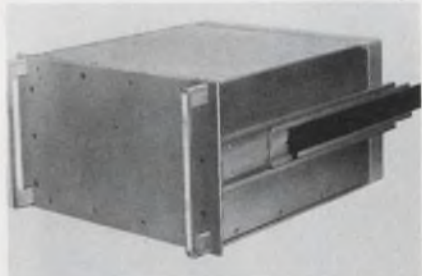

Signal Interference Control, Inc., 161 Gazza Blvd., Farmingdale, N.Y.

Using aluminum modular construction with a patented gasket retention groove, a new system of rfi enclosures provides a shielding effectiveness of 100 dB over a frequency range of 15 kHz to 18 GHz. The gasket retention feature permits the removal of all six panels, allowing high component density and reduced production costs. The modular construction provides the engineer with a custom enclosure.

CIRCLE NO. 287

Wash-away adhesive holds delicate parts

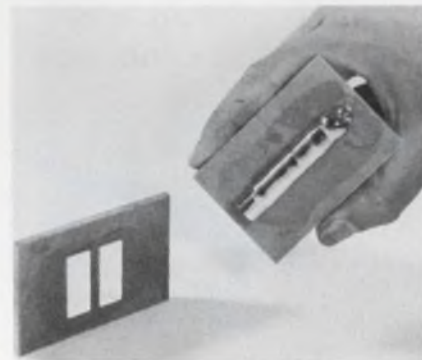

Aremco Products, Inc., P.O. Box 145, Briarcliff Manor, N.Y. Phone: (914) 762-0685. P&A: \$25/stick; stock.

Crystalbond 509, a thermoplastic polymer that is soluble in acetone, can be used as a temporary bond, wash-away adhesive, for holding delicate parts. It can bond crystals and ceramic substrates for slicing, grinding, dicing or polishing operations. The material, which comes in stick form, adheres to porous or non-porous metals and glass or ceramic surfaces.

CIRCLE NO. 288

Flexible PC mask withstands 500°F

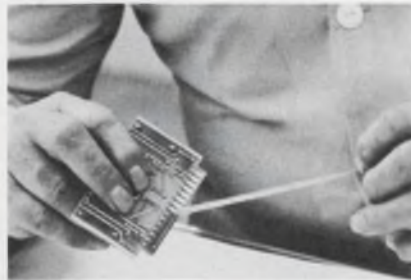

EPD Industries Inc., Laboratories Div., 2055 E. 223rd St., Long Beach, Calif. Phone: (214) 775-7141.

Providing full-time protection for PC boards through all manufacturing and assembly operations, a new low-viscosity flexible masking compound withstands temperatures up to 300°F for one to three hours or 500°F for a sufficient time to allow flow soldering. TC-533 can remain on the protected area of the board until ready for test, then with a mild pulling action, can be removed without leaving a residue.

CIRCLE NO. 289

Precious-metal solders come ready to use



Dynalog, Inc., 7 Great Meadow Lane, Hanover, N.J. Phone: (201) 887-9270. Price: \$15 for 2 oz (312), \$60 for 1/2 oz (412)

Filled with a precious metal, two new epoxy solders, type 312 silver and type 412 gold, are single-component materials, ready to use as supplied. The 412 gold is recommended for applications where silver migration might present a problem. Both products can be used for lead terminations, chip bonding, conductive paths, circuit assembly and repairs.

CIRCLE NO. 290

variety with ALCOSWITCH

The greater the variety, the more flexibility you have when designing a miniature ALCO-SWITCH into your quality equipment. The broad ALCOSWITCH line offers over a hundred different models.

Miniature Toggle Switches are available in five series including high performance waterproof types, locking handles, and switches with 15/32" bushings.

Miniature Push Button Switches include the new illuminated series, top-grade SPDT-DPDT-4PDT types, 15/32" bushings, and economy priced miniatures.

1/2" Dia. Miniature Adjustable-Stop Rotary Switches are built to meet the highest reliability standards and are available with or without their own specially mated knobs.

Whether you need one or one thousand switches you have a greater variety to choose from when you specify an ALCOSWITCH.

SEND FOR 20-PAGE ALCOSWITCH CATALOG



ALCO

ELECTRONIC PRODUCTS, INC.

Lawrence, Massachusetts 01843

**TWO
Relays in ONE!**

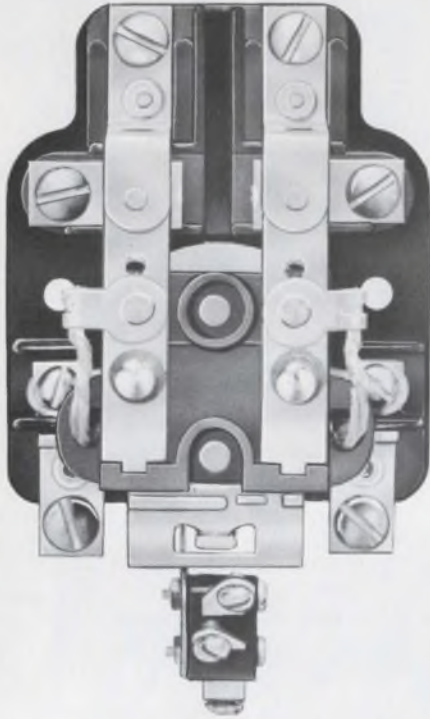
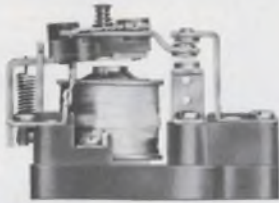

New 25 Amp Power Relay has a 10 Amp Auxiliary Switch

Deltrol Controls' New 900-1C Power Relay has a snap-action, 10 amp, 1/3 hp, SPDT auxiliary switch for switching signal lights or other sensing devices —and— heavy duty, 25 amp, contacts for motor control, heater loads, or other power switching applications. *You get two relays in one!* All 900 Series Power Relays are rugged, built to last: ■ coil terminal breakage is eliminated because coils terminate on the base ■ long-life, extra heavy gold-flashed, silver cadmium oxide contacts ■ 9.5VA nominal power ■ recognized under the UL & CSA component listing. Get the complete story by asking for *Engineering Bulletin No. 1372*.



RELAYS SOLENOIDS TIMERS

**DELTROL
CONTROLS**

1375-1

2745 So. 19th St. Milwaukee, Wis. 53215
Phone (414) 671-6800 Telex 2-6871

INFORMATION RETRIEVAL NUMBER 70

PRODUCTION

Wire stripper is portable unit



Lake Center Industries, 51 Johnson St., Winona, Minn. Price: \$99.

Designed and developed to solve production holdups in the assembly of a wire harness project, a new portable wire stripper is an air-operated (only 50 psi required) system that can also be bench mounted in any convenient position. Each set of its blades will strip three sizes of wire. A calibrated depth control adjustment insures uniform production at all times.

CIRCLE NO. 291

Soldering systems use IR radiation



Argus Engineering Co., Hopewell, N. J. Phone: (609) 466-1677. P&A: from \$2750; 60 days.

Series FS flat flexible cable soldering systems make all types of soldered connections rapidly and reliably by using focused infrared heating techniques. Entire rows or groups of joints are soldered simultaneously; the heater never touches the workpiece. A complete row of terminations, often as many as 200 joints, typically requires less than five seconds to complete.

CIRCLE NO. 292

Blasting system cleans small parts



Industrial Products Div., Inland Manufacturing Co. 1108 Jackson St., Omaha, Nebraska. Phone: (402) 342-1108.

Designed for precision blasting operations or cleaning of small intricate parts, the Mini-Blaster is a tabletop console that provides safe and clean blasting. It can be used on a production basis or for intermittent use throughout the day. The new unit consists of an all-steel blasting cabinet with an inside lighting fixture and a 7 by 18-in. plexi-glass window. The cabinet aids in eliminating environmental contamination.

CIRCLE NO. 293

Vacuum pickup tool has metal/Teflon tips



Labtron Scientific Corp., 100 Smith St., Farmingdale, N.Y. Phone: (516) 293-4898. Price: \$20.

Able to pickup and hold small and fragile items, a new vacuum forceps-like tool uses interchangeable tips of either metal or Teflon in sizes from 0.5 to 6 mm. Called Lab-69, the vacuum pickup connects directly to any convenient vacuum source, a vacuum pump or aspirator, and utilizes fine screen wires to prevent the tiny particles from being sucked into the tool. It has a comfortable pen-like shape.

CIRCLE NO. 294

light-quick



(click!)

If you're looking for a swift (and noiseless!) electronic switch that offers high voltage isolation of $10^{11}\Omega$ I/O, consider our MCT 1 coupled GaAs/LED phototransistor pair.

- 2500 volts isolation
- current transfer ratio of 35%
- Isolating capacitance: 3pf
- input/output IC-compatible
 - light, rugged, reliable
- analog or digital applications

Call your orders to Semiconductor Specialists, K-Tronics, Kierulff or Schweber. Want more details? Write us at 10131 Bubb Road, Cupertino, California 95014 Phone (408) 257-2140

Monsanto

INFORMATION RETRIEVAL NUMBER 71

ELECTRONIC DESIGN 20, September 27, 1969

Evaluation Samples

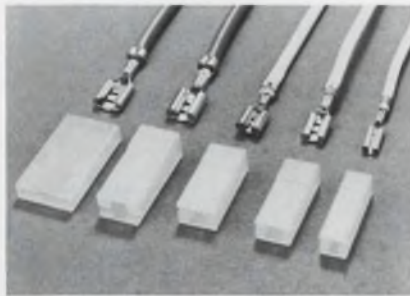

Terminal insulator

AMPIP post-insulating pods are one-piece molded nylon insulators designed for snap-on installation on crimped FASTON terminals. The pods are hand-installed and can be quickly and easily removed for terminal inspection or replacement. Each pod has a molded-in locking member which permits their use on standard non-insulated terminals allowing one terminal type to be used for either insulated or non-insulated applications. Once installed, the pod completely surrounds the terminal and provides a chamfered lead-in at the entry surface which eliminates mismatching due to terminal-to-tab misalignment. AMP Inc.

CIRCLE NO. 340



Module markers

Self-sticking Poly-Plates offer a fast, neat, permanent method of identifying electronic modules used in computers, switch gear, circuitry and equipment. All necessary data, including trademarks, wording, codes and colors, is sub-surface printed on these polyester labels. Individual specifications may include a special write-in area that accepts variable information written with a ballpoint pen, typewriter or other instrument. W. H. Brady Co.

CIRCLE NO. 341

here now



Our visible solid state light sources are being delivered in commercial quantities.

Very bright, typically 1000 ft/L @ 50 mA.

Long life: our tests indicate over 1,000,000 hours.*

Happily compatible with your IC circuitry.

Needs only 10 mW for 50 ft/L @ 6300-7000Å.

Instantly available in package shown or TO-18 header.

Ask Kierulff, Schweber, K-Tronics, or Semiconductor Specialists for our data sheets on the MV-10 series.

Monsanto ESP, 10131 Bubb Road, Cupertino, California 95014. Phone (408) 257-2140

* $T_A = 25^\circ C$, $I_F = 50$ mA. Result of step-stress testing with end of life projections.

Monsanto

INFORMATION RETRIEVAL NUMBER 72

109



ACOPIAN DUALS...

2

POWER SUPPLIES IN THE SPACE OF

1

Where your equipment or system requires more than one regulated DC output, consider Acopian duals. They consist of two independent regulated power supplies housed in a single module. You can select two like outputs (such as for op amps) or any of 80,000 combinations of different outputs.

Acopian duals cut mounting space requirements roughly in half, cost less than two individual modules and, like all Acopian power supplies save you time because they're shipped three days after receipt of your order.

For information on the complete line of 82,000 different Acopian power supplies, including singles and duals, regulated and unregulated, and rack mounted assemblies, ask for our new catalog. Write Acopian Corp., Easton, Pa. 18042 call (215) 258-5441.



INFORMATION RETRIEVAL NUMBER 73

Design Aids

M E M O I R S

OF THE

Royal Society ;

Being a New ABRIDGMENT of the

Philosophical Tranfactions.

Giving an ACCOUNT of the Undertakings, Studies, and Labours of the LEARNED and INGENIOUS in many considerable Parts of the WORLD; from the first Institution of that ILLUSTRIOUS SOCIETY in the Year 1663, to the Year of our LORD 1733 inclusive.

The whole carefully abridg'd from the Originals, and the Order of Time regularly observ'd, with a Translation of the

Ye olde memoirs

Interested in knowing how it really was way back when? Then "Memoirs of the Royal Society" is an absolute must for your insight into those days of yore. Learn how the great minds of the seventeenth and eighteenth century mapped out the design details of a machine for changing the air of a room of sick people. In-depth descriptions and precise equations reinforce the text. IMC Magnetics Corp., Eastern Div.

CIRCLE NO. 342

Resins folder

Epoxy, polyurethane and polystyrene resins as well as other stycast materials are charted in a new six-page folder. The properties tabulated include viscosity, cure temperature, yield strength, thermal conductivity, thermal expansion, service temperature, dielectric strength and volume resistivity. Emerson & Cuming, Inc.

CIRCLE NO. 343

PC coating selector

A new selector guide for printed circuit coatings lists the major characteristics of eight different printed circuit coatings, five urethane and three epoxy. Four of the coatings are available in military versions to meet the requirements of MIL-I-46058B. Differences between the various coatings, such as film thickness, pot life and shock resistance are treated in an easy-to-use reference form. The Dexter Corp., Hysol Div.

CIRCLE NO. 344

Annual Reports

Learn how to read annual reports in "How to investigate a company." For a copy, circle no. 474.

Associated Spring Corp., 18 Main St., Bristol, Conn.: springs, connectors, data processing; net sales, \$108,562,691; net income, \$5,366,571; assets, \$40,264,106; liabilities, \$10,561,734.

CIRCLE NO. 345

Diebold, Inc., Canton, Ohio: closed circuit television, vaults, surveillance systems; net sales, \$100,486,355; net income, \$4,746,774; assets, \$52,259,906; liabilities, \$12,026,620.

CIRCLE NO. 346

Emerson Electric Co., 8100 Florissant, St. Louis, Mo.: control, electronic and environmental systems and components; net sales, \$522,046,000; net earnings, \$39,458,000; assets, \$237,078,000; liabilities, \$54,314,000.

CIRCLE NO. 347

Farinon Electric, 935 Washington St., San Carlos, Calif.: microwave and communication systems and components; net sales, \$8,539,931; net income, \$751,381; assets, \$4,349,537; liabilities, \$2,645,850.

CIRCLE NO. 348

Loral Corp., 688 White Plains Rd., Scarsdale, N.Y.: defense, electronic and aerospace systems and components; net sales, \$50,005,285; net income (loss) \$1,444,025; assets, \$23,097,860; liabilities, \$8,596,758.

CIRCLE NO. 349

Viking Industries, Inc., 21001 Nordhoff St., Chatsworth, Calif.: connectors, sockets and fittings; net sales, \$6,874,477; net income, \$378,395; assets, \$2,442,275; liabilities, \$836,333.

CIRCLE NO. 350

Application Notes



Standards guide

The Standards Institute is now offering its 1969 catalog of USA Standards and international recommendations. Some 600 USA Standards and 300 international recommendations have been added to the new 112-page edition. It lists 3600 USA Standards approved by the Institute and 1350 international recommendations of the International Organization for Standardization (ISO), International Electrotechnical Commission (IEC), International Commission on Rules for the Approval of Electrical Equipment (CEE), and Pan American Standards Commission (COPANT). United States of America Standards Institute.

CIRCLE NO. 351

Cryogenics

Entitled "Cryogenic Data Reference," a new comprehensive 20-page booklet defines the science of cryogenics and provides a brief review of the state of the art. This review covers the alteration of matter at low temperatures, biological and medical applications, superconductivity, ultraprecise instrumentation, space simulation and metallurgy. Included are tables listing the cryogenic properties of gases, equivalent temperatures, and property equivalent of gases, as well as a temperature conversion table for Fahrenheit, Kelvin, Centigrade, and Rankine. Union Carbide Corp., Linde Div.

CIRCLE NO. 352



Permanent magnets

Temperature effects on permanent magnets are analyzed in a 12-page issue of "Applied Magnetism," Vol. 16, No. 1. The booklet tells how increasing temperature varies saturation magnetization and intrinsic coercive force for both alnico and ceramic magnets. The three temperature effects—reversible, irreversible and material—and their relationship to remanence are also explained and compared on temperature and second quadrant B-H curves. Indiana General Corp., Magnet Div.

CIRCLE NO. 353

Connector terms

Defining nearly 150 phrases, an eight-page glossary of connector terms eliminates the confusion that exists in connector terminology. Generic words such as barrel, ferrule, insert and ramp have specific meanings in terms of connector design. The glossary provides a solid basis for communication between engineers and the connector manufacturer. Cinch Distributor Div., Cinch Manufacturing Co.

CIRCLE NO. 354

Ku-band multipliers

A six-page application note gives design details for a practical times-eight single-stage step-recovery-diode frequency multiplier with typical maximum output power of 75 mW at 16 GHz. The literature includes references and a discussion of how to modify the design to meet other performance requirements. Hewlett-Packard Co.

CIRCLE NO. 355

AI RESEARCH

your avionic cooling system with AiResearch.



The AiResearch cooling enclosure for an airborne microwave receiver shown above is a good example of how we merge avionic cooling with a customer's total system requirements.

In this case, the customer needed an extremely efficient unit because of low air flow availability. It splits the airflow over three different fin densities to produce 340 watts of cooling.

We are ready to work with you, right from the beginning, to optimize your avionic cooling system for maximum savings in weight, size, power consumption, and time.

AiResearch capability includes over 30 years of experience and complete in-house component and system control.

For detailed specifications contact: AiResearch Manufacturing Company, 9851 Sepulveda Blvd., Los Angeles, Calif. 90009. (213) 776-1010 or (213) 670-0131.



AiResearch
Heat Transfer Systems

one of The Signal Companies

INFORMATION RETRIEVAL NUMBER 74

New Literature



Heathkit catalog

Said to illustrate the world's largest selection of electronic kits, the new 116-page Heathkit catalog shows over 300 kits for every budget and interest. Included are stereo and high-fidelity components, ham-radio equipment, marine gear, test equipment, shortwave and citizen-band receivers, photographic aids and educational kits. Heath Co.

CIRCLE NO. 356

Digital multimeter

A new eight-page brochure describes a precision five-digit multimeter with a sixth-digit 10% over-range capability. The instrument has an accuracy of 0.0025%. It can measure such parameters as millivolts, volts, resistances and ratios. It features single-point calibration and a one-year calibration warranty. Dana Laboratories, Inc.

CIRCLE NO. 357

Microwave products

Comprising a large comprehensive presentation, a new 48-page catalog contains complete information on a line of microwave components and equipment. Described are ferrite circulators and isolators, dummy loads, antenna horns, coaxial attenuators and terminations and slotted lines. Lectronic Research Laboratories, Inc.

CIRCLE NO. 358

MIL-type capacitors

Said to condense 202 pages of generic military specifications and 69 pages of data sheets into 28 pages of ready reference information, a new catalog details both solid and wet MIL-type tantanlum capacitors. Covered are MIL-C-39003, MIL-C-3965C, MIL-C-3965D and MIL-C-39006, along with part numbers, ratings, environmental requirements and failure rate information. NCI Capacitor Div.

CIRCLE NO. 359

Digital display terms

Containing a glossary of terms common to digital display devices, a new two-page technical bulletin defines analog and digital signals, sample rate, common-mode rejection, print command and other terms. The glossary is part of a data sheet on a digital panel meter that offers a 0.1% full-scale accuracy, a 3-1/2-digit display, and automatic polarity and overranging. The Triplet Corp.

CIRCLE NO. 360

Equipment rental

Listing a wide variety of electronic equipment available for short-term rental, a new 48-page catalog includes: oscilloscopes, counters, recorders, signal generators, digital voltmeters, power supplies, other types of general purpose test equipment, as well as small computers and computer peripheral equipment. Rentronix Div. of Inmark, Inc.

CIRCLE NO. 361

Electronics aerosols

Covering chemical products for electronic equipment servicing, a new eight-page catalog describes tuner sprays, contact and control cleaners, insulating sprays, lubricants and circuit coolers. Chemtronics Inc.

CIRCLE NO. 362



IC test sockets

Covering a complete line of sockets and carriers for testing integrated circuits, a new catalog also describes a variety of accessories and universal-type sockets. The products are divided into twelve different categories, including a line for MSI and LSI devices. Robinson-Nugent, Inc.

CIRCLE NO. 363

Transformer guide

Comprehensive information on how to select and apply a wide variety of dry-type transformers is presented in a new 28-page booklet. It contains application and ordering guidelines for general-purpose, buck-boost, distribution, and machine tool transformers. Integral distribution centers and ac voltage stabilizers are also featured. The brochure also provides application information on voltage-tap arrangements. General Electric Co.

CIRCLE NO. 364

Fluidic devices

Pneumatic logic and fluidic components are described in a new catalog. Included is detailed information on interface valves, five-port sockets, bistable and monostable amplifiers, proportional amplifiers, fluid diodes, and miniature pneumatic valves. Applications, specifications, operating characteristics, dimensions, ordering information and prices are fully discussed. Parker Hannifin Corp., Pneumatic Div.

CIRCLE NO. 365

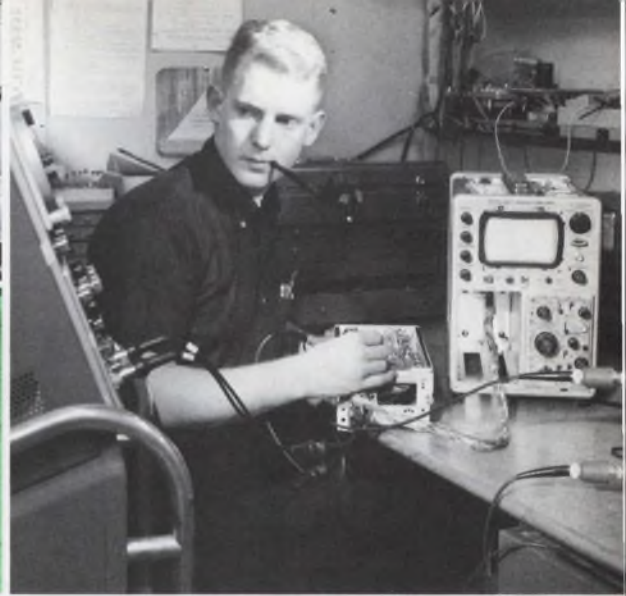

Here's technical achievement for you... better living for you and your family

We are particularly anxious to meet you if you are a Circuit Design Engineer; Packaging and Mechanical Engineer; Electron Optics, Vacuum Technology or Materials and Process Specialist. But whatever your technical strengths, if "roll-up-the-sleeves" engineering appeals to you, we'd like to hear from you.

Here you'll find an environment that emphasizes the individual, and his personal contribution to technical development—contribution by working on projects, not writing about them. Your work will benefit advanced engineering throughout the world. *You* will benefit from technical association with specialists experienced in developing state-of-the-art instrumentation, components and devices.

All Tektronix R & D—financed entirely from our annual sales of approx. \$150 million—is directed toward commercial products. Our community is prosperous, balanced, with a stability of employment not typical of every industrial center. And as for the Green Land we live in—it speaks for itself.

If you're seeking technical advancement and better living for you and your family, why not investigate Tektronix?

Write to D. A. Thompson, Tektronix, Inc., P. O. Box 500B, Beaverton, Oregon 97005, or send in the coupon.

Professional Placement Mgr., Tektronix, Inc.

P. O. Box 500B, Beaverton, Oregon 97005

Please send me your Booklet, "Tektronix" Application Form

NAME: _____

ADDRESS: _____

CITY: _____

STATE: _____

I am interested in: _____

Tektronix, Inc.

An Equal Opportunity Employer.



ELECTRO-MAG LO-HI FREQUENCY SHIELD

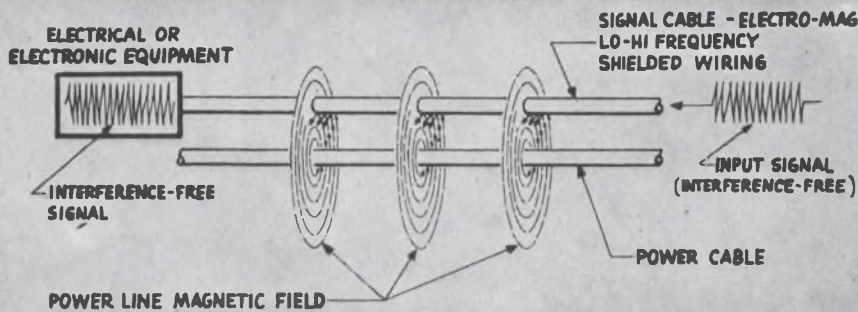

A new method of attenuating electro magnetic interference over an extremely wide frequency range 60 CPS to 10 KMC. Can be applied over power cable and assemblies to reduce noise.

Write for literature and test report.

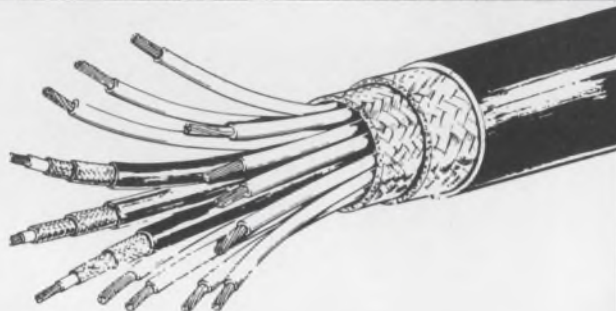

Manufacturers of Electronic wire, cable, cable assemblies and custom products.

ELECTRONICS CORP.

17360 S. Gramercy Place, Gardena, California
SEE US AT BOOTH 1522

B&B

INFORMATION RETRIEVAL NUMBER 84

NEW LITERATURE

Motor catalog

An eight-page catalog on computerized precision instrument motors shows how high-speed digital computer curves relate motor rpm to shaft torque, power factor, percent efficient and other variables to achieve optimum predictable motor performance. Presented are commercial and Mil-spec motors with helpful data on selection and performance. There is also tabular engineering information on polarized synchronous, hysteresis synchronous and induction motors. McLean Engineering Laboratories.

CIRCLE NO. 367

Rugged connectors

FRF firewall connector line is described in a new 12-page catalog. This high-temperature environmental-resistant series meets the requirements of MIL-C-5015, Class K subsonic, supersonic and hypersonic aerospace applications. ITT Cannon Electric.

CIRCLE NO. 368

Resistor array

Specifically designed, with resistance values and terminal arrangements, to be used with Fairchild's uA722 10-bit current source, a cermet thick-film binary resistor array is the subject of a four-page brochure. Schematic drawings, performance characteristics and specifications are provided for the array. Beckman Instruments, Inc., Helipot Div.

CIRCLE NO. 369

Multiplexer system

A time division multiplexer with a wide variety of remote terminal units is described in a comprehensive brochure. Typical applications of the multiplexer include computer systems devoted to time sharing. The system, which can be easily expanded, can transmit up to 38 full-duplex channels of data over a single 3-kHz voice-grade circuit. Tel-Tech Corp.

CIRCLE NO. 370

SPERRY RAND

DESIGN OPENINGS

in Phoenix, Arizona

Join the world's largest developers and producers of automatic flight controls and instrument systems for commercial and military jet aircraft.

DESIGNERS

Must have ability to prepare complex layouts and design investigations from engineering information, using the latest state-of-the-art techniques, and meeting schedule requirements.

Applicants will be familiar with drafting practices, manufacturing techniques, engineering principles, and have the ability to interpret customer specifications. Also able to read schematics, knows electronic component packaging, and both layout and checking (electronic and electro-mechanical).

Airborne electronic mechanical experience very desirable.

SENIOR DESIGNERS

Will coordinate the work of less experienced designers in layout of associated devices, and review finished drawings with checkers.

Send detailed resume (and salary information) for confidential consideration to:

William Leezer
Professional Recruitment Representative

SPERRY

FLIGHT SYSTEMS DIVISION

P.O. BOX 2529, PHOENIX, ARIZONA 85002

An equal opportunity employer M/F

INFORMATION RETRIEVAL NUMBER 902

Free Career Inquiry Service

Absolutely Confidential

Respond to the career opportunities advertised in this issue. Fill out and send us this handy resume. **Electronic Design** will do the rest – neatly typed copies of this form will be mailed to the companies of your choice, indicated by the circled Career Inquiry Numbers at the bottom of this page.

20

Name				Home Phone	
Home Address (Street)			City	State	ZIP Code
Age	U.S. Citizen <input type="checkbox"/> Yes <input type="checkbox"/> No		Security Clearance		
Prime Experience			Secondary Experience		
Desired Salary			Availability Date		
Employment History – present and previous employers					
Company					
City, State					
Dates		to		to	
Title					
Specialty					
Education – indicate major if degree is not self-explanatory					
Degree					
College					
City, State					
Dates		to		to	
Additional Training – non-degree, industry, military, etc.					
Professional Societies					
Published Articles					

- Career Inquiry Numbers:**
- | | | | | | | | | | | |
|-----|-----|-----|-----|-----|-----|-----|-----|-----|-----|-----|
| 900 | 901 | 902 | 903 | 904 | 905 | 906 | 907 | 908 | 909 | |
| 910 | 911 | 912 | 913 | 914 | 915 | 916 | 917 | 918 | 919 | 925 |

ELECTRONIC DESIGN
 850 Third Avenue
 New York, New York 10022

Design Data from Manufacturers

Advertisements of booklets, brochures, catalogs and data sheets. To order use Reader-Service Card.
(Advertisement)

Terminal Block Selector



A new 24-page, completely illustrated catalog contains photos, descriptions, ratings, engineering drawings, and prices of the complete line of Curtis terminal blocks. Included are printed circuit, insulated feed-thru, quick disconnect, track type, and high current terminal blocks. Handy selection chart quickly locates the perfect block for your particular requirements. Send today for your free copy.

Curtis Development & Mfg. Co.
3236 North 33rd Street
Milwaukee, Wisconsin 53216

174

How To Write Technical Articles



A guide for the engineer-author, "How to Write Articles for Electronic Design" shows how easy it is to write for publication—once the engineer knows what to write and how to write it. The Author's Guide includes a complete run-down of the types of articles published by Electronic Design—plus detailed instructions on how to prepare technical articles and short special features. A **MUST** for every "would-be-writer" in the electronics industry. Send for your complimentary copy by circling the number to the right.

Electronic Design
850 Third Avenue
New York, N.Y. 10022

175

FUNDAMENTALS OF INTEGRATED CIRCUITS

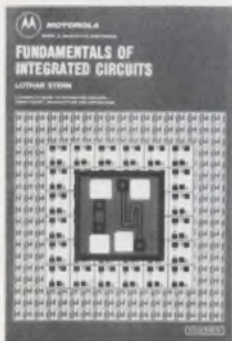

A practical guide to integrated circuits, their theory, manufacture, and applications. This new guide by Lothar Stern offers complete, highly readable coverage of the various techniques of circuit fabrication, and their effect on circuit design and performance. As to marketing considerations, it compares the characteristics of the numerous IC structures devised to date in terms of economics and logistics. A volume in the **Motorola Series in Solid-State Electronics**. 198 pages, 7 x 10, illustrated. \$8.95, clothbound. Send for 15-day examination copies.

Hayden Book Company, Inc.
116 West 14th Street
New York, N.Y. 10011

176

Electronic Design

ELECTRONIC DESIGN's function is:

- To aid progress in the electronics manufacturing industry by promoting good design.
- To give the electronic design engineer concepts and ideas that make his job easier and more productive.
- To provide a central source of timely electronics information.
- To promote two-way communication between manufacturer and engineer.

Want a subscription? ELECTRONIC DESIGN is sent free to qualified engineers and engineering managers doing design work, supervising design or setting standards in the United States and Western Europe. For a free subscription, use the postfree application form inside the back cover. If none is included, write to us direct for an application form.

If you do not qualify, you may take out a paid subscription for \$25 a year in the U.S.A., \$35 a year elsewhere. Single copies are \$1.50 each.

If you change your address, send us an old mailing label and your new address; there is generally a prepaid postcard for this inside the back cover. You will have to requalify to continue receiving ELECTRONIC DESIGN free.

The accuracy policy of ELECTRONIC DESIGN is:

- To make reasonable efforts to ensure the accuracy of editorial matter.
- To publish prompt corrections whenever inaccuracies are brought to our attention. Corrections appear at the end of the Letters column.
- To refuse any advertisement deemed to be misleading or fraudulent.

Microfilm copies are available of complete volumes of ELECTRONIC DESIGN at \$19.00 per volume, beginning with Volume 9, 1961. Work is now in process to complete the microfilm edition of Volumes 1-8. Reprints of individual articles may be obtained for \$2.00 each, prepaid (\$.50 for each additional copy of the same article) no matter how long the article. For further details and to place orders, contact the Customer Services Department, University Microfilms, 300 North Zeeb Road, Ann Arbor, Michigan 48106; telephone (313) 761-4700.

Want to contact us? If you have any comments or wish to submit a manuscript or article outline, address your correspondence to:

Howard Bierman, Editor,
ELECTRONIC DESIGN,
850 Third Avenue,
New York, N.Y. 10022.

Advertising Sales Staff

New York 10022

Edward F. Clancy
Sales Service Manager
Robert W. Gascoigne
Thomas P. Barth
Samuel M. Deitch
Byron Adams
850 Third Avenue
(212) Plaza 1-5530
TWX: 867-7866

Philadelphia 19066

William C. Repetto
P. O. Box 206
Merion Station, Pa.
(215) MA-3-5888

Boston 02110

Richard Parker
48 Commercial Wharf
Boston, Mass.
(617) 742-0252

Chicago 60611

Thomas P. Kavooras
Berry Conner, Jr.
200 East Ontario
(312) 337-0588

Cleveland

Thomas P. Kavooras
(Chicago)
(312) 337-0588
(call collect)

Los Angeles 90303

Stanley I. Ehrenclou
John V. Quillman
W. James Bischof
2930 Imperial Highway
Inglewood, Calif.
(213) 757-0183

San Francisco 94022

Arthur R. Shields, Jr.
175 San Antonio Rd., S 243
Los Altos, Calif.
(415) 941-3084

London W. 1

For United Kingdom & Holland
Brayton C. Nichols
44 Conduit Street
Tel: REGent 4714

Verviers, Belgium

For Continental Europe
Andre Jamar
1, Rue Mallar, 1
(087) 253.83 Telex 41563

Tokyo

Yoshiro Takemura
IPS Group Ltd.
Box 36, Ohsaki Post Office
Phone (504) 1485
Cable Joshplans, Tokyo



AMERICAN BUSINESS PRESS, INC.

THE UNSPOILERS!

NO DEVICE LEAD MANGLING IN HANDLING AND TEST WITH BARNES "TO" CARRIERS/CONTACTORS

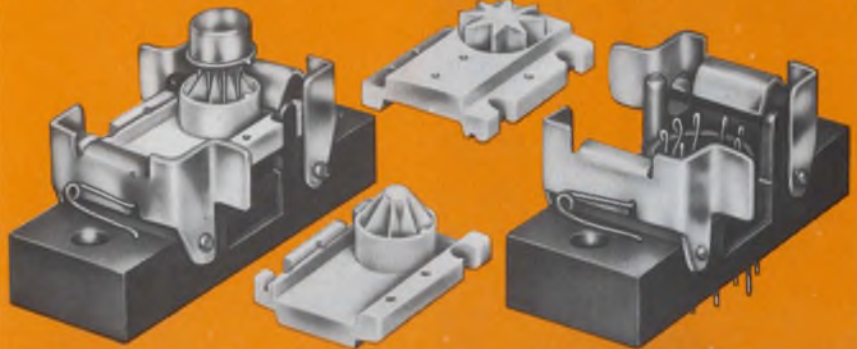

Plagued by spoilage caused by device lead damage? Get the Unspoilers from Barnes. The 029 Series Carriers protect TO packaged devices in handling and testing operations . . . through manual/semi-automatic and automatic systems. Deep tapered entrances of the carrier permit easy device alignment and insertion. Features include positive polarization, probing type contacts and a -65°C to 150°C operating range. The Unspoilers: Write for more data.



Lansdowne, Pa. 19050 • 215/MA2-1525

barnes / THE FIRST WORD IN CARRIERS, CONTACTORS AND SOCKETS FOR I.C.'S

INFORMATION RETRIEVAL NUMBER 75

"Why the hell would anyone buy a slotted line?"



Good question. When the Telonic Rho-Tector is available to provide faster answers, with accuracies equal to slotted lines, and at $\frac{1}{3}$ the cost, **why would anyone buy a slotted line?**

Rho-Tectors operate from 500 KHz to 5 GHz with 50,60,75 ohm systems, swept or fixed frequency, and are priced as low as \$75.00.

TELONIC ENGINEERING 

A Division of Telonic Industries, Inc.
21262 Laguna Canyon Road • Box 277
Laguna Beach, California 92652
Tel. 714 494-9401 • TWX 910 596-1320

INFORMATION RETRIEVAL NUMBER 76

**2 SPEED
10", 10 MV
1/2%
\$305.00**



**MODEL 28
SERVO GRAPHIC**

A RUGGED, DEPENDABLE, RACK MOUNTED, SERVO RECORDER WITH ACCURACY TO MEET YOUR REQUIREMENTS, BUT AT A PRICE TO SATISFY YOUR BUDGET. AVAILABLE IN SINGLE OR DUAL PEN MODELS FROM YEISER LABORATORIES, THE LEADERS IN SERVO RECORDER DESIGN FOR OVER FIFTEEN YEARS. DUAL OVERLAPPING CHANNELS FROM \$600.00.



- ALL SILICON SOLID STATE ELECTRONICS
- PLUG-IN CIRCUITRY
- FET CHOPPER
- ZENER REFERENCE

Remember! If you have an OEM requirement, Y-LAB can furnish strip chart or X-Y recorders to meet your specific needs, so call or write:



881 W. 18th ST.
COSTA MESA,
CALIF. 92627
714 - 548-2458

**Advertisers'
Index**

Acopian Corporation	110	Lockheed Electronics Company	88
Airpax Electronics, Incorporated	65	McCoy Electronics Company	86
Alco Electronic Products, Inc.	103, 105, 107	Matsuo Electric Co., Ltd.	105
Allen-Bradley Co.	41, 43	Monsanto Company	109
AiResearch Manufacturing Company	111	Motorola Communications & Electronics Inc.	95
Applied Digital Data Systems, Inc.	8, 9	Motorola Semiconductor Products, Inc.	4, 5, 16, 50
Atlas Fibre Co.	119	National Semiconductor Corporation.....	12, 13
Barnes Corporation	117	New Product Engineering, Inc.	54, 55
B & B Electronics Corp.	114	Nytronics, Inc.	31
Bourns, Inc.	53	Oak Manufacturing Co.	95
Burroughs Corporation	20	Power/Mate Corp.	92
Clevite Corporation, Burgess Battery Division	64	RCA Electronic Components and Devices	29, Cover IV
Clevite Corporation, Piezoelectric Division	119	Radio Materials Company	99
Components, Inc.	10	Raytheon Company, Industrial Components Operation	102
Corning Glass Works, Electronic Products Division	34, 35	Raytheon Company, Semiconductor Operation	62, 63
Cunningham Corporation, Subsidiary of Gleason Works	33	Schauer Manufacturing Corp.	106
Curtis Development & Mfg. Co.	116	Signetics Corporation	27, 84
Cutler-Hammer	92	Simpson Electric Company	101
Dale Electronics, Inc.	Cover III	Spectrol Electronics Corporation	66
Dana Laboratories, Inc.	47	Sprague Electric Company	18
Deltrol Controls	108	Systron-Donner Corporation	2
Du Pont Company	90	TRW Semiconductors, Inc.	58
Elco Corporation	11	Tektronix, Inc., Oscilloscopes	16 A-B-C-D
Electronic Design	116	Telonic Engineering, A Division of Telonic Industries, Inc.	117
Fairchild Controls, A Division of Fairchild Camera and Instrument Corporation	23	Tenney Engineering, Inc.	95
General Electric Company, Lamp Metals & Components Dept.	119	Texas Instruments Incorporated, Components Group	6, 7, 83
General Radio Company	1	Theta Instrument Corporation	17
Guardian Electric Manufacturing Company	15	Varo Inc.	98
Hayden Book Company, Inc.	116	Welch Allyn, Inc.	14
Hewlett-Packard	Cover II, 24, 77	Y-Labs	118
Honeywell, Computer Control Division	49	Career Advertising	
Honeywell Test Instrument Division	56 A-B, 57	Sperry Flight Systems Division.....	114
IMC Magnetics Corporation	97	Tektronix, Inc.	113
Ideal Precision Meter Co. Inc.	56	JFD Electronics Corp./ Components Division	100
Intel Corporation	60, 61	Kurz-Kasch, Inc.	96
Intronics, Incorporated	104	◀ INFORMATION RETRIEVAL NUMBER 77	
Isomet Corporation	73		



Axially Welded Wires?

...take our lead. General Electric has the facilities and advanced techniques to provide butt weld combinations of copper, nickel, Dumet, tungsten, molybdenum, nickel-iron-cobalt alloys, nickel clad copper, copper clad iron, and others. Available in wire diameters from .008 to .100 in. with many length and material combinations. Take advantage of GE's experience in producing billions of lamp, electronic tube and semiconductor lead wires every year. Minimum order of 100,000. Product data sheets on request. General Electric Company, Lamp Metals & Components Department, 21800 Tungsten Road, Cleveland, Ohio 44117. Tel: (216) 266-3472.

GENERAL ELECTRIC

INFORMATION RETRIEVAL NUMBER 78

ATLAS

Turned and Precision Ground



PHENOLIC RODS

STOCK SIZES OR CUSTOM-MADE

Specifically for

RELAY and SWITCH applications

- Most sizes available for immediate delivery.
- Stock sizes in any diameter from 1/32" to 3/8"*
- Increments of .001" at no extra charge
- Unsurpassed accuracy guaranteed to ±.001"

COMPLETE FACILITIES FOR FABRICATION

Atlas guarantees unequalled accuracy in the precision fabrication of parts from any of these materials. Send your blueprints and specifications for a prompt quote without any obligation.

*Larger sizes and closer tolerances quoted on request.

SEND FOR COMPLETE PRICE LIST

ATLAS FIBRE COMPANY
6970 N. Central Park Avenue
Chicago, Illinois 60645

INFORMATION RETRIEVAL NUMBER 79

ELECTRONIC DESIGN 20, September 27, 1969

Going to IC's? Or Higher IF's?

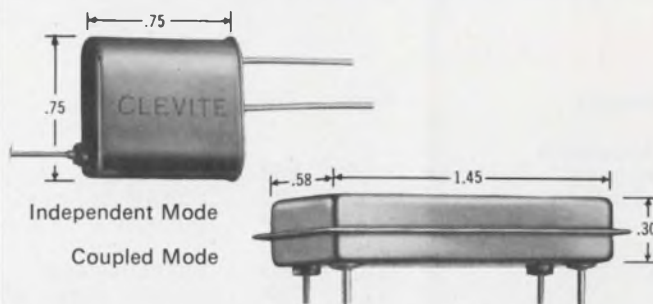

Go two ways with Monolithic Quartz Uni-Wafer® Filters

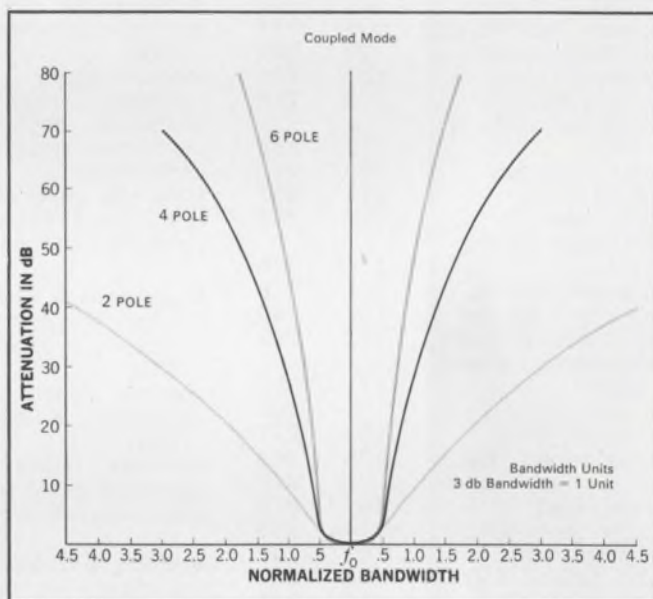

Go independent mode. Go coupled mode. You can go either mode with monolithic Clevite Uni-Wafer® filters. They're smaller and more reliable (fewer interconnections) than conventional filters.

Clevite Uni-Wafer filters are ideal for matching IC circuitry in communications receivers operating in the VHF and UHF frequency ranges as well as in telemetry, radar and aerospace systems.

They are 2, 4 and 6 pole crystal filters with a choice of center frequencies ranging from 8 MHz to 75 MHz. They've been developed using Clevite's advanced engineering techniques and Clevite's original thin film approach to quartz filters. In this concept, arrays of resonators are achieved on a single quartz wafer with resonator isolation and spurious suppression controlled by the trapped energy principle.

So if you're going to IC's or higher IF's, go Clevite Uni-Wafer filters. They're available in both independent and coupled mode.

For more information and complete specification data, write: Clevite Corporation, Piezoelectric Division, 232 Forbes Road, Bedford, Ohio 44146.

CLEVITE

INFORMATION RETRIEVAL NUMBER 80

Information Retrieval Service

All products, design aids (DA), application notes (AN), new literature (NL), and reprints (R) in this issue are listed here with Page and Information Retrieval numbers. Reader requests will be promptly processed by computer and mailed to the manufacturer within three days.

Category	Page	IRN	Category	Page	IRN	Category	Page	IRN
Components			sockets, IC	112	362	resistor array (NL)	114	368
amplifiers, Darlington	99	263	standards guide (AN)	111	351	standards guide (AN)	111	351
analyzer, digital	97	258	transistors, power	98	261	Packaging & Materials		
capacitor, trimmer	101	267	transistors, S-band	106	283	adhesive, wash-away	107	288
capacitors, military (NL)	112	359	Instrumentation			aerosols (NL)	112	362
capacitors, monolithic	102	269	counter, frequency	106	285	connector terms (AN)	111	354
connector terms (AN)	111	354	counter, LED-display	94	250	connectors (NL)	114	368
decoder/driver, Nixie	98	262	cyrogenics (AN)	111	352	cryogenics, (AN)	111	352
design memoirs (DA)	110	342	display system, CRT	103	273	enclosures, rfi	107	287
display terms (NL)	112	360	display terms (NL)	112	360	Heathkit catalog (NL)	112	356
fluidic devices (NL)	112	365	equipment rental (NL)	112	361	insulator, terminal (ES)	109	340
Heathkit catalog (NL)	112	356	generator, pulse	96	255	markers, module (ES)	109	341
insulator, terminal (ES)	109	340	Heathkit catalog (NL)	112	356	masking compound	107	289
LED, red	98	259	meter, digital panel	94	252	PC coating selector (DA)	110	344
magnets, permanent (AN)	111	353	meter, digital panel	96	253	resins folder (DA)	110	343
markers, module (ES)	109	341	microwave products (NL)	112	358	sockets, IC (NL)	112	362
memories, display	98	260	monitor, signal	106	286	solders, precious-metal	107	290
memory, core	103	275	multimeter, digital	94	251	standards guide (AN)	111	351
memory system	103	275	multimeter, digital (NL)	112	357	Production		
microwave products (NL)	112	358	multiplexer system (NL)	114	370	blasting system	108	293
mixer, balanced	100	266	oscilloscope	96	254	fluidic devices (NL)	112	365
motors (NL)	114	367	standards guide (AN)	111	351	pickup, vacuum	108	294
multiplexer	99	264	voltmeter, LED-display	94	250	soldering systems	108	292
multiplexer system (NL)	114	370	voltmeter, memory	96	256	standards guide (AN)	111	351
multiplier, analog	104	278	Microwaves & Lasers			wire stripper	108	291
multiplier, low-cost	104	280	counter, frequency	106	285	New Literature		
multipliers, economy	104	279	microwave products (NL)	112	358	aerosols, electronics	112	362
multipliers, Ku-band (AN)	111	355	monitor, signal	106	286	capacitors, military	112	359
op amp array	99	265	multipliers, Ku-band (AN)	111	355	connectors	114	368
photocell, CdS	102	271	oscillator, 5-GHz	106	284	display terms	112	360
power supply, logic	105	282	standards guide (AN)	111	351	equipment rental	112	361
readout, segmented	101	268	transistors, S-band	106	283	fluidic devices	112	365
relays, reed	102	270	Modules & Subassemblies			Heathkit catalog	112	356
resistor array (NL)	114	368	amplifiers, Darlington	99	263	microwave products	112	358
resistors, chip	102	272	analyzer, digital	97	258	motors	114	367
SCR, 1200-V 450-A	97	257	decoder/driver, Nixie	98	262	multimeter, digital	112	357
sockets, IC (NL)	112	362	display system, CRT	103	273	multiplexer system	114	370
standards guide (AN)	111	351	display terms (NL)	112	360	resistor array	114	368
transformers (NL)	112	364	fluidic devices (NL)	112	365	sockets, IC	112	362
transistors, power	98	261	Heathkit catalog (NL)	112	356	transformer guide	112	364
Data Processing			markers, module (ES)	109	341	Application Notes		
copier, electrostatic	103	276	memories, display	98	260	connector terms	111	354
display system, CRT	103	273	memory, core	103	275	cryogenics	111	352
display terms (NL)	112	360	memory system	103	275	magnets, permanent	111	353
equipment rental (NL)	112	361	microwave products (NL)	112	358	multipliers, Ku-band	111	355
fluidic devices (NL)	112	365	mixer, balanced	100	266	standards guide	111	351
memory, core	103	274	multiplexer	99	264	Design Aids		
memory system	103	275	multiplexer system (NL)	114	370	design memoirs	110	342
multiplexer system (NL)	114	370	multiplier, analog	104	278	PC coating selector	110	344
standards guide (AN)	111	351	multiplier, low-cost	104	280	resins folder	110	343
ICs & Semiconductors			multipliers, economy	104	279	Evaluation Samples		
analyzer, digital	97	258	multipliers, Ku-band (AN)	111	355	insulator, terminal	109	340
amplifiers, Darlington	99	263	op amp, FET	104	277	markers, module	109	341
decoder/driver, Nixie	98	262	op amp, FET	105	281			
LED, red	98	259	op amp array	99	265			
memories, display	98	260	oscillator, 5-GHz	106	284			
multiplexer	99	264	power supply, logic	105	282			
op amp array	99	265	readout, segmented	101	268			
resistor array (NL)	114	368	relays, reed	102	270			
resistors, chip	102	272						
SCR, 1200-V 450-A	97	257						



Dale connector line grows with new SHP-40 modular style

Make sure you have Dale on your list of connector sources. Describe Dale's connector line as: *"Small, but growing...able to supply volume quantities of all items in line...capable of meeting special design requirements."*

Among the new models now being produced by Dale is the SHP-40. This NAFI design conforms to BUWEPS 63A49F100 and gives us a strong entry into the modular field. For a quick look at some of the popular models we can

supply, see below. Then make sure you have our new connector catalog. It lists complete details on these styles:

PRINTED CIRCUIT • Direct card edgeboards as well as two-piece right angle and straight-thru types.

TEST POINTS • Printed Circuit Jacks or Points

RACK & PANEL (Rectangular)

- Miniature, Subminiature and Microminiature
- Shelled versions of Rack & Panel

UMBILICAL • Missile & Avionics Models • Shorting Plugs

NAFI • 40 pin

Write today for your catalog. Phone 402-564-3131 for price & delivery information:



DALE ELECTRONICS, INC. 1300 28th Ave., Columbus, Nebr. 68601
 In Canada Dale Electronics Canada, Ltd • A subsidiary of The Lionel Corporation



INFORMATION RETRIEVAL NUMBER 213

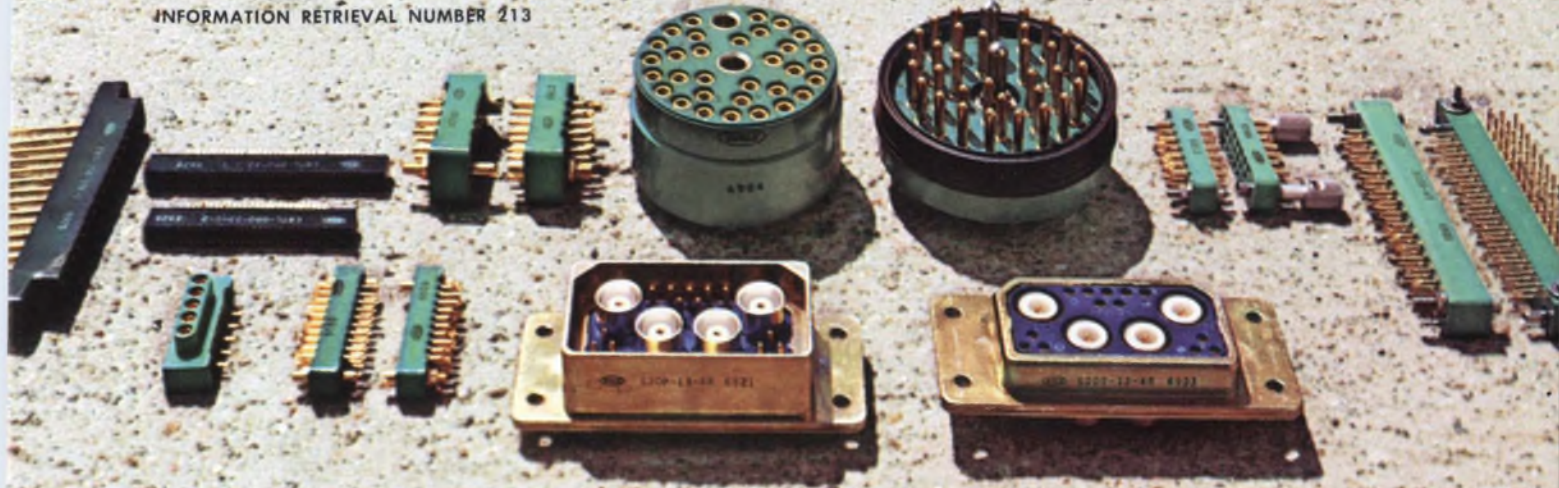

It's here NOW...from RCA

The 98¢ Op Amp

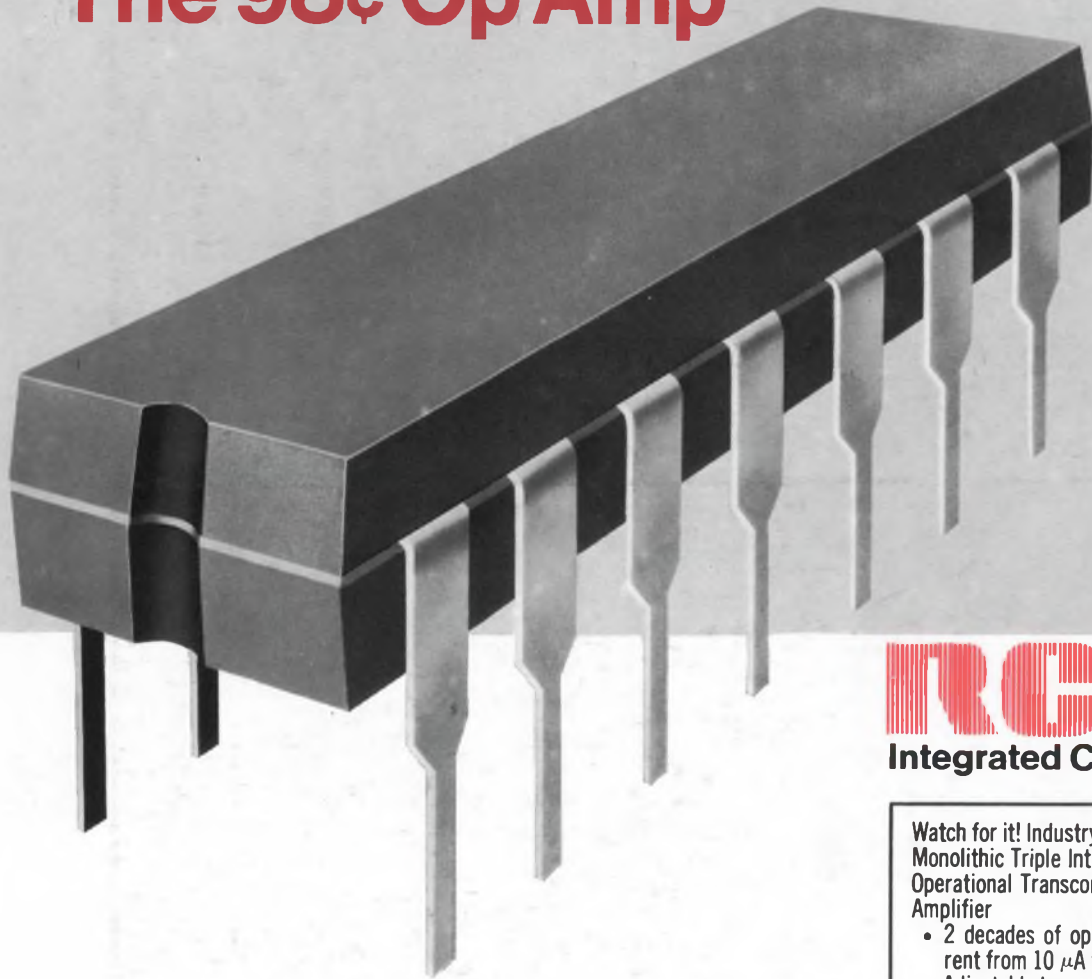

RCA
Integrated Circuits

Watch for it! Industry's First Monolithic Triple Integrated Operational Transconductance Amplifier

- 2 decades of operating current from 10 μ A to 1 mA
- Adjustable transconductance (100 mmho per mA of total amplifier current)

Now — more than ever — you can look to RCA for Op Amp economy. New levels of production now bring you RCA Op Amp performance at new low prices — across the entire line, starting with the CA3029 at 98¢ (1,000 units). Check your requirements against RCA's new Op Amp prices (1,000 units) shown at right . . . then see your local RCA Representative or your RCA Distributor. For specific circuit data, write RCA Electronic Components, Commercial Engineering, Sec. ICG9-2, Harrison, N.J. 07029

Match these RCA Op Amps to your design needs						
Low-noise Types and Economy Types				High-Gain, High-Power Types		
± 6 -V types		± 12 -V types		± 12 -V types	± 18 -V types	
Flat Pack (14-lead)	CA3008 \$3.90	CA3008A \$5.90	CA3016 \$5.40	CA3016A \$6.90		
TO-5 (12-lead)	CA3010 \$1.58	CA3010A \$2.90	CA3015 \$2.40	CA3015A \$3.90		
DIC (14-lead)	CA3037 \$1.90	CA3037A \$2.90	CA3038 \$2.90	CA3038A \$3.90	CA3033 \$2.90	CA3033A \$4.90
DIP (14-lead)	CA3029 \$.98	CA3029A \$1.90	CA3030 \$1.58	CA3030A \$2.90	CA3047 \$1.58	CA3047A \$2.90
Open Loop Voltage Gain	60 dB typ.	60 dB typ.	70 dB typ.	70 dB typ.	90 dB (Diff) typ.	96 dB (Diff) typ.
CMR	94 dB typ.	94 dB typ.	103 dB typ.	103 dB typ.	100 dB typ.	108 dB typ.
Input Bias Current	12 μ A max.	4 μ A max.	24 μ A max.	6 μ A max.	350 nA max.	200 nA max.
Input Impedance	10 k Ω min.	15 k Ω min.	5 k Ω min.	7.5 k Ω min.	1.5 M Ω typ.	1 M Ω typ.
Noise Figure @ 1kHz	—————	12 dB max.	—————	16 dB max.	—————	—————
(all prices shown at 1000-unit level)						