

Electronic Design EXTRA



Glickman

This readout tube never tells a lie



Others do

(and you never know when they fail)

Whatever data you input, a NIXIE® tube reads out. Exactly! You always have reliably accurate readouts, with no risk of a 1 when there should be a 7, a 0 instead of an 8, or a 3 instead of a 9. Rather than tell a lie, honest NIXIE tubes give you no reading ... protect you against false readouts caused by multiple segments that break down, blank out ... and don't indicate that they're wrong. You never know when they are faulty.

Selecting a readout display involves more than truth, so weigh every aspect. Check NIXIE tubes for their unmatched reliability, their proven long life (over

200,000 hours), natural readability, and uniform brightness (200 ft. lamberts, with no chance of partial fade-outs). See how only NIXIE tubes are unaffected by static charge ... meet mil specs ... offer unsurpassed packaging and design flexibility (no extra top leads required for decimals). All this, in the most complete and advanced line of tubes and accessories. No wonder NIXIE tubes lead the field.

For information, call or write: Burroughs Corporation, Electronics Components Division, P.O. Box 1226, Dept. N5, Plainfield, N. J. 07061; tel. (201) 757-5000.



the leader
in the world of displays

Burroughs



View above display from 6 ft. distance for complete realism

See us at WESCON Booths 4224-4225

INFORMATION RETRIEVAL NUMBER 721

It's a more practical Wescon this year

23 reorganized technical sessions, 1192 booths
and new conveniences in Cow Palace are yours



More than 250,000 square feet of exhibit space in the Cow Palace . . . 1192 booths displaying the latest in electronics . . . upward of 600 companies represented . . . 45,000 visitors expected.

What else is new at Wescon this year? Simply this: The stress is on quality, not quantity. Working engineers should find the show more useful to them.

For the first time, technical sessions have been organized according to the type of technology to be presented. And, wherever possible, an attempt has been made to see that technical sessions of interest to any particular group of engineers do not overlap. Three sessions are going on simultaneously at any one time, but the area of interest in each is different. To achieve this goal, the number of technical sessions has been trimmed from 32 last year to 23.

Contents

Linear ICs raid deeper into consumer field	E6
Apollo's success rubs off on earth	E10
Outlook bright for solid-state optics	E18
Underground nuclear blasts controlled electronically	E22
British seek larger U.S. market	E24
Future engineers compete at Wescon	E28
What engineers really do at Wescon	E30
The exhibitors and where to find them	E34
Canada displays wide range of exhibits	E48
The best in product design	E50
Coupons	E69
Wescon USA	U81

The sessions that have been dropped were, for the most part, state-of-the-art or theoretical in nature. This year the sessions are aimed at what can be done in today's world of engineering.

Exhibits, once again, are grouped by product category. To carry out this goal of the show, several companies have split up their exhibits to allow different divisions to have their own displays in different parts of the Cow Palace.

The showgoers streaming into San Francisco are occupying more than 8000 hotel and motel rooms, but a private mass transportation system is available to shuttle them by bus to the Cow Palace. Steady bus runs are leaving downtown San Francisco and Palo Alto, in the heart of the Bay area.

'Credit cards' available

Personalized plastic "credit cards" are being distributed to all who register at the show. With these, showgoers can request technical information and sales literature from the exhibitors for subsequent mailing. It eliminates one onerous chore: the need to collect and carry around pounds of catalogs and other material being distributed at the booths.

If you're the type who gets lost or confused easily in crowded exhibition halls, computers are on hand to rescue you. They're placed at strategic points in the Palace—time-shared computer terminals with cathode-ray-tube displays, programmed to direct visitors to any booth. The same terminals can also be consulted for bus directions.

Cafeteria an 'extra'

One extra that Ted Shields, the manager who works all year to see that each Wescon is better than the last, is offering is a Cow Palace cafeteria, built especially for the show.

Along with product exhibits and technical sessions, side activities abound. They include parties, luncheons, films, an art exhibit and a keynote luncheon.

Once again Wescon has a Science Film Theater. Outstanding technical motion pictures are being shown daily in the South Hall of the Cow Palace.



More than 45,000 visitors are expected to jam the aisles at the San Francisco Cow Palace to view electronic products on display.

The 21 winners of the annual Wescon Industrial Design Awards can be viewed in the East Hall.

A new touch this year is a one-man art show by a nationally recognized technologist and executive who is also a serious fine artist. He creates under the name "Elbon," but is better known as Dr. Daniel E. Noble, vice chairman of the board of Motorola.

Something for the ladies

The women's program at Wescon is extra special this year. The theme of the program is "Age of Elegance in San Francisco." A champagne luncheon is the opening-day event at the beautiful St. Francis Yacht Club, near the Golden Gate Bridge.

On Wednesday, the scene shifts to the Fairmont Hotel on Nob Hill, for a fashion luncheon. Models are wearing gowns from famous periods in San Francisco's colorful history, and the commentary describes the golden days of the city.

On Thursday morning, a continental breakfast precedes a conducted tour of the Wescon show for the women.

All week at the Hilton a hospitality suite is being operated for the enjoyment of the more than 600 wives who are expected to join

their husbands at Wescon.

It's a relaxing town

Aside from the electronics spectacle, there is for all showgoers and their wives the inviting panorama of San Francisco: Sea, hills, cable cars, bustling docks, beautiful parks and long bridges to places with names like Treasure Island.

The city's cable cars, now designated a National Historic Monument, offer a thrilling roller-coaster experience. The natives hop on and off with abandon, but visitors are advised to be more cautious.

The city's restaurants are diverse and numerous. The gold of the mining camps attracted some of the finest chefs in the world to San Francisco, and this heritage persists. Chinatown features the exotic cuisine of the Orient; the Fisherman's Wharf is famous for its dinners fresh from the sea; and Mexican, Italian, French, Armenian, Russian and American cooking are all here. You can make a culinary trip around the world without leaving San Francisco. Among the noted restaurants are Ernie's, Sally Stanford's Valhalla, Alioto's, DiMaggio's, Kan's, Trader Vic's and Paoli's. ■■

Data ers

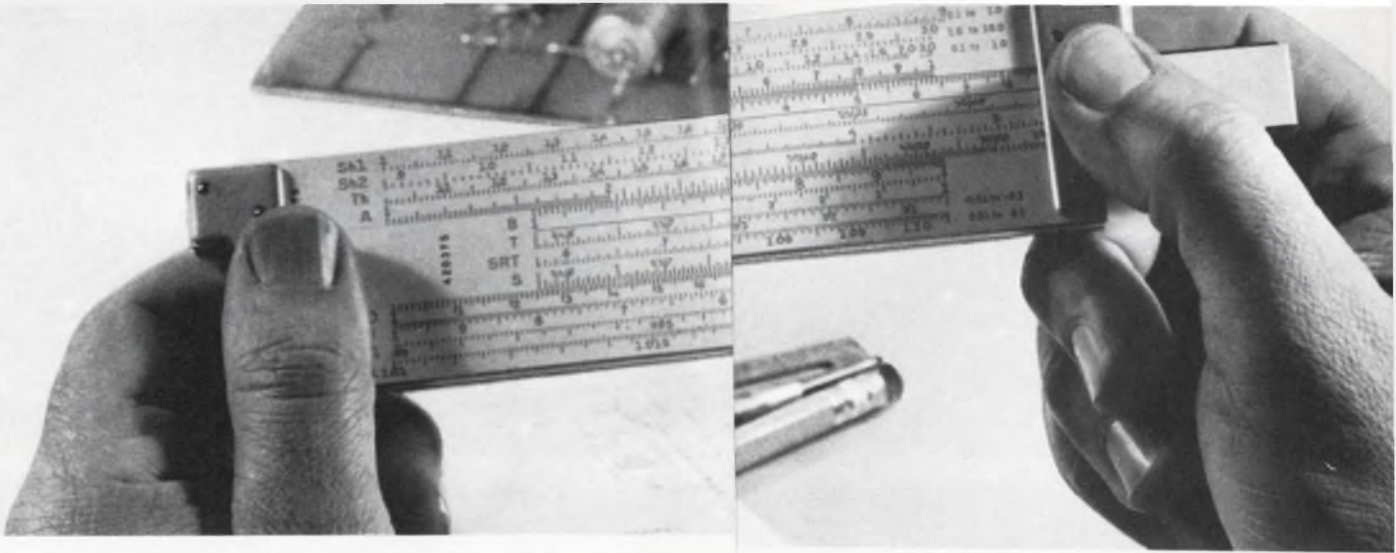

broad selection of ratings and characteristics for audio preamplifier, audio and video amplifier, computer switching and instrumentation circuits. Included in the family are transistors with integral heat-radiators which provide 50% lower thermal resistance between junction and ambient and thus twice the dissipation capability of the prototypes at ambient temperatures up to 25°C.

Take advantage of these ratings for your circuit designs:

AUDIO PREAMPLIFIER—NF as low as 2 dB at 10 kHz, beta values as high as 165 (min.) at $I_C=10$ mA.

AUDIO AMPLIFIER— P_T ratings as high as 2 W at T_C to 75°C for types with heat radiators, high current capabilities to 300 mA max.

HIGH CURRENT SWITCHING applications including core drivers up to 300 mA max.

INSTRUMENTATION—high beta values; leakages as low as 10 nA max. at $V_{CB}=25$ V; saturation voltages as low as 0.1 V typ., 0.2 V max. at $I_C=100$ mA; breakdown voltages to 40 V.

Circle Reader Response No. 792 for detailed specs.

"All Purpose" Economy For Linear IC Users

Wherever your designs call for economy—without sacrificing performance—look at the RCA-CA3053 Linear IC. CA3053 is specified to bring you important savings in a high-performance IF and general-purpose integrated circuit. It's designed to fit your plans for differential and cascode amplifiers, for limiters, detectors, mixers, modulators, converters and oscillators. You can figure on 40 dB typical cascode voltage gain, 30 dB typical differential voltage gain at 10.7 MHz.

RCA-CA3053 is offered in the hermetic TO-5 package at a 1,000 unit price of 49¢ per unit.

Circle Reader Response No. 793 for full details.

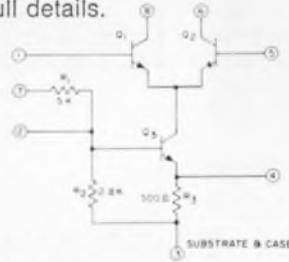

40 A to 50 A Performance For Your High-Speed Switching

Whatever you want to switch—control amplifiers, power gates, switching regulators, converters, or inverters—investigate RCA's new high-speed, high-current switching transistors. Other recommended applications include DC-RF amplifiers and power oscillators.

For instance, RCA developmental types TA7337 and TA7337A—silicon n-p-n types—both in modified TO-3 package (two 60-mil pins)—offer parameters like those listed below.

Additional benefit: These units have enhanced second breakdown capability under forward and reverse-bias conditions. Circle Reader Response No. 794 for full details.

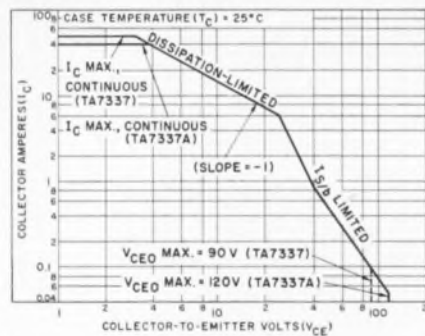

Type	V_{CE0} (sus) (V)	I_C (A)	V_{CE} (sat)	f_T (MHz)	t_{on}
TA7337A	120	40	1.2 V (max.) @ 40 A	50	1 μ s (max.) @ 40 A
TA7337	90	50	1.5 V (max.) @ 50 A	50	1 μ s (max.) @ 40 A

at the RCA Electronic Components exhibit at VESCON, Unit C, in the Cow Palace Arena

ndable,
like ad-
charac-
optimize

@ 200

@ 200

Char-

ithout

se

apaci-

Char-

rough

design

or you

ce by

e con-

te No.

t neu-

illator

esigns

mpli-

ilitary

quip-

cular

ment

tems)

n the

reader

Packaged in a hermetically-sealed, ceramic-metal, coaxial configuration, this silicon n-p-n device is ideal for large signal applications in coaxial, stripline and lumped-constant circuits.

Specifically, the TA7205 provides a 5.8-W (typ.) output, 7.6-dB (typ.) gain and 45% (typ.) efficiency at 2 GHz in a common-base circuit. At 1.2 GHz, it offers 11-W output with 11.5-dB (typ.) gain and 60% (typ.) efficiency.

Circle Reader Response No. 797 for further details.

High Performance At New Low Prices from RCA's COS/MOS Logic—COS/MOS Memory

Now, take advantage of the many opportunities for innovations in design, performance and application offered by RCA's unique monolithic integrated circuits using Complementary Symmetry MOS construction. These new COS/MOS integrated circuits provide:

- Nanowatt quiescent power dissipation
- Frequency capability—from DC to 5 MHz
- Noise immunity—4 V (typ.) @ $V_{DD}=10$ V
- Fanout capability up to 50
- Operation from a single power supply (6–15 V)
- Full military temperature range
- Operation with single-phase clocking

RCA has a package of bulletins for you on COS/MOS. Included in this package is a new product-line catalog which provides data on commercial and developmental COS/MOS types.

For your package of bulletins, circle Reader Response No. 798.

For price and availability information on all solid-state devices, see your local RCA Representative or your RCA Distributor. For specific technical data, write RCA Electronic Components, Commercial Engineering, Section QG9-1, Harrison, N. J. 07029.

t RF
pat-
con-
You
orm-
ons,
ave
dis-
col-

RCA

Linear ICs raid deeper into consumer field

The devices are cropping up in TV and radio sets as routinely as transistors or tubes

John F. Mason
News Editor

Manufacturers of consumer electronics, who live in a competitive, cautious, cost-conscious world, have, until recently, regarded the linear IC as a luxury that only the military could afford.

Now this has changed. ICs are cropping up in portions of television sets, radios and other electronic entertainment products almost as routinely as if they were transistors or tubes.

In time—and a very short time at that—this list will grow. Consumer electronics will soon become a significant share of the linear IC market.

Linear ICs used in entertainment and automotive products in the free world will jump from a \$9-million market this year to a \$44-million market in 1972, according to Ralph Greenburg, manager of consumer and industrial applications engineering, Motorola Semiconductors Products Inc., Phoenix, Ariz. He told ELECTRONIC DESIGN that,

in 1974, the market could hit \$93 million.

The six major consumer market segments, Greenburg says, are TV, audio/radio, large appliance, small appliance, hobbyist/recreation, and automotive.

Main session theme

The increased use of linear ICs in consumer products is one of the main themes, spelled out in detail with facts, figures and opinions to prove it, of the August 20 Session 9 called "Linear ICs in Communications."

S. B. Marshall and G. W. Haines of Sprague Electric, in their paper on linear ICs in consumer television and a-m/fm receivers, are the only ones who deal exclusively with the subject, but it also is given extensive treatment by the other three speakers, as well as the session organizer and chairman, Alan B. Grebene, manager of circuit research at Signetics Corp., in Sunnyvale, Calif.

"Two things have permitted

linear ICs to move into consumer electronics," Grebene told ELECTRONIC DESIGN. "ICs have been improved, providing more functions on a chip. And there is better coordination now between the IC manufacturer and the maker of the consumer product—still not enough, but better than it was."

A lack of communication

One linear IC manufacturer who wishes to remain anonymous says that the poor communications between themselves and the manufacturers of entertainment products was a big roadblock.

"We didn't really know what the TV-set people wanted or needed," he says. "We thought we could just build ICs and they'd come around and buy them. But it didn't happen. And," he adds, "why should it? Who wants to innovate just for the sake of innovation? We had to show them—and still have to—that linear ICs will help them put out a better, cheaper product." He corrected himself. "It may not be cheaper, but for the same money it will do more."

Chairman Grebene says, the TV set manufacturer used to have a

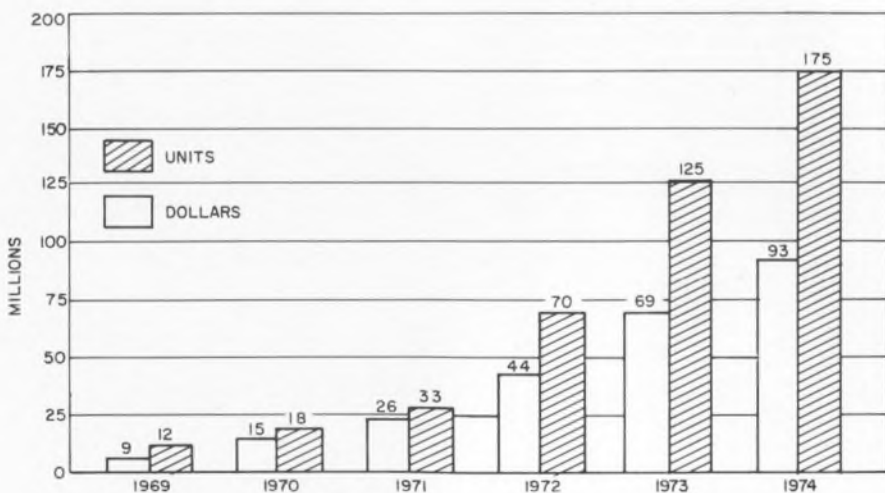

Market for linear integrated circuits (non-communist countries) for entertainment and automotive products is expected to jump ten-fold by 1975, according to a Motorola Semiconductor survey.

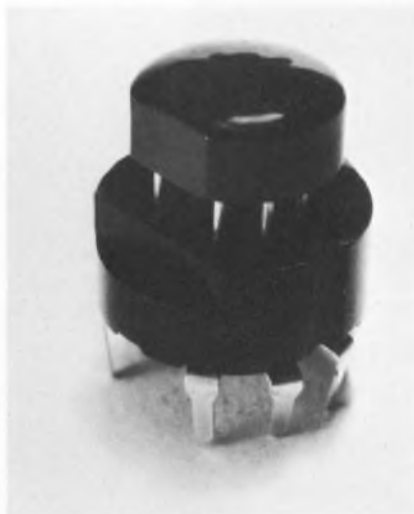

Doubly balanced chroma demodulator from Fairchild Semiconductor is housed in a nine-pin epoxy plug-in package.

'show me' attitude toward IC makers. Now, the linear IC is good, the set maker has taken an objective look at it, and he is gradually warming up to the idea that he can use it profitably."

According to David L. Campbell, manager of linear circuit development at National Semiconductor in Santa Clara, Calif., "ICs are going into consumer products now because they're cheaper. We foresee a strong trend toward the use of more ICs in home entertainment products over the next two years—products such as audio preamplifiers, signal processing sections of equipment and fm sets."

Grebene agrees that ICs are more economical. "When ICs can replace a large chunk of circuits they become cheap enough to use," he says.

Marshall of Sprague Electric, in his paper on linear ICs in TV and radio receivers, says that better performance has been noted in the i-f amplifier and stereo processing sections of the higher priced a-m/fm receivers in which linear ICs have been used.

Improved performance has also

resulted, he says, "in color demodulators, fm discriminators and video signal processing techniques. And," he adds, "they are responsible for improved signal processing techniques realized by the introduction of monolithic analog multipliers, wideband limiting amplifiers, phase-locked loops."

"Within the next few years," Grebene said he personally believes "phase-locked ICs will find a wide variety of applications in the design of fm receivers, particularly in i-f strips, detectors and the stereo demodulator sections.

"The next generation of ICs," he adds, "will provide more circuit functions on each chip, perhaps combining the functions of the chroma reference generator monolithically on the same chip with that of the chroma demodulator.

New approach needed

The way to attain greater use of linear ICs in consumer products is by taking a radical, new approach to designing the circuits and by using new and more flexible processes. This is the message of Hans

R. Camenzind's paper, and he told *ELECTRONIC DESIGN* that, with a few exceptions, "linear ICs have not been terribly successful to date." Camenzind is section head for communication subsystems at Signetics in Sunnyvale.

The company's new approach to circuit design is to use a phase-lock loop. The new approach to processes is dielectrical isolation rather than junction isolation.

"Dielectrical isolation," Camenzind says, "enables us to go in several directions: It gives us high voltage, which is valuable for color TV; high frequency, which is useful for rf front ends; and high power for audio output amplifiers.

"Later this year," Camenzind says, "we will announce an i-f amplifier demodulator in a receiver, using the phase-lock loop technique that eliminates the need for i-f coils, six transistors and 10 capacitors and resistors. In place of these components, there will be one lone linear IC and two external capacitors."

The initial IC targets, Motorola's Greenburg says, are the small signal processing of video, sound and chroma. In present partitioning philosophy, he adds, "the primary goal has been to incorporate the greatest amount of circuitry into the 14-pin dual-in-line plastic packages. As different packages become available, the circuit partitioning will be modified.

Motorola is pursuing two basic approaches to consumer ICs, Greenburg says. One is to use the reasonably complex circuits similar to those in industrial and military equipment.

"Such circuits," he says, "usually consist of several high-gain differential amplifier stages with considerable resistive degeneration and outputs buffered with emitter-followers. Such designs provide very consistent unit-to-unit gain and feature extremely low reverse gain. Control functions such as agc, are easily inserted, and the functions are limited only by the number of package pins.

"The second Motorola approach involves design of very simple 'gain blocks.' Some of these simple circuits involve as few as three transistors and five resistors. They perform a single function and are extremely low in cost." ■■

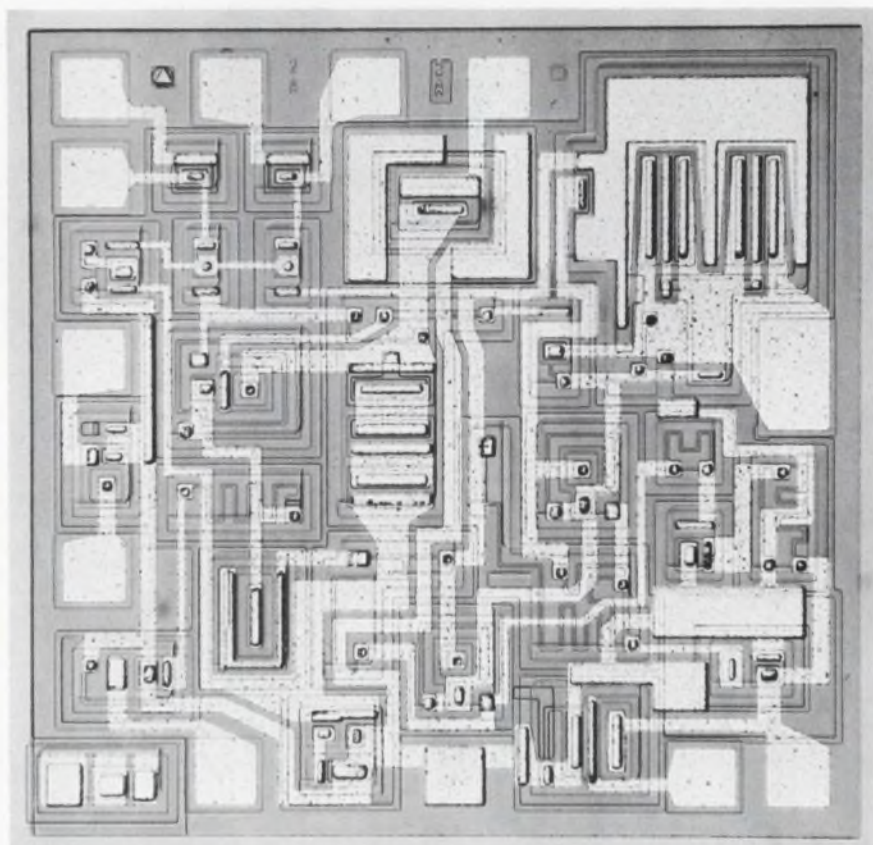

Chip photomicrograph shows Fairchild Semiconductor's $\mu A742$ TRIGAC, a monolithic IC which is designed for use in household appliances such as electric coffee pots and air conditioners.

Everybody talks about beam lead.



This is the dawning of the age of the leaded chip. In other words, sports fans, August is the month Raytheon uncorks beam lead, and the old semiconductor business will never again be the same.

- Simply meaning that now you can buy semiconductor chips with leads already formed and integrally attached. This lets you control packaging, save system assembly time and boost reliability.

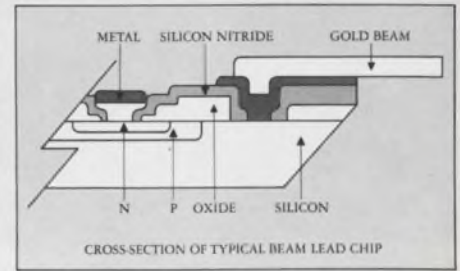

- Take a for instance. With a beam lead chip, bonding's a step, not a career. Every lead's bonded at once, whether you're working with diodes or LSI.
- And the chip stays healthier. Your operator can mash down on those little leads and cook them to a turn. The chip sits there, to one side of the action, calm, cool and uncracked.

□ But there's more. Every beam lead chip sports a Silicon Nitride passivation coat to give it complete hermetic sealing at all junctions. Raytheon's wafer separation process exorcises that evil old chip-cracker, the scribe.

Chips are separated by a delicate anisotropic etching process that eases those little babies apart with TLC.

No more hidden cracks to surprise you in final testing, or after your system's been fired up for a week. And just to sweeten the pot, in case you *really* hate surprises, we can provide 100% chip testing against all AC and DC parameters at -55 to $+125^{\circ}\text{C}$.



But we deliver it.



Type No.	Device (-55 to $+125^{\circ}\text{C}$)	100-999
RM709	Op amp	\$6.80
RG250	Expandable quad 2 input OR gate	4.05
RG220	Quad 2 input NAND gate	4.05
RG240	Dual 4 input NAND gate	4.05
RG200	Expandable single 8 input NAND gate	4.05
RG230	Quad 2 input OR expander gate	2.60
RF200	JK flip flop (AND inputs)	6.00
RF100	Dual JK flip flop (separate clock)	7.10
1N914	Fast switching diode	1.25
1N3600	High conductance fast switching diode	1.30
2N2484	Low level amplifier NPN	1.75
2N2605	Low level amplifier PNP	2.15

In segments of 5 chips only. Commercial grade units at lower prices; delivery to start 4th quarter 1969.

- We're kicking off our Beam Lead Derby with an even dozen types, available in quantity from our exclusive beam-lead-franchised distributors, Avnet Electronics and Cramer Electronics. Later on you can buy our whole line in beam lead... TTL, DTL, linears, transistors, diodes.
- After that, onward and upward to multi-chip arrays, MSI, LSI and so on. Proving once again the wisdom of doing business with the company that puts its chips where its mouth is. Send for data, including Raytheon-approved list of sources for beam lead bonders. Raytheon Semiconductor, Mountain View, California. (415) 968-9211.

Apollo's success rubs off on earth

Elizabeth deAtley,
West Coast Editor

Winning the "race" to the moon has cost this country billions. Is it all money down a lunar crater now that the feat has been proved feasible?

Not at all, says NASA. Aside from the breakthrough in scientific research, more than 2500 significant technological advances in the American economy are directly attributable to the space program. "Cross-fertilization" and spinoffs from the national space effort have produced improvements in everything from paints, materials and medicine to communications, computers and television, the space agency says.

Among major electronics industry advances are these:

- The Carousel IV inertial guidance system that has been installed on the new Boeing 747 jumbo jets is based on the same principles as the onboard Apollo system (see "\$1 million for 747 Superjet Electronics," ED 15, July 19, 1969, p. 28). The two were developed in parallel.

Engineers are applying software techniques they learned in developing the inertial systems to the computer control of everything from rush-hour traffic to shifts in the economy.

- TV display techniques used to simulate the rendezvous of the Apollo Lunar Module and Command Module are being used in highway safety research and computer-generated movies.

- Disc-recording techniques used to convert color TV pictures from the moon for commercial telecasting are similar to techniques now

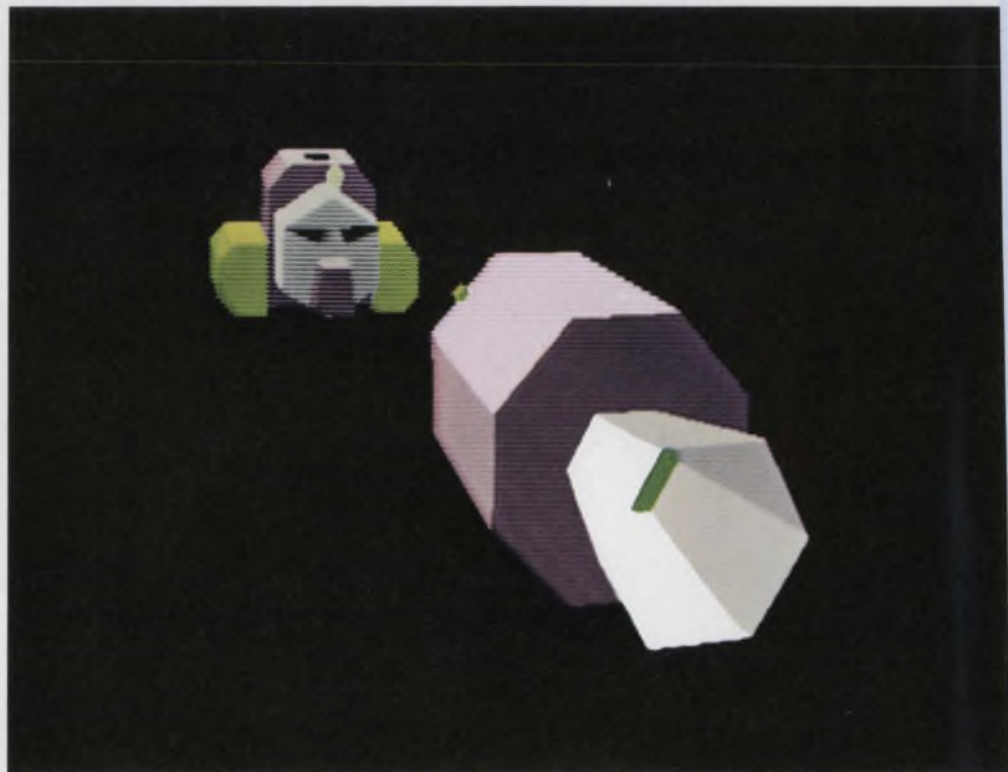

Computer-generated TV display shows a simulated docking of a lunar module and command module. By manipulation of a control stick, the objects can be shifted to any position.

being used in X-ray television photography for "stopping" the X-rays at a critical moment. The same technique is being applied to the transmission of graphic displays over telephone lines.

Inertial guidance for planes

Present jetliners use radio or radar systems to navigate. Over the ocean, star sightings by a crew navigator may be used. On the Boeing 747 jetliners that are coming into service, the pilot feeds his takeoff point and destination into

the Carousel IV inertial guidance system; the system's computer calculates the shortest course to fly. Enroute the pilot has a continuous display of longitude and latitude, true heading, wind direction and speed, ground track and speed, and time and distance to destination.

When connected to the autopilot, Carousel IV steers the plane, while the pilot monitors flight progress on the continuously updated control and display unit. On a recent test flight, the guidance system flew the aircraft automatically across

the Atlantic from Canada to the English coast.

Pan American World Airways says its test flights show the Carousel to be five times more accurate than present forms of navigation. It hopes the improved long-range accuracy will allow ocean air corridors to be narrowed so that twice as many planes can fly in the same airspace. Now planes must stay within assigned corridors over the North Atlantic—corridors fixed by international agreement at 120 miles wide in areas where traffic is heavy. With inertial guidance in general use, airline officials estimate that it would be safe to narrow the lanes to about 60 miles.

The Carousel navigation system includes an inertial reference unit—a stable platform—a digital computer, electronic and heat-control elements, and a power supply. Complete with a case and mounted in the aircraft, the system weighs some 50 pounds. It is less than one cubic foot in volume—smaller than an office file drawer. Federal Aviation Administration regulations specify that each aircraft must have three of these units for redundancy.

The Apollo guidance and control system is far more complex than Carousel IV, but the basic principle is the same. Both systems have an inertial platform. In the Apollo system, the platform is held fixed in space, regardless of vehicle motion, whereas in the Carousel it is held perpendicular to the earth's surface by rotation at a fixed rate. Both systems have a computer that calculates the trajectory in "inertial space"—that is, in the coordinate system determined by the inertial platform.

New software techniques

The ability of a small space or airborne computer to perform complex trajectory calculations stems from new software techniques developed for the space program, says Harlan Neuville, group head of engineering systems for the Apollo program, AC Electronics Div., General Motors Corp., Milwaukee. In the older technique of processing trajectory data—called least-square fitting—all the velocity/position readings were retained over a

period of time in the computer memory. For each new reading, the computer recalculated the average trajectory by performing the software analog of drawing a smooth curve through all the readings plotted on a graph.

This technique requires too much memory to be practical for a space computer, says Neuville. "After all, you can't very well send a whole IBM complex to the moon." The technique used in airborne space computers, he says, is based on programming a computer to evaluate data statistically as it is received.

"We make a mathematical model of the Apollo and use all the information from simulated flights, as well as from previous real flights, to update the model," he explains. "In this mathematical model, we put data on the statistical accuracy of every measuring device that will give information to the computer, as well as the statistical accuracy with which each astronaut makes measurements. The computer continuously calculates the estimated trajectory of the spacecraft, updating it as new measurements come in. It weighs every measurement it receives according to the statistical information preprogrammed in its memory. Based on this information, it may choose to accept, modify or even reject a measurement, if necessary. In this way the computer only needs to remember a specific position and velocity for a short increment of time, rather than for the duration of the flight, as with least-square fitting. So it doesn't need a huge storage capability."

The same technique of statistical analysis and mathematical modeling, Neuville points out, can be applied to control or monitor any complex process that can be modeled. "You can take measurements from which you derive a model that lets you predict what can happen," he notes.

Traffic control is an obvious application. "You can measure the traffic rate through a certain tunnel at different times and make a mathematical model of it," Neuville says. Then, based on this model, you can set up traffic lights that will allow just enough traffic in the tunnel so that everybody gets home as quickly as possible. Somebody may have to sit on

the ramp for 20 minutes, but if you let him go ahead immediately, it would take him a lot longer than that because of the congestion in the tunnel."

Simulating the unknown

One of the biggest developments in the Apollo program has been simulation techniques, says Gordon Heffron, manager of the Guidance and Navigation Dept. of Bellcom, Inc., a part of the Bell System that performs systems analysis and study, planning and technical support for NASA and the Bell System. Heffron says computer simulations are used to check out every part of the Apollo system.

For example, in checking out the onboard computer, not only is the computer itself simulated, but also its program, the measurements it receives and even the world outside the spacecraft. To simulate what the program calls the "actual world," Heffron says, "we set aside one part of the computer program as the actual world, and we assume that the information it contains is perfectly correct, whereas the information in the rest of the program is off by some amount. For example, we don't know the gravitational attraction of the earth to better than about 1 part in 10^5 , so we make it bigger by that amount in the actual-world model than in the rest of the program. We also put some atmospheric drag in the actual-world model."

Although the idea of simulating one computer on another is not brand new to Apollo, Heffron says, "we certainly demonstrated that it was feasible to do this on a very high level of complexity." He believes that simulation techniques will be used in many different areas of computer control in the next few years. In addition to rush-hour traffic simulations, which he says most major cities will be using in the next five years, he sees the measurement of the national economy as a big application area.

"I think we have finally reached the stage in our ability to simulate where probably we will be able to find out how to control our economy better," Heffron says, "and I know there is going to be a big push toward this over the next 10 years."

A powerful tool for generating TV displays by computer and moving them about on the screen has been developed by the General Electric Co.'s Electronics Laboratory in Syracuse, N.Y. In a system built for the Guidance and Control Div. of the Manned Spacecraft Center, Houston, a picture of an object, such as the Lunar Module or a simulated lunar surface, can be projected onto a screen in front of the observer. By manipulating a control stick, he can, in effect, enter the scene and move around in it. On his screen, he can observe the object from any angle and at any distance, in effect moving himself toward or away from the object at an apparent speed that he controls with the stick.

The scenes are produced by computer. The system contains no mockup models or cameras. Instead, a description of the various objects to be displayed are fed into the computer in the form of numbers. These numbers define the shape, color and size of each object. The observer can call up any object in the computer's memory. As he moves his control stick, the system continuously recomputes the appearance of the displayed object from the angle and distance that correspond to the instantaneous position of his stick.

NASA's 3-display system

The Apollo system, called the NASA Electronic Scene Generator, has three displays. It can be set up so that an observer at one display may see, for example, the Lunar Module on his screen, while a second observer at another display acts the part of the astronaut who guides the Lunar Module. The second observer sees the Command and Service Module and moves himself relative to it. Each observer sees not only the effects of his own motion relative to the other spacecraft, but also the movements made by the other observer. In addition an observer at a third display can see both spacecraft and control his own motions with respect to the two others.

William Miller, manager of the Simulator Guidance Development and Applications, Guidance and Control Div., Manned Spacecraft Center, says the displays are used

mainly to check out system performance. For example, the equipment was used in the development of the guidance and control systems.

"The scene generation equipment," he explains, "is tied in with special 'problem' computers that are programmed to simulate the behavior of systems you want to check out. Sitting in a mockup of the spacecraft, the engineer or astronaut can manipulate controls that are connected to the problem computers, causing the display to respond as if he were looking out the window of the spacecraft in flight. What he sees in the display can either be a simulated lunar surface, if he is doing a landing study, or another space vehicle if he is doing a docking or rendezvous simulation."

Most scene generators use a TV camera, which moves relative to a mockup real object. The mathematically modeled display has many advantages, according to Rodney S. Rougelot, manager of visual simulation at GE. For example:

- Mathematically formed images are always in focus.

- The observer can maneuver within his simulated environment with complete dynamic freedom. This capability allows an architect, for example, to inspect the interior of a house, or the driver of a car to pass beneath an overpass.

- Objects in the environment can freely move. Because they are simply numbers, one need not support them with gimbals or tracks.

In the NASA Electronic Scene Generator, the displays are 21-inch color monitors built originally for commercial TV at 525 lines per frame. These monitors have been improved, however, to allow display of a 600-line by 600-element TV raster. The equipment that drives the display monitors consists of two special-purpose digital computing units, controlled by a modified Raytheon 520 general-purpose computer.

The system creates TV images by computing them fast enough to keep up with the TV scanning rate. Consequently the computing units have a large logic capability—85,000 logic gates—but a relatively small memory—6000 30-bit words and 4000 24-bit words of magnetic core memory. The objects

to be shown in the image are stored as coded numbers in the memory, and the computing units reconstruct them in TV form as they are being displayed.

The computing units produce images at a rate of 20 frames per second—fast enough so that there is no flicker—and a scene can be represented by as many as 240 straight edges.

Applications for highway safety

Since the NASA system was built, says Rougelot, GE has developed a technique for generating up to 1500 straight edges per image at a rate of 30 per second. Such an expanded capability is useful for many purposes, he says.

"For example, according to a study we have just completed for the U.S. Department of Transportation through UCLA, it could be used for highway safety research," he notes. "The user could drive along a simulated highway and look for problem areas—such as dangerous intersections or sudden curves—as they appear on the screen.

"We have also proven the feasibility of making realtime changes in a complex display. Suppose, for example, that you have designed a highway and have simulated it in the computer. In a realtime system, you could make changes as you drove along. One obvious way to implement such a system would be to store in computer memory a catalog of precomputed items, like bridges, signs, overpasses, underpasses, etc. By touching the display with a light pen and perhaps pushing a button, you could call up one of these items and place it where you wanted it. Then, by pressing some more buttons, you could change its color and perhaps its scale."

This interactive capability requires very sophisticated software, Rougelot points out, "but it is definitely feasible."

In the Apollo TV built by Westinghouse, Baltimore, the color signals that arrive from the moon in serial form are stored on a disc recorder at Houston and played back in parallel for retransmission over commercial network channels. Essentially the same technique is being used in other fields—for ex-



Video disc recording system (right), developed by Data Disc Corp., is connected to standard X-ray equipment at Stanford University Medical Center in Palo Alto, Calif. The X-ray motion pictures are recorded and played back at slow speed for the physician.

ample, in stop-action X-ray photography and the transmission of high-resolution images over telephone lines.

The technique is simple in concept. The video signal is recorded on a disc, one frame or field per track, and played back in such a way as to obtain some desired effect. For example, in stop-action TV, a single track (or TV frame) is played back continuously to a TV monitor, causing it to scan the same frame repeatedly.

The Apollo camera—to hold size and weight to a minimum—contains a single tube instead of three (one each for red, blue and green light), as is standard in color TV cameras. Before the light enters this tube, it passes through a rotating wheel that is divided into red, blue and green segments. The wheel rotates at a speed that allows an entire scene to be scanned in each color. Thus the resulting

video signal consists of red, blue and green fields transmitted serially. On the ground, a video switch sorts out the fields, so that each is recorded on a separate disc track. The tracks are then read out in parallel to the commercial TV color encoder, just like the output of a standard three-gun color camera.

Stanley Lebar, program manager for the Apollo camera at Westinghouse, says disc storage is the only medium possible for this application. "We need many channels at a time," he points out, "and it is very difficult to get more than one high-level video channel onto tape because of the wide bandwidth required per channel."

The total weight of the Apollo camera is less than 14 pounds. Its single tube is a very low-light-level vidicon of the type used in Vietnam for taking nighttime pictures. According to Lebar, the camera, without the color wheel, will take

pictures at illuminations down to 10^{-3} foot-candles. "This is about the illumination you get on earth from a quarter moon," he explains. "But to take pictures in color, you need the color wheel, and that filters out the light. So you need about 1 foot candle illumination."

Medical applications predicted

Data Disc of Palo Alto, Calif., the company that built the disc storage converter used with the Apollo camera, has recently announced a new system for recording X-ray moving pictures. This system has several possible medical applications, according to Dr. Lou Wechsler, head of the Radiological Dept. at Stanford University Medical Center, Palo Alto. Its primary application, he says, is in recording X-rays of the heart during a cardiac catheterization.

"This is a minor surgical operation," he explains. "We run a catheter into the heart and inject a material that contains iodine through the catheter, so that the particular area of the heart we want to see will show up in an X-ray. We put a fluoroscopic device over the patient's chest to see the heart. The iodine only remains visible for 4 to 10 seconds—too fast for us to see what is going on in real time—so we take motion pictures at a rapid frame rate—50 to 80 frames per second—and play them back at slow speed."

Dr. Wechsler points out that ordinarily "you can't be sure you have gotten the area you wanted in the pictures until you develop them—and that takes at least a half hour, assuming you have a dark room in the hospital."

"You can't let your patient lie there with a catheter in his heart for a half hour or more while the X-rays are being developed," he points out. "On the other hand, you hardly want to remove the catheters, send him home, and risk having to repeat the whole operation if you didn't get what you wanted the first time."

This problem—and others like it—can be solved, Dr. Wechsler says, by storing the sequence on a video disc and playing it back immediately. ■■

With EECO 2D computer-automated plug-in IC Hardware...

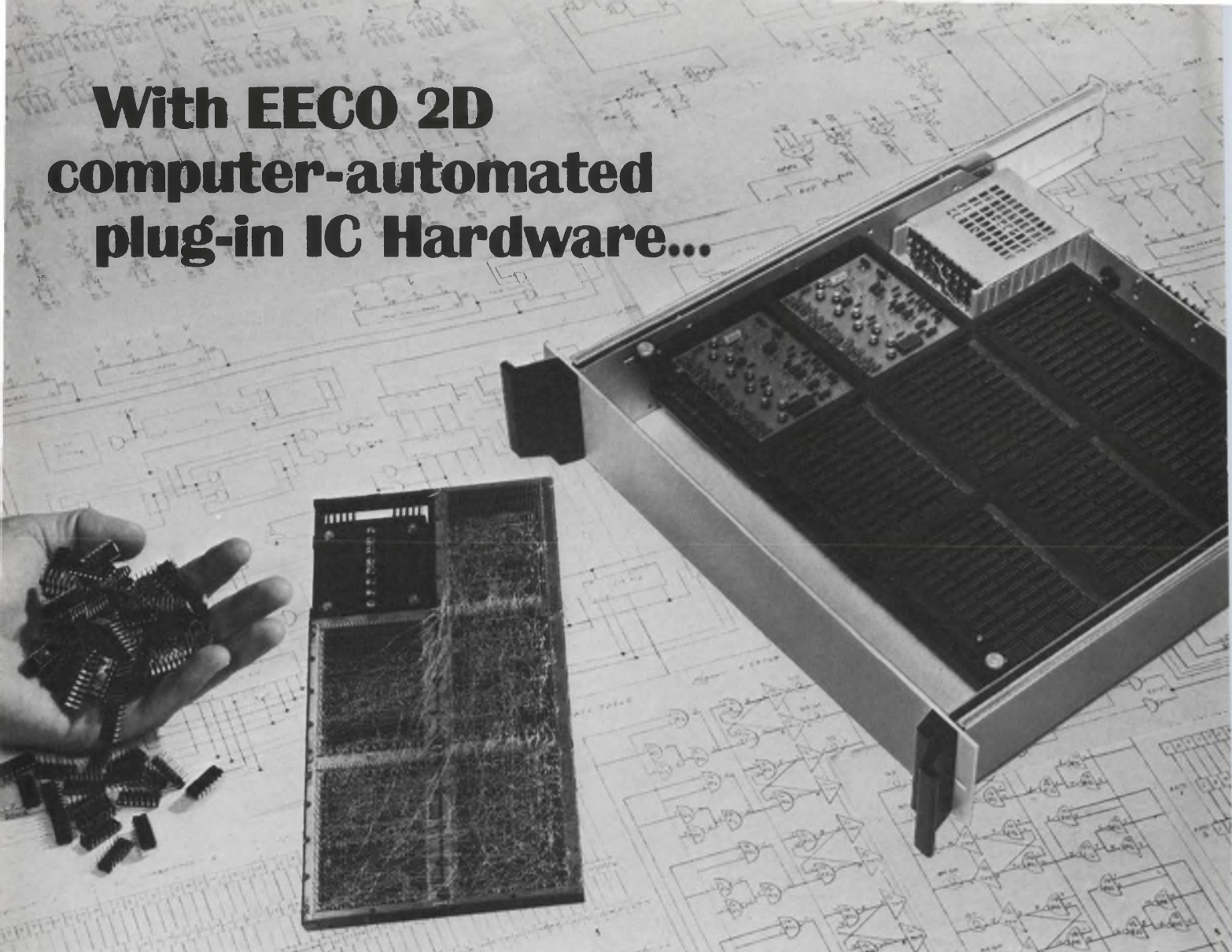

less than 30 days separate schematic and final system...

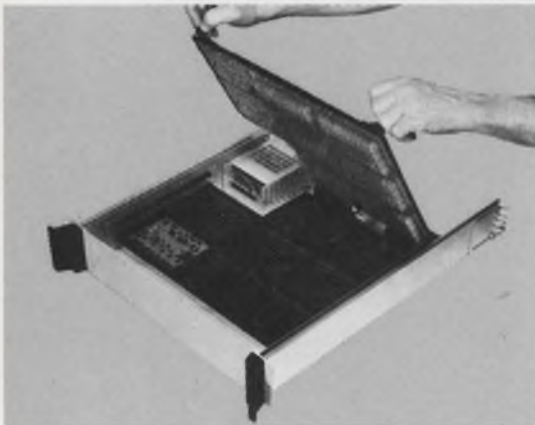

Catalog available.

When you specify EECO 2D Hardware a computer converts your "Pin Logic List"* into a wire plan and checks for errors and omissions before wiring begins. EECO plugs in the IC's, machine Wire-Wraps the backplanes and in days...your schematic is a drawer of working electronics with all necessary computer generated support documentation.

EECO 2D Hardware System provides more than time savings...it's up to 30% more economical...and it's versatile...ready for digital or analog IC's, discrete components, MSI or LSI. It offers higher density — up to 768 IC's and a power supply fit in one 3-1/2" high standard drawer.

Your first step is simple...just phone, write or circle the reply number.

*You simply choose the module and write the signal name by each pin number. You don't worry where the wires go or the order of listing.



ELECTRONIC PRODUCTS DIVISION

ELECTRONIC ENGINEERING COMPANY OF CALIFORNIA

1441 EAST CHESTNUT AVENUE • SANTA ANA, CALIFORNIA 92701 • (714) 547-5651

See EECO 2D
at Wescon Booth
numbers 3814 thru 3817

INFORMATION RETRIEVAL NUMBER 724

New. A true micro-system connector. Look at what you can do with it.

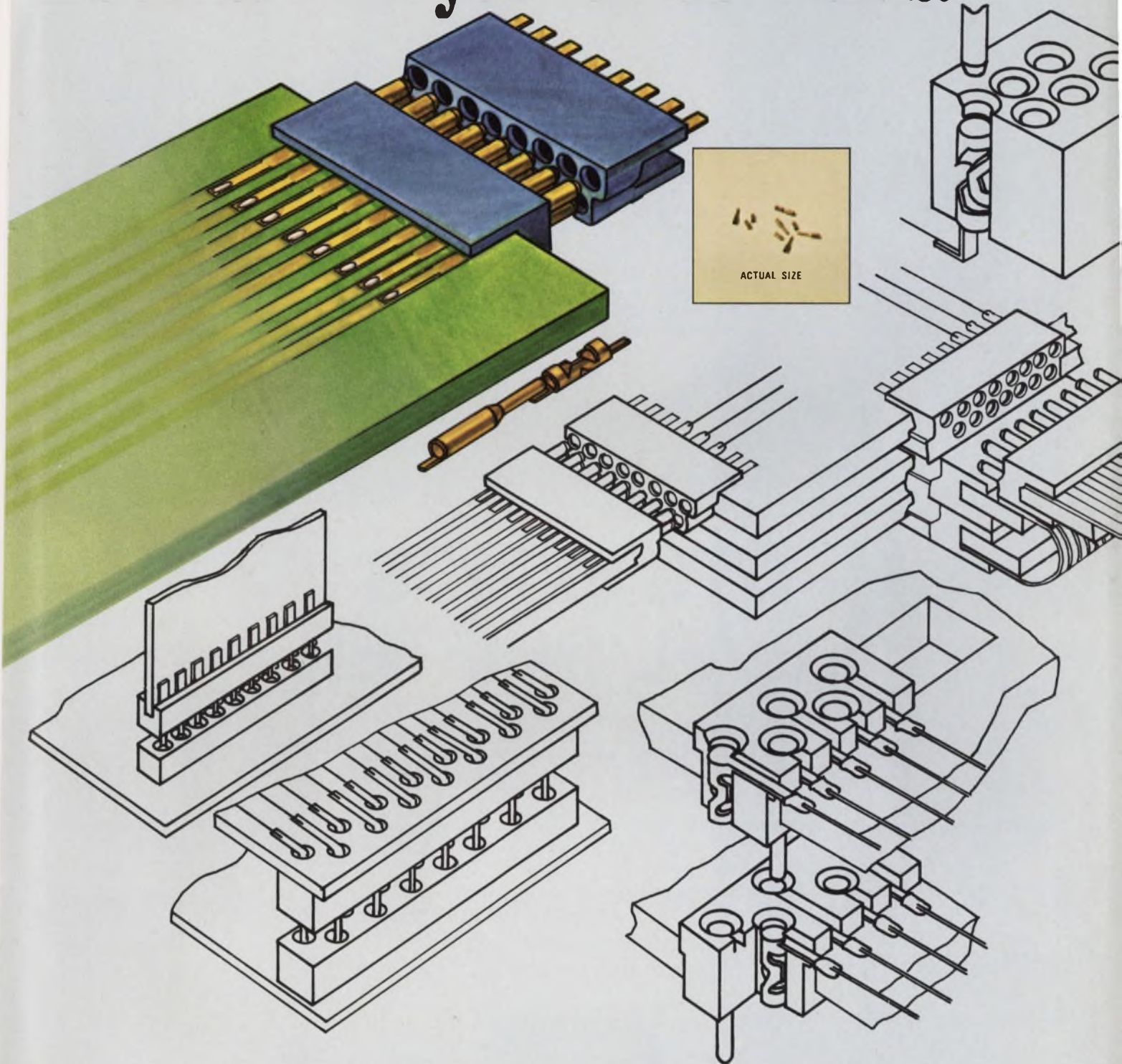

This is our new .025\"/.050\" Connector.

It fits all micro-system packaging situations. In all environments. Reliably. The redundant points of contact provided by the spiral springs of the receptacle assure it.

With stacked or staggered centers, the receptacles don't lose any critical contact spacing. Circuit centers of .050\" and .025\" are standard. The receptacles and pins come housed. The circuit contact tines are pre-solder coated so all you have to do is reflow and plug in. Easy? The low insertion

force and the wide misalignment allowance make it even easier.

So, what could be better for sophisticated electronic requirements? A reliable connector that's dense, convenient and versatile.

For further information write to Industrial Division, AMP Incorporated, Harrisburg, Pa. 17105.

AMP
INCORPORATED

Standard Circuit of the Month

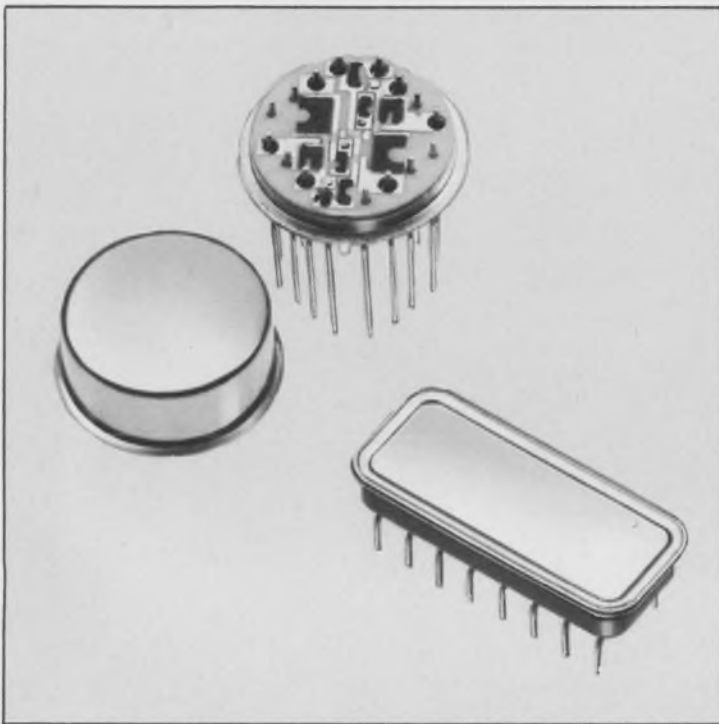

- Compatible with most MOS levels
- High speed 200 nanoseconds typical
- Full military temperature range
- Hermetically sealed TO-8 or DIP Cans
- High fan out

DTL to MOS LEVEL SHIFTER

Maximum Ratings

Power Dissipation:	180 mw per shifter
Operating Temperature:	-55°C to +125°C
Storage Temperature:	-65°C to +175°C
Supply Voltage:	40V

Mepco DTL/MOS Level Shifters eliminate the need for discrete components and add the benefit of miniaturization with higher reliability. This new microcircuit provides high speed operation and is compatible with most MOS levels.

These level shifters furnish the only DTL/MOS buffer stage necessary and require less room on your PC

board than with discrete components. The "worst case" design operates over the full military temperature range with all DTL, TTL levels. Packaging compatibility is offered with most system designs.

For complete information, phone collect or write for data sheet MC6-669.



MEPCO INC., COLUMBIA ROAD, MORRISTOWN, N. J. 07960 • (201) 539-2000 • TWX: 710-986-7437

INFORMATION RETRIEVAL NUMBER 726

from telonic

**...a new
concept for
information
display!**

..... for the research and development laboratory
..... in production testing and quality control
..... for medical diagnosis and patient monitoring
..... as a teaching aid in classroom demonstration





OPTIONAL TIME BASE Horizontal deflection in the 201 System is usually obtained from an external sweep signal. A calibrated Time Base is also available as an optional plug-in unit to provide sweep rates from 1 to 1000 milliseconds per inch. A vernier control extends sweep time to 10 seconds per inch.

SOLID STATE — MODULAR DESIGN The 201 System is completely solid state with the exception of the CRT. For maximum versatility, the Model 201 consists of a basic display chassis and functional plug-in units. Operating characteristics of the System are determined by the plug-in units selected.

Plug-ins presently available include vertical and horizontal amplifiers, a reference line generator, and a time base. Future units may occupy the entire plug-in area to provide the total signal processing and display functions for multiple parameter measurements.

VERTICAL AND HORIZONTAL PLUG-IN AMPLIFIERS

Three vertical amplifier plug-in units 1 2 3 are required for normal operation of the 201 Display System — one for each signal channel. If horizontal deflection is to be obtained from an external signal, an additional amplifier will be required for this channel 5. The Model 320 Time Base plug-in unit can be used in place of the horizontal amplifier to provide a linear calibrated horizontal sweep.

Two amplifiers are available — the Model 301 High Gain Differential unit and the Model 302 Basic Amplifier. Both units are direct coupled, enabling display of dc levels and low frequency signals. Either model may be used for vertical or horizontal channels.

The calibrated deflection factor of the Model 301 differential unit is adjustable from 100 μ V/inch to 50 V/inch, providing maximum versatility for both low-level and general purpose applications. The vernier control can be used to reduce the deflection factor to 100 V/inch. In differential operation, the common mode rejection is 30 dB.

The Model 302 Basic Amplifier plug-in is a general purpose unit with a continuously variable sensitivity of 100 mV/inch to 10 V/inch.

TIME BASE PLUG-IN The Model 320 Time Base plug-in is available for use in the horizontal channel 5 and provides calibrated sweep times of 1 to 1000 msec/inch in four ranges. The vernier control extends the slowest sweep range to 10 seconds/inch. The unit can be triggered by external or internal signals or by the power line.

Trigger slope and level adjustments enable triggering at any point on the waveform.

REFERENCE LINE GENERATOR PLUG-IN

The Model 310 Reference Generator 4 furnishes three vertical and three horizontal electronic cursors in red, green, and blue which can be positioned anywhere on the screen by independent front panel controls. These reference lines may typically be used to set min/max signal limits for both level and frequency, to compare amplitudes of various input signals, or as a "memory," enabling the user to return the signal amplitude to the original level if desired. Any one of the vertical reference lines may be triggered by an external time or frequency marker pulse.

is illustrated in the display shown in Figure 1. The blue vertical frequency markers were triggered by a sweep generator. The red and blue horizontal reference lines represent the specification limits of the unit under test.

Phase and amplitude relationships of three signals are displayed in Figure 2.

Figure 3 illustrates the variety of data that can be presented to provide maximum information in a single display — the response characteristics of three tuned circuits, vertical frequency markers, and upper and lower limit reference lines.



Figure 3

**the telonic
model 201
tri-color
display system
displays up to
three different
input signals
plus horizontal
and vertical
reference lines,
each in a
separate color
with high
resolution and
sensitivity.**

THREE-COLOR DISPLAY The 201 is a large screen, multi-channel, tri-color display unit that provides an entirely new perspective in analog presentations. Three vertical signal channels may be displayed on the 15" CRT simultaneously in red, green and blue with three vertical and three horizontal reference lines in the same colors. This multi-color presentation assures positive identification of each input, regardless of its proximity to the other signals. Even overlapping traces can be easily identified.

HIGH RESOLUTION, HIGH SENSITIVITY The unique three-color presentation also enables each signal to be displayed at full screen height for high resolution and accurate comparison without sacrificing trace identification. It is not necessary to restrict each signal to a separate segment of the display area.

The 201 System utilizes a separate amplifier for each input channel to provide maximum control of each signal and complete channel-to-channel isolation. Input signal sensitivity range is 100 μ V/inch to 100 V/inch assuring maximum resolution regardless of input level.

ELECTRONIC REFERENCE LINES The tri-color vertical and horizontal reference lines can be adjusted to any position on the screen by individual front panel controls. A vertical reference line may also be externally triggered by a time or frequency marker pulse.

These reference lines cover the full screen, facilitating relative frequency and level comparisons between each of the input signals.

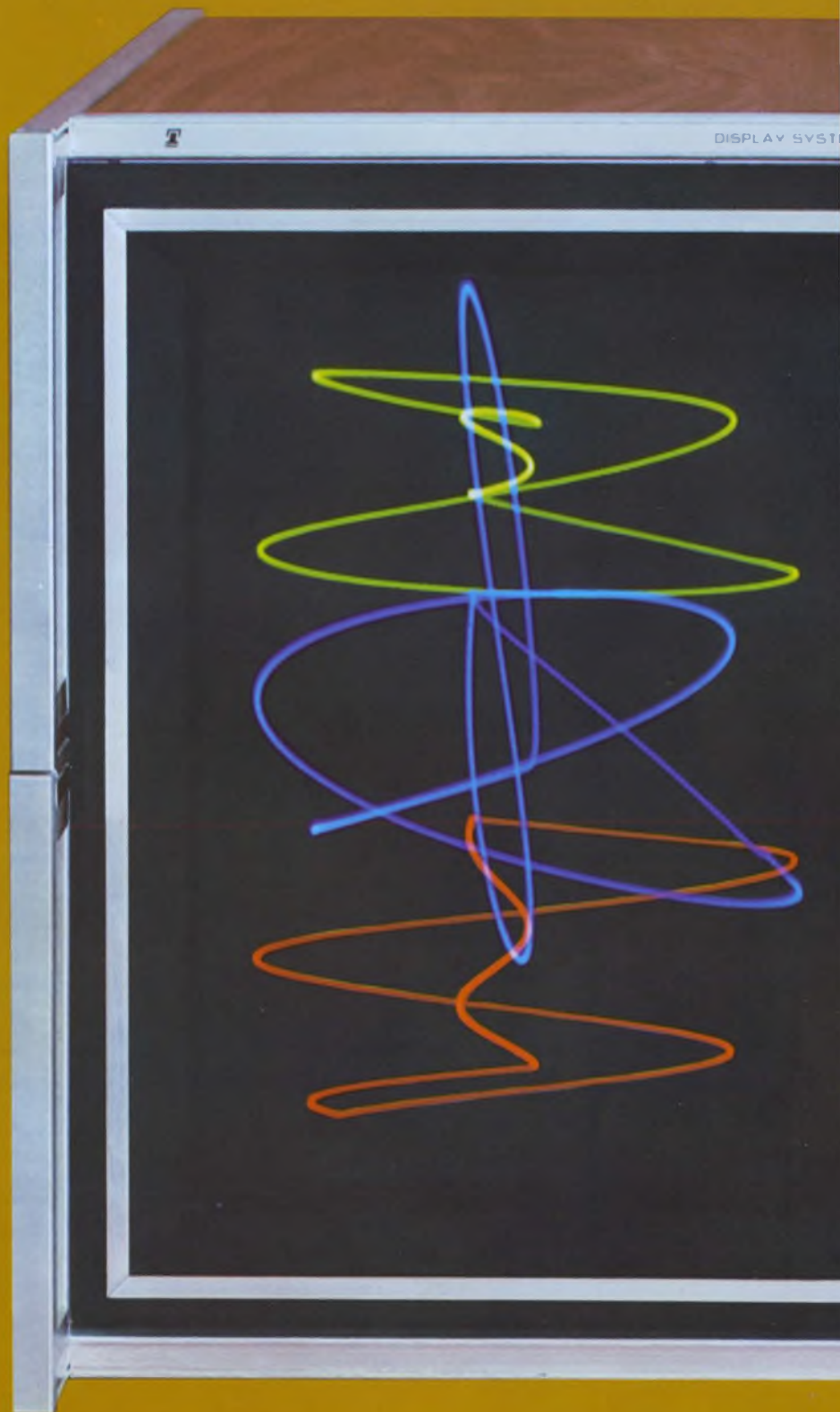

applications

The high sensitivity, direct coupling, and large screen area of the Model 201 make it an ideal display system for many applications in the fields of electronics, medicine, and education. Applications include any situation in which dc or video information is to be displayed with respect to time or frequency.

A swept frequency measurement of the gain and VSWR of a broad band amplifier



Figure 1



Figure 2

model 202 monochrome display system

The Telonic Model 202 Monochrome Display System provides all the features of the Model 201 with the exception of color. The advantages of a large screen display system, adjustable reference lines, and plug-in versatility are all available on the Model 202. This monochrome unit is capable of high resolution, low flicker displays with a choice of CRT phosphors. All plug-in units described are applicable to the 202 System.

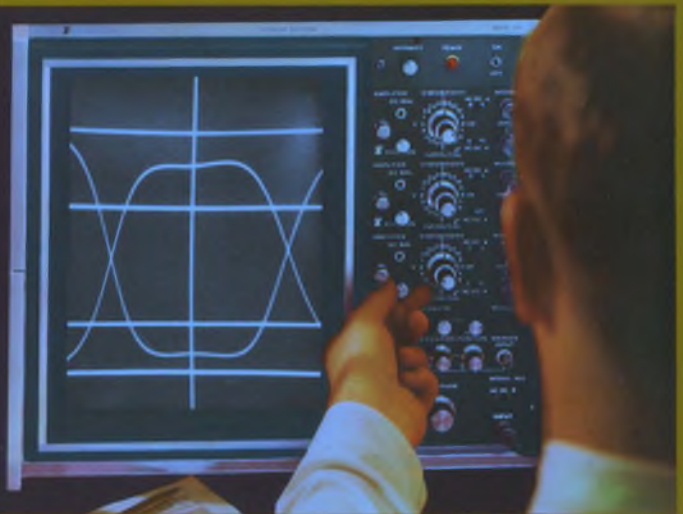

specifications

GENERAL The vertical sections of the Model 201 and 202 Display Systems utilize a scan/sampling technique. The CRT electron beam is scanned vertically at a 36.2 kHz rate. During down-scan the input signals are sampled producing a dot for each signal. During up-scan the reference lines are displayed. The rapid scan rate provides a high dot density. The highest frequency that can be displayed by the vertical channels is dependent upon both the scan rate and the video bandwidth of the plug-in amplifier being used.

The frequency response of the horizontal channel is dependent upon the small signal bandwidth and the maximum undistorted slew rate. These parameters are primarily a function of the display chassis.

MODEL 201 TRI-COLOR DISPLAY CHASSIS A three channel scan/sampling system providing simultaneous display of three input signals in red, green, and blue. The Model 201 has separate facilities for vertical, horizontal, and reference line functions.

Usable Screen Area: 10.5 inches by 7.9 inches.

Vertical Scan Rate: 36.2 kHz.

Horizontal Small Signal Bandwidth (3 dB): 50 kHz. Maximum Undistorted Slew Rate: 10 inches/msec.

Accelerating Potential: 20 kV.

Power: 115/230V, 50/60Hz, 350 watts.

Dimensions: 17" wide, 14" high, 18½" deep.

Weight: 50 pounds.

Price: \$2100

MODEL 202 MONOCHROME DISPLAY CHASSIS A three channel sampling system providing simultaneous display of three input signals. Separate facilities for vertical, horizontal, and reference line functions. Optional long persistence cathode-ray tube available.

Usable Screen Area: 10.5 inches by 7.9 inches.

Vertical Scan Rate: 36.2 kHz.

Horizontal Small Signal Bandwidth (3dB): 50 kHz. Maximum Undistorted Slew Rate: 10 inches/msec.

Cathode-ray Tube: P4 phosphor; P7 long persistence phosphor also available.

Accelerating Potential: 15 kV.

Power: 115/230V, 50/60 Hz, 300 watts.

Dimensions: 17" wide, 14" high, 18½" deep.

Weight: 50 pounds.

Price: \$1850 (with P4 phosphor) \$1950 (with P7 phosphor)

MODEL 301 HIGH GAIN DIFFERENTIAL AMPLIFIER

Deflection Factor: 0.1 mV/inch to 50 V/inch in 18 calibrated steps, 1-2-5 sequence; accuracy $\pm 5\%$; vernier provides continuous adjustment between steps and extends the 50 V/inch step to at least 100 V/inch.

Noise, max: 50 μ V p-p referred to input at maximum sensitivity.

Video Bandwidth (3dB): DC to 200 kHz; DC to 5 kHz at 0.1 mV/inch; DC to 9 kHz from 0.2 to 0.5 mV/inch. Maximum input frequency dependent upon video bandwidth and system scan rate.

Common Mode Rejection: 30 dB.

Input Coupling: AC, DC, or GND.

Input RC: 1 megohm shunted by 47 pF.

Price: \$350

MODEL 302 BASIC AMPLIFIER

Deflection Factor: Adjustable from 100 mV/inch to 100 V/inch.

Video Bandwidth: 50 to 200 kHz dependent upon vernier setting. Maximum input frequency dependent upon video bandwidth and system scan rate.

Input Coupling: AC, DC, or GND.

Input RC: 1 megohm shunted by 47 pF.

Price: \$150

MODEL 310 REFERENCE LINE GENERATOR

Marker Trigger Sensitivity: ± 3 V pulse, max. rise time 5 μ secs or birdy type marker.

Input Impedance: 47 kilohms.

Price: \$250

MODEL 320 TIME BASE

Sweep Time: 1, 10, 100, 1,000 msec/inch calibrated to $\pm 5\%$. Vernier provides continuous adjustment between steps and extends the 1,000 msec/inch range to 10 sec/inch.

Trigger Sources: Line, external AC or DC, Internal.

Trigger Requirements: Internal, 1-inch deflection. External, ± 0.5 V to 20 V peak

Price: \$300



BLANK PANELS

Blank plug-in unit panels are available for Systems not requiring all of the available plug-in units. The panel fits the space taken by one of the plug-ins listed above.

Price: \$12 Model 315 Blank Panel

RACK MOUNTING

Hardware for rack mounting the 201 or 202 Display Systems is included with each chassis

how to order

1. Select either the Model 201 Tri-Color Display Chassis or the Model 202 Monochrome unit.
2. Choose the vertical amplifiers. For three-channel operation, three separate vertical amplifiers are required; for two-channel, two amplifiers, etc.
3. Order the reference generator or, if this function is not desired, a blank panel may be used in this space.
4. Select either a horizontal amplifier or time base unit for the horizontal channel.

NOTE: The Model 201 and 202 Systems must have at least one vertical amplifier and a horizontal plug-in unit installed in order to operate.



telonic systems

A Division of Telonic Industries, Inc.

21282 Laguna Canyon Rd. • Box 277 • Laguna Beach, Calif. 92652

Phone: (714) 494-9401

TWX: 910 596-1320

© 1969 Telonic Industries, Inc. • Printed in USA • 1000/244M/769/JA











PATENT APPLIED FOR

THINK SMALL



The Minelco family of small components that solve big problems. Small? **Miniature!** Trimmer Potentiometers... Rotary Selector Switches... BITE (built in test equipment) Indicators. A size, a configuration, a type for every requirement. Name your specifications, we'll supply the component. We keep it in the family.

...THINK MINELCO!

 <p>NEW! MP32 5/16" dia. Pancake Trimmer Potentiometer</p>	 <p>Microminiature! MS1 1/4" dia. Trimmer Potentiometer</p>	 <p>For printed circuits! SW32 .350" dia. Rotary Selector Switch</p>	 <p>For panel mounting! SW37 .350" dia. Rotary Selector Switch</p>	 <p>Manual reset! BHGM 1/2" wide BITE Indicator</p>
 <p>Internal switching! M170 .2" x .4" x .7" BITE Indicator</p>	 <p>Electrical or mechanical reset! MI51SMS 1/2" dia. BITE Indicator</p>	 <p>Tiny...bistable... highly visible! BHGM21 1/4" dia. BITE Indicator</p>	 <p>Low-cost! MP2 .290" dia. Trimmer Potentiometer</p>	 <p>Infinite resolution! MF2 1/4" dia. Trimmer Potentiometer</p>

For additional information, contact:

MINELCO

a subsidiary of  **GENERAL TIME**
Progress in the World of Time

600 SOUTH STREET, HOLBROOK, MASS. 02343 / (617) 963-7717

BITE INDICATORS • ROTARY SWITCHES • TRIMMER POTENTIOMETERS • ELAPSED TIME INDICATORS • EVENTS COUNTERS

Visit us at WESCON Booth 4812

INFORMATION RETRIEVAL NUMBER 727

Outlook bright for solid-state optics

Light-emitting diodes are key to sales spurt in solid-state optoelectronics market

John N. Kessler
News Editor

Solid-state optics is about to make significant inroads on the electronics market. This is the conclusion of a report presented this week at Wescon by Egan E. Loebner, head of the Solid-State Laboratory, and Howard C. Borden, manager, Solid-State Development, both of Hewlett-Packard, Palo Alto, Calif.

It is estimated that the solid-state optics market is less than \$1 million a year. Yet within a few years, Borden says, the market for light-emitting diodes alone will reach \$50 million to \$100 million.

Why the rise? Borden told ELECTRONIC DESIGN that "heretofore light-emitting diodes have not been economically attractive. But now we can mass-produce them with controlled reproducibility."

Market up, prices down

There is an increasing need for man-machine interfaces—displays—that has led to big potential markets for solid-state lamps where small size and low voltage are required. (See "New phosphors con-

vert infrared to 4 colors," ED 16, Aug. 2, 1969, p. 42.)

As the market gets bigger, the prices will drop to less than one dollar per LED, says Borden. He estimates that LED prices will follow the same kind of price curve as the rest of the semiconductor industry; that is, about 30 per cent a year price decline.

While transistors now prevail over vacuum tubes in the electronics market, Borden does not believe it likely that solid-state lamps will eliminate gas tubes since they serve separate markets.

Loebner and Borden point out that solid-state electronics has brought us transistorized radios, TVs, computers and telephone switchboards, but that parallel developments in solid-state optoelectronics—electroluminescent ceilings, walls, TV picture panel displays, and solar-cell-studded rooftops—have not materialized.

Solid-state optoelectronic devices account for only about one per cent of the sales dollars of all electron devices. Why so little when transistor technology accounts for so much? The reasons that solid-state optics have not caught fire involve:

- poor control and lack of manu-

facturing reproducibility

- short lifetimes
- poor understanding of light generation in electroluminescent phosphors.

Photo devices on upswing

In recent years, according to Loebner and Borden, the availability of silicon integrated-circuit techniques and the compatibility of electroluminescent devices with TTL has created a place for solid-state photoelectric devices. And the percentage of solid-state photoelectric devices out of all photoelectric devices is quite significant.

In this particular area, Loebner and Borden say that solid-state devices are more sensitive at longer wavelengths than tubes. And they add that while Vidicon and Plumbicon tubes can operate beyond one micron, they "lack the higher sensitivity of the solid-state two-dimensional arrays of photo-diodes or phototransistors which can be operated in the photon flux integrated mode that is capable of TV frame storage."

They also say that p-i-n diodes, Schottky photodiodes, avalanche photodiodes and the high degree of "arrayability" enable solid-state optics to compete favorably in the area of photomultiplier tubes.

Most likely to succeed—GaAsP

In 1963, engineers at Hewlett-Packard predicted that electroluminescent semiconductor devices would be the "species of solid-state optics most likely to succeed." Since that time, Hewlett-Packard has produced a number of marketable devices. Recently, they developed a gallium arsenide (GaAsP) alloy that will have a wide range of applications, says Borden.

The specific features of light-emitting diodes and their three closest competitors are shown in the table at the left.

Tube and Solid-State Electrophotonic Devices

	Life Hours	Drive	Environmental	Failure Mechanisms	Cost	Arrayability
Incandescent	Low (10^3 – 10^4)	3V up dc 10 mA up or ac	Susceptible to shock and vibration	Catastrophic	\$0.50 & up	0.150" & up
Gas discharge	10^5	70 V up 1 mA		Gradual	\$0.40 & up	0.150" & up
EL capacitors	2 – 3 x 10^3	90V up ac 10 μ A	Susceptible to moisture	Gradual	\$0.50 & up	0.050" & up
LED's	10^6 – 10^7	1 1/2 V dc 2 mA up		Gradual	\$1.60 & up <1.00 in a year	0.020" & up

If signal analysis from 10 Hz to 50,000 Hz is your concern, Systron-Donner's new spectrum analyzer will simplify your tasks and extend your measuring capabilities as never before.

Our 710/800 gives you absolute amplitude measurements over a 140 dB dynamic range, any 60 dB of which appears on a large 7 x 10 cm high-contrast display. Wave analysis, distortion studies, and spectral display are enhanced by a full 50 kHz scan and a narrow 10 Hz resolution. For measuring EMI and other low-level signals, you get very high sensitivity (calibrated to 30 nanovolts/cm) plus selectable input impedances of 50 ohms, 600 ohms, 10k ohms, and 1 megohm. And you get X-Y outputs, pen lift, sync and sweep inputs, plug-in versatility and many other standard features—all for \$2495.

This spectrum analyzer is truly portable. It weighs only 25 lbs.—or 30 lbs. with an optional internal battery that operates up to 8 hours before recharging.

Write for complete specifications. Ask for a demonstration. Contact Microwave Division, Systron-Donner Corporation, 14844 Oxnard St., Van Nuys, Calif. 91409. Phone: 213-786-1760.

New spectrum analyzer covers 10 to 50,000 Hz with universal measuring capability*

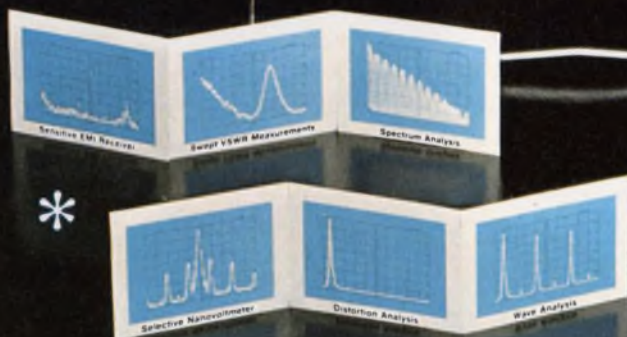

SYSTRON  DONNER

**Another first.
One of 145
Systron-Donner
instruments**

Electronic counters	Digital voltmeters
Pulse generators	Spectrum analyzers
Microwave frequency indicators	Digital panel meters
Digital clocks	Microwave signal generators
Memory testers	Laboratory magnets
Analog computers	Data acquisition systems
Time code generators	Microwave test sets
Data generators	

Telemetry



L and S band FM Signal Generator

PROGRAMMABLE (REMOTE) OPERATION

Carrier Frequency: Programmable within band by 3 decade (BCD) contact closures or logic levels

IRIG Channel: Programmable by contact closures, 21 lines

RF Attenuation: Fixed steps programmable by contact closure, 9 lines

MODEL 1522 new FM signal Generator for the telemetry L and S bands uses phase-lock techniques to provide

- superior stability and accuracy
- digital control of RF frequency
- set up for remote operation of BCD programmability.

RF FREQUENCY

Settability: 100 KHz, digital control

Accuracy: $\pm .002\%$, calibrated after one half hour warm-up.

Stability: Drift plus incidental FM less than $\pm 2\text{KHz}$ pk for 1 minute, less than $\pm 5.0\text{ KHz}$ pk for 10 minutes, less than $\pm 15\text{KHz}$ for one hour.

(Residual FM: $< 1.5\text{ KHz}$ on L Band; $< 2.0\text{ KHz}$ on S Band)

RF OUTPUT

Range: 0 dbm to -120 dbm

Calibration accuracy: Overall $\pm 1\text{ db}$ over band

Levelling: $< 1.5\text{ db}$ pk-pk across each band

Spurious: All in-band spurious signals more than 50 db below the calibrated output level

Harmonically related $> 20\text{ db}$ below calibrated output

MODULATION

Peak FM deviation: $\pm 3\text{ MHz}$ (from $< 10\text{ KHz}$)

Frequency response: $\pm 1\text{ db}$; DC to 750 KHz

$\pm 1.5\text{ db}$; to 1.0 MHz

$+2, -3\text{ db}$; to 2.0 MHz

Frequency linearity: 1% of straight line for all deviations up to $\pm 1.0\text{ MHz}$ at modulating frequencies from DC to at least 1.0 MHz

TO STRAIGHT LINE	DEVIATION		MODULATING FREQUENCY
L Band:			
$< 0.5\%$ @	$\pm .5\text{ MHz}$	and	.5 MHz
$< 1.0\%$ @	$\pm 1\text{ MHz}$	and	1 MHz
$< 7.0\%$ @	$\pm 3\text{ MHz}$	and	2 MHz
S Band:			
$< .03\%$ @	$\pm .5\text{ MHz}$	and	.5 MHz
$< 0.7\%$ @	$\pm 1\text{ MHz}$	and	1 MHz
$< 4.0\%$ @	$\pm 3\text{ MHz}$	and	2 MHz

CALIBRATED DEVIATION MONITOR

Range: DC to 3 MHz in five ranges. Full scale 30 KHz, 100 KHz, 300 KHz, 1.0 MHz, and 3.0 MHz.

Accuracy: $\pm 5\%$ of full scale, for all modulating frequencies from 5 Hz to 500 KHz

KAY ELECTRIC COMPANY

MAPLE AVENUE, PINE BROOK, NEW JERSEY 07058 / PHONE (201) 227-2000

INFORMATION RETRIEVAL NUMBER 729

A lecture that may change your future

Are you a frustrated writer? If you want to create the great American novel, you're probably in the wrong business.

Are you a frustrated engineer? If you want to get ahead, learn to write—technical articles.

It's easier than you might think when you do it the ELECTRONIC DESIGN way. Find out. An expert on the subject, Howard Bierman, editor of ELECTRONIC DESIGN, is giving a slide presentation, "How to Write for Technical Publications."

The time: Thursday, Aug. 21, at 8:30 a.m.

The place: Continental Parlors of the San Francisco Hilton, Mason and O'Farrell Sts.

Come early and have coffee and pastry on the house.

Distributors meet manufacturers

Manufacturers and sales representatives will have another opportunity this year to talk over successes and failures with their far-flung distributors, many of whom they know mainly as a voice on the telephone.

On the morning of Aug. 18, manufacturers and their sales reps can go to the San Francisco Hilton Hotel, as early as 7:30 a.m. if they like, have a continental breakfast and then seek out the table where the distributor they're looking for is holding forth. There will be about 60 such tables, representing approximately 53 distributing companies. Discussions will last 20 minutes. If everything isn't settled in that length of time, future appointments can be made.

Area members include:

Northern California: John Woodside of Sterling Electronics.

Los Angeles: Charles Sexton of Radio Product Sales.

San Diego: Jules DeWinne of Kierulff Electronics.

Arizona-New Mexico: Tom Chislock of Liberty Electronics/Ariz.

Utah: Charles Ballard of Ballard Supply Corp.

Colorado: Larry Walker of L. B. Walker Radio.

Rip cords, tire cords, window sash cords. Will your product flop because of a "little" thing? Like unacceptable abrasion wear that shows up only after use under actual conditions. Perhaps it's corrosion and/or heat degradation of small or inexpensive components. Or a lubricant that doesn't make the grade under certain conditions.

You'd be surprised how inexpensive it is for Ogden to environmentally test what may seem to be "little" things in your products. Test us. Ask for a quote from any of our seven test labs listed below. We'll also be happy to give you a quote for testing "big" things. Like entire refrigerated vans or critical spacecraft assemblies. We've been doing it since 1952. Or write to us for our whole environmental testing story.

Ogden Technology Laboratories, Inc.

Facility locations:

Deer Park, New York
(516) 667-7200

Oklahoma City, Oklahoma
(405) 946-9986

Sunnyvale, California
(408) 739-5900

Beaumont, California
(714) 845-1103

Woodside, New York
(212) 478-2010

Monterey Park, California
(213) 289-4425

Fullerton, California
(714) 879-6110



**It's little failures,
that make the biggest flops!**



INFORMATION RETRIEVAL NUMBER 730

Electronics to control nuclear testing

Computer for timing and firing underground blasts to make decisions based on monitored information

The time and place for an underground nuclear explosion has been set. The experiments are deployed and the monitoring systems ready. At this point begins the tediously precise work of making sure that temperatures, vacuums, voltage levels and meteorological conditions are "go." Only then comes the decision to detonate the bomb.

Today, the equipment for monitoring these parameters and for actuating the test is largely electromechanical. But it may be replaced by an almost wholly electronic system called CART (command, arming, recording, and timing). A paper on the new system is being presented this week at Wescon by Gerald St. Leger-Barter, an engineer at the Lawrence Radiation Laboratory, University of California, Livermore, and Stephen M. Walters an engineer at EG&G, Inc., San Ramon, Calif.

CART is designed for what St. Leger-Barter calls "environmental

testing." It is not geared for operation with defense systems.

Associated with underground nuclear tests are experiments that measure shock-wave propagation, light output from the explosion, and the recovery of samples from the test site. CART does not control these experiments directly. It does, however, control not only the sequence of events that detonate the bomb but also operation of such testing apparatus.

CART consists basically of:

- A controller—that determines the sequence of events during the test.
- An rf telemetry system—that transmits commands to the bomb site and receives verifications.
- Forward area systems—that detonate the bomb and transmit monitoring information about the explosive characteristics to the command site.

"CART" is an acronym that is also descriptive of the portability of the system. At the command

site, there are three large trailers containing equipment for power, environmental control, and transmission links. A relay-station trailer between the blast site and the command site contains monitor transmitters, receivers, and duplexers. At the forward area is a single trailer that sends information from the blast site to the relay trailer. It also contains the equipment that detonates the bomb and records the effects of the blast.

Two television cameras in the forward area are controlled from the command site. TV monitors in the command trailer enable the director to observe anything that happens near the forward trailer.

The digital computer that operates the command station is a 16-bit machine with a 1.8-microsecond cycle time. It can store 12,288 words in its memory, and this figure can be expanded to 32,768 words.

Computer's choice

The main computer program handles sequencing of events during a test and issues the appropriate commands. If something goes wrong and certain prerequisites are not met, the computer may send a command a second time, send the "go-code" regardless, or stop the program.

The operational functions are:

- control and monitoring of the bomb.
- control and monitoring of experiments.
- monitoring of the forward area via video links.
- monitoring and transmission of health and safety radiological information.
- control of photographic and seismic measurements.
- control of power and command links. ■■

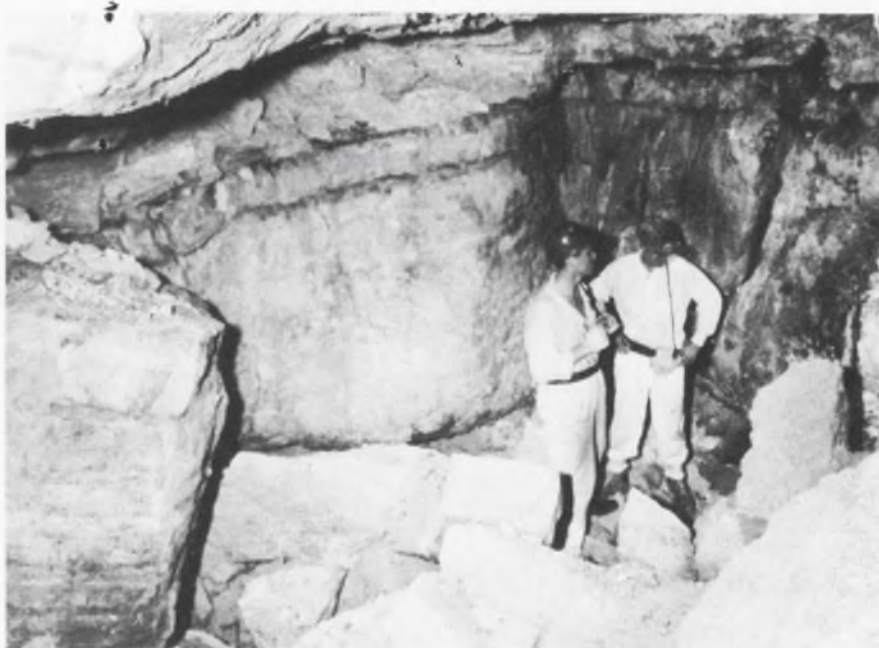

Entrance to a nuclear cavern. In one of the early underground nuclear tests, a cavern 8-stories high was formed by a three kiloton bomb.

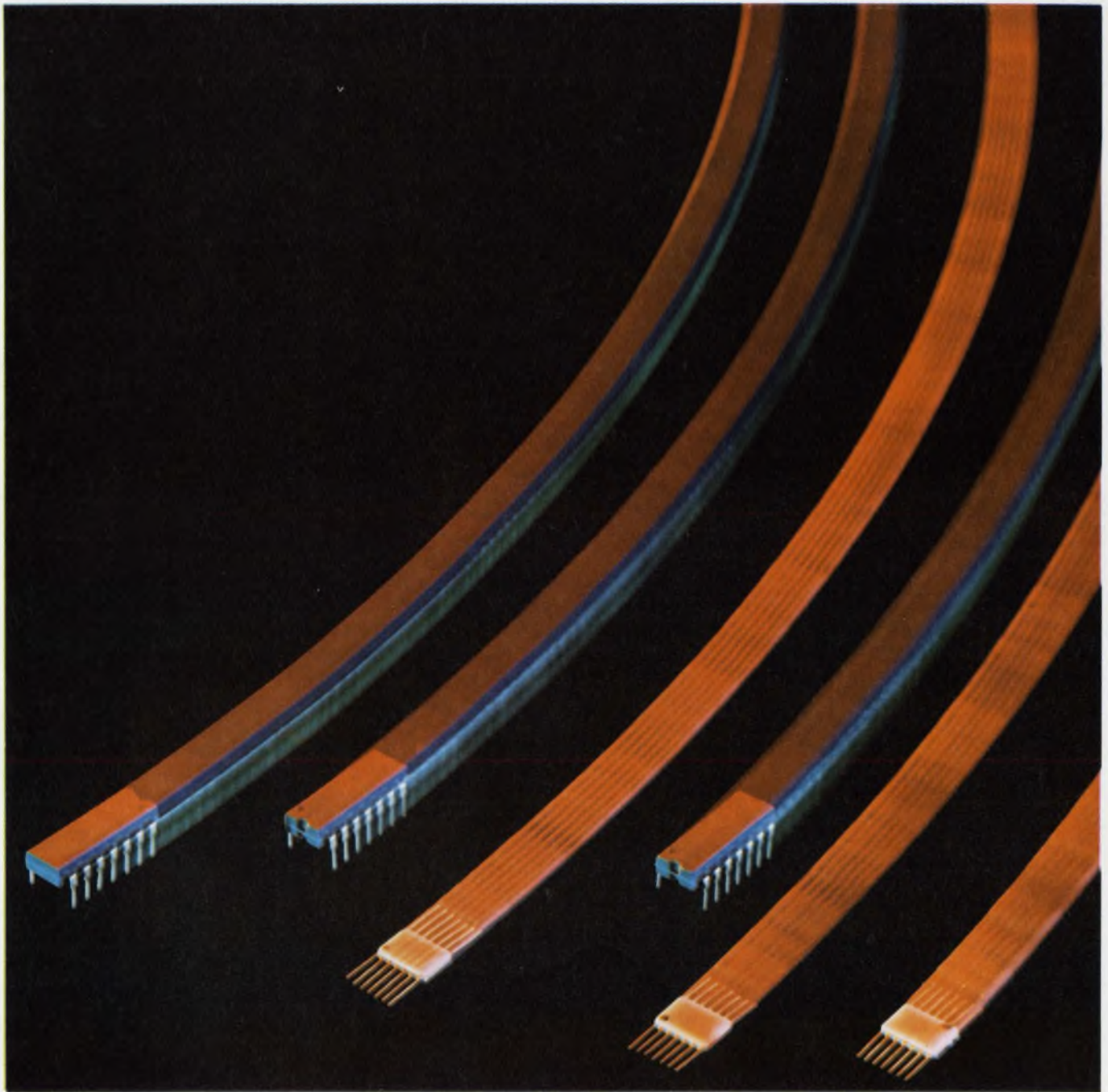

Sprague Digital ICs. Illustration: Series 54H/74H in flatpack and DIP

Just arrived. Series 54H/74H. The fast ones.

Just about the fastest saturated logic circuits around. Series 54H/74H from Sprague. The whole family. Flip-flops and all.

Use them in arithmetic and processing sections, where speed really counts. Mix and match them with Sprague's standard Series 54/74.

Get off to a fast start with Sprague Series 54H/74H.

TYPICAL CHARACTERISTICS	GATES	FLIP-FLOPS
Propagation Delay	6 nsec	17 nsec
Power Dissipation	22 mW	80 mW
Noise Immunity	1 V	1 V
Temperature Range	-55 to +125° C	
Series 54H	0 to +70° C	
Series 74H	DIP or Flatpack	
Packages		

Call Sprague Info-Central (617) 853-5000 extension 5474.

Or call your Sprague industrial distributor. He has them on the shelf.
For complete specifications, circle the reader service number below.

455-9127

INFORMATION RETRIEVAL NUMBER 731



British seek larger share of U.S. market

At Wescon they are featuring an airborne TV display and a variety of high-frequency equipment

The British have come to Wescon, bringing their newest electronic instruments—and hoping that next year they will capture a bit more of the U. S. market.

In 1968, Britain exported to this country \$70-million worth of electronic products—including consumer articles. Of this amount, the U. S. paid \$23.3 million for electronic equipment, such as instruments and components.

This year, the greatest increase in British exports to the U. S. is expected to be radio communications, and radio and navigational aids, particularly avionics and marine equipment.

Their exhibit at Wescon is sponsored jointly by Britain's Electronic Engineering Association and the Board of Trade.

What's new from overseas?

New British electronic products unveiled this week at the Cow

Palace include an airborne TV display system, high-grade high-frequency equipment, solid-state color-television switches, and several new developments in electronic testing equipment.

The new airborne TV display system, called Polyscan, is basically a small TV screen with a 7-inch rectangular CRT. The unit accepts inputs from closed-circuit and broadcast TV, normal weather radar, and ground mapping inputs. It can display any input capable of being shown on an X-Y coordinate system.

Polyscan is manufactured by Ekco Electronics Ltd., Southend-on-sea, Essex. The company says the TV unit is suitable for both civil and military applications and is designed to simplify display presentation and to reduce instrumentation clutter on flight decks.

There are two versions of the system: one has a single control to select the degree of brightness; the

other adds a loran/radar/TV channel selector. The scan connector type is available as a short 1/4 ATR unit and this, together with the Polyscan indicator, is available for use with other systems.

Ekco is also exhibiting a wide range of high-voltage modules. These are suitable for CRT displays including storage tubes and projection systems, fiber optics and applications where compact, reliable high-voltage units are required.

These modules, with outputs from 1 kV to 30 kV, are resin-encapsulated by a specially developed technique that, according to Ekco, provides ruggedness and prevents voltage breakdown. Excellent regulation with very low ripple is claimed for the units which are said to be capable of tolerating brief overloads and flashovers. They are electrically tested under extreme vibration and temperature. The units have either a built-in or an external choke.

Communications units shown

M. O. Valve Co., Ltd., London, is exhibiting a wide range of microwave components and instrument and radar cathode-ray tubes. These units are sold under the Genalex trademark.

New microwave devices include two compact J-band, solid-state power generators, types SSJ9 and SSJ10. These are low-noise, electronically tuned units, for commercial and military markets. Both operate from a 3-kV dc power supply.

In the CRT line, M. O. Valve has a double gun tube (the LD 708) that incorporates completely independent X and Y deflection systems. The Y deflection system, according to the company, is better than 4V/cm and the X sensitivity is better than 10V/cm. Final anode voltage of the tube is 8 kV. The scan size of each beam is 6 by 10 cm with an overlap of 5 cm, and the tube can be used at bandwidths of 30 MHz.

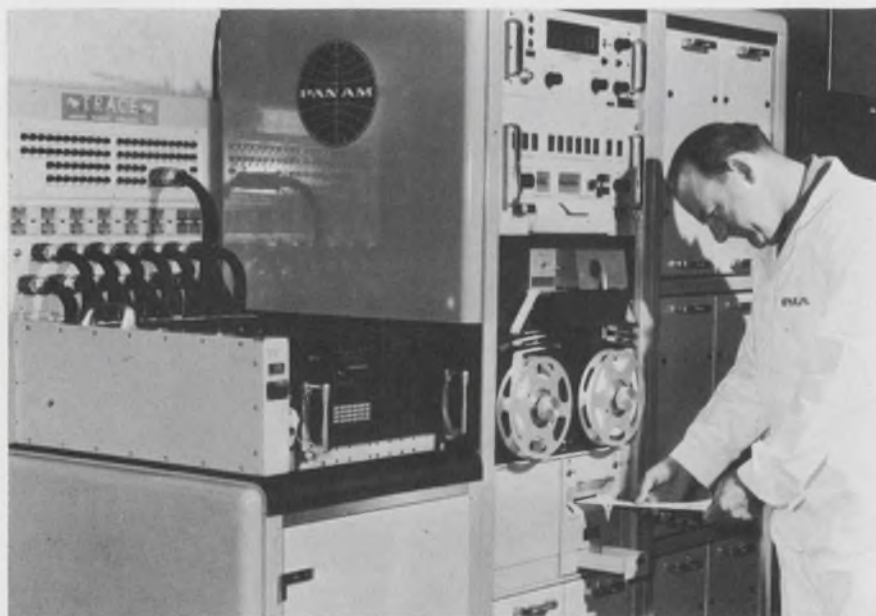

Automatic checkout for aircraft, ships and missiles. TRACE (Test equipment for rapid automatic checkout and evaluation) is manufactured by Hawker Siddeley Dynamics, Ltd.



Dale connector line grows with new SHP-40 modular style

Make sure you have Dale on your list of connector sources. Describe Dale's connector line as: *"Small, but growing...able to supply volume quantities of all items in line...capable of meeting special design requirements."*

Among the new models now being produced by Dale is the SHP-40. This NAFI design conforms to BUWEPS 63A49F100 and gives us a strong entry into the modular field. For a quick look at some of the popular models we can

supply, see below. Then make sure you have our new connector catalog. It lists complete details on these styles:

PRINTED CIRCUIT • Direct card edgeboards as well as two-piece right angle and straight-thru types.

TEST POINTS • Printed Circuit Jacks or Points

RACK & PANEL (Rectangular)

- Miniature, Subminiature and Microminiature
- Shelled versions of Rack & Panel

UMBILICAL • Missile & Avionics Models • Shorting Plugs

NAFI • 40 pin

Write today for your catalog. Phone 402-564-3131 for price & delivery information.



DALE ELECTRONICS, INC. 1300 28th Ave., Columbus, Nebr. 68601

In Canada: Dale Electronics Canada, Ltd. • A subsidiary of The Lionel Corporation

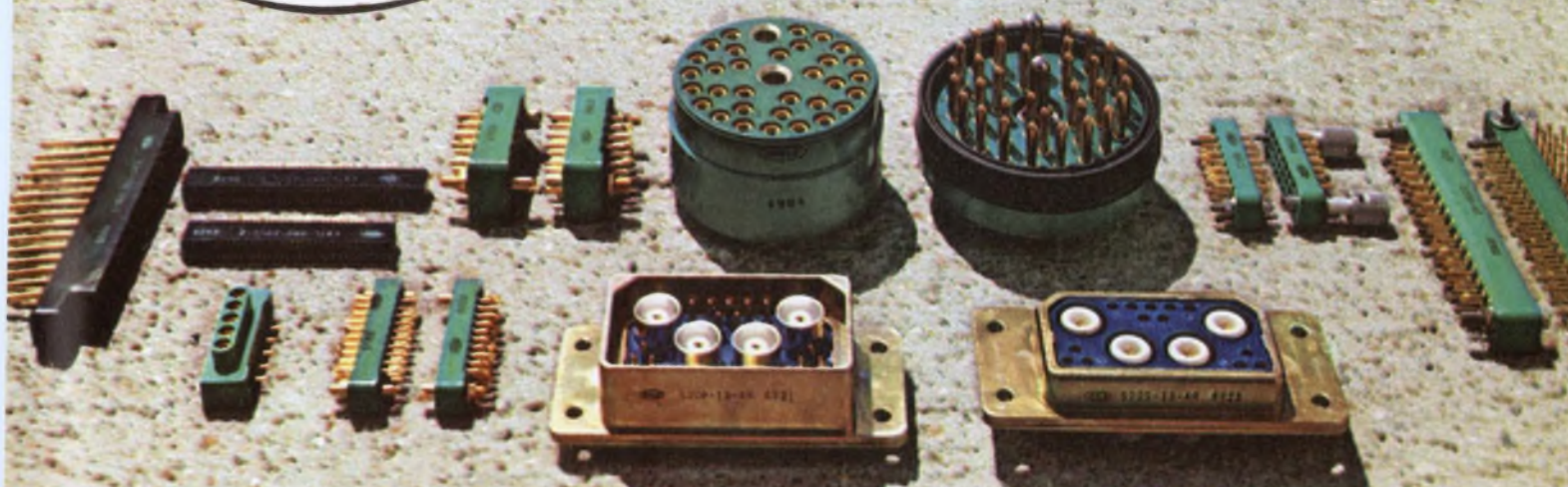

(British, continued)

Other new CRT's include rectangular-band high-sensitivity tubes with full 8 by 10-cm displays.

A selection of thyratrons for high-power radar, traveling-wave tubes for broadband communications systems and reed capsules for low-level industrial switching applications will also be shown.

Reditron Ltd., London, is exhibiting a number of all solid-state new high-frequency units:

- A general-purpose ssb/1sb communications receiver.
- A 10-channel spot-frequency mf/hf ssb receiver.
- A 100-watt portable aperiodic linear amplifier.
- An antenna distribution amplifier.
- A frequency-synthesized drive unit.

Receiver units, including the aerial distribution amplifier, have dynamic ranges of over 120 dB; front-end circuits are capable of withstanding a 30-V emf while protected against higher voltages by an easily replaceable fuse.

Trend Electronics, Ltd., High Sycombe, Buckinghamshire, is exhibiting a portable data-transmission set originally developed for the British Post Office. It consists of a data transmitter, data receiver, and measuring circuits that show peak telegraph distortions, bias distortion, and error count.

Testing the test set

The company has also designed a distortion generator specifically for the test set. It enables an operator to measure the threshold of terminal equipment. To do this, it applies "accurate distortion" to assess the performance of the data-transmission system and also provides its own source of data on which distortion can be imposed.

A.E.I. Semiconductors Ltd., Lincoln, has SCR's that operate at 5 to 30 A with turn-off times as low as 5 μ s. They also have Button pack SCR's at 500 A and 3 kV and plastic rectifiers rated at 80 A. These latest additions extend the present range of double diffused industrially proven devices from 1 to 80 A.



J-band solid-state generator (top) is manufactured by M. O. Valve under the Genalex trademark. **Semiconductor devices** (bottom) from AEI include SCR's and plastic rectifiers.

The firm is also showing germanium backward diodes, silicon low-noise and power transistors, tuning and multiplying varactors, P-I-N diodes, gallium arsenide Schottky barrier mixers, Gunn-effect oscillators and avalanche diodes. All of these units are being used in commercial and military microwave communication systems.

First look in the U.S.

AVO Ltd., Dover, Kent, is exhibiting a range of instruments not seen before in the United States. These include a portable digital meter with full multimeter facilities that combine the reliability of digital measurement with simple push-button operation. Another multimeter by the same firm combines the sensitivity of electronic multimeters with the versatility of the conventional type. Also new in the same range is a transistor set capable of measuring gain at the low currents appropriate to modern devices.

Solid-state color-television switches with a new switching concept using integrated circuits are introduced by Electrocraft Instru-

ments, Hampshire. The switches, VSS 620, provide one video signal output that may be selected from up to ten colors, or monochrome video signal inputs.

Another product to be seen for the first time at Wescon is a self-contained rack-mounted version of a nanovolt stabaumatic potentiometer, a new development of Tinsley & Co., London. It requires only one galvanometer amplifier and a secondary galvanometer for all ranges and permits standardizing checks to be made while using the nanovolt range.

British Physical Laboratories, Radlett, Hertfordshire, features a solid-state capacitance bridge designed for use in the manufacture and testing of electrolytic and tantalum capacitors. It is claimed to provide in one instrument a comprehensive range of measurement facilities for all capacitor parameters.

Marconi Instruments Ltd., St. Albans, Hertfordshire, displays new automatic test equipment and electronic test and measuring instrumentation.

Racal Instruments Ltd., Reading, Berkshire, is showing digital instrumentation and precise frequency generators.

Hawker Siddeley Dynamics Ltd., Hatfield, Hertfordshire, has a photographic display that features the firm's interest in avionics, electronics, missiles and aerospace.

Rank Precision Industries Ltd., Leicester, exhibits special machinery for producing continuous lengths of glass optical fiber.

Ferranti Ltd., Edinburgh, Scotland, is showing lasers, microwave units, circulators and isolators, as well as potentiometers used in such equipment as flight simulators, medical-care aids and power station and weapon control systems.

Jermyn Industries, Sevenoaks, Kent, features a 24 dual-in-line socket designed for printed-circuit board applications.

L.C.R. Compents Ltd., Tredgar, Monmouthshire, is showing an automatic component bridge that measures inductance, capacitance and resistance to better than 0.1 per cent. The firm will also show capacitors of polystyrene and polycarbonate, high-voltage pulse capacitors and medium-frequency capacitors. ■■

Hottest Product of the Year #2

Schweber Introduces the First Monolithic Voltage Regulator that breaks the voltage barrier.

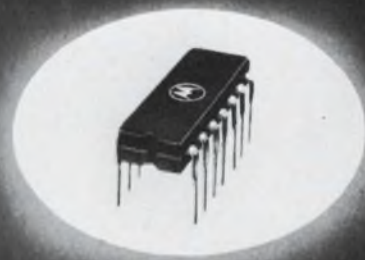

Motorola's MC1566L/1466L is a precision wide-range voltage and current regulator (Monolithic Epitaxial Passivated). This unique "floating" regulator can deliver hundreds of volts—limited only by the breakdown voltage of the external series pass transistor. Output voltage and output current are adjustable. The MC1566L/MC1466L integrated circuit voltage and current regulator is designed to give "laboratory" power-supply performance.

Some of the typical applications are: 0 to 15 VDC, 10 Amperes Regulator / 0 to 40 VDC, 0.5 Amperes Regulator / 0 to 250 VDC, 0.1 Amperes Regulator / Remote Programming.

Here are some of the features:

- Voltage/Current Regulation with Automatic Crossover.
- Excellent Line Voltage Regulation, 0.01% +1.0 mV.

- Excellent Load Voltage Regulation, 0.01%, +1.0 mV.
- Excellent Current Regulation, 0.1% +1.0 mA.
- Short-Circuit Protection.
- Output Voltage Adjustable to Zero Volts.
- Internal Reference Voltage.
- Adjustable Internal Current Source.

For more detailed information, write to Schweber Electronics, Westbury, N. Y. 11590. Circle No. 242

Product	Temperature	1-24	25-99	100-999
MC1566L(Mil)	-55 to +125 C	36.75	30.60	24.50
MC1466L(Com)	0 to 75 C	12.75	10.60	8.50

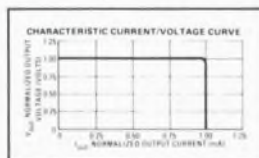

Call any of these locations for immediate delivery

Your franchised Motorola distributor: **Schweber Electronics, Westbury, New York: 516/334-7474** □ **Rockville, Maryland: 301/427-4977**

Other Sales Offices: Waltham, Mass: 617/891-8484 □ Cleveland, Ohio: 216/333-7020 □ Hollywood, Fla: 305/927-0511 □ Huntsville, Ala: 205/539-2756 □ Toronto, Canada: 416/925-2471



Future engineers compete at Wescon

Winners from 24 finalists will be awarded \$3400 in 13th annual contest for teen-agers

This week 24 high school students are competing for \$3400 in scholarships, offered as prizes in Wescon's 13th annual Future Engineers Program. The students, representing eight western states, are finalists in a competition based not only on academic record but also on involvement in school activities and community projects. In addition, each student has submitted a statement outlining his interests in technology and a proposed project for Wescon. The projects are on display in a special exhibit at the Cow Palace.

ELECTRONIC DESIGN interviewed four of these students to learn what they thought were the qualities of a successful engineer and their opinions about the role of technology in society.

In general, the students spoke of satisfaction and interest in building things. A good background is essential, they felt. For some, this began at an early age with electric trains, simple motors or experiments. The encouragement of parents and teachers helped spur interest, some said. Magazines helped, too.

Assuming an ability to absorb science and engineering information, they felt a successful engineer should also have:

- An interest in technology—in building, in solving, in coming up with answers or new questions that need answers.
- Creativity—the ability to apply knowledge in new ways to solve problems.
- Logical approach—a capacity to analyze situations and understand implications that may not be readily apparent.
- Administrative sense—the ability to see an entire problem and

yet handle small but important details.

- Open-mindedness—a willingness to accept new ideas.
- Confidence—a personal assurance in those approaches that you know are right.
- Endurance—staying with a job or project until it's finished.
- General interests in science and technology—an ability to use knowledge in a number of scientific fields to help come up with answers to specialized problems.

The short-range goal of most of these students is to acquire the knowledge and techniques that will help them do a good job in their future work. But their long-range goals most often involve the expectation of working on projects that will benefit others: mass-transportation, pollution control, medical electronics, and better communications.

They viewed the role of technology in society as one that has begun to improve the quality of man's life. One student put it this way: "People complain about technological chaos, and sometimes it's hard to see advances. . . . But I think technology will never advance beyond man's ability to control it."

What about people and machines? "People are beginning to feel diminutive," said one future engineer. He added, "There is some difficulty in dealing with automation, but people are getting more specialized and are freer to do creative work. It is important for people to learn to adapt to technological changes so they can find a useful place in the society."

Each of the 24 students, accompanied by his science instructor, receives air travel and expense allowances for their stay in San

Francisco, and each student—whether or not he wins one of four scholarship prizes—receives a \$50 U.S. savings bond.

Competitors for this year's Future Engineers and displays of their projects:

Alaska

Eric William Strid, 16, Diamond High, Anchorage, *Signal Separation Using New Delay Line or Attenuator Hybrid*.

Arizona

Albert Andrew Barbieri, 16, Arcadia High, Phoenix, *Holography, Three-Dimensional Photography*.

Northern California

Douglas Merritt Logan, 16, Sacramento Union Acad., Carmichael, *Using Doppler Effect in Velocity Analysis*.

Vincent Henry Tobkin, 17, Homestead High, Sunnyvale, *Electronic Measurement of Changing Gas Concentrations*.

Glenn Arthur Fujihara, 17, Sanger Union High, Sanger, *Linear Ion Accelerator*.

Robert Ernest Beach, 18, Menlo-Atherton High, Atherton, *Design and Construction of a Stored Program Digital Computer*.

John F. Belew Jr., 18, Mission San Jose High, Fremont, *Gravitational Interaction of Light with Matter*.

J. Kenneth Salisbury, Jr., 17, Menlo-Atherton High, Atherton, *Las Vegas Computer*.

Southern California

Brent Alan Dussia, 17, Buena High, Ventura, *Q-Switched Ruby Laser*.

Barry Dean Berry, 17, Madison High, San Diego, *A Study of Mag-*

Here's the fastest, most accurate source of programmable pulses available anywhere. The new Datapulse System 140 generates rep rates to 100 MHz, pulse widths from 5 ns, and independently variable rise and fall times from 2 ns.

Your program sets the upper and lower levels of the output waveform to any values between +10v and -10v. Each level can be independently positioned with an accuracy of $\pm 2\%$ of programmed value ± 20 mv. Pulse amplitude (the difference between levels) may be varied from 50mv to 5v into a 50 ohm load. Accuracy is typically $\pm 2\%$ of value for the other programmable pulse parameters: rep rate, pulse delay, pulse width and transition times.

System 140 can be programmed from computer, punched tape, magnetic tape, or other logic sources. All pulse parameters are controlled by BCD inputs compatible with DTL logic levels.

For complete information contact Datapulse Division, Systron-Donner Corporation, 10150 W. Jefferson Blvd., Culver City, California 90230. Phone (213) 836-6100.

Tests fast ICs automatically: the only 100 MHz programmable pulser!

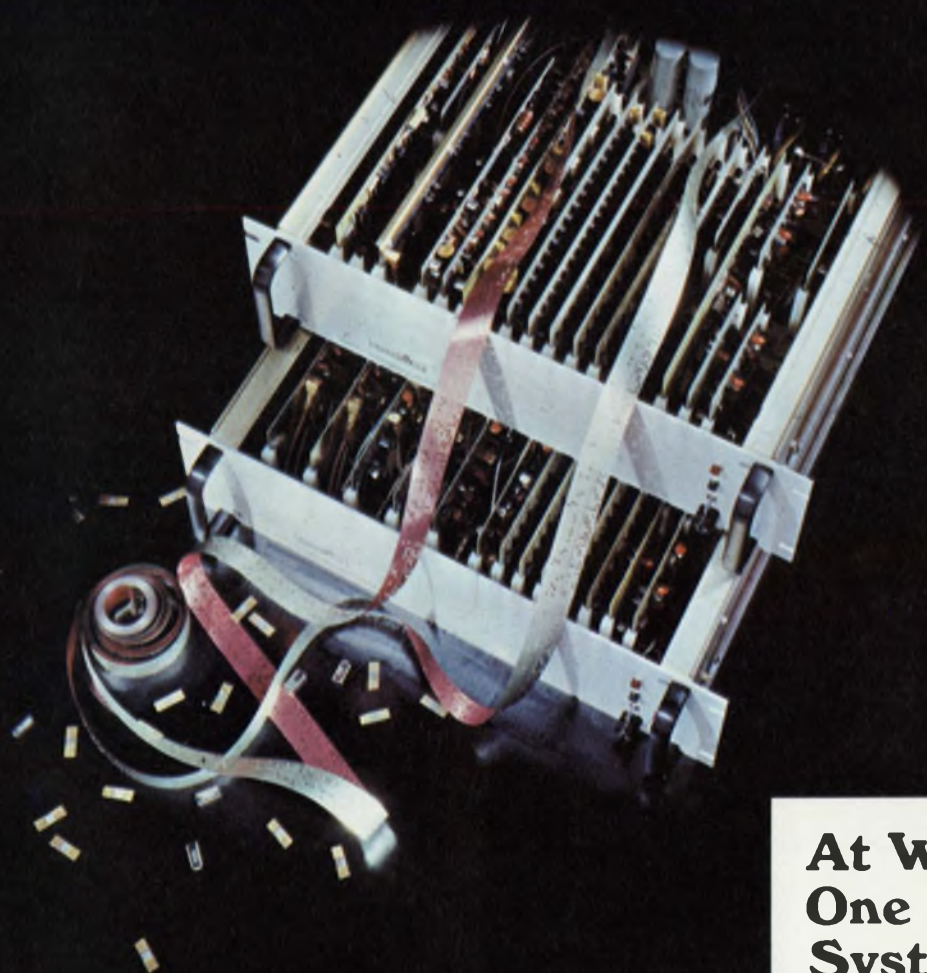

**At WESCON.
One of 157
Systron-Donner
instruments.**

Electronic counters	Digital voltmeters
Pulse generators	Spectrum analyzers
Microwave frequency indicators	Digital panel meters
Digital clocks	Microwave signal generators
Memory testers	Laboratory magnets
Analog computers	Data acquisition systems
Time code generators	
Data generators	Microwave test sets

DATAPULSE
DIVISION

SYSTRON  DONNER

neto- and Electro-Optical Rotary Effect Analysis.

Mark Ellis Dorian, 17, Madison High, San Diego, *Can an Electronic System Learn to Solve Mazes?*

Andy Sturman, 17, Madison High, San Diego, *A Study of Joule Magnetostriction in Ferromagnetic Materials.*

Idaho

James Robert Rasmussen, 17, Burley High, Burley, *Electronic Amplification by Electromagnetic Constriction of the Plasma Created in a Gas-Discharge.*

Montana

Joyce V. S. Westgard, 17, Anaconda Sr. High, Anaconda, *Light Amplification by Stimulated Emission of Radiation.*

James Earl Lalonde, 17, Sentinel High, Missoula, *Research and Application of Laser Light (Laser Light vs Tooth Decay).*

New Mexico

Clyde R. Sparks, 16, Alamagordo High, Alamagordo, *Digimatic: A Universal, Digital, Proportional Control System.*

Larry Roy Garcia, 18, Manzano High, Albuquerque, *Experiments in Magneto-Fluid Dynamics.*

Douglas Wescott White, 16, Los Alamos High, Los Alamos, *Experiments in Magneto Fluid Dynamics.*

William Carey Thompson, III, 17, Santa Fe High, Santa Fe, *An Experimental Determination of the Relativistic Mass Increase of an Accelerated Electron.*

Oregon

Robert W. Bales, 17, McNary High, Salem, *Design and Use of a Bio-potential Display/Recording System.*

Washington

Pamela Jane Mattern, 16, Columbia High, Richland. *The Biochemical Fuel Cell-Power Source of the Future.*

Robert James Crepin, Jr., 17, Charles Wright Academy, Tacoma, *An Electronic Rocket Engine.*

Vernon T. McDougall, 17, Inglemoor High, Bothell, *Nonlinear Intense Light Interactions with Crystals.*

Mark Franklyn Johnson, 17, Eastmont High, E. Wenatchee, *A Soundless Tunnel.* ■■



Joule magnetostriction in ferromagnetic materials is being studied by Andy Sturman, 17, of Madison High School, San Diego, Calif.



"Las Vegas Computer" is the intriguing title of a project being worked on by J. Kenneth Salisbury, Jr., 17, of Menlo-Atherton High School, Atherton, Calif.

The Standard of Excellence

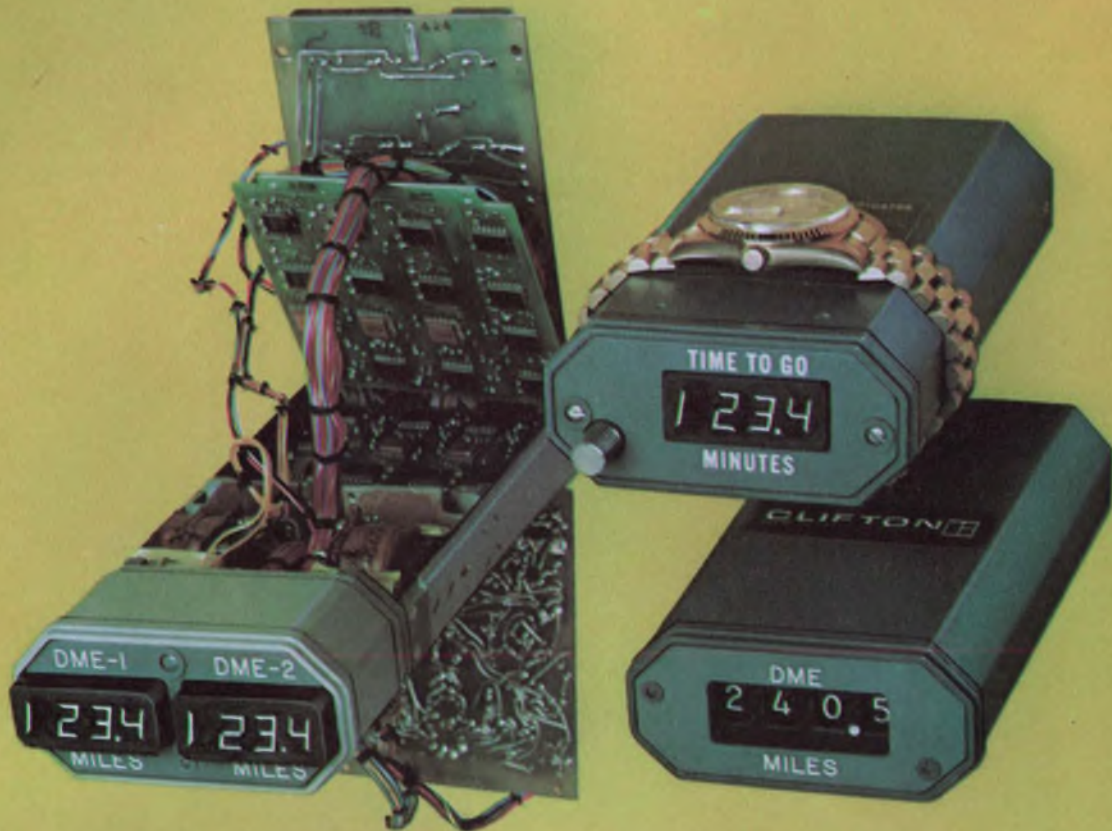

Digital Indicators by Clifton

In the Clifton family of ARINC type, solid state, Time-To-Go, INS and DME indicators, we are proud to have anticipated and produced advanced cockpit hardware for the new generation of commercial transports.

Important design advances in the areas of fault monitoring and detect circuitry plus central dimming capabilities are incorporated into the basic design.

In operation, each indicator recognizes the address of a specific function pa-

rameter, decodes the serial BCD data, and provides a digital display of the information. Each basic indicator in the family has the capability of being converted to any other indicator format by simply changing a lightplate and programmable connector. Seven segment lamp or magnetic wheel readouts are available for most designs.

Two basic display families, a 4 Digit and Dual 4 Digit configuration, are included in the INS and DME indicator product line. Sim-

ilar indicators are available for AIR DATA applications. A variety of indicator readout configurations meet all INS, DME or AIR DATA indicator requirements.

You can obtain full information on this advanced line of indicators which is available and now flying by calling your Local Clifton Sales Office or area 215 622-1000; TWX 510 669-8217.

CLIFTON 
DIVISION OF LITTON INDUSTRIES

Chronometer and Band from J. E. Caldwell Co., Philadelphia—\$1200.

What engineers really do at Wescon



A small group has been watching you at Wescon for the past few years. They know what you say you're going to do and then what you actually do. They know the kind of information you want. And they know what you pass by when time gets short.

The reason for all this surveillance was to give you what you want, to make the show more valuable to you. The study was made by Peter Sherrill, a private consultant, under contract with Wescon. And apparently the results have paid off. Attendance at Wescon has been rising, while the crowds that run through the spring rain to the Coliseum in New York every year have fallen off.

The IEEE may mend its ways, however, and benefit from Wescon's success, if plans go through for managers to come from the West to impart some of their newly

found expertise to the East.

Since Sherrill began the study in 1964, he has gained some very interesting insights into the habits and customs of the engineer.

Unlike the scientist, the engineer does not go to technical shows for a theoretical type of information. He goes to learn "another point of view on a unique problem." The engineer is more product-oriented, while the scientist is happier with abstractions. And the engineer likes to get his information from another person, a colleague, rather than from reading. This doesn't mean that the engineer doesn't read; he does. To keep abreast of what's going on in his field, or related fields, he reads trade magazines, manufacturer's specifications and new product announcements.

But the engineer has not been an avid attender of technical sessions. He plans to go but usually

doesn't. In 1964, out of 40,000 registrants, less than 10% attended the technical program. During the intervening years, this percentage steadily dropped. In 1968, less than 5% of the registrants sat through a paper in their project area.

The study blames this poor attendance on the "18th century" tutorial approach of these programs.

Wescon managers have tried to crack this problem by urging session organizers and speakers to talk directly to the engineer, and give him what he needs to do his job better. Papers, they say, should be practical rather than theoretical.

According to a poll taken at one session, 60 per cent of those who attended said they went "to keep up their job specialty." Only about 20 per cent said they went to learn something about an area that was *not* their specialty. And approximately 12 per cent went hoping to



**Somebody
beat you to it.**

It was intended for you. But if the 24-page Kearfott brochure we had bound into this magazine is missing, somebody took off with it.

No wonder. The 24 pages are filled with vital statistics and valuable information on Kearfott's products. On servo motors, tach generators, stepper motors and other DC rotary components.

But you can still get it if it's gone. Either circle the number shown on this page on the reader service card, or write us directly requesting it. Singer-General Precision, Inc., Kearfott Division, 1150 McBride Avenue, Little Falls, N.J. 07424.

That'll show 'em.

SINGER

KEARFOTT DIVISION

INFORMATION RETRIEVAL NUMBER 736

find the answer to a specific problem.

The star of the show is always the hardware. Apparently it's more exciting to see, and sometimes to operate, a device than to hear it described.

To pin down preferences, 334 engineers were asked how they felt about hardware as opposed to technical sessions. Thirteen per cent wanted no part of technical sessions—they just wanted to see the exhibits; 23% said they got more out of exhibits than papers, but that they planned to attend some sessions; 33% said they would vote for hardware if they had to choose but that they nevertheless thought highly of the sessions; 19% enjoyed the exhibits but found greater benefits in listening to papers; and 10% had no doubts about preferring papers to hardware.

Following up on these statements, Sherrill found what actually happened was that only 7% attended as many as two sessions; 10% attended only one; and 81% didn't ease down on a single folding chair—even for a quick nap. (For those of you crafty enough to have laboriously added up these percentages, the remaining 2% wouldn't talk.)

Sherrill also found other discrepancies. For example, in 1964, 38% of the show registrants said they planned to go to some of the technical sessions; 6% went. In 1968; 17% claimed they'd actually gone to a session, while the attendance analysis showed that only 4.8% turned up.

As to who goes to sessions, Sherrill found that the most loyal attenders are engineers working in the field of data processing; next, communications; and third, aircraft, missiles, space-vehicles, and support equipment.

Also generously represented are managing and marketing people who are looking for new markets as well as competition.

This year the sessions and the show may be better than ever before. And you, who have probably been suffering from nagging guilt every time you hide behind that potted palm as the doors close on another session, may feel free, happy, and normal again; you are not alone. You might even be inclined to try the new sessions that will talk directly to you. ■■

Wescon Exhibitors

The exhibitors and where to find them

Academy Computing Corporation
5525

Adams & Westlake Company
4708-09

Addington Laboratories, Inc.
5408

Addmaster Corporation
1802

Advance Process Supply Company
3323

Airco Industrial Gases
Division of Air Reduction, Inc.
3806

Aerovox*Corp.
4409-10

Airco Speer Electronic Components
3804-05

Aladdin Electronics
4521

Alco Electronic Products, Inc.
5120

Alford Manufacturing Co.
1906

Alfred Electronics
1806-07

Algo Div., Hamilton Electronic Corporation
2615

Allen Avionics, Inc.
4713

Allen-Bradley Co.
4723-25

Allen-Jones Electronics
2304-05

Alloys Unlimited, Inc.
3620-21

Almac Cryogenics, Inc.
1037

Amacoil Machinery, Inc.
3203

American Chamber of Commerce in Germany
Room S

American Machine & Foundry Co.
2114

American Optical Corp.
1403

American Optical Corporation
1402

Amphenol Connector Div.
2808-10

Anadex Instruments, Inc.
1904-05

Analog Devices, Inc.
1706-07

Anderson Laboratories, Inc.
4705

Andrew Corp.
5421-22

Anechoic Systems
A Division of Darr Industries
5416

Angelica Uniform Co.
3321

API Instruments Co.
1404-05

Applied Materials Technology, Inc.
2312

Applied Research, Inc.
3606

Approved Engineering Test Labs.
1502

Arra, Inc.
5423

Arrow-Hart, Inc.
5121-22

A S A P., Incorporated
2412

Associated Testing Laboratories, Inc.
1204-05

Astrodata, Inc.
1819

Astrosystems, Inc.
2215

Atec, Inc.
1342

Atomergic Chemetals Div. of Gallard-
Schlesinger Chemical Mfg., Corp.
4223

Augat, Inc.
2721-22

Automated Environments, Inc.
3410

Automated Packaging Systems, Inc.
3206-07

Automatic Electric Co.
4401-02

Avien, Inc.
1213

Bachi, Inc.
3109-10

Barnes Corp.
2606-07

Barry Instrument Corp.
1016

Beede Electrical Instr. Co., Inc.
1331

Belden Corp.
2701-02

Bell Electronic Corporation
4518-19

F. W. Bell, Inc.
1704-05

The Bendix Corporation
4205-07

Winfred M. Berg, Inc.
5209

Berkeley Glasslab Div. of Kinsington
Scientific Corp.
2316

Biomation
1029

Bird Electronic Corp.
1733-34

The Birtcher Corp./Industrial Div.
2601

The Birtcher Corp./Instrument Div.
3104-05 and 3224-25

Bishop Industries Corp.
3316

E. W. Bliss Co.
5207-5208

Blue M. Engineering Co.
3325

Bolt Beranek & Newman/Data
Equipment Div.
1809

Bolt Beranek and Newman, Inc.
5215

Bonus-Bilt, Inc.
3215

Boonton Electronics Corp.
2126-27

R. W. Borrowdale Co.
2921-23

W. H. Brady Co.
3204-05

Bristol Div. of American Chain & Cable
3921

BTU Engineering Corp.
2301 & 2401-02

Buckbee Mears Co.
2707

The Buckeye Stamping Co.
2824

Burdny Corp.
4506-08

Burr-Brown Research Corp.
1115-16

Burroughs Corp.
4224-25

Business Information Technology, Inc.
5514-5515

Bussmann Manufacturing Div./McGraw-
Edison Company
4321

California Computer Products, Inc.
5508-09

Give your designs the flexibility of these newest RCA "Building Blocks"

Box full of linear circuit "building blocks"—Your RCA Distributor has QK2202, RCA's linear circuits sampler containing 10 types of circuits (23 devices). Here's thorough documentation—virtually everything you need to sharpen your circuit ingenuity using linear "building blocks." The QK2202 is available at \$37.95 (optional distributor resale price). Get yours today.

Ask your local RCA Representative or your RCA Distributor for full details. For specific product data, write RCA Electronic Components, Commercial Engineering, Sec. ICG 8-3, Harrison, N. J. 07029.

RCA
Integrated
Circuits

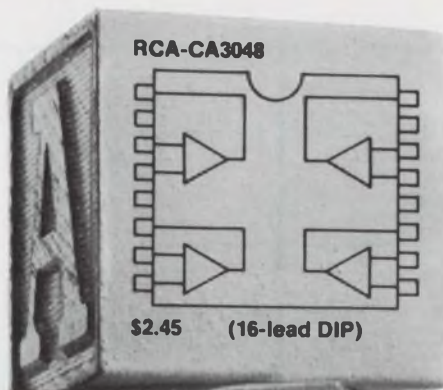

4 AC Amplifiers in a Package

Four independent AC amplifiers with 53 dB (min.) voltage gain per amplifier @ 10 kHz, for use to 300 kHz. For low-noise and general AC applications in industrial service.

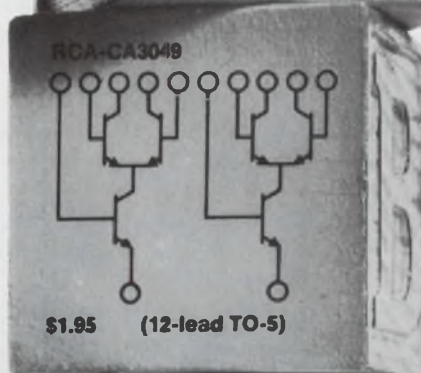

DC to 200 MHz Dual Diff Amp

Dual independent diff amps for low-power applications. Power gain 23 dB (typ.) @ 200 MHz; noise figure 4.6 dB (typ.) at 200 MHz. Wide application potential over the full military temperature range.

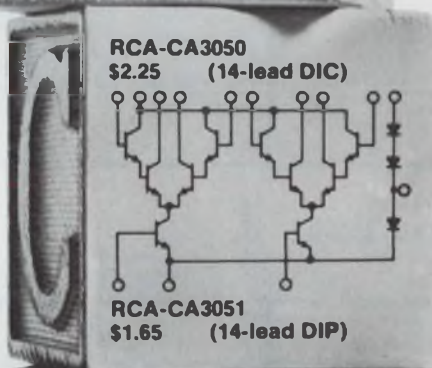

Darlington-Connected Dual Differential Amplifier

Two Darlington-connected diff amps with diode bias string for low-power applications from DC to 20 MHz. CA3050 for full military temperature range; CA3051 for -25°C to $+85^{\circ}\text{C}$ operation. Both feature high impedance input, low bias current, low offset current.

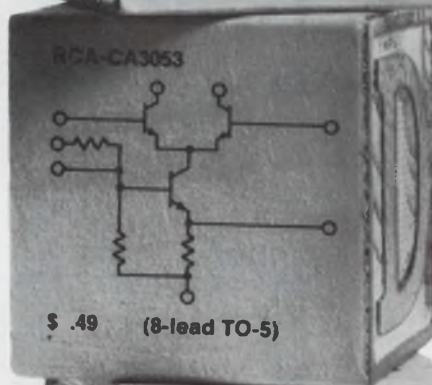

Economy Multi-Purpose Linear IC

New economy linear IC combining performance and versatility—at a new low in cost. 40 dB (typ.) cascode voltage gain @ 10.7 MHz, 30 dB (typ.) differential voltage gain @ 10.7 MHz. Recommended for IF and general-purpose applications. 6- or 12-V operation.

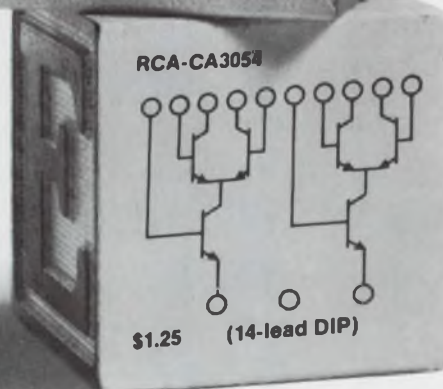

120 MHz Dual Diff Amp in 14-lead DIP

Matched diff amps with independently accessible inputs and outputs. Max. input offset voltage = 5 mV; max. collector current = 50 mA. Forward current transfer ratio (h_{fe}) (typ.) = 110. For 0° to 85°C operation. Also available as CA3026 in TO-5 package for full military temperature range.

Visit the RCA Electronic Components exhibit at WESCON, Unit C, in the Cow Palace Arena

All prices 1,000 unit level.

INFORMATION RETRIEVAL NUMBER 737

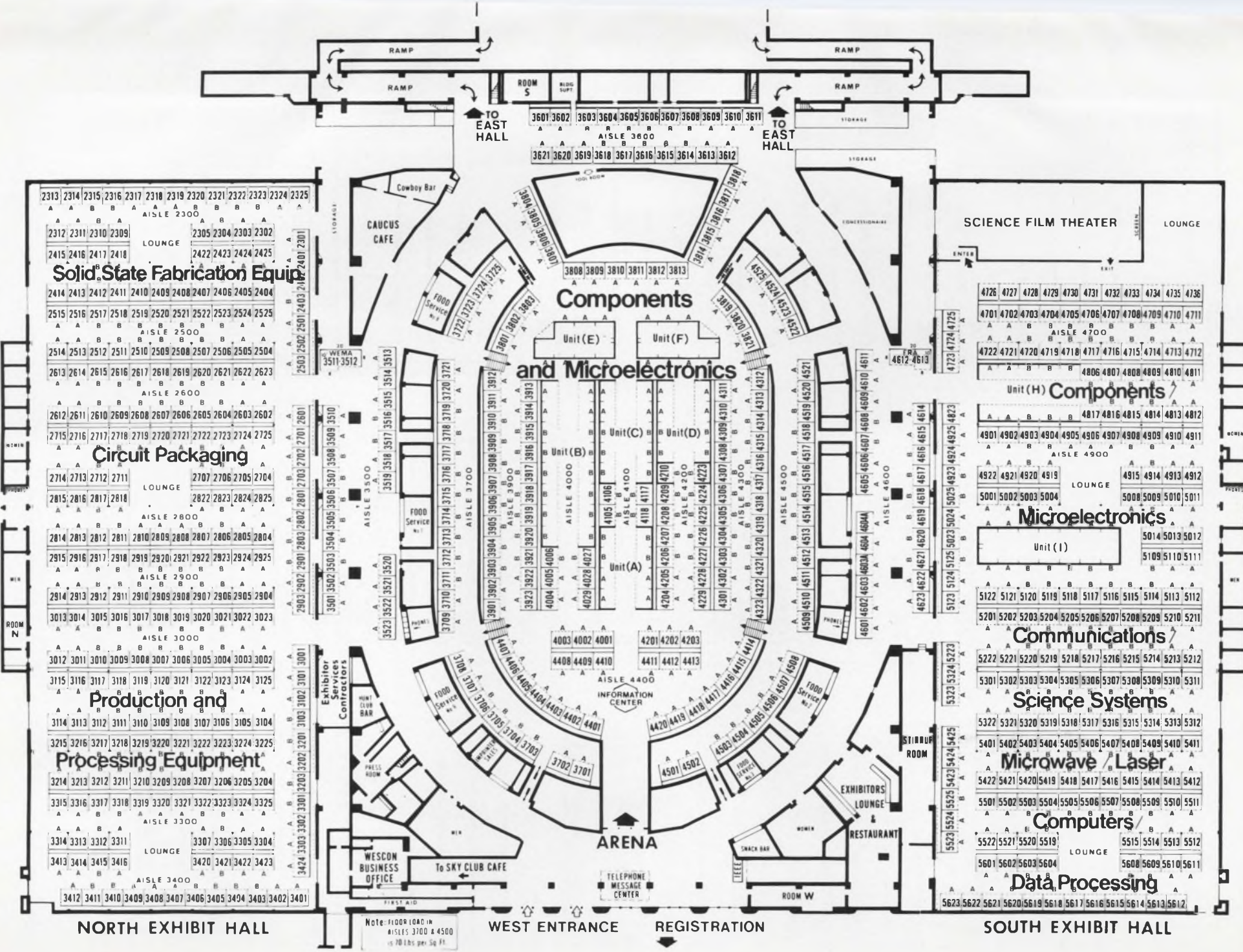

Exhibitors' List

- California ElectroScientific Corp.
1137
- California Instruments Corp.
1329-30
- California Process Supply
2424
- Cambridge Thermionic Corp.
4509
- Canadian Government Exhibition Comm.
3019 & 3501-10 & 5323 & 5613
- Carpenter Manufacturing Co., Inc.
2914
- Celco - Pacific Div.
4501-02
- Cerro Wire & Cable Co.
2706
- Chartpak Rotex
3108
- Chassis-Trak, Inc.
3005
- Cherry Electrical Products, Corp.
5117-19
- Chicago Dynamic Industries, Inc.
5025
- Chicago Switch, Inc.
4711
- Christie Electric Corp.
1345-46
- Chronetics, Inc.
1419
- Cintra/Physics International Co.
5612-5513
- Cipher Data Products, Inc.
1122
- C & K Components, Inc.
4811
- Clevite Corp.
1334-39
- Clevite Corp./Piezoelectric Div &
Brush Magnetic Components Group
4522-23
- CML, Inc.
2210
- Cohu Electronics, Inc.
2001-02
- Coil Winding Equipment Co.
3001 & 3101
- Coleman Engineering Co., Inc.
1801
- Collins Radio Co.
4405-07
- Compar Corp.
3807
- Components, Inc./Capacitor Div.
4717-18
- Computer Automation, Inc.
1120-21
- Computer Measurements Co.
1006-08
- Com-Share Incorporated
4732
- Comtel Corp./c/o Southfield Electronics
1208
- Condenser Products Corp.
4813
- Connecticut Environmental R&D Corp.
Subsid of Intertech Enterprises Ltd.
2908-09
- Consolidated Products Corp.
2620
- Continental Device
1326
- Control Data Corporation
1511-14
- Control Equipment Corp.
1804-1805
- Control Logic, Inc.
2202-03
- Cornell-Dubilier Electronics
4403-04
- Craig Corp.
5201-02
- CREI
4322
- CTS Corp.
3913-14
- Culligan, Inc.
3217
- Curtis Development & Mfg. Co.
4911
- Curtis Instruments, Inc.
1818
- Cutler-Hammer, Inc.
1106-12
- Cyclo-Tronics, Inc.
3314
- Damon Engineering, Inc.
5206
- Dana Laboratories, Inc.
2008-11
- Darcy Industries, Inc.
2117-18
- Data Chart Corp.
1902
- Data Disc, Inc./Display Div.
5510-11
- Data-Instrument Div.
1409-10
- Data Memory, Inc.
5306-07
- Data Royal Corp.
1113-14
- Data Technology Corp.
1827 & 2802-03
- The Datak Corp.
4513
- Datascan, Inc.
1815-16
- Daymarc Corp.
1126
- Del Electronics Corp.
3705
- Delta Design, Inc.
1327-28
- Deltrol Controls Corp.
5001-02
- Deltron, Inc.
1508
- Dempa Publications, Inc.
3907
- Deutsch Filters Relay Division
4901-02
- Device Seals, Inc.
4510
- Dialight Corp.
3707-08
- Digilin, Inc.
1014
- Digital Equipment Corp.
5620-23
- Dimensional Control Corporation
3403
- K. Dixon Corporation
3406
- Doall Company
3422-23
- Douglas Electronics, Inc.
2520
- The Dow Chemical Company
3303 & 3424
- Dranetz Engineering Labs., Inc.
1031
- Dressen-Barnes Electronic Corp.
4419-20
- DS America, Inc.
2413-14
- E. I. Du Pont De Nemours & Co./Freon Div.
2715-17
- E. I. Du Pont De Nemours & Co./Plastics
Dept.
2711-12
- Dynage, Inc.
1501
- Dynair Electronics, Inc.
5204-05
- Dynamic Gear Co., Inc.
4309
- Dynamics Research Corp.
2216
- Dynatel Limited
2201-A
- Dyonics, Inc.
4704
- Eastern Marking Machine Corp.
3319-20
- East/West Marketing Associates, Inc.
2315
- EG&G, Inc.
1105
- EG&G/Lab Products Div.
1129
- E-H Research Labs., Inc.
1033-36
- Eico, Electronic Instrument Co., Inc.
1217
- EIP Labs.
1911-13
- Elco Corporation
4105-06
- Eldorado Electronics, Inc.
1722-23
- Eldre Components, Inc.
5221-22
- Electro-Flex Heat, Inc.
4909
- Electro-Membrane Systems, Inc.
3307
- Electro-Nuclear Laboratories, Inc.
4914
- Electro Scientific Industries, Inc.
1601-02
- Electro Switch Corp.
3515-16
- Electroglas, Inc.
2404-06
- Electromite Corporation
5314
- Electronics Associates, Inc.
5522
- Electronic Controls, Inc.
3701-02
- Electronic Enclosures/Div. of Wyle Labs
2719-20
- Electronic Engineering Co. of Calif.
3814-17
- Electronic News
5312-13
- Electronic Representatives Assn.
4612-13
- Electronic Resources, Inc.
5409-10
- Electronics, McGraw-Hill, Inc.
5304-05
- Electronized Chemicals Corp.
2515-16
- Electrovert, Inc.
3115-17
- Ema-West Inc.
5614
- Emerson & Cuming, Inc.
1604-05
- Emerson Electric Co.
2213-14

Engelhard Minerals & Chemicals Corp.
3124-25

Enviroco, Div. of Becton/Dickinson & Co.
2918-20

Equipment Reporter
3020

The Eraser Company
3409

ERB & Gray Scientific Div. of A.
Daigger & Co.
1507

Esterline Angus, Div. of Esterline Corp.
1022

Ferranti Limited (U.K.)
4610-4611

Fetty Schoenduve, Inc.
4524

Field Emission Corp.
1143

Filtron Company, Inc.
4209-10

Fischer & Porter Co./Lab-Crest
Scientific Division
2321

John Fluke Mfg. Co., Inc.
1130-32

Fluoroware, Inc.
3420-21

Frequency Engineering Laboratories
1808

Friden Div./The Singer Company
5601-02

Fusite Corp.
2608

W. K. Geist Co.
1406-07

General Automation, Inc.
4734

General Electric Co.
4304-08 & 5316-18

General Radio Co.
1726-29

Geoscience Instrument Corp.
3123

Federal Republic of Germany
c/o Dusseldorfer Messgesellschaft
Unit "I"

Giannini Voltex
3904-05

Gibson-Egan Co.
1325

Globe-Union, Inc.
Globe Battery Div.
3906

Gordos Corporation
4514

W. L. Gore & Associates, Inc.
2801

Gorman Sales Corporation
3324

Gold Marathon Battery Company
3612-13

GPS Instrument Co., Inc.
1425-26

Graphcomp Sciences Corporation
5608

Graphic Electronics, Inc.
2522

Grayhill, Inc.
3922-23

GTI Corporation/Dix Engineering Div.
3209-12

Guardian Electric Manufacturing Co.
4823 & 4924-25

Gudebrod Bros. Silk Co., Inc.
4310

Guildline Instruments Limited
1713

W. & L. E. Gurley, A Teledyne Co.
1803



Engineers — are your hands tied?

Frustrated by the limitations of the average inductor? Nytronics research and development have created an inductor line that unties their hands, and their imaginations, to reach for hitherto unattained heights of quality and performance. An inductor line that is as close to perfection as it is possible to come.

NEW!

WEE CHIP-INDUCTOR—Magnetically shielded, wrap-around termination permitting contact to either face or ends. Designed to meet MIL-C-15305, Grade 2, Class B .280" x .195" x .100". Presently available .15 μ H to 1000 μ H.

NEW!

PEE-CEE-DUCTOR—Magnetically shielded Fixed Inductor—Range 0.1 to 100,000 μ H. Designed to MIL-C-15305, Grade 1, Class B. Epoxy molded 0.300" diameter x 0.270" height. Printed circuit mounting—0.200" grid spacing and unit has shielded construction to allow maximum density packaging.

MILI-DUCTOR—Subminiature Unshielded with Inductance Range 0.1 to 1000 μ H. Designed to MIL-C-15305, Grade 1, Class B. Molded Envelope: .095" diameter x 0.250" length.

MS LINE 90537 TYPE—Manufactured in accordance with MS90537, Molded Magnetically shielded with inductance range 0.1 to 100,000 μ H \pm 10% tolerance. Molded Envelope: 0.163" diameter x 0.410" length.

WEE-DUCTOR—Magnetically shielded with inductance range 0.1 to 180,000 μ H, designed to MIL-C-15305, Grade 1, Class B. Encapsulated Envelope: 0.157" diameter x .450" length.

SUPER WEE-DUCTOR—Manufactured in accordance with MIL-C-15305, Grade 1, Class B. Molded magnetically shielded with inductance range 0.1 to 100,000 μ H \pm 10% std. tolerance. Other tolerances and lead materials available on request. Molded Envelope: 0.163" diameter x 0.410" length.

SUPER WEE-WEE-DUCTOR—Miniature shielded with inductance range 0.1 μ H to 10,000 μ H. Designed to MIL-C-15305, Grade 1, Class B. Epoxy-Molded Envelope: 0.125" diameter x 0.335" length.

VARIABLE INDUCTOR—Unshielded with adjustable range 0.1 to 4700 μ H. Designed to meet MIL-C-15305, Grade 1, Class B. Encapsulated Envelope: 0.400" diameter x 0.500" length. Vertical or Horizontal mounting.

■ Send for our new 44-page catalog with the quality line of standard components.



NYTRONICS, INC.

The quality line of standard components

550 Springfield Ave., Berkeley Heights, N.J. 07922 ■ (201) 464-9300 ■ TWX: 710-984-7977

See our capacitor and inductor people at the Mark Hopkins.

INFORMATION RETRIEVAL NUMBER 738

shape

IS NO PROBLEM

when specifying Pulse Code Modulation (PCM) systems from Radix Telemetry Corp. All system components are packaged as separate functional modules, and can be arranged to meet a wide variety of envelope requirements. Or, if volume is insufficient to accommodate a complete system in one location, various subsystems can be located remotely from each other. Minimum system volume is achieved by micropackaging techniques, 0.3 cubic inches per channel is typical.

✈ **FOR AIRCRAFT... RADIX PCM SYSTEMS** are available for operation over full MIL-E-5400 environments. Modular construction allows the user to re-program the system with simple patch board techniques.

🚀 **FOR MISSILES... RADIX PCM SYSTEMS** have been qualified to 300 G shock and 125 G acceleration levels. Modular construction results in extremely rugged and versatile systems.

🚀 **FOR SPACECRAFT... Power consumption as low as 3.0 watts.** RADIX PCM SYSTEMS have operated successfully in a hard vacuum.

■ Specify RADIX PCM (or PAM) SYSTEMS for your airborne data acquisition requirements.



*Demonstrations of the Modular PCM SYSTEMS
and other RTC Systems arranged at your facility.*

RADIX TELEMETRY CORP.
A SUBSIDIARY OF RADIX CORPORATION

1600 ORANGETHORPE WAY | ANAHEIM, CALIF. 92801 | (714) 879-4360

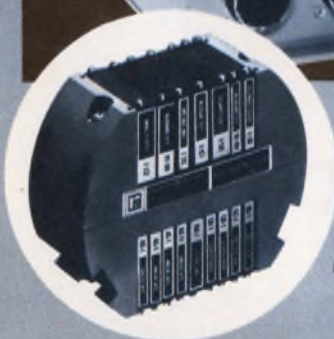

RADIX Telemetry product lines will be on display at the ITC/USA/'69 Exposition, September 15-18, Sheraton Park Hotel in Washington, D.C. in BOOTHS 12 & 15. See you there.

Exhibitors' List

- The Hallicrafters Company
5219-20
- Hallmark Standards, Inc.
1711-12
- The Hartwell Corporation
3015-16
- Hastings-Raydist, A Teledyne Co.
3103
- Hathaway Instruments, Inc.
3618-19
- Hayakawa Electric Co., Ltd.
4715-16
- Hayden Publishing Co.
3819-21
- Heath Company
Room "W"
- Heinemann Electric Co.
3801-03
- Hermetic Seal Corp./Div. of Sterling
Electronics
4004-06
- Carl Herrmann Associates
2425
- Hewlett-Packard
1040-46 & 1001-5 & 5615-18
- The Hickok Electrical Instrument Co.
1607-09
- HI-G, Inc.
Unit "E"
- Hirschmann Corporation
3022
- Hitachi/c/o Marubeni-Iida Co.
2109
- Holt Instrument Labs.
1319
- Honeywell, Inc.
1306-09
- Hoyt Electrical Instrument Works, Inc.
4117
- Hudson Tool & Die Co.
2613-14
- Hughes Aircraft Co.
Unit "H"
- Hughes Aircraft Co./Electron Dynamics Div
Unit "H"
- Hughes Aircraft Co./Vacuum Tube
Products Div.
4201-02 & 2422 & 2423
- Hugle Industries, Inc.
2323-25
- Hull Corporation
3301-02
- Hybrid Systems Corporation
1321
- Hybrinetics, Inc.
4733
- Hysol Div./The Dexter Corporation
2703
- IBM Corp./Industrial Products
3517-19
- The IEEE, Inc.
West Entrance
- Illumination Industries, Inc.
3513
- Industrial Electronic Engineers, Inc.
3715-16
- Industrial Specialists, Inc.
1123-25
- Industrial Technology Corp.
Unit "D"
- Industrial Test Equipment Co., Inc.
1144
- Information Control Corp.
1603
- Information Handling Services, Inc.
5310-11

Truth is stronger than fiction.



The truth about our A/D converters is stronger than the fiction you hear about others. .

The truth about ours is that word lengths vary from 4 bits to 9 bits; word conversion rates vary from 1 MHz to 25 MHz; and aperture time is as low as 0.2 nanosecond!

Prices range from only \$4,200 to \$9,660 and include internal sample-and-hold, power supplies, and self-test features.



Not only that . . .
We also have D/A converters
that match our A/D's in speed
and accuracy. Honest!

COMPUTER LABS

for tomorrow's technology today

(919) 292-6427 • 1109 SOUTH CHAPMAN ST.
GREENSBORO, N. C. 27403

INFORMATION RETRIEVAL NUMBER 740

If you don't
find it here,
give us a call.

SILICON RECTIFIERS

Ask about our many
types of custom
rectifiers and rectifier
assemblies.

FULL WAVE BRIDGE RECTIFIERS*		
50V	I ₀	1-99
W 111	1A	.95
100V		
VE 18	1A	1.00
VS 148	2A	1.00
VH 148	6A	1.93
200V		
VE 27	1A	1.20
VE 28	1A	1.10
VS 247	2A	1.20
VS 248	2A	1.10
VH 247	6A	2.25
VH 248	6A	2.15
IN 4436	10A	4.15
VT 200	25A	5.35
400V		
VE 47	1A	1.30
VE 48	1A	1.20
VS 447	2A	1.30
VS 448	2A	1.20
VH 447	6A	2.59
VH 448	6A	2.49
IN 4437	10A	5.45
VT 400	25A	7.00
600V		
VE 67	1A	1.59
VE 68	1A	1.49
VS 647	2A	1.60
VS 648	2A	1.50
VH 647	6A	2.98
VH 648	6A	2.88
IN 4438	10A	7.45
VT 600	25A	9.85

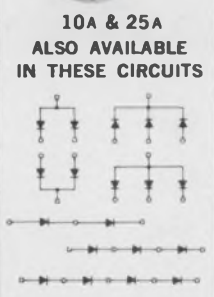
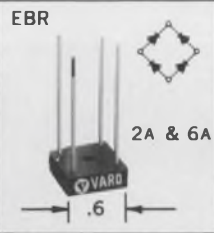
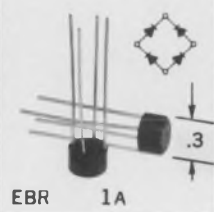

*Available with fast recovery characteristic



SEMICONDUCTOR DIVISION, 1000 N. SHILOH
ROAD, GARLAND, TEXAS 75040 (214) 272-4551
INFORMATION RETRIEVAL NUMBER 741

Exhibitors' List

Innovative Concepts Associates, Inc.
5612

Insaco, Inc.
4905

Instrument Specialists, Inc.
1123-25

Interdyne Company
2514

International Contronics, Inc.
5603-04

International Electronic Research Corp.
4912-13

International Light, Inc.
1214

Intronics, Inc.
2209

Ishimoto Trading Co.
5010

Isofilm International
4721-22

C. Itoh & Co.
3614-17 & 3605

Itron Corporation
1428

ITT
3808-13

James Electronic Tool Co.
2523

Jay-El Products, Inc.
4515

JBL International
5213-14

J-B-T Instruments, Inc.
4203

JFD Electronics Co./Components Div.
3911-12

E. F. Johnson Co.
5024

Julie Research Laboratories, Inc.
2128

Kasper Instruments, Inc.
2507-09

Kay Electric Co.
1613-15

Keithley Instruments, Inc.
1101-02

Keltron Corp.
1322

J. D. Kennedy Corp.
5610-11

Kepeco, Inc.
4001-02

Kester Solder Co.
3013-14

Kinologic Corp.
5218

Kings Electronics Co., Inc.
3706

Kingsley Machine Co.
3021

Kingsport Press, Inc.
1142

Kokusai Electric Co., Ltd.
2313-14

Kole Enterprises, Inc.
2901

Korad Dept./Union Carbide Corp.
5411

Krohn-Hite Corp.
1828

Kruse-Storke Electronics
1023

Kulicke & Soffa Industries
3413-16

Kulka Electric Co.
4411

Kyoto Ceramic Co., Ltd.
4412

La Marche Manufacturing Co.
5212

Lambda Electronics Corp.
3918-20

Laminated Plastics Industries
2403

Landis & Gyr, Inc.
4208

Lear Siegler, Inc./Cimron Div.
1716-18

Lear Siegler, Inc./Power Equipment Div.
4906

Ledex, Inc.
3520-23

Leeds & Northrup Co.
1914-16

Leesona Moos Laboratories
5320

Illinois Tool Works, Inc.
Licon/Paktron/EMC Divs.
4318-20

Lindberg Hevi-Duty, Div. of Sola
Basic Industries
2309-10 & 2417-18

Line Electric Co.
4512

Littelfuse, Inc.
4003

Littrell Western Sales, Inc.
2618-19

The London Company
1408

Long & Associates, Inc.
4520

Lorch Electronics Corp.
1343-1344

Lorlin Industries
1427

L & R Manufacturing Co.
3304-05

Luscombe Engineering Co.
4920-22

Luxo Lamp Corp.
3017

MAC Panel Company
3607

Magnavox Systems, Inc.
5315

Magnecraft Electric Co.
4311

Magnetic Shield Div. Perfection Mica Co.
2623

P. R. Mallory & Co., Inc.
4226-29

David W. Mann Co.,
Div. of GCA Corp.
3315

Marconi Instruments
1824-26

Marin Controls Co.
1903

Markem Corp.
3407-08

Marubeni-Iida (America) Inc.
2512

Master Specialties Co.
3722-23

Materials Research Corp.
2409-10

Mathatronics
5519-21

Matheson Gas Products
2408

R. D. Mathis Co.
2317

McFadden Electronics Co.
5301

McLean Engineering Labs.
1721

Measurements, A McGraw-Edison Div.
1140

Mechanical Enterprises, Inc.
5123-24

Mechanization Associates
2311

Adolf Meller Co.
4919

Metex Corp.
5113-14

Micom, Inc.
2012

Micro Instrument Company
1504

Micro Plastics, Inc.
2519

Micro Switch, Div. of Honeywell
3915-16

Microdot, Inc.
3714

Microdyne Instruments, Inc.
1518-19

Microfab Systems Corp.
2907

Microlab/FXR
5412-13

Microsemiconductor Corporation
5319

Microtran Co., Inc.
3908

Microwave Development Labs.
5401-02

Microwave Semiconductor Corp.
5407

Midtex, Inc./Aemco Div.
4702

Midwec Corp.
5216

James Millen Mfg., Co., Inc.
4204

J. W. Miller Co.
4323

Miller-Stephenson Chemical Co., Inc.
2609-10

Millivac Instruments, Inc.
1411

Miniature Electronic Components Corp.
4812

3M Company, Chemical Division
2813-14

3M Company, Duplicating Products Div.
2211-12

MM Electronic Enclosures, Inc.
3202

Modern Data
5619

Mohawk Data Sciences Corp.
1907-10

Monsanto Co.
1016-28 & 1017-19

Motorola Com. & Electronics, Inc.
1708-10

Moxon Electronics Corp.
1810-11

Mystik Tape Div./The Borden Chemical Co.
2611-12

The Narda Microwave Corp.
2106-08

National Electronic Distributors Ass'n (NEDA)
4609

National Radio Co., Inc.
5217

Naval & Aerospace Div. of A. T. Wall Co.
5415

Navan, Sub. of North American Rockwell
Corp.
2904-06

New Hermes Engraving Machine Corp.
3003

The J. M. Ney Co.
4414

NGK Spark Plug Co., Ltd.
2513

NH Research, Inc.
1015

Nikon Inc. (P.T.P. Inc.)
3317-18

Ni-Sil Cables Ltd.
4703

N J E Corp.
1332-33

North American Electronic Systems, Inc.
1219-20

North American Rockwell Corp.
2704-05

North Atlantic Industries, Inc.
1127-28

Norton Co./Vacuum Equipment Div.
3006-07

O'Halloran Associates
2111-13

Olivetti Underwood Corp.
5505-07

Olympus Corporation of America
2910-11

Omni Spectra, Inc.
5418-20

Ontario Government of Canada
Dept. of Trade & Development
4806-07

Optical Gaging Products Inc.
3401-02

Optimization, Inc.
1021

Opto-Metric Tools, Inc.
3113-14

Pace, Inc.
2521

Pacific Measurements Inc.
1320

Pacific Pure Water Co.
3112

Pamotor, Inc.
4923

Panasonic VIR/CCTV
4735-36

Panduit Corp.
2501-03

Parelco Inc.
4809

Parker Seal Co.
4908

Penfold Industries
3120

Perrygraf-Div. of Nashua Corp.
5003-04

Phaotron Instrument & Elect. Co.
1730-31

Philbrick/Nexus Research
2022-2024

Philco-Ford Corp./WDL Div.
1820-21

Philips Electronic Instruments
2120-23

Phoenix Materials Corporation
3218-19

Photocircuits Corp.
2621-22

Pic Design Corp.
4408

Pinlites, Inc.
4814-15

Plastic Capacitors Inc.
4415

Polarad Electronic Instruments Div. of
Polarad Electronics Corp.
1719-20

Polymetrics, Inc.
3106

ELFIN
2.99 *

think digital

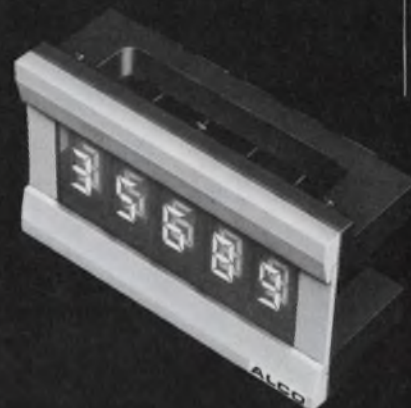

MS-4000
3.85 *

Think ELFIN — the new single plane, segmented neon readout indicator that provides brighter displays and wider viewing. Only 0.41" dia. ELFIN display 0-9, + and —, some alpha symbols and decimal.

The MS-4000 Series has new readouts added to include numeric and symbol indications. Each model is a miniature encased readout with the flat single-plane viewing, and uses 100,000 hr. #683 T-1 subminiature lamps. Plug-in feature expedites replacement. Photograph above shows five MS-4000 readouts used with a module mounting and bezel kit.

MS-250
4.97 *

ALCO's RK numeric and symbol readouts have a unique in-line design to provide clear displays without focusing problems. The precision machined 1-piece aluminum case also serves as a heat sink.

The MS Mosaic numeric segmented indicators are available in 2 sizes and use either 6, 14 or 24V lamps for flexibility in design.

MS
4.97 *

SEND FOR
ALCO - NUMERIC
CATALOG

MSM-5A
4.97 *

* 1000 Lot Prices
See us at WESCON 5120

ALCO

ELECTRONIC PRODUCTS, INC.

Lawrence, Massachusetts 01843

here now



Our visible solid state light sources are being delivered in commercial quantities.

Very bright, typically 1000 ft/L @ 50 mA.

Long life: our tests indicate over 1,000,000 hours.*

Happily compatible with your IC circuitry.

Needs only 10 mW for 50 ft/L @ 6300-7000A.

Instantly available in package shown or TO-18 header.

Ask Kierulff, Schweber, K-Tronics, or Semiconductor Specialists for our data sheets on the MV-10 series.

Monsanto ESP, 10131 Bubb Road, Cupertino, California 95014. Phone (408) 257-2140

*T_A = 25°C, I_F = 50 mA. Result of step-stress testing with end of life projections.

Monsanto

Exhibitors' List

Pomona Electronics Co., Inc.
3717

The Potter Company
5112

Potter & Brumfield Div. of AMF
4301-03

Power Designs, Inc.
1020

Power Instruments, Inc.
1032

Powercube Corp.
4516

Power/Mate Corp.
1423

PRD Electronics, Inc.
1714-15

Precision Lamp Engineers
3604

Prentice-Hall, Inc.
1401

Presco (Precision Systems Co., Inc.)
3120

Presin Company, Inc.
1141

Preston Scientific Inc.
1317-18

Princeton Applied Research Corp.
1038-39

Product Improvement Corp.
3118-19

Progress Electronics Co. of Oregon
2208

Commonwealth of Puerto Rico
2204-05

Quan-Tech Laboratories, Inc.
2201

Quick-Set, Inc.
5223 & 5324

Radiation Inc.
4503-05

Raychem Corp.
2822-23

Rayseel Corp.
4714

Raytheon Computer
5523-24

RCA Electronic Components
Unit "C"

Readouts, Inc.
4731

Redcor Corp.
1440-42

Remex Electronics
5503-04

Repex
3611

Republic Electronics Corp.
3610

Reynolds Electronics, Inc.
1218

RF Communications, Inc.
2110

RFL Industries, Inc.
1606

RHG Electronics Laboratory, Inc.
5403-04

Rimbach Publications/Div. of Chilton Co.
1013

RO Associates, Inc.
3609

Rogan Brothers, Inc.
5125

Rohde and Schwarz Sales Co. (USA) Inc.
1417-18

Rohn Manufacturing Co.
5414

Rolenn Manufacturing Company
2322

The Milton Ross Company
4413

Rotron Manufacturing Co., Inc.
3901-03

Rustrak Instrument Div./Gulton Industries, Inc.
1436-37

San Fernando Electric Mfg., Co.
4027-29

Sangamo Electric Co.
1607-09

Sargent-Welch Scientific Co.
3208

Scanbe Manufacturing Corporation
2510-11

Schry-Way Cases
2718

Scientific-Atlanta, Inc.
2524-25

Sealectro Corp.
4416-18

Secs, Inc.
3704

Semi-Elements, Inc.
5417

Semikron International, Inc.
4915

Servo Corp. of America
2206

Shibaden Corp. of America
5321-22

Siemens America Incorporated
1505

Signal Analysis Industries Corporation
1424

Signetics Corp.
Unit "F"

Siliconix Inc./Equipment Div.
2415-16

Simpson Electric Co.
1830-32

The Singer Co./Instrumentation Div.
2015-18

Skydyne, Inc.
2713-14

Sloan Instruments Corp.
2411

Herman H. Smith, Inc.
4411

Solid State Equipment Corp.
2318-19

Solid State Scientific, Inc.
3724-25

Solitron/Microwave
5424-25

Sony Corp. of America
5011-14 & 5109-11

Sorensen Raytheon Co.
2025-26

Southco, Inc.
2504-2506

Specialized Business Services, Inc.
1515-16

Spectrum Control, Inc.
4707

Speedfam Corp.
3121-22

Sprague Electric Co.
Unit "A" & 4118

SCR Div./Crescent Technology Corp.
1822-23

Stacey's
5008

Starlite Industries, Inc.
3404

Sterling Instrument Div. of Designatronics, Inc.
1901

Stevens-Arnold Inc.
3608

Geo. Stevens Mfg. Co., Inc.
3201

Stoddart Electro Systems
1030

The Sullins Company
1215-16

Sun Electric Corp.
1313

The Superior Electric Co.
3718-21

Susumu Industrial Co., Ltd.
4907

Sweet's Industrial Div. of Microfilm Systems
5210-11

Synergistics, Inc.
5609

Swiss American Precision Imports, Inc.
2917

Switchcraft, Inc.
3909-10

Sylvania Electric Products, Inc. Unit "B"

Synthane Corp./Div. Alco Standard Corp.
2723-25

Systron-Donner Corp.
1412-16 & 1429-32

Tally Corp.
1814

Tansitor Electronics, Inc.
5023

Tapeswitch Corporation of America
4517

TDK Electronics Corp.
5009

Teac Corporation
1212

Techni-Rite Electronics, Inc.
1438-39

Technibilt Corp.
1612

Technical Instrument Co.
4903

Technology Publishing Corp.
5203

Tecknit
2811-12

Tekform Products Co.
2518

Tektronix, Inc.
2101-04 & 2129-32

Telefunken Sales Corp.
3603

Telesciences, Inc.
3107

Teletype Corp.
5501-02

Telonic Industries, Inc.
1724-25

Tempil Div. of Big Three Industrial Gas & Equipment Co.
3213-14

Teradyne, Inc.
1117-19

Texas Instruments Inc./Industrial Products Div.
1420-22 & 1520-22

Texas Instruments Inc. Metallurgical & Chemical Material Div.
3514 & 2804-07

Texscan Corp.
1314-16

Thermco Products Corp.
3311-13

The Thomas & Betts Co., Inc.
2815-18

Time Systems Corporation
2207

H. Tinsley & Co., Ltd.
c/o Southfield Electronics
1207

Tizon Chemical Corp.
3306

Torin Corp.
2912-13

Torkon Fastener Corp.
4701

Tracerlab./Div. of LFE Corp.
2320

Tracor, Inc.
1701-03

Transformer-Electronics Co.
3601-02

Transistor Automation/A Teledyne Co.
3008-09

Transistor Devices, Inc.
4706

Transistor Electronics Corp.
4719-20

Transitron Electronic Corp.
4312-17

Transmagnetics, Inc.
4810

Transtector Systems
4712

Trimm, Inc.
4511

The Triplett Electrical Instrument Co.
1201-02

TRW Electronics
4726-30

Trygon Electronics Inc./Trymetrics Corp.
1812-13

Wagner Electric Corp./Tung-Sol Div.
4710

Tyco Laboratories, Inc.
1301-05

Ultimar, Inc.
3216

Umpco, Inc.
2517

Unger./Div. of Eldon Ind., Inc.
2902-02

Uniform Tubes, Inc.
2616-17

United Aircraft Corp.
3818

United States Dynamics
3322

United Systems Corp.
1024-25

United Van Lines, Inc.
3018

Unitek Corp./Weldmatic Div.
2924-25

Universal Manufacturing Co., Inc.
2915-16

U. S. Department of Commerce
Room 5

Uthe Technology, Inc.
2407

Vaco Products Co.
3004

Valtec Corporation
2021

Van Laarhoven Associates
3111

Varadyne, Inc.
5115-16

Varian Associates
3709-13

Vector Electronic Co., Inc.
2825

Veeco Instruments, Inc.
3010-12

designer's keyboard

SB-033 — INTERLOCK
SB-034 — MOMENTARY



28.50 User Net

The ALCO modular idea is a simple concept for the design engineer to create his own custom push button layouts from "stock" switch modules and assemblies.

The basic modules allow use of up to twelve (shown at right) switches per section. A designer may stack any number of these switch sections in a group by themselves or in conjunction with the ALCO mating 12-segment keyboard assemblies (shown above).

Highly efficient, single pole "normally open" reed switches are used throughout, thus assuring reliability and extremely long life expectancy.

For design-service assistance and price quotations, call (Area 617) 686-3887.

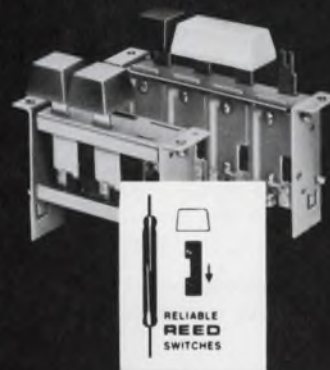

Available as Momentary and Interlock

See us at WESCON 5120

ALCO

ELECTRONIC PRODUCTS, INC.

Lawrence, Massachusetts 01843



**RPC
STAMPS
OUT
RESISTANCE
PROBLEMS...**

**WITH THE
LARGEST LINE
OF HIGH
VOLTAGE,
HIGH OHMIC
CARBON FILM
RESISTORS!**

For example, 15 basic styles are available:

WATTS: .25 to 100w.

RESISTANCE: 10 to $10^{14} \Omega$

TOLERANCE: to $\pm 1\%$

STAND. SIZES: .563" L x .1" dia.
to 19.687" L x 2" dia.

A variety of terminal configurations are available such as: radial lugs or bands, axial wire leads and ferrule ends.

SPECIALS

Only RPC has a special interest in solving those "special" problems. Resistors up to 40" long have been manufactured on request.

APPLICATIONS

Typical applications include those requiring high resistances, voltage capability from 250 to 125,000 v and high frequency or pulse circuits including power supplies, generators, X-ray equipment, electro-static air cleaners, paint sprayers, photo-copiers and high voltage-dropping monitors.

RPC's carbon film resistors will often exceed the requirements of metal oxide types, and with the lowest rejection rate in the industry.

For more information, call RPC . . . and give your resistance problems a real kick.

RPC Resistance Products Co.

914 South 13th Street
Harrisburg, Pa. 17104. (717) 236-5081

Exhibitors' List

Velonex/Div. of Pulse Engineering, Inc.
2105

Victor Compometer Corp.
1732

Victory Engineering Corp.
4525

Vidar Corporation
Instrumentation Division
1509-10

Viking Industries, Inc.
2602-03

Virginia Panel Corp.
4606

Visual Electronics Corporation
4808

Waber Electronics, Inc.
3703

Wakefield Engineering, Inc.
2604-05

Wang Laboratories, Inc.
2103-04

Wanless Instruments
2119

Ward Davis Associates
2103-14

Watkins-Johnson Co.
2302-03

Wavetek
2027-29

Wayne Kerr Co., Ltd.
1206

Weckesser Co., Inc.
3917

Weightman & Associates
3023

Weinschel Engineering Co., Inc.
1340-41

Wems, Inc.
4816-17

Western Electronic Manufacturing Assn.
3511-12

Western Electronic News, Inc.
4605

Westinghouse Electric Corp.
4601-03 & 4603A-4604-4604A

Weston Instruments Div.
2003-07 & 2030-34

W & G Instruments, Inc.
1323-24

S. S. White Industrial Div.
Pennsalt Chemical Corp.
3411-12

Whittaker Corp.
2124-25

Whittaker Corporation
Instrument Systems Division
1517

Wild Heerbrugg Instruments, Inc.
1506

Wiltron Co.
1138-39

B. J. Wolfe Enterprises, Inc.
1817

Xcelite Inc.
3002

Yeiser Labs.
1503

Yellow Springs Instrument Co., Inc.
4904

Carl Zeiss, Inc.
1203

Zeltex, Inc./Sub. of Redcor Corp.
1443-44

Ziff-Davis Publishing Co.
1829

The Zippertubing Co.
3102

LOOKING FOR THOSE HARD-TO-GET SPECIAL AND DISCONTINUED TRANSISTORS?



2N128	2N1672	2N1930	2N1135	2N1656	2N2163	2N2380
2N207	2N1673	2N1935	2N1135A	2N1663	2N2164	2N2380A
2N207A	2N1674	2N1936	2N1158	2N1676	2N2165	2N2398
2N207B	2N1675	2N1937	2N1158A	2N1677	2N2166	2N2399
2N223	2N1696	2N1938	2N1177	2N1683	2N2167	2N2400
2N224	2N1697	2N1939	2N1178	2N1711	2N2168	2N2401
2N225	2N1698	2N1940	2N1179	2N1726	2N2169	2N2402
2N226	2N1699	2N1941	2N1199	2N1727	2N2170	2N2410
2N227	2N1699A	2N1942	2N1199A	2N1728	2N2175	2N2451
2N231	2N1706	2N1943	2N1200	2N1742	2N2176	2N2478
2N232	2N1706A	2N1944	2N1201	2N1743	2N2177	2N2479
2N240	2N1706B	2N1945	2N1204	2N1744	2N2178	2N2487
2N317A	2N1708	2N1946	2N1204A	2N1745	2N2180	2N2488
2N344	2N1709	2N1947	2N1219	2N1746	2N2181	2N2489
2N345	2N1768	2N1960	2N1220	2N1747	2N2182	2N2537
2N346	2N1769	2N1961	2N1221	2N1748	2N2183	2N2538
2N352	2N1770	2N1962	2N1222	2N1748A	2N2184	2N2539
2N353	2N1771	2N1963	2N1223	2N1749	2N2185	2N2540
2N355	2N1772	2N1964	2N1267	2N1750	2N2186	2N2651
2N386	2N1773	2N1965	2N1268	2N1752	2N2187	2N2699
2N387	2N1774	2N1966	2N1269	2N1753	2N2199	2N2710
2N393	2N1775	2N1967	2N1270	2N1754	2N2200	2N2795
2N395	2N1776	2N1976	2N1271	2N1785	2N2217	2N2796
2N396	2N1777	2N1977	2N1272	2N1786	2N2218	2N2904
2N396A	2N1778	2N1979	2N1300	2N1787	2N2218A	2N2904A
2N408	2N1779	2N1980	2N1301	2N1788	2N2219	2N2905
2N428	2N1799A	2N1982	2N1411	2N1789	2N2219A	2N2905A
2N495	2N1799B	2N1983	2N1416	2N1790	2N2220	2N2906
2N496	2N1784A	2N1984	2N1427	2N1864	2N2221	2N2906A
2N499	2N1794	2N1985	2N1428	2N1865	2N2221A	2N2907
2N499A	2N1795	2N1986	2N1429	2N1866	2N2222	2N2907A
2N501	2N1796	2N1987	2N1436	2N1867	2N2222A	2N2908
2N501A	2N1785	2N1988	2N1437	2N1868	2N2223	2N2954
2N502	2N1828	2N1989	2N1467	2N1869	2N2224	2N2966
2N502A	2N1834	2N1990	2N1472	2N1893	2N2275	2N2967
2N502B	2N1835	2N1991	2N1478	2N1905	2N2276	2N2967A
2N503	2N1846	2N1992	2N1484	2N1917	2N2277	2N2968
2N504	2N1846A	2N1993	2N1494	2N1918	2N2278	2N2969
2N504A	2N1846B	2N1994	2N1494A	2N1919	2N2279	2N2970
2N505	2N1847	2N1995	2N1495	2N1983	2N2280	2N2971
2N505A	2N1848	2N1996	2N1496	2N1984	2N2281	2N2972
2N506	2N1849	2N1997	2N1497	2N1985	2N2282	2N2973
2N507	2N1850	2N1998	2N1498	2N1986	2N2283	2N2974
2N508	2N1851	2N1999	2N1499	2N1987	2N2284	2N2975
2N509	2N1852	2N2000	2N1500	2N1988	2N2285	2N2976
2N510	2N1853	2N2001	2N1501	2N1989	2N2286	2N2977
2N511	2N1854	2N2002	2N1502	2N1990	2N2287	2N2978
2N512	2N1855	2N2003	2N1503	2N1991	2N2288	2N2979
2N513	2N1856	2N2004	2N1504	2N1992	2N2289	2N2980
2N514	2N1857	2N2005	2N1505	2N1993	2N2290	2N2981
2N515	2N1858	2N2006	2N1506	2N1994	2N2291	2N2982
2N516	2N1859	2N2007	2N1507	2N1995	2N2292	2N2983
2N517	2N1860	2N2008	2N1508	2N1996	2N2293	2N2984
2N518	2N1861	2N2009	2N1509	2N1997	2N2294	2N2985
2N519	2N1862	2N2010	2N1510	2N1998	2N2295	2N2986
2N520	2N1863	2N2011	2N1511	2N1999	2N2296	2N2987
2N521	2N1864	2N2012	2N1512	2N2000	2N2297	2N2988
2N522	2N1865	2N2013	2N1513	2N2001	2N2298	2N2989
2N523	2N1866	2N2014	2N1514	2N2002	2N2299	2N2990
2N524	2N1867	2N2015	2N1515	2N2003	2N2300	2N2991
2N525	2N1868	2N2016	2N1516	2N2004	2N2301	2N2992
2N526	2N1869	2N2017	2N1517	2N2005	2N2302	2N2993
2N527	2N1870	2N2018	2N1518	2N2006	2N2303	2N2994
2N528	2N1871	2N2019	2N1519	2N2007	2N2304	2N2995
2N529	2N1872	2N2020	2N1520	2N2008	2N2305	2N2996
2N530	2N1873	2N2021	2N1521	2N2009	2N2306	2N2997
2N531	2N1874	2N2022	2N1522	2N2010	2N2307	2N2998
2N532	2N1875	2N2023	2N1523	2N2011	2N2308	2N2999
2N533	2N1876	2N2024	2N1524	2N2012	2N2309	2N3000
2N534	2N1877	2N2025	2N1525	2N2013	2N2310	2N3001
2N535	2N1878	2N2026	2N1526	2N2014	2N2311	2N3002
2N536	2N1879	2N2027	2N1527	2N2015	2N2312	2N3003
2N537	2N1880	2N2028	2N1528	2N2016	2N2313	2N3004
2N538	2N1881	2N2029	2N1529	2N2017	2N2314	2N3005
2N539	2N1882	2N2030	2N1530	2N2018	2N2315	2N3006
2N540	2N1883	2N2031	2N1531	2N2019	2N2316	2N3007
2N541	2N1884	2N2032	2N1532	2N2020	2N2317	2N3008
2N542	2N1885	2N2033	2N1533	2N2021	2N2318	2N3009
2N543	2N1886	2N2034	2N1534	2N2022	2N2319	2N3010
2N544	2N1887	2N2035	2N1535	2N2023	2N2320	2N3011
2N545	2N1888	2N2036	2N1536	2N2024	2N2321	2N3012
2N546	2N1889	2N2037	2N1537	2N2025	2N2322	2N3013
2N547	2N1890	2N2038	2N1538	2N2026	2N2323	2N3014
2N548	2N1891	2N2039	2N1539	2N2027	2N2324	2N3015
2N549	2N1892	2N2040	2N1540	2N2028	2N2325	2N3016
2N550	2N1893	2N2041	2N1541	2N2029	2N2326	2N3017
2N551	2N1894	2N2042	2N1542	2N2030	2N2327	2N3018
2N552	2N1895	2N2043	2N1543	2N2031	2N2328	2N3019
2N553	2N1896	2N2044	2N1544	2N2032	2N2329	2N3020
2N554	2N1897	2N2045	2N1545	2N2033	2N2330	2N3021
2N555	2N1898	2N2046	2N1546	2N2034	2N2331	2N3022
2N556	2N1899	2N2047	2N1547	2N2035	2N2332	2N3023
2N557	2N1900	2N2048	2N1548	2N2036	2N2333	2N3024
2N558	2N1901	2N2049	2N1549	2N2037	2N2334	2N3025
2N559	2N1902	2N2050	2N1550	2N2038	2N2335	2N3026
2N560	2N1903	2N2051	2N1551	2N2039	2N2336	2N3027
2N561	2N1904	2N2052	2N1552	2N2040	2N2337	2N3028
2N562	2N1905	2N2053	2N1553	2N2041	2N2338	2N3029
2N563	2N1906	2N2054	2N1554	2N2042	2N2339	2N3030
2N564	2N1907	2N2055	2N1555	2N2043	2N2340	2N3031
2N565	2N1908	2N2056	2N1556	2N2044	2N2341	2N3032
2N566	2N1909	2N2057	2N1557	2N2045	2N2342	2N3033
2N567	2N1910	2N2058	2N1558	2N2046	2N2343	2N3034
2N568	2N1911	2N2059	2N1559	2N2047	2N2344	2N3035
2N569	2N1912	2N2060	2N1560	2N2048	2N2345	2N3036
2N570	2N1913	2N2061	2N1561	2N2049	2N2346	2N3037
2N571	2N1914	2N2062	2N1562	2N2050	2N2347	2N3038

SPECIALS: T1750 through T2340
I.C.'S: 702, 709C, 710, 711

YOU JUST FOUND THEM!

All 100% tested . . . guaranteed
& at the Industry's lowest prices.
Write for new catalog and compare

LTE

LANSDALE
Transistor & Electronics, Inc.

COLMAR, PENNA. 18915 · 215-855-9002

CRYSTAL CLEAR EPOXY CASTING RESIN



Several transparent Stycast® resins are offered for making display embedments or castings. A convenient chart is available to aid in selection of the most appropriate system. It is yours for the asking.

INFORMATION RETRIEVAL NUMBER 871

ECCOMOLD® EPOXY MOLDING COMPOUNDS



Comparative physical, electrical and processing properties of Eccomold transfer molding compounds are in colorful chart. Typical applications are indicated.

INFORMATION RETRIEVAL NUMBER 872

CONDUCTIVE SILVER COATING IN AEROSOL SPRAY



Eccocoat CC-2 and Eccoshield ES coatings produce surface resistivities below 0.1 ohm per square. Silver particles are plastic bonded to form a tough film which adheres to most materials.

INFORMATION RETRIEVAL NUMBER 873

Emerson & Cuming, Inc.



CANTON, MASS.
GARDENA, CALIF.
NORTHBROOK, ILL.
Sales Offices
in Principal Cities

EMERSON & CUMING EUROPE N.V., Oevel, Belgium

Marketing seminar sponsored by Hayden

For those interested in the marketing aspects of the electronics industry, Hayden Publishing Co. is sponsoring its 14th semiannual marketing seminar at 9 a.m. Wed., at Fairmont Hotel's Terrace Room in San Francisco.

The seminar is held twice a year, during IEEE and Wescon weeks. It is directed to a wide spectrum of engineering management, marketing men, sales managers, technical representatives, distributors and advertising staff.

Speakers at Wescon are H. Zane Robbins, vice president and general manager of Burson-Marsteller Associates, a public-relations firm of Chicago. The subject of his talk will be "How to Use PR As an Effective Marketing Tool." Charles M. Kirkland, president of Weston Instruments, Newark, N. J., will speak on "Customer Orientation—Who Needs It?" Donald D. Winstead, marketing manager of Signetics Corp., Sunnyvale, Calif., will speak on "The Future of the MOS Market." Hugh D. Kennedy, vice president of Ness International Div. of Ness Industries, Inc., Palo Alto, Calif., will talk on the subject "International Electronic Marketing—a Rapidly Changing Ballgame."

Coffee will be served at 8:30 a.m. before the session begins, and there will be cocktails just before lunch at 12:30 p.m. You are also invited to visit Hayden's booth, 3819-3821. ■■

Fisherman's Wharf



Hungry Wescon visitors will flock to dozens of San Francisco's finest restaurants at the wharf.

INFORMATION RETRIEVAL NUMBER 747 ►

your best move



The world's first ultra-miniature 1/2" rotary switch with the invaluable feature of an adjustable stop. The MRA Series is available as 1, 2, 3, or 4 poles on a single deck with a maximum of 10 or 12 positions. You can choose the universal 1/8" diameter shaft, or a switch with its own specially mated knob. Ideal for installations where size and space limitations are a factor. Conservatively rated at 500 mA @ 125 VAC.

The MSRE waterproof rotary switch series is similar to the MRA Series, but built to meet the highest reliability standards required under any environmental condition.



LOCKING TOGGLE

World's first totally miniature toggle switches capable of being locked to safeguard against accidents. Full line available in 1-2-3-4 poles. 6 amps @ 125 VAC.

SLIDE SWITCH

The world's best mini-slide switch with a compact 1/2" case and new anti-tease design. Available in one and two pole, double throw models; 2 amps @ 120 VAC.



See us at WESCON 5120

ALCO

ELECTRONIC PRODUCTS, INC.

Lawrence, Massachusetts 01843

Canada displays wide range of exhibits

Electronics companies from north of the border are well represented at Wescon this year. Canada's ESE Ltd., of Rexdale, Ontario, is exhibiting its new phase-delay equalizers, designed with computer-aided mathematics. Called a "major break-through" by the company, the equalizer is reportedly capable of stepping up data transmission to as high as 9600 bits a second.

Garrett Manufacturing Ltd., also of Rexdale, brings to the Cow Palace its miniaturized printed circuits, including resistors, diodes, integrated circuits and conductors.

Ferrite-based components, said to be of high accuracy and uniformity, are being shown by Ferritronics Ltd., Richmond Hill, Ontario. The company designs and produces these ferrite-cored components for low audio frequencies all the way up to the vhf range.

Control by coded signals

Kameco Electronics Ltd., of Montreal, is displaying its Telemat sequential logic selector, a device that carries out control functions under the direction of coded signals. Also

being shown is the company's live-line detector for crews working on power transmission lines.

Educational electronics and solid-state modules, built by Micro-Com Electronics Ltd., Winnipeg, Manitoba, are being shown by the Manitoba Export Corp., a provincial government agency that helps Manitoba manufacturers sell their products outside the province.

The agency is also sponsoring Fototek, a division of Hallcraft Electronics Ltd., of Winnipeg, which produces circuit boards, photo etching, precious metal plating and escutcheons.

The third company in the Manitoba group is Manta Industries Ltd., of Winnipeg, which is displaying padded instrument-carrying cases for electronics and other delicate equipment.

Power units shown

An industrial power-stepper motor, which has an exceptionally high stepping rate, small step angle and high torque was brought down from Stratford, Ontario, by Muirhead Instruments Ltd. The company manufactures a wide range of standard three and four-phase stepper motors in frame sizes 08 to 23. It also produces Codex electromagnetic digital indicators, servomotors, logic drivers, gearheads and mechanical stepper transmitters.

Variable resistors and hot-molded potentiometers are shown by Precision Electronic Components Ltd., Toronto. The resistors, which meet military specifications, are designed for broad-spectrum reliability.

A captivated center connector of high-conductivity copper alloy that features sequential clamping action is on display by Trim-Line Connectors Ltd. of Weston, Ontario.

"Ultra high value, glass enclosed (Megox) type M51 resistors" are being shown by Welwyn Canada Ltd. of London, Ontario. The component is made to meet "or exceed" the requirements of MIL-R-14293A. ■■

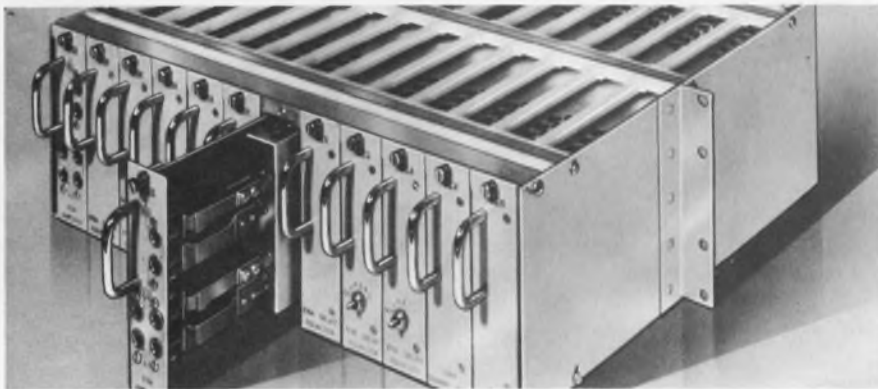

Up to 12 plug-in modules of ESE Ltd's Series E system fit easily into this 19-inch by 5-1/2-inch mounting shelf. Series E system is a modular group of equalizers and associated equipment designed for delay and attenuation equalization of frequency-division multiplex channels.

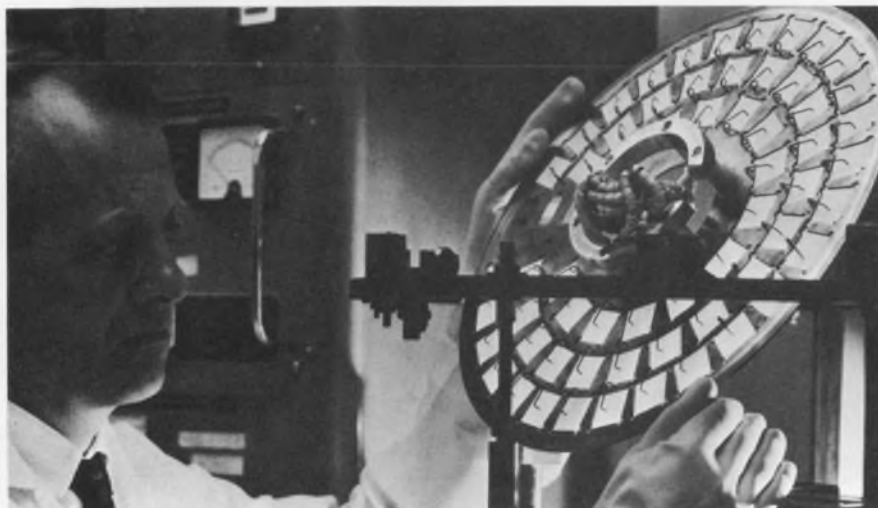

Substrates mounted in a work holder are readied for loading in a vacuum deposition station. Garrett Manufacturing Ltd. will show this product at Wescon.

It's time for a change in your digital displays! Increase versatility, decrease costs — with RCA's new NUMITRON Digital Display Devices

Compare these RCA product advantages:

- Sharper, cleaner displays
- Controllable high brightness
- Up-front planar numerals for wider viewing angle
- Unlimited filter-color selection
- Low voltage operation—designed for 4½ V
- Fully compatible with RCA's new Integrated Circuit Decoder/Drivers

- Rugged construction
- Long life—high reliability
- Designed for low-cost 9-pin miniature sockets

Interested? For more information on the new RCA NUMITRON Digital Display Devices, contact your local RCA Representative or write to RCA Electronic Components, Commercial Engineering, Section ICG-9, Harrison, N.J. 07029. Also ask for

data on the new RCA Integrated Circuit Decoder/Drivers, especially designed for use with RCA's Digital Display Devices. Type Numbers of NUMITRON Digital Display Devices:

RCA-DR-2000—Numerals 0 through 9
RCA-DR-2010—Numerals 0 through 9, with decimal
RCA-DR-2020—Plus-Minus and Numeral 1
RCA-DR-2030—Plus-Minus

Unretouched photograph of operating NUMITRON devices mounted on plastic tubing.

RCA
Digital Display Devices



Behind the new versatility and lower costs of digital displays...

RCA's New 7-Segment Decoder-Drivers

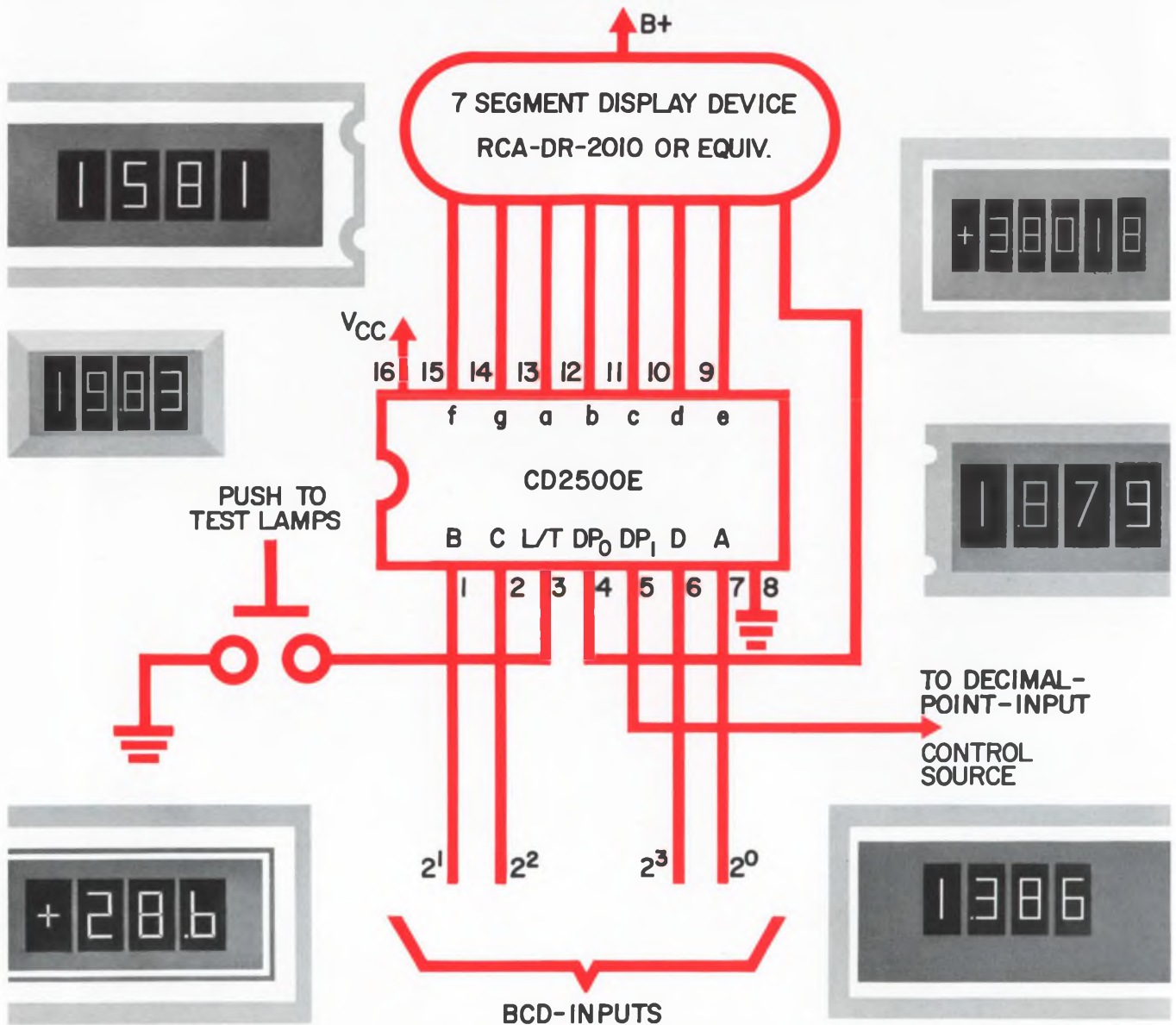

Whether you drive your digital displays with low current or high current, your drive circuits can now be more versatile—simpler—lower in cost. RCA's new CD2500E series of 16-lead DIP 7-segment Decoder Driver MSI integrated circuits includes both 30 mA devices for driving RCA's new NUMITRON 7-segment Digital Display Units and 80 mA devices to drive miniature low-voltage lamps or relays.

Look at the tabulation of the new CD2500E devices. Compare their prices and their advantages with present decoder-drivers and decoder and driver combinations. Then contact your local RCA Representative for details. For technical data, write to RCA Electronic Components, Commercial Engineering, Section ICG 8-3, Harrison, N. J. 07029.

RCA Integrated Circuits

RCA's 7-segment Decoder-Drivers		
Operating Current per Segment	Type Number	Price (1,000 units)
30 mA 80 mA	CD2500E CD2502E	\$6.75 \$8.00 with decimal point
30 mA 80 mA	CD2501E CD2503E	\$6.75 \$6.00 with ripple blanking
ADVANTAGES		
<ul style="list-style-type: none"> • Power supply and input voltages compatible with DTL and TTL devices • Lamp test provision • High current sinking capability for direct display driving 	<ul style="list-style-type: none"> • Clamp diodes on all inputs • Intensity control capability • Over-range detection • 0° to 75°C temperature range • Lamp supply voltage up to 8 V 	

new from the new DUMONT

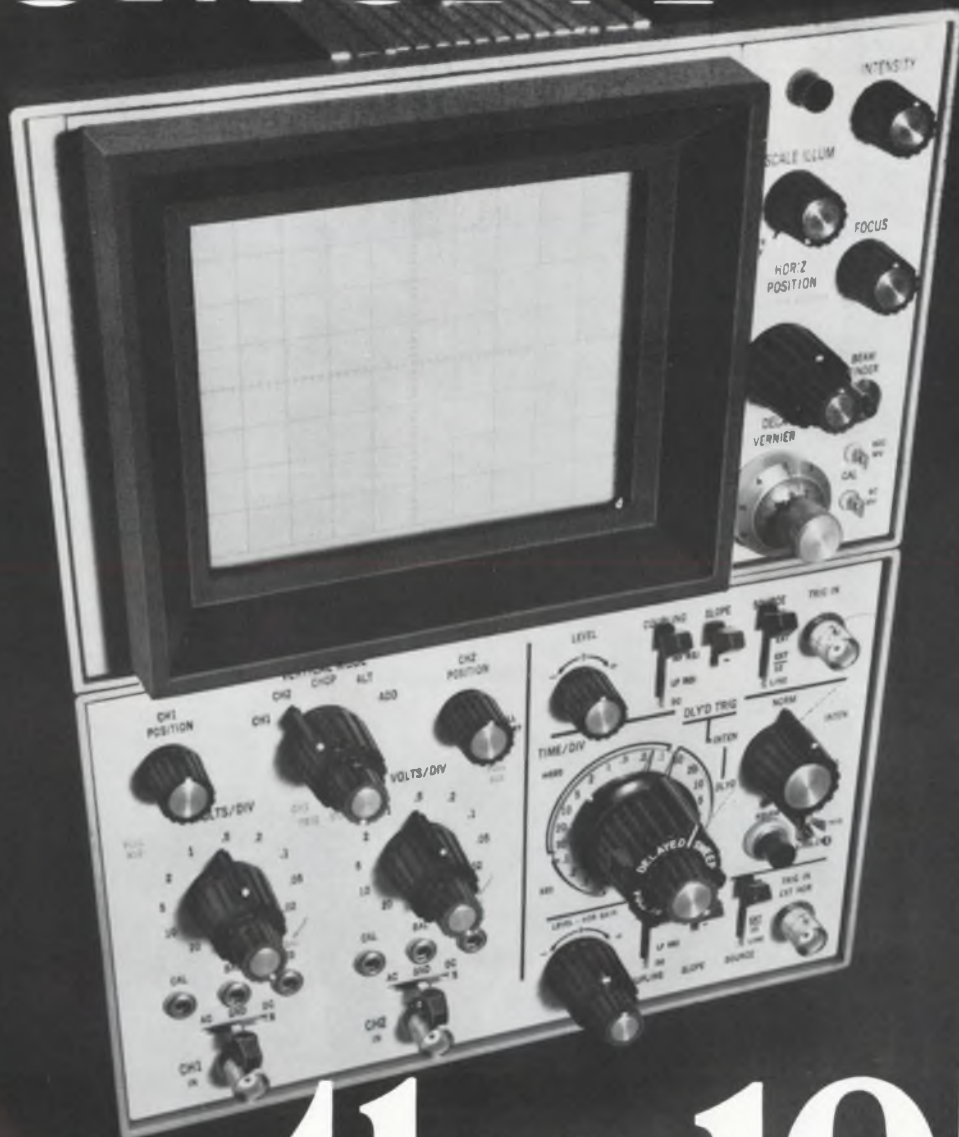

...the 1050

Band width to 50 MHz.
Sensitivity to 1 MV, both channels.
New exclusive triggering.
More important features
than any competitive scope.
*During WESCON, see the 1050
at the Sheraton Palace.*

For full information write
DUMONT OSCILLOSCOPE LABORATORIES, INC.
40 Fairfield Place, West Caldwell, N.J. 07006
(201) 228-3665/TWX (710) 734-4308

DUMONT
OSCILLOSCOPE LABORATORIES, INC.

...HERE IT IS AGAIN...

WESCON



**ELECTRONIC DESIGN
WELCOMES YOU
To Our Booths Nos. 3819-3820-3821**

COW PALACE • SAN FRANCISCO • AUGUST 19-22

Magnetic laboratory equipment

WALKER
MAGNETIC
GROUP



Walker Integrating Fluxmeter and Hall Gaussmeter

A line of precision magnetic measurement instruments to accurately measure magnetic flux and produce an accurate analogue voltage proportional to the flux for recording hysteresis loops or measurement of magnetic fields. Light weight, solid state design. Fast, accurate, easy to use.

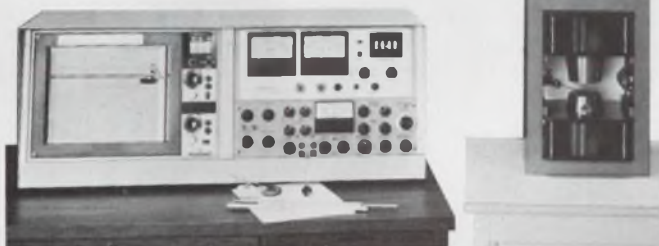

Walker Hysteresisgraphs

A line of magnetic material test equipment including the Model MH-1 Hysteresisgraph for materials with coercivities ranging from 100 to 3000 oersteds and saturation inductance up to 18,000 gauss, the Model MH-2 Hysteresisgraph for soft magnetic material testing and the Model MC-1 Coercivity Meter.



Walker Regulated Power Supplies

- 5, 11 and 15 Kilowatt Current Regulated Models
- One Part in 100,000 or Better Stabilities
- All Silicon Solid State Circuitry
- Ultra Stable Low Noise Input Circuitry
- Automatic Polarity Reversal (Optional)
- Electronic Sweep Circuitry (Optional)
- Impedance Matched to the Walker Line of Precision Laboratory Magnets

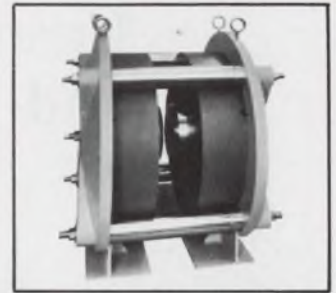

Walker Precision Laboratory Electromagnets

Moderately priced and specifically designed for high performance with flexibility and accessibility. Five models - 4, 4V (4 inch diameter), 7, 7V (7 inch diameter) and 10 (10 inch diameter). Magnet pole cap surfaces are precision ground and polished to optical tolerances to achieve optimum magnetic uniformity. 4V and 7V models are variable gap models with continuously adjustable spans. All magnets are capable of providing a stepped variable gap by means of precision ground spacer blocks.



Walker Superconductor Magnets

Available in bores up to 3" with intensities up to 65 kilogauss. Compensated solenoids are available for applications requiring high field uniformity. A complete line of accessories is available for these magnets.

Walker Custom Coils

The O.S. Walker Company produces to customer order numerous coil systems including Helmholtz coils, air core and iron core solenoids, plasma coils and laser coils.

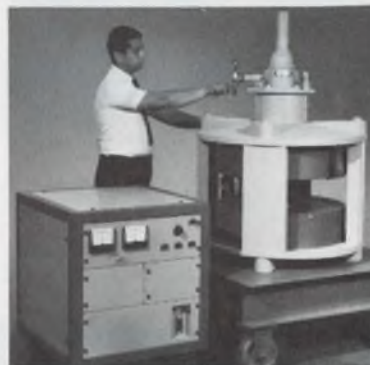

Walker Special Magnet Systems

Typical special magnet systems, designed and produced at O.S. Walker.

O. S. WALKER COMPANY, INC.
ROCKDALE STREET, WORCESTER, MASS. 01608 617-853-3232

WALKER
MAGNETIC
GROUP

BUX-SHRADER MAGNETIC PRODUCTS
12080 SOUTH WESTERN AVE., GARDEN GROVE, CALIFORNIA 92641 714-894-3391

INDUSTRIAL MAGNETICS DIVISION / MAGNETRICS DIVISION / EASTERN SCIENTIFIC DIVISION / WALKER-HAGOU N.V. HOLLAND

INFORMATION RETRIEVAL NUMBER 749

The best in product design

Here are the seven awards of excellence
and the fourteen awards of merit

Instruments and Instrumentation

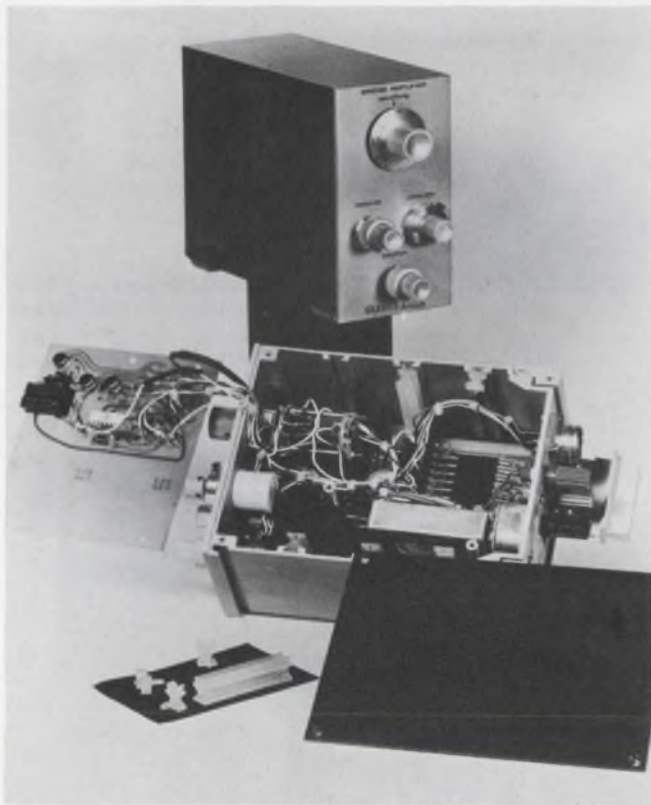

Award of excellence

DC bridge amplifier is solid state, portable, supplying stable d-c excitation, high sensitivity, precision performance and full functional control. It is designed for use with Brush recording systems, especially with the portable Brush Mark 220, 260 and 280 recorders.

Company: Brush Instruments div., Clevite Corp.
Designers: J. Esses, J. Petranic, F. Miller, F. Shoemaker

Award of excellence

Counter was designed and developed as the beginning of a distinct line image for a family of products. The goal was to permit the use of low cost tools, make it easy to produce and flexible in its utilization. Common die cast frames were used for top and bottom, thereby reducing tooling costs by 80%.

Company: Dana Laboratories, Inc.
Designers: L. Strikaitis, I. Achey, Dana: Gruye-Vogt-Opperman, Inc.



Award of merit

340 portable digital multimeter reads ac and dc current and resistance. It uses an amplifier technique that eliminates circuit loading, maintains a constant high input impedance. All controls are key command. It weighs 3 pounds, is completely self contained with no plug-ins or other extras to buy. Has automatic zero adjustment which eliminates drift.

Company: Digilin, Inc.
Designers: E. Hibbs, Jr., T. Tremble.



Award of merit

Test instrument cabinet

Blue-black, light-blue, and light gray cabinet made of natural burnished aluminum was designed for low cost despite the limited production expected.

Company: Cushman Electronics
Designers: Clement Labs: C. Clement, M. McIntyre, E. Lucey, S. Ostergaard.

Production Machinery & Fabrication Equipment

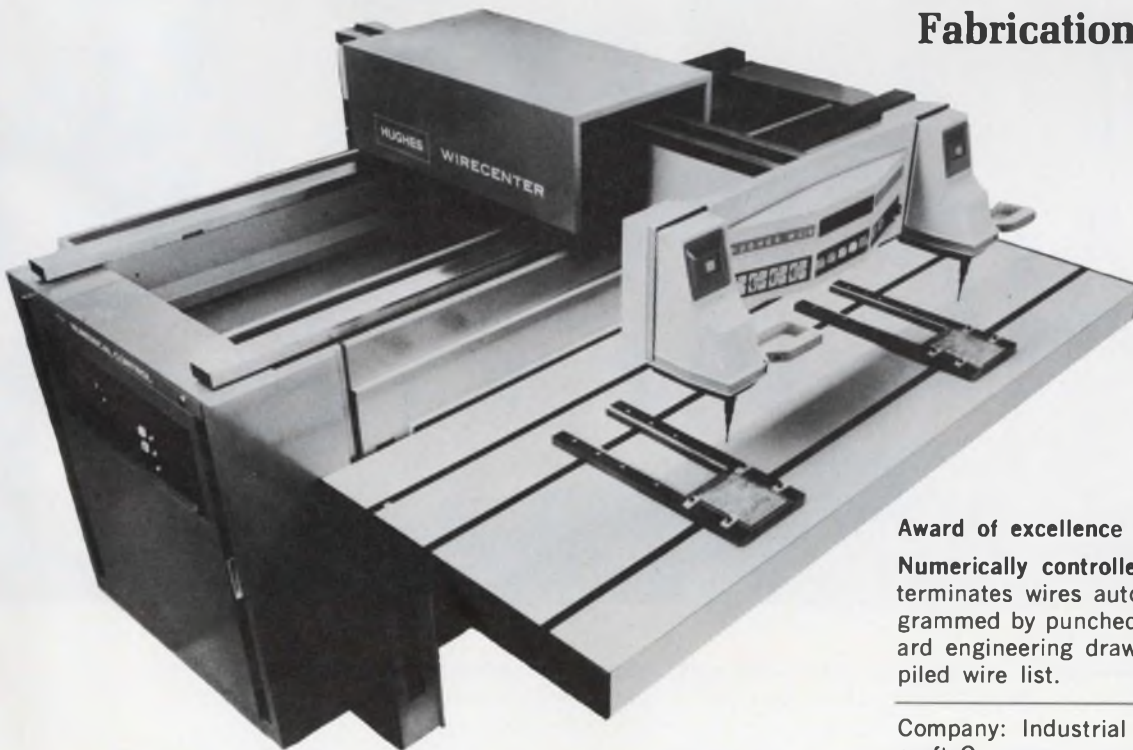

Award of excellence

Numerically controlled wirecenter locates and terminates wires automatically. Control is programmed by punched tape derived from standard engineering drawings or a computer compiled wire list.

Company: Industrial Systems div., Hughes Aircraft Co.
Designers: P. Kelpa, V. Reiter, J. Morris

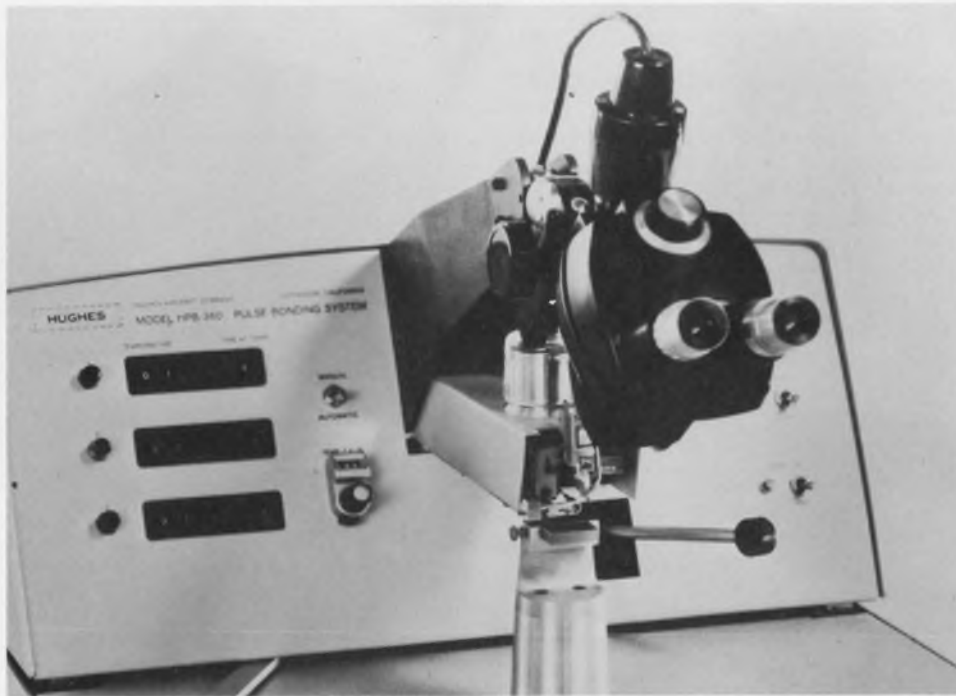

Award of merit

Pulsed-thermocompression bonder is a fine-wire device which operates on pulsed heat principles thereby eliminating the need for steady-state preheating of circuit elements, substrates or packages.

Company: Hughes Aircraft Co.
 Designers: W. Hill, R. Botting



Award of merit

Micro-Blaster is an abrading system that cuts, deburrs and strips hard, brittle materials from fragile crystals and from germanium, silicon and ceramic substrates.

Company: Comco Supply, Inc.
 Designers: Zierhut/Vedder/Shimano, A. Mar

Computer and Electronic Data Processing Equipment



Award of excellence

8200 series keyboards are solid-state units for use with perforators for computerized typesetting. The 8201 keyboard comes in two configurations. The basic unit, containing 64 keys, punches all standard codes while an expanded model adds the capacity to punch 6-, 7-, and 8-channel tape.

Company: Friden div. of The Singer Co.
Designers: E. Salter, H. Lee



Award of excellence

Digital tape memory system is IBM-compatible, operates in both 7- and 9-track modes, offers tape speeds up to 24 inches per second and packing densities up to 800 bits per inch.

Company: Ampex Corp.
Designers: L. Sanderson, S. Martin



Award of merit

Mini-computer H316 is the newest and smallest member of Honeywell's series 16 computer family. It is a general-purpose, full-scale digital computer of the stored-program, single-address, binary, parallel type. The memory is a four-wire coincident-current unit with magnetic core.

Company: Computer Control div. of Honeywell, Inc.
Designers: C. Mazza, D. Kelemen



Award of merit

Keytape KT901 is an off-line data preparation device that transcribes source data directly onto computer-ready magnetic tape through a keypunch-like keyboard. The keytape family consists of 52 models that provide varying capabilities for both 7-channel and 9-channel magnetic tape transcription.

Company: Honeywell Electronic Data Processing
Designers: J. Graham, F. Baker



Display of strength

There are several sound reasons to use our solid state numeric displays. One of the most important is this: they're so strong, they won't die of shock. So they can be used in the most demanding applications.

Another decisive factor is size: each display package measures just 1"x 0.5"x 0.16". And that's all there is to it. In this tiny framework, you get everything necessary to display numerals 0-9. The chip includes an IC driver/decoder and gallium arsenide phosphide diodes that make the bright red numerals visible clear across a room, even at an acute angle.

The display needs less than 5 volts to drive it, and takes a straightforward four line 8-4-2-1 BCD input. You can vary the brightness. And, as the modules are IC compatible, no special interfacing is required. You can buy our solid state numeric display in three-character packages, as well as the solo component. And our small displays of strength cost just \$42 each in 1000 quantities.

For all the bright details about this new technology for numeric indicators, call your local HP field engineer. Or write Hewlett-Packard, Palo Alto, California 94304; Europe: 1217 Meyrin-Geneva, Switzerland.

HEWLETT  PACKARD

SOLID STATE DEVICES
INFORMATION RETRIEVAL NUMBER 750



Award of merit

Datapoint 3300 CRT terminal is interchangeable with standard teletypewriter equipment. It provides high-speed data transmission and a high-capacity flexible CRT display. The unit is solid state, and totally self-contained with a 64-character set keyboard.

Company: Computer Terminal Corp.
Designers: Raymond Loewy/William Snaith, Inc.

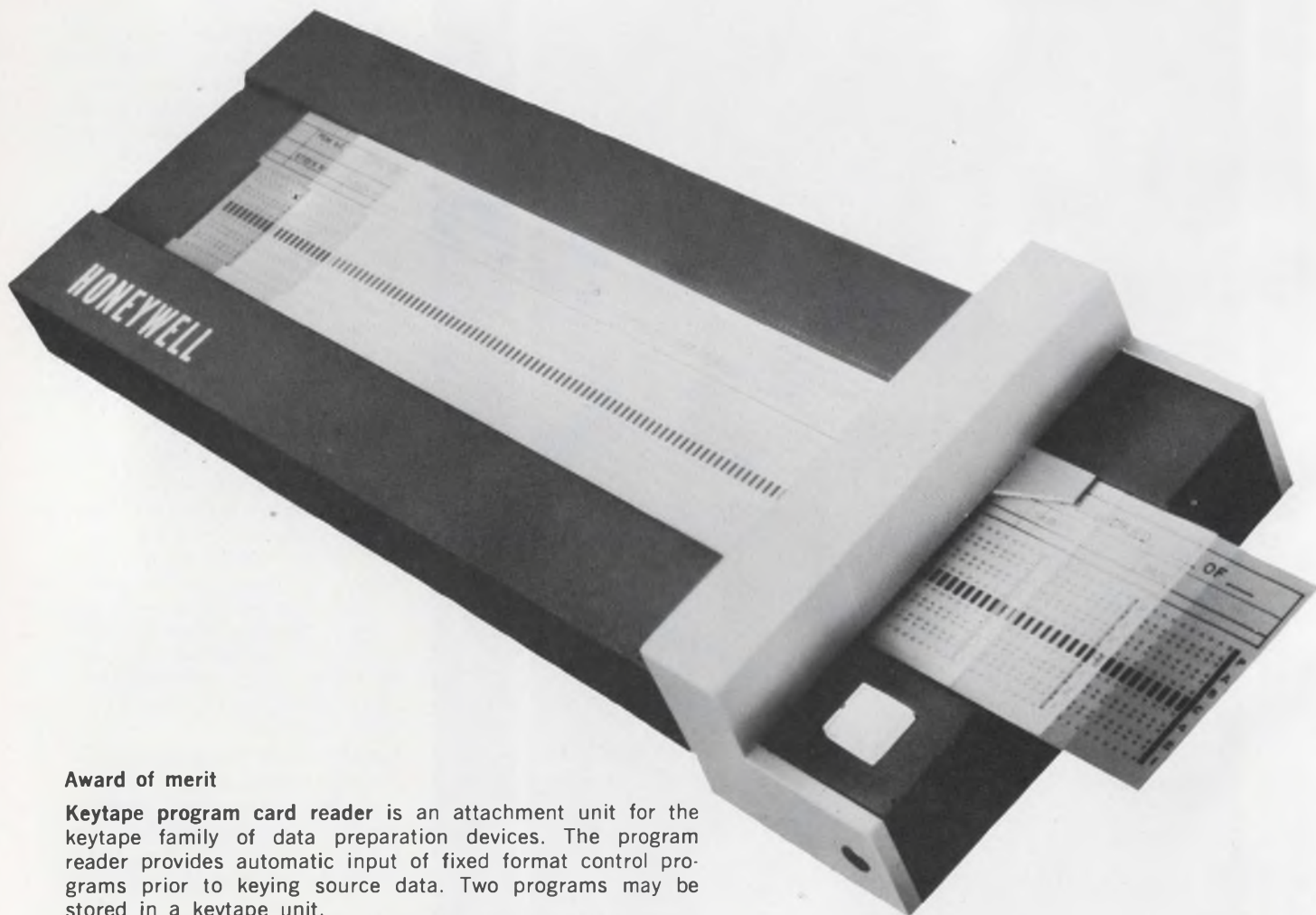

Award of merit

Keytape program card reader is an attachment unit for the keytape family of data preparation devices. The program reader provides automatic input of fixed format control programs prior to keying source data. Two programs may be stored in a keytape unit.

Company: Honeywell Electronic Data Processing
Designers: J. Graham, H. Schneider, A. Michaud.

The Transient Trappers are in the RCA-40673, the industry's FIRST dual-gate MOSFET with INTEGRATED PROTECTION-CIRCUITRY.

Back-to-back diodes, diffused within the same silicon pellet as the MOS Field-Effect Transistor, guard each gate against:

- static discharge during handling operations prior to circuit installation without the need for external shorting mechanisms.
- in-circuit transients.

Now you can design and build around the inherent, superior performance characteristics of dual-gate MOSFETs with assurance that RCA's TRANSIENT TRAPPERS are the real answer to transient-voltage problems.

Typical characteristics of the RCA-40673 are:

- Power Gain (MAG) = 20 dB @ 200 MHz
- Noise Figure (NF) = 3.5 dB @ 200 MHz
- Superior Cross Modulation Characteristics
- Wide Dynamic Range Without Diode Current Loading
- Reduced Spurious Response
- Extremely Low Feedback Capacitance = 0.02 pF
- Simplified AGC Circuitry
- Excellent Gain-Reduction Characteristics
- Reduced Oscillator Feedthrough

For more information, see your local RCA Sales Representative or your RCA Distributor. For technical data write to RCA Electronic Components, Commercial Engineering, Section EG-8-2 Harrison, New Jersey 07029.

The MOSFET Transient Trappers

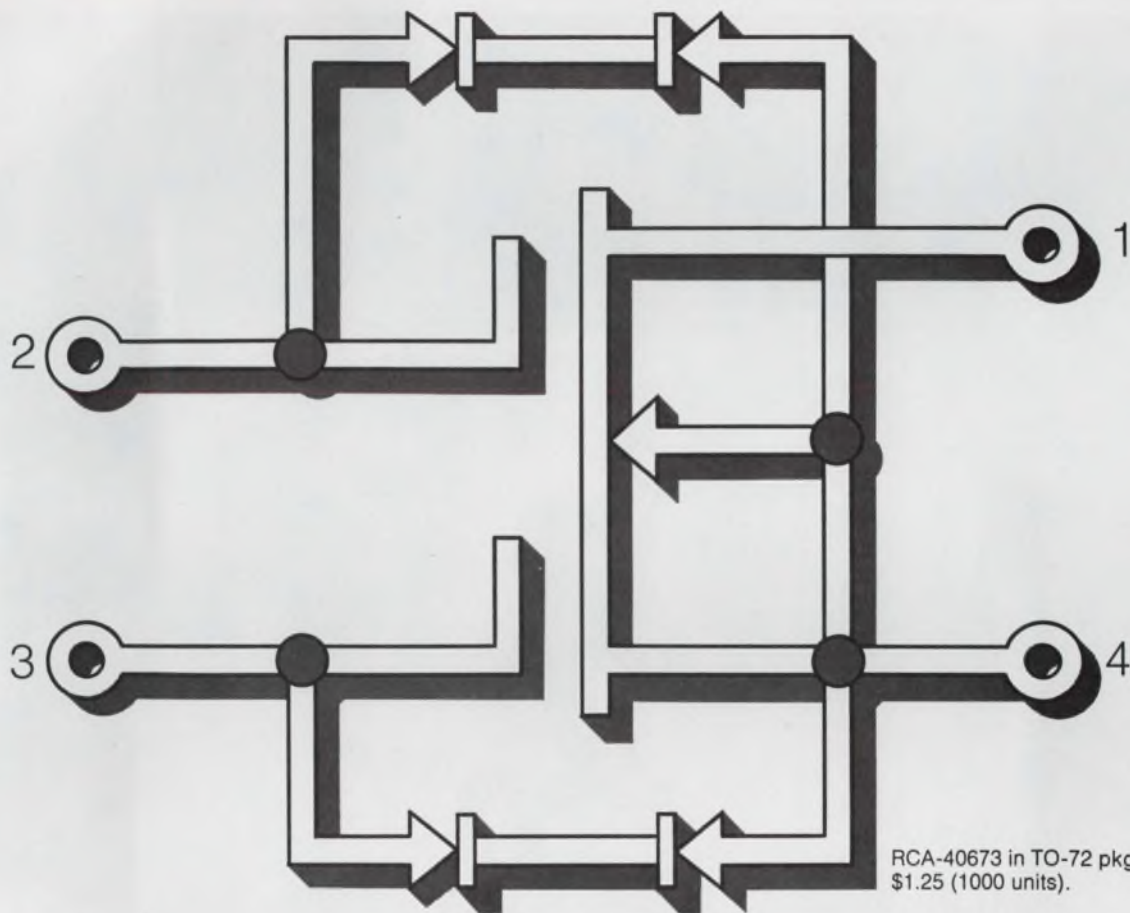

The major technical challenge associated with the development of the RCA-40673 was that gate protection must not significantly degrade the RF performance.

Special back-to-back diodes were developed as the answer to this objective. These back-to-back diodes are diffused directly into the MOS pellet and are electrically connected between each insulated gate and the FET's source. The back-to-back configuration of the diodes permits the device to handle a wide dynamic signal-swing. In addition, the low junction capacitance of the diodes adds little to the total capacitance shunting the signal gate. Further, the resistive components of these diodes are such that they do not materially affect the overall noise performance of the unit.

The net result of this engineering program is a MOSFET which is more rugged than any other solid-state amplifier providing comparable RF performance.

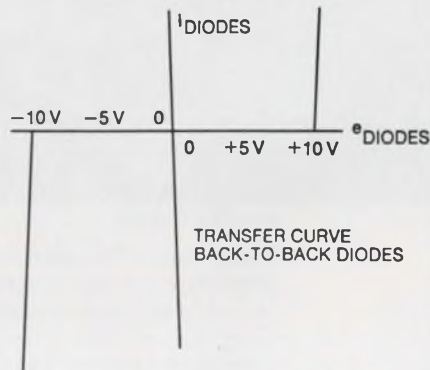

RCA
Integrated
Circuits

Visit the RCA Electronic Components Exhibit at WESCON, Unit C, in the Cow Palace Arena.

INFORMATION RETRIEVAL NUMBER 751



Award of merit

Compact terminal is a low-cost, lightweight portable computer terminal that provides two-way communications with an audio response computer through any standard telephone. The terminal is nine inches square and two inches thick, is made of break-resistant plastic, and weighs about six pounds.

Company: Honeywell Electronic Data Processing
Designers: J. Graham, F. Baker.



Award of merit

Model Apollo-Planetarium, intended for schools, is automatic, does not require a specially-designed structure or operator. A pupil can program it in minutes or it can be operated manually after a short instruction period.

Company: Viewlex, Inc.
Designers: Robert P. Gersin Associates, Inc., M. Minnefor, R. Gersin, V. Porcelli, E. Aeschlimann; from Viewlex: M. Mindell, J. Castellano

COS/MOS—RCA's technological breakthrough breaks through in economics, too!

New design flexibility! New operating features! RCA-CD4006D brings both to digital circuits with MSI complexity! Newest in RCA's growing line of COS/MOS integrated circuits, this Complementary Symmetry MOS 18-Stage Static Shift Register gives you:

Flexibility. It provides multiple register sections of 4, 5, 8 and 9 stages or single register sections of 10, 12, 13, 14, 16, 17, and 18 stages. And outputs are available from both fourth and fifth stages. Here's real flexibility—in both design and operation.

Low Power. Take advantage of COS/MOS low power requirements. Quiescent dissipation is only 100 nanowatts (typical). Even in dynamic operation, the dissipation is only 2 milliwatts at 1 MHz with input of

alternate "ones" and zeros.

Workability. CD4006D operates with a single power supply and with a single-phase clock. Clock amplitude is the same as logic swing. No need to supply an additional voltage level. And you won't lose stored information if the clock is interrupted. No information recirculation required.

Economy to Match

CD4006D—at \$17.25 (1,000 units)—provides full military temperature range operation and 18 flip-flops for less than \$1.00 each. That means you get the design and operating advantages of RCA's unique COS/MOS technology with real-world economics.

Check these device design innovations:

- -55° to +125°C operation
- 100 nanowatt quiescent dissipation (typ.)
- Static to 2 MHz shift rate
- Single 6- to 15-volt positive or negative power supply
- 4-V noise margin (10-V logic)
- Large fanout—up to 50

CD4006D is only one of the new circuits that are ready now to prove the practicality and economy of COS/MOS. Order now from your local RCA Representative or through your RCA Distributor. For technical data, write to RCA Electronic Components, Commercial Engineering, Section ICG-8-4, Harrison, N.J. 07029.

RCA-CD4006D 18-Stage Static Shift Register. MSI density with design flexibility.

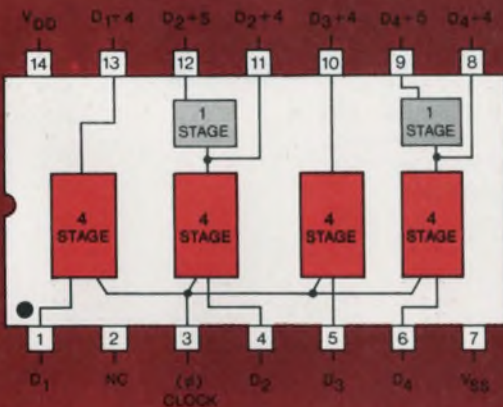

RCA-CD4006D in DIC, \$25.00 (1-99 units).
RCA-CD4006 in ceramic flat pack is \$26.50 (1-99 units).

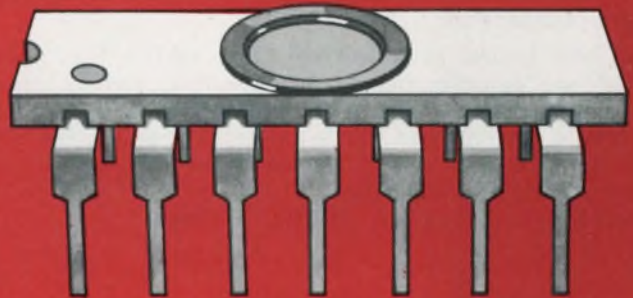

Design with these other COS/MOS Circuits—ready now:

Dual 3-Input Gate and Inverter	CD4000D	7-Stage Counter/Divider	CD4004T*
Quad 2-Input Gate	CD4001D	16-Bit NDRO Memory	CD4005D
Dual 4-Input Gate	CD4002D	Dual Complementary Transistor Pair and Inverter	CD4007D
Dual "D"-Type Flip-Flop	CD4003D		

*12-lead TO-5 Style Package

RCA Integrated Circuits

Visit the RCA Electronic Components exhibit at WESCON, Unit C, in the Cow Palace Arena.

INFORMATION RETRIEVAL NUMBER 752

Communications Equipment



Award of excellence

Auto pilot control box, part of Collins AP-104/FD-109H flight control system, includes the autopilot servo engage switch, vertical command and turn controls, pushbutton manual autopilot control selector and pushbutton yaw damper selector. All this is accomplished with a minimum of easy-to-see buttons and switches.

Company: Collins Radio Co.
Designers: R. Barclay, D. Schultz, D. Korëll.

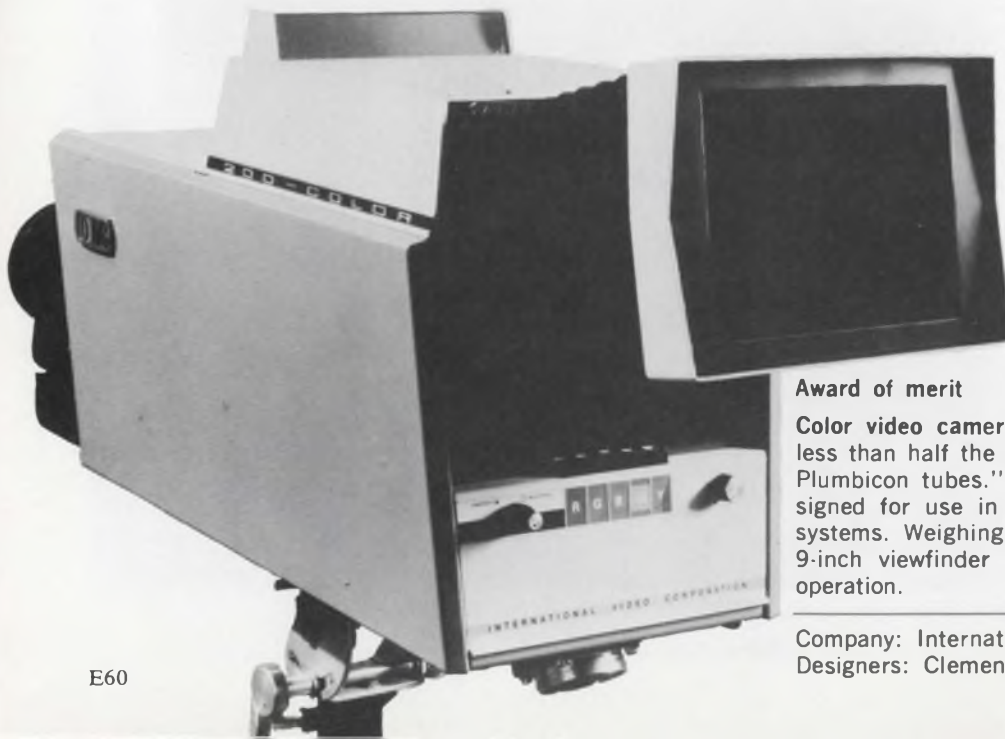

Award of merit

Color video camera using a three-Plumbicon tube sells "for less than half the cost of any other color camera using three Plumbicon tubes." Called "The Maverick" the camera is designed for use in broadcast and sophisticated closed-circuit systems. Weighing 86 pounds, with lens, the camera has a 9-inch viewfinder with built-in extendable hood for outdoor operation.

Company: International Video Corp.
Designers: Clement Laboratories: C. Clement, B. McIntyre

Dual Differential Amplifiers for DC to 120 MHz
RCA-CA3054 or CA3026
@ \$1.25 (1,000 units)

Here's new flexibility for your amplifier designs—RCA's latest addition to its line of linear "building block" IC's. It's RCA-CA3054 in a DIP package for easy handling and added accessibility. The fourteen-lead package provides access to bases and collectors of differential pairs, bases and emitters of constant-current-source transistors, and separate substrate connection.

You can design the CA3054 into a wide range of applications...including differential and/or cascode amplifiers; IF amplifiers; video amplifiers; doubly-balanced modulators and demodulators and more. If your design requires a full military tem-

perature range, then use RCA-CA3026 in a TO-5 package.

Ask your local RCA Representative or your RCA Distributor for price and delivery information. For technical data on either circuit, write: RCA Electronic Components, Commercial Engineering, Section ICG9-1, Harrison, N. J. 07029.

Other RCA Linear Diff Amp Array IC's for Design Flexibility Include:

- CA3050 Two Darlington-connected diff amps with diode bias string;
- CA3051 CA3050 in DIC, \$2.25; CA3051 in DIP, \$1.65.
- CA3045 Three isolated transistors and a differential pair; CA3045 in DIC, CA3046 \$1.50; CA-3046 in DIP, 98¢.
- CA3049 First 200 MHz ampl array—pair of diff/cascode amps on a single chip. In 12-lead TO-5, \$1.95.

(All prices are at 1,000-unit level.)

Matched differential amplifiers with:
 Independent inputs and outputs
 Input offset voltage = 5 mV max.
 Max. $V_{CE0} = 15 V$
 Max. collector current = 50 mA
 Dynamic forward current transfer ratio (h_{fe}) (typ.) = 110 @ 1 kHz,
 $V_{CE} = 3 V, I_o = 1 mA$
 Operating temperature ranges:
 0°C to + 85°C (CA3054)
 -55°C to +125°C (CA3026)
 Voltage gain @ 1 kHz, 32 dB (typ.)
 single-stage, double-ended output
 CMR = 100 dB (typ.)

RCA
Integrated
Circuits

This Flexible Linear IC "Building Block" Now Comes in Dual-In-Line Plastic

CA3054 in 14-lead Dual-In-Line Plastic (DIP) Package

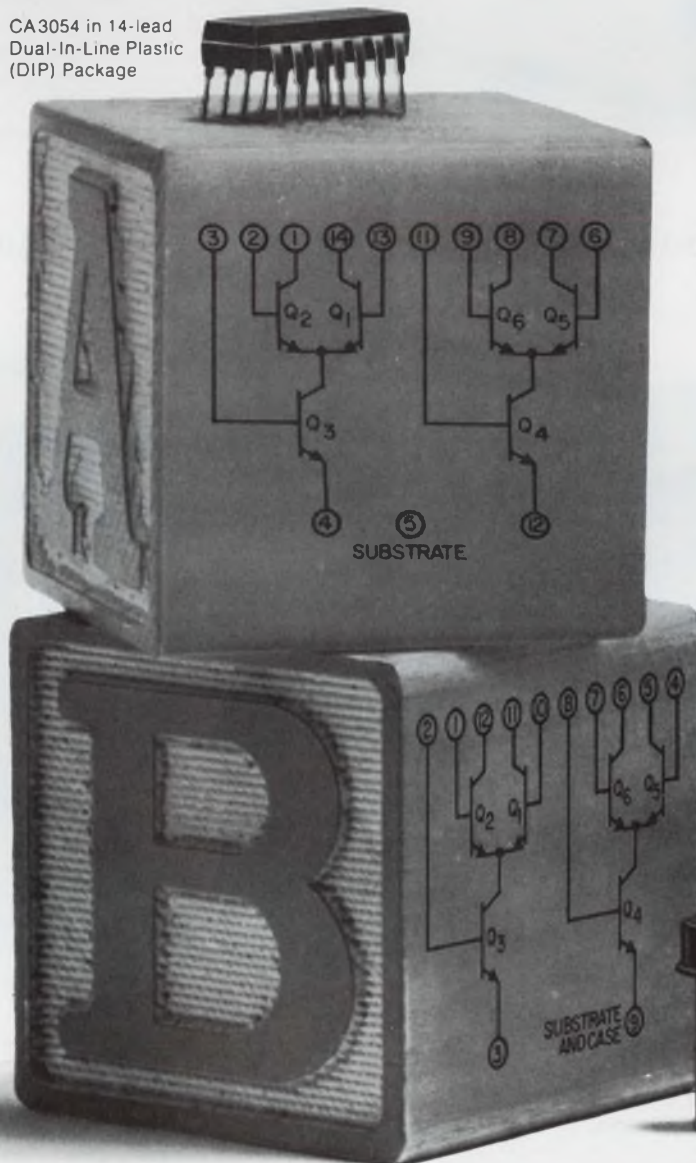

CA3026 in TO-5 Package for full military temperature range operation

Visit the RCA Electronic Components exhibit at WESCON, Unit C, in the Cow Palace Arena.

INFORMATION RETRIEVAL NUMBER 753



Award of merit

Portable television recorder weighs 37 pounds and occupies 0.6 cu. ft. of space, complete with tape, silver-cadmium battery, in a sealed case. It records up to a half hour of high resolution 4.25 MHz television signal. A single printed circuit drive motor provides high torque-to-inertial ratio, thus insuring responsive servo action and tape handling.

Company: Westel Co.

Designer: J. Streets, Quest Engineering

Sub-systems, Components and Materials



Award of excellence

Digital panel meter is a precision measuring instrument which provides a 3-digit, up-front display, 7/8 inch high, with 7-bar segmented digits. It is readable from 40 feet at angles of 140 degrees without the parallax or tunnel effects usually associated with cold cathode tubes.

Company: API Instruments Co.

Designers: J. Richey, S. Vasa, API; F. Eugene Smith and Associates

COS/MOS

**RCA's unique approach to digital design
—at new low prices**



For practical circuit designs...

High performance and new low prices combine to make COS/MOS—RCA's unique Complementary Symmetry MOS integrated circuits—an even greater value for a broader range of digital equipment designs. Now you can re-evaluate—and find even more advantages in—these COS/MOS features that no other logic circuitry has matched to date:

- Quiescent power dissipation in nanowatts
- Noise margin—4.5 volts
- Fanouts up to 50
- Single power supply required—6 to 15 V, positive or negative
- Logic level swing—"0" to power supply voltage
- Compatible gate level and MSI functions
- Frequency capabilities from DC to 5 MHz
- Single-phase clocking
- Full military operating temperature range—from -55°C to $+125^{\circ}\text{C}$
- Hermetic packages—DIC or ceramic flat pack

To get acquainted with COS/MOS, see your RCA Distributor for the COS/MOS Sampler QK2201, yours for only \$50.00 (optional distributor resale price).

For new economy...

Effective now, new low prices—combined with unrivalled application advantages—put COS/MOS squarely in the picture for all your digital designs. Check the list of device numbers, descriptions and prices. Then ask your local RCA Representative or your RCA Distributor for details. For specific circuit data, write RCA Electronic Components, Commercial Engineering, Sec. ICG8-3, Harrison, N. J. 07029.

CD4000D	Dual 3-Input Gate and Inverter (DIC)	NOW \$ 4.00
CD4001D	Quad 2-Input Gate (DIC)	NOW \$ 4.75
CD4002D	Dual 4-Input Gate (DIC)	NOW \$ 4.50
CD4003D	Dual "D" Type Flip-Flop (DIC)	NOW \$ 8.00
CD4004T	7-Stage Counter-Divider (12-lead TO-5)	NOW \$10.00
CD4005D	16-Bit NDRO Memory (DIC)	NOW \$10.00
CD4006D	18-Stage Static Shift Register (DIC)	NOW \$17.25
CD4007D	Dual Complementary Transistor Pair and Inverter (DIC)	NOW \$ 3.00

(All prices at 1,000 unit level. These COS/MOS IC's also available in ceramic flat-pack at slightly-higher prices.)

Consider the systems advantages to be provided by these developmental types, soon to be added to the growing COS/MOS series. See your local RCA Representative.

	Dev. Type No.	Description
Buffers	TA5660	Hex Inverting Buffer
	TA5668	Hex Non-Inverting Buffer
MSI	TA5519	4-Bit Full Adder
	TA5578	8-Stage Synchronous Parallel-Input/Serial-Output Register
	TA5579	Dual 4-Stage Serial-Input/Parallel-Output Register
	TA5684	Decade Counter
	TA5971	5-Stage Binary/Decade Counter
	TA5580	Pre-settable Divide by "N" Counter

RCA
Integrated
Circuits

Visit the RCA Electronic Components exhibit at WESCON,
Unit C, in the Cow Palace Arena

INFORMATION RETRIEVAL NUMBER 754



Award of merit

Corporate systems enclosures, fully-wired and ready-to-use, come in one-, two- and three-bay cabinets with 35-, 56- and 70-inch panel openings. Usual depth of cabinet is 27 inches; it is compatible with all Hewlett-Packard computers and instruments.

Company: Hewlett-Packard Co.
Designer: A. Inhelder



Award of merit

Modular instrument component cabinet is for rack or bench mounting and may be stacked or mounted in any position. The cabinet holds 20 3 1/2-inch by 3 1/2-inch printed circuit cards which are inserted into card guides.

Company: Ro Associates, Inc.
Design direction: M. Rudin

X 1 0 0

fA pA nA nV μ V

AT 1 Hz BANDWIDTH

+ 0 10 20 30 dB



Our singularly accurate transistor noise analyzer tells you the whole story

The singular advantage of Hewlett-Packard's new 4470A is its inherent ability to read out transistor noise voltage (e_n), noise current (i_n) and noise figure (NF), accurate to better than ± 1 dB. And when you tie these factors into one neat package, you end up with the most complete noise performance story ever told. Unless you want accuracy an order of magnitude greater by calculating your measurements with e_n and i_n .

The 4470A was designed for accuracy and convenience in laboratory, for incoming device inspection and for QC testing applications on FET and bipolar transistors. Yet the analyzer is simple enough to be used by production personnel.

Measurements are made at 4 Hz bandwidths, for precise checks at 11 spot frequencies between 10 Hz and 1 MHz. Noise figure is read directly

in dB, using conveniently applied external or internal source resistances.

Since transistor gain varies between devices, an automatic gain control normalizes overall system gain to a fixed value independent of the transistor being used. And the 4470A is completely flexible for biasing transistors under test. The price is just \$4450.

Find out more about the simplicity of measuring transistor noise from your HP field engineer, or write to Hewlett-Packard, Palo Alto, Calif. 94304; Europe: 1217 Meyrin-Geneva, Switzerland.

HEWLETT  PACKARD

INFORMATION RETRIEVAL NUMBER 755

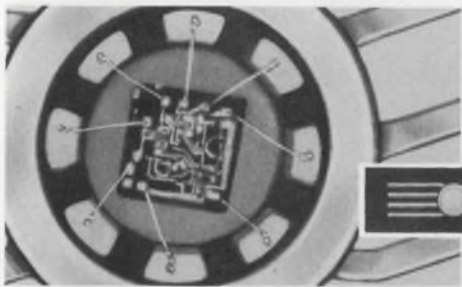

NEW HERMETIC TINY PAK™ 201 & 741 OP AMPS

For Hybrids and
Conventional
Circuit Boards.

Actual
size

New TINY-PAK™ OP AMPS by MINI-SYSTEMS, INC. provide guaranteed electrical performance in a miniature hermetic flat pack much smaller than any now available in the industry. The diameter of this package is approximately twice the maximum dimension of I C OP Amp dice.

This package has been perfectly tailored to the die, thus maintaining its "size advantage" and at the same time providing ideal environmental protection. Standard Lead spacing of .050" eliminates the need for special equipment and skills in handling, testing and mounting. Each TINY-PAK™ OP Amp is thoroughly tested for compliance with device specifications and further screened for abnormally high noise and capacitive loading instability. This provides a bonus in performance and reliability.

Applications include all those of conventional "101" and "741" types, plus those now made possible and practical by the miniature size of the TINY-PAK™ TINY-PAK™ "101/201" and "741/741C" I C OP Amps are available from stock. Other types are available on special order. e.g.: 100, 101A, 102, 107 & 108

Price: \$9.50, "201" or "741C", quantity 1-24
f.o.b. North Attleboro, Massachusetts.

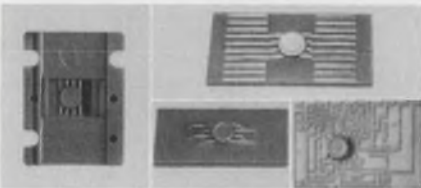

TINY-PAK™ op amps are handled and tested in standard Barnes carriers. Leads can be bent for insertion into PC boards or soldered or welded to ceramic substrates.

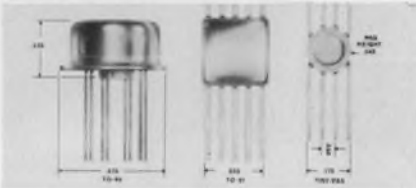

Note standard .050" spacing between .017" x .005" TINY-PAK™ leads.

For further information, write or call:

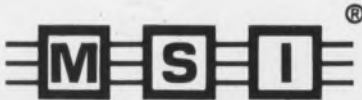

MINI-SYSTEMS, INC., P.O. Box 429, North Attleboro, Massachusetts 02781 (617) 895-0206
INFORMATION RETRIEVAL NUMBER 756

Advertisers' Index

Advertiser Page

ADC Products, A Division of
Magnetic Controls Co. U133, U178
AMP, Incorporated E15
Alco Electronic Products, Inc. E43, 45, 47
Allen-Bradley Co. U87
Amersil, Inc. U179
Amperex Electronic Corporation U168, U169
Augat, Inc. U129
Automatic Electric Company U88, U89

Barnes Corporation U184
Branson Corp. E67
Bulova Electronics Division of
Bulova Watch Company U156
Burroughs Corporation E Cover II

CMC, A Division of Pacific Industries U143
C-Cor Electronics, Inc. U128
CML, Inc. U160
Cherry Electrical Products Corp. U155
Clifton, Division of Litton Industries E31
Computer Labs E41
Cornell-Dubilier Electronics U128 A-B
Cunningham Corporation, Subsidiary
of Gleason Works E68

Dale Electronics, Inc. E25, U144 A-B
Datascan, Inc. U164
Delco Radio, Division of General
Motors U116, U117
Digital Equipment Corporation E71
DuMont Oscilloscope Laboratories, Inc. E48C

Eldre Components, Inc. U130
Electronic Engineering Co. of
California E15, U119
Electronic Research Associates, Inc. U132
Electrovert, Inc. U175
Emerson & Cuming, Inc. E47

General Electric Company, Electronic
Capacitor & Battery Dept. U157
General Radio Company U109
Guardian Electric Manufacturing
Company U110, U111

Hamlin, Inc. U168
Hewlett-Packard E55, E65, U137, U149
Honeywell Test Instrument Division U135

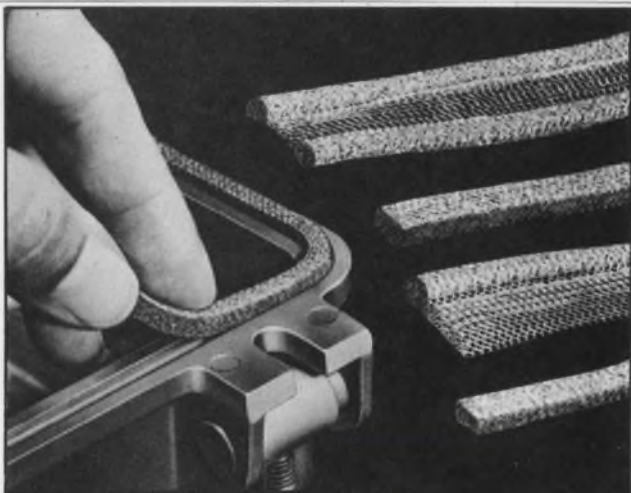

EMI/RFI SHIELDING GASKET CONDUCTIVE/RESILIENT STRIP

TECKNIT STRIP ■ Total Shielding Effectiveness up to 120 dB ■ Available in Tin Coated Copper Clad Steel, Monel, Aluminum, Silver Plated Brass ■ Variety of cross sections: square, round, rectangular, single fin, double core ■ Write for data #200, and FREE sample.

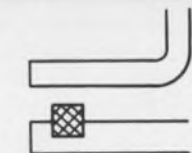

Easy groove mounting method shields flange to cover.



TECHNICAL WIRE PRODUCTS, INC.

East Division • 129 Dermody St., Cranford, N. J. 07016 (201) 272-5500
West Division • 427 Olive St., Santa Barbara, Calif. 93101 (805) 963-1867

INFORMATION RETRIEVAL NUMBER 767

SEE
US
BOOTH
2811-
2812

BRANSON**HALF-SIZE
CRYSTAL CAN****RELAYS****FOR HIGH
DENSITY
PACKAGING****TYPE SR 4-POLE RELAY**

Available in standard, bracket mounting, stud mounting, or flat mounting cases. Hook, plug-in or solder terminals may be selected. Coil voltage range: 6 to 48 VDC. Contacts rated at 2 amps 28 VDC resistive. Meets MIL-R-5757D and MIL-E-5272C.

**TYPE SR 2-POLE RELAY**

Obtainable in same case and header configurations as the 4-Pole Type SR. Two Form C DPDT contacts handle 2 amps to dry circuit load. Operates and releases in 5 ms max. Life expectancy is 100,000 operations min. Meets MIL-R-5757D and MIL-E-5272C.

**TYPE LS LATCHING RELAY**

Selection of four case and three header styles. A short duration low power pulse (150 mw) shifts the bi-stable contacts from one position to the other. Contact arrangements is 2 Form C DPDT and rating is 2 amps 28 VDC resistive. Meets MIL-R-5757D.

**TYPE QR TIME DELAY RELAY**

Three models cover time delay ranges of: .010 to .100 sec., .050 to .500 sec., and .500 to 60 sec. Operates on 20 to 32 VDC. All solid state. Switches 10 ma at 20 to 32 VDC. Two case and three header styles available. Unaffected by shock and vibration.



Write for Branson's Designers Catalog

**Relays...
Our Only Business****BRANSON CORP.****VANDERHOOF AVENUE
DENVER, NEW JERSEY
(201) 625-0600**

INFORMATION RETRIEVAL NUMBER 757

Advertiser	Page	Advertiser	Page
Howard Industries, A Division MSL Industries, Inc./Motor Group.....	U141	Oak Manufacturing Co.	U181
		Ogden Technology Laboratory, Inc.....	E21
IRC, Division of TRW, Inc.....	U147	Pinlites, Inc.	U166
ITC Circuit Products, a Division of Industrial Technology Corporation, A Subsidiary of Republic Corporation ..	U102	Potter & Brumfield Division of American Machine & Foundry Company.....	U139
ITC Control Components, A Division of Industrial Technology Corporation, A Subsidiary of Republic Corporation ..	U103	RCA Electronic Components and Devices	E4, E5, E35, E48 A-B, E57, E59, E61, 63, Cover IV
ITC Riedon, A Division of Industrial Technology Corporation, A Subsidiary of Republic Corporation ..	U101	Radix Telemetry Corp.	E40
ITC Tor, A Division of Industrial Technology Corporation, A Subsidiary of Republic Corporation ..	U100	Raytheon Company, Semiconductor Operation	E8, E9
Interelectronics Corporation	U181	Resistance Products Company	E46
		RtroN Corporation	U186
JFD Electronics Co./Components Division	U162	Robinson Nugent, Incorporated	U175
Johanson Manufacturing Corp.	U172	S & EI Mfg./Capacitors.....	U184
Johnson Company, E. F.	U126	Schweber Electronics	E27
		Sencore	U150
Kay Electric Company	E20	Shallcross, A Subsidiary of Cutler Hammer	U121
Kepeco, Inc.	U161	Signalite, Incorporated	U173
Kinetic Technology Incorporated ..	U112	Simpson Electric Company	U176
Kings Electronics Co., Inc.....	U124, U125	Singer General Precision, Inc., Kearfott Products Division	E32 A-X, 33
Krohn-Hite Corporation	U182	Singer Company, The, Friden Division ..	U177
		Sonotone Corporation, Battery Division ..	U158
Lansdale Transistor & Electronics, Inc.....	E46	Sprague Electric Company	E23
Line Electric Company	U188	Stackpole Carbon Company	U151
Lundy Electronics & Systems, Inc.....	U154	Standard Condenser Corporation	U134
		Switchcraft, Inc.	U185
		Systron-Donner Corporation	E19, E29
3M Company, Chemical Division.....	U145	Technical Wire	E66
3M Company, Film & Allied Products Division	U159	Telonic Systems, Division of Telonic Industries, Inc.	E16-A-B-C-D
McCoy Electronics Company	U131	Tenney Engineering, Inc.	U187
Marconi Instruments Division of English Electric Corporation.....	U127	Texas Instruments Incorporated	U167
Mechanics for Electronics, Inc.....	U174	Theta Instrument Corporation	U113
Mepeco, Inc.	E16	Transitron Electronic Corporation	U171
Minelco, A Subsidiary of General Time ..	E17	Trygon Power Supplies	U122
Mini-Systems, Inc.	E66		
Molex Products Company	U123		
Monsanto Company	E44, E Cover III	Varo, Inc.	E42, U180
Motorola Communications & Electronics, Inc.	U163		
		Wakefield Engineering, Inc.	U175
NJE Corporation	U156 A-B	Walker Company, Inc., O. S.	E49
Non-Linear Systems, Inc.	U153	Weston Instruments, Inc., Newark Division	U183
Nytronics, Inc.	E39	White Industrial, S. S. A Division of Pennwalt Corporation	U170

Isolation was the only thing preventing a high-frequency Reed Switch Matrix Until now.

The Cunningham Reed Switch Matrix reduces high frequency crosstalk and interference to a new low. In a unique "sandwich" design, matrix-mounted reed switches are sealed, shielded and separated from their controls, achieving maximum open circuit isolation and negligible crosstalk.

- **Excellent signal characteristics:** 50-ohm, distributed. Matches 50-ohm transmission line. Broadband handling characteristics, with excellent isolation. Very low thermal noise.
- **100% Random access:** Any number or combination of crosspoints can be set, any place, any direction, vertical or horizontal, without affecting the condition of other crosspoints in the matrix.

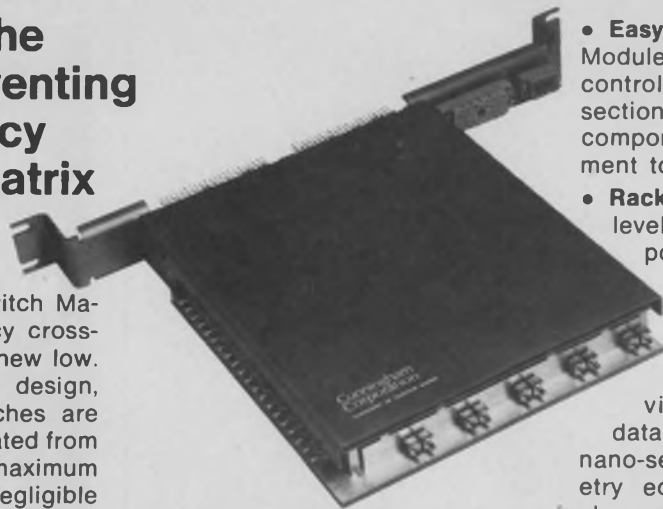

- **Computer compatible:** Can be directly addressed by all computers using +5 volt logic. No additional interfacing required. Single power supply.
- **One package** contains all signal switching elements and coil drivers as well as the logic required to translate the co-ordinate inputs into crosspoint address.
- **Reliability proven:** Up to 100 million operations.

- **Easy inspection and maintenance:** Module can be unplugged and the control separated from the signal section for easy access to all active components. No adjustment or alignment to perform after re-assembly.
- **Rack mounting:** Standard one-level matrix of 10x5x1 crosspoints. Plug-in and expandable to larger matrices.

The new Cunningham Reed Switch Matrix is ideal for interconnecting video channels, broadband data switching, test systems for nano-second digital pulses, telemetry equipment for multiple data channels, antenna switching, and medical data monitoring.

Write or call for Data Sheet No. 603, Cunningham Corporation, 10 Carriage Street, Honeoye Falls, New York 14472. Phone (716) 624-2000.

Cunningham Corporation

SUBSIDIARY OF GLEASON WORKS
INFORMATION RETRIEVAL NUMBER 758

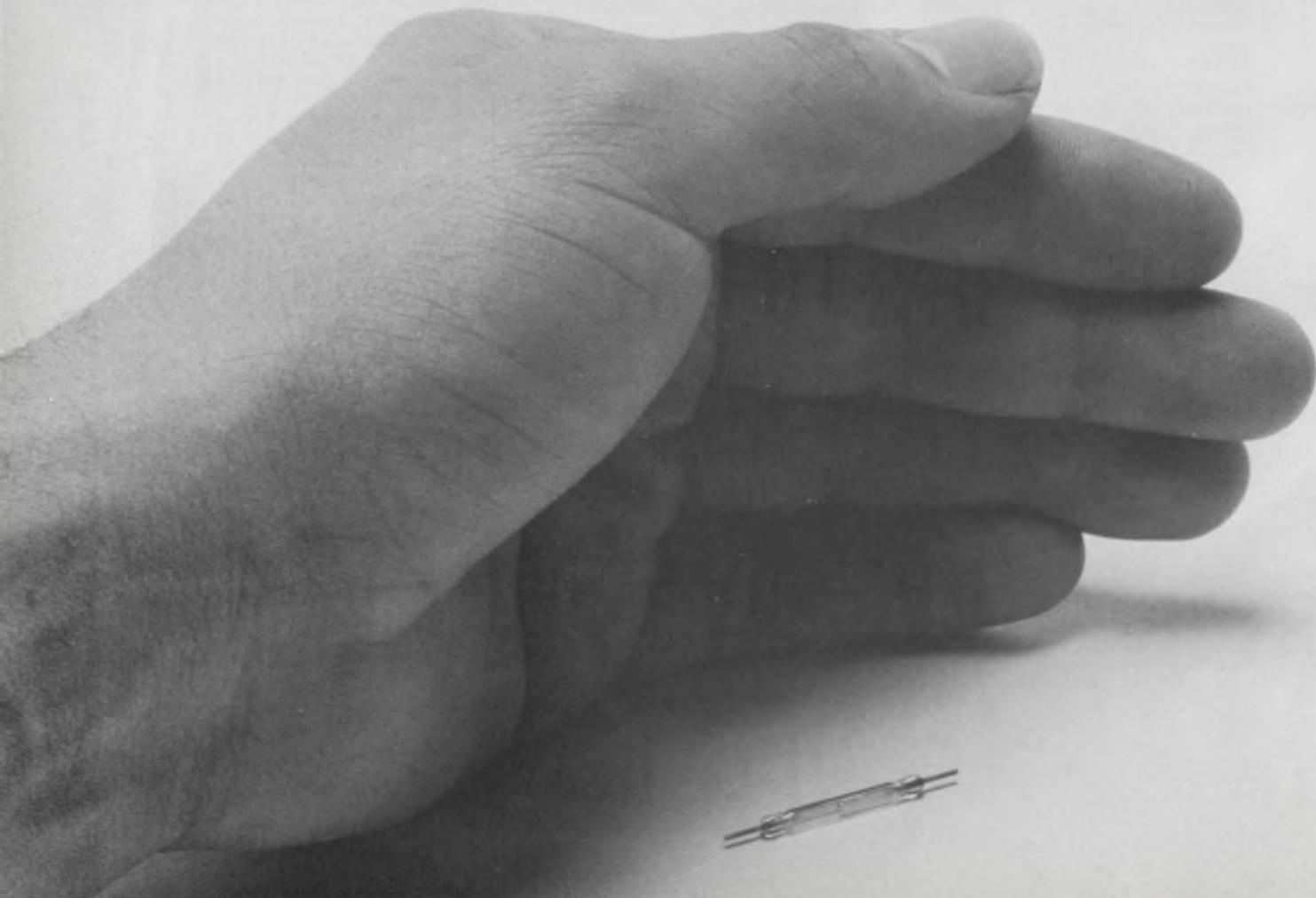



Save
Worth \$1.28

"400 Ideas for Design," by the editors of Electronic Design, sells regularly for \$9.95. It is available for \$8.45 when you present this coupon at Hayden Book Co.'s booth, 3819.

15%
Reduction

(See other side)

Save
\$1.73

(See other side)



Save
Worth \$1.92

The widely acclaimed "Electronic Design Techniques," edited by Edward Grazda costs \$12.75. You can get it for \$10.83 when you present this coupon at Hayden Co.'s booth, 3819.



Save
Worth \$1.80

The widely acclaimed "Engineer's Relay Handbook," by the National Association of Relay Manufacturers costs \$11.95. You can order it for \$10.15 when you present this coupon at Hayden Book Co.'s booth, 3819.

15%
Reduction

(See other side)



Save

Worth \$1.64

"Standard Dictionary of Computers and Information Processing, sells regularly for \$10.95. It is available for \$9.31 when you present this coupon at Hayden Book Co.'s booth 3819.

**Save
\$1.28**

(See other side)

**15%
Reduction**

(See other side)



Save

Worth \$1.73

The widely acclaimed "Microelectronic Design," by Howard Bierman, sells regularly for \$11.50. You can order it for \$9.77 when you present this coupon at Hayden Book Co.'s booth, 3819



Save

Worth \$1.36

"Fundamentals of Integrated Circuits," by Lothar Stern, is available for \$7.59 when you present this coupon at Hayden Book Co.'s booth, 3819. The book usually sells for \$8.95.

**Save
\$1.80**

(See other side)

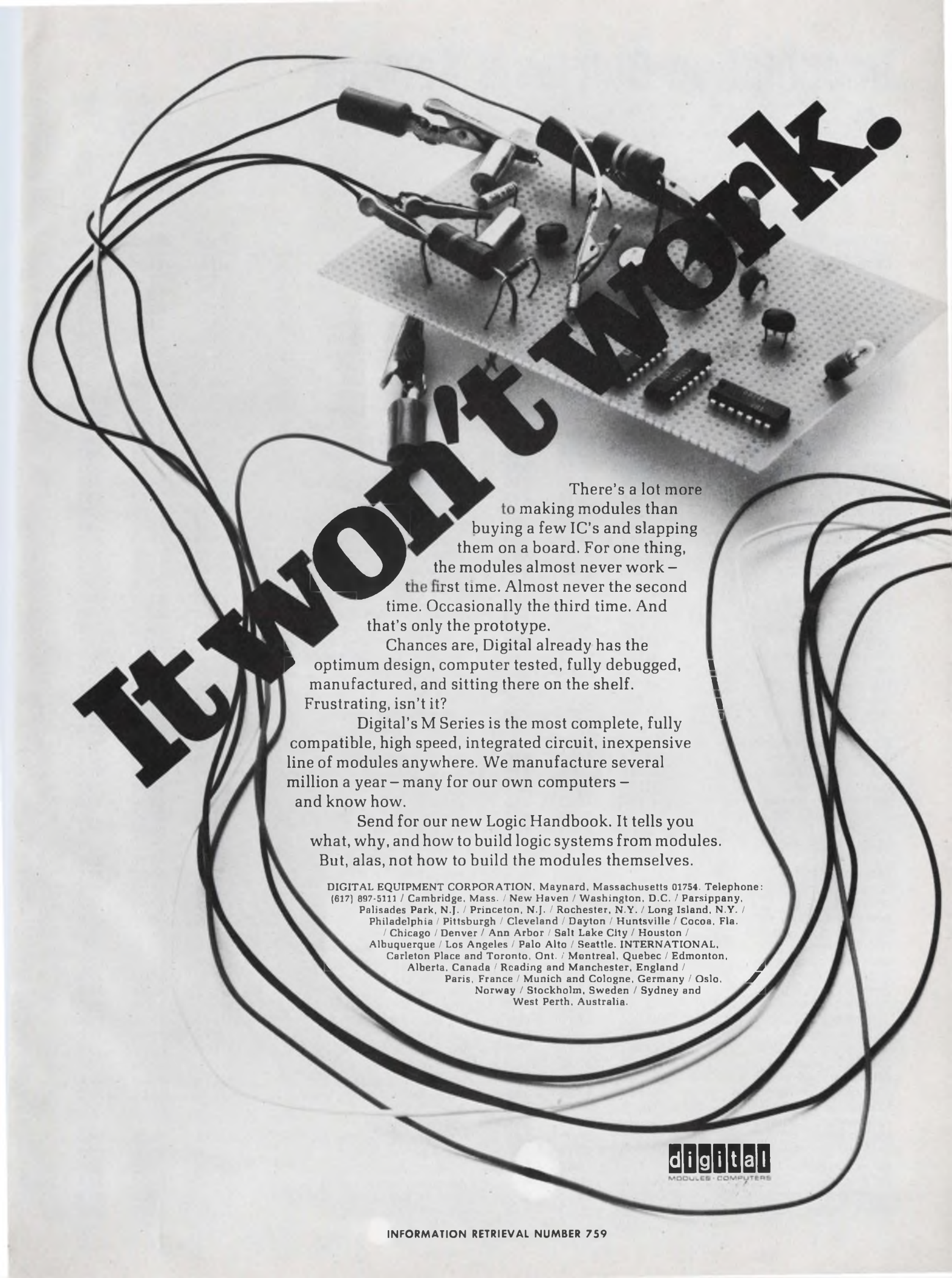

It won't work!

There's a lot more to making modules than buying a few IC's and slapping them on a board. For one thing, the modules almost never work – the first time. Almost never the second time. Occasionally the third time. And that's only the prototype.

Chances are, Digital already has the optimum design, computer tested, fully debugged, manufactured, and sitting there on the shelf. Frustrating, isn't it?

Digital's M Series is the most complete, fully compatible, high speed, integrated circuit, inexpensive line of modules anywhere. We manufacture several million a year – many for our own computers – and know how.

Send for our new Logic Handbook. It tells you what, why, and how to build logic systems from modules. But, alas, not how to build the modules themselves.

DIGITAL EQUIPMENT CORPORATION, Maynard, Massachusetts 01754. Telephone: (617) 897-5111 / Cambridge, Mass. / New Haven / Washington, D.C. / Parsippany, Palisades Park, N.J. / Princeton, N.J. / Rochester, N.Y. / Long Island, N.Y. / Philadelphia / Pittsburgh / Cleveland / Dayton / Huntsville / Cocoa, Fla. / Chicago / Denver / Ann Arbor / Salt Lake City / Houston / Albuquerque / Los Angeles / Palo Alto / Seattle. INTERNATIONAL, Carleton Place and Toronto, Ont. / Montreal, Quebec / Edmonton, Alberta, Canada / Reading and Manchester, England / Paris, France / Munich and Cologne, Germany / Oslo, Norway / Stockholm, Sweden / Sydney and West Perth, Australia.

digital
MODULES · COMPUTERS

Information Retrieval Service

All products, design aids (DA), application notes (AN), new literature (NL), and reprints (R) in this issue are listed here with Page and Information Retrieval numbers. Reader requests will be promptly processed by computer and mailed to the manufacturer within three days.

Category	Page	Booth	IRN
Components			
circuit breakers	U144	3801	372
circuit protector	U144	4712	250
counters, impulse	U146	4208	266
CRT, dual-gun	U146	4607	264
CRT, multi-color	U142	3808	409
delay lines	U146	4713	275
filters, emi	U148	5112	265
filters, monolithic	U146	5206	254
lamps, bi-pin	U148	3715	283
magnetic heads	U148	4522	251
protector, surge	U144	1505	387
pushbuttons, lighted	U144	5121	263
readout tubes	U148	4710	394
readouts, segmented	U148	5120	395
relays, PC	U146	4403	255
relay, reed	U146	4311	253
switch, pressure	U148	3921	261
switch, slide	U142	4711	252
switches, lighted	U144	3909	260
switches, pushbutton	U144	4515	262
trimmers, cermet	U142	3913	259
Data Processing			
calculator, electronic	U180	2021	343
computer/calculator	U180	5517	296
converter, a/d	U184	1706	258
converters, a/d	U182	1711	341
keyer, data	U180	1606	342
logic cards	U182	3814	274
memory, core	U180	3709	344
tape duplicator	U184	5503	410
ICs & Semiconductors			
diodes, hot-carrier	U154	1040	370
diodes, miniature	U156	Unit B	405
LEDs, infrared	U154	4304	371
multiplexer, analog	U152	4503	413
rectifiers, plastic	U154	Unit B	367
regulators, hybrid	U156	3601	272
SCRs, high-temp	U154	4601	345
Instrumentation			
amplifier, logarithmic	U130	1724	292
converter, d/ac	U132	1127	363
counter, 15-MHz	U130	1006	347
counter, time-interval	U126	1722	298
counter-timer	U132	1904	350
divider/generator	U128	1904	351
DVM, printing	U122	1141	407
generator, pulse	U129	1412	293
generator, pulse	U133	1419	402
generator, pulse	U134	1419	401
generator, pulse	U133	5603	356
generator, time-code	U134	1412	398
generator, time-code	U132	1722	294
generator, waveform	U134	1113	399
impedance bridge	U124	1726	359
multimeter/calibrator	U128	2027	348
multimeter, digital	U128	2008	355
multimeter, digital	U128	1827	346
multimeter, digital	U120	1014	406
noise analyzer	U125	1040	295
oscilloscope, dual-beam	U118	1040	412
panel meter, digital	U120	1404	352
phase meter, digital	U125	2027	349

Category	Page	Booth	IRN
picoammeter	U134	1129	404
power supplies	U125	2119	357
power supply	U129	1020	360
protector, lab-test	U126	4712	365
scope, dual-beam	U120	2101	297
scopes and plug-ins	U124	2101	388
servo system analyzer	U130	2206	358
spectrum analyzer	U132	2015	361
voltmeters, digital	U125	2008	354
Microwaves & Lasers			
amplifier, crossed-field	U138	5219	384
attenuator, rotary	U138	1724	389
detectors, directional	U138	1138	382
filter, rf	U138	1724	393
filters, phase-controlled	U136	5403	289
generator, signal	U136	1613	289
generator, signal	U138	1138	290
generators, power	U138	4607	383
millivoltmeter, rf	U138	1411	392
mixer, balanced	U138	1040	381
power meter, rf	U136	1320	379
pulse detector	U138	3705	291
radiometers	U138	1214	288
sources, frequency	U138	Unit H	380
switches, transfer	U138	5409	373
Modules & Subassemblies			
amplifier, linear	U166	5202	270
converter, synchro	U166	4180	271
delay lines	U146	4713	275
op amp, FET-input	U160	1115	374
op amp, low-cost	U164	1115	375
op amp, low-power	U160	2014	385
power converters	U169	3609	378
power supplies	U169	1508	269
power supplies	U169	1423	377
power supply	U169	4419	376
preregulator, supply	U162	2119	386
readout tubes	U148	2710	394
readouts, segmented	U148	5120	395
regulators, power	U160	4516	257
relays, PC	U146	4403	255
relays, time-delay	U164	4403	268
tone modules	U162	1708	267
transformers	U160	3601	256
Packaging & Materials			
connector, card-edge	U174	4105	277
connector, PC	U172	4105	278
heat pipes	U172	4524	299
heat sink, transistor	U172	2604	282
IC logic hardware	U174	3814	280
panel catch	U172	2504	368
panel, DIP	U176	2721	379
socket	U174	4413	281
tape, heavy-duty	U176	2611	276
tape, polyimide	U174	2611	273
Production			
bonder, chip	U186	2924	340
cleaner, ultrasonic	U186	3304	287
cleaner, ultrasonic	U186	1022	285
counter, metal-parts	U187	5207	284
lead straighteners, TO	U186	2606	411
printer, component	U187	3407	369

WESCON USA

An exclusive VIP visit to an
exciting four-day exhibition



WESCON, 1969...

Adjectives are the stock in trade of the show barker. Most shows prefer the superlatives "bigger," "better," "grander"... Not so, this year's Wescon. The stress is on "useful," "practical," "fewer but better."

Wescon, 1969, at the Cow Palace in San Francisco expects 45,000 vis-



Accent on quality

iting engineers Aug. 19-22. There are 23 technical sessions (compared with 32 last year), but all emphasize what designers can achieve today. On display at 1192 booths are the star products of 600 companies.

You can take the grand tour right now. Read on.



photo by GAF Corp., USA

TV Brings the University to

Industry	U84
Technology in the World of Today	U90
Design trends in the major engineering disciplines, as reflected in the technical papers	
Aerospace	U90
Circuit Design	U93
Communications	U94
Computers	U96
Microelectronics	U97
Microwaves	U98

Here's the Full Technical Program

A complete listing with times and places	U100
--	------

Outstanding New Products

Instrumentation	U118
Microwaves and Lasers	U136
Components	U142
ICs and Semiconductors	U152
Modules and Subassemblies	U160
Data Processing	U172
Packaging and Materials	U180
Production	U186

TV brings the university to industry

Stanford's new instructional network allows engineers to take courses for credit without leaving their plants

Jim McDermott
News Editor

Continuing education for graduate students employed in engineering, management, and other careers is being rapidly implemented in California with what is claimed to be the most cost-effective TV network instruction system so far devised anywhere. The new system, which recently began operation with four channels at Stanford University in the San Francisco Bay Area will eventually extend southward to San Diego. System potential and plans are the subject of Wescon's largest conference session: "University Instructional TV Networks and What They Mean to Industry."

Although similar systems have been operating for over five years in Florida and Texas, Albert J. Morris, president of Genesys Systems Inc., and Wescon session organizer, says that the Stanford system is the most cost-effective because it is a third-generation system and is based on a two-year study of how to best accomplish the university-industry tie. Morris further claims that the new system has not only become the pattern for other forthcoming California networks, but is rapidly being adopted throughout the country as well.

How the system works

All of these university instructional networks have an on-campus TV studio-classroom; a classroom in the industrial plant; and a means of transmitting the TV signal from the university to the remote off-campus room. There must also be a means for the students to talk back to the instructor.

An important advantage of the Stanford system is the low-cost method of student talk-back via a low-power fm transmitter located at the industry site. In contrast, the Florida system, with programs piped between Gainesville, Cape Kennedy, Daytona Beach, and Orlando, uses regular telephone lines. And the Texas network,

with transmissions between Southern Methodist University, Texas Christian University, University of Dallas, and the Southwest Center for Advanced Studies, uses telephone-system microwave repeaters.

One advantage of all these systems is that the employe need not commute to the university; he can attend the TV classroom set up in his plant. Furthermore, the lesson can be video-taped and played back later in-plant, for those who missed it due to the pressure of their jobs.

Of the present 1500 graduate students on the Stanford University Campus, the majority are full time, but some 300 to 400 of these students are employed in Bay Area industrial, government or research organizations. Because the classes are presented only during the day, much time is lost driving to and from the campus.

According to Joseph M. Pettit, Dean of the School of Engineering, one large company estimated that in one year, the commuting loss of time equalled two and one-half years of engineering time. Now, many students who could not normally be given time off to attend classes can do so through the university-industry TV setup.

Network supported by industry

The Stanford network, when fully implemented, will cover the entire San Francisco Bay area, as shown in Figure 1. This is largely because of the considerable interest in that locality, in combatting professional obsolescence. In fact, a non-profit corporation, the Association for Continuing Education (ACE) was formed, in 1968, by 18 prominent Bay Area industries together with Stanford University for the purpose of conducting a large-scale, continuing education program using Stanford's TV facilities.

According to Robert Turk, general manager of ACE, the organization is unique among university-industry television complexes. Actually ACE is an extension of Stanford University, in that it cooperates with industry members in organizing classes and courses appropriate to grad-

uate and other study needs at the particular location.

The curriculum that ACE presents is controlled by participating members, and the courses stress applied knowledge, rather than theory. ACE officially began telecasting in May of this year, with 89 industrial students and four courses.

Present ACE hours are: 7-8 a.m.; 12 m-1 p.m.; and 4-7 p.m. Later, hours will be extended from 7 to 11 p.m. and weekends.

The regular Stanford University daytime graduate courses are handled and programmed by the university. ACE will also provide these same courses, from other schools, through the Stanford network facilities. For example, San Jose State plans to offer, through this network, graduate engineering courses for credit, while graduate courses in business are planned by the University of Santa Clara.

In addition, ACE will program seminars in state-of-the-art engineering classes for which no engineering credit is received. These are taught by industry or university personnel who have done research on the latest developments in engineering, mathematics, and the sciences.

Equipment at the industrial classroom consists of one or two 21-inch TV monitors, plus a micro-

phone for each student, for talk-back facilities through the FM audio link.

How the joint effort began

The Stanford University efforts began, in 1967, with a feasibility study concerned with linking Stanford with classrooms in some 30 industrial organizations participating in the part-time graduate program. This study, Dean Pettit has pointed out, came up with a total capital cost of \$600,000 for the Stanford facilities for the four-channel network. This sum was obtained from industry participants on a basis that was graduated according to the size of the organization. The share could be paid in a lump sum or prorated over 5 or 10 years.

It turned out that, for even the largest company, the total annual cost is less than a technician's salary. And according to session organizer Albert Morris, analysis of records for a large company has shown that with a sizable number of graduate students over 10 years, the prorated cost is only twenty cents per student, per classroom hour, for amortization and operating costs of the in-plant facilities.

The Stanford industrial-TV curriculum empha-



Fig. 1. Educational TV coverage in the Stanford-San Francisco Bay Area is shown by geographical distribution. The size of each black dot represents the number

of companies in a section participating in the graduate study program. The Stanford network will be shared by other colleges and universities.

sizes graduate courses at the master's level for which no thesis is required. It is theoretically possible to obtain a degree via the televised course, but Dean Pettit cautions that this is not entirely practical nor desirable. Some courses don't lend themselves to TV treatment. He also suggests that the student take at least one seminar on the campus to become acquainted with one or more of the faculty.

In expanding the TV-education benefits, Stanford created a "non-registered" option that permits students in industry to take the TV classes without being matriculated at the university. They are tested and graded along with the regular students, but their performance does not affect the statistical standards of the others.

Included in the non-registered category are those who already have degrees, those who don't want to complete all of the work for a degree, and those who want a degree but are not yet academically qualified. In this last case, Dean Pettit points out, Stanford allows these students to matriculate, and to transfer completed units by petition, provided they perform well enough as non-registered students in competition with the matriculated students.

Future coverage to be broad

Stanford network coverage of the Bay Area is planned to include a two-way link to the University of California at Berkeley for sharing lectures, seminars and courses. Cooperative arrangements with the University of Santa Clara

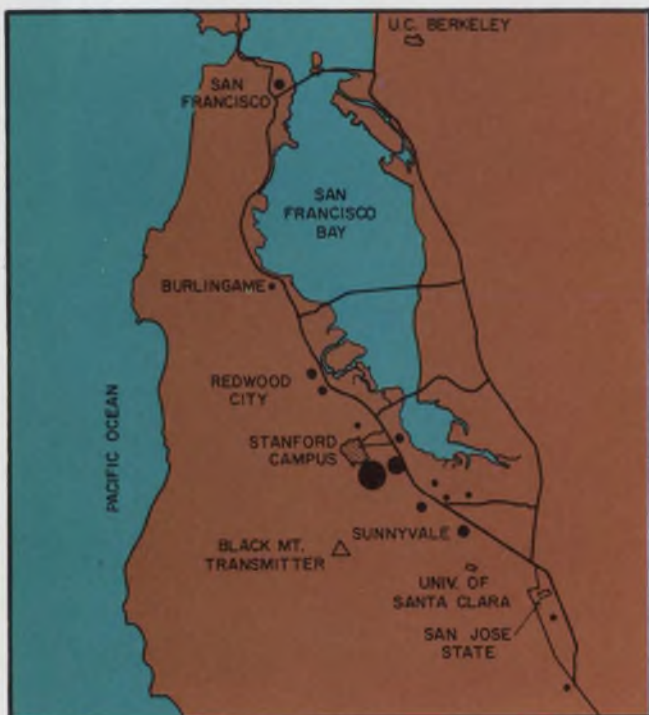

Stanford network coverage will eventually include links to the University of California at Berkeley, University of Santa Clara and San Jose State.

and San Jose State are also being worked out.

For coverage in the Southern California area, plans are being made to link the University of California at Los Angeles with the campus at Irvine: these two, together with the University of Southern California, will serve the Los Angeles basin. Robert M. Saunders, Dean of the School of Engineering at Irvine, told ELECTRONIC DESIGN that they have recently been awarded four ITFS (instructional television, fixed station) channels for the area. According to the FCC notice, construction is scheduled to be finished by mid-February of next year.

Saunders also said that it is eventually hoped to link Irvine, Los Angeles and the University of Southern California with Santa Barbara College, Riverside College, and San Diego State.

The new Stanford educational TV system uses channels in the band of 31 which the FCC designated in 1963 for microwave operation of this type of station. The band extends from 2500 to 2686 MHz, giving a 6-MHz channel to each station, using the standard TV signal format. The channels are allocated in groups of four, with adjacent channels being separated by 6 MHz from another assigned locality.

The audio talk-back capability is obtained by utilizing fm radio talk-back in a 4-MHz band (2686-2690 MHz) adjacent to the top end of the ITFS band for each of the available channels. This system required a rule-making decision from the FCC, which was effective in June of this year. The first type-acceptance models of the talk-back system have been designed by Genesys Systems, Inc., for the Stanford network.

TV signals from the Stanford classrooms are carried by cable to a master control room, then relayed via a 12-GHz link, with 4-foot dishes, to the main transmitter on Black Mountain, which is 7.9 miles from the campus.

Each company requires only one receiving antenna, mast, and down-converter for all four channels. The system is of broadcast quality.

Seven of the 10 available watts are radiated from an antenna covering an arc of 160 degrees, with a horizontal gain of 17 dB. This gives an effective coverage of up to 25 miles for a 6-foot receiving dish. To reach San Francisco (36 miles) 1 watt is fed from a 10-foot parabola, and 8-foot parabolas are used at the industrial receiving sites.

To reach the Emeryville-Berkeley area (39 miles) 2 watts are fed from a 6-foot dish, and 10-foot parabolas are used for receiving.

The talk-back transmitting antennas at the industrial location are mounted in a plane with the receiving antennas and are cross-polarized to reduce cross-talk. On Black Mountain, the talk-back receiving antennas are mounted colinearly with the transmitter antennas. ■■

with your reputation at stake, which resistor line would you specify?

take a close look—there'll be no question

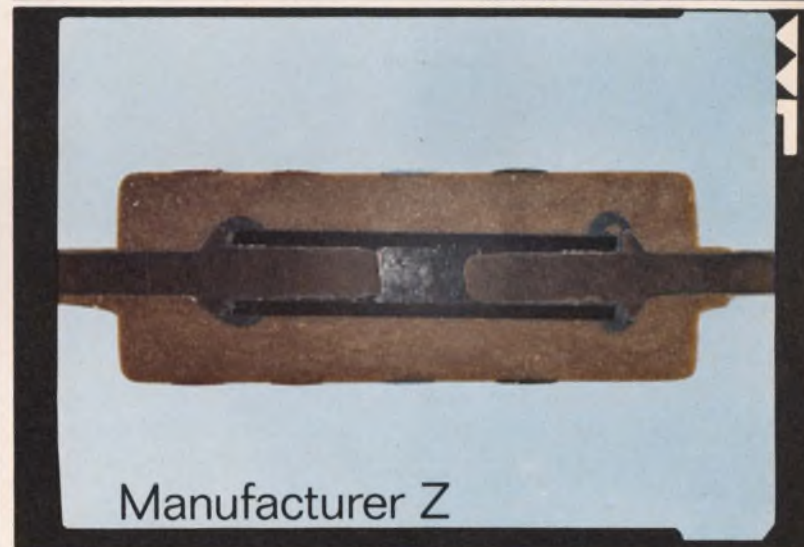

The above illustrations are from unretouched photomicrographs taken of four $\frac{1}{2}$ -watt fixed resistors. Compare the anchoring of the leads, the seal provided by the insulating jacket at the ends, the homogeneity of the resistance material, the sharp color code bands—and decide for yourself.

For more details on Allen-Bradley hot-molded resistors, please write for Technical Bulletin 5000: Allen-Bradley Co., 1201 S. Second St., Milwaukee, Wis. 53204. Export Office: 1293 Broad St., Bloomfield, N.J., U.S.A. 07003. In Canada: Allen-Bradley Canada Ltd.

© Allen-Bradley Company 1967

EC69-56

QUALITY ELECTRONIC COMPONENTS



A-B hot-molded fixed resistors are available in all standard resistance values and tolerances, plus values above and below standard limits. **A-B hot-molded resistors meet or exceed all applicable military specifications including the new Established Reliability Specification.** Shown actual size.



ALLEN-BRADLEY

**Reliability is six things we do
that nobody else does.**

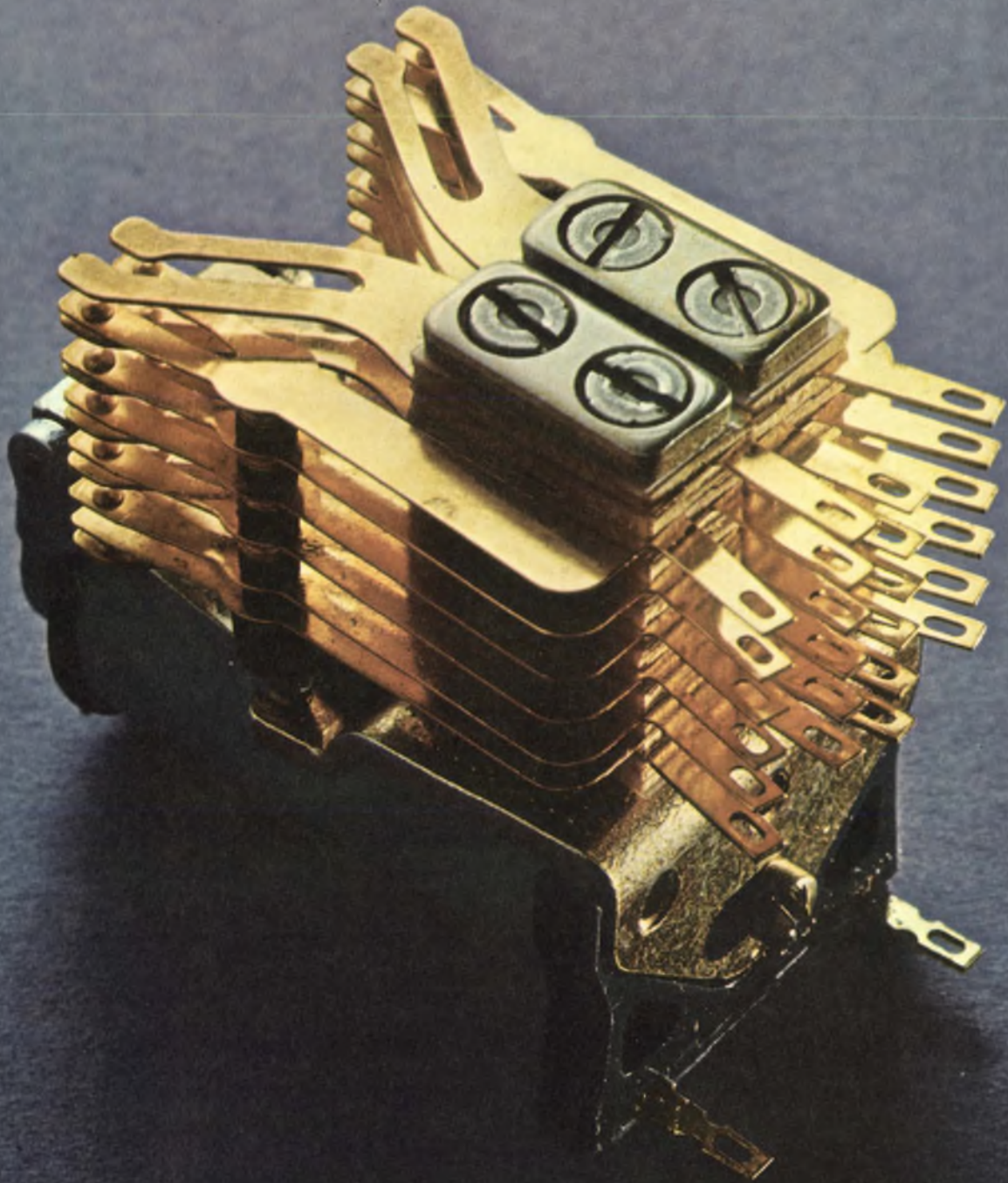



We're fanatics.

We build our relays stronger than we have to. That way, they last lots longer than they ever have to. Our Class E relay (shown on the opposite page) is a good example of our way of thinking.

The industry's strongest heelpiece.

We make the strongest heelpiece in the industry. A gigantic machine bangs them out extra fat and extra flat.

Extra fat to carry a maximum of flux. To handle big loads. Extra flat so that once an AE relay is adjusted, it stays adjusted.

Since our backstop is part of the heelpiece, it's just as thick and flat. But, tough as it is, the slightest wear here would throw the entire contact assembly out of whack. So, to be safe, we weld two tiny, non-magnetic pads where the armature arms meet the backstop. You might say we created the no-stop backstop.

Three parts that'll wear like crazy.

When you build a relay like a small tank, you have to think of everything. We try. Right down to the tiniest part. For example, we make our armature arms and bearing yoke extra thick.

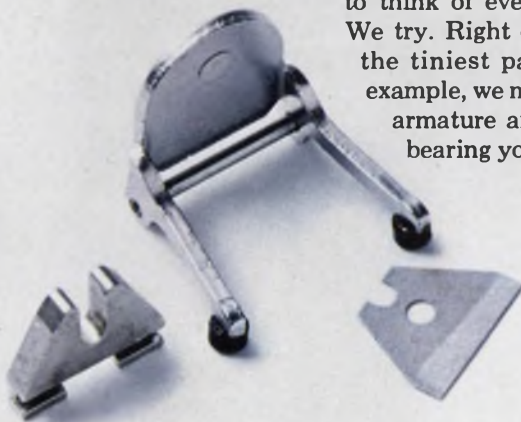

Thicker than years of testing and use say they have to be. Then, to make sure they don't cause wear problems, we insert a hardened shim between the hinge pin and the frame. The pin rides on the shim, instead of wearing into the heelpiece. (You can forget the bearing, it's permanently lubricated.)

Buffers with lots of muscle.

We make our buffers of a special tough phenolic material that lasts. And lasts. And lasts. All without wear or distortion. Another reason why our relays stay in whack.

To make sure our buffers stay in place, we weld the buffer cups to the armature arms. We weld, instead of using rivets, because our lab found that rivets have a habit of falling out.

For the very same reason, we weld buffer cups to the contact springs. And also use the same special tough phenolic buffers.



No, we didn't forget the contact springs.

We have some strong feelings as to what makes a contact spring reliable. Our sentiment is that two contacts are better than one. So, we bifurcate all the springs, not just the make and break. This slotting and the addition of another contact to each spring means you get a completed circuit every time.

We make each set of contact points self-cleaning. The bad stuff doesn't have a chance to build up.

Now, what's different about our bobbin?

Our bobbin is one piece—molded of glass-filled nylon. This provides the maximum in insulation resistance.

Because our bobbin is nylon, we don't have to impregnate with varnish. Moisture and humidity have no effect on the stubborn nylon material. No effect means no malfunctions for you to worry about.



What all this means to you.

What this all adds up to is reliability. The kind of toughness no one else can give you. It means an AE relay works when it's supposed to, longer than it has to.

Isn't this the kind of reliability you really need? Automatic Electric Company, Northlake, Ill. 60164.

AUTOMATIC ELECTRIC

SUBSIDIARY OF GENERAL TELEPHONE & ELECTRONICS

Technology in the world of today

Papers at Wescon stress the practical applications available now in developments that also have a future

Aerospace

Satellites preparing to explore the earth

How to bug the earth and its atmosphere with unmanned sensors that report to stationary satellites is described in detail in session No. 12. The report, part of a session devoted to data-relay satellites, is by S. D. Dorfman of Hughes Aircraft's Space Systems Div., El Segundo, Calif. Examples of the in situ sensors include buoys, balloons, seismic detectors, volcanic detectors, agricultural sensors that even measure the temperature of soil moisture, smoke detectors and weather stations.

Users of such systems are expected to include the U. S. Depts. of Commerce, Interior, Transportation and Agriculture, as well as agencies in other countries. By 1975 Dorfman foresees as many as 26,000 platforms, all serviced by three or four satellites. The cost of the data communication system over a five-year period—not including the platform sensors—would come to about \$100 million, Dorfman says. A conventional system, not using satellites, would cost \$1.25 billion.

Frequency choices are 149 MHz for the uplink and 137 MHz for the downlink.

Wide areas of interest

The session will appeal to a surprisingly large variety of engineers and scientists, session organizer S. H. Durrani of the Comsat Corp. in Washington, D. C., told *ELECTRONIC DESIGN*. Those who will find it particularly valuable include not only engineers working in the environmental sciences—meteorology, geology, agriculture, oil exploration, geodesy, fishing—but those working for oil or other companies that must collect information from remote, often unmanned,

stations. Their equipment suppliers will also be interested.

Another big group consists of communicators—companies that now supply the public with telephone service by high-frequency and microwave radio, as well as those interested in providing industry with quick transmission of correspondence and records.

A satellite communications network for domestic use to provide an "entirely new approach to telecommunications in the United States" is described by W. B. Gross, Program Manager, General Electric, Philadelphia. Whereas a call from Los Angeles to New York via terrestrial means passes through approximately ten distinct switching offices, a call by satellites goes through two.

The system GE proposes would use a minimum of two satellites in synchronous orbit. The earth station is modular in design and uses commercial equipment for the antenna, feeds and rf portions. The automatic digital exchange is a special-purpose digital computer oriented to communications control and processing. Local loop (telephone line) interface equipment is built in modules to provide flexibility in deploying the system.

To fully implement the system by 1980, Gross says, would cost \$321 million. This includes initial research and development, the cost of five satellites and boosters, earth facilities, and the continued research that would be needed through 1980. The largest single investment would be the earth facilities, which, Gross estimates, would cost approximately \$140 million. This includes 175 earth stations, one routing center, and other administrative facilities.

Building a satellite network

The problem of how to weave a large number of ground users into a satellite network is aired by P. J. Heffernan of the National Aeronautics and Space Administration's Goddard Space Flight Center in Greenbelt, Md.

Heffernan uses as a hypothetical case a system with 70 ground stations. He covers such problems as how multiple access techniques can accommodate this number, how the satellite can be tracked, and how the signal should be designed and modulated.

Multiple access will be different for a domestic system than for that used with Apollo, Heffernan says. Apollo ground stations acquire the carrier and remodulate the received code sidebands and send them back on another carrier. For the domestic system, Heffernan recommends that the user lock on carrier and code, regenerate the code and send it back to the satellite.

Very high frequency should be used rather than S-band or L-band to make the terminal equipment simpler. And tracking will be accomplished by a pseudo noise spread spectrum technique.

Those interested in transmitting photographic data will be interested in W. J. Gill's report on an experiment made by Philco-Ford of Palo Alto, Calif., in which photographs were transmitted via the Defense Department's interim communications satellite network.

The key elements in the system are the analog-to-digital conversion and the image-recording equipment—the image appears on a cathode ray tube that is photographed. Although originally designed for the military, such a system could be used commercially.

Coding and signal selection for the data relay satellite interrogation is probably the most tech-

nical paper in the session. It is given by G. D. Boyce of General Dynamics Convair in San Diego.

Boyce doesn't claim to have the best of all possible approaches, but he prefers the majority voting approach to error detection or error coding. He feels that phase lock loops are too complicated; he prefers to use frequency shift keying.

Defense Dept. unhappy over avionics

Recent criticism of avionics systems by the Defense Dept.'s Systems Analysis office should add a sense of immediacy to the session on "Future Avionics System Architecture" (No. 19).

The dissatisfaction the Defense Dept. expressed, however, came as no surprise to session organizer John A. Alexander of TRW Systems Group, Redondo Beach, Calif.

"We've known for a long time that a new approach to designing avionics is needed," he told ELECTRONIC DESIGN. "That's why we used the word 'architecture' in our session title. Architecture means the total disciplines and procedures needed to build something—in this case avionics systems." There is too much redundancy, he says; too many add-ons.

The session begins with a bid for integrated avionics by Richard D. Alberts, Air Force Avionics Laboratory, Wright Patterson AFB, Ohio. Alberts describes work under way by the Air Force on techniques to integrate the communications, navigation and identification functions to



Computer-controlled test system from Bendix Corp. automatically checks on the performance of analog, digital

and high-frequency avionic systems aboard commercial aircraft (Paper 21/3).

operate on a single radio frequency.

Will one computer solve all the problems in the aircraft or will each subsystem have its own processing unit? This much-debated controversy over "federated vs. integrated computer systems" is discussed by J. H. Crenshaw of IBM Federal Systems Div., Owego, N.Y.

While federated systems (one computer for every task) seems on the way out, a fully integrated system, using a single, central computer, has not yet arrived. Today's advanced aircraft use a combination of the two. After recounting the advantages and disadvantages of both extremes, Crenshaw concludes that integrated systems will continue to gain, with the actual system still remaining something of a hybrid.

To design for military avionics, L. S. Guarino, Naval Air Development Center, Johnsville, War-

minster, Pa., tells the engineer where his effort should be directed. If the pilot is to be given more time for decision making with all the collection, integration and processing of information performed by avionics there must be more confidence in the avionic systems.

To do this the engineer should concentrate on:

- The electrical interfaces between black boxes. "This has been a main cause of avionic system failures," Guarino says. "The number of wires between boxes must be drastically reduced. The use of MINCOMS (multiplexed interior communication system) appears promising and should be developed for the avionic system."

- Displays are important. The use of CRT tubes should be replaced with solid-state devices, and color should be added. For more realistic representation, engineer Guarino suggests holo-

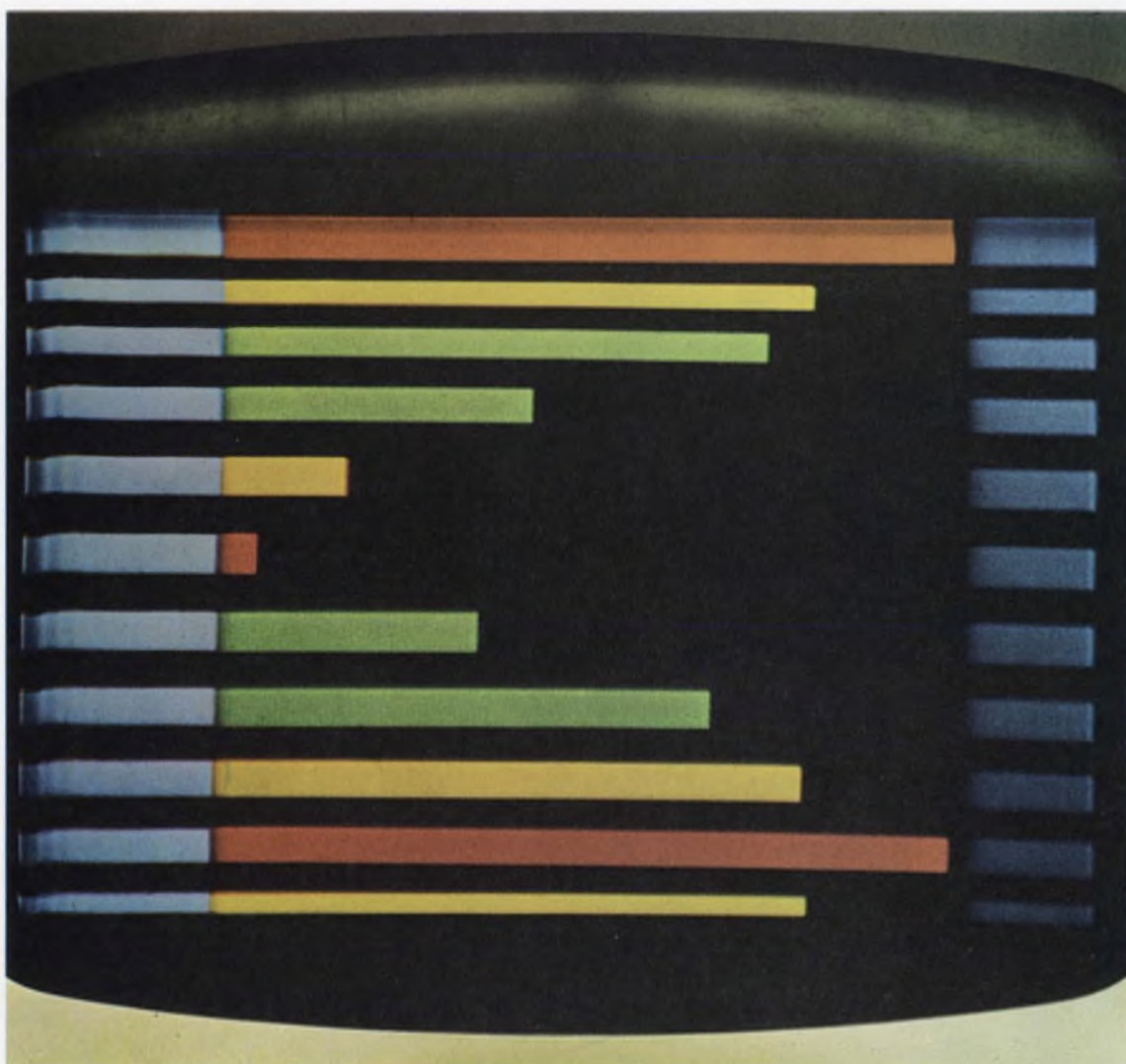

Experimental color CRT display, which is scanned in a standard 525-line television format, displays practically

any type of engineering data, according to W. H. Tew Jr. of General Electric Co. (Paper 18/2).

graphic techniques be used.

■ Man-machine simulators "should be the designer's most valuable tool."

The final paper, authored by J. R. Goodykoontz and V. A. Karpenko of TRW Systems Group, reports an interesting convergence taking place between the design of avionics and space equipment. Avionics on the one hand is getting more complex, while space equipment is becoming cheaper and more reliable, due to more enlightened techniques. ■■

Circuit Design

ICs and computers growing in influence

Circuit design and analysis are coming increasingly under the influence of the computer and the integrated circuit. Wescon coverage of such areas as filter design, mathematical modeling and oscilloscope techniques reflects the trend.

Session 4 on "Integrated Circuits in Active Filters" carries filter design through thick and thin films. Dr. George S. Moschytz of Bell Telephone Laboratories, Holmdel, N.J., uses tantalum thin-film RC networks and general-purpose silicon integrated operational amplifiers to construct a family of basic second-order filter building blocks, from which a wide variety of filters can be assembled. His paper, "FEN (Frequency Emphasizing Network) Using Hybrid Integrated Building Blocks," describes three pairs of blocks that operate from 100 Hz to 100 kHz. There is a pair for low-Q and one for medium-Q applications. A combination of the two is used for high-Q applications.

Moschytz derives the response of a medium-selectivity-frequency-emphasizing network and shows how his building blocks can be combined. He also describes techniques to construct the tantalum thin-film devices he uses.

The thick-film technique is upheld by Dennis Hollenbeck of Kinetic Technology, Los Gatos, Calif., in a paper on "Multiloop Negative Feedback Active Filters Using Thick-Film Integrated Circuit Techniques," and by William Broyles of Sprague Electric Co., North Adams, Mass., in "ICs and Thick Films Add Up to Improved RC Active Filters."

Broyles describes a method of producing custom filters that meet tight specifications and tolerances. Four standard topologies can be combined to meet a wide variety of needs. The frequency range is 0.01 Hz to 20 kHz, with Qs up to 300. Input impedance is high, and the output impedance is low. The significant aspects of the approach are to use thick-film resistor networks

and bonded-on capacitors. Gain is obtained from IC amplifiers. The desired requirements are programmed into an interactive computer. The designer can continue the computation with refinements, until he is satisfied that he has obtained the best design. The computed thick-film networks are then produced and assembled, along with the ICs, into finished networks.

The combination of accurate computation plus the stability and reproducibility of the thick films make for a superior product, Broyles contends. The size of a completed sixth-order filter is about one cubic inch. "This approach can turn theory into an economical product," he says.

Hollenbeck's designs allow the user of the product to make the final determination of its characteristics. This is done by external trimming. His filters also cover the audio band and may have Qs up to 2000, with high input and low output impedance. The user can choose high-pass, low-pass or bandpass operation, as well as the center frequency. The filters are individually packaged on aluminum substrates, with screened-on resistors in the passive networks and 80-dB operational amplifiers in the active networks. Each package contains one pole pair, and packages can be combined for more complex transfer functions. A key feature of the design is the very low supply power required for operation—between ± 2 V and ± 15 V.

Other Session 4 papers include "Active Filters Employing Silicon Monolithic Gytrators," by Robert Hove, Boeing Co., Seattle; "A State Variable and Gytrator Realization Comparison," by Robert Newcomb, Stanford University, and "Filter Design Using Integrated Operational Amplifiers," by Sanjit K. Mitra, University of California, Davis.

This Wescon session, organized by Gunnar Hurtig 3d of Kinetic Technology, Los Gatos, Calif., probably holds the greatest interest for the engineer in circuit design.

"High-Speed Oscilloscope Recording," is the subject of Session 13, organized by James R. Pettit of Hewlett-Packard, Colorado Springs, Colo. The ubiquitous computer appears even in this haven of measurement in a paper that discusses the mating of single transient oscilloscopes to on-line machines. Other papers cover photography of transients on oscilloscopes and high-frequency trigger circuit design.

The last listed session of Wescon is No. 23, "Computer-Aided Circuit Design," organized by Ron Rohrer, Fairchild Semiconductor, Mountain View, Calif., and Gabor Temes, Ampex Corp., Redwood City, Calif. This is another of the difficult-to-classify sessions, dealing as it does with both circuit design and computers. A paper presented by Harry B. Lee of Lincoln Laboratory,

Massachusetts Institute of Technology, Lexington, Mass., points out design-difficulties in programming circuits. Entitled "Circuit Simulation Present and Future," the paper states that as computers progress from the research stage to daily use, better programs must be written to meet the needs of the circuit designer. In particular, Lee thinks that the programs should be "human engineered" better to enable anyone to use a computer with little or no knowledge of programming. He also advises that new analysis techniques, such as the sparse matrix and implicit integration, be incorporated into computer programs. Implicit integration, by the way, can eliminate the problem of long computation time that arises when a circuit has widely spaced time constants.

Lee is strongly in favor of graphic output displays as an aid to the designer. He especially likes storage CRTs, which permit the designer to study the results of his efforts. He does not believe that elaborate input devices, like the light pen and graphic input terminal, can justify their cost.

Other Session 23 papers cover such diverse topics as transistor modeling, network optimization and layout. ■■

Communications

Solutions offered for digital hangups

Wescon is offering only a limited technical agenda for communications engineers, but what there is promises to be very worthwhile.

The most important session appears to be "Signal Processing Techniques in Digital Communications" (Session 11), which is being held in Meeting Room B on Wednesday afternoon. The chairman, Adam Lender of Lenkurt Electric Co., San Carlos, Calif., says the session is entirely devoted to new designs and techniques, presented from a practical point of view. It is considering the three most significant areas in digital communication:

- Signal design.
- Adaptive equalization.
- Error control.

The lead-off paper, by W. J. Melvin of Collins Radio, Newport Beach, Calif., discusses the digitalization of a communications terminal—both transmitter and receiver—so as to eliminate such analog devices as filters and modulators. The terminal actually becomes a small, special-purpose computer. The idea is explained by referring to a particular differentially coherent, four-phase PSK system with a matched-filter re-

ceiver. Performance data includes error rates in the presence of additive Gaussian noise.

Practical adaptive equalizers

The next two papers are concerned with adaptive equalization. This is the automatic adjustment of the receiver to compensate for changes in the transmission medium.

In their paper "A Simple Adaptive Equalizer for Efficient Data Transmission," D. Hirsch and W. J. Wolf, of Bell Telephone Laboratories, Holmdel, N.J., discuss several algorithms for directing the equalizer towards the properly matched condition. The methods vary from zero-forcing to minimizing the mean-square error. A practical example, employing a modified zero-forcing algorithm, is described.

Gerald K. McAuliffe of the IBM Watson Research Center, Yorktown Heights, N.Y., discusses adaptive equalization from an entirely different viewpoint. He focuses on a proposed method employing fast Fourier transform (FFT) techniques. He compares this with the tapped delay-line approach and the carrier-cancellation approach.

The final paper of the session—"Recent Developments in Error Control Techniques," by Allen H. Levesque of General Telephone and Electronics Laboratories, Waltham, Mass.—emphasizes the selection of an appropriate error-control coding technique for any transmission channel.

As many engineers already know, the optimum type of error control depends upon the error statistics of the channel. The usual simple assumption that errors occur singly and independent of one another is rarely valid.

It applies only in deep-space communications and some satellite links. Most other channels, such as hf, tropo and wire, tend to have clusters of errors. Therefore Levesque begins his discussion with a review of the statistics of the different channels and then analyzes the error-control methods appropriate for each.

In the case of channels with bursts of errors, a major objective is to break up the bursts. For block codes, this is done by interleaving the blocks at the decoder. The concept of concatenated codes—codes that make up long blocks by cascading many short ones—is discussed. A dual-mode type of error control, called burst-bracketing, is also described. Burst-bracketing codes actually switch the mode of decoding, depending upon whether densely clustered or independent errors are occurring. A discussion of convolutional codes wraps up the consideration of ways to combat burst errors.

The final error-control procedure being considered is the sequential decoding of convolutional



Array systems engineer Charles Mclean of Viatron Computer Systems Corp. is busy designing a composite layout for a complex MOS array (Paper 15/3).

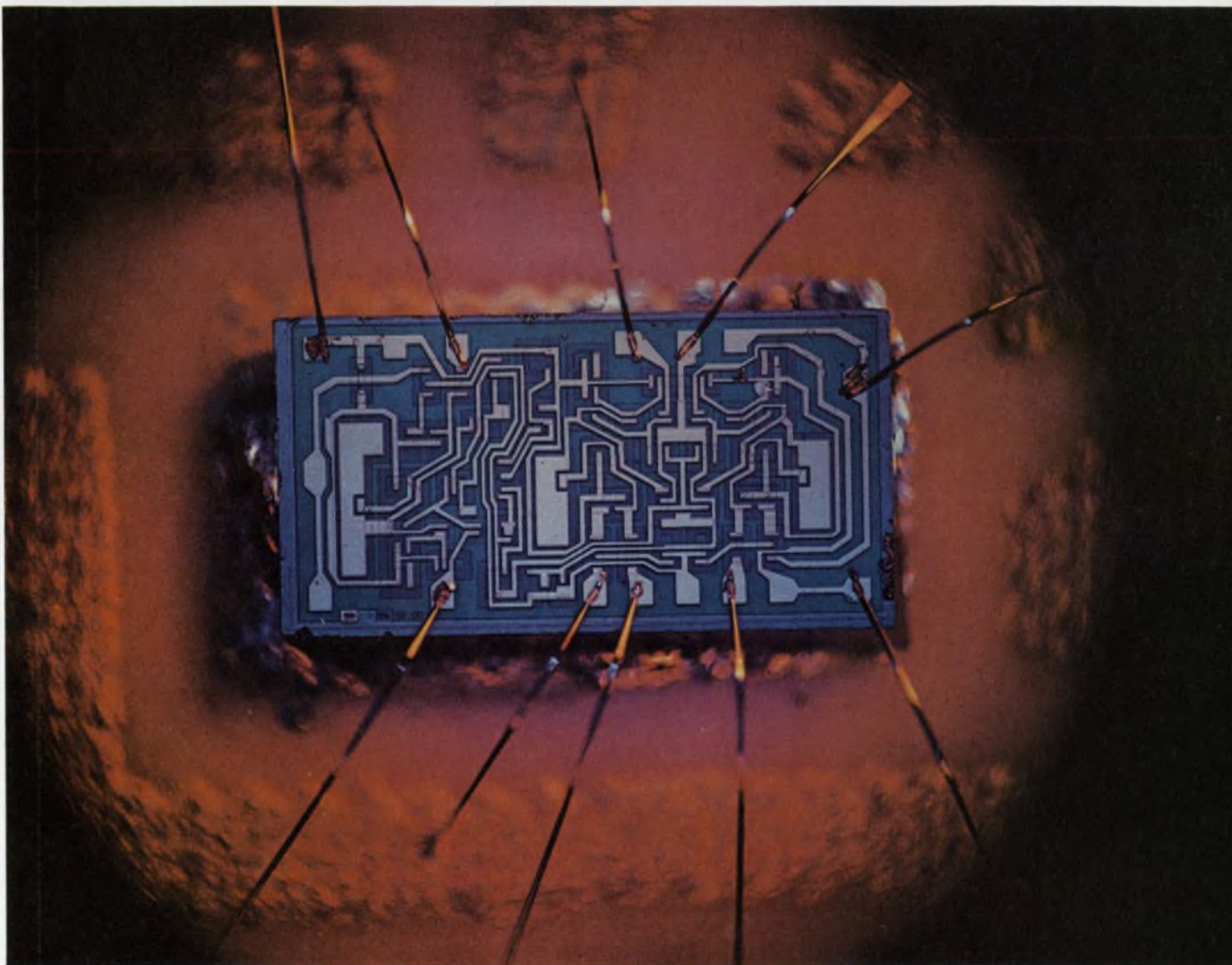

Monolithic integrated circuit chip containing three operational amplifiers will be used in a hybrid active

filter. These filters will be discussed in Paper 4/4 by Dennis Hollenbeck of Kinetic Technology Corp.

codes. This method is really useful only with independently occurring errors, but it approaches the ultimate theoretical performance promised by the analysis of optimum codes.

The entire session is being sponsored by the Communications Systems Discipline Committee of the IEEE Communications Technology Group.

Also of interest to communications engineers is Session 9 on "Linear Integrated Circuits in Communications" and Session 12 on "Data Relay Satellites." For further information on Session 12, see the Aerospace section of the review of technical papers. ■■

Computers

Automation spurring efficiency in factories

Two sessions at Wescon are devoted to a growing phenomenon: the use of the computer in factory quality control. Across the country, computers are being used to monitor test lines, control manufacturing processes, collect factory data and assist management. In at least one case, a computer is also being used in the field to test and trouble-shoot airborne navigational equipment from commercial airliners.

Session 8, organized by George H. Ebel of Conrac Corp., Caldwell, N.J., and S. Levy of RCA, Camden, N.J., considers "Manufacturing and Computers." In a paper on "Computer-Controlled On-Line Testing and Inspection," Peter H. Goebel of General Radio Co., Cambridge, Mass., describes how his company was able to make a routine task of the testing of electronic subassemblies used in measuring instruments. A test system was assembled to perform functional logic testing, test-fixture standardization, diagnostic trouble-shooting and go/no go testing. An important consideration was to make the entire test system operable by personnel with no special training.

The computer in General Radio's test system is a standard Digital Equipment PDP-8/L, and it serves as the control device for all peripheral system components. When not in use in the test system, it can be used to prepare test programs and tapes.

The other parts of the system hardware are the system interface, where computer and peripheral equipment interconnections are made; the control panel, which serves as the medium between operator and system; a readout scope, which aids in both go/no go and diagnostic testing, and a high-speed reader, which operates from punched paper tape. A device adapter is used to connect the device that is being tested

into the system.

The system software includes an easy-to-use and versatile programming language that can be used by personnel with no prior computer knowledge. Simple and logical commands are provided to perform the test on electronic modules. Some of the statements possible allow listing of test points, forcing of inputs, checking of outputs, repetition of tests and the calling of subroutines.

Among the benefits claimed for the system are reduction of lead time in module testing, fewer false indications of failure, a saving in set-up time and a higher yield of usable modules.

Four aspects of automatic testing—hardware, software, hardware-software package and management—are covered in Session 21, "Computer-Aided Testing, Management and Implementation," organized by A. Machi of Bendix Navigation and Control Div., Teterboro, N.J. A paper on the hardware-software package describes a significant departure from the usual computer test system. Entitled "A Computer Controlled Test System," by Frank M. Stutesman of Bendix, it describes a field test system for airlines.

Airliners use many pieces of electronic communication and navigation equipment. These systems, which may be either analog or digital, are housed in individual boxes. Failures in these boxes are usually reported by flight crews. Ordinarily the trouble is diagnosed manually by specialists, and the repairs are made at convenient airports.

Computer testing made easy

In the system designed by Stutesman, diagnosis of the faults and checkout of the repaired equipment is performed by computer, and these two tasks can be done by relatively unskilled personnel. The central computer in the system is the Bendix BDX 6200. The software is based on the Atlas language, developed by ARINC (Aircraft Radio, Inc.). Inputs to the system can be on perforated tapes or via keyboard. Unskilled personnel can interact with the system in a language that closely resembles English.

At this time the system can test 30 to 40 different avionic boxes of different manufacture. An extra dividend is use of the system in the Bendix plant for final inspection of airliner equipment.

Other Wescon sessions are devoted to time-sharing and computer display devices. The time-sharing session stresses applications. The papers in the display session emphasize on-line and real time displays.

In all, at least 13 Wescon papers report on computer applications in some aspect of manufacturing—either quality control or automatic processing. ■■

ICs are changing design picture

From Anaheim, Calif., to Boston, engineers are examining the changes that ICs are causing. Circuit design, system design, engineering communications and vendor-customer relations—all are different in age of the IC. But exactly what are the changes? And what are their effects?

In Session 1, "IC Systems: The Changing Interface," you learn that systems houses are becoming concerned. Their share of value added to their products is dropping drastically, and they fear that their profits may follow. They are making a serious analysis of the situation.

For instance, the Singer Co., Palo Alto, Calif., finds that about 40% of the factory cost of its Friden desk calculators is accrued in the purchase from outside vendors of semiconductor parts. Parts purchased in the past, from outside the company, for a mechanical calculator accounted for only 10% of factory cost.

How can systems houses make up their loss in value added? George Hare of Singer says, in the first paper of the session, that they probably should plan to produce ICs in-house.

Other papers in Session 1 discuss the growing use of computer aids in the production and testing of ICs, and the changing role of the circuit designer. How, for instance, does a system designer avoid design redundancy?

Typically, an engineer who wants to order a special IC will design and breadboard a prototype, and order the IC only after he has done this. The vendor's engineers then duplicate much of the original work in learning the circuit problem, developing the IC and preparing tests for it. But how can the needless duplication of effort be reduced? Clearly, by communicating more concisely, but how is this accomplished? Answers are given in Session 1.

Designers in a dilemma

You can take a close look at MOS ICs in Session 15, "MOS ICs: A Critical Review."

"Every systems designer," says Glen Madland, president of Integrated Circuits Engineering Corp., Phoenix, Ariz., in the first paper, "must decide whether to go MOS, bipolar, or hybrid, and the technical and economic success of his project depends on getting the right answer." Madland discusses the implications of MOS in device design, circuit design, and partitioning.

In the second paper, Ralph Parris, staff engineer at Burroughs Corp.'s Circuits and Packag-



Designers find that ICs account for as much as 40% of the factory cost of their systems.

ing Dept., presents guidelines on choosing MOS processes, and packaging and testing schemes, and he gives his views on the proper choice of an MOS vendor. In another paper, Dr. Leland Seely, general manager of General Instrument's Microelectronics Div., tells how the vendors are achieving TTL compatibility in their MOS.

For the designer who is having nightmares over his vulnerable single-source situation, Larry Drew, manager of engineering development at Viatron Computer Systems Corp., Burlington, Mass., has some soothing words. Drew sees single sourcing as inevitable, and MOS procurement as a joint business venture between vendor and customer. And a glimpse of the MOS future is provided by Al Phillips, assistant to the president at Autonetics, Anaheim, Calif.

Filters, linears, and power ICs

For engineers whose interest is in circuit design, there are papers galore, covering active filter design, linear ICs and high-power microcircuits.

Possibly the most interesting of these sessions is No. 4, "ICs in Active Filters". It was organized by Gunnar Hurtig, executive vice-president of Kinetic Technology, Inc., Los Gatos, Calif., and he has chosen speakers for a "practical session, with as much information on hardware as possible". He says that his company deals with "a lot of engineers who expect to use active filters but don't have a good practical knowledge of their capabilities. They don't know what's available and don't know where the pitfalls are."

The session opens with a paper by Sanjit Mitra,

a professor at the University of California, on the over-all problems encountered in building active filters. He gives a description of the types that can best be built with ICs. He says that IC active filters are the only economically practical ones.

The next paper discusses the popular methods of designing active filters, with gyrators and with multiple-loop negative feedback circuits, and the merits and disadvantages of each. The remaining four speakers describe the design and construction of actual filter circuits, including a monolithic silicon gyrator and thin-and thick-film negative feedback filters. They speak from valuable experience with hardware, and they have some invaluable tips for attending designers.

For the linear designer, Alan B. Grebene of Signetics Corp., Sunnyvale, Calif., has arranged Session 9, "Linear ICs in Communications." Fairchild Semiconductor's Richard Q. Lane presents a new MOS design for vhf receiver front ends, and Sumner B. Marshall of Sprague Electric Co., Worcester, Mass., discusses the use of linear ICs in consumer television and a-m fm receivers.

On the packaging and interconnection side, Robert A. Hirschfeld of National Semiconductor, Santa Clara, Calif., gives some valuable design tips on how to use pins efficiently in complex communication systems. And Hans R. Camenzind of Signetics Corp., Sunnyvale, Calif. describes the merits of a system approach to the design of IC communication circuits.

A 'high-power' session

And for the designer who works with power—in voltage regulators, amplifiers, or control circuits—there is Session 17, "High Power Microcircuits." Thomas M. Frederikson of Motorola's In-

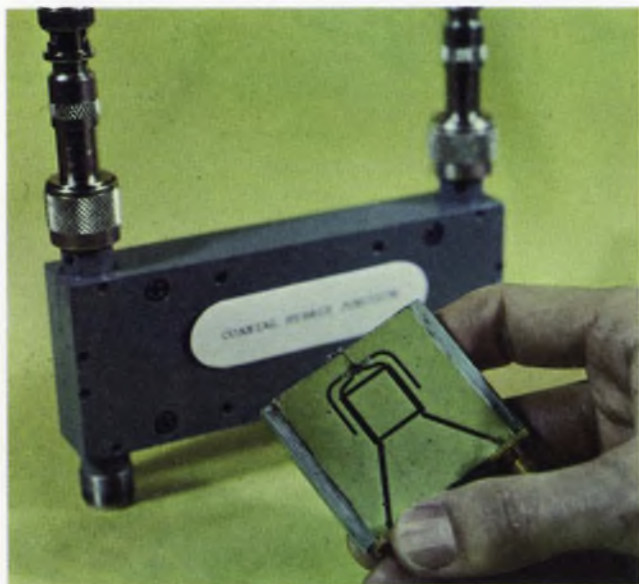

Uhf hybrid receiver module fabricated by IIT Research Institute is contrasted with a conventional coaxial mixer (Paper 3/5).

tegrated Circuits Center, Mesa, Ariz., and George Smith of Beckman Instruments Inc., Fullerton, Calif., explore the design and the capabilities of new monolithic and hybrid voltage regulators.

Herb Miezal, Dale Baughes and Leon Balents of RCA, Somerville, N.J., discuss high-power hybrid amplifiers, and William Whittekin Sr. of Texas Instruments, Dallas, Tex., present techniques for controlling power on an IC chip.

James Williams of Hughes Aircraft Co., Culver City, winds up the session with some valuable remarks on what he thinks is needed in power microcircuits. Williams feels that if ICs are to be used extensively in power circuits they will have to cost less, have improved temperature coefficients, and be used in systems designed to exploit their properties—perhaps in digital replacements for present analog circuits. ■■

Microwaves

EDP is password to clever design

Computer-aided design is the key phrase this year in the microwave sessions at Wescon. The digital designers are not only being used to design microwave integrated circuits; they are developing active devices as well.

Most of the papers on this subject are in Session 6, "Computer-Aided Design of High Frequency Circuits." Microwave engineers will probably be most interested in hearing the fourth paper, "Microwave Circuit Synthesis and Measurement," by H. Stinehelfer and W. Atwood of Microwave Associates, Burlington, Mass. It emphasizes the modeling problem in computer-aided design.

The usual design procedure, when computers are used, is to model the active devices and then to use these models to develop passive matching circuits. Often the original model is less than perfect, resulting in the design of less than optimum circuits.

To solve this problem, one can model the circuit by means of a theoretical circuit, with parameters adjustable to fit experimental data. As Stinehelfer and Atwood point out, however, the selection of an algorithm to adjust the theoretical circuit parameters isn't easy.

Essentially the problem boils down to minimizing a multi-dimensional function of many variables.

Most existing techniques consist basically of searching in some systematic fashion for the desired minimum point. To speed the process, other programs evaluate the gradients of the functions and use them to form a new estimate for the

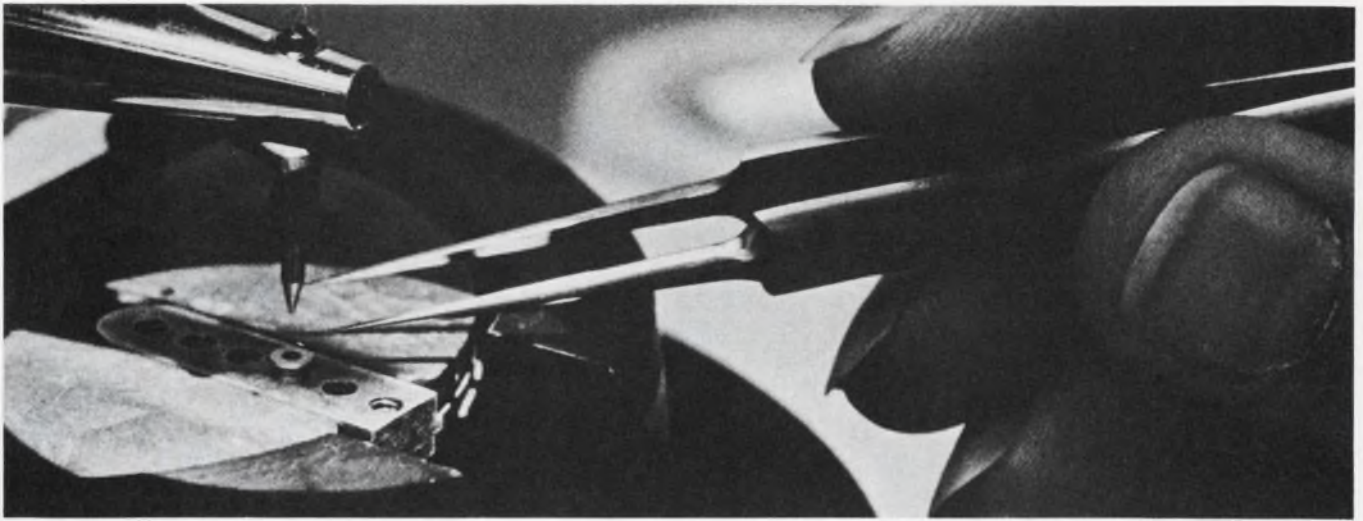

Computers help design GaAs diodes, as Chung K. Kim of Micro State Electronics, Murray Hill, N.J., will explain

theoretical circuit model. An example of the latter approach is given by Stinehelfer and Atwood.

The example is a one-section, capacitively coupled filter. The attenuation of the line is measured as a function of frequency, and the model's gap size and line thickness are allowed to vary until a good agreement with the measured data is obtained. The presentation includes a flow graph of the program.

Uhf microwave ICs

Another paper of high interest to the microwave designer is "Uhf Integrated Microcircuits," by Robert M. Knox of IIT Research Institute, Chicago. It is being presented in Session 3, "Current Solid-State Microwave Circuits." Knox's major thesis is that distributed-circuit techniques can be profitably employed at the lower microwave frequencies (0.3 to 3.0 GHz) if high dielectric constant substrate materials are used. He points out that area reductions of nearly an order of magnitude have been achieved by making MICs on a high- ϵ substrate instead of on alumina.

Traditionally, Knox points out, the design of circuits in the uhf range has been formidable because the performance of lumped circuits is generally regarded as inferior to that of distributed circuits, and distributed circuits have been too large to be practical.

Alumina, the substrate material on which most MICs are built, has a dielectric constant in the range of 9 to 15. Titanium dioxide, on the other hand, can provide dielectric constants up to 90.

What are the disadvantages of this high- ϵ material? For one thing, the propagation losses of a transmission line at a particular impedance level are higher than for the lower- ϵ case, because the conductor stripes are narrower. Fortunately the wavelength decreases in the high- ϵ material, so that the propagation loss per unit wavelength

in his paper in Session 6. The Varian unit shown here is about to be bonded to a single tuning screw.

does not increase unacceptably.

Other than that, Knox says, titanium dioxide is at least comparable to alumina in all important physical parameters.

For engineers who may have slipped behind the times, two other papers in Session 3 provide a review of the state of the art in two important areas: acoustic delay devices and solid-state sources. In his paper "Solid State Microwave Acoustic Variable Delay Devices," Ernst K. Kirchner of Microwave Electronics, Palo Alto, Calif., reviews the requirements for variable delay devices and then examines the hardware available to meet these requirements. The major areas of application he cites are array antennas, radar test equipment and electronic counter-measures gear. The first of these areas requires delays of up to 100 ns, with bandwidths of 500 MHz and center frequencies from 0.5 to 10 GHz. The second area needs a much longer range of delay: from about 1 to 150 μ s. Most of the characteristics desired for ECM delay lines are classified and cannot be discussed further.

To meet these requirements, a fairly large selection of devices is available. Kirchner believes that the mechanically variable magnetoelastic delay line is particularly promising. Other devices that he reviews include the electrically variable magnetoelastic delay line, the elasto-optical delay line, sliding acoustic crystals, ferroelectric materials and repetitive pulse-memory systems.

The other review paper is "Bulk GaAs and IMPATT Microwave Sources," by W. Keith Kennedy Jr. of Watkins-Johnson Co., Palo Alto. He compares the avalanche-diode sources (both IMPATT and TRAPATT) with the bulk GaAs sources. He does not distinguish between the various modes of diode operation in bulk GaAs because of the current disagreement in the literature on the exact locations of the boundaries between the different modes. ■■

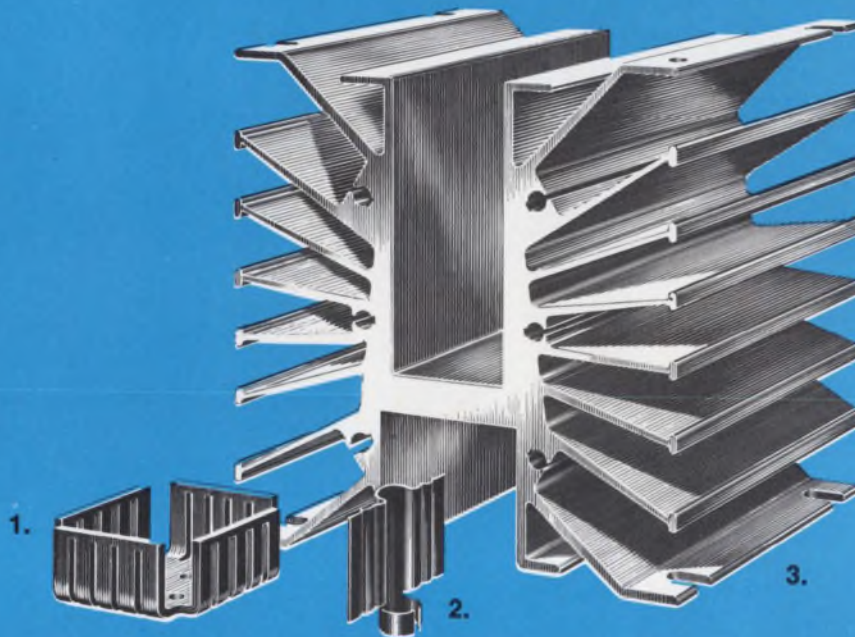

Over 200 styles and sizes with 24 hour delivery

If your heat dissipation requirements include:

- Maximum selection of heat sink styles
- Fast delivery
- Consistent quality
- Reliability of design
- Specialized engineering

Then heat sinks by ITC TOR are for you.

From a simple flag type dissipator to complex blower-cooled heat sinks; to dissipate ¼-watt or 500-watts; to cool one component or hundreds; ITC TOR offers a choice of over 200 styles and sizes, in-house control of all engineering and manufacturing phases, and creative engineering to solve any specialized heat dissipation problems.

AVAILABILITY. ITC TOR maintains a complete stock of standard heat sink styles and sizes and assures shipment of most orders within 24-hours.

SPECIAL SERVICES. Prototype through production-run quantities can be produced—economically and to your schedule—to the most exacting specifications by TOR machinists and fabrication specialists.

ENGINEERING. ITC TOR retains a complete engineering department to provide effective design for specialized heat sink applications. Since all engineering and

die making is accomplished at ITC TOR, the fastest design and delivery of specialized devices are assured.

NEW PRODUCTS. ITC TOR has just completed development of a line of liquid cooled heat dissipators capable of effectively replacing devices 20 to 40 times larger.

1. LP12 Series heat sinks are ideal for small space requirements and printed circuit applications. Measuring only 1.60 x 1.60 x .75 with less than 1 mil surface smoothness, they are capable of dissipating 16-watts for 100 degrees centigrade temperature rise. Prestamped configurations include both TO3 and TO66 transistor outline, and are available in a variety of finishes. Also available are special brackets for mounting multiple LP12's on a single side or back-to-back.

2. 400 Series flag-type heat sinks are one of several types available for TO-5 transistors. Friction mounting, the series provides high heat dissipation while requiring minimum layout space.

3. Series 1647 are specially engineered heat sinks providing heat dissipation up to 500 watts without forced con-

vection cooling. Heat sinks within this series can be pre-drilled to mount any type component or semiconductor device requiring high heat dissipation. Construction is extruded aluminum, and heat sinks are available unfinished or finished to customer specification.

4. Modular cooling units utilizing forced convection provide maximum heat dissipation performance of air cooled heat sinks. Special multiplane mounting surfaces accept all semiconductor types providing easy access and reduced circuitry. Units are available unassembled or assembled, with or without fan, pre-drilled or undrilled. Heat sink finish is black anodized with end plates of cadmium plated steel.

Heat dissipation problem? ... contact ITC TOR, a division of Industrial Technology Corporation, a Subsidiary of Republic Corporation, 1960 West 139th Street, Gardena, California 90249. Telephone (213) 334-4907. Complete catalog and wall chart on heat dissipators are available on request.

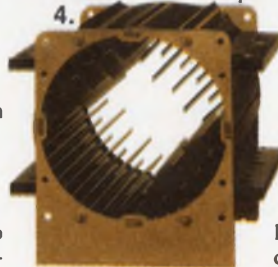

ITC TOR

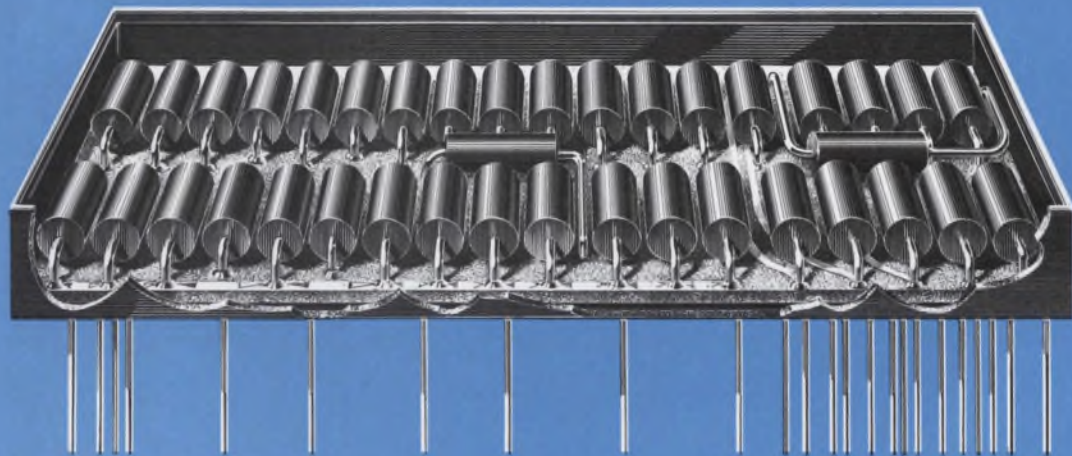

16 million hours of test time without a single failure.

ITC Riedon precision wirewound resistors combine this high reliability with close temperature coefficients, close tolerances, fast rise time and small size.

More specifically, they give you:

- Stability to 0.002%, provided by actually fusing resistance elements to terminations. Thermal emf is negligible.
- Standard temperature coefficient of 0 ± 10 ppm/°C above 100 ohms to 0 ± 30 ppm/°C for 0.1 to 9 ohms between -65°C and +150°C.
- Standard tolerance range from 1% down to 0.005%, measured at 25°C.
- Operation to 175°C, made possible by unique hot encapsulation, which eliminates virtually all moisture and voids.
- Rise time as fast as 10 nanoseconds up to 100KHz frequency input. (This puts

wirewounds where metal film was once the only solution.)

This performance should come as no surprise. Riedon originated the molding process for encapsulating resistors in epoxy. They were first to produce a molded epoxy encapsulated precision wirewound resistor that exceeded MIL-R-39005 and MIL-R-38100. They have qualified to the latest military specifications covering "Hi-Rel" parts (a failure rate of less than 0.01%/1,000 hours at 125°C and 60% confidence level).

These same resistors go into Riedon networks. We design and package

them in ladders, voltage dividers, analog-to-digital converters, operational amplifiers or miniaturized components. Combined with capacitors, conductors or diodes in a hermetically sealed package, one ITC Riedon element can replace 20 or more individual items.

We have a new 12-page folder that tells the full performance story of Riedon resistors. Why not send for a copy? ITC Riedon, a division of Industrial Technology Corporation, a subsidiary of Republic Corporation, 7932 Haskell Avenue, Van Nuys, California 91406 (213) 873-3464.



VISIT OUR BOOTH, UNIT D

*** WESCON/69**

ITC RIEDON

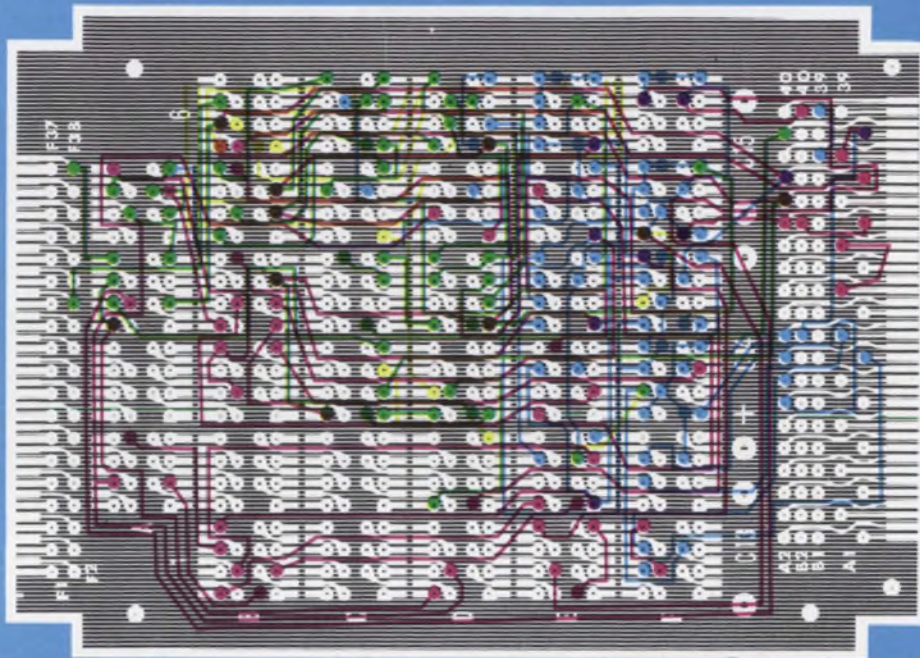

A few no-nonsense words about Multilayer Circuit Board cost vs. quality

We at ITC Circuit Products would like to set the record straight about the cost-to-quality relationship of multilayer boards.

When a multilayer circuit board manufacturer installs the most advanced equipment obtainable, institutes the best possible processes, places all development and production activity under rigorous engineering control, he will produce quality multilayer circuit boards.

And the net effect of all of this on cost is to lower it.

Yield is the key to cost Sound illogical? Not at all. The reason is that quality processes and equipment produce greater yield, and yield is the primary determinant of cost in any multilayer board production operation.

So when we set up our multilayer circuit board capability, that's the philosophy we built it on—the finest state-of-the-art facilities, equipment, and processes available in order to produce the best boards at lowest cost.

ITC's Laminating Presses finest in industry

Take our laminating press system, for instance. It's the most advanced of any circuit board manufacturer in the nation. The new system gives an unprecedented $\pm 1.5^\circ\text{F}$ temperature control over the entire platen which means absolute uniformity of resin state and cure. What does this do for us? To date, not a single board has been rejected at ITC for layer shift since the new laminating system was installed, a phenomenal record. Another example is precision cool and cure temperature control.

Because the temperature curve is so perfectly defined, we know the exact state of cure at all times and can take the board out of the press for oven-bake at just the right moment to achieve

predictable electrical characteristics. We never have to guess on oven curing.

Advanced equipment proving cost concept Precision laminating presses, numerically controlled, high-capacity drills, advanced photoresist processes — all these and many others daily are proving out ITC's concept of low cost through high-yield quality processes and equipment. ITC Circuit Products is ready for your order, be it quick turn-around prototype or long production run. Really, when at ITC Circuit

Products quality equals low cost, why take less?

ITC Circuit Products, a division of Industrial Technology Corporation, a subsidiary of Republic Corporation, 1111 Grand Street, El Segundo, California 90245, Telephone (213) 772-2531



VISIT OUR BOOTH, UNIT D
* WESCON/69

ITC CIRCUIT PRODUCTS

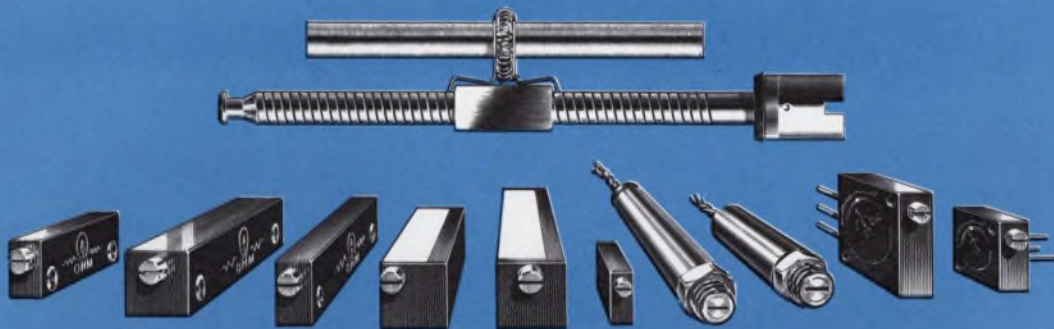

one source potentiometer buying

COMPARE THESE FEATURES BEFORE MAKING ANY POTENTIOMETER BUYING DECISIONS:

- SINGLE SOURCE FOR ALL REQUIREMENTS.** More than 9000 basic models, styles, resistance values and lead configurations assure the exact potentiometer for every application.
- WIDE RESISTANCE RANGE.** Rectangular, square, tubular, and slide wire configurations combine to provide resistance selection from ½-ohm to 150K ohms.
- PATENTED WIPER** trademarked "Quite Trim" is a most unique wiper design. Utilizing a ring of multiple contacts 360° around the resistance element, the wiper makes sequential contacts on each
- turn of resistance wire, greatly increasing resolution and decreasing noise even under extreme shock and vibration.
- LOW NOISE.** "Quiet Trim" wiper design provides extremely low contact noise. Every "Quite Trim" potentiometer is 100% inspected to assure noise of 20 ohms maximum.
- LOW TC** of only 50 ppm/° C of "Quiet Trim" potentiometers is far better than that required by MIL-R-27208.
- ESSENTIALLY ZERO END RESISTANCE.** An advanced technique of welding the leads to the resistance element permits the "Quite Trim" wiper to completely encompass the element and resulting in essentially zero end resistance.
- LOW COST INDUSTRIAL** units designed utilizing all MIL-SPEC techniques complement a complete line of MILITARY styles per MIL-R-27208.

Enough said...? Not quite! We haven't told you about our dual metal end clutch; insulated metal mandrell, imbedded in heat transfer epoxy for highest heat dissipation; emersion proof styles; and, how wire wound potentiometers have greater resolution, higher power capability, and lower TC than film types.

For complete specifications and prices, contact: ITC Control Components, a division of Industrial Technology Corporation, a subsidiary of Republic Corporation, 950 No. Sepulveda, El Segundo, California 90245, (213) 322-4950.

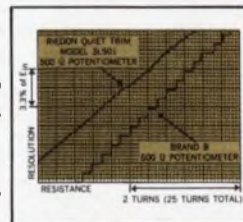

ITC CONTROL COMPONENTS

INFORMATION RETRIEVAL NUMBER 54

Here's the full technical program

A timetable showing who's giving papers, what the subjects are, and when and where the sessions are being held

Avionics and Aerospace

Collection of Data From in Situ Sensors Via Satellite—S. D. Dorfman, Hughes Aircraft Co. (12.1/Wed./p.m./C)

Application of Satellites to Domestic Record Data and Video Transmission—W. B. Gross, General Electric (12.2/Wed./p.m./C)

A Multiple Access Satellite Relay System for Low Data Rate Users—P. J. Heffernan, NASA-Goddard Space Flight Center (12.3/Wed./p.m./C)

Wideband Transmission of Photographic Data Using the IDCSP Satellites—W. J. Gill, Philco-Ford (12.4/Wed./p.m./C)

Coding and Signal Selection for the Data Relay Satellite Interrogation Channel—G. D. Boyce, General Dynamics Convair (12.5/Wed./p.m./C)

Integrated Avionics—Richard D. Alberts, AF Avionics Lab. (19.1/Fri./a.m./A)

Federated vs. Integrated Computer Systems—J. H. Crenshaw, IBM Federal Systems Division (19.2/Fri./a.m./A)

Role of Man and Machine in Future—L. S. Guarino, Naval Air Development Center (19.3/Fri./a.m./A)

Realizing Objectives for Complex Avionic Computer Systems—H. Barry Schoenky, Teledyne Computer Systems Division (19.4/Fri./a.m./A)

Design Concepts in Avionics and Space Equipment—J. R. Goodykoontz, V. A. Karpenko, TRW Systems Group (19.5/Fri./a.m./A)

Designing Avionic Equipment for Automatic Testing—Richard O. Barrett, Honeywell Aerospace Division (21.1/Fri./a.m./A)

Circuit Theory

Microwave Circuit Synthesis and Measurement—H. Stinehelfer, W. Atwood, Microwave Associates (6.4/Tues./p.m./C)

A Novel Approach to High Frequency Trigger Circuit Design—Richard McMorro, William Farnbach, Hewlett-Packard Co. (13.2/Thur./a.m./A)

Computer-Aided Circuit Analysis—Harry B. Lee, Mass. Institute of Technology (23.1/Fri./p.m./B)

Bipolar Transistor Modeling for Computer-Aided Design—William G. Howard Jr., University of California (23.2/Fri./p.m./B)

Network Design by Mathematical Optimization—S. W. Director, Univ. of Florida (23.3/Fri./p.m./B)

Computer-Aided Layout—Les Hazlett, Motorola (23.4/Fri./p.m./B)

Automatic Test Synthesis—E. R. Jones, Fairchild Semiconductor (23.5/Fri./p.m./B)

Papers by categories:

Avionics and Aerospace
Circuit Theory
Communications
Computers and Computer-Aided Design
Education
Industrial Electronics
Material and Packaging
Management and Marketing
Microelectronics
Microwaves
Solid-State Devices and Theory
Test Equipment and Measuring Techniques

Communications

VHF MOS Receiver "Front-End"—Richard Q. Lane, Fairchild Semiconductor (9.1/Wed./a.m./C)

Linear ICs in Consumer Television and AM/FM Receivers—S. B. Marshall, G. W. Haines, Sprague Electric Co. (9.2/Wed./a.m./C)

Efficient Use of Pins in Complex Communication Subsystems—Robert A. Hirschfield, National Semiconductor (9.3/Wed./a.m./C)

The Systems Approach to the Design of Integrated Communication Circuits—Hans R. Camenzind, Signetics Corp. (9.4/Wed./a.m./C)

University-Industry Television, Radio and Telephone Links—Albert J. Morris, Genesys Systems (10.1/Wed./p.m./A)

Stanford Instructional TV Network—Joseph M. Pettit, Donald J. Grace, Stanford University (10.2/Wed./p.m./A)

Association for Continuing Education (ACE)—Julian Johnson, ACE (10.3/Wed./p.m./A)

UC at Berkeley-TV Plans and Status—George Maslach, University of California (10.4/Wed./p.m./A)

University of Santa Clara-TV Plans and Status—Charles Dirksen, Univ. of Santa Clara (10.5/Wed./p.m./A)

Television Instruction at San Jose State College—Norman O. Gunderson, San Jose State (10.6/Wed./p.m./A)

UC at Irvine-UCLA-TV Systems, Plans and Status—Robert M. Saunders, UC, Irvine (10.7/Wed./p.m./A)

Univ. of Southern California-Instructional TV Network—Jack Munshian, USC. (10.8/Wed./p.m./A)

Digital Implementation of Data Transmission Modulators and Demodulators—W. J. Melvin, Collins Radio (11.1/Wed./p.m./B)

A Simple Adaptive Equalizer for Efficient Data Transmission—D. Hirsch, W. J. Wolf, Bell Telephone Lab. (11.2/Wed./p.m./B)

Practical Adaptive Equalizers for Data Transmission—Gerald K. McAuliffe, IBM Watson Research Center (11.3/Wed./p.m./B)

Recent Developments in Error Control Techniques—Allen H. Levesque, General Telephone and Electronics Labs. (11.4/Wed./p.m./B)

Collection of Data From in Situ Sensors Via Satellite—S. D. Dorfman, Hughes Aircraft Co. (12.1/Wed./p.m./C)

Application of Satellites to Domestic Record Data and Video Transmission—W. B. Gross, General Electric (12.2/Wed./p.m./C)

Multiple-Access Satellite Relay System for Low Data Rate Users—P. J. Heffernan, NASA-Goddard Space Flight Center (12.3/Wed./p.m./C)

Wideband Transmission of Photographic Data Using the IDCSP Satellites—W. J. Gill, Philco-Ford (12.4/Wed./p.m./C)

Coding and Signal Selection for the Data Relay Satellite Interrogation Channel—G. D. Boyce, General Dynamics Convair (12.5/Wed./p.m./C)

Bulk Semiconductor Devices for Microwaves, Millimeter Waves, and Beyond—John A. Copeland, Bell Telephone Labs. (20.3/Fri./a.m./B)

Linear Circuits for Communications Applications—Derek Bray, Fairchild Semiconductor (20.4/Fri./a.m./B)

Computers and Computer-Aided Design

Using Computer-Aided Design in Production and Testing of Custom LSI—Robert Ulrickson, Fairchild Semiconductor (1.2/Tues./a.m./A)

Stripline Characterization by Computer—H. E. Brenner, Bell Telephone Labs. (6.1/Tues./p.m./C)

Computer-Aided Small Signal Transistor Modeling—F. H. Musa, Motorola Semiconductor (6.2/Tues./p.m./C)

Computer-Aided Design of GaAs Impatt Diodes—C. K. Kim, Micro-

state Electronics (6.3/Tues./p.m./C)

Microwave Circuit Synthesis and Measurement—H. Stinehelfer, W. Atwood, Microwave Associates (6.4/Tues./p.m./C)

Computerized Wide-Band Amplifier Design—Les Besser, Hewlett-Packard (6.5/Tues./p.m./C)

Computer-Aided Design of Microwave Integrated Circuits—Gary J. Policky, Texas Instruments (6.6/Tues./p.m./C)

Time Sharing: Why, When, Whither?—Robert Forest, Datamation Magazine (7.1/Wed./a.m./A)

What can the Electronics Industry do for Time-Sharing?—Kas Terhorst, Computer Design Corp. (7.2/Wed./a.m./A)

Computer Languages—Why so Many, and What is the Application for each in the Engineering Community?—Paul Sleeper, Remote Computing Corp. (7.3/Wed./a.m./A)

Time-Sharing in Engineering Education—And After—Eugene H. Koff, California State College at Los Angeles (7.4/Wed./a.m./A)

The Stand Alone, Central or Satellite Approach for Computer Control of Manufacturing Processes—James E. Stuehler, IBM (8.1/Wed./a.m./B)

Factory Data Collection—A Case Study—James D. Edwards, Lockheed Missiles & Space (8.2/Wed./a.m./B)

Computer Controlled On Line Testing and Inspection—Peter H. Goebel, General Radio (8.3/Wed./a.m./B)

Automated Factory: An Overview and Predictions—Walter R. Anderson, IRA Systems (8.4/Wed./a.m./B)

Code to abbreviations

a.m.—Morning sessions (10 a.m. to 12:30 p. m.)

p.m.—Afternoon sessions (2 p.m. to 4:30 p.m.)

All sessions will be held in the following meeting rooms at the Cow Palace:

A—Meeting Room A

B—Meeting Room B

C—Meeting Room C

Numerals refer to sessions and to papers within a session—for example, 6/1 is paper 1 in session 6.

Computer Techniques in High Frequency Circuit Design—Alan J. DeVilbiss, Hewlett-Packard (13.1/Thur./a.m./A)

Theory of Automatic Processing—Frank E. Boerger, IBM Corp. (16.1/Thur./p.m./A)

Equipment for Automatic Processing—Donald G. Pedrotti, Hugel Industries (16.2/Thur./p.m./A)

Case History of Automatic Processing— (16.3/Thur./p.m./A)

The Future of Automatic Processing—C. Clifford Roe, Fairchild Semiconductor (16.4/Thur./p.m./A)

Status Trends & Predictions of Display Devices—Edwin H. Holborn, NASA Electronics Research Center (18.1/Thur./p.m./C)

Displaying Engineering Data in Systems Applications on a Color CRT—I. M. C. Griesacker, General Electric Co. & Walter H. Tew, General Electric (18.2/Thur./p.m./C)

Image Distribution System, An Approach Toward Personal Displays—Joe T. Ma, IBM Corp. (18.3/Thur./p.m./C)

The Application of Digital Television Displays to Computer-Directed Control Systems—S. E. Grooms, Philco-Ford (18.4/Thur./p.m./C)

On-Line Graphics for Information Handling & Display—John E. Peyton Jr., Boeing (18.5/Thur./p.m./C)

Designing Avionic Equipment for Automatic Testing—Richard O. Barrett, Honeywell Aerospace Division (21.1/Fri./a.m./C)

Development of Software Systems for Automated Test Equipment (CATE)—Eddie J. Johnson, James V. McCarthy, SDC (21.2/Fri./a.m./C)

A Computer Controlled Test System—Frank M. Stutesman, Bendix Navigation & Control Division (21.3/Fri./a.m./C)

Hardware / Software Management—Computer Aided Testing—D. S. Bassett, Emerson Electric Co. (21.4/Fri./a.m./C)

Computer-Aided Circuit Analysis—Harry B. Lee, Mass. Institute of Technology (23.1/Fri./p.m./B)

Bipolar Transistor Modeling for Computer-Aided Design—William G. Howard Jr., University of California (23.2/Fri./p.m./B)

Network Design by Mathematical Op-

Exclusive Technical Session Order Form

Please send me the following WESCON technical session preprints at \$2.00 per session (average: four papers per session), plus \$1 mailing charge per complete order. I understand this order will be mailed to my address within two weeks after receipt. Offer good until November 1, 1969. Packaging symposium record is also available.

(Note: Papers bound by sessions; no individual papers available).

Session No.	Quantity	Session No.	Quantity
1		15	
2		16	
3		17	
5		18	
6		19	
8		20	
9		21	
10		22	
11		23	
12			
13			
14			

Packaging Symposium Record \$12.00

Total Sessions x \$2.00 = \$ _____

Plus \$1.00 Mailing Charge = \$ 1.00

Total Cost = \$ _____

Make check payable to WESCON and mail with this form to:

WESCON
3600 Wilshire Blvd.
Los Angeles, Calif. 90005

DATE _____

NAME _____

FIRM _____

STREET ADDRESS _____

CITY, STATE, ZIP CODE _____

timization—S. W. Director, Univ. of Florida (23.3/Fri./p.m./B)

Computer-Aided Layout—Les Hazlett, Motorola (23.4/Fri./p.m./B)

Automatic Test Synthesis—E. R. Jones, Fairchild Semiconductor (23.5/Fri./p.m./B)

Education

Time-Sharing in Engineering Education—And After—Eugene H. Koff, California State College at Los Angeles (7.4/Wed./a.m./A)

University-Industry Television, Radio and Telephone Links—Albert J. Morris, Genesys Systems (10.1/Wed./p.m./A)

Stanford Instructional TV Network—Joseph M. Pettit, Donald J. Grace, Stanford University (10.2/Wed./p.m./A)

Association for Continuing Education (ACE)—Julian Johnson, ACE (10.3/Wed./p.m./A)

UC at Berkeley—TV Plans and Status—George Maslach, University of California (10.4/Wed./p.m./A)

University of Santa Clara—TV Plans and Status—Charles Dirksen, Univ. of Santa Clara (10.5/Wed./p.m./A)

Television Instruction at San Jose State College—Norman O. Gunderson, San Jose State (10.6/Wed./p.m./A)

UC at Irvine—UCLA—TV Systems, Plans and Status—Robert M. Saunders, UC, Irvine (10.7/Wed./p.m./A)

Univ. of Southern California—Instructional TV Network—Jack Munushian, USC (10.8/Wed./p.m./A)

Industrial Electronics

The Stand Alone, Central, or Satellite Approach for Computer Control or Manufacturing Processes?—James E. Stuehler, IBM (8.1/Wed./a.m./B)

Factory Data Collection—A Case Study—James D. Edwards, Lockheed Missiles & Space (8.2/Wed./a.m./B)

Computer Controlled On Line Testing and Inspection—Peter H. Goebel, General Radio (8.3/Wed./a.m./B)

Automated Factory: An Overview and Predictions—Walter R. Anderson, IRA Systems (8.4/Wed./a.m./B)

Theory of Automatic Processing—Frank E. Boerger, IBM Corp. (16.1/Thur./p.m./A)

Equipment for Automatic Processing—Donald G. Pedrotti, Hugel Industries (16.2/Thur./p.m./A)

Case History of Automatic Processing— (16.3/Thur./p.m./A)

The Future of Automatic Processing—C. Clifford Roe, Fairchild Semiconductor (16.4/Thur./p.m./A)

Material and Packaging

Solid Logic Technology Manufacturing—Walter J. Schuelke, IBM (2.1/Tues./a.m./B)

Bonding Techniques for Integrated Circuits—Robert W. Helda, Motorola Inc. (2.2/Tues./a.m./B)

Beam Lead Assembly Technology—Brian Dale, Sylvania Electronics System (2.3/Tues./a.m./B)

Manufacturing Concept for Beam Lead Assembly—D. K. Thomson, Western Electric Co. (2.4/Tues./a.m./B)

Management and Marketing

Impact of LSI Technology on the Electronic Market—Glenn E. Penisten, Texas Instruments (1.3/Tues./a.m./A)

The Vendor User Interface With MOS Universal Arrays—M. M. Kaufman, G. E. Skorup, RCA Defense Electronics (1.4/Tues./a.m./A)

The Many Routes to the Money Market—William B. Hugel, Hugel Industries (5.1/Tues./p.m./B)

Selling the Package: What They Want to Hear—David C. Thompson, Linear Systems (5.2/Tues./p.m./B)

Holding Your Own in the Money Market—Gordon L. Ness, Ness Industries (5.3/Tues./p.m./B)

Why, How and When to go Public—David S. M. Lanier Jr., Compar Corp. (5.4/Tues./p.m./B)

European Electronics Market: 1969—R. J. Larkin Jr., Ampex Corp. (14.1/Thur./a.m./B)

Marketing Electronic Products in Japan—James K. Imai, Mentor Japan (14.2/Thur./a.m./B)

The New Asian Electronics Market Outside of Japan—G. B. Levine,

Mentor International (14.3/Thur./a.m./B)

Alternatives to Direct Sales, License, Joint Venture, and Subsidiary—Carl J. Bradshaw, Oad Electronics Corp. (14.4/Thur./a.m./B)

Hardware / Software Management—Computer Aided Testing—D. S. Bassett, Emerson Electric Co. (21.4/Fri./a.m./C)

Microelectronics

Who Needs LSI In-House Capability—George Hare, The Singer Co. (1.1/Tues./a.m./A)

Using Computer-Aided Design in Production and Testing of Custom LSI—Robert Ulrickson, Fairchild Semiconductor (1.2/Tues./a.m./A)

Impact of LSI Technology on the Electronics Market—Glenn E. Penisten, Texas Instruments (1.3/Tues./a.m./A)

The Vendor User Interface With MOS Universal Arrays—M. M. Kaufman and G. E. Skorup, RCA Defense Electronics (1.4/Tues./a.m./A)

Solid Logic Technology Manufacturing—Walter J. Schuelke, IBM (2.1/Tues./a.m./B)

Bonding Techniques for Integrated Circuits—Robert W. Helda, Motorola Inc. (2.2/Tues./a.m./B)

Beam Lead Assembly Technology—Brian Dale, Sylvania Electronics System (2.3/Tues./a.m./B)

Manufacturing Concept for Beam Lead Assembly—D. K. Thomson, Western Electric Co. (2.4/Tues./a.m./B)

Solid State Microwave Variable Delay Devices—Ernst K. Kirchner, Microwave Electronics (3.1/Tues./a.m./C)

Bulk GaAs and Impatt Microwave Sources—W. Keith Kennedy, Jr., Watkins-Johnson (3.2/Tues./a.m./C)

Microwave Transistor Amplifier Design—James R. Reid, Avantek Inc. (3.3/Tues./a.m./C)

Parameters Used in Specifying Varactor-Tuned Solid State Oscillators—William D. Heichel, Thomas R. Bushnell, Stewart Div., Watkins-Johnson Co. (3.4/Tues./a.m./C)

UHF Integrated Microcircuits—Robert M. Knox, IIT Research Institute (3.5/Tues./a.m./C)



Miniature microwave counter by Systron-Donner counts from 300 MHz to 3 GHz. It will be on display at booth 1412.

Survey of Active Filtering Techniques Using Integrated Circuits—Sanjit Mitra, University of California (4.1/Tues./p.m./A)

A State Variable and Gyrator Realization-Comparison—Robert Bewcomb, Stanford University (4.2/Tues./p.m./A)

Active Filters Employing Silicon Monolithic Gyration—Robert Hove, Boeing Company (4.3/Tues./p.m./A)

Multiloop Negative Feedback Active Filters Using Thick Film Integrated Circuit Techniques—Dennis Hallenbeck, Kinetic Tech. (4.4/Tues./p.m./A)

FEN Filter Design Using Hybrid Integrated Blocks—George Moschytz, Bell Telephone Laboratories (4/5/Tues./p.m./A)

ICs and Thick Films Add Up to Improved RC Active Filters—William Broyles, Sprague Electric (4.6/Tues./p.m./A)

VHF MOS Receiver "Front-End"—Richard Q. Lane, Fairchild Semiconductor (9.1/Wed./a.m./C)

Linear ICs in Consumer Television and AM/FM Receivers—S. B. Marshall, G. W. Haines, Sprague Electric Co. (9.2/Wed./a.m./C)

Efficient Use of Pins in Complex Communication Subsystems—Robert A. Hirschfeld, National Semiconductor (9.3/Wed./a.m./C)

The Systems Approach to the Design of Integrated Communication Circuits—Hans R. Camenzind, Signetics Corp. (9.4/Wed./a.m./C)

MOS ICs: The Designer's Dilemma—Glen Madland, Integrated Circuit Engineering Corp. (15.1/Thur./a.m./C)

MOS ICs: Answers to Systems Problems—Ralph Parris, Burroughs Corp. (15.2/Thur./a.m./C)

MOS/LSI: A Joint Business Venture—Larry Drew, Viatron Computer Systems Corp. (15.3/Thur./a.m./C)

MOS ICs: Bipolar Compatibility Is Here—Leland Seely, General Instrument Corp. (15.4/Thur./a.m./C)

MOS ICs: The Promise of Things to Come—Al Phillips, Autonetics (15.5/Thur./a.m./C)

Monolithic Voltage Regulators—Thomas M. Frederiksen, Motorola Integrated Circuits Center (17.1/Thur./p.m./B)

Voltage Regulator Capabilities Using Hybrid Techniques—George W. Smith, Beckman Instruments Inc. (17.2/Thur./p.m./B)

High Power Hybrid Amplifiers—Herb Miezal, Dale Baugher, and Leon Balents, RCA (17.3/Thur./p.m./B)

Controlling Power on a Chip—William D. Whittekin Sr., Texas Instruments (17.4/Thur./p.m./B)

What is Needed in Power Microcircuits—James W. Williams, Hughes Aircraft Co. (17.5/Thur./p.m./B)

New Solid-State Products—Digital Circuits—Morris Chang, Texas Instruments, Semiconductor Circuits Division (20.2/Fri./a.m./B)

Linear Circuits for Communication Applications—Derek Bray, Fairchild Semiconductor (20.4/Fri./a.m./B)

Microwaves

Solid State Microwave Variable Delay Devices—Ernst K. Kirchner, Microwave Electronics (3.1/Tues./a.m./C)

Bulk GaAs and Impatt Microwave Sources—W. Keith Kennedy, Jr., Watkins-Johnson (3.2/Tues./a.m./C)

Microwave Transistor Amplifier Design—James R. Reid, Avantek Inc. (3.3/Tues./a.m./C)

Parameters Used in Specifying Varactor-Tuned Solid State Oscillators—William D. Heichel, Thomas R. Bushnell, Stewart Div., Watkins-Johnson Co. (3.4/Tues./a.m./C)

UHF Integrated Microcircuits—Robert M. Knox, IIT Research Institute (3.5/Tues./a.m./C)

Stripline Characterization by Computer—H. E. Brenner, Bell Telephone Labs. (6.1/Tues./p.m./C)

Computer-Aided Small Signal Transistor Modeling—F. H. Musa, Motorola Semiconductor (6.2/Tues./a.m./C)

Computer-Aided Design of GaAs Impatt Diodes—C. K. Kim, Microstate Electronics (6.3/Tues./

p.m./C)

Microwave Circuit Synthesis and Measurement—H. Stinehelfer, W. Atwood, Microwave Associates (6.4/Tues./p.m./C)

Computerized Wide-Band Amplifier Design—Les Besser, Hewlett-Packard (6.5/Tues./p.m./C)

Computer-Aided Design of Microwave Integrated Circuits—Gary J. Policky, Texas Instruments (6.6/Tues./p.m./C)

Bulk Semiconductor Devices for Microwaves, Millimeter Waves, and Beyond—John A. Copeland, Bell Telephone Labs (20.3/Fri./a.m./B)

Linear Circuits for Communications Applications—Derek Bray, Fairchild Semiconductor (20.4/Fri./a.m./B)

Solid-State Devices and Theory

Solid State Microwave Variable Delay Devices—Ernst K. Kirchner, Microwave Electronics (3.1/Tues./a.m./C)

Bulk GaAs and Impatt Microwave Sources—W. Keith Kennedy, Jr., Watkins-Johnson (3.2/Tues./a.m./C)

Microwave Transistor Amplifier Design—James R. Reid, Avantek Inc. (3.3/Tues./a.m./C)

Parameters Used in Specifying Varactor-Tuned Solid State Oscillators—William D. Heichel, Thomas R. Bushnell, Stewart Div., Watkins-Johnson Co. (3.4/Tues./a.m./C)

UHF Integrated Microcircuits—Robert M. Knox, IIT Research Institute (3.5/Tues./a.m./C)

Ecological Niches for Optoelectronic Devices—E. E. Loebner, H. Borden, Hewlett-Packard Co. (20.1/Fri./a.m./B)

New Solid-State Products—Digital Circuits—Morris Chang, Texas Instruments, Semiconductor Circuits Division (20.2/Fri./a.m./B)

Bulk Semiconductor Devices for Microwaves, Millimeter Waves, and Beyond—John A. Copeland, Bell Telephone Labs (20.3/Fri./a.m./B)

Linear Circuits for Communications Applications—Derek Bray, Fairchild Semiconductor (20.4/Fri./a.m./B)

Test Equipment and Measuring Techniques

A Novel Approach to High Frequency Trigger Circuit Design—Richard McMorro, William Farnbach, Hewlett-Packard Co. (13.2/Thur./a.m./A)

Transient Oscillography with Photographic Media—A. E. Ames, R. C. Jones, G. R. Bird, Polaroid Corp. Research Labs (13.3/Thur./a.m./A)

High Speed Single Transient Oscilloscopes, the State of the Art, and Current Potential for Mating to On-Line Computers—Gordon Longerbeam, Jay Wiedwald, Larry Ferdner, Lawrence Radiation Lab (13.4/Thur./a.m./A)

The TRAC System—G. St. Leger-Barter, Lawrence Radiation Lab. and S. Walter, EG&G (22.1/Fri./p.m./A)

Wideband Attenuation and Phase Measurements on High Quality Coaxial Cables—R. L. Rhoads, A. M. Evans, Lawrence Radiation Lab. (22.2/Fri./p.m./A)

Wideband System Function Analyzer Employing Time to Frequency Domain Translation—A. M. Nicolson, Sperry Rand (22.3/Fri./p.m./A)

An Iterative, Time Domain Method of System Response Correction—M. P. Ekstrom, Lawrence Radiation Laboratory (22.4/Fri./p.m./A)

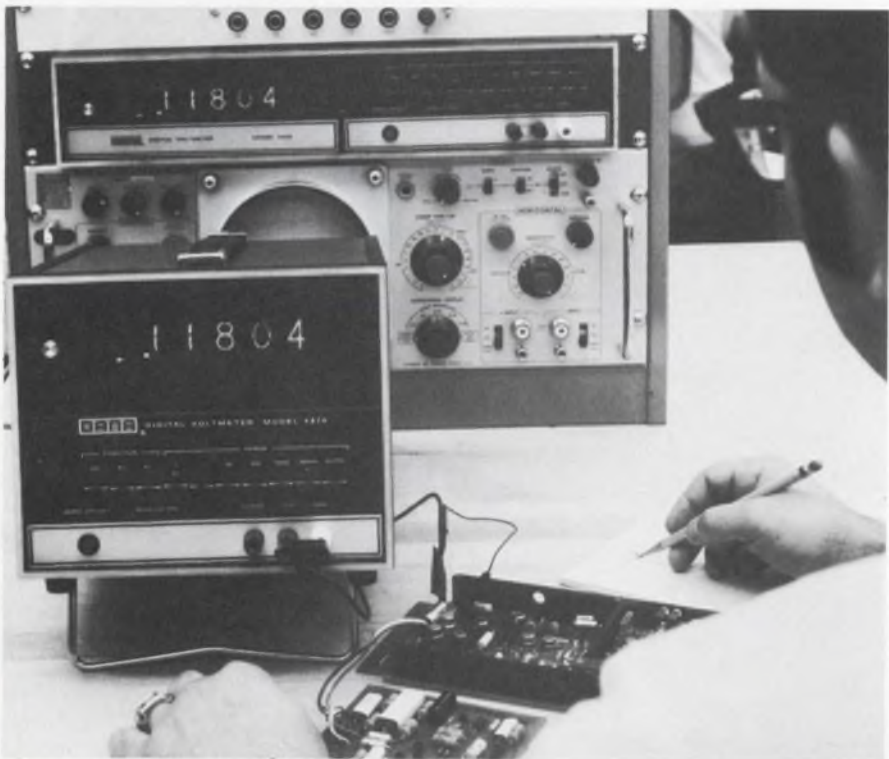

Model 4500 digital voltmeter in two packaging configurations for rack mount and bench applications will be on display at Dana Laboratories booth 2008.

It's a GRrrrand Counter

Aye, that's what you'll think of our new counter. From its wee size to its big performance, the 1192 is new in every respect.

- It's only 8½ inches wide by 3½ inches high.
- It measures frequency (from dc to 32 MHz), period (single and multiple), time interval, frequency ratio, and, of course, it counts.
- Units of measurement and decimal point are automatically displayed.
- Input sensitivity is another surprise, a wee 10 mV is all you need (up to 25 MHz); and you can control trigger threshold and attenuation.
- An internal crystal oscillator gives more than enough stability for most work.

You can select an 1192 with 5, 6, or 7 digits, with or without BCD output, and for bench or rack use. And if 32 MHz is not enough frequency range for you, add our new 1157-B scaler (same size) to the 1192 and zoom up to 500 MHz. The counter/scaler combination, the 1192-Z, has a common cabinet. There's more, lots more, to tell about the 1192; we'll gladly send you a free data sheet upon request.

But the grandest part of all about the 1192 is the money you'll save when you buy one. Prices* range from \$575 for the 5-digit bench model without data output to \$845 for a 7-digit rack model with data output. You can add the scaler for another \$850. Imagine, a 500-MHz counter for as little as \$1425. Man, that's a real bargain. You can save quite a few more dollars by ordering two or more units and taking advantage of GR's quantity-discount plan. Discounts range from 3% for 2-4 units to 20% for 100 units.

For free literature (postpaid) or a demonstration at our expense, write or call General Radio Company, West Concord, Massachusetts 01781; telephone 617 369-4400. In Europe (except Scotland), write Postfach 124, CH 8034 Zurich 34, Switzerland. In Scotland, write General Radio Company (U.K.) Limited, Bourne End, Buckinghamshire, England, for special attention.

*Prices apply only in the U. S. A.

GENERAL RADIO



What's NEW at GUARDIAN®

GUARDIAN® ELECTRIC MANUFACTURING COMPANY 1550 W. Carroll Ave., Chicago, Illinois 60607

NEW

GUARDIAN

LEVER SWITCHES

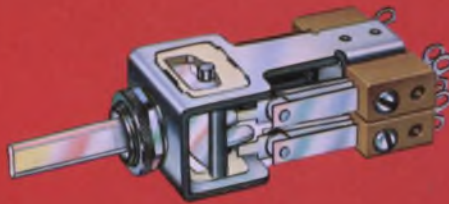

- Available with two or three switching positions. ■ Nine versions combining off, momentary or locked positions. ■ Snap-in inserts permit changing actuator switching positions at any time. ■ Non-illuminated or illuminated with color coding. ■ Contacts rated at both 1½ and 10 amps at 115V AC resistive. ■ Up to 4 pole double throw per station. ■ .110 Quick Connect Terminals and/or Solder Terminals.



Circle No. 231 For Literature.

NEW

GUARDIAN

PRINTED CIRCUIT PLUG-IN RELAY



- Unique, compact design. ■ All terminals on .1 grid spacing for standard printed circuit board. ■ Solders right on PC board. ■ Conforms to UL requirements for Business Machines. ■ 1 watt normal power—½ watt on request. ■ 3500 OHMS coil resistance (120V AC-60Hz). ■ Standard voltages 6 to 120 AC—6 to 24 DC. ■ Mechanical life over 10,000,000 operations. ■ 3 AMP. resistive 115V. 60Hz contact rating.



Circle No. 232 For Literature.

new

GUARDIAN SOLID STATE RELAYS



- Universal AC or DC control voltage with complete circuit isolation from load switching circuit.
- Externally-adjustable pull-in voltage level from 80-130V AC or DC, with close differential between pull-in and drop-out where accurate voltage sensing is required.
- Control of high inrush lamp, inductive or normal resistive loads from 10 ma to 3 amps.
- Internal filtering prevents random turn-on of "off" contacts.



Circle No. 233 For Literature.

NEW

GUARDIAN PUSH BUTTON SWITCH BANKS

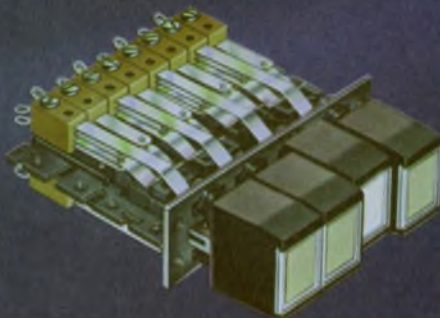

- Sleek, compact design—only 1 1/8" high.
- Non-illuminated or illuminated with color coding.
- Buttons on 5/8" centers.
- Up to 12 stations in multiples of 2.
- Contacts rated at both 1 1/2 amp and 10 amps at 115V AC resistive.
- Up to 4 pole double throw per station.
- .110 Quick Connect Terminals.
- End panel has four 5/32" tapped mounting holes.
- Long life—100,000 mechanical operations.



Circle No. 234 For Literature.

NEW

GUARDIAN LIFT OFF STEPPERS

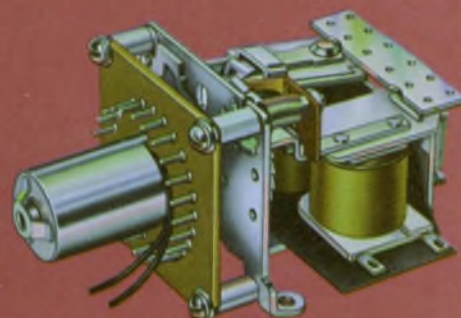

All the features of the widely used Guardian MER 24 point electrical reset stepper . . .

PLUS

- Solenoid "lifts" wiper contacts when stepping to reduce friction . . . and arcing.
- Increased contact ratings to 5 amps resistive at 120V AC.
- Increased function capability.
- Increased dependability.
- Increased life expectancy—now up to 10,000,000 steps.
- Compact design.



Circle No. 235 For Literature.

If Hybrid IC Active Filters
with passive filter
stability could solve your
problems,
you'd
probably
pay more
for them
than \$30
per pole pair.



Try our FS-20 (delivery is off the shelf!)

■ Here's what you get: Band-pass, high-pass and low-pass outputs simultaneously ■ Any desired form of the second order transfer function ■ Complex zeros anywhere in the S-plane ■ Multi-loop negative feedback for added stability ■ F_c and Q of basic unit can be tuned by adding external resistors ■ Frequency range from DC to 50 kHz ■ Q range from 0.1 to 500 ■ Voltage gain is adjustable to 40 dB ■ Supply voltages from $\pm 9V$ to $\pm 15V$ with 250 mW power consumption ■ Dimensions: (14-pin DIP) 0.804" x 0.366" x 0.474"

Gentlemen at KTI:

Please send me more information on:

- FS-20 All Active Filters Hybrid Subsystems
 Put me on your permanent mailing list

Name _____

Company _____

Address _____

City _____

State _____ ZIP _____

My applications are: _____

PRICES:	1-5	\$47	26-99	\$37
	6-10	\$42	100-999	\$35
	11-25	\$39	1000-2000	\$28

KTI

KINETIC TECHNOLOGY, INCORPORATED

17465 Shelburne Way, Los Gatos, California 95030

(408) 356-2131 TWX: 910-597-5390

The name to remember for Hybrid Integrated Systems and Active Filters . . .

New ways in digital automation with:

- Shaft Encoders, 34 types
- Synchro-to-Digital Converters, 6 types
- Analog-to-Digital Converters, 10 types
- Solid-State Digital Modules, 136 types

FREE . . . 58 Pages

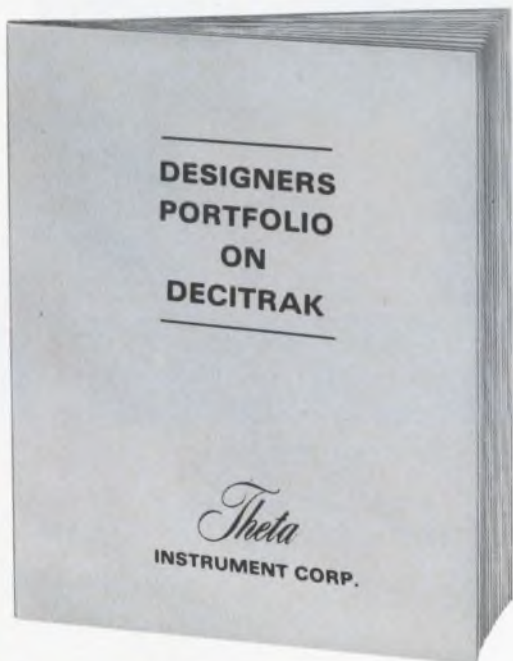

Includes copy of
"A Primer on Shaft Encoders"

We call it the DECITRAK® SYSTEM

Selecting from hundreds of off-the-shelf digital transducers and circuits, we assemble a remarkably low-cost, customized digital system for control/display/logging. DECITRAK can perform as simple a job as providing remote digital display of antenna pedestal position. Or, as impressive a task as the precise control of massive prime movers in response to punched-card commands.

Need a computer interface? A code converter? A typewriter driver? Set-point controls? Let a Theta Application Specialist tailor a system to your specific needs from the field-proven line of DECITRAK digital components.

More than 1,000 of these systems are now in use in nuclear installations, satellite tracking stations, wind tunnels, and aboard ships.

Theta

INSTRUMENT CORPORATION

FAIRFIELD, NEW JERSEY 07006 • PHONE: 201-227-1700 • TELEX: 138353

INFORMATION RETRIEVAL NUMBER 57

Curtains Up!

It's showtime.

Instrumentation.....	U118
Microwaves & lasers.....	U136
Components.....	U142
ICs & semiconductors.....	U152
Modules & subassemblies...	U160
Data processing.....	U172
Packaging & materials	U180
Production	U186

Dual-trace oscilloscope boasts a real-time frequency response from dc all the way out to 250 MHz.

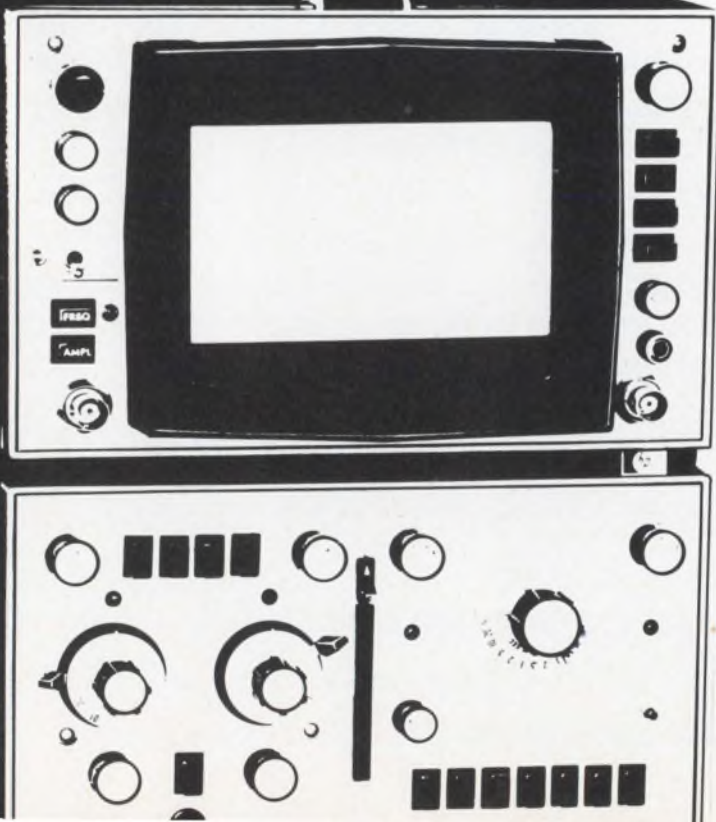

Segmented fluorescent readout with alphanumeric capability shrinks envelope to T-5-1/2 size for high-density packaging.

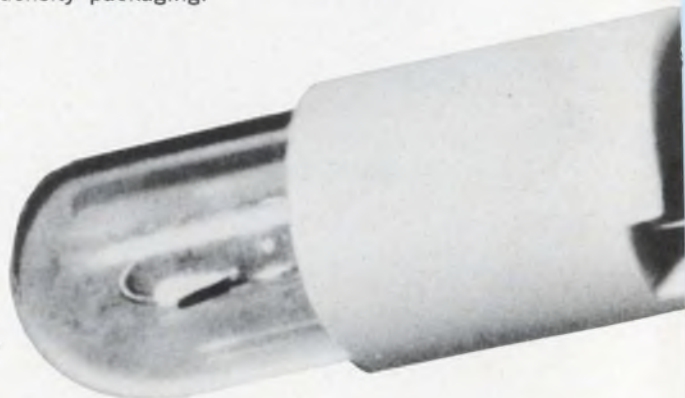

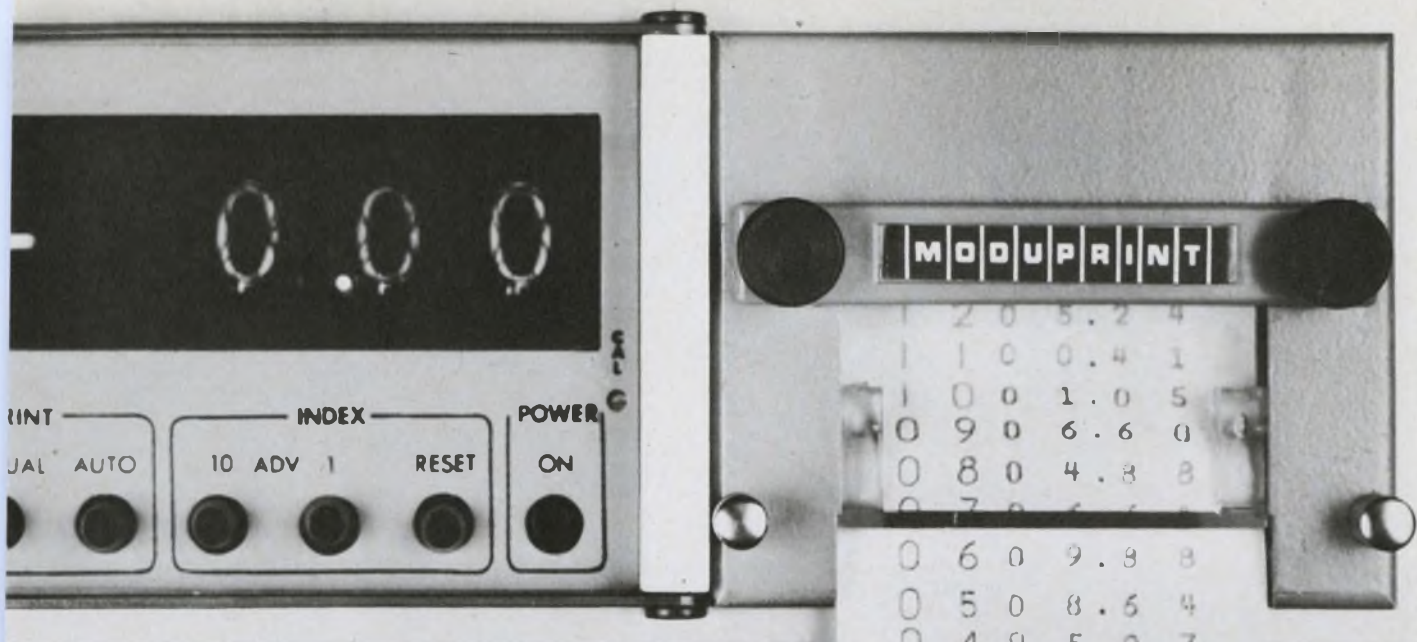

Printing digital voltmeter with 3-1/2-digit readout occupies only 3-1/2 by 8 in. of a front panel.

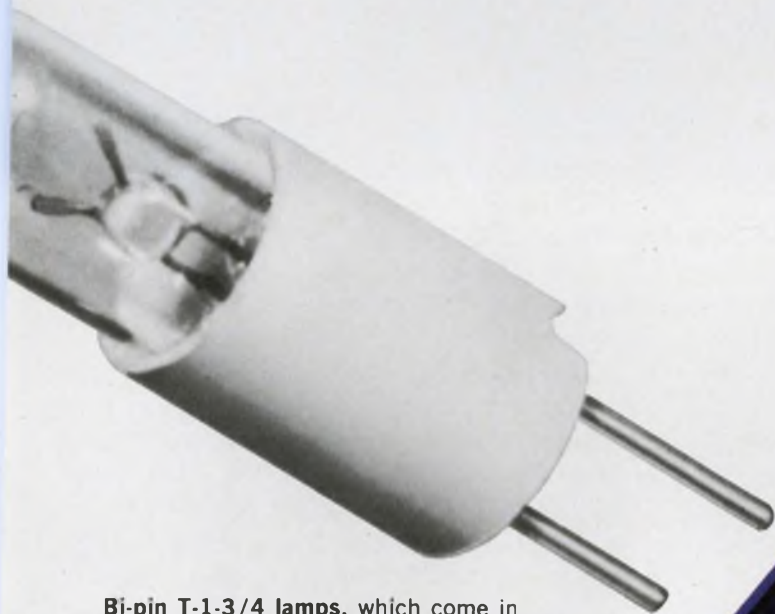

Bi-pin T-1-3/4 lamps, which come in five different styles, have a tough plastic base.

Streamlined digital multimeter, which costs only \$345, never loads the circuit being measured. It has a 3-1/2-digit readout.





Now, ready for you in quantity.

The new Delco Radio DTS-701 and 702 NPN triple-diffused silicon high voltage transistors. They were designed for the tough requirements of off-line deflection in large screen TV.

However, they're built and tested for extra reliability in all high energy circuits. Proved by the surest peak energy capability rating in the business: Pulse Energy Testing.

And right now, they're available in both production and sample quantities.

Why will you want to use the Delco 701 or 702?

For the tough jobs—high inductive load switching or for circuits subject to transients or fault conditions.

For reduction of weight, size and component costs. Circuit complexity and number of components are reduced, so assembly costs go down, too. And fewer components mean higher reliability.

So now you know. The pioneer in high voltage silicon power has done it again.

For prices, samples or complete data, just call us or the nearest Delco Radio distributor listed below.

SEMICONDUCTOR DISTRIBUTORS

ALA., BIRMINGHAM • Forbes Distributing Company, Inc.
(205)-251-4104

ARIZ., PHOENIX • Sterling Electronics, Inc. (602)-258-4531

CAL., LOS ANGELES • Kierulff Electronics, Inc. (213)-685-5511
• Radio Products Sales, Inc. (213)-748-1271

CAL., PALO ALTO • Kierulff Electronics, Inc. (415)-968-6292

CAL., SAN DIEGO • Milo of California, Inc. (714)-232-8951

COLO., COLORADO SPRINGS • L. B. Walker Radio Co. (303)-636-1661

COLO., DENVER • L. B. Walker Radio Co. (303)-935-2406

COLO., ENGLEWOOD • Hyer Electronics Co. (303)-771-5285

FLA., MIAMI • Mountain Electronics, Division of
Mountain National Co. (305)-634-4556

FLA., WEST PALM BEACH • Mountain Electronics, Division of
Mountain National Co. (305)-883-5701

ILL., ROSEMONT • F-J-R/Midwest, Inc. (312)-678-8560

ILL., SKOKIE • Merquip Electronics, Inc. (312)-282-5400

IND., INDIANAPOLIS • Graham Electronics Supply, Inc.
(317)-634-8486

MD., BALTIMORE • Radio Electric Service Co. (301)-539-3835

MASS., NEWTON • The Greene Shaw Co., Inc. (617)-969-8900

MICH., KALAMAZOO • Electronic Supply Corp. (616)-381-4626

MINN., MINNEAPOLIS • Stark Electronics Supply Co. (612)-332-1325

MO., KANSAS CITY • Walters Radio Supply, Inc. (816)-513-7015

MO., ST. LOUIS • Electronic Components for Industry Co.
(314)-647-5505



1200V - 3.0A
800V - 0.5A

DTS-701	
Collector to emitter voltage (V_{CE0})	800V
Sustaining voltage ($V_{CE0 (SUS)}$)	600V min.
Emitter to base voltage (V_{EB0})	5V
Collector current (I_C)	500mA
Base current (I_B)	100mA
Power dissipation (P_T)	25W
DTS-702	
Collector to emitter voltage (V_{CEX})	1200V
Collector to emitter voltage (V_{CE0})	1000V
Sustaining voltage ($V_{CE0 (SUS)}$)	750V min.
Emitter to base voltage (V_{EB0})	5V
Collector current (I_C)	3A
Base current (I_B)	1A
Power dissipation (P_T)	50W

Available in solid copper. JEDEC TO-3 package.

Kokomoan's Regional Headquarters

Union, New Jersey* 07083
 Box 1018 Chestnut Station
 (201) 687-3770
 Chicago, Illinois* 60656
 5151 N. Harlem Avenue
 (312) 775-5411
 Santa Monica, Calif.* 90401
 726 Santa Monica Blvd.
 (213) 870-8807
 Detroit, Michigan 48202
 57 Harper Avenue
 (313) 873-6560

Kokomo, Ind. 46901
 700 E. Firmin
 (317) 459-2175 Home Office
 *Office includes field lab
 and resident engineer
 for application assistance.



THE KOKOMOANS ARE IN POWER
DELCO RADIO
 DIVISION OF GENERAL MOTORS
 KOKOMO, INDIANA

N.J., CLIFTON • Eastern Radio Corporation (201)-471-6600
 N.M., ALBUQUERQUE • Hyer Electronics Company (505)-265-5767
 • Sterling Electronics Inc. (505)-247-2486
 N.Y., BINGHAMTON • Federal Electronics, Inc. (607)-748-8211
 N.Y., NEW YORK • Harvey Radio Co., Inc. (212)-582-2590
 N.Y., WOODBURY, L.I. • Harvey Radio Company, Inc. (516)-921-8700
 OHIO, CINCINNATI • United Radio, Inc. (513)-761-4030
 OHIO, CLEVELAND • The W. M. Pattison Supply Co., Industrial
 Electronics Division (216)-411-3000
 OHIO, DAYTON • F-J-R/Ohio, Inc. (513)-278-9411
 OKLA., OKLAHOMA CITY • Radio, Inc. (405)-235-1551
 OKLA., TULSA • Radio, Inc. (918)-587-9124

PENN., PHILADELPHIA • Almo Electronics, Division of
 Sterling Electronics (215)-676-6000
 PENN., PITTSBURGH • RPC Electronics (412)-782-3770
 TEXAS, DALLAS • Adleta Electronics Company (214)-742-8257
 TEXAS, FORT WORTH • Adleta Electronics Co. (817)-336-7446
 TEXAS, HOUSTON • Harrison Equipment Co., Inc. (713)-224-9131
 UTAH, SALT LAKE CITY • Hyer Electronics Company (801)-487-3681
 VA., RICHMOND • Meridian Electronics, Inc. (703)-353-6648
 WASH., SEATTLE • Kierulff Electronics, Inc. (206)-763-1550
 WASH., TACOMA • C & G Electronics Co. (206)-272-3181
 CANADA, ONT., SCARBOROUGH • Lake Engineering Co., Ltd.
 (416)-751-5980

Dual-trace oscilloscope performs from dc to 250 MHz

Hewlett-Packard, 1501 Page Mill Rd., Palo Alto, Calif. Phone: (415) 326-7000. P&A: \$1750 for mainframe; November, 1969.

Providing real-time response from dc all the way to 250 MHz, a new dual-trace oscilloscope, model 183A, does not sacrifice viewing ease, operating ease, sensitivity, or plug-in versatility. This means that the 183A can be used to view digital words and other groups of short-duration fast-rise pulses found in computers and high-speed

digital systems.

It is also useful for displaying single short pulses that occur at low repetition rates, like those generated by laser beam detectors. In addition, the new 250-MHz oscilloscope can analyze communications systems performance, and makes possible pre-detection display of modulation envelopes on rf carriers.

The 183A is a compact, all-solid-state, plug-in instrument that can be operated like any well-behaved dual-trace oscilloscope—with either

of two input signals displayed alternately on successive sweeps or at the same time in a chopped (time-shared) mode. It can also present the sum or difference of two input signals.

Calibrated deflection factors are switch selected from a sensitivity of 10 mV per division of 1 V per division. The sweep circuits trigger reliably on internally picked-off 250-MHz signals that produce 1-cm deflections, or on 250-MHz external signals with amplitudes as low as 20 mV pk-pk. Signal delay in the vertical channel allows viewing the leading edge of the signal that triggers the sweep.

The new 183A oscilloscope achieves its 250-MHz performance with a new cathode-ray tube that has distributed deflection electrodes to obtain high-frequency performance while preserving deflection sensitivity. Each deflection electrode is a metallic ribbon, wound in a helix and slightly flattened to improve the electrostatic field deflection between the two electrodes. This new CRT is actually capable of performance beyond 500 MHz.

The high-frequency performance of the new oscilloscope is obtained without restricting its usefulness for general-purpose applications. The mainframe works with all plug-ins designed for Hewlett-Packard's series 180 oscilloscopes. These include a four-channel 50-MHz amplifier, a delaying-sweep time base, and a 12.4-GHz sampling and time-domain reflectometer plug-in.

With its 1840A time base, the 183A triggers at repetition rates from dc to 250 MHz. A variable hold-off control allows stable display of pulse groups by permitting repeated triggering on a particular pulse in the group. Sweep times are selectable from 10 ns/cm to 0.1 s/cm.

Further contributing to precision measurements, the mainframe's calibrating waveform has risetime specified, as well as amplitude and frequency. The waveform is a pulse train with 10% duty cycle and 0.8-ns risetime. Its amplitude can be either -50 mV or -500 mV; repetition rate is 2 kHz or 1 MHz.

Booth No. 1040 Circle No. 412

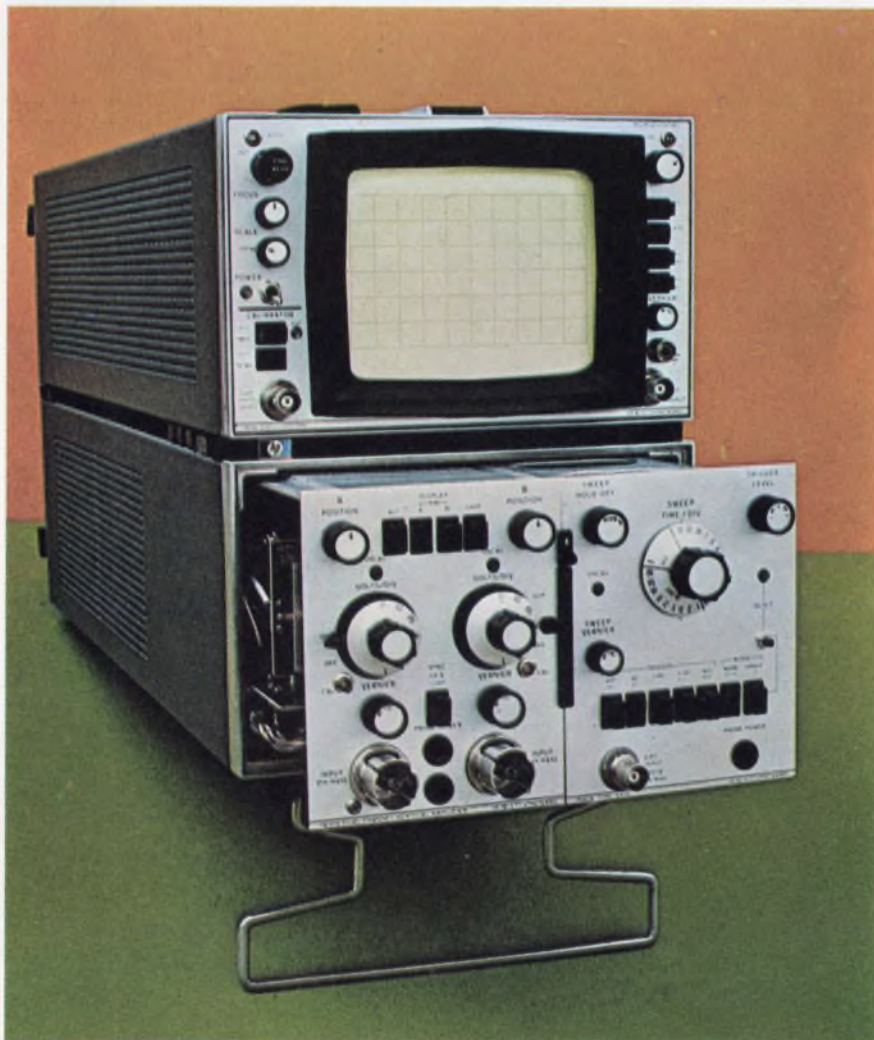

High-performance dual-trace oscilloscope with distributed-electrode CRT features a real-time response from dc out to 250 MHz. It can be used to analyze the short-duration fast-rise pulses of high-speed digital systems.

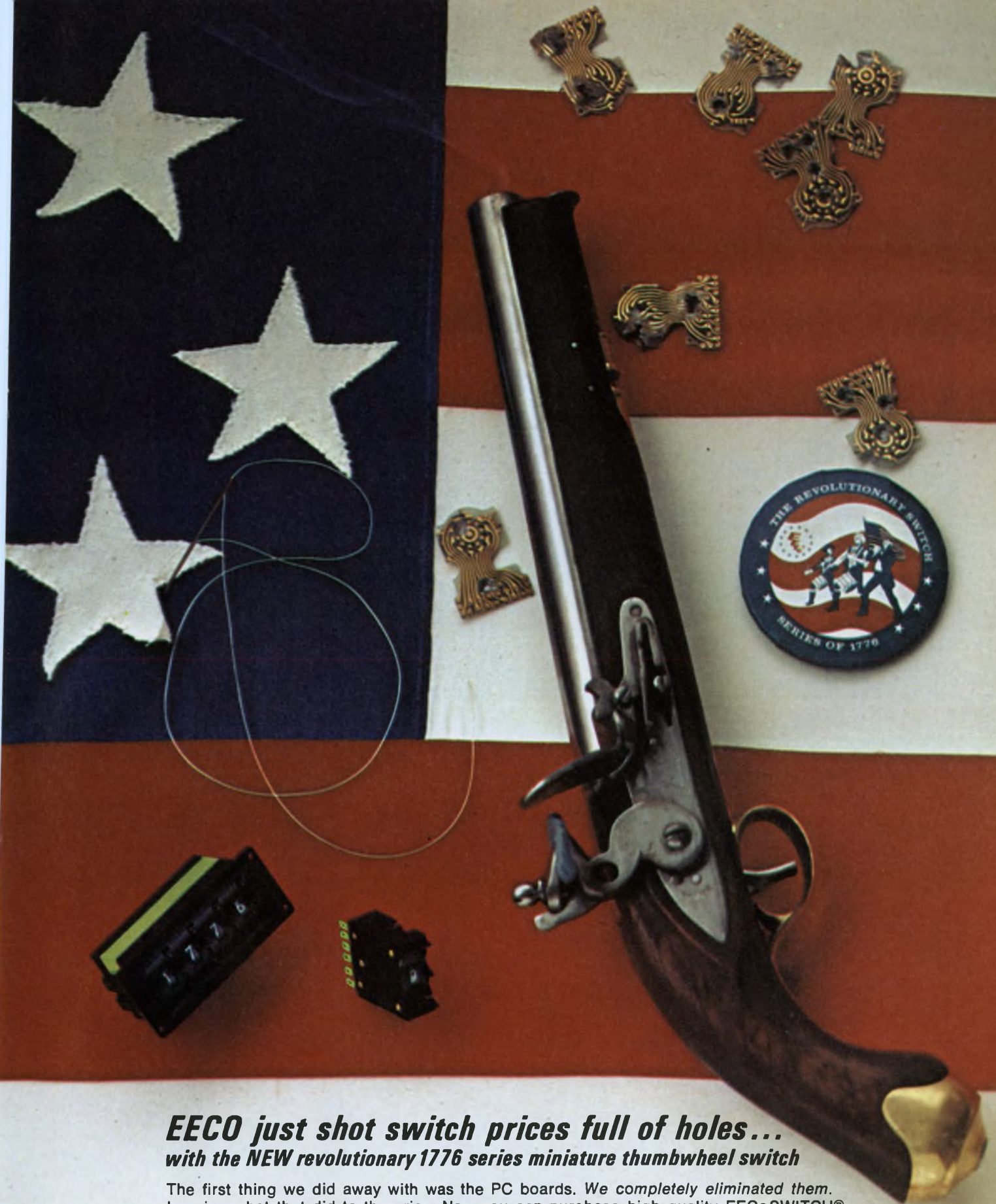

***EECO just shot switch prices full of holes...
with the NEW revolutionary 1776 series miniature thumbwheel switch***

The first thing we did away with was the PC boards. We completely eliminated them. Imagine what that did to the price. Now you can purchase high quality EECoSWHCH[®] thumbwheel switches for only \$3.00 in 1 to 9 quantities. How's that for representation without taxation? We've also developed a simplified technique for fast, low-cost assembly of multiple switch stations for this revolutionary new product. The 1776 is the all-American answer to your switch requirements.

Join the revolution! Write today for your campaign button and data sheet on the Series of 1776.



ELECTRONIC PRODUCTS DIVISION | ELECTRONIC ENGINEERING COMPANY OF CALIFORNIA

1441 East Chestnut Avenue | Santa Ana, California 92702 (714) 547-5651

See EECO's Series of 1776 at WESCON Booth numbers 3814 thru 3817.

Digital \$345 multimeter ends loading problems



Digilin Inc., div. of Cura-Containers, 6533 San Fernando Rd., Glendale, Calif. Phone: (213) 246-8161. P&A: \$340; 30 days.

Able to virtually eliminate circuit loading at all times, a new digital multimeter sells for only \$345 in quantities of one to four, with price dropping to \$299 in quantities of five to nine. Portable and compact, model 340 is a 3-1/2-digit completely self-contained instrument, free of all plug-ins.

Using a new patent-pending a/d conversion method called an input-amplifier technique, the 340 multimeter keeps its high input impedance constant so that the circuit being measured is not disturbed at all. In many other a/d techniques, such as dual-slope integration, input impedance drops after the measuring cycle. This can interject transient noise into the circuit being measured.

The readout display consists of three Nixie-type plug-in tubes, with memory capacity for a non-blinking display, and a neon "1" indicator. Decimal points are auto-

matically programmed by a range key; a minus sign lights to indicate negative signals.

To eliminate drift and assure instant stability, the new multimeter incorporates an automatic zero adjustment. The unit can operate directly from any ac line since it has a self-contained power supply.

The 340 can measure full-scale ac and dc voltages from 1 to 1000 V, full-scale ac and dc currents from 100 μ A to 1 A, and full-scale resistances from 1 k Ω to 10 M Ω . It offers 100% overranging on all ranges and an overvoltage protection of 100 times the range setting.

Its maximum sensitivity is 1 mV for voltage, 100 nA for current, and 1 Ω for resistance. Full-scale accuracies are $\pm 0.1\%$, ± 1 digit, for dc voltage; $\pm 0.2\%$, ± 1 digit, for ac voltage; and ± 0.2 to $\pm 1\%$, ± 1 digit, for resistance.

This 3-lb instrument has a measurement cycle of approximately five times per second. Its response time is 20 ms. Dimensions are 6 by 9 by 5-1/2 in., including the integral handle.

Booth No. 1014 Circle No. 406

Dual-beam oscilloscope displays scale factors



Tektronix Inc., P.O. Box 500, Beaverton, Ore. Phone: (503) 644-0161. P&A: \$1850; fourth quarter, 1969.

Using fiber optics to digitally indicate current or voltage deflection factors plus the time set on its deflection controls, a new dual-beam oscilloscope is a high-gain, differential, low-frequency instrument. Type R5030 also offers color-coded sections of controls to outline functions and a CRT viewing area that is increased by 50% over conventional 8 by 10 cm units. Booth No. 2101 Circle No. 297

Digital panel meter has 0.1% accuracy

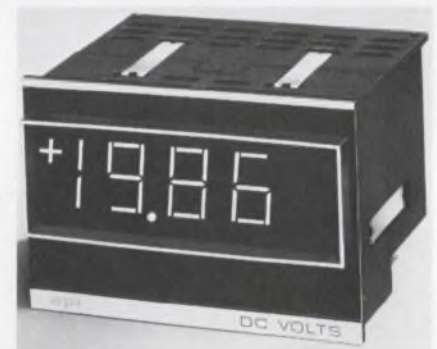

API Instruments Co., 11655 Chilli-cothe, Chesterland, Ohio. Phone: (216) 729-7377.

A new digital panel meter, with four digits for a display to 1999, has an accuracy of 0.1%, a resolution of 1 part in 4000, and a continuous BCD output that is DTL/TTL compatible. Other standard features include automatic polarity, display hold, print command, polarity and overrange outputs, and selectable decimal points. Model 4304 offers a seven-bar segmented display.

Booth No. 1404 Circle No. 352

Gold, silver, stainless steel and uncompromising design produce the Shallcross Series 1 Rotary.

We begin our Shallcross Series 1 rotary switches with the best materials. Materials that promise superior performance and long service.

Like stainless steel in non-current carrying parts. Coin silver contacts and terminals. Gold plating available on all current-carrying parts.

We deploy these materials in an uncompromising design. Enclosed diallyl phthalate construction keeps out airborne contaminants. Contact resistance is 2.5 milliohms max. initially and remains unusually stable. Our double-wipe-to-air action takes care of that.

Solid detent feel is provided by a set of stainless steel balls riding a hill-and-valley stainless plate. Special lubricants are used on all friction points.

Conform to MIL-S-3786/SR 28A

Shallcross one-inch Series switches are built to MIL-S-3786/SR 28A. Temperature range -65° to $+125^{\circ}$ C. Our new ratings are: 2 amperes (115 vac or 28 vdc)—5000 cycles; 1 ampere (115 vac or 28 vdc)—25,000 cycles.

End-of-life contact resistance typically 5 to 10 milliohms. 30° indexing, up to 12 positions per pole available.

Fast local service

Evaluate our Series 1 for military applications and your most demanding industrial and commercial needs. We're ready to supply prototypes to your specs on short notice. And deliver production quantities to your schedules. Contact your local Cutler-Hammer Stocking Switch Distributor.

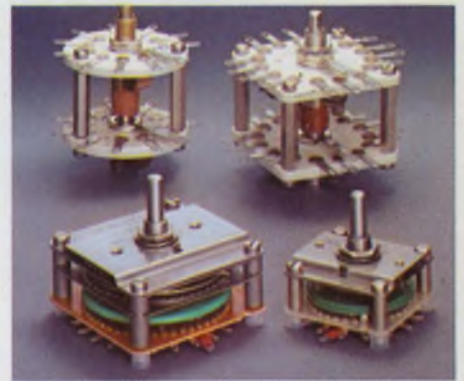

Cutler-Hammer's extensive line of Shallcross quality rotary switches includes $1\frac{3}{4}$ " and $2\frac{1}{2}$ " deck models as well as round and oval ceramics to fit your most demanding requirements.

shallcross

A CUTLER-HAMMER COMPANY Selma, N.C. 27576



Ingredients for greatness.



Switch
to No.1

More than just switches:
prompt availability,
field help, innovation,
quality assurance too.

TRYGON HAS THE POWER

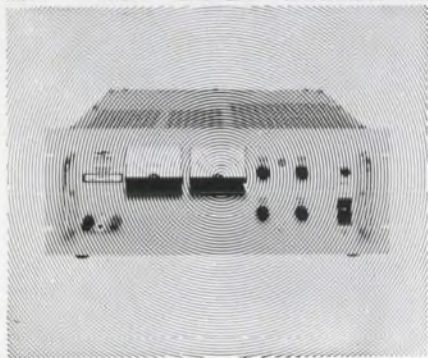

to deliver wide range constant voltage constant current performance for every lab and system application.

- All silicon design—precision performance
- Wide voltage ranges—currents to 100 amps
- Positive convection cooling—no derating
- Overvoltage and ultra-high stability options
- Automatic load share paralleling
- Priced from \$575.

"Super-Mercury from TRYGON . . . the competitively-priced series of fully programmable wide-range power supplies, power and value packed.

Super-Mercury: Designed for bench or rack installation with slide provisions at no extra cost . . . in ranges up to 160 volts and up to 100 amps. Regulation of 0.005% and 0.015% stability are standard (0.005% stability optional) as is MIL Spec, RFI-free performance. Total ripple and noise: less than 1 mV RMS; Master-slave tracking, auto-load share paralleling and remote sensing and programming also standard. Write for the full TRYGON power story

TRYGON DOES HAVE THE POWER!



TRYGON POWER SUPPLIES

111 Pleasant Avenue, Roosevelt, L.I., N.Y. 11575
 Trygon GmbH 8 Munchen 60, Haidelweg 20, Germany
 Write for Trygon 1968 Power Supply Handbook.
 Prices slightly higher in Europe.

INFORMATION RETRIEVAL NUMBER 61

Printing digital voltmeter occupies only 8-in. width

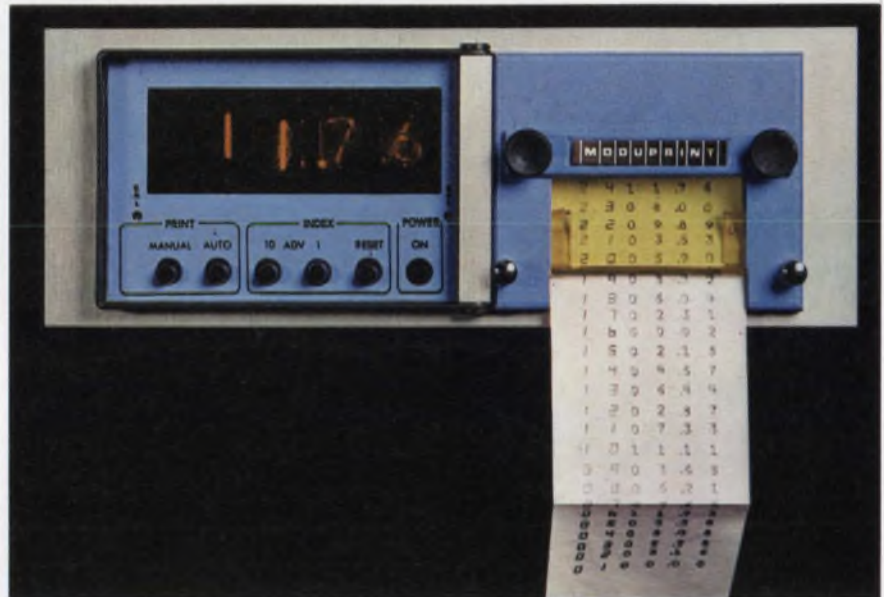

Presin Co., Inc., Trap Falls Rd., Shelton, Conn. Phone: (203) 929-1495. P&A: \$500, \$550 with index; 4 wks.

Designed for either half-rack or base mounting, a new printing voltmeter incorporates a 3-1/2-digit readout within a front-panel space measuring only 3-1/2-in. high by 8 in. wide. The PDM 611 operates from any line voltage; all its power supplies are built in. Measured values are displayed on illuminated numeric readout tubes.

Ranging is indicated automatically on the digital display by a decimal point, and by a fixed decimal point in the printer. Overranging to 100% is shown by a "1" in both the tube and printed readings.

This new digital printing voltmeter has an accuracy of 0.1%, ± 1 digit, and a normal-mode rejection ratio of 20 dB at 60 Hz. It also offers overload protection and an operating temperature range of 0 to 50°C.

The PDM 611 is a fixed-range device available for full-scale voltages from 1.999 mV to 199.9 V and full-scale currents from 1.999 μ A

to 199.9 mA.

Printing can be in one of two modes, either manual or automatic. In the manual mode, a pushbutton is used to trigger a drive pulse to the print solenoid. In the automatic mode, printing occurs at the completion of each encode. Automatic printing speeds can be as high as three lines per second.

As printing proceeds, a two-digit index advances and prints on each line. This serves to help identification.

These two index columns, with a separate type font for the data, can be changed by pushbutton pulsing into both the tens and units registers. The index can be reset by a single command pulse.

The recorded voltage reading is visible immediately after printing, and does not have to be extracted to be read. Fanfold paper, 2-1/4-in. wide, is used in the printer.

Optionally, the paper can be taken up in a box attached to the front panel. Printing is by means of a throw-away inked platen that is adequate for 40,000 lines of print.

Booth No. 1141 Circle No. 407



We call it INCONNECT®. Our new Molex modular system that provides five ways of interconnecting electrical-electronic printed circuit assemblies: Two ways to connect circuit boards to chassis, three ways to interconnect printed circuit boards. It's a giant step forward in helping speed production and assembly techniques in the area of printed circuits. Unique flexibility enables you to tailor connector components to your specific product needs. Easily. Simplifies assembly, testing, servicing and model change requirements. It's another example of the Molex creative approach to circuitry problems. One that demonstrates just how reliable and economical printed circuit connections can really be. But see for yourself. Write for details. Or you can make connections by calling (312) 969-4550.



THE MATING REASON

In the course of human events, it is that intangible something. In the relationship between cable and RF connector, it is that tangible K-Grip.[®] That's the mating reason. A crimp design, its unique 3-piece configuration makes assembly foolproof and simple, and guarantees a lasting cable-to-connector attachment. Where space and weight are design factors, Kings has the K-Grip Jr.[®] that's 50% smaller and lighter (with moisture-proof plugs and jacks), plus a new SMA series of miniature RF Connectors that can be assembled in 1/5 the time required for conventional types.

Time-saving, cost-saving K-Grips are matched to your cables — matched to fit, to last, to perform. For the K-Grip product story, see EEM Section 2100, or write —

KINGS

ELECTRONICS CO., INC.
40 Marbledale Road/Tuckahoe, N.Y. 10707
(914) SW 3-5000 / TWX 914-793-5879

Visit us at WESCON Booth 3706 Cow Palace
INFORMATION RETRIEVAL NUMBER 63

INSTRUMENTATION

Plug-in oscilloscopes show scale factors

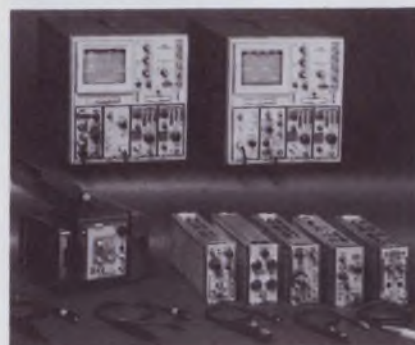

Tektronix, Inc., P. O. Box 500, Beaverton, Ore. Phone: (503) 644-0161. P&A: \$250 to \$2500; fourth quarter, 1969.

Forming a full measurement system, series 7000 plug-in oscilloscopes consist of two mainframes and 13 plug-in units. The new instruments feature a CRT that displays deflection factors, polarity, and any uncalibrated condition for all channels, corrected for probe attenuators and magnifiers. The plug-ins include six amplifiers, four time-base units, and three sampling units.

Booth No. 2101 Circle No. 388

Digital bridge tests impedance

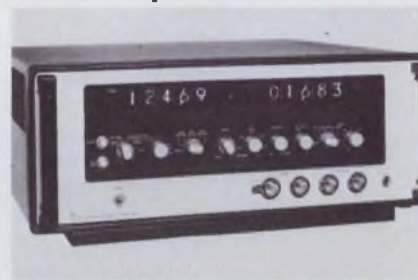

General Radio Co., 300 Baker Ave., West Concord, Mass. Phone: (617) 369-4400.

Model 1683 is a general-purpose, low-frequency, automatic series-impedance bridge with digital readout that measures capacitors, inductors, and resistors with loss expressed as equivalent series resistance or dissipation factor. Provisions for five-terminal connections to the unknown component ensure accurate measurements by minimizing errors due to lead impedances and stray capacitances.

Booth No. 1726 Circle No. 359

Transistor analyzer reads noise directly



Hewlett-Packard, 1501 Page Mill Rd., Palo Alto, Calif. Phone: (415) 326-7000. Price: \$4450.

A new transistor noise analyzer directly measures all three bipolar transistor noise characteristics: noise figure, noise current, and noise voltage. Model 4470A has a noise-figure measurement range for both bipolars and FETs from 0 to 40 dB, with source resistance selectable from 10 Ω to 10 M Ω . Noise voltage is measured with essentially short-circuit transistor input impedances; bipolar noise current is measured with practically infinite input impedances.

Booth No. 1040 Circle No. 295

Inexpensive DVMs reject 80-dB noise



Dana Laboratories, Inc., 2401 Campus Drive, Irvine, Calif. Phone: (714) 833-1234. Price: \$2000.

Series 4500 economy digital voltmeters offer 0.01% long-term accuracy, 80-dB normal-mode noise rejection, and full multimeter capability including dc/dc ratio measurements. Using dual-slope integration, the new instruments provide a full four-digit readout, with a fifth digit for 20% over-ranging. Other features include pushbutton operation, and auto-ranging and autopolarity in all functions except ratio.

Booth No. 2008 Circle No. 354

Digital phase meter resolves to 0.1°



Wavetek, P.O. Box 651, San Diego, Calif. Phone: (714) 279-2200. P&A: \$1500; 30 days.

Using a closed loop design to insure stable long-term phase measurements in varying temperature environments, a new digital phase meter gives 0.1° resolution with a plus or minus sign indicating the lead/lag relation. Model 750 has two ranges, -180 to +180° and 0 to 360°, to assure continuous phase data without discontinuities at 0 and +180°.

Booth No. 2027 Circle No. 349

Parametric supplies ignore line changes



Wanlass Instruments, 1540 E. Edinger Ave., Santa Ana, Calif. Phone: (714) 547-5171. P&A: from \$375; stock.

Providing parametric dc power, series PDC supplies allow input voltage to drop as low as 60 V ac and go as high as 150 V ac without affecting their dc output; voltages above and below this level merely turn off the units. In addition, normal-mode noise rejection is 80 dB to 1 MHz. Response time is 25 μ s.

Booth No. 2119 Circle No. 357

THE MATING REASON

K-Grip Jr.® — A crimp design whose unique 3-piece configuration makes assembly foolproof and guarantees a lasting cable-to-connector attachment.

K-Grip Jr.® — 50% smaller, 50% lighter... the design answer to better RF connectors.

Typical Types*

P/N	Series	Type	Finish
for RG Cable 174, 179A, 179B, 187, 187A, 188 & 188A/U			
KC-59-95	BNC	Plug	Silver
KC-59-152	BNC	Plug	TR-5™
KC-59-109	BNC	Angle Plug	Silver
KC-39-34	BNC	Jack	Silver
KC-39-50	BNC	Jack	TR-5
KC-19-68	BNC	Bulkhead Jack	Silver
KC-19-93	BNC	Bulkhead Jack	TR-5
KA-59-69	TNC	Plug	Silver
KA-59-120	TNC	Plug	TR-5
KA-59-70	TNC	Angle Plug	Silver
KA-39-27	TNC	Jack	Silver
KA-19-42	TNC	Bulkhead Jack	Silver
KA-19-60	TNC	Bulkhead Jack	TR-5
for RG Cable 122, 180, 180A, 195 & 195A/U			
KC-59-107	BNC	Plug	Silver
KC-59-169	BNC	Plug	TR-5
KC-59-108	BNC	Angle Plug	Silver
KC-59-171	BNC	Angle Plug	TR-5
KC-39-36	BNC	Jack	Silver
KC-39-52	BNC	Jack	TR-5
KC-19-67	BNC	Bulkhead Jack	Silver
KC-19-96	BNC	Bulkhead Jack	TR-5
KA-59-58	TNC	Plug	Silver
KA-59-142	TNC	Plug	TR-5
KA-59-74	TNC	Angle Plug	Silver
KA-39-28	TNC	Jack	Silver
KA-39-44	TNC	Jack	TR-5
KA-19-41	TNC	Bulkhead Jack	Silver
for RG Cable 58, 58A, 58C & 141/U			
KC-59-78	BNC	Plug	Silver
KC-59-123	BNC	Plug	TR-5
KC-59-101	BNC	Angle Plug	Silver
KC-59-153	BNC	Angle Plug	TR-5
KC-39-26	BNC	Jack	Silver
KC-39-38	BNC	Jack	TR-5
KC-19-61	BNC	Bulkhead Jack	Silver
KC-19-83	BNC	Bulkhead Jack	TR-5
KA-59-44	TNC	Plug	Silver
KA-59-103	TNC	Plug	TR-5
KA-59-71	TNC	Angle Plug	Silver
KA-59-151	TNC	Angle Plug	TR-5
KA-39-17	TNC	Jack	Silver
KA-39-34	TNC	Jack	TR-5
KA-19-38	TNC	Bulkhead Jack	Silver
KA-19-68	TNC	Bulkhead Jack	TR-5
for RG Cable 223, 55A, 142 & 142A/U			
KC-59-80	BNC	Plug	Silver
KC-59-162	BNC	Plug	TR-5
KC-59-103	BNC	Angle Plug	Silver
KC-39-27	BNC	Jack	Silver
KC-39-51	BNC	Jack	TR-5
KC-19-64	BNC	Bulkhead Jack	Silver
KC-19-140	BNC	Bulkhead Jack	TR-5
KA-59-45	TNC	Plug	Silver
KA-59-87	TNC	Plug	TR-5
KA-59-72	TNC	Angle Plug	Silver
KA-39-18	TNC	Jack	Silver
KA-39-35	TNC	Jack	TR-5
KA-19-40	TNC	Bulkhead Jack	Silver
KA-19-65	TNC	Bulkhead Jack	TR-5

*Also available moisture-proofed to meet Mil Spec. M 39012.

KINGS
ELECTRONICS CO., INC.
40 Marbledale Road
Tuckahoe, N. Y. 10707



Meet the "Mite".
Only .218" diameter. The toughest ceramic disc trimmer capacitor its size.

New from E. F. Johnson. And it's this small: 
Designed for printed circuit applications where space is at a premium. Stator of High Alumina for greater shock and vibration resistance. The rotor plate is encapsulated in ceramic for environmental stability and long life. The Q factor at 1 MHz is 500 minimum. Precision lapped bearing surfaces give you smooth linear tuning. Pick from a wide capacitance range: 1.0-3.0 pF, 2.5-9.0 pF, 3.5-20.0 pF, 5.0-25.0 pF. Designed to meet or exceed applicable requirements of MIL-C-81A.

Return the coupon today for information on Johnson's new Micro-J™. And if you have a special capacitor need, we'd like to work with you. The same engineering that made our air variable capacitors the standard of excellence goes into every new Johnson product.

E. F. JOHNSON COMPANY/3308 Tenth Ave. S.W./Waseca, Minnesota 56093

- Send product specification information on new Micro-J capacitor.
- Include information about your full capacitor line and other Johnson components.

NAME _____ TITLE _____

FIRM _____ ADDRESS _____

 CITY _____ STATE _____ ZIP _____

E. F. JOHNSON COMPANY

INFORMATION RETRIEVAL NUMBER 65

INSTRUMENTATION

Time-interval counter averages 1000 times



Elorado Electronics, 601 Chalomar Rd., Concord, Calif. Phone: (415) 686-4200. Price: from \$1750.

Able to measure 10-ns pulse rise-times, a new single-event time-interval counter is capable of averaging 1000 times. Model 784 has an eight-digit stored display. It can measure time interval, pulse width, risetime and period through an input signal conditioning discriminator on both channels. Options are available for greater stability and BCD

Booth No. 1722 Circle No. 298

Lab-test protector covers 5 to 50 V



Transtector Systems, M & T Chemicals Inc., sub. of American Can Co., 3025 W. Mission Rd., Alhambra, Calif. Phone: (213) 283-9278.

Incorporating 23 voltage protection levels from 5 to 50 V dc, a new lab-test protector guards laboratory breadboards, production components under test, and subsystems during checkout against damaging voltages. If a voltage above the protection level is applied, the unit clamps the line to 1 V dc in approximately 500 ns.

Booth No. 4712 Circle No. 365

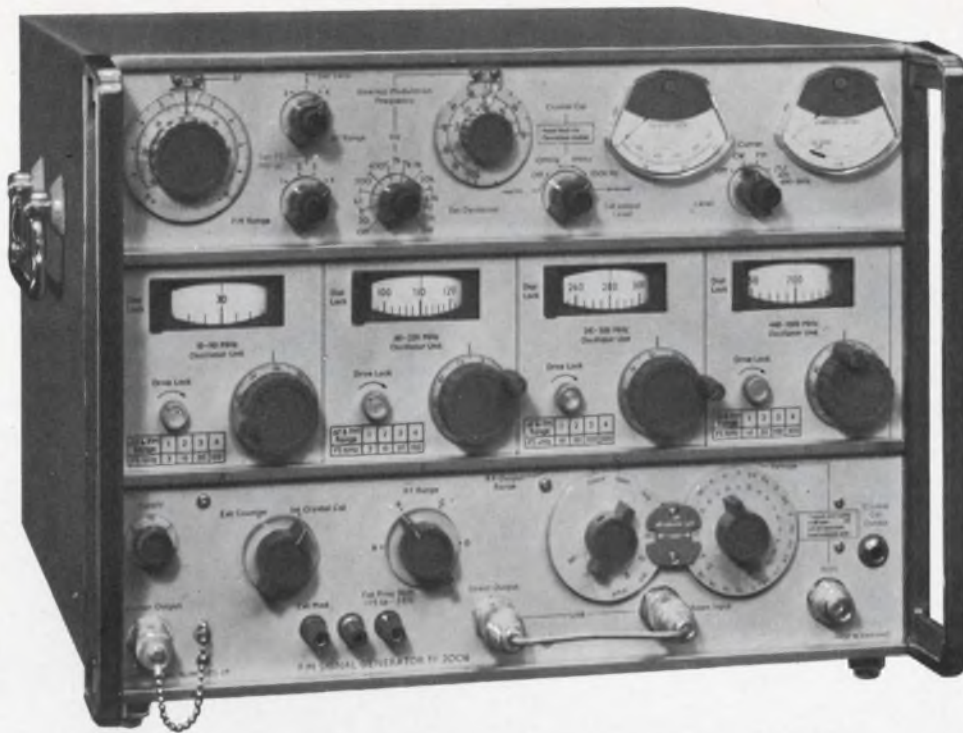

- **Wide Range:**
4-1000 MHz
- **Stability:**
Better than
15 PPM/15 minutes
- **Non-Microphonic**
- **No Range Change
Drift**
- **Fully Solid State**

the clean FM Signal Generator

F.M. Signal Generator TF 2006 is another "first" in the field of wide-range solid-state signal generators. Based on separate high Q resonant-line transistor oscillators, this instrument provides wide deviation f.m. on highly stable carriers up to 1 GHz. Rigid mechanical construction ensures that the precision oscillators have very low drift and microphony. Automatic levelling maintains constant r.f. output over the entire carrier frequency range, which extends down to 4 MHz, and accurate step attenuators offer a dynamic range of 120 db. Electrical fine tuning and f.m. may be simultaneously applied by the drive circuitry. As a result of their electrical relationship within the instrument f.m. as well as the fine tuning may be adjusted to a higher accuracy against the comprehensive crystal calibrator. This oven-controlled calibrator indicates carrier frequencies by meter nulls at 10, 1 or 0.1 MHz intervals and therefore provides almost 10,000 check points of the carrier frequency.

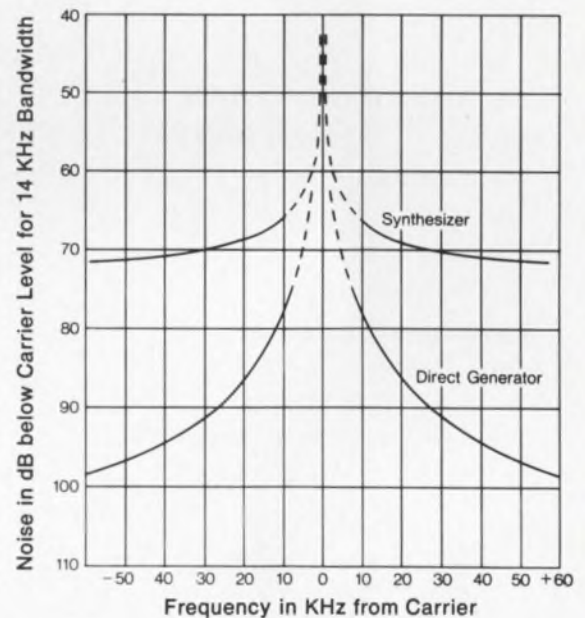

Comparison of Synthesized and Direct Frequency Signal Generator U.H.F. Spectra.

mi MARCONI
INSTRUMENTS
DIVISION OF ENGLISH ELECTRIC CORPORATION

111 CEDAR LANE □ ENGLEWOOD, NEW JERSEY 07631
TELEPHONE: (201) 567-0607



AVAILABLE UPON REQUEST...
Detailed specification brochure including operating principles, mechanical, electrical and environmental specifications.

SEE US AT WESCON BOOTH #1824-25-26

INFORMATION RETRIEVAL NUMBER 66

C-COR AMPLIFIER

-10 Hz — 200 MHz
Output +13 dBm

ONLY \$395

**COMPACT, VERSATILE,
NEW LABORATORY
AMPLIFIER
MODEL 4376 WITH
ADVANCED CIRCUITRY**



Features	Facts
High Input Impedance	1 M Ω 10 pf
Wide Bandpass	10 Hz — 200 MHz
High Gain	20/40 dB Selectable
Low Input Noise	60 μ V rms

Wide Dynamic Range
Input Protection Circuitry
Extends Range of Oscilloscopes
and RF Voltmeters

Package Includes Power Supply



C-COR
ELECTRONICS, INC.

60 Decibel Road
State College, Pennsylvania 16801
(814) 238-2461

OR SEE EEM CATALOG
FOR NEAREST REPRESENTATIVE

INSTRUMENTATION

Half-rack multimeter is 0.0025% accurate



Data Technology Corp., 1050 E. Meadow Circle, Palo Alto, Calif. Phone: (415) 321-0551. P&A: \$2400; 60 days.

Claimed to be the most accurate five-digit voltmeter/multimeter in the industry today, a new digital instrument features a dc accuracy of 0.0025% in a half-rack-size package only 3-1/2 in. high. Model 370 is also capable of measuring ac volts to 100 kHz, ohms to a resolution of 1 m Ω , and ratios to 0.99999:1.

Booth No. 1827 Circle No. 346

Digital instrument divides and generates



Anadex Instruments Inc., 7833 Haskell Ave., Van Nuys, Calif. Phone: (213) 782-9527. P&A: \$645; 4 wks.

With a crystal-controlled 1-MHz oscillator, a new instrument will generate periods from 10 μ s to 100 s and perform frequency division from 1 to 9,999,900. Model CF-611R frequency divider and period generator features plug-in TTL integrated circuits in a space saving 1-3/4-in.-high chassis. Maximum input frequency in the divider mode is 1 MHz.

Booth No. 1904 Circle No. 351

Dual-function instrument measures and calibrates



Wavetek, P.O. Box 651, San Diego, Calif. Phone: (714) 279-2200. P&A: \$2395; 45 days.

Without resorting to plug-in accessories, a new multi-function instrument provides six precision measurement functions and two accurate calibration capabilities in a single compact package. Model 220 Dialomatic multimeter/calibrator measures dc voltage, dc ratio, ac voltage, ohms, ohms ratio, and frequency. Its digital/analog readout has a six-digit resolution.

Booth No. 2027 Circle No. 348

Low-ohm DMM ignores noise



Dana Laboratories, Inc., 2401 Campus Drive, Irvine, Calif. Phone: (714) 833-1234. Price: \$3000.

Able to measure resistances as low as 1 m Ω , a new four-digit multimeter can make measurements of high-speed rms ac voltages in the presence of distortion. Model 5400/035, which has a fifth-digit for 10% overranging, can also measure dc volts, millivolts and dc/dc ratios. Normal-mode noise rejection is 80 dB; common-mode noise rejection is 120 dB at 60 Hz.

Booth No. 2008 Circle No. 355



You'll never get a bum wrap.

Not with a CDE wrapped tubular. For Cornell Dubilier has set the industry standard in wrap-and-fill capacitors. And we offer the most comprehensive stock in depth. Over 500 items, round and oval, covering capacities from .001 to 5 mfd, voltages from 50 to 600V DCW, and tolerances from 1% through 20%.

In polyester, polycarbonate, or polystyrene, in foil/film or metalized dielectrics—to meet every industrial or military need. And all are Sprint stock standards. SPRINT is the CDE program that assures you quick delivery of standardized components covering 98% of industry requirements.

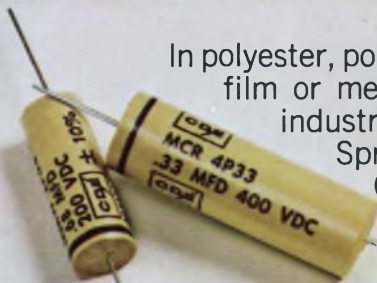

CDE **CORNELL-DUBILIER**

50 Paris Street, Newark, New Jersey 07101

STOCK STANDARDS—WRAPPED TUBULAR CAPACITORS

TYPE WCR. General purpose, round, polycarbonate capacitor

Voltage—50 to 600V DCW
Capacitance—.001 to 2.0 mfd
Tolerance— $\pm 5\%$, 10%
Temperature— -55°C to $+125^{\circ}\text{C}$ without derating
 $\pm 1\%$, 2% , 5% , 20% available on special order over 50V

TYPE WCP. General purpose, oval polycarbonate capacitor

Voltage—50 to 600V DCW
Capacitance—.01 to 2.0 mfd
Tolerance— $\pm 10\%$
Temperature— -55°C to $+125^{\circ}\text{C}$ without derating
 $\pm 5\%$ available on special order

TYPE WPR. General purpose, round, polystyrene capacitor

Voltage—100 to 600V DCW
Capacitance—.001 to 1.0 mfd
Tolerance— $\pm 1\%$, 2%, 5%, 10%, 20%
Temperature— -55°C to $+85^{\circ}\text{C}$

TYPE MFP. General purpose, oval, polyester miniature capacitor

Voltage—50 to 600V DCW
Capacitance—.01 to 5.0 mfd
Tolerance— $\pm 10\%$, 20%
Temperature— -55°C to $+85^{\circ}\text{C}$ without derating;
 $+125^{\circ}\text{C}$ with derating
 $\pm 5\%$ tolerance available on special order

TYPE MCR. General purpose, round, metallized polycarbonate capacitor

Voltage—50 to 600V DCW
Capacitance—.01 to 5.0 mfd
Tolerance— $\pm 10\%$, 20%
Temperature— -55°C to $+125^{\circ}\text{C}$
 $\pm 5\%$, 10% tolerances available on special order over 50V

TYPE MCP. General purpose, oval metallized polycarbonate capacitor

Voltage—50 to 600V DCW
Capacitance—.1 to 5.0 mfd
Tolerance— $\pm 10\%$, 20%
Temperature— -55°C to $+125^{\circ}\text{C}$ without derating
 $\pm 5\%$, 10% available on special order over 50V

TYPE MMW. General purpose, round, metallized, polyester miniature capacitor

Voltage—50 to 600V DCW
Capacitance—.01 to 5.0 mfd
Tolerance— $\pm 1\%$, 2%, 5%, 10%, 20%
Temperature— -55°C to $+85^{\circ}\text{C}$ without derating;
 $+125^{\circ}\text{C}$ with derating
 $\pm 1\%$, 2% , 5% tolerances available on special order over 50V

TYPE MMP. General purpose, flat metallized, polyester miniature capacitor

Voltage—50 to 600V DC
Capacitance—.1 to 5.0 mfd
Tolerance— $\pm 1\%$, 2%, 5%, 10%, 20%
Temperature— -55°C to 85°C without derating;
 $+125^{\circ}\text{C}$ with derating

TYPE WMF. General purpose, round, polyester miniature capacitor

Voltage—50 to 600V DCW
Capacitance—.001 to 5.0 mfd
Tolerance— $\pm 1\%$, 2%, 5%, 10%, 20%
Temperature— 55°C without derating;
 $+125^{\circ}\text{C}$ with derating
 $\pm 1\%$, 2% , 5% tolerances available on special order over 50V.

TYPE CTM. Military round, polyester per MIL-C-27287

Voltage—50 to 100V DCW, 200V DC to 300V DC at 125°C
Capacitance—.0033 to 1.0 mfd, .001 to .15 mfd
Tolerance— $\pm 5\%$, 10%
Temperature— -55°C to $+125^{\circ}\text{C}$

Entries in red available on special order only. All other items stocked in depth at your CDE authorized distributor.

For complete descriptions, see your component selector.



50 Paris Street, Newark, New Jersey 07101

Pulse generator reps to 100 MHz

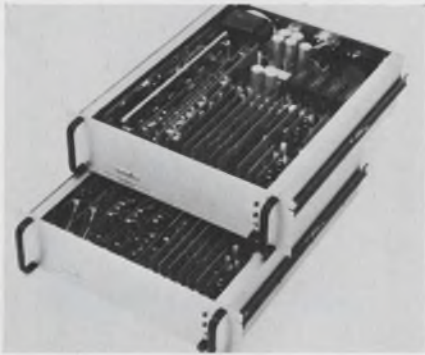

Systron-Donner Corp., Datapulse Div., 10150 W. Jefferson Blvd, Culver City, Calif. Phone: (213) 836-6100. P&A: \$10,000 to \$15,000; 90 days.

Model 140 fully programmable pulse generating system provides repetition rates to 100 MHz, pulse widths to 5 ns, and independently variable risetimes and falltimes from 2 ns. Accuracies are typically $\pm 2\%$ of programmed values; the upper and lower levels of the output waveform may be any values between +10 and -10 V.

Booth No. 1412 Circle No. 293

Lab power source calibrates output

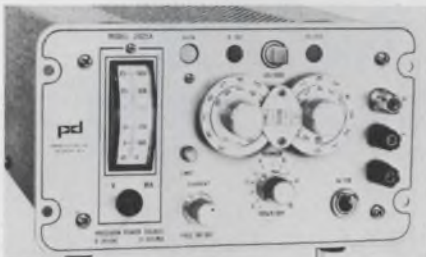

Power Designs Inc., 1700 Shames Drive, Westbury, N.Y. Phone: (516) 333-6200.

Combining precision calibrator and laboratory power source functions in a single compact unit, model 2005A power supply provides an output range of 0 to 20 V dc at 0 to 500 mA with a calibration accuracy of 0.1%. Front-panel, dual, concentric decade switches and a vernier potentiometer with 10- μ V resolution allow a digital readout to five places with a continuously adjustable fifth place.

Booth No. 1020 Circle No. 360

MODULAR TYPE IC PACKAGING PANEL

For High Density

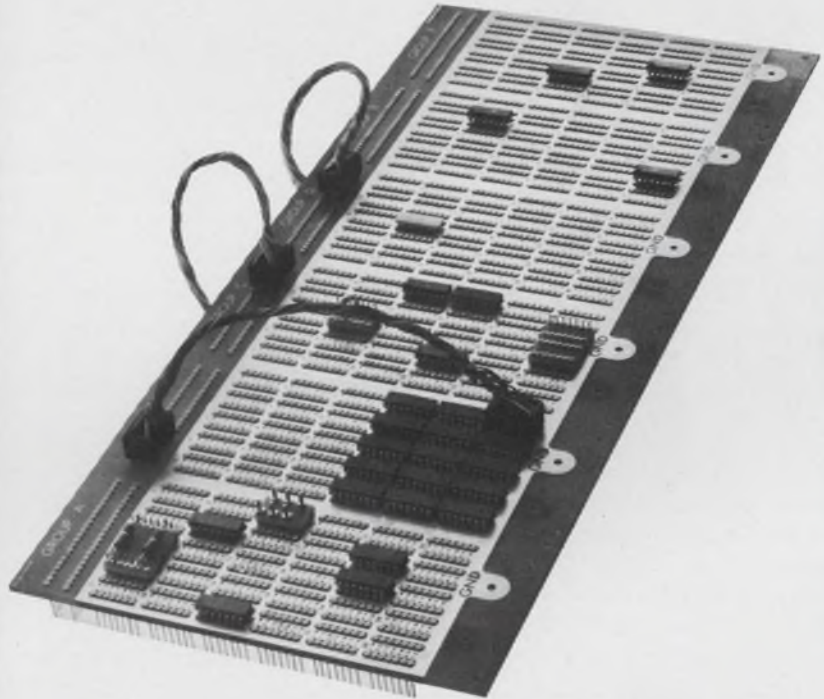

Simplifies design and production operations. Saves time and space. Direct mounting chassis eliminates need of logic cards — increases flexibility in prototyping, production and field service. A unique two dimensional approach to IC packaging with these outstanding features:

Multiple of 30 pattern sections, up to 180 patterns.

Two pins of each pattern tied directly to power and ground planes.

Provisions for input-output plugs and adaptor plugs for discrete components.

Excellent contact retention of flat lead dual-in-line (.022 max.) with machined closed entry design.

Choice of Wire-Wrap® or solder pocket terminations.

Three levels of connection on Wire-Wrap pins.

®Trademark Gardner-Denver Co.

Request Complete I. C. Folder

AUGAT

TEL: 617/222-2202
INC. 31 PERRY AVE., ATTLEBORO, MASS. 02703

WESCON Booth 2721-22

Logarithmic amplifier has 90-dB power range



Telonic Instruments, Inc., 60 N. First Ave., Beech Grove, Ind. Phone: (317) 787-3231.

Accepting any rf input from 400 kHz to 130 MHz over a power range of -70 to +20 dBm, a new logarithmic amplifier provides a linear detected output for oscilloscope, voltmeter, or graphic recorder presentation. Model 6001 is a solid-state instrument with an output that is accurate to ± 3 dB. It can make both steady-state and swept-frequency measurements.

Booth No. 1724 Circle No. 292

Solid-state instrument analyzes servo systems



Servo Corp. of America, 111 New South Rd., Hicksville, N.Y. Phone: (516) 938-9700.

Featuring all-solid-state design, a new servo system analyzer combines a function generator, phase shifter, internal modulator and a precision attenuator in one compact instrument. Model 1999 can be used for analysis and test of servo-mechanisms and complex control systems by observing phase and amplitude response with respect to various frequencies and wave shapes.

Booth No. 2206 Circle No. 358

Small IC counter goes out to 15 MHz



Computer Measurements div. of Newell Co. Industries, 12970 Bradley Ave., San Fernando, Calif. Phone: (213) 367-2161. Price: \$395.

Selling for as much as 35% less than comparable competitive instruments, a new compact 15-MHz IC counter incorporates a 1-MHz crystal oscillator and provides a five-digit readout. Model 905 comes in a small package, measuring only 3-1/2 by 5 by 7 in., that features a tip-up stand for easy visibility in bench work.

Booth No. 1006 Circle No. 347

now available . . . **STOCK BUS BARS**

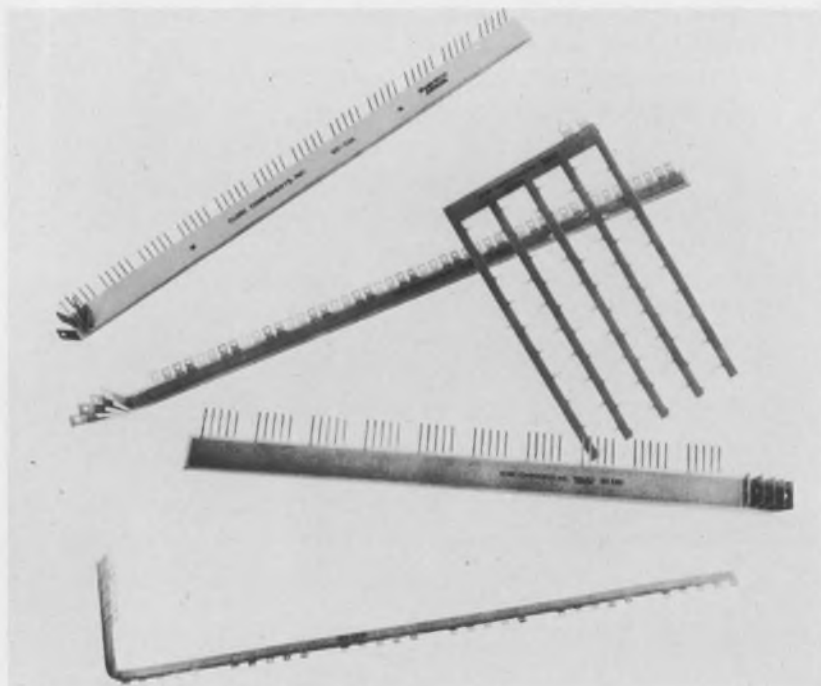

Designed for prototypes, small quantities and immediate delivery.

Write for price list and technical data . . .

ELDRE 
COMPONENTS, INC.
1239 UNIVERSITY AVENUE
ROCHESTER, NEW YORK 14607

 **WESCON/69**

See us at booths
5221 & 5222

INFORMATION RETRIEVAL NUMBER 69

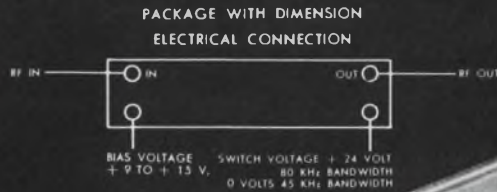

design freedom

yours with the new switchable dual bandwidth
crystal filters

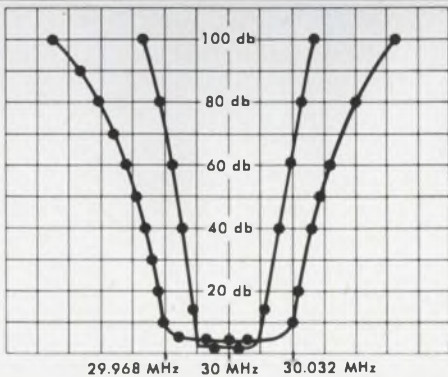

SPECIFICATION		CENTER FREQUENCY 30 MHz	
filter (A)		filter (B)	
1 db Bandwidth 35 KHz Min.		1 db Bandwidth 64 KHz Min.	
6 db Bandwidth 45 KHz Min.		6 db Bandwidth 80 KHz Min.	
60 db Bandwidth 90 KHz Max.		60 db Bandwidth 160 KHz Max.	
Ultimate Attenuation 80 db		Ultimate Attenuation 80 db	
Impedance 50 Ω in & out		Impedance 50 Ω in & out	
Ripple 1 db Max.		Ripple 1 db Max.	
I.L. \leq 4 db		I.L. \leq 4 db	
ENVIRONMENTAL:		Tol.	
TR -55°C to 105°C		Center Frequency \pm .005%	
Vibration—Mil. Std. 202	Method 204 A	Test Cond. D	
Shock—Mil. Std. 202	Method 205 C	Test Cond. C	

For multi-mode communication systems, M^CCoy has added another technological achievement in expanding applications for crystal filters. The switchable filter is custom-made to your specifications, economically, and in a small package.

At M^CCoy Electronics, the integration of crystal and filter engineering technology is your assurance of the finest crystal filter performance available today. And we'll be ready for tomorrow with the next dimension in crystal filters to suit your future needs.

Put our experience to work for you!



MCCOY ELECTRONICS COMPANY
MT. HOLLY SPRINGS, PENNSYLVANIA 17065
Tel. 717-486-3411 TWX: 510-650-3548
a subsidiary of OAK ELECTRO/NETICS CORP

New Concept AC Regulator Outperforms them all!



Compare!

	ERA SOLID STATE MODELS	CONVENTIONAL MAGNETIC TYPES
Small Size	Yes	No
Light Weight	Yes	No
Wide Freq. Range	Yes	No
Tight Regulation	Yes	No
Fast Transient Response	Yes	No
Silent Operation	Yes	No
Fully Repairable	Yes	No
Stable with Temperature	Yes	No
High Efficiency	Yes	No
Wide Temp. Range	Yes	No
High Surge Rating	Yes	No
Minimum RFI	Yes	No
Series Operation	Yes	No
Remote Sensing	Yes	No
Sinusoidal Output	Yes	Special Order

SPECIFICATIONS

Input: 105-130 VAC, 47-440cps
 Output: 115 VAC nom (See table for power rating)
 Line Regulation: Within $\pm 0.1\%$ for full input change.
 Load Regulation: Within 0.2% for full load change
 Frequency Regulation: Less than 0.002% per cycle
 Wave Form Distortion: Less than 5%
 Load Power Factor Range: +0.7 PF through -0.7 PF
 Response Time: Less than 16 millisecond
 Operating Temperature: -20°C to $+71^{\circ}$ free air

STANDARD MODELS

Power Rating	Size (Inches)	Weight	Model	Price*
250 VA	6 $\frac{1}{2}$ x7 $\frac{1}{4}$ x4 $\frac{7}{8}$	13 lbs.	RT250	\$130
500 VA	6 $\frac{7}{8}$ x8 $\frac{7}{8}$ x7 $\frac{1}{2}$	16 lbs.	RT500	\$175
1000 VA	7 $\frac{1}{2}$ x9 $\frac{1}{2}$ x7 $\frac{5}{8}$	22 lbs.	RT1000	\$235

* Liberal Discounts for Larger Quantities



Send for full technical data.

ELECTRONIC RESEARCH ASSOCIATES, INC.

67 Sand Park Road, Cedar Grove, N. J. 07009

INFORMATION RETRIEVAL NUMBER 71

INSTRUMENTATION

D/ac converter gives 10⁴ ratios

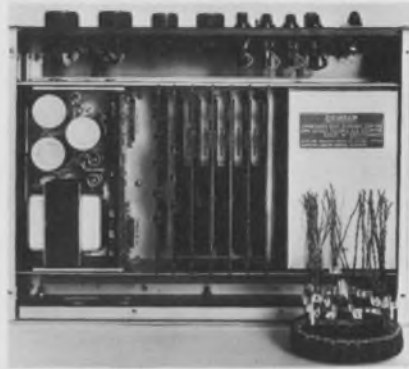

North Atlantic Industries, Inc.,
Terminal Drive, Plainview, N.Y.
Phone: (516) 681-8600. P&A:
\$3000; 8 wks.

Using precision tapped transformers for 0.01% long-term accuracy, a new all-solid-state digital-to-ac converter provides 10,000 discrete input-output voltage ratios or levels of digital-to-ac conversion. Model 508/10 can be set, under digital control, in 0.0001:1 ratio increments, feeding out a precise fraction of the 115-V 400-Hz reference excitation in response to BCD input commands.

Booth No. 1127 Circle No. 363

Time-code generator clocks and pulses



Eldorado Electronics, 601 Chalmar Rd., Concord, Calif. Phone:
(415) 686-4200. P&A; \$1950; 30 days.

Displaying time in days, hours, minutes and seconds, a new time-code generator can supply up to five serial codes simultaneously, has standard parallel and pulse rate outputs, and offers precision synchronizing to an external standard. Model 1710 extensively uses integrated circuits to achieve low cost and high capability.

Booth No. 1722 Circle No. 294

Digital counter-timer utilizes plug-in ICs

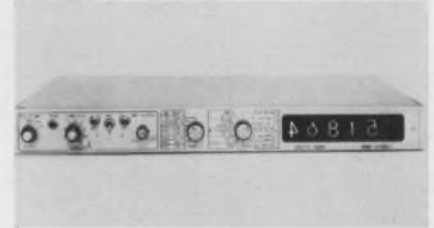

Anadex Instruments Inc., 7833 Haskell Ave., Van Nuys, Calif.
Phone: (213) 782-9527. Availability:
3 to 4 wks.

Featuring plug-in integrated circuits, a new 1-3/4-in-high counter-timer is designed for frequency, time-interval, ratio, period-averaging, and totalized measurements in both laboratory and system applications. Model CF-635R has a 1-MHz crystal-controlled time base. Its sensitivity is 10 or 100 mV; count rate is 15 MHz.

Booth No. 1904 Circle No. 350

Spectrum analyzer ends distortion

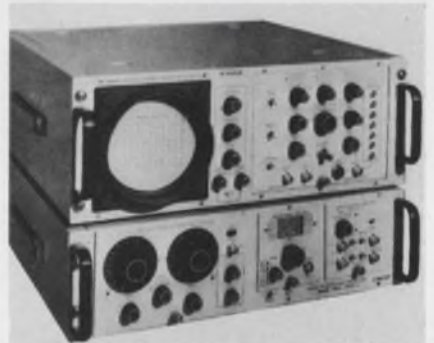

Singer Co., Instrumentation Div.,
915 Pembroke St., Bridgeport,
Conn. Phone: (203) 366-3201.
P&A: \$6810; 30 to 60 days.

Intended for single-sideband, a-m, fm, and multiplexed communications work, a new high-resolution spectrum analyzer has a frequency range of 10 Hz to 40 MHz, useable to 200 MHz, and a distortion-free dynamic range of 70 dB. Model SSB-50-1 provides a 10-Hz resolution over its entire tuning range. It also offers steep skirt selectivity and freedom from internal hum.

Booth No. 2015 Circle No. 361

Dual-pulse generator separates outputs

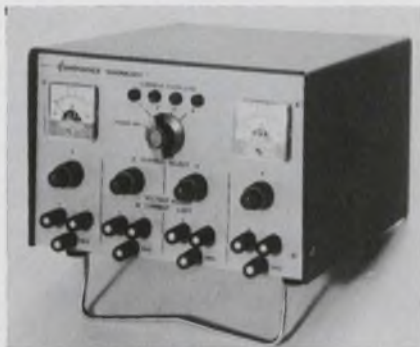

International Contronics Inc., 1038 W. Evelyn Ave., Sunnyvale, Calif. P&A: \$395; stock.

Said to be an industry first, a new logic pulse generator provides independently variable simultaneous complementary 10-V outputs. Called the Lochpulse CPG-300, the new instrument also offers an independently variable ± 2 -V dc offset on each pulse. Other features include a 100% duty cycle at 10 MHz, and precise and stable gating circuits.

Booth No. 5603 Circle No. 356

Double-pulse generator delivers 2 A at 100 V

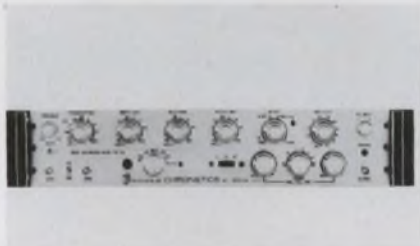

Chronetics, Inc., 500 Nuber Ave., Mount Vernon, N.Y. Phone: (914) 699-4400. P&A: \$1750; 60 to 90 days.

In a single- or double-pulse mode, model PG13A pulse generator can supply current pulses as large as ± 2 A and voltage pulses to ± 100 V, at repetition rates to 25 MHz. Continuously variable parameters include pulse repetition frequency, amplitude, risetime, falltime, delay, pulse width and dc offset. Triggering sensitivity is variable to ± 2 V into 50 or 500 Ω .

Booth No. 1419 Circle No. 402

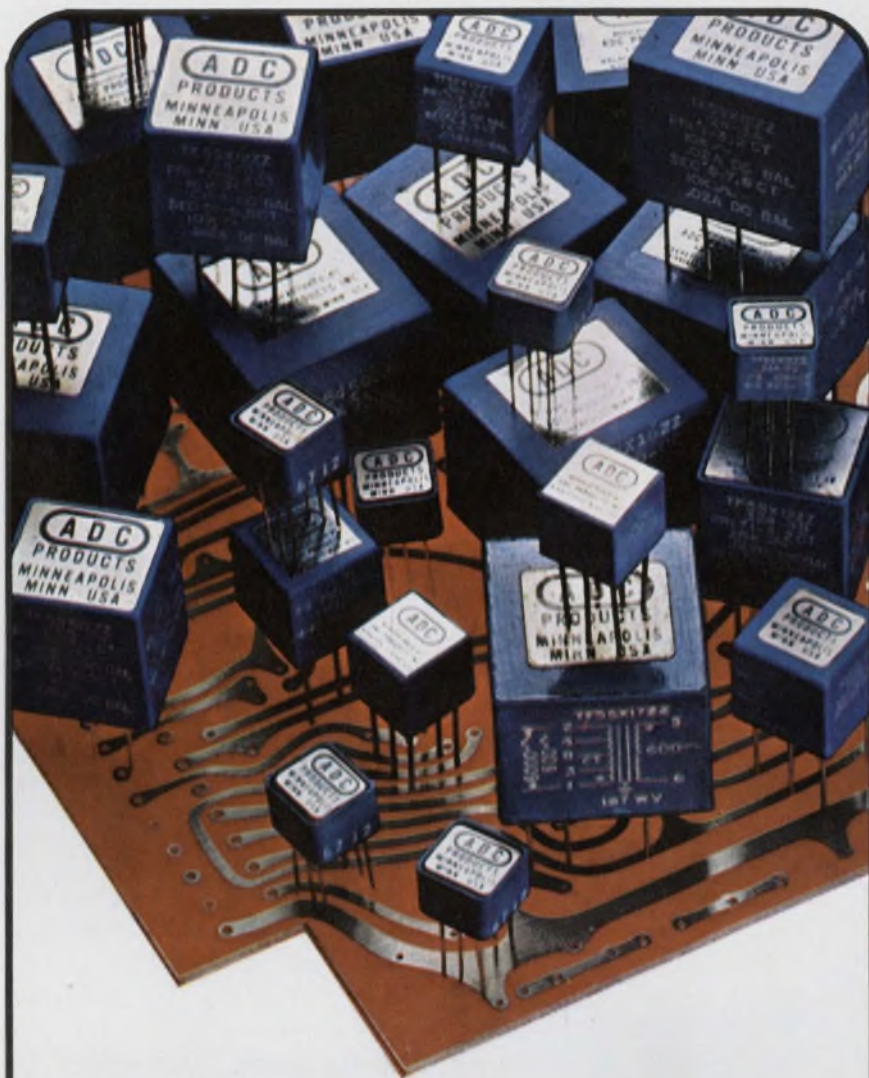

HOW MANY CHOICES?

"BLUE CHIP" TRANSFORMERS offer 71 different off-the-shelf versions that enable you to custom select transformers for printed circuit applications. The combination of choices in size, frequency, power and impedances available allows you the utmost in design flexibility. ■ Parameter choices available: Impedance: 4 ohms to 100,000 ohms, Frequency: 60 Hz to 100,000 Hz, Power: 30 MW to 7.5 W, Volume: .060 cubic inches to 1.16 inches (6 sizes), Weight: .09 oz. to 2.5 oz. ■ All Blue Chip transformers meet Mil-T-27B, Grade 5, Class S requirements.



ADC PRODUCTS

A DIVISION OF MAGNETIC CONTROLS CO.
6405 CAMBRIDGE STREET • MINNEAPOLIS, MINN. 55426

METALIZED POLYESTER CAPACITORS

ACTUAL SIZE



M2W
SERIES

ANY SIZE, VALUE,
VOLTAGE AND
TOLERANCE

to your exact specifications... at stock prices

Unique, self-healing units that remain in circuit during voltage surges with little or no loss of electrical properties. Use the M2W's where size and weight are limiting factors and long life and dependability are required. The units utilize metalized Polyester Dielectric with film wrap and custom formulated epoxy resin end fill. Available in round and flat styles.

Samples available on
your letterhead request



CONDENSER CORPORATION

Dept. ED-9 1065 W. Addison St.,
Chicago, Ill. 60613 • 312-327-5440

INFORMATION RETRIEVAL NUMBER 73

U134

INSTRUMENTATION

Metered picoammeter goes down to 0.3 pA



EG & G Laboratory Products Div.,
150 Aero Camino Way, Goleta,
Calif. Phone: (805) 967-0456.

Model 706A general-purpose picoammeter with meter display measures direct current from 0.3 pA to 10 mA full scale. The instrument features a built-in current source that can be used as a current suppressor, an internal calibrator, or a calibration source for an external instrument. Accuracy of the output multiplier is 0.05% of the multiplier setting.

Booth No. 1129 Circle No. 404

Time-code generator is size of a phone



Systron-Donner Corp., 888 Galindo
St., Concord, Calif. Phone: (415)
682-6161. P&A: \$950; stock.

About the size of a desk telephone, a new time-code generator provides a standard series code in IRIG B code format in terms of BCD hours, minutes and seconds. Model 8220 is a precise digital clock for use in indexing analog magnetic tape during data acquisition or for transmission over standard telephone lines for remote use and display. Time is initially preset by means of thumbwheel switches.

Booth No. 1412 Circle No. 398

Low-cost pulser reps to 20 MHz



Chronetics, Inc., 500 Nuber Ave.,
Mount Vernon, N.Y. Phone: (914)
699-4400. P&A: \$375; stock to 2
wks.

Operating from 10 Hz to 20 MHz in a single- or double-pulse mode, a new low-cost pulse generator provides a delayed or double pulse output to ± 15 V. Model PG-11 may be triggered from dc to 20 MHz and can be synchronously or asynchronously gated. Risetimes and falltimes are 5 ns maximum at full output amplitude.

Booth No. 1419 Circle No. 401

Waveform generator programs remotely



Data Royal Corp., 8014 Armour
St., San Diego, Calif. Phone: (714)
279-4020. P&A: \$1545; 30 to 45
days.

Covering the frequency range of 0.01 Hz to 1.1 MHz, model F280A waveform generator can deliver up to 11 V pk-pk into 50 Ω in the manual mode, or can be programmed to generate up to 16 V pk-pk into a similar load (32 V pk-pk into an open circuit). All manual controls are remotely programmable; signal and programing commons are isolated to reduce system ground loop problems.

Booth No. 1113 Circle No. 399

INFORMATION RETRIEVAL NUMBER 74 ►

High-performance Pen Pals

Honeywell's 530 X-Y Recorder: true differential input and proven reliability . . . for under \$1250.

Our 530 X-Y Recorder not only records low-level signals from any source, grounded or floating, it records them so efficiently and so reliably, you can depend on it, day in and day out.

And for good reason. This 530 X-Y Recorder has the same kind of improved snap fit pen assembly (with a polished sapphire tip), carriage assembly and cable arrangement that have made our model 550 and 560 Recorders the standard of the industry.

You'll be happy to know, too, that the Honeywell 530 X-Y Recorder is so simple to operate that even your non-technical people can learn to use it. And yet, it delivers high speed (30 in/sec. on X-axis, 20 in/sec. on Y-axis) and common mode rejection up to 130 db; offers a trouble-free vacuum holddown; and accepts either 8½" x 11" or 11" x 17" paper.

Honeywell's 540 X-Y-Y' Recorder: a two-pen recorder with double capability for a price less than \$2100.

Even though our 540 X-Y-Y' Recorder costs less, it doesn't give you any less. In fact, its operating characteristics are almost identical to our 530 Recorder, giving you the exact same true differential input, the same proven mechanical design features, the same unsurpassed reliability. Plus it offers 30 ips. slewing speed on each axis and 1 megohm input impedance on all calibrated ranges, as well as when operating at variable sensitivity. It also provides one millivolt sensitivity (each axis), a stylish appearance, vacuum holddown, and will accept either 8½" x 11" or 11" x 17" paper.

For more information on either of these new X-Y recorders, write or call (collect) Roy Washburn, 303-771-4700, Honeywell Test Instruments Division, P.O. Box 5227, Denver, Colorado 80217.

Honeywell

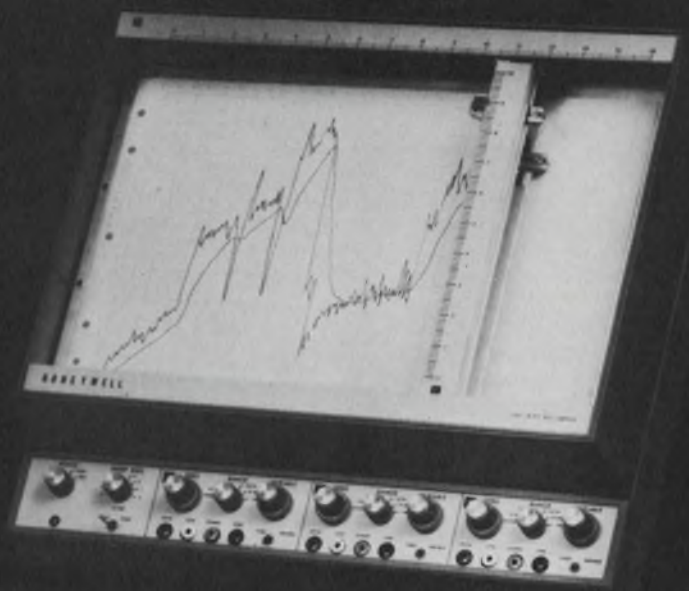
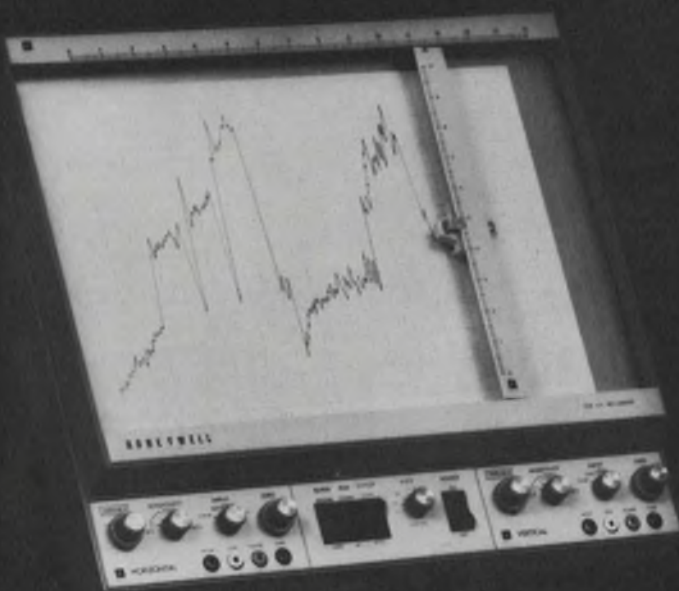

See us at WESCON, Booths 1306-1309

Honeywell engineers sell solutions

Solid-state signal generator programs frequency and level

Kay Electric Co., 12 Maple Ave., Pine Brook, N.J. Phone: (201) 227-2000. P&A: \$4950; 4 to 6 wks.

Offering superior phase-lock characteristics, a new solid-state L- and S-band signal generator features programmability of its rf output frequency and of 21 standard IRIG subcarrier frequencies as well as rf output level. Model 1522 can also be operated remotely.

This new generator has peak fm deviations as high as ± 3 MHz, modulated on its self-contained calibrated deviation meter. The calibrated rf output is adjustable from 0 to -120 dBm.

Packaged for action, the 1522 offers distinct operating controls that are well defined for ease of operation. Output connections are rear mounted for 19-in. rack slides, or may be positioned on the front panel for the cabinet version.

Internal sub-chassis construction is also designed with forethought. Swing-out printed circuit cards facilitate easy and speedy alignment, maintenance and troubleshooting.

The new signal generator performs in L band from 1.4 to 1.5999

GHz and in S band from 2.2 to 2.2999 GHz. Settability of the rf frequency is digitally controlled to 100 kHz.

After one-half hour warm-up, its calibrated accuracy is $\pm 0.002\%$. Drift plus incidental fm is less than ± 2 kHz pk for one minute, less than ± 5 kHz pk for 10 minutes, and less than ± 15 kHz pk for one hour.

The rf output can be attenuated from 0 to 119 dB in 1-dB steps, and is continuously variable and metered from 0 to 3 dB. Leveling is 1.5 dB pk-pk across each band; overall calibration accuracy is ± 1 dB.

All in-band spurious signals are held more than 50 dB below the calibrated output level. Harmonically related spurious signals are greater than 20 dB below the calibrated output.

Frequency linearity is within 1% of a straight line for all deviations up to ± 1 MHz at modulation frequencies from dc to at least 1 MHz. Frequency response is ± 1 dB from dc to 750 kHz, ± 1.5 dB to 1 MHz, and $+2$ and -3 dB to 2 MHz.

Booth No. 1613 Circle No. 408



Combining the reliability of solid-state construction with the desirability of remote operation, a new L- and S-band signal generator can be programmed for rf output frequency and level, as well as subcarrier frequency.

Rf power meter reads digitally



Pacific Measurements Inc., 940 Industrial Ave., Palo Alto, Calif. Phone: (415) 328-0300. Price: \$1850.

Shown at the bottom of a line of logarithmic instruments, a new digital meter makes direct measurements of rf power, on either a linear or dB scale. Model 1009 is designed for both swept- and single-frequency power measurements from 10 MHz to 12.4 GHz. It has a 50-dB dynamic range and, in a completely automated test system, can perform 1000 measurements per second.

Booth No. 1320 Circle No. 379

Phase-controlled filters fit waveguide and coax

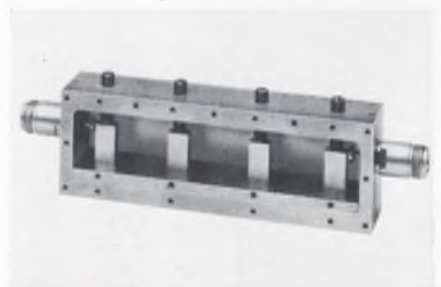

RHG Electronics Laboratory, Inc., 94 Milbar Blvd., Farmingdale, N. Y. Phone: (516) 694-3100.

A new line of L- and X-band phase-controlled waveguide and coaxial filters are computer-designed devices with precisely controlled phase characteristics. Available as fixed-tuned or tunable units, the FC coaxial series provides multipole performance coupled with a very wide tuning range, while the FW waveguide series offers low insertion loss and a readily adjustable passband characteristic.

Booth No. 5403 Circle No. 289

See us at WESCON-Booth #1040-1046

The FIRST Major Advance in RASTER DISPLAYS Since The "50's"

FROM NOW ON . . . OTHER RASTER DISPLAYS ARE FOR YESTERDAY'S SYSTEMS

A complete kit on Raster Displays is yours for the asking, including:

- Comparison Chart illustrating unity interlace, linearity, resolution, stability, staircase display and adjustable aspect ratio.
- Technical Data Sheets on 14" and 17" Raster Displays with optional line rates from 525 to 1029.
- Reprint of Article on "Precision Raster Displays" — An in-depth discussion of state-of-the-art circuitry in Hewlett-Packard Displays.



HP Model 6947A

HEWLETT  **PACKARD**

COMMUNICATION INSTRUMENTS

100 Locust Avenue, Berkeley Heights, New Jersey 07922 • (201) 464-1234

Directional detectors swing out to 8 GHz

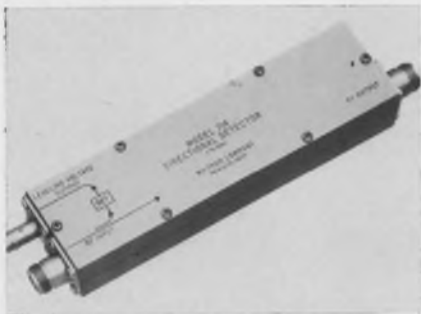

Wiltron Co., 930 E. Meadow Drive, Palo Alto, Calif. Phone: (415) 321-7428. Price: \$235 to \$275.

Covering octave bands from 500 to 8000 MHz, a new line of directional detectors consists of a maximally flat directional coupler with a crystal detector built into the coupled arm. By including the detecting element in the coupler, the new units feature a net leveling flatness of ± 0.2 dB over any octave band.

Booth No. 1138 Circle No. 382

Small balanced mixer mounts like DIP IC



Hewlett-Packard, 1501 Page Mill Rd., Palo Alto, Calif. Phone: (415) 326-7000. P&A: \$80; 30 days.

Said to be the smallest unit of its kind, a new 500-MHz double-balanced mixer features a pin spacing that is exactly the same as that of standard dual-in-line integrated circuits. When mounted on a circuit board, model 10514 occupies a space of only 0.4 by 0.35 in., less than 0.15 square inches. Its volume is under 0.07 cubic in., and its weight is less than 0.06 oz (1.5 grams).

Booth No. 1040 Circle No. 381

Transfer switches isolate to 18 GHz

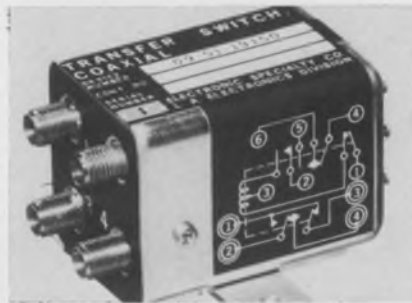

Electronic Resources Inc., 4561 Colorado Blvd., Los Angeles, Calif. Phone: (213) 246-6761.

Providing broadband rf performance in a lightweight subminiature package, a new series of coaxial transfer switches features a low VSWR of 1.25 at 12.4 GHz and unusually high interchannel isolation from 0 to 18 GHz. Actuating current for series 09-51 units is just 53 mA at 26.5 V for latching, and 177 mA for fail-safe operation.

Booth No. 1115 Circle No. 373

Multichannel sources oscillate to 9.6 GHz

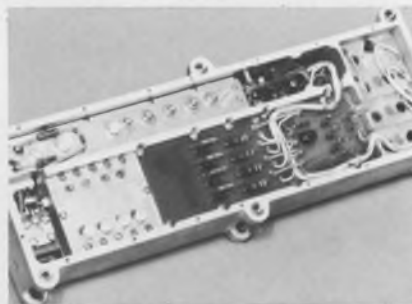

Hughes Aircraft Co., Electron Dynamics Div., 3100 W. Lomita Blvd., Torrance, Calif. Phone: (213) 534-2121.

A new line of solid-state multichannel crystal-controlled sources provide discrete output frequencies at any point in the frequency range from 800 to 9600 MHz. Series 40000H units achieve tight frequency stability (0.005%) and low-noise operation. Minimum power outputs range from 25 mW to 8 W, and 1-dB bandwidths go from 48 to 800 dB.

Booth No. Unit H Circle No. 380

Small attenuator spans 2-GHz band



Telonic Instruments Div., Telonic Industries, Inc., 60 N. First Ave., Beech Grove, Ind. Phone: (317) 787-3231. P&A: \$125; 30 days.

Slightly over 2 in. long and weighing less than 5 oz, a new rotary attenuator provides up to 60-dB attenuation in 10-dB steps from dc to 12 GHz. Model 8103 has an impedance of 50 Ω and an insertion loss of only 0.7 dB at 2 GHz. Its accuracy varies with frequency, ranging from $\pm 1\%$ at 500 MHz to $\pm 5\%$ at 2 GHz.

Booth No. 1724 Circle No. 389

J-band generators deliver up to 5 mW



M-O Valve Co. Ltd., Metropolitan Overseas Supply Corp., 468 Park Ave. South, New York, N. Y. Phone: (212) 686-2120.

Two new microwave devices, compact J-band solid-state power generators, are low-noise electronically tunable units. Type SSSJ9 has an operating frequency range of 12.4 to 14 GHz, a tuning range of 250 MHz and a power output of 5 mW. Type SSSJ10 operates from 14 to 16 GHz, tunes over 250 MHz and has a power output of 1 to 2 mW.

Booth No. 4607 Circle No. 383

Introducing Potter & Brumfield's unique

dual thin-line dry reed relays

An entirely new magnetic structure makes possible an exceptionally low seated height of only 0.275 inch for high density board packaging. Circuit boards employing JDT relays may be spaced on 0.5 inch centers.

This design minimizes magnetic flux dispersion, resulting in a very efficient magnetic circuit. This decreases coil power requirements and often permits direct operation of JDT relays in low-power semi-conductor logic circuits. An interfacing amplifier may be eliminated in many applications.

Terminals are similar to those on IC packages, permitting spot testing on either side of a circuit board. The dual in-line terminals on 0.1 inch centers simplify circuit board design. The reed switches are rated at 10 watts maximum resistive (50V or 0.5A DC maximum) switching.

A solid state time delay circuit may be incorporated in this small package. Or a Darlington amplifier can be included to compensate for low current applications. However, the number of available poles for switching is reduced by the addition of either of these circuits.

The JDT is completely encapsulated in epoxy, giving protection against environmental contamination. The Series is presently available in many combinations of Forms of A, B and C.



Get full information today by calling your local P&B representative or call direct to Potter & Brumfield Division of American Machine & Foundry Company, Princeton, Indiana. 812-385-5251.

Mounted height
is only 0.275"

Power requirements:
only 75mw per pole

Combinations of Forms
A, B and C are available

Single Lot Prices:

JDT 4000 Series (4-pole) \$ 7.65

JDT 8000 Series (8-pole) \$12.95

Quantity discounts apply.

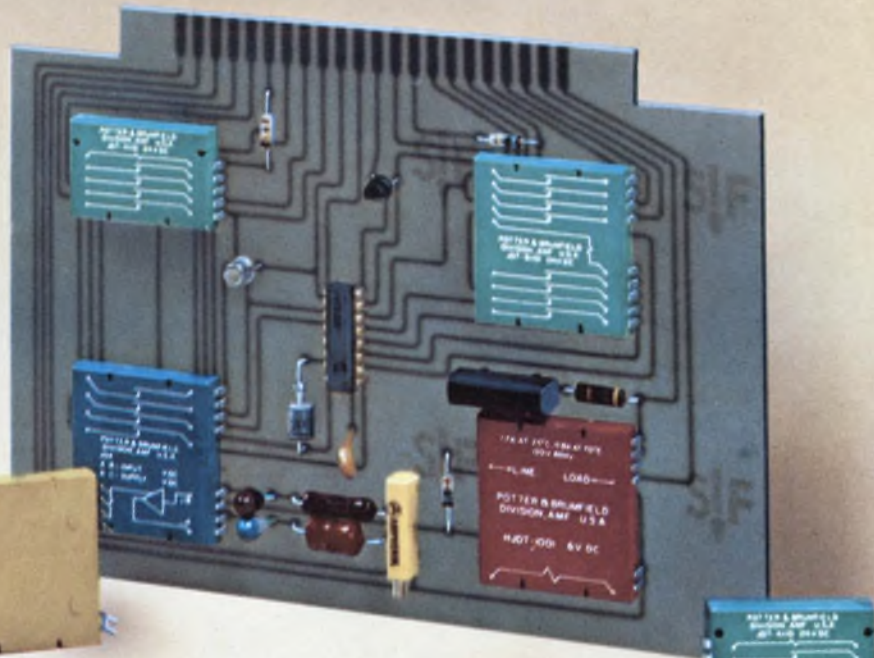

AMF

POTTER & BRUMFIELD

Missing pulse detector takes 5-kHz rep rates



Del Electronics Corp., 250 E. Sandford Blvd., Mt. Vernon, N. Y. Phone: (914) 699-2000. Price: \$1500.

Able to measure the rf energy stability of magnetrons, a new missing pulse detector accepts input video pulse widths of 0.1 to 100 μ s and repetition rates from 200 Hz to 5 kHz. Input pulse amplitude can be between 50 and 400 MV and reference pulse (trigger) amplitude can range from ± 5 to 50 V. The unit is completely solid state.

Booth No. 3705 Circle No. 291

Laser radiometers gauge power and energy



International Light Inc., Dexter Industrial Green, Newburyport, Mass. Phone: (617) 465-5923. P&A: \$250 to \$1100; stock.

Designed specifically for uniform acceptance of narrow beams, a new series of radiometer detectors is capable of measuring instantaneous power, integrated energy, and peak power of both cw and pulsed lasers. Series PT200/A203 units cover the wavelength region from 200 to 1200 nanometers. Their power range covers 3 nW to 60 W for cw lasers; their energy range goes from 3 nJ to 6 J for pulsed lasers.

Booth No. 1214 Circle No. 288

Vhf/uhf generator features stability



Wiltron Co., 930 E. Meadow Drive, Palo Alto, Calif. Phone: (415) 321-7428. P&A: \$4450; 4 wks.

Covering the frequency range of 220 to 410 MHz, a new solid-state a-m/fm signal generator (with the 63081 rf plug-in) provides a frequency stability of 1 in 10^5 per 10 minutes after only 30 minutes of warm-up. Model 6301 offers audio modulation to 80%, frequency modulation to ± 100 kHz or phase modulation, together with 2 V (+19 dBm) of rf output.

Booth No. 1138 Circle No. 290

Digital rf meter responds linearly



Millivac Instruments, Inc., P.O. Box 997, Schenectady, N.Y. Phone: (518) 355-8300. P&A: \$1095; 8 to 10 wks.

Model MV-722A solid-state digital rf millivoltmeter features a unique linearizing feedback circuit that allows true linear response with ± 1 -digit tracking. It has a three-digit readout with overrange indicator. Full-scale voltage ranges are from 3 mV to 10 V. Frequency response is $\pm 3\%$ from 10 kHz to 100 MHz, $\pm 5\%$ from 100 to 400 MHz, and $\pm 10\%$ from 400 MHz to 1.2 GHz.

Booth No. 1411 Circle No. 392

Rf telemetry filter tunes out to 420 MHz



Telonic Engineering Co., P.O. Box 277, Laguna Beach, Calif. Phone: (714) 494-9401. P&A: \$485 or \$545; stock.

A new rf filter designed especially for the 210-to-420-MHz telemetry band is capable of tuning any center frequency over this range. Model TTF-315-3-3EE, is a three-section device with a 30-dB form factor of 3. Typical insertion loss is only 1.3 dB at the center frequency and average power rating is 30 W. A five-section version, model TTF-315-3-5EE, is also available.

Booth No. 1411 Circle No. 393

Programmable CFA gives 20-dB gain

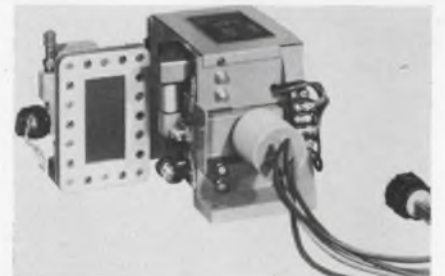

Warnecke Electron Tubes, Inc., affiliate of Northrop Corp., 175 W. Oakton St., Des Plaines, Ill. Phone: (312) 299-4436.

Rugged enough for airborne system or pod-mounted applications, a new S-band gridded injected-beam crossed-field amplifier (CFA) operates with 20-dB gain in any one of three modes. The power output of model RW-617 can be programmed over its full output range in any mode by simply varying the grid-to-cathode voltage.

Booth No. 5219 Circle No. 384



all fhp motors are alike?

Now that you're surprised at how different this Howard fhp motor looks on the *outside*, let's talk about *output*:

When Howard rates a motor 1/20 hp, we're not about to underpower your system with a 1/25 hp motor. We've always True Rated our fhp motors this way.

Now engineers and designers are finding that a carelessly overrated or underrated motor can cause system problems. And they want no part of either. That's why engineers look to Howard for True Rated fractional horsepower motors. . . .

and they get them. Our computer guarantees it. And your products benefit.

Next time you look at the outside of a Howard motor, you won't find mod painting. You will find that if the label says 1/20 hp, we don't mean 1/25 hp. Or 1/15 hp, either.

Get the complete Howard True Rated story. Find out in detail why it makes no difference that all fhp motors *look* alike. It's the output that counts. Write or call Howard for Fractional Horsepower Motor Information Packet ED-89.



HOWARD

HOWARD INDUSTRIES
MSL INDUSTRIES, INC./MOTOR GROUP
2420 18th STREET, RACINE, WISCONSIN 53403
414-632-2731 TWX 910-271-2387

INFORMATION RETRIEVAL NUMBER 77

Multi-color single-gun CRT responds to current density

International Telephone & Telegraph Corp., 3700 Pontiac St., Fort Wayne, Ind. Phone: (219) 743-7571. P&A: \$500; 30 to 90 days.

Using a new type of phosphor screen, a new multi-color single-gun cathode-ray tube generates color shifts from green to orange as the beam current density is changed. This new approach avoids the need for color masks, multiple-electron guns or beam-velocity modulation, previous methods of generating color displays in cathode-ray tubes.

The F3522 is a 5-in.-diameter round CRT that uses electrostatic focusing and magnetic deflection. It can provide the four distinct colors of yellow, red, green and orange, besides various hues of these.

The color shift is obtained by combining two different phosphors; one having a super-linear intensity versus density behavior, and another with linear or sub-linear behavior and a different emission

color.

At low current densities, the emission color will be that of the sub-linear phosphor. However, as current density is increased, the super-linear phosphor will contribute more, and the color will shift towards its characteristic emission.

Along with the color shift and higher current density, the brightness of the display will also increase. This is because the sub-linear phosphor continues to contribute, although not dominantly. The resulting color is a blend of the two phosphor emissions.

The new cathode-ray tube operates with a heater voltage of 6.3 V at 600 mA. Maximum anode voltage is 20 kV dc and the second grid voltage is 300 V.

Besides the 5-in. round tube, two other versions will be available. These are an 8-in. rectangular unit and a 10-in.-diameter round one. They will be priced slightly higher than the F3522.

Booth No. 3808 Circle No. 409

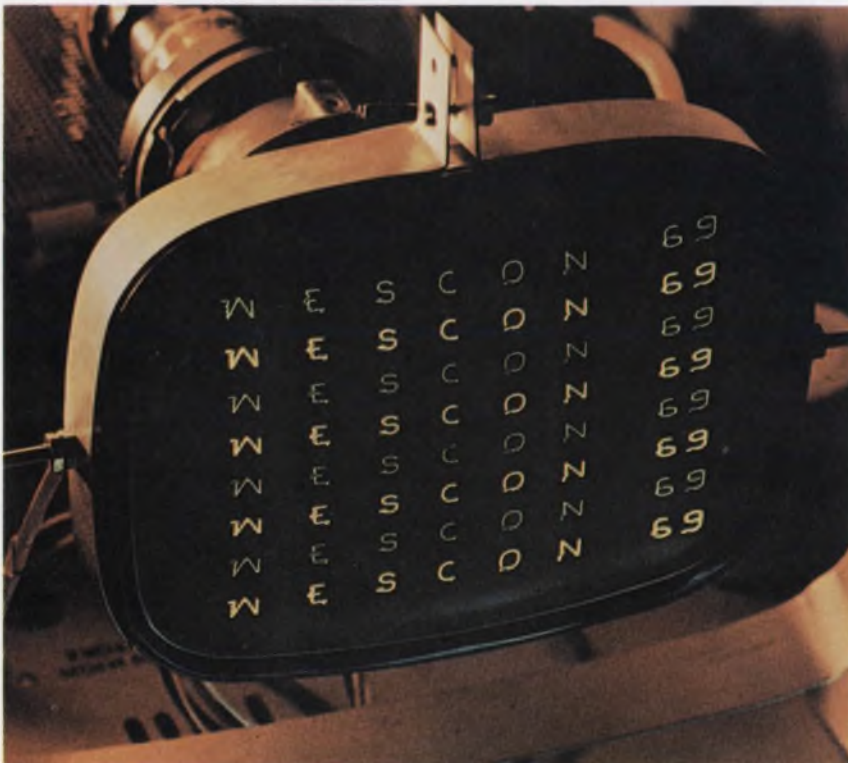

New multi-color single-gun cathode-ray tube shifts from green to orange as beam current density is varied. At least four distinct colors can be generated—yellow, red, green and orange—besides their tints.

Cermet trimmers sell for \$1.14

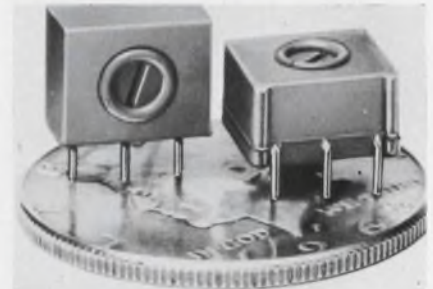

CTS Corp., 1142 W. Beardsley Ave., Elkhart, Ind. Phone: (219) 523-0210. Price: \$1.14.

Costing as little as \$1.14 in quantities of 100, a new line of industrial cermet trimmers features a setability of $\pm 0.03\%$, an average equivalent noise resistance of 1.5% and an average contact resistance variation of only 0.5%. Series 360 units have a power rating of 0.5 W at 70°C and a resistance tolerance of $\pm 20\%$. Standard resistance values range from 50 Ω to 1 M Ω .

Booth No. 3913 Circle No. 259

Tiny slide switch has 30-year life



Chicago Switch, Inc., 2035 Wabansia Ave., Chicago, Ill. Phone: (312) 489-5500. P&A: 54¢ to \$2.50; 4 to 8 wks.

Offering the ultra-high reliability of a 30-year life or 5×10^6 flawless operations with low-energy circuitry, a new microminiature switch features a true over-center toggle mechanism for precision snap-action inside a slide switch package. The unit can handle a resistive load of 0.5 A at 125 V ac. Contact bounce on make is 0.5 ms in the spdt version and 1 ms in the dpdt version.

Booth No. 4711 Circle No. 252

Is the 901 counter-timer just too good to be true?



Shown with optional 1.3-GHz plug-in.

NO!

But we can't blame you if you think so.

Picture a state-of-the-art, 200-MHz, universal counter-timer selling for \$250 to \$1000 below the competition. Having trouble? Picture won't focus? Of course not. Cheap price tags usually mean cheap products.

Focus in again. This time, picture technological breakthroughs — new circuitry and new components that the competition hasn't caught up with yet. Now, see how easy it is to make a better product and sell it for less, too?

How much better is the CMC 901? Take a look. Range: 200 MHz (instead of 125 or 135) without prescaling or plug-ins. Gate times: $1\mu\text{sec}$ to 100 sec instead of to just 10 sec. TIM: built-in, with a resolution of 10 nsec instead of 100. Input sensitivity: 20 mV instead of the usual 50 or 100. Read-out: 9 decades not just 8.

But specs aren't everything. How about the Model 901's "universality"? Besides counting to 200 MHz directly

(and 1.3 GHz or 3.3 GHz with optional plug-ins) the 901 also scales signals, measures time interval, period, and multiple-period average. It provides frequency and multiple-frequency ratios as well as total count; and, as an optional extra, it can be operated completely by remote control. The basic price tag? Just \$2475. So we can't blame you if you're skeptical, but would you be happy if you bought a lesser model and paid more?

For the full facts, circle the reader service card.

COMPUTER MEASUREMENTS



A DIVISION OF NEWELL INDUSTRIES

12970 Bradley/San Fernando, Calif. 91342/(213) 367-2161/TWX 910-496-1487

SEE IT AT WESCON BOOTH 1006-8!

INFORMATION RETRIEVAL NUMBER 78

Pushbutton breakers light green and white

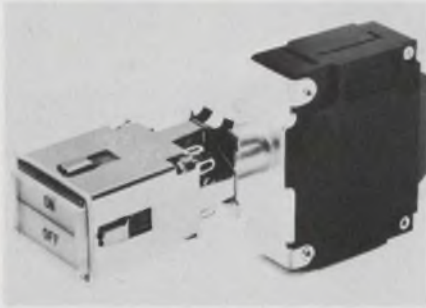

Heinemann Electric Co., 248 Magnetic Drive, Trenton, N.J. Phone: (609) 882-4800.

The top half of series JL lighted pushbutton circuit breakers lights in a soft green to indicate an on circuit, and the bottom half lights in white to indicate an off circuit. The new units are available with either a fast or a slow time-delay response; non-time-delay models are also available. Standard maximum voltage ratings are 240 V ac (60 or 400 Hz), and 65 V dc. Booth No. 3801 Circle No. 372

Lighted pushbuttons standardize colors

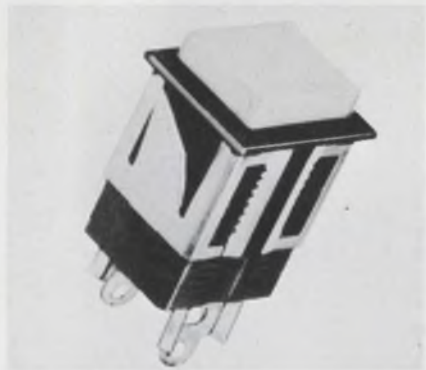

Switchcraft, Inc., 5555 N. Elston Ave., Chicago, Ill. Phone: (312) 774-1515. Availability: stock.

New Uniswitch pushbuttons are now available in red, white, blue, green and yellow colors as standard; clear amber and other colors may be obtained on special order. Series LUS units are compact momentary-action pushbutton switches supplied in both illuminated and non-illuminated types. They provide side, as well as front, lighting that is constant and independent of switching action. Booth No. 3909 Circle No. 260

Lighted switches adapt to needs

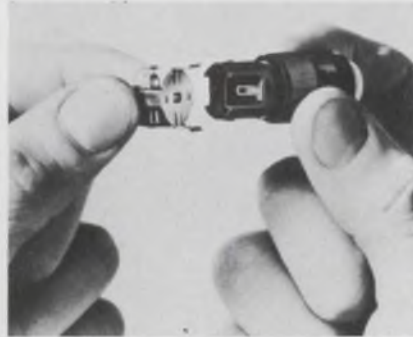

Arrow-Hart, Inc., Specialty Switch Div., 103 Hawthorn St., Hartford, Conn. Phone: (203) 249-8471.

Using a building-block concept, a new line of lighted pushbutton switches makes possible more than 25,000 switching variations with just 31 stock components. Called Adapt-a-Switch, the easy-to-mount snap-action units have two contact blocks, standard duty and low energy, which can be used to build up to four-pole switches. Booth No. 5121 Circle No. 263

Pushbutton switches accept 2 lamp types



Jay-El Products, Inc., 1859 W. 169th St., Gardena, Calif. Phone: (213) 323-7130. Availability: 6 wks.

Designed for maximum panel density for aircraft control and display requirements, Mark Eight illuminated pushbutton switches or indicators can accept T-1-3/4 lamps or T-1 lamps with an adapter. These type 10620 units are available in matrix mountings on 0.689-in. square centers or with individual bezel and integral mounting hardware on 0.75-in. square centers. Booth No. 4515 Circle No. 262

Miniature protector safeguards to 116 V

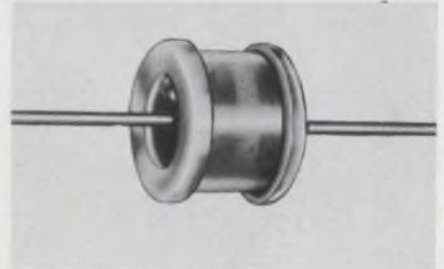

Siemens America Inc., 350 Fifth Ave., New York, N. Y. Phone: (212) 564-7674.

A new miniature gas-filled surge-voltage protector guards semiconductors and other electrical and electronic components against power surges and other transients. SVP type B1-C145, which measures only 0.38 in. in diameter and 0.272 in. long, provides protection for equipment with peak operating voltages up to 116 V. Booth No. 1505 Circle No. 387

Circuit protector responds in 50 ns



Transtector Systems, M & T Chemicals Inc., sub. of American Can Co., 3025 W. Mission Rd., Alhambra, Calif.

Developed for integrated circuits, transistorized equipment and complete electronic systems, a new protective device can sense and deflect damaging transient voltages and currents in less than 50 ns. This solid-state circuit protector can also guard against sudden losses of voltage below acceptable operating levels. In less than 500 ns, the device will return a transient to nominal line voltage. Booth No. 4712 Circle No. 250

Dale wirewounds can improve your memory.



The computer: General Electric's versatile GE/PAC[®] 4020 Process Control Computer...shown at left.

Resistor assignment: Establish line current values in the GE/PAC[®] 4020 core memory system.

The part used: Dale's Type NS...silicone coated, non-inductively wound.

Reason: Low inductance (less than 1 μ h) and unvarying stability (less than .5%/ 2000 hours).

Dale wirewounds give you unequalled design freedom in tailoring resistance, power, size and stability to your exact needs. Industrial.... precision.... established reliability.... standard or special....there's always a Dale resistor that can do the job better. Call 402-564-3131 for fast action, or circle 181 for Catalog A.



for optimum value in wirewound resistors

DALE ELECTRONICS, INC. 1300 28th Avenue, Columbus, Nebraska 68601

In Canada: Dale Electronics Canada, Ltd.

Printed in U.S.A.

Gard Testing is available to meet Established Reliability requirements at significant time/cost savings over typical 100 hr. burn in. Write for Test Report #19590.

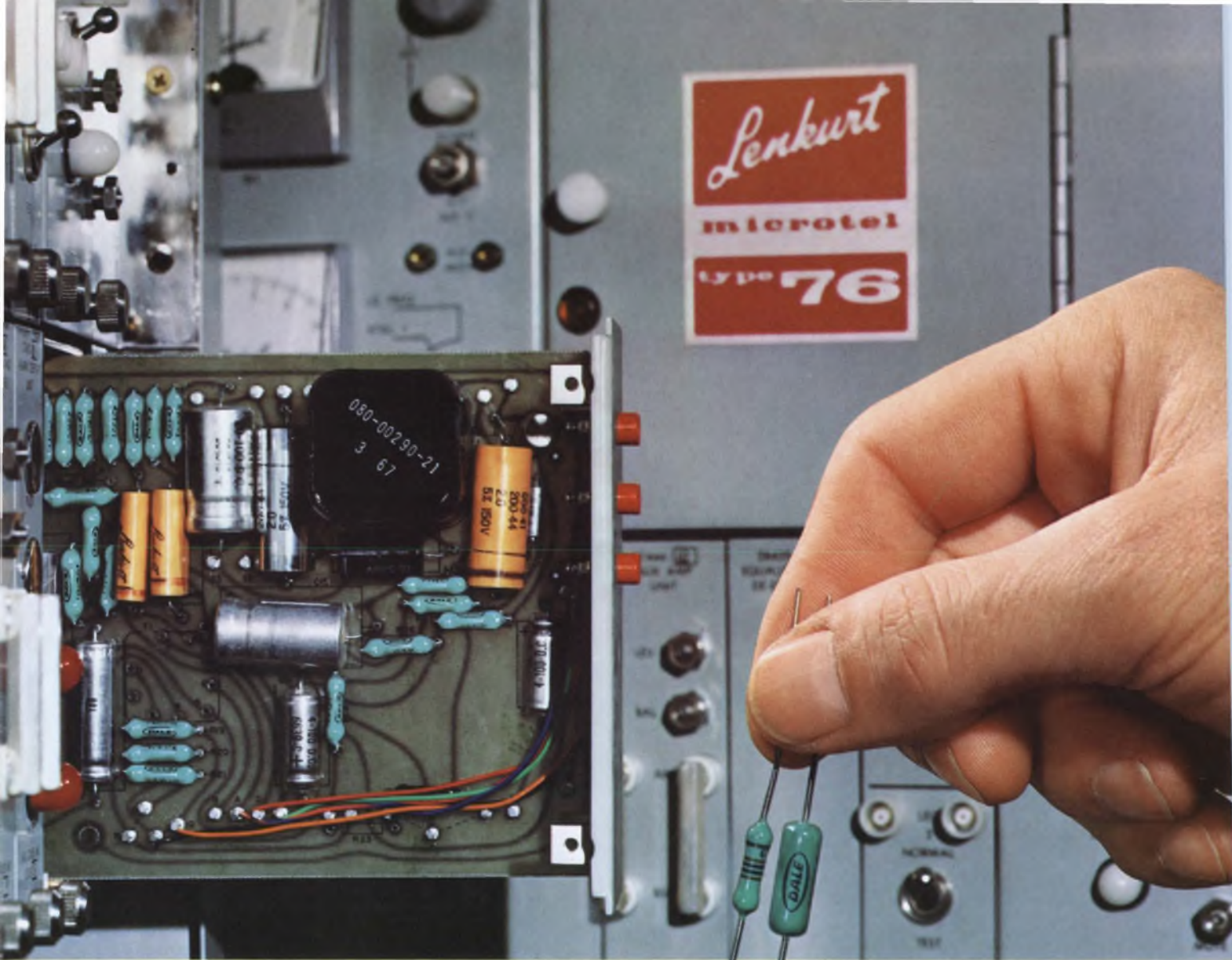

20 years of stability

...a job for DALE Metal Film Resistors

Twenty years – the design life of Lenkurt's versatile "76" Microwave Systems – puts stringent demands on a resistor. To meet them, Lenkurt uses Dale MFF Metal Film Resistors to maintain bias stability in critical amplification circuits. Their evaluation: "Good performance."

Here's how Dale multiplies the advantages of metal film for your application: **Broader design choice** – From subminiature 1/20 watt through 12 watts of housed power plus microresistive package and networks to your specification. **Proven failure rate** – See data at right. **Faster delivery** – Expanded production facilities let you call the shots on shipment of both MF and MFF types.

Call Dale today...402-564-3131 or circle 181 for complete Resistor Catalog A

GENERAL SPECIFICATIONS TYPE MF* MIL-R-10509F				
DALE TYPE	MIL TYPE	125° C RATING (Char. C & E)	70° C RATING (Char D)	RESISTANCE RANGE (Ohms)
MF50	RN-50	1/20 w	1/10 w	30.1 to 80.6K
MF-1/10	RN-55	1/10 w	1/8 w	30.1 to 301K
MF-1/8	RN-60	1/8 w	1/4 w	10 to 1 MΩ
MF-1/4	RN-65	1/4 w	1/2 w	10 to 1 MΩ
MFS-1/2	RN-70	1/2 w	3/4 w	10 to 1.5 MΩ
MF-1	RN-75	1 w	–	25 to 2.6 MΩ
MF-2	RN-80	–	2 w†	100 to 10 MΩ

*Also available in conformal coated (MFF) and housed chassis mount (D) styles with power to 12 watts. IChar. B.
 Tolerance: ±1%, ±.5%, ±.25%, ±.10% standard.
 Characteristics D, C, or E apply depending on T.C. required.
 Proven Failure Rate: .004% per 1,000 hrs. (60% confidence at 50% power, 70° C ambient). Based on 16,320,000 hrs. of load life testing without a failure (100% rated power, 70° C, failure defined as ΔR > 1%).
 Guard Testing is available to meet Established Reliability requirements at significant time/cost savings over typical 100 hr. burn in. Write for Test Report # 19590.



for optimum value in metal film resistors

DALE ELECTRONICS, INC., 1300 28th Ave. Columbus, Nebraska 68601
 In Canada: Dale Electronics, Canada, Ltd.





Call us for more information on the dry test bath

Yes, that telephone is working perfectly in its bath of Fluorinert® Brand Electronic Liquid.

In your testing procedures, Fluorinert Liquids will show up flaws and leaks with great accuracy. In fact, the MIL-Standard 883 and the MIL-Standard 750A tests for gross leak-

age in microcircuits approve the use of Fluorinert Liquids...which says a lot about dependability.

They are efficient over a wide temperature range and compatible with the most sensitive materials. Fluorinert Liquids are non-flammable and won't conduct electricity.

And because tested units drain clean and dry fast upon removal from the bath, you can use or package your product right out of the bath.

We have lots of interesting information about these unusual liquids. Send the coupon...or call your local 3M representative.

Fluorinert® Electronic Liquids 3M

3M Company, Chemical Division, 3M Center
St. Paul, Minn. 55101

Dept. KAP-8-69

Send me all the details about Fluorinert Brand Electronic Liquids.

Name _____

Company _____ Title _____

Address _____

City _____ State _____ Zip _____

INFORMATION RETRIEVAL NUMBER 79

PC 10-A relays operate in 10 ms

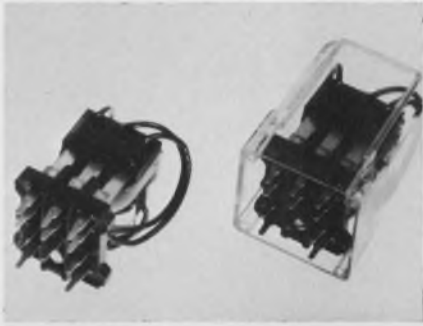

Cornell-Dubilier Electronics, div. of Federal Pacific Electronic Co., 50 Paris St., Newark, N. J. Phone: (201) 624-7500. P&A: \$4.89 to \$8.55; stock.

Available as a standard item, a new series of 10-A printed circuit general-purpose relays features a release time of 8 ms and a mechanical life in excess of 20×10^6 operations. Series 30 units have a minimum dc coil resistance of 10 k Ω . Contact configuration can be spdt, dpdt, or 3pdt.

Booth No. 4403 Circle No. 255

Spst reed relay switches 10 kV

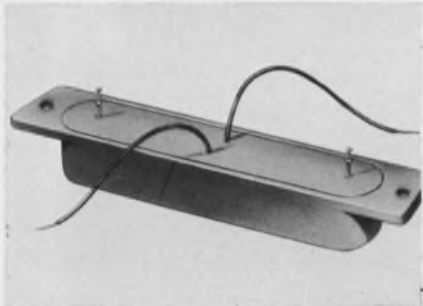

Magnecraft Electric Co., 5575 N. Lynch Ave., Chicago, Ill. Phone: (312) 282-5500. P&A: \$11.93 to \$19.88; stock.

With a peak contact load rating of 10 kV at 1 mA, a new high-voltage reed relay has a specially designed insulation system that provides maximum dielectric strength. This class 102HV spst normally open relay offers a nominal coil power of 850 mW, an operating time of 20 ms and a contact resistance of 100 m Ω . Typical life at rated load is one million operations.

Booth No. 4311 Circle No. 253

Fast impulse counters have readout switch



Landis & Gyr, Inc., 45 W. 45th St., New York City. Phone: (212) 586-4644.

Sodeco ES4 high-speed impulse counters are compact single-digit units equipped with a 10-position readout switch, a transfer contact, a zero contact and a predetermining switch. They can perform a wide range of functions including programing, impulse storage, predetermining, counting and control. These new counters are enclosed in a clear molded case that protects the units from dust while allowing full observation of the mechanism during operation.

Booth No. 4208 Circle No. 266

Double-gun CRT separates X and Y



M-O Valve Co., Ltd., Metropolitan Overseas Supply Corp., 468 Park Ave. South, New York City. Phone: (212) 686-2120.

Developed for applications where it is necessary to compare waveforms with widely differing frequency characteristics, a new double-gun cathode-ray tube features completely independent X and Y deflection systems. Genalex LD 708 is a 13 by 10-cm rectangular flat-faced tube having a scan size of 6 by 10 cm for each beam with a 5-cm overlap.

Booth No. 4607 Circle No. 264

Monolithic filters yield seven poles

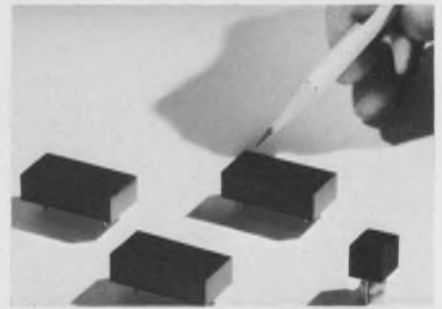

Damon Engineering, Inc., Electronics Div., 115 Fourth Ave., Needham, Mass. Phone: (617) 449-0800.

Four new monolithic crystal filters provide a seven-pole characteristic, with a center frequency of 10.6 or 21.4 MHz. Types 6457MA, 6457MB, 6458MA and 6458MB offer a minimum 3-dB bandwidth of 6 to 15 kHz; maximum 60-dB bandwidth is 18, 40 or 45 kHz. Their ripple is 1 dB maximum, and insertion loss is 6 dB maximum.

Booth No. 5206 Circle No. 254

Fixed delay lines up risetime ratio



Allen Avionics, Inc., 255 E. 2nd St., Mineola, N. Y. Phone: (516) 747-5450. Availability: stock.

Spiradel distributed-constant fixed delay lines boast delay-to-risetime ratios of over 20 to 1, with good temperature stability and pulse fidelity. The new units cover a delay range of 100 to 1000 ns. Standard impedance is $325 \Omega \pm 10\%$, but any impedance from 200 to 600 Ω is available. The compact delay lines are encapsulated for maximum environmental protection.

Booth No. 4713 Circle No. 275

New IRC rectangulars trim circuit space and cost

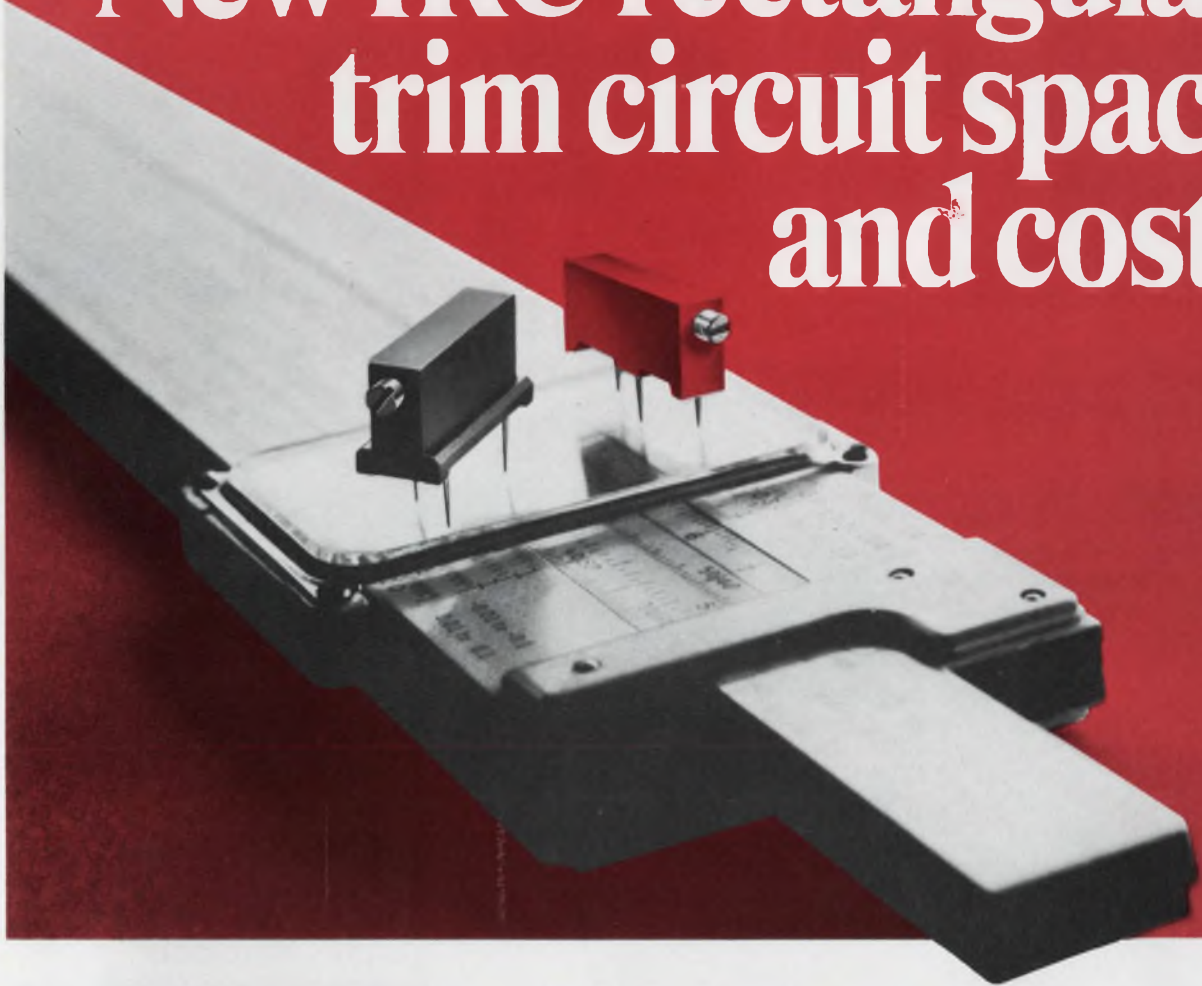

Metal Glaze and Wirewound types

These 3/4-inch-long rectangular trimmers are made and perform like bigger, more costly units. Only IRC offers a miniature general-purpose unit with these features:

- All-metal adjustment shaft that eliminates breakage or distortion, even under repeated use.
- Silver brazed terminations on Metal Glaze and Wirewound types end resistance buildup associated with pressure connections.
- Ultrasonic bonding of the housing into a one-piece unit that is free of seams or laps.
- Resistance to normal board washing. Units sealed to MIL-R-27208 are also available.

Metal Glaze Type 950 has a rugged, thick-film element that provides excellent high-frequency characteristics and infinite resolution over the entire resistance range of 100 Ω to 1 megohm. 1/4-watt @ 25°C. $\pm 10\%$ tolerance.

Precision Wirewound Type 900 has a long-wearing precious metal wiper spring that reduces noise and contact resistance. 1 watt @ 40°C. 100 Ω to 20K. $\pm 10\%$ tolerance.

PIN CONFIGURATIONS

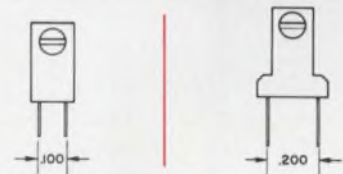

WIREWOUND	METAL GLAZE	WIREWOUND	METAL GLAZE
900-20 Std.	950-20 Std.	920-20 Std.	970-20 Std.
910-20 Sealed	960-20 Sealed	930-20 Sealed	980-20 Sealed

Immediate delivery from stock or from IRC Industrial Distributors. For information and prices write:

IRC St. Petersburg Division of TRW INC.
2801 72nd St., North, St. Petersburg, Fla. 33733



DIVISION OF TRW INC.

Bi-pin T-1-3/4 lamps have plastic bases



Industrial Electronic Engineers, 7720 Lemona Ave., Van Nuys, Calif. Phone: (213) 787-0311. P&A: 18.7¢ to 23.4¢; stock.

Supplied with a tough plastic base, standard bi-pin T-1-3/4 lamps are now available in five styles. These new lamps require less space than bayonet or screw-base lamps and sockets, yet provide comparable protection for the glass seal. Gas vent slots are designed into the base to prevent solder blowout during dip-solder operations.

Booth No. 3715 Circle No. 283

Broadband emi filters handle 60 mA to 10 A



Potter Co., 500 W. Florence Ave., Inglewood, Calif. Phone: (213) 678-2651. P&A: \$4 to \$15; stock to 8 wks.

Ideal for low-voltage ac or dc applications, Micro-Brute sub-miniature emi suppression filters operate over the frequency range of 30 kHz to 10 GHz with a current capacity of 60 mA to 10 A. Series 8330 units fulfill the requirements of broadband emi situations where size and weight must be held to a minimum, such as in airborne computers and radar.

Booth No. 5112 Circle No. 265

Segmented readouts have mosaic look

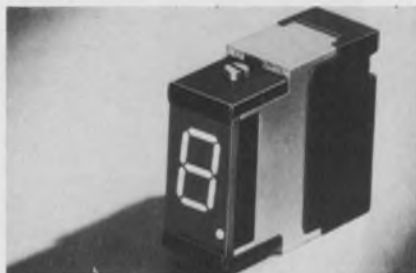

Alco Electronic Products, P. O. Box 1348, Lawrence, Mass. Phone: (617) 686-3887. P&A: \$8.25; stock.

Series MSM single-phase mosaic-style readouts display numerals 0 through 9 and some alphabetic indications by illuminating a combination of incandescent lamps through a simple diode matrix or encoding switch. The closely interlocked illuminated segments provide a wide viewing angle of approximately 150°. Miniature T-1 lamps are used.

Booth 5120 Circle No. 395

Pressure switch takes 30,000 psig



Bristol Div., American Chain & Cable Co., Inc., P.O. Box 1790, Waterbury, Conn. Phone: (203) 756-4451.

Used for switching circuits in response to pressure changes in gases and liquids, a new adjustable pressure switch features a calibration range of 100 to 10,000 psig and a burst pressure up to 30,000 psig. Weighing less than 4 oz, model 506351 has an externally adjustable range that may be field set with a screwdriver or can be furnished factory set. Setting accuracy is from ± 5 to ± 50 psig, depending upon calibration range.

Booth No. 3921 Circle No. 261

Magnetic heads track 48 mils

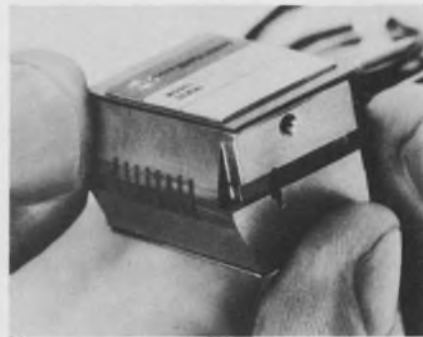

Clevite Corp., Brush Magnetic Products, E. 37th and Perkins, Cleveland, Ohio. Phone: (216) 361-3315.

Featuring satellite erase heads and connectors, a new series of digital magnetic heads offers track widths of 48, 30 or 40 mils for a seven-track format and 44 or 40 mils for a nine-track format. These IBM-compatible devices have a gap length of 250 microns and a gap depth of 0.016 in. nominal. They also feature a full metal face and 12-in. lead terminations.

Booth No. 4522 Circle No. 251

Readout tubes shrink envelope



Tung-Sol Div., Wagner Electric Corp., 630 W. Mt. Pleasant Ave., Livingston, N.J. Phone: (201) 992-1100. Price: \$2.55 typical.

Suitable for high-density component packaging, three new Digivac S/G digital readout tubes now come in a small T-5-1/2 envelope. The DT1704B is 9-pin-base alphanumeric readout, the DT1705D is 10-pin-base alphanumeric readout with a decimal, and the DT1707B is a ± 1 readout. All three are single-plane segmented fluorescent indicators.

Booth No. 4710 Circle No. 394

CROWBAR...?

The One Inside is FREE

Not so many years ago, the prudent transmitter engineer discharged a high voltage capacitor bank by dropping a shorting "crowbar" across its terminals. Today's "crowbar" is a protective overvoltage circuit found on DC power supplies — usually at extra cost. Now HP includes a crowbar as standard on its recently updated series of low-voltage rack supplies . . . at no change in price.

Long established as preferred system supplies for component aging, production testing, and special applications, these supplies have now been redesigned and expanded to meet the stringent demands of today's power supply user. Advantages include low ripple (peak-to-peak as well as rms), well-regulated constant voltage/constant current DC with outputs to 60 volts and 100 amps.

Where loads are critical and expensive, the extra pro-

tection — say, against inadvertent knob-twiddling — from a crowbar is invaluable. On all internal crowbars in this series, the trip voltage margin is set by screw-driver at the front-panel.

Pertinent specifications are: triggering margins are settable at 1V plus 7% of operating level; voltage ripple and noise is 200 μ V rms/10mV peak-to-peak (DC to 20 MHz); current ripple is 5 mA rms or less depending on output rating; voltage regulation is 0.01%; resolution, 0.25% or better; remote programming, RFI conformance to MIL-I-6181D.

Prices start from \$350. For complete specifications and prices, contact your local HP Sales Office or write: Hewlett-Packard, New Jersey Division, 100 Locust Avenue, Berkeley Heights, New Jersey 07922 or call (201) 464-1234 . . . In Europe, 1217 Meyrin, Geneva.

HEWLETT  PACKARD
POWER SUPPLIES

"See us at WESCON — Booth 1040-1046"

Additional data sheets available upon request

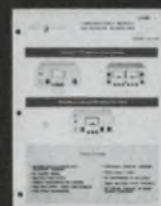

LAB SERIES
smaller package,
lower power,
optional crowbar

331



CROWBARS
A Technical
Discussion

332



**1969 Power
Supply Catalog**
— includes total
HP power supply line.

333

Circle # for details 330

Far Superior TO ANY VTVM OR VOM A NEW STANDARD OF THE INDUSTRY...

- Only Sencore makes a true field effect meter
- Less circuit loading than VTVM/obsoletes VOM
- Zero warm-up time — instant stability
- Complete circuit and meter protection
- Complete portability
- Greater frequency responses than most scopes

FE149 SENIOR FET METER

The only true Senior FET meter available today with outstanding accuracy and unbelievable ease of operation.

- **Unmatched Accuracy.** 1.5% on DC, 3% on AC, plus large 7-in. meter and mirrored scale, assure the most accurate tests possible.
- **Eight AC and DC ranges** .5V to 1500V full scale.
- **Zero center scale** with .25 v. either side assures measurements to less than .1 v. for transistor bias measurements.
- **AC peak to peak** readings to 4500V maximum with freq. response of 10HZ to 10MHZ \pm 3DB.
- **Eight resistance ranges** to R x 10 megohms with 6 OHMS center scale.
- **Nine DC and nine AC current ranges** 150 μ a to 5 amps.
- **Eight decibel ranges** for audio measurements.
- **Three HI-Voltage ranges**, 5 KV, 15 KV, 50KV with 39A21 high voltage probe. **\$14.95**
- **Absolute meter and circuit protection** against circuit overload.
- Non-breakable, scuff-proof, vinyl-clad steel case.
- **Three-way power.** Operates on AC, on self-contained rechargeable batteries, or on AC with batteries plugged in. Same readings all three ways.



\$149.50

Exclusive push-button design. Just push two buttons for any test — top row selects function, bottom row selects range. Action is instant and automatic.

FE14 and FE16 popular 4 1/2 inch FET Meters



\$69.95

FE14 — STANDARD FET METER

ACCURACY DC \pm 2.5%
AC \pm 4.5%

- 4 1/2-inch meter, vinyl-clad steel case.

- **Hi Accuracy.** For unsurpassed measurements. Mirrored scales prevent parallax errors.
- **Minimum circuit loading.** 15 megohm input resistance on DC; 10 megohm on AC.
- **Zero center scale** \pm 0.5 v. readings for transistor bias measurement.
- **Full meter & circuit protection** against possible circuit overload.
- **7 DC & AC voltage ranges** 1 to 1000 volts full scale.
- **AC peak to peak readings** 2800 v. maximum with freq. response of 10HZ to 10MHZ \pm 3DB.
- **5 resistance ranges** to 1000 megohms.
- **5 DC current ranges** 100 μ a to 1 amp.
- **3 Hi-Voltage ranges**, 3 KV, 10 KV, 30 KV, extended with 39A19 (\$9.95) high voltage probe.



\$84.50

FE16 HI ACCURACY FET METER

ACCURACY DC \pm 1.5%
AC \pm 3%

- 4 1/2-inch high-styled meter, high-styled knobs, and special meter-tilting metal handle. Vinyl-clad steel case.



See your Sencore distributor today or write factory for complete line catalog.

SENCORE
STANDARD OF THE ELECTRONIC INDUSTRY

426 SOUTH WESTGATE DRIVE,
ADDISON, ILLINOIS 60101

INFORMATION RETRIEVAL NUMBER 81

INFORMATION RETRIEVAL NUMBER 82 ►

THE 5000 PERM TOROID

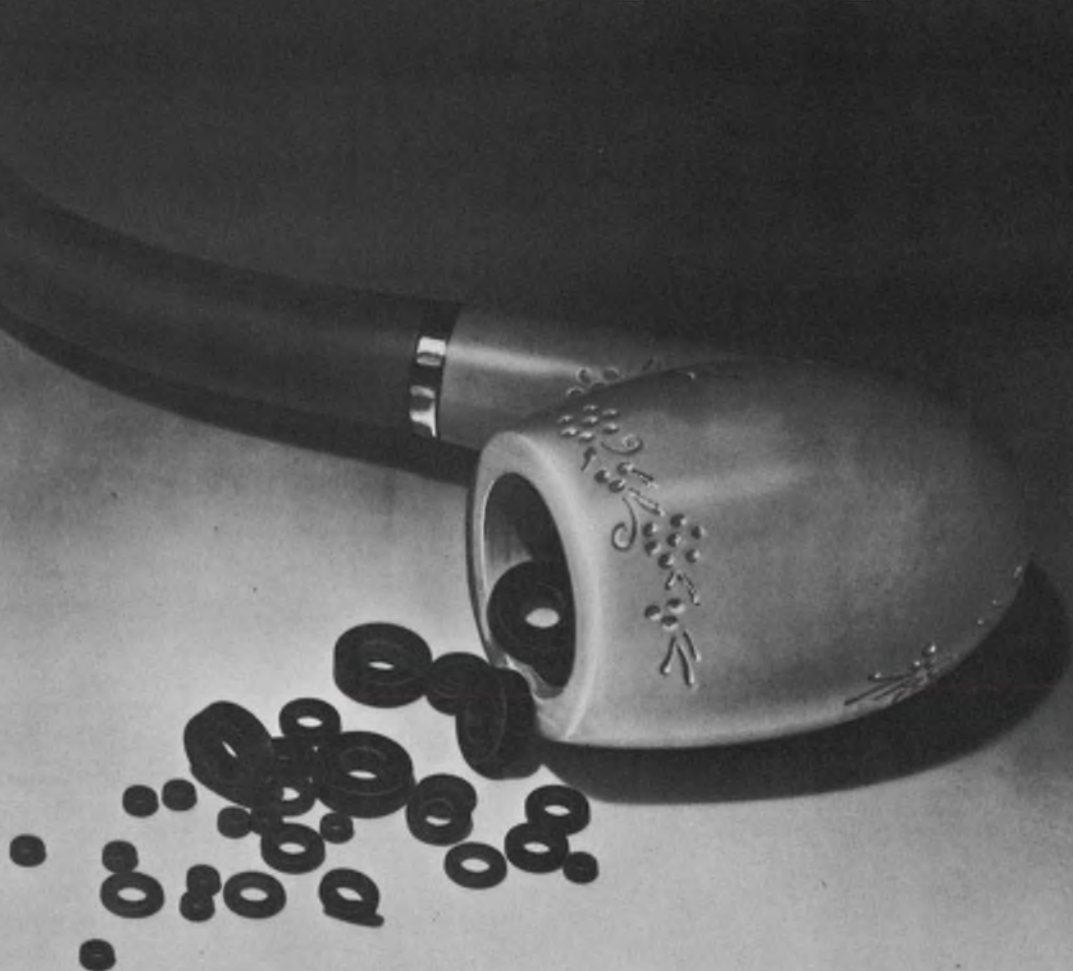

NO LONGER A PIPE DREAM

That's right. 5000 initial permeability. And we mean it!

Perhaps your designs for pulse transformers have gone up in smoke for want of a powerful enough material. Well, now you've got it. And then some. Stackpole Ceramag® 24H ferrite material.

Ceramag® 24H is a precision engineered product. Exact processing, density checks, rigid kiln controls and precise

sintering. You get more out of it simply because we put more into it.

Here are a few more conservative characteristics. Maximum permeability, 6900. Typical. Saturation flux density, 4100 gauss and residual magnetism of 850 gauss. If curie point is significant to your operation, how about one of 175° C. Then there's temperature coefficient. Ceramag® 24H goes + 0.700% / ° C at -25°

C to 25° C and -0.450% / ° C at 25° C to 75° C. And all of this with a disaccommodation factor of 1.4×10^{-6} .

Ceramag® 24H is ready. Are you? Drop us a line and we'll send you some even more interesting facts about this fantastic new material. And the charts to prove it. Stackpole Carbon Company, Electronic Components Division, St. Marys, Pa. 15857. Ph: 814-834-1521



STACKPOLE

Electronic Components Division

ALSO A LEADER IN THE MANUFACTURE OF QUALITY FIXED COMPOSITION RESISTORS

LSI analog multiplexer chip combines bipolars and FETs

Radiation Inc., sub. of Harris-Intertype Corp., Microelectronics Div., P.O. Box 37, Melbourne, Fla. Phone: (305) 727-4295. P&A: \$360; September, 1969.

Using large-scale integration, a new monolithic bipolar 16-channel analog multiplexer combines n-channel junction field-effect transistors with complementary npn/pnp bipolar transistors on the same dielectrically isolated substrate. This combination of both vertical and horizontal integration technologies doubles the number of bipolar-compatible data channels available to the systems designer.

Said to exceed the performance of discrete IC or MOSFET systems, the new RS-1000 multiplexer offers the advantages of complexity on a single chip, weight reduction and reliability. Systems applications for the new device include telemetry and guidance systems, and process control computers. Circuit applications include a/d and d/a converters, function generators, and sample-and-hold and analog cross-point circuits.

The device features near-ideal on-chip analog switches with a 100-nA off-state input leakage, 500- Ω on resistance, 4-pF off-channel in-

put capacitance, and an access time of 800 ns. The high off impedance virtually eliminates signal leakage to the load; the very low on impedance greatly reduces signal loss in the switch. In addition, there is effective isolation between the on-channel signal and all other input signals.

Operating at twice the rate of MOS devices, the RS-1000 has a commutation speed of 1.3 MHz because of its extremely fast access time. It requires a single negative and single positive power supply, accepts bipolar analog inputs of -10 to +10 V, and is compatible with standard DTL and TTL circuits.

There are 16 analog input lines and two analog outputs that can be used independently, or bussed together for 16-channel operation. Since the JFET switch elements are symmetrical, the new circuit can also be used as a demultiplexer where a one- or two-line input is commutated to eight or 16 output lines.

Random-access channel selection is accomplished through a four-bit binary address input. There is also an address enable input that can be used as an address expander for

applications employing several multiplexer circuits. A mode control input provides one-out-of-16 or two-out-of-16 channel selection. In addition, an external bias control allows optimization of signal input range and switching time.

Besides all these performance benefits, the RS-1000 can operate over the full military temperature range from -55 to +125°C. It meets the mechanical and environmental requirements of MIL-S-883 via its 28-pin hermetically sealed flatpack.

Two other new products from Radiation Inc. on display at Wescon are high-speed internally compensated operational amplifiers. Model RA-2510 has a unity-gain slew rate of ± 50 V/ μ s and a large-signal bandwidth in excess of 500 kHz. Model RA-2500 slews at ± 20 V/ μ s at unity gain and offers a large-signal bandwidth of greater than 200 kHz.

The RA-2500 has a voltage gain of 35,000, an offset current of 20 nA, and an offset voltage of 2 mV. The RA-2510, on the other hand, gives a voltage gain of 15,000 and offers input characteristics identical to those of the RA-2500.

Output impedance is 100 Ω and output current is ± 20 mA for both amplifiers. They are packaged in TO-86 and TO-99 metal cans.

Also on display is an expanded line of radiation-hardened TTL integrated circuits.

Booth No. 4503 Circle No. 413

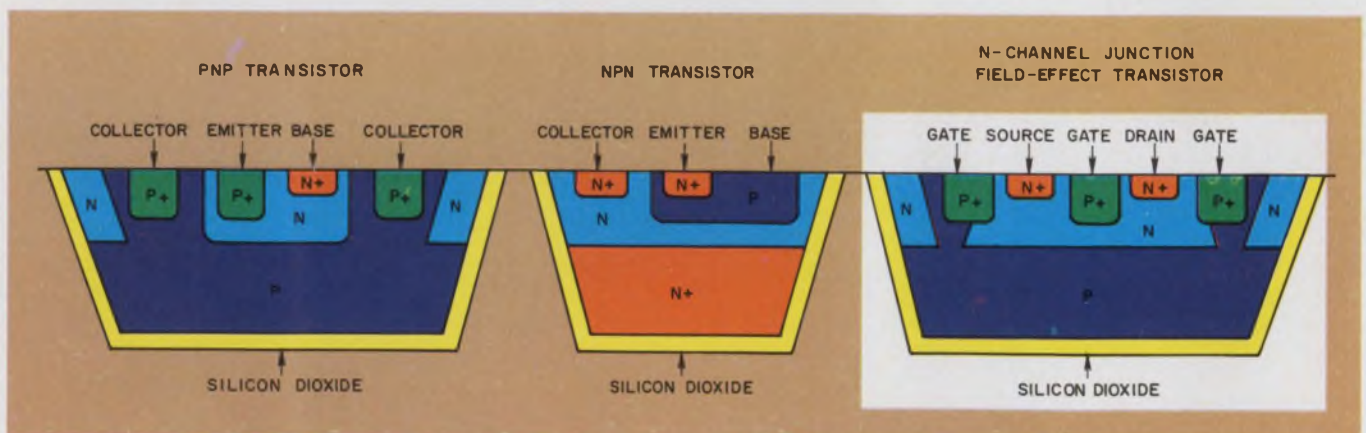

Achieving true interchannel isolation, a new monolithic 16-channel analog multiplexer forms near-ideal on-chip analog switches by combining complementary

bipolar transistors with n-channel junction FETs. This large-scale integrated circuit uses dielectric isolation to separate all structures, both horizontal and vertical.

WE'VE BLOSSOMED!

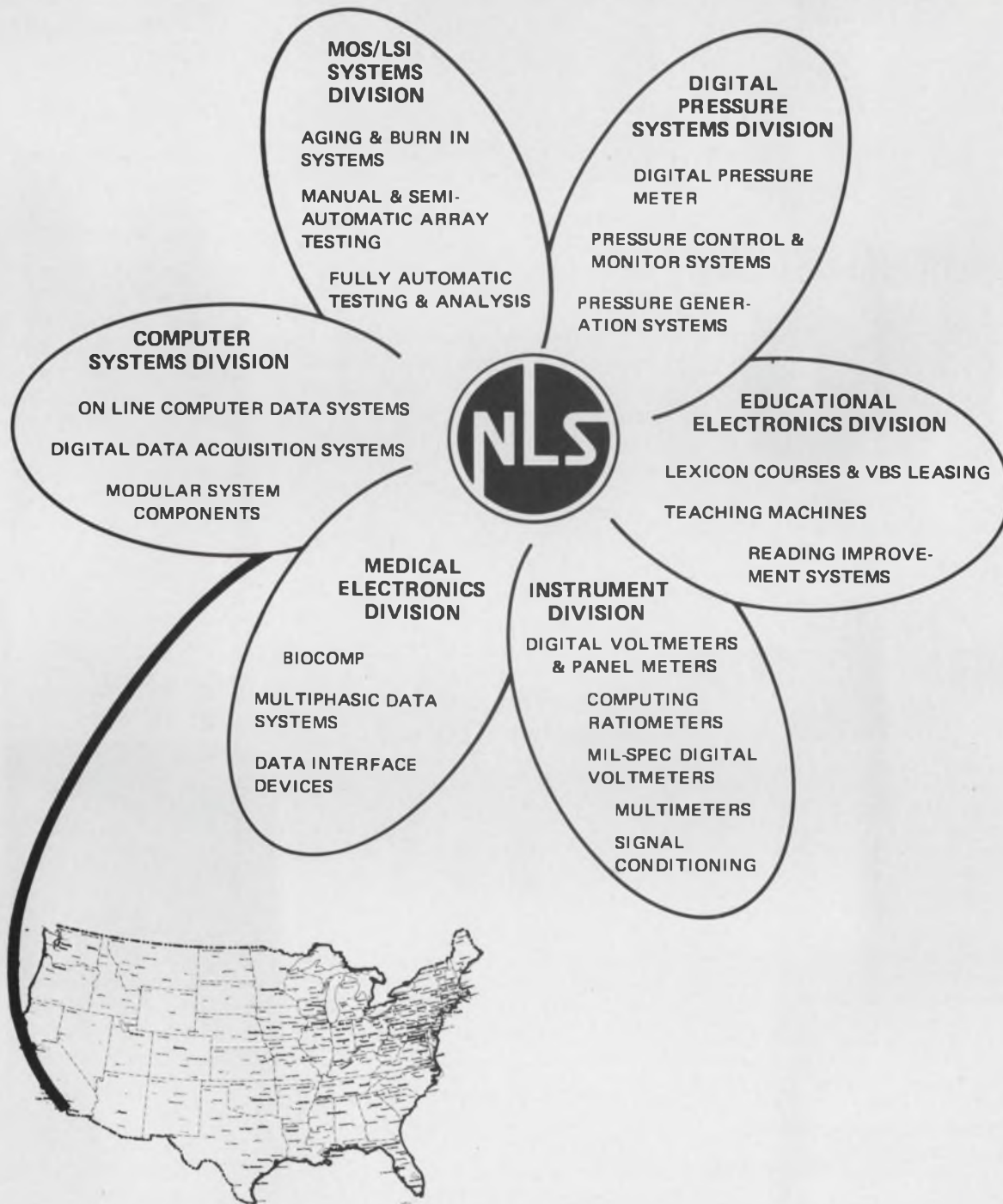

Employment Opportunities in Sales & Engineering



Originator of the Digital Voltmeter
NON-LINEAR SYSTEMS, INC.
DEL MAR, CALIFORNIA 92014

Call COLLECT (714) 755-1134 to request detailed brochures and/or applications engineering assistance.

INFORMATION RETRIEVAL NUMBER 83

**NO
OIL FILLING
NO
NO
SATURATION AT FULL LOAD
NO
RINGING**

**"LOSSYLINE"
SCREEN ROOM/POWER LINE
EMI FILTERS**

"LossyLine" screenroom/power line filters provide unsurpassed EMI suppression by use of a lossy approach. Conventional filters use L-C networks to reflect, reject or transfer unwanted RF energy. Lundy filters use "lossy" elements which absorb and completely dissipate this energy. No chance for it to escape, feedback or leak. By absorbing and dissipating the RF energy, shunt capacitance is minimized and reactive current is negligible. Attenuation does not fall off with current, since there are no saturable inductors. ■ No oil leaks to worry about, either. A lossy type filter develops a minimum amount of heat, therefore does not require oil for cooling.

- 100 dB from 14KHz to 100GHz
- Oper. Cur: 25-1000 amps
- Oper. Volt: 110, 220, 240, 440, & 550 VACW
- Freq: 25, 50, 60, 400, & 1000 cps



LUNDY ELECTRONICS & SYSTEMS, INC.
Glen Head, New York 11545
516-OR 6-1440 TWX 510-223-0605
INFORMATION RETRIEVAL NUMBER 84

ICS & SEMICONDUCTORS

**Plastic rectifiers
take 30-A surges**



Sylvania Electric Products, Semiconductor Div., West Main St., Hillsboro, N.H. Phone: (603) 464-5533. P&A: 45¢ to 90¢; 2 to 4 wks.

Designed to conserve space in computer, industrial, and consumer applications, seven new plastic miniature diffused silicon rectifiers are capable of delivering 1 A of output current and of withstanding overload currents as high as 30 A. Types 1N4001 through 1N4007 offer peak reverse voltages of 50 to 1000 V.

Booth No. Unit B Circle No. 367

**Hot-carrier diodes
trigger at 410 mV**



Hewlett-Packard, 1501 Page Mill Rd., Palo Alto, Calif. Phone: (415) 326-7000. Price: 99¢ or \$1.50.

Suited for mixer and detector applications at frequencies up to 3 GHz, a new line of hybrid hot-carrier diodes have a junction capacitance of only 1.2 pF, a forward conductance of 20 to 35 mA at 1 V, and a low turn-on voltage of 410 mV. The new units also boast the near absence of recovery time. Peak inverse voltage is 20 V for type 5082-2810 and 15 V for type 5082-2811.

Booth No. 1040 Circle No. 370

**Power SCRs
go to 150°C**



Westinghouse Electric Corp., Semiconductor Div., P.O. Box 868, Pittsburgh, Pa. Phone: (412) 255-3693. Price: \$50.50 or \$56.50.

Two new high-temperature silicon-controlled rectifiers will operate at a junction temperature of 150°C. Type 2615 has a forward current of 200 A rms and is rated at 125 A half-wave average. Type 2605 has a forward current of 275 A rms and is rated at 175 A half-wave average. Both SCRs have a guaranteed voltage change of 300 V/ μ s and forward blocking voltages to 600 V.

Booth No. 4601 Circle No. 345

**Tiny LEDs
emit IR**



General Electric Co., Miniature Lamp Dept., P.O. Box 2422, Cleveland, Ohio. Phone: (216) 266-2258. Price: \$3 or \$4.

Measuring only 0.1 in diameter, two new solid-state lamps produce noncoherent infrared radiation that peaks at 9400 Å. Type SSL-15 is a hermetically sealed unit with a standard top-mounted glass lens, while type SSL-25 is a plastic encapsulated device. Power output when driven at 20-mA forward current is 9.5 mW for the SSL-15 and 1.5 mW for the SSL-25.

Booth No. 4304 Circle No. 371

TWO ENGINEERS WITH THE SAME PROGRAMMING PROBLEM



USING ROTARY SWITCHES requires 330 soldered joints . . . over 8 hours of labor . . . occupies 293 square inches of panel space . . . costs \$88.00 installed.
(That's \$0.29 per switching point.)

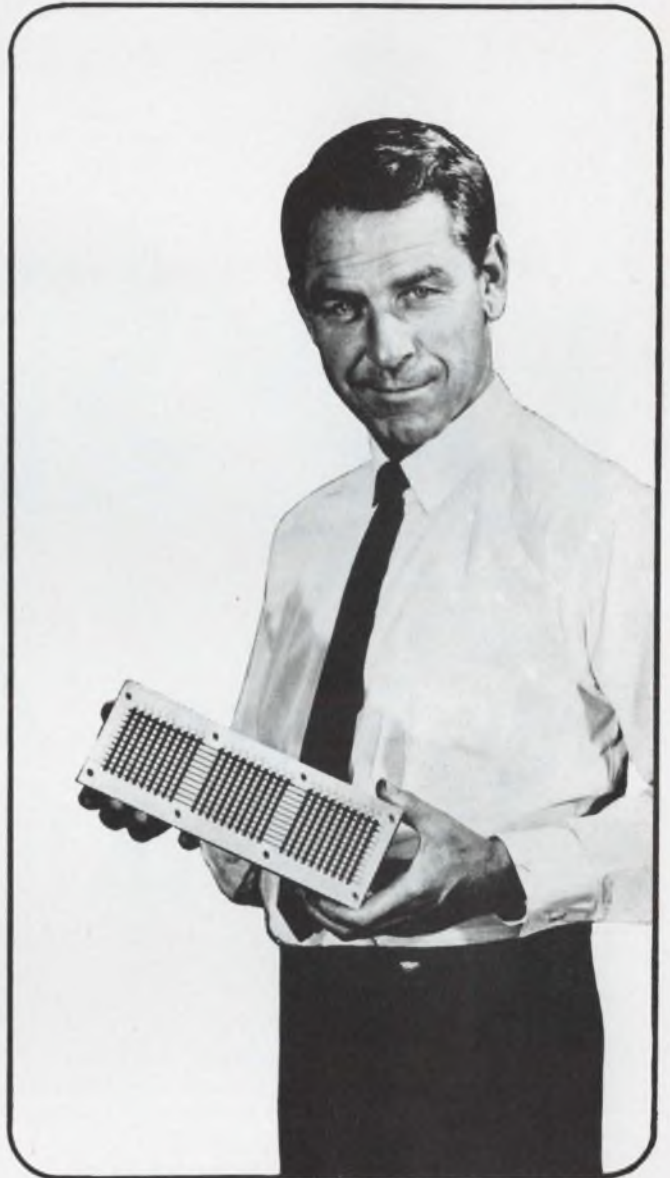

USING CHERRY SELECTOR SWITCH requires no soldering . . . less than 5 minutes of labor . . . occupies 41 square inches of panel space . . . costs \$32.95 installed.
(That's \$0.11 per switching point.)

WHICH ONE WOULD YOU LIKE TO CHECK FOR A MISTAKE IN WIRING?

WRITE TODAY for full details on the totally new Cherry Selector Switch. It may change all your old ideas about programming devices.

**SEE THIS
CHERRY
INNOVATION
AT
WESCON!**

booths
5117
5118 5119

CHERRY

CHERRY ELECTRICAL PRODUCTS CORP. • 1667 Old Deerfield Road • Highland Park, Illinois 60035

INFORMATION RETRIEVAL NUMBER 85

WHAT? Still chopping light with a wheel?

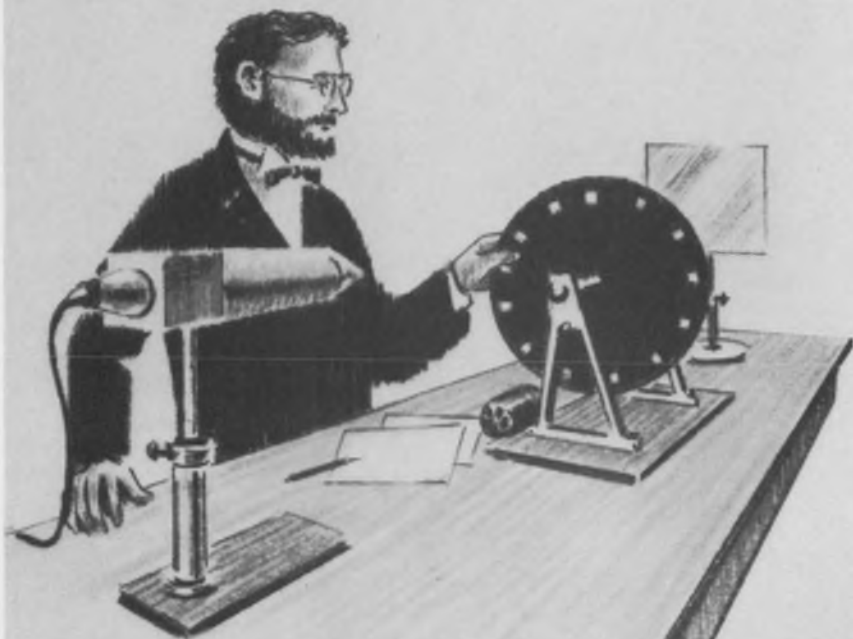

Hey Mister, get a FORK!



Many engineers already use Bulova/American Time Products tuning forks to chop light and similar energy beams. Those who are not are a bit behind the times, and should know the fork's tremendous advantages over motor-driven light choppers —

- No wearing parts / No lubrication needed
- Low power requirements / Much longer life
- More efficient light handling / Smaller and lighter

How is all this achieved? By attaching to a fork's tines a pair of vanes — slotted, notched, or pierced, to suit the need. Then the vibrating fork chops light or similar energy beams to produce optical effects never before achieved. What's more, it's all done in a very, very small package. For example, a 2 cubic inch package can chop 1,000 times per second!

Another variation is a scanner that uses a torsional fork scanning at a uniform repeat rate. A mirror or other optical device can be attached to vibrate the device torsionally.

Whatever your application, from burglar alarms to infrared spectrophotometers, if you've got some light to chop or scan, call American Time Products 212-335-6000, see EEM Section 3800, or write —



BULOVA AMERICAN TIME PRODUCTS

Electronics Division of Bulova Watch Company, Inc.
61-20 Woodside Ave., Woodside, N.Y. 11377 (212) 335-6000

Go Bulova, and leave the designing to us!

ICS & SEMICONDUCTORS

Tiny glass diodes rectify 160 mA



Sylvania Electric Products Inc., Semiconductor Div., Hillsboro, N.H. Phone: (603) 464-5533. P&A: 65¢ to \$1; 30 days.

Encased in a DO-34 whiskerless package, five new silicon epitaxial diodes can dissipate 500 mW of power in free air and can handle average rectified output currents of 160 mA. Reverse breakdown voltage for types IN4531 through IN536 ranges from 35 to 100 V. Applications include frequency detectors, fast logic circuits, and clamping and chopping circuitry.

Booth No. Unit B Circle No. 405

Hybrid regulators supply 5 to 36 V



Transformer Electronics Co., P. O. Box 910, Boulder Industrial Park, Boulder, Colo. Phone: (303) 442-3837. P&A: \$28; stock.

Supplied in a 14-lead dual-in-line package, series VR hybrid voltage regulators provide fixed output voltages of ± 5 to ± 36 V. All units deliver 500 mA of output current with a voltage regulation of 0.01%. Attenuation of noise and ripple is typically 10,000:1 (80 dB). The built-in reference voltage has a temperature coefficient of 0.005%/C°.

Booth No. 3601 Circle No. 272

SEE US AT NJE BOOTH 1332-1333 ►

INFORMATION RETRIEVAL NUMBER 247 ►

Tantalum Foil



3 ways better
than solid in
non-polar
applications

- smaller than solid tantalum
- more reliable than solid tantalum
- delivers more microfarads than solid tantalum

Design is the big difference between General Electric's Type 29F non-polar tantalum foil capacitor and an equivalent solid tantalum capacitor. A design that's specifically for **non-polar** applications.

GE Type 29F non-polar tantalum foil is about half the case size of an equivalent solid, yet accepts voltage and current variations in either direction. And from one small, single roll that in no way impairs the inherent reliability characteristics of tantalum foil. (Totally unlike its bulky solid counterpart that requires two slugs connected back-to-back and, in most cases, within a single case.)

The difference doesn't end with just size and reliability. Consider microfarads. GE tantalum foil delivers 50 percent more microfarads per case size, in practically all cases, when compared with solid tantalum.

So for your next non-polar application, contact your General Electric Sales Representative and ask to see the Type 29F tantalum foil capacitor. It could make a big difference. In size. In reliability. In microfarads. Electronic Capacitor and Battery Dept., Irmo, S.C.

430-36

GENERAL  ELECTRIC

Sonotone's Sub-C Cell.



One size, four power ratings supply the power needed for any cordless product.

Now you can match power to product with one of Sonotone's Sub-C nickel-cadmium sealed cells. Pick from these four:

S113, the industry standard, is a dependable, nickel-cadmium sealed cell rated at 1.2 ampere hours. This is the one that started the cordless revolution. Now in use in cordless toothbrushes, slicing knives, communications and standby power equipment.

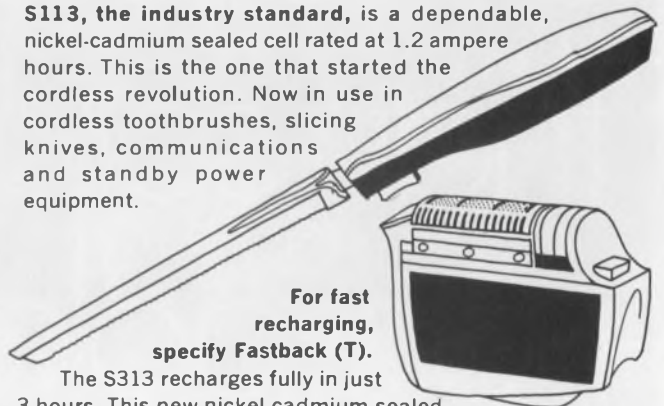

For fast recharging, specify Fastback (T).

The S313 recharges fully in just 3 hours. This new nickel-cadmium sealed cell is rated at 0.9 ampere hours. Currently used in cordless shavers and cordless hair clippers.

S413 is a high rate discharge nickel-cadmium sealed cell with 1.0 ampere hours. Puts out up to 75 amps. of surge power . . . ideal for engine-starting applications.

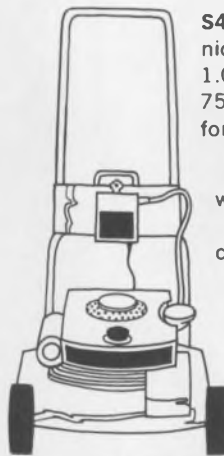

And finally, the economical S213 with performance the same as the S113, except 0.7 ampere hour capacity. It is used in many of the same applications as the S113 where running time is less critical and economy most essential.

What we've done with the Sub-C cell, we can do with any of our battery products.

Write for full information: Battery Division, Sonotone Corporation, Elmsford, N.Y. 10523.



CLEVITE SONOTONE

Scotchpar's producer uses more supporting players than any other big name film producer.

3M Company has the largest sales force—all engineers and insulation specialists calling exclusively on the electrical market—to make sure SCOTCHPAR® polyester film turns in a stellar performance for its customers. They're supporting a great film. It's thin, tough, transparent, flexible

and durable. It also has high dielectric strength, great temperature stability, and resistance to moisture and solvents.

Our men help capacitor manufacturers get the right kind of SCOTCHPAR film for their product—they can choose from a complete lineup of thin films down to .25 mils, plus SCOTCHPAK® film if they want heat sealable features.

They work equally hard for manufacturers who use SCOTCHPAR film as insulation in transformers, motors, wire and cable.

With all these men on the job, we still work harder than anybody else helping electrical men get the most out of polyester film.

All because we want our SCOTCHPAR film to win over a very critical audience.

3M Company, Film & Allied Products Division, 3M Center, St. Paul, Minnesota 55101.

Scotchpar 3M
BRAND POLYESTER FILM COMPANY



A 2 KVA 400 CYCLE, SOLID STATE BIPPY?



Around here, it's affectionately called just that. But you can simply refer to our newest creation as the CML Model CRS-2000A Frequency Converter until you get used to the idea of a Bippy hanging around. It features low distortion sine wave output and excellent regulation... less than 1% voltage regulation, less than 0.5% frequency regulation. Full power is available into leading and lagging power factor loads. The Bippy is solidly built (as all Bippys are), air cooled, and extremely quiet (as all Bippys are not)... measures 19" x 26 1/4" x 20". Ideal for marine and ground support installation, portable shelters, communications vans, radar systems, aircraft maintenance depots. This truly is the Bippy you can bet on. It socks the power to you!

CML, Inc.

a subsidiary of
Tenney Engineering, Inc.

350 Leland Avenue
Plainfield, N.J. 07062
(201) 754-5502 • TWX 710-997-9529



See us at WESCON, Booth 2210
INFORMATION RETRIEVAL NUMBER 88

MODULES & SUBASSEMBLIES

Miniature regulators handle up to 20 W



Powercube Corp., sub. of Unitrode Corp., 214 Calvary St., Waltham, Mass. Phone: (617) 924-1758. P&A: \$225; stock to 2 wks.

Able to handle up to 20 W, a new line of linear regulators measures only 0.5 cubic in. and weighs only 0.8 oz. These type R dc/dc regulators are available for inputs from 10 to 150 W, corresponding to regulated outputs from 4 V at 4 A to 110 V at 10 mA. Standard features include a zener-protected input, and short-circuit and current-overload protection.

Booth No. 4516 Circle No. 257

Modular transformers mount on PC boards

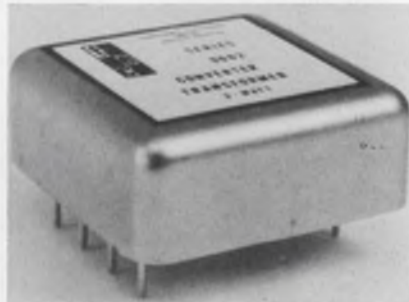

Transformer Electronics Co., P.O. Box 910, Boulder Industrial Park, Boulder, Colo. Phone: (303) 442-3837. Price: \$15.50 to \$21.30.

Housed in shielded metal cases that measure 1.5 by 1.5 by 0.75 in., a new series of dc-to-dc converter toroidal transformers can be conveniently mounted on a PC board. Fourteen models allow selection of output voltages from 3 to 1000 V dc. Improved regulation can be obtained by preregulating the inverter input voltage.

Booth No. 3601 Circle No. 256

Hybrid amplifier drains only 75 μ A



Philbrick/Nexus Research, a Teledyne Co., Allied Drive at Route 128, Dedham, Mass. Phone: (617) 329-1600. P&A: \$49; stock.

Designed for low-quiescent-power applications like long-term battery operation, a new hybrid operational amplifier draws a maximum quiescent current of only 75 μ A. Operating from supply voltages between ± 2 and ± 18 V, model 1404 has a typical offset current of 15 nA, typical common-mode rejection ratio of 10⁵, and initial offset voltages from 1 mV.

Booth No. 2014 Circle No. 385

Wideband op amp costs only \$11.90



Burr-Brown Research Corp., International Airport Industrial Park, Tucson, Ariz. Phone: (602) 294-1431. P&A: \$11.90; stock to 4 wks.

Selling for only \$11.90 in single quantities, a new FET-input operational amplifier features a minimum unity-gain frequency response of 4 MHz and a minimum full-power response of 100 kHz. Model 3308/12C has a maximum voltage drift of $\pm 50 \mu$ V/ $^{\circ}$ C over the temperature range of -25 to $+85^{\circ}$ C. Its output is ± 10 V at 5 mA.

Booth No. 3801 Circle No. 374



KEPCO'S SECRET IS THE I-C!

FROM THE LARGEST TO THE SMALLEST REGULATED POWER SUPPLY



KEPCO has 62 models whose voltage or current regulators employ a modern linear integrated circuit.

The result: **REMARKABLY WELL-BEHAVED POWER!**

The performance of our monolithic amplifier in the d-c comparison circuits of these 62 power supplies is properly impressive in the usual specifications of power supply performance.... *Line regulation* is well under 0.0005%; *load regulation* less than 0.005%. The performance is also spectacular in the not-so-frequently discussed specifications.

For example, the sensitivity to thermal shock is about nil. The Kepco I-C regulator, eliminates the small differences in component temperature due to self-heating or minor environmental changes, which in conventional designs causes much of the jitter, noise and "bobulation" in the output of d-c power supplies. Our I-C regulators are virtually immune to these influences. Their off-sets change less than 20 μ V per $^{\circ}$ C and 5 nanoamperes per $^{\circ}$ C, respectively!

There are six diverse groups offering you the advantages of I-C regulation.



CPS
6V-15V, 60-750W, crowbar-protected regulators for delicate I-C's



JQE
6V-100V, 60-750W, linear programmable regulators.



PAT
7V-100V, 20W programmable modules



PCX
7V-100V, 20W programmable modules
0.2-2A, 20W modular or plug-in metered models



CC
0.2-2A, 20W fast recovery current regulators



OPS
7V-100V, 20W high speed power amplifiers.

For complete specifications write Dept. CP-05



with **KEPCO...IT'S CONTROL!**

KEPCO, INC. • 131-38 SANFORD AVENUE • FLUSHING, N.Y. 11352 • (212) 461-7000 • TWX # 710-582-2631 • Cable: KEPCOPOWER NEWYORK

INFORMATION RETRIEVAL NUMBER 89

JFD

TINY....
BUT—MVMs
CAN TAKE IT!

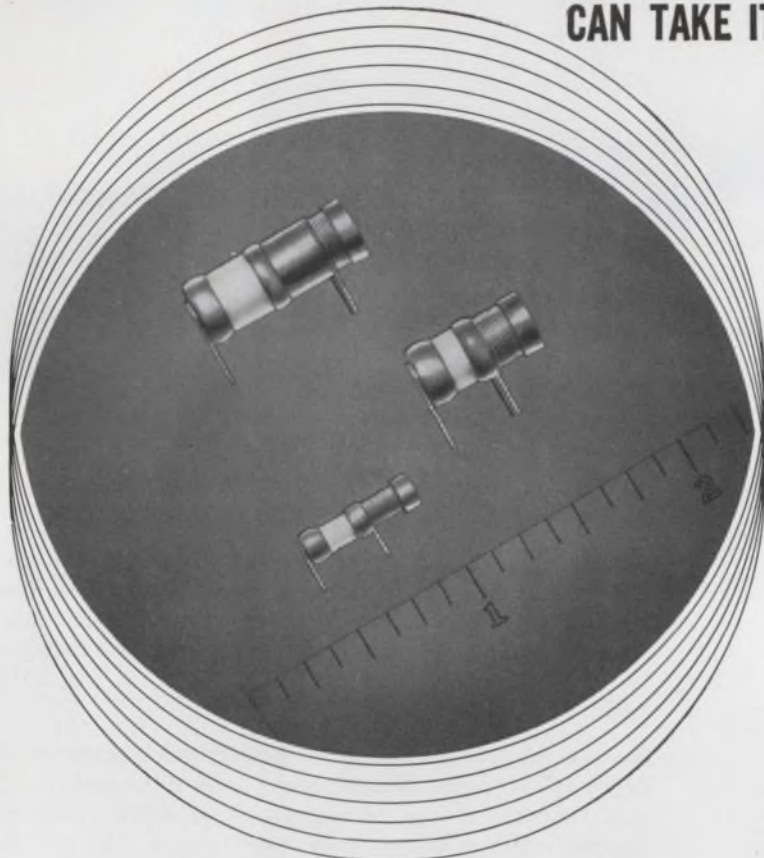

THESE NEW HIGH Q AIR VARIABLES ARE RUGGED

JFD has developed three sizes of unusually rugged air variable capacitors. All three feature a unique internal guiding mechanism with a positive stop. The result: concentricity is constant and these capacitors can withstand conditions of extreme shock and vibration.

Further, newly developed metal biasing elements provide smoother, more constant torque during and beyond life cycling.

Other unique features of the series are:

- Engineered to withstand heat — during soldering.
- Internal air meshing shells are silver plated to provide best surface conductivity and long life.

All MVM's are completely interchangeable with competitive models.

Write for MVM catalogs.

MVM-003 — Microminiature in size. Capacitance range is 0.35 pf to 3.5 pf. The Q factor measured at 3.5 pf and 100 MHz is 5,000. Available in 2 models.

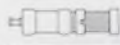

MVM-010 — Adjustable from 0.8 pf to 10 pf. Q greater than 3,000 measured at 10 pf and 100 MHz. Available in 4 models.



MVM-020 — Adjustable from 1 to 20 pf. Q ranging from 3,000 at minimum capacitance, to 1200 at maximum capacitance. Available in 4 models.



Illustrations actual size.

JFD

"TODAY'S COMPONENTS BUILT FOR TOMORROW'S CHALLENGES"

JFD ELECTRONICS CORP. / COMPONENTS DIVISION

15th Avenue at 62nd Street / Brooklyn, New York 11219 / Phone 212-331-1000

SUBSIDIARY OF RIKER-MAXSON CORPORATION

See us at the WESCON Show Booths #3911 and #3912.

INFORMATION RETRIEVAL NUMBER 90

MODULES & SUBASSEMBLIES

Preregulator fits in hand

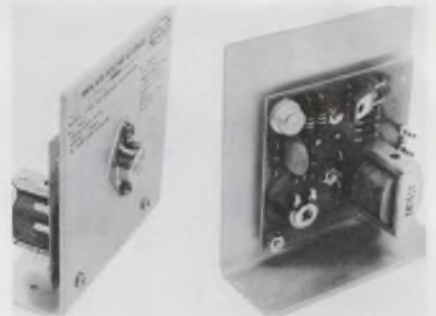

Wanlass Electric Co., sub. of
AMBAC Industries Inc., 2165 S.
Grand Ave., Santa Ana, Calif.
Phone: (714) 546-8990. P&A:
\$26.50; stock.

Providing either single or multiple dc outputs, a new economy power-supply preregulator measures only 4 by 4 by 2 in. and weighs but 10 oz. Operating from an ac input of 100 to 130 V, 47 to 420 Hz, model CVR-120 supplies 120 VA of regulated ac output at 135 V peak. Line, load and power factor regulation is $\pm 1\%$.

Booth No. 2119 Circle No. 386

Audio tone modules encode and decode



Motorola Inc., Communications
Div., 4501 W. Augusta Blvd., Chi-
cago, Ill. Phone: (312) 772-6500.

Two new solid-state audio tone modules are designed for secure selective signaling and switching applications. One series S-1400 unit performs as an encoder, a highly accurate and stable tone generators while its companion module acts as a decoder, a selective switch responding to a particular received tone. They can be operated in parallel, simultaneously or sequentially.

Booth No. 1708 Circle No. 267



**We make our frequency components too good
rather than merely good enough.
Because sometime, somewhere, it might make a difference.**

**Motorola's dependable,
precision frequency components
are now available.**

Many of our frequency components are used in emergency communications equipment. That's one reason why we will not compromise our insistence on quality.

And now, for the first time in 30 years, you and other designers and OEM manufacturers can take advantage of Motorola's experience and large production capa-

bilities for frequency components: crystals, filters, oscillators, tone modules, and resonant reeds.

You can choose from an extensive line of off-the-shelf precision components. Or we'll gladly design and produce your devices on a custom basis. If you need it, you'll get application assistance. And all components are made under clean room conditions.

Whatever application you have

in mind for our frequency components, you can count on one thing. All are designed with the same precision, the same quality, the same dependability. Because we won't settle for second best.

And neither should you.

Send for Bulletin TIC-3401. Write Component Products Dept., Motorola Communications & Electronics, Inc., 4501 W. Augusta Blvd., Chicago, Illinois 60651.



MOTOROLA TOTAL COMMUNICATIONS

below \$100 (full 3½ digits) for the OEM to package — we'll supply you with a digital voltmeter to meet your specifications — contact us today (201) 478-2800 Ext. S



as you like it-



below \$300 in quantities of 100 — you can get the best specified new 4½ digit panel meters — Model 720 — write today.

Whatever your requirement, open or shut, look into Datascan . . . we have Uni-polar digital panel meters with or without under-range "Zeroing" capability, 3½ digit and 4½ digit Bi-polar DPM's and an engineering department ready to go to work on your design.



Get your copy of our new DPM catalog-D201.

Datascan

1111 Paulison Avenue, Clifton, N. J. 07013
Telephone 201-478-2800

903

SEE US AT WESCON-BOOTH #1815
INFORMATION RETRIEVAL NUMBER 92

MODULES & SUBASSEMBLIES

Time-delay relays go solid state



Cornell-Dubilier Electronics, div. of Federal Pacific Electronic Co., 50 Paris St., Newark, N. J. Phone: (201) 624-7500. P&A: \$24 to \$28; stock.

A new line of high-accuracy, long-life variable-time-delay relays consist of a solid-state timing device operating an electromechanical relay. Standard units are supplied in a medium-sized octal-type plastic case with a dpdt function suitable for output switching from dry circuit to 10 A. They have variable delays from 0 to 15 s or 0 to 60 s.

Booth No. 4403 Circle No. 268

Low-cost op amp drifts 20 $\mu\text{V}/^\circ\text{C}$

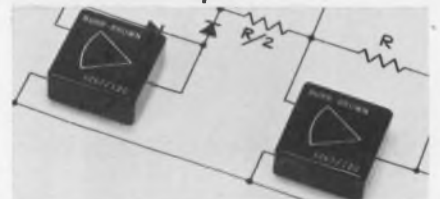

Burr-Brown Research Corp., International Airport Industrial Park, Tucson, Ariz. Phone: (602) 294-1431. P&A: \$11; stock to 4 wks.

Providing a maximum voltage drift of $\pm 20 \mu\text{V}/^\circ\text{C}$ over the temperature range of -25 to $+85^\circ\text{C}$, a new low-cost operational amplifier offers a minimum full-power response of 100 kHz and a minimum open-loop gain of 114 dB. Model 3267/12C supplies an output of ± 10 V at ± 5 mA and a minimum frequency response of 1 MHz. Its minimum slew rate is 6 V/ μs .
Booth No. 1115 Circle No. 375

CHECK OUR DJINNI'S BUILD.

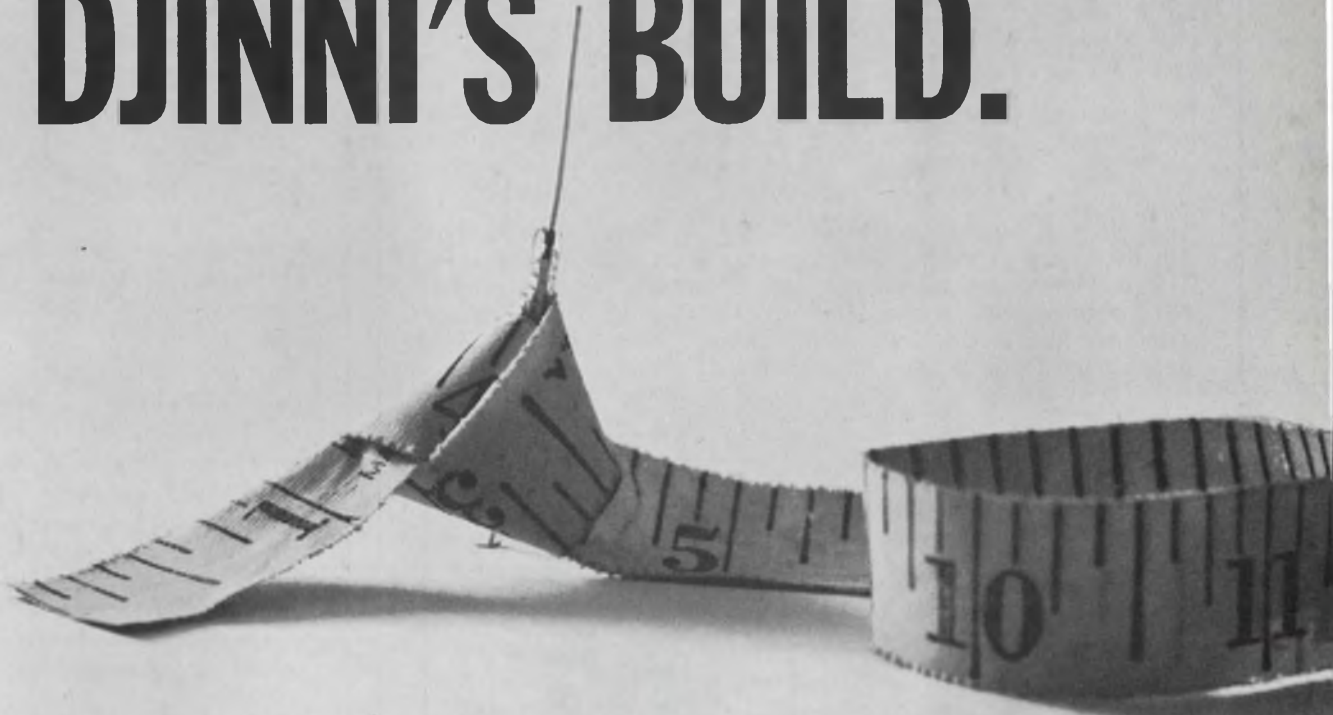

Low profile.

Which means you can build a complete relay only .187" high to fit dual in-line spacing using Hamlin's new Mini-2 reed switch. It has a sensitivity range of 7.5 to 32.5 ampere turns which will rate your relay at 100 milliwatts with an operate time of 200 microseconds.

Like all Hamlin Djinnis, it's built to last longer whatever your application. That's why we're asked to build more types of reed switches for more people than any other manufacturer.

For instance, our Micro-miniature Djinni is the world's smallest. Then, there's the Tiny, Subminiature, Miniature, Compact and Standard sizes just to make sure you won't have any packaging problems.

If your application calls for RF switching, we have a Djinni that will switch frequencies from 30-100 MHz with low resistive losses and an impedance level of 52 ohms. The tiny MTRF-2 measures only .092" glass diameter by .635" glass length.

Ultra-high voltage applications call for the type DRTV that will

switch voltages up to 20,000 VDC. Life expectancy is 1 million operations at full load and practically infinite life at lower voltage levels.

Work a little magic of your own the next time you have a control problem. As a starter, send for our free "Switch Lab" kit. Just write to Hamlin, Inc., "Baghdad on the Lake," Lake Mills, Wisconsin 53551.

HAMLIN 



How's that for low-cal magic?

Pinlites Inc.

manufacturer of the world's smallest incandescent lamps, offers a total of 16 different micro-miniature lamps. Ranging in size from .016 to .030 in diameter. Pinlites continue to offer unique design capabilities: Display modules with 200 individual lamps per square inch, optical multi-tracking heads, film encoding units, weapon status, readouts. Styles available are lens head, flat top, and axial leaded, with a broad spectrum of light outputs.



The all new, lower cost, Midgi-Lite® M series is a further advancement in digital and alphanumeric readout displays. The use of incandescent tungsten filaments permits brightness control, wide angle, single plane viewing. The M series are now in a rugged ceramic, metal, glass package. The depth from front to back is only 3/16".



M SERIES

Midgi-Lites® and Alpha-Lites represent a new design approach in the direct viewing of incandescent tungsten filaments as light bars. The use of filaments permits the most efficient use of power for display purposes. The seven segment Midgi-Lites are now in a new and slimmer, ceramic, metal, glass package for severe shock and vibration environments. Segment brightness has been further increased for readability in direct sunlight . . . up to 12,000 foot lamberts/segment. Alpha-Lites are 16 segment alphanumeric displays with the same new design features and sunlight readability.

For complete design data specification and pricing, write or call: Pinlites Inc., 1275 Bloomfield Ave., Fairfield, N. J. 07006 • Attention: Mr. Bruce Bundy, Sales Manager • (201) 226-7724. Visit us at the Wescon Show in San Francisco, August 19-22, 1969, Booths 4814-4815.

Pinlites Inc.

World's Smallest Incandescent Lamps • Digital Readouts • Micromodules
1275 BLOOMFIELD AVENUE • FAIRFIELD, NEW JERSEY 07006

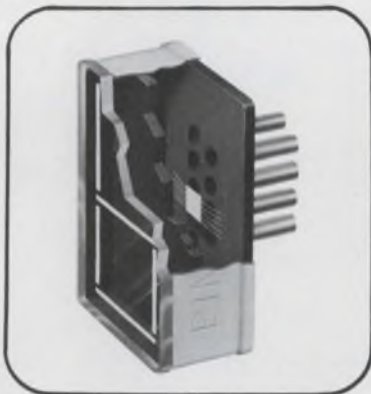

M6-IC

Midgi Coder-Lite — An "M" series, 5/16 character height, seven segment digital display with integral 8-4-2-1 BCD to seven segment decoding/driving. TTL 5 volt logic level is accepted for both decoding and lamp drive. The M6-IC is only 3/16" in front to back depth and allows a display density of 6 characters per square inch. Overall dimensions are .305 width and .465 high, with a total weight of 1½ grams. The combination of the inherent life expectancy of the I.C. and 100,000 hour segment design life team up for an ultra reliable and low cost readout system.

MODULES & SUBASSEMBLIES

Synchro converter replaces gear trains



Transmagnetics, Inc., 134-25 Northern Blvd., Flushing, N. Y. Phone: (212) 539-2750. P&A: \$100; 4 to 6 wks.

A new solid-state synchro-to-linear dc converter can replace gear train servos in dozens of applications at a saving in price and size. Model 1637 converts three-wire synchro inputs to linear dc outputs that are proportional to the synchro angle. The dc output is available directly or after a simple analog-to-digital conversion for computing recording and remote indication.

Booth No. 4180 Circle No. 271

Failsafe amplifier puts out 100 W



Redifon Ltd., Communications Div., Redifon Electronics Inc., 210 Summit Ave., Montvale, N. J. Phone: (201) 391-2627.

Delivering an output power of 100 W from 1.5 to 12 MHz, a new transistorized wideband linear amplifier needs no tuning and cannot be damaged by incorrect loading, even if the output socket is open or short-circuited. Model GA 480 is protected against excessive drive, is insensitive to wide variations in supply voltage and is safeguarded against supply transients.

Booth No. 5202 Circle No. 270

NEW TI ELECTRONIC CHEMICALS.

They've already made
our first customer
very happy.

For years, Texas Instruments has been manufacturing electronic chemicals for just one customer: ourselves. They've worked so well for us, we'd like you to try them. The same chemicals we use in silicon production, high-temperature gas reactions and epitaxial technology. All of which require, as you know, purity to parts-per-billion standards plus extremely high integrity in lot-to-lot uniformity.

Perhaps the wealth of experience behind TI chemicals can offer you some improvements... even if it's just the security of a new source. In either case, your files should contain the following data sheets:

- Epitaxy Grade Trichlorosilane (5 and 55 gallon stainless drums)
- Epitaxy Grade Silicon Tetrachloride (5 and 55 gallon stainless drums)
- Boron Tribromide Dopant (50 and 100 gram ampules)

Please write. You'll find us very eager to double our satisfied customer list.

TEXAS INSTRUMENTS INCORPORATED
Chemical Materials Division
P. O. Box 5621 • M/S 924
Dallas, Texas 75222



TEXAS INSTRUMENTS INCORPORATED

A small part of our new, high-capacity electronic chemicals facility.

INFORMATION RETRIEVAL NUMBER 95

Amperex 'Two-In-One' packaging gives you Plastic IC's with the Reliability you'd expect only from hermetics.

Through a new, double-encapsulation packaging technique which combines the economy of plastic with the reliability of hermetic sealing, Amperex is able to bring you, at regular plastic prices—a line of off-the-shelf, digital IC's...the most reliable line of all-plastic 74N TTL's in the business. The encapsulation approach is unique... here's how it's done:



1. The chip is mounted on a gold-plated grid and is protected with a lacquer coating. The assembly is then packaged in soft epoxy resin which protects the chip against moisture penetration and prevents thermal fatigue of the bonding wires.



2. This sub-assembly is then welded into the final tin-plated grid structure and packaged in the dual-in-line encapsulation. A special ultra-strong plastic is used for the body of the device to withstand severe bend-pull stresses on the external leads. The leads are specially designed for maximum adhesion to the plastic body. The tin-plating on the leads continues right inside the body of the device, ensuring excellent corrosion-resistance and high quality soldered connections even after storage under tropical conditions.

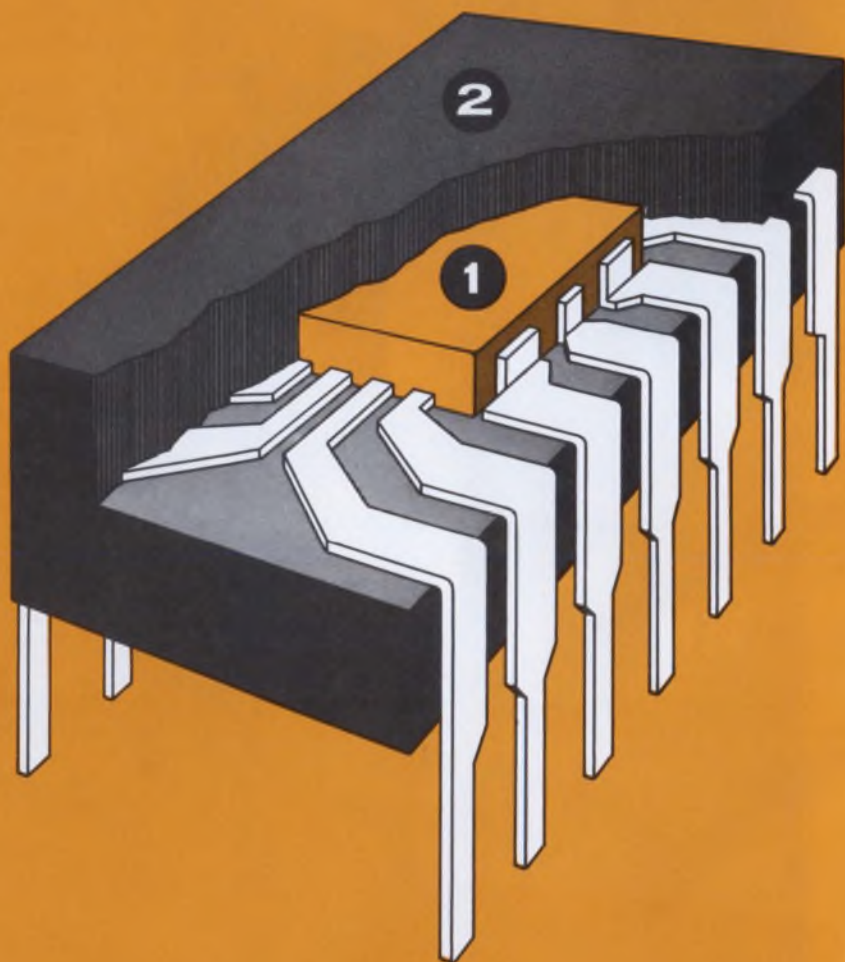

Amperex®

TOMORROW'S THINKING IN TODAY'S PRODUCTS

A NORTH AMERICAN PHILIPS COMPANY

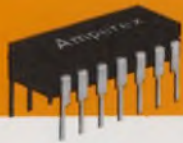

HERE'S HOW WE PROVE OUR RELIABILITY:

Apart from stringent quality control during each step of manufacture, batches from each production run are tested for reliability under every conceivable kind of stress... electrical, thermal, mechanical and climatic, including:

- Resistance to thermal fatigue
- Endurance under conditions of intermittent dissipation
- Bond strength
- Bulk leakage
- Degradation of electrical performance under severe thermal stress
- RTR-circuit endurance
- Ability to withstand high and low temperature storage
- Switching capabilities under maximum fan-out and temperature conditions
- Full sequential temperature treatment tests to MIL-specifications
- Solderability
- Shock Resistance, Acceleration and Vibration Step-Stress



A specially prepared Reliability Report, based on three years of constant test procedures, is available. Write for your free copy, on your company letterhead.

Amperex 74N TTL's are available off-the-shelf from Amperex Distributors listed below.

SERIES 74N		AMPEREX ULTRA RELIABLE IDENTICAL TYPE
GATES		
SN 7400N.....	FJH131	
SN 7401N.....	FJH231	
SN 7402N.....	FJH221	
SN 7410N.....	FJH121	
SN 7420N.....	FJH111	
SN 7430N.....	FJH101	
SN 7440N.....	FJH141	
SN 7450N.....	FJH151	
SN 7451N.....	FJH161	
SN 7453N.....	FJH171	
SN 7454N.....	FJH181	
SN 7460N.....	FJY101	
FLIP-FLOPS		
SN 7470N.....	FJJ101	
SN 7472N.....	FJJ111	
SN 7473N.....	FJJ121	
SN 7474N.....	FJJ131	
SN 7476N.....	FJJ191	
HIGHER ORDER FUNCTIONS		
SN 7475N.....	FJJ181	
SN 7490N.....	FJJ141	
SN 7492N.....	FJJ251	
SN 7493N.....	FJJ211	

PACE/AVNET

3961 Pace Court, Schiller Park, Illinois
Telephone: (312) 678-6310

ALMO ELECTRONICS

Roosevelt Blvd., at Blue Grass Rd., Phila., Pa.
Telephone: (215) 676-6000

INDUSTRIAL ELECTRONICS ASSOCIATES

P.O. Box 12444, Palm Beach Gardens, Florida
Telephone: (305) 848-8686

COMPUTER COMPONENTS CORPORATION

P.O. Box 30423, Dallas, Texas
Telephone: (214) 239-0271

HOLLYWOOD RADIO & ELECTRONICS, INC.

5250 Hollywood Blvd., Hollywood, Calif.
Telephone: (213) 446-3181

For data, write:
Amperex Electronic Corp., Microcircuits Division
Slatersville, Rhode Island 02876

Amperex
TOMORROW'S THINKING IN TODAY'S PRODUCTS
A NORTH AMERICAN PHILIPS COMPANY

MODULES & SUBASSEMBLIES

IC power modules regulate to 0.005%



Deltron, Inc., Wissahickon Ave., North Wales, Pa. Phone: (215) 699-9261. P&A: \$79 to \$289; 4 to 6 wks.

Free of thermal transients, a new series of power modules uses integrated circuits to provide a regulation of 0.005%. Series N units feature adjustable current limiting, remote sensing, remote programming and fast recovery times. They also offer convection cooling to 71°C, as well as electrostatically shielded transformers.

Booth No. 1508 Circle No. 269

Dual-output converters power entire system

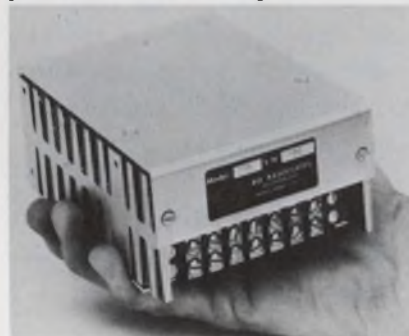

RO Associates, Inc., 3705 Haven Ave., Menlo Park, Calif. Phone: (415) 322-5321. P&A: \$225 to \$375; stock to 3 wks.

Designed for digital and analog integrated circuits, any single unit in a new line of multiple-output miniature power converters can supply an entire instrument or system. Models 211, 212 and 213 have one output of 5 ± 0.5 V at 5 A; and a second output of 24 V at 1 A, 200 V at 25 mA, or ± 15 V at 400 mA, depending on the model.

Booth No. 3609 Circle No. 378

OEM power sources satisfy many needs



Power/Mate Corp., 514 S. River St., Hackensack, N. J. Phone: (201) 343-6294. P&A: \$75; stock.

UNI OEM power supplies offer the advantages of an all-purpose wide-range source with the compact size of a narrow-range slot supply. They are available with internal or external controls, internal or external sensing, complete overload and short-circuit protection, and the convenience of three mounting surfaces. They meet the requirements of MIL-E-16400, MIL-E-6272, MIL-E-5422, MIL-E-4970 and MIL-I-6181D.

Booth No. 1423 Circle No. 377

Low-profile supply puts out 6 V at 2 A

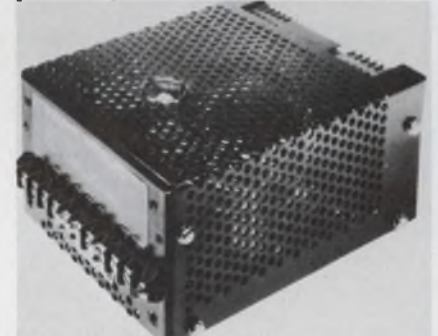

Dressen-Barnes Electronics Corp., 250 N. Vinedo Ave., Pasadena, Calif. Phone: (213) 681-0643.

Model 1301 is a low-profile high-performance dc power supply with an output of 0 to 6 V at 0 to 2 A. The new unit features an unregulated isolation transformer-rectifier followed by a stable high-gain regulator. It may be mounted on two sides, and it has remote voltage adjustment and remote sensing features for installation flexibility.

Booth No. 4419 Circle No. 376

New S. S. White system trims microelectronic hybrid resistors at 1,000 per hour...or more



If you're into hybrid circuitry in a big way, or hope to be, our Model AT-701AR may be just what you need. It offers high capacity, accurate trims, high yield — or, just what you need to keep your customers and your comptroller happy.

Model AT-701AR is similar to our highly successful Model AT-701A, but with the addition of a rotary feeding system which lets operator load and unload substrates during the machine's trimming cycle. Capacity is limited only by the man-



Model AT-701AR

ual dexterity of your operator.

Accuracy of the AT-701AR is guaranteed — within 0.5%. 0.1% is attainable with care and some sacrifice of speed. Trimming is monitored by a precision system of electronics featuring a four-wire Kelvin bridge, and tolerances may be programmed from $\pm 0.1\%$ through $\pm 11\%$. (No use making them better than the specs require!)

But suppose the Model AT-701AR is too big or too small for you?

Call us anyway. If you can get by with something like 600 accurate trims an hour, we can offer you our Model AT-701A, to which you can add the turntable feature later. If you're still experimenting, we have Model LAT-100 for breadboarding. It is accurate to 1% better, takes substrates up to 4 x 4 inches and sells for only \$5,950. If you're *really* big, there's the Model AT-704A, a rotary-feed

machine that trims four resistors simultaneously, monitors, and inspects them at the breathtaking rate of 4,000 per hour. And if *that's* not fast enough for you, buy two.

All the S. S. White resistor trimming systems are based on the proven Airbrasive® method of removing resistance material which produces neither heat nor shock, does not alter the substrate.

Call 212-661-3320 to arrange for a live demonstration. Speak to Hal Skurnick or Don Davis. These same gentlemen will be demonstrating the Model AT-701AR and the Model LAT-100 at major electronics trade shows around the country, and if that's not quick enough for you, we will arrange for you to visit our factory. We have also prepared an extensive technical bulletin on this equipment, called, rather cryptically, the "RT-14", a copy of which is yours for the asking.



RT-14

Write to S. S. White Division, Pennwalt Corporation, Dept. 28, 201 East 42nd Street, N.Y., N.Y. Tel.: 212-661-3320

**SEE US BOOTH 3411
WESCON SHOW**

PENNWALT

S.S. WHITE
INDUSTRIAL PRODUCTS

When run-of-the-mill won't do...

Transitron THYRISTORS solve your problems.

in opto- electronics

Our new RTPC Photo-SCR's for example – most advanced in the industry – operational over full MIL temperature range.



Design Engineers . . . looking for better circuit performance? Need a thyristor with special characteristics? Tell us your problem. Write details, or call collect (617) 245-4500 – ask for Thyristor Marketing.

in power conversion

Transitron fast turn-off TO-66, TO-64, TO-48 and press-fit thyristors are very big in inverter/converter applications

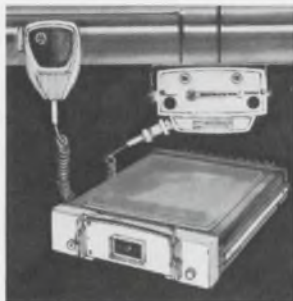

in hi-current pulse generation

Radar modulators and other pulse circuits perform better with our ultra-fast turn-on/turn-off thyristors



in video displays

Our TRIACs, power gate turn-off SCRs and fast turn-off SCRs provide new economical deflection circuit switching.



Send for **FREE**
Application Data
and **NEW**
Thyristor Selection
Guide

Transitron
electronic corporation
168 Albion Street Wakefield, Massachusetts 01880

New Johanson capacitors help you make ends meet.



Solder directly on P/C board (minimum stray capacity).



Solder one end to coupling link and other end to cavity wall.



Solder ends to terminals of another component.



Solder one end to P/C board and attach lead to other end.

The new Johanson 7200 capacitor is ideal for balancing of semi-conductors and microwave components, for trimming of small fixed capacitors, for UHF oscillators, for coupling (VHF and UHF), for terminations for UHF coupling links, and for strip lines and modular blocks.

The 7200 features tubular electrodes which provide for low losses and low inductance at microwave frequencies. They also feature a low minimum capacitance 0.1 pF (10:1 tuning ratio) and Q of 500 at 200 MHz. Call or write for complete information.

Johanson

**MANUFACTURING
CORPORATION**

400 Rockaway Valley Road
Boonton, N.J. 07005 • (201) 334-2676

Electronic Accuracy Through Mechanical Precision

INFORMATION RETRIEVAL NUMBER 101

U172

PACKAGING & MATERIALS

Transistor heat sink handles up to 20 W



Wakefield Engineering, Inc., Audubon Rd., Wakefield, Mass. Phone: (617) 245-5900. Price: 25¢.

Dissipating power of 10 to 20 W, a new transistor aluminum heat sink is a flat blank that is folded into a well-ventilated form and slotted in the direction of heat flow. Type 690 1100-H14 accepts the following transistors: TO-3, TO-8, TO-36, TO-59, TO-61, TO-62, TO-63, TO-66, TO-82, DO-8, DO-9, and DO-30. It is a 1.81-in. square, supplied without any finish or with black anodize.

Booth No. 2604 Circle No. 282

Modulator connector eliminates solder



Elco Corp., Willow Grove, Pa. Phone: (215) 659-7000. P&A: 15¢; 4 wks.

Designed for array mounting on a mother board, the new MOJO 6308 card-edge receptacle combines the advantages of modular design with a unique contact that eliminates soldering. Its contact tail combines a square wire-wrapping post with a specially designed shoulder which, when press-fitted into the plated-through hole in the mother board, provides a permanent gas-tight electrical connection without soldering.

Booth No. 4105 Circle No. 278

Simple heat pipes beat metal ducts



Energy Conversion Systems, Inc., 3821 Commercial, N.E., Albuquerque, N. M. Phone: (505) 242-1495. P&A: 50¢ to \$15; stock.

Compact and simple, a new heat-transfer device, the heat pipe, is said to have many times the heat transfer capability of metal conductors. Available in rigid or flexible versions, heat pipes are especially adaptable to the cooling of semiconductors, integrated circuits, electron tubes, and other electronic components. They can be inserted deep inside electronic packages.

Booth No. 4524 Circle No. 299

Snap-in panel catch opens with a pinch

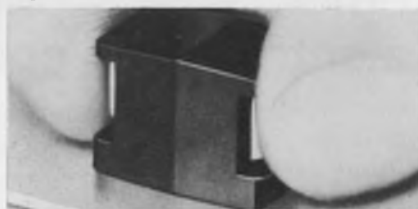

Southco, Inc., 200 Industrial Highway, Lester, Pa. Phone: (215) 521-0800. Availability: stock.

Improving the appearance and function of access panels, compartment doors, and hoods and covers of all types, model 60 squeeze-release catch is easily grasped by the fingertips and released in the same motion. Installation is literally a snap, as the body of the fastener is merely pushed into a rectangular hole (0.5 x 0.312 in.) in the door or panel, where it seats permanently. A slightly larger hole in the frame is caught by its spring-like gripping fingers as the panel closes.

Booth No. 2504 Circle No. 368

INFORMATION RETRIEVAL NUMBER 102 ►

Signalite

Sets The Pace In Gas Discharge Tubes and Glow Lamps

Signalite started supplying neon glow lamps as an indicator device almost two decades ago. Since then, Signalite developed the neon lamp into a circuit component that has solved problems in areas from voltage regulation to photocell drivers . . . from SCR triggering to unregulated power supplies.

Today, Signalite is a leading source for Neon Glow Lamps as indicators and circuit components.

Today, Signalite is a leading source for spark gaps designed to transfer energies and act as voltage sensitive switches.

Today, Signalite is a leading source for noise tubes and miniature noise sources for noise figure test equipment and monitoring system receiver sensitivities.

Only Signalite offers you this in-depth experience, capability, facility and technology in gas discharge devices and glow lamps . . . backed by an R&D program to explore new markets and devices.

Signalite Application Engineers are available to you. Share your design problems with them. They'll choose the right product for your application or design custom units to meet unique requirements.

Yours For The Asking . . . brochures on neon lamps, spark gaps, noise sources. Application Newsletter on technique and application of these products.

A General
Instrument
Company



Signalite INCORPORATED
1933 HECK AVENUE
NEPTUNE, NEW JERSEY 07753



Single Channel

DIRECT WRITING RECORDER

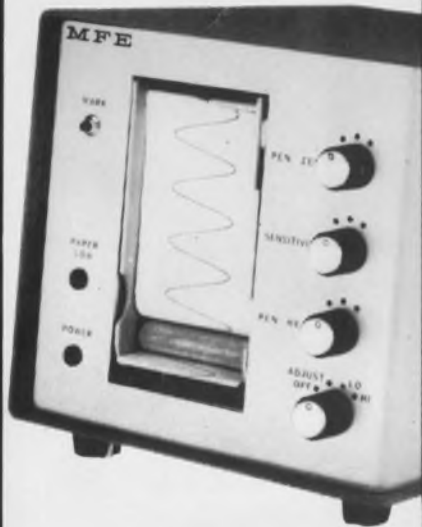

Model 20 Features

- Portable — self-contained
- Two chart speeds in ratio of 2/1
- 10 mv/mm sensitivity
- DC to 125 Hz frequency response
- Gain, position and pen heat controls
- Low paper indicator
- Front loading
- Event marker

PRICE \$450.00

An ideal accessory to other instrumentation in laboratory or field applications.

This instrument can be private branded in your color at OEM prices.

MFE offers stock recorders from one to six channels or will design custom recorders to suit your exact needs. Let us know your requirements — we will send complete information.

*See MFE at the WESCON SHOW, Holiday Inn, San Francisco Airport (415) 589-7200

MFE

MECHANICS FOR ELECTRONICS
Telephone (617) 864-8130
152 Sixth St., Cambridge, Mass. 02142

INFORMATION RETRIEVAL NUMBER 103

PACKAGING & MATERIALS

Card-edge connector builds in power lines

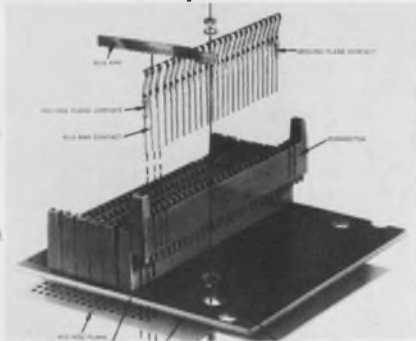

Elco Corp., Willow Grove, Pa.
Phone: (215) 659-7000. P&A:
\$1.50; 4 to 6 wks.

Within the connector body, a new metal-plate printed-circuit card-edge receptacle provides multiple power distribution lines, and voltage and/or ground plane connections. Since all power line connections are made without external wiring a low-noise high-speed system can be easily produced. Series 6305 units use a specially designed contact for each connection between the PC card and power line.

Booth No. 4105 Circle No. 277

IC logic hardware decouples on board



Electronic Engineering Co. of Calif., 1601 E. Chestnut Ave., Santa Ana, Calif. Phone: (714) 547-5501. Availability: 30 days.

A new line of 2-D computer-automated IC logic hardware features high-density packaging, laminated power bussing, and high- and low-frequency decoupling capacitors. The new line uses standard off-the-shelf hardware with IC plug-in sockets and computer-automated wiring. Before wiring, a computer provides an exception report from the customer-provided pin-logic list.

Booth No. 3814 Circle No. 280

Positive-mount socket ends misalignments

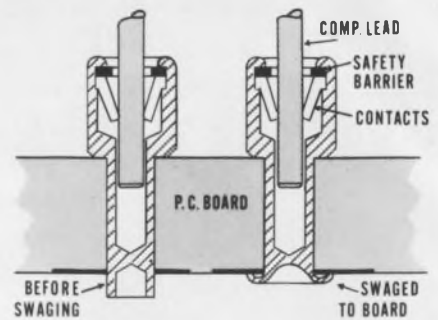

Milross Controls Inc., 511 Second St., Pike, Southampton, Pa. Phone: (215) 355-0200.

Intended for applications requiring a great deal of component insertions and withdrawals, the new Permatac socket assures positive mounting and solid support right on the printed circuit board. Providing a mechanical as well as an electrical connection, the body of the socket is a tubular rivet design which, when swaged, assures accurate stable positioning of the contact during soldering.

Booth No. 4413 Circle No. 281

Polyimide tape takes 7800 V



Mystik Tape, Borden Inc., 1700 Winnetka Ave., Northfield, Ill. Phone: (312) 446-4000.

Designated as Mystik 7367, a new pressure-sensitive polyimide film tape has a total thickness of 2.5 mils and a dielectric strength of 7800 V. This new tape can function as a carrier material in the manufacture of memory sensing devices or as a design component for microcircuitry. It covers the temperature range from -80 to +350°F.

Booth No. 2611 Circle No. 273



NEW UNIVERSAL IC FLAT-PAK SOCKET

FOR TEST BREADBOARD

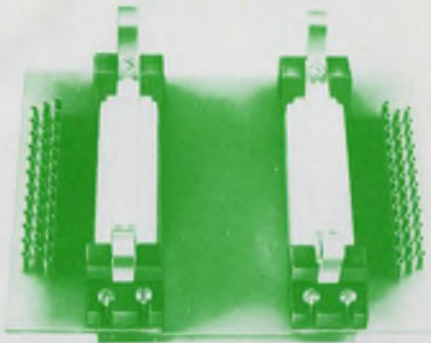

- For any custom-hybrid flat-pak style with leads on .050 spacing or multiples thereof. Up to 70 leads per side ($3\frac{3}{4}$ " long) x any width between sides.
- Allows custom tailoring of socket for any special or odd-size device, eliminating large tooling costs, long lead times or expensive hand-fabricated special sockets.
- Allows wide-open access to entire package when mounted in socket.
- Choice of terminations — fanned out on PCB to individual pin sockets or terminals (illustrated), or direct staggered contact terminations below socket.
- All materials good for -65° to 150°C .
- Combination of rugged spring clips on hold-down pressure bar and sliding action of cantilevered contacts against leads provide good wiping action.
- Large guide grooves at end insure precise mating of pressure bar to contact strip every time. Tolerances: Decimals $\pm .005$ Fractions $\pm \frac{1}{64}$ — unless otherwise specified

ORDERING INFORMATION: All sockets are supplied as 2 identical strips, or sets, fully assembled and tested. Just mount them on the spacing desired with the self-tapping screws provided.

1). Specify number of contacts per side: Available in 20, 30, 40 or 50.

2). Specify termination style as follows:

Dash A — Contact termination exit directly below socket on .1" staggered spacing.

Dash B — Contacts are terminated on a PCB on .1" staggered spacing with male terminals

Dash C — Contacts terminated as — Dash B above, except uses individual female pin sockets rather than male terminals.

EXAMPLE: Universal IC Socket part number for an LSI device with 60 leads (30 per side) with contacts terminating at male terminals on PCB would be: NP-305 (See #1 above) — (see #2 above), — or — NP-305-30-B



802 E. EIGHTH ST. NEW ALBANY, IND. 47150
AREA CODE (812) 945-0211 TWX 810-355-2912

INFORMATION RETRIEVAL NUMBER 104

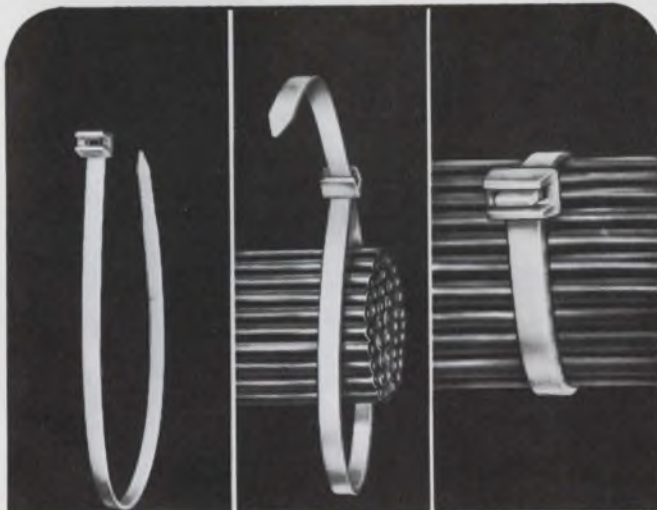

NEW CABLE TIES

... with improved self-locking mechanism. Easily applied either by hand or tool. Wrap ... Cinch ... Cut. Available in four sizes, each infinitely adjustable within its size range. Provides permanent, non-twisting, neat harnessing. Molded of virgin nylon in white, black and assorted colors. Meets MIL-S-23190 and MS-17821.

Send for Free Samples

ELECTROVERT INC.
Components Division
86 Hartford Ave., Mt. Vernon, N. Y. 10553
Milwaukee, Wis. • Burbank, Calif.



SOLD COAST-TO-COAST THROUGH AUTHORIZED DISTRIBUTORS

Visit **ELECTROVERT** at **WESCON SHOW, BOOTH NO'S. 3115-16-17.**
INFORMATION RETRIEVAL NUMBER 105



Best way to heat sink TO-5 case style transistors

Type 254-SI electrically isolated and stud-mounted

Type 254-S stud-mounted

Type 254-T tapped hole

Type 254-P plain

Flat face of the transistor header provides the most effective heat sinking surface. Wakefield Series 254 Thermal Retainers are designed to contact this preferred area.

Four types of No. 254 are available for mounting with stud, with a screw, or with soft-solder or by bonding. Type 254-SI (shown enlarged) has built-in 500v a-c electrical isolation. Thermal resistance range of 4 to 6°C/watt case to chassis for the various types.

For full details, request Distributor Products Catalog.

WAKEFIELD ENGINEERING, INC.

WAKEFIELD, MASS. 01880 ■ (617) 245-5900 •

WESCON SHOW BOOTH #2604-5

INFORMATION RETRIEVAL NUMBER 106



Simpson's new 2725.

Compare it with the electronic counter you were going to buy:

SPECIFICATIONS	SIMPSON 2725	YOUR COMPARISON
Wide frequency range?	YES. 5 Hz to 20 MHz.	
Measures frequency ratios?	YES. 1 to 1.99999×10^5 .	
Measures time periods?	YES. 300 μ seconds to 0.2 second.	
Measures time intervals?	YES. 300 μ seconds to 1.99999×10^5 seconds.	
Totalizes?	YES. 0 to 1.99999×10^5 counts.	
Crystal controlled time bases?	YES. 6 xtal-controlled bases, switch selected.	
Self-test circuitry?	YES. Front panel switch tests logic circuitry.	
Dependable solid state design?	YES. Integrated circuits.	
Number of full time digits	5. Plus automatic overrange indication.	
Accuracy	$\pm 0.01\%$ ± 1 digit	
Price	\$525. complete with probe and operator's manual.	\$

4-digit Model 2724 also available: \$450.

GET "OFF-THE-SHELF" DELIVERY OF THE NEW SIMPSON DIGITAL ELECTRONIC COUNTERS AT DISTRIBUTORS STOCKING SIMPSON INSTRUMENTATION PRODUCTS

Simpson

ELECTRIC COMPANY

5200 W. Kinzie Street, Chicago, Illinois 60644 • Phone (312) 379-1121
 Export Dept: 400 W. Madison Street, Chicago, Illinois 60606. Cable Simelco
 IN CANADA: Bach-Simpson Ltd., London, Ontario • IN INDIA: Ruttonsha-Simpson Private Ltd., International House, Bombay-Agra Road, Vikhroli, Bombay



INFORMATION RETRIEVAL NUMBER 107

PACKAGING & MATERIALS

Heavy-duty film tape shuns insulating oils



Mystik Tape, Borden Inc., 1700 Winnetka Ave., Northfield, Ill. Phone: (312) 446-4000.

Expressly designed for heavy-duty holding in electrical applications, a new rayon filament reinforced acetate film tape is compatible with insulating oils. Designated Mystik 7850, the new pressure-sensitive tape has a tensile strength of 215 pounds per inch and a dielectric strength of 5500 V. Its non-corrosive rubber resin system resists stress and is thermosetting.

Booth No. 2611 Circle No. 276

IC packaging panel has connector mate

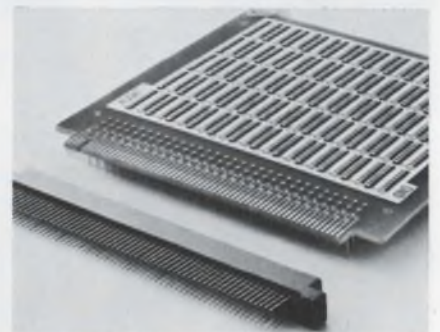

Augat Inc., 33 Perry Ave., Attleboro, Mass. Phone: (617) 222-2202. P&A: \$75 to \$150/panel, \$18 to \$13/connector; stock to 4 wks.

Series 8136-R high-density packaging panels are now available with mating edge connectors. The new panels will accept 14- and 16-lead dual-in-line integrated circuits. The connector is a dual-read-out edge unit with 60 dual contacts on a 0.1-in. grid spacing. Panel contacts are beryllium-copper gold over nickel.

Booth No. 2721 Circle No. 279

The Friden 1150 Digital Printer.

It didn't fail us.

So it won't fail you.

For nearly two years now, the Friden* 1150 Digital Printer has been an integral part of our electronic printing calculator.

So we know all about its reliability from first-hand experience, out in the field.

This 50-character-a-second printer is *durable* because it has fewer moving parts than ordinary medium-speed printers. It is easier to maintain. This means less downtime for your OEM product. The 1150 Digital Printer contains a single 20-character print wheel and a synchronized print hammer. Both are driven across the tape from right to left at a uniform speed. The hammer's short impact time insures quality printing from the continuously rotat-

ing wheel. And we have eliminated messy ribbons with our disposable ink roller.

Logic requirements are simple, making it easy to integrate the 1150 Digital Printer into your OEM product.

One more important thing: the 1150 Digital Printer is *not* expensive. It just sounds expensive. With its low initial cost and desirable operating features, the 1150 Digital Printer gives you a price/performance ratio unique among OEM printers.

The complete specs are all in our Specification 1001.

For your copy, write: Friden Division, Component Products, The Singer Company, San Leandro, California 94577.

*A TRADEMARK OF THE SINGER COMPANY

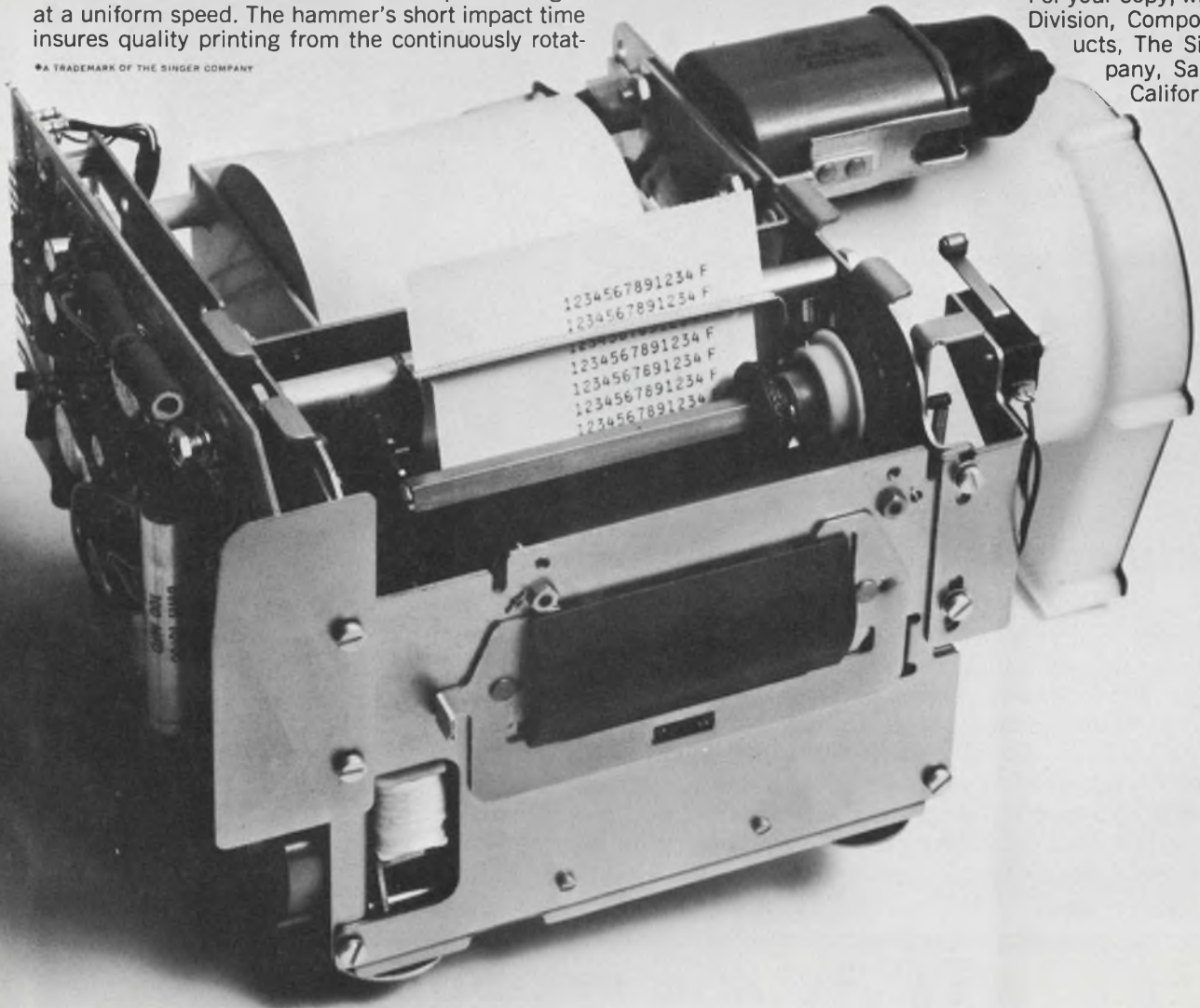

Chebyshev-you'd be amazed at what ADC puts into a custom designed Filter.

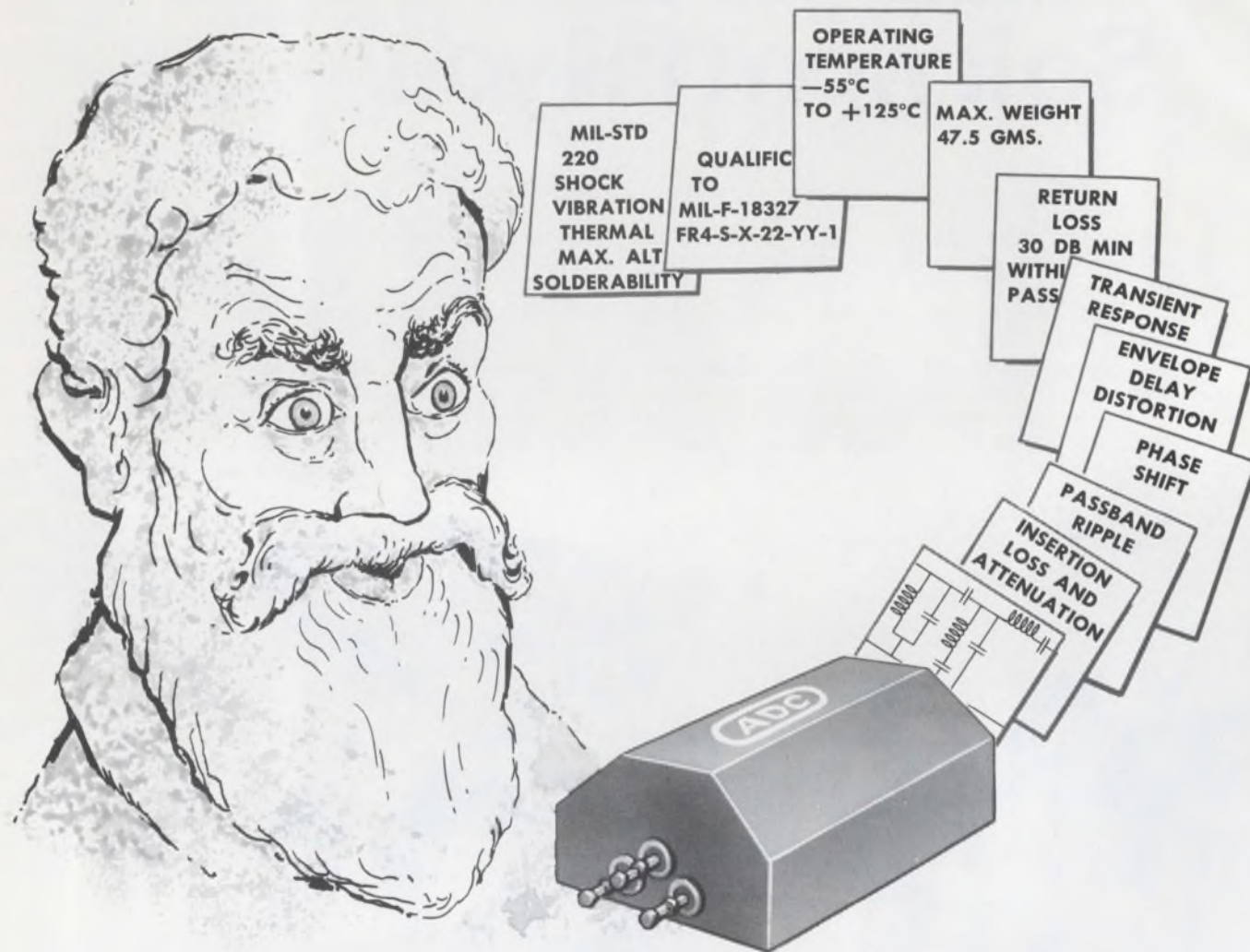

Whether your Filter requirements are

ADC has a staff to solve your problem

Modern filter design is a complex art. Good designs call for careful innovation of the highest order. Sometimes parts of classic designs can be applied to problems, but more and more a highly creative approach is needed to tailor a network to your parameters. Of course, a computer helps determine the element values and their required efficiencies and temperature characteristics for predetermined performance. Still we find there is no substitute for a staff that understands the mathematics, physics, and material specifications peculiar to complex filter networks. This staff is your key to "engineered filters." We'll engineer a filter to fit your requests.

simple

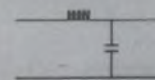

or complex

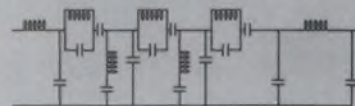

ADC PRODUCTS
A DIVISION OF MAGNETIC CONTROLS CO.
6405 CAMBRIDGE STREET • MINNEAPOLIS, MINN. 55426

Sunrise, Sunset Courtesy of Amersil—Spectrolab— NASA.

NASA needed an earthbound sun...technically, a Solar Simulator.

They went to Spectrolab.

Spectrolab needed a lens, 36" in diameter, 6" center thickness, that would conform to the stringent requirements set forth by NASA.

They came to Amersil.

Working closely with the Spectrolab designers and engineers, Amersil determined that Infracil Grade T-18 Fused Quartz had the characteristics to meet the specifications for the Solar Simulator. The lens was molded by Amersil, assembled into the Simulator by Spectro-

lab, and is now being placed into research operation at the NASA *Langley Research Center*, Hampton, Virginia.

This cooperation from the raw material to the finished products is common practice at Amersil. Our scientists, engineers and designers have the experience, know-how and facilities to meet the needs of industry for high purity Fused Quartz and Fused Silica. These include the finest casting, molding and drawing equipment available.

Get full information and/or technical assistance by writing Amersil today.

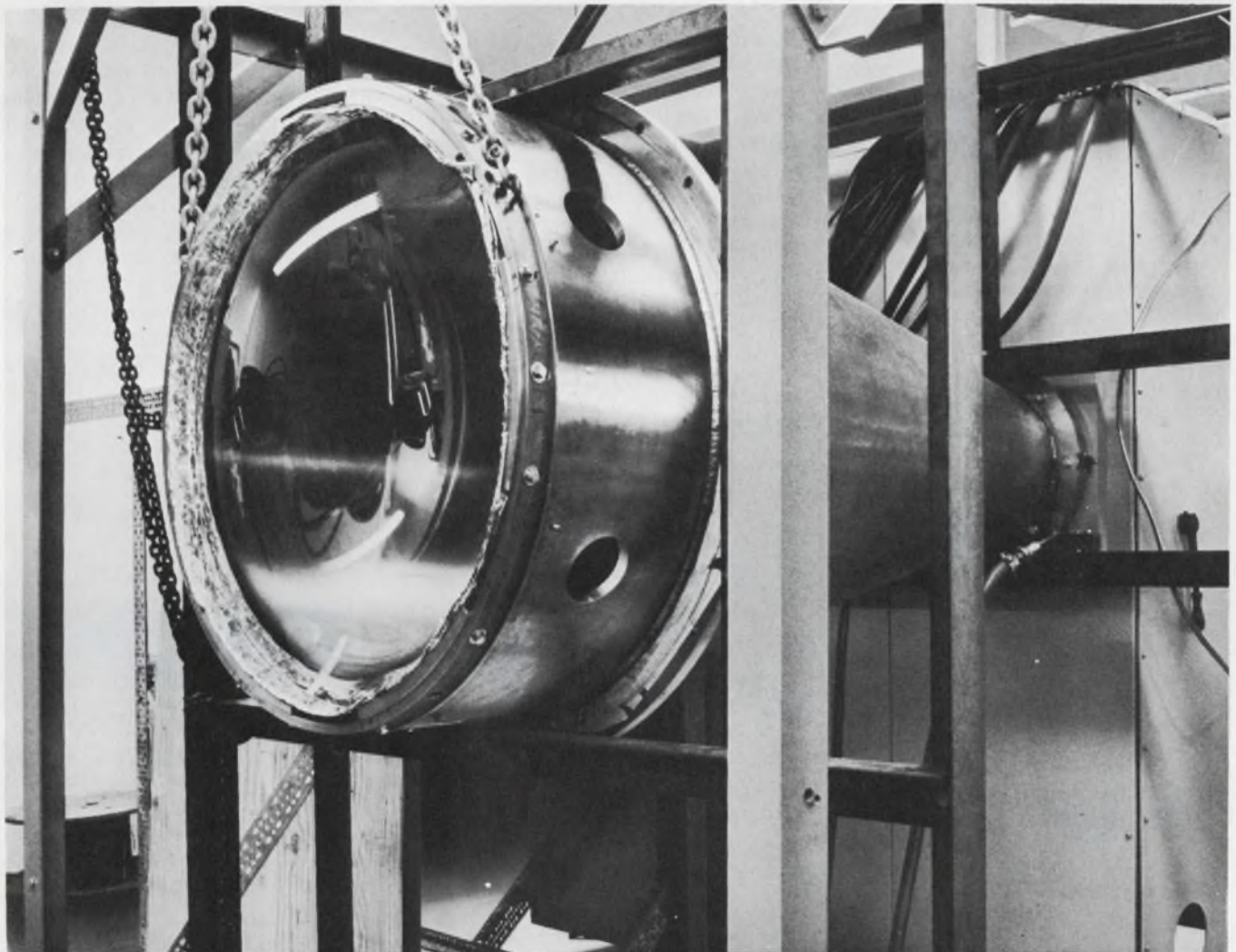

AMERSIL
INC.

**FUSED SILICA
AND QUARTZ**

685 RAMSEY AVE., HILLSIDE NEW JERSEY 07205

SEE US AT WESCON, BOOTHS #3124 AND 3125.

INFORMATION RETRIEVAL NUMBER 110

New High Voltage High Power Rectifiers

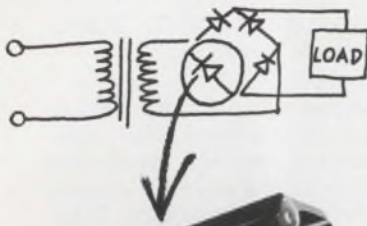

VC Series from Varo.

Our new VC Series rectifiers may be tiny (3" long, 3/4" high, 3/4" wide), but they're plenty tough enough to stand up under high voltage, high power conditions.

They have voltage ratings of from 2 KV to 8 KV, current ratings of 1 to 2 amps, and they're available with an optional 300 nanoseconds recovery time.

Varo VC Series rectifiers are made to handle the biggest jobs. Like X-ray power supplies, radio and radar transmitters, and things like the new microwave oven power supplies.

And they'll handle most of the new high voltage, high power system demands that'll be coming along in the future, too.

The new VC Series from Varo.

It's the kind of thing we know you've come to expect from us.

\$4.18

 EACH

VC-80 (8,000 Volts — 1 Amp).
1,000 quantity.



VARO

SEMICONDUCTOR DIVISION
1000 N. SHILOH ROAD, GARLAND, TEXAS
75040 (214) 272-4551
INFORMATION RETRIEVAL NUMBER 111

DATA PROCESSING

High-speed calculator finds square roots

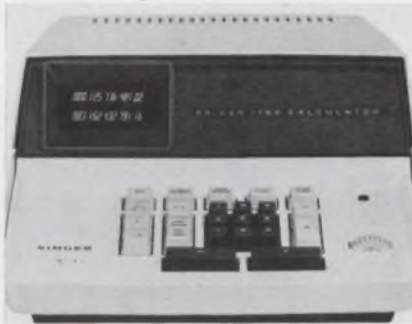

Singer Co., Friden Div., 2350
Washington Ave., San Leandro,
Calif. Phone: (415) 357-6800;
P&A: \$1195; stock.

Specially designed for engineering, statistical and scientific use, a new electronic calculator contains a key that extracts square roots instantly. Model 1162 calculates in milliseconds and flashes answers silently on its built-in miniature cathode-ray tube. There are five registers, each holding up to 14 digits, for calculation and storage.
Booth No. 2021 Circle No. 343

Wideband system keys data quickly



RFL Industries, Inc., Communica-
tions Div., Boonton, N.J. Phone:
(201) 334-3100. Price: \$325.

To answer the need for data-channel or data-terminal field keying, a new data keyer is capable of keying nonsynchronous data transmitters over wide ranges to facilitate adjustment and maintenance of data systems. Model 3865 permits neutral negative, neutral positive and EIA interfaces. Keying speeds from 2 dot cycles to 22k dot cycles are possible.

Booth No. 1606 Circle No. 342

Computer/calculator handles 16 terminals



Mathatronics Div., Barry Wright
Corp., 241 Crescent St., Waltham,
Mass. Phone: (617) 893-1630.

A new computer/calculator system permits up to 16 remotely located keyboards or 16 page printers (typewriters) to be operated at the same time. The terminals may be direct wired for short distances (1000 ft.) using four-wire telephone-type cable, or for unlimited distances with an acoustic coupler. The CS3 simultaneous central station performs all operations in floating point arithmetic.

Booth No. 5517 Circle No. 296

Memory system cycles in 900 ns

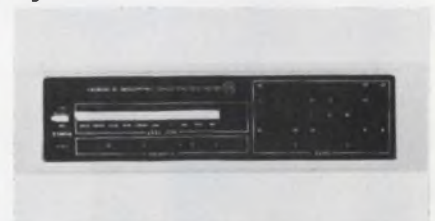

Varian Data Machines, 2722
Michelson Drive, Irvine, Calif.
Phone: (714) 833-2400.

A new coincident-current core memory system operates asynchronously with a full-cycle time of 900 ns and an access time of 350 ns. Two VersaSTORE IV models are available: one with a storage capacity of 4096 words of 40 bits, or 8192 words of 20 bits; the second can store up to 8192 words of 40 bits or 16,284 words of 20 bits. Bit length is available in 8-bit increments for both versions.

Booth No. 3709 Circle No. 344

Oak Versatility



Ultra Compact Rotary Switch 1/2" does a man-sized job

Rugged rotary outperforms its nearest competitors by the widest of margins, gives you man-sized performance at a bargain price. Don't believe it? Compare:

FEATURES	OAK 1/2" SWITCH	BRAND "A" SWITCH	BRAND "B" SWITCH
Double-wiping contacts	Yes	No	No
1/2" Diameter	Yes	Yes	Yes
Multiple Decks	Yes	No	Yes
P. C. Capability	Yes	Yes	Yes
Tri-Ball Detent	Yes	No	No
Adjustable Stops	Yes	No	No
Designed to Meet Mil-S-3786/19	Yes	No	No
Available through Electronic Distributors	Yes	No	No
COMPARE!	OAK LOWEST in Cost	Cost is 60% HIGHER	Cost is 140% HIGHER

GET OAK QUALITY PLUS THE LOWEST PRICE IN THE INDUSTRY

For full details on the sub-miniature switch that does more, write today for Bulletin SP-299.



OAK MANUFACTURING CO.
A Division of OAK ELECTRONETICS CORP.
Crystal Lake, Illinois 60014
Phone: 815-459-5000 TWX: 910-634-3353

— INFORMATION RETRIEVAL NUMBER 112

ELECTRONIC DESIGN 17, August 16, 1969

**PROVEN RELIABILITY—
SOLID-STATE POWER INVERTERS,
over 260,000 logged operational hours—
voltage-regulated, frequency-controlled,
for missile, telemeter, ground support,
135°C all-silicon units available now—**

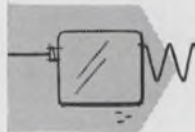
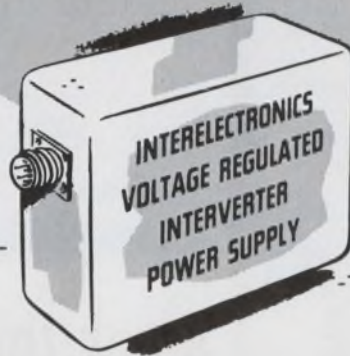

Interelectronics all-silicon thyatron-like gating elements and cubic-grain toroidal magnetic components convert DC to any desired number of AC or DC outputs from 1 to 10,000 watts.



Ultra-reliable in operation (over 260,000 logged hours), no moving parts, unharmed by shorting output or reversing input polarity. High conversion efficiency (to 92%, including voltage regulation by Interelectronics patented reflex high-efficiency magnetic amplifier circuitry.)



Light weight (to 6 watts/oz.), compact (to 8 watts/cu. in.), low ripple (to 0.01 mv. p-p), excellent voltage regulation (to 0.1%), precise frequency control (to 0.2% with Interelectronics extreme environment magnetostrictive standards or to 0.0001% with fork or piezoelectric standards.)



Complies with MIL specs. for shock (100G 11 msec.), acceleration (100G 15 min.), vibration (100G 5 to 5,000 cps.), temperature (to 150 degrees C), RF noise (I-26600).



AC single and polyphase units supply sine waveform output (to 2% harmonics), will deliver up to ten times rated line current into a short circuit or actuate MIL type magnetic circuit breakers or fuses, will start gyros and motors with starting current surges up to ten times normal operating line current.



Now in use in major missiles, powering telemeter transmitters, radar beacons, electronic equipment. Single and polyphase units now power airborne and marine missile gyros, synchros, servos, magnetic amplifiers.



Interelectronics—first and most experienced in the solid-state power supply field produces its own all-silicon solid-state gating elements, all high flux density magnetic components, high temperature ultra-reliable film capacitors and components, has complete facilities and know how—has designed and delivered more working KVA than any other firm!

INTERELECTRONICS CORPORATION
550 U. S. Route 303, Congers, N. Y.
Telephone: 914 ELmwood 8-8000

INFORMATION RETRIEVAL NUMBER 113

U181

KROHN-HITE MODEL 4200 VS MAJOR COMPET				
MFR	H-P	H-P	G-R	K-H
Model Number				4200
Price				\$350
Frequency Range				10 Hz to 10 MHz
Power Out				500 mw
Waveform Distortion				<0.1%



**Stack this
\$350 oscillator
against the
competition**

regardless of price!

Visit Us
Booth No.
1828

You'll be surprised! In spite of its low price, the Model 4200 exhibits extraordinary performance. It excels in those specifications most eagerly sought by men who really know oscillators. Krohn-Hite's twenty years of frequency-generator know-how has produced a unique circuit* that makes low-priced high performance a reality at last.

Here's how the Model 4200 stacks up against several competitors:

BROADER FREQUENCY RANGE: The Model 4200 out-ranges most of the others, including more expensive units.

MORE OUTPUT POWER: The Model 4200 has from 2.5 to 50 times the power of the other units.

BEST WAVEFORM PURITY: The Model 4200 is unexcelled.

BEST BUY: The \$350 price speaks for itself.

See for yourself. Write for data. Then contact your Krohn-Hite Representative for a no-holds-barred demonstration. The Model 4200 is a lot of oscillator for \$350.

*Patent applied for.

**KH KROHN-HITE
CORPORATION**

580 Massachusetts Ave., Cambridge, Mass. 02139, U.S.A.
Phone: (617) 491-3211 TWX: 710-320-6583

Oscillators / Filters / AC Power Sources / DC Power Supplies / Amplifiers

INFORMATION RETRIEVAL NUMBER 114

DATA PROCESSING

Logic cards shun noise

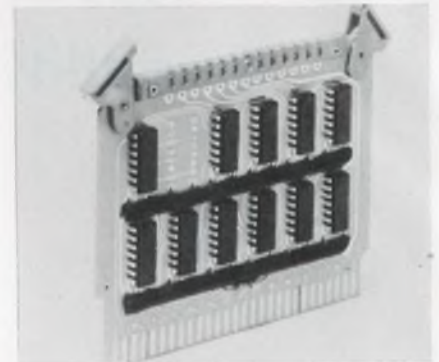

Electronic Engineering Co. of Calif., 1601 E. Chestnut Ave., Santa Ana, Calif. Phone: (714) 547-5501.

A new line of high-noise environment logic cards is designed for industrial applications requiring a high degree of inherent electrical noise immunity. The initial 15 members of the D-4400 series cover almost all system designs. They are mechanically compatible with current EECoLogIC 2 cards, but are easily distinguished by their red handles and test points.

Booth No. 3814 Circle No. 274

Fast a/d converters work 10 bits at 200 kHz

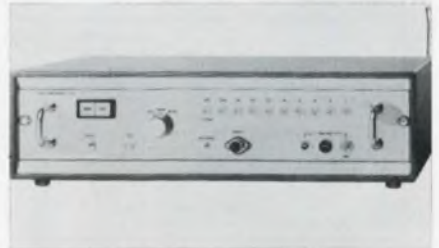

Biomation/Datalab, 1076 E. Meadow Circle, Palo Alto, Calif. Phone: (415) 321-9710. Price: \$1650 or \$2250.

Using a successive approximation conversion technique, series 700 analog-to-digital converters, combine fast conversion times with high resolution, low aperture times and good temperature stability. Model 710 is a 10-bit converter with a conversion rate of 200 kHz including sample-and-hold; model 712 is a 12-bit converter with a conversion rate of 125 kHz.

Booth No. 1711 Circle No. 341

INFORMATION RETRIEVAL NUMBER 115 ►

This is the world's smallest all-pluggable DPM.



Weston Model 1290
\$204

Then there's our less expensive model.



Weston Model 1260
\$99.50

We brought out our 3½-digit compact DPM* just last March. It's the one that plugs into a panel slot only seven inches square, and pulls out for servicing or replacement. If you need the accuracy of 3½ digits, Model 1290 is still your best buy. But if you can settle for a digit less, you can have our new Model 1260 at less than half the price. Don't be fooled by the price tag, though . . . there's nothing "cheap"

about this 2½-digit version. Housed in the very same plug-in case and fully compatible with its more sophisticated brother, Weston Model 1260 offers 0.5% ±1 digit accuracy—with far greater resolution capability than mechanical movements provide. Full scale reading is 199, with 25% over and under-range capability, remote command signal and Weston's usual high rejection characteris-

tics. In addition to the convenience of front panel pluggability and circularly polarized viewing, we've included front panel calibration as a built-in bonus feature on the 1260. Write to the originators of the DPM. WESTON INSTRUMENTS DIVISION, Weston Instruments, Inc., Newark, N.J. 01774.

a Schlumberger company
WESTON®

Prices for Models 1290 and 1260 based on quantities of 25.

*U.S. Pat. 3,051,939 and patents pending.

Look—NO HANDS!

BARNES ELIMINATES MANUAL LEAD STRAIGHTENING/CARRIER LOADING... FOR TO—STYLE IC'S

Are you tired of the high cost of straightening IC leads *by hand*? Then it's high time you tried the Barnes Oriole® Lead Straightener/Carrier Loader. You'll straighten 3 to 12 leads on TO-5's, 3 or 4 leads on TO-18's, or load them into Barnes Carriers. There's a manual model that straightens leads, or loads carriers, at 600 devices an hour. The semi-automatic model is pneumatically operated at 800 an hour. And conversion kits are available that add almost unlimited flexibility. Write or call us for the complete story.



*Patent Pending



Lansdowne, Pa. 19050 • 215/MA2-1525

barnes / THE WORLD'S MOST COMPLETE LINE OF SOCKETS, CARRIERS AND CONTACTORS FOR I.C.'S

INFORMATION RETRIEVAL NUMBER 116

DATA PROCESSING

Fast a/d converter works 10 bits/μs

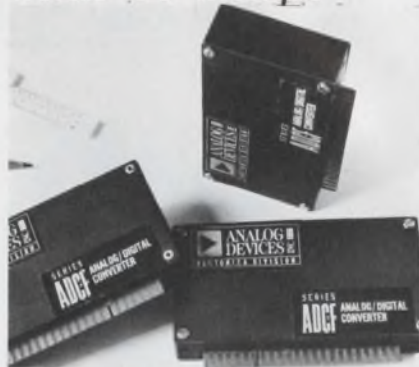

Analog Devices, Inc., Pastoriza Div., 221 Fifth St., Cambridge, Mass. Phone: (617) 492-6000. P&A: \$1990; 6 to 10 wks.

Model ADC-F analog-to-digital converter combines successive-approximation methods and single-card modularity to achieve complete 10-bit conversions within 1 μs. This new technique results in the elimination of sample-and-hold and multiplexing circuitry in many interfacing applications. Relative accuracy is 0.05%, and temperature coefficient is 50 ppm/°C from 0 to 70°C.

Booth No. 1706 Circle No. 258

High-speed tape system verifies and duplicates

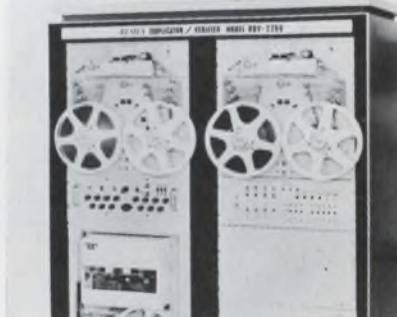

Remex Electronics, div. of Ex-Cell-O Corp., 5250 W. El Segundo Blvd., Hawthorne, Calif. Phone: (213) 772-5321. P&A: \$5295 to \$13,655; 10 wks.

A new high-speed punched-tape duplicator/verifier performs tape-to-tape verifications, from opaque to 70% transparent, at 300 characters per second with reader-spooler combinations. Model RDV-225-D can also duplicate tapes at speeds of 225 characters per second.

Booth No. 5503 Circle No. 410

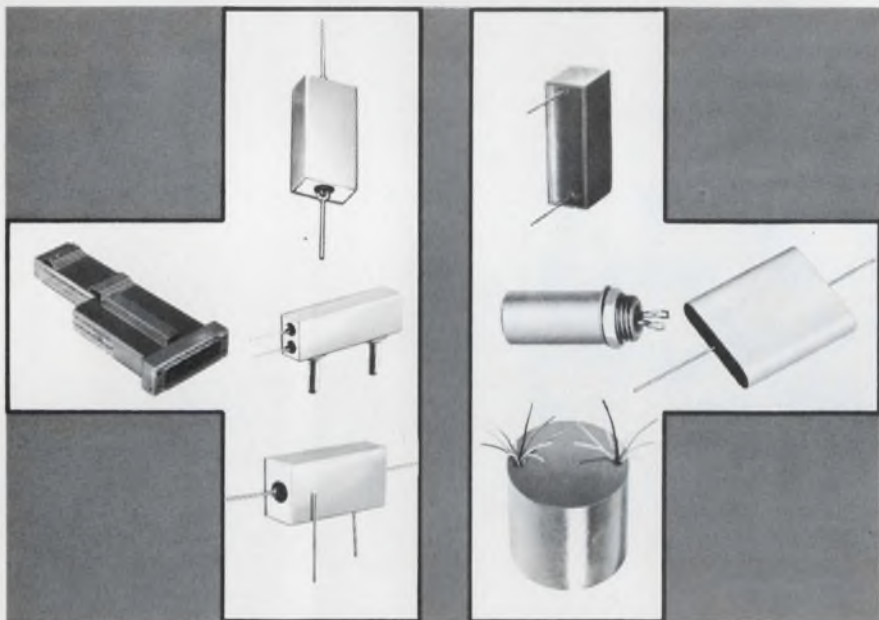

We Build That Special Capacitor... So if you should have an existing packaging problem and thinking in a new dimension, chances are S & E I can build you one, and in many cases at no extra cost or delivery delays. S & E I designs and manufactures specially applied capacitors for many aerospace, electronics and commercial programs with these added features: **Environmental Burn-in • Special Tests • Form Factor • Variety of Sizes and Ranges • Case Materials • Leads and Terminal Compositions • Dielectric Combinations • Special Mountings.** We invite you to call and discuss any configuration techniques, that could solve your problem.

S&E I Manufacturing/Capacitors

18800 Parthenia Street, Northridge, California 91324 • (213) 349-4111 • TWX 910-493-1252

INFORMATION RETRIEVAL NUMBER 117

How much space can I save by using the new "tini-telephone" jack panels and accessories?

You can figure on a fifty-percent reduction in space by using the Switchcraft "tini-telephone" patching system. And, we do mean system!

These aren't just scaled-down versions of standard-size patching components. The "tini-telephone" jack panels and accessories (see Fig. 1.) were designed from scratch to offer quality and convenience features never before available. (Just circle the reader service number to receive complete information.)

Sounds good, but how about the accessories? I don't want any compatibility problems in matching components from different vendors.

Let's take the accessories one-by-one and you'll see what we mean by "tini-telephone" system:

PATCH CORDS —

Circuit-wise, you can have two or three conductor single plug patch

cords or three or five conductor twin plug patch cords in a variety of cable lengths. The cable is high quality stranded plastic-jacketed type with shielding rated at 70-80%. All connections are soldered, and improved strain relief is accomplished by crimping a long tubular metal sleeve 360° around the cable jacket and plug sleeve.

Flexible, molded PVC handles minimize cable breakage and absorb any tolerance variations between twin plugs and mating panel jacks. Terminating, dummy and looping plugs are also available.

SWITCHES —

A gusseted extra-strength frame is provided on "tini-telephone" switches. Plenty of throw is provided to assure contact wipe and required pressure for low contact resistance. The switches are rated 2 amps 200 watts max., A.C. non-inductive load with circuit configurations up to 2C (or 3A) and momentary or push-pull actuation may be specified.

LAMP JAX —

"tini-telephone" lamp jax accept standard bi-pin lamps and offer convenient front panel relamping. Special heat sink fins dissipate heat and a unique jewel and sleeve

assembly eliminates the need for special insertion or withdrawal tools when relamping. (See Fig. 2.)

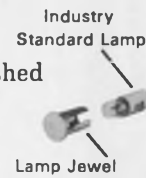

Fig. 2.

The jack panel, itself, has an extra wide flange for better rigidity and the molded panel inserts

permit the jack bushings to protrude slightly from the panel face for more positive electrical continuity in the sleeve circuit with the mating jack. Then there's the snap-on designation strips and reusable marking strips for fast, frustrationless nomenclature changes. Additional accessories such as, blank panel inserts, opaque-black hole plugs, plus designation strip kits gives you the most versatile, compact patching system ever designed.

Looks like you've thought of everything. I'll need complete specifications for my engineering group.

Just request our "FORUM FACTS" catalog on "tini-telephone" jack panels & accessories on your company letterhead.



5529 North Elston Avenue
Chicago, Illinois 60630

SWITCHCRAFT FORUM

Introducing the new "tini-telephone" patching system

See us at WESCON Booths 3909-3910, Cow Palace

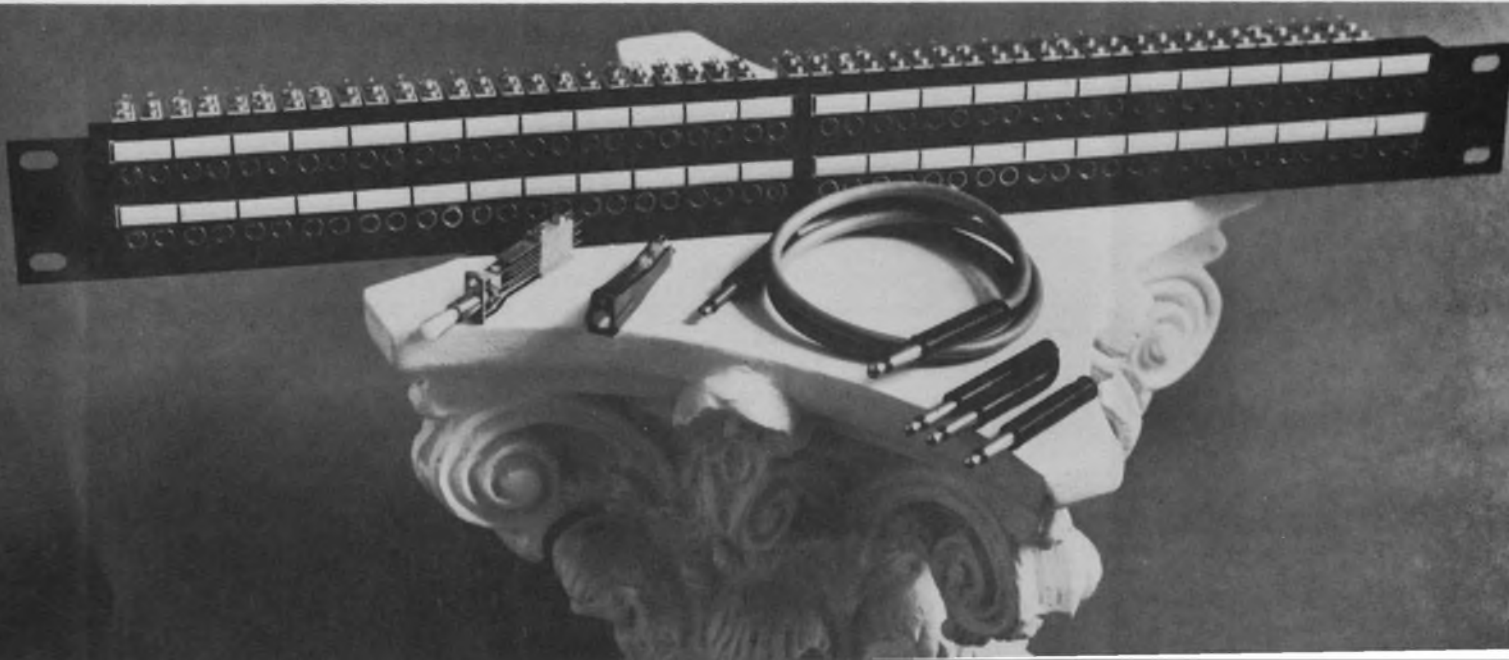

TUBULAR,
BULKHEAD
MOUNTING TYPE

RFI/EMI FILTERS



Rtron

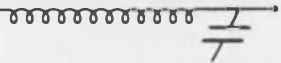

Cylindrical Style Interference Filters

that reduce or eliminate unwanted noise or signals. Small size, light weight, maximum attenuation. Voltage current or insertion loss characteristics required, determine physical size. Maximum isolation of terminals and high frequency performance are assured by threaded neck design for bulkhead mounting. Feed-thru capacitor circuitry conservatively rated for both military and commercial applications.

Rtron corporation

P.O.Box 743 Skokie, Illinois 60076

- Send catalog and prices.
- Have Representative call for appointment.
- Specifications enclosed on Multi-circuit or custom design filters. Send estimate.

Name _____

Firm _____

Address _____

City _____

State _____ Zip _____

INFORMATION RETRIEVAL NUMBER 122

PRODUCTION

Ultrasonic cleaner goes solid state



Esterline Angus, div. of Esterline Corp., P. O. Box 24000, Indianapolis, Ind. Phone: (317) 244-7611.

Designed for continuous operation, a new ultrasonic cleaner features completely transistorized all-solid-state circuitry. Model EA12 has a fine-action cleaning system that works on pens without damaging their points, the print wheels on strip-chart recorders, and many other items. It supplies 50 W of cleaning power.

Booth No. 1022 Circle No. 285

Semiconductor bonder handles 2-in. wafers



Unitek Corp., Weldmatic Div., 1820 S. Myrtle, Monrovia, Calif. Phone: (213) 359-8361. P&A: \$10,000; 60 days.

Performing thermocompression bonding, a new flip-chip and beam-lead bonder works on substrates up to 2-in. square. Model 8-152-01 is a semi-automatic unit that produces bond characteristics that are totally controllable and repeatable. Critical adjustments are programmed and preset to make operation extremely simple.

Booth No. 2924 Circle No. 340

Dual-action cleaner consolidates its tanks



L & R Manufacturing Co., 577 Elm St., Kearny, N. J. Phone: (201) 991-5330. Price: \$299.50.

A new dual-action ultrasonic cleaner features two transducerized tanks capable of simultaneous ultrasonic cavitation to double cleaning capacity and cut cleaning time; each tank may also be run separately. Handsomely packaged in a console cabinet with built-in generator, model 320D-2 has two 1-1/4-quart tanks with a multi-selector switch and automatic electrical timer.

Booth No. 3304 Circle No. 287

Lead straighteners correct TO packages



Barnes Corp., 24 N. Lansdowne Ave., Lansdowne, Pa. Phone: (215) 622-1525. P&A: \$2200 to \$3450; 4 to 6 wks.

Series 450-021 Oriole lead straighteners and series 450-022 carrier loaders can straighten leads on TO-5 and TO-18 packages or can load the packages into series 029-535 carriers. Both series accept TO-5-type axial-lead packages with 3 through 12 leads in TO-5 styles and 3 or 4 leads in TO-18 styles. Lead lengths can be 1/2 and 3/4 in. Both manual and semi-automatic versions are available.

Booth No. 2606 Circle No. 411

Component printer marks 16,000/hour

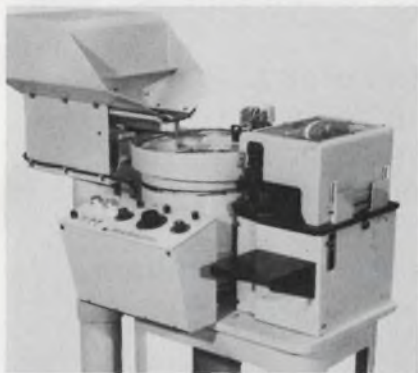

Markem Corp., 150 Congress St.,
Keene, N.H. Phone: (603) 352-
1130.

Model U-1184 high-speed component printer can mark components, such as TO-5 and TO-18 packages, on both their top and side, at speeds up to 16,000 parts per hour. Pieces are bulk stored in a bin and automatically fed to the conveyor from a vibratory feed bowl. The new system can also perform associated functions like component counting and packaging.

Booth No. 3407 Circle No. 369

Detector/controller counts 400 parts/min



Eagle Signal Div., Gulf Western Co., 736 Federal St., Davenport, Iowa. Phone: (319) 324-1361.

Model EW 70 metal detector system accurately counts and controls metal products in all shapes and sizes, from pins to locomotives. This compact solid-state system can count up to 400 parts per minute in any attitude. Dirt, oil, moisture and vibration are said to have little or no effect on its accuracy.

Booth No. 5207 Circle No. 284

Two great bench-top temperature chambers

to match your testing needs at great low prices from Tenney!

PLAIN

The new TENNEY SST

Sturdy new "Hermeticool" mechanically refrigerated chamber now available at a great low price. Check these features:

Range: -95° F to +350° F, $\pm 1/2^\circ$ F control

Chamber Dimensions: 16" wide x 11" deep x 12" high

Heatup: To +350° F in 35 minutes

Pulldown: From ambient to -95° in 55 minutes

Power: 110 volts

FULL PRICE:

\$890

including temperature indicator.

Available from stock.

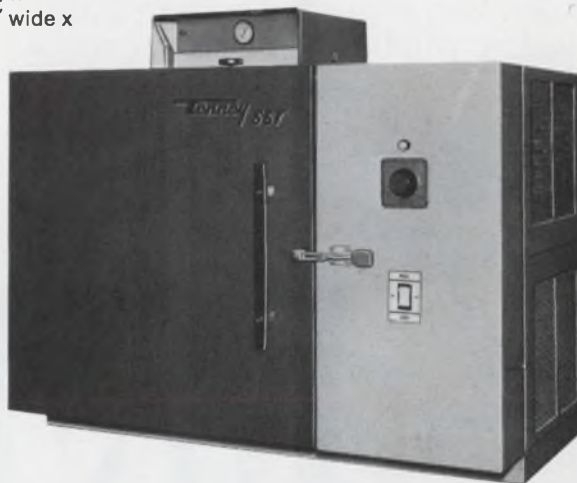

& FANCY

TENNEY JR.

The ultimate in a bench-top high-low temperature chamber. "Hermeticool" mechanically refrigerated, solid-state SCR instrumentation, and many other exceptional features!

Range: -120° F to +350° F, $\pm 1/4^\circ$ F control

Chamber Dimensions: 16" wide x 11" deep x 12" high

Heatup: To +350° F in 35 minutes

Pulldown: From +75° F ambient to -100° F in 35 minutes

Power: 115 volts

FULL PRICE:

\$1080

Available from stock

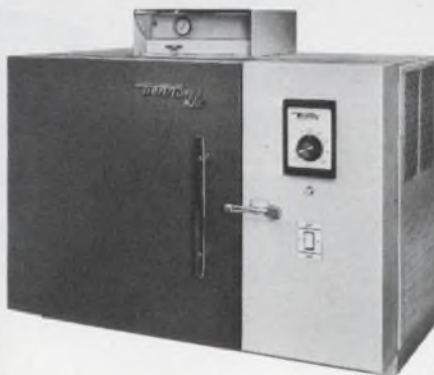

Tenney
ENGINEERING, INC.

1090 Springfield Rd., Union, New Jersey 07083 • (201) 686-7870
Western Division: 15721 Texaco St., Paramount, Calif. 90723

S14A

INFORMATION RETRIEVAL NUMBER 123

New bank book for savings

Send for our new 1969 Relay Catalogue and we guarantee it will open your eyes to ways of saving money on most frequently used Industrial Type Relays.

It will help you save time, which is worth money. Avoid production delays, which is worth money. And cut rejections to the bone, which is also worth money.

Besides, a quotation from Line Electric will be competitive every-

time, which could save you a lot more money, too.

We send out catalogues the same day we receive your request and, if you are in a great hurry, we will even try to give you a quotation over the phone. Just call 201-887-8200 and ask for our Relay Sales Manager. We're dedicated to service.

LINE ELECTRIC COMPANY
U.S. Highway 287, Parsippany, N.J. 07054
Manufacturers of Relays and the best service
in the business. SUBSIDIARY OF THE SINGER COMPANY



from dc to 3 GHz
with only
one plug-in



**This new "4th generation"
I-C plug-in counter/timer
Outperforms all others...**

And will for years to come!

Why compromise for less? The Model 1500A has a main frame counting range from dc to 125 MHz (to 3 GHz with a single plug-in). This instrument is fully programmable, has provision for external time base up to 10 MHz, and many other significant features, including the well recognized advantages of Monsanto's "4th generation" 90% integrated circuit design.

Shown above is the Model 1104B 3 GHz frequency converter plug-in. Also available: Model 1100A uncommitted

plug-in; Model 1101A 500 MHz prescale plug-in; Model 1102A 6-digit preset plug-in; Model 1103A 500 MHz frequency converter plug-in; Model 1107A time interval plug-in; Model 1201A DVM plug-in.

Unparalleled performance plus award-winning design make the Model 1500A the ultimate counter for the no-compromise engineer. The price for the main frame is \$2850.00, FOB West Caldwell, N. J. Other models of the 1500 Series offering a wide selection of fea-

tures and capabilities begin at \$1800.00.

Most engineers take Monsanto's reliability for granted because of our 2-year warranty. But, just in case, we maintain 37 Service Centers located strategically throughout the United States and overseas.

For a demonstration, or for full technical details, call your local Monsanto Field Engineer now or contact us directly at: Monsanto Company, Electronic Instruments, West Caldwell, New Jersey 07006, (201) 228-3800.

INFORMATION RETRIEVAL NUMBER 760

Monsanto

WESCON Booths 1017-19 and 1026-28

400 Hz RCA Triacs— ready to take over!



**120-V line operation and
200- and 400-V repetitive peak
off-stage blocking voltages**

Up in the air about 400 Hz controls? Would you like to forget electro-mechanical relays or switches for such aircraft applications as lighting controls for cabins and running lights; heater controls; motor controls; hydraulic valve controls? RCA has the answer: new 400 Hz triacs ready for your evaluation and inclusion in your circuit designs. Look at the tabulation of units you can work with—at RMS currents from 0.5 A to 40 A and repetitive peak off-state blocking voltages of 200 V and 400 V—all designed for 400-Hz operation and available in two and three-lead modified TO-5, press-fit and stud type packages.

Ask your local RCA Representative or your RCA Distributor for details. For preliminary technical data sheets to aid in your evaluation of these units for airborne controls applications, write RCA Electronic Components, Commercial Engineering, Section RG8-4, Harrison, N. J. 07029.

MAXIMUM RATINGS

0.5 A I_{rms}—In 3-lead modified TO-5		TA7615	400 V	press-fit		
TA7654	200 V	10 mA	I_{GT}	TA7616	200 V	stud
TA7655	400 V	10 mA	I_{GT}	TA7617	400 V	stud
TA7656	200 V	25 mA	I_{GT}	15 A I_{rms}—press-fit or stud		
TA7657	400 V	25 mA	I_{GT}	TA7618	200 V	press-fit
2.5 A I_{rms}—2-lead modified TO-5		TA7619	400 V	press-fit		
TA7671	200 V	25 mA	I_{GT}	TA7620	200 V	stud
TA7672	400 V	25 mA	I_{GT}	TA7621	400 V	stud
6 A I_{rms}—press-fit or stud		25 A I_{rms}—press-fit or stud				
TA7642	200 V	press-fit	TA7646	200 V	press-fit	
TA7643	400 V	press-fit	TA7647	400 V	press-fit	
TA7644	200 V	stud	TA7648	200 V	stud	
TA7645	400 V	stud	TA7649	400 V	stud	
10 A I_{rms}—press-fit or stud		40 A I_{rms}—press-fit or stud				
TA7614	200 V	press-fit	TA7650	200 V	press-fit	
			TA7651	400 V	press-fit	
			TA7652	200 V	stud	
			TA7653	400 V	stud	

Visit the RCA Electronic Components exhibit at WESCON, Unit C, in the Cow Palace Arena.

RCA Thyristors