

Is MOS really ready? Yes, say the vendors. They claim mastery of process control, and expect further innovation. And products find growing acceptance. But the

designer faces tough decisions. Where should he apply MOS? Should it be custom or standard product? And how does he pick a vendor? Report on page 49

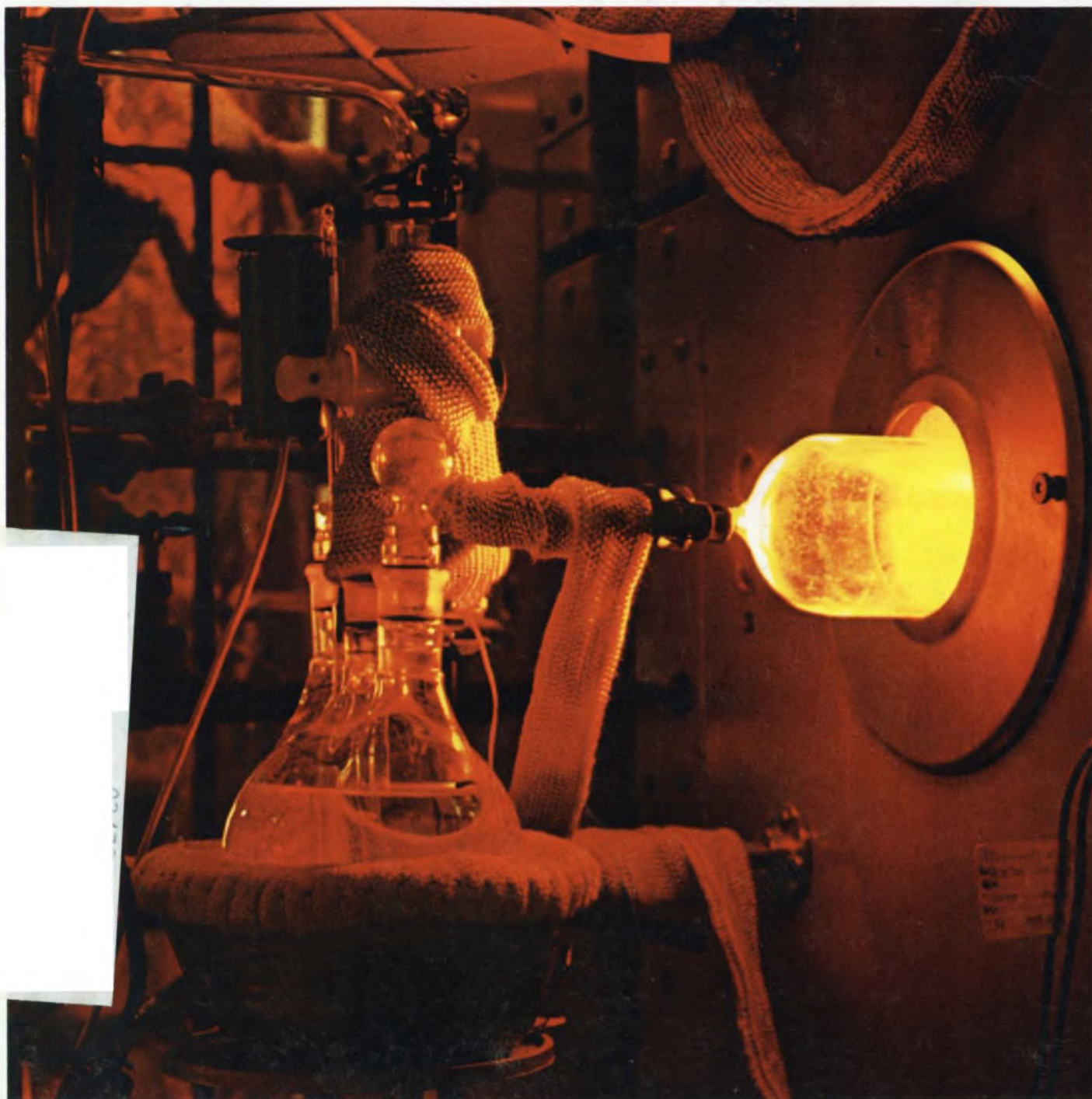

For the first time you have the added dimension of variable persistence and storage in a low frequency scope for your dc to 500 kHz measurements. And, *only* variable persistence gives you completely flicker-free displays of all your low frequency measurements.

Four new models in the HP 1200 series have pushbuttons allowing selection of conventional, variable persistence and storage modes. Having one of these new all-solid-state scopes is like having three scopes in one!

You can select storage writing speed by pressing the STD pushbutton for > 20 cm/ms. Press the FAST pushbutton for $> 1/2$ cm/ μ s writing speed. Persistence is continuously variable from 0.2 second to 1 minute or longer in STD mode and

0.2 second to 15 seconds in FAST mode.

In STD mode, you can vary storage time from 1 minute to 8 hours—in FAST mode, from 15 seconds to 1 hour. And, because of the mesh storage technique used in the 8 x 10 cm internal graticule CRTs, you get bright displays without the loss of trace brightness caused by phosphor deterioration. The 1200 storage CRTs have a life expectancy comparable to HP conventional CRTs.

The new HP 1201A (cabinet) and 1201B (rack) models are dual trace storage scopes with 100 μ V/cm deflection factor. Models 1207A and 1207B are single trace storage scopes with 5 mV/cm deflection factor. These new scopes have single-ended or differential input on all ranges, high common mode rejection ratio,

complete triggering versatility, external horizontal input, dc-coupled Z-axis, beam finder — many of the features normally associated only with high frequency scopes.

For full details on the new HP dc to 500 kHz variable persistence and storage scopes in the 1200 series, contact your nearest HP field engineer. Or, write to Hewlett-Packard, Palo Alto, California 94304. In Europe: 1217 Meyrin-Geneva, Switzerland.

Prices: HP 1201A or 1201B 100 μ V storage scopes, \$1800; HP 1207A or 1207B 5 mV storage scopes, \$1475.

HEWLETT  PACKARD
OSCILLOSCOPE SYSTEMS

089/9

Now You Can Get Flicker-Free Variable Persistence and Storage In A Low-Cost, Low Frequency Scope!

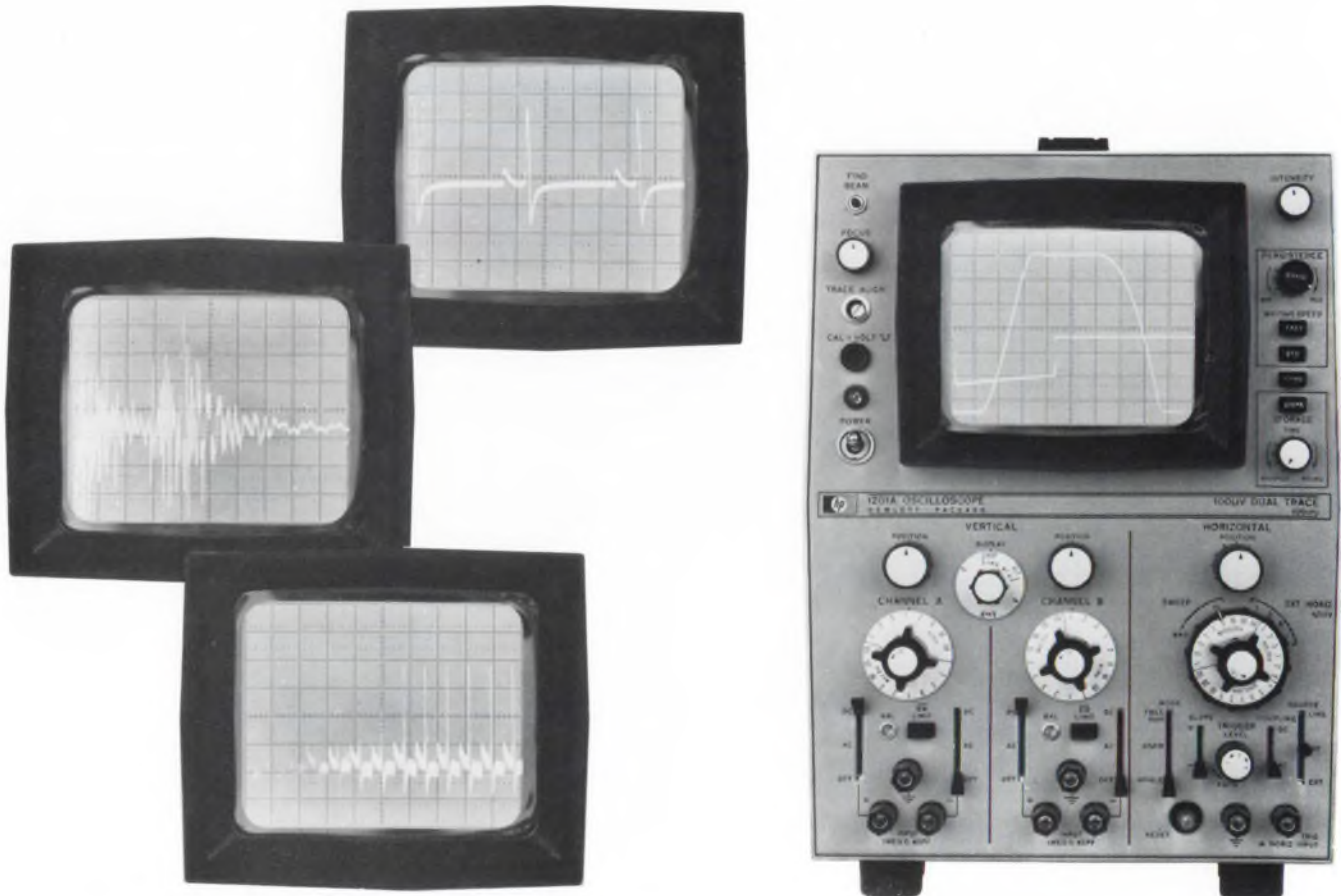



A "system" for testing tantalum and aluminum electrolytics

The Type 1617 Capacitance Bridge is really a system in one package designed specifically to test electrolytic capacitors at 120 Hz per MIL or EIA specifications. However, this 1% bridge can measure any capacitor, including those as large as 1.1 F. Besides having an exceptionally wide C range, the 1617 has many other features that make it an excellent general-purpose bridge for component testing at quality-control and incoming-inspection stations.

WIDE RANGE. C range of 10^{12} , from 1 pF to 1.1 F, with an accuracy of $\pm 1\% \pm 1$ pF and 2% from 0.11 F to 1.1 F. D range from 0 to 10 with an accuracy of approximately $\pm 2\% \pm 0.001$.

CONVENIENCE. The 1617 is completely self-contained; just plug it into a power line and start measuring. It includes a 120-Hz generator, a tuned detector, and an adjustable dc polarizing voltage, all enclosed in a handy, portable, flip-tilt carrying case.

MIL and EIA SPECIFICATIONS. It meets or exceeds the requirements of: MIL-C-39003 (Solid Tantalum), MIL-C-3965C (Tantalum Foil and Sintered Slug), MIL-C-39018 (Aluminum Oxide), (EIA) RS 154B (Dry Aluminum), MIL-C-62C (Polarized Aluminum), (EIA) RS 205 (Electrolytic), MIL-C-26655B (Solid Tantalum), (EIA) RS 228 (Tantalum).

OTHER FEATURES. The 1617 bridge:

- has a metered, dc polarizing voltage that is adjustable

from 0 to 600 volts; external bias up to 800 volts may be applied.

- provides for 2-, 3-, 4-, or 5-terminal connections to minimize the effects of residual impedances.
- detects leakage current down to $0.5 \mu\text{A}$.
- can operate at frequencies up to 1000 Hz with an external generator.
- has important safety features, such as warning lights and discharge circuitry, which protect both the operator and the instrument.
- has Orthonull® balance finder to permit rapid bridge balances and eliminate sliding nulls during high-D capacitance measurements.
- has a generator that is phase-reversible to reduce the effects of hum pickup; amplitude is selectable and limited to 0.2 V, 0.5 V, or 2 V.

The 1617 bridge can also measure the capacitance and loss of cables, transformers, insulating materials, and electric motors.

Price: \$1250 in the U.S.A. For complete information, write General Radio, W. Concord, Massachusetts 01781; telephone (617) 369-4400. In Europe: Postfach 124, CH 8034 Zurich 34, Switzerland.

GENERAL RADIO

INFORMATION RETRIEVAL NUMBER 2

Hardly a lab or production test line is without a Datapulse 101 or 110B pulse generator. If you select pulse generators you should know why:

Thousands of users have discovered that the compact 101 delivers unusually high performance for only \$395. And they recognize that years from now, the 101's specs will still be a match for most pulse test needs: rep rates to 10 MHz, 5 ns rise, simultaneous $\pm 10V$ outputs, width and delays to 10 ms, double pulses, and sync/async gating.

But when you want to tailor waveshapes to order, you need the unequalled control offered by the 110B: rep rates to 50 MHz, variable linear rise and fall from 4 ns to 500 μs , full baseline offset, 10 ns to 5 ms width, -10 ns to +50 ms delay, simultaneous $\pm 10V$ outputs, complement capability, paired pulses, and gated bursts. It all means that the 110B can simulate just about any pulse or waveform that can occur in circuits operating to 50 MHz. And it sells for a modest \$1250.

And talk about reliability! Just ask one of the thousands of 101 and 110B users. Then ask us for a demonstration. Write Datapulse Division, Systron-Donner Corporation, 10150 W. Jefferson Blvd., Culver City, California 90230. (213) 836-6100.

Meet the general-purpose pulsers you're most likely to see at work



Still first. Two of 144 Systron-Donner instruments

Electronic counters	Digital voltmeters
Pulse generators	Digital panel meters
Microwave frequency indicators	Microwave signal generators
Digital clocks	Laboratory magnets
Memory testers	Data acquisition systems
Analog computers	Microwave test sets
Time code generators	
Data generators	

DATAPULSE
 DIVISION
 SYSTRON  DONNER

NEWS

- 21 News Scope
- 25 **How and why man will explore the moon**
Scientists' plans for long-term moon stay are limited only by uncertainties of funding
- 30 **Electronic aids for the overburdened MD**
NASA contributions to biomedical instrumentation can help meet soaring demands for medical care
- 34 Laser-beam rotation measures high-voltage pulses
- 39 Washington Report
- 43 Sidelights of the Issue
- 45 **Editorial:** Computers, like enigneers, need to be managed

TECHNOLOGY

- 49 Special Report: MOS on the upswing
- 50 A bigger market for a better MOS
- 56 MOS at work: The good and the bad
- 64 MOS future hinges on processing
- 70 Decisions, decisions for MOS users
- 82 **Try this linear FET model with ECAP.** Several versions of the basic model fill a number of design needs.
- 88 **Get better dc servo motor performance** when using a transistor bridge by following these guidelines to more efficient design.
- 94 **Simplify your loss calculations** by using inverted log scales. The technique is easy to master and can save you time.
- 100 Ideas for Design

PRODUCTS

- 112 **Instrumentation:** Spectrum analyzer runs on internal battery.
- 118 **Data Processing:** Electronic calculator uses LSI to shrink size.
- 128 **ICs & Semiconductors:** IR light-emitting diode delivers 1 mW radiant power.
- 136 Modules & Subassemblies
- 142 Components
- 148 Microwaves & Lasers
- 153 Packaging & Materials
- 157 Production

Departments

- | | |
|-----------------------------------|------------------------|
| 14 Designer's Datebook | 162 Application Notes |
| 158 Evaluation Samples | 164 New Literature |
| 160 Design Aids | 174 Advertisers' Index |
| 176 Information Retrieval Service | |

Information Retrieval Service Card inside back cover

COVER CREDIT: Fairchild Semiconductor, Mountain View, Calif.

RCA Solid-State Data for Designers

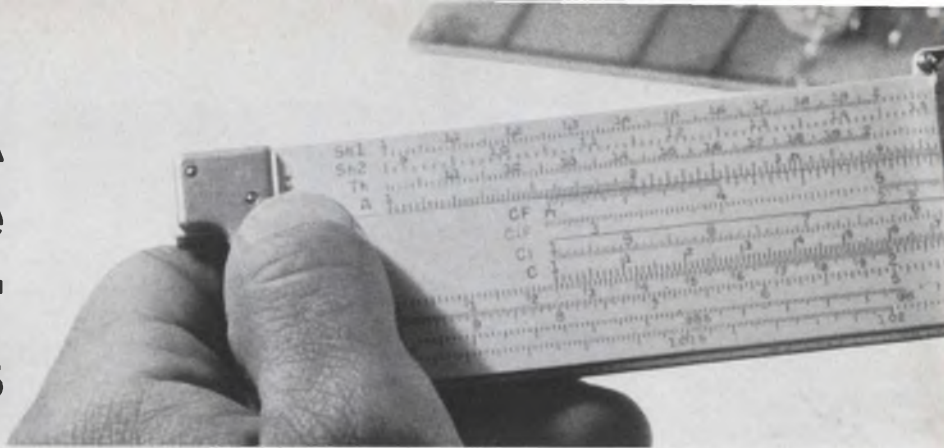

You Don't Have to See the Light... Just Look at the Data for the 40598A IR Emitter

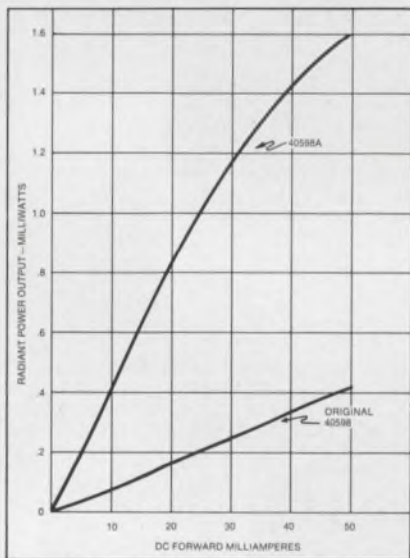

- 3X More Power Than Original 40598
- Same Drive Current—50 mA
- Same Small Package
- Same Low Price

Typical Irradiance on Photodetector

Distance from Photodetector to IR Emitter	Punched Card (mW/cm ²)	Punched Paper Tape (mW/cm ²)
0.150"	15	14
0.200"	10.5	10

Immediate availability in quantity. That's the story of our exceptional IR emitter and the entire RCA line of solid-state GaAs lasers. Each of these invisible light devices offers important electro-optic opportunities in secure communications, intrusion alarms, traffic control, instrumentation, ranging, and field illumination.

For further information, circle Reader Service No. 131.

Match Your RF Power vs. Frequency Requirements

RCA RF power transistors provide equipment designers with the proven advantages of the RCA "overlay" construction in a full line of ever-

expanding commercial and developmental devices. These devices cover frequencies up to 2 GHz and power outputs up to 80 watts PEP.

For your copy of RCA's new, completely-revised RF Power Transistor brochure featuring "overlay" transistors for HF, VHF, UHF and Microwave applications, circle Reader Service No. 132.

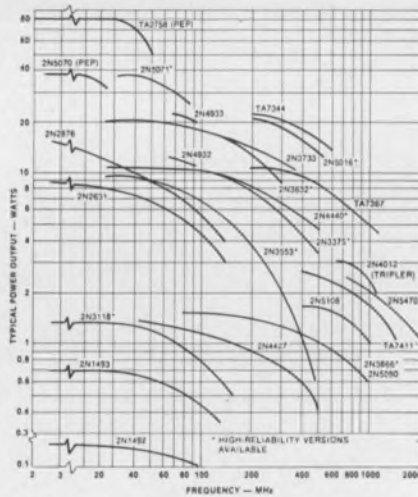

Send for Comprehensive Catalog to Keep Tabs on 98 RCA Thyristors



To help keep your controls under control, send for this new RCA quick reference guide to SCR's, triacs and diacs. It's RCA Publication SCR-500B ... complete and up-to-date information in handy form for designer use.

You'll find maximum ratings, electrical characteristics and quick reference charts for all 98 RCA Thyristors. There's also a cross-reference directory for more than 175 popular industry types. Look for

application information, too, along with a glossary of terms and symbols from latest JEDEC standards.

Circle Reader Service No. 133 for your copy of the new RCA Thyristors Quick Reference Guide. For specific product information or Application Notes listed in SCR-500B, see your local RCA Representative or your RCA Distributor.

- **READY with superior performance, inherent reliability**
- **READY with off-the-shelf delivery**

Power Gain*	
G _{pe} = 12.5 dB min. @ 450 MHz Gain - Bandwidth product f _T = 1000 MHz min.	
N.F. = 4.5 dB max. @ 450 MHz	N.F. = 3.4 dB max. @ 450 MHz
Ultra-High Reliability 40294	40296
High Reliability 40518	
Military and Aerospace JAN 2N2857 40294†	
40518† 40517†	
Commercial 2N2857	
2N3839	

*Neutralized common-emitter circuit
†Meet performance requirements of MIL-S-19500/343

READY for your critical applications, RCA's well-known, low-noise, communication-type 2N2857 family of silicon n-p-n epitaxial planar transistors will give unmatched performance and dependability in your:

- aerospace and other high-reliability circuit designs
- military communication, navigation and instrumentation equipments
- commercial and industrial instrumentation, control and communication gear

For further information on this family, circle Reader Service No. 134.

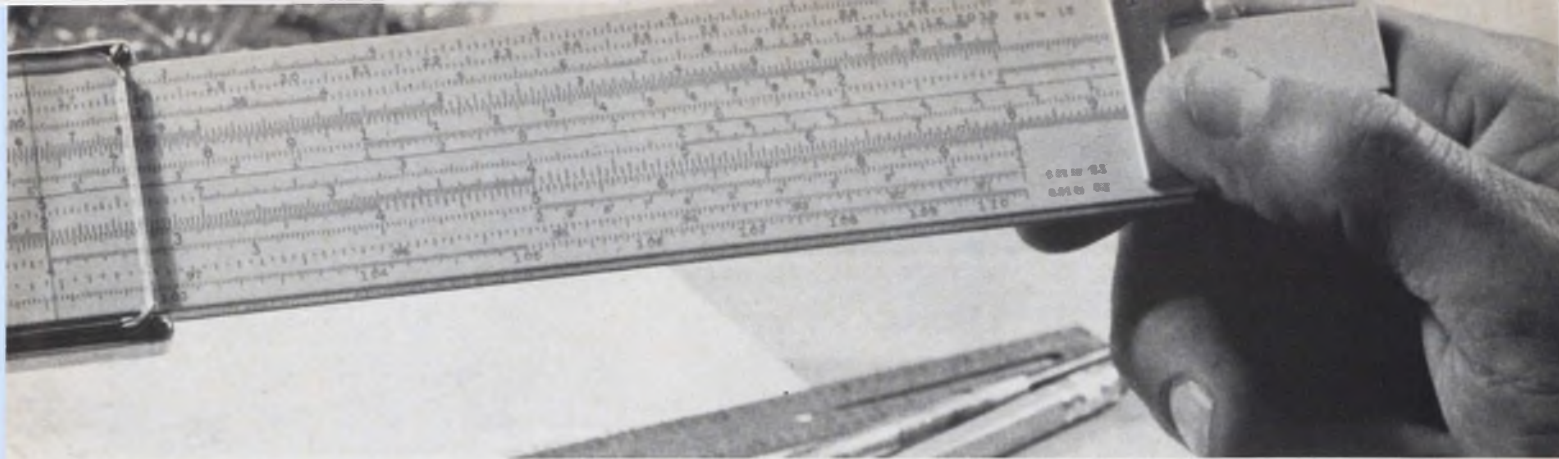

What Can You Do With a 300 W/100 A Silicon Power Transistor in a Modified TO-3 Case?



For complete design flexibility, RCA's new 2N5578 family of six high power, high current Hometaxial-base silicon n-p-n transistors is your best lead to military, industrial and commercial equipment applications. Best *three* leads, really! Choose from a new, heavy pin design...soldering lugs... flexible lead with solderless connectors.

All three take you to the same place—circuit cost savings in such uses as inverters, regulators, motor controls and other linear and switching applications. Check the chart for a quick rundown on these six devices. And for further information, check Reader Service No. 135.

Characteristic	Test Conditions		2N5575 2N5576 2N5577		2N5578 2N5579 2N5580		Units	
	V _{CE} V	V _{BE} V	I _C A	Min.	Max.	Min.		Max.
h _{FE}	4	4	40	10	40	10	40	
V _{CEO} (sus)	4		60	10	40	70		V
I _{S/b}	25		0.2	12	—	12	—	A
E _{S/b} *		-1.5	7	0.8	—	0.8	—	J
θ _{J-C}				0.5	—	0.5	—	°C/W

* With base forward biased
 * With base reverse biased and R_{BE} = 10Ω, L = 33mH

Design Delight—Dual Darlington Diff Amp Arrays

RCA-CA3050 and CA3051 offer designers a significant opportunity to work with the inherent device match of monolithic construction PLUS

building-block flexibility. On a single chip, in a dual-in-line package, each type offers:

- Independently accessible inputs and outputs
- Diode temperature compensation of constant-current-transistor bias
- High input impedance—460 KΩ typical
- Low input offset current—70 nA max.
- Low input offset voltage—5 mV max.

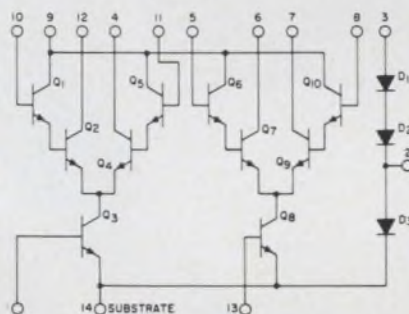

Get the feel of real design freedom with CA3050 or CA3051 for matched dual amplifiers, dual sense amplifiers, dual Schmitt triggers, doubly-balanced detectors and modulators—and anywhere you want matched device performance.

Prices: CA3050 in dual-in-line ceramic, \$2.25 (1000 units); CA3051 in dual-in-line plastic, \$1.65 (1000 units).

Circle Reader Service No. 136 for full technical data.

Using 830 and 930 DTL? RCA CD2300 Series Adds 4 Dual Flip-Flops in 3 Package Styles

Directly interchangeable with 830 and 930 series units, there are now 57 types in RCA's CD2300 Series DTL line. New 24-page technical bulletin, File No. 374, now contains information on all types including:

CD2315—dual JK flip-flop; with separate JK, clock, and set inputs, 6 KΩ pullup. For ripple counter applications.

CD2316—same as CD2315 except for 2 KΩ pullup.

CD2317—dual JK flip-flop; with common clock and clear inputs, with separate JK and reset inputs, 6 KΩ pullup. For shift-register and clocked counter applications.

CD2318—same as CD2317 except for 2 KΩ pullup.

Type numbers above indicate -55°C to +125°C ceramic flat pack. Add

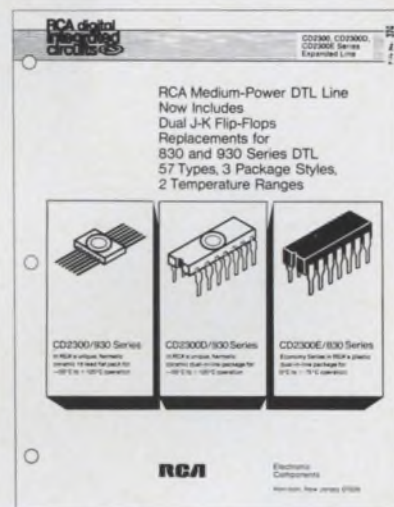

"D" suffix for 14-lead ceramic dual-in-line package; add "E" suffix for 14-lead dual-in-line plastic package for 0°C to +75°C operation.

For information on 57 RCA-CD2300 Series integrated circuits—plus High-Reliability Bulletin #373, covering 38 ceramic packaged types, processed and tested in accordance with MIL-STD-883—circle Reader Service No. 137.

For price and availability information on all solid-state devices, see your local RCA Representative or your RCA Distributor. For specific technical data, write RCA Electronic Components, Commercial Engineering, Section No QG4-2, Harrison, N.J. 07029.

RCA

**You
know about
wirewound
trimmers.**

**You've
heard about
cermet.**

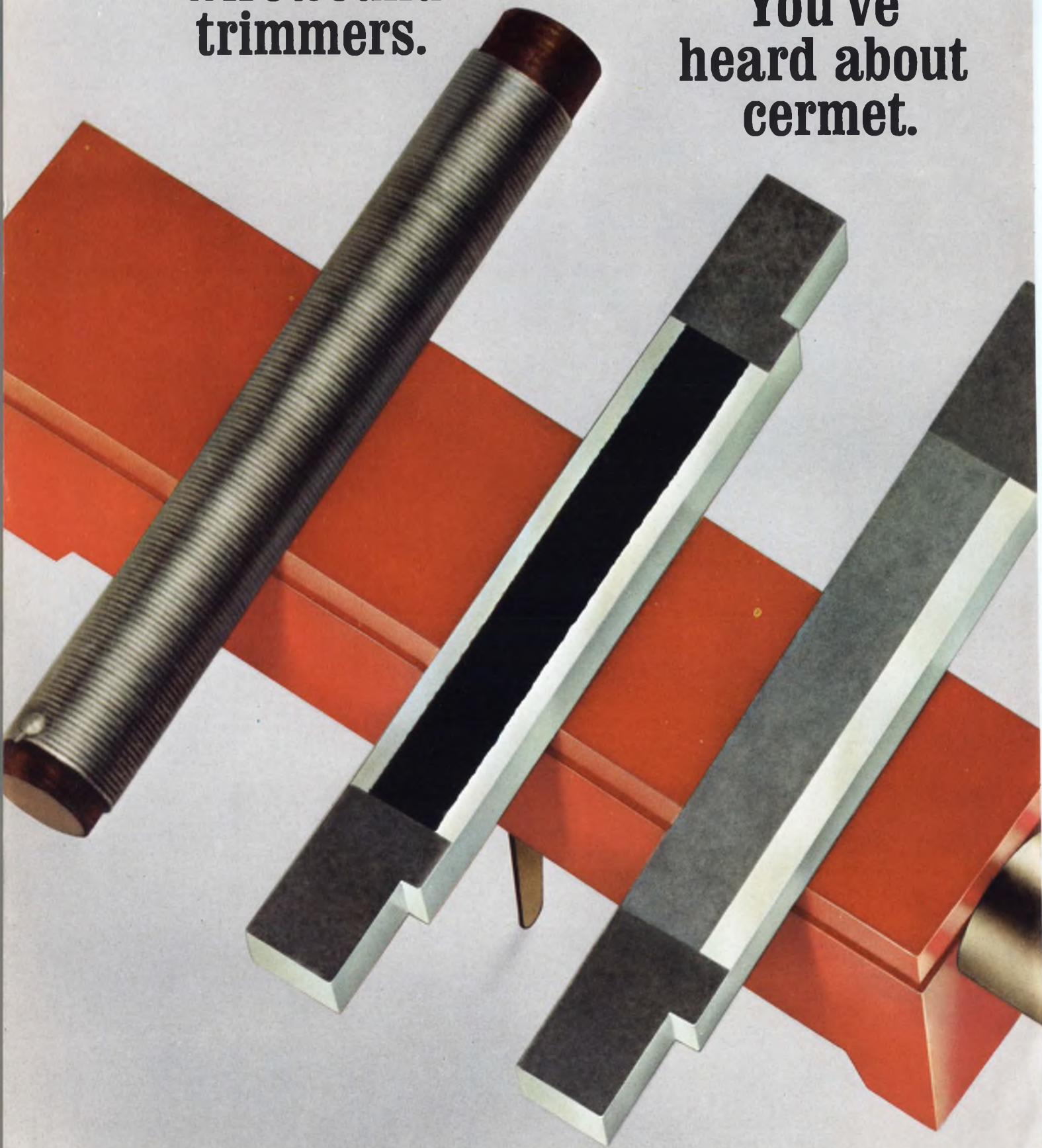

This one's called Film-Met.

It's the first major improvement in trimmers since cermet. Film-Met™ is an exclusive Amphenol resistance element* completely different from wirewound and cermet types.

Ends Compromise

This new trimmer won't always replace wirewounds and cermet, which Amphenol also makes. Their characteristics fit many design parameters perfectly. But not all!

For example: Film-Met offers both infinite resolution and low temperature coefficient. Amphenol's new resistance element also provides excellent high frequency and pulse characteristics along with low current and low thermal noise.

Temperature Coefficient

Film-Met has a low TRC of 100 ppm/°C maximum with 50 ppm/°C available on request. This

is comparable to wire, and better than any other infinite resolution trimmer.

Noise

For applications requiring critical current and thermal-noise levels, Film-Met must be your choice. This is especially true in applications where other components feature low thermal noise. Film-Met is now available for that critical job.

Other Film-Met Features

Film-Met should also be your choice for high frequency and pulse applications because of its excellent performance characteristics in these areas. Due to its high frequency characteristics and infinite resolution, Film-Met can be used for exact impedance matching.

100% Metal Element

Amphenol's exclusive Film-Met element uses the same

vacuum deposition process as metal-film fixed resistors.

Continuous monitoring techniques during deposition assure maintenance of established performance levels.

Amphenol's patented Film-Met elements are 100% protected by noble metal overlays. And they're 100% thermally stabilized to provide ultimate performance.

Film-Met trimmers are available in 3/4" rectangular commercial—3811 series; 1/2" square military—2901 series; and 1 1/4" rectangular military—2851 series.

The Next Step

Now you know a little about Film-Met. What it is, how it performs and how it's made.

Explore the possibilities of this new type of trimmer further.

Write today for evaluation samples and specification sheets. Amphenol Controls Division, Janesville, Wisconsin.

Film-Met™ by



AMPHENOL

THE BUNKER-RAMO CORPORATION

INFORMATION RETRIEVAL NUMBER 5

Monolithic logic today.
Monolithic systems tomorrow.
We've got ideas to deliver.

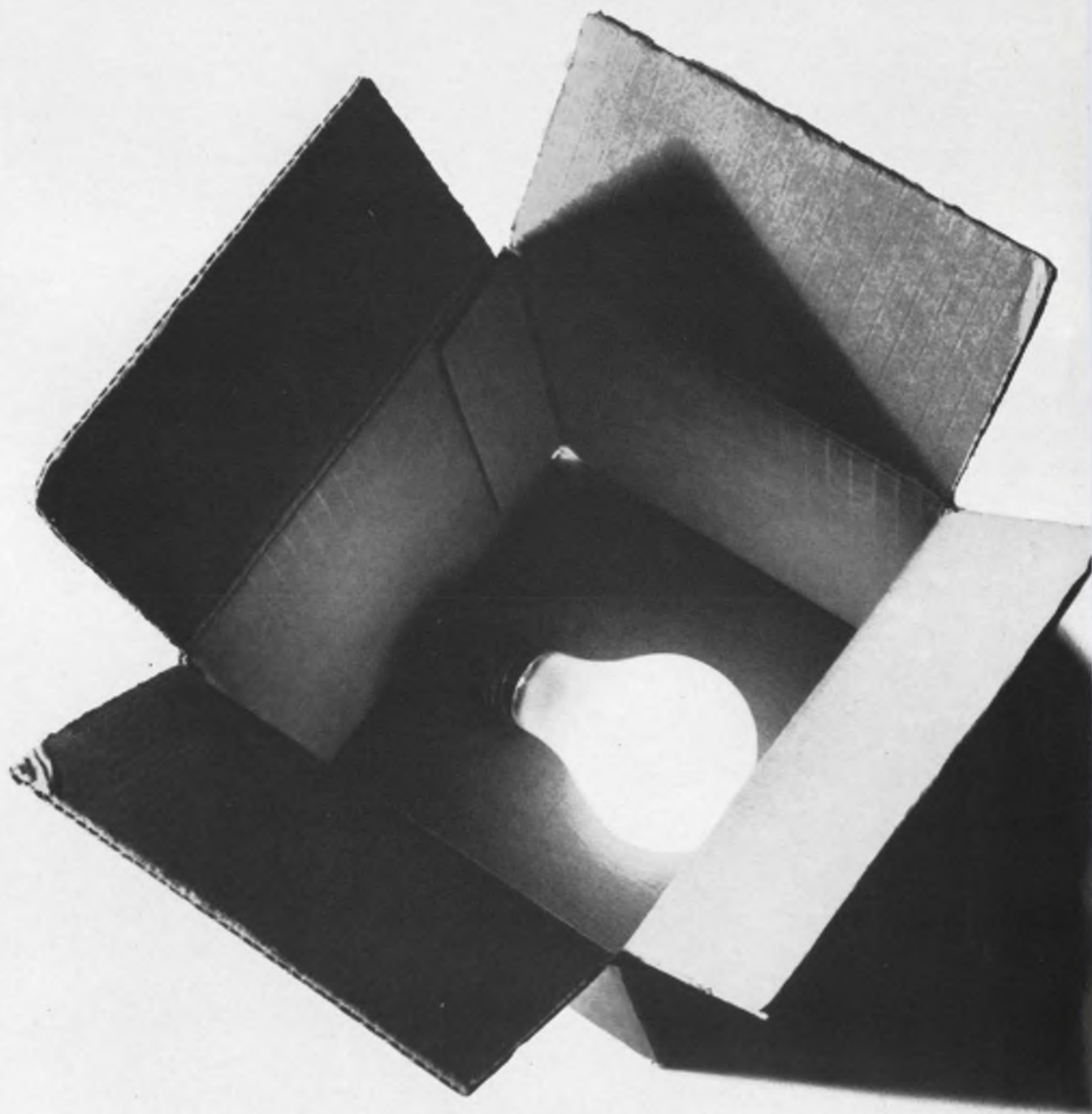

Many wafers ago Raytheon drafted a blueprint for success in the semiconductor industry. It's drawn around some very sharp idea men to nudge the state-of-the-art ever forward. Plus a production line that can turn ideas into products and pour them out en masse and on time. Here's a roll call of results, delivered and on the way.

Products for now

DTL: Over 95 circuits in Series 200, 930 and 1000.

TTL: More than 100 circuits in our industry's-fastest Ray III, and our SUHL-equivalent Ray I and II.

MSI: We're booming in TTL types, with 18 production circuits based on Ray I and II, 54/74 and 64/84 logic. And more coming fast.

Linears: Industry's broadest line of popular types. 17 circuits, including standard and 'A' versions of 100, 4100, 700 and 4700 Series.

Transistors: More than 400 standard and high-rel mil types. Switches, drivers, choppers. And amplifiers—general purpose, low level, high frequency, differential, dual and Darlington.

Diodes: 1800 types of switching and general purpose diodes, ranging from IN91 to IN4308, at speeds down to 1.0 nanoseconds.

And ideas for tomorrow

But the best is yet to come. Here's what's cooking for delivery within one year. Beam lead, of course. Plus 2-layer metal interconnects. 64-bit random access memories. 256-bit read-only memories. Multi-chip memory arrays. Very high speed logic. High speed NPN and PNP single and quad core drivers. Monolithic diode arrays. RF transistors.

And we've got even brighter things docketed for a little more distant delivery. Advanced packages—up to 78 leads, using beam lead and multi-layer substrates. Bipolar and MOS LSI. Computer-controlled LSI design. Radiation hardened circuitry. Low power ECL MSI.

Just promises? Not so. We're working on everything on that list, logging day-by-day progress toward production. So keep your eye on us. Because we intend to be getting the ideas—and delivering them—for a long time to come.

Browse through one of our detailed, just-completed catalogs. Yours for the asking. Raytheon Semiconductor, Mountain View, California, (415) 968-9211.





12

Ways to Solve

Cermet

POTENTIOMETER

PROBLEMS

*...All with TC of 150 PPM/°C Standard**

Model 3009

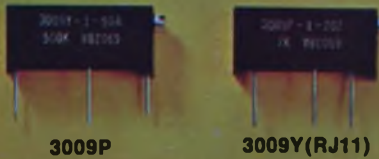

3009P 3009Y(RJ11)

- Low Cost Industrial (RJ11 Pin Configuration)
- Power 0.75 watt at 25°C
- Resistance: 10Ω to 1 Meg.

Model 3069



3069P

- Low Cost Industrial
- Mil-Spec Immersion
- Power 0.75 watt at 25°C
- Resistance: 10Ω to 1 Meg.

Model 3282



3282L 3282H 3282P 3282W

- Meets requirements of MIL-R-22097
- Power 0.5 watt at 85°C
- Resistance: 10Ω to 1 Meg.

Model 3012



3012L 3012P

- Meets or exceeds MIL-R-22097, Style RJ11
- Power 1.0 watt at 70°C
- Resistance: 10Ω to 1 Meg.

Model 3052



3052L 3052P 3052S

- Meets or exceeds MIL-R-22097, Style RJ12
- Power 1.0 watt at 70°C
- Resistance: 10Ω to 1 Meg.

Model 3262



3262W 3262P 3262X

- Meets or exceeds MIL-R-22097
- Power 0.25 watt at 85°C
- Resistance: 10Ω to 1 Meg.

Model 3252



3252L 3252P 3252W 3252X

- Meets or exceeds MIL-R-22097, Style RJ22
- CRV 1.6% over entire resistance range
- Power 1.0 watt 70°C
- Resistance: 10Ω to 2 Megs.

Model 3099



3099

- First Dual In Line Cermet Available
- Std DIP size (TO-116)
- Sealed to meet MIL-R-22097 Immersion
- Power 0.75 watt at 25°C
- Resistance: 10Ω to 1 Meg.

Model 3059



3059L 3059Y 3059P 3059J

- Meets or Exceeds MIL-R-22097, Style RJ12
- Power 1.0 watt at 70°C
- Resistance: 10Ω to 1 Meg.

Model 3292



3292L 3292P 3292W 3292X

- Meets or exceeds MIL-R-22097, Style RJ24
- Power 0.5 watt at 85°C
- Resistance: 10Ω to 1 Meg.

Model 3082



3082P

- Only .10" x .15" x .50"
- Power 0.3 watt at 85°C
- Resistance: 10Ω to 1 Meg.

Model 3329



3329P 3329H 3329W

- First Commercial single turn to meet or exceed MIL-R-22097
- Only 0.25" dia. x 0.18" high
- Power 0.5 watt at 70°C
- Resistance: 10Ω to 1 Meg.

For a detailed package of technical data on the entire line of TRIMPOT® cermet potentiometers write or call the factory, your local field office or representative!



**Reliability is a spring, a wheel
and two thingamajigs.**

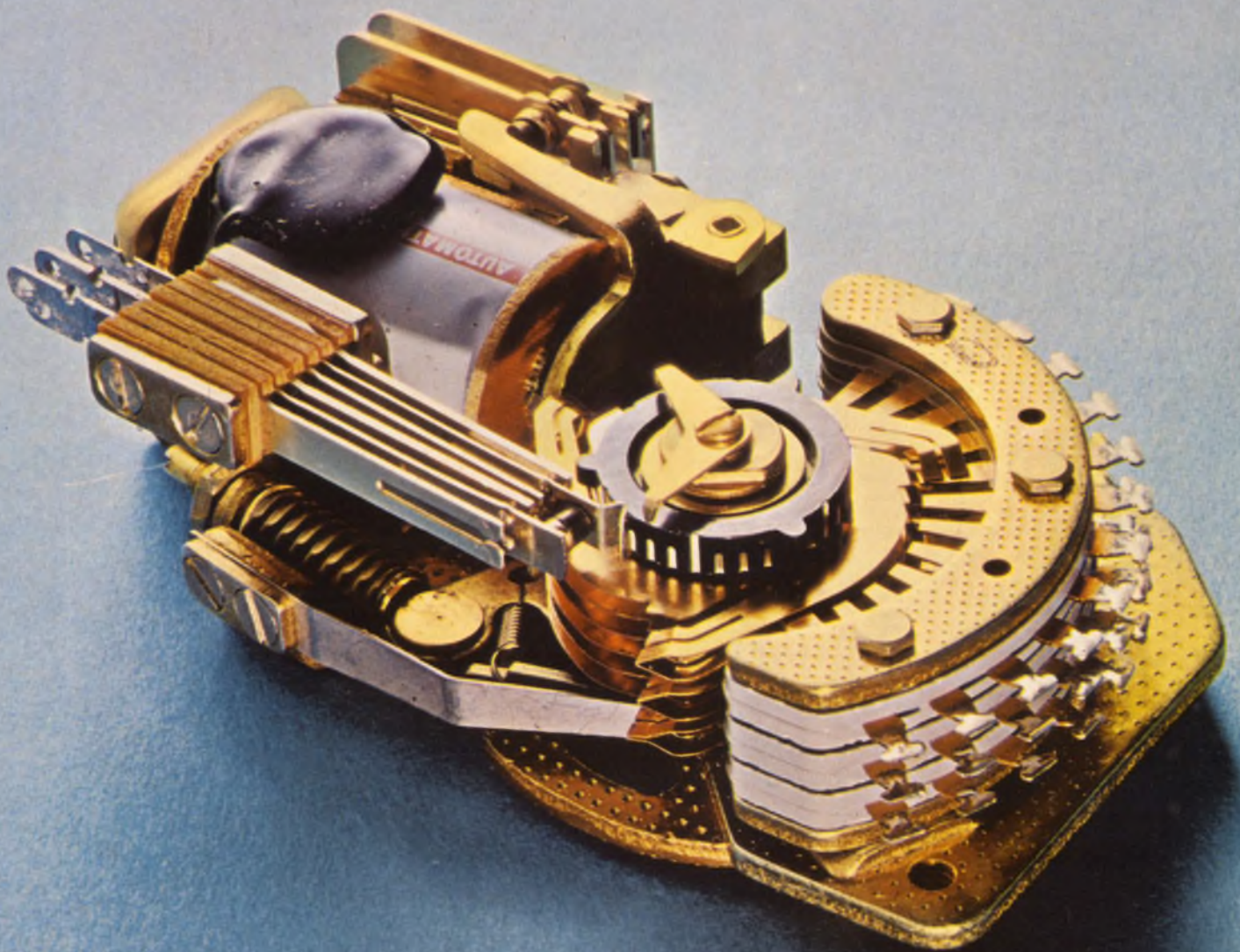



Every AE Type 44 stepping switch comes with them.

One-spring power.

The drive spring is a coil. What it does is store up power. When it comes time to switch, the spring lets loose and moves the wiper assembly forward. Each time using precisely the same pressure.

Notice our spring is tapered at one end. It's designed to perfectly match the power input. That's why you always get the best possible transfer of energy.

At one end of the drive spring is an adjusting screw. We turn it a little this way or a little that way and the tension is always perfect.

Try that with a flat spring.

We re-invented the wheel.

The ratchet wheel is a little different. The way it's made, for one thing. First, we blank it. Next, shave it. And finally, case-harden it. Then it's super strong.

Notice the big, square teeth that always provide a sure bite.

A thingamajig with teeth.

That thingamajig next to the wheel is the armature assembly. When the teeth on the end of it mesh with the teeth on the ratchet wheel, they stop the wiper assembly and position it precisely on the contact bank. Smooth as silk, every time. No jarring, no jamming, no banging.

No adjustments, either. As the teeth wear, they just drop further into the wheel. So nothing ever gets out of whack.

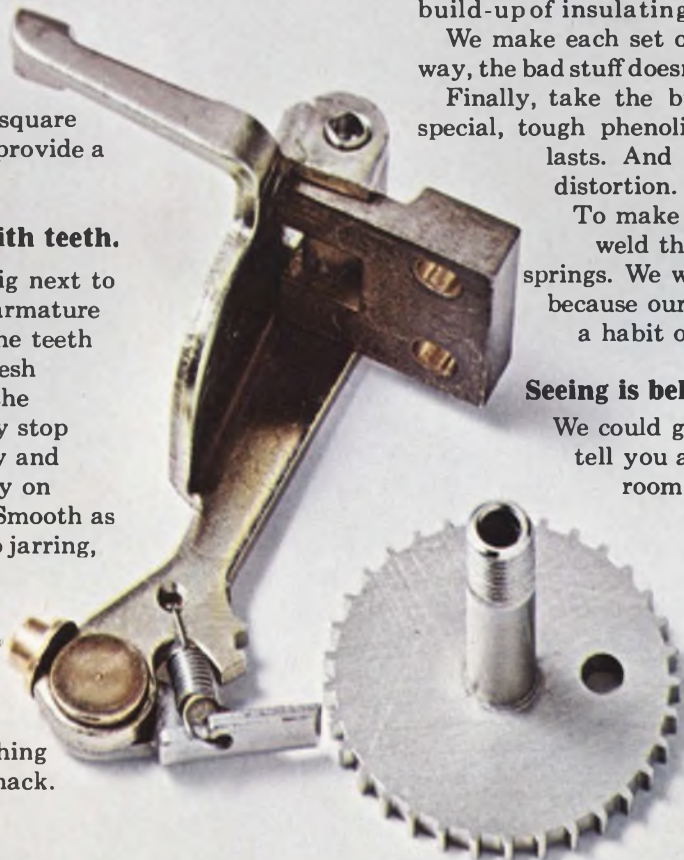

A pawl that floats.

On the end of the armature is the pawl. We made it "free floating" to eliminate the jamming and binding that go with the old style pawl stop block. And while we were at it, we stopped pawl breakage and put an end to double-stepping or overthrow.

Don't bother looking for this special set-up anywhere else. It's patented.

The other thingamajig.

It's called a contact spring. We've got some strong feelings as to what makes a contact spring strong.

In the first place, we believe there's strength in numbers. So we put two sets of contacts on each spring. This means you get a completed circuit every time. Without fail.

But some of the credit for this has to go to our solving the most common cause of contact failure—the build-up of insulating films on the contact points.

We make each set of points self-cleaning. That way, the bad stuff doesn't have a chance to build up.

Finally, take the buffers. We make ours of a special, tough phenolic material that lasts. And lasts. And lasts. All without wear or distortion.

To make sure they stay in place, we weld the buffer cups to the contact springs. We weld, rather than use rivets, because our lab found that rivets have a habit of falling off or wearing out.

Seeing is believing.

We could go on talking reliability and tell you about our testing and run-in room. There's a lot more to tell.

But we'd rather have our Sales Representative show you. And let you see first hand the reliability that's built into every AE stepping switch. Just call or write. Automatic Electric Company, Northlake, Illinois 60164.

AUTOMATIC ELECTRIC

SUBSIDIARY OF GENERAL TELEPHONE & ELECTRONICS

INFORMATION RETRIEVAL NUMBER 8

Improved brightness
solid-state lights
are attention-getting
panel indicators.

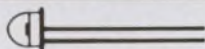

MV10B
Actual Size



MV10A
Actual Size

Solid-state lights from Monsanto are brighter than ever. 1,000 foot-lamberts is typical. They're RELIABLE—1,000,000 hours life*; FAST—1 ns switching time; and SMALL—.10 inch diameter for the MV10A3. SPECTRAL EMISSION is an attention-demanding 6,700 Å red.

Low current requirements, down to 5 ma for 50 ft/L output, make them compatible with low cost integrated

*T_A = 25°C, I_F = 50 ma. Result of step-stress testing with end of life projections.

circuits. The long life and solid state ruggedness of these emitters eliminates the need for redundant indicators and in-field servicing, even in the most critical applications.

For more information on our MV10A and MV10B red indicators and other Gallium Arsenide Semiconductors, write or call Monsanto Electronic Special Products, 10131 Bubb Rd., Cupertino, Ca. 95014, (408) 257-2140.

Monsanto

INFORMATION RETRIEVAL NUMBER 9

Designer's Datebook

MAY 1969						
Sun	Mon	Tue	Wed	Thu	Fri	Sat
				1	2	3
4	5	6	7	8	9	10
11	12	13	14	15	16	17
18	19	20	21	22	23	24
25	26	27	28	29	30	31

JUNE 1969						
Sun	Mon	Tue	Wed	Thu	Fri	Sat
	1	2	3	4	5	6
7	8	9	10	11	12	13
14	15	16	17	18	19	20
21	22	23	24	25	26	27
28	29	30				

For further information on meetings, use Information Retrieval Card.

May 14-16

Spring Joint Computer Conference (Boston, Mass.) Sponsor: G-C AFIPS, T. D. Bonn, Honeywell EDP, 200 Smith St., Waltham, Mass. 02154.

CIRCLE NO. 391

May 19-21

Aerospace Electronics Conference (NAECON) (Dayton, Ohio) Sponsor: G-AES, Dayton Section, J. E. Singer, 5705 Coach & Four Drive E., Kettering, Ohio 45440

CIRCLE NO. 392

May 19-22

Imagery in Medicine Symposium (Ann Arbor, Mich.) Sponsor: ISA & University of Mich., Ernest E. Sellers, BSIS Host Chairman, Box 618, Ann Arbor, Mich. 48107

CIRCLE NO. 393

May 26-28

Laser Engineering & Applications Conference (Washington, D. C.) Sponsor: G-Ed, G-MTT, W. B. Bridges, Hughes Res. Lab., 3011 Malibu Canyon Rd., Malibu, Calif.

CIRCLE NO. 394

June 9-10

Chicago Spring Conf. on Broadcast & Television Receivers (Des Plaines, Ill.) Sponsor: G-BTR, N. T. Watters, Zenith Radio Corp., 6001 W. Dickens Ave., Chicago, Ill. 60606

CIRCLE NO. 395

June 9-11

Int'l. Communications Conference (Boulder, Colo.) Sponsor: G-Com-Tech, Martin Nesenbergs, Inst. for Telecommunications Sci., R-614, Boulder, Colo. 80302

CIRCLE NO. 396

In microwave diodes, nobody likes surprises. When you buy from Varian you know what you're getting: We build every lot of diodes to your specification and 100% inspect it to make sure that spec is met. There is no product sorting. You never get a diode that's been downgraded from a tougher specification. Our exclusive material selection, production and QA procedures insure the high yields necessary to guarantee you on-time delivery at the highest acceptance rate — bar none — in the industry. We make tuning diodes, multiplier, switching and step-recovery diodes, paramp and oscillator diodes, either Impatt or Gunn-effect type. We build them to a standard tolerance of $\pm 10\%$ or at special tolerances to $\pm 3\%$.

And we package them in any of over 30 different case configurations or deliver them in chip form. So get the diode you really need, every time, from more than 30 Electron Tube and Device Group Sales Offices



varian
solid state micro-
wave project

throughout the world, or from our Solid State Microwave Project, Beverly, Massachusetts.

**You get
what you
specify.
Every time.**



CUSTOM CIRCUITS OFF-THE- SHELF...

ALMOST.

With Fairchild's new MOS MICROMOSAIC™ arrays, you get low-cost, custom digital subsystems so fast they're almost off-the-shelf.

The key to this lower cost and rapid turnaround time is the new computer-aided design technology we've developed for our MICROMOSAIC arrays. The entire design sequence — logic simulation and verification, cell selection and placement, artwork and test sequence generation — is performed by the computer directly from a logic diagram. Logic cells for the arrays are selected from a library of more than 45 pre-designed MOS functions (using either high- or low-threshold technology for MOS or bipolar interface compatibility). Each completed MICROMOSAIC array consists of only the logic your application calls for.

With MICROMOSAIC arrays, your small, custom computers and special-purpose logic functions for industrial or military control systems can be competitive with standard products on price and delivery. And way ahead on performance. (It offers so much, we're using MICROMOSAIC for some of our own standard products.)

Take the first step toward getting this technology into your systems. Write for our Micromosaic Array Design Handbook today. It'll tell you how much integration we can apply to your system. And give you an idea of how much time and money we can save you doing it.



Fairchild Semiconductor A Division of Fairchild Camera
and Instrument Corporation Mountain View, California 94040
(415) 962-5011 TWX: 910-379-6435.

INFORMATION RETRIEVAL NUMBER 11

...looking for a specific self-mounting 'lytic?

Choose from TWIST-LOK[®] or WRAP-LOK CAPACITORS



INFORMATION RETRIEVAL NO. 821

Two styles for use in entertainment electronics and other commercial equipment with similar environmental conditions. The widely-used Twist-Lok has integral mounting ears which are twisted after fitting through slots in chassis or mounting plate. The Wrap-Lok has sharp-cornered terminals for wire-wrap type connections.

Both styles have unique sandwich-type end seal and dependable venting system. All connections between terminals and capacitor sections are welded to assure freedom from intermittents or open circuits. Available with bare case, Kraftboard tube, or plastic sleeve.

480-8148

...need a reliable wirewound resistor?

Specify ACRASIL[®] PRECISION/POWER RESISTORS



INFORMATION RETRIEVAL NO. 822

Excellent stability and reliability, even under extended load life, extremely high humidity, and other adverse operating conditions. Expansion coefficient of silicone coating is closely matched to that of ceramic base to insure against damage to resistance winding. Coating provides exceptional protection against moisture, shock, vibration, fungus. Available with standard and non-inductive windings. Resistance tolerances as close as $\pm 0.05\%$.

For complete technical data on Twist-Lok and Wrap-Lok Capacitors, write for Engineering Bulletin 3140A. For information on Acrasil Resistors, request Bulletins 7450A and 7450.1. Write to: Technical Literature Service, Sprague Electric Co., 347 Marshall St., North Adams, Mass. 01247.

48R-8138



'Sprague' and '®' are registered trademarks of the Sprague Electric Co.

THE BROAD-LINE PRODUCER OF ELECTRONIC PARTS

News

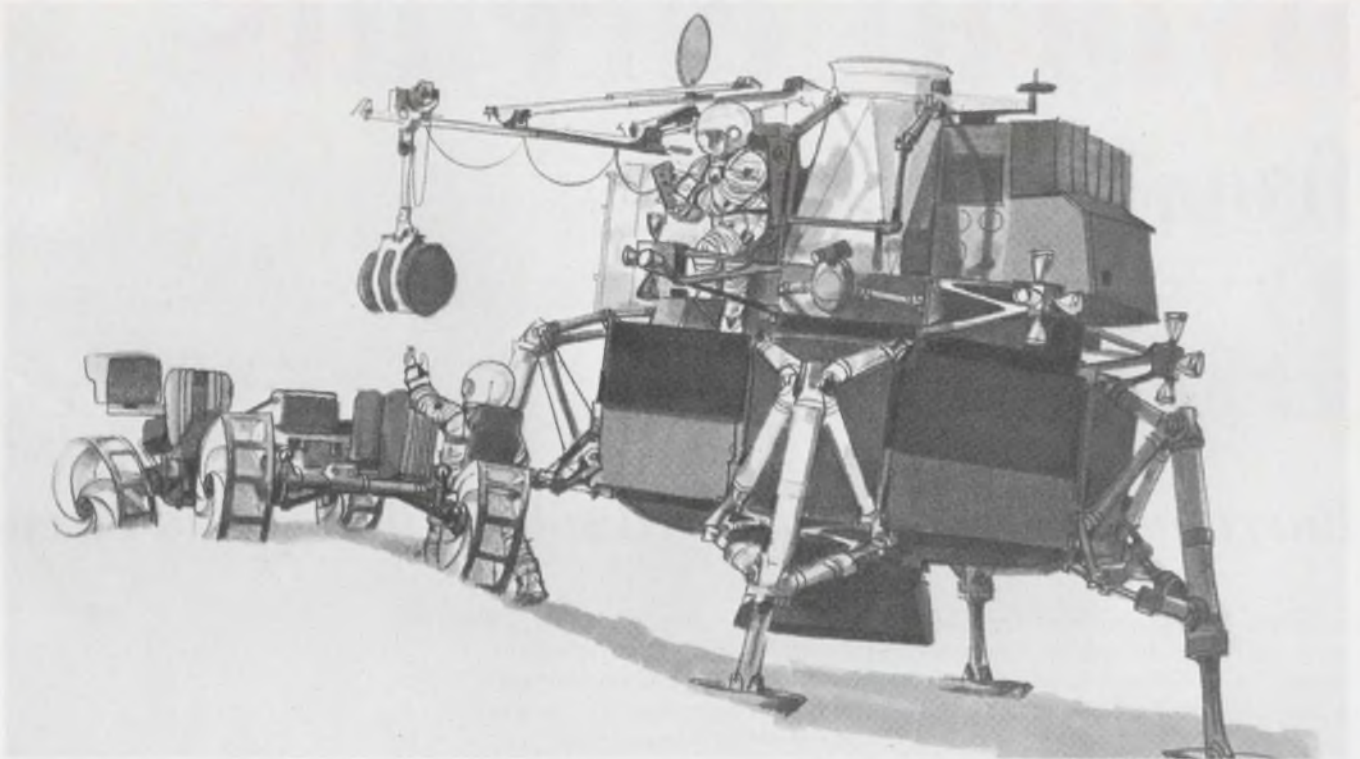

What man might do on the moon over the next decade, why he should do it—and how

—is being pondered by space experts. Details on page 25.



Spray-on electrode is one of many NASA contributions to health care. Page 30.

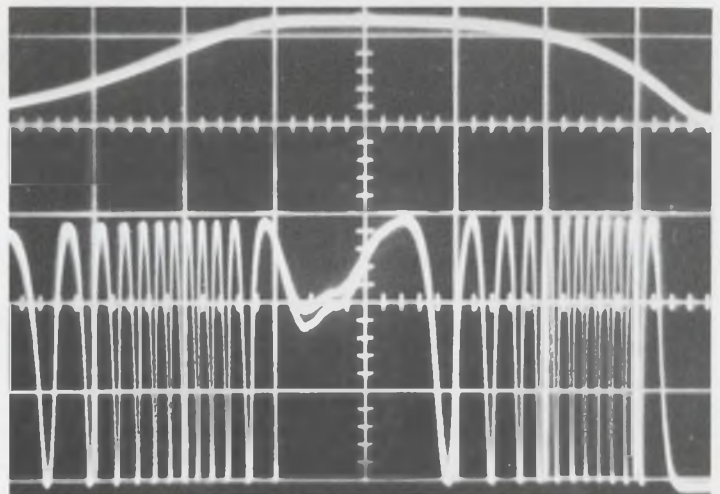

High-voltage microsecond pulses can be measured more accurately with Sandia's laser system. Page 34.

Also in this section:

News Scope. Page 21 . . . **Washington Report.** Page 39 . . . **Editorial.** Page 45.

hybrid circuits

from

Burroughs

Burroughs is your preferred source for hybrid circuits

Burroughs, a prime producer of high-volume, high-quality hybrid microcircuits, offers the entire circuit package and its components at competitive prices. Circuits are now available in various configurations with screened resistors and capacitors, as well as discrete components including IC and MSI chips. Burroughs does the whole job, and does it right—enabling you to reduce system size with increased reliability.

Every circuit is custom-designed and fabricated under the eyes of experts in complete in-house semiconductor and hybrid operations—assuring you economy, high reliability, quality control and on-schedule delivery.

Buy your hybrid microcircuits NOW from Burroughs, and discover what Burroughs' one-source circuitry capability can do for you.

We also offer hermetic packaging, computer testing, complete environmental facilities. And we are fully documented to MIL Specs.

Call or write Burroughs Corporation, Electronic Components Division, P.O. Box 1226, Dept. H1, Plainfield, New Jersey 07061. Tel. (201) 757-5000, or contact your nearest Burroughs representative or sales engineer.

- 1./ *Semi-automatic dual latch hybrid test unit for efficient, high-speed tests.*
- 2./ *High-speed resistor abrading process assures $\pm 1\%$ tolerances.*
- 3./ *Modern, contamination-free diffusion operation, atmospherically controlled for maximum quality assurance.*
- 4./ *Multifunctional computerized system performs all forms of AC & DC tests.*



1./



2./

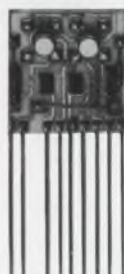

3./



4./

Burroughs



LSI on view in Paris at components show

Large-scale integration—an item only for discussion at last year's international electronic components show in Paris—turned up in equipment at this year's show. The show, formally titled "Salons Internationaux des Composants Electroniques et de l'Electroacoustique," ran from March 28 through April 2. Schneider Electronique—the third largest radio and TV manufacturer in France—displayed a portable digital multimeter that contains an LSI MTOS chip.

The chip, which contains 475 transistors and is enclosed in a 16-pin, dual in-line package, was custom-built for Schneider by General Instruments of Europe. The LSI device performs counting, logic, a/d conversion and some switching, normally done by discrete transistors.

The unit, which is called Digi-test 500, is about the size of a small book, weighs 2-1/2 pounds and will sell for \$190. It will be distributed in the U. S. by Honeywell Corp., probably some time in July, according to Francis Barroux, assistant director of Schneider's Electronics Div. He added that the company expects to sell 15,000 of the units in the next year. Honeywell already has orders for 5000 in the U. S., Barroux says.

The LSI chip measures 2.4×2.9 mm, operates at 200 kHz and dissipates about 200 milliwatts.

The multimeter has 17 measuring ranges. Its resolution is 100 microvolts, 100 nanoamperes and 1/10 ohm. The output display contains three Nixie tubes. The unit can be operated from a 12-volt source, eight 1.5-volt batteries or 117 volts.

In a related development, a spokesman for Siemens AG of Germany said that the company was

working with General Instruments of Europe to develop a custom LSI MOS chip for use in a desk-top computer. A prototype of the chip will be on display at a fair in Hanover, Germany, at the end of this month. Some 15 manufacturers of desk-top computers are reported to be very interested in the Siemens-GI circuit.

The Paris show attracted over 150,000 visitors from 70 nations. Of the 1076 companies that exhibited, about half were non-French. The U. S. had the largest foreign representation, with 170 exhibitors.

Fairchild's Dr. Hogan spells out some plans

A three-chip desk calculator has been designed by engineers at Fairchild's Semiconductor Div. in Mountain View, Calif., to demon-



Dr. C. Lester Hogan, president of Fairchild Camera and Instrument

strate the potential for large-scale integration. LSI chips 145-mils square were used.

But Dr. C. Lester Hogan, president of Fairchild Camera and Instrument Corp., doubts that such a calculator will be marketed. Instead, he speculated in an interview with ELECTRONIC DESIGN, a 20-chip calculator would make more economic sense. It would not cost much more than the three-chip version, he said, but would offer about seven times the calculating power. This added capability would make the price more reasonable.

Hogan also revealed that Fairchild plans to introduce an 8000B integrated-circuit test system in the third quarter of 1969. Computer-aided design of an LSI chip will include generation of a testing sequence on computer tape. This tape then will be used for directly driving the 8000B tester.

In the memory area, Hogan said he was "90 per cent confident" Fairchild would be able to build semiconductor memories for bulk storage in computers that would be competitive with magnetic cores. But this is some three to four years off, he commented. He declined to take sides on the bipolar versus MOS controversy for memory ICs, saying that Fairchild is pursuing both approaches. He agreed that there are problems in both areas, but added that smart engineers have solved worse problems in the past.

Flat-screen-television: Two more contenders

Joining a long list of potential developers of a flat-screen TV, two Japanese manufacturers—Matsushita Electric Corp. and Mitsubishi Electric Co., Ltd.—have announced experimental versions.

The Matsushita entry, which was exhibited at the recent IEEE show in New York, has a flat screen about the size of a standard 13-inch tube. Observers noted that the picture was not too bright and resolution substantially less than that of a conventional TV.

The flat screen was made of an electroluminescent panel with horizontal (x) and vertical (y) conducting strips and a zinc sulfide

phosphor sandwiched in between. In operation, it cast a characteristic green glow.

The pictures shown were regular commercial telecasts. They appeared with a resolution of 59,000 picture elements, one at each x and y intersection. The video signal was applied to all vertical strips simultaneously, and to the individual horizontal strips by a sequential decoding circuit.

Because the system had no interlace, the corresponding horizontal line-pairs were displayed on the same horizontal strip.

Mitsubishi did not show its flat-screen TV at the IEEE show, but it has announced in Japan that it is developing one 3 by 4 inches. Production is still several years away, the company has announced.

IR scanner a success, but RCA abandons it

An experimental infrared laser scanner, developed by Radio Corp. of America for high-speed projects of the United States Dept. of Transportation, has been shelved by RCA in spite of successful tests. The company's defunct New Business Programs Div. at the David Sarnoff Research Center, Princeton, N. J., built the prototype under a one-year, \$300,000 contract but now declines to continue its development.

"We don't really know why RCA decided not to continue with the program," says Edward J. Ward, chief of the Federal Office of High-Speed Ground Transportation. "Their design was very good, and we were very satisfied. The decision was surprising."

The warning device, or something similar to it, is essential if 300-mile-an-hour cushion trains are ever to become operational. Such vehicles will travel on a guideway with a vertical clearance of only a few millimeters. Any small obstacle on the rails must be detected and early warning given to

oncoming trains.

Functioning like a miniature lighthouse on one side of the guideway, RCA's IR scanner transmits a narrow beam through a slowly rotating parabolic mirror, sweeping across the track for up to 600 feet. The beam is returned by a reflective strip on the opposite side of the guideway and is received through the mirror. Any object over one inch wide interrupts the signal continuity and alerts oncoming trains.

"RCA tests of the system over a special segment of Penn. Central railroad track near Princeton were very successful," Ward reports. "The prototype is over-complex and must be simplified—or we may try a similar fixed transmitter."

RCA's project engineer, Fred Bernstein, declined to say why the company was discontinuing development of the scanner. But another RCA spokesman offered this comment: "In the selection of our research projects, we decided to put our emphasis closer to our traditional areas and not to pursue this market at this time."

Bernstein admits the prototype is "made like a Cadillac," because it is experimental and has special test points and other special circuitry. But it could easily be simplified, he asserts.

RCA studies show that for a system protecting 300 miles of guideway, a complete warning complex—including scanners, reflecting fence, communications equipment, ac power supply and wiring, installation and testing—might cost \$60,000 a mile, Bernstein says.

Navy reports it faces an obsolescence crisis

The Navy says that many ships in its fleet are so obsolete that it's impractical to attempt to modernize them.

In testimony at hearings before a House Armed Services subcommittee, top Navy officials declared that new ships are needed to meet the threat of an ever-increasing, modern Soviet fleet. The hearings ended Jan. 31, but the testimony was only recently released.

In discussing the current Navy repair program, called FRAM (for

Fleet Rehabilitation and Modernization), the subcommittee chairman, Rep. L. Mendel Rivers (D-S. C.), said heatedly: "We have FRAM'ed and FRAM'ed and FRAM'ed until you can't FRAM any more."

Rivers has introduced a bill calling for a greatly increased ship-building program. However, the Nixon Administration has indicated it will request much less for new ships than the Navy and Rivers demand (the Navy has asked for \$3.7 billion, and Defense Secretary Melvin Laird has cut this to \$2.4 billion).

Indicative of the problem, the Pacific Fleet Commander, Adm. John H. Hyland, testified that when new electronic systems were installed in old ships, often the only available space to put the equipment was in the ships' living quarters.

Air Force computer uses LSI arrays

An avionics computer, with 34 large-scale-integration arrays replacing integrated-circuit flat-packs in a previous design, is being delivered to the Air Force this month. The 16-bit-per-word machine with a 2-MHz clock rate was built by Texas Instruments under a \$2.1-million contract.

The Air Force will use the computer as part of its MERA (Molecular Electronics for Radar Applications) solid-state radar system, now under development.

Fourteen types of discretionary-routed LSI bipolar arrays are used in the computer, with an average of over 200 TTL logic gates per array. The project—designated the TI 2502 computer—demonstrates that complex arrays can be fabricated on 1-1/2-inch silicon wafers; that an automatic probe system can determine the exact location of every gate and flip-flop, and that an automatic test program can verify proper functioning of the completed array.

Three levels of metallization are used in the array design. The first layer connects devices into circuits or cells; the other two interconnect cells to achieve the desired function.

Need a small instrumentation amplifier with low power drain...



NEW 3233/15 SERIES

These FET input units offer extremely low quiescent drain (1.2mA max.). Ideal for mobile and portable applications. They operate from a wide, unregulated power supply range (± 5 to $\pm 20V$). Gain is adjustable from 1 to 1,000 by means of a single resistor. The 1.20" x 1.80" x .60" encapsulated package weighs just 2 oz. From \$85.00 in single unit quantity.

or one with high CM voltage?

NEW 3243/25 SERIES

These FET input units provide outputs up to $\pm 115V$ from an unregulated power supply range of ± 50 to $\pm 135V$. Gain is adjustable from 2 to 1,000 with a single external resistor.

The encapsulated package is just 1.80" x 2.40" x .60". Units are priced from \$145.00 in single unit quantity.



Burr-Brown has 'em!

These new units are part of a comprehensive line of small, encapsulated Burr-Brown instrumentation amplifiers which provide most of the useful features of big, rack-mount units . . . at a fraction of the cost. In fact, Burr-Brown has recently reduced prices on many older, popular models . . . making them more attractive than ever.

MODEL NUMBER	OLD PRICE*	NEW PRICE*
3161/25	\$ 95.00	\$ 75.00
3154/25	125.00	85.00
3061/25	125.00	95.00
3153/25	165.00	125.00

* in single unit quantity.

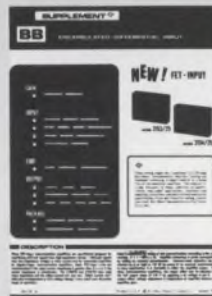

FOR COMPLETE SPECIFICATIONS

on the 3233/15 series and the 3243/25 series, plus up-to-date prices on other popular Burr-Brown instrumentation amplifiers, contact your Burr-Brown Engineering Representative or use this publication's reader service card.

BURR-BROWN

RESEARCH CORPORATION

International Airport Industrial Park • Tucson, Arizona 85706
TELEPHONE: 602-294-1431 • TWX: 910-952-1111 • CABLE: BBRCORP



Operational Amplifiers
Instrumentation Amplifiers
Function Modules
Active Filters
Power Supplies

ENGINEERING REPRESENTATIVES: ALABAMA, HUNTSVILLE (205) 534-1648 / ARIZONA, PHOENIX (602) 254-6085 / CALIF., LOS ANGELES (213) 245-9405, SAN DIEGO (714) 232-2017, SAN FRANCISCO (408) 244-1505 / COLO., DENVER (303) 388-4391 / CONN., EAST HARTFORD (203) 528-8192 / D.C., WASHINGTON (SEE MARYLAND) / FLORIDA, ORLANDO (305) 843-1510 / ILLINOIS, CHICAGO (312) 286-6824 / MD., SILVER SPRING (301) 588-8134 / MASS., BOSTON (617) 245-4870 / MICH., DETROIT (313) 358-3333 / MINN., MINNEAPOLIS (612) 781-1611 / MO., ST. LOUIS (314) 524-4800 / N.C., GREENSBORO (919) 273-1918 / N.J., CAMDEN (609) 365-2450 / N.M., ALBUQUERQUE (505) 255-1638 / N.Y., ALBANY (518) 489-4777, BINGHAMTON (607)

723-9661, MT. VERNON (914) 664-0080, NEW HARTFORD (315) 732-3775, ROCHESTER (716) 473-2115 / OHIO, CINCINNATI (513) 761-5432, CLEVELAND (216) 237-9145, DAYTON (513) 277-8911 / PENN., PHILADELPHIA (SEE CAMDEN, N.J.), PITTSBURGH (412) 243-6655 / TEXAS, DALLAS (214) 357-6451, HOUSTON (713) 774-2568 / UTAH, SALT LAKE CITY (801) 466-8709 / VIRGINIA, (SEE MARYLAND) / WASH., SEATTLE (206) 767-4260 / WISC., WAUKESHA (414) 786-2180 / CANADA, DOWNSVIEW, ONT. (416) 636-4910, MONTREAL QUE. (514) 747-9849, NEW WESTMINSTER, B.C. (604) 524-1161, OTTAWA, ONT. (613) 725-1288

Pick the
BEST IC
for the job

Problem: An accurate current-to-voltage conversion is required between a current source and a $20\text{K}\Omega$ load. Desired full-scale output is ± 12 volts (with a power supply of $\pm 15\text{V}$). The circuit must operate with a full-scale accuracy of 0.1% over the temperature range from -55°C to $+125^\circ\text{C}$. The output must be capable of slewing at $2\text{V}/\mu\text{s}$. Pick the best IC for the job.

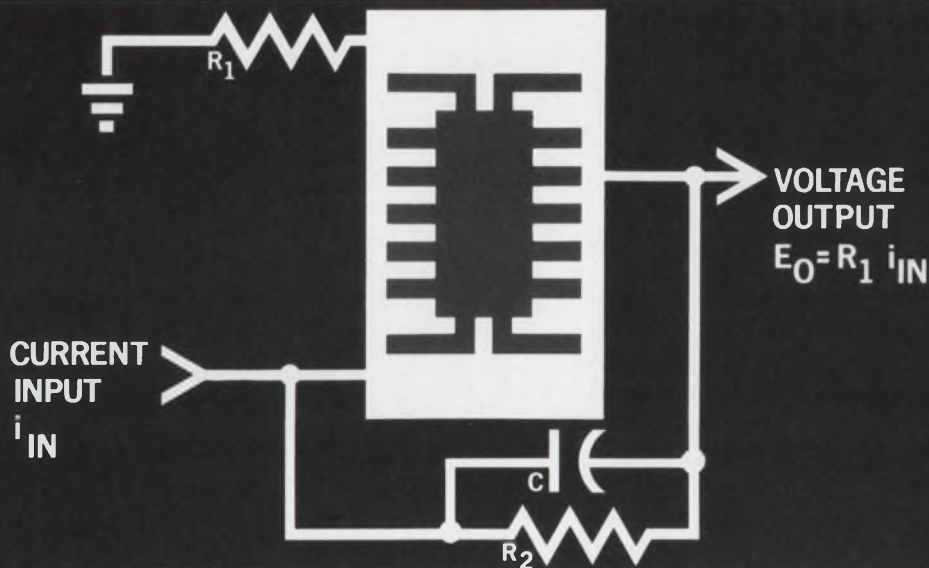

the **BEST** Solution:

THE RA-909 OPERATIONAL AMPLIFIER



Pick the RA-909 Compensationless Operational Amplifier. Low offset current and offset voltage over the full temperature range allow design of the current-to-voltage converter within 0.1% full-scale accuracy. The RA-909, with dielectric isolation, eliminates the need for external compensation and ensures a slew rate of better than $2\text{V}/\mu\text{s}$. An added advantage over any 709-type op amp—maximum power dissipation is only 80mW. Obviously, the best IC for the job.

The RA-909 is a direct replacement for all 709-type op amps, so use it in existing current-to-voltage converter circuits and increase their performance, too. Available in both a TO-99 package and a TO-86 flatpack configuration, the RA-909 offers other features such as transient response of 40ns (10 to 90% points) with a 200 millivolt output into a $2\text{K}\Omega$ 100pF load in the worst-case unity gain configuration; and a maximum equivalent input noise of $5\mu\text{V}$ RMS.

Contact your nearest Radiation sales office. Let us help you pick The Best IC for The Job.

WE MAKE THE **BEST IC** FOR THE JOB



RADIATION
INCORPORATED
SUBSIDIARY OF HARRIS-INTERTYPE CORPORATION
MICROELECTRONICS DIVISION

RADIATION SALES OFFICES: P. O. Box 476, Lexington, Mass. 02173, (617) 862-1055 • 600 Old Country Road, Garden City, N.Y. 11530, (516) 747-3730 • 2600 Virginia Avenue N.W., Washington, D.C. 20037, (202) 337-4914 • P. O. Box 30667, Dallas, Texas 75230, (214) 231-9031 • 6151 W. Century Boulevard, Los Angeles, California 90045, (213) 670-5432 • P. O. Box 37, Melbourne, Florida 32901, (305) 727-5430 • International Sales: Marketing Department, P. O. Box 37, Melbourne, Florida 32901, (305) 727-5412

How and why man will explore the moon

Scientists' plans for long-term moon stay are limited only by uncertainties of funding

John F. Mason
Military-Aerospace Editor

What man might do on the moon over the next decade, why he should do it—and how—are some of the questions that **ELECTRONIC DESIGN** put to the experts recently.

The first Apollo astronauts to land on the lunar surface will spend a limited time outside of their landing module, gather some rock samples and then return to earth.

It is certain that future astronauts will spend considerably longer periods on the moon's surface, perform a variety of experiments, break its rocks for minerals and water and peer through telescopes at stars never before seen so clearly in the moon's airless "sky."

The only uncertainty is when these wonderful missions will take place and how much funding present and future Administrations will provide for a long-term lunar exploration program.

If the Apollo II moon landing is successfully accomplished, NASA

will have 15 Saturn V rockets available for future lunar landing missions. The cost of equipping these vehicles for a comprehensive manned lunar exploration program has been estimated at \$100 million per year by Dr. George Mueller, NASA administrator for manned space flight.

Why we should go

Dr. Kenneth L. Franklin, astronomer and chairman of the board of Hayden Planetarium, gave several reasons why he feels a prolonged visit to the moon should be made.

"We can learn how the moon, as well as the earth and the entire solar system, were formed. We might also clear up the still unsettled debate over the origin of the craters on the moon. Are they impacts from meteors or volcanic depressions?"

"Also, we can use the moon for scientific purposes. It will be ideal for astronomy. It provides an un-

precedented clear and steady view of stars." He points out that "a 12-inch telescope above the earth's atmosphere will enable us to see as clearly as we do here on earth with a 200-inch instrument.

"The far side of the moon," he adds, "will be excellent for radio astronomy. There, we will be shielded from the electromagnetic noise from earth."

One problem the electronics industry must solve, Franklin says, is how to communicate with the earth from the moon's far side and between two points on the moon over its horizon. "How," he asks, "will a radio astronomy station on the moon's far side communicate with an optical station on the near side? All radio transmission on the moon is line-of-sight, even low-frequency waves, because there's no atmosphere to refract these long waves that are so conveniently bent over the horizon here on earth."

Lunar communications satellites do not provide an uncomplicated answer because of the speed with which they appear and disappear over the horizons. "Landlines, the

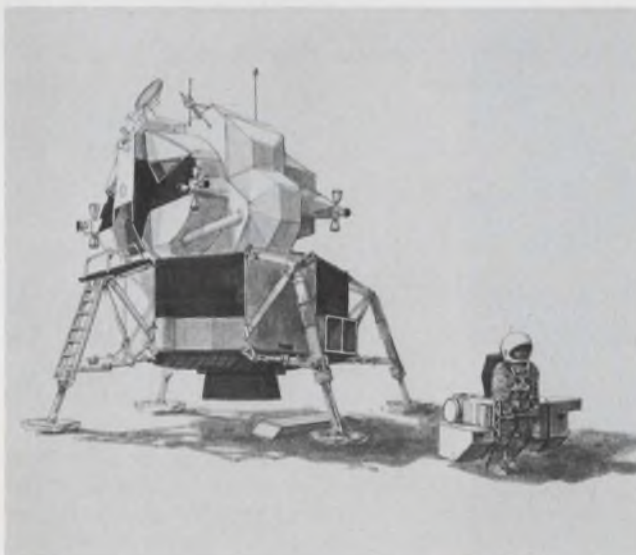

Basic Apollo Lunar Module (LM) is the two stage craft from which all follow-on concepts are derived. Astronaut is carrying the scientific experiment package.

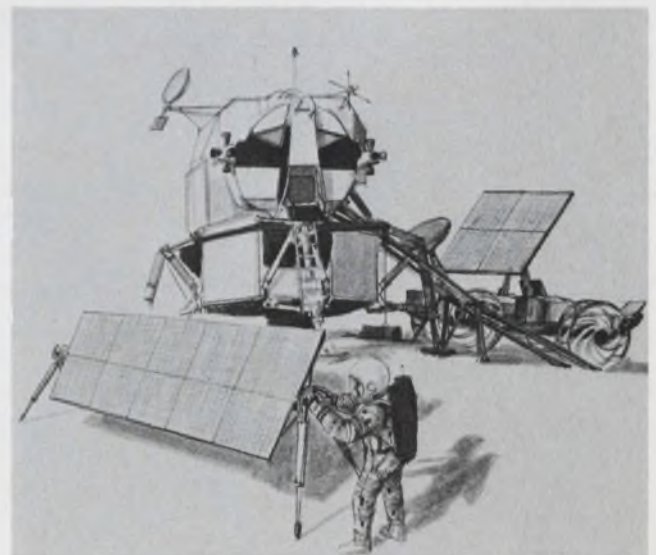

LM shelter is landed with life support for two men—who arrive later by LM taxi—for 14 days. Shelter also contains 30-meter drill, experiment package, mobility aids.

(moon exploration, continued) ~

most probable solution," Franklin says, "are expensive to transport and to install. Also, the moon's curvature—four times that of the earth's—will require installation of four times as many repeaters in the line.

"Ground current transmission might eventually be used, but not

enough is known yet about the moon's structure to predict the efficiency of this approach," he says.

Franklin does not believe we'll find minerals on the moon valuable enough to pay the cost of mining them and bringing them back—except, of course, for samples. Astronauts will need to look for certain minerals, however, to survive. If there's no water—the first thing the astronaut will look for—miner-

als containing hydrogen and oxygen will be sought. If these are found, it's possible that their crystalline forms could be broken down, the hydrogen used for rocket fuel, the oxygen for breathing, and the two combined for water.

Brawn and brain needed

Because of radiation bombardment, the surface of rocks won't be used; they must be broken up to find usable minerals. "There are going to be a lot of picks and hammers used in exploring the moon," Franklin says.

Other scientific tasks to be performed by a moon station include making biological studies—the effects of direct cosmic rays combined with zero gravity conditions; tracking deep space probes; and observing the earth's weather, ocean surface conditions and other geophysical phenomena.

How the astronauts are going to get around on the moon and what they're going to live in while there was answered by J. G. Gavin Jr., vice president of space programs for Grumman Aircraft Engineering Corp., Bethpage, N.Y.

Experience gained from the initial Apollo Lunar Module (LM) landings may permit an increase in LM payload that could extend the astronaut's time on the moon to three days—by providing them with up to 700 pounds of scientific equipment, including a lunar flying vehicle or a small lunar roving vehicle (see artist's conception).

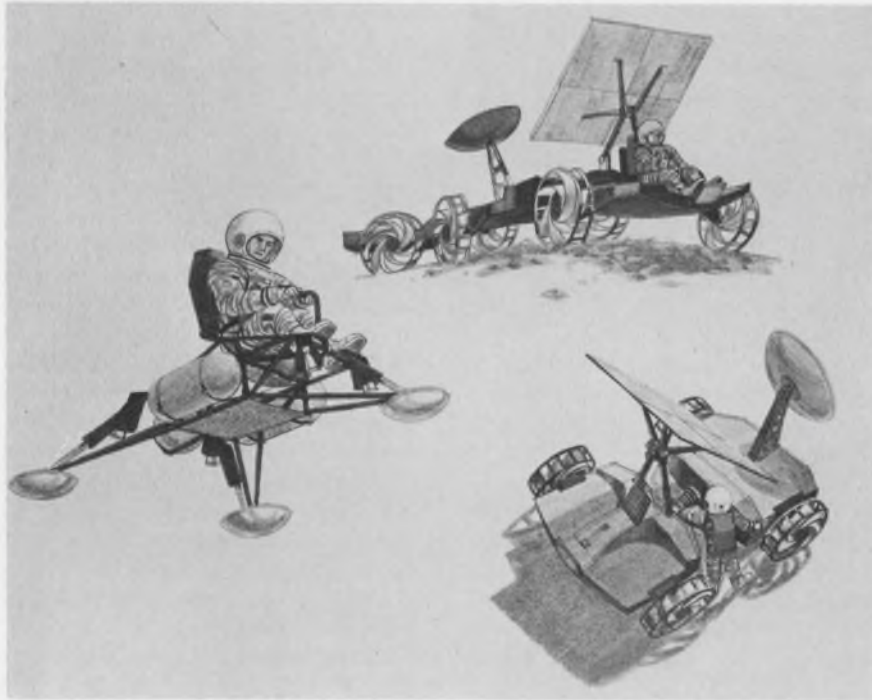

Lunar flying vehicle (left) carries one man with 370 pounds of gear or two men. Lunar roving vehicle (lower right) carries 500 pounds, including one man, two miles. Heavy-duty vehicle moves 500 pounds 25 miles.

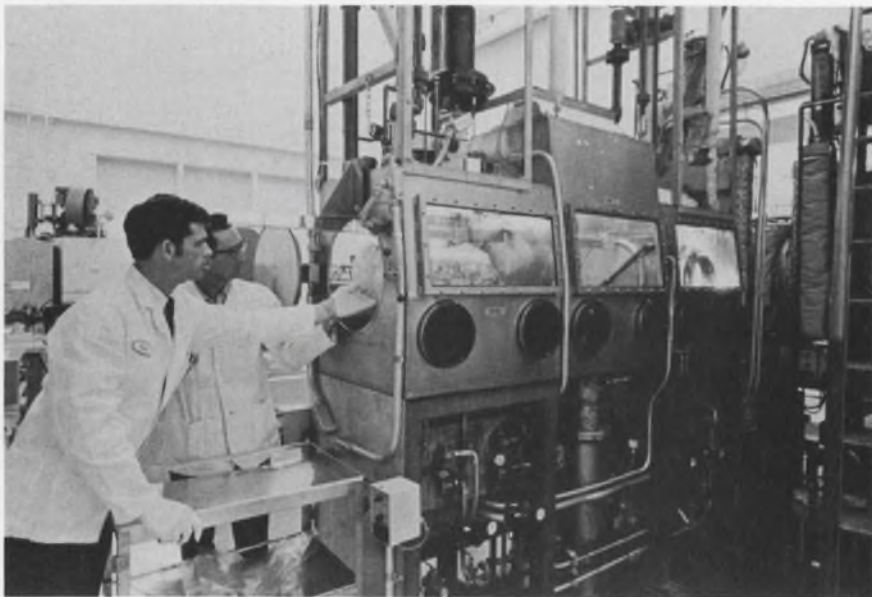

Vacuum containers will be cleansed of terrestrial contaminants before moon samples are stored for study under simulated lunar conditions.

Shelter may go first

Next is an augmented LM. With a more powerful Saturn V booster, the LM will be able to take 2000 pounds of scientific payload to support a 36-hour moon stay or 1000 pounds for an 8-day stay. If two launches are made, the scientific payload could be landed by one vehicle and the augmented LM could then carry more life-supporting expendables to support a crew for up to 14 days.

An LM shelter (page 25) is an Apollo LM minus its ascent propulsion system that has been modified to make an unmanned landing on the moon, remain quiescent there for up to 60 days, and support two men for 14 days.

This would be followed by an LM

Test your logic.

a) Suppose you designed the DCL MSI 8260, world's fastest adder, and its logic diagram looked like this:

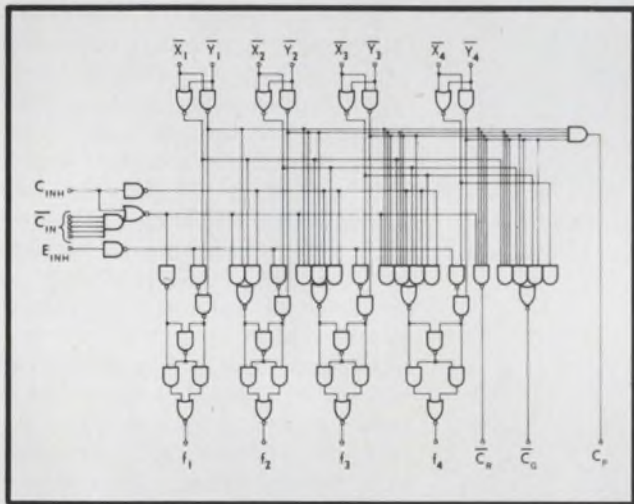

b) And it gave a speed and package count, which beat any other IC family, like this:

No. of Bits	Package Count			Addition Time per Bit (ns)	Total Addition Time Input to Output (ns)
	8260	8261	Quad 2-Input NAND Gates		
16	4	1	—	3.3	52
24	6	3	—	3.3	52
32	8	3	—	2.0	64
48	12	6	1	1.3	64
64	16	7	1	1.2	76

c) Next, suppose you came up with eleven new MSI elements—all perfect fits with the 8260, our other MSI elements, and the entire DCL family—like this:

8230	8-Input Digital Multiplexer
8232	8-Input Digital Multiplexer
8241	Quad Exclusive-OR
8242	4-Bit Comparator
8266	2-Input, 4-Bit Multiplexer
8267	2-Input, 4-Bit Multiplexer with Bare Collector
8268	Full Adder
8275	Quadruple Latch
8276	8-Bit Shift Register with Clock Inhibit
8284	4-Bit Binary Up/Down Counter
8285	BCD Up/Down Counter

d) Now then: wouldn't you logically buy a full-page ad to tell the world in *Electronic Design*? And wouldn't you sign it like this:

Signetics DCL

Signetics Corporation/811 E. Arques Ave., Sunnyvale, Calif. 94086/A subsidiary of Corning Glass Works

Logical afterthought: For written proof that Signetics is right in the middle of MSI, send for our DCL handbook. It's 120 pages—and free!

INFORMATION RETRIEVAL NUMBER 15

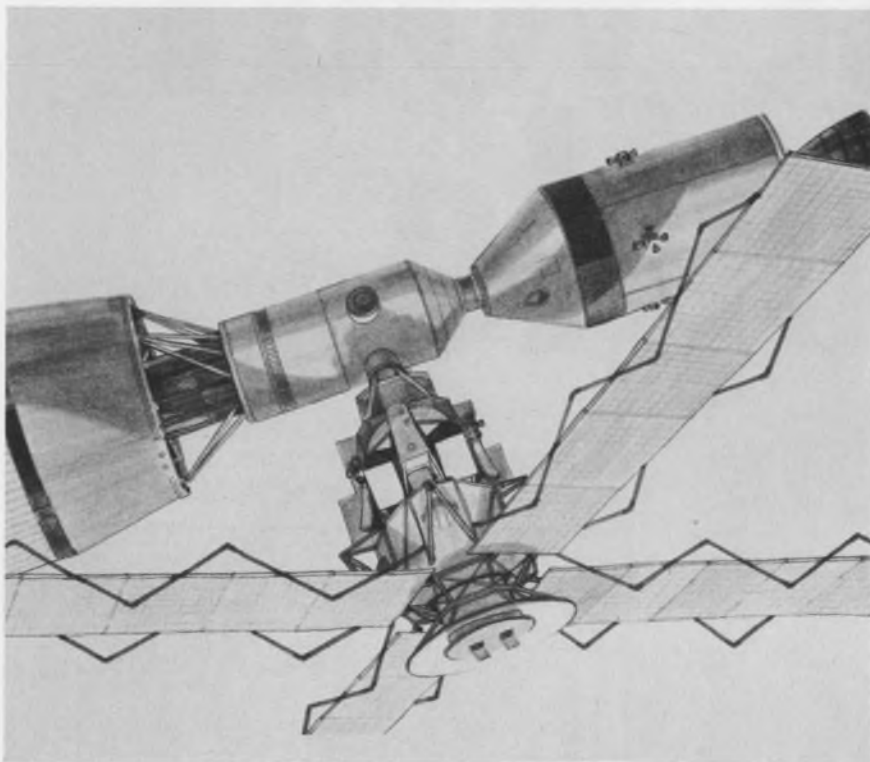

Telescope for earth-orbit or lunar station. Attached are solar astronomy experiment equipment, solar arrays, and control moment gyroscopes. Telescope will gather data on physical characteristics of the sun.

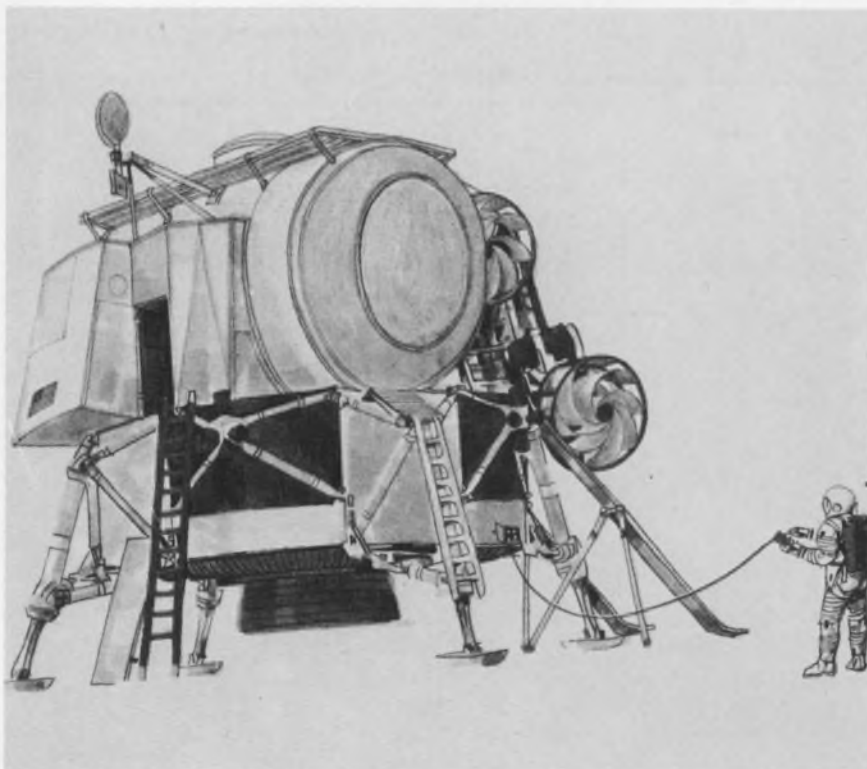

LM truck can transport cargo in the volume otherwise occupied by the LM ascent stage. The vacated volume, 1650 cubic feet, can be filled with 8800 pounds of payload. Living quarters here take up 760 cubic feet.

taxi bringing the two moon men. The shelter payload would consist of expendables, mobility aids, a 30-meter-long lunar drill and an advanced Apollo lunar surface experiment package.

How they'll get around

To move around (see page 26), the lunar flying vehicle, proposed by Grumman, weighs 180 pounds and carries 300 pounds of the same propellant used by the LM descent engine. The vehicle can hold one man with about 370 pounds of scientific equipment, or two men with no equipment on a rescue mission.

The lunar roving vehicle will carry 500 pounds, including one astronaut. Although its radius of operation is limited to two nautical miles because of back-pack communications restraints, its battery power does permit a 15-nautical mile sortie before recharging is necessary. The vehicle weighs between 600 and 800 pounds and may be converted to an unmanned-remote control vehicle.

A bigger lunar roving vehicle can move 500 pounds, but its radius is eight nautical miles, and it can traverse 25 nautical miles per sortie on a battery charge. This vehicle weighs 1500 pounds and would be carried on an unmanned logistics spacecraft. The vehicle can be operated by remote control through an earth-to-vehicle communications link.

Orbital lab next?

A large LM laboratory is planned that will sustain two astronauts for 45 days in earth or lunar orbit. Its sensors include radiometers, spectrometers, a stellar camera, a terrain camera, multispectral cameras, X-ray sensors, a day-night camera, and an infrared imager.

The telescope, which is currently being designed for an earth-orbit mission, can be modified for landing on the moon. ■■

Most of the material for this story appeared in ELECTRONIC DESIGN's IEEE Extra.

LARGE-SCALE LOGIC

MOTOROLA NEWS about MTTL Complex Elements and their Application

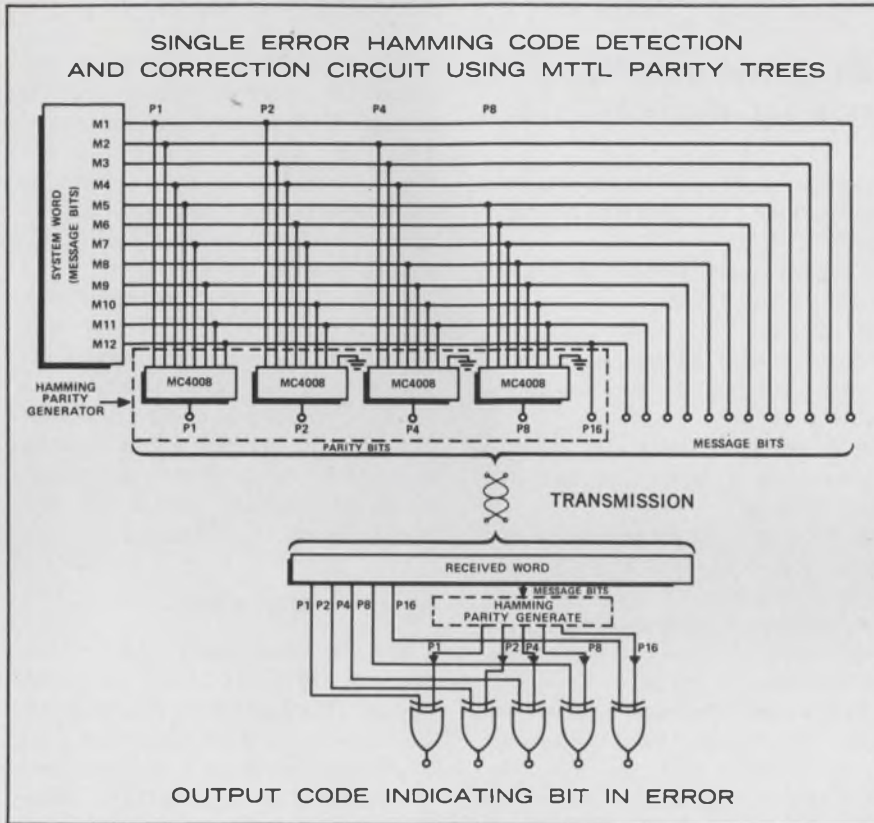

Parity Trees Are Key To Economical System Error-Detection and Correction

Two new MTTL complex-function parity trees offer the digital systems designer an economical approach to overall system reliability. The MC4008L 8-Bit Parity Tree consists of eight 2-input Exclusive NOR gates connected to form an 8-bit Parity Checker/Generator. An extra 2-input gate is also available for expanding the number of bits or can be used as the parity bit input when checking parity. The MC4010L Dual 4-Bit Parity Tree is ideal for checking word lengths of 4-bits or increments of 4-bits. It consists of six 2-input Exclusive NOR gates connected to form two independent 4-bit parity trees.

The Single Error Hamming Code Detection and Correction Circuit (illustrated) not only recognizes that an error has occurred but also

detects which bit is in error. Using this approach, a 4-bit system word (message word) requires that 3 additional bits (Hamming Parity bits) be added to provide single-error correction capability. A single-error detection Hamming parity code generator examines the message bits and generates the required parity bits. These generated parity bits are inserted into the message bits and the new longer "parity word," containing both the original message bits and parity bits is transmitted. Accuracy of the transmitted "parity word" is examined by a single-error Hamming parity detection circuit. When a single error has occurred the output of the detection circuit indicates the binary position in the parity word of the bit in error.

Both the MC4008L and the MC4010L are expandable to as many bits as are required without additional gate packages. The devices are TTL/DTL compatible and are supplied in the 14-pin dual in-line ceramic package.

MTTL Complex-Elements Offer Overall System Improvements

These new additions to Motorola's expanding MTTL complex-functions incorporate the system compatibility improvements pioneered by Motorola on its MTTL III line as follows:

1. Diode clamped inputs to reduce "ringing."
2. Squared transfer characteristic resulting from MTTL III active bypass network in high level output gates enables the use of internal high speed, non-saturating low level gates.

To find out more about MTTL complex-function integrated circuits, send for data sheets. For immediate evaluation units call your local franchised Motorola distributor.

- where the priceless ingredient is care!

 **MOTOROLA**
Integrated Circuits

Motorola Semiconductor Products Inc. / P. O. Box 20912

/ Phoenix, Arizona 85036

INFORMATION RETRIEVAL NUMBER 16

Electronic aids for the overburdened MD

NASA contributions to biomedical instrumentation can help meet soaring demands for medical care

Jim McDermott
East Coast Editor

The connection between sending men to the moon and improving care in the nation's hospitals may not be immediately evident to the average citizen. But the National Aeronautics and Space Administration has just published a survey, "NASA Contributions to Bioinstrumentation Systems," that reports a positive link.

NASA advances in bioinstrumentation—used to monitor the physical condition of orbiting astronauts—are readily adaptable to general medical care, the agency says. And never was the time more propitious. For paralleling the growth of the space program in the last 10 years have been rocketing demands for health care in the nation. Spurred by Medicare and other public programs, the demands have been outstripping the supply of medical personnel. NASA says its techniques can help ease

the crisis a bit by increasing the productivity of limited medical staffs.

The advances cited by the space agency include these:

- Spray-on electrodes that can be worn all day by people with ailments that must be constantly monitored.

- A complete telemetry system mounted in a helmet to measure brain waves.

- Improved transducers for measuring body temperatures and blood pressure.

- Implanted transmitters with novel circuitry that can radio data from inside the body.

From the electronics point of view, the various NASA biomedical monitoring systems, from the small to the complex, are comprised of four basic elements: (1) a means of acquiring the biological signal, either through direct electrical connection or by a transducer; (2) a method of amplify-

ing and filtering (conditioning) the signal to remove noise; (3) a means of transferring the signal from the pickup location to the display area, such as on wires or by telemetering; and (4) equipment for signal display and (computer) processing.

Some of the most important biomedical work by NASA has been concerned, not with spectacular developments, but with solutions to "simple" problems of the first system element. These include making noise-free, rapid electrical connections to various parts of the human body. (See Fig. 1.)

Spray on electrodes

Dr. Seymour Stein, Chief of the Medical Office at Ames Research Center, Moffett Air Force Base, Calif., tells of a development that is rapidly becoming a standardized technique. This is a spray-on electrode system that is rapidly applied, does not irritate, and can be worn all day by people who must be constantly monitored say, for a heart ailment, over a period of time.

"We developed these electrodes," says Dr. Stein, "for obtaining heart-rate data on aviators flying in high-performance aircraft . . . as well as the technique whereby these electrodes can be applied innocuously and rapidly."

The electrodes consist of a spray-on solution containing a conductive cement that is a mixture of a household cement, silver powder and acetone. But a limitation of these electrodes is their high impedance, on the order of 75 to 100 kilohms. This increases noise pickup, reduces system gain and attenuates low-frequency components of the signals. However, a high-input impedance amplifier overcomes most of these difficulties.

Mount electrodes in helmet

For measurement of brain waves or electroencephalograms



1. Electrode application and placement, shown here for electrocardiogram measurements in Project Mercury, can be a problem in bioelectronic instrumentation. NASA has developed "spray-on" and "sponge" electrodes that can be adapted for hospital use.

(EEG), NASA has come up with a wet sponge electrode that has wide clinical possibilities. Developed at Ames, these electrodes are part of a complete EEG telemetry system mounted in a flight helmet (See Fig. 2.). The sponge electrode consists of a flexible, hollow-cored, cellulose-acetate sponge impregnated with an electrode paste. When fitted to the head of the subject the tip is lightly compressed.

"We feel that these electrodes are a fine piece of work," Dr. Stein explained to ELECTRONIC DESIGN, "because they permit rapid placement which, in clinical practice, is an important element.

"Use of the electrodes in a helmet does several things. Because it is easy to use, more patients can be seen in the same period of time. It doesn't inconvenience the patient nearly as much as previous methods. The interference or noise problem is reduced somewhat because all electrodes mounted in the helmet are applied simultaneously. And, finally, undesirable electrical disturbance due to electrode jellies drying in a sequence, doesn't occur."

Transducers and telemetry

Another area in which NASA has advanced is the use of transducers for signaling body and skin temperatures and blood pressures.

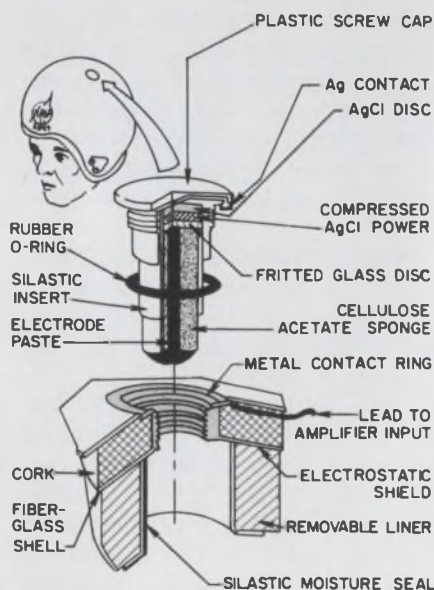

2. "Sponge" helmet electrodes developed by NASA at its Ames Research Center for brain-wave measuring telemetry system.

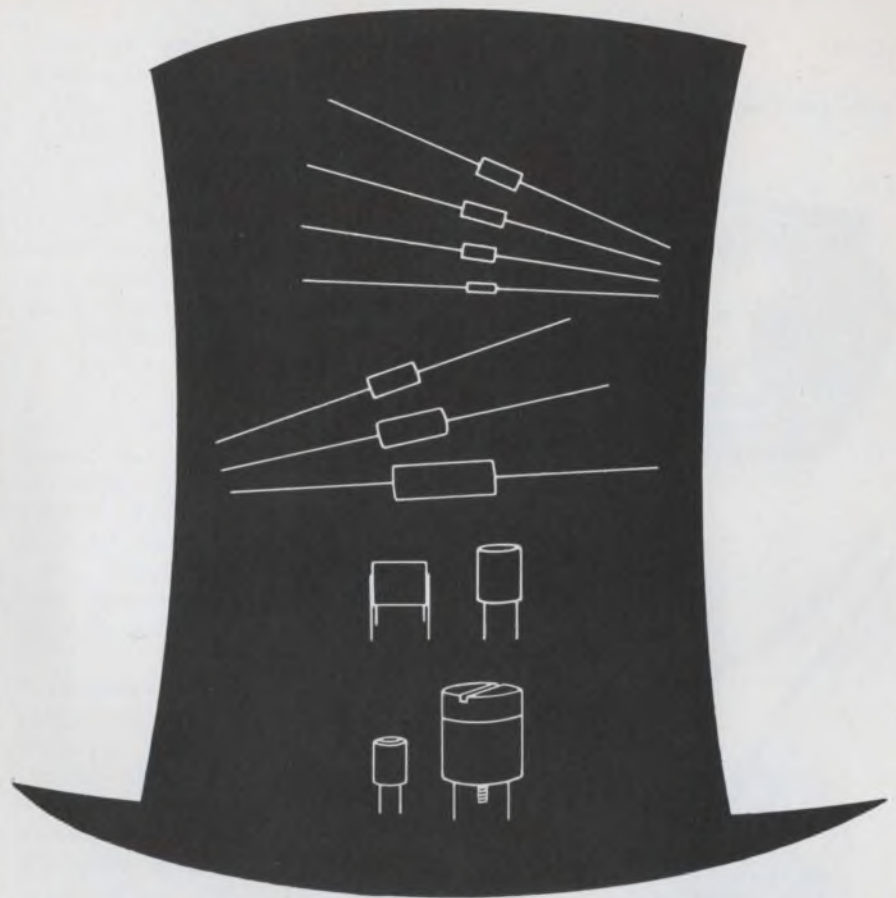

If you think Nytronics Inductors are tops...you ought to try our Ceramic Capacitors!

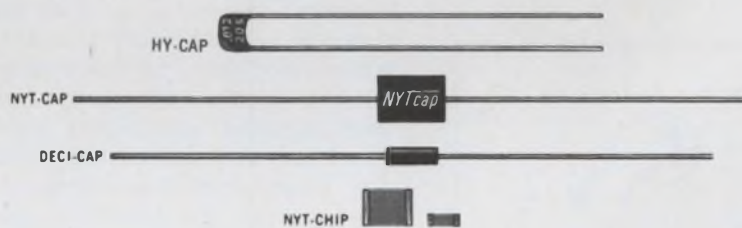

You'll find they're tops in quality and performance, too. Because they're the result of the very same unremitting research and development — and a standard line concept that links volume production with utmost precision. And you'll find the widest range of units with the greatest capacitance-to-unit size.

HY-CAP: .01 to 2.5 mfd.; $\pm 20\%$ tolerance; 100 WVDC; no derating to 125°C; and meets MIL-C-11015.

NYT-CAP: Molded epoxy package 0.1" diameter by 0.250" long... 4.7 to 220 pf; and 0.350" by 0.250" by 0.1"..... 270 to 4700 pf; T/C does not exceed ± 25

ppm/°C (-55°C to $+125^\circ\text{C}$); and 200 WVDC.

DECI-CAP: Epoxy molded envelope 0.100" diameter by 0.250" long... 4.7 to 27,000 pf; and $\pm 10\%$ tolerance.

NYT-CHIP: 0.170" by 0.065" by 0.070" ... 4.7 to 220 pf; and 0.280" by 0.195" by 0.070" ... 270 to 4700 pf; T/C does not exceed ± 25 ppm/°C (-55°C to $+125^\circ\text{C}$); and 200 WVDC.

In addition to ceramic capacitors and inductors, we maintain inventories of high quality delay lines and resistors. Complete engineering data on all products will be sent on request.



NYTRONICS, INC.

The quality line of standard components

550 Springfield Ave., Berkeley Heights, N.J. 07922 ■ (201) 464-9300 ■ TWX: 710-984-7977

INFORMATION RETRIEVAL NUMBER 17

(aids for the MD, *continued*)

3. Relatively crude body-temperature sensor for Project Mercury, at top, compared with more recent Project Apollo skin-temperature sensor, at bottom. Rapid advance in sensor technology is evident.

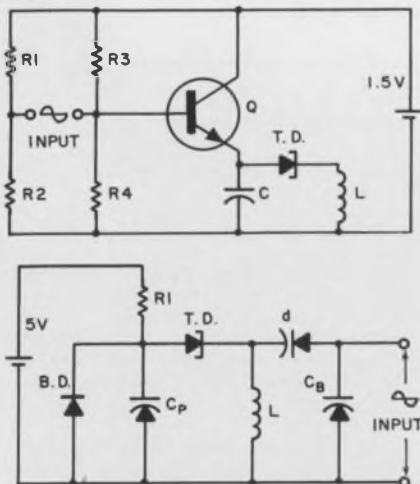

4. Two single-channel biotelemetry transmitters developed by Case Institute of Technology are an advance over previous all-transistor models. The circuits use tunnel, backward and varicap diodes. The lower circuit has the same sensitivity as the upper, but it has greater temperature stability and a higher input impedance of 100 megohms.

They have been adopted by manufacturers for the general medical community.

Evidence of NASA's progress in this field may be seen by comparing the crude Project Mercury body-temperature sensor (at top in Fig. 3) with the sophisticated model produced for the Apollo program (at bottom). The latter is attached directly to the skin and has a range of 80 to $115 \pm 0.3^\circ\text{F}$.

Of vital importance is the link between the signal and the display and processing area. In general, the use of wires is highly restricting. As a result, NASA effort has gone into many kinds of biotelemetry transmitters.

For general clinical work, the freedom afforded by telemetry is highly desirable.

Dr. Stein gives the example of an older man, still an active tennis player but with an apparent cardiac difficulty under stress. When the subject was wired to obtain heart data, his movements were so restricted as to reduce his activity below any useful diagnostic level. But when a miniature telemetry system was installed on the man, he regained complete freedom, and data under strenuous activity was obtained, confirming the original diagnosis.

One of the greatest challenges to bioelectronic designers lies in implanted telemetry, in which bioelectrical potentials are picked up inside the body by temperature sensors or other transducers and then amplified by a signal conditioner that modulates a tiny telemetry transmitter. The signals are sent out through the body walls and picked up by an external receiver, then demodulated, processed, and displayed.

Stringent design requirements of micro-size, mini-weight, and microwatt power consumption, plus high reliability, have produced a variety of clever circuits in which the functions of transducer, signal amplifier and transmitter are combined.

New implantable devices

Newer developments in implantable biotelemetry devices, by W. H. Ko and his research associates at the Case Institute of Technology, under NASA sponsorship, include

tunnel diodes, backward diodes and variable-capacitance diodes as shown in Fig. 4. A simplified version is shown at the top, and here the carrier is frequency modulated by varying the bias on the tunnel diode oscillator. Input impedance is 1 megohm.

In the improved, lower version of Fig. 4, a backward diode is used to bias the tunnel diode into the region where its oscillating frequency is relatively unaffected by power-supply variations. In addition, it acts as a temperature-stable voltage regulator.

The capacity of the variable-capacitance diode changes with the input signal, modulating the tunnel diode oscillator frequency. Input impedance for this circuit is 100 megohms.

The principal problem of implanted biotelemetry systems is the power supply, and NASA is pushing investigations on external sources (see "Problem: How to power the artificial heart", ED 25, Dec. 5, 1968, p. 25).

Some devices in use

Many electronic medical aids developed for NASA are already at work in hospitals around the country. One is a monitor for respiratory passages that alerts the medical staff when the patient's breathing is endangered.

Instead of 24-hour nursing surveillance in critical cases, an automatic alarm notifies attendants that there is an obstruction. "We get enough warning so that the condition can be cleared before the patient suffocates," says NASA's Dr. Stein. "It's a fail-safe system."

The device, he reports, is being used "on children in local hospitals."

Another valuable aid, Dr. Stein notes, is "a pressure transducer that is now being used by some universities and probably will be used by cardiologists.

"The transducer is so small," Dr. Stein says, "that it can be inserted into an artery and moved up into the heart itself, so that intercardiac pressures can be taken without injury to the patient. A proper evaluation of the pumping action of the heart can be made and a determination made as to whether or not heart surgery is indicated." ■■



less
than
\$1.00*

for new high performance
A-B solid hot-molded
variable resistor...

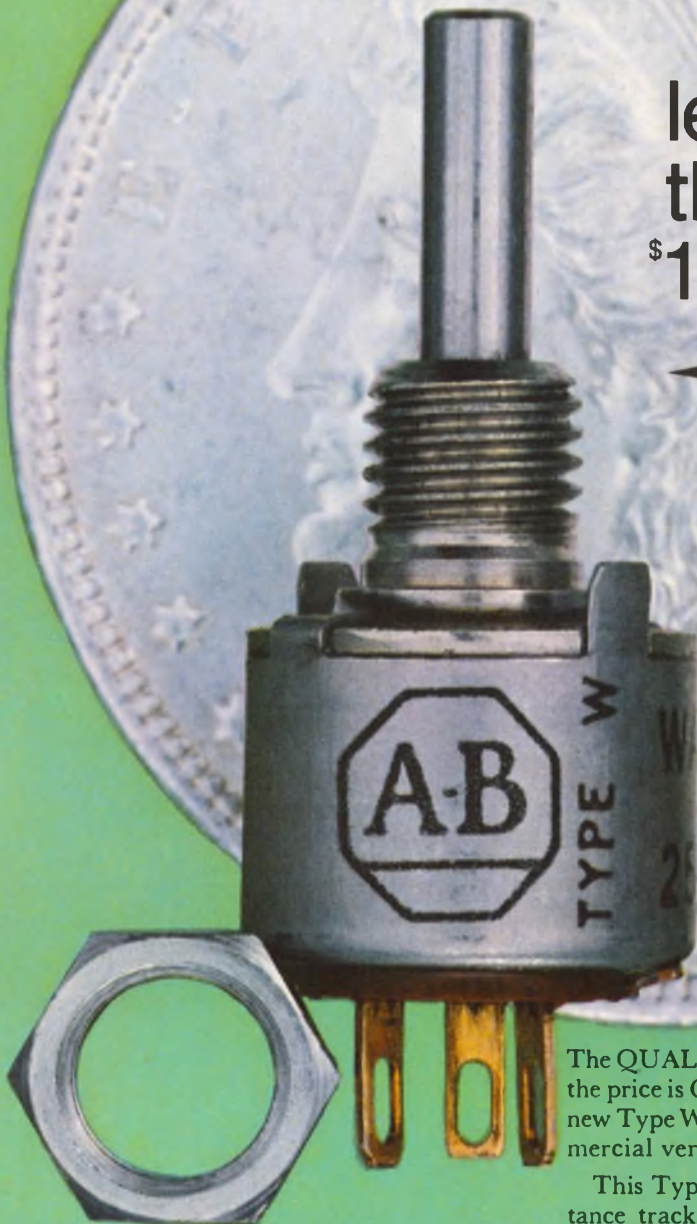

A-B Type W
variable resistor
shown about 5 times
actual size

The **QUALITY** is Allen-Bradley—the price is **COMPETITIVE!** This new Type W variable resistor is a commercial version of the Type G control.

This Type W variable resistor features a solid, hot-molded resistance track for long operating life. Life tests show less than 10% resistance change after 50,000 complete cycles. Noise level is low initially and actually becomes less after normal use. Furthermore, the resolution is essentially infinite, and the low inductance permits operation at high frequencies where wirewound controls are useless.

The Type W control, while only $\frac{1}{2}$ inch in diameter, is immersion-proof. The shaft is sealed with an "O" ring, making it watertight at that point.

Rated $\frac{1}{2}$ watt at 70°C, the Type W can be operated at 120°C ambient with zero load. Nominal resistance values are from 100 ohms to 5.0 megohms.

For complete specifications on tolerances, tapers, and options, please write Henry G. Rosenkranz and request Publication 5212. Allen-Bradley Co., 1201 S. Second St., Milwaukee, Wis. 53204. Export Office: 1293 Broad St., Bloomfield, N.J. U.S.A. 07003. In Canada: Allen-Bradley Canada Ltd.

EC69-1



ALLEN-BRADLEY
QUALITY ELECTRONIC COMPONENTS

Laser system measures high-voltage pulses

A new laser system for pinpoint measurement of high-voltage, microsecond pulses avoids many of the errors inherent in resistive and capacitive voltage-divider techniques in current use.

The system, developed jointly by the NBS Institute for Basic Standards, Washington, D.C., and Sandia Corp., N.M., has two important advantages:

- The measuring circuit is electrically isolated from the high-voltage circuit.

- The measurement resolution improves as the voltage increases.

The system, shown at bottom right, uses a laser and Kerr-cell setup. It has a linear frequency response up to 100 MHz; consequently it can readily measure pulses of a fraction of a microsecond. The method is seen as a useful new standard for calibrating pulse-voltage dividers.

How it works

The basic system, pictured here, incorporates a Kerr cell having two parallel-plate, nickel electrodes and filled with highly purified

nitrobenzene. The cell is installed in the path of the helium-neon laser beam (6326 Å). The beam penetrates the first polarizer and exits as plane-polarized light that is directed between and along the length of the plate electrodes in the Kerr cell.

The second polarizer, rotated and fixed at 90 degrees with respect to the first, blocks all light when no voltage is impressed across the cell. But as increasing voltage is applied, as during a pulse rise, the Kerr cell rotates the laser beam along its axis, and the light passing through the second polarizer increases to a maximum and decreases again to a minimum for each 90 degrees of beam rotation. By counting the number of maxima and minima that occur during a voltage-pulse rise and interpolating between, the magnitude of the voltage can be accurately established. According to E. C. Cassidy, Physicist with the NBS High Voltage Section, the beam has been experimentally rotated more than 28 times by 100 kV, producing 114 maxima and minima. The exact number of rotations for a given voltage depends entirely on the Kerr-cell characteristics.

A record of the instantaneous maxima and minima is obtained in the following manner. Since the light from the second polarizer is

spread onto the face of a photomultiplier, the tube output rises and falls with laser beam rotation. This photomultiplier voltage is applied to the vertical input of an oscilloscope that has a camera attachment and is triggered for a single sweep for each high-voltage pulse measurement.

Recorded on film

To make a measurement, the film in the camera is exposed to the screen, and the voltage pulse is applied to the Kerr cell. The beam sweeps across the oscilloscope face during the period required for duration of the pulse. As a result, the developed picture shows (below, at left) a series of sine-function curves. They start at the right (because of photographic reversal) and proceed to the peak voltage value at the center. Then, as the pulse voltage decreases, rotation reverses, and the pattern repeats itself until the pulse vanishes.

The high voltage is measured by counting the maxima and minima traced on the photograph as the voltage increases to its maximum, and then interpolating the final intermediate value at the center.

The transmitted intensity is a sine² function that oscillates between maximum and minimum values as the field changes. ■■

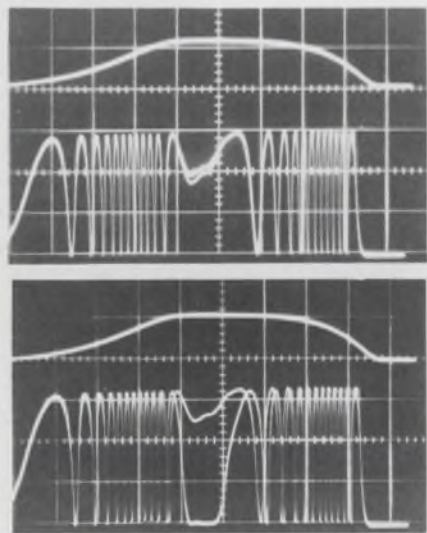

Oscilloscope records compare voltage-divider and laser measurements of same pulses. At top, pulses of 142.30 kV and 142.35 kV are superimposed on both divider and laser traces, while at bottom voltages are 142.30 kV and 142.80 kV.

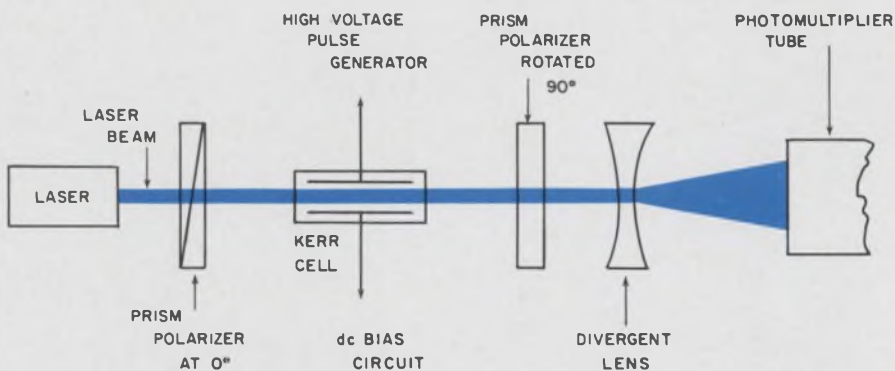

Laser and Kerr-cell pulse-voltage measuring system sends the laser beam through the first polarizer and then the Kerr cell, in which beam polarization is rotated by rising (or falling) voltage across the cell. As the beam rotates, the second polarizer output is a sequence of bright maxima and dark minima, occurring each 90 degrees. For each pulse, the photomultiplier output gives sine-traces such as shown at left, on the oscilloscope screen. The system was developed by National Bureau of Standards and Sandia Corp.

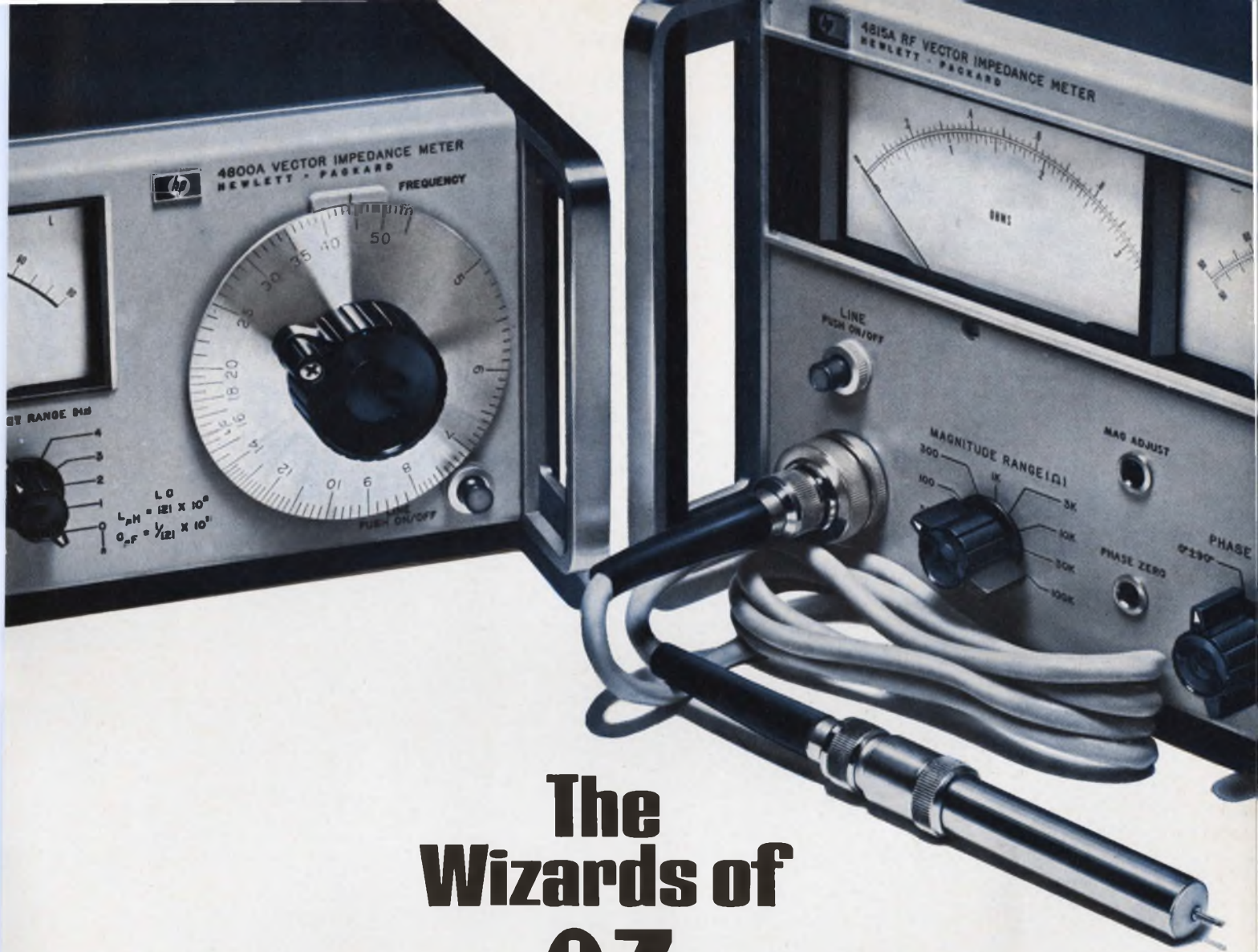

The Wizards of θZ

Like magic . . . vector impedance instruments read out complex impedance in an instant.

With the HP impedance meters, measurements involving impedance magnitude, Z , and phase angle, θ , no longer require tedious test procedures. These measurements are now as easy to make as voltage readings. No nulling . . . no balancing . . . no calculations to make. The wizardry of these HP instruments provides direct readout of Z (in ohms) and θ (in degrees) over a continuous frequency range.

HP 4800A Vector Impedance Meter covers the 5 Hz to 500 kHz range. You set the frequency, select

the impedance range and read: Z from 1 ohm to 10 Megohms, and θ from -90° to $+90^\circ$. \$1650.

HP 4815A RF Vector Impedance Meter covers 500 kHz to 108 MHz. Measures, via a probe, active or passive circuits directly in their normal operating environment. Z from 1 ohm to 100 K ohms; θ from 0° to 360° . \$2650.

Application Note 86 describes many applications of the 4800A and the 4815A Vector Impedance Meters including the measurement of Z , R , L , and C . For your copy and complete specifications, contact your local Hewlett-Packard field engineer or write: Hewlett-Packard, Green Pond Road, Rockaway, New Jersey 07866. In Europe: 1217 Meyrin-Geneva, Switzerland.



HEWLETT  PACKARD
IMPEDANCE INSTRUMENTS



We make components for guys who can't stand failures.

There's no such thing as a little failure to some guys. Either your system will perform as you designed it, or it won't. Either the right answer comes out, or it doesn't. Anything less is too much to bear.

At Corning we make our resistors and capacitors like all your customers were just that demanding. We build in an extra measure of performance into everything we do. Because like you and the guys who use your equipment, we can't stand failures either.

Take our precision tin oxide resistors, for example. They're the best of the metal film class. Because the resistive tin film is completely oxidized and molecularly bonded to the glass substrate, our tin oxide resistors are impervious to moisture and environmental degradation. No other resistor can deliver the same stability and reliability over load life. They offer guaranteed moisture resistance across all ohmic values to set a standard of reliability that can't be matched by metal film, wire wounds, carbon comps or metal glaze resistors.

After a 56-day-long heat test in an environment of extremely high humidity, our tin oxide resistors

showed a resistance change of just 0.2 per cent. And in an ambient temperature test—now in its ninth year—not one of the 600 tin oxide resistors being tested has exceeded a resistance change of 1.5 per cent.

You can get this kind of extra performance in miniature size, too. With our CORNING® C3 Resistors, circuit designers are now reducing the volume and weight of their boards a full 65 per cent.

Our tin oxide resistors represent extremely good value. They offer long-term economy over metal film, precision wire wound and metal glaze resistors. And our miniature C3 resistors compete costwise with carbon comps.

And take our glass capacitors. In an extensive lab test program, the U.S. Air Force has found that our glass capacitors have much better stability and much higher insulation resistance than the ceramic, mica and the other capacitor-types they tested. That's why glass capacitors are being designed into so many major aerospace and missile projects.

Then there's our line of Glass-K™ capacitors that give you the volumetric efficiency and economy of monolithic ceramic

capacitors, but with the much improved stability and reliability that only a glass dielectric can add. They're now being used in a number of computer systems.

We have other developments, too. Like our flame proof resistors. Ideal for circuitry where functions, environments and duty cycles demand low power resistors with excellent frequency characteristics, our flame proof tin oxide resistors can withstand overloads of up to 100 times rated power without any trace of flame. And, because they open under overload, they provide protection for your other, more expensive components.

At Corning, we make components for guys who can't stand failures. Guys like your most important customers. Guys like you.

Next time you're designing a system, reach for your Corning capacitor and resistor catalogs and call your local Corning authorized distributor for off-the-shelf delivery. They'll help you design-in an extra measure of performance.

If you don't have our catalogs, ask your Corning distributor for copies or drop us a line at: Corning Glass Works, Electronic Products Division, Corning, New York 14830.

CORNING
E L E C T R O N I C S

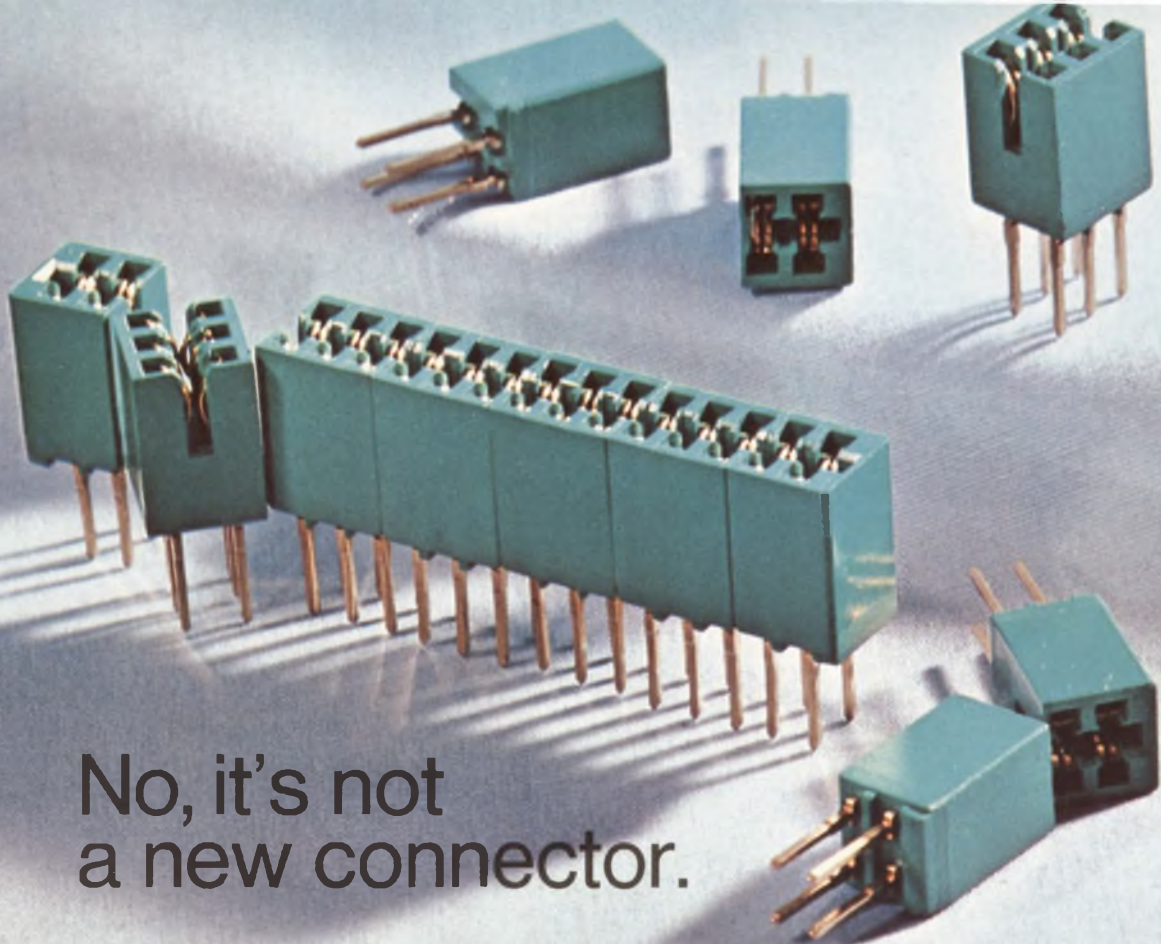

No, it's not
a new connector.

It's a new kind of connecting.

The little connectors above are really one connector. You take as many pieces as you need, mix them together, and use them to connect any size of p.c. board to a mother board.

That's not spectacularly new. Connector modules for use in bread-boarding have been around for a while.

But these new Mojo™ Series 6308 p.c. connector modules* are not just for bread-boards and prototypes.

Not hardly.

When used with plated-through holes on the mother board, they are one of the slickest production tricks to come along in quite a while. Contact tails combine a square wire-wrapping post with a specially designed locking feature which, when press-fitted into a plated-through hole, provides a gas-tight and reliable electrical connection.

No, you don't have to solder.

Yes, you can wire-wrap if you want.

And, yes, you'll save time and money in moving from prototype into production. Because connectors

of virtually any size can be built up economically from just two sizes of modules, you don't need a large inventory. Or custom connectors. And you only have to insert modules where connectors are required, saving a few more pennies.

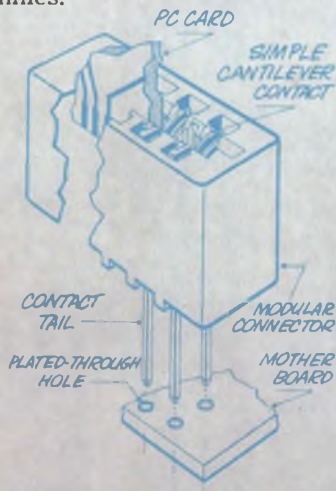

And, no, you don't give up a bit of connector reliability. The exclusive swaged single-beam design of the dual-readout contact provides optimum spring rate and deflection characteristics. A preload applied

to the contact nose in the insulator makes sure that the contact really holds on to the card, while keeping the contacts well apart when the card is removed from the connector.

Mojo™ p.c. connector modules:
Specs in brief

Material

Glass-filled DAP

Contacts

Cantilevered-beam, dual read-out, bifurcated nose. .150" centers. Center modules have 6 contacts. End modules have 4 contacts, molded-in card guide.

Tails

.031" square wire-wrapping type

Mounting

Press fit, in .048" dia. plated-through holes, 3/32" to 1/8" thick board.

For more information, write, wire, call, or TWX us for our Mojo™ p.c. connector module data sheet. Elco Corporation, 155 Commerce Drive, Fort Washington, Pa. 19034. (215) 646-7420; TWX 510-661-0.

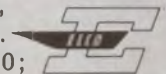

ELCO Mojo™ p.c.
Connectors

* Patent pending



Washington Report

CHARLES D. LAFOND
WASHINGTON BUREAU

Battle rages over Safeguard, but . . .

When all the arguments have ceased, the Nixon Administration's modified Sentinel, now officially renamed Safeguard, will be approved by the Congress—that is the feeling here in Washington. Congressional doves, and particularly the Senate Subcommittee on International Organization and Disarmament Affairs, will seek support to prevent or sharply decrease appropriations. The hawks, however, are expected to close the ranks. The House vote is not expected to be as close as that of the Senate.

Safeguard, according to Defense Secretary Melvin R. Laird, has the full support of the Joint Chiefs of Staff. And its point defense of the U. S. Minuteman ICBM sites rather than an area defense of key cities, weakens some of the previous arguments against ABM deployment.

For example, even Dr. Hans A. Bethe, professor for nuclear studies at Cornell University, and an early opponent of the ABM concept, approves the new plan. In a statement to the Senate subcommittee mentioned above, arguing against the Sentinel system, Dr. Bethe said: "A completely different concept of ABM is to deploy it around Minuteman silos and at command and control centers. This application has gone in and out of Defense Department planning. I am in favor of such a scheme." This statement was made only a week before the announcement of Safeguard.

The ABM system deployment will begin with complete installations of a perimeter acquisition radar and a missile-site radar, with Spartan and Sprint Missiles, at Malmstrom Air Force Base in Montana and Grand Forks Air Force Base in North Dakota. These initial systems would be used to integrate, thoroughly test and eliminate engineering problems in the basic system. And they will protect two Minuteman wings. The ultimate system

would involve the installation of missile-site radars at 10 other locations around the continental U. S. Perimeter acquisition radars would be located at five of these sites, which cover the four corners of the country, as well as the Michigan-Ohio area. There is also a possibility of installing radars in Hawaii and Alaska. All radar sites would be equipped with Spartans and Sprints.

A major change over the previous system is the addition of one more antenna face to at least two of the perimeter acquisition radars and an increase from two to four antenna faces for each missile-site radar. Largely due to the radar needs, Safeguard will cost \$1.5 to \$2 billion more than Sentinel, Secretary Laird estimates.

Will there be orbiting factories?

A special module, to be included as part of an earth-orbital manned laboratory in NASA's experimental Apollo Applications Program, will be used to study a variety of manufacturing processes in the pure vacuum condition found in space. Integrated with the chamber will be an electron-beam heat source. The space station is planned to be deployed and operational in the mid-1970s.

Experiments in the special module will attempt to produce materials and products that either cannot be made, or are very difficult to make, on earth because of the restrictions of gravity and atmosphere. Five experiments have already been approved. One is to determine the effects of weightlessness on weld-metal microstructure. Other experiments will include observations of crystal growth and composite and spherical casting.

Although not yet approved, a second phase

of the space manufacturing experiments involves a larger chamber provided with a cooling source and several types of energy sources, says James R. Williams of the Marshall Space Flight Center. An engineer in the Manufacturing Engineering Laboratory at Marshall, Williams says his group is now studying various experiments that could be included in the orbital laboratory.

Williams is also considering a third-phase chamber, which would be a room-size module. This would weigh 23,000 pounds, carry at least two astronauts and be capable of supporting continuous manufacturing processes. All products tested in the space station, says Williams, would later be returned to earth "for evaluation and possible use in special industrial, medical or government applications."

Defense asks 70 swingwing fighters

The controversial F-111 swingwing fighter may get a boost if the Department of Defense wins Congressional approval for 70 additional planes. Expected production would then rise to about 560 planes.

The Mark I avionics package used in the first versions of the aircraft costs about \$1 million per plane. The more advanced Mark II system used in the F-111D and advanced bomber versions may cost up to \$1.75 million each. The Mark II is under development by the Autonetics Div., North American Rockwell.

Sperry to direct data-buoy program

The Coast Guard has selected Sperry Rand Corp. to manage the National Data Buoy Development Project, for which R&D and procurement could total more than \$600 million in the next few years. Under its initial \$125,000 contract, Sperry's System Management Div. in Great Neck, N. Y., will look ahead to system needs, schedules and costs for implementing the program through fiscal 1971. The study is to take five months.

Two buoy-system deployments have been

considered by the Coast Guard. One would require 450 buoys spread throughout the Northern Hemisphere; the other would require only 150 buoys in the same area. The instrumented buoys will sense and telemeter to central ship and shore data. Receiving stations will collect, preprocess the data and relay it to a central processing center, probably in Washington, D. C.

R&D for the program is expected to approach \$90 million. If the full buoy network is approved, procurement costs are expected to exceed \$500 million, the Coast Guard estimates. The smaller system would probably cost \$120 million. The data-gathering network is expected to be operational by 1974-75.

Apollo launchings hit new pace

Only a short time ago, critics of the National Aeronautics and Space Administration scoffed at plans to launch Apollo spacecraft every two months; yet the space program is now keeping that schedule—at least through July. On March 13, even as the Apollo 9 command module splashed down for a safe recovery in the Atlantic Ocean, Apollo 10 was being installed on its launch site at Cape Kennedy, Apollo 11 was undergoing checkout in the vehicle-assembly building at the Cape, and the third stage of the launch vehicle for Apollo 12 was moved in for preliminary checkout.

Apollo 10 will lift off on May 18 for a dress rehearsal over the moon, and Apollo 11 will be fired July 16 for a moon landing at midday on July 20.

The flight of the Apollo 10 in May represents a victory for conservatives within the space agency who wanted one more long-term test of the lunar spacecraft. They cited the need for more experience in operating the moon landing craft and the desirability of learning more about navigation problems at the moon.

Apollo 8 encountered problems caused by mysterious mass concentrations that made the spacecraft speed up and slow down unpredictably. During the Apollo 10 flight, the astronauts will spend 63 hours in lunar orbit. During this time two of the men will lower themselves to within 10 miles of the lunar surface inside the spidery moon landing craft.

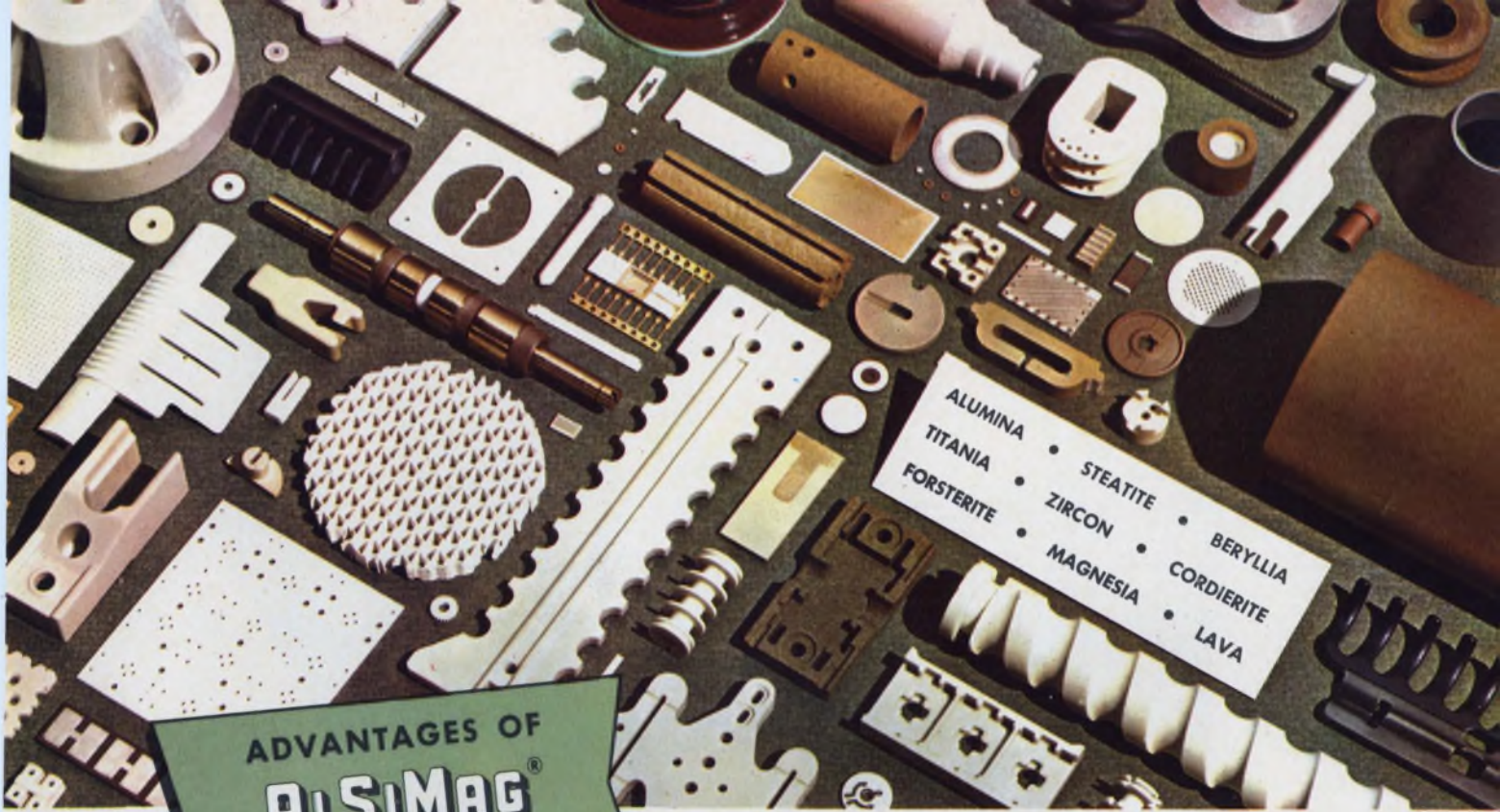

**ADVANTAGES OF
ALSIMAG[®]
TECHNICAL CERAMICS**

MORE MATERIALS

For many decades American Lava has worked with leading firms to develop special ceramics for their advanced designs. The result is the greatest number of special ceramic compositions available from any source. This wealth of ceramic materials can help in two ways. First, it may give you the exact performance you require. Second, it enables you to select the most economical material that meets your design requirements.

MORE PROCESSES

American Lava offers the broadest processing capabilities in the industry. These include forming ceramics by all modern methods including pressing, extrusion, injection molding, isostatic pressing, plus metallization, plating, chemical milling, machining, grinding, lapping, and hermetic bonding.

Many of these processes were pioneered by American Lava. Examples are (1) the ability to produce certain as-fired ceramics to precision tolerances and (2) the proprietary AlSiBase process for producing thin flat ceramics.

MORE SPECIALIZED ENGINEERING TALENT

American Lava, built on engineering ability, has demonstrated that it is the best source for any problem involving technical ceramics.

GREATER PRECISION

Technical ceramics play an increasingly important part in American industry because they can meet especially demanding requirements. American Lava has the experience, know-how and facilities to produce ceramics to the closest tolerances, and to measure and inspect them by agreed means.

MORE MODERN DESIGNS

Technical leadership at American Lava Corporation is based on working with its customers to give them what they want. This currently involves work on composite substrates, composite packages, buried metal patterns, super-smooth and flat substrates, special temperature compensating dielectrics, ceramic capacitors and new ceramic coatings for metal and low expansion glass.

VOLUME PRODUCTION

American Lava has the resources, know-how and the desire to make commitments required to meet volume requirements of its customers. A long parade of firsts in new manufacturing capabilities have allowed American Lava to keep pace with the ever changing need for technical ceramics in volume.

EXPEDITED PROTOTYPES

Special procedures speed the production of prototypes for your evaluation. A chart giving the characteristics of our most frequently used AlSiMag ceramic compositions will be sent on request. Suggestions are available from our specialized engineering staff.

CODE IDENT. NO. 70371

PHONE 615 265-3411 • CHATTANOOGA, TENNESSEE 37405, U.S.A.

American Lava Corporation **3M**
A SUBSIDIARY OF COMPANY

For service, contact American Lava representatives in Offices of Minnesota Mining and Manufacturing Company in these cities (see your local telephone directory): Boston: Needham Heights, Mass. • Chagrin Falls, Ohio • Chicago: Elmhurst, Ill. • Dallas, Tex. Indianapolis, Ind. • Laurens, S. C. • Los Angeles, Calif. • Metropolitan New York: Ridgefield, N. J. • Up-State New York and Canada: Phoenix, New York • Orange, Conn. • Philadelphia, Penna. • Roanoke, Virginia • St. Louis: Lee's Summit, Mo. South San Francisco, Calif. • International: c/o American Lava Corporation, Chattanooga, Tenn. 37405, U.S.A., TELEX 558432.



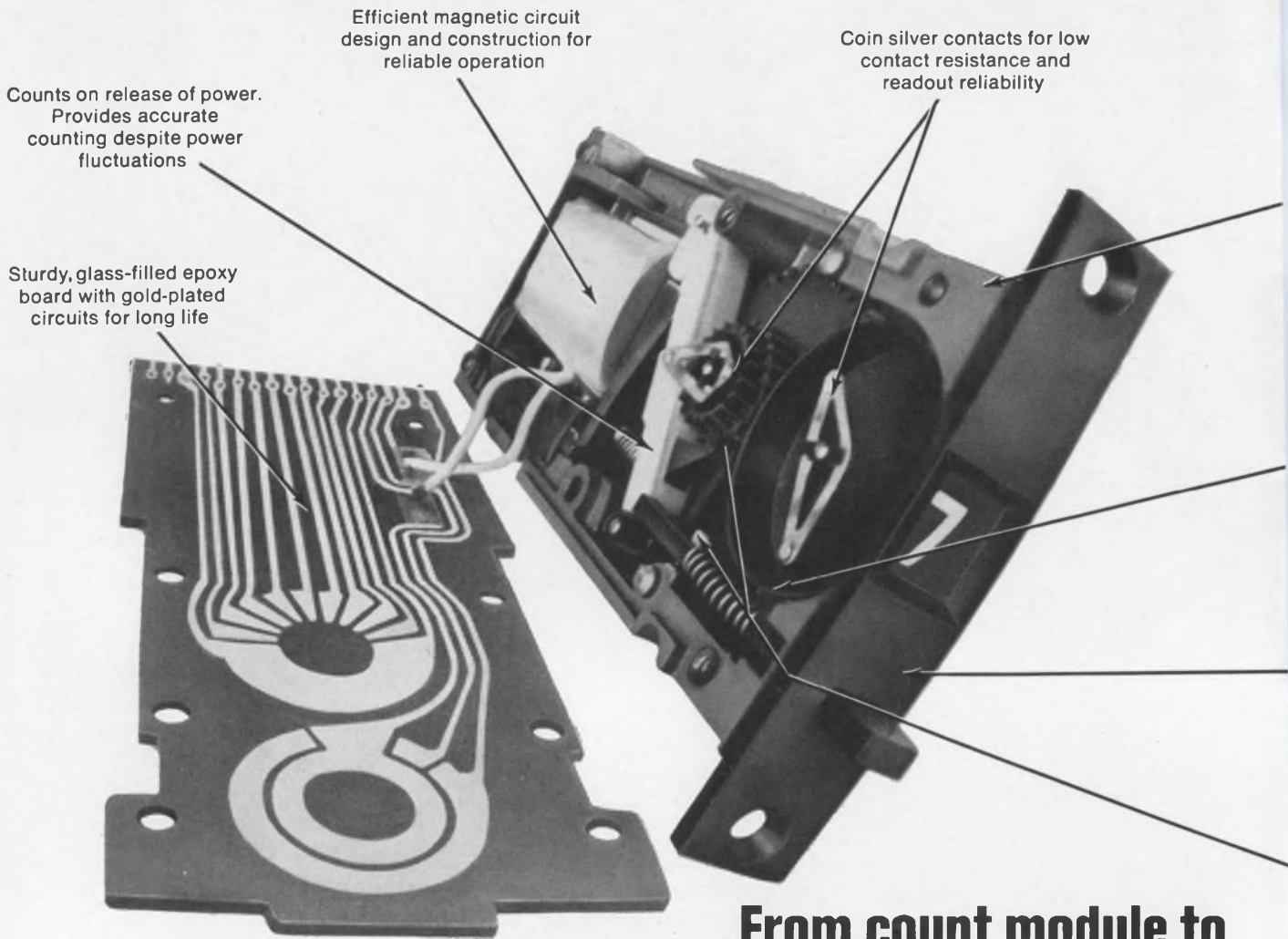

Counts on release of power.
Provides accurate counting despite power fluctuations

Efficient magnetic circuit design and construction for reliable operation

Coin silver contacts for low contact resistance and readout reliability

Sturdy, glass-filled epoxy board with gold-plated circuits for long life

From count module to preassembled control package, that's the versatile Veeder Decade

You'll like the great design flexibility of the Veeder Decade*, a module that's easily stacked into a compact, multidigit counter package. It's the ideal unit for high-speed count accumulation, storage and transfer in data processing, and control equipment systems.

The Series 1969 is a single wheel electric counter with electric readout (BCD or decimal), transfer and reset, and 2400 cpm speed. It combines large figure readability with narrow width for space economy. Another Veeder Decade model, the Series 7266, offers wheel configurations for recording time and counting dozens and denominations of money.

If you're after preassembled packages, we've got those, too. For example: The Series 710810 and 20 Digi-Con* Predetermining Counters which—unlike most electronic counters—won't reset during a power failure. The Series 710830 Digi-Con Totalizer is both a self-contained



Series 710810



Series 710840

counter and a module for more sophisticated control systems. And the Series 710840 Digi-Clock* time display features a wide range of optional features for computer input. For information about our complete line, write for Design Kit: Veeder-Root, Hartford, Conn. 06102.

*Trademark of Veeder-Root

Getting the mostest out of MOS

"MOS is going to take over the world," one developer enthuses.

"Things will really pick up in 1969-70—and 1970 is going to be the first big year for MOS production," says another.

For the last two months, Microelectronics Editor Raymond D. Speer has been interviewing MOS experts across the country and assembling their comments into an ELECTRONIC DESIGN Special Report. His visits took him to companies in Dallas, Phoenix, Los Angeles, San Francisco and the New York area. Every engineer interviewed said he expected a rise in MOS applications. Some termed the expected market "fantastic."

Contrary to widely held beliefs that the MOS process is now fully developed, researchers pointed to work on completely new processes. They said the best was yet to come, and some expected small MOS vendors to have trouble financing the research just to keep abreast of trends. For the full picture, turn to page 49.

The Special Report cover photo, incidentally, is by American Micro-systems, Inc., of Santa Clara, Calif. It shows the company's hermetic, ceramic, 40-lead MOS package.

Rugged, self-supporting die-cast Zamak frame

Molded Delrin parts reduce wear

8 mounting configurations. Modules stack for custom multidigit counter

No-back pawl and nonoverthrow feature for accurate figure positioning

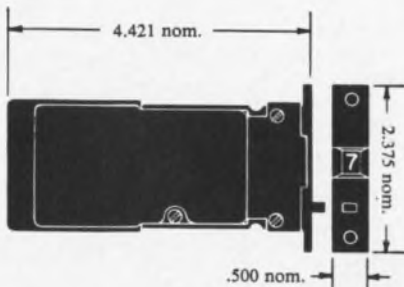

VEEDER-ROOT

INNOVATORS IN NUMERICS



Veeder-Root World-Wide: Australia: So. Melbourne, Victoria
 Brazil: Sao Paulo • USA: Hartford, Connecticut
 England: New Addington, Surrey • Scotland: Dundee
 West Germany: Neuhausen Filder • Canada: Toronto

INFORMATION RETRIEVAL NUMBER 23

ELECTRONIC DESIGN 8, April 12, 1969



"Custom development costs are high," concedes Motorola's Wally Raisanen, manager of MOS and memory products, "but they're justified where custom design offers a market or operational advantage." He sees the number of standard product types limited to 50 or less for at least two years, and he expects shift register prices to drop to a cent a bit by the later 1970s.

The Standard of Excellence



Bracelets by J. E. Caldwell Co., Philadelphia—\$13,200

Amplifiers by Clifton

Clifton care and know-how combine to make a line of amplifiers which offer you superb quality and reliability—and at a price you can afford!

In Clifton amplifiers, all soldering and welding meet or exceed the requirements of NASA NPC 200-4 and SP-5011. All amplifier components meet the

requirements of MIL-S-19500. Rigid quality control in-line and final inspection assure top workmanship. Extensive temperature testing is performed to verify end product performance. In addition, our over all quality program meets MIL-Q-9858.

The result is predictable! Clifton servo amps, booster re-

solver amps and electronic modules make your system look good!

Call your Local Clifton Sales Office or 215 622-1000 for prompt service.

Why not buy the best?

CLIFTON 
DIVISION OF LITTON INDUSTRIES

Publisher

Hugh R. Roome

Editor

Howard Bierman

Managing Editor

Robert C. Haavind

Technical EditorsFrank Egan
Michael J. Riezenman
Raymond D. Speer**Management and Careers Editor**

Richard L. Turmail

Chief News Editor

Ralph Dobriner

Washington News Bureau

Charles D. LaFond, Chief

Military/Aerospace Editor

John F. Mason

East Coast Editor

Jim McDermott

West Coast Editor

Elizabeth deAtley

New Products EditorsRobert Patton
Lucinda Mattera**Copy Editor**

Marion Allen

Editorial ProductionDollie S. Viebig
Phyllis Gura**Art Director**

Clifford M. Gardiner

Art Assistant

William Kelly

Technical IllustratorsWilliam Alvarez
Rita Jendrzewski
Lynn E. Thompson**Production Manager**

Thomas V. Sedita

Asst. Production Manager

Helen De Polo

Production AssistantsBernard Wolinsky
Carl A. Merkin**Circulation Manager**

Nancy L. Merritt

Information Retrieval

Genate Piccinetti

EDITORIAL



Computers, like engineers, need to be managed

Design automation is sweeping the electronics industry. Used correctly, it offers great benefits. Used ineptly, it can create mammoth problems and run up engineering costs.

Consider the situation at Company X. A new computer with blinking lights and whirring tapes entered the engineering section several months ago. The start-up proceeded slowly at first as the designers learned the strange rites associated with preparing their problems for the monster. Carefully they analyzed and reanalyzed both their circuits and their programs.

Then trouble started. Some engineers, seeing the wealth of detailed data that the computer could provide, began to wonder about all the painstaking pre-analysis they were doing before preparing programs. If the computer was so smart, why couldn't it do the analysis? Some problems began running longer and longer on the machine, and the results were worth less and less.

Now the computer is overloaded, and some engineers are begging for an expanded facility. What they really need to do is to stop trying to have the computer do their thinking for them.

Sound unlikely? We talked with a computer-aided design pioneer recently who described an experience he'd had with some engineers about to feed a problem into a computer.

"Using pnps or npns?" he asked. They weren't sure!

"How do your dc parameter calculations look?" They hadn't tried any.

Time-sharing of a remote computer can also be a boon or bust. We once observed one sharp engineer who had developed an efficient program for a filter design. He fed five sets of values over a Teletype link, waited a while and then watched as a table of points for five curves were returned. Once these were plotted, he could choose the best, or even interpolate to get a near optimum design. An alternate method would have been to specify an error criteria for the desired curve and then let the computer step values and simply keep on trying until it met the criteria. Unchecked, a computer might struggle for hours to solve such a poorly prepared problem.

At a recent meeting on time-sharing a panelist revealed that a student engineer working at his laboratory during the summer had put a time-sharing computer to churning for hours through a similar iterative problem. The student's manager didn't even learn about it until a tremendous bill arrived at the end of the month!

The lessons are clear. Engineers need to be instructed in how to use design automation aids efficiently. Managers must ensure that they have some control over computer use by their groups. They should require any time-sharing service they lease to cooperate with them in developing such controls. Otherwise, there's trouble ahead.

ROBERT HAAVIND

TEKTRONIX 50-MHz dual-beam oscilloscope

Type 556
delayed-sweep
7-ns risetime



The Tektronix Type 556 Dual-Beam Oscilloscope features 50-MHz bandwidth, calibrated sweep delay, 6 x 10 cm scan per beam and dual plug-in flexibility. Using two plug-ins at a time, the Type 556 offers many display combinations, including: dual-beam single-shot; multiple-trace; sampling and real-time; frequency and time; delaying and delayed sweep. The two independent horizontal deflection systems provide full bandwidth triggering and calibrated sweep speeds from 5 s/cm to 100 ns/cm, extending to 10 ns/cm with the X10 magnifier. The calibrated sweep delay range is from 100 ns to 50 seconds.

The Type 556 with the Type 1A4 Four-Channel Plug-in and the Type 1A2 Dual-Channel Plug-in provides up to six channels, each with 7-ns risetime and DC-to-50 MHz bandwidth. (Up to eight traces with two Type 1A4 Plug-ins.) You can also select from differential plug-ins with bandwidths to 50 MHz, TDR and sampling plug-ins with 90-ps risetimes, and spectrum analyzer plug-ins that cover the spectrum from 50 Hz to 40 GHz.

For a demonstration, contact your nearby Tektronix field engineer or write: Tektronix, Inc., P. O. Box 500, Beaverton, Oregon 97005.

Type 556 Dual-Beam Oscilloscope	\$3350
Type 1A2 Dual-Trace Plug-in	\$ 350
Type 1A4 Four-Channel Plug-in	\$ 825
Type 205-2 Scope-Mobile® Cart	\$ 145

U.S. Sales Prices FOB Beaverton, Oregon

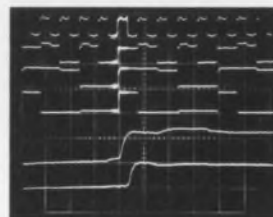

Multi-Trace

The six waveforms are time related digital pulses. The upper four displays are A Sweep ($2 \mu\text{s}/\text{cm}$) with the Type 1A4 Four-Channel Plug-in. The lower two displays are B Sweep Delayed ($100 \text{ ns}/\text{cm}$) with the Type 1A2 Dual-Trace Plug-in.

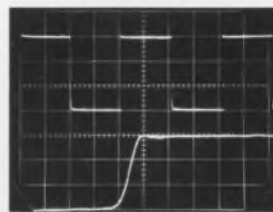

Sampling and Real-Time

The upper beam shows a square wave at $2 \mu\text{s}/\text{cm}$ as applied to a Type 1A2 Dual-Trace Plug-in. The lower beam shows the risetime of the same pulse with the Type 1S1 Sampling Plug-in at $1 \text{ ns}/\text{cm}$.

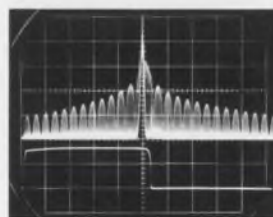

Frequency and Time

The upper beam shows the spectral output of a 200 MHz gated oscillator applied to the Type 1L20 Spectrum Analyzer; calibrated dispersion is $1 \text{ MHz}/\text{cm}$. The lower beam shows a real-time display of the $2.5 \mu\text{s}$ gating pulse.



Tektronix, Inc.
committed to progress in waveform measurement

Technology

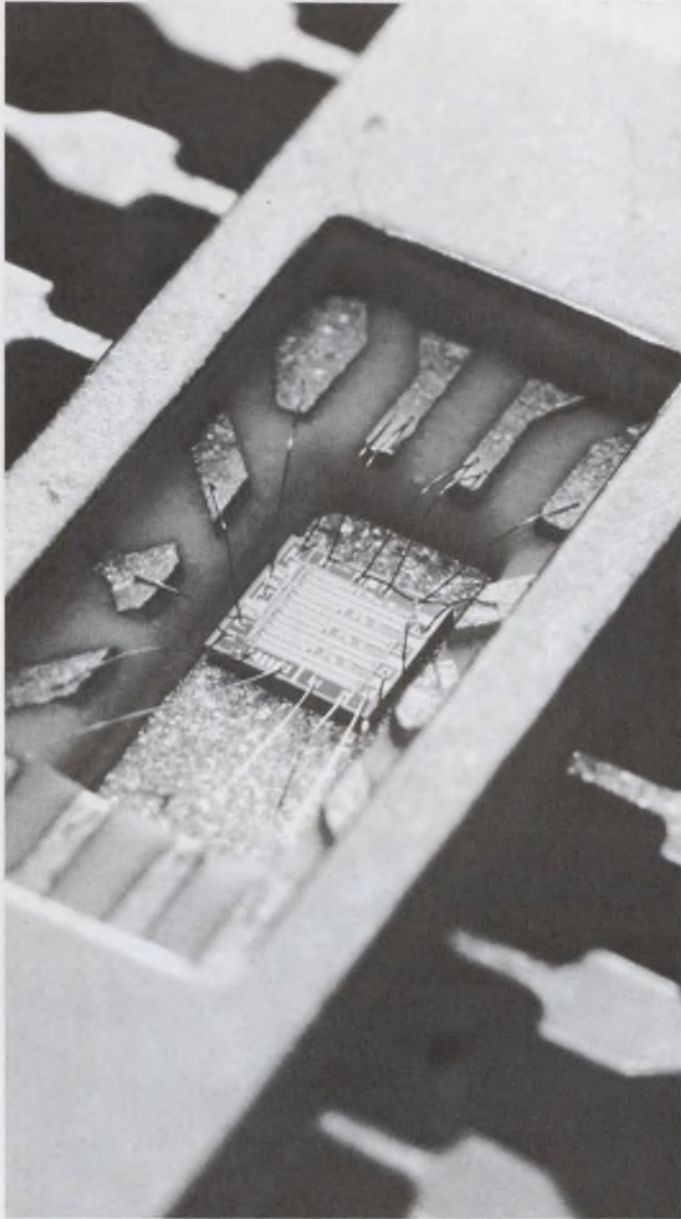

MOS is headed for big growth, manufacturers say. A Special Report. See p. 49

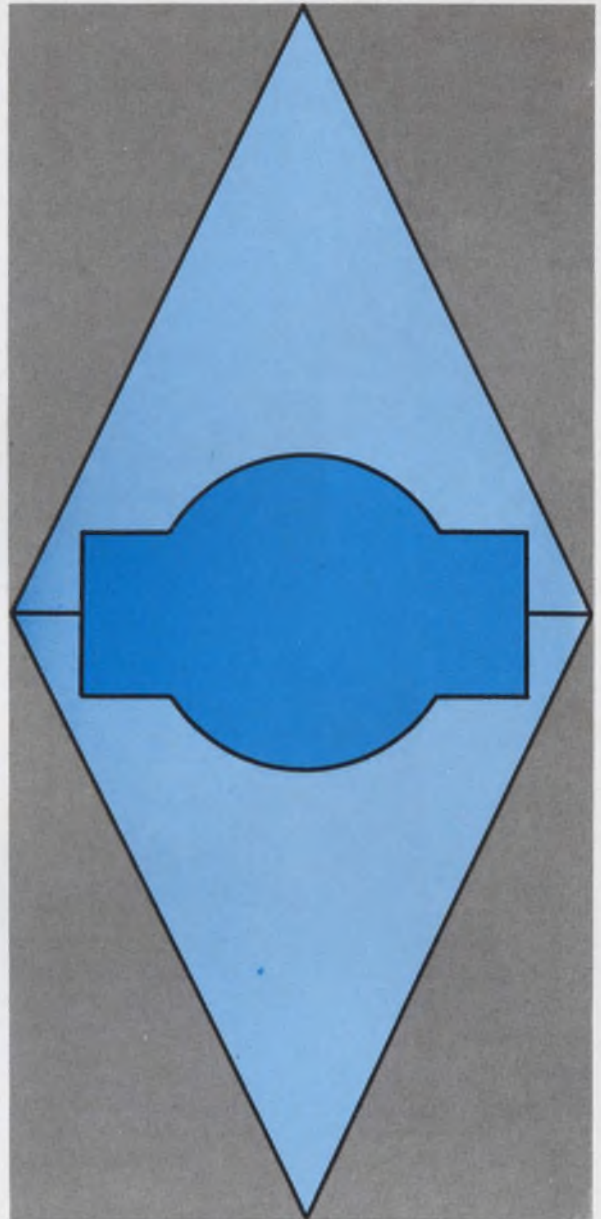

Boost dc servo motor performance when using a transistor bridge. See p. 88

Also in this section:

Try this linear FET model, designed for use with ECAP programs. Page 82

Simplify loss calculations with inverted log scales. Page 94

Ideas for Design. Page 100



Cimron's new Word Generator gives you up to 16,320 bits—and you pay only by the word!

The message is simple: this all-IC Word Generator is the last word in pushbutton programming flexibility—but plug-in design insures that you don't have to buy a bit more than you can use. Up to nine plug-ins, each providing a serial word of data from 1 to 16 bits are available—and up to four repeat controls. These can be installed in combination to give you the precise output you want—fast, slow, or very complex. With four repeat controls, this word generator can deliver up to 16,320 bits—repeatable up to

255 times on a bit by bit, single word or continuous basis as selected. Digital period control has a range of 0.2 Hz to 5 MHz, continuously variable. RZ or NRZ modes; 10 ns rise and fall, 10 ns to 100 ms delay and width. By cascading repeat controls, repeats of up to 1,020 times can be achieved. As always, Cimron's *customer concern* gives you what you need at the lowest possible price. For details on Model 3903, write Cimron, Dept. C-135, 1152 Morena, San Diego, California 92110.

LEAR SIEGLER, INC.



CIMRON DIVISION



An Electronic Design Special Report
MOS ON THE UPSWING

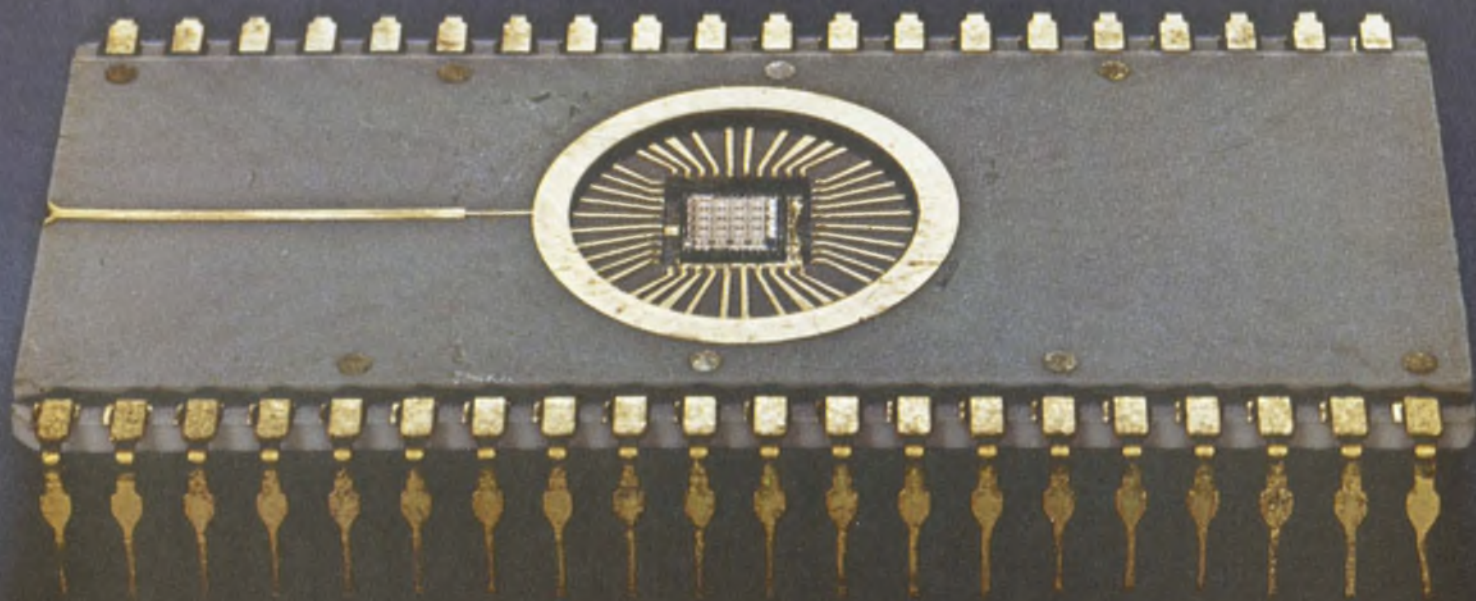

by Raymond Daniel Speer, Microelectronics Editor



A bigger market for a better MOS

Improved technology is catching on, vendors say, and the potential for computer memories is great

Robert Crawford, a senior development engineer in the MOS Engineering Center at Texas Instruments, Dallas, has no doubts. "I believe that MOS is going to take over the world," he draws. "I really do. I have no doubts about it."

Crawford has worked in developmental MOS at TI since the company started its program four years ago. His research has included investigation of MOS in capacitive pull-up circuits, the effects of capacitance on MOS inverters, and capacitive coupling between metal lines and p-diffusions. He has been in close cooperation with customer designers.

MOS integrated circuits, Crawford points out, can perform three basic functions on one chip: digital control, analog amplification and power control. Digital and linear bipolar circuits can't be put on the same chip with any success, he notes, because both types can't be optimized at the same time. But in MOS circuits the same process is used for digital, linear and power-control devices, with the various devices differing only in layout. And this layout is easily controlled by the circuit designer.

Pointing to a three-in-one chip design that

Texas Instruments is working on, Crawford continues: "We go digital for the control circuits; we have analog amplifiers on the chip, and we have power control." The power-control function is achieved with very large MOS devices or with bipolars on the MOS chip.

"This is really the computer on the chip," the TI researcher says, "and we can do it now."

Crawford's enthusiasm is shared by other vendors in the field. But is it catching on with customers? Manufacturers believe it is. The MOS market, according to estimates being tossed around in the industry, was \$7 million to \$10 million in 1967 and rose to about \$15 to \$16 million in 1968. Most manufacturers expect last year's sales figure to double this year. Beyond that the guessing is wild, ranging from \$45 million to \$200 million by 1972.

From a haphazard beginning, MOS technology has improved greatly, reliability is up and design engineers are starting to shed their previous suspicions. The advantages of MOS are becoming not only apparent but realistically attainable: small device size, high input impedance, good noise immunity, low power dissipation and simplified processing.

The big immediate expansion is expected to be in small memory applications. The technology is best-suited for this right now. MOS is still too expensive to compete with the present magnetic main-frame memory—cores, plated film and plated wire—but vendors look for such competition in four to five years.

Texas Instruments' Charles Phipps, manager of technology customer centers, says that 1968

MOS wafers, fresh from the diffusion furnace, await the next step in their processing. Special teflon boxes protect them from dust and handling abuse, while routing tags identify the contents and specify the process routing. Quality control inspectors must sign off each tag as the process steps are completed. Photo courtesy of Fairchild Semiconductor, Mountain View, Calif.

was the first year that the MOS market really started to move. Sales of catalog devices—largely shift registers and read-only memories—were on the increase, and so were custom design jobs.

"These things will really pick up in 1969-70," he predicts, "and 1970 is going to be the first big year for MOS production. By 1972 the market should exceed \$100 million."

Roger Helnik, manager of MSI and LSI product marketing at Motorola Semiconductor Products, Inc., Phoenix, Ariz., agrees with Phipps' estimate of the 1972 MOS market. He sees it going to \$140 million in 1973.

At Hughes Aircraft Co., Newport Beach, Calif., Carroll R. Perkins, manager of MOS marketing applications, looks forward to a "fantastic market growth"—\$200 million by 1972-73. He wants his share of the market to be 10 per cent by then.

Glen Dumas, marketing manager at American Micro-systems, Inc., Santa Clara, Calif., doubts that vendors will be able to keep up with the demand. "It's my feeling that the entire MOS industry is going to be production-limited before the end of 1969," he says. "The market will grow faster than we can produce the stuff." To meet the challenge, American Micro-systems is adding to its production capability.

And at General Instruments Corp., Hicksville, N. Y., Art Sidorsky, MTOS marketing manager, believes that the MOS market will probably double every year until 1972. By then, he says, it should be about \$120 million.

Sidorsky says the MOS market differs from other semiconductor markets, in that it developed largely without Government support. When MOS technology first appeared, the Government was facing heavy expenditures in Vietnam. Very few Government dollars were spent in the developing MOS industry, with the result that it became heavily commercial and industrial. Sidorsky says that he expects most of his large orders to come from the computer industry for memories, shift registers and some control logic.

Robert Graham, director of marketing for Intel Corp., Mountain View, Calif., estimates a market of \$340 million by 1972 for all non-electromechanical memory.

"I don't see more than about 10 per cent of these dollars being taken by MOS in 1972," he says, "and that would put the MOS memory market at roughly \$34 million."

As for the total MOS market—"perhaps as high as \$45 million in 1972," Graham says.

But he is not including National Security Agency purchases in his estimate, and his estimate is the lowest of the many received (see plot). No one will talk freely of the agency, of course, and many MOS engineers will protest, when asked, that they have never heard of it.

But it is accepted as fact in the industry that much of the current and near-future production of MOS registers and read-only memories is going into cryptographic and "secure communications" gear for the National Security Agency.

Graham reasons that a major part of the total memory market in 1972 will be core memory. The design-in period for that core memory is one and a half to two years; so if MOS is to replace cores as early as 1972, it would have to be considered for design in 1969-1970.

"We would have to be designing, by the end of 1970, machines with a big semiconductor memory, not just scratch pads but main-frame memory," Graham says. "I don't see this coming yet.

"Why? Because it only costs 2 cents a bit to put core memory in a machine—with a projection by core people that they can do it for 1.5 cents. The cheapest semiconductor memory that you can buy isn't even close to 2 cents a bit, and the MOS vendors are now projecting 5 cents a bit at best."

Early problems recalled

The delay in the growth of the MOS market has been largely because the first devices—those made in 1965 and 1966—had very limited performance. Shift registers had only 100-kHz or 200-kHz shift rates and fairly high threshold voltages, and they were very sensitive to capacitive loading. Most of the performance advancements during this period were obtained through circuit techniques—multiphase clocks and better output buffers, for instance.

Stability also was poor. According to Thomas Klein, section head of MOS technology for Fairchild's Research and Development Laboratory, Palo Alto, Calif., the main problem was in purification of the materials and processes.

Sodium impurity in the oxide layers increased both the threshold voltages of the devices and the leakage current of the junctions. The sodium ions drifted with time and caused drifts in the device parameters.

But the problems have largely been overcome, manufacturers report. Phipps at Texas Instruments says: "The MOS process is better understood now, and more effectively controlled. We can control the oxide-silicon interface and the oxide growth itself much more tightly."

Growth in the memory area

Memories and long shift registers—in which the circuit density possible with MOS is most attractive—are considered ideal now for MOS expansion. Helnick of Motorola thinks that MOS will be much more economical in such applica-

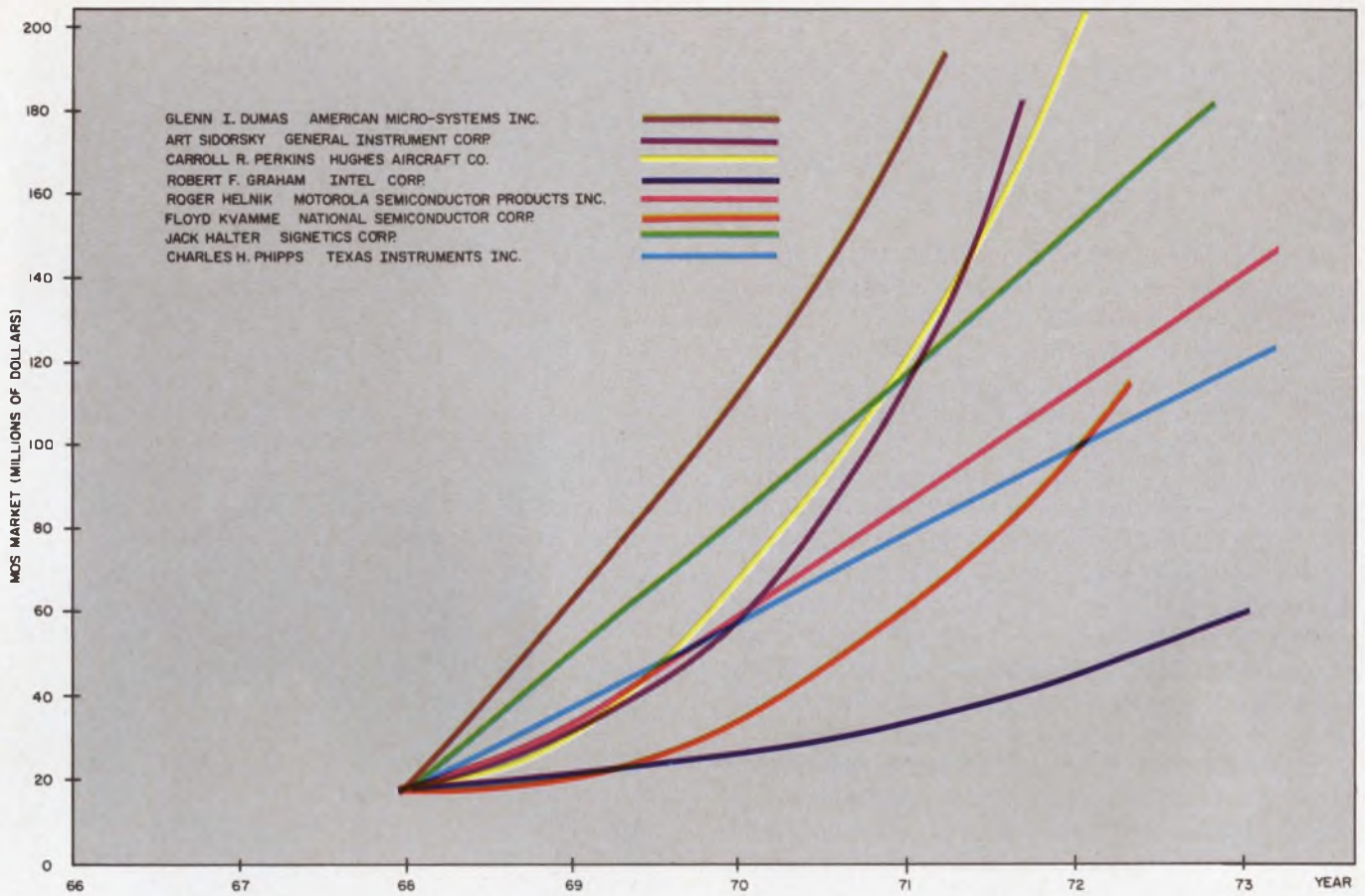

MOS vendors predict their market, and the guessing is wild! Market reporting is not yet a science for the MOS industry—in addition to subjective optimism or pessimism, unannounced government contracts lead to wide discrepancies in the market projections. But all projections are for vast increases in the next few years.

mism, unannounced government contracts lead to wide discrepancies in the market projections. But all projections are for vast increases in the next few years.



"The MOS industry will be production limited in 1969. The market will grow faster than MOS vendors can manufacture the products."—Glenn I. Dumas, Marketing Manager, American Micro-systems Inc., Santa Clara, Calif.



"Half of the MOS business from now on will be long shift registers and digital storage—at real low prices. Registers now sell for 10 cents a bit, next year they'll be 5 cents a bit, and in the late 1970's we'll see registers selling for 1 cent a bit."—Roger Helnik, Manager of MSI/LSI Product Marketing, Motorola Semiconductor Products Inc., Phoenix, Ariz.



"Things will really pick up in 1969-70. 1970 will probably be the first big year for MOS."—Charles H. Phipps, Manager of Technology Customer Centers, Components Group, Texas Instruments, Inc., Dallas, Tex.

tions than bipolar can ever be. He says his group "will concentrate on very long static and dynamic shift-registers and on random-access memories."

Intel's Graham cautions that design practices will have to change to accommodate the new MOS technology:

"You have to look at the unique properties of semiconductor memory—its high speed and lack of peripheral sense-write electronics—and ask yourself how to structure a memory to best use these properties. Semiconductor memory should not be confined to the same kind of organization that core memory is."

Core memory has destructive readout capability only, and the data must be written back into the core after each reading. This added write time introduces delay in data processing. And the peripheral drive and sense electronics are expensive when compared with the cost of the cores. But in MOS memories all this is contained in the package. In short, many constraints that apply to cores do not apply to MOS memory.

Graham points to long MOS shift registers in TO-5 cans as an economical approach. "The world's lowest-cost semiconductor memory package is the TO-5 can," he notes. But he warns that to keep the cost down and reliability up, vendors should use the fewest chip-to-lead bonds possible—a strong argument for serial data transfer into and out of the package.

"We can use serial data transfer for registers up to 1000 bits long and still meet most speed requirements," Graham says.

To demonstrate the potential for MOS, he plots memory products according to access time—the time between the decision to interrogate the memory and the output of the data from it—and cost per bit. In the plot he ignores the fact that magnetic memories have a rewrite time because, he says, this time is normally used to do intermediate calculations anyway. It's not always wasted.

Mass store, in his plot, is in the area of 4 milliseconds access time, which is typical of electro-mechanical storage—disk, drum and tape. The prices are very low—on the order of 0.02 cent a bit. Next is main-frame core memory, at roughly 1.5 cents a bit and 250 nanoseconds access time. Then come film and plated-wire memory, a little faster and a little more expensive, and then the scratch-pad memory—highspeed semiconductor—which presently sells for about 50 cents a bit.

It's the area between electromechanical storage and the main-frame core memory that interests Graham. "We'll build memories that have access times of 10 microseconds and cost around a tenth of a cent a bit," he says, "and the data transfer problem—between high-speed memory and low-



"MOS memory products will help with the demise of the drum, take a part of the disc business, and take the part of the core business in which speed isn't required."
—Robert F. Graham, Director of Marketing, Intel Corp., Mountain View, Calif.

speed mass storage—will be a lot easier." He feels that intermediate-speed registers, used in suitable computer organizations, will yield much more effective memory for the dollars spent.

Graham expects the price of the scratch-pad memory to fall to roughly 20 cents a bit in the next year or two. "They're saying great things about plated wire, too," he says. "They're saying that the price can go as low as a quarter cent a bit—but I doubt they can do it—and with access times as low as 150 nanoseconds."

Dumas of American Micro-systems also sees memory as a tremendous potential market. Several vendors are now offering read-only and random-access memories, and Dumas feels that the big orders will begin to come in this year.

"You don't sell these things in quantity until customers get hold of them and design them into systems," he says. "Toward the second half of 1969 you should see the memory sales growing by leaps and bounds."

So the MOS market is shaping up very well. But can a small vendor, with limited R&D facili-

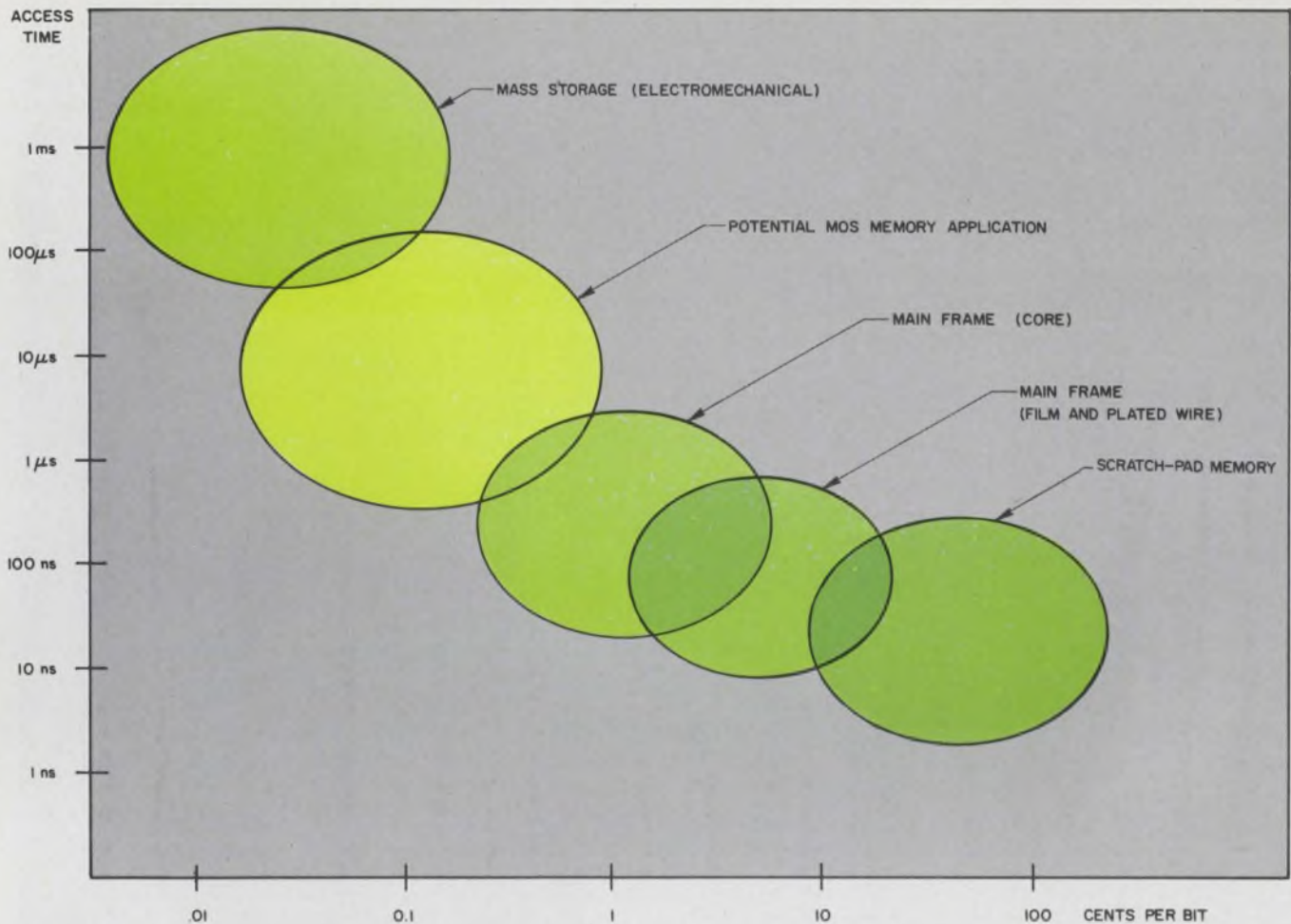

There's great potential for MOS in the memory market, according to Intel's Graham, in the area between electro-mechanical storage and main frame core memory. The MOS memory, intermediate-speed registers, for example, should have access times of 10 microseconds to offer

the designer a significant speed advantage over electro-mechanical storage, and should cost about 0.1 cent a bit to compete economically with presently available magnetic memory. It will have better speed compatibility with mass storage than core memory.

ties, make it in the long run? The big manufacturers think they'll have a tough time.

Will the Big 3 dominate the market?

Phipps feels that the small vendors' performance has been good. "These small companies in the MOS business have done, generally speaking, quite a good job in production and in servicing their customers," the Texas Instruments manager says. But with the three major semiconductor houses—Texas Instruments, Motorola and Fairchild—seriously entering the market, he cautions, the competition is going to be tough.

Phipps feels that the major equipment programs, the ones that will demand high-volume MOS production in the early 1970s, will be largely custom-design programs and that many large customers would feel uncomfortable staking a new project—one involving hundreds of thousands of units—on a small MOS vendor that had not demonstrated high-volume manufacturing experience.

But the smaller vendors are "aggressive competitors," Phipps acknowledges. "We see them everywhere. And we recognize that they have been in the market place a couple of years longer than we have, and they do have more application experience."

Perkins of Hughes Aircraft agrees. "The smaller vendors have been doing a lot of work," he says, "but when you get Motorola and Texas Instruments and Fairchild all investing millions in MOS, and equipping large development groups, it really gets difficult for smaller competitors to keep up."

"One of the difficulties with the smaller companies is that they can't afford the R&D effort. They can do very well for a year or two, but unless they reinvest in research and development, the technology outstrips them. Larger competitors get ahead because they go one step further—they put glass passivation over the metallized wafer, for instance, and improve their yields this way and then undersell you. You really need a strong R&D group, and this we have." ■■

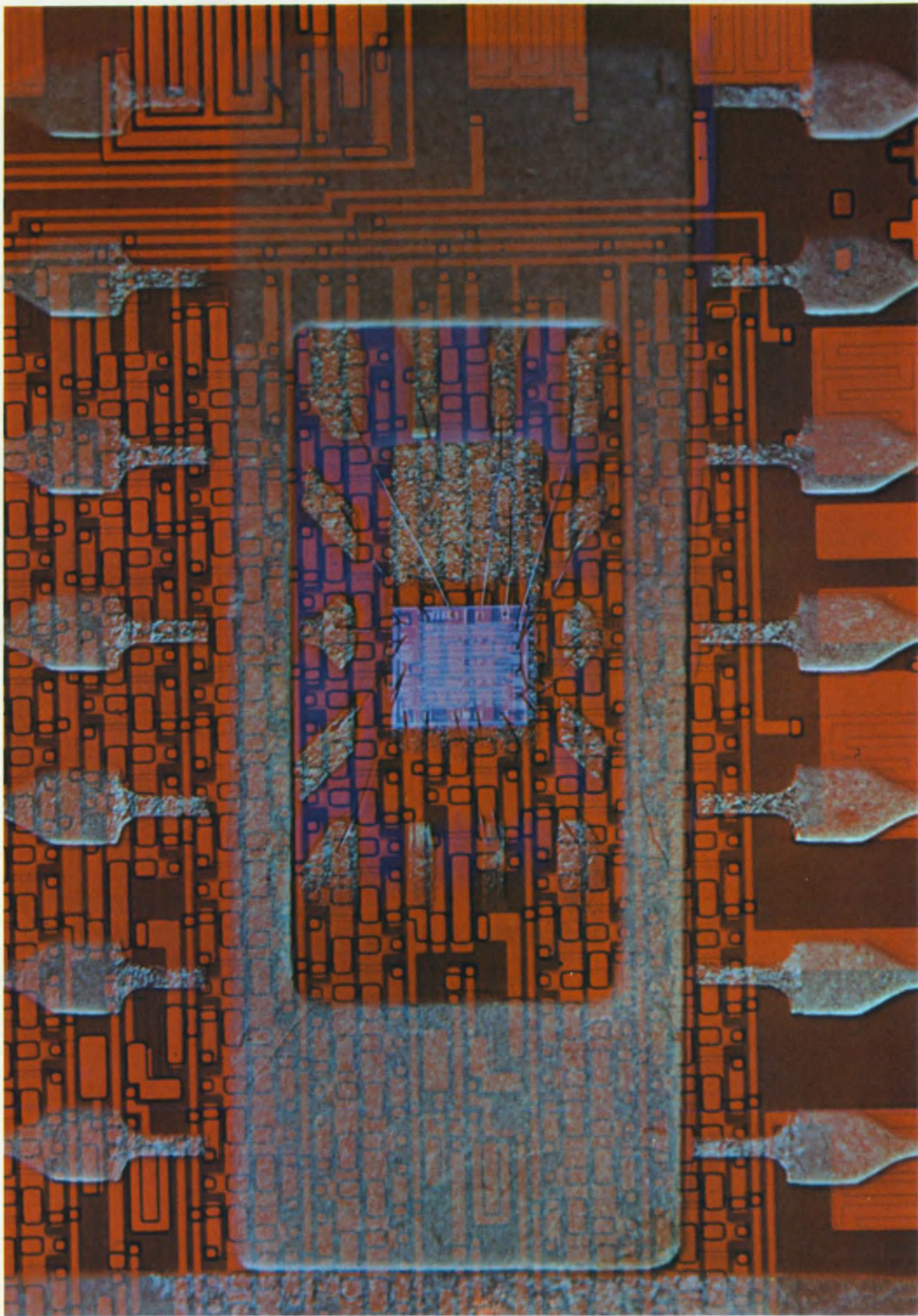

MOS at work: The good and the bad

Devices offer small size and natural advantages, but there can be fabrication and testing problems

MOS devices combine the characteristics of the pentode vacuum tube and the advantages of the transistor. On top of this they are extremely small, have low power dissipation and can be fabricated relatively simply.

The technology has its limitations too, of course, and the designer must have both advantages and limitations clearly in mind as he applies MOS to his system.

Consider the advantages:

The MOS device is extremely small. The average transistor in an IC array occupies as little as two square mils of chip area. This is a great reduction over bipolar transistors, which average about 40 to 50 square mils.

Most of the size reduction, explains Richard Corso, manager of device development at American Micro-systems, Inc., Santa Clara, Calif., results from the lack of isolation junctions in MOS ICs— isolation of one device from the other is inherent in the MOS structure. In a bipolar IC, as much as 30 per cent of the active area is occupied by isolation junction regions. Roughly

speaking, the area taken up by bipolar isolation regions can accommodate 200 MOS devices per chip. A further reduction in size results from the simpler MOS processing. Fewer process steps are necessary, fewer masks are used, and normally only one diffusion is needed. The tolerances that must be allowed in masking for bipolar diffusion steps don't accumulate in the MOS process to the same extent.

Keeping the chip size down is important. The probability of a defect on a chip increases in proportion to its area. As chip area goes up, production yield goes down, and the chips become more expensive to produce.

Increased chip complexity has other benefits. It results in fewer chips per system, with fewer interconnections and a smaller, lighter, even more reliable product, manufacturers say.

In one typical MOS system, an excess-three adder-subtractor built by American Micro-systems, the logic is performed on one chip, with a total area of about 3200 square mils. Going the *RTL* route, the same logic would require 18 separate chips and a total silicon area of 26,000 square mils.

The MOS device has an extremely high input impedance. With a dc gate impedance of typically, 10^{18} ohms, it behaves as a nearly ideal voltage-controlled resistor. Input-output isolation is excellent. No input current flows in the gate lead, except to charge and discharge the input capacitance, and MOS transistors can be direct coupled with virtually no dc fan-out limitation.

Bilateral operation is unique to the MOS transistor. The device is completely symmetrical,

A monolithic quad 32-bit dynamic shift register chip lies nestled in its dual-in-line package. The four registers on the chip can be interconnected to provide 128 bits of register, or used independently. Each will operate to 3 MHz on a two phase clock, at 0.6 mW per bit dissipation. Applications for this typical MOS chip include digital delay lines, "drum" memory, and data processing. Photo courtesy of Electronic Arrays Inc., Mountain View, Calif.

This is MOS: Controlled conductance by field effect

One of the most exciting features of the MOS—metal-oxide-silicon—device is its simplicity. An electric field, applied through an oxide-insulated gate electrode, is used to control the conductance of a channel layer in semiconductor material under the gate. The channel is a lightly doped region between two highly doped areas called the source and the drain.

There are four basic types of MOS structure. The channel can be a p- or n-type, depending on whether the majority carriers are holes or electrons, and the mode of operation can be enhancement or depletion, depending on the state of the channel region at zero gate bias. If a conducting channel exists at zero bias, the device is called depletion mode, because current flows unless the channel is depleted by an applied gate field. If a channel must be formed by the gate field before current can flow, the device is termed enhancement mode.

The enhancement mode is attractive in digital circuits, because it provides inherent noise immunity—input voltage must exceed a threshold voltage before the device turns on. This mode is also suitable for self-biasing circuitry schemes, and is used in linear ICs.

Depletion-mode devices, on the other hand, which conduct at zero gate voltage, are especially attractive for tuner input stages. The high-impedance gate is simply connected to an antenna coil, and the input signal modulates the conductance between source and drain. Since the depletion-mode device is formed of material that has a higher doping level than in the enhancement-mode device, and channel mobility is also higher, it can operate at higher frequencies.

The most common device, the p-type enhancement-mode, is built on a substrate of n-type silicon, into which are diffused two p-regions: the source and the drain (Fig. A). These are normally formed by diffusing two wells of n-type impurity (phosphorous) into the substrate, and in operation are connected by an induced p-region, which is the channel.

The gate or control element covers the region between the source and the drain and is insulated from the semiconductor material by a layer of silicon oxide. The input resistance of the gate is extremely high—on the order of 10^{15} ohms—and the input impedance at high frequencies is almost purely capacitive. The gate is a layer of metal, usually aluminum, as are the contacts to the source and the drain. Normally the oxide layer under the gate is made much thinner than the protective oxide on the rest of the chip, to enhance the effect of the gate field on the conductance of the channel region.

If the gate, source and substrate are grounded and a negative voltage is applied to the drain, no current will flow between the source and

drain because they are isolated from each other by the reverse-biased drain-to-body pn junction.

If a negative voltage is applied to the gate, the surface of the n-type silicon inverts, becoming essentially p-type. The negative gate voltage attracts holes from the n-type substrate to the surface. The channel area, very near the surface, initially has an excess of electrons, because the material is n-type, but the holes drawn into the area by the gate field neutralize these electrons. At some gate voltage the attracted holes just compensate for the excess electrons, and the channel behaves like the intrinsic semiconductor. At higher gate voltages, the holes predominate, and the channel area, a few microns deep, is referred to as “inverted”—it now behaves like a p-type semiconductor, providing a current path from source to drain.

The surface region under the gate does not invert, and no conduction can occur, until the gate voltage is more negative than the threshold voltage V_T , which is about -5 volts for most p-channel enhancement-mode devices. This effect results, in part, from the presence of impurity charge in the silicon, which must be neutralized before the channel region can invert. In general, the thinner the gate oxide, the lower the threshold voltage.

As the gate voltage becomes more negative than the threshold V_T , the conducting channel is formed, and its depth increases with increasingly negative gate voltage. For low-drain current, the channel is an ohmic resistance, and the current, I_D , is directly proportional to the drain-to-source voltage V_{DS} . As V_{DS} becomes more negative, however, the channel saturates, and the current levels off (Fig. B).

The saturation phenomenon is easily understood. Assume that the device is operated with the source grounded and the gate at -12 volts. If the drain voltage is zero volts, no current flows, even though a channel exists. As the drain voltage is made negative, current flows from the source to the drain through the resistive channel (Fig. C). The voltage difference between the gate and the body of the device is -12 volts at the left and decreases along the length of the channel, due to the resistive voltage drop, to a minimum of $(-12 - (-V_{DS}))$ at the drain. This voltage difference determines the extent to which a channel is formed in the substrate material.

If the negative voltage $-V_{DS}$ increases enough, the gate-to-body voltage at the drain $(-12 - (-V_{DS}))$ approaches the threshold voltage V_T , and the voltage near the drain is just sufficient to form a channel at that point. If V_{DS} is made still more negative, the inversion channel terminates short of the drain; the drain current is limited and becomes independent of further changes in V_{DS} .

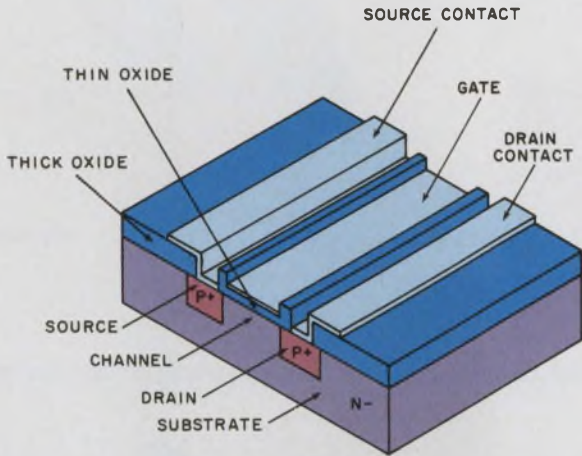

A. The MOS transistor: a simple configuration of source, drain and gate electrodes.

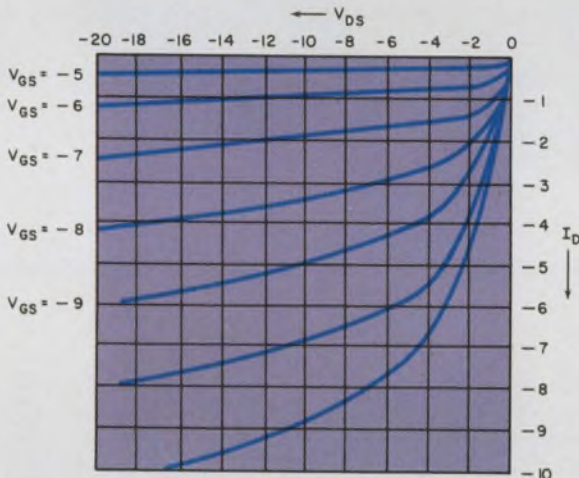

B. The dc characteristic: channel conductance is determined by the gate-to-source voltage.

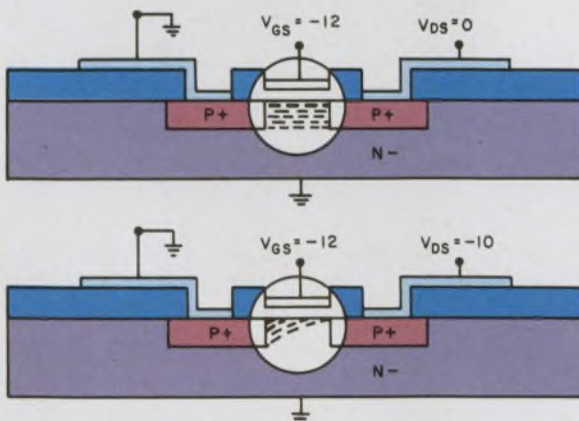

C. The saturation phenomenon: drain-to-source voltage effects are limited by channel pinch-off.

since the source and drain are identical and interchangeable, and current can flow in either direction in the channel. The transistor operates as a switch, with essentially infinite resistance in its OFF state, and is ideal as a coupling device. Its bilateral nature is used to great advantage in MOS multiplexer circuits.

The MOS device is a natural data storage element. The gate-to-source capacitance can be used to store charge, since the dc gate impedance is extremely high. The time constant of the gate-to-source capacitance and the gate leakage resistance is on the order of 10 milliseconds. This property makes the operation of low-power dynamic shift-registers possible.

The MOS transistor makes an excellent active load resistor. Very high values of resistance—100 K to 400 K—can be achieved in an area as small as one square mil. A 100-K resistor built by the standard bipolar diffusion method would be about 0.4 mil wide and 400 mils long, or 160 square mils. The MOS resistance characteristic is nonlinear, since the resistance varies as a function of gate-to-source bias, but this is not usually a disadvantage. The MOS load device can be turned on and off under the control of the gate voltage, and power dissipation becomes a function of the clock duty cycle.

The MOS process is much simpler than the bipolar process. Only a single diffusion step is required. There are only about a third as many process steps for MOS as for the standard double-diffused bipolar IC. In particular, several expensive and critical high-temperature steps—emitter diffusion, for example—are avoided. And so are the accompanying dangers of crystal dislocations and oxide pitting.

The gain of an MOS device is controlled by its dimensions. It is therefore easily and accurately determined at the layout stage.

According to Richard Przybylski, senior member of the technical staff at American Micro-systems, the MOS process is normally kept constant, with the topology of the device the only variable. The transconductance is controlled by the width and length of the channel region, and the MOS designer can scale the geometry to get exactly the performance that he wants in his circuit. This is done in bipolar circuits, too, but it is much more complicated, since bipolar transconductance is controlled by varying the degree of doping in the diffusion steps. Tight control and prediction of the performance in bipolar ICs is much more difficult.

MOS devices have very high gain at cryogenic temperatures. The mobility of the inverted channel-region layer increases dramatically at low temperatures. The gain of bipolar devices, on the other hand, decreases drastically as temperature is reduced.

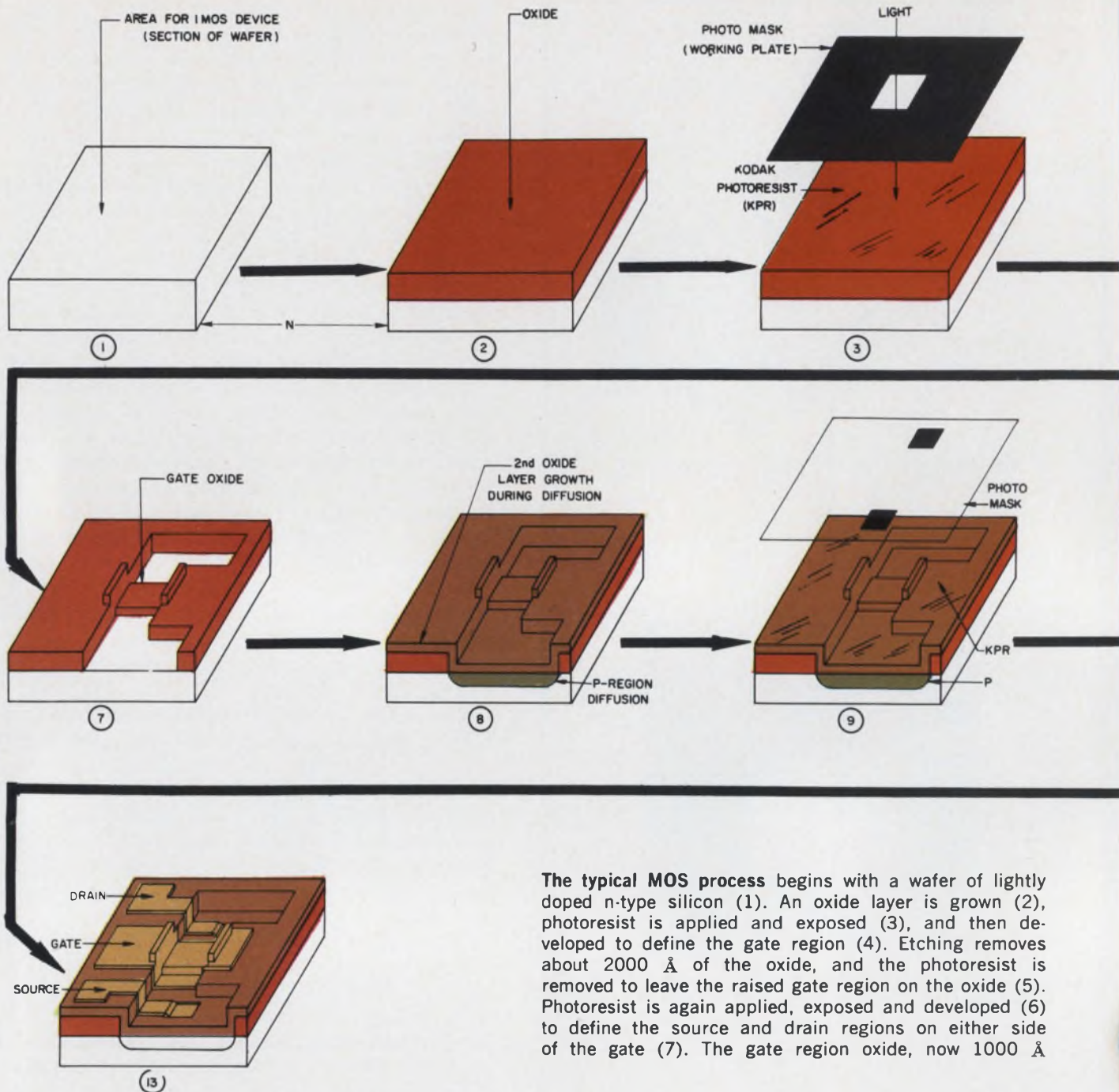

The typical MOS process begins with a wafer of lightly doped n-type silicon (1). An oxide layer is grown (2), photoresist is applied and exposed (3), and then developed to define the gate region (4). Etching removes about 2000 Å of the oxide, and the photoresist is removed to leave the raised gate region on the oxide (5). Photoresist is again applied, exposed and developed (6) to define the source and drain regions on either side of the gate (7). The gate region oxide, now 1000 Å

An obvious application for cryogenically cooled MOS is an infrared sensing apparatus, in which the detector must be cryogenically cooled. An MOS amplifier can be placed right in the cryogenic bath, where it can boost the very low level detector signals to a level more suitable for transmission out of the detector unit.

MOS enhancement mode transistors have built-in noise immunity. This is because of their threshold voltage effect. MOS thresholds vary, depending on the vendor's process, in the range of 2 to 6 volts. In bipolar devices, the comparable threshold is only about 0.6 volt.

The MOS devices can be easily characterized

with five relatively simple and straightforward equations. These define behavior in the saturation region and the triode region, and describe the effects of the pn junction, back gate bias and stray capacitance.

According to Robert Crawford, senior development engineer at Texas Instruments, Dallas, "This is one of the beauties of MOS—you can mathematically predict its operation. In bipolar work there are no such simple equations."

Crawford says these equations lend themselves to analysis by computer aids; the circuit can be laid out and its operation checked before it's built.

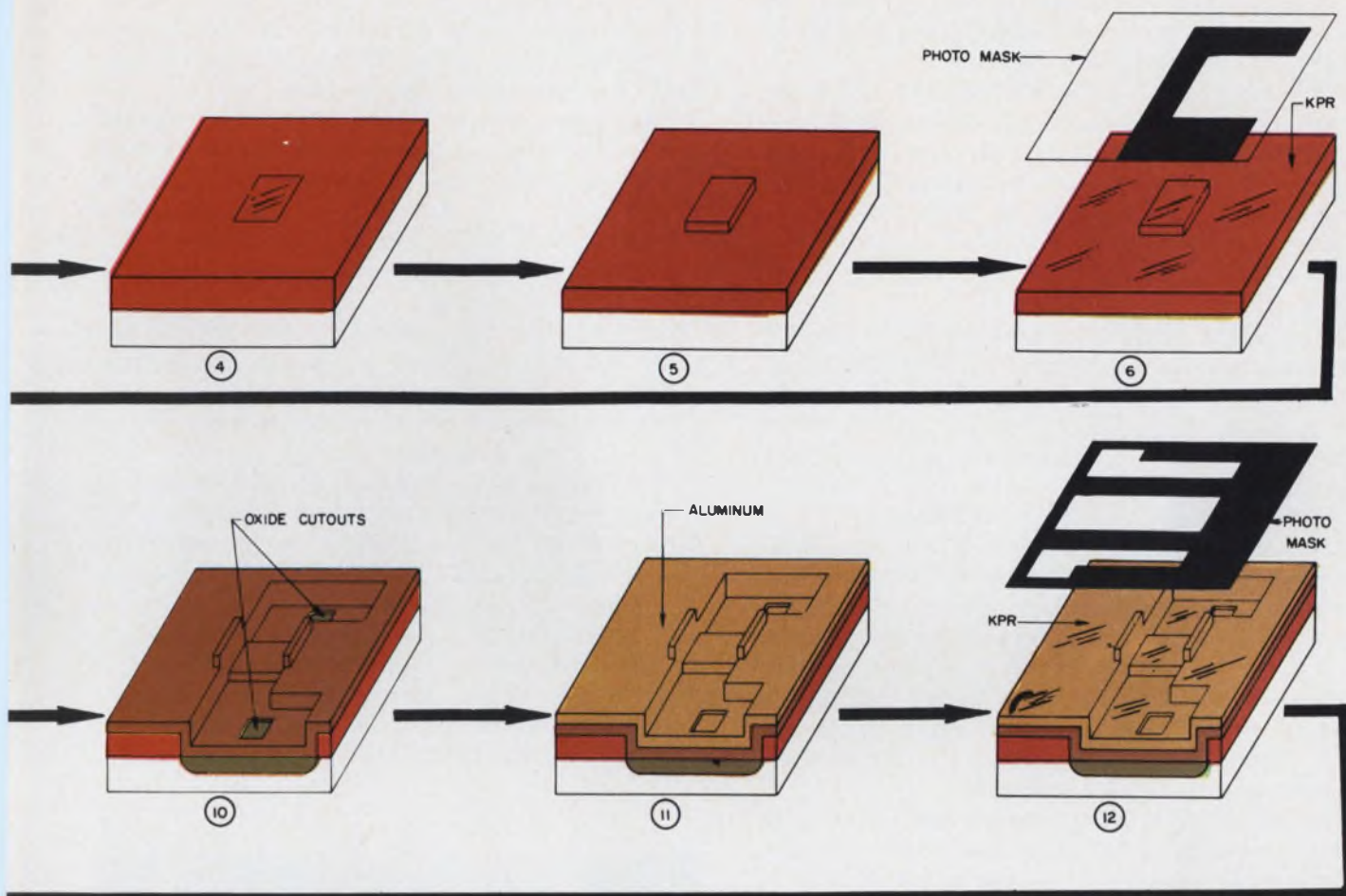

thick, is not removed because of its increased relative thickness. A p-type impurity, usually boron, is then diffused into the exposed source and drain regions, and a second protective oxide layer is grown (8). A second layer of photoresist is applied, exposed, and developed to define oxide cutouts for contacts to the source and drain diffusions, and the cutouts are made by etching (9). The photoresist is removed (10) and a layer of aluminum is applied over the entire wafer surface (11).

The aluminum metallization pattern is defined by a fourth photoetch step (12) to define the source, gate and drain contacts in the finished device (13). Each such MOS device occupies as little as one square mil of chip area, and a typical wafer can contain thousands of individual devices. The process is much simpler than the bipolar process because only one high-temperature diffusion is required. Problems of out-diffusion and unwanted diffusion migration are therefore avoided.

The MOS substrate can be doped to form "tunnels" that act as conductors. Diffused p-regions can be used as one level of interconnection, with a single layer of metalization providing the second level. The high sheet resistivity of the p-region, about 100 ohms per square, causes no trouble—it's negligible when compared with the very high impedance of the MOS circuitry. (The ON resistance of an MOS device is on the order of 10 K, and that of a typical load around 100 K. The resistance of a p-region conductor, 10 by 100 microns, is only 1 K). P-region interconnections are diffused simultaneously with the p-region source and drain; so no extra processing steps

are required. Crawford has designed circuits with tunnels 0.4 mil wide and as long as 12 to 15 mils.

"Lately," he says, "there has been a lot of talk of very small bipolar transistors competing against MOS, but device size is only part of the story. In random logic much more area is committed to routing and interconnecting than to active cells. In bipolar circuits you have to develop a second layer of metal for interconnections or go to a larger layout. But in MOS you can use the tunnels for crossovers."

MOS reliability is good. Fairchild's section head of MOS technology, Thomas Klein, says that

the reliability of modern MOS circuits is about as good as that of bipolar circuits, although he concedes it's hard to prove—there aren't as many hours of data available on MOS.

Klein says that because MOS circuits are more sensitive to contamination than bipolar, MOS has, of necessity, been very carefully researched and failure modes have been more carefully checked than those of bipolar circuits. Many of the reliability improvements in bipolar circuits have come about as a result of MOS studies, Klein asserts.

MOS offers obvious economies. Since devices are smaller, more can be put on a chip. Chips can be kept small and yields high; so manufacturing cost is lower. High chip complexity means fewer chips per system; so the system interconnection cost is lower, too.

However, there are these limitations:

MOS devices have a relatively low transconductance and high ON resistance. The transconductance is proportional to the term $\sqrt{2BI_D}$, where B is a constant determined by the process used and I_D is the drain current. The transconductance of a bipolar device, however—which is a junction rather than a surface-effect device—is proportional to qI_E/KT , where I_E is the emitter current, and q/KT is a constant.

A typical MOS driver device has an ON resistance of about 1000 ohms and must be roughly 300 to 400 square mils in area to achieve a resistance even this low (the ON resistance is inversely proportional to the device area). A bipolar device this size, on the other hand, would have an ON resistance of 1 or 2 ohms. Further, the ON resistance of a bipolar device is inversely proportional to the exponential of the area, and it increases much more quickly, as area is increased, than it does in the MOS device.

MOS gates are fundamentally slower than bipolar gates. The speed-power product of a typical gate, according to Wally Raisanen, manager of MOS and memory products at Motorola Semiconductor Products Inc., Phoenix, Ariz., is proportional to the square of the logic swing, and the logic swing is related to the transition width of the inverter. Because the MOS device is a square-law device with low transconductance, its transition width is always larger for an MOS device of a given area than it is for a bipolar device.

There is about two orders of magnitude difference, says Raisanen. The transition width is typically 200 mV in a bipolar gate and 3 to 10 volts in an MOS gate. The large difference means that logic swing for the MOS circuits has to be larger, and since the speed-power product is proportional to the square of the logic swing, the product for MOS is always much larger.

A given design is limited to a certain amount of power dissipation, which is dictated by the

thermal resistance of the package. If power is thus held constant in the speed-power product, only the speed can be varied, and the result must be that the speed of the MOS gate is lower than that of an equivalent bipolar gate.

MOS gates require both V_{GG} and V_{DD} supplies for best operation. Raisanen contends that circuits can be easily designed to operate from a single power supply, V_{DD} , but that such design is not efficient. The circuit dissipates more power for the same logic swing output. The logic swing at the output, he says, is a lot smaller than the difference between the supply, V_{DD} , and ground because the load resistor is an active device with a threshold voltage and secondary effects that effectively subtract one-third of the logic swing potential from the supply voltage.

Since the power dissipation is proportional to the current drain times the power supply voltage, power dissipation is higher than it need be to accomplish that logic swing. But if a separate V_{DD} supply is used, Raisanen says, it can be typically one-half of V_{GG} , and the logic swing is approximately equal to the difference between V_{DD} and ground. Power dissipation in this case is proportional to the voltage V_{DD} , so the dissipation per volt of logic swing is less. The V_{GG} supply,



"We can talk about 160-170 mil chips, but we just don't have economy at that size. Yield is too low, we have trouble mounting the chips, and we don't have standard, economical packages to accommodate them,"—George Vashel, Operations Manager, MOS ICs, Fairchild Semiconductor, Mountain View, Calif.

Raisanen explains, adds only moderately to the system cost because the current drain is very low.

MOS devices have intrinsic capacitance associated with the charges stored on the gate and in the channel. It appears as a shunt to the input signal, and so the apparent input impedance of the device decreases with the increasing frequency. The capacitance imposes a speed limitation on digital MOS circuits. Since the charge distributions on the gate and in the channel change with the applied voltage, the capacitance also changes with voltage.

Overlap capacitances, between the gate and the source and the gate and the drain, are also inherent in the MOS device. In all enhancement mode MOS devices available today, the gate metal must overlap the source and drain regions to allow for alignment and processing variations, and it is this overlap that accounts for most of the capacitance, roughly 0.01 pF for each 10 microns of gate width. For a typical gate of 40 microns wide, the capacitance from the gate to each other electrode is 0.04 pF. Gate-to-drain capacitance is enhanced by the Miller Effect.

Drain-to-body junction capacitances between the source and the substrate and between the drain and the substrate are also intrinsic to the MOS device. This capacitance depends on the amount of reverse-bias, decreasing with increasing bias.

Small MOS devices pose process problems. The alignment of the gate mask to the p-diffusion mask is extremely critical—more than in the bipolar process because of the smaller dimensions. If the gate is misaligned by a fraction of a micron in an enhancement mode device, for instance, the inversion layer will not extend completely across the channel, thereby adding series resistance in the channel. And MOS chips are typically larger than bipolar chips, according to Motorola's Raisanen, so old-style tooling isn't very well suited to lining up big chips to tight tolerances. "Our newer mask alignment machines use split optics devices and make alignment much easier," Raisanen says. "We have gone exclusively to that type of instrument."

Cameras are also a problem. Vern McKinney, senior design engineer in Texas Instruments MOS engineering center, sees read-only memories going as large as 4096 bits per chip, but says that this is a practical limit at the moment because the chips get too large. "Our cameras can't handle the large chips," he says. "Right now we're limited to chips roughly 150 by 150 mils (a chip of this size will hold roughly 5000 devices). We lose resolution around the edges if we start to go to bigger chips. Making devices smaller is not feasible either. "Emulsion resolution," McKinney says, "is a problem too—nobody

can etch a metal line as fine as 1/10 mil wide so far!"

MOS devices still fail due to static discharge between the gate and the other elements. Although vendors provide protection devices on the chips, the failure rates between shipment of products from the vendors and final testing in end-use circuits is rumored to be as great as 2 per cent. Customers try to keep all leads shorted together as a means of protecting the circuits, but failures still occur during shipment, customer incoming inspection, customer sample testing or assembly into circuits. According to Raisanen, protective diode devices on the chips are not fully successful, and most vendors avoid discussion of the problem. Protection circuits are being modified by the vendors in an attempt to reduce the failure rate but for the present their only advice is "be careful."

Testing problems are often not anticipated. According to Texas Instruments' manager of technology customer centers, Charles Phipps, "You can easily put a complex circuit or array in a 50-pin package, but the testing is very difficult."

Phipps feels that many customers have been led slightly astray in this area in buying complex MOS chips. According to Phipps, "vendors came along and said 'we'll put all of this in a package for you' and the customer tended not to think about the testing problems, because he was so excited about getting such high packing density. When he finally got his parts, he found the testing problem enormous."

Phipps says that he has had to refuse orders for complex chips in which the customer specified that Texas Instruments do extensive testing. "We just couldn't afford to do it," he says.

Packages are a problem for the more complex MOS arrays. The more bits of memory in a package, the more input and output pins are needed. "The multilead packages are extremely expensive," says Vern McKenny, "and you can lose the cost advantage in the package that you gain by increasing the complexity of the chip."

MOS devices are not generally considered suitable for plastic packages.

Motorola's Wally Raisanen is hesitant, too, to put MOS in plastic. "We packaged some passivated circuits in plastic," he says, "but we stopped because I got nervous about it." All of the reliability test results that Raisanen's group obtained were good, but they didn't do really exhaustive tests and aren't satisfied that they have proof of reliability.

"We anticipate going to plastic packaged MOS in the future," says Raisanen, "depending on the results of further reliability tests and on customer acceptance. But our customers are very nervous about accepting MOS in plastic." ■■



MOS future hinges on processing

New methods in works offer lower thresholds, an increase in speed and reduced dissipation

Advances in MOS technology continue, and the emphasis is expected to shift from circuit design to process innovation and improvement. Texas Instruments' Charles Phipps points out that throughout 1964, 1965 and 1966 the Big 3 in semiconductors—TI, Motorola and Fairchild—didn't consider MOS technology really ready for the market place. Almost all product advancement, even in 1968, came about because of improved circuitry techniques; there was a minimum of process improvement.

"The real process perfection is still to come," Phipps says. "From now on, you'll see real emphasis on performance advancement through process improvement. Motorola, Fairchild and Texas Instruments have large process technology groups to draw upon, and they'll explore the ways of forming the structures, of combining bipolar and MOS, of working at very low thresholds, using different dielectrics and multiple layers of metal."

Phipps says that most of the small companies that started with a standard process in 1964-

1965 are using the same process now. "Their processes are lagging," he says. "They can keep up if they keep acquiring knowledgeable people, but they won't be able to lead."

Fairchild R&D's section head of MOS technology, Thomas Klein, agrees. He has found that most designers believe the only advances still to come in MOS will be in device and circuit design; that processes are fully developed. "But there is a lot of mileage left in MOS technology," he says. "We certainly haven't seen the end of process improvement."

Klein expects to see, in the near future, many MOS circuits operating at supply voltage levels of 5 to 6 volts and more MOS circuits interfacing with bipolar circuits. He expects higher circuit speeds—to 10 MHz in dynamic circuits—and much higher circuit densities.

Klein's group is working on a new MOS process that he hopes will solve some of the low-threshold and high-density problems.

The silicon gate

The Fairchild R&D group is using deposited polycrystalline silicon as the gate material. To make the material sufficiently conductive, researchers are doping it with a p or n-type impurity. For p-channel MOS devices, the impurity being used is boron.

The effect of the doped silicon gate is to reduce the threshold voltage of the device to 1 or 2 volts, rather than a more typical 3.5 to 5 volts, and this is achieved without significant effect on the high-voltage capability of the

MOS diffusion furnaces glow white-hot at 1200°C. The temperature of the diffusion zone in the quartz diffusion tubes is controlled to within 1°C. The flasks contain water vapor which is conducted through the tubes where it reacts with the silicon wafers to form a silicon dioxide film. The film formed after every diffusion step, protects the wafer from contamination and prepares the wafer for the next photo-etch step. Photo courtesy of Fairchild Semiconductor, Mountain View, Calif.

circuits.

And since the diffusion step is performed after the gate is defined, the edge of the gate material can be used as the reference line for the source and drain regions. The structure is self-aligning, and there is no worry about alignment tolerances. The source-to-drain and gate-to-drain overlap capacitance is defined by the diffusion alone, and it can be reduced by a factor of about 5 from that of conventional MOS devices.

"In the conventional MOS process," Klein says, "you diffuse p⁺ regions first, then cut the oxide layer for the gate region and grow the thin gate oxide. The gate oxide region has to slightly overlap the drain and source to allow for possible misalignment. Then the gate metal is deposited, and it has to extend slightly over the edges of the gate oxide to allow for misalignment in this step. The result of these overlap allowances is increased capacitance between the gate, source and drain, and slower speed.

But in the self-aligning silicon gate process, the gate is defined first and is used as a mask to etch the oxide. Then the source and drain are diffused simultaneously with the gate. Overlap effects are avoided.

The threshold voltage of the silicon gate device is lower because the metal-to-semiconductor work function that exists in conventional circuits is avoided. The geometry is smaller because the misalignment tolerances are unnecessary, and this increases the possible density and further decreases capacitance. The decrease in the threshold voltage due to the improved work function can be traded off for further decreased capacitance by making the gate oxide thicker.

The process staff doesn't have to worry about out-diffusion or increased diffusion depth during the gate oxide growth, because all diffusion is done after this high-temperature step. So the tolerances for this, too, are avoided.

The metalization contact to the gate can be made outside of the active device region. Metalization alignment in this region becomes much less critical, and geometries can be shrunk.

Harry Neil, MOS/LSI product manager at Fairchild, points out that the silicon gate device has one significant advantage that many low-voltage MOS circuits do not offer: It is capable of operation at high supply and signal levels. And high-voltage capability can be important.

Hughes Semiconductor's manager of MOS marketing applications, Carroll Perkins, says that of all the low-threshold circuits offered in the industry, only those made by a couple of vendors will withstand voltages above 24 volts. The others, he says, are quite limited in their maximum voltage ratings—typically 15 to 18 volts.

"These ratings are not too bad," he continues,

"if the customer learns to limit himself to the lower voltages." But too many customers, he says, have been used to the higher threshold circuits and to supply voltages above 24 volts. "Those customers should be warned that they may not be able to use some low-threshold circuits in their existing systems," he says.

Low threshold solves interface problems

Low threshold voltages are attractive because they allow direct interfacing with DTL and TTL

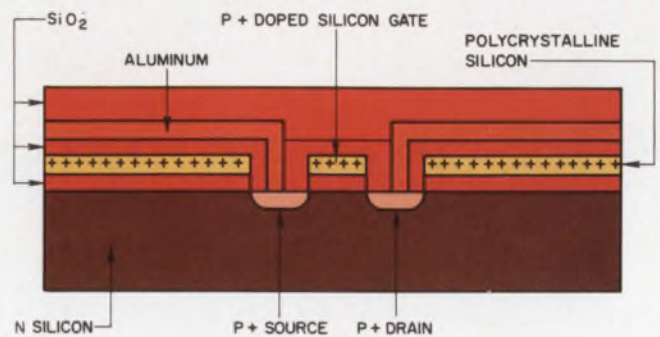

The silicon gate MOS device uses a p⁺ doped silicon region as the gate electrode. The gate, source and drain are diffused simultaneously, and perfect alignment is automatic. Source-to-drain and gate-to-drain overlap capacitance is reduced by a factor of 5 from that of conventional devices.



"There's still a lot of mileage left in MOS technology—we haven't seen the end of process development yet!"—Thomas Klein, Section Head of MOS Technology, Fairchild Research & Development, Palo Alto, Calif.

logic. Several vendors offer, or plan to offer, low-threshold circuits.

The new substrate material being used in the low-threshold MOS process is 1-0-0 crystal orientation silicon, rather than the 1-1-1 orientation material. The threshold voltage of the MOS device depends on the molecular surface states between the oxide layer and the silicon. With the 1-0-0 substrate material the interface conditions are such that the device threshold voltage is lower, by a factor of about 2, than it is for 1-1-1 orientation material.

A 1-1-1 material was used in early MOS products because oxide stability and drifts in threshold voltages were problems. With higher thresholds, drifts were less significant.

According to Edmund Karcher, manager of advanced IC development at ITT Semiconductor, West Palm Beach, Fla., there is one disadvantage to the new trend: Low threshold devices of identical size are slower because their transconductance is lower. If the device designer increases size to increase the transconductance, he does regain some speed. But he also increases the power dissipation. "We are trying," Karcher says, "to make our output devices large enough to sink about 2 milliamperes at 0.4 volt, say, over the full military temperature range, and we find that the output device requires a channel area of roughly 0.2 mil by 60 mils.

The power dissipation of a gate circuit is becoming more and more important as circuit density increases. And vendors are continually trying to decrease dissipation.

In conventional bipolar or MOS ICs, most of the power dissipated is quiescent; it predominates because a resistor is used for the load device. But in a complementary circuit, in which the load resistor is replaced by a transistor, the quiescent power can be lowered appreciably. Complementary circuits have the added advantage of being insensitive to variations in the parameters of individual devices. They have higher speed, lower power consumption and they work well at lower supply voltages.

Complementary MOS for low power

A complementary inverter stage is a pair of complementary MOS devices connected in series, with the gates tied together and driven by the input signal. When the input is zero volts, the p-channel device is ON and the n-channel device is OFF. When the input signal is positive, the reverse is true.

Each device, when ON, is required to supply a direct current equal only to the leakage current of the other device. During transistions of the input signal, capacitive loads are charged and discharged through the low output impedance of

one or the other of the two devices. Time constants are short and the circuit is fast.

But the complementary circuit takes up more room on the chip than the conventional resistive-load inverter, and processing is more involved (see next page).

The major problem in fabrication is the process, that must yield both enhancement n-channel devices and low-threshold p-channel devices with good stability and gain. The processing, according to Karcher, is as complex as—or more complex than—bipolar processing, and it is harder to control.

"But the low-power requirement and high-speed operation more than compensate for these shortcomings," says Karcher, "and if you really need the high performance, complementary MOS is the way to go."

Manufacturers are always investigating the possibility of simplifying the MOS process. One doping technique, for example, that shows great promise is ion implantation, which can be used to dope the source and drain regions of the MOS device, with the gate metal used as a mask against implantation. The dopant is ionized, and the ions are accelerated to high velocity and beamed at the semiconductor to be doped. They penetrate the surface and deposit in the interior. Since the ions are not given enough kinetic energy to penetrate the metalization, the semiconductor under the metal is unaffected. The striking advantage of this technique is that perfect alignment of the source and drain under the gate is automatic.

The absence of gate overlap reduces parasitic capacitance to a small fraction of its usual value, eliminating this source of high-frequency instability and increasing the switching speed of the device. Input capacitance is two to four times lower, and Miller capacitance is about 40 times less than in a conventional device with the same g_m .

The new techniques can implant almost any conceivable dopant into any substrate, unlike diffusion technology, which is largely limited to silicon, germanium and gallium-arsenide substrates and a small range of about 8 different dopants.

Ion implantation is a low-temperature process—typical substrate temperatures are 400-500°C—and it has very little effect on previously doped areas. There is little tendency for dopants to migrate laterally in the substrate.

The advantages of ion implantation are especially important in integrated arrays, according to Robert Bower, manager of the Applied Solid State Research Dept. at Hughes Semiconductor, Newport Beach, Calif.

"The low gate-drain feedback capacitance of a single implanted MOSFET device cannot be ex-

ploited in a conventional package because of the package capacitance," he notes, "but integrated arrays could take full advantage if interconnection capacitance is kept low enough."

In the new process, the energy of the ions is easily controlled, and junction depth can be precisely determined. Junctions can even be formed beneath passivation layers.

The drawback is the need for sophisticated and expensive manufacturing equipment. It has to generate ions of almost any material in a vacuum, accelerate them, separate them by mass and implant them in a substrate at controlled temperature and orientation. A suitable system costs from \$30,000 to \$100,000, depending on its acceleration capabilities and its versatility.

One popular technique for increasing the speed and decreasing the power dissipation of MOS circuits, at least until now, has been multiphase logic—usually 2- or 4-phase for simplicity of clock pulse generation.

Multiphase systems employ repeating cycles of pulses from two or more clock supplies. These systems take advantage of the charge storage capability and the bilateral nature of the MOS device, and use MOS switchable loads to control the flow of digital information.

Four-phase systems, for example, typically consume only 20 microwatts of power per bit, or node, and will operate to 4 or 5 MHz. And because multiphase systems use MOS devices in a dynamic mode and no "voltage divider" effects are necessary, all devices can be of identical, minimum size. This reduction from the size of static logic systems increases the speed even further.

But according to Floyd Kvamme, microcircuit product manager at National Semiconductor Corp., Santa Clara, Calif., four-phase logic

schemes are not the solution to speed limitations. They merely transfer the problem. They do operate fast, he concedes, but in going to a four-phase scheme, the MOS vendor transfers almost all of the design problems to the designer of the clock drivers. "That poor guy," says Kvamme, "has a problem you couldn't believe!"

The clock drivers that operate a four-phase system have to supply pulses of about 27 volts, with stringently specified rise and fall times, to several separate circuits that must operate in synchronism—and do it at a rate of, say 10 MHz. Timing is a great problem.

"Four-phase has been preached as a solution to a lot of problems where it absolutely is not a solution," says Kvamme.

Kvamme thinks that MOS vendors can do with two-phase anything that they can do with four-phase. He holds that he has never seen a system in which it was really necessary to bring four phases off the clip.

Klein of Fairchild agrees. The reason for four-phase systems was to allow dynamic operation, reduce geometries and increase speed, he notes. If the designer can go fast enough without it, he argues, it's not worth the trouble. But in some cases, "especially in some random logic, there are things you can do with four-phase that you can't do with two-phase," Klein admits. "You can get much more logic flexibility because you can design complex gates."

The design rules for MOS are a lot different from those for TTL and DTL, in which the designer works with simple NAND or NOR gates and inverters. MOS devices can be arranged to form very complex logic structures that cannot be subdivided into simple gates. The same amount of logic that is accomplished in three levels with bipolar circuits can be accomplished in essentially

In the complementary-symmetry MOS process a standard n-type substrate (a) is prepared by diffusing into it a p-type region to serve as the substrate for the n-channel transistors (b). The wafer is reoxidized (c), the oxide is etched to define the source and drain of the p-channel transistor, and these regions are doped with p-type impurity (d). The wafer is then oxidized once more (e), the source and drain of the n-channel device are defined by etching, and n-type impurity is diffused into the specially prepared p-region in the substrate (f). The oxide is then completely removed from the active regions, and a new oxide, which determines the characteristics of both devices, is grown in this area (g). Finally, the contact openings are formed over the source and drain diffusions, the wafer is metallized, and the metal interconnect pattern is defined (h). The complementary process is almost as complex as bipolar processing, and is considered by vendors to be harder to control.

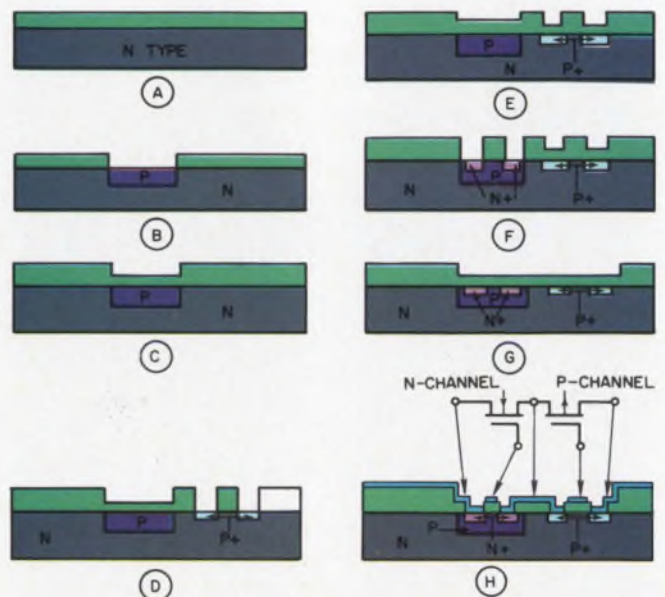



In an ultra-clean spinning hood, MOS wafers are coated with photoresist in preparation for photo-etching. The wafers are spun at 7000 rpm for 2 minutes to remove the excess, leaving a uniform coating of resist about 0.4 microns thick. The air in the hood is filtered to exclude all particles over 5 microns in diameter, and the photoresist to exclude particles over 0.5 microns, to minimize pinholes in the photoresist layer. Photo courtesy of National Semiconductor, Santa Clara, Calif.

one level with MOS.

The complex gate approach to MOS logic requires fewer devices and fewer active loads, and hence there is less power dissipation. There are fewer interconnections between gates as well.

"But to design complex gates that are useful in a customer's system, you have to understand it completely," says Ralph Spencer, senior design

engineer at Texas Instruments, Dallas. Traditionally, customers have used logic diagrams to inform the vendors of their needs. But the logic diagrams have been drawn in terms of simple NAND/NOR gates. "This isn't the best way to communicate for MOS orders," says Spencer. He feels that Boolean equations or some kind of general system description is more suitable, because logic diagrams are too constrictive.

Four-phase logic is much better for complex gates than static logic, according to Spencer. You don't have a zero level dc design requirement in four-phase; you can put in many more devices, and you can build more complex logic.

In a three-input static NAND gate, for instance, the resistance of the load device has to be at least 10 times higher than the resistance of each of the active devices to get a "low" zero level output. This means that the active devices must be much larger than the load device. The more devices you put in series, the bigger they have to be to keep the equivalent ON resistance the same. The extra area taken up limits chip complexity—and all this just to satisfy dc design requirements. The increased size means increased capacitance and lower speed, of course.

But in a four-phase gate there is never a dc path to ground; you just charge and discharge capacitors. All devices can be the same size, which greatly simplifies layout. Of course, says Spencer, the more devices in series, the longer it takes to discharge a capacitor to ground and the slower the circuit.

Complex gates make the comparison of ICs on a "gates per chip" basis meaningless. It is often very difficult to determine how many simple gates a complex gate is equivalent to. "Roughly speaking," says Spencer, "10 complex MOS gates on a chip can do the job of 100 simple gates. ■■"

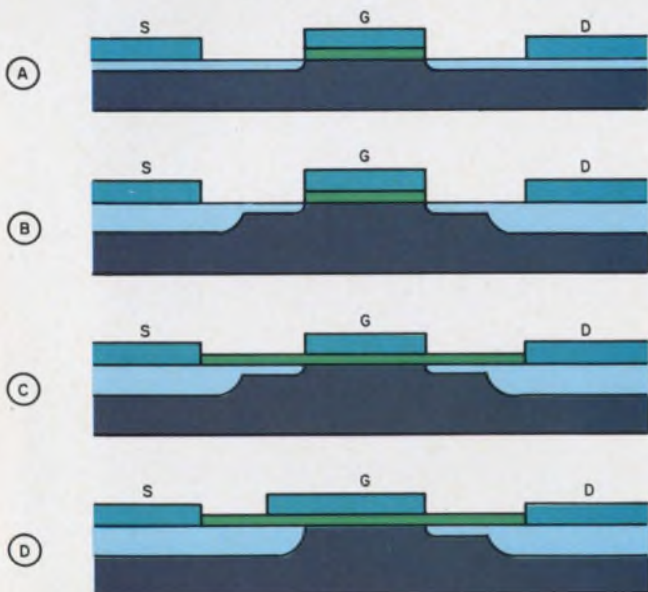

MOS ion implantation has evolved from early techniques, in which the source and drain were formed by implantation, using the gate metal as a mask, with source and drain contacts added later (a). This configuration was subject to instabilities because of the absence of a passivation oxide on the source and drain. It required an extra metalization and masking step, and it was difficult to make good contact to the implanted areas. The last two difficulties are eliminated by diffusing source and drain areas offset from the gate and then filling in the offset area by implantation (b). If gate oxide is not removed from the area of implantation, stability is much improved (c), but the implanted ions must be given sufficient energy to penetrate the oxide. If ion implantation is used only on the drain, the gate-drain capacitance, and hence instability, is reduced, and the possibility of degenerative source resistance due to high implanted-source resistivity is avoided (d).

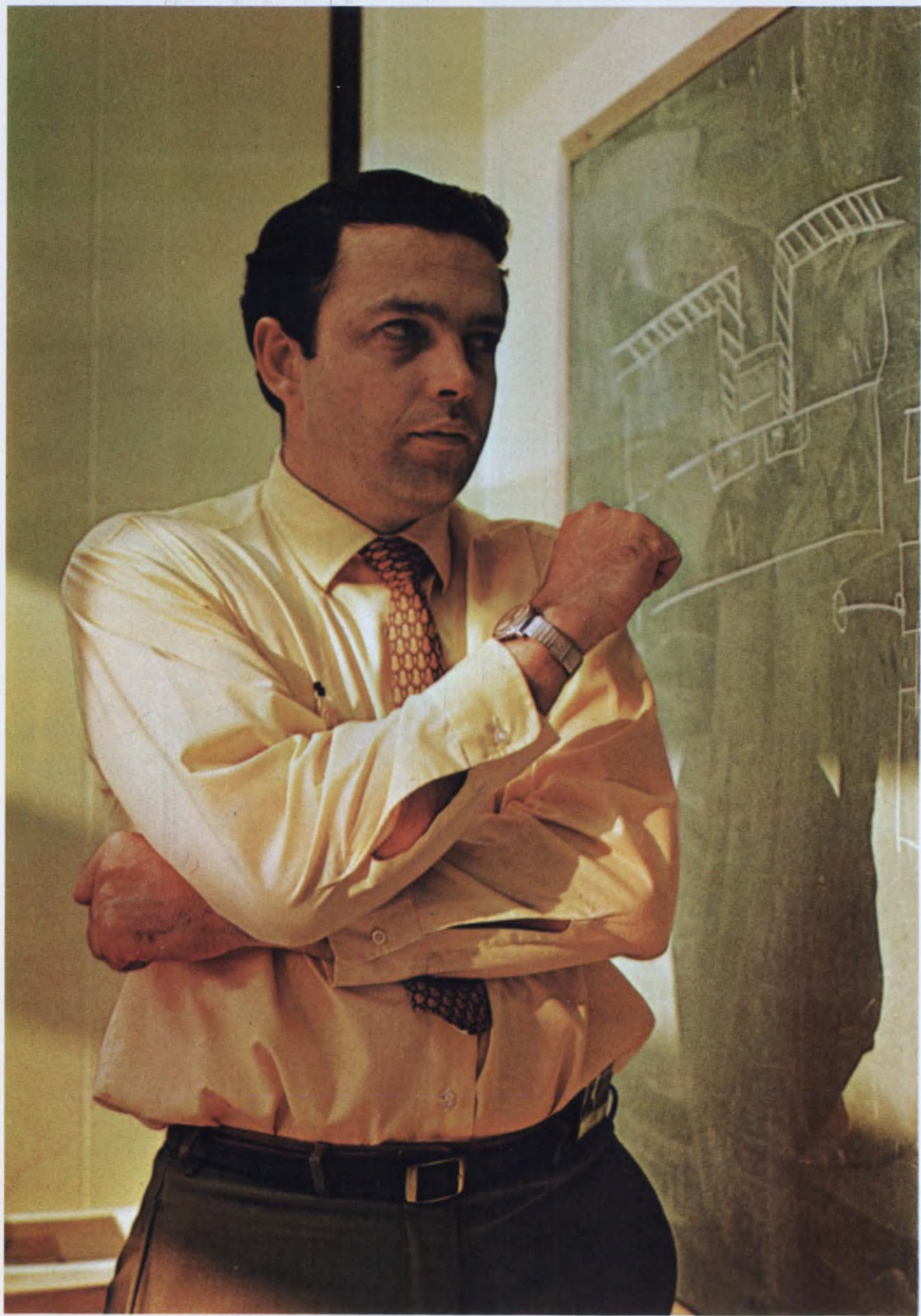

Decisions, decisions for MOS users

Custom or standard? What's the best way to interface with a vendor? And what vendor?

A designer who contemplates using MOS faces many decisions. He'll have to weigh the cost of custom work, for instance, against the economy of a circuit designed specifically for his system, and make a choice between custom and standard products. If he decides on custom circuits, he'll have to learn how to communicate his needs accurately to the MOS manufacturer.

And he'll have to choose a vendor from the many who compete for his order.

Some vendors will argue for standard products only and offer advice on using their products in a variety of applications. They say their standard products are fully proven, even available in quantity off-the-shelf.

Others offer sophisticated custom design programs and point to savings in system design costs and packaging to justify the custom circuit expense. They are often willing to amortize custom development costs over a production run to make the expense less painful.

Floyd Kvamme, microcircuit product manager at National Semiconductor Corp., Santa Clara, Calif., strongly opposes custom work. "Any buyer who thinks that a development contract is a good deal for a vendor is out of his mind," he

says. He points out that National sells semiconductors, and is not in the business of selling design engineering. He feels that it is a mistake to confuse those two functions, and that if they are confused, someone loses money.

"Besides, you'd be amazed at how little most guys in a semiconductor production environment know about electronic engineering," he says. "They aren't system designers. They're chemists! They're physicists!"

"What I expect a systems applications man to do at National is to look at the customer's system and to know enough about both systems and semiconductors to recommend a technology—a means of doing the job."

Kvamme pictures the customer as "not interested in a red-hot engineering or R&D group." What customers want to know, he says, is "whether their vendor has a good MOS production facility, good MOS design and production men, and good quality control."

Many users have approached MOS, Kvamme says, with the idea that anything can be built. This is due in part to the claims of some suppliers. In many cases, of course, the claims are justified—the vendors can and do build that special little system. But they only build it once—custom jobs are rarely repeated—and that's the problem. Costs can't go down if production stays in low gear.

"A misconception popular with semiconductor users," Kvamme says, "is that a system with 10 packages in it is less expensive than a system with 20 packages in it. If those 10 packages have to be custom units, it just won't necessarily be true. Purchase costs are usually much higher for

Designers ponder the new technology. They face strenuous arguments from the vendors, both for and against custom design. If they choose custom, they must learn to adequately communicate their needs to the vendor to reap the full benefits of MOS. Their choice of vendors is wide, and product performance, reliability and delivery varies. Photo of Harry Neil, MOS/LSI Product Manager, Fairchild Semiconductor, Mountain View, Calif.

custom circuits."

Kvamme pushes hard for standard products. He's seen too much money spent on custom development when standard products would have done the job for less. In his past design experience in bipolar, he says, he's dealt with "myriads of inquiries" from customers who wanted to duplicate a system function in ICs and greatly reduce the size and the number of packages required.

"The engineers," he says, "were looking at their production problem. They wanted to cut costs by cutting the number of circuit boards and the number of separate components in their products and by reducing their production staff."

The obvious solution seemed to be to duplicate some circuitry in custom ICs. "What they didn't realize," Kvamme says, "was that the price was going to be just awful. It was really going to be exorbitant."

Kvamme drives home a very important distinction between redesigning a system and redesigning an IC. The IC design must be fixed if production costs are to come down, but the system design can be changed to incorporate a new technology. But, he adds, "we shouldn't redesign the customer's system for him; that is not our business."

And Kvamme isn't impressed by the small design groups typical of IC vendors. "Twenty-five engineers aren't going to solve the systems problems of the world, anyway," he scoffs.

But at Texas Instruments, Charles Phipps, manager of technology customer centers, doesn't agree. "One of our major hypotheses," he says, "is that MOS will be largely a custom business for the next two or three years, if not longer. We have worked hard to build up a capability to do a large number of custom designs."

The MOS staff at TI estimates that 60 per cent of the total MOS dollar volume will be devoted to custom circuits in 1969. Of that portion, they expect a little less than two-thirds will go for custom engineering costs. They expect also that the market for custom circuits will grow more rapidly than the market for standard circuits.

Motorola, too, plans to go the custom-array route, in addition to offering standard circuits. It will develop a line of essentially standard products, but instead of packaging them as individual gates, flip-flops and so on, it will put them on a single chip in custom combinations. "This sort of thing," says Warner Bridwell, manager of Motorola's MOS Product Design Dept., "will give the customer a custom chip at minimum cost and turn-around and the whole bit."

Fairchild Semiconductor in Mountain View, Calif., is using this approach, which they call Micromosaic, with the building blocks stored in computer memory. Philco-Ford Microelectronics



"Any customer who thinks a development contract is a good deal for a vendor is out of his mind! We shouldn't participate in the design of a customer's system."—Floyd Kvamme, Microcircuit Product Manager, National Semiconductor Corp., Santa Clara, Calif.

Div. in Blue Bell, Pa., uses a similar building-block approach.

General Instruments' MTOS marketing manager, Art Sidorsky, says that engineers who expect to buy MOS circuits in considerable volume should plan to buy custom circuits.

"A custom circuit gives you exactly the circuit you need," he argues. "It is built to your individual specification." But ordering in quantity is essential—the vendor can't lower the price unless he is able to produce in large volume, Sidorsky emphasizes.

Ordering a custom design

Suppose you want a custom design. How do you approach a vendor? What information does he need about your requirements, and how can you protect your proprietary design?

Some manufacturers are extremely flexible. They will process wafers to a customer's mask set (provided the customer follows certain design rules), talk directly to customer design engineers, or accept logic diagrams or even a black box specification.

At Texas Instruments, for instance, your input as a customer can be just about anything. It will depend, in part, on how much you know about



"The custom business is going to be so big that the major vendors will be swamped with engineering work unless they have effective computer aids."—Wally Raisanen, Manager of MOS and Memory Products, Motorola Semiconductor Products Inc., Phoenix, Ariz.



"We won't even need to see a logic diagram. Our computers will accept Boolean equations and give us a wiring list."—L. J. Sevin, Manager of the MOS Engineering Center, Components Group, Texas Instruments, Inc., Dallas, Tex.

MOS. But you can define a black-box specification in words, if you like, and TI engineers will take your specification and do the system concept and design work. Then they'll do the detailed logic drawings and any necessary partitioning and produce your circuits. The price, of course, depends on the work involved.

TI engineers are also working on a computer program that will enable them to do partitioning without doing a detailed logic diagram. The program will work directly with Boolean logic expressions. There are some arguments that Boolean algebra doesn't really lend itself to such manipulation and simplification, but L. J. Sevin, manager of the MOS Engineering Center in the Texas Instruments Components Group, Dallas, brushes them aside. "We won't even necessarily see a logic diagram," he says. "We'll go straight from equations to a wiring list." The latter is a computer listing of all interconnections among logic gates that are needed to implement the equation.

There has been some speculation in the industry that vendors will accept placement and routing information on computer tapes, but this is unlikely to happen, a sampling of manufacturers shows. Tape equipment varies in performance from machine to machine, and it is not good

practice to record data on one machine and read it on another. If the customer wants to take part in design, it is widely advised, he should give the vendors art work. This is easy to inspect.

But vendor inspection of art work doesn't mean acceptance of design responsibility. "We refuse to be responsible for logic errors," says Sevin. "If the customer comes to us halfway through a production run saying he's made a mistake, and gate so and so should be connected here instead of here, we can't start over again for free. That mistake is going to cost him some money."

Sevin says that vendors have to be extremely careful. In complex MOS production the vendors' and customers' interests tend to overlap; a great deal of communication is necessary.

Despite this, Sevin finds that Texas Instruments does have some problems. "We'll accept customers' art work," he says, "but we won't take masks—absolutely not." TI has had real difficulties with almost invisible errors in customer-generated masks. "Usually," Sevin adds, "the customers don't want to build masks anyway."

As for protection of proprietary design, customers should expect to negotiate. The standard agreement is that the vendor will not disclose or sell the design to any other customers, unless

a third party requests an identical circuit or a third party publicizes the circuit.

But vendors will hesitate to make any such agreement on general application products. Sevin points to visual display encoders as an example of circuitry TI would not consider proprietary.

"We talk to a lot of companies in the computer-terminal and in CRT-display business who come to us with a detailed design for a new system that they consider proprietary" he says. "And we show them standard products for most sections of their systems. It really shakes them up."

In random logic, however, chips are rarely duplicated, and proprietary agreements are easy to conclude.

Bridwell notes a special problem that he has encountered with customer art work. "We found," he says, "that customers coming to us with art work were looking not only for a product but for strong second and third sources as well. So what they were trying to do was come up with a layout, a set of design rules and a set of masks that were compatible between two or more manufacturers. This is extremely difficult."

Choosing the MOS vendor

What's the best way to choose an MOS manufacturer?

The most important thing is that your vendor have a top-notch quality assurance program. Even a small percentage of faulty units in your order will cause testing headaches, expense and loss of time.

Evaluate the vendor's reliability program. Where, and how many times, are chips and circuits tested? At some stage there should be 100 per cent testing of wafers. When sampling tests are used, how large a sample is taken?

The involvement of the manufacturer's QA (quality assurance) staff will be obvious if you visit the plant. Find out where the quality tests are performed, where the data on quality monitors are kept. Find out how lot flow is controlled (there should be a QA tag or equivalent for every lot).

Engineering and production staffs may, through pressure of work, neglect quality. The QA group should be keeping a constant check on them. These fundamentals should be understood by everyone at the vendor's plant.

And don't mistake voluminous reports for quality control. National Semiconductor's Kvamme warns that too many customers judge QA by the poundage of data collected. "I could name programs," he says, "in which the vendor could have sent in The Daily News bound up as reliability reports, and no one would have known



"There just aren't going to be enough engineers in the world to do the MOS design that will hit the market in the next year or two."—Robert Crawford, Senior Development engineer, MOS Engineering Center, Texas Instruments Inc., Dallas, Tex.

the difference."

Once you're convinced that your vendor has taken the proper steps to ensure reliability, evaluate the company's product. You may not be able to get a sample of the particular circuit you want to buy, but you can buy one of the manufacturer's standard circuits of about equal performance. Avoid specially prepared samples; they may not indicate long-term capability. Rather, go unannounced to a distributor and ask for some parts from regular stock. Evaluate the product against the vendor's specifications. Then check it beyond the specs. Is the design critical or are there adequate guard bands? Run it through a rigorous "incoming inspection" and see how good it is. Keep in mind that you're evaluating a vendor, not a product.

And don't limit your testing to a one-time check. Let the circuit operate for a while, perhaps at its upper voltage, signal and temperature extremes, as listed by the vendor.

If the product that you evaluate differs greatly from the one you want to order, ask the vendor to show you a product of equal complexity and performance, to let you talk to a customer who has received such products. Be cautious in the complex-product area.

"The truth of the matter," says Kvamme, "is that the vendors who claim to be building the

extremely complex products aren't delivering yet."

And look at your vendor's documentation. "Process control would be a real problem," says Texas Instruments' Sevin, "if we didn't have adequate documentation."

If you're going to buy custom circuits, try to evaluate your vendor's design capability, too. Does he need computer aids, for instance?

Motorola Semiconductor Products' Wally Raisanen, manager of MOS and memory products, says that it's important that the vendor have computers—but not as important now as its going to be in the future. "The custom business is going to be so big," he says, "that the four or five major vendors will be swamped with engineering work unless they have effective computer aids."

Raisanen says that no one has a truly effective system. "Most vendors claim to have computer aids," he says, "but when you get right down to it there are serious holes in their systems. No MOS computer-design facility is operational yet."

According to Raisanen, vendors need a logic simulation program, an effective means of doing chip layout and optimization, and a wiring layout program for custom arrays. When vendors arrange standard MOS cells in a custom interconnection they also need computer-aided mask master preparation, he says, and they need computer test pattern generation. If one of these capabilities is missing, they don't have a system.

"Right now," says Raisanen, "most vendors have good logic simulation programs, but everybody falls down in chip layout. The problem is usually in the man-machine communication—it has to be done on-line with a graphics display system to get the quick turnaround and accuracy that you need. No vendor has this capability to my knowledge."

"Several vendors, including Motorola, have a working wiring-layout program," says Raisanen. "None of these gives 100% routing on a complex chip, but all of them are useful." He says several vendors have automated master preparation too, but cautions that a system in which the automatically cut rubylith is stripped by a technician is a "bad scheme." The technician makes unavoidable errors, he says. "A good system should be completely automatic."

In test generation Raisanen says that the major vendors have roughly equal capability.

Warner Bridwell, Motorola's manager of MOS product design, says that the vendor engineers need computers to handle complex design equations, too.

A basic minimum, he feels, are analysis routines for transient and dc effects within the MOS circuits, and routines for establishing the best device design for a given performance, noise

margin and ON and OFF levels.

MOS devices can be designed with simplified equations, but Bridwell has found that more complex design equations, which include second-order effects, are necessary for really efficient designing of complex circuits.

Texas Instruments' development engineer, Robert Crawford, agrees. "There just aren't going to be enough engineers in the world," he says, "to do all of the MOS design that will hit the market in the next year or two. We must use computer aids—they'll be the only way to achieve short turnaround on custom design." ■■

Bibliography:

- Bower, R. W., Dill, H. G. & Aubuchon, K. G., "MOS Field Effect Transistors Formed by Gate Masked Ion Implantation [1]," Hughes Research Laboratories, Newport Beach, Calif.
- Boysel, Lee, "Cutting systems costs with MOS," *Electronics*, January 20, 1969, pp. 105-107.
- Boysel, Lee, and Murphy, Joe, "Multiphase Clocking Achieves 100 ns MOS Memory," *EDN Magazine*, June 10, 1966, pp. 51-55.
- "Complementary MOS Transistor Logic ICs," RCA ICs Application Note, ICAN-5593, RCA, Harrison, N. J.
- Downey, J. B., "MOS Logic Circuit Organization for Custom LSI Applications," *NEREM*, 1968.
- Engineering Course in P-MOS Technology, American Micro-systems Inc., Santa Clara, Calif.
- Einhorn, Richard N., "LSI improves computer memory bit by bit," *Electronic Design* 7, April 1, 1968, pp. 25-32.
- Faggin, F., Klein, T., Vadasz, L., "A New Approach to Fabricating Insulated Gate Field Effect Transistor ICs," Fairchild Semiconductor, Palo Alto, Calif.
- Karp, Joel, and deAtley, Elizabeth, "Use four-phase MOS IC logic," *Electronic Design* 7, April 1, 1967, pp. 62-66.
- Microelectronic Device Data Handbook*, Vol. 1, (NASA Handbook 0900-1), August, 1967, ARINC Research Corp., Annapolis, Md.
- MOS IC Handbook*, General Micro-Electronics Inc., Santa Clara, Calif.
- Pound, Alan E., "Three MOS Building Blocks Perform Many Functions," *EDN Magazine*, August, 1968, pp. 50-53.
- Thompson, Stephen A., "Ion implantation: the sock-it-to-'em method to dope semiconductors," *The Electronic Engineer*, January, 1969, pp. 68-76.
- "Toward MOS memories," *Electronics*, October 28, 1968, Vol. 41, pp. 49-50.
- Watkins, Boyd G., "A Low-Power Multiphase Circuit Technique," *IEE Journal of Solid-State Circuits*, December 4, 1967, Vol. SC-2, pp. 213-220.

Acknowledgments:

Special thanks, for advice and assistance and for valuable background information, to the MOS experts quoted in the report, and to **Richard M. Eiler**, Product Marketing Manager, Electronic Arrays Inc., Mountain View, Calif.; **Albert Hemel**, Senior Engineering Specialist, Defense Control Systems, Philco-Ford Western Development Laboratory, Palo Alto, Calif.; **Earl H. Schaefer**, General Manager, Microelectronics, Autonetics, Anaheim, Calif.; **Dennis Walz**, Director, Semiconductor Laboratory, Collins Radio, Newport Beach, Calif.; **Dr. Jean A. Hoerni**, President, Intersil Inc., Cupertino, Calif.; **Jack Halter**, Manager of Product Marketing, Signetics Corp., Sunnyvale, Calif. and **Dan Rasdal**, Division Manager, TRW Semiconductor, Lawndale, Calif.

MOS application notes and literature

The following manufacturers will send their MOS literature free of charge to engineers who request it on company letterhead. Please write directly to the companies, listing the literature that you would like to receive by title, number and issue date.

MANUFACTURER	MOS APPLICATION NOTES	NUMBER	ISSUE DATE
American Micro-systems, Inc. 3800 Homestead Rd. Santa Clara, Calif. 95051 Atten: Joe Mingione	MOS low power logic Doubling register speed-power product Function life test analysis; MOS LSI arrays Engineering course in MOS technology Systems development with MOS LSI Two-phase non-overlapping clock generator	AN01 DB02	July '67 Dec. '67 Apr. '68 Jan. '69 June '68 Sept. '68
Electronic Arrays, Inc. 501 Ellis St. Mountain View, Calif. 94040 Atten: Dick Eiler	Design considerations, EA 1200 and EA 1201 dynamic shift registers	TA-10	Feb. '69
Fairchild Semiconductor 313 Fairchild Drive Mountain View, Calif. 94040 Atten: Harry Neil	The 3800 arithmetic unit	172	Mar. '69
General Instrument Corp. 600 W. John St. Hicksville, N.Y. 11802 Atten: T. Esteves	A 30 MHz amplifier stage using a 2N4353 Multiplexing with MTOS ICs Tracking A to D converter using MTOS devices MTOS shift registers Successive stage binary to BCD conversion for numbers less than 1.0 RF applications of the N-channel dual-gate MTOS FET FM receiver using the N-channel dual-gate MTOS transistor MTOS IC digital differential analyzer Criteria for designing custom MTOS LSI circuits	MEM 554 MEM 554C	Mar. '67 Mar. '67 Mar. '67 Dec. '67 Sept. '67 Jan. '68 June '68 Sept. '68 Sept. '68
Hughes Aircraft Co. 500 Superior Ave. Newport Beach, Calif. 92668 Atten: Carroll Perkins	MOSFET operation in basic circuitry The FET as a switch A few comments on handling FET's The MOSFET electrometer	68-03 68-04 68-05 68-06	Aug. '68 Aug. '68 Aug. '68 Aug. '68
Motorola Semiconductor Products Inc. 5005 E. McDowell Rd. Phoenix, Ariz. 85002 Atten: Roger Helnick	Field effect transistors in theory and practice Insulated gate FETs used in ICs A unified approach to optimum FET mixer design Field effect transistor rf amplifier design techniques	AN-211 AN-402 AN-432 AN-432	
National Semiconductor Corp. 2975 San Ysidro Way Santa Clara, Calif. 95051 Atten: Regis P. McKenna	MOS memory applications MM420/MM520 character generator Putting MOS to work MOS clock driver Low power MOS memory systems Delay line applications using MOS MOS load elements MOS 100-bit word generator MOS scratch pad/content addressable memory MOS analog function generator MOS delay lines MOS clock savers Arithmetic functions using MM415/MM515	AN-7 AN-14 AN-16 AN-18 AN-19 AN-25 TP-7 Brief 1 Brief 2 Brief 3 Brief 4 Brief 5 Brief 6	Sept. '68 Mar. '69 Jan. '69 Feb. '69 Feb. '69 Mar. '69 Apr. '68 Sept. '68 Oct. '68 Nov. '68 Dec. '68 Mar. '69 Apr. '69
Philco-Ford Microelectronics Union Meeting Rd. Blue Bell, Pa. 19422 Atten: John Kitzrow	MOS reliability report Building block handbook Assessment of reliability of MOS devices (NASA report)—Astrionics Laboratory PL5R100 dynamic MOS shift register Use of PL4G01 in Sequential circuitry Bipolar/MOS interface techniques PL4M01 MOS dual JK flip flop PM1024 MOS 1024-bit permanent memory PL4S16 MOS 16-channel multiplexer		Nov. '67 Oct. '67 Oct. '67 Oct. '67 Nov. '67 Jan. '68 Jan. '68 Apr. '68 Mar. '68
RCA Electronic Components 415 S. 5th St. Harrison, N.J. 07029 Atten: David Griswald	Complementary MOS transistor logic ICs	ICAN-5593	Dec. '67
Siliconix Inc. 1140 W. Evelyn Avenue Sunnyvale, Calif. 94086 Atten: Lee Lynberg	Drivers and FET switches		Aug. '68
Texas Instruments Inc. P.O. Box 5012 Dallas, Tex. 75222 Atten: Berry Cash	MOS static shift registers and TTL/DTL systems MOS IC reliability facts	CA-114 CA20974	Nov. '68 Jan. '69

5 revealing questions to ask hybrid manufacturers:

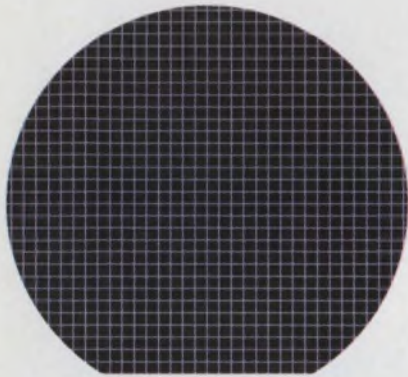

1 Do you manufacture your own chips? Fairchild does. We're the only manufacturer that manufactures, tests and stores our own chips. We test over three million dice in our hybrid facility every month. And we store over 10 million dice, ready to be used right now. Response to any demand is quick and in volume. From Fairchild.

2 How large is your selection of hybrid components? Back to the Fairchild stores, where we've got those 10 million dice. They include everything from simple diodes to complex LSI functions. If you need it, you can get it right now. From Fairchild.

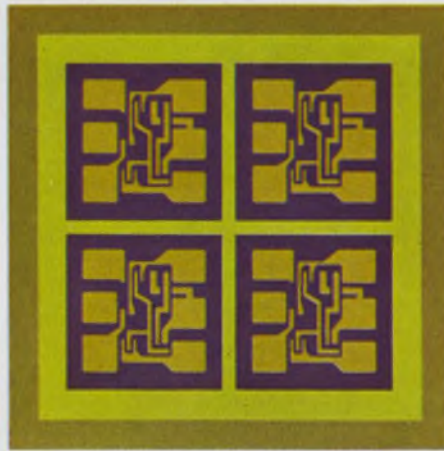

3 Can you offer computer-aided design? Fairchild not only offers, but delivers. If those 10 million single chips in our facility won't do your job best, we give your problem to our CAD group. With our new computer-aided design technology, the whole design procedure

—choosing the logic elements to implement your function, generating diffusion and metalization masks, even setting up functional and electrical test sequences for checking out the completed device — is all handled by the computer. It's just one of the things that



makes our prices the lowest in the industry. Your special functions are available fast and economically. From Fairchild.

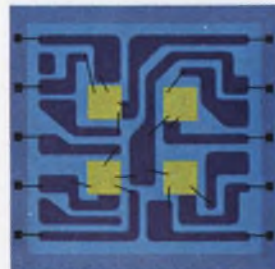

4 Are you limited to any specific technology? Not at Fairchild. We use the technique that's best for you. Thick film for economy. Thin film for accuracy and radiation resistance. Thin film on silicon if the function calls for a lot of active devices—discretes, MOS or LSI—and few passive ones. Whatever's right. From Fairchild.



5 Can you make hybrids in production quantities? At Fairchild, we make so many hybrids we've even got a line of standard hybrid functions priced like discretes. Hybrid production is on an assembly line basis, with the lines split according to the complexity of the functions being manufactured. Skills and equipment are matched exactly to the products. The products are right on price, performance and reliability. From Fairchild.

When all the answers are in, you'll find that Fairchild is the only manufacturer that qualifies as a complete hybrid source. For everything. Packages. Products. Substrates. Volume.

If there are more questions, you can get one brochure that has all the answers. Only from Fairchild. Write for it today!

FAIRCHILD
SEMICONDUCTOR

Fairchild Semiconductor / A Division of Fairchild Camera and Instrument Corporation
313 Fairchild Drive, Mountain View, California 94040 (415) 962-5011 / TWX: 910-379-6435

New from United Aircraft

control logic



A family of 28 volt integrated circuits including dual and quad gates, expandable gates and gate expanders, set-reset flip flops, 5 volt to 28 volt converters and 28 volt to 5 volt converters, featuring:

- **Large supply variation tolerance** – 16 to 40 volts
- **High A.C. noise immunity** – rejects 2 u sec pulses of up to 90 V
- **High D.C. noise immunity** – 8.5 volt input threshold
- **High current sinking ability** – 100 mA steady state, 1 ampere transient
- **High output signal swing** – up to 90 V
- **Full military temperature operating range** – -55°C to $+125^{\circ}\text{C}$
Also available in industrial range from 0°C to $+85^{\circ}\text{C}$
- **Packaged** in $\frac{1}{4} \times \frac{3}{8}$ flatpack

United Aircraft control logic, operates from 16 to 40 volt sources and is ideally suited for directly driving indicators and actuators. Control logic replaces relays and discrete device circuitry and provides significant reduction in size and weight. For more information, contact:

Electronic Components DIVISION OF **United Aircraft**

TREVOSE, PENNSYLVANIA Tel. 215-355-5000 TWX: 510-667-1717
IN THE WEST: 128 E. KATELLA AVE., ORANGE, CALIF., (714) 639-4030

INFORMATION RETRIEVAL NUMBER 28

INFORMATION RETRIEVAL NUMBER 29 ►



We call it INCONNECT®. Our new Molex modular system that provides five ways of interconnecting electrical-electronic printed circuit assemblies: Two ways to connect circuit boards to chassis, three ways to interconnect printed circuit boards. It's a giant step forward in helping speed production and assembly techniques in the area of printed circuits. Unique flexibility enables you to tailor connector components to your specific product needs. Easily. Simplifies assembly, testing, servicing and model change requirements. It's another example of the Molex creative approach to circuitry problems. One that demonstrates just how reliable and economical printed circuit connections can really be. But see for yourself. Write for details. Or you can make connections by calling (312) 969-4550.



Try this linear FET model with ECAP.

Several versions of the basic model fill a number of design needs. Parameters can be taken from a spec sheet.

Getting the most out of powerful computer-aided design programs usually starts with the selection of an accurate device model. If you're using ECAP^{1,2,3} (Electronic Circuit Analysis Program), this selection isn't too difficult—unless you want to model a FET. There are good models for conventional transistors, diodes and op amps, but not much for the FET.

Don't give up. Here is a linear FET model developed for use with ECAP. The model has the following features:

- Very high input impedance—that is, nearly infinite resistance shunted by the input capacity.
- Changes in drain current that are a function of the input voltage.
- Ability to sense the current feedback of the external source impedance.
- Parameters that are readily available from a typical specification sheet. The specific ones needed are I_{DSS} , g_m at I_{DSS} and, at various values of $I_D < I_{DSS}$, output conductance and the input, output and feedback capacitances.

Various circuit configurations, as well as ac and dc analysis, can be handled with the proper version of the basic linear model.

Current sources do the trick

Derivation of the FET model is based on the gain equation

$$A_v = - (g_m Z_L) / (1 + g_m Z_s).$$

A detailed look at how the model was derived is shown in the accompanying box.

Since the FET is essentially a voltage-controlled device, and ECAP doesn't recognize dependent voltage sources, a voltage-controlled dependent current source had to be devised to represent the input. To meet this requirement, a "buffering" technique¹ was used, as follows: The input (Fig. 1) consists of a bias resistor, R_B , of any desired resistance. A dependent current source, T_1 , is

placed across the bias resistor and driven by the current flowing through R_x .

The β will be ± 1 , depending on the assigned direction of current flow. The current direction shown in Fig. 1a requires $\beta = -1$. This supplies the current required by R_x , so that the input source sees only R_B shunted by C_{in} (Fig. 1b) as a load. Since the gate current of a FET is on the order of nanoamps, this results in a reasonably accurate representation of the FET input.

To simulate the drain-source channel of the FET, a conductance is shunted by an I_{DSS} generator, and a dependent current source is driven by the transconductance. For the basic dc model shown in Fig. 1a, the g_m at I_{DSS} for some specified V_D can be taken from the spec sheet

The drain V-I characteristics of the model are compared with those of an actual FET in Fig. 2. The shaded area shows where the model departs from the true condition. Therefore this model imposes two restrictions on circuit operation:

- The gate-source diode must never be forward biased.
- V_{D_s} must be greater than V_p .

These, however, are normal restrictions for linear operation.

Initial assignment of current direction is arbitrary, but the sign of β in the dependent current sources must agree with the assumed direction of current. For example, in Fig. 1a, a current flowing from node *one* to node *zero* in branch *two* must cause an equal current to flow in branch *one* from node *zero* to node *one*; but this is in opposition to the direction assigned in branch *one*—thus, $\beta = -1$. Also, in branch *three*, where the current is assumed to flow from node *two* to node *zero*, the sign of I_{DSS} must be negative. This results from the way independent current generators are treated by ECAP².

If there is any doubt about whether these relationships have been properly chosen, a miscellaneous output can be requested on the first run, which will give the nodal conductance and impedance matrices. Examination of the main diagonal element corresponding to the input node (in Fig. 1a, it would be the first main diagonal element) will clear up the doubt. If the impedance or conductance corresponds to the value of R_B , the proper

William Spencer, Design Engineer, Bell & Howell, CEC Transducer Div., Monrovia, Calif.

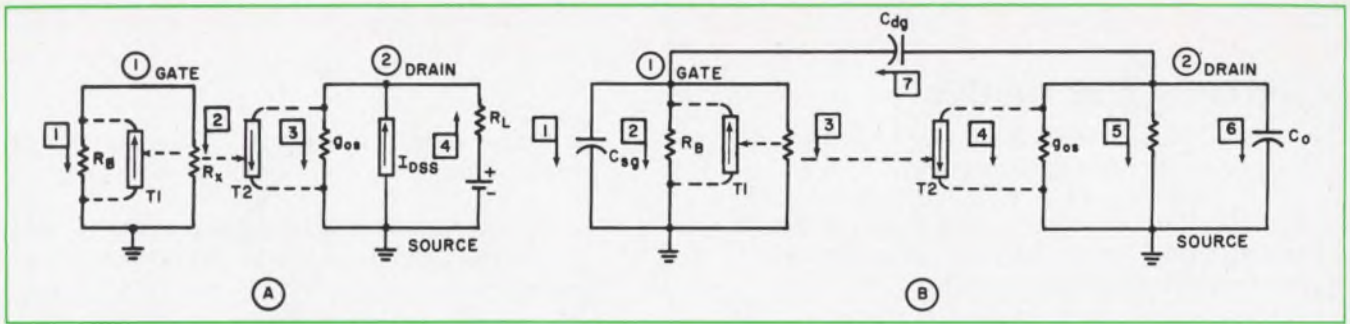

1. **Dependent current sources are key elements** in this linear FET model for use with ECAP. The basic dc model

shown in (a) can be adapted easily for ac use with a few simple modifications.

Key to symbols

The following symbols are used throughout the text and illustrations:

- g_o = Output conductance.
- C_{dg} = Drain-to-gate capacitance.
- C_{sg} = Source-to-gate capacitance.
- C_o = Output capacitance.
- R_s'' = Dummy *to* branch—five orders of magnitude greater than R_s' .
- R_s' = Source bias resistor.
- C_s = Source bypass capacitor.
- R_B = Gate bias resistor.
- R_s = Dummy current sensing resistor.
- R_L = Load resistor.
- T_1, β = -1
- T_2, g_m = Non-degenerated g_m .
- $T_3, g_m' = \frac{g_m}{1 + g_m R_s'}$
- $T_4, \beta^* = \frac{g_m - g_m'}{g_m'}$

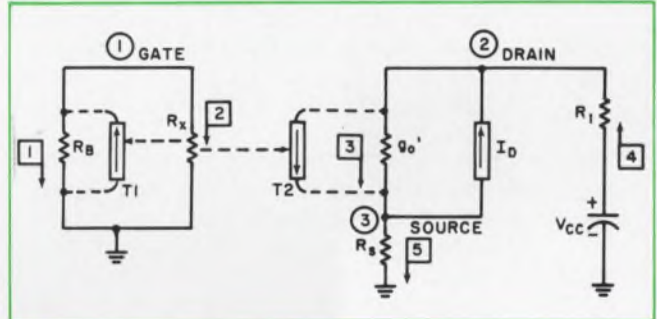

3. **Resistor stabilizes the operating point.** Selection of the proper value for stabilizing resistor R_s can be done graphically or with a curve tracer.

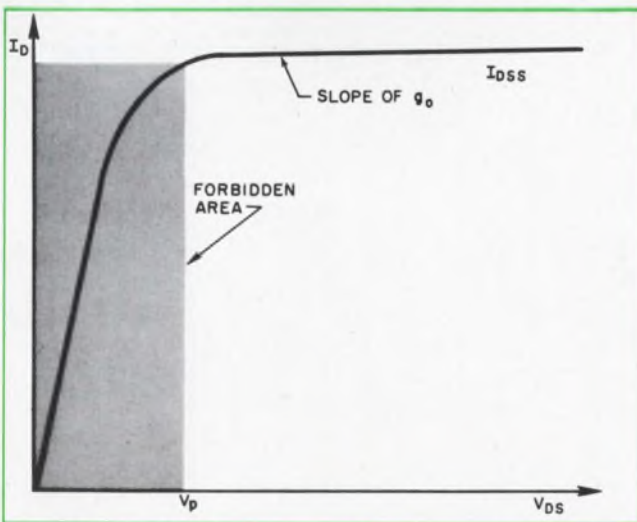

2. **Plot shows good linear performance** of the FET model. The shaded area indicates the portion of the model's range that is not suitable for linear representation.

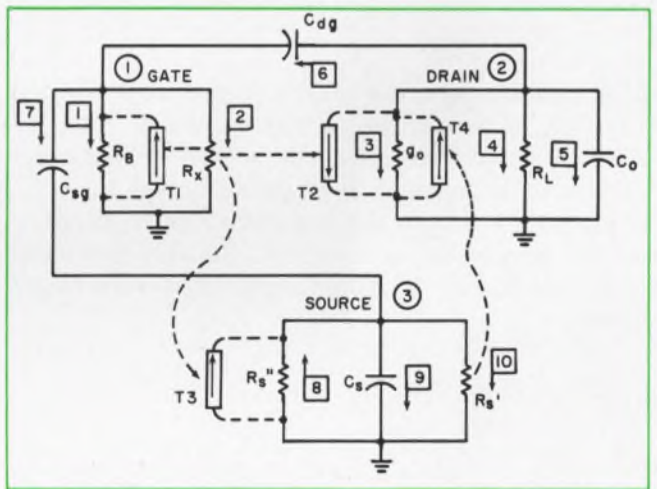

4. **General FET model for ac** requires two additional current sources, T_3 and T_4 .

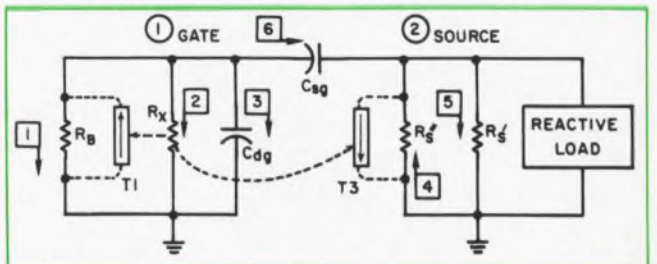

5. **Reduce current sources** by using this source follower version of the model. Only two current sources are required here, rather than four as in other versions.

Deriving the model

The models described in the text were developed around the gain formula

$$A_v = -[g_m / (1 + g_m Z_s)] Z_L \quad (1)$$

Therefore, for the basic model, where the source is grounded (for example, no source resistor), the transfer function is simply

$$A_v = -g_m Z_L \quad (2)$$

However, when an impedance is inserted between source and ground, the transfer function becomes Eq. 1 above. If no reactive components are considered, as in dc amplifier applications, the transconductance becomes,

$$g_m' = g_m / (1 + g_m R_s) \quad (3)$$

Returning to Eq. 1, we see from inspection that

$$\lim_{z_s \rightarrow 0} [g_m / (1 + g_m Z_s)] = g_m \quad (4)$$

Thus we assign to T_2 the value of g_m without any degenerative effects. The voltage seen at the source will be (source-follower gain):

$$V_s = [g_m / (1 + g_m R_s)] R_s |_{V_G = 1} \quad (5)$$

Thus, we define

$$g_m' = g_m / (1 + g_m R_s) \quad (6)$$

and assign to T_3 the value of g_m' .

Now, $|I_D| = g_m V_o$, and $|I_{R_s}| = g_m' V_o$, and therefore, clearly, $I_D \neq I_{R_s}$. In order to equalize these currents, either $R_s \rightarrow 0$, or we must develop

a "fudge factor" to equalize them. This fudge factor, which we will define as β^* , is equal to

$$-(g_m - g_m') / g_m' \quad (7)$$

The two dependent current generators, T_2 and T_3 , couple currents into the drain channel as follows:

$$\begin{aligned} T_2 &= g_m \\ T_3 &= g_m' \beta^* \end{aligned}$$

$$\begin{aligned} \text{Therefore, } I_D &= (g_m + g_m' \beta^*) V_o \\ &= [g_m + g_m' (-g_m + g_m') / g_m'] V_o \\ &= g_m' V_o, \end{aligned}$$

which results in $|I_D| = |I_{R_s}|$, and the fudge factor is proved.

If we shunt a capacitance across R_s and increase frequency, the current flowing in R_s , due to T_3 , approaches zero as frequency increases. Since β^* is a function of I_{R_s} , $\beta^* \rightarrow 0$ as $I_{R_s} \rightarrow 0$, and the $\lim_{\beta^* \rightarrow 0} (g_m + g_m' \beta^*) = g_m$.

Also, $V_s = I_{R_s} R_s$ and $V_s \rightarrow 0$ as $I_{R_s} \rightarrow 0$. β^* is a complex function because of the phase relationships produced by the parallel $R_s C_s$ circuit.

A sample ac analysis was run using a model where all capacitive elements, except C_s , were disregarded. The model is shown in (Fig. 6), and the results are plotted in (Fig. 7). A sample of the program is given in the table at right.

direction has been assigned; if the impedance is $(1/2)R_s$, however, the sign of β must be changed. Also, if I_{DSS} is assigned the wrong polarity, the voltage at node two will be greater than V_{cc} .

Figure 1b shows the modifications required to use the model for ac analysis; the I_{DSS} generator is removed, and the appropriate capacitances are added.

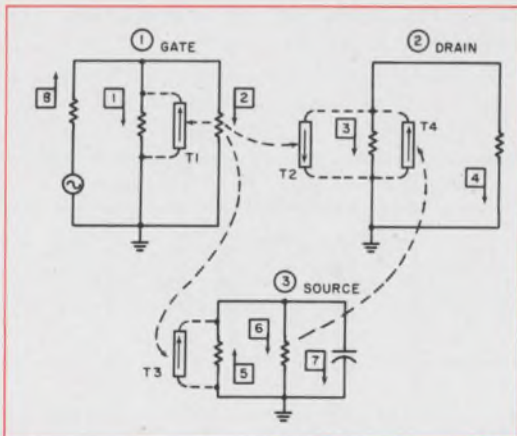

6. All capacitive elements except C_s are excluded in this ac model.

So far in the model, $V_G = V_{GS}$ and $I_D = I_{DSS}$. To stabilize the operating point, some value of R_s (Fig. 3) is usually inserted in the source. The value of R_s is determined as follows:

$$R_s = V_{G_s} / I_D$$

V_{G_s} can be determined graphically by examination of the V_{D_s} vs I_D characteristics, if available, or by

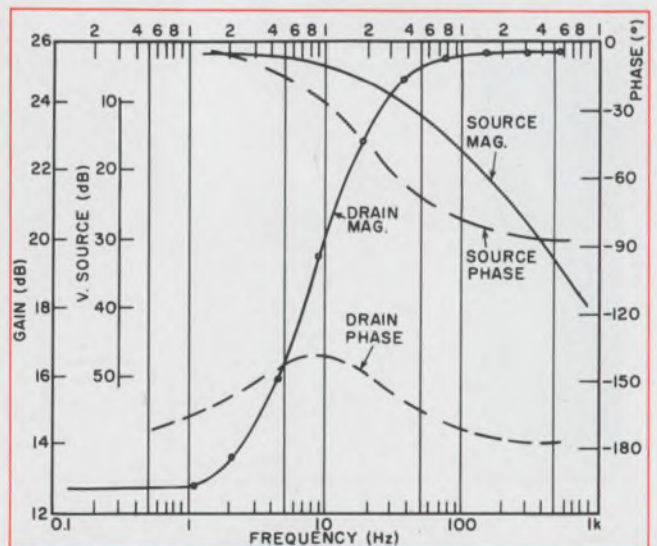

7. Curves show the analysis results of the ac model depicted in Fig. 6.

Sample Program

```

C Sample program using ac model of Fig. 6,
C where all frequency sensitive elements are re-
C moved except for the source bypass capacitor.
C ac analysis

B1 N(1,0),R=1E6
B2 N(1,0),R=1E4
B3 N(2,0),G=1E-5
B4 N(2,0),R=5.1E3
B5 N(0,3)R=1E8
B6 N(3,0),R=9.1E2
B7 N(3,0),C=1E-5
B8 N(0,1),R=.01,E=.1/0

T1 B(2,1),BETA=-1
T2 B(2,3),GM=4E-3
T3 B(2,5),GM=3.62E-4
T4 B(6,35),BETA=-3.64037
Frequency=.001
PU,NV,CA
EX

C Sweep frequencies to obtain frequency/phase
C response.

MO
Frequency=1.098832(2)1.125E3
EX

```

use of a curve tracer. V_{G_s} can also be determined analytically by using the following formula⁴:

$$V_{G_s} = V_p (1 - \sqrt{I_D/I_{DSS}}).$$

The g_m of T_2 must be altered to account for the degenerative feedback of R_s . To do this, let g_m' be the altered g_m . From the spec sheet, determine the value of g_m corresponding to the chosen value of I_D . Now,

$$g_m' = g_m / (1 + g_m R_s).$$

If R_L is reduced to some very low value, this model will work as a source follower. By addition of the appropriate capacitances and removal of the I_D generator, the ac version of a source follower results. However, this source-follower model will not work properly if the load is reactive. To obtain the characteristics of a FET with reactive elements in the source, the models shown in Figs. 4 and 5 are used.

In Fig. 4, R_s is detached and moved to R_s' , and shunted by some value of bypass capacity, C_s . By use of an additional dependent current source, T_3 , the appropriate current can be made to flow in R_s' . Then, a negative feedback is developed by use of another dependent current source, T_4 .

R_s'' is also required, because a single resistor

cannot be a *to* and a *from* branch for dependent current sources. R_s' is made equal to R_s , and R_s'' is made very large (approximately five orders of magnitude greater than R_s'). R_s'' is just a dummy *to* branch, and should not appreciably affect the characteristics of $R_s' C_s$. The value of $g_{m3} = g_m'$, and $g_{m2} =$ non-degenerated g_m , corresponding to the dc operating point.

It is now necessary to derive a feedback factor to determine the β value of T_4 . This is accomplished as follows: The voltage gain is

$$A_v = -[g_m / (1 + g_m R_s)] R_L$$

and

$$g_m' = g_m (1 + g_m R_s).$$

Here, g_m' represents the degenerated transconductance and g_m is the non-degenerated transconductance. Therefore if the feedback reduces I_D by the difference between g_m and g_m' , we should get a true gain. Thus we define

$$\beta^* = - [(g_m - g_m') / g_m'].$$

From inspection, we see that

$$\lim_{g_m' \rightarrow g_m} [(g_m - g_m') / g_m'] = 0,$$

which is the desired result. As frequency increases, the shunting effect of C_s will draw more of the current and R_s will draw less, thereby reducing negative feedback and producing the appropriate phase shift. This results in an accurate analysis of the low frequency roll-off characteristics of the amplifier.

The relative current directions of T_3 and T_4 must correspond to the assigned branch current directions, or a positive feedback will result. A small error, usually negligible, will result because of the change in output conductance as the feedback changes.

This model requires the use of four dependent current sources. These are always at a premium, but the results justify the extravagance. The proper gain/phase relationships are duplicated at both the drain and source terminals. If a source follower (Fig. 5) is desired and the drain is ac grounded, the dependent current sources, T_2 and T_4 , can be eliminated, thus reducing to two the number of dependent current sources required. ■ ■

References

1. IBM 1620 Electronic Circuit Analysis Program, Users' Manual #H20-0170-1, pp. 117-118.
2. IBM 1620 Electronic Circuit Analysis Program, Users' Manual #H20-0170-1, p. 6.
3. R. W. Jensen and M. D. Lieberman, IBM Electronic Analysis Program (ECAP) Techniques and Applications (Englewood Cliffs, New Jersey: Prentice-Hall).
4. FET Applications Handbook, Chap. 7, editor; J. Eimbinder, New York: Tab Books, 1968).

**We've made child's play
out of toroid selection
for pulse transformers.**

INDIANA GENERAL

We make it easy for the design engineer.



Indiana General's popped up with an end to trial-and-error spec'ing: the first and only toroids with specified characteristics for pulse transformer applications.

Not just the usual irrelevant magnetic properties, either. Each part is designed as a pulse component, and listed by its pulse inductance, pulse magnetizing current and ET product. All according to ASTM methods.

And thanks to our automatic high speed testers, we can guarantee all parameters. Every pulse transformer toroid we make is 100% pulse-tested to performance specifications. So reliability is assured, from samples to production quantities. And all toroids can be coated, to prevent the wire's insulation from being scraped when winding, or penetrated later. Various toroid sizes from 0.080" are available. Tell us your pulse transformer core problems.

Indiana General Corporation
Electronics Division/Ferrites
Keasbey, New Jersey

Let's see how your pulse-rated toroids can make it easier for me. Attached are details of my pulse transformer core problems.

NAME _____
TITLE _____
COMPANY _____
ADDRESS _____
CITY _____ STATE _____ ZIP _____

Get better dc servo motor performance

when using a transistor bridge by following these guidelines to more efficient design.

Dc servo motors are frequently driven by transistor bridges. Many of these designs, though, are not as efficient or economical as they could be. The pitfalls include:

- Selection of improper transistors.
- Under-design or over-design of the required heat sink.
- Improperly specified motor winding requirements.

Yet, by adhering to a few basic guidelines, the designer can avoid each of these snags and optimize his design. Although these guidelines cannot cover all possible situations, they provide a useful framework for most designs.

We will use the circuit configuration of Fig. 1 as the basis for the design guidelines. In the diagram, control signals from the operational amplifier are boosted by the driver stage to the level required to operate the bridge. Since the driver stage affects the design of the bridge, it will be assumed that the driver has the following characteristics:

- Output configuration is compatible with npn bridge transistors in order to minimize transistor cost.
- Output voltage swing is at least ± 20 V, with

28-V line voltage, so the bridge transistors can provide unity gain.

- Output current is sufficient to drive a high-current power transistor (± 0.75 A is considered a reasonable value).

- The driver is capable of limiting the motor current to some preselected value, to protect the motor and the transistors.

- The driver can withstand voltage spikes, as specified in MIL Std 704 (such a characteristic, in fact, is frequently a practical requirement in commercial systems as well).

The output characteristics of a driver that has all these features is shown in Fig. 2.

With a given driver stage, then, the design of the output bridge involves proper selection of the output transistors and the design of their heat sinking. To do this, the electrical load characteristics of the servo motor must be determined. And since most servo motors are, or can be, wound to suit performance requirements, this means determining the optimum motor armature winding.

Winding solution is straightforward

The optimum motor armature winding for a given application is normally the one that will

John A. Luneau, President, Inland Controls, Boston.

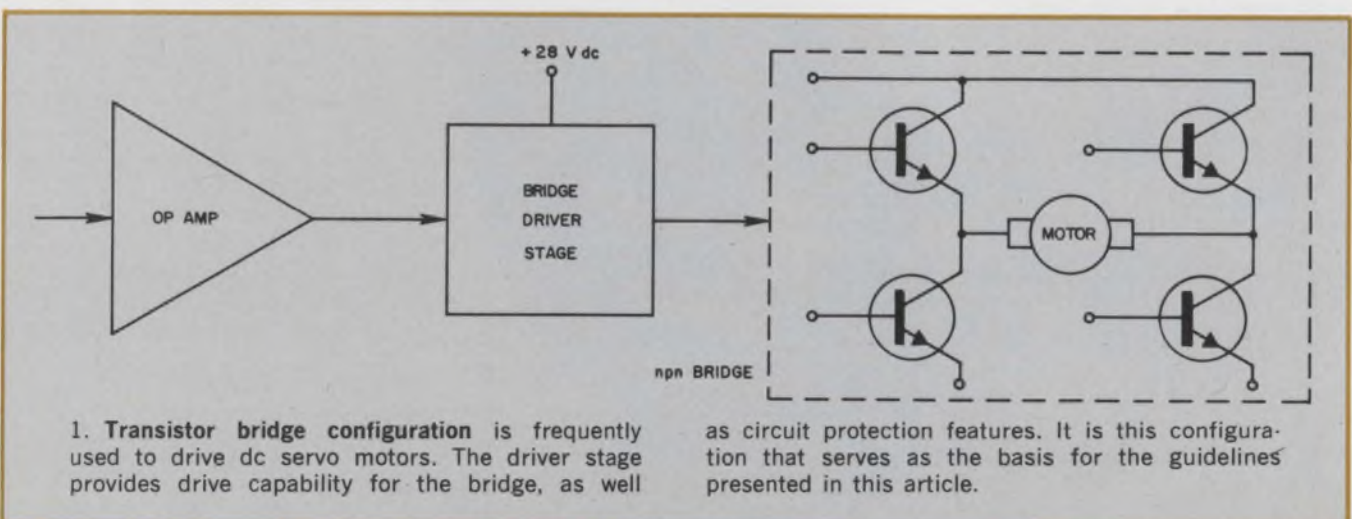

cause the motor to deliver a specified torque at a specified speed and under the specified terminal voltage. The following expression relates these parameters, as well as the basic motor size parameter, K_M (all symbols are defined in Box 1):

$$R_M = \left[\frac{V_{max}}{(T/K_M) + 1.36 K_M \omega} \right]^2 \quad (1)$$

Since the output bridge transistors provide unity gain, the output voltage is approximately 20 volts at saturation (Fig. 2). Therefore,

$$R_M = \left[\frac{20}{(T/K_M) + 1.36 K_M \omega} \right]^2$$

The nearest available value of armature resistance, R_M , below this number should be selected. In most instances resistance values are available in geometric steps of 1.59, whether or not they appear on the manufacturer's data sheets.

Thus for cases where the motor size (K_M) is fixed, Eq. 1 provides a straightforward solution to the winding selection question. Equation 1 is also very useful in establishing trade-off decisions between motor size and amplifier power requirements. Of course, in either case, some margin should be provided in the over-all design to account for motor resistance tolerances and variations with temperature, as well as the need for voltage control margin below saturation.

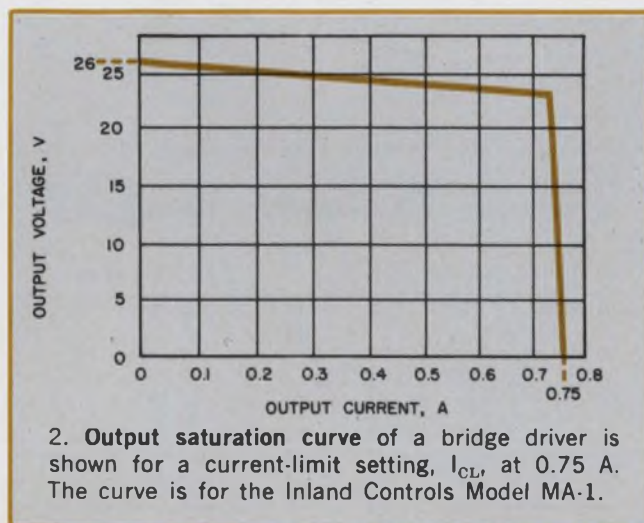

Once a motor with the correct armature resistance has been selected, the maximum circuit current, I_{max} , and maximum back emf, V_{Bemf} , can be calculated from the following equations:

$$I_{max} = T_{max}/K_T$$

$$V_{Bemf} = K_B \omega_{max}$$

Typically the current limit set-point for the bridge is the calculated value of I_{max} .

Transistors must handle worst-case power

For reliable circuit operation, the bridge transistors must be able to dissipate the worst-case power at the highest ambient temperature. This means that at least the following three worst-case situations must be considered:

1. Generation by the motor of the maximum back-emf possible during servo operation. This includes slewing, testing or other abnormal situations.
2. A possible requirement for "screwdriver" short-circuit protection (of short duration).
3. A possible requirement for indefinite short-circuit protection (continuous and with highest ambient temperature).

The first of these situations exists in practically all linear servos. It occurs under a full

Symbols and units

R_M	Motor armature resistance
V_{max}	Maximum output voltage from bridge amplifiers, loaded
T	Torque at speed ω , in lb-ft
K_M	Motor constant, in lb-ft/(watts) ^{1/2}
ω	Motor speed, in radians/second
K_T	Motor sensitivity, in lb-ft/A
K_B	Motor back emf, in volts/radian/second
W	Power, in watts
I_{CL}	Current limit set point, in A
V_B	Line voltage, in V

“plugging” (reversal) condition from maximum slew speed, and results in the following power dissipation in each of the bridge transistors:

$$W_{max} = [(V_B + K_B \omega_{max}) I_{CL} - R_M I_{CL}^2] / 2 \quad (2)$$

The resulting power value exists only instantaneously, since the motor speed begins falling exponentially. Nevertheless, for systems having mechanical time constants of 10 ms or more, the transistors must be able to withstand this rating at the temperature anticipated.

For very low mechanical time-constant systems (of less than 10 ms), as well as for large electrical time-constant systems (of greater than a few ms) the thermal dynamics of the transistor junction may be successfully utilized to reduce the required power rating. However, such a situation, which is beyond the scope of this article, is uncommon, and very tricky at best.

For applications involving types 2 and 3 worst-case situations, Eq. 3 describes the power dissipation requirements for each bridge transistor.

$$W = V_{B+} I_{CL} / 2. \quad (3)$$

In addition, the type 3 situation requires special heat-sink considerations.

If the driver stage incorporates common-mode feedback, the voltage across any single transistor in the bridge will not exceed the maximum value of V_{B+} , even under plugging conditions of the servo motor. Thus the V_{CEO} of the transistor need

not be more than 40 V for most applications, although for cases involving MIL-Std-704, an 80-V unit must be used. With no such feedback, the V_{CEO} rating of the bridge transistors must be at least equal to $2 \times V_{B+}$.

The required minimum value of beta for the bridge transistor is the ratio of the required output current to the current that the driver can deliver to each base, over the specified operating temperature range.

A selection of six commercially available power transistors, together with their specified values for the parameters just discussed, is given in Table 1. Although the listed devices were selected for their general usefulness in these applications, there are many more that are also applicable.

Heat sink design: the final problem

The heat sink used with the output transistors must keep the transistor case temperatures within the manufacturer's specified limits. To do this, the heat sink must have a suitably low thermal resistance to ambient air, where the thermal resistance includes the transistor mounting insulators. Some of the typical thermal resistances for different heat sink designs are listed in Table 2.

Once the maximum ambient temperature and the maximum allowable transistor case tempera-

Table 1. Representative power transistors

No.	Various Mfrs.	Max power dissipation watts*	V_{CEO} (V)	h_{FE} at 25°C	Max current (A)	Advertised price (small quant.)
2N3055	Soliton	115	60	20 to 70	15	\$1.82 each
2N5301	Motorola	200	40	15 to 60	30	6.90
2N5302	Motorola	200	60	15 to 60	30	7.65
2N5303	Motorola	200	80	15 to 60	30	18.00
154-10	Westinghouse	200	100	16 min.	7.5	15.85
164-10	Westinghouse	200	100	25 min.	20	25.60

* This power dissipation capability is at 25°C case temperature. Derate this value linearly to zero at 200°C case temperature.

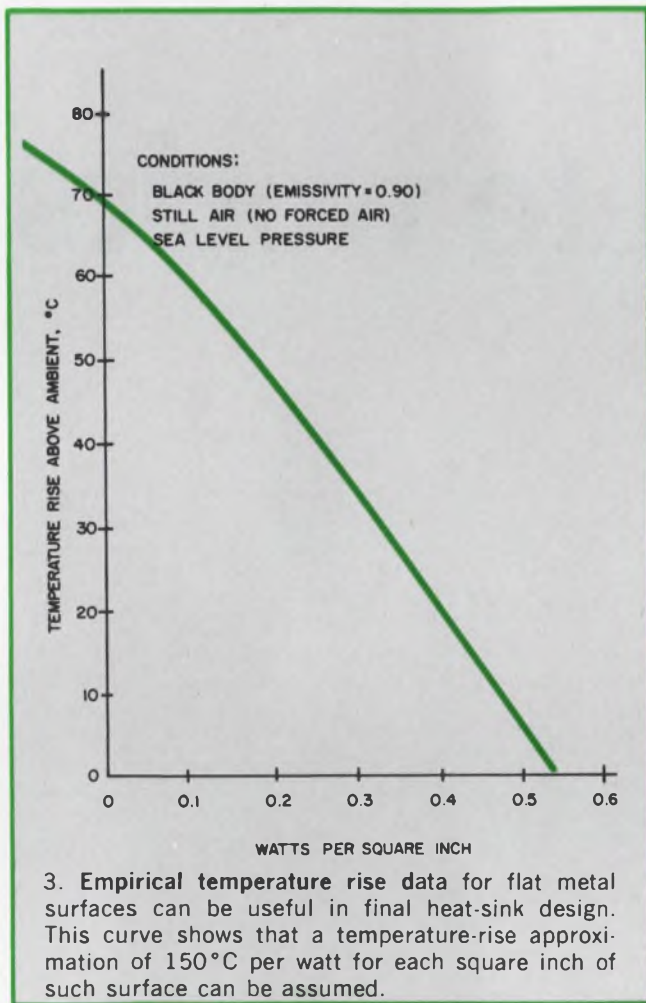

Table 2. Types of heat sinks

Technique	Thermal resistance heat sink to ambient air (°C/Watt)
Flat plate mounting	3 to 6
Extruded-type passive heat sink	1 to 3
Extrusion sink with area air flow	0.3 to 1.0
High efficiency forced and ducted air onto finned heat sink	0.1 to 0.2

Note: For the type of power bridge covered in the article, the transistor must be electrically insulated from the heat sink. For a good beryllia insulator, add 0.25°C per watt to the above values.

ture are established, the remaining task is to determine the average power dissipation in the transistor (or in the transistors, if all four are clustered together). The average dissipation requirement for all four transistors is only two times higher than that for a single unit, if we assume that the motor torque directions more or less average out.

For a single bridge transistor, the average power dissipation, W_{ave} , can be calculated from the equation:

$$W_{ave} = [(V_B - K_H \omega_{SS}) T_{SS} / K_T - (T_{SS} / K_T)^2 R_M] / 2.$$

The SS subscripts here indicate the average, steady-state values of the particular parameters.

Heat-sink temperature-rise data, such as that shown in Fig. 3, can then be used for final heat-sink design. The curve of Fig. 3 is based on empirical data taken on flat metal surfaces exposed only to radiation and convection cooling effects (no forced air). From the curve, a safe temperature-rise approximation of 150 degrees C per watt for each square inch of such surface can be arrived at. ■■

Test your retention

Here are questions based on the main points of this article. Their purpose is to help you make sure you have not overlooked any important ideas. You'll find the answers in the article.

1. In any given application, what is the optimum dc servo motor armature winding?

2. Under what conditions does the transistor bridge experience worst-case power dissipation requirements?

3. Are the heat-sink requirements based on average or peak power considerations?

Monolithic Voltage Regulators

the complete works

now in paperback



Five voltage regulator application notes including two just published; 60 pages of design information on positive and negative voltage regulators. Sixteen pages of specification information including significant graphs of performance characteristics. An eight page Reliability Report encompassing Production Processing, Quality Control, Screening, Life Testing, Environmental Testing and Design Philosophy. The most complete set of design aids in print for monolithic voltage regulators. You can see the performance; send for the book. National Semiconductor Corporation, 2975 San Ysidro Way, Santa Clara, California 95051 (408) 245-4320
TWX: 910-339-9240 CABLES: NATSEMICON

National / Linear

National Semiconductor
2975 San Ysidro Way
Santa Clara, California 95051

Send my copy of your Monolithic Voltage Regulator Library to:

Name _____

Title _____

Company _____

Street _____

City _____

State _____ Zip _____

Mail Station _____

My application is _____

Simplify your loss calculations

by using inverted log scales. The technique is easy to master, and can save considerable time.

The logarithm to the base 10 is used for converting decibels to power, voltage or current ratios according to the familiar equations:

$$\left. \begin{aligned} \text{dB} &= 10 \log P_o/P_i, \\ \text{dB} &= 20 \log V_o/V_i, \\ \text{dB} &= 20 \log I_o/I_{in}, \end{aligned} \right\} \text{ only if } R_o = R_i.$$

When transforming gains to ratios greater than unity, or ratios to dB gains, no difficulty is encountered, since the logarithm is always positive. However, for ratios less than unity negative characteristics are involved. Time and effort can be saved by using inverse logarithms (commonly known as cologarithms), where *the inverse logarithm is the logarithm of the reciprocal of a number*. The inverse logarithm automatically eliminates the need for obtaining the reciprocal of a number, and simultaneously removes the necessity of converting negative characteristics to positive values.

By subtracting the normal logarithm mantissa from 1.0, the log scale is, in effect, inverted.

P. B. Wright, Chief Engineer, Elcom Research Labs., Fontana, Calif.

Thus, a slide rule log scale would then be read from right to left, for increasing values—from 0 to 1.0, instead of from left to right (see Figure). Similarly, a table of logarithms would be read in reverse order from 0 to 1.0. The inverse scale would therefore become 1.0 minus the tabulated value.

The following examples illustrate this technique in converting insertion loss ratios to dB, and vice versa.

Converting power ratio to dB

A network has a power ratio of 0.0025. What is the loss in dB?

Solution: On the slide rule, set the cursor hair line to 25 on the D scale and read 0.602 for the mantissa of the inverted log scale (i.e., one division to the left of 4 on L scale; $1 - 0.398 = 0.602$).

Next prefix the characteristic, which is equal to the number of zeros between the decimal point and the first significant figure. There are two

The inverse log scale is generated on a slide rule by reading the L scale from right to left.

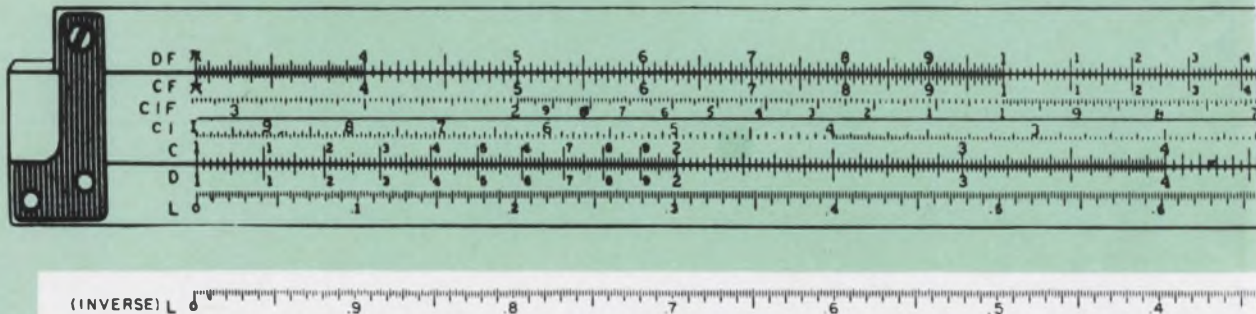

zeros; hence the logarithm of the reciprocal of 0.0025 is 2.602.

Then move the decimal point one place to the right (multiplication by 10). The loss of the network is 26.02 dB.

Voltage ratio to dB

For a network having a voltage or current ratio of 0.00056, what is the loss in dB?

Solution: Set the cursor of the slide rule to 56 on the D scale and read 0.252 on the inverse log scale (1.0—0.748 on the L scale). Assign the characteristic of 3, since there are three zeros after the decimal. Therefore, the logarithm of the reciprocal of 0.00056 is 3.252. Next, move the decimal one place to the right and multiply by 2 (multiplication by 20). The loss of the network is 65.04 dB.

dB to power ratio

What is the power ratio corresponding to -52.0 dB?

Solution: This is the reverse of the operation given in the first example, except for the magnitudes involved. The log of the reciprocal of the power ratio is $52/10$, or 5.2. The characteristic is 5 and the inverse log mantissa is 0.2. Setting the cursor hair line to 0.2 on the inverse log scale (0.8 on the normal log scale), read 631 on the D scale under the hair line. The number of zeros is 5. Therefore, the power ratio in this case is 0.00000631.

dB to voltage ratio

What voltage or current ratio results from a loss of 75 dB?

Solution: This is the reverse of the operation given in the second example, except for magnitudes. The log of the reciprocal of the ratio is $75/20$, or 3.75. There are three zeros. Setting the slide rule cursor hair line to 0.75 on the inverse log scale (0.25 on the normal log scale), read 178 on the D scale. The voltage or current ratio is therefore 0.000178. ■■

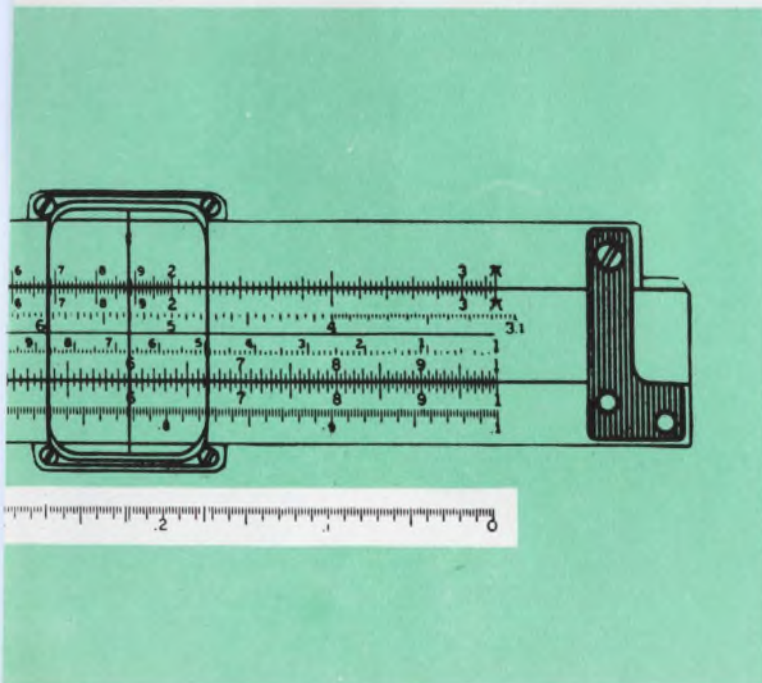

Logs—A quick review

Logarithm comes from the Greek: *logos*, meaning number, and *arithmos*, meaning proportion. Logarithms are the exponents of numbers with a given base. For example, $2^3 = 8$ in terms of logs would be written $\log_2 8 = 3$. So the log of 8 to the base 2 is 3.

For dB calculations common logarithms to the base 10 are used.

The log of a number has two parts:

The **characteristic** may be positive or negative.

The **mantissa** is tabulated or read from a slide rule. It is only defined for positive values from 0 to 1.0.

Therefore, $\log N = \text{characteristic} + \text{mantissa}$

$$\log 500 = 2 + 0.6990$$

The characteristic of the log of a number less than 1 is negative, but the mantissa is positive.

$$\log 0.005 = \bar{3}.699 = 7.699 - 10$$

CONTROL DATA

COMPUTER SYSTEM

6634



We made a tiny contribution to their esprit de core.

Or rather, our microminiature connectors did.

And it's a sophisticated memory core, too—the Extended Core Storage (ECS) System, for the huge #6000 Series computers of Control Data Corporation.

One of the largest and most powerful computers built, the #6600 has a transfer rate up to 10 million words per second to and from central memory. And the ECS will handle up to four of these computers at once.

We supply 11 different special microminiature connectors for the ECS. This includes various sizes and configurations of our basic 50-MIL STRIP connectors, supplied on a harness for interconnection between all the memory planes. Over 1,000 connector assemblies per system.

These connectors feature the 2 things most required by a computer: high density and exceptional reliability.

Both are achieved by the unique, MICROPIN® twisted pin* contact. This flexible twist pin allows .050" centers; gives 7 spiral lines of contact; will mate under the most severe misalignment; and maintains contact during intense vibration and shock.

This type of advanced design interest you? We can cover just about any need you may have in rectangular,

circular, edgeboard or strip with our microminiature connector corps: MICRO-D; MICRO-K; 50-MIL STRIP; CENTI-K; and CENTI-LOC.

For further information, write ITT Cannon, 3208 Humboldt Street, Los Angeles, California 90031. A division of International Telephone and Telegraph Corporation.



*Licensed by New Twist

CANNON ITT

Chip specs.

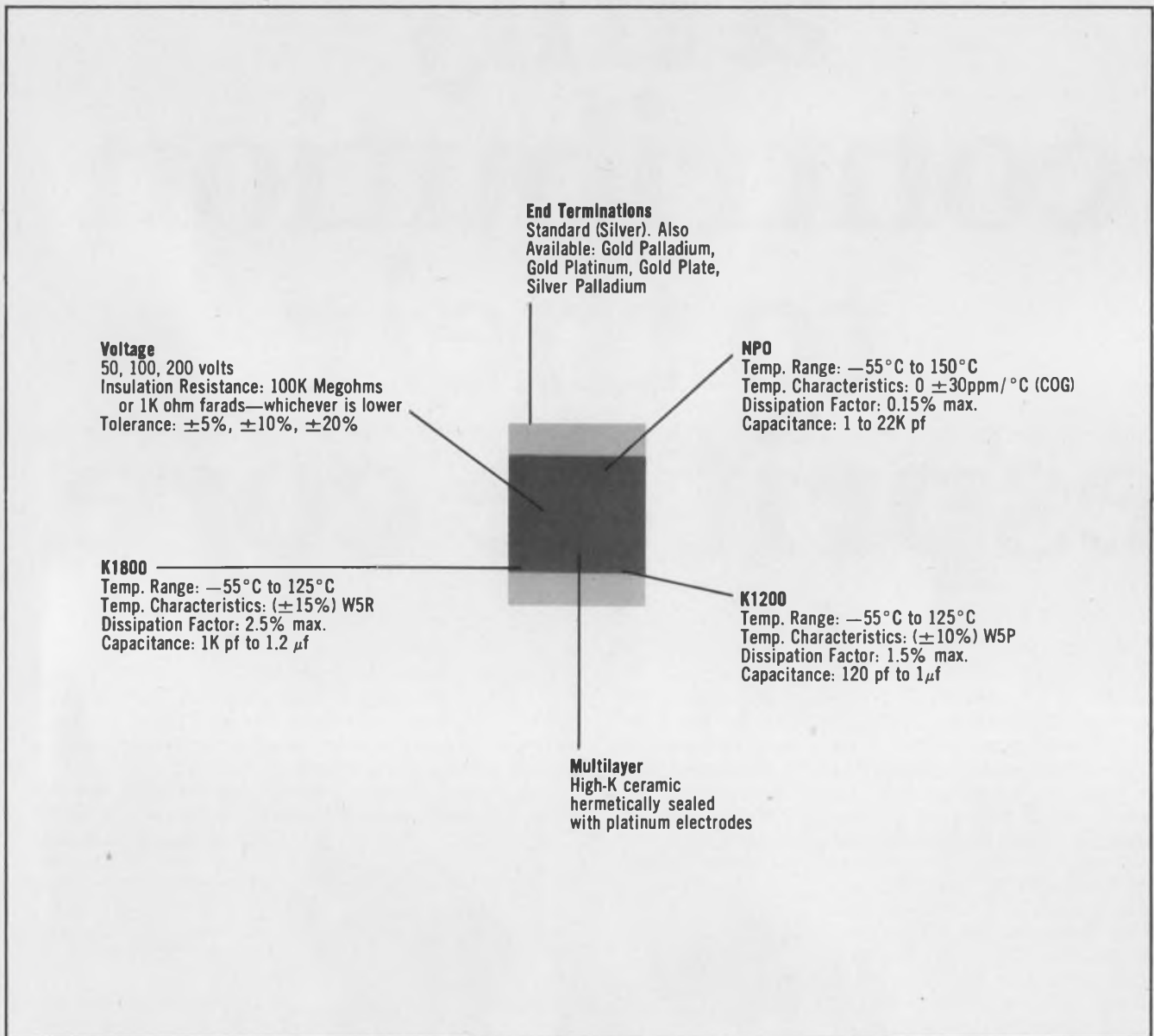

The above specs pretty well tell the story on our standard line of ceramic chip capacitors. Except that they're available in a variety of sizes in rectangular and near-square types.

And they're off-the-shelf items with COMPAR, our nationwide distribution network.

But you also should know that we can provide you with many other end terminations, capacitance val-

ues, ceramic valuations and voltage ratings.

Just get in touch with our Engineering Department. You'll find that even though you've seen one of our chips, you haven't seen 'em all.

Electro Materials 

11620 Sorrento Valley Rd., San Diego, Calif. 92121, Phone (714) 459-4355, TWX 910 322-1130
Division Illinois Tool Works Inc. Represented by COMPAR

INFORMATION RETRIEVAL NUMBER 33

INFORMATION RETRIEVAL NUMBER 34 ►

General Electric triac and SCR Power Pac... New in 1969 from the industry leader

GE plastic power pac triacs and SCR's combine low-cost with continued reliability, versatility.

General Electric, the originator of the thyristor, has developed two new 6A and 10A plastic power pac triacs and an 8A SCR; both feature a sharp cost reduction.

The cost advantage was obtained by the development of the new molded silicone plastic package that gives the devices added durability even under rough use. A solid copper heat sink terminal is used for low junction-to-case thermal resistance ($2^{\circ}\text{C}/\text{W}$).

Round leads greatly simplify your assembly and give added versatility. The leads can be conveniently formed to various configurations for easy mounting.

Dimensionally compatible with the hermetic TO-66 package, both the triac and SCR are designed for either printed circuit board or chassis mounting. Mounting is virtually foolproof because there is no maximum torque limit on the mounting screw.

SC141/146 triacs and the C122 SCR contain *glass passivated* (glassivated) pellets that mean top reliability under a wide range of operating conditions. And they are top performers for either replacement or new circuit applications.

Power Pac (SC141/146 and C122), press fit, stud mount triacs and SCR's, and the very popular C106 silicone

encapsulated SCR combine to keep General Electric the industry's thyristor leader. Performance characteristics remain compatible with GE's complete line of trigger devices for SCR's and triacs.

Applications for power pac triacs and SCR's include washers, refrigerators, and electric ranges, in houseware items—electric skillets, and coffee makers. They are also suited for industrial usage in electric furnace control, machine tools, business machines, copy machines....

Power pac units are now available through GE authorized semiconductor distributors.

For more information on these and other General Electric semiconductor products, call or write your GE sales engineer or distributor, or write General Electric Company, Section 220-70A, 1 River Road, Schenectady, N. Y. 12305. In Canada: Canadian General Electric, 189 Dufferin St., Toronto, Ont. Export: Electronic Component Sales, IGE Export Division, 159 Madison Avenue, New York, N. Y. 10016.

GENERAL  ELECTRIC

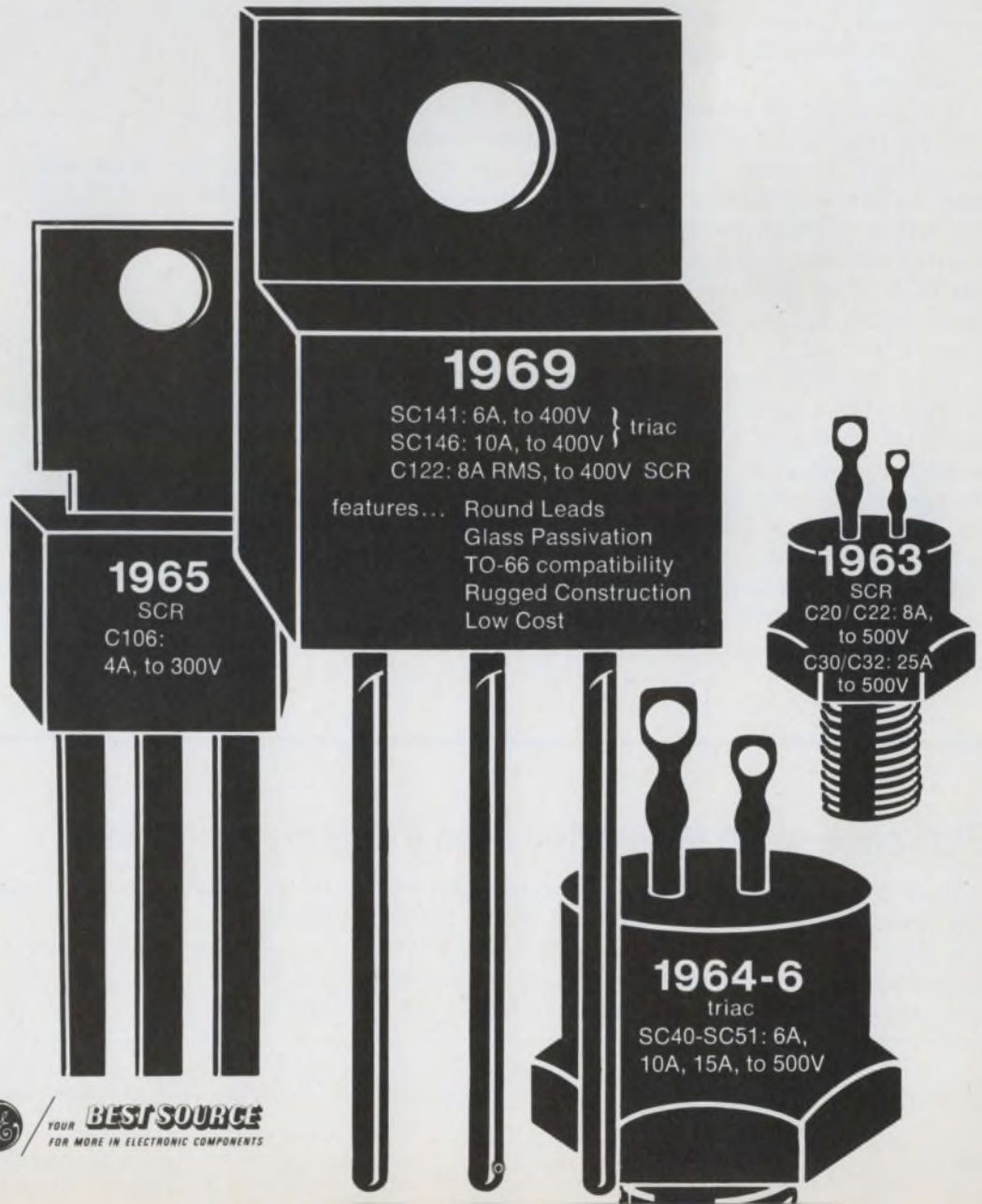

 **BEST SOURCE**
YOUR FOR MORE IN ELECTRONIC COMPONENTS

Timing circuit has many uses; like windshield-wiper control

Here is a timing circuit that can provide variable ON and OFF times for a motor. One obvious application is the control of automobile windshield wipers.

During long drives in moderate rain or fog, it is not absolutely necessary to have the windshield wipers running continuously. Usually, it is enough to clean the windshield for a few seconds at relatively short intervals. The following circuit will do the work automatically. It can be adjusted for a wiper-motor turn-off period of 5 to 35 seconds, and has a motor running time of 5 seconds.

If switch S_1 is closed, capacitor C_1 charges through resistor R_4 , potentiometer R_5 and contact a_2 of relay A . After the pre-adjusted charging time, t_1 , the unijunction transistor fires and C_1 discharges through resistor R_1 , causing a short positive increase in the potential at the cathode of the SCR. The SCR is then fired by the same pulse, which arrives at the gate (after a delay) through R_2 and C_2 .

When the SCR fires, a short discharge current is drawn from capacitor C_3 , and then relay A is energized by the SCR anode current. As a result, contact a_1 energizes the motor and contact a_2 changes state, connecting R_6 to C_1 . Capacitor C_1 then charges and fires the UJT, after t_2 . Due to the rapid increase in potential at the cathode of the SCR, it becomes reverse biased for a short time, and turns OFF. Relay A therefore switches OFF, contact a_1 deenergizes the motor, and con-

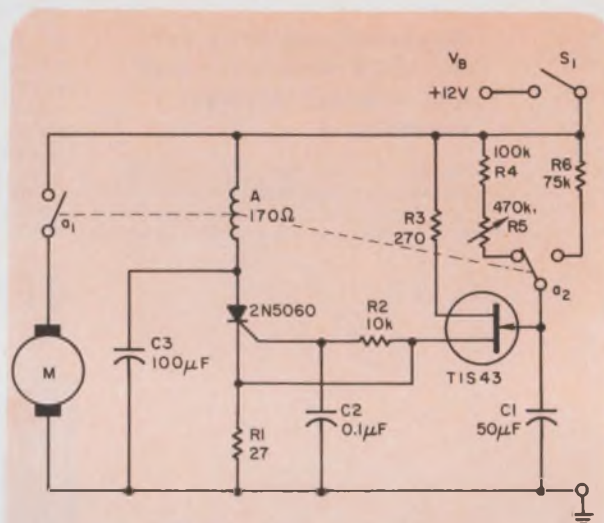

The OFF time of the motor being controlled can be varied between 5 and 35 seconds by potentiometer R_5 . The motor ON time is constant at 5 seconds.

tact a_2 changes to its previous state.

At the moment the SCR turns off, the voltage across capacitor C_3 is lower than V_B . Further, the C_3 voltage increases more slowly than the time required for the delayed pulse to arrive at the SCR gate, and so prevents the SCR from renewed triggering. C_3 also acts as a damper for the spike that occurs when the relay is deenergized.

R. Kleemann, Design Engineer, Zellweger Ltd., Uster, Switzerland.

VOTE FOR 311

Staircase-wave generator uses integrated circuits

Here is an example of how integrated circuits can change the approach to a circuit design problem. The basic components of this staircase-wave generator are a unijunction oscillator, a decade counter, and a digital-to-analog converter. If discrete components were used, the approach might not be feasible because of high component count. With integrated circuits, though, the component

count becomes nominal and the approach quite feasible.

Operation of the generator is simple. The unijunction oscillator, $Q1$, and a shaper, $Q2$, generate a continuous train of pulses. These pulses are counted by the decade counter, $A1$, and registered as a BCD output. The BCD output of the counter is converted to an analog voltage

MOLY-PERMALLOY POWDER CORES

16 standard sizes with ID's from .110" to 1.40", and OD's from .250" to 2.25". Guaranteed $\pm 8\%$ inductance limits on toroids with permeabilities of 14, 26, 60, 125, 160, 200, 300 and 550. Available either stabilized or unstabilized with temperature.

TAPE WOUND CORES

Made from nickel, silicon, or cobalt irons. We supply all AIEE standards plus special sizes in thicknesses from $\frac{1}{8}$ through 14 mils. All sizes boxed in phenolic or plastic, aluminum or GVB-coated aluminum boxes.

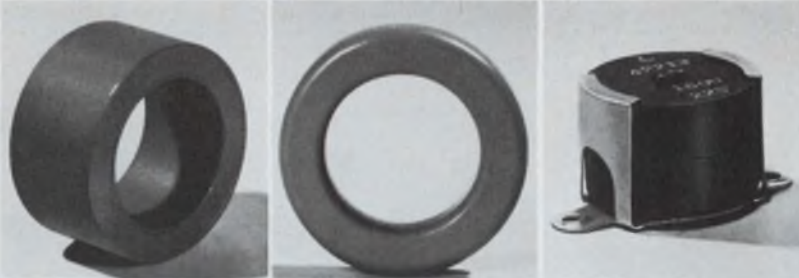

FERRITES

Guaranteed linear temperature coefficients on 750, 1400 and 2000 perm materials. Flat temperature coefficient on 2300 perm material also guaranteed. A total of 175 part numbers to choose from.

BOBBIN CORES

Made from Permalloy 80 and Orthonol[®] strip .000125" to .001" thick and .023" to .250" wide. Diameters range to less than .050", with flux capacities as low as several maxwells.



PHOTOFAB[®] PARTS

Precision flat components chemically milled from almost any magnetic or specialty alloy. Thickness tolerances range from $\pm 5\%$ to $\pm 10\%$, depending on thickness and type of material.

MAGNETIC LAMINATIONS

Nickel-iron materials in thicknesses of .004", .006" and .014". 38 standard shapes in sizes from DU-87 and EI-12 down to EI-093, EE-30-31 and F-094.

Magnetics Inc. gives you total quality control and single-source responsibility on every component

At Magnetics Inc., we're particular about what the finished component does for you. So particular that we maintain up-tight control right from the start. On ferrites and powder cores, we begin with the exact blending of powders. Our metal strip products also evolve from closely controlled custom blending and composition. This emphasis on precision, from start to finish, results in product uniformity—you get optimum characteristics and full-measure performance every time. That's what we mean by single-source responsibility. For additional information on any of our products, mail coupon today.

Magnetics Inc.
Dept. ED-103, Butler, Pa. 16001

Please send me additional information on:

Tape Wound Cores Bobbin Cores Moly-Permalloy Powder Cores Ferrite Cores Magnetic Laminations Photofab Parts Specialty Metals

Name _____
Title _____
Company _____
Street _____
City _____ State _____ Zip _____



Tape, Powder, Bobbin, Ferrite Cores • Laminations • Photo-etched Parts • Specialty Metals • Engineered Control Systems

INFORMATION RETRIEVAL NUMBER 45

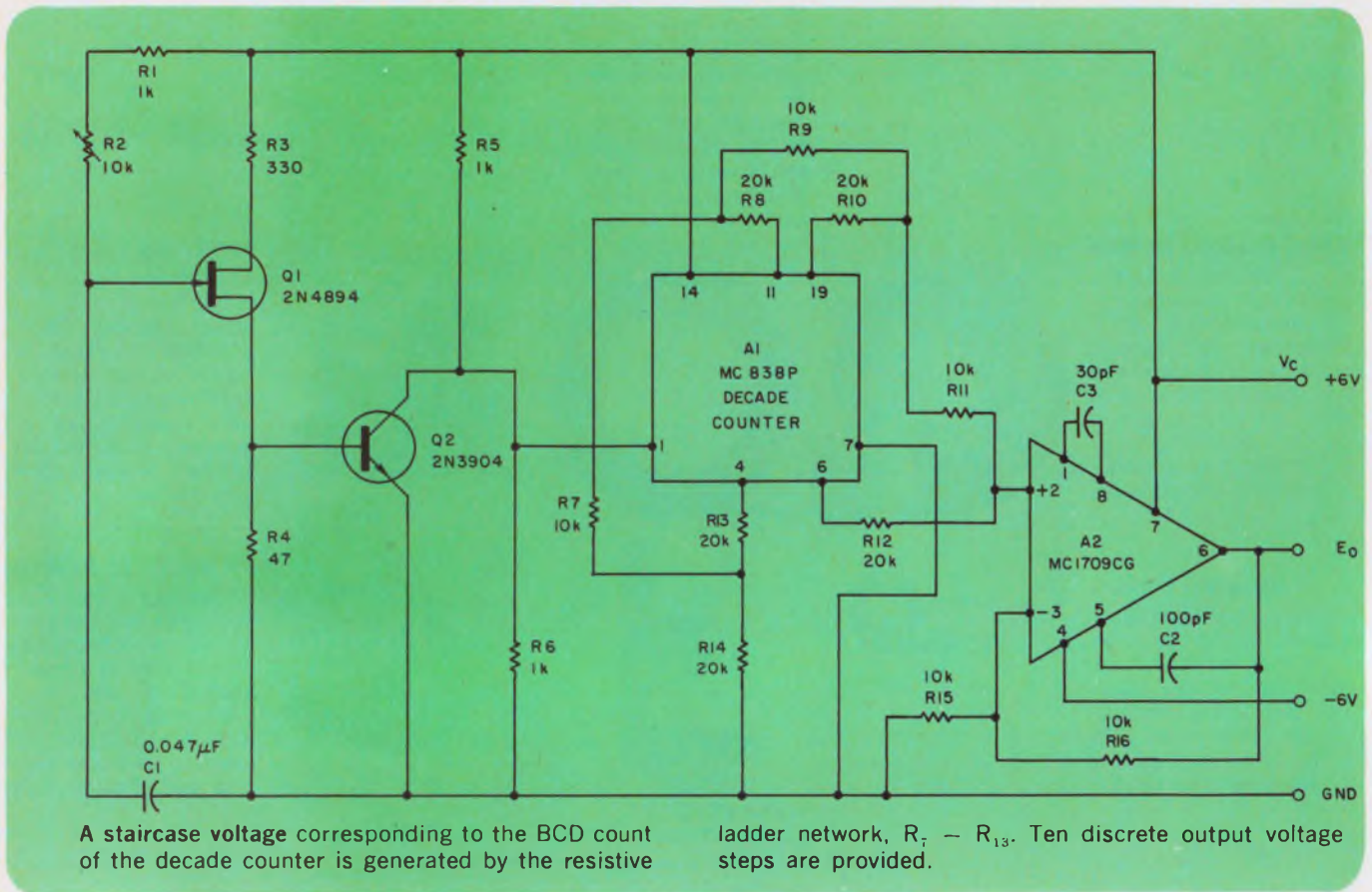

by the resistive ladder network, R_7 through R_{13} . Since the BCD count changes in discrete steps, the analog output of the ladder network also changes by discrete steps that increase as the BCD count increases. The analog output voltage of the ladder network is given by the equation:

$V_A = (1/2 Q_8 + 1/4 Q_4 + 1/8 Q_2 + 1/16 Q_1) V_C$ where Q_8, Q_4 , etc. are the logical output states (ONE or ZERO) for a given BCD count. As an example, the output voltage for a count of 9 would be

$$V_A = [1/2 (1) + 1/4 (0) + 1/8 (0) + 1/16 (1)] V_C = 9/16 V_C.$$

The output voltage will thus increase in ten discrete steps, from zero to $9/16 V_C$ volts, and then return to zero volts.

crete steps, from zero to $9/16 V_C$ volts, and then return to zero volts.

The operational amplifier serves as a gain-of-one isolation amplifier. If the supply voltage and the gain of the operational amplifier are increased, the maximum output voltage of the generator can be increased. The frequency of the circuit is adjusted with R_2 .

Acknowledgment:

This work was supported by the U.S. Atomic Energy Commission.

John Schwind, Assistant Development Engineer, University of California, Davis, Calif.

VOTE FOR 312

Oscillator circuit measures small capacitance changes

Extremely small capacitance changes can be measured with this oscillator circuit, which changes in frequency as the capacitance being measured varies.

A Clapp oscillator is used, because its tank circuit is series tuned (low impedance), and any changes in the transistor parameters have little

effect on the frequency of the tank circuit. The tank circuit operates around 10 to 20 MHz when the external capacitance (capacitance being measured) is 80 to 20 pF.

The oscillator has been found to be stable within ± 200 Hz at 10 MHz, for 8-hour runs. This corresponds to a change in external capacitance

What is the life of a good aluminum capacitor?

Sample #7, shown below, survived 100,000 hours. It is one of a group of computer grade aluminum electrolytic capacitors that we put under test back in 1957.

All capacitors were operated at rated DC working voltage, surge voltage, ripple current and temperature range found in typical computer type power supply circuits.

Sample #7 works almost as well today as it did eleven years ago.

Mallory capacitors enjoy long, reliable life because they are built to exacting standards and tested for surge voltage, vibration resistance, container seal tightness, shelf life, and capacitance, ESR, DC leakage current

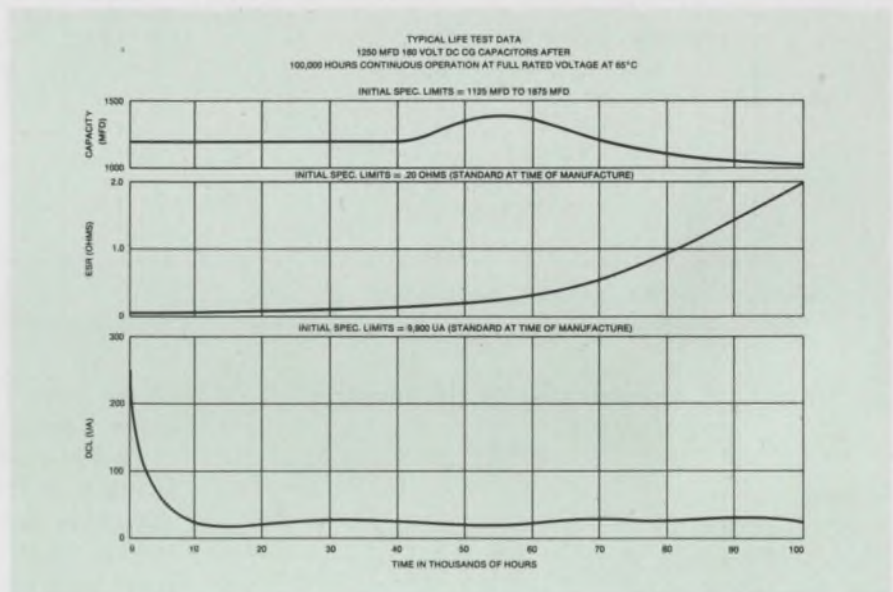

and electrolyte leakage.

All Mallory CG capacitors should have a useful life of about ten years, when operated at specified conditions. They will last even longer if derated in one or more operating conditions.

Temperature Range

CG capacitors are designed to operate within a range of -40°C to $+85^{\circ}\text{C}$. They have been tested at 105°C at less than rated voltage without immediate catastrophic failure. Extended operation under these conditions, however, will shorten their life.

Capacitance

Capacity is measured at 120 cps and at 25°C . Tolerance of capacitors rated at 3 to 150 volts is $-10, +75\%$. For capacitors rated at 151 to 450 volts, the tolerance is $-10, +50\%$.

Low Temperature Capacitance

Capacitance of Mallory CG capacitors at reduced temperatures and 120 cps does not fall below

the following percentage of nominal rated room temperature ($+25^{\circ}\text{C}$) capacity.

Rated DC Voltage	Percent of Nominal Rated Capacitance		
	-20°C	-30°C	-40°C
0-15	65	50	30
16-100	80	65	40
101 and up	85	75	50

Equivalent Series Resistance

ESR measurements are made at 120 cps and 25°C . ESR for Mallory computer grade capacitors is very low.

Mallory wants the highest possible rating for its CG capacitors—but not at the expense of long life and reliable operation. The object of all our research and care in manufacturing and testing is to provide our customers with the “best” capacitor. For data, write or call Mallory Capacitor Company, a division of P. R. Mallory & Co. Inc., Indianapolis, Indiana 46206.

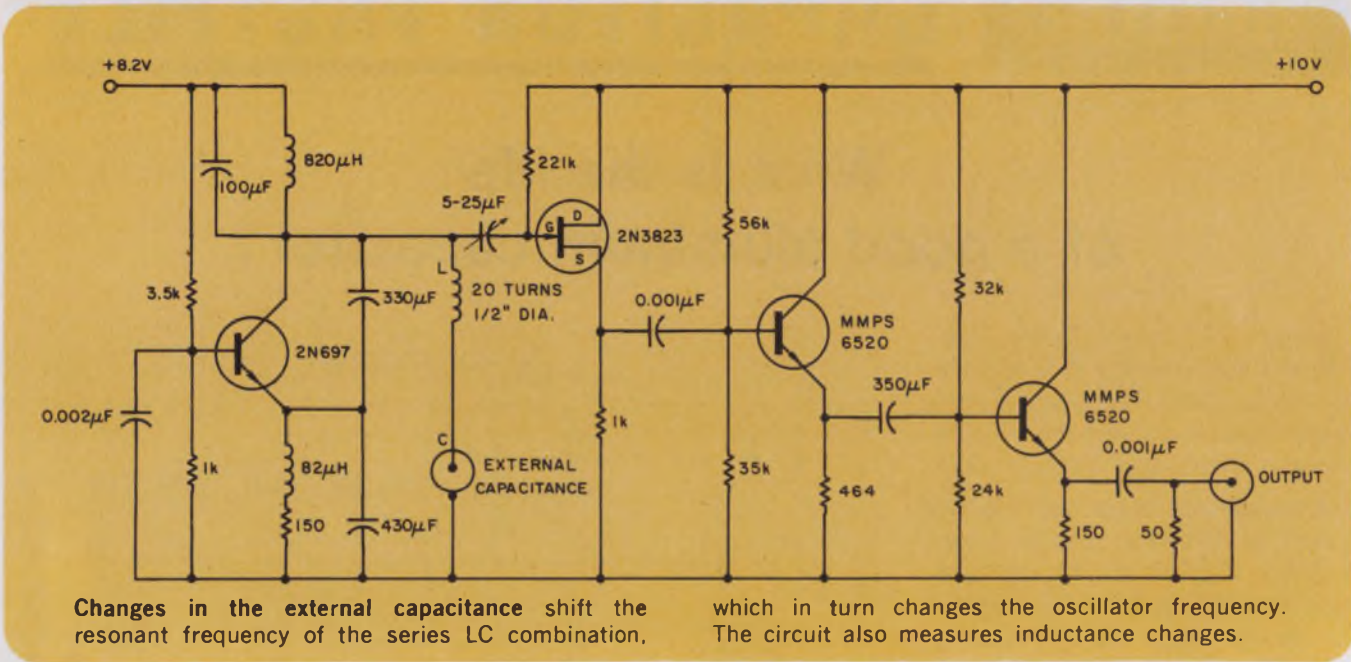

of ± 0.004 pF, as calculated by the formula

$$C_1 = C_o \left[\frac{2(F_1 - F_o)}{F_o} + 1 \right],$$

where

- $F_o = 10$ MHz,
- $F_1 =$ frequency shift,
- $C_o = 100$ pF, and
- $C_1 =$ capacitance shift.

The FET and the two emitter-follower stages are used to prevent loading of the oscillator and

at the same time to provide a 50-ohm output to drive a counter.

This circuit can also be used to measure small changes in inductance, instead of capacitance, by switching the positions of L and C in the tank circuit. That is, by using a fixed value of capacitance, and having L vary externally.

Kenneth Gilbreth, Electronics Engineer, UCLA, Los Angeles, Calif.

VOTE FOR 313

J-FET and gate provide delay followed by reset signal

The last step in the logic sequence of a semi-automatic system had to be a brief delay followed by a reset signal—normally a job for a one-shot. However, the delay time wasn't critical, and there was an unused NAND gate in the system; therefore the circuit shown, which is cheaper than a monostable multivibrator, was used instead.

In addition to the NAND gate, a J-FET, two resistors and a capacitor are used in the circuit.

The last system logic operation (A) drives the gate input (B) to a logical ONE, via source follower Q1. At a time that depends on R, C and the threshold voltage of the gate input, the gate output (C) returns to a logical ONE, to reset the system for the next cycle of operation.

Ralph Tenny, Design Engineer, Texas Instruments, Richardson, Tex.

VOTE FOR 314

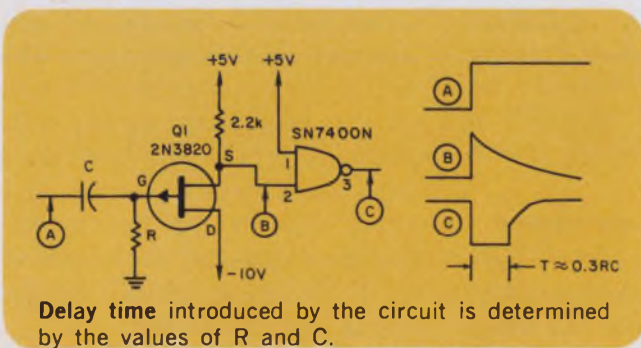

VOTE! Go through all Idea-for-Design entries, select the best, and circle the appropriate number on the Reader-Service-Card.

SEND US YOUR IDEAS FOR DESIGN. You may win a grand total of \$1050 (cash)! Here's how. Submit your IFD describing a new or important circuit or design technique, the clever use of a new component or test equipment, packaging tips, cost-saving ideas to our Ideas-for-Design editor. You will receive \$20 for each accepted idea, \$30 more if it is voted best-of-issue by our readers. The best-of-issue winners become eligible for the Idea Of the Year award of \$1000.

HOW LONG IS 426 BITS?

About 1/10th of an inch square.

Or, at AMI it is 2571 transistors
in a TO-5.

- Longest off-the-shelf shift register
 - Directly bipolar compatible
 - Shift rates to 5 MHz
 - Meets full Mil. Specs.

For more information about the
426—the RD15 (Mil. Specs.) or
RD65 (commercial/industrial)—
and over 60 other AMI MOS standard
products, contact:

**new
dimensions
with mos
technology**

American Micro-systems, Inc.

3800 Homestead Road, Santa Clara, California 95051, Tel: (408) 246-0330
TWX: (910) 338-0018



Simple and inexpensive current source has $\pm 0.1\%$ regulation

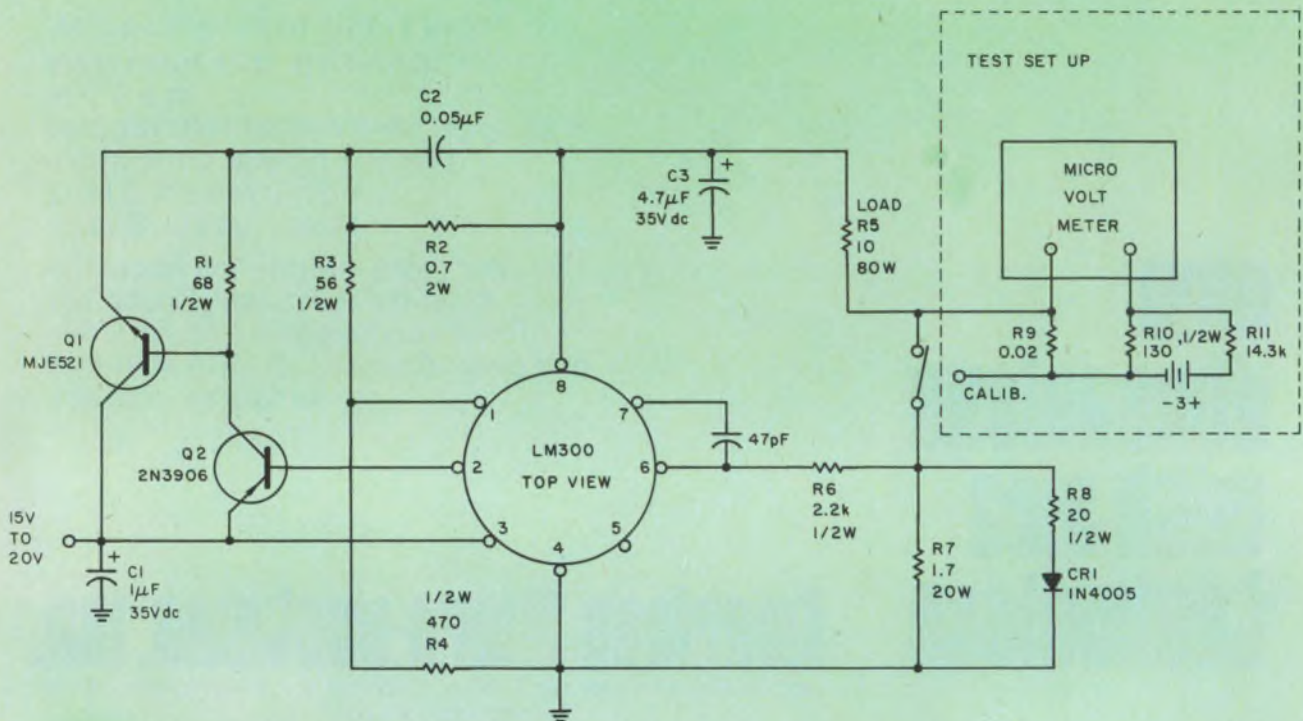

Constant current of 1 A is maintained through the load, despite changes in load resistance or supply voltage.

A simple and inexpensive—yet accurate—1-ampere current source results when a voltage regulator is connected in a constant current configuration. Input to the circuit is 15-20 V, and the load current is through resistor R_5 .

The feedback sense voltage (approximately 1.6 V), developed across resistor R_7 , is voltage-regulated by the LM300. Since both R_7 and the sense voltage, V_s , are constant, the current through the load resistor, R_5 , must also be constant. The current will remain constant to within $\pm 0.1\%$ from 0 to 70° C even though the load resistance or supply voltage varies. However, the load resistance may not be increased, or the supply voltage decreased, so that Q1 is brought into saturation. In addition the load resistance cannot be increased indefinitely without exceeding the 20-V output limit of the LM300. To achieve the $\pm 0.1\%$ regulation, it is also important that ground loops in the sense resistor ground return be avoided.

The feedback sense voltage is temperature-compensated with resistor R_8 and diode CR1 to null out the LM300 temperature drift. This is accomplished by the diode voltage drop, which increases 2 mV for each degree centigrade of

drop in temperature, thus changing the current through R_8 , which in turn changes the effective value of R_7 . Resistor R_8 may be calibrated easily for different LM300 voltage regulators with the test circuit shown. The voltage divider in the test setup is used to zero the microvoltmeter.

Resistor R_2 provides foldback current-limiting, and limits the load current to half an ampere when the load is shorted. The foldback bypass capacitor, C_2 , desensitizes the current-limiting resistor to transients.

Edward W. Jekowski, Design Engineer, EG&G, Inc., Bedford, Mass.

VOTE FOR 315

IFD Winner for December 19, 1968
 Dan Lubarsky, Research Engineer, The Rucker Co., San Carlos, Calif. His Idea "FET and UJT provide timing over wide temperature range" has been voted the most Valuable of Issue Award.
 Vote for the Best Idea in this Issue.

Helipot building blocks stack up to more convenience and economy.

Helipot's wide and expanding selection of *standard hybrid cermet microcircuits*—locally stocked throughout the country—give you reliable, inexpensive, off-the-shelf solutions to your complex design problems. In addition, Helipot building blocks help eliminate expensive design time and reduce purchasing, stocking, and production to their minimums. Whatever your need, you'll be interested in the new 48-page *Helipot Microcircuits Catalog*. For your copy, simply send a request on your company letterhead.

Beckman
 INSTRUMENTS, INC.
 HELIPOT DIVISION
 2500 HARBOR BOULEVARD
 FULLERTON, CALIFORNIA • 92634

INTERNATIONAL SUBSIDIARIES: AMSTERDAM; CAPE TOWN; GENEVA; GLENROTHES, SCOTLAND; LONDON; MEXICO CITY; MUNICH; PARIS; STOCKHOLM; TOKYO; VIENNA

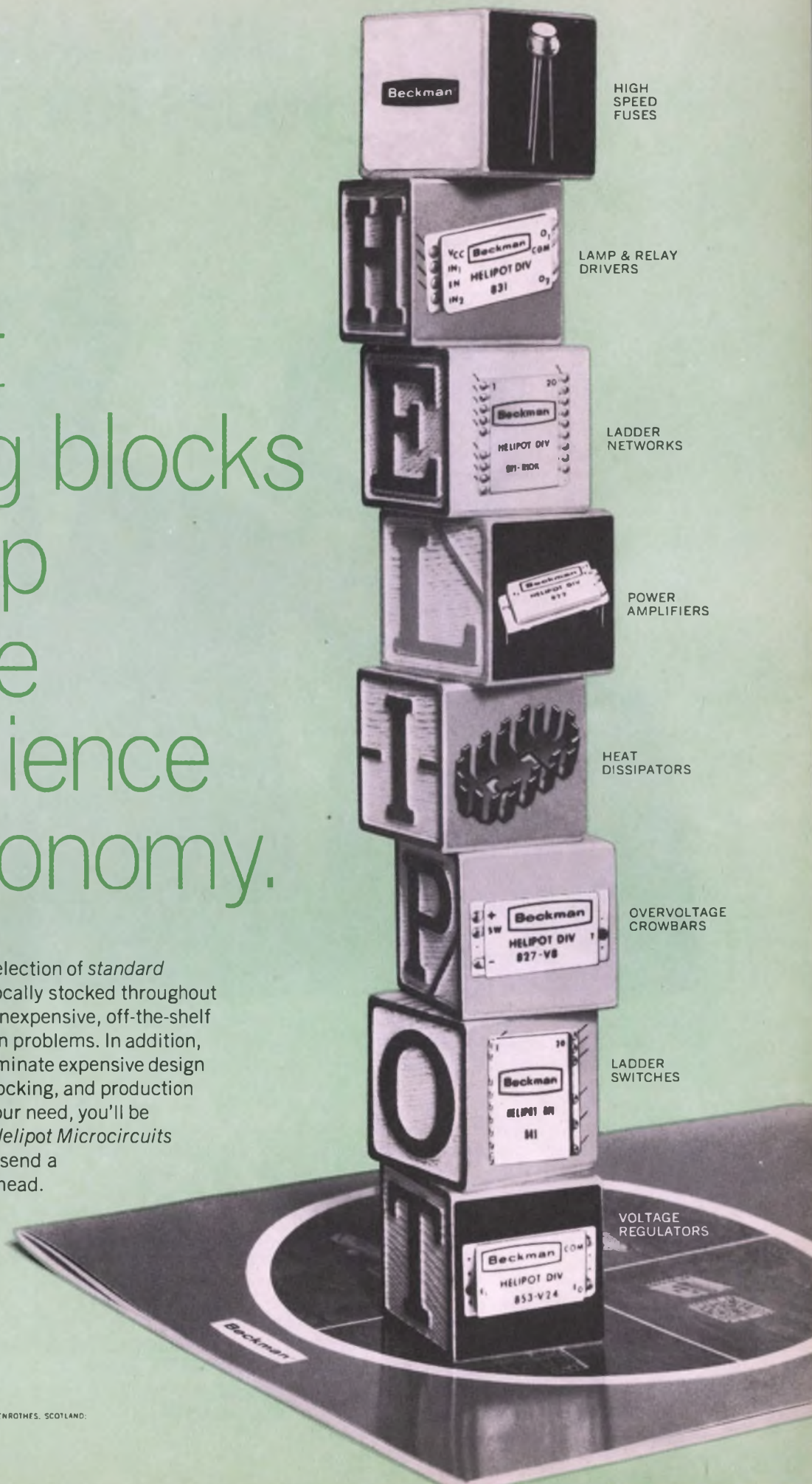

HIGH SPEED FUSES

LAMP & RELAY DRIVERS

LADDER NETWORKS

POWER AMPLIFIERS

HEAT DISSIPATORS

OVERVOLTAGE CROWBARS

LADDER SWITCHES

VOLTAGE REGULATORS

THE MEMORY SQUAD. YOURS FOR THE ASKING.



You're looking at the senior engineering staff of ELECTRONIC MEMORIES. And, if you're designing computer or memory systems, they're all yours for a day. Free.

They'll give you a one-day seminar on memories and memory systems in your plant. Or even your office. On everything from memory basics to system configuration, implementation and final checkout and test. When they're done, you'll be checked-out on everything you need to know to make your systems perform the way you expected them to when you bought the hardware.

Write for them now, though, because we're limiting the number of seminars. We need these guys, too.

Phil Harding, Manager, Systems Development, investigates new system concepts and develops product line hardware. Harding has been granted 13 memory-related patents, has six more on file and another two disclosures in process. When he investigates, he investigates.

Tom Gilligan manages our Commercial Memory Engineering Department. He designed the first sub-microsecond 2½D memory system and has participated in the design and manufacture of stacks and systems that run the gamut from "small and slow" to "large and fast." He's responsible for every commercial memory system or stack that goes out our doors. And that's a lot.

Robert Johnston is our plated wire specialist. We're keeping this quiet at the moment. Keeping competition off guard. You know how it is. But we'll tell you more at the seminar.

Brian Rickard manages our Military Magnetics operation. He implements the design of core memory stacks specifically for severe environments and has built hardware for Pioneer, Lunar Orbiter, Advanced IRLS and other spacecraft.

Max Van Orden performs the same kind of function as Rickard in our Commercial Division. As Manager of Commercial Magnetics, he's responsible for the implementation of all commercial magnetic arrays, assemblies and stacks.



Daniel Brown is our resident core expert. He carries through from R and D on magnetic materials to pilot production and has developed a broad spectrum of cores, from wide-temperature range cores for military programs to fast-switching cores for commercial computers.

Part of this group developed our Nanomemory 2650; maybe that's why it's selling as fast as we can build it. It has a cycle time of 650ns, uses 2½D magnetics, IC electronics and comes with an optional self-tester. All this is built into a 2% cubic foot module, designed for easy use and easy maintenance. The entire memory is built on plug-in cards and can be stripped down to its

case and power supply in six minutes flat. But we've built it so you'll never even have to open the case.

They also developed our Micro-memory 1000 giving you storage at less than 6.5¢ / bit for commercial systems. For this price, you can get up to 32K bits of storage with a cycle time of 2.5µs. This memory is designed for OEM use and consists of a stack and five cards of electronics which all plug into a mother board for easy maintenance. A single connector provides the interface to your system.

So whether you're looking for hardware or are still on the drawing board, write us. We'll see that you get just what you need.

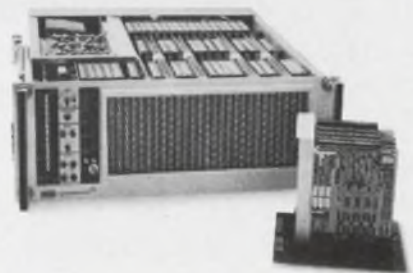

EM ELECTRONIC MEMORIES
12621 Chadron Avenue
Hawthorne, California 90250

INFORMATION RETRIEVAL NUMBER 49

The case of Lockheed vs. Lockheed

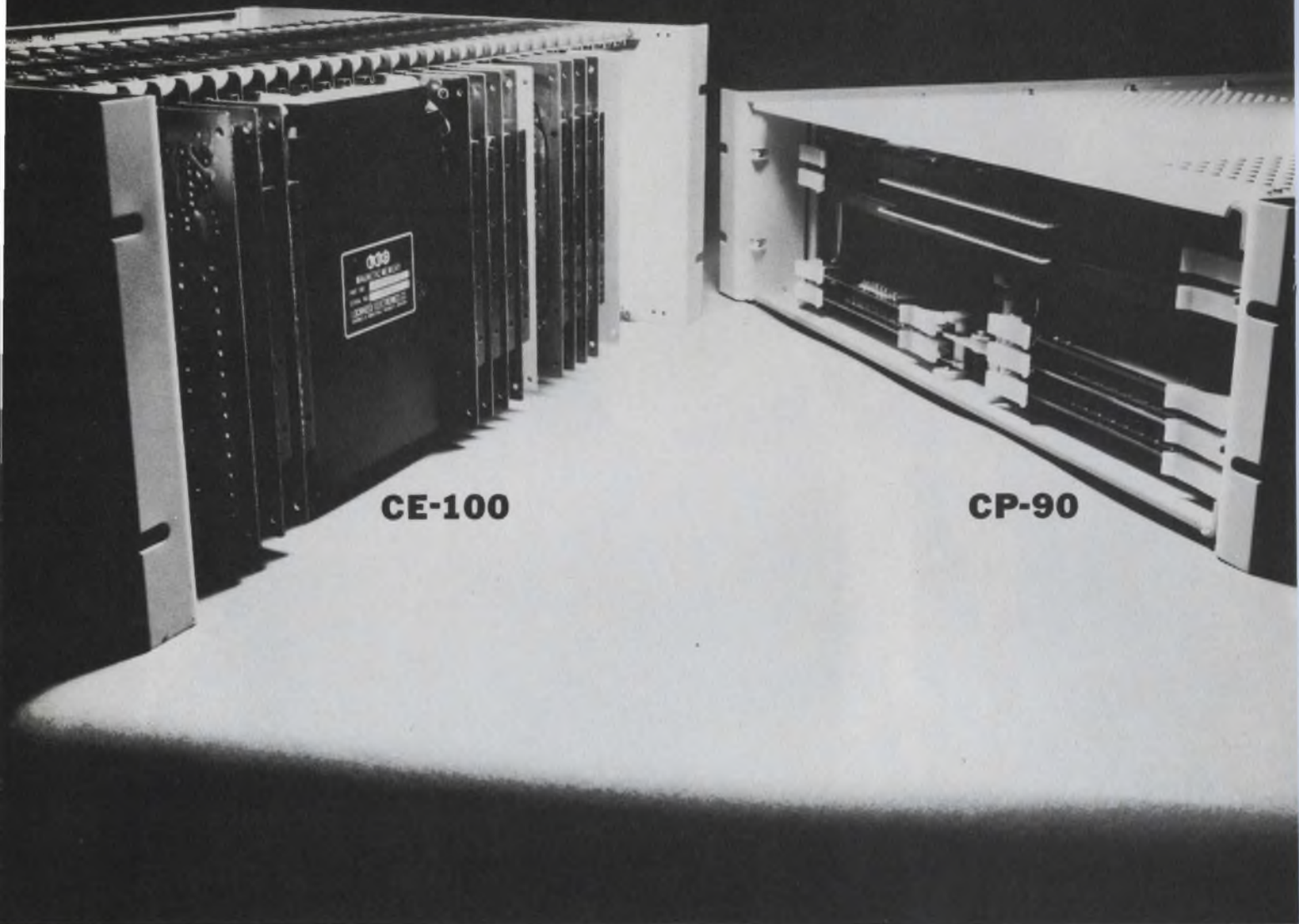

CE-100

CP-90

- 1.** Capacity: 4,096 words x 16 bits.
- 2.** Available in capabilities of 4, 8, 16K with 8 to 32 bits.
- 3.** Size: 19" x 7" x 13".
- 4.** Speed: 1 microsecond.
- 5.** Random access time: 450 nanoseconds.
- 6.** Market Response: Excellent.

- 1.** Capacity: 4,096 words x 16 bits.
- 2.** Available in 4K by 16 or 18 bits.
- 3.** Size: 19" x 5¼" x 13".
- 4.** Speed: 900 nanoseconds.
- 5.** Random access time: 400 nanoseconds.
- 6.** Market Response: Too early to form any sort of judgment.

VERDICT

The CE-100 has been the most successful low-cost memory unit on the market (and with good reason).

But since the CP-90 is faster, smaller, and since the 16-bit version costs less — it is our considered opinion that the CP-90 will become one of Lockheed's all-time best-selling memory units.

For further information write: Memory Products, Lockheed Electronics Company,
Data Products Division, 6201 East Randolph Street,
Los Angeles, California 90022. Telephone (213) 722-6810.

LOCKHEED ELECTRONICS COMPANY

 A Division of Lockheed Aircraft Corporation

Products

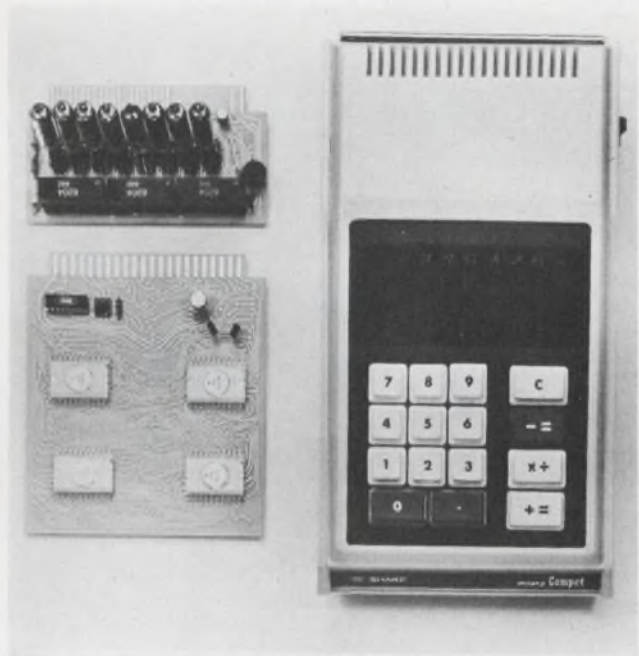

Electronic calculator trims size and weight with five integral LSI MOS circuits, p. 118.

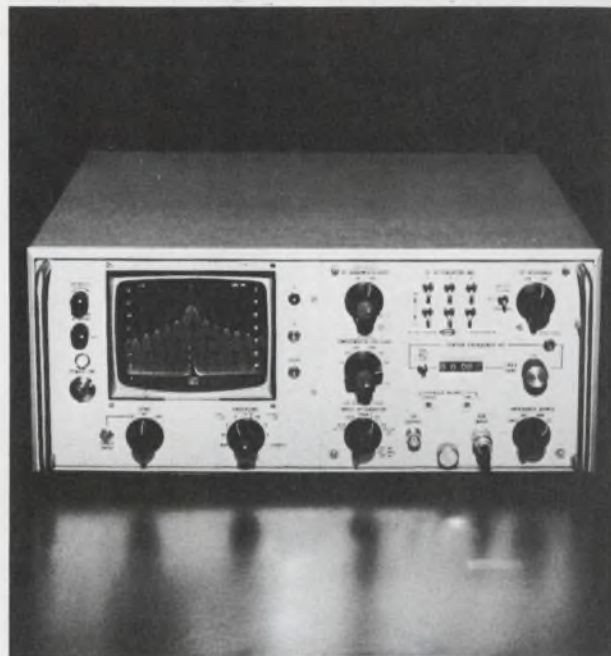

Calibrated spectrum analyzer operates 8 hours from internal battery, p. 112.

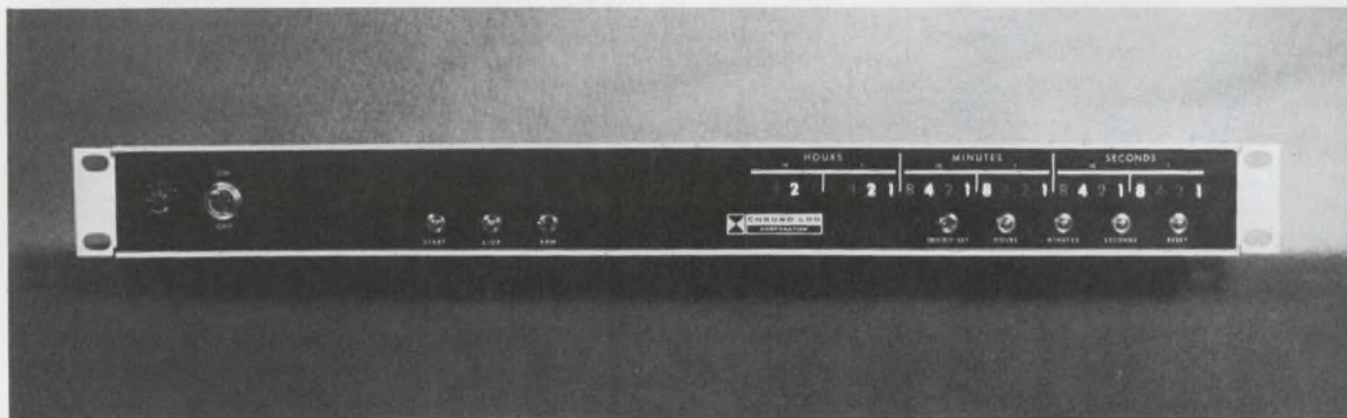

Time-code generators incorporate ICs to improve performance and lower price tags. Sim-

ultaneous time-code formats are modulated carrier and level shift forms, p. 116.

Also in this section:

Infrared light-emitting diode supplies 1-mW minimum radiant power, p. 128.

Military operational amplifier holds input bias to less than 10 pA, p. 136.

Mercury switch features a contact risetime of under 1 ns, p. 142.

Design Aids, p. 160 . . . **Application Notes**, p. 162 . . . **New Literature**, p. 164

New from the **SPEC-TROLL!**



A 10-TURN INDUSTRIAL WIREWOUND POT WORTH BLOWING OUR HORN ABOUT!

Selling for only \$4.39 in quantity, our new Model 532 features "designed-in" reliability to give you top pot performance at bargain prices. The 532 offers:

- Longer element for "tighter" resolution.
- Precious metal contacts for minimum noise characteristics.
- Improved vibration-resistant slider design and dual slip ring contacts.
- Rugged mechanical stops for dependability.
- Passivated stainless steel shaft.
- A tough industrial design that can handle most of the requirements associated with MIL-R-12934.

Brief Specs

Size:	3/8" diameter
Resistance Range:	15 ohm to 180K
Resistance Tolerance:	± 5%
Independent Linearity:	± 0.25%
Power Rating:	3 watts @ 40°C

The model 532 is available through your local Spectrol distributor. For full specs, circle the reader service number. Qualified respondents may obtain a sample free of charge through their Spectrol representative.



Spectrol Electronics Corporation
A subsidiary of Carrier Corporation
17070 East Gale Avenue
City of Industry, Calif. 91745
Phone: (213) 964-6565
TWX: (910) 584-1314

Calibrated spectrum analyzer operates on internal battery



Systron-Donner Corp., Microwave Div., 14844 Oxnard St., Van Nuys, Calif. Phone: (213) 786-1760. P&A: \$2495; 90 days.

Battery-operated and completely portable, a multipurpose, calibrated spectrum analyzer covers the frequency range of 10 Hz to 50 kHz. The instrument consists of two units, the model 710 display unit and the model 800 analyzer module. It features calibrated frequency readout as well as calibrated sweep time, scan width, and i-f bandwidths.

The capacity of the optional internal, rechargeable battery permits up to eight hours of continuous field service. Power dissipation is 15 watts, and the unit may be recharged overnight. Battery power is also useful when low-level signal measurements, isolated from the ac line, are required.

Total weight, including the battery, is only 30 pounds. Measurements under high ambient light conditions are facilitated by a bright display produced by a long-persistence CRT with a matched high-contrast filter.

A wide variety of frequency domain measurements can be made with the analyzer; spectrum analysis, waveform analysis, and distortion analysis are prime examples. Other applications include use as a selective nanovoltmeter, a sensi-

tive emi/rfi receiver, or a log VSWR indicator. These capabilities may be extended further by additional plug-in modules.

Calibrated features include: scan width from 100 Hz/cm to 5 kHz/cm, linear vertical display from 30 nV/cm to 3 V/cm, log vertical display to 10 dB/cm, i-f bandwidths of 10 and 100 Hz, sweep times from 3 ms/cm to 10 s/cm, and four-digit frequency readout from 10 Hz to 50 kHz.

Calibrated sweep times enable the instrument to scan the 10 Hz to 50 kHz range with 10-Hz resolution in less than 100 seconds. Signals separated by as much as 60 dB in amplitude are easily measured on the display screen. Manual sweep, baseline blanking, pen lift and X-Y output facilitate recording measurements. Pen lift and the X-Y outputs are available at connectors on the rear panel.

A front-panel switch can be used to select input impedances of 50 Ω , 600 Ω , 10 k Ω , or 1 M Ω . Sensitivity as a low-noise receiver is better than -140 dBm. A convenient carrying handle is provided on the rear panel, and a tilt-up stand folds up beneath the cabinet when it is not in use. Rack-mounting brackets for standard 19-inch racks are provided. Over-all dimensions are 7 by 16-3/4 by 14 inches deep.

CIRCLE NO. 270



Handyman

You can't beat our 3000 series PIN diodes for odd jobs. They can control or condition RF signals in all sorts of circuits like attenuators, AGC, constant impedance levelling – any circuit that uses dc or low frequency bias to manage higher frequencies.

But the HP 5082-3003 PIN diode is one up on the rest as a current-controlled RF resistor. Specs on this one are so tightly controlled in manufacturing and testing that two or more will track each other nicely in matched circuits. Resistance is specified at 500 MHz for two

bias values. It swings from 1 ohm to 10,000 ohms, always within 20% on the high and low values, and the slope in between is held within the range 0.9 to 0.86. Low reverse-bias capacitance, low series resistance, plus low harmonic distortion qualify the 3003 for a broad range of instruments and communications systems. Prices start at \$15.30 (10-99).

Then, there's our glass package, 3039. You can get this one for \$5.00 (10-99) with improved – very competitive – specifications.

And check our quantity prices, too.

Ask your HP field engineer for detailed information. Or write Hewlett-Packard, Palo Alto, California 94304; Europe: 1217 Meyrin-Geneva, Switzerland.

HEWLETT *hp* PACKARD
SOLID STATE DEVICES

INFORMATION RETRIEVAL NUMBER 52

For Extreme Processing Temperatures to 1400°F

E-I SUPER STRENGTH CERAMIC-TO-METAL

NEW! SEALS

Vacuum-tight, hermetically-sealed components offer exceptional resistance to shock, vibration and corrosion, and conform to all ASTM F-18-64 requirements.

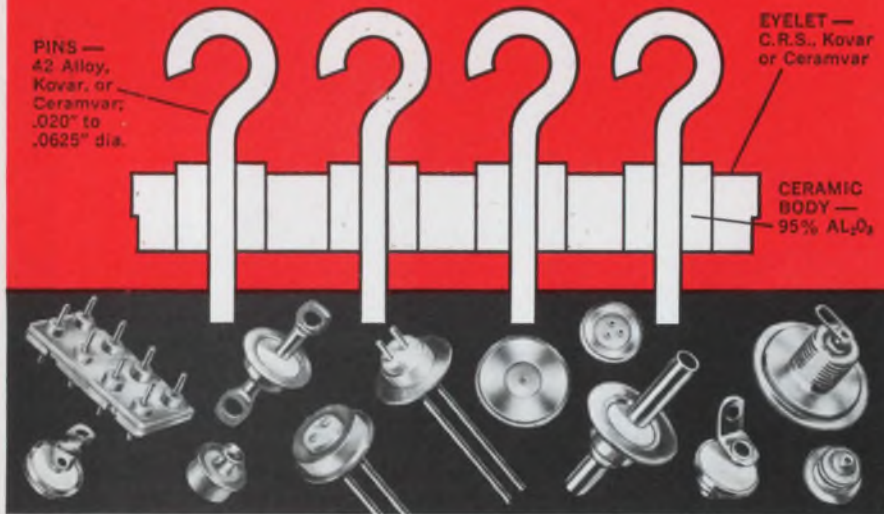

- Superior dielectric properties
- Maximum rigidity and durability
- Withstand extreme thermal stresses
- Miniaturization and design standardization

These E-I components are specifically designed to provide maximum reliability under severe environmental conditions. For example, they withstand repeated heat cycling up to 1400°F, and thermal shock comparable to electron tube processing.

E-I alumina insulated, ceramic-to-metal seals can be economically produced from hundreds of stock designs; where special configurations are required, E-I sales engineers will make recommendations from your blueprints or sketches.



Electrical Industries

A Division of Philips Electronics and Pharmaceutical Industries Corp.
Murray Hill, N. J. 07974 —Tel.: (201) 464-3200

INFORMATION RETRIEVAL NUMBER 53

INSTRUMENTATION

Palm-sized instrument tests logic circuits



Dataprobe Inc., South Hackensack, N.J. Phone: (201) 768-4797. P&A: \$85; stock.

A multifunction, logic test set for DTL and TTL systems is designed for field service. When used to test digital systems, it replaces scopes, pulse generators, and other complex test instruments. It indicates logic level 1 and logic level 0, detects open circuits, random noise pulses and level transitions; it also generates logic level transitions and 10 kHz and 2 pps logic-compatible pulses.

CIRCLE NO. 271

Miniature generator has nine functions



Exact Electronics, 455 S. 2nd, Hillsboro, Ore. Phone: (503) 648-6661. P&A: \$445; 4 wks.

Claimed to be the smallest multiple-waveform generator on the market (7.38 by 2.85 by 8.5-inches), a solid-state instrument features nine different output signals that include sine, bipolar square, ground-referenced positive or negative square, triangle, ramp, reverse ramp, pulse and trigger (differentiated square wave).

CIRCLE NO. 272

SSPI announces the world's first high-voltage transistors designed for power switching.

Now, let's make something out of it.

Like, say, a high-voltage circuit with about half as many components. Because we now offer you power-switching transistors that sustain up to 325 volts, guaranteed high speed switching (total turn-on turn-off time of less than a microsecond) and throw in saturation voltages less than .4 volts at three amps in the bargain.

Which means this:

In one fell swoop you can get rid of a whole passle of transformers in the typical aerospace high-voltage circuit. End up with a much-simplified circuit design, in things like pulse modulators, switching regulators, converters, and inverters.

Choose the 2N 5660 (up to two amps), or the 2N 5664 (up to five amps) in either TO-66 or TO-5 packages. Try them for new designs and as a replacement in existing high voltage circuits.

Add in the longevity factor of planar oxide passivation, to keep the thing from crackling itself to death, and you've got one of the most exciting transistors that ever came down the pike.

So. If you'd like to make something out of it, just call Alex Polner at (617) 745-2900 and tell him to send you back the HVST Data Kit. It'll help.



**SOLID STATE
PRODUCTS**

DIVISION OF UNITRODE CORPORATION

ONE PINGREE STREET
SALEM
MASSACHUSETTS 01870
PHONE: 617-745-2900
TWX: 710-347-0228

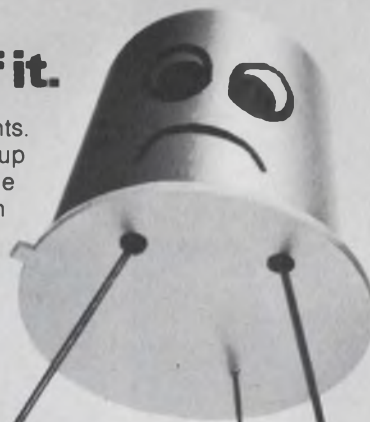

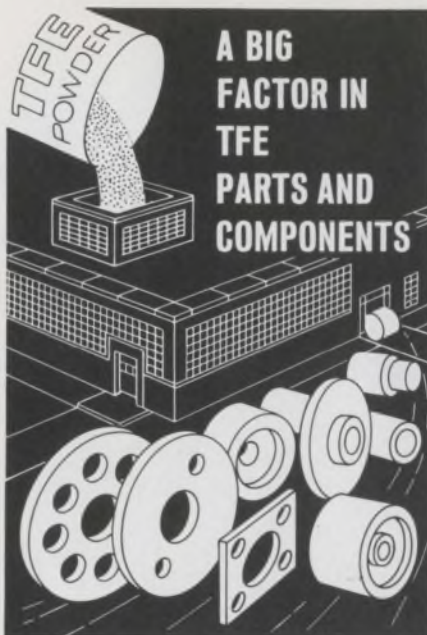

**A BIG
FACTOR IN
TFE
PARTS AND
COMPONENTS**

IS THE CAPABILITY OF YOUR FABRICATOR

That's why you should investigate Crane Packing Company's manufacturing facilities and know-how:

- A completely modern plant especially designed for manufacturing of TFE basic forms and products.
- Climate control to insure proper density, piece after piece.
- Air filtration systems to eliminate impurities.
- The latest in extruding, molding, curing and machining equipment.
- Quality control second to none to insure freedom from flaws and other defects and to maintain uniformity.
- A pioneer from the very beginning of TFE, with over 20 years experience.

Request full details. Send b/p or specs. for a prompt quotation.

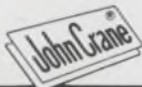

**DuPONT TEFLON
HALON
OTHER FLUOROCARBONS**

CRANE PACKING COMPANY

6432 Dakton St., Morton Grove, Illinois 60053

PLANTS IN: Canada, Mexico, Brazil
England, Australia and Japan

INFORMATION RETRIEVAL NUMBER 55

Time-code generators use ICs to cut costs

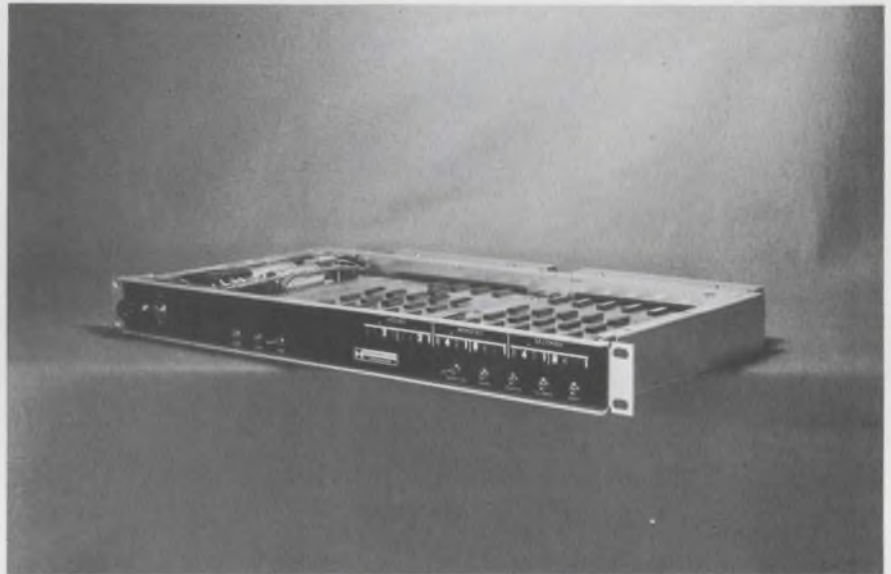

Chrono-log Corp., 2583 West Chester Pike, Broomall, Pa. Phone: (215) 356-6771. P&A: from \$985; 6 wks.

Costing at least \$500 less than its nearest competitor, a new family of time-code generators uses integrated circuits throughout to supply timing information to analog magnetic tape recorders, computers and digital recording and telemetry systems. Series 4000 instruments simultaneously provide an IRIG time-code format in both modulated carrier and level shift forms.

Time-code formats are for time only, and do not include day-of-year or the 17-bit straight binary word. Zeros are generated for all omitted bits. There is also a parallel output in 8421 binary coded decimal (BCD) for hours, minutes and seconds.

A unique tracking-oscillator time base locks and synchronizes the new generators to the 60-Hz line. Since the line frequency is corrected by the power company, the new IC instruments virtually eliminate long-term drift. With this type of oscillator, errors range from 15 to 20 seconds at the end of a 30-day period. If desired, the generators can be supplied with a precision internal oscillator instead of the tracking oscillator, or can

be operated from an external 1-MHz frequency input.

Designed for 19-inch relay rack mounting and requiring only 1-3/4 in. of panel height, the units occupy only 10 in. behind-the-panel, including mating connectors. The front-panel display is an 8421 BCD presentation of time in hours, minutes and seconds. Nixie-tube front-panel displays are also available with a resulting increase in panel height to 3-1/2 inches.

Provisions are made on the front panel to start, stop, reset or set the new time-code generators. External signals can also be used to perform reset and start functions. A switch allows the starting of the generator to be synchronized to an external standard such as WWV or system time.

Several time-code formats are available. These include the NASA 28-bit and 36-bit codes, IRIG-A with a 10-kHz carrier, IRIG-B with a 1-kHz carrier, IRIG-C with a 1-kHz or 100-Hz carrier, IRIG-D with a 100-Hz carrier, and IRIG-E with a 1-kHz or 100-Hz carrier.

Battery operated models can also be furnished that draw five volts dc with a five-watt internal oscillator and with the binary coded decimal front-panel lamps turned off.

CIRCLE NO. 273



Another First...

FOR THE FIRST TIME, A HANDSIZE*, ALL SOLID-STATE (F.E.T.) V-O-M

Triplet's super-sensitive tester—Model 310-FET—features dynamic design, unprecedented performance, $\pm 3\%$ DC accuracy, $\pm 4\%$ AC, taut suspension movement. It ushers in an exciting new breed of miniaturized measurement mightiness.

1. All Solid-State (F.E.T.) with 10 Megohm input resistance, Battery operated.
2. High sensitivity (300 mV DC fs) for transistor bias measurements, resistance measurements to 5,000 Megohms.
3. Handsize with single selector switch and provision for attaching AC clamp-on adapter.

AN ADDITION TO THE FAMOUS TRIPLETT 310 SERIES

SEE YOUR TRIPLETT REPRESENTATIVE OR DISTRIBUTOR FOR A FREE DEMONSTRATION!

*Photo Actual Size

SUGGESTED U.S.A. USER NET PRICE \$70.00

TRIPLETT

THE TRIPLETT ELECTRICAL INSTRUMENT COMPANY • BLUFFTON, OHIO 45817

Electronic calculator reduces size via LSI

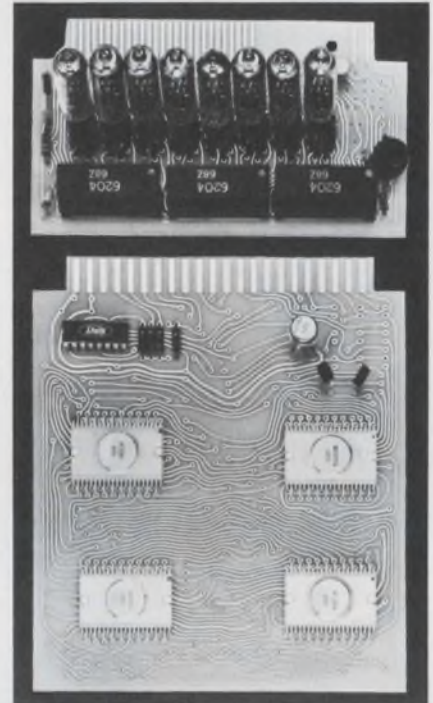

Hayakawa Electric Co., Ltd., Osaka, Japan. P&A: less than \$500; 12 wks.

Achieving its small size and light weight through the use of large-scale integration, a new electronic calculator can perform four arithmetic computations of up to eight digits in 0.3 second. Called the world's smallest electronic calculator, the QT-8D weighs only 3-1/8 pounds and measures 4-5/8 by 2-1/4 by 9-1/2 inches.

Completely silent, the new calculator is capable of performing addition, subtraction, multiplication, division, as well as mixed calculations. In addition, it features automatic credit balance and a full-floating decimal point.

Said to be the first mass-produced product using large-scale integrated circuits, the QT-8D electronic calculator contains five MOS devices, manufactured for Hayakawa by North American Rockwell's Autonetics Div. These are incorporated in the wiring board. Each large-scale integrated circuit has anywhere from 240 to 633 MOS-FETs to perform between 183 and 253 distinct gate functions.

The calculator also features green-colored long-life fluorescent display tubes of the digitron type.

CIRCLE NO. 274



Cermetrol[®] made it.

Semiconductor devices and integrated circuits require efficient dissipation of heat to perform their functions to capacity. Cermetrol metallized beryllia assemblies for transistor packaging perform this essential function, and assure maximum performance at RF, UHF, medium power/high frequency and high power ratings, because Berlox beryllia ceramics permit designers to work with more power in smaller packages.

Currently in use for the packaging of the highest power, highest frequency devices available, Berlox assemblies have the capacity for thermal and

electrical efficiency far beyond the present spectrum.

Cermetrol assemblies have a gold plated die mount pad, which provides easy bonding of active devices; molybdenum metallizing assures maximum braze strength. These, and advanced production techniques pioneered by the Cermetrol Division, make possible greater reliability of encapsulated or hermetic sealed devices, increased production yields, and miniaturized packaging for sophisticated electronic devices.

Write or call today for complete specifications.

10728



CERMETROL DIVISION

National Beryllia

Haskell, N.J. 07420 Telephone: 201 • 839-1600

CORP

INFORMATION RETRIEVAL NUMBER 57

The Transient Trappers are in the RCA-40673, the industry's FIRST dual-gate MOSFET with INTEGRATED PROTECTION-CIRCUITRY.

Back-to-back diodes, diffused within the same silicon pellet as the MOS Field-Effect Transistor, guard each gate against:

- static discharge during handling operations prior to circuit installation without the need for external shorting mechanisms.
- in-circuit transients.

Now you can design and build around the inherent, superior performance characteristics of dual-gate MOSFETs with assurance that RCA's TRANSIENT TRAPPERS are the real answer to transient-voltage problems.

Typical characteristics of the RCA-40673 are:

- Power Gain (MAG) = 20 dB @ 200 MHz
- Noise Figure (NF) = 3.5 dB @ 200 MHz
- Superior Cross Modulation Characteristics
- Wide Dynamic Range Without Diode Current Loading
- Reduced Spurious Response
- Extremely Low Feedback Capacitance = 0.02 pF
- Simplified AGC Circuitry
- Excellent Gain-Reduction Characteristics
- Reduced Oscillator Feedthrough

For more information, see your local RCA Sales Representative or your RCA Distributor. For technical data write to RCA Electronic Components, Commercial Engineering, Section EG-4-2, Harrison, New Jersey 07029

The Transient Trappers

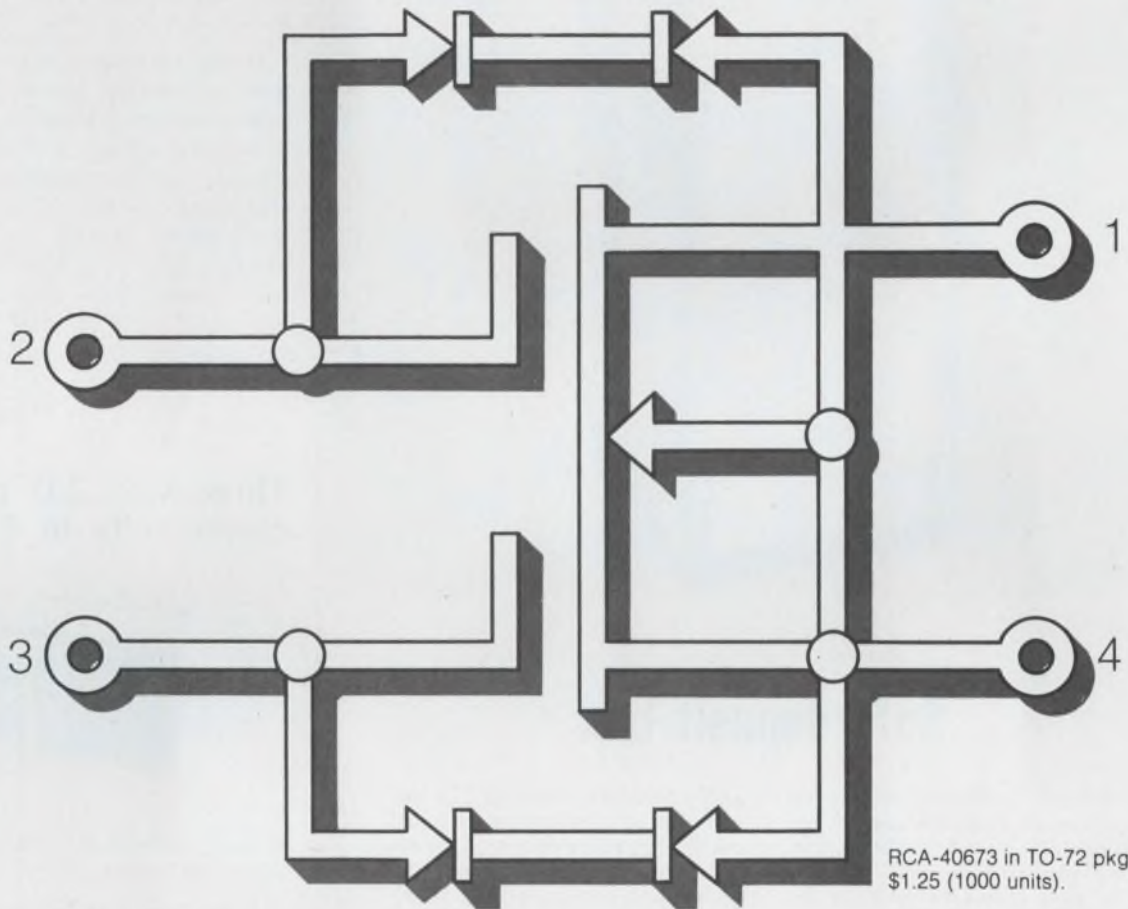

The major technical challenge associated with the development of the RCA-40673 was that gate protection must not significantly degrade the RF performance.

Special back-to-back diodes were developed as the answer to this objective. These back-to-back diodes are diffused directly into the MOS pellet and are electrically connected between each insulated gate and the FET's source. The back-to-back configuration of the diodes permits the device to handle a wide dynamic signal-swing. In addition, the low junction capacitance of the diodes adds little to the total capacitance shunting the signal gate. Further, the resistive components of these diodes are such that they do not materially affect the overall noise performance of the unit.

The net result of this engineering program is a MOSFET which is more rugged than any other solid-state amplifier providing comparable RF performance.

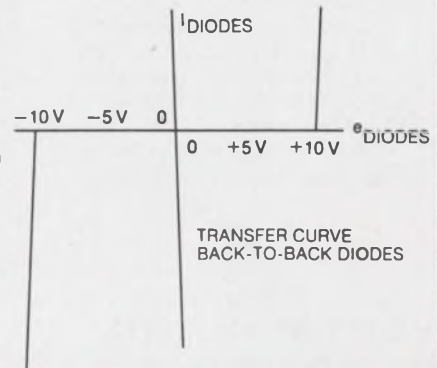

RCA
Integrated
Circuits

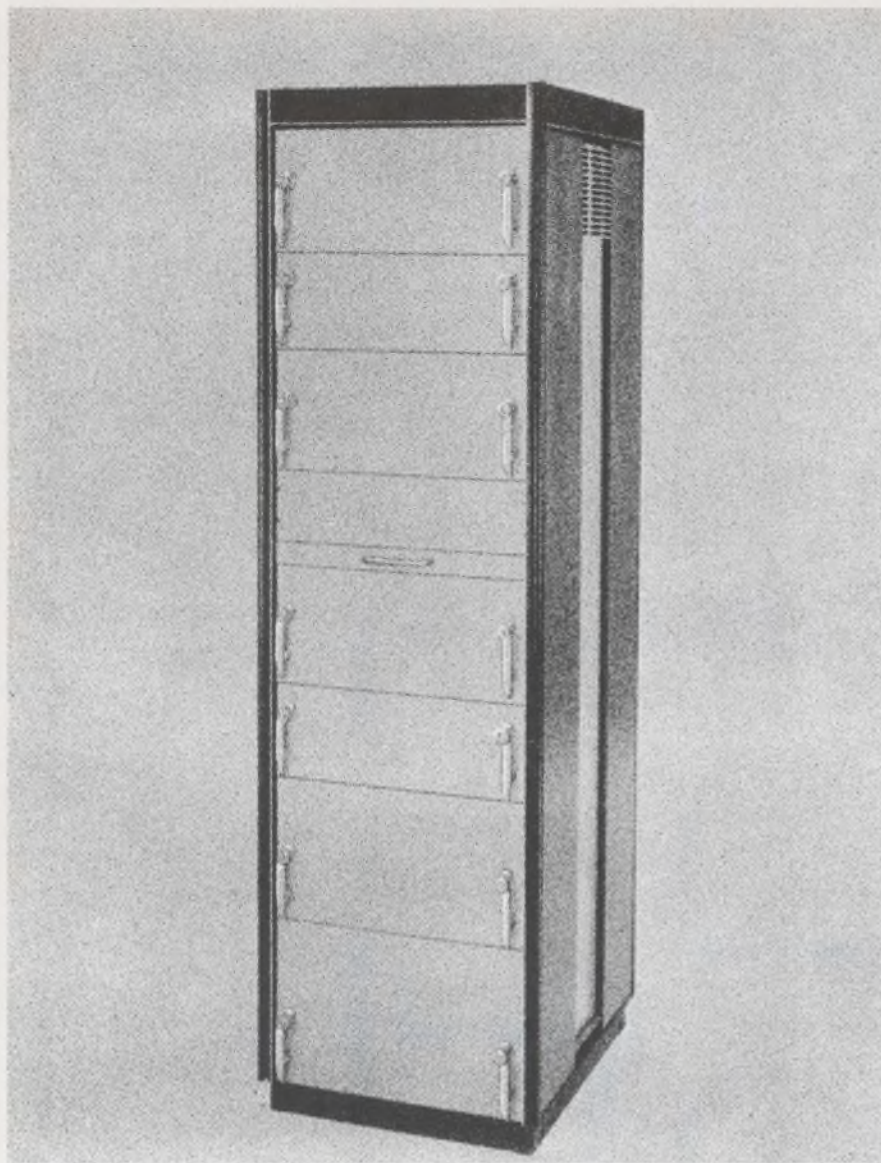

Safe deposit box

Expensive test and laboratory equipment deserves maximum protection. You can protect this valuable investment with the Vent-Rak Slim-Line 5000 Series Cabinet . . . designed and engineered to meet and exceed military specifications.

The Vent-Rak 5000 Series Cabinet is the first economically-priced, heavy-duty construction modular electronic enclosure in the market today.

Components are interchangeable, sides are easily removed,

and assembly is simple . . . accomplished with ordinary hand tools. Separate frames can be bolted together to form bays in unlimited combinations. Add handsome finish, aluminum trim, and choose from a host of accessories . . . the rugged 5000 Series Cabinet is ideally suited to almost any type of commercial electronic packaging need.

For more detailed information write Vent-Rak, Inc., 525 South Webster Avenue, Indianapolis, Indiana 46219.

VENT-RAK, INC.
525 South Webster Avenue
Indianapolis, Indiana 46219



INFORMATION RETRIEVAL NUMBER 59

DATA PROCESSING

Digital data systems communicate 50 kbits/s



General Electric Co., Communications Products Dept., P.O. Box 497, Lynchburg, Va. Phone: (703) 846-7311.

Designed to minimize the equipment needed to install and maintain complex wideband communication networks, a new line of digital communications systems transmits synchronous or non-synchronous duplex serial binary digital data at up to 50 kilobits per second. The systems include baseband and carrier data sets, vestigial sideband modems and repeaters.

CIRCLE NO. 275

Three-wire 3-D memory cycles fully in 650 ns



Data Products Corp., 6219 De Soto Ave., Woodland Hills, Calif. Phone: (213) 887-8000. Price: \$4500.

Providing word capacities up to 16k, the Store/33 memory uses three-wire 3-D organization and 18-mil cores to achieve a full-cycle time of 650 ns. With this type of organization, the fourth wire normally associated with coincident-current organization is eliminated, thus reducing assembly costs and enhancing reliability. The basic unit uses only four types of plug-in circuit cards that contain the IC electronics used throughout the memory, plus a plug-in magnetic stack.

CIRCLE NO. 276

Being an HP Frequency Synthesizer is a tough life.

Using one is a snap.

The trouble with being a reliable instrument is that everyone is always asking you to prove it. Especially if you're a Hewlett-Packard Frequency Synthesizer, because many synthesizer users freeze them to -20°C, heat them to +65°C, engulf them in humid air, drop them 2½ feet (a 50G shock when they hit sand), and whack them with a 400 lb. hammer to prove conformance to military specification MIL-E-16400F. It is a tough life; that's why every HP synthesizer would much rather be the operator.

Look what he gets:

- Frequency change by pushbutton or remote command (20 µsec, typical).
- Frequency increments as small as 0.01 Hz.
- Search oscillator for continuous tuning or sweep capability.
- Low spurious signals, low phase noise, high spectral purity.
- Direct synthesis for best stability, fast switching, fail-safe operation.

MODEL	RANGE	MINIMUM INCREMENT	SPURIOUS SIGNALS	PRICE
5105A	100 kHz—500 MHz	0.1 Hz	70 dB	\$14,100.*
5100B	0.01 Hz—50 MHz	0.01 Hz	90 dB	\$12,500.*
5102A**	0.01 Hz—100 kHz 0.1 Hz—1 MHz	0.01 Hz 0.1 Hz	90 dB 70 dB	\$7200.
5103A**	0.1 Hz—1 MHz 1—10 MHz	0.1 Hz 1 Hz	70 dB 50 dB	\$7800.

*Includes required 5110B Driver (\$4350) which operates up to four synthesizers.
**Dual range unit; has internal driver.

Military-type reliability at commercial instrument prices is an extra benefit provided by HP synthesizers for commercial, scientific and military users.

It's easy to see why, after high and low temperature, humidity, jarring drops and fierce hammer blows, it's still the user of our frequency synthesizers who gets all the breaks.

Call your local HP field engineer or write Hewlett-Packard, Palo Alto, California 94304; Europe: 1217 Meyrin-Geneva, Switzerland.

HEWLETT  PACKARD

FREQUENCY SYNTHESIZERS

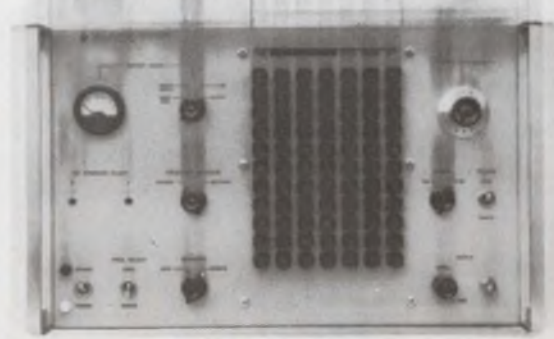

Ever wonder why Leitz created the world's most accurate toolmakers' microscope?



To manufacture our renowned Leica camera to the fine tolerance we insisted on, we needed measuring devices infinitely more accurate than anything on the market. So we created our own. And that was the beginning of the most complete line of toolmakers' microscopes in the world. They range from the economical Simplex model with a 1" x 1" range in 0.0001" to the world's

largest toolmakers' microscope, 8" x 40" with readouts in 0.00005".

If you are not familiar with the entire range of possibilities of this versatile line of superaccurate scopes, you may be letting your competition get away with one-upmanship. For a catalog that tells you everything about Leitz Toolmakers' Microscopes and their wide variety of accessories, write to Opto-Metric Tools, Inc.

OPTO-METRIC TOOLS, INC. 
A SUBSIDIARY OF E. LEITZ, INC., 304 HUDSON ST., N.Y., N.Y. 10013

03368

INFORMATION RETRIEVAL NUMBER 61

Wide dispersion spectrum analysis without *unwanted* responses... Singer Model SPA-3000

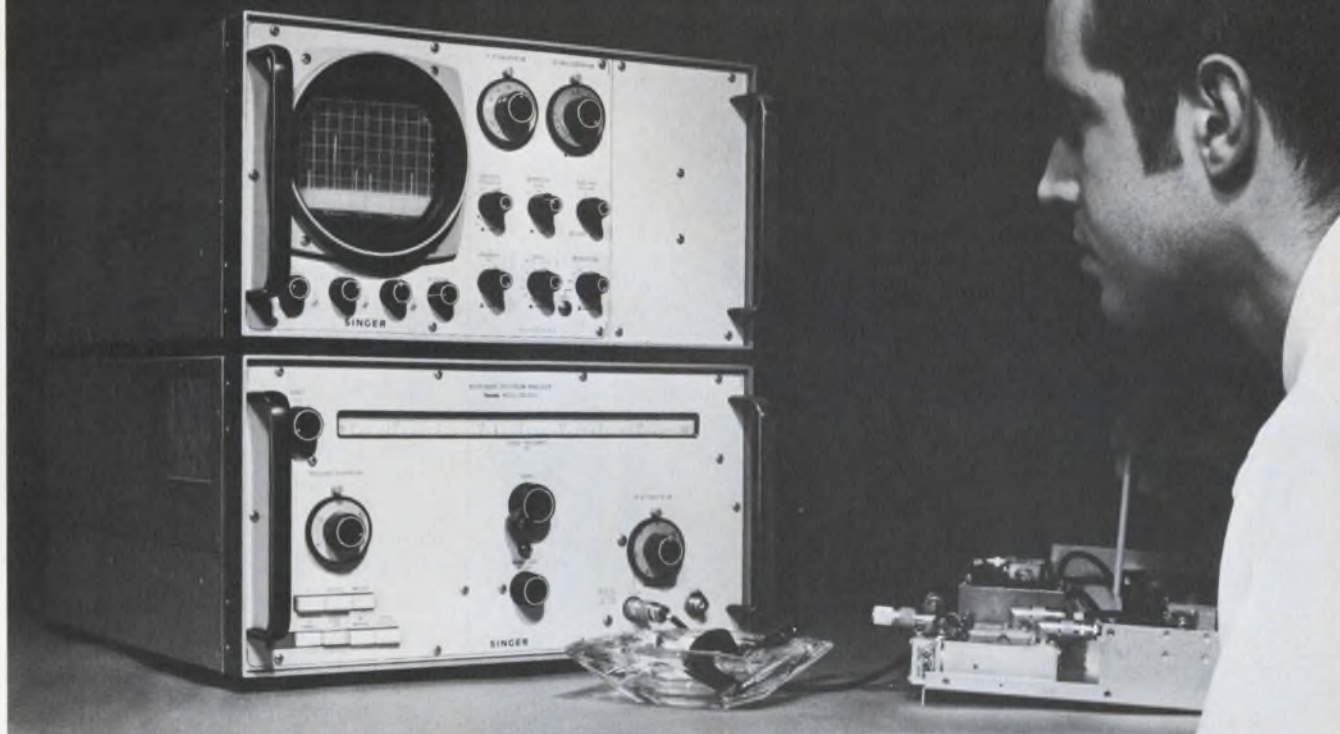

With some spectrum analyzers you have to play a guessing game, in order to identify the true responses from the ones which are analyzer generated and displayed.

The Singer Model SPA-3000 Microwave Spectrum Analyzer eliminates guesswork and displays *only* signal inputs. When aligning a communications band frequency quadrupler on the competition's equipment you could see as many as six extra (unwanted) responses. On the SPA-3000, with the analyzer set for 3 GHz dispersion around a 1.7 GHz center frequency, the 1.55 GHz quadrupler signal and its harmonics are displayed . . . *no more and no less*. The other unit set at its maximum dispersion of 2 GHz (ours is 3 GHz) around a 1 GHz center frequency displays six extra internally generated signals.

Only five of these responses are real.

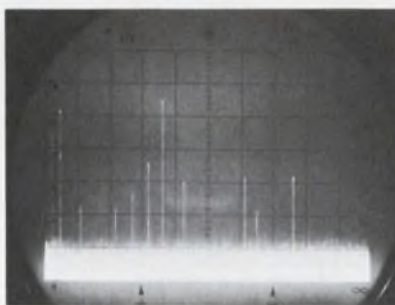

But which five?

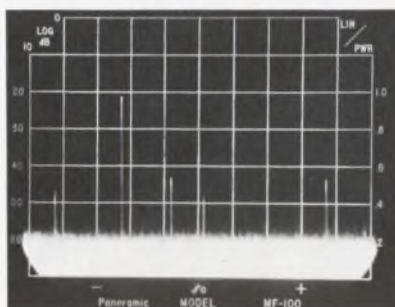

The five presented on
the SPA-3000

- **Phased locked display**—for narrow-band signal analysis. It is fool proof, because there is only one control and a positive lock indicator light to observe. Signals can be displayed over the entire 10 MHz to 40 GHz band with 1 kHz of resolution.
- **Unique log amplitude scale**—enables the measurement of narrow band pulse spectrums in a 1 MHz bandwidth mode for maximum sensitivity and dynamic range.

Frequency domain measurements are explained in Singer Instrumentation's new Application/ Data Bulletin SA-11. Copies are obtainable by contacting your nearest Singer Field Representative or by writing directly to The Singer Company, Instrumentation Division, 915 Pembroke Street, Bridgeport, Connecticut 06608.

SINGER

INSTRUMENTATION

sweeps
5 to 1500 MHz
in 7.5 milliseconds
flat!



We can supply a sweep generator with rally stripes on special order, but the frequency range and the sweep rate are standard.

Telonic's 2003 Sweep Generator will cover that entire band—14.5 MHz—in a single sweep, or in any segment down to 0.02 Hz wide. You can instantly see response characteristics over all, or any portion, of a circuit's operating frequencies.

And don't overlook that word "instantly." If you're still in the habit of using a signal generator for point-to-point testing, it's time to upshift into swept techniques. Let your local Telonic rep show you the '69 floor models.

Model 2003 Sweep/Signal Generator System

- Frequency Range (Seven different plug-in oscillators available)..... 0.02 Hz-1500 MHz
- Sweep Width (F₁-F₂ or F_c/ΔF)..... 0.02 Hz-1495 MHz
- Frequency Marking (Four different marker plug-ins available)..... Fixed or variable
- Attenuation (Eight attenuator plug-ins available)..... 1 db to 109 db (50 or 75 Ω)
- Sweep Rate (Select from two rate plug-ins)..... 0.001 to 60 sweeps/sec.
- Log Amplification (One plug-in does it all)..... 105 dB dynamic range
- Detection (Two detector plug-ins available)..... P-P passive, 50 and 75 Ω
- Display (Two display processing plug-ins)..... Amplitude and marker tilt control

Catalog 70-A and Supplements contain complete descriptions on all Telonic Sweep Generators plus a full section devoted to "how-to" applications. Get your copy today.



TELONIC INSTRUMENTS
A Division of Telonic Industries, Inc.
60 N. First Avenue
Beech Grove, Indiana 46107
TEL (317) 787-3231 • TWX-810-341-3202
INFORMATION RETRIEVAL NUMBER 63

DATA PROCESSING

Passive equalizer is Bell-compatible



Sangamo Electric Co., P.O. Box 359, Springfield, Ill. Phone: (217) 544-6411.

Featuring electrical and mechanical compatibility with Western Electric 384, 385 and 359 equalizers, a new passive equalizer provides envelope delay and attenuation equalization in the 300-to-3000-Hz voice-frequency band. Model T300 consists of modular units that are identical to the Bell system modules. Equalization is accomplished by inserting the proper modules for optimum compensation of the facility makeup.

CIRCLE NO. 277

Communication terminal uses LSI MOS memory



Data Computer Systems, 1612 S. Lyon St., Santa Ana, Calif. Phone: (714) 542-4789. P&A: from \$29,000; 120 days.

Compatible with most major computers using the ASC11, ASC11-8 or EBCD1C transmission modes, a high speed, four-wire, full-duplex remote communication terminal allows simultaneous operation of four functions: read, transmit, receive and print. The CP-4 system has an advanced MOS LSI memory with a capacity of 400 standard characters, expandable to 3200 characters. Data rates are up to 4800 bits per second over private lines or up to 2000 bits per second over switched lines.

CIRCLE NO. 278

You say you want a

low-profile snap-in mounting push button switch or matching indicator that is interchangeable with most 4-lamp displays . . . available in a full range of cap colors . . . with a choice of bezels with or without barriers in black, gray, dark gray or white.

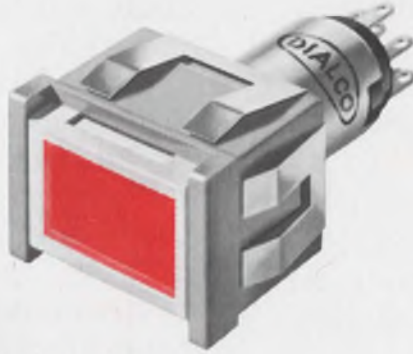

and a

legend presentation that's positive (like this one) or negative (like the one below) or just plain (like the one above) . . . one that's white when "off" and red, green, yellow (amber), blue or light yellow when "on" . . . or colored both "on" and "off."



and a

highly reliable switch proven in thousands of installations . . . available in momentary or alternate action . . . N.O., N.C. or two circuit (one N.O., one N.C.) . . . that accommodates a T-1 $\frac{3}{4}$ bulb with midjet flanged base, incandescent, in a range of voltages from 6–28V.



*etc.
etc.
etc.*

Now, Dialight gives you custom panel designing with a standard line of push-button switches and matching indicators

Dialight offers a broader range of switch and indicator possibilities than you'll find anywhere in a standard single-lamp line. Sizes: $\frac{3}{4}$ " x 1", $\frac{5}{8}$ " square and round. Send today for our new full-color catalog L-209.

DIALIGHT

Dialight Corporation, 60 Stewart Ave., Brooklyn, N. Y. 11237

INFORMATION RETRIEVAL NUMBER 64

New bank book for savings

Send for our new 1969 Relay Catalogue and we guarantee it will open your eyes to ways of saving money on most frequently used Industrial Type Relays.

It will help you save time, which is worth money. Avoid production delays, which is worth money. And cut rejections to the bone, which is also worth money.

Besides, a quotation from Line Electric will be competitive every-

time, which could save you a lot more money, too.

We send out catalogues the same day we receive your request and, if you are in a great hurry, we will even try to give you a quotation over the phone. Just call 201-887-8200 and ask for our Relay Sales Manager. We're dedicated to service.

LINE ELECTRIC COMPANY
U.S. Highway 287, Parsippany, N.J. 07054
Manufacturers of Relays and the best service
in the business. *SUBSIDIARY OF THE SINGER COMPANY*



Far Superior

TO ANY VTVM OR VOM

A NEW STANDARD OF THE INDUSTRY...

- Only Sencore makes a true field effect meter
- Less circuit loading than VTVM/obsoletes VOM
- Zero warm-up time — instant stability
- Complete circuit and meter protection
- Complete portability
- Greater frequency responses than most scopes

FE149 SENIOR FET METER

The only true Senior FET meter available today with outstanding accuracy and unbelievable ease of operation.

- **Unmatched Accuracy.** 1.5% on DC, 3% on AC, plus large 7-in. meter and mirrored scale, assure the most accurate tests possible.
- **Eight AC and DC ranges** .5V to 1500V full scale.
- **Zero center scale** with .25 v. either side assures measurements to less than .1 v. for transistor bias measurements.
- **AC peak to peak readings** to 4500V maximum with freq. response of 10HZ to 10MHZ \pm 3DB.
- **Eight resistance ranges** to R x 10 megohms with 6 OHMS center scale.
- **Nine DC and nine AC current ranges** 150 μ a to 5 amps.
- **Eight decibel ranges** for audio measurements.
- **Three HI-Voltage ranges**, 5 KV, 15 KV, 50KV with 39A21 high voltage probe. \$14.95
- **Absolute meter and circuit protection** against circuit overload.
- Non-breakable, scuff-proof, vinyl-clad steel case.
- **Three-way power.** Operates on AC, on self-contained rechargeable batteries, or on AC with batteries plugged in. Same readings all three ways.



\$149.50

Exclusive push-button design. Just push two buttons for any test — top row selects function, bottom row selects range. Action is instant and automatic.



\$69.95

FE14 — STANDARD FET METER

ACCURACY DC \pm 2.5%
AC \pm 4.5%

- 4½-inch meter, vinyl-clad steel case.

FE14 and FE16 popular 4 1/2 inch FET Meters

- **Hi Accuracy.** For unsurpassed measurements. Mirrored scales prevent parallax errors.
- **Minimum circuit loading.** 15 megohm input resistance on DC; 10 megohm on AC.
- **Zero center scale** \pm 0.5 v. readings for transistor bias measurement.
- **Full meter & circuit protection** against possible circuit overload.
- **7 DC & AC voltage ranges** 1 to 1000 volts full scale.
- **AC peak to peak readings** 2800 v. maximum with freq. response of 10HZ to 10MHZ \pm 3DB.
- **5 resistance ranges** to 1000 megohms.
- **5 DC current ranges** 100 μ a to 1 amp.
- **3 Hi-Voltage ranges**, 3 KV, 10 KV, 30 KV, extended with 39A19 (\$9.95) high voltage probe.



\$84.50

FE16 HI ACCURACY FET METER

ACCURACY DC \pm 1.5%
AC \pm 3%

- 4½-inch high-styled meter, high-styled knobs, and special meter-tilting metal handle. Vinyl-clad steel case.



See your Sencore distributor today or write factory for complete line catalog.

SENCORE
STANDARD OF THE ELECTRONIC INDUSTRY

426 SOUTH WESTGATE DRIVE,
ADDISON, ILLINOIS 60101

INFORMATION RETRIEVAL NUMBER 66

We make selenium rectifiers:

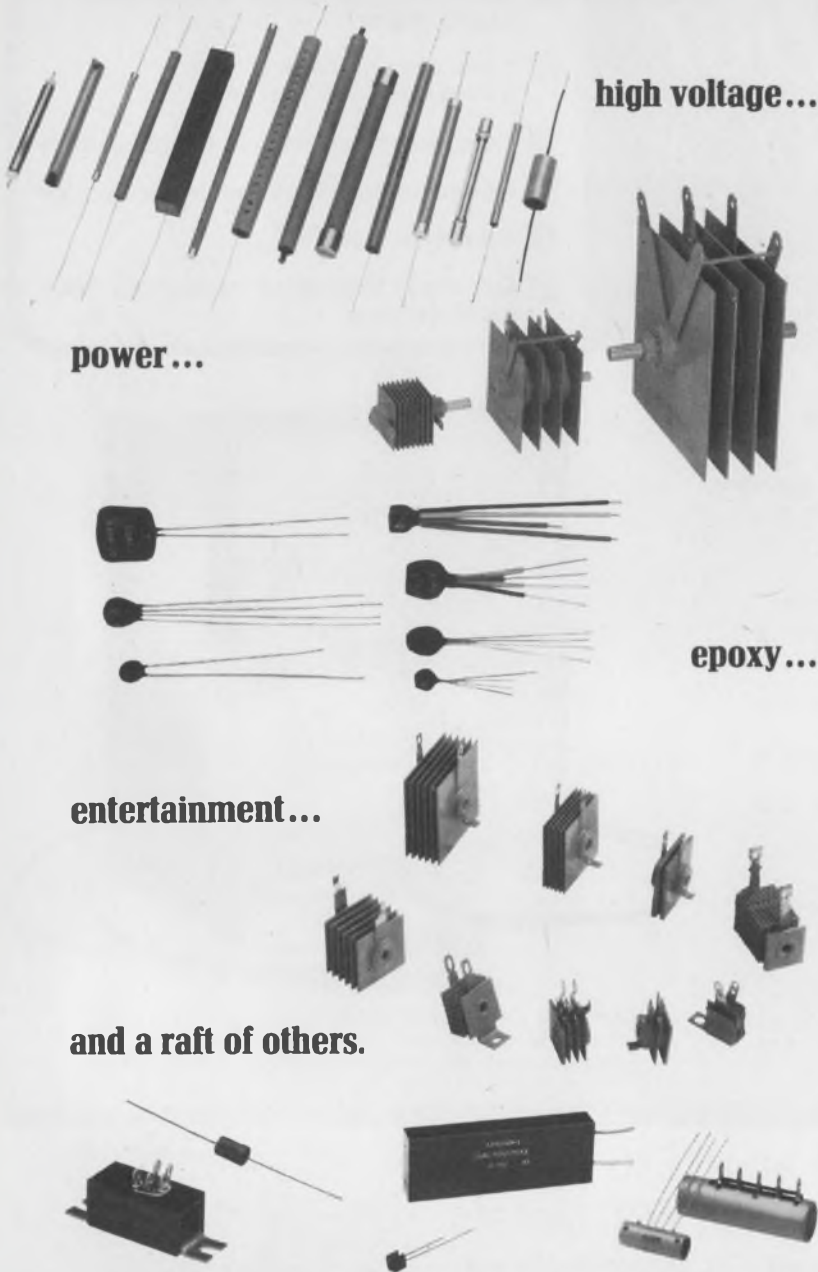

high voltage...

power...

epoxy...

entertainment...

and a raft of others.

Why settle for ordinary selenium rectifiers more or less equal in design construction and performance, when you can go Edal and get much, much more.

And we do mean measurably, obviously, more. Prove it to your-

self. Just ask and we'll send you samples. You can put them to the test. If you prefer, let us send you complete descriptive literature or have our local Technical Representative come in and give you our story. Just ask.

EDAL

Edal Industries, Incorporated
4 Short Beach Road, East Haven, Connecticut 06512

Rectifiers
Silicon
Selenium
Copper Oxide

WE MAKE MORE DIFFERENT TYPES OF RECTIFIERS THAN ANYONE IN THE WORLD
INFORMATION RETRIEVAL NUMBER 67

ICs & SEMICONDUCTORS

Light-emitting diode triples radiant power

RCA/Electronic Components, 415 South 5th St., Harrison, N.J. Phone: (201) 485-3900. Price: \$7.

With triple the radiant power output of its predecessor, the 40598, a new high-efficiency gallium-arsenide infrared light-emitting diode emits 1 mW minimum of radiant power output at an operating current of 50 mA and a wavelength of 9300 Å (930 nm). The new device, designated 40598A, is designed for operation in either continuous or pulse service at temperatures ranging from -73 to +75°C. Its small size, 0.09 in. in diameter, facilitates mounting on printed circuit boards.

CIRCLE NO 279

Plastic diodes rectify 100 A

A.E.I. Semiconductors Ltd., Carholme Rd., Lincoln, England. Availability: May, 1969.

A new family of medium-current plastic encapsulated rectifier diodes has current ratings from 50 to 100 A over the voltage range of 100 to 600 V. The first member of this new family is the M70-601A, a stud cathode rectifier rated at 70 A and 600 V with a case temperature of 100°C.

CIRCLE NO. 280

Npn/pnp transistors carry 60 A at 120 V

Transitron Electronic Corp., 168 Albion St., Wakefield, Mass. Phone: (617) 245-4500. P&A: from \$41.50; stock to 4 wks.

Nine new complementary power transistors with collector voltage ratings of 80, 100 or 120 V handle currents from 30 to 60 A. The 30-A units are supplied in a TO-61 package rated at 150 W, while the 40- and 60-A units come in a TO-63 package rated at up to 300 W. These new npn/pnp pairs comprise types ST17060, -61, -62, ST10007, -08, -09, ST15043, -44, -45, ST-54004, -05, -06, ST14030, -31, -32, and ST40002, -03, -04.

CIRCLE NO. 281

an industrial relay from the originator and world's most experienced producer of TO-5 relays

(at industrial prices)

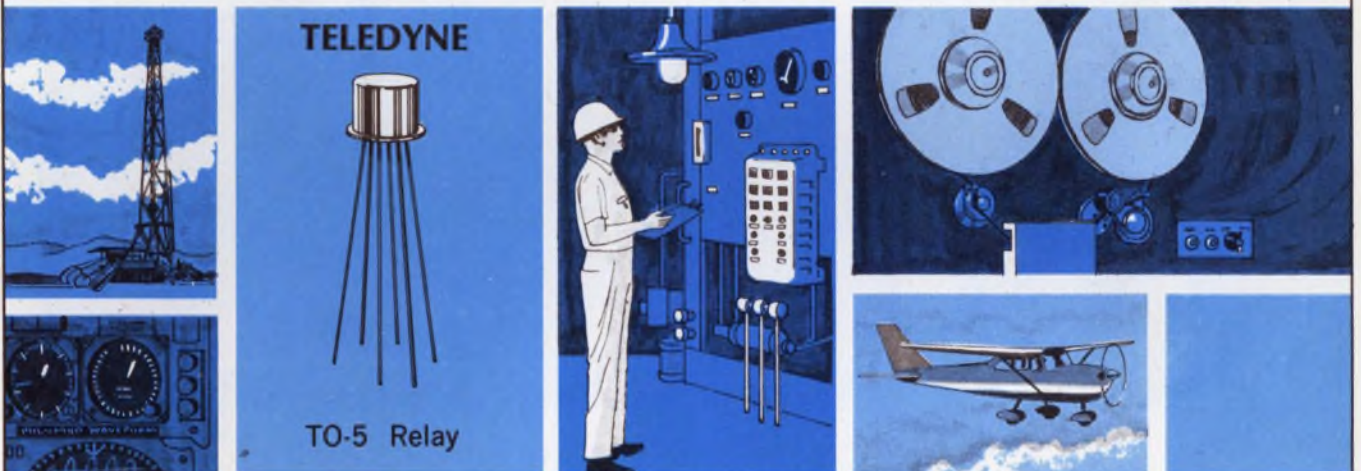

What we've learned about relay design, reliability, quality, new materials and methods from the relays Teledyne has produced for the military market is now part of our everyday procedure. This experience added to breakthroughs in automated production enables us to economically produce sophisticated relays for the industrial market.

Automated production doesn't mean a relaxation in the development of more advanced designs . . . this Teledyne philosophy has made us the leader in the aerospace market.

In support of this philosophy our industrial relays are presently available with internal diode coil transient suppression.



Effective May 1969, we will offer a DPDT TO-5 Relay with an internal transistor driver. These relay products will assure our leadership in the industrial market too!



Phone, wire or write for complete technical data.



TELEDYNE RELAYS
A TELEDYNE COMPANY

3155 West El Segundo Boulevard Hawthorne, California
90250 Telephone: (213) 679-2205

Hybrid power drivers perform two functions

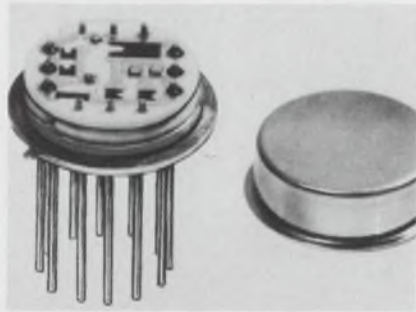

CTS Microelectronics, Inc., West Lafayette, Ind. Phone: (317) 463-2565.

New hybrid circuit power drivers that operate without a regulated power supply can also be used as dual gate functions. Packaged in hermetically sealed TO-8 cans, series 850 single drivers handle high output currents of 700 mA, while series 851 dual drivers provide a medium current capability of 350 mA. Supply voltages can range from 4 to 35 V dc and control inputs are TTL or DTL circuitry.

CIRCLE NO. 282

Compensated op amp uses chip capacitors

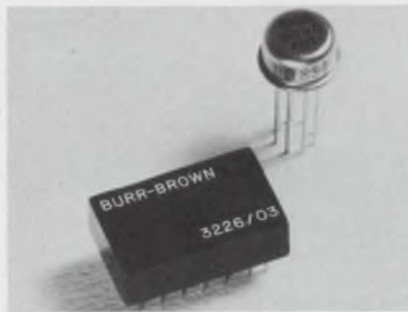

Burr-Brown Research Corp., International Airport Industrial Park, Tucson, Ariz. Phone: (602) 294-1431. P&A: \$19.80; stock to 4 wks.

Stable for all values of gain, a new hybrid IC operational amplifier fully compensates itself with internal thick-film resistors and chip capacitors in a standard 14-pin dual-in-line package. Model 3226/03 provides a minimum slew rate of 0.9 V/ μ s over its full output voltage range of ± 10 V. Its input bias current is ± 50 nA maximum and bias current drift is ± 1 nA/ $^{\circ}$ C maximum.

CIRCLE NO. 283

Plastic complements withstand 5 A peak

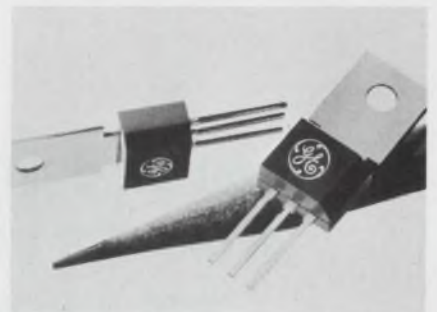

General Electric Co., Semiconductor Products Dept., 1 River Rd., Schenectady, N.Y. Phone: (518) 374-2211. P&A: 40¢ to 50¢; stock.

Two new plastic complementary 3-A silicon power-tab transistors can handle peak operating currents of 5 A. The D27C power-tab transistor is encapsulated with red silicone for easy identification as an npn device, and the D27D is encapsulated with green silicone for easy identification as a pnp device. Both units offer a total power dissipation of 1.7 W at 50 $^{\circ}$ C.

CIRCLE NO. 284



actual size



NEW Series 270

...time to go DIGI-EC

with the smallest, low cost, all solid state digital panel meter

- Size: 2 1/16" x 4 1/2" x 7 7/8"
- Accuracy 0.1%
- D.C. Ranges from 200MV and 20 μ A
- Non-blinking display
- High Input $\geq 100M\Omega$
- 100 μ V/digit resolution
- Fast sample rate
- Completely self-contained
- Reading retention
- B.C.D. option

\$195

QTY. 1-9

\$129

QTY. 100

DIGI-EC

by UNITED SYSTEMS CORPORATION

Stocking Representatives
Throughout the World

918 Woodley Road • Dayton, Ohio 45403 • (513) 254-6251

Signalite

Sets The Pace In Gas Discharge Tubes and Glow Lamps

Signalite started supplying neon glow lamps as an indicator device almost two decades ago. Since then, Signalite developed the neon lamp into a circuit component that has solved problems in areas from voltage regulation to photocell drivers . . . from SCR triggering to unregulated power supplies.

Today, Signalite is a leading source for Neon Glow Lamps as indicators and circuit components.

Today, Signalite is a leading source for spark gaps designed to transfer energies and act as voltage sensitive switches.

Today, Signalite is a leading source for noise tubes and miniature noise sources for noise figure test equipment and monitoring system receiver sensitivities.

Only Signalite offers you this in-depth experience, capability, facility and technology in gas discharge devices and glow lamps . . . backed by an R&D program to explore new markets and devices.

Signalite Application Engineers are available to you. Share your design problems with them. They'll choose the right product for your application or design custom units to meet unique requirements.

Yours For The Asking . . . brochures on neon lamps, spark gaps, noise sources. Application Newsletter on technique and application of these products.

A General
Instrument
Company



Signalite INCORPORATED
1933 HECK AVENUE
NEPTUNE, NEW JERSEY 07753

san fernando

electric manufacturing company

Electronic components
of proven reliability

INTRODUCES AN OUTSTANDING RFI FILTER

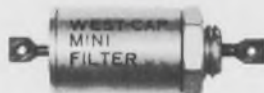

Actual Size

TYPE CF MINIATURE RFI LOW PASS
FILTER SERIES DEVELOPED BY WEST-CAP®

▶ PACKS MORE INSERTION LOSS IN A
SMALLER UNIT THAN EVER BEFORE

Plus all these features:

MINIATURE SIZE • LOW WEIGHT • LOW D.C. RESISTANCE • HIGH
ATTENUATION • HERMETICALLY SEALED • BROADER RANGE OF
VALUES • GOLD OR SILVER PLATED. STEEL CASE • HIGHER CUR-
RENT RATINGS (TO 15 AMPS.)

Dimensions (inches)

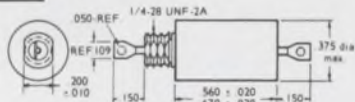

NOTE: Supplied with nut and lockwasher

Ordering information

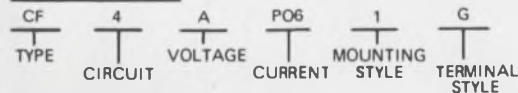

Voltage

A	50 VDC
B	100 VDC
C	200 VDC (115 VAC)

Circuit

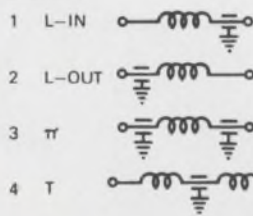

Mounting Style

1	.312	NO FLATS
2	.312	2 FLATS
3	.190	NO FLATS
4	.190	2 FLATS

Terminal Style

G	90° LUG
L	LEADS

Current in Amperes

PO6	.06 Amps.
P15	.15 Amps.
P25	.25 Amps.
P50	.50 Amps.
1P0	1.0 Amps.
2P0	2.0 Amps.
3P0	3.0 Amps.
5P0	5.0 Amps.
10P	10.0 Amps.
15P	15.0 Amps.

Call your representative of West-Cap high-reliability
products or contact West-Cap Division - where service
and quality count.



WEST-CAP DIVISION

1501 First Street, San Fernando, California
Telephone: (213) 365-9411 TWX (213) 764-5963

STANWYCK WINDING
NEWBURGH, NEW YORK

WEST-CAP ARIZONA
TUCSON, ARIZONA

GENERAL SCIENTIFIC
SAN FERNANDO, CALIFORNIA

INFORMATION RETRIEVAL NUMBER 71

ICs & SEMICONDUCTORS

MSI circuit arrays compare and check

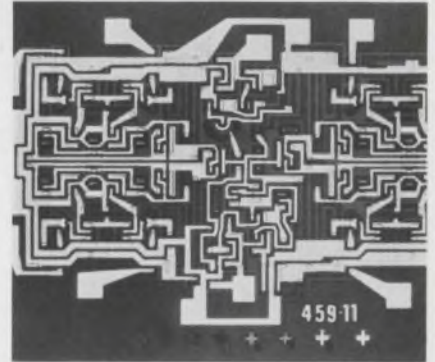

Sylvania Electric Products Inc.,
Semiconductor Div., 100 Sylvan
Rd., Woburn, Mass. Phone: (617)
933-3500.

Two new medium-scale inte-
grated circuit arrays include the
SM120 parity generator/checker,
which replaces the equivalent of
13 IC packages, and the SM130
two-word four-bit comparator,
which contains the equivalent of
nine IC gate packages. Series
SM120 devices operate with a de-
lay time per gate as low as 22 ns;
series SM130 devices feature com-
plementary outputs and typical
speeds of 24 ns.

CIRCLE NO. 285

Hybrid dc regulators handle 750-mA loads

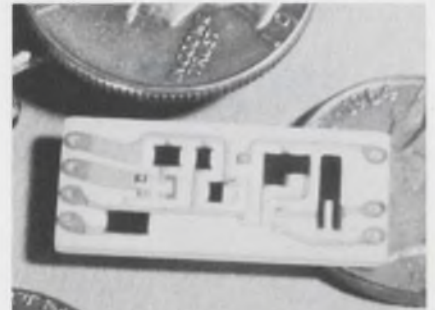

Beckman Instruments, Inc., Heli-
pot Div., 2500 Harbor Blvd., Ful-
lerton, Calif. Phone: (213) 691-
0841. Price: \$13.50.

Completely self-contained, low-
cost series 809 positive dc voltage
regulators and series 859 negative
regulators feature a load regula-
tion of ±0.003%/mA and a load
capability of 750 mA. These hybrid
cermet devices come with stand-
ard fixed outputs of plus or minus
5, 6, 9, 12, 15, 18, 21, 24, and 28 V.

CIRCLE NO. 286

**MODULAR DESIGN MEANS
MAINTENANCE-FREE
SERVICE... WITH MDS
CARD PUNCH CONSOLES**



MDS 6011
CARD PUNCH COMPACT CONSOLE

MDS Card Punch Consoles are designed with interface and performance capabilities compatible with most computers and communication systems.

MDS Punched Card equipment features modular design... your assurance of simplified maintenance and long-term reliability. Card punch heads are sealed, oil-filled mechanisms insensitive to environmental conditions. Interface, control circuits and power supplies are included.

The MDS 6011 Card Punch Compact Console is a complete self-contained unit, ideal for mobile applications as well as typical fixed data handling installations. The card punch is matched to a complete card transport system with 1000 card capacity hopper and stacker. Throughput of 200 cards per minute. Cards are end-fed, column "1" first.

MDS 6012 Card Punch Console has interface and performance characteristics like those of the 6011. Modular deck assembly and electronics are designed to allow pre-read and/or post-read stations to be incorporated as options.

Ask for information on the MDS 6014... includes a card reader station incorporated ahead of the punch station.

Ask for: The MDS folder-file on MDS 6011, 6012, 6014.

FOR MORE — MEET YOUR MAN FROM MDS



MDS 6012
CARD PUNCH CONSOLE

MOHAWK^{MS}
DATA SCIENCES CORPORATION
OEM MARKETING

122 EAST RIDGEWOOD AVENUE • PARAMUS, N.J. 07652
Telephone 201/265-7333

Every MDS office is an OEM Marketing office

DIGITAL STRIP PRINTERS • BUFFERED TAPE UNITS
HIGH-SPEED AND LOW-SPEED LINE PRINTERS
CARD PUNCHES AND READERS
PAPER TAPE PUNCHES AND READERS

REGIONAL MANAGER OFFICES

Atlanta, Ga. Tel. 404/261-8036
Waltham, Mass. Tel. 617/891-4430
Des Plaines, Ill. Tel. 312/298-4141
S. San Francisco, Calif. Tel. 415/761-0750

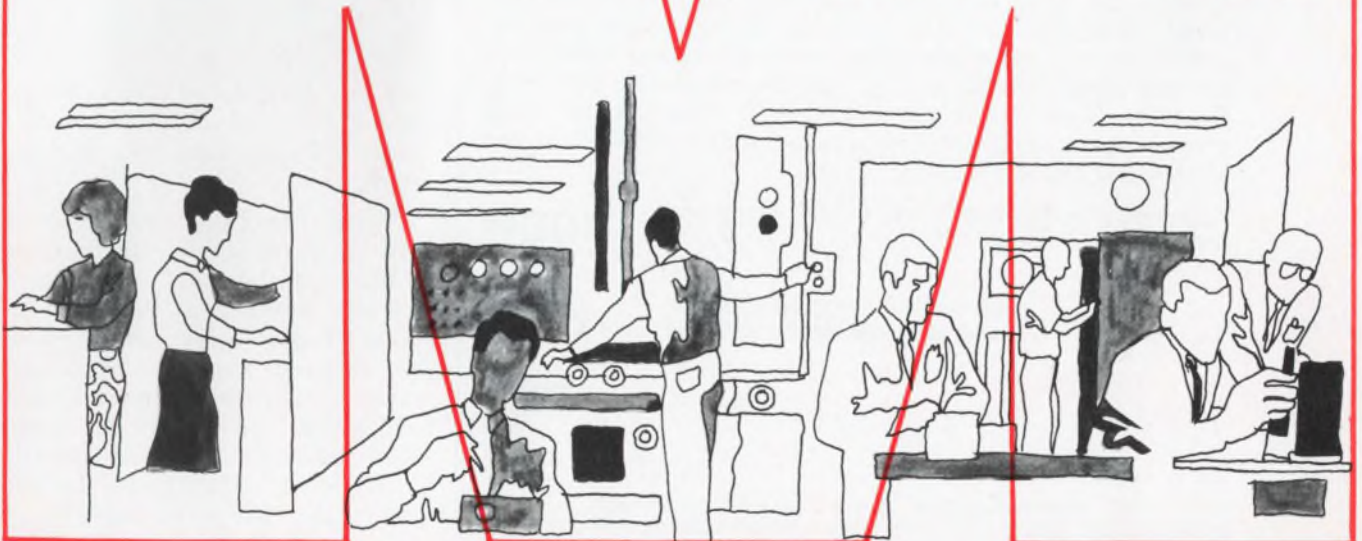

SCL circuits are MOS chips

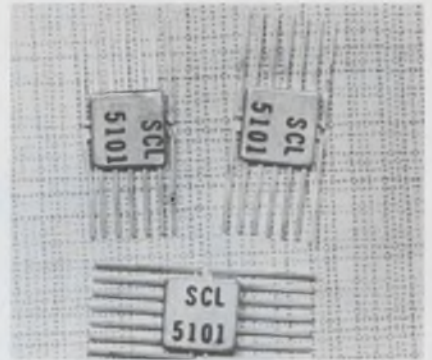

Solid State Scientific Corp., Montgomeryville Industrial Center, Montgomeryville, Pa. Phone: (215) 855-8400. P&A: \$12, stock.

A new series of MOS static-complementary-logic (SCL) circuits feature low power consumption, low leakage currents and zener-protected inputs. Series SCL-5100 units are ideal for use as building blocks for constructing large arrays. Their operating temperature range is from -55 to +125° C.

CIRCLE NO. 287

Analog comparators indicate differences



Optical Electronics, Inc., P. O. Box 11140, Tucson, Ariz. Phone: (602) 624-8358. P&A: \$74 to \$255; stock.

Using monolithic circuits in a hybrid construction, three new window-type analog comparators indicate whether an unknown is below, equal to, or greater than the reference voltage. Comparison error is ±3 mV for models 5233 and 5372A, and ±1 mV for model 5385; maximum response time is 3 μs for the 5233, 15 μs for the 5372A, and 100 μs for the 5385.

CIRCLE NO. 288



Simpson's NEW solid-state VOM with FET-Input

- **HIGH INPUT IMPEDANCE...**
11 Meg Ω DC 10 Meg Ω AC
- **PORTABLE..... battery operated**
- **7-INCH METER..... overload protected**

Simpson's new 313 gives you high input impedance for accurate testing of latest circuit designs . . . free of line cord connections. Over 300 hours operation on inexpensive batteries. And the new 313 is *stable*, which means positive, simplified zero and ohms adjustments. Protected FET-input handles large overloads. DC current ranges to 1000 mA. Sensitive Taut Band movement and 7-inch meter scale provide superior resolution down to 5 millivolts. Write today for complete specifications.

Complete with batteries, 3-way AC-DC-Ohms probe, and operator's manual..... **\$10000**

Simpson ELECTRIC COMPANY

GET "OFF-THE-SHELF" DELIVERY FROM YOUR LOCAL ELECTRONIC DISTRIBUTOR



5200 W. Kinzie Street, Chicago, Illinois 60644 • Phone (312) 379-1121
 EXPORT DEPT.: 400 W. Madison Street, Chicago, Illinois 60606. Cable Simelco
 IN CANADA: Bach-Simpson Ltd., London, Ontario • IN INDIA: Ruttonsha-Simpson Private Ltd., International House, Bombay-Agra Road, Vikhroli, Bombay

INFORMATION RETRIEVAL NUMBER 73

Your license to drive...

NIXIE® DRIVER LICENSE		Class A: <i>New</i>
Name: NPN—2N5550/5551—MPS L01 PNP—2N5400/5401—MPS L51		Conditions: <i>Off-the-shelf</i>
BV _{CEO} : 100 to 160 V (min) @ 1 mA		
I _{CEO} : <i>Low</i>	h _{FE} : <i>Excellent</i>	V _{CE(sat)} : <i>Low</i>
Fee: 5,000 to 9999 quantity		
2N5550 — \$.37	2N5400 — \$.40	
2N5551 — .45	2N5401 — .49	
MPSL01 — .31	MPSL51 — .34	
		 TO-92

With the real economy of Motorola's Unibloc* transistors... for nixies and other display tubes of similar high voltage requirements.

Six rugged new low-cost plastic transistors provide excellent solutions to the problem of finding economical high-voltage drivers for display tube readout circuits — your license to drive. Applications for these versatile devices by no means end here, however, for they fit well into a variety of industrial high-voltage designs.

And they are ideal for use in aircraft systems where high-voltage transients create problems, or for reducing the need for transformers in line-operated applications. In addition to their versatility as switches, they have the necessary specs to function in high-voltage amplifier sockets.

Detailed specifications for the NPN 2N5550/-5551 or MPSL01 and the PNP 2N5400/5401 or MPSL51 are available from Motorola Semiconductor Products Inc., Technical Information Center, P.O. Box 20912, Phoenix, Arizona 85036.

*Trademark of Motorola

©Trademark of Burroughs

- where the priceless ingredient is care!



MOTOROLA
Plastic Transistors



3 ways to prevent numerals from "spotting" at 55°C.

Fill with freon...
keep in shade...
or specify Datavue*
Indicator Tubes.

All Datavue tubes are rigorously tested to meet commercial and military specifications, produced for 200,000 hours of reliable operation. U.S.-made, they can cost less than \$3.95 each.

Datavue tubes feature: straight, stiff leads for fast insertion; fully formed, high-brightness characters; rated for strobing operation; wide range of alphanumeric, decimals, special characters. More than 40 different sockets, including right-angle types, are available.

Call your Raytheon distributor or sales office. *Raytheon Company, Industrial Components Operation, Quincy, Mass. 02169.*

*Trademark of Raytheon Company



INFORMATION RETRIEVAL NUMBER 75

MODULES & SUBASSEMBLIES

Military op amp drops bias to 10 pA

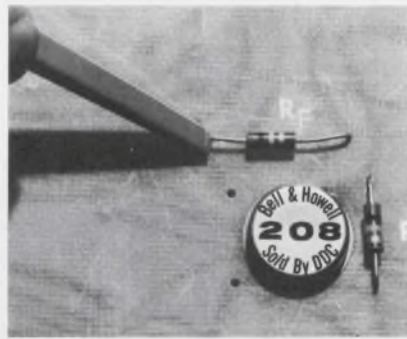

Data Device Corp., 100 Tec St., Hicksville, N.Y. Phone: (516) 433-5330. P&A: \$150; 2 wks.

Model 208 FET operational amplifier boasts input bias currents of less than 10 pA over the full military temperature range. Designed by Bell & Howell for such applications as buffers, integrators, and electrometer amplifiers, these units offer full frequency compensation. They are internally offset trimmed, and fully protected voltage drift vs temperature is 25 $\mu\text{V}/^\circ\text{C}$ max. The FET front end provides $10^{11} \Omega$ differential and common-mode input impedance.

CIRCLE NO. 289

Circuit card has 6 toggles

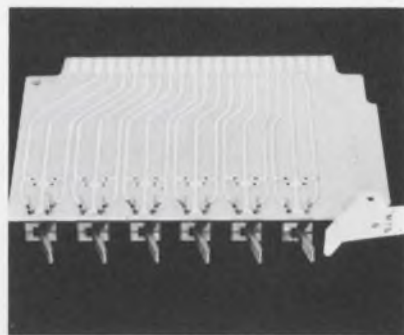

Wyle Laboratories, Computer Products Div., 128 Maryland St., El Segundo, Calif. Phone: (213) 678-4251.

Eliminating the need for front-panel-mounted switches in small systems, a new toggle-switch IC card allows all control wiring to be mounted on the back plane, rather than front-unit to front-panel mounting. This provides savings in space as well as cost. The MTS-6 card contains six double-pole double-throw toggle switches.

CIRCLE NO. 290



3 ways to insert indicator tube leads efficiently.

First, hammer them flat...or press with flatiron...
or specify Datavue*
Indicator Tubes.

All Datavue tubes have straight, stiff leads for fast, accurate insertion...to save hours of assembly time.

U.S.-made Datavue tubes can cost less than \$3.95 each. Rigorously tested, they're produced for 200,000 hours of reliable operation.

Datavue tubes feature: fully formed, high-brightness characters; rated for strobing operation; wide range of alphanumeric, decimals, special characters. More than 40 different sockets, including right-angle types, are available.

Call your Raytheon distributor or sales office. *Raytheon Company, Industrial Components Operation, Quincy, Mass. 02169.*

*Trademark of Raytheon Company



INFORMATION RETRIEVAL NUMBER 76

TODD

cost cutting system power supplies



MMS Series

Slot Range

\$69⁰⁰

FEATURING THE TODD FORMULA FOR SYSTEM POWER SUPPLY ECONOMY

More watts/in³/°C/\$

More watts /cubic inch

Space saver—only 3⁷/₁₆" x 3²¹/₃₂" x 4¹/₂"

More watts / °C

71°C operating temperature. Designed to meet MIL environmental SPECS.

More watts /cost dollar

M Series — your best buy in a system power supply.

7 series — 33 amperes max.

18 models per series

Outputs to 150 Vdc

.01% regulation

.5 mV rms ripple

Remote sensing/programming

5 year warranty — parts & labor

For complete information, contact your local Todd representative or:

ATC

TODD PRODUCTS CORP.
28 Laurel Street, Hicksville, N.Y. 11801
(516) 822-0784

Low-cost wideband amp powers fully to 100 kHz



Analog Devices, Inc., 221 Fifth St., Cambridge, Mass. Phone: (617) 492-6000. P&A: \$18 or \$27; stock.

With a small-signal bandwidth of 4 MHz, a new low-cost FET operational amplifier develops full power output, ± 10 V at 5 mA, to 100 kHz. The low 2-mV initial offset of model 144 permits a maximum 0.2% error when it operates as an untrimmed buffer handling 7-V signal levels. Two versions are available—the 144A with ± 100 - μ V/°C maximum voltage drift and the 144K with a higher stability of ± 30 μ V/°C.

CIRCLE NO. 291

Low-cost programmer uses captive pins

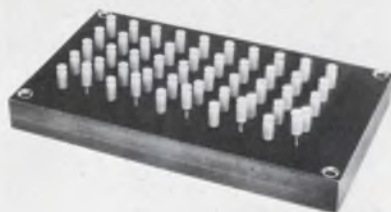

Co-Ord Switch, Div. of LVC Industries, 102-48 43rd Ave., Corona, N.Y. Phone: (212) 899-5588. P&A: from 13¢/crosspoint; 4 wks.

A new, captive-pin programmer provides an economical means of switching, as opposed to mounting an equal number of individual toggle switches. Mounted on 1/2 by 1/2-in. centers, the program pins supply either spst or spdt functions by merely pulling up or pushing down. This permits rapid switching and easy readout of program.

CIRCLE NO. 292

Quality Product of
Sigmund Cohn Corp.



Large Diameter

GOLD WIRE

for Evaporation
and Other Usage

Diameters: .010" to .030"
Purities of 99.99%
... of 99.999%

Send us specs for quotes

Sigmund Cohn Corp.

121 So. Columbus Ave.,
Mount Vernon, N.Y. 10553

Since 1901



ac ratiometry... broadband



Gain and phase measurements In-phase and quadrature ratios to .001% Direct phase angle reading to .0001°

The Model CRB-8 provides in-phase and quadrature ratio measurements (signal with respect to reference) over a frequency range of 350-5100Hz. Using RatioTran techniques for AC Ratiometry, resolution to 1 ppm (.0001%) is readily available. Unique circuitry provides for direct angular measurements with resolution of .0001 degree.

For a demonstration, or for full technical details, call your local Singer Instrumentation representative or contact us directly at the Singer Company, Instrumentation Division, Gertsch Operation, 3211 S. La Cienega Blvd., Los Angeles, Calif. 90016, (213) 870-2761.

APPLICATIONS

- Amplifier gain and phase
- Transformer TR and phase error
- Transducer linearity
- Motor tach test
- Resolver angular accuracy
- General transfer function measurements

SINGER
INSTRUMENTATION

INFORMATION RETRIEVAL NUMBER 79

MODULES & SUBASSEMBLIES

Crystal filter bank goes to monolithics

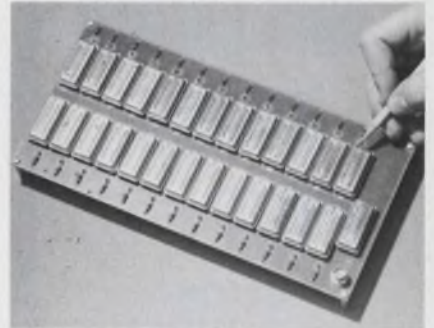

Damon Engineering, Inc., Electronics Div., 115 Fourth Ave., Needham Heights, Mass. Phone: (617) 449-0800.

The first comb set made entirely of monolithic crystal filters, model 6356MA1-MA26 filter bank consists of 26 individual monolithic crystal filters and one common matching network installed on an etched circuit board. Center frequencies are 4.00125 to 4.01375 MHz spaced at 500 Hz and the 3-dB bandwidth is 550 Hz \pm 50 Hz.

CIRCLE NO. 293

Thinline readouts mount on front panel



Discon Corp., 4250 N.W. 70th St., Fort Lauderdale, Fla. Phone: (305) 933-4551. Price: \$7.95/digit, \$19.95/decoder.

Completely specified with only two part numbers, new thinline readout assemblies with miniature plug-in decoder/drivers mount on the front of a panel rather than behind it. This cuts installation time to one-third that required for conventional equipment. Digator 20/5720 display units are available with up to eight digits per assembly.

CIRCLE NO. 294

TRW METALLIZED POLYCARBONATES



...good things come in small packages

A 10 mfd 50 volt type X483 capacitor measures a scant .670" x 1 $\frac{1}{16}$ ". It's hermetically sealed and provides outstanding temperature stability and electrical properties. Meets all MIL-C-18312 and MIL-C-19978 requirements.

Type X483 are advanced technology capacitors tailor-made for advanced technology applications. Values from .001 to 10 mfd, 50, 100, 200 and 400 volts.

Contact TRW Capacitor Division, Box 1000, Ogallala, Neb.

INFORMATION RETRIEVAL NUMBER 80

Phone: (308) 284-3611. TWX: 910-620-0321.

TRW®

KROHN-HITE MODEL 4200 VS MAJOR COMPET

MFR	H-P	H-P	G-R	K-H
Model Number				4200
Price				\$350
Frequency Range				10 Hz to 10 MHz
Power Out				500 mw
Waveform Distortion				<0.1%



**Stack this
\$350 oscillator
against the
competition**

regardless of price!

You'll be surprised! In spite of its low price, the Model 4200 exhibits extraordinary performance. It excels in those specifications most eagerly sought by men who really know oscillators. Krohn-Hite's twenty years of frequency-generator know-how has produced a unique circuit* that makes low-priced high performance a reality at last.

Here's how the Model 4200 stacks up against several competitors:

BROADER FREQUENCY RANGE: The Model 4200 outranges most of the others, including more expensive units.

MORE OUTPUT POWER: The Model 4200 has from 2.5 to 50 times the power of the other units.

BEST WAVEFORM PURITY: The Model 4200 is unexcelled.

BEST BUY: The \$350 price speaks for itself.

See for yourself. Write for data. Then contact your Krohn-Hite Representative for a no-holds-barred demonstration. The Model 4200 is a lot of oscillator for \$350.

*Patent applied for.



580 Massachusetts Ave., Cambridge, Mass. 02139, U.S.A.
Phone: (617) 491-3211 TWX: 710-320-6583

Oscillators / Filters / AC Power Sources / DC Power Supplies / Amplifiers

INFORMATION RETRIEVAL NUMBER 81

MODULES & SUBASSEMBLIES

**Operational amplifiers
settle in 1 μ s to 0.01%**



Control Logic, Inc., 3 Strathmore Rd., Natick, Mass. Phone: (617) 235-1865. P&A: \$25 to \$50; stock.

Developed for high-speed a/d conversion and multiplexed data acquisition, series FST-100 operational amplifiers have a unity-gain settling time to 0.01% accuracy in less than 1 μ s for a 10-V step output, with no appreciable overshoot or ringing. The units slew at 20 V/ μ s minimum and have a common-mode rejection of 90 dB. Gain is typically 500,000 with 300,000 minimum guaranteed.

CIRCLE NO. 295

**Analog multipliers
accept 2 input types**

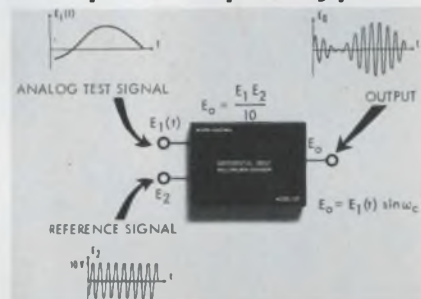

Burr-Brown Research Corp., International Airport Industrial Park, Tucson, Ariz. Phone: (602) 294-1431. P&A: \$75 or \$95; stock to 3 wks.

Employing a proprietary circuit technique that is similar to the variable transconductance method, two new, four-quadrant analog multipliers accept either differential or single-ended inputs. In addition, no external trimming is necessary to set up initial conditions. Including offset and scale factor errors, model 4098/25 has a 1% maximum accuracy; model 4097/25 has a 2% maximum accuracy.

CIRCLE NO. 296



**YOU CAN BUY 3
FM SIGNAL GENERATORS
TO COVER 10 TO 470 MHz**

**... OR 1
MARCONI
FM
SIGNAL
GENERATOR
MODEL 1066B**

The Marconi 1066B Series of FM Signal Generators are now considered standards of the industry for all RF and IF checks on FM equipment including telemetry, communications, sensitivity, bandwidth, and limiting of receivers, FM transceivers, etc. Outstanding features of these instruments are:

1066B/1 (6625-929-4277)

- No sub-harmonics
- Stepped and Continuously variable incremental tuning
- Internal or external modulation
- Output 0.2 μ V to 100 mV into 50 Ω
- FM on CW < 100 Hz

1066B/6 (6625-937-2801)

- All the features of 1066B/1 plus ...
- Built-in crystal calibrator: 10 mc & 1 mc
- FM deviation: up to \pm 400 KHz
- Modulation range: 30 Hz to 100 KHz
- Modulator distortion < 5% 215 to 265 MHz; < 10% elsewhere

Available Upon Request



THE SIG GEN BOOK

This 28-page book presents detailed discussions on signal generators and receiver measurements including: source impedance of feeder connected receivers, coupling to loop antennas, signal-to-noise ratio, automatic gain control, plotting response characteristics, measurement of adjacent channel suppression and spurious response, etc.



TECHNICAL DATA SHEETS

Technical Data Sheets on the Model 1066B/1 and Model 1066B/6 Marconi FM Signal Generators detail all specifications, operation, applications, features and accessories available.

MARCONI INSTRUMENTS
Division of English Electric Corporation
111 CEDAR LANE, ENGLEWOOD, NEW JERSEY 07631 • (201) 567-0607

INFORMATION RETRIEVAL NUMBER 82

COMPONENTS

Hall generators use thin films

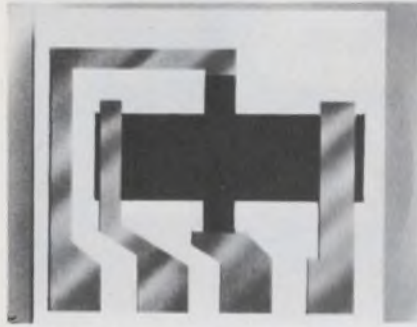

F. W. Bell, Inc., 1356 Norton, Columbus, Ohio. Phone: (614) 294-4906. Price: \$6.50 per sample kit.

A new line of low cost, thin-film Hall generators are now available. The three basic models are: the FH-300, a flip-chip device measuring only 0.1 by 0.125 in.; the FH-301 with the same basic dimensions but having conventional wire leads attached; and the FH-302 with a flexible printed-circuit lead strip attached. Typical control current levels range from 15 to 35 mA.

CIRCLE NO. 297

Mercury switch contacts in 1 ns

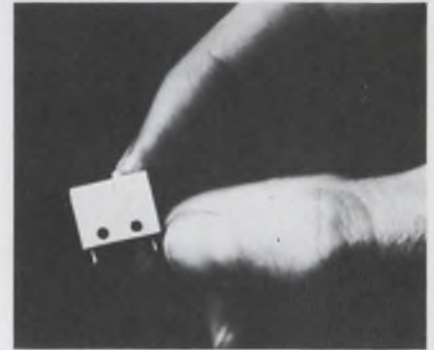

Mechanical Enterprises, Inc., 3127 Colvin St., Alexandria, Va. P&A: \$1.25; stock.

Combining the mechanical advantages of a snap-action switch with the electrical properties of a mercury switch, the Mercutron switch cycles at a rate of 200 Hz and has a contact risetime of less than 1 ns. Rated at 50 mA and 24 V dc with a contact resistance of 35 mΩ, the new switch is ideal for the low-energy circuits found in digital and control applications.

CIRCLE NO. 298

Can you

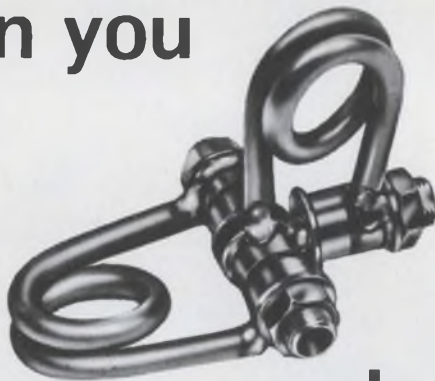

do this?

These new Johanson glass *capacitors* are designed to bridge the gap between conventional trimmers and high frequency air capacitors. They have high Q—low inductance; they have high RF current characteristics, they can be soldered together with components to simplify circuitry and they are *strong*.

Models include:



Series II: High RF voltage *low cost* units with $Q > 1200$ and TC; 0 ± 50 ppm.

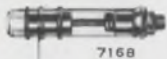

Johanson 7168: High voltage quartz capacitors which feature 7000 VDC; 2500 V peak RF at 30 mc and current capacity > 2 amps.

Also available are:

- Tuners and ganged tuners; linear within $\pm 0.3\%$
- Differential capacitors
- Mil spec capacitors
- Microminiature capacitors .075" diameter and .1-1 pf

Write today for full catalog.

Johanson MANUFACTURING CORPORATION

400 Rockaway Valley Road, Boonton, N. J. 07005 (201) 334-2676

Electronic Accuracy Through Mechanical Precision

INFORMATION RETRIEVAL NUMBER 83

Capacitor chip kits total up 600 devices



Monolithic Dielectrics, Inc., P.O. Box 647, Burbank, Calif. Phone: (213) 848-4465. P&A: \$49.50; stock.

Two new ceramic capacitor chip kits each contain 300 chips with capacitance tolerances of $\pm 10\%$ and ratings of 50 Vdcw. The first kit has ten chips of each standard RETMA value from 1.2 to 270 pF; the second kit has ten chips of each standard RETMA value from 330 pF to 0.1 μ F. Both kits are packaged in a 7 by 10-in. hardcover holder, with individual see-through pockets for the chips.

CIRCLE NO. 299

SEMPER PARATUS

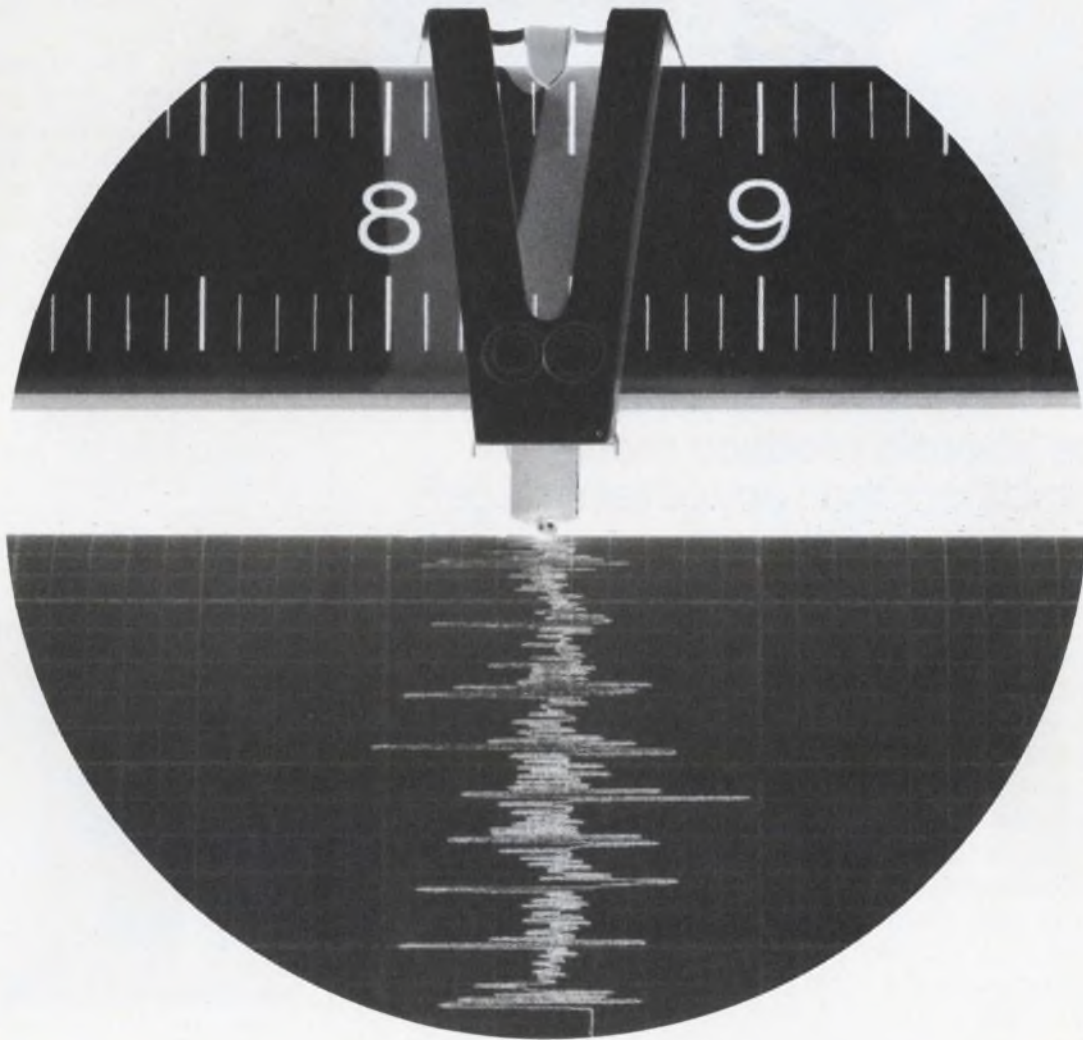

There are times when electric writing is best. Lots of times. Like when you can't be around to check your ink supply. When you've got an unattended station in a remote area. When your recorder may be on standby for long periods, yet must start and stop instantly to catch a one-shot event. When you have to be certain your records will be permanent. When environmental conditions may threaten the readability of your traces. Or, to put it more simply, when the odds are against a standard pen stylus.

Hewlett-Packard's electric writing option for strip-chart recorders is adding a new

degree of dependability to data gathering operations around the world. The technique uses special electrosensitive paper and a low-voltage writing stylus. It gives you records that are impervious to heat, pressure or light. Altitude and vibration can be tolerated; no priming is necessary before operation. With very low chart speeds you can record data 24 hours a day, seven days a week, for extended periods of time. Yet it costs only \$75 to add this option when you buy either the HP 680 five-inch recorder or the 7100 series ten-inch recorder.

Find out more about this remarkably sim-

ple way to make certain your records will be there even if you're not. Just call your local HP field engineer. Or write Hewlett-Packard, Palo Alto, Calif. 94304; Europe: 1217 Meyrin-Geneva, Switzerland. We'll send you a sample of electric writing.

11813

HEWLETT  **PACKARD**
GRAPHIC RECORDERS



Does Sherold produce more crystal filters than any other source?

Clearly.

In fact, we're the largest single independent source for both crystal filters and discriminators. And we've built more PRC and VRC filters than any other company. Plus, we've got the widest range of models in production. But . . . biggest doesn't necessarily mean best, although it's a good indication. Sound out our crystal technology capabilities and you'll find Sherold has a solid reputation for being able to produce top-quality frequency selection devices in the full range from 1 to 150 megaHz. For commercial and military applications. The real proof, though, is to let Sherold tackle your frequency selection application. Send us the electrical and mechanical characteristics of your problem and we'll put our Filter Technology Department to work on it. Quickly. Write Sherold Crystal Products Group, Tyco Laboratories, Inc., 1510 McGee Trafficway, Kansas City, Missouri 64108. Or phone (816) 842-9792. TWX 910-771-2181.

TYCO

INFORMATION RETRIEVAL NUMBER 85

COMPONENTS

Pushbutton switch rivals thumbtack



Specialty Products Div., Cutler-Hammer, Inc., 4201 N. 27th St., Milwaukee, Wis., Phone: (414) 442-7800. P&A: \$1.45; stock.

Slightly larger than an ordinary thumbtack, a new ultra-miniature pushbutton switch is an spst momentary-contact device rated at 0.5 A, 125 V ac normally open and 0.25 A 125 V ac normally closed. Standard design features include gold-plated contacts, molded nylon operators, 0.02-in. minimum pre-travel, 0.06-in. maximum over-travel, and eight-ounce maximum actuating force. The new switch is available in a choice of 10 operator cap colors.

CIRCLE NO. 335

Flange-based lamps slim dia to 0.093 in.



Lamps, Inc., 17000 South Western Ave., Gardena, Calif. Price: 83¢.

With a maximum diameter of 0.093 in. and an over-all length of 0.285 in., new flange-based sub-miniature lamps can be installed and replaced without soldering. They are unsupported filament T-3/4 units available in 1.5-V ratings with amperage of 0.01 or 0.015 A, and in 5-V ratings with amperage of 0.015, 0.06, 0.075, 0.08 or 0.115 A. Stock designs include standard tips for undistorted end-viewing.

CIRCLE NO. 336

Scans and Logs Signals Without an Operator

3 0 1 4 2 7
3 0 1 4 2 7
3 0 1 4 2 4
3 0 1 4 2 5
3 0 1 4 2 6
3 0 1 4 2 4

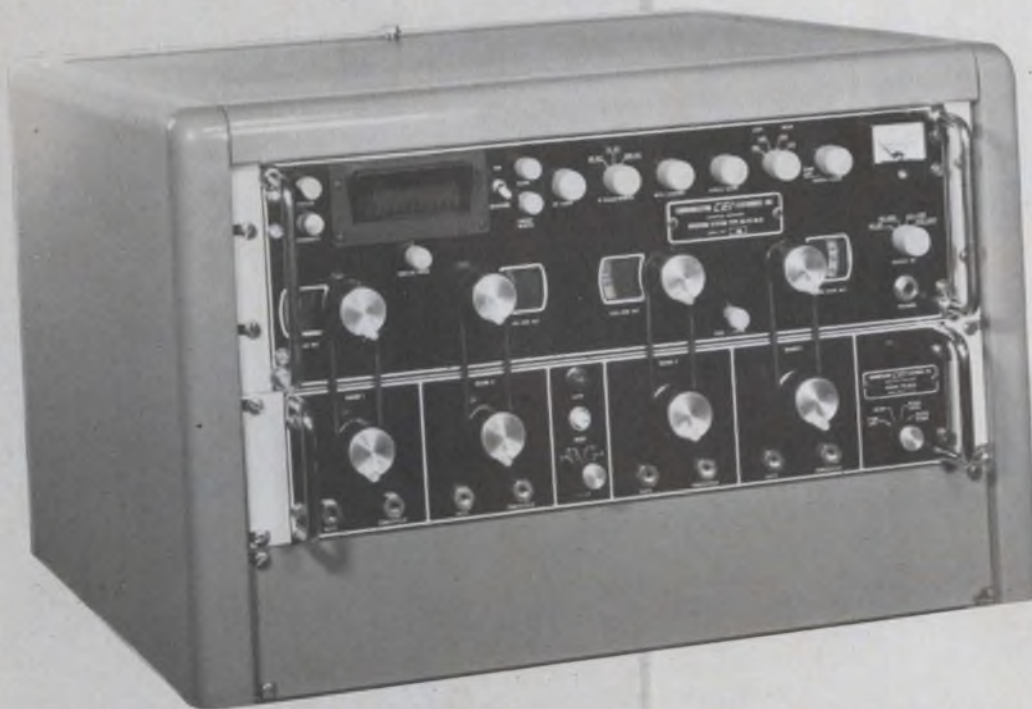

NEW MD-104 AUTOSCAN FROM WATKINS-JOHNSON

The MD-104 converts the Type RS-111-1B-17 VHF-UHF Manual Receiving System into a scanning Receiving System. It externally drives the tuning knobs on the receiver at rates from 4 to 34 rpm and provides commands to a tape recorder for storing information. The autoscanner has four channels, each channel controlling one pulley, and features variable scan speed and variable threshold level adjustments for each channel.

The MD-104 (1) Scans for a signal. (2) Upon finding a signal stops and fine tunes itself to the selected signal. (3) Commands the associated counter to measure the frequency of the selected signal. (4) Commands print out of measured frequency. (5) Monitors the selected signal for a predetermined time and supplies signal to an external recorder or other monitor. (6) Repeats the operations.

The RS-111-1B-17 Receiving System is the latest version of the performance-proved RS-111-1B Series Receivers and has been modified especially for use with the MD-104. It receives AM, FM and CW signals, in the 30-1000 MHz range and tunes the range in four bands. It features digital automatic frequency control capability when used with an ancillary counter.

A modification kit is available for field conversion of any RS-111-1B Series Receiving System into an RS-111-1B-17.

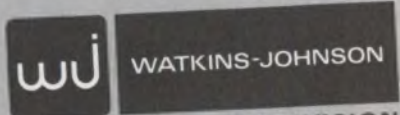

WATKINS-JOHNSON

CEI DIVISION

6006 Executive Blvd.
Rockville, Md. 20852

World's largest selection of receiving equipment for surveillance, direction finding and countermeasures.

INFORMATION RETRIEVAL NUMBER 86

METALIZED POLYESTER CAPACITORS

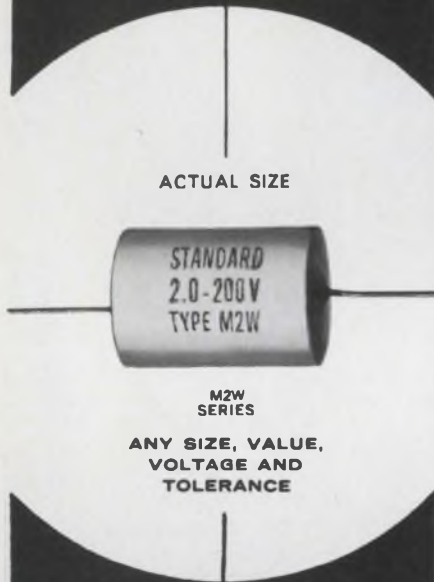

to your exact
specifications...
at stock prices

Unique, self-healing units that remain in circuit during voltage surges with little or no loss of electrical properties. Use the M2W's where size and weight are limiting factors and long life and dependability are required. The units utilize metalized Mylar* Dielectric with film wrap and custom formulated epoxy resin end fill. Available in round and flat styles.

*Du Pont Trademark for Polyester Film

Samples available on
your letterhead request



CONDENSER CORPORATION

Dept. ED-4 1065 W. Addison St.,
Chicago, Ill. 60613 • 312-327-5440

INFORMATION RETRIEVAL NUMBER 87

COMPONENTS

Tiny permanent magnets down diameters to 1 mm

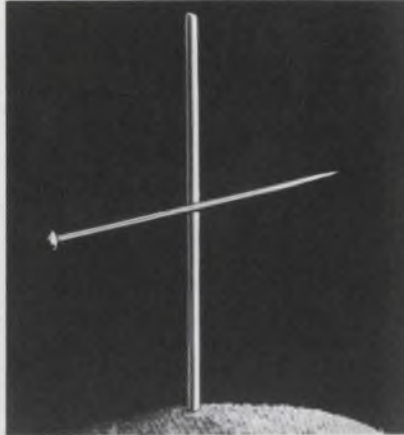

General Electric Co., Magnetic Materials Business Section, P.O. Box 999, Edmore, Mich. Phone: (517) 427-5151.

Smaller than pinheads, powerful permanent magnets for use in micro-miniature electronic circuitry can have diameters of less than one millimeter (0.028 in.). The new magnets are made of extruded Lodex, a magnetic material consisting of elongated single-domain iron-cobalt particles. Lodex can be formed into small, complex shapes meeting very close tolerances.

CIRCLE NO. 337

Magnetic reed switch twists away bounce

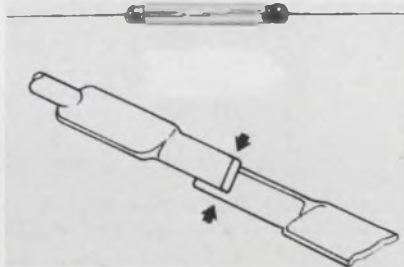

Gordos Corp., 250 Glenwood Ave., Bloomfield, N.J. Phone: (201) 743-6800. Price: \$1.25.

Boosting its expected life to 500 million operations, a new magnetic reed switch drops bounce time to about 70 μ s because its switch blades are twisted from their normal planes. Called the Tiny Twister, the unit has a closing and opening action that is more akin to sliding or wiping. This minimizes bounce and maintains a low contact resistance by wiping films from the contact area.

CIRCLE NO. 338



Order your FREE Statham Transducer Catalog today!

This new 16-page Statham Transducer catalog features model descriptions of all transducers and readout accessories as well as notes on industrial, research and scientific applications. Write to Tom Culhane, MS 216A Honeywell, Test Instruments Division, P.O. Box 5227, Denver, Colo. 80217.

Honeywell engineers
sell solutions

Honeywell

are you covered?



from 2 MHz to 500 MHz in one sweep

Texscan Corporation introduces the new VS-50 solid state sweep generator. Designed as a laboratory and production instrument, the VS-50 provides multiple octave coverage, variable sweep rates, internal and external capability and complete control of RF output level.

Using the latest circuit design techniques such as a double sweep heterodyne oscillator-amplifier system makes the VS-50 versatile enough to sweep from 2 MHz to 500 MHz in one sweep.

The RF output is extremely flat and is specified for a flatness of $\pm .25$ db at maximum sweep width with an output of 1 V rms into 50 ohms.

SPECIFICATIONS

Center Frequency Range	2 MHz to 500 MHz
Sweep Width	500 kHz to 500 MHz
Attenuation	0-6 db vernier 0-80 db in 1 db steps
Output Impedance	50 ohms or 75 ohms
Output Voltage	1 V rms

OTHER TEXSCAN VS-TYPE SWEEP GENERATORS

VS-20
200 Hz — 25 MHz

VS-40
1 — 300 MHz

VS-80
1 — 1200 MHz

VS-120
1 — 2.5 GHz

Contact your nearest Texscan Field Application Engineer
... a specialist in electronic instrumentation



Texscan Corporation 2446 North Shadeland Avenue, Indianapolis, Indiana 46219 • Tel. 317-357-8781 • TWX 810-341-3184

INFORMATION RETRIEVAL NUMBER 89

new
4 reasons why
USCC
chip capacitors
are best for
hybrid circuits

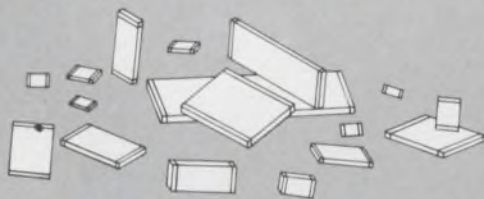

1. HIGH RELIABILITY

100% electrical testing on all units. Power screening available on all high rel units.

2. SMALLEST CHIP SIZES

Featuring the smallest chip available—only .075" x .035" x .040". 16 miniature sizes ranging from 10 pF to 3.3 Mfd.

3. MOUNTING PADS

Self leveling noble metal mounting pads for superior attachment, mounting stability and ultrasonic bonding.

4. MARKED CHIPS

Each chip individually marked for: capacitance value, tolerance and working voltage.

Do you need more reasons to use USCC chip capacitors?
Ask your USCC sales representative or call or write us. We have a catalog full of chip information.

USCC

U. S Capacitor Corporation, 2151 No. Lincoln Street, Burbank California 91504 • Telephone: (213) 843-4222 • TWX 910-498-2222

MICROWAVES & LASERS

Amplifier transistors gain 12 dB at 2 GHz



Avantek, Inc., 2981 Copper Rd., Santa Clara, Calif. Phone: (408) 739-6170.

Representing Avantek's first entry into the microwave semiconductor field are these three new amplifier transistors. Housed in microminiature, nonmagnetic, low-parasitic stripline packages, the devices have a maximum frequency of 8 to 10 GHz and a gain of 8 to 12 dB at 2 GHz. Output power for 1-dB gain compression is 0 dBm for type AT 101; +10 dBm for type AT 201; and +16 dBm for type AT 301.

CIRCLE NO. 339

Coaxial switches respond in 50 ns



Daico Industries, Inc., 1711 W. 135th St., Gardena, Calif. Phone: (213) 532-7621.

Switching from standard DTL or TTL outputs, a new line of sp4t and sp3t coaxial switches operate from 135 to 185 MHz at speeds as fast as 50 ns. Weighing less than 5 oz. including their OSM connectors, the new units integrate binary decoding and drivers in the same lightweight package. The drivers require dc power supplies of ± 5 V.

CIRCLE NO. 340



**Some people still don't know
Motorola crystals are on the open market.**

We've been making precision, high-tolerance crystals for thirty years. Crystals good enough to use in our own equipment. And for thirty years, people have been trying to get their hands on a few. But we found out something. You can't keep a great thing to yourself forever.

Now, our wide range of precision crystals, including temperature com-

pensated varieties, are available to designers and manufacturers in the electronics industry. Characteristics like tight tolerances and low-aging are our specialties. Choose from glass, solder seal and cold weld holders.

Crystals, oscillators, filters, and tone modules: the list of Motorola components currently in production is a mile long, but the way things are

going that may not be long enough. If you need something special, just call. Our designers are ready to go to work on projects for you alone.

For additional information on existing products and on design potentials, write to Motorola Communications & Electronics Inc., 1301 Algonquin Rd., Schaumburg, Ill. 60172

Ask for Bulletin TIC-3401.



use low cost
Birtcher PCB-TAINERS®
 and racks to solve
 your printed circuit board
 retention problems

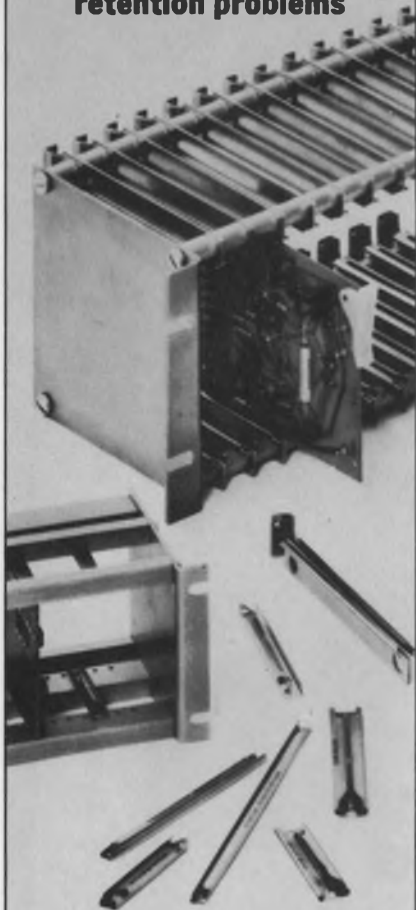

There are sizes and styles of Birtcher PCB-TAINERS to solve every printed circuit board retention problem. Simple installation. Provides excellent retention under severe shock and vibration and an excellent ground and thermal path. Made from steel or beryllium copper in choice of MIL Spec finishes. Or let Birtcher build the entire assembly. You'll be pleasantly surprised by the low cost and fast delivery.

Available from authorized
 distributors coast-to-coast



A big new catalog is
 available now—write

**the BIRTCHER
 CORPORATION**
 INDUSTRIAL DIVISION

745 Monterey Pass Road
 Monterey Park, California 91754

Mailing Address:
 P.O. Box D, Monterey Park, California 91754
 Tel: (213) 268-9584 • TWX 910-321-3076

MICROWAVES & LASERS

Compact counter
 logs to 3 GHz



Systron-Donner Corp., 888 Galindo
 St., Concord, Calif. Phone: (415)
 682-6161. P&A: \$1350; 30 days.

Ideal as a precision measurement tool for frequency alignment and calibration in the communication, radar, and navigational fields, the 153 compact microwave counter operates over the frequency range of 300 MHz to 3 GHz. Using the ACTO (Automatic Computing Transfer Oscillator) principle, the new instrument provides instantaneous measurements, even on changing uhf inputs. Typical sensitivity is -10 to -20 dBm.

CIRCLE NO. 341

Snap varactor diode
 develops 8 W at 2 GHz



Microwave Associates (West), Inc.,
 999 E. Arques Ave., Sunnyvale,
 Calif. Phone: (408) 736-9330.
 Price: \$65.

In a times-five multiplier circuit, a new snap varactor diode delivers a minimum output of 8 W at 2 GHz, when input power is only 30 W. Model MA4-B300 has a minimum breakdown voltage of 100 V, with capacitance ranging from 6 to 8 pF. Maximum thermal resistance is 7°C/W.

CIRCLE NO. 342

STABILITY & QUALITY



FNX-D3W3H
 3 MFD(K)
 50 W.V.

MATSUO

METALLIZED POLYESTER FILM
 CAPACITOR -"TYPE FNX-H"-

Sub-miniature size and oval section ideal for space economy. Lightweight, self-healing and with high insulation resistance. Capacitance values up to 10 MFD. Outer wrap of tough polyester protects against moisture. Perfect in both transistorized and low voltage tube circuits and others where size and cost are paramount.

Specifications:
 Operating Temperature Range: -40°C to +85°C
 Standard Voltage Rating: 100, 200, 400, 600VDC
 Standard Capacitance Value: .1 MFD to 10 MFD.
 Standard Capacitance Tolerance: ±20% (available ±10%)

MATSUO'S other capacitors include:

Solid Tantalum Capacitors: MICROCAP

for hybrid ICs, Type TAX hermetically sealed in metallic case, Type TSX encased in metallic case and sealed with epoxy resin, Type TSL encased in metallic case and sealed with epoxy resin

Polyester Film Capacitors: Type MFL

epoxy dipped, Type MFK epoxy dipped, non inductive, Type MXT encased in plastic tube, non inductive.

For further information, please write to:
MATSUO ELECTRIC CO., LTD.
 Head Office: 3-5, 3-chome, Sennari-cho, Toyonaka-shi, Osaka, Japan
 Cable: "NCOMATSUO" OSAKA Telex: 523-4164 OSA
 Tokyo Office: 7, 3-chome, Nishi-Gotanda, Shinagawa-ku, Tokyo

The new Alcoswitch "A" Series fills a need for those who want the best switch possible at an optimum price. This series has the important features wanted in a good miniature: turret terminals, extra-wide contacts, heavier current capabilities, low-loss, high heat and high impact case construction. An additional

feature is the "No Tear" shoulder on the bushing. The overall dimension allows use in tight quarters. Rated 6 amps @ 125 VAC. Choose carefully and use the best — the Alcoswitch "A" Series. It doesn't cost anymore.

* Photo shows the new 3-Pole "A" Series Alcoswitch (4) times actual size.



choose carefully

To: ALCO Electronic Products, Inc., Dept. A , Lawrence, Mass.

NAME _____ (Please Print)

FUNCTION _____

COMPANY _____

ADDRESS _____

CITY _____ STATE _____ ZIP _____

Send your latest 20-page catalog.

Have your representative hand deliver a sample.

Switch Type _____ No. Poles _____

Proposed Use _____

FREE SAMPLE

Send for your free sample and new 1969 Alco switch catalog

ALCO[®] ELECTRONIC PRODUCTS, INC. ■ LAWRENCE, MASS. 01843

INFORMATION RETRIEVAL NUMBER 94

Operating Instructions for Wanlass Phasac™

The New Single-to- Three Phase Converter

1
Carry to any
lab without
three-phase
power.



2
Plug into
standard 115 volt,
60 Hz, single
phase outlet.

3
Turn on for
1 KVA of instant
three-phase
output, regulated
to 5%.



This all passive and static Parax device utilizes phenomena inherent in the Wanlass PARAFORMER™ to provide true phase conversion with either wye or delta outputs. It is ideal for laboratory and production applications requiring instant three-phase power. Yet the cost is only a fraction of that required to install a new three-phase line. Every lab should have one. For complete technical information, contact Wanlass Instruments or your local representative.

Specifications:

AC Input: 105 to 125 VAC, 60 Hz, Single Phase
AC Output: Three Phase, 60 Hz, 208/240 VAC
Regulation: $\pm 5\%$
Output: 1 KVA, 333 VA/Phase
Price: \$475.00 (off the shelf)

400 Hz Model Also Available: \$625.00

WANLASS INSTRUMENTS



a division of WANLASS ELECTRIC COMPANY
A SUBSIDIARY OF AMBAC INDUSTRIES INC.

1540 EAST EDINGER AVENUE ■ SANTA ANA, CALIFORNIA 92707
TELEPHONE (714) 546-1811 ■ TWX: 910-595-1526

INFORMATION RETRIEVAL NUMBER 95

Simplify power requirements

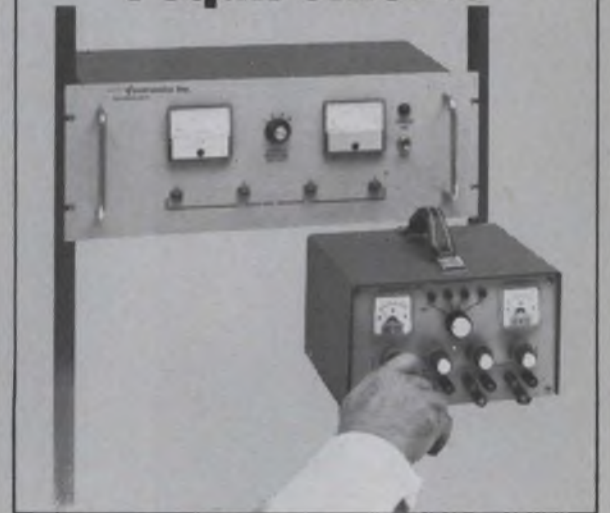

Now you can fit 4 power supplies in the space normally occupied by 1 or 2. The CONTRONICS QUADRALOCH™ features current overload and short circuit protection as well as floating outputs. These units incorporate low ripple and noise and fast recovery time. Compare the specs with your requirements then fill out the coupon.

SPECIFICATION	CPS 500-1 (rack mount)	CPS 400-1 (bench model)
Output (Each sect. adj.)	2 V to 25 V 0 to 7.5 amps	100 mv to 36 V 0 to 1.0 amps
Input (Single phase 50 to 60 Hz)	115/230 VAC $\pm 10\%$	115 VAC $\pm 10\%$
Voltage Reg. (Worst case, line and load)	.07% max	.07% max
Ripple & Noise (Worst case, line and load)	5 mv p-p	5 mv p-p
Current Limiting (adj.)	10 to 100%	10 to 100%
Price (F. O. B. factory)	\$695	\$395

I have the following application for the CONTRONICS QUADRALOCH™

- Please send me CPS-500-1 and/or CPS-400-1. Purchase order enclosed.
- Please send me information about your 10 day free trial.

Send this coupon with your name and address to:

International **Contronics Inc.**

1038 W. Evelyn Ave. Sunnyvale, Calif. 94086 (408) 736-7620

INFORMATION RETRIEVAL NUMBER 96

ELECTRONIC DESIGN 8, April 12, 1969

Urethane stripper protects leads



Aremco Products, Inc., P. O. Box 145, Briarcliff Manor, N.Y. Phone: (914) 762-0685. P&A: \$58/gal; stock.

A selective solvent for urethane polymers contains no caustics or acids that could attack lead wires in the encapsulated assembly being stripped. Aremco-Strip 532 is a single-component system that can be stored at room temperature indefinitely. The material will dissolve urethane polymers at room temperature, although heating on a hot plate at 250°F will speed the reaction. After the urethane flakes off, the parts can be removed from the solution and washed in water or alcohol.

CIRCLE NO. 343

Transparent resin pots connections



EPD Industries, Inc., 2055 E. 223rd St., Long Beach, Calif. Phone: (213) 775-7141.

A flexible connector-potting resin is so clear that all connections and components can be visibly inspected. Now being used on various military projects, the material does not harden with age and adheres well to rubber neoprene, PVC, nylon and Kapton. Designated TC-447, it has excellent physical and electrical properties and puts very little stress on connections and components.

CIRCLE NO. 344

Solitron RF Power

Covers the Spectrum!



Solitron's wide range of RF power transistors can provide the right devices for your required applications. These transistors cover a useful frequency range from 40 to 1000 MHz and output power levels of 1 to 30 Watts. All popular package types are available.

Take your pick from Solitron's power frequency spectrum and contact us today.

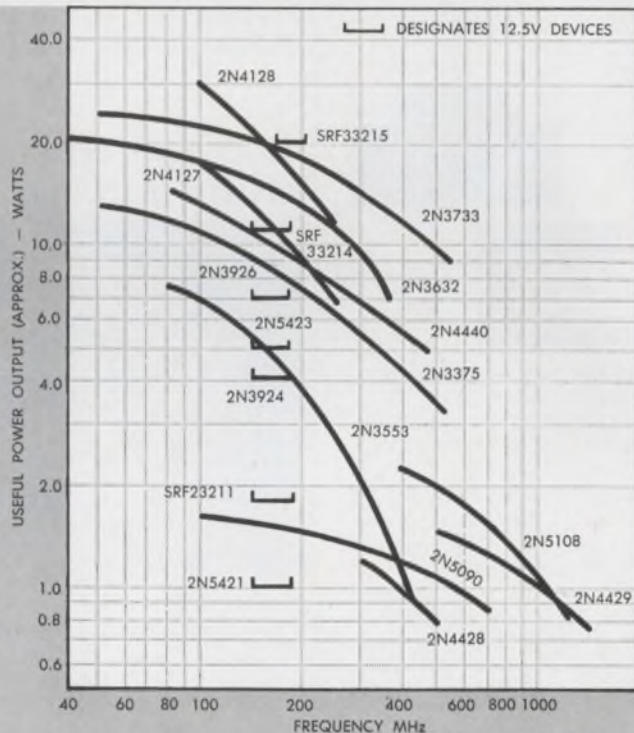
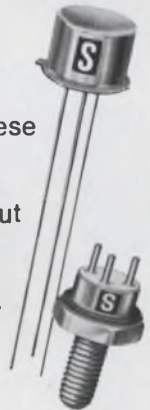

Dial 1-800-327-3243 for a "No Charge" telephone call and further information

Solitron

DEVICES, INC.

1177 BLUE HERON BLVD. / RIVIERA BEACH, FLA / TWX: (510) 952-6676

WE'RE UNVEILING



THE ALL NEW SERIES 8000 GORDON METERS

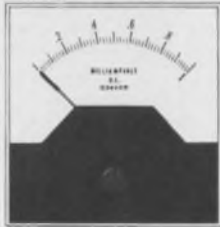

- Quality, reliability and styling from Gordon, famous for instruments since 1914!
- Tops for your OEM equipment or black-box applications, GORDON METERS feature covers of clear, high-impact G.E. Lexan®.
- Core magnets are high-coercive Alnico for the sustained accuracy you need.
- Spring-backed sapphire pivot bearings and one-piece bridge construction standard.
- Popular 2½", 3½" and 4½" models; square; edgewise; DC and AC rectifier type.
- Custom design available, too, in color masks, scales, ranges, resistances and pointer style and color.

FREE GORDON PANEL METERS BULLETIN 1-800



4042

Write Today

PDC GORDON
A SUBSIDIARY OF
PNEUMO DYNAMICS CORPORATION
5710 KENDSHA ST. RICHMOND, ILL. 60071

INFORMATION RETRIEVAL NUMBER 98

PACKAGING & MATERIALS

Conductive epoxy is gold filled



Epoxy Products Co., 166 Chapel St., New Haven, Conn. Phone: (203) 562-2171.

E-Kote 3207 is a gold-filled, conductive epoxy for adhesive or coating applications in which the physical or chemical characteristics of a silver conductive are undesirable. Adhesive (tensile-shear) strength to 1500 psi, and resistivity of 0.0005 ohm-cm (77°F) suit it to precision electronic/electrical requirements. This gold-filled epoxy is a solvent-based thermosetting system which requires only a half-hour air-dry and one-hour cure at 320°F (160°C) without hardener or catalyst.

CIRCLE NO. 345

Thick-film cermet resists leaching

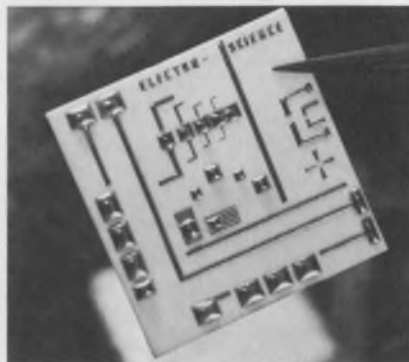

Electro-Science Laboratories, Inc., 1130 Arch Street, Philadelphia, Pa. Phone: (215) 563-1360. P&A: \$66/oz.

Featuring extremely high adhesion and exceptional resistance to solder leaching, a thick-film palladium-gold cermet can withstand twenty 10-second dips in 60/40 solder at 225° C without damage. The new material, type 68008, has a peel strength of 2000 to 2500 psi and a pull strength of about 3000 psi.

CIRCLE NO. 346

SCHAUER

1%

tolerance

1 WATT ZENERS ARE A REAL BUY!

ANY voltage from 2.0 to 16.0 at the industry's LOWEST PRICES!

Quantity	Price each
1-99	\$1.07
100-499	.97
500-999	.91
1000-4999	.86
5000 up	.82



THE HI-RELIABLE!

No fragile nail heads. Silicon junction aligned between two, parallel, offset tantalum heat sinks . . . great lead tension strength. All welded and brazed assembly. High pressure molded package. Gold plated nickel-clad copper leads. Write or phone for Form 68-4 for complete rating data and other tolerance prices.

Semiconductor Division

SCHAUER MANUFACTURING CORP. 4511 Alpine Avenue Cincinnati, O. 45242 Ph. (513) 791-3030

INFORMATION RETRIEVAL NUMBER 99
ELECTRONIC DESIGN 8, April 12, 1969

The 5 MHz MOS Clock Driver System

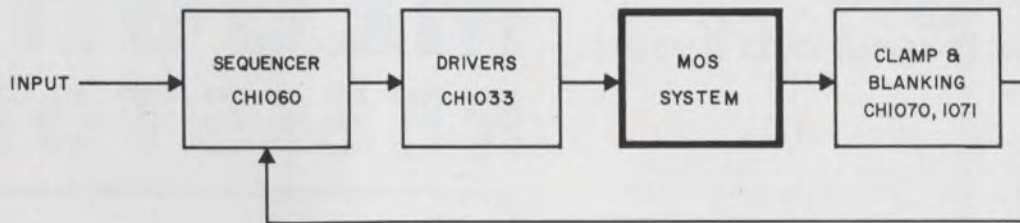

The 5 MHz Clock Driver System above uses all off-the-shelf Cermetek circuits, but you don't have to operate at 5 MHz to benefit from Cermetek's complete line of compatible MOS Clock Driver circuits. They are immediately available in a wide range of voltages and frequencies to suit your individual needs.

The Cermetek Thick Film Hybrids combine the low cost and small size of integrated circuits with the performance of discrete circuit designs. For example, our CH 1033 UNIVERSAL CLOCK DRIVER will supply 1 amp to drive a 1000 pf load. It operates from DC to 10 MHz over a wide range of output voltages. This enables the use of one driver for all MOS applications at an extremely low interface cost.

Cermetek's standard off-the-shelf line includes the following units in dual in-line packages.

CH 1031 High Speed Clock Driver
CH 1032 Low Cost Clock Driver

CH 1033 Universal Clock Driver
CH 1050 Clock Generator (oscillator)
CH 1060 Four Phase Sequencer
CH 1070 Dual Clamp and Blanking
CH 1071 Quad Clamp
CH 1040 EIA to Logic Converter (Receiver)
CH 1100 Logic to EIA Converter (Transmitter)
CH 2001A Relay and Lamp Driver

The same expertise that enables Cermetek to design up-to-date proprietary products for the market can help solve your custom circuit requirements.

Call or write for more information.

OFF THE SHELF HYBRID CIRCUITS



660 National Avenue, Mountain View, California 94040, (415) 969-9433

INFORMATION RETRIEVAL NUMBER 100

NEW

VARIABLE RATE RASTER GENERATOR WITH BLANKING AMPLIFIER AND PHOSPHOR PROTECTION LINEAR DUAL SWEEPS

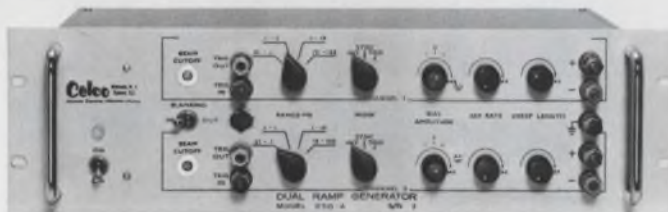

Model 2SG-4

- Wide Range of Raster Rates
- Sweeps from 20 μ sec to 100 msec
- Sweeps Available to Seconds
- 10% to 90% Duty Cycle
- Linearity Better than 0.5%
- Internal, External Trigger or Sync
- ± 5 Volt dc Bias
- 5 1/4" High for 19" Rack
- Compatible with CELCO Drivers

The CELCO Dual Ramp Generator provides the display designer with a versatile tool for producing a wide variety of raster or line scan CRT displays. Your answer to a need whenever linear, variable ramp lengths and rates are required — plus the convenience of blanking and phosphor protection.

Immediately available from stock.

Constantine Engineering Laboratories Company



Mahwah, N.J.

07430

Tel. 201-327-1123

INFORMATION RETRIEVAL NUMBER 101

5 days

can do a lot for your next 5 years.

If you're involved in systems and equipment design, research, production or management . . . five days at one of our Seminars may make your next five years—and many more after that—much more productive.

More and more key management and high-level technical personnel from top companies all over the United States are attending RCA Institutes Seminars. Just as they are doing, you'll acquire information and techniques of immediate value in your work. You will also gain the kind of knowledge that can help build your professional standing in the years just ahead.

We believe we can increase your productivity by providing you with a firm grasp of many of the latest engineering techniques. Our experienced staff maintains constant contact with "what's happening" in industry. The texts and audio-visual materials are prepared exclusively by us for each seminar.

You can attend RCA Institutes Seminars around the country the year-round. Check your subject and send along the coupon for your brochure. Now—while you're thinking about it.



RCA Institutes, Inc. Dept. ELD-49

Institute for Professional Development
Box 962
Clark, N.J. 07066

For FREE descriptive brochure, check the Seminar in which you are interested:

- | | |
|--|---|
| <input type="checkbox"/> Logic Design | <input type="checkbox"/> Information Systems for Executives |
| <input type="checkbox"/> Digital Systems Engineering | <input type="checkbox"/> Digital Communications |
| <input type="checkbox"/> Modern Optics | <input type="checkbox"/> Digital Electronics |
| <input type="checkbox"/> Integrated Circuits | <input type="checkbox"/> Numerical Control Systems |
| <input type="checkbox"/> Reliability of Integrated Systems | |

Name _____

Title _____

Company _____

Address _____

City _____ State _____ Zip _____

INFORMATION RETRIEVAL NUMBER 102

MINIATURE MEGOHM RESISTORS

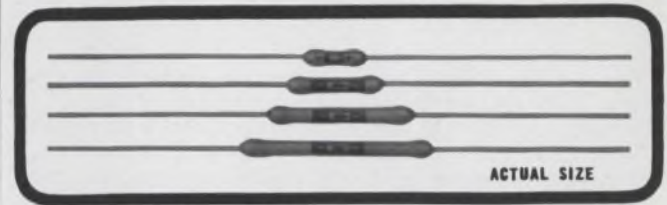

T.C. Absolute: 80 PPM/°C*
T.C. Tracking: to 5 PPM/°C on special order.

Applications include high voltage dividers, high resistance networks, precision RC timing circuits, etc. We specialize in network sets with matched characteristics. Facilities available to perform Hi Rel screening.

Model No.	Wattage	Max. Voltage	Dielect Str'gth	Resistance		Dimensions		
				Min.	Max.	Length	Dia.	Lead Dia.
MG 650	.5	600	750	500 K	5 meg	.313 ±.020	.094 ±.015	.025 ±.002
MG 660	.6	1000	750	1 meg	10 meg	.500 ±.030	.094 ±.015	.025 ±.002
MG 680	.8	1500	750	1 meg	15 meg	.750 ±.030	.094 ±.015	.025 ±.002
MG 710	1.0	2000	750	1 meg	20 meg	1.000 ±.040	.094 ±.015	.025 ±.002
MG 721	2.0	2500	1000	1 meg	30 meg	1.000 ±.050	.240 ±.030	.040 ±.002
MG 750	3.0	3000	1000	3 meg	150 meg	2.125 ±.060	.315 ±.030	.040 ±.002
MG 780	5.0	4000	1000	4 meg	220 meg	3.125 ±.060	.315 ±.030	.040 ±.002

*Temperature Coefficient: 80 ppm/°C referenced to 25°C, ΔR taken at -15°C and +105°C. Maximum operating temperature: 225°C. Resistance Tolerance: ±1% (tolerances to .2% on special order). Insulation Resistance: 100 megohms, minimum. Overvoltage: 1.5 times working voltage for 5 seconds, R shift .8% max. Thermal Shock: MIL-STD-202, method 107, cond. C, R shift .5% max. Moisture Resistance: MIL-STD-202, method 106, R shift .8% max. Loadlife: 1000 hours at rated power, R shift .8% max. Encapsulation: Silicone Conformal. Leadwire: Gold Plated Dumet 1½" long ±¼".

MICRONOX™ Resistance Films

Micronox resistance films are produced exclusively by Caddock Electronics. They are composed of complex oxides fired in air at temperatures above 1400°F. The resulting films are relatively insensitive to high ambient temperatures and thermal shock. Films show negligible effect from moisture.

This totally new approach to precision resistors and networks opens new design possibilities because of the wide resistance range, precise temperature characteristics, and high temperature and power capability. Temperature coefficient can be accurately reproduced (within ±10 ppm/°C of curve if required). The typical curve shown below will vary slightly with resistivity of the film and configuration of the substrate.

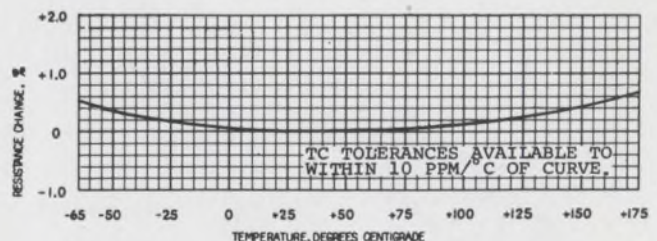

CADDOCK ELECTRONICS

3127 Chicago Avenue, Riverside, California 92507 • Telephone: (714) 683-5361

INFORMATION RETRIEVAL NUMBER 103

Heat jacket cures epoxies

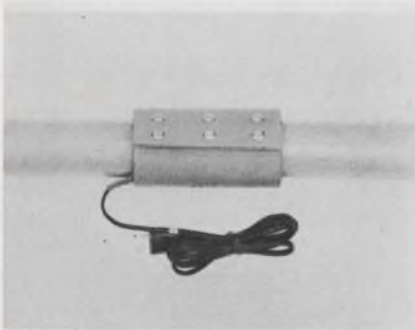

Watlow Electric Co., 141 W. Hazel St., Inglewood, Calif.

A new cylindrically shaped heat jacket with integral thermostat wraps and then snaps into position to cure epoxy adhesives. Portable and lightweight, the jacket is designed to reduce curing time and eliminate the need for expensive and cumbersome gas ovens as well as the heat sinks normally used. The 115-V device is constructed of silicone rubber with fiberglass insulation, has a minimum diameter of 1.5 in., and supplies temperatures ranging from 100 to 300°F.

CIRCLE NO. 347

Circuit card fixture holds and positions



Technical Devices Co., 11242 Playa Court, Culver City, Calif. Phone: (213) 870-3751.

The Mark III circuit card fixture offers automatic position indexing in both rotation and tilt angles. Preset stops can automatically lift, turn and drop the card back down to a predetermined angle. The standard fixture accepts cards measuring from 1 by 1 in. to 8 by 8 in.

CIRCLE NO. 348

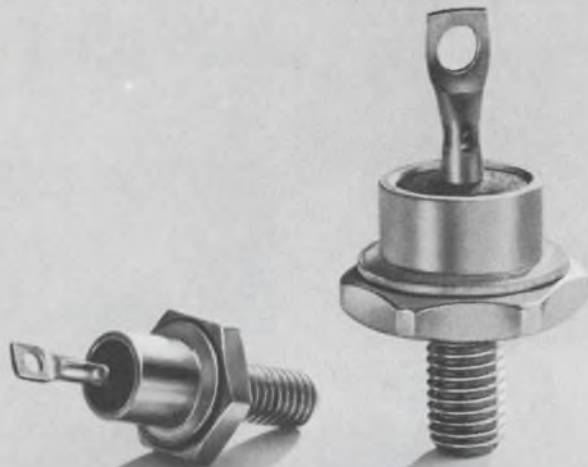

Solitron DO-4 and DO-5 packages

...the glass passivated ones.

Up to now, junctions of DO-4 and DO-5 stud rectifiers were coated with conventional materials: plastic, epoxy or varnish. The possibility of contamination was always present.

Now Solitron has incorporated its Solitron chip into these two configurations. The Solitron's glass passivated junction withstands temperatures of up to 1000° C., giving higher-than-ever reliability. High temperature reverse bias is no longer a problem due to the elimination of the effects of ionic migration. These packages exceed the applicable environmental requirements of MIL-S-19500E.

Solitron DO-4 and DO-5 packages are available in normal and fast-switch versions, with recovery speeds of 250 and 400 nanoseconds, depending upon voltage. Peak inverse voltages of up to 1000 volts per junction are available.

The DO-4 is available in the following types: 1N3879 to 3883; 1N3889 to 3893; and 1N3909 to 3913. The DO-5 is available in these types: 1N1183 to 1190; 1N1191 to 1198; 1N1195A to 1198A; 1N3208 to 3214; and 1N3899 to 3903. Reverse polarity types are available in both packages.

New specification sheets are now available.



256 OAK TREE ROAD
TAPPAN, N. Y. 10983
PHONE (914) 359-5050
TWX: 710-576-2654
TELEX: 13-7346

DC
Meters



Mod
Meters



Pick your panel meter

from

VU Meters



API's exclusive combination

Pyrometers



These API panel meters offer you a unique choice of styles, features and functions:

DC meters—standard 1% tracking and taut-band construction in 20 to 100 μ a ranges, at no extra charge. Optional 0.5% tracking at published prices. Stocked in 15 models with clear plastic, recessed-mounting and black phenolic case styles.

Mod Meters—with interchangeable scales for measuring different variables. Many meters for the price of one.

VU meters—for recording and broadcasting applications. Most stylish in the industry. Stocked in 12 models.

Pyrometers—widest selection available anywhere, including ruggedized type shown above.

For detailed specifications, ranges and prices, ask for Bulletin 47.

api

INSTRUMENTS CO.

Chesterland, Ohio 44026
(216) 729-1611

INFORMATION RETRIEVAL NUMBER 105

Evaluation Samples



Graphic arts samples

Graphic arts samples are included at no charge with a new catalog of dry-transfer lettering styles. The line of transfer lettering is available in over 100 styles and sizes up to 288 points (four inches). Color pages in the catalog present useful how-to tips on using transfer lettering. Letraset USA.

CIRCLE NO. 349

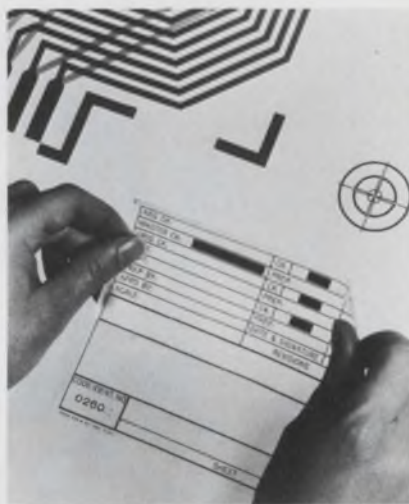

Predrawn title blocks

Custom-designed, predrawn title blocks for identification and control of engineering drawings have been added to a line of drafting aids. Drawn to customer specifications, the title blocks are printed on pressure-sensitive matte acetate sheets. Reproduction is clear and accurate with no shadowing. The pressure-sensitive adhesive backing makes them easy to reposition, if they are applied with light pressure before being permanently affixed. Free evaluation samples and descriptive literature are available. Bishop Graphics, Inc.

CIRCLE NO. 350

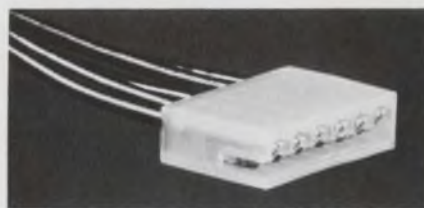

PC connector

Added to a line of printed-circuit edge connectors, a new six-circuit model has one open end that eliminates the need for a special cut-out on a PC board. The series, with reliable crimp-type terminals supplied in chain-link form, is handled easily with automated crimping machines. Terminals snap-lock into their nylon housing, but can be easily removed with a simple tool. The complete line also includes 9-, 15- and 21-circuit right-angle and straight-on models, and a 22-circuit right-angle model. Prices, detailed specifications, and a free sample are available on request. Molex Products Co.

CIRCLE NO. 351

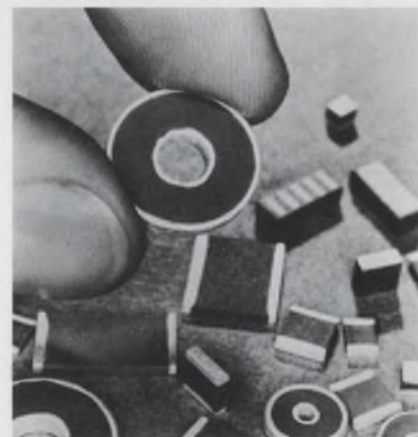

Gold-electroded capacitor

Samples of a new ceramic capacitor chip with gold termination are offered for engineering evaluation. Solderable, gold chip capacitor terminations eliminate silver migration and provide a better solder connection. Gold cermet provides an interface between the gold and the ceramic that is stronger than the ceramic itself. Rated life is 1000 hours at 125°C. These gold terminated capacitors meet applicable portions of MIL-C-11015 and MIL-C-39014. Monolithic Dielectrics.

CIRCLE NO. 352

SCRs and Triacs from the Power House.

Need to control electrical power? Check with us. We have the industry's finest selection of power-control components and assemblies to help you keep design problems in line.

Our SCRs range from 4.7 to 550 amperes rms, 25 to 1300 volts. And we make the firing circuits, heat sinks and surge arrestors you need to go with them. Get individual components or complete assemblies, pre-engineered and guaranteed. Or go all the way and buy our complete power-control systems. And if it's AC power you're wrestling with, remember we're still the only ones on the market with the 100- and 200-ampere logic-triacs.

Write for complete 32-page Product Selection Guide, or tell us your particular problem. We specialize in complete engineering assistance. The Power House, 233 Kansas Street, El Segundo, California 90245.

INTERNATIONAL RECTIFIER

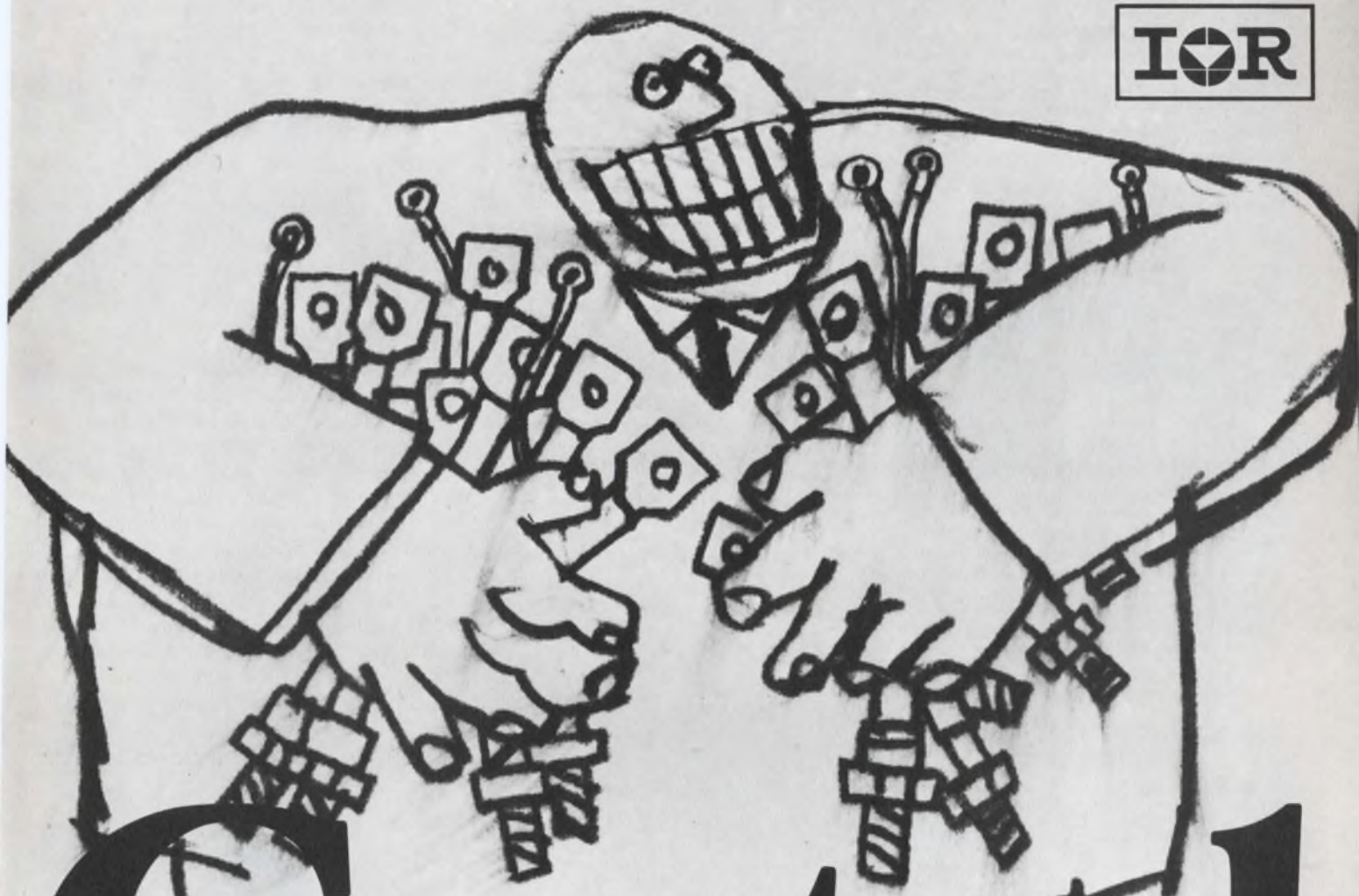

Control power.

CONDUCTIVE FABRIC FOR RF SHIELDING



ECCOSHIELD® MNF is a series of light-weight, pliable fabrics woven from conductive fibers. It can be cut, sewn or draped to protect equipment and personnel from RF and microwave radiation. Available in two-foot widths, any length. Weight about 3 ounces per square yard.

INFORMATION RETRIEVAL NUMBER 231

LOW DENSITY CASTABLE RTV SILICONE

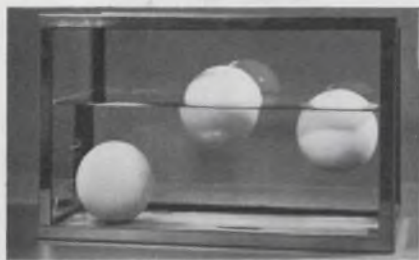

ECCOSIL® 4659 is a castable RTV silicone that cures to a resilient foam with less than half the density of conventional silicones. Photo shows buoyancy comparison of Eccosil 4659 (center) with other silicone foam (R) and conventional silicone (L). Recommended for encapsulation of delicate electronic assemblies.

INFORMATION RETRIEVAL NUMBER 232

LOW-LOSS IMPREGNANT CURES TO SOLID



ECCOSEAL® 63 is a low-viscosity, solvent-free impregnant that cures to a rigid, low-loss crosslinked polymer. Developed specially for impregnating capacitors, filters and coils. Useful from -65°F to $+375^{\circ}\text{F}$. Dielectric constant is 2.4; dissipation factor is 0.0005 at 1 MHz.

INFORMATION RETRIEVAL NUMBER 233

Emerson & Cuming, Inc.



CANTON, MASS.
GARDENA, CALIF.
NORTHBROOK, ILL.
Sales Offices
in Principal Cities

EMERSON & CUMING EUROPE N.V., Oevel, Belgium

Design Aids



Connector slide rule

A circular cross-reference rule illustrates a growing line of connectors and relates company part numbers to OSM numbers. The circular design aid describes 14 different connectors including straight-cable, bulkhead-cable, right-angle and flange-mount units. Outline drawings are supplied, as are the proper coaxial cables for which the units are designed. These connectors are gold plated, stainless-steel units that are engineered for applications between dc and 18 GHz. Sealectro Corp.

CIRCLE NO. 353



Logic design guide

A 38 by 28-in. wall chart simplifies control logic design by converting electromechanical symbology into MIL or NEMA symbols. Each basic logic function can be designed with either electromechanical devices or by K-series solid-state control modules. The chart shows general designs and JIC (Joint Industry Conference) symbology. Digital Equipment.

CIRCLE NO. 354



MIL selection chart

The reliability specification established by the military for fixed film resistors, MIL R 55182 C, includes a wide variety of part types. To help engineers make the proper selection of physical characteristics, performance capabilities and reliability requirements, a cross-reference selector has been prepared. The graphic aid displays the MIL spec information in easy-to-read form, and offers recommendations on part types that are most readily available and most likely to fill needs. Mepco, Inc.

CIRCLE NO. 355



Vacuum pump selector

Designed to simplify the selection of vacuum pumps, a circular slide rule is offered without charge. The durably constructed rule is six inches in diameter, and has accurate sliding scales. It can be used to indicate system volume, pressure, connecting-tube information and evacuation time, as well as the capacity of the pump that best fits a given application. Sargent-Welch Scientific Co.

CIRCLE NO. 356

Our package deal is a complete fabrication.

We make every part of our hermetic integrated circuit packages in our own plants.

We have to.

It's the best way we can be sure that every one will measure up to specs. Both ours and yours.

Take, for example, our off-the-shelf dual inline package. It uses our own special blend of hard glass and alumina to get the best properties. High electrical insulation, thermal shock resistance, hermeticity, and a thermal expansion that matches the metal alloy parts.

It meets Mil-specs and can be plated to your requirements.

If this package doesn't suit your needs, we'll design one to your specs.

Each hermetic package gets to you in first-class condition. No bent or shorted leads. No excess glass-ceramic flow.

In short, the perfect package deal.

*Sylvania Metals & Chemicals, Parts Division,
Warren, Pa. 16365.*

SYLVANIA
A SUBSIDIARY OF
GENERAL TELEPHONE & ELECTRONICS



For a true record
of temperature
in service...

Tempilabel^o

Easy to use . . .



Easy to read



Self-adhesive Tempilabels^o assure dependable monitoring of attained temperatures. Heat-sensitive indicators, sealed under the little round windows, turn black and provide a permanent record of the temperature history. Tempilabel^o can be removed easily to document a report.



AVAILABLE

Within the range 100° to 500°F Tempilabels^o are available to indicate a single temperature rating each — and also in a wide choice of four-temperature combinations per Tempilabel^o.

JUST A FEW OF THE TYPICAL APPLICATIONS

- Electrical Apparatus
- Electronic Assemblies
- Appliance Warranties
- Aircraft and Rockets
- Machinery and Equipment
- Storage and Transportation of Heat Sensitive Materials.

For descriptive literature and a sample Tempilabel^o for evaluation . . . (please state temperature range of interest).

Write to: SPECIAL APPLICATIONS DIVISION



132 WEST 22nd St., NEW YORK, N.Y. 10011
Phone: 212-675-6610 TWX: 212-640-5478

INFORMATION RETRIEVAL NUMBER 108

Application Notes

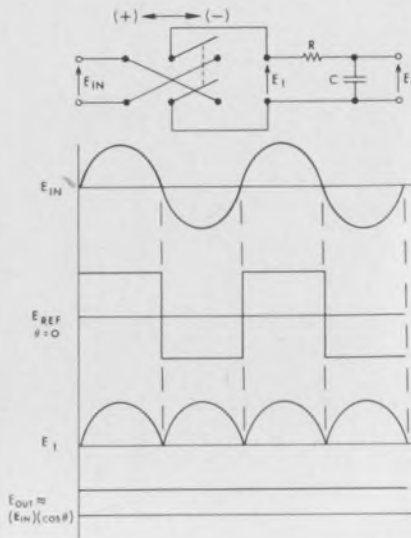

Lock-in amplifiers

Basically a phase-sensitive detector that can be considered as a simple dpdt reversing switch, a lock-in amplifier can be used to measure extremely small signals buried in noise or in a wide variety of signal processing areas. The polarity of the reference input determines the position of the switch. If the input is a noise-free sinusoid, in phase with the reference signal, the output of the switch will be a full-wave rectified sinusoid. The total transfer function of the lock-in amplifier is proportional to the rms value of the input and to the cosine of the input phase angle. Besides describing the theory of operation of these amplifiers, a new 4-page bulletin discusses the measurement techniques of amplifier crosstalk, sensitive bridge null detection, op-amp open-loop gain, and low-level impedance. Princeton Applied Research Corp.

CIRCLE NO. 357

Electron beam evaporation

A 12-page booklet covers the basics of electron beam evaporation and outlines the scope and benefits of its use. The booklet is written with a minimum of highly technical material. Airco Temescal, Div. of Air Reduction Co., Inc.

CIRCLE NO. 358

Thermocouple guide

A handy 12-page booklet covers the installation and use of chromel-alumel thermocouples. Included in the booklet are suggestions on the proper installation and use of thermocouples, as well as tips on locating the source of trouble in an installation suspected of giving erroneous readings. Also included is a brief discussion of metallurgical factors that affect the performance of thermocouples. Hoskins Manufacturing Co.

CIRCLE NO. 359

Digital measurements

How to record instrument data for computer analysis is discussed in a new 24-page application note. The note describes techniques for recording measurements from digital voltmeters, counters and nuclear scalars on computer-compatible input media. Also discussed are techniques for easy entry of data through local time-sharing terminals that employ the basic language. Hewlett-Packard Co.

CIRCLE NO. 360

Instrument reference

Instrument mechanisms, their principle, theory and application, are the subject of a 42-page brochure. Originally a series of informal sketches and explanatory notes that were part of a lecture series, the booklet has been prepared in present form for those interested in the field. Comprehensive information, complete with performance curves and detailed drawings, are included on the subject of electrostatic and permanent-magnet moving-oil mechanisms, as well as application details on specific aspects of the technology. Special or unique environmental conditions and their impact on instrument design are covered in separate detailed notes. Weston Instruments, Inc.

CIRCLE NO. 361

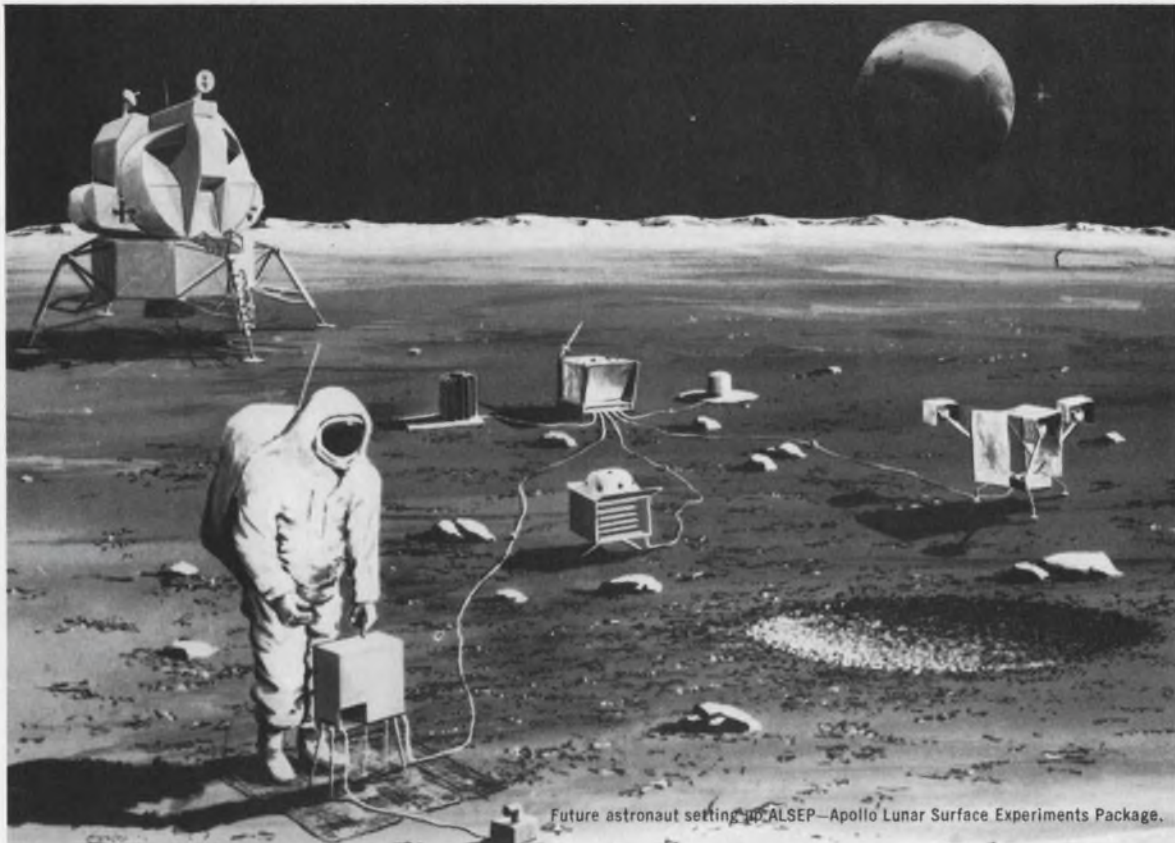

Future astronaut setting up ALSEP—Apollo Lunar Surface Experiments Package.

Bendix needed a battery to command ALSEP, Apollo's full geophysical station for the moon.

Mallory made it.

What can we do for you?



Bulova Accutron® lunar timer—self-powered to operate for years on the moon.

Bendix needed a battery. A battery to power the master timer of ALSEP—unattended instruments to be left by future astronauts on the surface of the moon. A battery that could meet the rigid environmental requirements of the National Aeronautics and Space Administration (NASA). A battery that could power the timer for as long as two years.

Mallory made it. The battery—a Mallory mercury battery. It resists the effects of temperature. And most important, it packs enough power in a small volume to provide steady flat voltage for years.

ALMOST OUT OF THE LAB

We've made some dramatic advances recently—and we're almost ready to publicize them. Here's a peek at a new development just out of the lab:

Improved Anodes—a glance at the graph will show you what our new improved anode structure does for battery efficiency at low temperatures. The same structure greatly improves performance under heavy current drains.

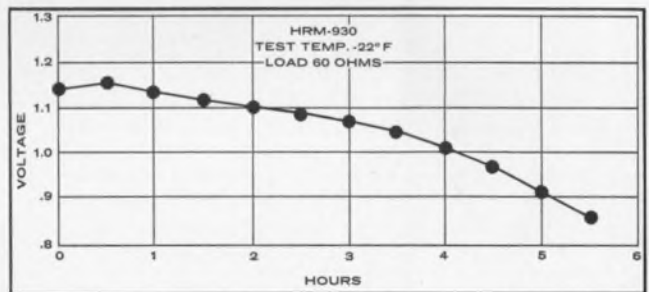

We're not talking specifics about this or other developments yet, but if you've got a challenging application, give us a ring.

OVER 1000 DIFFERENT TYPES

Mallory currently makes over 1000 batteries of all sizes and capacities. If we're not actually producing the battery you need, we'll be happy to work with you in designing a new one. Please write the Technical Sales Department, Mallory Battery Company, a division of P. R. Mallory & Co. Inc., South Broadway, Tarrytown, N.Y. 10591. Or call 914-591-7000. (In Canada: Mallory Battery Company of Canada Limited, Sheridan Park, Ontario.)

® Registered trademark of Bulova Watch Co., Inc.

It's good business to do business with Mallory



**A
new lightweight
wheel did big
things for our
instrument counters**



Our new counting wheel gives you two important high-performance options in "D" Series instrument counters.

Operate your "D" at standard speeds and you'll have substantially longer counter life. Or run it at a speed 50% higher than was possible with the old wheel (3000 rpm vs. 2000 for the old) and you'll have the same counter life as before.

These benefits are the direct result of a breakthrough in molding techniques and materials that let us reduce the standard Delrin wheel's weight by 30%. This means the new wheel has 20% lower torque requirements, lower inertia, and creates far less radial load and strain on the counter mechanism. And that a counter equipped with it operates 30% more quietly, regardless of speed.

The new Delrin wheels are available in two styles. One has a bronze bushing. Use this if you need exceptionally high performance or very long counter life. The other style has no bushing, and is ideal for standard applications.

Both styles are fully interchangeable with wheels supplied on previous "D" models. Figures are permanently impressed into the Delrin, and meet Mil specs for readability. Dull instrument finish is standard. For full information write for Instrument Counter Catalog, 622 N. Cass St., Milwaukee, Wis. 53201.

Versatile "D" series 3, 4, 5, or 6-figure model without case. 3000 rpm. 1/4" Delrin wheels, special unit wheels available. 44 different models

Compact "Y" series Small. Speeds to 1500 rpm continuous, 2000 rpm intermittent. Open or closed design. Some models resettable, all add and subtract.

Sub-miniature "S" series 3, 4, 4, or 5-figure sub-miniature model without case. For use where space and weight are limited. 2500 rpm intermittent. 1/8" figures, 12 different models.

See the difference! Wheel samples free with request for information.

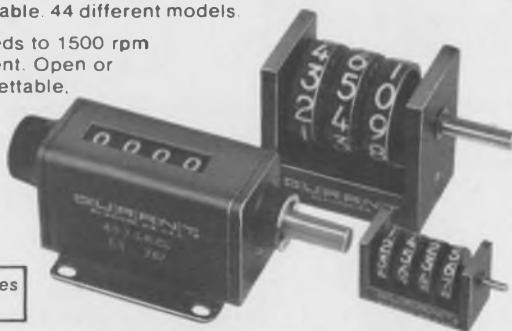

DURANT®
DIGITAL INSTRUMENTS

A CUTLER-HAMMER COMPANY

In Europe: Durant (Europa) N.V. Barneveld, Netherlands
INFORMATION RETRIEVAL NUMBER 110

New Literature



Rf components

A six-page catalog includes specifications and application material on double-balanced mixers, hybrids, power dividers, single-balanced mixers, switches and balanced transformers. Included are a spurious chart that shows the relative amplitude of intermodulation products and a two-tone graph of 3rd order products as a function of input level. The use of mixers as current-controlled attenuators, amplitude modulators, and phase detectors is also explained. Relcom.

CIRCLE NO. 362



Power supplies

A new combination catalog and file folder enlarges on a line of miniaturized high voltage power supplies and related products. The folder contains data sheets on power supplies and new high-voltage gate generator. Venus Scientific Inc.

CIRCLE NO. 363

RF power devices in hermetic stripline packages



TYPICAL DEVICES AVAILABLE

Power Rating	Device Number		Similar to
	ungrounded emitter	grounded emitter	
1w@1GHz	S3042	S3043	2N4429
2.5w@1GHz	S1007	S1008	2N4430
5w@1GHz	S1009	S1010	2N4431
15w@400MHz	S3512	S3511	2N5016
10w@1GHz	S1054	S1055	S1050

- Single chip reliability
- Choice of grounded or ungrounded emitter
- Available from the shelf in quantity
- Wide variety of devices available upon request

FOR MORE INFORMATION, CONTACT:

Electronic **United**
 Components DIVISION OF Aircraft[®]

TREVOSE, PENNSYLVANIA
 Tel. 215-355-5000 TWX: 510-667-1717
 IN THE WEST: 128 E. KATELLA AVE., ORANGE, CALIF., (714) 639-4030

INFORMATION RETRIEVAL NUMBER 111

Are you a creative software designer?



Like to
join Hughes
in California?

You'll be doing conceptual design of new-generation aerospace software systems. For an advanced, real-time computer system.

You'll be part of a small team of exceptional software/hardware specialists. But also part of a growing, highly diversified company where good work and creative thinking are recognized and rewarded.

It's a great spot to grow professionally. And Southern California isn't such a bad spot for your family to grow up, either.

Requirements: Degree (MS preferred) in engineering, mathematics, or physics. At least three years' experience with software systems, assembler and compiler languages, simulation systems, and use of large-scale computers.

Please airmail resume today to:

Mr. Robert A. Martin
Head of Employment
Hughes Aerospace Divisions
Dept. 95
11940 W. Jefferson Blvd.
Culver City, Calif. 90230

An equal-opportunity employer—
M & F. U.S. citizenship is required



Free Career Inquiry Service

Absolutely Confidential

Respond to the career opportunities advertised in this issue. Fill out and send us this handy resume. **Electronic Design** will do the rest – neatly typed copies of this form will be mailed to the companies of your choice, indicated by the circled Career Inquiry Numbers at the bottom of this page.

8

Name		Home Phone	
Home Address (Street)		City	State ZIP Code
Age	U.S. Citizen <input type="checkbox"/> Yes <input type="checkbox"/> No	Security Clearance	
Prime Experience		Secondary Experience	

Desired Salary	Availability Date
-----------------------	--------------------------

Employment History – present and previous employers

Company			
City, State			
Dates	to	to	to
Title			
Specialty			

Education – indicate major if degree is not self-explanatory

Degree			
College			
City, State			
Dates	to	to	to

Additional Training – non-degree, industry, military, etc.

Professional Societies

Published Articles

Career Inquiry Numbers:

900	901	902	903	904	905	906	907	908	909	
910	911	912	913	914	915	916	917	918	919	925

ELECTRONIC DESIGN
850 Third Avenue
New York, New York 10022

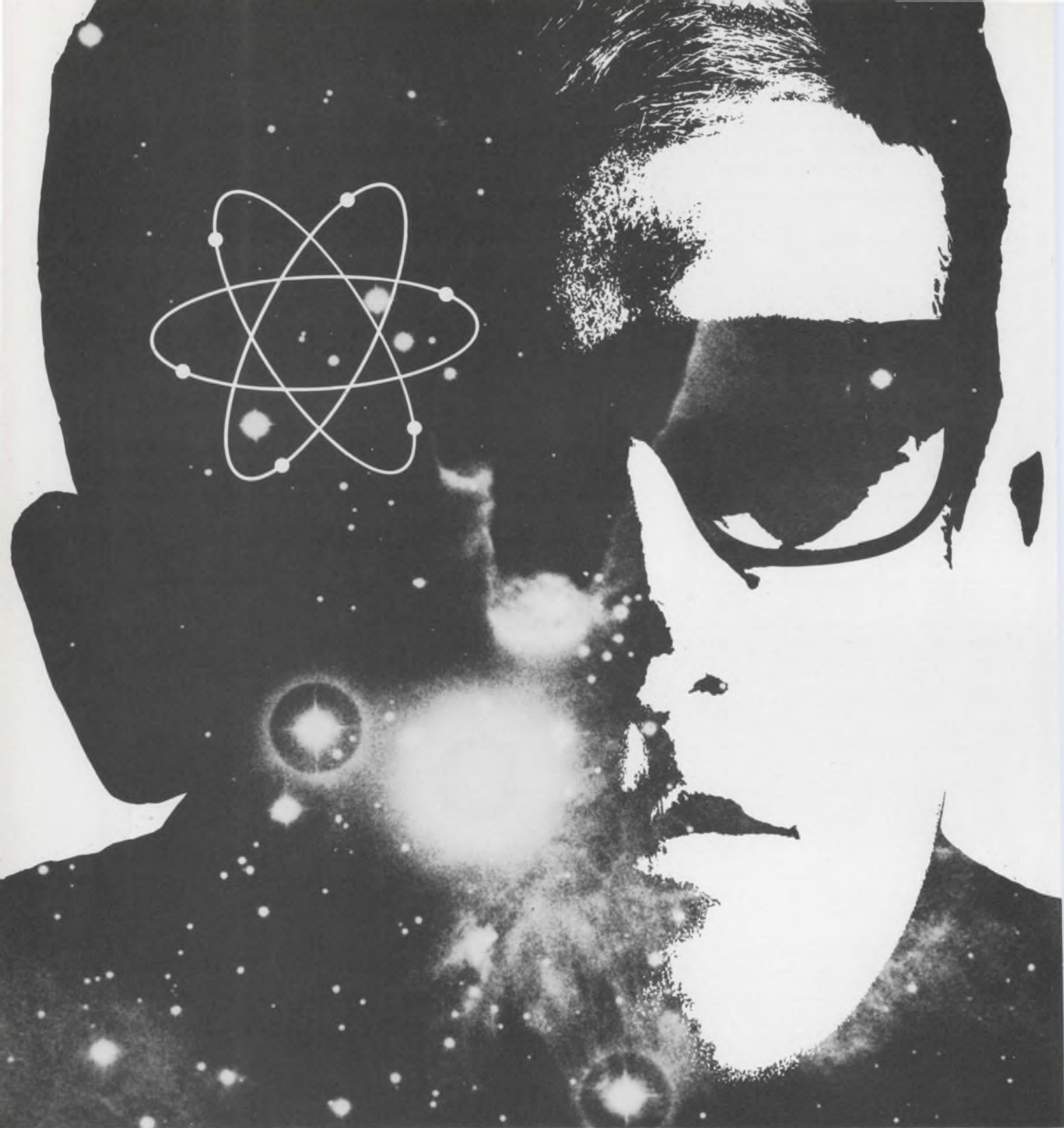

We're in the business of extending man's senses.

Watch inbound traffic from outer space.

Talk safely in bits and pieces for 5,000 miles.

Scan the ocean bottom for an exact fix.

Tune in the fleet with two million watts of RF power.

Control joint forces from an electronic command post 20,000 feet above the action.

Whatever the mission, no matter how impossible, how big, or how soon it's needed, LTV Electrosystems produces.

We can turn a mission concept into sophisticated hardware faster, better, at lower cost than just about anyone.

Our technological spectrum ranges from re-entry physics installations and international communications nets to high-reliability components. We have 15 production facilities countrywide and some of the best scientific and engineering minds anywhere.

Our mission: Extending man's senses.

What's yours?

See the opposite page for a listing of current professional opportunities at LTV Electrosystems.

LTV ELECTROSYSTEMS, INC.

PO BOX 6030, DALLAS, TEXAS 75222

A quality company of Ling-Temco-Vought, Inc. **LTV**

Voltage regulators

A new catalog describes line-voltage regulators with a static magnetic design that provide response times on the order of 10 Hz. Available in ratings from 1/2 kVA through 500 kVA, these units are ideally suited for installations requiring good voltage regulation. Hevi-Duty Electric Div., Sola Basic Industries.

CIRCLE NO. 364

Hour meters

Complete details on a line of hour meters are given in a four-page brochure. Covering basic ac and dc meters, the brochure contains descriptions, uses, specifications, operation details, features and how-to-specify information. Another section covers mounts and accessories in detail. Engler Instrument Co.

CIRCLE NO. 365

IC logic design

A comprehensive application guide to series 5400/7400 high-speed TTL integrated circuits is now available. The 32-page booklet describes various standard gate and flip-flop circuits in the family and explains their basic operation. The material in the guide was originally developed for a series of seminars on integrated circuits for engineers new to integrated circuit logic design. Sprague Electric Co.

CIRCLE NO. 366

Switch catalog

An expanded catalog gives complete technical specifications on six new series of miniature rotary switches. Included are many modifications on various switches that can now be obtained. These include units designed for printed circuit use, plus switches with specially coded outputs including decimal to binary for digital work. RCL Electronics, Inc.

CIRCLE NO. 367

Solvent application

A 39-page, fully illustrated booklet describes applications, recovery, economics, properties and toxicological considerations relating to the in-plant use of solvents. The brochure describes a patented, specially inhibited grade of 1, 1, 1, trichloroethane that is used by the automotive, aerospace, and metal working industries for cleaning applications such as ultrasonics, printed circuits, missile components, automotive parts, adhesives and electrical motors. The Dow Chemical Co.

CIRCLE NO. 368

Borescopes

Recently updated, this bulletin is concerned with the entire history and make-up of the borescope. With diagrams and pictures, the bulletin describes the three main systems of any borescope—the optical system, the electrical system, and the mechanical design. Lenox Instrument Co.

CIRCLE NO. 369

Connector manual

Expanded to 32-pages, a new design manual contains complete information for metal plate back-panel interconnecting systems. Of special interest is an in-depth discussion on a plate concept and a capability profile on a new in-house wiring service. Also discussed, in detail, are acceptable grid patterns, plate size, plate layouts and dimensioning. Elco Corp.

CIRCLE NO. 370

Microwave energy

A bibliography of works dealing with industrial applications of microwave energy is now available. The 36-page brochure describes books, articles, and papers on a wide range of subjects and covers many aspects of theory and applications. Varian Industrial Microwave Operation.

CIRCLE NO. 371



A new bulletin of professional opportunities at LTV Electrosystems.

Greenville Division

(Systems for strategic and tactical surveillance, reconnaissance, detection; tracking; command and control; airborne lighting systems; artificial intelligence; tactical warfare.)
Digital Systems Analysts
Digital Circuits Designers
Electro-Optics Systems Analysts
RF Systems Analysts
RF Circuits Designers
Scientific Programmers
Business Programmers

Facilities — Greenville, Texas; Greenville, South Carolina; Roswell, New Mexico

Garland Division

(Long-range digital communications; fluid mechanical systems for aircraft, missiles, spacecraft; high-precision antennas; guidance and navigation systems; space systems.)
RF Circuits Designers
RF Systems Analysts
Digital Circuits Designers
Digital Systems Analysts
Antenna Design Engineers
Scientific Programmers

Facilities — Garland and Arlington, Texas

Continental Electronics

(This subsidiary company builds super-power RF transmitters for radio communications, broadcasting, re-entry physics radars, radio astronomy, nuclear accelerators.)
Transmitter Design Engineers
RF Circuit Designers
RF Systems Engineers

Facilities — Dallas, Texas; Waltham, Massachusetts

Memcor Division

Portable and stationary TACAN systems, tactical radio systems, gyro systems, nuclear controls, resistance products.)
Project Engineers (TACAN Systems)
Electronic Design Engineers
Instrumentation Engineers
Mechanical Engineers
Digital Systems Engineers

Facilities — Huntington, Indiana; Boyne City, Michigan and Salt Lake City, Utah

Please call or write: Bill Hickey, Supervisor of Professional Placement, LTV Electrosystems, Inc., P. O. Box 6118, Dallas, Texas 75222, Telephone (214) 276-7111. An equal opportunity employer.

LTV Electrosystems:
extending man's senses.

COMMERCIAL FLIGHT CONTROLS AND AVIONICS ENGINEERS

Conceptual design and development of flight controls, flight instrumentation, automatic landing, navigation, and advanced avionic systems.

Rapidly expanding commercial aircraft programs have created excellent openings, with growth potential, for engineers with recent commercial avionic experience in design, development, and test of all-weather landing systems, autopilots, flight directors, advanced displays, stability augmentation systems, inertial navigation systems, or air-data computers.

Engineers interested in developing new designs for aircraft of the 70's, not just repackaging today's shelf items, are invited to write Mr. C. R. Alexander, Professional Placement Manager, Dept. 1704, 3415 Empire Avenue, Burbank, California 91503. Or call (213) 847-1328 collect. An equal opportunity employer.

LOCKHEED-CALIFORNIA COMPANY

A Division of Lockheed Aircraft Corporation
INFORMATION RETRIEVAL NUMBER 902

REED RELAYS Certifiable to MIL-R-5757/29B



- Choice of 14 basic Form A, Form C, and combinations of A and C capsules in three standard-size metal cases.
- Coils: 6, 12, and 26.5 volts, or to specifications.
- Printed circuit type pin on standard 0.1-inch grid spacing, in standoff insulating header.
- All units magnetically and electrostatically shielded.
- Resists humidity, vibration, and shock.
- Fast operate time; long life; high reliability.

Ask for Bulletin GR-5.



19 Walnut Ave. (Box 858), Clark, N.J. 07066
Tel. 201-382-7373

INFORMATION RETRIEVAL NUMBER 112

YOUR HEART FUND FIGHTS

HEART ATTACK
STROKE
HIGH BLOOD
PRESSURE
INBORN HEART
DEFECTS



NEW LITERATURE



Relays & switches

Over 480 different relays are featured in a new catalog. The revised, 16-page catalog incorporates several new products that include time-delay switches; it also features a full line of stock relays. Magnecraft Electric Co.

CIRCLE NO. 372

Miniature parts

A new brochure deals with miniature cold headed parts used in the manufacture of small electronic and mechanical products. The brochure, a reprint of a recent technical article, covers the methods used to manufacture the tiny parts, which are only 0.5 in. in length and 0.025 in diameter. Tolerances for these parts, as well as quality control procedures, are described in detail. General Electric Co., Lamp Metals & Components Dept.

CIRCLE NO. 373

Hardware catalog

Thousands of individual connectors, sockets, coaxial cable, switches and twin leads are described in a new general line catalog. Included in the 2-color, 18-page catalog are photographs, line drawings, electrical characteristics and mechanical specifications of these components. The line encompasses tube sockets, relay sockets, test jacks, tip jacks, microphone connectors, home and industrial type ac plugs, and receptacles plus coaxial cable, connectors and switches. Amphenol Distributor Div., The Bunker-Ramo Corp.

CIRCLE NO. 374

Telemetry modules

A 52-page catalog describes a line of fm-fm telemetry modules including voltage-controlled oscillators, dc amplifiers, dc signal isolators, frequency-to-dc converters, tone oscillators, mixers, phase detectors, analog-to-digital converters, discriminators, pressure transducers and a telemetry system. All units have completely solid-state and miniature design and have been widely utilized for military, industrial, and research applications. Solid State Electronics Corp.

CIRCLE NO. 375

Compact keyboard

Wired and encoded solid state keyboards are the subject of a 2-color, 16-page illustrated booklet containing a description of the Hall effect used to produce an analog control voltage. Included in the product description are switch specifications, operating characteristics, switch module mounting dimensions, double-shot molded button specifications, legends, key spacing, keyrow offset and keytop orientation. Micro Switch, A Division of Honeywell, Inc.

CIRCLE NO. 376

Dielectrics and absorbers

A colorful new folder on high-loss dielectrics and electromagnetic absorbing materials is available at no charge. Special emphasis is placed on complete performance data for 16 materials, useful in a wide variety of applications including transmission line components, reduction of surface waves, reduction of mutual coupling between adjacent elements of antenna arrays, and reduction of reflections. The dielectric data is complete enough to allow a designer to build his own free space or transmission line absorber. Emerson & Cuming, Inc.

CIRCLE NO. 377



Do you measure up?

If you are an **Electronic** and/or **Simulation Specialist**, you're invited to "measure" your talents against our needs...

**Aerodynamics • Circuit design
Reliability engineering • Components engineering • Systems engineering
Scientific Programming
Manufacturing engineering
Contract administration
Math modeling**

Send us your resume today. Write: Mr. D. H. Besgrove, Professional Employment, Conductron Corporation, P.O. Box 426, St. Charles, (near St. Louis), Mo. 63301

**CONDUCTRON
CORPORATION**



An equal opportunity
employer

Design Data from Manufacturers

Advertisements of booklets, brochures, catalogs and data sheets. To order use Reader-Service Card.
(Advertisement)

NEW 68-PAGE DRAFTING CATALOG — FREE



Bishop Catalog 104 — the most comprehensive manual type catalog of pressure-sensitive electrical/electronic component drafting aids ever assembled. Filled with thousands of printed wiring symbols and patterns to speed artwork preparation time and cut drafting costs. Featuring the latest information on printed wiring drafting techniques. Contains multi-pad component symbols, including flatpacks and dual in-lines. Also, general purpose wiring symbols, logics, schematics, reference designations, tapes, pads, shapes and many, many more. Send today for your free copy and samples.

Bishop Industries Corp.
7300 Radford Ave.
North Hollywood, California 91605
Phone: (213) 982-2000

174

Miniature Rotary Switches



A new catalog, giving complete engineering specifications on 7 series of miniature rotary switches. Included are switches permitting up to 10, 12, and 24 positions per deck, shorting or non-shorting! Also included is the new RCI "F" series, with printed circuit terminals, ideal for printed circuit mounting. Photographs and engineering drawings of each switch is included. The industry's best delivery is featured. Send for your free copy!

RCL Electronics, Inc.
700 South 21st Street
Irvington, N. J. 07111
(201) 374-3311

175

Terminal Block Selector



A new 24-page, completely illustrated catalog contains photos, descriptions, ratings, engineering drawings, and prices of the complete line of Curtis terminal blocks. Included are printed circuit, insulated feed-thru, quick disconnect, track type, and high current terminal blocks. Handy selection chart quickly locates the perfect block for your particular requirements. Send today for your free copy.

See us at Design Eng. Show-Booth 3735

Curtis Development & Mfg. Co.
3236 North 33rd Street
Milwaukee, Wisconsin 53216

176

Electronic Design

ELECTRONIC DESIGN's function is:

- To aid progress in the electronics manufacturing industry by promoting good design.
- To give the electronic design engineer concepts and ideas that make his job easier and more productive.
- To provide a central source of timely electronics information.
- To promote two-way communication between manufacturer and engineer.

Want a subscription? ELECTRONIC DESIGN is sent free to qualified engineers and engineering managers doing design work, supervising design or setting standards in the United States and Western Europe. For a free subscription, use the postfree application form inside the back cover. If none is included, write to us direct for an application form.

If you do not qualify, you may take out a paid subscription for \$25 a year in the U.S.A., \$35 a year elsewhere. Single copies are \$1.50 each.

If you change your address, send us an old mailing label and your new address; there is generally a prepaid postcard for this inside the back cover. You will have to requalify to continue receiving ELECTRONIC DESIGN free.

The accuracy policy of ELECTRONIC DESIGN is:

- To make reasonable efforts to ensure the accuracy of editorial matter.
- To publish prompt corrections whenever inaccuracies are brought to our attention. Corrections appear at the end of the Letters column.
- To refuse any advertisement deemed to be misleading or fraudulent.

Microfilm copies are available of complete volumes of ELECTRONIC DESIGN at \$19.00 per volume, beginning with Volume 9, 1961. Work is now in process to complete the microfilm edition of Volumes 1-8. Reprints of individual articles may be obtained for \$2.00 each, prepaid (\$0.50 for each additional copy of the same article) no matter how long the article. For further details and to place orders, contact the Customer Services Department, University Microfilms, 300 North Zeeb Road, Ann Arbor, Michigan 48106; telephone (313) 761-4700.

Want to contact us? If you have any comments or wish to submit a manuscript or article outline, address your correspondence to:

Howard Bierman, Editor,
ELECTRONIC DESIGN,
850 Third Avenue,
New York, N.Y. 10022.

Electronic Design

Advertising Sales Staff

New York 10022

Robert G. Drake
Sales Manager
Edward F. Clancy
Sales Service Manager
Robert W. Gascoigne
Thomas P. Barth
Samuel M. Deitch
Byron Adams
850 Third Avenue
(212) Plaza 1-5530
TWX: 867-7866

Philadelphia 19066

William C. Repetto
P. O. Box 206
Merion Station, Pa.
(215) MA-3-5888

Boston 01945

Richard Parker
P.O. Box 645
Clifton Station
Marblehead, Mass.
(617) 742-0252

Chicago 60611

Thomas P. Kavooras
Berry Conner, Jr.
200 East Ontario
(312) 337-0588

Cleveland

Thomas P. Kavooras
(Chicago)
(312) 337-0588
(call collect)

Los Angeles 90303

Stanley I. Ehrenclou
John V. Quillman
W. James Bischof
2930 Imperial Highway
Inglewood, Calif.
(213) 757-0183

San Francisco 94022

Arthur R. Shields, Jr.
175 San Antonio Rd., S 243
Los Altos, Calif.
(415) 941-3084

London W. 1

For United Kingdom & Holland
Brayton C. Nichols
44 Conduit Street
Tel: REGent 4714

Verviers, Belgium

For Continental Europe
Andre Jamar
1, Rue Mallar, 1
(087) 253.83 Telex 41563

Tokyo

Yoshihiro Takemura
IPS Group Ltd.
Box 36, Ohsaki Post Office
Phone (431) 5804



AMERICAN BUSINESS PRESS, INC.

DUAL-IN-LINE SOCKETS

for testing and packaging plug-in IC's

LOW COST • HIGH PERFORMANCE • WIDE APPLICATION

- Sockets for 14 and 16 lead packages having flat or round leads
- Large contoured entry holes for easy IC insertion
- Gentle wiping leaf contacts provide high reliability
- Available with or without mounting saddle for panel mount or printed circuit applications
- Molded diallyl phthalate body; beryllium copper, gold-plated contacts

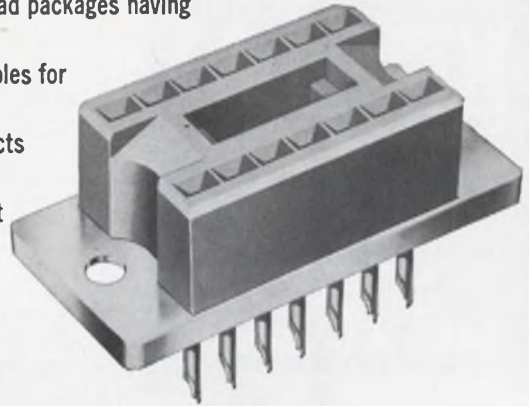

Request Complete I.C. Folder

AUGAT

INC. 31 PERRY AVE., ATTLEBORO, MASS. 02703

TEL: 617-222-2202

INFORMATION RETRIEVAL NUMBER 113

Par.Metal INTRODUCES — The **CONTEMPO SYSTEM** of ELECTRONIC HOUSING

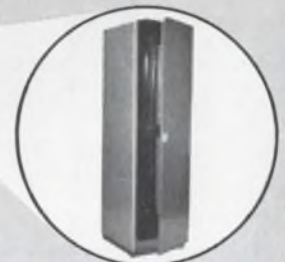

"FC" CONTEMPO-RACK with Side Panels, Flush Handle and Front Door and Recessed Base.

SPOTLIGHTING:—



Double Console with "PT" Top Cabinets and "CCT" Exterior Table.

- RACKS/CONSOLES—Matched Modern Design
- Heavy gauge steel — Fully welded
- Two-toned Gray Textured Vinyl Finish
- TEN New Desk Panel Cabinets & Wedges
- Stand-up and Desk high Pedestals
- 30° & 45° welded Wedges for ALL Units
- Flush door handles on Pan-shaped Doors
- New standard depths, 26" & 31" — 6 Heights
- Semi-Custom units made to your "specs"

FREE! Our Complete Catalog #136 of Racks, Consoles, Panels and Accessories.

Par.Metal Products
DIVISION OF EON CORPORATION

32-52 — 49th STREET
LONG ISLAND CITY, N.Y. 11103 • (212) 278-8905

INFORMATION RETRIEVAL NUMBER 114

YOUR FREE COPY IS READY!

NEW 1969 NEWARK INDUSTRIAL ELECTRONICS CATALOG

★ The one-source buying guide ★ Over 70,000 items—500 major brand lines

★ 700 pages

★ Over \$7,000,000 industrial electronic inventory

NEWARK HAS IT NOW, THE COMPLETE LINE OF

NEW LOW COST TI



NPN/PNP
Complimentary
Power
Transistors

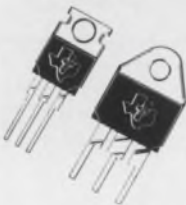

Reduce power circuitry costs with these new plastic package units. Available in four basic types, 1, 3, 10 and 25 amps, with power dissipations to 90 watts.

Will mount in old TO-3 or TO-66 metal can sockets without adapter hardware. Reliability documentation available.

Immediate delivery from stock—factory OEM prices
—fast efficient service from 11 Newark warehouses.



New Main Office & Warehouse

NEWARK ELECTRONICS CORPORATION

500 North Pulaski Chicago, Illinois 60624
(312) 638-4411

AUTHORIZED TI WAREHOUSES IN

★ Chicago, Illinois (312) 638-4411	Detroit, Michigan (313) 548-0250	★
★ Cincinnati, Ohio (513) 421-5282	Grand Rapids, Michigan (616) 452-1411	★

OTHER NEWARK WAREHOUSES IN

★ Minneapolis, Minn. (612) 331-6350	New Orleans, Louisiana (504) 834-9470	★
★ Denver, Colorado (303) 757-3351	Dallas, Texas (214) 271-2511	★
★ New York City (212) 255-4600	Houston, Texas (713) 782-4800	★

INFORMATION RETRIEVAL NUMBER 115

174

Advertisers' Index

Advertiser	Page	Advertiser	Page
API Instruments Co.	158	Motorola Communications & Electronics, Inc.	149
Alco Electronic Products, Inc.	151	Motorola Semiconductor Products, Inc.	29, 135
Allen-Bradley Co.	33	National Beryllia Corporation	118
American Lava Corporation	41	National Semiconductor Corporation	92, 93
American-Micro Systems, Inc.	105	Newark Electronics Corporation	174
Amphenol, The Bunker-Ramo Corporation	6, 7	Nytronics, Inc.	31
Arvin Frequency Devices	175	Opto-Metric Tools, Inc.	122
Augat, Inc.	173	Par Metal Products, A Division EON Corp.	173
Automatic Electric, A Subsidiary of General Telephone & Electronics	12, 13	RCA Electronic Components and Devices	4, 5, 119, Cover IV
Beckman Instruments, Inc., Helipot Division	107	RCL Electronics, Inc.	172
Birtcher Corporation, The	150	RCA Institutes, Inc.	156
Bishop Graphic, Inc.	172	Radiation, Incorporated	24
Bourns, Inc.	10, 11	Ratheon Company, Industrial Components Operation	136
Burr-Brown Research Corporation	23	Raytheon Company, Semiconductor Operation	8, 9
Burroughs Corporation	20	San Fernando Electric Manufacturing Company	132
Caddock Electronics	156	Schneider	120 A-B-C-D
Cermetek	155	Schauer Manufacturing Corp.	154
Clifton Division of Litton Industries	44	Sencore	127
Cohn Corp., Sigmund	137	Signalite, Incorporated	131
Constantine Engineering Labs. Co.	155	Signetics Corporation	27
Corning Glass Works, Electronic Products Division	36, 37	Simpson Electric Company	134
Cratex	175	Singer Company, The Instrumentation Division Gertsch Operation	138
Crane Packing Company	116	Singer Company, The	123
Curtis Development & Mfg. Co.	172	Solid State Products, Division of Unitrode Corporation	115
Dale Electronics, Inc.	Cover III	Solitron Devices, Inc.	153, 157
Dialight Corporation	125	Spectral Electronics Corporation	112
Durant Instruments, A Cutler Hammer Company	164	Sprague Electric Company	18
Edal Industries, Incorporated	128	Standard Condenser Corporation	146
Elco Corporation	38	Sylvania Electric Products, Inc.	161
Electro Materials Corp.	98	Systron-Donner Corporation	2
Electronic Industries	114	TRF Incorporated	175
Electronic Memories, Inc.	108, 109	TRW Inc., Capacitor Division	139
Emerson & Cuming, Inc.	160	Tektronix, Inc., Oscilloscopes	46
Fairchild Semiconductor, A Division Fairchild Camera and Instrument Corporation	16, 17, 78, 79	Teledyne Relays, A Teledyne Company	129
General Electric Company, Electronic Components, Sales Operation	99	Telonic Instruments, A Division of Telonic Industries, Inc.	124
General Radio Company	1	Tempil Division of Big Three Industrial Gas & Equipment Co.	162
General Reed Company	170	Texscan Corporation	147
Gordon, a Subsidiary of Pneumo Dynamics Company	154	Todd Products Corp.	137
Hewlett-Packard	Cover II, 35, 113, 121, 143	Triplet Electrical Instrument Company	117
Honeywell Test Instrument Division	146	Tyco Laboratories, Inc.	144
ITT Cannon, A division of International Telephone and Telegraph Corp.	96, 97	U. S. Capacitor Corporation	148
Indiana General Corporation	86, 87	United Aircraft Corporation, Electronic Components Division	80, 165
International Contronics, Inc.	152	United Systems Corporation	130
International Rectifier Corp.	159	Varian Solid State Division, Micro-wave Operation	15
Johanson Manufacturing Corp.	142	Veeder-Root	42, 43
Krohn-Hite Corporation	140	Vent Rak, Inc.	120
Lear Siegler Inc., Cimron Division	48	Wanlass Instruments, a division of Wanlass Electric Company	152
Line Electric Company	126	Watkins-Johnson, CEI Division	145
Lockheed Electronics Company	110	Career Advertising	
Magnetics, Inc.	101	Conductron Corporation	171
Mallory Battery Company	163	Hughes Aircraft Company, Aerospace Division	166
Mallory & Co., Inc., P. R.	103	LTV ElectroSystems, Inc.	168, 169
Marconi Instruments Division of English Electric Corporation	141	Lockheed-California Company	170
Matsuo Electric Co., Ltd.	150		
Mohawk Data Sciences Corporation	133		
Molex Products Company	81		
Monsanto Company	14		

CRATEX RUBBERIZED ABRASIVES

DEBURR SM-O-O-TH POLISH



\$7.50 BUYS IT ALL—80 piece introductory Kit 777 equally assorted in 4 grit textures: coarse, medium, fine and extra fine. **TRY IT**—Cratex Rubberized Abrasives improve the surface while preserving critical workpiece dimensions by its unique cushioning action. **FINISH THE JOB**—to your most exacting specifications—often in a single operation. **SEND FOR KIT 777**—or your **FREE SAMPLE** and catalog illustrating the full Cratex product line and its applications.

CRATEXTM RUBBERIZED ABRASIVES

1600 Rollins Road • Burlingame, California
Sold through leading industrial distributors
INFORMATION RETRIEVAL NUMBER 116

OVEN OSCILLATORS CAN'T COMPETE WITH ARVIN TCXOs

Instant Response
Greater Reliability
As Small as 1 cu. in.
Lighter Weight
Frequency to 200 MHz
Stability to ± 1 pp 10⁷
Input Voltage ± 12 VDC $\pm 5\%$
Power Input 50 MW
Output 1 MW RMS Across 50 Ω

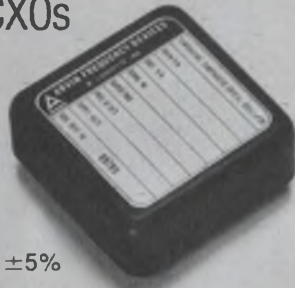

Arvin Temperature Compensated Crystal Oscillators are working now in satellites, missiles, aircraft, and portable communications equipment by the hundreds. Many TCXO models available off-the-shelf, others designed to your requirements. Write for Arvin TCXO bulletin, or phone (317) 463-2589.



ARVIN FREQUENCY DEVICES
ELECTRONIC SYSTEMS DIV., ARVIN INDUSTRIES, INC.
2505 N. Salisbury, West Lafayette, Indiana 47906

INFORMATION RETRIEVAL NUMBER 117

ELECTRONIC DESIGN 8, April 12, 1969

TRF MAKES THEM VERSATILE



... which adds to their **VALUE**

Did the last receiver you bought meet both your specs and your budget?

The Model R-104 is designed for a wide range of "non critical" applications at frequencies from 216 MHz to 550 MHz. This receiver is ideal for applications which require:

- High Reliability
- Ruggedness
- Small Size
- Low Cost
- Fast Delivery

The versatility is the value. No matter whether the function is Command, Control or DME, this receiver will meet the task.

Companion decoders are also available.

Write or call for complete information:

TRF INCORPORATED
a Subsidiary of Quanta Systems
5265 Port Royal Road
Springfield, Virginia 22151
PHONE (703) 321-8300



TELEMETRY AND COMMUNICATION EQUIPMENT

INFORMATION RETRIEVAL NUMBER 118

Information Retrieval Service

All products, design aids (DA), application notes (AN), new literature (NL), and reprints (R) in this issue are listed here with Page and Information Retrieval numbers. Reader requests will be promptly processed by computer and mailed to the manufacturer within three days.

Category	Page	IRN	Category	Page	IRN	Category	Page	IRN
Components			ICs & Semiconductors			connector, PC (ES)	158	351
amplifiers, lock-in (AN)	162	357	capacitor chip kits	142	299	connector sliderule (DA)	160	353
capacitor chip kits	142	299	comparators, analog	134	288	connectors (NL)	169	370
capacitor chips (ES)	158	352	diode, light-emitting	128	279	dielectrics (NL)	171	377
card, switch	136	290	diode, varactor	150	342	epoxy, conductive	154	345
comparators, analog	134	288	diodes, rectifier	128	280	hardware (NL)	170	373
components, rf (NL)	164	362	drivers, power	130	282	potting resin	153	344
connector, PC (ES)	158	351	Hall generators	142	297	solvents (NL)	169	368
connector sliderule (DA)	160	353	ICs, MSI digital	132	285	urethane stripper	153	343
connectors (NL)	169	370	logic circuits, MOS	134	287			
diode, light-emitting	128	279	logic design, IC (NL)	169	366	Production		
diode, varactor	150	342	logic tester	114	271	circuit card fixture	157	348
diodes, rectifier	128	280	op amp, hybrid	130	283	graphic arts (ES)	158	349
drivers, power	130	282	regulators, voltage	132	286	heat jacket	157	347
filter bank	138	293	transistors, amplifier	148	339	solvents (NL)	169	368
Hall generators	142	297	transistors, plastic	130	284	title blocks (ES)	158	349
hardware (NL)	170	373	transistors, power	128	281			
ICs, MSI digital	132	285				New Literature		
keyboard (NL)	171	376	Instrumentation			boscopes	169	369
lamps, subminiature	144	336	boscopes (NL)	169	369	components, rf	164	362
logic circuits, MOS	134	287	counter, 3-GHz	150	341	connectors	169	370
logic design (DA)	160	354	digital data (AN)	162	360	dielectrics	171	377
logic design, IC (NL)	169	366	electron beams (AN)	162	358	hardware	170	373
magnets, miniature	146	337	generator, function	114	272	keyboard	171	376
multipliers, analog	140	296	generators, time-code	116	273	logic design, IC	169	366
op amp, FET	136	289	instruments (AN)	162	361	meters, hour	169	365
op amp, FET	137	292	logic tester	114	271	microwave energy	169	371
op amp, hybrid	130	283	meters, hour (NL)	169	365	power supplies	164	362
op amps	140	295	spectrum analyzer	112	270	regulators, voltage	169	364
power supplies (NL)	164	362				relays & switches	170	372
programmer	137	291	Microwaves & Lasers			solvents	169	368
readout assemblies	138	294	components, rf (NL)	164	362	switches (NL)	169	367
regulators, voltage	132	286	counter, 3-GHz	150	341	telemetry modules	171	375
regulators, voltage (NL)	169	364	dielectrics (NL)	171	377			
relays & switches (NL)	170	372	diode, varactor	150	342	Application Notes		
resistor chart (DA)	160	354	microwave energy (NL)	169	371	amplifiers, lock-in	162	357
switch, mercury	142	298	switches, coaxial	148	340	digital data	162	360
switch, pushbutton	144	335	transistors, amplifier	148	339	electron beams	162	358
switch, reed	146	338				instruments	162	361
switches (NL)	169	367	Modules & Subassemblies			thermocouples	162	359
switches, coaxial	148	340	amplifiers, lock-in (AN)	162	357			
telemetry modules (NL)	171	375	card, switch	136	290	Design Aids		
thermocouples (AN)	162	359	drivers, power	130	282	connector sliderule	160	353
transistors, amplifier	148	339	filter bank	138	293	logic design	160	354
transistors, plastic	130	284	keyboard (NL)	171	376	logic design	160	356
transistors, power	128	281	logic design (DA)	160	354	pump selector	160	356
			logic design, IC (NL)	169	366	resistor chart	160	354
Data Processing			multipliers, analog	140	296			
calculator, electronic	118	274	op amp, FET	136	289	Evaluation Samples		
communication terminal	124	278	op amp, FET	137	292	capacitor chips	158	352
comparators, analog	134	288	op amp, hybrid	130	283	connector, PC	158	351
data systems	120	275	op amps	140	295	graphic arts	158	349
digital data (AN)	162	360	power supplies (NL)	164	362	title blocks	158	349
equalizer, passive	124	277	programmer	137	291			
generators, time-code	116	273	readout assemblies	138	294			
ICs, MSI digital	132	285	regulators, voltage	132	286			
keyboard (NL)	171	376	regulators, voltage (NL)	169	364			
logic circuits, MOS	134	287	relays & switches (NL)	170	372			
logic design (DA)	160	354	switches, coaxial	148	340			
logic design, IC (NL)	169	366	telemetry modules (NL)	171	375			
logic tester	114	271						
memory, 3-D	120	276	Packaging & Materials					
multipliers, analog	140	296	coating cermet	154	346			
programmer	137	291						

Dale expands square trimmer line

New 3/8" & 1/2" models do more for you

Dale's expanded line of square wirewound trimmers has seven new models to meet your needs at prices near rectilinear levels.

NEW 3/8" LINE. Better for packaging because they're thinner—only .145". Stronger PC mounting. Heavier (22 AWG) pin design reduces mechanical problems caused when lighter pins fail under mounting stress.

NEW 1/2" LINE. Complete internal redesign for better performance and prices that are equal to or lower than competition.

Both new Dale square trimmer lines are rated at one watt at 70°C. Both are made to MIL-R-27208 specs. Dale has a lot going for you in square trimmers—and more are on the way. For complete technical and price information, phone 402-564-3131.

3/8" MODELS



- 5850—Insulated leads
- 5880—PC pins, top adjust
- 5887—PC pins, side adjust
- 5891—PC pins, base mount
- Size: .375" x .375" x .145"

1/2" MODELS



- 5050—Insulated leads
- 5091—PC pins, base mount
- 5080—PC pins, top adjust
- Size: .50" x .50" x .19" (5050)
- .50" x .50" x .22" (5091, 5080)

Resistance Range: 10 ohms to 50K ohms

Resistance Tolerance: ±5% standard

Resolution: 1.01% to .09% (3/8") .54% to .10% (1/2")

Power Rating: 1 watt at 70° C

Operating Temperature Range: -65° C to +175° C

Temperature Coefficient: ±50 PPM/° C Max.

Moisture Resistance: 10 Meg. minimum insulation resistance

Mechanical Adjustment: 25 turns (3/8") 25 turns (1/2")



thinner

stronger

lower cost



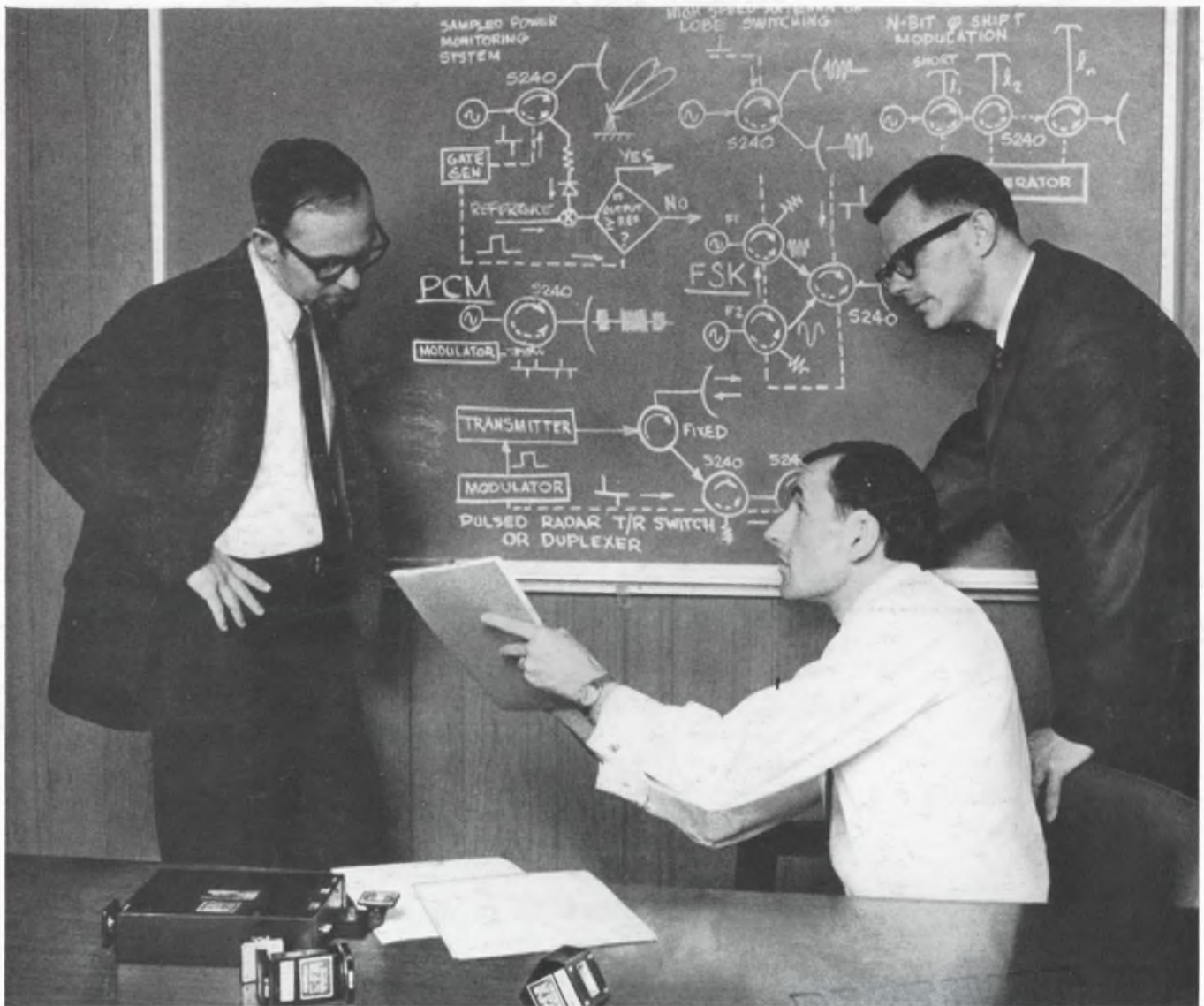

Ferrites... The new course in high-speed, high-power microwave switching capability

You should be putting RCA's high-power microwave ferrite "know-how" to work in your system design. Out of our long experience in basic materials and microwave circuitry, we've developed a whole family of solid-state devices using ferrite materials.

We have a high-power, high-speed Transmit/Receive switch that can provide the reliability needed in radar. Our high-power, switchable circulators operate with low energy pulses and require no holding power. Isolators? We have a small, fixed unit hardly as large as a waveguide flange. For extra protection of your receiver, choose our high-power ferrite limiter. And for your radar applications, be sure to in-

vestigate the advantages of our solid-state duplexers.

Offering new performance and reliability levels for many systems, these microwave ferrite devices are suitable for such applications as: pulsed radar T/R switching and duplexing, high-speed antenna or lobe switching, PCM, FSK, and N-bit phase shift modulation, and sample power monitoring systems.

For more information on these RCA microwave ferrite devices, see your local RCA Representative. For applications assistance, call our application engineers direct: (201) 485-3900, Ext. TF-261. For technical data, write: RCA Electronic Components, Commercial Engineering, Section No. D18Q-2, Harrison, N.J. 07029.



1. S255—Solid-State T/R Switch for radar applications
High Power: Up to 100 kW Peak
High Speed: Less than 0.5 μ s
Low Insertion Loss: 0.8 to 1.5 dB
High Isolation: 60 to 100 dB



2. S240—X-Band Switchable Circulator
High Speed: — 150 ns
Low Insertion Loss: 0.2 dB
High Power: Up to 25 kW
Low Switching Energy



3. S242—X-Band Isolator
Small Size, Wide Band
Low Insertion Loss
Isolation: 20 dB



4. S239—X-Band Limiter
High Power: Up to 100 kW Peak
Low Loss Below 100 W Peak:
0.2 dB

RCA