

# Electronic Design

FOR ENGINEERS AND ENGINEERING MANAGERS

VOL. 17 NO.

# 5

MARCH 1, 1969

**Shift to MOS registers!** They're cheaper — 5 to 7 cents per bit for short delay lines — and offer small size, low dissipation and clock rates variable to system

needs. They interface readily with TTL, can be paralleled for operation to 32 MHz, and are expected to compete strongly with drum memories. Page 50.

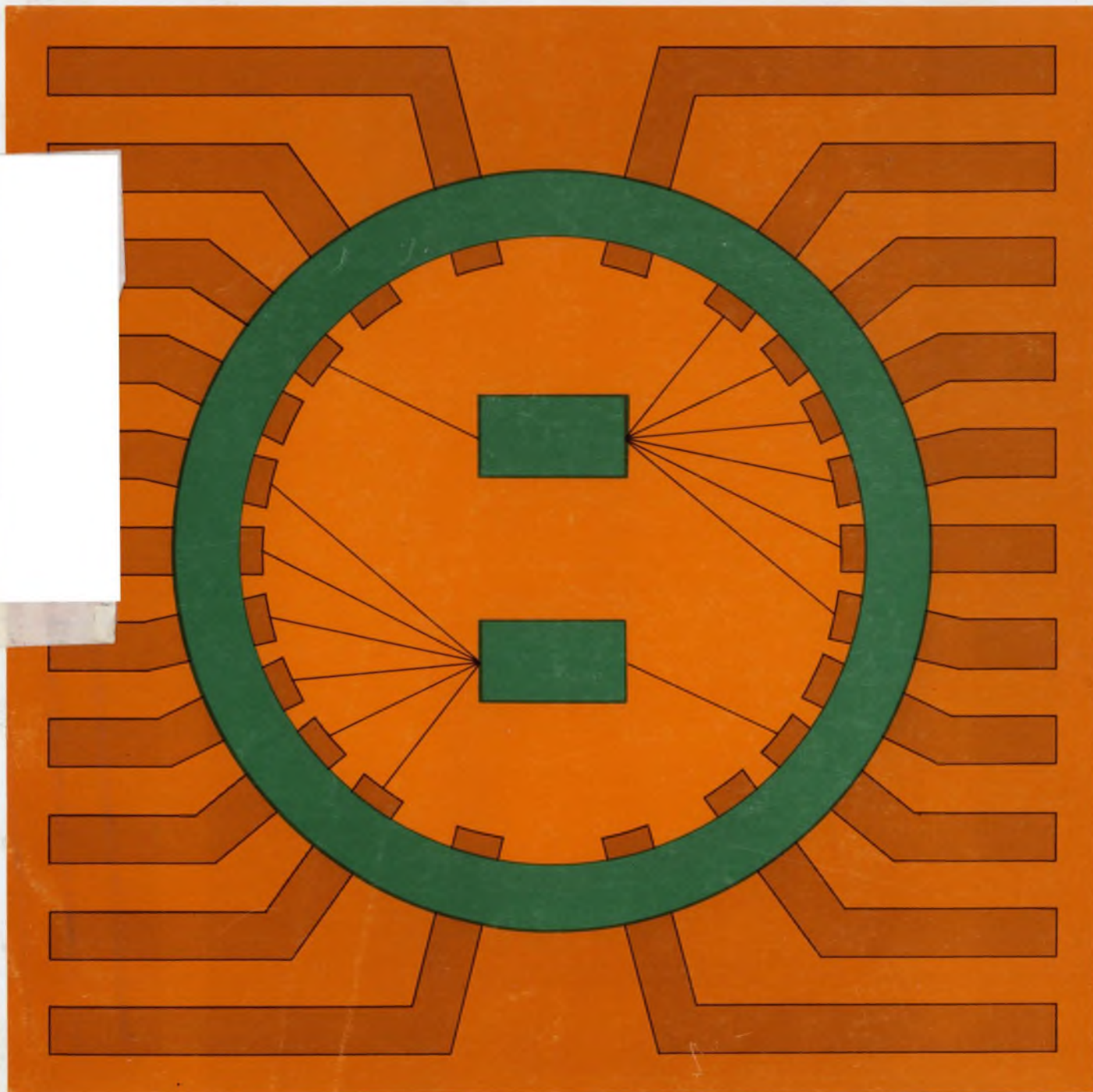



# Cornucopia



## Get UTC's NEW 1969 Catalog—the quick-and-easy locator for transformers and filters.

UTC's 1969 Catalog is the most comprehensive in our history. Over 1350 standard parts, including audio, power and pulse transformers, inductors, electric wave filters, high Q inductors, magnetic amplifiers, saturable reactors, and similar iron-core inductance devices. Many of these new products are listed for the first time.

Eighty-eight clear pages make it easy to locate and specify the part you need: product lines categorized, product selection guide for each line, engineering specifications and applications, new

drawings, new curves, expanded charts.

Also included are: audio and power application circuitry, plus a lucid digest of the new MIL Specs (MIL-T-27C, MIL-F-18327C, MIL-T-21038B).

The "special" you need is probably a "standard" in the NEW UTC Catalog. All items are immediately available from your local distributor. For your copy of the catalog contact: United Transformer Company, Division of TRW INC., 150 Varick Street, New York, N. Y. 10013. **TRW** UNITED TRANSFORMER COMPANY



# CROWBAR...?



## The One Inside is FREE

Not so many years ago, the prudent transmitter engineer discharged a high voltage capacitor bank by dropping a shorting "crowbar" across its terminals. Today's "crowbar" is a protective overvoltage circuit found on DC power supplies — usually at extra cost. Now HP includes a crowbar as standard on its recently updated series of low-voltage rack supplies . . . at no change in price.

Long established as preferred system supplies for component aging production testing and special applications, these supplies have now been redesigned and expanded to meet the stringent demands of today's power supply user. Advantages include low ripple (peak-to-peak as well as rms), well-regulated constant voltage/constant current DC with outputs to 60 volts and 100 amps.

Where loads are critical and expensive, the extra pro-

tection — say, against inadvertent knob-twiddling — from a crowbar is invaluable. On all internal crowbars in this series, the trip voltage margin is set by screw-driver at the front-panel.

Pertinent specifications are: triggering margins are settable at 1V plus 7% of operating level; voltage ripple and noise is 200  $\mu$ V rms/10mV peak-to-peak (DC to 20 MHz); current ripple is 5 mA rms or less depending on output rating; voltage regulation is 0.01%; resolution, 0.25% or better; remote programming, RFI conformance to MIL-I-6181D.

Prices start from \$350. For complete specifications and prices, contact your local HP Sales Office or write: Hewlett-Packard, New Jersey Division, 100 Locust Avenue, Berkeley Heights, New Jersey 07922 or call (201) 464-1234 . . . In Europe, 1217 Meyrin, Geneva.

**HEWLETT**  **PACKARD**  
POWER SUPPLIES

SEE US AT IEEE SHOW—BOOTH #3K28-29, 2F25-36.

Additional data sheets  
available upon request

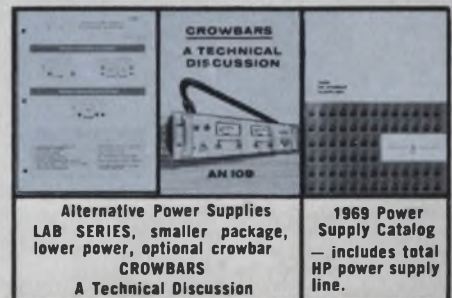



Systron-Donner's Model 6316A gives you automatic final-answer frequency readings non-stop from dc through X band.

It's the perfect systems counter—a completely programmable unit that mounts in a slim 1¾ inches of panel space and costs only \$4750. Before now you needed a collection of instruments totaling five times the bulk and costing half again as much to do the same job.

Model 6316A covers the full range by combining a dc-to-100 MHz counter with built-in automatic frequency extenders. Readings can be taken in milliseconds, and the extenders lock in phase with the input to preserve counter accuracy to 12.4 GHz. That accuracy depends only on time base stability—which can be an ultra-high 5 parts in  $10^{10}$  per 24 hours.

Reliability is superb—proven by more than a year's operation in the field. For a prompt demonstration, phone or write Measurements Division, Systron-Donner Corporation, One Systron Drive, Concord, California 94520. Phone (415) 682-6161.

## First counter to measure automatically from dc to 12.4 gigahertz!



SYSTRON  DONNER



### Another first. One of 144 Systron-Donner instruments

Electronic counters	Digital voltmeters
Pulse generators	Digital panel meters
Microwave frequency indicators	Microwave signal generators
Digital clocks	Laboratory magnets
Memory testers	Data acquisition systems
Analog computers	Microwave test sets
Time code generators	
Data generators	



---

## NEWS

- 21 News Scope
- 25 **Accusations rocking the aerospace industry**  
Officials challenging report by Budget Bureau analyst Richard Stubbing, citing deficiencies found in electronics systems aboard military aircraft
- 28 **Reading aids brighten outlook for the blind**  
Machines under development scan printed letters or words and provide an output that is tactile or in the form of speech
- 36 **Air-defense display does more**  
'Friend or foe' determination is simplified with the assistance of a versatile TV-type screen and digital computer
- 41 Washington Report
- 44 Sidelights of the Issue
- 47 **Editorial:** Technology may yet save this madding world

---

## TECHNOLOGY

- 50 **Shrink delay line costs with MOS.** New shift registers offer low cost, size and dissipation, along with independently variable clock rates.
- 60 **Keep your rf power level constant** by using a servo loop and a saturated rf amplifier to correct temperature drifts and other perturbations.
- 68 **Build your own acoustic coupler** and convert a standard teletypewriter into a portable time-shared computer terminal.
- 76 **Use—don't abuse—the SCR.** Here's a refresher for those who are not getting the most from their SCR designs.
- 82 **Manage creative engineers creatively** by giving them room to innovate on the job. Add the personal touch.
- 88 Ideas for Design

---

## PRODUCTS

- 104 **Microwaves & Lasers:** Rf log detectors span 40-MHz band.
- 108 **ICs & Semiconductors:** Up/down counters have 30-MHz clock.
- 118 **Instrumentation:** Small low-frequency counters program remotely.
- 112 Data Processing
- 116 Modules & Subassemblies
- 121 Components
- 124 Production
- 126 Packaging & Materials

---

## Departments

- 14 Designers' Datebook
  - 100 Books
  - 130 Evaluation Samples
  - 132 Design Aids
  - 134 Application Notes
  - 136 New Literature
  - 146 Advertisers' Index
  - 148 Information Retrieval Service
- Information Retrieval Service Card inside back cover  
COVER CREDIT: Art by Clifford M. Gardiner



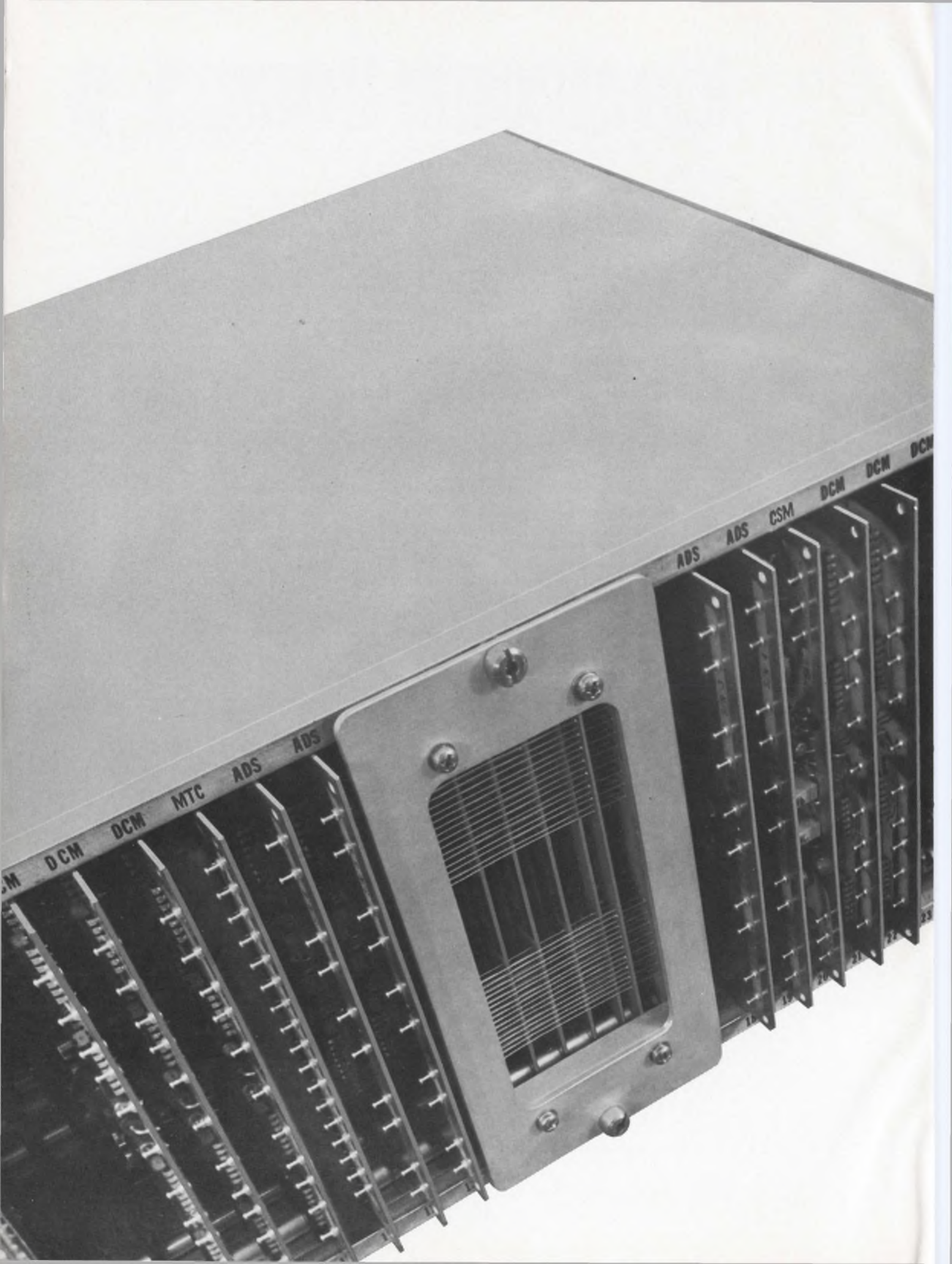



# 2½D cycle time at 3D cost!

Data Products' new 3-wire, 3D memory

## ...the STORE/33™

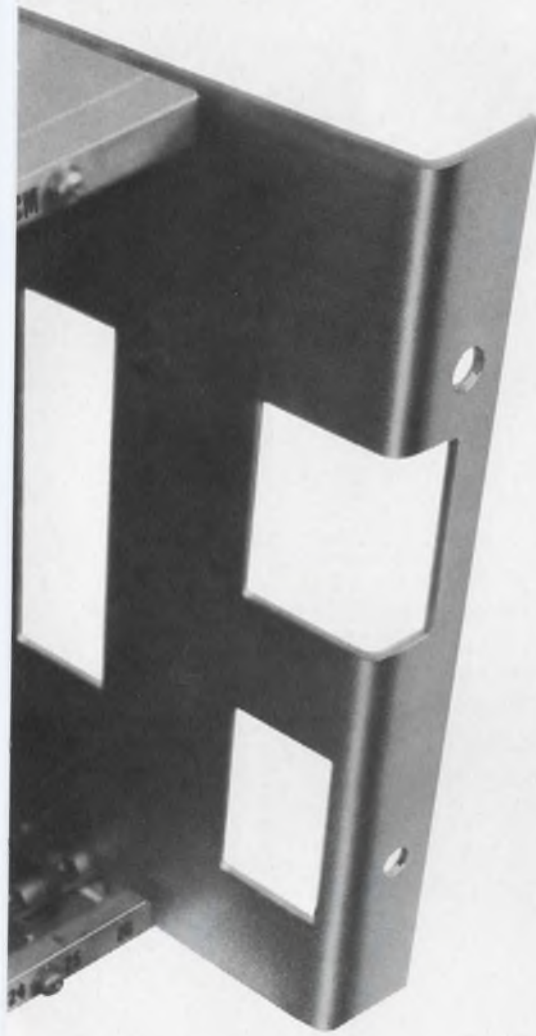

STORE/33 is in full production at Core Memories, Inc.\* . . . now you can have 2½D speed at coincident-current prices! For example, the 4K x 16 version of STORE/33 uses 18 mil cores to give a full-cycle time of 650 nsec. The price? Under \$4500\*\* in production quantities.

What makes this price breakthrough possible without a tradeoff in speed? The key, of course, is 3-wire 3D organization in which the fourth winding normally associated with coincident-current organization is eliminated. By utilizing the same winding for both sensing during reading and inhibiting during writing, assembly costs of the magnetic planes are reduced . . . But 3D organization is only part of the story.

STORE/33 employs IC electronics throughout to increase reliability, reduce power consumption and achieve more compact packaging. The basic memory uses only four types of plug-in cards. The memory stack also plugs in. This standardization of circuit card types and modular construction reduces your inventory costs and simplifies maintenance. Word capacities to 16K, interface flexibility, plus a wide range of options . . . for the full story, write Data Products Corporation, 6219 De Soto Ave., Woodland Hills, Calif. 91364.

Los Angeles, Calif. 213/887-8000    Melbourne, Fla. 305/262-4773  
Bethesda, Md. 301/652-8120    Acton, Mass. 617/263-3961  
Minneapolis, Minn. 612/338-4717    Dallas, Tex. 214/239-9641  
Amsterdam, 020/156-297    London, 1-579-3116



*"the peripheralists"*

\*Core Memories, Inc. is a subsidiary of Data Products Corporation.  
\*\*Price does not include optional power supply.

Data Products manufactures LINE/PRINTERS™, DISCFILES®, Core Memories, Off-Line Printer Systems, Card Readers & Punches.

INFORMATION RETRIEVAL NUMBER 4



# Dream OP AMPS

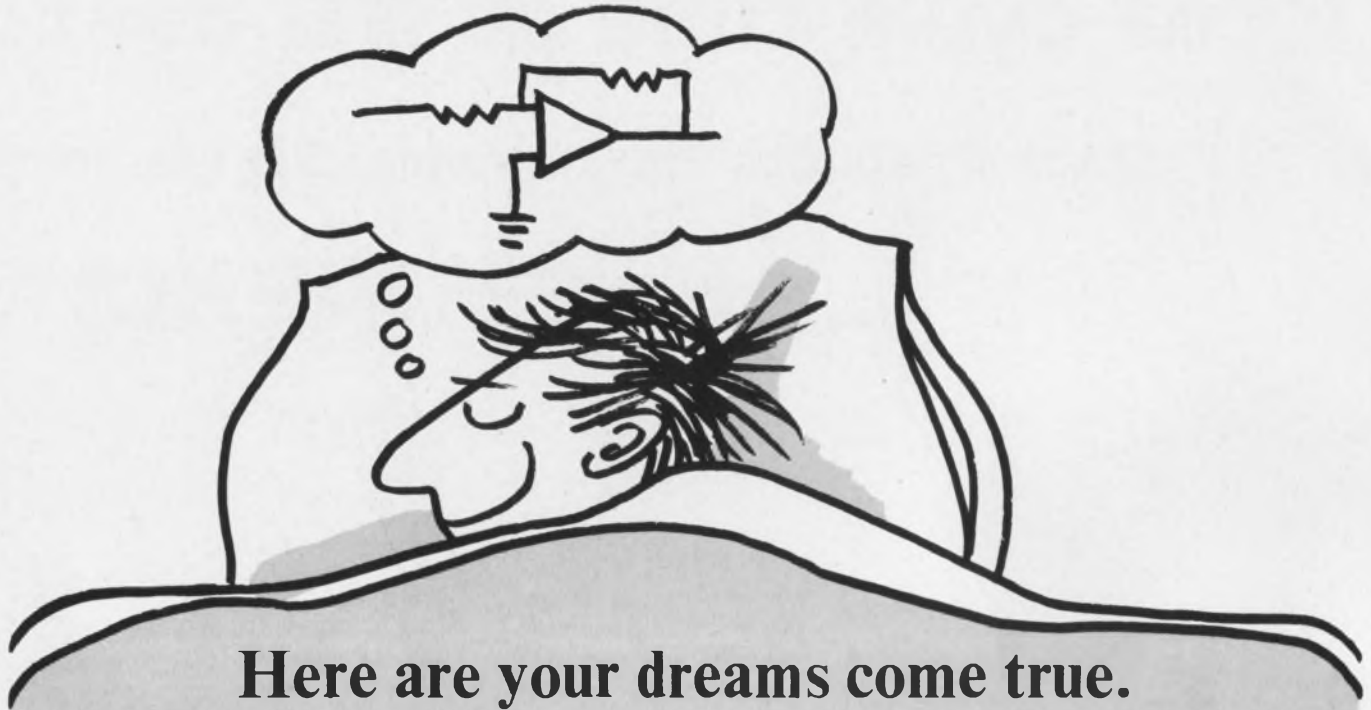

Here are your dreams come true.

**MIL hybrid FET ADO-101B**

Metal can DIP  
400,000 gain  
20,000 CMRR  
3  $\mu$ V rms noise

**100 V/ $\mu$ sec for \$55.00 ADO-60**

FET input  
2  $\mu$ sec settling time (0.01%)  
1,000,000 gain  
1.5 MHz full power frequency

**0.5  $\mu$ V/ $^{\circ}$ C bipolar ADO-72A**

500,000 gain  
250,000 : 1 CMRR  
5  $\mu$ V/V supply rejection  
10  $\mu$ V/week drift (typ)

**0.5 pA bias current ADO-32**

Junction FET input  
10<sup>12</sup>  $\Omega$  input impedance  
12  $\mu$ V rms noise  
20,000 : 1 CMRR

**2  $\mu$ V/ $^{\circ}$ C FET ADO-26B**

100,000 gain  
20,000 : 1 CMRR  
100  $\mu$ V/V supply rejection  
5  $\mu$ V p-p noise

**Milliwatt power drain ADO-39**

200  $\mu$ A supply current  
FET input  
75,000 gain  
 $\pm$ 4.5 to  $\pm$ 20 V operation

These specifications are guaranteed. For complete details on these and other dream-fulfilling op amps, consult your local Fairchild Controls representative.



A DIVISION OF FAIRCHILD CAMERA & INSTRUMENT CORP., 423 National Ave., Mountain View, CA 94040 (415) 962-3833

**REPRESENTATIVES**

**Alabama**

Reynolds & Associates, Inc.  
(205) 536-1941

**Arizona**

PLS Associates  
(602) 258-0067

**California**

CDH Associates  
(213) 345-1644  
Jack Pyle Co.  
(415) 349-1266

**Colorado**

PLS Associates  
(303) 771-0140

**Florida**

Reynolds & Associates, Inc.  
(305) 424-3836  
(305) 581-6611  
(305) 727-3205

**Georgia**

Reynolds & Associates, Inc.  
(404) 252-5360

**Illinois**

Fiat Engineering Associates  
(312) 547-6200

**Indiana**

Fiat Engineering Associates  
(317) 282-5676

**Kansas**

Technical Marketing  
Associates, Inc.  
(913) 831-2888

**Maryland**

Stemler Associates, Inc.  
(301) 944-8262

**Massachusetts**

Vector Sales, Inc.  
(617) 489-1400

**Michigan**

WKM Associates, Inc.  
(313) 892-2500

**Minnesota**

Technical Associates, Inc.  
(612) 929-6721

**Missouri**

Technical Marketing  
Associates, Inc.  
(314) 427-3600

**New Jersey**

H. R. C. Associates  
(516) 627-4644  
Stemler Associates, Inc.  
(609) 966-4070

**New Mexico**

PLS Associates  
(505) 255-2330

**New York**

H. R. C. Associates  
(516) 627-4644  
Ossmann Component  
Sales Corp.  
(315) 454-4477  
(607) 785-9949  
(716) 442-3290  
(914) 297-7773

**Ohio**

WKM Associates, Inc.  
(216) 885-5616  
(513) 434-7500

**Pennsylvania**

Stemler Associates, Inc.  
(215) 644-3477  
WKM Associates, Inc.  
(412) 892-2953

**Texas**

Dannemiller-Smith, Inc.  
(214) 357-8249  
(713) 668-4461

**Washington**

Brett Engineering Associates  
(206) 935-1062

**Canada**

BRH Associates, Limited  
Montreal (514) 733-5331  
Ottawa (613) 728-0113  
Vancouver (604) 985-6221  
Willowdale (416) 223-4008

**Europe**

Zurich, Switzerland  
(051) 906357



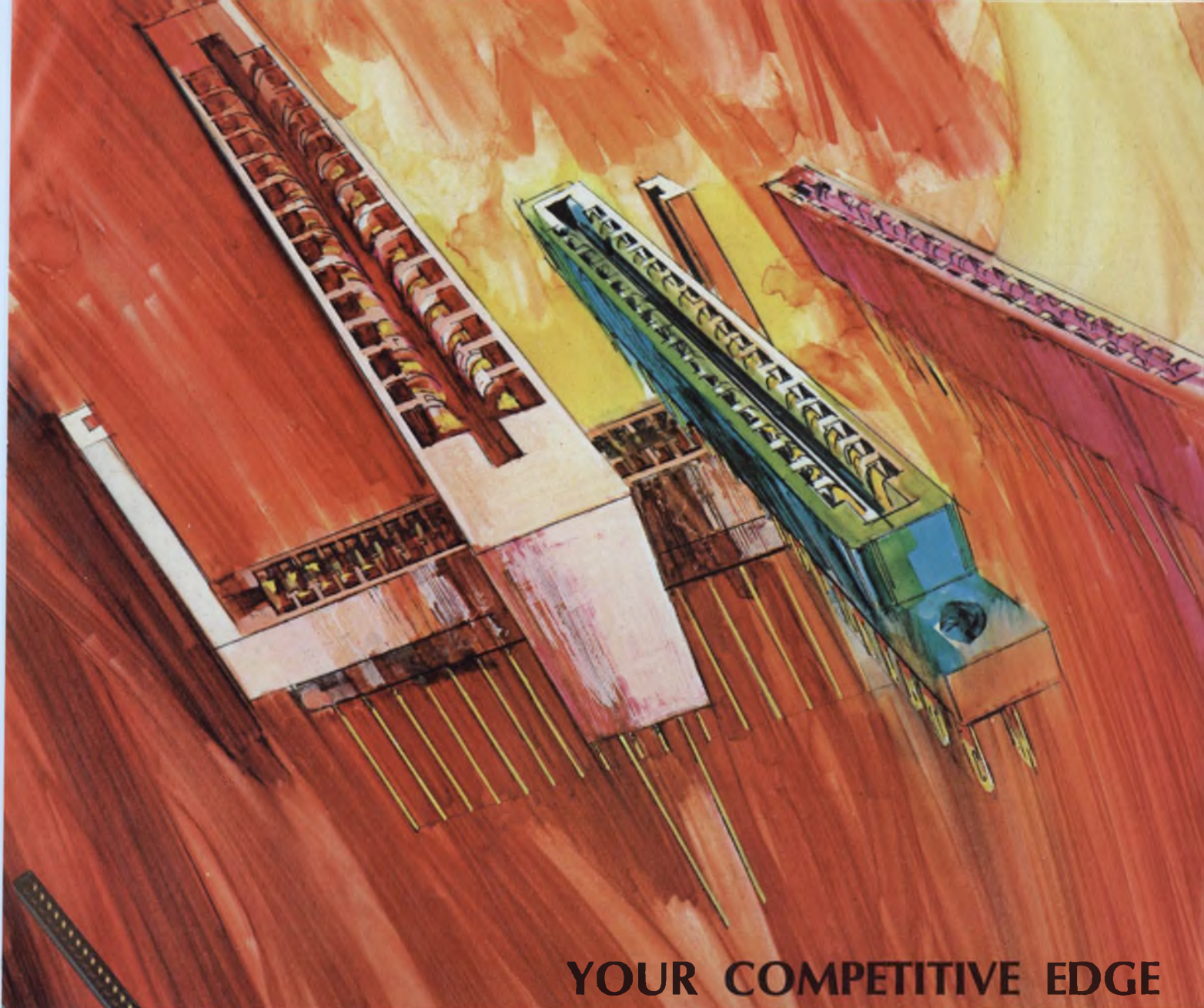

**YOUR COMPETITIVE EDGE**

## **CINCH PRINTED CIRCUIT CONNECTORS**

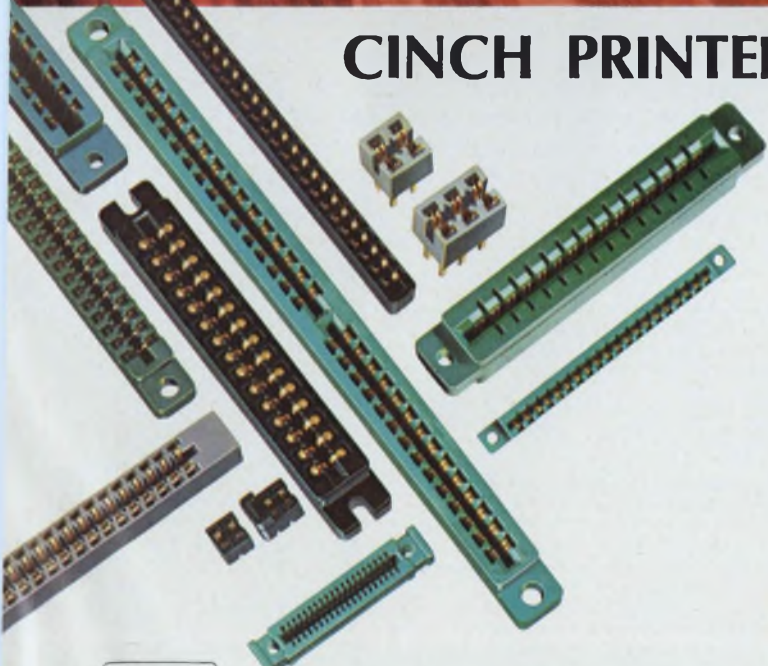

Improved performance and lower cost are the best competition beaters . . . and you get either or both with Cinch PC connectors.

There are 22 basic designs described in the new Cinch PC Connector catalog. If the one you need isn't there, Cinch can develop a special connector for your application.

It can incorporate any of six methods of gold deposition (including two selective plating techniques), eight types of contacts, eight types of terminations and six insulator materials . . . whatever best gives you your competitive edge. The resulting product can be produced in quantity in a surprisingly short time.

Write for the Cinch Printed Circuit Connector catalog to Cinch Manufacturing Company, 1501 Morse Avenue, Elk Grove Village, Illinois 60007.

**IMMEDIATE DELIVERY** of many Cinch printed circuit connectors—from stock—can be obtained through Cinch Electronic distributors.

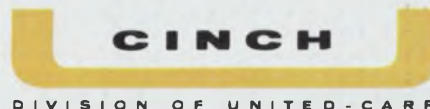



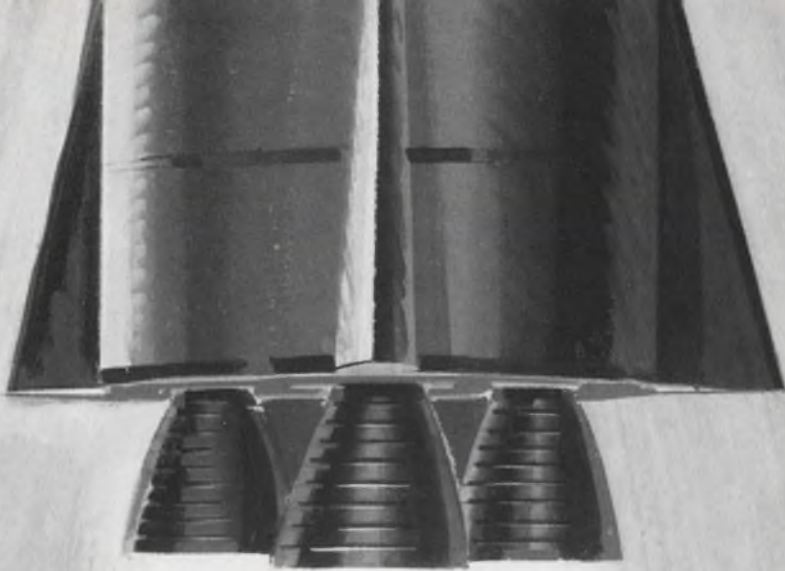

**RCA Announces**  
**The industry's first**  
**integrated circuits**  
**high-reliability program**  
**based on MIL-STD-883**

Now you can evaluate and design across a broad range of critical applications with integrated circuits processed to the requirements of the first military standard of test procedures for microelectronics.

RCA's high-reliability program — conforming to the test methods and procedures of MIL-STD-883 — covers integrated circuits for aerospace, military, and other critical applications from RCA's major integrated circuit lines: RCA Linear Integrated Circuits; RCA Digital Integrated Circuits; and shortly this program will be expanded to include RCA COS/MOS (Complementary-Symmetry MOS) Integrated Circuits.

Integrated Circuits in this program are classified in four screening levels corresponding to the three classes of MIL-STD-883. (See chart below.) A comparison of RCA's four screening levels is

illustrated in the flow chart at right.

Comprehensive high-reliability-format data bulletins are now available for the following types:

- HIGH-RELIABILITY VERSIONS OF CA3000, CA3001, CA3006, CA3015A, C3020A
  - 19 HIGH-RELIABILITY VERSIONS OF CD2300 Series DTL in flat pack
  - 19 HIGH-RELIABILITY VERSIONS OF CD2300D Series DTL in dual-in-line ceramic package
- (RCA Levels /1, /2, /3, and /4 are detailed for each type)

Add your name to our mailing list for these bulletins and subsequent high-reliability information. Contact your RCA Representative or write: RCA Electronic Components, Commercial Engineering, Section FK-2-4A, Harrison, N. J. 07029.

RCA Level	MIL-STD-883 Equivalent	Application	Description
Level/1 and Level/2	Class A	Aerospace and Missiles	For devices intended for use where maintenance and replacement are extremely difficult or impossible and reliability is imperative
Level/3	Class B	Military & Industrial— For example in Airborne Electronics	For devices intended for use where maintenance and replacement can be performed but are difficult and expensive
Level/4	Class C (Class B without Burn-in)	Military & Industrial— For example on Ground Based Electronics	For devices intended for use where replacement can readily be accomplished

RCA screening level/1 is equivalent to MIL-STD-883 Class A except that reverse-bias burn-in is performed only in Group B.  
 RCA screening level/2 is the same as level/1 but radiographic inspection is not performed.



## RCA High-Reliability Integrated Circuits Product Flow Diagram

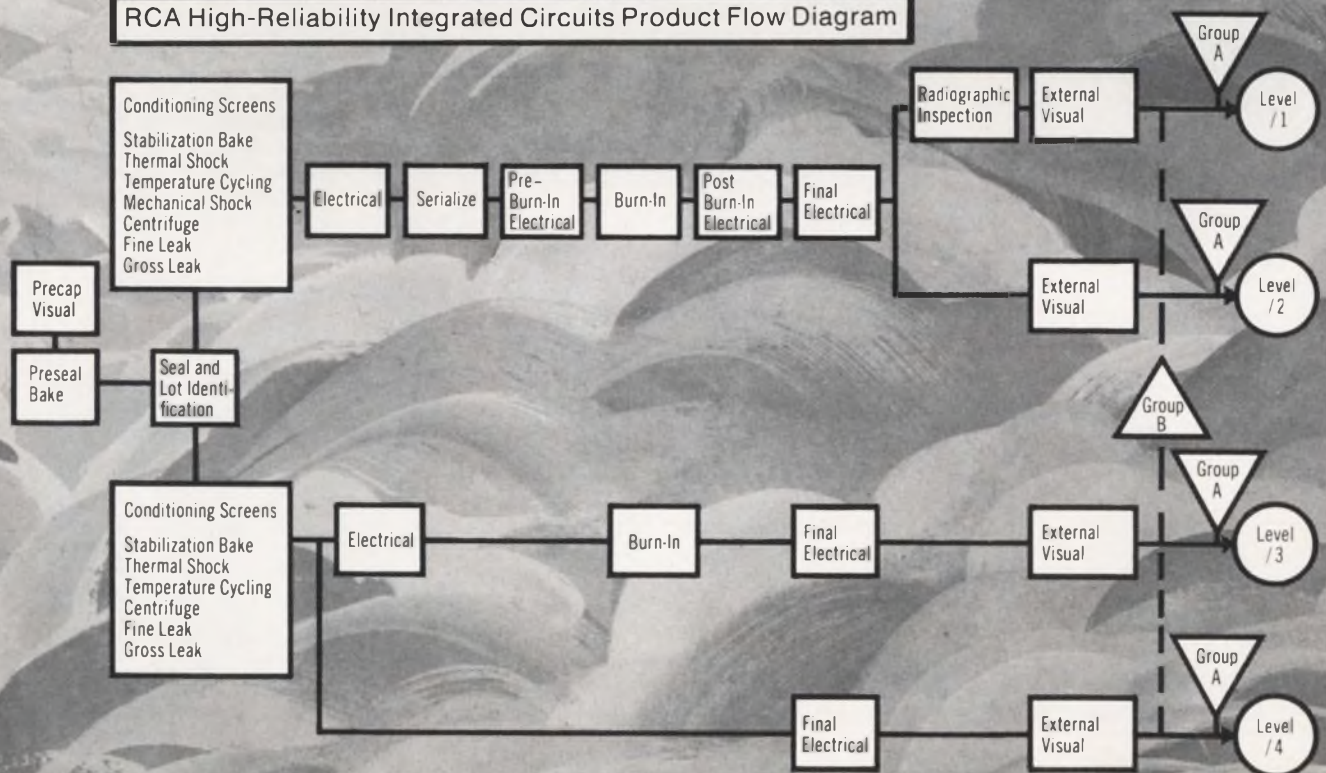



# How a lab wallflower, measuring ohms at 10 ppm, has blossomed in the field:

news and innovations in metrology **e|s|i**

Upgrading of accuracy by resistor manufacturers has made a triple-threat star out of our newest general purpose Resistance Measuring System—the Model 242C. It's "flown the coop" (standards lab) for bigger things in the production and engineering departments or wherever resistors need to be checked to 10-ppm-or-better in batches.

By delivering 10 ppm direct-reading accuracy over a wide range and 1-ppm comparison accuracy—all in an exceptionally easy-to-operate console—we apparently have discovered a flexible answer for which both makers and buyers of precision resistors have found a need.

The 242C is simple enough for batch testing on a GO-NO-GO basis (meter deflection without bridge adjustment). Or if you prefer to read percent deviation from nominal value, you do so with a one-dial adjustment. Then when the perfectionist has a need, he can resolve actual value of a resistor to 10 places (with 8 decades plus a vernier). And when calibrated against ESI standards, comparisons can be made to 0.1 ppm with accuracy directly traceable to the National Bureau of Standards.

The 242C is the latest in a 10-year model series of general purpose Kelvin bridge systems, which owe their accuracy, dependability and wide range (10

milliohms to 120 megohms) to a unique guarding and lead compensation technique. Trimmable ratios and decades in our new "C" model simplify calibration for any production environment—even yours. Price \$5500.

## ESI's portable lab—the 300A PVB® that measures "everything"—now 0.01%

We call it our little portable lab—and indeed it's all of that with measurement capability for seven different electronic functions. It's a potentiometric voltmeter, a precision voltage source, ammeter, guarded Kelvin bridge, resistance comparison bridge, ratiometer, electronic null detector, pH indicator, temperature bridge, meter calibrator, components tester and more—with the addition of several plug-in accessories.

Our news is that accuracy on the Model 300A PVB has been improved to .01% on all functions and ranges. And yet the basic 300A PVB package sells for only \$1045.

As with the proven 300 PVB, the Model 300A affords the user 5 dc-voltmeter ranges to 511.10 volts with 1 microvolt minimum steps, 8 ammeter ranges to 5.1110 amperes with 10 pA minimum steps and 10 resistance ranges to 511.10 MΩ with 10 microhm minimum steps and it's completely portable with typical one-year battery life.

Applications include potentiometric temperature measurement, calibration of recorder controllers, dc voltmeters and ammeters, X-Y recorders, analog computing elements, checking of dc power supplies, measurement of chemically generated potentials and calibration of resistance thermometers and thermocouples.

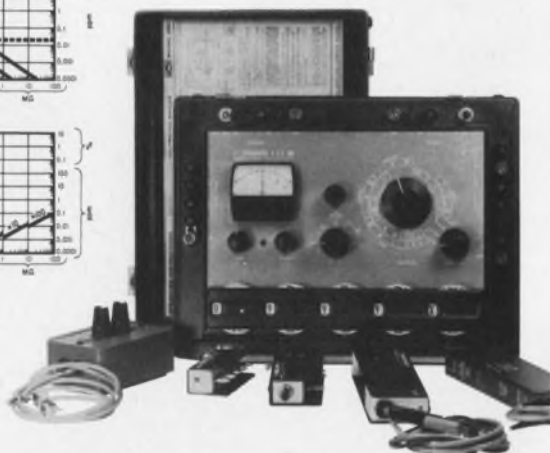
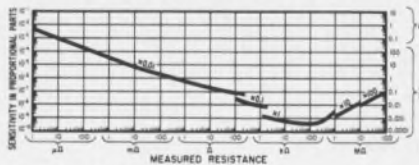
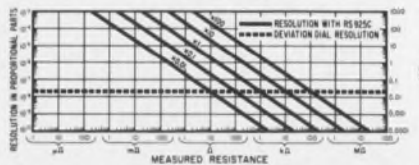
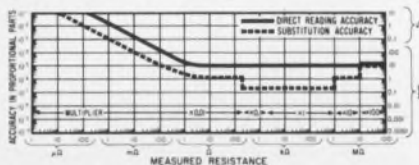

**e|s|i**®

**ELECTRO SCIENTIFIC INDUSTRIES, INC.**

13900 N.W. SCIENCE PARK DRIVE • PORTLAND, OREGON 97229

242C—Circle #191

300 PVB—Circle #192



**MDS LOW-COST  
PAPER TAPE READERS  
MAKE NO COMPROMISE  
WITH QUALITY**



MDS 2119 Paper Tape Reader—Speed: 30 cps, bi-direct;  
Panel Size: 3½" x 11"



MDS 2131 Edge-Punched Card Reader.

These MDS Paper Tape and Card Readers come from specialists in the design and manufacture of compact, reliable Readers. Models in this MDS Series are designed to meet a multitude of needs in programming and control applications.

They are available in models for 5, 6, 7 or 8 channel tape . . . reading speeds from 0 to 60 characters per second . . . bi-directional or uni-directional sensing . . . panel or table mounting . . . all provide star-wheel sensing. A unique dual cross-coupled electro-magnetically actuated pawl system (patented) advances the tape bi-directionally and provides the simplest method of integrating the tape reader into a system.

The star-wheel sensing system used in MDS Readers effects minimum wear on tapes . . . tolerates wide variation in punching . . . reads any type of tape.

For simplicity in design . . . reliability in action . . . specify MDS low-cost Paper Tape and Card Readers.

Ask for: The MDS file-folder on Paper Tape Readers, giving general specifications and more complete information.

**FOR MORE — MEET YOUR MAN FROM MDS**

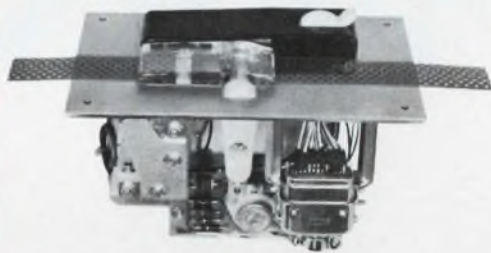

MDS 2153 Horizontal Mount Paper Tape Reader—Speeds of 30 or 60 cps, uni-direct. Reads up to 8 channel punched paper tape.

**MOHAWK MDS**  
DATA SCIENCES CORPORATION  
**OEM MARKETING**

122 EAST RIDGEWOOD AVENUE • PARAMUS, N.J. 07652  
Telephone 201/265-7333

Every MDS office is an OEM Marketing office

DIGITAL STRIP PRINTERS • BUFFERED TAPE UNITS  
HIGH-SPEED AND LOW-SPEED LINE PRINTERS  
CARD PUNCHES AND READERS  
PAPER TAPE PUNCHES AND READERS

**REGIONAL MANAGER OFFICES**

Atlanta, Ga. . . . . Tel. 404/261-8036  
Waltham, Mass. . . . . Tel. 617/891-4430  
Des Plaines, Ill. . . . . Tel. 312/298-4141  
S. San Francisco, Calif. . . . . Tel. 415/761-0750

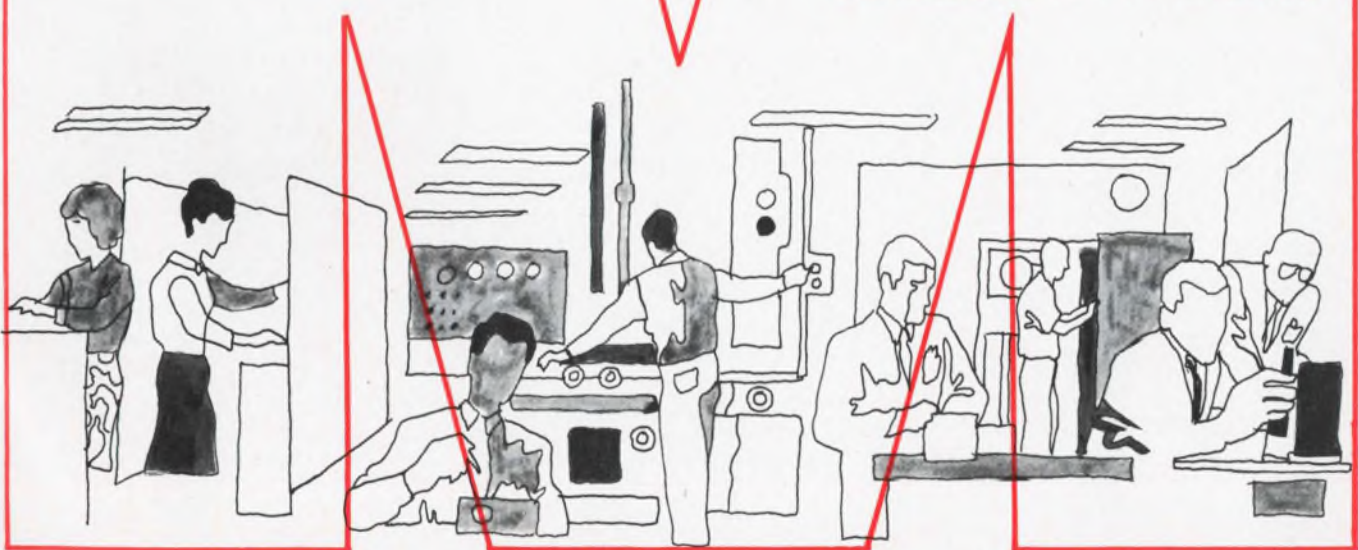





# 29 FETS FOR SWITCHES OR CHOPPERS

## What's your most important switch or chopper requirement?

ON resistance . . . low as 5 ohms  
 Gate-to-drain capacitance . . . little as 0.25 pF  
 Price . . . some low as \$2.00 (100 up)  
 Somewhere in the 29 FETs listed here you'll find the right tradeoff for your switching or chopping application. Contact us for complete data on any or all of these devices!

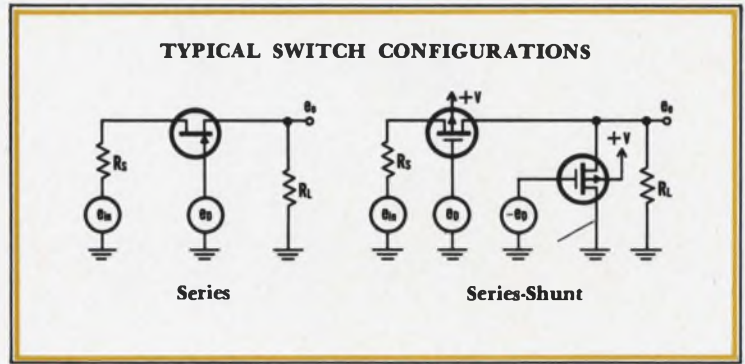

Type	r <sub>DS(ON)</sub> Max. (Ohms) <sup>(1)</sup>	C <sub>gd(OFF)</sub> (pF) <sup>(2)</sup>	I <sub>D(OFF)</sub> (pA) <sup>(3)</sup>	V <sub>P</sub> Max. (Volts) <sup>(4)</sup>	BV <sub>DSS</sub> Min. (Volts) <sup>(5)</sup>	Price <sup>(6)</sup>
MOS						
M105	20	9	10	—	30	\$23.50
M103	200	2.7	8	—	30	5.30
M104	1200	0.25	3	—	30	4.65
JUNCTION						
2N5432	5	9.5	40	10	25	40.00
2N5433	7	9.5	40	9	25	20.00
2N5434	10	9.5	40	4	25	33.50
U240 <sup>(7)</sup> (2N4445)	5	9.5	40	10	25	31.50
U241 <sup>(7)</sup> (2N4446)	10	9.5	40	10	25	14.25
U242 <sup>(7)</sup> (2N4447)	6	9.5	40	10	20	18.00
U243 <sup>(7)</sup> (2N4448)	12	9.5	40	10	20	11.70
2N4856	25	2.9	8	10	40	4.50
2N4857	40	2.9	8	6	40	3.80
2N4858	60	2.9	8	4	40	3.15
2N4859	25	2.9	8	10	30	4.35
2N4860	40	2.9	8	6	30	3.70
2N4861	60	2.9	8	4	30	3.00
2N4391	30	2.9	8	10	40	4.70
2N4392	60	2.9	8	5	40	3.70
2N4393	100	2.9	8	3	40	3.00
2N4091	30	2.9	8	10	40	4.35
2N4092	50	2.9	8	7	40	3.70
2N4093	80	2.9	8	5	40	3.00
2N3970	30	5.5	10	10	40	3.50
2N3971	60	5.5	10	5	40	2.60
2N3972	100	5.5	10	3	40	3.00
U200	150	5.5	20	3	30	2.35
U201	75	5.5	20	5	30	2.20
U202	50	5.5	20	10	30	2.00
2N3824	250	1.2	2.5	8	50	2.70

- NOTES:  
 (1) Maximum ON Channel resistance measured at V<sub>GS</sub> = 0, V<sub>DS</sub> = 0, for junction FETs, and V<sub>GS</sub> = -20V, V<sub>DS</sub> = 0 for MOS FETs.  
 (2) Typical gate-to-drain OFF capacitance values measured at V<sub>GS</sub> = -10V, V<sub>DS</sub> = 10V for junction FETs and V<sub>GS</sub> = 0, V<sub>DS</sub> = -10V for MOS FETs. C<sub>gd(ON)</sub> is approximately three times C<sub>gd(OFF)</sub>.  
 (3) Typical OFF drain current measured at V<sub>GS</sub> = -10V, V<sub>DS</sub> = 10V for junction FETs and V<sub>GS</sub> = 0, V<sub>DS</sub> = -10V for MOS FETs.  
 (4) V<sub>P</sub> max. to data sheet conditions.  
 (5) BV<sub>DSS</sub> for MOS FETs.  
 (6) 100-999 Prices.  
 (7) Identical to 2N4445 series, except for package.

**\* Applications Power: An ever-expanding catalog of quality devices, plus an in-depth applications team waiting to serve you!**



# Siliconix incorporated

1140 West Evelyn Ave. • Sunnyvale, Calif. 94086  
 Telephone (408) 245-1000 • TWX 910-339-9216

INFORMATION RETRIEVAL NUMBER 11

**ON CONDITION:** ON error voltage is a function of FET r<sub>DS(ON)</sub> value relative to source and load resistance values of the circuit. Since, for different FET geometries, lower ON resistance means larger capacitance, a good figure of merit is the r<sub>DS(ON)</sub> C<sub>gd</sub> product for a given V<sub>P</sub>. The 2N5432 series has the lowest r<sub>DS(ON)</sub> C<sub>gd</sub> product available!

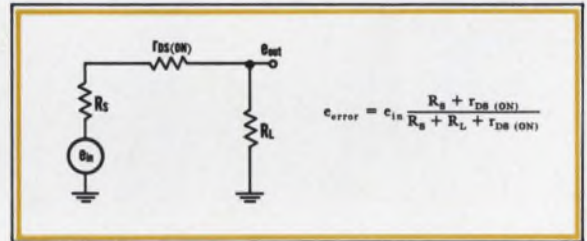

**OFF CONDITION:** Static OFF error voltage is extremely small due to low drain leakage current, I<sub>D(OFF)</sub>. AC feedthrough is low since drain-to-source capacitance, C<sub>ds</sub>, is always less than 0.4 pF.

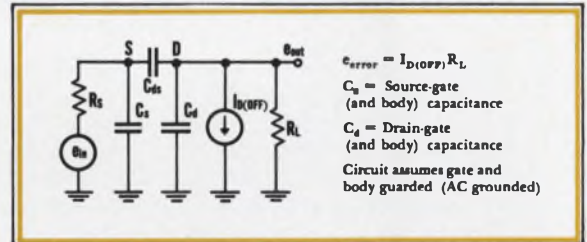

**SWITCHING:** Going from the ON condition to the OFF condition is generally the limiting case, and the important parameters are gate-to-drain capacitance, C<sub>gd</sub>, and the output load impedance R<sub>L</sub> and C<sub>L</sub>. Silicon FETs offer lower C<sub>gd</sub> for a given r<sub>DS(ON)</sub> and V<sub>P</sub>.

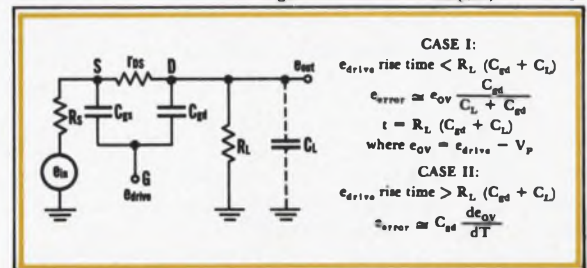

For further information and immediate applications assistance call the number below. Ask for Extension 19.





## How to Buy a Good Power Supply Without Spending a Bundle . . .

Take a long look at the Abbott line of over three thousand standard models *with their prices listed*. The unit shown above, for instance, is the Abbott Model AL6D-27.6A, a DC to DC converter which puts out 28 volts of regulated DC at two amps and sells for only \$220.00. Other power outputs from 5 to 240 watts are available with *any output voltage from 5 volts to 10,000 volts*, all listed as standard models in our catalog. These converters feature close regulation, short circuit protection, and hermetic sealing for rugged application found in military environment.

If you really want to save money in buying your power supply, why spend many hours writing a complicated specification? And why order a special custom-built unit which will cost a bundle — and may

Please write for your FREE copy of this new catalog or see EEM (1968-69 ELECTRONIC ENGINEERS MASTER Directory), Pages 1727 to 1740.

**abbott transistor**  
LABORATORIES, INCORPORATED  
5200 W. Jefferson Blvd./ Los Angeles 90016  
(213) WEBster 6-8185 Cable ABTLABS

bring a bundle of headaches. As soon as your power requirements are firmed up, check the Abbott Catalog or EEM (see below) and you may be pleasantly surprised to find that Abbott already has standard power supplies to meet your requirements — *and the prices are listed*. Merely phone, wire, or write to Abbott for an immediate delivery quotation. Many units are carried in stock.

Abbott manufactures a wide variety of different types of power supply modules including:

60 $\infty$  to DC, Regulated  
400 $\infty$  to DC, Regulated  
28 VDC to DC, Regulated  
28 VDC to 400 $\infty$ , 1 $\phi$  or 3 $\phi$   
60 $\infty$  to 400 $\infty$ , 1 $\phi$  or 3 $\phi$

TO: Abbott Transistor Labs., Inc., Dept. 87  
5200 West Jefferson Blvd.  
Los Angeles, California 90016

Sir:  
Please send me your latest catalog on power supply modules:

NAME \_\_\_\_\_ DEPT. \_\_\_\_\_  
COMPANY \_\_\_\_\_  
ADDRESS \_\_\_\_\_  
CITY & STATE \_\_\_\_\_

## Designer's Datebook

MARCH 1969						
Sun	Mon	Tue	Wed	Thu	Fri	Sat
						1
2	3	4	5	6	7	8
9	10	11	12	13	14	15
16	17	18	19	20	21	22
23	24	25	26	27	28	29
30	31					

APRIL 1969						
Sun	Mon	Tue	Wed	Thu	Fri	Sat
6	7	8	9	10	11	12
13	14	15	16	17	18	19
20	21	22	23	24	25	26
27	28	29	30			

For further information on meetings, use Information Retrieval Card.

### Mar. 24-27

**IEEE International Convention**  
(New York City) Sponsor: IEEE;  
J. M. Kinn, 345 E. 47 St., New  
York, N. Y. 10017

CIRCLE NO. 469

### Mar. 25-27

**Conference on Lasers and Opto-  
electronics** (Southampton, Eng-  
land) Sponsor: IEE, Savoy Place,  
London W.C.2, England

CIRCLE NO. 470

### Apr. 16-18

**Geoscience Electronics Sympos-  
ium** (Washington, D. C.) Spon-  
sor: G-GE; Maurice Ringenback,  
Weather Bureau, ESSA, Gramax  
Bldg., Silver Spring, Md. 20910

CIRCLE NO. 471

### Apr. 22-23

**Relay Conference** (Stillwater,  
Okla.) Sponsor: NARM & Okla.  
State Univ.; Dr. D. D. Lingelbach,  
Engineering and Industrial Ex-  
tension, Okla. State Univ., Still-  
water, Okla. 74074

CIRCLE NO. 472

### Apr. 23-25

**Southwestern IEEE Conference  
and Exhibit** (San Antonio, Texas)  
Sponsor: W. H. Hartwig, Univ. of  
Texas, EE Dept., Austin, Tex.  
78712

CIRCLE NO. 473

### Apr. 30-May 2

**Electronic Components Conference**  
(Washington, D. C.) Sponsor:  
G-PMP, EIA; James O'Connell,  
ITT Hdqs., 320 Park Ave., New  
York, N.Y. 10022

CIRCLE NO. 474



# Hybrids from United Aircraft?

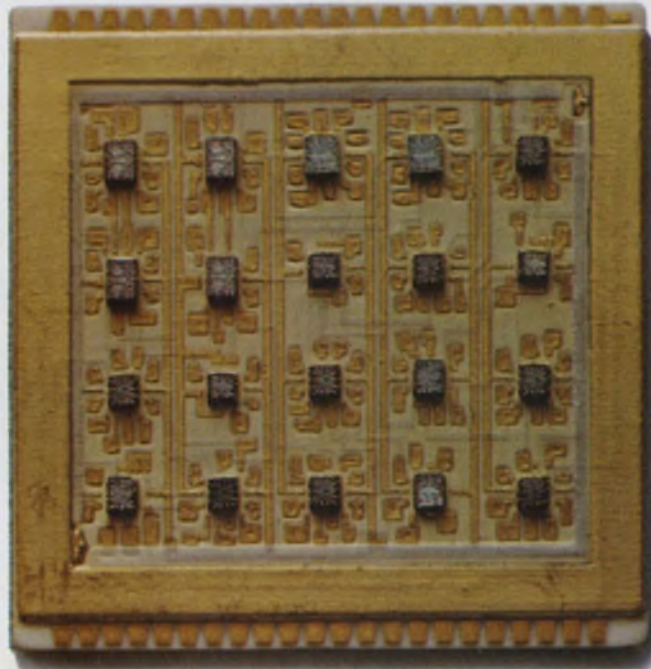

Unretouched photograph of a typical 1¼" square Multilayer MSI Module.

## You'd better believe it!

Thin film. Thick film. Single layer. Multilayer. Hermetic and nonhermetic packages. Whatever you need in custom hybrid microcircuits, you can get it from us. Because—beyond engineering skills—we have proven capability in every major hybrid production and

packaging technique.

And we have a pilot line that lets you prove out designs before committing to full production.

Call our Hybrid Microcircuit Marketing Manager at (215) 355-5000. TWX 510-677-1717. Or write direct.

**Electronic  
Components**

DIVISION OF

**United  
Aircraft**

TREVOSE, PENNSYLVANIA 19047

In the West: 128 E. Katella Ave., Orange, Calif. (714) 639-4030

INFORMATION RETRIEVAL NUMBER 13



# Signal Generator Versatility + Synthesizer Accuracy + Programming and Sweep Flexibility + IC Economy = LORCH-ADRET SIGNAL GENERATOR-SYNTHESIZERS

Models to 100KHz,  
2MHz and 60 MHz

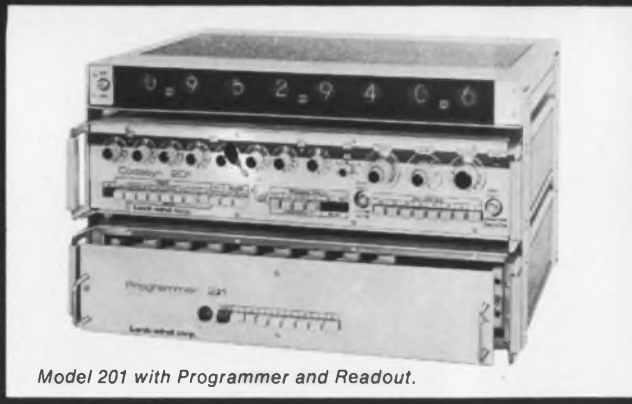

Model 201 with Programmer and Readout.

## SPECIFICATIONS

Model	301 100 KHz	201 2 MHz	202 60 MHz
Frequency Stability	$3 \times 10^{-5}$ / week	$1 \times 10^{-7}$ / day ( $2 \times 10^{-9}$ / day optional)	
Digital Decades	4	8	8
Resolution (with vernier)	0.1 Hz	0.001 Hz	0.001 Hz
Modulation AM	none	0 - 100%	0 - 100%
Deviation FM	100 KHz (external only)	2 MHz	10 MHz
Sweep Range	100 KHz	2 MHz	12 MHz
Output Level	+21 dbm	+13 dbm	+13 dbm
Attenuator	continuous	0 - 100 db	0 - 60 db
Spurious Output (nonharmonic)	- 60 db	- 70 db	- 80 db
Signal to Phase Noise	60 db	70 db	70 db
Rack Panel Height	3½" (½ rack)	3½"	5¼"
Price	\$2150.00	\$3800.00	\$6900.00

Also available: BCD Programmable DC Voltage Standard (6 digit); Remote Displays; Remote Programmers; Programmable Attenuators; IRIG Programmers and Comb Generators.

- Digital Frequency Selection . . . . . YES
- Excellent Frequency  
and Amplitude Stability . . . . . YES
- Coherent Output . . . . . YES
- High Spectral Purity . . . . . YES
- Built-In Digital Attenuator . . . . . YES
- BCD Programmable Frequency  
and Attenuation . . . . . YES
- Programmable Search Oscillator . . . . . YES
- AM and FM Internal  
and External Modulation . . . . . YES
- Sweep: Narrow Band  
and Wide Band . . . . . YES
- IC Design using MSI Devices . . . . . YES
- Small Size . . . . . YES
- Attractive Price . . . . . YES

See us at Booths 2B33 and 2B35 at the IEEE Show

## Lorch-adret corp.

105 Cedar Lane, Englewood, N.J. 07631 • 201-569-8282

INFORMATION RETRIEVAL NUMBER 14



# SEMICONDUCTOR NEWSBRIEFS

PUBLISHED BY MOTOROLA SEMICONDUCTOR PRODUCTS INC.

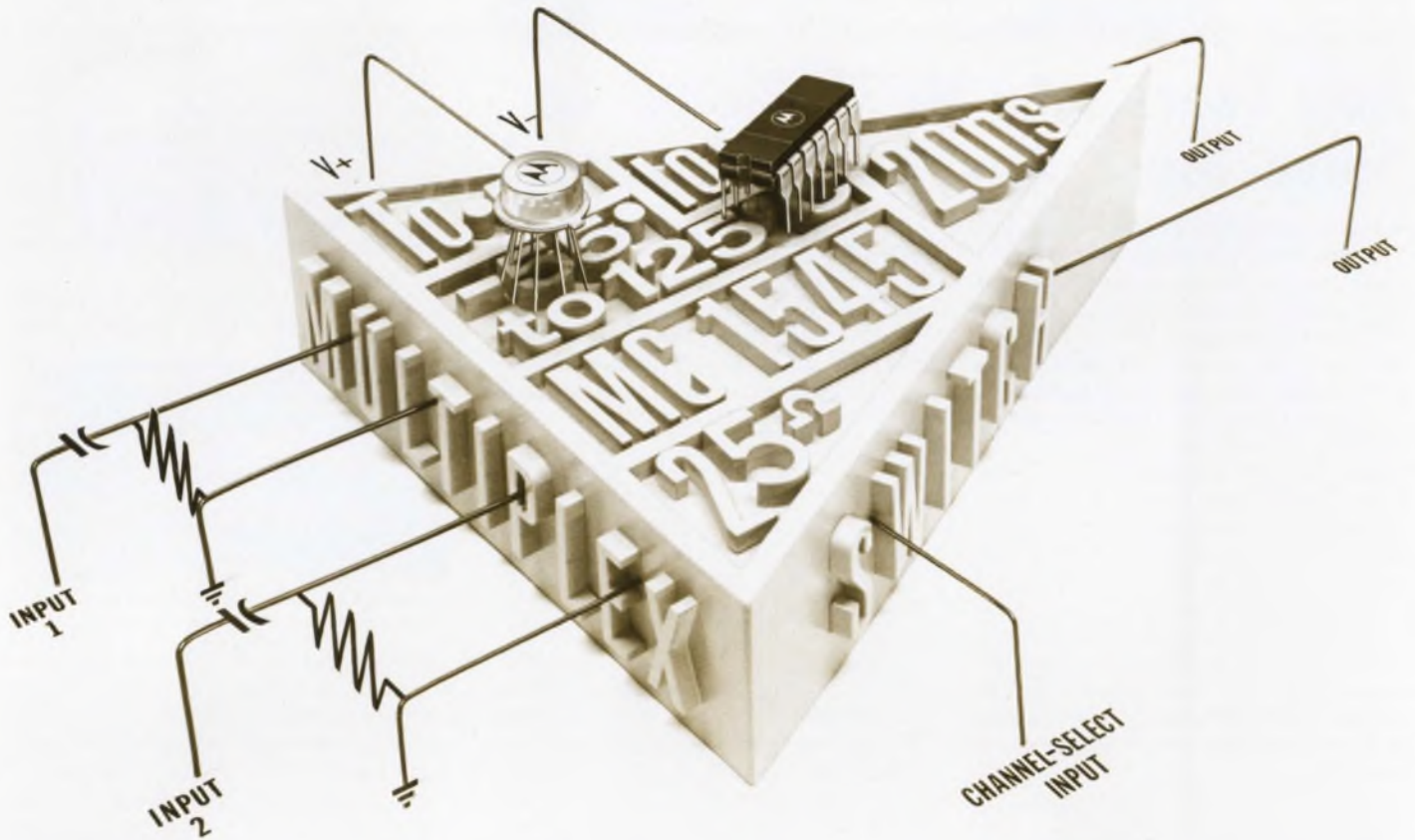

## Dual-Channel Gated Wideband Amplifier Serves Most Anywhere!

Although the new MC1545 linear integrated circuit is characterized as a gated, dual-channel wideband amplifier, its range of application is seemingly endless. For example, it can be used as a video switch, sense amplifier, multiplexer, modulator, frequency-shift keying (FSK) circuit, limiter, AGC circuit, or pulse amplifier . . . to name just a few!

And, its low-cost further enhances its universal appeal for practically any linear application — just \$5.50 for the 10-pin metal-can packaged version (“G” suffix), in 100-up quantities. The MC-1545 is also available in the TO-116 14-lead ceramic dual inline (“L” suffix) and the 14-lead TO-86 ceramic flat-pack (“F” suffix). All versions operate over the -55 to +125° temperature range.

This versatile linear integrated circuit is particularly well suited for broad frequency range applications such as in C.A.T.V. and closed-circuit TV, due to its excellent wideband characteristics (B.W. = 75 MHz, typ) and gate-controlled, dual-channel design.

Other outstanding features include:

- 20 ns channel-select time (typ)

- Differential inputs and outputs
- High Input Impedance—10 K $\Omega$  (typ)
- Low Output Impedance — 25 ohms (typ)

Evaluate the MC1545 now and you’ll be ready to use it the next time you come up against a tough design situation.

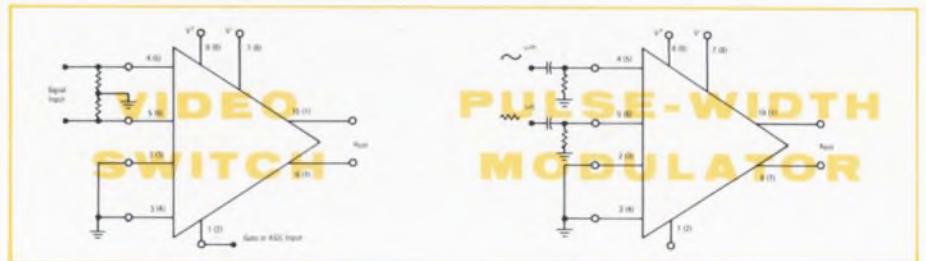

For details circle Reader Service No. 211





The transfer curves on the right illustrate the large logic swing available from MHTL compared with MDTL.

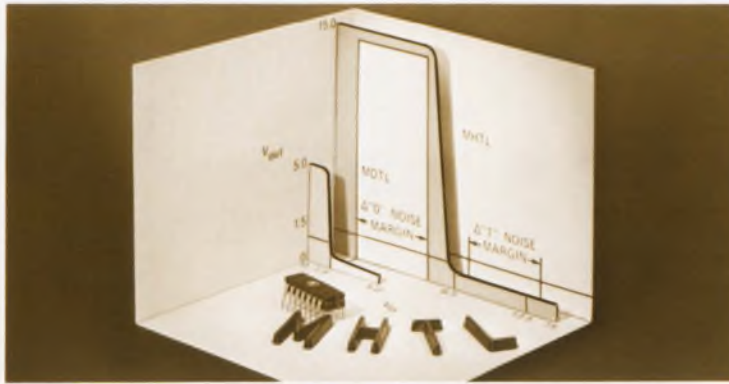

## Now There's An MHTL Circuit To Solve Most Any Noise Problem!

Eleven new high-threshold integrated logic circuit functions that offer 7.5-volts (typ) noise-immunity are now available in hermetically-sealed, TO-116 dual in-line ceramic packages. With these latest additions, the designer of high noise-environment equipment now has a wide choice of 15 MHTL integrated circuit types from which to select.

For example, in addition to a full complement of multiple-input gates (with both active and passive pull-up options), several flip-flops and a line driver, the series includes two triple-level translators and a monostable multivibrator. As MHTL is pin compatible with other forms of saturated logic, these circuits can be used in high-speed system designs where economical solutions to high noise environment conditions are required.

Combining a voltage swing of 13 volts with a 7.5-volt noise margin, a wide operating temperature range of  $-30$  to  $+75^{\circ}\text{C}$ , high fan-out of up to 30; and 35 mW dissipation, the MHTL family will prove an invaluable aid in industrial applications such as: numerical and supervisory control systems and computer peripheral equipment. These monolithic I/Cs can be interfaced with discrete componentry in many designs.

And, they carry the same low price tags associated with plastic encapsulated types. For example, the MC670L/671L Triple 3-Input Gates sell for as little as \$2.60 each (in 1,000-up quantities).

A comprehensive Perpetual Data Brochure, detailing the complete MHTL line, and two Application Notes covering MHTL flip-flops and noise-immunity criteria are available.

For copies circle Reader Service No. 212

## Three More MECL II I/Cs Broaden High-Speed Design Flexibility

With the introduction of a 1.8 ns propagation delay (typ) Line/Clock Driver — the MC1026/1226 — along with the MC1034 Type "D" Flip-Flop and MC1040 Quad Latch, the designer of high-speed digital equipment has 29 different MECL II circuits from which to

choose. And, he can now exclusively use fast emitter-coupled logic functions throughout his entire system!

For example, the illustration shows how the MC1026 and MC1034 combine with three MC1027's to yield a decade counter that will operate in excess of

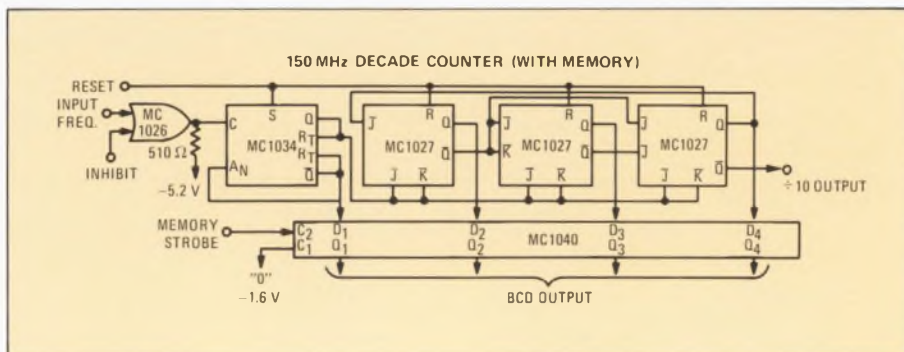

For copies circle Reader Service No. 214

## New I/C Voltage Regulator Handles Up to 35-V Inputs

Now, there's a Motorola "Double-Regulated" I/C Voltage Regulator for just about any application up to 35-Volts input!

The new MC1561/1461 types are essentially the same as the recently-introduced MC1560/1460, internally-compensated voltage regulators . . . except that they have a higher input voltage capability! The new devices offer a maximum 35-Volts input, compared to 20-Volts (max) for the MC1560/1460.

The "built-in" reference-voltage regulator stage of this unique linear integrated circuit line provides characteristics that are essentially independent of output voltage (no other I/C regulator, currently available, offers this important advantage)! Yet, 100-up prices start as low as \$4.50 (MC1461G).

These new I/C regulators are available in both the "G" 10-pin metal-can and



The new MC1561/1461 voltage regulators can handle inputs of up to 35-volts.

the 9-pin TO-66 "R" package (dissipating up to 17.5-Watts). The MC1561 is a full temperature range circuit ( $-55$  to  $+125^{\circ}\text{C}$ ), while its MC1461 counterpart operates over the  $0$  to  $75^{\circ}\text{C}$  range.

For details circle Reader Service No. 213

150 MHz. In this design, the MC1040 is used as a buffer storage for the BCD data from the counter. The MC1034, since it utilizes a true master-slave design, eliminates data "rippling-through" when the clock is in the low state.

Both the MC1034 and MC1040 are available in the  $0$  to  $+75^{\circ}\text{C}$  temperature-range and come in the 14-pin dual in-line ceramic package. The MC1026/1226 come in either limited or full temperature versions and are packaged in both the TO-116 ceramic dual-in-line and TO-86 flat-pack.

Two application notes — one called "I/C Crystal Controlled Oscillators;" the other "High Speed Monostable Multivibrators" — along with comprehensive data sheets on these new MECL II types have just been published. Add them to your high-speed design library.



## XC177 Provides Ingredients For Low-Cost Custom MSI/LSI!

*The recipe is really quite simple.* Take the basic XC177 chip — a flexible array of 25 uncommitted TTL gates, each having 4 circuit options. Add your own circuit and logic layout for transition to two layers of intraconnecting metal. And, send to Motorola!

The result can be an inexpensive, custom, complex-circuit such as the Quad "D" Flip-Flop illustrated . . . or, any other that you can design. And, your costs can be a great deal less than for circuits of comparable complexity. For still greater complexity and functional capability, up to 100 gates may be interconnected using 4 adjacent XC177's.

Even though customizing costs normally run to \$15,000 and up, development costs for your designs with the XC177 are only \$2,500 per layer of metal; and, even then, unit costs will be in the \$15 to \$30 range, depending on the function and tests required.

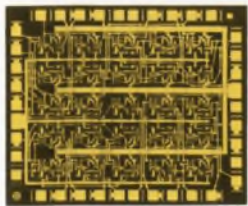

The XC177 shown formed into a universal Quad D Flip-Flop.

are drastically reduced — because of the flexibility offered through two metalization layers. So, you get custom-designed basic gates with passive pullups, for wired OR capability and low-noise; plus, almost unlimited flexibility.

The various options of the XC177 are available in five different package configurations: 14 and 16-pin dual in-line plastic, and both 14-pin and 32-pin ceramic flat packs.

For details circle Reader Service No. 215

*The "how" of it is almost as simple as the recipe:* By starting with a standard chip that houses 25 bipolar gates, development time and mask-making costs

Only two MC4006 Decoders and 16 MC4004/5's are needed to form a complex, yet compact system such as this 64-Word, 4-Bit Memory.

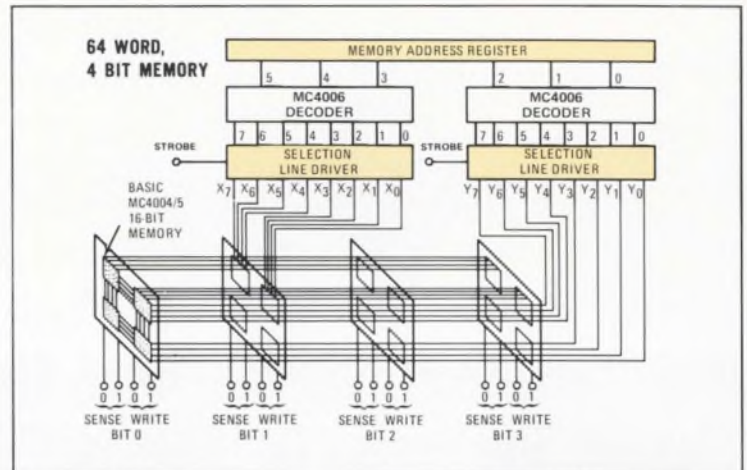

## Family of 23 MTTL Complex-Element I/Cs Led-Off by Two Memories and a Decoder

Improved performance, lower system costs and inter-family (MDTL, T<sup>2</sup>L, etc.) compatibility are just three of many advantages offered by a new series of complex-element transistor-transistor logic circuits — the first introductions being two 16-bit memory circuits and a binary to one-of-eight-line decoder. *The rest of the family, consisting of twenty more types, is scheduled for release during the first half of 1969.*

The MC4004 and MC4005 16-Bit Random Access Memories can serve as "building blocks" for 100 ns scratchpad memory systems; while the MC4006 Decoder offers greatly improved operating efficiency and a lowering of "can-count" and system costs. As shown in the illustration, these new MTTL complex-elements can be combined to form expanded memory systems.

The MC4004/05 provide 16-words of one-bit memory each, operating in the NDRO mode. Each of these units contains 16 flip-flops, arranged in a four-by-four matrix, plus two amplifiers and two "write" circuits. Eight "select" lines pro-

vide for the selection of one of the bits by applying a logic "1" level to one of the "X" and one of the "Y" select lines. After selection, information may be written into the bit by applying a logic "1" level to one of the "write" circuit inputs.

The MC4006 combines low-level, non-saturating gates with high-level gates, all on a single chip. The "enable" line provides an inhibit capability and also allows the decoder to be expanded for larger systems.

These new circuits offer the same system compatibility improvements pioneered by Motorola with its MTTL III line. That is, diode-clamped inputs and a by-pass network to improve transfer characteristics and reduce "ringing."

MC4004/05/06 are on distributor's shelves now, in the 14-lead dual in-line ceramic package and the TO-86 ceramic flat-pack. All operate over the 0 to 75°C range. 100-up prices are:

MC4004L—\$11.80	MC4004F—\$17.70
MC4005L— 9.05	MC4005F— 12.65
MC4006L— 7.50	MC4006F— 12.80

For details circle Reader Service No. 216

## Now One MC1514 Can Do The Job Of Two Diff-Comparators

**Why use two when one will do?**

With Motorola's new MC1514 Dual Differential Comparator I/C you can replace **two 710-types**, thus reducing package count, system-size, costs and complexity in low-level detection, sensing and memory designs.

In addition to two separate outputs,

the MC1514 also offers a strobing capability as well as a high output current-sink — 2.8 mA (min) for *each comparator!* This circuit also features a propagation delay time of only 40 ns. And, its output is compatible with saturated logic forms.

It is capable of transferring differential signals directly into dc output levels —

thus making it useful in a variety of applications such as variable threshold Schmitt triggers, pulse-height discriminators, memory sense amplifiers, and high-noise-immunity line receivers.

The MC1514 comes in the 14-lead, TO-116 dual inline ceramic case and operates over the -55 to +125°C temperature range. It is 100-up priced at \$13.

For details circle Reader Service No. 217





"Isolated-collector" packaged silicon power transistors can be thermally-mounted to a heat-sink without using electrical insulation — making them ideal for critical high-wattage applications.



## New "Isolector" Silicon Power Transistors Simplify The Design Of "Floating" Systems!

Increased system design flexibility and a decrease in hardware requirements — that's what's wrapped-up in four new NPN, TO-59 packaged, 7-Amp silicon power transistors that feature a unique isolated-collector design.

These new isolated-collector power transistors allow the designer to thermally-mount the units, but keep them electrically isolated from the heat-sink — a requirement often found in non-grounded or "floating" systems in missiles and satellites. In addition, mounting and insulating hardware are virtually eliminated.

The new 60-Watt "Isolector" series — EIA registered 2N5346-49 — has been specifically developed for power switching and wideband amplifier applications

in critical industrial and military designs where reliable performance under demanding conditions is important.

The new series features a wide spectrum of advantages such as: dc current gain spec'd at three points up to 5 Amps; excellent dc safe operating area (5 Amps at 10 Volts) and saturation voltage of only 1.2 Volts @ 7 Amps . . . plus a 200°C maximum operating temperature.

TYPE NO.	V <sub>CEO</sub> (sus)	h <sub>FE</sub> @ I <sub>C</sub> (min)	SWITCHING TIME		
			t <sub>on</sub>	t <sub>r</sub>	t <sub>off</sub>
2N5346	80 V	30 @ 2A 20 @ 5A	200 ns 2.0 μs 200 ns @ V <sub>CC</sub> = 40V / I <sub>C</sub> = 2A (max)		
2N5347	80 V	60 @ 2A 40 @ 5A			
2N5348	100 V	30 @ 2A 20 @ 5A			
2N5349	100 V	60 @ 2A 40 @ 5A			

For details circle Reader Service No. 218

## New Si<sub>3</sub>N<sub>4</sub> Dual-Gate MOSFETs Are Low-Cost, Yet Versatile

The new dual-gate MOSFETs — types MFE3007 and 3N140 — offer RF circuit designers all the basic advantages of field-effect transistors coupled with low cross-modulation distortion, more efficient AGC action and lower feedback capacitance. Cascode operation is facilitated by the series arrangement of two channels, with a separate and independent control-gate for each, thereby maintaining separation of RF-signal and AGC voltage. They are ideal for RF amplifier and mixer applications such as required in frequency converters, TV/FM tuners, AGC amplifiers, and color demodulators.

These N-Channel, TO-72 packaged dual-gate MOSFETs exhibit excellent long-term stability under both high temperature and reverse biasing conditions — due to Motorola's Silicon-Nitride passivation process. C<sub>iss</sub> values are minimal, namely 0.02 pF typical for the MFE3007 and 0.03 pF max for the 3N140, while maximum input capacitance (C<sub>iss</sub>) is 5.5 pF and 7.0 pF, respectively.

Characteristics	MFE3007	3N140
G <sub>p</sub> , min @ 200 MHz	18 dB	16 dB
y <sub>r</sub> , (μmhos) @ 1 kHz	10,000 min 18,000 max	6,000 min 18,000 max
NF max @ 200 MHz	4.0 dB	4.5 dB
I <sub>oss</sub> (mA)	5.0 — 20	5.0 — 30
Price: (1,000-up)	99¢	98¢

For details circle Reader Service No. 219

## 4 Diodes, 5 Transistors Now Join Micro-T Packaged Line

### Fast-Switching Diodes Offer Assortment of Configurations

Four new Micro-T silicon epitaxial diodes with typical reverse recovery times of just 3 ns are now available for



Four Micro-T diode configurations offer greater high-density design flexibility.

designers who have severe space limitations in computer, instrumentation, and military switching applications.

The MMD6050 is a single diode in a two-lead variation of the one-piece, injection-molded plastic Micro-T package. The others are dual-diodes (in the 3-leaded package). They are the MMD6100, a common-cathode device, MMD6150 (common-anode), and the MMD7000, a series configuration.

Adding to the advantages of these fast-switching diodes are premium specs like: high breakdown voltage of 70 V (min) @ 100 μA and capacitance values as low as 2 pF (max). The power dissipation for all types is 225 mW @ 25°C; and, they operate over a wide junction temperature range of -55 to +135°C.

### Ultra-Fast-Switch Heads List Of 5 New Micro-T Transistors

Take a familiar NPN silicon Annular fast-switching transistor like the 2N3960,

For details circle Reader Service No. 220

Application	Polarity	Type No.	Key Parameters
Current-Mode Logic Very Fast Switch	NPN	MMT3960A	t <sub>off</sub> = 2.1 ns (typ) f <sub>r</sub> = 2250 MHz (typ) @ I <sub>C</sub> = 10 mA
Low-Noise Amplifier	NPN	MMT930 MMT2484	f <sub>sw</sub> = 175 (min) @ 100 μA (MMT2484) NF = 3.0 dB @ I <sub>C</sub> = 10 μA
DC-to-VHF Amplifier High-Speed Switch	NPN	MMT2222	f <sub>r</sub> = 200 MHz (typ) @ I <sub>C</sub> = 10 mA t <sub>sw</sub> = 16 ns (typ) @ I <sub>C</sub> = 150 mA
General Purpose Amplifier & Switch	PNP	MMT2907	f <sub>sw</sub> (range): 100-300 @ I <sub>C</sub> = 150 mA t <sub>sw</sub> = 20 ns (typ) @ I <sub>C</sub> = 150 mA V <sub>CE(sat)</sub> = 0.4 V (max) @ I <sub>C</sub> = 150 mA

speed it up even more, and improve its current-gain — bandwidth product, then package it in the Motorola Micro-T housing, and you have the best high-speed current-mode logic switch yet — the MMT3960A. And, you are afforded the flexibility of being able to use discrete devices while retaining the circuit shrinkage attributes of I/Cs.

Four other additions to the Micro-T transistor line include: two NPN low-noise amplifiers, an NPN dc-to-VHF amplifier/high-speed switch, and a PNP general-purpose transistor.





## Zener Diode Chips Now Make Internally-Regulated Hybrid I/C Designs Practical

Built-in voltage regulation has just become simple and economical to achieve in hybrid microcircuit designs!

Two new MZC series of unencapsulated, 400 mW zener diodes (both high and low current-level versions) are now available for cost-cutting, assembly-simplifying applications in virtually any type of hybrid design requirements, from

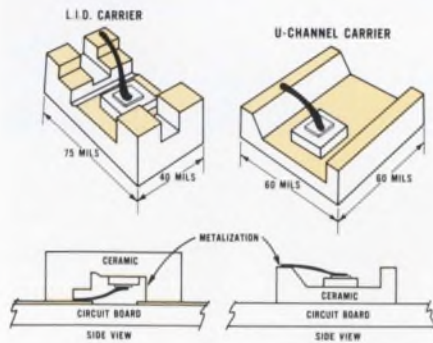

Zener diode "chips" can be supplied on metallized ceramic U-channel and L.I.D. carriers (as well as unmounted), to satisfy most any Hybrid thick or thin-film circuit mounting and fabrication requirement.

1.8 to 200 volts ... in a choice of three, compatible configurations: (1) chips only; (2) chips-on-U-channels; (3) chips-on-L.I.D.'s.

The MZC series "A" — equivalent to chips used in the popular Surmetic 1N-5221 family — has test currents which are specified at standard milliamp levels and, can be incorporated into most higher-current circuits where power drain is not a prime consideration.

For space, instrumentation and other low-current-level, battery-operated systems where power drain must be minimized, the "B" series offers test currents spec'd at only 250  $\mu$ A! These chips are closely akin to those found in the 1N4614 and 1N4099 "glass" RamRod family.

Both series are available in 5% and 10% voltage tolerances, offer anode/cathode metallization compatibility with standard wire and die-bonding techniques, and feature gold-plated bonding surfaces — to facilitate thin or thick-film assembly operations.

Chip Series No.	Voltage Range	Test Current (Iz)	Leakage Current (Ia)	1M Device Equivalent
MZC "A" Series (High-Level)	2.4-200V	0.65-20 mA	0.1-100 $\mu$ A	1N5221* Series
MZC "B" Series (Low-Level)	1.8-200V	250 $\mu$ A	0.01-10 $\mu$ A	1N4099 Series 1N4614 Series

\*Also equivalent to 1N4370,A thru 1N4372,A; 1N746,A thru 1N759,A; 1N964,A,B thru 1N922,A,B.

For details circle Reader Service No. 221

## Mini/Micro-T Opto-Sensor Entries Make For Maxi-Visibility Arrays!

Like women's latest fashions, they're mini-sized, maxi-produced and specially-designed for optimum optical properties!

Unlike the new fashions though, they're low in cost!

We're talking about the new, clear plastic packaged, Micro-T and Mini-T optoelectronic transducers — state-of-the-art devices that clear-the-way to more economical, high-density-array punched-card and tape-readers, shaft encoders, pattern and character recognition, process inspection, counting, sorting, switching and logic circuit systems designs.

So tiny you can put more than 100 of them in a thimble without reaching the top, the Micro-T units are available with (MRD100), or without external base leads (MRD150). They can be closely spaced and mounted on the underside of PC boards, with only their active areas exposed — making it possible to design smooth, uncluttered close-contact interface configurations.

Covering the visible and near-infra-red spectral range, Micro-T's feature a sensitivity of 0.04 mA/mW/cm<sup>2</sup> (min).

For details circle Reader Service No. 222

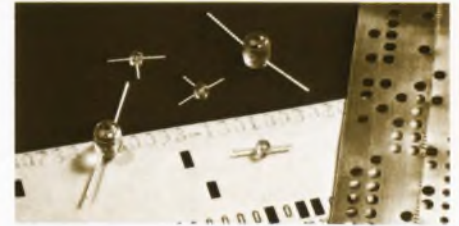

New Micro-T (2 and 3-leads) and Mini-T opto-devices expand opportunities to develop low-cost high-density/high sensitivity sensors.

The Mini-T (MRD450) exhibits an even higher radiation sensitivity — 0.20 mA/mW/cm<sup>2</sup> — due to a unique, molded lens design which concentrates more light onto the active die surface. It is especially suitable for sensing designs in inspection, production and detection equipment as well as alarm systems, SCR triggering and optical interfacing with data processing systems.

Type No.	Package Type	Dark Current	Rise Time	Fall Time	Price (100-up)
MRD 100	Micro-T	100 nA (max)	2.5 $\mu$ s (max)	4.0 $\mu$ s (max)	\$1.00
MRD 150	Micro-T				.80
MRD 450	Mini-T				1.50

## Latest Premium Tuning Diode Line Increases Broad-Frequency-Control Design Flexibility

A new premium-performance EPICAP tuning diode series, types 1N-5461-76, can now serve to improve the design of tuning circuits for such exacting frequency control requirements as are found in ECM equipment, ground and aerospace radio and frequency synthesizers. The significant features of this line include: very high Q's — for sharp response at high frequencies; high tuning

them into matched multi-stage configurations and for continuous wide-band tuning requirements.

Their tuning ratios are closely held to indicated typical values by guaranteed min. and max. values on each type (see table). The series covers all standard nominal capacitance values from 6.8 pF to 100 pF.

These new EPICAP tuning diodes are supplied in the Motorola RamRod DO-7 "glass" case. The 100-up price for suffix A types is \$4.50 each, suffix B — \$5.80 and suffix C — \$8.00.

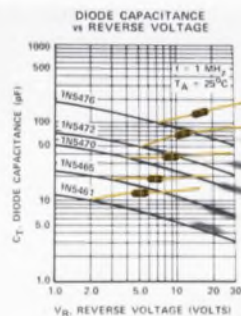

The slopes of capacitance change vs. voltage are the same for all types in the 1N5461 Epicap tuning diode series.

ratios — to facilitate tuning over broad frequency ranges; and uniform linear changes in capacitance with voltage — making it a simple matter to "gang"

Type No.	Fig. of Merit (Q) @ 4V/50 MHz	Capacitance (C <sub>1</sub> ) @ 4V/1 MHz	Tuning Ratio C <sub>2</sub> /C <sub>10</sub> @ 1 MHz
	Min.	pF*	Typ
1N5461A	600	6.8	2.8
1N5462A	600	8.2	2.9
1N5463A	550	10.0	2.9
1N5464A	550	12.0	2.9
1N5465A	550	15.0	2.9
1N5466A	500	18.0	3.0
1N5467A	500	20.0	3.0
1N5468A	500	22.0	3.0
1N5469A	500	27.0	3.0
1N5470A	500	33.0	3.1
1N5471A	450	39.0	3.1
1N5472A	400	47.0	3.1
1N5473A	300	56.0	3.1
1N5474A	250	68.0	3.1
1N5475A	225	82.0	3.1
1N5476A	200	100.0	3.1

\*Nominal capacitance tolerance of  $\pm 10\%$ ,  $\pm 5\%$ , or  $\pm 2\%$  indicated by suffix A, B or C, respectively.

For details circle Reader Service No. 223





**NEW ULTRA-LOW-NOISE JFETS**

— *Feature Low-Frequency Noise-Figures Below 1.0 dB!*

Three new ultra-low-noise N-Channel JFETs (2N5556-58) offer excellent noise characteristics making them exceptionally well-suited for low-signal, high impedance input circuits, such as required in electrometers and medical electronic amplifiers. For example, they exhibit a small equivalent input-noise-voltage ( $e_n$ ) = 20 nV/ $\sqrt{\text{Hz}}$  typ. @ 10 Hz and a noise-figure (NF) of only 1.0 dB max. @ 10 Hz.

In addition to the specs shown in the table below, these TO-72 packaged devices exhibit a minimum breakdown voltage of 30 volts and a low  $I_{GSS}$  of just 0.1 nA max. Typical figures for  $C_{iss}$  and  $C_{rss}$  are also quite low — 4.5 pF and 1.2 pF, respectively.

Type No.	$I_{DSS}$ (mA) Min — Max	$V_{GS(off)}$ (V) Min — Max	$y_{fs}$ ( $\mu\text{mhos}$ )			Price (100-up)
			Min	Typ	Max	
2N5556	0.5 — 2.5	0.2 — 4.0	1500	3500	6500	\$9.50
2N5557	2.0 — 5.0	0.8 — 5.0				8.00
2N5558	4.0 — 10.0	1.5 — 6.0				7.50

For details circle Reader Service No. 224

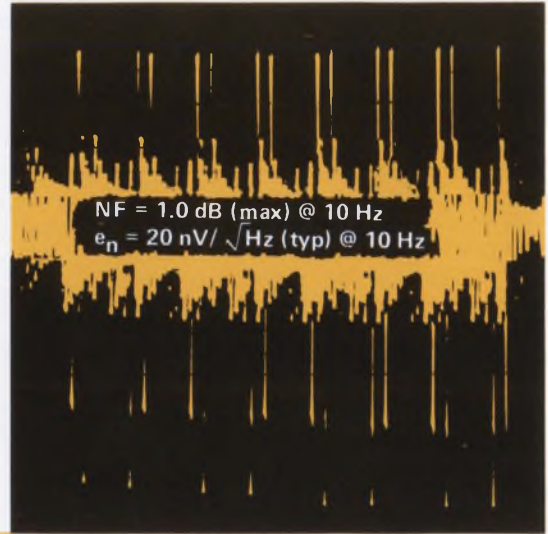

**TWO LOW-LEVEL PNP AMPLIFIER TRANSISTOR SERIES**

— *Provide High-Gain At Low Collector-Currents, Plus Low Noise-Figures!*

With the availability from Motorola of two PNP silicon Annular transistor series — the 2N2604/05 and their premium versions, the 2N3798/99 — designers can now utilize low-level, high-gain amplifiers with noise figures that are typically less than 3 dB (even when operating over a wide frequency bandwidth of 10 Hz to 15.7 kHz).

While the 2N3798/3799 are premium devices by virtue of their lower capacitance, lower noise figures, higher gain, and higher collector-emitter breakdown voltage, the 2N2604/2605 have the advantage of being encased in the space-saving TO-46, low-silhouette, solid Kovar package and, they carry significantly lower price-tags (see table at right).

For details circle Reader Service No. 225

HIGHLIGHT CHARACTERISTICS	2N2604	2N2605	2N3798	2N3799
Low Noise: NF(max) @ 1c (B.W. = 10 Hz to 15.7 KHz)	4.0 dB @ 10 $\mu\text{A}$	3.0 dB @ 10 $\mu\text{A}$	3.5 dB @ 100 $\mu\text{A}$	2.5 dB @ 100 $\mu\text{A}$
High Voltage: $BV_{CEO(min)}$ @ 1c $BV_{EBO(min)}$ @ 1e	40 V @ 10 mA 6 V @ 10 $\mu\text{A}$		60 V @ 10 mA 5 V @ 10 $\mu\text{A}$	
Low Capacitance: $C_{ob(max)}$ @ $V_{ce}$	6 pF @ 5 V		4 pF @ 5 V	
High Gain: $H_{FE(min)}$ @ 1c	60 @ 500 $\mu\text{A}$	150 @ 500 $\mu\text{A}$	150 @ 500 $\mu\text{A}$	300 @ 500 $\mu\text{A}$
Package Type:	TO-46		TO-18	
Prices (100-up):	\$2.30	\$2.70	\$4.00	\$4.50

**SIX NEW SILICON JAN TRANSISTORS**

— *Join Motorola's Extensive Mil-Type Availability List*

Two each universal high-speed switches, general purpose medium-current high-speed switches, and high-speed switching/DC-to-VHF amplifier transistors now join over 300 Motorola semiconductors that are now available to meet MIL requirements.

Test data on the JAN/JANTX2N708 and JAN/JAN-TX2N914 NPN types is available on request. A comprehensive Designers data sheet, containing complete limit curves, covers the PNP JAN2N3467/3468 core drivers — while, the space savings provided by the low-profile TO-46 packaged PNP JAN2N3485A/3486A make them ideal for high component-density applications.

Type No.	Mil-S-19500/	Case	$P_o$ @ 25°C	$C_{ob}$ @ 10V	$f_T$ @ 1c (min)	$V_{CE(sat)}$ @ 1c (max)	$V_{CEO}$
JAN/JAN-TX2N708	312B(USAF)	TO-18	360 mW	6 pF (max)	300 MHz @ 10 mA	0.4V @ 10 mA	15V
JAN/JAN-TX2N914	373(USAF)	TO-18	360 mW	6 pF (max)	300 MHz @ 20 mA	0.7V @ 200 mA	15V
JAN/JAN-TX2N3485A/86A	392(USAF)	TO-46	400 mW	8 pF (max)	200 MHz @ 50 mA	0.4V @ 150 mA	60V
JAN3467/68	348(NAVY)	TO-5	1.0 W	25 pF (max)	175/150 MHz @ 50 mA	0.3/0.35 V @ 150 mA	40V/50V

For details circle Reader Service No. 226



**RADIATION-RESISTANT PNP "DIONIC" TRANSISTOR**

— *Especially Processed For High Neutron Tolerance Levels!*

Motorola's new MM4261H PNP silicon Annular "Dionic" transistor marks the first time that a radiation-resistant device, which has also met the highest high-rel criteria, is available "off-the-shelf." Advanced processing techniques provide an exceptional tolerance to neutron radiation ( $h_{FE}$  degradation is less than 50% after exposure to  $5 \times 10^{11}$  neutrons/cm<sup>2</sup>) and reliability is doubly assured through testing standards which are over-and-above those specified for typical JAN-TX requirements.

Applications in ordnance, space, and wherever low-level switching or low-voltage amplifier circuits require high radiation tolerance, are natural for the MM4261H. Among its key specifications, this TO-72 four-lead metal-can packaged device features a high current-gain — bandwidth product ( $f_T$ ) of 2,000 MHz (min) @ 10 mA. Input and output capacitances are both a low 2.5 pF (max), while its fast switching capability is shown by a  $t_r$  = 0.5 ns (typ) @ 10 mA.

For details circle Reader Service No. 227

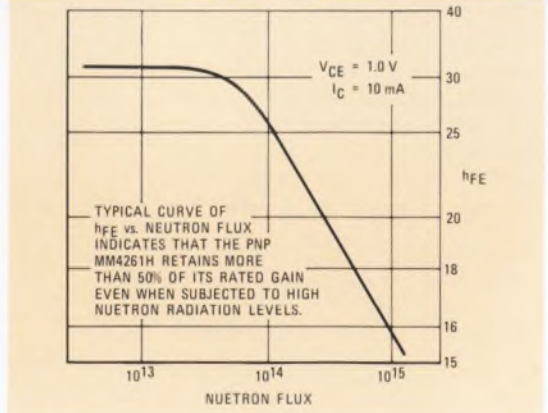

## New Linear I/C HANDYLab Kit Makes Prototyping Quick and Easy



MCK1500 is the latest in a continuing series of prototype design kits, developed to give the working engineer a complete, "all-in-one" source of information and devices for evaluation and breadboarding.

This new kit contains 24 linear integrated circuits — 2 each of 12 types — representing a cross-section of Motorola's Linear I/C line. Ten of the circuits are in TO-5 metal cans and two are in 14-pin ceramic dual in-line packages. In addition, a complete library of technical data is also included in the kit. For example, data sheets for all Motorola Linear I/Cs are included, plus Application Notes that are representative of the wide range of uses for the circuits that are in the kit. In addition, an "Applications Selector Guide" for Motorola Linear I/Cs makes it possible to tell at-a-glance which is the proper circuit for your application.

The material is all contained in a sturdy, compact vinyl-covered case that will fit in a desk drawer. The MCK1500 is available now from franchised Motorola distributors for \$94.50 each. The value of the device alone, in 1-24 quantities, is \$361.00!

## First RF Selector Guide Provides Applications-Oriented Device Data



As an aid to the design of UHF and VHF circuitry, Motorola has just published a comprehensive selector guide that includes *all* types of RF characterized semiconductors — from 2 MHz to more than 10 GHz. The power and small-signal sections are further divided into three sequential selectivity levels. The first level being graphical representations of application areas covered by specific devices; the second is

in the form of charts which list the devices by their frequency of operation as related to their most pertinent parameter; while the third is an alphanumeric listing of the devices with their abbreviated specifications.

A spectrum-chart covering major areas of applications is also included.

For a copy circle Reader Service No. 228



## LITERATURE ORDER FORM

NOTICE: Requests for literature on items described in this publication cannot be honored after July 1, 1969.

### NEWSBRIEFS No. 5-69

Please circle the Reader Service number of item(s) you are interested in receiving.

ED				
211	212	213	214	215
216	217	218	219	220
221	222	223	224	225
226	227	228	229	230

Please Print Clearly

NAME \_\_\_\_\_

TITLE \_\_\_\_\_

COMPANY NAME \_\_\_\_\_

DIVISION \_\_\_\_\_

DEPARTMENT \_\_\_\_\_

COMPANY ADDRESS (Street or P. O. Box) \_\_\_\_\_

CITY \_\_\_\_\_

STATE \_\_\_\_\_ ZIP CODE \_\_\_\_\_

If you wish to receive mail at a different address, fill out below:

ADDRESS \_\_\_\_\_

CITY \_\_\_\_\_

STATE \_\_\_\_\_ ZIP CODE \_\_\_\_\_

Do you wish a Motorola Representative to contact you?

VISIT

PHONE

Phone No. \_\_\_\_\_ Area Code \_\_\_\_\_

Tear Along Perforated Line and Drop in Mail (No Postage Required)



FOLD HERE

FIRST CLASS  
Permit No. 2565  
PHOENIX  
ARIZONA

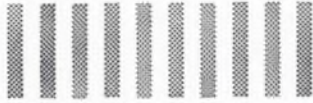

**BUSINESS REPLY MAIL**

No postage stamp necessary if mailed in the United States

POSTAGE WILL BE PAID BY

Semiconductor NEWSBRIEFS No. 5-69  
Motorola Semiconductor Products Inc.  
P. O. Box 20924  
Phoenix, Arizona 85036

FOLD HERE

## For Fast Action!

... on delivery of literature for items described in this publication — fill out this coupon, fold as indicated and drop in the mail.

(NO POSTAGE IS REQUIRED)

Seal Here

## NEW LITERATURE BRIEFS

### Over 650 Semiconductors Covered In Motorola's New Hi-Rel Catalog!



The most complete guide to semiconductors for Hi-Rel applications ever compiled, has just been published by Motorola. This 28-page, condensed catalog and selector guide describes over 650 types, in terms of their performance criteria for Hi-Rel requirements. Over 400 discrete devices that meet NASA, JAN/JAN-TX or Motorola's MEG-A-LIFE specifications are shown cross-referenced to the specific program under which they are available. In addition, condensed specifications are given for all the listed types. Process flow charts are also shown to provide details on Motorola's Hi-Rel procedures.

The listings include: Over 300 zener diodes; more than 100 germanium and silicon transistors (in both small-signal and power categories); eight thyristors and UJT's; three silicon rectifiers; over 230 digital I/C functions covering all popular families — MDTL, MECL, MTTL and MRTL — and, 24 linear I/C types, including diff-amps, op-amps, sense-amps, power and high-frequency amplifiers.

No design engineer whose work areas and interests include the Hi-Rel field should be without this new all-inclusive semiconductor catalog and selector guide.

For a copy circle Reader Service No. 229

### Better Ideas In Custom Hybrid Microcircuits Shown In New Brochure

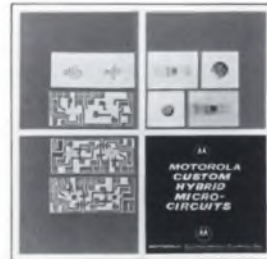

The ability to combine any of 19,000 different semiconductor chips into a virtually endless variety of custom hybrid microcircuits, at economical costs, keynotes Motorola capability — detailed in this new publication.

With more and more systems designers searching for the optimum answer to bridging the gap between sometimes-costly, sometimes-cumbersome discrete device assemblies and power and performance-limited monolithic circuits, the brochure provides much starting-point impetus to new-design thinking along custom hybrid lines.

What they are, where they fit, their advantages and graphic examples of specific, finished custom designs in thick and thin-films are shown. Quality assurance considerations (including 100% stress tests) are also treated.

If you're planning to or already working in miniaturization through microelectronics . . . you'll want this new brochure!

For a copy circle Reader Service No. 230

Published by Motorola Semiconductor Products Inc., P. O. Box 20924, Phoenix, Arizona 85036.

SEMICONDUCTOR  
newsbriefs

© Motorola Inc. 1969

The circuitry shown external to Motorola products is for illustrative purposes only, and Motorola does not assume any responsibility for its use or warrant its performance or that it is free from patent infringement.

MHTL, MTTL, MECL II, Micro-T, Mini-T, Unibloc, Isolector, Epicap, Surmetic, RamRad, Thermopad, Designers, DIONIC, and HANDYLab used in this publication are trademarks of Motorola Inc. Annular Semiconductors are patented by Motorola Inc.

NOTE: If coupon is missing use magazine's Reader Service numbers to order literature on items described in NEWSBRIEFS



# HAPPENINGS IN ELECTRONICS

**Schweber salutes the Barnes Corporation.**

March, 1969

The mercurial growth of integrated circuits created a need for sockets that the big-name socket manufacturers did not attempt to meet. Turning a deaf ear to the exploding solid-state technology, the big names continued punching out tube sockets. A dynamic new group stepped into this vacuum, and by working closely with the leaders in the transistor and IC field developed a line of sockets that met the testing, breadboarding, and production needs of the industry. That group is the Barnes Corporation. With the emergence of MSI and LSI and 40-lead devices, some of the big names are taking another look, but the industry can't afford to wait for the results. It's an amazing fact that just as the three leaders in the semiconductor field never made a vacuum tube, the leader in semiconductor sockets never made a tube socket. As part of our salute to Barnes, we will send you the standard 46-page Barnes catalog as well as the special MSI/LSI supplement. Circle #241.

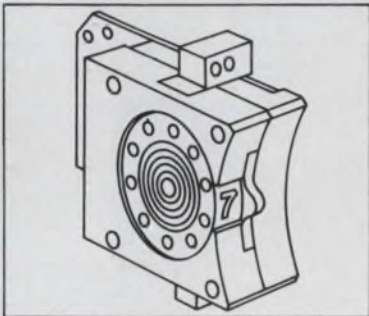

**Rotary thumbwheel switch is state-of-the-art.**

The EECoSITCH,<sup>®</sup> made by Electronic Engineering Company of California, can solve most of your switching problems. The switch is operated by a rotary thumbwheel (see drawing). The switch position is indicated by a window framed readout number controlled by the thumbwheel (you don't need dials or decals). Behind-panel space requirements are significantly reduced by printed circuit board terminations. The switch can be installed without preliminary between-deck wiring. Both back-of-panel and front-of-panel assemblies are available. Contact chambers come sealed or unsealed; lighted or unlighted with a long life permanent lamp. We have a 12-page catalog and price list for you. Circle #242.

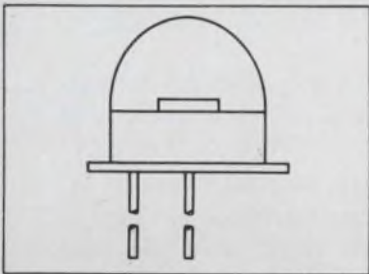

**Monsanto gallium arsenide semiconductors.**

Schweber now stocks GaAs semiconductors, a product of Monsanto Electronic Special Products Division. Individual light-emitting diodes in the visible range cover the green, amber, and red frequencies. Also available is an infrared emitter diode. In addition to these incoherent light emitters, Monsanto has a lineup of GaAs semiconductor injection lasers with peak power outputs of 5 to 28 watts at peak emission wavelengths of 8,600 and 9,000 angstroms. For catalog, circle #243.

**Review of new catalogs: RCA Mosfet Product Guide.**

This 20-page booklet is both a catalog and a comprehensive application note for MOS Field Effect Transistors. Four pages are devoted to typical FET circuits, all components specified including coils. Three more pages discuss handling of FETs, their features and areas of applications, as well as a description of the dual-gate FET. The remaining pages list FET devices for consumer, industrial, and military equipment. Circle #244.

**Fairchild MOS/LSI Brochure.**

Here again we have the unusual combination of a catalog and an introductory section describing the union of MOS technology and Large Scale Integration. LSI can be described in the phrase: "A-subsystem-on-a-chip." This 40-page Fairchild brochure is divided into three parts. The first seven pages introduce the technology voted most likely to succeed in LSI, namely Metal-Oxide-Silicon (MOS). An unusual catalog of standard\* MOS/LSI devices follows. (Unusual because some of the devices listed were not known to the public when the catalog was released.) The final section is devoted to Custom Arrays. Circle #245.

\*Standards are always stocked by Schweber unless a later date is specified.

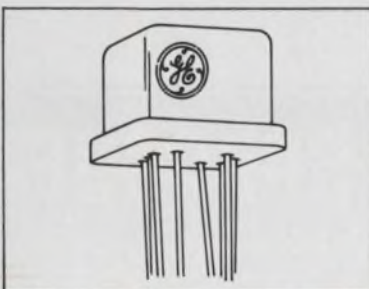

**The logic of the TO-5<sup>2</sup> sealed relay.**

GE squared the TO-5 can and created the TO-5<sup>2</sup> sealed relay. The logic of TO-5<sup>2</sup> is magnetic superiority. In a square enclosure, the magnet provides 2.5 times the magnetic pull achieved in a round enclosure. This results in higher contact forces, larger contact gaps, and greater contact over-travel. Extremely small relays are susceptible to mechanical shifts during environmental stress. The larger forces, gaps, and over-travel characteristic of the square design will minimize such shifts. The square design also permits greater accessibility of contacts and more precise adjustments. For data sheet, circle #246. Call Schweber for shipment from stock.





**Now from Sprague Electric!**

# Your *custom* pulse transformer is a *standard* DST\* transformer

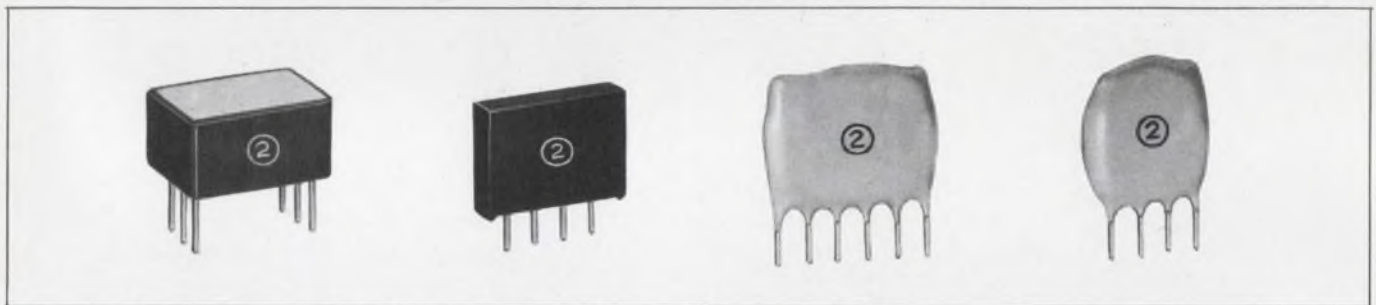

Some of the case styles in which Sprague DST Pulse Transformers are available. Note the in-line leads.

**You can select** the transformer design you need from the new Sprague DST Family, a fully-characterized series of Designer Specified Transformers which Sprague Electric has pioneered. It's easy. Start with the two basic parameters dictated by your circuit requirements: primary (magnetizing) inductance and volt-second capacity.

New Sprague engineering data gives basic information from which all nominal sine wave parameters are derived. This data allows you to specify the one transformer from thousands of possibilities which will optimize performance in your application.

**Design Style A** minimizes magnetizing inductance change as a function of temperature. Typically it's  $< \pm 10\%$  change from 0 to 60 C;  $< \pm 30\%$  from  $-55$  to  $+85$  C.

**Design Style B and C** give you broad band-pass characteristics, and still keep magnetizing inductance change  $< \pm 15\%$  from 0 to 60 C.

**Design Style D** is *fast*. Associated leakage inductance and coupling capacitance are kept at a minimum. This style is just what you need for interstage and coupling devices in computer drive circuits.

The Sprague DST Series packs a lot of transformer into minimum volume packages — epoxy dipped for minimum cost, or pre-molded. The 100 mil in-line lead spacing is compatible with integrated circuit mounting dimensions on printed wiring boards.

To solve your pulse transformer design, start now. Write for Engineering Bulletin 40,350 to the Technical Literature Service, Sprague Electric Company, 347 Marshall St., North Adams, Massachusetts 01247.

\*Trademark

## SPRAGUE COMPONENTS

PULSE TRANSFORMERS  
THIN-FILM MICROCIRCUITS  
TRANSISTORS  
CAPACITORS  
RESISTORS

INTEGRATED CIRCUITS  
INTERFERENCE FILTERS  
PULSE-FORMING NETWORKS  
TOROIDAL INDUCTORS  
ELECTRIC WAVE FILTERS

CERAMIC-BASE PRINTED NETWORKS  
PACKAGED COMPONENT ASSEMBLIES  
BOBBIN and TAPE WOUND MAGNETIC CORES  
SILICON RECTIFIER GATE CONTROLS  
FUNCTIONAL DIGITAL CIRCUITS

**SPRAGUE**<sup>®</sup>  
THE MARK OF RELIABILITY

'Sprague' and '®' are registered trademarks of the Sprague Electric Co.

# News



**The Cognodictor**, one of several reading aids under development for the blind, spells aloud

the letters that appear beneath the probe in the operator's hand. Details are on page 30.



**Display for Back-Up Interceptor Center** (Buic III), which would replace a bombed-out Sage air defense network, shows twice as much

information as its predecessor. Improvement comes from more memory and better software. Page 36.

## Also in this section:

**Aerospace electronics** under attack. Page 25.

**News Scope.** Page 21 . . . **Washington Report.** Page 41 . . . **Editorial.** Page 47.



**Now from Sprague!**

QUALITY  
STABILITY  
RELIABILITY  
SMALL SIZE

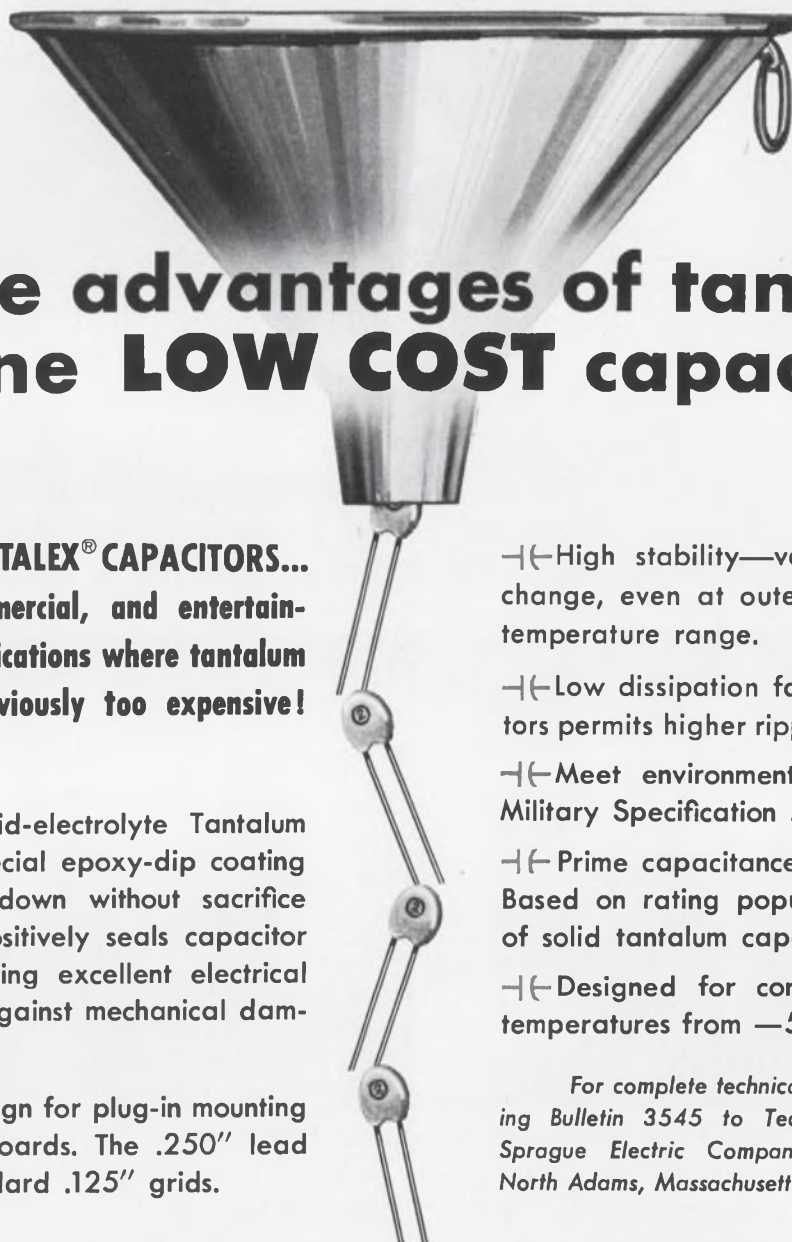

## All the advantages of tantalum in one **LOW COST** capacitor!

**EPOXY-DIPPED TANTALEX® CAPACITORS...**  
For industrial, commercial, and entertainment electronic applications where tantalum capacitors were previously too expensive!

⊖ Type 196D Solid-electrolyte Tantalum Capacitors have special epoxy-dip coating which keeps costs down without sacrifice in dependability. Positively seals capacitor section while providing excellent electrical insulation. Protects against mechanical damage in handling.

⊖ Radial lead design for plug-in mounting on printed wiring boards. The .250" lead spacing will fit standard .125" grids.

⊖ High stability—very little capacitance change, even at outer limits of operating temperature range.

⊖ Low dissipation factor of these capacitors permits higher ripple currents.

⊖ Meet environmental test conditions of Military Specification MIL-C-26655B.

⊖ Prime capacitance and voltage ratings. Based on rating popularity of other types of solid tantalum capacitors.

⊖ Designed for continuous operation at temperatures from -55 C to +85 C.

For complete technical data, write for Engineering Bulletin 3545 to Technical Literature Service, Sprague Electric Company, 347 Marshall Street, North Adams, Massachusetts 01247.

**Now available for fast delivery from your Sprague Industrial Distributor**

### SPRAGUE COMPONENTS

CAPACITORS  
TRANSISTORS  
RESISTORS  
INTEGRATED CIRCUITS  
THIN-FILM MICROCIRCUITS  
45C-4138R2

PULSE TRANSFORMERS  
INTERFERENCE FILTERS  
PULSE-FORMING NETWORKS  
TOROIDAL INDUCTORS  
ELECTRIC WAVE FILTERS

CERAMIC-BASE PRINTED NETWORKS  
PACKAGED COMPONENT ASSEMBLIES  
BOBBIN and TAPE WOUND MAGNETIC CORES  
SILICON RECTIFIER GATE CONTROLS  
FUNCTIONAL DIGITAL CIRCUITS

**SPRAGUE®**  
THE MARK OF RELIABILITY

'Sprague' and '®' are registered trademarks of the Sprague Electric Co.

INFORMATION RETRIEVAL NUMBER 16

## Showdown on Sentinel is due this month

The battle lines are forming in Washington for a struggle over deployment of the Nike-X/Sentinel antiballistic missile system. Only early capitulation by the Nixon Administration can forestall open conflict with Congressional foes of the ABM system.

Nike-X is the program for research and development of advanced ABM techniques; Sentinel is the program to develop, build, test and deploy a "thin" operational ABM defense system. The announced goal of Sentinel is protection against possible nuclear attack by Red China. Opponents say the system is too costly (estimates range from \$5.5 billion to \$10 billion) and would probably be ineffective when complete.

Washington observers believe the President has three major options. He can:

- Order an indefinite halt to Sentinel deployment, revamp the entire Nike-X concept and press development of a more acceptable ABM system.

- Order a temporary halt to Sentinel deployment, continue with Nike-X development and reassess the Sentinel program with a view toward modifying it and deploying it in the near future.

- Fight to continue both R&D and deployment schedules as they now exist.

If the President selects the latter course, informants predict he probably can win continued support in both the House and Senate for 'ABM deployment. But this option would leave him open to critics' suggestions that his Administration has downgraded urban and social needs.

Proponents assert, however, that if Mr. Nixon continues Sentinel deployment or delays it only temporarily, he can strengthen his hand in upcoming arms-control dis-

cussions with the Soviet Union.

The Administration's review of the Sentinel program is scheduled for completion this month. Many observers in the capital recall that, prior to his election, President Nixon advocated Sentinel deployment, as did his Defense Secretary, Melvin R. Laird. The latter stated:

"If there are any errors that are going to be made, as far as my administration of the department is concerned, they will be made on the side of the safety of the people of this country."

### Be an EE, not an MD, surgeon tells engineers

Should the electronics engineer working in the growing field of medical electronics go back to school for a medical degree and perhaps take a few courses in chemistry, biology and physics? No, says Dr. Michael E. DeBakey, a leading heart surgeon and chief ex-



Dr. Michael E. DeBakey, chief executive officer, Baylor Medical College.

ecutive officer at Baylor Medical College in Houston, Tex.

While stressing the need to advance bio-engineering, Dr. DeBakey told engineers at a symposium in New York that this could best be done if the biologist, engineer, physicist, chemist and mathematician each stayed in his own field. The objective can then be achieved through collective endeavor, Dr. DeBakey said.

He recommended this approach because, he said, "the man who tries to acquire expertise in too wide a range of endeavor will find that he has only become the proverbial jack of all trades and master of none."

In examining the progress so far in the alliance between medicine and engineering, Dr. DeBakey said:

"The medical profession has lagged far behind industry in availing itself of the versatile computer and its usefulness in facilitating diagnosis and treatment and in coping with the information revolution.

"A properly programmed computer can flag abnormal results of many tests, offer diagnostic suggestions, and predict, with 80 per cent accuracy, the six-month survival rate of patients with lung cancer. These mechanical analyzers can process 3000 samples of blood and other body fluids in one hour, make 18 separate tests on each sample, and print a data sheet on each specimen in minutes."

### NASA urged to speed earth resources work

Full, unhesitating support for an earth-resources satellite program was urged by Rep. Joseph E. Karth (D-Minn.) in a speech before electronics engineers and managers at the WINCON conference in Los Angeles. He blamed NASA "foot-dragging" for delays thus far.

Karth, a member of the House Science and Astronautics Committee, urged that NASA look beyond the general-purpose spacecraft designed for many different uses.

"There is one very special planet in our solar system," he said, "and that is the one we live on. Perhaps we ought to spend at least as much money looking at it as we spend looking at other planets. The next



few years ought to see an earth-resources satellite system take its place as one of NASA's major projects." (See Washington Report, p. 41.)

Karth noted that the time from initiation to scheduled launching of the earth-resources satellite in 1972 would be twice as long as for any other NASA program. "There is a preponderance of evidence," he said, "of foot-dragging, the setting up of straw men and the assignment of unique, unusual, and, I might say, ridiculous yardsticks. The major cause of the delays is the fact that NASA, as a matter of policy, has decided earth-resources experiments should be conducted as part of the manned space flight "effort."

The Congressman pointed out that a cost effectiveness test had been applied to the earth-resources program. "I know of no precedent for such a requirement anywhere else in the space program," he asserted. "Certainly no one ever applied such a test to the Manned Space Flight Program, the Physics and Astronomy Program, or the Planetary and Interplanetary Program. One shudders to think what the results of a cost-effectiveness analysis would have been for the Apollo Program. If each new project must pass the cost-effectiveness test, I have a strong feeling that the only one that will pass is the one that hasn't passed yet—the earth-resources program."

## U. S. advised to check nonprofit R&D costs

The General Accounting Office has recommended the Executive branch study all nonprofit research organizations that are supported by Government contracts, with a view to determining if their contributions are economically sound. The Survey would include such organizations as the RAND Corp., the MITRE Corp., the Jet Propulsion Laboratory and the Institute for Defense Analysis. The GAO

says that the functions and contributions of these organizations are of "sufficient importance to warrant a Presidential-directed inter-agency or commission study." The last such study of major research groups was conducted in 1962.

In fiscal 1969 Government R&D expenditures will exceed \$17 billion. About 80 per cent of this goes to support private organizations. The GAO, the watchdog agency that reports directly to Congress, has indicated that the time might be ripe for a reconsideration of the present large use of contractors for the performance of R&D. The GAO suggests that the Nixon Administration redefine what research should be performed by existing Federal laboratories and what should be farmed out to nonprofit companies.

The nonprofit concerns regularly come under fire because of their relatively high pay scales. What is perhaps being overlooked is that they were organized originally to mobilize the best brains obtainable for military and space agency work—not easy to do at comparatively low Civil Service salary rates.

A review in 1962 indicated a real need for such nonprofit R&D groups. But, with the Federal raises approved over the last seven years, the GAO no doubt feels it's time to take another look.

## Europe seeks to beef up its computer firms

The European computer industry, which has taken a back seat to American companies in its own territory, is trying to whip up some competition for the future.

International Computers, Ltd., of England, has had talks with Siemens and Telefunken of West Germany and Philips of Holland to explore possible European cooperation in computer research and development. This proposal follows the lines suggested by J. J. Servan-Schreiber, a Frenchman, in a book that long topped European best-seller lists and that caused much comment here.

IBM presently dominates the European computer market. It has about 70% of the market in West Germany, France, Italy, Sweden and Holland. International Com-

puters, which recently acquired the computer section of English Electric Co., has about 50% of the British market.

Siemens has dipped into the continental computer market by buying some 100 RCA Spectra 70 systems and then reselling them; it plans to develop its own line. Philips also plans to come out with a line of five systems, ranging from small to large scale. Its first entry was in the medium range, and a gradual build-up is expected. Philips, too, has bought American machines from Honeywell and then competed for sales against Honeywell, according to Claude Smith, general manager of the company's New Information Services Div.

France, which has been trying to develop its own national computer industry under Plan Calcul, has not been very successful, Smith says. French businessmen are not backing the nationalistic effort, preferring instead to do business with American companies.

Servan-Schreiber suggested that computers are the key to the future of industrial strength. Thus, he believes if Europe did not mount a united effort the United States would gradually assume greater and greater dominance over European affairs.

According to International Computers, Ltd., the six countries mentioned earlier had a payments deficit of \$72 million in computers (imports over exports) in 1967. This will rise to about \$96 million by 1975. A coordinated effort, according to the company, could create a surplus of \$312 million by 1975, expand European computer output by \$672 million, and create 60,000 additional jobs.

## Explorer I—11 years old

America's first satellite, the Explorer I that was launched into orbit on Feb. 1, 1958, completed 60,000 Earth revolutions as it ended its 11th year in orbit. The craft—modest by today's standards, it measures only 6 inches in diameter, 80 inches in length and weighs only 30.8 pounds—was never expected to last much over six years in orbit. It is now expected to say a fiery goodbye to space this year.



**Rectifiers, diodes, SCRs and Zeners  
from Power House distributors.**

For those commercial and industrial applications where both performance and price are critical parameters, International Rectifier offers the industry's most complete line of high reliability power rectification components in low cost, rugged plastic packages.

For instance, our proprietary 21PT half-wave rectifier unit: only about ¼-inch square, it replaces stud-mounted DO-4 rectifier packages up to 15 amps, at a fraction of their size and cost.

And we have rectifier bridges from 1 through 10 amperes. We offer diodes, SCRs, zeners. Even plastic Klip-Sels, our handy surge arrestors for use with our other power components. Everything you need, at the price and performance you want, and available now from your Power House distributor's shelves.

**INTERNATIONAL RECTIFIER**



**Plastic  
power.**



# winning form

from the  
form-factor  
specialists  
at Damon

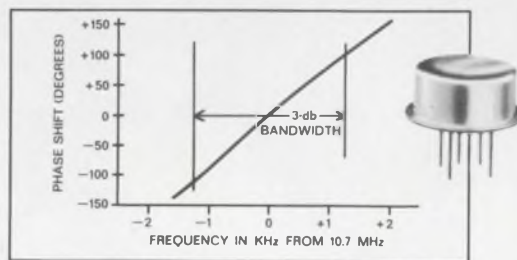

Take all the virtues of conventional Gaussian or Bessel filters . . . add monolithic construction . . . and you have the new **Damon line of Monolithic Gaussian Crystal Filters**. They're smaller, more reliable, and less costly than previous designs. And they're the ideal filters for minimum delay distortion in FM, non-overshooting pulse response in radar systems, and reduced ringing in swept-frequency applications.

The Damon Model 6354MA, for example, is a four-pole design housed in a cold-welded TO-8 enclosure. Specifications: Center frequency ( $f_c$ ): 10.7 MHz. 3-dB bandwidth: 2.5 KHz. 40-dB bandwidth: 17.5 KHz max. Source impedance: 500 ohms resistive. Load resistance: 2 kilohms resistive. Insertion loss: 9-dB max. Impulse response: Gaussian shape, ringing >35-dB down. Package: TO-8 (.580" dia. x .260" high).

Whatever your signal shaping needs . . . from a Gaussian curve to a sharp rejection notch . . . rely on the form-factor specialists at Damon. Write: Electronics Div., Damon Engineering, Inc., 115 Fourth Ave., Needham, Mass. 02194, or call (617) 449-0800.

## DAMON



# Accusations rocking the aerospace industry

## Officials challenging report by Budget Bureau analyst of deficiencies in electronic systems

**Charles D. LaFond**, Chief  
Washington News Bureau

"A growing and prosperous nation can afford many luxuries, but the low over-all performance of electronics in major weapon systems developed and produced in the last decade should give pause to even the most outspoken advocates of military hardware programs."

With this introduction, Richard A. Stubbing, an analyst in the U. S. Bureau of the Budget, begins a graduate-study thesis that might have remained covered behind the ivy walls of Princeton University but for the fact that it was reviewed publicly by a Washington newspaper late in January. It is now being circulated, unabridged, by the hundreds throughout the country.

In part, the Stubbing paper, titled "Improving the Acquisition Process for High Risk Military Electronics Systems," charges:

- The performance of major weapons systems in the 1950s was poor; in the 1960s it was worse.

- The faulty performance results largely from the unreliability of overly complex electronic sub-systems.

- Aerospace prime contractors obtain profits on defense programs that greatly exceed the average non-defense industrial return.

- Major contracts are awarded to aerospace companies despite their records of poor performance in meeting program requirements.

To reverse these trends, the author recommends a return to the competitive development approach employed by the Government more than two decades ago—that is, after examining definitive system needs and narrowing potential manufacturers in the contract definition stage, the Government should pick two suppliers to continue through to prototype development.

This step would be followed by rigorous system tests. A prime contractor would be selected on the basis of performance on each identified risk area for major sub-systems. The minimum development time prior to procurement should be from five to seven years, Stubbing suggests.

He further proposes early establishment of a second procurement source "to provide an element of competition in the award of annual requirements."

Major contractors queried by

ELECTRONIC DESIGN take sharp issue with Stubbing.

### Major failures reported

The Government analyst, who wrote this controversial thesis while studying for a master's degree at Princeton during a year's leave of absence from Government service, draws a grim picture of past weapons systems development and performance. Nine of a sample of 13 major Air Force and Navy aircraft and missile programs started since 1955 show dismal reliability, he asserts. Combined, they required a total expenditure of \$40 billion, he reports.

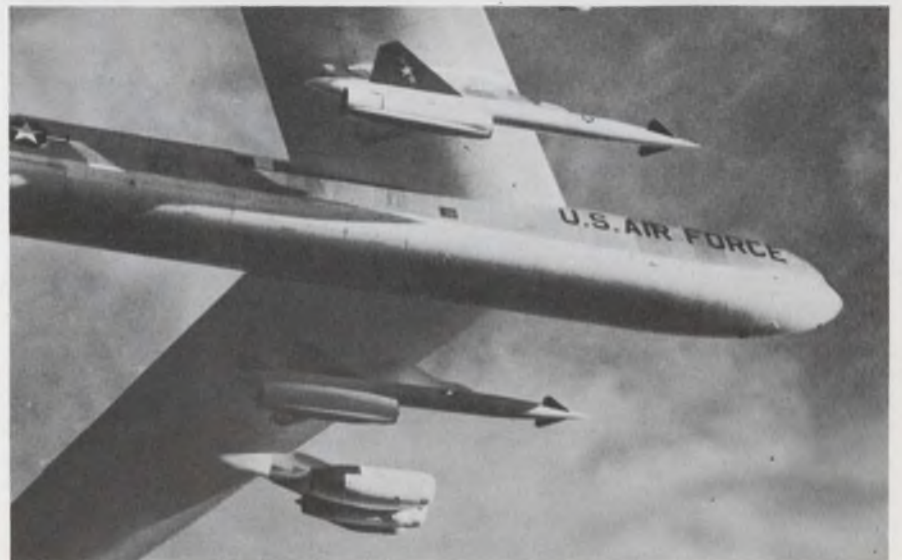
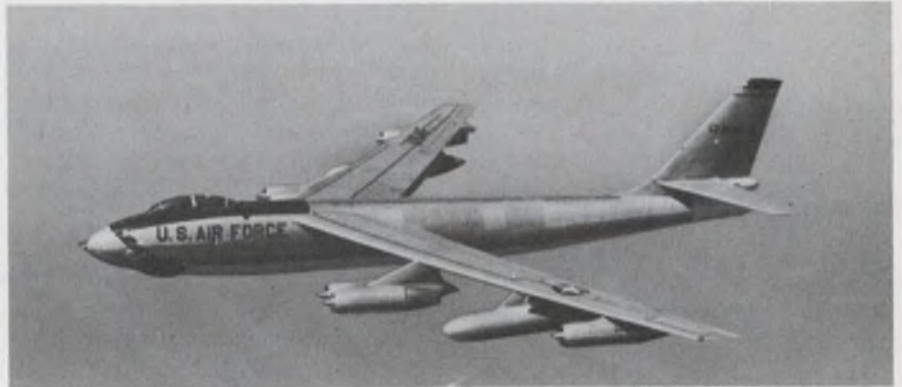

The electronic systems aboard the retired B-47 (above) had one of the lowest reliability figures of any major aircraft system, according to aerospace critic Richard A. Stubbing. The B-52 (below) received a high rating.



*(Aerospace, continued)*

Two programs, costing \$2 billion, were canceled, Stubbing says. Two, costing \$10 billion, had only a three-year operational life and were phased out because of low reliability, he continues. And five, he says, that cost \$13 billion had electronics reliabilities of less than 75 per cent of that required contractually.

"Less than 40 per cent of the effort produced systems with acceptable performance—an uninspiring record that loses further luster when cost overruns and schedule delays are also evaluated," Stubbing asserts.

Stubbing notes the increasing complexity of weapons electronics following World War II and the tendency to stretch the state of the art. Emphasis grew, he says, for more automatic fire control and all-weather capability for aircraft, and by 1967 costs rose by factor of 15 over those in 1955. Similarly, as missiles progressed from using ground radio control, to on-board inertial systems for guidance and control, their costs soared.

### Conclusions are challenged

ELECTRONIC DESIGN has questioned officials at General Dynamics, General Electric, Northrop, North American Rockwell, Sylvania, United Aircraft and Westinghouse.

Most have challenged the conclusions in the Stubbing paper and all have requested anonymity.

In particular, they note his reference to the two multibillion dollar programs canceled, presumably the supersonic B-70 nuclear bomber and the long-range Skybolt air-to-surface missile. Neither weapon, they say, was dropped because of deficient electronics.

One expert close to the program reports the B-70 never did have its full complement of avionics. The program emphasis was on the development of a radically advanced supersonic, high-altitude aircraft, he says. Most of the electronics aboard the craft were used to support the night testing, he notes, and the B-70 avionics that were employed were subjected to tests far more stringent than those required by the specifications. They proved successful, he asserts.

The huge bomber reportedly was canceled because of a change in strategic requirements. The craft was intended for global high-altitude penetration. Advances in detection radars and anti-aircraft missile defenses dictated low-altitude intrusion. Moreover, under the then Secretary of Defense Robert S. McNamara, the military emphasis switched from bombers to ICBMs.

The Skybolt cancellation was based on more complex political-military policy decisions. The present Defense Secretary, Melvin R. Laird, emphatically denies that

the cancellation was in any way associated with electronic deficiencies, as implied by Stubbing.

Industry officials point out that the paper totally neglects the pressures created by a strategic weapons race in the mid-1950s. Following the Korean conflict, U. S. weapons progress was slow. Long-range bomber forces were limited, as were intermediate-range ballistic missiles. The only intercontinental ballistic missile nearing deployment was the Snark, a subsonic air breather similar to a jet drone.

On the other hand, the Soviet Union had developed, earlier than expected, both high-yield nuclear weapons and high-thrust, long-range ballistic missile systems.

A crash program was instituted by the U.S. for concurrent development of three ICBMs—the Atlas, Titan and Minuteman. Each made use of different propulsion systems, reflecting the state of the art of fuels: Atlas used liquids, Titan liquid storables and Minuteman solid fuel.

The associated electronics, too, reflected the state of the art and the deployment needs. The first Atlas series used ground radio command for guidance and navigation. Follow-in Atlases, Titan and Minuteman used progressively more advanced all-inertial guidance systems to reduce response time and to negate the effects of radio blackout following any surprise nuclear attack.

Similarly new aircraft programs had to contend with substantial technological improvements in electronic countermeasures, new missile interception systems, long-range radar detection and discrimination capabilities.

Sophisticated weapons and defenses demand counter sophistication. Stubbing, industry spokesman declare, ignores these influences while damning complexity as an unnecessary luxury.

### MTBF, a common denominator?

Stubbing defines "high risk" in the development of electronic systems as a condition wherein a major component must be redesigned to permit development of the weapon system. He also uses one parameter to assess performance—Mean Time Between Failure

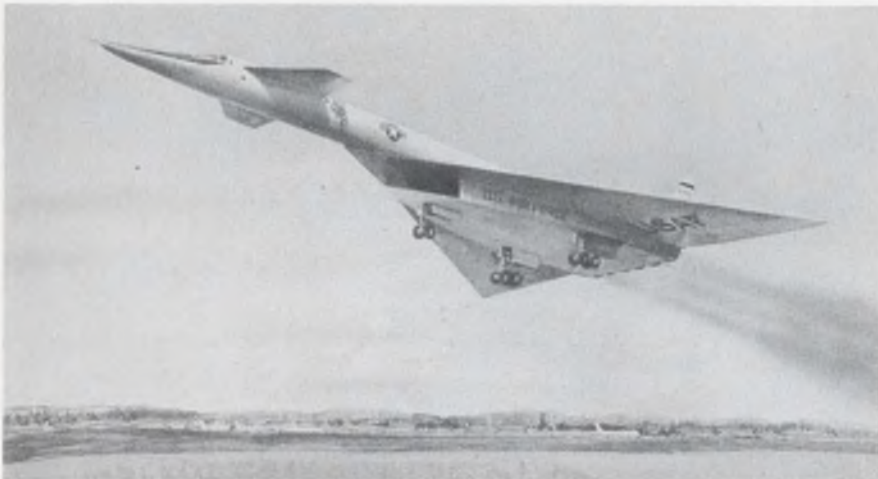

The B-70 is one of several multibillion-dollar programs canceled in recent years. Stubbing reports the program was dropped because of deficient electronics, but industry spokesmen vehemently deny the charge.

# First second source

(Immediate delivery on 54/7400 IC's, even hard-to-get ones.)

Some people think 54/7400's are primarily a secondary interest with us. (New designs should be using our DCL line, of course.)

But our 54/74's are so good some people are coming to us as a second source first.

The reasons are simple:

First, we've got a good broad line. Second, we can deliver them *all*, in volume, even the hard-to-get ones.

Third, we've got a superior package, silicone instead

of epoxy. Fourth, we can guarantee the same kind of reliability you'd get in our proprietary lines.

Fifth, it's all backed by our excellent sales and service organization. And sixth, for 54/74's that makes us the first second source.

**Signetics Integrated Circuits**

A SUBSIDIARY OF CORNING GLASS WORKS

811 East Arques Ave., Sunnyvale, California 94086



**We're the easiest place to get hard-to-get-ones**

Quad 2-Input NAND	5401/7401
Dual 4-Input Power NAND	5440/7440
BCD-to-Decimal Decoder/Driver	7441
Quadruple Bistable Latch	5475/7475
Full Adder	5480/7480
8-Bit Shift Register	5491/7491

**And not quite so hard-to-get-ones**

Quad 2-Input NAND	5400/7400
Quad 2-Input NOR	5402/7402
Triple 3-Input NAND	5410/7410
Dual 4-Input NAND	5420/7420
Eight Input NAND	5430/7430
Dual AND-OR Invert w/Expander	5450/7450
Dual AND-OR Invert without Expander	5451/7451
Single 4 wide 2-Input AND-OR Invert Gate Expandable	5453/7453
Quad 2 AND-OR Invert Not Expandable	5454/7454
Dual 4-Input Expander	5460/7460
Single Phase J-K Flip Flop	5470/7470
Single M.S. Flip Flop	5472/7472
Dual M.S. Flip Flop	5473/7473
Dual D Flip Flop	5474/7474
Dual M.S. Flip Flop Preset & Clear	5476/7476

And there are more to come.

**Call your nearest Signetic's Sales Office or distributor.**

See us at IEEE, booth number 3A01 to 3A04

INFORMATION RETRIEVAL NUMBER 19



(Aerospace, continued)  
(MTBF).

He rates performance in terms of actual MTBF attained, as compared with the specified MTBF in the program contract. He further groups the resulting percentages "for simplicity" in "quartiles." Thus, if a system MTBF percentage falls between 13 and 37 per cent, he lists reliability as 0.25; between 38 and 63 per cent as 0.50;

64 to 89 per cent as 0.75; 90 to 115 per cent as 1.00; etc.

In 12 weapon systems deployed during the 1950-1960 period. Stubbing shows the following reliability for their electronics:

Aircraft			
B-47	(0.25)	B-52	(1.00)
B-58	(0.50)	F-100	(1.00)
F-102	(0.50)	F-104	(0.75)
F-4	(1.00)		
Missiles			
"A"	(0.50)	"B"	(0.25)
"C"	(1.25)	"D"	(0.50)

Sidewinder (1.25)

All are considered high-risk except the B-52, F-100 and F-104. Stubbing does not identify any of the missiles, except the infrared-homing, air-to-air Sidewinder, but he notes that missiles A, B, and C were produced under concurrent crash programs and were operational on time. No comment is made on missile D.

Current electronic systems (1960-1970) have become progressively worse, Stubbing charges. ■■

## The sensational Stubbing report: How it developed

Who is Richard A. Stubbing, and how did his thesis gain such wide publicity?

Stubbing is a 38-year-old Bureau of the Budget examiner who was selected to attend the Woodrow Wilson School at Princeton University in 1967-68. In his work with the Budget Bureau, Stubbing, a Grade 14 employe, was an examiner of Air Force and Navy aerospace weapons programs.

Thus it appears that he carried with him to Princeton a fund of privy information concerning military development and procurement contracts, much of it classified, as well as study reports prepared previously by several national authorities.

With these data and his own accumulation of information gathered during his five years at the bureau and during a previous four-year stint as a cost engineer with Eastman Kodak, Stubbing subsequently wrote and submitted a master's-degree thesis, "Improving the Acquisition Process for High Risk Electronics Systems," dated May 3, 1969.

From that time onward, the facts become muddled.

Last November the Joint Subcommittee for Economy in Government, headed by Sen. William Proxmire (D-Wis.) held hearings on Defense Dept. contracting procedures and defense industry profits. Among the many who testified was Col. Albert W. Buesking, a retired Air Force officer, then a lecturer in public administration at the

University of Southern California. Previously the colonel had been with the Air Force Office of Controller in the Pentagon.

Colonel Buesking revealed a picture of unusually high profits on over \$8 billion of Minuteman ICBM contracts from 1958-1966. He cited after-taxes profits on the missile system program of over 20 per cent, or nearly double what he termed the general industrial average.

More to the point, he referred to an unpublished document that he described as prepared by a "Bureau of the Budget Analyst," and he quoted from it. "The current special partnership which exists between Government and the aerospace industry not only results in a very high incidence of delivered electronics systems with degraded performance, but there are not effective mechanisms in contractual arrangements to reward or penalize contractor performance."

The quotation is from Page 25 of the Stubbing thesis, except for a slight paraphrase of the italicized portion (Stubbing said "is no effective mechanism").

Shortly after this testimony, it was reported that the Budget Bureau had "no knowledge of the document" cited by Colonel Buesking.

Nothing was heard publicly of the Stubbing paper until a summary of its entire contents was revealed in an exclusive story in the Washington Post by Bernard D. Nossiter last Jan. 26. He withheld Stubbing's identity but referred to the author as "a key

Government official with access to secret data and responsibility for examining the costs of the Pentagon's complex ventures."

How the paper found its way to Nossiter has not been revealed. However, the most persistent rumor throughout Washington industrial offices is that a top aid on the Proxmire subcommittee staff placed a copy of the Stubbing thesis in the hands of Nossiter on Jan. 24.

Response to the revelations of poor electronic weapons performance and high industry profits was rapid. The newspapers and magazines cautiously rewrote the story and credited the *Washington Post*. A national TV commentator did the same but labeled the paper "junk."

The Electronic Industries Association obtained a copy of the thesis and reportedly sent out further copies to its member companies. It is awaiting their reaction.

William H. Moore, the EIA's vice president and director of its Government Products Div., acknowledges that release of the paper may lead to a Congressional inquiry "and is a threat to all military programs."

EIA's counterpart, the Aerospace Industries Association, is also waiting for member comments. An AIA spokesman, Carlyle Jones, notes that the publicity may add impetus to a bill introduced by Rep. Chet Holifield (D-Calif.) to establish a Hoover-type commission to study the entire Government procurement process.

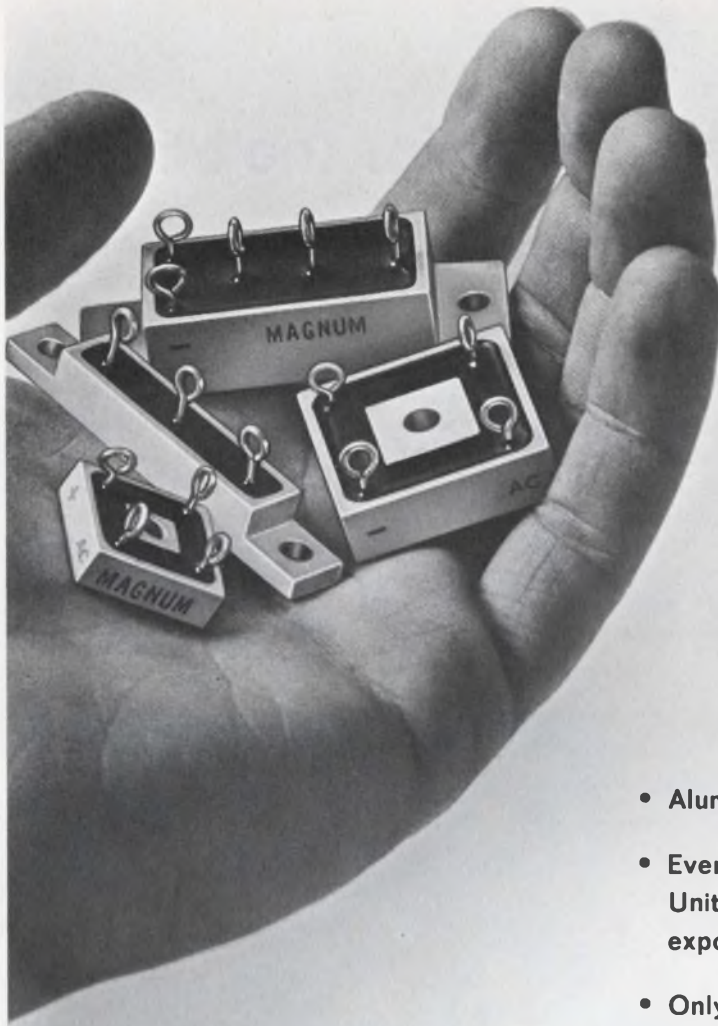

The "inside-out" bridge --  
the first  
high-current  
rectifier assemblies  
designed for reliability  
from the inside out...  
and priced competitively

- Aluminum package optimizes heat dissipation.
- Every chip individually fused in glass in a complete Unitrode monolithic package, so . . . silicon is not exposed to possible contamination by plastic filler.
- Only controlled avalanche rectifiers used.
- Terminal pins directly connected to silicon make direct thermal path — not only to case, but to lead wires — thus lower junction temperatures.

- #678 Series Three Phase 25 Amp Bridges
- #679 Series Single Phase 25 Amp Bridges
- #680 Series Single Phase 10 Amp Bridges
- #681 Series 15 Amp Doublers and Center Tap Rectifiers

PIV'S to 600V.  
4 different packages  
6 circuit configurations  
All available in regular,  
fast, or ultra-fast recovery

THE MAGNUM RECTIFIER ASSEMBLY by

**UNITRODE**

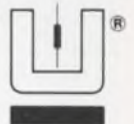

580 Pleasant Street, Watertown, Massachusetts 02172 • (617) 926-0404

IN ITS HEART, YOU KNOW IT'S RIGHT . . .



Actual Size

HERE'S WHAT IT LOOKS LIKE INSIDE

Even before it's potted, the Magnum has all the toughness, reliability, and electrical characteristics of the unique Unitrode fused-in-glass diode as the heart of its construction.

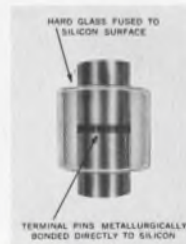

HERE'S WHAT IT LOOKS LIKE INSIDE THE INSIDE

With the silicon die metallurgically bonded between terminal pins of the same thermal coefficient, the hard glass sleeve is fused to the entire outer silicon surface. Result — a voidless, monolithic structure.

For fast action, call Dave Greene COLLECT at (617) 926-0404.

INFORMATION RETRIEVAL NUMBER 20



# Reading aids brighten outlook for the blind

**Machines under development scan printed letters or words and provide a tactile or speech output**

**Elizabeth deAtley**  
West Coast Editor

"By the year 2000 I'll be able to move a probe or pick-up across the pages of a book and listen while a computer reads aloud to me from the page." So says Eugene Apple, blind chief of the Western Blind Rehabilitation Center, Veterans Administration Hospital, Palo Alto, Calif.

"A machine like that," he says, "would give the blind person what he has never had before—complete privacy. He could read anything—a personal letter, a periodical, or even the label on a can—without having to call in the neighbor or his Aunt Susie to read it to him."

The blind person can never hope to achieve comparable independence with Braille. Although reading rates can be high—over 200 wpm (100 wpm is average)—Braille is so difficult to learn that only about 10 per cent of all blind persons ever master it. Many use Braille only for specialized, simple tasks—like playing cards. Furthermore not all books are published in Braille, and few periodicals are available in it.

What efforts are engineers making to design a talking reader for the blind person? Must he wait, as Apple suggests, until the year 2000? Or is a system almost ready for him now?

Researchers in this field are following three main design approaches. They are attempting to develop:

- A low-cost, semiportable machine, with simple circuitry, that translates printed letters into a "tone code" that the blind person can hear, or into a "touch code" that he can feel with one hand. The user must learn to interpret the aural or tactile sensations, and so far the reading rates have been disappointingly low—10 to 35

words a minute, even after long practice.

- A nonportable machine that scans the printed page and produces speech output. The equipment includes an optical character recognizer, a speech synthesizer and a control computer. Too large and costly for individual ownership, it could be used in libraries

or schools to translate books and periodicals.

- The best of both worlds—a fully portable machine that could be hooked into a central computer at will through time-sharing. It would scan printed pages and produce speech.

These experimental machines have already been built:

- A semiportable tactile system composed of two units: a probe or scanner, and a stimulator. The blind person moves the probe



To use the Bliss-Linville portable tactile reading aid, the operator moves the probe along the line of print and feels a bundle of stimulator pins vibrating in the shape of the letters. The light display box is used for visual troubleshooting.



across the printed page with one hand and, by placing his other hand over the stimulator, receives vibrations in the shape of each letter. The machine was designed by Dr. James C. Bliss, manager of the Bio-Information Systems Group at Stanford Research Institute, Menlo Park, Calif., and Prof. John G. Linvill, head of electrical engineering at Stanford University.

■ The Cognodictor, a speech machine developed by Mauch Laboratories of Dayton, Ohio. It scans printed pages and spells out each word.

■ A speech machine developed at the Research Laboratory of Electronics, Massachusetts Institute of Technology. It scans texts and can recognize 40,000 different words, which it pronounces in real time with appropriate pauses and intonations.

Dr. Bliss and Professor Linvill believe their tactile machine can be adapted for speech and ultimately be linked to a time-sharing computer system.

"We have in mind," says Dr. Bliss, "that a person will have one of our reading aids to use as a stand-alone device, so he can read anywhere, though perhaps at a relatively slow rate. Then if he's near a phone, there will be another attachment that he can plug in, allowing him to call a central system and have it read aloud to him."

### The letters tingle

To use the present Bliss-Linvill instrument, the operator moves a probe across the page with one hand and, with the index finger of the other (see photo), feels a bundle of stimulator pins that vibrate rapidly in the shape of letters. There are enough pins so that the operator can feel all or most of a letter at the same time.

This instrument seems to have a considerably higher potential reading rate than other tactile machines. After about 100 hours of practice, Dr. Linvill's teenage daughter Candy, who has been blind since infancy, reads at 35 wpm. This is as fast as a blind adult could expect to read Braille after instruction for the same length of time. Dr. Bliss believes the secret

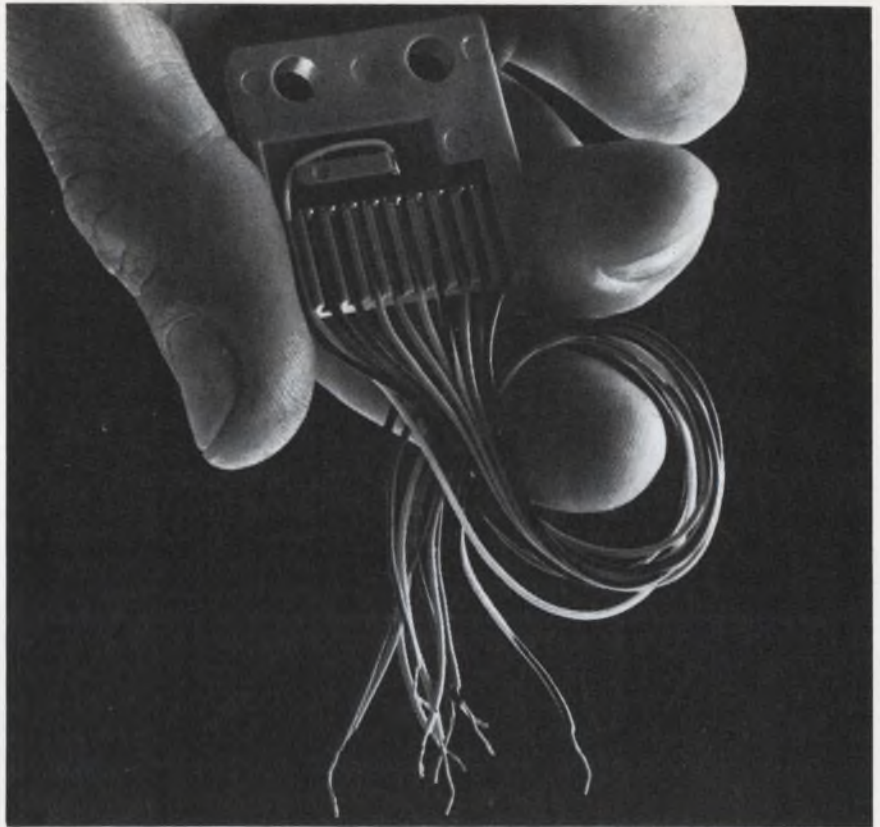

**We'll even send your light sensors in a sealed package.**

### For top security.

That's our specialty. We were the first company to mount fragile light sensor devices in custom-designed, secure, durable packages. And we're the most experienced at producing them for commercial applications. Our skilled personnel use our specially-designed precision equipment to place and wire the sensors in your package. We save you the handling risk . . . and the time. You can buy anything from a single cell in a TO-18 can up to a special 960-position, plug-in, full-card reader. Or an array for a tape reader, or a badge or key recognition system. We'll even design for your special application we may never have heard of before. We'll package it securely, color-code it, design it so it can be easily incorporated into your system. But first we have to know what that is. Send your requirements to the engineering design department of Solar Systems Division, Tyco Laboratories, Inc., 8241 N. Kimball Avenue, Skokie, Illinois 60076. Or phone (312) 676-2040.

# TYCO

ON READER SERVICE CARD CIRCLE 21



(Blind, continued)

of his machine's practicality lies in the large number of stimulators—144 compared with a single row of eight in earlier models. He has found, in fact, that speed is a direct function of the number of rows of stimulator columns being used (each column contains 24 stimulators).

At present the instrument costs between \$6000 and \$7000 to produce, including labor, Dr. Bliss reports, but he believes it can be mass-produced for considerably less.

### ABC's on the go

Another approach to the personally owned reading machine is the spelled-speech output. A laboratory prototype of the Cognodictor spells aloud at the rate of 80 to 90 wpm. It was developed by Mauch Laboratories under the auspices of the Veterans Administration. Dr. Hans A Mauch, head of the company, points out that to make sense out of the rapidly spelled letters, "you must learn a vocabulary of spelled words, so that when the machine

says 'p-a-r-t-y,' your mind clicks and you think 'this is party.'" Tests conducted by Prof. Milton Metfessel of the University of Southern California indicate that it is possible to understand spelled speech at this rate, says Dr. Mauch.

The Mauch machine has a pre-recorded vocabulary consisting of 26 letters and certain additional signals for special purposes. It recognizes 26 upper- and lower-case letters in nine different styles of typography, but it cannot identify numerals or punctuation marks.

The instrument consists of two parts—a hand-held probe that the operator moves across the page, and a separate box that contains character-recognition circuitry, a drum for storing prerecorded spoken letters, a loudspeaker and a light panel for trouble-shooting. A new prototype that is being designed will be the size of an office typewriter but somewhat lighter in weight, says Glendon C. Smith, designer of the system.

The hand-held probe of the Cognodictor is called a Vistotactor. It is similar in principle to the Bliss-Linville device. The operator moves it along the line of print

and feels the vibrations of a single row of eight stimulators—two on each finger. As the probe moves over an "H," for example, six stimulators vibrate, then a single one in the middle, and finally the same six again. The operator uses this instrument to ensure proper alignment and to identify symbols that the machine misreads or fails to recognize. The Vistotactor contains a mechanism for adjusting the magnification, so that a wide range of type sizes can be read. The instrument can also be used as a "stand alone" device, if desired, but the reading rate is low—10 to 15 wpm.

At present only a single operator has used the machine extensively, Smith points out. The last time this operator was tested—after about 200 hours' practice—she read 32 wpm on a single line, Smith says, and averaged 23 to 24 wpm for a whole page.

### A dream come true?

The experimental machine developed at MIT is reported to have an error rate of less than 0.3 per cent as it scans and recognizes the 40,000 different words and pronounces them.

The system is surprisingly compact, in view of its complexity. The total bulk—flying-spot scanner, a small general-purpose computer, and the speech synthesizer circuitry—is about the size of two grand pianos and two TV sets.

The machine scans words on the page and translates them into phonemes, or speech sounds, according to rules contained in a built-in dictionary. Then, following programmed instructions, it translates the phonemes into electronic control signals. The speech output sounds quite mechanical—like a pipe organ talking—but it is clearly recognizable.

The built-in dictionary does not list all possible forms of every word—such as love, loving, lovely, etc., says Prof. Francis Lee, one of the designers of the system. This would require too large a memory. Instead, it contains root words, prefixes and suffixes. Thus the machine can break a word that is not in the dictionary into separate parts and consult the dictionary for the pronunciation of each part. For example, Professor Lee

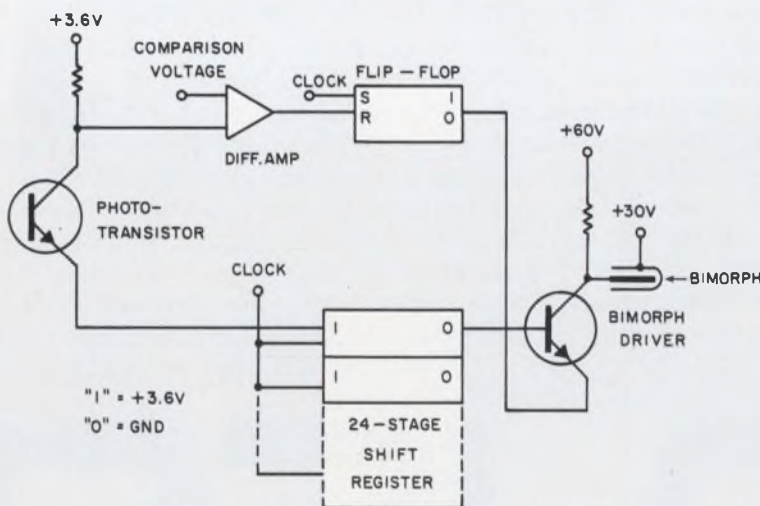

1. A single channel of the circuitry in the Bliss-Linville reading aid connects a phototransistor to a corresponding bimorph driver. A bimorph is a reed that has the property of bending when a differential voltage is applied. A 24-bit shift register clocked at 4800 Hz, multiplexes corresponding arrays of 6 by 24 phototransistors and 6 by 24 bimorph drivers. If the base of a phototransistor is dark at a given bit time, the bimorph driver turns on, bending the bimorph and lifting the stimulator pin attached to it. Each dark area beneath the probe causes the corresponding stimulator pin to vibrate 200 times per second.



says, the machine would break the word "lovelier" into the root word "love" and the suffixes "li" and "er."

But suppose the dictionary does not contain the root word "love"? In this case, says Professor Lee, "the machine will apply the phonic rule that the final 'e' is mute and will probably says something like 'lohvelier,' because it won't recognize that the 'o' is pronounced 'uh.'"

In fact, he points out, the machine would attempt to apply phonic rules even to a string of consonants—like czprt. "It would probably blindly put all these consonants together," he says, "and come up with a sound no human being could produce."

This machine does what the blind person wants—it reads aloud from any text he chooses. But what about the cost? Could an individual ever hope to own one? Not, its designers think, within the next five or ten years, but they do expect to see it used in libraries and schools for the blind within that time.

"What about time-sharing?" asked the VA's Eugene Apple when he heard about the MIT system. "You'd only need one computer for the whole San Francisco Bay Area and all the blind people around here could use it at the same time!"

Dr. Bliss agrees. He points out that the blind person could use such a system for many purposes besides merely reading from the printed page. For example, he says, "If you want to send a letter to a blind person now, you have a problem. You aren't about to write it in Braille, and if you type it or write it in longhand, the blind person has to get someone to read it to him. If there was a time-sharing facility available, you could call up the center and say, 'I'd like to leave a message in so-and-so's file.' Then you would type the message and it would be relayed to him."

Dr. Bliss and other researchers at the Stanford Research Institute are setting up simulation studies to determine whether blind users can tolerate the delays inherent in a time-shared system, when combined with the mechanical computer speech. ■■



## Chassis-Trak Slides ... where it really counts!

See you at  
the IEEE  
Booth 1F02

Hard, cold-rolled steel makes Chassis-Trak Slides extra strong and cadmium-plating gives them protection against corrosion. Poxylube 75 dry-film lubricant continues to give smooth slide operation even after years of use . . . no matter what climate, what conditions.

Chassis-Trak Slides are instantly removable and interchangeable for in-

spection or emergency replacement when it really counts. Three basic slide designs—tilt, non-tilt, and tilt-detent—support up to 1,000 lbs., and permit thorough flexibility of use and application.

These are just some of the reasons Chassis-Trak is specified for military applications throughout the world . . . where it really counts. Why don't you find out why!

A package for every Major Missile Project from . . .

525 South Webster Ave., Indianapolis, Indiana

INFORMATION RETRIEVAL NUMBER 22

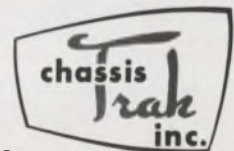



## Standard Circuit of the Month

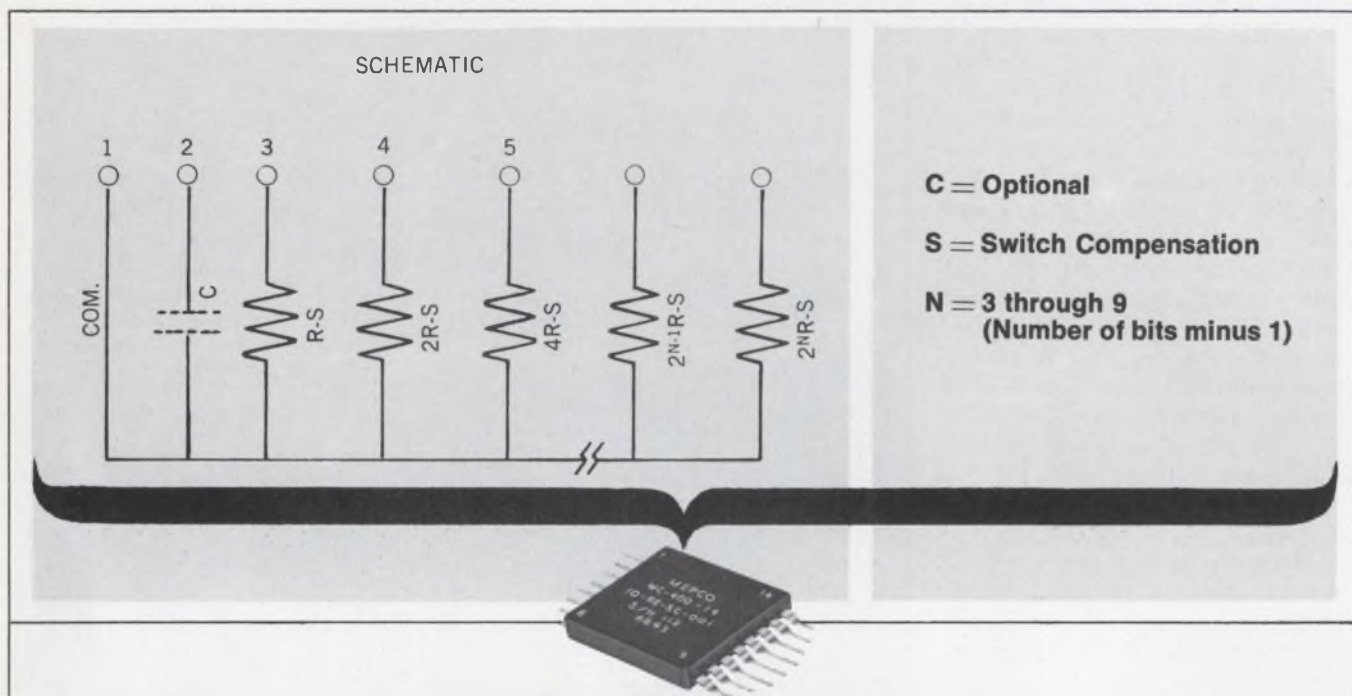

# D/A Binary Current Summing Ladder

- Resolution to 10 Bits
- Accuracy to 10 Bits ( $\pm \frac{1}{2}$  LSB)
- Standard Flatpack configuration

Mepeco Binary Current Summing Ladder Networks provide high speed, high accuracy conversion to within  $\frac{1}{2}$  LSB over a variety of standard temperature ranges. Available as factory stock in standard resistance values. These networks can also be compensated for specific switch requirements or adjusted for unique resistance values in accordance with customer specifications, assuring perfect mating with each customer's application.

When used in conjunction with current-controlling logic switches and a summing amplifier, the Mepeco current ladder provides digital to analog conversion to within  $\frac{1}{2}$  least significant bit. The

low profile, small size, modified dual in-line package assures close spaced board sandwiching and compatibility with automatic insertion equipment.

Standard DIP mounting pins furnish standoffs for ultrasonic board cleaning with extra leads provided for increased vibration and shock resistance.

Flatpack configuration offers an alternative attachment technique for integrated circuit compatibility. When used with a comparator, a buffer amplifier, and logic switches, the Mepeco current ladder also provides analog to

digital conversion.

Write or call for Data Sheet MC3—or talk to any MEPCO representative.

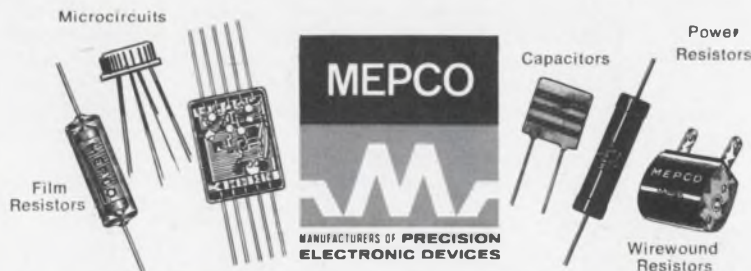



# At \$11,950, MAC makes every little bit count.

Why is MAC great, though small? Price, surely. But look at what else makes MAC the best Multi-Application Computer in its class:

Its standard 4K memory of 16-bit words is expandable to 65K. Fast? The fastest. Memory cycle time is 1  $\mu$ sec. Add, 2  $\mu$ sec. Full-word shift, 5  $\mu$ sec. Interrupt response, 6  $\mu$ sec. That's a big head-start: capacity and speed.

Now, add 72 basic hardware instructions and most-wanted options: hardware multiply/divide, automatic bootstrap, multiplex data channel, direct memory access channel. And MAC's programmed data channel has 255 I/O addresses.

Then consider a basic quartet of true-nesting priority interrupts, expandable to 64 levels if needed.

And MAC is compatible with almost any real-time systems environment—data communication and acquisition, instrumentation, automatic test, or you name it.

MAC's third-generation software and documentation are ready now, all checked out and debugged. FORTRAN IV, loaders, debugging and editing programs, utility routines, I/O drivers, and LEAP, a macro-handling assembler that's way ahead of others in the MAC class. Plus LEAPFORT, to prepare new MAC programs off-line on large machines, and

MACSIM, which lets you use a large computer to simulate MAC in operation.

In every feature and function, MAC gives the systems user his greatest measure of value. As a long-standing producer of computer memories and printed circuits, we've learned to make every little bit count. In performance, reliability and flexibility—and at a good price.

For more information, write to MAC, Lockheed Electronics Company, Data Products Division, 6201 East Randolph Street, Los Angeles, California 90022.

## LOCKHEED ELECTRONICS COMPANY

 A Division of Lockheed Aircraft Corporation

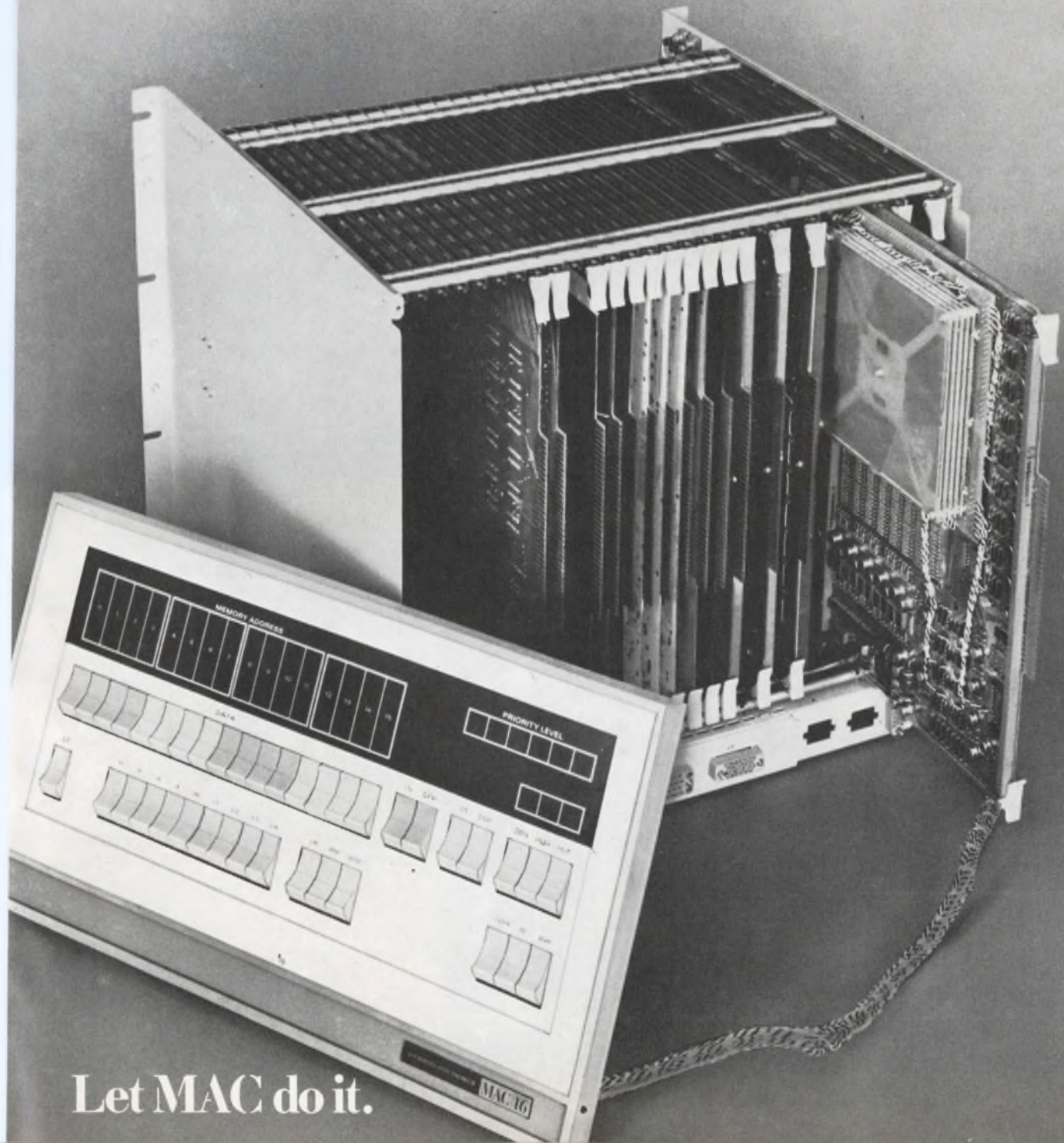

Let MAC do it.



# Air-defense display does more

'Friend or foe' determination simplified with versatile TV-type screen and digital computer

**John F. Mason**  
Military-Aerospace Editor

Photographs by Thecla

1. The TV-like display shows the geographical area (enclosed by broken lines) that the Buic III site in Fort Fisher, N. C., is responsible for defending should Sage, the first-line air-defense network, become inoperative. The area shown extends roughly from Washington, D.C., to Savannah, Ga. The blips are raw radar returns from aircraft. (No information about them has been requested from the computer.) The zigzag line (dead center) running through the air boundary forms the righthand side of an air corridor through which interceptors have been cleared to fly. The lefthand side of the corridor is the broken line that represents the coast line. This coast line is the only geographical data the operator has requested.

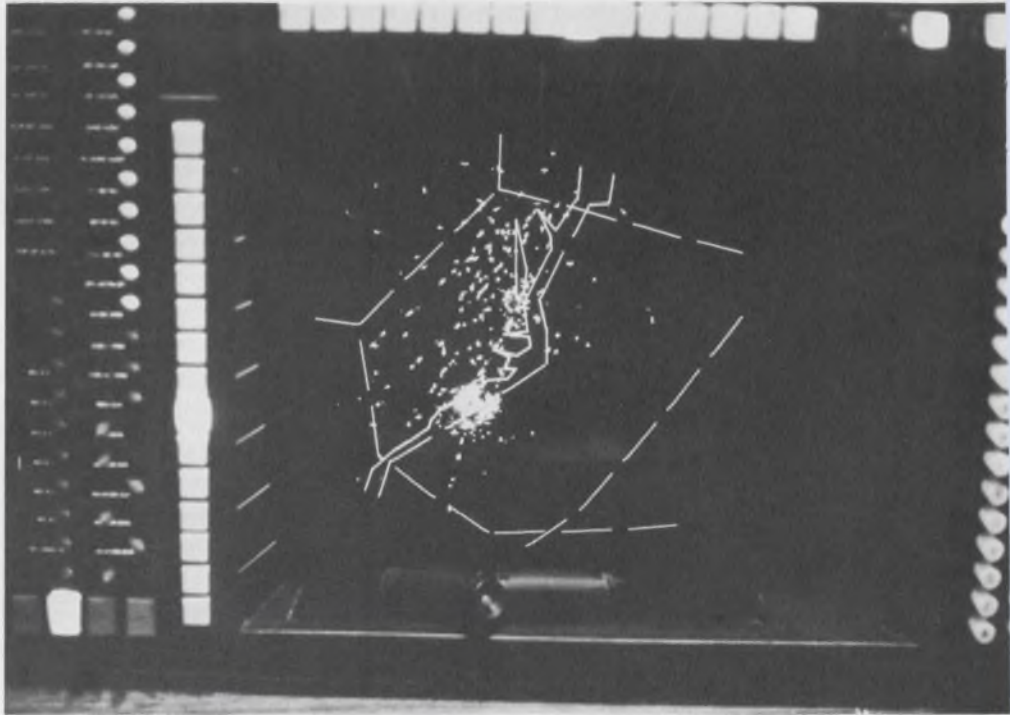

2. The same area, shown with different information. (In this display, the air-boundary lines have been removed.) The operator has just pushed the lighted button which shifts the entire scene to the center of his display. The other buttons in this row and along the top are used to center a particular area of interest. The aircraft displayed are no longer raw radar returns; they have been processed by the computer. Additional information appearing alongside each blip reveals the plane's altitude, heading and identification.

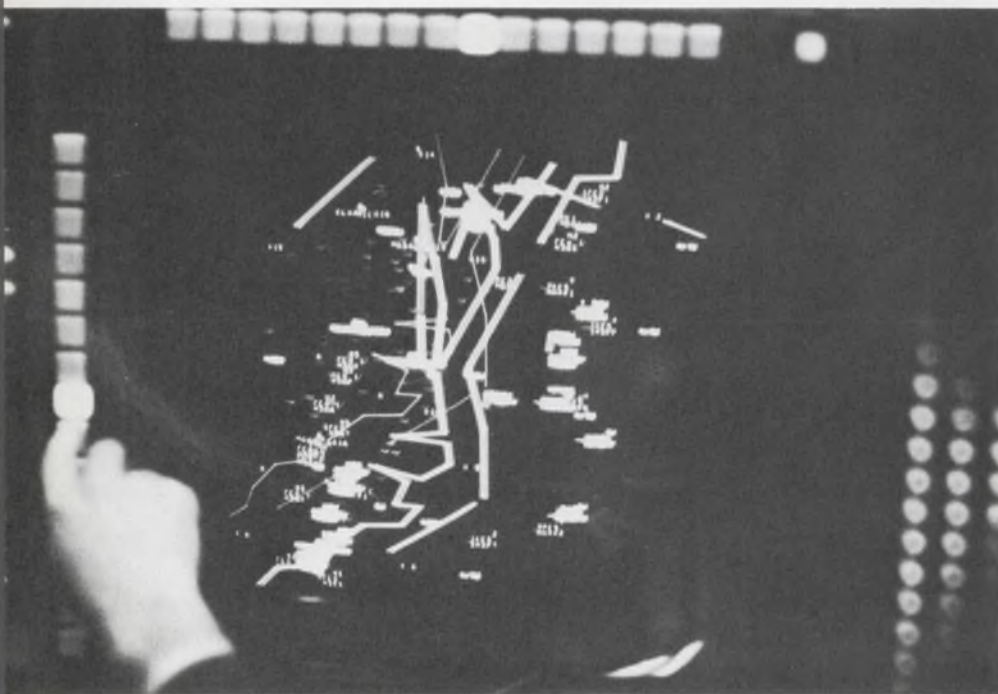



An Air Force sergeant, seated before a TV-type display, moves a small switch. Instantly, he sees a raw radar-picture of all the aircraft flying in his area. He flips another switch and these blips become aircraft symbols, processed by a digital computer that identifies each plane. A third switch brings forth data in alphanumeric form that reveal each plane's altitude, heading and speed.

One plane is not identified. Is it friend or foe? The operator points his light gun at the blip and asks the computer.

The computer checks through prefled flight plans but has no stored information about the plane. The computer then assigns the unidentified aircraft a number so it can be easily referred to by other operators in the Buic III network while they try to identify it.

Buic III, (for Back-Up Interceptor Control system) (ED Sept. 12, 1968, p. 25), is a network of 15 sites—13 in the U.S. and two in Canada—that, upon completion, will stand ready to command and control an air-defense operation if the first-line Sage sites should ever become inoperative. The first Buic III site was turned over to the Air Force at Fort Fisher, N.C., last month (ED 3, Feb. 1, 1969, News Scope, p. 21.)

The Buic III display, the newest data-display defense system to become operational, is considered to be a big jump over other displays—Sage displays, for example, are more than 10 years old—and could well dictate features that will appear in later displays. Buic III's versatility and capacity for displaying selective situations undoubtedly makes it desirable for a submarine sonar room, an airborne command and control system, and, of course, for other ground-based systems.

Other switches on the Buic III console will, at the sergeant's command, bring forth:

- A geographical map of the area;
- The air-space boundaries—geographical area of responsibility—assigned to a particular Buic III site;

*(Continued on page 38)*

# THE Gulton **BUTTON** FILTER



## EMI SUBMINIATURE DEVICES

ACTUAL SIZE



**SUB-MINIATURE BUTTON FILTER  
SOLVES MAJOR E.M.I. PROBLEMS!**

Developments in ceramic capacitor technology have made possible this further miniaturization of EMI high current, low pass devices. The **BUTTON** filter occupies less than 20% of the volume of a miniature broad band filter.

The **BUTTON** series guarantees a minimum attenuation (60 db at 10 MHz) with full load applied and no voltage derating up to 125°C. It consists of an L type network and has a 50 VDC and 15 amp rating. The **BUTTON** filter is supplied in a hermetically sealed or epoxy potted version.

For further information on the **BUTTON** series and other EMI filter devices, write for our catalog to:

**GULTON INDUSTRIES, INC.**  
Gulton Street  
Metuchen, New Jersey 08840

**Gulton Industries, Inc.**

Metuchen, New Jersey 08840 / Tel. (201) 548-2800 / TWX 710-998-0592



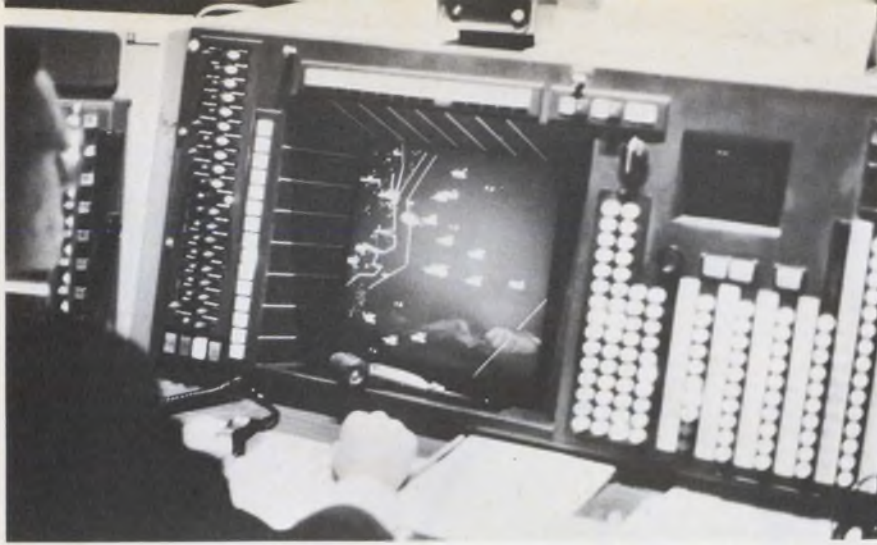

3. The operator has moved the scene off to the left so he can get a better look at several unknown aircraft (center screen). The vertical rows of buttons, at right, are used to query the computer. The operator may aim his light gun (lying at bottom of screen above his hand) on the unidentified blip and press a button to ask the computer to assign a number to the plane. He may push another button in this keyboard for data from a particular radar. Left of the screen there is a vertical row of square buttons that move the picture. Farther left, a vertical row of switches are used to add or delete categories, such as geographic displays, radar sites, airbases and raw data.

4. The communications console, to the left of the operator, permits him to talk with any other console operator in the room, with another Buic site, with a Sage site, or with any aircraft shown on the screen. Air-ground communications might go first by landline to the ground-air line-of-sight transceiver station that is nearest to the aircraft of interest. In the background, the big screen is a status display showing battle damage and weather.



- The airbases that stand ready to receive, rearm and refuel manned interceptors;
- Ground-air missile site locations, marked off by circles that describe their effective ranges;
- Radar sites, similarly depicted, with range areas described;
- Ground-air radio transmitters that operate in line-of-sight frequencies—which link the Buic III commander, by landline, to the radio station closest to the aircraft; the station, in turn, relays the ground-to-air communications between an airborne pilot and the Buic III operator.

Another handy feature of the new display is its repositioning ability. It can shift the picture on its screen—in a sense, change its visual perspective—to give the operator a better view. For example, if action is all on one side of the screen, the operator shifts the entire scene to the other side, thus putting the focal point of activity in dead center—right before his eyes.

The superiority of the Buic III display over that generated by Buic II is achieved by better computer programming and some extra hardware. Requiring only one-third more equipment than Buic II—mainly memory cores and drums—the new system generates twice as much information to twice as many operator consoles.

Burroughs Corp.'s Defense Group, Paoli, Pa., produced the display and the two D825 computers that generate the information. The Systems Development Corp. of Binghamton, N.Y., produced and installed the programming.

Each data-processing set consists of two D825 digital computers—one operates in an active mode while the other performs a diagnostic function. Each contains four drum memories, and each memory contains two independent memory modules—word-organized ferrite core arrays that operate with a read-write cycle time of 4.33 microseconds. Access time is 1.67 microseconds. Each memory holds 4096 words of 48 information bits and one parity bit, for a capacity of 32,768 words. ■■



# Put noise to work

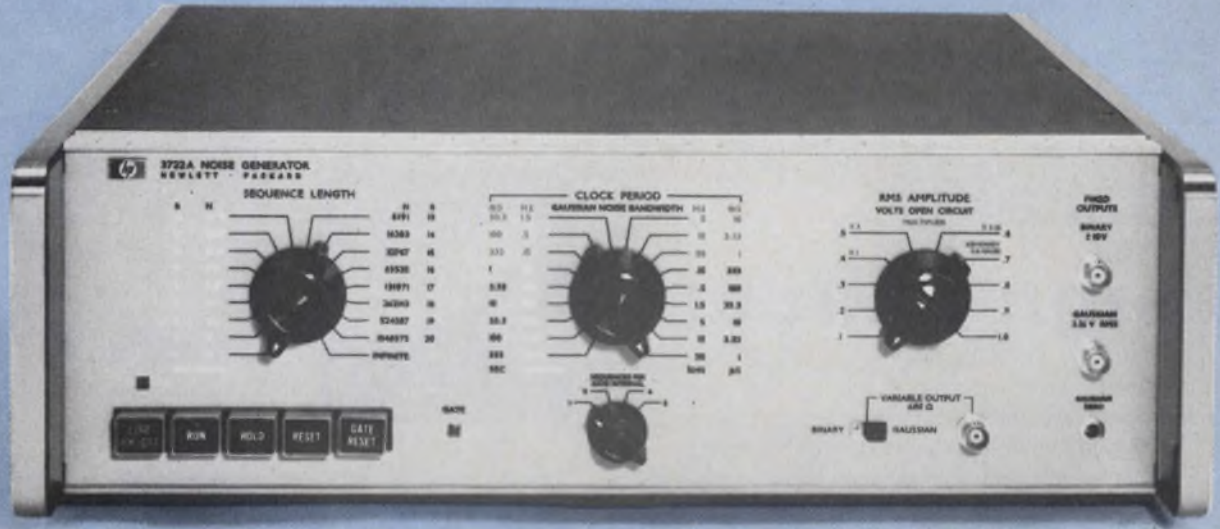

DC to 50 kHz, HP now offers calibrated, repeatable noise patterns, random or pseudo-random, constant power and excellent Gaussian distribution.

Write for Application Note 98-1, first in a series entitled "Noise at Work," this one discussing the design of process control systems.

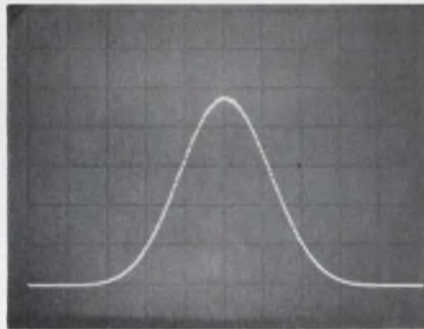

#### EXCELLENT GAUSSIAN DISTRIBUTION

Using HP 5400A Multi-Channel Pulse Height Analyzer,  $\pm 250$  mw; 1024 channels; Noise Generator: sequence length, 1,048,575; clock period, 3.33  $\mu$ sec.

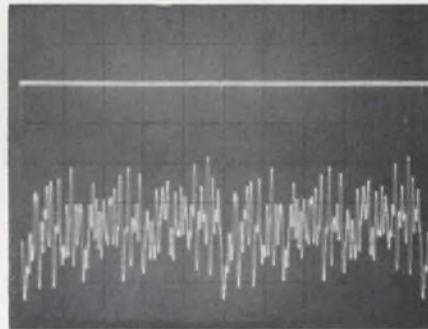

#### REPEATABLE

Sweep time of oscilloscope, 0.2 millisecc/cm; Noise Generator, 1023; sequence length, 1023; clock period, 1  $\mu$ sec.

The Hewlett-Packard 3722A Noise Generator now lets you harness noise so that it becomes a defined and calibrated input to your system. It allows you to synthesize and reproduce at will noise signals of constant noise power with a probability density function (pdf) in the classical Gaussian construction. This unique new instrument uses computer techniques to synthesize noise patterns of selectable length that are thoroughly defined and repeatable.

Because the 3722A employs a unique combination of digital and analog filtering, it is able to produce usable controllable power at low frequencies not previously possible. And, too, the digital nature of noise generation enables exact repetition of noise patterns of selectable length. This can save you hours of testing time, and you can test circuits, components or systems with confidence. System responses can be completely defined.

Ideal for such applications as control system response measurements, communications testing, acoustic measurements, temperature and flow fluctuations, study of air, water and earth turbulence—and other real-time analog simulation. HP 3722A, \$2650.

For more information call your local HP field engineer or write Hewlett-Packard, Palo Alto, Calif. 94304; Europe: 1217 Meyrin-Geneva, Switzerland.

18703A

HEWLETT  PACKARD

SIGNAL SOURCES



# When you need

# RF CAPACITORS,

# Centralab designs them

Need dependable ceramic dielectric capacitors to replace vacuum, oil-filled or mica units? **Centralab designs them.** Need capacitors that are stable at high temperatures? **Centralab designs them.** Need capacitors to handle high voltage and high current? **Centralab designs them.** Need small size capacitors with high capacitance? **Centralab designs them.** Need capacitors to operate at medium current and voltage? **Centralab designs them.** Need transmitting capacitors for plate blocking with high power transmitting tubes? Or high transmission line coupling? Or bypassing in high voltage circuits? Or neutralizing? **Centralab designs them, too.** In fact, Centralab custom engineers transmitter capacitors for industrial equipment, commercial and military transmitters of all kinds.

And ceramic capacitors from Centralab offer more custom-design features, last longer and are backed by more comprehensive application engineering skill than any other capacitor you can use. Don't let lesser capacitors shut down your equipment. Stay operational with Centralab.

To put the reliability of Centralab's ceramic RF capacitors to work for you, send reader service card today. Centralab's Application Engineering Department will contact you to discuss your design requirements. Or, if you prefer, send drawings and requirements directly to Application Engineering Department 2X0 at the address below.

M-6828



**CENTRALAB**

Electronics Division  
GLOBE-UNION INC.

5757 NORTH GREEN BAY AVENUE  
MILWAUKEE, WISCONSIN 53201



Header or Double Cup

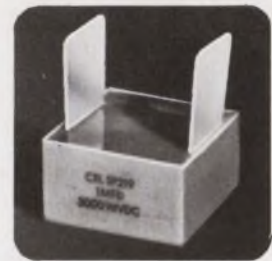

Monolithic



Feed Through



Single Cup,  
including water cooled

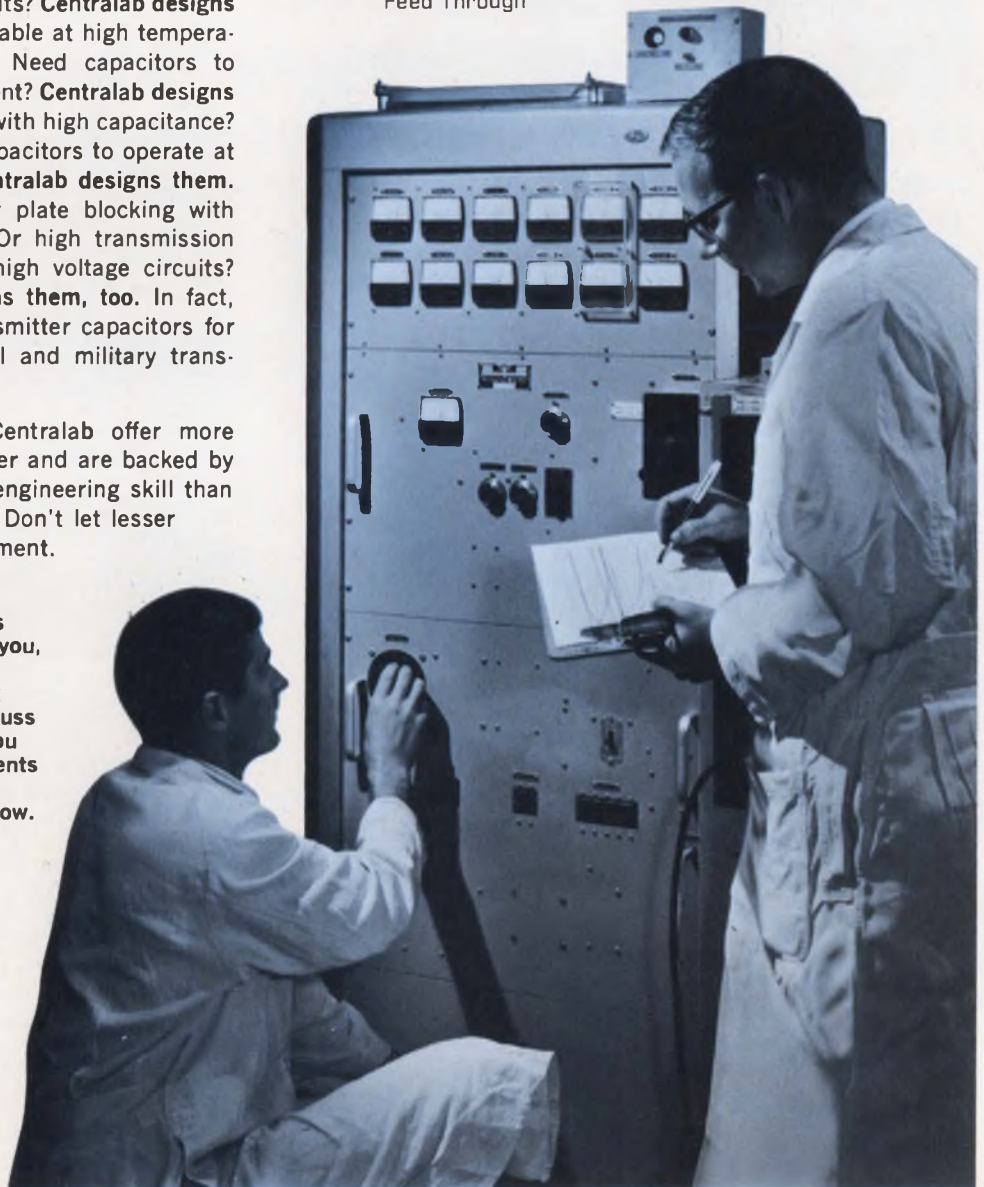



Push Earth satellites



# Washington Report

CHARLES D. LAFOND  
WASHINGTON BUREAU

## More money for Earth-oriented satellites

Expand the applications satellite program, so say the experts of the National Research Council's Division of Engineering, in their latest—second—report covering the "Useful Applications of Earth-Oriented Satellites." The report recommends a broad continuing program that would cost from \$200-300 million annually. The council says that "the practical benefits to be obtained from Earth-orbiting satellites appear to be very substantial, and would justify two to three times the current level of Federal support."

The report concedes that high economic gains have already resulted from the use of satellites in meteorology and communications. But applications for satellite techniques are needed in other fields. These include:

- A multi-channel distribution system for both public and private TV broadcasting.
- A multi-channel system for educational broadcasting to developing countries that could also be used for programs beamed to special interest groups (physicians, lawyers, engineers, etc.).
- A North Atlantic navigational satellite system that would provide traffic control while enroute for transoceanic aircraft and ships. (The council notes that such a system "would be likely to pay for [its] cost" when used by such internationally bound aircraft and ships alone.)

The council's report also stresses the need for an Earth-sensing satellite system to report on everything from agricultural conditions and water-resource management to global weather variations. The report stresses that the practical use of imaging sensor satellites is at hand, but that their practicality depends on the

development of sensor signature: a catalog of data that would permit the discrimination of data for practical applications. The council recommends an immediate Earth-resources pilot program, and the initiation of a 10 to 12-year development plan for more sophisticated sensors.

## Navy classifies news stories

For years, news reporters here have fought the "battle of the security stamp." Now, it's getting tougher. The Navy has recently been placing a Secret classification on newspaper articles appearing here and throughout the country that openly reveal information concerning a "Project Sanguine." Just because information appears in public print, Navy officials say, is no reason for them to regard it as having been declassified. And, they say, continuing to classify the articles the Navy thus does not sanction publication of the material.

Now about the Project in question: establishment by the Navy of a large, very-high-power, very-low-frequency, transmitting station at a undisclosed location in Wisconsin.

The new system is designed to provide instant communications around the globe to all Naval forces, including submarines. This, by itself, conflicts with the fact that the Navy already owns two high-power megawatt, low-frequency stations established for exactly this same purpose in Maine and Washington.

Because Rep. Alvin D. O'Konski (R.-Wis.) has made much of the expected prosperity to come to his



# Washington Report

CONTINUED

Congressional district (he has projected up to 10,000 new jobs), it can be presumed that the Sanguine site is destined for the west central part of the state, in the vicinity of Chippewa Falls. The area is considered to be economically depressed, which may explain why the Congressman is so elated over the impending boom.

Also presumed: only those with a Secret clearance should have been able to read this.

## New Zealanders fear Omega site

The U. S. Navy is apparently having the same trouble with New Zealanders that the Army is experiencing with people here at home in its attempts to locate ABM sites near cities. The Navy wants to locate new Omega navigational transmitter stations along the New Zealand coast, to cover a large part of the South Pacific area. The New Zealand Government has already agreed to let the U.S. make site surveys but, with the announcement that informal discussions were being held on location of the site, protests arose.

It's now evident that the Navy failed miserably in its public relations. The New Zealanders are convinced that erection of an Omega site automatically sets their country up as a prime target for a nuclear attack, in case of war. Nothing could be further from the truth. While Omega will indeed help U.S. Naval forces to establish more reliable means of navigation, the same system will be open for use by ships of all countries. As reported previously in this column, several British ships, including the new Manchester Guardian, plan to employ the Omega network.

Why the Navy didn't say this, before the New Zealanders became aroused, only the Navy knows. For not only would Omega aid other nations, but construction of the site itself could only help the local economy.

Sites now under consideration include Lake Pearson and Lake Summer in the New Zealand Alps. Construction costs alone, which will probably go to local firms, will range from \$4 to \$6 million.

## Army wants new tactical missiles

The Army missile command has just awarded conceptual design contracts to Boeing, Chrysler, LTV, Martin-Marietta and Northrop for development of a new Multiple Artillery Rocket System.

Worth roughly \$500,000 each, the six-month studies seek designs for a mobile intermediate-range bombardment system that would be capable of performing area saturation and that could carry up to ten missiles. Informants say the weapon will include some form of simplified but reliable guidance and control system—very possibly, all fluidic.

The Missile Command has also asked industry to submit conceptual designs for four other missile systems. In a recent request for quotations, the Army asked for proposals for a tank-type device, with emphasis on fire power; a new weapon to replace the present light anti-tank assault weapon; an anti-tank assault air defense weapon for use against both aircraft and armored land vehicles, and a new artillery-type missile that would be fired from Army aircraft.

No indication was given by the Army as to the type of electronic fire-control support and of guidance and control it wants for any of these weapons. The Army has left the complete design concept of each system up to the imagination of industry, in the hope that this open approach will serve to reduce R&D time for each system.



MIL-R-27208



RT11



RT22



RT24



RT12

MIL-R-22097



RJ22



RT10



RJ12



RJ11

# 8 BOURNS MIL-SPEC MODELS...

## count 'em!

### ...available from Distributor stocks, for immediate delivery!

These units not only meet the specs, they *beat* the specs . . . and they're all in distributor stocks ready for immediate delivery! All eight models have higher operating temperature, better shock and vibration performance, lower temperature coefficient, higher dielectric strength and insulation resistance than the specs call for.

Although MIL-R-27208 sets a maximum operating temperature of 150°C for wirewound units, Bourns gives you 175°C. And where MIL-R-22097 asks for 125°C in carbon units, Bourns gives you 150°C. Every Mil-Spec unit exceeds MIL-STD-202, Method 106, for cycling humidity. Specifically, insulation resistance is called out as 10 megohms; Bourns delivers 100 megohms. For vibration, the Mil-Spec requires 20G, but every Bourns unit must pass 30G. Yes, in all important parameters, Bourns surpasses the requirements.

When looking for a Mil-Spec potentiometer, investigate the eight Bourns models. You can depend on the fact that when it comes to Mil-Spec potentiometers — Bourns has a unit that meets and beats the specs. So don't short-change yourself . . . Don't Mil-Speculate — Specify Bourns!

*Write for complete technical data today, or call your local Bourns office, representative or stocking distributor.*



BOURNS, INC., TRIMPOT PRODUCTS DIVISION  
1200 COLUMBIA AVENUE, RIVERSIDE, CALIFORNIA 92507  
714 684-1700 • TWX: 910 332-1252 • CABLE: BOURNSINC

TRIMPOT® and Precision Potentiometers - Miniature Relays - Electronic Modules - Microcomponents.



# Introducing PLUSISTOR VECO



## slayer of dragon-size heat regulation problems



PLUSISTOR is VECO's all-new positive temperature coefficient thermistor for temperature measurement and compensation. A solid state silicon resistor, PLUSISTOR features an average coefficient of  $+0.7\%/^{\circ}\text{C}$  which remains virtually constant through the range of  $-60^{\circ}\text{C}$  to  $+150^{\circ}\text{C}$ . These small-but-stalwart heat defenders are available to you in a variety of designs—

- $\frac{1}{4}$  &  $\frac{1}{2}$  watt axial lead, molded design
- $\frac{1}{4}$  watt, hermetically sealed can
- $\frac{1}{4}$  watt axial lead, glass body adjacent lead, glass probe

Available in decade multiples of E.I.A. standard resistance values from  $10\Omega$  to  $10\text{K}\Omega$ ... 10% standard tolerance or tighter tolerances and special values other than standard where required. PLUSISTOR is just one of a complete line of thermistors from VECO designed to solve the most gigantic of problems.

**VECO VICTORY  
ENGINEERING  
CORPORATION**  
VICTORY ROAD, SPRINGFIELD,  
NEW JERSEY 07081  
(201) 379-5900 • TWX 710-983-4430

INFORMATION RETRIEVAL NUMBER 28

## SIDELIGHTS OF THE ISSUE

### 'Frighten us with orders'

Some very interesting predictions are being made by Dale Mrazek—wide use of MOS registers in memory and logic applications, and prices as low as 3 cents a bit. Skeptics who challenge National Semiconductor's ability to produce MOS at these prices don't bother him. "Frighten us with production orders," he says with a grin.

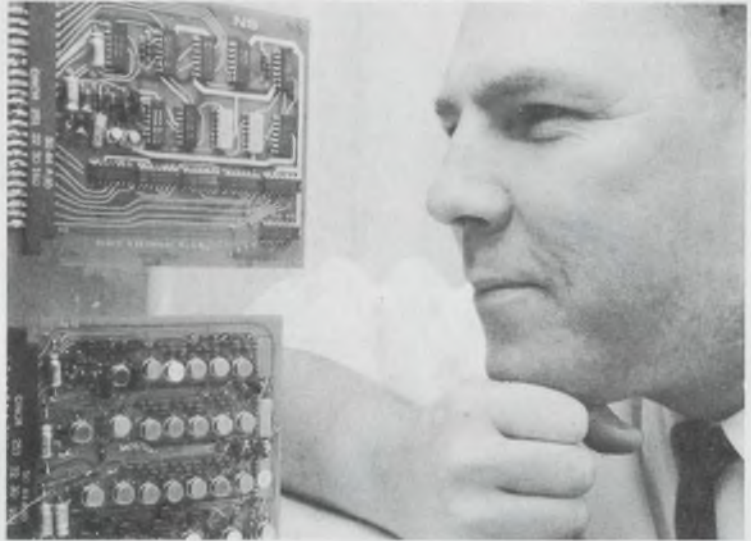

After earning a BSEE degree and doing post-graduate work at the University of Denver, Dale spent some time in the Midwest working on a/d converters, analog stimuli generators, logic switching and multiplexers. Then he joined Signetics to work in read-write and read-only memories—and was lured to National a year ago. Since then Dale has been spending a lot of his time acquainting engineers with the possibilities of MOS devices. See p. 50.

### 'Lighting' the world of the blind

Candy has been blind since infancy. She plans to enter college next fall and doesn't consider her blindness a real obstacle; she can read Braille at 160 wpm. Candy also happens to be the daughter of Prof. John Linvill, head of the Electrical Engineering Dept. at Stanford University and co-developer, with Dr. James Bliss of Stanford Research Institute, of a portable tactile reading machine for the blind.

Candy hopes to use the device to scan college lecture notes or books not available in Braille. After about 100 hours of practice, she has learned to read with the machine at 35 wpm. There are other reading aids under development for blind people like Candy. For a glimpse at the latest, turn to p. 30.



# Our package deal is a complete fabrication.

We make every part of our hermetic integrated circuit packages in our own plants.

We have to.

It's the best way we can be sure that every one will measure up to specs. Both ours and yours.

Take, for example, our off-the-shelf dual inline package. It uses our own special blend of hard glass and alumina to get the best properties. High electrical insulation, thermal shock resistance, hermeticity, and a thermal expansion that matches the metal alloy parts.

It meets Mil-specs and can be plated to your requirements.

If this package doesn't suit your needs, we'll design one to your specs.

Each hermetic package gets to you in first-class condition. No bent or shorted leads. No excess glass-ceramic flow.

In short, the perfect package deal.

*Parts Division, Sylvania Metals & Chemicals,  
Warren, Pa. 16365.*

**SYLVANIA**  
A SUBSIDIARY OF  
GENERAL TELEPHONE & ELECTRONICS





Pick the  
**BEST IC**  
for the job

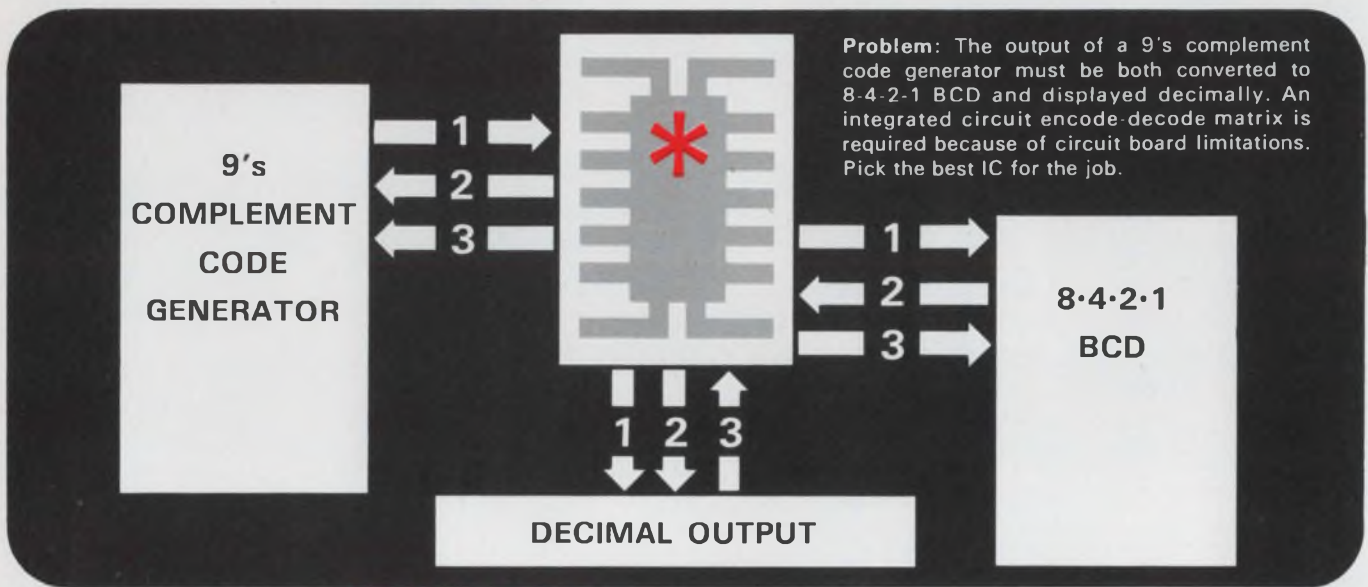

the **BEST** Solution:

### THE RADIATION RM-84 DIODE MATRIX



Solve the problem easily. Combine only *four* \* RM-84 diode matrices from Radiation and form a 16 x 10 matrix array. Six code conversions can be performed by this single bi-directional array to replace approximately 80 logic elements. The code pattern will be customized quickly from our complete stock of standard matrices.

Radiation diode matrices are dielectrically isolated, eliminating cross-coupling and allowing easy customization. These circuits can be combined with Radiation interface circuits to provide the most economical, convenient and reliable diode logic available.

Contact your nearest Radiation sales office. Ask about our diode matrix line. Let us help you pick The Best IC for The Job.

WE MAKE THE **BEST IC** FOR THE JOB



**RADIATION**  
INCORPORATED  
SUBSIDIARY OF HARRIS-INTERTYPE CORPORATION  
MICROELECTRONICS DIVISION



**Publisher**

Hugh R. Roome

**Editor**

Howard Bierman

**Managing Editor**

Robert C. Haavind

**Technical Editors**Frank Egan  
Michael J. Riezenman  
Raymond D. Speer**Management and Careers Editor**

Lawrence Locke

**News Editor**

Ralph Dobriner, Chief

**Washington News Bureau**

Charles D. LaFond, Chief

**Military/Aerospace Editor**

John F. Mason

**East Coast Editor**

Jim McDermott

**West Coast Editor**

Elizabeth deAtley

**New Products Editors**Robert Patton  
Lucinda Mattera**Copy Editor**

Peter Irving

**Editorial Production**Dollie S. Viebig  
Phyllis Gura**Art Director**

Clifford M. Gardiner

**Art Assistant**

William Kelly

**Technical Illustrators**William Alvarez  
Rita Jendrzejewski  
Lynn E. Thompson**Production Manager**

Thomas V. Sedita

**Asst. Production Manager**

Helen De Polo

**Production Assistants**Bernard Wolinsky  
Carl A. Merkin**Circulation Manager**

Nancy L. Merritt

**Information Retrieval**

Genate Piccinetti

## EDITORIAL



## Technology may yet save this madding world

How many social hours have you spent defending the engineer's and the scientist's role in improving civilization, while your doctor, lawyer and Indian chief friends have blamed modern technology for the evils in today's world? And how much time have you put in arguing against your friends' dire premonitions that computers will one day reduce all people from names and personalities to numbers with blank expressions?

Well, if you've been through these sessions, take heart. An educator with facts says you're right and they're wrong. Modern technology has elevated man to his highest level of individualism, according to a preliminary report on a long-range study of the impact of technology on society. Reporting in the fourth year of a 10-year study funded by IBM, Dr. Emanuel G. Mesthene, executive director of the Harvard University Program on Technology and Science, says: "This is probably the first age in history in which such a high proportion of people have felt like individuals." Technology, according to the study, is creating a fruitful society with a wide range of personal choices and high levels of self-worth.

However, individuals with their new-found freedoms have begun to make bolder demands on their government, warns Prof. Edward Shils, one of the Harvard program's researchers. And to demonstrate their individualism, he says, they will increase their demands, with a high probability of a rise in public disorders.

One step to maintaining stability in government, Dr. Mesthene suggests, may be to rely more on "technocrats" who can apply computer analysis techniques to solving the increasingly complex affairs of our growing society. How best to allocate the billions in the national budget . . . how to assign priorities so the most urgent programs are tackled first . . . how to adapt electronics systems approaches to social problems—these and more are likely areas for computer analysis.

But the individual citizen must be made fully aware of the role of the technocrat, lest his new feeling of individualism be submerged once more.

No easy task. Still, the new Administration in Washington may do well to fill important government positions with more experienced scientific and engineering decision makers and fewer experienced politicians.

HOWARD BIERMAN



# The phenomenal ferrite bead:

## Stackpole's simple solution to noise and filter problems.



Ceramag<sup>®</sup> ferrite beads offer a simple, inexpensive, yet effective means of obtaining RF decoupling, shielding, and parasitic suppression without sacrificing low frequency power or signal level.

Unlike conventional RF chokes, beads are compact, have no DC losses, and will not couple to stray capacity and introduce detuning or spurious oscillations. Ceramag<sup>®</sup> beads offer an impedance which varies from quite low at low frequencies to quite high at noise frequencies. Beads need not be grounded; however, chassis contact is permissible when desired, as beads possess sufficiently high resistivity to preclude grounding.

Installation of Stackpole

beads is easy. Simply slip one (or several) over appropriate conductor(s) for the desired noise suppression or high frequency isolation. Beads are available in sleeve form in a range of sizes starting at .025 ID, .060 OD, and .400 long. For special compact filtering applications such as cable connectors, beads can be supplied to tight mechanical tolerances.

Several ferrite grades provide a variety of attenuation characteristics. Inductance tolerance is normally  $\pm 30\%$  as measured on an LC meter. The performance of a Ceramag<sup>®</sup> 7D bead as a parasitic suppressor is shown in Figure 1.

Other applications might include: decoupling in "B" circuitry; noise suppression; RF isolation in filament circuits;

use in combination with capacitors to form "L" networks.

FIGURE 1

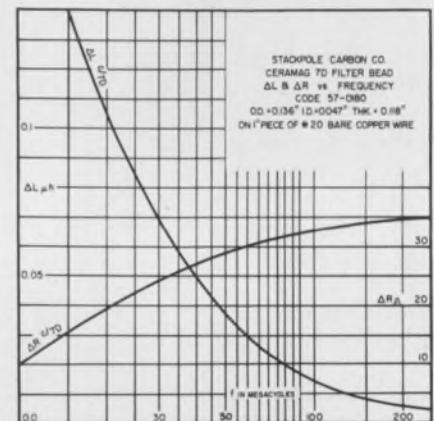

Sample quantities of Ceramag<sup>®</sup> beads and beads with leads are available without charge upon request. Send your requirements to Stackpole Carbon Company, Electronic Components Division, St. Marys, Pennsylvania 15857. Phone: 814-781-8521. TWX: 510-693-4511.



## Now available...Ceramag<sup>®</sup> beads with leads

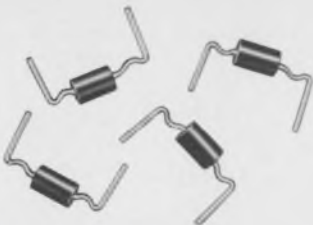

Additional savings in production time and labor costs are now possible by utilizing automatic insertion equipment to install Ceramag<sup>®</sup> ferrite beads in printed circuit boards.



product report

# PLUG-IN OSCILLOSCOPES

## New Tektronix 560B Series

### New Solid-State Versions

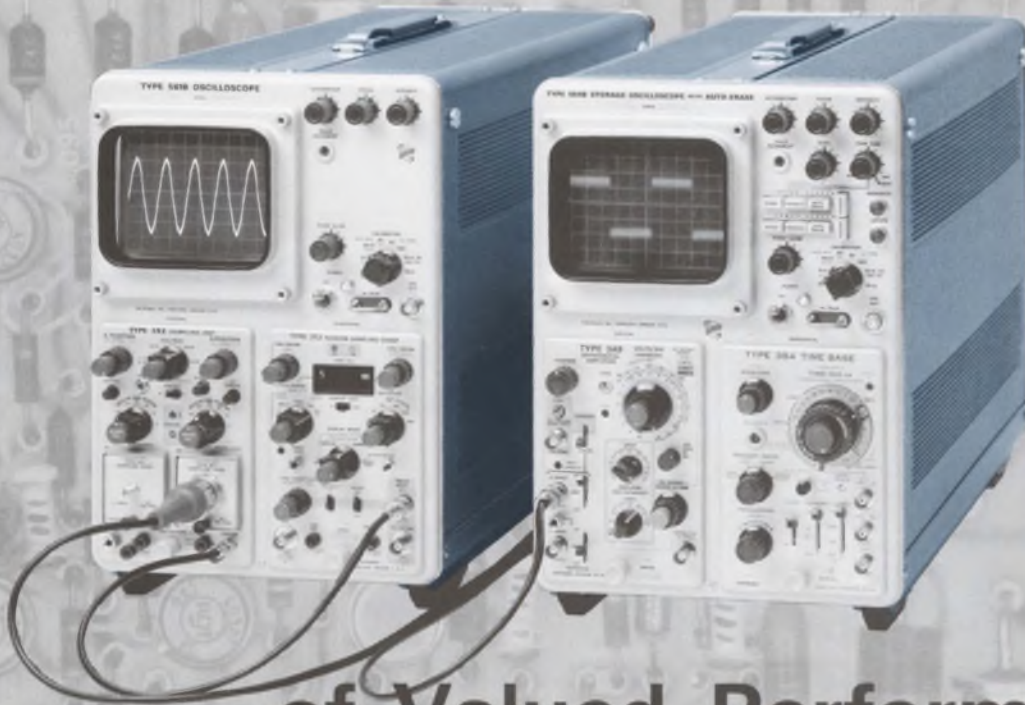

### of Valued Performers

Solid-state, large screen (8 x 10 cm), internal graphic, dual plug-in oscilloscope defines the new Type 561B. Use of solid-state components throughout offers low-heat dissipation for reliable operation to further expand the performance capabilities of this oscilloscope. Short-proof circuitry has been designed into all low-level power supplies, providing lower output impedance and minimum signal crosstalk. The addition of a quick-change line voltage selector permits operation from any of the following voltage ranges: 90 to 110 V, 104 to 126 V, 112 to 136 V, 180 to 220 V, 208 to 252 V, or 224 to 272 V over a line frequency range from 48 Hz to 440 Hz. The Type 561B calibrator accuracy has been significantly improved in both frequency and amplitude. The 1-kHz frequency is held to  $\pm 1\%$ , while the amplitude is maintained at  $\pm 1\frac{1}{2}\%$ .

Total measurement capabilities, through the use of more than 25 different plug-in units, offer the user complete versatility in measurement applications. The dual plug-in unit feature allows conventional displays or X-Y displays with either single-trace, dual-trace or four-trace units. Sampling displays, as well as spectrum analysis and raster generation, are also possible with the Type 561B.

The Type 564B offers all the advantages of the Type 561B, plus an added split-screen storage feature. Greater versatility is thus provided in that either half of the 8 x 10 cm display can be independently controlled, allowing stored or conventional displays on either the upper or lower half. The contrast ratio and brightness of the stored displays are constant and independent of viewing time, writing and sweep rates, or signal repetition rates.

Automatic erasure, after a preselected viewing time of 1 to 12 seconds, is added to the Type 564B MOD 121N. Also incorporated is a SAVE mode which interrupts the automatic erase cycle and preserves the stored information. Remote operation of the erase function is also possible with the Type 564B MOD 121N.

Both the Type 561B and Type 564B have rack-mounted counterparts that occupy only seven inches of rack height.

Type 561B .....	\$ 560
Type 564B .....	\$ 995
Type 564B Mod 121N .....	\$1150

U.S. Sales Prices FOB Beaverton, Oregon

← please open for additional information →



# Measurement Capability Series Oscilloscopes

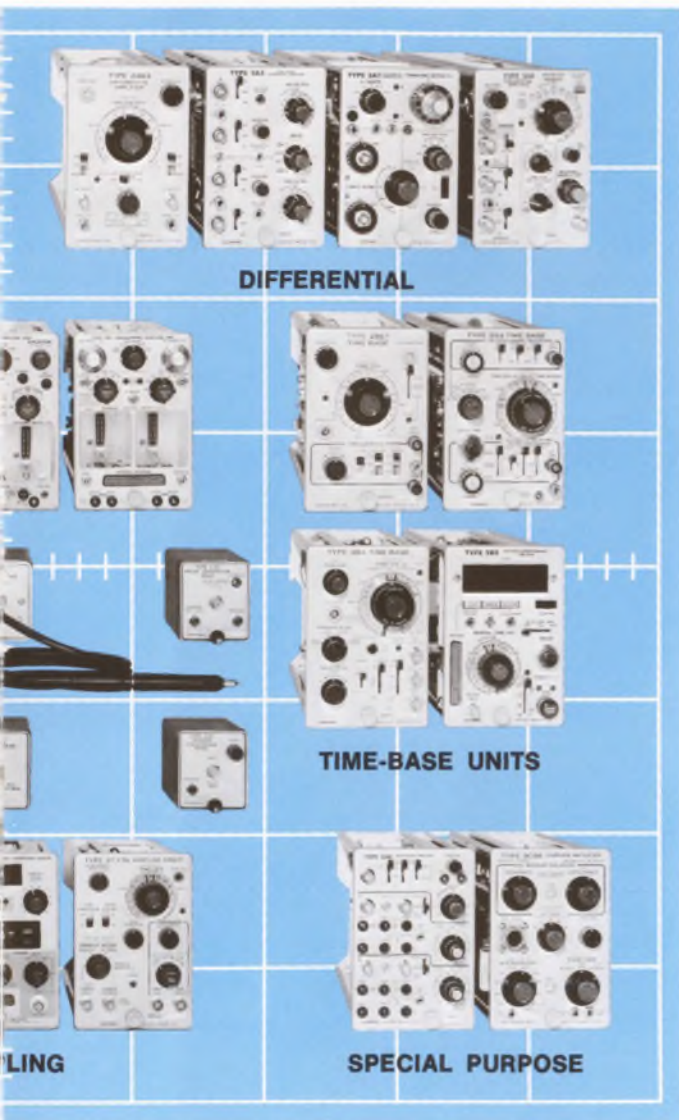

**DIFFERENTIAL**

**TIME-BASE UNITS**

**SPECIAL PURPOSE**

## DIFFERENTIAL

PLUG-IN	DF	BANDWIDTH	$T_r$	PRICE
2A63	1 mV/div	DC to 300 kHz	1.2 $\mu$ s	\$ 175
3A3	100 $\mu$ V/div	DC to 500 kHz	0.7 $\mu$ s	850
3A7	1 mV/div	DC to 10 MHz	35 ns	695
3A9	10 $\mu$ V/div	DC to 1 MHz	350 ns	490

Differential operation is useful for measurements between two above ground points and for cancellation of in-phase signals such as hum pick-up at the signal source.

The Type 2A63 is a low-cost DC coupled differential unit. It provides 1 mV/div deflection factor at a bandwidth of DC—300 kHz. The common-mode rejection ratio of this unit is up to 250:1.

The Type 3A3 is a dual-trace differential unit with deflection factors of 100  $\mu$ V/div to 10 V/div at a constant bandwidth of DC—500 kHz, and up to 50,000:1 CMRR.

The Type 3A7 adds to its capabilities of up to 20,000:1 CMRR and deflection factors of 1 mV/div to 50 V/div, an internal comparison voltage for use as a differential comparator.

The Type 3A9, a state-of-the-art differential plug-in, provides selectable upper and lower frequency limits from DC to 1 MHz, 10  $\mu$ V/div to 10 V/div deflection factors, and a CMRR of up to 100,000:1. A separate current probe input provides AC current readings from 1 mA/div to 1 A/div using available Tektronix current probes.

## TIME-BASE UNITS

PLUG-IN	FASTEST RATE	MAGNIFIER	PRICE
2B67	1 $\mu$ s/div	X5	\$ 225
3B3	0.5 $\mu$ s/div	X5	650
3B4	0.2 $\mu$ s/div	X1 to X50	450
3B5	0.1 $\mu$ s/div	X10, X100	950

Time-base plug-ins are linear sweep generators that provide a wide range of calibrated time ranges for accurate time measurements.

The Type 2B67 is a low-cost time base providing calibrated sweep speeds from 1  $\mu$ s/div to 5 s/div. A 5X magnifier operates over the full time base and increases the fastest rate to 0.2  $\mu$ s/div.

The Type 3B3 is used to generate normal and delayed sweeps from 0.5  $\mu$ s/div to 1 s/div. A 5X magnifier increases the fastest rate to 0.1  $\mu$ s/div, while an incorporated single sweep function facilitates photographic recording of waveforms.

The Type 3B4 features a direct reading magnifier of up to 50X operating over the full range of 0.2  $\mu$ s/div to 5 s/div and extending the fastest range to 0.05  $\mu$ s/div. A single sweep function and a calibrated external horizontal input are also incorporated.

A companion to the Type 3A5 vertical unit, the Type 3B5 operates automatically from 0.1  $\mu$ s/div to 5 s/div.

## SPECIAL PURPOSE

PLUG-IN	DF	BANDWIDTH	$T_r$	PRICE
3A8	20 mV/div	DC to 3.5 MHz	100 ns	\$ 650
3C66	10 $\mu$ strain/div	DC to 5 kHz	70 $\mu$ s	450

The Type 3A8 provides two operational amplifiers, each with an open loop gain of 15,000 at DC and an open loop gain bandwidth product of 10 MHz or greater.

The Type 3C66 carrier amplifier unit with suitable transducers allows for measurements as broad as the mechanical field itself. The Type 3C66 provides calibrated deflection factors from 10  $\mu$ strain/div to 10,000  $\mu$ strain/div at a bandwidth from DC to 5 kHz.

lines normally preclude the need for a pretrigger.

The Type 3S2 and its programmable counterpart, the Type 3S5, use the new sampling head principle. Both units are dual trace and will accept any of 6 available heads: the Type S-1 head is 50- $\Omega$  input, 350-ps  $t_r$ ; the Type S-2 head is 50- $\Omega$  input, 50-ps  $t_r$ ; the Type S-3 head includes a captive probe with 100 k $\Omega$ , 2.3-pF input impedance, 350-ps  $t_r$ ; the Type S-4 head is 50- $\Omega$  input, 25-ps  $t_r$ ; the Type S-50 head is a 25-ps pulse generator with a 400-mV, 100-ns wide pulse; and the Type S-51 head provides trigger countdown for stable synchronization from 1 GHz to 18 GHz. When using the S-1, S-2, S-3 or S-4 heads both the Type 3S2 and 3S5 provide deflection factors of 2 mV/div to 200 mV/div.

Companion sampling time bases are the Types 3T2, 3T5 and 3T77A. The Type 3T2 provides for either random or sequential sampling with sweep ranges from 20 ps/div to 100  $\mu$ s/div. The Type 3T5 is a programmable counterpart of the Type 3S5 and provides 10 ps/div to 100  $\mu$ s/div sweep ranges, as well as a calibrated sweep delay. The Type 3T77A provides calibrated sweep ranges of 20 ps/div to 10  $\mu$ s/div. Each of these time bases includes a time expander that provides 10X expansion of the time scale while maintaining a constant number of dots/div.



# Complete Measure with Tektronix 560

## MULTI-TRACE

PLUG-IN	DF	BANDWIDTH	T <sub>r</sub>	PRICE
3A3 Dual-Trace	100 $\mu$ V/div	DC to 500 kHz	0.7 $\mu$ s	\$ 850
3A6 Dual-Trace	10 mV/div	DC to 10 MHz	35 ns	525
3A72 Dual-Trace	10 mV/div	DC to 650 kHz	0.54 $\mu$ s	295
3A74 Four-Trace	20 mV/div	DC to 2 MHz	0.18 $\mu$ s	650

Multi-trace plug-ins provide a time-sharing method of displaying output signals of two or more channels with a single gun CRT. It may be done in one of two ways: alternate mode of operation—switching is done in sequence after each sweep; chopped mode—switching is done in sequence at a rate not referenced to the sweep.

The Type 3A3 contains two independent high-gain differential amplifier channels with FET inputs. Deflection factors of 100  $\mu$ V/div to 10 V/div at a constant bandwidth of DC—500 kHz as well as 50,000:1 common-mode rejection ratio are features of this plug-in.

The Type 3A6 can be operated in any one of five modes for variety of single- and dual-trace displays. The Type 3A6 has 10mV/div deflection factor, 35-ns risetime and internal vertical signal delay lines.

The Type 3A72 is a general-purpose dual-trace plug-in featuring 10 mV/div—20 V/div deflection factor with DC — 650 kHz bandwidth.

The Type 3A74 provides four separate but identical channels. Each channel has a deflection factor of 20 mV/div from DC to 2 MHz. An internal trigger signal can be selected from one of two sources.

## SINGLE TRACE

PLUG-IN	DF	BANDWIDTH	T <sub>r</sub>	PRICE
2A60	50 mV/div	DC to 1 MHz	0.35 $\mu$ s	\$ 125
3A5	10 mV/div	DC to 15 MHz	23 ns	825
3A75	50 mV/div	DC to 4 MHz	90 ns	195

The Type 2A60 is a low-cost general-purpose plug-in with a DC — 1 MHz bandwidth and decade deflection factor steps from 0.05 V/div to 50 V/div.

The Type 3A5, an automatic plug-in unit, features a bandwidth of DC — 15 MHz and deflection factors from 10 mV/div to 50 V/div in its seeking mode. A manual control provides additional deflection factors of 1, 2 and 5 mV/div. Programmable functions include V/div, input coupling and AC trace stabilization by contact closure to ground.

The Type 3A75 is a wideband general-purpose plug-in unit with deflection factors of 50 mV/div to 20 V/div and a bandwidth from DC — 4 MHz.

## SPECTRUM ANALYZERS

PLUG-IN	DF	CENTER FREQ	PRICE
3L5	10 $\mu$ V/div	50 Hz to 1 MHz	\$1,125
3L10	-100 dBm	1 MHz to 36 MHz	1,275

Spectrum analyzer plug-ins provide a method of studying the energy distribution of a given electrical signal by plotting relative amplitudes against a frequency base.

The Type 3L5 operates over a center frequency range of 50 Hz to 1 MHz and provides accurate spectral and time-base displays from 10 Hz to 1 MHz. A deflection factor of 10  $\mu$ V/div to 2 V/div and a dynamic range of 60 dB makes the Type 3L5 applicable for vibration studies, waveform analysis and noise measurements.

The Type 3L10 operates over a center frequency range of 1 MHz to 36 MHz, with a CW sensitivity of -100 dBm. Calibrated dispersion and coupled resolution on both the Type 3L5 and 3L10 make frequency measurements as easy and accurate as time measurements.



MULTI-TRACE



SINGLE TRACE



SPECTRUM ANALYZERS

SAMP

## SAMPLING

PLUG-IN	DF	BANDWIDTH	T <sub>r</sub>	PRICE
3S1 Dual-Trace	2 mV/div	DC to 1 GHz	350 ps	\$1,195
3S2 Dual-Trace	2 mV/div	S-Series Heads		850
3S5 Program	2 mV/div	S-Series Heads		1,550
PLUG-IN	FASTEST RATE	MAGNIFIER	PRICE	
3T2	0.2 ns/div	X10		\$1,000
3T5 Program	0.1 ns/div			1,650
3T77A	0.2 ns/div	X10		700

Sampling plug-in units convert the Types 561B and 564B into sampling oscilloscopes. As opposed to conventional or real-time oscilloscopes, sampling oscilloscopes do not display a waveform directly but rather rely on a stroboscopic approach of looking at many discrete portions of the input waveform to reconstruct it. Compared with conventional oscilloscopes, sampling provides better sensitivity with risetimes of 25 ps and equivalent bandwidths of 14 GHz and beyond. Time scaling, random-noise cancellation and better overload-recovery capabilities are other advantages offered by sampling techniques. However, as its name implies, multiple samples must be taken with the requirement that the input waveform must be repetitive.

The dual trace Type 3S1 is a nominal 50- $\Omega$  input unit with a risetime of 350 ps. Deflection factors of 2 mV/div to 200 mV/div are available. Internal delay



# Extra Values . . . . .

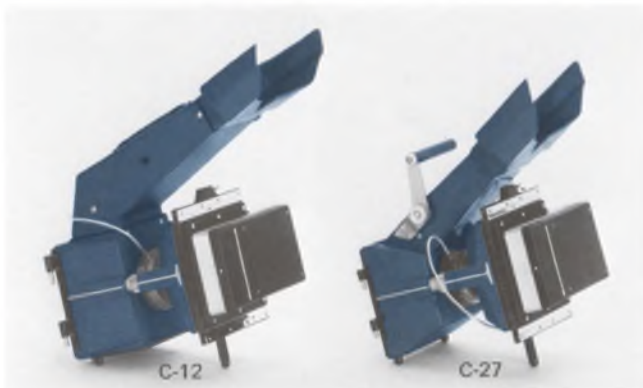

## CAMERAS

The C-12 and C-27 general purpose trace recording cameras are suitable for use with the Tektronix 560 series oscilloscopes. Both cameras feature lift-on mounting, swing-away hinging, comfortable binocular viewing, easily-accessible controls, and lens and back options. A special beam-splitting mirror in the C-12 reflects a portion of the image up through the viewing tunnel, giving the viewer the impression of a straight-on view of the CRT. This no-parallax binocular viewing is especially desirable when the oscilloscope has an external graticule.

C-12 .....	\$460
C-27 .....	\$430

## ELECTRIC SHUTTER/SPEED COMPUTER

An Electric Shutter/Speed Computer is available for both the C-12 and C-27 cameras, permitting remote actuation of the camera. It is intended for use in areas where a large number of cameras need to be remotely controlled or when there is limited access to the oscilloscope and camera at the time of use.



C-12-E Electric Shutter Camera .....	\$665
C-27-E Electric Shutter Camera .....	\$635

## SCOPE-MOBILE® CARTS

Type 201 Scope-Mobile® carts feature tilt locking in any one of nine tray positions. The adjustable tray locks in six 4.5° steps in the upward direction and two 4.5° steps in the downward direction from the horizontal axis. A storage drawer is provided in the Type 201-1 while the Type 201-2 provides both a storage drawer and a plug-in carrier.



Type 201-1 .....	\$130
Type 201-2 .....	\$140

U.S. Sales Prices  
FOB Beaverton, Oregon

**For a demonstration, call your local Tektronix field engineer or write:  
Tektronix, Inc., P. O. Box 500, Beaverton, Oregon 97005.**

## PROBES

Tektronix offers a choice of voltage and current probes designed to be compatible with circuit measurement requirements. The probes are designed to monitor the signal source with minimum circuit loading while maintaining waveform fidelity.

A prime consideration in selecting the proper probe is the circuit loading effect of the oscilloscope/probe combination. The probe with the highest input impedance will provide the least circuit loading. Probe attenuation ratio is also an important consideration. The oscilloscope must have enough gain to compensate for the attenuation of the probe.



The P6021 AC Current Probe and Type 134 Amplifier provide the facility for accurate current measurements over the wide range of 12 Hz to 40 MHz without breaking the circuit under test. Used with any plug-in unit having a deflection factor of 50 mV/div, the P6021/134 provides deflection factors from 1 mA/div to 1 A/div.

P6021/134 .....	\$295
-----------------	-------



The P6042 DC-50 MHz current probe utilizes a variation of the Hall effect, offering capabilities for making both high-frequency and DC current measurements. The P6042 consists of an amplifier with built-in power supply, six-foot probe cable, and probe head. Deflection factors from 1 mA/div to 1 A/div are provided when the P6042 is used with a plug-in unit having a deflection factor of 50 mV/div.

P6042 DC Current Probe .....	\$625
------------------------------	-------

To help you select the right probe for your application, please consult Tektronix Catalog #28 or call your Tektronix Field Engineer.



# Tektronix, Inc.

*committed to progress in waveform measurement*

# Technology

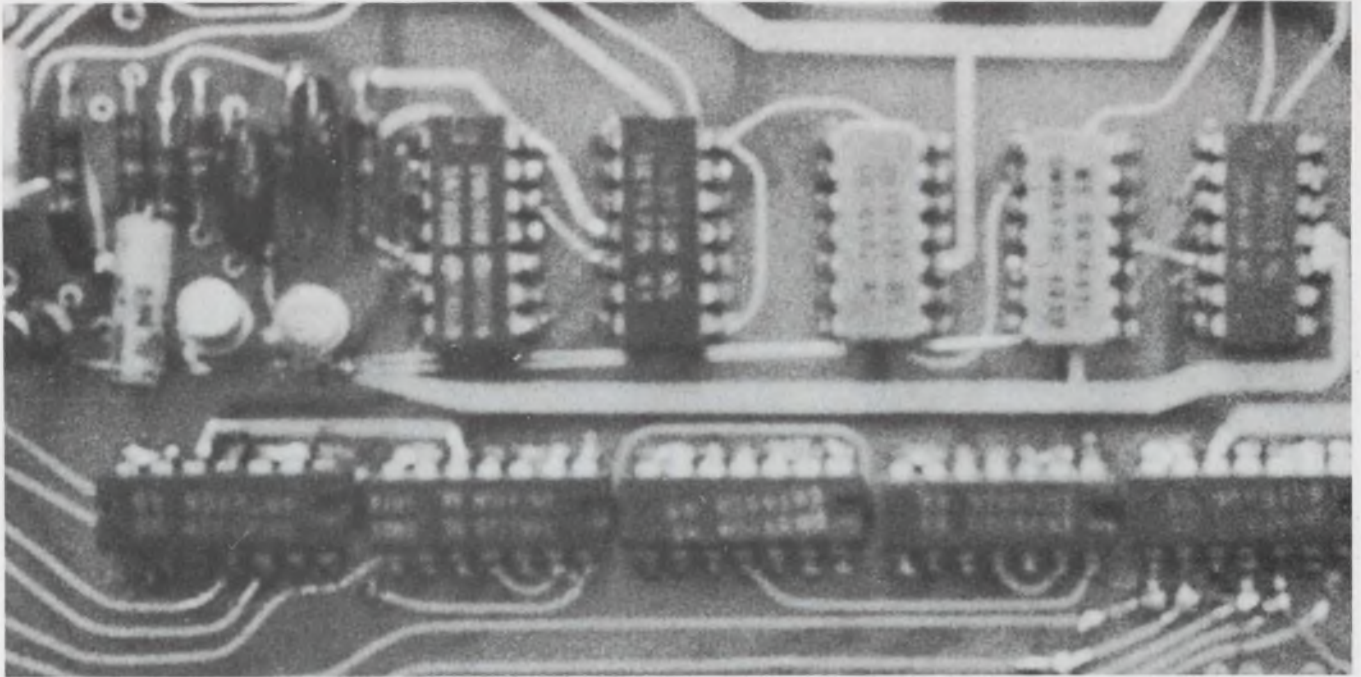

When you shift to **MOS registers** you shrink delay line cost, size and dissipation, and you

also get the benefit of independently variable clock rates. Page 50.



Fever or chills got your rf power level? Try headache remedy No. 1: a servo loop that

stops linear and nonlinear power variations caused by temperature variations. Page 60.

## Also in this section:

Want a portable time-shared terminal? Convert a teletypewriter. Page 68

Use—don't abuse—the SCR. Get the most from SCR designs. Page 76

Give them room to innovate on the job. Hints on Page 82

Ideas for Design. Page 88



# Shrink delay line costs with MOS.

New shift registers offer low cost, size and dissipation plus independently variable clock rates.

Digital system designers used to be very cautious about committing themselves to electronic delay techniques. The required bistable circuitry was bulky and expensive and physical delay systems—glass rods with suitable drivers and transducers, for example—were usually more economical. But MOS shift registers have changed all that! MOS delay lines are a practical—often the least expensive—means of obtaining delay.

Short MOS delay lines, up to 500 bits, are now much cheaper than physical delay devices of comparable length. Typical MOS registers currently cost only 5 to 7¢ per bit, against 15 to 25¢ per bit for magnetic or physical lines. And medium-length lines, up to a few thousand bits, are cost-competitive.

A potential cost saving, of course, is something that cannot be ignored by any designer. And that is what MOS registers offer. Coupled with their low cost is their versatility. In addition to performing register functions for manipulation of serial data, they provide time delay within a digital system, and store data—indefinitely, in the case of the static register. Properly gated arrays of registers will operate perfectly as small drum memories—and can compete economically in applications in which drum memories cannot be used to their full capacity.

MOS lines offer variable delays and data rates. An MOS shift register has a fixed number of storage locations, of course, but the shift rate and delay time per bit are governed by the clock period. To change the delay time, as required by the system, the clock period can be varied—from dc to a fraction of a microsecond for some registers. The clock can even be interrupted to temporarily store data in the line. This flexibility is exceedingly attractive to systems designers because the delay time can now accommodate the needs of the system. With physical delay lines, the system often has to be designed around the unalterable characteristics of the delay device.

Two families of MOS registers—static and dynamic—are used in digital delay lines. Both types produce output logic levels within the standard MOS range of eight to ten volts. The outputs can be tied to the inputs, to recirculate data (Fig. 1), or data can be shifted directly into other register or logic circuits. Both register families are readily interfaced with bipolar logic circuits such as TTL. There are, however, several important differences between static and dynamic registers.

## Register types and how they differ

Dynamic registers require a two-phase clock that must always run at or above some minimum frequency, typically 400 Hz at an operating temperature of 70°C. They depend upon charge storage for data retention, and if the clock runs too slowly, or stops, the information stored in the register is lost. The minimum frequency rises with temperature, since high temperature increases leakage current and reduces charge-storage time.

Static registers, in contrast, contain a feedback latch in each storage cell (register stage) and will not lose data even if the clock is stopped. Also, they require only a single external clock, internally generating a second, complimentary clock. The price paid for the nondestructive storage feature of static registers is more transistors per storage cell. Static cells are about one and a half times as large as dynamic cells—they occupy about 45 square mils of area on the chip. Cost per bit is higher—static registers cost about 7¢ per bit, in large quantities, as opposed to 5¢ per bit for dynamic registers. Power dissipation is also higher. Static cells generally dissipate 1.8 mW per bit (independent of frequency) against 0.8 mW per bit (at 1 MHz) for dynamic registers (new dynamic cell designs will make possible 0.3 mW per bit operation at 1 MHz in the near future).

Registers capable of storing up to 512 bits per IC package are representative of the present state of the art. Generally, the more cells per package the lower the per-bit cost of the registers

---

Dale Mrazek, Senior Application Engineer, National Semiconductor Corp., Santa Clara, Calif.



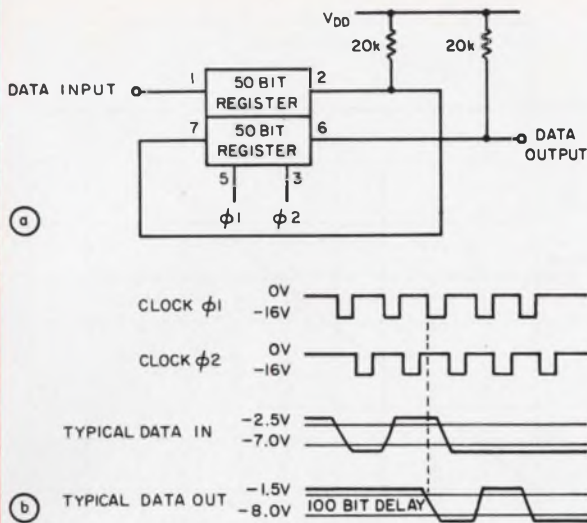

1. A dual dynamic register is series-connected to make a simple 100-bit delay line (a). Data clocked to the register input appears 100-clock-pulses later (b) at the output.

and thus of the delay line itself. Off-the-shelf registers generally have capacities that are powers of 2, such as 64 bits, because they are designed for use by logic designers who use binary systems. They are also available in capacities that are multiples of 25, such as dual 100-bit (200 bits per chip), for designers who live in the decimal world. Odd-numbered capacities for special applications can be produced to order by the vendors.

The total delay in each type of register equals the product of the clock-period and the number of storage locations. A 100-bit register clocked to shift data at 1 MHz, for instance, will delay each bit of data by 100  $\mu$ s. Lines and recirculating loops within lines can be composed of series or parallel units clocked at the same or at different rates. Line capacities, data storage, and delays can therefore vary greatly.

A storage stage in an MOS dynamic register typically contains six field-effect transistors: two inverters, called  $Q1$  and  $Q4$  (Fig. 2), load resistances  $Q2$  and  $Q5$ , and couplers  $Q3$  and  $Q6$ . The clocks,  $\Phi1$  and  $\Phi2$ , supply the negative gate voltages required to turn on the resistors and couplers, while the data input signal biases the inverters. The register operates as follows:

Assume that the register has been set up by a  $\Phi1$  clock pulse to receive a logic "1" pulse at the input. Conventionally, the input data-bit for a logic "1" is a negative voltage near the drain-voltage level  $-V_{DD}$  (and for a logic "0" is a voltage near ground level). Input coupler  $QA$ , inverter  $Q1$  and resistance  $Q2$  will all be off (no conduction between source and drain). As clock  $\Phi2$  goes negative it turns on  $QA$ , coupling the data input to node A, turning on  $Q2$ . Since the input was negative,  $Q1$  also turns on, charging

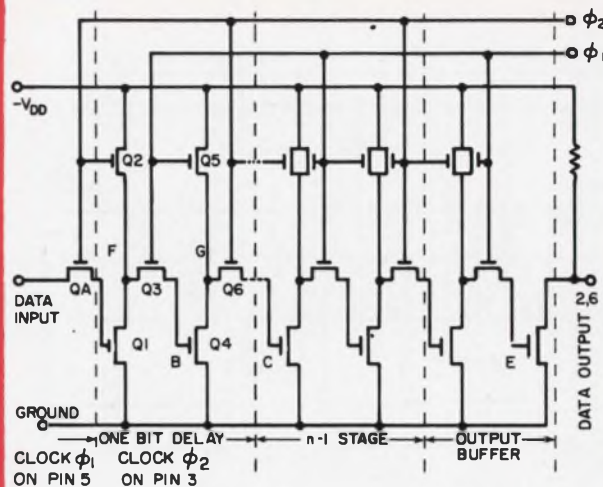

TYPICAL PIN DIAGRAM

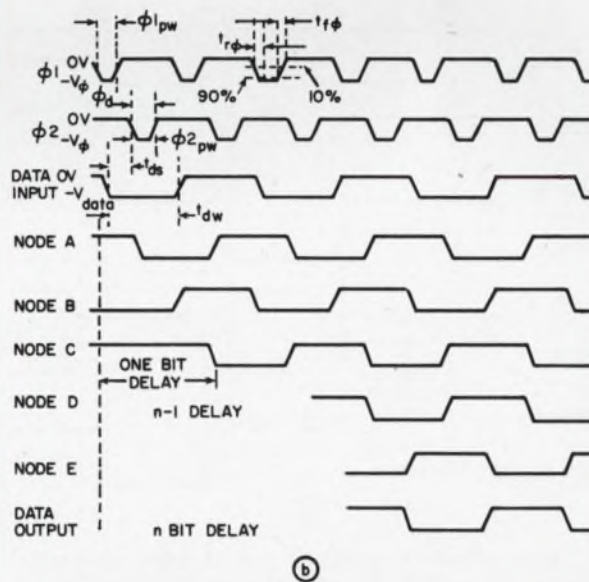
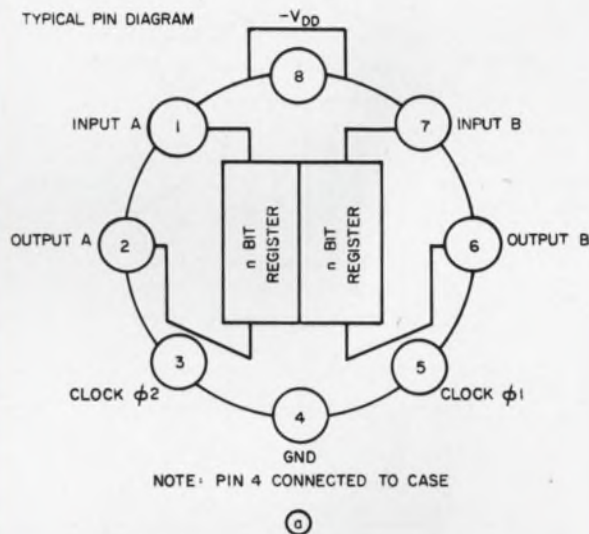

2. The dynamic shift-register cell contains six MOS transistors. Information is shifted within the cells when  $\Phi1$  goes negative (turning on devices  $Q3$ , etc.) and is shifted between cells when  $\Phi2$  goes negative (a). The data is clocked out of the register during the  $\Phi1$  clock time, n-clock-periods after data entry, where n is the size of the register in bits (b).



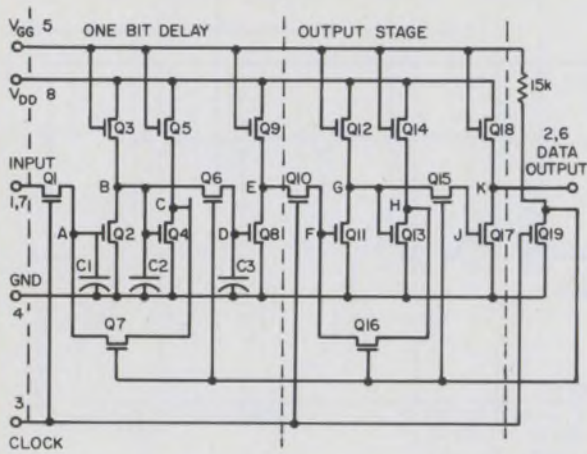

TYPICAL PIN DIAGRAM

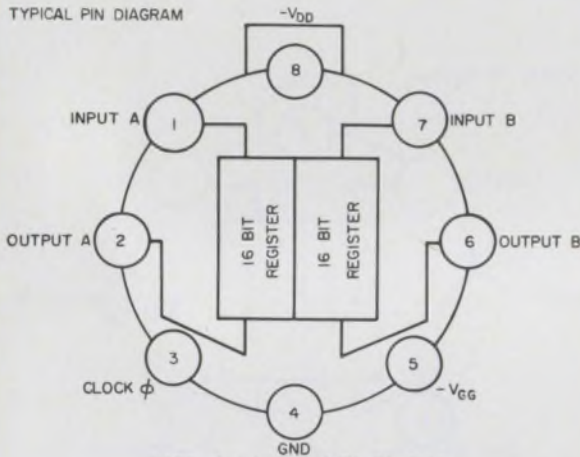

NOTE: PIN 4 CONNECTED TO CASE

(a)

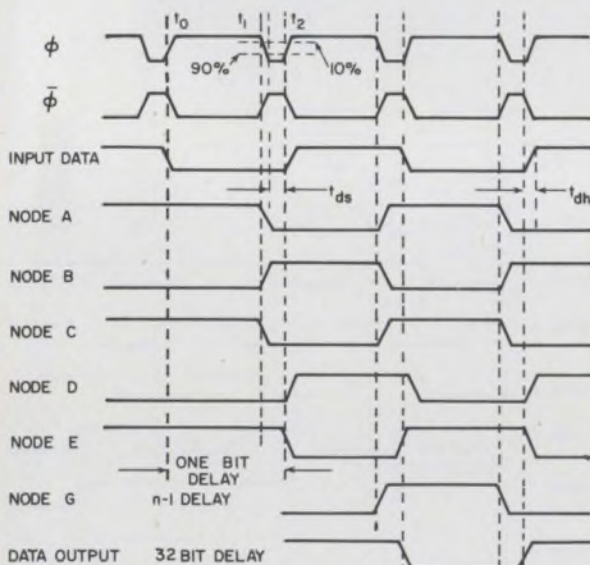

(b)

3. Each static shift-register cell contains nine transistors in an Eccles-Jordan feedback-latch configuration (a), with Q6 and Q7 acting as cross-coupling resistors. Information is transferred between cells on the clock pulses via Q1 and Q10 (b), and is transferred within cells on the complementary clock pulses ( $\bar{\Phi}$ ), which are generated internally. The static register will store bits indefinitely, even if the clock is interrupted.

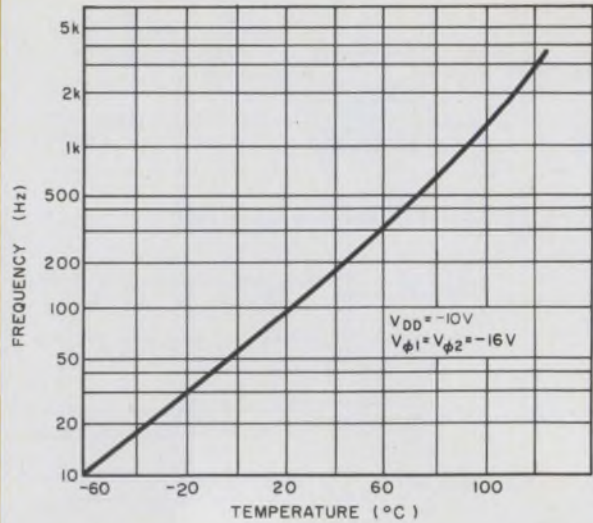

4. The minimum operating frequency of a dynamic register depends on its operating temperature. The dynamic cell does not have a feedback latch and must depend on charge-storage for retention of data. Leakage resistance, directly proportional to temperature, limits the storage time—and hence imposes a minimum operating frequency.

the gate-to-source capacitance at node A. Now the voltage at node F can be  $-V_{DD}/2$ . As  $\Phi 2$  returns to ground level (zero state), Q2 turns off and node F is allowed to discharge to 0 V.

When  $\Phi 1$  goes negative, Q3 and Q5 turn on. However, Q4 is held off, since node F is now at ground potential. Therefore node G is at  $-V_{DD}$ , and it maintains that potential until the next  $\Phi 2$  clock appears. Coupler Q6 is the input to the next cell; it performs the same function as does QA, and the "1" bit represented by  $-V_{DD}$  can be transferred into the next stage.

If the data input was near ground level (logic "0"), T1 would be held off at  $\Phi 2$  and Q4 would turn on at  $\Phi 1$ . Node G would then be at ground level at the next  $\Phi 2$  pulse, and the next stage would see a "0" bit through Q6.

In a typical static register, on the other hand, each storage cell consists of nine FETs (Fig. 3); couplers Q1, Q6 and Q7; inverters Q2, Q4 and Q8; and load resistances Q3, Q5 and Q9. The loads are continually biased ON by the input gate voltage  $-V_{GG}$ , while the complimentary clocks  $\Phi$  and  $\bar{\Phi}$  switch the other FETs.

Each data bit is maintained within a stage by the feedback and latching action of couplers Q6 and Q7; these can be considered the cross-coupling resistors of an Eccles-Jordan flip-flop. If the external clock  $\Phi$  is stopped (that is, reduced in frequency to dc), Q6 and Q7 will remain on or off, depending on the state of  $\bar{\Phi}$ . Aside from making the state of the stored bit independ-



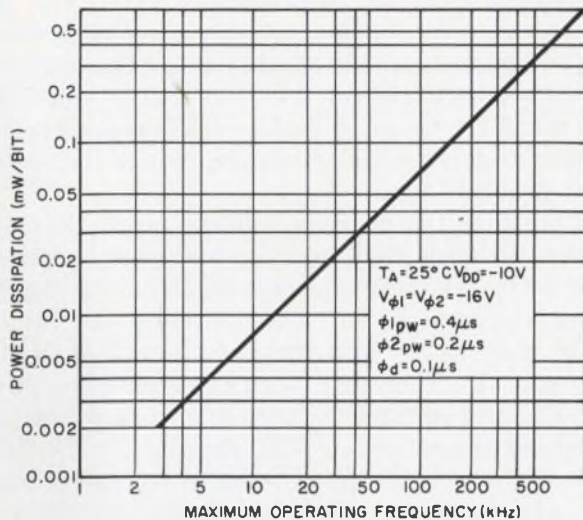

5. Power dissipation increases with operating frequency in a dynamic register, because a current path between a supply and ground exists only during the time that one of the clock phases is in the negative state. Since the clock pulse width is held constant, the clock duty-cycle—hence power dissipation—increases with frequency.

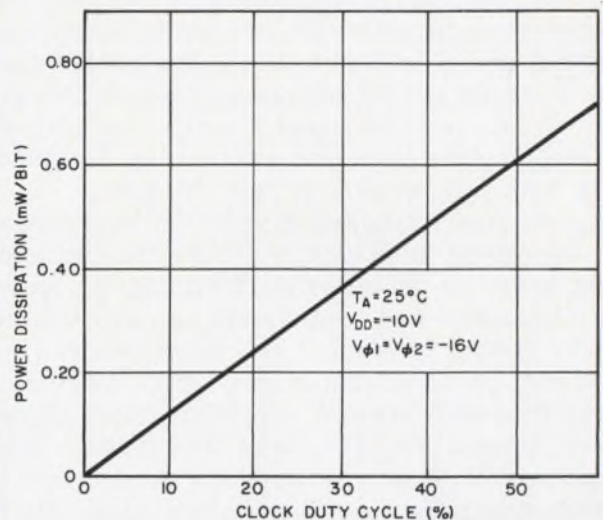

6. The dynamic register-cell dissipates power only when the load resistor is clocked ON. If the clock-pulse duty-cycle is lowered, power dissipation is decreased, so the narrowest possible clock should be used. A typical cell will dissipate the same power at 100 kHz with 1.0  $\mu$ s clock pulses as it will at 10 kHz with 10.0  $\mu$ s clock pulse.

ent of leakage time, this arrangement simplifies external clocking and driving circuitry.

When the  $\Phi$  clock goes negative it switches on  $Q1$ ,  $Q10$ , and  $Q19$ . Device  $Q19$  and the 15-kilohm resistor generate the positive pulse of clock  $\Phi$ , which turns off  $Q6$  and  $Q7$ . Node  $E$  is now at the level appropriate to the state of the delayed data bit. This bit can now move into the output stage, and the storage cell is set up to receive a new input data bit.

Assume the new bit is a "1", a pulse near  $-V_{DD}$ . As  $Q1$  turns on, the input charges the gate-to-source capacitance of  $C1$ ,  $Q2$ , turning on  $Q2$ . This allows node  $B$  to discharge. The gate-to-source capacitance,  $C2$ , of  $Q4$  also discharges, turning off  $Q4$  and placing the logic "1" level of  $-V_{DD}$  at node  $C$ .

When  $\Phi$  returns to ground level and  $\Phi$  goes negative,  $Q1$  and  $Q10$  turn off,  $Q6$  and  $Q7$  turn on, and any information stored in  $C3$  at the gate of  $Q8$  discharges to ground. Hence,  $Q8$  turns off and node  $E$  rises to the "1" level.

However, if the new input bit is a "0" (signal near ground level),  $Q2$  cannot turn on. The  $-V_{DD}$  level is maintained at node  $B$  and  $Q4$  remains on. Therefore, node  $C$  goes to ground. When  $Q6$  and  $Q7$  switch on,  $Q8$  is also turned on and node  $E$  is held at ground level. Thus  $Q10$  sees a "0" bit during the next clock cycle.

#### Off-the-shelf registers run at 1 MHz

Specially designed and processed MOS registers can operate at frequencies up to 5 MHz.

The more typical off-the-shelf registers being discussed here will run at up to 1 MHz with relatively low signal, supply and clock voltages (such as  $-10$  V rather than the maximum of  $-25$  V). They achieve 2-MHz operation with reasonable amplitudes and tolerances  $V_{DD} = 10.5 \pm 5\%$  and  $V_{\Phi} = 17 \pm 1$  V, for example.

The minimum frequency, or maximum clock period, of a static register can be whatever the designer desires. The minimum frequency of a dynamic register, however, depends largely on operating temperature (Fig. 4). The lower the operating temperature, the less the leakage current, and the longer the charge-storage time available for data retention.

Power dissipation in both types varies with applied voltages, but a dynamic register dissipates power only when a load resistor is clocked on, only when a current path exists between  $-V_{DD}$  and ground. Its power dissipation thus varies with frequency (Fig. 5). This characteristic offers the user of dynamic register numerous options for reducing power dissipation. He can, for instance, minimize the ON time of the loads in the circuit, by making the clock pulses narrow and lowering the duty cycle (Fig. 6). After the storage capacity and input-output rates needed by the external system are satisfied, power consumption can be reduced further by slowing down the internal register operation.

Power dissipation in a static register is higher, on a per cell basis, than in a dynamic register; it varies little with frequency. A static register's load resistors are always ON. Also loads  $Q3$  and



$Q9$  ( Fig. 3) must be large compared with the ON resistance of inverters  $Q2$  and  $Q8$ , to assure that nodes  $B$  and  $E$  will go to the  $-V_{DD}$  level. Power can be conserved by minimizing applied voltages and, if data is to be stored for extended periods, by stopping the clock and maintaining the stored data with minimum dc supply voltages.

Lower power dissipation generally implies lower operating temperature. For the dynamic type, lowering the minimum frequency by lowering dissipation and temperature can give the designer greater freedom in his clocking techniques. It should be noted that higher temperature at a given frequency does not necessarily mean higher power dissipation. The large temperature coefficients of MOS devices produce a net decrease in power dissipation as temperature rises. High-temperature operation is not generally desirable. Furthermore, operation at less than maximum temperature improves frequency response; the charging resistances of the MOS devices are less and RC time constants are shorter.

### Break the speed limit

For some applications, the normal maximum frequency of 2 MHz is too low. Suppose, for example, that a 3-MHz or 4-MHz rate will allow the delay line to work more efficiently with transmission lines or external logic circuits. Increases in frequency of up to 100% can be achieved at little additional cost, by using certain types of TTL logic gates between registers, as follows:

An MOS register's upper frequency is generally limited by the output transistor. Its ON resistance is usually made low (Fig. 7) to guarantee that capacitive loading of the register by a following register or MOS device will not produce an RC product high enough to seriously impair the information response time.

However, low-impedance MOSFETs are physically large devices (typically in mils, 100-times larger than internal MOS devices; they take up 10% of the available real estate on a typical die) with large input capacitances (typically 0.2 pF), which must be driven by a high-impedance transistor in the last storage stage of the register. As a result, the output time constant is relatively long, perhaps 100 ns, and the clock period must be long enough to permit charge transfer through the output stage. Internal MOS cells can run at 20 MHz, but coupling to the output devices reduces speed capability to roughly 2 MHz.

An easy way around this seeming impasse is illustrated in Fig. 8. Test results show that the TTL gates used allow the MOS registers to run at a maximum frequency of nearly 4 MHz rather than 2 MHz. Input-output times can be shorter because the importance of capacitive effects is reduced—the source driving the input has lower

impedance than an MOS output circuit, and the MOS output terminates in much lower impedance (3.3 kilohms against 10 kilohms). The register output-voltage swings are much less than the normal MOS range, but since TTL gates are designed to detect smaller voltage swings they solve that problem, too.

Note that the negative voltage levels that are conventional in MOS logic are not used in Fig. 8. The MOS registers do not need negative inputs. They are designed to treat the more positive inputs as logic "0" and the more negative inputs as logic "1". Therefore, each register is supplied +10 V and ground, to keep the voltage swings positive, as required by TTL circuits. To the TTL gates, however, the more positive voltage is logic "1" and the more negative is logic "0". This is taken care of by the +5 V and ground supplied to the gates.

The reversal doesn't affect the data accuracy. Although a positive input is shifted through the register as though it were a logic "0", the TTL gate detects the output as a logic "1". Likewise, an input at ground is shifted as a logic "1" but detected as a logic "0".

Not all TTL gates can be interfaced with MOS. The gate must be designed so that its positive output of about +4 V can be pulled up to about +10 V (Fig. 8) and look like a high-impedance load to the MOS register input. A standard TTL gate can achieve this voltage translation. The output stage contains a high-value resistor in parallel with the external 2-kilohm pull-up resistor connected to the +10 supply. The smaller resistor between the register output and ground pulls the MOS output down to the TTL input level.

### Parallel delay lines for high data rates

If registers, or register series, are operated in parallel, the input-output data rates can be multiplied by the number of delay lines in parallel.

The general configuration of such a high-speed line is shown in Fig. 9. The data demodulator distributes the input data stream so that register 1 gets bits 1, 5, 9, etc.; register 2 gets bits 2, 6, 10, etc. and so forth. The data modulator reassembles the bit stream and restores the original data rate. With four registers in parallel, the delay line can accept data at four times the shift rate of the individual registers.

A circuit design that takes advantage of the MOS/TTL interface technique and that has accepted data at rates up to 16 MHz, is given in Fig. 10. The eight-to-one improvement in speed, compared with a conventional MOS delay line of similar capacity (800 bits), is achieved at the cost of only seven TTL packages. The capacity can be raised, at no additional cost, by using larger registers.



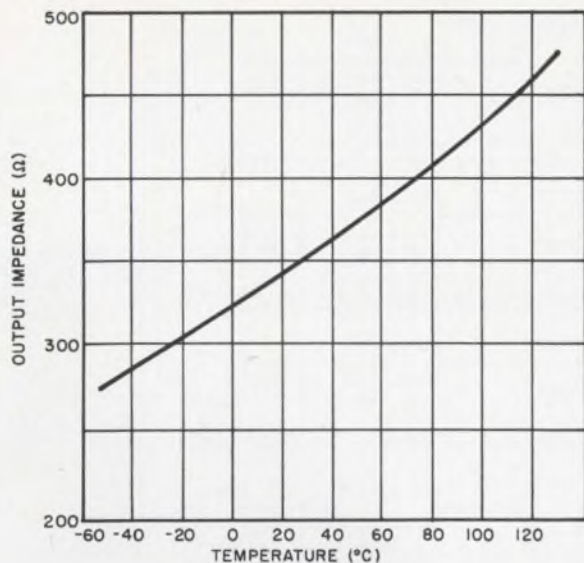

7. The output impedance of the dynamic register is typically below 500 ohms; when the output device is ON the output terminal is connected to ground through less than 500 ohms. The output impedance increases with temperature.

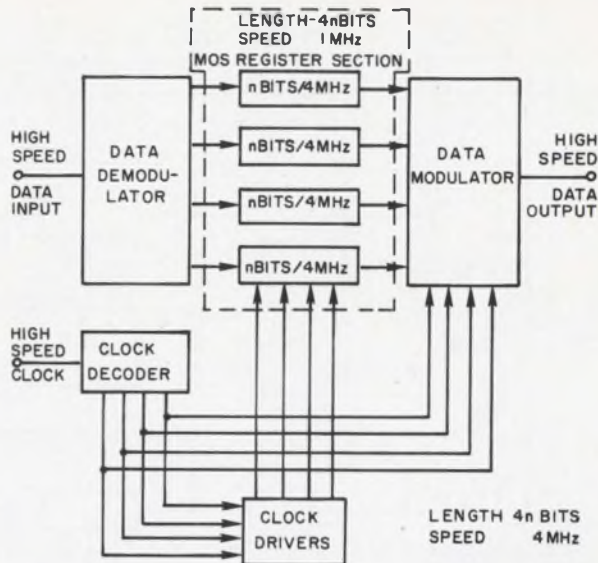

9. Clock rates can be multiplied by paralleling registers and using data modulators and demodulators. Data can enter and leave this line at 4 MHz, while individual registers are clocked at only 1 MHz. This system can be expanded.

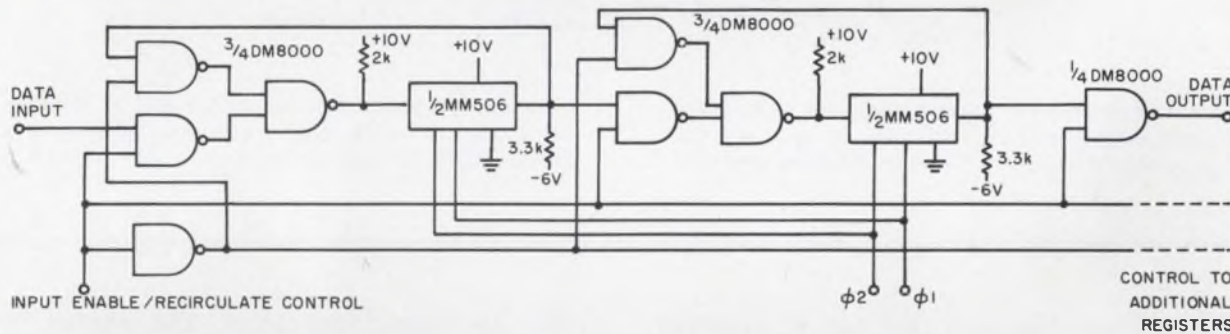

8. TTL interfaces lower register loading and improve output detection, allowing higher register

speed. Each segment of the line may be used as a recirculating loop, controlled by steering gates.

Table. Characteristics of typical MOS registers

Typical characteristics	Static registers	Dynamic registers
Minimum operating frequency at 25°C at 125°C	dc dc	10 Hz 10 kHz
Maximum operating frequency	2 MHz	2 MHz
Line delays per bit (typical)	no maximum 0.5 μs* minimum	25 ms maximum 0.5 μs* minimum
Normal clock configuration	single phase	two-phase**
Signal voltage levels logic "1" logic "0"	-8.0 V -1.0 V	-8.0 V -1.0 V
Power dissipation at 1 kHz at 1 MHz	1.5 mW/bit 1.5 mW/bit	0.8 μW/bit 0.8 mW/bit

\* The minimum may be lowered to 0.25 μs by the use of TTL input drivers and output detectors.  
\*\* Some types of dynamic registers employ four-phase clocks but generate the two additional phases internally from the normal two-phase clock input.



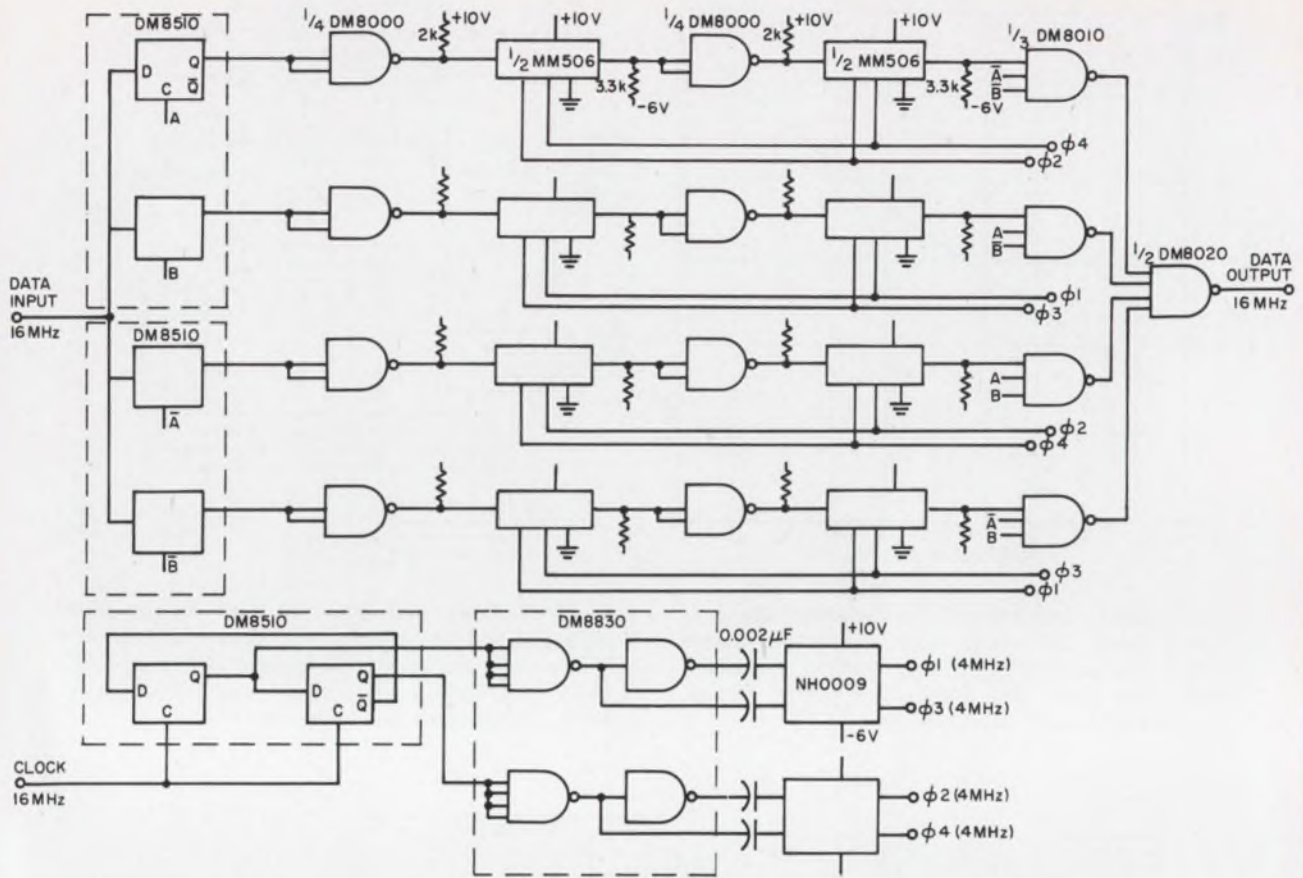

10. A combination of parallel registers and MOS/TTL interfacing permits data rates to approach 16 MHz in this circuit (a). Rates to 32 MHz are pos-

sible, and capacity can be increased, at minimal extra cost, by using larger registers. Division of a master clock is used because it is economical.

The maximum data rate that can be achieved by paralleling registers is about 32 MHz at present. The limit is imposed by the speed with which TTL circuits can detect and reassemble the outputs of the parallel registers. Today's TTL circuits can commute data down to easily acceptable MOS register clock rates.

The operation of the circuit shown in Fig. 10 is straightforward. The high-speed clock enters at TTL logic levels and is divided into a two-phase clock by the A and B flip-flops, which are connected as a synchronous counter. The clock is divided again at the line driver into four clock phases, which are distributed to the system components. The phases used by the registers, and their sequence, are shown in the figure. The clock pulses can be as wide as 0.2  $\mu$ s.

Division of a master clock was used because it is a more economical technique than generating four separate clocks, and it synchronizes operation of the delay line. However, other clocking techniques (some of which will be discussed later) could be used.

The memory capacity of a conventional magnetic-drum memory is often too great for a com-

puter peripheral application. The wasted "overhead" makes the drum's cost per bit prohibitive. Since a drum memory is basically a rectangular array of synchronous delay lines, MOS registers can be substituted at much less cost.

As an example, a 60,000-bit MOS "drum" is shown in Fig. 11. Word length is six bits. Each line in the array contains 100 registers storing 100-bits each. MOS digital multiplexers or TTL gates will handle the input gating required to recirculate data in the memory—that is, they revolve the "drum"—or write in new data and erase the data that was stored.

The system differs from those previously described, since all bits in a word appear in parallel at the input or output of a register series. A single enable pulse causes the multiplexer to gate a new word into the drum at any specific bit-position interval. The system can therefore access a specific word on the data-output lines by using a counter-addressing technique to tap into the data-output line. All registers can be operated by the same clock signals.

To reduce the access time, each delay line may be segmented into minor loops such as in Fig.



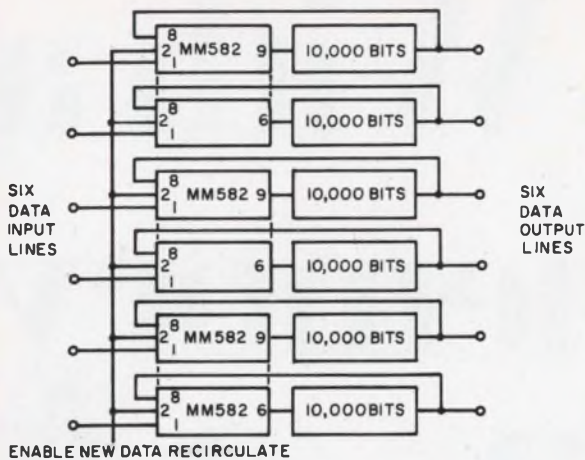

11. An MOS drum memory is a rectangular array of synchronous delay lines. This design stores 10,000 six-bit words, with MOS multiplexers handling the required input gating.

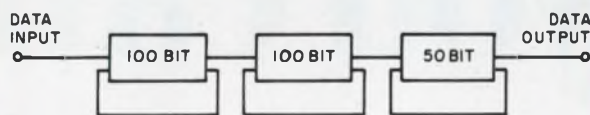

12. The access time of a large MOS memory is reduced by breaking the line into minor recirculating loops. Any segment of the above line can be accessed at 100-bit intervals.

12. It is possible, for example, for a bipolar-logic system to individually access each 100-bit or 50-bit segment of the drum by employing the MOS/TTL configuration (Fig. 8). The effective reduction in access time equals the number of bits in a line, divided by the number of bits in the largest minor loop. For example, the over-all delay in a 10,000-bit line is 5 ms at 2 MHz, but the access time of each 100-word segment of the drum is only 50  $\mu$ s. The loops should be equal in size, or multiples of one another, to keep the stored bits parallel and the word structure intact.

### Special clocking varies delay and data rate

Only the most basic forms of clocks have been described so far. Specialized clocking techniques can be devised to vary the delays within a line, to vary the input or output data rates (or both), and to reduce the power dissipation by reducing the duty cycles in a line or segment of a line.

If the designer wishes to extend delay duration in a line or recirculating loop, for instance, he can inhibit the clock. As soon as the register is loaded, the block of a static register may be stop-

ped, or the clock of a dynamic register may be delayed (for the maximum period permitted by the operating temperature).

Suppose a designer wants to take 1,000-bit samples of sensor data and process them with a computer. The sensor's data-output rate is 200 kHz, but the computer operates at 2 MHz and may not, because of higher-priority tasks, be able to accept the sensor data as it is accumulated. The delay may last as long as 10 ms. Recirculation of the data in a delay line is not desirable, it must be available any time the computer demands it. Nor does the designer want to fill computer memory with low-priority data.

To solve his problem, the designer builds a serial 1,000-bit, 2-MHz delay line. While the sample is being accumulated in the registers, a 200-kHz clock is applied. After 5 ms (1,000-times the clock period), the clock is inhibited and the data sample is held in store until a command from the computer starts the 2-MHz clock. The data is on its way into the computer in 500 ns. The delay line can be made part of the sensor subsystem, where it will not affect any part of the computer.

Two-speed clocking has many other uses. It is handy whenever digital circuitry operating at one rate must be mated to circuitry operating at some other rate, such as in the time-sharing of high-speed transmission lines or processors. The input rate and delay per bit can be near dc (25 ms is the maximum clock period of a dynamic register at 70°C; the clock period of a static register may be as long as desired in a static register), while the output rate can be made extremely high by paralleling registers. ■■

### Test your retention

*Here are questions based on the main points of this article. Their purpose is to help you make sure you have not overlooked any important ideas. You'll find the answers in the article.*

1. What are two important differences between static and dynamic registers?

2. What is the maximum practical frequency for off-the-shelf MOS registers?

3. What is a safe minimum frequency for dynamic MOS registers at 70°C?

4. Two schemes for increasing the clock rate of shift registers are proposed. What are they?



**With a  
memory  
like this  
you can  
forget the  
logic**



FROM YOUR TRUTH TABLE

Inputs								Outputs			
A	B	C	D	E	F	G	H	W	X	Y	Z
0	0	0	0	0	0	0	0	0	1	0	1
0	0	0	0	0	0	0	1	0	0	1	1
0	0	0	0	0	0	1	0	0	1	1	0
0	0	0	0	0	0	1	1	1	1	0	0
0	0	0	0	0	1	0	0	0	1	0	0
0	0	0	0	0	1	0	1	0	1	1	1
0	0	0	0	0	1	1	0	0	0	0	0
0	0	0	0	0	1	1	1	1	0	1	0
0	0	0	0	1	0	0	0	1	0	1	1
0	0	0	0	1	0	0	1	1	1	1	1
0	0	0	1	0	1	1	1	1	0	0	1

TO YOUR MM 521

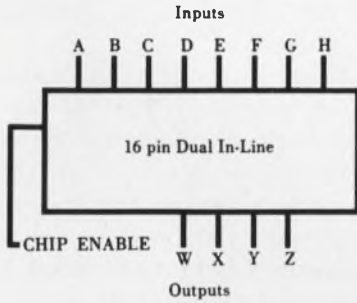

Use the logic easily programmed into our ROM (Read Only Memory) elements. With a minimum of time (typically four weeks), we can set up the simple interconnection metalization pattern your needs dictate and start shipments. Costs about a thousand dollars.

ROM elements are far simpler to make than a new, untried logic design. No logic race conditions; no logic circuit debugging. Our MOS ROM elements are fast, 500 nanoseconds. They operate from  $\pm 12$  volt supplies, easily compatible with DTL and TTL.

MM521, 1024 bit element (256 x 4), 16 pin Dual In-Line device, is \$45.00 in 100 quantity. MM522, 1024 bit element (128 x 8), 24 pin Dual In-Line is \$60.00.

Write for a memorable packet of information. National Semiconductor, 2975 San Ysidro Way, Santa Clara, California 95051. (408) 245-4320. TWX: 910-339-9240. Cables: NATSEMICON.

# National/MOS

# Keep your rf power level constant

by using a servo loop and a saturated rf amplifier to correct temperature drifts and other perturbations.

## *Part 1 of a two-part article*

If you've ever been involved in the design of rf equipment, you know that it is often necessary to keep the output power level of a device constant under a variety of environmental conditions. For example, if you are designing an exciter to drive a TWT, you know that TWTs are extremely sensitive to their input drive level and that, therefore, system specifications on the exciter output power stability are very tight.

To obtain constant output power under hostile environmental conditions is no easy task; especially when the power source is a chain of rf amplifiers and frequency multipliers. Linear temperature compensation in the rf stages is of some help, but it's not enough.

Another approach, discussed here, is the use of a servo loop to reduce output power level variations.

In the servo-loop approach (Fig. 1) a small sample of output power is converted to a dc voltage and compared with a reference voltage to generate an error signal. The error voltage then controls the gain of a preceding stage of rf amplification. This closed-loop control system provides several advantages over open-loop approaches; the most important advantage is that it keeps the output power level fixed, despite severe nonlinearities in the rf chain. It also offers flexibility in setting the power level and suppressing power-supply ripple, transients and other external variables.

Of course, as is well known, servo loops can introduce problems of their own when they are introduced into a system. These problems, however, can be successfully corrected once their cause is recognized, as we shall see.

## **Full control is best**

If the power level is sensed at some point in the rf chain other than at the output, the system is said to have *partial control*. This is to distinguish it from the *full control* situation in which the power is monitored right at the output where the level-

stability specifications must be met. Full control is obviously better than partial control, because it can compensate for all errors in the chain, no matter where they occur.

In some situations, however, full control may not be feasible. For example, if the last few stages in the chain are multipliers, the output power level may be too low to operate a sensor. In this case, sensing must be done at an earlier stage, where there is enough power; the uncontrolled portion of the chain must then be compensated by conventional open-loop techniques, such as the use of thermistors or diodes.

Generally speaking, the servo loop will have to compensate for two types of variables, external and internal. External variables include such items as variations in input drive power and power supply voltage. Internal variables are the impedance and gain changes within the rf chain that are caused by temperature changes.

In designing a loop for a particular set of specifications, you may find that the effects of all the variables cannot be reduced to the required level at the same time. For instance, a loop with sufficient gain to eliminate certain temperature-variation effects may not be fast enough to handle power-supply ripple. Therefore, the first step in designing a servo loop system is to reduce the number of variables to a minimum. Fortunately, the external variables can be reduced quite easily.

Input power variations can be reduced by driving the chain from a series of limiter stages. All amplifier stages following the level-control stage must be linear, of course, to achieve linear control characteristics.

Power supply voltage variations can be reduced by employing a regulated dc-to-dc converter. If this isn't possible, because of space or efficiency requirements, then the servo loop will have to take care of this problem itself.

Ripple and transients are always present to some degree on power supply lines. As mentioned before, the loop may be too slow to remove the relatively high ripple frequency. If left uncorrected, this will result in undesirable amplitude modulation of the output power. To prevent this, a low-pass filter whose cutoff frequency is slightly

---

Arpad D. Vincze, Senior Design Engineer, Philco-Ford Corp., Palo Alto, Calif.



below the loop's cutoff frequency should be placed in the supply line. This way, the servo loop and the line filter will combine to eliminate ripple from dc to the highest ripple frequency.

The only variables that are left are internal to the loop. Under these conditions, the loop may properly be called an *isolated loop*. In addition to providing better performance than a non-isolated loop, the isolated loop has the advantage of being easier to analyze because of the reduced number of variables.

### A saturated stage provides control

At this point in the design of our system, we must decide what type of control to use. Our decision will depend on the signal level and frequency at the point of control, as well as considerations of economy, space and the time that is available to complete the job.

One widely used method employs a p-i-n diode as a variable attenuator. The attenuation of such a diode can be controlled by adjusting the forward bias current through it. Although these diodes can provide continuous level control in many applications, some of their properties make them a bad choice in certain cases. For example, if a single p-i-n diode is used as a series or shunt attenuator, it may cause a considerable mismatch in the rf circuit. Reasonable match over a broad dynamic range can only be achieved at the cost of additional circuit complexity.

A second disadvantage of p-i-n diodes is that they only act as variable attenuators, for signals whose period is much shorter than the minority-carrier lifetime of the diode semiconductor. As the signal period increases, the p-i-n diodes begin to behave like ordinary rectifying junctions. Thus, at the lower rf frequencies (100-200 MHz) and higher power levels (over 10 mW), they can cause considerable distortion by rectifying the signals. One approach that overcomes these two problems is the use of a saturation-type level control employing a transistor stage instead of a diode.

With this scheme, the level-controlling stage is operated in saturation and the output power is controlled by controlling the supply voltage to the stage. Thus, this method is most properly called *automatic level control*, (alc). This can be contrasted with conventional agc, where the gain of the agc stage (or stages) is controlled, most often, by changing the small-signal impedances in a fairly linear fashion. In this case, linear operation occurs below the saturation region. It is clear that the conventional analysis of an agc scheme does not apply to the saturation method; we will have to analyze this loop ourselves.

The simple block diagram of Fig. 1 is expanded in Fig. 2 to show the details of each block. Each of the components of the two major blocks is char-

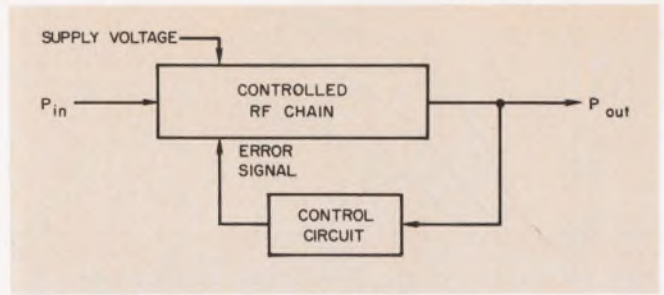

1. **Simplicity itself: the basic servo loop** consists of an rf chain and a control circuit. The chain is a series of cascaded rf amplifiers and frequency multipliers; the control circuit contains an amplifier and a stable reference voltage.

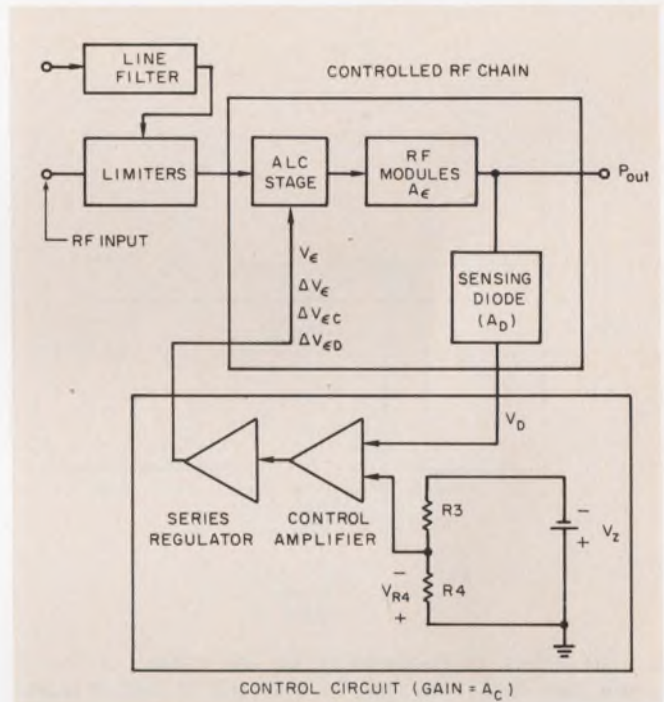

2. **Automatic level control** is provided by a saturated rf amplifier whose output is controlled by varying its supply voltage.



The author, Arpad D. Vincze, is holding a  $\times 24$  frequency multiplier/rf amplifier chain.



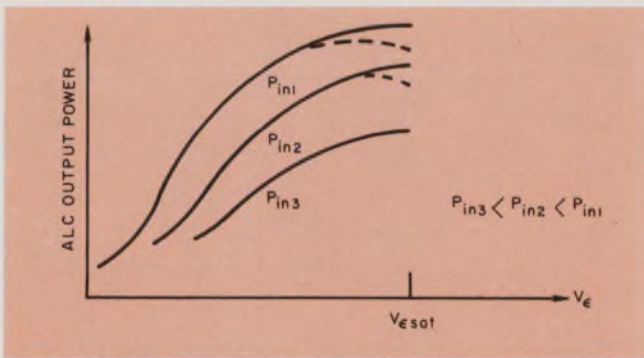

3. The alc stage transfer characteristics are plotted for different values of input power. Note that as the supply voltage gets high enough to pull the amplifier out of saturation, the output power may dip (dashed lines) if the amplifier  $Q$  is too high.

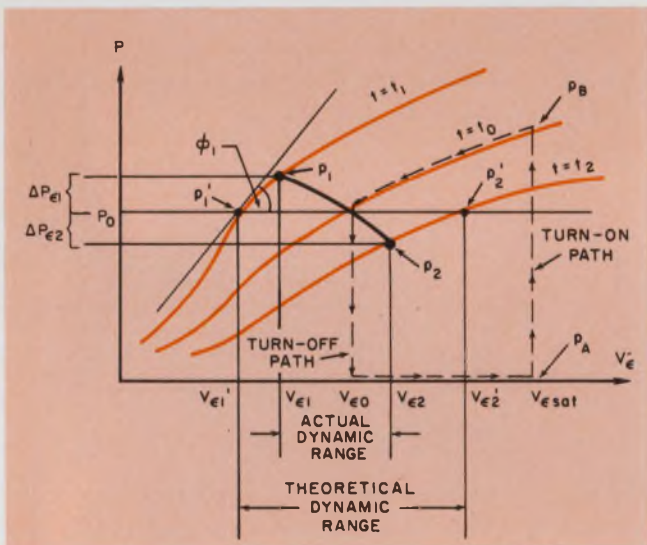

4. The effect of temperature on the output of the rf chain can easily be seen in this plot of output power vs error voltage for three different temperatures. The reference temperature is  $t_0$ ;  $t_1$  is below  $t_0$ , and  $t_2$  is above it. The dashed line shows the turn-on/turn-off locus. The solid black line is the locus of normal operation.

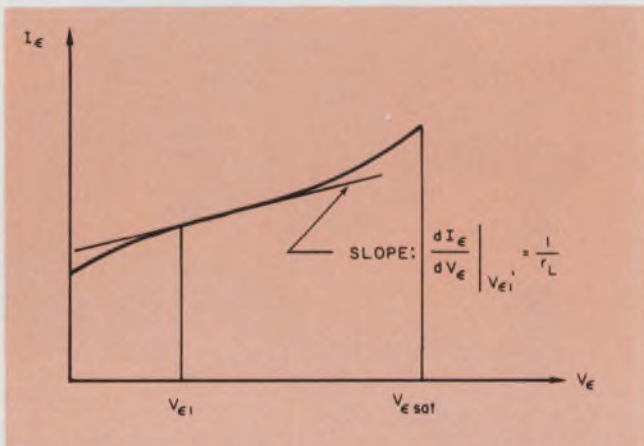

5. The incremental input resistance of the alc stage can be found from this plot of  $I_e$  vs  $V_e$ . The resistance is the reciprocal of the slope of the curve.

acterized by certain nonlinear parameters. A full description of these parameters, over a wide operating range, would involve solving a nonlinear differential equation with variable coefficients for each of these parameters. Fortunately, this laborious job can be avoided because operation is restricted to a small neighborhood about an operating point. This allows us to perform a linear analysis without introducing a significant amount of error.

### Let's examine the rf chain

The controlled rf chain basically consists of the alc stage, additional rf modules (amplifiers, multipliers, etc.) and the sensing diode. Although they are not within the rf chain, the preamplifier/limiters have the important role of providing isolation from input power variations.

Let's examine each of the components of the controlled rf chain, in turn, to clearly see how each affects the performance of the loop.

The operation of the *alc stage* is based on the simple fact that the output power of a saturated rf amplifier is limited by the supply voltage. The type of biasing on the alc stage transistor is unimportant—class A, B or C can be used. It is important that sufficient input power be applied to this stage to keep it within the linear control region (that is, well into saturation); otherwise, the loop gain will go down to zero, resulting in total loss of control.

It is also important to have a relatively low- $Q$  circuit in the collector of the alc transistor to minimize detuning effects. This is understandable, because of the change in depletion layer capacitance that results from changes in supply voltages. This all means that higher power stages, in general, yield greater stability and broader dynamic ranges, because their collector impedance levels are low.

A typical alc stage transfer characteristic curve with input power as a parameter, is shown in Fig. 3. Detuning near the endpoint of the dynamic range may cause a negative sloping—shown by the dashed line—resulting in a  $180^\circ$  phase reversal in the loop. However, as we shall see later (Eq. 22), if the loop gain is less than unity and the static-error voltage is sufficiently high, then the operating point can go "over the hill" without difficulties.

The transfer characteristic of the controlled rf chain is shown in Fig. 4. The output power of the chain is plotted against the alc voltage for three different temperatures. The transfer constant of the chain,  $A_e$ , is defined at a particular point as  $A_e = dP/dV_e$  ( $P, t, V_e$  fixed). (1)  $P$  is the output power of the chain and  $V_e$  is the alc voltage.  $A_e$  is always positive in the active operating region of the system.

The incremental input resistance of the alc stage



is also important, as it will affect the stability of the loop. This resistance,  $r_L$ , is determined from the curve of alc current vs alc voltage in Fig. 5. The slope of the curve is given by

$$dI_\epsilon/dV_\epsilon = 1/r_L \quad (2)$$

If  $r_L$  is too high, it may cause excessive loop gain—hence, loop instabilities. This problem can be cured by putting a lower resistance (in series with a large dc blocking capacitor) across the alc supply line.

We note that the curve of Fig. 5 does not intersect the  $I_\epsilon$  axis at the origin. This is because the large input signal can cause current flow, even at zero power supply voltage. As the rf drive power is lowered, the intercept point will move down toward the origin.

Referring to Fig. 6, the resistors  $R_e$  and  $R_b$  are used to set the correct bias level and damp parasitic oscillations, respectively.

The sensing diode converts the output power to a dc analog signal at the sensing point. Conversion is obtained by rectifying a small sample of output power, coupled by either a directional coupler or a small resonant coupling loop.

A plot of sensing-diode voltage vs output power is shown in Fig. 7. The diode transfer constant,  $A_D$ , is defined at a particular power level—as

$$A_D = dV_D/dP, (P=\text{const.}) \quad (3)$$

The flat portion of the curve, at high power levels, is caused by reverse breakdown of the diode. The diode should be operated below this region.

High diode efficiency and fast turnon and turn-off times are important for good performance, especially at high frequencies. Hot carrier diodes are very suitable in this regard. For example, the HP 2350 type can provide 5 Vdc into a 10-kilohm load with only 10 mW of coupled power at 2 GHz.

The detector diode has an incremental resistance,  $r_D$ , that must also be considered. For the HP 2350,  $r_D = 2$  kilohms. In our future calculations,  $r_D$  will refer to the resultant of the internal diode resistance and all the external resistors that may be put across it (such as  $R_{DL}$  in Fig. 6).

Although the temperature drift of the hot carrier diode is small, compared with conventional diodes, it still contributes to the total loop drift, and must be taken into account. The sensing diode drift constant is defined as

$$K_D = \Delta V_D/\Delta t, \quad \text{V}/^\circ\text{C.} \quad (4)$$

Note that  $K_D$  is a constant—not dependent on the operating point—therefore an incremental, rather than a differential, notation has been used.

There are additional components of drift that can be added to  $K_D$ . The low-pass filter capacitor may vary with temperature, and the loading across the diode and the VSWR of the line may also change, resulting in different output voltages at different temperatures.

The following suggestions should be followed

in designing the rf sensing circuit:

- Aim for high detected voltage, preferably a couple of volts. One way to do this is to increase the fraction of power coupled to the diode. As will be seen later, this will reduce all other drift components and minimize the compensation required for differential drifts.

- Locate the diode where the VSWR is low and where there are no temperature-sensitive field intensities caused by high-Q circuits.

- Use a clean rf signal (with the second harmonic at least 15-dB down) for monitoring purposes, because the coupling loop may respond to the higher harmonics and yield erroneous results.

- If any parts of the sensing-diode assembly must be cemented together, use a bonding agent that exhibits low mechanical hysteresis when it is temperature cycled. (Q-Max A27 is a good choice.) If this is not done, the small permanent deformations that will result can cause a long-term drift in the reference level. The cemented assembly should be temperature-cycled a few times, to cure the cement before final measurements are made.

Since the monitored output power changes very little when the loop is closed, and the diode contact potential changes linearly with temperature,  $A_D$ ,  $r_D$  and  $K_D$  can be considered constant at any given output power level.

### The control circuit closes the loop

The control circuit contains a high-gain dc amplifier with low temperature drift. Any simple circuit or device, such as a dc operational amplifier with adjustable gain, can be used. The amplifier must sense the output power variations as represented by changes in the sensing-diode voltage, must compare them with a reference voltage, and must amplify the difference to provide an error signal. A series-regulator transistor is used after the high-gain stage to provide additional current amplification.

The simple control circuit of Fig. 6 was chosen for analysis because it explicitly shows some of the important factors governing the drift mechanism.

An npn transistor was chosen as the series regulator ( $Q2$ ), and a matched pair of pnp transistors ( $Q1$ ) was selected as the high-gain amplifier. This combination allows  $V_\epsilon$  to vary from zero to  $V_{cc}$  while using only one single-polarity power supply. The common-mode variations are suppressed by making  $R_E$  sufficiently large or, perhaps, by replacing it with a current source. (A good value for  $R_E$  is  $R_E = 10[r_e + (R_B + r_{bb'})/\beta_1]$ , where, referring to  $Q1$ ,  $r_e$  is the emitter-base diode incremental resistance;  $R_B$  is the equivalent parallel resistance of  $R_1$  and  $R_2$ ;  $r_{bb'}$  is the base spreading resistance, and  $\beta_1$  is the current gain.)

The power level is adjusted by varying  $R_1$ .



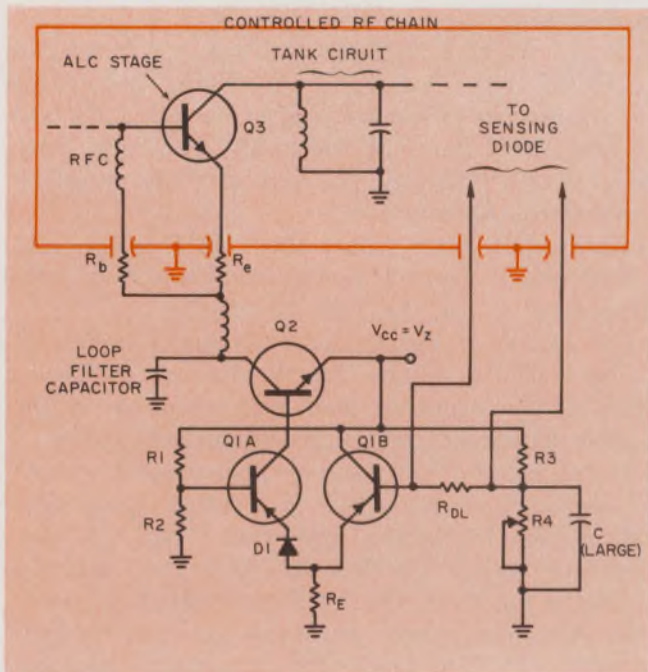

6. A wide dynamic range is achieved with only a single-polarity power supply by using an npn transistor for Q2 and a pnp pair for Q1. Diode D1, in the emitter leg of Q1A, provides linear temperature compensation for the control circuit, and  $R_e$  sets the bias level of the alc stage.

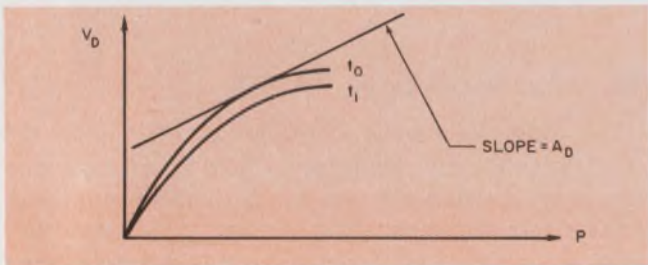

7. Stay away from the flat portion of these sensing diode curves. The flattening is caused by reverse breakdown of the diode. The curves are shown for two temperatures,  $t_0 > t_1$ .

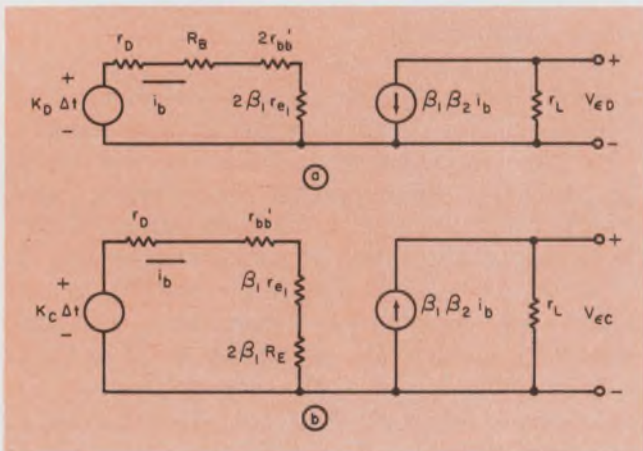

8. The linear drift behavior of the control circuitry is analyzed with these equivalent circuits. Separate models are needed for differential-mode drift (a) and common-mode drift (b).  $R_B$  is the equivalent parallel resistance of  $R_1$  and  $R_2$  of Fig. 6.

The required dynamic range of the control circuit can be read off the abscissa of Fig. 4. Actually two ranges are shown: a theoretical one and an actual one. The actual dynamic range is smaller than the theoretical, because, for finite loop gain, the system follows the operating locus of Fig. 4 rather than the horizontal line,  $P = P_o$ . Nevertheless, good design practice dictates considering the wider dynamic range. Hence, the amplifier performance must be specified between  $V_{\epsilon_1}'$  and  $V_{\epsilon_2}'$ . The output current required from the alc stage can be easily read off the curve of Fig. 5, using the voltages we just mentioned. These numbers will determine the power dissipation of the series regulator transistor.

While it is not necessary for the control amplifier to be perfectly linear, it is obviously important that it stay out of saturation over the theoretical dynamic range. The operating point should be set about halfway between minimum and maximum collector current.

At this point we can see an additional reason for wanting a rather high voltage out of the sensing diode. When there is no rf input power into the system, the control amplifier is saturated, sitting at point  $P_A$  on Fig. 4. When the power is turned on, the operating point jumps vertically to  $P_B$  and then moves toward its final position, as the loop filter capacitor discharges towards  $V_{\epsilon_o}$ . The sensing diode voltage must be large enough to pull the amplifier out of saturation, from  $P_B$  to the final operating point.

The control circuit operates as follows: if the output power increases,  $V_D$  will increase so that Q1B becomes more forward biased. This will reduce the collector current of Q1A, which, in turn, will lower the collector current in Q2. This will cause a decrease in  $V_{\epsilon}$  and a lowering of the output rf power. The gain of the control circuit is defined, at a point, as

$$A_c = dV_{\epsilon} / dV_D, (V_{\epsilon_1} \text{ specified}). \quad (5)$$

It is a negative quantity and will vary with the operating point.

### Handling nonlinearities

Since all of the parameters in Eqs. 1-5 (except  $K_D$ ) are strong functions of the operating point, and since we want to operate the system over a relatively wide dynamic range, we might anticipate formidable difficulties in analyzing the behavior of our system. Actually, graphical techniques can be used to find the locus of output power variations very neatly. Although the locus isn't coincident with the  $P = P_o$  line (Fig. 4), it is close enough for us to evaluate  $A_c$  at the intersection of the  $P = P_o$  line and the appropriate constant-temperature curve, without introducing any significant errors.



The other nonlinear variables are handled in a similar way, using the curves of Figs. 4, 5 and 7. The slope of the tangent to these curves yields the transfer characteristic at any point.

An important point to note in this connection is that the transfer characteristics should be plotted with the actual loading present. For example, when plotting  $P$  vs  $V_D$ , the diode should be loaded with the equivalent input impedance of the control circuit. Since the equivalent impedance may be a tricky thing to duplicate, the safest bet is to plot these curves with the actual circuit loading, wherever this is possible.

### Find the setting sensitivity

Now that we have described the system building blocks, their functions, the parameters that describe them and methods of measuring them, we can proceed to establish the system design equations. First, we will discuss the static performance of the system; the dynamic performance will be covered in part 2 of this article.

We define the *setting sensitivity*,  $S$ , of the system as follows

$$S = dP/dR_4 = (dP/dV_{R4}) (dV_{R4}/dR_4), \quad (6)$$

where  $V_{R4}$  and  $R_4$  are shown in Fig. 6. Note that  $V_{R4}$  is derived from a stable zener diode voltage,  $V_Z$ .

Referring to Fig. 2, we see that a change in  $R_4$  results in a change in  $P$ , and hence in  $V_D$  as well. This will generate an error voltage,  $dV_\epsilon$ . Since  $V_D$  and  $V_{R4}$  are in series, we can write

$$dV_\epsilon = A_C (dV_{R4} + dV_D). \quad (7)$$

Substituting  $dV_\epsilon = dP/A_\epsilon$ , and  $dV_D = A_D dP$ , and arranging terms, we get

$$dP/dV_{R4} = A_C A_\epsilon / (1 - A_L), \quad (8)$$

where  $A_L = A_C A_\epsilon A_D =$  the loop gain.

From Fig. 2 (or Fig. 6) we see that  $V_{R4} = V_Z [R_4 / (R_3 + R_4)]$ . Differentiating with respect to  $R_4$  gives

$$dV_{R4}/dR_4 = V_Z [R_3 / (R_3 + R_4)^2]. \quad (9)$$

And finally, we can write

$$S = [A_C A_\epsilon / (1 - A_L)] [V_Z R_3 / (R_3 + R_4)^2]. \quad (10)$$

In the case of very large total loop gain ( $A_L \gg 1$ ), this reduces to

$$S = [V_Z / A_D] [R_3 / (R_3 + R_4)^2]. \quad (11)$$

It is a good idea to keep  $S$  as low as possible, to make the system as insensitive as you can to aging effects in the resistors.  $S$  can be reduced by increasing  $R_4$  and decreasing  $V_Z$ . However, this places unnecessary restrictions on the operating point. A better approach is to make  $A_D$  as high as possible. This, as we have mentioned, will improve the loop performance in many other ways as well.

The temperature drift of our system will have two components: linear and nonlinear. The linear drift is caused by changes in the various junction potentials and leakage currents; the nonlinear, by temperature gradients in the rf chain. Let's first

look at the linear temperature variations.

These are of two types: common mode and differential mode. The common-mode drift will be negligible, if the amplifier is designed properly. The differential-mode drift is the important component; it is, essentially, the drift of the sampling diode.

In our analysis of the linear temperature drifts, we will make the following assumptions:

- Leakage currents in  $Q_1$  are negligible, because the driving source is essentially a voltage source.
- The dual transistors ( $Q_1$ ) have negligible differential temperature drift.
- The drift in dc  $\beta$  of  $Q_2$  can be neglected because the closed loop compensates for it.
- $\beta \gg 1$ .

Referring to Figs. 2 and 8, the change in output power caused by an incremental change of the error voltage is given by

$$\Delta P_{\epsilon D} = A_\epsilon (\Delta V_{\epsilon C} + \Delta V_{\epsilon D}) + \Delta P_{\epsilon D} A_C A_\epsilon A_D. \quad (12)$$

Note that, because of feedback, the output power change appears on the righthand side of the equation as well as on the left.

From the circuits of Fig. 8, we can write

$$\Delta V_{\epsilon C} = \frac{\beta_2 r_L K_C \Delta t}{[(r_{bb'} + r_D) / \beta_1] + r_{e1} + 2R_E} = A_{CC} K_C \Delta t, \quad (13)$$

and

$$\Delta V_{\epsilon D} = \frac{-\beta_2 r_L K_D \Delta t}{[(R_B + 2r_{bb'} + r_D) / \beta_1] + 2r_{e1}} = A_C K_D \Delta t. \quad (14)$$

$A_{CC}$  and  $A_C$  are the common- and differential-mode gains, respectively;  $K_C$  and  $K_D$  are the common- and differential-mode drift coefficients, and  $\Delta V_{\epsilon C}$  and  $V_{\epsilon D}$  are the error voltages caused by the two drifts. Next, we define the common-mode rejection ratio,

$$G_C = A_{CC} / A_C; \quad (15)$$

and finally, we substitute Eqs. 13, 14, and 15 into Eq. 12 to get

$$\Delta P_{\epsilon D} = [A_\epsilon A_C K_D \Delta t / (1 - A_L)] [1 + G_C K_C / K_D]. \quad (16a)$$

Now, for a well-designed differential amplifier,  $R_E \gg [(R_B + 2r_{bb'} + r_D) / \beta_1] + 2r_{e1}$ , so that  $G_C \ll 1$ .

This means that

$$\Delta P_{\epsilon D} = K_D A_\epsilon A_C \Delta t / (1 - A_L) \quad (16b)$$

and, if  $A_L \gg 1$ ,

$$\Delta P_{\epsilon D} = -K_D \Delta t / A_D. \quad (16c)$$

Eqs. 16b and 16c will both be needed, depending upon the loop gain. If  $A_L$  is greater than about 20, Eq. 16c can be used, otherwise Eq. 16b is safer.

### What about the nonlinear drift?

In Eq. 16 we have an expression for the change in output power caused by linear temperature drift effects. Now, we will find the change caused by nonlinear effects. To do this, we will make three assumptions.

- $A_D$  is constant over the temperature range.
- $A_\epsilon$  is constant in the vicinity of the operating point.
- The loop is statically stable (see Eq. 22).

Our approach will be graphical because the system nonlinearities make an analytical approach quite difficult, to say the least. Referring to Fig. 4, we see a horizontal line drawn at the power reference level,  $P_o$ . If the loop gain were infinite, the locus of operation of the system would be this horizontal line, that is,  $P = P_o$  for every temperature. In reality, the loop gain is not infinite and the locus tilts upward to the left because

$$\Delta P_\epsilon = \Delta V_\epsilon / A_D A_C \neq 0, \quad (17)$$

and because  $A_C$  is negative and  $A_D$  is positive. This means that the power will be below the reference line for all temperatures above the reference temperature,  $t_o$ , and be above it for the lower temperatures.

From Fig. 4 and Eq. 17, we can write

$$\Delta V_{\epsilon_1} = V_{\epsilon_1} - V_{\epsilon_0} = A_C A_D \Delta P_{\epsilon_1}. \quad (18)$$

If we draw a line tangent to the  $t = t_1$  curve, where it crosses the  $P = P_o$  line (at point  $P_1'$ ), and we let this tangent represent the curve in the vicinity of  $P_1'$ , we can write:

$$\tan \phi_1 = A_{\epsilon_1} = \Delta P_{\epsilon_1} / (V_{\epsilon_1} - V_{\epsilon_1}'), \text{ from which} \\ \Delta P_{\epsilon_1} = A_{\epsilon_1} (V_{\epsilon_1} - V_{\epsilon_1}'). \quad (19)$$

Eqs. 18 and 19 contain two unknowns,  $V_{\epsilon_1}$  and  $\Delta P_{\epsilon_1}$ . Solving for them, we get

$$\Delta P_{\epsilon_1} = -A_{\epsilon_1} (V_{\epsilon_1}' - V_{\epsilon_0}) / (1 - A_L), \quad (20a)$$

which, for  $A_L \gg 1$ , becomes

$$\Delta P_{\epsilon_1} = (V_{\epsilon_1}' - V_{\epsilon_0}) / A_C A_D; \quad (20b)$$

and

$$V_{\epsilon_1} = (V_{\epsilon_0} - A_L V_{\epsilon_1}') / (1 - A_L). \quad (21)$$

Now, once the data of Fig. 4 has been obtained, we can find  $\Delta P_\epsilon$  as follows: Say we want to find  $\Delta P_{\epsilon_1}$ , the change in output power when the temperature goes from  $t_o$  to  $t_1$ . We draw a horizontal line at the specified output power level. Then, we read the values of  $V_{\epsilon_1}'$ ,  $A_{\epsilon_1}$ , and  $V_{\epsilon_0}$  off the graph at the intersection of the  $t = t_1$  curve and the horizontal line. We get  $A_D$  from the  $t = t_1$  curve of Fig. 7 at the reference power level. And, we can get  $A_C$  from Eq. 14. Finally, we get  $\Delta P_{\epsilon_1}$  from Eq. 20.

#### Make sure the loop holds

In closing our discussion of the static behavior of the loop, we will consider a phenomenon that is often mistaken for oscillation but is really a static problem. It sometimes happens — usually at a high temperature — that the loop fails to hold the power level; the alc stage jumps to full saturation, and

the output power goes to its highest value.

This can be caused by insufficient loop gain. To see how this might happen, assume that the output power increases by an amount  $dP$ . Then an error voltage,  $dV_\epsilon = dP/A_\epsilon$ , must be generated to keep the operating point stable. This means that the error voltage supplied by the sensing diode/control amplifier combination must exceed the above value of  $dV_\epsilon$ , or, in other words,  $|(dP) (A_C A_D) | > dP/A_\epsilon$ . This can be written as

$$|A_C A_D A_\epsilon| = |A_L| > 1. \quad (22)$$

If this loop-hold criterion is violated (usually because of insufficient  $A_\epsilon$ ) the loop will be unable to correct for the temperature drift and, if its  $Q$  is too high, or the rf chain and/or the alc stage are not tuned properly, the alc stage may follow the dashed curve of Fig. 3 and drive the output power to its maximum.

Equation 22 sets a lower limit on the loop gain. The upper limit will be determined in the discussion of loop stability in Part 2. However, in the meantime, we can ask this question: "For a given value of  $A_L$ , what should the relative values of  $A_\epsilon$ ,  $A_C$ , and  $A_D$  be?" Based on our earlier discussions, the best play is to make  $A_D$  as large as possible; this will reduce  $S$  (Eq. 11), reduce  $\Delta P_\epsilon/\Delta t$  (Eq. 16c), and reduce  $\Delta P_\epsilon$  (Eq. 20b).  $A_D$  can be increased most easily by increasing the fraction of the output power that is coupled to the sensing diode. Merely increasing  $A_C$  may not solve the problems; it may even cause instabilities, as we shall see next time. ■ ■

#### Test your retention

*Here are questions based on the main points of this article. Their purpose is to help you make sure you have not overlooked any important ideas. You'll find the answers in the article.*

1. *What is a saturation-type automatic level control? How does it differ from conventional agc?*

2. *A high-power alc stage will, in general, be more stable than a low-power stage. Why?*

3. *Why is it desirable to have the sensing diode transfer function ( $A_D$ ) as high as possible? How can you increase it?*

4. *What is the source of most of the linear temperature drift in the system?*

5. *What is the loop-hold criterion?*



# Now! High Power, High Efficiency at 225-400 MHz with New Family of RCA "overlay" Transistors

New power performance for VHF/UHF comes in RCA's new radial lead package—in a family of "overlay" transistors. For your driver, pre-driver, and output circuit requirements, RCA offers the following developmental types:

TA7344—16 W (min.) output at 400 MHz; 6 dB gain

TA7367—10 W (min.) output at 400 MHz; 8 dB gain

TA7411—2 W (min.) output at 400 MHz; 10 dB gain

These units, silicon "overlay" n-p-n transistors, are housed in a package

designed for low input and output parasitic lead inductances. And low capacitances, too. The wide leads, all isolated from the stud, are uniquely "sandwiched" between ceramic layers to provide an over-all hermetic case with exceptional mechanical strength.

TA7344, TA7367, and TA7411 can be used effectively as direct replacements for plastic stripline types. All are intended for large signal, broadband linear RF power amplifiers for military and industrial equipment operating in

VHF/UHF frequencies.

For more information on this expanded family of "overlay" types and other RCA "overlay" transistors, see your local RCA Representative or your RCA Distributor. For technical data on specific types, write: RCA Electronic Components, Commercial Engineering, Section No. PG-31A, Harrison, New Jersey 07029.



INFORMATION RETRIEVAL NUMBER 33

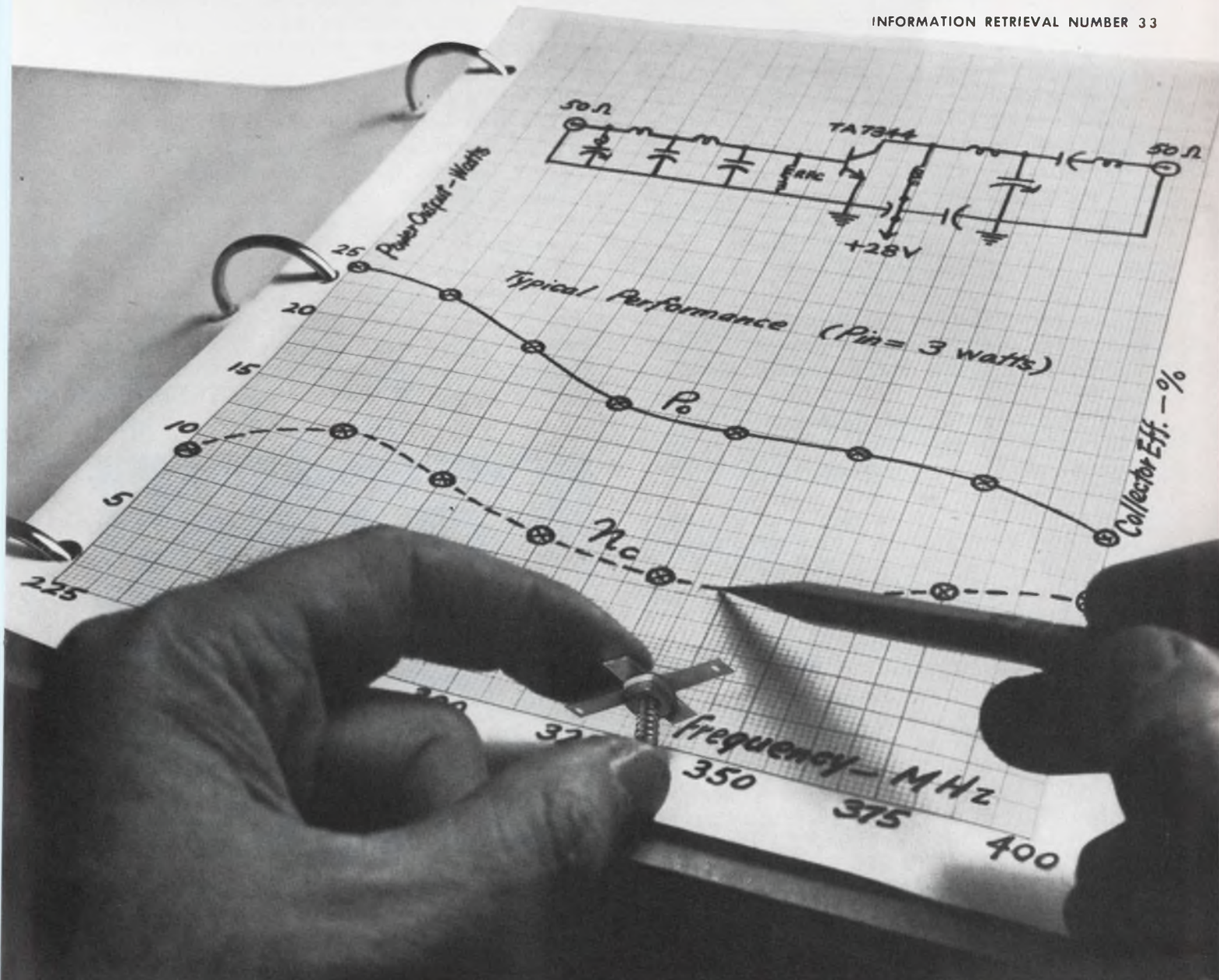



# Build your own acoustic coupler

and convert a standard teletypewriter into a portable time-shared computer terminal.

A time-shared computer is as close as the nearest telephone, for those who have a portable computer terminal. Such a terminal can consist of nothing more than a standard teletypewriter coupled acoustically to the telephone line through the telephone handset. This differs from the conventional approach, in which teletypewriter terminals are directly wired into the telephone network through special data-sets. Although the inputs to these data-sets are dc, tone signalling is used for actual data transmission, since the telephone network will not pass direct currents. The acoustic telephone coupler also uses tone signalling—but it eliminates the need for wired connections by sending and receiving its tones through the handset and thus can be used with any telephone.

The design and construction of such an acoustic coupler involves inexpensive, readily available components. It is simple to connect to a teletypewriter, needs no control knobs or adjustments for signal level, and performs well over ordinary telephone lines. The circuitry is enclosed in a small box that contains two foam-padded apertures, in which the telephone handset is cradled.

To operate the terminal, the user dials the computer on the telephone and waits for the computer to send back its answering tone. Upon hearing the tone, he “plugs” the handset into the coupler and turns on the coupler and teletypewriter. The terminal is now connected to the computer and is ready for use. To disconnect, the user simply hangs up the telephone handset and shuts off the terminal.

The coupler is designed to be connected to a Model 33 or 35 Teletypewriter, or equivalent unit (Fig. 1). These units normally operate at 10 characters per second, or about 100 words per minute. They use the 8-unit ASCII code, preceded by a one-unit start pulse (space), and followed by a two-unit stop pulse (mark) for each character. There are 11 equal-length bits per

character, with bit durations being about 9 ms.

The teletypewriter has separate pairs of terminals for its keyboard and printer. Each time a key is depressed, the keyboard circuit opens and closes to generate the serial binary code that corresponds to the character to be transmitted. The changing current through the keyboard-contacts shifts the frequency of a tone generator in the coupler, and this FSK tone is sent to the computer. For receiving, FSK tones from the computer are demodulated in the coupler and converted into an on-off current that drives the printer.

To permit simultaneous transmission and reception over a single telephone line (full-duplex operation), two sets of frequencies are used. At the user terminal, one set is assigned for transmitting and a different set for receiving. The computer uses the same two sets of frequencies, but these are interchanged with respect to transmit and receive.

To eliminate confusion as to assignments, in situations where one terminal can call another terminal, the one which initiates the communications operates in the originate mode; the responding terminal in the answer mode. The coupler



With the flip of a switch, author Roubique converts his teletypewriter into a time-shared terminal that operates over conventional telephone lines.

---

Charles J. Roubique, Design Engineer, ESSA Research Laboratories, Boulder, Colo.



described here operates only in the originate mode (see box).

The coupler circuitry is comprised of two units: a transmit unit, on an etched circuit card for convenience, and a receive unit on two etched circuit cards. Liberal use is made of inexpensive linear integrated circuits in the design. A digital integrated circuit is also used.

### Transmitting unit uses twin-T oscillator

The transmitting unit (Fig. 2) consists of a twin-T oscillator driving an audio amplifier. The frequency of the oscillator is shifted by changing the value of the shunt resistance ( $R_3$  and  $R_1$ ) in the feedback circuit. This can be done with little effect on the output amplitude. An LC oscillator was tried, but rejected, because it had larger amplitude changes, and also required extensive magnetic shielding to avoid coupling the transmitter signal into the receiver input coil.

Maximum frequency stability in this type of oscillator is achieved when the twin-T network ( $R_1$  through  $R_4$ , and  $C_1$ ,  $C_2$ ), made up of stable components, is isolated from changes in transistor parameters. This is accomplished in the circuit by driving the twin-T from the low-impedance output of emitter follower,  $Q_3$ , and by letting the network output drive the high-impedance input of another emitter follower,  $Q_1$ . The required amplification is provided by voltage amplifier  $Q_2$ . Control transistor  $Q_4$  acts as a switch, which shifts the output to a higher frequency by paralleling  $R_{4a}$  and  $R_{4b}$  with  $R_{3a}$  and  $R_{3b}$ . This occurs each time a "mark" is produced by the keyboard.

Resistors  $R_{3a}$  and  $R_{3b}$ , from the base of  $Q_4$  to ground, cause a current of 20 mA to flow through the keyboard contacts in the teletypewriter. This

## Originate vs answer mode

For a terminal to operate in the answer mode, its transmit and receive frequencies are the reverse of those of a terminal operating in the originate mode. These frequencies are as follows:

	Mark	Space
<b>Originate mode</b>		
transmit	1270 Hz	1070 Hz
receive	2225 Hz	2025 Hz
<b>Answer mode</b>		
transmit	2225 Hz	2025 Hz
receive	1270 Hz	1070 Hz

The conversion is accomplished by changing the values of certain frequency-determining components, as specified in the text.

amount of current is required for reliable operation of the contacts. Diode  $CR_3$  is needed when pin 8 is connected for half-duplex operation. If this pin 8 is connected to pin 8 of the receiver output card, any characters being transmitted will also be typed on the transmitting teletypewriter.

The diode feedback network,  $CR_1$  and  $CR_2$ , around bias resistor  $R_{11}$  is used to limit the oscillator output so that no change in amplitude occurs when the frequency is shifted.

The audio amplifier consists of an integrated-circuit operational amplifier,  $AR_1$ , driving a complementary output-pair of transistors,  $Q_5$  and  $Q_6$ , which operate class-B. Bias stability is provided by the feedback loop consisting of  $R_{15}$  and  $R_{16}$ . Ac feedback through  $C_7$  eliminates the cross-over distortion inherent in class-B operation.  $R_{14}$  adjusts the output level for reliable operation.

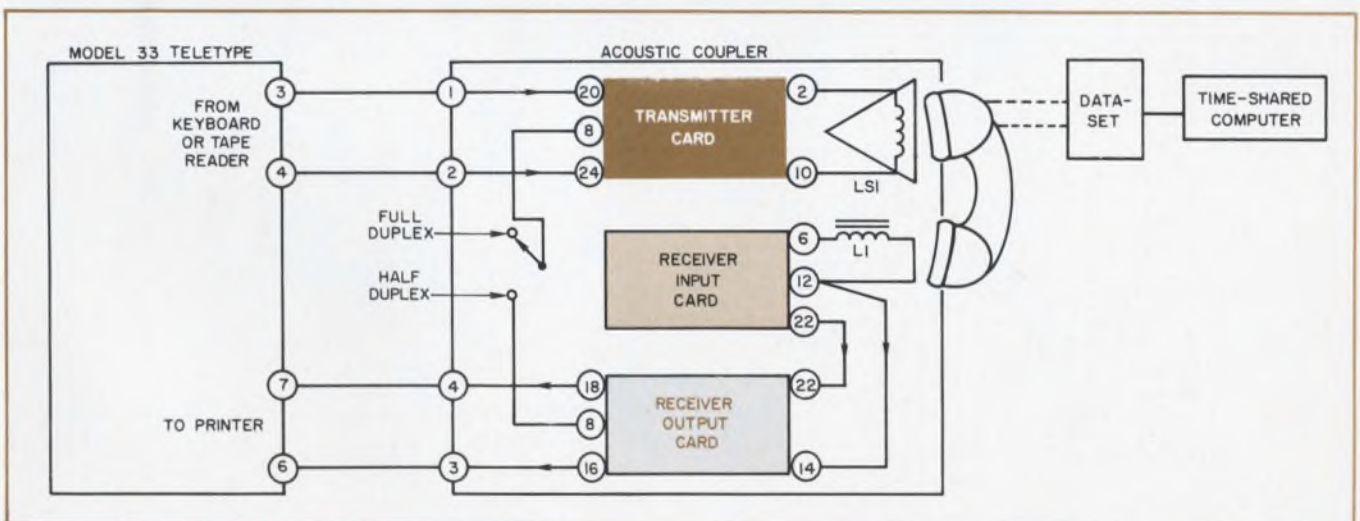

1. Acoustic coupler converts a teletypewriter into a time-shared computer terminal. The transmitter portion of the coupler converts the dc signals from the teletypewriter

into tones that can be sent over telephone lines. The receiver portion converts the tone signals from the central computer back into dc.

To convert the transmitting unit of Fig. 2 for operation in the answer mode, capacitors  $C_1$  and  $C_2$  are changed to  $0.0015 \mu\text{F}$ , capacitor  $C_3$  to  $0.0033 \mu\text{F}$  and resistor  $R_{4a}$  to  $33 \text{ k}\Omega$ .

### Receiving unit converts FSK signal to dc

The receiving unit of the coupler consists essentially of an amplitude limiter feeding two tuned circuits, which act as a demodulator. The demodulated signal is then shaped by a digital circuit and supplied to the teletypewriter printer.

A diagram of the receiver input card, which provides amplification, noise rejection and limiting, is shown in Fig. 3. The input signal comes from a simple, commercial magnetic pickup coil designed for recording from telephones. This type of coil is used instead of a microphone to reduce response to room noise.

After amplification by stages  $Q1$  and  $Q2$ , the signal is filtered by band-pass filter  $L_2-C_{11}$ , which attenuates telephone-line noise that lies outside the frequency region of interest. For optimum noise rejection, the 3-dB points of the filter should coincide with the frequencies of maximum deviation from the mean.<sup>1</sup> The required  $Q$  in this case is approximately 10, which is closely realized

with the  $L_2-C_{11}$  band-pass filter. The filter is resonated at  $2125 \text{ Hz}$ , which is the mean receiving frequency.

The integrated circuit operational amplifier,  $AR1$ , is used at full open-loop gain as a limiter. Full limiting is realized with a signal of  $1 \text{ mV}$ , peak-to-peak, from the input pickup coil. Above this voltage, the operation of the receiving unit is independent of signal level.

The receiver output card (Fig. 4) takes the amplified and limited FSK signal and demodulates it into the dc current pulses required for teletypewriter operation. The signal from the  $AR1$ , is used at full to open-loop gain as a limiter. limiter is divided by resistors  $R_{16}$  and  $R_{17}$  (on the receiver input card), and supplied to the mark and space filters. These filters use operational amplifiers connected in the so-called infinite-gain multiple-feedback arrangement to obtain the equivalent of a parallel-resonant, single-tuned circuit.<sup>2</sup>

For demodulation of this type of FSK signal, there is an optimum  $Q$  for proper filtering. A very low  $Q$  would not provide sufficient rejection of the space frequency by the mark filter, and vice versa. A very high  $Q$ , on the other hand, would not allow the filter output to follow the

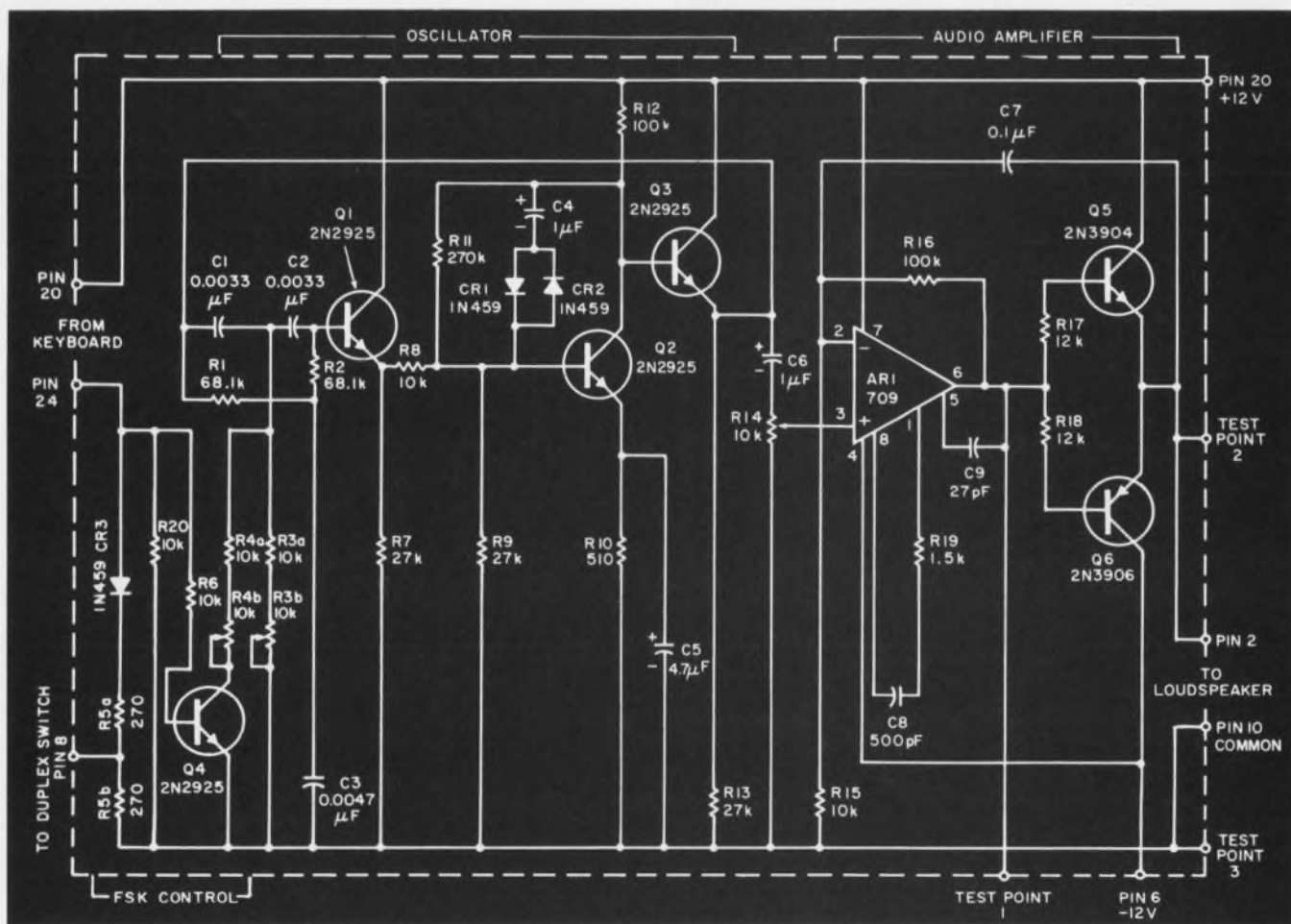

2. The transmitter portion of the coupler converts the ON-OFF dc currents from the teletypewriter into a fre-

quency-shift tone signal, which is applied to the telephone handset through the output loudspeaker.



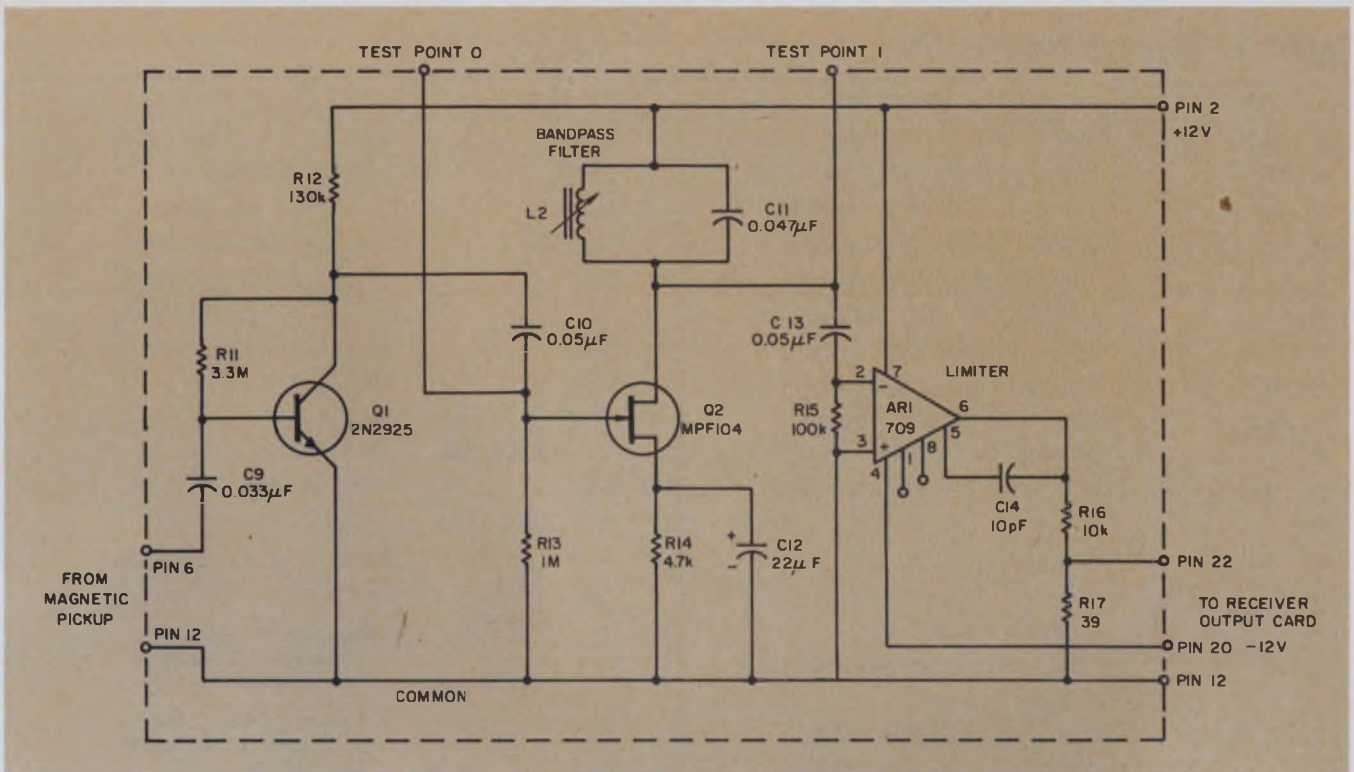

3. The receiver input circuit provides noise rejection and limiting of the tie signals received on the telephone lines.

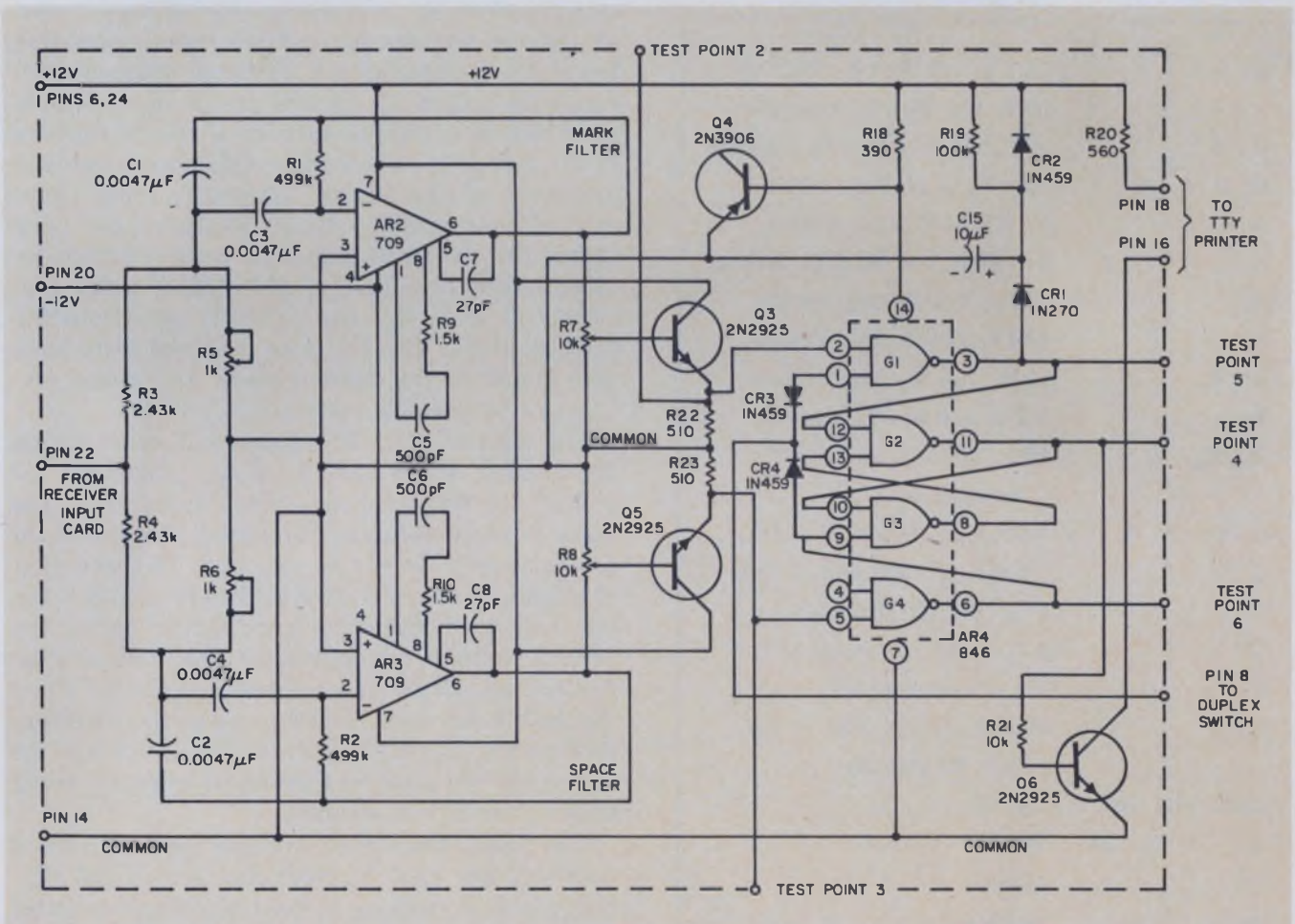

4. The receiver output circuit converts the frequency-shift tone signal into the ON-OFF dc currents required

by a teletypewriter. The circuit uses two IC operational amplifiers and one digital IC.

**Table 1. Receiver parts list**

Part	Description	Part	Description
R <sub>1</sub> , R <sub>2</sub>	499 k, 1/2 W, 1%, metal film	C <sub>11</sub>	0.047 μF, 100 Vdc, 10%
R <sub>3</sub> , R <sub>4</sub>	2.43 k, 1/2 W, 1%, metal film	C <sub>2</sub> , C <sub>6</sub>	500 pF, 50 Vdc, disc
R <sub>5</sub> , R <sub>10</sub>	1.5 k, 1/4 W, 5%, carbon	C <sub>7</sub> , C <sub>8</sub>	27 pF, 50 Vdc, disc
R <sub>11</sub>	3.3 M, 1/4 W, 5%, carbon	C <sub>10</sub> , C <sub>13</sub>	0.05 μF, 50 Vdc, disc
R <sub>12</sub>	130 k, 1/4 W, 5%, carbon	C <sub>12</sub>	22 μF, 6 Vdc, tantalum
R <sub>13</sub>	1 M, 1/4 W, 5%, carbon	C <sub>15</sub>	10 μF, 10 Vdc, tantalum
R <sub>14</sub>	4.7 k, 1/4 W, 5%, carbon	C <sub>16</sub>	10 pf, 100 Vdc, mica
R <sub>15</sub> , R <sub>19</sub>	100 k, 1/4 W, 5%, carbon	CR1	1N270
R <sub>16</sub> , R <sub>21</sub>	10 k, 1/4 W, 5%, carbon	CR2, CR3, CR4	1N459
R <sub>17</sub>	39 ohm, 1/4 W, 5%, carbon	Q1, Q3, Q5, Q6	2N2925
R <sub>22</sub> , R <sub>23</sub>	510 ohm, 1/4 W, 5%, carbon	Q2	MPF104, N-channel FET
R <sub>18</sub>	390 ohm, 1/2 W, 5%, carbon	AR1, AR2, AR3	709, IC op amp
R <sub>20</sub>	560 ohm, 1/2 W, 5%, carbon	AR4	846P IC quad dual-gate
R <sub>3</sub> , R <sub>4</sub>	1 k, 15 turn, wirewound potentiometer	Q4	2N3906
R <sub>7</sub> , R <sub>8</sub>	10 k, 15 turn, wirewound potentiometer	L <sub>1</sub>	Telephone pickup coil, Burstein-Applebee No. 17C253
C <sub>1</sub> , C <sub>2</sub> , C <sub>3</sub> , C <sub>4</sub>	0.047 μF, 100 Vdc, 10%	L <sub>2</sub>	Tunable inductor, 60-130 mH, J. W. Miller No. 6324
C <sub>5</sub>	0.033 μF, 100 Vdc, 10%		

**Table 2. Transmitter parts list**

Part	Description
R <sub>1</sub> , R <sub>2</sub>	68.1 k, 1/2 W, 1%, metal film
R <sub>10</sub> , R <sub>41</sub>	10 k, 1/2 W, 1%, metal film
R <sub>5</sub> , R <sub>21</sub>	270 ohm, 1/4 W, 5%, carbon
R <sub>6</sub> , R <sub>7</sub> , R <sub>15</sub> , R <sub>20</sub>	10 k, 1/4 W, 5%, carbon
R <sub>9</sub> , R <sub>13</sub>	27 k, 1/4 W, 5%, carbon
R <sub>10</sub>	510 ohm, 1/4 W, 5%, carbon
R <sub>11</sub>	270 k, 1/4 W, 5%, carbon
R <sub>12</sub> , R <sub>16</sub>	100 k, 1/4 W, 5%, carbon
R <sub>17</sub> , R <sub>18</sub>	12 k, 1/4 W, 5%, carbon
R <sub>19</sub>	1.5 k, 1/4 W, 5%, carbon
R <sub>3</sub> , R <sub>4</sub> , R <sub>14</sub>	10 k, 15 turn, wirewound potentiometer
C <sub>1</sub> , C <sub>2</sub>	0.0033 μF, 100 Vdc, ±10%
C <sub>3</sub>	0.0047 μF, 100 Vdc, ±10%
C <sub>4</sub> , C <sub>8</sub>	1 μF, 35 Vdc, tantalum
C <sub>5</sub>	4.7 μF, 25 Vdc, tantalum
C <sub>7</sub>	0.1 μF, 50 Vdc, disc
C <sub>9</sub>	500 pF, 50 Vdc, disc
C <sub>6</sub>	27 pF, 50 Vdc, disc
CR1, CR2, CR3	1N459
Q1, Q2, Q3, Q4	2N2925
Q5	2N3904
Q6	2N3906
AR1	709, IC op amp
LS1	2 in., 8-ohm speaker

signal modulation at the required transmission rate. A filter having a variable Q was tested at various settings on a FSK signal, and was found to operate at the required transmission rate with a Q of 15. This Q yields an amplitude ratio of 3 to 1 for the outputs of the two filters. In the case of the mark filter, this means that the amplitude of the "mark" output is three times that of the "space" output. Practical ball-park values for the input resistors were obtained by using a Q of 15, a gain of about 80, a center frequency of 2125 Hz, and 4700-pF capacitors for C<sub>1</sub> through C<sub>4</sub>. The filters so designed were then each tuned to the desired mark and space frequencies by variable resistors R<sub>3</sub> and R<sub>4</sub>.

The outputs from the mark and space filters are applied, by means of emitter followers Q<sub>3</sub> and Q<sub>5</sub>, to threshold detectors, which sense the mark or space status of the signal. The threshold detectors each consist of one gate (G<sub>1</sub> and G<sub>4</sub>) of a digital integrated circuit. Power of +6 V for the integrated circuit is provided by using the reverse voltage breakdown of the base-emitter diode of transistor Q<sub>4</sub> as a shunt regulator. When the peak input signal level to one of the detectors exceeds the threshold voltage (about 1.5 V), the output of that gate is a group of negative-going pulses from 6 V to ground.

The pulses from the mark and space threshold detectors are used to reset and set an RS flip-flop, which is made up of the remaining two gates of the integrated circuit (G<sub>2</sub> and G<sub>3</sub>). The output of the flip-flop is +6 V in the mark interval, and 0 V in the space interval. Transistor Q<sub>6</sub> is thus



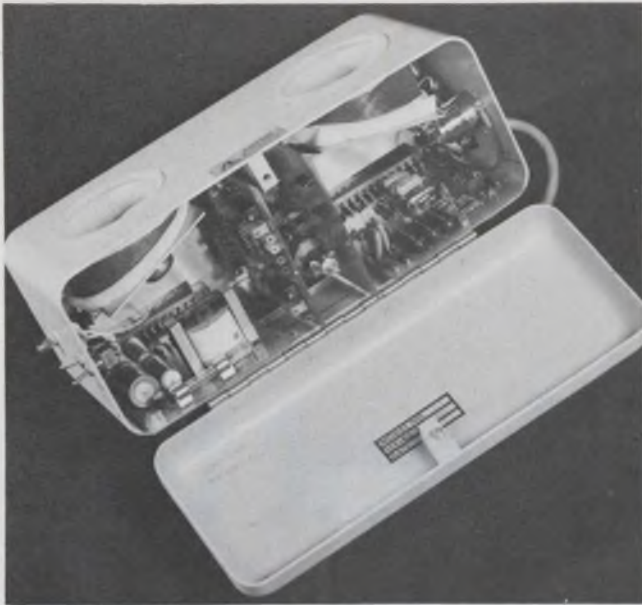

**Compact packaging is easy** due to the relative simplicity of the coupler circuitry. The two receiving boards are mounted vertically in the center, while the transmitting board is at the lower right. The power supply, which must provide a +12 V and a -12 V at a current of 100 mA, is at the lower left.

driven into saturation for mark intervals and cut off for space intervals. The mark intervals cause a current, limited to 20 mA by resistor  $R_{20}$ , to flow through the teletypewriter printer terminals. No current flows during space intervals.

The network, made up of  $CR1$ ,  $CR2$ ,  $C_{15}$ , and  $R_{19}$ , ensures that the flip-flop delivers a mark output when the ac power is first turned on. This feature keeps the teletypewriter from running "open" (chattering away in a random fashion before being connected to the computer).

The power supply for the coupler, not shown here, must provide a regulated +12 V and -12 V dc, both at 100-mA capability. A line or load regulation of  $\pm 1\%$ , with a 0.1-V ripple is adequate for this application.

To convert the receive unit for operation in the answer mode, capacitors  $C_1$  through  $C_4$  are changed to 0.01- $\mu\text{F}$  each, and  $C_{11}$  to 0.20  $\mu\text{F}$ .

All components used in the coupler are standard items, and are listed in Tables 1 and 2.

### Initial adjustment is easy

The procedure for initial adjustment of the coupler is not difficult; it requires only a few pieces of common test equipment. For the transmitter, the space frequency is set at 1070 Hz by adjusting  $R_{3b}$ , with the input terminals open. Next, the input terminals are shorted together and the mark frequency is set to 1270 Hz by adjusting  $R_{1a}$ . The acoustic drive to the telephone transmitter must then be adjusted so that the level on the telephone line is approximately

1 mW. For the 8-ohm speaker used here, this level corresponds to about 0.2 V peak-to-peak across the speaker terminals.

Adjustment of the receiving unit is somewhat more complicated. The band-pass filter is set by feeding a 2125-Hz signal of about 0.1 V into test point 0, and adjusting variable inductor  $L_2$  for maximum signal at test point 1. This is easily checked by sweeping an audio oscillator through 2125 Hz and observing the frequency at which peaking occurs.

The mark and space filters are set next. For the mark filter, an oscilloscope is connected to test point 2 and the oscillator is again swept to find the resonant frequency. If potentiometer  $R_5$  is initially set at about 500 ohms, the mark filter frequency should be reasonably close to 2225 Hz. (It may be necessary to adjust gain potentiometer  $R_7$  so that an output can be seen.) The oscillator is set to 2225 Hz, and  $R_5$  is adjusted for peak amplitude, as seen on the scope.  $R_7$  is now adjusted so that the output is a series of positive-going partial sinusoids, with the peaks at 2 V above the zero-volts baseline, as observed on the dc-coupled oscilloscope.

Adjustment of the space filter is similar, except that potentiometers  $R_6$  and  $R_8$  are used to set the center frequency of 2025 Hz and the 2-V peak output. Sweeping the oscilloscope back and forth between 2025 Hz and 2225 Hz should now cause the output at test point 4 to switch between two levels.

The coupler has been found to perform satisfactorily under normal telephone communication conditions, over local and long distance circuits. In typical use, the error rate is less than one wrong character per thousand.

Noise immunity tests have been made by injecting random noise through a large isolation resistor into test point 0, while receiving a standard test message over an essentially noise-free local circuit. The random noise was bandwidth-limited by a 300-Hz to 3-kHz filter, an approximation of voice-grade-line bandwidth. The noise input was adjusted to cause an average of one error per line. Then, signal power and signal-plus-noise power were both measured at test point 1 with an rms voltmeter. Five units were tested; the signal-to-noise ratios at one error per line (72 characters) were all between -1.4 dB and 0.0 dB. If a nominal signalling bandwidth of 300 Hz is assumed, then the equivalent signal-to-noise ratio in that bandwidth is 8.6 to 10 dB. ■■

### References:

1. H. S. Black, *Modulation Theory* (Princeton, N. J.: D. Van Nostrand Co., 1953), p. 200.
2. "Handbook of Operational Amplifier Active RC Networks," Burr-Brown Research Corporation, 1966, p. 78.

**We've ironed out the  
pressing problem of  
gluing ferrite parts.**



# INDIANA GENERAL *We make it easy for the design engineer.*



Know what happens to magnetic characteristics, costs and delivery schedules when small ferrites are epoxied together to make a large one? It's enough to make you come unglued. So Indiana General's *pressing* them. The results are single piece large parts with dimensions that will open your eyes — and a lot of new design opportunities.

We've already made tubes up to 7" o.d. x 12" long, and 15" tubes with a wall thickness of only 0.250". Solid plates, 6" x 6" x 2". Pot cores up to 7" o.d. And these aren't even our maximum capabilities. Nor our only configurations. For instance, we're working right now on 6½" o.d. flared yokes, and in the future, 10" o.d. x 20" tubes.

Whether your applications involve very low frequency or high frequency/high power, material selection is critical. And Indiana General not only makes single piece large parts; we make them with the "right" ferrites. Our 0-5 is the industry's best material for VLF, due to its high permeability and low power loss characteristics needed for "brute force" demands of denser-than-air media. And we introduced Q-1, Q-2 and Q-3 ferrite materials to the market for HF/HP; they're still the leader.

So instead of looking high and low for high power, low frequency ferrites, look to Indiana General. Where we stick with the solution of magnetics problems to keep them from becoming sticky ones for you. Our coupon brings you further technical information on our large ferrite parts.

Mr. K. S. Talbot, Manager of Sales  
Indiana General Corporation  
Electronics Division/Ferrites  
Keasbey, New Jersey

Let's take a closer look at how single piece large ferrites can make it easier for me.

NAME \_\_\_\_\_ TITLE \_\_\_\_\_  
COMPANY \_\_\_\_\_  
ADDRESS \_\_\_\_\_  
CITY \_\_\_\_\_ STATE \_\_\_\_\_ ZIP \_\_\_\_\_

# Use--don't abuse--the SCR.

Here's a refresher for those who, through over-familiarity or under-exposure, are not getting the most from their SCR designs.

## Part 1 of a two-part article

SCRs have been a common circuit component for a long time, but cases of misapplication are still not unusual. The trouble usually arises because the wrong device is selected for a particular application or because important firing considerations are neglected or misunderstood.

This article is aimed at those designers who may be growing careless in their approach to SCR design. In this first part, the specifications that define an SCR and indicate its usefulness for a particular application are analyzed. The second part of the article will cover the firing requirements and characteristics of SCRs.

### Specifications tell the story

The parameters normally specified by the SCR manufacturer are listed in Table 1. Although manufacturers may use different designations for the same parameter, the information on most spec sheets is usually the same.

The first current parameter of an SCR that

### Average forward current, $I_{ave}$

The first current parameter of an SCR that should be examined by the designer is the average forward current of the device ( $I_{ave}$ ). This tells the designer the maximum average current that the device can conduct under certain conditions of case temperature and conduction angle. For any application, the maximum  $I_{ave}$  that the device will carry must be determined, and an SCR must be selected that can conduct this current.

There are two important factors to consider in selecting a device having the proper  $I_{ave}$  rating. The first is the minimum angle of conduction at which the SCR will carry this maximum  $I_{ave}$  current. From the curves of  $I_{ave}$  vs power dissipation and  $I_{ave}$  vs maximum case tem-

perature given on the manufacturer's data sheet, one can see that the smaller the conduction angle, the greater is the power dissipation and the lower is the allowed case temperature for a fixed  $I_{ave}$ . Therefore, if a device is to carry a maximum average current when its conduction angle is  $90^\circ$ , the maximum case temperature and the power dissipated must be obtained from the  $90^\circ$  conduction angle curve.

For example, if the device depicted by the curves of Fig. 1 were to conduct an average current of 30 A, with a minimum conduction angle of  $90^\circ$ , the case temperature would have to be maintained at a maximum of  $98^\circ\text{C}$ . Although the  $I_{ave}$  maximum rating specified by the manufacturer for this particular SCR is 70 A, it would be difficult at such a current and with a  $90^\circ$  conduction angle, to maintain the case temperature at or below the maximum allowable value of  $63^\circ\text{C}$ . This seeming discrepancy arises from the fact that the  $I_{ave}$  rating given in the title of the specification sheet is for a conduction angle of  $180^\circ$ . The reason for the derating of the SCR with decreasing conduction angle is that the form factor of the current increases, so the peak and rms currents increase accordingly, thereby causing increased heating in the device.

### $T_j$ and $\theta_{jc}$

The next two specifications are related to the  $I_{ave}$  specification in that they determine whether or not the device may be sufficiently cooled. The first of these two is the maximum operating junction-temperature of the device ( $T_j$ )—one of the most important SCR specifications. If this junction temperature is exceeded, the junctions that give the SCR its switching characteristics become permanently damaged, causing the device to fail permanently. Although most SCR manufacturers' specifications show maximum case temperatures rather than junction temperatures, their main concern is that the user maintain the junction temperature of the device ( $T_j$ )—one of The actual junction temperature of a production SCR cannot be measured; it must be calculated.

---

Wendell W. Ritchey, Senior Project Engineer, and Ronald H. Randall, Project Engineer, Acme Electric Corp., Cuba, N. Y.



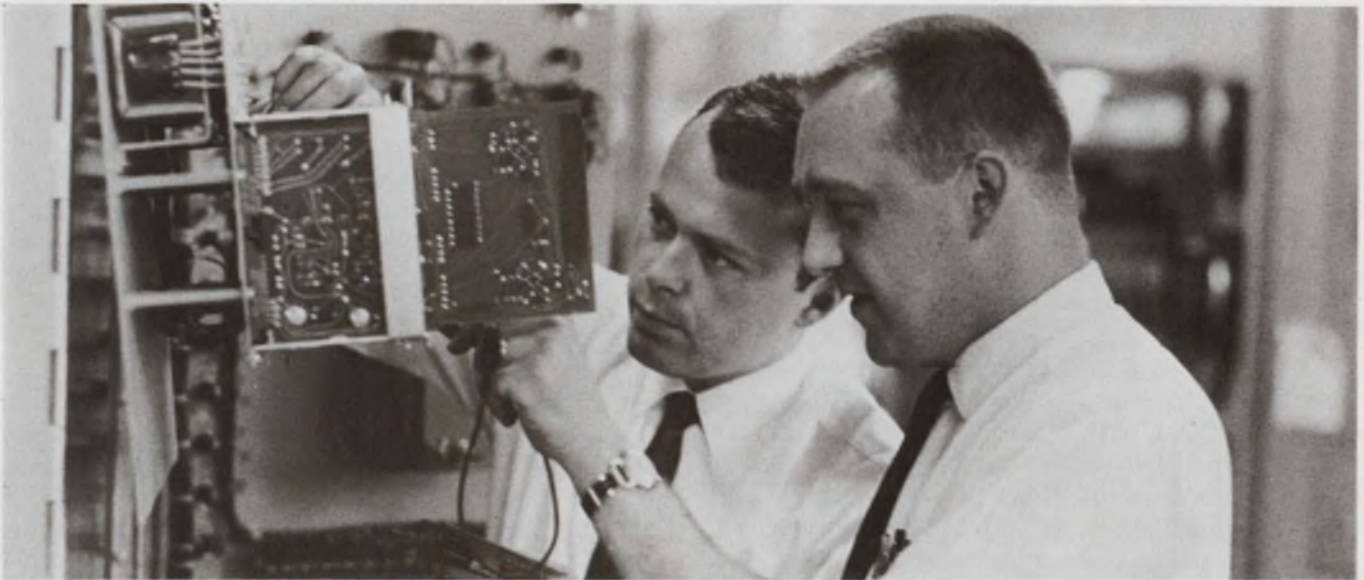

Authors Randall (left) and Ritchey check the control circuitry in an SCR static power rectifier.

This is where the second specification,  $\theta_{jc}$  enters the picture.

$\theta_{jc}$  is the maximum thermal impedance of the device from junction to case; it is defined as the ratio of the difference between the junction temperature and the case temperature to the power dissipated in the device, and is given in degrees centigrade per watt.

Since the case temperature of an SCR can be measured rather simply, and the power dissipated can generally be measured, the actual junction temperature may be calculated from  $T_j = P_d \theta_{jc}$ , where  $P_d$  is the power dissipated in the device. In general, the SCR manufacturers have performed this calculation for the designer by displaying the maximum case temperature requirements of a device.

#### Rms forward current, $I_{rms}$

Mention should be made of the rms forward current ( $I_{rms}$ ) rating of an SCR. This is the current that actually causes the junction to heat up.

But since, in most applications, it is the  $I_{ave}$

current that is usually of most concern, SCR manufacturers publish their data with respect to  $I_{ave}$ . However, there is a fixed ratio between  $I_{rms}$  and  $I_{ave}$  for any conduction angle, and this ratio is taken into account in the manufacturers' specifications.

#### Peak forward surge current, $I_{tm}$

The next parameter to be considered is peak forward surge current ( $I_{jm}$ ). This defines the maximum peak current, based on one half-cycle of a 60-cycle sine wave, that the device can withstand in the forward direction. Most specifications contain a derating graph that shows the maximum peak current that an SCR may conduct for a specific number of cycles. For example, the curve of Fig. 2 shows that the SCR depicted by the curve can tolerate a peak sine-wave current of 875 A for 60 cycles. The main use of this parameter is to determine whether or not a particular SCR can withstand the peak current it may be subjected to for a certain number of cycles, such as in-rush currents to a motor or



capacitor bank, or during fuse blowing in current limited circuits.

### $I_{fb}$ and $I_{rb}$

The peak forward ( $I_{fb}$ ) and peak reverse ( $I_{rb}$ ) leakage current parameters are self-explanatory, in that they are the currents that flow through the SCR when it is in its blocking, or nonconducting, state. An important point to be considered in the case of the reverse leakage current, though, is the condition of the gate circuit of the SCR. The  $I_{rb}$  parameter specified is generally valid only when the gate-to-cathode junction has a zero or negative voltage applied to it. If the gate of the SCR is forward biased when a reverse current is trying to flow through the SCR, the reverse leakage current will be higher than that listed in the specification. This increase causes greater heating of the SCR junction and it is necessary, therefore, that it be considered when determining the cooling requirement for the device.

An example of this is when a pair of SCRs is being used in a back-to-back configuration in an ac circuit and both SCRs are gated simultaneously. The SCR that has its anode-to-cathode junction reverse biased will have a higher  $I_{rb}$  than normal, since its gate is forward biased. This increase in reverse leakage current will then result in additional heating taking place in that SCR.

### Holding current, $I_{ho}$

The holding current ( $I_{ho}$ ) of an SCR is the minimum current that must flow through the device in the forward direction to insure that it will remain in the conducting state if the gate

signal is removed.  $I_{ho}$  is also important for commutation, or turnoff, of an SCR; because, for proper commutation, a reverse current must be provided that, when combined with the maximum forward current, results in a net forward current that is less than the  $I_{ho}$ .

### Fuse rating

The last parameter involving the current flowing from anode to cathode of an SCR is the fuse rating, or  $I^2t$  rating. This has the unit ampere<sup>2</sup>-seconds, and is the product of the rms current squared that flows through the device and the time during which this current flows. When selecting a fuse for protecting an SCR, the fuse rating must be less than that of the SCR. Otherwise, an overload will cause the junction of the device to exceed its  $I^2t$  rating, causing excessive heating of the junction and possible destruction of the SCR.

### Repetitive peak forward blocking voltage $V_{fb}$

Thus far the parameters discussed have been concerned with the various currents that can flow through the anode-cathode circuit of an SCR. The next class of parameters covered includes the various voltages which can be applied across the anode-cathode of the device. The first of these is the repetitive peak forward blocking voltage ( $V_{fb}$ ), which is the maximum peak voltage that can be applied between anode and cathode and have the SCR remain in its blocking state. This parameter is extremely important to the designer, because the usefulness of the SCR depends primarily on its ability to remain in the blocking state with a forward voltage applied across it. It is essential, therefore, that the peak voltage applied across the anode-to-cathode of an SCR does not exceed this rating.

### Repetitive peak reverse voltage rating $V_{rb}$

Every SCR also has a repetitive peak reverse voltage rating ( $V_{rb}$ ), which defines the maximum peak voltage that can be applied between anode and cathode, in the reverse direction, without causing the device to switch from the nonconducting to the conducting state. This rating has the same function as the reverse blocking voltage of an ordinary diode.

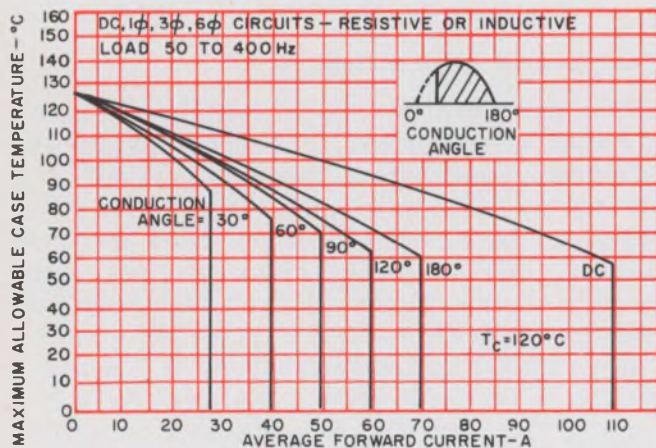

1. Power dissipation in an SCR, and therefore the allowable case temperature, is dependent on the conduction angle. The curves shown are for the G.E. series C52 SCRs, and are based on a sinusoidal current waveform.

### $V_{ft}$ and $V_{rbt}$

The nonrepetitive peak forward voltage ( $V_{ft}$ ) and nonrepetitive peak reverse voltage ( $V_{rbt}$ ) parameters are transient ratings of the  $V_{fb}$  and



$V_{rb}$ , respectively, based on one half-cycle peak of a 60 cycle sine-wave. These parameters are very important for selecting the proper SCR for an application where transients are encountered. This is particularly true in the case of the  $V_{rbt}$  rating, since, if it is exceeded, the SCR will be permanently damaged.

If the  $V_{ft}$  parameter is exceeded, the device may switch from the nonconducting to the conducting state, but may not necessarily be permanently damaged. Such transient switching ON of the SCR for a half cycle may or may not be acceptable to the designer, depending on the particular type of circuit in which the device is being used.

### Forward voltage drop, $V_f$

The final parameter concerning the anode-cathode voltage across an SCR is forward voltage drop ( $V_f$ ), which defines the voltage drop from anode to cathode when the device is conducting. It is this voltage that must be considered when determining the power dissipated in the SCR. The  $V_f$  parameter is also an important consideration when the SCR is to be used in power circuits of very low voltages (below 10 V).

### dv/dt rating

The dv/dt rating of the SCR specifies the maximum allowable rate of rise of the forward anode-cathode voltage applied to the SCR. If a voltage is applied between anode and cathode at a higher rate, the device may switch from the nonconducting state to the conducting state. In any circuit, therefore, the rate of rise of the applied forward voltage of the SCR must be considered; when necessary, this must be limited by some means. Techniques for accomplishing this will be covered in Part 2 of this article.

### Gate trigger current, $I_{gt}$

Thus far the parameters discussed have dealt primarily with the anode-cathode structure of the SCR. The following discussion deals with the gate-cathode ratings.

The first of these parameters,  $I_{gt}$ , is the minimum gate current that will cause the SCR to switch from the nonconducting to the conducting state. In other words, the SCR is guaranteed to turn on when the specified  $I_{gt}$  is flowing through the gate-cathode junction and anode current is available. For any gate current less than the specified  $I_{gt}$ , the device may or may not turn on.

If the SCR is to be subjected to high  $di/dt$  values, special design considerations must be

**Table 1. Typical SCR parameters**

Symbol	Definition	Typical units
$V_{rb}, V_{rom}$	Repetitive peak forward blocking voltage	V
$V_{rbt}, V_{rom}$	Repetitive peak reverse voltage	V
$V_{ft}$	Nonrepetitive transient peak forward voltage	V
$V_{rbt}, V_{rom}$ (Nonrep)	Nonrepetitive transient peak reverse voltage	V
$I_{rb}$	Peak forward leakage current	mA
$I_{rb}$	Peak reverse leakage current	mA
$I_{rms}$	RMS forward current	A
$I_{ave}$	Average forward current	A
$I_{fm}$	Forward surge current	A
$I^2t$	Fusing rating	A <sup>2</sup> - s
$V_f, V_{fm}$	Forward voltage drop	V
$I_{ho}$	Holding current	mA
$T_j$	Operating junction-temperature range	°C
$T_{stg}$	Storage temperature range	°C
$\Theta_{jc}$	Maximum thermal impedance, junction-to-case	°C/W
$I_{gt}$	Gate trigger current	mA
$V_{gt}$	Gate trigger voltage	V
$V_{gnt}$	Nontriggering gate voltage	V
$I_{gfm}$	Peak forward gate current	A
$V_{grm}$	Peak reverse gate voltage	V
$P_{gm}$	Peak gate power	W
$P_{g(ave)}$	Average gate power	W
$V_{gfm}$	Peak forward gate voltage	V
$T_{on}$	Typical turnon time	$\mu$ s
$di/dt$	Rate of rise of anode current	A/ $\mu$ s
$T_{off}$	Turnoff time	$\mu$ s
$dv/dt$	Rate of rise of anode-to-cathode forward voltage	V/ $\mu$ s

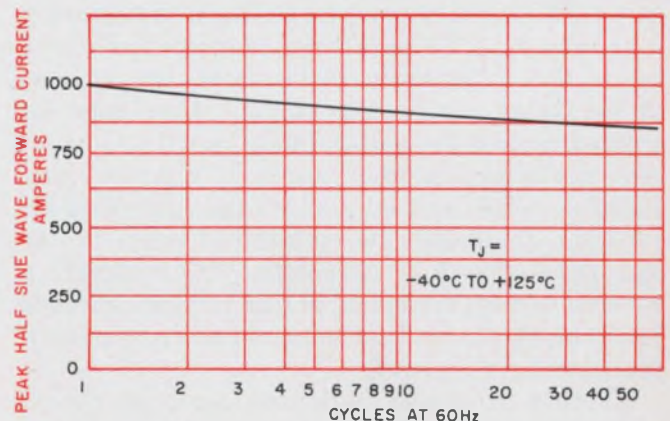

2. The peak forward surge current,  $I_{rms}$ , of an SCR must be derated if the peak current is to be conducted for more than one half-cycle.



given to the  $I_{gt}$  parameter. In these cases, the gate current should reach a peak of at least five times the  $I_{gt}$  rating within at least 1  $\mu$ s. This current should then decay exponentially to the minimum value of  $I_{gt}$  specified, and should remain at this value for the required width of the gate pulse. The term "hard-gate firing" is used to describe a gate current that has this characteristic. The purpose of hard-gate firing is to spread the anode-cathode structure of the SCR into conduction as rapidly as possible, thereby rendering the whole area available to conduct current.

#### Peak forward gate current, $I_{gfm}$

The next gate-cathode parameter to be considered is the peak forward gate current ( $I_{gfm}$ ). This parameter defines the maximum forward peak current that can flow through the gate-cathode junction of the SCR without causing damage. The designer must take care not to exceed the  $I_{gfm}$  rating when he is designing or selecting a circuit for supplying hard-gate firing to an SCR.

#### Gate trigger voltage $V_{gt}$

The gate trigger voltage ( $V_{gt}$ ) parameter given in the specification defines the minimum voltage that must be applied to the gate to insure that the SCR turns on. Since the SCR is a current operated device, the more important gate parameter to consider is the gate current. However, the  $V_{gt}$  parameter aids the designer in determining the open-circuit voltage of the required gate-current source.

#### Nontriggering gate voltage, $V_{gnt}$

The nontriggering gate voltage ( $V_{gnt}$ ) defines the maximum voltage that can appear across the gate-cathode junction of the SCR without causing it to turn on. This parameter is particularly useful to the designer in determining the amount of back-bias, or reverse voltage, that must be applied across the gate-cathode junction to prevent misfiring. In other words, if there are any voltage noise spikes across the gate-cathode junction, they must be maintained equal to—or less than—the  $V_{gnt}$  parameter. If, however, a reverse voltage is applied across the gate-cathode junction, this must be considered when designing the gate firing source.

Another parameter to be considered, if a back-bias voltage is used across the gate-cathode junction of the device, is the peak reverse gate voltage ( $V_{grm}$ ). The designer must be sure that

the back-bias voltage does not exceed the value specified for  $V_{grm}$ . If it should, the gate-cathode junction may be permanently damaged.

#### Peak forward gate voltage, $V_{gftm}$

When a hard-gate-firing circuit is being designed, the peak forward gate voltage ( $V_{gftm}$ ) rating of an SCR must be considered. This parameter defines the maximum peak voltage that can be applied across the gate-cathode junction of the device without causing permanent damage. The gate source, therefore, must not apply a voltage higher than the  $V_{gftm}$  rating.

#### $P_{g(ave)}$ and $P_{gfm}$

The average gate power,  $P_{g(ave)}$ , and peak gate power,  $P_{gfm}$ , parameters must also be considered when designing hard-gate-firing circuits. A careful check of the current and voltage waveforms across the gate-cathode junction of the device will usually tell the designer whether or not he is exceeding these ratings.

The remaining parameters generally given on an SCR specification sheet are the turnon ( $T_{on}$ ) and turnoff ( $T_{off}$ ) times of the device. These define the actual time it takes the device to switch on or off. Both parameters are most important in applications such as inverters where proper circuit operation depends upon how fast the SCR can be turned on or off. ■■

*The second part of this article will cover the firing requirements and characteristics of SCRs.*

#### Test your retention

*Here are questions based on the main points of this article. Their purpose is to help you make sure you have not overlooked any important ideas. You'll find the answers in the article.*

1. *What is the significance of conduction angle in selecting an SCR having a suitable  $I_{ave}$  rating?*

2. *What SCR parameters must be considered in the design of hard-firing gate circuits?*

3. *What is the fuse rating of an SCR, and why is this significant when designing SCRs into circuits?*

4. *What is the primary usefulness of the nontriggering gate voltage specification  $V_{gnt}$ ?*



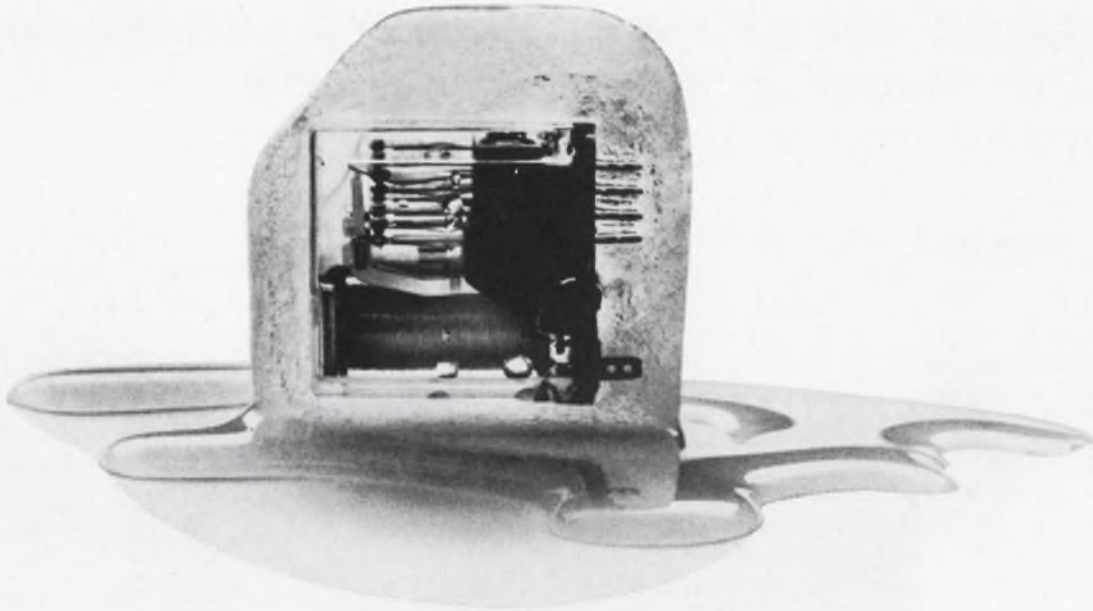

## The stable, well-adjusted relay.

A real cool customer. That's our cradle type relay. Freeze it down to  $-55^{\circ}\text{C}$ . and it stays adjusted. Or, heat it to  $+71^{\circ}\text{C}$ . and it stays adjusted. And all that performance in less than a cubic inch.

Our cradle type relay has a right to be well adjusted. Because it has so much going for it. Like magnetic structure of hydrogen annealed iron, which allows it to operate as low as 35 milliwatts. And nickel plated bearing parts. And gold plated terminals and contacts. Add to that its unique plug-in design, integral dust cover, and one million operation life expectancy at rated load, and you'd feel stable too.

What do you do with a cradle type relay that has this much going for it? Some people use them in computer systems, control systems, business machines, flight simulators, data processing equipment and vending machines.

You can do the same thing. Or you can use your imagination and find some applications we haven't even thought of yet. Whatever you decide, you can find out all you want to know about our well-adjusted relay. Just fill in and mail the coupon.

Deutsch Filtrors Industrial Products, Dept. B  
Industrial Road, East Hampton, New York 11937

Please send me more information on your  
cradle type relay.

Name \_\_\_\_\_

Address \_\_\_\_\_

City \_\_\_\_\_ State \_\_\_\_\_ Zip Code \_\_\_\_\_

Company \_\_\_\_\_

Title \_\_\_\_\_



INFORMATION RETRIEVAL NUMBER 35

## Manage creative engineers creatively

Give them room to innovate on the job and add the personal touch. Here are some hints.

Lawrence Locke, Management and Careers Editor

Creative workers have surface traits that sometimes bother other people. Some wear wildly printed neckties or sport long sideburns or a handlebar moustache. Some go to the other extreme and dress extraordinarily slovenly. The first impression many managers get is:

"This guy is a kook. Watch out."

You could, as a supervisor, lose a gifted talent if you handle creative engineers this way. Supervisors who would work effectively with creative engineers must be creative managers. You can start by shucking off extraneous personal biases.

To provide working conditions that will yield the maximum output from creative engineers, know how the creative process works and what the creator's outstanding traits are (see "Yes, You Can Develop Your Creativity," ED 3, Feb. 1, 1969, p. 66, and "Don't Wait for Brainstorms," ED 4, Feb. 15, 1969, p. 102).

But that isn't all you need to manage innovative engineers. You must add understanding, tolerance and encouragement—frequently encouragement of traits and behavior that may seem to be adding a wrench to the cogs of a smooth-running organization.

### The personal touch helps

How a manager gets along with his creative engineers has little to do with rules and regulations. He is dealing with people who think of themselves as different—and they are different. So the supervisor's personal touch—his ability to empathize with other people—is the key to success. Most management experts agree that the *creative person's relationship with his working supervisor is more important in motivating him than any other factor.*

That's a surprising statement. It may topple completely a few shaky assumptions you already have—for instance, that money is the major magnet for creative people with talent to sell; that creative people tend to ignore their supervisors and go it on their own; that the manager should cut himself loose from the creative man.

All these ideas go overboard. What remains is this: the manager is not a time-oriented boss, but an advisor who works with his creative engineers. He learns what they want, what will help them turn out better solutions faster—and he gets it for them.

What do creative engineers want? The same things, in large part, that all engineers want. But in the case of the innovator, they are vital to his productivity; he won't function well at all without them.

Here are 11 guidelines for managers. The creative engineer wants:

- A permissive atmosphere where he is trusted to be productive. He believes in himself, and he wants his manager to.
- Freedom to pursue problems he finds intriguing. This not as risky as it sounds, since studies indicate that more-creative people are more concerned with practical values than less-creative people.
- The chance to talk freely and frankly with his supervisor.
- Freedom from routine jobs—filling out reports, for instance—that pull him away from his problem research.
- Colleagues of his caliber with whom he can mix on the job. Of course, this does not mean that all creative engineers are "groupers." Some prefer to work strictly alone.
- Information on the company policy under which he must operate. This does not refer to narrow procedures; rather, the company's broad aims.
- Appraisal of his work by his supervisor soon after it is submitted.
- Time—and a place—where he can be alone without looking like an oddball or a loafer.
- The option of having professional colleagues and contacts who are not in the company. This includes membership in professional societies, lecturing, writing.

---

Dr. Daniel E. Noble, vice-chairman of the board of Motorola, Inc., and the holder of eight patents in electronics, suggests how to find and use creative people.





*“We use the search-and-find method, not esoteric analysis, to find creative men. We urge our supervisors to watch for, and give credit to, young innovators (old ones should be known already).”*

*“Plant your creative people in stimulating soil. Expose them to new facts. More important, expose them to product-design problems at all levels—engineering, production and consumer.”*

*“Few creative people make it without support. A man who gets an idea must get a hearing—and back-up from his superiors. Here, it’s important to have a high-ranking executive who supports creative talent.”*



## Who's who in creativity: eight types

Creative people don't fit into molds. Yet when researchers at the Institute of Personality Assessment and Research, University of California, Berkeley, studied 45 engineers, and scientists who were working on space or missile problems, they found eight discernible creative types.

But—as a report by Wallace B. Hall, associate research psychologist at the institute, makes clear—no one person fits any one type perfectly. The traits overlapped, so that each creator had some of the characteristics of several of the eight types. Researchers classified the people they were studying by noting the *predominant* traits.

Harrison C. Gough at the institute lists the eight creative types as follows:

1. **Zealot.** Dedicated, driving, indefatigable, with a lively sense of curiosity. Others see him as tolerant, serious-minded and conscientious, but not as getting along easily with others.
2. **Initiator.** Begins at once to generate ideas; stimulating to others and a good team man. Seen as ambitious, well-organized, industrious, a good leader, efficient and not a worrier.
3. **Diagnostician.** Sees himself as a good evaluator; finds strong and weak point quickly in any problem, a good troubleshooter. Not critical of others' mistakes. Observers label him forceful, self-assured and unselfish.
4. **Scholar.** A man with an exceptional memory, looking for detail and order, but not a perfectionist. Seeks help when needed and ad-

apts to others. Well-informed in his own field, not a bluffer. Described as conscientious and thorough, dependable, lacking somewhat in confidence and decisiveness.

5. **Articifer.** Sees himself as good at perfecting ideas that others suggest; does not attempt to do what he cannot. Seen as direct, honest, getting on well with others, observant and responsive to cues given by others' behavior.

6. **Ethetician.** Favors analytical thinking, prefers problems leading to elegant solutions. Has widespread interests and tends toward impatience with too much order and detail or if results are slow. Observed as clever and spontaneous, with a degree of immaturity, impatience and indifference toward deadlines and obligations.

7. **Methodologist.** Vitally interested in methodological issues; open about own work and enjoys discussing his plans. Has little competitive spirit and is tolerant. Characterized by others as considerate, not too ambitious but occasionally difficult.

8. **Independent.** Dislikes and avoids administrative details; not a good team man nor a driving one, but has a lively sense of curiosity. Prefers to think in reference to physical and structural models rather than in analytical and mathematical ways. Seen as active, robust, hard-headed and forthright in judgment. May behave abruptly or impolitely, but has little self-doubt.

- Special consideration for harmless idiosyncrasies that might upset strait-laced managers.
- Freedom to fail—or to suggest far-out solutions without being ridiculed.

### Ways to keep creative engineers content

Corresponding in a rough way to the creative engineer's wants are positive steps that a manager can take to create a good working atmosphere. These actions apply, incidentally, to less-creative engineers, too.

Here they are:

- Be honest. Creative engineers want straight answers that they can rely on. Most really are not interested in "office politics."
- If you have a criticism or comment to make about the man's work, tell him and not your fellow managers. And tell it to him privately.
- Use personal conversations, rather than elaborate evaluative forms and reports, to get a fix on the status of a project. Conversations with your engineers may take more of your immediate time, but you'll get fuller, straighter answers in person—and you won't tie your engineers up

filling out forms you haven't time to read."

- Keep your engineers informed of developments in the company. You don't have to have the whole story, if company security is involved, but your men should hear the significant facts from you, not from the office grapevine.

- Show concern for your engineer's personal welfare and problems. Don't pry, but if a death in the family, illness, even a divorce occurs, express your willingness to overlook a temporary drop in the man's productivity.

- Consciously try to develop a warm and affectionate attitude toward your men. Many managers are stunned to learn that their subordinates think they are cool, indifferent or brusque. Consider how you handle daily contacts with the staff. Are you interested, abrupt, friendly, businesslike? Put yourself in their shoes.

- When you evaluate an engineer's work, balance criticism with praise. One good technique is to pick out the good elements and mention them first. Then, establishing confidence, move into the points that need improvement.

- Give your engineers feedback from the top when there is favorable comment on their



achievements. If there is criticism, talk it over with the engineer without saying that the dissatisfaction originated higher up. If you think the criticism is invalid, go to the top and find out why it was made. Perhaps blame is falling on the wrong man.

So far so good. But what does the manager do when Mr. Creative balks at a rule or attracts unwanted attention? Let's look at two problems a manager might encounter with his creative engineers. Each problem situation is followed by action choices. Pick as many as you think are solutions. The answers are on p. 129.

Note: The choices are by no means the *only* actions a manager could take, but they are to help you see if you are moving in the right direction. Pick the best solutions of those available.

Here are the two problem situations:

**Case A.** *Bill Creative makes a point of coming in an hour late and leaving two hours early. He deliberately attracts attention when he does this, irritating other department employes who work 9 to 5. Yet he consistently comes up with good insights and problem solutions. He is valuable, but he is causing trouble among the other employes. What does the manager do?*

#### Action choices:

1. Ask him in and tell him he is doing outstanding work. Then explain to him that though he may not know it, he is causing a problem. Could he come in at 9 a.m. and, if he must leave before 5 p.m. could he do it only occasionally—and without fanfare?

2. Publicly embarrass him one morning by telling him he is late and note that he has been leaving early while all the other engineers are working full hours.

3. Invite him in and tell him he is doing an excellent job, but you have some pressing problems you'd like him to put his talents to. Could he arrange his schedule so that in the future he could stay until you leave—usually not later than 6 p.m. Let him know that if he follows through successfully, he could get a substantial raise.

4. Tell him privately that he is doing fine work but would he please keep the department hours. If he comes in late next day (without excuse or explanation) fire him immediately.

5. Ignore your department's reaction and do nothing. You are dealing with a highly temperamental person and to say anything will only create more problems and worsen the situation.

**Case B.** *Several engineers have made it known to you that Charles Creative sits at his office desk for long periods with his feet up as he*

*taps the side of his head with a pencil. Recently two engineers, thinking he was killing time, walked into his office and tried to strike up a conversation. Each was met by blank, rather cold stares. Is something wrong with Charles? The office conversation about him is beginning to embarrass him. What do you do?*

#### Action choices:

1. Mention casually in presence of all engineers that Charles is doing an excellent job on this or that problem.

2. Suggest to Charles that he be more receptive to other staff members.

3. Have a door put on Charles' office or move him to a more secluded area.

4. Warn your other engineers not to bother Charles because he is doing creative thinking.

As you can see, there are many possible solutions to each management problem. Obviously, there is no pat formula that will guarantee that creative engineers will hurdle obstacles and create for you, while the rest of the staff happily carries on the less-innovative assignments. There always will be problems. But some of the major roadblocks can be removed when they are in your personality or management manner, or when they are the result of popular misconceptions and fears about creative people.

The cardinal rule for the manager of creative engineers is: Work *with* them and be willing—almost eager, in fact—to change the job environment and the rules to suit their needs. ■■

#### Reference:

1. M. R. Feinberg, "Fourteen Suggestions for Managing Scientific Creativity," *Research Management*, Vol. XI, No. 2 (1968).

#### Test your retention

*Here are questions based on the main points of this article. Their purpose is to help you make sure you have not overlooked any important ideas. You'll find the answers in the article.*

1. *What is the most important of all work factors for the creative engineer?*

2. *What is a good technique to use when evaluating an engineer's work?*

3. *In what three "places" are obstacles to creative management most likely to arise?*

4. *In general, which should you change to improve working conditions: the creative person's habits or the environment?*

5. *Can managers use the same techniques when supervising creative engineers that they use with less-creative engineers?*



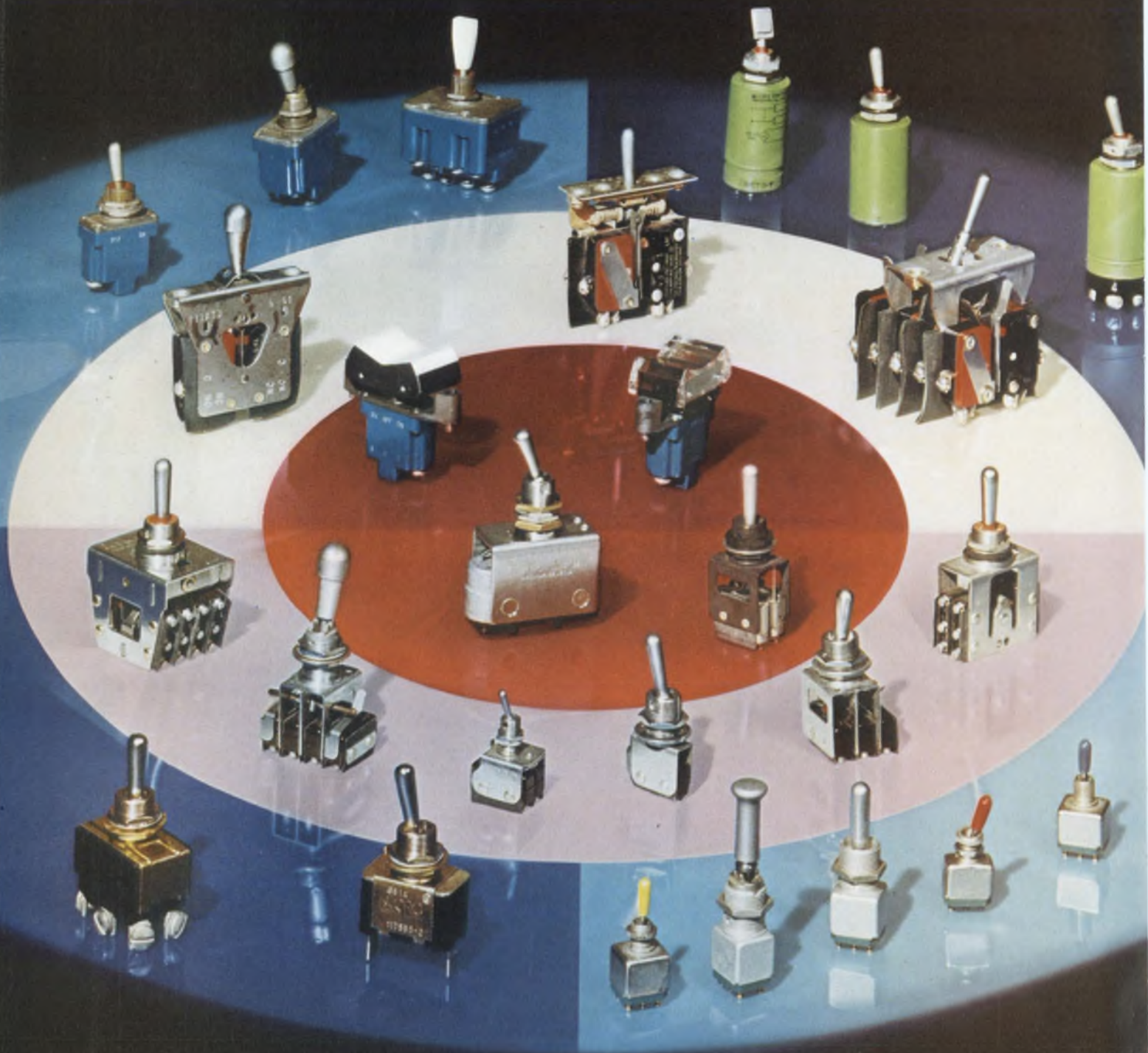



# Sure way to target in on all your toggle needs. Call MICRO SWITCH!

You'll score every time, no matter what combination of features you require. MICRO SWITCH offers the world's broadest line of toggle switches with an almost limitless selection of specifications. Such as size, circuitry, capacity and toggle action.

You can select special features, too, and get them right off the shelf. For example, environment-proof construction, magnetic hold-in, electric memory, and dry circuit capabilities.

Many in the MICRO SWITCH line are designed to meet military specifications. What's more, quality is

assured by a program that is the model of the industry.

Maybe you can use some new design ideas—ways to simplify circuit design, combine functions in fewer controls, improve operator efficiency. The most extensive field engineering staff in the industry is available to offer you help and suggestions whenever you need them.

A sampling of our thousands of toggle switches are shown at left and described below. For more details, call a Branch Office or an Authorized Distributor (Yellow Pages, "Switches, Electric"). Or write for Catalogs 51 and 52.

**1. Miniature toggle switches, Type TW**—Weight and space savers (extend only  $\frac{3}{8}$ " behind panel), yet they provide good operating feel and 35° toggle travel. Molded-in terminals. Lever seal and optional panel seal. Versatility, too:  $\frac{1}{4}$  or  $\frac{15}{32}$  inch bushings. 1 or 2 pole. Small, standard or large pull-to-unlock levers with 2 or 3 positions. Colored lever caps.

**2. Environment-proof toggle switches, Type TL**—Only switch of its kind which meets the complete environmental sealing requirements of MIL-S-3950. Case is of high impact, arc-resistant material. Rugged, molded-in, stepped terminals. 1, 2 or 4 pole. 2 or 3 position with momentary or maintained action, and special "on-on-on" circuitry. Standard or pull-to-unlock levers. 15 amps 115 vac, 20 amps 28 vdc.

**3. Assemblies with subminiature basic switches, Type AT**—Versatility is the keyword for these compact assemblies. Miniature, standard, or pull-to-unlock levers. Momentary or maintained contact action 2 or 3 position levers.  $\frac{1}{4}$  or  $\frac{1}{2}$  inch bushings. Up to a dozen or more precision snap-acting Type SM basic

switches, each SPDT. Silver contacts for 5 amp. rating or gold contacts for low energy reliability. Solder post, or single or double turret terminals.

**4. Assemblies with high-capacity basic switches, Type AT**—Precision snap-acting Type V3 basic switches are UL and CSA listed for 15 amps and  $\frac{1}{3}$  hp at 125-250 vac. Up to 10 individual SPDT switches can be ganged in one assembly. Rugged construction, positive 3-hole mounting. Two lever lengths. Convenient screw terminals.

**5. Magnetically-held toggle switches, Type ET**—Two or three position levers, magnetically maintained, manual or remote electrical release. Environment-

proof construction. MIL-S-3950 (immersion-proof). MIL-S-5272 (explosion-proof). SPDT or DPDT. Turret, screw or leadwire terminals. Standard, flat tab, or pull-to-unlock levers.

**6. Assemblies with hermetically sealed basic switches, Type AT**—Maximum protection for switch contacts with hermetically sealed (MIL-S-8805, Class 5) subminiature or standard size precision basic switches. MIL-S-5272 (explosion-proof). MIL-S-6743 (corrosion-resistant). For temperature extremes from  $-300^{\circ}$  to  $+500^{\circ}$  F.

**7. Rocker button toggle switches, Type TP**—Pushbutton operation with toggle switch versatility. Translucent button for edge-lighting and engraved legends, or transparent button for removable legends. Above-panel or flush-panel mounting. Same circuitry and rating as Type TL.

**8. Panel sealed toggle switches, Type TS**—Rugged construction, vibration and shock resistant. Sealed lever, plus panel seal (MIL-S-3950B). 1 or 2 pole, 2 or 3 position. UL and CSA listing: 15 amp. 125-250 vac,  $\frac{1}{2}$  hp 125 vac, 1 hp 250 vac. Solder, screw, or quick-connect terminals.

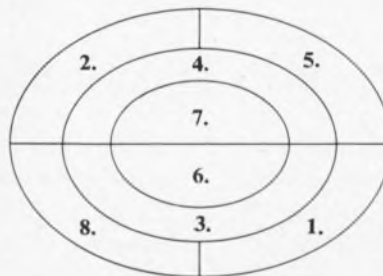

## MICRO SWITCH

FREEPORT, ILLINOIS 61032

A DIVISION OF HONEYWELL

# Pre-settable up/down counter is simple and inexpensive

The design of an up/down counter becomes somewhat complex when specifications require the counter to be preset to any starting number. A relatively simple circuit that performs the function is shown in (a).

In the circuit, only two types of standard logic blocks are used: dual-input NAND gates, with outputs collector-ORed, and J-K flip flops. No discrete components are used, and the logic yields maximum counter stages for a given number of logic blocks. The timing required to preset and count is shown in (b). Counter input is always a standard, positive pulse with flip-flop transition occurring on the ONE-to-ZERO edge.

To preset the counter, a dc reset pulse resets all flip-flops, followed by a dc set pulse that selects

the proper starting binary number. One important requirement is that during the set pulse, the J-K inputs must be held at ground to disable any false inputs caused by a flip-flop going from the ZERO-to-ONE state.

As in normal counter operation, gates *D1* and *D2* select the count-up mode, and gates *U1* and *U2* select the count-down mode. To count, positive pulses on the complement clock line of the flip-flop for the least-significant digit will step the counter in the selected direction.

The timing for counting down from binary number 101 is illustrated in (b).

*Edwin M. Goldberg, Senior Engineer, Dataram Corp., Princeton, N.J.*

VOTE FOR 311

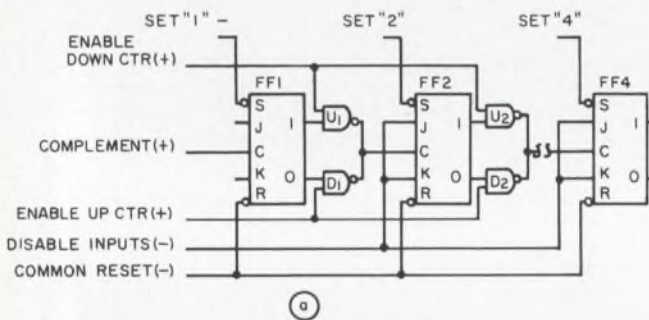

J-K flip-flops and dual-input NAND gates form this simple up/down counter (a), which uses only two types

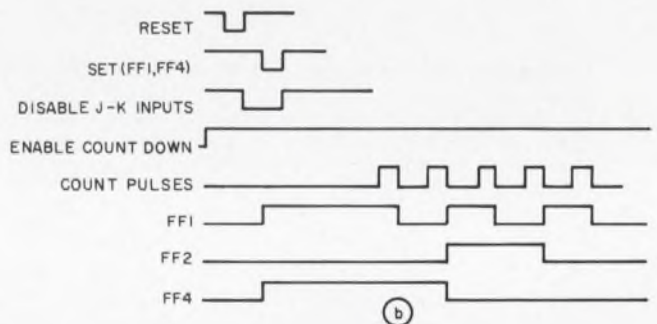

of standard logic blocks. Timing waveforms are shown for counting down from binary 101 (b).

## Linearize your TTL gates – then build useful circuits with them

A TTL logic gate can be easily transformed into a linear amplifier and can thus become the basic circuit for some interesting designs. As shown in Fig. 1 for the SN7400 gate, the addition of the feedback results in a quite linear relationship between gate input and output.

Two such linearized gates connected in series create a linear amplifier that has a phase lag equal to 360 degrees. If the loop is closed through a crystal or a capacitor, oscillations will result.

One very useful circuit that has been built with this technique is a high-accuracy clock (Fig. 2). The output voltage is a square wave that can be used for directly driving other gates, flip-flops or frequency dividers. The supply voltage specified for the SN7400 is  $5\text{ V} \pm 0.25\text{ V}$ . However, supply voltage changes of  $\pm 0.25\text{ V}$  have been found to have a negligible effect on frequency drift, with the actual drift being only one part in  $10^7$ .



# Helipot building blocks stack up to more convenience and economy.

Helipot's wide and expanding selection of *standard hybrid cermet microcircuits*—locally stocked throughout the country—give you reliable, inexpensive, off-the-shelf solutions to your complex design problems. In addition, Helipot building blocks help eliminate expensive design time and reduce purchasing, stocking, and production to their minimums. Whatever your need, you'll be interested in the new 48-page *Helipot Microcircuits Catalog*. For your copy, simply send a request on your company letterhead.

**Beckman®**

INSTRUMENTS, INC.  
HELIPOT DIVISION

2500 HARBOR BOULEVARD  
FULLERTON, CALIFORNIA • 92634

INTERNATIONAL SUBSIDIARIES: AMSTERDAM; CAPE TOWN; GENEVA; GLENROTHES, SCOTLAND;  
LONDON; MEXICO CITY; MUNICH; PARIS; STOCKHOLM; TOKYO; VIENNA

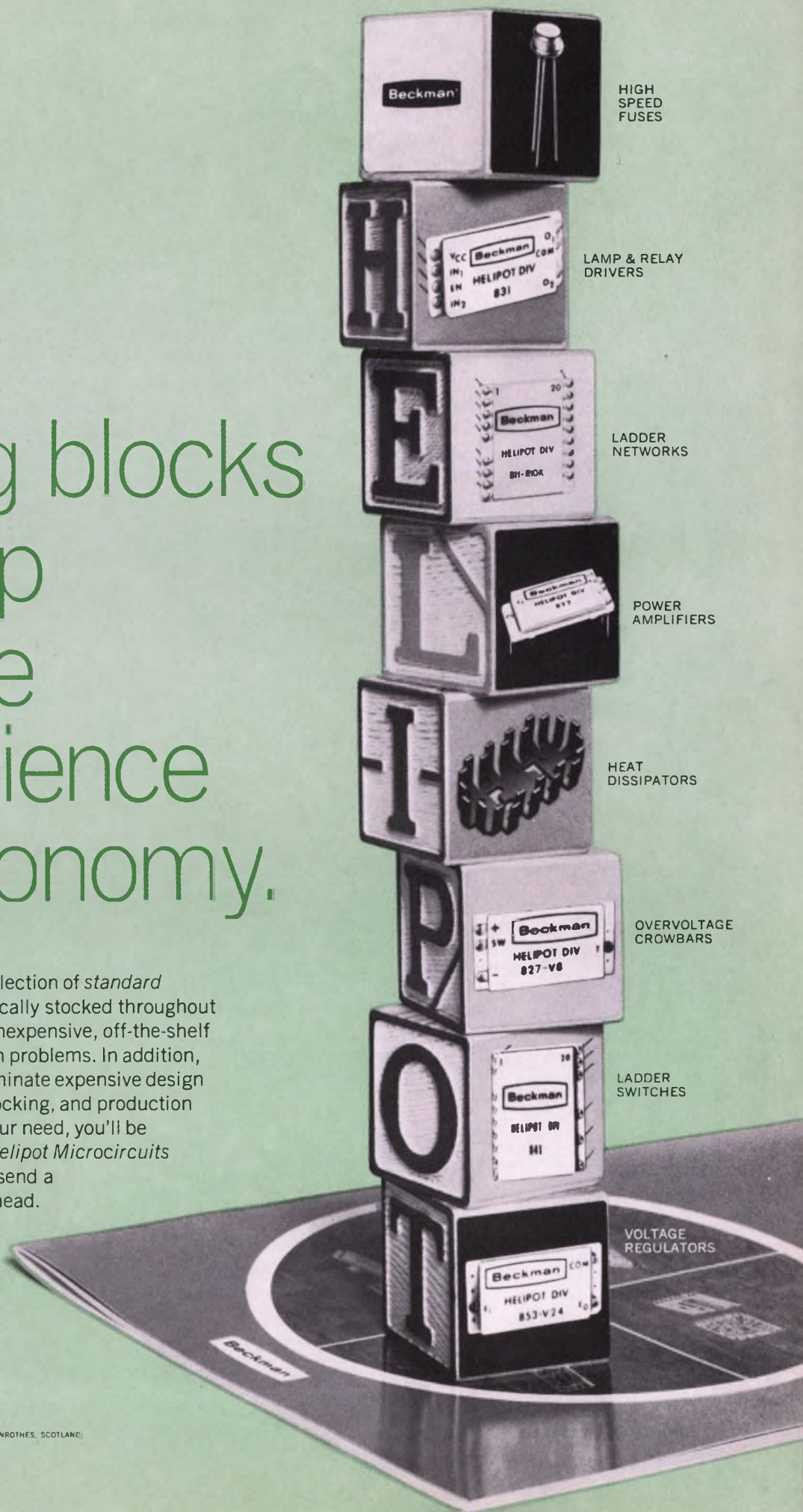

During temperature tests of the clock it was found that frequency drift with temperature, due to changes in integrated-circuit parameters, is negligible. Keeping the crystal at constant temperature, and changing the temperature of the microcircuit chip, resulted in a frequency drift equal to 0.1 PPM/°C (or  $10^{-7}/^{\circ}\text{C}$ ). Thus, when the complete clock (the crystal and the microcircuit) are subjected to temperature changes, only the crystal is responsible for frequency drift. The highest operating frequency for the crystal clock is 20 MHz and the lowest frequency is 1 MHz.

Applications for this kind of clock include remote-control systems using pulse coding, or telemetry systems. One simple arrangement for keying the clock is shown in Fig. 3. Another useful application is in a ramp-type a/d converter. The clock in this case is switched on and off at the start and end of conversion. (capacitor discharging).

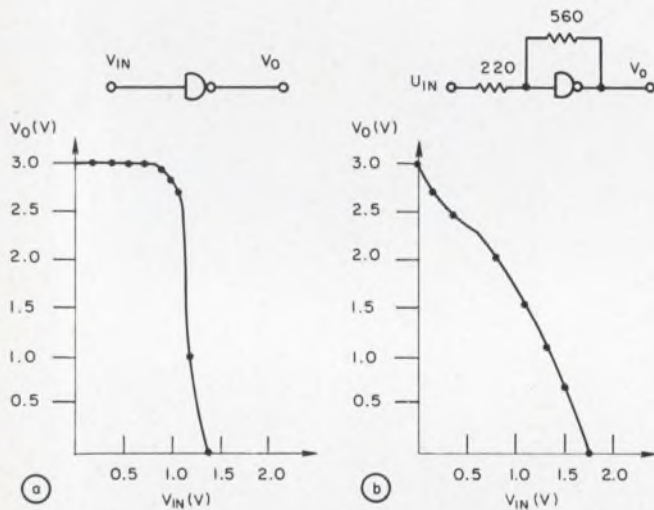

1. Normal input/output voltage relationship of a TTL NAND gate (a) can be made quite linear by the addition of a feedback circuit (b).

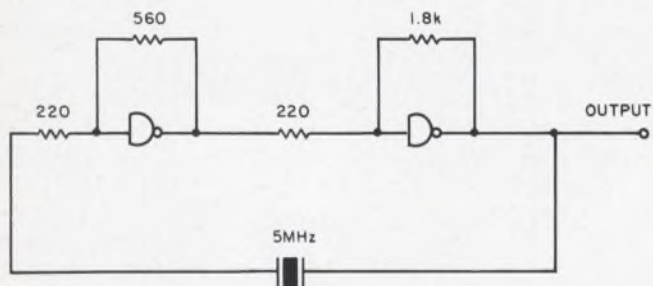

2. Highly accurate clock can be built from two linearized gates and a crystal.

The same linearized-gate principle can be used to build a cheap square-wave generator whose outputs are identical to those of a free-running multivibrator; that is, both  $Q$  and  $\bar{Q}$  outputs are available. Such a generator is shown in Fig. 4.

The highest operating frequency for the generator is 12 MHz. The lowest operating frequency is unlimited, and the unit has been found to be working at 0.1 Hz.

Potentiometer  $P1$  is used for frequency adjustment. For a fixed value of capacitor  $C1$ ,  $P1$  can cover one decade of frequencies. Diode  $D1$  provides temperature stabilization.

All of the above circuits have worked satisfactorily with TTL NAND gates manufactured by Texas Instruments, Sprague and Siemens.

*Jacek H. Kolataj, Design Engineer, Oy Nokia AB Electronics, Helsinki, Finland*

VOTE FOR 312

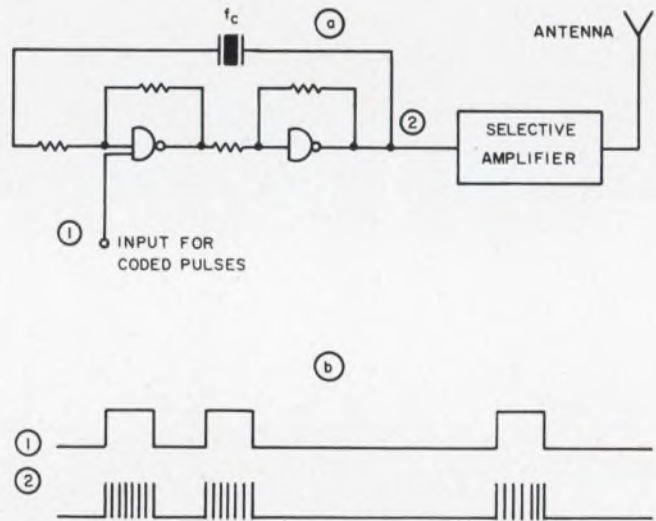

3. Keying feature can be added easily to the clock circuit of Fig. 2.

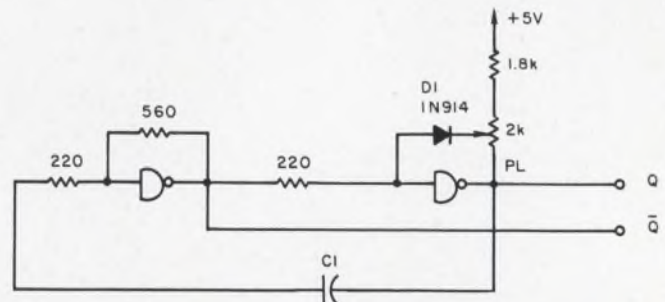

4. Square-wave generator with complementary outputs can be varied in frequency over a wide range.



# "ALLEN BRADLEY HOT-MOLDED RESISTORS ENHANCE THE QUALITY STANDARD OF OUR DATA-RECORDERS"

Mohawk Data Sciences Corporation

**MDS** The time reduction achieved by the MDS Data-Recorder method of computer input preparation demands continuously reliable operation. And this in turn demands the highest standards of performance from each and every component.

Allen-Bradley fixed composition resistors were a natural selection. Made by an automatic hot-molding technique—developed and used exclusively by Allen-Bradley—A-B resistors afford the ultimate in uniformity. From resistor to resistor—year in and year out—physical and electrical properties are unvarying. Predictable. Always of the highest order.

Performance records are equally excellent. For example, Allen-Bradley hot-molded resistors meet the requirements of the new MIL-R-39008A Established Reliability Specification at the *highest* level—the S level. And this is true for *all* three ratings—the 1 watt, ½ watt, and ¼ watt—and over the *complete* resistance range from 2.7 ohms to 22 megohms.

For complete specifications on this quality line of hot-molded resistors, please write to Henry G. Rosenkranz, and request a copy of Technical Bulletin 5000. Allen-Bradley Co., 1201 S. Second St., Milwaukee, Wis. 53204. Export Office: 1293 Broad St., Bloomfield, N.J., U.S.A. 07003. In Canada: Allen-Bradley Canada Ltd.

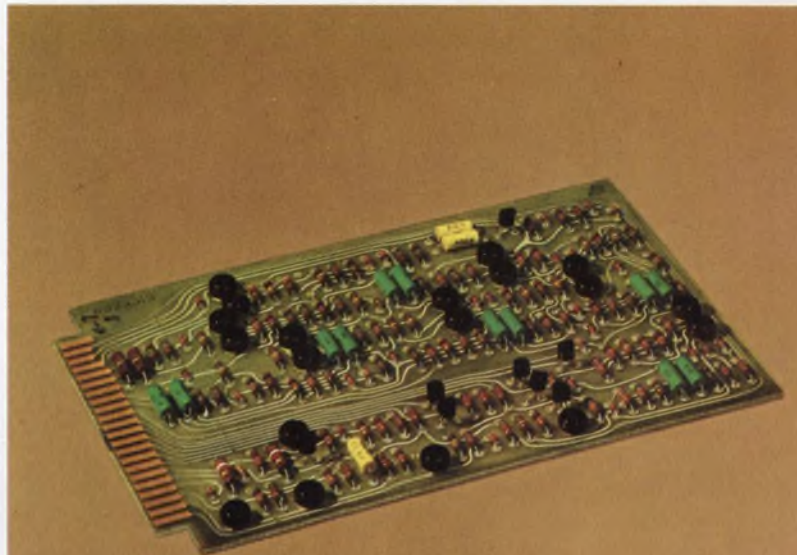

Typical printed circuit board used in the MDS 1101 Data-Recorder, showing the extensive use of Allen-Bradley hot-molded ¼ watt resistors.

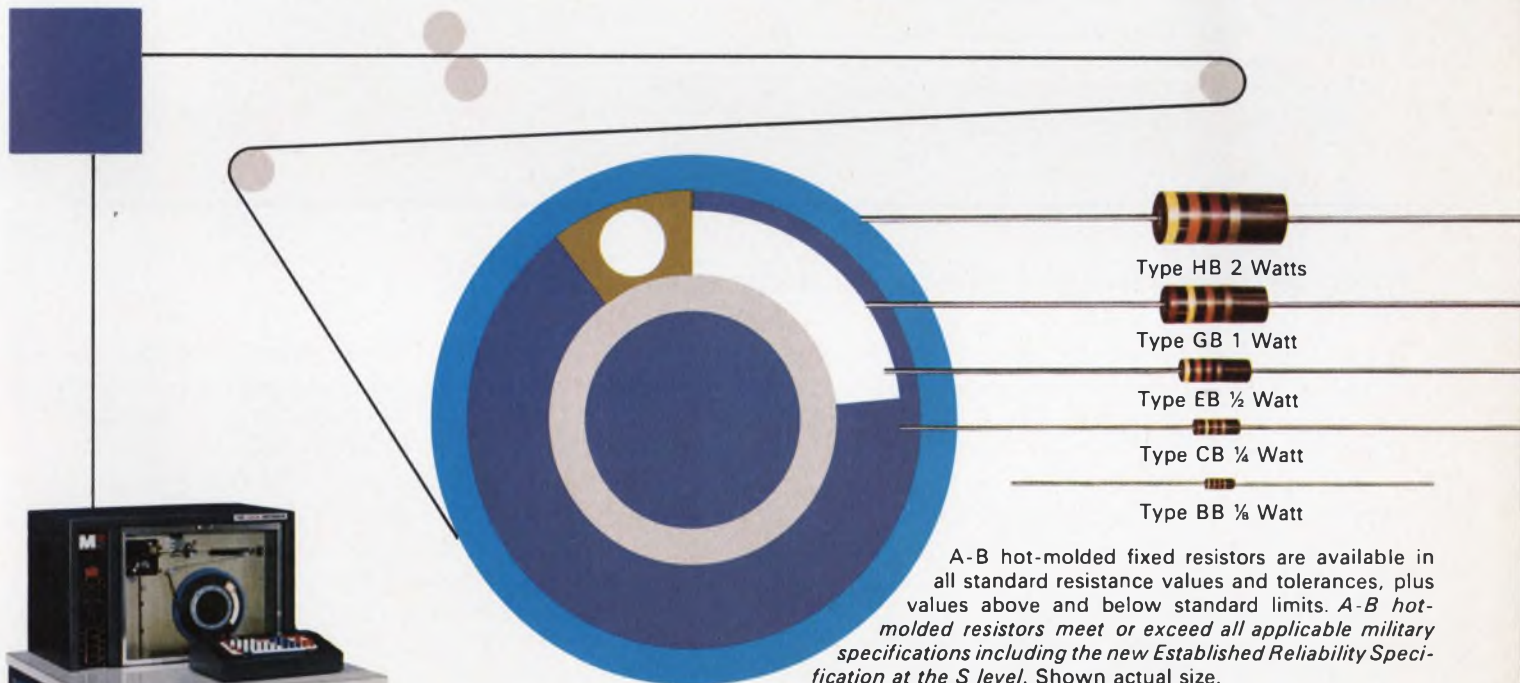

Mohawk 1101 Data-Recorder permits transcribing of data from source documents direct to ½" computer magnetic tape.





## Low-cost meter uses Hall effect for magnetic measurements

When working with magnets and magnetic structures, the need sometimes arises for a simple technique of comparing the magnetic devices with a known standard. Such qualitative measurements are often useful for incoming inspection, quality assurance, etc. A low-cost Hall-effect device can be used as the basis of a simple instrument for making measurements. If the instrument is calibrated with a standard magnet (available from most magnet companies), the instrument can also be calibrated to read magnetic flux.

The heart of the instrument is a Hall-effect device, 0.1-by-0.1 by 0.031-in, that costs approximately \$6.

For protection and ease of handling, the Hall-effect sensor is epoxy-cemented to the end of a phenolic rod. The control and output leads run down the rod and are also epoxy-coated. The output of the device, with a 15-mA control current and a link flux of 10 Maxwells is greater than 80 mV.

In the circuit (see illustration), the Hall-effect device is loaded with 40 ohms, which is the recommended value for optimum linearity. The voltage drop across the 1-ohm resistor, which is controlled by the "current-calibrate" resistor and a 1.5-V D-cell, is used to establish the 15-mA control current.

After initial set-up, the standard magnet is measured and a corresponding mark is made on

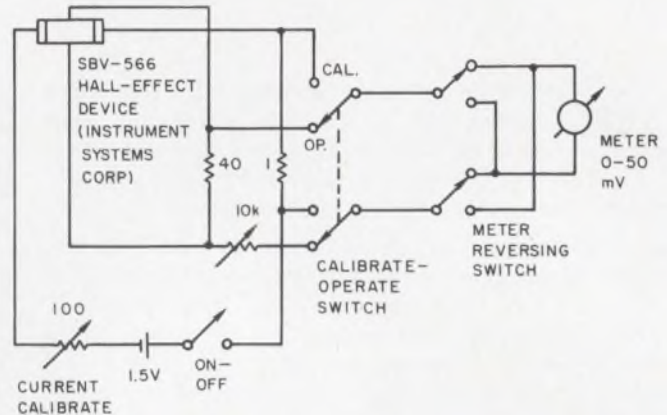

Hall-effect device produces an output voltage that is proportional to the strength of the magnetic field it is measuring.

the scale of the instrument meter. This mark is then the basis of comparison for the magnetic measurements. The flux calibration potentiometer is used to adjust the meter, so it reads in the desired portion of the scale. The reversing switch is necessary, since a magnet or magnetic structure can be magnetized in either of two directions. Battery life for the unit is in excess of 300 hours of operation, at 4 hours per day.

*Harry Teder, Chief Engineer, Advanced Development, Telex-Magnecord-Viking, Minneapolis, Minn.*

VOTE FOR 313

## Inexpensive circuit boosts op amp output current

Most electronic laboratories have stocks of IC operational amplifiers that are capable of delivering a few milliamperes of current—but operational amplifiers having higher current capabilities ( $\pm 100$  mA or more) are rare, and they are usually more expensive. Thus, large load-power comes at great expense if operational amplifiers are used.

The circuit shown in Fig. 1 is essentially an inexpensive operational amplifier current-booster. Transistors  $Q_1$  and  $Q_2$  are arranged in push-pull fashion, and operate as emitter followers ( $Q_1$  amplifies positive-going signals and  $Q_2$  amplifies negative-going signals). The four biasing resistors,  $R_1$  through  $R_4$ , serve to eliminate cross-over distortion, which is a common problem in class-B operation.

With zero output signal from amplifier  $K$ , point  $A$  is at ground potential. For this condition,  $R_1$  and  $R_2$  are chosen so that  $Q_1$  is at collector cutoff. Alternatively, collector current may be idling at a few milliamperes. As the voltage at point  $A$  increases (a positive-going signal), the voltage across the load,  $R_L$ , increases in a similar manner, since  $Q_1$  is acting as an emitter follower. The same action occurs when point  $A$  is negative-going, except that  $Q_2$  is operating. Feedback, through resistor,  $R_f$ , is included for linearization.

The same technique shown in Fig. 1 can be used for even larger power outputs by using two Darlington pairs in a similar arrangement. A four-transistor current booster capable of supplying well over an ampere of load current, is shown in Fig. 2. Again, the four resistors,  $R_1$  through



# Allen-Bradley cuts space requirements with new sealed type Z cermet trimmers

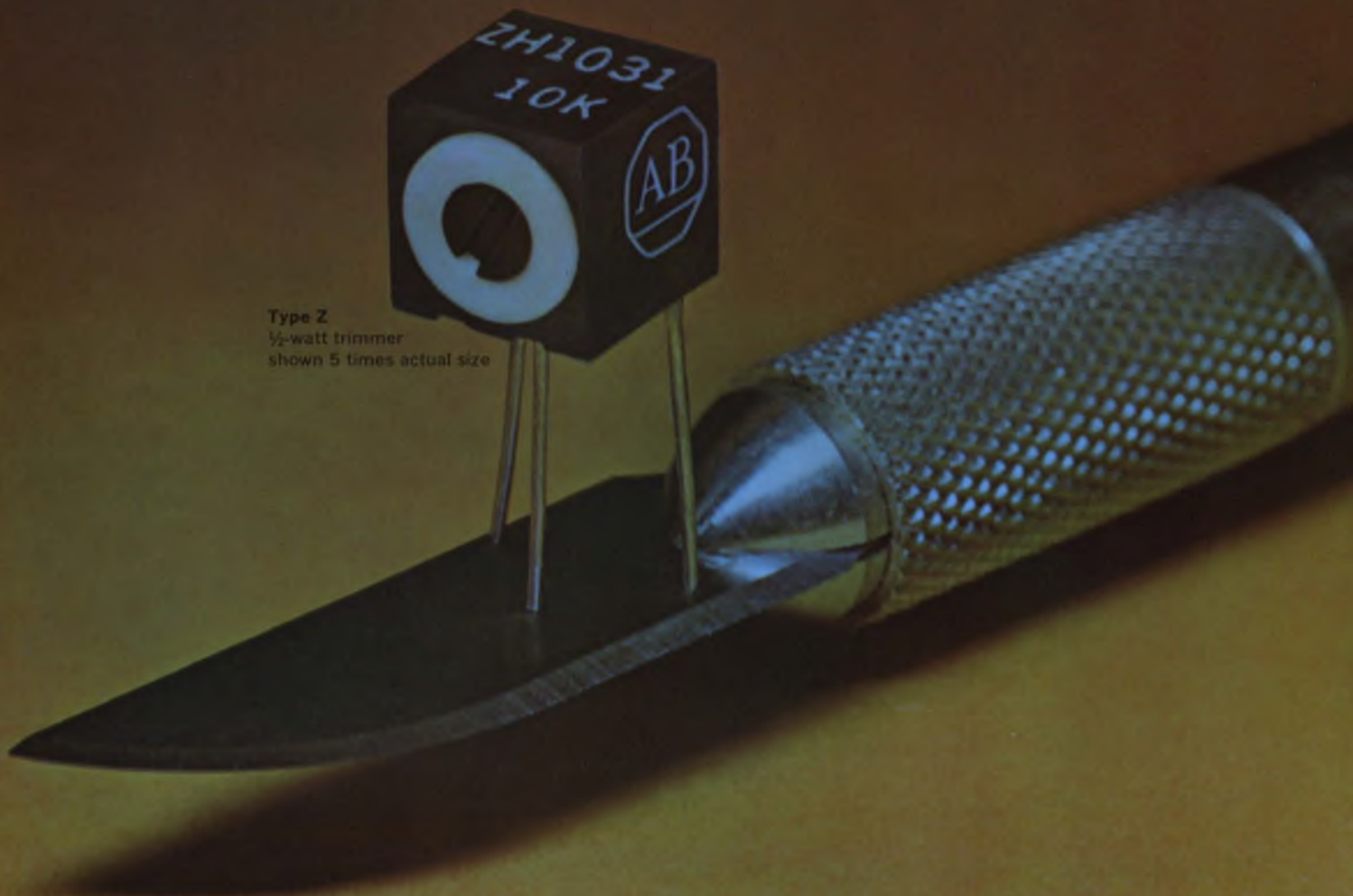

this latest addition to the Allen-Bradley line of cermet trimmers...the type Z...affords high performance in an especially compact package

The cermet material—an exclusive formulation developed by Allen-Bradley—provides superior load life, operating life, and electrical performance. For example, the full load operation ( $\frac{1}{2}$  watt) for 1000 hours at  $70^{\circ}\text{C}$  produces less than 3% total resistance change. And the temperature coefficient is less than  $\pm 250$  PPM/ $^{\circ}\text{C}$  for all resistance values and throughout the complete temperature range ( $-55^{\circ}\text{C}$  to  $+125^{\circ}\text{C}$ ).

The Type Z is ruggedly constructed to withstand shock and vibration. The unique rotor design ensures smooth adjustment and complete stability under severe environments. The leads are permanently anchored and bonded. The connection exceeds the lead strength—opens cannot occur. Leads are weldable.

The enclosure is *SEALED*. It is both dust-tight as well as watertight, and can be potted. Mounting pads prevent moisture migration and also post-solder washout. For full specifications on this new spacesaving cermet trimmer, please write Henry G. Rosenkranz, Allen-Bradley Co., 1201 S. Second St., Milwaukee, Wis. 53204. Export Office: 1293 Broad Street, Bloomfield, N.J., U.S.A. 07003. In Canada: Allen-Bradley Canada Ltd.

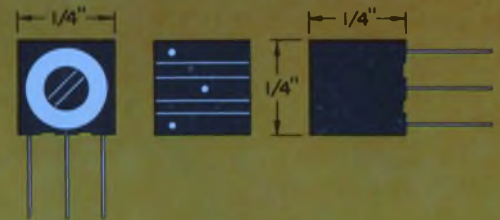

#### SPECIFICATIONS SUMMARY

- Adjustment:** Horizontal or vertical.
- Temperature Range:**  $-55^{\circ}\text{C}$  to  $+125^{\circ}\text{C}$ .
- Resistances:** 50 ohms through 1 megohm.  
Lower resistances available.
- Tolerances:**  $\pm 20\%$  standard,  $\pm 10\%$  available.
- Resolution:** Essentially infinite.
- Rotational Life:** Less than 2% total resistance change after 200 cycles.
- Rotation:**  $300^{\circ}$  single turn.
- End Resistance:** Less than 3 ohms.



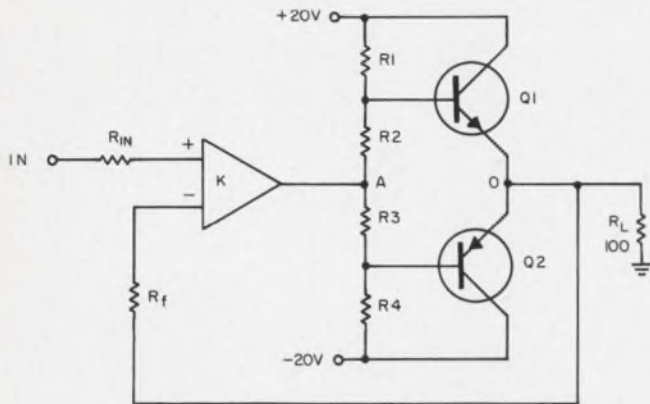

1. Push-pull emitter followers Q1 and Q2 boost the output current from the operational amplifier. The circuit can deliver 15 V to a 100-ohm load.

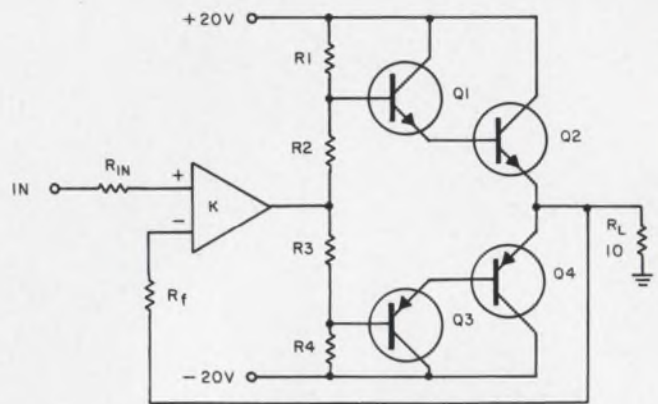

2. Q1 through Q4 are complementary Darlington pairs. They can boost the output of a low-current operational amplifier to well over 1 A.

$R_{1,}$  are chosen so that each Darlington pair is just beginning to conduct.

Transistors Q1 and Q2 are a 2N5190 and a 2N5193, respectively, which are marketed as a complementary pair. Although the use of a high-gain operational amplifier and feedback reduces the need for matched transistors, for best linearity a complementary pair should be used.

The configuration shown in Fig. 1 can deliver  $\pm 15$  V to a 100-ohm load. The input impedance to point A is approximately 2000 ohms, and the

voltage gain from point A to point O is approximately 0.7.

Corresponding results can be expected from the circuit of Fig. 2. The voltage gain is less, but the input impedance is higher. A typical value of load resistor would be 10 ohms. This would yield an output current of approximately  $\pm 1.5$  A.

*D. K. Belcher, Research Associate, University of Kentucky, Lexington, Ky.*

VOTE FOR 314

## Network provides broadband input-capacity compensation

Techniques for video interstage compensation of shunt parasitic capacities are well-known and normally involve the manipulation of a voltage transfer function until a required passband is obtained. Separating the stages, though, may

necessitate a transmission line interconnection, which requires a specific resistive termination to minimize reflections. Thus, a network is required that provides broadband compensation of an input capacity and that, at the same time, maintains a constant input resistance. A circuit for accomplishing this, in which the maximum frequency of interest and the amount of shunt parasitic capacity is given, is shown in (a).

A low-pass filter, composed of one T-section and an m-derived initiating and terminating half-section, makes up the circuit. The circuit is redrawn in (b), in which the series m- and T-section inductances have been combined.

The following relationships are derived for the circuit of (b) from ordinary filter theory.

$$\begin{aligned} L_1 &= (1 + m) [R / (2\pi f_0)] && \text{henrys} \\ L_2 &= R(1 - m^2) / (2\pi f_0 m) && \text{henrys} \quad (1) \\ C_2 &= m / (2\pi f_0 R) && \text{farads} \\ R &= 1 / (\pi f_0 C_1) && \text{ohms,} \end{aligned}$$

where  $f_0$  is the cutoff frequency of the filter and

# VOTE

**VOTE!** Go through all Idea-for-Design entries, select the best, and circle the appropriate number on the Reader-Service-Card.

**SEND US YOUR IDEAS FOR DESIGN.** You may win a grand total of \$1050 (cash)! Here's how. Submit your IFD describing a new or important circuit or design technique, the clever use of a new component or test equipment, packaging tips, cost-saving ideas to our Ideas-for-Design editor. You will receive \$20 for each accepted idea, \$30 more if it is voted best-of-issue by our readers. The best-of-issue winners become eligible for the Idea Of the Year award of \$1000.





**This counter fell off a plane.  
It didn't need service  
(but when one does, we're ready).**

This Model 100A Counter-Timer was enroute to a customer. A freight handler laid it on the wing of the airplane—and forgot it. The package finally slid off as the wheels left the runway. Instantly freed of its container, the “Small Wonder,” as our customers sometimes call it, chased the plane for about a hundred yards, then ground-looped.

Our nearby Service Center, bored with inaction, brightened at the thought of a real challenge when it was brought in. But they were disappointed: electrically, the “Small Wonder” picked up right where it left off in Final Inspection. (Of course, *mechanically* there were a few abra-

sions to take care of, as you can see.)

Please help us keep our 37 Service Centers with their factory-trained technicians alive and well. Call the one nearest you anytime you feel that a Monsanto instrument requires service or calibration... or even verification of its performance. In addition to their expertise and factory specified test equipment, all carry a complete stock of spare parts. If there should be a defect in materials or workmanship during the 2-year warranty period, it won't cost you anything.

Monsanto Company, Electronic Instruments, West Caldwell, New Jersey 07006.

**Monsanto**



$m$  is the well-known parameter of an  $m$ -derived termination.

The maximum frequency of interest,  $f$ , is assumed to be below the cutoff frequency to ensure a flatter characteristic over the passband. Experience has shown the following relations to be adequate in most cases:

$$\begin{aligned} f_0 &= 7f/6 \\ m &= 0.6 \end{aligned} \tag{2}$$

Combining Eqs. 1 and 2, results in the following design data:

$$\begin{aligned} R &= 0.273 / (f C_1) \text{ ohms} \\ L_1 &= 0.0595 / (f^2 C_1) \text{ henrys} \\ L_2 &= 0.0397 / (f^2 C_1) \text{ henrys} \\ C_2 &= 0.3 C_1 \text{ farads} \end{aligned} \tag{3}$$

These circuit values may be adjusted by increasing  $f$  and/or  $C_1$ . However, minimum power is expended for constant voltage across  $C_1$  when  $R$  is maximum, consistent with the given values of  $f$  and  $C_1$ . A trade-off may be necessary, therefore, when practical values of circuit components are considered.

An actual design example of the circuit is as follows:

$$\begin{aligned} \text{Given: } f &= 30 \text{ MHz} \\ C_1 &= 43 \text{ pF} \end{aligned}$$

the circuit values, as calculated from Eq. 3, are:

$$\begin{aligned} R &= 212 \text{ ohms} \rightarrow 210 \text{ ohms} \pm 5 \text{ per cent} \\ L_1 &= 1.54 \text{ } \mu\text{H} \rightarrow 1.5 \text{ } \mu\text{H} \pm 5 \text{ per cent} \\ L_2 &= 1.025 \text{ } \mu\text{H} \rightarrow 1.0 \text{ } \mu\text{H} \pm 5 \text{ per cent} \\ C_2 &= 12.9 \text{ pF} \rightarrow 12.0 \text{ pF} \pm 5 \text{ per cent} \end{aligned}$$

where the calculated values are rounded off to the nearest standard values.

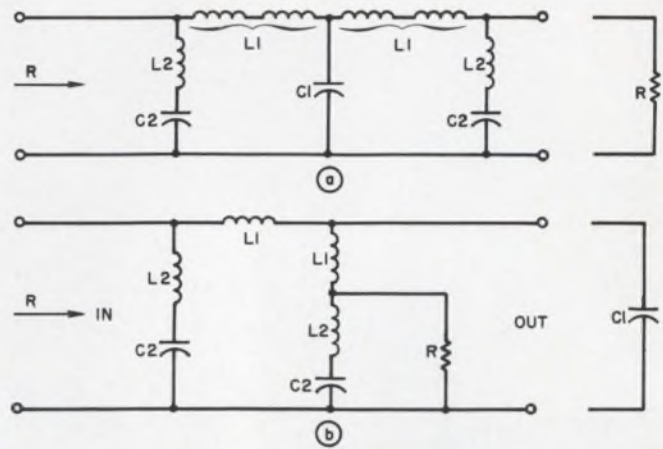

A low-pass T-section with  $m$ -derived terminations makes up the low-pass filter network (a). Rearrangement of the network shows the input and output terminals (b).

A network using the above component values fulfills the given boundary conditions. It is now necessary to match the calculated value of  $R$  to the coaxial cable feeder. In an actual example of this circuit, a 53-ohm coaxial cable was used. Assuming sufficient driving power,  $R$  could be taken as 53 ohms, thus directly matching the feeder, with  $f$  and  $C_1$  appropriately adjusted. Power was marginal, so a transformer was used for matching the feeder, resulting in an acceptable SWR of 1.5 from 2 to 30 MHz.

*S. Sabaroff, Senior Scientist, Hughes Aircraft Co., El Segundo, Calif.*

VOTE FOR 315

## SCR relaxation flasher has long life, low power drain

Battery-operated power flasher lights are used in an endless variety of applications, including warning lights, automobiles and advertising displays. A major disadvantage of many flasher units, though, is that their usability depends greatly on battery charge condition. This limitation is reduced to a large extent by the SCR relaxation flasher shown. The circuit will maintain a slower—but—good flashing capability even after considerable battery degradation, such as up to 1000-ohms internal impedance.

The flasher is astable because charging current falls below the SCR holding current during capacitor discharge. To verify this, note that the discharge path for the 100- $\mu\text{F}$  capacitor is through the lamp, through the diode, and to ground through the SCR. Forward-biasing the diode back-biases the transistor, and the only

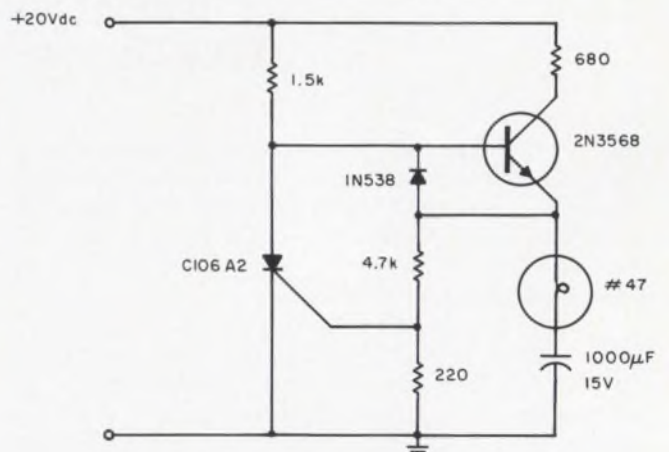

Flashing occurs each time the capacitor discharges through the turned-on SCR. When the discharge current falls below the SCR holding current, the SCR turns off, and the capacitor begins charging for another cycle.



# Who's Afraid of CRT?

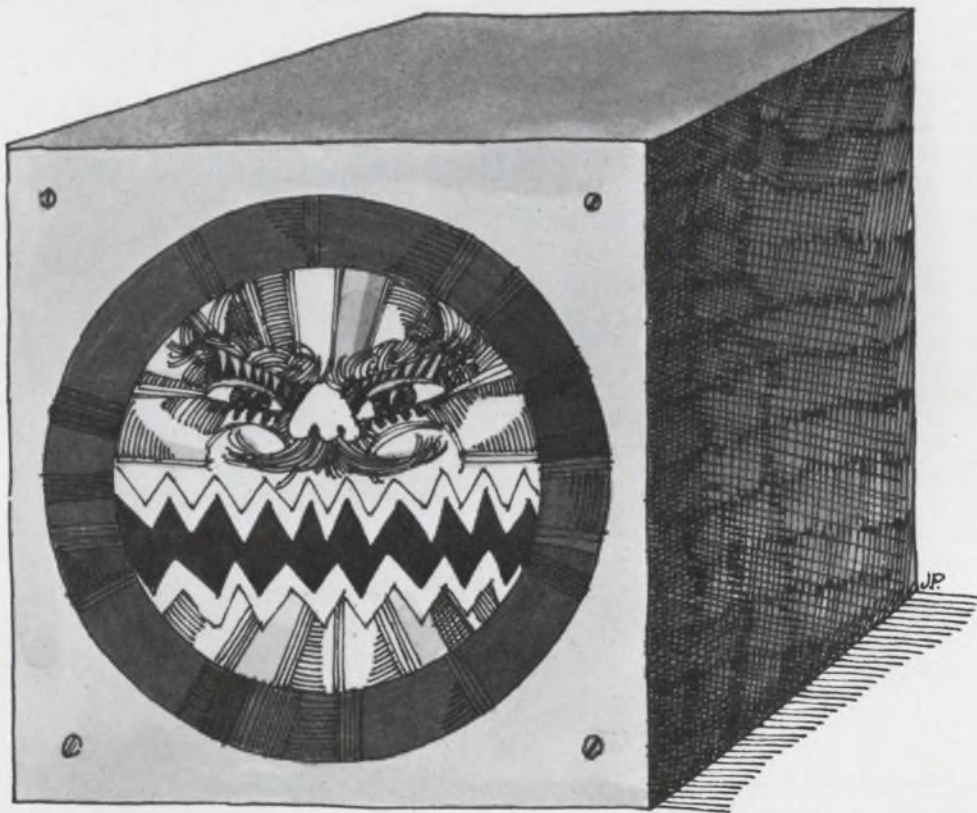

Got a CRT hangup? Let Beta unbug you. We're specialists in sophisticated, high-performance, high-resolution Precision X-Y CRT Displays. For film recorders and readers, flying spot scanners, bubble chamber experiments, video recorders, scan converters, and hard-copy printers. Three models are available. And all are backed by Beta dependability, engineering know-how and systems capability. So don't be afraid. Whatever your CRT problem. Just ask.

**Beta Instrument**

BETA INSTRUMENT CORP 377 Elliot St., Newton Upper Falls,  
Massachusetts 02164 / Tel. 617 969-6510

INFORMATION RETRIEVAL NUMBER 41

remaining current from the power supply is through the 15-kΩ pull-up resistor. With the large (220-Ω) gate resistor, the SCR will not stay ON with this small current. Therefore, once the capacitor discharges (flashing the bulb), the SCR turns off.

Once the SCR is OFF, the diode becomes back-biased and the transistor conducts again, supplying about 30-mA capacitor charging current. The 4.7 kΩ-220 Ω divider across the capacitor determines the capacitor voltage at which SCR gate conduction, and therefore flashing, occurs.

*Peter Lefferts, Chief Engineer, Tia Electric Co., Princeton, N.J.*

VOTE FOR 316

## Two wires transmit and identify remote switch closures

An unusual and intriguing problem arises in control applications when a single pair of wires must transmit and identify a number of separate switch closures. One technique for accomplishing this, in the case of three remote switches, is shown in the illustration. Although the circuit shown is for three switch closures, more than three can be accommodated by extending the circuit.

In the circuit, a supply voltage is selected that will actuate all three relays in series. The value of  $R_1$  is chosen to permit only sufficient current flow to actuate  $K1$ . Shunt resistor  $R_2$  is selected to prevent  $K2$  from being actuated when switch  $S1$  is closed. Resistor  $R_3$  is selected so that, when  $S2$  is closed, sufficient current flows to actuate  $K2$ . Zener diode  $D1$  limits the voltage drop across  $K1$  by carrying the extra current needed to actuate  $K2$ .

Shunt resistor  $R_4$  is chosen to prevent  $K3$  from being actuated when switch  $S2$  is closed; and resistor  $R_5$  is selected to conduct sufficient current

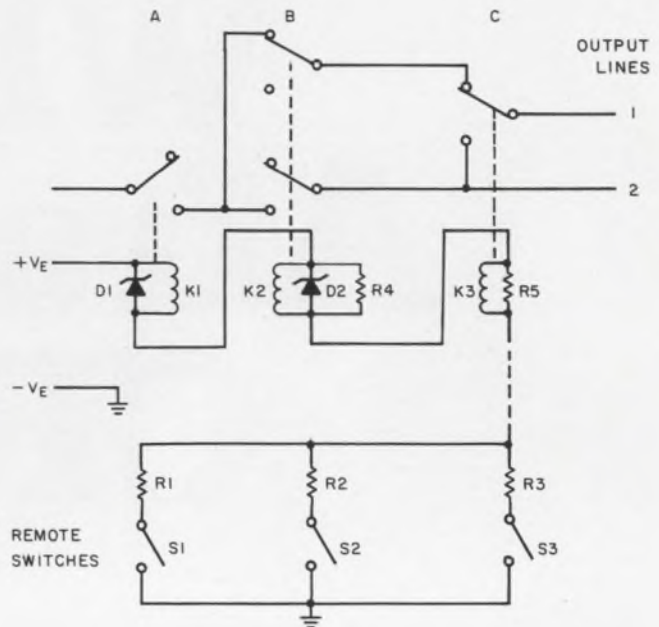

Logical states of the two output lines depend on which remote switches are closed.

to actuate  $K3$ . Zener diode  $D2$  limits the voltage drop across  $K2$  by carrying the extra current needed to actuate  $K3$ . The relay-contact transfer logic used in this application is as follows (different logic can be used depending on the requirements):

LINE	ABC	ABC	ABC	ABC
1	0	1	0	1
2	0	0	1	1

Typical circuit values when using Allied Control T154-2C, 6-volt coil relays are:  $R_1$ —120 ohms;  $R_2$ —86 ohms;  $R_3$ —62 ohms;  $R_4$ —110 ohms;  $R_5$ —51 ohms;  $D1$  and  $D2$ —3.3 V, 1 W,  $V_E = 18$  V. Current requirement for the circuit is approximately 100 mA, maximum.

*Roy J. Krusberg, Engineer, Winder, Ga.*

VOTE FOR 317

### IFD Winner for November 7, 1968

**M. Stevens**, Staff Engineer, Harlow, Essex, England. His Idea "Two op amps provide floating output circuit" has been voted the Most Valuable of Issue Award.

Cast your vote for the Best Idea in this Issue.

### IFD Winner for November 21, 1968

**Walter Ellermeyer**, Design Engineer, San Diego, Calif. His Idea "Infinite input impedance circuit uses one op amp" has been voted the Most Valuable of Issue Award.

Cast your vote for the Best Idea in this Issue.





ACTUAL SIZE

# RELAYS

## 1/6-Size Relay Model BR10

- Dry Circuit to 1 Amp.  DPDT
- Welded or Soldered  Universal Contacts  To MIL-R-5757

Babcock's Model BR10 1/6-size crystal can relay packs a lot of performance in a small package. Its unique universal contacts give you "non-stop" operation from dry circuit to 1 amp...one subminiature relay to meet all your requirements for high-density circuit-board applications—at no cost premium.

You'll find that this small, versatile, DPDT unit has everything. Designed to specification MIL-R-5757, it features rugged unitized construction for increased shock and vibration resistance. Both soldered or welded versions are offered. Regular and gold-plated plug-in, solder-hook, and long-lead terminal styles are available, in standard circuit-board grid pattern, with a range of mounting types.

The Model BR10 has a record of dependability, attested by its proven conformance to MIL-R-5757 and specified use in programs requiring operation under the most severe environmental extremes. Built-in reliability, outstanding performance, application flexibility...all assurances that your relay is better because it's Babcock.

The Babcock Model BR10 relay has proven its reliability in a variety of aerospace and commercial avionics applications. Its subminiature size makes it ideal for single and multi-relay circuit-board installations. In fact, a brace of four BR10's has been found to take less board space than a similar group TO-5 units. You get efficient high-density packaging, plus full 1-amp. capability.



**Need 2-amp. performance?** The Model BR10 will operate dependably at 2 amps. (28 VDC), through 100,000 operations, in the temperature range  $-65^{\circ}\text{C}$  to  $+125^{\circ}\text{C}$ . Contact our Applications Engineering Group for further details.

### SPECIFICATIONS

Contact Rating.....	1 amp. @ 28 VDC
Operate/Release Time.....	3.5 ms., max.
Pull-In Power.....	100 mw
Bounce Time.....	2 ms., max.
Shock.....	50 g's (11 ms.)
Vibration.....	30 g's, 38-2000 Hz
Operating Temp.....	$-65^{\circ}\text{C}$ to $+125^{\circ}\text{C}$
Life.....	100,000 operations, min.

Get complete information on the versatile, subminiature Model BR10 today...contact Babcock Electronics Corp., Relays Division, Subsidiary of Esterline Corp., 3501 Harbor Blvd., Costa Mesa, Calif. 92626. CALL COLLECT (714) 540-1234 or TWX 910-595-1517.

Available off-The-Shelf from  
AVNET, POWELL or PDQ.

Challenging opportunities now exist at Babcock for experienced relay-switch engineers.



# Book Reviews

## Shop manual

*Machinery's Handbook*, 18th Edition, Erik Oberg and Franklin D. Jones (Industrial Press, New York) 2293 pp. \$16.00.

Any engineer who occasionally must roll up his sleeves and get his hands dirty will have considerable use for *Machinery's Handbook*. A must item for every shop and production area, this is one of the few "handbooks" that is really hand-sized—3 × 6-1/2 inches.

Its 2293 pages contain nearly all the data that might conceivably be required in a model shop. Unlike other shop handbooks of similar scope, this one is not merely a compendium of tables. It contains a lot of how-to-information for the man who is more at home with a Smith chart than a Bridgeport.

CIRCLE NO. 401

## Birth of a dream

*The Story of Jodrell Bank*, Sir Bernard Lovell (Harper & Row, New York) 265 pp. \$5.95.

Bernard Lovell's account of the birth of the world's largest, fully steerable radiotelescope cannot fail to impress the reader with the magnitude of this achievement.

Drawing on his correspondence and diaries, Lovell recreates a time when the mammoth reflector was only a vision. He paints the tale of its creation against a backdrop of political conflict and bureaucratic bungling. In recapturing his uncertainties and his triumphs, the author has given us the story of the telescope and the story of a man who had the courage to stand firmly behind an idea through uncertain trying years.

CIRCLE NO. 402

## EE Handbook

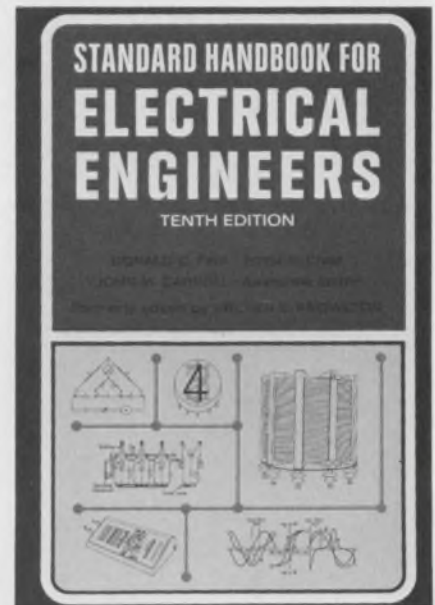

*Standard Handbook for Electrical Engineers*, 10th ed., Donald G. Fink, (McGraw-Hill Book Co. New York City), 2466 pp. \$32.50.

Useful to engineers in all the technologies, the tenth edition of the *Standard Handbook for Electrical Engineers* retains the basic design data and applications information relating to the generation, transmission, distribution, control, and conversion of electricity. Expanded to include such current material as semiconductors and data processing, the revised handbook also covers other new topics, for example, high-voltage dc transmission, and nuclear power fuels and reactors.

The information on solid-state technology covers basic semiconductor theory, the properties of many semiconductor materials, transistor fabrication, and transistor circuit models. The data-processing section discusses analog and digital computation, computers, computer organization, number systems, logic design, input-output systems, and programing.

The handbook has 29 sections in all, in addition to a comprehensive index. Standard listings include units and conversion factors, as well as codes and standards.

CIRCLE NO. 403

Outstanding orders for the Lockheed 1011 make up that backlog. Additional on-going Lockheed programs include the Rigid Rotor AH-56A Cheyenne and commercial derivatives, ASW aircraft, and supersonic aircraft development.

Lockheed has a huge backlog of opportunity in: Structural Design and Design of Avionics, Flight Controls, Real-Time Computers, Digital Displays, and EMI. Also openings in Analysis and Reliability Engineering.

These positions require an appropriate degree and experience. Send your resume to: Mr. C. R. Alexander, Professional Placement Manager, Dept. 1703, 3415 N. Hollywood Way, Burbank, California 91503. An equal opportunity employer.

**Engineers: You're looking at a 2.6-billion-dollar backlog of opportunity. Look into it!**



INFORMATION RETRIEVAL NUMBER 901







## New 35-MHz Counter



### **MORE** of Everything You Want in a Counter for only \$1395

We have made significant improvements to the popular 1191 Counter. Now you can get more performance but still at low price. The 1191-B has:

**More Frequency Range.** DC to 35 MHz, direct count. The addition of an inexpensive GR scaler (now or at a later time) extends the frequency range to 100 MHz or 500 MHz.

**More Sensitivity.** A 10-mV signal is all that is needed to trigger the instrument up to 20 MHz. (Beyond 20 MHz, sensitivity gradually decreases, but no more than 100 mV is required up to 35 MHz.)

**More Versatility.** The 1191-B provides all the functions you'd expect from a high-quality counter-timer: frequency, single and multiple period (1 to  $10^8$  periods), time interval ( $10^{-7}$  s to  $10^9$  s), frequency ratio (1 to  $10^8$ ), count (to  $10^8$ ). In addition, a unique strobed-period mode (described below) affords even more performance per dollar. All functions, including secondary controls, are dc programmable.

**More Useful Counting Time.** A unique strobed-period mode of the

1191-B allows you to measure the period between successive pulses or the time between successive occurrences. The count-display scheme used by other counters allows measurement of every other period, at best. But the 1191-B can generate a clear and restart signal immediately upon completion of display time (which is as low as 1  $\mu$ s), so no information is lost.

**More Value.** The base price of the 1191-B is \$1395; this model contains a room-temperature crystal oscillator with drift  $< \pm 2 \times 10^{-6}$  per month. An additional \$300 buys a high-precision oscillator with drift  $< \pm 1 \times 10^{-8}$  per week. Fully buffered 1-2-4-8 BCD output at standard DTL levels can be ordered for another \$100.

For more information call your nearest GR Office. Or write General Radio, West Concord, Mass. 01781; telephone (617) 369-4400. In Europe: Postfach 124, CH 8034 Zurich 34, Switzerland.

## GENERAL RADIO

INFORMATION RETRIEVAL NUMBER 43



# Products

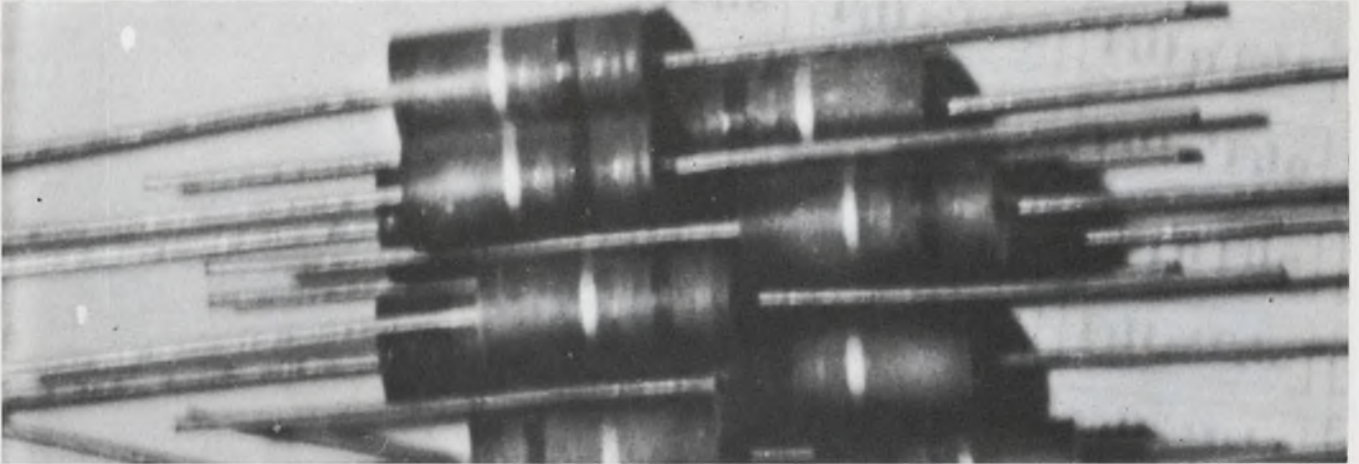

**Filing system** for component parts uses combination see-thru plastic dome and heavy-

duty index card. Try it out for yourself through our Evaluation Samples, p. 130.

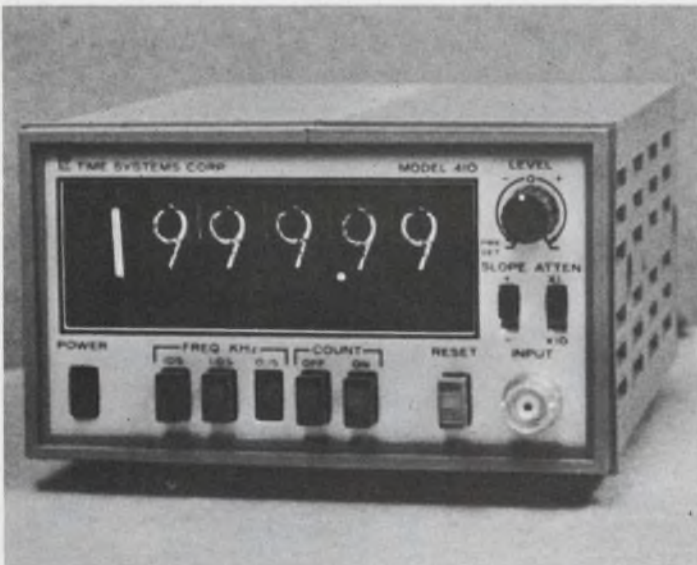

**Low-frequency counters** in 3 by 4.9 by 6-3/4-in. package can be remotely programmed, p. 118.

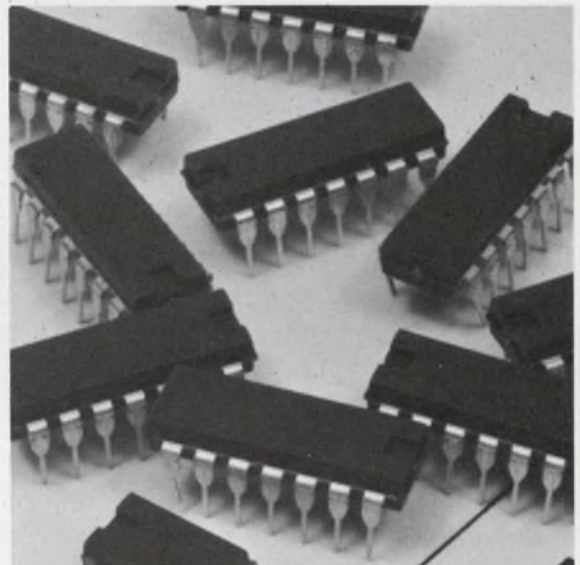

**Two up/down counter chips**, binary and decimal, rep to 30 MHz, p. 108.

## Also in this section:

**Rf log detectors** span 40-MHz video bandwidth, p. 104.

**Low-cost digital clock** accepts four-line BCD data, p. 112.

**Oxide capacitor strips** jam 100 pF in 0.016-in. square, p. 121.

**Design Aids**, p. 132 . . . **Application Notes**, p. 134 . . . **New Literature**, p. 136.

## Two-stage rf log detectors cover 40-MHz video band

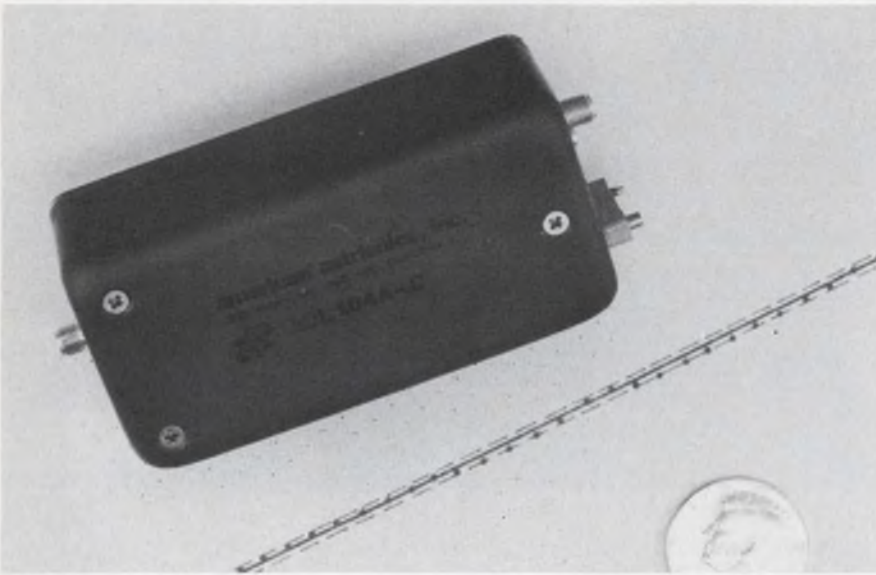

American Astrionics, Inc., 3950 Fabian Way, Palo Alto, Calif. Phone: (415) 328-6800. P&A: detectors, \$1650 each; amplifiers, \$690 to \$11.95; 4 wks.

Providing the ability to go directly from rf to video frequencies in one small package, a new line of rf log detectors features a 40-MHz bandwidth over rf passbands between 0.1 to 0.5 GHz and 12 to 18 GHz. Series ADL-8040 units consist of an rf tunnel diode detector and a video log amplifier. The entire assembly is contained in a box that measures only 2 by 2 by 4 in.

To yield an over-all transfer function, the video log amplifier has a transfer function that is matched and calibrated to the square-law transfer function of the rf detector. The linearity of this combined transfer function is  $\pm 1.5$  dBm, referred to the input over the temperature range of  $-55$  to  $+100^\circ\text{C}$ .

Because they are linear systems for low-amplitude signals and logarithmic ones for high-amplitude signals, the new detectors can amplify small signals and attenuate large ones. This type of performance is ideal for detecting a large number of channels of pulsed data.

The new detectors have an input dynamic range of  $-42$  dBm minimum to  $+5$  dBm maximum. Their

tangential sensitivity is  $-48$  dBm, and maximum input power is  $+15$  dBm. Nominal input impedance is  $50\ \Omega$ , while VSWR ranges from 2.5 maximum to 2 minimum. Each assembly dissipates 1.3 watts of power while operating from a  $\pm 12$ -V ds supply.

Seven standard versions are available: model ADL-8040-V with an rf passband of 0.1 to 0.5 GHz; model ADL-8040-U, 0.5 to 1 GHz; model ADL-8040-L, 1 to 2 GHz; model ADL-8040-S, 2 to 4 MHz; model ADL-8040-C, 4 to 8 GHz; model ADL-8040-X, 8 to 12 GHz; and model ADL-8040-K, 12 to 18 GHz.

Series AL video log amplifiers can be purchased separately. They have an input dynamic range of 50 dB minimum to 80 dB maximum. Their output risetimes and fall-times vary from 9 ns minimum to 35 ns maximum. Output noise with zero input ranges from as little as 5 mV rms to a maximum of 10 mV rms.

Other rf passband characteristics for the detectors are available on request, as well as linearities of better than  $\pm 1$  dB. In addition, units can be matched to track each other within  $\pm 0.5$  dB, for such applications as side lobe suppression systems.

CIRCLE NO. 250

## Pushbutton attenuator goes up to 8 GHz

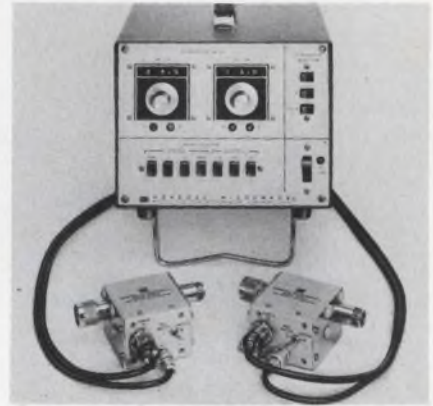

General Microwave Corp., 155 Marine St., Farmingdale, N.Y. Phone: (516) 694-3600.

When combined with one or two model N172AL p-i-n diode attenuators, a new control unit operates as a direct-reading continuous or a step-variable microwave attenuator from 50 MHz to 8 GHz. The 310 pushbutton system enables direct programming of attenuation levels as well as remote programming through external resistances or voltages. Attenuation varies from 30 dB per attenuator in the matched mode to 90 dB per attenuator in the mismatched mode.

CIRCLE NO. 251

## Rf power transistor gains 5.6 dB at 400 MHz



Fairchild Semiconductor, 313 Fairchild Dr., Mountain View, Calif. Phone: (415) 962-2530. P&A: \$60; stock.

Capable of dissipating 21 W at  $25^\circ\text{C}$ , an rf power transistor, model MSA 8505, delivers 5.6 dB of power gain at a frequency of 400 MHz. This unit can evenly distribute internal currents, with no sacrifice in frequency response, by using thin-film stabilizing feedback resistors and discrete emitters.

CIRCLE NO. 252



## TRW METALLIZED POLYCARBONATE CAPACITORS



... small enough to fit!

TRW 50-volt Metallized Polycarbonate Capacitors are made to squeeze into tight places. Imagine 10 microfarads measuring .547" x 1¼" long... the smallest wound capacitor on the market!

Short on size and long on reliability, the X463UW series meets all requirements of MIL-C-27287.  
**VOLTAGE**—50V, 100V, 200V, 400V  
**CAPACITANCE**— .001 through 10 mfd  
**TOLERANCE**—available to  $\pm 1\%$ .

INFORMATION RETRIEVAL NUMBER 44

For data, write TRW Capacitor Div., Ogallala, Neb. Phone (308) 284-3611. TWX 910-620-0321.

# TRW®

### Rf power transducer senses 10 $\mu$ W to 1 mW



The Narda Microwave Corp., Commercial St., Plainview, N.Y. Phone: (516) 433-9000. P&A: \$375; stock.

With an accuracy of  $\pm 1\%$ , a new power transducer for continuous monitoring applications measures low-level rf power (10  $\mu$ W to 1 mW) from 10 MHz to 12.4 GHz. Model 474 converts rf power at the source to dc power for transmission to remote stations for readout. It weighs only 22 oz.

CIRCLE NO. 253

### Solid-state modulators operate to 14 GHz



G-L Microwaves Corp., sub. of G-L Industries, Inc., 825 Black Oak Ridge Rd., Wayne, N.J. Phone: (201) 835-1717. P&A: \$335 typical; 2 to 3 wks.

Using hybrid IC techniques to optimize performance, octave-bandwidth solid-state modulators for frequencies from 100 MHz to 14 GHz feature low reflection characteristics with a high isolation of 50 dB minimum. These stripline current-controlled attenuator/switches provide fast and noiseless control of signal source level.

CIRCLE NO. 254

### Low-loss capacitors have Q of 10,000

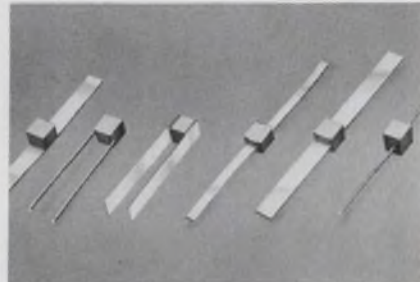

American Technical Ceramics, One Norden Lane, Huntington Station, N.Y. Phone: (516) 271-9600. Availability: stock to 2 wks.

Occupying only one-tenth of a cubic inch, microwave porcelain capacitors handle 10 W at 1 GHz and have a Q of 10,000 at 100 MHz. Series MPC units hold insertion loss to less than 0.03 dB and VSWR to under 1.05. They are self-resonant above C band and always maintain an extremely low inductance.

CIRCLE NO. 255

## EASTMAN 910<sup>®</sup> Adhesive cuts assembly time of missile guidance system components by 25%

General Dynamics, Pomona Division uses EASTMAN 910 Adhesive to bond the lid to a potting cup filled with a low density epoxy potting compound. Both the lid and the cup are made of diallyl phthalate plastic, and are components of an electronic assembly for a missile guidance system.

General Dynamics has been using EASTMAN 910 Adhesive in this application for more than three years. Because the adhesive is a one-component system, it eliminates the need for catalysts or mixing. And because it requires neither heat nor pressure to form a strong bond in sec-



onds, production rates have been increased substantially.

EASTMAN 910 Adhesive is versatile, will form a bond with almost any kind of material. Requires no heat, solvent evaporation,

or catalyst. Offers fast setting, high strength and low shrinkage. Comes ready to use, cures at room temperature with only contact pressure. And gives approximately 20 one-drop applications for only a nickel.

Try EASTMAN 910 Adhesive on your toughest bonding jobs. For technical data and further information, write Chemicals Division, EASTMAN CHEMICAL PRODUCTS, INC., Kingsport, Tennessee. EASTMAN 910 Adhesive is distributed by Armstrong Cork Company, Industry Products Division, Lancaster, Pennsylvania.

Here are some of the bonds that can be made with versatile EASTMAN 910 Adhesive

**Among the stronger:** steel, aluminum, brass, copper, vinyls, phenolics, cellulose, polyesters, polyurethanes, nylon; butyl, nitrile, SBR, natural rubber, most types of neoprene; some woods.

**Among the weaker:** polystyrene, polyethylene (shear strengths up to 150 lb./sq. in.).

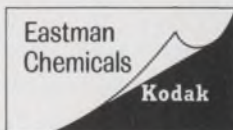

See Sweet's Product Design Catalog File



## X-band power divider isolates 8 outputs

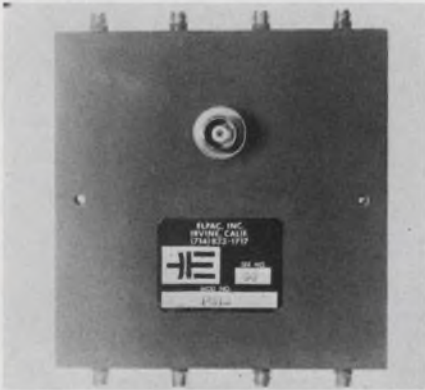

*Elpac, Inc., RF/Microwave Div., 18651 Von Karman Ave., Irvine, Calif. Phone: (714) 833-1717.*

Operating over the frequency range of 8 to 12 GHz, a stripline power divider accepts up to 50-W cw input power and provides eight outputs that are mutually isolated by at least 10 dB. The phase of the output signal at all output ports is identical within  $\pm 10^\circ$ . Insertion loss is  $9.5 \text{ dB} \pm 1 \text{ dB}$  to any output port; input VSWR is 1.5 maximum.

CIRCLE NO. 256

## PTM laser system socks out 1.2 GW

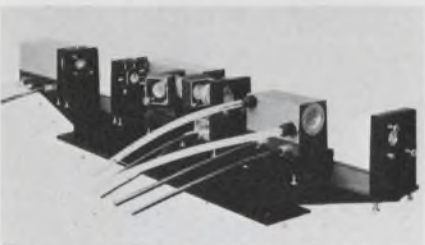

*Union Carbide Corp., Korad Dept., 2520 Colorado Ave., Santa Monica, Calif. Availability: 60 days.*

The first commercial laser system to use a pulse-transmission mode (PTM) technique at gigawatt levels is now available. The new laser, designated as model K-1600, has output powers as high as 1.2 GW. According to the company, previous giant-pulse lasers using the PTM technique have attained only 30 to 40 mW. Besides greatly reducing damage to optical components, the PTM technique decreases laser pulsewidth from 15 ns to 5 ns or less.

CIRCLE NO. 257

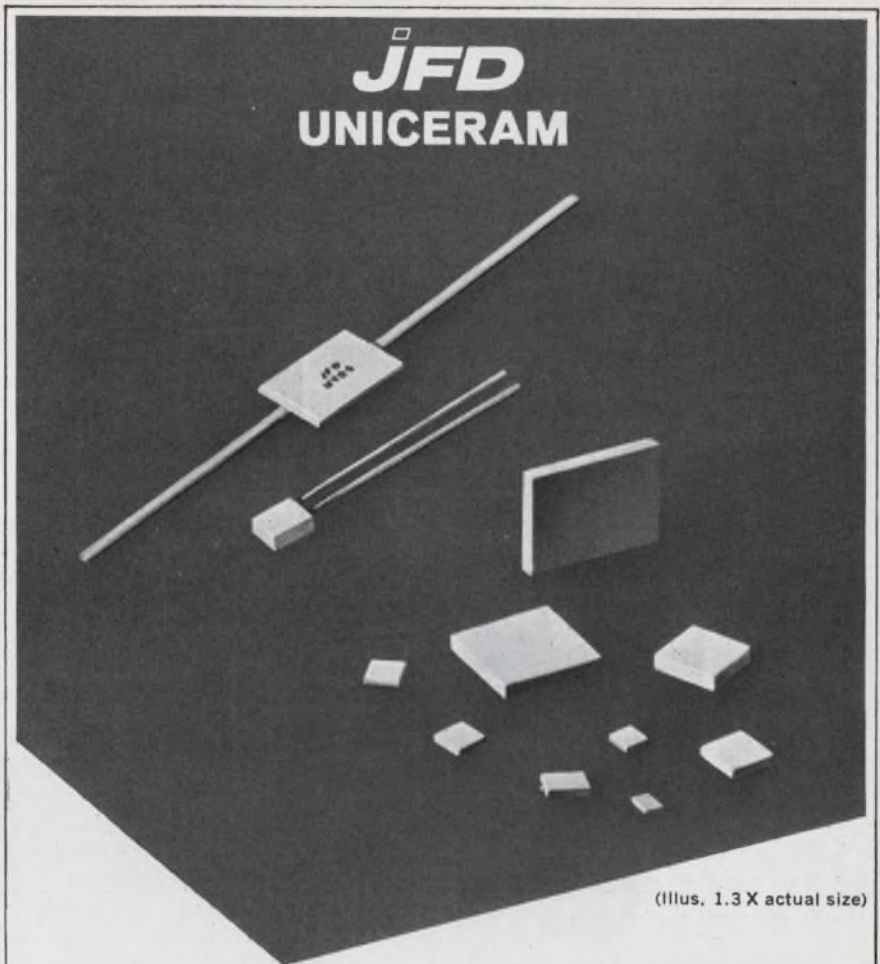

(Illus. 1.3 X actual size)

## HIGH Q AND HIGH K CERAMIC FIXED CAPACITORS

### UNICERAM HIGH Q

JFD High Q monolithic ceramic fixed capacitors in wafer and leaded configurations offer the ultimate in 'Q'. A high ratio of capacitance per unit volume results in an exceptionally stable, smaller-sized-package than competitive units. 'Q' at 1 MHz for values of 1000 pf or less is 5000 min.

Over 1000 glass encapsulated and unencapsulated miniature models, in 5 square case sizes, are offered with capacitance values of 0.5 to 3000 pf. The highly reliable and stable glass encapsulated models meet applicable requirements of MIL-C-11272B.

Write for catalogs UNM-H/Q-67-A and UNM-H/K-67.

### UNICERAM HIGH K

JFD High K wafer series ceramic monolithic capacitors offer high capacitance per unit volume. Capacitance range offered in this series is 10 pf to 1.5 mfd.

This High K wafer series is a quality 'Industrial Grade' ceramic multi-layer construction available in 5 squares and 12 rectangular sub-miniature and miniature metalized-edged configurations — inherently impervious to moisture and contamination. Each unit meets or exceeds applicable portions of MIL-C-11015C and MIL-C-39014.

Uniceram High Q and High K wafer capacitors are ideally suited to hybrid integrated circuitry, as well as discrete component designs. Their metalized-edge construction assures easy soldering to printed circuit boards.

"TODAY'S COMPONENTS BUILT FOR TOMORROW'S CHALLENGES"



**JFD ELECTRONICS CO. / COMPONENTS DIVISION**

15th Ave. at 62nd St. • Brooklyn, N.Y. 11219 / Phone 212-331-1000

Offices and subsidiaries in principal cities, world-wide.

**SEE US AT THE IEEE SHOW BOOTH #s 4D35 and 4D36  
THE PARIS COMPONENTS SHOW MARCH 28th - APRIL 2nd**

INFORMATION RETRIEVAL NUMBER 46





*now...*  
**VITREOSIL®**  
 PURE FUSED QUARTZ  
**CONICAL  
 PIPE JOINTS**

Designed as a practical demountable joint for vacuum or pressure, liquid or gaseous systems. The conical (or Buttress) joint is available in clear pure fused quartz in sizes to 2" I.D. and in opaque fused silica in sizes 3" I.D. to 6" I.D.

Clear fused quartz joints have grooves into which gasket material is forced for tighter joints. Opaque fused silica joints have precisely ground flat ungrooved surfaces. Gasketing material may be selected to meet requirements.

Conical pipe joints are ideal for joining fused quartz or fused quartz to metal, ceramics, plastics, etc. Interchangeable with borosilicate pipe joints. Joint hardware can be supplied at additional cost.

Special auxiliary apparatus with furnace annealed pipe joints includes thermocouple wells, end caps, closed and/or reduced end furnace tubes in various sizes, one, two and three neck round bottom flasks up to 2 liters capacity in clear pure fused quartz and up to 15 liters in opaque fused silica.



**THERMAL AMERICAN**  
 FUSED QUARTZ CO.  
 RT. 202 & CHANGE BRIDGE RD.  
 MONTVILLE, NEW JERSEY  
 ZIP CODE 07045

ICs & SEMICONDUCTORS

**Up/down counters  
 clock at 30 MHz**

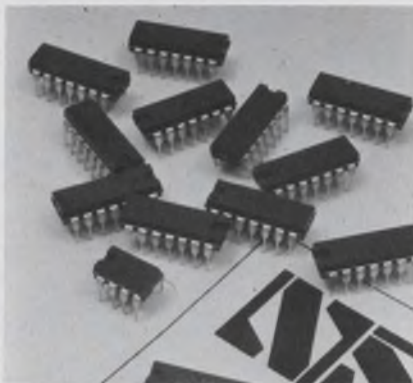

*National Semiconductor Corp., 2975 San Ysidro Way, Santa Clara, Calif. Phone: (408) 245-4320. P&A: \$31.50 or \$54.25; stock.*

Two new monolithic up/down counters perform with a maximum clock frequency of 30 MHz. They operate synchronously within each stage, but semi-synchronously when cascaded from one counter to another. This type of operation is due to their clocks which go through a two-gate delay between stages from input to output.

The DM7560/DM8560 is an up/down decade counter that can be preset to any number from 0 to 9; the DM7563/DM8563 is an up/down binary counter that can be preset to any number between 0 and 15. Both devices are TTL compatible.

Counting is performed through two clock lines: one controlling the count in the up direction; the other in the down direction. Two outputs, the borrow and carry functions, can be connected to the clock inputs of subsequent counters to provide for counting to large numbers.

A load input controls the asynchronous entry of preset numbers and sets all outputs to the appropriate state. An extra, clear pin allows presetting to 0. In addition, the new counters permit two or more stages to be cascaded by using only four pins—clock up, clock down, carry and borrow.

Both units are housed in a 16-pin dual-in-line package.

The DM7560 and DM7563 are military temperature models. The DM8560 and DM8563 are industrial temperature models.

CIRCLE NO. 258

**FET analog gates  
 switch in 50 ns**

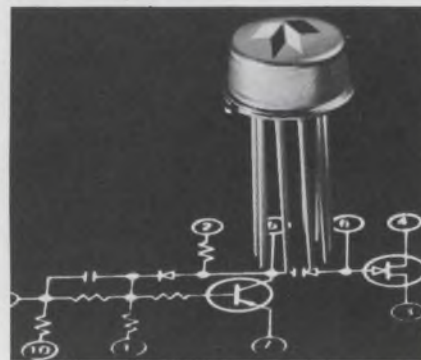

*Crystalonics, A Teledyne Co., 147 Sherman St., Cambridge, Mass. Phone: (617) 491-1670. P&A: \$42; stock.*

Designed for analog gating, an spst FET switch is a hybrid IC that has maximum turn-on and turn-off times of only 50 ns. Other features of model CA610 include 30-Ω maximum on-resistance, zero offset voltage and direct operation from DTL or TTL circuits. The unit is packaged in a low-profile TO-5 metal can.

CIRCLE NO. 259

**Plastic transistors  
 are TO-18 devices**

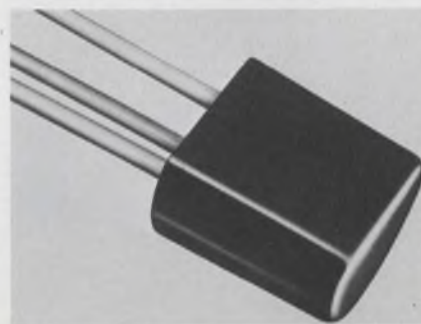

*General Electric Co., Semiconductor Products Dept., 1 River Rd., Schenectady, N.Y.*

Designed for use in switching and amplifier applications, npn and pnp epoxy-encapsulated transistors are now available with TO-18 lead configurations. Four devices initiate the new family: types GET706, GET2222, GET3013, and GET3638 (electrically corresponding to the 2N series of products). These high-reliability units can withstand high-temperature reverse bias at 150°C for 168 hours.

CIRCLE NO. 260



# Time Delay

which

## FITS YOUR REQUIREMENTS?

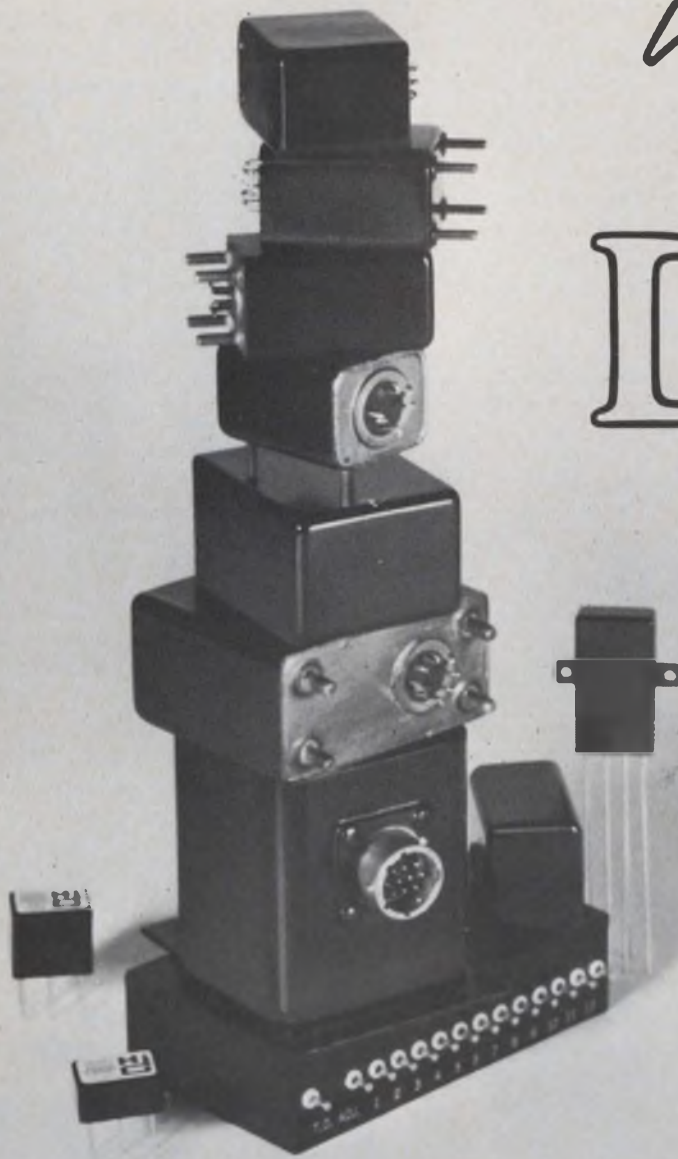

### Hi-G time delays come in many packages.

In addition to the series 2400 crystal can type highlighted below, our electronics line includes:

#### Fixed and Adjustable Time Delays

Up to 300 seconds delay. Contact ratings up to 10 amps. Special variations available to accomplish delay-on-break and interval timing.

#### Solid State Timing Modules

Solid state reliability offers flexibility in choice of secondary switching capability.

#### Voltage Sensors

DC and AC level sensing provides precise switching logic over the temperature range of  $-55$  to  $+125^{\circ}\text{C}$ . Interface with transducers to sense heat, light, and pressure.

#### Phase Sequence Relays

To protect phase sensitive loads against phase reversal, open or grounded phase.

The spotlight is on Hi-G's 2400 series time delay relays, which combine *solid state timing circuits* with dependable *half-size electromechanical relays* in packages only slightly longer than a standard crystal case.

**Results?** Small size (0.4 x 0.8 x 1.5 inch), lightweight (1.2 ounces). High current carrying capacity (see below) and the rugged performance of Hi-G electro-mechanical relays. Long life and fast response of hybrid circuits.

Hi-G 2400 series relays operate on 18 to 31 volts unregulated and need no external resistance or capacitance to obtain maximum timing.



### SPECIFICATIONS:

#### Delay Times:

50 milliseconds to 100 seconds on make.

#### Delay Time Tolerance:

$\pm 10\%$  (5% on special request).

#### Contact Rating:

2 amps resistive @ 30 VDC.

1 amp @ 115 V, 400 Hz.

Temperature Range:  $-55^{\circ}\text{C}$  to  $+125^{\circ}\text{C}$ .

Vibration: 20 G, 10 to 2000 Hz.

#### Shock:

50 G,  $11 \pm 1$  milliseconds duration.

Call, write, or check the reader service number for more information. If you want application engineering assistance, an experienced Hi-G representative awaits your telephone call.



SPRING STREET AND ROUTE 75 • WINDSOR LOCKS, CONN. 06096 • 203-623-2481



### Hybrid audio amp delivers 5 watts

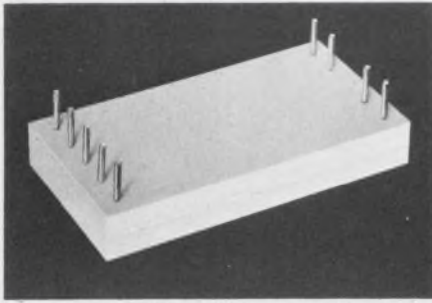

*Bendix Semiconductor Div., South St., Holmdel, N.J. Phone: (201) 946-9400. P&A: \$6.23; stock.*

Operating from a 14-V supply, a new hybrid IC audio amplifier develops 5-W rms output power. Designated the BHA0004, the thick-film class B complementary amplifier features internally set idle current and requires only three external components.

CIRCLE NO. 261

### ECL integrated circuits have another source

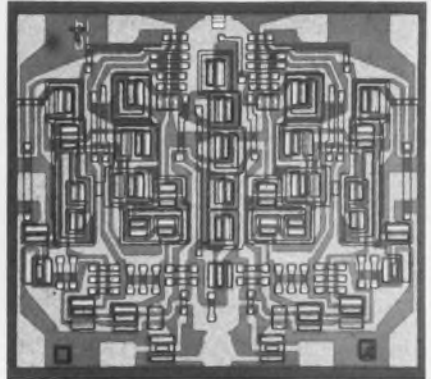

*Stewart Warner Microcircuits, Inc., 730 East Evelyn Ave., Sunnyvale, Calif. Phone: (408) 245-9200. Price: \$1.70 to \$8.60.*

Fourteen new logic circuits are now available from Stewart Warner, another source for Motorola's line of MECL II ICs. Two series initiate the new family, which is called ECL II. These are the SW1000 units for industrial temperature ranges and the SW1200 units for military temperature ranges. Circuit functions include gates, clocks, and expanders.

CIRCLE NO. 262

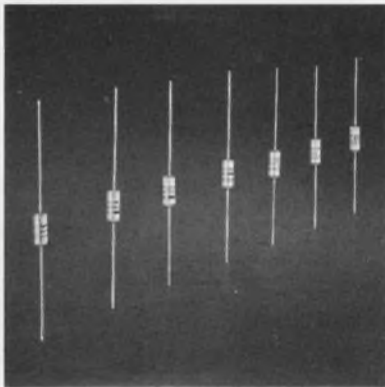

### MS 90537 Molded Shielded RF Chokes

Miller Part No. 9250	MS. No. 90537	Inductance Microhenries ±10%	Rated DC Current Milliamps	Miller Part No. 9250	MS. No. 90537	Inductance Microhenries ±10%	Rated DC Current Milliamps
-101	-1	0.10	2900	-333	-31	33.0	490
-121	-2	.12	2800	-393	-32	39.0	410
-151	-3	.15	2750	-473	-33	47.0	400
-181	-4	.18	2200	-563	-34	56.0	380
-221	-5	.22	1700	-683	-35	68.0	370
-271	-6	.27	1500	-823	-36	82.0	360
-331	-7	.33	1300	-104	-37	100.0	325
-391	-8	.39	1100	-124	-38	120.0	290
-471	-9	.47	1000	-154	-39	150.0	275
-561	-10	.56	900	-184	-40	180.0	260
-681	-11	.68	750	-224	-41	220.0	250
-821	-12	.82	600	-274	-42	270.0	240
-102	-13	1.00	1900	-334	-43	330.0	225
-122	-14	1.20	1600	-394	-44	390.0	200
-152	-15	1.50	1300	-474	-45	470.0	180
-182	-16	1.80	1200	-564	-46	560.0	174
-222	-17	2.20	1100	-684	-47	680.0	168
-272	-18	2.70	950	-824	-48	820.0	152
-332	-19	3.30	800	-105	-49	1,000.0	135
-392	-20	3.90	750	-125	-50	1,200.0	115
-472	-21	4.70	650	-155	-51	1,500.0	110
-562	-22	5.60	550	-185	-52	1,800.0	105
-682	-23	6.80	500	-225	-53	2,200.0	99
-822	-24	8.20	475	-275	-54	2,700.0	83
-103	-25	10.0	450	-335	-55	3,300.0	80
-123	-26	12.0	400	-395	-56	3,900.0	67
-153	-27	15.0	620	-475	-57	4,700.0	63
-183	-28	18.0	610	-565	-58	5,600.0	56
-223	-29	22.0	600	-685	-59	6,800.0	54
-273	-30	27.0	500	-825	-60	8,200.0	52
				-106	-61	10,000.0	49

CALL OR WIRE FOR SHIPMENT TODAY

Get factory prices from your local distributor in quantities to 750; ask for new full line catalog.



## J.W. MILLER COMPANY

5917 SOUTH MAIN STREET ■ LOS ANGELES, CALIFORNIA 90003

### MOS clock driver adjusts pulse width

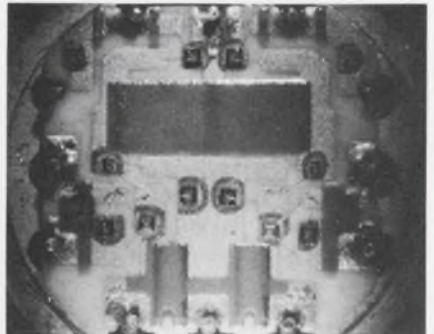

*National Semiconductor Corp., 2975 San Ysidro Way, Santa Clara, Calif. Phone: (408) 245-4320.*

Using two external capacitors, model NH0009/NH0009C MOS clock driver varies its pulse width from 100 to 300 ns. Designed to operate in conjunction with a line driver to provide fixed-width clock pulses for MOS shift registers, the device reps to over 2 MHz with typical risetimes of 40 ns and typical falldtimes of 120 ns.

CIRCLE NO. 263



## Amplifier chip holds 20-nA offset

National Semiconductor Corp., 2950 San Ysidro Way, Santa Clara, Calif. Phone: (408) 245-4320. P&A: \$50; stock.

Featuring on-chip frequency compensation, a high-performance operational amplifier guarantees a bias current of 100 nA and an offset current of 20 nA over the full military temperature range. Model LM107 achieves these specifications with no sacrifice in drift (0.2 nA/°C, 15  $\mu$ V/°C) and offset voltage (3 mV).

CIRCLE NO. 264

## Hybrid circuits use MSI chips

Fairchild Semiconductor, 313 Fairchild Dr., Mountain View, Calif. Phone: (415) 962-2530. Price: \$28 to \$68.

Two new hybrid integrated circuits, a byte parity generator and a ripple carry adder, are made with two identical MSI circuits that consist of four independent binary adders with complementary outputs. The SH2204 generator has a 35-ns typical input to odd parity delay, while the SH2205 adder has an 8-ns typical carry propagation delay per bit. The functional differences between these twin circuits are due to the different interconnection patterns between the two MSI chips.

CIRCLE NO. 265

## High-voltage rectifiers sell for under a dollar

Motorola Semiconductor Products Inc., P.O. Box 20924, Phoenix, Ariz. Phone: (602) 273-8466. Price: 50¢ to 90¢.

Costing less than one dollar, high-voltage Surmetic rectifiers reflect price cuts of 47% to 87%, depending on the reverse voltage rating. Types MR990A to MR996A are capable of handling continuous forward currents of 0.25 A at temperatures as high as 75°C.

CIRCLE NO. 266



# this is Simpson's 2700 digital system...

- 4½ digits
- 0.05% accuracy
- 5 plug-in function modules



- Automatic Polarity Selection
- Built-in Self Calibration
- 100 Microvolt Resolution
- Optional BCD output
- IC Modular Design for reliability

Standard single and dual rack mount kits available.

**2700 DIGITAL SYSTEM** \$615<sup>00</sup>  
complete with DC voltage range module, test leads, and operator's manual

AVAILABLE "OFF-THE-SHELF" AT ELECTRONIC DISTRIBUTORS STOCKING SIMPSON INSTRUMENTATION PRODUCTS.

**Simpson** ELECTRIC COMPANY



5200 W. Kinzie Street, Chicago, Illinois 60644 • Phone (312) 379-1121  
Export Dept: 400 W. Madison Street, Chicago, Illinois 60606. Cable Simelco  
IN CANADA: Bach-Simpson Ltd., London, Ontario • IN INDIA: Ruttonsha-Simpson Private Ltd., International House, Bombay-Agra Road, Vikhroli, Bombay

INFORMATION RETRIEVAL NUMBER 50

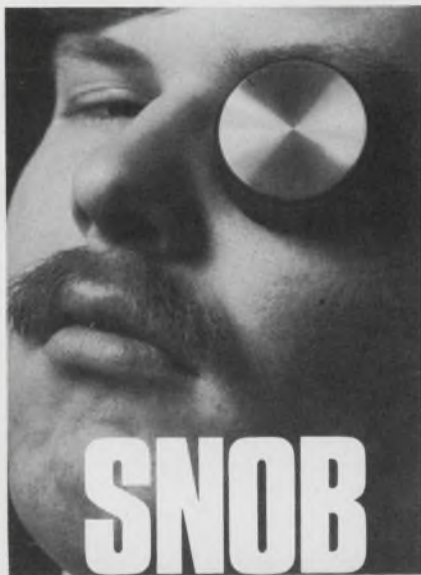

# SNOB KNOB

The first new styling innovation in fifteen years!

900 Series Snob Knobs come in four bright, handsome models. Spun aluminum cap. Spun aluminum inlay. Decorative metallic ring. And Black. From 1/2" to 1 3/4" diameter.

Kurz-Kasch is known as the quality knob source by electronics manufacturers the world over. If you're not familiar with the outstanding Kurz-Kasch line, we'll send you a complete catalog. And if you're just anxious to see the new Snob Knob, we'll send you a free sample. Just fill out the coupon below and mail it to Kurz-Kasch.



**Kurz-Kasch, Inc.**

Standard Parts Division  
1415 South Broadway • Dayton, Ohio 45401

Please send me the following:

Free Snob Knob     Kurz-Kasch catalog

Name \_\_\_\_\_ Position \_\_\_\_\_

Firm \_\_\_\_\_

Address \_\_\_\_\_

City \_\_\_\_\_ State \_\_\_\_\_ Zip \_\_\_\_\_

INFORMATION RETRIEVAL NUMBER 51

## DATA PROCESSING

### Keyboard display console works like teleprinter



Digital Equipment Corp., Maynard, Mass. Phone: (617) 897-5111. P&A: \$7900; summer, 1969.

A new keyboard display terminal, which operates like a conventional teleprinter, is virtually noiseless and accepts data at the rate of 1200 baud, as compared to the 110-baud rate of a teleprinter. Model VT03 full-duplex console has a local memory for display refreshing, thus eliminating the demand on processor time that is usually required for this function. It displays up to 960 characters, arranged in 12 rows of 80 characters.

CIRCLE NO. 267

### A/d converter module compares in 100 ns



Pastoriza Electronics, Inc., 385 Elliot St., Newton Upper Falls, Mass. Phone: (617) 332-2131. P&A: \$2500 to \$3500; stock to 30 days.

Using a successive approximation technique, a new analog-to-digital converter module completes each bit comparison within 100 ns (1- $\mu$ s total conversion time for 10 bits). Model FAD-10 is completely contained on a single plug-in card.

CIRCLE NO. 268

### Acoustic data sets transmit over noise



ComData Corp., 7544 Oakton St., Niles, Ill.

Series 301 acoustic data sets incorporate advanced signal-processing techniques to assure reliable transmission of data under such adverse operational conditions as high ambient noise, degradation of telephone line service caused by low signal levels, and variation in the characteristics of handsets used by different telephone companies.

CIRCLE NO. 269

### High-speed scanners handle 10<sup>4</sup> inputs

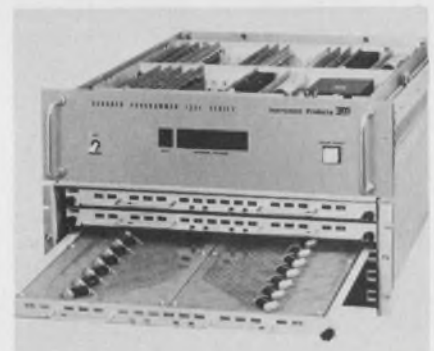

3M Co. Instrument Products, 300 S. Lewis Rd., Camarillo, Calif. Phone: (805) 482-1911. P&A: from \$4900; 30 to 45 days.

Directly interfacing to TTL positive or negative logic levels, high-speed programmable reed-relay scanners select one of ten thousand input channels and route the selected channel to one of ten output channels. Models 1221A and 3383 are supplied in standard rack-mountable chassis and feature complete guarding for high common-mode rejection in system applications. Their thermal emf is less than 10  $\mu$ V.

CIRCLE NO. 270



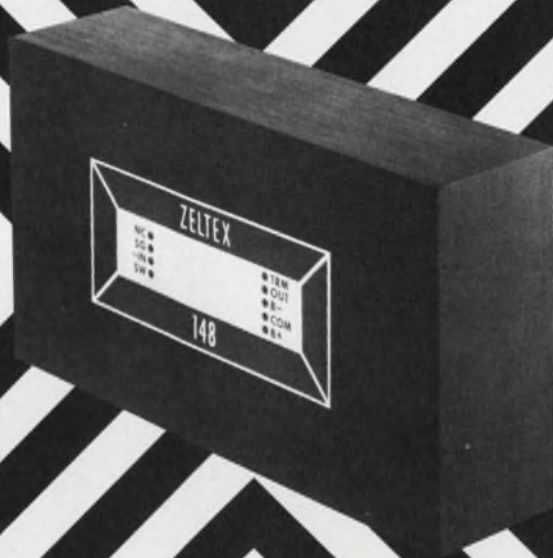

## If You Think The New Zeltex Model 148 'Op Amp' Is Expensive, (((((((((You're In For A Shock))))))))))

### This Chopper-Stabilized Amplifier Costs Only...

\$58

Model 148 has greater gain and is faster than anything comparable. Take a look at the next best thing.

	Model 148	Brand X
DC Voltage Gain, Minimum	10 <sup>8</sup>	10 <sup>7</sup>
Gain Bandwidth	1 MHz	500 kHz
Input Bias Current, Maximum	50 pA	100 pA
Full Output Frequency, Minimum	100 kHz	3 kHz
Input Voltage Drift	0.5 $\mu$ V/ $^{\circ}$ C	0.5 $\mu$ V/ $^{\circ}$ C
Slew Rate	6 V/ $\mu$ s	0.2 V/ $\mu$ s
Temperature Range	-25 $^{\circ}$ to 85 $^{\circ}$ C	10 $^{\circ}$ C to 60 $^{\circ}$ C
Price (10-24)	\$58.00	\$84.00

Ask for more information today, or better yet, order several for evaluation. You really will be shocked at how fast we ship them.

■ 1000 Chalomar Rd., Concord, Calif. 94520. Phone (415) 686-6660.



A Subsidiary of REDCOR CORP.



### Acoustic coupler isolates 20 dB



Direct Access Computing Corp., Communications Equipment Group, Southfield, Mich.

A new line of acoustic/magnetic data couplers, Telemate 300, provide an acoustic isolation of 20 dB minimum with a data rate of 300 baud. They connect conventional telephones to remote input/output terminal devices and have several different cable interface connections. Each unit also features half- and full-duplex operating modes.

CIRCLE NO. 271

### Digital tape transport operates at 10 kHz

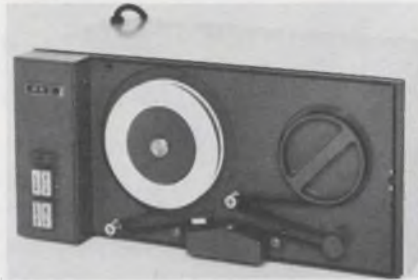

Peripheral Equipment Corp., 9551 Irondale Ave., Chatsworth, Calif. Phone: (213) 882-0030. Price: \$2750.

Designed for use with small digital computers and data communication terminals, a digital magnetic-tape transport transfers data at rates as fast as 10 kHz. Model 7820 is an IBM-compatible, 9-track write/read unit that handles 800 bits per second at tape speeds of 12.5 in. per second. It uses a single-capstan velocity servo system to eliminate the pinch roller.

CIRCLE NO. 272

### Card-reader system works photo-optically



Vema Industries, Wyckoff, N.J. Phone: (201) 891-3200. P&A: from \$900; 6 to 10 wks.

Model 500-30A card-reader system, which features an automatic hopper feed that can stack up to 250 cards, functions photo-optically for accuracy and speed. The new system can be supplied with interfacing, from Hollerith to ASCII, for use with standard teletype equipment. It is also available with data phone.

CIRCLE NO. 273

## Shed a little light on digital circuit testing. Model 301A LogicProbe® ...\$60

The Model 301A Logic Probe® indicates quiescent logic levels and displays and identifies single pulses as narrow as 100 nano-seconds! The lamp flashes on for a positive pulse, or flashes off for a negative pulse ■ The Model 301A will also display symmetrical or non-symmetrical waveforms, and is not sensitive to rise or fall times ■ At low repetition rates, the lamp will flash in synchronism with the pulse train, as the repetition rate increases, the lamp continues to flash rapidly but visibly, ALL THE WAY TO 10 MHZ ■ The Model 301A is compatible with most varieties of DTL, TTL, and RTL integrated circuits ■ Unit price: \$60, quantity discounts available. Send for complete details.

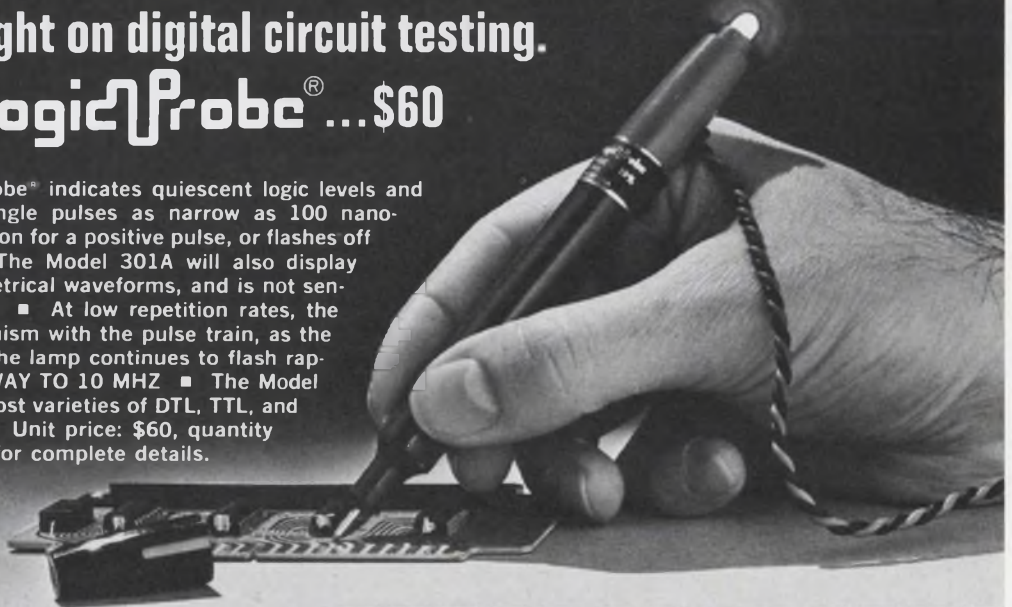

#### SPECIFICATIONS INCLUDE

Vcc: + 5VDC ± 10%  
Power consumption: 0.6 watt  
Logic level threshold: + 1.4 V  
Guaranteed logic "0" detection: gnd to + 0.8 V  
Guaranteed logic "1" detection: + 2.0 V to + 6 V

#### Input Impedance

2.5k with logic "0" input  
400k with logic "1" input



Automated Control Technology, Inc.  
3452 Kenneth Drive  
Palo Alto, Calif. 94303  
(415) 328-6080

- Please send me complete information on the Model 301A Logic Probe.
- Send me \_\_\_\_\_ Model 301A Logic Probes.
- Bill me  Check enclosed

NAME \_\_\_\_\_

ADDRESS \_\_\_\_\_



## Microfilm recorder generates graphics



Information International, 11161 W. Pico Blvd., Los Angeles. Phone: (213) 478-2571. Price: from \$225,000.

Able to generate graphic information directly on microfilm from a digital output, a high-speed recorder offers four times the resolution of previous systems—16,384 by 16,384 programmable points. Ideal for data retrieval systems, the FR-80 microfilm reader has over 300 million addressable points per film frame and a speed of 10,000 characters/s.

CIRCLE NO. 274

## Digital correlator works on-line



Mandrel Industries, Inc., Electro-Technical Labs Div., P.O. Box 36306, Houston, Tex. Phone: (713) 774-7561. Price: \$20,000 to \$22,000.

For the first time, an on-line system correlates digital data for eventual analog display. Previous correlators handled only analog data. The DC-100 digital correlator can be used with any system that receives and/or records echo-sounding signals in digital format and employs a sweep signal. It automatically accepts digital output from the system and correlates that output to the sweep signal generated by the system. The correlated signals may then be passed through an eight-bit d/a converter for analog monitoring.

CIRCLE NO. 275



Model 41A Microwattmeter with new 12.4 GHz head

# SOMETHING NEW IN POWER MEASUREMENTS UP TO 12.4 GHz

Our new power detector head measures down to  $-60$  dBm, has a dynamic range of 70 dB, and offers all these other advantages:

- No zeroing (except for fractional microwatt measurements).
- Insensitivity to shock and handling drift.
- Overload protection to 300 mW cw.
- One head for all power levels, to save you time and money.
- Accuracy to  $\pm 0.5$  dB (including power detector).
- 200 KHz to 12.4 GHz range for easy low frequency calibration and noise power measurements.
- Doubles as detector for slotted line vswr measurements.

**Ask for a demonstration of our 41A Microwattmeter with the new 12.4 GHz head, or send for a data sheet.**

Prices: 41A Microwattmeter — \$600; 41-4B 12.4 GHz head — \$250.

**BOONTON  
ELECTRONICS  
CORPORATION** ||||

ROUTE 287  
PARSIPPANY, N.J. 07054  
Telephone: 201-887-5110  
TWX: 710-986-8241

IEEE: Booth 2E46-50

INFORMATION RETRIEVAL NUMBER 54

### Fast FET op amp has gain of $10^6$



Fairchild Controls, Modular Products, 423 National Ave., Mountain View, Calif. Phone: (415) 962-3833. Price: \$55.

In addition to a 2- $\mu$ s settling time to 0.01% of final amplitude, a high speed FET-input op amp features an open-loop dc voltage gain of one million. Model ADO-60 slews at the rate of 100 V/ $\mu$ s and has an output current of 20 mA. Its full-power frequency is 1.5 MHz maximum, while its gain-bandwidth product is 10 MHz minimum.

CIRCLE NO. 276

### Dual op-amp supply has 100-mA outputs



Computer Products, Inc., 2801 E. Oakland Park Blvd., Fort Lauderdale, Fla. Phone: (305) 565-9565. P&A: \$42.95; stock to 3 days.

Model PM 552 is a regulated dual power supply for operational amplifiers that provides two floating outputs of  $\pm 15$  V dc at 100 mA. It has provisions for external trimming each output to the exact desired voltage. The compact supply measures 2.3 by 3.5 by 1 in. and can be mounted on a PC board; it weighs less than 13 oz.

CIRCLE NO. 277

### Palm-sized VCO resonates at 4.6 MHz

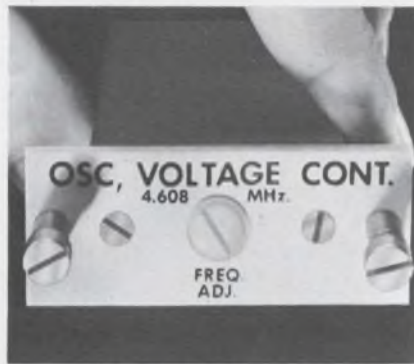

Electronic Research Co., div. of Textron Electronics Inc., 10,000 W. 75th St., Overland Park, Kan. Phone: (913) 631-6700.

Designed for communications systems with limited space and power, a new voltage-controlled oscillator delivers a frequency output of 4.6 MHz within a space of 3 by 1.75 by 1 in. Model EROS-400-147L has a temperature stability of 20 ppm from  $-35$  to  $+85^\circ\text{C}$  and an aging rate of 15 ppm per year.

CIRCLE NO. 278

### Operational amplifiers deliver 20-mA output



Analog Devices Inc., 221 Fifth St., Cambridge, Mass. Phone: (617) 492-6000. P&A: \$24 or \$34; 3 wks.

Using a new circuit-design principle to greatly increase the collector impedance of the input-stage transistors, two high-current operational amplifiers are able to supply 20 mA at  $\pm 10$  V. Voltage drift for model 119A is 20  $\mu\text{V}/^\circ\text{C}$ ; 5  $\mu\text{V}/^\circ\text{C}$  for model 119B. Both units feature a small-signal bandwidth of 1.5 MHz and a full-power bandwidth of 100 kHz.

CIRCLE NO. 279

### Modular displays stack together

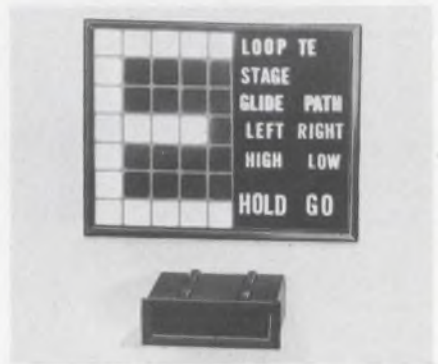

Info-Lite Div. of Cartelli Technology, Inc., 103 Ascan Ave., Forest Hills, N.Y. Phone: (212) 263-2495. P&A: \$1 to \$2; 3 to 4 wks.

Modular lighted information displays employ a building-block approach for such display applications as annunciators, numeric and alphanumeric readouts, and code/pattern indicators. Series 68000 includes modules that measure, in inches, 3/8 by 3/8, 3/8 by 3/4, 3/8 by 1-1/8, and 3/8 by 1-1/2. They use standard T-1-3/4 lamps.

CIRCLE NO. 280

### Active IC filter rolls-off 54 dB

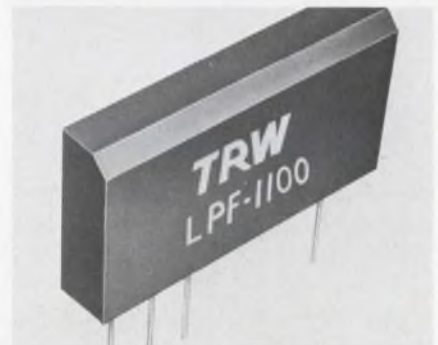

TRW Microelectronics Div., 14520 Aviation Blvd., Lawndale, Calif. Phone: (213) 477-6061. P&A: \$16; 60 days.

Occupying less than 0.2 in.<sup>3</sup>, a low-pass active filter with a combined notch filter provides 54-dB/octave roll-off near cut-off. This new microcircuit, designated as type LPF-1100, operates over a temperature range of  $-30^\circ$  to  $+70^\circ\text{C}$ . It is available with cut-off frequencies to 20 kHz and voltage ratings from 10 to 15 V dc.

CIRCLE NO. 281





**Somebody  
beat you to it.**

It was intended for you. But if the 24-page Kearfott brochure we had bound into this magazine is missing, somebody took off with it.

No wonder. The 24 pages are filled with vital statistics and valuable information on Kearfott's products. On synchros, resolvers, gimbal components and the like.

But you can still get it if it's gone. Either circle the number shown on this page on the reader service card, or write us directly requesting it. Kearfott Products Division, Singer-General Precision, Inc., 1150 McBride Avenue, Little Falls, N. J. 07424.

That'll show 'em.

**SINGER**  
**KEARFOTT**

INFORMATION RETRIEVAL NUMBER 236

ELECTRONIC DESIGN 5, March 1, 1969

## Vhf transistor amps challenge power tubes



*Microwave Power Devices, 226R Merrick Rd., Lynbrook, N.Y. Phone: (516) 593-2430. Availability: 4 to 8 wks.*

Covering the instantaneous bandwidths of 125 to 175 MHz, transistor amplifiers achieve output powers as high as 100 W with a nominal power gain of 10 dB. The over-all gain of these amplifiers can be increased to provide full output power with an input power drive of only 10 mW. Typically their harmonic response is greater than -20 dB below rated power output with efficiencies in excess of 50%. Input VSWRs are on the order of 1.5.

CIRCLE NO. 282

## Wideband amplifier slews at 1600 V/ $\mu$ s



*Data Device Corp., 100 Tec St., Hicksville, N.Y. Phone: (516) 433-5330. P&A: \$200; stock to 3 wks.*

With a slew rate of 1600 V/ $\mu$ s, model VA-23 dc wideband amplifier has a full output of  $\pm 10$  V at 30 mA when frequency is 30 MHz. At 60-mA output, the frequency for full output is 15 MHz, and the slew rate is 1000 V/ $\mu$ s. The unit has an open-loop voltage gain of 98 dB at rated load, and a voltage drift of 10  $\mu$ V/ $^{\circ}$ C. Its unity-gain frequency is 150 MHz.

CIRCLE NO. 283

### Pushbutton counters have 3 by 5-in. face



Time Systems Corp., 265 Whisman Rd., Mountain View, Calif. Phone: (415) 961-9321. P&A: \$345 to \$395; 2 wks.

Four new, low-cost low-frequency counters, which occupy only one-third the volume of comparable instruments, offer an 8-4-2-1 BCD output along with remote programming capability. Also featuring full input signal conditioning controls and pushbutton selection of function and time base, series 410 counters can measure frequency as well as totalize. Their package size is only 3-in. high by 4.9-in. wide by 6-3/4-in. deep; they weigh approximately two pounds.

Models 410-1 and 410-2 have a five-digit display plus overrange for measurements from 2 Hz to 200 kHz. Models 410-3 and 410-4, which have a six-digit display plus overrange, cover the frequency range of 2 Hz to 2 MHz. All models provide a flashing, overflow indicator and automatically locate decimal point for reading out in kilohertz.

Input signal conditioning provisions include a trigger level control with a preset position for triggering at zero crossover, switch-selectable positive or negative slope; and a two-position attenuator (X1 and X10). These controls allow the user to employ the counters over a wide range of input waveform conditions, including noisy signals.

Maximum input signal sensitivity is 100 mV rms for a sine wave and 300 mV pk-pk for a pulse. All the 410 counters have an accuracy of plus-and-minus one count, plus-and-minus the time-base accuracy. The gate times, which can be selected either manually or remotely, are 0.1, 1 and 10 seconds.

CIRCLE NO. 299

### Digital clock costs \$240



Instrument Displays, Inc., 18-36 Granite St., Haverhill, Mass. Phone: (617) 373-1333. Price: \$240.

A new digital clock display, which accepts four-line 8-4-2-1 BCD data and converts it to decimal time of the year or of the day, sells for only \$240 in single-unit quantities. Model MD600T uses integrated circuits and Nixie display tubes to present time in hours, minutes and seconds. It is packaged in an extruded housing that occupies only 5-1/2 by 2-1/2-in. of front-panel space.

CIRCLE NO. 284

### Digital counter has dual channels



Monsanto Co., Monsanto Electronics Technical Center, 620 Passaic Ave., West Caldwell, N.J. Phone: (212) 751-2323. P&A: \$895; 4 wks.

Compact model 106A five-digit reversible counter has a 5-Hz-to-5-MHz counting rate for each of its two channels. It can count each channel to 5 MHz; find the sum and difference of both channels to 1 MHz; count one channel to 1 MHz with direction controlled by the polarity of a third signal; or count one channel to 1 MHz with direction determined by the phase of channel A with respect to channel B.

CIRCLE NO. 285

### Benchtop inspector simplifies operation



Field Emission Corp., Melrose at Linke St., McMinnville, Ore. Phone: (503) 472-5101. P&A: \$2380; 30 to 60 days.

A workbench X-ray inspection system works with the simplicity of an office machine to solve the two problems of voltage setting and exposure time. Faxitron 805 uses a voltage sensor to give the optimum setting for radiographic contrast and exposure time, and shuts itself off automatically when the film receives the proper exposure.

CIRCLE NO. 286

### Digital multimeter disregards noise



Dana Laboratories, Inc., 2401 Campus Dr., Irvine, Calif. Phone: (714) 833-1234. P&A: \$1800; 30 to 60 days.

Model 4470/230 digital multimeter maintains an accuracy of  $\pm 0.01\%$  of reading,  $\pm 0.01\%$  full-scale, against virtually any noise found in normal operating environments. Designed with a 10-M $\Omega$  input impedance and active three-pole broadband filtering, the new instrument has thirty times the noise protection of an integrating DVM at line frequency.

CIRCLE NO. 287



# Photocells ain't what they used to be...



## they're a heck of a lot better

Photocells are doing jobs today that they couldn't have done ten—five—  
or even two years ago. There have been that many improvements!

HIGHER STABILITY  
MORE UNIFORM RESPONSE TO COLOR TEMPERATURE  
HIGHER SPEED RESPONSE  
WIDER VARIETY OF PACKAGES AND SIZES  
INCREASED EFFICIENCY  
HIGHER LINEARITIES

Let us show you how the "light touch in automation and control" can  
help solve your problems. Call (212) 684-5512 or write Clairex, 1239  
Broadway, New York, N. Y. 10001.

**CLAIREX ELECTRONICS, INC.<sup>®</sup>**

### Digital multimeter is 0.001% accurate

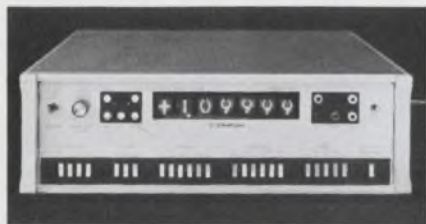

Lear Siegler, Inc., Cimron Div., 1152 Morena Blvd., San Diego, Calif. Phone: (714) 276-3200. P&A: \$2990; stock.

Featuring IC plug-in circuitry and closed-loop tracking logic, a six-digit multimeter has an accuracy of  $\pm 0.001\%$  full-scale ( $\pm 0.005\%$  of reading from 100 nV to 1099.9 V dc) and continuously samples the output at a rate of 14 readings per second. Also able to measure dc ratios, model 6753 is the first DVM incorporating automatic desensitization to insure valid readings in the presence of extreme noise.

CIRCLE NO. 288

### Solid-state af source has 0.005% stability



Pioneer Electronics, 738 Pacific St., San Luis Obispo, Calif. Phone: (805) 543-0930. P&A: \$169.50; 4 wks.

Model 300R is a secondary audio-frequency standard with a high stability of 0.005%. It has provisions for switch selecting up to three frequency outputs, from 1 to 6 kHz. There is also a built-in attenuator for receiving applications. This compact solid-state unit can be used in the receiving mode to directly calibrate oscillators without using an oscilloscope or other indicating device.

CIRCLE NO. 289

### Pen-sized probe shows logic state



Automated Control Technology Inc., 3452 Kenneth Dr., Palo Alto, Calif. Phone: (415) 328-6080. P&A: \$18.50; stock to 30 days.

Presenting a visual distinction between logic 1 and logic 0 conditions, a pen-sized probe can be used to observe quiescent states or low-repetition-rate pulses. The solid-state device, called LogicProbe 31A, has a high input impedance to prevent the upset of flip-flops or one-shots.

CIRCLE NO. 290

WHEN THE FUSE GOES OUT, THE LIGHT GOES ON!



Littelfuse Indicating Micro-fuse Holders for military and commercial applications. Ranges 2-1/2 thru 250 Volts. Also available with RFI shielding.

**LITTELFUSE**

DES PLAINES, ILLINOIS

INFORMATION RETRIEVAL NUMBER 57

### TRUE SOLID-STATE RELAY



Opening New Relay Applications in Multiplexing, Isolated Sensing, High Speed Isolated Control, etc. Offered in A - B - C Contact Configurations for Direct Replacement of Mechanical Types.

- Switching Time . . . . . less than  $65\mu$  sec
- Contact Open Resistance . . .  $10^9$  ohms
- Contacts Capable of switching DC to 4 M HZ
- Non-Polarized Effective Coil
- Effective Coil Accuate/Release Voltage Hysteresis . . . less than 10 mV . . .
- Non-Polarized Contacts
- No Reference Required Between Effective Coil and Effective Contacts
- Life Expectancy—tested to  $10^{10}$  operations with no failure.

**SHAFFSTALL-BALL CORPORATION**

5149 E. 65th Street, Indianapolis, Indiana 46220  
Phone: 317-257-6296

INFORMATION RETRIEVAL NUMBER 58



### Square TO-55 relay doubles inside pull

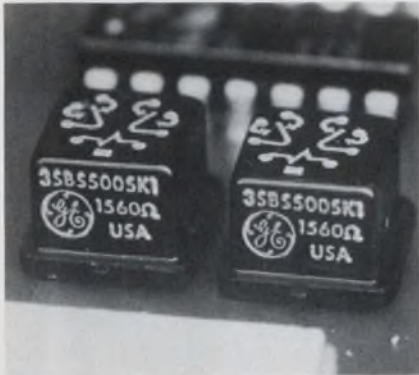

General Electric Co., Schenectady, N. Y. Price: from \$29.

Housed in a square enclosure, a TO-55 transistor-sized dpdt relay allows extra room for a magnet that has two and a half times the pull of magnets designed for a round enclosure, and room for larger contact gaps and greater overtravel—thus improving contact closure. Rated at 1 A, the unit measures 0.370-in. square by 0.275-in. high.

CIRCLE NO. 291

### Oxide capacitor strips put 100 pF in 0.016 in.<sup>2</sup>

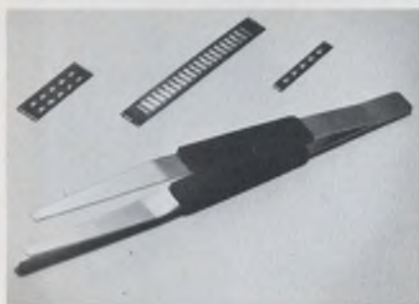

Syncrotech Inc., Edgerton, Ohio. Phone: (419) 2346.

Offering a component density that exceeds even the smallest sub-miniature mica capacitors, new refractory oxide capacitors present 100 pF in a space as small as 0.016-in. square. Designed for use in delay lines, filters and hybrid circuitry, type ROC capacitors are furnished in chip strips 0.020-in. thick, with widths from 1/8 to 1/2 in.

CIRCLE NO. 292



It's a 40-pin Plug-in-Package (PIP) from the Cermetron Division of National Beryllia—30% lighter, and with 8 to 10 times the thermal conductivity of similar packages using other materials, because it is made from BERLOX—Beryllium Oxide.

It is used in a system which saves 25 miles of wiring and 400 pounds weight in aircraft communications.

Beryllium Oxide dissipates heat as fast as most metals, permitting higher power in smaller space, which contributes to lighter weight and further miniaturization of electronic components.

Practical design criteria, combined with precision metallizing, production and assembly techniques, many of them pioneered by National Beryllia, and typified by the 40-pin PIP, can be

major considerations in systems cost effectiveness through higher production yields, reduced installation costs, and greater package reliability.

Cermetron packages for microelectronics are available in plug-in, radial lead flatpack, and dual inline configurations, and in special designs to meet specific requirements.

The Cermetron Division manufactures metallized beryllia components, headers, packages, substrates and assemblies for electronics which require the thermal, electrical and physical properties available only in BERLOX.

You are invited to send for the Cermetron Division Facilities and Capabilities booklet, and to confer with our engineers and research staff on your design problems.



CERMETRON DIVISION

**National Beryllia**  
CORP.

Haskell, N. J. 07420 Telephone: 201 • 839-1600

10703

INFORMATION RETRIEVAL NUMBER 59

# NOW!

## 5VDC at 1A

### IC POWER SUPPLY

for... **\$24.00** IN SINGLE QUANTITY

The LIC5-1A is another of Elasco's new series of low-cost, high-quality plug-in power supplies. This power supply is designed to power approximately 25 IC's. The unit delivers 5 volts D.C. at 1 Ampere with regulation and ripple specifications commensurate with integrated circuit requirements. The power supply is manufactured to mount in a standard 5¼" basket, and is available with an overvoltage protection option.



The LIC5-1A power supply is designed for mounting either on a chassis or in a 5¼" IC Basket. As many as 9 units can be mounted in a standard Elasco basket.

## FEATURES

- ▲ SHORT CIRCUIT PROOF
- ▲ 71°C OPERATION
- ▲ LOW COST OVERVOLTAGE OPTION
- ▲ DELIVERY: STOCK TO 2 WEEKS

WRITE FOR BULLETIN  
269 FOR DATA ON THE LIC5-1A  
POWER SUPPLY



**ELASCO INCORPORATED**  
33 SIMMONS ST., BOSTON, MASS. 02120  
TELEPHONE 617/442-1600

INFORMATION RETRIEVAL NUMBER 60

## COMPONENTS

### Gas-filled trigger tube switches 5-kA circuits



*Amperex Electronic Corp., Professional Tube Div., Hicksville, N.Y. Phone: (516) 931-6200.*

A subminiature gas-filled trigger tube, type ZC1060, can handle peak currents as high as 5000 A at 60 J per discharge. The required trigger waveform is a 30  $\mu$ s 3.5-kV pulse at 400 to 500 kHz; trigger energy can be as low as 1 mJ. With normal anode voltage (350 to 800 V), ignition delay of the ZC1060 is a maximum of 2  $\mu$ s. Open circuit impedance is 300 M $\Omega$ ; in the conducting condition, impedance falls to 30 m $\Omega$ .

CIRCLE NO. 293

### Monolithic filter minimizes ringing



*Damon Engineering, Inc., 115 Fourth Ave., Needham Heights, Mass. Phone: (617) 449-0800.*

For minimum delay distortion in pulse-modulated systems and reduced ringing in swept-frequency applications, a new monolithic crystal filter provides an impulse response with a Gaussian shape and holds ringing down at least 35 dB. Model 6354 MA is a 4-pole design housed in a cold-welded TO-8 enclosure. It has a center frequency of 10.7 MHz, a 3-dB bandwidth of 2.5 kHz and a 40-dB bandwidth of 17.5 kHz maximum.

CIRCLE NO. 294

### Chip resistor kit goes to 100 k $\Omega$



*Mepco, Inc., Columbia Rd., Morristown, N.J. Phone: (201) 539-2000. Price: \$149.50.*

A new kit of chip resistors, which contains a total of 400 chips, offers a selection of forty resistance values, from 56  $\Omega$  to 100 k $\Omega$ . The chips are packed in individual compartments in a storage/selection tray, and resistance values are marked on each envelope. This expedites quick selection, eliminates the need for measuring each chip as it is needed, and guards against picking a chip resistor with the incorrect value.

CIRCLE NO. 295

### Fluidic rate sensor differentiates output

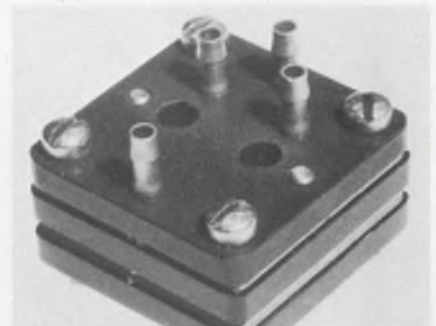

*General Electric Co., Specialty Fluidics Operation, Section 37-209, Schenectady, N.Y. Phone: (518) 374-2211.*

Model MD11 rate-sensing circuit is a fluidic frequency-sensing device whose output is proportional to the rate of the input signal. It can also detect a single-sided frequency signal and produce a corresponding differential output signal.

CIRCLE NO. 296



**PRINCIPLES OF FEEDBACK DESIGN.** G. Edwin and Thomas Roddam. A practical guide for the designer of feedback amplifiers and similar systems, which brings together the fundamentals and advanced considerations. Book presents a thorough examination of negative feedback to simple amplifiers for both tube and transistor types, general problems, the analytical approach, use of feedback amplifiers as filters. Many signal flow diagrams and illustrations are included. 220 pages, 5½ x 8½, illus., cloth cover. #5533 ..... \$8.75

**DESIGN OF COMMUNICATION SYSTEMS.** Keats A. Pullen. This practical book brings together basic physical and theoretical data and subjects them to practical evaluation based on the latest signal theory. Consideration is given to design limitations of electronic communication systems and the variations resulting from controlled change of the parameters. Related information-engineering problems are examined and show how simple changes can significantly improve sensitivity and effectiveness of existing systems. 108 pages, 6 x 9, illustrated, cloth cover. #5012 ..... \$4.75

**SIMPLIFIED MODERN FILTER DESIGN.** Phillip R. Geffe. Bringing together the various modern, or network-synthesis methods in filter design, this book enables the engineer to achieve practical designs more easily. Extensive tables of numerical data preclude much of the difficulties in design. Covers lowpass, highpass, simplified and refined designs, bandstop, attenuation, equalizers, linear-phase and delay equalizers, measurement techniques, etc. 182 pages, 5½ x 8½, illustrated, cloth cover. #0317 ..... \$9.95

**ELECTRONIC DESIGN TECHNIQUES.** Edward E. Grazda. A vital new reference presenting reports of fresh ideas and proven techniques culled from Electronic Design magazine. Grouped in sections, they cover the use and design of amplifiers, resistor networks, filters, control devices, power supplies, microwave systems, oscillators, and pulse and switching circuits. Tables, nomographs, performance charts and guidelines for techniques in many areas make this an extremely valuable tool for the engineer. 312 pages, 8½ x 11, illustrated, cloth cover. #5648 ..... \$12.75

**SYNTHESIS OF RC NETWORKS.** Hun H. Sun. A convenient reference for faculty and research personnel which deals with the fundamentals of both active and passive networks. The book includes new and original contributions by the author. Such as the algorithm for ladder development and the criteria for determining the negative real roots of a polynomial. These class-tested materials are backed up by problems and suggested readings. 150 pages, 6 x 9 illustrated, cloth cover. #5676 ..... \$7.50

**400 IDEAS FOR DESIGN.** Selected from Electronic Design. Here are over 400 tested ideas written by engineers and selected from the popular "Ideas for Design" column of Electronic Design magazine. These ideas proved useful as parts of larger designs and aids in measuring the parameters or testing the effectiveness of designs. Arranged in convenient categories for handy reference, they provide valuable tips on improving equipment performance, developing versatile designs, saving on materials and time, etc. 232 pages 8½ x 11¼, illustrated, cloth cover. #5537 ..... \$9.95

# Idea books    Practical guides

*prove them in your work for 10 full days — FREE*

Please send me examination copies of the books checked to test in my work. If after 10 days I am not satisfied, I may return the books without obligation. Otherwise, I will remit payment, plus postage.

Check here if payment enclosed. Publisher pays postage with same return guarantee. (On all overseas orders, payment in \$ U.S. must be enclosed).

Name \_\_\_\_\_  
 Firm \_\_\_\_\_  
 Address \_\_\_\_\_  
 City \_\_\_\_\_ State \_\_\_\_\_ Zip \_\_\_\_\_

Send FREE 1968 catalog of electronics references. ED-169

**HAYDEN BOOK COMPANY, INC. 116 W. 14 ST., NEW YORK, N. Y. 10011**

**MICROWAVE SYSTEMS PLANNING.** Kenneth L. Dumas and Leo G. Sands. Designed for managers and engineers, this book defines and explains in a semi-technical manner the important criteria involved in the planning, engineering and installation of microwave equipment used for communications. Covers point-to-point FM systems beginning with frequency, wave theory and propagation, and following through to hardware theory and the practical aspects of establishing a microwave path with a high probability of good performance. 152 pages, 6 x 9 illustrated, cloth cover. #5696 ..... \$8.00

**MATRIX ALGEBRA FOR ELECTRONIC ENGINEERS.** Paul Hlawiczka. A basic course for the student and practicing engineer, for whom matrix algebra is often an indispensable tool for solving certain problems in physics and electronics. Gives a general orientation and shows the solutions of simple problems. Part I covers the essentials of matrix methods and their applications, requiring only a basic algebra background. Part II treats more complex methods, applying them to differential equations of linear networks. 224 pages, 5¾ x 8¾, illustrated, cloth cover. #5629 ..... \$8.75

**NONDESTRUCTIVE HIGH POTENTIAL TESTING.** Harold N. Miller. Now in one volume, all the information necessary for understanding, performing, and evaluating the results of high potential testing. Presents the entire field of nondestructive electrical testing from general principles to specific how-to instructions. Stresses important techniques for determining the ability of solid, gas, and liquid insulation to withstand predetermined amounts of over-voltage without failure. Guides to proper selection of test sets and mechanical features also included. 160 pages, 5½ x 8½, illustrated, cloth cover. #5028 ..... \$7.95

**CIRCUIT THEORY ANALYSIS.** Joseph Mittleman. An amply illustrated, clear-cut discussion ranging from fundamentals to more complex electronic circuits. The book includes step-by-step mathematical examples necessary for circuit analysis, and backs up each chapter with helpful problem sections. Cover page includes configurations of circuit elements, complex algebra and single element response, complete response of RL and RC networks, source-free response networks, and steady-state sinusoidal response. 461 pages, 6 x 9, illustrated, cloth cover. #5525 ..... \$9.50

**ENGINEERS' RELAY HANDBOOK.** NARM. An indispensable reference bringing together the knowledge of 31 experts in an all-encompassing work on electromagnetic and thermal relays and their characteristics. Complete basic relay information, inspection testing, life test information, military specification requirements and standardized definitions accumulated in an elementary yet comprehensive form. Diagrams, charts, tables and guidelines clarify and illustrate the text and a complete bibliography is included. 312 pages, 7¾ x 10¾, illustrated, cloth cover. #5665 ..... \$11.95

**ELECTRICAL INTERFERENCE.** Rocco Ficchi. Provides the designer, field engineer, program manager and technician a broad view of interference in modern electronics systems. This volume shows the entire field as a unified discipline and makes it possible to solve problems encountered in small radio receivers on up to large missile systems. Includes material on how interference control is introduced in design and the best practices to contain interference. 256 pages, 6 x 9, illustrated, cloth cover. #5512 ..... \$9.95



# LOW PROFILE IC PACKAGING SOCKET

**New**

Directly interchangeable! Exclusive socket configuration, identical to IC package, saves time, simplifies mounting on PC board.

- Permits card stacking on 1/2" centers
- Accepts packages with flat or round leads
- Easy IC insertion with wiping type beryllium copper contacts
- Easy extraction, minimum lead damage—optional extractor tool available
- Available in diallyl phthalate or black phenolic with gold or tin-plated contacts
- Dimensions .79 L x .49 W x .31 H

Request Data Sheet 166.

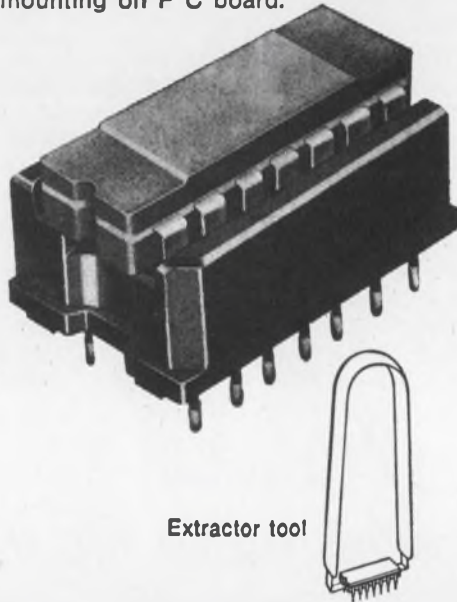

Extractor tool

**AUGAT**

INC. 31 PERRY AVE., ATTLEBORO, MASS. 02703

INFORMATION RETRIEVAL NUMBER 62

PRODUCTION

## Computerized tester measures solderability



Multicore Sales Corp. div. of British Industries Co., Westbury, N.Y.  
Phone: (516) 334-7450. Price: \$1785.

With a highly reliable digital timing method, a computerized test machine accurately measures the degree of solderability of terminal component wires. The testing procedure consists of lowering a previously fluxed specimen into a molten globule of solder. The solder is then cut in two and the time required for it to reunite is measured.

CIRCLE NO. 297

New and Better  
Communications with . . .

## TELEMATE 300 ACOUSTICAL COUPLER



TELEMATE 300 was designed and developed to specifications of DACC, a time-sharing computer company that knows the needs of users.

That's why Telemate 300 is more compact, more reliable and elegantly styled.

### Top Quality • Competitively Priced

- Easily portable
- Data Rate: 300 Baud
- Carrier and on/off lights
- Highly selective tuned oscillator circuit
- Half/full Duplex
- Triple tuned circuitry
- AGC circuit
- Acoustic isolation min. 20 db
- Teletype or EIA Interface
- Optional: Carrying case, originate/answer, cable interface, loud speaker and RS 232B

FULL WARRANTY • WRITE FOR BROCHURE



Use TELEMATE 300 with your telephone and/or your teletype system. Comes in walnut and attractive office decorator colors.

**DACC**

DIRECT ACCESS COMPUTING CORP.

Communications Equipment Group

24175 Northwestern Highway  
Southfield, Michigan 48075

313/358-5000

INFORMATION RETRIEVAL NUMBER 63

## Mixer/dispenser cleans itself



Jesco Products Co., Inc., 20749 Ryan Rd., Warren, Mich. Price: \$1575.

A unique fluid dispenser precisely meters and mixes small quantities of dual-component materials such as epoxies, polyesters and polyurethanes and then cleans itself before fouling can occur. Model 100 delivers any pourable material into a mixing chamber by means of air-operated positive-displacement pistons.

CIRCLE NO. 298



## Flat-cable stripper removes polyimide

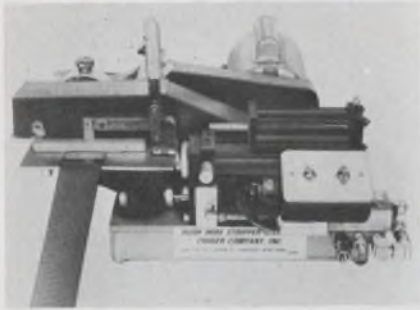

The Eraser Co., Oliva Dr., P.O. Box 1342, Syracuse, N.Y. Phone: (315) 454-3237. P&A: \$1495; stock.

Using a single polyimicon stripping wheel, model 3000 stripper removes insulation, including polyimide, from only one side of a flat cable. Any width of cable up to 6 in. may be stripped as far back as 5 in. from the cable end.

CIRCLE NO. 330

## Vacuum-base vise swivels and tilts

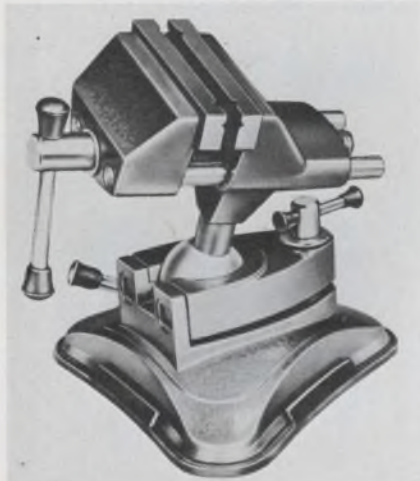

Edmund Scientific Co., 380 Eds-corp Bldg., Barrington, N.J. Phone: (609) 547-3488. Price: \$17.98.

Acting as the operator's third hand, a swivel-action vacuum-base vise keeps virtually any position. The new tool, model 71,144, is able to rotate 360° horizontally and 180° vertically. It comes supplied with special slip-on rubber jaws for handling fragile and delicate objects. Over-all dimensions are 6-1/4-in. high by 6-1/4 in. wide.

CIRCLE NO. 331

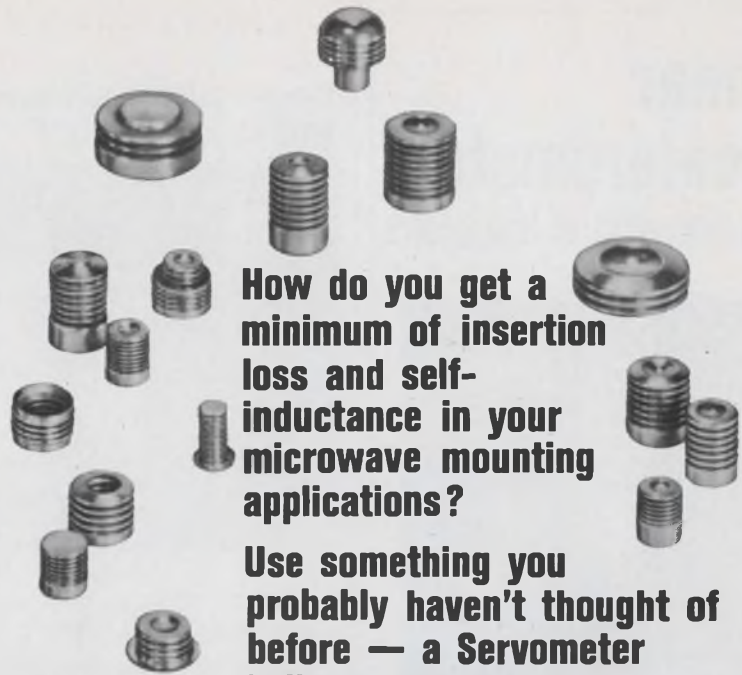

How do you get a minimum of insertion loss and self-inductance in your microwave mounting applications?

Use something you probably haven't thought of before — a Servometer bellows contact spring.

Achieving adequate and reliable electrical continuity in the mounting of microwave components is no easy task. Since microwave currents travel on the surface of cylindrical conductors, the continuous wall of a bellows contact is ideal for that purpose. Insertion loss is minimized.

In addition, the bellows section not only cushions the mounted part from shock and vibration, it also maintains tight electrical contact through varying temperature and pressure conditions. The bellows' lifetime spring repeatability insures that they will compensate for expansion and contraction of your microwave package, whatever the cause.

A glance at the chart below, which lists standard contact springs available from stock, will give you an idea of the minimum self-inductance and D.C. resistance they offer. If none of the listed bellows contacts meets your requirements, Servometer will design custom contacts with special properties.

All Servometer contacts remain "clean room clean" in use due to their unbroken exterior surface. All can be manufactured for any life expectancy desired, from 100 cycles to infinity, and all will maintain their full spring qualities over an extremely wide temperature range.

If you face the problems of insertion loss, self-inductance, tolerance build-up, vibration or shock in microwave mounting applications, especially where the connection cannot or should not be soldered, why not call or write for further information? Who knows. You might wind up with the kind of electrical continuity and reliability you haven't thought possible before. Servometer Corporation, 82 Industrial East, Clifton, New Jersey 07012. Phone (201) 773-0474.

### STANDARD CONTACT SPRINGS AVAILABLE FROM STOCK.

PART NUMBER	OUTSIDE DIAMETER (inches)	OVERALL LENGTH (inches)	CONVOLUTION LENGTH (inches)	MAXIMUM COMPRESSION STROKE (inches)	MINIMUM FORCE @ FULL COMPRESSION (oz.)	METALLIC OHMS D.C. RESISTANCE	SELF-INDUCTANCE HENRYS $\times 10^{-10}$	SURFACE FINISH
1571-1	.105	.055	.044	.015	3.0	.005	3.1	00005" gold
1571-2	.085	.055	.044	.015	4.0	.005	3.8	"
2012	.125	.197	.135	.065	4.0	.009	9.5	"
2013	.125	.160	.122	.060	4.0	.008	8.0	"
2014	.125	.178	.142	.072	3.5	.010	9.0	"
2023	.245	.081	.076	.035	6.0	.004	4.5	"
2146	.066	.082	.057	.030	1.1	.013	4.0	"
2156	.096	.114	.082	.047	2.4	.011	5.5	"
2510	.037	.080	.043	.012	0.22	.030	3.2	"

GOLD PLATED BELLOWS CONTACT SPRINGS

# SERVOMETER

(say serv'-o-meter)

INFORMATION RETRIEVAL NUMBER 64

# Linear Accelerometers

... a new class of transducers

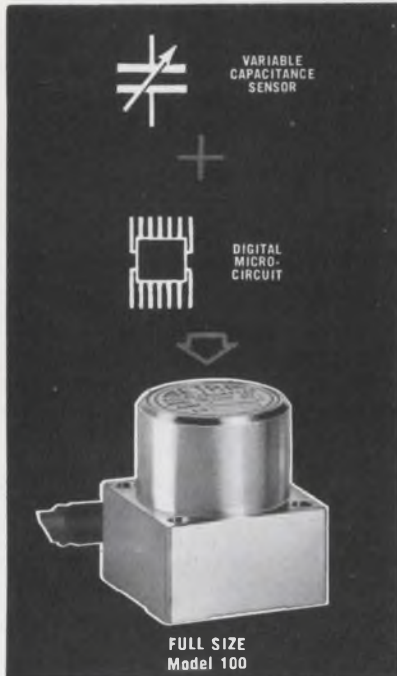

SETRA SYSTEMS' line of linear accelerometers (Models 100, 106, and 110) have the following outstanding features:

- Gas damping.
- Hammer-like ruggedness.
- High natural frequency.
- Steady state response.
- Economy.

Other salient characteristics . . . ■ Model 100 provides an output of  $\pm 1.5$  volts dc with 6 volts dc excitation — available in ranges down to  $\pm 1g$  ■ Model 106 has a similar dynamic performance with a 0-5 volt dc output (or  $\pm 2.5$  volts) with 15 volts excitation ■ Model 110 is available in high g ranges with high frequency response and gas damping — ideally suited for shock testing applications.

Write for bulletins containing complete technical data. Inquiries regarding pressure transducer applications are also invited.

Tel: 617 655-4645



**SETRA SYSTEMS INC.**  
12 Huron Drive • Natick, Mass. 01760

INFORMATION RETRIEVAL NUMBER 65

## PACKAGING & MATERIALS

### Room-cured silicone withstands 525°F



Emerson & Cuming, Dielectric Materials Div., Canton, Mass. Phone: (617) 828-3300.

Curing at room temperature, a two-part silicone rubber potting and encapsulating compound withstands temperatures as high as 525°F. Eccosil 4852 can be bonded to other silicones, or to other substrates when used with a primer. It is pourable in its uncured state, contains no solvents, and is 100% reactive. Its dielectric strength is 550 V/mil.

CIRCLE NO. 332

### Amber epoxy cures red



Epoxy Technology, Inc., 65 Grove St., Watertown, Mass. Phone: (617) 926-1949.

Providing a visual check of its curing cycle, a new two-component epoxy compound goes from clear amber to a deep red, as its curing progresses. The time-temperature relationship for Epo-Tek 360 may be varied at will to permit controlled curing. A primary application, using this property, is the bonding of optical glass fibers.

CIRCLE NO. 333

### Rubber compound retains shape



Plastic and Rubber Products Co., 2150 Parco Ave., Ontario, Calif.

Called Parco-Fluor 994-75, a new fluoroelastomer exhibits twice the ability to recover its original shape after compression than do previously available and similar rubber compounds. It resists even the most corrosive fluids and is capable of withstanding extremely high temperatures for extended periods.

CIRCLE NO. 334

### Fluorocarbon epoxy resists 450°F



Mereco Products, div. of Metachem Resins Corp., 530 Wellington Ave., Cranston, R. I. Phone: (401) 781-4070. Price: \$16/kit.

Designed for bonding Teflon, Rulon and similar fluorocarbon polymers, either to themselves or to other substrates, a new epoxy adhesive extends the continuous-duty working temperature of these materials to 450°F. In addition, type 3446 adhesive can intermittently withstand temperatures as high as 1000°F.

CIRCLE NO. 335



# Thou shalt not invert.

Not when you have AND, OR, NAND and NOR functions available in one logic family.

With the recent addition of seven new

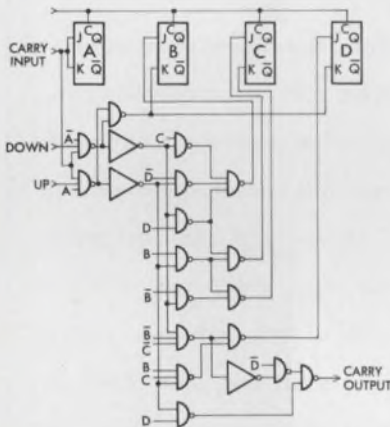

DTL implemented up-down counter

gates to the line, Utilogic II now allows you to implement functions simply, any way you choose — with AND, OR, NAND or NOR elements. No other logic family permits this flexibility.

It's possible to eliminate inverters, commonly required in DTL designs. The Utilogic II implementation of the Up-Down Counter shown below requires 11% fewer packages than the typical DTL version. In terms of comparative system costs based on 1000-up pricing, the Utilogic II implementation saves you 30% in parts cost alone.

The new circuits include dual 4-input expandable, triple 3-input and quad gates in both OR and NAND logic functions, plus a triple 2-input expandable OR gate and a diode expander.

All the new circuits are immediately available in volume in a 14-pin dual-in-line silicone package in the SP (0°C to 75°C) and LU (10°C to 55°C) operating temperature

ranges. Utilogic II, as you recall, has three times greater noise margins and double the fan-out of any other available logic family. And its performance has been proven by over 15 million elements in the field. For our Utilogic II Handbook write Signetics, 811 East Arques Avenue, Sunnyvale, California 94086. Bless you.

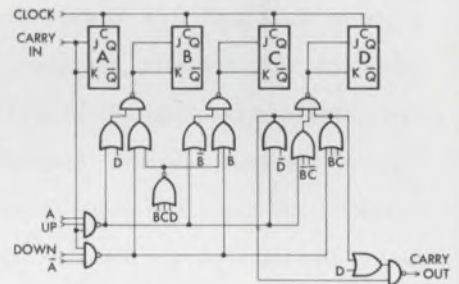

UTILOGIC II implemented up-down counter

Signetics Integrated Circuits   
A SUBSIDIARY OF CORNING GLASS WORKS

**SIGNETICS SALES OFFICES:** Wakefield, Massachusetts (617) 245-8200; Trumbull, Connecticut (203) 268-8010; Poughkeepsie, New York (914) 471-3292; Syracuse, New York (315) 469-1072; Fort Lee, New Jersey (201) 947-9870; Radnor, Pennsylvania (215) 687-2660; Silver Spring, Maryland (301) 946-6030; Clearwater, Florida (813) 726-3734; Winter Park, Florida (305) 671-5350; Dayton, Ohio (513) 433-4133; Minneapolis, Minnesota (612) 920-3256; Rolling Meadows, Illinois (312) 259-8300; Richardson, Texas (214) 231-6344; Garden Grove, California (714) 636-4260; Burbank, California (213) 846-1020; Redwood City, California (415) 369-0333.

**DISTRIBUTORS:** Avnet Electronics Corp., Burlington, Mass. (617) 272-3060; Cescio Electronics, Ltd., Montreal, Quebec, Canada (514) 735-5511. Compar Corporation at the following locations: Huntsville, Alabama (205) 539-8476; Los Angeles, California (213) 245-1172; Burlingame, California (415) 347-8244; Hamden, Connecticut (203) 288-9276; Clearwater, Florida (813) 446-2991; Orlando, Florida (305) 855-3964; Park Ridge, Illinois (312) 692-4125; Baltimore, Maryland (301) 484-5400; Newton Highlands, Mass. (617) 969-7140; Minneapolis, Minnesota (612) 922-7011; St. Louis, Missouri (314) 542-3399; Albany, New York (518) 489-7408; Endwell, New York (607) 723-8743; Woodbury, New York (516) 921-9393; Fairport, New York (716) 271-2230; Syracuse, New York (315) 471-3356; Winston-Salem, North Carolina (919) 723-1002; Seattle, Washington (206) 763-1711. Hamilton Electro Sales, Culver City, Calif. (213) 870-7171; Cherry Hill, N.J. (609) 662-9337; Hammond Electronics, Orlando, Florida (305) 241-6601; Kierulff Electronics, Seattle, Wash. (206) 763-1550; G. S. Marshall, San Marino, Calif. (213) 684-1530; Milgray-Delaware Valley, Inc., Philadelphia, Pa. (215) 228-2000; Pioneer Standard Electronics, Rockville, Maryland (301) 427-3300; Schley Electronics, Watertown, Mass. (617) 926-0235; Semiconductor Specialists, Inc., Elmhurst, Illinois (312) 279-1000; Terminal-Hudson Electronics, New York, New York (212) 243-5200; Universal Electronics, Inc., Houston, Texas (713) 781-0421; Wesco Electronics, Inc., Los Angeles, Calif. (213) 685-9525; Palo Alto, Calif. (405) 968-3475.

**DOMESTIC REPRESENTATIVES:** Compar Corporation at the following locations: Scottsdale, Arizona (602) 947-4336; Denver, Colorado (303) 781-0912; Southfield, Michigan (313) 357-5369; Haddonfield, New Jersey (609) 429-1526; Albuquerque, New Mexico (505) 265-1020; Albany, New York (518) 489-7408; Endwell, New York (607) 723-8743; Fairport, New York (716) 271-2230; Syracuse, New York (315) 471-3356; Rocky River, Ohio (216) 333-4120; Fairborn, Ohio (513) 878-2631; Dallas, Texas (214) 363-1526; Houston, Texas (713) 667-3420. Ozark Electronic Marketing, Inc., St. Louis, Missouri (314) 423-7200.

**INTERNATIONAL SALES:** France, Germany, Italy, Belgium, Holland, Luxemburg, Spain—Sovcor Electronique, 11, Chemin de Ronde, Le Vesinet, (S & O.) France. United Kingdom, Ireland, Sweden, Denmark, Norway, Switzerland, Austria, Portugal—Electrosil Ltd., Lakeside Estate, Colnbrook By Pass Slough, Buckinghamshire, Great Britain. Australia—Corning, 1202 Plaza Building, Australia Square, Sydney, N.S.W. 27-4318. Canada—Corning Glass Works of Canada, Ltd., Leaside Plant, Ontario, Canada (416) 421-1500. Israel—Talvion, P.O. Box 3282, Tel-Aviv, Israel 236-666. Japan—ASAHI Glass Co., Ltd., Corning Products Sales Dept. No. 14, 2-Chome Marunouchi, Chiyoda-ku, Tokyo, Japan 211-0411.

Another useful design tool  
from Electronic Design:

# "A Practical Design Guide For A/D and D/A Conversion"

By Hermann Schmid, senior engineer, General Electric Company

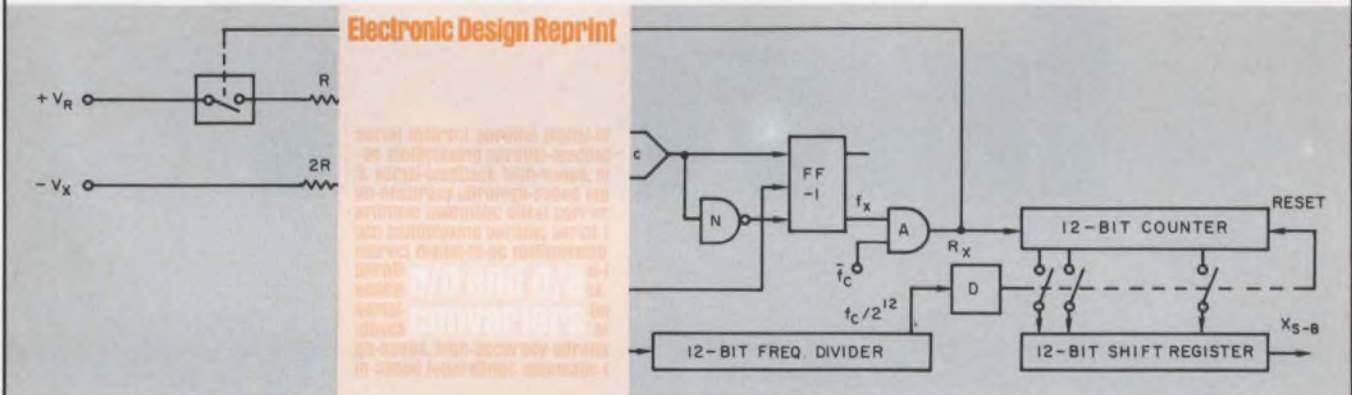

100 pages, 8½ x 11

This Electronic Design reprint contains complete, up-to-date design information covering all aspects of A/D and D/A converters. Here are just some of the subjects covered: A/D Converter Types-Successive Approximation; Charge Equalization; Indirect; Serial Feedback; Ultra-High Speed; D/A Converter types-Parallel; Serial; Indirect; Digital-to-A/C. Also covers automatic offset correction and time sharing.

As digital computation techniques are used in increasingly broad areas such as industrial control systems, instrumentation systems, computers and telemetry systems, this information-packed "how-to-do-it reprint" is one you can't afford to be without. To get your copy, order now at \$2.75 each. To keep the price of this valuable reprint as low as possible, we must ask your check or money order be included with the request.

Reader Service Department, Electronic Design, 850 Third Avenue, New York, N.Y. 10022

Gentlemen:

Please send me ..... copy (ies) of "A Practical Design Guide For A/D and D/A Conversion." (\$2.75 each. This includes all mailing and handling charges.)

Enclosed is .....  Check  money order.

Checks payable to Electronic Design.

Name \_\_\_\_\_

Company \_\_\_\_\_

Address \_\_\_\_\_

City \_\_\_\_\_

State \_\_\_\_\_

Zip \_\_\_\_\_



**Hydrocarbon greases lubricate controls**

*William F. Nye, Inc., P.O. Box G-927, New Bedford, Mass. Phone: (617) 992-1327.*

Kilopoise damping greases are special lubricants that smooth the motion of instrument controls, optical-system focusing mechanisms and other delicate equipment. They are hydrocarbon greases intended for assemblies where a fine adjustment or slow motion is produced by hand, and where free motion must be damped. The Kilopoise greases are also suitable as sealants and pressure-tight greases.

CIRCLE NO. 336

**Answers to problems posed on p. 85**

**Case A.** Right off, forget choices 2 and 5. Ignoring the situation (choice 5) will only increase employe unrest and gossip, which may well foment a much more unpleasant situation in a short time. If you try choice 2, your creative man may walk out on you. The reaction in choice 4 is a little too hasty. Give the man time to think over and change his habits. Choice 1 might work, depending on how subtly you handle it. Choice 3 probably is best. By telling your man he is important to the company and to you, and by showing that you are willing to acknowledge his importance, you may win him over.

**Case B.** Choice 3 isn't bad. A creative man should have privacy to mull over a solution. As a follow-up action, choice 1 would let your other employes know you value Charles for good reasons. Forget about choices 2 and 4. You didn't hire Charles to converse with the staff; protect him so he can work with ease. Choice 4 probably would prompt a lot of embarrassing remarks about "the creative genius," etc. There's no need to point out creative people in this way; their work will speak for them.

**We make selenium rectifiers:**

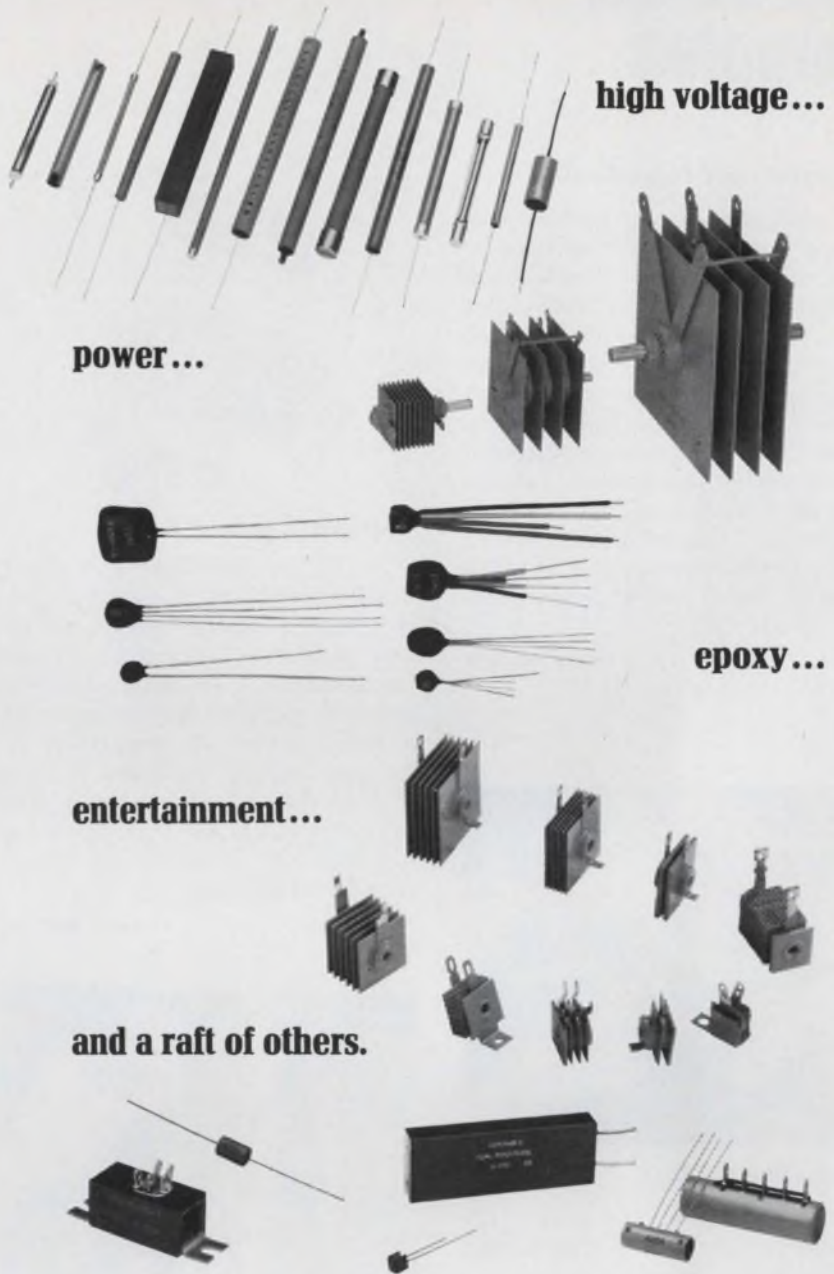

Why settle for ordinary selenium rectifiers more or less equal in design construction and performance, when you can go Edal and get much, much more.

And we do mean measurably, obviously, more. Prove it to your-

self. Just ask and we'll send you samples. You can put them to the test. If you prefer, let us send you complete descriptive literature or have our local Technical Representative come in and give you our story. Just ask.

**EDAL**

**Rectifiers**  
Silicon  
Selenium  
Copper Oxide

**Edal Industries, Incorporated**  
4 Short Beach Road, East Haven, Connecticut 06512

WE MAKE MORE DIFFERENT TYPES OF RECTIFIERS THAN ANYONE IN THE WORLD  
INFORMATION RETRIEVAL NUMBER 67



# Evaluation Samples

## Transformer insulation

A sample packet of flexible-coated and mica-based insulation materials for transformer construction is available free. The packet contains samples of flexible-coated nonwoven fabrics for class B and F applications and corona-resistant flexible mica insulations for class F and H applications. Included are: materials descriptions, listings of typical properties, and a handy applications chart for determining the proper materials to use in many transformer construction techniques. 3M Co.

CIRCLE NO. 337



## Inventory system

The key element of a new file system is a reusable transparent plastic dome permanently secured to a heavy-duty index card with a sliding (self-stopping) card insert. Pulling out the sliding card insert until its opening matches the opening in the file card, allows a part to be placed into the container. Repeating the process removes the part. The new system permits the actual part to be inventoried with both file card and records in one self-contained unit. The system is mistake-proof, because the actual part is filed with the written records for visual identification. These record/inventory cards are available in a wide range of standard sizes. Cost is as low as 10¢ per card. Samples and literature are available. APSCO Packaging Co.

CIRCLE NO. 338



## Captive floating nuts

A kit of self-locking, captive floating fasteners, designed to correct hole misalignments in chassis and panels, is offered as an aid to electronic packaging. Locking effect is achieved by distortion of a round extension, situated above the base of the fasteners. A dry, Teflon-type lubricant is applied to the thread to facilitate insertion and removal of the screws. Precision Metal Products Co.

CIRCLE NO. 340



## Self-adhesive gaskets

Designers are invited to sample a new type of self-adhesive finger strips for rfi/emi shielding applications. Designated series 97-555, these beryllium copper strips measure only 3/8-in. in width and are stocked in 24-in. lengths. Installation is simplified by an aircraft-quality self-adhesive backing that eliminates soldering or mechanical fastening. Complete specifications and a sample strip of the new material are available without charge. Instrument Specialties Co., Inc.

CIRCLE NO. 341



## Snap terminal

A bullet-type snap terminal that accommodates 16 to 14 gage wire features several production advantages and is available in both insulated and noninsulated versions. The new terminal is made from pure annealed electrolytic copper and exceeds U. S. Government pull-test requirements. A full 1/4-in. crimp barrel offers sufficient room for use with any crimping plier. Further information and samples are available from the manufacturer. Zerick Manufacturing Corp.

CIRCLE NO. 342



## Teflon tape

Test the ruggedness of a new self-adhering Teflon tape that exhibits a high degree of chemical inertness and essentially zero moisture absorption. An evaluation sample of the 2-mil film is now made available to design engineers. The new tape can be thermoset for greater resistance to commercial solvents. The Connecticut Hard Rubber Co.

CIRCLE NO. 343



# ANNOUNCING THE WANG 700



...from any angle,  
the most significant advance in calculator capabilities since the Wang 320.

#### 960 Core-stored Program Steps.

**120 Data Registers.** Every register can add, subtract, multiply and divide.

**Dual Nixie-type Display,** 12 digits plus 2-digit ( $-98$  to  $+99$ ) exponent, each register.

**Basic Keys** for  $+$ ,  $-$ ,  $\times$ ,  $\div$ ,  $\sqrt{x}$ ,  $1/x$ ,  $\text{Log}_{10}X$ ,  $\text{Log}_eX$ ,  $e^x$ ,  $|X|$ ,  $\text{INT}(X)$ ,  $\pi$ .

**Special Function Keys** for SIN, COS, TAN, ARCSIN, ARCCOS, ARCTAN, SINH, COSH, TANH, ARCSINH, ARCCOSH, ARC TANH, Polar Conversion, Rectangular Conversion. (Others may be readily substituted.)

**Commands for Loops, Branches and Subroutines.** Unmatched power for matrix and array operations.

**Programs Stored by Tape Cassettes;** up to 10 blocks of 960 steps each.

**Fastest Execution Time,** approximately 300  $\mu\text{sec.}$  for  $+$  and  $-$ , 3.0 m sec. for  $\times$ , 3.5 m sec. for  $\div$ , 15 m sec. for  $\text{Log} A$ , 35 m sec. for  $e^A$ .

**Fully Self-contained** with rear panel connector for forthcoming Selectric output writer.

**Exclusive Integrated Circuit Design.** First and only high-powered programmable calculator with IC's for more performance at less cost.

For details,  
call your nearby Wang office ...

#### SALES/SERVICE OFFICES

<b>Alabama</b> (205) 595-0694	<b>New Jersey</b> (201) 272-7160
<b>Arizona</b> (602) 265-8747	<b>New Mexico</b> (505) 255-9042
<b>California</b> (415) 692-0584 (213) 776-2985 (916) 489-7326 (714) 234-5651 (805) 962-6112	<b>New York</b> (212) 682-5921 (716) 381-5440 (518) 463-8877 <b>North Carolina</b> (919) 288-1695
<b>Colorado</b> (303) 364-7361	<b>Ohio</b> (614) 488-9753
<b>Connecticut</b> (203) 288-8481 (203) 223-7588	<b>Pennsylvania</b> (216) 333-6611 (513) 531-2729
<b>Florida</b> (305) 841-3691 (305) 564-3785 (813) 877-6590	<b>Oklahoma</b> (918) 747-0018
<b>Georgia</b> (404) 633-4438	<b>Tennessee</b> (615) 524-8648 (901) 272-7488 (615) 482-3040
<b>Illinois</b> (312) 889-2254 (309) 674-8931	<b>Texas</b> (512) 454-4324 (214) 361-4351 (713) 668-0275 (817) 834-1433 (915) 772-4111
<b>Indiana</b> (317) 631-0909	<b>Virginia</b> (301) 821-8212 (301) 588-3711
<b>Iowa</b> (712) 286-5578	<b>Washington</b> (206) 622-2466
<b>Louisiana</b> (504) 729-6858	<b>West Virginia</b> (304) 344-9431
<b>Maryland</b> (301) 821-8212 (301) 588-3711	<b>Wisconsin</b> (608) 244-9261
<b>Massachusetts</b> (617) 851-7311	<b>Calgary</b> (403) 266-1804
<b>Michigan</b> (313) 278-4744 (616) 454-4212 (517) 835-7300	<b>Montreal</b> (514) 482-0737
<b>Minnesota</b> (612) 881-5324	<b>Ottawa</b> (613) 244-4554
<b>Mississippi</b> (601) 982-1721	<b>Toronto</b> (416) 364-0327
<b>Missouri</b> (314) 727-0256 (816) 421-0890	<b>Vancouver</b> (604) 685-2835
<b>Nebraska</b> (402) 341-6042	
<b>Nevada</b> (702) 322-4692	

 **WANG**  
LABORATORIES, INC.

Dept. 3CB, 836 North Street Tewksbury, Massachusetts 01876 Telephone: (617) 851-7311

INFORMATION RETRIEVAL NUMBER 61



Please send me the brand new 1969 Acopian catalog that lists

**82,000 DIFFERENT POWER SUPPLIES**

available for shipment in 3 days.

Name \_\_\_\_\_

Title \_\_\_\_\_

Company \_\_\_\_\_

Address \_\_\_\_\_

City \_\_\_\_\_

State \_\_\_\_\_

ZIP \_\_\_\_\_

ACOPIAN CORP.  
EASTON, PENNSYLVANIA  
TEL: (215) 258-5441



INFORMATION RETRIEVAL NUMBER 69

## Design Aids

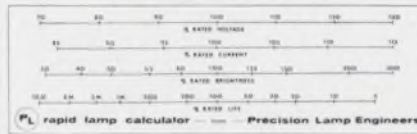

### Lamp calculator

A rapid lamp calculator is included with a four-page brochure on miniature incandescent lamps. Current, candlepower and life can be computed from applied voltage using this four-scale nomogram. In addition, a full page is devoted to definitions and graphs that simplify the specification of miniature lamps. Precision Lamp Engineers.

CIRCLE NO. 348

### Printed circuit chart

A die-stamped circuit chart shows how the thickness of conductors effects circuitry temperature at various voltage and current levels. GTI Corp., Dytronics Div.

CIRCLE NO. 345

### Transducer data chart

A large summary chart lists the characteristics of standard surface-type temperature transducers. The chart describes over a dozen models and gives operating characteristics, accuracy ranges, sizes and general feature summaries. Trans-Sonics.

CIRCLE NO. 346

### Conversion factors

A reference table for engineers in wall chart form includes common conversions such as inches to centimeters or watts to horsepower as well as many conversions that are difficult to locate in reference manuals. Some examples are atmospheres to kg/cm<sup>2</sup>, cm/s to mph, ft<sup>3</sup> to liters, microns to meters, and quintals to pounds. Precision Equipment Co.

CIRCLE NO. 347

### Rfi-emi conversion chart

Included with a capabilities brochure on a completely automated rfi/emi test facility is a handy chart that gives noise power densities equivalent to sinusoidal signals from -152 to +53 dBm. Also presented as voltage and dB $\mu$ V for a 50 $\pi$  impedance, the noise-power densities are calculated for seven bandwidths from 10 Hz to 10 kHz. White Electromagnetics, Inc.

CIRCLE NO. 344

### Switch wall chart

A rotary switch wall chart guide contains complete specifications on microminiature, miniature, and standard enclosed rotary switches. The new wall chart features a simple diagram showing how to order rotary switches according to your specific needs. Janco Corp.

CIRCLE NO. 349

### Transistor chart

A new quick-reference guide to rf power transistors lists key parameters for 24 different units. A frequency vs power chart for the devices covers frequencies from 10 to 1000 MHz at power outputs up to 100 W, giving quick-reference frequency/power capabilities for each device. Package drawings are included. ITT Semiconductors.

CIRCLE NO. 350



# Ceramic substrates in less time, for less money.

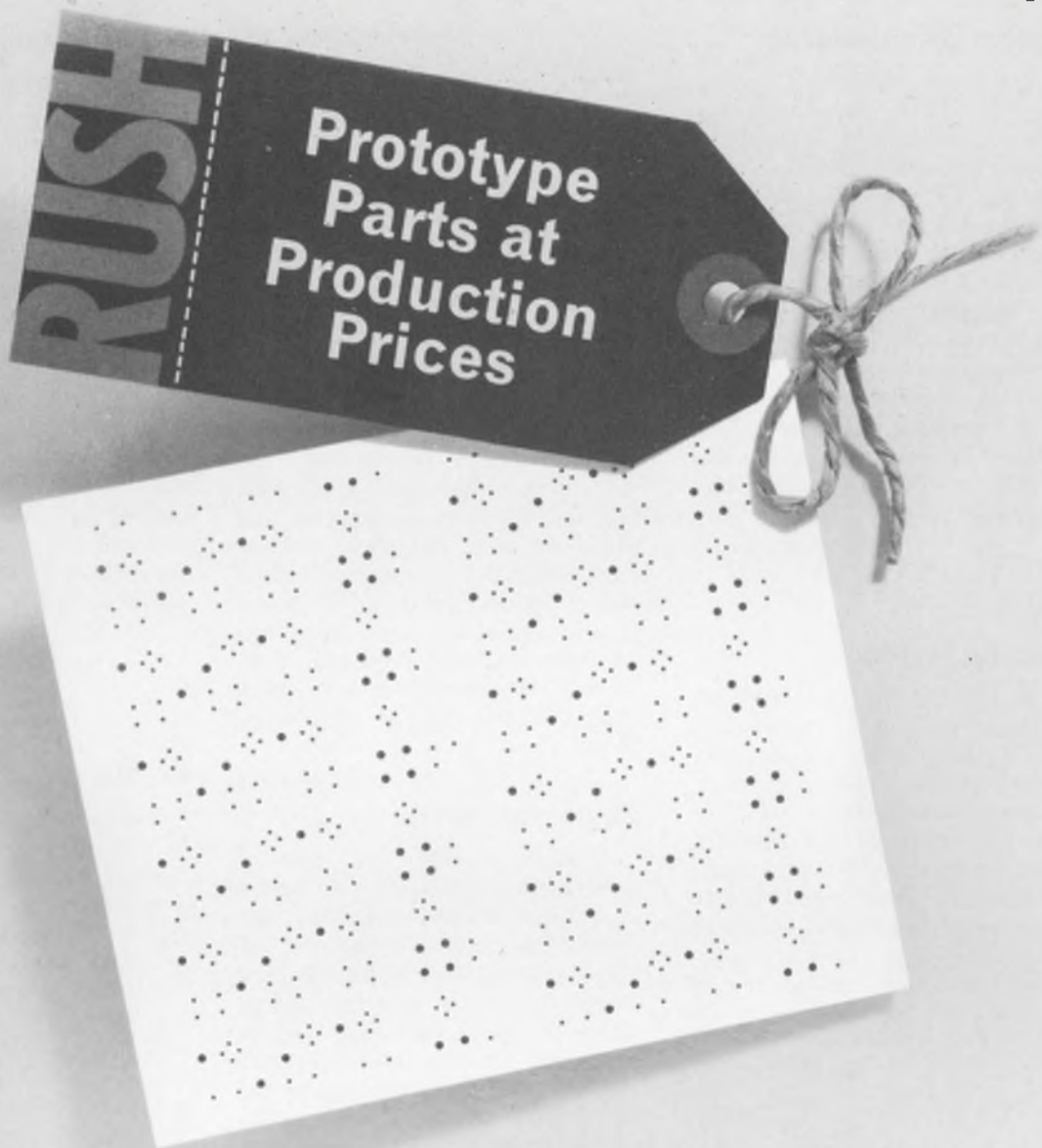

Hole-patterned ceramic substrates in quantities up to 250 are now available from Coors at *prices much lower* than ever before.

Parts shipments are faster too – *two weeks maximum* after receipt of order.

Substrates  $\frac{1}{4}$  to 17 square inches in size, 10 to 35 mils thick, can be obtained with any practical number of holes in practically any pattern.

Tolerances on hole locations and substrate length and width dimensions can be held to  $\pm 1/2\%$  (not less than  $\pm 0.003$ " ) if required. Substrate thickness and hole diameters can be kept within  $\pm 10\%$ .

Materials are Coors famous-quality 96% and 99.5% alumina ceramics.

Turn breadboards into prototypes, prototypes into finished circuits quicker, cheaper.

Mail or phone your substrate specifications to Coors Custom Products Division – today. Coors Porcelain Company, 600 Ninth Street, Golden, Colorado 80401, (303) 279-6565.

**Coors**/CERAMICS

# Application Notes

## Low-ohm measurement

A four-page illustrated application note briefly describes techniques used in the measurement of low resistances. The advantages of using an ac four-terminal technique for the measurement of resistances from 1 m $\Omega$  to 1000  $\Omega$  are described. In the ac four-terminal measurement, two terminals supply an ac constant current to the sample and two are used to measure the resultant voltage drop with an ac voltmeter. This technique eliminates thermal emfs and allows very stable measurements. Keithley Instruments, Inc.

CIRCLE NO. 351

## Switching handbook

Designed for the systems engineer, a 40-page manual discusses switching as related to computers, communications, instrumentation, and automatic testing. Scanning, crosspoint switching and interfacing are emphasized. Such problems as interfacing three computers to a selection of two displays through multiple 144-line parallel paths are solved. As an alternative to solid state or reed switching arrays the use of new devices that can reduce system cost and size is described. Electronic Controls, Inc.

CIRCLE NO. 352

## Microwave attenuators

Criteria for selecting microwave attenuators are discussed in a 12-page article appearing in a quarterly technical publication. The article presents the various trade-offs that may be made to obtain the optimum component at lowest cost. Included is a table of 89 fixed, 15 variable, and 4 step attenuators, which are compared in all significant parameters. The Narda Microwave Corp.

CIRCLE NO. 353



## Operational power supplies

Just published, a 12-page monograph discusses the capabilities of modern dc regulators for the control of voltage or current. The paper reviews the operational analogy for power supplies and brings it up to date, with a thorough discussion of the input offset rating techniques by which regulators can be specified. There are 29 figures and photographs illustrating the application of feedback theory for the purpose of control. Kepco, Inc.

CIRCLE NO. 354

## Digital memories

A guide to delay line types of serial memories presents the theory of operation and describes the capabilities and limitations of glass, quartz, and wiresonic type digital stores for specific applications. It lists factors that must be considered when choosing the correct type of ultrasonic store for buffer applications. Various tables provide additional data, such as delay shift versus temperature. Andersen Laboratories.

CIRCLE NO. 355

## Gearmotor data

Can a product design engineer accept gearmotor nameplate ratings at face value when seeking a motor for a particular application? According to this newsletter, each manufacturer has his own set of rating conditions, so nameplate information on any specific gearmotor may be misleading as it relates to unit life and performance on the job. Bodine Electric Co.

CIRCLE NO. 356

## Network analysis

How to determine network transfer and insertion characteristics over a 10 kHz to 32 MHz swept frequency range is described in a new 13-page application note. The note describes how a sweep signal generator and a phase/amplitude tracking detector work together to measure the gain/attenuation and phase response characteristics of networks and how these techniques are applied to the measurement of gain, insertion loss, envelope delay, and common-mode on a swept-frequency basis. Techniques for obtaining 100 dB dynamic range or 0.01 dB and 0.01 $^\circ$  resolution, and for making log-log (Bode) plots are also described. Hewlett-Packard Co.

CIRCLE NO. 357

## Crystal polishing

Step-by-step instructions on how to recondition fogged or scratched NaCl, KBr and CsBr windows are detailed in a 4-page illustrated folder. Techniques for cleaving and grinding crystals are described. Polishing methods detailed include the alcohol-felt technique and the aqueous solution-glass method. Procedures for handling transmission materials are also listed. Barnes Engineering, Inc.

CIRCLE NO. 358

## Synchro standards

A 4-page illustrated bulletin describes procedures for determining the accuracy and the internal impedance characteristics of synchro and resolved standards at all angular settings. Information given includes step-by-step procedures, test setup diagrams, equivalent circuit diagrams and recommended test equipment. Astrosystems, Inc.

CIRCLE NO. 359



sweeps  
5 to 1500 MHz  
in 7.5 milliseconds  
flat!



We can supply a sweep generator with rally stripes on special order, but the frequency range and the sweep rate are standard.

Telonic's 2003 Sweep Generator will cover that entire band—1495 MHz—in a single sweep, or in any segment down to 0.02 Hz wide. You can instantly see response characteristics over all, or any portion, of a circuit's operating frequencies.

And don't overlook that word "instantly." If you're still in the habit of using a signal generator for point-to-point testing, it's time to upshift into swept techniques. Let your local Telonic rep show you the '69 floor models.

Catalog 70-A and Supplements contain complete descriptions on all Telonic Sweep Generators plus a full section devoted to "how-to" applications. Get your copy today.

#### Model 2003 Sweep/Signal Generator System

- Frequency Range**  
(Seven different plug-in oscillators available) ..... 0.02 Hz-1500 MHz
- Sweep Width**  
( $F_1-F_2$  or  $F_c/\Delta F$ ) ..... 0.02 Hz-1495 MHz
- Frequency Marking**  
(Four different marker plug-ins available) ..... Fixed or variable
- Attenuation**  
(Eight attenuator plug-ins available) .... 1 db to 109 db (50 or 75  $\Omega$ )
- Sweep Rate**  
(Select from two rate plug-ins) ..... 0.001 to 60 sweep/sec.
- Log Amplification**  
(One plug-in does it all) ..... 105 db dynamic range
- Detection**  
(Two detector plug-ins available) ..... P-P passive, 50 and 75  $\Omega$
- Display**  
(Two display processing plug-ins) ..... Amplitude and marker tilt control

TELONIC INSTRUMENTS



A Division of Telonic Industries, Inc.  
60 N. First Avenue  
Beech Grove, Indiana 46107  
TEL (317) 787-3231 • TWX-810-341-3202

INFORMATION RETRIEVAL NUMBER 71

# New Literature



## IC testing

A new eight-page brochure on integrated-circuit testing by analog techniques discusses the economics of IC testing, the needs for logical and parametric testing, and the use of the firm's analog circuit test instrument. Teradyne, Inc.

CIRCLE NO. 365

## Polyester film data

How to adhere polyester film to aluminum or copper foil, chipboard, cellulose acetate and to itself is explained in detail in a new technical bulletin. Emulsion and lacquer type adhesives that are commercially available for bonding polyester film are listed and related to specific applications. Methods of applying adhesives for flexible circuit laminates are also discussed in the eight-page bulletin. Celanese Plastics Company.

CIRCLE NO. 366

## Plastic fasteners

A 12-page, two-color brochure provides detailed engineering data on a wide range of plastic fasteners including screws, nuts, washers, screw insulators and rivets as well as plastic-headed metal machine and self-tapping screws. In addition to details on numerous individual fastener types, the brochure furnishes a wealth of technical information on engineering properties of nylon and other thermoplastics. Data includes figures for both mechanical and electrical properties. Gries Reproducer Co.

CIRCLE NO. 367



## Fasteners

An eight-page brochure describes standard fasteners of internal tooth design that are easily applied with a simple tool. No machining or other costly shaft preparations are involved. The cone-shaped high carbon steel fasteners slip easily over shafts, studs and rods, and are locked in place by strong spring tension. Illinois Tool Works, Inc.

CIRCLE NO. 368

## Rotary switch catalog

A complete line of 1-in. diameter enclosed rotary switches is described in detail in a new 20-page catalog. Complete engineering data, specifications, dimension drawings, and code numbers are presented in a unique format that simplifies selection. An ordering guide with complete price lists is included. The ASM Corp.

CIRCLE NO. 369

## Oceanographic connectors

Submersion-proof power connectors and environmentally sealed submarine connectors are described in a new six-page bulletin. Information for ordering the connectors is included. Amphenol Connector Div., The Bunker-Ramo Corp.

CIRCLE NO. 370



## Selective plating

Principles, advantages and case histories relating to new selective plating techniques are detailed in a six-page brochure. The booklet describes a process that can plate strip material on a continuous basis at high speed. Burton Research Laboratories.

CIRCLE NO. 371

## Silicons

The latest issue of the GE Silicone Digest (CDS-987) is available on request. The issue features three new GE product developments: higher strength, one-package RTV adhesive/sealants; heat-curing silicon potting and encapsulating compounds and new heat-cured silicon-rubber compounds with improved physical properties. Also included are articles on silicone applications. General Electric.

CIRCLE NO. 372

## Pollution control

One section of a 10-page bulletin deals with the use of dissolved oxygen measurement to reduce costs in waste treatment and pollution control. For one example it cites aeration as the largest single operating cost in activated sludge treatment; it then points out how the use of polarographic oxygen sensors for direct in situ measurement can control this operation and prevent excess aeration. Illustrated with graphs, diagrams and photographs, the brochure also outlines specific application requirements. Beckman Instruments, Inc.

CIRCLE NO. 373



# A Page From The History of Surveillance

Geese, highly sensitive by nature to intrusion, were used by the ancients as an enemy detection device. They are credited with saving Rome from invasion by barbarians.

Applied Technology is making history today as a quick reaction developer and manufacturer of sophisticated electronic warfare equipment. Our ECM products are noted for providing maximum utilization, easy upkeep and easy checkout. They have been employed with considerable effectiveness in Vietnam and are credited with saving many lives.

If you would like to be part of tomorrow's ECM achievements, call or write Applied Technology. ATI is conducting a talent search for rare individuals with Ability, Talent and Imagination.

Needed are electronic engineers, designers and technicians.

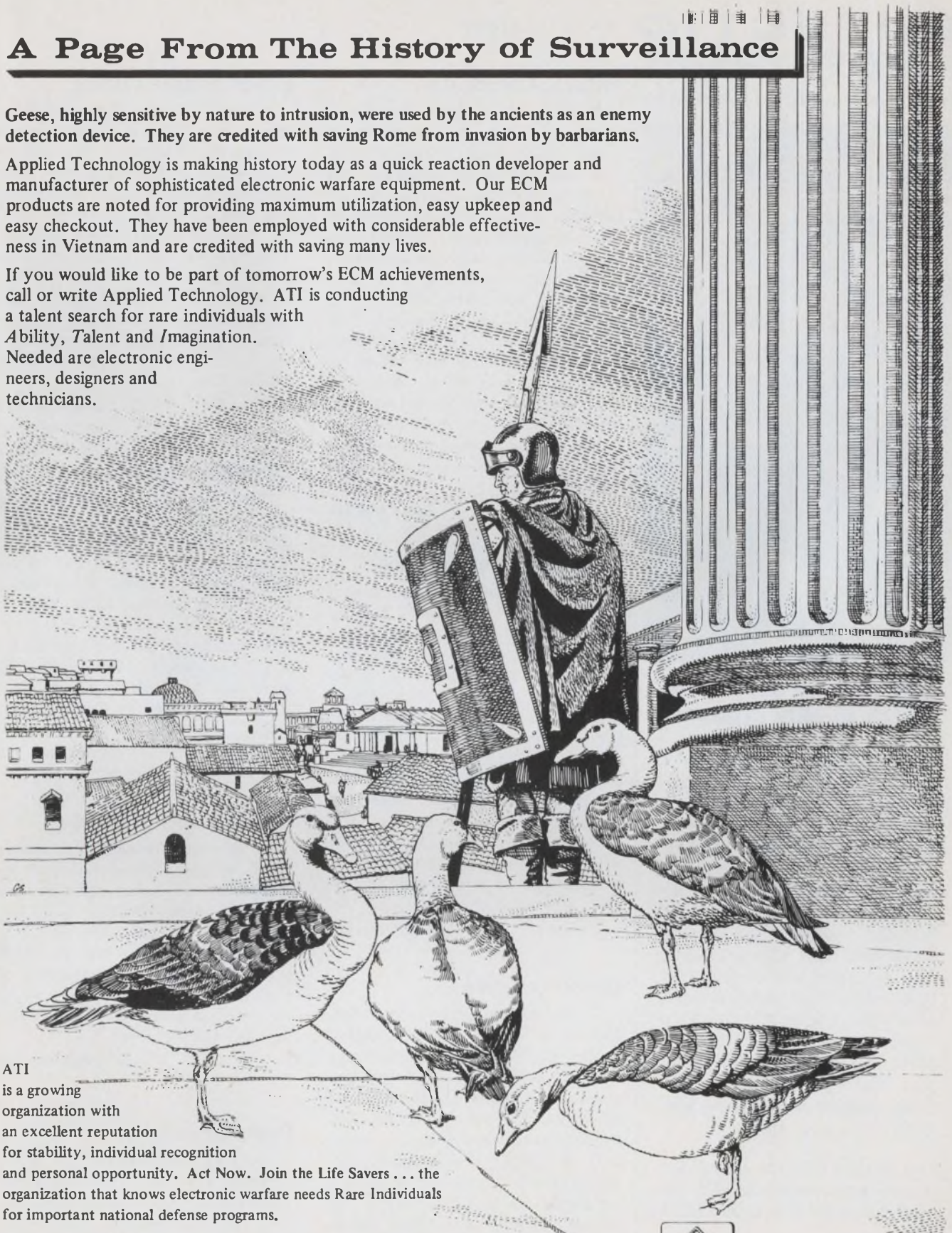

ATI is a growing organization with an excellent reputation for stability, individual recognition and personal opportunity. Act Now. Join the Life Savers... the organization that knows electronic warfare needs Rare Individuals for important national defense programs.

## APPLIED TECHNOLOGY

A Division of Itek Corporation

3410 HILLVIEW AVE. • STANFORD INDUSTRIAL PARK • PALO ALTO, CALIFORNIA



(415) 321-5135

An Equal Opportunity Employer

ELECTRONIC WARFARE SYSTEMS • MICROWAVE COMPONENTS • SPECIAL COMMUNICATIONS • AIRCRAFT MODIFICATION

INFORMATION RETRIEVAL NUMBER 86



# EUTECTIC PREFORMS

for semiconductor assembly



## with quality service to match quality products

CRM makes perfect preforms of eutectic alloys of Gold-Tin, Gold-Silicon, and Gold-Germanium.

CRM preforms can help you to produce perfect ICs, hybrids, transistors, and diodes. Quality is controlled from the ingot on, including not only standard tests, but also checks of foil surface finish and flow characteristics. The extensive die inventory at CRM makes most preforms available without delay and without a tooling charge.

CRM will meet your strictest specifications.

CRM delivers what it promises. CRM delivers on TIME.

*Call or write CRM for a quotation on your preforms or the CRM catalog with a list of over 300 stock dies.*

**CONSOLIDATED  
CRM REACTIVE  
METALS, INC.**

a Division of CONSOLIDATED REFINING CO., Inc.  
118 Hoyt Avenue, Mamaroneck, N.Y. 10543  
Tel: (914) 698-2300 □ TWX 710-566-1112

INFORMATION RETRIEVAL NUMBER 72

## NEW LITERATURE

### MOS/LSI brochure

A 44-page brochure describing MOS/LSI integrated circuits and other recent MOS IC products is now available upon request. The 8-1/2 by 11-inch reference guide provides a section on off-the-shelf MOS products and a second section on custom MOS arrays. Illustrative charts and diagrams accompany the text, which also gives specifications for a complete line of MOS circuits. Among the products, some of which are yet to be announced, are more than ten standard LSI circuits; and a representative cross-section of static and dynamic circuit designs to complement the LSI devices. Fairchild Semiconductor.

CIRCLE NO. 374

### Dc-to-dc power supplies

A 12-page bulletin describes a complete line of power supplies for photomultipliers, scintillation counters, Geiger-Muller tubes, ionization gauges, solid-state detectors, channeltrons, CRTs, image intensifiers, nuclear particle detectors, electrostatic deflection plates, digital and analog integrated circuits and operational amplifiers. Optimized for minimum ripple and output changes with line, load and temperature variation, the compact power supplies are packaged to survive over a wide range of operating environments. Velonex, Inc.

CIRCLE NO. 375

### Capacitor guide

A 68-page capacitor cross-reference is a handy tool for locating single, dual, triple and quadruple section replacement electrolytics quickly and easily. Units are listed in three different ways: the first permits selection by catalog number, the second is a complete listing by capacity, and the third is a complete electrolytic listing by voltage. There are three cross-reference sections, designed to solve selection problems. Also included is a complete listing by voltage of new wide-range tubular capacitors. Cornell-Dubilier Electronics.

CIRCLE NO. 376

### Power supply catalog

A comprehensive 56-page catalog of power supplies, instruments and systems for laboratory, test equipment and OEM applications gives detailed specifications and prices and complete ordering information for more than 300 power supplies. The new catalog includes a convenient selection guide that lists all models, with specifications and features to facilitate customer selection. Also shown are several system applications. Lambda Electronics Corp.

CIRCLE NO. 377

### Control computers

Two brochures that describe data acquisition and direct digital-control computer systems are available on request. This line of industrial control systems is designed to allow a knowledgeable user to set up and operate his own system. Both brochures provide system descriptions, function data, and software and application information. Honeywell Computer Control Division.

CIRCLE NO. 378

### Motor-speed controls

A 28-page catalog on motor speed controls gives detailed information on many brands and types. It covers three lines of motor speed controls, the Reliance line, the Bodine line and the B&B line. Also listed are hundreds of variable speed motors that can be used with the controls. B & B Motor and Control Corp.

CIRCLE NO. 379

### Power shears

Complete information on medium-gage capacity power squaring shears is offered in a 16-page bulletin. New accessories covered include a manual front-operated micrometer back gage and an automatic tripping device which increases output and assures consistently square cuts. Niagara Machine & Tool Works.

CIRCLE NO. 380



# Take a Good Look

( You'll Never Have To See  
Traces Like These Again )

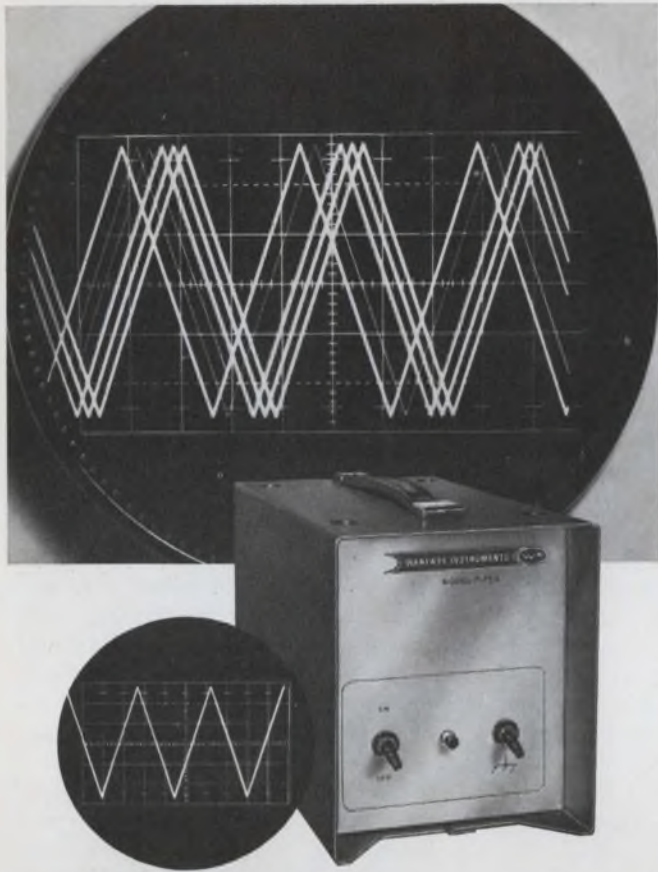

## Wanlass Scopac™

Scope Conditioner  
Eliminates AC Line Disturbances  
From Your Oscilloscope

Merely plug your scope into SCOPAC. Let it provide the necessary noise filtering of 50 db to 1 MHz and line regulation to ¼%. You can proceed immediately with consistent, accurate oscilloscope readings. Gone are problems associated with jitter, zero-line stabilization, false triggering (top photo above), jumping off scale, erroneous signals and readings caused by normal plant or laboratory AC-line disturbances.

SCOPAC Model P-TEK operates all 300, 400 and 500 Tektronix scopes as well as those from Hewlett-Packard, Dumont and other scope manufacturers. Available off-the-shelf, priced at \$375. Contact factory or local representative for literature.

See SCOPAC and PHASAC™, our new 1 to 3 phase converter, at IEEE March 25 in New York. Booths 4D11 and 4D13.

**WANLASS INSTRUMENTS**



a division of **WANLASS ELECTRIC COMPANY**  
A SUBSIDIARY OF **AMBAC INDUSTRIES INC.**

1540 EAST EDINGER AVENUE ■ SANTA ANA, CALIFORNIA 92707  
TELEPHONE (714) 546 1811 ■ TWX: 910-595-1526  
INFORMATION RETRIEVAL NUMBER 73

# 5 days

can do a lot for your next 5 years.

If you're involved in systems and equipment design, research, production or management . . . five days at one of our Seminars may make your next five years—and many more after that—much more productive.

More and more key management and high-level technical personnel from top companies all over the United States are attending RCA Institutes Seminars. Just as they are doing, you'll acquire information and techniques of immediate value in your work. You will also gain the kind of knowledge that can help build your professional standing in the years just ahead.

We believe we can increase your productivity by providing you with a firm grasp of many of the latest engineering techniques. Our experienced staff maintains constant contact with "what's happening" in industry. The texts and audio-visual materials are prepared exclusively by us for each seminar.

You can attend RCA Institutes Seminars around the country the year-round. Check your subject and send along the coupon for your brochure. Now—while you're thinking about it.

# RCA

**RCA Institutes, Inc. Dept. ELD-39**

Institute for Professional Development  
132 West 31st Street  
New York, New York 10001

For FREE descriptive brochure, check the Seminar in which you are interested:

- |  |   |
|--|---|
| <input type="checkbox"/> Logic Design                      | <input type="checkbox"/> Management Information Systems |
| <input type="checkbox"/> Digital Systems Engineering       | <input type="checkbox"/> Digital Communications         |
| <input type="checkbox"/> Modern Optics                     | <input type="checkbox"/> Digital Electronics            |
| <input type="checkbox"/> Integrated Circuits               | <input type="checkbox"/> Numerical Control Systems      |
| <input type="checkbox"/> Reliability of Integrated Systems |   |

Name \_\_\_\_\_

Title \_\_\_\_\_

Company \_\_\_\_\_

Address \_\_\_\_\_

City \_\_\_\_\_ State \_\_\_\_\_ Zip \_\_\_\_\_

INFORMATION RETRIEVAL NUMBER 74



# P/C Reed Relays

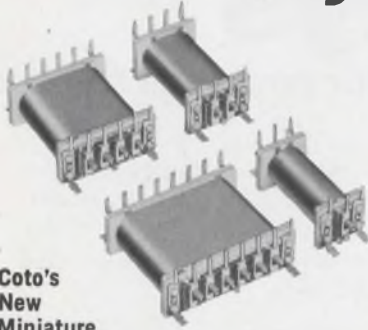

## Coto's New Miniature Series 1000

- Especially designed for P/C board applications
- Pin spacing 1" x .150" centers
- Stock voltages 6, 12, 24, 32 and 48 volts
- Form A contacts, up to 6 poles, ratings 10 watts
- Form C contacts, up to 4 poles, ratings 3 watts
- Form A mercury-wetted, up to 6 poles, ratings 28 watts
- Electrostatic and/or magnetic shields

Special voltages and resistances available, with multiple windings for flip-flop, memory and crosspoint selection applications.



**COTO-COIL COMPANY, INC.**  
54 Pavilion Avenue, Providence, R. I. 02905  
Tel: (401) 941-3355

INFORMATION RETRIEVAL NUMBER 75

## NEW! High Temperature LIQUID CRYSTALS

Now, it is possible to measure high temperatures to 135° C and within a fraction of a degree on almost any surface with Liquid Crystals. Experimental kits including all instructions and materials necessary for complete testing available. Write or call:

**FREE LITERATURE AND INFORMATION**

**VARI-LIGHT CORPORATION**  
9970 Conklin Road  
Cincinnati, Ohio 45242  
Phone: AC 513-791-1300



INFORMATION RETRIEVAL NUMBER 76

## NEW LITERATURE

### Copper specifications

A 32-page copper-alloy specifications guide contains a section listing the most generally used alloys with specifications by the ASTM, ASME, SAE, GSA and others. Another section lists specs in numerical order and describes each alloy according to its grade, type, temper and anneal, etc. Also included is an alloy listing that gives nominal chemical compositions. Anaconda American Brass Co.

CIRCLE NO. 381

### Pressure transducers

Pressure transducers, capable of withstanding severe environments and providing the latest advances in pressure measurement technology—from 1 psi to 10,000 psi—are described in a new general catalog. Detailed in the two-color catalog are absolute, gage, and differential pressure transducers, all designed to provide maximum reliability where high or low temperatures, high vibration and shock, and high pressure overloads are factors. Genisco Technology Corp.

CIRCLE NO. 382

### Semiconductor devices

Listing performance data on a wide range of special semiconductor devices, a brochure gives specifications on a broad line of npn and pnp silicon triple-diffused epitaxial power transistors. Solid State Devices, Inc.

CIRCLE NO. 383

### Industrial control

A free, illustrated catalog gives details on such products for the automotive field as electronic speedometers, hour meters, and others. It includes such industrial products as electronic counters, and maintenance meters for industrial applications. Engler Instrument Co.

CIRCLE NO. 384

### Indicator lights

Catalog L-209 provides complete data, drawings and ordering information for momentary and alternate action switches. Described are new pushbutton caps that are available in a full range of colors. Low-profile, snap-in mounting bezels, with or without barrier, are available in a choice of four colors. Rectangular bezel units are interchangeable with most 4-lamp displays. The light source is the incandescent T-1-3/4 bulb, with midget flanged base in a range of voltages up to 28 V. Dialight Corp.

CIRCLE NO. 385

### Automation computer

A 20-page technical brochure on an automation computer can assist system designers in configuring automatic control systems from functional off-the-shelf building blocks. The new brochure presents detailed information on the computer's organization, addressing, instruction repertoire and classes, software, I/O systems, system interface units, fail-safe options, specifications and ordering information. Features of the processor's automation safety measures, and automation executive provisions are fully described and illustrated. General Automation, Inc.

CIRCLE NO. 386

### Charge amplifier

Color-coded status indicator display, nonambiguous range-switching, multiple-level calibration and sine/random selection are among a broad array of user-oriented design features that are detailed in a six-page brochure on a new charge amplifier. The advanced-design charge amplifier also offers a choice of three different output levels, improved sensitivity range, low noise and wide frequency response in a single coordinated package. Complete electrical, environmental and physical specifications, optional equipment, accessories and prices of the model 2720 are included. Endeveco.

CIRCLE NO. 387



Now  
For The  
First Time

You can completely design,  
layout, construct and test  
your most intricate new  
circuitry with the dynamic  
elite 1

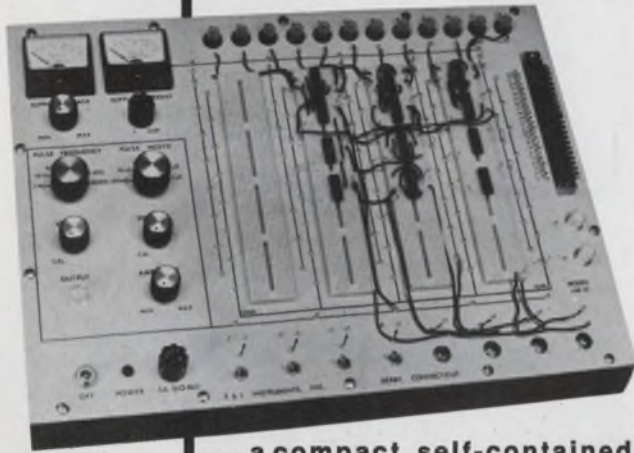

... a compact, self-contained,  
general-purpose Electronic  
Testing Laboratory for \$650.00



EL Instruments Incorporated  
61 First Street, Derby, Connecticut 06418 Telephone: 203-735-8774

INFORMATION RETRIEVAL NUMBER 77



Our family plan makes motor variations  
unlimited.

Indiana General's Family Plan concept provides an unlimited variety of motor characteristics from five sizes of PM and WF motors. We simply vary such factors as stack lengths and windings. And for just a fraction more than standard units cost, in any quantity.

IGC has also put an end to blind specifying, by providing *all* characteristics for your specified motor through *actual tests*. So you save considerable system development time, and get just what you order.

We'll send you specifying forms, and complete data on our standard 2 1/4, 3 1/4, 4, 4 1/2 and 5" motors. Write Mr. R. D. Wright, Manager of Sales, Indiana General Corporation, Electro-Mechanical Division, Oglesby, Ill. 61348.

**INDIANA GENERAL**  We make it easy  
for the design engineer.

INFORMATION RETRIEVAL NUMBER 78

ELECTRONIC DESIGN 5, March 1, 1969

# Your inductor sources aren't complete without Dale's new catalog



Think Dale—if you design or specify for circuits using inductive components. Long a source of custom-built inductors, Dale's Sioux Division has expanded its production to include a broad line of standard inductors and transformers. This rapidly growing line is described in our new catalog. It includes:

**MINIATURE SHIELDED TUNABLE** 3/8" round and 1/2" square models meet MIL-C-15305C, Grade 2, Class O.

**MINIATURE UNSHIELDED TUNABLE** Vertically and horizontally tuned models meet MIL-C-15305C, Grade 2, Class B and O.

**MINIATURE UNSHIELDED FIXED** Toroidal and bobbin versions meet MIL-C-15305C, Grade 2, Class O.

**TRANSFORMERS • INDUCTORS** Hermetically sealed versions meet MIL-T-27B, Grades 1 and 4, Class Q, R, S, V. Encapsulated versions for Grades 2 and 5, Class Q, R, S, V.

**SERIES RESONANT TRAPS** Combining the electrical characteristics of an inductor and a capacitor in series. Standard models: 10.7, 12, 14, 18 MHz.

Send for new Dale Inductor Catalog today — for price, delivery and custom design information phone 605-665-9301 or write:

**DALE ELECTRONICS, INC.**  
**SIoux DIVISION** Dept. ED  
Yankton, South Dakota 57078



INFORMATION RETRIEVAL NUMBER 79

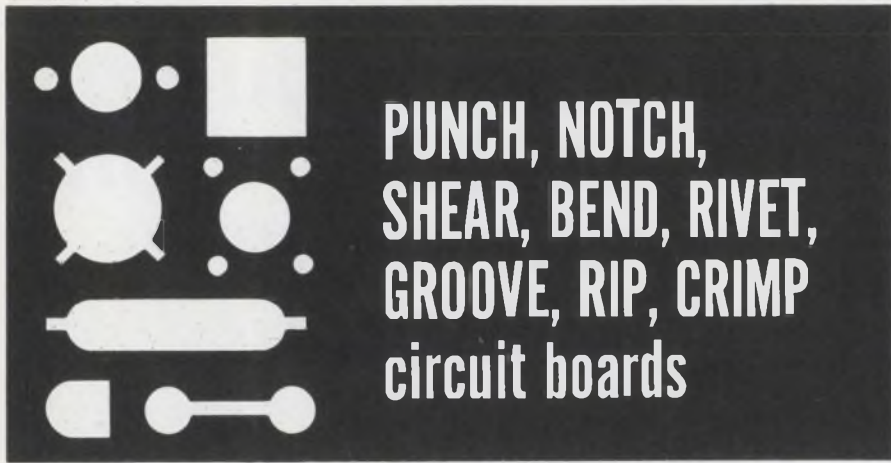

# PUNCH, NOTCH, SHEAR, BEND, RIVET, GROOVE, RIP, CRIMP circuit boards

Sheet metals of all kinds and gauges can be worked and formed with ease using Whitney-Jensen hand tools. You have great flexibility of application when breadboarding or designing prototypes.



**Free** Ninety pages of information on metalworking tools are yours for the asking. Hand, bench, floor, manually operated, foot-operated and power tools are detailed along with standard and special dies.

WHITNEY METAL TOOL COMPANY  
2833 HUFFMAN BLVD.  
ROCKFORD, ILLINOIS 61101

**WHITNEY-JENSEN**

INFORMATION RETRIEVAL NUMBER 80

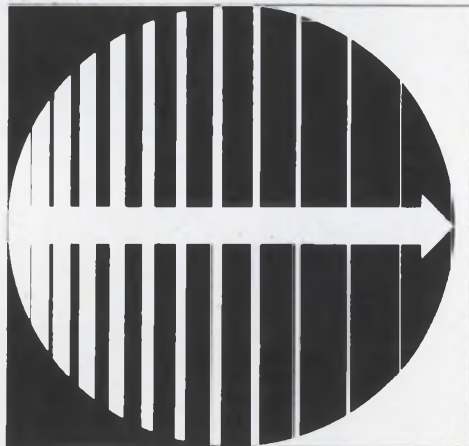

**Nobody  
knows enough!  
Not even you!**

Products, materials, methods.  
Technological innovations.  
Hanover's credo: Important  
trade fairs in one place  
at one time.  
Information. Contacts.  
Know more. Do better.

**You must visit!**



For information, room reservation forms and admission tickets:  
**German American Chamber of Commerce**

666 Fifth Avenue  
New York, N.Y. 10019  
(212) 582-7788

77 E. Monroe Street  
Chicago, Ill. 60603  
(312) 782-8557

INFORMATION RETRIEVAL NUMBER 81



## Delay line catalog

Fixed, variable, lumped-constant and distributed-constant electromagnetic delay lines are described in a 12-page catalog. Virtually a manual for specifying delay lines, it gives definitions and formulas for delay time, risetime, pulse attenuation, pulse amplitude, characteristic impedance and bandwidth. Factors affecting cost are also discussed. In addition, the catalog covers a wide variety of standard delay lines and provides a form to facilitate design of custom units. JFD Electronics Co.

CIRCLE NO. 388

## Relay buying guide

A 12-page brochure covering the selection of relays includes information on trade-offs in selection, including many cost-saving practices. A relay ordering checklist also is included to answer most questions asked in fitting a relay to a particular application. Cornell-Dubilier Electronics.

CIRCLE NO. 389

## Computer careers

A 24-page booklet provides detailed information on careers in the design, production, and marketing of computers. It traces the rapid, continuing growth of the computer industry, explains the techniques of information processing, describes the types of job available and summarizes the qualifications. Business Equipment Mfr. Assoc.

CIRCLE NO. 390



## Microwave devices

A new short-form catalog describes a line of high-power and medium-power traveling wave tubes, TWT amplifiers, backward-wave oscillators, solid-state devices and lasers. Separately printed catalogs are also available on the TWTA and laser product lines. Hughes Electron Dynamics Div.

CIRCLE NO. 391



## Emi filters

A new series of subminiature emi filters for ac applications is described in a six-page brochure. The ceramic dielectric capacitor elements used in these filters have a low temperature coefficient for capacitance. A curve has been included in the engineering bulletin which illustrates the minimal effect of temperature on the insertion-loss characteristics over the complete operating range. Sprague Electric Company.

CIRCLE NO. 392

## Quartz crystals

A listing of low and high frequency quartz crystals, in a range from 90 kHz to 210 MHz, is given in a new bulletin. Available in a range of 16 sizes and types of holders, the crystals are both standard and custom units that are suited for a wide variety of applications. The bulletin gives complete specifications and dimensional data. Tedford Crystal Labs.

CIRCLE NO. 393

## Modular cabinetry

A 28-page catalog of modular cabinetry lists rugged cabinets for rack-mounting electronic equipment. The illustrated catalog covers four basic types of frames: straight front, slope front, wedge and sloping wedge. The catalog also details the wide range of options available in the line: plain and louvered panels and doors; individual and multiple bases; shelves and drawers, and fixed or retractable writing surfaces. Cabinets are offered in 100 optional colors. Honeywell Apparatus Controls Division.

CIRCLE NO. 394

## Laminated metals

A six-page brochure describes how laminated metals offer engineers the opportunity to achieve production economy by eliminating the staking or welding of rivets. Case histories illustrate the application of laminates in electrical, electronic, appliance and automotive devices. Schematic drawings show laminated metals in sheet, strip, wire and tubing. General manufacturing specifications for each mill form are given along with suggested hardness ranges for common laminated sheet combinations. Improved Seamless Wire Company.

CIRCLE NO. 395

## Microwave ICs

The 1969 edition of a 24-page component catalog lists several new product advances. Microwave integrated circuits are shown for the first time. Both ferrite and ceramic substrates are employed to realize fully integrated circulators, phase shifters, mixers and complete operating transmitters, as well as hybrid arrays that combine several functions. Also included are solid state signal sources, isolators, circulators, duplexers, phase shifters and equalizers. Sperry Microwave Electronics Div.

CIRCLE NO. 396

Another Exclusive from  
Sigmund Cohn Corp.

like  
this ...



not  
this ...



# me

## Spools for Total Quality Control of Gold Bonding Wire ...

Most efficient way to deliver Gold Bonding Wire is on Stainless Steel Spools ... Our staff developed the idea of Matched Expansion Spools exclusively for this purpose ... The spools have an expansion coefficient closely conforming to the Gold Wire ... When the wire is wound on M.E. spools tension and pitch are fully controlled so that it always stays put — cannot shift or slip ... Provides extra economy by substantial reduction of scrap. Every production step is checked to be sure that each foot of wire meets our high standards. Write for data.



Single or Multi-layer

**Sigmund Cohn Corp.**

121 So. Columbus Ave.  
Mount Vernon, N. Y. 10553



Since 1901



ELECTRONIC DESIGN's function is:

- To aid progress in the electronics manufacturing industry by promoting good design.
- To give the electronic design engineer concepts and ideas that make his job easier and more productive.
- To provide a central source of timely electronics information.
- To promote two-way communication between manufacturer and engineer.

**Want a subscription?** ELECTRONIC DESIGN is sent free to qualified engineers and engineering managers doing design work, supervising design or setting standards in the United States and Western Europe. For a free subscription, use the postfree application form inside the back cover. If none is included, write to us direct for an application form.

If you do not qualify, you may take out a paid subscription for \$25 a year in the U.S.A., \$35 a year elsewhere. Single copies are \$1.50 each.

**If you change your address,** send us an old mailing label and your new address; there is generally a prepaid postcard for this inside the back cover. You will have to requalify to continue receiving ELECTRONIC DESIGN free.

**The accuracy policy** of ELECTRONIC DESIGN is:

- To make reasonable efforts to ensure the accuracy of editorial matter.
- To publish prompt corrections whenever inaccuracies are brought to our attention. Corrections appear at the end of the Letters column.
- To refuse any advertisement deemed to be misleading or fraudulent.

Microfilm copies are available of complete volumes of ELECTRONIC DESIGN at \$19.00 per volume, beginning with Volume 9, 1961. Work is now in process to complete the microfilm edition of Volumes 1-8. Reprints of individual articles may be obtained for \$2.00 each, prepaid (\$ .50 for each additional copy of the same article) no matter how long the article. For further details and to place orders, contact the Customer Services Department, University Microfilms, 300 North Zeeb Road, Ann Arbor, Michigan 48106; telephone (313) 761-4700.

**Want to contact us?** If you have any comments or wish to submit a manuscript or article outline, address your correspondence to:

Howard Bierman, Editor,  
ELECTRONIC DESIGN,  
850 Third Avenue,  
New York, N.Y. 10022.

# Design Data from

## Free — Brushless Torque Motor Guide



A comprehensive guide to the Aeroflex line of Brushless DC Torque Motors, DC Moving Coil Torque Motors, DC Tachometers, DC Torquer/Tachometers and DC Torquer Amplifiers. Includes a concise, definitive evaluation of the "Brushless" concept, its benefits and application directions. Complete specification guide of typical types, related performance curves and a "Table of Conversion Factors" provide the Design Engineer of Direct Drive DC Devices with the graphic facts to make specifying decisions.

**Aeroflex Laboratories Incorporated**  
South Service Road  
Plainview, L.I., N.Y. 11803

174

## How To Write Technical Articles



A guide for the engineer-author, "How to Write Articles for Electronic Design" shows how easy it is to write for publication—once the engineer knows what to write and how to write it. The Author's Guide includes a complete run-down of the types of articles published by Electronic Design—plus detailed instructions on how to prepare technical articles and short special features. A MUST for every "would-be-writer" in the electronics industry. Send for your complimentary copy by circling the number to the right.

**Electronic Design**  
850 Third Avenue  
New York, N.Y. 10022

175

## FUNDAMENTALS OF INTEGRATED CIRCUITS

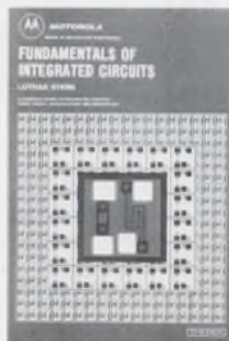

A practical guide to integrated circuits, their theory, manufacture, and applications. This new guide by Lothar Stern offers complete, highly readable coverage of the various techniques of circuit fabrication, and their effect on circuit design and performance. As to marketing considerations, it compares the characteristics of the numerous IC structures devised to date in terms of economics and logistics. A volume in the **Motorola Series in Solid-State Electronics**. 198 pages, 7 x 10, illustrated. \$8.95, clothbound. Send for 15-day examination copies.

**Hayden Book Company, Inc.**  
116 West 14th Street  
New York, N.Y. 10011

176



# Manufacturers

Advertisements of booklets, brochures, catalogs and data sheets. To order use Reader-ServiceCard (Advertisement)

## Quality Fasteners For All Designs



This 8-page catalog provides design data on the complete group of DZUS 1/4-turn self-locking fasteners for standard, high speed and panel applications, as well as universal high strength multiple thread fasteners for high tensile and shear stresses. Dzus stud assemblies, wire forms and receptacles offer an exceptional, wide variety of combinations from stock to fit specific fastening requirements. Diagrams and tables give full details for rapid, unlimited design selection. Condensed or complete Catalog available on request.

**Dzus Fastener Co., Inc.**  
425 Union Boulevard  
West Islip, L. I., N. Y. 11795

177

## Bus Bars For Noise Reduction

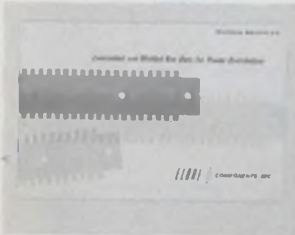

A 16 page Technical Bulletin is now available, describing a new concept in power or signal distribution. Basic mechanical and electrical design principles, along with descriptive pictures and diagrams, are included in this bulletin. These compact buses can replace bulky cable harnesses and repetitive wiring for computer or modular application. This method of construction satisfies the demanding requirements of low inductance and resistance of high speed, solid state systems, while controlling electrical noises.

Send For Free Sample

**Eldre Components, Inc.**  
1239 University Avenue  
Rochester, New York 14607

178

## A FREE Cross Reference Guide



to better Printed Circuit drafting

No engineer or draftsman should be without the NEW By-Buk Printed Circuit Drafting Aids P-45 Catalog with color-coded MIL-SPEC sizes. Also contains over 2000 pads, shapes, tapes, transistor tri-pads, spaced integrated circuit terminal pad sets and many other drafting aids for faster, more accurate, distortion-free printed circuit master drawings. Send for your FREE catalog.

**By-Buk Company**  
4326 West Pico Blvd., Los Angeles, Calif. 90019  
Telephone: (213) 937-3511

179

# Electronic Design

## Advertising Sales Staff

### New York 10022

Robert G. Drake  
Sales Manager  
Edward F. Clancy  
Sales Service Manager  
Robert W. Gascoigne  
Thomas P. Barth  
Samuel M. Deitch  
Byron Adams  
850 Third Avenue  
(212) Plaza 1-5530  
TWX: 867-7866

### Philadelphia 19066

William C. Repetto  
P. O. Box 206  
Merion Station, Pa.  
(215) MA-3-5888

### Boston 01945

Richard Parker  
P.O. Box 645  
Clifton Station  
Marblehead, Mass.  
(617) 742-0252

### Chicago 60611

Thomas P. Kavooras  
Berry Conner, Jr.  
200 East Ontario  
(312) 337-0588

### Cleveland

(216) 247-7670

### Los Angeles 90303

Stanley I. Ehrenclou  
John V. Quillman  
W. James Bischof  
2930 Imperial Highway  
Inglewood, Calif.  
(213) 757-0183

### San Francisco 94022

Arthur R. Shields, Jr.  
175 San Antonio Rd., S 243  
Los Altos, Calif.  
(415) 941-3084

### London W. 1

For United Kingdom & Holland  
Brayton C. Nichols  
44 Conduit Street  
Tel: REGent 4714

### Verviers, Belgium

For Continental Europe  
Andre Jamar  
1, Rue Mallar, 1  
(087) 253.83 Telex 41563

### Tokyo

Yoshihiro Takemura  
IPS Group Ltd.  
Box 36, Ohsaki Post Office  
Phone (431) 5804



# New High Voltage High Power Rectifiers

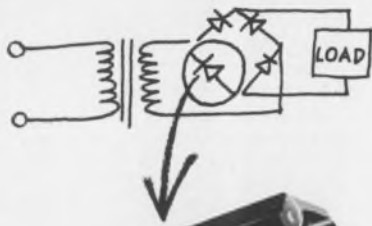

## VC Series from Varo.

Our new VC Series rectifiers may be tiny (3" long, 3/4" high, 3/4" wide), but they're plenty tough enough to stand up under high voltage, high power conditions.

They have voltage ratings of from 2 KV to 8 KV, current ratings of 1 to 2 amps, and they're available with an optional 300 nanoseconds recovery time.

Varo VC Series rectifiers are made to handle the biggest jobs. Like X-ray power supplies, radio and radar transmitters, and things like the new microwave oven power supplies.

And they'll handle most of the new high voltage, high power system demands that'll be coming along in the future, too.

The new VC Series from Varo. It's the kind of thing we know you've come to expect from us.

### \$4.18 EACH

VC-80 (8,000 Volts — 1 Amp).  
1,000 quantity.



**VARO**

**SEMICONDUCTOR DIVISION**  
1000 N. SHILOH ROAD, GARLAND, TEXAS  
75040 (214) 272-4551

INFORMATION RETRIEVAL NUMBER 84

## Advertisers' Index

Advertiser	Page	Advertiser	Page
Abbott Transistor Laboratories Incorporated	14	Leach Corporation	96 A-B
Acopian Corp.	132	Lear Siegler Inc., Cimron Division	Cover 111
Aeroflex Laboratories, Incorporated	144	Littlefuse	120
Air France	147	Lockheed Electronics Company	35
Allen-Bradley Co.	91, 93	Lorch-Adret Corp.	16
Applied Technology A Division of Itek Corporation	137		
Augat, Inc.	124	Mepco, Inc.	34
Automated Control Technology	114	MicroSwitch, A Division of Honeywell	86, 87
		Miller Company, J. W.	110
Babcock Relays, Division of Babcock Electronics Corporation	99	Mohawk Data Sciences Corporation	11
Beckman Instruments, Inc., Helipot Division	89	Monsanto Company	95
Beta Instrument Corp.	97	Motorola Semiconductor Products, Inc.	16 A-H
Boonton Electronics Corp.	115		
Bourns, Inc.	43	National Beryllia Corporation	121
By-Buk Company	145	National Semiconductor Corporation	58, 59
Centralab, the Electronics Division of Globe-Union, Inc.	40	RCA Electronic Components and Devices	8, 9, 67, Cover IV
Chassis-Trak Inc.	33	RCA Institutes, Inc.	139
Cinch Manufacturing Company	7	Radiation, Incorporated	46
Clairex Electronics, Inc.	119		
Cohn Corp., Sigmund	143	Schweber Electronics	17
Consolidated Reactive Metals, Inc.	138	Servometer Corporation	125
Coors Porcelain Company	133	Setra Systems, Inc.	126
Coto Coil Company, Inc.	140	Shaffstall Ball Corporation	120
		Signetics Integrated Circuits, A Subsidiary of Corning Glass Works	27, 127
Dale Electronics, Inc.	141	Siliconix Incorporated	12, 13
Damon Engineering, Inc.	24	Simpson Electric Company	111
Data Products Corporation	4, 5	Singer-General Precision	
Deutsch Filters Industrial Products	81	Kearfott	116 A-X, 117
Direct Access Computer Corporation	124	Sprague Electric Company	18, 20
Dzus Fastener Co., Inc.	145	Stackpole Carbon Company	48
		Sylvania Electric Products, Inc.	45
EL Instruments, Inc.	141	Syston-Donner Corporation	2
ESI/Electro Scientific Industries, Inc.	10		
Eastman Chemical Products, Inc.	106	TRW, Inc., Capacitor Division	105
Edal Industries, Incorporated	129	Tektronix, Inc., Oscilloscopes	48 A-B-C-D
Elasco, Incorporated	122	Telonic Instruments, A Division of Telonic Industries, Inc.	135
Eldre Components, Inc.	145	Thermal American Fused Quartz Co., Inc.	108
Electronic Design	128, 144	Tyco Laboratories, Inc.	31
Electronic Measurements, A Division of Rowan Industries	80 A-F		
		United Aircraft Corporation, Electronic Components Division	15
Fairchild Controls, A Division of Fairchild Camera and Instrument Corporation	6	United Transformer Co., Division of TWR, Inc.	Cover 11
		Unitrode Corporation	29
General Radio Company	102		
German American Chamber of Commerce	142	Vari-Light Corporation	140
Gulton Industries, Inc.	37	Varo Inc.	146
		Victory Engineering Corporation	44
Hayden Book Company, Inc.	123, 144		
Hewlett-Packard	1, 39	Wang Laboratories, Inc.	131
Hi-G, Inc.	109	Wanlass Electric Co.	139
		Whitney Metal Tool Company	142
Indiana General Corporation	74, 75, 141		
International Rectifier Co.	23	Zeltex, Inc.	113
JFD Electronics Co./Components Division	107	Career Advertising	
		Lockheed-California Company	100
Kearfott Products Division, Singer-General Precision, Inc.	116A-X, 117		
Kurz-Kasch, Inc.	112		



# The Air France guide to European markets

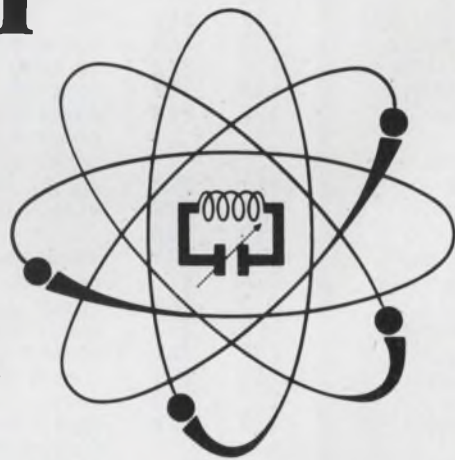

## The International Exhibition of Electronic Components

Paris March 28-April 2, 1969

Once again Air France is happy to be the official carrier for the Show, with a ticket reservation and Welcome Service counter on the Show grounds for overseas visitors.

Fly to Paris on Air France 707 Intercontinental jets and enjoy the finest in French food and wines, and unexcelled service.

Direct service from New York, Chicago, Los Angeles, Washington and Boston.

For information and reservations, see your travel agent or call the Air France office nearest to you.

**AIR FRANCE**  
We know where you're going.







## Cimron's new Word Generator gives you up to 16,320 bits—and you pay only by the word!

The message is simple: this all-IC Word Generator is the last word in pushbutton programming flexibility—but plug-in design insures that you don't have to buy a bit more than you can use. Up to nine plug-ins, each providing a serial word of data from 1 to 16 bits are available—and up to four repeat controls. These can be installed in combination to give you the precise output you want—fast, slow, or very complex. With four repeat controls, this word generator can deliver up to 16,320 bits—repeatable up to

225 times on a bit by bit, single word or continuous basis as selected. Digital period control has a range of 0.2 Hz to 5 MHz, continuously variable. RZ or NRZ modes; 10 ns rise and fall, 10 ns to 100 ms delay and width. By cascading repeat controls, repeats of up to 1,020 times can be achieved. As always, Cimron's *customer concern* gives you what you need at the lowest possible price. For details on Model 3903, write Cimron, Dept. C-124, 1152 Morena, San Diego, California 92110.

LEAR SIEGLER, INC.



CIMRON DIVISION



# The RCA QUANTACON Photomultiplier First with a Gallium Phosphide Dynode— Offers Order of Magnitude Improvement in Electron Resolution

Electron Resolution Capability of photomultipliers formerly attainable.

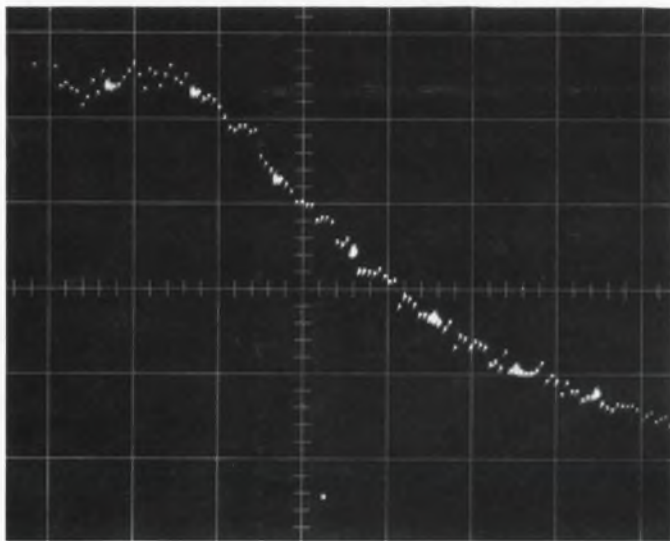

1e 2e 3e 4e 5e 6e  
Pulse Height-Photoelectron Equivalents

Electron Resolution Capability of RCA—C31000D.

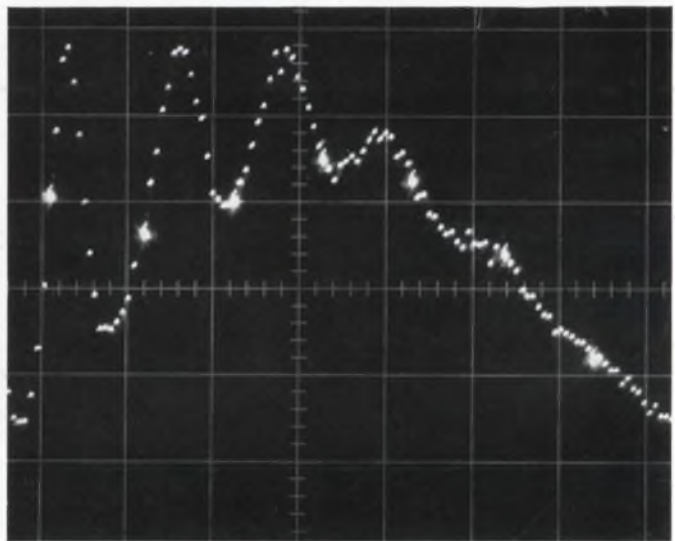

1e 2e 3e 4e 5e 6e  
Pulse Height-Photoelectron Equivalents



It's new... even revolutionary! It's the QUANTACON—a photomultiplier employing a new dynode material for extremely low-light-level applications, such as photon and scintillation counting, with a pulse height resolution so outstanding you can distinguish with ease single, double, triple, and quadruple photoelectron events.

Gallium Phosphide does it! Providing up to an order of magnitude increase in gain over conventional dynode materials, this gallium phosphide approach must be considered at the forefront of new photomultiplier designs for greatly improved low-light-level performance. In addition to improvements in electron resolution, Gallium Phosphide promises lower values of rise time and transit time in future photomultiplier designs.

RCA-C31000D is a 12-stage, bialkali, photocathode type photomultiplier utilizing Gallium Phosphide as the first dynode secondary emission material. At a cathode to dynode No. 1 voltage of 900 volts, the first dynode secondary emission ratio is typically 45.

For more information on RCA Photomultipliers and QUANTACON in particular, see your RCA Representative. For technical data, write: RCA Electronic Components, Commercial Engineering, Section No. Q-18C1, Harrison, New Jersey 07029.

RECEIVED  
MAR 5 1969  
CALMA CO.

**RCA**