

Electronic Design 26

VOL. 16 NO.

FOR ENGINEERS AND ENGINEERING MANAGERS

DEC. 19, 1968

Radio astronomers probe the sky for mysterious sources of radio energy. The search for signals from distant pulsars, quasars and galaxies demands powerful new

electronic tools. Interferometer antennas, on-line computers and sensitive autocorrelation receivers are helping scientists to map the universe. For details, see p. 25

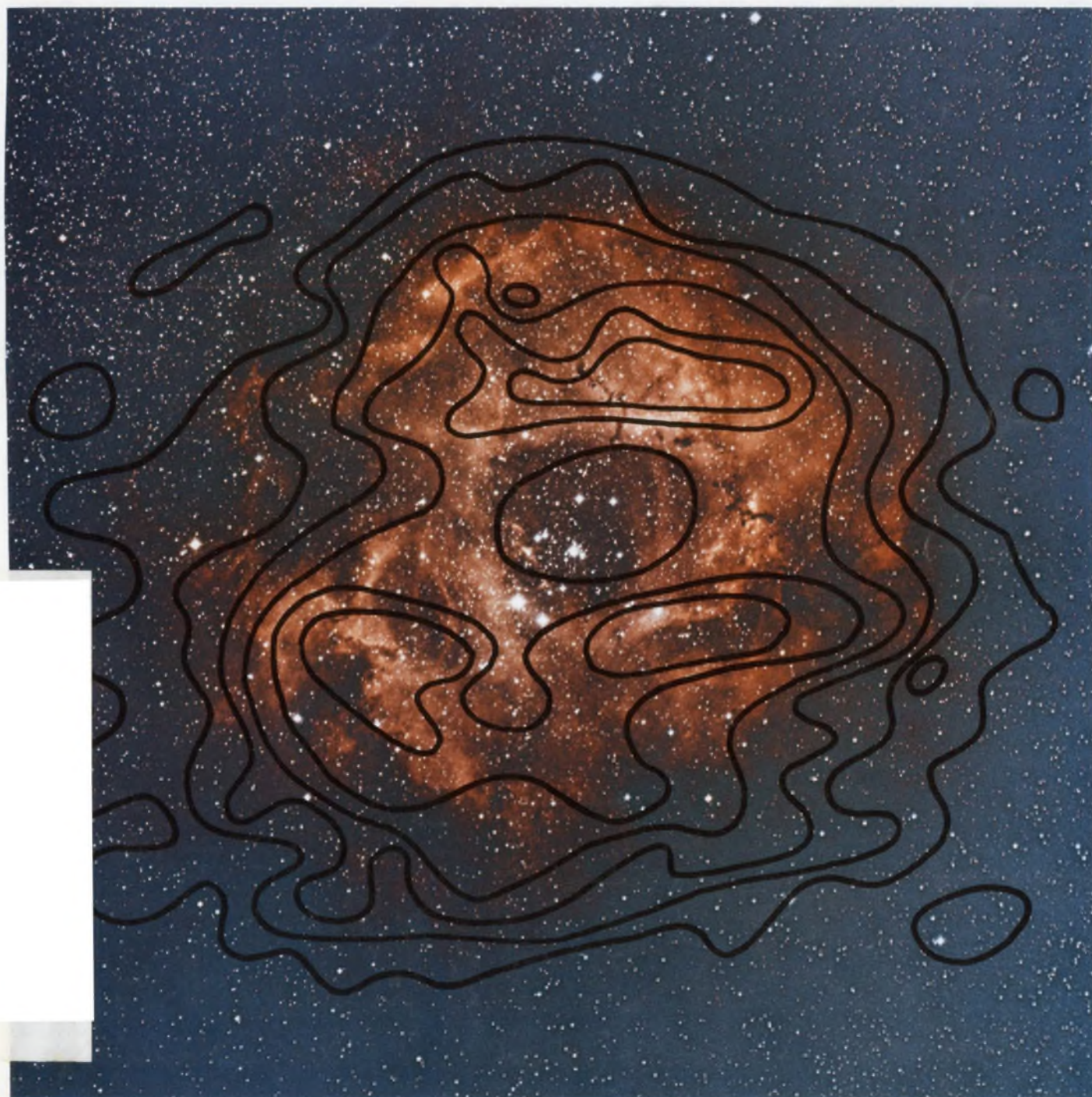

Supercalifragilisticexpialidocious...

If it only were so!

Wouldn't it be nice if all you needed to make your measurements was one instrument? The modern oscilloscope comes as close as possible. Scopes today, for example, are being used as voltmeters, frequency meters, spectrum analyzers and a multitude of other instrument functions.

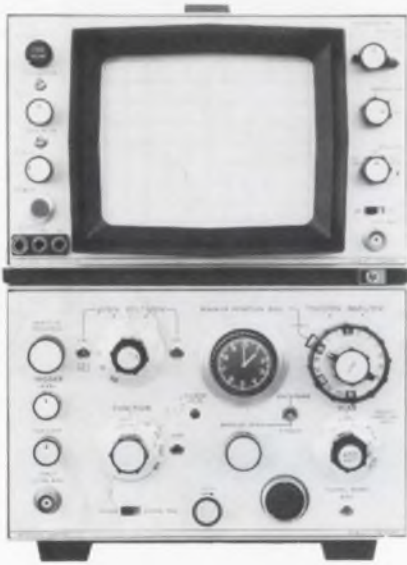

The state-of-the-art HP 180 scopes already extend from dc to 100 MHz *real time*. Use the 180 as a sampling scope, and you can see up to 12.4 GHz. You can vary persistence so you can see changes in traces—or you can store traces for days, if you want. The 180 does have state-of-the-art design and plug-in versatility. It does give you measurement information that is available only by looking at a CRT.

But... much as we hate to admit... it is not the universal instrument we'd like it to be! *Occasionally*, you need to use the 180 with other instrumentation.

How many times have you been frustrated matching a balanced input with an unbalanced output? Didn't work too well, did it? This happens time and again when you use your scope as the core of your instrumentation set-up with several manufacturers supplying your instruments.

You won't find this condition with the HP 180 system and HP manufactured equipment. Your HP field engineer has a complete line of more than 1500 compatible instruments from which you can design your measurement system.



For example, if you're interested in low frequency wave analysis, ask your HP field engineer about the HP 3590A with automatic sweeping plug-in. It'll make distortion, filter, noise, sideband, and spectrum measurements previously unattainable. You can see the results on your 180 CRT—and you can get a permanent plot of what you've seen with an HP X-Y plotter.



Suppose you want a digital display of horizontal or vertical information along with your oscilloscope display? Your HP field engineer offers a large choice of digital voltmeters and digital counters.

And—if you need a special configuration of the 180 scope to get the complete compatibility and configuration you need to match your instrument system's requirements, contact your nearest HP field engineer.

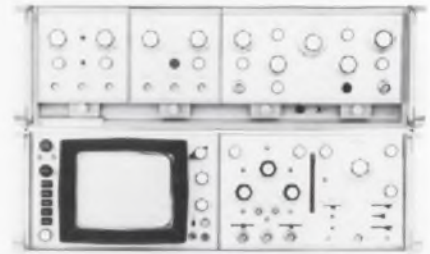

As you know, the accuracy and reliability of your measurement system depends on the quality and compatibility of your scope and your signal source. Your HP field engineer has any type of signal source you may need—power supplies, oscillators, pulse generators and function generators—sine, square, sawtooth signals.

Pick up your phone and talk to your local HP field engineer. Why? Because he's a complete instrumentation analyst who can do a lot more than recommend a scope. He can recommend from a group of over 1500 electronic measuring instruments. Much as we both would like, the real measurement world is not supercalifragilisticexpialidocious — it's seldom a simple one instrument buy. It may focus on a scope, but odds are you will need peripherals to make your system complete.

When your job depends on your measurements, when your reputation rests on your purchases, when you want maximum performance per dollar invested, your HP field engineer is a man you can rely on. Call him today.

089/5

STEP FORWARD

HEWLETT  PACKARD

OSCILLOSCOPE SYSTEMS

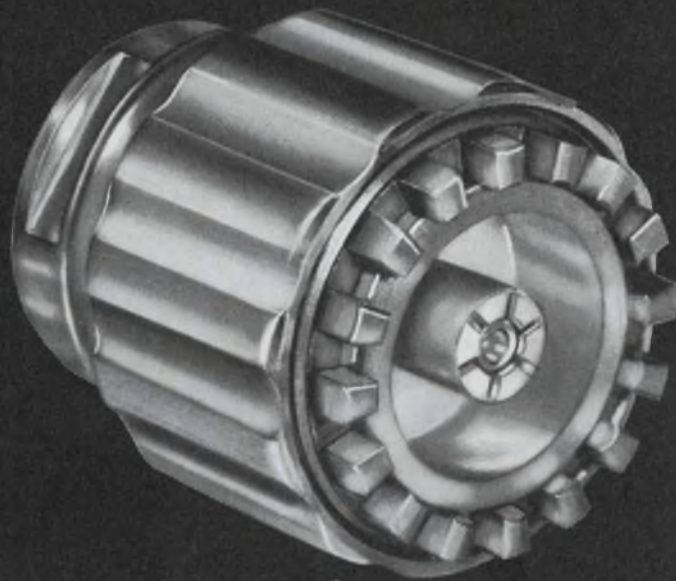

Break Performance Bottlenecks

When you're looking for every bit of precision from a coaxial system, ordinary connectors become the limiting factors. You can break these performance bottlenecks with the GR900® connector and its family of precision components.

The GR900 connector, with unexcelled electrical characteristics in the dc-to-8.5 GHz frequency range, meets all specifications of IEEE 287, Standard for Precision Coaxial Connectors (50-Ω, 14-mm size). VSWR is guaranteed to be no greater than $1.001 + 0.001f_{\text{GHz}}$ for both single connectors and calibrated pairs. Its excellent VSWR and insertion-loss repeatability (typically within 0.03% and 0.002 dB, respectively, for a pair of connectors) allows extremely high accuracy in attenuation and other substitution measurements. It has a precisely defined electrical reference plane, an important feature for phase and impedance measurements. And its leakage of better than 130 dB below signal level makes it the "coolest" coaxial connector in use today.

GR900 stands for more than just a precision connector. It also designates an ever-growing family of precision coaxial com-

ponents that includes adaptors, terminations, reference lines, attenuators, impedance standards, and tuners. Sixteen precision adaptors mate the GR900 to 10 other popular connectors, with even lower VSWR than found in their "natural" matings. They make it possible to take advantage of GR900 precision in measurements on systems and components fitted with other connectors. An immittance bridge and a slotted-line/recorder assembly bring GR900 precision to routine microwave measurements.

It's no wonder that so many GR900 connectors are replacing bottlenecks . . . try them in your most demanding coaxial requirements.

For complete information, write General Radio Company, West Concord, Massachusetts 01781; telephone (617) 369-4400. In Europe: Postfach 124, CH 8034, Zurich 34, Switzerland.

GENERAL RADIO

INFORMATION RETRIEVAL NUMBER 2

LF

MF

HF

VHF

UHF

SHF

First counters to operate automatically across the VHF gap.

Until now you couldn't make simple, automatic frequency measurements from 100 to 300 MHz without a special VHF plug-in. The extra plug-in was clumsy in the lab. And when switching plug-ins was impossible—as in automatic console systems—the VHF gap was unavoidable. Now two self-contained Systron-Donner counters span the VHF gap, operating automatically from DC to the microwave region.



Non-stop DC to 12.4 GHz. The VHF gap is filled by a built-in prescaler in this new Thin Line counter. The instrument operates just like a simple frequency counter across the board from DC to 12.4 GHz. You merely connect the signal and read the final answer on the display. Built with IC's to take only 1-3/4" of rack space and operable by remote control, it is the ideal instrument for automatic systems.



Non-stop DC to 3 GHz. New ACTO® plug-in with built-in prescaler carries this counter across the VHF gap to 3 GHz with fully-automatic operation. The new broadband plug-in can be replaced by others to raise the frequency range to 40 GHz, to measure very noisy signals, to measure FM and pulsed RF, to read time interval, etc. This is the best available wide-range laboratory counter—the root of a system that can accomplish nearly everything possible with counter instrumentation.

**...two more reasons
to check with
Systron-Donner
before you buy.**



Send for Catalog.

SYSTRON  DONNER

888 Galindo Street, Concord, California 94520.

NEWS

- 21 News Scope
- 25 **Indirect design piercing celestial 'barriers'**
'Brute force' approach to observation of universe is giving way to ingenious computer techniques
- 36 **Three ways to put a Russian on the moon**
Craft can be sent directly, be assembled in space or employ a lunar-surface rendezvous method
- 45 Washington Report
- 48 Letters
- 50 Sidelights of the Issue
- 53 **Editorial: Who does a man really work for . . . ?**

TECHNOLOGY

- 57 **Practical guide to a/d conversion, Part 2.**
- 58 **Indirect a/d converters** require few critical components.
- 67 **High-speed, high-accuracy a/d converters** use parallel operating techniques.
- 80 **Design better sequential circuits** by combining flow tables with Karnaugh maps to minimize the number of logic elements needed.
- 88 **Stop the revolt in the labs!** Engineers demand more than pay to be content. Learn how to 'involve' them in their work.
- 98 Ideas for Design

PRODUCTS

- 110 **Instrumentation:** Counter reciprocally measures rf carriers.
- 116 **ICs and Semiconductors:** Chip zener diodes dissipate 400 mW.
- 122 **Data Processing:** Code converters deliver any desired output.
- 124 Modules and Subassemblies
- 126 Production
- 128 Microwaves and Lasers
- 132 Packaging and Materials
- 136 Components

Departments

Cover Credit: Photograph by the Mt. Wilson and Palomar Observatories.
Copyright by the California Institute of Technology & The Carnegie Institution of Washington, D.C.

- 16 Designer's Datebook
 - 94 Books
 - 140 Design Aids
 - 142 Application Notes
 - 144 New Literature
 - 154 Advertisers' Index
 - 160 Information Retrieval Service
- Information Retrieval Service Card inside back cover

HP 3450A Multi-Function Meter:

The basic HP 3450A digital multi-function meter measures dc voltage and **true four-terminal** dc ratio. From there you make up your own unit with options to fit your needs now—then add other field-installable capabilities later to make your unit a complete "dodecameter" with five digit plus overrange digit readout for dc, ac and ohms measurements. Full autoranging capability for all functions is standard.

Add the AC Option and you can make **true RMS** ac measurements from 45 Hz to 1 MHz—and true four-terminal ac ratio. Add the OHMS Option for six four-wire ohms ranges including a 100 Ω range and ohms ratio. Put in the LIMIT TEST Option and you have HI GO LO and digital readout with two preselected limits for dc, ac and ohms — and ratio limit tests for ac, dc and ohms. That gives you a total of twelve measurement functions. But, that's not all! Add the DIGITAL OUTPUT Option for nine columns of digital output to a printer. With the addition of the REMOTE CONTROL Option, you have added full programmability for systems use. The only option that must be factory-installed is the REAR INPUT Option for isolated front and rear input capability! All this capability is contained in a rack-mountable cabinet only 3½ inches high. All-solid-state construction—including more than 220 integrated circuits—gives you increased reliability and lower maintenance. Turn the instrument on, and in seconds it's ready to operate.

Call your nearest HP Sales and Service Office to learn how you can save time and reduce bench clutter with the one multi-function meter with twelve measurement capabilities. For

full specifications, write to Hewlett-Packard, Palo Alto, California 94304. Europe: 1217 Meyrin-Geneva, Switzerland.

DC VOLTAGE and DC RATIO

DC voltage and dc ratio capabilities are contained in the basic unit.

The 3450A uses a dual-slope integration technique and is fully guarded for excellent noise immunity at 15 readings per second on

all five dc voltage ranges (100 mV to 1000 V). Input resistance is $> 10^{10} \Omega$ on the lower three ranges and $10^7 \Omega$ on upper ranges to minimize the effects of resistive loading of your sources. The four-terminal ratio on the 3450A gives you complete isolation between X and Y inputs so you can measure the ratio of two independent dc voltages. Four ranges (1:1 to 1000:1) of true four-terminal dc ratio are provided. Price of

basic 3450A, \$3150.

AC VOLTAGE and AC RATIO (Option 001)

The 3450A with ac option is the only true RMS digital voltmeter with five-digit resolution for ac measurements



from 45 Hz to 1 MHz. This greatly increases the capability previously available in a digital meter. You get true RMS responding measurements on four ranges (1 V to 1000 V). And the 3450A has a $\pm 0.05\%$ midband accuracy!

Adding the ac converter (Option 001) to your basic 3450A provides ac voltage and true four-terminal ac ratio. Price Option 001, \$1250.

THE INCREDIBLE DODECAMETER

Start with the basic meter... Order what you *need* now...
Add what you *want* later!

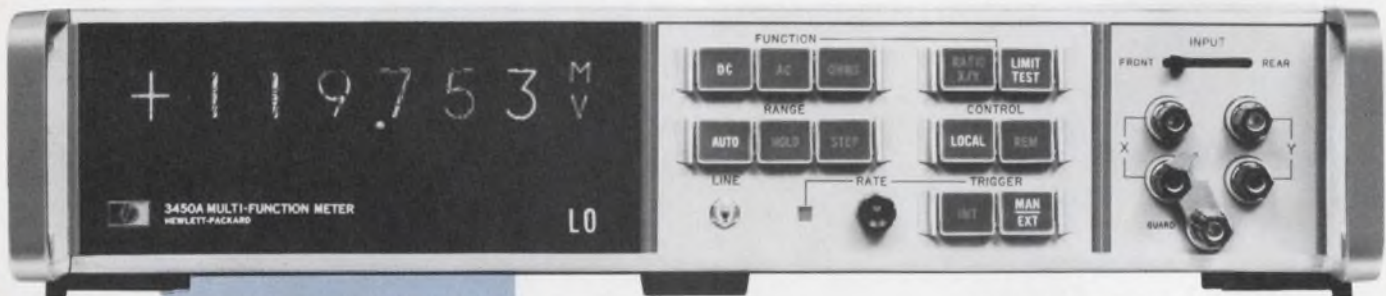

dc ratio limit test

dc limit test

ohms ratio limit test

ac limit test

OHMS and OHMS RATIO (Option 002)

Six ranges (100 Ω to 10000 k Ω) of four-wire ohms measurements at 15 readings/sec are available when you add the ohms converter to the 3450A basic unit. A maximum of 1 mA signal current reduces self-heating in the resistor under test. The ohms converter also adds four ranges of ohms ratio. Price Option 002, \$400.

LIMIT TEST (Option 003), DIGITAL OUTPUT (Option 004)

Install the limit test converter in your 3450A. Then you can use contact-

closures-to-ground to preset two four-digit limits (with an additional digit for 20% overranging) and polarity for dc and dc ratio limit tests. When your 3450A has ac and ohms capability, plus the limit test option, you have ac limit and ac ratio limit tests, ohms limit and ohms ratio limit tests. HI, GO, LO front panel lights clearly indicate results of a test. With the digital output (Option 004), you get 9 columns of information including HI, GO, LO limit test decisions in 1-2-4-8 "1" state positive BCD form. Buffered BCD output stores previous reading until printer can record it and allows DVM to immediately make another reading. Price Option 003, \$350; Option 004, \$175.

REMOTE CONTROL (Option 005)

For systems applications, remote control option installed in the 3450A allows full programmability. All programmable front panel controls can be locked out in remote operation. Price Option 005, \$225.

REAR INPUT TERMINALS (Option 006)

Addition of this option provides a set of rear input terminals and a FRONT / REAR INPUT selector switch on the front panel. Price Option 006, \$50.

HEWLETT  PACKARD

DIGITAL VOLTMETERS
INFORMATION RETRIEVAL NUMBER 7

THE GREAT MOS-FET "HANG UP"

The listing below is the broadest line of single and dual MOS-FETs available anywhere. It is another example of our great "hang up" — which is to constantly extend General Instrument's recognized leadership, not only in complex integrated circuitry and LSI, but in MOS-FETs

TYPE	CHANNEL	MODE OF OPERATION	DESCRIPTION	TEMP RANGE	CASE #	V _{GS(M)} (VOLTS TYP)	I _{ON(M)} (mA TYP)	I _{OFF} (nA TYP)	V _{DS} (VOLTS)	V _n (mVrms TYP)	G _{SS} (pF TYP)	R _{ON(OFF)} (Ω TYP)	G _m (dB TYP)	NF (dB TYP)	1-99	100-999
MEM511 2N4353	P P	Enhancement Enhancement	General Purpose MOS-FET†	-65° to +125°C	TO-72	-4.0	-6.0	-0.2	-30	2,500	2.0	150	*	*	8.00 10.00	5.35 6.70
MEM511C	P	Enhancement	General Purpose MOS-FET†	-50° to +100°C	TO-72	-4.0	-6.0	-1.0	-25	2,500	2.0	150	*	*	1.98	1.30
MEM517	P	Enhancement	Power MOS-FET†	-65° to +125°C	TO-33	-3.5	-60	-0.3	-30	12,000	10	30	*	*	19.00	12.75
MEM517A	P	Enhancement	Power MOS-FET†	-65° to +125°C	TO-5	-3.5	-60	-0.3	-30	12,000	10	30	*	*	19.00	12.75
MEM517AC	P	Enhancement	Power MOS-FET†	-50° to +100°C	TO-5	-3.5	-60	-1.5	-25	12,000	10	30	*	*	3.98	2.70
MEM517B	P	Enhancement	Power MOS-FET†	-65° to +125°C	TO-72	-3.5	-60	-0.3	-30	12,000	10	30	*	*	19.00	12.75
MEM517BC	P	Enhancement	Power MOS-FET†	-50° to +100°C	TO-72	-3.5	-60	-1.5	-25	12,000	10	30	*	*	3.98	2.70
MEM517C	P	Enhancement	Power MOS-FET†	-50° to +100°C	TO-33	-3.5	-50	-1.5	-25	12,000	10	30	*	*	3.98	2.70
MEM520	P	Enhancement	MOS-FET	-65° to +125°C	TO-72	-4.0	-6.0	-0.2	-30	2,500	2.0	150	*	*	8.00	5.35
MEM520C	P	Enhancement	MOS-FET	-50° to +100°C	TO-72	-4.0	-6.0	-1.0	-25	2,500	2.0	150	*	*	1.98	1.30
MEM550 3N151	P P	Enhancement Enhancement	Dual MOS-FETS†	-65° to +125°C	TO-77	-4.0	-5.0	-1.0	-30	1,400 2,000	1.1	250	*	*	17.50 17.50	11.30 11.30
MEM550C	P	Enhancement	Dual MOS-FETS†	-50° to +100°C	TO-77	-4.0	-5.0	-0.5	-25	1,400	1.1	250	*	*	3.98	2.70
MEM551	P	Enhancement	Dual MOS-FETS	-65° to +125°C	TO-77	-4.0	-5.0	-0.2	-30	1,400	1.1	250	*	*	17.50	11.30
MEM551C	P	Enhancement	Dual MOS-FETS	-50° to +100°C	TO-77	-4.0	-5.0	-1.0	-25	1,400	1.1	250	*	*	3.98	2.70
MEM554	N	Depletion	VHF Cascode	-65° to +150°C	TO-72	-1.5	10	*	20	13,000	0.2	50	20 @ 200 MHz	2.8 @ 200 MHz	8.00	5.35
MEM554C	N	Depletion	VHF Cascode	-50° to +125°C	TO-72	-1.5	10	*	20	11,000	0.2	50	18 @ 200 MHz	3.5 @ 200 MHz	1.50	1.10
3N140 3N141	N N	Depletion Depletion	VHF Amplifier VHF Converter	-65° to +150°C	TO-72	-1.5 -1.5	10 10	*	20 20	11,000 11,000	0.2 0.2	50	18 @ 200MHz 17	3.2 @ 200MHz *	1.60 1.50	1.15 1.10
MEM556	P	Enhancement	High Voltage MOS-FET†	-65° to +125°C	TO-72	-4.0	-7.0	-0.1	-50	950	0.3	700	*	*	10.00	6.70
MEM556C	P	Enhancement	High Voltage MOS-FET†	-50° to +100°C	TO-72	-4.0	-7.0	-0.5	-45	950	0.3	700	*	*	2.98	2.00
MEM557	N	Depletion	VHF Triode	-65° to +150°C	TO-72	-2.0	8.0	*	20	10,000	32	200	19 @ 200 MHz	2.5 @ 200 MHz	5.35	3.60
MEM557C	N	Depletion	VHF Triode	-50° to +125°C	TO-72	-2.0	8.0	*	20	8,000	32	200	17 @ 200 MHz	3.0 @ 200 MHz	1.60	1.00
MEM560	P	Enhancement	General Purpose Switch†	-65° to +125°C	TO-72	-2.0	-20	0.5	-40	3,500	3.0	100	*	*	8.00	5.35
MEM560C	P	Enhancement	General Purpose Switch†	-50° to +100°C	TO-72	-2.5	-15	1.0	-35	3,000	3.5	175	*	*	1.98	1.30
MEM562	N	Enhancement	General Purpose Switch	-65° to +125°C	TO-72	1.5	15	0.5	20	4,000 @ 10 mA	0.3	150	*	*	5.85	3.80
MEM562C	N	Enhancement	General Purpose Switch	-50° to +100°C	TO-72	1.5	15	3.0	20	4,000 @ 10 mA	0.3	150	*	*	1.65	1.10
MEM563	N	Enhancement	High Gain Switch	-65° to +125°C	TO-72	1.5	40	1.0	20	7,000 @ 10 mA	0.3	50	*	*	8.00	5.35
MEM563C	N	Enhancement	High Gain Switch	-50° to +100°C	TO-72	1.5	40	5.0	15	7,000 @ 10 mA	0.3	50	*	*	1.98	1.30
MEM564C	N	Depletion	VHF Cascode†	-50° to +125°C	TO-72	-1.5	10	*	20	12,000	0.2	50	17 @ 200 MHz	3.5 @ 200 MHz	1.65	1.25
MEM571C	N	Depletion	VHF Triode†	-50° to +125°C	TO-72	2.0	8.0	*	20	10,000	32	200	17 @ 200 MHz	3.0 @ 200 MHz	1.75	1.15

†With Gate Protection *Not Applicable

Contact your authorized GI distributor for complete information on General Instrument's full line of MOS-FETs.



GENERAL INSTRUMENT CORPORATION • 600 WEST JOHN STREET, HICKSVILLE, L. I., NEW YORK

Start solving your FET "hang ups." — Send for your copy of General Instrument's free, colorful MOS-FET wall chart. Write to General Instrument Corporation, 600 West John Street, Hicksville, L.I., N.Y. 11802. (In Europe, to General Instrument Europe S.P.A., Piazza Amendola 9, 20149 Milano, Italy)

**From Monsanto:
130,000,000
discrete frequencies
with almost perfect purity.**



**New "4th generation"
digital frequency synthesizer achieves new level of
perfection in signal generation
with computer-aided design
and I-C construction.**

Monsanto's new Model 3100A Digital Frequency Synthesizer obsoletes just about every present concept of general purpose signal sources.

Pick your frequency from 0.1 Hz to 1.3 MHz in 0.01 Hz steps. The result—signal purity you can get only from Monsanto, with a stability of one part in 10^9 per day.

Other refinements include: internally supplied rapid or slow sweep and provision for external sweep; continuous control of output level over a 90 db range; provision for both amplitude modulation and frequency modulation or both, simultaneously; in the remotely programmable version, switching time is less than 20 microseconds.

You can put this *better* way of signal generation to work for you for only \$3950.00, FOB West Caldwell, N.J.

For a demonstration, or for full technical details, call your local Monsanto Field Engineer now or contact us directly at: Monsanto Company, Electronic Instruments, West Caldwell, New Jersey 07006, (201) 228-3800.

Monsanto



With this plug-in it becomes a . . . **High Precision Power Differential Voltmeter**

FEATURES OF THE HIGH PRECISION POWER DIFFERENTIAL VOLTMETER

DRAW POWER AS YOU MEASURE VOLTAGE

The first and only differential voltmeter to furnish high stability power output while being used as a voltmeter. . . no need for a separate power supply.

PLUS ALL POWER SUPPLY SPECIFICATIONS

FEATURES OF THE METERED HIGH PRECISION POWER SOURCE

0.0005% PLUS 100 μ V REGULATION

Best of any high stability power supply in this price range.

RIPPLE

35 μ V rms; 100 μ V p-p.

ACCURACY

0.01% + 1mV

2 METERS

Monitor both voltage and current simultaneously and continuously.

GUARANTEED FOR 5 YEARS

The only 5-year guarantee that includes labor as well as parts. Guarantee applies to operation at full published specifications at end of 5 years.



MULTI-CURRENT-RATED

for 30°C, 40°C, 50°C, 60°C—Covers temperatures most often encountered in laboratory work.

5 MODELS

With ranges of 0-10, 0-20, 0-40, 0-120, 0-250VDC—Wide selection of ranges to suit your specific needs.

ILLUMINATED DIGITAL READOUT MILLIMATIC™ GANG DIALING

5-digit voltage dials with automatic decade switching provides convenient precise adjustment (200 μ V resolution over entire range).



MOUNT IN RACK ADAPTERS

LRA-1 (\$60.00) or LRA-2 (\$35.00). Rack adapter LRA-1 only is available with chassis slides mounted. Add suffix "CS" to rack adapter model number and \$50 to price.



With this plug-in it becomes a . . . **Metered High Precision Power Supply**



LAMBDA'S LS SERIES IS TWO INSTRUMENTS IN ONE

TWICE THE POWER

in a convenient 1/2-rack package.

ONLY 5 1/4" HIGH

convenient half rack size for rack or bench use.

STABILITY

0.001% + 100 μ V for 8 hours

ALL-SILICON DESIGN

for maximum reliability

CONVECTION-COOLED

for convenience and reliability. . . no blowers or heat sinks.

REMOTE PROGRAMING

by changes in voltage or resistance for convenience in systems, test equipment and automatic equipment applications.

AUTO SERIES/AUTO PARALLEL

with Master-Slave tracking.

CONSTANT I/CONSTANT V

by automatic crossover

COMPLETELY PROTECTED

short-circuit proof; continuously adjustable automatic current limiting.

OVERVOLTAGE PROTECTION

available as low cost add-on accessory.

RUBBER FEET

provided for bench use.

AC INPUT

105-132VAC, 47-440 Hz (derate dc output current 10% at 50 Hz). 205-265VAC at no extra charge. ("V" option)

Basic Non-Metered Model	Voltage Range	Max. Amps at Ambient of (1)					Metered Accessory		Diff. VM Accessory		Over Volt. Protect.		
		30°C	40°C	50°C	60°C	Price (2)	Model	Price	Model	Price	Model	Adj. V. Range	Price
LS-511	0-10VDC	2.8A	2.5A	2.1A	1.7A	\$375	LS-FM1	\$55	LS-DM1	\$85	LHOV-4	3-24	\$35
LS-512	0-20VDC	1.8A	1.6A	1.3A	1.1A	375	LS-FM2	55	LS-DM2	85	LHOV-4	3-24	35
LS-513	0-40VDC	1.0A	0.9A	0.75A	0.6A	375	LS-FM3	55	LS-DM3	85	LHOV-5	3-47	35
LS-515	0-120VDC	0.33A	0.29A	0.25A	0.21A	375	LS-FM5	55	LS-DM5	85			
LS-516	0-250VDC	0.1A	0.09A	0.08A	0.07A	380	LS-FM6	55	LS-DM6	85			

Notes: 1. Current rating applies over entire voltage range. Ratings based on 55-65 Hz operation. Derate current 10% for 50 Hz.

2. This price is for non-metered Precision Power Source. Addition of Metered Accessory Plug-In (next two columns) is necessary to have Metered High Precision Power Supply. Addition of Differential Voltmeter Accessory Plug-In to the basic model is necessary for the unit to function as a High Precision Differential Voltmeter.

Write, wire, or call to order direct, for information, or for new Lambda Power Supplies catalog. **LAMBDA Electronics Corp., 515 Broad Hollow Road, Melville, L. I., New York 11746, TEL. 516-894-4200, TWX 510-224-6484.**



INFORMATION RETRIEVAL NUMBER 6

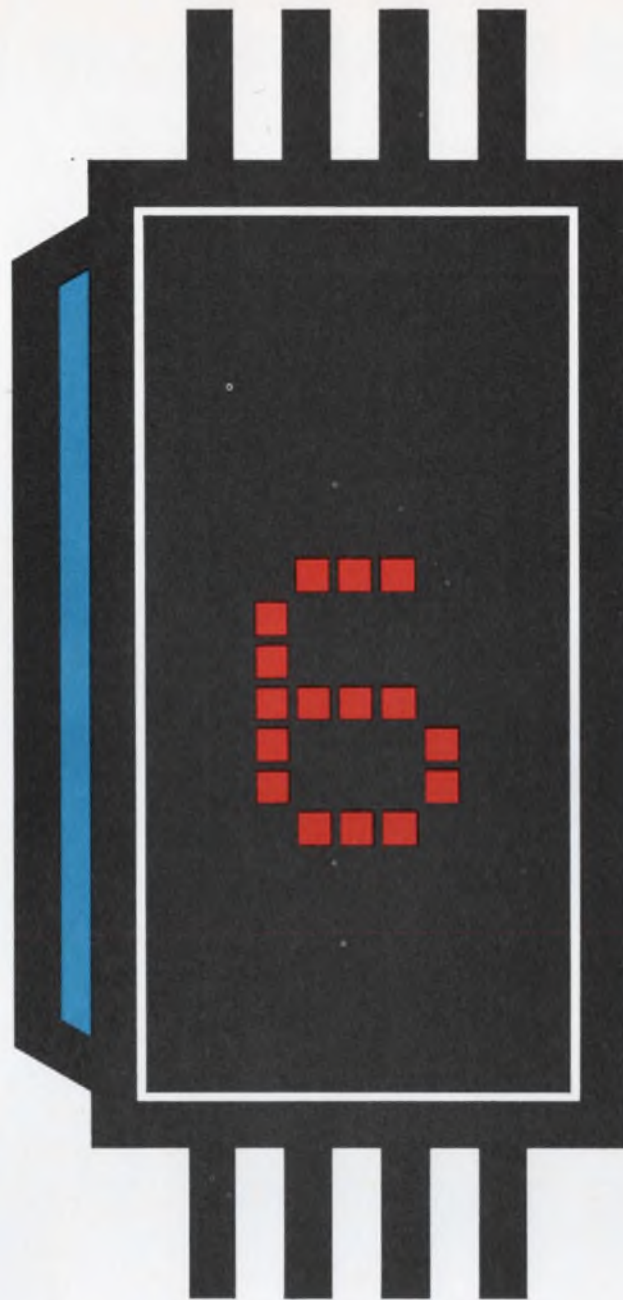

Surprise package (1" x 1/2" x 1/10")

It's a completely new way to display digital information. The Hewlett-Packard solid state numeric display packs everything in one, small unit only 1"x 0.5"x 0.16". Gallium arsenide phosphide diodes and an IC driver/decoder chip deliver bright red numerals—bigger than life, visible for yards.

This new "total package" also gives you the edge on cost. You don't have to buy driver elements, or anything else. No special interfacing is needed. Only four line 8-4-2-1 BCD input and less than five volts to drive it. The modules are available in three-character packages, too.

The Hewlett-Packard solid state numeric display is ideal for instruments requiring smaller, tighter display panels. Or any ap-

plication demanding either low power or resistance to shock and vibration, without catastrophic failures.

Get more information about the new technology for numeric indicators. Call your local HP field engineer or write Hewlett-Packard, Palo Alto, California 94304; Europe: 1217 Meyrin-Geneva, Switzerland.

HEWLETT  **PACKARD**

SOLID STATE DEVICES

INFORMATION RETRIEVAL NUMBER 4

Fairchild can make more hybrids in

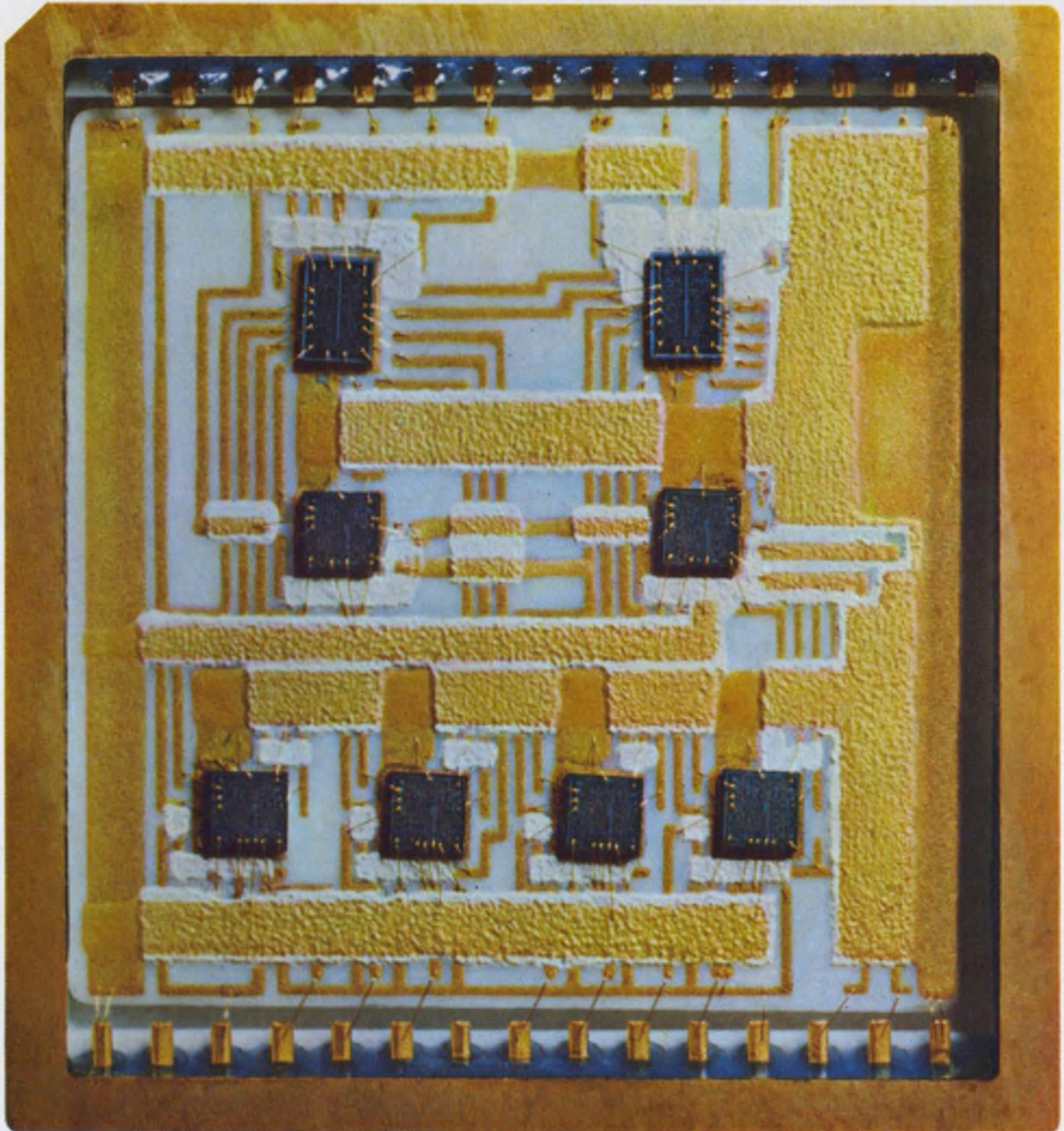

an hour than you can use in a month.



We can make any hybrid, in any quantity, using any method: Thick film. Thin film. Thin film on silicon.

We can make them faster than anyone in the industry. And deliver them quicker to anyone in the world.

We'll take any functions you need and package them any way you want. Our list of hybrid components has everything from a simple diode to a complex LSI array.

For your less complex applications, we have a line of off-the-shelf standard hybrids priced like discretes.

If this commitment makes sense in general, we'd like to send you the whole story in detail. Our brochure is called Fairchild Hybrid Microcircuits. It can give you more ideas in an hour than you could use in a year. Write for it.

Fairchild Semiconductor/A Division of Fairchild Camera and Instrument Corporation//313 Fairchild Drive, Mountain View, California 94040 (415) 962-5011 TWX: 910-379-6435

FAIRCHILD
SEMICONDUCTOR

INFORMATION RETRIEVAL NUMBER 5

Now get IC Op Amp power...

with high gain and high voltage

RCA has these two monolithic OP AMP units for you—ready to meet your design requirements for high input impedance, high gain and high power output. Only the price isn't high! Ask your RCA Distributor for his price and delivery. Write RCA Electronic Components, Commercial Engineering, Section IC-G-12-2 Harrison, New Jersey 07029 for Data Sheet.

All characteristics below are typical

Power output (8% THD)
Output swing voltage (P-P)
Input impedance
Open-loop Gain
Input Offset Voltage
Input Offset Current
Input Bias Current
Slew Rate

RCA-CA3033
for $\pm 12V$ Supply

122 mW
21V
1.5 M Ω
90 dB
2.6 mV
5 nA
83 nA
1.2V/us

RCA-CA3033A
for $\pm 18V$ Supply

255 mW
32V
1 M Ω
96 dB
2.9 mV
9 nA
103 nA
2.5V/us

\$3.95 (1000 units)

\$4.95 (1000 units)

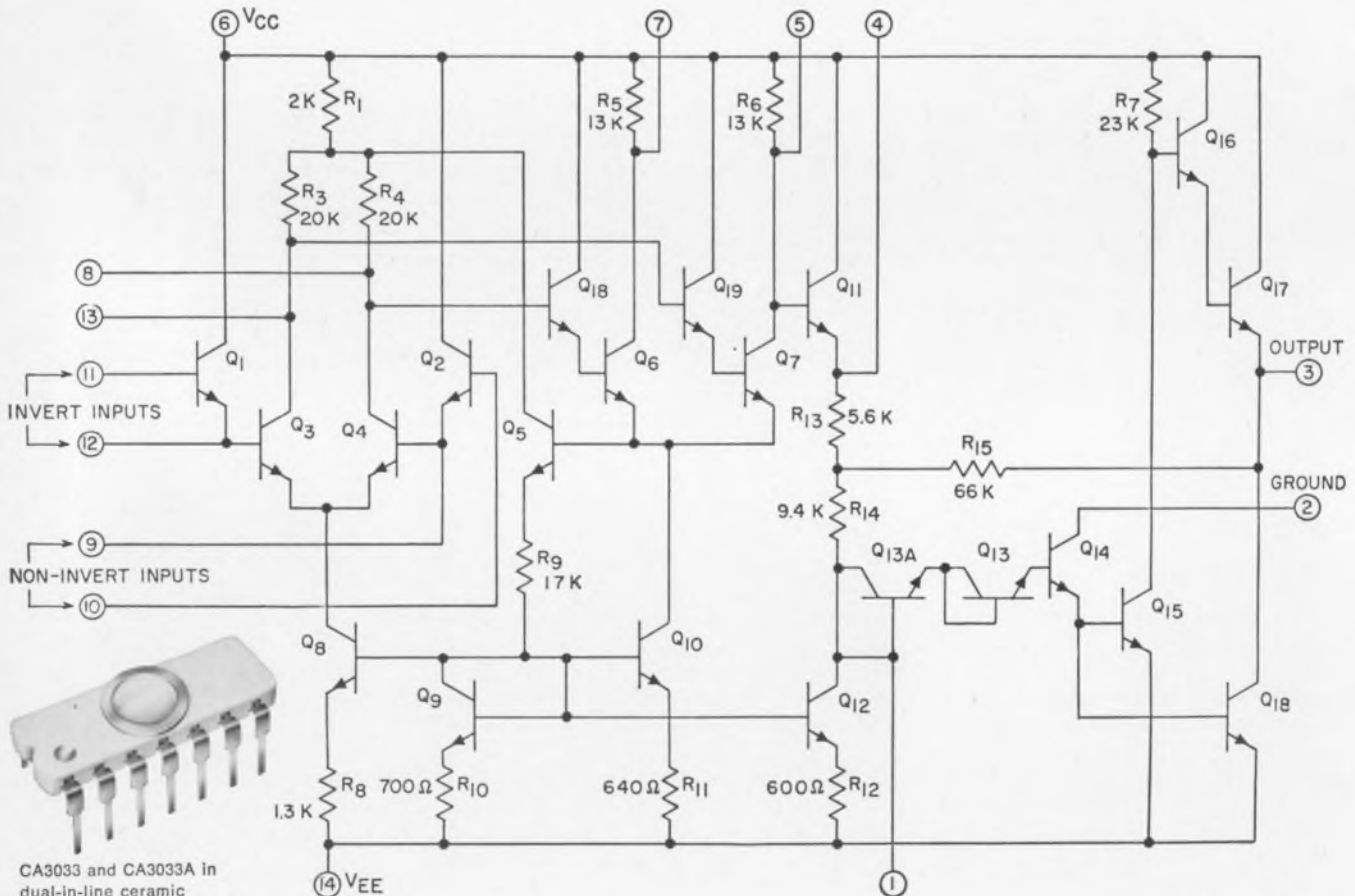

CA3033 and CA3033A in dual-in-line ceramic package (-55° to $+125^{\circ}$ C operating temperatures)

RCA
Integrated
Circuits

Now in plastic packages at economy prices.

CA3033 now available in dual-in-line plastic as CA3047 at \$1.95 (1000 units)

CA3033A now available in dual-in-line plastic as CA3047A at \$2.95 (1000 units)

THE ORIGINAL MINIATURE 4PDT POTTER & BRUMFIELD KH RELAY WAS BORN IN 1960



LOOK HOW
THE FAMILY
HAS GROWN!

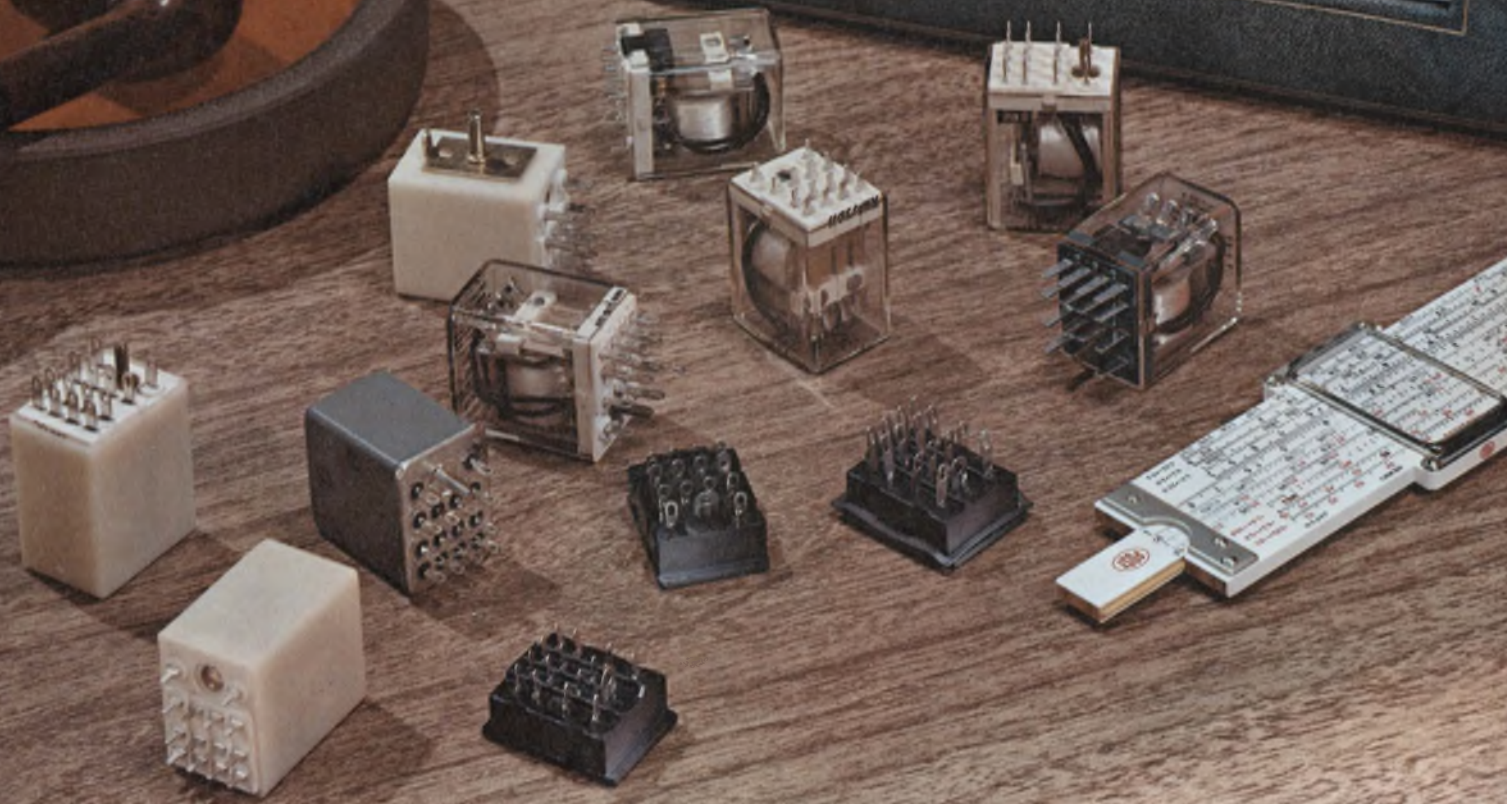

We designed the original relay of this type. We've made more, by far, than anyone else. And we make more variations than anyone, too!

When your circuit calls for a 4PDT relay to switch from low level to 3 amperes, specify a KH from P&B and get these advantages:

Exceptional long life . . . up to 100 million mechanical operations DC (50 million AC).

Small size . . . only slightly larger than one cubic inch.

Wide choice of mountings, enclosures, terminals, sockets and contact materials.

Underwriters' Laboratories list this relay (KHU Series) under their Component Recognition Program. The KHX Series is U/L recognized for opposite polarity ratings.

Partial list of variations of original KHP Series:

- KHS Hermetically-sealed KHP.
- KHC KHP relay with printed circuit terminals.
- KHU U/L rated for 1/10 HP, 3 amperes @ 120V AC; 3 amperes @ 28V DC resistive.
- KHF Same U/L recognition as KHU Series but with printed circuit terminals.
- KHX U/L recognized for opposite polarity ratings.
- KHE Same U/L recognition as KHX Series but with printed circuit terminals.

Let us show you the most complete family of miniature four pole relays available anywhere. Let us tell you about our vast production capacity. Talk with your local P&B sales engineer today or call Potter & Brumfield Division of American Machine & Foundry Company, Princeton, Indiana. 812-385-5251.



POTTER & BRUMFIELD

Pick a number...

Only Amphenol lets you pick from all four PC connector families

No matter which printed circuit connector family you choose, Amphenol produces it. In hundreds of thousands of combinations. No one else gives you this choice.

Expect to save. While gold, copper and labor costs go up, we keep modernizing production methods. Enough to maintain prices, even reduce them. We can show you how to save with all four families.

Check the PC connector families below. Then call your Amphenol Sales Office or Distributor. The connector you need is probably on the shelf. If it's a special we can help you design it. Write today for new PC Connector Catalog PC-5. Amphenol Industrial Division, The Bunker-Ramo Corp., 1830 S. 54th Avenue, Chicago, Ill. 60650.



1 BIFURCATED BELLOWS CONTACTS For smooth, positive mating action—that's easy on your PC board surface—pick Amphenol's 225 Series. Bifurcation provides 2 points of contact, even on irregular surfaces. Bellows action exerts positive pressure, even under extreme vibration. Gives you thousands of insertions and withdrawals without failure. Nine sizes, ten tail styles, four mounting configurations, two contact platings, and solder, taper pin or Crimp Poke-Home® terminations. Exceeds MIL-C-21097B.

2 TUNING FORK CONTACTS For the lowest contact resistance in the industry today—even with PC boards at the extremes of tolerance in thickness—pick Amphenol's 143 Series. Amphenol's tuning fork contacts provide excellent current-carrying capability with uniform tine pressure and positive wiping action. For non-direct card entry applications, the 143 Series receptacle can be mated with a 133 Series plug. Nine tail styles, eight sizes and choice of solder or solderless wrap terminations. Series 233/243 exceeds MIL-C-21097B.

3 PRELOADED CANTILEVER CONTACTS For a low cost, high performance connector—designed especially for automatic wire wrapping—pick Amphenol's 261 Series. Cantilever contacts are confined in the dielectric to a predetermined load force. This gives you uniform pressure and positive mating action. Contacting surfaces have a minimum of 50 microinches of gold over phosphor bronze. Wire wrap capability on .100", .125", .150", .156" and .200" centers. Also, high contact density multi-board connectors for your special applications.



4 MODULAR PLATE ASSEMBLIES For custom designed specials at production line prices—with up to 36,000 contacts—pick Amphenol's 230 Series Snap-Wrap® or 240 Series Mini-Wrap® connectors.

Design your own interconnection system using Amphenol's building block concept. The contacts you need are inserted into nylon insulators and mounted into aluminum plates. These plates can be drilled, formed or notched to your specifications. Snap-Wrap 230 Series: 7 contact styles, 12 color-coded insulators with plate sizes up to 22" x 45". Mini-Wrap 240 Series: 4 contact styles, 12 color-coded insulators, .100", .125" or .150" centers with plate sizes up to 21" x 24". The same modular concept is now available for direct card entry applications with our 250 Series.

®Registered trademarks of The Bunker-Ramo Corporation



AMPHENOL

THE BUNKER-RAMO CORPORATION

INFORMATION RETRIEVAL NUMBER 11

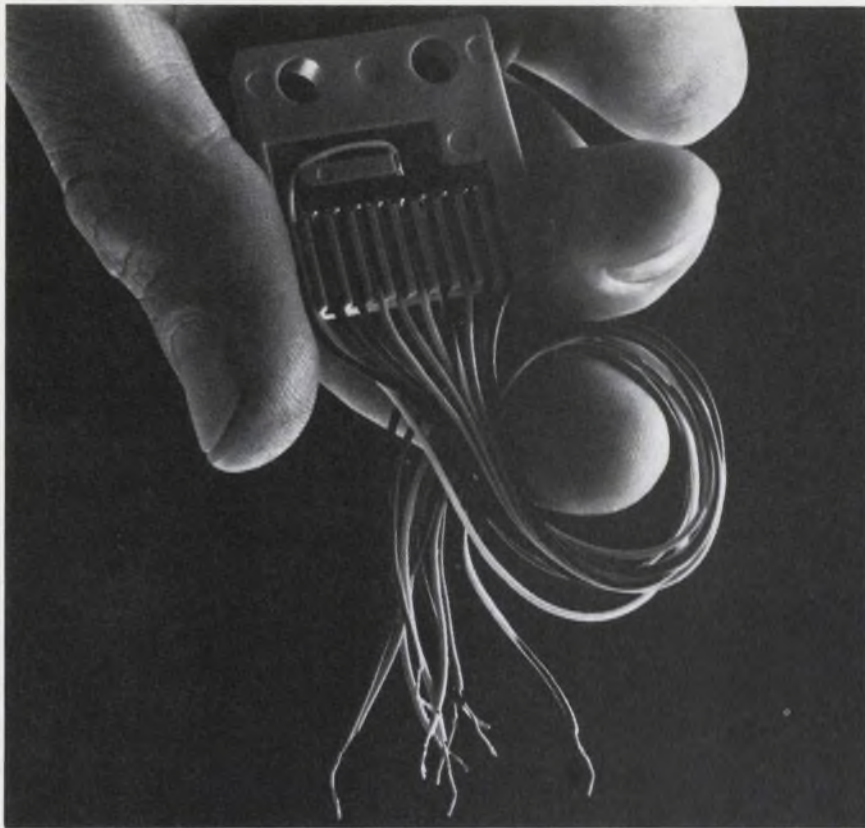

We'll even send your light sensors in a sealed package.

For top security.

That's our specialty. We were the first company to mount fragile light sensor devices in custom-designed, secure, durable packages. And we're the most experienced at producing them for commercial applications. Our skilled personnel use our specially-designed precision equipment to place and wire the sensors in your package. We save you the handling risk . . . and the time. You can buy anything from a single cell in a TO-18 can up to a special 960-position, plug-in, full-card reader. Or an array for a tape reader, or a badge or key recognition system. We'll even design for your special application we may never have heard of before. We'll package it securely, color-code it, design it so it can be easily incorporated into your system. But first we have to know what that is. Send your requirements to the engineering design department of Solar Systems Division, Tyco Laboratories, Inc., 3241 Kimball Avenue, Skokie, Illinois 60078. Or phone (312) 676-2040.

TYCO

INFORMATION RETRIEVAL NUMBER 12

Designer's Datebook

FEBRUARY 1969						
Sun	Mon	Tue	Wed	Thu	Fri	Sat
						1
2	3	4	5	6	7	8
9	10	11	12	13	14	15
16	17	18	19	20	21	22
23	24	25	26	27	28	

MARCH 1969						
Sun	Mon	Tue	Wed	Thu	Fri	Sat
						1
2	3	4	5	6	7	8
9	10	11	12	13	14	15
16	17	18	19	20	21	22
23	24	25	26	27	28	29
30	31					

For further information on meetings, use Information Retrieval Card.

Feb. 10-11

Transducer Conference (Washington, D. C.). Sponsor: IEEE; H. P. Kalmus, Harry Diamond Labs., Dept. of the Army, Washington, D. C. 20438

CIRCLE NO. 400

Feb. 11-13

Aerospace and Electronic Systems Convention (WINCON) (Los Angeles). Sponsor: IEEE, G. D. Bagley, TRW Systems Inc., One Space Park, Redondo Beach, Calif. 90278

CIRCLE NO. 401

Feb. 13-14

Electrical Insulation Workshop, (Chicago). Sponsor: Society of Plastics Engineers; J. McCarthy, Workshop Publicity, c/o Insulation, Box 270, Libertyville, Ill. 60048

CIRCLE NO. 402

Feb. 19-21

Solid-State Circuits Conference (Philadelphia). Sponsor: IEEE, U. of Pennsylvania; L. Winner, 152 W. 42 St., New York, N. Y. 10036

CIRCLE NO. 403

Mar. 12-14

Microwave Technique Conference (Cologne, Germany). Sponsor: IEEE; H. H. Burghoff, Stresemann Allee 21, VDE-Haus, 6 Frankfurt/Main 70, West Germany.

CIRCLE NO. 404

Mar. 24-27

IEEE International Convention (New York City). Sponsor: IEEE; J. M. Kinn, IEEE, 345 E. 47 St., New York N. Y. 10017

CIRCLE NO. 405



MOS DELAY LINES

Integrated delay lines let digital system designers escape one of nature's small tyrannies—finding a match between system timing and the prefixed delay set by a glass or wire line's length, or a drum's rpm. In contrast, the input-output rates and storage time of an MOS shift register can be controlled individually to mate with any part of the system, be it instrumentation, data link, or computer.

The simplest, smallest, and least power-hungry delay lines are those made with MOS dynamic shift registers. Each silicon chip contains up to 200 storage nodes and the digital equivalents of input transducers and output detectors. All the designer supplies is a few microwatts of power per bit, clock signals, and data. Data can be shifted through the register at rates from near DC to greater than 15 MHz.

Lines that store only a few hundreds or thousands of bits are less expensive to build with MOS. The line in Figure 1a is just the series-connected halves of an MM506 dual 100-bit dynamic register and a few pull-down resistors. A dynamic register is run with a two phase clock, static registers require a single clock. At 700 KHz or less the clock driver (Figure 1b) can drive three or more MM506's or more than a dozen dual 16-bit static registers.

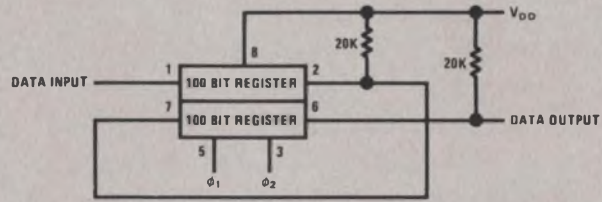

FIGURE 1a. Series-connected Delay Line.

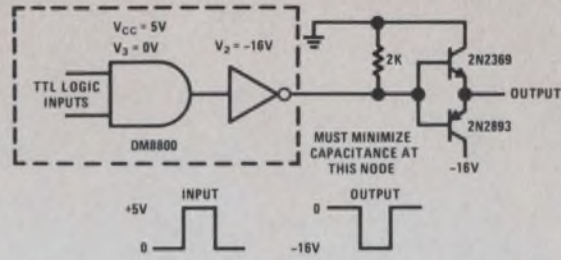
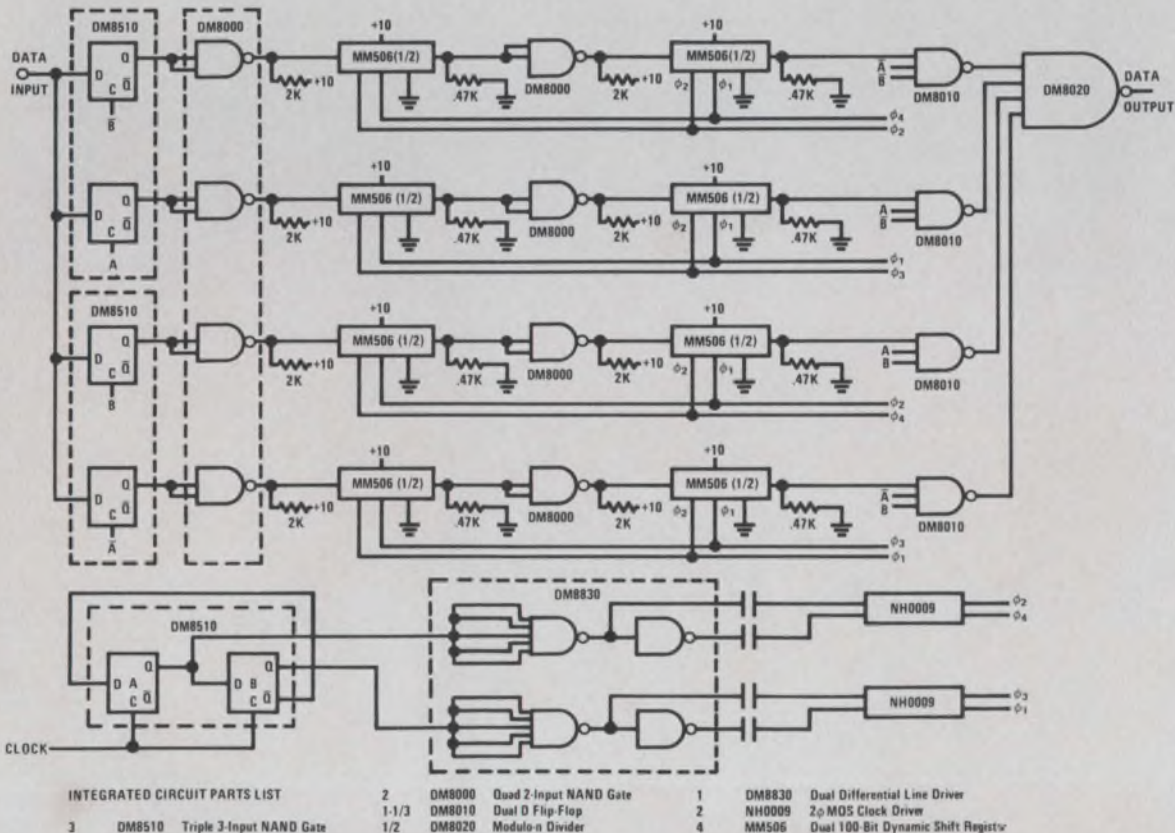

FIGURE 1b. Line Driver.

Delay duration is the product of the clock period and the number of bit-storage nodes in the registers. At 1 MHz, for instance, 200 bits would be delayed 200 microseconds. The longest delay possible in a dynamic register is determined by the minimum operating frequency, which ranges from about 10 to 25 Hz at 25°C to 10 KHz at 125°C. If the designer wants a shift rate in the megahertz



INTEGRATED CIRCUIT PARTS LIST		
2	DM8800	Quad 2-Input NAND Gate
1-1/3	DM8810	Dual D Flip-Flop
1/2	DM8020	Modulo-n Divider
1	DM8830	Dual Differential Line Driver
2	NH0009	2-Phase MOS Clock Driver
4	MM506	Dual 100-Bit Dynamic Shift Register
3	DM8510	Triple 3-Input NAND Gate

FIGURE 2. High-speed Register Uses TTL Logic to More Than Double MOS Shift Rates.

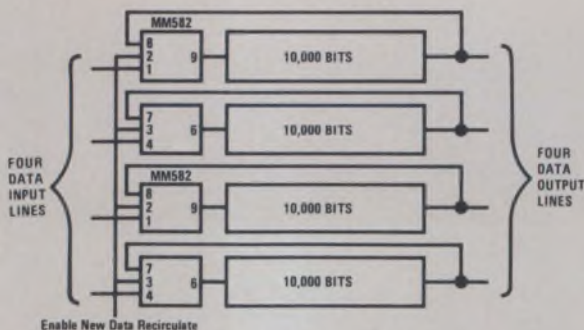

FIGURE 3. Synchronous Delay-line Array Operates as a 60,000-bit Drum Memory.

range, but wants to delay the data much longer than microseconds, he can inhibit the clock between loading and unloading of the register, or recirculate the bits at low frequency within the register while reading in and out at high speed. To overcome a data synchronization problem, data can be shifted in at one rate and out at another,

Dynamic registers would lose data if the clock is stopped indefinitely, since they don't contain latching devices. Static registers do have latches, and can therefore operate at DC clock rates at any temperature. Their clocks can be stopped, allowing indefinite delays. The price of latching and other special features of static registers is less bit capacity per chip than dynamic registers.

Clock rates much higher than the normal MOS speed limit of 1 to 5 MHz can be achieved by operating registers in parallel or interfacing them with TTL logic. Both methods are combined in the Figure 2 delay line, which has been clocked at 16 MHz. The high-speed clock and data inputs are distributed among the registers so that the upper MM506 transfers and delays bits numbers 1, 5, 9, 13, etc., of the data. The next two MM506 halves handle bits 2, 6, 10, 14, etc. The bits flow through the registers at a 4 MHz rate. When the four bit streams are reassembled in the DM8020 NAND gate, the data rate of 16 MHz is restored.

In an all-MOS system, an MM506 register could be clocked at 1 or 2 MHz. The limit is largely imposed by RC time constants raised by the high

impedances of adjoining MOS elements. The register runs at 4 MHz in the Figure 2 configuration because TTL gates are fore and aft of each MM506 half. Thus, each register is driven at its input by a low-impedance source and each output terminates in a low impedance, low level sensor, making the outputs more easily detected. The TTL-MOS interfaces are simply pullup resistors at the register inputs and pull-down resistors at the outputs.

Parallel series of registers also make a fine "drum" memory—that is, a rectangular array of synchronous delay lines (Figure 3). When less than about 200,000 bits of storage are needed, MOS drums are less costly than electromechanical drums. An MOS multiplexer (MM582) does the gating required to write a word into a register, recirculate it and access it upon command. With counter addressing, the contents of a specific register in a series can be read out without disturbing the contents of other registers.

If the data stored in a line is recirculated within several minor loops in each line, the access time will be reduced proportionately. The recirculating loops in Figure 4 were designed to allow the continual shuttling of data from TTL logic into the MOS delay loops, and back out into TTL logic. The loop lengths should be kept to multiples of one another—say 100 or 50 bits—to avoid clocking complications. Here, too, the few additional TTL gates and resistors allow the registers to be clocked at up to 4 MHz.

Since each register in a delay line can operate independently, almost any combination of the basic operating modes in different segments of a line can be used. For instance, assemble a delay line with variable taps, build buffer memories with selectable delays to facilitate time-shared processing of data from several sources, or match low-speed sensor data to relatively high-speed logic circuits. Numerous specialized design-options are also available, such as clock formats that permit asynchronous operation of registers in a line or keep power dissipation well below the normal levels.

Write for data sheets on MOS and TTL devices used in delay lines.

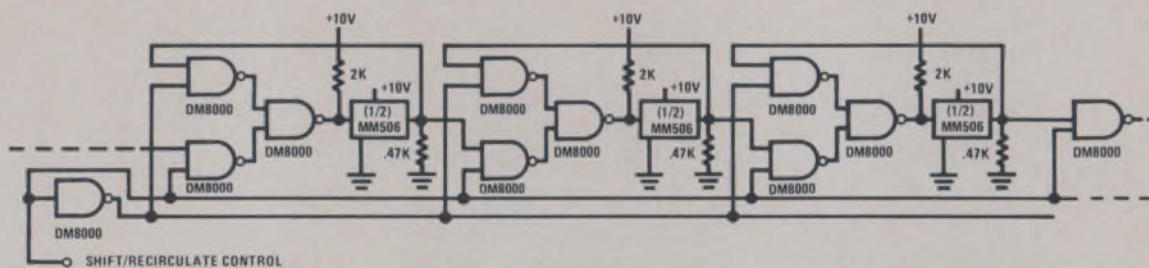

FIGURE 4. Recirculating Loops are Compatible with TTL Logic and Can Operate to 4-MHz Shift Rates.

National Semiconductor Corporation

2975 San Ysidro Way, Santa Clara, California 95051
(408) 245-4320/TWX (910) 339-9240



BORDEN™

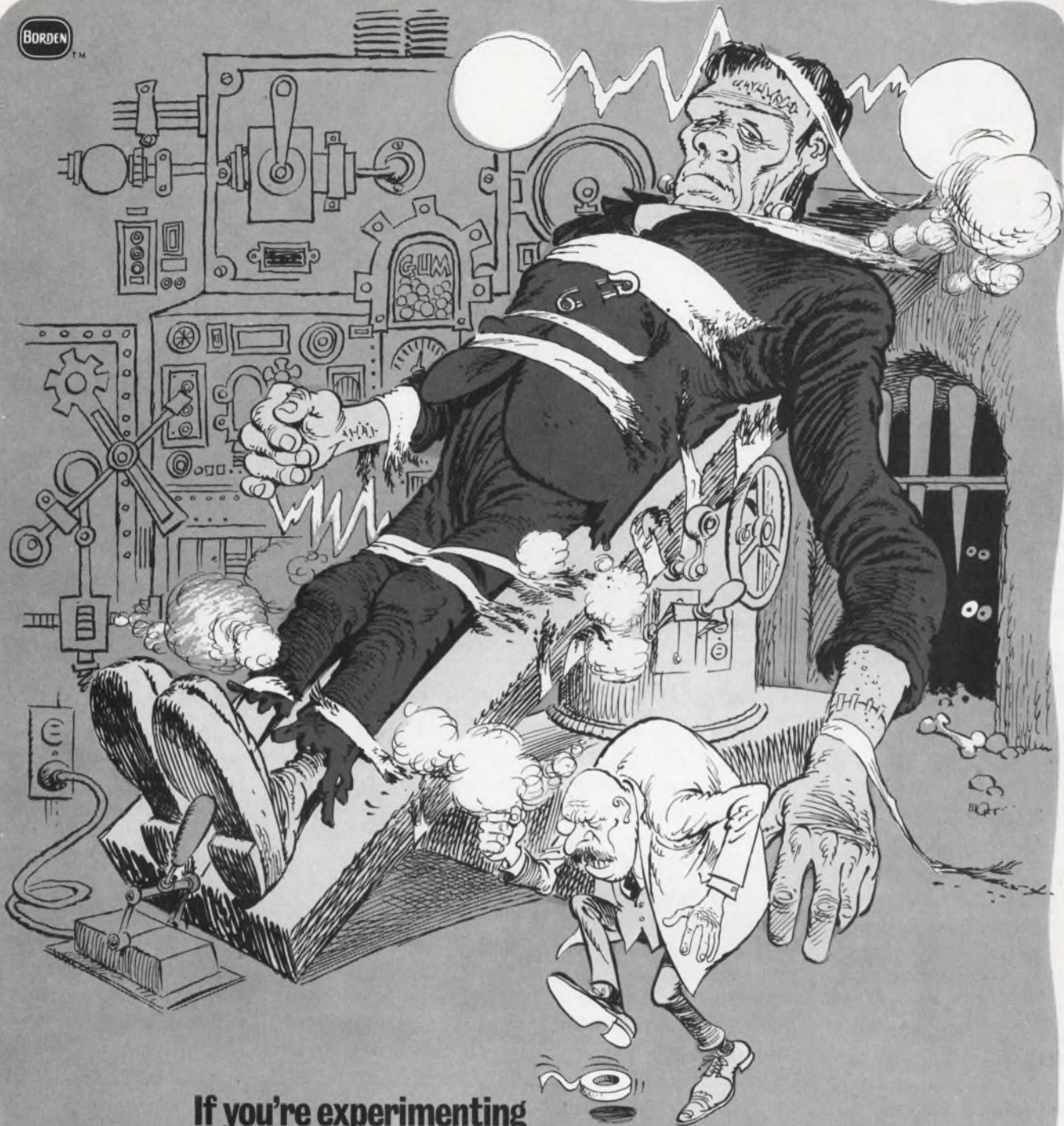

**If you're experimenting
on an unusual project involving high voltage,
maybe we can help you.**

We have an assortment of electrical tapes whose uses are almost unlimited.

They come in various backings and strengths. And have high corrosive and solvent-resistant qualities.

Which means we can probably supply the one for your pet project. No matter how inventive it may be.

Take our double-coated Kapton® Film tape, for example. It takes tem-

peratures up to 800 degrees F. and has a dielectric strength of 7,500 volts. That's enough to make anything jump.

Our Tedlar® Electrical Film tape is another favorite. Its adhesion is excellent. And it can carry as much as 6,000 volts. Without burning up.

Mystik developed Nomex®, Beta-Cloth and Fiberglass pressure-sensitive tapes, too.

If your application requires the use of high voltage tapes, or any type of tape, let us know about it. Check your Yellow Pages under "Tapes."

Or, start something with our Technical Sales Department at Borden Chemical, Mystik Tape Div., 1700 Winnetka Ave., Northfield, Ill. 60093.

**MYSTIK
TAPE**
THE MARK OF QUALITY

INFORMATION RETRIEVAL NUMBER 13

Wet-sintered-anode Tantalex[®] Capacitors

Buy the best.

And save money

doing it.

Here's how: Select from the broadest line of tantalum capacitors anywhere. From Sprague. The lower your temperature requirement, the lower your cost.

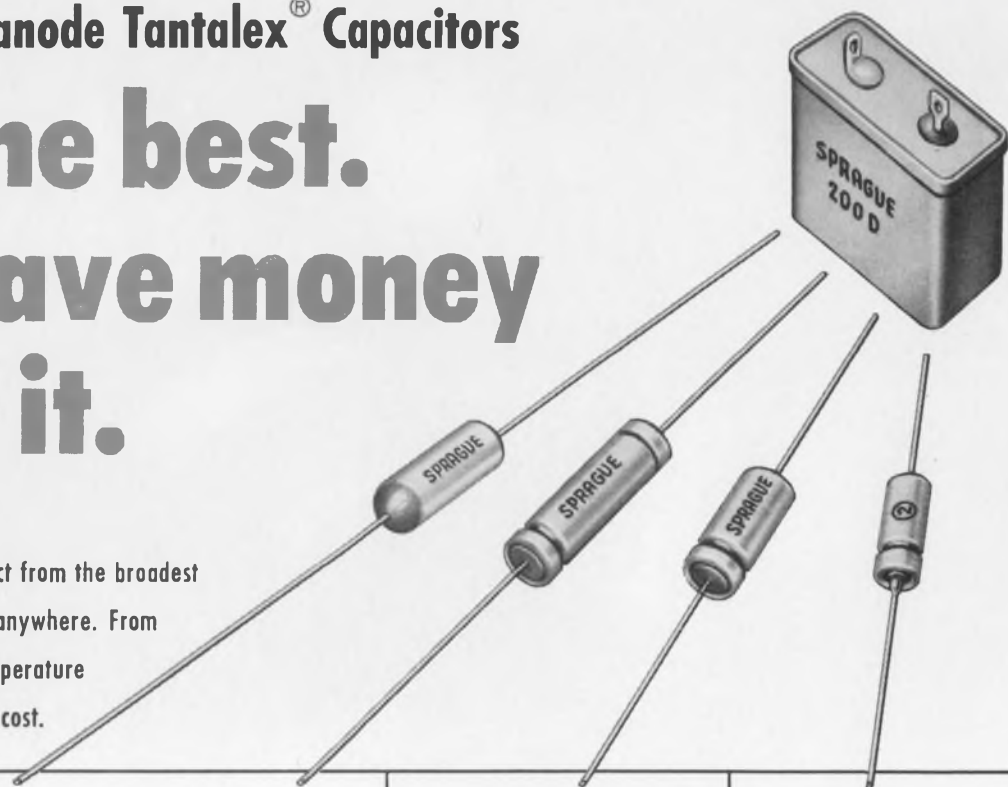

For operation to + 85 C		For operation to + 125 C		For operation to + 175 C			
<p>Type 145D</p> <p>Volumetric efficiency up to 210,000 μF-volts per cubic inch. For use in miniature commercial/industrial printed wiring boards, packaged circuit modules, and wherever else cost and space are prime considerations. Elastomer end seal capped with plastic resin insures against electrolyte leakage and lead breakage. Available in voltage ratings from 6 to 75 VDC.</p>		<p>Type 109D</p> <p>A superior design that meets all the basic military requirements for capacitors within this temperature limit. There is no compromise in quality. Voltage ratings from 6 to 150 VDC.</p> <p>For extra large values of capacitance, use Type 200D or 202D package assemblies, which consist of several 109D - type capacitor elements in a hermetically-sealed case.</p>		<p>Type 130D</p> <p>Exceptional electrical stability due to chemical inertness of tantalum oxide film to specific electrolytes used, low diffusion of TFE-fluorocarbon elastomer seal, and special aging for 125C operation. Voltage ratings from 4 to 100 VDC.</p> <p>Dual temperature ratings of Type 200D and 202D package assemblies give you extra high capacitance values for +125 C operation.</p>		<p>Type 137D</p> <p>Proven glass-to-metal hermetic seal qualifies these outstanding capacitors for use in satellites, missiles, and other critical aerospace applications. They have greater volume efficiency than has been previously available for wet-sintered-anode capacitors in this temperature range. Type 137D capacitors exhibit extremely low leakage currents. Available in voltage ratings from 2 to 150 VDC.</p>	

INFORMATION RETRIEVAL NO. 000

INFORMATION RETRIEVAL NO. 000

INFORMATION RETRIEVAL NO. 000

INFORMATION RETRIEVAL NO. 000

Select the capacitor type that meets your temperature requirements. That's how to save money. Specify Sprague Tantalex[®] Capacitors. That's how to get the best.

For complete information on Type 145D Capacitors, write for Engineering Bulletin 3750 (Type 109D, Bulletins 3700F and 3700.2; Type 130D, Bulletins 3701B and 3701.2; Type 137D, Bulletin 3703A; Type 200D and 202D, Bulletin 3705B) to the Technical Literature Service, Sprague Electric Company, 347 Marshall St., North Adams, Mass. 01247.



'Sprague' and '®' are registered trademarks of the Sprague Electric Co.

THE BROAD-LINE PRODUCER OF ELECTRONIC PARTS

INFORMATION RETRIEVAL NUMBER 14

ELECTRONIC DESIGN 26, December 19, 1968

News



Paraboloid antennas, such as these at the National Radio Astronomy Observatory, en-

able scientists to tune in on signals from galaxies 10^{10} light years away. P. 25

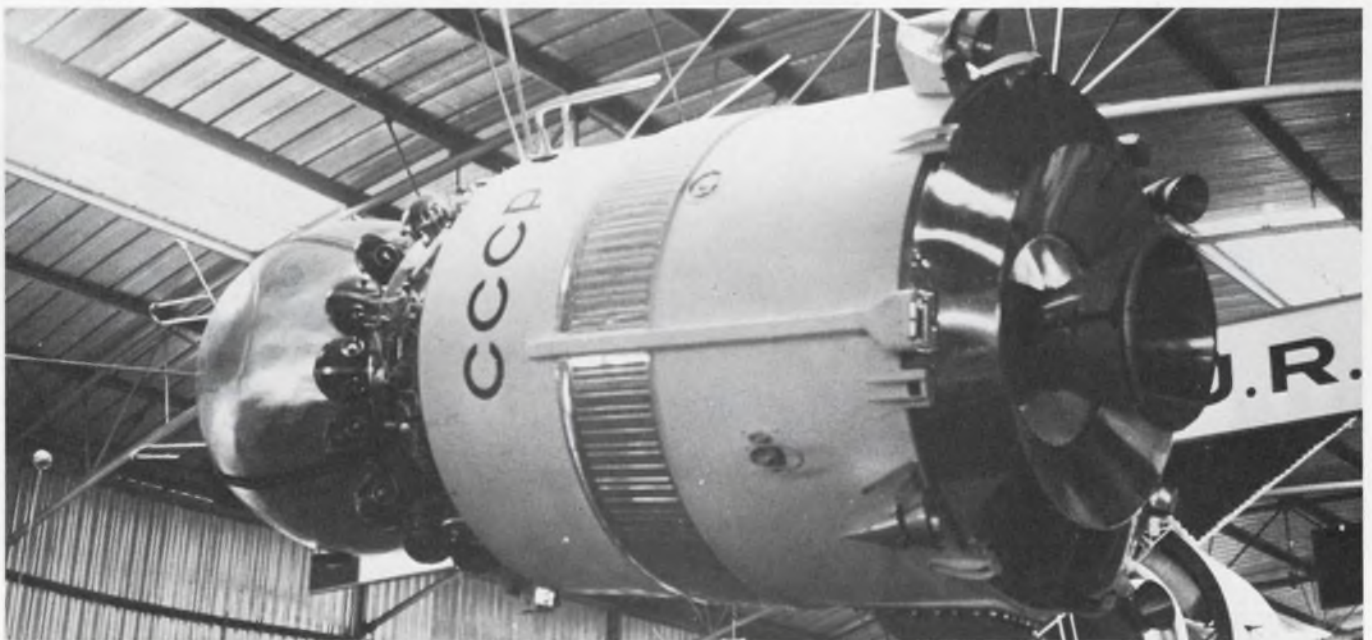

Voshtok spacecraft is a forerunner of the third-generation Soyuz spacecraft, which

many believe will take Soviet cosmonauts on a trip around the moon. P. 36

Also in this section:

News Scope, Page 21 . . . **Washington Report**, Page 45 . . . **Editorial**, Page 53



Something to
ROAR
 about...



A thinner cermet trimmer that saves 30% on board space and costs less too!

Spectrol's thin new Model 78 cermet trimmer is only .195-inches thick...takes 30% less board space than most other rectangular trimmers... is thoroughly sealed... and yet sells for less than comparable competitive units.

With essentially infinite resolution, this line of high-quality, general-purpose, cermet trimmers is good for a wide range of industrial and commercial applications. In quantity, these units sell for less than \$2 each. Why pay more?

For the full specs, circle the reader service card. Or for immediate off-the-shelf delivery (in standard resistance values) contact your local Spectrol distributor.

BRIEF SPECS

Package Size	1.250 x .320 x .195
Weight01 oz.
Temperature Range	-25°C to +125°C
Resistance Tolerance	± 20%
Element	Cermet
Configurations	Offset pins, leads, or solder hooks
Resistance Range	10 ohms to 1 megohm

Spectrol Electronics Corporation

A subsidiary of Carrier Corporation
 17070 East Gale Avenue
 City of Industry, Calif. 91745
 Phone: (213) 964-6565 • TWX: (910) 584-1314



Better Components for Better Systems: precision potentiometers • trimming potentiometers • turns-counting dials • miniature switches

Senator Stennis predicts boost in military R&D

Military R&D programs that have been limping along on token funds for years should have easier financial going in fiscal 1970.

This is the conclusion drawn from remarks made by Sen. John Stennis (D-Miss.) in an exclusive interview with *ELECTRONIC DESIGN*.

The Senator is chairman of the Preparedness Investigating Subcommittee.

Asked to forecast the fortunes of specific military development programs that, for years, have been dragging along on limited funds, Stennis began by saying:

"The Nixon Administration will strongly support the military strength concept . . . particularly [for] new weapons." This is a concept the Senator has long supported.

Concerning strategic offense, Stennis says he will advocate accelerating research on the Advanced Manned Strategic Aircraft.

The program got a token award of \$5 million in fiscal 1969—but no authorization for a contract-definition phase.



Senator speaks out on R&D

As for funding any new family of ICBMs, Stennis does "not think the time has come yet [to go beyond the research stage]. We have an abundance of Minuteman and Polaris missiles deployed," he says.

Concerning tactical warfare and continental defense, he says "We need the FX."

This is the high-speed Air Force fighter that will be designated the F-15. The new plane will succeed the McDonnell Douglas F-4 and will compete with the Soviet Union's Foxbat—rumored to be the world's fastest (Mach 2.8) operational fighter (see ED 16, *News Scope*, Aug. 1, 1968, p. 21).

Asked about the proposed Navy fighter, the VFX, Stennis says: "The VFX has a high emergency rating. It is needed to take the place of the canceled F-111B."

The five industry teams that have been preparing studies for the VFX-1—which will eventually be designated the F-14A—will be narrowed to two this month. Cost of producing the F-14A will probably hit \$2 billion. Follow-on models, plus a reconnaissance version, could put the entire program into the \$10 billion class.

Concerning surveillance, Stennis says he plans to ask for money to revive production of the YF-12A interceptor. Only two of these Mach-3 planes, as far as is known, exist. A reconnaissance version of the Lockheed-built plane is being flown by the Strategic Air Command, under the designation of SR-71. The YF-12A could be used to collaborate with the proposed airborne watchdog, Awacs, that will be equipped with down-looking radar to detect incoming enemy bombers.

Concerning electronic warfare, Stennis says more electronic countermeasures are needed, on planes "that we use in several places, in-

cluding the Mediterranean."

Asked about the Grumman EA-6B Intruder, which was not funded in fiscal 1969, he says: "It will move. It's something that's really needed."

The EA-6B is equipped with a pod-mounted tactical jamming system that generates false signals and jams enemy radars as it escorts fighters and bombers to their targets. The twin turbojet is designed for both carrier and advanced-base operation.

Concerning naval superiority, Stennis' reaction to the Soviet fleet's presence in the Mediterranean is that the U.S. "must be there, quick, with a large, strong fleet that leaves no doubt about superiority. That's the way to avoid trouble." He points out that "more money will probably be needed for antisubmarine warfare" and that "more submarines are [also] needed in the Mediterranean." He says that he will advocate building "at least a few more attack submarines beyond those now planned, the last of which would be rolled out in 1970, unless more are ordered."

Looking beyond the "quiet" submarine, work on which has already begun by General Dynamics, Stennis says that a "fast" submarine is also under active consideration. "I think a family of fast submarines will mature," he says. Concerning the cost of submarines: "They used to be about \$30 million each. Now, we're projecting submarines that will cost \$180 million each."

Concerning army hardware, Stennis reveals that he is enthusiastic about the new Main Battle Tank, MBT-70, being built as a joint U. S.-West German effort.

New king of computers unveiled in Wisconsin

The new king of computers, Control Data Corp.'s CDC-7600, is four to eight times faster than its predecessor, the CDC-6600.

Described as "the world's most powerful computer," the 7600 was unveiled at the company's laboratory in Chippewa Falls, Wis. It features a 27.5-ns logic clock cycle, compared with 100 ns for the 6600. It will execute instructions, on the

average, five times faster.

The 7600 has a hierarchy of memory: 65,536 words (60 bits) in a small central-processing-unit core memory and 512,000 words in a large core memory in the same unit.

The price for the new king is headier, too: It sells for \$9 million to \$15 million, or rents for \$190,000 to \$300,000 a month. This compares with \$4.5 million and \$85,000 a month for the CDC-6600.

Remarkably, the 7600 is made completely from discrete components.

"There's something basic you don't read in the ads for integrated circuits," super-computer designer Seymour Cray confided to reporters at the unveiling. "The process used in making ICs inherently compromises performance, mostly manufacturing tolerance and speed. The payoff should be cost, and that's why ICs are taking over in small- and medium-sized computers."

Tinted-blue glass panels and walnut metal trim distinguish the 7600 from other machines. It has 14 panels, only two of them being the central processing unit. There is no facility for the central processor to connect with input-output peripherals. Six peripheral units—separate computers—are provided for this.

Six 7600s have been ordered by Government agencies, and the first is due for delivery early next year to the Lawrence Radiation Laboratory at Berkeley, Calif.

Digital system speeds jetliner communications

Ordinarily it would take about a minute for the crew of a flying jetliner to radio to airline headquarters such information as the plane's identification number, its position, the engine performance and other data. A new air-to-ground digital communications system being tested by Pan American World Airways does the job in 0.6

of a second.

Called Digicom, the system is being tried out on a 707 jet on flights between New York and the Caribbean. Upon cockpit command, a binary-coded digital message in the form of a keyed, phase-shifted audio tone is transmitted from the airliner to a Federal Aviation Administration ground station at Avalon, N.J., and a Pan Am station at Kennedy International Airport. The message is then relayed by land line from the FAA station to Pan Am's message switching center in Cedar Rapids, Iowa, and then back to the Pan Am Building in New York. Here, the message is printed on a teletype and also displayed on a cathode-ray tube. A line from Kennedy Airport goes directly to the building.

In addition, analog data taken from engine sensors is converted to a binary-coded decimal signal and is also transmitted to the Pan Am Building for system evaluation.

11 telescopes in space offer new view of stars

The Orbiting Astronomical Satellite launched on Dec. 7 is the largest, heaviest and most automated scientific satellite ever launched by NASA.

The 11-telescope space package is expected to provide astronomers with data on young hot stars in the ultraviolet spectrum, and may also provide clues to the origins of the universe. The observatory was launched into a circular orbit some 480 miles above the earth.

In the past, acquisition of ultraviolet data from stars has been a time-consuming effort, mainly because the radiation does not pass through the atmospheric layer that surrounds the earth.

The 4400-pound satellite, which stands 10 feet tall and spans 21 feet with its eight solar panels extended, was built by Grumman Aircraft Engineering Corp., Bethpage, L.I.

The stabilization and control system, built by General Electric, Valley Forge, Pa., enables a telescope to lock onto a star by providing a course pointing accuracy of one minute of arc. This pointing accuracy, which must be maintained within 15 arc seconds for 50

minutes, is equivalent to zeroing-in on a person's eye from 500 feet, then holding steady for up to an hour and conducting a detailed study of its color and brightness.

The star-tracking system consists of six small telescopes which are capable of locking onto starlight and converting it into satellite-orienting commands.

Computers will link California crime net

The fight against crime in the state of California will soon be time-shared.

A \$5-million police communications network, scheduled to be fully operational by October, 1969, will allow a policeman on duty anywhere in the state to check—by radio or land line—the legal status of suspects in both state and national crime files and to get back an answer at computer speeds.

The new California Law Enforcement Telecommunications System will link more than 450 state law-enforcement agencies to computer crime files in both Sacramento, the state capital, and Washington, D.C. It will replace a state teletype system that was established in 1931.

The centers of the high-speed system will be a complex of four RCA Spectra 70/40 computers, which will be placed in pairs at opposite ends of the state—Los Angeles and Sacramento—to protect the system against interruption by local disaster.

A policeman in the field will query his dispatcher by radio or telephone. The latter, in turn, will transmit coded inquiries over the network to data banks maintained by the state's Depts. of Justice, Motor Vehicles and Highway Patrol, and to the FBI's National Crime Information Center in Washington.

The computers will not only check their own files; they will also talk to each other. Information will be displayed at the dispatcher's terminal.

The system will be a cooperative effort: The state will provide the computers and switching-center personnel; the local agencies will set up the equipment that will link them to county terminals.

How to use the Singer model SSB-50-1 Spectrum Analyzer to monitor tone level in a multiplexed communications system

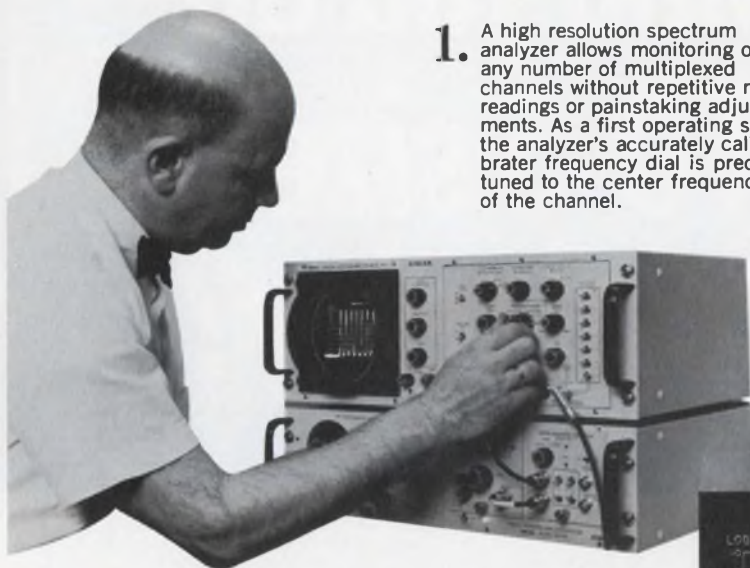

1. A high resolution spectrum analyzer allows monitoring of any number of multiplexed channels without repetitive meter readings or painstaking adjustments. As a first operating step, the analyzer's accurately calibrated frequency dial is precisely tuned to the center frequency of the channel.



2. A selector knob sets the frequency scale in one of five settings from 15Hz/division to 1.4KHz/division. Interlocked circuit functions in the analyzer automatically optimize the display for any setting of the frequency scale.

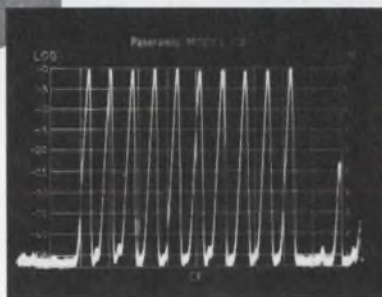

3. The high resolution of the Singer Model SSB-50-1 provides this clear display of the multiplexed channel. The amplitude of each subcarrier is shown as a function of frequency. The display demonstrates complete operational readiness at a glance . . .

4. . . . but often a subcarrier level changes with a resulting communications malfunction. This display on the CRT shows that one subcarrier's level is down 12 db. Another is over the predetermined acceptable level.

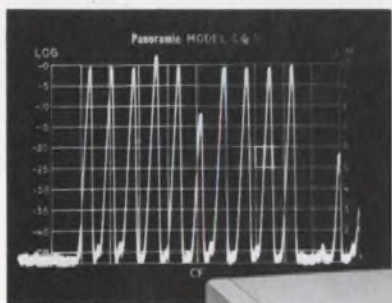

5.

Because the entire spectrum is continuously visible on the display, a lost channel shows up instantly . . . A frequency range of 10Hz to 40 MHz makes the Model SSB-50-1 an invaluable tool for this application and for general laboratory or field use.

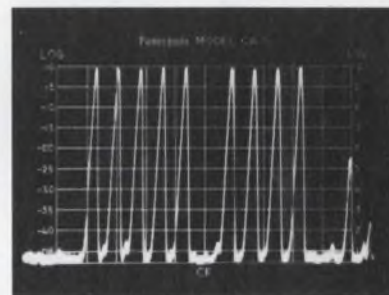

Model MF-5/CA-5-1 Spectrum Analyzer display section (features high resolution/low distortion and 70 db dynamic range)

Model TTG-3 Two-Tone Audio Generator 20-20,000 Hz frequency range and IM distortion of less than 70 db for testing single sideband transmitters

Model REC-2 Range Extending Converter (extends the tuning range down to 10 Hz)



Model RF-8 Tuning Head (highly stable LO with coarse and vernier two speed tuning from 2 MHz to 40 MHz . . . usable to 200 MHz)



SINGER
INSTRUMENTATION
The Singer Company, Metrics Div.,

915 Pembroke Street, Bridgeport, Conn. 06608 (203) 366-3201
SEE SINGER AT WESCON BOOTH 1712-1716

INFORMATION RETRIEVAL NUMBER 16

What could you do with a T0-5 size commercial relay?



**Deutsch-Filtors
has one.**

A brand new industry first from Deutsch-Filtors Industrial Products. The TC is a one amp, DPDT commercial relay with a clear dust cover, and sensitivity as low as 235 milliwatts. With a wealth of knowledge in relay design to back it up.

Are the ideas already coming to you? We'll see to it that a sample does too. Just drop us a line on your letterhead. And then see what you can do.

** Available immediately from COMPAR STOCK **

NEW AIDS FOR RADIO ASTRONOMY

Indirect design piercing celestial 'barriers'

'Brute force' approach to observation of universe is giving way to ingenious computer techniques

Elizabeth deAtley
West Coast Editor

The breakthrough, as Dr. Gerrit L. Verschuur recalls it today, was almost anticlimactic. It came shortly after 10 a.m. last July 4 while the noted radio astronomer was in his office at the headquarters of the National Radio Astronomy Observatory in Charlottesville, Va.

Dr. Verschuur was poring over a string of asterisks on a long strip of computer paper. For seven years he had been scanning read-outs like this, looking for signs of a magnetic field in the Milky Way Galaxy. Suddenly his attention focused on a bulge in the pattern of asterisks.

"You know," he said quietly to two colleagues. "I think I've got it at last. There seems to be something here."

What he was looking at was a representation of radio waves emitted by hydrogen gas some 10,000 light years away. He saw a split in the absorption spectrum of the waves that would enable him to measure, for the first time in the history of radio astronomy, the strength of magnetic fields in our galaxy. It would enable radio astronomers everywhere to check their calculations of the strength of these fields and would give them new clues to how stars are born.

The delicate measurement was made possible by the development of a new 413-channel digital autocorrelation receiver. Before this receiver was put into operation at the observatory last May, no receiver anywhere was capable of resolving small enough bands of frequencies to detect such minute splitting in the radio waves.

Dr. Verschuur's discovery is typical of advances being made everywhere in radio astronomy through innovations in equipment design.

The old "brute force" solutions—building bigger antennas and more sensitive receivers—have reached practical limits. Now, electronic engineers are resorting to ingenious, indirect solutions, made possible by the computer. As a result, they are designing more sensitive equipment than ever before.

At the National Observatory installation in Green Bank, W. Va., for example, radio astronomers are taking radio intensity "pictures" of regions of the sky that are invisible to optical telescopes. At Cornell University's Ionospheric Observatory in Puerto Rico, they are resolving pulsar signals—those periodic pulses that come from unidentified sources in space—into subpulses of much higher repetition rate. In Europe and this country, scientists are synchronizing their telescopes in a single system trained on quasars—the very luminous radio galaxies that seem to be located at the outer reaches of the universe, some 10^{10} light years away.

Antenna arrays developing

The indirect engineering approach is yielding important results in antenna design. The resolving capabilities of a very big antenna dish can now be approximated by two or more small dishes spaced at intervals. The radiation collected at each spacing is processed by computer to produce a radio-intensity picture of the source at which the dishes were pointed. In other words, two small dishes and a computer can do the job of one enormous dish. The greater the separation between the dishes, the higher the resolution obtained. But until recently, the separation has been limited by the lengths of cables that link such installations.

This limitation has been dramatically overcome in the transcontinental or transoceanic long-baseline interferometer, developed by the National Radio Astronomy Observatory, the Massachusetts Institute of Technology, Cornell University and the Onsala Space Observatory in Sweden. In this type of system, measurements are made at two or more widely separated radio antennas that have no communication link between them. At each site the received signals are processed and digitally recorded. Atomic clocks, which provide equal frequencies for tuning the receivers and controlling the sampling rate, are synchronized by LORAN C pulses. These pulses are emitted at precise intervals from stations throughout the world. The information obtained from the various antennas is stored on magnetic tape and sent to a central computer for processing.

Up to four telescopes have been used in a common system: one at Westford, Mass., another at Green Bank, W. Va., a third at Hat Creek, Calif., and a fourth at On-

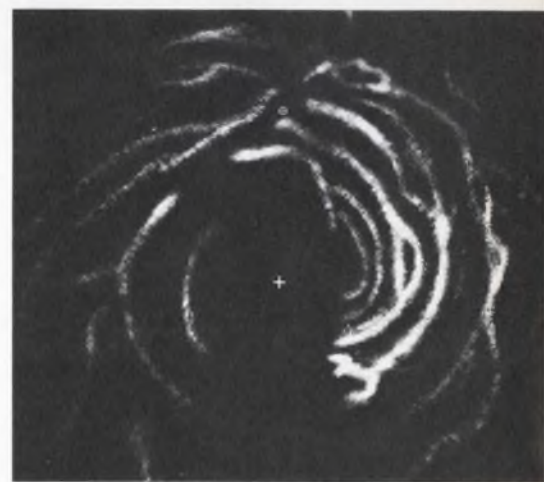

Schematic map of the Milky Way, based on measurements of the absorption spectrum of hydrogen gas, shows how our galaxy might look to an observer face-on. Circled dot marks the sun's position; plus sign is the center of the galaxy.

(Radio astronomy, continued)

sala, Sweden. An interferometer that spans the Pacific between the United States and Australia is planned for the near future. Thus the diameter of the earth now becomes the limit on baseline length. Radio astronomers are already studying methods for space-borne interferometers that could overcome this limitation.

Minute resolutions result

Existing long-baseline interferometers have increased the obtainable resolution by two orders of magnitude, and this is expected to jump to three with the longer baselines planned for the future. With telescopes in Sweden and West Virginia, resolutions of up to 0.0006 seconds of arc have been obtained. Radio astronomers compare this to the angle that would be subtended by a Volkswagen if the car were placed on the moon and viewed from the earth. To achieve comparable resolutions of optical wavelengths, the 200-inch telescope at Mount Palomar, Calif.—the world's largest optical telescope—would have to be several hundred feet in diameter.

Some remarkable discoveries are being made with these new systems. Consider the case of quasars, or quasi-stellar radio sources, which have puzzled astronomers since their radio emissions were first studied in 1962. They appear to be galaxies, possibly as far away as 10^{10} light years, with a luminosity equal to 1000 average galaxies. More puzzling yet, they seem to be considerably smaller than other galaxies—a few light years across, compared with a hundred thousand light years or more. They are so small and so far away, in fact, that their precise angular size has been impossible to determine. Now, with the long-baseline interferometer, these small, distant objects are being resolved. Recently, for example, it was found that most of the radio emissions from the 3C273—the brightest quasar and the first one discovered—come from a region in its center that subtends an angle of less than 0.0006 seconds of arc, and therefore seems to be less than a light year across.

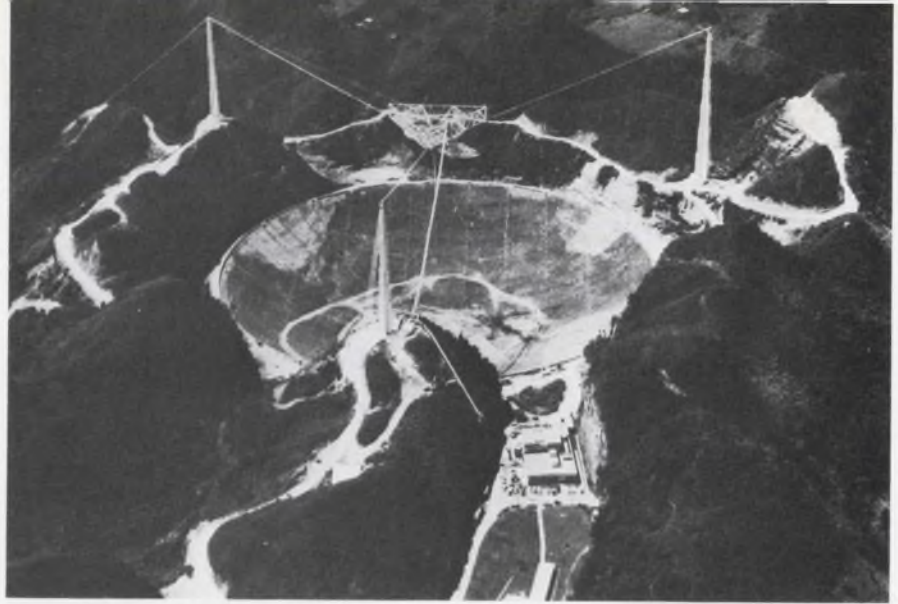

The 1000-foot spherical dish at the Arecibo Ionospheric Observatory in Puerto Rico has a movable feed. It is being used for pulsar study because these strange pulsations, which extend from 40 to 2300 MHz, are strongest at the lower frequencies, for which this dish was designed. The observatory is operated by Cornell University under a contract from the Advanced Research Projects Agency of the Defense Dept.

Possible future applications for this new type of system are far-flung.

"Geologists may be able to check the theory that continents are drifting, by directly measuring the drift rate," says Dr. Kenneth Kellermann, a radio astronomer at the National Observatory who helped set up the long-baseline project. This measurement should be possible, he says, because the distance from one telescope to another can now be determined to within a few centimeters by taking the data obtained with a common radio source

at the two telescopes and processing it in a central computer.

Today computers are being used to steer the telescopes, translate antenna position into convenient astronomer's coordinates, process signals, reduce and analyze data, and make theoretical models to describe observed phenomena.

The search for new pulsars has greatly accelerated this trend toward computerization.

"For the first time in the history of radio astronomy," says Dr. Sander Weinreb, head of instrumentation at the National Observ-

The origin of pulsars

Pulsars may be burned out neutron stars, according to Dr. Frank D. Drake of Cornell's Arecibo Ionospheric Observatory in Puerto Rico.

Theoreticians have long predicted the existence of these extremely dense stars and estimated them to be about 10 miles in diameter—much too small to be observed by existing optical telescopes. They have predicted that objects of such density and size would oscillate at a rate of about 100 Hz if set off by some kind of explosion—possibly in the surface gases. This rate—about 100 Hz—is the repetition

rate of subpulses that are often observed traveling across the oscilloscope screen superimposed on the much larger main pulses.

The theory is that the neutron star is oscillating at 100 Hz and rotating typically once a second. One can imagine, then, that a hot spot on one side of the star is beamed at the earth once a second, making it possible to observe the 100-Hz oscillations of the star only at these times.

Neutron stars are believed to be remnants of a burned-out star whose internal pressure is no longer able to support its outer layers.

Normal Mode Noise Clouding Your Low-Level DC Measurements?

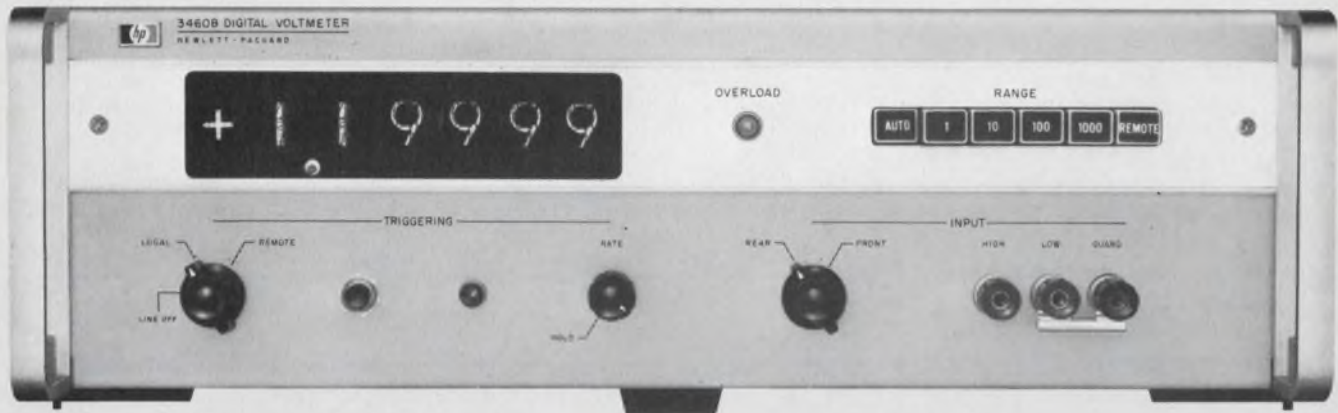

Not Here! The HP 3460B was introduced as a super accurate, 5-digit voltmeter. To make 0.004% of reading accuracy practical, a dual technique was utilized—integrating and potentiometric. The integration technique in itself gave a high common mode rejection of 160 dB at dc.

Now HP has added a filter option which is a programmable filter that cancels out frustrating noise picked up by leads and input devices. This

filter effectively adds 26 dB of ac normal-mode rejection at 60 Hz to rejection provided by integration. Now you can accurately measure low level dc signals with as much as 100% of range (peak) ac riding on the measured dc signal.

Other features of the 3460B include a sixth digit for 20% overranging, automatic polarity selection, four ranges from 1 V to 1000 V, guarded inputs, 15 readings per second (without filter) fully programmable functions with BCD output for systems compatibility.

To make the 3460B a multiple function DVM, add the HP 3461A AC/Ohms Converter-DC Preamplifier. Measure 0.1 V dc voltages with 1 μ V sensitivity, 50 Hz to 100 kHz ac measurements with 10 μ V sensitivity, and resistance measurements from 1

k Ω to 12 M Ω with 10 millionhm sensitivity on lowest range.

If you're interested in a precision DVM, look up the 3460B in your HP catalog. If you're interested in adding the filter option to pick low level dc out of noisy environments, call your local HP field office. (Price HP 3460B, \$3800; 3461A, \$2400. 3460B Option 002 or 003 is required for operation with 3461A. Price option 002 or 003, \$150. Filter option prices on request.) Or for a data sheet, write to Hewlett-Packard, Palo Alto, California 94304. Europe: 1217 Meyrin-Geneva, Switzerland.

099/1

HEWLETT  PACKARD
DIGITAL VOLTMETERS

(Radio astronomy, continued)

atory, "the weakest signal that can be detected depends directly on the computer time available."

What are these strange pulsations, which come from regions in the sky where optical telescopes find nothing? Why does it require so much computer time to detect their presence?

A pulsar emits a series of pulses that occur at very precise intervals. Dr. Michael Davis, radio astronomer at the National Observatory, says that the average period of the first pulsar, which was discovered at Cambridge, England, about a year ago, "has not changed by one part in 10^{11} —this is pushing even the hydrogen maser clocks to the limit of their accuracy."

The first pulsar occurs at intervals exactly 1.33730113 seconds apart. Ten other pulsars are now known, each with its own very precise pulse rate. In addition a new pulsar-like aperiodic pulse was detected in the Crab Nebula early in November. Individual pulsars have been measured over a very wide band of frequencies (40 MHz to 230 MHz).

The detection of pulsars is complicated by several factors:

1. Although typically pulsars occur at very precise intervals, the strength of the pulse may vary

Classification of Radio Waves

Name	Year of Discovery	Spatial Dependence	Signal Description	Source
Continuum Background	1932 Jansky	Continuous in Plane of Galaxy	Broadband Noise	Electrons in our Galaxy
Sun	1942 Hey	Solar, Disc and Corona	Broadband Noise, Time Variable	Solar Plasma
Discrete Sources	1946 Hey	Discrete "Stars"	Broadband Noise	External Galaxies, Hot Galactic Regions, Supernova Remnants, Planets, Quasars
Spectral Lines, Hydrogen, OH, Helium	1951 (Many)	Continuous and Discrete	Discrete Frequencies	Atomic Transitions in Gases
Pulsars	1968 Hewish	Discrete "Stars"	Broadband Pulses of Noise	White Dwarfs?

greatly from one interval to the next. At some intervals, the pulse is very strong and at others it is too weak to detect. However, when a pulse occurs at all, it occurs at the precise time interval that is characteristic of that particular pulsar.

2. Characteristically pulsars are much stronger at low frequencies than at high.

3. Individual pulses associated with a given pulsar may contain "sub-pulses" of much higher frequency (on the order of 100 Hz).

4. The velocity of electromag-

netic radiation is slowed as it travels through ionized gas in interstellar space. The long wavelengths are slowed more than the shorter ones, and thus arrive at the earth later. This effect, known as dispersion, causes a differential delay in the arrival time of the same pulsar at different frequencies. At 2300 MHz this delay may be only a few microseconds, whereas at 40 MHz it may be as much as 40 seconds.

To identify a pulse repetition rate at a given frequency as a particular pulsar requires subtle cross-



1. The effects of resolving power are shown by these two photos of the Whirlpool Galaxy, taken with an optical telescope at about one second of arc (left) and two minutes of arc (right). Because radio waves are so much longer than light waves, even the largest individual radio

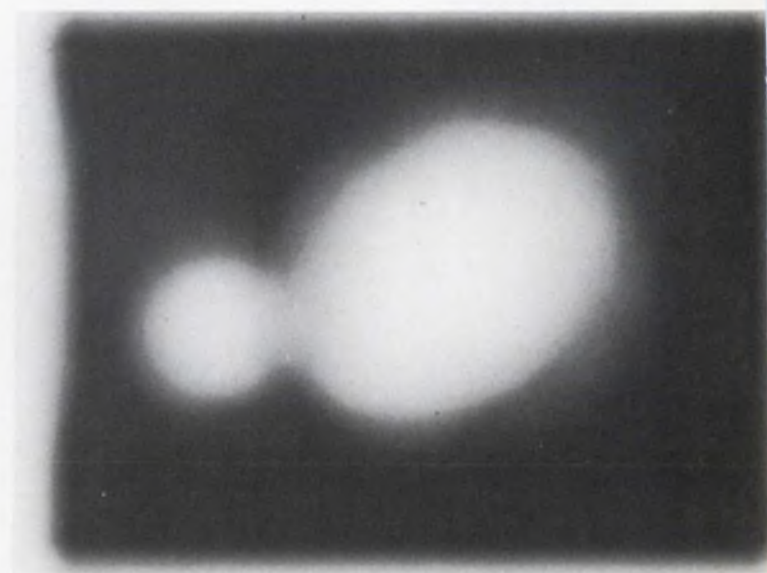

telescopes cannot observe detail as finely as a small optical telescope. The new very large array paraboloid antennas at the National Observatory, Green Bank, W. Va., will have a maximum resolution of one second of arc—comparable to that in the photo at left.

Would a 15W power IC audio amplifier be music to your ears?

Listen to what the new Bendix Model BHA-0002 audio amplifier can do for you.

This 1" x 2" x 5/16" package actually costs less to use than discrete components—and outperforms them as well. It has 25Hz-20KHz frequency response, a voltage range of 14 to 40 volts, power gain of 55db, THD less than 1%, high-power operation to 100°C case temperature, and 350 mV input for $P_o = 15$ watts.

The BHA-0002 offers some exciting possibilities for stereo amplifiers, trancivers, PA systems, phonographs, musical instrument amplifiers, intercoms and movie projector/sound systems.

It's one of a whole new family of thick-film power circuits from Bendix. These additions include two more audio amplifiers, 2W and 5W (see chart), plus a new Darlington, bridge rectifier and power driver module for industrial applications.

It's a lot of power for a lot of applications. From the real power in power: Semiconductor Division, The Bendix Corporation, Holmdel, New Jersey 07733.

POWER AUDIO AMPLIFIER CIRCUITS

Part Number	Maximum Power Output (W)	Voltage Range (V)	Input Voltage (mV)	Frequency Response (Hz)
BHA0001	2	11 to 16	5	40 to 10K
BHA0004	5	11 to 20	20	25 to 20K
BHA0002	15	14 to 40	350	25 to 20K

Bendix **Electronics**

Chicago—(312) 637-6929; Dallas—(214) 357-1972; Detroit—(313) 548-2120; Great Neck, N.Y.—H. V. Sales Co. (516) HU 7-1142; Greenwich, Conn.—(203) 869-7797; Holmdel, N.J.—(201) 946-9400; Lexington, Mass.—(617) 861-8350; Los Angeles—(213) 776-4100; Minneapolis—(612) 926-4633; Orlando, Fla.—(304) 241-6559; Rochester, N.Y.—(716) 266-5550; Runnemede, N.J.—(609) 933-2550; Seattle—Ray Johnston Co., Inc. (206) LA 4-5170; Export—Cable: "Bendixint," 605 Third Avenue, New York, (212) 973-2121; Ottawa, Ont.—Computing Devices of Canada, P.O. Box 508 (613) 829-1800; San Juan, Puerto Rico—Southern International Sales Co. 723-3879.

(Radio astronomy, continued)

correlation techniques. As Dr. Weinreb puts it: "You have to correlate the signal with a possible pulsar having a certain rate and dispersion. You've got to do this for all possible rates—all the rates that are reasonable for pulsars and all the dispersions that are reasonable—and that is a very long computing job."

Not only is the computer being used more and more to help the radio astronomer search for and interpret signals that are buried in noise; it is also helping the equipment designer, by making it practical for him to use the indirect solutions to old problems.

The brute-force approach to the design of a good radio astronomy antenna is to build an enormous, very smooth paraboloid dish, freely adjustable in two coordinates and yet so rigid that it will hold its paraboloid shape to within a very fine tolerance as it tracks a point in the sky. Why is such a dish a good radio-astronomy antenna? What does it have that the dipole, for example, does not have?

For one thing, it has a large collecting area. This gives the big dish two essential qualities: high resolving power—the ability to distinguish two objects separated by a very small angle of arc—and high sensitivity—the ability to detect weak signals. Both resolving power and sensitivity are inverse functions of wavelength; so the dish should be even bigger for long-wavelength radiation than for short.

Although not all existing big dishes are paraboloids, this shape is desirable because parallel rays from distant radio sources will strike the paraboloid surface and

converge in phase at the focal point. This paraboloid surface must be very smooth, because any slight irregularities in it will deflect the shorter wavelengths away from the focal point. For the same reason, if the dish bends slightly out of shape as it tracks a source in the sky, the shorter wavelengths will be deflected away from the focal point. Thus the smaller the wavelengths received, the more perfect the shape of the dish must be.

There are practical limits, of course, to the size of such a dish. The bigger it is, the heavier it is and the more it will bend out of shape when moved about.

Scientists at the National Observatory estimate the maximum practical size for an antenna dish to be about 400 to 500 feet in aperture diameter. And, of course, the cost of building a fully steerable dish close to this theoretical limit is so high that no one has been willing to pay for it. The biggest fully steerable antenna in the world is a 250-foot-diameter paraboloid dish at the Jodrell Bank Observatory, University of Manchester, England. Most dishes like it are less than half its diameter. And, unfortunately, existing dishes provide far less resolving power than a good optical telescope (Fig. 1) and far less than the radio astronomer needs for many purposes.

The 'aperture synthesis' method

To solve this problem, the equipment designer is turning more and more to an indirect approach known as "aperture synthesis." In its simplest form, aperture synthesis is a method of synthesizing the collecting area of a large dish by measurements with an interferometer which consists of two dishes, one fixed and one movable.

In the case of the big dish, the incoming waves that fall on each elemental area add at the focal point. In the aperture-synthesis approach, the measurements made with the two dishes in different positions are summed by a computer.

The two antennas of the radio interferometer are separated by a base line of given length. Radio waves impinging on the antennas are fed to a summer and integra-

tor. The phase difference in the waves from the two antennas, as they arrive at the summer, produces fringe patterns analogous to those of an optical interferometer. These fringe patterns vary, depending on the base line length, the position of the source and the distribution of radio intensity across the source.

A source is tracked over a period of time, fringe patterns are recorded at frequent intervals during this time, and this information is processed by computer. A radio intensity contour map of the source (see cover photo) can be obtained by repeating this procedure for many different base line lengths and by taking the Fourier transform of all data collected.

The more dishes there are in an array, the faster the data can be collected. For this reason, multi-dish arrays are becoming more and more popular.

36-antenna array planned

One of the largest—now in the design and proposal stages at the National Observatory—is an equiangular Y configuration of 36 paraboloid antennas, each 82 feet in diameter and transportable on railroad tracks. Each arm is 15 miles long. The system includes 630 receivers—one for each pair of antennas.

In eight hours this array will make a radio-intensity contour map containing 14,000 dots at any of four different resolutions: 1, 3, 9 or 27 seconds of arc, depending on the size of the map. For example,

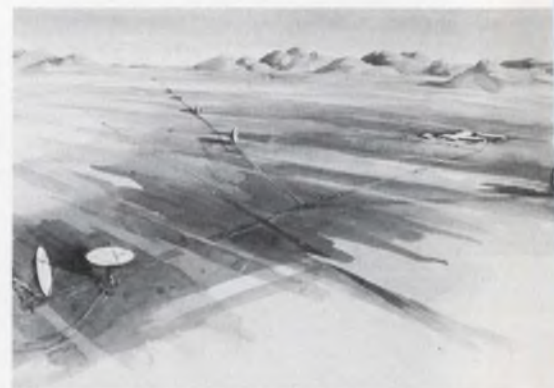

Artist's conception of the very large array of paraboloid antennas that the National Radio Astronomy Observatory is planning to build at Green Bank, W. Va.

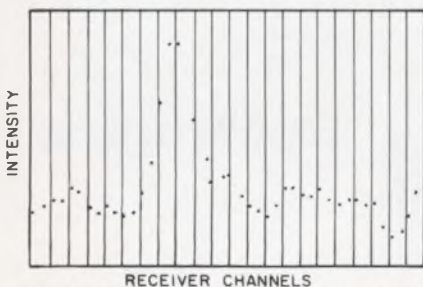

2. Typical output of a spectral line receiver.

NEW TUNG-SOL[®] DIGIVAC S/G

TRADE MARK



Vacuum Fluorescent
Readout with
Matching Logic

A Significant Second Generation Readout

1. Low cost
2. Single plane display
3. 150° viewing angle
4. Standard 9-pin base
5. High brightness
6. Low power
7. Low voltage
8. Simplicity of design
9. I.C. compatability
10. Optional decimal
11. 10 numerals; 13 letters
12. Variety of colors with appropriate filtering

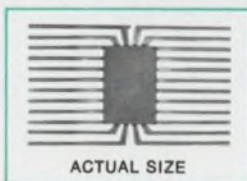

LOGIC FOR TUNG-SOL DIGIVAC S/G

This is a monolithic integrated MTOS circuit. It contains (1) decade counter, (2) storage register, (3) decoder/driver, and (4) appropriate input, output, and command terminals. Two important features are provision for leading zero blanking and false count indication.

Write for complete information.

TUNG-SOL DIVISION
WAGNER ELECTRIC CORPORATION

One Summer Avenue, Newark, N.J. 07104 • Telephone: (201) 484-8500

© T.M. Wagner Electric Corporation

INFORMATION RETRIEVAL NUMBER 20

(Radio astronomy, continued)

it will map a solid angle, whose diameter is about half that of the moon, with a resolution of 10 seconds per dot. To achieve comparable speed and resolution, a single paraboloid antenna would have to be about 23 miles in diameter, yet freely movable in two coordinates.

In eight to 12 hours, this array of antennas will collect data for some 10^4 independent Fourier components of the brightness distribution, which will be transformed into a "picture" of the region observed. A data reduction project of such magnitude would be inconceivable without a computer.

Doppler shifts are the key

Mapping the brightness distribution of a source and pinpointing its location in the sky are essential to an understanding of the nature of the source. However, this information tells the radio astronomer little about its contents and nothing about its speed toward or away from the earth. To determine these things, he must study the Doppler shifts in radio frequencies. Radiation from a source that is moving away from the earth, for example, is Doppler-shifted toward the longer wavelengths by an amount that is proportional to the speed. Like the spectral line of optics, certain radio frequencies are known to be emitted or absorbed by certain elements or molecular compounds under certain conditions. If the radio astronomer can identify one of these known emission or absorption frequencies, he can determine the amount of the shift and thus the velocity of the source.

The first line detected in the radio wavelengths was the H line, which is emitted or, under certain conditions, absorbed when the magnetic fields of the hydrogen proton and electron change their relative directions. This was a discovery of great importance to radio astronomy, since neutral hydrogen constitutes a major portion of interstellar matter and it is invisible to optical telescopes. Since that time several other spectral lines have been isolated in the radio-frequency range. Many such lines

coming from sources at various distances from the earth, traveling at various speeds, appear as a bulge on the frequency spectrum (Fig. 2).

For spectral line analysis, the radio astronomer needs a receiver that can determine the average power in each of a number of very narrow bandwidths that make up a larger bandwidth of interest. The power in each narrow band varies, first of all, because of noise from the atmosphere and the receiver itself. It varies further because the atomic and molecular transformations that emit a particular frequency fluctuate randomly about that frequency. The receiver must average the power at each narrow bandwidth and plot this average power over the desired larger bandwidth. In attempting to design such a receiver, designers first used a brute force approach: the multi-filter receiver. In this type of receiver, the output from the superhet is fed to several narrowband filters in parallel. The output of each filter is averaged and displayed as a single point on the frequency spectrum.

The trouble with this technique is that some frequency bulges are wider than others, and most are Doppler-shifted by an unknown amount. Thus the radio astronomer needs to observe over a wide band of frequencies to locate the spectral bulges before he closes in on

one or more for scrutiny. For this work, he needs different amounts of resolution and therefore, with the multi-filter receiver, a different set of narrowband filters for each bandpass.

Plainly some more versatile approach was needed, and Dr. Weinreb of the National Observatory looked to the autocorrelation function, digital processing and computer techniques to build the first radio astronomy autocorrelation receiver in 1961.

In this type of receiver, the desired resolution is obtained not by expanding the frequency spectrum directly, but by forming the expanded autocorrelation function in the time domain and converting it to the frequency domain by Fourier transformation.

The incoming signal is sampled at a certain rate that is inversely proportional to the desired resolution. These samples are used to create the autocorrelation function.

Assume a receiver with N channels at the output (Fig. 3). The incoming signal is divided into separate pulse trains: One contains frequency information, and the other amplitude information. The pulse train that contains frequency information is sampled at a rate of $1/\tau$ per second (see point X in Fig. 3). Every τ seconds a sample is stored in an N -bit serial-to-parallel shift register until N such samples have been accumul-

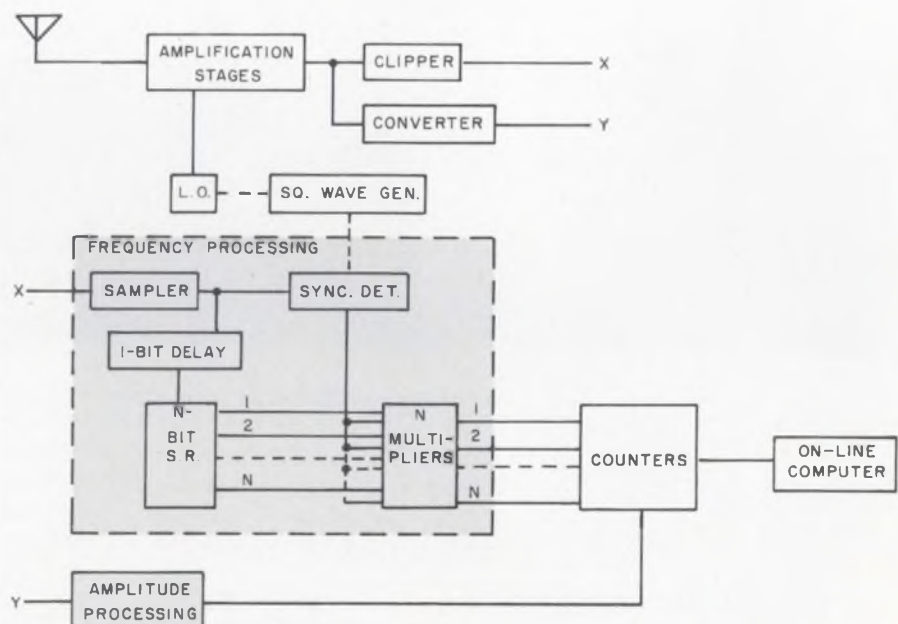

3. Block diagram of N -channel digital autocorrelation receiver of the type used at the National Observatory, Green Bank, W. V.

ed in the register. The $N + 1$ th sample—call it $f(t)$ —is multiplied simultaneously by each of the preceding N samples. Then $f(t)$ is stored in the first shift register bit. This process of multiplying the present sample by the N preceding samples is repeated over a 10-second interval, during which the products are summed and averaged. The amplitude information is then added, forming the autocorrelation function of the signal

$$\int_0^T f(t)f(t+\tau)dt$$

expanded in the time scale by an amount that depends on the sampling rate. For example, if the sampling rate is 20 MHz, the period τ between samples is 50 ns. If we assume the number of channels (N) is 400, the scale of the autocorrelation function is $400 \times 50 \text{ ns} = 20 \mu\text{s}$. If the sampling rate is reduced to 10 MHz, the period τ is 100 ns and the scale of the autocorrelation function becomes $400 \times 100 \text{ ns} = 40 \mu\text{s}$. The autocorrelation function is then converted to the desired power spectrum by Fourier transformation.

The square-wave generator and sync detector are used to subtract the background radiation, so that the desired spectral radiation will be displayed on a base of zero (Fig. 2).

The latest model, a 413-channel receiver designed by Arthur M. Shalloway and Robert Mauzy of the National Observatory, can display simultaneously the entire bandwidth of interest in 29 channels plus a narrowband of interest, much expanded, in 384 channels, or two bands in 192 channels. This receiver is considered by officials of the observatory to be the fastest digital system of its size ever built. Its maximum sampling rate is 20 MHz. ■■

Bibliography:

- IEEE Proceedings, January 1958.
- IEEE Transactions, December 1964.
- Kraus, J. D. *Radio Astronomy*. New York: McGraw-Hill, 1966.
- Kuiper, G. P. and Middlehurst, Barbara M. *Telescopes*. Chicago: Univ. of Chicago Press, 1960.
- Saxton, J. A. *Advances in Radio Research*, Vol. II. New York: Academic Press, 1964.
- Jennison, R. C. *An Introduction to Radio Astronomy*. New York: Philosophical Library, 1966.
- Shklovskii, I. S. and Sagan, Carl. *Intelligent Life in the Universe*. San Francisco: Holden-Day, 1966.

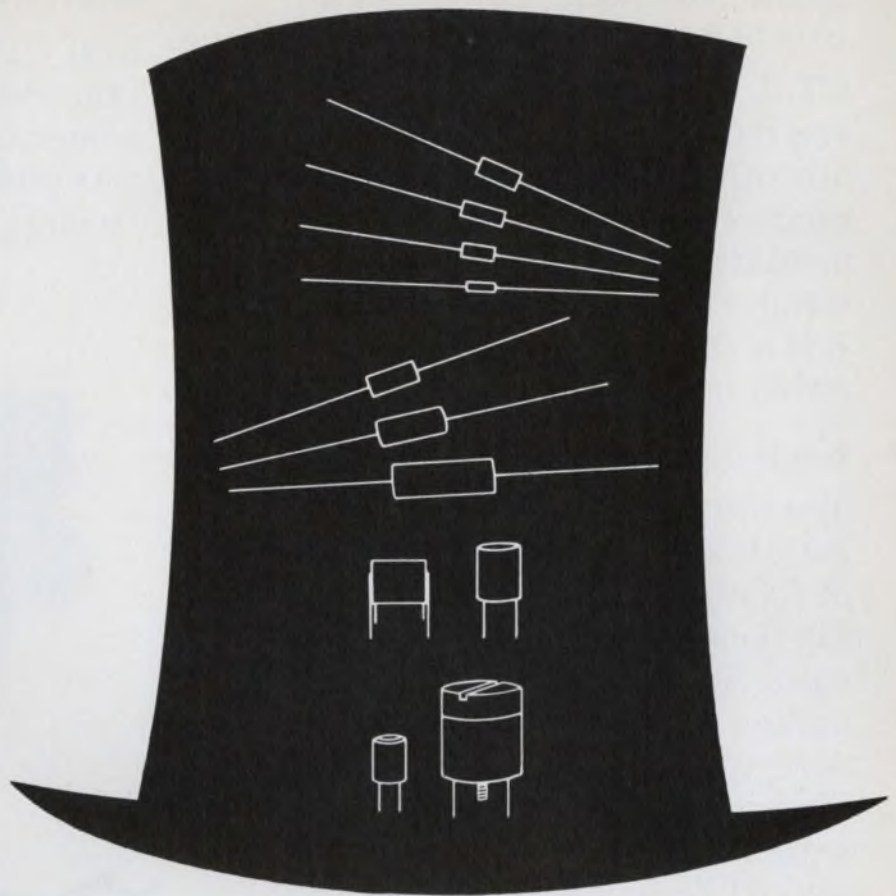

If you think Nytronics Inductors are tops...you ought to try our Ceramic Capacitors!

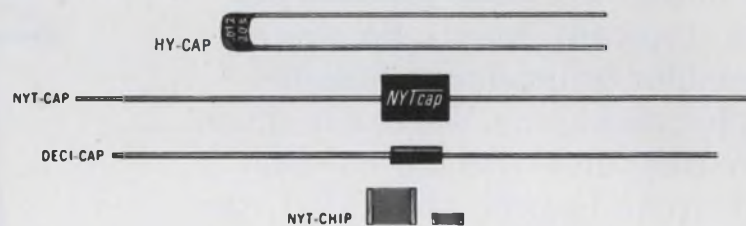

You'll find they're tops in quality and performance, too. Because they're the result of the very same unremitting research and development — and a standard line concept that links volume production with utmost precision. And you'll find the widest range of units with the greatest capacitance-to-unit size.

HY-CAP: .01 to 2.5 mfd.; $\pm 20\%$ tolerance; 100 WVDC; no derating to 125°C; and meets MIL-C-11015.

NYT-CAP: Molded epoxy package 0.1" diameter by 0.250" long... 4.7 to 220 pf; and 0.350" by 0.250" by 0.1"..... 270 to 4700 pf; T/C does not exceed ± 40

ppm/°C (−55°C to +125°C); and 200 WVDC.

DECI-CAP: Epoxy molded envelope 0.100" diameter by 0.250" long... 4.7 to 27,000 pf; and $\pm 10\%$ tolerance.

NYT-CHIP: 0.170" by 0.065" by 0.070" ... 4.7 to 220 pf; and 0.280" by 0.195" by 0.070"..... 270 to 4700 pf; T/C does not exceed ± 40 ppm/°C (−55°C to +125°C); and 200 WVDC.

In addition to ceramic capacitors and inductors, we maintain inventories of high quality delay lines and resistors. Complete engineering data on all products will be sent on request.



NYTRONICS®

Essex Electronics Division

550 Springfield Ave., Berkeley Heights, N. J. 07922 ■ (201) 464-9300 ■ TWX: 710-984-7977

INFORMATION RETRIEVAL NUMBER 21

If you're building any computer except a Computer, you need CT μ L.

CT μ L integrated circuits will give you more speed for less money than any other ICs. They're perfect for process control systems, test instrumentation, central processing units, computer peripheral equipment — just about anything short of an airborne computer.

Keep it in the family.

You can build a complete digital logic system with Fairchild's family of CT μ L devices. We have gates, flip-flops, inverters and memory circuits. A dozen different devices that make a computer easy to package. And, you'll need only about 80 percent as many packages as required with TTL.

You get out of it what you put into it.

The key CT μ L characteristic is non-saturating logic. That means you get fast gate propagation delay (typically 3nsec) with slow rise and fall times (typically 6nsec). So, there's no need for transmission lines or complex packaging. You can build an entire computer with normal two-sided circuit boards. Also, CT μ L can handle signal swings as large as 3V. It also provides typical noise immunity of 500mV.

What we'll do for an encore:

MSI CT μ L will be out before the year ends. CT μ L-II will be out even sooner, offering improvements like gate propagation delay of 1.5nsec. (typical, loaded) and a buffer and

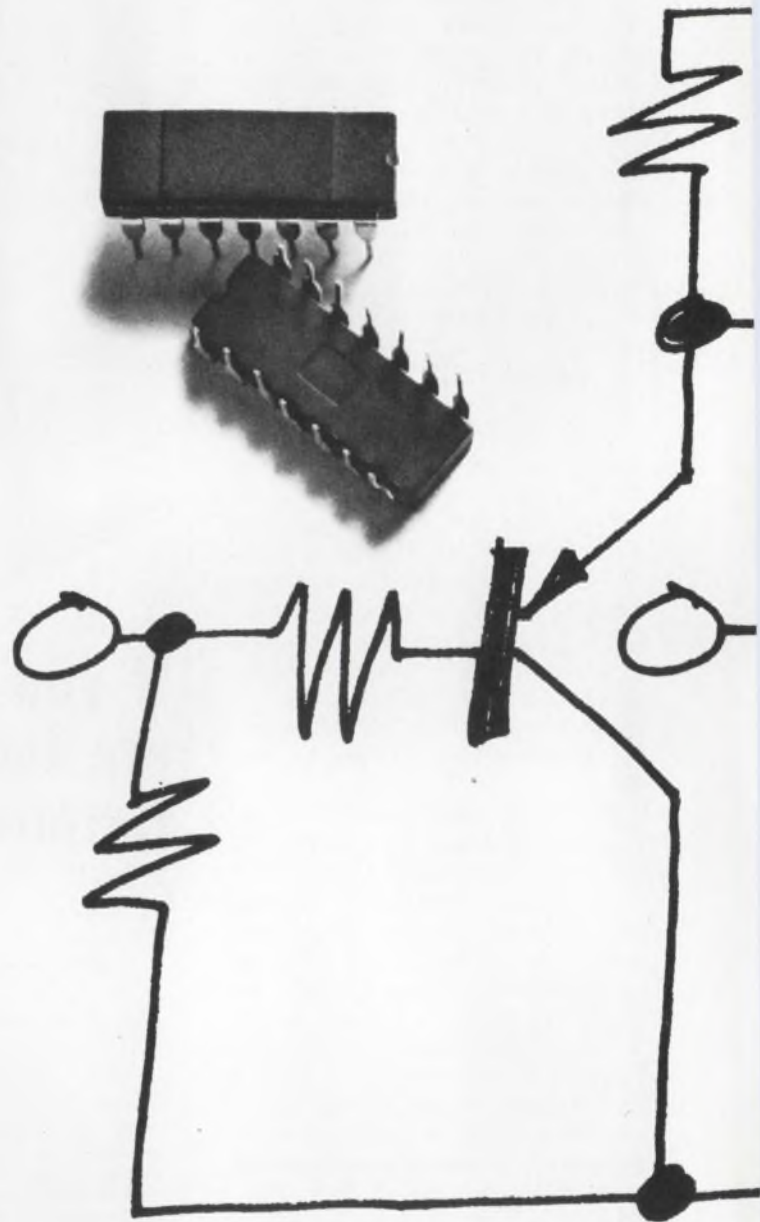

The world's largest manufacturer

inverter with propagation delays of 5nsec, compared with 12nsec in standard CT μ L. And, the new MSI and CT μ L-II circuitry will interface beautifully with all these standard CT μ L devices:

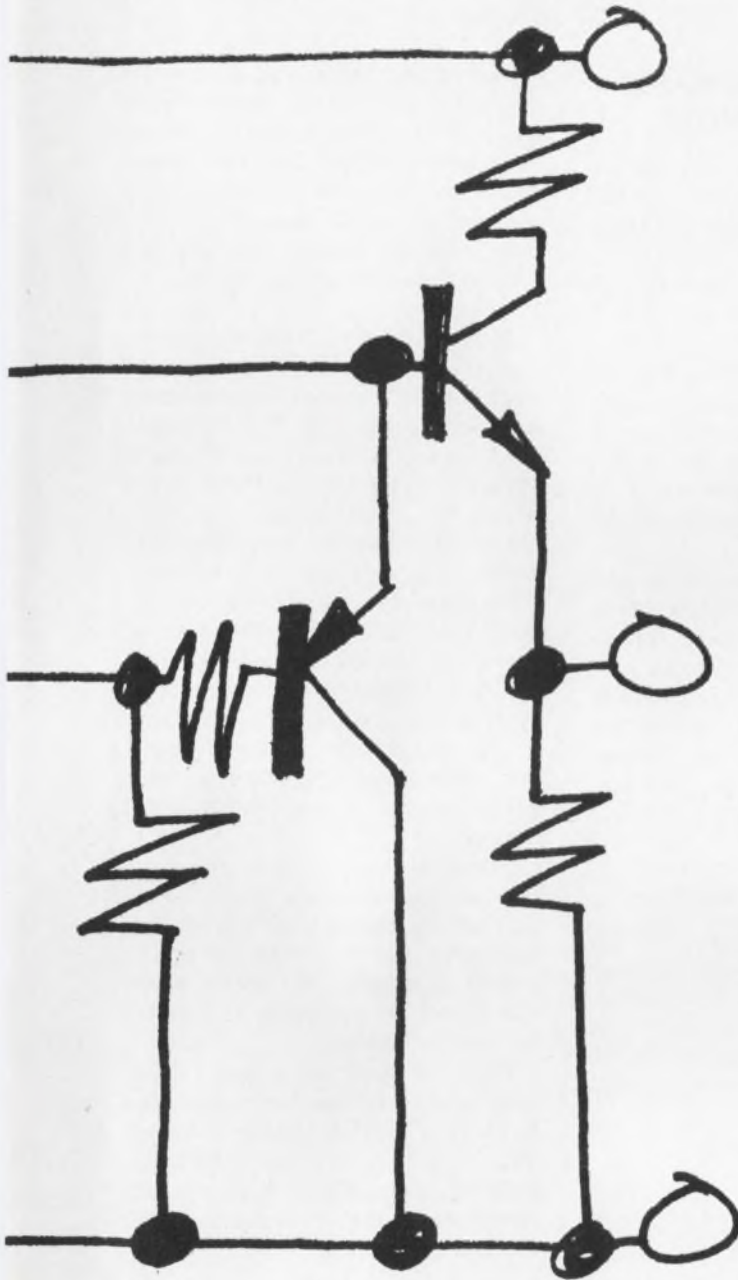

Device	Price (100-999)
9952 Dual NOR Gate	\$1.25
9953 Triple AND Gate	1.25
9954 Dual Four-input AND Gate	1.25
9955 Eight-input AND Gate	1.25
9956 Dual Buffer	1.25
9957 Dual-rank Flip-flop	2.00
9964 Dual Three-input and Single-input AND Gates	1.25
9965 Quad Single-input AND Gate	1.25
9966 Quad Two-input AND Gates, one pair with OR-tie	1.25
9967 JK Flip-flop	2.00
9968 Dual Latch	2.00
9971 Quad Two-input AND Gates with OR-tied pairs	1.25
9972 Quad Two-input AND Gates, one pair with OR-tie	1.25

If you want CT μ L-II in sample quantities, call Fairchild. If you want standard CT μ L in production quantities, call a Fairchild distributor. He has everything you need to build any computer. Even a Computer.



Fairchild Semiconductor / A Division of Fairchild Camera and Instrument Corporation / 313 Fairchild Drive, Mountain View, Calif. 94040 (415) 962-5011 / TWX: 910-379-6435

of LSI admits there's another way:

Three ways to put a Russian on the moon

Craft may be sent directly, be assembled in space or employ a lunar-surface rendezvous approach

Charles D. LaFond
Chief, Washington News Bureau

Space scientists in the United States have believed for some time that the Soviet Union has three options anytime it wants to send a man to the moon.

It can, with a limited-thrust launching vehicle, send the moon craft aloft in sections and assemble the sections as they orbit the earth. Once assembled, the craft would have sufficient thrust to carry it to the moon and back.

A second approach, suggested in October by Dr. Wernher von Braun, director of the Marshall Space Flight Center, Huntsville, Ala., calls for a lunar-surface rendezvous.

The Russians would first launch an unmanned vehicle to the moon and soft-land it. It would have stored propulsive power on board, and once it is checked out by telemetry, a second vehicle, with cosmonauts, would be sent to the moon. Landing close to the first spacecraft, the cosmonauts would explore the lunar surface, then board spacecraft No. 1, ignite its propulsive unit and return to the earth.

The third approach is probably

the simplest, but it requires an enormous boost capability—on the order of 10 million pounds of thrust or more. It calls for a direct manned flight from the earth to the lunar surface, without any intervening rendezvous.

The flights of Soyuz 2 and 3 last Oct. 26-30 are viewed by some U. S. authorities as attempts to begin preparations for the subsequent assembly of lunar craft in sections while the latter orbit the earth.

Soyuz 3 was described in several Soviet newspapers, including *Pravda*, as a three-compartment vehicle designed primarily for use as part of a much larger manned orbiting laboratory. U.S. space experts believe it can also serve as the nucleus for a spacecraft that can carry Russians to the moon.

Spacecraft has extra room

According to the description, the Soyuz has two crew cabins, compared with one, in the U.S. Apollo. In addition there is a rear unit that houses instruments and rocket engines, much like Apollo's service module.

During launching and the return to earth, as well as during such key maneuvers in space as rendezvous with another ship, the cosmonauts are seated in the middle compartment, a small, pressurized capsule protected by heat shielding and containing most of the navigation instruments.

Most of the time while the cosmonauts are in orbit, they live and work in the roomier compartment up front in the nose. To get there, they open a hatch and climb through a passage. In the forward cabin the cosmonauts have room for eating, sleeping, exercising and conducting scientific experiments. Altogether the two cabins are reported to have 318 cubic feet of space for the cosmonauts to move about in, compared with 210 cubic feet in the Apollo crew cabin.

The Soviet says Soyuz is equipped with four TV cameras, two inside the cabin and two mounted outside.

Soyuz also has two large, wing-like panels extending from either side of its midsection. These contain solar cells to power the spacecraft's instruments. Apollo relies for power on fuel cells housed in its service module.

Soyuz is designed to use the atmosphere's braking properties and to make a partial gliding re-entry. This capability was also tested, apparently successfully, with the circumlunar flight of the unmanned Zond 6 last month.

Soyuz is large Voshkod

Published information on all Soviet manned vehicles has been extremely meager and any attempt to describe onboard systems and operating techniques must be based heavily on speculation. Dr. von Braun and many other U.S. scientists believe that the Soyuz series is an updated and enlarged version of the second-generation Voshkod. It probably has the more advanced electronics necessary to



Soviet space vehicle boosters, of the type that lifted the manned Vostok and Cosmos satellites into orbit, are displayed at a British air show.

**Commit in near-zero
visibility?
Without blurring - only
by Westinghouse SEC
camera tube with
image intensifier**



Meat-ball or no meat-ball, the decision to commit or wave-off rests with the Landing Signal Officer. And he must see to decide—even on low, overcast nights.

So meet the unique Westinghouse TV sensor package. The first in the industry to give an un-blurred picture of a moving object in the total dark.

This "off the shelf" package WX-32000 consists of a new Image Intensifier perfectly mated to our exclusive Secondary Electron Conduction camera tube. The Intensifier gives you a brightness gain of 200 with low background, minimum distortion, and good resolution. Together they make a compact unit that gives you crisp, fast-motion, halo-free images at 10^{-5} foot candles.

For full details on our night-seeing, non-blurring TV Sensor Package, write Westinghouse Electronic Tube Division, Elmira, New York 14902. Then we'll talk you in!



(space craft, continued)

support the lunar mission plus the addition of a much larger propulsion unit. The first test of Soyuz 1 encountered early attitude control instability in orbit and ended in tragedy 25 hours after launching. Following re-entry, the craft's parachute failed to open properly, and Col. Vladimir Komarov, the cosmonaut on board, died in a crash landing.

The result was an over 18-month delay before the next Soyuz 2 and 3 flights. It might have been expected that the second Soyuz flight would have been a repeat of the first, to check out the modified or improved onboard systems.

Instead, Soviet space officials launched Zond 5 the middle of September and Zond 6 two months later in flights around the moon, with living specimens in the spacecraft. The Zond vehicle is believed to be the command capsule portion of the Soyuz. In fact Tass, the Soviet press agency, admitted that the Zond flights were made as tests for a manned space ship to be sent to the moon.

The Tass disclosure indicated the Soviet Union may be close to trying a manned moon flight, perhaps before the United States launches Apollo 8 on Dec. 21.

Between the two unmanned shots the Soviet proceeded with the dif-

ficult task of launching on Oct. 26 one manned and the following day one unmanned Soyuz into earth orbit. Thus in less than 30 days the Russians exhibited an immense competence in both automatic flight controls and launching capability.

As a matter of fact, it is doubtful that the U.S. has achieved such a capability with automated flight systems. Even Dr. Thomas Paine, NASA's Deputy Administrator, in commenting on the Soviet unmanned automatic-mode operational achievement, says: "It's a rather shifty question as to whether or not at this particular point in time we would indeed have had that capability."

The question, however, is moot, since the U.S. approach has never included such a degree of automatic control; rather, man has always been considered an integral part of the spacecraft systems loop.

A heavy use of telemetry

As a starting point in any speculation concerning Soviet manned-spacecraft onboard systems, U.S. scientists assume that its vehicles provide functions equivalent to those of U.S. spacecraft. It is apparent that the Russians have very effective data and voice communications systems and an adequate but limited ground-communications supporting network. They make heavy use of telemetry for data

retrieval and provide a high concentration of biological and medical observations.

They apparently use an inertial autopilot and a good attitude control system but may not employ a complex inertial-guidance and navigation system, possibly due to an early decision to use radio command and control from a central earth station. Navigation and control computations are believed to be performed by a very large, high speed digital computer at the control center in Moscow. There must be at least one small digital computer in the spacecraft with reasonably large storage capacity.

The Zond 5 and Zond 6 missions appear to have successfully tested all the systems necessary to support a manned circumlunar flight. Communications were maintained throughout the flights, and there is evidence that even the voice links were exercised, either through direct relay of a ground transmission or from an onboard tape. The guidance and navigation systems appear extremely accurate, since only very minor firings were needed as mid-course corrections on the flights to and returns from the moon. Finally, the re-entry guidance and control systems brought the spacecraft well within planned landing corridors, according to Soviet officials. Zond 5 landed and was recovered in the Indian Ocean. Zond 6 is presumed to have come down in Kazakhstan, Central Asia.

Only one cosmonaut per Soyuz

The Soyuz 2 and 3 missions still offer some consternation to U.S. space experts, principally because there seems no practical explanation for the Soviet use of only a single cosmonaut. It can be presumed that in addition to the normal checkout of flight hardware, a principal experiment was the accomplishment of both automatic and manual space rendezvous of the two vehicles. The flight could also have tested docking procedures; yet the two craft were never physically joined.

The Russians had previously performed automatic rendezvous and docking procedures last April with the two unmanned Cosmos 212 and 213 satellites. Thus the closed-loop rendezvous radar and the control

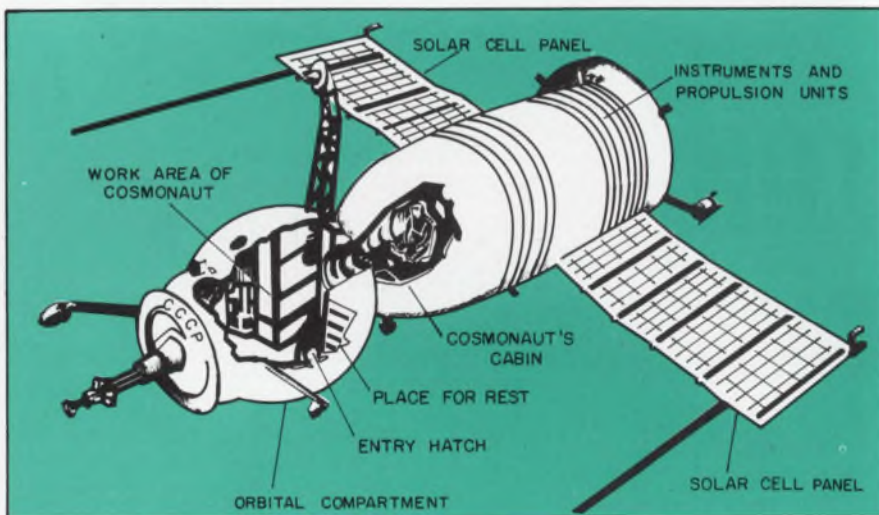

Soyuz 3 spacecraft, as depicted in the Soviet press. The cosmonaut sits in the middle cabin during launching, re-entry and certain maneuvers in orbit, but he has extra work room in the front during flight. The middle cabin makes a parachute-aided landing after the forward cabin and propulsion engine are jettisoned.

A sampling

Category	Type	Description	Experience
Discretes	HRN1030	General Purpose, Insulated Gate, Switch	4 years
	HRN8318D	General Purpose, Gate Diode Protected, Switch	4 years
Multiplexers	HRM8014D	General Purpose Quad, Gate Diode Protected	3 years
	HRM2206	8-Channel Switch, Gate Diode Protected	2 years
D-A & A-D Converters	HRM8013	4-Channel Multiplexer with Drive Logic	3 years
	HRM8068	Dual DPDT Analog Switch with Drive Logic	3 years
Counters	HRM2302	A/D and D/A Converter Elements	2 years
	HRM F/2 HRM2034	Low Cost Frequency Divider Seven Stage Binary Counter	1 year 2 months
Combinational Logic	HRM2304	Triple 3 Input, Dual 2 Input NOR Gates	2 years
Shift Registers	HRM2026	Dual 2 ϕ 25 Bit Shift Register	3 months
Arithmetic	HRM2032	Differential Digital Analyzer	new

THE TOMORROW MOSFETS. TOMORROW.

We call our line "The Tomorrow MOSFETS" because they have features that, someday, all MOSFETS will probably have.

Features like lower threshold voltage with the ability to operate at higher voltage levels; lower channel resistance; and the lowest 1/f noise in the industry.

These features result in more design freedom, in faster operating speeds, in lower power consumption, and in the elimination of level translators.

But there's another reason we call them The Tomorrow MOSFETS.

They're built for tomorrow. The longer they're used, the more applications they find.

You can see from the sampling up above that the oldies are still the goodies.

And that's just a sample. We have more where those came from.

Write Hughes, MOSFETS, 500 Superior Ave., Newport Beach, Calif. 92663. Phone (714) 548-0671. TWX (714) 642-1353.



(space craft, *continued*)

systems had already been proved in the automatic mode, and the performance of manual docking might have been anticipated in the recent flight.

However, with only one cosmonaut involved, it has been suggested that actual docking would have been a dangerous maneuver. If the two craft had locked, it might have been necessary for a cosmonaut to leave the vehicle and physically assist with vehicle separation—but this would require at least one more cosmonaut.

That the Russians lay great stress on automatic rendezvous and docking was revealed in New York last October during the 19th Congress of the International Astronautical Federation. Dr. Victor P. Legostaev, an associate professor at the Academy of Sciences in Moscow, emphasized that unless the need for cosmonauts is required for other functions, the automatic mode for assembling vehicles in space is the more rational approach.

The Soviet automatic technique applies a passive role to one vehicle, an active role to the other. Each is placed in roughly the same

orbital plane at an altitude of from 125 to 155 miles. Both vehicles carry search radars to detect and lock onto the other vehicle. Rendezvous radars are gimballed to provide directional maneuverability.

After acquiring its target, the active spacecraft maneuvers to within roughly 1000 feet of and into the same plane as the target vehicle. In the meantime each vehicle has automatically self-aligned itself, so that the docking elements can be mated. The closure rate at this time is about 6.5 feet a second.

Each vehicle then stabilizes itself spatially, reducing roll to zero. As the two vehicles approach for docking, the closure rate is reduced to about 1.5 feet a second until mating occurs.

According to the Soviet scientist, the entire operation—which includes radar range and range rate sensing and computation and all the control procedures—is performed with onboard subsystems, not by ground control.

Automatic docking with radar

In the Soyuz 2-3 missions this fully automatic maneuvering (but without actual docking) was achieved first automatically and later manually by cosmonaut Col.

Georgy Beregovoy. The automatic approach, according to Soviet reports, brought the two vehicles to within 650 feet. Radar lock-on for the automatic approach, they say, occurred when the two craft were separated by several kilometers.

Under manual control, Beregovoy is reported to have brought his vehicle to within several hundred feet of the other with a closure rate of about 1.5 feet a second. It has also been reported by the Soviet that the two vehicles flew in formation for some time at the same speed.

Communications satellite used

Because of the sparsity of Russian ground tracking stations, performance data were stored for as long as 10 hours before they were released through the telemetry link as the spacecraft passed over a receiving facility. As has been done before by the Russians, live television pictures from within the spacecraft were transmitted to ground successfully. These were relayed from the tracking centers through the Molniya communications satellite system to Soviet broadcast stations for transmission to the public.

There were reported improvements in the Russian tracking network for the latest series of flights, compared with what was available in 1967. The Soviet is believed to have instrumented six tracking ships in addition to its land bases, the latter largely in the Soviet Union. In addition a permanent tracking station has been set up in India to support Indian Ocean landings.

It should be pointed out, however, that while the U.S. space program has always employed the concept of soft landing and recovery by water, the Russians, with their large land mass, have favored soft-landing techniques on solid ground. The Zond 5 flight indicates the Russians are learning the techniques of water recovery.

There had been some speculation that Zond 5 missed its landing target and may have come down so hard that any life on board would have been injured. All the Russians conceded was that turtles in the craft had suffered spleen damage. ■■

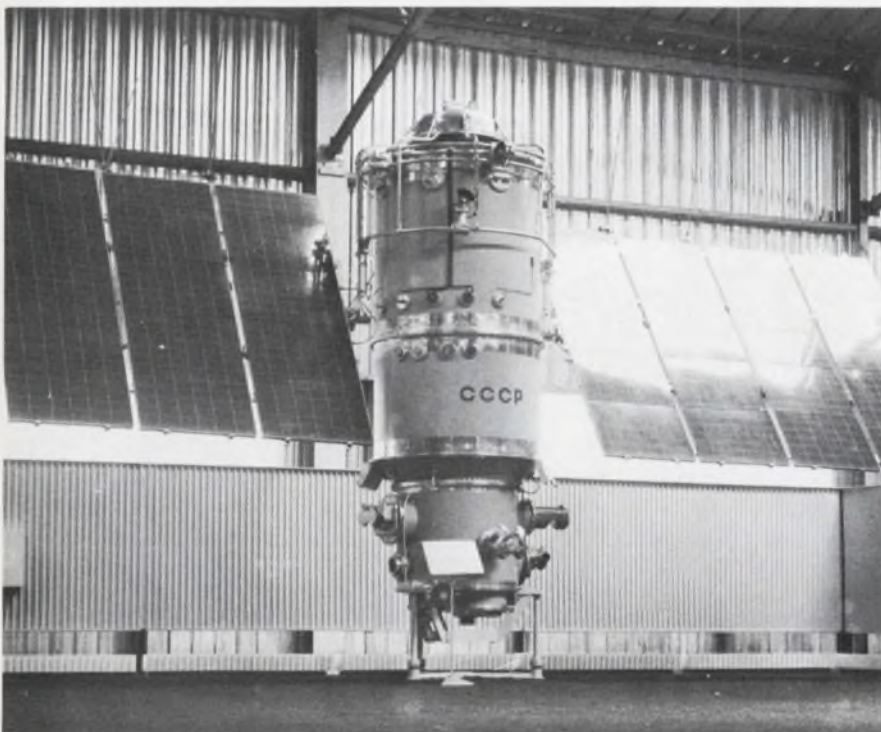

Cosmos satellites accomplished automatic rendezvous and docking in space last April.

A new series of snap varactors — the first of which guarantees output power of 4 watts at 2 GHz — by Microwave Associates

The circuit tested varactors are silicon epitaxial diodes diffused for optimum impurity gradients. The high storage capacity and fast transition time guarantee superior circuit performance in high and low order multipliers.

The MA-43000 reliability has been proven by extensive environmental testing and multi-system usage and meets the requirements of MIL-S-19500.

Write or call (617) 272-3000.

Electrical Specifications at 25°C

Characteristic	Test	Min.	Max.	Units
Breakdown Voltage	$I_R = 10\mu A$	85	—	volts
Junction Capacitance (-6V)	1MHz	3.0	4.5	pF
Minority Carrier Lifetime	—	250	—	nsec
Thermal Resistance	—	—	12	°C/watt
Power Output at GHz	Pin 15W @ 333 MHz	4.0	—	watts

Price: 1-9 \$55.00/Delivery: Stock

Guaranteed 4 Watts out at 2 GHz



MICROWAVE ASSOCIATES
Burlington, Massachusetts

Offices: Northwest Industrial Park, Burlington, Mass.
3605 Long Beach Blvd., Long Beach, Cal.

Subsidiaries: Microwave Associates (West) Inc., Sunnyvale, Cal.
Microwave Associates, Ltd., Luton, Beds, England

**POWER
TRANSISTORS**



SCR's



**DIGITAL
IC's**



DIODES



TRIACS



**PHOTO
SCR's**



COUNTERS



**TRIGGER
DIODES**



**SIGNAL
TRANSISTORS**



RECTIFIERS



**REFERENCE
DIODES**



**ZENER
DIODES**



**Hot buttons from
Transitron**

If you're in a hurry to button down a new design or button up a big production run — call us. Transitron builds, stocks, and ships rapidly one of the broadest lines of semiconductor products in the business, not to mention a variety of other precision components.

If you want prototypes, quantities or simply complete data on any of these quality candidates, a phone call will produce action just as fast as you need it. Or just buttonhole your local Transitron sales engineer or distributor.

Transitron Electronic Corporation, 168 Albion Street, Wakefield, Mass. 01880.

**NUMERICAL
DISPLAYS**



CONNECTORS



**LINEAR
IC's**



**SPECIAL
PRODUCTS
& ASSEMBLIES**



Use This Giant "Economy-Size" Coupon at Once.

SAVE TIME and MONEY on WIRE WRAPPING

Connector Panels. Yours or Ours.

Please tell me how I can close the time-and-cost gap by letting you wire wrap our connector panels, or having you furnish your panels completely wrapped and ready for installation.

Name _____

Company _____

Address _____

Mail to Elco Corporation, Fort Washington, Pa. 19034

Now, under one roof, Elco wire wraps connector panels via fully-automatic, semi-automatic, or hand-wrapping methods. We will wrap your panels, or Elco metal plates—ready for installation. We can assure you of saving both time and money plus giving you the added benefit of greater reliability. So for your current or contemplated prototypes or production runs—contact your Elco Sales Office. Or call, wire, TWX or write ELCO Corporation, Fort Washington, Pa. 19034; 215-646-7420; TWX 510-661-0363.



GARDNER-DENVER FULLY-AUTOMATIC MACHINE WRAPPING.



SEMI-AUTOMATIC MACHINE WRAPPING.



PRECISION HAND WRAPPING.



INFORMATION RETRIEVAL NUMBER 27

WAFERPOT™

Maximum outputs in minimum space.

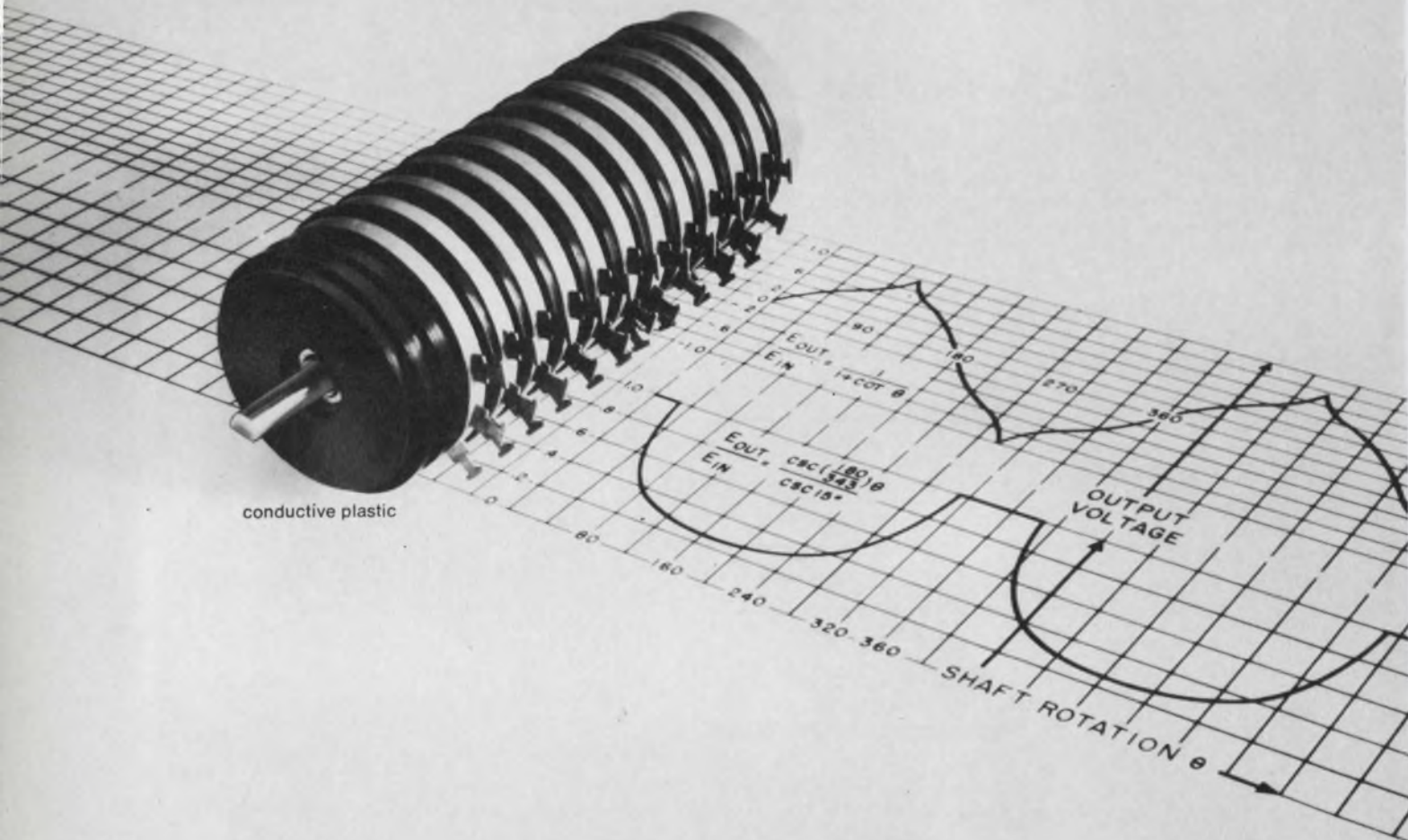

Your potentiometer requirement is complex
 ... single-shaft control of many circuits ... linearities as close as 0.05%
 ... complex nonlinears demanding tight conformities ... per-cup depth of 0.200".

Your potentiometer solution is simple.

NEI's compact, reliable WAFERPOT™ designs can meet your most stringent requirements. Our engineers couple more precise design techniques with a higher order of mathematics, through computer assisted design, to arrive at the optimum function with minimum error. You receive the ultimate in quality & reliability with faster response at the lowest possible cost.

If you need precision pots or elements, conductive plastic or wirewound, custom or standard, turn to NEI ... innovators in the potentiometer industry since 1957.

new england instrument company

The only manufacturer with equal capability in single turn conductive plastic & wirewound precision potentiometers

281 Billerica Road • Chelmsford, Mass. 01824 • Tel. 617-256-3711
 STANDARDS DIVISION



14 Kendall Lane • Natick, Mass. 01760 • Tel. 617-873-9711
 GENERAL OFFICES & CUSTOM DIVISION



Spiraling C-5A costs revealed

Testimony before the Senate Subcommittee on Economy in Government (see this column, ED 25, Dec. 5, 1968), continues to describe the tendency of large defense-contract costs to seriously inflate in time. While the rising costs for the Minuteman ICBM series, in the years from 1958 through 1966, and the unusually high profits that were obtained grabbed headlines, the most serious discussion before the Subcommittee focused on ballooning development costs for the Air Force C-5A Galaxy, the world's largest aircraft.

The reason for dismay over the rapidly rising expenditures of the C-5A, as compared with those of the Minutemen, is understandable. The Minuteman effort culminated a massive missile build-up in this country, during which time three major ICBM series, the Atlas, the Titan and the Minuteman, were developed and deployed concurrently. It was expected, then, that realistic cost estimates would be impossible, because of duplication and the application of state-of-the-art technology to highly sophisticated and complex weapons systems. However, under the McNamara regime, the C-5A program was intended to serve as a model for the concept of "total package procurement" on a rigid, fixed-price basis. The argument advanced then, when Lockheed-Georgia Company won the multi-billion dollar prime contract, was that all of the technology required to build the monstrous aircraft was available and that, therefore, the problem was largely a problem of engineering. Something obviously went wrong.

The program began three years ago when the Air Force estimated that the total development and production cost

Washington Report

CHARLES D. LAFOND
WASHINGTON BUREAU

for the first 58 of the C-5A aircraft would be \$2.3 billion. The firm also was given to understand that it would most probably produce a second batch, numbering 57 aircraft, and that the Air Force held an option to buy 85 more. In contrast, current estimates, according to Pentagon officials, indicate that the first 58 aircraft will cost a total of at least \$3.25 billion and that successive aircraft procurements will be correspondingly higher.

Looking back, informants here recall that Lockheed won the contract with an unusually low bid, compared to cost proposals submitted by Boeing and Douglas Aircraft, its competitors. At that time, to many observers, it looked like Lockheed expected to recover the losses it incurred in the first aircraft purchase—hopefully through succeeding procurements.

As it stands now, Lockheed will probably have to absorb a \$970 million loss. It will have to seek recompense in its negotiations with the Air Force for the second batch of 57 aircraft. It is also anticipated that in the 91st Congress legislation will be sought to further tighten control over defense contracting.

Astronauts defend circumlunar flight

Late last month, the Apollo 8 astronauts vigorously defended their circumlunar mission plan. The flap grew out of comments made by Sir Bernard Lovell, director of Britain's Jodrell Bank Observatory. He had been quoted as saying that: "On a scientific basis this project is

wasteful and silly. We've reached the stage with automatic landings when it's not necessary to risk human life to get information about the Moon."

NASA officials quickly took issue. They said that at no time had the mission's purpose been declared to be scientific; it was, they said, the next operational test needed to develop lunar-landing capability. In voicing the disagreement with Lovell that was shared by all three Apollo 8 crewmen, astronaut Maj. William A. Anders stressed that the lunar-orbital mission will strongly support future Apollo flights by collecting finer photographs of lunar landing sites, by area mapping and by gaining necessary operational experience in actually performing such a flight.

Astronaut Anders stressed that in addition to obtaining detailed color photographs of the Sea of Tranquility—considered to be the prime landing area—more tracking data are urgently needed for future lunar-landing missions. Ground trackers today, he said, are still not certain of the precise orbit path that will be taken by Apollo spacecraft, because of insufficient data on the Moon's sphericity; this could lead to landing errors of as much as 45 miles. He also declared that: "The more we learn about the Moon's gravitational field and how to navigate in it, the less will be our error when astronauts try to land."

Warning on manpower cutbacks

William G. Torpey, a top manpower specialist in the Office of Emergency Planning, admonished the Government to very carefully consider manpower displacement problems before cancelling major defense contracts. His concern, as he expressed it in the November issue of *Personnel Journal*, is

principally with changes in the nation's defense posture and the effects that such cancellations may have on the nation's existing scientific and engineering manpower pool.

Torpey points out that the defense industry today directly employs 215,000 engineers and that a great number of these are employed by small R&D firms as well as by large prime contractors. Personnel cutbacks, he asserts, more often affect engineers, rather than lesser technicians, because engineers possess specialized skills in narrow technological areas.

He also notes this irony in the situation: although a distinct need exists today for engineers in the civilian economy, it is often difficult to match many engineers with existing nondefense job opportunities because of their high degree of specialization on defense contracts.

Communications policy release imminent

The long-awaited Communications Policy Report, due to be made by a Presidential Task Force and which was expected to reach the White House late last month, may be delayed again because of the impending change in administration.

Nevertheless, Electronic Industries Association officials believe that many of the recommendations made in the EIA/IEEE Joint Technical Advisory Committee Report, "Spectrum Engineering—The Key to Progress," will be included in the Task Force study. The joint report strongly recommended that a carefully planned centralized approach be taken for solving the problems of managing the communications spectrum. It urged establishment of both a pilot project and a central data-clearing house to implement a long-term frequency-selection and experimental-operations program.



HONEYWELL

SERIES 16

Tomorrow computer systems today...

**that you'll want to live with a long,
long time**

Some computers come and go. And when they go, you're out of luck if you own one and want to extend the system to keep pace with your expanding needs.

No problem when you own a member of the Honeywell Series 16 family of real-time integrated-circuit computer systems. This prolific brood includes standard computer mainframes like the DDP-516 and DDP-416, many peripherals, a mature and expanding software library plus support services tailored to stretch the life of your investment. Special systems, functional application packages and new configurations like our Ruggedized and Ruggedized/EMI suppressed models give you even greater flexibility. No wonder Series 16 systems are being used so much in applications

like communications, research, medicine, industrial control and flight simulation.

And Honeywell's Series 16 family will continue to grow — investment today in time, money and effort will not go down the drain because of sudden obsolescence tomorrow.

For more information about the Series 16 family and some of the ways Honeywell computers are being used, write:
Honeywell, Computer Control Division, Framingham, Massachusetts 01701.

Honeywell
COMPUTER CONTROL
DIVISION



sweeps
5 to 1500 MHz
in 7.5 milliseconds
flat!



We can supply a sweep generator with rally stripes on special order, but the frequency range and the sweep rate are standard.

Telonic's 2003 Sweep Generator will cover that entire band—14.5 MHz—in a single sweep, or in any segment down to 0.02 Hz wide. You can instantly see response characteristics over all, or any portion, of a circuit's operating frequencies.

And don't overlook that word "instantly." If you're still in the habit of using a signal generator for point-to-point testing, it's time to upshift into swept techniques. Let your local Telonic rep show you the '69 floor models.

Model 2003 Sweep/Signal Generator System

- Frequency Range** (Seven different plug-in oscillators available)..... 0.02 Hz-1500 MHz
- Sweep Width** (F₁-F₂ or F_c/ΔF)..... 0.02 Hz-1495 MHz
- Frequency Marking** (Four different marker plug-ins available)..... Fixed or variable
- Attenuation** (Eight attenuator plug-ins available)..... 1 db to 109 db (50 or 75 Ω)
- Sweep Rate** (Select from two rate plug-ins)..... 0.001 to 60 sweeps/sec.
- Log Amplification** (One plug-in does it all)..... 105 dB dynamic range
- Detection** (Two detector plug-ins available)..... P-P passive, 50 and 75 Ω
- Display** (Two display processing plug-ins)..... Amplitude and marker tilt control

Catalog 70-A and Supplements contain complete descriptions on all Telonic Sweep Generators plus a full section devoted to "how-to" applications. Get your copy today.



TELONIC INSTRUMENTS
A Division of Telonic Industries, Inc.
60 N. First Avenue
Beech Grove, Indiana 46107
TEL (317) 787-3231 • TWX-810-341-3202

INFORMATION RETRIEVAL NUMBER 30

Letters

Sharp-eyed author corrects our typo

Sir:

The author of Reference 2 in my article "Count Your Foot-Candles with Photodiodes" (ED 17, Aug. 15, 1968, pp. 206-209) should be George T. Daughters III and not G. I. Laughters III, as printed.

Howard Murphy

Optoelectronics Section
Device Development Dept.
Fairchild Semiconductor
Palo Alto, Calif.

Accuracy is our policy

Electronic Design 21

In Vietnam, seeing in the dark often means life or death. This Starscope (below), a direct viewing device, helps protect the air base at Da Nang. Elsewhere low-light-level tv and line scanners help airborne observers find their targets. For a look at these new devices and how they are designed turn to page 25.



Photographs of the Starlight Scope, shown on our Oct. 10, 1968 cover and on page 26 of the same issue, were made for the Army by Varo, Inc., of Garland, Texas. We regret the omission of these picture credits. Varo is one of the leading makers of night-vision equipment in the field.

In the Idea for Design "Counter divides by either 3 or 4" (ED 21, Oct. 10, 1968, p. 114), the state of flip-flop Y produced by clock pulse 3 was erroneously given as $J_y = K_y = 1$. It should be $J_y = 0$ and $K_y = 1$.

New emitter-grid construction used in Amperex RF power transistors brings fail-safe operation to VHF transmitters.

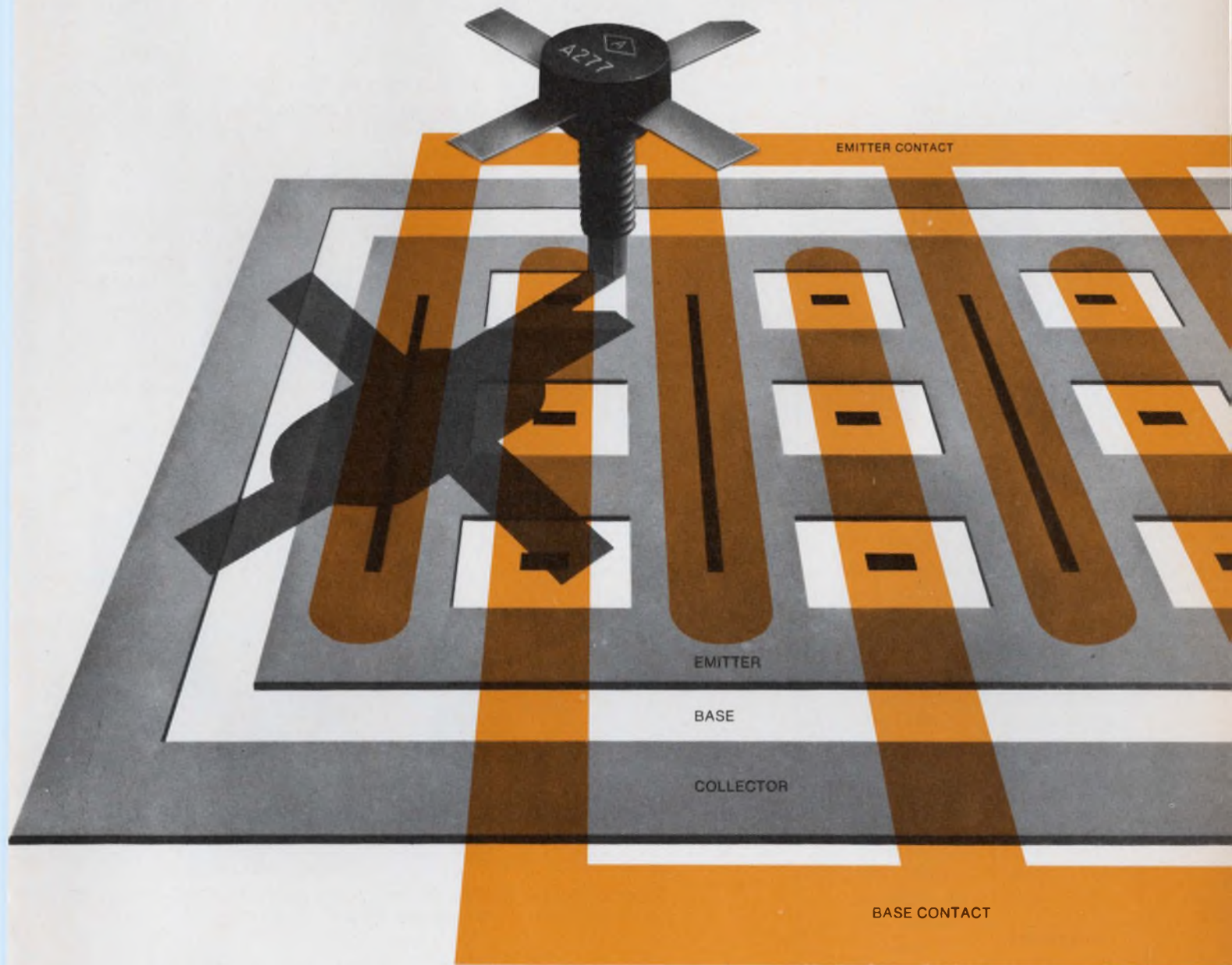

By diffusing the Emitter directly into the Base as a rectangular Grid, we get an emitter periphery equal to the total perimeter of the grid openings, with perfect contact and constant voltage-drop along the entire junction. We then metallize the openings and one set of parallels; the former serve as current-sharing Base contacts, and the latter as Emitter contacts.

This new geometry results in RF power transistors with maximum tolerance for the large overloads typical of power stages in mobile VHF transmitters, virtually guaranteeing fail-safe operation. It also results in high efficiency at high gain and power-handling ability superior to that of overlay

or interdigital devices. Other important advantages include high gain-bandwidth product and excellent linearity.

The first eight devices of the emitter-grid series are the types A270 through A277 for mobile and airborne 175 MHz transmitters. They are available now, in sample quantities from stock. Types A270 and A274 come in TO-39 cases... the others in low-profile, strip-line packages.

The most important parameters are listed at right; for complete data and applications assistance, write: Amperex Electronic Corporation, Semiconductor and Microcircuits Division, Slatersville, Rhode Island 02876.

IMPORTANT PARAMETERS: AMPEREX E-GRID RF POWER TRANSISTORS							
$V_{CE} = 28 V$				$V_{CE} = 12.5 V$			
Type	P_o (W)	G (db)	Eff. (%)	Type	P_o (W)	G (db)	Eff. (%)
A270	3	>11	>55	A274	3	>8	>60
A271	7	>12	>50	A275	7	>9	>70
A272	14	>10	>55	A276	14	>7.5	>70
A273	22	>9	>65	A277	22	>6	>70

Amperex[®]
TOMORROW'S THINKING IN TODAY'S PRODUCTS

SANGAMO TUNABLE TONE FREQUENCY TRANSFORMERS

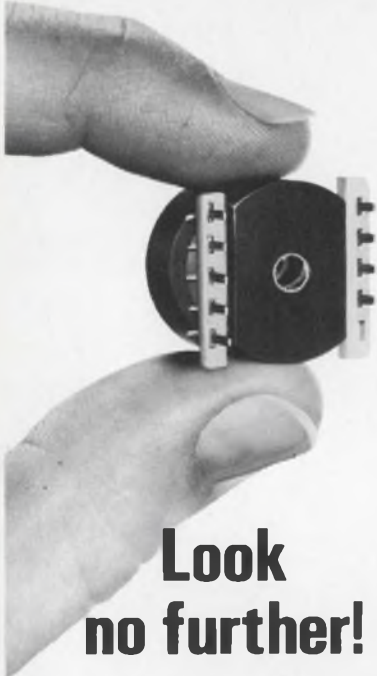

**Look
no further!**

Here's a Communications Grade tone frequency transformer as attractive in quality as it is in price. Designed for use in push-button telephones, in data sets, in any oscillator circuit requiring adjustable transformers.

Stock items available in a low frequency design from 694 to 937 Hz and a high frequency transformer from 1207 to 1633 Hz with a $\pm 3\%$ frequency adjustment.

Price: 50 for \$2.59 each; 250 for \$2.25 each. Larger quantity pricing available on request.

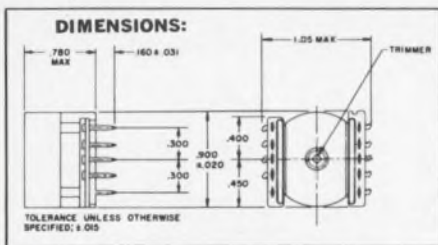

Communication Systems
SANGAMO ELECTRIC COMPANY
Springfield, Illinois 62705 T68-11

INFORMATION RETRIEVAL NUMBER 32

SIDELIGHTS OF THE ISSUE

Big stories from little press releases . . .

Sometimes—and we're sure you're familiar with this—you notice a small object or idea, and the more you examine it and explore it, the larger it becomes—until you've uncovered a giant phenomenon. Iceberg hunters are aware of this; they know that the hidden potential of what they observe is likely to be far greater than what meets their eyes. And, in her own quiet way, Elizabeth deAtley, **ELECTRONIC DESIGN's** new West Coast editor, has just spent two months proving the point again. The result is a new glimpse of the universe for ED readers, a comprehensive survey of electronics for the radio astronomer.

It began with a press release. A builder of integrated circuits was announcing briefly that its circuits had been installed in a new autocorrelation receiver. "Autocorre-what?" Elizabeth asked herself. Autocorrelation receiver at the National Astronomy Observatory, she learned. A phone call to Dr. Sander Weinreb, the observatory's head of instrumentation, and Elizabeth was off on a trip to the world of quasars, pulsars, interferometers and . . . "the hairiest hairpin mountains I've ever seen" in a night



Elizabeth deAtley and Bill Alvarez, artist, plan the illustrations for her story of electronics for astronomy.

drive to the observatory installation at Green Bank, W. Va. She asked hundreds of questions.

In the process, she uncovered a developing trend in electronics: The "brute force" approach to piercing outer space—the radar dish the size of a football field—is nearing the point of impracticality; designers are turning to clever, indirect ways to achieve their goals. For a glimpse at some of these ways, start reading on page 25.

Before joining ED, Elizabeth worked as an applications engineer for Philco-Ford's Microelectronics Div. in Santa Clara, Calif. She has a degree in physics from Stanford University.

Being an HP Frequency Synthesizer is a tough life.

Using one is a snap.

The trouble with being a reliable instrument is that everyone is always asking you to prove it. Especially if you're a Hewlett-Packard Frequency Synthesizer, because many synthesizer users freeze them to -20°C, heat them to +65°C, engulf them in humid air, drop them 2½ feet (a 50G shock when they hit sand), and whack them with a 400 lb. hammer to prove conformance to military specification MIL-E-16400F. It is a tough life; that's why every HP synthesizer would much rather be the operator.

Look what he gets:

- Frequency change by pushbutton or remote command (20 µsec, typical).
- Frequency increments as small as 0.01 Hz.
- Search oscillator for continuous tuning or sweep capability.
- Low spurious signals, low phase noise, high spectral purity.
- Direct synthesis for best stability, fast switching, fail-safe operation.

MODEL	RANGE	MINIMUM INCREMENT	SPURIOUS SIGNALS	PRICE
5105A	100 kHz—500 MHz	0.1 Hz	70 dB	\$14,100.*
5100B	0.01 Hz—50 MHz	0.01 Hz	90 dB	\$12,500.*
5102A**	0.01 Hz—100 kHz 0.1 Hz—1 MHz	0.01 Hz 0.1 Hz	90 dB 70 dB	\$7200.
5103A**	0.1 Hz—1 MHz 1—10 MHz	0.1 Hz 1 Hz	70 dB 50 dB	\$7800.

*Includes required 5110B Driver (\$4350) which operates up to four synthesizers.
**Dual range unit; has internal driver.

Military-type reliability at commercial instrument prices is an extra benefit provided by HP synthesizers for commercial, scientific and military users.

It's easy to see why, after high and low temperature, humidity, jarring drops and fierce hammer blows, it's still the user of our frequency synthesizers who gets all the breaks.

Call your local HP field engineer or write Hewlett-Packard, Palo Alto, California 94304; Europe: 1217 Meyrin-Geneva, Switzerland.

HEWLETT  PACKARD
FREQUENCY SYNTHESIZERS

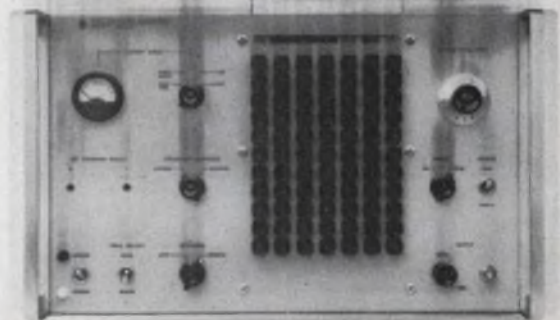

TRW
Varicap
**DIODES
STRETCH
YOUR
TUNING
RANGE**

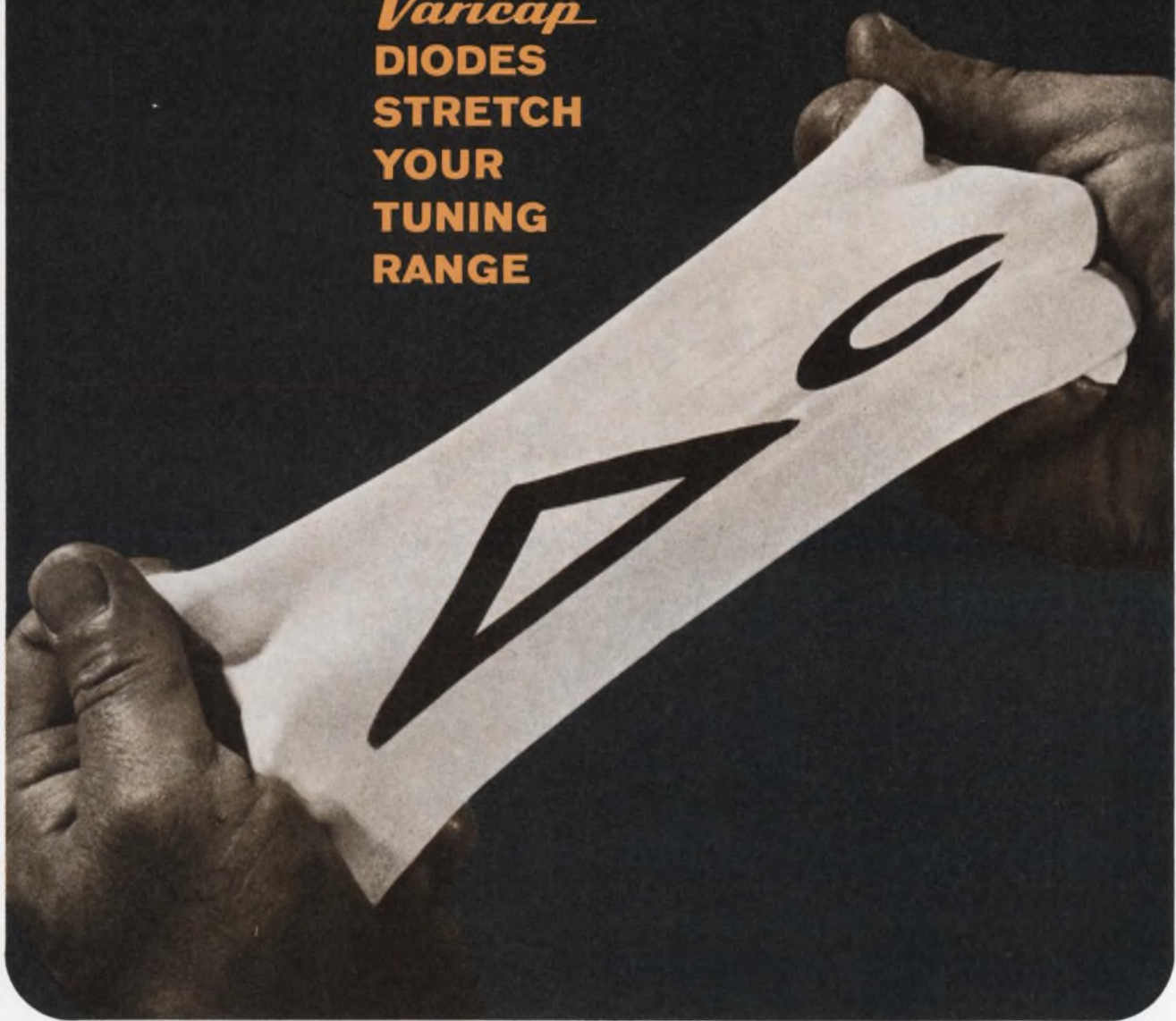

Varicap is the trademark of silicon voltage-variable capacitors manufactured by TRW Semiconductors Inc.

...up to 20% greater $\Delta c!$

You have a lot of things working for you when you design your tuning system around TRW Varicap diodes. First of all, your circuit will provide controlled tuning range to spare — in many cases you can eliminate additional band switching.

Circuitry is simplified and fewer components are required. Varicap-controlled tuning systems assure the performance characteristics

required in the most sensitive communications and monitoring networks.

TRW Varicap diodes are true abrupt junction devices, produced by proprietary processes. This construction gives the designer maximum capacitance change with voltage; optimum uniformity and tracking and superior performance under all operating conditions.

Varicap Bulletin No. 101 discusses wide-range theory in detail. Get a copy from your authorized distributor or write TRW Semiconductors Inc., 14520 Aviation Boulevard, Lawndale, California (213) 679-4561. TWX 910-325-6206. *TRW Semiconductors is a subsidiary of TRW INC.*

TRW®

Publisher

Hugh R. Roome

Editor

Howard Bierman

Managing Editor

Robert C. Haavind

Technical Editors

Frank Egan
 A. Craig Reynolds, Jr.
 Michael J. Riezenman
 Raymond D. Speer

Management and Careers Editor

Bruce Trabue

News Editor

Ralph Dobriner, Chief

Washington News Bureau

Charles D. LaFond, Chief

Military/Aerospace Editor

John F. Mason

East Coast Editor

Jim McDermott

West Coast Editor

Elizabeth deAtley

New Products Editors

Robert Patton
 Lucinda Mattera

Copy Editor

Peter Irving

Editorial Production

Dollie S. Viebig
 Phyllis Gura

Art Director

Clifford M. Gardiner

Art Assistant

William Kelly

Technical Illustrators

William Alvarez
 Rita Jendrzejewski
 Barney Krochek
 Lynn E. Thompson

Production Manager

Thomas V. Sedita

Asst. Production Manager

Helen De Polo

Production Assistants

Bernard Wolinsky
 Carl A. Merkin

Circulation Manager

Nancy L. Merritt

Information Retrieval

Genate Pazmino

EDITORIAL



Who does a man really work for . . . ?

Your best employees don't work for you—they work for themselves. They strive for their own personal growth—for professional competence, cultural broadening and recognition from their peers. That semi-monthly paycheck, and the status and social acceptance that go with it, are only a few of the things that they expect from their work.

Are you treating these men as though they are motivated by tangible rewards, by money alone? If you are, you may be making a costly mistake. Pay, by itself, often ranks low on the list of rewards that such workers seek. This explains why increases in salary may be ineffective motivators. They must be accompanied by equally important opportunities for personal satisfaction.

It's quite a simple matter to influence employees with tangible rewards—you give a raise for work well done and withhold it for marginal efforts. You do this now. But are you paying proper attention to the less obvious incentives that you can offer? Do you, for example, share your sense of accomplishment with your employees when a project is completed? Do you let your men operate with some degree of autonomy, so they can take pride in work that is identifiably their own?

Suppose you're a project manager, and you want increased output from your group. Try this:

Share the involvement. Tell your people what the project is and why you are working on it. Give each man a chance to show his own capability. And give him part of the project—his alone—to organize and to carry through. Take a chance. Give him this measure of responsibility. Trust him, and let him know that you trust him. And watch him grow. Then pass along the credit when the job is done.

Chances are good that you'll find productivity is up.

RAYMOND D. SPEER



plug-in

- multi-trace
- differential
- sampling
- spectrum analysis

Tektronix 530, 540 and 550-series plug-in oscilloscopes offer a wide range of performance, designed to meet your changing measurement needs. Select the performance and measurement functions you need from multi-trace, differential, sampling and spectrum analyzer plug-ins.

For multi-trace applications, the new Type 1A4 Four-Channel amplifier offers constant DC-to-50 MHz bandwidth and 7-ns risetime capabilities over its 10 mV/cm to 20 V/cm deflection factor range. Operating modes include alternate or chopped four channel, dual channel differential, and 2, 3, or 4 channels added or subtracted. Two dual-trace plug-ins are also available, the Type 1A1 with 28 MHz at 5 mV/cm (50 MHz at 50 mV/cm) and the Type 1A2 with 50 MHz at 50 mV/cm.

Type 1A1 Dual-Trace Plug-in	\$625
Type 1A2 Dual-Trace Plug-in	\$340
Type 1A4 Four-Trace Plug-in	\$780

For differential applications, the new Type 1A5 Differential amplifier features 1 mV/cm deflection factor, 1,000:1 common-mode rejection ratio at 10 MHz, ± 5 V comparison voltage and 50 MHz bandwidth with 7-ns risetime at 5 mV/cm. The low-cost Type 1A6 Differential plug-in has 1 mV/cm deflection factor, 10,000:1 CMRR and 2-MHz bandwidth. The high-gain Type 1A7A Differential plug-in has 10 μ V/cm deflection factor, 100,000:1 CMRR and 1 MHz bandwidth.

Type 1A5 Differential Plug-in	\$550
Type 1A6 Differential Plug-in	\$240
Type 1A7A Differential Plug-in	\$440

For sampling applications, choose from two high performance plug-ins, the Type 1S1 general purpose sampling plug-in and the Type 1S2 TDR sampling plug-in. The Type 1S1 features internal triggering, 0.35-ns risetime, DC-to-1 GHz bandwidth and calibrated sweep speeds from 100 ps/cm to 50 μ s/cm. The Type 1S2 is a time-domain reflectometer with a system risetime of 140 ps, 0.005 p/div deflection factor and sweep rates from 100 ps/div to 10 μ s/div. With its 90-ps risetime, 5 mV/div deflection factor and built-in triggering, the Type 1S2 can be used in many other sampling applications.

Type 1S1 Sampling Plug-in	\$1175
Type 1S2 TDR Plug-in	\$1375

Four spectrum analyzer plug-ins covering the spectrum from 50 Hz to 40 GHz convert your oscilloscope to a high-performance spectrum analyzer. The plug-ins cover the following frequency bands: Type 1L5 from 50 Hz to 1 MHz with 10 μ V/cm deflection factor; Type 1L10 from 1 MHz to 36 MHz with -110 dBm sensitivity; Type 1L20 from 10 MHz to 4.2 GHz with -110 to -90 dBm sensitivity; and Type 1L40 from 1.5 GHz to 40 GHz (optional accessories necessary) with -110 to -70 dBm sensitivity.

Type 1L5 Spectrum Analyzer Plug-in	\$1000
Type 1L10 Spectrum Analyzer Plug-in	\$1150
Type 1L20 Spectrum Analyzer Plug-in	\$1925
Type 1L40 Spectrum Analyzer Plug-in	\$2150

U. S. Sales Prices FOB Beaverton, Oregon

For a demonstration, contact your Tektronix field engineer or write: Tektronix, Inc., P. O. Box 500, Beaverton, Oregon 97005



Multi-trace, differential, sampling and spectrum analysis

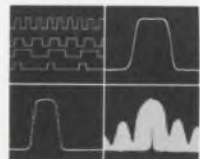

... in all Tektronix 530-540-550-series plug-in oscilloscopes

Technology

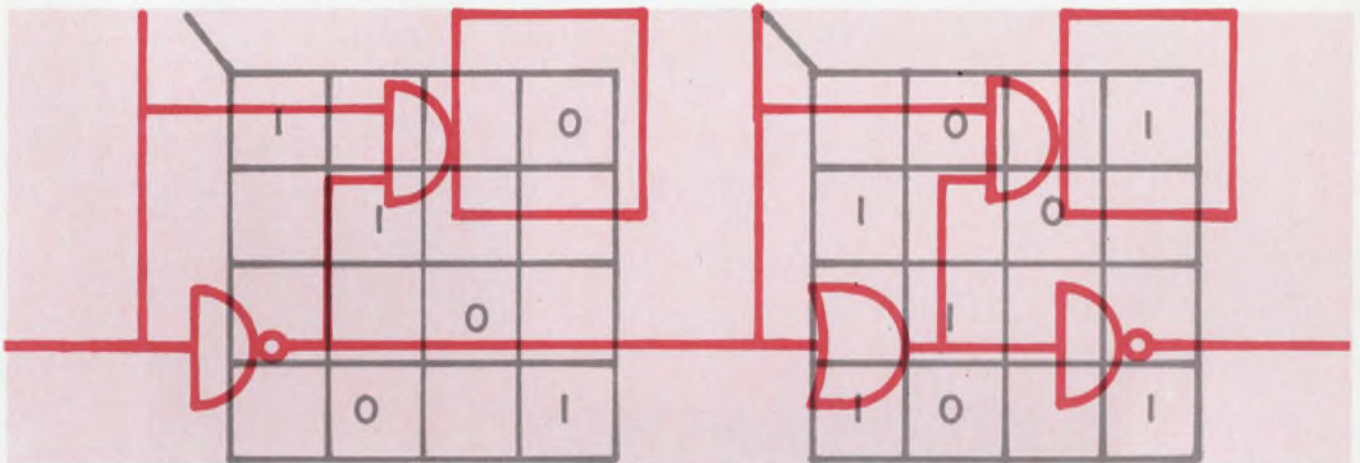

Keep them simple—your sequential circuits, that is. By combining Karnaugh maps with

flow tables, you can come up with minimum logic designs. Page 80



Do you feel your abilities are too closely channeled? Many engineers do. Others feel

they're not getting a "fair shake." They want a bigger voice on the job. Page 88

Also in this section:

A practical guide to a/d conversion, Part 2. Page 57

Ideas for Design. Page 98



The most accurate multimeter in the world: try one free for ten days.

The Fluke 853A is the most accurate multimeter in the world and the most reliable. Once you've tried the 853A, we're willing to bet you won't let it go. Laying it on the line, try the 853A free for ten days with absolutely no obligation.

Here are the key specs and features. DC volts, 0.2%. AC volts, 0.5%. Range, 0 to 1.1 KV. DC amps, 0.2%. AC amps, 0.5%. Range, 0 to 11 amps. Ohms, 0.2%. Range, 0 to 110 megohms. All of these specifications are

guaranteed to hold for one full year without recalibration. Complete overload protection is featured. And the price is only \$445.

Available from local stock for fast delivery.

The Fluke 853A is now available off the shelf in major cities throughout the country. To painlessly arrange a free trial, simply call the nearest Fluke sales-engineering office (listed below) or, if you wish, drop us a line and we'll take care of all the details.

Call the number nearest you for a free trial.

Huntsville, Ala. (205) 534-1648
 Phoenix, Ariz. (602) 959-2115
 Los Angeles, Cal. (213) 245-9404
 San Diego, Cal. (714) 232-2017
 San Francisco, Cal. (408) 244-1505
 Denver, Colo. (303) 934-5505
 Hartford, Conn. (203) 633-0777
 Orlando, Fla. (305) 425-2764
 Honolulu, Hawaii (808) 506-095

Chicago, Ill. (312) 825-1144
 Indianapolis, Ind. (317) 244-2456
 Baltimore, Md. (301) 744-7700
 Boston, Mass. (617) 646-1034
 Detroit, Mich. (313) 838-7324
 Minneapolis, Minn. (612) 920-1022
 St. Louis, Mo. (314) 423-1234
 Newark, N.J. (201) 687-8737
 Albuquerque, N.M. (505) 265-7766

Long Island, N.Y. (516) 433-1421
 New York, N.Y. (914) 769-1811
 Rochester, N.Y. (716) 381-8330
 Syracuse, N.Y. (315) 454-9377
 Greensboro, N.C. (919) 273-1918
 Cleveland, Ohio (216) 734-0960
 Dayton, Ohio (513) 298-9964
 Portland, Ore. (206) 767-4260
 Philadelphia, Pa. (215) 279-0377

Pittsburgh, Pa. (412) 371-1231
 Dallas, Tex. (214) AD 1-2573
 Houston, Tex. (713) NA 1-0040
 Seattle, Wash. (206) 767-4260
 Washington, D.C. (301) 946-0300
 Vancouver, B.C. (604) 291-7161
 Ottawa, Ont. (613) 725-1288
 Toronto, Ont. (416) 636-4910
 Montreal, Que. (514) 747-9849

Fluke, Box 7428, Seattle, Washington 98133. Phone: (206) 744-2211. TWX: 910-449-2850. In Europe, address Fluke Nederland (N.V.), P.O. Box 5053, Tilburg, Holland. Telex: 844-50237. In the U.K., address Fluke International Corp., P.O. Box 102, Watford Herts, England. Telex: 851-934-583.



An Electronic Design practical guide to **a/d** **conversion**

Part 2

**Written by: Hermann Schmid, Senior Engineer,
General Electric Co., Binghamton, New York**

Edited by: Frank Egan, Technical Editor

Part 1 of this design guide covered parallel- and serial-feedback a/d converters, their performance criteria and design considerations.

Part 2 continues with additional converter types—namely, indirect a/d converters and high-speed, high-accuracy a/d converters. Within these broad categories, the following specific converter types are covered:

- Indirect a/d converters 58
 - Simple ramp-comparison type
 - Precision ramp-comparison type
 - Up/down integration type
 - Precision type without precision components

- High-speed, high-accuracy a/d converters 67
 - Cascade, analog-to-pure-binary type
 - Cascade, analog-to-Gray-code type
 - Variable-reference cascade type
 - Multi-threshold type
 - Partially-cascaded type

indirect

Indirect a/d converters require few critical components. Their conversion speed, though, is low.

Parallel-feedback and serial-feedback a/d converters can also be classified as direct encoders because they convert directly from analog signals into digital signals. In contrast, the a/d converters described here can be classified as indirect decoders, because they convert the analog signals first into intermediate signals, which are half-analog and half-digital. The intermediate signals are then converted into pure digital signals.

Indirect a/d converters have several distinct advantages. They offer circuit simplicity; they employ mostly noncritical components, and they exhibit none of the high-speed problems that are common to serial-feedback converters. The penalty for these advantages, though, is a lower conversion rate.

To count, for example, from 0 to 2^{12} with a 1-MHz clock frequency requires 4096 μ s. Hence the conversion rate is only about 250 per second. This is slow by successive-approximation standards, but is still fast enough for many control applications. Moreover, when higher speeds are required, there are several techniques for obtaining them.

The first approach is to raise the clock frequency, f_c , although there are, of course, limitations on how high f_c can be made. The second approach is to use fewer bits in the digital word. The designer, however, usually has little control over this.

1. Simple ramp comparison a/d converter

The ramp-comparison technique is the fundamental principle of all indirect encoders. However, although it is conceptually very simple, the technique has never been used extensively. The reason for this is that it has been generally assumed that the ramp-comparison method is:

- Very slow.
- Very sensitive to noise.
- Not very accurate, since the accuracy is a function of the integration capacitor precision.

The following discussion will show that these assumptions are not necessarily true today.

The simple ramp-comparison a/d converter (Fig. 1a), first converts the analog input signal V_x into a pulse-width signal, t_x , and then converts t_x into a parallel binary number X_p . The conversion from voltage to pulse width is accomplished by comparing V_x with a linear ramp

function, or a sawtooth voltage, $V_s = tV_R$. When V_x is smaller than V_s , the comparator output is ZERO, and when V_x is larger, the output is a logical ONE (Fig. 1b).

Since the sawtooth function is periodic, t_x is also a repetitive waveform having an ON-time of $T - t_x$ and a repetition period T . The linear relationship of t_x and V_x can be easily verified. At the point when the comparator switches from ZERO to ONE, the following equation can be written.

$$V_x = t_x V_R$$

$$\text{or } t_x = V_x/V_R,$$

where V_R is a reference voltage.

The conversion from the pulse width signal, t_x , to a parallel binary number, X_p , is usually performed by counting a clock frequency, f_c , during t_x .

As shown in Fig. 1a, the ramp-comparison a/d converter can be divided into three parts: the ramp generator, the comparison circuit and the digital circuit. The ramp generator consists of one dc amplifier, one analog switch, one resistor and one capacitor. These components are interconnected as a resettable integrator in which the reference voltage, V_R , is constantly integrated. The output voltage of the amplifier, V_s , hence increases linearly with time so long as switch S_1 is open.

When S_1 is closed, the integration capacitor is discharged, and the amplifier output, V_s , is held at zero for as long as the switch is closed. In the circuit shown, S_1 is controlled by the most-significant stage of the 12-bit counter, which closes the switch during time period T_2 .

The amplitude of sawtooth voltage V_s is directly proportional to V_R and to time, and is inversely proportional to R and C . Therefore, the magnitudes of R and C are extremely important

and precision components are needed.

The reset operation of the integrator requires a finite amount of time; this depends on the slewing capabilities of the amplifier, the value of the integrating capacitor, and the ON-resistance of the switch. It would be desirable if the reset operation could be performed in less than one clock period. But because this would impose very stringent speed requirements on the linear circuits, the full period T_2 is provided. This allows more than sufficient time to properly reset the integrator.

The converter of Fig. 1a should be able to operate with a 10-MHz clock frequency, which means a repetition period of approximately 400 μ s. In this case, the values of R and C must be chosen so that

$$V_{s \max} = \frac{V_R T / 2}{RC}.$$

Setting $V_{s \max} = 5$ V, $V_R = 5$ V and $R = 20$ k Ω , the value of the integrating capacitor becomes $C = (T/2)/R = 10,000$ pF.

With these values, the dc amplifier can be a monolithic device, like the μ A709, and switch S_1 can be a high-impedance J-FET or MOSFET series switch. With the total reset period being 200 μ s, the discharge time constant of the circuit can be as long as 10 μ s, and the ON-resistance of the switch does not need to be any lower than 1000 ohms.

The comparator circuit of the simple ramp-comparison converter of Fig. 1 is comprised of the actual comparator, the input filter and a clocked digital differentiator. The actual comparator should have a sensitivity of better than ± 1 mV and a total offset voltage of less than ± 1 mV. It should also respond in less than one clock period, or 100 ns for a 10-MHz clock fre-

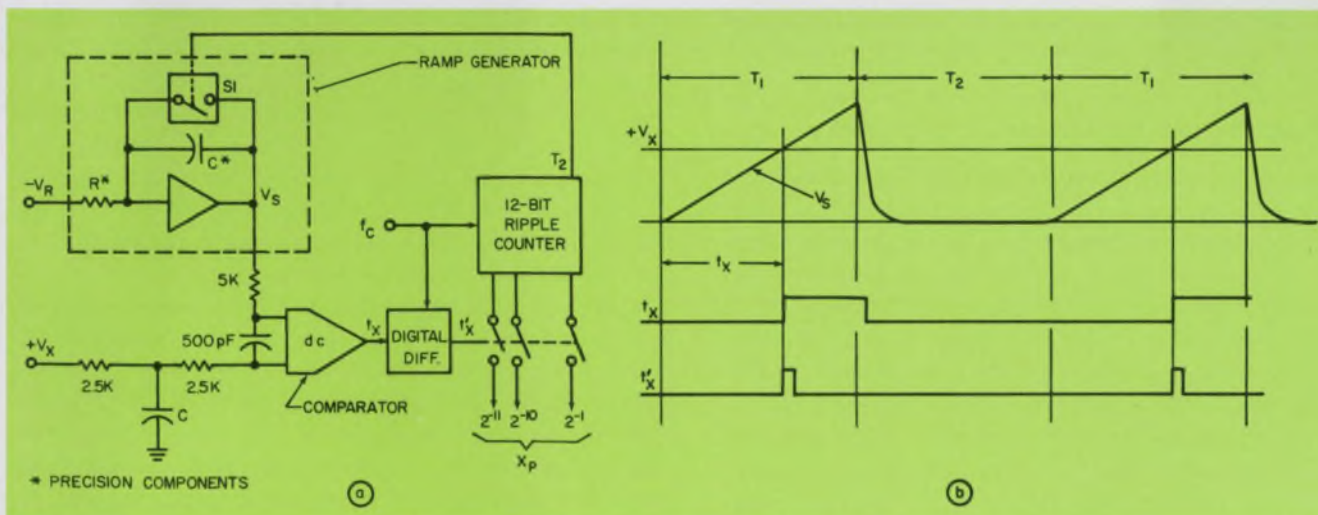

1. Simple ramp-comparison a/d converter (a) compares the analog input voltage, V_x , with an internally generated linear ramp. Pulse-width signal, t_x , is generated as a

result of this comparison; the duration of t_x being proportional to the time it takes the ramp to reach the value of V_x (b).

quency. Various commercially available monolithic comparators can fulfill these requirements. The purpose of the input filter is to reduce the effect of high-frequency noise on the input signal and on the sawtooth.

The clocked digital differentiator of Fig. 1a generates a narrow pulse when the input signal t_x and clock pulse f_c change from LOW to HIGH. The width of the narrow output pulse, t'_x , is determined by the propagation delay of the three NAND gates, N_1 to N_3 , shown in Fig. 2. The latch, consisting of N_2 and N_3 , is reset when the input t_x returns to a LOW level. Power gate N_1 provides the capability of driving the converter-output switches.

The digital circuits of the simple ramp-comparison converter are comprised of a 12-bit counter together with counter output gating. A synchronous counter is needed for high-speed operation. The counter output-gating circuits connect the parallel digital number X_p to the output terminals at the instant that $V_x = V_s$. The narrow output pulse t'_x of the digital differentiator closes the switches for only a short time at the beginning of each clock period.

The accuracy of the simple ramp-comparison a/d converter is a function of how precise a sawtooth can be generated and the accuracy with which the comparison can be performed. With a clock frequency of 10 MHz, a maximum output voltage of 5 V, a comparison accuracy of ± 1 mV and precisely trimmed RC values, the ramp-comparison converter can perform with an accuracy of $\pm 0.05\%$ of full scale. This remains true, however, only for a constant operating temperature, since RC cannot be maintained at the desired value over the temperature range. With the 10-MHz clock frequency, the device can perform 2500 conversions per second.

Another drawback of this converter is that there is no simple way to transform it into a bipolar device, mainly because an integrator cannot easily be reset to a negative reference voltage.

2. Precision ramp-comparison a/d converter

Many limitations of the simple ramp-comparison a/d converter can be overcome by a more precise method of generating the sawtooth function. One such method, to be described here, generates the sawtooth wave by means of a parallel d/a converter operating in combination with a master counter. There is no need for precision capacitors, and the resulting circuit is therefore capable of high accuracy. However, the cost, size and weight of this converter are considerably higher than that of a simple ramp-comparison converter.

The additional complexity of the precision ramp-comparison converter involves only the

sawtooth generator. And because the same sawtooth waveform can be connected to many comparators, this technique is highly suitable for multichannel a/d conversion applications.¹

A precision ramp-comparison converter for multichannel use is shown in Fig. 3.

The multichannel ramp-comparison converter consists of only one sawtooth generator, which is common to all channels; one comparator, and one digital-differentiation circuit for each input channel. The 12-bit digital storage circuits provide intermediate storage for the output signals.

Each of the "n" analog input voltages, V_{x1} to V_{xn} , is connected to one input of a comparator, while the sawtooth voltage, V_s , is connected to the other. As V_s becomes equal to, and then larger than V_x , the output of that particular comparator switches from LOW to HIGH. At this instant, the digital-differentiation circuit produces a narrow pulse which is used to close a row of transfer switches and to connect the output of the master counter to the 12-bit digital storage circuits.

The master counter operates continuously, and provides as outputs binary digital signals that represent a linearly increasing number, from 000 . . . 00 to 111 . . . 11. Here 000 . . . 00 represents a maximum negative value, 111 . . . 11 a maximum positive value and 100 . . . 00 represents zero. A continuously operating counter can be regarded as a digital sawtooth generator, since it resets itself to 000 . . . 00 after it has reached 111 . . . 11.

Conversion from the digital number in the master counter to an analog sawtooth voltage is performed with a conventional d/a converter. With appropriate biasing, the output of the d/a converter swings between the negative reference voltage, $-V_R$, and the positive reference, $+V_R$.

In addition to generating the sawtooth voltage, the outputs of the master counter are also gated into the digital storage circuits. Since the number in the counter increases linearly with time, the number transferred out at any given time is proportional to the elapsed time, measured from the start of the counting cycle. By gating the outputs of the master counter into the storage circuits at the end of the t_x pulse—whose width is proportional to V_x —a number proportional to V_x is actually transferred.

Any of the parallel d/a converters described in reference 2 can be used in this application. For best accuracy and speed, however, the resistor-ladder or the inverted ladder d/a converter should be given preference. The amplifier at the output of the d/a converter must have sufficient current capability to drive all n-comparators.

The comparison and differentiation circuits of this converter are similar to those described for the simple ramp-comparison converter.

Over-all accuracy of this converter can be better than $\pm 0.05\%$. And as the number of parallel input channels is increased, it can become just as fast as many multiplexed successive-approximation converters.²

3. Up/down integration a/d converter

The up/down integration converter uses the well-known up/down-integration technique, which is now employed in many digital voltmeters.³⁻⁸ This technique represents the most accurate method of converting from analog to digital. The technique completely eliminates the dependence of the pulse-width signal, t_x , on the magnitude of the integration RC time constant. The value of the integration capacitor, therefore, can change over a wide range without effecting the value of t_x .

The up/down-integration a/d converter is also less susceptible to noise than any of the ramp-comparison converters, because the input signal, V_x , is integrated for a relatively long time. Another advantage is that t_x is independent of the initial voltage on the integration capacitor, which means that any voltage or current offset in the comparator will not introduce errors.

Another advantage of this converter, in fact, is that *any* offset can be easily corrected with an extremely simple offset-correction network.

The heart of the up/down integration converter is a pulse-width modulator, a simplified version of which is shown in Fig. 4. In the modulator, an unknown input voltage, V_x , is integrated for a precise and constant period, T_1 . During this period the output V_o of the integrator increases linearly with time. If V_x is constant during T_1 , the output at the end of T_1 is

$$V_{o_1} = V_i + V_x(T_1/RC),$$

where V_i is the initial voltage on the integrator.

During the second period, T_2 , a reference voltage, V_R , having opposite polarity to V_x is integrated until the output of the integrator becomes again V_i . The time required for the second operation is the desired information.

It can be shown that the result of this second integration is

$$V_{o_2}(t) = V_{o_1}(T_1) - \frac{1}{RC} \int_0^t V_R dt$$

or $t_x = T_1 (V_x/V_R)$.

Thus, not only is t_x linearly related to V_x , but it is also completely independent of both the integration time constant RC , and the initial integrator voltage.

A four-channel up/down-integration a/d converter is shown in Fig. 5. Again, although a multichannel arrangement is shown, the basic operation is the same for single-channel use. The analog section converts each of the four input

signals, V_{x1} to V_{x4} , into four pulse-width signals, t_{x1} to t_{x4} . These conversions are done sequentially in time. The digital section then transforms the four pulse-width signals into four serial-binary signals, X_{S1} to X_{S4} .

The master and sequence counters generate the timing and control signals; these determine which input signal is to be converted and the phase in which the converter is operating. The

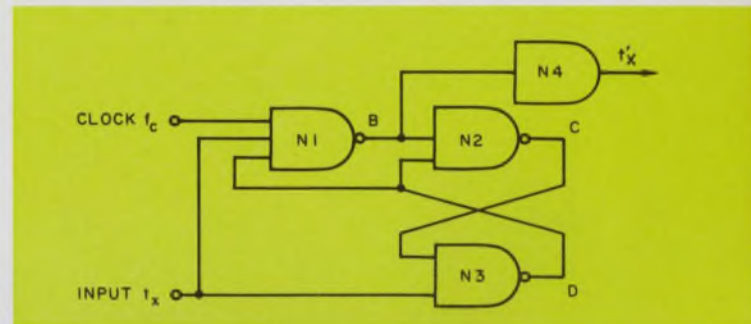

2. Digital differentiation circuit produces narrow output pulse, t'_x , when both the clock pulse and pulse-width signal, t_x , go HIGH.

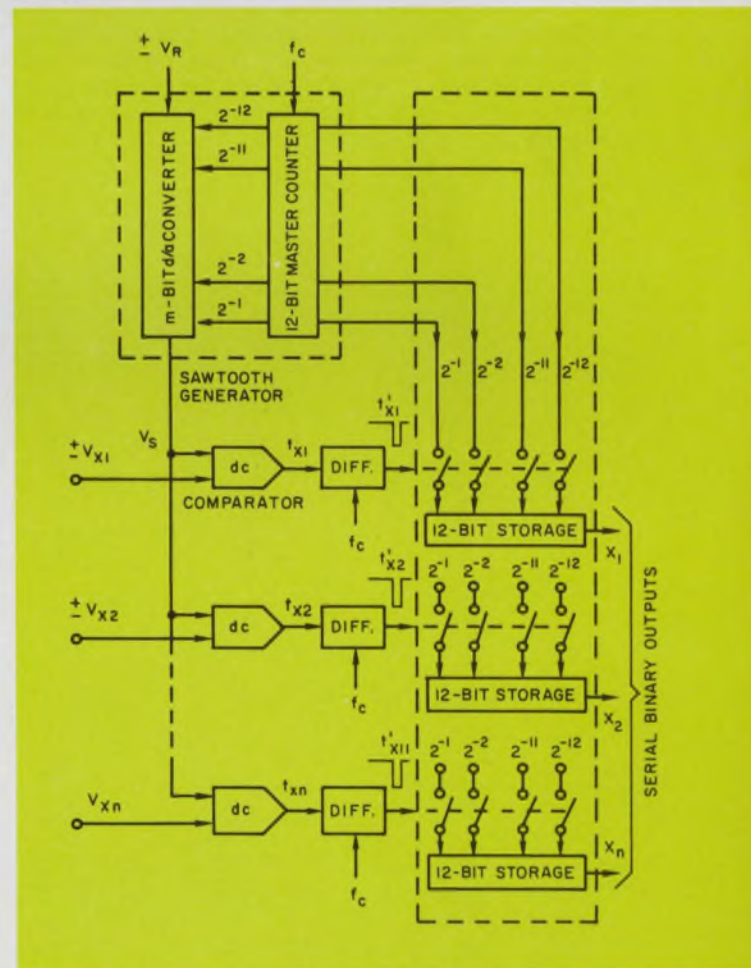

3. Precision ramp-comparison a/d converter uses a digital technique for generating the precision linear ramp. This is accomplished with a d/a converter and a 12-bit master counter.

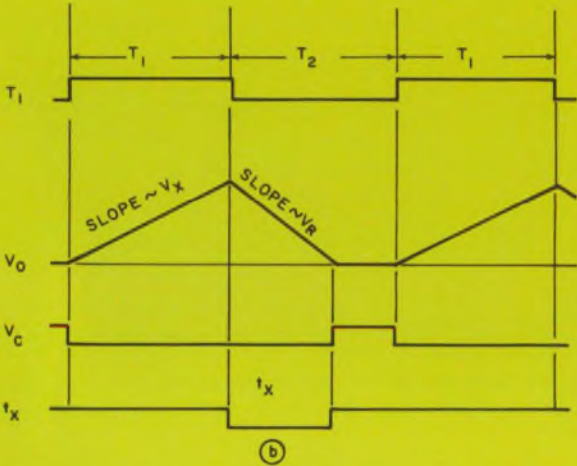
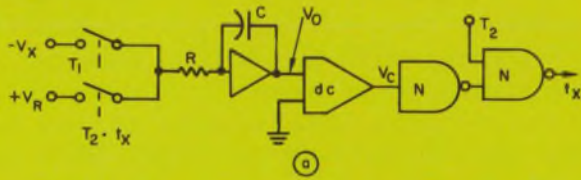

4. Pulse-width modulator (a) performs an up/down integration by first integrating the input signal V_x , and then a reference voltage, V_R , which has a polarity opposite that of V_x . Output waveforms for the pulse-width modular circuit are shown in (b).

operation of the up/down integrator and master counter are thus synchronized, so that the output of the master counter at any specific instant is related to pulse-width signal, t_x , and analog input voltage, V_x .

In addition to the four time periods, T_1 to T_4 , required to convert V_{x1} through V_{x4} , there is one other period, T_0 , during which the input to the converter is zero. During this period, the pulse-width output signal, t_x , is compared with a reference pulse-width signal, T_{REF} . The difference between T_{REF} and t_x is used to generate an error voltage, V_E , which is stored in a capacitor and fed back to the input of the integrator during T_1 to T_4 to correct for the offset error.

The timing and waveform diagram for the 4-channel up/down-integration converter is shown in Fig. 6. As shown, each conversion period, T_i , is divided again into halves. During the first half, T_{i1} , the input voltage V_{xi} is integrated; during the second half, T_{i2} , the reference voltage, V_R , is integrated. The diagram also shows when the differentiated pulses, t'_{xi} transfer the contents of the master counter into the appropriate 12-bit storage register.

The analog section of the up/down-integration converter is an extension of the simple up/down pulse-width modulator of Fig. 4.

The input resistors (Fig. 5) transform the various input and reference voltages into currents which are selectively connected to the input

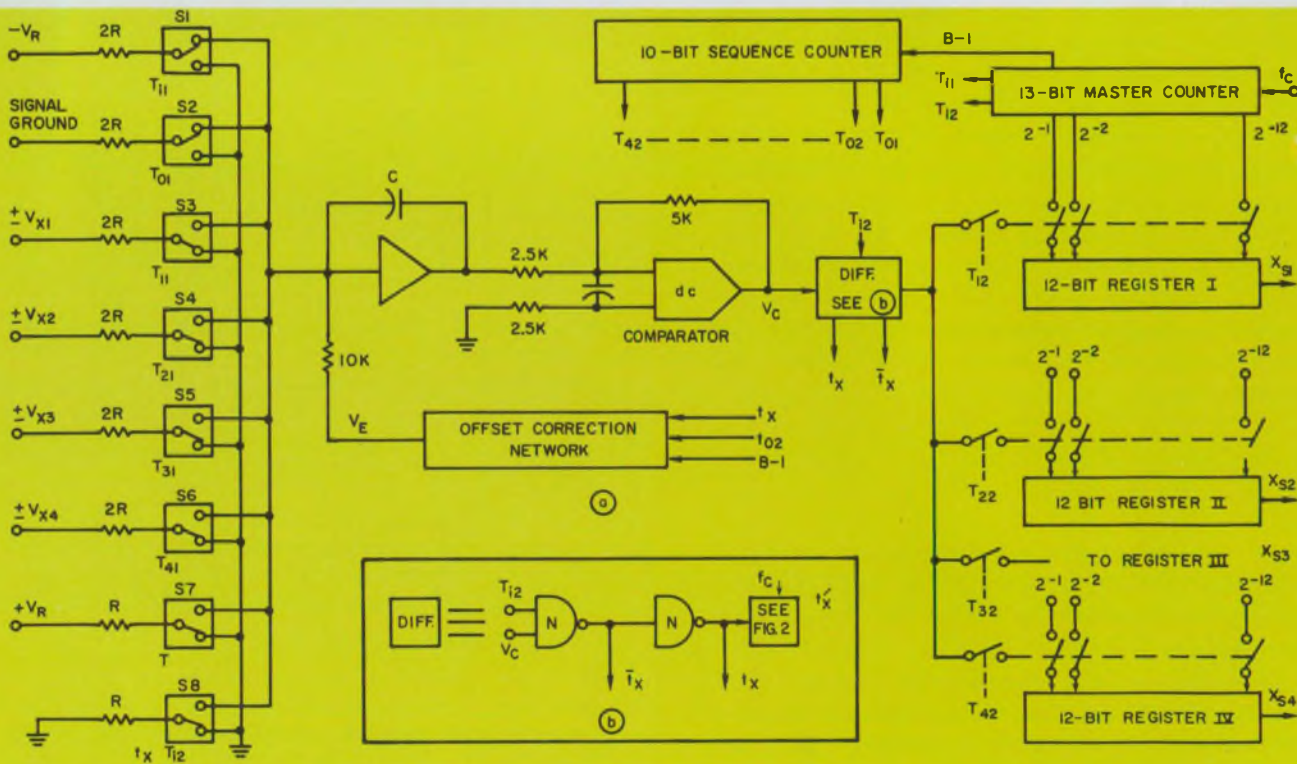

5. Up/down-integration a/d converter can provide multichannel a/d conversions using only a single integrator.

of the integrator by the analog current switches. These resistors also perform the function of scaling, so that almost any reasonable value of input voltage can be accepted by this a/d converter. Only the magnitude of the current is important. If, for example, the value of the input current must be $100 \mu\text{A}$, then R_i must be $100 \text{ k}\Omega$ if $V_x = 10 \text{ V}$, or R_i must be $1 \text{ M}\Omega$ if $V_x = 100 \text{ V}$.

The over-all accuracy of the converter is a function of the precision of these scaling resistors. Absolute accuracy, however, is not required; only the ratio between the various resistors need be precise.

Either J-FET or MOSFET current switches are suitable for this application. Most of the switches are controlled directly by the outputs of the 10-stage sequence counter. It can be shown that the performance of this converter is not a function of the ON-resistance of these switches, but only of how well their ON-resistances can be matched. With identical scaling resistors, R_x , the maximum difference in R_{ON} between any two of the switches should be less than 0.01% of R_x .

The only important requirements of the integration amplifier are high gain (larger than 10,000) and a capability to drive the integration capacitor, which commonly has values between 5000 and 20,000 pF.

The integration capacitor must have a low voltage-coefficient and a high leakage-resistance; but otherwise it needs to be neither very accurate,

nor have a very low temperature-coefficient.

The comparator circuit of Fig. 5 is built around the $\mu\text{A}710$ monolithic comparator, like that previously described for the simple ramp-comparison converter.

The digital section of the up/down-integration a/d converter (Fig. 5) consists of the master counter, the sequence counter, the four output registers, the digital differentiation circuit, and the output multiplexer.

For high-speed operation it is best that the 12-bit master counter be synchronous. It should also be capable of operating with a clock frequency of about 4 MHz, so that the half period, T_{ij} , can be made approximately 1 ms.

The sequence counter must have $2(n + 1)$ stages, where n is the number of input channels. A 4-channel converter therefore requires a 10-stage ring counter. Switch S_1 , which connects the reference voltage $+V_R$ to the integrator, must always be closed during the first-half of each period, T_{i1} ; switch S_7 , which connects $-V_R$ to the integrator, must be closed only when the pulse-width output signal t_x is HIGH. The control signal for S_1 , namely T_{i1} , can be generated simply by OR-ing T_{01} , T_{11} , T_{21} , T_{31} and T_{41} ; the control signal for S_7 is simply t_x .

The intermediate storage circuits are 12-bit parallel-in, serial-out registers. The control signal for transferring the contents of the master counter into the storage circuits is the output of the

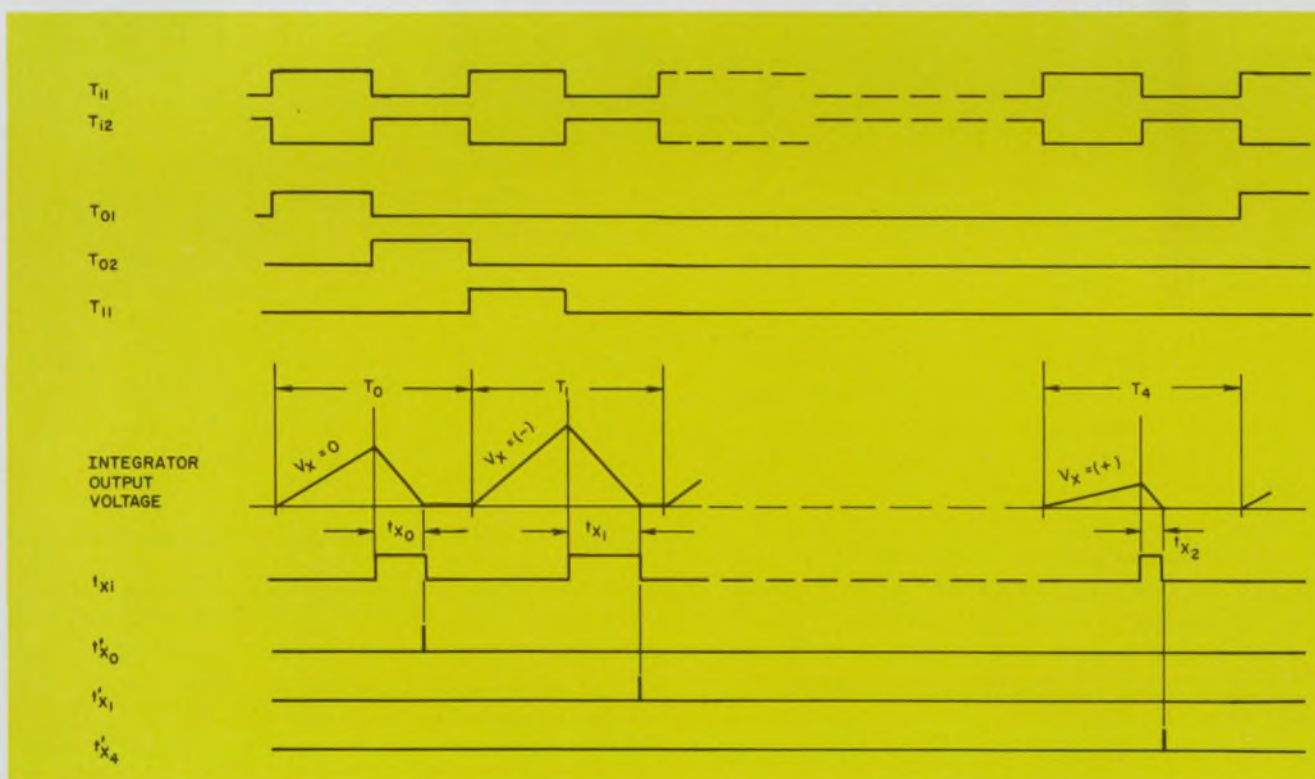

6. Each conversion of the up/down-integration converter is divided into two halves.

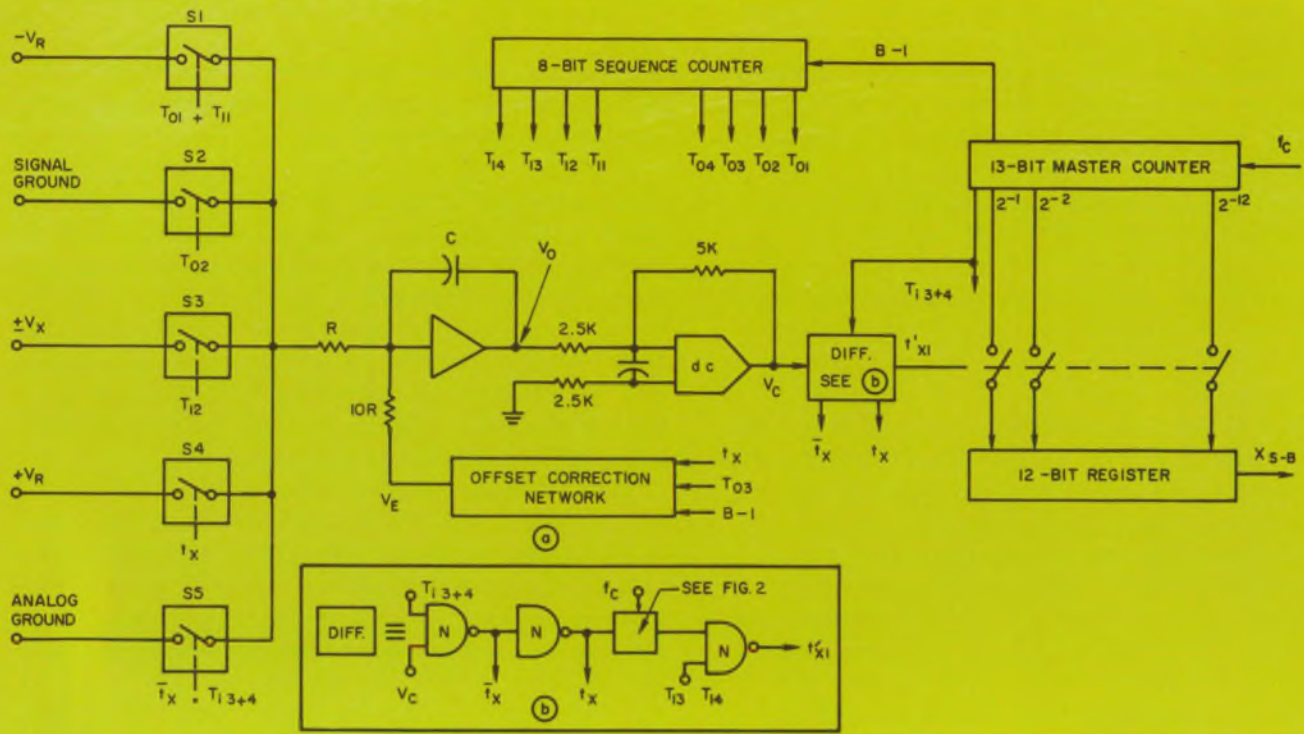

7. Precision up/down-integration a/d converter uses voltage switches at its input. This allows a single input-

resistor to be used for all channels, instead of a separate resistor for each channel.

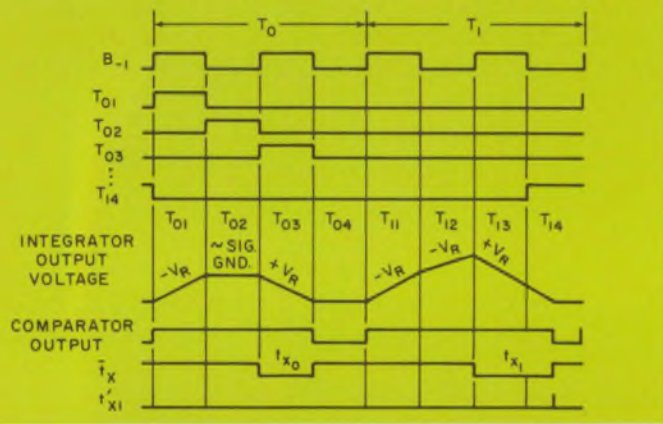

8. Waveforms show operation of precision up/down integration converter of Fig. 7.

digital differentiation circuit, t_x' . This pulse occurs at the instant when t_x and f_c change from LOW to HIGH. Because the operation of the integrator is synchronized with the master counter, the content of the master counter at that instant is proportional to both t_x and input voltage V_x .

The up/down-integration converter of Fig. 5 can accept bipolar input signals. This is made possible by biasing $\pm V_x$ with $V_R/2$. More specifically, switch S_1 connects $-V_R$ through a $2R$ resistor to the input of the amplifier during the first-half of all periods of T_i .

The static accuracy of the up/down-integration converter can be analyzed most conveniently by examining its three basic types of errors; name-

ly, offset, linearity and gain errors.

There are two major sources in the converter that can cause a constant offset error at the output. These are the voltage and current offsets of the integration amplifier.

Other sources of offset error are the delays introduced by the logic circuits, the comparator and the low-pass filter in front of the comparator. As mentioned previously, an offset in the comparator will *not* cause an offset error at the converter output.

Linearity errors are produced by the up/down integrator. These are caused by the finite gain and finite bandwidth of the amplifier.

Finally there are the gain errors which are caused by changes in the reference voltages, variations in the input resistor ratios, and differences in the ON-resistance of the analog switches. To achieve high accuracy from the converter, such as 0.05%, it is essential that these three parameters be well controlled.

4. Precision converter without precision components

In the foregoing analysis of the up/down-integration a/d converter, it was shown that the pulse-width signal, t_x , is independent of the value of the integration capacitor C . This concept is further extended by the converter of Fig. 7, which does not require any precision components; that is, no precision resistors or precision capacitors.

There are two basic differences between the

up/down integration a/d converter of Fig. 5 and that of Fig. 7. The first uses current switches and two basic time periods for each conversion. The second employs voltage switches and four basic time periods. In all other respects, the principles of operation and the implementation are very similar.

The use of analog "voltage" switches in the converter of Fig. 7 eliminates the need for one resistor per switch. Instead, the five series switches, S_1 to S_5 , are interconnected and operated as a 5-channel multiplexer switch, which means that only one of the switches is closed at any one time. With such a multiplexer switch, only one input resistor is required. Since the pulse-width signal t_x is independent of the RC time constant, there is no need for this resistor to be precise.

The use of a multiplexed voltage switch, however, also has disadvantages. First, with only one resistor, the convenient method of scaling no longer exists. Second, since only one input voltage can be connected to the integrator at any one time, the simultaneous summation of two input signals cannot be performed.

Although the circuit of Fig. 7 cannot perform simultaneous summation, it can perform sequential summation, thus making bipolar operation possible.

From the timing and waveform diagram of Fig. 8, it can be seen that the operation of this single-channel converter is divided into eight equal time-intervals. Of these, T_{01} to T_{04} are used exclusively for offset correction. During T_{11} to T_{14} , input signal $\pm V_x$ is converted to digital form.

More specifically, the negative reference voltage $-V_R$, (Fig. 7) is integrated during T_{01} so that the output V_o of the integrator increases linearly to positive half full-scale. During T_{02} , switch S_2 is closed, and the signal ground is connected to the integrator. Thus any voltage difference between the analog ground of the converter and the ground of the signal source is also integrated. Consequently, the offset correction network compensates for slowly-varying differences in the ground potentials.

At the beginning of T_{03} , switch S_4 closes, and the positive reference voltage $+V_R$ is connected to the integrator until V_o again becomes zero. The time required to reduce V_o back to zero, t_{x0} , is used only as input to the offset correction network, where it is compared with the time period T_{03} . The difference between these two pulse-width signals is used to generate the offset correction voltage V_E , which is fed back to the input of the integration amplifier to compensate for any offset and to force t_{x0} to become equal to t_{03} .

The actual signal conversion starts with T_{11} , when S_1 is closed again to bias the integrator to

positive half full-scale. During T_{12} , switch S_3 is closed and the input signal $\pm V_x$ is integrated. Depending on whether V_x is negative or positive, the integrator voltage will rise or fall. At the beginning of T_{13} , the positive reference voltage $+V_R$ is connected to the integrator until V_o again becomes zero. Both T_{13} and T_{14} are necessary for the down integration. This is because two periods are used for the up integration and because the slope for the down integration is the same as the maximum slope for the up integration.

To reduce the effects of leakage currents in the switches, to avoid picking up noise in the integration resistor, R , and to provide a constant source impedance for the integrator, switch S_5 is provided to connect R to analog ground, whenever S_1 to S_4 are open.

With the offset correction network, the offset errors of this converter are practically zero. In addition, the linearity errors are very small. Because there is only one resistor in this converter, the major source of gain-error—the resistors—has also been eliminated. As a result, given enough time, it is presently the most accurate type of a/d converter.⁸

5. Voltage-to-pulse-rate a/d converters

In the voltage-to-pulse-rate method of a/d conversion, an analog voltage is first converted into a pulse-rate signal, or a frequency, and then into a parallel or serial-binary number. Although the technique is quite common in digital voltmeters, it is seldom used in actual a/d converters. The reason for this is that the conversion speed is very low, even with state-of-the-art components.

Voltage-to-pulse-rate conversion can be accomplished either with the basic ramp-comparison technique or with the up/down integration technique. Only the up/down integration technique will be described here.

In the voltage-to-pulse-rate converter (Fig. 9), the input voltage, V_x , is permanently connected to the integrator, while the reference voltage, $+V_R$, is connected to the integrator only when the pulse-rate signal R_x is a logical ONE. The inputs to the comparator are the output, V_o , of the integrator and the constant voltage, $+V_R/K$. In the waveform diagram of Fig. 10, it is assumed that the integrator starts at zero volts, that $V_x = 3/4 V_x \text{ max}$, that $+V_R/K$ is 1 V and that the RC time constant of the integrator is selected so that

$$\frac{1}{RC} \int_0^{t_{11}} V_{x \text{ max}} dt = +2V_R/K = 2 \text{ V}$$

where $V_R = 10 \text{ V}$, $K = 10$, and the time from 0 to t_{11} is half a clock period, $t/2$, or $1/2 f_c$.

The output of the integrator, V_o , thus increases

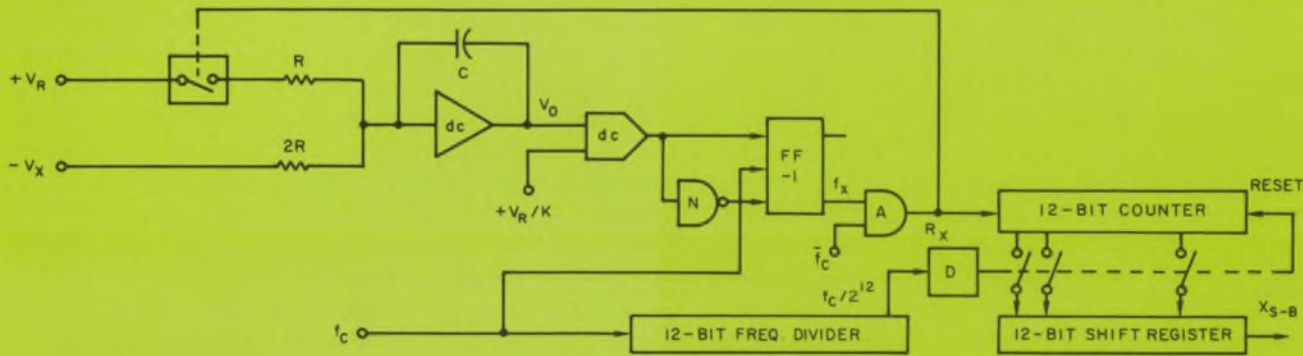

9. Up/down integration technique is used in this pulse-rate a/d converter.

during the first half of clock period t_{11} with a slope of $3/4$. When V_o becomes larger than 1 V , the output of the comparator becomes ONE, but V_o continues to increase until the end of t_{11} , where it becomes $+1.5\text{ V}$.

At the beginning of t_{12} , the logical ONE is shifted into the single-stage shift register, consisting of flip-flop FF-1. The output of FF-1, f_x , is gated with clock pulse \bar{f}_c . Since f_x is a ONE during t_{12} , switch S_1 is closed, connecting $+V_R$ to the integrator. Note that the input resistor for $+V_R$ is only R while the input resistor for V_X is $2R$. The total current flowing into the summing point of the integration amplifier is hence

$$I_T = -V_X/2R + V_R/R$$

and if

$$-V_X = -V_{X_{\max}} = -10\text{ V}, \text{ and if } +V_R = +10\text{ V}$$

$$I_T = -10\text{ V}/2R + 10\text{ V}/R = +V/2R$$

Thus, the current caused by V_R is twice as large as the current caused by $V_{X_{\max}}$. The total integration current in t_{12} is positive, whereas the

current during t_{11} was negative. The output of the integrator therefore decreases with a slope proportional to $2/K(V_X - 2V_R)$, which is, for the numbers above, $1.5\text{ V} - 4.0\text{ V} = -2.5\text{ V}$ per half clock period. At the end of t_{12} , the integrator output is $1.5\text{ V} - 2.5\text{ V} = -1\text{ V}$.

During t_{21} , S_1 is open, only V_X is connected to the integrator, and V_o increases with a rate of $1.5\text{ V}/(t/2)$. At the end of t_{21} , the integrator output voltage is $V_o = -1\text{ V} + 1.5\text{ V} = +0.5\text{ V}$. The output of the comparator remains a ZERO, which is also shifted into FF-1 at the beginning of t_{22} . With R_x being a ZERO, during t_{22} , S_1 stays open and V_o keeps increasing at the same rate, and is $+2.0\text{ V}$ at the end of t_{22} and $+3.5\text{ V}$ at the end of t_{31} .

As soon as V_o became larger than 1.0 V in t_{22} , the output of the comparator became a ONE; but there is no negative transition on the clock pulse until the beginning of t_{32} . At that time the ONE is shifted into FF-1 to make R_x a ONE also. Switch S_1 closes, and V_o decreases during t_{32} from $+3.5\text{ V}$ to $+1.0\text{ V}$. During t_{11} , S_1 is again open and V_o increases to $+2.5\text{ V}$. During t_{12} , R_x is again ONE, S_1 is closed and V_o decreases from $+2.5\text{ V}$ back to zero, which is the value V_o started from in t_{11} .

With an input voltage, V_X , of $3/4 V_{X_{\max}}$, a total of three out of four possible pulses were generated, with no voltage left in the integrator. This is, of course, the desired output from the voltage to pulse-rate converter.

The conversion from pulse-rate to a serial-binary number is accomplished by summing all the R_x pulses during a constant time period $T = 2^{12} \cdot t_c$, where $t_c = 1/f_c$.

Just as for pulse-width converters, the voltage-to-pulse-rate conversion is independent of the RC time constant of the integrator and is only a function of V_X , V_R , the clock period t_c , and the total conversion period T . The time required for one 12-bit conversion is determined by how fast the integration amplifier can integrate 2 V up and 2 V down. ■■

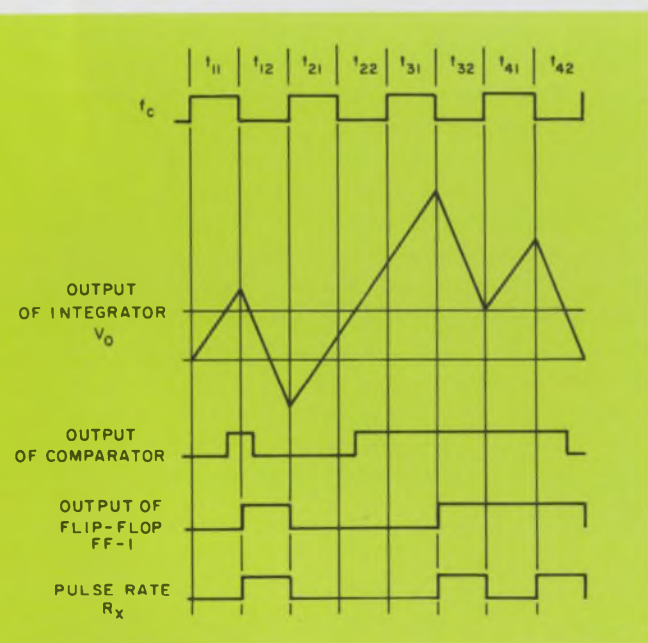

10. Wave forms describe the operation of the pulse-rate a/d converter using up/down integration.

high-speed

High-speed, high-accuracy a/d converters use parallel operating techniques.

There is an ever increasing demand today to reduce a/d conversion time without sacrificing conversion accuracy. To meet these demands, a variety of different high-speed, high-accuracy a/d conversion techniques have been developed.

These conversion techniques are characterized by the fact that they do not obtain their high speed by using higher-speed circuits or components, but by using parallel, rather than serial, circuit configurations. Although this requires additional hardware, it does not necessarily mean that converters employing such techniques are more expensive than other types. With the price of components steadily decreasing, the cost of actual hardware is becoming a smaller percentage of total converter price.

1. Multi-threshold a/d converter

The multi-threshold converter is by far the fastest and most straightforward of all a/d converters.^{9,10} It operates almost instantaneously and is limited only by the delays of one comparator and a few logic gates. The total conversion time is less than 100 ns with conventional $\mu A710$ comparators and with ordinary TTL logic gates.

The multi-threshold converter requires one comparator for each comparison level, except for zero. In an n -bit converter, there are therefore $2^n - 1$ comparators. Obviously, this seriously limits the number of bits to be converted, even when using integrated circuits. The approach is nevertheless of interest and can be used, as will be shown later, as a basic building block to partially-cascaded, high-speed converters.

A unipolar 3-bit multi-threshold a/d converter is shown in Fig. 11 to consist of seven comparators and two OR gates. The analog signal voltage, V_x , is connected to one input of each comparator, and one of seven reference voltages, $1/8 V_R$, $2/8 V_R$, $3/8 V_R$, etc., is connected to the other input. Input voltage V_x is thus compared simultaneously with seven possible threshold levels. If, for example, $V_x = 0.3 V_R$, then the outputs of the first two comparators, $CP1$ and $CP2$, are logical ONES, which indicates that V_x is larger than $1/8 V_R$ and $2/8 V_R$. The total digital output from the seven comparators is 0000011. Similarly, if $V_x = 0.55 V_R$, the output of the seven comparators is 0001111, indicating a value larger than $4/8 V_R$.

The seven reference voltages are generated with a resistor voltage-divider, consisting of

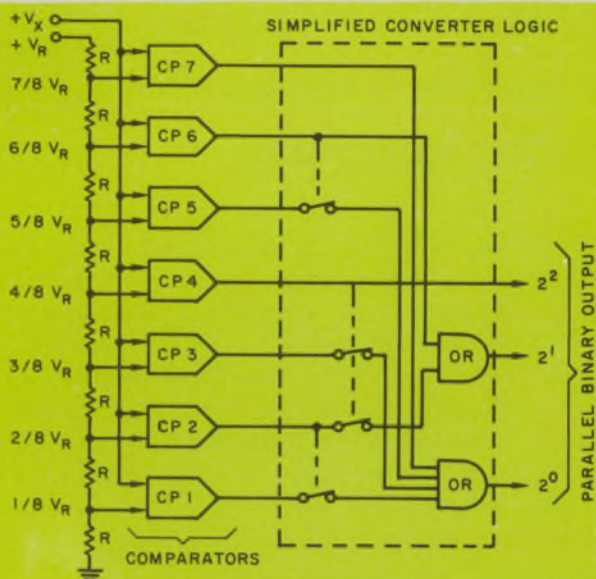

11. Multi-threshold a/d converter requires $2^n - 1$ comparators to generate an n -bit digital output signal.

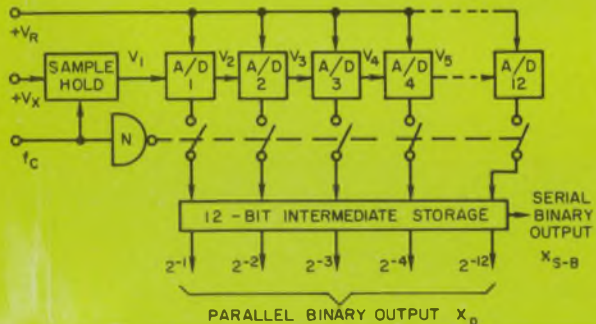

12. Cascade, analog-to-pure-binary a/d converter employs a cascade arrangement of identical, single-bit a/d conversion stages.

eight equal resistors. The values of these resistors must be sufficiently low so that any current flowing into or out of the comparators will not appreciably change the reference voltage levels.

The seven comparators can be relatively simple devices, inasmuch as the comparison accuracy need not be very high. For a single 3-bit converter, this accuracy has to be only slightly better than the converter resolution.

The output of the 3-bit multi-threshold a/d converter is a binary signal between zero and seven, with the specific value determined by the comparator outputs. This can be seen from Table 1.

2. Cascade, analog-to-pure-binary a/d converter

The cascade, analog-to-pure-binary conversion technique is also referred to as sequential or propagation a/d conversion.¹¹⁻¹⁴ Early implementations of this technique, using vacuum tubes, were not very accurate and proved no faster than converters that used less hardware. But with

today's components, considerably higher accuracies are possible—although conversion speed is still a problem.

As shown in Fig. 12, a 12-bit cascaded analog-to-binary converter consists basically of 12 single-bit a/d conversion stages, if we neglect, for the moment, the sample-hold and intermediate storage circuits. The first stage of the converter receives the analog voltage signal, V_x , as an input. For all other stages, the input voltage is the analog output from the previous stage: in short, the n conversion stages are cascaded. The reference voltage, $V_R/2$, is connected to each single-bit converter. The digital output from each converter stage represents one bit of the parallel-binary output signal, with the converter having V_x as its input representing the most-significant bit.

One major advantage of this converter is that all n -conversion stages are identical, both in circuitry and in operation. A generalized diagram of one of these stages is shown in Fig. 13. It consists of a comparator, an analog switch, a subtractor and an amplifier having a gain of two.

The comparator determines whether the input voltage, V_i , is larger or smaller than the reference voltage, $V_R/2$. When V_i is larger, the output of the comparator, a_i , is a ONE, switch S is closed and $V_R/2$ is subtracted from V_i . When V_i is smaller than $V_R/2$, a_i is ZERO, switch S is left open and nothing is subtracted from V_i . The amplifier multiplies the output of the subtractor by two. The amplifier output is therefore:

$$V_{i+1} = 2[V_i - (a_i V_R/2)].$$

For illustration, consider the example where $V_x = +8.4$ V and $V_R = +10$ V. For the above equation, the outputs a_i (where $X_i = a_i$) and V_{i+1} from the cascade series of single-bit converters are:

- For converter 1: $a_1 = \text{ONE}$ and $V_2 = +6.8$ V
- For converter 2: $a_2 = \text{ONE}$ and $V_3 = +3.6$ V
- For converter 3: $a_3 = \text{ZERO}$ and $V_4 = +7.2$ V
- For converter 4: $a_4 = \text{ONE}$ and $V_5 = +4.4$ V
- For converter 5: $a_5 = \text{ZERO}$ and $V_6 = +8.8$ V

The parallel-binary output of the first five converter stages is thus 11010, or $26/32$, which is the closest approximation to 8.4 V/ 10 V = 0.84 in a 5-bit binary word.

One possible implementation of a unipolar single-bit a/d converter is outlined in Fig. 14. A monolithic comparator, like the Fairchild $\mu A710$, can determine to within a few millivolts whether input voltage V_i is larger or smaller than the reference voltage $+V_R/2 = +5$ V. A low-pass filter, consisting of two 2-k Ω resistors and a 200-pF capacitor reduces the effects of noise on the input and reference voltage. A monolithic amplifier, like the $\mu A709$, is connected as a voltage follower with a gain of two. The subtraction $[V_i - (V_R/2)]$ is carried out by returning the

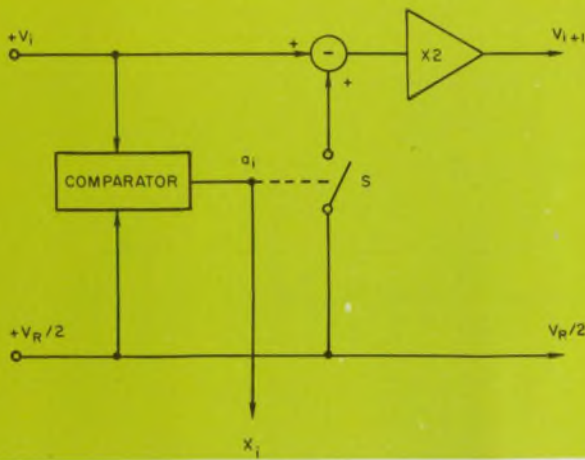

13. Single-bit converter stage for a/d converter of Fig. 12 compares the voltage V_i , from the previous stage with the reference voltage to determine whether digital output bit X_i is ONE or ZERO.

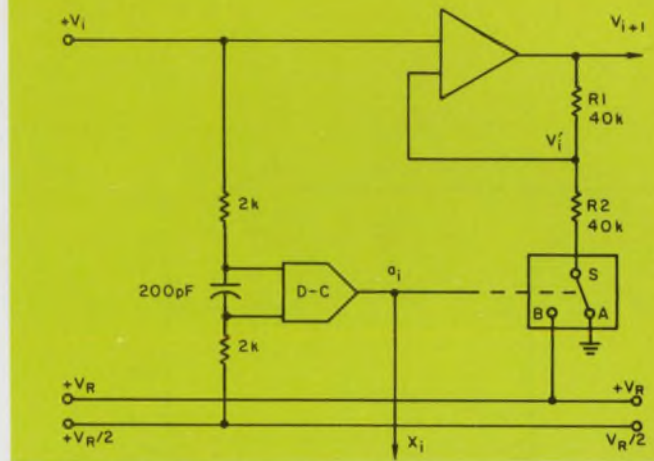

14. Operations of subtraction and multiplication by two are performed by the amplifier in this unipolar implementation of the single-bit conversion stage for the converter of Fig. 12.

Table 1. Multi-threshold converter logic

Threshold levels	Comparator outputs							Converter output		
	CP1	CP2	CP3	CP4	CP5	CP6	CP7	2^2	2^1	2^0
0	0	0	0	0	0	0	0	0	0	0
1	1	0	0	0	0	0	0	0	0	1
2	1	1	0	0	0	0	0	0	1	0
3	1	1	1	0	0	0	0	0	1	1
4	1	1	1	1	0	0	0	1	0	0
5	1	1	1	1	1	0	0	1	0	1
6	1	1	1	1	1	1	0	1	1	0
7	1	1	1	1	1	1	1	1	1	1

voltage divider, $R_2/(R_1 + R_2)$, to 10 V. The voltages at the input to the amplifier are thus V_i and V_i' , where V_i' is the voltage at the junction of resistors R_1 and R_2 , or

$$V_i' = (V_{i+1} + V_R)/2.$$

If it is assumed that V_i' is equal to V_i , which must be true if the amplifier is to work correctly, then the above equation can be solved for V_{i+1} ,

$$V_{i+1} = 2[V_i - (V_R/2)]$$

The operational amplifier thus performs both the subtraction and the multiplication by two.

A series-shunt switch is used to connect $+V_R$ or ground to the voltage divider of the single-bit converter, depending on whether the output, a_i , of the comparator is ONE or ZERO, respectively. There are some rather strict requirements on the ON-resistance of this switch, as its resistance will add directly to that of R_2 . If the converter is to be accurate to 1 part in 4096 (12 bits), then the gain of the voltage follower must be maintained to about 1 part in 20,000. The voltage divider must have the same accuracy, so the ON resistance of the switches, or at least the change

in R_{ON} , must be less than 1/20,000 of $(R_1 + R_2)$, which is less than ± 2 ohms.

Returning now to the complete 12-bit cascade converter of Fig. 12, the sample hold circuit is needed because the digital output signal, V_D , can be temporarily in error when input signal V_X changes. If, for example, V_X increases from +4.998 V to +5.001 V, where $+V_R/2 = +5$ V, then the output signal will change as follows:

V_X	X_D
4.998 V	011111111111
	111111111111
	101111111111
	100111111111
	100011111111

	100000000001
5.001 V	100000000000

The time required for this changeover is determined by how fast the change can propagate through the 12 cascaded converter stages. This

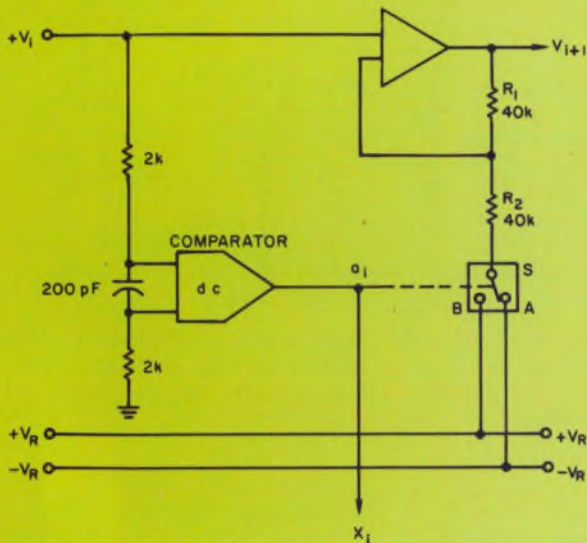

15. Bipolar signals can be accepted by this version of the single-bit conversion stage for the converter of Fig. 12.

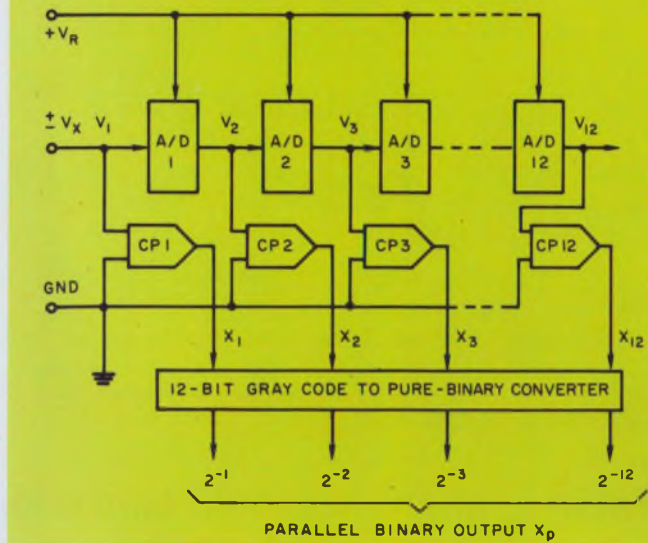

16. Cascade, analog-to-Gray-code a/d converter converts the analog input voltage into a Gray-code signal which is then converted into a pure binary signal.

17. Operation of the cascade, analog-to-Gray-code converter is described by the digital and analog transfer characteristics of the first four stages.

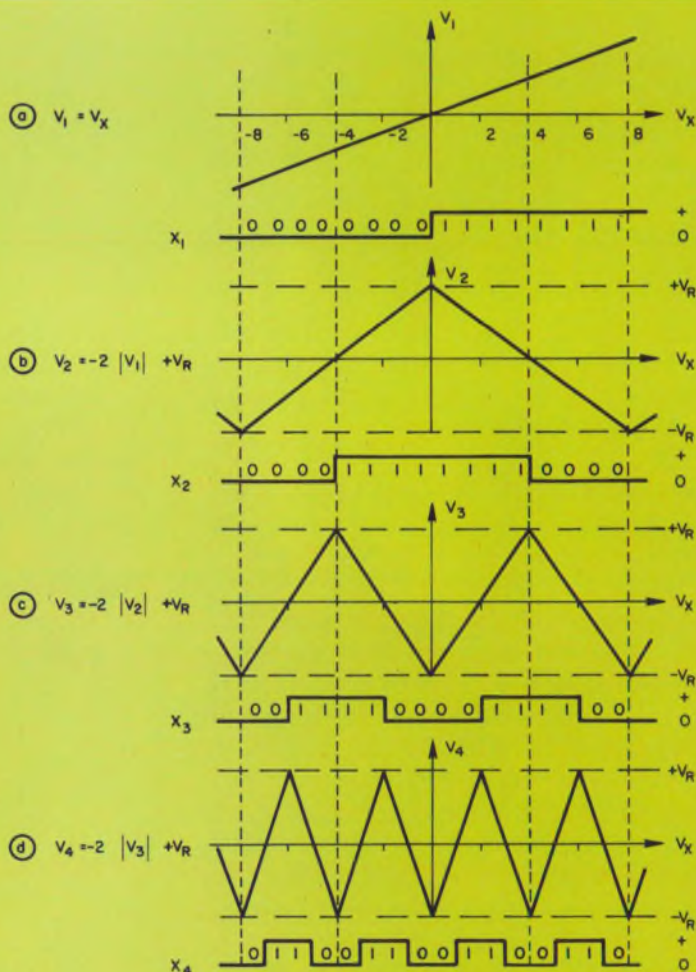

is mainly a function of the slewing rate and the settling time of the converter amplifiers, since the switches and comparators are about one order of magnitude faster than the amplifier.

The sample-and-hold circuit applies the input signal to the converter at the beginning of the clock period t_c . Thereafter, it holds V_x at a constant value. If the first-half of the clock period is equal to the time required to propagate a change through all 12 stages, then the digital output signal, X_n , will be constant during the second-half of t_c .

The accuracy of a cascade a/d converter is mainly determined by the accuracy of the most-significant stages. This is because the error caused by the most-significant stage is included unattenuated in the total error of the system, whereas the error in the second-most-significant bit is attenuated by a factor of two; the error in the third-most-significant bit by a factor of four, and so on.

With presently available monolithic comparators, monolithic amplifiers, bipolar junction-transistor switches, and precision resistors having a $\pm 0.01\%$ ratio tolerance—assuming offset correction is used—it is possible to achieve a 12-bit accuracy (1 part in 4096) over temperature for a single-bit converter.

The over-all accuracy of the cascade a/d converter is a function of the sum of the errors of the 12 individual stages and of the sample-and-hold circuit. As mentioned previously, the magnitude of the total error from the 12 converter stages is between 2 and 12 times the magnitude of the error of the most significant stage, typically, somewhere between 0.05 and 0.1%.

The speed of conversion of this converter is almost exclusively a function of the type of amplifier used. Since the amplifier must be capable of slewing between zero and full scale, even for small changes in the input signal, the propagation delay is mainly a function of how far each of the 12 amplifiers must slew. Since this is a random function of the input voltage, V_x , it can be assumed that the total excursion of all amplifiers is an average of $12 \times 1/2$ -full scale, or $6 \times$ full scale. With a monolithic amplifier that has a slew rate of $200 \text{ mV}/\mu\text{s}$ and using a full scale of 10 V, it would require $300 \mu\text{s}$ for the 12 amplifiers to reach steady state. However, this does not include the comparators and switches, which will add another few microseconds delay.

It is obvious that faster amplifiers are needed to make this converter high-speed. There are now several monolithic amplifiers available, like the Fairchild $\mu\text{A}715$, which have slew rates of 10 and $25 \text{ V}/\mu\text{s}$. With these slew rates, the total conversion time is less than $10 \mu\text{s}$.

The term "slew rate" as used here refers not only to the time required by the amplifier to slew from one value to another, but also the time required by the amplifier to settle to the final value to within $\pm 0.05\%$.

The cascade a/d converter of Figs. 12 through 14 can accept only unipolar input signals. Several techniques, though, are available for making this converter operate with bipolar input signals.

The first method is to bias the input signal by one-half full scale in the sample-and-hold circuit, or some other preceding circuitry.

The second method requires no additional hardware and introduces no additional errors. All that is needed are two changes in circuit interconnections. As shown in Fig. 15, these are:

- The reference voltage connected to the input of the comparator must be made zero.
- The potentials connected to the series-shunt switch must be $+V_R$ and $-V_R$.

With these changes, the conversion accuracy and speed of the bipolar converter are identical to those of the unipolar converter.

3. Cascade, analog-to-Gray-code a/d converter

In the cascade, analog-to-pure-binary a/d converter of Fig. 12, the sample-and-hold circuit, the transfer gates and the intermediate storage register are needed to overcome the significant errors that would otherwise occur when the output signal changes, for example, from 011 . . . 11 to 100 . . . 00, or vice versa. These transient errors and the circuits required to suppress them, can be eliminated by converting first to Gray code and then to pure binary.^{12,15} The reason for this is that only one bit in a Gray code changes at any one time.

In addition to eliminating the binary transition problems and reducing hardware, the cascade, analog-to-Gray-code converter also offers higher accuracy and higher speed. The only disadvantage is that the Gray code output must eventually be converted into a pure-binary signal, because most digital control and computation circuits cannot work with a Gray code-signal. However, this can be accomplished with relatively little hardware.

Figure 16 shows the generalized form of a 12-bit cascaded, analog-to-Gray-code converter. The first stage is comprised of only the comparator, $CP1$, while all other 11 stages contain an amplifier circuit and a comparator.

All 12 stages are cascaded, which means that the output of stage i is the input to stage $i+1$. The transfer function for the 11 identical stages is:

$$V_{i+1} = -2|V_i| + V_R.$$

The transfer function of the first stage is simply

$$V_1 = V_x.$$

The 12 comparators are identical, and compare the voltage V_i with ground. The output of the comparator is therefore

$$X_i = 1 \text{ if } V_i > 0$$

$$X_i = 0 \text{ if } V_i < 0.$$

The analog and digital output signals of the first four stages of the converter of Fig. 16 are plotted on Fig. 17 as functions of the analog input signal V_x . More specifically, Fig. 17a shows that the digital output signal X_1 is ONE when analog signal $V_1 = V_x$ is positive, and X_1 is ZERO when V_1 is negative.

Figure 17b shows the transfer characteristics of the second stage as a function of V_x . Since $V_1 = V_x$, the analog transfer function could also be written as

$$V_2 = -2|V_x| + V_R,$$

which indicates that $V_2 = V_R$ when $V_x = 0$, that $V_2 = 0$ when $V_x = V_R/2$, and that $V_2 = -V_R$ when $V_x = V_R$. The digital transfer function expresses that X_2 is ONE when V_2 is positive, and X_2 is ZERO when V_2 is negative.

Figure 17c represents the transfer function for the third stage, which is

$$V_3 = -2|V_2| + V_R.$$

Replacing V_2 with its equivalent gives

$$V_3 = -2|[-2|V_x| + V_R]| + V_R.$$

Therefore, $V_3 = -V_R$ when V_x is 0, +8 V, or -8 V. Similarly, $V_3 = 0$ when V_x is -6 V, -2 V, or +6 V, and $V_3 = +V_R$ when V_x is +4 V or -4 V. Again the digital output X_3 is ONE when V_3 is positive, and ZERO when V_3 is negative.

Finally, Fig. 17d depicts the analog and digital transfer functions of the fourth stage, which are

$$V_4 = -2|V_3| + V_R$$

$$= -2|[-2|[-2|V_x| + V_R]| + V_R]| + V_R.$$

And, as in the other stages, X_4 is ONE when V_4 is positive, and ZERO when V_4 is negative.

The transfer characteristics of the four converter stages in Fig. 17 show that the slopes of the analog curves increase by a factor of two for each successive stage. This means that for a change of 1 V in V_x , the outputs of the four stages, V_1 , V_2 , V_3 and V_4 , will change 1, 2, 4 and 8 V, respectively. However, these voltages never exceed the reference voltage levels $+V_R$ and $-V_R$. Therefore, the frequency of reflection (not of time) also increases by a factor of two with each additional stage.

By dividing the analog input signal V_x into 16 equally spaced 1-V intervals and by specifying the status of each of the four output signals, X_1 through X_4 , for each of the voltages, the binary numbers shown in Table 2 result. These binary numbers represent the 16 intervals in the

conventional Gray code. As an example, for a voltage, V_x , of -4 V, $X_1 = 0$, $X_2 = 1$, $X_3 = 1$ and $X_4 = 0$. The converter, therefore, does indeed convert an analog voltage to a digital Gray-code signal.

Each stage of the analog-to-Gray-code converter, except the first, consists of an absolute value circuit, an amplifier with a gain of minus two, a summing circuit and a comparator. Although there are several possible implementations of this circuit, only one will be described.

As shown in Fig. 18, the single-bit converter consists of two amplifiers, three diodes, one transistor and six precision resistors.

The first amplifier operates as a precision rectifier and also as a comparator. It is well known that an operational amplifier having a diode in series with the feedback resistor has a transfer characteristic like that of an ideal diode (Fig. 18a). In other words, the output voltage, V_o , is zero if the input voltage, V_i , is negative, and $V_o = V_i$ if V_i is positive. The only difference between this circuit and the ideal diode is that when V_i is positive, the output voltage of the amplifier, V_o , equals $-V_i$, because of the inversion in the amplifier.^{16,17}

The first amplifier performs also as a comparator because when V_i is positive, the output of the amplifier, V_o' is negative. And when V_i is negative, even if by only a millivolt, V_o' is approximately 1.4 V (2 diode-drops) positive. A transistor, $Q1$, whose base is connected to V_o' is turned ON when V_o' is +1.4 V, and is turned OFF when V_o' is negative. The output of $Q1$ swings between zero and +5 V and is, therefore, compatible with TTL and DTL circuits.

The second amplifier sums V_i with V_o and $+V_R$. If V_i is positive, V_o is negative; the sum of the two is therefore

$$V_i + 2V_o = V_i - 2V_i = -V_i.$$

If V_i is negative, V_o is zero and the effective input to the second amplifier is only $-V_i$. The feedback resistor around the second amplifier is chosen as 40 k Ω , to amplify V_i by the required factor of two. The input resistor for the reference voltage V_R is also 40 k Ω . The two amplifiers with the associated circuitry thus perform the absolute value function, the multiplication of two for V_i , the addition of V_R and the comparison function as well.

The static accuracy of the single-bit converter of Fig. 18 is mainly a function of the offsets of the amplifiers and the precision of the resistors. The operation of the precision rectifier is largely independent of the diode characteristics. Assuming that the amplifier offsets can be maintained at less than $\pm 0.01\%$ of full scale, or ± 1 mV, and that the resistors can maintain a ratio tolerance of $\pm 0.01\%$ through temperature and life,

then the accuracy of a single-bit conversion stage will be better than 1 part in 4000. The total accuracy of a 12-bit converter will thus be about $\pm 0.05\%$ over temperature, if the lower-significant stages are also fairly accurate. Schafer¹⁵ claims a 12-bit ($\pm 0.025\%$) accuracy for his converter; but this is probably at 25°C.

The dynamic accuracy of any such one-bit converter is a very complex function of many factors. Slewing rate and settling time of the amplifiers are the most important ones, but delays through the resistors are also important. The 12-bit converter built by Schafer¹⁵ exhibited a transport delay of $1.2 \pm 0.2 \mu\text{s}$, and a settling time for a step-function input of less than $2 \mu\text{s}$. This means that a converter of this type could convert

multiplexed inputs at a rate of approximately 500,000 per second.

4. Variable-reference cascade a/d converter

In all of the cascade a/d conversion techniques described so far, the speed of response is mainly a function of the propagation delays in the amplifiers. Thus high-speed operation can be obtained only when high-speed amplifiers are used.

The variable-reference cascade a/d converter overcomes this dependence on high-speed amplifiers. It does not require any amplifiers, because each conversion stage compares the input signal V_x directly with a specific fraction, V_{R_i} , of the

Table 2. The Gray code

V_x	X_1	X_2	X_3	X_4
+7 V	1	0	0	0
+6	1	0	0	1
+5	1	0	1	1
+4	1	0	1	0
+3	1	1	1	0
+2	1	1	1	1
+1	1	1	0	1
0	1	1	0	0
-1	0	1	0	0
-2	0	1	0	1
-3	0	1	1	1
-4	0	1	1	0
-5	0	0	1	0
-6	0	0	1	1
-7	0	0	0	1
-8	0	0	0	0

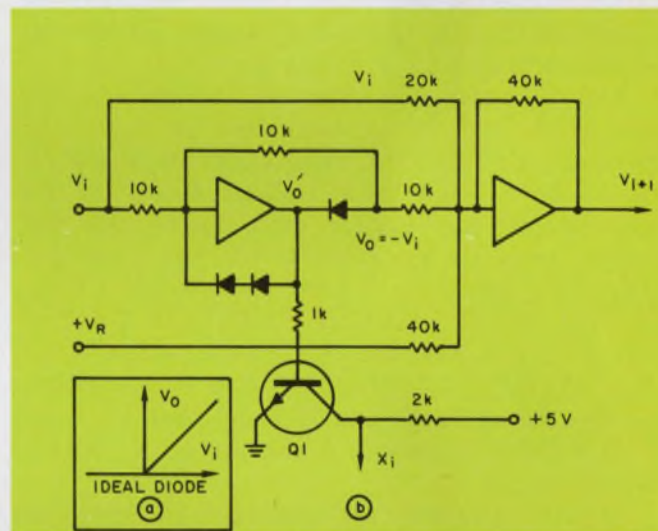

18. Single-bit conversion stage for a/d converter stage of Fig. 16 requires two amplifiers (b). The first amplifier operates as both a precision rectifier and a comparator, and has a transfer characteristic similar to that of an ideal diode (a).

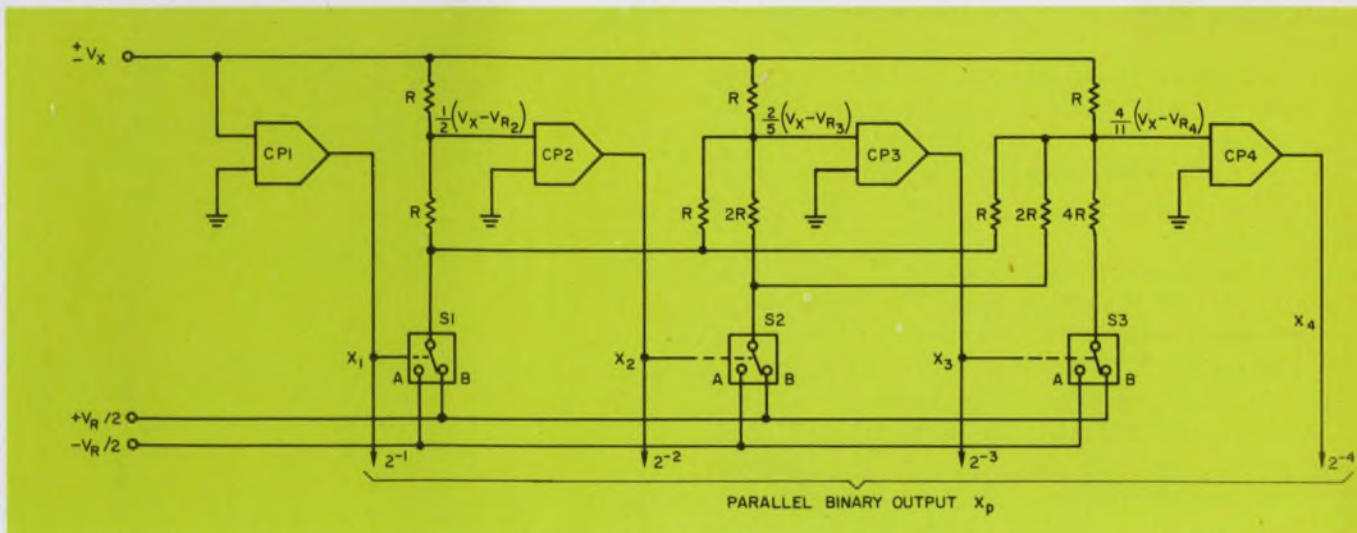

19. Variable-reference cascade a/d converter does not require any amplifiers. This is because each stage com-

pares the analog input voltage with a specific fraction of the reference voltage.

reference voltage to determine the status of the digital output signal X_i .

A variable-reference cascade a/d converter stage consists only of a comparator and a resistor network that generates the variable reference voltage (Fig. 19). The first converter stage compares V_x with ground and thus does not even need a resistor network. The networks for the three other stages of Fig. 19 are all different. While the output of the first resistor network, namely V_{R_2} , is only a function of X_1 , V_{R_3} is a function of X_1 and X_2 , and V_{R_4} is a function of X_1 , X_2 and X_3 .

In general, the output voltages, V_{R_i} , of the resistor networks can be expressed as

$V_{R_i} = X_1 V_R/2 + X_2 V_R/4 + X_3 V_R/8 + \dots$, where X_1, X_2, X_3 are the digital outputs, and are either ONE or ZERO.

All values of reference voltage required for a four-bit variable-reference cascade encoder are shown in Table 3.

The 4-bit variable-reference cascade a/d converter of Fig. 19 is comprised of four comparators, $CP1$ to $CP4$, three series-shunt switches, $S1$ to $S3$, and three resistor networks. The switches, in combination with the resistor networks, generate the variable reference voltages, V_{R_2} to V_{R_4} , while V_{R_1} is zero. From Table 3 it can be seen that V_{R_2} must be $+1/2 V_R$ if $X_1=1$, or $-1/2 V_R$ if $X_1=0$; that V_{R_3} must be either $+3/4 V_R$, $+1/4 V_R$, $-1/4 V_R$ or $-3/4 V_R$, depending on the status of X_1 and X_2 ; and that V_{R_4} must have 8 different values, depending on X_1, X_2 and X_3 .

Strictly speaking, the three resistor networks do not generate V_{R_2} to V_{R_4} but instead the voltages $1/2(V_x - V_{R_2})$, $2/5(V_x - V_{R_3})$ and $4/11(V_x - V_{R_4})$. This allows one side of the comparator to be connected always to ground; it also makes smaller both the absolute and differential input voltages to the comparator. The latter is quite important when monolithic comparators are used.

To illustrate the operation of this converter consider the case where $V_x = +8.4$ V, $+V_R/2 = +5$ V, and $-V_R/2 = -5$ V. The first comparator, $CP1$, determines if V_x is larger or smaller than zero. Since V_x is positive, X_1 becomes a ONE.

As a result, switch $S1$ must be in position A, connecting -5 V to its output. The input to the second comparator, $CP2$, is hence $1/2(V_x + V_{R_2}) = 1/2(+8.4$ V -5 V) $= +1.7$ V. Since $1/2(V_x - V_{R_2})$ is positive, X_2 also becomes a ONE.

Accordingly, $S2$ must be in position A, also connecting -5 V to its output. So the input to $CP3$ becomes $2/5(V_x - V_{R_3}) = 2/5(+8.4$ V -5 V -2.5 V) $= +0.36$ V. The resultant voltage is still positive, and X_3 becomes ONE. Switch $S3$ must therefore be in position A, connecting

-5 V to the $4R$ resistor, and making $4/11(V_x - V_R) = 4/11(+8.4$ V -5 V -2.5 V -1.25 V) ≈ -0.1 V. Therefore X_4 becomes ZERO.

The resultant digital output signal is 1110, which represents $+6/8$. This is the closest approximation possible for a 4-bit encoder with an input of $+8.4$ V and a reference voltage of 10 V.

Any high-speed comparator can be used in this application if its input resistance is high or if its input current is low. The switches used must have either small voltage offsets or small ON-resistances. This is especially true of the switch in the most-significant stage, because it must not only drive lower-value resistors, but more of them as well. This problem could be overcome, somewhat, by using one switch for each resistor, but this would increase circuit complexity. The more practical solution is to make R large enough so that the switch can still drive three resistors in parallel.

In these resistor networks, only the ratio of the resistors must be accurate. Several types of precision resistors can provide a ratio accuracy of $+0.025\%$ over temperature and through life.

The accuracy of the variable-reference cascade a/d converter is determined by the precision of the resistors, the voltage offsets or the ON-resistance of the analog voltage switches, and by the offset and gain of the comparator. With suitable components, the four-bit converter of Fig. 19 is capable of performing to an accuracy of approximately ± 1 part in 2000.

Basically, this technique can be extended to 10 or 12 single-bit stages. However, a 12-bit converter would require as many as 77 precision resistors, and the switch in the second most-

Table 3. Reference voltages

$V_{R_1} = 0$	
$V_{R_2} = + 1/2 V_R$ if $X_1 = 1$	
$- 1/2 V_R$ if $X_1 = 0$	
<hr/>	
$V_{R_3} = + 3/4 V_R$ if $X_1 = 1, X_2 = 1$	
$+ 1/4 V_R$ if $X_1 = 1, X_2 = 0$	
$- 1/4 V_R$ if $X_1 = 0, X_2 = 1$	
$- 3/4 V_R$ if $X_1 = 0, X_2 = 0$	
<hr/>	
$V_{R_4} = + 7/8 V_R$ if $X_1 = 1, X_2 = 1, X_3 = 1$	
$+ 5/8 V_R$ if $X_1 = 1, X_2 = 1, X_3 = 0$	
$+ 3/8 V_R$ if $X_1 = 1, X_2 = 0, X_3 = 1$	
$+ 1/8 V_R$ if $X_1 = 1, X_2 = 0, X_3 = 0$	
$- 1/8 V_R$ if $X_1 = 0, X_2 = 1, X_3 = 1$	
$- 3/8 V_R$ if $X_1 = 0, X_2 = 1, X_3 = 0$	
$- 5/8 V_R$ if $X_1 = 0, X_2 = 0, X_3 = 1$	
$- 7/8 V_R$ if $X_1 = 0, X_2 = 0, X_3 = 0$	

significant stage would have to drive as many as 11 resistors of magnitude R , or a load of 5 k Ω . The over-all accuracy of a 12-bit converter, assuming a reasonable value of comparator offset voltage, would be approximately 1 part in 1000.

The speed of conversion of this converter is determined only by the propagation delays in the comparator and the analog voltage switches, which can be made 50 and 200 ns, respectively. The total time for a 4-bit conversion is therefore on the order of 1 μ s, or about 3 μ s for a 12-bit conversion.

5. Partially-cascaded a/d converter

In successive-approximation and serial a/d converters, n basic encoding operations are performed sequentially in time with the same circuitry. In contrast, multi-threshold a/d converters use one comparator for each of the $2^n - 1$ quantizing levels, whereas cascade a/d converters employ one single-bit encoder for each of the n bits of the parallel-binary output signal X_p .

A reasonable compromise between these extremes in speed and hardware are the partially-cascaded a/d converters; these are sometimes also referred to as serial/parallel converters.^{18,19} The generalized form of a 12-bit "4 \times 3" partially-cascaded a/d converter is shown in Fig. 20. The "4 \times 3" implies that there are four stages of three-bit converters. Other possibilities for building a 12-bit encoder would be (3 \times 4) or (6 \times 2).

Theoretically, any a/d conversion technique lends itself to a partially-cascaded system. However, some of these implementations would not offer any advantage over the present methods.

For example, there would be little advantage in partially cascading three 4-bit successive approximation a/d converters or three 4-bit circulation converters, since this would neither improve the conversion accuracy nor the conversion speed, but would only increase the parts count.

Conversely, partial cascading of three 4-bit, variable-reference converters offers a lower parts count with better accuracy and at slightly reduced conversion speed than a 12-bit variable-reference a/d converter. But much more drastic is the parts-counts-reduction for a partially-cascaded 4 \times 3 multi-threshold encoder. This would require only 21 comparators as compared with 4096 comparators for a straightforward 12-bit multi-threshold encoder. This tremendous reduction in hardware is obtained without sacrificing accuracy, just conversion speed.

An m -by- n bit partially-cascaded a/d converter can be built by cascading m identical n -bit a/d and d/a converter combinations with $(m-1)$ operational amplifiers. As an example, in Fig. 20, four 3-bit converters are cascaded with three operational amplifiers. The input signal V_x is connected to the first 3-bit encoder $A/D-1$, which converts V_x into the three most-significant parallel binary bits, 2^{-1} , 2^{-2} and 2^{-3} . This three-bit digital output signal is then converted back into an accurate analog voltage, V_{F1} , by the 3-bit decoder $D/A-1$, and V_{F1} is subtracted from V_x . The difference $V_x - V_{F1}$ is then multiplied by a factor of 8 in operational amplifier $A1$, so that the output voltage of $A1$ becomes

$$V_2 = 8(V_x - V_{F1}).$$

This voltage, V_2 , is encoded by $A/D-2$ into the three next-most significant digits, 2^{-4} , 2^{-5} and 2^{-6} , which are converted back into V_{F2} by

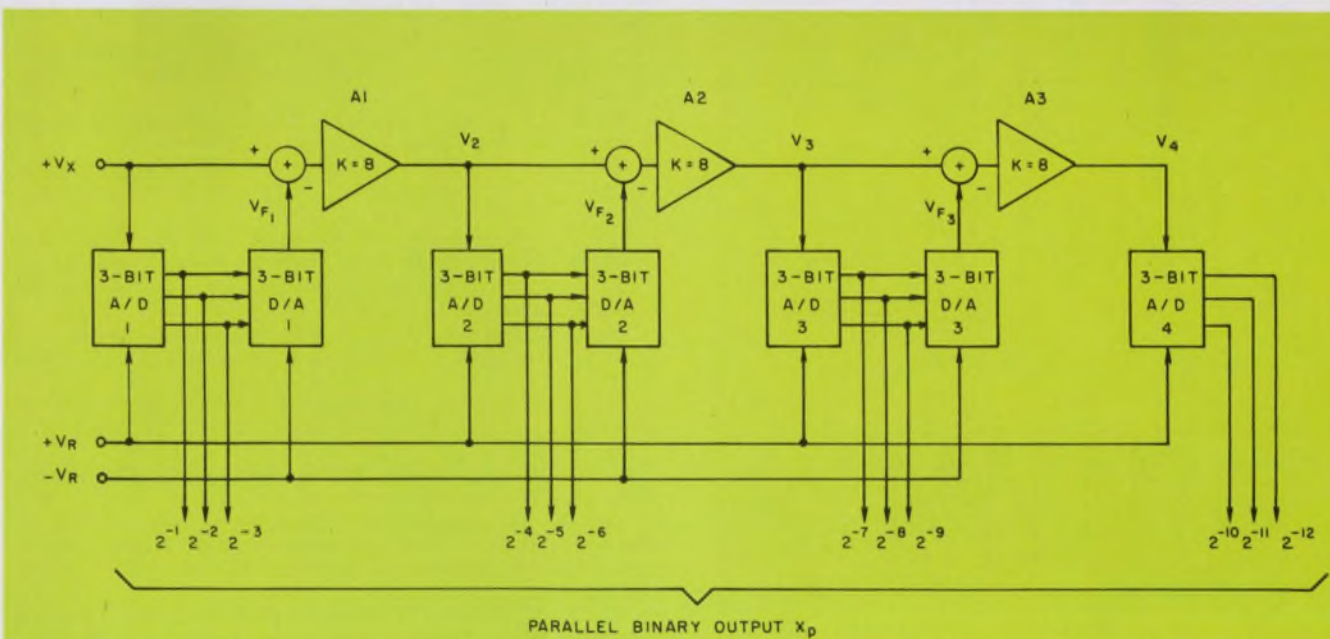

20. Concept of partially-cascaded a/d converters is shown by this generalized form of a 12-bit converter.

$D/A-2$. V_{F_2} is then subtracted from V_2 and multiplied by 8 in amplifier A_2 , whose output is $V_3 = 8(V_2 - V_{F_2})$.

The next three bits, 2^{-7} , 2^{-8} and 2^{-9} , are generated in a like manner by $A/D-3$, while $D/A-3$ produces V_{F_3} . The output of amplifier A_3 is

$$V_4 = 8(V_3 - V_{F_3}),$$

which is converted by $A/D-4$ into the three least-significant bits 2^{-10} , 2^{-11} , 2^{-12} . There is obviously no need for $D/A-4$, as $V_4 - V_{F_4}$ is of no interest.

Although the performance of a partially-cascaded a/d converter is very much dependent on the specific techniques used for the a/d and d/a conversions, there are still many features that are common to all.

- The over-all accuracy is mainly a function of the precision obtained in the first stage. The second, third, and fourth stages can have errors that are 8, 64, and 512 times as large as the allowable error for the first stage.

- Plotting the outputs of any of the three stages, V_{F_i} , as a function of their inputs, V_i , results in a sawtooth relationship, as shown in Fig. 21. When both the 3-bit a/d and the 3-bit d/a converters of one stage are precise (when the gain through them is exactly unity), the sawtooth voltage, V_{F_i} , never exceeds the limits of $+V_L$ and zero (Fig 21a). Here, $+V_L = V_{x\ max}$, which for convenience is assumed to be $+8$ V. When the gain through the converters is smaller than unity, V_{F_i} can become smaller than V_i and the sawtooth voltage will exceed the $+8$ -V limit for cer-

tain values of V_i (Fig. 21b). When the gain is larger than unity, V_{F_i} can become larger than V_i , and the sawtooth voltage becomes negative for certain values of V_i (Fig. 21c).

- Only the 3-bit d/a converters need to be precise.

- Any errors in the 3-bit d/a converters can be detected by determining whether the sawtooth waveform is larger than $+8$ V or whether it is negative.

- If any of the amplifier output-voltages exceed the above limits, corrective measures can be initiated. This, however, requires additional comparison circuits and means for storing and changing the digital outputs of the 3-bit encoders.

- The question thus arises whether it would not be more economical to make the 3-bit a/d converters accurate in the first place and, by so doing, eliminate the need for the error-correction circuits. ■■

References:

1. H. Schmid, "Shrink a/d Conversion Costs," *ELECTRONIC DESIGN*, Nov. 8, 1966, pp. 96-99.
2. H. Schmid, "Practical d/a Conversion," *ELECTRONIC DESIGN*, Oct. 24, 1968, pp. 49-88.
3. R. W. Gilbert, "Pulse Time Encoding Apparatus," U.S. Patent No. 3,074,057, Jan. 15, 1963.
4. H. Schmid, "Pulse Width Modulator Offers Precision Performance," *Electronics*, Oct. 11, 1963, pp. 29-31.
5. P. M. Garratt, "Investigation of Integrated Circuit A-D Converters for Digital Transducers," General Electric TIS Report 67C116, March, 1967.
6. H. Schmid, Digital Meters for Under \$100.00, *Electronics*, Nov. 28, 1966, pp. 88-94.
7. "Digital Volt-Ohm-Ratiometer, Model 7110," Technical Specifications, Fairchild Semiconductor Co., Mountain View, Calif.
8. "Integrating Digital Voltmeter, DVX-315," Technical Specifications, Data Technology Corp., Mountain View, Calif., Jan. 1966.
9. P. Barr, "Voltage to Digital Converters," *Electromechanical Design*, Systems Designers Handbook, Jan. 1964.
10. F. W. Cheney, "Analog-to-Digital Conversion with Threshold Circuits," *IRE Transactions on Electronic Computers*, March 1961, pp. 100-101.
11. F. D. Daley, "Analog-to-Digital Conversion Techniques," *Electro-Technology*, May 1967.
12. D. Savitt, "A High-Speed Analog to Digital Converter," *IRE Transactions on Electronic Computers*, March 1959.
13. R. I. Greenberg, "Propagation a/d Converters are Fastest," *Electronic Design*, April 27, 1964, pp. 64-69.
14. "Analog to Digital Converters Catalog," Computer Labs, Greensboro, N. C., 1967.
15. P. E. Shafer, "A System for Very High-Speed Conversion," National Telemetry Conference, 1964, Section 7-1.
16. T. R. Brown, *Handbook of Operational Amplifier Applications*, Burr-Brown Research Corp., Tucson, Ariz., 1963, pp. 73.
17. H. Schmid, "Pulse Width Modulator," *Electronics*, Oct. 11, 1963, pp. 29-31.
18. G. G. Gorbatenko, "High-Performance Parallel-Serial Analog to Digital Converter with Error Correction," *IEEE National Convention Record*, New York, March 1966.
19. T. C. Verster, "A Method to Increase the Accuracy of Fast Serial-Parallel Analog to Digital Converters," *IEEE Transactions on Electronic Computers*, Aug. 1964, pp. 471-473.

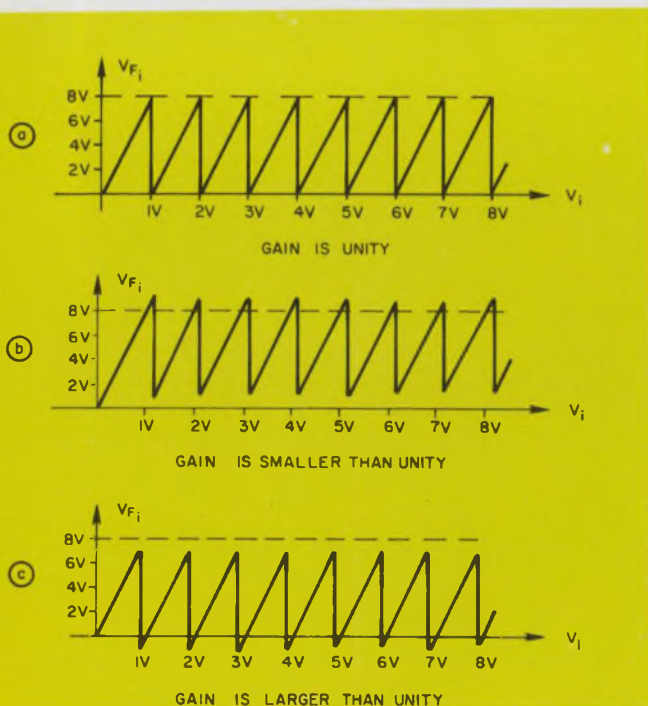

21. Errors occur in a cascaded a/d converter when the gain through one of the 3-bit stages is other than unity.

You design RF circuits in terms of frequency domain.

Now you can measure their performance that way, too.

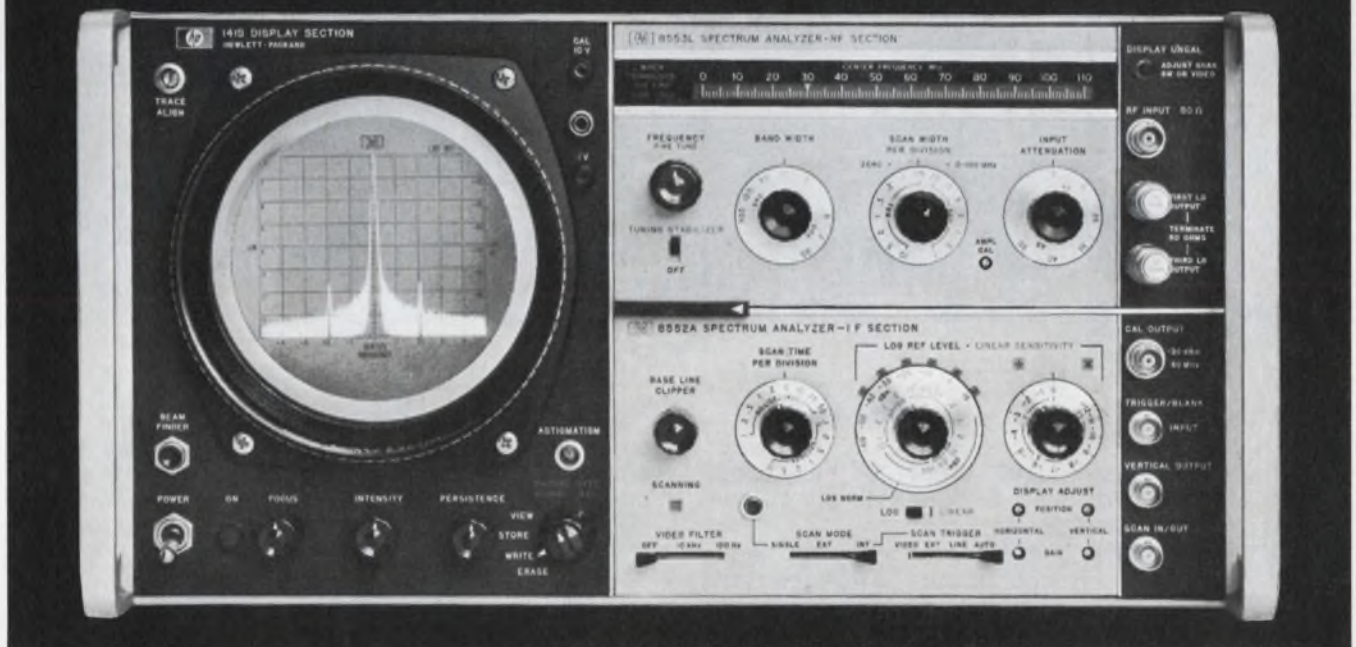

Forget all equipment limitations that used to plague signal analysis in the 1 kHz to 110 MHz range. The HP 8552A/8553L Spectrum Analyzer has all the characteristics—absolute calibration, high stability, freedom from internal distortion and spurious responses—that make it an indispensable tool for virtually every frequency domain measurement.

Absolute signal levels are displayed from -130 dBm to $+10$ dBm ($0.07 \mu\text{V}$ to 0.8 V). With the wide 100 MHz scan, you see the broad spectrum quickly, precisely. Reduce the scan width in calibrated steps (to as narrow as 2 kHz) for detailed examination of individual signals. With the analyzer's distortion-free 70 dB dynamic range and narrow 50 Hz resolution, you can characterize complex signals, even in the presence of other high-level signals.

Yours for the asking—a brochure describing how these

vital circuit performance characteristics are measured accurately and conveniently: *oscillator* spectral purity; *amplifier* response and distortion; *mixer* conversion efficiency; *modulation* index; *filter* response. Price of the full system—8553L RF section, 8552A IF section, 141S Variable Persistence Display section—\$5225.

Your HP field engineer can give you the details on how this remarkable new instrument can solve your frequency domain measurement problems, in circuit design lab or final system evaluation. Or write to Hewlett-Packard, Palo Alto, California 94304; Europe: 54 Route des Acacias, Geneva.

HEWLETT  PACKARD

SPECTRUM ANALYZERS

04807

INFORMATION RETRIEVAL NUMBER 37

Our new
high energy
silicon power
transistors.
15 Amperes.
80 to 120 Volts.

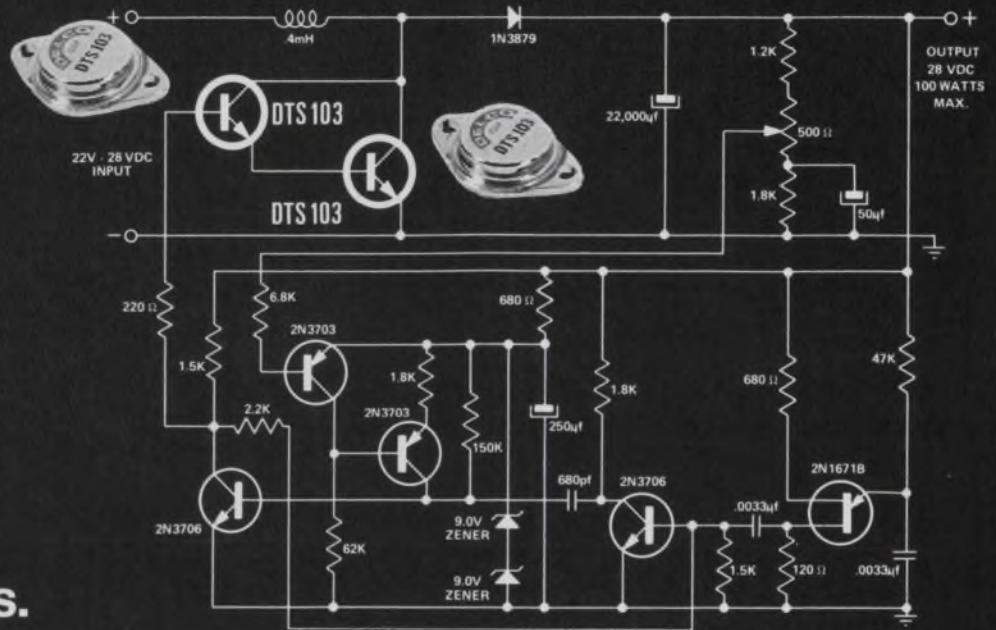

For Switching.

The Delco Radio DTS-100 series. NPN. Triple difused. Rugged.

All the experience gained from our very high voltage silicon power line has gone into the development of these new transistors.

They were especially designed for the extreme under-the-hood environment of our I.C. voltage regulator. We found these devices ideal for applications requiring high efficiency switching or high power amplification.

The Delco triple sequential diffusion gives the DTS-100 series the high

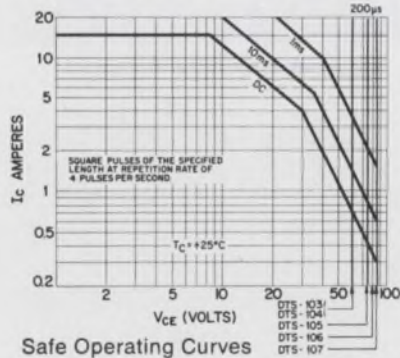

energy reliability that's needed for very tough switching jobs—resistive or inductive. The 28-volt shunt regulator above, for example, is amply handled by the DTS-103 (V_{CEX} of 80 volts). For complete data on this circuit, ask for our application note No. 42.

In the direct coupled audio amplifier above right, the DTS-107 displays the excellent frequency response, gain linearity and transconductance of this family. This circuit is covered in our application note No. 43.

Our solid copper TO-3 package provides maximum thermal capacitance to absorb peak power pulses. Its low thermal resistance ($0.75^{\circ}\text{C}/\text{W}$ Max.) assures the extra reliability you expect from Delco.

Like more information? Just call us or your nearest Delco Radio distributor. All our distributors are stocked to handle your sample orders.

SEMICONDUCTOR DISTRIBUTORS: EAST—BALTIMORE, MD. 21201, Radio Electric Service Co., 5 North Howard Street, (301)-539-3835 BINGHAMTON, N.Y. 13902, Federal Electronics, Inc., P. O. Box 1208, (607)-748-8211 CLIFTON, N.J. 07015, Eastern Radio Corporation, 312 Clifton Avenue, (201)-471-6600 NEWTON, MASS. 02195, The Greene Shaw Co., Inc., 341-347 Watertown St., (617)-969-8900 NEW YORK, NEW YORK 10036, Harvey Radio Co., Inc., 2 West 45th St., (212)-582-2590 PHILADELPHIA, PENN. 19123, Almo Industrial Electronics, Inc., 412 North 6th Street, (215)-922-5918 PITTSBURGH, PENN. 15206, Radio Parts Company, Inc., 6401 Penn Ave., (412)-361-4600 WOODBURY, L. I., N.Y. 11797, Harvey Radio Company, Inc., 60 Crossways Park West, (516)-921-8700 **SOUTH**—BIRMINGHAM, ALA. 35233, Forbes Distributing Company, Inc., 1416 Fourth Ave., South, (205)-251-4104 MIAMI, FLORIDA 33142, Mountain Electronics, Division of Mountain National Co., 3730 Northwest 36th St., (305)-634-4556 RICHMOND, VA. 23220, Meridian Electronics, Inc., 1001 West Broad Street, (703)-353-6648 WEST PALM BEACH, FLA. 33402, Mountain Electronics, Division of Mountain National Co., 1000 N. Dixie Highway, (305)-833-5701 **MIDWEST**—CINCINNATI, OHIO 45237, United Radio, Inc., 7713 Reinhold Drive, (513)-761-4030 CLEVELAND, OHIO 44125, The W. M. Pattison Supply Co., Industrial Electronics Division, 4550 Willow Parkway, (216)-441-3000 INDIANAPOLIS, IND. 46225, Graham Electronics Supply, Inc., 122 South Senate Avenue, (317)-634-8486 KALAMAZOO, MICH. 49005, Electronic Supply Corp., P. O. Box 831, (616)-381-4626 KANSAS CITY, MO. 64111, Walters Radio Supply, Inc., 3635 Main

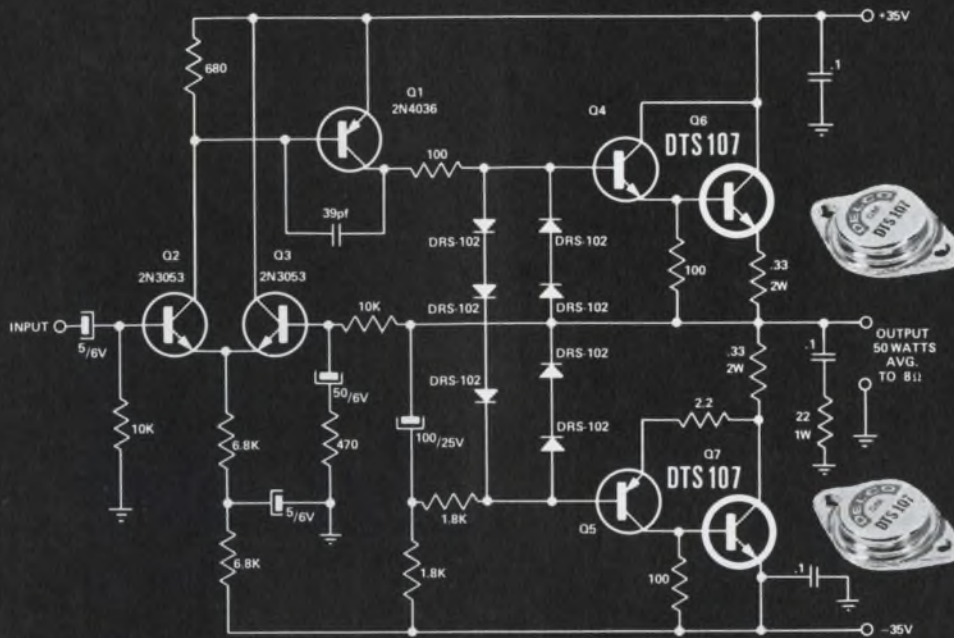

For Audio Amplification.

	I _c Cont. Amps.	I _c Pulsed Amps.	V _{CEX} @ .5mA Volts	V _{CEO} @ .25mA Volts	V _{CEO(SUS)} @ 250mA Volts	h _{FE} @ 5A	h _{FE} @ 20A (Min.)	V _{CE(sat)} @ 10A (Max.)	f _t MHz (Min.)	P ₁ Watts (Max.)
DTS-103	15	20	80	60	60	20-55	5	1.8	4	125
DTS-104	15	20	80	60	60	50-120	10	1.5	4	125
DTS-105	15	20	100	80	75	20-55	5	1.8	4	125
DTS-106	15	20	110	90	80	20-55	5	1.8	4	125
DTS-107	15	20	120	100	85	20-55	5	1.8	4	125

FIELD SALES OFFICES

Union, New Jersey* 07083
Box 1018 Chestnut Station
(201) 687-3770

Detroit, Michigan 48202
57 Harper Avenue
(313) 873-6560

Syracuse, New York 13203
1054 James Street
(315) 472-2668

Chicago, Illinois* 60656
5151 N. Harlem Avenue
(312) 775-5411

Santa Monica, Calif.* 90401
726 Santa Monica Blvd.
(213) 870-8807

Kokomo, Ind. 46901
700 E. Firmin
(317) 459-2175 Home Office

*Office includes field lab and resident engineer for application assistance.



MARK OF EXCELLENCE



DELCO RADIO

**DIVISION OF GENERAL MOTORS
KOKOMO, INDIANA**

THE KOKOMOANS ARE IN POWER

Street, (816)-531-7015 MINNEAPOLIS, MINNESOTA 55401, Stark Electronics Supply Co., 112 3rd Ave., North, (612)-332-1325 SKOKIE, ILL. 60076, Merquip Electronics, Inc., 7701 N. Austin Ave., (312)-282-5400 ST. LOUIS, MO. 63144, Electronic Components for Industry Co., 2605 South Hanley Road, (314)-647-5505 WEST—ALBUQUERQUE, N. M. 87103, Sterling Electronics, Inc., 1712 Lomas Blvd., N. E., (505)-247-2486 DALLAS, TEXAS 75201, Adleta Electronics Company, 1907 McKinney Ave., (214)-742-8257 DENVER, COLO. 80219, L. B. Walker Radio Company, 300 Bryant Street, (303)-935-2406 HOUSTON, TEXAS 77001, Harrison Equipment Co., Inc., 1422 San Jacinto Street, (713) 224-9131 LOS ANGELES, CAL. 90015, Radio Products Sales, Inc., 1501 South Hill Street, (213)-748-1271 LOS ANGELES, CAL. 90022, Kierulff Electronics, Inc., 2585 Commerce Way, (213)-685-5511 OKLAHOMA CITY, OKLAHOMA 73102, Radio, Inc., 903 North Hudson, (405)-235-1551 PALO ALTO, CAL. 94303, Kierulff Electronics, Inc., 3969 East Bayshore Road, (415)-968-6292 PHOENIX, ARIZ. 85005, Sterling Electronics, Inc., 1930 North 22nd Ave., (602)-258-4531 SAN DIEGO, CAL. 92101, Milo of California, Inc., 2060 India Street, Box 2710, (714)-232-8951 SEATTLE, WASH. 98108, Kierulff Electronics, Inc., 5940 6th Ave., South, (206)-763-1550 TACOMA, WASH. 98402, C & G Electronics Company, 2502 Jefferson Ave., (206)-272-3181 TULSA, OKLAHOMA 74119, Radio, Inc., 1000 South Main Street, (918)-587-9124 CANADA—SCARBOROUGH, ONTARIO, Lake Engineering Co., Ltd., 123 Manville Rd., (416)-751-5980

INFORMATION RETRIEVAL NUMBER 38

Design better sequential circuits

by combining flow tables with Karnaugh maps
to minimize the number of logic elements needed.

In designing sequential circuits, such as counters, you can rely on timing diagrams—and then hope that your design doesn't use too many extra logic elements. Or you can adopt a systematic approach that uses flow tables and Karnaugh maps—and wind up with a guaranteed minimum-element logic design.

It's a little more work to use the systematic method, but it will increase the reliability of the circuits and will probably save you money in the end. Consider, for example, the design for a decade counter.

A counter consists basically of a series of memory elements connected by a combinational network. The memory elements are normally flip-flops, and the combinational network is usually an array of gates that feed the outputs back into the inputs of the flip-flops to form a sequential circuit. As the counter receives pulses, the series of flip-flops changes its state, according to a predetermined pattern. The state at a particular time reflects the number of pulses received, until a maximum number of counts is reached; at this time the counter begins another cycle and the pattern of states is repeated.

For a decade counter, there are 10 states.

First write your specs

In designing a counter, you must consider the following design points:

- Counting speed.
- Logic characteristics of flip-flops.
- Synchronous or asynchronous operation.
- Maximum count or modulo required.
- Counting code.

The required counting speed will determine the family of integrated circuits to be used. Typical counting rates are shown in Table 1. The logic characteristics of the flip-flop will be determined mainly by the device types available in the chosen family.

Synchronous operation, in which all the flip-flops are switched simultaneously by the active

transition of a common clock pulse, can be used to increase the counting speed. In the asynchronous mode, the output of one flip-flop is used to trigger the next. Asynchronous operation provides simpler counters, but the delay caused as the count ripples through several flip-flops in series requires a slower counting rate.

In a modulo M counter, M pulses will be received before the count cycle is repeated. This requires that the counter have M distinct states in normal operation. These M states can be chosen from the 2^N states obtained by connecting N flip-flops in a sequential circuit. The states chosen, and the order in which they are made to occur, will depend on the design objectives. Once these are chosen, we can draw a flow table showing the state of all of the flip-flops as each of the input pulses indexes the counter. We can then examine the changes that each flip-flop must undergo as the counter indexes from its state at bit time t to the state at $t+1$. A Karnaugh map can then be made for each of the N flip-flops.

Each map will have a square for each of the 2^N possible states. The changes that a particular flip-flop must make (determined from the flow table) can be entered onto its Karnaugh map. This procedure will leave us with N maps (one for each flip-flop) that show the logic changes required for each state of the counter.

We can then use the maps to determine the simplest inputs to the flip-flops that will do the job.

Hence the task of designing a counter that counts to a particular code is reduced to the determination of a combinational network. This network will provide the correct inputs to the flip-flops to ensure that each makes a correct change as the counter changes state.

Note that by constructing maps for both the forward and reverse direction of the state flow table, the input conditions for an up-down counter can be obtained.

The $2^N - M$ redundant states on the map can be marked "optional" to provide further simplification. However, noise may trigger the counter into one of these spare states. If this occurs, it will

Kevin McDonagh, Senior Engineer, ITT Semiconductors, West Palm Beach, Fla.

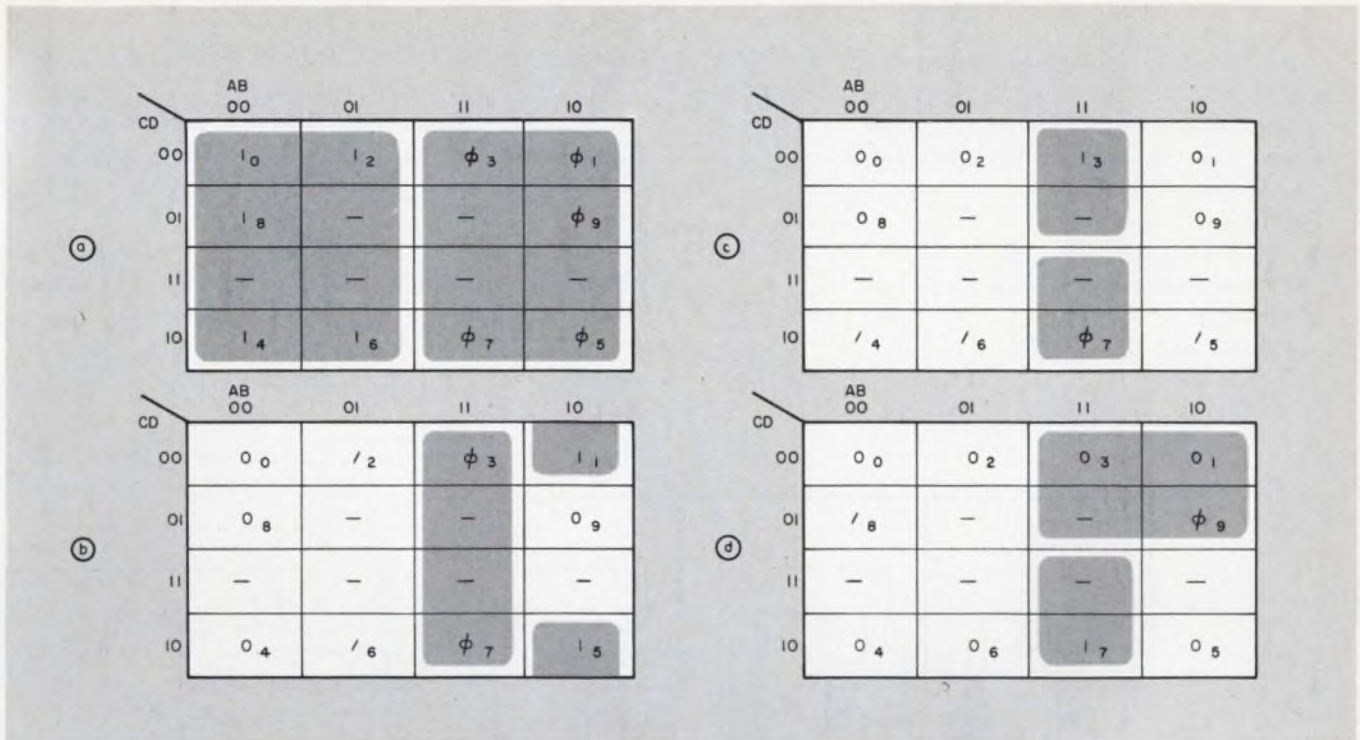

1. These Karnaugh maps, derived from Table 2, can be used to formulate the synchronous counter equations.

The numbers in each square correspond to the state numbers in the table.

be desirable to have the counter index back into the normal cycle and thus avoid a "locked up" condition. Therefore, when the counter has been constructed with use of the minimized connections obtained from the Karnaugh map, it should be forced into each of the spare states and checked to see that it will index back into the normal counting cycle. Modifications may be required to ensure that no "locked up" condition occurs.

Designing a synchronous decade counter

By definition, a decade counter must have 10 unique states. This requires four flip-flops, since three can produce only $2^3 = 8$ states. A flow table can be constructed showing the states of each of the four flip-flops—A, B, C and D—for 10 consecutive time periods. This has been done in Table 2. In the table, the state of each flip-flop is shown for two consecutive time periods, t and $t+1$. As we proceed down the two columns labeled "A," we can see the change required of flip-flop A each time the counter is indexed. These changes are noted on the Karnaugh map for flip-flop A, along with a notation showing the state of the counter. The Karnaugh maps for the four flip-flops are shown in Fig. 1. The symbols used in the maps are defined in the nomenclature box.

To understand the use of these maps and tables, let's examine, in detail, the changes occurring between states 3 and 4. At the termination of state 3, flip-flops A and B are RESET so a ϕ is in-

serted in the squares ABCD of Fig. 1a and 1b. At the same time flip-flop C is SET and a 1 is placed in the ABCD square of Fig. 1c. Flip-flop D remains RESET and therefore a 0 is placed in the ABCD square of Fig. 1d. There are six squares corresponding to the six unused states of the 16 states that are possible with four flip-flops. These can be marked "optional" and used to simplify the Boolean terms derived for the SET and

Table 1. Typical counting rates

Metal oxide semiconductor	(MOS)	0.5 MHz
Diode transistor logic	(DTL)	0.5 MHz
Transistor transistor logic	(TTL)	0.20 MHz
Complementary transistor logic	(CTL)	0.20 MHz
Emitter coupled logic	(ECL)	0.35 MHz

Table 2. Decade counter flow table

STATE	t				t + 1			
	A	B	C	D	A	B	C	D
0	0	0	0	0	1	0	0	0
1	1	0	0	0	0	1	0	0
2	0	1	0	0	1	1	0	0
3	1	1	0	0	0	0	1	0
4	0	0	1	0	1	0	1	0
5	1	0	1	0	0	1	1	0
6	0	1	1	0	1	1	1	0
7	1	1	1	0	0	0	0	1
8	0	0	0	1	1	0	0	1
9	1	0	0	1	0	0	0	0

RESET conditions.

The rules for writing equations from the maps are different for the three basic types of flip-flops and are given in the box on page 84.

From Fig. 1a, we get the equations:
 $S_A = \bar{A}$ and $R_A = A$.

From Fig. 1b, we get:
 $S_B = A \bar{B} \bar{D}$ and $R_B = AB$,
 or, alternatively: $R_B = ABD$.

From Fig. 1c, we have:
 $S_C = ABC$ and $R_C = ABC$,
 or alternatively: $S_C = ABC\bar{D}$ and $R_C = ABCD$.

And, finally, from Fig. 1d, we get:

$S_D = ABC$ and $R_D = AC$,
 or, alternatively: $S_D = ABC\bar{D}$ and $R_D = AD$.

The alternatives are preferred in constructing the decade counter, since they can be formed from existing signals, as illustrated in the final design of Fig. 2, where a counter was designed with R-S flip-flops.

As the colored areas on the Karnaugh maps show, the equations are written by describing, in Boolean algebra, the inputs necessary to produce the desired changes in the outputs. The map-reading rules for R-S flip-flops tell us how to do this.

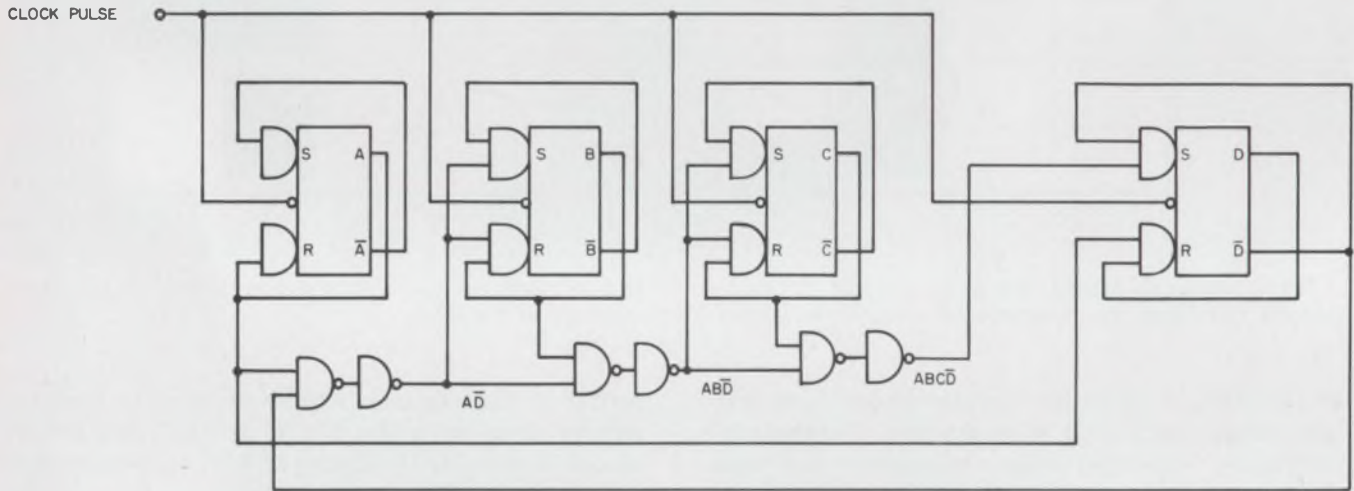

2. The simplicity of this synchronous decade counter has been enhanced by taking maximum advantage of existing

signals in constructing the combinational network. Only R-S flip-flops have been used.

Karnaugh map nomenclature

The following notation is used to indicate each of the five possible conditions.

- 1 The flip flop changes from the RESET to the SET state.
- / The flip flop is initially in the SET state and remains in the SET state.
- ϕ The flip flop changes from the SET state to the RESET state.
- 0 The flip flop is initially in the RESET state and remains in the RESET state.
- Input conditions do not occur or a DON'T CARE state occurs.

More concisely

Change	t	t + 1
1	0	1
/	1	1
ϕ	1	0
0	0	0

OPTIONAL

The SET state of flip-flop A is defined by the output A being 1 and $\bar{A} = 0$. The RESET state occurs when $A = 0$ and $\bar{A} = 1$.

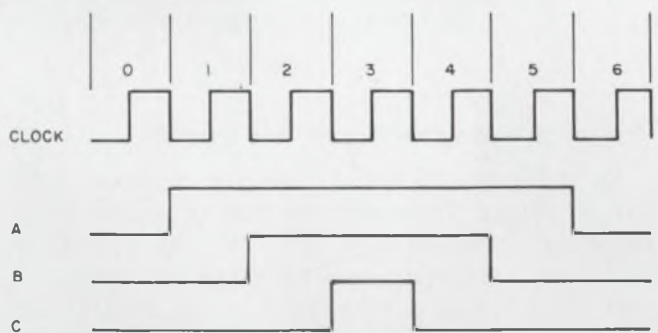

3. A problem arises in the generation of these three waveforms, because the states in the sequence are not all unique. The solution is a fourth waveform designed to resolve the ambiguity.

Table 3. Waveform generator table

STATE	t				t + 1			
	A	B	C	D	A	B	C	D
0	0	0	0	0	1	0	0	0
1	1	0	0	0	1	1	0	0
2	1	1	0	0	1	1	1	1
3	1	1	1	1	1	1	0	1
4	1	1	0	1	1	0	0	1
5	1	0	0	1	0	0	0	0

For example, if we consider flip-flop B , we note that the SET term, S_B , must include all of the ones and omit all of the zeros and ϕ s. Any of the six redundant squares and those marked with a / can be used to obtain a minimum SET term. Since the ones occur in the boxes $A \overline{B} C D$ and $A \overline{B} C \overline{D}$, we can write $S_B = A \overline{B} D$. Similarly $R_B = AB$. Here we note that if we make the equation more complex, by writing $R_B = AB \overline{D}$, we do not change its validity because the two states we eliminated were optional, but we have changed the logic to a form including $A \overline{D}$, which we are going to need anyhow to satisfy $S_B =$

$A \overline{B} \overline{D}$. Thus we have reduced the complexity of the final circuit.

Synchronous waveforms can be generated

The techniques we have been considering can be used for other sequential circuit applications, such as the generation of a set of synchronous waveforms. In the latter application, each waveform is taken from the output of an individual flip-flop, and the set of sequential states that the set of flip-flops go through can be used as the basis for a flow table, as before.

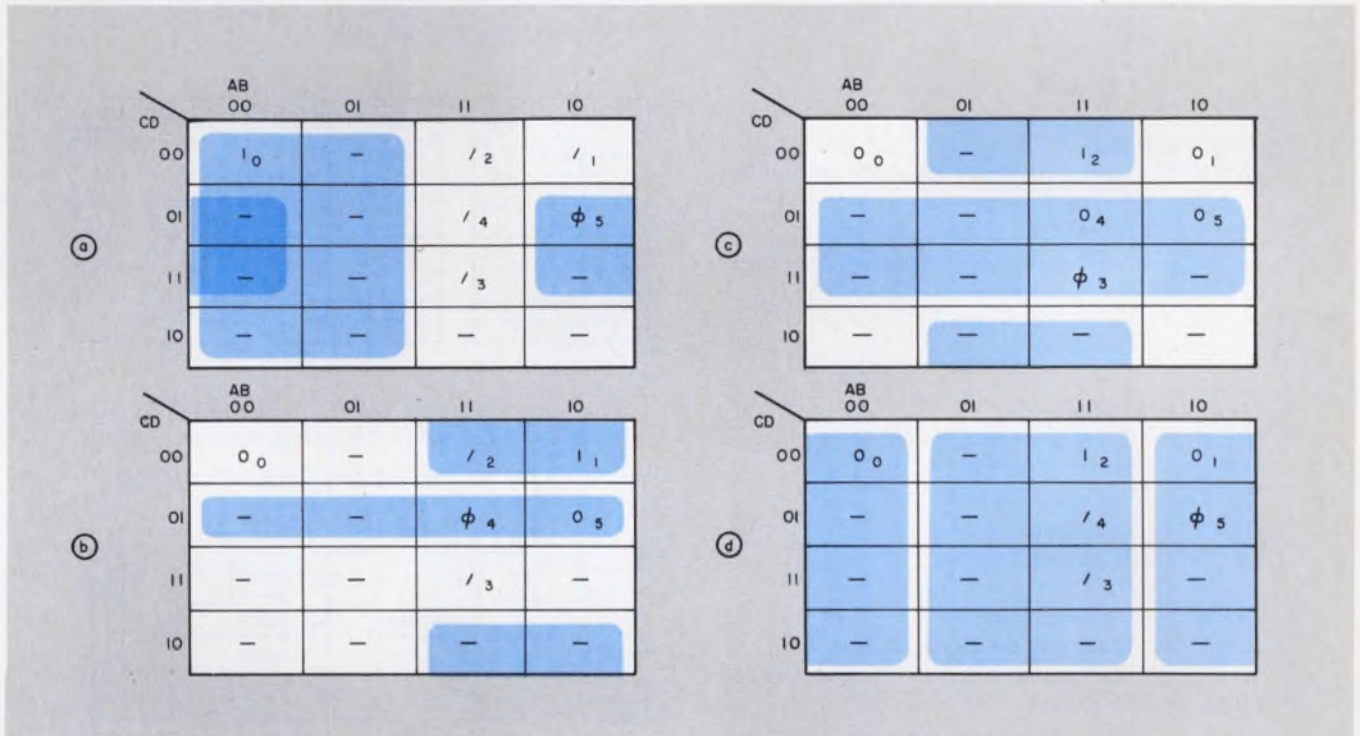

4. Four Karnaugh maps are needed to generate the three waveforms of Fig. 3, because of the need for ambiguity

resolution. The fourth map (d) provides it by introducing a fourth waveform.

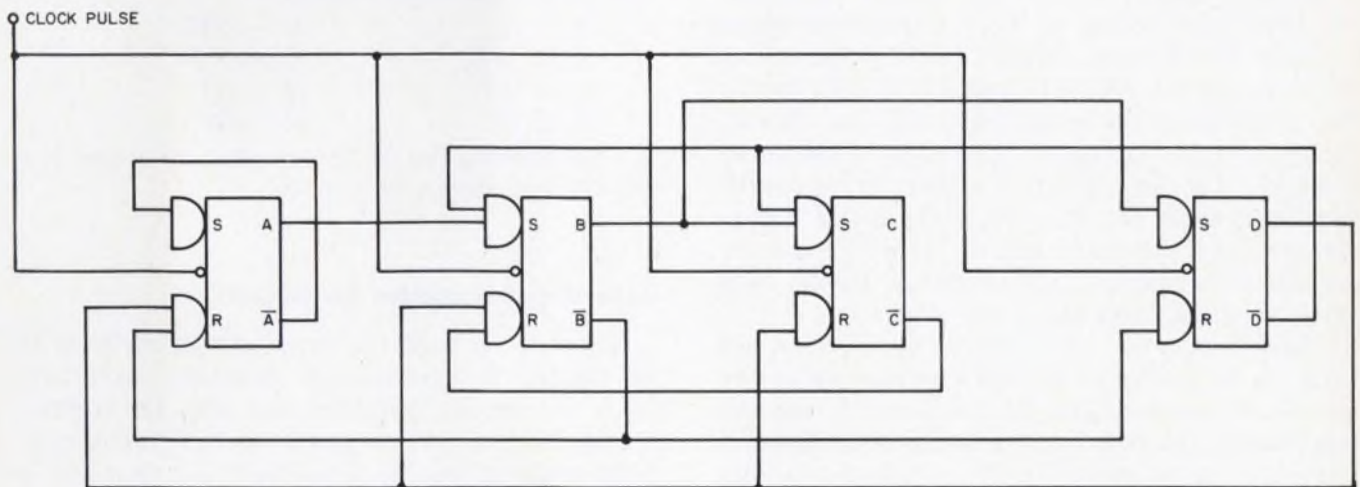

5. The three waveforms of Fig. 3 are generated by flip-flops A, B and C of this synchronous waveform

generator. Flip-flop D is employed to ensure that all of the generator states are unique.

Map reading rules

For the R-S flip-flop

- S TERM 1 Each 1 square must be accounted for in S Term
- / Optional
- ϕ Must not be used
- 0 Must not be used
- Optional

- R TERM 1 Must not be used
- / Must not be used
- ϕ Each ϕ square must be accounted for in R Term
- 0 Optional
- Optional

For the T flip-flop

- T TERM 1 Each 1 square must be accounted for in T term
- / Must not be used
- ϕ Each ϕ square must be accounted for in T term
- 0 Must not be used
- Optional

For the J-K flip-flop

- J TERM 1 Each 1 square must be accounted for in J term
- / Optional
- ϕ Optional
- 0 Must not be used
- Optional

- K TERM 1 Optional
- / Must not be used
- ϕ Each square must be accounted for in K term
- Each ϕ square must be accounted for in K term

- 0 Optional
- Optional

The differences between the various types of flip-flops are shown in the truth tables below. In each case the output is shown as a function of the input signals. But, since the flip-flop has memory properties, the output may also be a function of its history. Thus, the notation "NC" means no change from its previous condition and "C" means complement or change the output. In the case of the R-S flip-flop, the notation "?" is used to indicate an indeterminate condition.

INPUTS			OUTPUT
SET	RESET	NC	
0	0	NC	
1	0	1	
0	1	0	
1	1	?	

INPUT	OUTPUT
TRIGGER	NC
0	NC
1	C

INPUTS			OUTPUT
J	K	NC	
0	0	NC	
1	0	1	
0	1	0	
1	1	C	

The logic diagrams for the three kinds of flip-flops show how the R-S flip-flop is converted to the J-K type by adding two feedback signals.

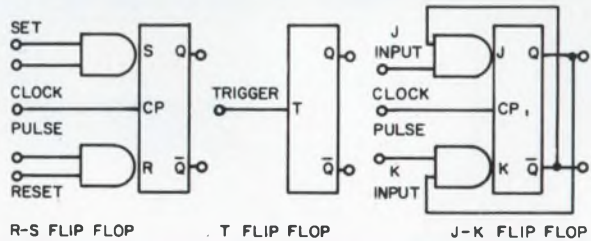

As an example, suppose we want to generate the three waveforms of Fig. 3. An interesting subtlety arises here, because the flip-flop states are symmetrical about clock period 3. This means that the state of the generator cannot be uniquely determined by examining the states of the three flip-flops. To eliminate this ambiguity, a fourth flip-flop is employed. It is left in the RESET state for periods 0 through 2 and in the SET state for periods 3 through 5. This artificially makes each state different from all of the others.

The complication of identical states does not arise in the design of counters because all of the states are unique, but in the case of random waveforms, the possibility must be considered.

Proceeding as we did in the decade-counter design, we construct the flow table (Table 3) and, from it, four Karnaugh maps (Fig. 4). These

lead to the following equations:

$$\begin{aligned}
 S_A &= \bar{A}, & R_A &= \bar{B}D \\
 S_B &= A\bar{D}, & R_B &= \bar{C}D \\
 S_C &= \bar{B}D, & R_C &= D \\
 S_D &= B, & R_D &= \bar{B}
 \end{aligned}$$

An implementation of these equations using R-S flip-flops is shown in Fig. 5.

Asynchronous counters are no problem

There is no need for these design methods to be limited to synchronous counters; asynchronous, or ripple, counters can also be treated. These counters do not have a clock input common to all of the flip-flops. Only the first one is activated by an external clock.

To illustrate the peculiarities of an asynchro-

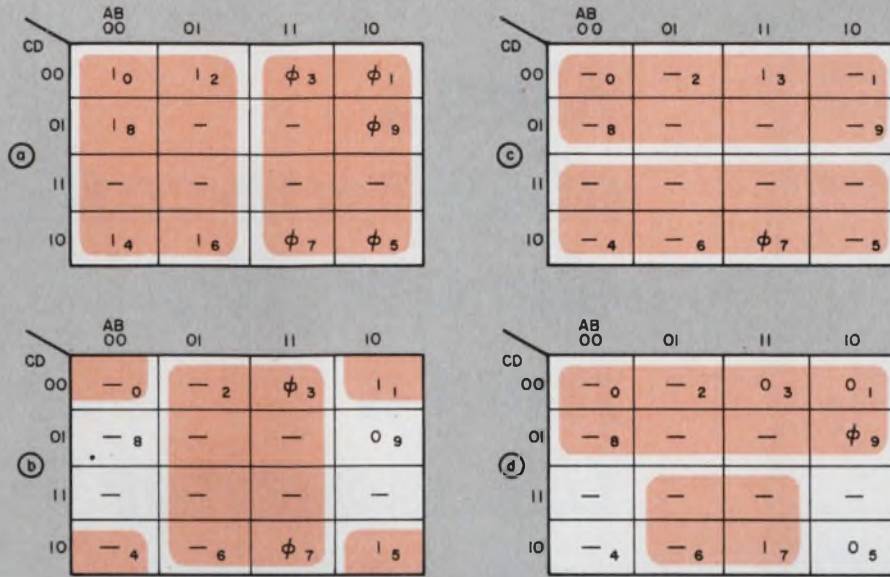

6. These maps differ from those of Fig. 1, even though they are based on the same flow table. The reason is that the asynchronous counter does not have all of its flip-flops clocked with every input pulse.

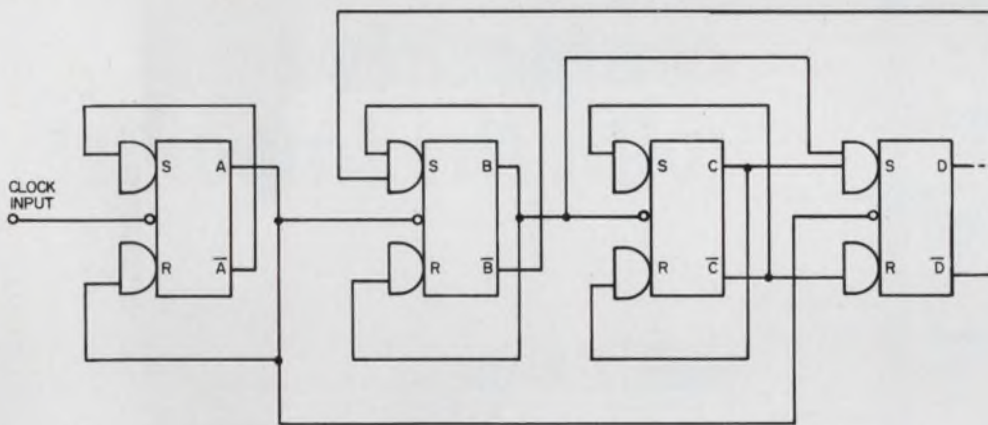

7. The asynchronous counter is simpler than its synchronous counterpart (Fig. 2) but not as fast. The speed is limited by the need to wait for each pulse to ripple through the entire counter before the next one is applied.

nous design, let's do an asynchronous decade counter. Table 2, for the synchronous counter, still applies. However, Fig. 6, the Karnaugh maps, differs from Fig. 1 because all of the flip-flops do not receive a clock pulse every time flip-flop A does.

For the type of flip-flop we will use in our design, the active edge of the clock signal is that which occurs when the clock input is falling from a 1 level to a 0 level.

Working from Table 2, we can choose the A output to activate the clock input of flip-flop B and the B output to activate the clock input of flip-flop C. However, we must use the A output for the clock input of flip-flop D, as this is the only output with an active edge at state 9, when flip-flop D must be reset.

After choosing the clock inputs, we must com-

plete the Karnaugh maps. It will be observed that each square for a particular map must be defined whenever an active transition of the clock input occurs for the flip-flop corresponding to that map. For flip-flop A, each of the squares for the 10 separate states has a 1 or ϕ , because an active clock transition occurs at its clock input for each of the 10 states.

For flip-flop B, active input clock transitions occur for states 1, 3, 5, 7 and 9. For states 0, 2, 4, 6 and 8, we can place an optional mark in the corresponding squares of the B Karnaugh map. This indicates that we should choose a clock input with the minimum number of active transitions to maximize the number of optional squares. After the maps have been completed, the minimum SET and RESET terms can be used to construct the ripple counter shown in Fig. 7. ■■

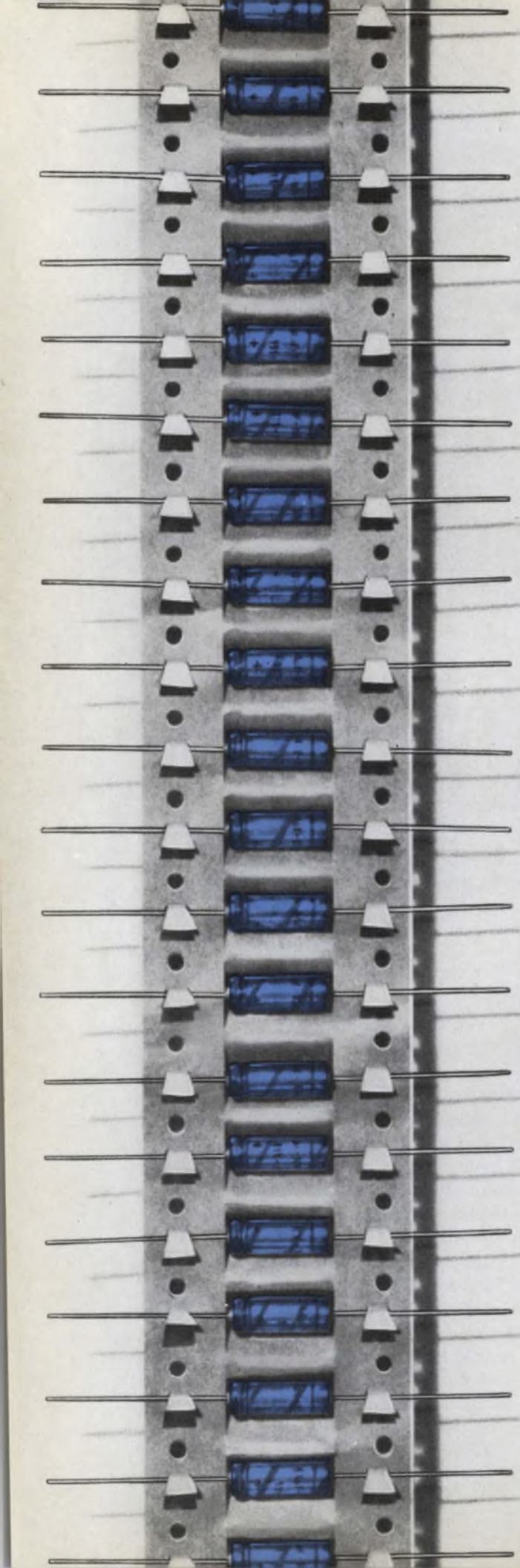

**Now...
aluminum-cased
electrolytics
from a
U.S. capacitor
manufacturer...
at prices
competitive
with the imports!**

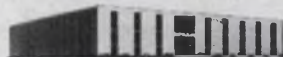

Amperex has the solution to the problem of delivering top-quality electrolytics at mass-produced prices in production quantities, from stock.

The solution is a brand new, million-dollar, fully-automated plant —right here in the U. S. A., in Hauppauge, New York.

Automation of production and quality control combined with a computerized order-processing system has resulted in meaningful mass-production economies. For the first time, you can get top-quality electrolytic capacitors, in production quantities, from stock, at prices competitive with the imports.

Through the use of ultra-high-purity etched foil and associated electrolyte . . . plus an exclusive double-cathode tab construction, we are producing the highest CV-product-per-can-size available.

Sealed in aluminum cans and insulated with the famous "Amperex blue" polyester sleeves, Amperex dry electrolytics operate efficiently from -40°C to $+85^{\circ}\text{C}$. No other line, domestic or imported, offers the Amperex combination of smaller size, higher performance, lower leakage and higher stability.

Amperex electrolytic capacitors are available in a wide range of capacitance and voltage ratings in both axial lead and vertical configurations. They are packaged to suit the requirements of the user . . . in oriented bulk or "ammo-pack."

For more information, write: Component Division, Amperex Electronic Corporation, Hauppauge, New York 11787.

Amperex[®]

TOMORROW'S THINKING IN TODAY'S PRODUCTS

Tips on cooling off hot semiconductors and microcircuits

Read on. Find out how circuit designers use IERC heat dissipators to protect and improve circuit performance of semiconductors and microcircuits.

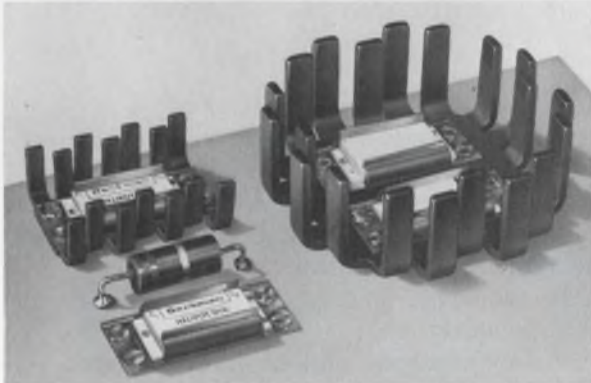

Cool off microcircuit devices with a choice of four new dissipator/retainers. Example: with natural convection, a typical microcircuit device dissipates 1.8 watts with case temperature rise of 103°C. Add IERC's model LBOC2-61B and retainer and you dissipate 5 watts with the same case temperature rise. Retainer-clip may also be used alone to mount package to conduction plane.

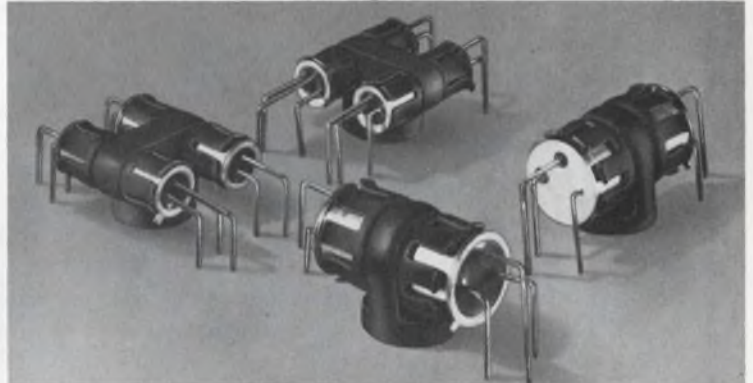

These special dual and quad Thermo-Link dissipators permit thermal mating of matched transistors. Thermo-Link retainers do exactly as their name says: They provide a thermal link between transistors and the chassis or heat sinks. They are also available with beryllium oxide washers which have the excellent thermal conductivity of aluminum, are electrically insulative and reduce normal mounting capacitance by 1/2 to 1/3. The washer is brazed to a brass slug or hex stud for mounting.

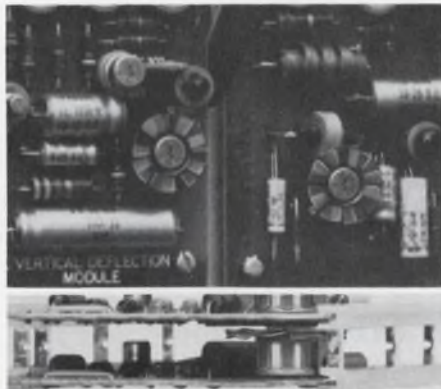

Fan Top Dissipators for TO-5 and TO-18 cases add almost nothing to board height. Don't need much room on the board either. Available for both metal and plastic cases. Spring fingers make installation simple. And Fan Tops cost just pennies.

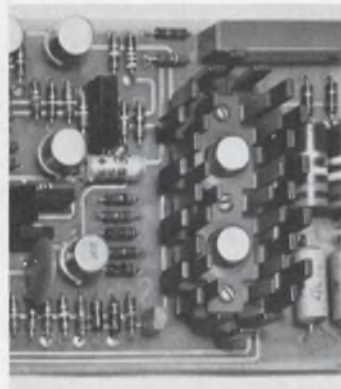

Help low-to-medium power transistors keep their cool with IERC's stagger-fingered LP's. Available in single or dual mounting for thermal mating of matched transistors. They fit both TO-5 and TO-18 cases.

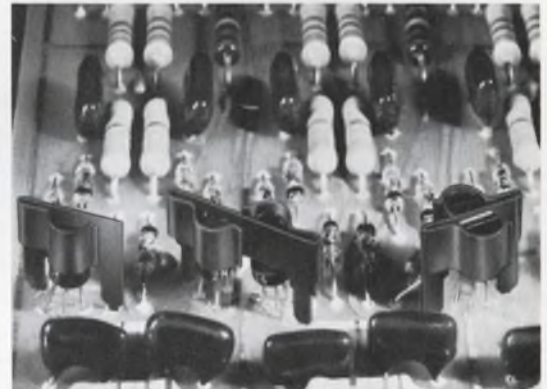

New "Universal" Spade Series for plastic transistors fits all D-case sizes. Spring clip allows for variation in case diameters. Excellent dissipation lets you boost operating power 33%. Both single and dual models as shown. IERC has heat dissipators for all popular epoxy and ceramic semiconductors.

Need a non-hygroscopic finish with excellent dielectric properties, 50 K megohms insulation resistance and high heat emissivity? Use Insulube® 448. It also protects against salt spray and fungus and other adverse environments.

Got a tough one? Our engineers welcome your inquiry for more specific information. Write us on your company letterhead, please.

ierc
SEMICONDUCTOR
HEAT DISSIPATORS

INTERNATIONAL ELECTRONIC RESEARCH CORPORATION  A corporate division of Dynamics Corporation of America • 135 West Magnolia Blvd. • Burbank, Calif. 91502

Stop the revolt in the labs! Engineers demand more than pay to be content. Learn how to 'involve' them in their work.

Unlike the college campus, on which students are resorting to picketing, faculty lockouts and riots to gain participation in decisions affecting their careers, there is no visible revolt in the nation's laboratories.

Yet numerous opinion studies among engineers and scientists in industry reveal that, like the students, many feel that their wishes on the job have been receiving short shrift. Like today's students, they're seriously dissatisfied with the situation. Only their dissatisfaction shows up, not in wrecked classrooms, but in such symptoms as turnover and just-enough-to-get-by performance.

Surveys show that basic managerial practices may be to blame for much of the problem. They can be corrected, in some cases relatively painlessly, but in others, only by reversal of ingrained policy.

Why pick out engineers and scientists? Do they need more say-so in their work than other groups? The answer is yes, as indicated by a number of studies conducted by Opinion Research Corp., Princeton, N.J.

In the excerpted ratings of the importance of various job factors to the employees of three companies (Table 1), compare the way electrical, mechanical and chemical engineers feel with the way clerical and hourly rated employees do. Such factors as pay and job security were deliberately omitted to gain insight into the satisfactions that employees seek once these basic needs are met.

More so than clerical or hourly employees, engineers seek personal involvement in their work. On the other hand, they are less sensitive than other employees to fringe factors of the job such as a clean house, a one-big-happy-family atmosphere and the like.

Note the shift of engineers' interest away from areas that supervisors and company personnel structures traditionally stress as the survey continues in Table 2.

In yet another study that covered only research scientists and engineers most respondents rated work enjoyment and the authority to

make decisions second and third behind pay as of major importance on the job.

Fit management to the men

Results like these, which have been confirmed in numerous studies, carry a clear message to the engineering manager: A "we know best what you need" style of supervision simply falls short of the mark with engineers. Leaning on it invites, in sequence, apathy, noninvolvement and minimal productivity.

Conversely, a strong clue to gaining maximum productivity from engineers lies in their openly expressed desire for job involvement. Giving serious consideration to engineers' views, letting them assist in making decisions involving their work and seeing to it that they're given meaningful responsibilities and the chance to make the most of their talents could open the door to new heights of achievement.

What continues to surprise, however, is the continued apathy of many companies toward meeting these expectations of their professional employees. In 1959, Opinion Research Corp. published a study, "The Scientific Mind and the Management Mind." This report documented the widespread discontent among scientists and engineers with how they were being treated in

Table 1. Engineers want involvement

"It's of top importance to me—	Engineers	Clerical employees	Factory employees
That I make the most of my talents."	73%	57%	50%
That I feel my views are taken seriously by those above me."	63	51	44
That I have important responsibilities."	41	20	16
That I be allowed to make important decisions affecting my work."	34	18	15

Alfred Vogel, Director of Employee Relations and Management Research, Opinion Research Corp., Princeton, N.J.

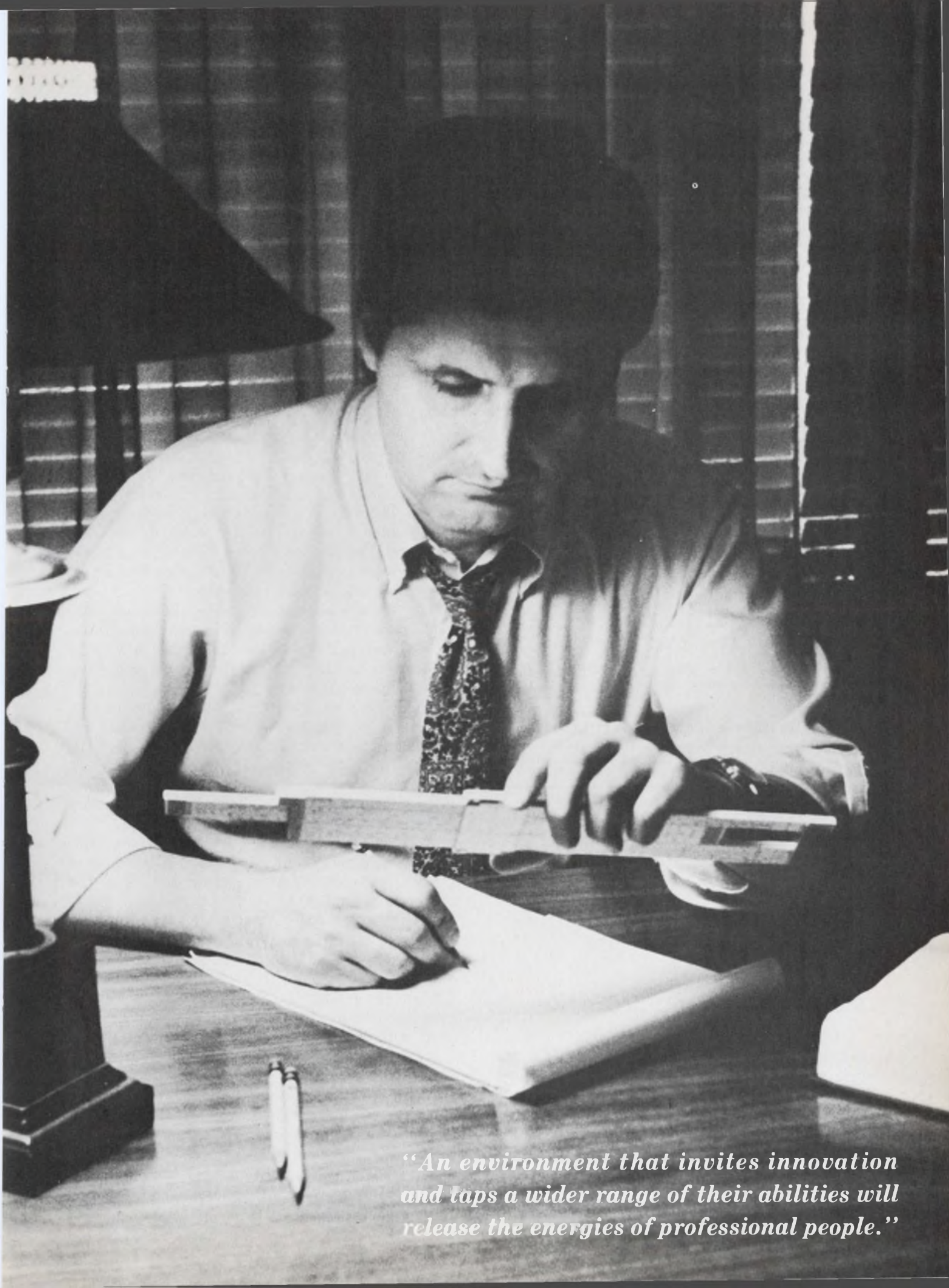

“An environment that invites innovation and taps a wider range of their abilities will release the energies of professional people.”

Table 2. Job-fringe factors rate low

"It's of top importance to me—	Engineers	Clerical employees	Factory employees
That I get along well with fellow employees."	38%	56%	62%
That I have clean working conditions."	25	50	59
That I work with people I like."	24	39	38

Table 3. Management short of expectations

"I rate my company 'poor' on—	Better-educated employees	Less-educated employees
Taking employe interests into account when making important decisions affecting you."	49%	27%
Understanding employes' point of view."	39	24
Respect shown employe as an individual."	33	22
The ability of management and employe to work together."	26	15

Table 4. The more-educated are critical

"I agree that—	Better-educated employees	Less-educated employees
There is not enough opportunity for employes to let the company know how we feel on things that affect us and our work."	62%	54%
Management does a good job of explaining the reasons behind important business decisions."	43	67

industry. In it substantial majorities of engineers and scientists in six companies noted that they were forced to overspecialize, that they weren't given enough freedom on the job, that too often they were immersed in detail, that their abilities were being too closely channeled to what had already been proved—in short, that they were poorly utilized.

Today, as new studies are undertaken, the

same problems are turning up in many companies, some of which are constantly recruiting new talent in the market. Quite often little or no attempt has been made to give the talent on hand an opportunity to reach full potential, according to scientists and engineers.

Education breeds disbelief

The evidence is mounting through opinion surveys that younger, better-educated employes tend, in fact, to be more dissatisfied with their experiences in industry than older, less educated employes. There is, of course, a high correlation between age and education. Younger people, by and large, have had more schooling, and three factors cause them to question managerial attitudes that they encounter in industry.

(1) A product of today's education is an attitude of questioning "the establishment." The more recently schooled employes tend to ask of high-sounding management policies, "Is it so, or is the management only giving lip service to it?"

(2) There is a rising trend in society, especially among young people, toward favoring democratic values. And young people have learned to equate participation in decisions that affect their lives with democratic values.

(3) Young people today have higher expectations regarding work than previous generations. A job is regarded as more than just a way of earning a living; it's a means of achieving psychological satisfaction.

The results of a study of all employe groups in a large company (Table 3) illustrates the relationship between education and employe attitudes. The better-educated group includes engineers and other who attended or graduated from college. Note that better-educated employes consistently give their company lower ratings.

A second example from a study among employes in another company (Table 4) touches on other areas and further points out how the "acceptance gap" widens with education.

Both studies show that better-educated employes are more critical. Indications are that this trend will grow and that widespread frustration and discontent among them will increase.

Lack of outspoken resentment should not be taken as an indication that a manager's decisions meet with his engineers' approval and support, as the companies sponsoring the preceding surveys learned. And the manager seeking to avoid the effect of frustration and discontent on the job will do well to consider delegating to his engineers certain important decisions affecting their work. It may make the difference between a group which merely "puts in time" and one that more fully cooperates in reaching goals.

At the opposite pole from the engineer who

Table 5. A monument to status-quo management

		Engineers	All management employees
Many managers here practice a don't-rock-the-boat philosophy, rather than attacking problems aggressively	Agree Hard to decide Disagree	95% 1 4	84% 3 13
One can get by in this company merely by keeping one's nose clean	Agree Hard to decide Disagree	97% 0 3	80% 16 1
Good ideas for improving performance often don't get to the people who have the power to make decisions	Agree Hard to decide Disagree	86% 4 10	71% 22 7
There is too much emphasis on established procedures, not enough on providing new ways	Agree Hard to decide Disagree	81% 3 16	68% 6 26
Many people here are against change—they prefer to keep things the way they were in the past	Agree Hard to decide Disagree	73% 1 26	68% 3 29

The above judgements were expressed in an opinion survey made among engineers (largely EEs) and management personnel of one company.

"puts in time" is the one who comes up with creative performance. A prized commodity, creative performance calls for a high degree of voluntary self-commitment to the job by the engineer, which one would think an employer would go to great lengths to generate through his chains of command.

But studies show that in more than one company *preventing innovation* has become an institutional feature; it's part of the company's reward structure through which engineers and managers alike take their cues as to what is legitimate and what is prescribed behavior. Results of an opinion survey in one such company are shown in Table 5.

While major upheavals may be called for to reverse the anti-creativity climate in such companies, two steps are basic:

(1) Rewards for innovation must be incorporated into the compensation structure.

(2) "Change-mindedness" must be institutionalized through strong management actions. The higher up the ladder they begin, the more effective.

Back-talk is not a waste product

The fond delusion exists among some top managements that professional employees consider themselves "one of us" and are more willing than other employees to exert themselves for company goal as a result—"Aren't they allowed more freedom of motion, consultation and expression than the man on the machine or the clerk at the desk?"

But this feeling is frequently unfounded. Surveys show that engineers, often only to a slightly

lesser extent than other employees, feel left out when it comes to shared confidences with management.

In many companies, management stands to cut away layers of resentment that block fuller job commitment on the part of engineers by diverting some of the attention now lavished on elaborate house organs and programs designed to communicate *to or at* employees into encouraging questions from employees and listening to their views.

One 10-plant company discovered this when these survey responses were returned from its employees:

Generally, management is more interested in telling us what they think we ought to know than what we want to know.

	Agree	Disagree	No Opinion
Clerical employees	73%	25%	2%
Production employees	67	29	4
Engineers-scientists	68	31	1

There is not enough opportunity for employees to let management know how we feel on things that affect us and our work.

	Agree	Disagree	No Opinion
Clerical employees	78%	21%	1%
Production employees	75	22	3
Engineers-scientists	61	38	1

Constricted communication lines to management are a root cause of engineer dissatisfaction. And the second article in this series will show just how serious this problem is and what can be done about it. ■■



Which discipline will Ed Whitaker use tomorrow

When Delco says multi-disciplinarian, they mean it. Just ask Ed Whitaker. And the solid professionals who have helped him grow into jobs like developing the microcircuits for a fire and overheat detection computer for jet aircraft. Twenty-five hundred components in a package 4" x 2" x 1/2". From concept to hardware in eight months flat. And then a fast hop to Air Force testing. From beginning to final delivery, Ed was a full member of the team. The question is . . . does your job permit you this kind of growth? Take a good look at how your career shapes up, compared with Ed Whitaker's and his colleagues at Delco. You might even call us collect. Or, write: Mr. C. D. Longshore, Supervisor, Salaried Employment, Dept. 602, Delco Radio Division of General Motors, Kokomo, Indiana.

**DELCO
RADIO**



AN EQUAL OPPORTUNITY EMPLOYER
DIVISION OF GENERAL MOTORS
KOKOMO, INDIANA

Free Career Inquiry Service

Absolutely Confidential

26

Respond to the career opportunities advertised in this issue. Fill out and send us this handy resume. **Electronic Design** will do the rest – neatly typed copies of this form will be mailed to the companies of your choice, indicated by the circled Career Inquiry Numbers at the bottom of this page.

Name		Home Phone	
Home Address (Street)		City	State ZIP Code
Age	U.S. Citizen <input type="checkbox"/> Yes <input type="checkbox"/> No	Security Clearance	

Prime Experience	Secondary Experience

Desired Salary	Availability Date
-----------------------	--------------------------

Employment History – present and previous employers

Company	City, State	Dates	Title
		to	
		to	
		to	

Education – indicate major if degree is not self-explanatory

Degree	College	City, State	Dates
			to
			to
			to

Additional Training – non-degree, industry, military, etc.

Professional Societies

Published Articles

Career Inquiry Numbers:

900	901	902	903	904	905	906	907	908	909
910	911	912	913	914	915	916	917	918	919

ELECTRONIC DESIGN
850 Third Avenue
New York, New York 10022

YEARS AHEAD

ENGINEERS

PUT TIME AND TECHNOLOGY ON YOUR SIDE

L-1011 The largest airliner order in history—over \$2 billion—demands extensive engineering work. First L-1011 deliveries are not until late 1971. And that's only the beginning.

VS(X) A new carrier-based, state-of-the-art U.S. Navy ASW plane, the VS(X) is now in final phases of contract definition. This \$2-billion program will run well into the 1980's—not to mention possible VS(X) derivatives.

AH-56A The U.S. Army's initial AH-56A production contract calls for 375 vehicles. So engineering opportunities are great. This is merely the first compound helicopter to use the new Lockheed-developed Rigid Rotor.

If long-term projects are what you've been waiting for, act now. Lockheed-California Company has immediate openings in structural design and design of avionics, flight controls, real-time computers, digital displays, EMI, and tooling. Analysis assignments in human engineering, acoustics, aerodynamics, structural dynamics, thermodynamics, propulsion, weights, and reliability.

Write: Mr. C. R. Alexander, Professional Placement Manager, Dept. 1712, 3415 Empire Avenue, Burbank, California 91503. An equal opportunity employer.

LOCKHEED-CALIFORNIA COMPANY

A Division of Lockheed Aircraft Corporation

INFORMATION RETRIEVAL NUMBER 902

**Digilog: first with
NON-LINEAR POTS**
—custom wirewound under
direct punched tape control

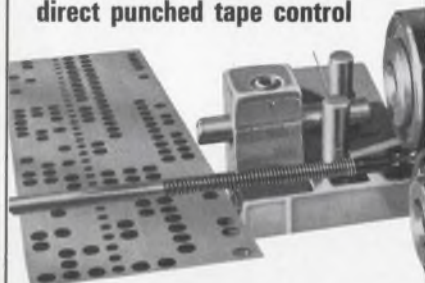

Production can start in hours from the time you tell us your custom requirements.

- (1) Design alternatives are analyzed by time-sharing computer, which then punches control tape for best design;
- (2) Unique punched tape control directly actuates coil winding machine. No delays to prepare cams or strip charts; an order-of-magnitude improvement in wire position accuracy;
- (3) Finished potentiometers, to your exact specifications, are delivered in as little as 10 days, and at reasonable cost.

See your Digilog rep or contact

Digilog electronics
corporation

701 Third Ave. No., Seattle, Wash. 98109
Phone (206) 284-6811; TWX 910-444-1665

Precision potentiometers, linear or non-linear
"Mechatrim" and "Differatio" trimmers

INFORMATION RETRIEVAL NUMBER 41

YOUR HEART FUND FIGHTS

HEART ATTACK
STROKE
HIGH BLOOD
PRESSURE
INBORN HEART
DEFECTS



CIRCLE NO. 250

Book Reviews

Mathematical methods

Mathematical Methods for Physicists and Engineers, Royal Eugene Collins (Reinhold Book Corporation, New York), 385 pp., \$14.95.

Focusing on the requirements of beginning graduate students in science and engineering, R.E. Collins has attempted to place in their hands the mathematical tools that they most sorely need. "Tools" is the term used by the author himself in describing his design of eliminating unnecessary rigor in order to impart a sound practical command in the shortest possible time. The areas covered include vector calculus, matrix algebra, linear vector operations, the calculus of variations, integral equations and methods of solving linear boundary problems. Because of the inadequacies of many university courses, much time is often spent, in physics and engineering courses, on the teaching of mathematics. With a view toward eliminating such deficiencies, this book offers a solid grounding in the mathematical methods that are the foundation of both science and engineering.

CIRCLE NO. 250

Scientific glass work

Creative Glass Blowing, James E. Hammesfahr and Clair L. Stong, (W. H. Freeman & Company, San Francisco, Calif.), 196 pp. \$8.00.

Together with the companion color film available from the publisher, *Creative Glass Blowing* can serve as the nucleus of a training program for you or members of your staff. It can also help personnel dealing with outside glass blowing firms to understand what is involved in creating a complex piece of apparatus.

Three chapters lay the groundwork by describing the tools, the equipment and the techniques. One full chapter is devoted to a discussion of scientific glassware including details on the fabrication of a helium-neon laser tube.

CIRCLE NO. 251

INFORMATION RETRIEVAL NUMBER 101 ▶



Psst!

Wanna buy some nice crystals?

Motorola's Precision Crystals are on the market.

We've been making them for thirty years. Precision, high-tolerance crystals that had to be good enough to use in our own products. But we found out something. You can't keep

a great thing to yourself forever.

Now, our wide range of precision crystals, including temperature compensated varieties, are available to designers and manufacturers in the electronics industry. Characteristics like tight tolerances and low-aging are Motorola specialties. You can choose from types of holders too—glass, solder seal and cold weld.

Crystals, oscillators, filters, and tone modules: the list of Motorola

components currently in production is a mile long, but the way things are going that may not be long enough. If you need something special, just call. Our designers are ready to go to work on projects for you alone.

For additional information on existing products and on design potentials, write to Motorola Communications & Electronics Inc., 4501 West Augusta Boulevard, Chicago, Illinois 60651.

Ask for Bulletin TIC-3401.



MOTOROLA

Do you want faulty debugged in your

Of course not.

That's

Isolated
PRODUCTION
Facilities

Group A

Group B

100%
Temperature
Cycling

Temperature
Stability

100%
Controlled
Burnin

Surge Voltage

100% Leakage,
Capacitance, and
Dissipation Factor

100% X-Ray

100% Seal Test

100%
Visual and
Mechanical

All KEMET KG HIGH RELIABILITY Solid Tantalum Capacitors are 100% tested: five temperature cycles, -65°C to $+125^{\circ}\text{C}$...grading (statistically controlled burn-in)...cap value test, and D.F. test...X-Ray...and seal test.

In addition, sample tests are performed on each batch of KEMET KG parts that further guarantee that you get only the ultimate in HIGH RELIABILITY parts.

As a result, this special testing eliminates those capacitors with lower survival rates during these exhaustive testing cycles — they're debugged for you. And what's more important, you're also

capacitors finished equipment?

why you need 100% tested

KEMET® KG Solid Tantalums.

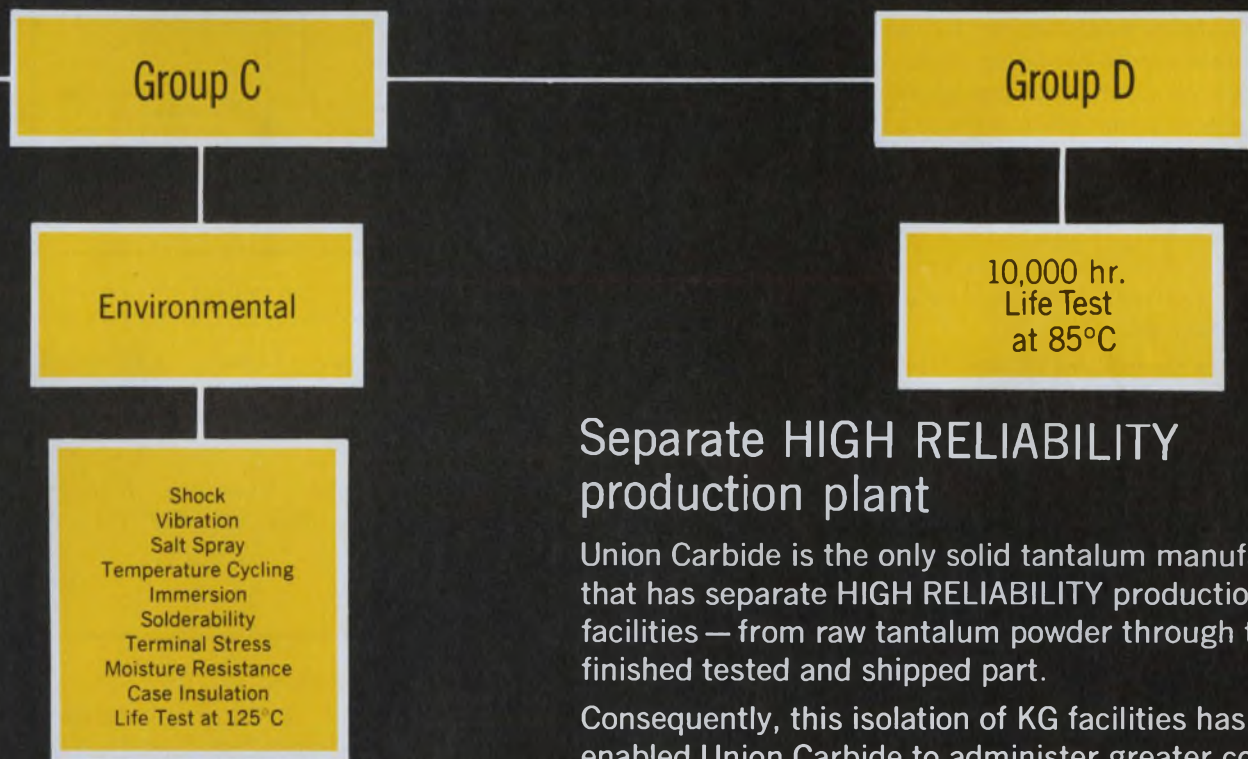

supplied a unique statistical history of the burn-in procedure for added confidence and tracability.

We do it with Weibull analysis and accelerated voltage aging. The results prove that:

- (1) KEMET KG Capacitors have a failure rate that decreases with time;
- and (2) the failure rate desired by you has been demonstrated *before* you receive the parts.

The block diagrams show the completely thorough testing performed on KEMET KG parts. The HIGH RELIABILITY is *built-in* and then confirmed by extensive testing.

Separate HIGH RELIABILITY production plant

Union Carbide is the only solid tantalum manufacturer that has separate HIGH RELIABILITY production facilities — from raw tantalum powder through to the finished tested and shipped part.

Consequently, this isolation of KG facilities has enabled Union Carbide to administer greater control while developing superior manufacturing techniques.

A detailed analysis of how the KEMET KG Capacitors acquire their proven HIGH RELIABILITY is spelled forth in Union Carbide's new HIGH RELIABILITY "Specification GR 500" and "Detail Specification GR 500/J."

For your copies, contact your local Union Carbide representative, call us collect (216-221-0600, Ext. 232 or 288), or write us direct — P.O. Box 5928, Greenville, South Carolina 29606.

KEMET KG Solid Tantalums, the HIGH RELIABILITY Debugged Capacitors, from Union Carbide, The Discovery Company.

**UNION
CARBIDE**
ELECTRONICS

FET and UJT provide timing over wide temperature range

The combination of an n-channel junction FET and a programmable unijunction transistor (the General Electric D13T2) can provide accurately timed pulses (1 second to many hours) over a wide temperature range.

In operation (see figure), capacitor C_T charges to the threshold voltage of the unijunction circuit (Q_2), minus the V_{GS} OFF voltage of the FET (Q_1). C_T then discharges through the now forward-biased gate-to-source diode of Q_1 . The voltage at which C_T discharges to deliver an output pulse across resistor R_3 is:

$$V_{\text{firing}} = (R_1/R_1 + R_2) V_{CC} - V_{GS \text{ off}}$$

The gate-to-source diode of the FET has been examined for devices of several different manufacturers, and only the two shown have been found to contain characteristics suitable for this discharge.

If R_1 and R_2 are selected so that V_{firing} is about 63 per cent of the supply voltage (V_{CC}), then the period of oscillation, T , for the circuit is one time constant.

$$T = R_T C_T$$

The circuit is a 30-second timer, and has been temperature cycled between -30°C and $+75^\circ\text{C}$ with the following results.

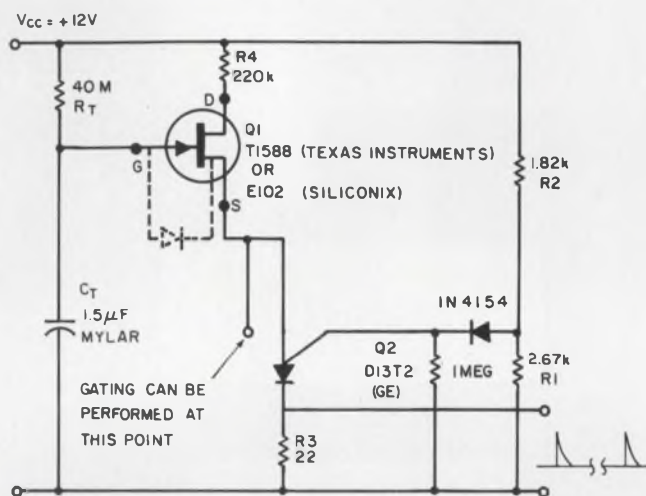

Accurately-timed output pulses are delivered each time C_T discharges through R_3 , Q_2 and the gate-to-source diode.

Temperature	-30°C	$+25^\circ\text{C}$	$+75^\circ\text{C}$
Measured time in seconds	30.20	30.55	30.60

Dan Lubarsky, Research Engineer, Moore Associates Div., The Rucker Co., San Carlos, Calif.

VOTE FOR 311

Use DDA techniques for arc sine/arc cosine generation

A past article in ELECTRONIC DESIGN¹ described the implementation of sine/cosine generation by means of digital-differential-analyzer (DDA) integrators. These integrators are based on MOS technology, and a complete integrator is composed of only two chips. Using a similar technique, arc sine/arc cosine generation can also be accomplished (see illustration).

The implementation of the digital arc sine/arc cosine generator as shown here, was performed with the General Instrument Corp.'s MEM5021 DDA adder element, MEM3016 dual shift register, and MEM5031 servo adder element. The DDA adder element and the shift register combine to form one DDA integrator, with the complete generator comprising three such integrators

and one servo adder.

The operation of the DDA integrator is described in References 1 & 2 and is quite straightforward. The servo adder is a logic element that serially examines a shift register and determines whether the contents are greater than, equal to, or less than zero. For anything other than zero,

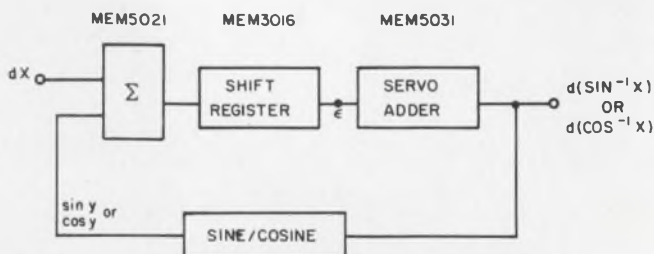

Either arc sine x or arc cosine x is generated at the circuit output, depending on whether sine or cosine output of the feedback generator is used.

If Brand-Rex is already supplying wire and cable to Burroughs, Control Data, G. E., Honeywell, IBM, NCR, Univac and RCA...

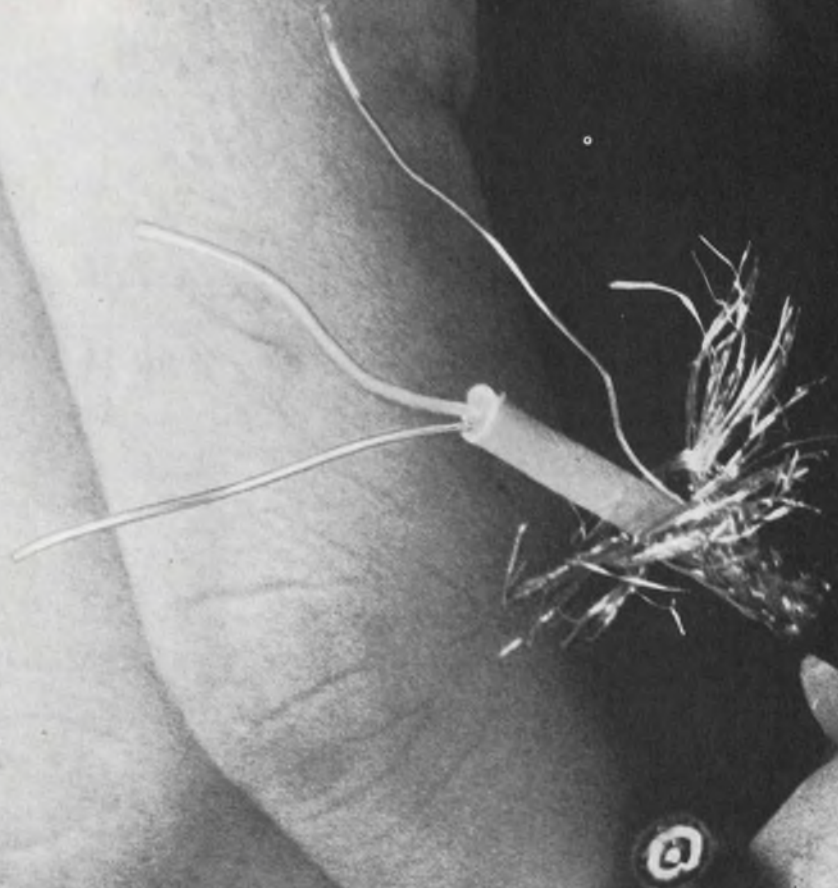

why are we so interested in making connections with you right now?

Brand-Rex can help make wire and cable procurement the easiest part of your next computer. Here's what we offer:

BROAD PRODUCT LINE Brand-Rex is the largest supplier of wire and cable to the computer industry. Our EDP line includes back-panel wires, hook-up wires, miniature air-spaced coaxial cables, power supply wires, patch cord wires, interconnecting and communication cables.

DESIGN CAPABILITY We're probably already making the wire and cable you

need. If not, we can quickly develop new constructions for new applications. The miniature 95 ohm coaxial cable illustrated here was specifically designed for one of the leading data processing systems. Brand-Rex designs cable to standard specifications or to your specific requirements. (Over 3,000 new designs last year alone.)

Any insulation. Any configuration.

U.L. APPROVAL We are well equipped to help you get U.L. approvals. Brand-Rex has more of them on computer wire and

cable than any other manufacturer.

ENGINEERING KNOW-HOW With more than 16 years' experience serving the computer field, you'll find our engineers eager and able to work with you — from drawing board to production line. Call Brand-Rex now — while your next design project is only a gleam in your eye.

AMERICAN  CORPORATION

BRAND-REX DIVISION

WILLIMANTIC, CONNECTICUT 06226
PHONE 203 431-7711



the servo adder continuously puts out pulses. These pulses can be of either polarity, with specific polarity being dependent on the shift-register contents. The feedback signal, ($\sin y$) is compared with input x and the result is applied to the input of the servo adder. The output of the servo adder, y , will move incrementally in such a way as to make $\Delta\epsilon$ go to zero. For instance, if $\sin y > x$, a sequence of increments will occur at the output of the servo adder which will reduce y , which will in turn reduce $\sin y$. If $\sin y < x$, then the reverse will happen. In this fashion a sine function is generated that is equal in amplitude to the input. Since the feedback block

is a sine generator, it follows that the input to the sine generator is y , or $\arcsin x$, when $\sin y = x$.

If $\arccos x$ is required, then the feedback loop is connected to the cosine output of the sine-cosine generator.

References:

1. James Garvey, "Resolve Angles with Samples," *ELECTRONIC DESIGN* 18, Sept. 1, 1967, p. 60.

2. J. D. Callan, "MTOS Integrated Digital Differential Analyzer," General Instrument Corp., Hicksville, N.Y., Application Note, March 1967

Nick Kapsokavathis & LeVell Tippetts, Design Engineers, Lear Siegler, Inc., Astronics Div., Santa Monica, Calif.

VOTE FOR 312

Simple resistor network eliminates dc tachometer

In servomechanisms, there is often a need for a feedback voltage that is proportional to the rate at which the servo is being driven. This signal voltage is sometimes required to stabilize a positional servo loop, or it is used as the total feedback, as in the case of a velocity loop.

If the servo is driven by a dc motor, a dc tachometer will often be used to provide the rate feedback. Consider a common application of a dc tachometer in a velocity loop, as shown in Fig. 1. The tachometer feedback signal is compared with the input signal, and the difference voltage is amplified. The amplifier error signal causes the dc motor to speed up or slow down until the error is minimized. The speed of the output is therefore made proportional to the input signal.

The same feedback voltage can be readily supplied with the simple resistor network shown in

Fig. 2. An understanding of the circuit's operation can be obtained by considering the following derivation:

The voltage across the armature of a shunt dc motor (with a fixed field excitation) can be expressed by the equation

$$V_A = I_A R_A + V_B,$$

where

V_A = armature voltage (V),

I_A = armature current (A),

R_A = armature resistance (ohms),

V_B = back electromotive force (V).

The back emf is proportional to the speed of the motor, and therefore

$$V_B = K \times S,$$

where

K = proportionality constant and S = motor speed (RPM).

Combining equations yields

$$V_A = I_A R_A + (K \times S).$$

Analyzing this equation, we see that the armature voltage consists of two components, one proportional to the current passing through the

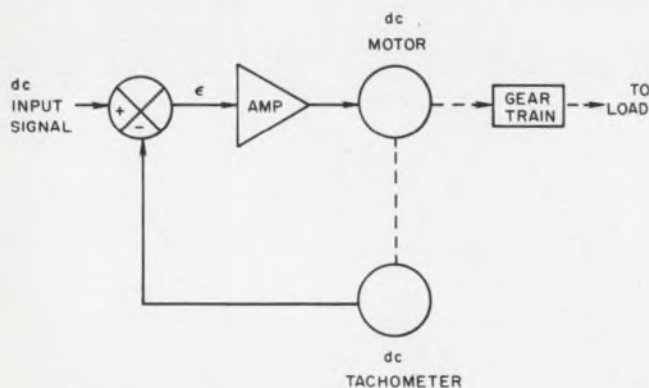

1. Dc tachometer feedback as commonly used in velocity servo loops.

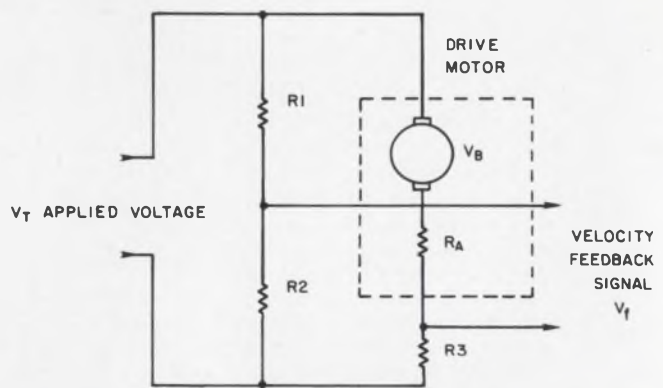

2. Simple resistor network can provide the same feedback characteristic as a dc tachometer.

**BUILD MDS
"DATA-RECORDER QUALITY"
INTO YOUR SYSTEMS**

The MDS 701 and 901 Buffered Tape Units each provide three modes of operation . . . Write, Read or Search. The 701 handles data on 7-channel magnetic tape at 200 bpi, while the 901 provides 9-channel, 800 bpi facilities.

Input and output communication between a parent machine and the magnetic tape are via a program-controlled buffer. A controller of your design and construction usually must be placed between the parent machine and the MDS unit, thus allowing a wide range of applications.

Manual key-entry of variable data and header or trailer records also is possible.

Only 14 moving parts are used in the tape movement control, thereby greatly reducing down time due to mechanical wear. Units have a life expectancy of 10 years, or 20,000 hours, before major overhaul.

These units may be easily integrated with your own data processing systems through the simple asynchronous bit parallel, character serial interface provided.

Many advantages accrue with these units:

- Higher operational speed
- Less main-frame time
- Less lag time from source to report
- Each written record checked for parity and bit-for-bit against core buffer
- Established programs can be stored for re-use
- "Sensed" errors are quickly, easily corrected
- Almost silent operation
- Greater information security
- Less down time and maintenance

ASK FOR: Complete folder-file on MDS 701/901 Buffered Tape Units with general specifications.



UNIT 701



UNIT 901

FOR MORE — MEET YOUR MAN FROM MDS

MOHAWK MDS
DATA SCIENCES CORPORATION
OEM MARKETING

305 WEST GRAND AVENUE • MONTVALE, N. J. 07645
Telephone 201/391-7000

Every MDS office is an OEM Marketing office

DIGITAL STRIP PRINTERS • BUFFERED TAPE UNITS
HIGH-SPEED AND LOW-SPEED LINE PRINTERS
CARD PUNCHES AND READERS
PAPER TAPE PUNCHES AND READERS

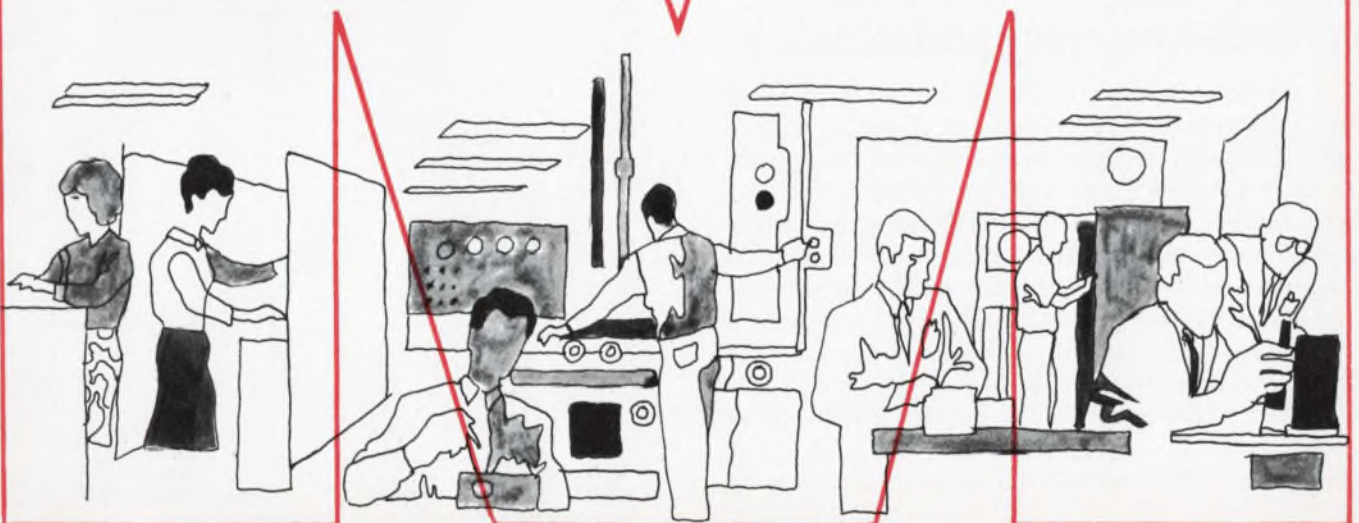

INFORMATION RETRIEVAL NUMBER 43

armature and the second proportional to the speed of the motor. The voltage V_A therefore cannot be used as a velocity feedback signal, but a voltage proportional to V_B would be usable. This requirement is satisfied as follows:

The voltage across R_2 is

$$V_{R2} = \frac{R_2}{R_1 + R_2} (V_T),$$

where V_T = total applied voltage (V).

The voltage across R_3 is

$$V_{R3} = (V_T - V_B) \frac{R_3}{R_A + R_3}$$

and

$$V_{R3} = V_T \left(\frac{R_3}{R_A + R_3} \right) - V_B \left(\frac{R_3}{R_A + R_3} \right).$$

The feedback signal (V_f) can be seen to be

$$V_f = V_{R2} - V_{R3}.$$

And, by substitution,

$$V_f = V_T \left[\left(\frac{R_2}{R_1 + R_2} \right) - \left(\frac{R_3}{R_A + R_3} \right) \right] + V_B \frac{R_3}{R_A + R_3}.$$

It can be seen that if the ratio of $R_3:R_A$ is made equal to the ratio of $R_2:R_1$, then the above equation reduces to

$$V_f = V_B \frac{R_3}{R_A + R_3}.$$

The feedback signal is therefore made proportional to the back emf of the motor and also proportional to its speed.

There is only one critical design decision in selecting values for a particular motor: the value of R_3 . From the preceding equation, we see that the larger R_3 is, the greater the feedback voltage will be. However, R_3 cannot be made indiscrimi-

nately large, since the total armature current must pass through it. Generally, R_3 should be anywhere from 1/10 to 1/3 of R_A .

As an example, consider a typical dc shunt motor whose armature resistance is 10 ohms. At rated load it would draw 1 A, with 100 V applied to its armature, and it would run at 10,000 rpm. If R_3 is made 2.9 ohms, the total applied voltage would have to be increased to 102.9 V. The feedback voltage is derived and found to be

$$V_f = 90 \left(\frac{2.9}{10 + 2.9} \right) = 20 \text{ V.}$$

This is generally considered to be a good signal level, and the loss in R_3 is only 2.9 W.

The factors that determine the selection of R_1 and R_2 are the output impedance of the feedback voltage and the losses in these resistors. If the sum of R_1 and R_2 is made equal to 10,000 ohms, the output impedance of the network could never exceed the value of R_3 , and in this particular case it would be 2.25 k Ω . The maximum loss would be 1 W (100² \div 10,000).

The tachometer network is handled analytically, as one would handle an ordinary tachometer in a servo loop analysis. Further, the benefits derived from ordinary tachometer feedback are also derived from tachometer network feedback. For example, the dynamic gain of a positional servo loop would be reduced and stabilized, its open-loop characteristic linearized and, finally, its bandwidth extended. All of this can be had for the cost of a few resistors.

Martin Kanner, Staff Engineer, Grumman Aircraft Engineering Corp., Bethpage, N.Y.

VOTE FOR 313

Emitter-coupled multi boosts variable-frequency performance

A simple addition to the basic emitter-coupled multivibrator circuit provides a versatile way to vary frequency without modifying the duty cycle. The circuit has good stability with respect to both temperature and supply-voltage variations, and it may be used in the nonsaturated current mode for wide-range, high-frequency operation.

A basic emitter coupled multivibrator is shown in Fig. 1. If the circuit is operated so that each transistor is saturated during its ON period, the boundary conditions do not depend on the transistor parameters to a first approximation. The operating frequency can therefore be expressed in terms of R_1 , R_2 , i_1 , i_2 and the supply voltages.

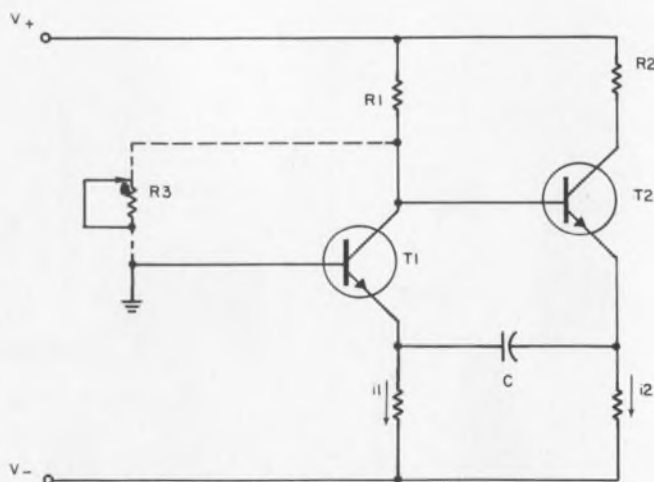

1. Adjustment of resistor R_3 provides adjustment of frequency without affecting the duty cycle.

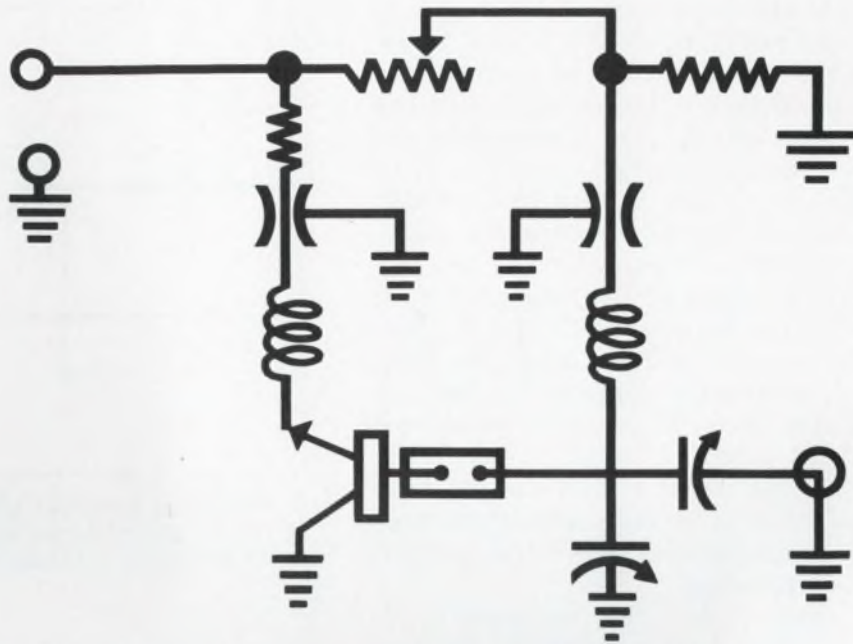

A Microwave
Fundamental
Frequency
Oscillator
Circuit is as
simple as
RCA-TA7403
"overlay" can
make it



TA7403 is a new configuration... designed especially to simplify oscillator circuitry. Featuring 0.5 watt output at 2 GHz (at 21 V operation), this all-new RCA epitaxial silicon n-p-n transistor will be especially attractive to designers looking for a device that acts as a superior self-excited oscillator at L-band and higher microwave frequencies.

Incorporating all the advantages of the RCA-developed "overlay" structure, RCA developmental type TA7403 is a compact unit in a hermetically-sealed ceramic-to-metal coaxial package... a package that features very low inductances and low parasitic capacitances. This is the industry's first unit that lends itself to cavity, stripline, and "lumped" constant circuits.

Here, then, is definitely a transistor intended primarily for simple oscillator circuits. TA7403 will find applications in such areas as: local oscillator for receivers, microwave power source—low power klystron replacement, sonde oscillator.

For more information on RCA-TA7403, see your RCA Representative. Ask him, too, about RCA-2N5470 for your UHF and microwave amplifier applications. For technical data, write: RCA Electronic Components, Commercial Engineering, Section P-G-12-1, Harrison, N.J. 07029.

RCA

However, if the circuit is required to operate in the nonsaturated mode, the T2-ON boundary condition is heavily β dependent. As a result, the frequency of oscillation in the nonsaturated mode is not predictable and is also temperature dependent, due to variations of β .

The inclusion of resistor R_3 from the collector of T1 to ground immediately rectifies the inadequacy (see reference). Now, when T1 is OFF and T2 is ON, the emitter of T2 rises to a voltage determined only by the ratio of R_1 and R_2 , provided the base current of T2 is small. Further, the addition of R_3 does not appreciably affect the T1-ON condition, since it presents merely an additional shunt across a small voltage. The modification to the basic circuit causes both boundary conditions to be well defined and predictable, and eliminates the severe temperature dependency of frequency.

It may be observed now that variation of R_3 provides an excellent means of varying the frequency of oscillation of the circuit. Further, since the duty cycle (ON-OFF ratio) is determined only by the relative magnitudes of i_1 and i_2 , adjustment of R_3 provides control of frequency without modifying the duty cycle. This feature is most attractive, since a considerable amount of additional circuitry must normally be added to conventional oscillators to achieve equivalent performance.

When a voltage-controlled oscillator (VCO) or voltage-to-frequency converter (VFC) is required, R_3 may be replaced by a transistor, as

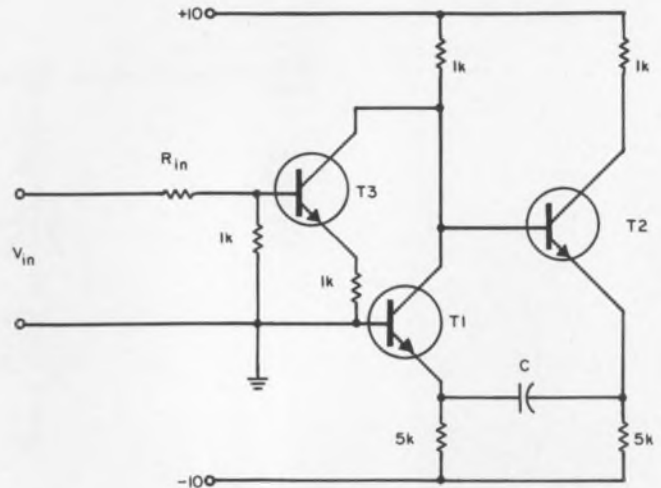

2. Connecting transistor stage T3 between the collector of T2 and ground allows the emitter-coupled multivibrator to operate as a voltage-to-frequency converter.

shown in Fig. 2. The basic circuit of Fig. 2 was used with $C=100$ pF and 2N2369 transistors in a closed-loop, frequency-control application involving control in the range 2 to 5 MHz.

Acknowledgment:

The author would like to thank Burroughs Corp. for permission to publish this circuit note.

Reference:

P. J. Beneteau and A. Evangelisti, Fairchild Applications Bulletin, "An Improved Emitter-coupled Multivibrator."

J. J. Pinto, Director of Engineering, Bissett-Berman Corp., E-Cell Product Div., Santa Monica, Calif.

VOTE FOR 314

Auxiliary power supply uses IC gates

In a single-supply logic system, the need sometimes arises for a second dc supply of opposite polarity to furnish a small amount of power to interface circuits. This second supply can be constructed using IC gates as choppers (see diagram).

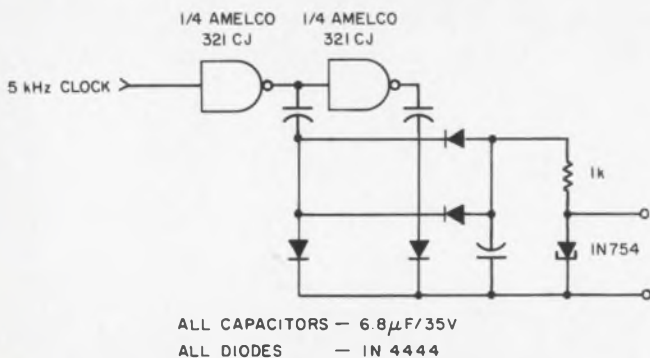

ALL CAPACITORS — 6.8 μ F/35V
ALL DIODES — 1N 4444

Two gates and a few discrete parts form the basis for a simple, low-output power supply.

The power supply shown here uses one-half of an Amelco 321 quad gate, which provides full-wave chopping. The gate may be driven by the system clock. This supply furnishes 5 V at 2 mA, when driven with a 5-kHz system clock.

Lanny L. Lewyn Sr., Research Engineer, Jet Propulsion Lab, Calif. Institute of Technology, Pasadena.

VOTE FOR 315

VOTE! Go through all Idea-for-Design entries, select the best, and circle the appropriate number on the Reader-Service-Card.

SEND US YOUR IDEAS FOR DESIGN. You may win a grand total of \$1050 (cash)! Here's how. Submit your IFD describing a new or important circuit or design technique, the clever use of a new component or test equipment, packaging tips, cost-saving ideas to our Ideas-for-Design editor. You will receive \$20 for each accepted idea, \$30 more if it is voted best-of-issue by our readers. The best-of-issue winners become eligible for the Idea Of the Year award of \$1000.

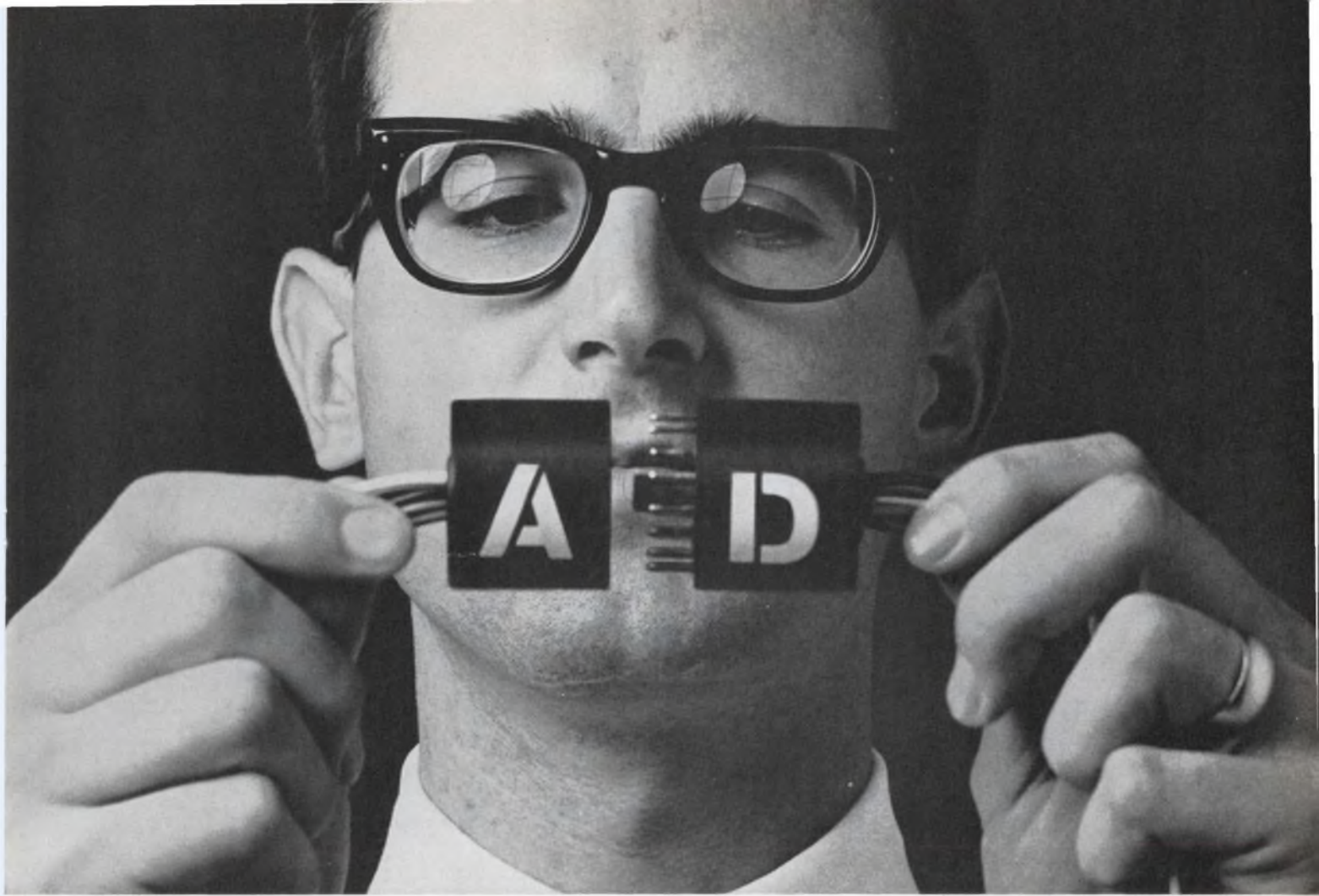

Even a digital engineer can interface our new analog instruments.

Analog engineers design analog instruments for analog engineers. Digital engineers aren't usually analog engineers. This leads to problems.

Because we're involved with both D and A, we developed a group of instruments everyone can understand and use.

Before they were put on the market, our systems engineers demanded that analog signals get in and out of digital equipment with blinding speed and stunning accuracy. As a result, here are bold statements about our new line: **Our new instruments are:** A. As fast and more accurate than . . . B. Faster and more accurate than . . . C. Almost as fast and just as accurate as anyone else's. Whether A, B, or C applies depends on the instrument you choose.

Here are some of the new ways to get from analog to digital and back again.

Multi-channel digitizers

64 channel high-level multiplexers with sample and hold amp, plus a 15-bit A-D converter in the same chassis. Accuracy: 0.01%. The MD51 has a sample and conversion time of 10 μ sec for \$8,250 plus \$200 for each eight channels. If you can spare another 20 μ sec, you'll save \$3,050 with the MD41.

Single channel digitizers

15-bit, high-level A-D converters with built-in sample and hold amps. Accuracy is $\pm 0.01\%$. The AD51 has a through-

put word rate of 100 KHz for \$5,400. The AD41, though it only costs \$4,000, isn't a slowpoke. Throughput is 33 KHz.

Digital to analog conversion

The DA40 is a 10-bit, 16 channel D-A converter. If you need more channels, up to 16 DA40's can be ganged together for 256 analog outputs. Each includes address decode and channel controls, plus a power supply. \$375 per channel.

One of the world's fanciest op-amps

Variations on a theme called the HT58 universal operational amplifier include a single-ended op-amp, differential amp, a unity gain buffer and a buffer with gain, all for use with our "T" and "J" series modules. Input impedance of 10^8 ohms and ± 40 ma. output current over a voltage range of ± 10 V. Accuracy: 0.01%. Settling time: 5 μ sec. You can adjust the gain, zero offset, and the input offset voltage temperature coefficient. \$170.

Our spec sheets meet the same requirement as our new instruments: they're understandable by digital engineers, analog engineers, and anyone else who can understand the specs above. For a complete set of spec sheets contact us digitally, or by using Mr. Bell's analog data transmission device.

SDS
Scientific Data Systems,
El Segundo, California

Slowdown!

(and read about the world's fastest IC adder.)

Signetics announces a no-kidding leadership device: the 8260 Arithmetic Logic Element, latest addition to our DCL family.

The 8260, now available in volume, is a monolithic gate array incorporating four full adders structured in a look-ahead mode. The device may be used as four mutually independent Exclusive-NOR or AND gates by proper addressing of the inhibit lines. Here is a device which in typical application increases speed three to four times, greatly reduces package count and appreciably lowers over-all system costs.

As a four-bit adder, the 8260 permits parallel addition of four sets of data and features simultaneous (look ahead) carry on each bit within the package. Extension of the look-ahead feature for 16 bits or more is facilitated by the 8261 Fast Carry

Extender.

Access to the 8260 from previous stages is provided through five OR-ed channels, and inhibition of carry-in-data and bit-to-bit carries is accomplished by a true (active high) logic level of C_{INH} .

The "carry-outs" available are: Internally Generated (\bar{C}_G); Propagated (C_P); and Ripple (\bar{C}_R). This gives the 8260 complete flexibility when used in Ripple Carry or Anticipated Carry Adder systems.

The 8260 is available now in 24-lead flat pak, -55°C to $+125^\circ\text{C}$ and 0°C to $+75^\circ\text{C}$, and will soon be available in both full MIL and commercial DIPs.

For complete information on the world's fastest adder write Signetics, 811 East Arques Avenue, Sunnyvale, California 94086. Fast!

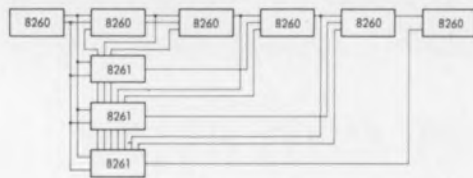

24-bit Fast Adder System; 9 packages; minimum external connections.

No. of Bits	Package Count			Addition Time per Bit (ns)	Total Addition Time Input to Output (ns)
	8260	8261	Quad 2-Input NAND Gates		
16	4	1	—	3.3	52
24	6	3	—	3.3	52
32	8	3	—	2.0	64
48	12	6	1	1.3	64
64	16	7	1	1.2	76

Increased speed and reduced package count far exceed what is attainable with any other IC family.

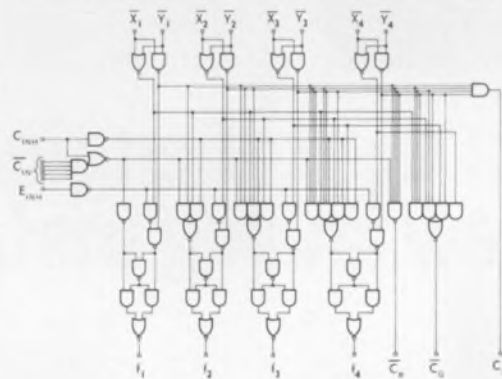

The 8260 Arithmetic Logic Element.

Signetics Integrated Circuits 
A SUBSIDIARY OF CORNING GLASS WORKS

SIGNETICS SALES OFFICES: Wakefield, Massachusetts (617) 245-8200; Trumbull, Connecticut (203) 268-8010; Poughkeepsie, New York (914) 471-3292; Syracuse, New York (315) 469-1072; Fort Lee, New Jersey (201) 947-9870; Radnor, Pennsylvania (215) 687-2660; Silver Spring, Maryland (301) 946-6030; Clearwater, Florida (813) 726-3734; Winter Park, Florida (305) 671-5350; Dayton, Ohio (513) 433-4133; Minneapolis, Minnesota (612) 920-3256; Rolling Meadows, Illinois (312) 259-8300; Richardson, Texas (214) 231-6344; Garden Grove, California (714) 636-4260; Burbank, California (213) 846-1020; Redwood City, California (415) 369-0333.

DISTRIBUTORS: Avnet Electronics Corp., Burlington, Mass. (617) 272-3060; Cesco Electronics, Ltd., Montreal, Quebec, Canada (514) 735-5511; Compar Corporation at the following locations: Huntsville, Alabama (205) 539-8476; Los Angeles, California (213) 245-1172; Burlingame, California (415) 347-8244; Hamden, Connecticut (203) 288-9276; Clearwater, Florida (813) 446-2991; Orlando, Florida (305) 855-3964; Park Ridge, Illinois (312) 692-4125; Baltimore, Maryland (301) 484-5400; Newton Highlands, Mass. (617) 969-7140; Minneapolis, Minnesota (612) 922-7011; St. Louis, Missouri (314) 542-3399; Albany, New York (518) 489-7408; Endwell, New York (607) 723-8743; Woodbury, New York (516) 921-9393; Fairport, New York (716) 271-2230; Syracuse, New York (315) 471-3356; Winston Salem, North Carolina (919) 723-1002; Seattle, Washington (206) 763-1711; Hamilton Electro Sales, Culver City, Calif. (213) 870-7171; Hamilton Electro Sales, Cherry Hill, N. J. (609) 662-9337; Hammond Electronics, Orlando, Florida (305) 241-6601; Kierulff Electronics, Seattle, Wash. (206) 763-1550; G. S. Marshall, San Marino, Calif. (213) 684-1530; Milgray Delaware Valley, Inc., Philadelphia, Pa. (215) 228-2000; Pioneer Standard Electronics, Rockville, Maryland (301) 427-3300; Schley Electronics, Watertown, Mass. (617) 926-0235; Semiconductor Specialists, Inc., Elmhurst, Illinois (312) 279-1000; Terminal-Hudson Electronics, New York, New York (212) 243-5200; Universal Electronics, Inc., Houston, Texas (713) 781-0421; Wesco Electronics, Inc., Los Angeles, Calif. (213) 685-9525; Palo Alto, Calif. (405) 968-3475.

DOMESTIC REPRESENTATIVES: Compar Corporation at the following locations: Scottsdale, Arizona (602) 947-4336; Denver, Colorado (303) 781-0912; Southfield, Michigan (313) 357-5369; Haddonfield, New Jersey (609) 429-1526; Albuquerque, New Mexico (505) 265-1020; Albany, New York (518) 489-7408; Endwell, New York (607) 723-8743; Fairport, New York (716) 271-2230; Syracuse, New York (315) 471-3356; Rocky River, Ohio (216) 333-4120; Fairborn, Ohio (513) 878-2631; Dallas, Texas (214) 363-1526; Houston, Texas (713) 667-3420; Ozark Electronic Marketing, Inc., St. Louis, Missouri (314) 423-7200.

INTERNATIONAL SALES: France, Germany, Italy, Belgium, Holland, Luxembourg, Spain—Sovcor Electronique, 11, Chemin de Ronde, Le Vesinet, (S & O) France; United Kingdom, Ireland, Sweden, Denmark, Norway, Switzerland, Austria, Portugal—Electrosil Ltd., Lakeside Estate, Colnbrook By Pass Slough, Buckinghamshire, Great Britain; Australia—Corning, 1202 Plaza Building, Australia Square, Sydney, N. S. W. 27-4318; Canada—Corning Glass Works of Canada, Ltd., Leaside Plant, Ontario, Canada (416) 421-1500; Israel—Talviton, P.O. Box 3282, Tel Aviv, Israel 236-666; Japan—ASAHI Glass Co., Ltd., Corning Products Sales Dept. No. 14, 2 Chome Marunouchi, Chiyoda-ku, Tokyo, Japan 211-0411.

Far Superior

TO ANY VTVM OR VOM

A NEW STANDARD OF THE INDUSTRY...

- Only Sencore makes a true field effect meter
- Less circuit loading than VTVM/obsoletes VOM
- Zero warm-up time — instant stability
- Complete circuit and meter protection
- Complete portability
- Greater frequency responses than most scopes

FE149 SENIOR FET METER

The only true Senior FET meter available today with outstanding accuracy and unbelievable ease of operation.

- **Unmatched Accuracy.** 1.5% on DC, 3% on AC, plus large 7-in. meter and mirrored scale, assure the most accurate tests possible.
- **Eight AC and DC ranges** .5V to 1500V full scale.
- **Zero center scale** with .25 v. either side assures measurements to less than .1 v. for transistor bias measurements.
- **AC peak to peak** readings to 4500V maximum with freq. response of 10HZ to 10MHZ \pm 3DB.
- **Eight resistance ranges** to R x 10 megohms with 6 OHMS center scale.
- **Nine DC and nine AC current ranges** 150ma to 5 amps.
- **Eight decibel ranges** for audio measurements.
- **Three HI-Voltage ranges**, 5 KV, 15 KV, 50KV with 39A21 high voltage probe. \$14.95
- **Absolute meter and circuit protection** against circuit overload.
- Non-breakable, scuff-proof, vinyl-clad steel case.
- **Three-way power.** Operates on AC, on self-contained rechargeable batteries, or on AC with batteries plugged in. Same readings all three ways.



\$149.50

Exclusive push-button design. Just push two buttons for any test — top row selects function, bottom row selects range. Action is instant and automatic.



\$69.95

FE14 — STANDARD FET METER

ACCURACY DC \pm 2.5%
AC \pm 4.5%

- 4½-inch meter, vinyl-clad steel case.

FE14 and FE16 popular 4 1/2 inch FET Meters

- **Hi Accuracy.** For unsurpassed measurements. Mirrored scales prevent parallax errors.
- **Minimum circuit loading.** 15 megohm input resistance on DC; 10 megohm on AC.
- **Zero center scale** \pm 0.5 v. readings for transistor bias measurement.
- **Full meter & circuit protection** against possible circuit overload.
- **7 DC & AC voltage ranges** 1 to 1000 volts full scale.
- **AC peak to peak readings** 2800 v. maximum with freq. response of 10HZ to 10MHZ \pm 3DB.
- **5 resistance ranges** to 1000 megohms.
- **5 DC current ranges** 100ma to 1 amp.
- **3 Hi-Voltage ranges**, 3 KV, 10 KV, 30 KV, extended with 39A19 (\$9.95) high voltage probe.



\$84.50

FE16 HI ACCURACY FET METER

ACCURACY DC \pm 1.5%
AC \pm 3%

- 4½-inch high-styled meter, high-styled knobs, and special meter-tilting metal handle. Vinyl-clad steel case.



See your Sencore distributor today or write factory for complete line catalog.

SENCORE
STANDARD OF THE ELECTRONIC INDUSTRY

426 SOUTH WESTGATE DRIVE,
ADDISON, ILLINOIS 60101

INFORMATION RETRIEVAL NUMBER 47

**WHEN ONE INSTRUMENT MEASURES
RETURN LOSS, VSWR, GAIN, INSERTION
LOSS, FREQUENCY RESPONSE, ABSOLUTE
POWER, AND LOCATES FAULTS, TOO...**

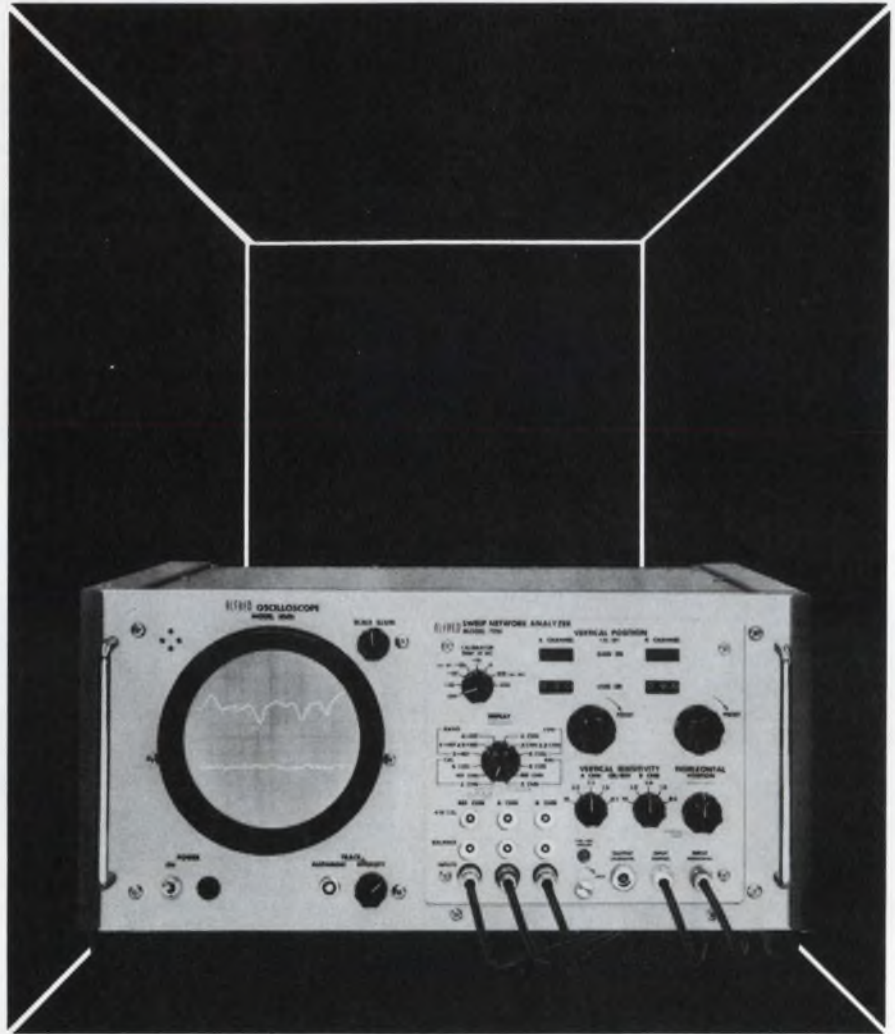

YOU'VE GOT A MICROWAVE LAB IN A BOX!

Look what \$1830 will put on your bench. The Alfred 8000/7051 Sweep Network Analyzer is the economical, convenient way to do all of the functions of a SWR meter, power meter, ratiometer, lin log converter, precision attenuator and oscilloscope. One low price includes everything but the directional coupler and crystal detectors. All measurements are made over a 60 db dynamic range with either direct db or dbm readout.

Fast measurements with high accuracy. Measure return loss and insertion loss or gain *simultaneously* at fast sweep speed for oscilloscope display. Digital readout for accurate measurements.

Applications notes 101 & 105 tell all. For complete information on the Alfred 8000/7051 Sweep Network Analyzer, please write for Applications Notes 101 and/or 105. Note 101 provides detailed applications data for all measurements, including noise. Note 105 offers information on the use of the analyzer to test microwave transmission systems, including coaxial cable and waveguide runs. Please address Alfred Electronics, 3176 Porter Drive, Palo Alto, California 94304. Phone: 415-326-6496. TWX: 910-373-1765.

ALFRED ELECTRONICS

INFORMATION RETRIEVAL NUMBER 48

Products



High-speed code converters translate 5-to-8-level inputs to any desired output. P. 122

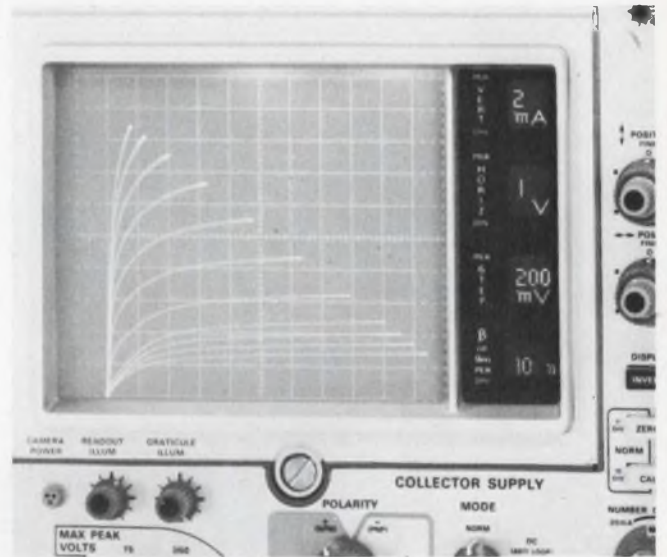

Transistor curve tracer uses fiber optics to display parameter readout directly. P. 110



Reciprocal-taking counter directly measures rf carriers, from 0.125 Hz to 20 MHz. P. 110

Also in this section:

Eight-channel multiplexer converts standard scopes to multiple-trace ones. P. 110

Flip-chip and LID zener diodes dissipate up to 400 mW. P. 116

Modular op amps increase stability with internal varactor bridge. P. 124

Design Aids, P. 140 . . . **Application Notes**, P. 142 . . . **New Literature**, P. 144

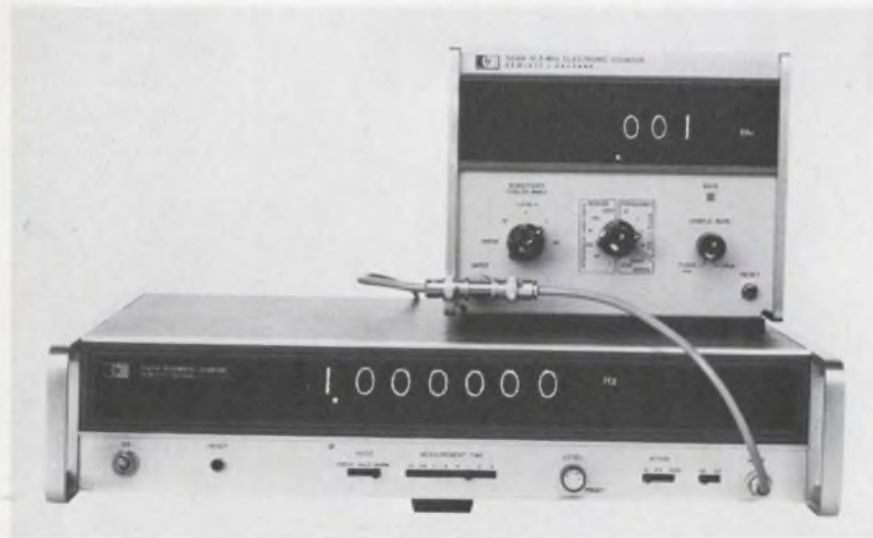

Reciprocal-taking counter reads rf carrier frequency

Hewlett-Packard, 1501 Page Mill Rd., Palo Alto, Calif. Phone: (415) 325-7000. P & A: \$2150; March, 1969.

Measurements from 0.125 Hz to 20 MHz with automatic ranging, plus the capability of measuring the carrier frequency of rf pulses directly, are features of the model 5323A automatic counter. Accuracy of the counter is ± 1 count (neglecting time-base error and noise) over the operating range.

The 5323A is one of the new class of automatic, reciprocal-taking counters, which measure the input-waveform period, calculate the reciprocal of the period and display the result directly in terms of frequency.

Instead of the conventional decade values of measurement time, the 5323A can be operated over its full range with switch-selectable measurement times of 0.01, 0.04, 0.1, 0.2, 0.4, 1, 2 or 4 s. With an externally supplied gate, measurement times can be any value from a few microseconds up to four seconds. Regardless of the measurement time selected, the 5323A automatically fills its 7-digit readout to provide maximum resolution.

A hysteresis feature, built into the range-selection circuitry, stabilizes the readout at range-

change points to reduce readout confusion. Should the selected measurement time be too short to obtain the required accuracy for 7-digit resolution, the counter displays only the significant digits and blanks the others.

Additional features of the new instrument include: the capability of displaying rpm directly; a BCD and print-command output; a buffer storage that holds the BCD output constant while the next measurement is being made. Also included are a hold-off input that inhibits data transfer to buffer storage, when the cycle time is less than required for external interrogation of the BCD output, and programmability of all front-panel controls by means of external circuit closures to ground.

The 5323A uses a time base that is derived from a 10-MHz crystal. A front-panel switch can apply the 10-MHz time base to the counting decades and to the reciprocal-taking circuitry for self-checking.

Input specifications include a decoupled range from 0.125 Hz to 20 MHz and an ac-coupled range of 10 Hz to 20 MHz. Sensitivity is 0.1 V rms for a sine wave and 0.3 V pk-pk for a pulse with a minimum width of 25 ns. Input impedance is 1 M Ω shunted by 35 pF.

CIRCLE NO. 252

Eight-channel device drives standard scope

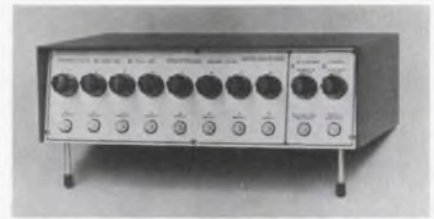

JS Consultants, P.O. Box 5316, Ormond, Calif. Phone: (805) 486-3710. P&A: \$500; 4 to 6 wks.

A new electronic device accepts two to eight signal inputs; each has a gain control that is adjustable from 0 to 100% of input value—for converting a standard single-trace oscilloscope into an eight-trace scope. All traces are adjustable so that they can be positioned on the screen for comparison and phase-checking. Internal sampling rate is 200 kHz, adjustable by $\pm 50\%$, to allow synchronization of input signals that lie close to the sampling frequency.

CIRCLE NO. 253

Transistor curve-tracer has digital readout



Tektronix, Inc., P.O. Box 500, Beaverton, Ore. Phone: (503) 644-0161. P&A: \$2125; 1st quarter, 1969.

Direct parameter readout is offered by type 576 curve tracer. This parameter readout is a fiber-optic digital indicator of the vertical deflection factor, horizontal deflection factor, step generator amplitude, and beta/cm or transconductance/cm. Readout values are automatically corrected for changes in vertical or horizontal magnification and in step amplitude multiplication.

CIRCLE NO. 254

Our new AC Designer Line switches come in an endless variety of colors, sizes and styles.

Sure, we know you'd never order a switch with a painted body. Or a style quite like this.

But our turned-on switch helps demonstrate the customizing possibilities these new Designer Line AC switches offer. The choices just don't quit.

Three types of terminals. In 1-, 2-, 3-, and 4-pole models. With special configurations like momentary-contact and center-off.

As for the lever, pick one to your liking and we'll deliver. Our unique design permits our Distributors to supply a broad array of sizes, shapes and colors. Or have our factory build them to your

own design at a truly modest tooling cost.

Select attractive new decorator nuts, too. Two smart styles, four stock colors. Dozens of other colors on request.

But we're not playing the numbers game. Just giving you unmatched flexibility to design our new AC switches into your products. Plus capacities from low-power dry circuits up to 25 amps, and Cutler-Hammer quality you know and expect.

Write for Brochure LA-136-Y217, or call your Cutler-Hammer Sales Office or Stocking Distributor. Even our off-the-shelf delivery will turn you on.



These are the building blocks that provide new flexibility in designing with Cutler-Hammer AC Designer Line Switches.

The switched-on switch



Switch
to No. 1

More than just switches:
prompt availability,
field help, innovation,
quality assurance too.

INFORMATION RETRIEVAL NUMBER 49



CUTLER-HAMMER
Milwaukee, Wisconsin 53201

Digital panel meter shrinks its size



Analogic Co., 296 Newton St., Waltham, Mass. Phone: (617) 891-4708. Price: \$199.50.

Series AN2500 digital panel meters occupy approximately one-half the space of competitive units and offer superior accuracy specifications. The basic AN2510-1B offers non-blink 1/2-in. display of three digits, plus overrange and automatic polarity. Self-contained in a behind-panel case that is only 2 by 3-1/2 by 2-3/4-in. deep, the unit's small size permits it to be directly substituted for conventional moving-pointer meters.

CIRCLE NO. 255

Three-inch scope saves shelf space

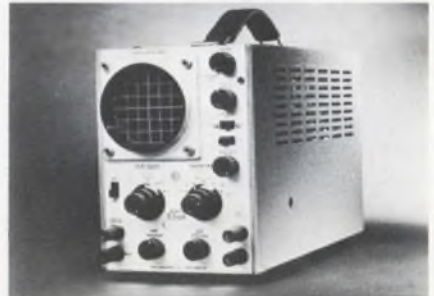

Data Instruments Div., 7300 Crescent Blvd., Pennsauken, N.J. Price: \$128.

A low-cost miniature oscilloscope with a 3-in. CRT, measures only 5-1/2 by 7-1/2 by 14 in. Model 536A is intended for applications where panel and shelf space are critical. Sensitivity is better than 20 mV/cm over a 1.5-MHz bandwidth and a 4-by-6-cm display area. Amplifiers are solid-state, multi-stage and dc-coupled and are fully compensated for optimum response.

CIRCLE NO. 256

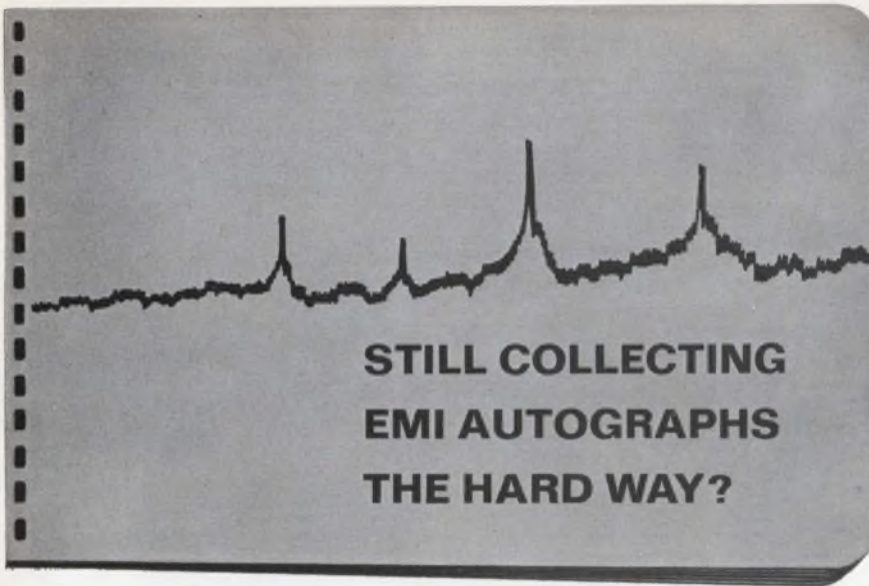

STODDART
MAY SAVE
YOU
THOUSANDS
IN 1968!

If you're still using manual tuning to make spectrum signature recordings, you're throwing away dollars...by the hatful.

How many? The do-it-yourself arithmetic is simple:

- 1) Enter here your estimate of 1968 hours required to make complete spectrum signature recordings with your present tune-by-hand EMI meter hrs.
- 2) Estimate the time you'll save by converting to semi-automatic operation* (often up to 50%, but do be conservative) hrs.
- 3) Subtract to obtain hours saved hrs.
- 4) Enter your cost per hour (industry standard is \$25/hr.) \$
- 5) Multiply your cost per hour by the hours saved: Your gross saving \$
- 6) Subtract the modest cost of a Model APC-10B Auto-Plot Controller -2,500
- 7) Your net 1968 saving \$

*THE APC-10B

AUTO-PLOT CONTROLLER converts your manual EMI meter to semi-automatic operation in making radiated and conducted interference tests per MIL-STD-826B. Just connect the APC-10B to your EMI meter and X-Y plotter... you get a permanent record of signal amplitude vs. frequency in approximately 1 minute per band. Completely eliminates manual tuning, recording and plotting, as well as individual slide-back peak readings for transients. **No chance of operator error, either.**



If you'd like to save \$\$ in 1968 (and every year thereafter) get in touch with us today!

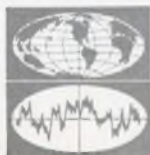

STODDART
ELECTRO SYSTEMS

A Division of Tamar Electronics, Inc.
2045 West Rosecrans Avenue · Gardena, California 90249
Phone (213) 770-0270

INFORMATION RETRIEVAL NUMBER 50

Performs more tests with no adjustments than any other IC or discrete op amp tester

Philbrick/Nexus Model 5102 Integrated Circuit Tester performs all tests automatically without calibration or manual programming. The only time you touch a dial is to select the desired test and for a minimum of scale changing for offset voltage and current measurements. Everything else is automatic, including offset zeroing. What's more, it is the only tester that performs CMRR and PSRR tests.

For only \$1400 you get all these additional features in a single instrument: direct reading meter displaying values of all parameters including large signal DC gain, external terminals for displaying IC output, selection of output resistors to match load, oscillation indicator, internal supply of ± 15 VDC programmable for ± 6 VDC — plus many more features. Contact your Philbrick/Nexus sales representative for complete details and specifications. Or write Philbrick/Nexus Research, 46 Allied Drive at Route 128, Dedham, Mass. 02026.



PHILBRICK/NEXUS RESEARCH

A TELEDYNE COMPANY



INFORMATION RETRIEVAL NUMBER 51



when you think
**HIGH
VOLTAGE**
think
**KEPCO
Hybrid**

The Kepco hybrid technique for taming high voltage uses high voltage tubes in high voltage control circuits and low voltage transistors in small signal gain circuits. A natural division of labor that places no undue strain on any component — the secret of high reliability.



Model HB 4AM — \$365.00

We also get reliability by using hermetically sealed metal can TO-5 transistors plugged into nylon sockets, on coated glass epoxy plug-in circuit boards. Filter capacitors are all high temperature aluminum types; rectifiers are of silicon and all wiring is harnessed. HB models are available from 0–250 volts at 1 ampere to 0–525 volts at a half amp. All have built-in coarse/fine voltage controls and are, additionally, programmable.

For complete specifications,
write Dept. AS-5

with **KEPCO**
IT'S CONTROL!



131-38 SANFORD AVE. • FLUSHING, N.Y. 11352
(212) 461-7000 • TWX # 710-582-2631

INFORMATION RETRIEVAL NUMBER 52

INSTRUMENTATION

**Transistor tester
handles FETs, too**



Sencore, Inc., 426 Westgate, Addison, Ill. Phone: (312) 543-7740. Price: \$129.50.

A combination FET-and-transistor tester, the TF151, is the first instrument on the market that tests both transistors and FETs. Flip the large function-control knob to the left and the tester is a regular in- and out-of-circuit transistor tester; flip the knob to the right and the tester becomes an in- or out-of-circuit tester for field-effect transistors. It also tests enhancement-type FETs.

CIRCLE NO. 257

**Digital voltmeter
spans four decades**



Dana Laboratories, Inc., 2401 Campus Dr., Irvine, Calif. Phone: (714) 833-1234. Price: \$1395.

Model 4430/212 digital voltmeter is capable of autoranging over a span from ± 100 mV to ± 1000 V full scale. Resolution on the lowest range is $10 \mu\text{V}$ per digit, for a dynamic range of 100,000,000:1. A four-digit instrument with fifth-digit overrange, the unit's accuracy is $\pm 0.01\%$ of reading at $\pm 0.01\%$ of full scale. A built-in filter rejects superimposed noise by a factor of 1000:1 at power-line frequencies.

CIRCLE NO. 258

**Low-cost instrument
has sine/square out**



Heath Co., Benton Harbor, Mich. Phone: (616) 983-3961. P&A: \$99.50 (\$67.50 kit); 30 days.

Sine or square waves at frequencies variable between 1 Hz and 100 kHz are provided by the low-priced IG-18 generator that offers features usually found only on more costly instruments. Sine-wave output can be varied between 0.003 and 10 V rms; square-wave amplitude is switch-selected between 0.1, 1.0 and 10 V. Distortion in the sine-wave output is less than 0.1% within the audio range. Square-wave rise time is less than 50 ns.

CIRCLE NO. 259

**Handheld test probe
checks logic circuits**

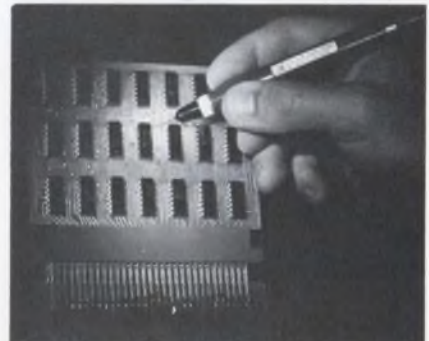

Hewlett-Packard Co., 1501 Page Mill Rd., Palo Alto, Calif. Phone: (415) 326-7000. P&A: \$95; December.

A handheld probe checks the performance of logic circuits; it shows when pulses occur, and indicates whether logic levels are in high or low states. Logic-level indication is given by a light near the probe tip. Model 10525A operates automatically; triggering or threshold adjustments are not required. Threshold level is +1.4 V. Above this level, the light is on; below it, the light is off.

CIRCLE NO. 260



Allen-Bradley's experience in resistor production reaches...

to the
moon
and
back!



TYPE BB 1/8 WATT



TYPE EB 1/2 WATT



TYPE HB 2 WATTS



TYPE CB 1/4 WATT



TYPE GB 1 WATT

A-B hot-molded fixed resistors are available in all standard resistance values and tolerances, plus values above and below standard limits. A-B hot-molded resistors meet or exceed all applicable military specifications including the new Established Reliability Specification at the S level. Shown actual size.

After more than three decades and untold billions of hot-molded resistors, Allen-Bradley has accumulated manufacturing "know-how" which cannot be approached by anyone else. The fact that the resistors made by A-B over the years—if placed side by side—would more than reach to the moon and back, may be impressive. But "how" they are made is the key.

Allen-Bradley resistors are produced by an exclusive hot-molding technique—developed by A-B. They're made by completely automatic machines—also developed, built, and used only by Allen-Bradley. The human element of error is removed. Uniformity is so precise from one resistor to the next—year in and year out—that long-term resistor performance can be closely predicted.

And there has been no known incident of catastrophic failure of an A-B hot-molded resistor.

The reputation for quality and performance established by Allen-Bradley hot-molded resistors is reflected in the fact that they have been an integral part of virtually every U.S. space probe. And they are "on" the moon. No other resistor applications demand a higher measure of reliability.

For detailed specifications on this superior line of hot-molded resistors, please write Henry G. Rosenkranz and request a copy of Technical Bulletin 5000: Allen-Bradley Co., 1201 South Second Street, Milwaukee, Wisconsin 53204. Export Office: 630 Third Ave., New York, N.Y., U.S.A. 10017. In Canada: Allen-Bradley Canada Limited.

EC 6815

QUALITY ELECTRONIC COMPONENTS



ALLEN-BRADLEY

Unijunction transistor operates at 4 V

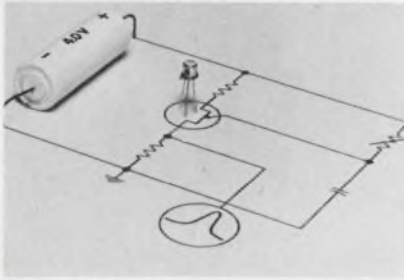

Motorola Semiconductor Products Inc., P.O. Box 20924, Phoenix, Ariz. Phone: (602) 273-8466. Price \$3.25.

Characterized for operation on source voltages (V_{BB}) as low as 4 V, the 2N5431 UJT is fabricated by a surface-passivated, all-diffused process. One advantage is the device's low emitter-leakage current, of only 20 nA maximum.

CIRCLE NO. 261

Chip zeners take 400 mW



Components, Inc., Semcor Div., 3540 W. Osborn Rd., Phoenix. Phone: (602) 272-7671. P&A: \$3 or \$3.95; stock.

Satisfying the packaging demands of thick-film and thin-film circuits, as well as of monolithic ICs, 400-mW zener diodes are now available in flip-chip and LID configurations. They cover a zener-voltage range of 6.8 to 33 V. The flip-chip unit, which is only 0.027-in. square, has a completely passivated junction. The LID unit, which measures 0.04 by 0.075 in., uses a die that is mounted in a ceramic package and then coated.

CIRCLE NO. 262

When reliability is the rule

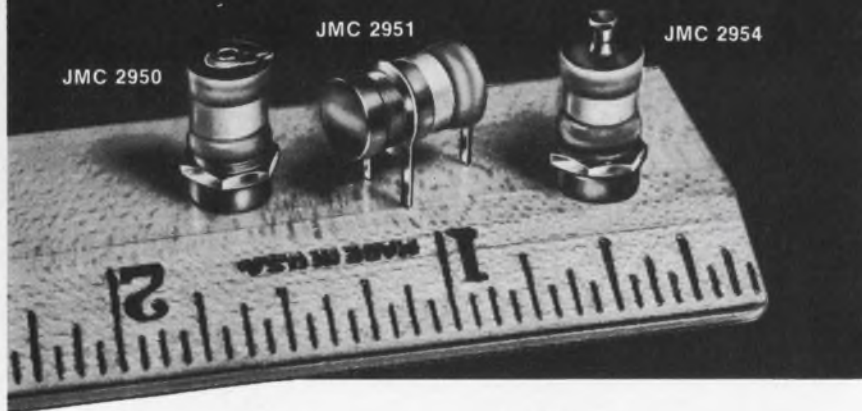

... specify *Johanson*

HIGH Q, HIGH FREQUENCY VARIABLE AIR CAPACITORS

This versatile series provides, in miniature size, exceptionally high Q, superior ruggedness for protection against shock and vibration, -55° to $+125^{\circ}\text{C}$ operating temperature range, protection against fungus, salt spray and humidity... plus all the other construction and performance features that have made Johanson capacitors the industry standard for excellence.

Specifications

Capacitance Range: 0.8 — 10.0 pF
Dielectric Withstanding Voltage:
 Rating 250 VDC breakdown >500 VDC
Insulation Resistance: $>10^6$ megohms @ 500 VDC
Q: >2000 @ 100 mc
Temperature Coefficient: 0 ± 20 ppm/ $^{\circ}\text{C}$
Rotational Life: >800 revolutions

Write Today for Complete Catalog, Prices.

Johanson MANUFACTURING CORPORATION
 400 Rockaway Valley Rd., Boonton, N.J. 07005, (201) 334-2676

Electronic Accuracy Through Mechanical Precision

INFORMATION RETRIEVAL NUMBER 54

Transistor complements match dual amplifiers

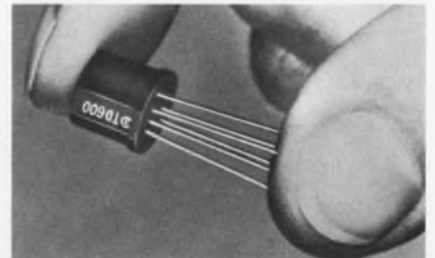

Sprague Electric Co., 347 Marshall St., North Adams, Mass. Phone: (413) 664-4411.

Two new complementary families of dual transistors form precisely matched differential amplifiers. The TD-400 family, which has pnp polarity, matches base-to-emitter voltages within 2.5 mV, tracks within $6 \mu\text{V}/^{\circ}\text{C}$, and provides minimum current gains of 120 at 100 μA . Its complementary counterpart, the TD-600 family, features maximum noise levels of 2 dB and gain-bandwidth products of 200 MHz.

CIRCLE NO. 263

Foxboro engineers select A-B hot molded potentiometers
"Best repeatability—component-to-component
and setting-to-setting"



Foxboro Model 62H electronic controller for process regulation. The control mode adjustments use Allen-Bradley Type J hot molded variable resistors with values of 10, 100, and 200 megohms.

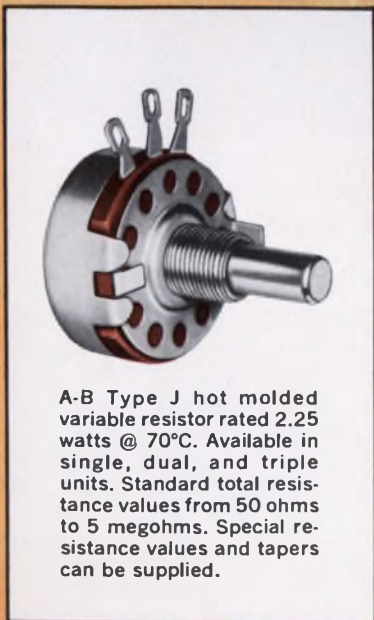

A-B Type J hot molded variable resistor rated 2.25 watts @ 70°C. Available in single, dual, and triple units. Standard total resistance values from 50 ohms to 5 megohms. Special resistance values and tapers can be supplied.

Widely used throughout the process industries, the Foxboro Model 62H Universal Controller is a highly dependable precision instrument. During the years of painstaking development, Allen-Bradley engineers worked closely with Foxboro to provide a potentiometer having unusually high resistance values, which would provide the precise performance required.

Allen-Bradley Type J potentiometers were the answer. They have a solid hot molded resistance track which is produced by an exclusive A-B molding technique that assures extremely long operating life. Accelerated tests—exceeding 100,000 revolutions—show very slight resistance change. Control is smooth at all times with adjustment approaching infinite resolution. There are none of the abrupt turn-to-turn resistance vari-

ations inherent in wirewound controls. Furthermore, Allen-Bradley Type J potentiometers are—for all practical purposes—noninductive, permitting their use throughout the frequency spectrum.

Whether your particular circuit design can be best satisfied with one of the millions of standard Type J variations or whether it calls for unusual resistance characteristics, it will pay you to look first to A-B Type J potentiometers. Their more than 25-year history of providing superior performance is your guarantee of complete satisfaction. For full details, please write for Technical Bulletin 5200: Allen-Bradley Co., 1344 South Second Street, Milwaukee, Wisconsin 53204. In Canada: Allen-Bradley Canada Limited. Export Office: 630 Third Avenue, New York, N. Y., U.S.A. 10017.



ALLEN - BRADLEY
QUALITY ELECTRONIC COMPONENTS



This probe lights up when a pulse goes by.

Even a pulse as short as 30 ns—positive or negative—will cause this logic indicator to flash a signal. You can trace pulses, or test the logic state of TTL or DTL integrated circuits, without taking your eyes off your work. In effect, the probes act like a second oscilloscope at your fingertips.

No adjustments of trigger level, slope or polarity are needed. A lamp in the tip will flash on 0.1 second for a positive pulse, momentarily extinguish for a negative pulse, come on low for a pulse train, burn brightly for a high logic state, and turn off for a low logic state.

The logic probe—with all circuits built into the handpiece—is rugged. Overload protection: -50 to +200 V continuous; 120 V ac for 10 s. Input impedance: 10 k Ω . Price of HP 10525A Logic Probe: \$95, quantity discounts available.

Ask your HP field engineer how you could put this new tool to work in logic circuit design or troubleshooting. Or write Hewlett-Packard, Palo Alto, Calif. 94304; Europe: 54 Route des Acacias, Geneva.

02825A

HEWLETT  PACKARD

INFORMATION RETRIEVAL NUMBER 56

ICs & SEMICONDUCTORS

Semiconductor arrays substitute for relays

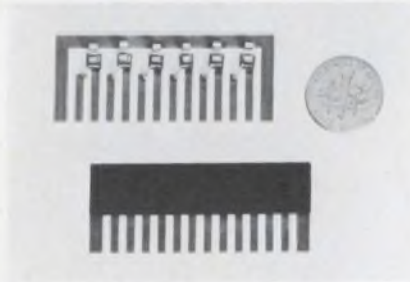

Electronic Control Corp., 1010 Pamela Dr., P.O. Box J, Euless, Tex. Phone: (214) 264-2429.

Employing a new packaging concept, substrate-mounted semiconductors can be used as solid-state replacements for electromechanical relays and in thyristor applications. The new substrate semiconductors contain multiple-chip 1.6-A triacs (with or without triggers) or SCRs in a choice of configurations. These functions may be laid down as single devices or with a common electrode. The substrate can be hand- or flow-soldered.

CIRCLE NO. 264

Fast-firing 80-A SCRs turn on with 100 mA



International Rectifier, Semiconductor Div., 233 Kansas St., El Segundo, Calif. Phone: (213) 678-6281. Price: \$59.50 to \$223.

A series of 80-A fast-firing SCRs (types 81RLA50 through 81RLA120) features the industry's highest available di/dt capability, 800 A/ μ s. These SCRs can be turned on with 100-mA gate drive. They can handle high inrush currents with minimum current surge suppression and minimum drive complexity.

CIRCLE NO. 265

Power transistors switch in 450 ns



Solid State Products, 1 Pingree St., Salem, Mass. Phone: (617) 745-2900.

Two new switching transistors, types 2N5487 and 2N5488, have maximum turnoff times of 450 or 550 ns, respectively, when operating at 1 A. Minimum collector-to-emitter sustaining voltage is 80 or 100 V, minimum current gain is 100 or 40, and maximum collector saturation voltage is 0.25 V.

CIRCLE NO. 266

Dual comparators sink over 5 mA



Transitron Electronic Corp., 168 Albion St., Wakefield, Mass. Phone: (617) 245-4500. Price: \$9.85 to \$20.10.

Supplied as both DIPs and flat-packs, monolithic dual differential comparators meet the sink-current demands of high-speed logic forms. Types TDC 4711 and 5711 have a minimum sink current of 5 mA to directly drive up to four TTL input loads. Because types TDC 6711 and 7711 offer dual independent circuits, they double the sink-current capability. Types TDC 8711 and 9711 combine high sink-currents with independent outputs.

CIRCLE NO. 267

there
is
no
end
to
what you
can do
with Optima
enclosures –
for new
brochures
on consoles
and cases
call or write
OPTIMA –
a product of
Scientific-Atlanta
P.O. Box 13654
Atlanta, Ga. 30324
404 938-2930.



PICK THE TOP TEN!

WIN 2 ROUND-TRIP TICKETS BETWEEN

HERE'S ALL YOU HAVE TO DO Examine the January 4 issue of Electronic Design with extra care. Pick the ten advertisements that you think will be best remembered by your 69,000 fellow engineer-subscribers. List these advertisements (not necessarily in rank order) on the special entry blanks bound in the Jan. 4 issue, and mail to our Contest Editor. Your selections will be measured against the ten ads ranking highest in the "Recall Seen" category of Reader Recall—Electronic Design's method of measuring readership. Remember . . . in making your choices be sure to consider not only your own tastes and interests in the subject matter of each particular advertisement, but also those of the other engineer and engineering manager readers of this magazine. All Electronic Design subscribers may enter the contest (see rules in Jan. 4 issue). Good Luck! If you study the ads with care, you might wake up one morning in Paris!

FIRST PRIZE

Round-trip tickets for two between New York and Paris via AIR FRANCE. You can schedule your flight anytime you wish—stay up to 21 days before returning.

2ND PRIZE

DELUXE HEATHKIT®/THOMAS "PARAMOUNT" TRANSISTOR THEATER ORGAN

19 Organ Voices, 200 Watts Peak Power, Chimes, Color-Glo Key Lights, Rotating Leslie Speaker, Horseshoe-Shaped Console, Plus Many Other Features.

Here is a truly sophisticated organ with a wide variety of deluxe features to give professional playing versatility. Kit comes complete with all parts, step by step assembly instructions, and alignment tools.



Electronic Design 1969



NEW YORK AND PARIS VIA AIR FRANCE!

3RD PRIZE

DELUXE HEATHKIT® "180" COLOR TV WITH CONTEMPORARY WALNUT CABINET

Kit comes complete with all parts including chassis; hi-fi 90° 180 sq. in. rectangular color tube with anti-glare safety glass; 24,000 volt regulated picture power; rare earth phosphors; 27 tube, 10 diode, transistor circuit; automatic color control circuit; gated automatic gain control; extra B+ boost, etc. etc. All critical circuits are pre-wired and tested.



4TH THROUGH 10TH PRIZES

7 BULOVA ACCUTRON® "SPACEVIEW" ELECTRONIC TIMEPIECES

The "Spaceview" is an ideal timepiece for electronic engineers. Its clear-view dial reveals transistorized electronic circuit and tuning fork assembly. Accuracy guarantee is 99.9977% during actual wear on the wrist. Stainless steel case with luminous hands and dots.



PLUS 100 ADDITIONAL PRIZES

"ELECTRONIC DESIGN TECHNIQUES" edited by Edward E. Grazda

Contains a comprehensive collection of over 55 articles from Electronic Design covering almost all areas of interest to electronic design engineers. The articles are grouped in sections considering the use and design aspects of amplifiers, resistor networks, filters, control devices, power supplies, microwave systems, oscillators, and pulse and switching circuits. Hard cover, 312 pages.



TOP TEN CONTEST

WATCH FOR ENTRY BLANKS IN JAN. 4 ISSUE

There's a separate contest for electronic marketers. In addition to the valuable prizes listed at right, if you are a winner in the contest for marketers, and have an ad in the January 4 issue, that ad will receive a free re-run! Complete information, rules, and entry blanks will be bound in the January 4 issue of Electronic Design.

PRIZES—MARKETER CONTEST

1ST PRIZE: Round-trip tickets for two between New York and Paris via Air France.

2ND PRIZE: RCA "Carry-ette" portable 14" color TV set.

3RD PRIZE: Bulova Accutron® "Spaceview" electronic time-piece.

IN JUST

3
DAYS

ACOPIAN WILL SHIP ANY
OF 62,000 DIFFERENT
POWER SUPPLIES

This catalog lists 62,000 models of AC to DC plug-in power supplies available for shipment in just three days. Choose the exact outputs you need. Singles or duals, regulated or unregulated. Write or phone for your free copy.



Name _____
Title _____
Company _____
City _____
State _____ Zip _____



Acopian Corp., Easton, Penna. 18042
Phone: (215) 258-5441

INFORMATION RETRIEVAL NUMBER 58

DATA PROCESSING

Fast code converters deliver any output



Measurement Technology Corp., 7124 Owensmouth Ave., Canoga Park, Calif. Phone: (213) 887-9300.

Designed for use with data processing equipment, a new line of high-speed solid-state code converters translate any 5-, 6-, 7- or 8-level input code to any desired output code. The units will I/O interface between paper-tape or card readers, typewriters, magnetic tape decks, optical readers and computers, in any combination, for one-way or two-way code conversion. Conversion speed is greater than 10,000 codes/s and essentially depends on the speed of I/O devices and voltage levels.

CIRCLE NO. 268

Printing calculators self-check accuracy



Victor Comptometer Corp., Business Machines Group, 3900 N. Rockwell St., Chicago. Phone: (312) 539-8210. Price: \$1775 to \$2375.

High-speed desk-top electronic printing calculators feature the same type of internal accuracy control systems that are usually found only in computers. As problems and solutions are printed out at 60 characters per second in logical arithmetical order, models in this 1500 series internally check the accuracy of their own calculations.

CIRCLE NO. 269

Digitizing camera system converts optical images



Westinghouse Astroelectronics Laboratory, P.O. Box 245, Newbury Park, Calif. Phone: (805) 498-3651.

When focused on any scene, display, image or graphical representation, a data reader camera converts these optical images to precise digital signals by producing a corresponding series of electrical impulses. The camera follows any desired pattern when scanning an image. Scanning commands can be supplied by any digital computer or by the camera's own optional image conversion control unit. The camera and control unit together form a complete optical image-digitizing system.

CIRCLE NO. 270

Digital data modems double line utility



International Communications Corp., Sub. of Milgo, 7620 N.W. 36th Ave., Miami. Phone: (305) 691-1220.

Two new data sets, models 4400/20H and 440/20L, significantly reduce the cost of computer communication by transmitting two separate 2000-bit/s messages at the same time over a single telephone line. Each message stream is transmitted independently, as if two individual phone lines were being used.

CIRCLE NO. 271

How many Mil-Spec counter-timers now provide performance to 3.3 GHz?

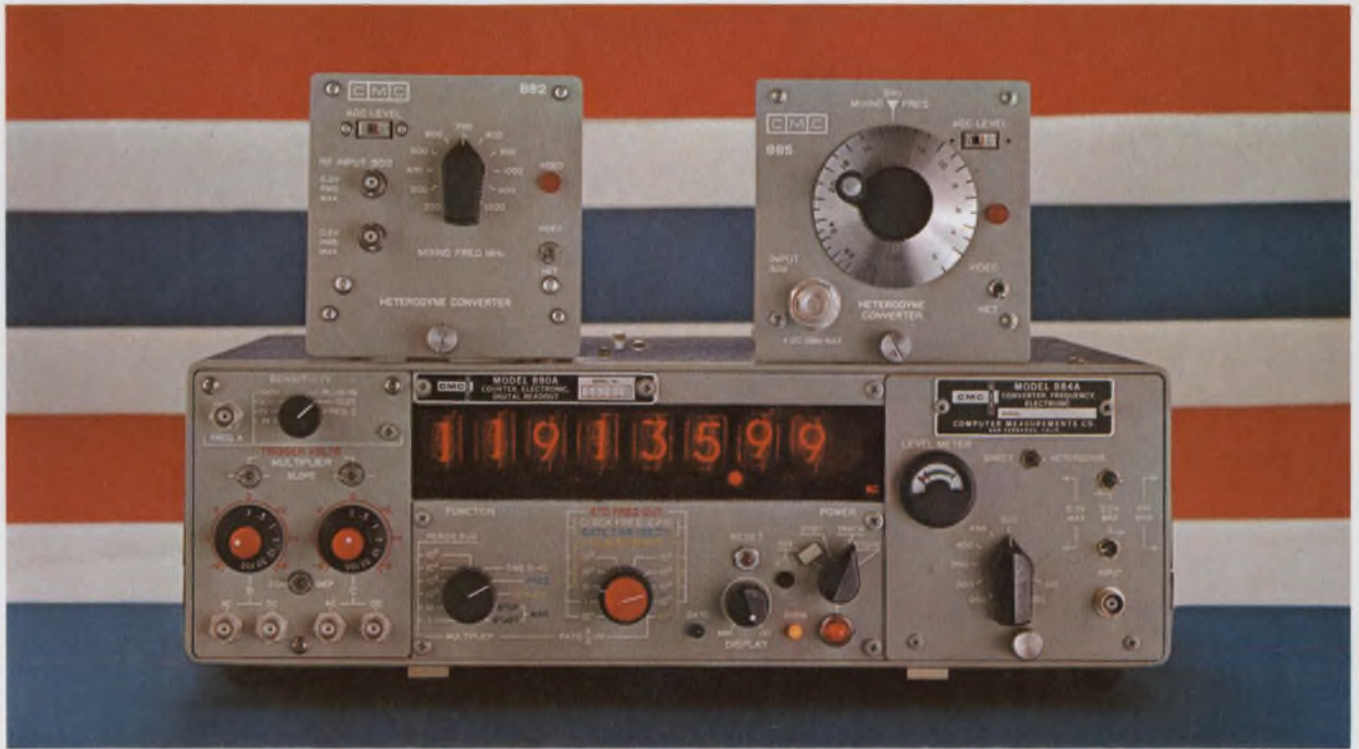

ONE!

And it's the CMC 880 with two new plug-ins!

The CMC Model 880 is the only high-frequency counter-timer commercially available that has been designed, tested, and field-proven to meet all pertinent military specifications.*

This rugged, completely portable instrument, with its drip-proof clip-on cover and valise handle, has already proven itself in the toughest military and industrial applications. And the CMC 884, a companion heterodyne converter, has been right there when needed to boost the 880's 100-MHz direct-counting range up to 555 MHz. So what else is new? Plenty!

Here are two new plug-ins that further set the 880 apart as the only Mil-Spec counter-timer offering performance in the gigahertz range. The Models 882 and 885 Heterodyne Converters will now boost the 880's frequency range to 1.3 GHz and 3.3 GHz respectively, and both feature built-in video amplifiers providing a sensitivity to 10 mV, the use of

all solid-state components, and an accuracy equal to that of the basic counter.

So when you've got a job to do where the going's rough—try the 880. You'll be in good company if you do. And for your copy of CMC's new 12-page Military Counter brochure with complete specifications, circle the reader service card.

**The Model 880 meets all requirements of MIL-E-16400, Shock Spec MIL-S-901, and RFI Spec MIL-I-16910.*



A Division of Pacific Industries

12970 Bradley/San Fernando, Calif. 91342/(213) 367-2161/TWX 910-496-1487

INFORMATION RETRIEVAL NUMBER 59

GLASS ENCLOSED Thermostatic DELAY RELAYS



by
AMPERITE



Offer true
hermetic
sealing —
— assure
maximum
stability
and life!

Delays: 2 to 180 seconds

Actuated by a heater, they operate on A.C., D.C., or Pulsating Current... Being hermetically sealed, they are not affected by altitude, moisture, or climate changes... **SPST only** — normally open or normally closed... Compensated for ambient temperature changes from -55°C . to $+80^{\circ}\text{C}$. Heaters consume approximately 2 W. and may be operated continuously. The units are rugged, explosion-proof, long-lived, and inexpensive!
TYPES: Standard Radio Octal and 9-Pin Miniature... List Price, \$4.00
PROBLEM? Send for Bulletin No. TR-81.

AMPERITE

BALLAST REGULATORS

Hermetically sealed, they are not affected by changes in altitude, ambient temperature (-50°C . to $+70^{\circ}\text{C}$.), or humidity... Rugged, light, compact, most inexpensive.

List Price, \$3.00

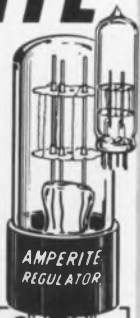

Write for
4-page
Technical
Bulletin
No. AB-51

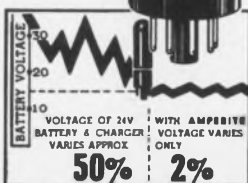

AMPERITE

600 PALISADE AVE., UNION CITY, N.J. 07087
Telephone: 201 UNION 4-9503
In Canada: Atlas Radio Corp., Ltd.,
50 Wingold Ave., Toronto 10

MODULES & SUBASSEMBLIES

Varactor-bridge op amps replace electrometers



Analog Devices, Inc., 221 Fifth St., Cambridge, Mass. Phone: (617) 492-6000. Price: \$125.

Models 310 and 311 varactor-bridge operational amplifiers embody a voltage-controlled capacitor that simultaneously upgrades voltage and current stability. These varactor-bridge op amps match the electrometer tube's current stability and impedance and provide better voltage stability and noise. Models 310B (inverting) and 311B (noninverting) feature $10\ \mu\text{V}/^{\circ}\text{C}$ maximum voltage drift, 10 fA maximum initial bias current, and 1 fA current drift.

CIRCLE NO. 272

Modular rf switch has 50-MHz range



Omega-T Systems, Inc., 516 W. Belt Line Rd., Richardson, Texas.

Modular, expandable, and offering excellent frequency coverage, a solid-state switch is available in any size or configuration using a 1×2 through a 10×10 basic matrix. In the frequency range of dc to 50 MHz, the switch offers minimal crosstalk and maximum isolation—typically 50 dB at 30 MHz. Noise contribution is normally less than $0.1\ \mu\text{V}$ in a 4-kHz bandwidth. VSWR is 1.2 or less.

CIRCLE NO. 273

Solid-state relays isolate contacts

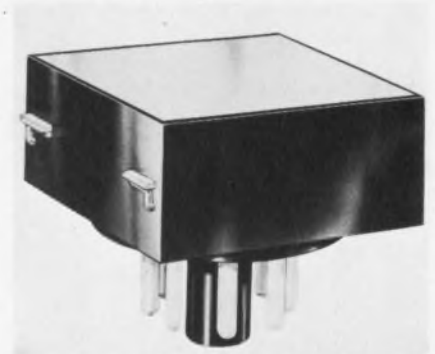

Ohmite Mfg. Co., 3601 W. Howard, Skokie, Ill. Phone: (312) 675-2600. Price: \$15 to \$28.

Closely approximating the contact isolation of electromechanical relays, series SSA solid-state relays offer a predictable threshold voltage for both pull-in and drop-out. They operate on any input voltage within the range of 0 to 140 V ac, or 0 to 200 V dc. The units can withstand momentary current surges that are ten times greater than rated.

CIRCLE NO. 274

Voltage regulator stabilizes 100 V

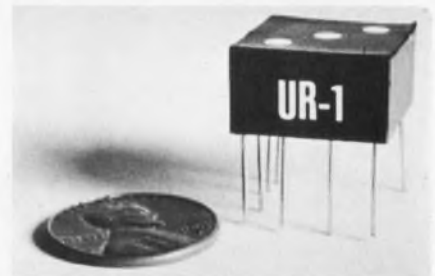

Space Age Microcircuits, P.O. Box 426, Chatham, N.J. Phone: (201) 635-8484. P&A: \$15; stock.

Model UR-1, a miniature hybrid IC, stabilizes unregulated dc voltages ranging from 1 to 100 V. It can be used for very low current applications, as well as currents in excess of 100 A when used with suitable external power transistors. The unit features a regulation of better than 10 mV for zero to full-load changes, 5 mV for input changes of $\pm 10\%$. Noise is less than $200\ \mu\text{V}$ pk-pk, and ripple attenuation is typically 80 dB.

CIRCLE NO. 275



Don't risk it!

This hookup wire was wrapped around a mandrel and heat-aged for 88 hours at its rated temperature. When it was unwrapped, cracks developed and exposed the conductor.

This won't happen with insulation of Du Pont TEFLON* (TFE). At its own high rated temperature (up to 500°F, depending on the specification), TEFLON shows excellent resistance to cracking after much longer periods of heat aging.

That's only one of the reasons we call TEFLON the sure one. Among others: TEFLON is nonflammable. It's inert to virtually all chemicals and corrosives. It resists solder-iron damage. And it provides weight and space savings without sacrificing performance.

In short, when you specify insulation of TEFLON, you minimize risk.

For detailed data on the resistance of TEFLON to thermal stress cracking and other hazards, write Du Pont Company, Room 6670C, Wilmington, Delaware 19898.

*Reg. U.S. Pat. Off. for Du Pont fluorocarbon resins and film.

TEFLON®...the sure one



Better things for better living
...through chemistry



At 12.4 GHz, forget about crosstalk.

This new switch gives 60 db of isolation at 12.4 GHz. You can forget about crosstalk at high frequencies because it's held to an absolute minimum.

Besides excellent isolation across its entire operating range (zero to 12.4 GHz), electrical characteristics are well suited to

high-frequency applications. VSWR at 12.4 GHz is 1.5 max. Insertion loss is only 0.5 db max.

Mechanical characteristics make Amphenol's high-isolation switch easy to use. Switches come with standard N or TNC connectors. They measure a small $2\frac{1}{8}$ " x $2\frac{3}{16}$ " x 1" and can be easily

stacked. Temperature range is from -55° to 85° C. Altitude range goes from zero to 70,000 feet. Shock and vibration performance meets MIL-S-3928B.

For high-isolation, high-frequency switches, talk to Amphenol RF Division, 33 E. Franklin St., Danbury, Conn. 06810.



AMPHENOL
THE BUNKER-RAMO CORPORATION

Active filters span 100 kHz



Washington Technologic Associates, Inc, 979 Rollins Ave., Rockville, Md. Phone: (301) 427-7550.

Negative impedance converter techniques are used to provide a stable, accurate bandpass filter. The resulting circuitry is small and simple, yielding in a less costly and more reliable design. Units are available in frequency ranges from 0.1 Hz to 100 kHz with Q up to 50. Size is less than 1.3 in.³

CIRCLE NO. 276

Battery monitor regulates charge

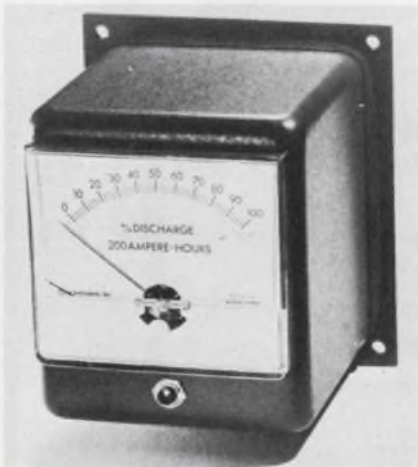

Curtis Instruments, 200 Kisco Ave., Mt. Kisco, N.Y. Phone: (914) 666-2971. Price: \$248.

Specifically designed for monitoring and for controlling the charging of standby battery systems, model 926 provides both direct and remote readout of per cent of discharge. The unit's sensors automatically turn it on when a preset discharge point is reached and shut it off when the battery is recharged.

CIRCLE NO. 277

◀ INFORMATION RETRIEVAL NUMBER 246

A specialty of the house...



cooking up new ideas in electric motors.

Like the GT1612 that runs up to 60,000 rpm on hydrostatic air bearings. Extreme accuracy in locating the beryllium shaft helps make this possible. Other specialties to help you serve up exactly what's needed include induction, hysteresis, torque, synchronous, AC drive, DC drive and servo motors, in the milli- to integral-horsepower range, and without the compromise of run-of-mill

mass-produced motors. For motors for spacecraft, avionics, control, computer peripherals and other systems, contact IMC Magnetics Corp., Eastern Division, 570 Main St., Westbury, N.Y. Phone (516) 334-7070 or TWX 516 333 3319. If you need information for future projects write IMC's Marketing Div., at the same address, or circle the bingo number at the bottom of this ad.



INFORMATION RETRIEVAL NUMBER 61

This is our 3 step. Give us a call and see all the steps in our routine.

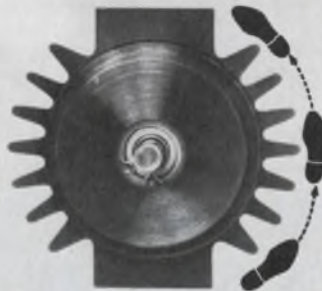

If you really want to swing you can also step 4, 8, 12, 24, 48, and 200 increments without gears.

Or to Indicate, Measure and Control using flag and remote angle indicators, synchros, resolvers, steppers, or solenoids. They are in stock at IMC Magnetics Corp., Western Division. For quick service contact the Applications Section at Western Division, 6058 Walker Ave., Maywood, Calif. 90270. Phone 213 583 4785 or TWX 910 321 3089.

If you need data sheets for references or consideration for future projects, write IMC's Marketing Division at 570 Main Street, Westbury, New York 11591.



INFORMATION RETRIEVAL NUMBER 62

**Desoldering tool
uses tinned braid**

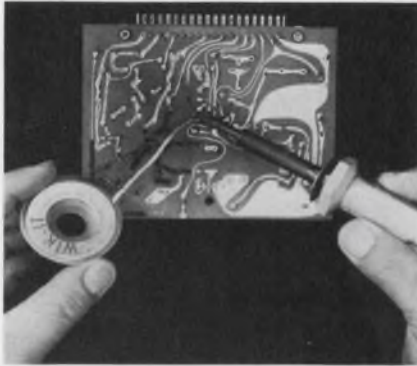

Wik-It Electronics Corp., P.O. Box 414, Fremont, Calif. Phone: (415) 451-7971.

Using a specially treated tinned braid, a desoldering tool quickly draws up solder when heat is applied with an ordinary soldering iron. The unit acts as a heat sink to protect delicate components, and its tinned braid leaves the joint ready to be resoldered. It is available as a service kit and in spool rolls.

CIRCLE NO. 278

**Pocket-sized lubricator
works in any position**



Jonard Industries Corp., Precision Tools Div., 3047 Tibbett Ave., Bronx, N.Y. Phone: (212) 549-7600. Price: \$1.89.

Completely leakproof, a pocket-sized lubricator lubricates in any position, including upward. Using a controlled-flow applicator, model 05-84 dispenses the exact amount of lubricant required and automatically draws back any excess.

CIRCLE NO. 279

**Flexible oven
bags epoxies**



Watlow Electric Co. of Calif., 141 W. Hazel St., Inglewood, Calif. Phone: (213) 672-0050.

Ideal for use on multi-wire connectors, a portable bag-like oven cures potting compounds at accelerated rates, while maintaining heat accuracy to within 10°F. The flexible oven uses a silicone sponge lining for thermal insulation. A drawstring at the top closes the oven, and a thermostat controls the temperature from ambient to 300°F.

CIRCLE NO. 280

A number one company exists in almost every industry. In some fields the identity of the concern is surmised, while in others it is strongly established. The following facts clearly define the position of Andersen Laboratories in the delay line field.

*Speaking
of*

Hz

Andersen designs and develops many more different types of delay devices (including optical and microwave) than any other concern.

Andersen is the only firm producing delay devices for the entire range of frequencies. (DC through 5 GHz.)

Andersen is the sole major manufacturer of delay devices specializing in signal processing systems.

Andersen supplies a substantially greater volume of delay equipment than any other source.

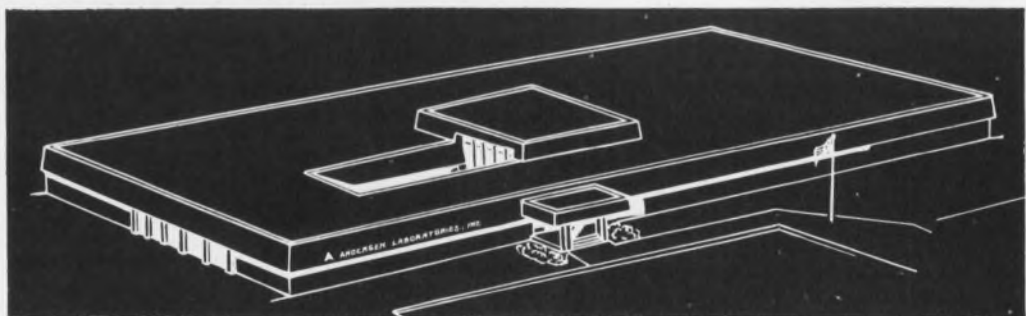

SEND FOR FREE LITERATURE DESCRIBING THEORY OF VARIOUS TYPES OF DELAY DEVICES.

ANDERSEN LABORATORIES, INC.

1280 Blue Hills Avenue

Bloomfield, Conn. 06002



**“We will offer
a total service
from equations to
completely
coordinated
computer
systems.”**

**Charles Russ, V.P. and General Manager,
Inter-Pak Electronics**

■ Inter-Pak Electronics, the newest division of the Litton components group, was formed to fill a widespread need for total control of electronic packaging programs.

■ Right now, we offer a unique service supplying you with complete packaging systems. We'll take your wiring diagrams and lists, program for the wire-wrap machine—make drive deck—assemble hardware, and, using the Accur Frame* packaging concept of molded connector assembly—deliver the whole package. Fast.

■ And we plan to offer much more.

■ We know that computer manufacturers have contracted electronic drive systems piece by piece. Devoted engineering time to design concepts, evaluated individual suppliers, followed up on many delivery promises, and spent large amounts of time and effort in areas peripheral to their basic product.

■ Inter-Pak computer technology will augment the mathematics of new computer design at the initial stage. We're storing in our computers the specifications of all known components to permit automated logic design. We will engineer circuitry and software—program the wire-wrap deck—provide a *total* service.

■ Our job is to lighten the computer manufacturer's engineering and manpower load. And we will do that best by supplying completely coordinated systems. We will, of course, provide any part of the systems spectrum desired.

■ We welcome the opportunity to work with you. For further details, please contact Mr. Charles Russ at Inter-Pak Electronics, 341 N. Maple Drive, Beverly Hills, California 90211. Phone 213-273-7209.

*Patent Pending

INTER-PAK 
A DIVISION OF LITTON INDUSTRIES

"PIXIEPOT"™



**LITTLE
PRICE
BIG
FEATURES**

The biggest little \$3.97 precision
10-turn wirewound pot
in the world!

The Duncan "PIXIEPOT" potentiometer gives you the big features at a little price. It is the one and only precision 10-turn miniature pot for under \$4 that has all these features: ■ Length: ONLY 3/4" ■ Diameter: ONLY 7/8" ■ Linearity: ±0.25% ■ Resistance Range: 100 ohms to 100K ohms ■ Power Rating: 2 watts @ +20°C ■ Temperature Range: -25°C to +85°C ■ Resolution: Better than ANY wirewound pot TWICE its size ■ Slotted Stainless Steel Shaft/C ring ■ Now you can save big dollars on your instrument and system requirements. Specify Model 3253 "PIXIEPOT" for as low as \$3.97 each in production quantities and only \$5.95 each for 1-24 units. In-stock delivery, of course. Call, write or wire Duncan today for complete specifications.

DUNCAN electronics, inc.
A DIVISION OF SYSTRON-DONNER CORPORATION
2865 FAIRVIEW ROAD,
COSTA MESA, CALIFORNIA 92626
Phone: (714) 545-8261

INFORMATION RETRIEVAL NUMBER 65

MICROWAVES & LASERS

MIC chips use thin films

Tek-Wave, Inc., Raymond Rd., Princeton, N.J. Phone: (609) 921-8910.

Load terminations and chip resistors that are fabricated with microwave thin-film techniques are now available for microstrip circuit applications such as isolated combiner/dividers and diode bias networks. The load terminations, which measure 0.075 by 0.025 by 0.025 in., are 50-Ω devices with typical VSWR of 1 to 1.15. The chip resistors, which measure 0.075 by 0.025 by 0.012 in., are mounted in a flip-chip arrangement. Standard resistance values are 50 or 100 Ω, ±1%.

CIRCLE NO. 281

Rf power transistors offer 1 W at 1 GHz

Solitron Devices, Inc., 1177 Blue Heron Blvd., Riviera Beach, Fla. Phone: (305) 848-4311. Availability: stock.

Silicon rf power transistors, types 2N3375, 2N3632, 2N4440, 2N5090 and 2N5108, operate at frequencies from 100 MHz to 1 GHz. Power ratings are from 13.5 W at 175 MHz to 1 W at 1 GHz. The devices are packaged in TO-5 and TO-60 cases. A wide variety of rf power transistors are available in plastic stripline cases as well.

CIRCLE NO. 282

Semi-rigid waveguide can be 500-ft long

Airtron, div. of Litton Industries, 200 E. Hanover Ave., Morris Plains, N.J. Phone: (201) 539-5500.

A semi-rigid field-assembled, continuous waveguide called Ellipta-guide is available in continuous lengths up to 500 feet. It has a frequency band of from 5.925 to 6.425 GHz. Attenuation is less than 1.5 dB per 100 feet. Untuned VSWR is 1.15 max.; tuned, 1.08 max. The patented construction offers high impact-strength.

CIRCLE NO. 283

Three oscilloscopes span 14-GHz range



Tektronix, Inc., P.O. Box 500, Beaverton, Ore. Phone: (503) 644-0161. P&A: \$560 to \$1125; 4 wks.

Three solid-state oscilloscopes are compatible with over 25 plug-in units. These include dc to 15-GHz, 25-ps sampling, 35-ns dual-trace, 10 μV/div differential, and spectrum analyzer capabilities. The 561B oscilloscope, the 564B storage oscilloscope and the 564B with automatic erase all feature 8-by-10-cm cathode-ray tubes, 1-1/2% amplitude and 1% time calibration, and reliable operation with low heat dissipation.

CIRCLE NO. 284

Wideband switches hold VSWR to 1.5

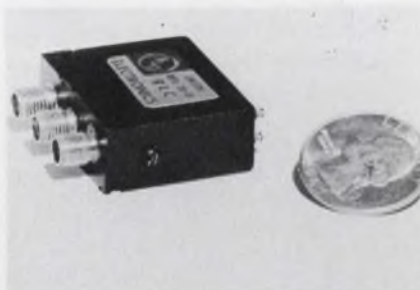

RLC Electronics Inc., 25 Martin Rd., Port Chester, N.Y. Phone: (914) 937-4770. Price: \$125.

From dc to 12.4 GHz, series SRM coaxial switches exhibit a maximum insertion loss of 0.4 dB and a maximum VSWR of 1.5. In addition, they maintain a high isolation of 60 dB minimum over the same frequency range. Rf power rating is 50 W average, and nominal operating voltage is 28 V dc at 200 mA. Over-all volume is less than 0.75 in.³, and weight is 2 oz.

CIRCLE NO. 285

General Electric introduces a faster, more convenient and less costly technique for production line encapsulating and potting. And the RTV's used in the process are as tough as any previously available.

Called the RTV-800 series, the new liquid silicone rubbers do not need a catalyst to activate them, so no premixing is needed.

They cure at temperatures ranging from 200°F to 450°F, so pot life is far longer than is customary with RTV's. A typical deep section cure would be one hour at 300°F. For really rapid cure, components can be preheated and dipped into the RTV.

These three new products are supplied in both opaque and clear grades, with viscosities ranging from very pourable to pourable. They can be blended with one another to suit your particular encapsulating job.

For more information about these new encapsulating RTV silicones (they also make good short-run molding-

materials), write Section 300, Silicone Products Dept., General Electric Company, Waterford, N.Y. 12188.

TYPICAL PROPERTIES

Uncured	RTV-815	RTV-830	RTV-835
Color	Clear	Beige	Beige
Consistency	Easily pourable	Pourable	Easily pourable
Viscosity, cps	3500	200,000	8000
Specific Gravity	1.02	1.28	1.18
Solids, %	100	100	100
Shelf Life, months	4	4	4
Cured, ±1 hr. @ 150°C	RTV-815	RTV-830	RTV-835
Hardness, Shore A durometer	35	50	35
Tensile Strength, psi	700	800	500
Elongation, %	150	250	200
Tear Strength, lb/in.	15	100	20

GENERAL  ELECTRIC

Now. Heat-curing,
no-mixing, high-strength
RTV silicones.

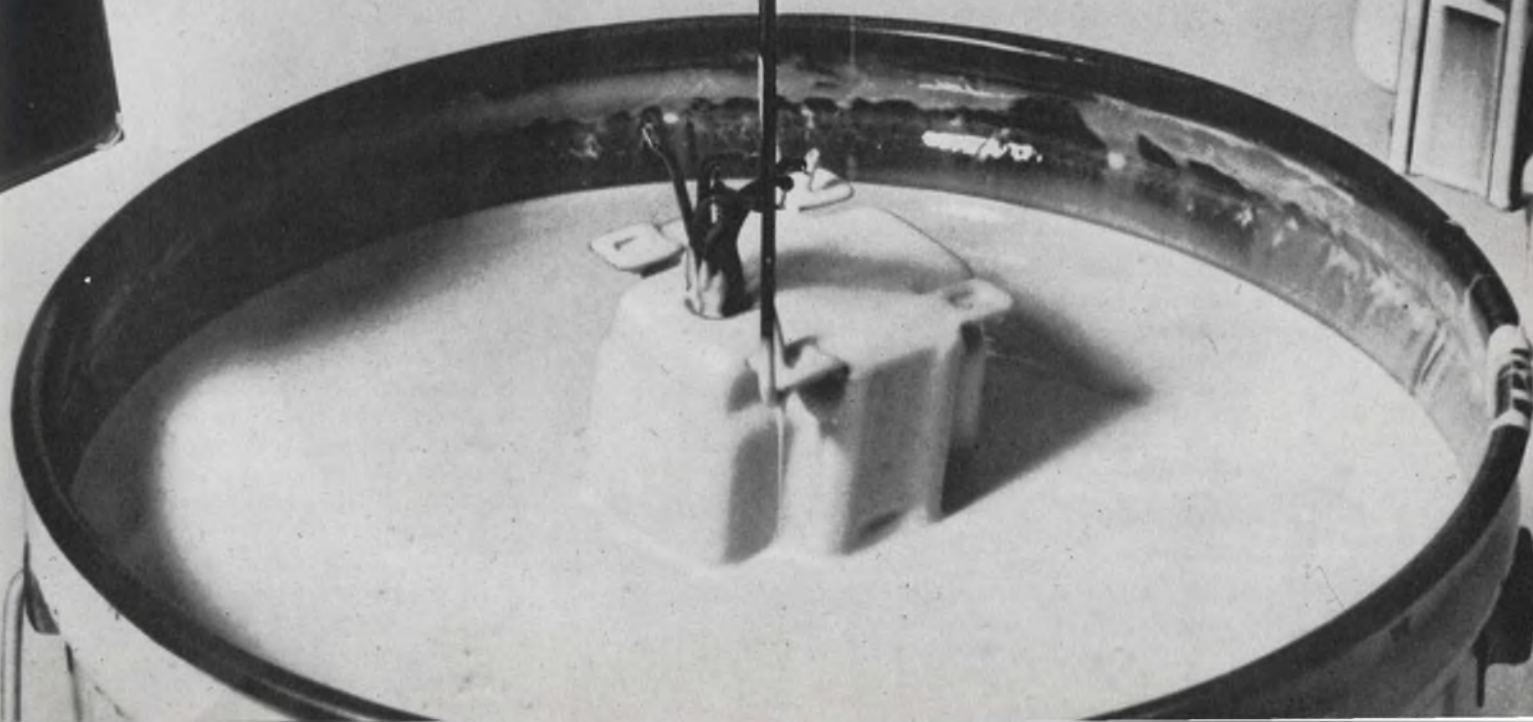

Solid-state attenuators have flat response



Hyletronics Corp., Ainsworth Rd., Wilmington, Mass. Phone: (617) 272-0670.

Octave-bandwidth diode variable attenuators cover the frequency range from 0.5 to 11 GHz. Insertion loss at zero bias is 0.8 dB from 0.5 to 7 GHz, and 1 dB from 7 to 11 GHz. Full attenuation is over 80 dB for frequencies below 4 GHz.

CIRCLE NO. 286

Rf signal generator sweeps four bands



Servo Corp. of America, 111 New South Rd., Hicksville, N.Y. Phone: (516) 938-9700.

Completely self-contained, a four-band microwave swept signal generator supplies rf signals for any or all frequency segments in the 1-to-12.4-GHz range. Model 404 automatically and continuously sweeps through the four bands of L, S, C and X. The multi-band rf signals are available at a single output connector. Rapid band switching allows four-band sweep to be completed in 100 ms.

CIRCLE NO. 287

Can you

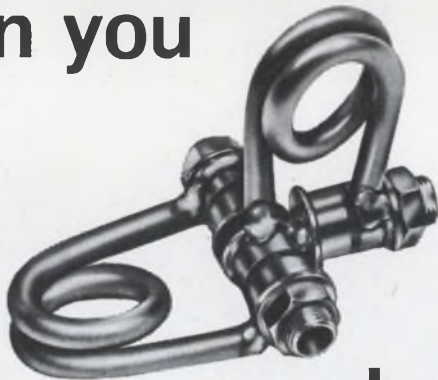

do this?

These new Johanson glass *capacitors* are designed to bridge the gap between conventional trimmers and high frequency air capacitors. They have high Q—low inductance; they have high RF current characteristics, they can be soldered together with components to simplify circuitry and they are *strong*.

Models include:



Series II: High RF voltage low cost units with $Q > 1200$ and TC; 0 ± 50 ppm.

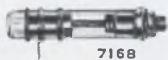

Johanson 7168: High voltage quartz capacitors which feature 7000 VDC; 2500 V peak RF at 30 mc and current capacity > 2 amps.

Also available are:

- Tuners and ganged tuners; linear within $\pm 3\%$
- Differential capacitors
- Mil spec capacitors
- Microminiature capacitors .075" diameter and .1-1 pf

Write today for full catalog.

Johanson MANUFACTURING CORPORATION

400 Rockaway Valley Road, Boonton, N. J. 07005 (201) 334-2676

Electronic Accuracy Through Mechanical Precision
INFORMATION RETRIEVAL NUMBER 67

Coax diode switches span 1 to 18 GHz



Hewlett-Packard, 1501 Page Mill Rd., Palo Alto, Calif. Phone: (415) 326-7000. P&A: \$200; 6 wks.

Microwave diode switches, at any octave range between 1 and 18 GHz, select attenuation levels of 40, 60, or 80 dB max. Assembled from off-the-shelf parts, the switches can be quickly tailored to meet particular requirements at low cost. The switches are p-i-n diode reflective types in an spst configuration. They are useful as attenuators, levelers, pulse modulators, T-R switches, and in other low-power microwave applications.

CIRCLE NO. 288

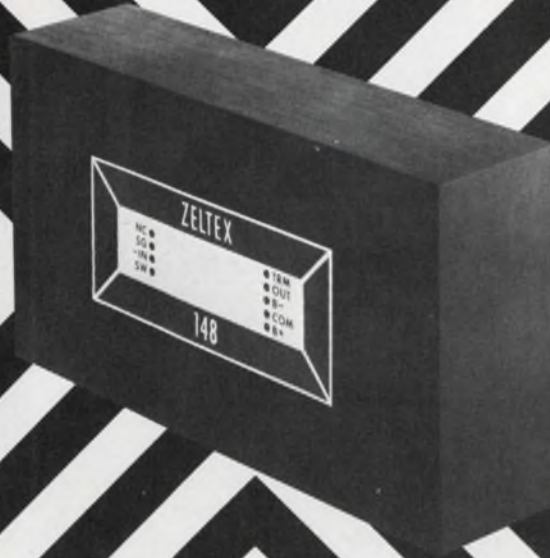

**If You Think The New Zeltek Model 148 'Op Amp' Is Expensive,
 (((((((((You're In For A Shock))))))))))**

**This Chopper-Stabilized
 Amplifier Costs Only...**

\$58

Model 148 has greater gain and is faster than anything comparable. Take a look at the next best thing.

	Model 148	Brand X
DC Voltage Gain, Minimum	10 ⁸	10 ⁷
Gain Bandwidth	1 MHz	500 kHz
Input Bias Current, Maximum	50 pA	100 pA
Full Output Frequency, Minimum	100 kHz	3 kHz
Input Voltage Drift	0.5 μ V/ $^{\circ}$ C	0.5 μ V/ $^{\circ}$ C
Slew Rate	6 V/ μ s	0.2 V/ μ s
Temperature Range	-25 $^{\circ}$ to 85 $^{\circ}$ C	10 $^{\circ}$ C to 60 $^{\circ}$ C
Price (10-24)	\$58.00	\$84.00

Ask for more information today, or better yet, order several for evaluation. You really will be shocked at how fast we ship them.

■ 1000 Chalomar Rd., Concord, Calif. 94520. Phone (415) 686-6660.



A REDCOR CORP. Subsidiary

Dual-in-line socket accepts 28 pins

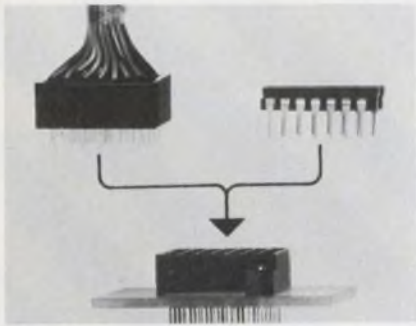

SAE Advanced Packaging, 1357 Edinger Ave., Santa Ana, Calif. Phone: (213) 849-5000. P&A: \$1.82; stock.

A multipurpose receptacle mounts on a metal (wire-wrap) plate or printed-circuit board. The receptacle has 28 beryllium spring sockets that mate with either a dual-in-line flatpack or a male plug. Input/output is provided through the receptacle or by a module with 0.02-in. diameter pins.

CIRCLE NO. 289

Clear acrylic spray halts corrosion



Sprayon Products, Inc., 26300 Fargo Ave., Bedford Heights, Ohio.

A high degree of rust and corrosion protection for critical circuit components is offered by a clear acrylic spray. It dries quickly to form a flexible film that seals and waterproofs the treated area. Sprayon 2000 is one of a line of Aerosols for Electronics that are sold locally by both electronic supply and industrial distributors.

CIRCLE NO. 290

Woven ribbon-cable has 102 conductors

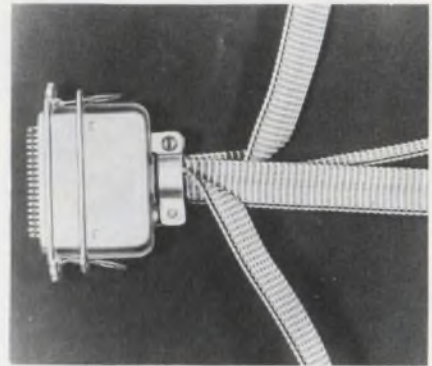

Zippertubing Co., 13000 S. Broadway, Los Angeles. Phone: (213) 321-3901.

Versatile ribbon-cable supplies a broad range of design capabilities due to a loom-weaving production process. The flexible cable is flat, lightweight and economical. As many as 102 conductors of any type can be woven; they may be shielded, unshielded or both. Twisted pairs are also available.

CIRCLE NO. 291

POWER/MATE CORP.

UNI-88

UNIVERSAL POWER SUPPLY

- * 0 to 34 volts at 1.5 AMPS.
- * .005% Regulation
- * 250 Microvolts ripple
- * Meets MIL-E-5272 specs
- * 100,000 hours MTBF
- * 5 year warranty

\$99.00

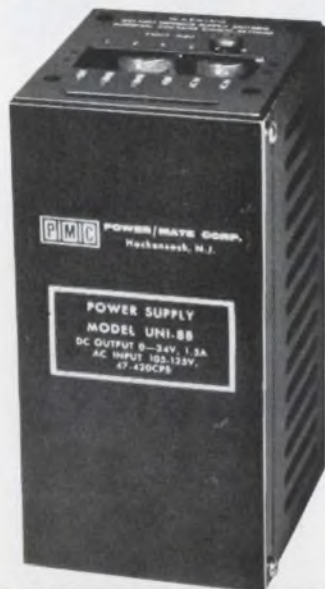

SAME DAY SHIPMENT



POWER/MATE CORPORATION
163 Clay St. ■ Hackensack, N. J. 07601
(201) 343-6294 ■ TWX (710) 990-5023

INFORMATION RETRIEVAL NUMBER 69



Indicating Devices

Whether your application is industrial or military, you can now choose the indicating devices you need from a complete line offered by The A. W. Haydon Company:

- Microminiature "BITE" (Built-In-Test-Equipment) indicators to monitor circuit or system performance to meet DOD Systems Readiness Requirements.
- Elapsed Time Indicators — microminiature, subminiature, and standard sizes, both reset and nonreset types.
- Microminiature Events Counters, reset and nonreset types.
- Laboratory Stop Clocks for bench use or panel mount, 50 or 60 Hz
- Military Stop Clocks AC and DC, sweep-scale or digital readouts.

Special problems are welcome — send for data now!



232 North Elm Street
Waterbury, Conn. 06720
4060 Ince Boulevard
Culver City, Calif. 90231

Timing & Stepper Motors • Electromechanical & Electronic Timing Devices & Systems REPRESENTATIVES THROUGHOUT THE U.S. (SEE EEM) • IN EUROPE CONTACT POLY MOTOR, BRUSSELS.

INFORMATION RETRIEVAL NUMBER 70

THE PROBLEM-SOLVING BOOKSHELF

FUNDAMENTALS OF INTEGRATED CIRCUITS

Lothar Stern

A practical guide to integrated circuits — their theory, manufacture and applications. This book offers complete discussion of the various techniques of integrated circuit fabrication and their strong influence on circuit design and performance. From a marketing viewpoint, it compares the relative qualities of the numerous IC's devised to date in terms of economics and logistics.

The book covers basic semiconductor principles, monolithic integrated circuits, thin-film circuits and their characteristics, hybrid and other integrated structures. There is also discussion of packaging, design and layout principles, and LSI. A volume in the Motorola Series in Solid-State Electronics. 208 pages, 7 x 10, illustrated, cloth cover.
#5695 \$8.95

PROJECT ESTIMATING BY ENGINEERING METHODS

Paul F. Gallagher.

A practical approach to attaining consistently accurate estimates by summarizing many general practices and introducing specific methods proven valuable in various kinds of work. Five methods of estimating are discussed, the fifth of which combines the two most important developments in the field: standard hours and the learning curve. To insure complete understanding, full coverage is given to construction and use of learning curves. Nearly 100 pages of learning curve tables appear in the appendix. 344 pages, 8½ x 11, illustrated, cloth cover.

#5018 \$15.00

TRANSISTOR CIRCUITS IN ELECTRONICS

S. S. Hakim and R. Barrett.

This indispensable sourcebook introduces the working principles of transistors in both amplifiers and oscillators, and linear and switching circuits. The book begins by discussing transistor characteristics and the functions performed by various types, then goes on to consider the transistor as a switch and to discuss regenerative switching circuits. In addition, the book shows how Boolean Algebra, the algebra of sets and binary arithmetic are applied in the study of computer and other logical circuits. 341 pages, 6 x 9, illustrated, cloth cover.

#5034 \$9.50

MICROPHONES A. E. Robertson.

Intended for the user rather than the designer, this book concentrates on principles of operation of different kinds of microphones. The author describes microphones when they illustrate an important feature or have historical significance only, and omits much of the mathematics not necessary for the user. An ideal book for technicians and users of quality microphones for broadcasting, public address systems, and recording. 359 pages, 6 x 9, illustrated, cloth cover.
#5528 \$12.75

LEVEL-HEADED LETTERS

Dr. Dugan Laird and Joseph R. Hayes.

Will help the executive to write better letters, faster. In practical, down-to-earth style, this book shows how to find the real reasons for writing; provides a simple plan for organizing ideas logically and psychologically, and points out ways to get affirmative responses from readers. Shows how to avoid cliches, verbiage and how to inject an air of informality into letters. Key feature is the programmed learning section on painless grammar. 134 pages, 6 x 9.

Paper cover, #5032 \$3.50
Cloth cover, #5033 \$4.95

THEORY AND APPLICATIONS OF TOPOLOGICAL AND MATRIX METHODS

Keats A. Pullen.

The dependence of electrical circuit theory on topology (theory of line graphs) is of growing importance because line graphs for networks represent their flow patterns. Application of topological methods has lagged behind the use of matrix methods only because of minor application problems. This volume resolves these problems in a logical and understandable way. 100 pages, 5½ x 8½, paper cover.
#0300 \$2.50

DESIGN OF LOW-NOISE TRANSISTOR INPUT CIRCUITS

William A. Rheinfelder.

Design engineers and others interested in low-noise circuit design will find this book a real time saver. Gives a multitude of labor saving graphs and design curves for the practical circuit designer. Simple derivations of all important formulas help the reader obtain a deeper insight into the fundamentals of practical low-noise design. 128 pages, 6 x 9, illustrated, cloth cover.

#5014 \$5.50

THE ELECTRON THEORY IN ELECTRONICS: Modern Scientific Concepts for Electronic Engineers

M. G. Scroggie.

Deals with the revolutionary physical concepts of the 20th century from the viewpoint of the electronics engineer, whose approach is different from that of the mathematical physicist who developed the concepts. The entire development of these vital concepts is expressed in terms and symbols familiar to the engineer. 276 pages, 5½ x 8¾, illustrated, cloth cover.

#5707 \$9.95

UNDERSTANDING SILICON CONTROLLED RECTIFIERS

Saul Heller

A compact, illustrated guide to the capabilities and operation of the versatile SCR and the triggering circuits associated with these devices. Throughout the book, schematic diagrams illustrate the application of the various SCR's as static switches, phase-control switches, inverters, choppers, etc. Emphasis is placed on choosing the right SCR to do a given job. 134 pages, 5¾ x 8¼, illustrated, paper cover.

#0782 \$3.50

INDUSTRIAL STROBOSCOPY

Gilbert Kivenson.

A comprehensive description of the history, development and use of stroboscopy in industry, commerce and research. Stroboscopy for analysis and measurement has spread to many specialized areas of science and engineering, such as high-speed cinematography, photometry, radiometry, torsional vibration and other areas. This book discusses the state of the art today and areas of further usage. 284 pages, 6 x 9, illustrated, cloth cover.

#5045 \$9.95

UNITS OF MEASUREMENT OF PHYSICAL QUANTITIES

A. G. Chertov.

In a classic treatment, this volume provides a comprehensive introduction to the world's major systems of physical measurement. The author describes, analyzes and interrelates the wide range of quantitative measuring systems. Precise tables, constants, conversions — everything necessary to the user — are given for each system. The scope and detail of this book meets a vital reference need for the engineer, chemist and physicist. 165 pages, 6 x 9, illustrated.

Paper cover, #5025 \$2.95
Cloth cover, #5026 \$4.75

REVIEW ANY OF THESE BOOKS FOR 10 FULL DAYS — FREE!

HAYDEN BOOK COMPANY, INC. Dept. ED-268, 116 W. 14 St., N. Y., N. Y. 10011

Please send me the books circled below, on a 10-day free examination. At the end of that time I will remit payment, plus postage, or return the books without obligation.

0782	5528	5707
5695	5032	5018
5034	5033	5045
	0300	5025
	5014	5026

- Payment enclosed (Hayden pays postage). Same return privilege.
 Please send me a copy of your free 1968 catalog.

Name _____

Firm _____

Address _____

City _____ State _____ Zip _____

On all overseas orders, payment in U.S. dollars must be enclosed. Publisher pays postage with same return privilege.

HOT RODS!

**SPEED PRODUCTION WITH
BARNES MSI/LSI FLAT-PACK
CARRIERS/CONTACTORS
AND SOCKETS**

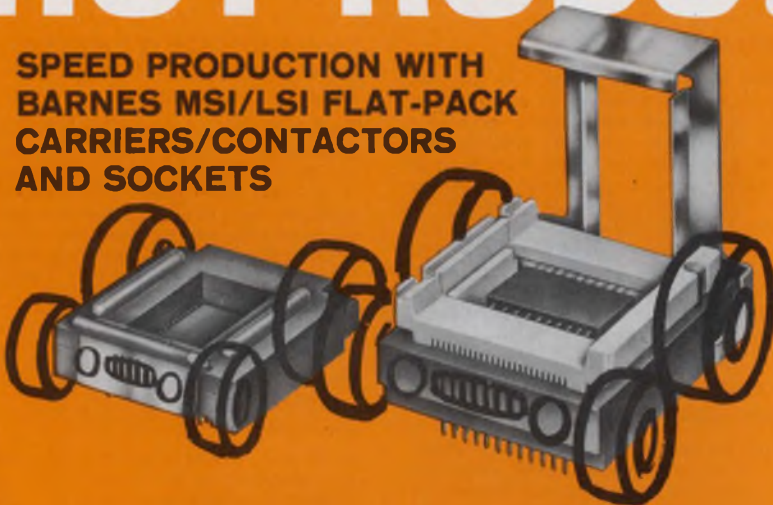

I.C. production bogged down? Barnes Hot Rods keep it moving at top speed. The 039 Series Carriers protect flat-packs through handling, environmental and ambient testing, branding and shipping . . . increasing speed and yields in every process step by eliminating handling damage. MD-100 Sockets and 039 Series Contactors feature fast one-hand loading and unloading—for individual devices or those in carriers. Write or call collect for details on the Hot Rods.

barnes
CORPORATION

Lansdowne, Pa. 19050 • 215/MA2-1525

barnes / THE FIRST WORD IN CARRIERS, CONTACTORS AND SOCKETS FOR I.C.'S

INFORMATION RETRIEVAL NUMBER 72

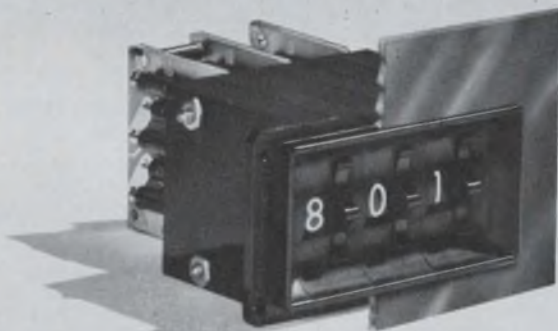

precise potentiometer

Dial the exact voltage or resistance setting you need. With Digidecades and Digividiers it takes less time than you needed to read this sentence. If you want to repeat a previous setting, it's yours. For example: an error-free change from 10 ohms to 910 ohms is made with one flick of a finger rather than cranking a knob 360° several times. High reliability combines with low contact resistance thanks to redundant, non-oxidizing contacts. And contact resistance is very stable.

Digidecade resistance decades provide your choice of one, two, or three

decades per unit. More can be ganged together, with accuracy at 25°C of 1±% of setting, or better.

Digivider voltage dividers, with your choice of Kelvin-Varley or Poggendorf circuits, are available in a wide range of input impedances, and are accurate to .1% of full scale.

For precise pot data, write Digitran.

THE DIGITRAN COMPANY
Subsidiary of Becton, Dickinson and Company [80]
855 S. Arroyo Pkwy./Pasadena, Cal. 91105
Tel: (213) 449-3110/TWX 910-588-3794

INFORMATION RETRIEVAL NUMBER 73

PACKAGING & MATERIALS

Nylon grommets fit any opening

*Plastiglide Mfg. Corp., 1757 Stanford St., Santa Monica, Calif.
Phone (213) 451-1681.*

Nylon grommets provide excellent electrical insulation in a wide range of stock sizes. Three sizes are available from stock, to fit 10- to 24-gauge steel and aluminum sheets. Free evaluation samples are available.

CIRCLE NO. 292

Epoxy adhesive bonds Teflon

Leal Co., 1716 S. 6th St., Camden, N.J. Phone: (609) 365-0098.

CC Epoxy serves to bond treated Teflon to metals, ceramics and other substrate materials with a bond strength of 2000 psi in lap shear. In peel failure, the adhesive removes the etched layer from the Teflon, indicating a cohesive failure in the Teflon before bond failure. The adhesive features a heat-cure system that changes color at temperatures ranging from 200 to 500°F when cured. It resists exposure to 500°F temperatures indefinitely.

CIRCLE NO. 293

Copper-filled epoxy rivals silver epoxy

Ablestik Adhesive Co., 833 West 182nd St., Gardena, Calif. Phone: (213) 321-6252.

A 0.004 Ω-cm resistivity copper-filled adhesive exhibits a lower resistivity than do most silver-filled adhesives. Costing about 20% less than typical silver-filled adhesives, this conductive adhesive eliminates problems associated with silver migration. Ablebond 163-4 is a strong epoxy/amine adhesive with shear strength of 1350 psi. Available as a three-component 1-lb kit, the adhesive cures in one hour at 200°F, and in two hours at 150°F.

CIRCLE NO. 294

HERE'S HELP FOR YOUR COST-REDUCTION PROGRAM

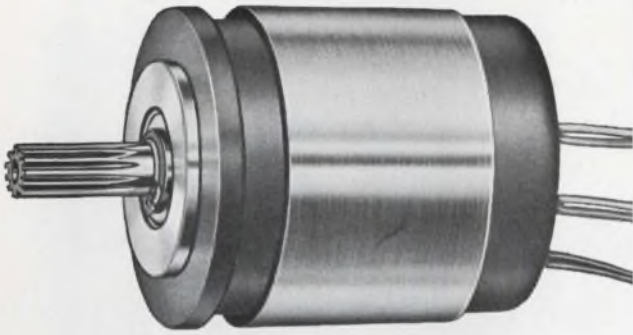

Cedar's new **JETLINE** Servo Motor

With Cedar's traditional high quality and performance but at far less cost than conventional motors

The new Jetline motors are a family of standard motors available from stock for quick delivery. Modifications and special designs on request. Size 8, 10 and 11 servo motors and Size 8 and 10 motor-tachs are available for both 26-volt and 115-volt applications.

These new motors are an extension of Cedar's more than 10 years experience in the transfer-molding of stators. Molded plastic replaces the case and end cap resulting in fewer parts. Efficiency is maximized through the use of larger stator laminations. The larger flanged bearings fit against the molded plastic, run cooler and provide greater reliability.

Thorough testing of these motors has proven them to meet traditional Cedar quality standards. Our normal warranty applies. Jetline motors have, however, demonstrated over 3500 hours at 100°C ambient.

The important difference to you when you specify Cedar's Jetline motors is that they cost less. For example, a standard Size 10 Servo Motor costs only \$16.50 in quantities up to 1000. To get all the facts on how Cedar's new Jetline servo motors can help in your cost-reduction efforts, write or call today.

CEDAR CONTROL DATA
DIVISION CORPORATION

5806 West 36th Street, Minneapolis, Minnesota 55416
Phone: 612/929-1681

INFORMATION RETRIEVAL NUMBER 74

ELECTRONIC DESIGN 26, December 19, 1968

ANOTHER DATA CONVERSION SOLUTION BY ANALOGIC



AN EXPANDABLE 12 BIT HIGH SPEED A/D CONVERTER WITH POWER SUPPLY AND DISPLAY FOR ONLY \$1595

Analogic's AN5200 series converter systems offer complete data reduction capability in a single 3½" x 8½" x 12" enclosure. Utilizing standard Analogic data conversion modules, the basic unit at \$1595 includes the AN2212 12 bit high speed A/D converter, the AN713B binary display, and the AN3001 power supply. Basic systems are also available at even lower cost, incorporating AN2208 8 bit or AN2210 10 bit A/D converters.

Plug-in modules add:

- Up to 32 multiplex channels
- 0.01% Sample & Hold
- 13 bit accuracy and resolution

Total 32 channel 13 bit system cost with Sample & Hold ... only \$3140

AN5200 series converter systems include all pre-wired connectors and controls required to also accept AN4100 series 8 channel multiplexer modules, the AN250-01 0.01% Sample and Hold module, the AN2200-AVS Sign & Absolute Value module to provide a 13th bit for increased accuracy and resolution, and AN350 series code translator modules to provide special output codes with additional buffering. Features of a complete system include:

- Up to 32 internal multiplex channels expandable to 256 channels with external Analogic multiplexer expander
- Random address, sequential, or manual multiplexing
- 2000 megohm input Z with 0.005% multiplexer transfer accuracy
- Sample & Hold settling time 5µs (max.) to 0.01% with less than 50 ns aperture and 15µv/ms. Hold decay
- Guaranteed A/D relative accuracy (ISA) 0.015% F.S. ± 1/2 LSB ± 0.001% /°C @ 2 us/bit; variable internal clock permits optimum combinations of speed vs. accuracy (up to 0.01%)
- Internal reference accuracy (ISA) 0.005% ± 0.0009% /°C
- Both parallel and serial NRZ outputs @ 12 ma/line sink current
- 12 bit system throughput speed (including multiplexer and Sample and Hold) up to 40 kHz standard; even higher speeds available
- Operates from 117/234 VAC; 47-420 Hz.
- Also available in BCD configurations with decimal display
- Operates over 0°C to +70°C temperature range.

Write for complete specifications on AN5200 series converter systems, and on Analogic's complete line of data conversion products.

ANALOGIC

Analogic Company, 296 Newton Street
Waltham, Mass. 02154 (Tel. 617 891-4708)

© 1968. Analogic Co

INFORMATION RETRIEVAL NUMBER 75

Miniature 3-pole switch double-breaks 6 circuits

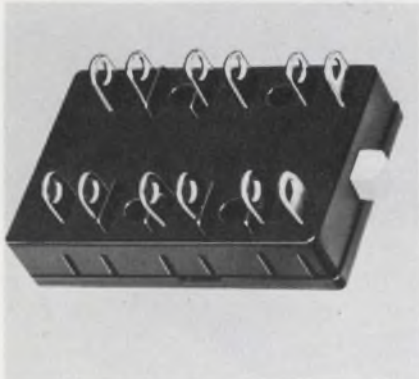

Plessey Components Group, Micro-switch Unit, Titchfield, Hampshire, London.

Type 36 3-pole miniature switch can be used for triple-pole change-over or for 6-circuit double-break switching. A special linkage between mechanisms assures simultaneous operation of all three poles. The unit is rated at 10 A, 250 V ac, 28 V dc. It measures 25/32 by 1-3/16 by 1/4-in.

CIRCLE NO. 293

Small inertia switch senses all directions

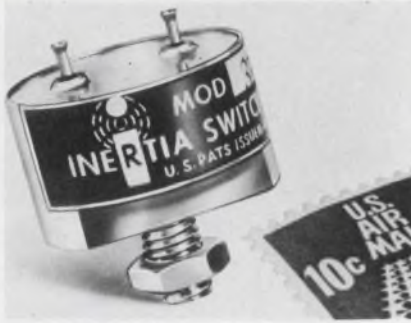

Inertia Switch, Inc., 311 W. 43rd St., New York City. Phone: (212) 687-7215.

Measuring less than 5/16 in.³ and weighing 3/4 oz, model 3RO-499 inertia switch responds to acceleration forces from any direction. Model 3RO-499 is hermetically sealed and operates over a temperature range of -55 to +125°C. It complies with the requirements of MIL-E-5272. Its two turret-type terminals and threaded stud provide greater mounting density.

CIRCLE NO. 296

Printed-circuit heaters break thermal barrier

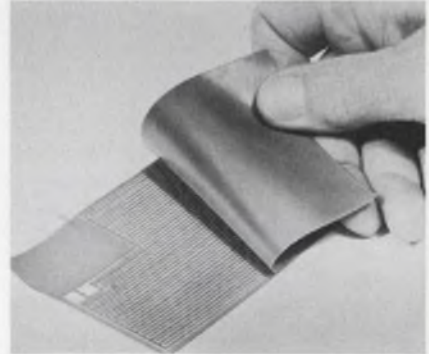

Rama Industrial Heater Co., 39651 Esplanade, San Jacinto, Calif.

Available in silicone rubber, Kapton and other materials, Ramaflex printed-circuit heaters reduce the thermal barrier between heater circuit and the surface to be heated. The units' flat surfaces, which can be flexible or rigid, reduce the possibility of dielectric failure. They are supplied in 30-in. widths, in thicknesses as small as 0.006 in., and to any desired length.

CIRCLE NO. 297

POWER/MATE CORP.

UNI-128

UNIVERSAL POWER SUPPLIES
TWO MODELS AVAILABLE



SAME DAY SHIPMENT

- * 0 to 16 volts at 4 AMPS. (UNI-128 - 16)
- * 15 to 30 volts at 4 AMPS. (UNI-128 - 30)
- * Regulation .005%
- * Ripple 250 microvolts
- * Meets MIL-E-5272 specs
- * Short circuit proof
- * 100,000 hours MTBF
- * 5 year warranty

\$128.00



POWER/MATE CORPORATION
163 Clay St. ■ Hackensack, N. J. 07601
(201) 343-6294 ■ TWX (710) 990-5023

INFORMATION RETRIEVAL NUMBER 76

For the Computer Industry

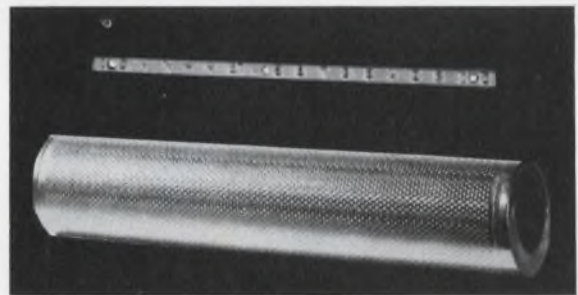

Print Bars and Drums

At Buckbee-Mears we etch the entire drum in one operation. Costly assembly problems are eliminated because there are no segments to line up. We are also geared to etch print bars faster at lower costs. Our print drums and bars are made of hardened tooled steel for extra long life.

For more information, see your nearest Buckbee-Mears representative. Or contact Bill Amundson, our industrial sales manager. You'll be glad you did.

BUCKBEE-MEARS COMPANY



245 E. 6th St., St. Paul, Minn. 55101 / (612) 227-6371

INFORMATION RETRIEVAL NUMBER 77



Helipot's new, economy dc voltage regulators are only \$10⁸⁰ (100 piece quantity)

Helipot's new *positive* (Model 809) and *negative* (Model 859) *self-contained* hybrid *cermet* units are designed to give you high performance at budget prices.

- 5 to 28 volts fixed outputs
- 0.003%/ma maximum load regulation
- 2 volt minimum ΔV across regulator
- 750 ma load capability
- 34 db ripple attenuation to 100 kHz
- -55° to $+125^{\circ}\text{C}$ operating temperature range
- Add-on capabilities include: short circuit protection with an external transistor, loads over 5 amps with an external pass transistor, and adjustable outputs with an external resistor.

These regulators are small (1" x 0.5" x 0.170" high), fully sealed (1×10^{-7}) and compatible with flat pack and dual in-line packaging. And, they're available from local stock. For more information, call your local Helipot sales representative or circle the reader service number.

Beckman

INSTRUMENTS, INC.

HELIPOT DIVISION

FULLERTON, CALIFORNIA • 92634

INTERNATIONAL SUBSIDIARIES: GENEVA, MUNICH, GLENROTHES, SCOTLAND;
TOKYO, PARIS, CAPE TOWN, LONDON, MEXICO CITY, STOCKHOLM, VIENNA

Bulova ovens are the smallest going

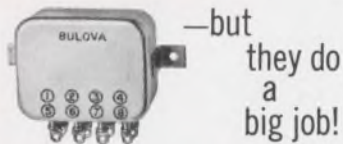

—but they do a big job!

Simply stated, the Bulova BDX series is the smallest and most versatile in the miniature oven field!

Now, for the details. External dimensions are just 1.5" x 1.19" x .46" (or up to .9375", for larger models). Yet, the BDX can hold 1 to 6 tubular devices such as diodes, capacitors or resistors, up to .25" in diameter and length.

Controller is an RFI-filtered snap-action thermostat, meeting MIL-I-6181B. You get the BDX with your components installed and encapsulated in fluoro-carbon blown polyurethane foam insulation and hermetically-sealed. Result: a unit with minimal thermal leak that will withstand the most severe shock and vibration specifications.

The BDX is available with stud mounting, printed circuit board mounting, flange mounting or captive nut. Temperature settings from 50°C to 100°C are available, with a range of operating voltages from 6.3 to 117 VAC or DC. Temperature stabilities are as fine as .5°C over a -55°C to 90°C with a power drain as low as 5 watts.

This is just one of a complete line of Bulova ovens, including bi-metal thermostat, transistat, solid state switched mercury, and AC or DC proportional controls. For more information, write today to Dept. ED-28.

Try Bulova First!

FREQUENCY CONTROL PRODUCTS

ELECTRONICS DIVISION
OF BULOVA WATCH COMPANY, INC.

61-20 WOODSIDE AVENUE
WOODSIDE, N.Y. 11377, (212) DE 5-6000
INFORMATION RETRIEVAL NUMBER 84

COMPONENTS

Plug-in line monitor detects power faults



Dearborn Wire and Cable Co., 3333 W. Ohio St., Chicago. Phone: (312) 638-6711.

Called Circuit Guard, a plug-in line monitor indicates proper ground and ac polarity for 115-V 3-wire outlets. About one-half the size of a cigarette pack, the device pinpoints circuit conditions by discretely illuminating three letters. Both O and K indicate that the circuit is okay; O only, improper ground; K only, improper neutral; O and X, reversed polarity; both K and X, reversed ground and power; no indication, power is off.

CIRCLE NO. 321

Monolithic filters resonate at 30 MHz

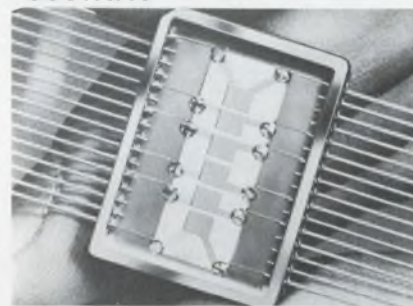

Hughes Aircraft Co., 500 Superior Ave., Newport Beach, Calif.

Over the center-frequency range of 3 to 30 MHz, monolithic coupled-mode crystal filters use a quartz crystal element as both resonator and coupling medium for pairs of film-deposited electrodes. Filter networks, such as Butterworth, Chebychev and linear phase, can be achieved through various designs and combinations of the coupled resonators. The new filter line is available with 2-, 3- or 4-resonator elements in single or cascaded configurations.

CIRCLE NO. 322

Photocell-lamp modules provide total isolation

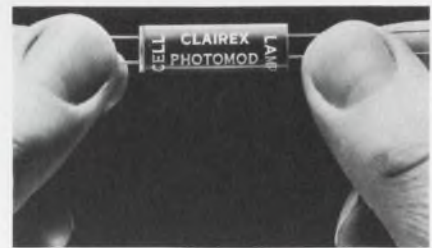

Clairex Electronics, Inc., 1239 Broadway, New York City. Phone: (212) 684-0940.

Combining hermetically sealed photoconductive elements with long-life lamps, Photocell-lamp modules completely isolate electrical and mechanical circuits. A low-current model, CLM5H10A, supplies lamp current with low-level transistors for switching and analog applications. Another model, CLM7H16A, is designed for interfacing solid-state power supplies to measurement or computer circuitry.

CIRCLE NO. 323

Flexible tubes transmit images



Van Deusen Co., P.O. Box 1251, Laguna Beach, Calif. Phone: (714) 494-4310. Price: \$25/ft.

Series 3000 image light tubes remotely read numbers, scale markings and other symbolic information. Each light tube consists of hundreds of plastic fibers that divide the image into dots of light. Since the fibers at one end of the tube correspond in arrangement to those at the other end, the image is identically recreated at the viewing end. A standard light tube contains 625 fibers in a 1/4-by-1/4-in. image face.

CIRCLE NO. 324

FREE

MOTOROLA
S1302A
PORTABLE
DUAL-BEAM
OSCILLOSCOPE

Solid-State - Internal Battery Option - Choice of Plug-In Amplifiers

Ideal for Aircraft,
Computer, Microwave, Radar,
And Other Sophisticated
Electronic Systems.

Get technical literature on new solid state, portable dual-beam oscilloscope. Choice of two plug-in Y-amplifiers. Features differential input, internal voltage calibration, and both signal and time delay.

Write to Motorola Communications & Electronics Inc., 4501 W. Augusta Blvd., Chicago, Ill. 60651.



MOTOROLA
Precision Instrument Products

INFORMATION RETRIEVAL NUMBER 79

POWER/MATE CORP. POWER TWIN-99 DUAL OP AMP SUPPLY

- * Dual output 12.0 to 18.0 VDC at 400 ma.
- * $\pm 0.05\%$ regulation
- * 1.0 Mv rms ripple
- * Overload and Short Circuit protected
- * Meets MIL-E-5272 specs



SAME DAY SHIPMENT

Send for Literature describing thousands of Power Supplies to 400 Volts and to 50 Amps.

\$99.00



POWER/MATE CORPORATION
163 Clay St. ■ Hackensack, N. J. 07601
(201) 343-6294 ■ TWX (710) 990-5023

INFORMATION RETRIEVAL NUMBER 80

ELECTRONIC DESIGN 26, December 19, 1968



Transients stop here!

New Dale Arrester Provides Reliable, Low-Cost Surge Protection

Dangerous transient voltages get nowhere when you put Dale's new Surge Protector in their path. For a few dollars, this new design provides the best insurance you can buy against damage from direct lightning strikes, and from transients induced by lightning and switching. Here are just a few of its advantages over other low-cost protectors:

SENSITIVITY Typical breakdown voltage is 1500 volts when subjected to a voltage pulse rising at 10 kv/ μ sec. Power-follow current is extinguished within $\frac{1}{2}$ cycle or less.

REPEATABILITY Will bypass repeated overvoltages without significant change in breakdown level.

It's weatherproof, mounts anywhere, meets all applicable NEMA, USAS and IEEE standards. For a few bucks, it can save you a bundle. Write for complete information.



DALE ELECTRONICS, INC.
SIoux DIVISION Dept. FD
Yankton, South Dakota 57078

Producers of: Toroids, Series Resonant Traps, Variable Pitch Inductors, Miniature High Frequency Inductors, Degaussing Coils, Industrial and Military Coils, Subminiature Coils, Surge and Lightning Arresters, Custom Assemblies, Motor Driven Potentiometers.

INFORMATION RETRIEVAL NUMBER 81

Design Aids



IC cost counter

The cost of defective digital ICs can be quickly estimated with a new two-scale calculator. When the scale indicating the number of ICs used per year is set opposite the estimated percentage of defective ICs shown on the top scale, this digital IC cost estimator gives annual replacement cost as a function of replacement cost per defective unit. Teradyne

CIRCLE NO. 325

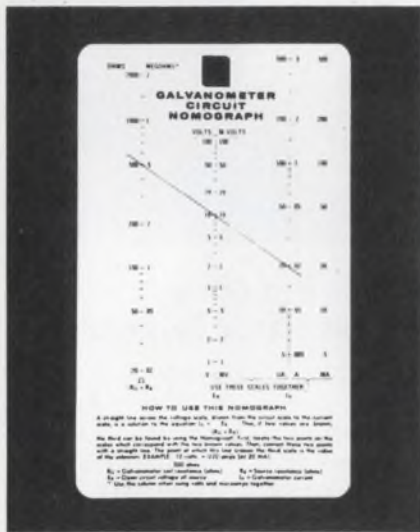

Galvanomogram

A pocket-size reference guide lists galvanometer characteristics and provides a nomogram to calculate related circuit values. The front side of the plastic design aid contains convenient galvanometer tables. Characteristics of both electromagnetic and fluid damped galvanometers are given. On the back is a handy galvanometer circuit nomogram to determine relationships between current, resistance and source voltages. When two values are known the third can be found by intersecting the two known points by a straight line. Honeywell Test Instruments Division.

CIRCLE NO. 326

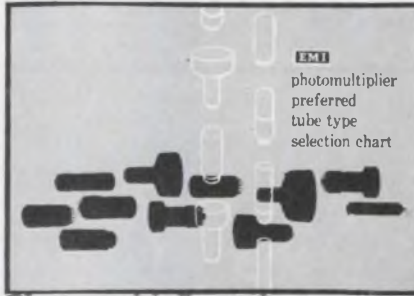

Photomultiplier tubes

A 17 by 22-in. two-color wall chart gives details on more than 70 photomultiplier tubes. The chart, which may be folded for filing, shows mechanical, cathode, and operating specifications for each tube, including easy-to-read curves for UV transmission, spectral response and typical over-all sensitivity vs. over-all voltage. Other relevant information is included. Whitaker Corp., Gencom Div.

CIRCLE NO. 327

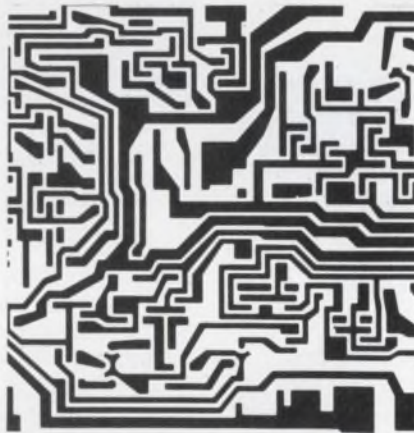

IC dictionary

Most engineers can remember a moment when their recall powers failed and they just couldn't remember the meaning of a technical term. Here's a handy little item that can come to the rescue. This pocket dictionary contains definitions of most of the terms used in the integrated circuit field. It clearly defines such expressions as CML (current mode logic), diffusion, J-K flip-flop, R-S flip-flop, skewing, wired OR and many others. The dictionary also contains an appendix of standardizations for input-output switching signals. Sylvania Electronic Components.

CIRCLE NO. 328

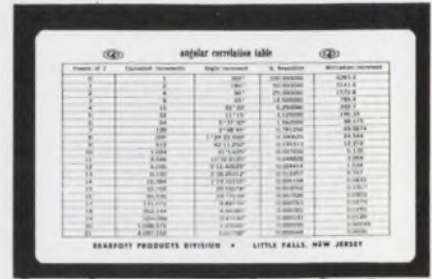

Angular conversion chart

A wallet-size plastic card displaying an angular correlation table is offered free of charge. Providing ready reference for technical people, the tabulation proves particularly useful when making analog-to-digital and digital-to-analog conversions. Kearfott Products Div., General Precision Systems Inc.

CIRCLE NO. 329



Coax calculator

Characteristics of Styroflex coaxial cable can be quickly determined with this handy slide rule. When over-all size and desired impedance are set opposite a pointer, all pertinent mechanical and electrical specifications appear in windows on the rule. Phelps Dodge Electronic Products.

CIRCLE NO. 330



Electronic materials

A 26-by-11-in. wall chart lists a wide variety of materials for electronic applications. They are broken down into categories with electrical, mechanical, physical and chemical properties listed for each item. The chart folds for insertion into a looseleaf binder. Dow Corning Corp.

CIRCLE NO. 331

THE COMPLETE LINE OF MODERN SWEEP SIGNAL GENERATORS

1968 CATALOGUE

Send for the complete 64-page Catalogue and Technical Brochure of Texscan products. Includes information on all four series of sweep/signal generators Plus:

- Definition of Specifications
- Interpretation of Specifications
- How Hidden Specifications Affect Measurements
- Application Techniques
- 24-page Section on RF Attenuators
- Oscilloscopes



RS SERIES—Range from 1 MHz to 2000 MHz

An extremely sophisticated, solid state line of instruments. Includes all features of the VS series plus additional features such as triggered sweep, start-stop frequency indicator, dual trace sweep width, dual trace sweep time, logarithmic detection and internal AM modulation.



LS SERIES—Range from 1 MHz to 1000 MHz

A low priced, line rate sweep generator designed for specific test situations not requiring the versatility of the VS and RS lines. This series is most competitive for production, broad sweep requirements.



VS SERIES—Range from 200 Hz to 2500 MHz

A solid state instrument line which features variable sweep rates, low distortion and high stability. Many options are available to increase the capabilities of this instrument line.



HS SERIES—Range from 20 MHz to 1000 MHz

High power sweep/signal generators providing up to 8 watts swept RF output. These instruments are line rate sweep generators with CW and amplitude modulation capabilities.



Texscan's complete line of sweep/signal generators offer the modern electronic engineer the widest choice of generators in the industry. The instrument you want, with the features you need, at a price you can afford, are now available in the four basic series of solid state generators by Texscan.

Contact your nearest Texscan Field Application Engineer
... a specialist in electronic instrumentation.



2446 North Shadeland Avenue Indianapolis, Indiana 46219

Tel. 317-357-8781 • TWX. 810-341-3184

INFORMATION RETRIEVAL NUMBER 83

Application Notes

Computer-aided design

Application Note 4.2, "Modeling Transistors and Diodes for Computer-aided Nonlinear Circuit Analysis," reprints three articles from *ELECTRONIC DESIGN*. This note helps anyone who uses computer programs for circuit analysis to model his transistors and diodes correctly. Proper modeling is crucial to obtaining correct answers from the computer and often proves to be one of the most difficult obstacles facing new users of computer-aided circuit analysis. Design Automation, Inc.

CIRCLE NO. 332

Magnet design

A 4-page guide reviews loud-speaker-magnet design, as it evolved from long, small-area alnico to the short, large-area Indox 5 used today. Six drawings illustrate this historical transition. A design procedure presented for Indox 5 includes a design example. Another example shows how to predict magnet performance in a specific air gap and includes a nomograph for determining safe operating temperatures with given flux density and permeance coefficient. A large, easy-to-read demagnetization curve—with energy-product curves and permeance coefficient points—can be used to solve a design problem. A checklist of parameters is included. Indiana General Corp. Magnet Division.

CIRCLE NO. 333

Plexiglas techniques

Describing methods of working with Plexiglas, a 20-page brochure contains techniques for cutting, machining, finishing, forming and joining acrylic sheet. Also described are filing, scraping, sanding and buffing methods. Plug, ring, blow and vacuum forming techniques are included. Cadillac Plastic and Chemical Co.

CIRCLE NO. 334



Data handling

"Data Handling in a Transmission Network" is a technical discussion that begins at the origins of data transmission and continues on to consider contemporary methods of character coding, data formats, and the effective rates of data transmission. The 12-page booklet is illustrated with charts, graphs and drawings. Tally Corp.

CIRCLE NO. 335

Zener diodes

Comprehensive information is offered on the characteristics, testing, and reliability of temperature-compensated zener diodes. An 8-page application note is a valuable aid for designing circuits that require the use of these devices. After first defining reference diodes, the note discusses the three most important characteristics of reference diodes: reference voltage, voltage temperature stability, and voltage time stability. Motorola Semiconductor Products Inc.

CIRCLE NO. 336

Spectral density

An application work sheet describes the use of a constant percentage bandwidth analyzer to reduce to only 42 minutes the time required for sweeping frequencies from 20 Hz to 19 kHz. Conventional methods would require seven hours. Work sheets on a variety of other topics are also available. B & K Instruments, Inc.

CIRCLE NO. 337

Meter movements

A free reprint describes the various aspects and properties of a patented bifilar suspension. The bifilar suspension reprint is important reading for anyone interested in unusual sensitivity or frictionless meter movements. The 4-page text discusses in detail the mathematics involved in the coil's swing, relative to the two-wire bifilar suspension.

CIRCLE NO. 338

Magnetron data

Voltage-tunable magnetrons are described in a 15-page booklet that covers modulation and power-supply requirements. The handbook also covers the key features and advantages of the VTM, its types and general applications. General Electric Co.

CIRCLE NO. 339

Magnetic drives

Magnetic drives that can transmit torque through a barrier without the use of a mechanical connection are discussed in a two-page bulletin. Drive characteristics, general considerations and design requirements are given for synchronous axial and radial, eddy-current and hysteresis drives. Line drawings of each type illustrate drive configuration and proper positioning of component parts. Indiana General Corp.

CIRCLE NO. 340

Ultrasonic assembly

Using the programmed learning concept, a 63-page text covers basic ultrasonics, assembly equipment and techniques. Information is broken down into small units called frames with each frame placed in a logical learning sequence. Most of these require the reader to write in certain essential information in order to reinforce his learning process. Branson Sonic Power Co.

CIRCLE NO. 341

Pick the
BEST IC
for the job

Problem: 80 milliamps minimum per bar is required to drive a 15 volt seven segment display. One integrated circuit package is to be used. Input to the package is BCD. Pick the best Custom IC capability for the job.

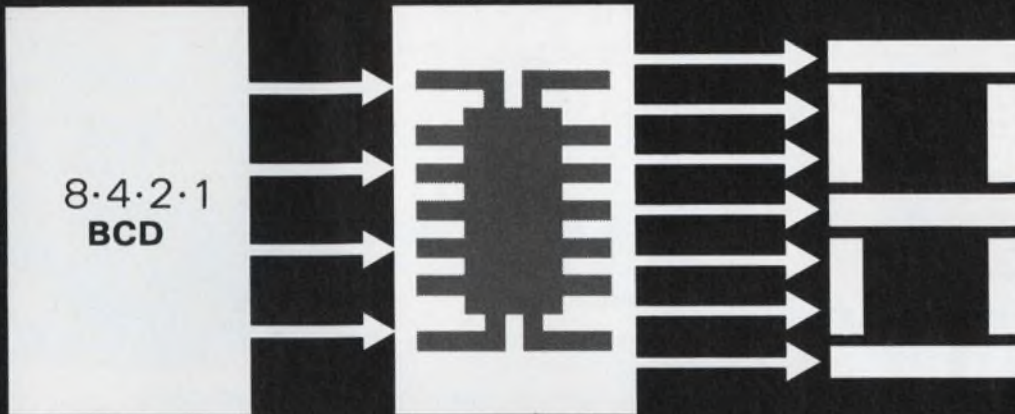

the **BEST** Solution:

THE CUSTOM MSI SEVEN SEGMENT DECODER/DRIVER



One of our customers had the exact problem stated above. Radiation solved the problem reliably and economically with dielectric isolation and medium scale integration. BCD to decimal to seven-bar with built-in drivers... three hundred elements on a single chip! And an 80 MA per bar minimum drive current. The best IC solution for the job.

Radiation has mastered dielectrically isolated MSI. We would like to work with you on your particular application. Medium scale integration is the best solution to the packaging density problem. Dielectric isolation is the best approach.

Contact your nearest Radiation sales office. State your problem. Let us help you pick the Best IC for the job.

WE MAKE THE **BEST** IC FOR THE JOB



RADIATION
INCORPORATED

SUBSIDIARY OF HARRIS-INTERTYPE CORPORATION
MICROELECTRONICS DIVISION

RADIATION SALES OFFICES: P.O. Box 476, Lexington, Mass. 02173, (617) 682-1055 • 600 Old Country Road, Garden City, N.Y. 11530, (516) 747-3730 • 2600 Virginia Avenue N.W., Washington, D.C. 20037, (202) 337-4914 • 6151 W. Century Boulevard, Los Angeles, California 90045, (213) 670-5432 • P.O. Box 37, Melbourne, Florida 32901, (305) 727-5430 • International Sales: Marketing Department, P.O. Box 37, Melbourne, Florida 32901, (305) 727-5412

ECCOFOAM[®] PLASTICS/CERAMICS FOAM CHART



Complete physical and electrical data are displayed for eighteen foams—liquids, powders, sheet stock—plastics, ceramics and even artificial dielectrics. Fold-out chart in full color for notebook or wall mounting is yours.

INFORMATION RETRIEVAL NUMBER 231

STYCAST[®] CASTING RESINS CHART COMPLETELY REVISED



This chart for notebook or wall mounting has just been brought up to date. It contains comparative property data on over 20 Stycast[®] epoxies and urethanes.

INFORMATION RETRIEVAL NUMBER 232

ECCOBOND[®] ADHESIVES FREE WALL CHART



Fully illustrated fold-out chart gives complete physical and electrical data on over 20 adhesive systems—conductive, nonconductive—liquids, powders, pastes—for electrical or mechanical applications—various chemical types.

INFORMATION RETRIEVAL NUMBER 233

Emerson & Cuming, Inc.



CANTON, MASS.
GARDENA, CALIF.
NORTHBROOK, ILL.
Sales Offices
in Principal Cities

EMERSON & CUMING EUROPE N.V., Oevel, Belgium

New Literature

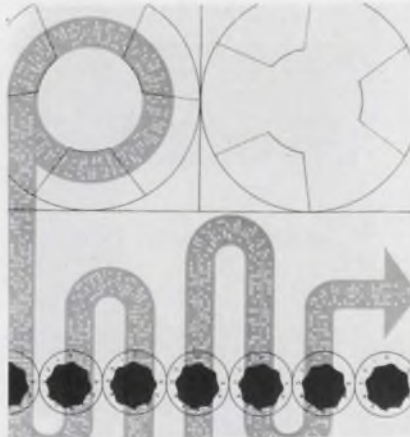

Instrument catalog

Instruments, systems and components are described in a 16-page catalog. Ratiometric techniques—a concept for measuring and controlling resistance, voltage, current and ratio—are used throughout the line. Automated instruments and precision components are emphasized. Julie Research Laboratories, Inc.

CIRCLE NO. 342

Fastener catalog

A new 12-page catalog and selection guide contains application and specification information for a line of four new fasteners. Two are for use in blind-hole applications; two are designed for fastening honeycomb or sandwich panels. A special application section is designed to assist engineers in solving unusual fastening problems. Paneloc Corp.

CIRCLE NO. 343

Rectifier modules

A 12-page application note describes the uses of self-stacking silicon rectifier modules in high-voltage and high-current power supplies, in high-voltage pulse circuits, and for tube replacement purposes. Presented are details of the module's construction as well as circuit application information. Unित्रode Corp.

CIRCLE NO. 344



Load cells

Technical information on bonded strain gauges for use in research, industrial, and aerospace applications is given in a 62-page catalog. Mechanical and electrical specifications on eleven different series of load cells in ranges from one to 10 million pounds, are included. Recommended practices and a description of load cell terminology assist the design engineer in selecting the proper strain gauge for his application. Visual reference curves are furnished. Transducer.

CIRCLE NO. 345

Motor speed controls

A 28-page catalog on motor speed controls contains detailed information on many brands and types. Included is an extensive list of hundreds of variable-speed motors that can be used with the controls. B & B Motor and Control Corp.

CIRCLE NO. 346

Dc motor catalog

A 32-page bulletin gives complete engineering data for a line of dc motors and gearmotors that provide continuous-duty power outputs from 0.004 to 0.3 horsepower. Diehl Div., The Singer Co.

CIRCLE NO. 347

INFORMATION RETRIEVAL NUMBER 85 ▶

This time try EECOSWITCH®...



...on your front panel

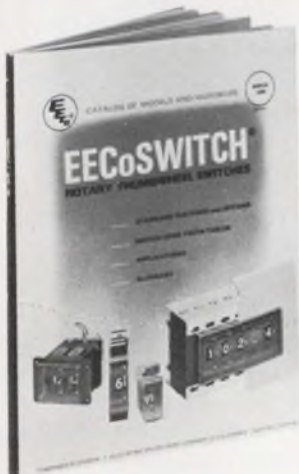

There's an EECOSWITCH
for almost any application

Why settle for second best on your equipment when at no extra cost you can have EECOSWITCH.

With EECOSWITCH you get:

- **7 complete lines** with dozens of coded outputs to choose from.
- **Off-the-shelf** delivery of standard models.
- **Interchangeability** with other makes of rotary thumbwheel switches without panel alterations.
- **Answers** for your application problems generated by EECO's 20 years of switch and digital system experience.
- **Sample assemblies** for new design prototypes.
- **EECO's exclusive 2-year warranty.**

The EECOSWITCH catalog describes our complete line and includes 15 pages of useful application data. Send for your copy today.*



COMPONENTS DIVISION

ELECTRONIC ENGINEERING COMPANY OF CALIFORNIA

1441 EAST CHESTNUT AVENUE • SANTA ANA, CALIFORNIA 92701 • (714) 547-5651

HICKOK

DMS 3200 DIGITAL MEASURING SYSTEM (Fully solid state with IC's)



This all-solid-state precision measurement system offers unlimited expansion capability through plug-in additions, resulting in a specialized instrument for each type of measurement. New plug-ins now broaden the measurement capability of this field-proven unit. Over 10,000 are in use at present.

Scaling controls make possible resolution of up to seven digits on the three-digit display by utilizing the overrange capability of many of the plug-ins, thus providing high resolution and accuracy with minimum investment. Companion devices such as the PR 4900 Digital Printer and 1050 Digital Set-Point Controller further extend the utility of the DMS 3200 System.



DC VOLTMETER PLUG-IN DP 100 \$175
00.1 mv to 999. volts
 $\pm 0.1\%$ rdg ± 1 digit

DC MICROVOLTMETER PLUG-IN DP 110 \$450
0.001 mv to 999.9 volts
 $\pm 0.05\%$ rdg ± 1 digit
4-digit resolution

AC VOLTMETER PLUG-IN DP 130 \$375
0.01 mv to 999. volts
 $\pm 0.1\%$ rdg ± 1 digit
22 Hz to 1.0 MHz

EVENT COUNTER/S�AVE PLUG-IN DP 140 \$90
Up to 1,000,000 counts/sec
Cascade with second DMS to obtain 6-digit display

1 MHz COUNTER PLUG-IN DP 150A \$230
00.1 Hz to 999. kHz
 $\pm 0.0005\%$ rdg ± 1 digit
7-digit resolution

80 MHz COUNTER PLUG-IN DP 160 \$395
00.1 Hz to 80.0 MHz
 $\pm 0.00005\%$ rdg ± 1 digit
7-digit resolution

OHMMETER PLUG-IN DP 170 \$275
.001 ohm to 999. megohms
 $\pm 0.1\%$ rdg ± 1 digit
Microamp test current

CAPACITY METER PLUG-IN DP 200 \$275
.001 picofarad to 9,999 mfd
 $\pm 0.1\%$ rdg ± 1 digit
Low DC test voltage

TIME INTERVAL METER PLUG-IN DP 210 \$230
0.01 ms to 999. seconds
 $\pm 0.0005\%$ rdg ± 1 digit
Period or time interval

DC CURRENT METER ADAPTER D 310 \$90
.0001 microamp to 9.99 amps
 $\pm 0.15\%$ rdg ± 1 digit

NEW LITERATURE

Pneumatic tools

A complete handbook on pneumatic assembly tools for screw and nut sizes from #00 to #10 includes a table of torque values for determining proper fastener tension. Also offered are guidelines for proper tool selection; special information on a complete line of straight and pistol-grip screwdrivers, as well as illustrated descriptions of over 70 time-saving accessories. Standard Pneumatic Motor Co.

CIRCLE NO. 348

Aluminum enclosures

A 24-page catalog lists a new line of aluminum enclosures. Parts are carefully indexed to facilitate ordering. While standard material for these enclosures is 3003-0 aluminum alloy, 6061-0 is optionally available, and alloy 1100-0 is also offered in certain sizes. Parts are deep-drawn on hydraulic presses; they feature good wall uniformity and smooth finish. Halliburton Enclosures.

CIRCLE NO. 349

Component selector

The 1968-1969 Cornell-Dubilier Electronics Component Selector, completely revised and updated, is now available. This 120-page catalog fully describes an entire product line of capacitors, filters and relays. The book includes application charts, selection charts, and standard rating tables arranged to ease the designer's task. Cornell-Dubilier Electronics.

CIRCLE NO. 350

Computer-aided drafting

How a computer, teamed with closed-circuit television, aids large-scale drafting is discussed in a new technical application bulletin titled, "Computer-Aided Drafting with CCTV." Seven photographs and a case history of one such system are included. Cohu Electronics, Inc.

CIRCLE NO. 351

HICKOK ELECTRICAL INSTRUMENT COMPANY, 10514 Dupont Ave., Cleveland, Ohio 44108
INFORMATION RETRIEVAL NUMBER 86

HICKOK CRO 5000 25 MHz Oscilloscope (all solid state)

Circular connectors

Standard military and commercial circular power connectors are described in a new 80-page catalog, which contains specifications and illustrations of a complete connector line. Complete assembly instructions, accompanied by step-by-step drawings, are included for each connector type. Design information—compiled in handy guide-book sections—includes quick-reference pages on insert specifications, and product availability. A valuable data section on MIL-C-5015 connectors defines nomenclature, constructions, shells, finishes, inserts and contact types. Easy-to-use reference charts detail compatible connector plugs and receptacles. Amphenol Connector Division.

CIRCLE NO. 352

Capacitor catalog

General characteristics of capacitors for numerous applications are detailed in a 40-page catalog. Information given includes sizes and configurations in each series, temperature ranges and coefficients, capacitances, tolerances, types of leads and electrical parameters. San Fernando Electric Manufacturing Co.

CIRCLE NO. 353

Relay catalog

Relays, solenoids and stepping switches are described in a 32-page catalog. Hundreds of different relay types are listed. Universal Relay Corp.

CIRCLE NO. 354

Indicator lights

A 12-page, two-color catalog describes a series of two-terminal subminiature indicator lights, designed for mounting in 15/32-in., 1/2-in. and 17/32-in. clearance holes. Data, specifications, drawings and ordering information are provided for all units. Dialight Corp.

CIRCLE NO. 355



This high-precision laboratory oscilloscope equals the basic performance of higher priced, sophisticated 'scopes, yet meets the industry need for such performance in the \$600 price range. Emphasis has been placed mainly upon those characteristics most important in precise measurements, eliminating some of the more exotic and somewhat superfluous functions found in higher priced instruments. The result is an all-solid-state instrument in the medium price range with extraordinary stability, sensitivity, bandwidth, sweep-speed range, trigger capability, reliability, and ruggedness.

- 25MHz vertical bandwidth (to 3db down points)
- Usable to 50MHz
- All solid state for high stability and reliability
- 12 calibrated vertical attenuator ranges
10 mv/div to 50 volts/div ($\pm 3.0\%$ accuracy)
- 24 calibrated sweep ranges
0.05 microseconds/div to 2 sec/div ($\pm 3.0\%$ accuracy)
- Vertical delay line assures viewing of full leading edge of pulses
- "Sweep Delay" of up to 40 divisions
- Sweep speed continuously variable between ranges
- X-axis channel bandwidth DC — 5MHz
- 4" flat-faced CRT, 6 x 10 division graticule
- 3.8 kv HV provides sharp, bright trace
- Vertical amplifier will handle overloads, with negligible distortion of waveforms increased to 5 times screen height
- Internal 1.0% calibration squarewave
- Fast, convenient push-button selection of trigger modes
- Positive, solid triggering on all displays
- Small — 11 $\frac{1}{4}$ " W, 6 $\frac{7}{8}$ " H, 19" D; 24 pounds

HICKOK ELECTRICAL INSTRUMENT COMPANY, 10514 Dupont Ave., Cleveland, Ohio 44108
INFORMATION RETRIEVAL NUMBER 87

Aircraft Flight Mechanisms:

4 weeks delivery.
MIL-SPEC quality.
The industry's lowest prices.

Nobody else but Ideal brings you all these benefits. Including high torque and sensitivities, up to 80° deflection, complete shielding, low weight, synchro or standard mounting, all shapes of pointers and flags—and customizing of all parameters. American-made.

We're known for experience and

promises kept. Write for free 34-page catalog. Ideal Precision Meter Co., Inc., 218 Franklin St., Brooklyn, N.Y. 11222 (212) EVERgreen 3-6904.

National Master Distributor: EN-CER, Inc., 16850 So. State St., So. Holland, Illinois 60473 (312) 339-6310.



INFORMATION RETRIEVAL NUMBER 88

*Unlocking
the Future*

**Electrical
Electronics
Engineering**

**4 FLOORS OF EXHIBITS
NEW YORK COLISEUM**

**48 TECHNICAL SESSIONS
NEW YORK HILTON**

Monday through Thursday

• 48 TECHNICAL SESSIONS at the New York Hilton. Hours: 10:00-12:30; 2:00-4:30.

• FOUR FLOORS OF EXHIBITS at the N. Y. Coliseum including over 600 firms. Hours: 10 a.m.-8 p.m. 4 Days.

• GALA ANNUAL BANQUET—Wednesday 7:15 p.m. N. Y. Hilton Grand Ballroom — \$18.00.

• FREE SHUTTLE BUSES between the Hilton and the Coliseum — every few minutes.

• REGISTRATION — Good all days — Technical Sessions and exhibits. In and out privileges. — IEEE Members \$3.00. Non-members \$6.00. Ladies \$1.00. High School Students \$3.00 if accompanied by an adult — One student per adult; Thursday only — limit of 3 students per adult.

• REG-IDENT CARD speeds request for exhibitors' literature. Ask for one when registering.

• ESCALATORS/EXPRESS ELEVATORS to the Fourth Floor.

IEEE '69  **INTERNATIONAL CONVENTION & EXHIBITION MARCH 24-27, 1969**

INFORMATION RETRIEVAL NUMBER 89

NEW LITERATURE



Chart recorders

Miniature strip-chart recorders are described in a 20-page catalog. Presented are more than 30 models that record parameters of current, voltage, power, pressure and temperature and convert recorded parameters to voltage or current. Rustrak Instrument Div., Gulon Industries, Inc.

CIRCLE NO. 356



Instrumentation

A 12-page two-color catalog on transmission measurement equipment includes detailed information on tunable voltmeters and tracking signal generators, wave analyzers and spectrum display units; line and cable fault locaters, cable carriers and semiconductor test sets. Engineering specifications include those pertaining to measurement accuracy, frequency, power requirements, and special features of each unit or instrument. Sierra Electric Operation, Philco-Ford Corp.

CIRCLE NO. 357

POWER/MATE CORP.

UNI-76

UNIVERSAL POWER SUPPLY

- * 0 to 34 volts at 0.5 AMPS.
- * .005% regulation
- * 250 Microvolts ripple
- * Meets MIL-E-5272 specs
- * 100,000 hours MTBF
- * 5 year warranty

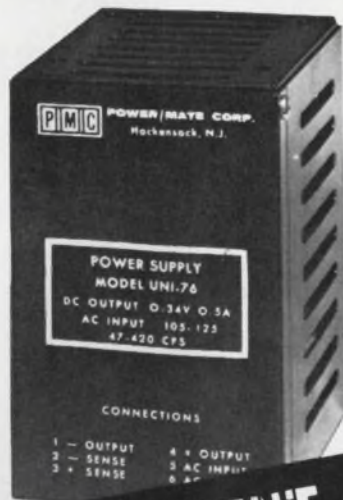

SAME DAY SHIPMENT

\$76.00



POWER/MATE CORPORATION

163 Clay St. ■ Hackensack, N. J. 07601
(201) 343-6294 ■ TWX (710) 990-5023

INFORMATION RETRIEVAL NUMBER 90

Need Electrolytic Samples?

**CAPACITOR
IS OUR
MIDDLE NAME!**

We offer Quality Dry Electrolytics for OEM's in the Industrial, Entertainment and Instrument industries. *Exclusively!*

Please furnish complete specifications when requesting quotations and/or samples.

WRITE FOR CATALOG!



1081

SYNCRON Capacitor Corporation

HICKSVILLE, OHIO 43526 • (419) 542-2711 • TWX 810-490-2550
INFORMATION RETRIEVAL NUMBER 91

ELECTRONIC DESIGN 26, December 19, 1968

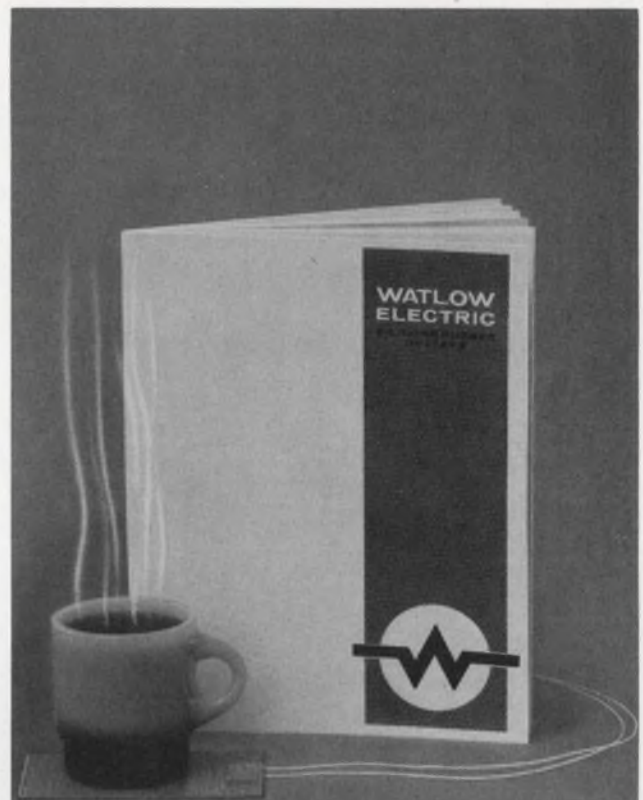

*have a hot
cup of coffee
on us...*

while reading our new industrial heater application guide

Send for Watlow's new silicone rubber heater application guide! It will show you how flexible silicone rubber heating elements provide heat up to 500°F in the most difficult places. It will give you a multitude of new ideas for solving your own industrial heating problems. And will provide you with charts, graphs and prices for determining your own requirements.

Plus — when your copy arrives — you can relax and have a cup of coffee on us. Because we'll also send you a free coffee kit including a packet of instant coffee and a sample silicone rubber heater to keep your coffee hot while reading.

To receive your application guide and coffee kit, write "coffee" on your letterhead and mail to Watlow Electric Company of California. Or, if you just want the guide and *not* the kit, circle the appropriate number on this magazine's reader service card.

WATLOW ELECTRIC CO.
OF CALIFORNIA

Subsidiary of Watlow Electric Manufacturing Company
141 W. Hazel Street, Inglewood, California, Tel. (213) 673-4711

INFORMATION RETRIEVAL NUMBER 92

TRYGON HAS THE POWER

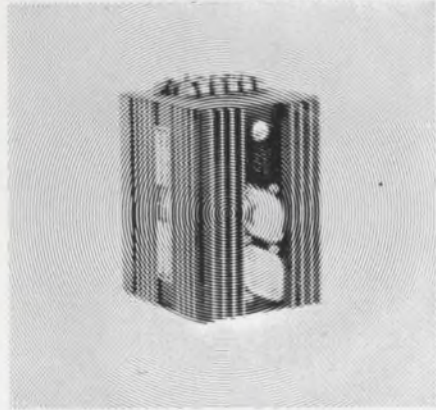

**to deliver systems
power modules
with all these features:**

- All silicon circuitry
- 71°C rating/no derating
- Independent of external heat sinks
- More regulated power for less money

Trygon's all silicon power supply modules: more regulated power for less money. Designed for unattended operation in military, industrial or commercial systems, they feature automatic reset short-circuit and optional overvoltage protection.

Choose from dual output tracking models, fixed voltage units and full-range programmable modules to provide versatile combinations for your multiple output system requirements.

Highest quality components: generously derated and aged power transistors—hermetically sealed rectifiers—temperature stabilized zener diodes—computer grade capacitors.

0.01% line regulation; temperature range from 0° to +71° C; remote programming; remote sensing; and more.

Compact 3¼" modules with ratings from 0 to 210 V, 0 to 1 amp, from as little as \$94. Ratings to 160 V in 4½" size (0 to 2 amps, from \$162); 5" size (0 to 5 amps, from \$177).



TRYGON POWER SUPPLIES

111 Pleasant Avenue, Roosevelt, L.I., N.Y. 11575
Trygon GmbH 8 Munchen 60, Haidelweg 20, Germany
Write for Trygon 1968 Power Supply Handbook.

INFORMATION RETRIEVAL NUMBER 93

NEW LITERATURE

Power-supply modules

A 16-page, two-color catalog describes a broad line of regulated power-supply modules. Listed are specifications of thousands of models with outputs from 0 to 400 V, and from 50 mA to 25 A. Availability is off-the-shelf. Back pages present mechanical data, connections, output impedance, options, accessories, along with a complete price list. Power/Mate Corp.

CIRCLE NO. 358

Dry-film lubricants

A 12-page brochure describes a full line of dry-film lubricants. Offering a low coefficient of friction and long wear life, these lubricants are applicable in a wide range of mechanical and electromechanical assemblies. Applied by spray, brush or dip techniques, they dry to a durable coating that has excellent chemical and corrosion resistance. Acheson Colloids Co.

CIRCLE NO. 359

Circuit protection

Literature describing a new device that protects solid-state equipment, explains the action taken by the unit to prevent damage from transients, overvoltages, and overcurrents. The eight-page bulletin also includes a description of options available, and offers dimensional drawings and information for ordering. Heinemann Electric Co.

CIRCLE NO. 360

Glass-to-metal seals

Glass-to-metal seals are the topic of a 90-page catalog that includes general engineering data. In addition to covering a complete line of terminals, headers and connectors, the catalog includes information on ordering and specifying. Mechanical dimension tolerances and seal tolerances for compression or matched seals are defined and explained. Airpax Electronics Inc.

CIRCLE NO. 361

PROFIT

from iron core research
by
PERMACOR®
Iron Core Engineers

Countless years in the research, development and production of quality iron cores for various applications enable us to more efficiently serve your needs in the following ways:

- In the development of specialized iron cores for unique product applications.
- In providing qualified research personnel familiar with your product and production problems including circuitry and coil winding.
- In supplying iron cores, based on experience, that perform better, lower product and production costs.

Whether your problems involve military, commercial, miniaturization, micromodular, or special applications, let us show you why PERMACOR "Engineered Economy" has made us the largest iron core manufacturer.

We invite your inquiry at any time
... no obligation, of course!

PERMACOR®

A Division of Radio Cores, Inc.

9540 Tully Ave., Oak Lawn, Ill.

Phone: 312/GA 2-3353

INFORMATION RETRIEVAL NUMBER 94

TEMPERATURE COMPENSATED CRYSTAL OSCILLATOR

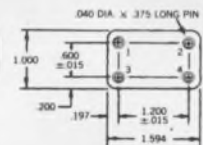

MODEL T-291

Frequency Range: 200 KHz to 2.99 MHz (Fixed)
Stability: $\pm 4 \times 10^{-6}$ over the temperature range
 $\pm 1 \times 10^{-6}$ over A $\pm 5^\circ\text{C}$ Range
 $\pm 1 \times 10^{-9}$ averaged for one second at a constant temperature

Frequency Adjustment: ± 15 parts per million minimum

Temperature Range: 0°C to +50°C

Output: Square Wave with a duty cycle of 50/50 $\pm 1\%$

Output Voltage: 0 $\pm .25$ V to +5 $\pm .5$ V
(These output levels assume that the customer's load is resistive and terminated to Vcc of +5 VDC $\pm .5$ V) This unit is designed to drive any popular DTL/TT1 type of logic (see output circuit below)

Input Voltage: +5 volts DC $\pm .5$ volts

Input Power: (210 MW nominal)

Case Size: (1" x 1.6" x .5")

Price: 1-3 units \$289.00

100 units \$115.60

ORDERING INFORMATION: Specify Model T-291 and exact output frequency desired.

Order direct from this ad or send for our complete catalog today.



**Greenray
Industries, Inc.**

840 West Church Road, Mechanicsburg, Pa. 17055

Phone (717) 766-0223

INFORMATION RETRIEVAL NUMBER 95

Design Data from Manufacturers

Advertisements of booklets, brochures, catalogs and data sheets. To order use Reader-Service Card.
(Advertisement)

Potentiometer catalog

Precision linear and nonlinear potentiometers, miniature turns-counting dials and commutator switches are covered in a 6-page catalog. Military and commercial specifications on single-turn and multi-turn potentiometers are included. Also covered are three miniature turns-counting dials designed for accurate positioning of multi-turn devices. Duncan Electronics, Inc.

CIRCLE NO. 362

PC enclosures

A 16-page catalog describes and illustrates a line of enclosure components for packaging PC cards and connectors. They can be used in any electronic equipment design where rows of cards and connectors must be packaged together. The connectors, mounted on the back panel, are easily accessible for cross-wiring and checkout. Elco Corp.

CIRCLE NO. 363

Aluminum cases

Specifications and ordering information on a line of seamless deep-drawn aluminum industrial carrying cases are given in a new 8-page catalog. The standard line encompasses 13 sizes. Each basic shell can, however, be modified in size, either in the drawing process or by adding riser sections to provide additional sizes. Zero Manufacturing Co.

CIRCLE NO. 364

Instrumentation

A 16-page catalog describes a complete line of controllers, recorders, indicators, control systems, precision measuring instruments, thermocouples and accessories for temperature and pressure applications. These instruments cover a full range of temperatures from cryogenic levels to 6000°F. West Instruments Corp.

CIRCLE NO. 365

Terminal Block Selector



A new 24-page, completely illustrated catalog contains photos, descriptions, ratings, engineering drawings, and prices of the complete line of Curtis terminal blocks. Included are printed circuit, insulated feed-thru, quick disconnect, track type, and high current terminal blocks. Handy selection chart quickly locates the perfect block for your particular requirements. Send today for your free copy.

Curtis Development & Mfg. Co.

3236 North 33rd Street
Milwaukee, Wisconsin 53216

171

Bus Bars For Noise Reduction

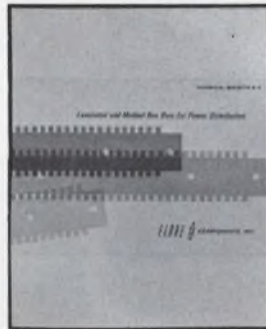

A 16 page Technical Bulletin is now available, describing a new concept in power or signal distribution. Basic mechanical and electrical design principles, along with descriptive pictures and diagrams, are included in this bulletin. These compact buses can replace bulky cable harnesses and repetitive wiring for computer or modular application. This method of construction satisfies the demanding requirements of low inductance and resistance of high speed, solid state systems, while controlling electrical noises.

Send For Free Sample

Eldre Components, Inc.

1239 University Avenue
Rochester, New York 14607

172

RECTIFIER, ZENER & HV ASSEMBLY DATA



Interesting info and complete specs on a full line of fused-in-glass diodes, rectifiers, zeners and high-voltage assemblies, yours in Unitorde's 16-page short-form catalog C-146. Full dope on rectifiers from 0.5 amps to 12 amps and fast recovery rectifiers to 9 amps with recovery times from 500 nsec. down to 75 nsec. You get specs on high-surge 3, 5 and 10 watt zener diodes, MIL type rectifiers and zeners, and high-voltage stacks, bridges — even the inimitable DOORBELL® rectifier module. Get yours.

Unitorde Corporation

580 Pleasant Street
Watertown, Mass. 02172

173

Electronic Design

ELECTRONIC DESIGN's function is:

- To aid progress in the electronics manufacturing industry by promoting good design.
- To give the electronic design engineer concepts and ideas that make his job easier and more productive.
- To provide a central source of timely electronics information.
- To promote two-way communication between manufacturer and engineer.

Want a subscription? ELECTRONIC DESIGN is sent free to qualified engineers and engineering managers doing design work, supervising design or setting standards in the United States and Western Europe. For a free subscription, use the postfree application form inside the back cover. If none is included, write to us direct for an application form.

If you do not qualify, you may take out a paid subscription for \$25 a year in the U.S.A., \$35 a year elsewhere. Single copies are \$1.50 each.

If you change your address, send us an old mailing label and your new address; there is generally a prepaid postcard for this inside the back cover. You will have to requalify to continue receiving ELECTRONIC DESIGN free.

The accuracy policy of ELECTRONIC DESIGN is:

- To make reasonable efforts to ensure the accuracy of editorial matter.
- To publish prompt corrections whenever inaccuracies are brought to our attention. Corrections appear at the end of the Letters column.
- To refuse any advertisement deemed to be misleading or fraudulent.

Microfilm copies are available of complete volumes of ELECTRONIC DESIGN at \$19.00 per volume, beginning with Volume 9, 1961. Work is now in process to complete the microfilm edition of Volumes 1-8. Reprints of individual articles may be obtained for \$2.00 each, prepaid (\$.50 for each additional copy of the same article) no matter how long the article. For further details and to place orders, contact the Customer Services Department, University Microfilms, 300 North Zeeb Road, Ann Arbor, Michigan 48106; telephone (313) 761-4700.

Want to contact us? If you have any comments or wish to submit a manuscript or article outline, address your correspondence to:

Howard Bierman, Editor,
ELECTRONIC DESIGN,
850 Third Avenue,
New York, N.Y. 10022.

Design Data from

ALL-NEW MSC UNLIGHTED SWITCH CATALOG



Complete Design Data for seven series of Master Specialties Company precision, unlighted manual switch assemblies, featuring the MSC snap-action design for instantaneous, virtually simultaneous switch contact transfer. Included are electrical and mechanical characteristics, dimensions and ordering information for 2PDT and 4PDT Pushbutton and Toggle Switches, Building-Block Pushbutton, Snap-On Switch Assemblies and optional turret-type, wire-wrap and quick connect terminals.

INDUSTRIAL AND MIL-SPEC ASSEMBLIES!

MASTER SPECIALTIES COMPANY

1640 Monrovia, Costa Mesa
California 92627

174

Free!



"The Semiconductor Story" . . . from the cat's whisker to the transistor to large scale integration . . . in language you will enjoy. Fully illustrated to tell the technical story and to introduce the personalities responsible for the explosive growth of the semiconductor industry. Additional copies \$1.00 each.

Schweber Electronics

Westbury, New York 11591
516-334-7474

175

How To Write Technical Articles



A guide for the engineer-author, "How to Write Articles for Electronic Design" shows how easy it is to write for publication—once the engineer knows what to write and how to write it. The Author's Guide includes a complete run-down of the types of articles published by Electronic Design—plus detailed instructions on how to prepare technical articles and short special features. A MUST for every "would-be-writer" in the electronics industry. Send for your complimentary copy by circling the number to the right.

Electronic Design

850 Third Avenue
New York, N.Y. 10022

176

Manufacturers

Advertisements of booklets, brochures, catalogs and data sheets. To order use Reader-ServiceCard (Advertisement)

NEW, DUAL-MODE CHARGE AMPLIFIER



Bulletin 270968 describes Model 504D, a dual-mode charge amplifier that functions (1) as an amplifier for quartz pressure, force, or vibration sensors; and (2) as an amplifier/power supply for low-impedance Piezotron® transducers. A front-panel switch changes modes. Also covered are reasons for this amplifier being the only available unit offering short-term DC response with both classes of transducers. Details on unique resonance-suppressors for extending frequency response are also given.

Kistler Instrument Corporation

8969 Sheridan Drive
Clarence, New York 14031

177

FUNDAMENTALS OF INTEGRATED CIRCUITS

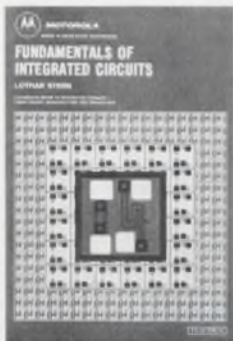

A practical guide to integrated circuits, their theory, manufacture, and applications. This new guide by Lothar Stern offers complete, highly readable coverage of the various techniques of circuit fabrication, and their effect on circuit design and performance. As to marketing considerations, it compares the characteristics of the numerous IC structures devised to date in terms of economics and logistics. A volume in the **Motorola Series in Solid-State Electronics**. 198 pages, 7 x 10, illustrated. \$8.95, clothbound. Send for 15-day examination copies.

Hayden Book Company, Inc.

116 West 14th Street
New York, N.Y. 10011

178

ELECTRONIC DRAFTING AIDS CATALOG



Just published! Bishop Industries' NEW Catalog No. 103. This NEW catalog shows Bishop's complete line of PreKut StikOn drafting patterns and symbols for the electronic/aerospace industries. These patterns save countless hours of repetitive drafting time. Use Bishop's Drafting Aids Systems and save labor, time, money, and achieve perfect exactness every time! Bishop's NEW catalog features pre-printed patterns for integrated circuits, printed circuits, micrologics, flat packs, tape, plus hundreds of symbols for varieties of pads, elbows, corners and dozens of other shapes. Send today for your NEW catalog and sample pack.

Bishop Industries Corp.

7300 Radford Ave.
North Hollywood, California 91605

179

Electronic Design

Advertising Sales Staff

New York 10022

Robert G. Drake
Sales Manager
Edward F. Clancy
Sales Service Manager
Robert W. Gascoigne
Thomas P. Barth
Samuel M. Deitch
Byron Adams
850 Third Avenue
(212) Plaza 1-5530
TWX: 867-7866

Philadelphia 19066

William C. Repetto
P. O. Box 206
Merion Station, Pa.
(215) MA-3-5888

Boston 01945

Richard Parker
P.O. Box 645
Clifton Station
Marblehead, Mass.
(617) 742-0252

Chicago 60611

Thomas P. Kavooras
Berry Conner, Jr.
200 East Ontario
(312) 337-0588

Cleveland

(216) 247-7670

Los Angeles 90303

Stanley I. Ehrenclou
John V. Quillman
W. James Bischof
2930 Imperial Highway
Inglewood, Calif.
(213) 757-0183

San Francisco 94022

Arthur R. Shields, Jr.
175 San Antonio Rd., S 243
Los Altos, Calif.
(415) 941-3084

London W. 1

For United Kingdom & Holland
Brayton C. Nichols
44 Conduit Street
Tel: REGent 4714

Verviers, Belgium

For Continental Europe
Andre Jamar
1, Rue Mallar, 1
(087) 253.85 Telex 41563

Tokyo

Yoshihiro Takemura
IPS Group Ltd.
Box 36, Ohsaki Post Office
Phone (431) 5804





**“Four to six weeks
for power supply
delivery?”**

Forget it!

**Acopian will ship
any of their
62,000 different
AC to DC plug-in
power supplies
in just 3 days!”**

This catalog lists 62,000 models of AC to DC plug-in power supplies available for shipment in just three days. Choose the exact outputs you need. Singles or duals, regulated or unregulated. Write or phone for your free copy.



Name _____

Title _____

Company _____

City _____

State _____

Zip _____

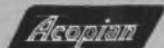

Acopian Corp., Easton, Penna. 18042
Phone: (215) 258-5441

Advertisers' Index

Advertiser	Page	Advertiser	Page
Acopian Corporation	122, 154	Kepco, Inc.	114
Alfred Electronics	108	Kistler Instrument Corporation	153
Allen-Bradley Co.	115, 117		
American Enka Corporation, Brand-Rex Division	99	Lambda Electronics Corp.	8
Amperex Electronic Corporation	49, 86		
Amperite	124	Master Specialties Company	152
Amphenol, The Bunker-Ramo Corporation	14, 15, 124B	Microwave Associates, Inc.	41
Analogic Company	135	Mohawk Data Sciences Corporation	101
Andersen Laboratories, Inc.	126	Monsanto Company	7
		Motorola Communications & Electronics, Inc.	95, 139
Barnes Corporation	134		
Beckman Instruments, Inc., Helipot Division	137	National Semiconductor Corporation ..	16 A-B
Bendix Corporation, The, Semiconductor Division	29	New England Instrument Company	44
Bishop Industries Corp.	153	Nytronics, Inc.	33
Borden Chemical, The Mystic Tape Division	17		
Buckbee Mears Co.	136	Philbrick/Nexus Research, A Teledyne Company	113
Bulova Electronics Division of Bulova Watch Company	138	Potter & Brumfield Division of American Machine & Foundry Company	13
		Power/Mate Corp.	132, 136, 139, 149
CMC, A Division of Pacific Industries	123		
Cedar Division, Data Control Corporation	135	RCA Electronic Components and Devices	12, 103, Cover IV
Curtis Development & Mfg. Co.	151	Radiation, Incorporated	143
Cutler-Hammer	111	Radio Cores, Inc.	150
Dale Electronics, Inc.	139, Cover III	Sangamo Electric Company	50
Delco Radio, Division of General Motors	78, 79	Schweber Electronics	152
Deutsch Filters Industrial Products	24	Scientific Atlanta, Inc.	119
Dialight Corporation	155	Scientific Data Systems, Inc.	105
Digilog Electronics Corporation	94	Sencore	107
Digitran Company, The	134	Signetics Integrated Circuits, A Subsidiary of Corning Glass Works	106
Duncan Electronics, Inc.	128	Singer Company, The	23
Du Pont Company	124A	Spectrol Electronics Corporation	20
		Sprague Electric Company	18
Elco Corporation	43	Stoddart Electro Systems, A Division of Tamar Electronics, Inc.	112
Eldrc Components, Inc.	151	Synco Capacitor Corporation	149
Electronic Design	120, 121	Systron-Donner Corporation	2
Electronic Engineering Co. of California	145		
Emerson & Cuming, Inc.	144	TRW Inc., Semiconductor Division	52
		Tektronix, Inc., Oscilloscopes	54
Fairchild Semiconductor, A Division Fairchild Camera and Instrument Corporation	10, 11, 34, 35	Telonic Instruments, A Division of Telonic Industries, Inc.	48
Fluke Mfg. Co., Inc., John	56	Texscan Corporation	141
		Transitron Electronic Corporation	42
General Electric Company, Silicone Products Department	129	Trygon Power Supplies	150
General Instrument Corporation	6	Tung Sol Division, Wagner Electric Corporation	31
General Radio Company	1	Tyco Laboratories, Inc.	16
Greenray Industries	150		
		Union Carbide Corporation	96, 97
H P Associates	9	Unitrode Corporation	151
Hayden Book Company, Inc.	133, 153		
Haydon Company, A. W.	132	Watlow Electric Co. of California	149
Hewlett-Packard—Cover II, 4, 5, 27, 51, 77, 118		Westinghouse Electronic Tube Division	37
Hickok Electrical Instrument Co., Inc., The	146, 147		
Honeywell, Computer Control Division	47	Zeltex, Inc.	131
Hughes Aircraft Company	39		
		Career Advertising	
IEEE	148	Delco Radio Division, General Motors	92
IMC Magnetics Corporation	125	Hughes Aircraft Company	39
Ideal Precision Meter Co. Inc.	148	Lockheed-California Company	94
InterPak, A Division of Litton Industries	127		
International Electronic Research Corporation	87	Johanson Manufacturing Corp.	116, 130

You say you want a

low-profile snap-in mounting push button switch or matching indicator that is interchangeable with most 4-lamp displays . . . available in a full range of cap colors . . . with a choice of bezels with or without barriers in black, gray, dark gray or white.

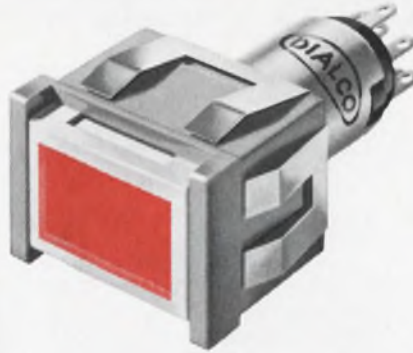

and a

legend presentation that's positive (like this one) or negative (like the one below) or just plain (like the one above) . . . one that's white when "off" and red, green, yellow (amber), blue or light yellow when "on" . . . or colored both "on" and "off."



and a

highly reliable switch proven in thousands of installations . . . available in momentary or alternate action . . . N.O., N.C. or two circuit (one N.O., one N.C.) . . . that accommodates a T-1 $\frac{3}{4}$ bulb with midget flanged base, incandescent, in a range of voltages from 6–28V.



*etc.
etc.
etc.*

Now, Dialight gives you custom panel designing with a standard line of push-button switches and matching indicators

Dialight offers a broader range of switch and indicator possibilities than you'll find anywhere in a standard single-lamp line. Sizes: $\frac{3}{4}$ " x 1", $\frac{5}{8}$ " square and round. Send today for our new full-color catalog L-209.

DIALIGHT

Dialight Corporation, 60 Stewart Ave., Brooklyn, N. Y. 11237

INFORMATION RETRIEVAL NUMBER 99

Competitively priced

Dale Econo-Trims

let you choose wirewound or film T-Pots in both 3/4" and 1" styles – sealed or unsealed!



3/4" ECONO-TRIM

2400 SERIES/WIREWOUND 8400 SERIES/FILM

SPECIFICATIONS

Dimensions: .31" H x .16" W x .75 L

Standard Resistance: 2400 = 10 ohms to 50K ohms; 8400 = 10 ohms to 2 Megohms

Resistance Tolerance: 2400 = $\pm 10\%$;
8400 = $\pm 10\%$ 100 ohms thru 500K ohms,
 $\pm 20\%$ all other values

Power Rating: 2400 = 1 watt at 40° C;
8400 = .75 watt at 25° C

Operating Temperature Range: -55° C to 125° C

Mechanical Adjustment: 20 turns nominal

Mechanical Stops: None. Clutch permits overtravel without damage

Models: Sealed or unsealed with gold-plated PC terminals

DALE ELECTRONICS, INC.

1336 28th Avenue, Columbus, Nebr. 68601
In Canada: Dale Electronics Canada, Ltd.

1" ECONO-TRIM

2300 SERIES/WIREWOUND 8300 SERIES/FILM

SPECIFICATIONS

Dimensions: .36" H x .28" W x 1.00" L

Standard Resistance: 2300 = 10 ohms to 50K ohms; 8300 = 10 ohms to 2 Megohms

Resistance Tolerance: 2300 = $\pm 10\%$;
8300 = $\pm 10\%$ 100 ohms thru 500K ohms,
 $\pm 20\%$ all other values

Power Rating: 2300 = 0.5 watt at 25° C;
8300 = .75 watt at 25° C

Operating Temperature Range: -55° C to 105° C

Mechanical Adjustment: 15 turns nominal

Mechanical Stops: None. Clutch permits overtravel without damage

Models: Sealed or unsealed. Gold-plated PC terminals or gold-plated hook type solder lugs

DALE ELECTRONICS, INC.

1336 28th Avenue, Columbus, Nebr. 68601
In Canada: Dale Electronics Canada, Ltd.

*You can do more with
Dale T-Pots... call 402-564-3131 today*



A new lead to a 300 W, 100 A silicon power transistor in a TO-3 case



2N5578 showing new, heavy pin terminal design.

What are you looking for in your linear and switching applications? 100 ampere pulsed current capability? 300 watts power dissipation? The highest second breakdown capability of any device on the market in a modified TO-3 package?

Look no further. Here's another first from the silicon power leader—RCA's new 2N5578 family... six high-power, high-current Hometaxial-base silicon n-p-n transistors designed for applications in military, industrial, and commercial equipment.

2N5575, for example, has a pulsed collector current of 100 A. Dissipation

is 300 watts at 25°C with V_{CEX} (sus) of 70 V. The useful beta range is 10-40 at 60 A.

For complete design flexibility, there are three terminal variations: 2N5575 and 2N5578 have heavy pins; 2N5576 and 2N5579 have soldering lugs; and 2N5577 and 2N5580 have flexible leads with solderless connectors.

This family of types all adds up to circuit cost savings in inverters, regulators, motor controls, and other linear and switching applications. Check the chart. For more information, see your RCA Representative or

your RCA Distributor. For technical data, write: RCA Electronic Components, Commercial Engineering, Section No. 1-G-12-2, Harrison, N. J. 07029.

Characteristic	Test Conditions			2N5575 2N5576 2N5577		2N5578 2N5579 2N5580		Units
	V_{CE} V	V_{BE} V	I_C A	Min	Max	Min	Max	
h_{FE}	4	—	40	—	—	10	40	V
V_{CE0} (sus)	4	—	60	10	40	—	—	
I_{C}/s^{\dagger}	25	—	0.2	50	—	70	—	A
E_{C}/s^*	—	1.5	7	12	—	12	—	
θ_{JC}	—	—	—	0.8	—	0.8	—	°C/W
	—	—	—	—	0.5	—	0.5	

[†]With base forward biased

^{*}With base reverse biased and $R_{\theta J} = 10\Omega$, $L = 33mH$

RCA