

# Electronic Design 21

FOR ENGINEERS AND ENGINEERING MANAGERS

VOL. 15 NO.

OCT. 11, 1967

Move to the head of your field by going into management. Top engineering managers cite these guides for the "Chief Engineer Game": map out a career design,

learn management techniques, keep technically current, become business-oriented and diversify your experience. For the views of chief engineers, see page 86.

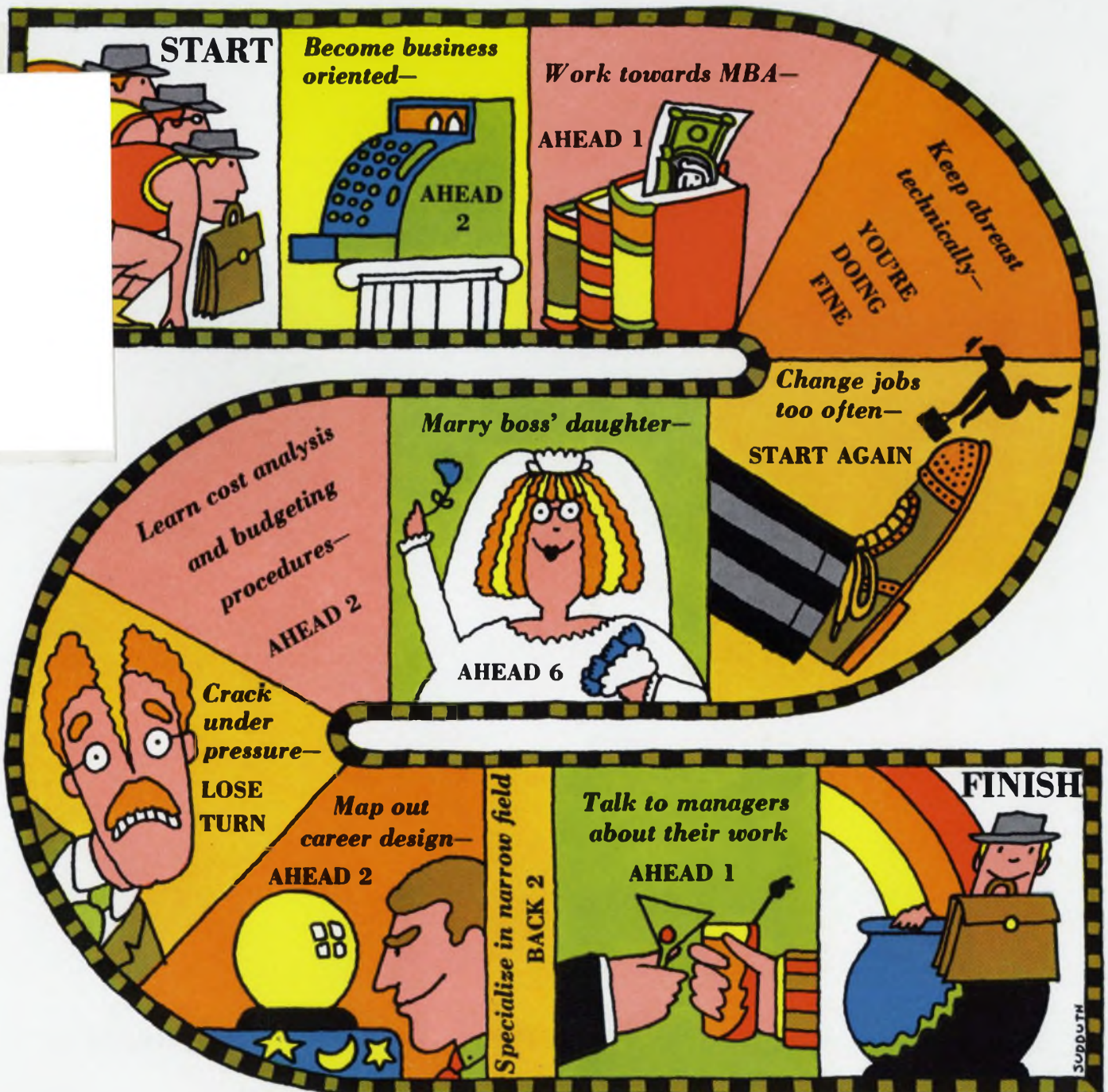

**TRW**  
announces

**50 W at  
500 MHz**



ACTUAL SIZE

## **28 Volts...5dB Gain...60% Efficiency!**

TRW announces a major breakthrough in communication transistor technology with the introduction of this high efficiency, high gain 50 watt/500 MHz device.

In high power military aircraft transmitters, a single 2N5178 will do the job formerly requiring vacuum tubes or multiple-transistor circuits. The 2N5178 is also

well suited for use in radar pulse circuits.

This state-of-the-art device employs a patented cellular construction in a grounded emitter stripline package comparable in size to the TO-37. A 25-watt version, type 2N5177, is also available.

For evaluation quantities and complete technical details, con-

tact any TRW distributor or TRW Semiconductors, 14520 Aviation Blvd., Lawndale, Calif. 90260. Phone: 679-4561. TWX: 910-325-6206. *TRW Semiconductors Inc. is a subsidiary of TRW INC.*

**TRW**<sup>®</sup>

# SPECTRALLY PURE FREQUENCIES up to 500 MHz

(Yes, 500)

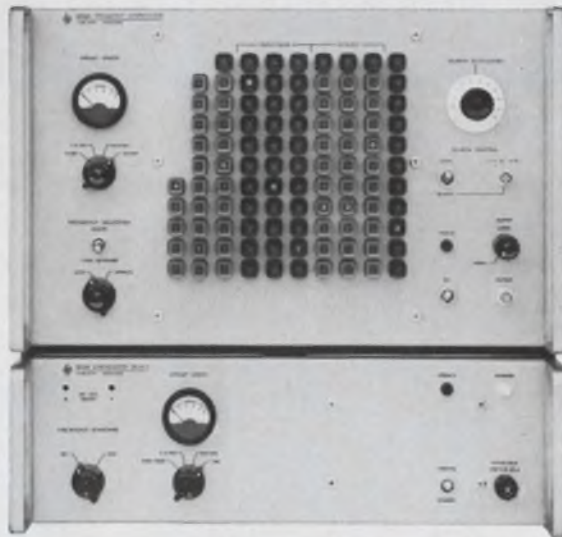

The new Hewlett-Packard 5105A Frequency Synthesizer generates spectrally pure frequencies from 0.1 MHz to 500 MHz in 0.1 Hz steps—a frequency range 10 times higher than previously available by direct synthesis.

Now you can get rapidly switched UHF signals without multiplication and without the accompanying noise increase. Spurious signals are at least 70 dB below the selected output. The 5105A affords extremely rapid digital frequency selection either remotely (typical switching time, 20 microseconds) or from the front-panel pushbuttons. An internal search oscillator provides continuous tuning. Output of the 5105A is 0 dBm  $\pm$  1 dB; phase modulating capability, dc to 1 MHz rate; frequency stability is at least 3 parts in 10<sup>8</sup> per day.

The 5105A uses direct frequency synthesis, with the output frequencies derived from a quartz crystal by arithmetic operations instead of by phase-locked oscillators. This provides faster frequency selection and fail-safe operation.

Model 5105A—\$9150.

Model 5110B driver, required for the synthesizer (will drive up to four 5105A's)—\$4350.

Need a lower frequency model? 1, 10 and 50 MHz models are also available.

Call your local field engineer or write for complete information to Hewlett-Packard, 1501 Page Mill Road, Palo Alto, California; Europe: 54 Route des Acacias, Geneva.

HEWLETT  PACKARD

ON READER-SERVICE CARD CIRCLE 3

# NANO 2 SECOND



**VARIABLE RISE PULSE GENERATOR WITH PRECISION DC BASELINE OFFSET** The Datapulse Model 111 extends general purpose pulse generator technology a full octave in rise time capability, with full control over every major pulse parameter. No other pulse generator is so ideally suited for high speed integrated circuit testing and digital logic circuit design.

**SPECIFICATIONS** — 2 ns to 500 ns linear rise, 4 Hz to 40 MHz repetition rates,  $\pm 5V$  output into 50 ohms, precision baseline offset to  $\pm 5V$  with  $\pm 50mV$  accuracy, single or double pulse operation, 50 MHz simulated rep rates on double pulse, and 8 ns to 500  $\mu s$  pulse widths. ■ PRICE: \$1480.00

#### TYPICAL APPLICATIONS —

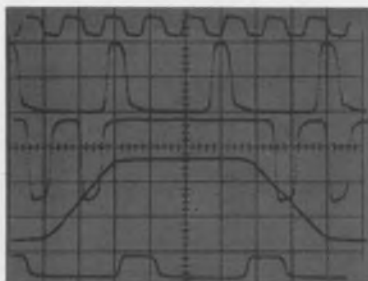

20ns/cm, 1V/cm

The 111's fully controllable fast pulses permit construction of a nearly limitless number of test waveforms for the design and test of high speed components, integrated circuits, analog devices, and other elements.

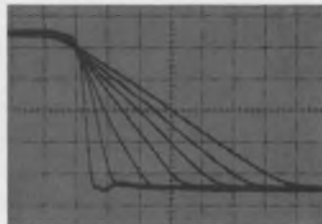

0.3V/cm, 5 ns/cm

**Independently variable, linear rise and fall times** permit marginal testing and exact simulation of pulse circuit rise and fall times.

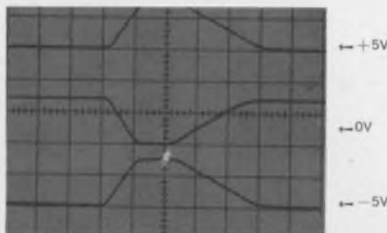

2V/cm, 20 ns/cm

**Precision variable baseline level** provides dc biased outputs for off-ground logic simulation; also for worst case tolerancing of logic circuitry and noise susceptibility analysis.

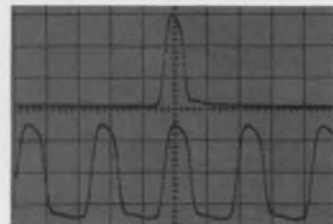

10 ns/cm, 0.5V/cm

**Narrow pulse output** to 8 nanoseconds provides impulse type signals for high speed circuit development, high frequency complex impedance analysis, and other transient tests.

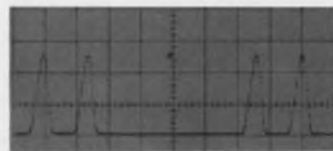

2V/cm, 0.1  $\mu s$ /cm

**Double pulse operation** provides two identical pulses in each cycle. Ideal for flip-flop resolution checks, navigational signal simulation.

The 111 is available NOW! Ask your Datapulse representative for a demonstration! Write for complete technical literature!

**DATAPULSE**®



Datapulse Incorporated — A Subsidiary of Systron-Donner Corporation, 10150 West Jefferson Blvd., Culver City, California 90230. Telephone: (213) 836-6100, 871-0410. TWX: 910-340-6766. CABLE: Datapulse • Microwave Division: DeMornay-Bonardi.

ON READER-SERVICE CARD CIRCLE 4

ELECTRONIC DESIGN 21, October 11, 1967

---

## NEWS

- 13 News Scope
- 17 **Designers' IC testing costs head downward**  
Testers are offered at \$495, but user can still pay \$60,000 to 100,000 for an automatic system.
- 24 **Army unveils its combat electronics at 'fair'**  
Suppliers view mobile radar and other equipment suited for surveillance along Vietnam's 'wall'.
- 29 Washington Report
- 33 Carrier control called key to solid-state future
- 36 **Whiskered cathodes are cool emitters**  
Cornell study shows semiconductors may replace conventional barium oxides in CRT electron guns
- 38 'Detective' computer matches bullets to guns
- 42 Letters
- 49 **Editorial: Is there room at the top for you?**

---

## TECHNOLOGY

- 52 **Build complementary-symmetry amplifiers** with the aid of a few straightforward equations to compute the component values and circuit parameters.
- 58 **Computer talks to the circuit designer** in his own language. Designs are evaluated and changes made immediately by simple conversation.
- 66 **Which delay line is best** to simulate very fast targets for Doppler radars? The choice narrows to two groups, but there is no clear-cut boundary.
- 72 **The paper is as mighty as the pen** in taking a good trace. Know your papers and you'll avoid pitfalls in data recording.
- 78 **Put the varactor's inductance to use** instead of looking upon it as a nuisance. Its effects on frequency range and losses can be overcome.
- 86 **How can YOU become a chief engineer?** Come along on a fact-finding trip and learn the best way to reach the ranks of management.
- 98 Ideas for Design

---

## PRODUCTS

- 114 **Test equipment:** Tester analyzes 40 IC pins, with option for dynamic scope.
- 138 Microelectronics
- 140 Semiconductors
- 146 Microwaves
- 148 Materials
- 153 Systems
- 156 Production equipment
- 158 Components

---

## Departments

- 94 Book reviews
- 170 Design aids
- 172 Application notes
- 174 New literature
- 179 Reprints
- 180 Advertisers' index
- 183 Designers' datebook

# FOR YEARS, YOU'VE PROBABLY HEARD WE'RE IN "2nd PLACE" IN THYRISTOR PRODUCTS...

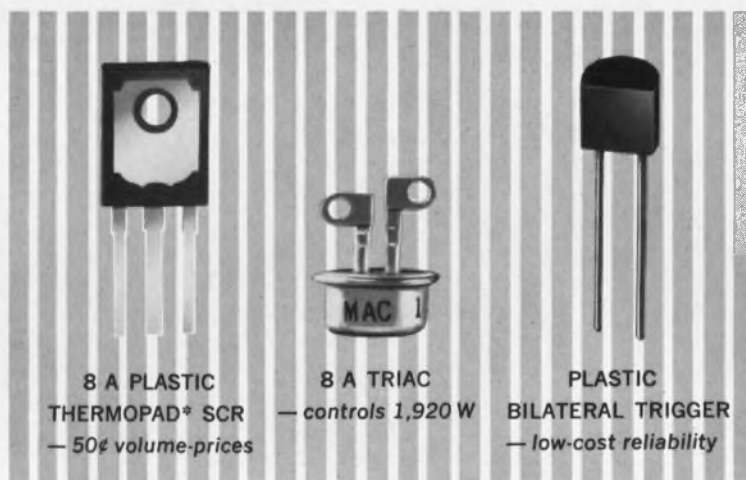

8 A PLASTIC  
THERMOPAD\* SCR  
— 50¢ volume-prices

8 A TRIAC  
— controls 1,920 W

PLASTIC  
BILATERAL TRIGGER  
— low-cost reliability

## LISTEN CAREFULLY NOW.

In just 6 months, Motorola has introduced more than 15 state-of-the-art thyristor and trigger products — more than all other manufacturers combined! There are now more than 270 different Motorola SCR's, TRIAC's, triggers and unijunctions in 14 individual cases available for your power control applications. And, since you'll design in thyristor power control only once this year, why not look over the newest developments first? . . . send for the comprehensive, new, applications-oriented, "Power Control Circuits Library" and a Selection Guide to the broadest, up-to-35-ampere thyristor line available. Box 955, Phoenix, on your company letterhead.

\*Trademark of Motorola Inc.

*— where the priceless ingredient is care!*



**MOTOROLA**  
**Semiconductors**

ON READER-SERVICE CARD CIRCLE 5

ELECTRONIC DESIGN 21, October 11, 1967

## Subminiature Nanosecond Delay Line

# Now! Maximum Reliability in the Smallest Size Available

Featuring high packaging density, this series of delay lines offers a relatively high figure of merit in a small volume without compromising reliability. Originally used in computer applications, the SM Series conforms to applicable portions of MIL-D-23859A. These units are designed for printed circuit board mounting. Special variations with or without taps available upon request.

Units listed are available from stock.

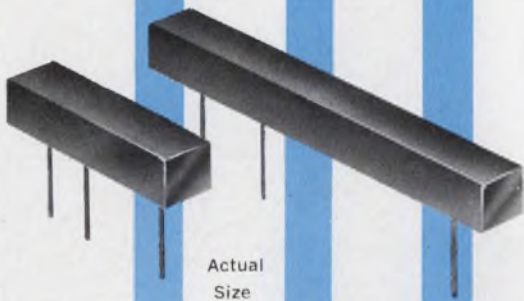

### Specifications

- Operating Temperature:  $-55^{\circ}\text{C}$  to  $+125^{\circ}\text{C}$
- Temperature Coefficient: 100 ppm/ $^{\circ}\text{C}$
- Attenuation: 0.5 db max.
- Distortion (typical):  $\pm 10\%$ ; with an input rise time of 20% of specified rise time or 1 nsec. whichever is greater
- Dielectric Strength: 100 VDC

IMPEDANCE $100\ \Omega \pm 10\%$				IMPEDANCE $200\ \Omega \pm 10\%$				IMPEDANCE $500\ \Omega \pm 10\%$			
MODEL NO.	DELAY nsec. $\pm 5\%$	RISE TIME nsec. MAX.	CASE	MODEL NO.	DELAY nsec. $\pm 5\%$	RISE TIME nsec. MAX.	CASE	MODEL NO.	DELAY nsec. $\pm 5\%$	RISE TIME nsec. MAX.	CASE
SMA10	10	2.5	1	SMB10	10	2.5	1	SMC100	100	30	1
SMA20	20	6.0	1	SMB20	20	6	1	SMC150	150	45	1
SMA30	30	8.5	1	SMB30	30	8.5	1	SMC200	200	60	1
SMA40	40	12	1	SMB40	40	12	1	SMC300	300	80	1
SMA50	50	15	1	SMB50	50	15	1	SMC400	400	55	2
SMA60	60	12	2	SMB60	60	12	2	SMC500	500	70	2
SMA80	80	16	2	SMB80	80	16	2	SMC600	600	80	2
SMA100	100	20	2	SMB100	100	20	2	SMC1200	1200	250	2

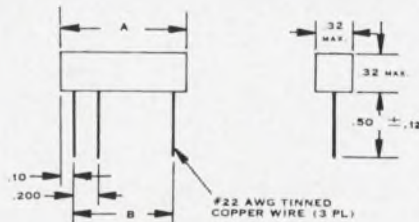

CASE	A	B
1	1.00	0.800
2	2.00	1.800



# ESC

**ELECTRONICS CORP.**  
534 BERGEN BOULEVARD  
PALISADES PARK, N. J. 07650  
(201) 947-0400

World's Leading Producer of Delay Lines

# NEW DVM



## Dual Technique for 0.004% Accuracy

*hp 3460B Integrating/Potentiometric Voltmeter Has High Accuracy...  $>10^{10}\Omega$  Input Resistance... Systems Compatibility*

The new hp 3460B Digital Voltmeter is a dual-technique instrument that combines the best features of an integrating voltmeter with those of a potentiometric voltmeter—to give an accuracy of 0.004% of reading, superimposed noise immunity of integrating DVM's and a high common mode rejection of 160 dB at dc.

You get up to 15 readings per second with five full digits and 20% overranging indicated by a sixth digit. Polarity selection is automatic. The 3460B has 10  $\mu\text{V}$  sensitivity. Four ranges are selectable by pushbuttons on the front panel, or, range selection can be automatic or remote.

Floating and guarded input connectors are on both the front and back of the instrument. Input resistance is  $>10^{10}\Omega$  at balance on 1 V and 10 V ranges (minimum 10 M $\Omega$ ), and a constant 10 M $\Omega$  on 100 V and 1000 V ranges.

*Programmability.*—hp 3460B is designed for

fully automatic operation in a digital data acquisition system. A four-line BCD output (1-2-4-8) on the back of the instrument contains 6 digits of data, polarity, decimal location and overload information. Voltage range and two integration periods can be selected by external circuit closure to ground.

Get the full story on the new dual-technique hp 3460B Digital Voltmeter from your nearest hp field engineer. Or, write to Hewlett-Packard, Palo Alto, California 94304. Europe: 54 Route des Acacias, Geneva. Price: hp Model 3460B, \$3600.00.

097/13

**HEWLETT**  **PACKARD**  
An extra measure of quality

ON READER-SERVICE CARD CIRCLE 6





**Don't try to sell her  
on the challenging career  
Hughes has offered you.**

**Just mention . . .**



**The climate.** Often it's compared with the Riviera's. In truth, Southern California's is better. Drier in summer: no mosquitos, little mugginess. Balmy in winter: seven hours of sunshine a day. You'll save on galoshes!



**Family fun.** You literally can ski and sunbathe the same day here. Swimming pools and ski runs are an hour apart. The kids will love mountain climbing, surfing, sailing, desert rockhounding. Every weekend's a vacation.



**Great schools.** Some of America's most respected school systems are in the Los Angeles area. Also, many fine city colleges; three branches of California State; U.C.L.A., U.S.C., Caltech, Occidental, Loyola, and *more*.



**The good life.** You can find it in communities like Westchester, Redondo, Playa del Rey. Or Sherman Oaks, Canoga Park or Pasadena. We have literally scores of beautiful residential areas within easy reach of Hughes plants.

**About that challenging career . . .** The Hughes Aerospace Divisions have over 200 openings now for graduate engineers. Opportunities exist on advanced projects and programs like ATS, VATE, TOW, PHOENIX, Communications Satellites, and many others. Please send resume to:

**Mr. Robert A. Martin  
Head of Employment, Dept. 4  
Hughes Aerospace Divisions  
11940 W. Jefferson Blvd.  
Culver City, California 90230**



# Starting today you voltage regulator on

# can afford to put a every circuit card.

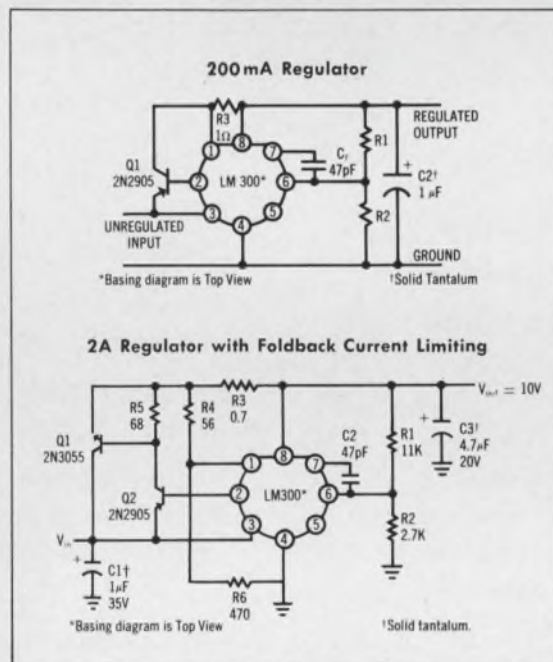

For \$3.60 in 1000 lots you can now simplify your power distribution problems with our new LM-300. It's a plastic TO-5 version of the LM-100. It operates

over a temperature range of 0°C to 70°C with output voltage adjustable between 2 and 20 volts.

The LM-300 is built on a single silicon chip and can

deliver up to 5A with added external transistors.

It's probably the biggest bargain you'll find in this magazine.

You can get them at any of

our distributors, or for more information, write National Semiconductor Corporation, 2975 San Ysidro Way, Santa Clara, California 95051 (408) 245-4320.

## National Semiconductor

ON READER-SERVICE CARD CIRCLE 9

**Now from Sprague!**

QUALITY  
STABILITY  
RELIABILITY  
SMALL SIZE

## All the advantages of tantalum in one **LOW COST** capacitor!

### EPOXY-DIPPED TANTALEX<sup>®</sup> CAPACITORS...

For industrial, commercial, and entertainment electronic applications where tantalum capacitors were previously too expensive!

⊣ Type 196D Solid-electrolyte Tantalum Capacitors have special epoxy-dip coating which keeps costs down without sacrifice in dependability. Positively seals capacitor section while providing excellent electrical insulation. Protects against mechanical damage in handling.

⊣ Radial lead design for plug-in mounting on printed wiring boards. The .250" lead spacing will fit standard .125" grids.

⊣ High stability—very little capacitance change, even at outer limits of operating temperature range.

⊣ Low dissipation factor of these capacitors permits higher ripple currents.

⊣ Meet environmental test conditions of Military Specification MIL-C-26655B.

⊣ Prime capacitance and voltage ratings. Based on rating popularity of other types of solid tantalum capacitors.

⊣ Designed for continuous operation at temperatures from -55 C to +85 C.

For complete technical data, write for Engineering Bulletin 3545 to Technical Literature Service, Sprague Electric Company, 347 Marshall Street, North Adams, Massachusetts 01247.

**Now available for fast delivery from your Sprague Industrial Distributor**

### SPRAGUE COMPONENTS

CAPACITORS  
TRANSISTORS  
RESISTORS  
INTEGRATED CIRCUITS  
THIN-FILM MICROCIRCUITS  
45C-4138R1

PULSE TRANSFORMERS  
INTERFERENCE FILTERS  
PULSE-FORMING NETWORKS  
TOROIDAL INDUCTORS  
ELECTRIC WAVE FILTERS

CERAMIC-BASE PRINTED NETWORKS  
PACKAGED COMPONENT ASSEMBLIES  
BOBBIN and TAPE WOUND MAGNETIC CORES  
SILICON RECTIFIER GATE CONTROLS  
FUNCTIONAL DIGITAL CIRCUITS

**SPRAGUE<sup>®</sup>**  
THE MARK OF RELIABILITY

\*Sprague' and ® are registered trademarks of the Sprague Electric Co.

ON READER-SERVICE CARD CIRCLE 10

# News



**New low-cost IC testers** in the \$500 to \$5000 range have reduced the cost of testing inte-

grated circuits. In addition, IC testing services are on the increase. Page 17

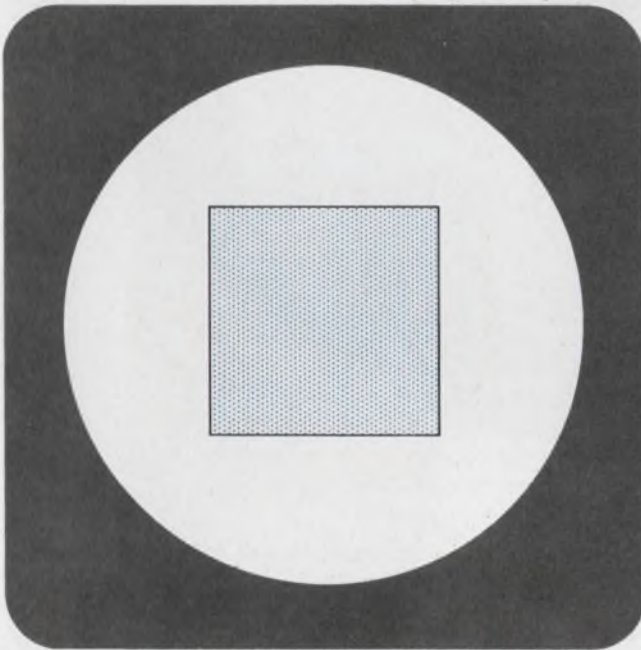

A 'whiskered' cold-cathode in a CRT produces high current densities at low power. Page 36



**Army manpack radar** was among combat devices shown at a military fair. Page 24

## Also in this section:

**Future of solid-state electronics** said to rest on carrier control. Page 33

**Computer techniques** may solve gun crimes of the future. Page 38

**News Scope**, Page 13 . . . **Washington Report**, Page 29 . . . **Editorial**, Page 59

# SPRAGUE SSL<sup>★</sup>

(Super-Speed Logic)

## IS THE BEST DOGGONE TTL



★ Trademark

**DON'T BE DOGGED  
BY CIRCUIT SPEED**

**SPRAGUE SSL  
TO THE RESCUE!**

PROPAGATION DELAY .....	5 nsec*
POWER DISSIPATION .....	25 mW*
NOISE IMMUNITY .....	1.0 V
FANOUT .....	11
FLIP-FLOP TOGGLE FREQUENCY .....	60 MHz

\* As faithful as our four-footed friend, these values are typical, NOT exceptions.

*For additional information on  
Sprague SSL Super-Speed Logic,  
write to:  
Semiconductor Division  
Sprague Electric Company  
115 Northeast Cutoff  
Worcester, Mass. 01606*



**SPRAGUE WORCESTER... the world's finest microcircuit facility**

\*Sprague\* and \*®\* are registered trademarks of the Sprague Electric Co.

ON READER-SERVICE CARD CIRCLE 11

ELECTRONIC DESIGN 21, October 11, 1967

## Defense Dept. rules out standards for IC types

The Defense Dept., in a move to give design engineers more latitude in selecting integrated circuits for military systems, has decided not to standardize the IC types that can be used at this time.

Col. John W. Elder, deputy director of the Technical Data and Standardization Policy Directorate, says that premature employment of piecemeal standardization would lead to undesirable constraints on the design of each succeeding system. Because of the increased reliability of ICs, Colonel Elder says, the Defense Dept. believes that the lifetime of devices will be relatively long and that replacement parts will be relatively few, thus posing little threat to logistics needs. Another factor is the dynamic state of IC design, particularly with the move toward large scale integration.

There has been considerable activity, however, on the part of the

Defense Dept. and NASA to speed standardization of definitions, common test methods, packaging and recommended applications. A five-part program, started in July, includes:

(1) Terms and definitions released to industry as MIL-STD 1313.

(2) Test methods and procedures, including environmental as well as physical and electric tests.

(3) Parameters to be controlled for circuit characterization—for selection of digital ICs.

(4) General application guidance, sign engineers.

(5) Packaging techniques, to cover requirements and quality assurance for packaging, shielding and marking of IC containers.

MIL-STD-1313 was released in early August, and the remaining four parts of this standardization program are expected to be put into effect in the next six months.

### Navy acts to automate its avionics testing

The Navy has briefed industry on its avionics test system called VAST, to clarify its notice in May that it expects all future avionics to be compatible with that computer system.

Under the sponsorship of the Naval Air Systems Command and the Electronics Industries Association, one-day briefings were held at four cities around the country. The Navy plans to install VAST (Versatile Avionic Shop Test System) on its aircraft carriers in 1970.

A navy spokesman told industry that the automatic testing was needed to replace the profusion of special test equipment now required to support airborne electronics. He reported that about 85 per cent of the Navy's avionic test

equipment is now custom-made for specific applications, thereby creating "serious maintenance problems for the Navy." He reported that 20 years ago only about 15 per cent of the test equipment in use then was in this category.

The Navy spent more than \$165 million on special support equipment in the last fiscal year.

Other factors listed by the Navy for encouraging adoption of VAST included these:

- A shortage of skilled technicians to man the avionics shops ashore and afloat.

- A shortage of space, particularly on aircraft carriers, to house the equipment.

The VAST concept is the result of more than three years of study by PRD Electronics, Inc., of Westbury, N. Y. A Univac 1218 computer performs the logic and other procedures usually done by trained technicians. As many as three VAST test stations can be time-shared with a single computer.

The Navy says that the family of functional building blocks that was developed will permit it to test and isolate faults in up to 85 per cent of its existing and projected carrier-based avionics.

### Air Force stressing electronics for today

Electronic warfare programs are running into budget obstacles in the Pentagon for two major reasons:

- The programs are emphasizing far-out research rather than production capabilities.

- There is a lack of good "system effectiveness" measures to evaluate these systems.

These are the trouble areas cited by Lt. Gen. Jack J. Catton, Air Force Deputy Chief of Staff for Programs and Resources. He has urged the electronics industry to improve its competence in these two areas.

In citing the importance of electronic warfare, General Catton said in a Washington address to electronic specialists that Russian-built surface-to-air missiles (SAMs) had not been nearly as effective as the North Vietnamese had hoped they would be. He reported that American electronic systems for avoidance of both SAMs and radar-di-

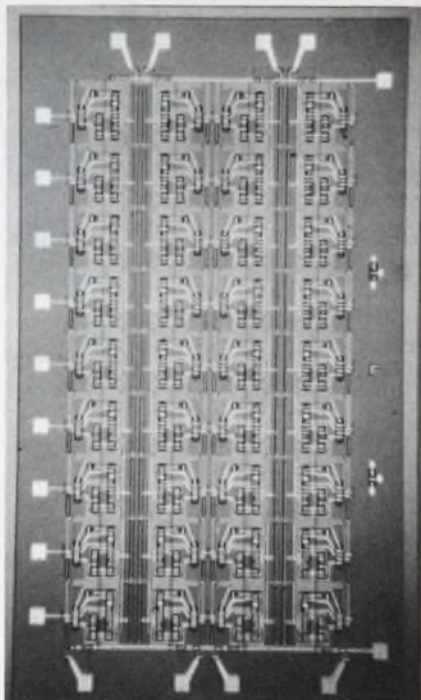

LSI is coming—here's a 36-bit complementary-MOS memory from RCA.

rected anti-aircraft fire have led to steadily decreasing aircraft loss ratios. Despite the public impression of the war, the general said, "... not everybody is crawling around the jungle in black pajamas; we are engaged in a contest with an intelligent enemy who possesses extremely sophisticated and complicated electronic equipment and who knows how to exploit it to the maximum."

The electronic systems now being used in American aircraft were not available at the beginning of the conflict, he noted. In fact, he said, not one tactical aircraft now operating in Southeast Asia was designed with sufficient attention to electronic warfare systems. The F-111, soon to be operational, is the first such plane to have these provisions in its basic design.

In calling for the electronics industry to direct more attention to immediate production, General Catton said: "... too large a segment of the electronic industry is preoccupied with solving the problems of tomorrow rather than the problems of today."

To compete for funds in the Pentagon, the general commented, proposals for electronic warfare systems must be more firmly based on cost-effectiveness factors. Some standard measures are needed, he said, to permit comparisons of electronic warfare systems with other types of systems when the budgets are drawn. He suggested "penetrability" of an aircraft to its target might be one such measure.

The fall meeting of the Air Force Scientific Advisory Board will be devoted completely to electronic warfare.

## New 'bird,' Pacific II, hovers over Hawaii

Pacific II, a new communications satellite, has joined an ailing Pacific I in synchronous equatorial orbit. The new "bird" is expected to be on station approximately over Hawaii and in full operation by mid-October.

One of the four traveling-wave

tubes in the earlier satellite had failed, and the system was being used to full capacity. Although the tube that failed was on stand-by, another failure would have reduced service. Thus the new satellite was needed, according to the Communications Satellite Corp., in order to ensure uninterrupted operations.

If all goes as planned, four satellites, two over the Atlantic and two over the Pacific, will provide commercial service. Comsat Corp. contracts for the satellites under the 58-nation Intelsat consortium. NASA provides launching facilities.

The new satellite includes two redundant linear repeaters with 125-MHz bandwidth and four 6-watt TWTs. This provides 40 two-way voice channels. An omnidirectional biconical horn array radiates 15 watts of transmitted power,

Pacific II was launched Sept. 27 from Cape Kennedy, Fla.

## More electronics sought for air safety

Congressman Richard L. Ottinger (D-N. Y.) has introduced new legislation to modify the Federal Aviation Act of 1958, which deals with air traffic rules. Essentially, he proposes a new subsection for the act to promote safety in commercial aviation (see "CAS: Aid to traffic safety in crowded skies, ED 10, May 10, 1967, pp. 17-23).

He has called on the FAA to consider strengthening flight rules in eight major categories. He has also urged the agency to install available advanced electronic traffic control equipment and to start developing and testing new types.

Many of the innovations pressed by the congressman are based on equipment and systems already proved by the military. Chief among his suggestions are:

**3-D radars**—He pointed out that the Navy has successfully used 3-D radar in Vietnam for nearly two years, yet the FAA has failed even to seek operational data on such equipment. The units he referred to are manufactured by ITT Gilfillan and cost \$1.5 million each. While not necessarily feasible for direct domestic use, he said, the principle of 3-D radar should be explored as a possible alternative to the alphanu-

meric systems now in use.

**Downed aircraft locators**—The FAA, he declared, should develop a signaling device that would be activated immediately and automatically as soon as an aircraft crashes, to pinpoint the site of the disaster for ground and air search parties.

**Airborne recorders**—Testing of an airborne recording system that would keep a constant check on both pilot and aircraft performance should be accelerated. He cited the system now being tested by American Airlines as the sort of equipment needed.

**Secondary radars and ILS**—Back-up radars must be installed at each of the 23 principal U.S. airports, he said, and instrument landing systems should be installed at every airport handling scheduled airline services.

**Airborne transponders**—All regular aircraft should be required by the FAA to carry on-board transponders capable of automatically reporting the aircraft's identity and altitude.

**Collision avoidance system**—The development of an effective low-cost anticollision system for general aviation should be given top priority by the FAA. The danger of midair crashes will continue to be high until all aircraft are equipped with such devices, he said. The cost of developing such a system could be borne by the commercial airlines, he borne by the commercial airlines, the Congressman added.

## Seamans to quit NASA

Dr. Robert C. Seamans, Jr., will leave his post as deputy administrator of NASA on Jan. 1. The number-two man in the National Space Agency, he ranks immediately below its head, James E. Webb.

Dr. Seamans has recently been involved in tangles with Congress over cuts in the NASA budget. He has expressed concern that the manned flight to the Moon may now be delayed to the early Seventies.

He said that he has no definite plans, but "I have been thinking for a period of time of leaving and going back to industry or to a university."

Before joining NASA in 1960, he was chief engineer for RCA's Missiles and Space div. in Burlington, Mass.





## When it comes to electrical tapes, Mystik is king!

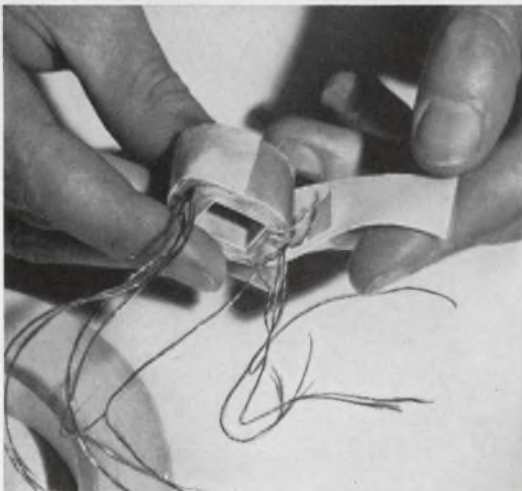

No doubt about it, Mystik leads the field in special-purpose tapes. Our extensive line of top quality products are perfect for hundreds of applications ranging from conventional industrial uses to the more sophisticated demands of the space age.

Mystik tapes are made in a wide range of materials including paper, plastic, cloth and glass cloth as well as many types of films and foils. They provide physical and performance characteristics of every description and are suitable for binding, shielding, strapping and insulating. Mystik pioneered tapes with heat-resistant silicone adhesives that grip like a vise even when exposed to high temperatures. Other new tapes are continually being developed to keep pace with the needs of the rapidly-expanding electrical industry.

We'll gladly prove our right to the "crown". Our local distributor will assist you in selecting the right tape for your application. He's in the Yellow Pages under "Tape" or write The Borden Chemical Co., Mystik Tape Div., 1700 Winnetka Ave., Northfield, Ill.



**BORDEN  
CHEMICAL**

ON READER-SERVICE CARD CIRCLE 12

**FROM PAR** Detection, Measurement or Comparison of Noisy Signals



## New Signal Correlator

**PERFORMS AUTO- OR CROSSCORRELATIONS IN REAL TIME**

**CORRELATION FUNCTION COMPUTED FOR 100 DELAY POINTS SIMULTANEOUSLY**

The PAR Model 100 Signal Correlator, a general purpose, high accuracy instrument of wide dynamic and delay range, computes the auto- or cross-correlation function of input signals and makes them available for continuous display. This system computes 100 points of the correlation function over total spans from 100 microseconds to 1 second. It operates by simultaneously multiplying one input signal by 100 separate delayed replicas of the second input signal. The resulting 100 products are individually averaged and stored in analog memory elements. Readout, which may be performed continuously as the correlation function is being computed, is accomplished by scanning the memory bank at a rate consistent with the speed of the external readout device, e.g., an oscilloscope or x-y recorder.

Correlation analysis — an extremely powerful signal processing technique in many areas of science and engineering — has heretofore been neglected, largely due to a lack of availability of suitable equipment. The

PAR Model 100 Signal Correlator will be useful in such diverse fields as aero- and hydrodynamics, plasma physics, vibration analysis, radio astronomy, radar, lasers, medical physics and geophysics.

### PAR Model 100— Hundred Point Time Delay Correlator SPECIFICATIONS IN BRIEF:

**Total Delay Range:** 100  $\mu$ Sec to 10 Sec in 1, 2, 5 sequence.

**Input Signal Levels:** Peak-to-peak signals of 0.4 volts to 200 volts are accommodated without overload in each channel.

**Correlator Gain Factor:** At gain of 1 in each channel, 1 volt into each input will give 1 volt of correlated output. Gain for each channel is .01 to 5, in 1, 2, 5 sequence.

**Noise and Dynamic Range:** Base line noise with no signals,  $10^{-3}$  volts peak-to-peak. Maximum correlated output,  $\pm 3.5$  volts.

**Frequency Response and Resolution:** Channel amplifiers flat to 1 megacycle. Resolution: 100 sampling points on output function.

**Averaging Time - Constant:** Nominally 20 seconds; May be changed to any value from 0.1 to 100 seconds.

**Accuracy:** Better than 1%.

**Readout:** 0-3.5 volts at sweep rates of 20 per Sec, 1 per 10 Sec, 1 per 50 Sec.

**Price:** \$8500.00. Export price approximately 5% higher, except Canada.

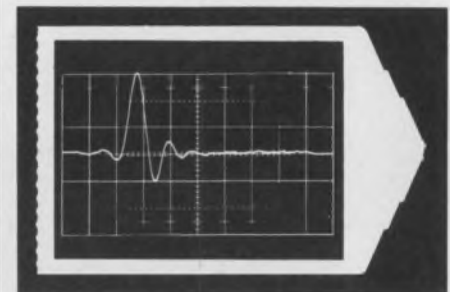

Typical Photograph of Crosscorrelation Function of Input and Output Signals of Complex Passive Network Driven by White Noise.

For more information call (609) 924-6835 or write Princeton Applied Research Corp., Dept. E, P.O. Box 565, Princeton, N. J. 08540.



**PRINCETON APPLIED RESEARCH CORP.**

ON READER-SERVICE CARD CIRCLE 13

ELECTRONIC DESIGN 21, October 11, 1967

# Designers' IC testing costs head downward

Testers are offered at \$495, but user can still pay \$60,000 to \$100,000 for an automatic system

Ron Gechman  
West Coast Editor

"How can I test the integrated circuits I buy, and do it inexpensively, before assembling them in my equipment?"

Until a year ago this question was asked often by the small users of ICs who could not afford to buy the high-priced automatic testers available then.

Today users like these have a number of low-priced testers to choose from, and more are on the way. Their question now is: "What tester should I buy?"

Tester prices, previously at \$60,000 or more, have dropped to \$495 and up. You can still spend \$60,000 or even \$100,000 if you want a costly computer-operated automatic system. But a wide range of testers is available, depending on:

- How much information is needed about an IC.
- How automatic you want the testing to be.
- How many integrated-circuit

devices must be tested.

■ How much documentation is needed.

In addition, competition for IC-tester manufacturers may come soon from a new source. Testing service organizations, equipped with large, automatic computer-controlled testers, are beginning to operate. They are capable of running tests on small quantities of ICs at a relatively nominal cost, thus eliminating the need for the small IC user to purchase capital equipment.

## \$40-million market seen

Many tester manufacturers predict that the present IC test-instrument market of around \$20 million a year should reach \$40 million to \$50 million by 1970. With the possibility of widespread use of ICs for applications in the home and in automobiles, some manufacturers feel that even these figures may be conservative.

Tester manufacturers generally agree on where their market is and the people who need testers. Richard Barr, sales manager for one manufacturer, the Redcor Corp. of Canoga Park, Calif., sums up the categories of users this way:

■ Semiconductor manufacturers that have produced small lots of ICs for a special purpose. Programming their automatic testers for testing these devices would be too costly and more time-consuming than using a small manual or semi-automatic tester.

■ Small-production users, who may use one or more testers for receiving inspection, production testing and quality assurance.

Evaluation engineers in both large and small companies, for evaluating new devices and circuits and for qualifying a manufacturer's IC.

■ Colleges and universities, for laboratory and classroom work.

## Dynamic testing pressed

One of the more recent changes in testing philosophy is the move toward dynamic testing—testing under conditions that the IC will encounter when operating in its intended circuit. If an IC user is interested only in determining if a device is good or bad, such as in receiving-inspection functions, dc testing may be sufficient. However, a detailed evaluation of the device may be necessary to determine its suitability in a new circuit design.

Testers with a price tag of around \$5000 seem to be the most popular on the market, with less sophisticated testers selling for \$2000 and less.

The popular-priced testers include these:

■ Beckman Instruments' Model 999, probably the least expensive. It sells for \$495, and it tests the entire IC family for such parameters as input threshold levels, output current (both high and low levels) and short-circuit output currents.

■ Birtcher Corp.'s Model 800. It includes the basic modules for dc



Compact design of Beckman Instrument's analog-reading IC tester is evident in these units. They are said to be the least expensive on the market.

(IC tester, *continued*)

## Low-priced integrated circuit testers

Manufacturer	Model	Price	Readout	Current Range Measuring	Voltage Range Measuring	Forcing Voltage	Forcing Current	Program Technique
<b>Aertronic Assoc., Inc.</b> Contoocook, N.H.	1061	\$5900	Meter, provision for ext. DVM or oscilloscope	0 to 1 A	0 to 25 V	0 to 10 V	0 to 1 A	Thumbwheel switches
<b>Beckman Instruments Inc.</b> Richmond, Calif.	999	\$495	Meter, provision for ext. DVM or oscilloscope	0 to 100 mA	0 to 10 V	0 to 10 V	0 to 100 mA	Slide and decade switches
<b>Birtcher Corp.</b> Monterey Park, Calif.	800	\$2200	Meter, provision for ext. DVM or oscilloscope	0 to 100 mA	0 to 100 V	0 to 100 V	0 to 100 mA	Slide switches and pushbuttons
<b>Computer Test Corp.</b> Cherry Hill, N.J.	MICA-150	\$11,200	DVM, meter optional	0 to 1000 mA	0 to 1000 V	0 to 100 V	0 to 100 mA	Slide switches
<b>Continental Device Corp.</b> Hawthorne, Calif.	9545	\$4500	Go/No-go, provision for ext. DVM and printer	0 to 100 mA	0 to 20 V	0 to 20 V	0 to 75 mA	Plug-in cards
<b>Integrated Systems Corp.</b> Stowe, Vt.	1100	\$750	Meter, provision for ext. DVM or oscilloscope	Presently not measured	0 to 30 V	0 to 28 V	0 to 200 mA	Slide switches
<b>Microdyne Instruments Inc.</b> Waltham, Mass.	710	\$995	Meter, DVM and printer optional	0 to 100 mA	0 to 50 V	0 to 25 V	0 to 100 mA	Slide switches
<b>Monitor Systems Inc.</b> Ft. Washington, Pa.	851	\$1920	Oscilloscope	—	—	0 to 7 V	0 to 35 mA	Prewired program
<b>Optimized Devices, Inc.</b> Pleasantville, N.Y.	IC 101	\$1600	Meter, provision for ext. DVM	0 to 100 mA	0 to 100 V	0 to 100 V	0 to 100 mA	Slide switches
<b>Redcor Corp.</b> Canoga Park, Calif.	990	\$4950	Meter, provision for ext. meter or oscilloscope	0 to 1 A	0 to 100 V	0 to 100 V	0 to 100 mA	Thumbwheel and pushbutton switches
<b>RFS Engineering Co.</b> Philadelphia, Pa.	1800	To be announced (Under \$10,000)	DVM	0 to 100 mA	0 to 100 V	0 to 100 V	0 to 100 mA	Slide switches, automatic programmed tape optional
<b>Signetics Corp.</b> Sunnyvale, Calif.	1100	\$4995	Go/No-go	—	—	0 to 5.5 V, jacks for ext. 10 V supply	0 to 20 mA	Plug-in cards
<b>Teradyne, Inc.</b> Boston, Mass.	J133	\$4850	Go/No-go	—	—	0 to 8 V	0 to 50 mA	Plug-in cards

Terminals	Dynamic Testing Capability	Sampling Oscilloscope	Pulse Generator	Tester Operation	Construction	Input Power	Weight	Size	Manufacturer
To 20 pins	No	No	No	Manual, programmer available for semi-automatic operation	Modular	115 V ac, 60 Hz, 80 W	90 lbs	W 21 in. H 22 in. D 23 in.	<b>Aerotron Assoc., Inc.</b> Contoocook, N.H.
To 16 pins	No	No	No	Manual	Hardwired	115/230 V ac, 50-60 Hz, 10 W	10 lbs	W 16.50 in. H 7 in. D 12.25 in.	<b>Beckman Instruments Inc.</b> Richmond, Calif.
To 16 pins	Yes	Provision for ext. connection	Plug-in module	Manual	Modular	115/230 V ac, 50-60 Hz	65 lbs	W 19.50 in. H 25 in. D 13 in.	<b>Birtcher Corp.</b> Monterey Park, Calif.
To 40 pins	Yes	Provision for ext. connection	Plug-in module	Semi-automatic	Modular	105-125 V ac, 50-60 Hz	—	W 23.50 in. H 31 in. D 32 in.	<b>Computer Test Corp.</b> Cherry Hill, N.J.
To 20 pins	Yes	Provision for ext. connection	Provision for ext. connection	Automatic and manual	Hardwired	115/208 V ac, 50-60 Hz, 300 W	80 lbs	W 17 in. H 10.50 in. D 22 in.	<b>Continental Device Corp.</b> Hawthorne, Calif.
To 20 pins	Yes	Provision for ext. connection	Provision for ext. connection	Manual	Hardwired	115 V ac, 60 Hz, 85 W	14 lbs	W 14 in. H 9 in. D 8 in.	<b>Integrated Systems Corp.</b> Stowe, Vt.
To 16 pins	Yes	Provision for ext. connection	Built-in	Semi-automatic	Hardwired	115 V ac, 50-60 Hz, 10 W	—	W 12 in. H 10.50 in. D 15.50 in.	<b>Microdyne Instruments Inc.</b> Waltham, Mass.
To 16 pins	Yes	No	Built-in	Manual	Hardwired	115 V ac, 47-63 Hz, 50 W	27 lbs	W 17.25 in. H 7 in. D 11.75 in.	<b>Monitor Systems Inc.</b> Ft. Washington, Pa.
To 16 pins	Yes	Provision for ext. connection	Provision for ext. connection	Manual	Modular	115 V ac, 50-60 Hz, 25 W	30 lbs	W 23 in. H 10.50 in. D 14 in.	<b>Optimized Devices, Inc.</b> Pleasantville, N.Y.
To 16 pins	Yes	Provision for ext. connection	Plug-in module	Manual	Modular	110/220 V ac, 50-60 Hz	82 lbs	W 21.25 in. H 24.50 in. D 19.25 in.	<b>Redcor Corp.</b> Canoga Park, Calif.
To 16 pins	Yes	Provision for ext. connection	Plug-in module	Manual, automatic with optional programmer	Modular	115/230 V ac, 50-60 Hz	70 lbs	W 22 in. H 20 in. D 20 in.	<b>RFS Engineering Co.</b> Philadelphia, Pa.
To 14 pins	No	No	No	Semi-automatic	Hardwired	105-130 V ac, 50-60 Hz, 100 W	22 lbs	W 17 in. H 9 in. D 13 in.	<b>Signetics Corp.</b> Sunnyvale, Calif.
To 16 pins	No	No	No	Automatic	Hardwired	105-130 V ac, 50-60 Hz, 45 W	32 lbs	W 19 in. H 5.50 in. D 18 in.	<b>Teradyne, Inc.</b> Boston, Mass.



# introducing the "PIXIEPOT" at an IMPossibly low price!

Duncan Electronics now offers for the first time in the history of the potentiometer industry a PRECISION, TEN-TURN WIREWOUND pot for less than \$6.00. In fact, the new Model 3253 "PIXIEPOT" potentiometer is yours for as low as **\$3.97** each in production quantities and only **\$5.95** each for 1-24 units.

#### Outstanding "PIXIEPOT" potentiometer features:

- Length: ONLY  $\frac{3}{4}$ "
- Diameter:  $\frac{7}{8}$ "
- Linearity:  $\pm 0.25\%$
- Resistance Range: 100 ohms to 100K ohms
- Power Rating: 2 watts @ 20°C
- Temperature Range: -25°C to +85°C
- Resolution: Better than any precision pot twice its size.

The Model 3253 "PIXIEPOT" potentiometer incorporates all of the fine engineering workmanship you've come to expect from other Duncan products. Only our new, unique production techniques enable us to bring this potentiometer to you at these unheard of prices.

And if you need your "PIXIEPOT" potentiometers in a hurry, we guarantee they'll be on an airplane out of Los Angeles within 24 hours after receipt of your order!

How can a "PIXIEPOT" potentiometer help you?

Call or write your Duncan representative (listed on the facing page). He will personally deliver to you, FREE, a 1K "PIXIEPOT" potentiometer for your evaluation in exchange for the filled out certificate.

#### This certificate redeemable for one 1K "PIXIEPOT"

(TYPE OR PRINT)

MY APPLICATION IS \_\_\_\_\_

---

NAME \_\_\_\_\_

COMPANY \_\_\_\_\_ TITLE \_\_\_\_\_

ADDRESS \_\_\_\_\_ DIVISION \_\_\_\_\_

CITY \_\_\_\_\_ STATE \_\_\_\_\_ ZIP \_\_\_\_\_

This offer expires December 1, 1967



DUNCAN ELECTRONICS, INC. • 2865 FAIRVIEW ROAD, COSTA MESA, CALIFORNIA 92626

ON READER-SERVICE CARD CIRCLE 15

ELECTRONIC DESIGN 21, October 11, 1967

## ENGINEERING SALES REPRESENTATIVES

ALABAMA, Huntsville  
Orbe, Inc.  
Tel: (205) 881-8230

ARIZONA, Phoenix  
Southwest Engineering Company  
Tel: (602) 944-1521

CALIFORNIA, Costa Mesa  
Duncan Electronics, Inc.  
(Factory Sales Office)  
Tel: (714) 545-8261

CALIFORNIA, San Francisco  
Jack Pyle Company  
Tel: (415) 349-1266

COLORADO, Denver  
Hyde Electronics Co., Inc.  
Tel: (303) 936-3456

CONNECTICUT, New Haven  
Gerber Sales Co., Inc.  
Tel: (203) 777-6279

FLORIDA, Orlando  
Orbe, Inc.  
Tel: (305) 424-0978

FLORIDA, St. Petersburg  
Orbe, Inc.  
Tel: (813) 894-0687

ILLINOIS, Chicago  
Carlson Electronic Sales Co.  
Tel: (312) 774-0277

MARYLAND, Baltimore  
Biechler Associates, Inc.  
Tel: (301) 825-8222

MARYLAND, Rockville  
Biechler Associates, Inc.  
Tel: (301) 762-6210

MASSACHUSETTS, East Longmeadow  
Gerber Sales Co., Inc.  
Tel: (413) LAurel 5-3059

MASSACHUSETTS, Waltham  
Gerber Sales Co., Inc.  
Tel: (617) 891-8040

MICHIGAN, Detroit  
Grant Shaffer Company  
Tel: (313) 273-5390

MINNESOTA, Minneapolis  
Carlson Electronic Sales Co.  
Tel: (612) 788-4111

MISSOURI, Kansas City  
Harris Hanson Company  
Tel: (816) 444-9494

MISSOURI, St. Louis  
Harris Hanson Company  
Tel: (314) 647-4350

NEW JERSEY, Harrington Park  
B. B. Taylor Corporation  
Tel: (201) 768-0969

NEW YORK, Baldwin, L.I.  
B. B. Taylor Corporation  
Tel: (516) 223-8000

NEW YORK, Rochester  
Reed Electronics, Inc.  
Tel: (716) 473-2767

NEW YORK, Syracuse  
Reed Electronics, Inc.  
Tel: (315) 468-5488

NEW YORK, Vestal  
Reed Electronics, Inc.  
Tel: (607) 748-7391

OHIO, Cleveland  
Rockford Controls Ohio, Inc.  
Tel: (216) 531-4841

OHIO, Dayton  
Rockford Controls Ohio, Inc.  
Tel: (513) 274-1911

PENNSYLVANIA, Millersville  
Biechler Associates, Inc.  
Tel: (717) 872-2793

PENNSYLVANIA, Pittsburgh  
Rockford Controls Ohio, Inc.  
Tel: (412) 731-4600

TEXAS, Dallas  
Robert R. Thomas Company  
Tel: (214) 363-8591

TEXAS, Houston  
Robert R. Thomas Company  
Tel: (713) 644-2369

WASHINGTON, Seattle  
Hamilton-Electro Corporation  
of the Pacific Northwest  
Tel: (206) 624-5930



DUNCAN electronics, inc.

## NEWS

(IC tester, *continued*)

testing, as well as modules for testing linear ICs and generating pulse parameters for testing digital ICs. A built-in analog meter monitors each power supply or any device leads selected.

■ Computer Test Corp.'s MICA-150. It is capable of a wide variety of pre-programming test combinations, ranging from a single test on a 40-pin device to as many as 20 different tests on a 2-pin device. All test conditions are set up on two independent crossbar programming switches, which connect any of up to eight different function generators and a built-in DVM to the desired pins of the device under test. A pushbutton keyboard advances the test from pin to pin and program to program without resetting any switches.

■ Redcor Corp.'s Model 1900, which can perform dc, ac, linear, dynamic and functional tests on all currently available monolithic ICs. Programming is achieved with a dig-

it switch register that selects the matrix connections. Testing is performed by sequentially depressing a series of programmable pushbuttons.

■ Signetics Corp.'s Model 1100. It subjects all devices to a series of six functional tests: continuity, orientation, power dissipation, functional, noise immunity and high-frequency toggle rate. Test results are displayed on go/no-go lights. A plug-in program board automatically programs the tester for the device to be tested.

■ Teradyne Corp.'s Model J133, automatically programmed by inserting two plug-in cards in the front panel. One card is for the IC family being tested and the other for the particular device under test. The tester compares the results of the device under test with a similar device installed on the program board. Test results are indicated by a group of go/no-go lights on the front panel.

For the very-high-speed, computer-controlled systems prices start at about \$60,000 and climb above

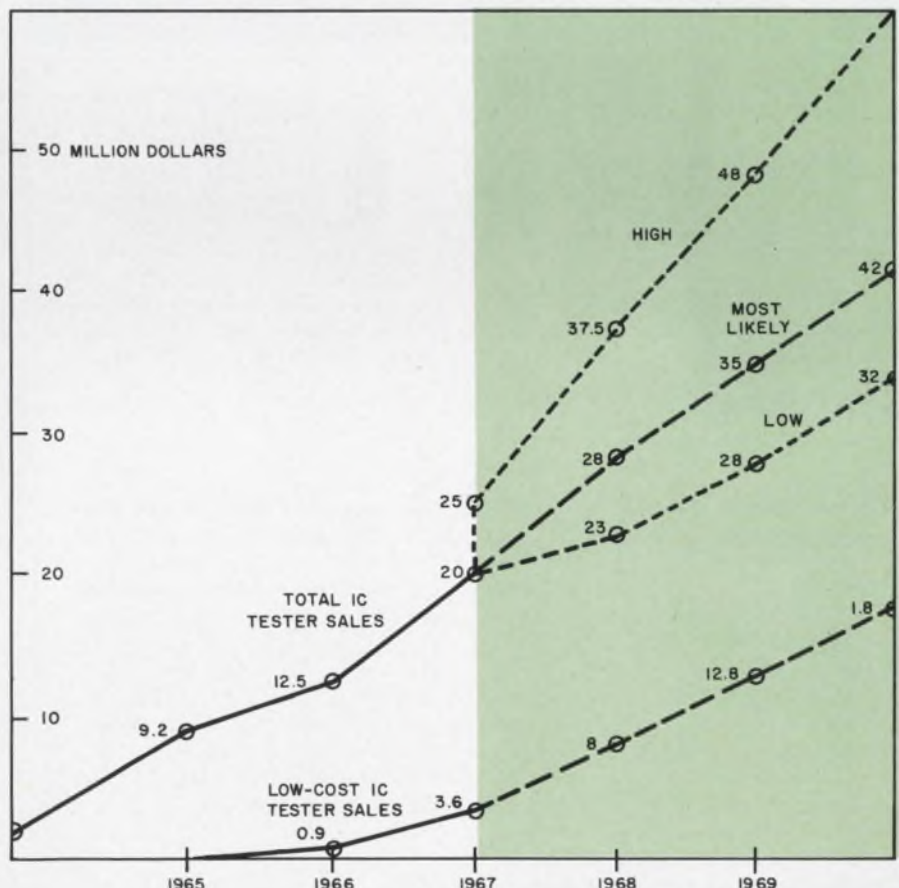

Annual IC tester sales of \$20 million are expected to rise to about \$40 million by 1970. Surveys see low-cost tester sales increasing five-fold in three years. The above data were compiled by Gordon L. Ness Associates, Los Altos, Calif.

(IC tester, *continued*)

\$100,000. Fairchild Instrumentation holds about 80 per cent of the high-priced equipment market with its Series 4000 and 5000 IC test systems. Competitors include Texas Instruments' Model 861, AAI Pacific Div.'s Series 1000 and, to some extent, Teradyne Corp.'s Model J259.

### Testing companies forging ahead

Typical of the companies that will test ICs for you is Fairchild Instrumentation's Los Angeles Test Facility, which began operating last June. The company uses a Fairchild 4000M test system to provide high-speed testing of dc and switching-speed parameters.

Capabilities include complete environmental testing and automatic recording of devices tested to a customer's specification. The cost of testing is based on the customer's requirements, test complexity and volume of testing. A typical charge to test a device on a go/no-go basis, at ambient temperature with about 34 dc tests, is 17 cents a device in quantities of 500 to 5000, plus a set-up charge of \$40.

Other manufacturers of IC test equipment are considering establishing service organizations for testing. Raymond Wells, vice presi-



Modular design of Birtcher Corp. tester can be upgraded by replacing the blank panel with a decade load module, for adding RC networks to the device under test, and a pulse generator, for measuring pulse parameters of digital logic circuits.

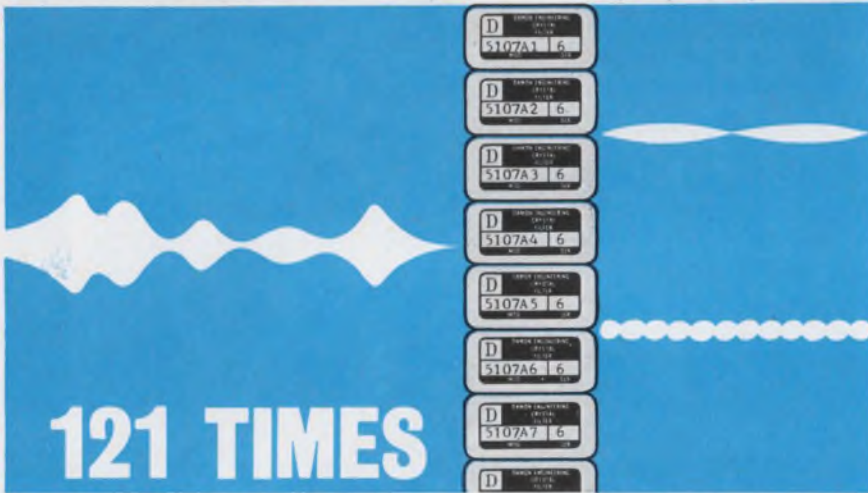
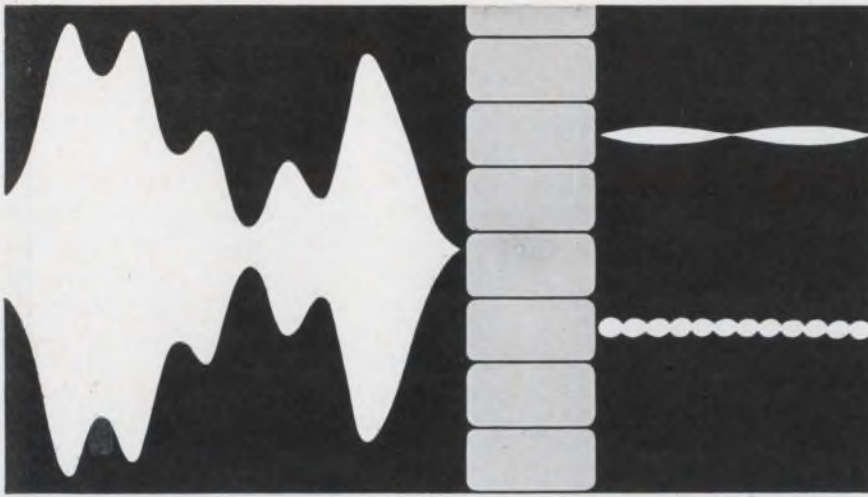

# 121 TIMES

# LESS DRIVE POWER

## with Contiguous Comb Filter Sets by Damon



Typical Contiguous Comb Crystal Filter, Model 5107A is  $1\frac{1}{8}$ " L x  $\frac{3}{8}$ " W x  $\frac{1}{8}$ " H.

Damon has produced a bank of 200 contiguous comb crystal filters that requires a total of 6.6 watts of drive power to obtain 10 milliwatts from each of the Gaussian (non-overshoot) response filters. This is only 1/121 of the 800 watts of drive power normally required to achieve the same output using conventional resistive padding techniques.

This significant achievement is the result of two advances in crystal filter technology: high efficiency contiguous comb crystal filters combined with new synthesis techniques. These advances permit the adherence to both frequency and time response specifications and offer a

new concept in the design of radar and other spectrum-based systems. Contiguous comb crystal filter banks are also the most reliable, efficient, compact and economical precision systems available for multichannel signal processing of all kinds.

Write for data on Gaussian Response Contiguous Comb Crystal Filters to Damon Engineering, Inc., Needham Heights, Mass. 02194, Tel. (617) 449-0800.

# DAMON

ON READER-SERVICE CARD CIRCLE 18



dent of the AAI Pacific Div. in Northridge, Calif., says his company is establishing a testing service using its Series 1000 as the basic test system. AAI expects to be in operation within a few months. Continental Testing Laboratories, Inc., at Orlando, Fla., is using Fairchild Series 4000 test equipment to provide testing service.

Integrated-circuit manufacturers have spent considerable sums to advertise the fact that they test their devices thoroughly before shipment, and often a small company just beginning to use ICs feels it is unnecessary to conduct further tests. However, even at the high testing speeds that the device manufacturers employ, only a partial profile of the device can be made. Testing costs would mount considerably otherwise.

The manufacturer of instrumentation equipment who designs with ICs must examine the IC himself in greater detail to determine all its limitations as they apply to his intended use.

### Failures are expensive

Dugald Roy, product marketing manager for Texas Instruments' Apparatus Div. in Houston, says that a serious problem facing the IC user is to remove those devices from production that have failure characteristics before time is invested in mounting a bad device on a printed-circuit board. The cost for removing a defective IC from a board ranges from \$15 to \$100, with \$30 the average price, according to Donald Ristine, test facility engineer for Fairchild Instrumentation in Los Angeles. It's cheaper

to test a device before it is installed.

Some failure modes develop with time and cannot be determined at the time of the seller's final test of a device. Roy points to these possible failure modes:

- Cracks in the substrate caused by voiding or lead bonding that propagate with time.
- Wire embrittlement caused by overheating during bonding.
- Hot spots caused by diffusion spikes that stem from crystal faults.
- Thin spots in aluminum interconnects that fail under load.
- Shock-inflicted damage during shipment.

But the fact that a device has passed its static tests does not necessarily mean that it is suitable under dynamic conditions, Roy says. Tolerances in the manufacturing process, while improving, still cause variation from device to device. Even a slight variation of device geometry can cause serious degradation in the operation of a device. This, plus two other factors—cross talk and bandwidth degradation due to parasitic components and device geometry—create a need for dynamic testing, according to Roy.

The equipment to perform dynamic testing usually includes a pulse generator, sampling oscilloscope, high-frequency test fixture and a switching time converter. This equipment rapidly increases the cost of test equipment. Some of the lower-priced equipment can perform dynamic testing or have provisions for easily connecting the necessary equipment.

Most manufacturers report that technology has not been their major problem in designing testers. The



Dynamic testing is performed by Computer Test Corp. tester by connecting a sampling oscilloscope to an internal pulse generator.

problem has been to construct a machine with a minimum of operator set-up time. Daniel Marshall, product-line manager for Beckman Instruments, Inc., in Richmond, Calif., says: "Our biggest problem was to design a system so that an operator with a basic familiarity with ICs could run it without constantly consulting a manual."

As for future prices, some companies feel that the cost gaps between the different categories of testers may become wider; others disagree. Irwin Roth, manager of instrumentation at the Signetics Corp. in Sunnyvale, Calif., believes that IC tester prices should decrease as more of any particular type are manufactured. He says, for example, that the price of Signetics tester will remain at \$4995 for about the next six months, but will decrease thereafter. ■ ■

## Fluidic tester developed for weapon circuitry

Electrical circuits in nuclear weapons may soon be checked automatically with a fluidic tester developed at Sandia Laboratories, Albuquerque, N. M.

The tester, according to Sandia scientists, would make greater use of automation than conventional testers, yet still comply with safety regulations limiting the use of electric current. Heretofore, automatic equipment has required larger pow-

er sources than Sandia standards permitted.

The fluidic tester operates as follows:

A perforated tape with programmed instructions is threaded into the sensing head of a reader. The instructions are "read" by the action of air passing through the code holes in the tape. The holes are arranged in blocks of 320 and are read simultaneously.

The perforations in the tape allow the air to flow into an outlet in the bottom of the head, then into the 320 plastic tubes, one for each hole.

The air flow in each line sets up the selected metering circuit by flexing a leather diaphragm that pushes rods, linking the test circuit to conductors for the desired positive or negative polarity. The tester checks the circuit and tells the operator to record the test results. ■ ■

# Army unveils its combat electronics at 'fair'

## Suppliers view mobile radar and other equipment suited for surveillance along Vietnam's 'wall'

Neil Sclater  
East Coast Editor

A cigarette-pack-sized electronic device designed to warn of sneak infantry attacks . . . a manpack radar that locates vehicles 10,000 yards away . . . a mobile radar with a computer that pinpoints enemy mortar and rocket emplacements.

These were a few of the 150 items on display at Fort Monmouth, N. J., as the Army Electronics Command held a Procurement Fair for more than 6000 suppliers in the United States and Canada. Communications, surveillance and meteorological equipment was shown. Conspicuously absent were such novelties as lasers and all-solid-state field radars.

The fair, designed to induce more manufacturers to participate in Army procurement, stirred added interest among observers who were seeking clues to what the Defense Dept. might use in the "electronic wall" to be built just south of the de-militarized zone in Vietnam.

The pocket-sized intrusion detector, intended to fend off sneak attacks by an enemy at night or in thick jungles, is essentially a combi-

nation buzzer and flashlight, activated by a break in a hair-thin loop of wire. The AN/GSS-9, as the trip-wire device is called, is probably the least complex solid-state circuit now being procured by the Army.

A flick of a switch can make the alarm either a light or a buzzer. The small, olive-drab, waterproof plastic box contains a standard 1-1/2-V cell and a replaceable plug-in cartridge with two miles of No. 44 wire. According to the Army, broken strands can be fused together with a match.

### False alarms expected

One sergeant at the fair, a veteran of Vietnam, was asked about the possibility of false alarms. He said he would prefer to crawl out at night to mend a circuit broken by wind or animals than to be unaware of approaching Viet Cong. The circuit may find use in the anti-infiltration barrier proposed in Vietnam.

The Army has been working for years to develop effective manpack combat surveillance radars, but they have gone into the field only recently. The inventory lists three models. All use noncoherent Dop-

pler pulses to furnish aural intruder detection signals. They are intended to detect the movements of humans or vehicles in combat zones, primarily by means of an audio tone related to the radial velocity of the target.

All models have headphones that plug into main frame jacks and small telescopes for visual alignment of the antenna. Batteries are used for primary power but some have adapters for use with a vehicle power supply.

One model, the AN/PPS-4, has an effective range of about 1500 yards against personnel and 6000 yards against vehicles. The newer, lighter and more compact PPS-6 has a comparable range for personnel but its range on vehicles is only 3000 yards. The Army favors the heavier, more versatile PPS-5, because, in addition to producing an audio doppler beat note, it has a video chassis attachment with "A" and "B" scopes for visual target indication. The set's range is better than 5000 yards when people are the targets and 10,000 yards for vehicles.

### Developed since 1955

The PPS-4 was first built by the Sperry Gyroscope Div. of Sperry Rand Corp. of Great Neck, N. Y., in 1955. The covered antenna produces a narrow pencil beam. More than 800 units were made by Sperry before production was discontinued. They are now on duty in Vietnam combat zones and are used for training in the United States.

The self-contained PPS-6, designed by the Army but favored by the Marine Corps, weighs 35 pounds. It employs solid-state circuitry but has a magnetron as a transmitter tube. It is tunable through the X-band region of 9.0 to 9.5 GHz. Its antenna also forms a narrow pencil beam. The Radio Receptor Div. of the General Instrument Corp., Hicksville, N. Y., is the builder of the system.

The PPS-5, a Ku-band system, weighs 95 pounds with all attachments: power supply, headphone,



Infantry troops use the AN/PPS-5 to detect the approaching enemy. The soldier in the center position is viewing target movement on a dual CRT attachment, but headphones can also be used to hear Doppler tone changes.

# Union Carbide's New Integrated Circuit Operational Amplifier

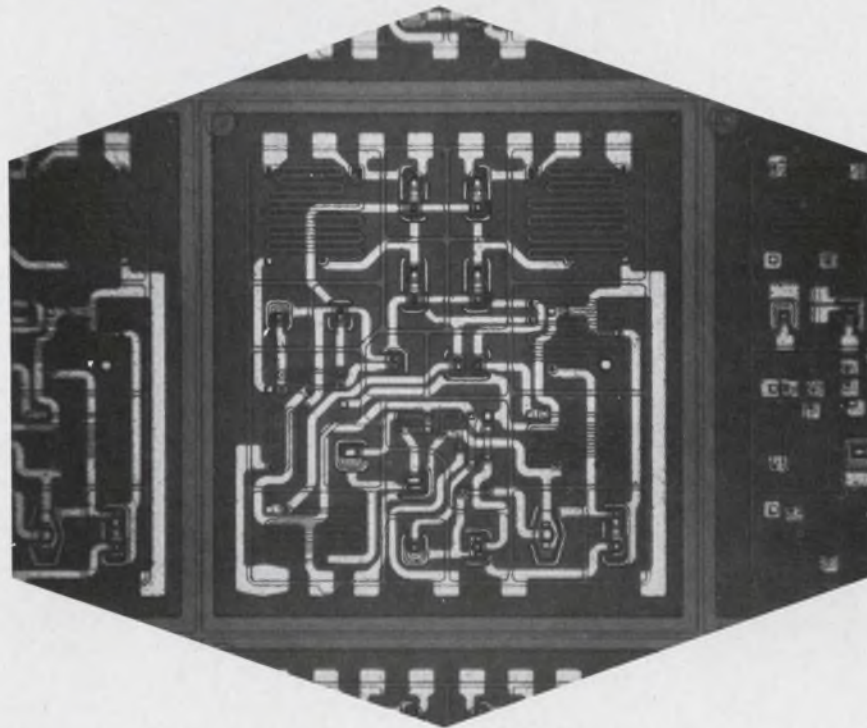

## The 15nA Operational Amplifier UC4000

- 15nA differential input offset current (max)
- 175pA/°C differential input offset current drift (max)
  - 5mV input offset voltage (max)
- 10 $\mu$ V/°C input offset voltage drift (max)
  - 50nA input biasing current (max)
  - $\pm 10$ V common mode voltage (min)
  - $\pm 10$ V output voltage swing (min)
  - 2mA output current drive (min)
  - 20,000 open loop voltage gain (min)
- $-55^{\circ}\text{C}$  to  $+125^{\circ}\text{C}$  operating temp. in TO-101
- Offset Voltage adjustable to zero with external potentiometer
  - Off the shelf delivery

*applications:* A to D converter • Bridge amplifier • DC amplifier • Differential amplifier  
Integrator (DC to AC) • Sample and hold amplifier



**ELECTRONICS**

Semiconductor Department / 365 Middlefield Road, Mountain View, California 94040 TWX: 910-379-6942; Telephone (415) 961-3300

ON READER-SERVICE CARD CIRCLE 19

(Army 'fair', *continued*)

tripod, antenna and video chassis. It uses a magnetron operating in the 16-to-16.5-GHz region as its power tube. The antenna, a paraboloidal segment, produces a narrow fan-shaped beam. The builder is the Airborne Instrument Laboratory, a division of Cutler-Hammer, Deer Park, N. Y.

Manpack radars are expected to play a key role in routine patrolling of the Vietnam barrier.

### Radar pinpoints enemy mortars

Army personnel report excellent results in Vietnam from a radar mortar locator that was originally procured more than 10 years ago. An outgrowth of a model intended to locate North Korean mortars in a war with relatively stable front lines, the AN/MPQ-4 has nevertheless been remarkably successful in ferreting out Viet Cong mortar and rocket sites. The Army is buying more improved versions.

At first glance the MPQ-4 hardly looks like an ideal piece of equipment for war where jungles abound and the enemy is likely to be anywhere. Trailer-mounted, it is heavy and has a complex, rotating mechanical antenna feed, all-vacuum-tube circuitry and an electromechanical computer. And it has an antenna reflector that is more than 10 feet high. As if these were not bad enough, the system needs a large, heavy power-supply and can scan only a 25° sector at one time.

But when emplaced in critical areas where the general direction of the enemy is known, the set has proved to be invaluable. While it was designed to pick out mortars, field troops have found it extremely effective against rocket sites, too,—even those more than five miles from the radar.

The prime contractor of the MPQ-4, General Electric's Heavy Military Electronics Dept. at Syracuse, N. Y., has received orders for additional units. Company spokesmen say that kits will be furnished to improve the present equipment, but the circuitry will be essentially unchanged from that of 10 years ago. The Army wants to hold all changes to a minimum for technical



**Mortar-and-rocket-locating radar, AN/MPQ-4**, which has been around for 10 years, is proving itself against the Viet Cong. General Electric is building additional systems, but the Army still seeks an omnidirectional mortar locator.

and logistical reasons.

The MPQ-4 transmits 16-GHz pulsed power in the form of two pencil beams having a vertical separation of 2°. A dual-beam Foster scanner feed system, rotating at 1000 rpm, emits radiation in successive half revolutions, thus producing alternate upper and lower fan-shaped sweeps. The rotor is calibrated so that the azimuth of any target within the 25° scan is determined. A shell or rocket passing through the scan patterns gives two echo blips on the "B" scope range and azimuth display.

Two electronic cursors can be moved to intersect successively at the two target blips. The built-in analog computer receives range and azimuth data on the two points in the trajectory. The computer is then able to extrapolate the trajectory to ground level and thus locate the launcher. Accuracy is said to be 50 yards.

In Vietnam, the Army is using the MPQ-4 in conjunction with helicopter observers. The copters, hovering over enemy positions at night, pick up indications of a concealed enemy gun emplacement with infrared-detection equipment. The flight crew then calls for support from the radar, which is directed toward the suspected area. A helicopter crewman then tosses out a sand-filled soda can, which falls through the rf beam patterns. The radar's computer quickly determines

the exact geographical coordinates, and artillery begins dropping shells on the Viet Cong emplacement.

The Army would like to have a weapon-locating system with all of the qualities of the MPQ-4 but able to scan through 360°.

The Army Electronics Command has held a design competition for an omnidirectional mortar locator. A contract has been awarded to ITT Gilfillan, Inc., Los Angeles, for a frequency scanned system. It will use four separate panel reflectors, each covering about 90°. Gilfillan expects to deliver the development model, AN/TPQ-28, to the Army next year.

Industry observers say that this procurement is so important to the Army that it is narrowing the time gap between approval of a development model and production to about a year instead of the more usual two to three years.

In addition to the omnidirectional problem, an effective replacement for the MPQ-4 would have to do a better job of handling signal attenuation due to rain. The present equipment uses a circular polarizer consisting of conductive strips embedded in a fiberglass cover. It is positioned over the feed slots on the antenna. General Electric engineers admit that the ability of the set to pick out targets in a driving rain is marginal, but fortunately rain also makes it difficult for the Viet Cong to fire mortars. ■ ■

**THIS IS THE WIDEST SELECTION of  
MINIATURIZED CERAMIC CAPACITORS  
IN THE INDUSTRY!**

*New*  
**RED CAPS**



**BROAD RANGE OF CAPACITANCE VALUES**

**1.0 pF.** **4.7 uF.**

**AVAILABLE IN EVERY  
STANDARD TEMPERATURE COEFFICIENT  
...and in SEVEN DIFFERENT HI-K® Formulations**

- *Red Caps meet or exceed all applicable requirements of MIL-C-20 and MIL-C-11015 per MIL-STD-202*

**RED CAPS feature**  
**ERIE'S EXCLUSIVE NEW JET-SEAL ENCAPSULANT**

- Erie's new *Jet-Seal* excels in mechanical and electrical ruggedness
- Provides excellent moisture protection • Maintains electrical and mechanical stability at temperatures from -55°C through 150°C • *Jet Seal's* bright color and gloss finish will be outstanding in even the most sophisticated equipment.



WRITE FOR SAMPLES on your company letterhead  
ERIE TECHNOLOGICAL PRODUCTS, INC.  
State College, Pennsylvania  
Attention: Applications Engineering



Erie, Pennsylvania

ON READER-SERVICE CARD CIRCLE 20



# SEMICONDUCTORS

NEW IDEAS IN APPLICATION AND DESIGN

- NO OTHER PHOTO TRANSISTOR CAN MATCH IT
- ... IN LOW PRICE
- ... IN HIGH SENSITIVITY

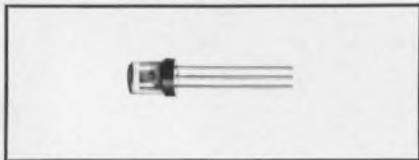

New L14B photo transistor shown actual size

Save with them now. They're priced as low as 97¢ in lots of 100-999.

Housed in a clear epoxy encapsulant, GE L14B photo transistors can sense the presence (or absence) of either visible or infra-red light. They're more sensitive than competitive devices, too, with 75% light response at  $\pm 40^\circ$ . Light current, typically, is 7 milliamps at 10 volts with irradiance at 5 milliwatts per square centimeter. And a base lead is also provided to control the sensitivity of the device, even though only the collector and emitter leads are needed for many applications.

Typical applications include machine controls, counters, coin machines, burglar alarms, solid state relays and frictionless potentiometers ... also position controls, pyrometers, light meters, cameras, day-night controls and limit switches.

Circle Number 811.

- STILL ANOTHER NEW GE ECONOMY IC:
- THE PA223 OPERATIONAL AMPLIFIER

Go ahead and compare these features with those of any other low cost operational amplifier IC:

- Input impedance ... 2.5 megohms
- Offset current ... 20 nanoamps
- Offset voltage ... 4 millivolts
- Voltage gain ... 8,000

The PA223 IC is fabricated on a single monolithic silicon substrate and housed in a 14-lead dual-in-line economy plastic package. By virtue of its darlington amplifier input configuration, it requires very little input current. PA223's also provide a current limiting feature for short circuit protection. Output is Class B. Circle Number 812.

## New high in solid state load control: up to 4150 Watts with GE 15-AMP TRIACS



SC51 15-amp press-fit type Triac (shown actual size)



SC50 15-amp stud-mounted Triac (shown actual size)

That's 50% more power than you can now control with 10-amp Triacs, and 150% more than you can control with 6-amp units. Yet the new 15-amp models are housed in the same size packages as your lower-rated GE Triacs.

SC50 and SC51 devices are particularly useful for temperature control in residential and commercial

heating applications. Or you can use them for static switching in motor control, power conversion applications, and as overvoltage protective devices. 200-, 400-, and 500-volt ratings are ready for delivery now for use on 120-, 240- and 277-volt lines. 50- and 100-volt ratings are also available.

Circle Number 813.

Complete 3600-watt Temperature Control Circuit using the SC51 Triac and General Electric PA424 zero-voltage switch IC. (Circle Reader's Service Card Number 814 if you'd also like more information on the PA424.)

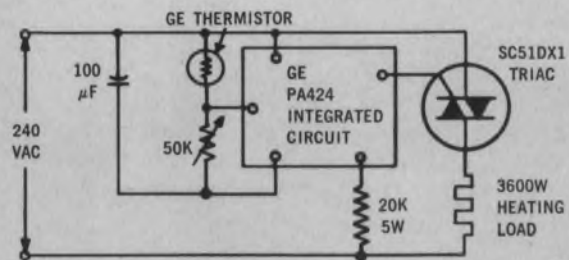

These are just three more examples of GE's total electronic capability. For more information, call your GE engineer/salesman or distributor. Or write to Section 220-60, General Electric Com-

pany, Schenectady, N.Y. In Canada: Canadian General Electric, 189 Dufferin St., Toronto, Ont. Export: Electronic Components Sales, IGE Export Division, 159 Madison Ave., New York, N.Y., U.S.A.

# GENERAL ELECTRIC

One guarding land—and another sea?



### Sea-based missile defense sought

Defense Secretary Robert S. McNamara's announcement of approval for a thin-defense antiballistic missile system set off a round of oratorical applause that lasted several days in both houses of Congress. Dissenters remained very quiet.

One missile-hawk, Rep. Clinton P. Anderson (D-N.M.), proposed an early expansion of the Nike-X system with a sea-based antiballistic interception capability. He likened the Spartan-Sprint terminal-phase defense system to "the gladiator's helmet and breast plate." The United States scientific establishment "now offers us a shield or net," he said in referring to the sea-launched interception potential.

Hughes Aircraft of Redondo Beach, Calif., has been awarded a six-month, \$720,000 contract to study the sea concept, code-named SABMIS. Lockheed Missiles and Space in Sunnyvale, Calif., will do subcontracting work on the project. The system probably—but not necessarily—would employ Spartan missiles together with the electronic support components of Nike-X. It would be carried aboard surface ships. It would complement the ground-based Nike-X elements but would intercept ballistic missiles during the phase of flight prior to separation of multiple warheads or decoys. The cost of the system has been estimated optimistically by the Navy at about \$2 billion. It should be noted, however, that even if feasibility studies prove out, the earliest that the program definition phase could be initiated would be 1969, and if all went well, operational elements would not be available before 1975.

### Electronics raising bombing accuracy

To assure pinpoint bombing and strafing accuracy for the close support of troops in Vietnam, greater emphasis is being placed on electronics development—not only for on-board systems but for air and ground fire-support

# Washington Report

CHARLES D. LAFOND  
WASHINGTON BUREAU

techniques. During the annual Air Force Association conference here, Col. A.B. Martin of the Air Force's Limited Warfare Office, disclosed that both F-4 and F-105 fighter-bombers have had their bombing systems modified to perform "surgical strikes." Typical new approaches for attacking obscured targets include the use of modified radar bomb-scoring systems for ground-controlled bombing. For greater accuracy in the future, Colonel Martin said, new programs employing laser technology and other terminal guidance schemes are being developed.

The bomb-scoring system technique is the reverse of the conventional use of such hardware—that is, instead of plotting the hit location based on an aircraft's position, speed, etc., at the time of ordnance release, the curve is plotted electronically from a known target to the aircraft by ground controllers, and the bomb release is directed by them. The first laser guidance system expected to see operational use, informants claim, probably will be semi-active. In this approach, a forward air controller illuminates the target from a station-keeping aircraft and the missile or guided bomb homes on the reflected echo or point of high radiation contrast.

### Voyager cutbacks assailed in Senate

Expressing his concern over further reductions in NASA's appropriation for fiscal 1968, Sen. Thomas H. Kuchel (R-Calif.) has denounced the total elimination of funds for Project Voyager and advanced missions and a 50 per cent cutback of funds for Nerva, the nuclear rocket engine. Kuchel cited a recent report from the President's Science Advisory Committee that strongly urged a high national priority for planetary exploration in the post-Apollo period (1975-1980). The deletion of Voyager, the Senator told his colleagues in a Senate speech, "may well mean a halt to the U.S. planetary program after Mariner Mars 1969, and thus abdication of the program to the

# Washington Report

CONTINUED

Russians, who have launched 18 planetary missions to our five."

## Britain joins Mallard program

Reversing its earlier position, Great Britain has expressed its desire to join the United States, Canada and Australia in developing an advanced automatic military field communication system. To be constructed under what is called the Mallard program, the system would provide high-speed, versatile digital communications (voice, telegraph, data and facsimile) with automatic switching from the field army headquarters level down to battalion. It also would include supporting air and naval elements. Research and development costs alone for Project Mallard are estimated by the Dept. of Defense at \$126 million, and the total system costs are expected to reach \$1 billion to 1.5 billion over an eight-year period.

The British had held out for specific allocations of contracts by the participating nations, while the United States, which will bear the largest share of costs, pressed for open competition. Apparently a compromise was reached, in which an open competition will be held for Mallard design contracts but with the stipulation that two U.S. and one British contractor be selected. Initial contracts are expected to be on the order of \$20 million each.

In the final production phase, according to project headquarters officials at the Army Electronics Command, Fort Monmouth, N. J., major subsystems will be contracted individually. American team bids have been submitted by Communications Systems, Inc.; Hughes, ITT, Philco-Ford, RCA, Raytheon and Sylvania.

## Rise in contractor benefits proposed

A new clause to raise the war-zone benefits for contractor personnel has been proposed for future U.S. defense contracts by the Armed Services Procurement Regulations Committee. The present Defense Base Act states: ". . . the cost of such war-risk insurance shall not be reimbursable under a cost type contract or a proper element of cost for consideration in

negotiating a fixed-price contract."

The armed services committee clause would raise disability payments from \$70 to \$150 a week, funeral-cost payments from \$400 to \$1000, and the maximum injury compensation from \$24,000 to \$50,000. It also would raise the maximum average weekly wage limit used for computing death benefits from \$104 to \$224. Industry comments, sought by the committee chairman, Col. Reagan A. Scurlock, should be submitted by Oct. 23.

## IC sales climb 56% in six months

Integrated-circuit sales for the first-half of the year totaled \$104 million, an increase of \$38 million, or 56.6%, over the same six months of last year, according to the Electronic Industries Assoc. Despite a steady decline in unit prices, the association says, factory sales jumped from roughly 12,000 units in 1966 to over 27,000 units this year, for a 128% gain.

## Electronics: weighty in the budget pie

Ever wonder where your taxes go? Well, excluding interest payments on the national debt, the Air Force Systems Command takes the largest piece of the pie. And from 40 to 45 per cent of its expenditures were for electronics or associated R&D. According to Air Force figures, 6% of the total Federal budget for fiscal 1966 went to the Systems Command for research, development, tests, evaluation and production. This turns out to be about one-third the entire Air Force appropriation for that year.

## FCC moving to new headquarters

The Federal Communications Commission has begun moving to new Washington quarters in a new building at 919 M St., N.W. For 33 years the agency has occupied offices in the Post Office Department's headquarters building at 12th St. and Pennsylvania Ave., N.W. The new FCC headquarters, occupying some 205,000 square feet in the eight-story building, will house all FCC facilities, except the laboratory in Laurel, Md., a license-processing office in Gettysburg, Pa., and 24 field offices and 18 monitoring stations in the country. The move which began Oct. 1, will be completed over a five-to-six week period.



GOOF-  
PROOF

VOM



Here's the most foolproof volt-ohm-milliammeter ever made. Protection approaches 100%. It's the VOM you will want to have on hand where inexperienced people are running tests . . . or will reach for yourself on those days when you're all thumbs. The 260-5P will save you all kinds of headaches from burned out meters and resistors, bent pointers, and inaccuracies caused by overheating.

**Combined Protection You Won't Find In Any Other VOM**

1. Reset button pops out to indicate overload.
2. You cannot reset circuits while overload is present.
3. Protective circuit does *not* require massive overloads which can cause hidden damage to the instrument.
4. All ranges are protected except those not feasible in a portable instrument—1000 and 5000 volts DC and AC; 10 amp DC.

**SIMPSON**  
**260-5P**

**ONLY \$88.00**

*Write for Bulletin 2076*

**Ranges**—The 260-5P has the same ranges and takes the same accessories as Simpson's famous 260-5 volt-ohm-milliammeter.



**Simpson**  
INSTRUMENTS THAT STAY ACCURATE

**SIMPSON ELECTRIC COMPANY**

5200 W. Kinzie Street, Chicago, Ill. 60644 • Phone: (312) 379-1121  
Representatives in Principal Cities . . . . See Telephone Yellow Pages  
Export Dept.: 400 W. Madison St., Chicago, Ill. 60606 Cable, Simelco  
In Canada: Bach-Simpson Ltd., London, Ontario  
In India: Ruttonsha-Simpson Private Ltd., Vikhroli, Bombay

**WORLD'S LARGEST MANUFACTURER OF ELECTRONIC TEST EQUIPMENT**

ON READER-SERVICE CARD CIRCLE 22

a tough little

# BACKWARD-WAVE OSCILLATOR

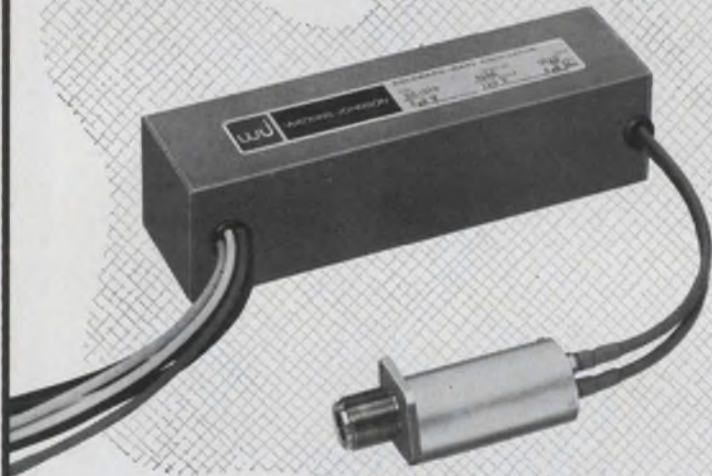

for rugged assignments

**The SE-310** is an S-band militarized, miniaturized BWO. Its small size is well adapted to high-density systems—it is ideal for space, airborne and shipboard applications as a local oscillator in swept or FM receivers, master oscillator in transmitters and ECM jammers or as a signal source in generators. The SE-310 features low operating voltage (1280 V Max.). Power output (80 – 330 mW) and tuning curves are uniform and highly reproducible. Its rugged construction ensures performance under the severe environmental conditions defined in MIL-E-5400, Class 2. The same size is available in straddle frequency bands.

WATKINS □ JOHNSON

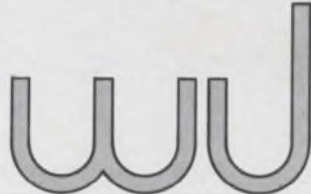

3333 HILLVIEW AVENUE  
STANFORD INDUSTRIAL PARK  
PALO ALTO, CALIFORNIA 94304

ON READER-SERVICE CARD CIRCLE 23

NEWS

## Thin beam doubles CRT resolution

A new cathode gun that produces a very narrow or, "laminar," beam of electrons is reported to double the resolution of CRTs.

The development is being incorporated in a new series of cathode-ray tubes to be manufactured by the English Electric Valve Co. of Chelmsford, England.

In the new tube, the cathode and focusing assembly produce an electron beam with no crossover, and thus only a narrow divergence. The resulting laminar beam has a uniform electron density across the beam, instead of the normally Gaussian, or bell-shaped distribution.

The even density of the laminar beam produces a spot with uniform brightness and a very sharp edge. In addition the narrowness of the beam at the deflection point results in much reduced deflection defocusing. The spot size may be varied also without defocusing.

Roger Thompson, English Electric's manager of display tubes, asserts that these advantages give the laminar beam tube a 2:1 improvement in resolution.

Thompson also notes that the narrowly divergent beam requires a weaker focusing field, enabling the manufacturer to use a metal spiral mounted on the inside of the neck of the tube. This precludes the possibility of breakdown between high-voltage-focusing electrodes—an important consideration in transistorized equipment.

The cost of the new tube is expected to be approximately 30% higher than that of a conventional tube.

Gettering, the removal of residual gases from the tube, is less effective with the new design. A smaller gettering area—the result of placing the getter behind the cathode gun—means that the tubes have to be vacuum pumped for a longer time. Work is in progress to place the getter in front of the focusing spiral, to enlarge the sputtering area and thus reduce the pumping time, Thompson reports.

After two years of development work, English Electric expects to begin delivery of CRTs with laminar beams in November. ■ ■



Collins Radio uses  
Dale 1600 Wirewound  
Trimmers in this  
RF Oscillator  
Circuit

# Accurate frequency adjustment ...a job for Dale trimmers



Single sideband radio demands precise frequency control. This is assured with Dale 1600 Series Trimmers. One application of these RT-12 wirewounds is in the RF oscillator circuit of the versatile Collins 618T/HF SSB Transceiver. Here, Dale wirewound trimmers provide: (1) The smooth resolution necessary for fast, accurate crystal adjustment during assembly; (2) Long-term stability which is a factor in the universal acceptance of Collins-built military and commercial radio equipment.

Let Dale trimmers handle your circuit adjustment needs. From any angle—reliability...price...delivery...they deserve a place on your prints.

Circle 201 for Potentiometer Catalog B

Call today for fast delivery of  
these Dale Mil-Style Trimmers

**600 SERIES** Mil. Equiv. RT-10

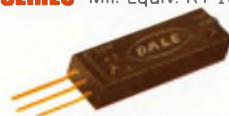

**1200 SERIES** Mil. Equiv. RT-11



**1600 SERIES** Mil. Equiv. RT-12



**5000 SERIES** Mil. Equiv. RT-22



Available in all standard terminal configurations in  
regular or panel mount styles.



**for optimum value in potentiometers**

DALE ELECTRONICS, INC., 1300 28th Ave., Columbus, Nebr. 68601 Phone 402-564-3131  
In Canada: Dale Electronics Canada, Ltd.





**DALE**

**stacks up  
better in  
industrial  
wirewounds!**



*Dale CW Resistors chosen for North Electric's  
advanced NX Crossbar Switching System*

For more than seven years, Dale CW Wirewounds have been an integral part of the high efficiency NX Crossbar Switching Systems produced by North Electric Company, Galion, Ohio. Found in Independent telephone exchanges nationwide, North's NX Crossbar uses proven components, such as the CW, to provide decades of continuous, trouble-free service.

Chances are your industrial applications are similar – requiring long-term assurance of stable performance and uninterrupted delivery. Here are three solid reasons why Dale CW Resistors provide the best all-around value:

**FOR COMPLETE INFORMATION OR A QUICK QUOTE PHONE 402-564-3131**

*Circle No. 181 for Dale's complete Resistor Catalog A*

**1. HIGHER STABILITY** is provided by silicone coating and wirewinding methods patterned after Dale's precision RS Series. Meets MIL-R-26C, RW-57, 58, 59.

**2. HIGH POWER TO SIZE RATIO.** Eight standard models provide up to 13 watts (Char. V) in 1.781" x .375" size.

**3. VERSATILE.** Pre-engineered to meet hundreds of special applications.

**DALE ELECTRONICS, INC.**  
1300 28th Avenue Columbus, Nebraska  
In Canada: Dale Electronics Canada, Ltd.



## Carrier control is key to solid-state future

The control and precise location of ionizable atoms or dopants in host semiconductor materials is the next major step in the advance of solid-state technology, according to a Cornell University physicist.

Prof. Robert Sproull, a vice president of the university, told a recent conference at the Ithaca, N. Y., campus: "We are approaching a whole new era of sophistication in the doping of solids." He added that in future not only would the concentration and types of dopants be known, but it would also be possible to specify their exact location in the crystal.

Professor Sproull, speaking at the recent High-Frequency Generation and Amplification Conference, said there were many promising approaches in solid-state physics that could be expected to yield new, exciting devices. He listed some of these as:

- Superconductivity phenomena based on the use of semiconductors containing various iron ions.
- Channeling techniques in which heavy ions are made to oscillate between the crystal planes.
- Ion implantation in which the surface of the solid is bombarded selectively with ions at specified energies.
- Geometrical control of impurities in solids in which known impurities are placed at specific dislocation boundaries or lattice discontinuities within the solids.

Professor Sproull predicted that within twenty years it would be possible to specify impurity concentration of less than ten parts per million in crystals. He said that this would open the door to future developments equal to those which have already been made with relatively impure materials within the past few years.

We are a long way from "scratching the ceiling" on fundamental limitations in solid-state physics, the professor said. As an example of how great a gap there is between the present state of advancement and fundamental limits, he cited information storage.

At present, he said, it takes about

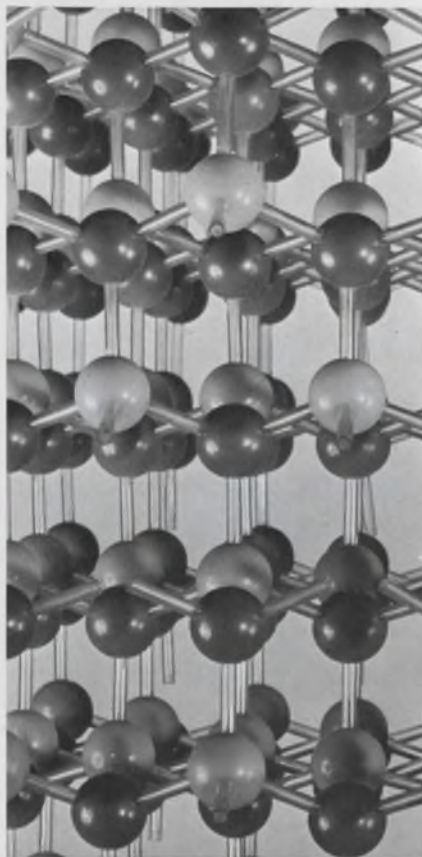

Precise control of dopants is the next step for solid-state lattices.

$10^{-8}$  cubic meters to store one bit of information. Now memory devices such as thin films are progressing toward the goal of  $10^{-15}$  cubic meters to store one bit. But the fundamental limit is the space occupied by one active atom:  $10^{-29}$  cubic meters, he explained. So, too, switching power is still a long way from its theoretical limit, he added.

Professor Sproull referred to a widespread notion that "science is running out of steam" and that future effort was not likely to come up with such interesting devices as Gunn oscillators and solid-state lasers. He also noted a tendency to reject concepts if they were not immediately applicable to a practical device.

He disagreed with such views. Based on the accomplishments of the past 20 years, he forecast that many undreamt-of devices will come out of future research if it continues at its present pace. ■ ■



**WHY SHOULD YOU  
SPECIFY  
MECATORN<sup>®</sup>  
SPUN  
REFLECTORS?**



The exclusive Torngren Mecatorm<sup>®</sup> hydraulically controlled spinning process has produced thousands of spun-to-specification "dishes" in use today by both military and commercial communication networks — at substantial savings over other more costly fabricating methods.

If you have a requirement for parabolic reflectors from 4 inches to 16 feet in diameter call Torngren today for complete details on the cost saving and metallurgical advantages of the Mecatorm<sup>®</sup> process.

*Send for a free copy  
of our new capabilities  
brochure today!*



**C.W.**

**TORNGREN**

COMPANY, INC.

236 Pearl St., Somerville, Mass. 02145

Area 617/666-3250

ON READER-SERVICE CARD CIRCLE 25



**Amphenol has 7000  
different coaxial connectors.  
Good thing we don't sell elephants.**



We have an existing design to fill every need.

From low-cost UHF types to the highly sophisticated 7mm precision connector. Connectors in all common series, including the new ones to meet MIL-C-39012. Subminiature connectors to MIL-C-22557. Crimp connectors in BNC, TNC, and N se-

ries. And adapters of all sorts.

You'll find these connectors in our complete, cross-indexed catalog—or on Amphenol distributors' shelves.

If you need a connector that's not in this wide range of products, our engineers will create one to meet your specific needs.

Get the full story from our sales

engineers or distributors. Or write us. (Unless you need elephants.) **Amphenol RF Division**, 33 E. Franklin Street, Danbury, Conn. 06810.



**AMPHENOL**

Specify Amphenol . . . the leading name in cable, connectors, assemblies, RF switches, potentiometers, microelectronics.

ON READER-SERVICE CARD CIRCLE 26

# Whiskered cathodes are cool emitters

## Cornell study shows semiconductors may replace conventional barium oxides in CRT electron guns

Neil Sclater  
East Coast Editor

A new cold cathode with hundreds of microscopic "whiskers" on its emitting surface may be used in electron guns for cathode-ray tubes and other electronic display devices. The cathode, which requires no external heating, produces high current densities that are competitive with conventional barium oxide emitters. Moreover the new emitter uses less power.

The high electron emitting quality of certain semiconductors with the whiskered surfaces was discovered by two Cornell University scientists: Dr. Takao Utsumi and Prof. G. Conrad Dalman, both of the School of Electrical Engineering, Ithaca, N. Y.

The micron-sized projections act as individual electron stream sources, Dr. Dalman explains. So effective are they at emitting electrons when set in parallel plane diodes

with appropriate voltages that no external heat energy is required, he says.

Generated initially by a voltage breakdown process, the whiskers, according to the researchers, apparently go through a continuous death and regrowth cycle. Electron densities of greater than 1 ampere per square centimeter have been obtained from both silicon and germanium samples, with emitting surfaces of only 1 square millimeter.

To demonstrate the feasibility of the cathode, Dr. Dalman and Dr. Utsumi constructed a laboratory cathode-ray tube (see illustration). The cathodes used were typically bars of n-type germanium with a 1-square-millimeter cross section, 15 millimeters long. The material, with a resistivity of 2 ohm-cm at room temperature, was machined, polished and then chemically etched.

The emitting whiskers were pro-

duced initially by a voltage breakdown process. However, Dr. Dalman indicates that other successful growth methods have been demonstrated.

In the successive breakdown process, the raw cathodes were mounted in a test diode within a high-vacuum bell jar. Controlled low energy arc discharges were produced between the cathode and a removable tungsten anode. The electrostatic forces apparently caused the semiconductor growth. The process was repeated until the researchers grew what they considered a satisfactory number of whiskers.

### Growing the whiskers

Dr. Utsumi and Dr. Dalman were able to measure the current produced by the cathode after each breakdown and were able to view the emission patterns, by inserting a fluorescent screen in place of the movable tungsten anode.

As a result of beam-spreading measurements, the researchers were able to estimate the approximate whisker height and thickness on a satisfactory sample. Each whisker was found to be about 0.2 micron in diameter and about 2 microns high. With a distribution of about 50,000 per square centimeter, the quantity was found to be relatively sparse on a one-square-millimeter surface. The spacing between whiskers is roughly comparable to one paper clip standing alone on a desk top. Electron microscope observations tended to confirm the estimates.

The Cornell scientists mounted the processed cathode in the experimental cathode-ray tube (see illustration). The electron gun consisted of the cathode, an accelerating grid mesh, and a pair of apertures to define the beam. This assembly was mounted on a removable feed-through assembly.

The demonstration gun, which was never removed from the vacuum pump, was used to produce Lissajous figures. A simple magnetic

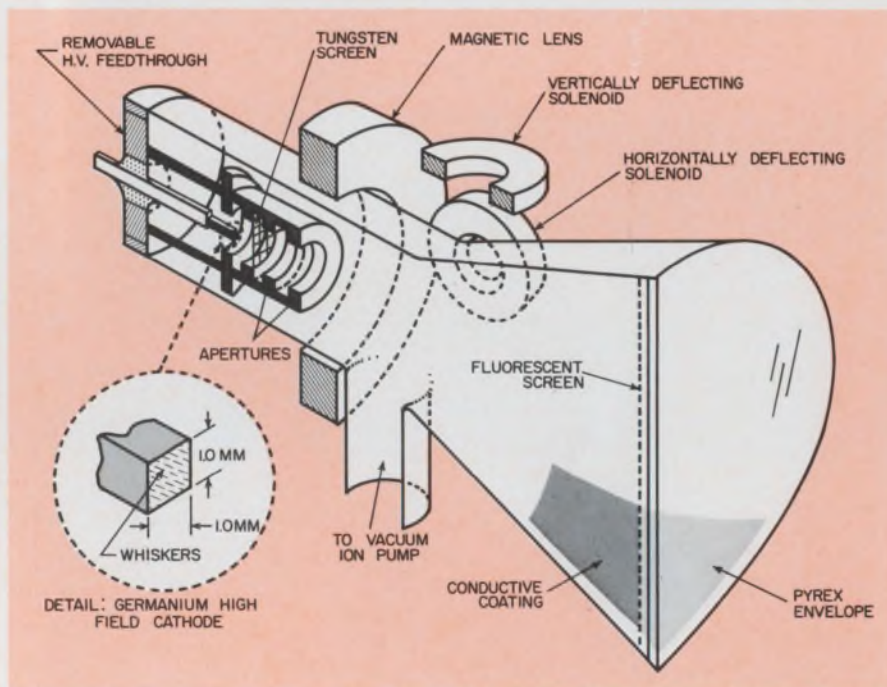

**High field cathode** in demonstration cathode-ray tube needs no heater. Cornell University device gives 1 A/cm<sup>2</sup> electron emission density from novel whiskered cathode in the parallel plane diode structure.



**new...**

**smaller...**

**4 amp**

**50-100 nanosec.**

**ultra-fast recovery**

**controlled avalanche**

**high voltage epitaxial**

**rectifiers**

**THE UNIQUE UNITRODE CONSTRUCTION**

With the silicon die metallurgically bonded between terminal pins of the same thermal coefficient, the hard glass sleeve is fused to the entire outer silicon surface. Result — a voidless, monolithic structure.



ACTUAL SIZE

**the only  
lead mounted 4 amp with  
100 nanosec. max recovery  
PIV's to 250 V  
80 amp surge capacity  
Full power operation  
at frequencies up to  
100 kHz square wave  
and 350 kHz sine wave  
1/10 the size . . .  
1/14 the weight of  
a comparable stud-mount.**

*Check 27 Readers Service Card*

ACTUAL SIZE

**2 amp  
typically 50 nanosec. recovery  
PIV's to 250 V  
25 amp surge capacity  
Full power operation  
at frequencies up to  
100 kHz square wave  
and 350 kHz sine wave  
1/7 the size . . .  
1/3 the weight of  
comparably rated devices.**

*Check 27 Readers Service Card*

**UNITRODE®**

580 PLEASANT ST., WATERTOWN, MASS. 02172  
TELEPHONE (617) 926-0404 TWX (710) 327-1296

# Deposit Any Thin Film

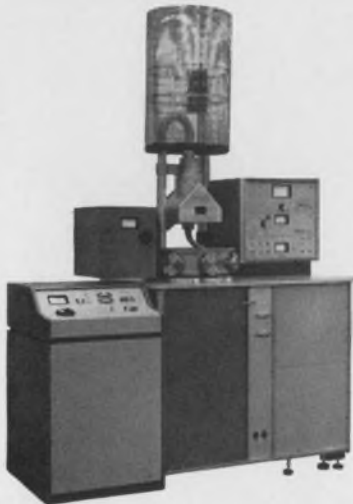

## New RF Plasma Sputtering Systems

- High deposition rates: up to 1200 Å / minute
- High uniformity of deposition
- Elimination of heated filaments increases reliability and film purity
- Low operating pressure: down to  $2 \times 10^{-4}$  Torr
- Bakeable to 200° C
- Easy to use
- Complete system, nothing more to buy

Write for complete information. Varian Vacuum Division, Palo Alto, California; Zug, Switzerland; Georgetown, Ontario.



**varian**  
vacuum division

ON READER-SERVICE CARD CIRCLE 28

## NEWS

(cold cathode, *continued*)

lens focused the electron beam on the fluorescent screen, and two external solenoids were used to deflect the beam.

Although they see possible applications in display tubes, cold cathode vacuum tubes and radiation resistant electron devices, the researchers do not believe that the concept, in its present state of development, is adaptable to low noise tubes.

The cathode work was supported by the U.S. Air Force Rome Air Development Center. ■ ■

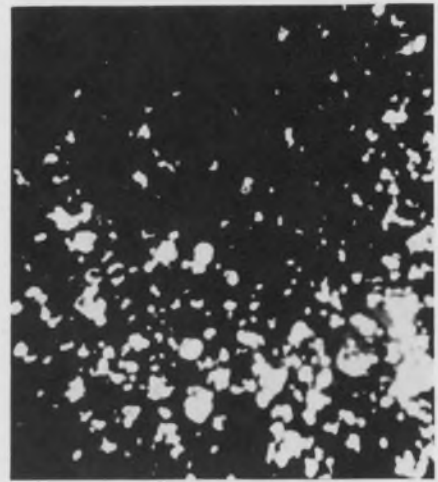

Electron-emission patterns from the whiskered cold cathode, as seen on a microphotograph.

## 'Detective' computer matches bullets to guns

Gun crimes of the future may be solved with digital computer techniques. With a new system called BALID (for Ballistics Identification), developers at Computer Technology, Inc., say that markings on a recovered bullet can be scanned and compared automatically with pre-stored data to establish the origin and possibly the ultimate ownership of a weapon.

The technique employs three different computer programs and electromechanical scanning, according to Bernard Scott, developer of the system and research director at Computer Technology. A Digital Equipment Corp. model PDP-85 scientific computer and a Talysurf 4 surface analyzer have been used in laboratory demonstrations. The latter produces analog tracings that are then converted to digital form for entry into the computer.

### Bullet markings are stored

One program is employed to accept scanner outputs and produce an index reference of the ballistic markings of a bullet from each particular weapon. The second stores these data approximately on magnetic tape. The third program is used to match the characteristics of a "search" bullet against the stored information and to find and identify the most probable match, if one ex-

ists in the data bank.

The Talysurf 4, manufactured in England by the Rank Taylor Hobson Div. of the Rank Organization, uses a standard 0.0001-inch-diameter stylus to obtain surface tracings of the lands and grooves of a bullet. A solid-state scanner, it provides horizontal amplification of up to 500 times and vertical amplification of up to 100,000 times. The pick-up arm has a bearing force of 0.1 gram and traces at a rate of 0.002 inch per second. A typical six-land bullet can be scanned completely in 10 minutes, Computer Technology says. Repeatability of the pengraph used is 99%, the company reports, providing an accurate graphic representation of surface characteristics.

During the scanning process, the resultant analog signal is sampled 20 times a second, and these data are converted to 10-bit ordinates for entry into the digital computer. The data are then processed for storage as surface indices suitable for conventional comparison techniques. Coarse-mesh logic is used for recognition—that is, a reasonable distortion range is permitted before it loses the capability for recognition.

The BALID system was described by its developer at the recent 1967 Conference of the Association for Computing Machinery in Washington. ■ ■

...and switch to the highest quality switches ever made: Shallcross!

These are the switches designed for function and performance, not to low price. Yet they're priced competitively!

They give you a quality "feel." A solid feel. The kind you don't get in cheaper switches.

Not surprising. Because we use only the best materials and conservative design standards in creating Shallcross rotaries. For both commercial ratings and switches designed to MIL-S-3786.

All this pays-off for you. With Shall-

cross switches, you get lower initial contact resistance. So you can use them on more exacting applications.

You get better contact-resistance stability, so your equipment holds calibration better.

And you get better voltage and current ratings for a given size. More switch per volume.

You get versatility, too. Select from 1" wafer, 1 3/4" deck, and 2 1/2" deck configurations, plus round and oval ceramics —for every rotary application.

Join our rotary club. Switch to the Number One rotary switch: Shallcross. See your local Cutler-Hammer Sales Office or Shallcross Stocking Distributor. Or write for catalog LA-163-U217.

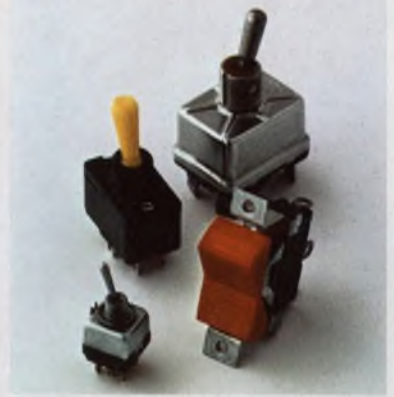

Cutler-Hammer offers a complete selection of other quality switches. Commercial forms are covered in catalog LL-290, Military ratings in Catalog LL-291.



**CUTLER-HAMMER**  
Milwaukee, Wisconsin 53201

# Join our rotary club

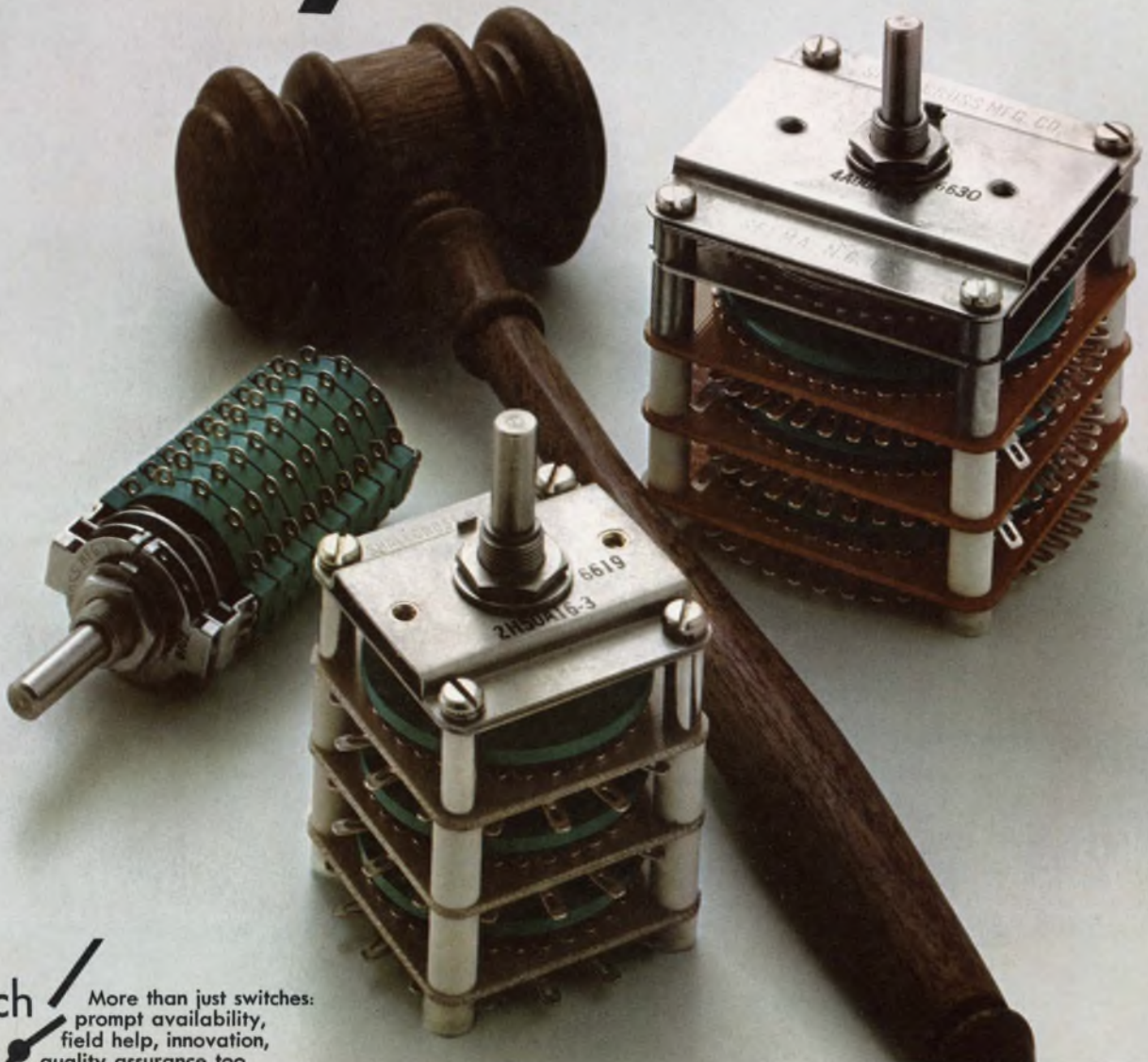

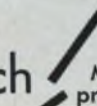
Switch to No. 1  More than just switches: prompt availability, field help, innovation, quality assurance too.

# How to keep relay contact forces balanced at 30 G's.

Picking a relay for an extreme shock/vibration environment is a tough problem for many a circuit designer. Few relays are designed to meet the problem head on. There is now one notable exception—a 4PDT, 10 ampere relay in a one-inch cube.

Using a new design principle—balanced-force—this relay withstands severe shock, vibration or acceleration while maintaining high contact and overload capabilities. It will take more than 30 G's to 3000 Hz vibration, a shock of 100 G's and has a minimum life of 100,000 cycles. This one-inch cube is all welded, weighs 2.5 ounces, and is rated at 2.9 watts coil power.

## EFFICIENT MAGNETIC CIRCUIT

In the conventional relay motor, forces for open and closed contacts are unequal. Energized coil power causes the armature to close the normally open contacts. But, when the coil power is removed and the contacts return to the normally closed position, only the spring forces of the contacts and the return spring provide the force. These combined spring forces are usually low, allowing the contacts to bounce. In addition, the low spring force allows the armature to rebound off the armature stop, again knocking the contacts open—sometimes, for as long as several milliseconds after they have initially closed.

Force-Stroke Curve of Typical Relay and Balanced-Force Relay

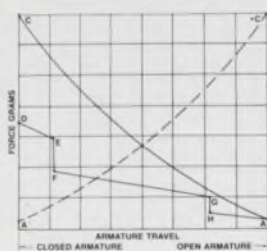

Curve CA—Balanced-Force Relay normally closed contacts.  
Curve AC—Balanced-Force Relay normally open contacts.  
Curve DEFGH—Typical Relay

An obvious method of getting rid of a bounce condition is to balance the armature forces exactly. This is achieved in the

Leach Balanced Force Relay by use of an extremely efficient magnetic design. It has to be to

keep the forces balanced while ignoring 30 G's. Basically it is a controlled application of magnet and coil flux. In the de-energized position, a permanent magnet flux flows between the armature and the tip of the adjacent pole piece, resulting in a high holding force. The motor is, therefore, relatively immune to shock and vibration. When coil power is applied, the flux from the permanent magnet is nullified by the coil flux flowing in an opposite direction. The armature closes with a rapid build-up of magnetic force driving it against the contact overtravel forces and into a sealed position.

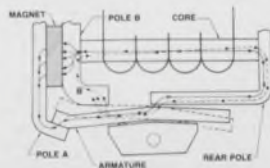

Balanced-Force Motor De-Energized

When coil power is removed and the armature returns, the

restoring force of the permanent magnet builds up quickly. The armature is then driven against the overtravel forces of the normally closed contacts and into its de-energized sealed position. With this type of force-displacement, the armature isn't about to rebound.

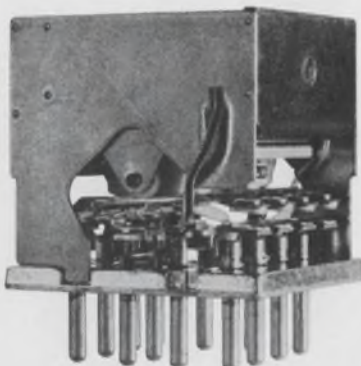

New Leach Model k employs balanced-force concept

## BUFFERED CONTACTS

The moving contacts are mounted to an armature, which is held firmly at the end of each stroke by high magnetic forces. Since the armature can't move during shock

or vibration, undesirable contact opening is eliminated.

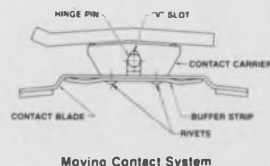

Moving Contact System

Reinforcing the moving contact is a buffer strip which assumes a

variety of chores. It has a bow in the center to act as a spring load while serving as a rivet plate. It works as a heat sink. It will break the contact strip free from a weld if one occurs because of excessive overload. It makes contact with the moving blade which results in excellent low contact drop. It serves as an electrical contact between the moving blade system and the header. And, as the name implies, it buffers the contact blade against extreme shocks and vibrations.

## WELDED ASSEMBLY

In assembling the relay all detail parts are welded. No part is solder assembled. There is no possibility of contamination from solder flux. The unit is then pressed into a can and electron-beam sealed, leaving only an evacuation hole. After a high temperature bake, the relay is filled with a dried inert gas, and the hole is welded shut. Here, ready for shipment, is a relay with a magnetic circuit designed so the force without coil power applied is equal to the force with coil power applied, but in exactly the opposite direction. And you can rest assured those forces stay balanced no matter how you shake them.

Complete Motor and Contact Assembly

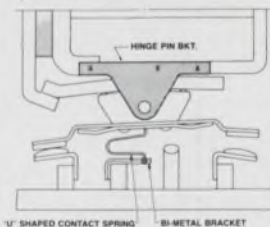

Write for your copy "Tomorrow's Relay Today", a technical paper presented at the

National Relay Conference. Leach Corporation, Relay Division, 5915 Avalon Boulevard, Los Angeles, California 90003  
**LEACH** (213) 232-8221.

# ...and another MTOS first

## the only monolithic 16 channel random access multiplexers available...anywhere!

The MEM 5015 is the first multiplexer with address storage and decoding capability and the first with voltage and current mode operation.

**MEM 5015 Random Access Multiplexers . . . . . \$198<sup>00</sup> each\***

**OTHER FEATURES:**

- **Exclusive Differential Mode** . . . permitting multiplexing of eight differential signal pairs
- **Expandable** . . . to permit larger multiplexing arrays
- **Low Power Consumption** . . . 80mW (total)
- **Low Leakage** . . . less than 2 nA per channel
- **Zero Offset Voltage** . . . not possible with bipolar switches

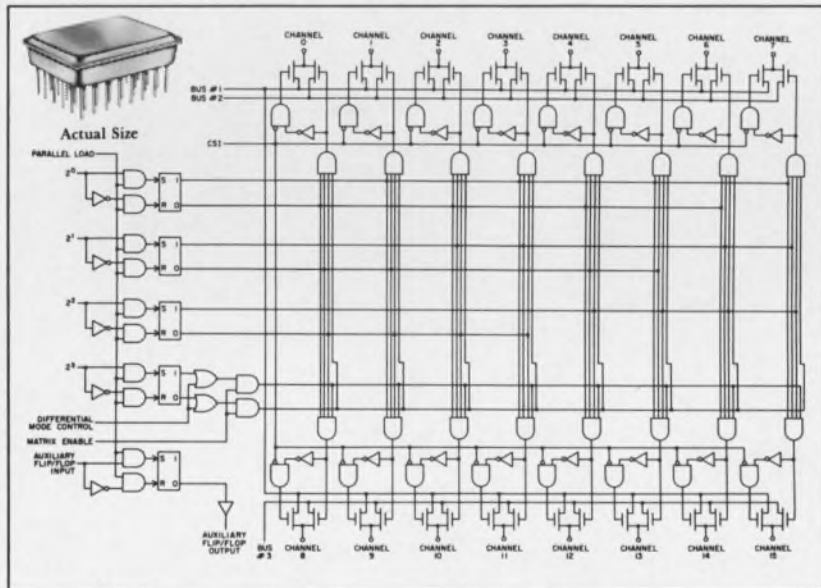

General Instrument's MEM 5015 is the newest complex integrated circuit available in the rapidly expanding line of MTOS firsts. It is a monolithic MTOS Large Scale Integrated Circuit containing 223 P-channel enhancement mode transistors on a chip 77 x 74 mils operating as a 16 channel randomly addressable multiplexer. The unit consists of four address holding flip-flops, a "four-in/sixteen-out" decoding matrix, 16 single-pole-double-throw switches, and some auxiliary logic for increased versatility. A Current Shunt Inhibit control line permits the selection of Current Mode or Voltage Mode multiplexing, while the Differential Control allows the switches to operate as eight ganged pairs. A Matrix Enable line allows multiple MEM 5015s to be connected to form larger multiplexing arrays.

The MEM 5015 is in a 40 lead hermetically sealed in-line package which can be soldered to a printed circuit board or used with a 40 pin socket. They're available off-the-shelf from your authorized General Instrument Distributor. In Europe, contact General Instrument Europe, Via Turati 28, Milano, Italy. Write for complete data.

\*in quantities of 100



GENERAL INSTRUMENT CORPORATION • 600 WEST JOHN STREET, HICKSVILLE, L. I., NEW YORK

ON READER-SERVICE CARD CIRCLE 31

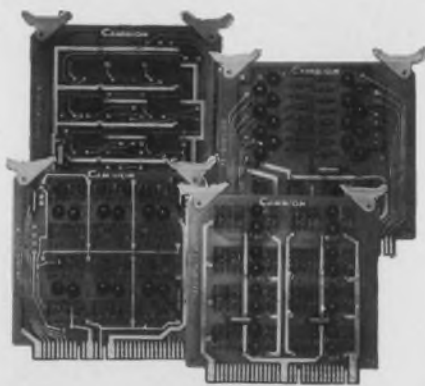

## You've got a bigger logic selection with Cambion<sup>®</sup> IC Assemblies

We started with the idea of providing the widest selection of standardized integrated circuit assemblies anywhere in the industry. We're over 200 already and continuing to add.

You name the function you want and chances are we have a standard assembly for it, whether it's a counter, decoder, or register. We've even tried to anticipate your needs and have some complex functions available.

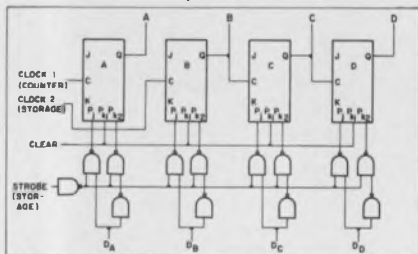

Up to 5 digit decade counters per card.

And we'll help you design digital logic assemblies into efficient, low cost systems for a variety of special applications, if you wish.

For complete information and specifics on integrated circuit assemblies, contact: Cambridge Thermionic Corporation, Digital Products Division, 453 Concord Avenue, Cambridge, Massachusetts 02138. Phone: (617) 491-5400.

REG. U.S. PAT. OFF.

**CAMBION**<sup>®</sup>

Standardize on CAMBION . . .

21,541 guaranteed electronic components



ON READER-SERVICE CARD CIRCLE 32

## Letters

### Corona detection method criticized as retrograde

Sir:

Your May 24, 1967, issue has an Idea for Design, "Pocket radio detects corona or insulation breakdown" [ED 11, p. 114]. When I read this, I felt that the industry had taken a giant step backward, at least 15 years.

It has been shown in the literature that the proposed radio detection method will in fact detect corona, but it can be extremely insensitive and in this case uncalibrated. This could be compared to making a voltage measurement with a voltmeter without a scale and without knowing what its full-scale deflection is. The only thing you know is that you have an indication.

It has further been shown that this type of detection produces an integrated evaluation, in that there are two conditions that could produce the same result:

- Corona in one site producing large-amplitude signals which could be quite damaging.
- Corona in several sites producing small-amplitude signals which could be quite harmless.

The idea of inserting an antenna into a case which has high voltage contained in it could be extremely hazardous.

I hope I have not appeared too critical, but I felt it necessary to express my views on this approach to corona-testing.

C. J. Saile

Development Engineer  
Engineering Dept.  
James G. Biddle Co.  
Plymouth Meeting, Pa.

### The author replies

Sir:

It would seem appropriate to point out that all test laboratories are not equipped with specialized corona test sets. Under these circumstances simple checks by the method I have described may be used initially to determine if more complex testing is required. Moreover, certain kinds of go/no-go testing may be completely per-

formed in the manner described. The key feature of the method lies in the novel use of a pocket radio as a simple test set.

In the case of any high-voltage testing, it must be expected that appropriate caution would be exercised at all times. Doing otherwise would be analogous to operating an ac-dc radio while taking a bath.

Kenneth G. Holmes

Chief Engineer  
Magnetic Circuit Elements, Inc.  
Montrose, Calif.

### Human-factors report defended by authors

Sir:

As the authors of the human-factors study cited in your "Washington Report" in ELECTRONIC DESIGN for July 19, 1967 [ED 15, p. 30], we take exception to the way in which the article was slanted. The casual reader might infer from your story that:

- It is worthless to provide human-factors data to engineers because those data are less than perfect.

- Design engineers have been unjustly accused (perhaps by human-factors engineers) of ignoring the data "handed to them at great expense by the military establishment."

Neither conclusion is justified.

The research study performed was part of a continuing effort by the Office of Naval Research to improve the manner in which human-factors data are disseminated to engineers. Among other things, the study pointed out that design engineers do ignore human-factors data and that their designs are much less effective than they would be if they used such data. One of the major problems in communicating with design engineers is their unwillingness to consider concepts and data from outside their own disciplines. This is why it is so necessary for such specialties as reliability, maintainability, systems engineering, value engineering, etc., as well as

(continued on p. 46)

ON READER-SERVICE CARD CIRCLE 33 ➤

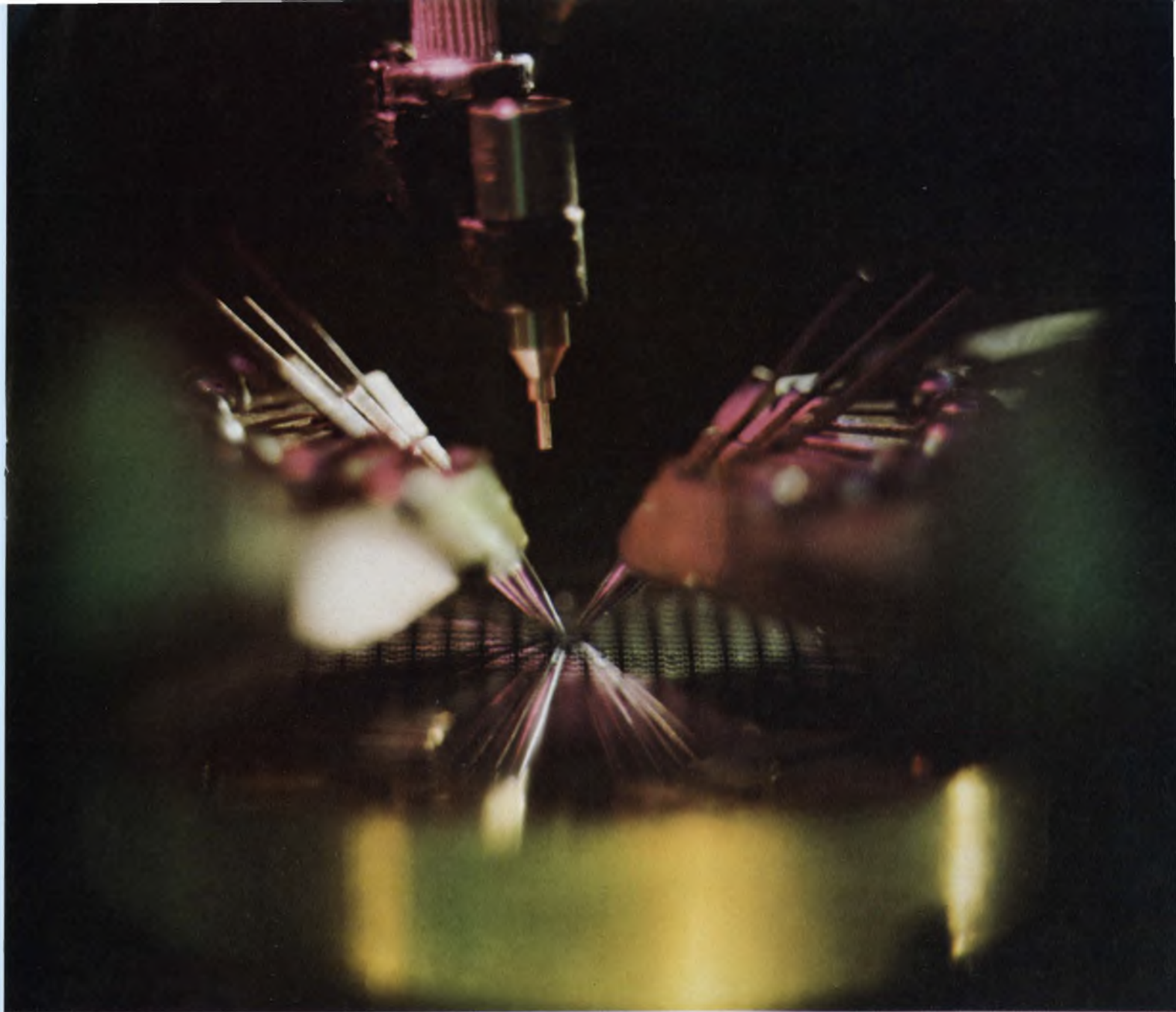

## We cross examine every IC at 14 points... and that's just the beginning.

Early in production, every Sylvania IC is 100% DC tested on our fully automated 14-point probe.

At the end, each Sylvania IC must pass final operational tests in four consecutive, temperature-controlled chambers from  $-55^{\circ}\text{C}$  to  $125^{\circ}\text{C}$ .

And there's no let-up in testing in between. All bonds are air-blasted and mechanically tested prior to package sealing. All packages are baked at  $300^{\circ}\text{C}$  to insure absolute dryness before sealing.

After sealing, all units are aged at  $300^{\circ}\text{C}$  for

60 hours. Then all IC's are temperature cycled from  $-65^{\circ}\text{C}$  to  $200^{\circ}\text{C}$ , centrifuged at 20,000 Gs in the  $Y_1$  plane, and all packages are 100% leak tested for hermetic seal.

These tests are far more comprehensive and thorough than any performed by our competitors. And we minimize errors in the first place with our fixed production process.

Sylvania Semiconductor Division, Electronic Components Group, Woburn, Mass. 01801.

**SYLVANIA**  
SUBSIDIARY OF  
GENERAL TELEPHONE & ELECTRONICS **GTE**

# There's a NEW title at your RCA Distributor

RCA's new SILICON POWER CIRCUITS MANUAL (SP-50) was written by engineers for engineers (the circuits and systems design variety) who are working with solid-state power devices and want to know more about them.

With more than 10 main chapters and more than 400 pages, the new manual provides comprehensive design information for a broad range of power circuits using RCA silicon transistors, rectifiers, and thyristors (SCR's and Triacs). Procedures are also included for applications involving rectification and power-supply filtering, power conversion and regulation, ac line voltage controls, rf power amplifiers, and control and low-frequency power amplifiers.

While the new manual is intended primarily for engineers, it will also be of use to educators, students, hobbyists and others interested in learning about solid state devices.

The introductory chapters of the manual familiarize the reader with semiconductor physics and describe each type of silicon power device in terms of construction, operation, and ratings. Clear understanding of the fundamentals of silicon power devices and how they operate in circuits is set forth with specific design criteria.

Drop by at your RCA Distributor and pick up your copy of this important new manual today.



RCA Electronic Components and Devices,  
Harrison, N.J. 07029



**The Most Trusted Name  
in Electronics**



# WAVETEK uses Allen-Bradley Type F variable resistors exclusively because of their

- \* Quality performance
- \* Excellent stability
- \* Infinite resolution

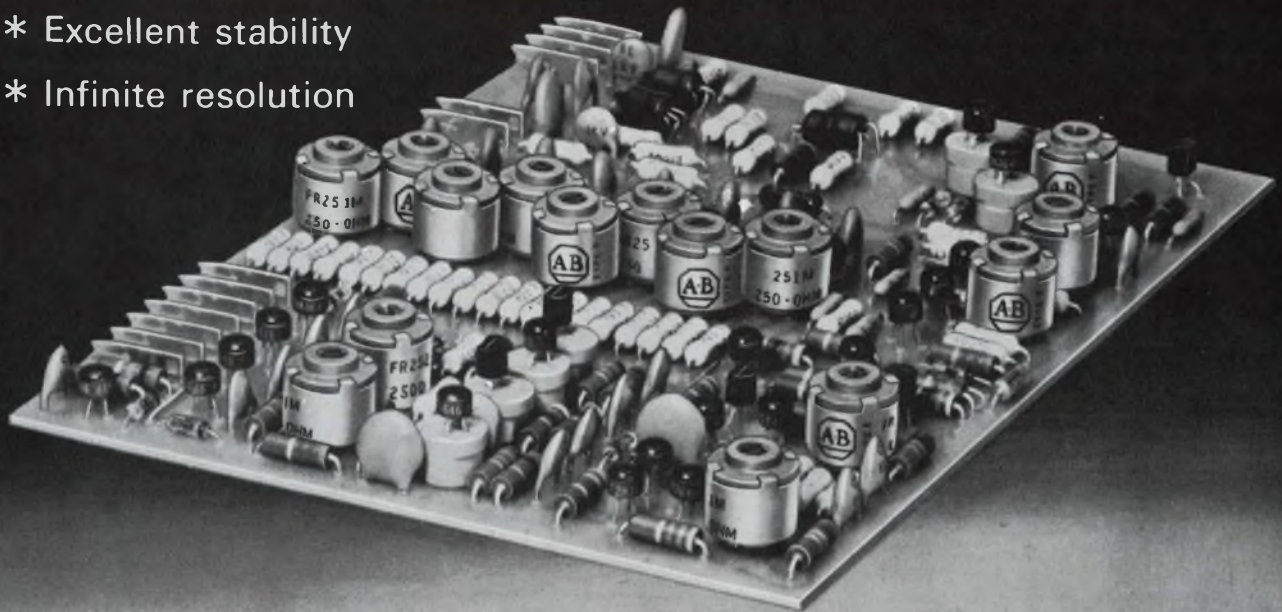

One of the 5-inch by 6½-inch Wavetek printed circuit cards, showing 15 of the 25 Allen-Bradley Type F hot molded variable resistors and numerous hot molded fixed resistors used in the Model 111 VCG function generator.



**Type F variable resistor** with pin type terminals for mounting directly on printed wiring boards. Rated ¼ watt at 70°C. Total resistance values from 100 ohms to 5 megohms.

Actual Size



**Wavetek Model 111 VCG** generates sine, square, triangle, and ramp waves from 0.0015 Hz to 1 MHz, and offers precision control of the frequency of the waveforms by external voltage.

■ The precision waveforms generated by Wavetek's Model 111 VCG place exacting demands on the large number of variable resistors used to set amplitudes to very precise values and assure symmetry of all functions. They must provide velvet smooth control, and quiet operation. And since this is a Wavetek adjustment, it is essential that the variable resistors, once adjusted, will stay "put".

Allen-Bradley Type F variable resistors satisfy all of these requirements, because they have the same solid hot molded resistance track as the famous Type J and Type G variable resistors. There's velvet smooth control at all times—never the problem of discrete steps com-

mon to all wire-wound units. And since Type F variable resistors are essentially noninductive and have low distributed capacitance, they can be used at high frequencies where wire-wound controls are useless.

When a manufacturer like Wavetek has standardized on the quality of A-B electronic components, you can be sure of the superior performance of such equipment.

For more details on the complete line of Allen-Bradley quality electronic components, please write for Publication 6024. Allen-Bradley Co., 1344 South Second Street, Milwaukee, Wis. 53204. In Canada: Allen-Bradley Canada Limited. Export Office: 630 Third Avenue, New York, N.Y., U.S.A. 10017



## ALLEN-BRADLEY

QUALITY ELECTRONIC COMPONENTS

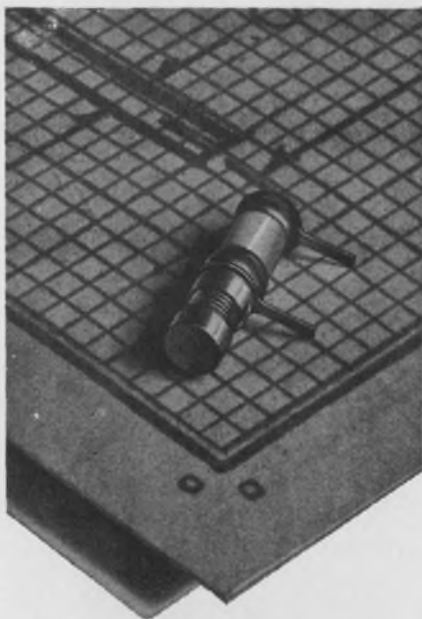

# Sub-Miniature Low-Inductance Capacitor

High Q > 1500 @ 500 mc

10:1 capacitance ratio in micro miniature size — extra fine tuning <.35 pF per turn. High Q, (greater than 1500 at 500 mc).

### Specifications

Size: 1/8" diameter, 1/2" length  
 Capacitance Range: 0.35 pF to 3.5 pF  
 Working Voltage: 250 VDC  
 (test voltage, 500 VDC)  
 Q @ 100 mc: >5000; @ 250 mc, >2000  
 Insulation Resistance: >10<sup>6</sup> Megohms  
 Temperature Range: -55°C to 125°C  
 Temperature Coefficient: 50  
 ± 50 ppm/°C

Features 570° Solder. Prevents distortion. Not affected by conventional soldering temperatures.

Call or write for complete information.

**MANUFACTURING  
CORPORATION**

400 Rockaway Valley Road  
 Boonton, N.J. 07005 • (201) 334-2676  
 Electronic Accuracy Through Mechanical Precision

ON READER-SERVICE CARD CIRCLE 36

## LETTERS

(continued from p. 42)

for human factors, to improve the nature of their dialogue with the engineer.

The study was certainly not designed to demonstrate, as your story subtly implies, that human-factors data and the human factors discipline itself are unimportant and unnecessary for better design. Quite the contrary. With 20 years of human-factors experience behind us, we are astounded by the gross errors produced by engineers who "ignore human-factors data." We are even more dismayed when we contemplate what design would be like today if the human-factors discipline did not exist.

While it is unlikely that a single study would "jolt" the Pentagon into reversing its "unending battle to coordinate engineering design with human-factors studies," it is unfortunate that reputable engineering journals such as ELECTRONIC DESIGN misinterpret the effort which the human-factors discipline is making to improve the quality of its services to the engineering profession.

The study that we performed demonstrated that there is still a hard core of indifference and hostility to human factors which permeates "old-line" engineers. Apparently your story demonstrated that indifference and hostility also exist among engineering reporters.

D. Meiser

Technical Director  
 Human Factors Programs  
 The Bunker-Ramo Corp.  
 Canoga Park, Calif.

### Modification urged for 'ideal rectifier'

Sir:

The "ideal rectifier" of Fig. b, ["Ideas for Design" section, ED 13] June 21, 1967, p. 96, is a fine idea except for one easily remedied shortcoming. It amplifies negative inputs by -1.5 and positive inputs by +1.0. This unequal rectification can be remedied by making  $R3 = 2/3$  the value of the other resistors.

The reason for this unequal amplification is that positive inputs

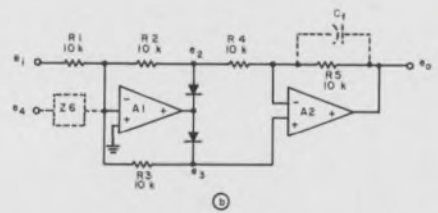

**Full-wave rectifier amplifies unequally unless  $R3$  is made equal to two-thirds the value of the other resistors.**

are multiplied by  $(R2/R1)(R5/R4) = 1.0$ , while negative inputs are multiplied by  $[R3/R1][(R2 + R4 + R5)/(R2 + R4)] = 1.5$ . The latter holds because the  $e_2$  diode cuts off for negative input and the junction of  $R1$  and  $R2$  is a virtual ground. Thus the summing resistor for  $A2$  is  $(R2 + R4)$ , giving a gain from the  $A2$  positive input terminal of  $[(R5 + R2 + R4)/(R2 + R4)] = 1.5$ .

If we change  $R3$  to  $2/3$  the value of the other resistors, we get a gain for negative signals of  $2/3$  from the  $e_1$  input to the positive input of  $A2$ . This gives an over-all gain of 1.0 when multiplied by the 1.5 gain calculated above.

Nathan O. Sokal

President  
 Design Automation, Inc.  
 Lexington, Mass.

Myron S. Wolf

Design Engineer  
 Missile Systems Div.  
 Raytheon Co.  
 Bedford, Mass.

### Accuracy is our policy

In "Y-parameters simplify mixer design," ED 7, April 1, 1967, pp. 68-74, author Ernest Klein has made the following corrections:

On p. 71, column 2:

$1/y_{11e}^* = (160 \Omega || -50.5 \text{ pF})$ ,  
 not  $y_{11e}^* = \dots$  as printed.

$1/y_{22e}^* = (3.7 \text{ k}\Omega || 9.0 \text{ pF})$ ,  
 not  $1/y_{22e}^* = (37 \text{ k}\Omega || -9.0 \text{ pF})$  as printed.

On p. 72, column 1:

$L_p \approx L_s = 43.5 \mu\text{H}$ ,  
 not  $54.5 \mu\text{H}$  as printed.

On p. 72, column 2:

The required inductance for resonance at 30 MHz is  $L = 0.3 \mu\text{H}$  (not  $0.6 \mu\text{H}$  as printed). The reason for this is that the capacitance at this point is  $C_p$  plus the capacitance of the transistor, or  $49.5 \text{ pF} + 50.5 \text{ pF} = 100 \text{ pF}$ . Therefore, for resonance,  $L = 0.3 \mu\text{H}$ .

# DON'T SPEC A SINGLE TURN UNTIL YOU'VE SEEN THE 6 new INFINITRON<sup>®</sup> CONDUCTIVE PLASTIC ELEMENT PRECISION POTENTIOMETERS FROM BOURNS



The new Bourns units are available in  $\frac{7}{8}$ ",  $1\frac{1}{16}$ " and 2" diameters with either bushing or servo-mount lids. Standard linearity is 0.5% with special linearities on request. Rotational life of the new conductive plastic units is 50,000,000 shaft revolutions and temperature range is  $-55^{\circ}\text{C}$  to  $+125^{\circ}\text{C}$ . All have outstanding resistance to humidity and exceed the moisture resistant requirement of MIL-R-39023. Most are available in ranges of 100 to 1,000,000 ohms. All models are manufactured to the stringent quality specifications you have come to expect from a Bourns product line. As with all products manufactured by Bourns, every single INFINITRON unit is guaranteed by the Bourns Reliability Assurance Program,

which includes individual inspection to published electrical and physical characteristics. Standard units are ready to ship off-the-shelf to fit your production or engineering requirements. . . special resistance values, taps, electrical angles and mechanical stops are available upon request.

Don't gamble in down-time, extended deliveries, etc., and don't speculate on quality and specifications! Investigate all the outstanding specs offered by the six new INFINITRON conductive plastic precision potentiometers from Bourns! For complete technical data contact your nearest Bourns office, representative or write the factory direct.



BOURNS, INC., TRIMPOT DIVISION • 1200 COLUMBIA AVE., RIVERSIDE, CALIF.  
TELEPHONE (714) 684-1700 • TWX: 910 332-1252 • CABLE: BOURNSINC.

TRIMPOT<sup>®</sup> and Precision Potentiometers • Miniature Relays • Electronic Modules • Microcomponents

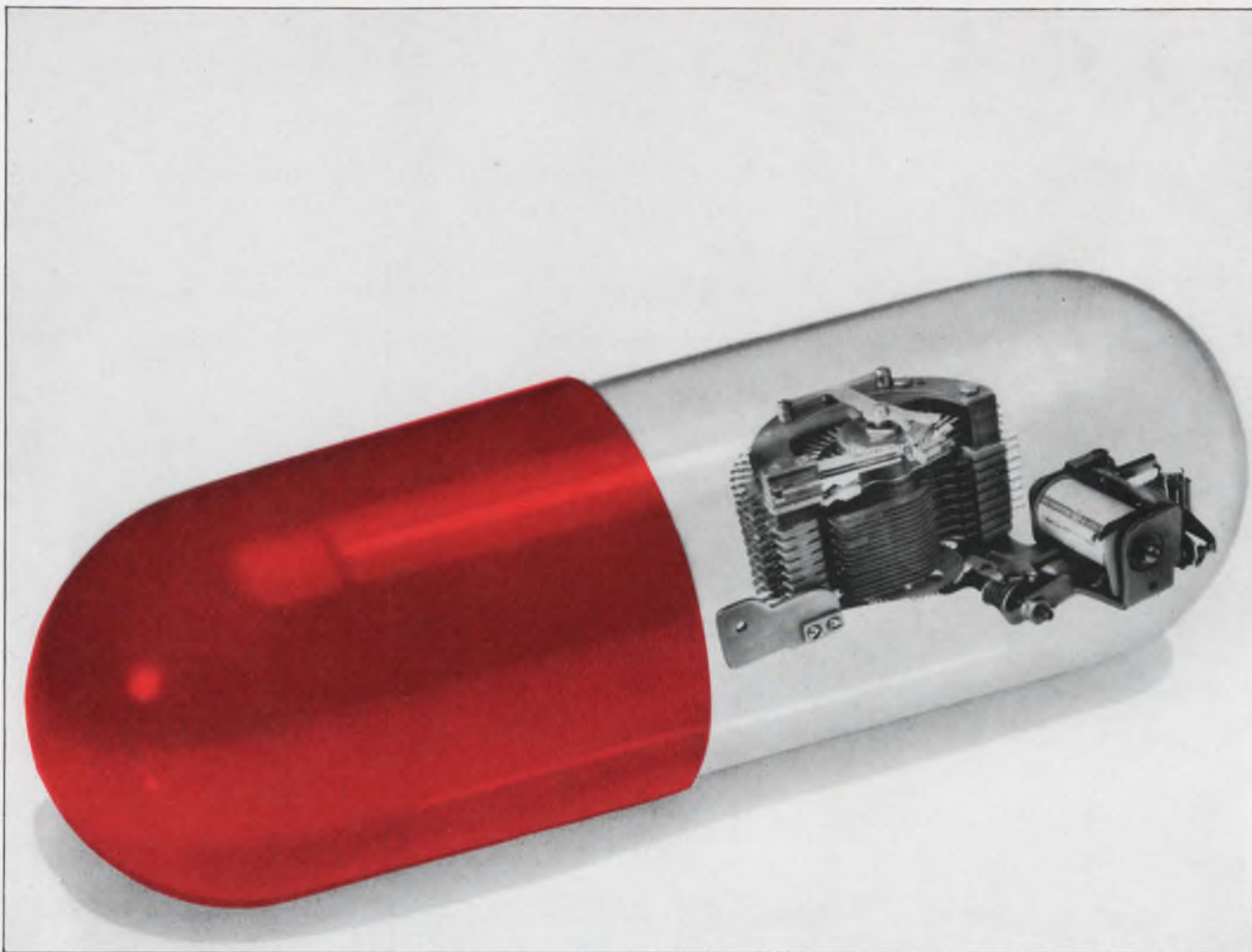

## Remedy for nightmares: AE's Type 45NC stepping switch with "shorting" levels.

Many of today's complex switching circuits look like an engineer's nightmare. Why not simplify them? You can replace whole groups of components with an AE Type 45NC "stepper."

This switch has normally closed ("shorting") levels. It's designed so that pairs of contacts *open* successively when the rotor is stepped.

The Type 45NC can solve almost any circuit-transfer or testing problem.

It's ideal for self-interrupted hunting, and you don't need auxiliary relays.

You get one or two electrical levels of either 26 or 52 point normally-closed contacts. For extra versatility, you can specify addi-

tional levels of *normally-open* contacts—on the same switch.

Contacts are gold-plated phosphor bronze. Contact resistance: a maximum of 50 to 100 milliohms, measured at 6 volts 100 milliamperes.

When you specify AE rotary stepping switches, you get the benefit of our continuous research—in design, in metals and insulating materials. All this plus *positive positioning* — a unique AE design

feature that locks the rotor and makes overthrow impossible.

Find out more about AE rotary stepping switches—an economical, rugged and reliable way to simplify switching circuits. There's a lot of helpful application information in our new reference circular 1698-L. To get your copy, just ask your AE representative. Or write to the

Director,  
Relay Control Equipment Sales,  
Automatic Electric,  
Northlake,  
Illinois  
60164.

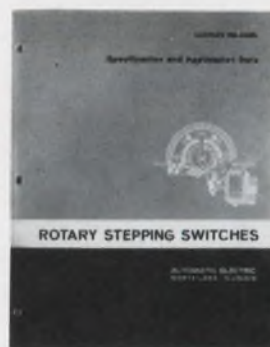

# AUTOMATIC ELECTRIC

SUBSIDIARY OF  
GENERAL TELEPHONE & ELECTRONICS **GT&E**

ON READER-SERVICE CARD CIRCLE 38

**Co-Publishers**

James S. Mulholland, Jr.  
Hugh R. Roome

**Editorial Director**

Edward E. Grazda

**Editor**

Howard Bierman

**Managing Editor**

Robert C. Haavind

**Technical Editors**

Jeffrey N. Bairstow  
Peter N. Budzilovich  
Maria Dekany  
Roger K. Field  
David H. Sorgan

**Management and Careers Editor**

Howard S. Ravis

**News Editors**

Ralph Dobriner, Chief  
Richard N. Einhorn

**Washington News Bureau**

Charles D. LaFond, Chief

**East Coast Editor**

Neil Sclater

**West Coast Editor**

Ron Gechman

**New Products Editor**

Steven B. Futterman

**Copy Editor**

Peter Beales

**Editorial Production**

Dollie S. Viebig  
Marian Arkin

**Art Director**

Clifford M. Gardiner

**Art Assistant**

William Kelly

**Technical Illustrators**

Cheh Nam Low  
Sheila F. Ward  
William Alvarez

**Production Manager**

Thomas V. Sedita

**Asst. Production Manager**

Helen De Polo

**Production Assistants**

Bernard Wolinsky  
Robert M. Henry  
Murray Friedman

**Circulation Manager**

Nancy L. Merritt

**Reader Service**

Diane Mandell

**EDITORIAL**

## Is there room at the top for you?

Yes . . . and there's recognition and a high salary if you make it. Fine, you say. But how does today's design engineer become tomorrow's chief engineer? You can take the first step by checking a survey **ELECTRONIC DESIGN** recently completed among chief engineers and engineering managers in the country (see p. 86 for details).

Here's what managers advise aspiring managers to do:

- Become business oriented. Practice cost analysis and budgeting, learn corporate finance procedures, and become keenly aware of profit and loss factors.
- Develop a sensitivity for human relations. Learn and apply the psychology of dealing with people, so they will work better with you and other members of your engineering team.
- Keep technically current. Be informed of the latest advances in your field. Also diversify your interests, so you become knowledgeable in allied fields.

Many of you may feel that some of this advice is not startling. You're already keeping abreast of technology, aren't you? Otherwise you wouldn't be reading this publication. But are you actively pursuing the other areas of career development?

Don't kid yourself that you can't find the time. If you want to move into management, you must learn to manage yourself first. Make the time. Evaluate your daily schedule carefully and eliminate some less important activity.

It's possible, though, that you can't set aside enough time to attend 12-week sessions at a university. **ELECTRONIC DESIGN**'s management and careers editor, Howard Ravis, will assist you. He has been conferring with the American Management Association, the Industrial Educational Institute and other leading management organizations and, through their assistance, will bring you outstanding management guidance. Follow the management section of the magazine in coming issues and start your move to the top.

You'll get straight talk from the leading management consultants, concise and detailed counseling on all phases of your career development, and carefully planned tests, when applicable, to permit you to check your progress.

Here's to your future!

HOWARD BIERMAN

variable viewing time 5 cm/ $\mu$ s stored writing speed

# split-screen displays

## all in the Tektronix Type 549 Storage Oscilloscope

Waveform display showing train of pulses. Upper screen in the stored mode shows three pulses with falltime of the pulse trailing edge showing system deficiency. Lower screen in conventional display mode shows the same pulse train with corrections applied to provide a well formed pulse shape. Pulse width shown is 8  $\mu$ s with risetime of 0.1  $\mu$ s. Vertical deflection factor is 0.5 volts/cm. Horizontal deflection factor is 10  $\mu$ s/cm. Repetitive sweep used for both displays.

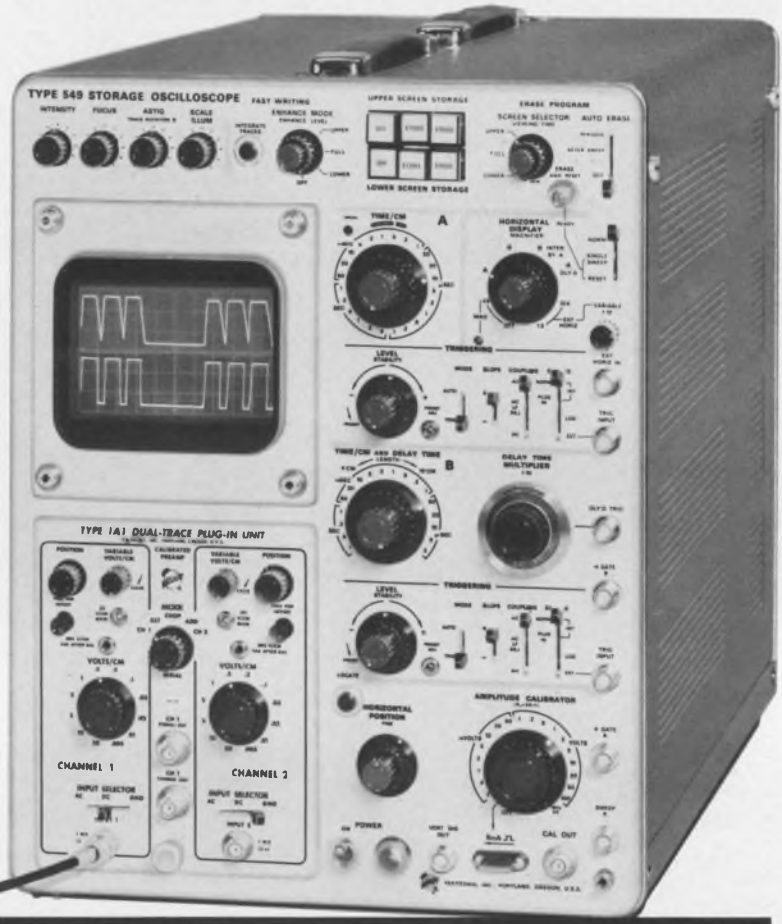

The Type 549 allows up to one hour of continuous visual storage, giving you ample time in most applications to measure and analyze stored waveforms. Stored displays can be erased in less than one-quarter of a second.

### Split-screen displays

Unique with Tektronix storage oscilloscopes, split-screen displays bring you many advantages in waveform-comparison applications. You can use either half of the 6 cm by 10 cm display area for stored displays, the other half for nonstored displays, with independent control of each half. You can also use the entire screen for either type of display.

### Variable viewing time

Variable viewing time — an outstanding feature of the Type 549 — allows you to automatically store displays, view them for a selected time, then automatically erase them on either or both halves of the screen. Two modes of operation are possible. In the After-Sweep Automatic Erase Mode, the selectable viewing time of 0.5 s to 5 s begins at the end of each complete sweep. After the viewing time, the display is automatically erased and the cycle begins again when the next sweep is triggered by a signal.

In the Periodic Automatic Erase Mode, the sequence of storing, viewing time and erasure is continuous and independent of the sweep or signal. In this mode, the viewing time can also be varied from 0.5 s to 5 s.

There is no degradation of stored traces during the selected viewing time, in either mode, and you can retain or erase displays manually whenever desired.

For a demonstration, contact your nearby Tektronix field engineer or write: Tektronix, Inc., P. O. Box 500, Beaverton, Oregon 97005.

### Bistable storage advantages

With bistable storage oscilloscopes, such as the Type 564 and Type 549, the contrast ratio and brightness of stored displays are constant and independent of the viewing time, writing and sweep speeds, or signal repetition rates. This also simplifies waveform photography. Once initial camera settings are made for photographs of one stored display, no further adjustments are needed for photographs of subsequent stored displays.

Tektronix bistable storage cathode ray tubes are not inherently susceptible to burn-damage and require only the ordinary precautions taken in operating conventional oscilloscopes.

### Plug-in unit adaptability

Vertical deflection characteristics of the Type 549 are extremely flexible through use of any of the Tektronix letter- or 1-series plug-in units. These include multi-trace, differential, sampling, and spectrum analyzer units. Depending upon the plug-in being used, bandwidth of nonstored displays extends from DC to 30 MHz.

Among other features of the Type 549 are 5 cm/ $\mu$ s stored writing speed, calibrated sweep delay from 1  $\mu$ s to 10 s, sweep speeds to 20 ns/cm, amplitude calibrator from 0.2 mV to 100 V and a locate zone for easy positioning of stored traces.

Type 549, without plug-in units . . . . . \$2475

Type 1A1 Dual-Trace Plug-In Unit . . . . . \$ 625

DC to 30 MHz at 50 mV/cm; DC to 23 MHz at 5 mV/cm.  
2 Hz to 14 MHz at 500  $\mu$ V/cm, single-channel.

U.S. Sales Prices, FOB Beaverton, Oregon



Multi-trace, differential,  
sampling and spectrum analysis

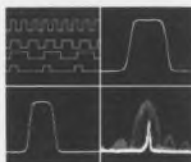

. . . in all Tektronix 530-540-550-series  
plug-in oscilloscopes

# Technology

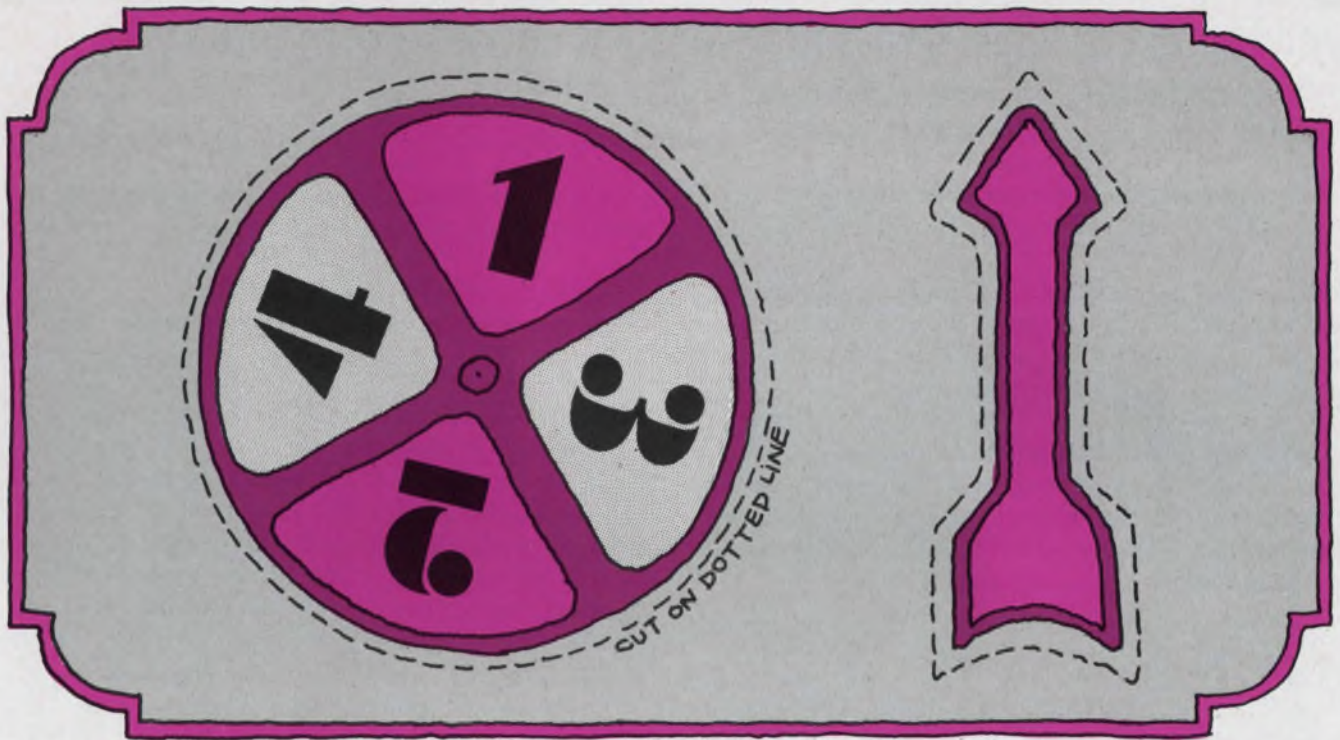

Playing the "Chief Engineer Game" is more than just idle fun. You can win the game by

developing the proper skills, and not by spinning the wheel of chance. Page 86

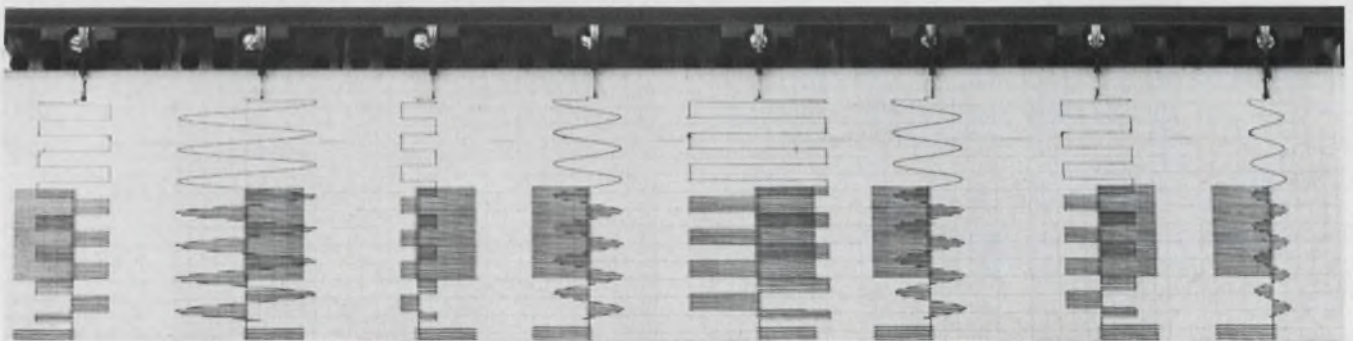

A good trace depends on the paper as well as the recorder. A knowledge of the paper

and recording process can help you use your equipment to its best advantage. Page 72

## Also in this section:

**Build complementary-symmetry amplifiers** with these equations. Page 52

**Computer-designer conversation** allows quick changes. Page 58

**Which delay line is best** for doppler radars? Page 66

**A varactor's inductance** can be put to use. Page 78

# Build complementary-symmetry amplifiers

with the aid of a few straightforward equations to compute the component values and circuit parameters.

The major advantage of complementary symmetry is that the output transformer is eliminated. Each output transistor, therefore, instead of seeing a maximum collector-emitter voltage equal to twice the supply voltage, sees a maximum of only one-half the supply voltage. This moreover leads to lower cost without deterioration in performance.

A rigorous analysis of complementary-symmetry amplifiers is difficult because the transfer characteristics of transistors are nonlinear. However, a set of simple design equations yielding component values which require little or no adjustment can be developed and used for practical design.

## The basis for analysis formulated

The equations are derived by analyzing the quiescent condition as well as circuit conditions when the output transistors are conducting peak current. They interrelate pertinent circuit parameters, so that selecting values for most circuit parameters—such as output power required and load resistance required—enables the remaining circuit parameters or component values to be obtained. The major assumptions made are these:

- Clipping by the output transistors occurs as soon as the collector-base junction of either one becomes forward-biased.

- When one of the output transistors is conducting peak collector current, the other output transistor is conducting a negligible amount of collector current.

A basic configuration for complementary-symmetry amplifiers is shown in Fig. 1. Other configurations are simply variations of this one, and design equations for them may be derived by means of the same approach used in analyzing this circuit.

In Fig. 1 there are three conditions to be considered:

1. *Q1* is conducting peak current, and *Q2* is cut off.
2. *Q2* is conducting peak current, and *Q1* is cut off.
3. The quiescent condition—both *Q1* and *Q2* are conducting.

If  $P_o$  is the effective output power to the load, the peak current and voltage for the load are:

$$I_{L \max} = (2P_o/R_L)^{1/2};$$

$$V_{L \max} = (2P_o R_L)^{1/2}.$$

In the following discussion of conditions 1 and 2, all values of voltage and current are peak instantaneous values.

Consider condition 1 when *Q1* is conducting peak current and *Q2* is cut off. It is assumed that the collector current of *Q3*,  $I_{C3}$ , is negligible. Capacitor *C2* acts as a power supply for *Q1*. To obtain the maximum voltage swing across  $R_L$ , Capacitor *C2* should be charged to  $12 V_{CC}$ . It should also be large enough to supply enough power for the low-frequency response without increase in distortion. The circuit for this condition reduces to that shown in Fig. 2.

The maximum base current available is:

$$I_{B1 \max} = (V_{CC}/2 - V_{BE1})R1,$$

and since  $P_o$  is the output power required, the *Q1* collector current is:

$$I_{C1 \max} = (2P_o/R_L)^{1/2}.$$

The acceptable minimum gain is therefore:

$$h_{FE1 \min} = [R1/(V_{CC}/2 - V_{BE1})] [(R_L/2P_o)^{1/2}].$$

Thus:

$$R1 \leq (h_{FE1 \min}/2)(V_{CC} - 2V_{BE1})(2P_o/R_L)^{1/2} \quad (1)$$

## Glossary of symbols

$I_{L \max}$	peak load current
$V_{L \max}$	peak load voltage
$P_o$	effective output power
$I_c$	collector current
$V_{BE}$	base-to-emitter voltage
$I_{B \max}$	peak base current
$R_L$	load resistance
$T_J$	junction temperature
$h_{FE}$	forward current transfer ratio
$i_e$	emitter current
$V_{CEA}$	collector-to-emitter voltage
$P_{ca}$	maximum power dissipation
$V_{cc}$	supply voltage
$\theta$	emitter current phase angle

**Prabodh Shah**, Applications Engineer, General Instrument Corp., Woonsocket, R.I.



It is assumed that clipping due to saturation occurs as soon as the collector-base junction becomes forward-biased. Therefore the requirement that  $V_{CB1} \geq 0$  at peak load current will ensure unclipped operation. The higher the gain of the transistor, the greater the drop across  $R_L$  for a given base current and hence for a given drop across  $R1$ . The next concern, then, is maximum acceptable gain.

$$V_{CB1} = I_{B1(\max)} R1 - I_{C1(\max)} R_L \geq 0; \quad (2)$$

$$R1 \geq h_{FE1(\max)} R_L,$$

where  $I_{B1(\max)}$  is the instantaneous peak base current at these conditions. Although the gain limits obtained from the above equations apply to  $Q1$ , they also apply to  $Q2$  with some matching requirement to minimize distortion.

Now consider the case when  $Q2$  is conducting peak current and  $Q1$  is cut off. The circuit for this condition is shown in Fig. 3.

The capacitor  $C2$  may be thought of here as a  $V_{CC}/2$  power supply (ac short). To guarantee that  $Q2$  will not clip, it is necessary for  $Q3$  not to clip. This is ensured by requiring that  $V_{CB3} \geq 0$  or  $V_{CE3} \geq V_{BE3}$ .

$$V_{CE3} = V_{CC}/2 - V_{L(\max)} - V_{EB2} \geq V_{BE3}$$

$$\therefore V_{CC} \geq 2 [ V_{BE3} + V_{EB2} + (2P_o R_L)^{1/2} ].$$

On the assumption that  $V_{BE3} \approx V_{EB2}$ ,

$$V_{CC} \geq 2 [ 2V_{EB2} + (2P_o R_L)^{1/2} ]. \quad (3)$$

If Eqs. 1, 2 and 3 are satisfied, the output is limited by the driver transistor,  $Q3$ , alone—that is, the driver will saturate before  $Q2$ , since  $Q2$  is operating as an emitter follower. As in the preceding development, it has been assumed that clipping begins as soon as the collector-base junction becomes forward-biased, and not before. If the saturation characteristics of the transistors are good ( $V_{CE(sat)} < V_{BE(sat)}$ ), then there is a small built-in safety factor in Eqs. 1, 2 and 3. If the saturation characteristics are poor ( $V_{CE(sat)} > V_{BE(sat)}$ ), then clipping will begin before  $V_{CB}$  becomes forward-biased or when  $V_{CB}$  is still reverse-biased. The design equations must then be modified accordingly.

Consider now condition 3, the quiescent condition. Transistors  $Q1$  and  $Q2$  should be slightly forward-biased to eliminate crossover distortion. Because the voltage across  $R2$  is the sum of  $V_{BE1}$  and  $V_{EB2}$ ,  $V_{R2}$  is known if the  $V_{BE}$  of the two devices is known.

The capacitor voltage is:

$$V_{CC}/2 = I_{R1} R1 + V_{BE1}$$

$$\therefore I_{R1} = (V_{CC} - 2V_{BE1}) / 2R1 = I_{C3} \quad (4)$$

$\therefore Q3$  should be biased at  $I_{C3}$  (Eq. 4) and:

$$V_{CE3} = V_{CC}/2 - V_{EB2}. \quad (4a)$$

In Eqs. 1, 3, 4 and 4a, the value of base-emitter voltage used should be that at the highest operating junction temperature.

### Consider additional requirements

Resistor  $R3$  determines how much ac and dc negative feedback is present (see Fig. 1). If, through the reduction of  $R3$ , enough negative feedback is used,

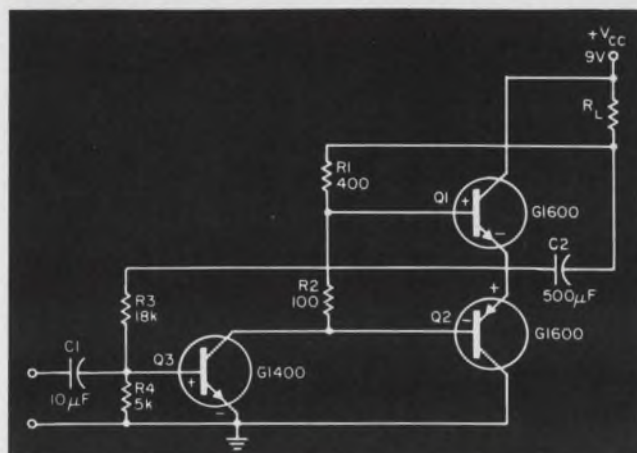

1. **Generalized complementary-symmetry amplifier** schematic includes three transistors. In this case  $Q1$  and  $Q2$  are a matched complementary pair of silicon epoxy transistors (GI 600) and  $Q3$ , the driver, is an epoxy GI 400. Note that each output transistor sees only a maximum of one-half the supply voltage. All values are computed in the design example.

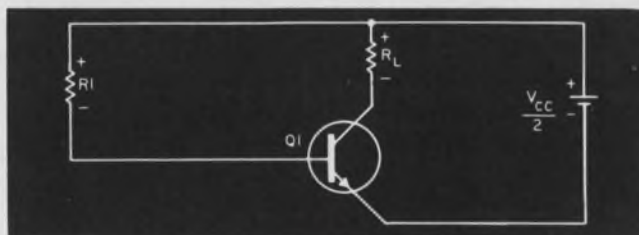

2. **When  $Q1$  is conducting peak current** and  $Q2$  is cut off the circuit of Fig. 1 is reduced to this.

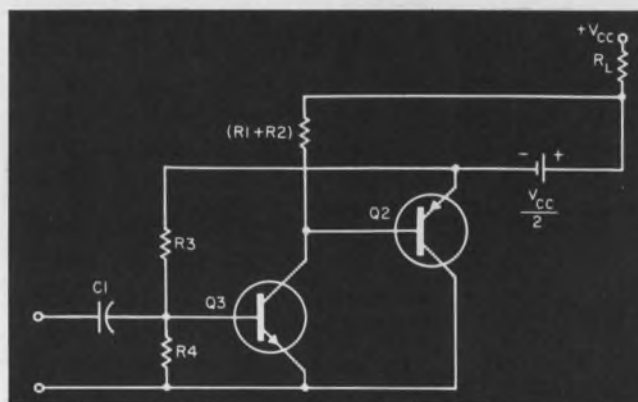

3. **Equivalent amplifier circuit** of Fig. 1 when  $Q2$  is conducting peak current and  $Q1$  is cut off.

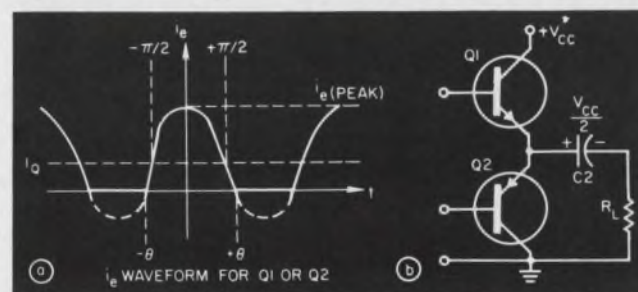

4. **Transistor power dissipation** is computed by means of an equivalent circuit (b) and its current wave (a).

it is possible to use output transistors that are not matched for gain or  $V_{BE}$ . The selection of  $R_3$  and  $R_4$  is primarily influenced by the input impedance and feedback desired, and the gain of  $Q_3$ .

Distortion at low frequencies is seriously affected by capacitor  $C_2$ . The value of  $C_2$  is determined empirically on the basis of the tolerable distortion at the lowest frequency of interest and the lower cut off frequency desired.

The other major consideration is power dissipation of the output transistors.

### Calculate power dissipation

To derive the expression for power dissipation in  $Q_1$  or  $Q_2$ , it is assumed that collector current is equal to emitter current and that  $\pi/2 - \theta$  (see Fig. 4a) is extremely small—in other words, that  $i_{e(peak)} \gg I_Q$ .

Now  $i_c = I_{C(max)} \cos \theta$  and  $v_{ce} = V_{CC}/2 - I_{C(max)} R_L \cos \theta$ , so that:

$$P_c = (V_{CC} I_Q/4) + 1/\pi \int_0^{\pi/2} (i_c v_{ce}) d\theta$$

$$= (V_{CC} I_Q/4) + 1/\pi \int_0^{\pi/2} [I_{C(max)} \cos \theta (V_{CC}/2 - I_{C(max)} R_L \cos \theta)] d\theta$$

$$= (V_{CC} I_Q/4) + 1/\pi [(V_{CC} I_{C(max)}/2) - (I_{C(max)}^2 \pi R_L/4)].$$

Maximum power dissipation,  $P_{c(max)}$ , occurs not at maximum load (output) power, but at  $I_{C(max)} = V_{CC}/\pi R_L$ :

$$P_{c(max)} = (1/4\pi^2)(V_{CC}^2/R_L) + (V_{CC} I_Q/4).$$

The second term is of negligible magnitude in relation to the first, so one can write:

$$P_{c(max)} \approx V_{CC}^2/4\pi^2 R_L. \quad (5)$$

The above expression for the maximum power dissipation does not take into account the heat sinking of the transistor. It is well known that more power can be obtained from a given device with the use of a properly designed heat sink.

### Formulating the design procedure

Now that the major design equations needed to calculate all the component values for a complementary amplifier have been derived, a detailed design procedure can be formed.

For convenience, the design equations are repeated below:

$$R_1 \leq (h_{FE(min)}/2)(V_{CC} - 2V_{BE1})(R_L/2P_o)^{1/2}. \quad (1)$$

$$R_1 \geq h_{FE(max)} R_L. \quad (2)$$

$$V_{CC} \geq 2 [2V_{EB2} + (2P_o R_L)^{1/2}]. \quad (3)$$

Bias point of  $Q_3$ :

$$I_{C3} = (V_{CC} - 2V_{BE1})/2R_1, \quad (4)$$

$$V_{CE3} = V_{CC}/2 - V_{EB2}. \quad (4a)$$

$$P_{c(max)} = V_{CC}^2/4\pi^2 R_L. \quad (5)$$

The design procedure is as follows:

- Select  $P_o$  and  $R_L$ .
- From Eq. 3, calculate the minimum value of  $V_{CC}$  and select a value of  $V_{CC}$ .
- From Eq. 5, calculate the power dissipation of the transistor.
- Select a transistor, and from Eqs. 1 and 2 calcu-

## GI 600 and GI 400 parameters

Specification for General Instrument Type GI 600, a matched complementary pair of silicon epoxy transistors:

- $V_{CBO} > 25 \text{ V} @ I_C = 10 \mu\text{A}$
- $V_{CEO} > 25 \text{ V} @ I_C = 10 \text{ mA}^*$
- $V_{EB0} > 3 \text{ V} @ I_E = 10 \mu\text{A}$
- $h_{FE} > 50 @ V_{CE} = 5 \text{ V}, I_C = 5 \text{ mA}$
- $I_{CBO} < 10 \text{ nA} @ V_{CB} = 10 \text{ V}$
- $I_{EB0} < 10 \text{ nA} @ V_{OB} = 2 \text{ V}$
- $h_{FE}$  groups @  $V_{CE} = 1 \text{ V}, I_C = 250 \text{ mA}^*$ 
  - a. 30 - 35
  - b. 35 - 40
- $V_{BE} 0.75 - 1.05 \text{ V} @ I_C = 250 \text{ mA}, V_{CE} = 1 \text{ V}^*$

Specifications for General Instrument Type GI 400, an npn silicon epoxy transistor:

- $V_{CEO} > 25 \text{ V} @ I_C = 10 \text{ mA}^*$
- $V_{CBO} > 50 \text{ V} @ I_E = 10 \mu\text{A}$
- $V_{EB0} > 5 \text{ V} @ I_E = 10 \mu\text{A}$
- $I_{CBO} < 50 \text{ nA} @ V_{CB} = 40 \text{ V}$
- $I_{EB0} < 50 \text{ nA} @ V_{OB} = 3 \text{ V}$
- $h_{FE} 75 - 150 @ V_{CE} = 4 \text{ V}, I_C = 10 \text{ mA}$

\* Pulse width = 300  $\mu\text{s}$ , duty cycle  $\leq 2\%$ .

late  $R_{1(max)}$  and  $R_{1(min)}$  respectively, and select  $R_1$ .

- Calculate the bias point of  $Q_3$  from Eq. 4.

This is merely a suggested design procedure, and one can just as well start with a device.

### Design an amplifier

Consider, for example, the design of an amplifier like that in Fig. 1, using General Instrument transistors GI 600 and GI 400 (for specifications for these types, see box). The GI 600 is a matched complementary pair of silicon epoxy transistors especially suited to low-cost, low power complementary-symmetry amplifiers, because of their excellent gain and saturation characteristics. The GI 600 is used for  $Q_1$  and  $Q_2$ , and GI 400 is used for  $Q_3$ .

Suppose an output power of 300 mW is required and it is desired to limit maximum power dissipation to 210 mW. For a 4-ohm load, this requires a peak collector current of 387 mA, and for a 16-ohm load, a peak collector current of 194 mA is required. For GI 600, when  $I_C = 250 \text{ mA}$ ,  $V_{CE} = 1 \text{ V}$  and  $T_J = 25^\circ \text{C}$ , the  $V_{BE}$  is typically 0.9 V. Since the  $V_{BE}$  of silicon transistors decreases at approximately 2 mV/ $^\circ \text{C}$ , a value of  $V_{BE} = 0.75 \text{ V}$  at  $V_{CE} = 1 \text{ V}$  and  $T_J = 100^\circ \text{C}$  (maximum anticipated operating temperature) may be used as an approximation in the  $I_C = 195$ -to- $390$ -mA current range.

From Eq. 5:

$$(1/4\pi^2)(V_{CC}^2/R_L) \leq 0.21; \quad \therefore V_{CC}^2 \leq 8.3R_L. \quad (6)$$

From Eq. 3:

$$V_{CC} \geq 2 [1.5 + (0.6R_L)^{1/2}].$$

If  $R_L = 10 \Omega$ , then:

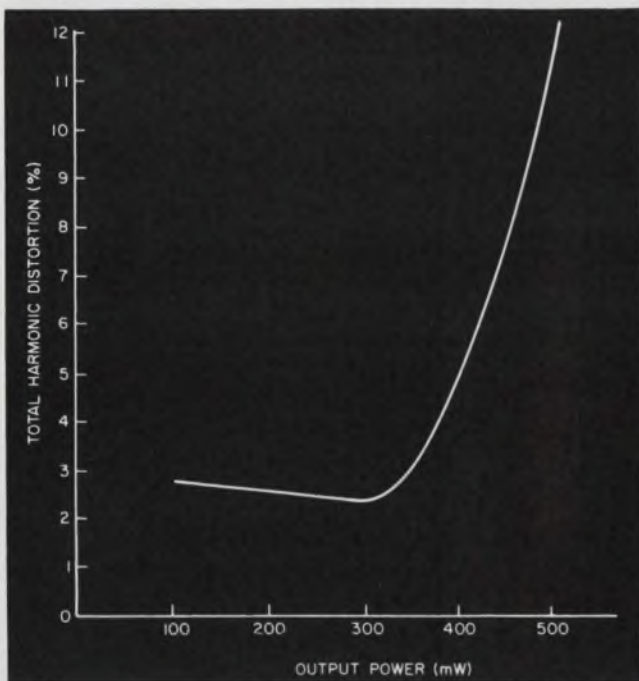

5. Total harmonic distortion at 1 kHz is less than 3% over the design power output range (300 mW). The gain of the amplifier under these conditions is 44 dB and the input impedance is 3 k $\Omega$ .

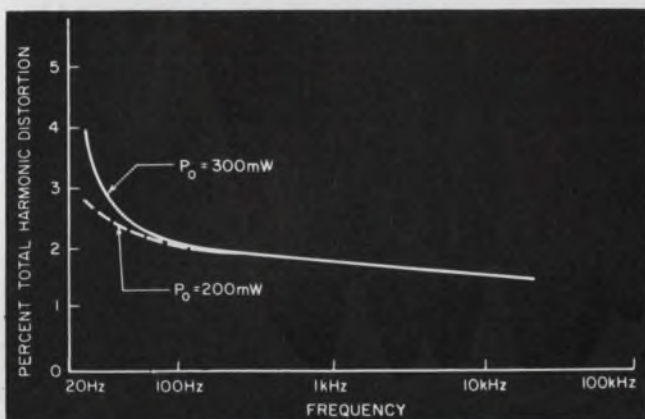

6. Total harmonic distortion as a function of frequency for two values of output power is under 4% at 25 kHz and 300 mW.

$$V_{CC} \geq 7.9 \text{ V.}$$

And from Eq. 6:

$$V_{CC} \leq 9.1 \text{ V.}$$

Therefore let  $V_{CC} = 9 \text{ V}$  and  $R_L = 10 \Omega$ ,

$$\therefore I_{C(\max)} = 245 \text{ mA.}$$

The same high-temperature value for  $V_{BE1}$  (0.75 V) yields from Eq. 1:

$$R1_{(\max)} = 15.3 h_{FE(\min)}.$$

From Eq. 2:

$$R1_{(\min)} = 10 h_{FE(\max)}.$$

For GI 600, at  $I_C = 250 \text{ mA}$  and  $V_{CE} = 1 \text{ V}$ :

$$h_{FE} = 30 \text{ to } 40.$$

$$\therefore R1_{(\max)} = 460 \Omega.$$

$$R1_{(\min)} = 400 \Omega.$$

Therefore let  $R1 = 400 \Omega$ .

From Eq. 4:

$$I_{C3} = 9.6 \text{ mA,}$$

$$V_{CE3} = V_{CC}/2 - V_{EB2}.$$

For  $Q1$  and  $Q2$  at  $T_J = 100^\circ \text{C}$ , the  $V_{BE}$  at  $I_C = 10 \text{ mA}$  and  $V_{CE} = 5 \text{ V}$  is typically 0.5 V.

Therefore:

$$V_{CE3} = 4.0 \text{ V.}$$

Since  $I_{B1}$  for the quiescent condition is negligible in comparison with the  $I_{C3}$  of 9.6 mA, it may be assumed that the current in  $R2$  ( $I_{R2}$ )  $\approx 9.6 \text{ mA}$ . The  $V_{BE}$  of  $Q1$  and  $Q2$  is typically 0.5 V at  $I_C = 10 \text{ mA}$ ,  $V_{CE} = 5 \text{ V}$  and  $T_J = 100^\circ \text{C}$ .

Therefore:

$$R2 = 2V_{BE}/9.6(10^{-3}) \approx 100 \Omega.$$

Therefore let  $R2 = 100 \Omega$ .

The GI 400 has a typical gain of 100 at  $I_C = 10 \text{ mA}$  and  $V_{CE} = 4 \text{ V}$ , and it has a typical  $V_{BE}$  of 0.65 V under the same conditions. Therefore:

$$I_{B3} = 100 \mu\text{A.}$$

Let  $R4 = 5 \text{ k}\Omega$ .

$$I_{R4} = 0.65/5\text{K} \Omega = 130 \mu\text{A.}$$

$$I_{R3} = 230 \mu\text{A.}$$

$$R3 = (V_{EC2} - V_{BE3})/I_{R3} \\ \approx (4.5 - 0.65)/(230 \cdot 10^{-6}) = 16.7 \text{ k}\Omega.$$

Therefore let  $R3 = 18 \text{ k}\Omega$ .

The component values thus become:

$$R1 = 400 \Omega.$$

$$R2 = 100 \Omega.$$

$$R3 = 18 \text{ k}\Omega.$$

$$R4 = 5 \text{ k}\Omega.$$

$$V_{CC} = 9 \text{ V.}$$

$$C1 = 10 \mu\text{F} \text{ (selected experimentally).}$$

$$C2 = 500 \mu\text{F} \text{ (selected experimentally).}$$

An amplifier that incorporated these values was built and found to have the following characteristics:

At zero output power, supply current = 9 mA.

At 300-mW output, supply current = 90 mA.

The lower half-power frequency is 25 Hz, and the upper half-power frequency is in excess of 600 kHz.

At 25 Hz and 300 mW output, the total harmonic distortion (THD) = 4%.

At 25 Hz and 200 mW output, THD is less than 3%.

At 1 kHz and an output power of 300 mW, the amplifier has a power gain of 44 dB, and the input impedance is approximately 3 k $\Omega$ .

Figure 5 shows THD vs output power at 1 kHz.

Figure 6 shows THD vs frequency.

Other circuit parameters are as follows:

Parameter	Design objective	Measured
$V_{CE1}(\text{dc})$	4.5 V	4 V
$V_{CE2}(\text{dc})$	4.5 V	5 V
$V_{CE3}(\text{dc})$	4.0 V	4.5 V
$V_{R2}(\text{dc})$	1 V	0.9 V

Quiescent supply

current (mA dc)	10.0 mA	9.0 mA
-----------------	---------	--------

It may be observed that the measured and the desired values are in good agreement. Thus one can conclude that the simplifying assumptions made in the beginning of this analysis do not appreciably affect the accuracy of the results and that the equations actually describe the performance. ■ ■



AF

DR

3C ICM-500 I/C CORE MEMORY SYSTEM

New I/C 500-600 nsec  
Memory System . . .

**. . . Stores 1/4 million bits in  
single 5-1/4" high unit, features  
MTBF of 12 years under normal  
40-hour week operation**

The ICM-500 Series\* is the newest addition to Honeywell's broad line of  $\mu$ -STORE magnetic core memory systems. It combines high speed, large capacity, flexible packaging, high reliability, and maximum use of integrated circuits in a compact, economical system. Plus, you get a choice of standard model configurations to meet your special design requirements.

**Speed** — Standard Systems: 600 nanoseconds full cycle time. Special systems: available with cycle times as low as 500 nanoseconds.

**Capacity** — Standard models now up to 16,384 words with 54 bits/word; or up to 4096 words with 72 bits/word. (Over  $\frac{3}{4}$  of a million bits in little more than 15" of vertical rack space, including power supply). Special memory systems are available with larger capacities.

**Packaging** — Model ICM-500E is designed for pull-out rack mounting; Model ICM-500 for flexible mechanical mounting. All circuit modules, core stack, and interconnections are easily accessible from the front of the rack.

**Integrated Circuits** — Used for all major functions, including X-Y current drivers, resulting in a highly compact and reliable unit. Circuit organization has drastically reduced system interconnections and lead lengths.

**Reliability** — MTBF exceeds 25,000 hours.

**Temperature Range** — 0° to 50°C

If you've drawn a block marked "core memory system" recently, let us tell you the full ICM-500 story. You'll find our eight years' experience has again produced a standard product designed to solve your memory problems.

Write today for our new brochure. It gives all the details. Honeywell, Computer Control Division, Old Connecticut Path, Frammingham, Massachusetts 01701.

\*Patent applied for.

**Honeywell**

 **COMPUTER CONTROL**  
DIVISION

ON READER-SERVICE CARD CIRCLE 40

# Computer talks to the circuit designer

in his own language. Designs are evaluated and changes made immediately by simple conversation.

A major drawback of computer-aided circuit design programs has been the designer's lack of contact with the solution process. He sends his problem to a typical batch-processing computer facility and some time later gets results back. This means that he has no equivalent of laboratory breadboarding, because no changes can be made while the program is in progress. The delays that this can lead to may well dissuade him from using these programs.

Now there is a program that gets around the problem. It allows the engineer to "chat" with the computer as it works toward a solution. The CIRCuit design analysis program gives the engineer real-time conversational control of the input and output of the program and enables him to control parameter variation, without having to run the program again. Off-line working—that is, where the designer is not involved with the actual computer operation—is also possible for routine analysis where on-line facilities are unnecessary.

Additional features of CIRC are:

- The conversational language is easy to learn, and requires no previous programming knowledge.
- It may be used for discrete or integrated circuits with up to approximately 50 nodes.
- It provides nonlinear models to simulate accurately diodes and transistors.
- It is implemented on small-to-medium scale computers, (see box on CIRC availability).
- The necessary circuit equations are normally written by CIRC but the equations can be supplemented or modified if required.

## CIRC at work

An example will demonstrate how CIRC analyzes a simple circuit (Fig. 1a). In this instance CIRC derives nominal results with the nominal-analysis section of the program. The program could equally well derive worst-case results or permit parameter variations through the user-control (UC) feature. User control will be discussed further on and worst-case

analysis will be the subject of a later article.

Since CIRC proceeds in question-and-answer fashion, the analysis of Fig. 1a can be considered step by step together with the printouts on the opposite page (Figs. 2 and 3).

**Step 1:** The engineer numbers all nodes, supplies, and components. This produces a diagram labeled as in Fig. 1b. No transistor equivalent circuit is necessary for this program.

**Step 2:** Once CIRC has been loaded into the computer and set to run, the computer's input-output typewriter will print out the questions for the engineer to answer (Fig. 2).

**Step 3:** The engineer next specifies the connections for each element as the computer asks the questions (Fig. 3). Each of the questions in Step 3 is followed by a further question. These yield the data for Step 4.

**Step 4:** The engineer describes the component

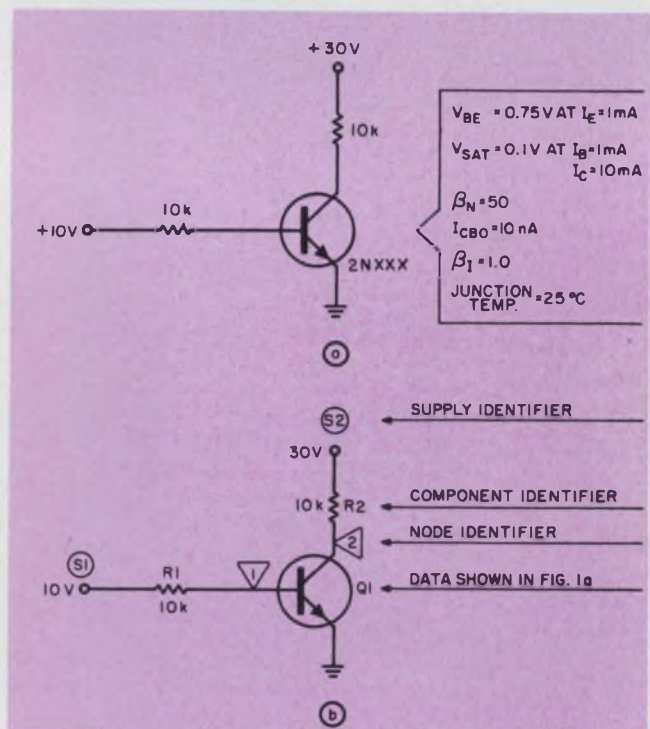

1. At the starting point of a CIRC analysis the engineer takes his circuit design (a) and numbers each element and node (b). This simple example has two nodes but CIRC can handle fifty.

Richard McNair, Staff Engineer, Scientific Data Systems, Inc., Santa Monica, Calif.

Step 2 begins with a CIRC question. Engineer's answer.

NUMBER OF NODES  
2.

NUMBER OF VOLTAGE SUPPLIES  
2.

ARE SPECIAL EQS USED  
NO

Resistors, Voltage Resistance Sources, Current Sources, Diodes, Transistors.

SPECIFY THE QUANTITY OF THE FOLLOWING CIRC STND ELEMENTS THAT ARE USED.  
RES., VRS., CUR., DIO., TRAN.  
2, 0, 0, 0, 1.

VOLTAGE SUPPLIES  
SPECIFY THE FOLLOWING.  
NOM VAL, MIN INFO, MAX INFO, (FOR ALL PARAMETERS INDICATED)

Only nominal values are given since only a nominal analysis is required.

SUP 1 = PARAMETER NUMBER 1  
10.,  
SUP 2 = PARAMETER NUMBER 2  
30.,

JUNCTION TEMPERATURE (DEG. CENT.)  
SPECIFY THE FOLLOWING.  
NOM VAL, MIN INFO, MAX INFO, (FOR ALL PARAMETERS INDICATED)

TEMP 1 = PARAMETER NUMBER 3  
25.,

## 2. Description of circuit is given to computer by a question and answer process.

Step 3.

### RESISTORS

SPECIFY THE FOLLOWING.  
TERM 1 INFO, TERM 2 INFO,  
NOM VAL, MIN INFO, MAX INFO, (FOR ALL PARAMETERS INDICATED)

Resistance 1 is connected between S1 and N1, and has a value of 10 kilohms (Step 4).

RES. 1  
S1, N1,  
RES. 1 = PARAMETER NUMBER 4  
10000.,

RES. 2  
S2, N2,  
RES. 2 = PARAMETER NUMBER 5  
10., E3,

### TRANSISTORS

SPECIFY THE FOLLOWING.  
BASE INFO, COLL. INFO, EMIT. INFO, COPY DATA INFO, P IF PNP,  
NOM VAL, MIN INFO, MAX INFO, (FOR ALL PARAMETERS INDICATED)

Transistor 1 base, collector and emitter connections.

TRAN 1  
N1, N2, G0,  
IC-S 1 = PARAMETER NUMBER 11  
.010,  
IB-S 1 = PARAMETER NUMBER 12  
.001,  
IE-A 1 = PARAMETER NUMBER 13  
.001,  
VBE 1 = PARAMETER NUMBER 6  
.75,  
VSAT 1 = PARAMETER NUMBER 7  
.1,  
BN 1 = PARAMETER NUMBER 8  
50.,  
BI 1 = PARAMETER NUMBER 9  
1.,  
ICBO 1 = PARAMETER NUMBER 10  
10., E-9,

Transistor 1 parameters specified (nominal values only).

### NOMINAL SOLUTIONS 14

Nominal solutions are printed out in the same order as the specify statement of Fig. 2.

V	VALUE	V	VALUE	V	VALUE	V	VALUE
1	.7900025E 00	2	.7473989E-01				
D	VALUE	D	VALUE	D	VALUE	D	VALUE

Resistor 1.  
Resistor 2.

1	.9209997E-03 (I)	2	.8482405E-02 (P)
3	.2992526E-02 (I)	4	.8955212E-01 (P)

Transistor 1.

5	.9209997E-03 (I <sub>B</sub> )	6	.2992536E-02 (I <sub>C</sub> )	7	.3913526E-02 (I <sub>E</sub> )	8	.9512539E-03 (P)
9	.7900025E 00 (V <sub>BE</sub> )	10	.7152626E 00 (V <sub>BC</sub> )	11	.7473989E-01 (V <sub>CE</sub> )	12	.3249226E 01 (I <sub>C</sub> /I <sub>B</sub> )

## 3. Connection and component data are requested by CIRC. Then CIRC outputs the solutions requested.

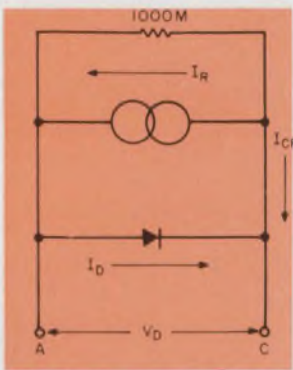

4. Simple models are used by CIRC. The diode model has three parameters and is easily specified from the manufacturer's data. The shunt resistor is needed for CIRC mechanization.

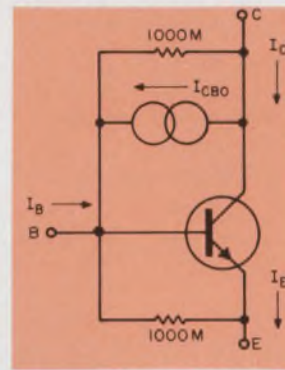

6. The eight-parameter transistor model is described by considering the transistor as two diode junctions. Npn is shown; for pnp the direction of the currents is reversed.

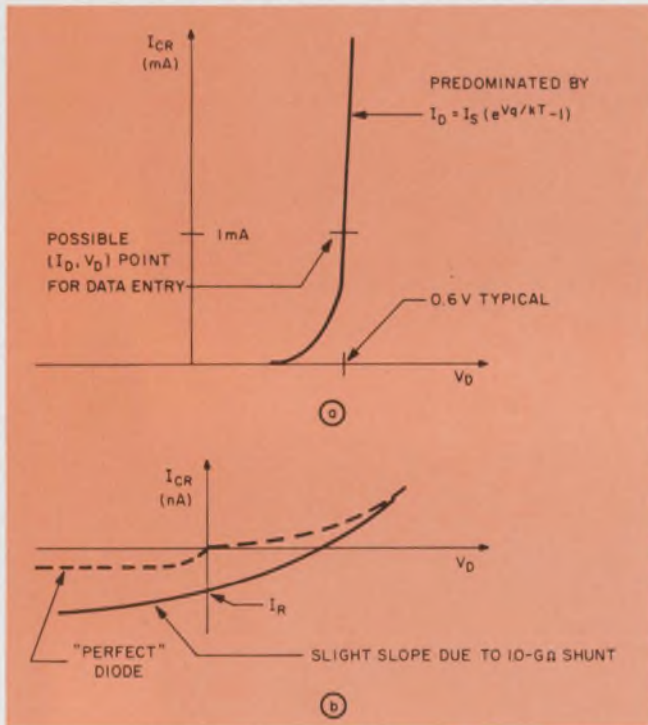

5. Nonlinear characteristic of model (a) compares well with actual diode. Reverse bias line (b) has slight slope due to the shunt resistor required by the program.

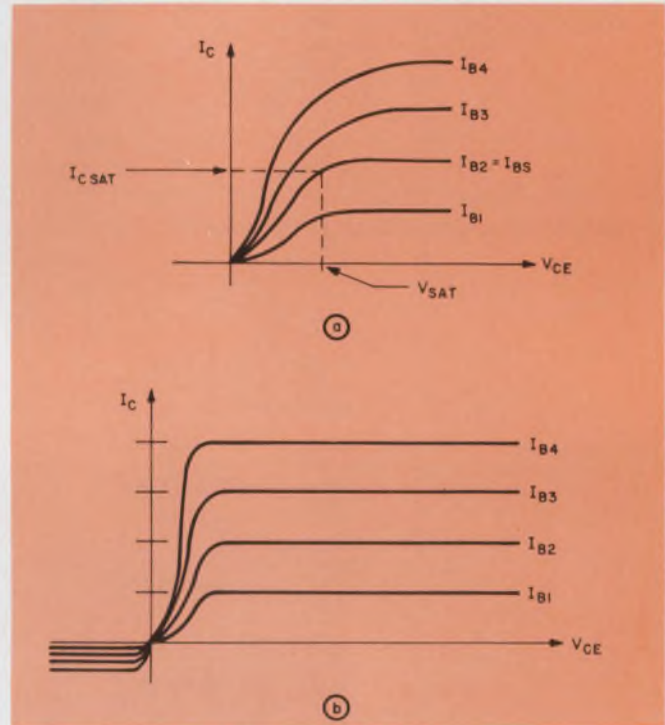

7. CIRC locates model in the appropriate part of the characteristics. Load line shows operation in active or saturation region according to base current level.

specifications or performance characteristics. CIRC simultaneously assigns a parameter number to each element or variable. These numbers are used as identifiers in the CIRC parameter-variation section.

When the last transistor parameter,  $I_{CBO}$ , has been entered, CIRC analyzes the circuit and prints out the nominal results (Fig. 3) for two classes of circuit variables—node voltages and dependent variables (see Table 1). The term dependent variable is used to describe all the circuit variables, such as element currents, power dissipations and voltage drops, which are dependent on the node voltages and the element parameters.

For initial input and routine circuit analysis, however, this conversational mode may be too time-consuming. Then the questions may be anticipated and the answers punched on card or tape to be fed into the computer with CIRC in the same way as programs are run in a batch-processing operation. In

this case a line printer output could show both the questions and the answers.

### CIRC models are specified simply

If an engineer intends to use a circuit design program, it is important for him to have some insight into the nature of the program's network elements, particularly nonlinear models. At present, CIRC contains five types of network element: resistor (RES), voltage-resistor source (VRS), current source (CUR), diode model (DIO) and transistor model (TRAN).

The mathematical representations of the first three elements are based on Ohm's law. The latter two are based on the basic Ebers-Moll model.<sup>1,2</sup>

The diode model implements the diode equation:<sup>3</sup>

$$I_D = I_S [\exp(V_D q/kT) - 1],$$

where  $V_D$  is the voltage across the diode for cur-



rent  $I_D$ ,  $q$  is the electron charge,  $k$  is Boltzmann's constant,  $T$  is the junction absolute temperature in degrees Kelvin, and  $I_S$  is the saturation current.

The model itself consists of three parts—a perfect diode, a reverse or leakage current source, and a high-impedance shunt (Fig. 4). The shunt impedance is required for CIRC mechanization purposes and is normally unimportant since its value is  $10^9$  ohms. The diode-element routine calculates  $I_S$  as a function of the input pair ( $I_D$ ,  $V_D$ ), the parameter  $T$ , and the constants  $q$  and  $k$ . This calculation is a simple curve-fitting process that makes the diode fit the point  $I_D$ ,  $V_D$  exactly, while maintaining a close fit for all the other diode operating points, since the model is based on the nonlinear diode equation.  $I_R$ , the reverse current, simulates diode leakage, which is normally much larger than the saturation current of the perfect diode. Saturation currents are typically  $10^{-12}$  amps and leakage currents  $10^{-9}$  amps and larger. The electrical characteristics of the diode element (Fig. 5) show that it possesses the nonlinear features of an actual diode.

Since the diode model uses data normally specified by diode manufacturers, it is entitled the SPEC model. The SPEC model does not, however, possess all possible diode device characteristics. Those lacking are:

- The bulk resistance (this may be added by use of a resistor element).
- The voltage breakdown with reverse bias.
- The voltage dependence of  $I_R$ .
- The diode slope factor,  $M$ , as used in the modified form of the diode equation:

$$I = I_S [\exp (Vq/kTM) - 1] .$$

The slope factor is significant for some devices, particularly integrated-circuit designs, and will be described in a later article.

### Eight parameters describe transistor model

Like the diode, the transistor model is a basic Ebers-Moll model.<sup>4,5</sup> The model parameters are:

- $I_{C(sat)}$  the collector current at saturation.
- $I_{B(sat)}$  the base current at saturation.
- $I_{E(act)}$  an emitter current in the active state.
- $V_{BE}$  the base-to-emitter voltage at  $I_{E(act)}$
- $V_{SAT}$  the collector voltage at  $I_{C(sat)}$  and  $I_{B(act)}$
- $\beta_N$  the normal-mode (common-emitter) current gain.
- $\beta_I$  the inverted-mode current gain (emitter and collector interchanged).
- $I_{CBO}$  the collector-to-base leakage current with the emitter open.

The transistor model (Fig. 6) consists of the current gains  $\beta_N$  and  $\beta_I$ , and a pair of diode elements comprising the base-emitter and base-collector junctions. The base-emitter junction is described at one point ( $I_{E(act)}$ ,  $V_{BE}$ ) on the nonlinear junction characteristic. The base-collector junction

## Description and availability

A FORTRAN II-based program, CIRC operates on any SDS-900-Series computer that has a minimum of 16,384 words of memory and a typewriter and paper-tape equipment. The program contains 29 FORTRAN and 17 SYMBOL machine-language sections.

At the present time, the dc analysis section of CIRC is available to "installation members" of the SDS User's Group. It is released in the form of a magnetic tape that contains both object versions ready for execution by the computer, and the major portion of CIRC in the card image of its original, source language form. CIRC is copyrighted by SDS. Non-SDS users interested in CIRC should contact Richard McNair, Scientific Data Systems, Inc., 1649 Seventeenth St., Santa Monica, Calif. 90404.

Table 1. Dependent variable outputs

Element	Output quantities
RESistor	Current and power
Voltage-Resistor-Source	Current and power
CURrent-source	Power
DIODE	Current, power dissipation and voltage drop
TRANSistor	Base, collector and emitter currents, power dissipation, forward base-emitter and base-collector voltage drops and circuits gain, $I_C/I_B$ .

tion is specified by the collector current,  $I_{C(sat)}$ , and the base current,  $I_{B(sat)}$ , at which saturation voltage  $V_{SAT}$  is measured. A separate parameter,  $I_{CBO}$ , is used for the base-collector leakage, since this current is normally much larger than for an ideal junction.

The transistor model, like the diode model, is set up with the data normally cited for a transistor, so it, too, is called the SPEC model. Likewise, certain features are omitted:

- Bulk resistances; where known, these may be added with resistor elements. Since normally there is no collector bulk resistor, saturation conditions are set up with ideal transistor characteristics. This may result in a different dynamic saturation impedance. For high-power devices it may be desirable to use a separate resistor element in the collector path.

■ There is no breakdown voltage, very little reverse feedback of voltage, and very little voltage effect on  $I_{CBO}$ .

■ Neither junction has a slope factor. Another CIRC model does include slope factors and will be discussed in a later article.

■ The model has a linear current gain,  $\beta_N$ , as shown in Fig. 7 by the fact that equal base current

After CIRC produces a set of nominal solutions as in Fig. 3, the program invokes user control by printing

PROVIDE CONTROL MESSAGES

CPPR

SPECIFY THE FOLLOWING.

PAR. NO. (0 TO COMPLETE ENTRIES), CONTROL (0=SPECIFY, 1=NOM., 2=MIN., 3=MAX),  
PAR. VALUE,

Supply S1 is 60 V.

1,  
60.

PAR. NO. 1 = 60000000E 02

Supply S2 is 35 V.

2,  
35.

PAR. NO. 2 = 35000000E 02

Error (deleted).

5, ~~---~~

Resistor R1 is 1 MΩ.

4,  
1.E6,

PAR. NO. 4 = .10000000E 07

Carriage return provides implied zero to close list.

PROVIDE CONTROL MESSAGES

UC is relinquished.

EXIT

Nominal solutions.

TEMP. RY SOLUTIONS 12

Node voltages.

V	VALUE	V	VALUE	V	VALUE	V	VALUE
1	.7784164E 00	2	.5382150E 01				
D	VALUE	D	VALUE	D	VALUE	D	VALUE
1	.5922158E -04	2	.3507196E -02				
3	.2961785E -02	4	.8772171E -01				
5	.5922158E -04 ( $I_B$ )	6	.2961795E -02	7	.3021007E -02	8	.1598692E -01
9	.7784164E 00 ( $V_{BE}$ )	10	-.4603733E 01	11	.5382150E 01	12	.5001209E 02

Resistor 1.  
Resistor 2.

Transistor 1.

UC is invoked.

PROVIDE CONTROL MESSAGES

CPPR

SPECIFY THE FOLLOWING.

PAR. NO. (0 TO COMPLETE ENTRIES), CONTROL (0=SPECIFY, 1=NOM., 2=MIN., 3=MAX),  
PAR. VALUE,

Revised S1.

1,  
60.778

PAR. NO. 1 = 60778000E 02

PROVIDE CONTROL MESSAGES

EXIT

TEMP. RY SOLUTIONS 4

Base current now 59.999  $\mu$ A.

V	VALUE	V	VALUE	V	VALUE	V	VALUE
1	.7787515E 00	2	.4993516E 01				
D	VALUE	D	VALUE	D	VALUE	D	VALUE
1	.5999925E -04	2	.3599910E -02				
3	.3000648E -02	4	.9003091E -01				
5	.5999925E -04 ( $I_B$ )	6	.3000658E -02	7	.3000648E -02	8	.1503056E -01
9	.7787515E 00 ( $V_{BE}$ )	10	-.4214764E 01	11	.4993516E 01	12	.5001160E 02

8. Breadboard capability of parameter variation is provided by the user-control feature. Here it is used to fix

the base current at 60  $\mu$ A for a saturation performance check of the transistor model of CIRC itself.

**Table 2. Saturation study results**

$R_1 = 1M; R_2 = 10K; S_1 = 60.778$				
$S_2$ (V)	$I_C$ (mA)	$V_{CE}$ (V)	$V_{BC}$ (V)	$I_C/I_B$
35.	3.00	5.382	-4.60	50.00
32.	3.00	1.99	-1.22	50.00
30.	2.97	0.254	0.525	49.57
25.	2.48	0.172	0.602	41.37
15.	1.49	0.132	0.629	24.77
5.	0.49	0.095	0.642	8.17

steps produce equal changes in collector current.

The 1000-megohm shunts are included for CIRC mechanization purposes but their effect on the model should normally be negligible.

### Engineer controls CIRC

For a circuit analysis program such as CIRC to give significant aid with design, it must perform more than just nominal circuit analyses. It must also enable the designer to experiment with the proposed design much as he can with a breadboard. CIRC provides this ability through a facility called user control (UC). For example, user control can allow element values to be temporarily or permanently changed; elements may be removed from or added to the circuit; a transistor may be converted from one device type to another by appropriate parameter changes. Other UC features enable the designer to control the progress of the program. In particular they allow him to control the peripheral output equipment, the nature and volume of CIRC labor and output, and the type of operations the program performs.

The user control feature is made available at set points in the program. For example, it is available after nominal solutions are completed and printed out, provided that certain switches are set on the computer operating console. At these points CIRC types the message:

PROVIDE CONTROL MESSAGE

and then looks for a control message.

The control messages are four-letter mnemonics that direct CIRC to some specific action. For example, POTY means that the Printed Output is to be provided with the Typewriter. Forty control messages are available.

### CIRC looks at itself

To illustrate user control, one of the most significant of these messages, the parameter-change control, will be used to study the nonlinear characteristics of the transistor element in the circuit of Fig. 1a. The control message to be used is CPPR, Change the Present value of the PaRameTer.

For this example, the saturation performance of the transistor model will be examined by generating one of the collector characteristic (common-emitter)

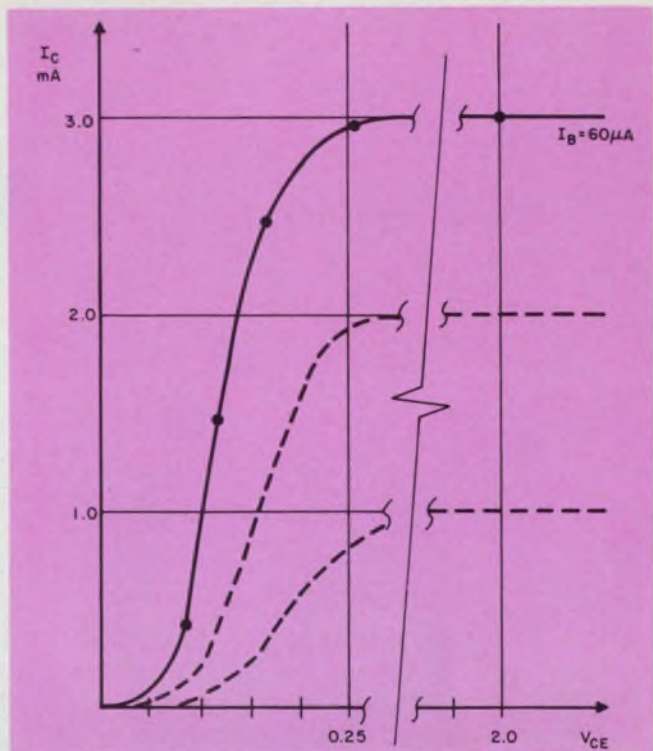

9. User control enables parameter changes to be made—in this case, in collector supply voltage—to obtain model characteristics for the CIRC transistor so that its performance may automatically be checked.

curves. This is done by forcing the base current to be constant and generating data to plot collector current ( $I_C$ ) versus the collector-to-emitter voltage, ( $V_{CE}$ ). The easiest way to do this is to use a CIRC current element to keep this base current constant, but in this case a large base resistor will be used so that the configuration of Fig. 1 can be referred to. The base current is forced to approximately  $60 \mu A$  by setting the input supply,  $S_1$ , to 60 volts with an input resistance,  $R_1$ , of 1 megohm.  $V_{CE}$  can be varied by changing the collector supply voltage,  $S_2$ . Part of the resultant conversation between the user and CIRC is shown in Fig. 8.

After the first analysis the base current is  $59.2 \mu A$  instead of  $60 \mu A$ , so drive source  $S_1$  is increased to 60.778 volts. This gives a base current of  $59.9992 \mu A$ . A complete examination of saturation performance is carried out in this manner by changing the collector supply voltage,  $S_2$ . The results show the saturation of the transistor element (Fig. 9). ■ ■

### References:

1. Nathan O. Sokal *et al.*, "Use a good switching transistor model," *ELECTRONIC DESIGN*, XV, No. 12 (June 7, 1967), 54-59.
2. C.T. Kleiner, E.D. Johnson, W.D. Ashcraft, "A general purpose system of digital computer codes for linear/nonlinear network and systems analysis," *I.E.E.E. Conv. Record*, XV, Part 5 (March 1967), 136-148.
3. Sokal *et al.*, "Diode model is analyzed by computer," *ibid.*, No. 14 (July 5, 1967), 80-83.
4. ———, "Assign the proper numerical values," *ibid.*, No. 13 (June 21, 1967), 60-66.
5. ———, "Use a good switching transistor model," *loc. cit.*

This **NEW G-V**

**QUICK  
CONNECT**

**THERMAL  
TIMING RELAY...**

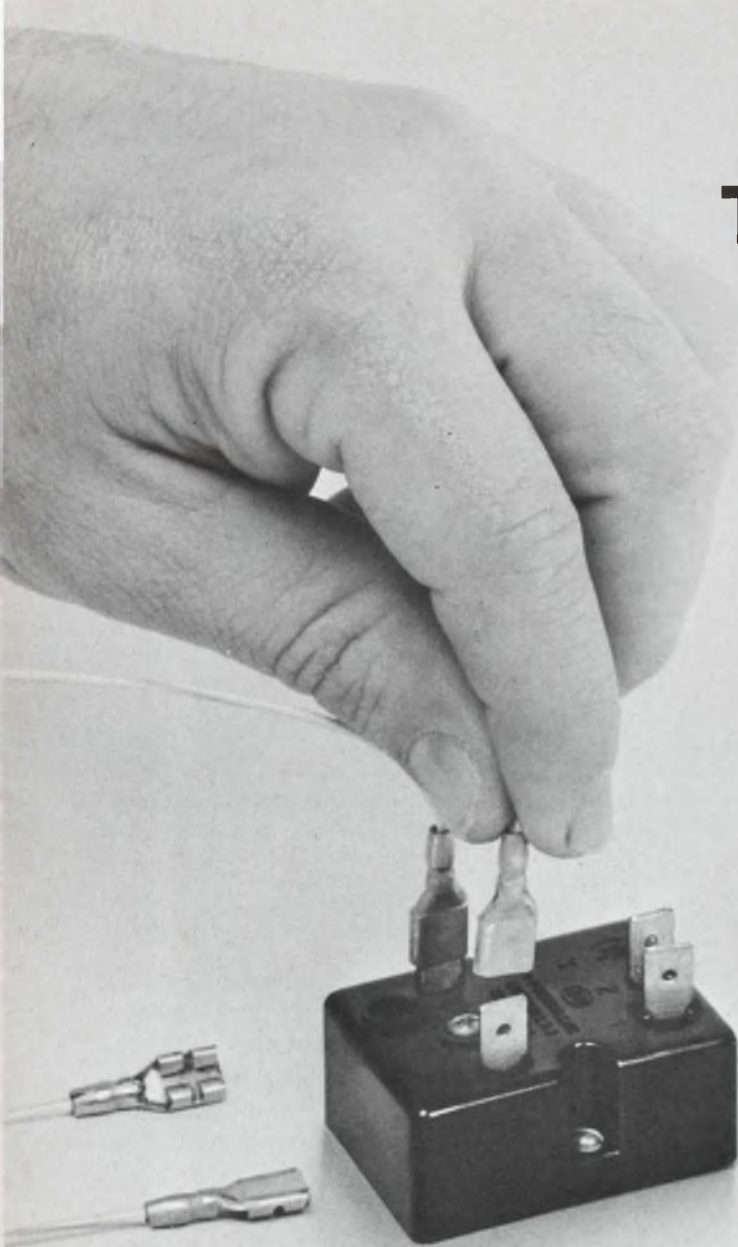

**THERMAL TIMING RELAY**  
For PC board mounting

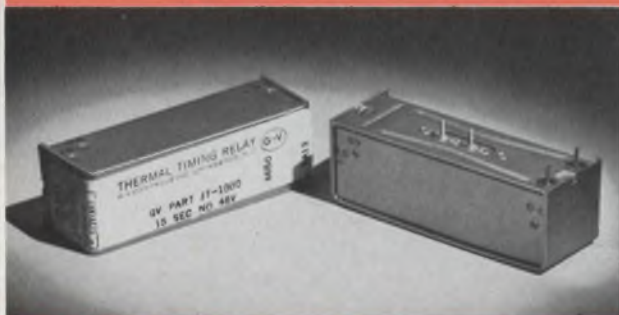

The JT Series is the only thermal relay designed to mount directly on pc boards without need for adapters or sockets. This design conserves space, reduces weight, allows greater packaging densities for pcb's. **Features:** time delays, 2 to 180 sec.; contacts, SPST, NO or NC; heater voltages, 6.3 to 230V. AC or DC; temperature compensated; operates in any position.

only from **G-V**

On Reader Service Card Circle 210

**SUBMINIATURE THERMAL  
TIMING RELAYS**



The LT Series relays provide hi-level performance in a subminiature hermetically sealed housing — space saving without loss of performance. Meets military standards. **Features:** height above mounting panel 40% of standard relays (7 pin flange mount); time delays, 2 to 75 sec.; operating temp.,  $-65^{\circ}\text{C}$  to  $+85^{\circ}\text{C}$ ; operating voltages, 6.3 to 115V. AC or DC.

**G-V**

On Reader Service Card Circle 211

**HIGH PRECISION THERMAL  
RELAYS**



The PT Series relays provide the most precise performance available in thermal relays. Meet the exacting military requirements for reliability under extreme operating environments. **Features:**  $\pm 5\%$  tolerance over a temp. range of  $-55^{\circ}\text{C}$  to  $+125^{\circ}\text{C}$ ; 2000 Hz vibration; 50g shock; time delays, 3 to 180 sec.; heater voltages, 6.3, 28 and 115V. AC or DC.

only from **G-V**

On Reader Service Card Circle 212

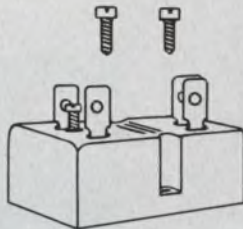

Recognized Under  
The Components Program  
Of Underwriter's  
Laboratories, Inc.

# reduces installation time and cost!

**NEW PACKAGING FEATURES EASY MOUNTING . . .**  
**PUSH-ON TERMINALS . . .** *it's from G-V*

The new G-V Quick Connect Thermal Timing Relays are rugged and versatile enough to withstand the most demanding industrial applications. They are a low cost series designed to reduce installation time and cost. Only two mounting screws are necessary, eliminating the need for special brackets, sockets or retainers. Push-on terminals provide flexibility of wiring, part location and equipment servicing. A dust-tight molded phenolic case houses a stainless structure with nickel-chromium heater winding, assuring long life and dependable service. The low profile Quick Connect thermal timing relays can be mounted in any position. Specifications include: Contacts, SPST, NO, NC; Resistive Rating, 2 amps 115V AC or 1 amp 28V DC; Heater Voltage, 6.3, 26, 115V AC or DC; Time Delays, 5-180 seconds; Time Delay Tolerance,  $\pm 20\%$ ; Heater Power,  $2\frac{1}{2}$  Watts, nominal. Suitable for continuous operation to 160°F. Ambient compensated.



**G-V CONTROLS INC.**

LIVINGSTON, NEW JERSEY 07039  
(201) 992-6200

ON READER-SERVICE CARD CIRCLE 216

## THERMETTE 9 PIN RELAY



Metal enclosed thermal time delay is dust proof and shatter proof — designed for industrial applications requiring reliable operation and long life. **Features:** temp. compensated; time delays, 2 to 180 sec.; heater voltages, 6.3, 26, and 115V. AC or DC; contacts, SPST, NO or NC.

Recognized Under The Components Program Of Underwriter's Laboratories, Inc.



On Reader Service Card Circle 213

## INSTANT RESET THERMAL TIMING DEVICES



Instant reset during or after timing is available by combining G-V's unique instant reset timing element with a magnetic relay. Widely used in communication systems and data processing equipment. **Features:** delay time, 2 sec. to 5 min.; ambient operating temp., 32°F to 185°F.

only from 

On Reader Service Card Circle 214

## DIRECT-LINE FIELD ENGINEERING SERVICE



G-V assistance is always available to help you design and produce a better product. G-V Regional Field Engineers in your area will assist you and your design group in new applications and proper selection of your controls. G-V Product Engineers will help you with special applications. When you require experience, products and services in electro-mechanical and solid-state controls . . . call your man from G-V.



On Reader Service Card Circle 215

# Which delay line is best to simulate very fast targets for Doppler radars? The choice narrows down to two groups but there is no clear-cut boundary.

The simulation of aircraft, missiles and other very rapidly moving targets is essential to the testing and production of radar systems. There are two types of black box that can do the job, each with its own peculiarities. In order to make the best choice, the designer should have a good grasp of the devices' basic designs, their present performances and future potentials.

## The classic conflict: solid-state or tube

The two types of device are solid-state delay lines and electron-beam delay lines operating at microwave frequencies. (The concern here is only with delay lines that can simulate both the range and velocity characteristics of rapidly-moving targets. There are other approaches that combine transmission lines and variable-delay devices, but they work well only when range information alone is sought. These systems have either fixed or slowly variable delays, which make it very difficult to simulate the Doppler shift of fast targets.)

In general, solid-state delay lines provide large ranges of delay but are lossy. Electron-beam lines—in particular, traveling-wave types—offer wide bandwidths and less insertion loss, but also less delay.

The solid-state approach is designed around a semiconductor material (yttrium iron garnet, for example) with a transducer attached to each end. The incoming signal is converted into some other wave—acoustical, shear, magnetoelastic, etc.—by the first transducer. The propagation in the material introduces the delay. The wave is then converted back into a signal by the other transducer. There is some variation in the actual systems. The delay, for instance, may be doubled if the wave is bounced back and travels twice the length of the material.

In electron-beam lines, the delay is introduced by a strategically-placed electrode, which is at a potential that may be varied externally, to control the speed of the electron beam in a vacuum tube.

---

Jack Lucken, Senior Engineer, Microwave Associates, Inc., Burlington, Mass.



Testing an O-type delay line, Jack Lucken adjusts the bias voltage on the electrode that controls the delay.

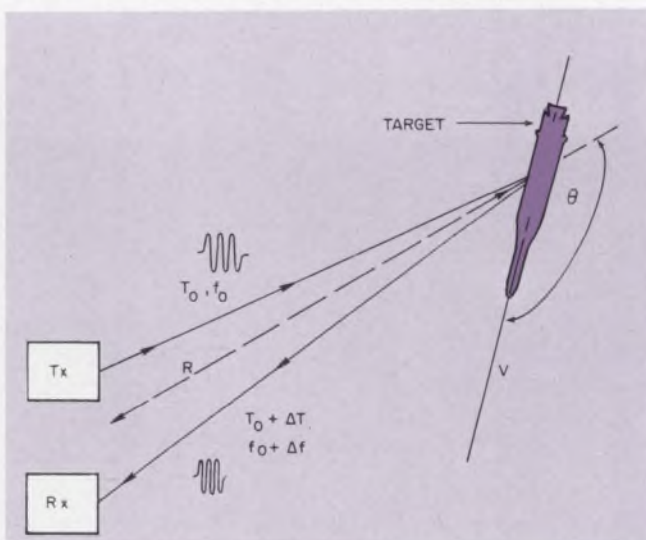

1. A Doppler radar tracks a moving target. The rate of change in the delay of the received signal depends on the target's velocity. To simulate a target traveling at a velocity of 10,000 mi/h, the delay should change at a rate of  $1.5 \times 10^{-8}$  seconds/second.

The beam is generated by the incoming signal.

### What are the typical specs?

For an idea of the performance required of these variable delay lines, consider a typical case. The reproduction method of both range and velocity characteristics is shown in Fig. 1. A pulse of energy with carrier frequency  $f_0$  is transmitted at time  $T_0$ , is reflected from the moving target and reaches the receiver at time  $T_0 + \Delta T$  with a Doppler-shifted frequency of  $f_0 + \Delta f$ . If  $c$  is the velocity of light and  $R$  is the range, the change of frequency with velocity may be calculated:

$$\Delta T = 2R/c, \quad (1)$$

$$d/dT(\Delta T) = (V/c) \cos \theta, \quad (2)$$

and:

$$\Delta f/f_0 \approx -(V/c) \cos \theta. \quad (3)$$

From these relations, the rate of change of the delay can be found for a given closing velocity. Assume a closing velocity of, say, 10,000 mi/h where  $\theta = 180^\circ$ :

$$-(\Delta f/f_0) = d/dT(\Delta T) \approx 1.5 \times 10^5.$$

Hence, if  $f_0 = 10$  GHz, then  $\Delta f = +0.15$  MHz, and the rate of change of delay needed to simulate this effect is:

$$d/dT(\Delta T) = -1.5 \times 10^5 \text{ seconds per second.}$$

The block diagrams of some typical delay systems are shown in Fig. 2. Electronically variable delay lines can achieve such calculated delay rates. They have the advantage over fixed delay lines that a variable attenuator can be ganged to the delay line in many instances, allowing a reduction in pulse with the range under simulation.

The most promising approaches to electronically variable delay lines that are under investigation at present are:

- Solid-state delay lines—devices using magneto-static and spin waves.
- Electron-beam delay lines—using either crossed-field or O-type beams.

### Solid-state types offer large delay variations

The most practical solid-state microwave variable delay line to date uses magnetoelastic and spin wave<sup>1,2</sup> in a ferrite material—typically yttrium iron garnet (YIG). Large variations of delay are obtainable—on the order of tens of microseconds. The main assets of this type of delay line are:

- Large variation of delay time. Typical variations are about 3  $\mu$ s, and some measurements

were reported up to 20  $\mu$ s.

- Small size and power requirement. The maximum dimensions of the YIG crystal itself are typically about 1 cm. The only power requirements are for trimming the magnetic field, if the main field is obtained with a permanent magnet. In a parametrically pumped delay line (Fig. 3), a suitable oscillator is required, together with its own power supplies.

The major drawbacks of these delay lines are:

- High insertion loss at room temperature—typically 70 dB for a 2- $\mu$ s delay line in X band.
- Narrow bandwidth—approximately 2 to 3%.
- Pulse distortion on short pulses because of the bandwidth limitation. At 3 GHz, for example, a bandwidth of 3% results in a rise time of greater than 6 ns.
- Large delay sensitivity to small changes in the magnetic field. This means that a high degree of homogeneity of the magnetic field is necessary for minimum pulse distortion. The minimum rate of change of delay of magnetoelastic waves with magnetic field is about 25 ns/Oe<sup>3</sup> and increases rapidly at the maximum delay.
- Rapid changes in delay are limited by how rapidly the magnetic field can be varied.

The uniformity of the magnetic field used with solid-state delay lines depends on the proper design of the magnet gap and the use of the region in the gap in which the magnetic field maintains the required degree of uniformity. Temperature control is important, to maintain time stability and repeatability of delay.

Variation of magnetic field is best achieved by a combination of a permanent magnet and a small adjusting coil, which can also be used to compensate the field for time variations. The maximum frequency at which the field can be swept without excessive losses is determined by the resistance and inductance of the modulating coil, within a range of  $\pm 100$  kHz. The coil should have an inductance as low as 100 mH and a capacitance as low as 100 pF.

The high insertion loss of solid-state delay lines has been overcome in some devices by applying the parametric amplification principle.<sup>4</sup> However, the need for large rf pump powers (typically greater than 20 watts at S band) and the narrower bandwidth of this form of interaction are difficulties that have not yet been solved satisfactorily.

### Electron-beam types have low insertion loss

Crossed-field delay lines<sup>5,6</sup> offer a lower insertion loss at comparable delay values than solid-state ones. For example, the loss of an Sband crossed-field delay lines was measured at 60 dB at a 3- $\mu$ s delay.<sup>7</sup> This major advantage, however, has to be set against their shortcomings:

- Like solid-state delay lines, they have limited

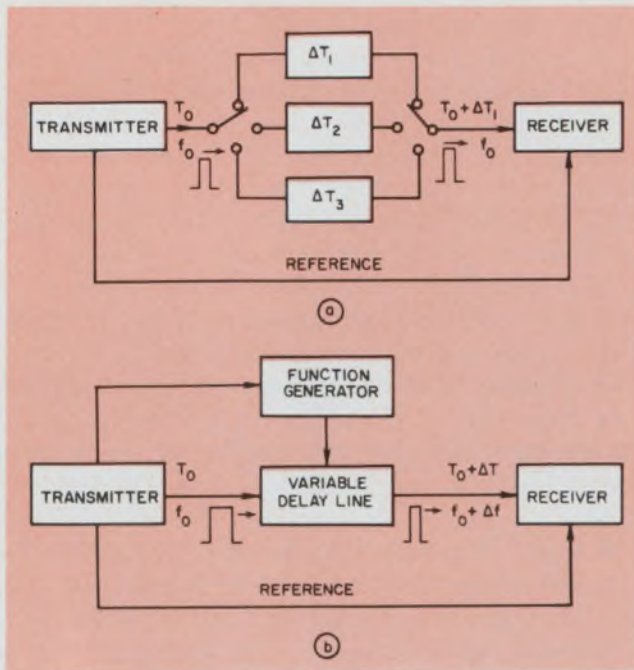

2. **Simulators of moving targets** may use several fixed delay devices (a) or a variable delay line (b) controlled by a function generator.

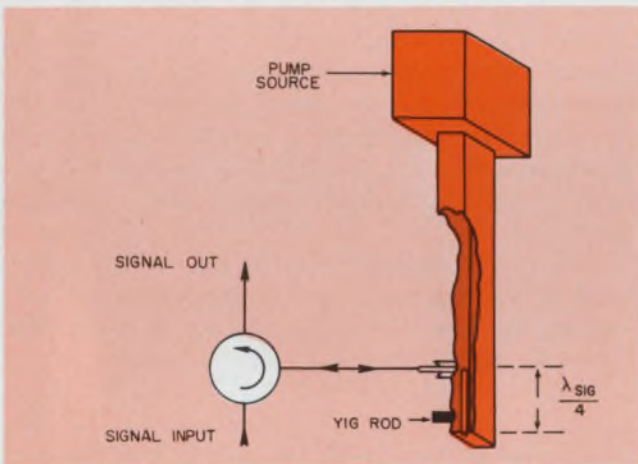

3. **Parametrically pumped solid-state delay line** needs large rf pump powers: typically greater than 20 watts in S band. They offer large variations in delay times: up to 20  $\mu$ s was reported.

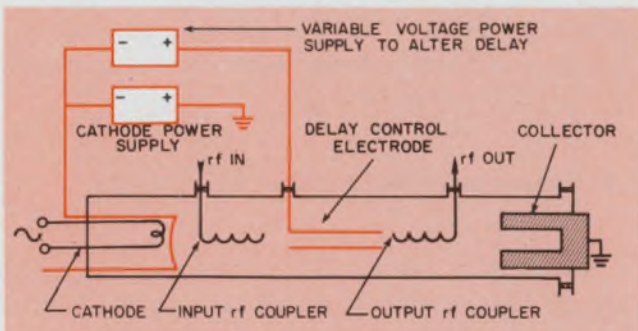

4. **Traveling-wave delay lines** are basically modified TWTs. As a delay line, the TWT circuit is severed and has a drift space that changes the beam velocity. The delay depends on the potential and the length of the drift region in the tube.

bandwidth (a few per cent). This limitation is inherent in the principle of operation, owing to the dispersive nature of the waves carrying the rf signal.

■ Since the time delay depends on the value of applied magnetic field, it is sensitive to field inhomogeneities, which cause pulse distortion.

Traveling-wave delay lines (O-type lines) completely eliminate bandwidth limitations. They are basically modified TWTs. The difference is that in the delay line the circuit is severed and has in the partition a drift space of variable potential, which causes a corresponding variation of beam velocity. The delay depends only on the length and potential of this region. A long drift space or a low potential causes a long delay and vice versa. The drift tube is supported inside the tube shell and is varied in potential by means of a lead taken through a coaxial pin seal (Fig. 4).

The advantages of this construction are fourfold:

■ Because of their similarity to traveling-wave tubes, these delay lines are capable of very broad bandwidths—greater than an octave.

■ The magnetic fields are used solely for beam-focusing and are not involved in determining the delay time. These qualities, together with the broad, instantaneous bandwidth, make the tube suitable for use with very short pulses and, allow simultaneous multiple signal-handling at frequency separations up to the full bandwidth of the tube. (Within the specified instantaneous bandwidth, the delay line needs no adjustments, and all frequencies have the same delay and suffer the same insertion loss.)

■ Minimum delays on the order of 10 to 20 nanoseconds can be achieved.

■ These delay lines are simpler than the crossed-field devices and so are more reliable and less expensive.

The major disadvantage of traveling-wave delay lines is that variable delays are presently limited to several tenths of a microsecond.

Measurements on traveling-wave delay lines have shown that bandwidths of about 2.5 octaves are obtainable with a gain variation of  $\pm 2$  dB in a type MA 2018 tube built for the 500–1500-MHz band (Fig. 5).

Particularly noteworthy is the rapidity with which the delay can be varied with these tubes. The delay-controlling electrode has a capacitance to ground of some 100 pF. Because of this low capacitance, the electrode potential can be swept through its full range in about 10  $\mu$ s. This is a sweep rate on the order of  $10^{-2}$  seconds/second, or approximately  $10^7$  ft/s. Furthermore, since the delay value is controlled by a dc potential, it is very easy to govern the shape of the output pulse by applying suitable waveforms to the control electrode.

The major objective of development work is to push the delay of traveling-wave lines to one microsecond and beyond.



Bearing the properties of these different delay lines in mind the systems engineer should have little difficulty in selecting the one best suited to his purposes.

### Typical applications guide proper selection

The commonest applications of microwave delay lines are in crosscorrelators, autocorrelators, in pulse synthesis and in electronic-countermeasure (ECM) systems.

In crosscorrelators (Fig. 6a), one of the signals is passed through a fixed delay line (which may have zero delay in some cases) and the other through a variable delay line. The signals are then combined and their product examined as a function of the variable delay, to determine the degree of correlation. Autocorrelators (Fig. 6b) perform the same function by comparing a signal with itself at different points in the wave train. In both cases, the product of the amplitudes will peak at certain values of delay if the signals are correlated with each other.

In general, cross- and autocorrelators require broad bandwidth but do not need a long delay capability. Thus electron-beam variable delay lines lend themselves to these applications.

In pulse synthesis applications (Fig. 7), the delay is varied in a preset fashion to produce a frequency shift and change in the pulse length. This can be combined, if necessary, with an electronically variable attenuator to alter the height of the pulse in conjunction with its frequency. The large delay variations in solid-state lines makes them suitable in these applications.

ECM applications involve detecting pulses from an enemy radar and retransmitting them with altered delays with the idea of confusing the hostile system.

In these applications, long variable delays are desirable. However, broad bandwidth and low dispersion are also required, so that the use of an electron-beam variable delay line in combination with a switched, fixed delay, or two variable delay lines in cascade, probably offers the best performance. ■ ■

### References:

1. Herman van de Vaart, "Understanding Solid-State Delay Lines," *MicroWaves*, V. No. 7 (July 1966), 26-33
2. Irving Kaufman, "Microsecond Time Delay of Microwave Signals," Part 1, *The Microwave Journal*, IX, No. 6 (June 1966), 51-58, and Part 2, *ibid.*, No. 7 (July 1966), 69-73.
3. Van de Vaart, *op. cit.*
4. Kaufman, *op. cit.*
5. J.W. Kluver, "An Electronically Variable Delay Line," *Proc. IRE*, L, No. 12 (Dec. 1962), 2487
6. K.R. Evans, J.A. Lucken and F.A. Romanelli, "A Broad-Band, Electronically Variable Delay Line," paper presented at the Conference of Microwave and Optical Generation and Amplification, Cambridge, England, Sept. 1966.
7. G. Kantorowicz, "Tube a Retard Reglable Electroniquement, avec Coupl. eur Cyclotron a Champs Croises a Progression D'onde," presented at the International Congress on Microwave Tubes, Paris, 1964.

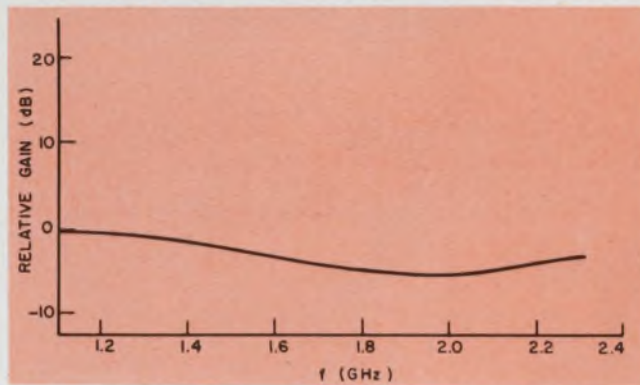

5. Typical test result for an O-type delay line shows its wide band (about 2.5 octaves). The tube is a type MA 2018 of Microwave Associates, Inc.

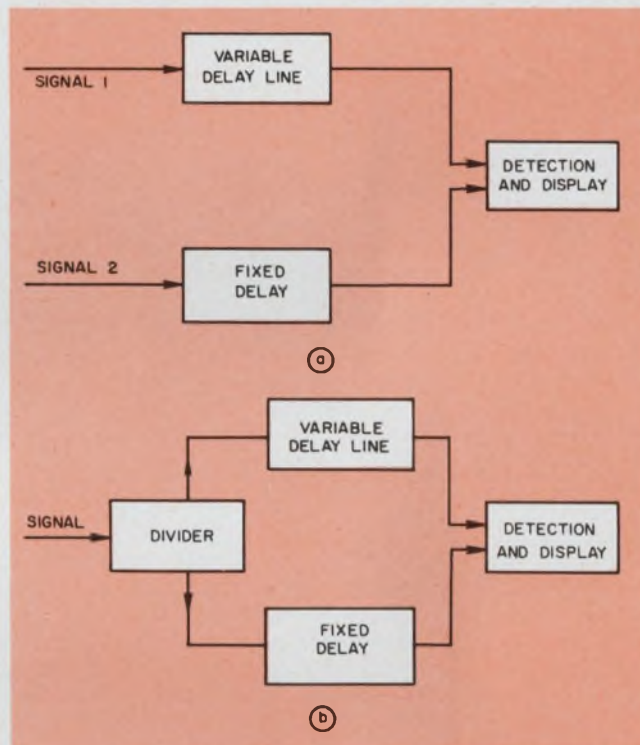

6. Typical applications of variable delay lines occur in crosscorrelators (a) and autocorrelators (b). There the major requirement is wide bandwidth.

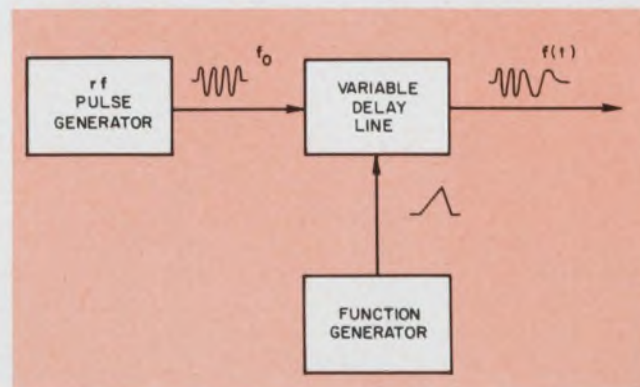

7. In pulse synthesis the delay line produces a frequency shift and changes the pulse's length. A large variable delay is essential in these systems.

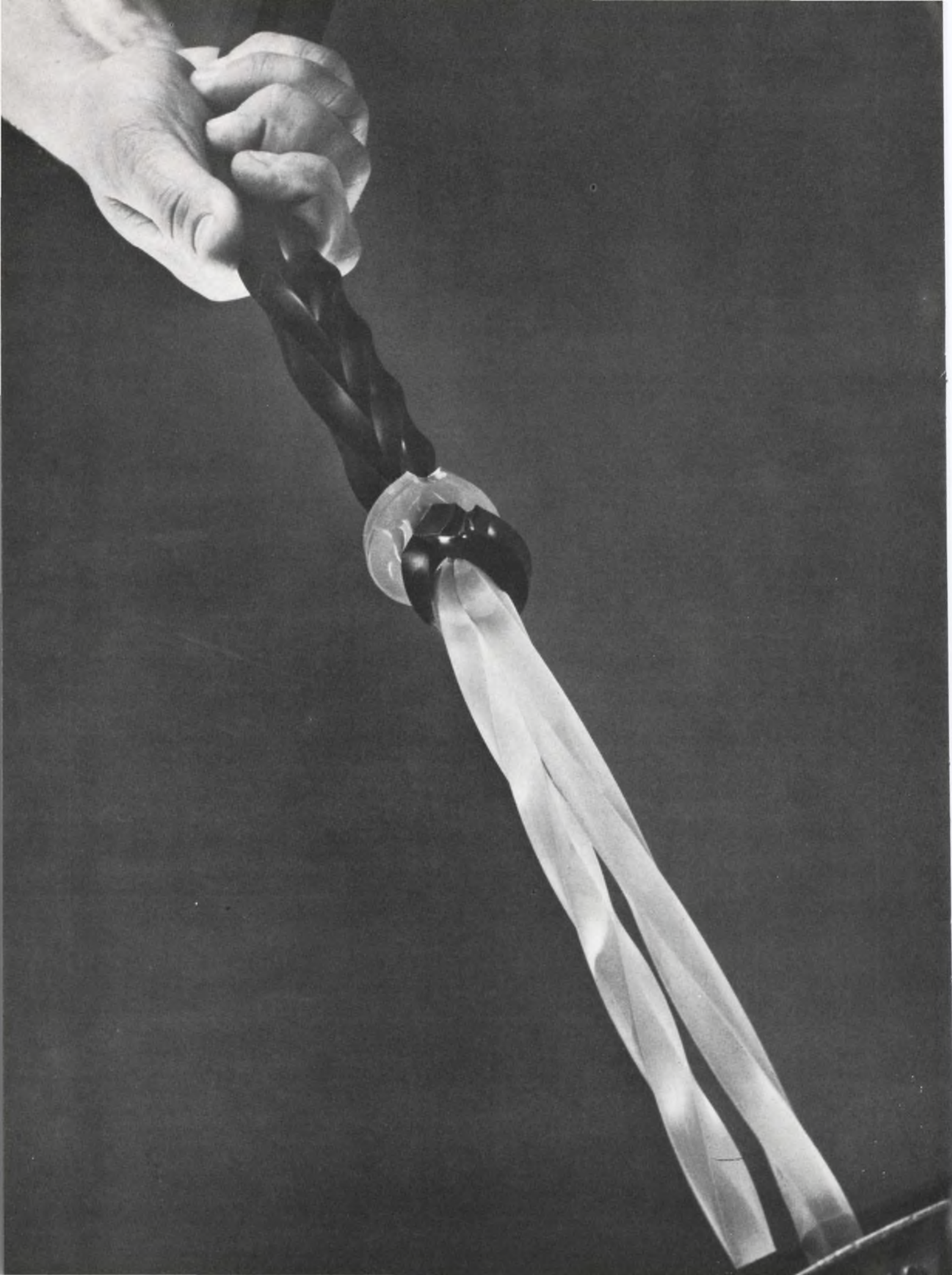

# T est these new high-strength silicone resins before you specify!

Send for a cured sample of Sylgard® 186 or Sylgard® 187 silicone resin and test your own strength! These resins are *tough . . . flexible . . .* and highly tear resistant, even after being knicked.

Yet, they cure without danger of exothermic damage to delicate electronic parts . . . without damage due to stresses caused by shrinkage during cure. They are ideally suited for encapsulating, potting, filling, coating and embedding.

Sylgard 186 resin is transparent while Sylgard 187 resin is black. Both cure at room temperature . . . provide deep section cure . . . and have a service temperature range from -65 to 250 C with no post cure.

We will be happy to send you a sample\* of either Sylgard 186 or 187 silicone resin; plus complete technical data on both.

For the name of the Dow Corning representative in your area, write to: Dept. 3922, Electronic Products Division, Dow Corning Corporation, Midland, Michigan 48640.

**DOW CORNING**

\*Offer good in U.S.A. only.

*We're a materials producer exclusively. Let us tailor a material to your need.*

Circle No. 851

# The paper is as mighty as the pen

in taking a good trace. Know your papers and you'll avoid pitfalls in data recording.

A few years ago, all that was needed to record information was a pencil and a couple of pages in an engineer's laboratory notebook. Today, however, it may take hundreds of feet of recording paper to nail down all the details of a design test, thousands of feet of analog channels to preserve all the information from a test run of a new engine, or literally miles of multichannel recording charts to present all the data on a single satellite shot. This makes it important for the engineer to know the advantages and limitations of his recording paper if he is to make the best possible use of his equipment.

There are six basic kinds of recording paper in common use today for data recording:

- Ink-process, of fluid-process.
- Thermal-process.
- Pressure-process
- Ultraviolet-process.
- Electric-process.
- Pressure-process.

Each of these recording papers has its own pros and cons and peculiarities.

## Paper depends on recorder

Any recorder or recording system generally functions only with the particular recording paper selected for it by the manufacturer. Since the recording elements, chart drive system, and recording paper are designed together for optimum operation, the user cannot expect equivalent results with other chart papers. The user, however, does have some choice in the way the paper is stored. Some recorders provide for rolls of recording paper, some are designed for Z-fold packs of recording paper; others allow use of either type. The familiar roll-feed is somewhat less expensive than Z-fold paper, but either needs to be unrolled manually or requires a chart-viewing assembly whenever the user wishes to look at any portion of the recording. Z-fold charts, on the other hand, permit immediate access to any part of the recording, and, unlike rolls, occupy a full

100 per cent of their storage space (Fig. 1).

## Ink and fluid processes in greatest use

Ink or fluid-process recording papers operate by depositing a film of ink or dye on the surface of the recording chart as it moves beneath the recording pen. Low-speed recorders, such as those used in industry to monitor a full working shift or 24-hour day, are often circular, with the time axis represented by the angular displacement of the chart. Higher-speed recorders generally use a strip chart, where the time axis runs along the length of the chart. The smooth paper surface provides a permanent, quick-drying, smudge-free recorded line.

Temperature and humidity will have little effect on the recording process except in extreme cases. They can, however, affect the dimensional stability of the recording and this can introduce error when measuring long time intervals. Such time-axis errors, whether caused by dimensional change or by changes in chart drive speed, may be overcome by registering a series of timing "pips" along the data strip. These pips are derived from a precise time source. Checking the pips against the printed grid will reveal any inaccuracies in the

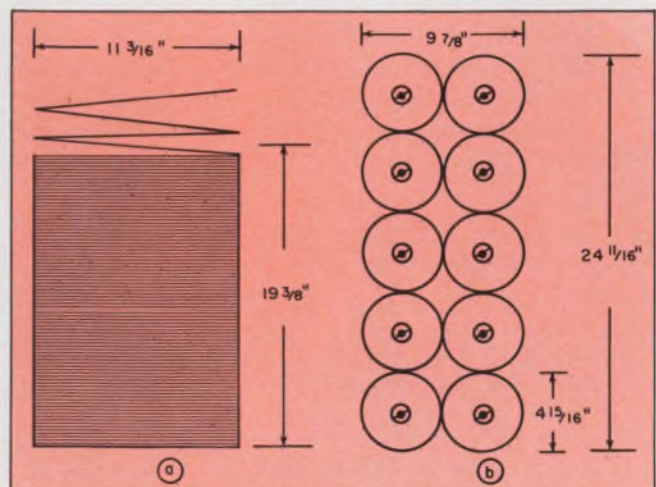

1. Z-fold paper saves space. Five thousand feet of Z-fold (a) stand 19-3/8-inches tall; a comparable amount of roll-fed paper (b) takes over 40% more space. Z-fold records are easily accessible; roll-fed is unraveled foot by foot.

Hector French, Manager, Training Publications, Hewlett-Packard, Sanborn Div., Waltham, Mass.

grid lines with respect to time.

Amplitude-axis errors caused by dimensional change will not usually be great enough to cause appreciable error. In the unlikely case that dimensional change occurs between setup and recording, the dimensional change may appear as a borderline shift in the zero position of one or more channels in the recording charts. This can be detected by recording a short section of zero-input signal immediately before and after the actual data, to provide a true zero reference. This procedure, however, is reliable only when using drift-free amplifiers with a servo-feedback recorder. With other recorders, the error may be detected only by actual measurement of chart width with a metal rule.

In some cases, different weights of recording chart paper are available. Selection of the best weight depends largely on the intended use. A heavier stock is more rugged, but thinner stock allows a longer recording time with one roll or pack of paper, and requires less storage space per thousand feet of recording. Color, contrast, and density of the grid lines are considerations if good-quality reproduction on a copier is desired.

The handling properties of ink-process recording papers have also to be borne in mind. If the recording has to pass through many hands before it reaches its final destination, its resistance to scratches, pressure, finger marks, wrinkling, moisture and mounting adhesives should be checked beforehand.

### Thermal papers are prone to scratching

Thermal-process recording chart paper is a sandwich of base stock, a black coating on this base, and a plastic coating which conceals the black. Heating the surface with a concentrated, well-defined heat source, such as a hot-wire recording stylus, will melt the plastic coating at the point of contact to reveal the black coating beneath. The recording may be made in either of two ways: by wiping the hot-wire recording stylus across the chart paper in accordance with the signal, while the paper is moving over a knife-edge writing surface; or by moving a hot-tip recording pen across the chart paper, while the paper is moving over a flat writing surface. In a good thermal recording paper, the plastic coating is resistant to pressure and moisture, and will respond only to the application of heat. Modern thermal papers are more scratch-resistant than earlier types, but repeated, careless handling may scrape the plastic coating.

The quality of the recorded line, as well as the frequency and transient response of the recording, depend on stylus temperature and pressure. For best results, stylus pressure should be kept constant at the value specified by the

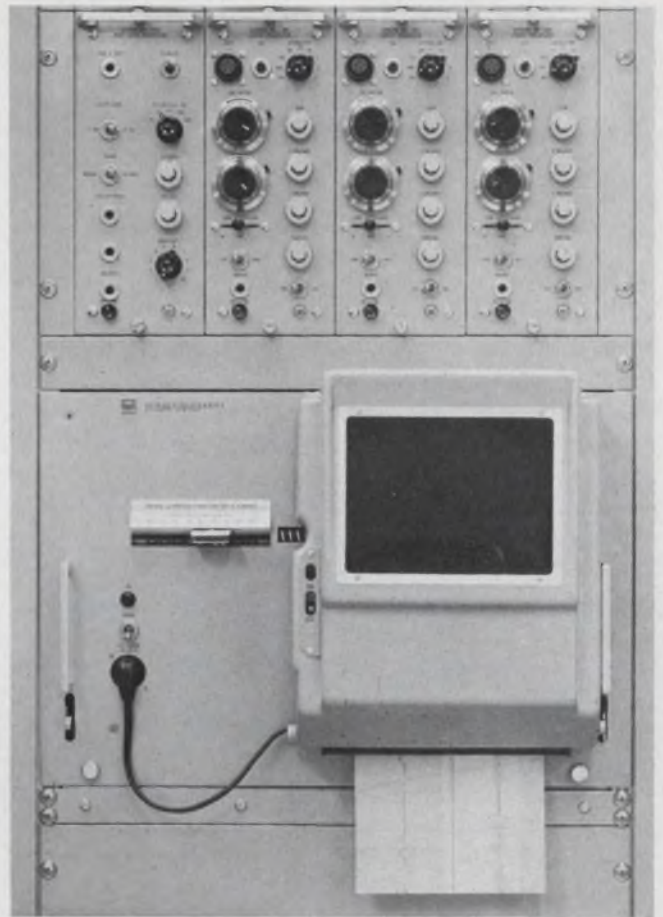

2. Photographic-paper processing can be sped up with a rapid-developing adapter. Such recordings exhibit very high contrasts and lend themselves well to duplication by any standard method.

manufacturer, and stylus temperature should be adjusted for optimum recording quality. Many modern recorders use a regulated stylus heat, which not only requires no adjustment, but is also automatically varied in accordance with chart speed.

Grid lines are printed on the plastic surface of the chart. Any dimensional changes can be treated in the same way as those of the ink-process papers. Thermal papers, however, will tolerate a wider range of ambient temperature and humidities than ink-process papers.

Options are sometimes available for the weight of the recording paper. Some manufacturers offer a translucent paper, which is designed for immediate reproduction on an ammonia-process duplicator. This translucent paper is not of sandwich construction. It is semitransparent over its entire surface to the ultraviolet illumination of the ammonia-process duplicator, except for the almost completely opaque printed grid lines and for the almost completely transparent recorded line made by the hot-wire stylus. This produces a duplicate which appears as a white recording and a dark blue grid against a light blue background. Some users prefer an office-type duplicator to copy the

standard thermal-process recording papers. This will give satisfactory reproductions if the original has clear, sharp grid lines. Any duplicator may be used except those which work by heat.

### Photographic papers take a little time

Photographic papers are made from a sturdy, moisture-resistant base covered with a light-sensitive coating. A fine beam of light, reflected from a moving galvanometer mirror onto the moving paper, produces a latent image on the chart paper, which is then developed by standard photographic chemical processing. Photographic papers are often used for recording high-frequency data, since the only moving part in the process, other than the chart drive, is a tiny galvanometer with a high natural frequency. The moment arm is replaced by the beam of light from galvanometer to paper. This does not restrict deflection velocities at the paper, so long as sufficient light energy is available per unit of chart paper area at the higher speeds of beam spot motion. With photographic papers, the recording is not immediately visible. This minor fault may be almost completely overcome, however, by using one of the rapid-developing adapters (Fig. 2) offered by many units.

Humidity is not a limitation, but the processing is somewhat dependent on the temperature of the processing solutions. This limitation is normally controlled by the manufacturer's selection of papers and his recommendations for processing solutions and methods. Since the grid lines are impressed on the recording photographically along with the data, dimensional change may be overcome by using the grid lines themselves as the definitive references of time and amplitude. Different weights of photographic recording paper are available. The best weight depends on the intended use; this can be found by experiment. Most photographic papers have excellent resistance to scratches, pressure marking and mounting adhesive, so handling need cause no worry.

Photographic-process recordings usually have a higher contrast than those made by any other process. As a result, they are ideal for display purposes and reproduce excellently with a standard office duplicator.

### Watch the clock when exposing ultraviolets

Ultraviolet-process recording papers are much the same as photographic papers, but have a special photographic coating that makes high-speed direct writing possible. The coating records a latent image by exposure to a strong beam of ultraviolet light. This is developed and made visible by brief exposure to a fluorescent light of lower energy concentration at the surface of the

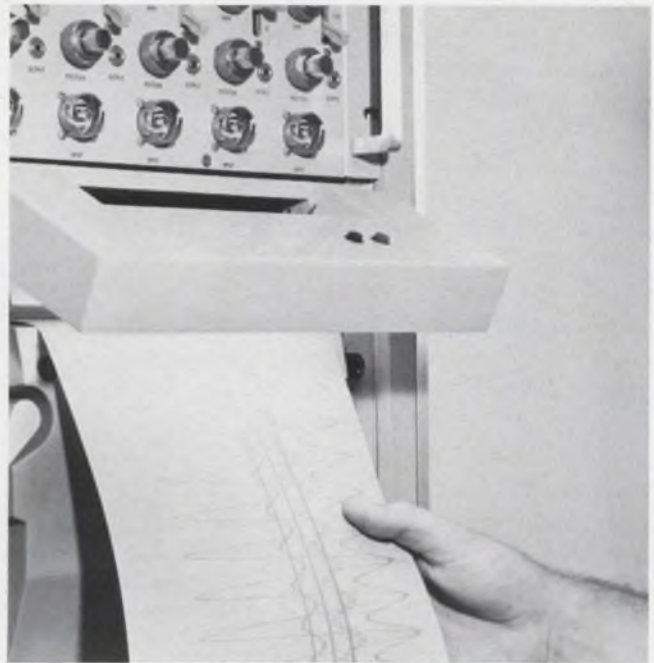

3. Ultraviolet paper requires fluorescent post-exposure to bring out the latent image. Care must be taken during development, since overexposure will render records totally useless.

paper (Fig. 3). This eliminates the liquid chemical development required with standard photographic papers. However, there is still a time lag between the instant of recording and the first view of the recorded data. This is a minor detail in view of the convenience and high recording speed which this class of paper can provide.

The recording may be made by reflecting a beam of ultraviolet light from a galvanometer mirror, as in photographic recording, or by using an electron-beam-fiber-optic combination to bring the illumination right to the paper surface.

Humidity and temperature have little effect on the recording process, although they can affect the dimensions of the stock. Since the grid lines are recorded on the chart along with the data, the grid lines themselves are the reference for time and amplitude.

Ultraviolet recording presents neither the knife-sharp definition nor the extreme black-and-white contrast which are characteristic of standard photographic papers. As a result, the recordings will not reproduce so cleanly on an office duplicator. The recording is less permanent, since the development process will continue until the recording is useless, if the paper is allowed to remain exposed to light. The recording can, however, be made permanent by photographic development and fixing, as though it were a standard photographic paper.

### Electric process can interfere with test rig

Electric-process recording chart papers respond to the passage of an electric current. Three types

## Pros and cons of different papers

**Ink-process papers** are rarely affected by temperature and humidity, only occasionally troubled at extreme values; with good quality contrast and density of grid, they reproduce well by any standard copying process.

**Thermal-process papers** resist pressure and a wide range of ambient temperatures, humidities and moisture; they respond only to application of stylus heat. Care is necessary to avoid scratching the plastic coating of the paper. Duplication can be accomplished with any duplicator except a thermal process.

**Photographic-process papers** take time to develop; a rapid-developing adapter can speed the process. Little care is needed in handling, as resistance to scratches, pressure, marking and moisture is excellent. The printed trace exhibits a higher contrast than any other process, so reproduction can be made with any duplicator.

**Ultraviolet-process papers** need a fluorescent post exposure; too long an exposure will render the trace useless. Photographic fixing can make the record permanent. Contrast and definition are less sharp than photographic papers; reproductions on an office duplicator are usually unsatisfactory.

**Electric-process papers** can create objectionable fumes. In addition, high voltages can be dangerous to the operator and can interfere with nearby circuitry. Duplication is good by any standard method. A low-voltage method reduces the chance of interference and allows greater operator safety.

**Pressure-process papers** are extremely susceptible to unintentional damage through handling. It is wise to duplicate, by any standard method, those important portions of the trace and use the duplicate as a reference.

are in common use: high-voltage papers which record from a current passing through the entire thickness of the chart paper; low-voltage papers which record from a current passing through the entire thickness; and low-voltage papers where a current passes through a current-sensitive surface layer of the paper.

The high-voltage, whole-thickness papers operate on the basis of a physical change at the paper surface. The necessary high voltages can be dangerous to the operator and could interfere with nearby circuitry. With some of the papers, the process releases objectionable fumes.

The low-voltage, whole-thickness papers operate on the basis of an electrolytic action, which transfers metallic ions from the recording electrode, to produce a visible indication on the chart. These papers must be damp for this electrolytic action to take place.

Papers which pass a current through a sensitive coating are of sandwich construction, built with a paper base and a current-sensitive surface, separated by a conducting foil such as aluminum. Passage of current from a stylus in contact with the sensitive surface through this surface layer to the foil results in a permanent change at that point on the chart. This appears as a recorded trace as the chart paper moves past the recording pen. This low-voltage method is safer for the operator and reduces the likelihood of interference. No objectionable fumes are emitted.

Recording speed is limited with these papers by the same mechanical considerations that are found with the ink-based and thermal-based processes—

a mechanical element must move across the chart to make the actual recording. The grid lines are printed on the stock as with ink-process and thermal-process charts. Normal office duplicators may be used to make satisfactory copies of electric-process recordings.

### Pressure papers need careful handling

In the carbon-transfer pressure process, two separate paper stocks are used: one is the chart paper, with printed grids, and the other is a carbon stock which is discarded after use. The two papers pass beneath the pressure recording pens together, so that pressure on the back of the carbon stock will transfer an image of the data onto the recording paper. In the paper encapsulation process, the surface of the recording paper is coated with microscopic granules of ink or dye, each in a protective coating. Pressure against the paper surface will break these capsules at the point of contact and so release the ink or dye and produce an image on the paper. Characteristics of this paper are similar to those of fluid and thermal-process papers, especially with regard to dimensional changes. Pressure recordings made from encapsulation papers are more susceptible to damage from handling than those of other processes. For this reason, it is often helpful to make a duplicate of the important segments of these recordings, then use the duplicate as a reference, to keep the original from damage. The copy may be made photographically or with an office-type duplicating machine. ■ ■

# ORDINARY 5 AND 10 AMP RELAYS MIGHT PERFORM LIKE THE NEW SIGMA SERIES 50.

If they had these features.

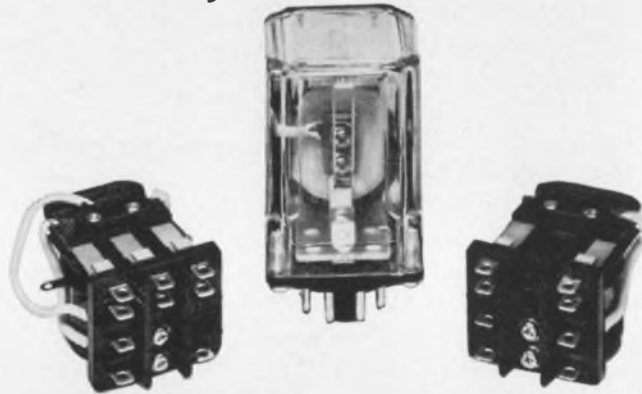

New 1, 2 and 3 pole Sigma Series 50 relays have five advantages over ordinary relays of this type.

**All versions are recognized under the U.L. component program:** AC-DC types; 1, 2 or 3 poles; open or plastic-dust-covered; the complete variety of coil and contact ratings.

**Longer Contact Life:** Slots in contact base between fixed contacts eliminate build-up of vaporized contact material and leakage paths. This prevents premature failure and is particularly effective at higher loads.

**Coil Lead Breakage Eliminated:** Molded phenolic bobbin assures positive mechanical interlock with frame preventing coil rotation and lead breakage.

**Greater Motor Efficiency:** Adjustable armature hinge permits optimum seating of armature on

pole face. Assures precise contact alignment as well as maximum use of drive circuit power.

**Better Adjustment Stability:** Contact base and armature support of diallyl phthalate. This does not deform under mechanical and thermal stresses.

**We'd like to give you a new Sigma Series 50—** or any of our other standard relays. Test and compare it against the brand you may now be using. It's the best way we know to prove what we say about Sigma relay performance. Just circle our reader service number. We'll send you the new Sigma relay catalog and a "free relay" request form. Return the form to us and your Sigma representative will see that you get the relay you need.

**Need fast delivery? The new Series 50 is available off-the-shelf from your Sigma distributor.**

SIGMA DIVISION  SIGMA INSTRUMENTS INC  
Assured Reliability With Advanced Design / Braintree, Mass. 02185  
Sigma Instruments (Canada) Ltd., P.O. Box 43, Toronto 18

ON READER-SERVICE CARD CIRCLE 41

ELECTRONIC DESIGN 21, October 11, 1967



# RCA Announces New Dual-Gate (MOS) FET'S

- Unneutralized 200 MHz Power Gain 18dB typ ■ Feedback Capacitance 0.03pF max
- Transconductance 10,000  $\mu$ mhos typ

For the first time in communications history!... all solid-state VHF receivers with vacuum-tube front-end performance

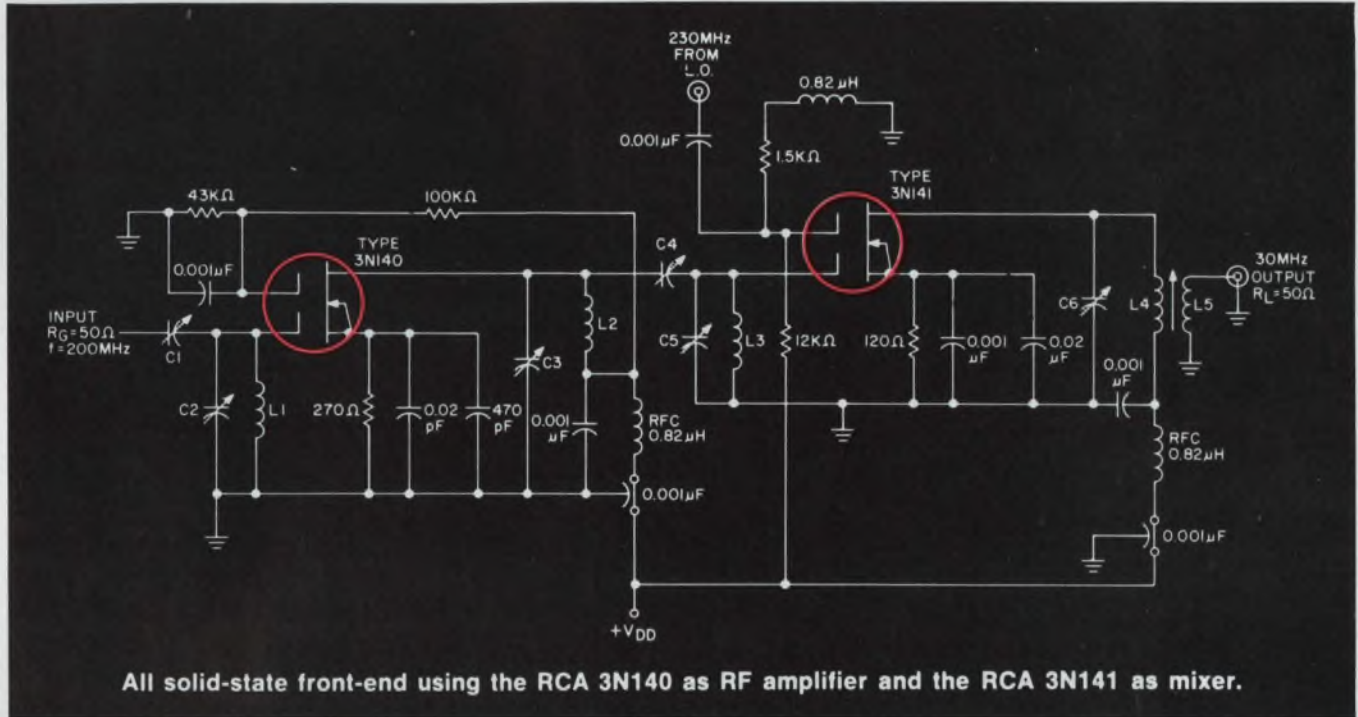

**98¢**  
1000 up quantities

## is the low price for the RCA 3N140 dual-gate RF Amplifier

RCA'S NEW DUAL INSULATED-GATE DEPLETION TYPE (MOS) FET'S COMBINE THE BEST FEATURES OF VACUUM-TUBES AND BIPOLAR TRANSISTORS

### The RCA 3N140 RF Amplifier and 3N141 Mixer Feature...

#### SERIES CONTROL ELEMENTS FOR:

- Improved Crossmodulation Performance
- Reduced Spurious Response
- Exceptional Stability at VHF
- Reduced Oscillator Feedthrough
- Increased Gain Control Range



TO-72

#### INSULATED GATES FOR:

- Increased Signal handling without Diode-Current Loading
- Negligible AGC Power
- Improved Thermal Stability

#### ELECTRICAL CHARACTERISTICS 3N140 and 3N141

##### Gate-to-source cutoff voltage

$V_{G1S}(Off) = V_{G2S}(Off) = -4V$  max.

##### Gate Leakage Current

$I_{G1SS} = I_{G2SS} = 1nA$  max.

##### Forward Transconductance

$G_{fs}$  (Gate No. 1-to-drain) = 6,000  $\mu$ mhos min.  
10,000  $\mu$ mhos typ.

##### 200 MHz Power Gain (unneutralized) (3N140)

$G_{ps}$  = 16dB min.  
18dB typ.

##### 200 MHz Noise Figure (3N140)

N.F. = 4.5dB max.  
3.5dB typ.

Developed and introduced by RCA, the 3N140 and 3N141 Dual Insulated-Gate (MOS) FET's are two of the most revolutionary transistors on the market today. For technical data and application information write RCA Commercial Engineering, Section EG-101 Harrison, N.J. 07029. Check your RCA Distributor for his price and delivery.



The Most Trusted Name in Electronics

ON READER-SERVICE CARD CIRCLE 42

# Put the varactor's inductance to use

instead of looking upon it as a nuisance. Its effects on frequency range and losses can be overcome.

The effect of varactor inductance is one of the most troublesome aspects of the design of varactor-tuned circuits above 50 MHz. It degrades the diode's  $Q$ , and limits the frequency. These effects can be largely overcome, but to do so, many factors must be taken into consideration.

The recent availability of very high- $Q$  voltage-variable capacitors<sup>1</sup> has made possible extensive application of these diodes in both the vhf and uhf ranges. As many designers have doubtless learned, however, merely having a high  $Q$  is not enough to ensure satisfactory performance.

## Package adds inductance

The tuning diode, also known as varactor or voltage-variable capacitor, is a reverse-biased pn junction. In itself this junction has negligible inductance—its equivalent circuit at higher frequencies is solely the voltage-dependent junction capacitance,  $C_j$ , with a series resistance,  $R_s$ . The housing that protects the circuit contacts, however, gives rise to both an internal series lead inductance,  $L_s$ , and a shunting case capacity,  $C_c$ . The lead, in the form of a strap, wire, whisker or spring from the junction to the package contact, contributes most of this inductance. Inductance is also added by lead connections (Fig. 1).

The internal lead inductance is a function of the package and its internal structure. For tuning diodes housed in a DO-7 glass package (Fig. 2a), the inductance is approximately 3 nH; in a ceramic pill (Fig. 2b), it is about 0.5 nH.

The inductance of nonmagnetic round leads in the external circuit can be estimated from:

$$L(\mu\text{H}) = 0.00508 l [2.303 \log_{10} (4l/d) - 1 + \mu\delta], \quad (1)$$

where:

- $l$  = length (inches),
- $d$  = diameter (inches),
- $\mu$  = permeability (1 for nonmagnetic material),
- $\delta$  = skin effect factor.<sup>2</sup>

At low frequencies a 0.020-in.-diameter wire has an inductance of 26.8 nH/in., for example.

Gerald Schaffner, Applications Engineer, Motorola Semiconductor Products, Inc., Phoenix, Ariz.

The skin effect decreases inductance by about 6% at frequencies above about 100 MHz.

Most tuned circuits use parallel resonant tanks either in lumped or distributed form, and these are the circuits most sensitive to varactor inductance. Therefore it is desirable to use a series resonant circuit whenever the frequency approaches one-fourth the diode's self-resonant frequency. The diode's inductance can be made to appear either in series or in parallel with the tuning circuit. In a parallel configuration, it can be shown that it degrades the frequency range; in a series mode, it raises the operating frequency.

## Inductance detunes parallel resonant tanks

Consider a varactor in a lumped tank circuit where the diode is in parallel with the tuning elements. The inductance of the diode's lead,  $L_s$ , is neglected in the equivalent circuit of Fig. 3a; it is included in Fig. 3b. In both figures,  $g_c$  denotes the loss of the external circuit, and  $g_s$  and  $g_L$  represent the source and the load, respectively.

Calculation of the insertion loss involves two assumptions: that the diode  $Q > 5(\omega C_j R_s) \cong 5$  at the operating frequency, and that the source and load conductances are equal,  $g_s = g_L$ .

If inductance is not taken into account, the insertion loss at resonance is:

$$I_L = P_{\text{available}}/P_{\text{out}} = \{1 + [(g_c + \omega^2 C_j^2 R_s)/2g_s]\}^2. \quad (2)$$

The term  $\omega^2 C_j^2 R_s$  is merely the equivalent parallel conductance of the varactor. Equation 2 can be simplified to:

$$I_L = \{1 + [(1/Q_c + 1/Q_D)/(1/Q_{\text{ext}})]\}^2, \quad (3)$$

where  $Q_c$  is the  $Q$  of the coil,  $Q_D$  is the  $Q$  of the varactor, and  $Q_{\text{ext}}$  depends on the external circuit and is equal to  $\omega C_j/2g_s$ .

The bandwidth is determined by the loaded  $Q$ ,  $Q_L$ , which can be calculated from the circuit  $Q$ s:

$$1/Q_L = 1/Q_{\text{ext}} + 1/Q_c + 1/Q_D. \quad (4)$$

The diode's inductance modifies the loss:

$$I_L = \left[ 1 + \left( g_c + \frac{\omega^2 C_j^2 R_s}{(1 - \omega^2 L_s C_j)^2 + \omega^2 C_j^2 R_s^2} \right) / 2g_s \right]^2, \quad (5)$$

1. Equivalent circuit of a mounted tuning diode includes the inductance of leads to the tuning diode  $L_s'$ , the case capacity  $C_c$  which is approximately 0.3 pF, the internal lead inductance  $L_s$ , and the pn junction parameters,  $C_j$  and  $R_s$ .

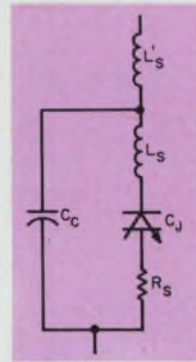

2. Two widely used package types are the DO-7 (a) and the pill with prongs (b). The DO-7 package inductance is about 3 nH, while the ceramic pill's is about 0.5 nH. The dimensions are in mils.

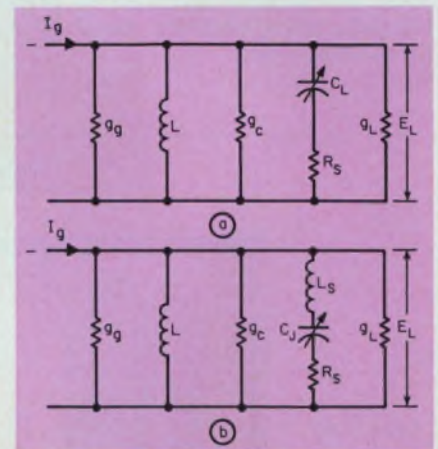
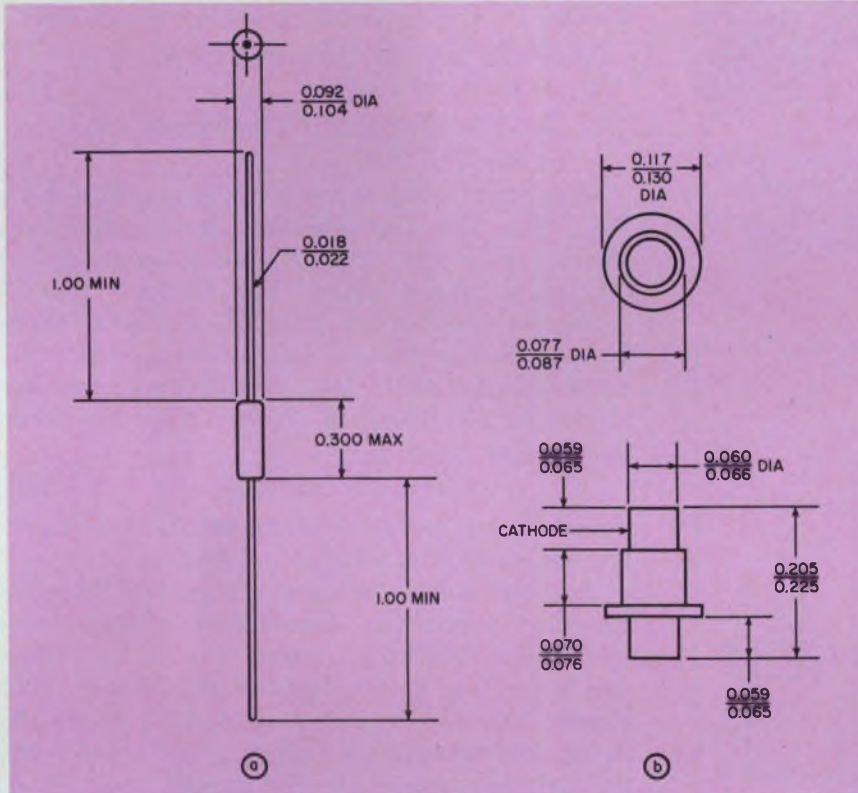

3. Equivalent circuit of parallel resonant tank circuit may omit the varactor's inductance (a). Its inclusion (b) leads to a more accurate analysis.

which can be more simply written as:

$$I_L = [1 + (1/Q_c + 1/Q_{d'}) / (1/Q_{ext})]^2, \quad (6)$$

where  $Q_{d'}$  is the diode  $Q$  modified by the inductance:

$$\begin{aligned} 1/Q_{d'} &= (1/Q_d) / [(1 - \omega^2 L_s C)^2 + 1/Q_d^2] \\ &= (1/Q_d) / \{ [1 - (f/f_{sr})^2]^2 + 1/Q_d^2 \}, \end{aligned} \quad (7)$$

where  $f_{sr}$  is the self-resonant frequency of the varactor:

$$f_{sr} = 1/2\pi(L_s C_j)^{1/2}, \quad (8)$$

and  $f = \omega/2\pi$ , the frequency at which  $Q$  is calculated.

If the operating frequency is  $0.223 f_{sr}$ , for example, the diode  $Q$  has been degraded by 10 per cent by its inductance:  $Q_{d'} = 0.9 Q_d$ . In general, tuning diodes in parallel resonant circuits should not be used at frequencies higher than  $0.223 f_{sr}$  because of the excessive  $Q$  degradation. This limit is shown in Fig. 4 for both DO-7 glass and ceramic-pill diodes.

When the diode is placed in a cavity, the limita-

tions are essentially the same as those developed for a lumped circuit.

### Cavity parameters are modified

Consider a typical case of a varactor tuning a foreshortened quarter-wave coaxial cavity,<sup>3,4,5,6</sup> as in Fig. 5.

The resonant frequency of this system without the diode's inductance is found from:

$$1/(2\pi f C_j) = Z_0 \tan(2\pi f l/v_c), \quad (9)$$

where:

$Z_0$  = characteristic impedance of the shorted coaxial line,

$l$  = length of the coaxial line,

$v_c$  = velocity of light =  $3 \times 10^{10}$  cm/s.

The effect that inductance has on cavity response is identical to that it has on the lumped circuit, provided that the following two points are remembered.

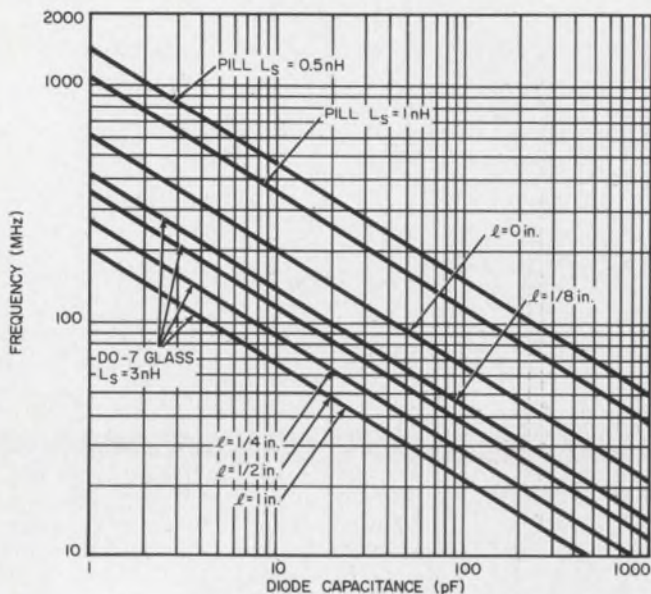

4. The diode's frequency limits depend on the type of package and lead length. The limit is determined by a 10% decrease of  $Q_A$ . Parallel resonant tuning, where the inductance degrades the Q by more than 10%, is not recommended.

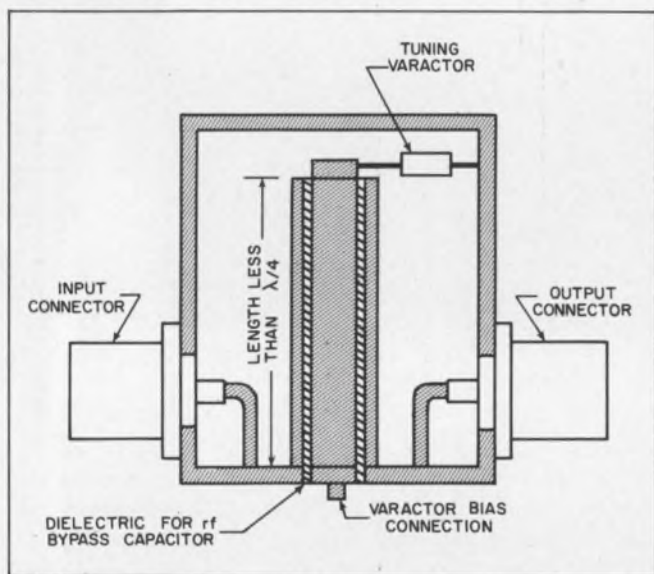

5. In a varactor-tuned coaxial cavity, the cavity length should be less than  $\lambda/4$ , so that the cavity impedance is inductive at the varactor terminals. The diode's capacitance resonates with the inductance at the mean frequency.

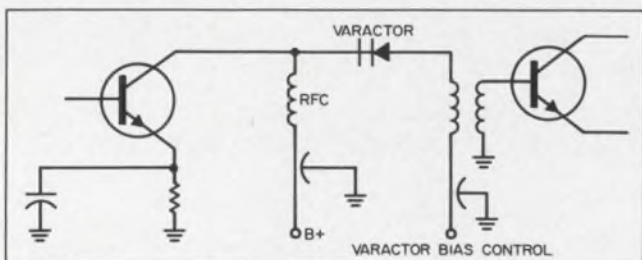

6. Series resonant tuning permits the varactor inductance to be added to tank circuit inductance, thereby raising the possible operation frequency.

■ The equivalent circuit of the cavity is identical to that of a lumped tank if the point of reference is the varactor itself. Conductances  $g_o$  and  $g_L$  must then be transformed to the impedance level of the varactor. Conductance  $g_c$  represents the cavity loss looking out from the varactor terminals and can usually be neglected in a well-constructed cavity.

■ The shorted transmission line can be represented by an inductance in parallel with a capacitance over a fairly broad frequency range.

These equivalences may be derived by equating the magnitude and phase of the admittances of the shorted transmission line and the equivalent parallel LC circuit at the operating frequency:

$$L_{eq} = [Z_o/\pi f] / [(2\pi fl/v_c) \csc^2(2\pi fl/v_c) + \cot(2\pi fl/v_c)]; \quad (10)$$

$$C_{eq} = [1/4\pi f Z_o] [(2\pi fl/v_c) \csc^2(2\pi fl/v_c) - \cot(2\pi fl/v_c)]. \quad (11)$$

One complicating factor with the cavities is the fact that the transmission line's admittance changes over the desired tuning range. For a maximum tuning range, the shortest possible cavity is recommended. This also applies to shorted cavities less than a quarter-wave long. This point is made clear by the examination of resonant conditions. The resonant frequency for the cavity in Fig. 5 is given by:

$$2\pi f C_j = Y_o \cot(2\pi fl/v_c), \quad (12)$$

where  $Y_o$  is the cavity's characteristic admittance and the diode's inductance is ignored.

The best tuning conditions will prevail when the curve of percentage capacitance change vs a percentage frequency change has a zero slope derivative; that is, the dependence is linear. Thus assume that a frequency change,  $+\Delta f$ , is the result of a capacitance change,  $-\Delta C_j$ . Then find the derivative and set it equal to zero, to arrive at:

$$2\pi f C_j (1 + \Delta f/f) (1 - \Delta C_j/C_j) = Y_o \cot [2\pi fl (1 + \Delta f/f)/v_c]. \quad (13)$$

If Eq. 12 is subtracted from Eq. 13 and higher-order differentials are neglected, the result is:

$$\Delta C_j/C_j = (\Delta f/f) [1 + (4\pi fl/v_c) / \sin(4\pi fl/v_c)]. \quad (14)$$

A change of  $C_j$  will best approach linearity with a change of  $f$  when the bracketed expression is minimum, or when  $\tan(4\pi fl/v_c) = 4\pi fl/v_c$ , which occurs when  $l = 0$ . Hence, for maximum tuning range, the minimum cavity length should be used.

#### Series resonant circuits alleviate some problems

The frequency limitations of parallel resonant circuits (Fig. 4) can be partially overcome by exploiting the inductance in lumped series resonant circuits, where the diode inductance adds directly to circuit inductance.

A single-tuned, resonant lumped circuit for tuning and coupling transistor circuits is shown in Fig. 6. Here the varactor bias is between the col-

lector supply voltage and a lower-value control voltage.

In a double-tuned series resonant circuit (Fig. 7a), the varactor inductances again merely add to the circuit inductances so that performance is not degraded. Coupling capacitor  $C_m$  can be replaced by a varactor to provide wider tuning range. Its equivalent circuit (Fig. 7b) is useful for determining the necessary design equations.

For minimum insertion loss and a single-peaked response, the ratio of the capacitances should be:

$$C_m/C_A = 1.4(f_0/BW) - 1, \quad (15)$$

where:

- $C_m$  = coupling capacitor,
- $C_A$  = series capacitor,
- $f_0$  = center frequency,
- $BW$  = 3-dB bandwidth.

For lowest midband insertion loss,  $I_{L_0}$ , critical coupling should be achieved. The condition is:

$$I_{L_0} = [(1 + Q/Q_u)^2 + 1]^2/4, \quad (16)$$

where  $Q \approx 1 + C_m/C_A$ . The loaded  $Q$  of each circuit is much less than  $Q_u$ , its unloaded  $Q$ , which is:

$$1/Q_u = (1/Q_c) + C_m/[(C_A + C_m)Q_A] + C_A/[(C_A + C_m)Q_m], \quad (17)$$

where  $Q_A$  is the  $Q$  of the series capacitor or varactor, and  $Q_m$  is the  $Q$  of the coupling capacitor or varactor.

To illustrate the use of these equations, assume that a circuit is needed with a 10% bandwidth. Then  $C_m/C_A = 1.4(10) - 1 = 13$ . The selection of a specific  $C_A$  depends on frequency and available varactors. Varactors with smaller capacitances have higher  $Q$ s, however. Larger inductances would then be required and these, in turn, would probably have lower  $Q$ s and so degrade the over-all figure. At 400 MHz, for example, for a  $C_A$  of 2 pF, a reasonable  $Q_A$  to expect is about 100. A coil with a  $Q$  of about 200 is easy to obtain. Then  $Q_u = 64$  and:

$$I_{L_0} = [(1 + 14/16)^2 + 1]^2/4 = 1.57, \text{ or about } 2 \text{ dB.}$$

In the coupling capacitor of Fig. 7b, inductance problems can still occur, especially if a varactor is used. Though the  $Q$  of the coupling capacitor is less critical than that of the series capacitor, care should be taken that the operating frequency is well below the coupling capacitor series resonant frequency. If this is impossible, an inductance can be placed in series with the coupling varactor to give a net inductive reactance (tunable by the varactor) as the coupling impedance.

#### Diode is put in series with the line of the cavity

The frequency limitations of distributed resonators can be bypassed in much the same manner as those of lumped circuits. The varactor inductance is made part of the cavity by placing the diode in series with the transmission line. A varactor, with

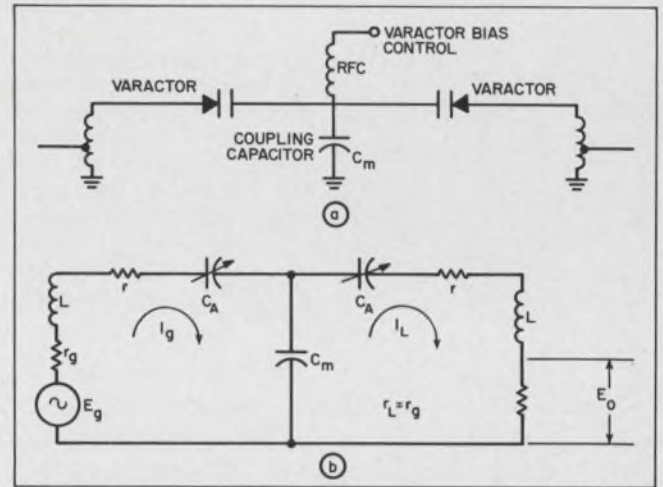

7. The varactor inductance adds to circuit inductance, hence response of circuit is not degraded. The coupling capacitor,  $C_c$ , can be replaced by a varactor for wider tuning range (a). In its equivalent circuit (b), it is assumed that the circuit coupling is adjusted for  $r_L = r_g$ , and is otherwise symmetrical.

junction capacity  $C_J$  and lead inductance  $L_S$ , tunes a line that is loaded by capacity  $C_T$ , as shown in Fig. 8. Making  $L_S$  and  $C_J$  resonant,  $C_T$  large (hence, line length small), and  $Z_u$  small enables a wide tuning range to be achieved.

The philosophy of this series-tuned cavity design is to keep the equivalent fixed capacity that appears in series with the varactor as large as possible. This allows the voltage-variable junction capacitor to control the resonant frequency to the greatest extent. The largest tuning range is obtained when the equivalent capacitance of the transmission line in series with  $C_J$  is maximum. A few equations will prove this. A capacitively loaded line has an impedance:

$$Z = j2\pi f L_{eq} - j/(2\pi f C_{eq}) = j[(Z_0^2 2\pi f C_T \tan \theta - Z_0)/(Z_0^2 \pi f C_T + \tan \theta)], \quad (18)$$

where:

- $C_T$  = tuning capacitance,
- $Z_0$  = line's characteristic impedance,
- $\theta$  = line's electrical length =  $2\pi fl/v_c$ ,
- $L_{eq}$  = line's equivalent series inductance,
- $C_{eq}$  = line's equivalent series capacitance.

Differentiating Eq. 18, multiplying it by  $2\pi f$  and subtracting the result from Eq. 18 yield:

$$\frac{2}{2\pi f C_{eq}} = \frac{Z_0 + Z_0^2 2\pi f C_T \theta \sec^2 \theta}{Z_0^2 \pi f C_T + \tan \theta} - \frac{(Z_0 2\pi f C_T + \theta \sec^2 \theta)(Z_0^2 2\pi f C_T \tan \theta - Z_0)}{(Z_0 2\pi f C_T + \tan \theta)^2} \quad (19)$$

The maximum capacity occurs when the line appears as a short circuit, in which case  $1 = Z_0 2\pi f C_T \tan \theta$ . Then Eq. 19 can be simplified to:

$$C_{oq} = (2/\omega Z_0)(\cot \theta + \tan \theta)/(1 + \theta \cot \theta \sec^2 \theta) = (2/\omega Z_0)/(\theta + \sin \theta \cos \theta). \quad (20)$$

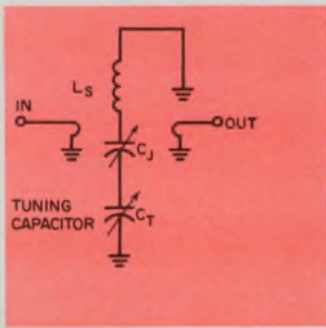

8. In a varactor-tuned cavity, where the diode may be in series with the line, the cavity consists of a capacity-loaded open-circuit line. The varactor and its associated inductance terminates the other end of the line. Inductive input and output couplings are used.

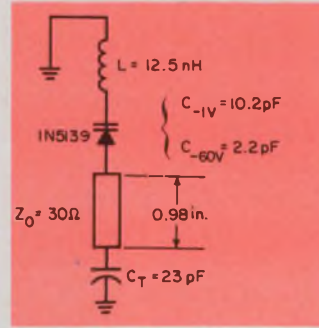

9. Equivalent circuit of a varactor-tuned cavity covering from 470 MHz to 890 MHz uses the values calculated in the text. The given values for  $C_T$ ,  $Z_0$  and  $L$ , and a Smith chart permit calculation of the 1N5139 capacity values:  $C_{max} = 11.1$  pF and  $C_{min} = 2.35$  pF.

Equation 20 is maximum when both  $Z_0$  and  $\theta$  are as small as possible. In other words, for maximum tuning range, the end turning capacitor should be large,  $Z_0$  should be small, and the varactor should be resonated by the inductance to ground at the design center frequency.

### Design can be completed in seven steps

A design procedure encompassing these considerations can be synthesized in seven steps. A numerical example accompanies the procedure, the results of which have been experimentally verified.

1. For the desired tuning range,  $f_{max}/f_{min}$ , select a varactor with the highest possible  $Q$ , where  $C_{max}/C_{min} > (f_{max}/f_{min})^2$ .

To tune, for instance, from 470 MHz to 890 MHz,  $f_{max}/f_{min} = 1.89$ , or  $C_{max}/C_{min} > 3.58$ . For the 1N5139,  $C_{-1V} = 10.2$  pF and  $C_{-60V} = 2.2$  pF; hence,  $C_{-1V}/C_{-60V} = 4.64$ .

2. Find the mean frequency,  $f_m = (f_{max}f_{min})^{1/2}$ . Then pick a lead length of the varactor so that it will resonate with the junction capacitance at  $f_m$ .

For the 1N5139, for instance, the mean capacitance between  $C_{-1V}$  and  $C_{-60V}$  is 4.8 pF at 10 volts' applied bias. To resonate 4.8 pF at the mean frequency of 650 MHz requires  $L = 12.5$  nH. With 27 nH/in. for lead inductance and a 3-nH internal varactor inductance, the required lead length is 0.35 inch.

3. Select a low characteristic impedance,  $Z_0$ , for the transmission-line portion of the cavity; between 20  $\Omega$  and 40  $\Omega$  is reasonable.

Select  $Z_0$  to be 30  $\Omega$ , for example. For a coaxial line where OD = 1 inch and ID = 0.6 inch,  $Z_0 = 30$   $\Omega$ .

4. Calculate the minimum allowable equivalent transmission-line capacity,  $C_{eq}$ , which is in series with the capacity of the varactor, according to:

$$\frac{[(C_{min} + C_{eq}) / (C_{max} + C_{eq})]}{C_{max}/C_{min}} = (f_{max}/f_{min})^2. \quad (21)$$

Equation 21 is derived from:

$$f_{min} = 1/[LC_{max}C_{eq}/(C_{max} + C_{eq})]^{1/2}$$

$$f_{max} = 1/[LC_{min}C_{eq}/(C_{min} + C_{eq})]^{1/2},$$

which express cavity resonance at the tuning diode's limit frequencies.

For the example, where  $(f_{max}/f_{min})^2 = (890/470)^2 = 3.58$ ,  $C_{max} = C_{-1V} = 10.2$  pF and  $C_{min} = C_{-60V} = 2.2$  pF, then  $C_{eq} = 24.5$  pF.

5. Calculate the transmission line's electrical length,  $\theta$ , at the mean frequency, from the transcendental equation, Eq. 20:

$$\theta + \sin \theta \cos \theta = 2/(\omega C_{eq} Z_0).$$

Since  $\theta$  is normally fairly small, a first-order approximation is acceptable. This yields:

$$\theta \approx 1/(\omega C_{eq} Z_0).$$

The correct  $\theta$  is usually slightly larger than the trial  $\theta$ , but a precise calculation of  $\theta$  is generally unnecessary.

For the example, where  $Z_0 = 30$   $\Omega$ ,  $\omega = 2\pi 650 \times 10^6$ ,  $C_{eq} = 24.5 \times 10^{-12}$ ,  $\theta$  is calculated to be 0.34 rad.

6. From  $\theta$  calculate the transmission-line length,  $l = \theta\lambda/2\pi$ , where  $\lambda$  is the mean frequency wavelength.

$$\text{Thus, } l = 0.34/2\pi \times 18.2 = 0.98 \text{ in.}$$

7. Calculate the loading capacity,  $C_T$ , from  $1 = Z_0 2\pi f C_T \tan \theta$ , for maximum tuning range, where  $f$  is the mean frequency.

Thus,  $1 = 30 \times 2\pi 650 \times 10^6 \times C_T \times \tan 19.6$ ; hence  $C_T = 23$  pF.

An equivalent circuit of the varactor-tuned cavity for 470 to 890 MHz is shown in Fig. 9.

An exact check of the tuning range was made using transmission-line theory and a Smith chart for the two extreme frequencies, 470 and 890 MHz. At 890 MHz, the junction capacitance needed to tune the cavity was calculated to be 2.35 pF, and at 470 MHz, to be 11.1 pF. These were close enough to the values of  $C_{-1V} = 10.2$  pF and  $C_{-60V} = 2.2$  pF to permit the design to stand. ■ ■

### References

1. "Hyperabrupt Junction Gives Varactor Diodes Tuning Ratios to 20:1,  $Q$  to 300," *ELECTRONIC DESIGN*, XV, No. 12 (June 7, 1967), 116-118.
2. F. E. Terman, *Radio Engineers' Handbook* (New York: McGraw-Hill Book Co., 1943), pp. 48-50.
3. Gerald Schaffner, "A New Look at Coaxial Cavities for Varactor Multipliers," *Electronics*, XXXVIII, No. 10 (May 17, 1965), 56-64.
4. *Reference Data for Radio Engineers* (New York: IT&T Corp., 1956), Chaps. 20 and 21.
5. Harvard University Radio Research Laboratory Staff, *Very High Frequency Techniques* (New York: McGraw-Hill Book Co., 1947), Chap. 28.
6. A. Kiriloff, "Designing Cavities in the 500-Mc Range," *ELECTRONIC DESIGN*, IX, No. 4 (Feb. 15, 1961), 180-183.

# If it's so great, how come it's so cheap?

It's only \$5,000 because you said that's what it ought to cost. Our market research boys told us there was a tremendous need for an IC tester specifically designed for QC, QA, reliability testing, and everyday engineering evaluation. They also told us we could sell four times as many at \$5,000 as we could at \$7,500.

So we gave our design department a list of functions, a \$5,000 pricetag, and locked the door. Here's what came out: A \$5,000 IC tester that:

- Performs both pulse and dc parameter tests as well as functional tests without external equipment.
- Has a measurement accuracy of 1% (0.1% with an optional digital readout DMM.)
- Can be operated by a bright girl with half-a-day's training.
- Programs with thumbwheels in less than 60 seconds for most IC's.
- Has power supply accuracy of 0.1%  $\pm$ 1mv. (All supplies have adjustable current or voltage limiting and will both source or sink current.)

- Has Kelvin connections to the device under test.
- Has self powered, line-isolated modules.
- Has a complete line of device adaptors available.

How were we able to deliver so much machine per dollar? It was a snap. All we did was make every damn penny do a dime's work. We did it by committing to an annual agreement wherever there was a price advantage.

We did it by cutting out the fat. If a function was non-essential, it went. (This is one un-gilded lily.)

We did it with painstaking project engineering. For example, the loads module: We could have made 1% capacitive loads. But it would have cost three times as much, and no one knows what to do with capacitive accuracy of better than 5% anyhow. Another example: the thumb-wheel switches. We found a great one, but discovered the price included \$2 each for a pair of stainless-steel screws. We bought them knocked-down,

assembled them ourselves and used 6¢ screws instead.

Or the pulse generator. Ours is equivalent to two single-channel output units like the ones that Datapulse sells for \$775. They're great, but by sacrificing separate control and adjustment (which isn't necessary in our tester anyway) and the fancy case cut the price in half.

We found a terrific \$15 digital switch. But we didn't use it. We built one without superfluous extras for a buck and a half apiece.

We're handling the AC-switching with 32 controlled planar devices. This saves 192 reed relays, that is to say, greenbacks.

One thing we did was hardest of all. We cut the profit margin. We're honest-to-gosh taking only 3/4 the typical profit.

One more thing. The 990 turns out to cost \$4,950 instead of \$5,000. Use the extra \$50 to take the little woman out to a show and dinner.

Write for complete technical data, or if you're in a hurry, call us collect.

## Redcor's 990 IC tester



Redcor Corporation/7800 Deering Avenue/Canoga Park, California/(213) 348-5892/TWX 910-494-1228

ON READER-SERVICE CARD CIRCLE 43



## Now look what they've done to the DG 5511!

They could have left our favorite portable well enough alone. The two-channel, low cost DG 5511 was already the star performer in its class. Mainly because this thermal writing recorder was so versatile it equaled the capability formerly achieved only through multiple instruments.

But you know how engineers are. If they can think of a way to improve something they won't rest until it's done. And here's what they've done to the DG 5511.

It now offers increased flexibility in pre-amplifier selection with these advanced plug-in signal conditioners: the 1-512 Medium Low Gain Amplifier, the 1-513 Medium Gain Amplifier and the 1-514 Low Gain Isolation Amplifier. These

new preamps complement the previous line of signal conditioners used with the DG 5511.

And—trace quality and contrast have been improved even further thanks to an exclusive new stylus design.

### THESE ADVANTAGES HAVE NOT CHANGED:

You may convert from high-level signal inputs to low-level inputs by a simple change of plug-in attenuator/amplifier units.

Ink is out. You are assured consistently clean traces with a high degree of resolution on heat-sensitive paper.

Unique snap-in, front chart loading, combined with pushbutton selectable chart speeds, makes the DG 5511 the

easiest-to-use direct-writing recorder available today.

Extremely light weight—less than 40 pounds—adds up to an ideal traveling companion.

Why not call your nearest CEC Field Office now for a "desk-top" demonstration? And let the DG 5511 speak for itself.

Or write Consolidated Electrodynamics, Pasadena, Calif. 91109. A subsidiary of Bell & Howell. Bulletin DG 5511-X7.

**CEC/DATAGRAPH PRODUCTS**

**BELL & HOWELL**

ON READER-SERVICE CARD CIRCLE 44

ELECTRONIC DESIGN 21, October 11, 1967



Report from

**BELL  
LABORATORIES**

# "Functional" Tantalum Integrated Circuits

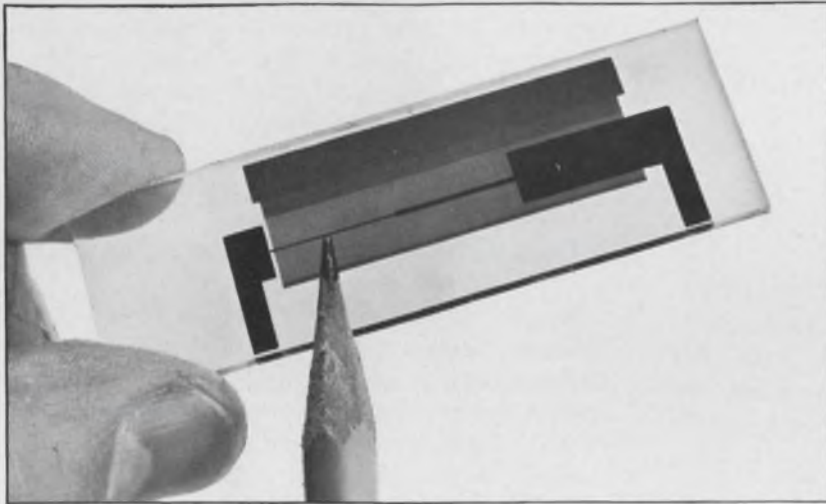

The new "functional" thin-film circuit, shown in the above photo and in the drawing, right, is a two-terminal network consisting of thin films deposited on a glass substrate. For equivalent electrical performance, a conventional thin-film circuit would require at least three resistors and four capacitors (drawing, below).

NEW  
"FUNCTIONAL"  
CIRCUIT

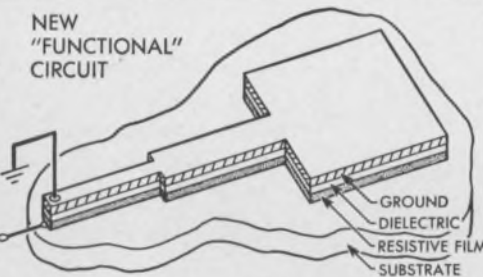

EQUIVALENT  
CONVENTIONAL  
THIN-FILM  
CIRCUIT

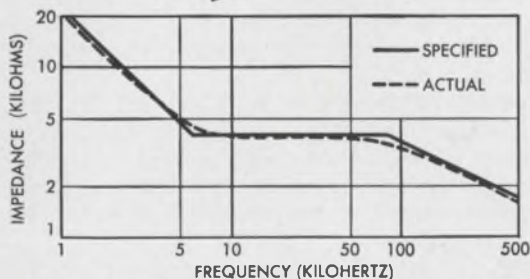
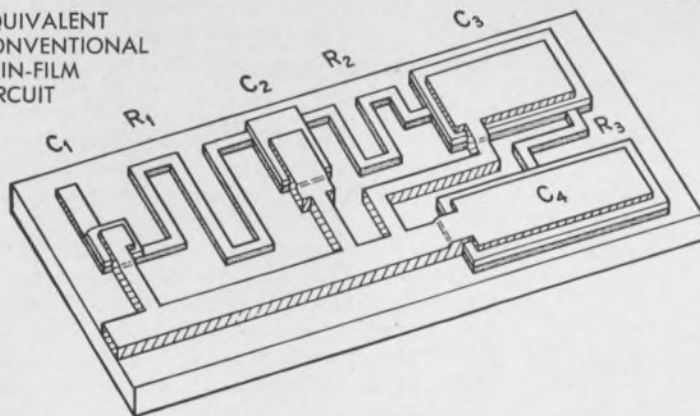

Wyndrum formulated a class of equations which relate frequency response to the geometry of the thin-film pattern. The curves, left, show the specified and actual performance of such a circuit.

As electronic systems have grown in size and complexity, tantalum integrated circuits have reduced costs while increasing reliability and performance. To obtain even further integration of circuit functions, however, engineers at Bell Telephone Laboratories have used tantalum technology to build single thin-film components equivalent to networks of thin-film resistors and capacitors.

This new single, "functional" component (left) is basically a film capacitor with one electrode of resistive tantalum and a second electrode of conductive gold, separated by a dielectric layer of tantalum pentoxide. The component is made by depositing a thin film of tantalum onto a glass substrate, converting a portion of this layer to the insulating oxide, and then depositing the conductive gold electrode onto the oxide. In this arrangement, resistance and capacitance are distributed throughout the structure rather than among discrete electrical components. In addition to providing reliability and economy, this approach also offers the advantages of simpler fabrication and fewer electrical parasitics.

As an important contribution to the design of such structures, Bell Laboratories engineer Ralph W. Wyndrum, Jr., showed that it was possible to convert circuit performance specifications directly to tantalum thin-film patterns. Furthermore, he showed how appropriate geometries and film compositions could yield a wide range of impedance and transfer functions.

Wyndrum developed this synthesis technique while doing graduate work at New York University. He has advanced this technique further at Bell Laboratories, where tantalum integrated circuits were first created some ten years ago.



**Bell Telephone Laboratories**  
Research and Development Unit of the Bell System

# How can YOU become a chief engineer?

Come along on a fact-finding trip and learn the best way to reach the ranks of management.

*Dear Management and Careers Editor:*

*I want to become a chief engineer. What's the best path to follow?*

*Engineer*

*Dear Engineer:*

*The best path to follow is one that takes you all over the country, talking to as many chief engineers as possible, finding out how they did it.*

*Management and Careers Editor*

The mythical exchange of correspondence is closer to the truth than you may think. And since you--the engineer who is designing his career and may want to move into management--probably would not find it convenient or practical to make the cross-country trip, ELECTRONIC DESIGN did it for you.

We put ourselves in your shoes, asking questions of chief engineers, vice presidents of engineering and other top engineering managers throughout the nation.

The answers provide some guidelines for the engineer who wants to move into or up in management. But don't expect a pat formula of "10 easy steps to becoming a chief engineer." The survey indicates that this cannot be done; there is no one sure path to top engineering management.

What the survey did establish is that it takes more than engineering competence to move successfully into management. It takes business, financial, human-relations and technical skill, plus the ability to get more done in less time.

Here is how the picture emerged in questions and answers:

## Why is there no pat formula for becoming a chief engineer?

No two chief engineers' jobs are the same. No two engineering departments are the same. No two companies are the same. Ask a manager, "How much of your work is nonengineering?" and you'll get answers ranging from "95 per cent nonengineering" to

---

Howard S. Ravis,  
Management and Careers Editor

"I do more engineering now than I ever did before."

Or, as one respondent said: "Once you decide that you want to move up in management, you have to determine the type of organization in which you would like to manage. Find out what you'll be getting into before you make the move. Look around, ask questions--in your own company and elsewhere."

## Is there such a thing as a typical chief engineer?

No. As already stated, no two chief engineers' jobs are the same--even within the same company. If you want a picture of the hypothetical "average" chief engineer, the ELECTRONIC DESIGN survey can furnish a statistical picture. But you are cautioned to treat it as statistical and subject to variation.

The average chief engineer, according to the survey:

- Was an engineer for 15 years before becoming chief engineer. For seven of those years, he was in lower management positions, such as supervisor, project manager and department head (see Fig. 1).
- Held between two and three management jobs before his present one.

---

## About the survey

The editors of ELECTRONIC DESIGN questioned engineering managers throughout the nation in person and on the telephone. Great effort was made to obtain diversified distribution in geography, company size and type of electronics company.

The term "chief engineer" is used in a broad context. It connotes the top engineering manager of the firm or division, regardless of his title. Thus we interviewed men with such titles as chief engineer, vice president of engineering and engineering manager.

Each was asked a series of questions pertaining to his position, as well as his views on engineers and engineering in general. The results are the basis of this article.

A second article, appearing in the Oct. 25 issue, will take this approach one step farther: How can engineering schools, engineering societies and engineering companies help engineers become successful managers? The chief engineers will pinpoint the present failings.

---

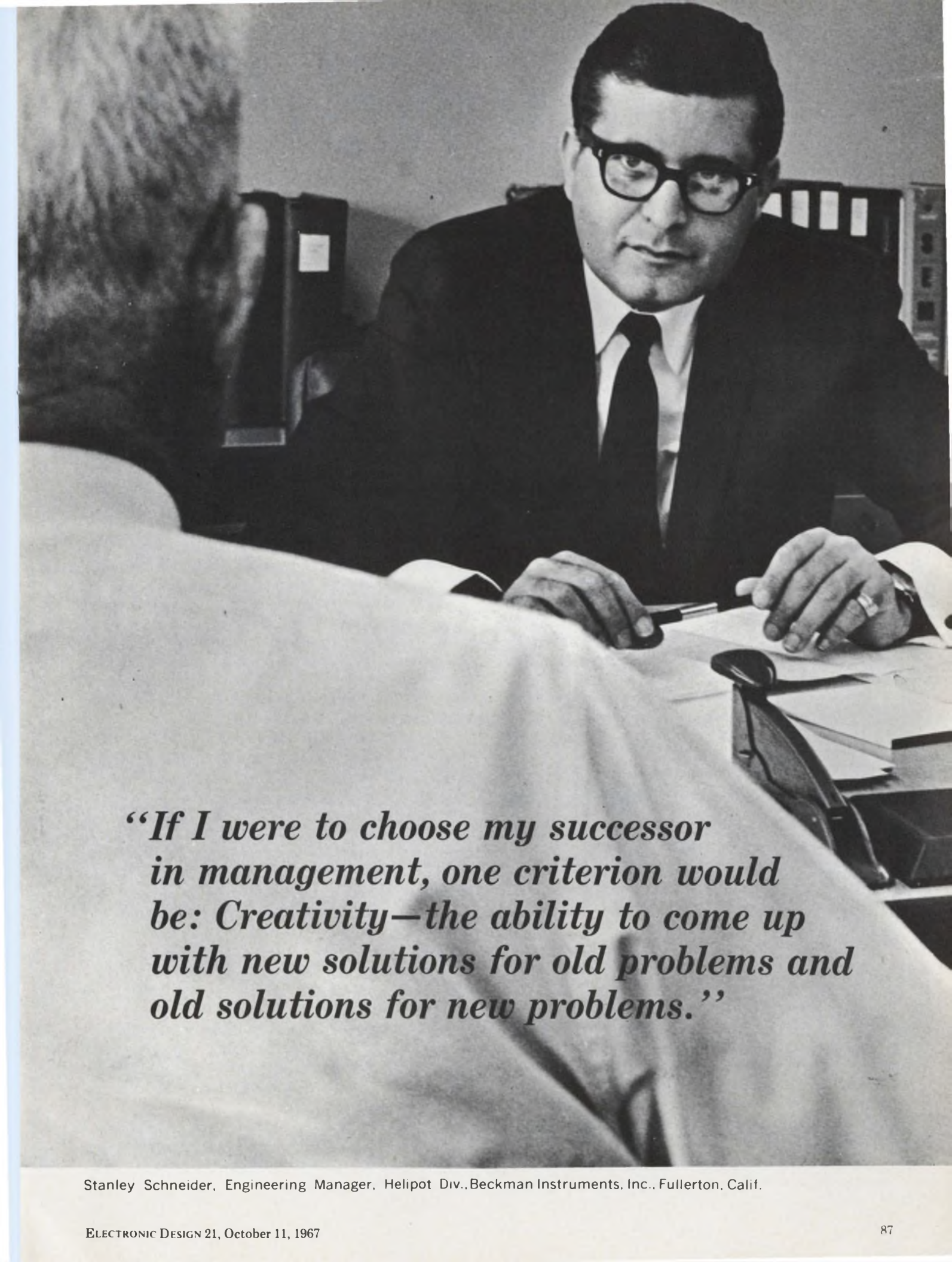

*“If I were to choose my successor in management, one criterion would be: Creativity—the ability to come up with new solutions for old problems and old solutions for new problems.”*

Stanley Schneider, Engineering Manager, Helipot Div., Beckman Instruments, Inc., Fullerton, Calif.

■ *Worked for four companies, including his present one (Fig 2).*

■ *Makes 38.7 per cent more in his present position than he would be making if he had not moved into management (Fig. 4).* Those interviewed were asked to cite a percentage based on the top salary of a non-management engineer in the company. (A recent salary survey conducted by the Engineering Manpower Commission of the Engineers Joint Council generally corroborates these findings. (See Fig. 3)

■ *Spends half his time in nonengineering work, administrative, personnel, etc. (Fig. 5).* Time spent supervising engineering projects was considered engineering work for survey purposes.

■ *Supervises 70 technical employees.* The survey clearly demonstrated that there was absolutely no correlation between the number of years a man was in engineering before becoming chief engineer and the number of technical people he was now supervising or the size of his company. One chief engineer was in the field of 36 years before moving into his present post. He now supervises 45 technical people. Another became chief engineer after only 14 years, and he is in charge of 125 technical employees.

#### **What training or experience do they wish they had more of before moving into management?**

There's no doubt how they feel about this. Four of every five--79.3 per cent--cite business management in general as essential to management, especially finance. And, further, this 79.3 per cent represents every manager who responded to the question. The other 20.7 per cent did not answer the question.

Only 7 per cent listed additional engineering or other technological training as needful. And all of these also listed business management experience as well.

Here are the most frequent responses (many gave multiple answers; thus the percentage total exceeds 100):

Business management (Specific areas mentioned most often were supervision, manufacturing, contract law, patent law and labor relations).	79.3%
Psychology or human relations	10.3%
Engineering or technological	6.9%
Liberal arts	5.0%
No response	20.7%

Many respondents placed strong emphasis on budgeting and cost accounting training:

"I sure wish I had much more business administration, especially finance and accounting, so I could read and understand these reports I get."

"More financial training definitely would have helped. I was lost when it came to budgeting. It took me a while before I could combat the accounting department."

Another response was this: "Although practical experience is still the best experience, a thorough

knowledge of accepted practices usually taught in college would have been a great help."

If there is one answer to why four-fifths of all engineering managers in the survey felt they did not have sufficient business and finance training, it may be reflected in this answer: "I wish I had taken more management courses in college. I never took any, because at age 22 I never expected to be a manager. I only wanted to become an engineer."

#### **What are the engineer's biggest adjustments in moving into management?**

You must develop the management viewpoint. You must make significant adjustments along these lines:

■ *Moving out of total engineering environment.* As already pointed out, the chief engineers polled spent half of their time on the average in nonengineering work. The engineer in moving into management gets away from the drawing board--if not entirely, at least in good part. At the same time, however, chief engineers are unanimous in believing that the other rewards--both professional and economic--more than make up for the decrease in creative engineering work.

■ *Broader responsibilities.* In moving away from the drawing board, you are no longer just an engineer responsible for yourself and your own project. You are responsible for the work of many others. If they bungle, you are held at fault.

■ *Greater pressures and demands.* You will have more people and projects making demands on your time. You will find you have less time for personal matters. But keep in mind that you are being paid more as a manager. More is expected of you.

■ *Dealing more with people instead of things.* You will have to learn how to handle people, supervise them, work with them. You will have to get to know people, how they act, react and interact.

■ *Self-discipline.* No longer can you afford to spend a disproportionate amount of time on things that you are interested in. You will have to allow time not only for your own work but also find time for the people who work for you when they need you.

■ *Communication with other departments.* As part of management, you will have to deal with your counterparts in other departments. Most engineers have no comparable experience before moving into management. Many engineers are scarcely aware other departments exist.

■ *Moving into the world of business and finance.* You must acquire the profitmaking incentive. You must learn that the company was established to make money. Many nonmanagement engineers refuse to accept this premise.

■ *Trying to remain technically current.* Paradoxically you will find yourself with less time but more need to keep up with the broader technological area into which you are moving.

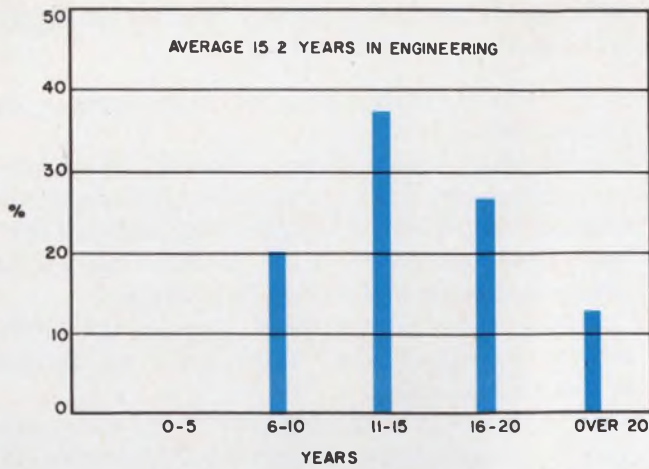

1. The chief engineers surveyed were in the engineering field an average of slightly more than 15 years before reaching their current top management positions. This graph shows the breakdown in five-year groupings.

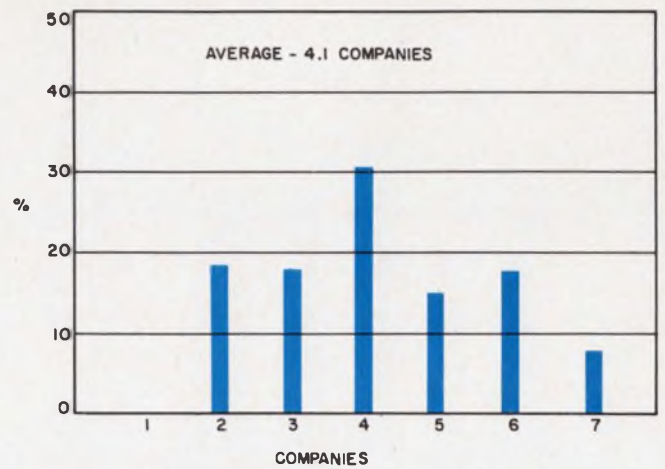

2. In his rise to top management, the chief engineer worked for an average of four companies. Above a third of the respondees cited this total, with answers ranging from two to seven companies.

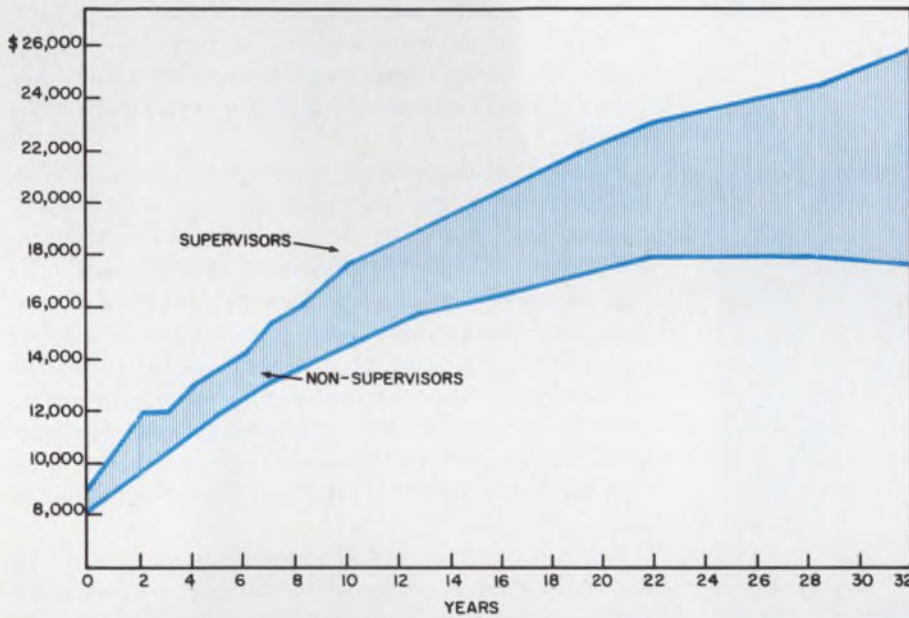

3. This graph shows the results of a recent salary survey conducted by the Engineering Manpower Commission of the Engineers Joint Council. It represents the top decile in salaries of engineers and engineering supervisors, and in general, it concurs with the ELECTRONIC DESIGN survey. Note that the salary differential continues to widen each year.

4. While the chief engineers estimated an average salary differential of 38.7% over what they would be making if they did not move into management, more than half placed the differential at 25% or less. Responses ranged from 0 to a whopping 200%. (See Fig. 3.)

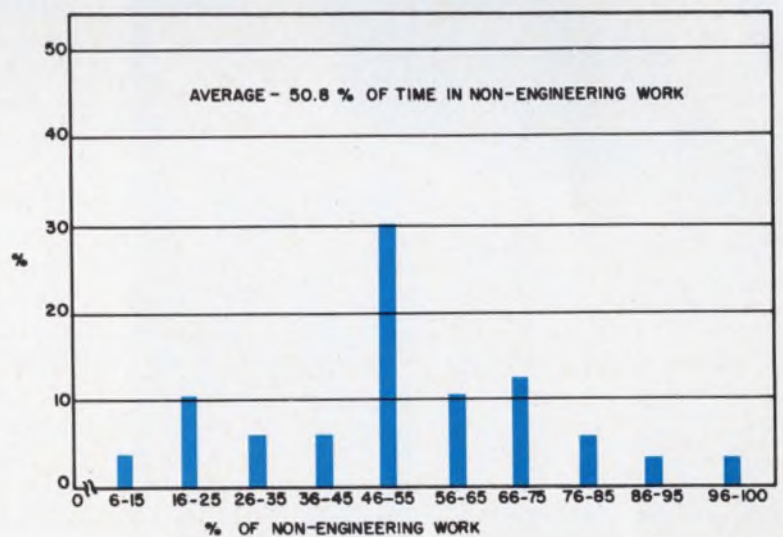
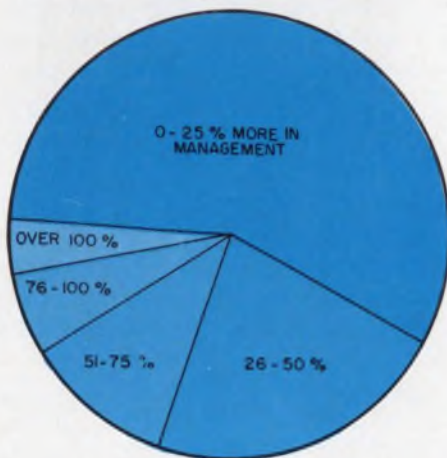

5. When asked how much time the chief engineer spends in non-engineering work, the responses followed an organized pattern. It was one of the few instances in the survey where there was such a pattern—where the mathematical average and the mean coincided. Both were 50%.

*“The way to reach the top is, pure and simply, to work hard. Keep as broad horizons as possible. Keep abreast of technology in as many areas as possible.”*



Werner Brack (left) Chief Engineer, Communication Associates, Inc., New Hyde Park, N.Y.

## What advice do chief engineers have for easing the transition to management?

While no two managers gave the same answer, a few general themes do recur:

- *Obtain a broad company outlook.* Think past your engineering work. Learn what the rest of the company is all about. A key criticism that chief engineers have of engineers is the latter's tendency "to isolate themselves in their own little worlds."

- *Become business oriented.* Acquire the profit-making incentive. Learn to think both as an engineer and as a businessman.

- *Keep pace with developments in your own and your company's areas of technology.* Maintain also a broad view of the engineering world.

- *Diversify your engineering background.* Usually this is preferred to specialization when managers are chosen. However, there are occasional exceptions, where the prime requisite is the chief engineer's knowledge of a narrow area of the company's work. Note that diversification of background does not mean a steady stream of job shifts to different companies.

- *Learn management techniques formally (by taking courses, for example) and informally (by reading and observing).* If possible, get this training before you make the movement to management. The vast majority of chief engineers surveyed found they had less time for these pursuits once they became managers. And the majority said that if they were to choose their successor, they would not necessarily promote the better engineer but the engineer with better management qualifications, assuming he satisfied the minimum technical requirements of the job.

- *Know what you are getting into before you make the move into management.* Because no two chief engineers' jobs are the same, one may involve engineering work 95 per cent of the time and another--perhaps even in the same company--engineering only 5 per cent of the time.

Here is other advice from chief engineers for paving the way to management:

"After you get that PhD in engineering, go after a Master in Business Administration."

"A good education--and I don't just mean those four years you spent getting the bachelor's degree--is vital. Continue your education. Never lose track of the status of the field. If you do, the results can be tragic."

"Learn what it means to run a business, what a business is all about."

"Have a good idea of your talents, capabilities and weaknesses. A good engineer who enjoys engineering sometimes gets shoved into management, and it proves to be the last thing he's suited for, and he hates it."

"First, pass the threshold of technical capability, then tackle management. In other words, don't try to advance too fast. Young engineers often want to

move into management before they are qualified and before they know what it's all about."

### What happens to the engineer who refuses to move into engineering management?

There is a general tendency among chief engineers to hedge on this. Many answered that nothing would happen to such engineers professionally, but then they offered qualifying statements that tended to contradict the initial responses. Nearly 100 per cent of those surveyed concurred on one obvious point, however: the nonmanagement engineer would not do as well financially.

Many engineering concerns have no place for the creative engineer to advance to once he has reached a certain plateau, unless he wants to move into management. Some chief engineers surveyed admitted that they would "take a dim view" of the man who declined to move into management.

"There would be a tendency for his stature to be reduced," one put it. "It shows that perhaps he wasn't aggressive and didn't want to get ahead."

Another: "In a small company, if the man is qualified and didn't take the job, he'd find himself in an awkward position."

But, this situation seems to be changing slowly. Some chief engineers admit that their companies found it necessary to reshape their thinking, because they were losing good engineers.

One chief engineer summed up the problem this way: "The company I worked for before would have been very averse to any engineer who did not want to move into management. Its very structure is such that they don't have anything above development engineer, unless you move into management. It was a source of great frustration, and many engineers left because of it. The company sometimes took a good engineer and made him into a manager, and this failed miserably, both from the engineer's and the company's points of view."

More and more, however, top company management around the country is recognizing the need to reshape its thinking on the nonmanagement engineer. Not all engineers have what it takes to be a manager, yet these men can be of great value in nonmanagement engineering posts.

More and more companies are adopting this policy expressed by one chief engineer:

"Our firm realizes that not every man makes a good supervisor. We are making every effort to keep good engineers by establishing pay grades and job classifications for engineers desiring to remain purely in technical areas."

But if the rewards of management are what you are after, there is this advice from a corporate director of research and development:

"There's no problem getting to the top once you're in management. The real problem is getting through the crowd at the bottom." ■ ■

*'A good engineering manager must be prepared to make decisions and then stick by them. And he must realize that there will be times when he'll make the wrong decision.'*

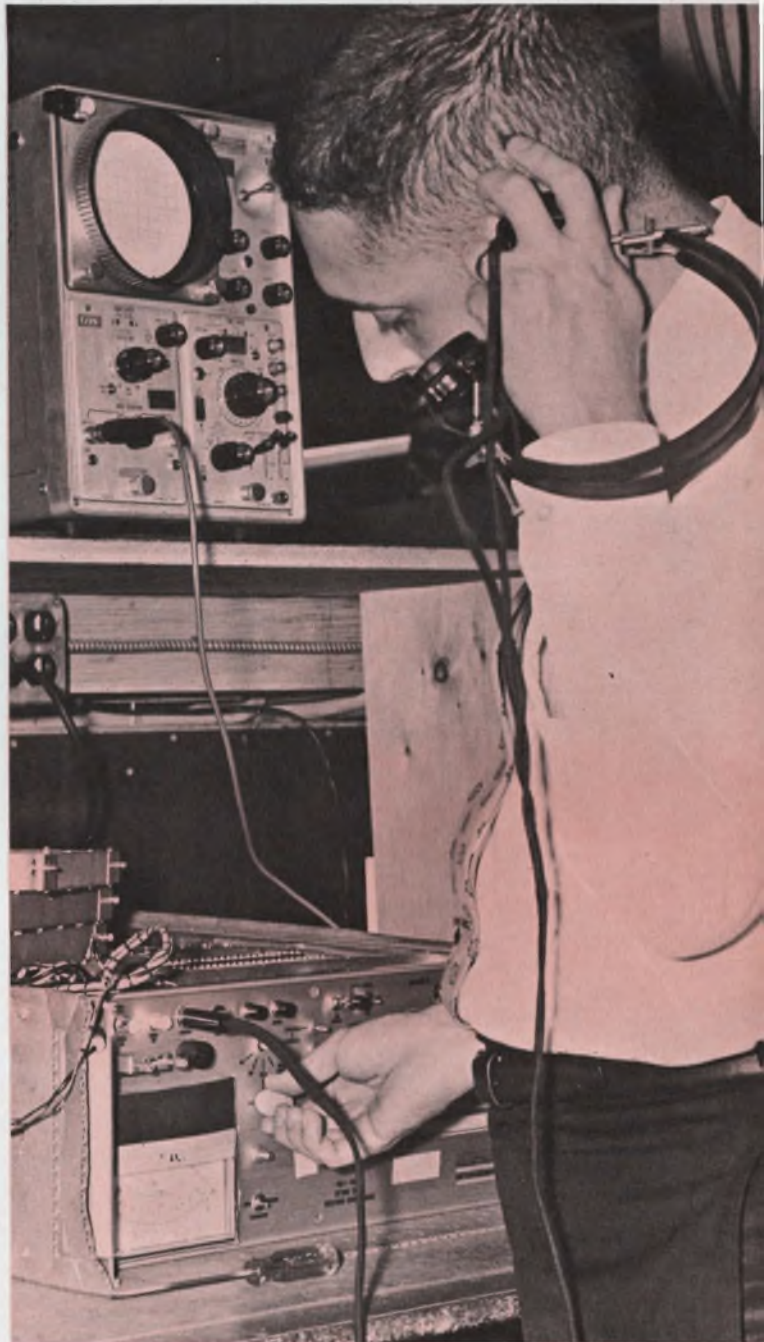

David E. Smoler, Chief Electronic Engineer, Fairchild ElectroMetrics Corp., Amsterdam, N.Y.



# information systems

---

## designed for tomorrow

In Classical Greece, a scholar could get almost all the information he needed about society, geography, science, military tactics, and religion from the poems of Homer. Today's information systems, complex as they are, will someday look nearly as quaint.

How do we know? Because our scientists and engineers are building toward tomorrow's information systems, right now. Underway now at Sylvania Electronic Systems are □ programs aimed at global communications networks □ data gathering satellite systems that will make no place on earth inaccessible □ new data handling and display techniques that will bring the world's information into useful focus quickly and efficiently.

We are designing our tomorrow. It can be your tomorrow too. Come help to create it. Send your resume in strict confidence to Mr. Kimball Shaw, Professional Staffing, Sylvania Electronic Systems, Division of Sylvania Electric Products Inc., Box 905, 40 Sylvan Road, Waltham, Massachusetts 02154.

*Opportunities in suburban Boston,  
Buffalo or San Francisco.*

**GTE**

GENERAL TELEPHONE & ELECTRONICS  
Total Communications from a single source through

**SYLVANIA ELECTRONIC SYSTEMS**

RESEARCH • SYSTEMS DEVELOPMENT • PRODUCT & FIELD ENGINEERING

An equal opportunity employer

ON CAREER-INQUIRY FORM CIRCLE 907



# Free Career Inquiry Service

## Absolutely Confidential

Respond to the career opportunities advertised in this issue. Fill out and send us this handy resume. **Electronic Design** will do the rest – neatly typed copies of this form will be mailed to the companies of your choice, indicated by the circled Career Inquiry Numbers at the bottom of this page.

# 21

<b>Name</b>		<b>Home Phone</b>	
<b>Home Address (Street)</b>		<b>City</b>	<b>State</b>   <b>ZIP Code</b>
<b>Age</b>	<b>U.S. Citizen</b> <input type="checkbox"/> Yes <input type="checkbox"/> No		<b>Security Clearance</b>

Prime Experience	Secondary Experience

<b>Desired Salary</b>	<b>Availability Date</b>
-----------------------	--------------------------

**Employment History – present and previous employers**

Company	City, State	Dates	Title
		to	
		to	
		to	

**Education – indicate major if degree is not self-explanatory**

Degree	College	City, State	Dates
			to
			to
			to

**Additional Training – non-degree, industry, military, etc.**

---



---



---

**Professional Societies**

---

**Published Articles**

---

- Career Inquiry Numbers:**
- |     |     |     |     |     |     |     |     |     |     |
|-----|-----|-----|-----|-----|-----|-----|-----|-----|-----|
| 900 | 901 | 902 | 903 | 904 | 905 | 906 | 907 | 908 | 909 |
| 910 | 911 | 912 | 913 | 914 | 915 | 916 | 917 | 918 | 919 |

**ELECTRONIC DESIGN**  
 850 Third Avenue  
 New York, New York 10022

## transistor circuits engineer

to work in Industrial Controls with Marathon's new R&D division in Southern Connecticut. If you want the freedom to tinker, designing generator voltage regulators and variable speed drives for both AC and DC motors, and industrial control applications, like logic functions, etc. . . . then you're our man. There are no limitations on salary . . . because the man we seek must be good.

This is the ground floor opportunity you've been seeking . . . to work in green New England and see your plans and ideas come to life at the start of this new division.

Interested? Write today with complete resume and your salary needs.

\*Mr. A. Gutterman

**Marathon**  
**Electric**  
MANUFACTURING CORPORATION  
Control Development Group  
533 Pacific St., Stamford, Conn. 06902

ON CAREER-INQUIRY FORM CIRCLE 902

MOLDED Diallyl Phthalate

## TERMINALS TEST JACKS

- Highest Reliability
- Meet Military Specs  
MS-16108 Rev. F Test Jacks  
MIL-T-55155 Terminals

Metal inserts are molded into high-temperature DIALLYL PHTHALATE, forming a strong integral unit that will not crack while soldering.

Replacements for competitive items available. Send us your requirements.

**Nurl-Loc**<sup>®</sup>

- Metal-to-metal press-in design
- Solid molded Diallyl Phthalate construction
- Highest radial and axial pullout resistance.

SEND FOR  
CATALOG!

30 pages with complete drawings and specifications of over 500 terminals and test jacks, in 10 colors with Mil. Spec. platings.



**ELECTRONIC  
MOLDING CORP.**

36 Church St., Pawtucket, R. I. 02860  
(401) 728-2100

ON READER-SERVICE CARD CIRCLE 73

## Book Reviews

### Technical Dictionary of ELECTRONICS ELEKTRONIK ÉLECTRONIQUE ЭЛЕКТРОНИКА

Obering, Dr.-Ing. Peter Neidhardt

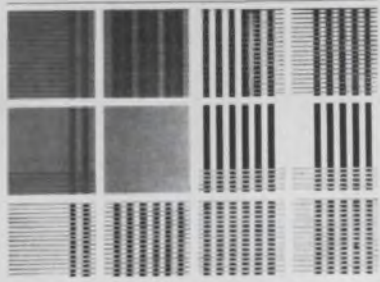

### Electronics Dictionary

*Technical Dictionary of Electronics*, Peter Neidhardt (Pergamon Press, New York), 1660 pp. \$38.50.

While the author and publishers are to be commended for their ambition in publishing a comprehensive, four-language (English, Russian, German, French) technical dictionary, its value, at least in the case of the Russian-English, English-Russian section is, at best, questionable.

Even a very brief review of these sections reveals many gross inaccuracies that tend to make the book practically useless except to those who can spot such errors (but such readers do not need the dictionary). For example, on page 1306, entry N 320 in Russian (I transliterate) reads "gorelka." This means not "nozzle" as stated, but "burner." A nozzle in Russian (when it is a nozzle of, say, an oil burner, would be called "forsunka").

There are many other errors too numerous to list. The point is, that in technical translation, even minor inaccuracies in jargon can totally nullify the value of an article.

While a multilingual dictionary would be of value, this one falls short of the mark.

Peter N. Budzilovich

CIRCLE ON. 250

### Semiconductor devices

*Physics and Technology of Semiconductor Devices*, A. S. Grove (John Wiley & Sons, New York), 366 pp. \$12.95.

This treatment of semiconductor-device physics focuses on modern planar silicon devices which form the basis of integrated circuits. Important physical principles are brought to the fore by simple physical models and illustrated by experimental measurements. The first part of the text is a quantitative treatment of those processes of solid-state technology that determine the electrical characteristics of semiconductor devices. The second part deals with semiconductors and semiconductor devices. The third part covers surface effects and surface-controlled devices.

CIRCLE NO. 251

### Communications engineering

*Communication System Engineering Handbook*, Donald H. Hamsher, ed. (McGraw-Hill Book Co., New York), 970 pp. \$28.50.

This digest of communications system engineering ranges from the preliminary analysis of system requirements to the installation of wires and cables. Designed to help the specialist in one field relate his expertise to associated fields, the book covers principles, customary practices and variations, and standards. The book begins with information needed prior to system design, goes through the development of the communication system plan, and the variety of transmission and switching components of the system, to the essential auxiliary and supplementary topics of power, facility layout, operation, and costing. Particular consideration is given to data transmission, closed-circuit television, potential address systems, and radio frequency assignment procedures.

CIRCLE NO. 252

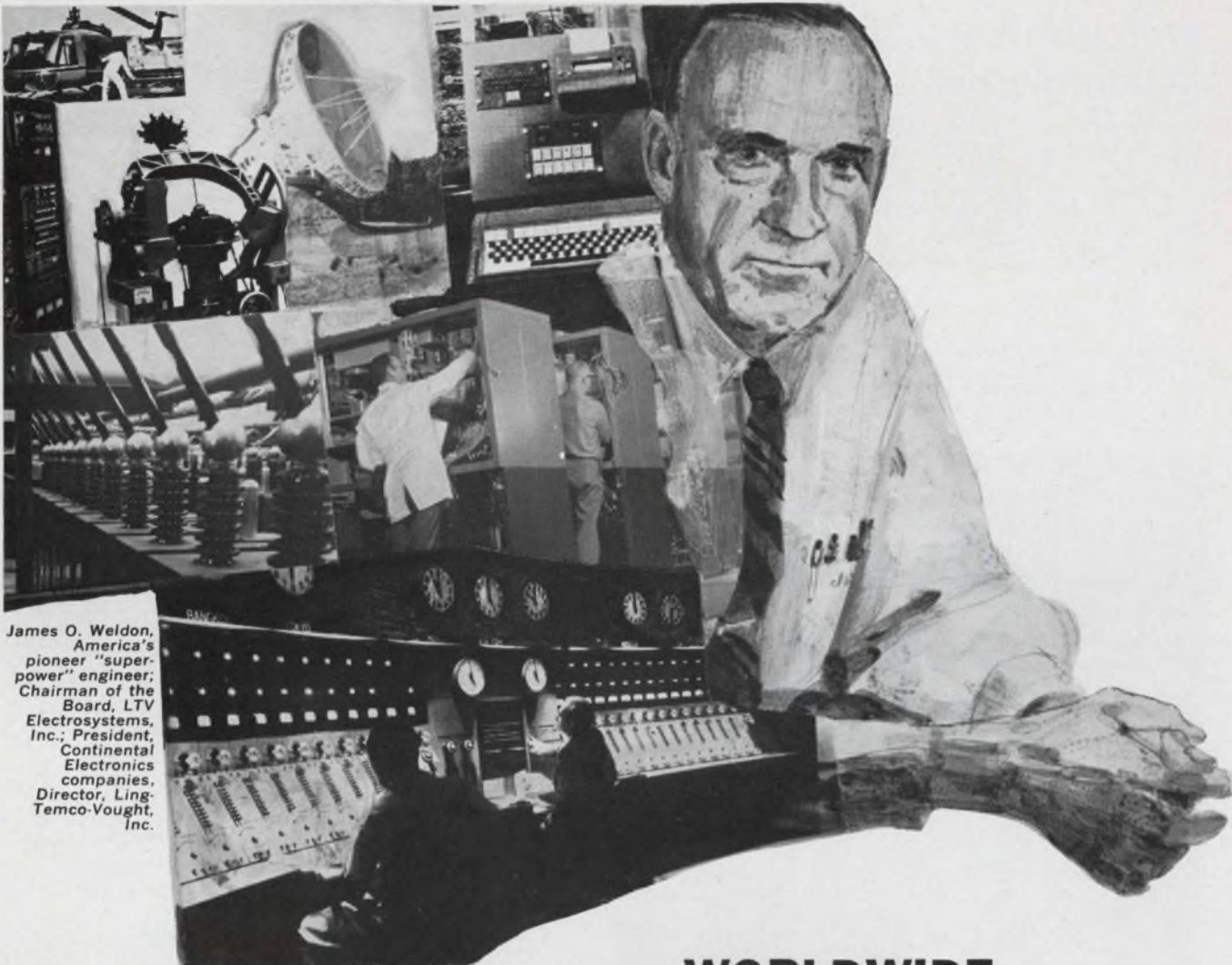

James O. Weldon, America's pioneer "super-power" engineer; Chairman of the Board, LTV Electrosystems, Inc.; President, Continental Electronics companies, Director, Ling-Temco-Vought, Inc.

## WORLDWIDE COMMUNICATIONS: STATESMAN OF THE ART

If you have the penchant to design RF transmitters capable of bouncing signals off the sun, or broadcasting the Voice of America to the four corners of the world, or beaming orders to a submerged submarine 10,000 miles from home — perhaps you should be working for Continental Electronics.

Continental, under the leadership of its founder, James O. Weldon, is the Free World's most experienced designer and producer of super-power transmission systems. In the past decade, Continental has been prime contractor for every major operational VLF installation, including the Navy's NAA at Cutler, Maine, and NWC in Australia, the world's most powerful radio stations; NATO VLF England; NATO VLF Mediterranean; and, currently under construction, the \$15 million NATO VLF Norway.

The company is also a prime contractor for the VOA, building much of its present network and primary feeder station (world's most powerful broadcast facility).

Continental — a major operating unit of LTV Electrosystems — produces transmitters and related equipment for any requirement: MF and HF broadcasting; long-range military communications; acquisition, space-probing and missile re-entry

physics radars; high-power RF energy sources and worldwide navigation systems. The company recently doubled its manufacturing capacity with the opening of a new high-power transmitter volume production facility — the first in the industry. First-rate technical talent is always welcome at LTV Electrosystems. A wide variety of challenging engineering, production and managerial positions are available throughout the company, which, in addition to Continental Electronics, includes the Greenville, Garland and Memcor divisions.

Specialists in the following (and related) disciplines are invited to examine the challenging career opportunities now open at LTV Electrosystems: RF systems analysis; RF circuits design; digital systems analysis; digital circuits design; broadcasting, communications and radar transmitter design; electro-optics; airframe design; weights and stress analysis; electromechanical engineering; information theory; physics; scientific programming; business programming; EDP systems analysis.

Write or call today: Mr. Bill Hickey / Supervisor of Professional Placement / P. O. Box 6118 / Dallas, Texas 75222 / Telephone (214) 276-7111. An equal opportunity employer m/f.

**LTV ELECTROSYSTEMS, INC.**  
A SUBSIDIARY OF LING-TEMCO-VOUGHT, INC

ON CAREER-INQUIRY FORM CIRCLE 903

# The lighted pushbutton switch with aerospace quality at commercial prices!

The MSC Series 12 embodies aerospace features that reduce installation costs, increase performance and simplify maintenance, yet it is priced for commercial use. Compare the features below. From the Twist/Lock front end removal for easy lamp, legend and color filter change to the time and cost saving internally bussed lamp circuits, you'll see why it is your best buy for industrial controls and any commercial equipment.

## GET THE 20-PAGE CATALOG 2001

It details the many options offered by the versatile Series 12. Use the reader service card . . . or write on your letterhead and ask for an operating demonstration by your nearby MSC specialist.



# Series 12

## TWIST-LITE® II

### LIGHTED PUSHBUTTON SWITCH

**4-LAMP VERSATILITY**  
INDIVIDUAL COLOR CONTROL

**REMOVABLE FRONT-END ASSEMBLY**  
Will not actuate switch when replaced.

**SNAPS INTO PANEL CUTOUT**  
No tools or hardware required

**SNAP-ON SWITCH MODULES**  
RATED AT 5 AMPS/125 OR 250 VAC

**OPTIONAL HOLDING COIL FOR ELECTRICAL INTERLOCK**

**INTERNALLY BUSSED LAMP CIRCUITS**

**12 MOUNTING OPTIONS**  
Spring clip or colored barriers

**TWIST**

**EXCLUSIVE FRONT RELAMPING**  
with Twist/Lock safety  
No tools required.

**FULL DISPLAY TO 4-WAY SPLIT**  
Legends supplied with order

# Master Specialties Company

25 YEARS IN INFORMATION DISPLAY AND CONTROL DEVICES

**MSC** Master Specialties Company, 1640 Monrovia, Costa Mesa, Calif. 92627 • Telephone (714) 642-2427 • TELEX 6-78433  
Offices in Principal Cities.

**Also available thru AVNET ELECTRONICS**  
WESTBURY, LONG ISLAND, NEW YORK • (516) 333-5800

ON READER-SERVICE CARD CIRCLE 108

## BOOK REVIEWS

### 'Slip-stick' manual

*The Slide Rule: A Complete Manual*, Alfred L. Slater (Holt, Rinehart and Winston, Inc., New York), 291 pp. \$5.50.

This manual is a prime source for skill in manipulating the slide rule's scales. The basic mathematical scales (C, D, CI, CF, DF, CIF, R, Sq,  $\sqrt{\quad}$ , A, B, & K) are clearly explained. A little elementary algebra will suffice for these chapters. Trigonometry that would be needed is shown on the slide rule itself. The trigonometric scales (S, St, & T), the logarithmic scale (L), and the log-log scales (LL) are discussed in separate chapters.

Numerical examples aid understanding; exercises are included in each chapter; correct answers are supplied for each exercise.

The base-10 LL scales, the hyperbolic scales (Sh, Th), and exponential scales (Ln) are briefly discussed in the appendix.

The college student or twelfth-year mathematics student will find this book valuable, but for further, more esoteric "slip-stick" handling, the reader will have to go to other sources of information.

*William Alvarez*

### Electronic sensors

*Electronic Sensing Devices*, A. F. Giles, (CRC Press, A Div. of Chemical Rubber Company, Cleveland), 158 pp. \$13.50.

The application of physical- and chemical-electronic effects to the solution of industrial problems is reviewed, with chapters on solids, liquids and gases and on capacitance and magnetic induction effects. Applications covered range from polarography to digital-positioning systems. The book assumes some knowledge of electronics but the treatment is non-mathematical.

CIRCLE NO. 253

As a further service to our readers, ELECTRONIC DESIGN is now including a Reader's Service number with book reviews. Publishing companies have agreed to supply information about their books to interested readers.



# **AGE engineering is the art of anticipation**

## **Keeping ahead of this one requires a special sophistication**

The F-111 places heavy demands on the foresight of an AGE engineer.

This—the most advanced combat aircraft in the U.S. arsenal—has already been extended to several versions. Ground- and carrier-based fighters. Attack bomber. Reconnaissance craft. Our AGE engineers, who pioneered and developed AGE for the original F-111, are now committed to a still more challenging task: developing equipment to test all aircraft configurations—present and future—so that as new avionics systems and aircraft missions are defined, the additional test needs can be met without major redesign. Necessarily, the equipment will require an expanded depth of testing capability, combined with a high degree of compactness and rugged construction for deployment and usage in all areas of the world.

The magnitude of the systems and design problems to be encountered really comes into focus when you consider the complexity of Aerospace

Ground Equipment: it's a highly-automated test and fault-location system which includes a video station, radar/receiver/transmitter modulator station, indicator/controls station, central air data computer station, radar servo and indicator station, computer station, penetration aids station, attitude and rate station, UHF communications station, HF communications station, TACAN station, HF communications flight-line tester, IR station, UHF guidance station and digital station—each sophisticated enough to test state-of-the-art equipment.

And this is only one of the programs our AGE laboratory is "writing the book" on. Other programs include internal and external checkout systems for missiles such as Atlas, Nike-Zeus and Polaris . . . flight-line and depot systems for terrain-following radar . . . SSB equipment . . . automated vehicular trouble-shooting systems, and many more.

Obviously, if any of these areas dovetails with your interests, we have a lot to talk about. (You'll quickly see why so many engineers like the growth atmosphere of the Electronics Division.)

If you'd prefer to move in another direction, send us your resume anyway. We have rapidly expanding study and development programs going in ASW, radio communications, data equipment, navigational aids, tracking equipment and countermeasures. Opportunities are wide open.

Direct your resume, in confidence to, Mr. J.P.O'Reilly, Dept. 131.

**GENERAL DYNAMICS**

*Electronics Division*

1400 N. Goodman Street, Rochester, New York 14601  
An Equal Opportunity Employer (M&F)

# Level detector has independently adjustable hysteresis and trip point

This regenerative level detector (see figure) has several advantages over a conventional Schmitt trigger; its trip point and hysteresis are independently adjustable, it has good temperature stability obtained by using a differential comparator circuit and a low-temperature-coefficient Zener diode, and the full supply voltage is available in the on state.

Q1 and Q3 form a differential comparator. The reference level is fixed by Zener diode D1, adjusted to the desired value by means of R7, and applied to the base of Q3. The input signal is applied to the base of Q1 through R1.

When the input signal exceeds the reference, Q1 starts conducting and Q3 cuts off. Then Q2 is turned on by a negative swing of the Q1 tapped collector load and its collector voltage rises to near the positive supply value. The regenerative effect takes place through R4, which is tied to the sliding contact of potentiometer R5, and results in fast switch on. R5 is the Q2 collector load. When the input signal decreases below the reference value, the reverse process takes place and Q2 switches off.

Varying the loop gain by means of R5 allows the hysteresis to be adjusted from few millivolts to one volt without altering the trip level.

Varying the reference level by means of R7 allows the trip point to be adjusted from 0.7 volt to 5 volts without affecting hysteresis.

Temperature-stable reference is achieved by

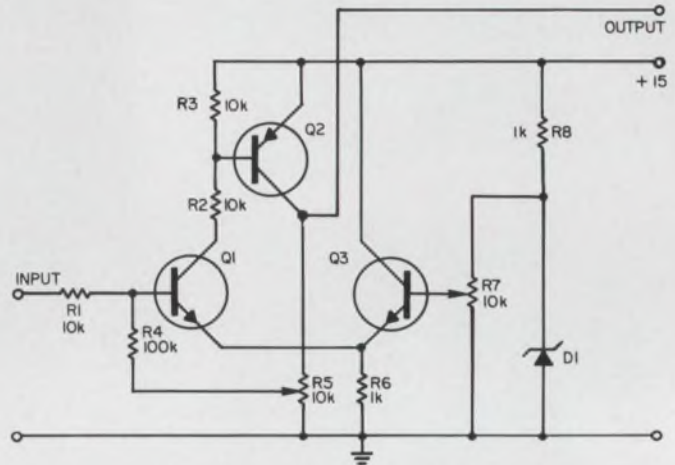

**Trip point and hysteresis** can be independently adjusted by varying R5 and R7, respectively. See text for suitable transistors and diodes.

using the Zener diode within a 5.6-volt range, because its temperature coefficient is very low.

Tests carried out with a 15-volt supply voltage showed that varying it from 10 to 20 volts had negligible effect on trip level and hysteresis.

Suitable semiconductors are the following: for Q1 and Q3: 2N1711, 2N2219, 2N2222, 2N3904 or equivalent types; for Q2: 2N2905, 2N2907, 2N3906, or equivalent types; and for D1: 1N708

*Robert Billon, Design Engineer, Meylan, France.*

VOTE FOR 110



**VOTE!** Go through all Idea-for-Design entries, select the best, and circle the appropriate number on the Reader-Service-Card.

**SEND US YOUR IDEAS FOR DESIGN.** You may win a grand total of \$1050 (cash)! Here's how. Submit your IFD describing a new or important circuit or design technique, the clever use of a new component or test equipment, packaging tips, cost-saving ideas to our Ideas-for-Design editor. You will receive \$20 for each accepted idea, \$30 more if it is voted best-of-issue by our readers. The best-of-issue winners become eligible for the Idea Of the Year award of \$1000.

## Fail-safe unit operates from NiCad batteries or ac line

The circuit (see figure) used in a 12-volt NiCad battery or an ac-operated unit simplifies front-panel switching and protects against battery failure. In addition, the battery-charging circuit provides the power supply for ac operation.

Objections to battery-operated equipment have been that failure of the battery makes the unit unusable unless complicated and confusing switching is incorporated. This switching scheme has three stable positions—off, ac or battery operation—and one momentary position—battery test. In ac operation, a low ripple dc voltage of about 15 volts powers the unit and charges the

## PROGRESS REPORT



The lines on this part are about one-seventh the diameter of the usual paper staple

3 mil lines on 5 mil centers

APPROXIMATELY ACTUAL SIZE

ENLARGED 5 TIMES TO SHOW DETAIL



## PRECISION METALLIZING ON Substrates

New precision of metallized patterns is now practical on Substrates produced to the customer's blue print. Definition is sharper, tighter pattern tolerances are now possible, line widths have been materially reduced, and line conductivity has been increased.

The basic ALSiBase substrate is usually an ALSiMag high-alumina ceramic, which has excellent heat dissipation. Where heat conduction is especially important, ALSiMag beryllia ceramics may be specified.

The size and complexity of design control the metallizing capabilities to some extent. This new precision metallizing offers several advantages to the designer:

- Circuit space is saved.
- Pattern sizes up to 3" square are practical.

- Line widths of 7 mils on 14 mil centers are readily handled.
- 4 mil lines on 8 mil centers can converge about a chip area.
- In some instances, even smaller line widths and closer centers are feasible. Specific inquiry is suggested.
- Line resistance down to 10 milliohms per square or better is often possible.
- The metallized areas can be supplied with plating to facilitate chip attachment, wire bonding and hermetic sealing.

Designers are invited to explore with our Engineers the possibilities of these newest capabilities in precision. All production processes of metallizing and plating are concentrated in one specially designed climate controlled area. Prototypes are available at reasonable cost.

CODE IDENT. NO. 70371

PHONE 615 265-3411, CHATTANOOGA, TENN. 37405

American Lava Corporation **3M**  
A SUBSIDIARY OF COMPANY

For service, contact American Lava representatives in Offices of Minnesota Mining and Manufacturing Company in these cities (see your local telephone directory): Boston: Needham Heights, Massachusetts • Chicago: Glen Ellyn, Illinois • Cleveland, Ohio • Dallas, Texas • Laurens, S. C. • Los Angeles, Calif. • Metropolitan New York: Ridgefield, N. J. • Up-State New York and Canada: Baldwinsville, N. Y. • Orange, Conn. • Philadelphia, Penna. • Roanoke, Virginia • St. Louis: Lee's Summit, Missouri • So. San Francisco, Cal. • Troy, Mich. • 3M International: c/o American Lava Corp., Chattanooga, Tenn. 37405, U.S.A., 615/265-3411

66th  
YEAR  
OF  
CERAMIC  
LEADERSHIP

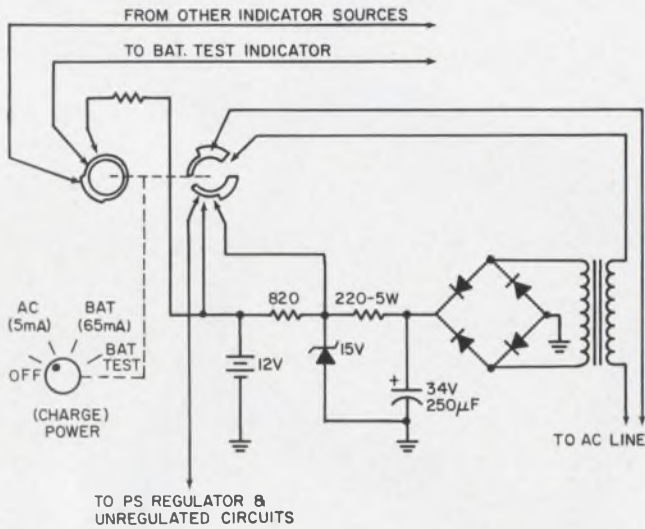

**Battery-charging circuit** doubles as the power supply to operate the unit either from ac or a battery.

battery at a trickle current of 5 mA. Shorting or opening the battery causes no failures. In battery operation the trickle-charge 820- $\Omega$  resistor is shorted out and the 12-V dc from the battery powers the unit. For fast battery-charging, the power cord is plugged in when the unit is in battery operation. The Zener diode prevents overcharging by limiting the battery voltage to 15 volts. If the battery shorts, the unit will still function in ac mode. If the battery opens, the Zener will protect the circuitry in the unit from overvoltage. The battery test position checks the battery while the ac power is removed, but the loading of the unit is on the battery.

*John Collins, Chief Engineer, and William Whitaker, Engineer, Rycom Instruments, Inc., Raytown, Mo.*

VOTE FOR 111

## Linear demodulator combines high output and phase sensitivity

The circuit in Fig. 1a is a standard connection for a phase-sensitive demodulator. The output is limited by the transistor's  $V_{BE0}$ ; when point A exceeds  $V_{BE0}$ , there is distortion. When  $e_{IN}$  is in phase with  $e_{REF}$ , reducing  $R3$  to 1 k $\Omega$  will forward-bias the collector diode and  $Q1$  will lose its transistor action. Both half cycles will then pass through and yield an erroneous dc output.

For a high transfer function, the transistor grounding network is located at the input, as shown in Fig. 1b.

Transistor  $Q1$  grounds the positive half cycle of

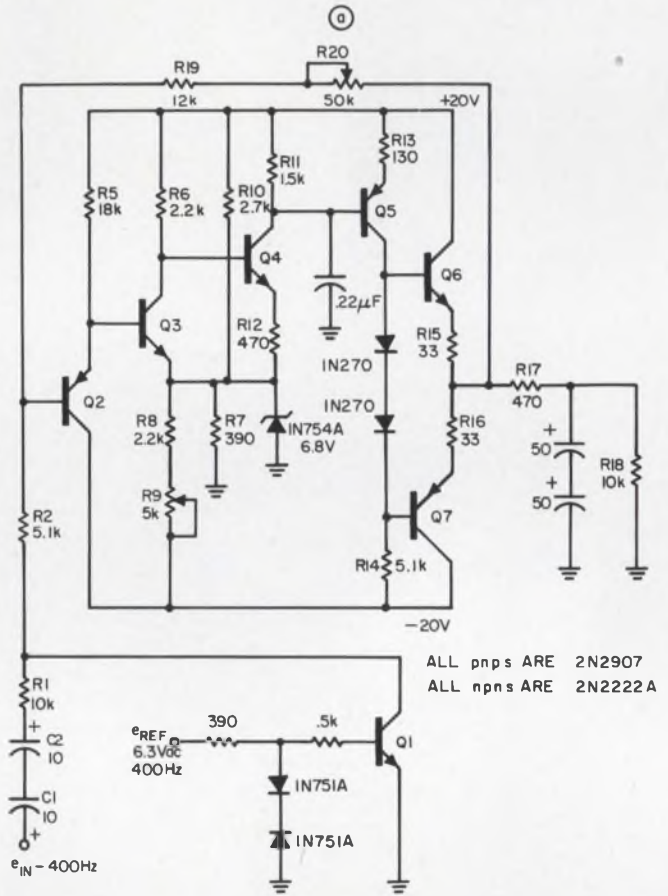
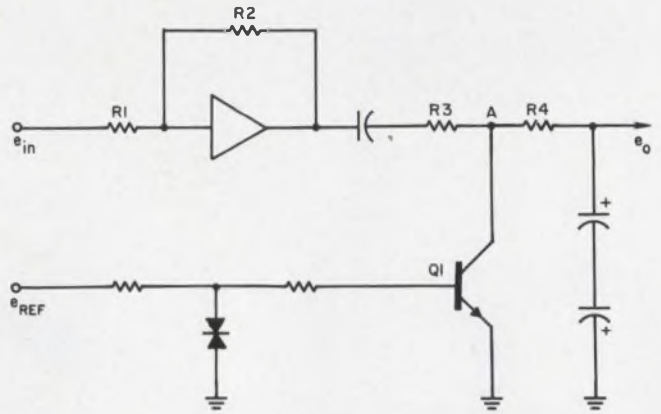

(b)

1. Standard phase-sensitive demodulator (a) is implemented as shown in (b). The dc output is positive when  $e_{IN}$  is in phase with  $e_{REF}$  and negative when  $e_{IN}$  is out of phase with  $e_{REF}$ .

the input signal, when  $e_{IN}$  is in phase with  $e_{REF}$ , to produce a positive dc output. Similarly the output is negative when  $e_{IN}$  is out of phase with  $e_{REF}$ .

The output is linear when:

$$e_{IN(peak)} R2 / (R1 + R2) < V_z + 0.7$$

or:

$$e_{IN(peak)} < (V_z + 0.7) (R1 + R2) / R2,$$

where  $V_z$ , the Zener voltage, is less than the  $V_{BE0}$  of  $Q1$ .



# How to improve your memory: Part I

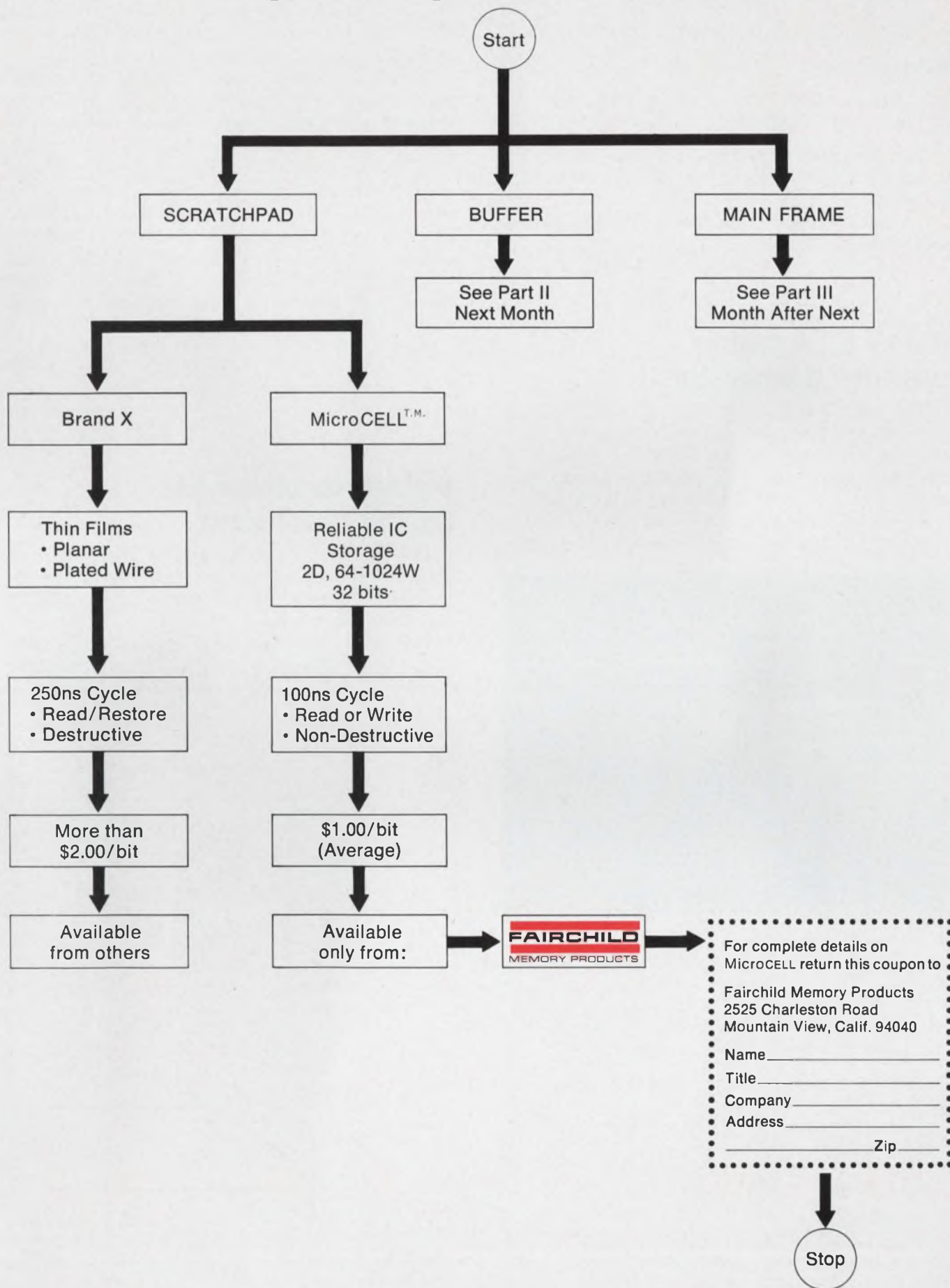

ON READER-SERVICE CARD CIRCLE 47

The input-output transfer function is:

$$E_{O (dc)} / E_{IN (rms)} = [(R19 + R20) / (R1 + R2)] [R18 / (R17 + R18)] [(1.41) (0.636) / 2].$$

The maximum dc output is 5.5 volts.  $R9$  sets the dc output to zero with  $e_{IN} = 0$  after  $R20$  has been adjusted.

*Nelson Nekomoto, Designer, Tasker Instruments Corp., Van Nuys, Calif.*

VOTE FOR 112

## A 2-kV 0.1-A switch uses mesa transistors

The use of mesa transistors in the avalanche mode to obtain short-rise-time, high-speed switching has long been known. It is also possible to operate high-voltage mesas in series to obtain an economical high-voltage switch, as illustrated in the accompanying figure. A 5-volt pulse is used to turn on  $Q1$ . This permits  $Q2$  through  $Q5$  to oper-

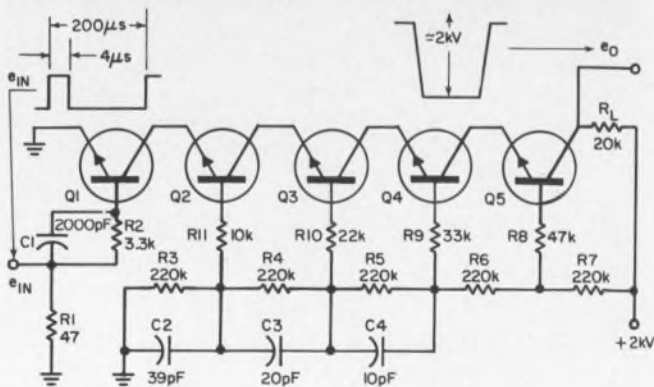
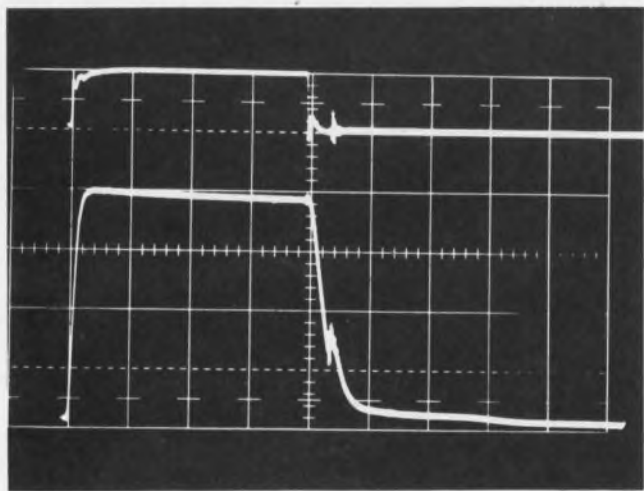

$Q1=Q2=Q3=Q4=Q5=2N5095$

**2-kV pulses are obtained** by applying a pulse of 5 volts to the base of  $Q1$ . Input (upper) and output (lower) traces show the circuit action.

ate.  $R3$  through  $R7$  force equal sharing of supply voltage on a dc basis. Capacitors  $C2$  through  $C4$  prevent excessive voltage surges during turn-on.  $R8$  through  $R11$  prevent excessive base drive and also offer some  $V_{BE}$  compensation.

Transistor leakage current is in the microampere region. Therefore, if the entire circuit is operated as a series element, the off resistance is essentially that of  $R3 + R4 + R5 + R6 + R7$ , which is more than 1 megohm. The oscilloscope photograph shows a 5-volt, 4- $\mu$ s input pulse and the output pulse (shown inverted for comparison). The drop across the transistor after avalanche is negligible.  $t_d + t_r \approx 0.4 \mu$ s and  $t_s + t_f \approx 0.4 \mu$ s. In this case the duty cycle is 2%. The storage and fall time can be reduced by returning the bases to a slightly negative (2-4 volts) supply.

An inductive load will require diode-clamping.

*Saul A. Ritterman, Assistant Professor, Bronx Community College, New York.*

VOTE FOR 113

## Voltage regulator has built-in delay time

This high-gain voltage regulator with only two transistors (see schematic) has characteristics superior to those of the commonly used compound emitter-follower type.

The circuit was used in a 30-watt stereo amplifier which required not only a well regulated supply, but also an output voltage that would rise

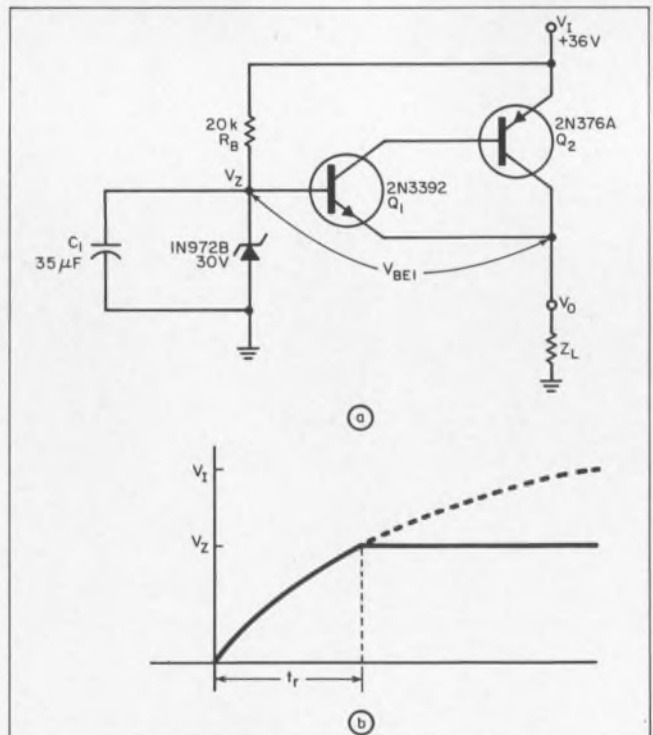

**Slow build-up of output voltage is obtained** (a). The delay time is about 2 seconds (b).

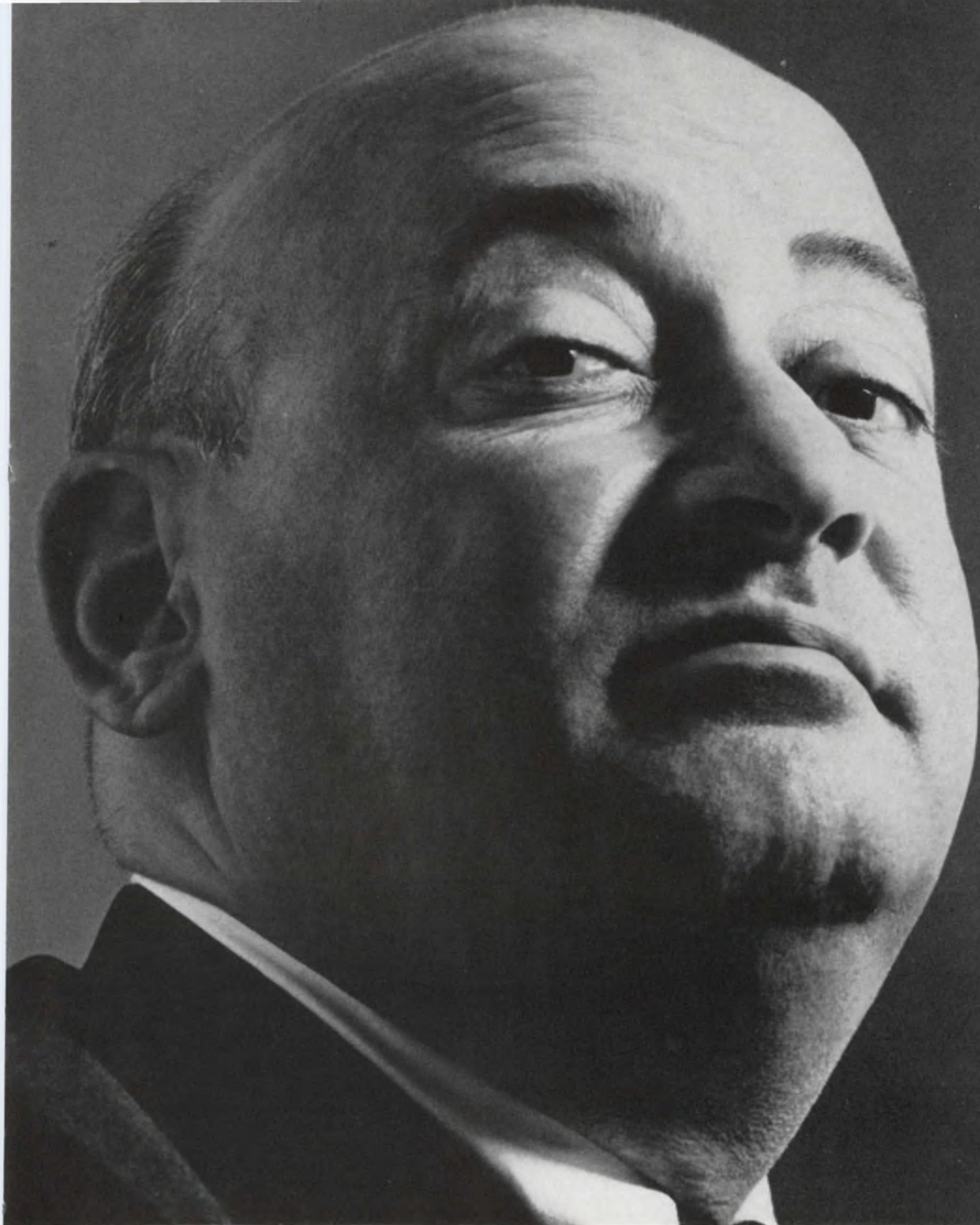

## Why do so many people come to us when there's GE, Westinghouse and Tung-Sol?

Hudson designs and makes a full line of great miniature, sub-miniature and micro-miniature lamps—millions of them. But we're not giant-killers for that alone. Our product is lamps. Our business is service.

We climb beanstalks for our customers. If you need lamps—a box of ten or a carload—there's nothing more important to us than getting them to you on time,

in quantity. And if you need a bulb that's off the beaten path, we'll supply it without fuss or bother. At the right price. Soonest.

Next time you get a giant pain in your bulb supplier, ask for Hudson. (We get more new customers that way!) Hudson Lamp Company, 528 Elm Street, Kearny, New Jersey 07032. Telephone: (201) 997-1850.



LAMP COMPANY  
**Hudson**

Free: a new Hudson Catalog (The Giant-Killer)

slowly from zero volts when the system was first turned on. This slow application of power (approximately 2 seconds) to the power amplifiers allowed the 2000- $\mu$ F output capacitors to charge without causing excessive collector current in the output transistors.

Typical regulator output impedance is 0.1 $\Omega$ .

Output voltage is expressed by:

$$V_o = V_z - V_{BE1}$$

Output voltage rise time is:

$$T_r = -R_B C_1 \ln(1 - V_z/V_1)$$

Some digital and other systems require a preset turn-on sequence for their several power supplies. By fixing appropriate  $R_B C_1$  values, the circuit's output rise time can be set to provide this sequence or delay.

Using this circuit for the system's power supplies would simplify the task of providing several well-regulated voltages with delayed or slow rising outputs where required.

George R. Skoblin, Kearfott-San Marcos Div., General Precision, Inc., San Marcos, Calif.

VOTE FOR 114

## Integrated circuit is key to foolproof voltage regulator

A tiny and inexpensive voltage regulator (see figure) can be built with a CA 3018. In this fairly conventional circuit, the fourth available transistor in the IC and one resistor form a safety circuit, so that the IC cannot be damaged by overloading or short-circuiting the output.

When current flow is too high, the voltage drop

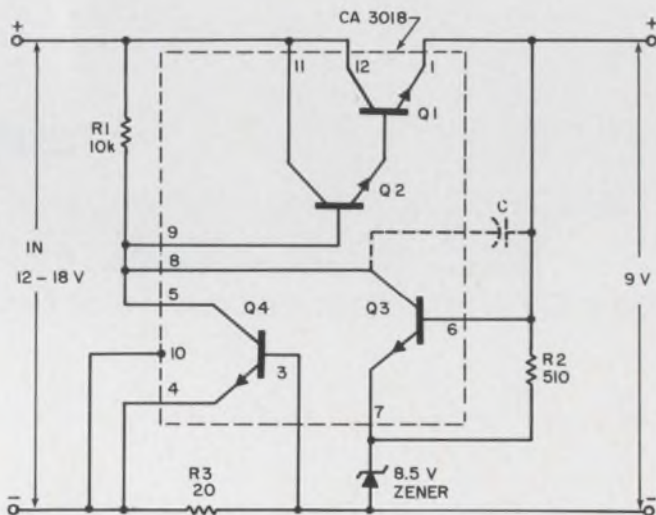

Overload and short-circuit protection is obtained in a simple voltage regulator by using Q4 and R<sub>3</sub> to limit the output current to just under 30 mA.

across R<sub>3</sub> becomes large enough to open Q<sub>4</sub> so that it can limit the current through Q<sub>1</sub>-Q<sub>2</sub>. If the value of R<sub>3</sub> is about 20 ohms, the maximum current is limited to a little less than 30 mA. At lower currents, Q<sub>4</sub> will stay closed and the circuit will act as a normal voltage regulator. To avoid high-frequency oscillations, a small capacitor (about 1000 pF or so) may be necessary.

Eckart Schmitzer, Development Engineer, Nuremberg, West Germany.

VOTE FOR 115

## Output impedance is cut in a transistor amplifier

The output impedance of a transistor amplifier can be substantially reduced by connecting load R<sub>L</sub> from the collector of Q<sub>1</sub> to an unbypassed emitter resistor, R<sub>1</sub>, as shown in Fig. 1a. Coupling capacitor C<sub>o</sub> is optional. This is a form of positive current feedback which reduces the output impedance seen by the load. For moderate ratios of R<sub>2</sub> <

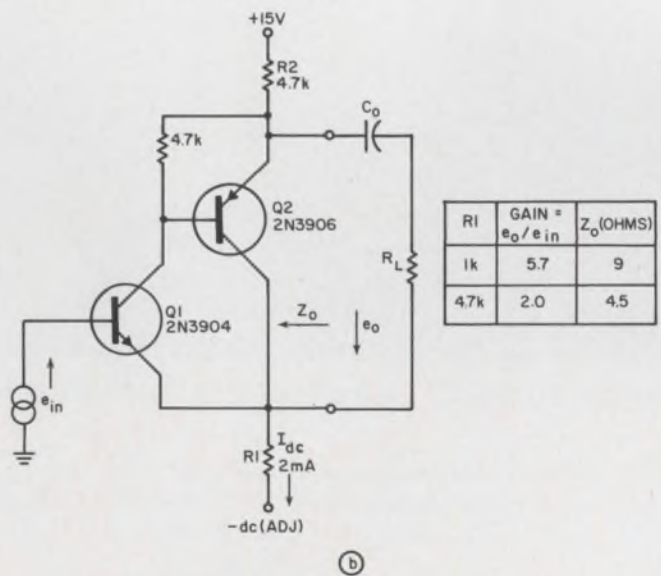
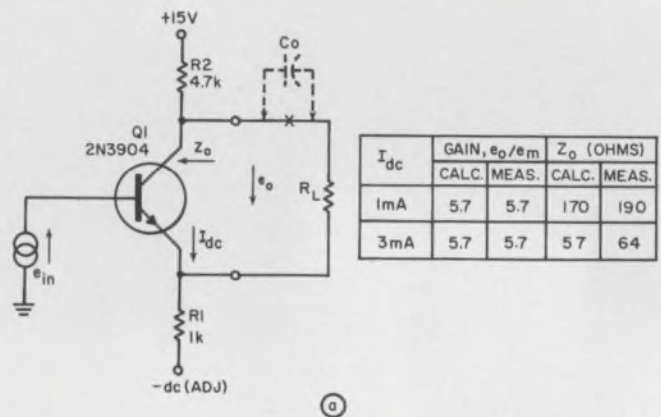

1. Low output impedance is obtained in circuit (a) when R<sub>1</sub> is connected across the transistor. Note effect of operating current I<sub>dc</sub> on the Z<sub>o</sub>. Two-transistor version (b) has much lower Z<sub>o</sub>. Note the effect of gain.

# MEPCO TRIMMING POTENTIOMETERS

Ultra-stable Film Element — Infinite Resolution

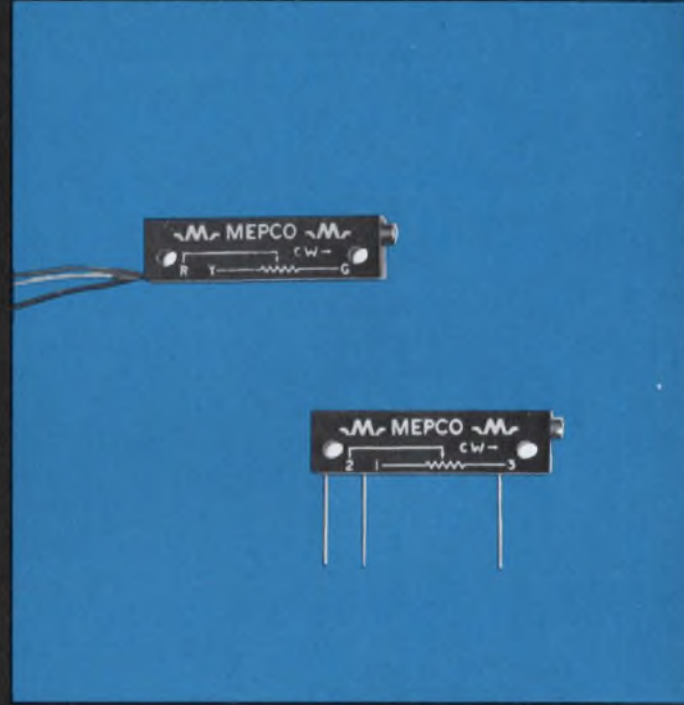
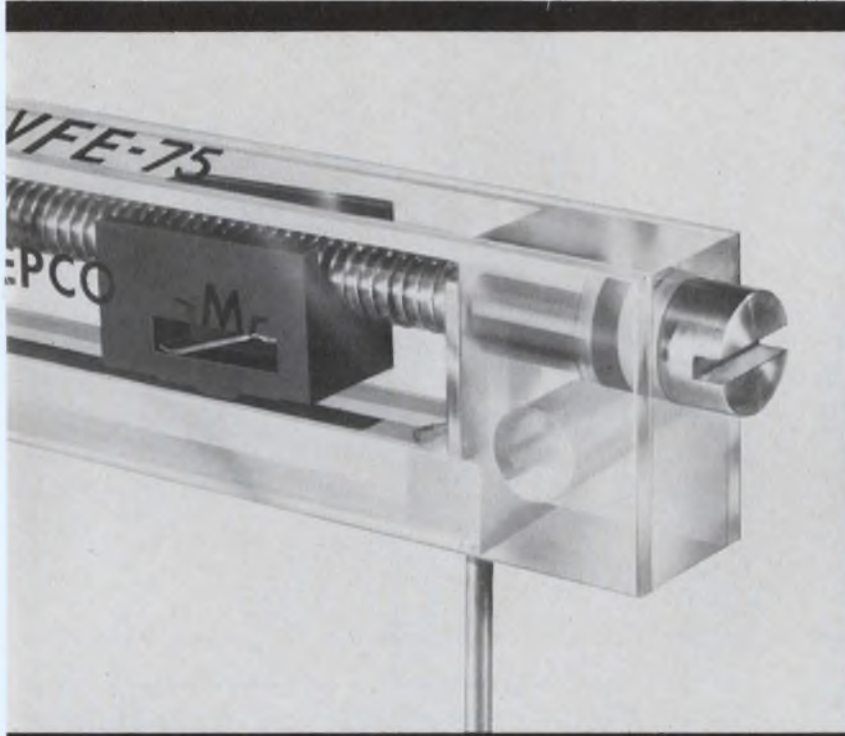

- MEPCO'S **Accutrim** Potentiometer exceeds requirements of MIL-R-22097C, Char. B.
- Temperature Coefficient  $\pm 200$  PPM; All resistance ranges;  $-55^{\circ}\text{C}$  to  $+125^{\circ}\text{C}$ ;  $\frac{3}{4}$  watts at  $70^{\circ}\text{C}$ .
- Longer Resistance Element Life assured by matching of unique slider with Fired Film Element
- Range: 100 ohms to 1 megohm
- Excellent high frequency characteristics
- Clutching life greater than 100,000 cycles
- Pin type leads molded integrally in case; Also available with flexible leads
- All welded termination construction
- High power stress capability
- One Piece stainless steel lead screw
- Precision molded case
- Sealed construction

For technical data, write or call Mepco, Inc., Columbia Rd., Morristown, New Jersey 07960 (201) 539-2000. TWX: 710-986-7437 O.E.M. Sales Offices from Coast to Coast.



*A Heritage of Reliability*  
Resistors... Potentiometers... Microcircuits... Capacitors

10  $R_1$ , the voltage gain is:

$$G = e_o/e_{in} = 1 + R_2/R_1, \quad (1)$$

and output impedance is:

$$Z_o = (1 + R_2/R_1)R_e, \quad (2)$$

where  $R_e = 30/I_{dc}$  (mA) in parallel with  $R_1$ .

$R_e$  is recognized as the output impedance of the transistor connected as an emitter follower ( $R_2 = 0$ ). The collector dc operating voltage and gain are practically independent of  $R_L$  ( $C =$  short circuit). Collector Q-point is calculated easily by assuming  $R_L = \infty$ . Connecting  $R_L$  changes the collector voltage only by the small amount given by  $\Delta E_o = \Delta I_o Z_o$ , where  $Z_o$  is given by Eq. 2. The collector-emitter junction looks like a constant voltage source to load  $R_L$ . A disadvantage of this circuit is that both ends of load  $R_L$  must be off ground.

Figure 1b shows a higher-gain version of the circuit. Performance figures for both circuits are tabulated in the figures.

Allan G. Lloyd, Project Engineer, Avion Electronics, Inc., Paramus, N. J.

VOTE FOR 116

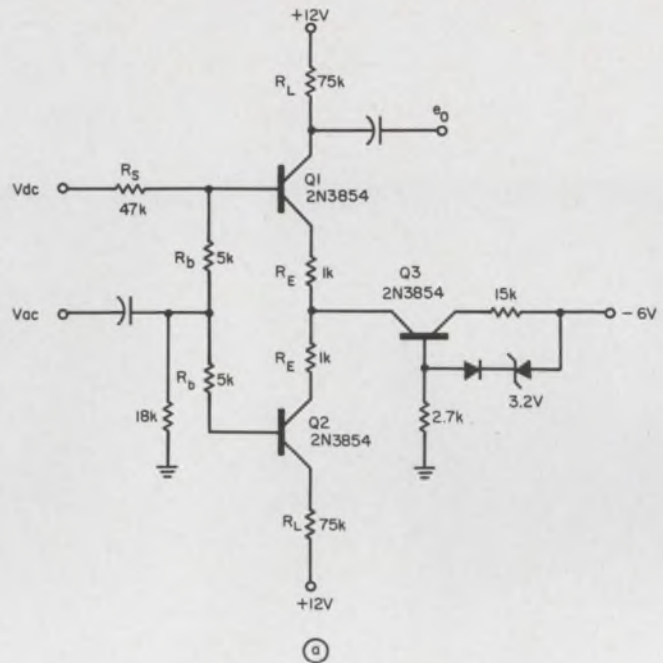

## Transformerless chopper circuit built with a differential amplifier

Standard chopper circuits use transformers. These, in certain applications, may be undesirable. Moreover, circuits with transformers are hard to adapt to integrated-circuit design.

A method for eliminating the transformers is illustrated in Fig. 1a. The circuit comprises a differential amplifier, Q1 and Q2, with a constant-current source, Q3, which offers good temperature and drift stabilization in the input stage. The operation of the circuit, however, is best explained with the aid of Fig. 1b.

$D_1$  and  $D_2$  are the base diodes of the differential amplifier input, with  $R_e$  acting as the equivalent resistance of the constant-current source. Since the output of the differential amplifier is proportional to the difference of the base diode currents of the input transistors,

$$e_o = K(I_1 + I_2 - I_3).$$

With  $V_{dc} = 0$ , the differential amplifier is balanced so that:

$$I_1 + I_2 = I_3,$$

an adjustment that is made only once with point A grounded. This produces a zero or reference output from the unit. When  $V_{dc}$  differs from zero, then the balanced state of the device is disrupted by the offset of the diode currents. By capacitive coupling out the output, the dc offset is removed so only the resultant ac offset current is transmitted.

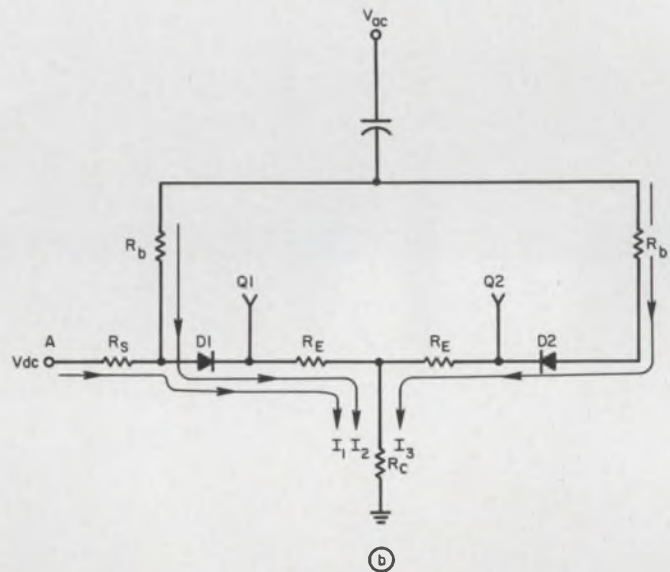

1. Transformerless chopper (a) uses a differential amplifier (Q1, Q2) and a constant-current source (Q3). The circuit action is explained in (b).

Conversion of very low dc signals can best be obtained by operating the differential amplifier at low ( $\approx 10$  microamperes) currents.

Anthony C. Caggiano, Scientific and Technical Advisor, Ridge, N. Y.

VOTE FOR 117

## Use single printed circuit for several logic card types

In designing digital circuit cards, it is desirable to build general-purpose cards which can be used in many places in the same system. One logic card

*We asked 20 of your fellow engineers*

# "WHY DO YOU CHOOSE CTS SWITCHES?"

## HERE ARE THEIR REASONS:

### "NO BREAKAGE"

They don't break on production lines or on finished equipment if dropped or jarred . . . CTS glass alkyd wafers are not brittle like phenolic . . . easy to handle.

### "NO SHIFTING"

Precision molded construction eliminates mechanical shifting of stator circuitry and terminals.

### "MORE COMPACT"

No spacers needed when stacking wafers . . . Maximum switching capability with minimum depth . . . Smaller diameter—only 1-1/8" (Series 212 wafers)

### "VERSATILITY OF CIRCUITS"

Many circuit variations available due to varied rotor contact configurations. External jumpers eliminated by CTS internal connections between positions.

### "AVAILABILITY OF POWER SWITCHES":

Available with 4 types of power switches and/or numerous potentiometers.

### "SUPERIOR INSULATION"

Glass alkyd is superior to phenolic insulation.

- Soldering heat can't loosen terminals.
- Meet MIL-S-3786 A&B, Style SR03 (Series 211 and 212.)
- Balanced contact spring.
- Natural solder barrier provided by glass alkyd insulation.

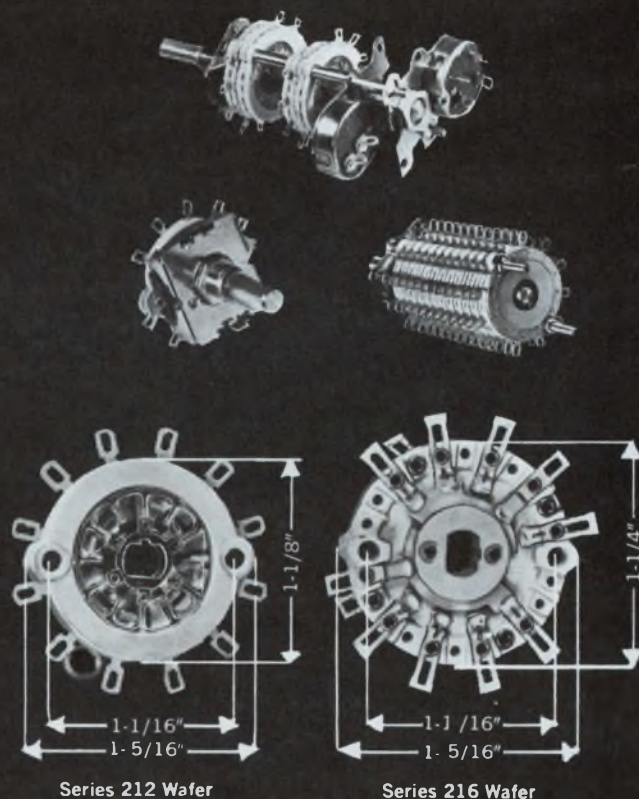

## DETENTS



**Type 211—STAR WHEEL DETENT**  
HIGHEST QUALITY • POSITIVE FEEL  
• 250,000 CYCLE LIFE • FREE FROM  
END AND SIDE THRUST • HIGH  
SWITCHING TORQUE 15–60" OZ.



**Type 212—HILL AND VALLEY DETENT**  
LOW COST • DESIGNED FOR HOME  
ENTERTAINMENT AND LOW COST IN-  
STRUMENT APPLICATIONS • 25,000  
CYCLE LIFE • SWITCHING TORQUE  
20–48" OZ.



**Type 212 ND—DIE CAST DETENT**  
LOWEST COST OF ALL DETENTS  
• LOW COST STAKED CONSTRUCTION  
• AVAILABLE FOR 1 AND 2  
WAFER SWITCHES • 20,000 CYCLE  
LIFE • SWITCHING TORQUE 18–  
40" OZ.



**Type 215—DOUBLE BALL DETENT**  
DESIGNED PRIMARILY FOR INSTRU-  
MENT MARKET • HIGH QUALITY  
• CRISP FEEL • 100,000 CYCLE LIFE  
• SWITCHING TORQUE 6–35" OZ.

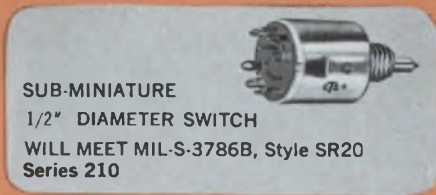

Discover for yourself the advantages of working with CTS for your switch requirements. Switches produced in Elkhart, California and Canada. Request Catalog 4000 containing the full CTS Switch line.



Founded 1896

**CTS**  
CORPORATION  
Elkhart, Indiana

Sales Offices and Representatives conveniently located throughout the world

### Principal Products

- Variable Resistors
- Selector Switches
- Loudspeakers
- Trimming Potentiometers
- Microminiature Components & Circuit Packages
- Crystals, Filters, Oscillators & Ovens

### Subsidiaries:

- CTS of Asheville, Inc., Skyland, N. C.
- CTS of Berne, Inc., Berne, Indiana
- CTS of Paducah, Inc., Paducah, Kentucky
- Chicago Telephone of California, Inc., South Pasadena, California
- CTS of Canada, Ltd., Streetsville, Ontario
- CTS Microelectronics, Inc., Lafayette, Ind.
- CTS Research, Inc., Lafayette, Indiana
- CTS Knights, Inc., Sandwich, Illinois

ON READER-SERVICE CARD CIRCLE 50

may thus contain several groups of 2-input AND gates, another card may contain flip-flop storage registers, and so forth.

The number of integrated-circuit (IC) components that can be placed on such a general-purpose type of board is usually pin limited—that is, there is space for additional components but pins are not available to provide the necessary input and output signals to the ICs. Normally each different type of logic card is built on a different circuit board.

In this proposed packaging scheme, printed circuitry for extra ICs used in building other logic-card types is placed on the available left-over board space, and the pins are shared among these "extra" ICs. This results in a single printed-circuit board which can be used for several different types of logic cards.

During the assembly process, the particular ICs

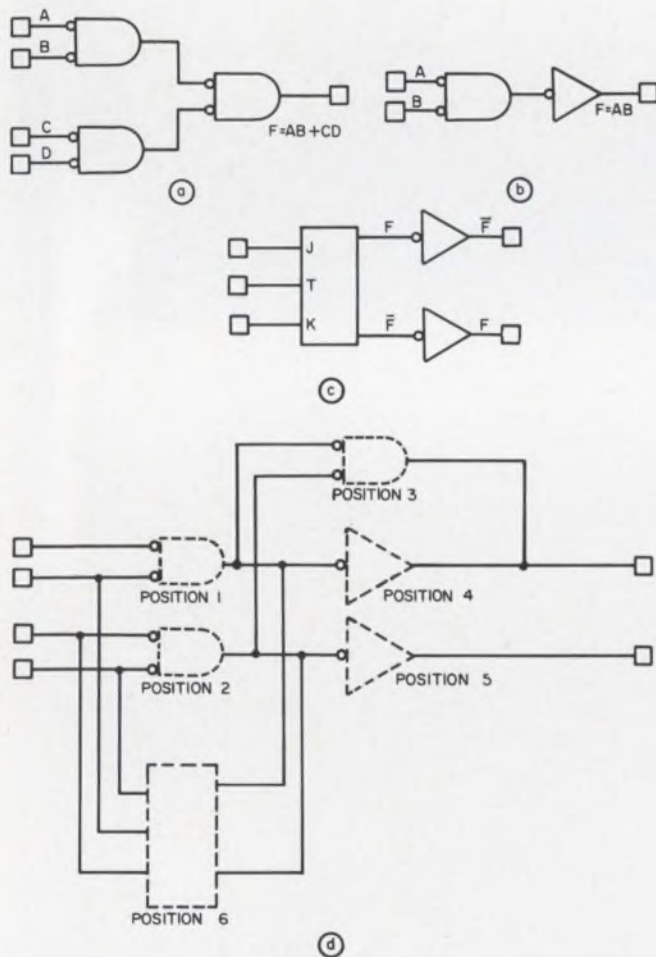

1. One printed-circuit board (d) can be used for three logic functions (a, b, c) by placing ICs in proper positions. Function (a) is obtained by leaving positions 4, 5 and 6 empty; (b) by leaving positions 3 and 6 empty; (c) by leaving 1, 2 and 3 empty.

inserted into the printed-circuit board determine the type of logic card that will be produced. The advantages of this are to reduce the number of types of circuit board thus cutting over-all board-design and -drafting time, to lower the costs per board, and to shrink the spare parts inventory. This packaging technique is best illustrated by the following example.

Figure 1a represents one of a group of 2-input AND/OR gates that have an output  $F = AB + CD$ ; Fig. 1b shows one of a group of 2-input AND gates with an output  $F = AB$ , Fig. 1c is one of a group of flip-flops containing buffered outputs; and Fig. 1d is the schematic for the circuit board which can be used to build any of the foregoing three logic functions. In these schematics all gates are NAND gates. From Fig. 1d it can be seen that:

- If the ICs are not inserted into positions 4, 5 and 6 during assembly, then the logic-card is of the type in Fig. 1a.

- If the components are left out of positions 3 and 6, the logic card is of the type in Fig. 1b.

- If the components are left out of positions 1, 2 and 3, the card is as in Fig. 1c.

The pins and ICs are so arranged that it is impossible for different signals from the various logic-card types to interfere with one another. The outputs from the flip-flop in Fig. 1d, for example, enter the inverter buffers located at positions 4 and 5. If the card is not used as a flip-flop card, however, then the IC in position 6 will be absent and the lines from the flip-flop outputs to the buffers will be left open. The buffers can therefore receive their inputs from the components in positions 1 and 2. Also note that some of the IC components are common to both logic functions that are to share a printed-circuit board, very little extra board space is necessary to mechanize these extra functions. For example, in Fig. 1d the components in positions 1 and 2 comprise both the functions in Figs. 1a and 1b.

*Norton Markin, Senior Engineer, Bendix Corp., North Hollywood, Calif.*

VOTE FOR 118

**IFD Winner for July 5, 1967**

Carlos A. Riveros, Systems Development Div., International Business Machines Corp., San Jose, Calif. His Idea, "Composite amplifier has improved dc bias stability," has been voted the \$50 Most Valuable of Issue Award.

**Cast Your Vote for the Best Idea in this Issue.**



Radiation now offers

# 36 Monolithic Diode Matrices & 12 Monolithic Interface Circuits

in TO-84 and Dual In-Line Packages

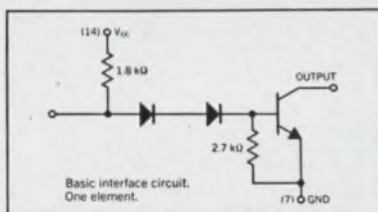
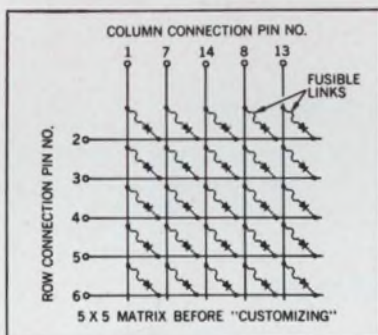

Radiation's Monolithic Diode Matrices and Interface Circuits form a compatible family of integrated circuits to implement any logic design. These circuits perform the AND, OR, and INVERT logic functions. In combination they provide the AND/OR, NAND/NOR and expandable NAND/NOR logic functions. These circuits are compatible to all logic families, RTL, DTL, T<sup>2</sup>L and CML.

The node-input on the interface circuits provides a universal inverter for circuit applications. They can operate at conventional IC voltages and are ideally suited for interfacing to high-voltage logic to 55 volts.

Radiation's interface circuits and matrices are available for immediate shipment at attractive prices. For example, hex interface circuits are priced as low as \$3.50, and diode matrices as little as \$2.50.

MONOLITHIC DIODE MATRICES			
TO-84 DUAL IN-LINE			
Matrix Size	Fast Recovery	Medium Recovery	General Purpose
5 x 5	RM-74	RM-75	RM-77
	RM-174	RM-175	RM-177
5 x 8	RM-10	RM-12	RM-13
	RM-110	RM-112	RM-113
6 x 8	RM-30	RM-31	RM-34
	RM-130	RM-131	RM-134
8 x 5	RM-80	RM-81	RM-84
	RM-180	RM-181	RM-184
8 x 6	RM-40	RM-41	RM-44
	RM-140	RM-141	RM-144
4 x 10	RM-90	RM-91	RM-93
	RM-190	RM-191	RM-193

MONOLITHIC INTERFACE CIRCUITS		
TO-84 DUAL IN-LINE		
Hex Interface Inverters Output 6 volts	Hex Interface Drivers Output 35 volts	Hex Indicator Drivers Output 55 volts
RD-534	RD-535	RD-536
RD-1534	RD-1535	RD-1536
RD-234	RD-235	
RD-1234	RD-1235	

All Radiation integrated circuits are dielectrically isolated.



**RADIATION**  
**INCORPORATED**  
SUBSIDIARY OF HARRIS-INTERTYPE CORPORATION

MICROELECTRONICS DIVISION

Sales Offices: Suite 622, 650 North Sepulveda Blvd., El Segundo, California (213) 772-6371—Suite 232, 600 Old Country Road, Garden City, N.Y. (516) 747-3730—P.O. Box 738, Islington, Massachusetts (617) 762-3470—Suite 704, 2600 Virginia Avenue, N.W., Washington, D.C. (202) 337-4914—P.O. Box 37, Melbourne, Florida (305) 723-1511.

ON READER-SERVICE CARD CIRCLE 51

# Throw away your old '67 Burr-Brown Catalog. It's 1967½!



## NEW OPERATIONAL AMPLIFIERS

Model 3049/15—SMALLEST CHOPPER STABILIZED UNIT. Only 1.80" x 1.20" x .60". Maximum voltage drift: 1  $\mu$ V/°C. Maximum current drift: .002 nA/°C. 500 kHz full power response. 160 dB gain. \$165.00

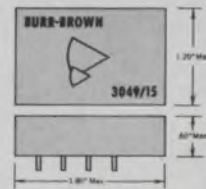

Model 3038/25 — HIGH COMMON MODE VOLTAGE, HIGH SUPPLY REJECTION LOW CURRENT OFFSET. Rated output: 100 V at 20 mA, minimum. 100 V common mode limit. Operates from any power supply voltage from  $\pm 40$  V to  $\pm 135$  V with output voltage 20 volts less than supply. Input impedance 10<sup>11</sup> ohm. Input current offset: 0.1 nA. In a 2.40" x 1.80" x .60" package. \$175.00

Model 3071/25 — LOW FLICKER NOISE (6  $\mu$ V peak to peak), FAST OVERLOAD RECOVERY (less than 1  $\mu$ sec). Voltage drift less than 0.5  $\mu$ V/°C max. Current drift 0.001 nA/°C max. From -25°C to +85°C. \$175.00

Model 3044/15 — HIGH SUPPLY REJECTION (2  $\mu$ V per Volt and 0.5 nA per Volt) VARIABLE POWER SUPPLY ( $\pm 6$  to  $\pm 32$  V) Output Voltage = supply voltage minus 4 Volts. Output current:  $\pm 10$  mA. \$75.00

Model 3063/40 — HIGH OUTPUT CURRENT ( $\frac{1}{2}$  Amp) — HIGH SUPPLY REJECTION (2  $\mu$ V per Volt and 0.2 nA per Volt). Ideal for servo applications. Completely encapsulated in 2" x 2" x 1" package. No external heat sinks required. Operating temperature range: -40°C to +85°C. \$135.00

## NEW QUARTER SQUARE MULTIPLIER

Model 4012/25 — Fully encapsulated in 2.40" x 1.80" x .60" package. Accuracy:  $\pm 0.15\%$ , 3 db response is 1 mHz. Rated output: 10 Volts at 10 mA. Will operate in multiply, divide, square, and square-root modes. Requires no external amplifiers. \$695.00

## NEW SAMPLE AND HOLD MODULE

Model 4013/25 — Fully encapsulated in 2.40" x 1.80" x .60" package. Accuracy:  $\pm 0.1\%$ . Aperture time: 50 nsec. Acquisition time as low as 1  $\mu$ sec. Frequency response: 500 kHz. \$225.00

## NEW 20-PAGE FALL CATALOG

These and many other important new product developments are included in the new Burr-Brown 20-page fall 1967 catalog. It's available from your Burr-Brown Representative . . . or, use this publication's reader service card.

# BURR-BROWN

## RESEARCH CORPORATION

International Airport Industrial Park • Tucson, Arizona 85706  
TELEPHONE: 602-294-1431 • TWX: 910-952-1111 • CABLE: BBRCORP



Operational Amplifiers  
Instrumentation Amplifiers  
Function Modules  
Analog Simulators  
Geophysical Instruments

ENGINEERING REPRESENTATIVES: ALABAMA, HUNTSVILLE (205) 534-1648 / ALASKA, ANCHORAGE (907) 272-5231 / ARIZONA, PHOENIX (602) 254-6085 / CALIF., LOS ANGELES (213) 665-5181, SAN FRANCISCO (408) 245-3321 / COLO., DENVER (303) 388-4391 / CONN., ENFIELD (203) 749-7888 / D.C., WASHINGTON (SEE MARYLAND) / FLORIDA, ORLANDO (305) 425-2764 / ILLINOIS, CHICAGO (312) 286-6824 / LA., NEW ORLEANS (504) 888-2266 / MD., SILVER SPRING (301) 588-8134 / MASS., BOSTON (617) 245-4870 / MICH., DETROIT (313) 353-3822 / MINN., MINNEAPOLIS (612) 781-1611 / MO., ST. LOUIS (314) 524-4800 / N.C., GREENSBORO (919) 273-1918 / N.J., CAMDEN (215) 925-8711 / N.M., ALBUQUERQUE (505) 255-1638 / N.Y.,

ALBANY (518) 436-9649, BINGHAMTON (607) 723-9661, MT. VERNON (914) 968-2200, NEW HARTFORD (315) 732-3775, ROCHESTER (716) 473-2115 / OHIO, CINCINNATI (513) 761-5432, CLEVELAND (216) 237-9145, DAYTON (513) 277-8911 / OKLA., TULSA (918) 835-2481 / OREGON, PORTLAND (503) 292-8762 / PENN., PHILADELPHIA (SEE CAMDEN, N.J.), PITTSBURGH (412) 243-6555 / TEXAS, DALLAS (214) 363-1671, HOUSTON (713) 928-5251 / UTAH, SALT LAKE CITY (801) 466-3709 / VIRGINIA, (SEE MARYLAND) / WASH., SEATTLE (206) 767-4260 / CANADA, TORONTO (416) 293-7011

read a little



**Pay a Little.** The price is as small as the product. It's a miniature rear projection readout, and it costs as little as \$14.00. The new IEE Series 345 Readout requires very little space, but it offers the readability and versatility available only with rear projection readouts. And the price is comparable to other types of readouts with limited messages and cluttered displays.

The Series 345 operates on the rear projection principle. A lamp in the rear of the unit illuminates one of the 11 film messages, and projects it to the front viewing screen. A single plane display on the non-glare screen, so you get no distortion or confusion. It is very versatile, since anything that can be put on film can be displayed on the screen. You can display a variety of messages or colors.

The Series 345 has a front plug-in feature. It can be quickly inserted into the housing. It can be just as easily removed to insert a new readout with a different display, or to replace a lamp.



*Series 345 Readout:*  $\frac{1}{2}$ " wide x  $\frac{3}{4}$ " high. Six digits will fit in a 3" wide panel space. Depth,  $2\frac{1}{2}$ ". Character height,  $\frac{3}{8}$ ". Weight,  $\frac{3}{4}$  oz. Six available colors, including white, amber, yellow, blue, red or green.

Straight decimal input. Vertical and horizontal viewing angle  $175^\circ$  with V-1 viewing screen, or  $160^\circ$  with standard screen.



"I double-E," the world's largest manufacturer of rear projection readouts.  
Industrial Electronic Engineers, Inc., 7720 Leona Ave., Van Nuys, California

ON READER-SERVICE CARD CIRCLE 52



**JANCO BUILDS ROTARY SWITCHES JUST A LITTLE BETTER THAN TODAY'S REQUIREMENTS!**

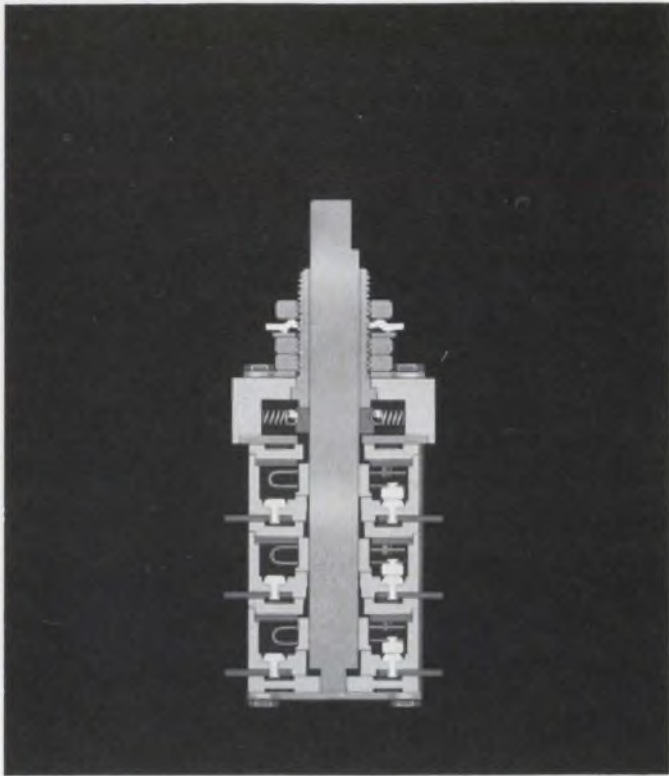

**{ HERE'S THE INSIDE STORY }**

If you were to slice away half of a Janco Rotary Switch, you would see the reason why "Janco Builds Rotary Switches Just A Little Better Than Today's Requirements!"

**CONSTRUCTION**

Upon examination you would immediately recognize a design simplicity meticulously constructed into a totally enclosed, explosion-proof package affording you the highest degree of protection when operating in a volatile, chemically mixed atmosphere at sea level or altitudes. It is this same design simplicity that utilizes the U-shaped rotor concept which results in low contact resistance throughout the life of the switch.

**MATERIALS**

Before reaching the optimum in design simplicity a manufacturer must reach for the optimum in materials. Janco Rotary Switches are totally enclosed in high impact, glass-reinforced alkyd MAI-60 for superior mechanical and electrical characteristics. Current conduction is handled by Beryllium copper and solid silver alloy contacts.

**FREE WALL CHART**

If you are interested in rotary switches that are built to exceed present day requirements, Janco Corporation will send you a wall chart of basic Janco rotary switches. From this chart you can determine the correct switch for your requirements . . . the proper degree of indexing, exact make or break current capacity, and whether single or multi pole construction is available. This chart is your building block to a rotary switch that is built a little better than today's requirements. Send for it today.

**JANCO CORPORATION**

3111 WINONA AVENUE ■ BURBANK, CALIFORNIA

ON READER-SERVICE CARD CIRCLE 91

ELECTRONIC DESIGN 21, October 11, 1967

# Products

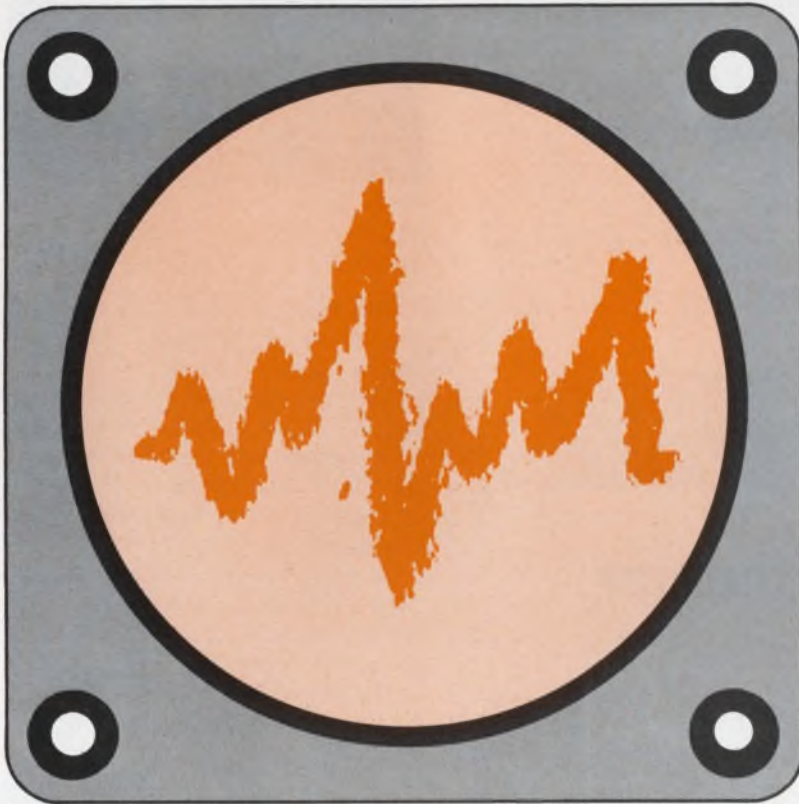

Now is the time for all test equipment to come to the aid of the engineer. Test equipment section. Page 114

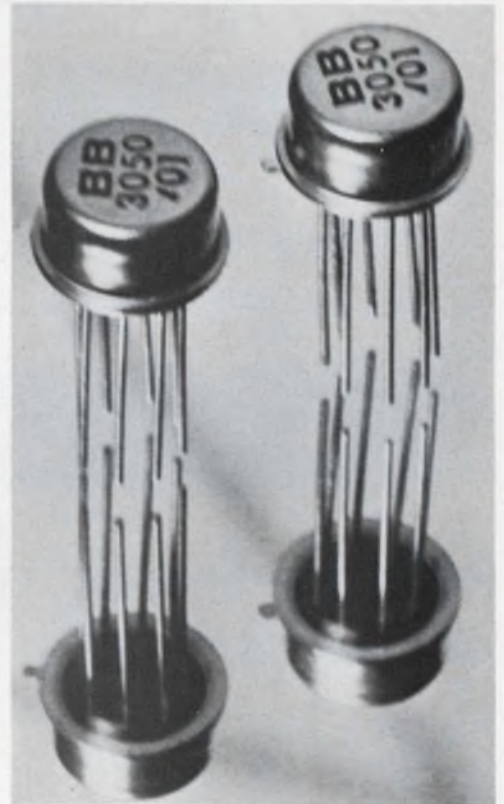

Low-noise operational amplifiers will overcome shorting. Page 138

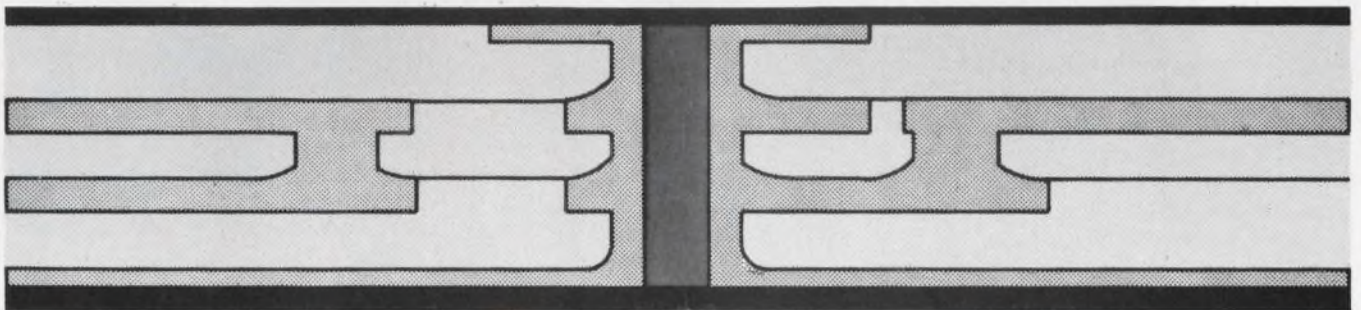

A wiring board in multilayer form uses a solid post technique that will allow dual-in-line ICs

to be surface mounted. Holes may also be drilled through the posts. Page 148

## Also in this section:

Triac hits 200-A operation using epitaxial process. Page 140

A camera-port microscope-laser exhibits 100% reflection. Page 146

Encapsulated power supply gives 20,000 V out on 28 V in. Page 158

Design Aids, Page 170 . . . Application Notes, Page 172 . . . New Literature, Page 174



## Portable French multimeter offers 23 ranges

Honeywell, Test Instruments Div., 4800 E. Dry Creek Rd., Denver, Colo. Phone: (303) 771-4700. Price: \$525.

The Digitest, a three-digit multimeter built in France and distributed by Honeywell, can measure 23 different ranges, including voltage, resistance and current. It is said to provide accuracies of  $\pm 0.5$  per cent for dc voltages and  $\pm 1$  per cent for ac. The instrument can be operated from a standard line outlet or by a rechargeable nickel cadmium battery. Other capabilities are shown in the following table.



A new French import shows a thing or two, like a sloping profile, 23 ranges and an overload light.

Function	Range	Accuracy
Ohmmeter	100 $\Omega$	
	1000 $\Omega$	
	10 k $\Omega$	1%
	100 k $\Omega$	$\pm 1$ digit
Voltmeter	1000 V	
	dc 100 V	0.5%
	10 V	$\pm 1$ digit
	1000 mV	
	100 mV	
Voltmeter	300 mV	
	3 V	1%
	ac 30 V	$\pm 1$ digit
Voltmeter	300 V	

The digitest is manufactured by Schneider Radio Television, S. A., Professional Electronics Div., Ivry-Seine, France. Under the distribution agreement, Schneider is supplying Honeywell's Test Instruments Div. with the multimeter for exclusive distribution throughout the United States, Mexico, Canada, and Central and South America.

CIRCLE NO. 254

## Thermocouple controls in gauge form



Veeco Instruments, Inc., Terminal Dr., Plainview, N. Y. Phone: (516) 681-8300.

The TG-7 and TG-27 supplement the line of gauge controls and will replace models TG 6 and TG 20 respectively. The new gauge controls utilize the solid-state design and construction, and modular 1/4 rack size which is adaptable to bench use by the addition of four rubber feet. Pressure range for the TG 7 is 1-1000 millitorr, and 0-20 torr for the TG-27. The units are recommended for use with matched-V thermocouple gauge tubes DV IM and DV 4AM. Dimensions of both units are 5-3/16 x 4-5/32 x 11 in. and each weighs 6-3/4 lb.

CIRCLE NO. 255

## Half-rack counter spans 5 Hz to 12.5 MHz



Monsanto Electronics Technical Center, 620 Passaic Ave., West Caldwell, Mo. Phone: (314) 694-2889. P&A: \$575; stock.

The instrument provides capabilities which include measurement of average frequency from 5 Hz to 12.5 MHz, and its frequency ratio is from 1 to  $10^6$ . The unit embodies a crystal-controlled clock having an aging rate of better than 5 parts in  $10^7$  per day after 72 hour warm-up, and has a basic sensitivity of 50 mV, rms. The final decade carry-pulse is available at a rear panel connection, permitting cascading of slave units to extend range and/or resolution in multiples of 5 digits.

CIRCLE NO. 256

## IC test set has 6 levels



Signetics Corp., 811 E. Arques Ave., Sunnyvale, Calif. Phone: (408) 739-7700. P&A: \$4995; 10 wks.

With the appropriate device-test head installed, the unit can test any of the present standard integrated-circuit-package configurations 14 or 16 lead dual in-line, 10 or 14 lead flat pack, and ten lead TO-5. All devices are subjected to a series of six consecutive tests which dynamically check the performance of the device under realistic applications-simulated conditions. The tests include continuity, orientation, power dissipation, a functional test, noise immunity and a toggle-rate test.

CIRCLE NO. 257

## Measure switching times from ns to $\mu$ s



B-Line Electronics Corp., 4 Music Hall Ave., Waltham, Mass. Phone: (617) 899-3880. Price: \$835.

Extremely useful for the measurement of stored charge, this unit gives an accurate measurement of the switching time of semiconductor diode devices. With its stored charge range of 100 nC and forward current bias levels to 50 mA, it possesses large applications for the measurement of the switching time of so-called fast rectifiers, slow germanium gold-bonded diodes and PIN diodes, from 20 ns up to  $\mu$ s region.

CIRCLE NO. 258

# Two Ballantine Voltmeters for Laboratory, Production, and Q.C. Needs

Ballantine solid state, wide-band voltmeters, one average-responding and one true-rms responding, feature exceptionally wide frequency ranges, high accuracy over entire 5-inch log scales, and operation from built-in rechargeable battery or line

## BALLANTINE VOLTMETER

2 Hz to 6 MHz

Battery or line-powered--  
1% accuracy at midband

### MODEL 303



- Voltage range 300  $\mu$ V to 330 V (models with 20 dB probe, 1 mV to 1000 V) ● 1% accuracy, 30 Hz to 1 MHz
- Logarithmic indicator for uniform accuracy over entire 5 inch scale ● Average responding ● Built-in rechargeable battery (models for line only) ● Isolated signal ground ● 40 dB amplifier, 2 Hz to 6 MHz ● PRICES: Model 303 (Battery/line/no probe) \$320; Model 303-01 (line only/no probe) \$290; Model 303-50 (Battery/line/with probe) \$382; Model 303-51 (line only/with probe) \$352.

## BALLANTINE TRUE RMS VOLTMETER

10 Hz to 20 MHz

Battery or line-powered

### MODEL 323

- Voltage range 300  $\mu$ V — 330 V (as null detector to 70  $\mu$ V) ● 2% accuracy 50 Hz to 10 MHz ● Logarithmic indicator for uniform accuracy over entire 5 inch scale ● True-RMS responding ● Built-in rechargeable battery (optional model for line only) ● Isolated signal ground ● DC output of 0.1 - 1.0 V for each 10 dB range for application to recorder or DVM where output is proportional to mean square of input ac voltage. ● PRICES: Model 323 (Battery/line) \$520; Model 323-01 (line only) \$485.



Write for brochures giving complete details



**BALLANTINE LABORATORIES INC.**  
Boonton, New Jersey

CHECK WITH BALLANTINE FIRST FOR DC AND AC ELECTRONIC VOLTMETERS/AMMETERS/OHM METERS, REGARDLESS OF YOUR REQUIREMENTS. WE HAVE A LARGE LINE, WITH ADDITIONS EACH YEAR. ALSO AC/DC LINEAR CONVERTERS, AC/DC CALIBRATORS, WIDE BAND AMPLIFIERS, DIRECT-READING CAPACITANCE METERS, AND A LINE OF LABORATORY VOLTAGE STANDARDS FOR 0 TO 1,000 MHZ.

ON READER-SERVICE CARD CIRCLE 54

# FREE

## NEW 1968

# ALLIED

INDUSTRIAL  
ELECTRONICS  
CATALOG

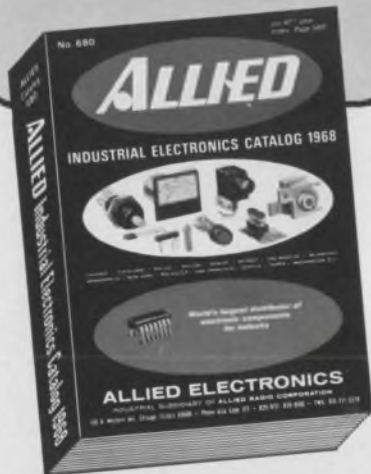

**World's Largest Selection  
of Electronic Components  
for Industry**

- Scores of new products
- Same-day shipment
- All merchandise stocked in depth
- Factory OEM prices

**600 VALUE-PACKED PAGES**

# P&B

RELAYS

**SEE THE 1968  
ALLIED CATALOG**

Allied stocks Potter & Brumfield Relays in depth: General purpose, special purpose, power, high performance, mercury wetted contact, telephone types

Write for Your Copy Today to Dept. 76J

# ALLIED ELECTRONICS

A Subsidiary of Allied Radio Corp.

Our 47th Year

100 N. Western Ave. Chicago, Ill. 60680

ON READER-SERVICE CARD CIRCLE 55

## Tester analyzes 40-IC pins, with option for dynamic scope

*Computer Test Corp., 3 Computer Dr., Cherry Hill, N. J. Phone: (609) 424-2400. Price: \$11,200 to \$17,500.*

A semi-automatic bench tester has been developed for dc-analysis of integrated circuits that have up to 40 pins. Dynamic testing with an auxiliary sampling scope is also available as an option.

The tester, designated MICA-150 by the Computer Test Corp. of Cherry Hill, N. J., can be used for incoming inspection, small-run production, and laboratory and failure analysis. The analyzer can be sequenced from pin to pin of the device under test by application of a pre-programmed series of precision voltages that simulate typical or worst-case operating conditions. Test results are indicated on a direct digital readout.

All test conditions are set up on two independent 11-by-40 cross-bar programming switches that connect any of up to eight function generators and a built-in digital voltmeter to the pins of the device under test.

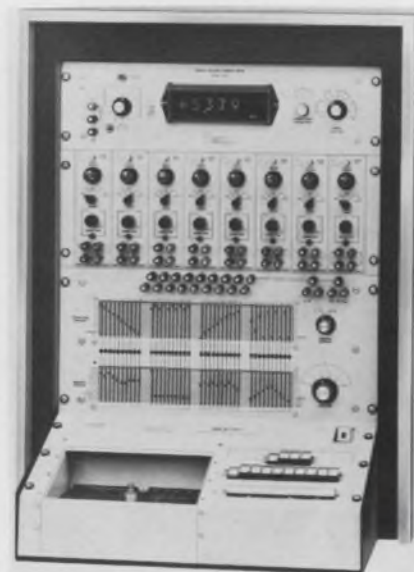

Dc analysis of ICs with up to 40 pins can be handled by this tester. Dynamic testing with a sampling scope is available as an option.

The flexibility provided by the crossbar matrices permits a wide variety of test combinations. For example, a two-terminal device can be checked with as many as 20 different tests; a 10-pin circuit with four different programs; in which function generators are transposed as desired; or a two-pin device with Kelvin connections with up to 10 test programs.

It is possible to have the digital meter measure current on one pin of the device and voltage on another; the operator can change the polarity of the meter leads, as necessary. Once the program has been established, the test can be sequenced quickly by a numbered pushbutton keyboard arranged in a 10-by-4 matrix. The number of the pushbutton that is depressed determines the pin at which the test is to be made. The operator initiates the test by depressing a finger bar that applies power to the device under test. The readout indication is delayed by a "soak time" control, to provide a period for thermal stabilization of the device prior to measurement. This control makes it possible to detect marginal device operation. A position on this control allows the operator to vary the output of the function generators while observing device reaction for further analysis of marginal circuit operation. Upon completion of the measurement, the power is automatically removed. The memory readout of the digital voltage/current meter continues to display the measurement until the data are replaced by new information in the test sequence.

Universal test adapters are designed to speed testing and reduce adapter inventory by accepting all devices of the same package configuration and the appropriate number of pins, regardless of manufacturer or circuit type. Adapters are available for ICs.

CIRCLE NO. 259



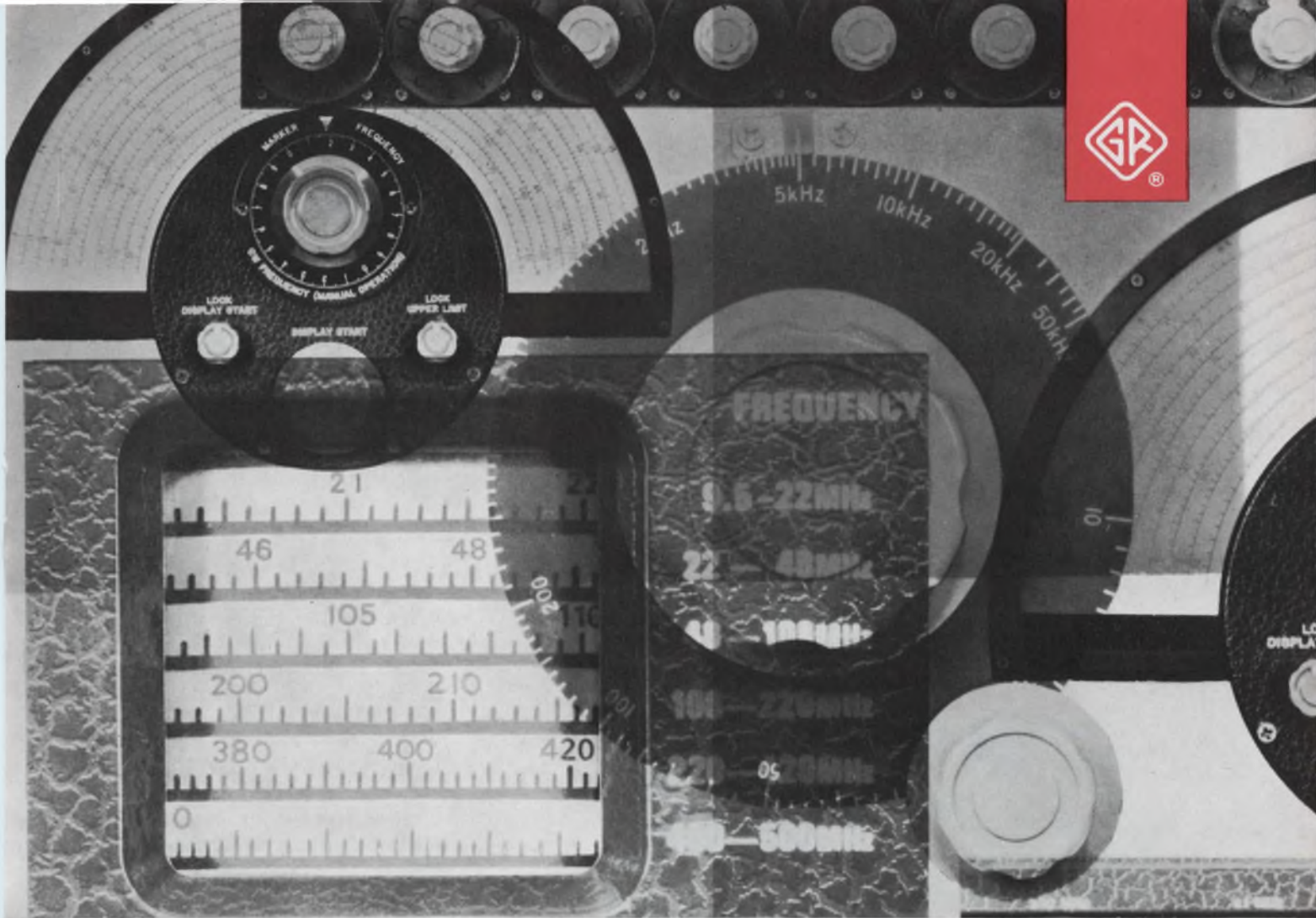

## Dial GR for Sine-Wave Signals

Over 100 different models of GR oscillators, signal generators, and synthesizers are listed in our catalog. These sine-wave signal sources provide a wide choice of frequencies, power outputs, and modulation and sweeping capabilities. For instance:

Included among the oscillators are our four new "sync-able" oscillators, each a small (8 x 6 x 8 in.), self-contained unit with a sync jack for phase-locking to an external signal. These oscillators offer a wide choice of performance: fixed frequencies (to 10 kHz) or continuous tuning (to 2 MHz), up to 1-watt output, as much as 0.001% short-term frequency stability, and distortion as low as 0.05% or less.

If you need a high-resolution signal source with a wide choice of operating features, you can satisfy your need with one of the 80 versions of our frequency synthesizers. Their modular construction makes it possible to order any of the four basic models with from three to seven manual step-decade modules, programmable modules, and with or without a continuously adjustable decade module that provides additional resolution and sweep capability. Upper frequency limits of the four basic models are 100 kHz, 1 MHz,

12 MHz, and 70 MHz with maximum possible resolutions of 0.0001, 0.001, 0.01, and 0.1 Hz, respectively.

The newest addition to our ensemble of sine-wave sources is the 1026 Standard-Signal Generator. This unique instrument puts out  $\frac{1}{2}$  watt into 50  $\Omega$  (10 V behind 50  $\Omega$ , 5 V when modulated), has excellent output leveling, and has true single-dial tuning over its entire 9.5- to 500-MHz frequency range. The ease of operation and outstanding performance of the 1026 in the most critical applications must be experienced to be appreciated. Request a demonstration and see for yourself.

Prices for GR sine-wave signal sources range from \$225 for a "sync-able" audio oscillator with 11 fixed frequencies to \$7515 for a full-complement, 70-MHz frequency synthesizer. For complete information, write General Radio Company, W. Concord, Massachusetts 01781; telephone (617) 369-4400; TWX (710) 347-1051. Sales Engineering Offices are located in major cities throughout the United States and Canada.



Type 1026 Standard-Signal Generator, \$6500 in U.S.A.

## GENERAL RADIO

# The ultimate in Q

## JFD Uniceram capacitors

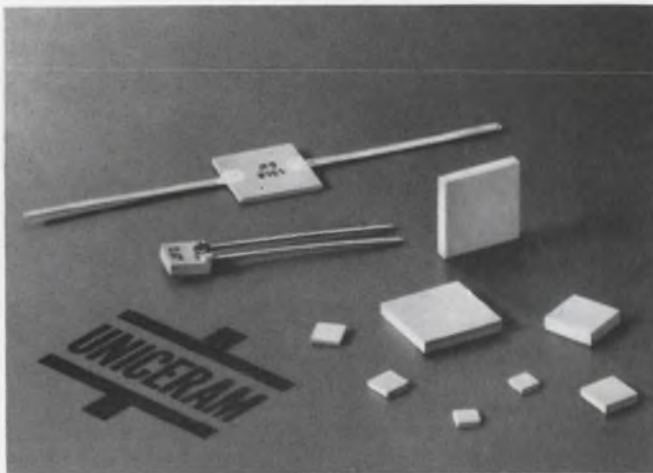

Capacitors shown enlarged 25%

Glass encapsulated or unencapsulated wafer Uniceram monolithic High Q ceramic fixed capacitors—offer a high ratio of capacitance per unit volume. They combine exceptional stability and a guaranteed minimum Q in a smaller size package than competitive units.

Over 1,000 glass encapsulated models, with capacitance values from 0.5 to 3000 pf, provide the ultimate in High Q—proven reliability and stability. All models meet applicable requirements of MIL-C-11272B.

Uniceram High Q capacitors are also available as wafers with metalized edges. These lower-cost units in the same capacitance values offer the same outstanding electrical properties. These wafers, or chips, ideally suited for hybrid integrated circuits, can be soldered directly to printed circuit boards or used as discrete components.

A High K series of encapsulated Uniceram fixed capacitors with up to 1 mfd capacitance is also available.

Write for Catalog UNM 65-2

**JFD** "TODAY'S COMPONENTS BUILT FOR TOMORROW'S CHALLENGES"  
**JFD ELECTRONICS CO. / COMPONENTS DIVISION** 15th Avenue at 62nd Street  
 Brooklyn, N. Y. 11219 / Phone 212-331-1000 • Sales Offices—Arcadia, Calif.  
 Chi., Ill. / Balt., Md. / Saxonville, Mass. / Bklyn., N. Y. / New Hartford, N. Y.  
 Cinn., Ohio / Phila., Pa. / Pitts., Pa. / Paris, France / Azor, Israel

ON READER-SERVICE CARD CIRCLE 29

## TEST EQUIPMENT

### Power-factor meter covers 50 to 2500 Hz



Weston Instruments, Inc., 614 Frel-  
 inghuysen Ave., Newark, N. J.  
 Phone: (201) 243-4700.

This instrument is designed to measure and indicate power factor over an input frequency range of 50 to 2500 Hz. It will maintain its accuracy rating of  $\pm 1\%$  of total span with sine-wave inputs of 120 V and currents ranging from 1 to 5 A. Using a transistorized squaring amplifier, the model 83 operates on the zero crossing points of current and voltage waveforms to produce dc outputs linearly dependent upon the phase angles between parameters.

CIRCLE NO. 260

### Microwave power weighed on 8 scales



General Microwave Corp., 155 Ma-  
 rine St., Farmingdale, N. Y. Phone:  
 (516) 694-3600. Price: \$350.

Designed for field and laboratory applications requiring portable instrument, the unit is solid-state and battery-operated, and is housed in a walnut-grained instrument case with hinged cover and handle. Power measurements can be made from  $-25$  to  $+20$  dBm. Eight scales are provided and its accuracy is  $\pm 3\%$  full scale over the temperature range from  $0$  to  $+50^\circ\text{C}$ ; or  $\pm 4\%$  from  $-25$  to  $+75^\circ\text{C}$ . The model 464 will operate with all coaxial and waveguide models in the TFT power head series, which ranges in frequency from 10 MHz to 40 GHz.

CIRCLE NO. 261

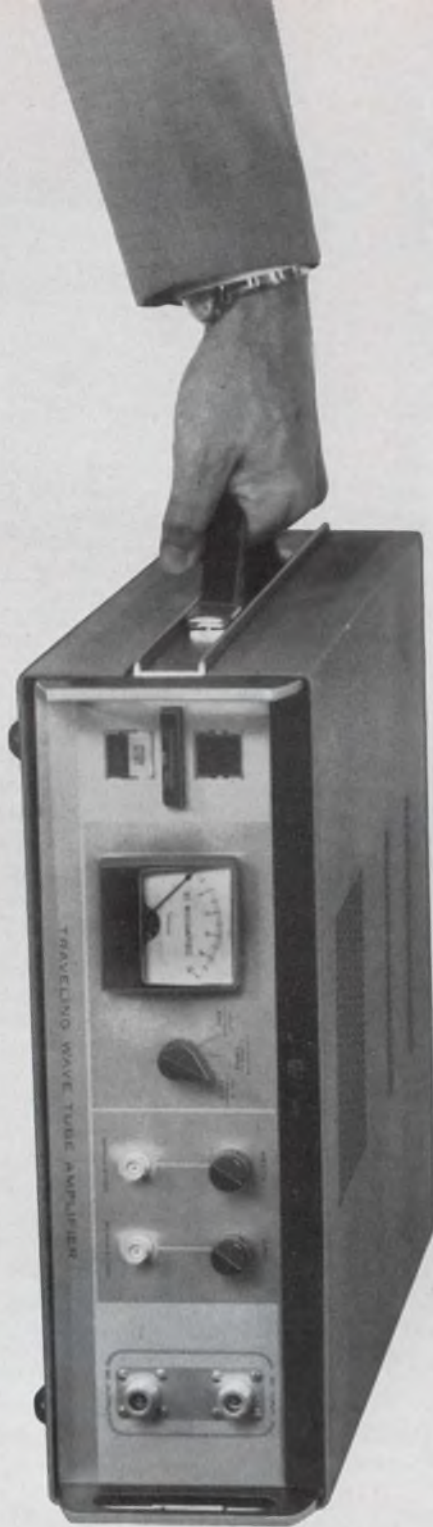

## A brief case for TWT Amplifiers

Frequency range from 0.5 through 12.4 GHz. Power outputs up to 10 watts. Front panel connection for grid and helix modulation, and best of all . . . our own built-in Traveling Wave Tubes. For more details, write Microwave Associates today, leaders in TWT's and TWT Amplifiers since 1951.



### **MICROWAVE ASSOCIATES**

Burlington, Massachusetts

Offices: Burlington, Mass.; 9911 Inglewood Ave., Inglewood, Cal.;  
Subsidiaries: Microwave Associates (West) Inc., Sunnyvale, Cal.  
Microwave Associates, Ltd., Luton, Beds, England.

Compare the  
All-New PAMOTOR  
Model 4500 with  
the miniature  
axial fan  
you're now using!



**COMPACT SIZE**

Only 4 1/16" x  
4 1/16" x 1 1/2".  
Weighs just 1 1/4  
lbs. Inter-  
changeable with  
similar, less reli-  
able 4 1/16" fans.

**POWERFUL MOTOR**

Dependable shad-  
ed-pole motor  
operates with low  
internal heat rise.  
Efficient inside-  
out design.

**ALL-METAL CONSTRUCTION**

Precision die cast housing, hub, impellers.  
Corrosion resistant. Natural heat sink.  
Warp-free, unlike conventional plastic fans.

**115 CFM WITH LESS  
THAN 37.5 dB SIL\***

\*Speech Interference Level

- Lubrication-free life in excess of 20,000 operational hours, continuous duty at 55° C.
- Delivers more air at a lower noise level, yet priced under similar conventional plastic fans.
- Model 4500 designed for 117V/50-60 Hz operation. Model 4550 operates at 230V/50-60 Hz.
- Immediate delivery through distributors or from factory stock.
- Has Underwriters' Laboratories Inc. Yellow Card Component Recognition Number E41168.

**ONLY  
\$855  
EACH**

in lots  
of 100

PAMOTOR, INC., 312 Seventh St.  
San Francisco, California 94103.

**PAMOTOR, INC.**

2P-7104R1

ON READER-SERVICE CARD CIRCLE 59

120

TEST EQUIPMENT

**O<sub>2</sub> analyzer  
unaffected by organic gas**



The Hays Corp., Michigan City,  
Ind. Phone: (219) 872-5561. Price:  
\$400.

Accurate oxygen analyzation is unaffected by organic gases such as methane, ethane, propane, butane, ethylene and propylene. No power is required, as the cell generates its own output. It is suitable for hazardous areas with no modification. This small, hand-held, membrane-type oxygen analyzer fills the need of boiler men, plant operators, health and safety inspectors and many others with a need for a quick portable means of measuring oxygen in gas streams.

CIRCLE NO. 262

**Multirange meter senses  
100,000 V per Ω**



Weston Instruments, Inc., 614 Frel-  
inghuysen Ave., Newark, N. J.  
Phone: (201) 243-4700.

The model 401 is a new design featuring an optical pointer system for sensitivity gain and freedom from parallax problems. Provided with flat scale presentation it has the reading ease of a single-range instrument. The shrouded case reduces external light and swivels to the desired reading position.

CIRCLE NO. 263

**Detect light  
at 0.2 lm/ft<sup>2</sup>**



Photo Research, 837 N. Cahuenga  
Blvd., Hollywood, Calif. Phone:  
(213) 462-6673. Price: \$250-\$300.

Extremely sensitive, this is an accurate instrument for laboratory or field use. It features a taut-band meter, a 7-in. mirror scale and full-scale reading of 2 lm/ft<sup>2</sup>. The sensitivity range may be extended as needed by the use of attenuators supplied with the meter. The light sensor is a selenium photocell with a sensitive area of 9 sq in. The combination of this photocell and the meter dial assure accurate reading at light levels as low as 0.2 lm/ft<sup>2</sup>.

CIRCLE NO. 264

**Calibrator receiver  
spans 10 mHz to 40 GHz**

Narda Microwave Corp., Plainview,  
N. Y. Phone: (516) 433-9000. P&A:  
\$2,475; stock.

The model 61A1A allows calibration of gain or loss characteristics accurately over 100 dB dynamic range in a single step, independent of operating frequency. Modified square-wave phase-shift control provides signal switching 0 to 75 V with 0° or 180° phase. Measurements over ranges from 10 mHz to 40 GHz, can be made to calibrate components, signal generators and other microwave devices. Precision and resolution is 0.02 dB. The unit may also be used as a conventional lin-log receiver. For antenna pattern measurements, a 60-dB log scale and recorder output are provided. In conventional linear operation, the unit can be used as a microwave detector.

CIRCLE NO. 265

FOR DTL ON READER-SERVICE CARD CIRCLE 149 ➤  
FOR RTL ON READER-SERVICE CARD CIRCLE 60 ➤

# Sperry delivers DTL & RTL

**SPERRY**  
SEMICONDUCTOR DIVISION  
NORWALK, CONNECTICUT 06852  
TELEPHONE: (203) 847-3851

- Please have a salesman call with full details.  
 Please send me literature on Sperry RTL Integrated Circuits.  
 Please send me literature on Sperry DTL Integrated Circuits.  
 I'm specifically interested in \_\_\_\_\_

\_\_\_\_\_ . Please have a representative contact me.

NAME \_\_\_\_\_

TITLE \_\_\_\_\_

COMPANY \_\_\_\_\_

ADDRESS \_\_\_\_\_

CITY \_\_\_\_\_

PHONE \_\_\_\_\_

STATE \_\_\_\_\_

ZIP \_\_\_\_\_

RTL* AVAILABILITY CHART add prefix for package choice: 3 = flat pack, 5 = TO-5				DTL* AVAILABILITY CHART add prefix for package choice: 3=flat pack, 6=DIP		
Function	Military (-55°C to +125°C)	Industrial (0°C to +100°C)	Coml. (+15°C to +55°C)	Function	Military (-55°C to +125°C)	Industrial (0°C to +75°C)
Buffer	90021	90022	90029	Dual 4 input gate	93051	93059 <sup>#</sup>
R-S flip flop	90221	90222	90229	Dual 4 input buffer	93251	93259
3 input gate	90321	90322	90329	Dual 4 input extender	93351	93359
Half adder	90421	90422	90429	Dual 4 input power gate	94451	94459
½ shift register	90621	90622	90629	Clocked flip flop	94551	94559
4 input gate	90721	90722	90729	Quad 2 input gate	94651	94659
Dual 2 input gate	91421	91422	91429	Clocked flip flop	94851	94859
Dual 3 input gate	91521	91522	91529	Quad 2 input gate	94951	94959
J-K flip flop			92329	A.C. binary	95051	95059
Gate expander	92521	92522	92529	Mono. Multivibrator	95151	95159
J-K flip flop	92621	92622	92629	Dual 4 input gate	96151	96159
Quad inverter	92721	92722	92729	Triple 3 input gate	96251	96259
				Triple 3 input gate	96351	96359

\* Sperry Rand Corporation, through a cross-licensing agreement with Fairchild Camera & Instrument Corporation, is licensed under processing techniques patented by Fairchild to produce integrated circuits which are completely interchangeable with Fairchild units.

*Rushed?*

Call our marketing headquarters (203) 847-3851 or TWX 710-468-0591 for further information, quotations and 18-page data packages.

# If You're Still Using A V.T.V.M. It's Time To Change ... Go Solid-State!



**A**  
Kit  
IM-16  
**\$44.95**



**B**  
Kit  
IM-25  
**\$80.00**  
Wired  
IMW-25  
**\$115.00**

## These New Heathkit® Solid-State Meters Feature State-Of-The-Art Performance At Prices You Can Afford

- Modern, stable, long-life solid-state circuitry
- New low-voltage ranges to accurately analyze modern transistor circuits
- Full capability to go "out on the job" . . . instant selection of internal battery power or 120/240 v. 50-60 Hz AC operation
- Exceptional accuracy . . . 3% on DC volts, plus a large, easy-to-read 6" meter face
- High impedance F.E.T. input for minimum circuit loading

### **A** New! Deluxe Solid-State Volt-Ohm Meter

Features 8 DC and 8 AC voltage ranges from 0.5 v to 1500 v full scale; 7 ohmmeter ranges (10 ohms center scale) x1, x10, x100, x1k, x10k, x100k, & x1 megohm; 11 megohm input on DC ranges; 1 megohm on AC ranges; internal battery or 120/240 v 50-60 Hz AC power for portable or "in shop" use; large readable-across-the-bench 6" meter; separate switches for individual functions; single test probe for all measurements; modern, stable solid-state circuit-board construction.

Kit IM-16, 10 lbs. . . . . **\$44.95**

### **B** New! Deluxe Solid-State Volt-Ohm-Milliammeter

All silicon transistors plus FET's. Features 9 AC and 9 DC voltage ranges from 150 mV to 1500 volts full scale; 7 ohmmeter ranges (10 ohms center scale) x1, x10, x100, x1k, x10k, x100k, & x1 megohm; 11 current ranges from 15 uA to 1.5 Amperes full scale; 11 megohm input on DC voltage ranges; 10 megohm input on AC voltage ranges; internal battery power or 120/240 v 50-60 Hz AC power for maximum versatility; easily readable 6" meter face;  $\pm 3\%$  accuracy on DC volts;  $\pm 4\%$  on DC current;  $\pm 5\%$  accuracy on AC voltage and current; separate range switches "human engineered" for efficiency in actual use; modern circuit board construction; all solid-state components; easy to assemble.

Kit IM-25, 10 lbs. . . . . **\$80.00**  
Wired IMW-25, 10 lbs. . . . . **\$115.00**

**HEATHKIT**

**HEATH COMPANY,**  
Benton Harbor, Mich. 49022 Dept. 520-26  
In Canada, Daystrom Ltd.

Please send my FREE 1968 Heathkit Catalog.

Enclosed is \$ \_\_\_\_\_, plus postage.

Please send model(s) \_\_\_\_\_

Name \_\_\_\_\_

Address \_\_\_\_\_

City \_\_\_\_\_ State \_\_\_\_\_ Zip \_\_\_\_\_

Prices & Specifications subject to change without notice. TE-165

## TEST EQUIPMENT

### Transistor shock tester is air-operated



*Mechanization Associates, 2622 Frontage Rd., Mountain View, Calif. Phone: (415) 967-4262. Price: \$285 to \$1885.*

A transistor, IC or similar device is inserted into the venturi section of a long tube. It is drawn in by air jets and then accelerated down the tube by the expanding air stream. After leaving the tube it impacts against a hinged striker plate and drops into a tray. The acceleration down the tube is determined by the air pressure. By varying the air pressure, the striker plate mass and/or resilience, the device can be made to undergo various peak shock loadings and durations.

CIRCLE NO. 266

### Tangential sensitivity measured on X-Y plot



*Emerson Electric, 24003 Ventura Blvd., Calabasas, Calif. Phone: (213) 347-5446.*

The ET-24 automatically measures and records noise output, tangential sensitivity and detected pulse height of a microwave video detector, sweeping across an entire octave. A permanent X-Y recorder plot of tangential sensitivity and video output versus frequency is provided plus a record of the white noise level in a 10-MHz bandwidth. A quick disconnect coaxial holder, and an automatic chart advance for the recorder permits 500 units to be tested in one day. The unit is available in coax through X-band.

CIRCLE NO. 267

ON READER-SERVICE CARD CIRCLE 61

# $\pm 0.05\%$ regulation is only one of twelve outstanding specs in Helipot's exclusive new microcircuit dc voltage regulator series.



MODEL 803 DC Voltage Regulator, one of a complete family of six miniature, hybrid cermet thick film units with outputs from 3 to 32 volts.

## The other eleven:

- short circuit proof models
- small size—0.5 sq. in.
- low profile—0.170"
- up to 5 amps load current
- output range—3 to 32 volts
- fixed and adjustable outputs
- fully sealed
- hybrid cermet construction
- operating temperature range:  $-55^{\circ}\text{C}$  to  $+125^{\circ}\text{C}$
- 60 db ripple rejection
- mil spec tested

## The price:

- \$30.00—fixed output models
- \$35.00—adjustable output models

(prices are 1-9 quantity, delivery from factory stock)

## The applications:

Helipot Series 800 DC Voltage Regulators are physically compatible with dual in-line and flat pack integrated circuits. This permits system use of unregulated power with precise regulation at the point of use. In addition to the 1,000:1 ripple rejection capability, these units provide excellent circuit decoupling and protection from transients and sudden power surges.

	Application		
	Digital Circuits 3 to 9 Volts	Analog Circuits 9 to 21 Volts	Airborne and General Purpose Circuits 20 to 32 Volts
Fixed Output	Model 805 Reader Service No. 241	Model 801 Reader Service No. 242	Model 803 Reader Service No. 243
Adjustable Output	Model 806 Reader Service No. 244	Model 802 Reader Service No. 245	Model 804 Reader Service No. 246

Ask your local Helipot sales representative for information or circle the appropriate number on the reader service card.

**Beckman**

INSTRUMENTS, INC.  
HELIPOT DIVISION

FULLERTON, CALIFORNIA • 92634

INTERNATIONAL SUBSIDIARIES: GENEVA; MUNICH; GLENROTHES, SCOTLAND; TOKYO; PARIS; CAPE TOWN; LONDON; MEXICO CITY

ON READER-SERVICE CARD CIRCLE 241-246

Like one of Lamb Electric's complete line of motors. They turn your products on and keep them going with exceptional reliability. Whatever your product has to do—scrub, polish or vacuum—Lamb Electric has the motor with just the right combination of performance, life and cost. If necessary, we'll even custom build a gear motor from standard Lamb parts.

So whatever your design is, Lamb Electric has the power. The power with performance and durability enough to turn your product on and give it extra sell.

If you'd like a better motor for your better floor-care product, write us. We'll send you details and performance curves that will turn you on about Lamb. Address: Ametek, Inc., Lamb Electric Division, Kent, Ohio 44240. In Canada: Sangamo Company, Ltd., Toronto.

**FOR A  
TOUGH,  
LONG-  
LASTING  
FLOOR-CARE  
PRODUCT,  
PUT A LITTLE  
LAMB IN IT!**

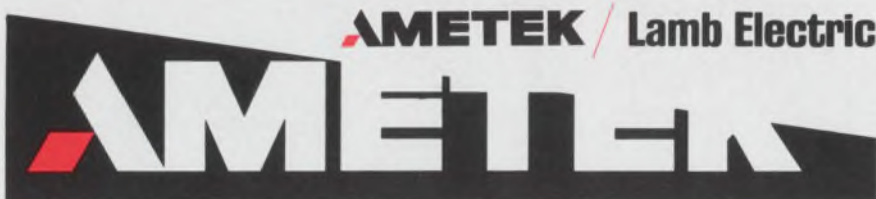

ON READER-SERVICE CARD CIRCLE 62

## TEST EQUIPMENT

### Ni-Cad batteries in portable multimeter



*California Instruments Corp., 3511 Midway Dr., San Diego, Calif. Phone: (714) 224-3241.*

Multimeter performance of three ranges of dc V, three of ac V and five of resistance are offered. Performance characteristics of the model 8000B includes 4-digit readout, with 10% 5th-digit over-ranging. Accuracy is 0.05% and resolution is 0.01%. Input impedance on all ranges is 10 M $\Omega$ . The batteries are rechargeable nickel-cadmium and supply up to 6 to 8 hours of use in normal operation without recharging.

CIRCLE NO. 268

### Counter-timer out to 8 digits



*Fairchild Instrumentation, 475 Ellis St., Mountain View, Calif. Phone: (415) 962-2011. Price: \$2495.*

The model 8300 is an eight-digit instrument with 10-ns resolution, high input impedance and ac or dc input coupling. By adding a plug-in module, the instrument's frequency range may be extended to 500 MHz. The unit makes frequency, multiple period average, frequency ratio, time interval and totalizing measurements. Time base stability is attained with a proportionally controlled oven for the quartz crystal. A variety of options makes it possible to interface the unit with other instruments and systems.

CIRCLE NO. 269



you get a choice,

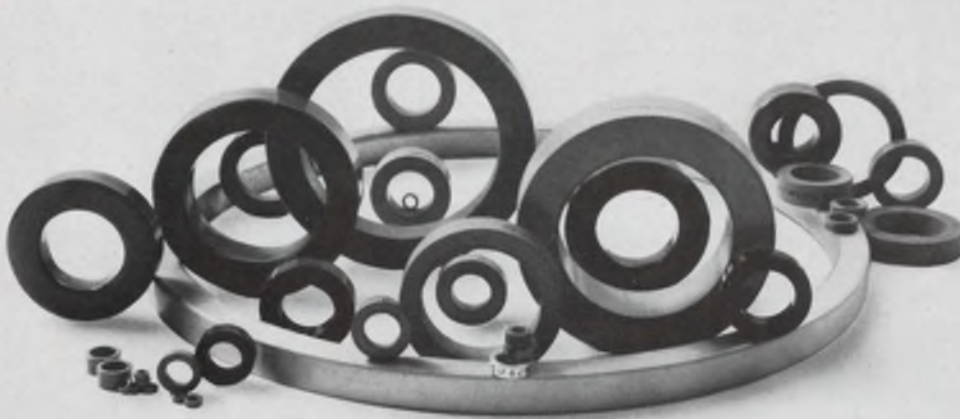

not a challenge



**Most complete line of high quality tape wound cores available from any manufacturer**

Magnetics' selection of tape wound cores encompasses eight material types, in a range of sizes from 0.050" to 12" inside diameter. For frequencies from DC through 500 kc, materials are produced in thicknesses ranging from 1/8 mil through 14 mils. All core sizes are available boxed in phenolic or plastic, aluminum or GVB- coated

aluminum. Magnesil<sup>®</sup>, less sensitive to external stresses, is also available unboxed or epoxy encapsulated.

In addition to offering this broad range of tape wound cores, Magnetics has improved its production of raw materials, using the most advanced testing devices to control quality in metals, winding, annealing, potting compounds, boxing processes and the application of encapsulating

materials. This across-the-board control assures you of getting what you pay for in performance.

If you have an application for tape wound cores, why settle for an approximation of your specifications? With Magnetics, you don't have to "make do"—you get a choice, not a challenge. For further information on our complete line of tape wound cores, write for Catalog TWC-300, Magnetics Inc., Butler, Pennsylvania 16001

**MAGNETICS inc.**  

# TEST

**Integrated Circuits  
Quickly, Accurately,  
Economically**

(DTL, TTL, RTL, MECL & OP AMPS)



**\$995**

## **Introducing the NEW Low-Cost MICRODYNE 710 Integrated Circuit Tester**

— offers an extremely high degree of flexibility in circuit testing, as a manually operated instrument or as a rapid change, programmed functional tester. The analyzer is ideal for incoming inspection, small run production, laboratory and failure analysis. The model 710 is capable of testing all DC parameters of micrologic circuits and most micro linear circuits.

### **FEATURES/model 710**

- Pre-Programmed Patch Plugs for rapid testing.
- Direct meter readout for voltages and currents.
- Adjustable test voltages and current limiting.
- Adjustable pulse rates and variable amplitude.
- Selectable circuit loads, both resistance and capacitance.
- Cross point matrix for manual device testing.
- Alarm indicator for power supply overload.
- Selectable threshold indicators.

**\$995.00**

Write for descriptive brochure or  
call (617) 893-8210

**MICRODYNE INSTRUMENTS INC.**  
Waltham Engineering Center / 225 Crescent St.  
Waltham, Mass. 02154 / tel. (617) 893-8210

## TEST EQUIPMENT

### **Electron beam supply operates in 3 modes**



*Sloan Instruments Corp., 535 E.  
Montecito St., Santa Barbara, Calif.  
Phone: (805) 963-4431.*

An electron-beam power supply for either manual or automatic control has a constant-voltage, variable-emission type with a gun-filament source and two-gun magnet supply. It provides 10,000-V dc at 0.6 A. In addition to beam-position-control a variable beam-sweep function allows evaporation from a large area without defocusing beam. A second emission control module may be added for simultaneous two-gun operation. A hand-held remote control permits manual emission and beam positioning from up to 8 feet from supply. All controls and indicator lights are front panel mounted. Operator safety is assured through three interlocks. Forced-air cooling and electronic overload protection offer reliability.

**CIRCLE NO. 270**

### **Wide chart recorder responds in 0.5 s**

*Honeywell, Inc., Ft. Washington,  
Pa. Phone: (215) 643-1300. P&A:  
\$900 to \$2300; 10 to 12 weeks.*

The Electronik-194 recorder, has a 10-inch calibrated chart. The instrument is available in one-and two-pen, multi- and single-range models for bench use or relay rack and panel mounting. It is expected to find application in areas involving analysis, precision production-line testing, and monitoring of automotive, aircraft and rocket test-stand data. The instrument measures dc signals over a range of 100  $\mu$ V to 100 V. It is for use in conjunction with low-impedance (up to 25,000  $\Omega$ ) sensing devices, high-impedance bridge circuits, and high-level dc signals.

**CIRCLE NO. 271**

# Only new Lambda LP Series lab power supplies provide all these big system features in a small, low-cost package.

## Starting at only \$114.

- High power output—up to 28 watts.
- Wide voltage range versatility—0-10 VDC up to 0-250 VDC.
- Bench or rack use—without adapters.
- Unusually wide automatic current limiting—from 1% (or 5 MA) to 105% of rated output current.
- Two meters for voltage and current.
- Both coarse and fine adjustment of voltage and current.
- Over-temperature protection by thermal relay—prevents overheating.
- Convection cooled—no blower failures.



You can mount up to 4 units in a standard LRA-1 or LRA-2 rack adapter.

### Other features

- Regulation (line or load): .01% + 1 MV.
- Ripple: 500  $\mu$ V RMS, 1.5 MV p-p
- Temperature coefficient: .015% + .5 MV/ $^{\circ}$ C.
- CV/CC with automatic crossover.
- A-C input: 105-132 VAC 45-440 Hz (ratings based on 57-63 Hz operation).
- All Lambda power supplies are guaranteed for 5 years.

### Select from six models

Model	Voltage Range	MAX. CURRENT AT AMBIENT OF:				Price <sup>1</sup>
		30 $^{\circ}$ C	40 $^{\circ}$ C	50 $^{\circ}$ C	60 $^{\circ}$ C	
LP 410	0-10 VDC <sup>2</sup>	2A	1.8A	1.6A	1.4A	\$129
LP 411	0-20 VDC <sup>2</sup>	1.2A	1.1A	1.0A	0.8A	119
LP 412	0-40 VDC <sup>3</sup>	0.70A	0.65A	0.60A	0.50A	114
LP 413	0-60 VDC <sup>3</sup>	0.45A	0.41A	0.37A	0.33A	129
LP 414	0-120 VDC	0.20A	0.18A	0.16A	0.12A	149
LP 415	0-250 VDC	80MA	72MA	65MA	60MA	164

<sup>2</sup>Overvoltage Protection available as an accessory—\$40.00 each.

<sup>1</sup>Prices are for non-metered models. For metered models, add suffix (FM) and add \$10.00 to price.

SEND FOR COMPLETE LAMBDA CATALOGUE



**LAMBDA**  
ELECTRONICS CORP.

515 BROAD HOLLOW ROAD - MELVILLE, L.I., NEW YORK 11746 - (516) 894-4200

A  SUBSIDIARY

VESCO HIGH VACUUM EQUIPMENT / LAMBDA POWER SUPPLIES

MAKES EVERYONE LOOK GOOD...

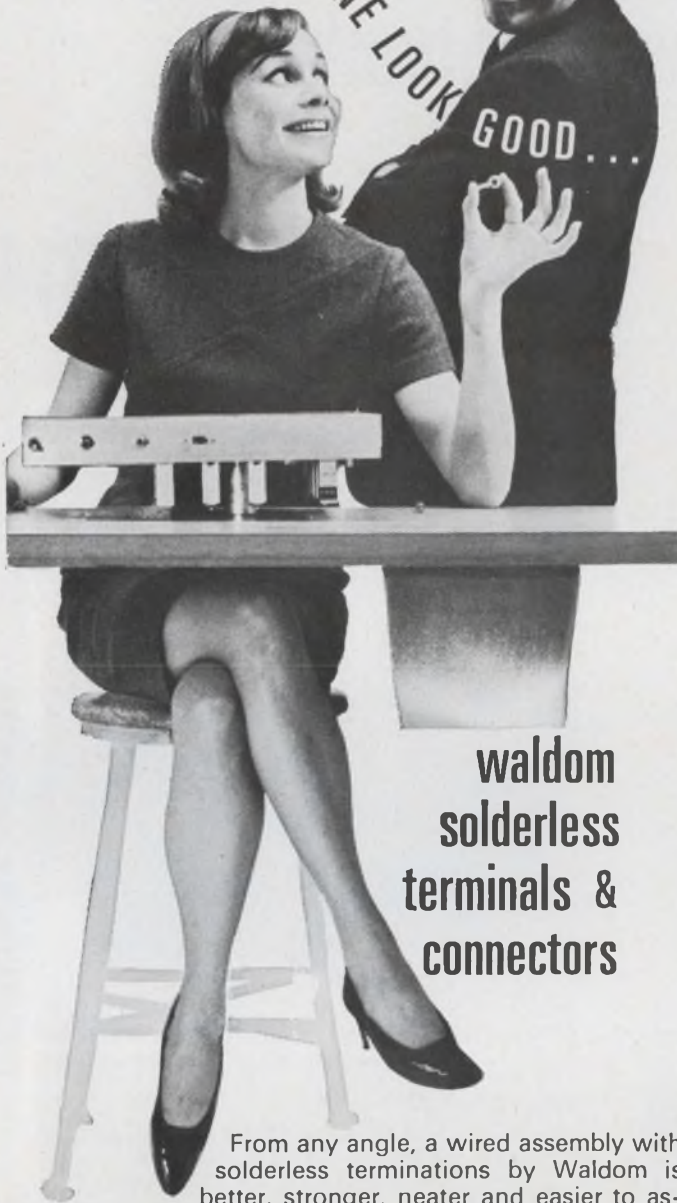

## waldom solderless terminals & connectors

From any angle, a wired assembly with solderless terminations by Waldom is better, stronger, neater and easier to assemble. Everyone gains . . . the pretty assembler on the line, her foreman, the company officers and stockholders and, most of all, the user of the completed product.

Waldom Solderless Terminals and Connectors make positive connections, are vibration and temperature proof and they will never wear out or lose their grip. If that's not enough, check these other benefits. . . .

- \* Broad selection including Quick Disconnects. \*
- All construction styles. \*
- Absolute dependability. \*
- Saves time and labor. \*
- Easier servicing. \*
- All types made to military specs.

Fast delivery from your electronics or electrical distributor. Write for FREE Waldom catalog listing more than 3000 electronic hardware items.



**waldom** ELECTRONICS, INC.  
4643 West 53rd Street,  
Chicago, Illinois 60632

ON READER-SERVICE CARD CIRCLE 65

## TEST EQUIPMENT

### Broad spectrum surgical monitor

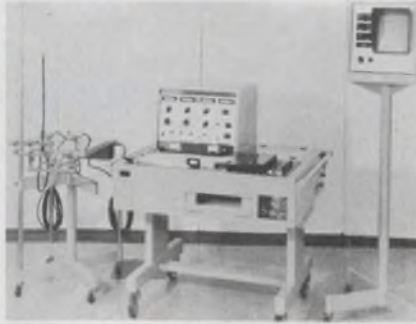

*Medical Systems Corp., 43 Plymouth Rd., Great Neck, N. Y. Phone: (516) 488-4848.*

A surgical monitor designed to monitor and record arterial and venal pressure, EEG, ECG, EMG, and phonocardiograph consists of a four-channel viewing oscilloscope, a four-channel recorder (including time and event markers), and a transducer holder and calibration mount. The unit is used in operating rooms and catheter treatment centers. Modular in design, the unit has several optional plug-in accessories including transducers to measure respiration curve, galvanic skin resistance, and photoelectric plethysmogram. Another feature is remote control operation, allowing the oscilloscope to be viewed in the operating room while the recording unit can be maintained at a different location. The recorder can also be operated remotely by a foot switch.

CIRCLE NO. 272

### Micrologic circuits checked with IC tester

*Microdyne Instruments, Inc., Waltham Engineering Center, 225 Crescent St., Waltham, Mass. Phone: (617) 893-8210.*

Designed as a low-cost analyzer, it is capable of testing most dc parameters of micrologic circuits. Portable, the model 701 is self contained, with all necessary power supplies, electronic current/voltage meter, output indicators and pulse generator. Testing can be achieved utilizing the pre-programmed patch plug. Four tests can be operated in series to provide 16 tests in a single sequence. 15 seconds per unit is required for functional testing.

CIRCLE NO. 273

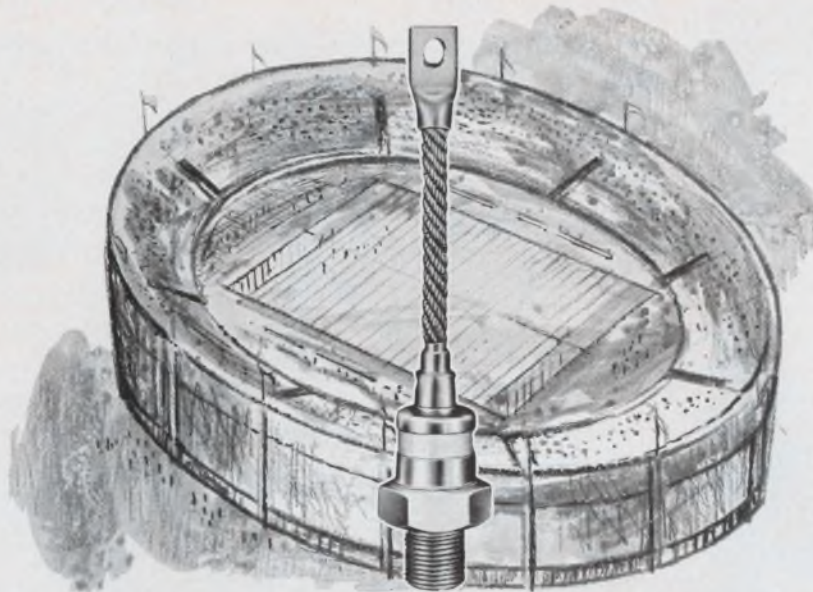

## All-American Blocker!

A Syntron Avalanche Silicon Rectifier blocks out voltage transients; assures dependable operation.

Avalanche characteristics are built right into these solid-state silicon rectifiers to limit voltage across the rectifying junction. Multi-diffusion permits exact control of individual junction parameters. Mail coupon for information about Avalanche Silicon Rectifiers available from 1 AMP-250 AMPS. Voltage from 50 to 1600 volts.

Please send details about Syntron Avalanche Silicon Rectifiers	283
Name and Title _____	
Company _____	
Street _____	
City and State _____	Zip _____



**SYNTRON COMPANY**

283 LEXINGTON AVE. • HOMER CITY, PA. 15748

TELEPHONE 412-479-8011

Sales Representatives Coast-to-Coast

67R2



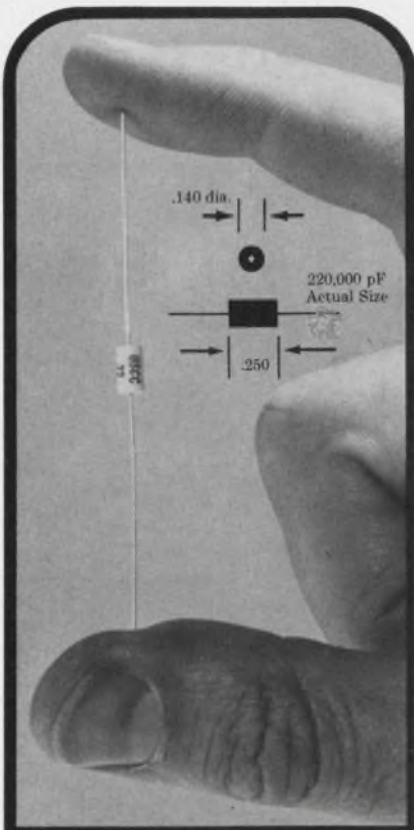

## USCC announces the highest capacitance density in a micro-miniature size

If you have problems obtaining high capacitance values in your microelectronic circuits, let USCC's C20 Series help you. These Ceramolitic® capacitors feature the best capacitance per unit volume available anywhere in a ceramic capacitor for filtering, bypass, coupling and blocking in micro-miniature circuits.

Here's what you get:

C20 SERIES Capacitance (pF)	Size (in.) Diameter	Length
10 - 12,000	.080 x	.150
15,000 - 27,000	.095 x	.185
33,000 - 56,000	.095 x	.250
68,000 - 120,000	.125 x	.250
150,000 - 220,000	.140 x	.250

Designed for "cordwood" applications, epoxy resin encapsulation offers outstanding insulation resistance, adhesion qualities and high temperature characteristics. Axial leads of .016" diameter Nickel per MIL-STD-1276 N-1 are excellent for soldering and welding. ■ Ceramolitic® capacitors of the C20 Series give you large size performance in a small size with no sacrifice in electrical characteristics.

**CERAMOLITHIC®**

... advanced design in ceramic capacitor construction

For complete technical information on the new C20 Series, contact:

**USCC**

U. S. CAPACITOR CORPORATION  
2151 NO. LINCOLN STREET • BURBANK, CALIFORNIA 91504  
(213) 843-4222 • TWX: 910-498-2222

ON READER-SERVICE CARD CIRCLE 67

## TEST EQUIPMENT

### Strip chart recorder plots 24 points



West Instrument Corp., 3860 N. River Rd., Schiller, Pk., Ill. Phone: (312) 678-6400.

Up to 24 points can be recorded with this potentiometric recorder. The unit uses solid-state electronics including the photochopper. Printed circuit plug-in cards for zero position, span and function (suppression) on mV ranges provides flexibility. The three separate cards plug into an amplifier socket. For thermocouple reading, the cards are replaced by a single temperature card with a complete choice of ranges. Accuracy of readings is  $\pm 0.25\%$  of full scale or  $\pm 5 \mu\text{V}$ . Three types of graphic displays are possible. Through a mechanical adjustment, an operator can select graphic presentation of dots only, dots with input number next to every twenty-fifth dot or dots with input number next to every dot.

CIRCLE NO. 274

### In-line voltage calibrator to 1111.110 V in 3 ranges

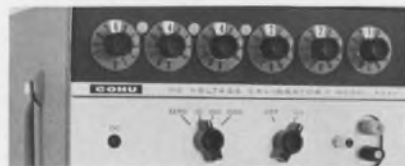

Cohu Electronics, Inc., Box 623, San Diego, Calif. Phone: (714) 277-6700. P&A: \$995; stock.

The model 324 A features an in-line readout, a voltage range from 0 to 1111.110 in three ranges of 10 V, 100 V and 1000 V and a stability of 30 RPM for 24 hours and 50 ppm for 30 days. Output-voltage dials control make-before-break switches and permits the output voltage to be varied in steps as small as 10  $\mu\text{V}$ . Output current capability is 25 mA at any voltage setting.

CIRCLE NO. 275

### Circuit board simplifies design



Grid Craft, Inc., 2217 S. Anthony Blvd., Fort Wayne, Ind. Phone: (210) 744-4314. Price: \$25.

Complete with multigrip terminals installed in all holes, this patchboard simplifies prototype circuit development on closely spaced grids which can later be translated into equivalent printed circuits for production runs. Offered is a packaged selection of the board, including four units 3 x 6 in. in size (a fifth board of the same size is provided with the holes but without installed terminals); three 6 x 1/2 in. strips for joining adjacent cards without losing grid spacing; and one submodule card. The larger boards have 402 terminals.

CIRCLE NO. 276

### Dc power supply to 15,000 V



Spellman High Voltage Co., Inc., 1930 Adeo Ave., Bronx, N. Y. Phone: (212) 547-0306.

This unit features solid-state design with an adjustable output from 100 to 15,000-V dc. Polarity is reversible. It is short-circuit proof and upon removal of the short circuit, the unit will return immediately to normal operation. The unit has a maximum current capability of 2 mA. The power supply with carrying handle is 10-1/4 x 8-1/2 x 8 in. and weighs 12 lb.

CIRCLE NO. 277

ON READER-SERVICE CARD CIRCLE 68 ➤

# 1.34 × 10<sup>5</sup> COMBINATIONS

(ONE OF THEM HAS GOT TO WORK FOR YOU.)

When we say our Trim Trio has enormous application potential, we're not kidding. The combination of numbers surprised us too. For any of our three types of contacts—sub-min coax, machined or continuous formed strip—will work in any of nine connector blocks (14 to 152 positions). In any combination.

And if you wanted to count wire sizes, or figure the twisted pairs our sub-min coax can

accommodate, or leave some contact holes open, the possibilities would truly be endless. Probably most of them haven't been used yet. Surely some of them will

solve your problems.

And Burndy can make your installation problems easier, too. Whether you crimp one at a time on a hand tool or 3,000 per hour with a Hyfematic™ you can count on built-in quality control, save time and money. For the full story and details on the combination that will work for you—from breadboard to production—write for our Bulletin MS67.

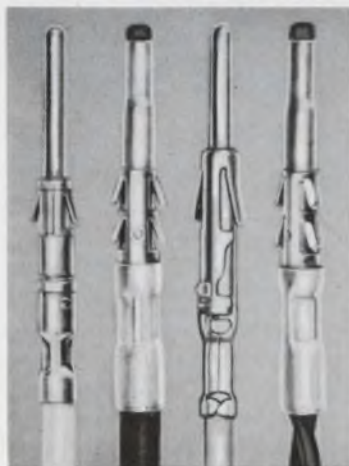

Machined Sub-min Coax Strip Hyfen Twisted Pair

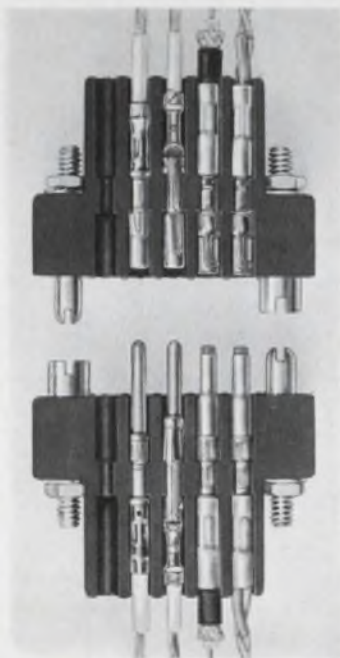

See more at  
WESCON Booths 5344-6

 **BURNDY**  
NORWALK, CONNECTICUT

INTERNATIONAL SALES HEADQUARTERS AND MANUFACTURING FACILITIES:

CANADA: Scarboro, Ontario / ENGLAND: St. Helens, Lancs. / BELGIUM: Mechelen / MEXICO: Naucalpan de Juarez  
BRAZIL: Sao Paulo / JAPAN: Tokyo / Sales Offices in Other Major Cities



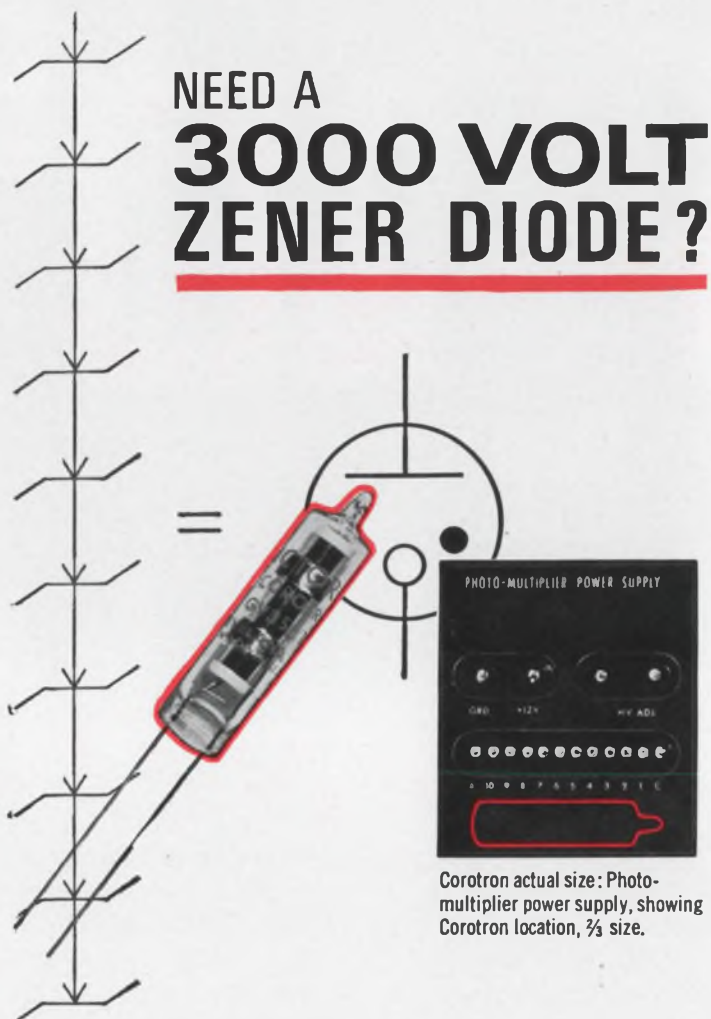

# NEED A 3000 VOLT ZENER DIODE?

Corotron actual size: Photo-multiplier power supply, showing Corotron location, 1/3 size.

You could string together several hundred zeners. Or you could specify one Victoreen Corotron. It is the gaseous equivalent of the zener with all the advantages of an *ideal* HV zener diode.

For space research and other rugged applications requiring absolute power supply stability, GV3S Series, shown, provide the ideal reference voltage anywhere in the range of 400 to 3000 volts. They enable circuitry to maintain constant high voltage regardless of battery source voltage or load current variations. Cubage and weight (GV3S Corotron weighs only 4 gm.) are important considerations. So is temperature variation (Corotrons operate from 200°C down to -65°C). Ruggedized versions withstand shock to 2000 G, vibration 10 to 2000 cps.

If you're trying to simplify circuits . . . to cut cost, size and weight . . . to upgrade performance—you need Corotron high voltage regulators. Models are available now from 400 to 30,000 volts. A consultation with our Applications Engineering Dept. will speed up the countdown.

8501-A



**VICTOREEN INSTRUMENT DIVISION**  
10101 WOODLAND AVENUE • CLEVELAND, OHIO 44104  
IN EUROPE: GROVE HOUSE, LONDON RD., ISLEWORTH, MIDDLESEX, ENGLAND

ON READER-SERVICE CARD CIRCLE 69

## TEST EQUIPMENT

### Instrument calibrator with 0.2% accuracy

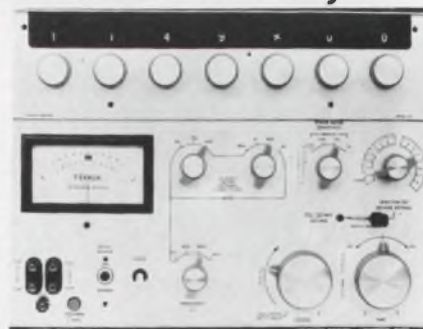

Weston Instruments, Inc., 17 Hartwell Ave., Lexington, Mass. Phone: (617) 861-9000.

This calibrator provides a means of calibrating meters both portable and panel mounted. The operation is accomplished by using a fractional scale-divider which enables calibration throughout a meter range without resetting full-scale values or amplitude controls. Operator calculations are eliminated when determining per cent accuracy at fractional scale points, since the results are always displayed in terms of full scale. Ac and dc voltages to 1100 V, currents to 11 A and resistance to 11 MΩ are provided with 6-digit resolution. Accuracy is specified at 0.1% of reading for dc voltages, and 0.2% for most other functions.

CIRCLE NO. 278

### Frequency meter to 500 MHz



Fairchild Instrumentation, 475 Ellis St., Mountain View, Calif. Phone (415) 962-2011. Price: \$1695.

Featuring direct frequency measurement and seven-digit resolution, this light, compact instrument is designed to meet the needs of the communications industry as well as other industrial and laboratory applications. The 8229 requires no tuning adjustments for direct reading across the entire range of 10 Hz to 500 MHz.

CIRCLE NO. 279



# Sealed hi-density switching

from 12 PDT to 144 PDT . . . with MIL-R-5757 protection against humidity

sand

dust

moisture

splash

explosion

corrosion . . .

. . . and withstands shock and vibration too! How? Tried T-Bars® lately?

ENVIRONMENTALLY SEALED  
**T-BAR** SERIES 831  
RELAYS



12P, ST or DT 24P, ST or DT 36P, ST or DT 48P, ST or DT 52P, ST or DT 60PST

All contacts epoxy sealed in back-filled metal enclosure for ground support and shipboard applications or other demanding environments. Pulse operated magnetic latching available. Simple crimp snap-in contacts fit into single block connectors for easy wiring.

HERMETICALLY SEALED  
**T-BAR** SERIES 808  
RELAYS

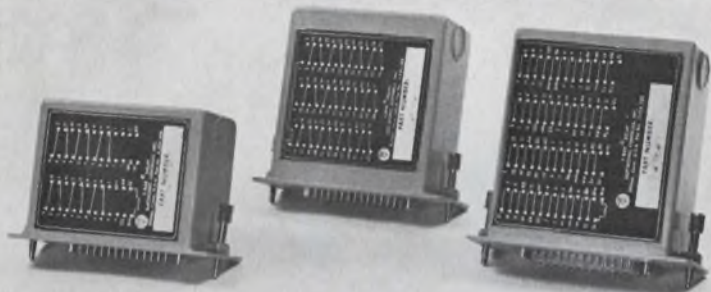

12PDT or 24PST

24PDT or 36PST

34PDT or 48PST

Hermetically sealed glass and metal-to-metal enclosures back-filled for ground support and selected airborne applications. Mates with MS connectors. Pulse operated magnetic latching available.

ENVIRONMENTALLY SEALED  
**T-BAR** SERIES 832  
SWITCHES

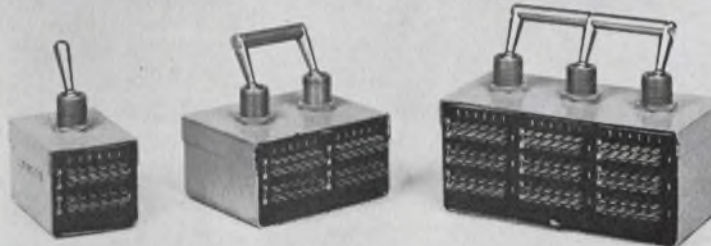

12P, 24P, 36P, ST or DT

48P, 60P, 72P, ST or DT

84P, 96P, 108P, 144P, ST or DT

Toggle switches with contacts epoxy sealed in backfilled metal enclosures. Lever operates through diaphragm. Dust boot supplied to exclude salt and sand from mechanical actuator. Simple crimp snap-in contacts fit into single block connectors for easy wiring.

**Interested?**  
Write for our Bulletin TB-801/L  
. . . it gives you complete details  
. . . or call (203) 762/8351



MANUFACTURED BY:  
**electronic controls, inc.**  
T-Bar Switch/Relay Division  
Danbury Road, Wilton, Conn. 06897  
(203) 762/8351

® "T-Bar" — Reg. T.M.

ON READER-SERVICE CARD CIRCLE 70

Specify  
**PERMACOR®**  
where iron cores  
is our one and  
only business

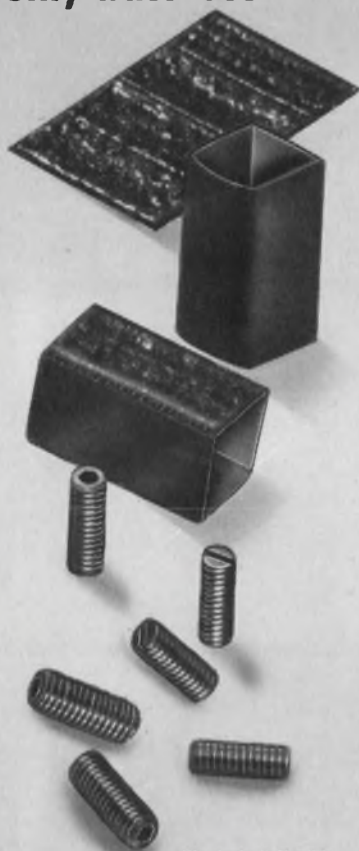

Illustrated: flexible shielding and threaded iron cores

In this age of specialists, PERMACOR stands above all others in the production and design of powdered iron cores. This is our sole business and our cord specialists can solve any problem. We have a full line of stock cores and unexcelled facilities for manufacturing any custom cores.

IRON CORES... Plain, Hollow, Threaded, Insert, Tuning, Cup, and Toroidal Iron Cores, Iron Coil Forms, Sleeves, Flexible Magnetic Shielding, Bobbins and special shapes...our only business and we're the world's largest. We invite your inquiry.

**PERMACOR®**

A Division of Radio Cores, Inc.

9540 Tully Ave., Oak Lawn, Ill. 60454  
Phone: 312-422-3353

## TEST EQUIPMENT

### Reference junction for monitoring temperature

*Scientific Engineering & Mfg. Co., Inc., 11505 Vanowen St., North Hollywood, Calif. Phone: (213) 982-1400.*

This unit features multiple inputs so that various thermocouple materials may be utilized in each channel. The reference-junction temperature is adjustable by means of an external, ten-turn potentiometer. A well is provided to allow insertion of a probe to monitor the equalizing block temperature. The proportional, solid-state, temperature controller used to maintain the constant reference temperature, has a very high degree of accuracy and stability.

CIRCLE NO. 280

### Mass spectrometer registers 1 to 250 amu



*EAI, Scientific Instruments, 4151 Middlefield Rd., Palo Alto, Calif. Phone: (415) 321-7801. Price: \$13,850.*

A laboratory mass spectrometer features linear mass resolution from 1 to 250 amu. The QUAD 160 can sweep the mass range from 10 to 250 amu, (optional 1-150 amu) or any portion of this range, in 100 ms to 10 minutes. Manual control also permits continuous monitoring of a single peak. The sensitivity of the unit assures a detectability of less than 1 ng. Other features of the system include emission regulation, variable automatic or manual mass scan, and a mass marker/emission meter. Resolution is better than unity, using a 10% valley definition.

CIRCLE NO. 281

### Conductivity meter ranges from 0.5 to 103%



*Uresco, 12412 Benedict Ave., Downey, Calif. Phone: (213) 923-3278.*

Eddy current instrument, model FC-500, permits direct reading of electrical conductivity values in percent covering the entire range of metals with conductivities from 0.5% to 103%. It is possible to measure conductivity of thin gauge aluminum (below 0.020 in.) as well as titanium and other low-conductivity alloys with one instrument. In addition, other scales make it possible to read directly nonconductive coating thickness. Because a direct relationship exists between electrical conductivity and many other material properties and characteristics it is possible with the FC-500 to indirectly determine mechanical properties for many metals in structures. An accessory gate and alarm system permits automatic scanning.

CIRCLE NO. 282

### Frequency counter ranges to 200 kHz

*Analex Instruments, Inc., 7833 Haskell Ave., Van Nuys, Calif. Phone: (213) 782-9527.*

Called the model-CF-503C frequency counter, it is used for measuring frequency or totalizing the number of input cycles or events. Maximum input sensitivity is 10-mV rms for frequencies from 3 Hz to 200 kHz, which permits direct operation from low-level sine-wave signals. The unit can be used with turbine flowmeters, tachometers, oscillators, and other frequency-generating devices. Gates times of 0.1, 0.6, 1, 6 and 10 seconds are derived from a 60 Hz line frequency. Variable display time is from 0.2 seconds to 6 seconds and hold. Plug-in transistors in the circuit boards offer simplified trouble shooting and maintenance. The counter measures 9 x 6 x 13 in. and four, five or six-decade models are available.

CIRCLE NO. 283

ON READER-SERVICE CARD CIRCLE 74

# We're ready for you now!

RCA's popular "Under \$1" sensitive-gate Triacs are now immediately available in mass production quantities... and what a combination of low-cost and exceptional performance!

Over a year in the field has demonstrated the unmatched advantages of RCA sensitive-gate Triacs for ac phase control, load switching, and solid-state replacement for relays. And now we're ready for mass production orders. Just check these circuit benefits:

**High gate sensitivity**—10 mA max. gate current is many times more sensitive than conventional Triacs... and types as low as 3 mA are also available for designs where critical heat-sinking is not an important consideration.

**Low current**—2.5A (rms) is ideal for many 110V or 220V appliances and motors... plus surge current protection to 25A.

**Convenient size**—popular TO-5 package combines the advantages of a compact, hermetically sealed metal case with the Triac's inherent ability to perform the full-wave functions of 2 SCR's.

Your RCA Field Representative can give you complete information on RCA's six different versions of sensitive-gate Triacs, including price and delivery. For additional technical data, write RCA Commercial Engineering, Section RG10-2, Harrison, N.J. 07029. See your RCA Distributor for his price and delivery.

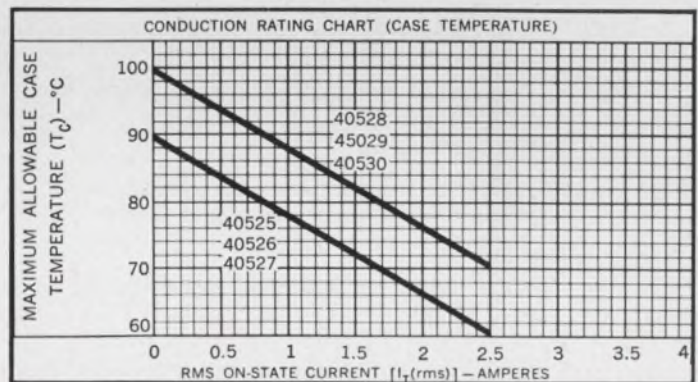

I <sub>T</sub> (rms)	I <sub>GT</sub>	Low Voltage (V <sub>DRM</sub> =100V)	120V Line (V <sub>DRM</sub> =200V)	240V Line (V <sub>DRM</sub> =400V)
2.5A	3 mA Max	40525 (0.95*)	40526 (0.98*)	40527 (1.40*)
	10 mA Max	40528 (0.95*)	40529 (0.98*)	40530 (1.40*)

\*Prices in quantities of 1,000 and up

RCA Electronic Components and Devices



The Most Trusted Name In Electronics

CUSTOM-MADE

# R-C Networks

ANY SIZE  
ANY POWER RATING  
ANY COMBINATION  
ANY CONFIGURATION

- For • RFI Suppression • Arc Suppression  
• Relay Contact Protectors • Noise Filters  
• Spark Suppression

*R-C Networks available in any combination, for example:*

**Capacitor Section can be . . .** Mylar, Metalized Mylar, Polystyrene, Polycarbonate . . . any voltage or tolerance.

**Resistor Section can be . . .** Composition, Wire-wound, Metal Film, Deposited Carbon . . . in any wattage or tolerance.

Total Networks available in tolerances as close as  $\pm 1\%$ .

All Networks are manufactured under rigid Quality Control to meet your specific requirements.

Send us your specifications for quotation. Prototype quantities furnished prior to production.

For Complete details write Dept. ED-9



1065 W. Addison Street, Chicago, Illinois 60613

ON READER-SERVICE CARD CIRCLE 76

## TEST EQUIPMENT

### Sensitive ac/ $\Omega$ converter for digital voltmeter



Hewlett Packard, 1501 Page Mill Rd., Palo Alto, Calif. Phone: (415) 326-7000. P&A: \$2075; 30 day.

The instrument converts ac voltage or resistance to a proportional dc voltage for measurement by the digital voltmeter. It thus enables the digital voltmeter to work with dc, ac, and resistive transducers, as well as to make a wide variety of other measurements. It is designed to be used with the model 3460 B digital voltmeter. The converter-preamp produces a dc output proportional to the average value of sine wave inputs over a 50 Hz-100 kHz frequency range. Four voltage ranges are provided from 1 V full scale to 1000 V full scale, and the instrument makes measurements accurately up. Resistance measurements are made in five ranges, from 1000 to 10 M $\Omega$  with 20% overranging on all ranges. The unit also functions as a dc preamplifier. The input impedance, on the 0.1-, 1-, and 10-V ranges, is greater than 10<sup>10</sup> $\Omega$  making possible measurements on devices of high source resistance, such as standard cells, with negligible loading error.

CIRCLE NO. 284

### CO analyzer sounds the alarm

Mine Safety Appliances Co., Pittsburgh, Pa. Phone: (412) 241-5900

A carbon monoxide analyzer-alarm uses a catalytic oxidation principle for the analysis of carbon monoxide features solid-state circuitry. The model 701 can give visible as well as audible warnings when carbon monoxide in the atmosphere reaches a predetermined point. It can be set to give an alarm for concentrations in the range of 0 to 500 parts per million. A small pump draws a continuous sample through a cell which has active and inactive chemical surrounding two thermistors, which are part of a bridge circuit.

CIRCLE NO. 285

# NEW EXCLUSIVE DERINGER MULTI-PURPOSE EQUIPMENT REDUCES SUB-ASSEMBLY LABOR COSTS UP TO 75%

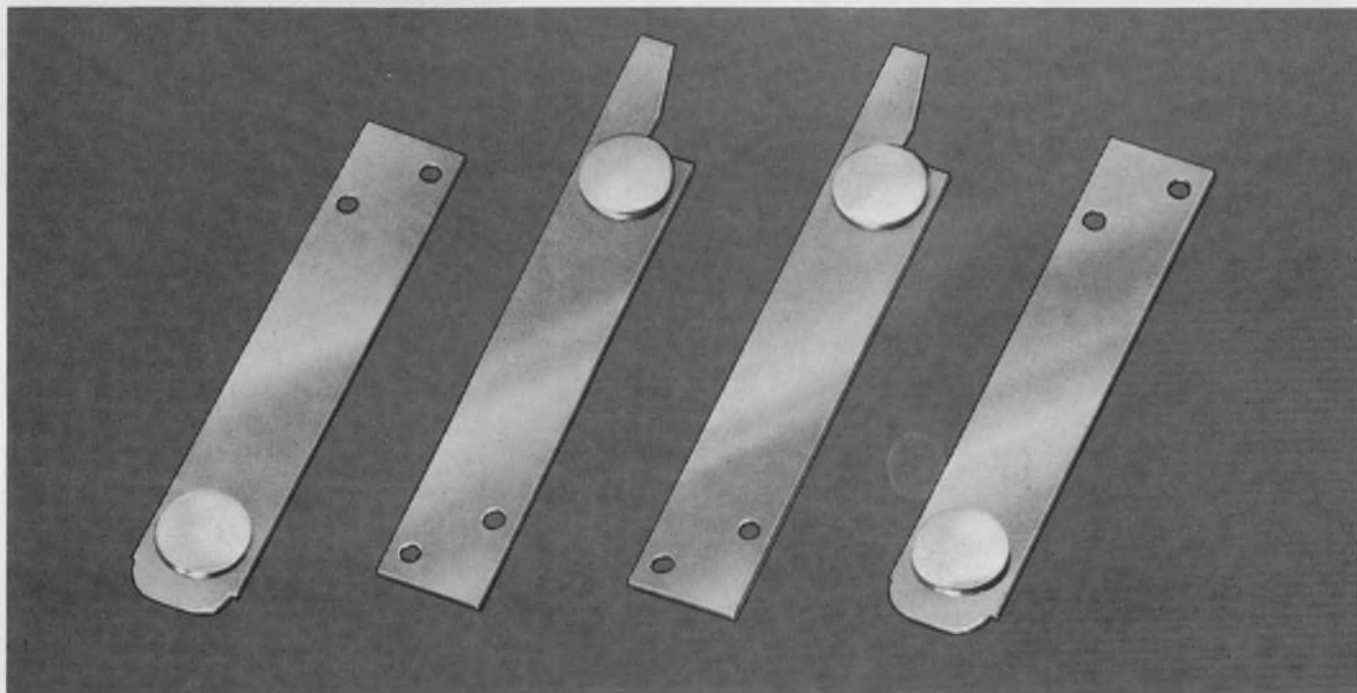

Yes, a 75% saving is being accomplished on sub-assemblies such as pictured above by the use of Deringer engineered and built equipment that encompasses an unusual variety of operations. Some of these operations are: blanking, welding, forming, marking, etc. All this is done in a complete operation from the raw material to the finished sub-assembly. This Deringer developed equipment also has the flexibility so necessary to accommodate a large range of sizes and configurations.

This exclusive new Deringer equipment is just one of Deringer's new developments aimed at helping you reduce the cost of your electrical contacts and sub-assemblies. This and other unique Deringer developments also make it possible to reduce the silver content of certain contacts. This material

cost reduction is particularly important when you consider the scarcity of silver and the increasing cost of silver. These savings are most important to you in a competitive market, particularly as the savings are made with no sacrifice in contact or sub-assembly quality and reliability. *To coin a phrase, Deringer gives you more for your silver dollar!*

For a review of your contact applications to determine if one or more of Deringer's unique manufacturing processes and equipment can save you money while maintaining or improving reliability, contact Deringer.



FOR CONTACTS—CONTACT

**DERINGER**

METALLURGICAL CORPORATION

1250 Town Line Road - Mundelein, Illinois 60060

ON READER-SERVICE CARD CIRCLE 77

# Would you believe we make 9,694 tapes?



## we do!

Here's the world's largest collection of pressure sensitive tapes. Available in dozens of colors, opaque and transparent, glossy and matte, border art tapes and hundreds of printed tapes and symbols.

If you use self-sticking tape, Prestape makes a precision slit tape for you in widths from 1/64th to 2 inches.

FREE! Write for your copy of brand new 48 page Prestape catalog. It's a handy reference of over 9000 Prestape tapes.



136 West 21st St. New York, N. Y. 10011

ON READER-SERVICE CARD CIRCLE 78

## Shorting can't harm operational amplifiers

*Burr-Brown Research Corp., International Airport Industrial Park, Tucson, Ariz. Phone: (602) 294-1431. Price: \$8 to \$45 in 100 lots.*

Eight models of integrated-circuit operational amplifiers can be shorted indefinitely to ground without damage, and the input is protected up to the supply voltage. Unity gain stability is assured with any capacitive loading without changing phase compensation or adding a decoupling resistor.

Specifications for the models include selection of input voltage offset drifts from  $\pm 5 \mu\text{V}/^\circ\text{C}$  to  $\pm 30 \mu\text{V}/^\circ\text{C}$  maximum, and of maximum offset current drifts from  $\pm 0.2$  to  $\pm 0.4 \text{ nA}/^\circ\text{C}$ . These specifications apply over the full  $-55$  to  $+125^\circ\text{C}$  for the four military temperature range units and from  $-25$  to  $+95^\circ\text{C}$  for commercial amplifiers. The voltage gain is typically 100 dB for all units, and the open loop gains range between 93 and 100 dB. Rated output voltage is  $\pm 10 \text{ V}$  on all units. The output current is  $\pm 10 \text{ mA}$  for the wide temperature units and  $\pm 5 \text{ mA}$  for the commercial amplifiers. Two low-noise units are offered with  $3\text{-}\mu\text{V}$  peak and  $0.15\text{-nA}$  peak input noise. All units are supplied in a standard TO-99 can (low-profile TO-5). Supply voltages from  $\pm 9 \text{ V}$  to  $\pm 18 \text{ V}$  may be used.

CIRCLE NO. 286

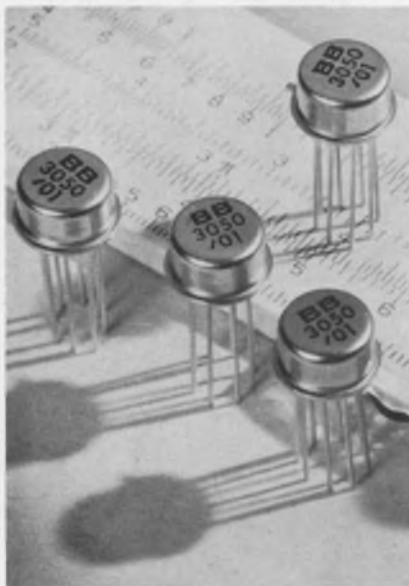

## Four-junction FETs in a flat pack

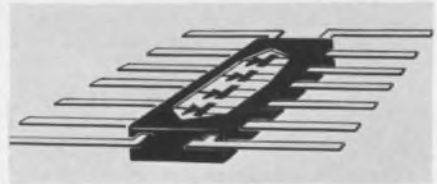

*Siliconix Inc., 1140 W. Evelyn Ave., Sunnyvale, Calif. Phone: (408) 245-1000. P&A: From \$20 to \$34.80 per 100; stock.*

Eight new 4-channel junction FET switches, the G125F-132F, are packaged four to a TO-84 and are designed primarily for switching applications; however they are also useful in amplifiers, voltage-controlled-resistors, and constant-current applications. Maximum pinch-off voltages are 5 and 10 V; maximum ON resistances are 500, 250, 90 and  $45 \Omega$ .

CIRCLE NO. 287

## Dc regulators handle 1/2 A



*Helipot Div., of Beckman Instruments, 2500 Harbor Blvd., Fullerton, Calif. Phone: (714) 871-4848. P&A: \$35; stock.*

Beckman's model 802 and 804 cermet dc regulators are short-circuit proof and externally adjustable from 9 to 21 V and 20 to 32 V respectively. Both provide output regulation of  $\pm 0.05\%$  for line as well as load variations. Units have a load current handling capability of 1/2 A, which can be increased to 5 A with the addition of an external power transistor. Power rating of 1.8 W at  $25^\circ\text{C}$  can be increased to 5 W by mounting the unit on a  $3 \times 3 \times 0.125$ -inch aluminum plate. Operating temperature range is  $-55^\circ\text{C}$  to  $125^\circ\text{C}$ .

CIRCLE NO. 288

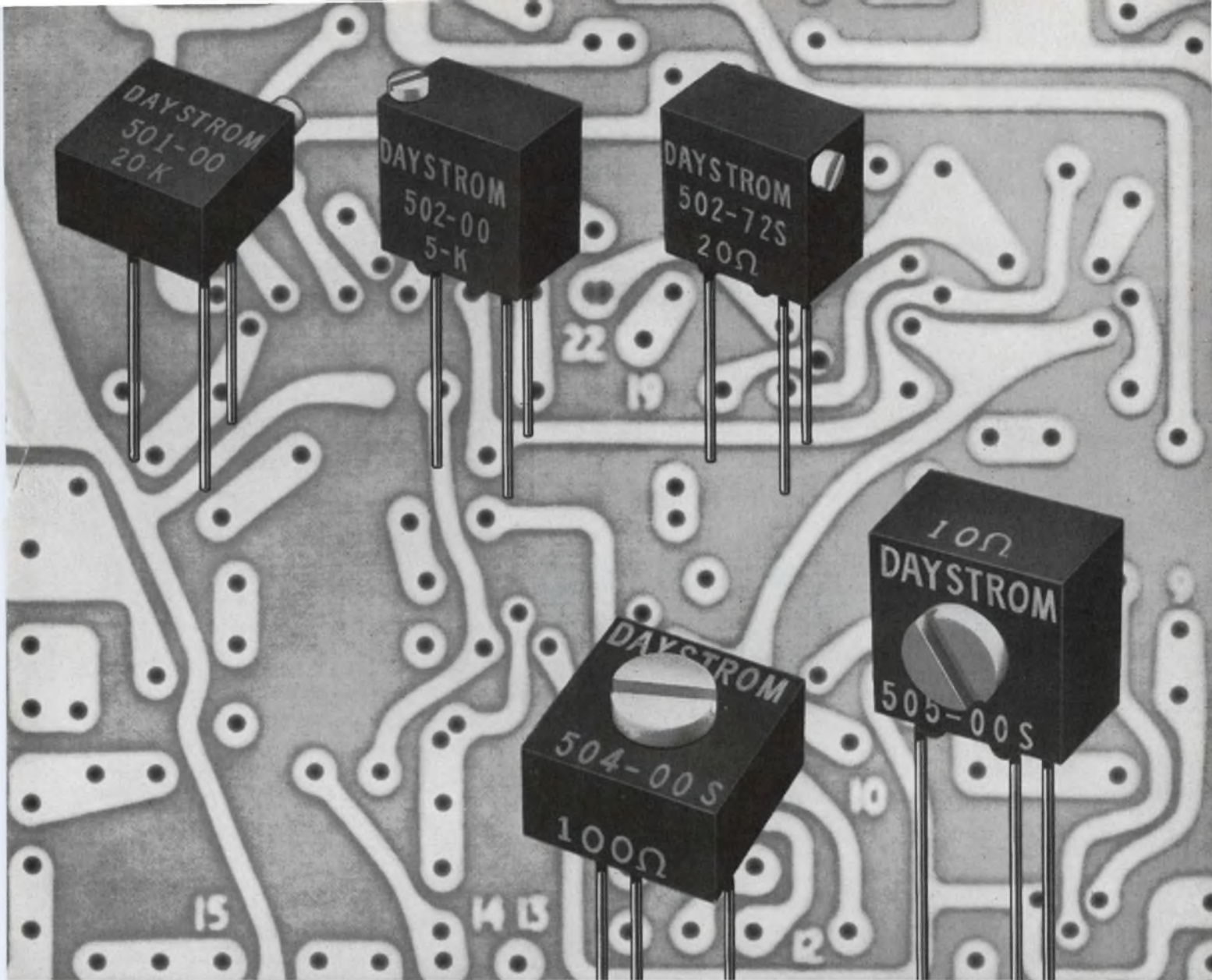

## Savings across the board just took a new turn

DAYSTROM Commercial Squaretrim® potentiometers now include single-turn types. New models 504 and 505 are fully adjustable with just one turn. Models 501 and 502 are 15-turn types. They all clear up to 80% more PC board space—at no extra cost. But the trim .02 cubic inch size is only one reason why these commercial 500 Series pots are proving so popular. They also feature Weston's exclusive wire-in-the-groove design, and all these performance extras:

Convenience 5 different configurations with adjusting screw on top, side or end • Tolerance  $\pm 5\%$  • Adjustability 15 turns or single turn • Slip Clutch eliminates wiper damage, cuts production delays • Suregard™ Terminations for better protection against vibration, shock and humidity—no pressure taps • Superior Resolution 0.125% or less • Wide Range  $10\Omega$  to  $20K$  (higher values on request) • High Power 0.6 watt in still air at  $70^\circ C$  • Wide Temperature Range  $-55^\circ C$  to  $150^\circ C$  • Low Temperature Coefficient 70 ppm max. • Low Noise  $100\Omega$  max. ENR • Small Size  $\frac{1}{16}'' \times \frac{5}{16}'' \times \frac{3}{16}''$  • Low Cost \$2.10 each for 501/502 in 500 lot quantity, \$1.95 each for 504/505 in 500 lot quantity.

Daystrom potentiometers are another product of:

**Weston Instruments, Inc. • Weston-Archbald Division • Archbald, Pa. 18403**

**WESTON®** prime source for precision... since 1888

ON READER-SERVICE CARD CIRCLE 79

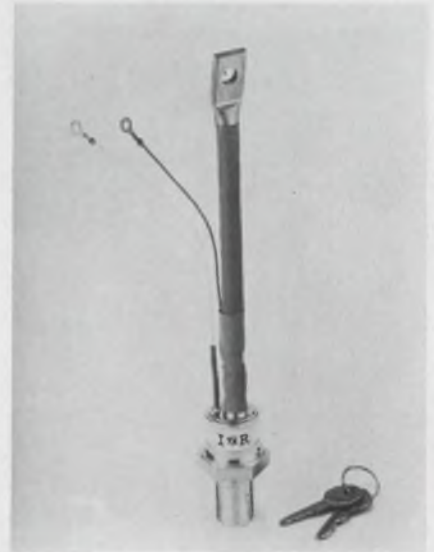
Epitaxial Triac  
reaches 200 A

International Rectifier, 9220 Sunset Blvd., Los Angeles. Phone: (213) 678-6281. P&A: \$216-\$680 ea., samples 10-99.

The "logic" capability allows the selection of the direction the current flows as a function of the gate signal. This power logic-triac offers current rating up to 200 A and rms and peak voltage ratings as high as 1000 V. The 220 kW power handling capacity of the device is twenty times that of comparable electronic range devices now on the market. Applications for these devices are in industrial controls, temperature regulators, motor controls and overload protection, emergency lighting systems, and welding equipment, as well as in inverters and dc-ac converters. In these and other applications where the logic-triac can replace two SCRs connected in antiparallel and in some cases actually accomplish part of the control function within the device itself, the advantages are: a reduction in the number of heat sinks required, the necessity of only one control gate instead of two, a reduction in the complexity of the gating circuits, and self protection against damage by high voltage transients.

Other important features include a transient voltage rating in both directions exceeding the operating voltage rating as well as a guaranteed  $dv/dt$  and  $di/dt$  rating on all devices.

CIRCLE NO. 289

# Low Cost 4 DIGIT

## 400 SERIES INTEGRATING DC DIGITAL VOLTMETER



**Extended Range Measurements:** Fifth digit over-range.

**Precise Measurements:** With accuracies to 0.05%.

**Input Flexibility:** Four voltage ranges and a micro-current input for measuring in "Engineering Units" (psi, degrees, etc.)

**System Compatibility:** BCD Outputs and Remote Programming.

**High Noise Rejection:** Differential input and integration techniques provide common mode rejection greater than 120 db at 60 Hz.

**Economical:** 3 and 4 digit models range from \$349.50 to \$495.50.

These DVM's are not only **NEW**, they're **AVAILABLE** from Janus representatives from coast to coast!

CALL OR WRITE FOR A DEMONSTRATION.



296 NEWTON STREET • WALTHAM • MASSACHUSETTS 02154 • TEL: (617) 891-4700

ON READER-SERVICE CARD CIRCLE 80





## Metal Glaze resistors offer .02% reliability and low cost

IRC Metal Glaze resistors now offer you a combination of proved reliability and economy that just can't be matched. You can upgrade your circuit designs and still keep the lid on costs.



- **RELIABILITY PROVEN DESIGN.** A design so conservatively rated that even at *twice rated load*, performance still far exceeds applicable MIL requirements.
- **RELIABILITY PROVEN BY TESTS.** After more than 4 million unit hours of testing, estimated maximum failure rate is .02%/1000 hours, full load @ 70°C, at 60% confidence. Failure is defined as  $\Delta R > \pm 4\%$ .
- **RELIABILITY PROVEN IN USE.** Millions used in a wide range of applications. No in-circuit failure—*catastrophic or otherwise*—has ever been reported.

Metal Glaze resistors offer other benefits, too: indestructible thick-film resistance element, plated-on copper

end cap, high-temperature soldered termination and a smooth, tough molded body that resists solvents, corrosion, and mechanical abuse.

For top resistor performance without any cost penalty, specify IRC Type RG. Write for data, prices, and sample. IRC, Inc., 401 N. Broad St., Phila., Pa. 19108.

### CAPSULE SPECIFICATION

		
WATTAGE:	¼ W @ 70°C	½ W @ 70°C
RESISTANCE:	51Ω thru 150K	10Ω thru 470K
TOLERANCES:	± 2%, ± 5%	± 2%, ± 5%
TEMP. COEF.	± 200ppm/°C	± 200ppm/°C
IRC TYPE:	RG07	RG20



ON READER-SERVICE CARD CIRCLE 81

Isn't  
this  
the  
darndest  
cable  
you  
ever  
saw?

It just goes to show you that Markel can make just about any cable you can dream up! We make not only a wide variety of standard constructions, including all standard RG/U coaxial cables, but also a tremendous number of special constructions to customers' specifications. These may provide single, twisted pair or multiple conductors—bare copper or with tin, silver or nickel coatings; may combine insulations of Teflon\*, silicone rubber, fiberglass and nylon; braided metal shields; fillers, liners and jackets of various materials. Just give us your specs . . . we'll make your cable. For free samples, write:



**L. FRANK MARKEL & SONS**  
Norristown Pa. 19404 • 215-272-8960  
INSULATING TUBINGS AND SLEEVINGS  
HIGH TEMPERATURE WIRE AND CABLE  
°TM of DuPont



**FLEXLEAD**  
®  
**COAXIAL CABLES  
AND SPECIAL  
CONSTRUCTIONS**

ON READER-SERVICE CARD CIRCLE 82

SEMICONDUCTORS

**FET preamplifier  
for antenna mounting**

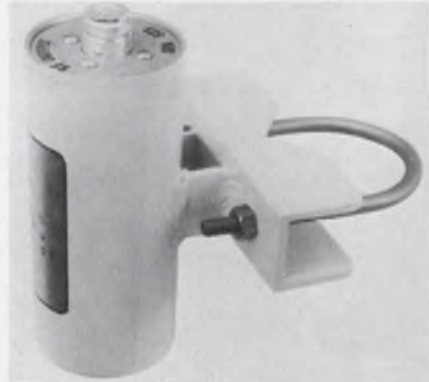

*Smyth Research Associates, 3555  
Aero Court, San Diego, Calif.  
Phone: (714) 277-0543.*

The SRA-823 preamplifier is a solid-state unit designed for mounting near the antenna feed. The unit is powered by 12-V-dc feed through the transmission-line center conductor. Installation of the preamplifier near the antenna feed eliminates the transmission line as a contributor to system degradation, reducing the system noise figure to very nearly the noise figure of the preamplifier alone. The intermodulation response of this unit provides a wide dynamic range when used in areas of heavy interference. Typical noise figures range from 2.2 dB at 150 MHz to 4 dB at 500 MHz. Nominal gain is 20 dB.

CIRCLE NO. 290

**Miniature reed relay  
has transistor drive**



*Wheelock Signals, Inc., Long  
Branch, N. J. Phone: (201) 222-  
6880.*

This design offers high packaging densities, since the reed relay with the transistor driving stage occupies 0.05 cubic in. Typically, 40 two-pole 442SS relays with their built-in driver stages, can be mounted on a 4-1/2 by 5-1/2 in. PC board. Contact for the 442SS series is rated at 7 W. They are available in 1 to 4 pole models.

CIRCLE NO. 291

# Attacking industrial counting on all fronts takes unusual counter-intelligence.

We've attacked it with two complete lines of integrated-circuit counting instruments that will take any man's measure.

The new 6200 Series for up to 200 kHz counting. Closed-box design. No cooling fan needed. Drip-tight. Dustproof. Able to stand severe work environments. Compatible with a wide range of input transducers. Available with 1-2-4-8 binary data output for direct feed into printers or tape punchers.

And the unique expandable 6300 Series for low-cost frequency-and-time measuring. Dual sets of plug-in modules tailor your cost to your desired function and frequency. You buy for today's need, expand capability for tomorrow's. 6-7- or 8-digit display with optional 9th.

Any way you figure it, EiD's up front in counter-intelligence.

To learn more of our secrets, contact your local EiD agent... or write direct to our nearest regional office.

EiD more than measures up.

**Beckman®**

INSTRUMENTS, INC.  
ELECTRONIC INSTRUMENTS  
DIVISION

2400 Harbor Blvd., Fullerton, Calif. 92634, (213) 691-0841

7360 N. Lincoln Ave., Lincolnwood, Ill. 60646, (312) 583-1020

12051 Tech Rd., Montgomery Ind. Park, Silver Spring, Md. 20904,  
(301) 622-2500

International Subsidiaries: Geneva; Munich;  
Glenrothes, Scotland; Tokyo; Paris; Capetown; London; Mexico City



**Pellet-diode under one cover**



Microsemiconductor Corp., 11250 Playa Court, Culver City, Calif. Phone: (213) 391-8271. Price: 79¢/100 up.

These micro-silicon devices are suited for thin/thick film and printed circuit-board insertion. The units are whiskerless, hermetically sealed and occupy approximately 1/50 of the volume of standard DO-7 packages. Users have options of either a pellet or microdiode in the same package. Pellet and microdiode mechanical sizes are 0.035 in. in diameter x 0.020 in. in height with 0.004 x 0.20 in. in. kovar leads. MIL-S-19500 reliability requirements are standard. Device specifications of 4 pF and 4 ns are used.

CIRCLE NO. 292

**FET amplifiers are battery operated**



K & M Electronics Corp., 102 Hobart St., Hackensack, N. J. Phone: (201) 343-4518. PA: \$55 ea.; stock.

FET operational amplifiers with current drains of less than 1 mA have been designed for applications that require battery power as well as high input impedance ( $10^{12} \Omega$ ), negligible current offset (10 pA), extremely low offset voltage (from 1  $\mu\text{V}/^\circ\text{C}$ ) and large slewing rate. They are suited for integrators; sample and hold circuitry; isolation amplifiers; low-noise, high-impedance ac amplifiers; and general instrumentation amplifiers.

CIRCLE NO. 293

**Transistors show 50 V at 500 MHz**



TRW Inc., 1100 Glendon Ave., Los Angeles. Phone: (213) 477-6061. P&A: \$71 to \$142 eg; one month.

This high-power communications transistor is capable of producing 50-V-rf output at 500 MHz from a 28-V source. Designated as the type 2N5178, this device employs a patented interdigitated cellular construction in a grounded emitter stripline package comparable in size to the TO-37. A 25-W version, type 2N5177, is also available. In addition to its application as final amplifiers in high-power uhf military transmitters, the transistors are suited for use in radar-pulse circuits.

CIRCLE NO. 294

**DIALIGHT READOUTS**

**BRIGHT BOLD CHARACTERS WITH MAXIMUM RELIABILITY**

Need more data? Ask for Catalog L-181.

Modular Display  
**\$4.75**  
per digit  
1000 lot quantities

**DIALCO** Foremost Manufacturer of Indicator Lights  
**DIALIGHT CORPORATION**  
60 STEWART AVE., BROOKLYN, N.Y. 11237 Area Code 212 497-7600

ON READER-SERVICE CARD CIRCLE 84

**FOR THE GUARANTEED ANSWER TO YOUR AIR MOVEMENT NEEDS ASK FOR THESE BULLETINS**



In the Howard CYCLOHM Fans and Blowers they describe, you get this unique combination of values:  
**MORE AIR AT LESS COST**  
For proof, see the performance data and price schedules in the Bulletins.

**GUARANTEED PERFORMANCE**  
All CYCLOHM air movement units are Powered by the Howard Unit Bearing Motor, guaranteed for 5 years to require no maintenance or re-lubrication.

**IMMEDIATE DELIVERY**  
of standard models. For availabilities contact Standard Motor Product Sales, 23 Broadway, Des Plaines, Ill. 60016 (TWX 910-233-1658).

3 Good Reasons for Requesting Bulletins 8-01 and 9-03 describing Fans and Blowers with Air To Spare.

**HOWARD INDUSTRIES**  
MSL INDUSTRIES, INC./MOTOR GROUP  
1760 STATE STREET  
RACINE, WIS. 53404

ON READER-SERVICE CARD CIRCLE 85

# AE stocks over 200 types of relays and switches

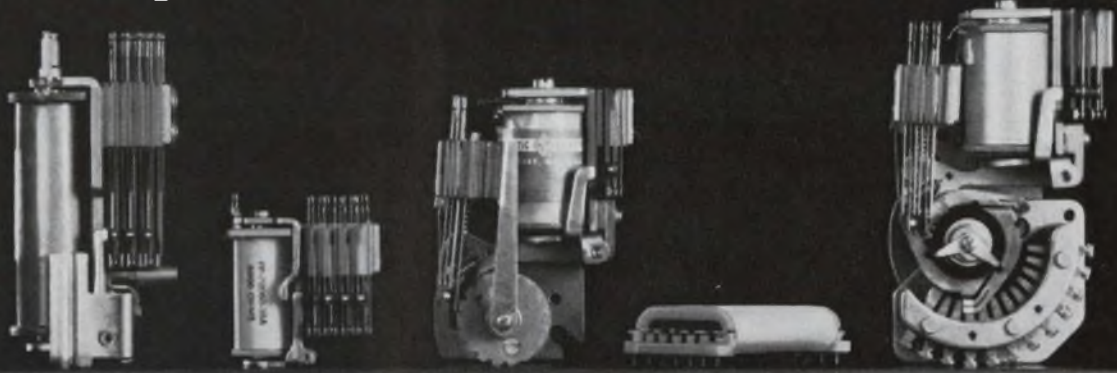

## for off-the-shelf delivery within one week!



Get fast, direct delivery—at no extra charge. Thanks to the Automatic Electric Stock Program.

This program keeps growing. Now, we stock over 200 kinds of relays, switches, and accessories. In large enough quantities to fill your normal prototype requirements within 7 days.

That means fast delivery on many of the most popular types from AE's broad line. EIN (integral socket) relays with power contacts; mercury-wetted-contact relays; PC Correeds; rotary step-

ping switches with gold levels for dry- and low-level circuits; ERM (magnetic latching) relays; Class E relays with four different wire termination methods; and many more.

Send for a free copy of Circular 1053, our newest "Stock Letter." It's the latest listing of items you can get quickly. Just write to the Director, Relay Control Equipment Sales, Automatic Electric, Northlake, Illinois 60164.

***AUTOMATIC ELECTRIC***  
SUBSIDIARY OF  
**GENERAL TELEPHONE & ELECTRONICS GTE**

ON READER-SERVICE CARD CIRCLE 86



## NEW / FROM NORTRONICS



## FIRST COMBO HEAD FOR 8-TRACK STEREO

MODEL Z-B2L

### ELIMINATES: ASSEMBLY TOLERANCE, TRACK ALIGNMENT AND PRESSURE PAD PROBLEMS

This new Nortronics Z-Combo head — a major engineering accomplishment — reduces the spacing between erase and playback gaps from the conventional .250" to an extremely small .050"!

Because of the close tolerances required in 8-track stereo, the conventional gap-to-gap spacing creates serious problems.

A 1° azimuth correction of the R/P gap in conventional combo heads creates a vertical displacement of .004" of the erase gap. As a result, the erase gap may incompletely erase the proper tracks and at the



same time erase wanted material on adjacent tracks. With the Nortronics Z-Combo heads, the equivalent displacement is less than .001".

The new head also permits simplified circuitry in the recorder, since it features internal automatic biasing.

The new Z-Combo head displays the quality, engineering, ingenuity, and responsiveness to every recording need that have made Nortronics the world's largest manufacturer of laminated core tape heads and the standard-setter for the industry.

Complete technical data is available on request.

# Nortronics

COMPANY, INC.

8101 Tenth Avenue North  
Minneapolis, Minnesota 55427

ON READER-SERVICE CARD CIRCLE 87

## MICROWAVES

### Microscope laser with 100% reflection

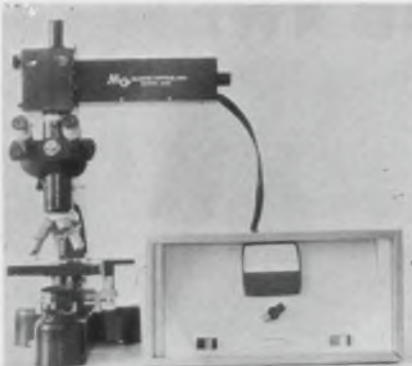

Maser Optics, Inc., 89 Brighton Ave., Boston, Mass. Phone: (617) 254-7880.

The model M-L microscope laser is designed to fit most microscopes adapted to photo-micrography. This unit fits into the camera port, yet allows the camera to be fitted into the new port directly over it so as not to lose the ability to photograph through the unit. It utilizes a dichroic mirror that will transmit all wave-lengths excepting 6943Å which are reflected 100%. It also utilizes the microscope objective for focusing the laser beam on a small spot, in order to increase laser-energy density. Because light coming from a point on a focused image is nearly parallel in the microscope tube, the laser beam works in reverse and its image plane will very nearly coincide with the object plane. The energy density on target of 1-micron hole coming through a 0.004 in. hole and a 60-x lens is in the order of 10,000 joules per sq. centimeter.

CIRCLE NO. 295

### Beacon transmitter on 6 to 6.3 GHz

Microwave Associates, Burlington, Mass. Phone: (617) 272-3000.

This all solid-state, fixed, tuned, C-band rf generator is crystal controlled, providing frequency stability in extreme environmental conditions up to an altitude of 70,000 feet. It operates within the 6 to 6.3 GHz frequency range with a minimum power output of 1 W. The transmitter has been designed for high-performance aircraft and ground-based beacon applications.

CIRCLE NO. 296

### Junction circulator spans 16.6 to 17.1 GHz



Raytheon Co., 130 Second Ave., Waltham, Mass. Phone: (617) 646-7648.

This waveguide-junction circulator is designed to operate at a peak power of 50 kW and at a frequency of 16.6 to 17.1 GHz. Designed model CKuM7, the high-power circulator will operate at an average power of 50 W. The unit weighs 5 oz and achieves a minimum isolation of 12 dB and a maximum insertion loss of 0.4 dB. Maximum VSWR is 1.20. Cooling is not required.

CIRCLE NO. 297

### Varian pumps for noble gas



Varian, 611 Hansen Way, Palo Alto, Calif. Phone: (415) 326-4000.

These pumps have elements that handle noble as well as active gases with speed and stability. Even with pure argon, the pumps ensure complete pumping stability below  $1 \times 10^{-5}$  Torr. These units come in three sizes, 140, 270, and 500 liter per second. They pump argon at 21%, and helium at 30%, of their respective speeds for air. An oil-free device, it functions electronically, chiefly on the principles of gettering of active gases by titanium sputtering, and permanent pumping of noble gases by ion burial on the pump wall. The units are for use with large space-simulation chambers, mass spectrometers, and physics experiments involving noble gases.

CIRCLE NO. 298



# try this for size...

there's no doubt about performance!

Sized right for high density pcb switching—as small as .145 cu. in.—the MicroClareed MR Relay adds a new dimension to Clare Sealed Contact Reed Relay capabilities. Design around 1 to 5 contacts in epoxy sealed and open coil modules—take advantage of all of the inherent reliability and performance achievements of CLAREED Relays in only 1/5th the size.

Super-clean in construction, the 100% operation-tested, glass-encapsulated contacts never need maintenance or adjustment. Fast... with switching speeds in the low millisecond range. On the job, insensitivity to electrical transients... and complete input/output isolation... provide high reliability with maximum circuit simplicity.

For complete design information, circle reader service number—or ask Clare for Data Sheet 961... Write Group 10A9.

C. P. Clare & Co., Chicago, Illinois 60645



Length: 1<sup>15</sup>/<sub>64</sub>" max.

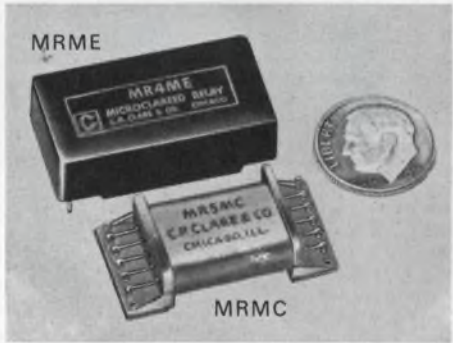

- Inherent reliability with no maintenance (Contacts sealed in glass)
- Switching times 0.5 to 2 ms
- Insensitive to transient electrical/electronic noises
- Contact load versatility—low level to 10 va
- Life:
  - .125 amp., 28 v: 10 x 10<sup>6</sup> operations
  - low level: 100 x 10<sup>6</sup> operations
- 1 to 5 contacts per module—open coil or molded epoxy modules

## MICROCLAREED SEALED-CONTACT REED RELAYS

for industrial control, data logging and instrumentation, communication switching, ground control, checkout systems

ON READER-SERVICE CARD CIRCLE 88

## Wiring board in multilayer form

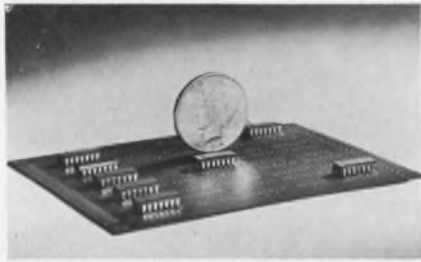

*Intellux, Inc., 26 Coromar Dr., Santa Barbara Industrial Pk, Goleta, Calif. Phone: (805) 968-3541. Price: \$1 per sq. in.*

Multilayer printed wiring boards are designed for high volume printed wiring-board applications requiring speed, economy and quality in manufacturing, processing and repair. This solid post technique allows dual in-line ICs to be automatically positioned and surface mounted to pads on the top surface of the board. Holes may be drilled through the solid posts where automatic insertions of modules is required. Engineered for applications in which there would be a requirement for a ground layer, voltage

layer and two signal layers. Inexpensive production techniques recommended by the manufacturer include the use of programmed or hot gas soldering methods allowing module leads to be attached to the surface pads.

CIRCLE NO. 299

## Board connectors of annealed copper

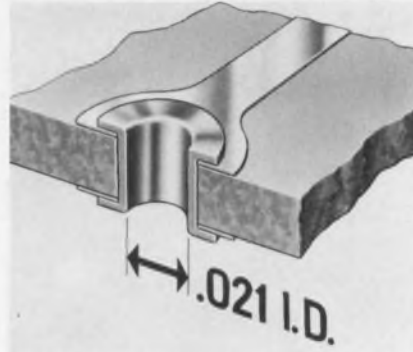

*Mark Eyelet & Stamping Inc., 63 Wakelee Rd., Wolcott, Conn. Phone: (203) 756-8847.*

Flat flange eyelets with consistent diameters and graduating lengths are suitable for various thicknesses of printed circuit boards. Tolerances

are held on the 0.03-in. barrel OD and 0.021-in. barrel ID while increasing lengths from 0.048 to 0.165 in. under the flange. They have a standard 0.046-in. flange diameter which can be spaced on 100-mil centers for IC packages. These eyelets are manufactured from oxygen-free, high-conductivity copper to federal specification QQ-C-576. They can be supplied with any of the standard plating finishes.

CIRCLE NO. 311

## Quick-drying cement for joining vinyl

*Quelcor, Box 33, Media, Pa. Phone: (215) 544-7710.*

Designed specifically for vinyl-to-vinyl cementing applications Quel-seal provides high shear lap strength and dries in minutes to provide a permanent liquid and airtight joint. Formulated especially for aerosol dispensing, it comes in 16-oz spray cans. It is clear; where color is required for color coding or marking or where metal brackets, clamps, hardware are to be coated, use the self-adhering vinyl.

CIRCLE NO. 312

## NEW STANDARD OF QUALITY

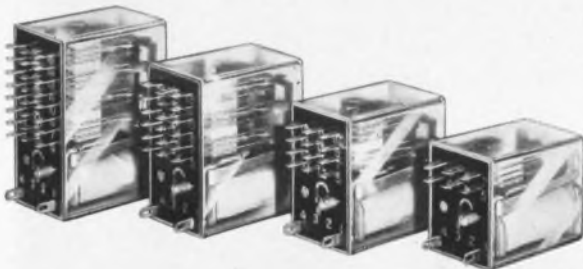

### Hart-Advance "VersaPac" 67

Available in 2, 4, 6, and 8 Form C, with solder terminals and printed-circuit sockets, the "VersaPac" 67 is undoubtedly one of the most adaptable industrial-type relays for applications requiring ultimate performance along with space and cost savings. Single and bifurcated contacts rated at 3 and 5 amps available. Mechanical life tested at over 100-million operations! For full performance data, write for Specification Sheet VP-67.

### NEW PRODUCT LINE

The Hart-Advance product line, combining the former Phillips-Advance and Hart relays, now provides one of the broadest ranges of relay types and sizes in the industry.

### NEW NAME AND LOCATION



HART-ADVANCE RELAY DIVISION  
OAK ELECTRO/NETICS CORP  
ELKHORN, WISCONSIN 53121  
TEL. 414-723-4080 TWX: 910-278-2491  
(formerly Phillips-Advance and Hart Relays  
by Hart Mfg. Co., Hartford, Conn.)

ON READER-SERVICE CARD CIRCLE 89

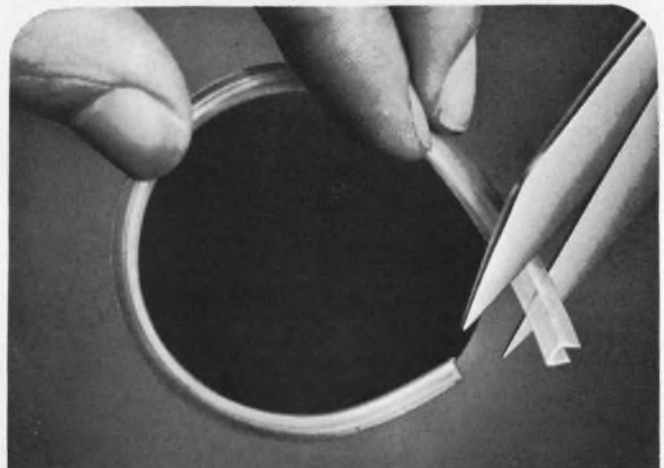

## SNIP-N-FIT GROMMET STRIPS

Lightweight polyethylene grommets by the roll! Fit any size or shape openings in panels and sheet-made equipment. Just snip the required length from any one of five sizes and fit. For thicknesses from 20 gauge to 1/4 inch. Fits easily. No tools or adhesives needed. Protects wires and tubing from fraying, abrading or cutting on sharp edges.

Send for Free Samples

**ELECTROVERT** INC.

Components Division  
86 Hartford Ave., Mt. Vernon, N. Y. 10553  
Milwaukee, Wis. • Burbank, Calif.



SOLD COAST-TO-COAST THROUGH AUTHORIZED DISTRIBUTORS

See us at NEC Show, Chicago, Booth 841

ON READER-SERVICE CARD CIRCLE 90

ELECTRONIC DESIGN 21, October 11, 1967



# Blue chip.



## COLLEGE IS BUSINESS' BEST FRIEND

Published as a public service in cooperation with The Advertising Council and the Council for Financial Aid to Education.



**SPECIAL TO MANAGEMENT**—A new booklet of particular interest if your company has not yet established an aid-to-education program.

Write for: "THE RATIONALE OF CORPORATE GIVING," Box 36, Times Square Station, New York, N. Y. 10036.

# Bulova can supply the crystal you need



to match your specs!

Many years of supplying crystal control units for the most advanced military and space programs enable Bulova to offer a full line encompassing virtually the entire frequency spectrum—2 kc to 125 Mc for oscillator and filter applications. We can supply every type of packaging—including koldweld and glass sealed. Our military crystals meet latest MIL-C-3098D specifications. All reasons why you should make Bulova your single source of supply.

**HIGH PRECISION GLASS SEALED CRYSTALS** 1 Mc to 125Mc. Available in vacuum sealed, glass enclosures of the HC-26/U and HC-27/U type.

**Example: Precision SSB Crystals**

Frequency: 1 Mc to 5 Mc  
Holder: HC-27/U  
Tolerance:  $\pm .0025\%$   
from  $-55^{\circ}\text{C}$  to  $+90^{\circ}\text{C}$ , or to specification  
Aging:  $3 \times 10^{-8}$  per week after one week stabilization at  $75^{\circ}\text{C}$



**KOLDWELD SEALED CRYSTALS**—low aging, high reliability, 1 Mc to 125 Mc. Now available in TO-5, HC-6/U and HC-18/U type cans sealed by the koldweld process to eliminate effects of heat and to reduce contamination.

**Example: TO-5**

Frequency: 15 Mc to 125 Mc  
Tolerance:  $\pm .0025\%$  from  $-55^{\circ}\text{C}$  to  $+105^{\circ}\text{C}$ , or to specification  
Aging:  $1 \times 10^{-7}$  per week after one week stabilization at  $75^{\circ}\text{C}$



Write or call for specifications on Bulova's complete line of crystals. Address: Dept. ED-17

## BULOVA

FREQUENCY CONTROL PRODUCTS

ELECTRONICS DIVISION OF BULOVA WATCH COMPANY, INC.

61-20 WOODSIDE AVENUE WOODSIDE, N.Y. 11377, (212) DE 5-6000

ON READER-SERVICE CARD CIRCLE 92

## MATERIALS

### Cup core for IC's

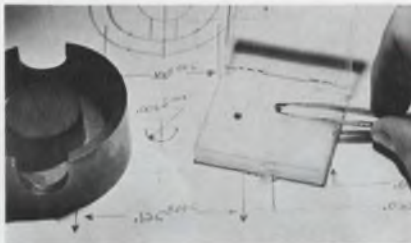

Indiana General Corp., Keasbey, N. J. Phone: (201) 826-5100.

Offered is a cup core with an OD of 0.125 in. ground to a 0.035 in. thickness. Main applications are in portable and vehicular communications equipment where size reduction is a prime concern. Its small size allows it to be used in ICs of frequency synthesizers and i-f sections such as radio frequency chokes and transformers. The core material is ferrite because of its good frequency response in the 10 to 65 MHz range and its flat temperature coefficient range is from  $-55$  to  $+125^{\circ}\text{C}$ .

CIRCLE NO. 313

### Impregnant resin has low viscosity



Emerson & Cuming, Inc., Canton, Mass. Phone: (617) 828-3300. P&A: 90¢ to \$1.00 per lb.

Stycast 3050 T is a low viscosity resin system, which is useful for impregnation and encapsulation in one operation. Thus, coils, transformers, motor windings, etc. can be cast in resin without a previous impregnation and cure. Because of low viscosity in many applications, void free castings can be obtained without the use of vacuum processing. The resin may be cured at room temperature with catalyst 9 or at an elevated temperature with catalyst 11.

CIRCLE NO. 314

### High-purity mullite solves laser problem

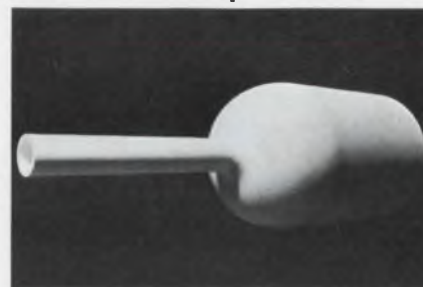

McDaniel Refractory Porcelain Co., Dept. S., Beaver Falls, Pa. Phone: (412) 843-8300.

High temperatures to  $2600^{\circ}\text{F}$  are needed to melt the high-barium crown glass used in the rods. Before PMV 31, crucibles failed under thermal stress or contaminated the glass with stones and trace impurities of iron. Minute stones in laser rods may cause explosions when the rods are energized, and trace impurities of iron can impair the transmitting capabilities of the rod. These problems are eliminated through use of PMV 31. While this substance is now being used exclusively for crucibles and rods for laser-glass production, its high purity, together with its thermal shock resistance offer applications when these properties are the critical requirements.

CIRCLE NO. 315

### Silicone elastomer is self-catalyzed

Transene Co., Inc., Route 1, Rowley, Mass. Phone: (617) 948-2501. P&A: \$4. up; stock.

A self-catalyzed silicone elastomer can be used as a protective coating and encapsulant for semiconductor devices and for potting sensitive electronic components. It is designed to stabilize semiconductor surfaces and p-n junctions. Available in a pre-polymerized state, ready for application, it cures by heating without the addition of a catalyst. The cured product is a white, resilient, dielectric material that is heat stable and waterproof. Cured SSE exhibits flexibility at  $-75^{\circ}\text{C}$ . Heat resistant up to  $300^{\circ}\text{C}$ , it has a bulk resistivity of  $5 \times 10^{14}\Omega$  and a dielectric strength of 550 V/mil.

CIRCLE NO. 316

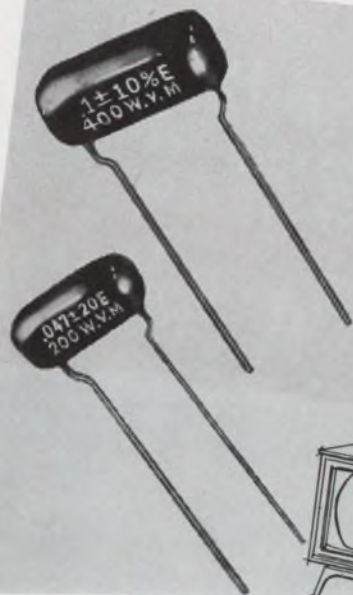

# Proof Positive of High Reliability of EL-MENCO \*MYLAR-PAPER DIPPED Capacitors

OVER 330,000,000 OF THESE HIGH QUALITY UNITS USED IN TV SETS SINCE 1959!

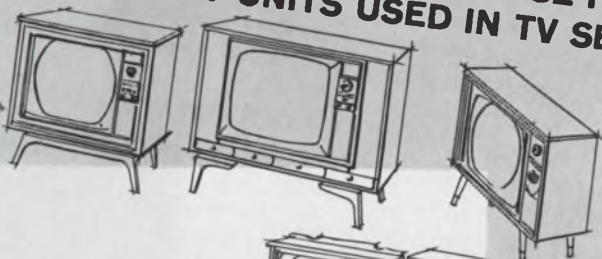

The number of EL-MENCO capacitors in TV sets is truly amazing. This figure of 330,000,000 represents more than the total population of the following countries:

- United States and Possessions
- United Kingdom and Canada
- Argentina    Belgium
- Denmark    Ecuador    Chile

299,813,929 people (1960 Census)

Even with this tremendous mass production the quality of EL-MENCO capacitors has not suffered. Here's a fine tribute of the high reliability of EL-MENCO capacitors from a leading TV manufacturer:

**"... I am certain that you are aware of the enthusiasm our Engineering and Quality people have displayed for this unit, for to us it represents the virtual elimination of capacitor field problems in the future ..."**

Write dept. AE for descriptive bulletin #MPD

Imagine!  
Over 330 million EL-MENCO Mylar\* Paper Dipped Capacitors have been used in black and white and in color TV sets since 1959! These capacitors of the highest quality and reliability help bring programs to millions of people who have invested in TV sets... and 330 million is just a drop in the bucket! For the demand for EL-MENCO capacitors still far exceeds the supply!



**EL-Menco Capacitors**

**THE ELECTRO MOTIVE MFG. CO., INC.**  
WILLIMANTIC, CONNECTICUT

Exclusive Supplier to Jobbers and Distributors in the U. S. and Canada  
**ARCO ELECTRONICS, INC., COMMUNITY DRIVE,**  
GREAT NECK, L. I. NEW YORK

DIPPED MICA  
MOLDED MICA  
SILVERED MICA FILMS  
MICA TRIMMERS & PADDERS  
MYLAR\* PAPER DIPPED  
PAPER DIPPED  
MYLAR\* DIPPED  
TUBULAR PAPER

\*Registered Trade Mark of DuPont Co.

West Coast Manufacturers Contact:  
**COLLINS & HYDE CO., 1020 CORPORATION WAY, PALO ALTO, CALIFORNIA**  
5380 WHITTIER BOULEVARD, LOS ANGELES, CALIFORNIA

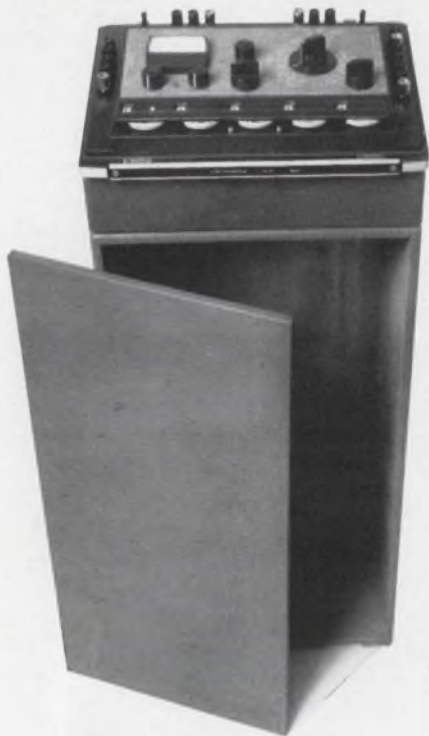

## We thought of putting a false bottom on it.

We toyed briefly with the idea of making our PVB (Potentiometric Voltmeter-Bridge) bigger than it had to be. We were worried about the skeptics who wouldn't believe we could combine seven high-accuracy measurement functions in a portable case the size of a typewriter.

But we resisted temptation. We designed the PVB as compact as solid-state technology permits. And we said to the skeptics, "Seeing is believing. If you don't think that one \$875 instrument can deliver 0.02% accuracy or better on voltage, resistance, current and ratio measurements—just watch."

The skeptics watched and they became believers. They passed the word along to friends and made the PVB one of our best sellers. (If word hasn't reached you yet, write us direct.) They showed us this instrument has more uses than even *we* knew—including potentiometric temperature measurement, checking of dc power supplies, measuring pH and calibration applications galore.

We should have known that false bottoms went out with the bustle. ESI, 13900 NW Science Park Drive, Portland, Oregon 97229.

Electro Scientific Industries **esi**®

ON READER-SERVICE CARD CIRCLE 94

## MATERIALS

### High temperature paints work to 4400°F

*Industrial Infra-Red, Inc., 157 Dayton Way, Sharon, Pa. Phone: (412) 342-8457.*

These paints produce an extremely hard, abrasion-resistant surface of very low porosity. All paints are water base and are spray-applied like regular paints with the same basic metal preparation normally required. Designed for use on a variety of substrates, they find their use on almost any application, from low-temperature corrosion to high-temperature oxidation protection. They have a maximum temperature range from 2000°F on metals to 4400°F on refractory linings. The natural high emissivity of these paints produces significant fuel savings and dust elimination, when used on refractory linings as in boilers, furnaces and ovens.

CIRCLE NO. 317

### Asbestos fiber flexes its muscle

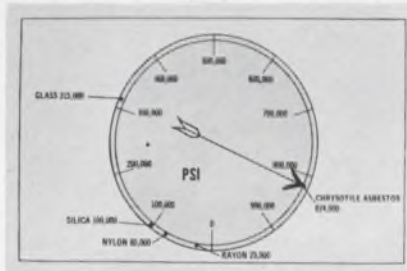

*Raybestos-Manhattan, Inc., Manheim, Pa. Phone: (717) 665-2211.*

Laboratory and simulated field tests show that the tensile strength of the asbestos fibers as compared to the strength of such other fibers as glass, silica, nylon and rayon, is far superior. Its strength is at least twice that of glass and almost eight times that of nylon. Reinforced asbestos provides low thermal conductivity and diffusivity, uniform ablation, excellent dimensional stability and high resistance to thermal shock. The fineness of the asbestos fibers also permits a dense structure with maximum surface area for resin adhesion. Pyrotex is a composite material, available as asbestos-reinforced felts, tapes, mats and molding compounds.

CIRCLE NO. 318

## Buy Bonds where you work.

## They do.



They work for freedom. And more than seven out of ten of them are supporting freedom with their dollars, too—through investment in U.S. Savings Bonds. When *you* buy Bonds, you can save up for a rainy day, a home, a free and comfortable future—and at the same time show these brave men you're on their side. Join the Payroll Savings Plan where you work or buy Bonds where you bank. You'll walk a bit taller.

### New Freedom Shares

Now, when you join the Payroll Savings Plan or the Bond-a-Month Plan, you are eligible to purchase new Freedom Shares. They pay 4.74% when held to maturity of just four-and-a-half years (redeemable after one year), and are available on a one-for-one basis with Savings Bonds. Get the facts where you work or bank.

Join up. America needs your help.

### U.S. Savings Bonds, new Freedom Shares



*The U.S. Government does not pay for this advertisement. It is presented as a public service in cooperation with the Treasury Department and The Advertising Council.*

### Solid-state alarms offer custom options

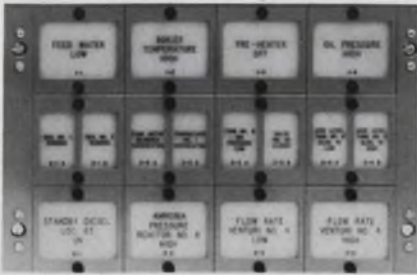

*Deltron, Inc., Wissahickon Ave., North Wales, Pa. Phone: (215) 699-9261. Price: \$40 per point.*

Alarms featuring ICs and silicon-controlled rectifiers offer solid-state reliability. All sequences including first out and ringback types are available and all units provide transformer-isolated alarm contact and lamp circuits for protection against shock. Inputs are diode-protected and filtered against transients and surges. Contact options are easily changed by a linkage system eliminating slide switches.

CIRCLE NO. 319

### Optical Fiberscope to 12.5 ft long

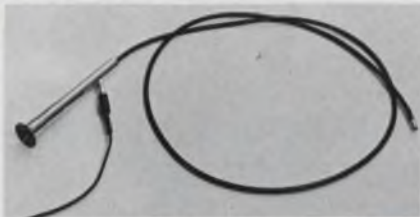

*American Optical Co., Southbridge, Mass. Phone: (617) 764-3211.*

Areas into which entry is only possible through extremely small openings can be inspected with the optical FS-21 Fiberscope. This flexible unit is specially designed for remote viewing of locations inaccessible to either large or rigid devices. The unit can pass through openings of 1/4 in. and relay visual information. The scope is made in lengths up to 12-1/2 feet, and can negotiate narrow passages with a band radius of as little as 3/4 in. In a unit as small as the FS-21, there are more than 40,000 individual fiber-optics elements. As a result, the device has a resolving capability of 45 lines per mm. A small lamp supplies light to the halo.

CIRCLE NO. 320

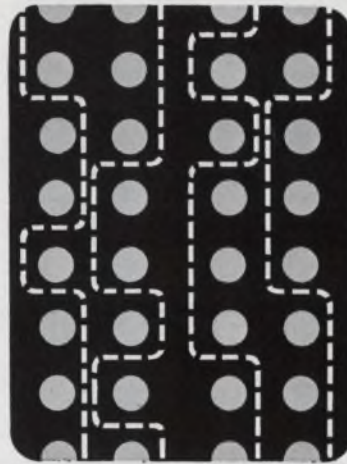

### "BRAID-PAK" reduces cost of High-Speed Read-Only Memory Systems



By combining the art of braiding with electronic logic, Memory Technology's new high-speed, read-only "Braid-Pak" Memory Systems cost significantly less, yet provide far better performance than systems using conventional storage techniques.

There are two classes of these non-volatile, high-speed, read-only braid transformer memory systems. One class provides capacities up to 10,000 bits. The other accommodates up to a million bits or more. The illustration shows the Model SBS-1B, a complete 10,240 bit Memory System on a 10" x 13.5" printed circuit board. The memory pro-

gram may be changed by simply replacing the "Braid-Pak" as shown. All inputs and outputs are buffered and feature DTL and TTL compatible integrated circuits with 500 nanosecond read-cycle and 200 nanosecond access times.

Applications include binary word generators for CRT displays, code conversion, pattern generation, computer micro-programming, look-up tables, industrial process control, high speed arithmetic computation, automatic typesetting, automatic machine controllers and other fixed read-only memory requirements. Write for data.



## MEMORY TECHNOLOGY INC.

223 Crescent Street • Waltham, Massachusetts 02154 • Tel. (617) 891-8465  
ON READER-SERVICE CARD CIRCLE 96

# COOL

KLYSTRONS · MAGNETRONS · TRANSFORMERS  
TRAVELING-WAVE TUBES · SWITCH TUBES  
WAVE GUIDES · DUMMY LOADS · LASERS

with New **ELLIS and WATTS**  
Liquid-to-Air Heat Exchangers\*

One of the new Ellis and Watts Heat Exchangers may be the answer to a need for tailoring a cooling system to your type of electronic equipment. Minimum space, low noise level and optimum performance have been achieved in each of a wide range of designs which include indoor/outdoor types in ratings from 5 to 300 KW. Proved in military, aerospace and commercial applications, these designs offer flexibility for quick modification to meet any specific cooling requirements.

Why not put the widely recognized Ellis and Watts custom-cooling "know-how" to work for you. Write us at the address below.

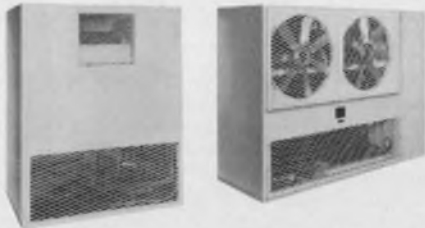

\*Liquid-to-Liquid Heat Exchangers also available.



**ELLIS AND WATTS COMPANY**  
Ellis and Watts Company, P.O. Box 36033  
Cincinnati, Ohio 45236

ON READER-SERVICE CARD CIRCLE 97

## SYSTEMS

### Integrator converts biological data



Biocom Inc., 5883 Blackwelder St.,  
Culver City, Calif. Phone: (213)  
839-2581. P&A: \$450; 30 days.

The model-2501 integrator is used to reduce physiological and biological data which is not readily handled in its raw form. It may be used to yield volume from a respiratory flow meter, fluid-dynamics studies, physiological studies (patient activity, voice studies of intensity of amount of speech, etc.). This instrument does this continuously, automatically and accurately. It may be tied into any existing recorder or data-acquisition system such as Grass, Cambridge, Sanborn or Beckman. Data such as patient activity or conversation may be tape recorded in the field and brought back to the laboratory for subsequent reduction and analysis.

CIRCLE NO. 321

### Photo sensor cycles at 40 Hz

Durant Manufacturing Co., 693 N.  
Cass St., Milwaukee. (414) 271-  
9300.

The photocell assembly consists of a pick-up control, cable pre-wired to the count input connector, and three sizes of reflectors (3-3/8 x 1-1/4 x 1/2 in). It has the capability to count light weight and fragile items as well as large bulky pieces. Typical applications are in production control, processing, packaging and assembly procedures for glass, paper and wood products. The sensor will respond to a 1/16 in. square beam of light projected onto the lens. It can be adjusted or adapted to reduce sensitivity to ambient lighting and undesired reflections. It is totally insensitive to fluorescent lighting.

CIRCLE NO. 322

### Pyrometer has 5 ms response



Barnes Engineering Co., 30 Commerce Rd., Stamford, Conn. Phone: (203) 348-5381. P&A: \$4950; 60 days.

A fast-responding, photoelectron-ic pyrometer is for direct temperature measurement of remote targets in the 700 to 3000°C range. This instrument provides non-contact measurement of "true" target temperature. Its sensitivity is 1°C at all temperatures, and reaches 0.1°C at 1000°C. Temperature readout is direct in two expanded scales—700 to 1500°C, and 1400 to 3000°C. Response time is 5 ms. The model EP-1 is capable of reducing the effect of unexpected emissivity changes that are often encountered in transient measurements by operating in either one of two selectable narrow wavelength regions. In the low range, operation is centered at 0.62 micron. The high-range wavelength region is centered at 0.37 micron. Input power is 110/220 V, 50-400 Hz and 30 W.

CIRCLE NO. 323

### Differential amplifiers for instrumentation

Astrodata, Inc., 240 E. Palais Rd.,  
Anaheim Calif. Phone: (714) 772-  
1000.

The basic amplifier is a chopperless, direct-coupled, differential unit for either single- or dual-output operation. The single-output model delivers a wideband signal of  $\pm 10$  V at 100 mA for galvanometers and the dual-output model provides both the 100-mA output and  $\pm 10$  V at 5 mA selectable bandwidth output for multiplexers, VCO's analog-to-digital converters, etc. Bandwidth of the dual-output model is controlled by a three-pole, linear-phase, 10-position, selectable filter. Ten fixed gain ranges from 1 to 1000 with a 2.5 times vernier are offered. Settling time to 0.02% accuracy is 150 ms; overload recovery accuracy is 0.1% in 300 ms.

CIRCLE NO. 324

# GREGARIOUS!

The tighter you cram little Turbowrap™ wires together, the happier they are. Kynar and polysulfone insulation make them as tough in tight spots as much bigger wires.

Think of the opportunities that Turbowrap 312 (with Kynar) and Turbowrap 412 (with polysulfone) open up for higher-density wiring.

Made in sizes as small as 30 AWG, with walls as thin as .004" — these wires zip through automated wire-wrap operations with never a jam, skip, nick, short or break. And they perform faithfully, once in place.

Special thin-wall extruding techniques, plus the fine electricals and mechanicals of the insulation, have made it possible for Brand-Rex to produce small O.D. wires with excellent cut-through resistance.

Looking for ways to put more wire into less space? Call on our tough little extroverts, Turbowrap 312 and 412.

AMERICAN **ENKA** CORPORATION

**BRAND-REX DIVISION**

WILLIMANTIC, CONNECTICUT 06226  
PHONE 203 423-7771

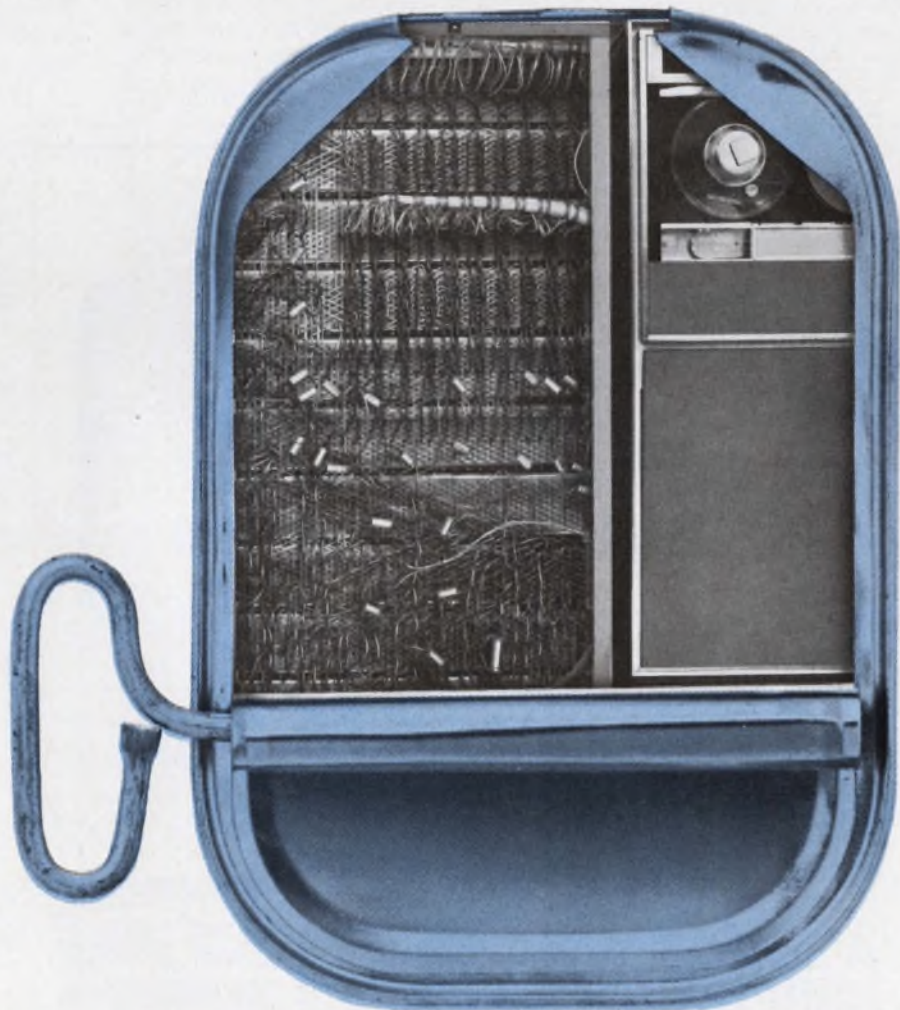

ON READER-SERVICE CARD CIRCLE 98

## Shipping container suspends parts in foam

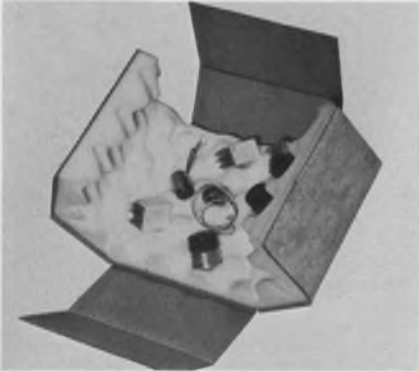

Federal Paper Co., 4200 Olson H'wy., Minneapolis. Phone: (612) 522-6644.

Fold-Pac is made of boxboard. It has corner protectors and a non-slip double bottom and is lined with urethane foam that is convoluted into cone-shaped fingers which yield and envelop items placed inside. The products are placed on the foam and the box is folded shut and then sealed with one strip of tape. The packaging is available in dimensions from 3-1/2 x 3 x 2 in. to 15 x 12 x 3 in.

CIRCLE NO. 325

## Die bonder handles to 400 per hour



Unitek Corp., 950 Royal Oaks Dr., Monrovia, Calif. Phone: (213) 359-8361.

Adaptable for glass, glass eutectic, and eutectic bonding, this unit is capable of handling flat packs, header mounts, and a wide variety of current specialty packages. Using automatic vacuum pickup and attach cycle, the bonder is alignable without side adjustments. Repeatable and stable placement characteristics ( $\pm 0.001''$  in both axes present) give numerous automatic programming possibilities. Heater cavities and pickup-arm as-

sembly rods interchange to accept virtually all current package styles. Produced to customer specifications on lead frame, substrate, and chip characteristics, the unit measures 17 x 18 x 18 in.

CIRCLE NO. 326

## Digital blender mixes and matches

Foxboro Co., Foxboro, Mass. Phone: (617) 543-8750.

The model 99C blender is available in two configurations: to ratio one flow to the other or to ratio one flow to the total flow. Typical applications of the unit include blending heavy crude and cutter stock to produce a specified viscosity; blending gasoline of two octane values to produce an intermediate octane; feed dilution into chemical reactors; and diluting syrup in food processing. The new instrument will accept high-frequency turbine-meter inputs or low-frequency meter inputs. Equipped with memory capability, it produces a 10-50 mA signal to control the ratioed flow.

CIRCLE NO. 327

## Reed Relay Problems?

A special hi-reliability relay for the Hawk Missile.

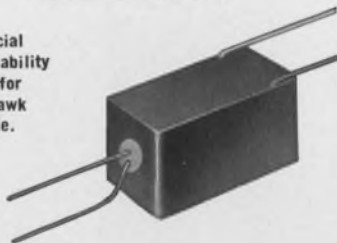

## Can We Solve Your Problem?

Operating Inputs: low as 1mA. and 15mW  
Standard Coil Voltages: 6, 12, 24, 32, 48V in stock for immediate delivery.

Special Voltage or Resistance, multiple windings for flip flop, memory and crosspoint selection applications — to customer specifications.

Relay Contacts in Form A, B, C and latching. Also high vacuum type 5000V Form A

Write for catalog and prices of our standard line of magnetic reed relays. For special requirements, give complete details for quotation.

# Coto-Coil

COMPANY INC.

59 Pavilion Ave.  
Providence, R. I. 02905  
Phone: (401) 941-3355

ON READER-SERVICE CARD CIRCLE 99

## TIME MARK GENERATOR

TMG-1

New hand-held time mark generator for use as calibrator or frequency standard. Three frequencies (100KHz, 1MHz, 10MHz) with tolerance of  $\pm 0.005\%$  in standard unit, other frequencies available. Battery powers units, and standard BNC connector allows direct plug-in. Size: 1 5/16" diameter x 3 29/32" long.

### FEATURES:

- SELF-CONTAINED
- COMPACT SIZE
- CRYSTAL CONTROLLED
- STANDARD INTERFACING
- TRANSISTORIZED



## DAYTON ELECTRONIC PRODUCTS COMPANY

117 E. Helena St./Dayton, Ohio 45404  
513/461-4967

ON READER-SERVICE CARD CIRCLE 100



## Arc-welding system fine for bench-top use



Sippican Corp., Barstow St., Mattapoisett, Mass. Phone: (617) 758-6905.

This unit, model 720, has an automatic gap-setting mechanism that permits an operator to make up to six times as many welds per minute as was possible with previous equipment. Once a weld schedule has been developed, the materials to be joined only have to be placed in the fixture and the firing switch activated. No other timing or alignment adjustments are necessary. The fixture is compatible for use with the model-520 pulse arc power supply. Many production-line accessories and special-purpose tools are available for butt welding and other modes of arc-percussion joining.

CIRCLE NO. 328

## Timer/counter accepts 30,000 counts

E. W. Bliss Co., 736 Federal St., Davenport, Iowa. Phone: (319) 324-1361.

This combination timer and counter is of solid-state construction and can accept up to 30,000 counts per second. The count speed of this unit, designated the CT 101, approaches that of laboratory instruments. By flipping an integral mode switch this new instrument is easily converted from a counter to a timer. Precise intervals from  $10 \mu$  to 9.99 seconds in  $10 \mu$  increments, can then be timed. Reset time is 8 ms (max.) and accuracy is  $\pm 0.01$  s or 0.5%, whichever is greater. The CT 101 measures  $7 \times 3\text{-}1/2 \times 6\text{-}1/2$  in. A  $3\text{-}1/2$ -in.-sq bezel shows on panel front and the weight is 4 lbs.

CIRCLE NO. 329



# Did he have wave filters in mind?

## Чебышёв

Above is the original Russian spelling of Chebyshev, the name of a nineteenth century mathematician to whom modern network theory owes a debt of gratitude. His well known polynomials were published in "Oeuvres" Vol. 1, St. Petersburg, 1899, for use in studying the construction of steam engines. Obviously, he didn't have wave filters in mind.

When Chebyshev Polynomials are applied to modern filter synthesis they produce ladder networks with controlled pass band ripple, and roll-off which is more rapid than that produced by "classical" networks such as the image parameter "constant K".

The illustration below shows the improved sharpness at cutoff and increased roll-off rate for a one section Chebyshev Filter. Admittedly, this is a simplified example, but it provides an easily understandable comparison between "old" and "new" design methods.

When the use of more sophisticated tools such as elliptic functions and Bessel Polynomials are added to the Chebyshev Polynomials, Modern Network Synthesis becomes a powerful vehicle for the realization of today's computer and space oriented filtering problems.

ADC staff specialists are skilled in the art of Modern Network Synthesis. The classical, modern or computer approach to network design is used as each may fit a particular application. Facilities include those for design, prototype sampling, testing, and production.

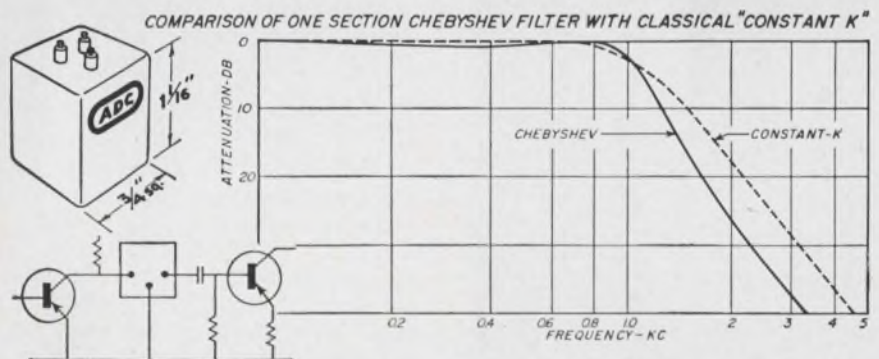

If modern network theory and its application interests you, we'll be glad to send you a copy of "General Approaches to Wave Filter Design"—no charge, no obligation.



### ADC PRODUCTS

A DIVISION OF MAGNETIC CONTROLS CO.  
6405 CAMBRIDGE STREET ■ MINNEAPOLIS, MINN. 55426

ON READER-SERVICE CARD CIRCLE 101

# Mold-A-Terms cut terminal insulating costs to 50%!



This technique consists of encapsulating any desired portion of the standard open barrel terminals after they are crimped onto wire leads. PVC and various other thermoplastic materials have been found equally adaptable.

Beman refined "MOLD-A-TERMS" to overcome price inequities found in comparable cost studies with pre-insulated and post-insulating methods.

## ADVANTAGES OF "MOLD-A-TERMS"

Freedom of Design...Smaller size...  
Protection against Moisture and  
Natural Contaminants.

Applied singly or in multiples...  
Write for further details on "MOLD-  
A-TERMS."



P. O. Box 370 New Cumberland, Pa., 17070  
Phone: (717) 774-0210

ON READER-SERVICE CARD CIRCLE 102

## COMPONENTS

### Supply 28 V in, get 20,000 out



MIL Associates, Inc., Dracut Rd., Hudson, New Hampshire. Phone: (603) 889-6671. P&A: \$350 to \$390; 30 days.

A complete encapsulated power supply, designed specifically for use with cathode-ray tube displays, provides up to 20,000-V-dc output with a 28-V-dc input. The 15 cubic in. power supply weighs less than 16 oz. and is supplied with insulated leads. Output ripple of all models is less than 100 V and each provides an isolated output. Packaged to meet appropriate specifications for military airborne equipment, models in the series may be operated within an ambient temperature range from 55 to +71°C.

CIRCLE NO. 330

### Power supply ranges to 1000 V



Arnold Magnetics Corp., Los Angeles, Calif. Phone: (213) 837-5313. P&A: \$295; 3 to 8 wks.

Multiple output power supplies for digital computers, cathode-ray tubes and solid-state circuitry are available with up to six individual specified outputs. These static converters are rated up to 1000-V dc. Outputs are floating and as low as 10 pF to ground. Input is 26 - 30 V dc. Line regulation is 0.06% per V. The units meet MIL-E-5272C and the case size is 21 cu in.

CIRCLE NO. 331

### Power rectifiers in button packages



Electronic Devices, Inc., 21 Gray Oaks Ave., Yonkers, N. Y. Phone: (914) 965-4400.

Three series of flexible, fast recovery silicon rectifiers in flat button form are the TR, RU and RD. They have ratings of 20, 40 and 200 A. Both the TR and RU series have 500-ns recovery times. RD units offer a 700-ns recovery time when measured from 1-A forward current to 30-V blocking. All rectifiers can be supplied singly or in stack combinations. Featuring ratings from 50 to 1000 V, the new power rectifiers are best suited for inverters, alternators, motor controls and other higher input frequency or pulse devices.

CIRCLE NO. 332

### Single-turn encoder with 13-bit accuracy



Litton Industries, 9370 Santa Monica Blvd., Beverly Hills, Calif. Phone: (213) 273-7500.

Consisting of a size 11 self-decoding pin-contact encoder and a 32:1 speed increaser this unit provides 13-bit accuracy and resolution in a single turn. During MIL tests the encoder was subjected to temperatures of 120°C together with the shock and vibration experienced in the vicinity of the exhaust of a jet aircraft.

CIRCLE NO. 333

# The "non-plastic" plastic transistors

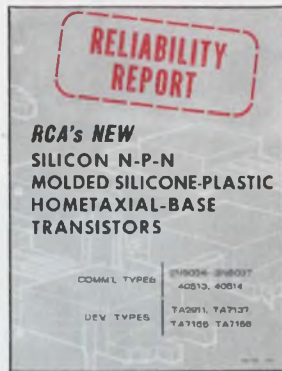

So reliable you'd think they were hermetic

We're big enough to realize that with any plastic transistor, you're bound to have questions concerning reliability.

So...long before RCA announced this family of "Hometaxial-Base" silicon power plastic devices (10 transistors with ratings of 36W or 83W), our reliability engineers devised a most rigorous new-product testing program. RCA

subjected hundreds of units to stresses beyond device ratings and the results are so impressive that, frankly, you'd think the transistors were hermetic.

We thought it would be appropriate for you to see our reliability manager's comment on the tests to date.

Here's what he had to say: "...sure we've had failures to our end points. But take a close look at them. Out of 376 units totalling 410,000 device hours at 175°C (versus an actual transistor rating of 150°C) only 3 failed. There were 2 failures from 119 units subjected to 25 temperature cycles of -65°C to 175°C (device rating is 5 cycles of -65°C to 150°C). In all, our actual unit hours on all life tests, including storage, operating, and reverse bias, total over 1,600,000 with a failure rate of 1.7% per 1,000 hours. And if you adjust for the fact that all these tests were essentially at over-stress conditions, the result is an estimated failure rate of less than 0.1% per 1,000 hours."

Why not evaluate the facts behind RCA's "non-plastic" plastic transistors yourself? We documented all of the details in a no-nonsense brochure (HBT-600A) which we'll be glad to send you. Just write RCA Commercial Engineering, Section IG10-2, Harrison, N. J. 07029, or see your local RCA representative.

RCA Electronic Components and Devices

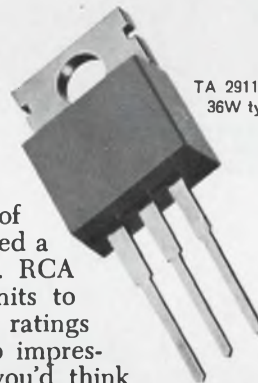

TA 2911  
36W type for printed-circuit boards

TA 7155  
36W type for TO-66 sockets

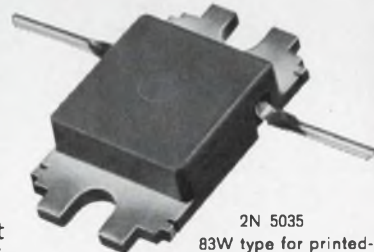
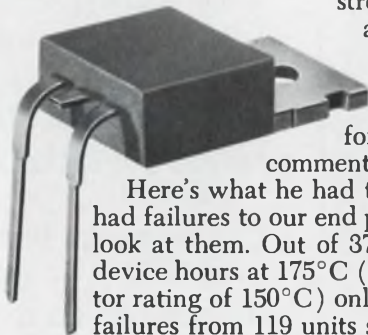

2N 5035  
83W type for printed-circuit boards



2N 5034  
83W type for TO-3 sockets

ON READER-SERVICE CARD CIRCLE 249



The Most Trusted Name in Electronics

Don't sacrifice insulator design and functional requirements to the limitations of ceramics and plastics

## TAKE ADVANTAGE OF THE BEST FEATURES OF BOTH WITH CERAMOPLASTICS

- Absolute dimensional stability
- High temperature resistance
- Non-combustible; no tracking or outgassing
- Zero moisture absorption
- Complex design geometry
- Moldable or machinable with metal inserts  
(Thermal expansion coefficient equivalent to that of many insert metals)
- Good impact, tensile and dielectric strength

MYCALEX® glass-bonded mica and SUPRAMICA® ceramoplastics are the only true ceramoplastics.

Write today for "Facts About MYCALEX glass-bonded mica and SUPRAMICA ceramoplastics" . . . technical and design data.



### MYCALEX CORPORATION OF AMERICA

World's Largest Manufacturer of ceramoplastics, glass-bonded mica and synthetic mica products.

125 Clifton Boulevard, Clifton, N.J.

#### COMPONENTS

### Differential transducer sensitive to 20 mV/V

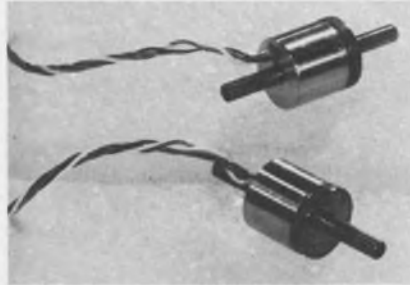

Scientific Advances, Inc., 1400 Holly Ave., Columbus, Ohio. Phone: (614) 294-5436.

This subminiature transducer has the same volume pressure cavity on each side of the diaphragm to provide improved reciprocal performance. The transducer body is 0.290 x 0.270 in. Pressure stems are 0.063 in. OD and extend 0.188 in. from either end. This unit utilizes semiconductor-type, bonded-strain gauges in a fully active four-arm bridge and provides sensitivity up to 20 mV/V. The unit contains internal temperature compensation, available to 300°F.

CIRCLE NO. 334

### 300,000 V ac supplied to 10,000 hours



Condenser Products Co., Brooksville, Fla. Phone: (904) 796-3562.

Subminiature solid-state high-voltage power supplies range from 1000 to 300,000 V ac and 1 mA to 10 mA, and have a guaranteed operating life up to 10,000 hours. They are hermetically sealed. Applications include linear accelerators, oscilloscopes, electrostatic equipment and precipitation, ground-control radar and communications equipment, display tubes and photo flash devices, spectographic analyzers and radiation counters.

CIRCLE NO. 335



## MEASUREMENTS



### MODEL 88 STANDARD FM SIGNAL GENERATOR

- Carrier frequency: 86-108 mcs.
- Frequency accuracy:  $\pm 0.5\%$
- Output voltage: 0.1 to 100,000 microvolts across 50 ohms
- Deviation: 0 to 300 kcs. in 3 ranges
- Source impedance: 50 ohms; low VSWR
- Distortion: Less than 0.5% at 75 kcs. deviation
- Modulation fidelity: Within 1db to 75 kcs; less than 3db down at 200 kcs.

Price: \$585.00 f.o.b. Boonton, N. J.

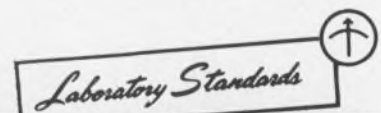

## MEASUREMENTS

A McGraw-Edison Division

P.O. Box 180, Boonton, N. J. 07005

Phone: 201-334-2131

ON READER-SERVICE CARD CIRCLE 105

ELECTRONIC DESIGN 21, October 11, 1967

ON READER-SERVICE CARD CIRCLE 104

## Crystal oscillators perform to 50 MHz.

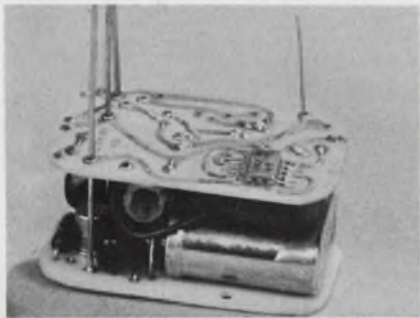

Arvin Frequency Devices, 2505 N. Salisbury, West Lafayette, Ind. Phone: 743-9639.

The solid-state TC/VCXOs are designed for communications and aerospace applications where small size, accuracy, and low-power drain are considerations. They are available for generating any frequency to 50 MHz. Units generating two or more frequencies also can be provided. The units are manufactured with pre-aged quartz crystals. Sine, pulse, and sawtooth wave forms are offered. Frequency adjustment range is 6 ppm. Aging rate is less than 1 ppm/year. Warmup time is zero. Models can be designed to accept any input voltage from  $\pm 10$ -to  $\pm 50$ -V dc. Units can be furnished to meet MIL or NASA specifications.

CIRCLE NO. 336

## Wirewound resistors with $\pm 0.01\%$ accuracy

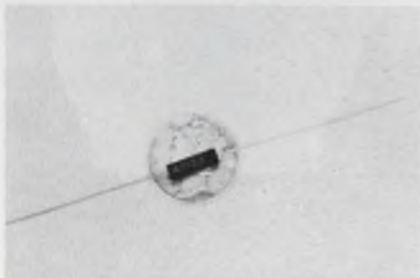

General Resistance, Inc., 430 Southern Blvd., Bronx, N. Y. Phone: (212) 292-1500.

These wirewound resistors feature  $\pm 0.01\%$  accuracy and rugged construction. They include operating temperature of from  $-55$  to  $+145^{\circ}\text{C}$ , minimum resistance of 24  $\Omega$  with maximum resistance to 250 k and a stability of  $\pm 40$  PPM per yr.

CIRCLE NO. 337

**Push-pull, push-pull, push-pull, push-pull, push-pull, push-pull, push-pull, push-pull, push-pull, push-pull, push-pull, push-pull, push-pull, push-pull, push-pull, push-pull, push-pull, push-pull, push-pull, push-pull. That's the monotony of reliability.**

Monotonous reliability characterizes IMC's solenoids, even at 4 millisecond speeds. There's a whole catalog of them in stock at IMC's Western Division, in sizes and configurations for avionics, instrumentation, computer peripherals and other systems.

If you need to push-pull, or to Indicate, Measure, and Control using steppers, synchros, resolvers, flag indicators or solenoids, contact the Applications Section at 605B Walker Ave., Maywood, Calif., 90270. Phone (213) 583-4785 or TWX 910 321 3089.

For the catalog or data sheets contact the Marketing Div., 570 Main St., Westbury, N.Y. 11591 or circle the inquiry number.

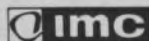

ON READER-SERVICE CARD CIRCLE 151

## Why you won't get burned with an IMC vaneaxial fan.



### Airmoving capability.

A vaneaxial fan is the most versatile of all the airmovers. It has a high aerodynamic efficiency over a wide range of specific speeds and offers the lowest noise level of any airmover when used properly. Primarily because of high efficiency. Delivers exceptionally well against high back pressures. **Mechanical** and other advantages. Long life—the motor is cooled by the air passing over it. Exceptionally good resistance to shock and vibration because there are no overhanging

parts. Good mechanical balance. Because of the rigidity of the moving parts and easy mounting in duct work (can be flanged at both ends). **Cost** is competitive with other types. **Competence.** IMC designs and produces the entire airmover (motors, impellers, housings, gas bearings) to the demanding requirements of the Minuteman, TFX, and other advanced projects. We also produce standard vaneaxials ranging from the IMCube (1-inch cube) to real big blasters, producing thousands of cfm.

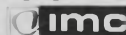

IMC Magnetics Corp., Eastern Division, 570 Main St., Westbury, N.Y. 11591  
Phone (516) 334-7070 or TWX 510 222-4469

ON READER-SERVICE CARD CIRCLE 152

## DIGITAL CAPACITY METER WITH 0.1% ACCURACY AND 1pf TO 10,000mfd RANGE



DMS-3200 Main Frame **\$320**  
 DP-200 Capacity Meter Plug-in **\$240**  
**\$560**

The type DP-200 Capacity Meter Plug-in, when used with the DMS-3200 Main Frame, provides digital display of capacitance measurements from 1.0 pf to 10,000 mfd in eight ranges. The system offers accuracy capability of  $\pm 0.1\%FS \pm 0.1\%$  of reading. Direct readout of capacitance over such a broad range represents an industry first in digital instruments.

Using a low potential DC test signal, capacity measurement is by means of a bridge comparing charge storage capability of the unknown capacitance against that of a precise internal standard capacitor. The reading is immediately obtained and no balancing or nulling operation is required. Provision is included for balancing out test lead capacity for accurate low capacity measurements.

The three-digit, all-electronic display uses "Nixie" type readout tubes and includes automatic decimal point indication. 40% over-range capability is provided and display time is variable from .5 second to 6 seconds per reading with provision for holding a reading indefinitely.

Like other DP series plug-ins, the DP-200 is all-solid-state, uses glass-epoxy printed circuit boards, and is complete within a compact plug-in housing which slides into the plug-in port of the DMS-3200 Main Frame. Main Frame size is approximately 9" x 7" x 13" and combined weight is 13 pounds. Combination price is \$560.

The DP-200 is but one of a complete line of plug-ins designed for use with the Hickok DMS-3200 Digital Measuring System main frame. All plug-ins are available from stock through franchised Hickok Industrial Distributors.



DC Voltmeter Plug-in  
 0.1 mv to 100 v;  
 0.1% accuracy  
 DP-100 — \$175

1 Mc Counter Plug-in  
 0.1 cps to 1 Mc;  
 0.005% accuracy  
 DP-150 — \$195

Ohmmeter Plug-in  
 0.001 ohm to  
 1000 Megohms;  
 0.1% accuracy  
 DP-170 — \$240

Capacity Meter Plug-in  
 1.0 pf to  
 10,000 Microfarads;  
 0.1% accuracy  
 DP-200 — \$240

Event Counter Plug-in  
 Counting Speed  
 1,000,000 pps  
 DP-140 — \$75

THE HICKOK ELECTRICAL INSTRUMENT COMPANY  
 10514 Dupont Avenue • Cleveland, Ohio 44108

ON READER-SERVICE CARD CIRCLE 122

## COMPONENTS

### Heating tapes range to 1500°F



Hotfoil Electric Co., 242 E. Irving Park Rd., Wood Dale, Ill.

Conventional heating tapes incorporate round wires as resistor heating elements. These tapes utilize a flat foil as a resistance heating element. Improved heat-transfer efficiency enables the tapes to be used in applications up to 1500°F. They can be used to raise temperatures of objects as well as maintain temperatures. Available in various sheath materials that cover the range of temperatures and environmental conditions, in PVC (125°F), melinex (230°F), silicone rubber (400°F), refrasil (850°F) and quartz fabric (1500°F).

CIRCLE NO. 338

### Adjustable thermocouple reaches 1400°F

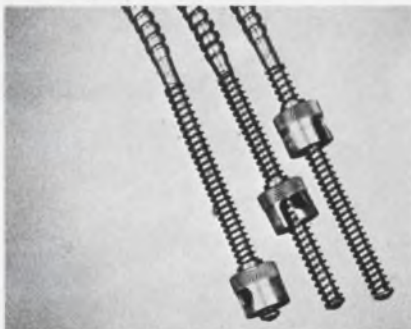

Thermo Electric, Saddle Brook, N. J. Phone: (201) 843-5800.

Spring-loaded thermocouples with locking caps are adjustable over the entire length of the probe and have a 1400°F upper temperature limit. No tools are required to adjust the cap up or down the spring. The standard locking cap can be used with previously installed mounting adapters. The most common temperature measuring applications for the adjustable cap thermocouples are: measuring plastic extruder crosshead body, die and barrel temperatures, plastic molding machine barrel temperatures, and measuring pipe wall temperature when combined with a pipe clamp adapter.

CIRCLE NO. 339

### Octave band limiters limit 250 W to 100 mW

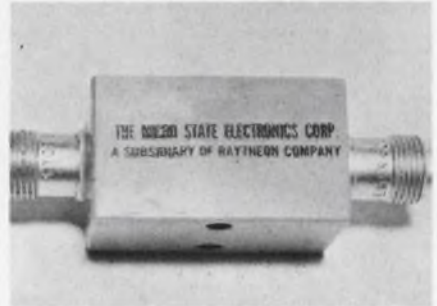

Micro State Electronics Corp., 152 Floral Ave., New Providence, N. J. Phone: (201) 464-3000.

Octave-band limiters that limit peak power of 250 W to 100 mW at 2-4 and 4-8 GHz handle an average power of up to 5 W. Insertion loss across the bands is less than 2 dB. The recovery time of the devices is 100 ns. They will operate within specifications at temperatures up to 100°C. The limiters weigh 2 oz in a package measuring 1-1/2 x 3/4 x 3/4 in. Applications include protection of tunnel diode amplifiers and mixers.

CIRCLE NO. 340

### Electromagnetic clutch has 1-1/2 in. diameter



Simplatrol Products Corp., 675 Plantations St., Worcester, Mass. Phone: (617) 791-6308.

The FFC-33 is rated at 5 lb/in. with the next size 10 lb/in. and with ranges up to 600 lb/in. This clutch has a 1-1/2 in. diameter, is 1-15/32 in. long, and has a 1/4 in. bore. It is available in 24 and 90 V dc. Design features include a sine-drive diaphragm armature to accomplish this response. Typical applications include business machines, film-processing equipment and instrumentation.

CIRCLE NO. 341

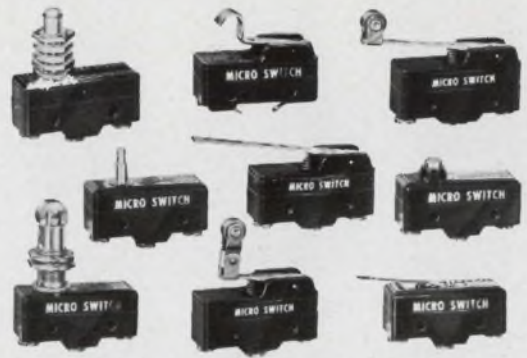

**Type BZ basic switches provide  
a complete selection of actuators.**

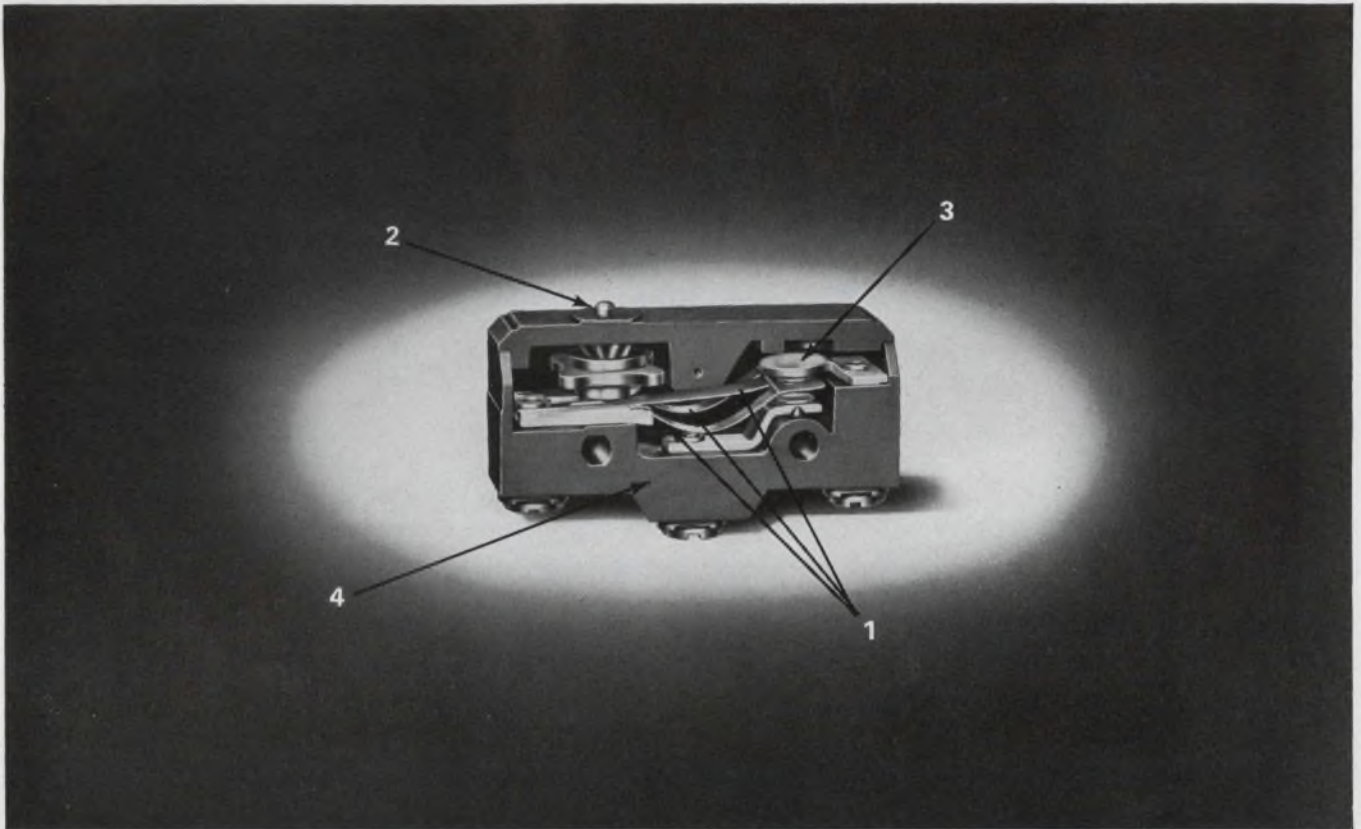

## **Two or a thousand... they're all alike**

Whether you receive two or thousands of basic switches from MICRO SWITCH, you can be sure *all* are *consistent*—in sensitivity and precision operation through millions of cycles.

Reason: MICRO SWITCH has the facilities to give careful attention to the smallest details on a mass production basis. For example:

The standards set by MICRO SWITCH for the one-piece beryllium copper spring (1) are the industry's highest. Exhaustive testing assures proper alloy content, grain structure and heat treat properties. Every inch of spring material is checked for uniformity of thickness. Result: Consistent, precise repeatability, positive switching force, longest possible flexure life in *every* switch.

Plunger (2), contacts (3) and even the case (4) also conform to exclusive MICRO SWITCH standards of precision, operating sensitivity, wear life and protection.

Call a Branch Office or Distributor (Yellow Pages, "Switches, Electric"). Or, write for Catalog 50.

## **MICRO SWITCH**

FREEPORT, ILLINOIS 61032  
A DIVISION OF HONEYWELL

HONEYWELL INTERNATIONAL—Sales and service offices in all principal cities of the world. Manufacturing in United States, United Kingdom, Canada, Netherlands, Germany, France, Japan.

ON READER-SERVICE CARD CIRCLE 123

**Power transformer develops 2 W**



Abbott Lab., Inc., 5200 W. Jefferson Blvd., Los Angeles. Phone: (213) 731-9331. P&A: \$14.40; stock.

This 400-Hz power transformer is encased in diallyl phthalate and can develop voltages of 50 to 150 V ac with a power rating of 2 W. Designated as model 2E, this unit is only slightly larger than a sugar cube and is suited for aerospace and industrial applications where small size is a prime factor. It measures 0.87 x 0.74 x 0.78 in. high. Model 2E is built to meet the specifications of MIL-T-27A and is capable of operating at a maximum of 105°C. This encapsulated and hermetically-sealed unit will also meet the requirements of MIL-E-5272C.

CIRCLE NO. 342

**Tantalum capacitors carry 2 to 35 W/V dc**

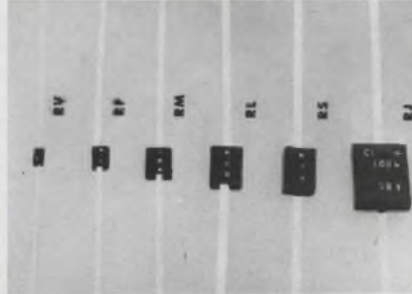

Components, Inc., Smith St., Biddeford, Me. Phone: (207) 284-5956.

Rectangular cross-section capacitors have ribbon leads and can be welded or soldered and have application for use with hybrid and monolithic ICs. The R series is available in six case sizes from 0.001 to 220  $\mu$ F and 2 to 35-W/V dc. The ultraminiature RU case size handles up to 0.33  $\mu$ F at 10-V dc in a 0.0035 cu in. package. The units have gold-plated kovar leads which will withstand a pull of 8 oz for 5 seconds in any direction. The series is rated for operation to 125°C.

CIRCLE NO. 343

**Deflection amplifier 0.1% accurate**



Celco, Mahwah, N. J. Phone: (201) 327-1123.

Offered are all silicon deflection drivers operating at a power input of plus and minus 20-V dc at 4, 6 or 12 A. They feature low-drift characteristics and high stability over a temperature range of 0-50°C. These units are available with regulated or unregulated power supplies and may be rack mounted. They offer direct conversion of input voltage waveforms to output current waveforms with a linearity of  $\pm 0.1\%$ . Inputs can range from dc to pulses and complex waveforms. The unit is compatible with single-ended yokes, and has low ripple and crosstalk.

CIRCLE NO. 344

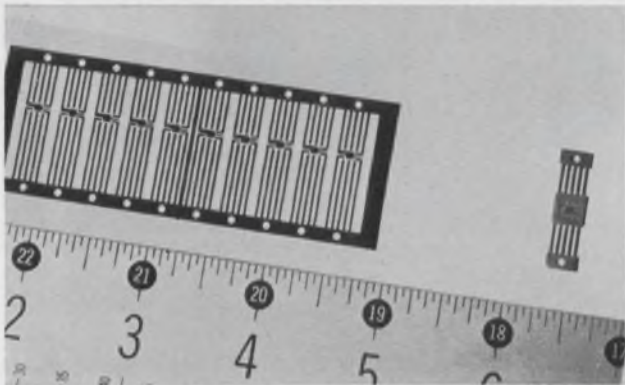

**ETCHED KOVAR FOR MICROCIRCUIT PACKAGING**

Etched kovar for microcircuit packaging is made in any configuration, adequately framed for support. Kovar material up to 16 inches wide and in thicknesses up to .015 inches may be etched.

NEW—we can now quote you on gold plating these parts—write for information.

**BUCKBEE MEARS COMPANY**

245 E. Sixth St./St. Paul, Minn. 55101/Phone 227-6371

ON READER-SERVICE CARD CIRCLE 124



**GLOBE**

**1/10 hp, d.c. motor**

Type GRP, 2 1/4" Dia.

Globe Type GRP permanent magnet d.c. motors are rated at 1/10 hp at 6,000 to 10,000 rpm, 6 to 115 v.d.c. Motors are 2 1/4" diameter by 3 3/4" long and weigh 2 lbs. 8 oz. Type GRP motors are designed to meet applicable MIL specs for construction and environmental protection. They are available with a wide variety of accessories including geartrains, governors, brakes, clutches, radio noise filters, and others. Wound field designs are also available in this frame size for series, split series, shunt, split shunt, or universal a.c./d.c. operation. For further information, request Bulletin GRP.

**GLOBE INDUSTRIES DIVISION OF TRW INC.**  
2275 Stanley Ave., Dayton, Ohio 45404, Tel: 513 222-3741

ON READER-SERVICE CARD CIRCLE 125

ELECTRONIC DESIGN 21, October 11, 1967



## Dc torque motor withstands 230°

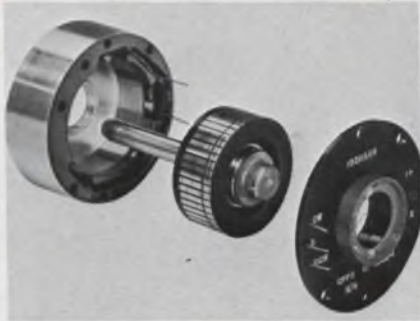

Clifton, Div. of Litton Ind., Marple at Broadway, Clifton Hts., Pa. Phone: (215) 622-1000.

This torque-pot combination can withstand internal temperatures above 230°. It has a 90-minute life test and dithers at 275 Hz about a single point over 1.2° of actual effective electrical travel.

CIRCLE NO. 345

## Dc power modules for IC application

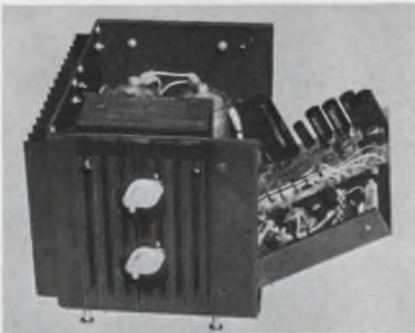

Electronic Research Associates, Inc., 67 Sand Park Rd., Cedar Grove, N. J. Phone: (201) 239-3000. P&A: \$395; stock.

The units provide regulated outputs with ratings of 1 through 7-V dc and up to 40 A. All units in the series incorporate differential dc amplifiers, compensated temperature zener references, silicon rectifiers, and are fully protected with automatic recovery against short circuits. Full current and voltage ratings are applicable up to 71°C without external heat sinking or air blowers. Input for the modules is 105 to 125 V ac 50 to 400 Hz. Line regulation is 0.01% and load regulation 0.05%. Ripple is less than 800  $\mu$ V rms. The temperature coefficient is better than 0.01% per degree C with an operating temperature range of -20 to +71°C.

CIRCLE NO. 346

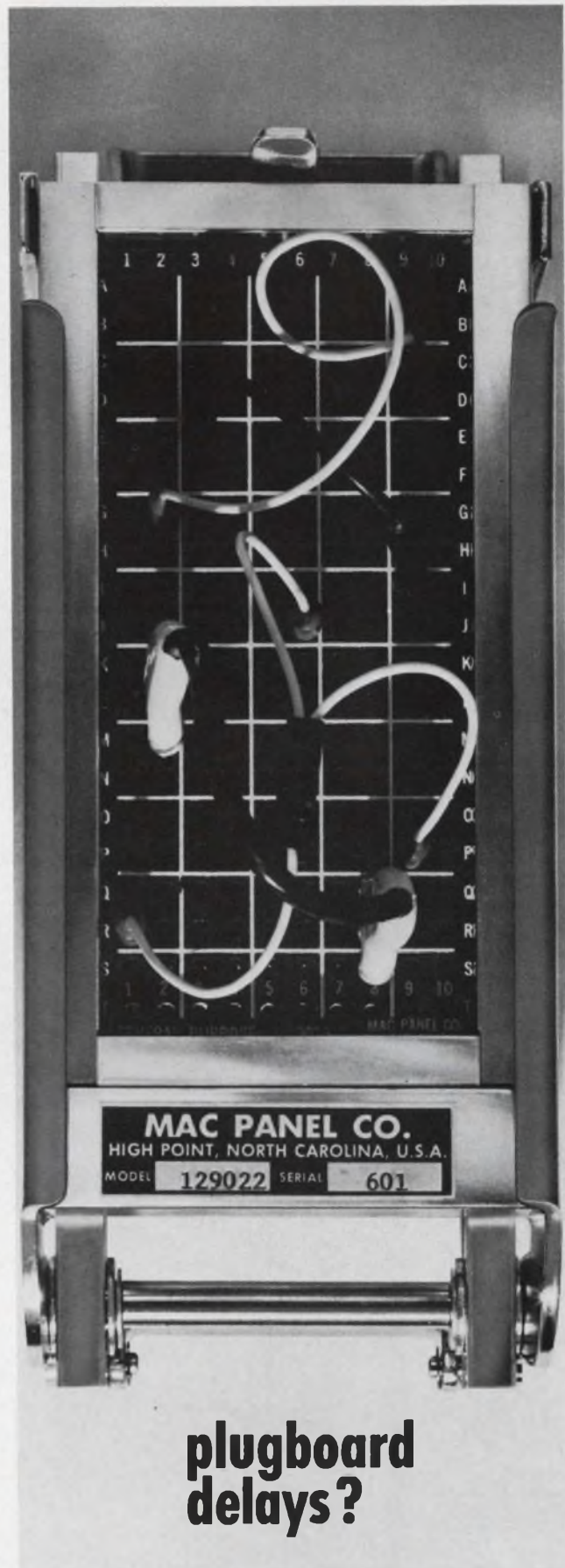

plugboard  
delays?

**MAC ships off-the-shelf!**

ON READER-SERVICE CARD CIRCLE 126

# Microsonics

## State of the Art Design in Filters Oscillators and Delay Lines



Continuously  
Variable Delay  
Systems

Bulletins 4301 and 4302



Broad Bandwidth  
Highly Selective  
Crystal Filters  
Bulletin 6350

Comb. Filter Sets  
Bulletin 6350



Broad Bandwidth  
Delay Lines  
Bulletin 4300



Highly Stable  
Oscillators — Bulletin 6350



Voltage Controlled  
Crystal Oscillators  
Bulletin 6350

High Density  
Digital Storage  
Systems

Bulletin  
5350



Send for literature.



**MICROSONICS, INC.**  
60 Winter Street  
Weymouth, Mass. 02188  
Tel: 617 337-4200

A subsidiary of the Sangamo Electric Company

## COMPONENTS

### Solid-state commutator withstands 600 G



Stellarmetrics, Inc., 416 E. Cota St.,  
Santa Barbara, Calif. Phone: (805)  
963-3566. P&A: \$400; 4 wks.

The model-235 commutator will withstand launching or firing shocks to 600 G. It is suitable for weapon system instrumentation. The commutators utilize FET transistors at the basis of gating. The units are single-pole 15-channel, high-level, PAM-RZ commutators. Output characteristics include a frame sync width of 2 channels, with temperature range from  $-40$  to  $70^{\circ}\text{C}$ .

CIRCLE NO. 347

### Solid-state switch surges 7000 A



Calvert Electronics, Inc., 220 E.  
23rd St., N. Y. Phone: (212) 679-  
1340.

The CR7K series of thyristors offers surge ratings of 7000 A and rms current from a pair in inverse parallel of 770 A. The SCR can be mounted in any position because there is no pool of mercury to worry about. The arc-volt drop and the triggering time have been brought down by a factor 20 and the power requirement of the gate is only 5-W peak. Compare this with a minimum of 2,400 W needed in a style-D ignitron.

CIRCLE NO. 348

### Divider module wanders only 1%



Transmagnetics, Inc., 134-25 North-  
ern Blvd., Flushing, N. Y. Phone:  
(212) 539-2570. Price: \$345.

The module, model-480 CP5, provides a voltage output equal to  $+10X/Y$ , where X is  $-10$  to  $+10$  V into  $15\text{ K}\Omega$  and Y is always minus and less than 10 into  $10\text{ K}\Omega$  minimum. Conformity ranges from 1% full scale for  $Y = -10$  V to 2.5% for  $Y = -1$  V. Scale factor stability is  $\pm 1.2\%$  over 0 to  $70^{\circ}\text{C}$ .

CIRCLE NO. 349

### Time delay relays Rated to 60 kW



Ebert Electronics Corp., 130 Jeri-  
cho Turnpike, Floral Pk, N. Y.  
Phone: (212) 776-1800.

Factory preset or adjustable de-  
lays on make of from 100 ms to 300  
seconds are available with load rat-  
ings up to 60 kW in 1-, 2- and 3-pole  
models. A spst contact is all that is  
required to actuate the delay circuit  
which has the advantage of imme-  
diately resetting itself upon firing.  
The solid-state timing circuit and  
relay coil are hermetically sealed  
within an epoxy-filled nylon case to  
insure complete isolation. The oper-  
ating temperature range of these  
units is from 10 to  $65^{\circ}\text{C}$ . Repeat-  
ability is  $\pm 2\%$  at the stated volt-  
ages and temperature range.

CIRCLE NO. 350

ON READER-SERVICE CARD CIRCLE 127

Take a close look at the total area your present Monolithic Integrated Circuit Differential Amplifiers are using, and compare with the new ZELTEX 161/162 Hybrid Circuit family. These high-reliability devices are truly universal. They flush mount in less space than splayed-lead TO cans and require no external components to insure stability in all modes of operation. ■ Performance? Model 162, for example, is the only FET IC Diff Amp on the market and, like the rest of the family, it's burnout-proof! ■ So, take a close look at ZELTEX integrated Circuit Amplifiers now. The price is as small as the size — totally!



**Key Specifications — Model 162**

- Input Impedance  $10^{11}$  ohms
- DC Gain 200,000
- Input Current 25pa
- Fully Stabilized (-6db/octave)
- Output  $\pm 10v$  @ 4ma
- Drift  $10\mu v/^{\circ}C$
- Common Mode Voltage 10v
- Short Circuit Proof

Zeltex Inc., 1000 Chalomar Road, Concord, California 94520, Phone (415) 686-6660

*total  
size  
is what  
makes an  
IC amplifier  
universal*

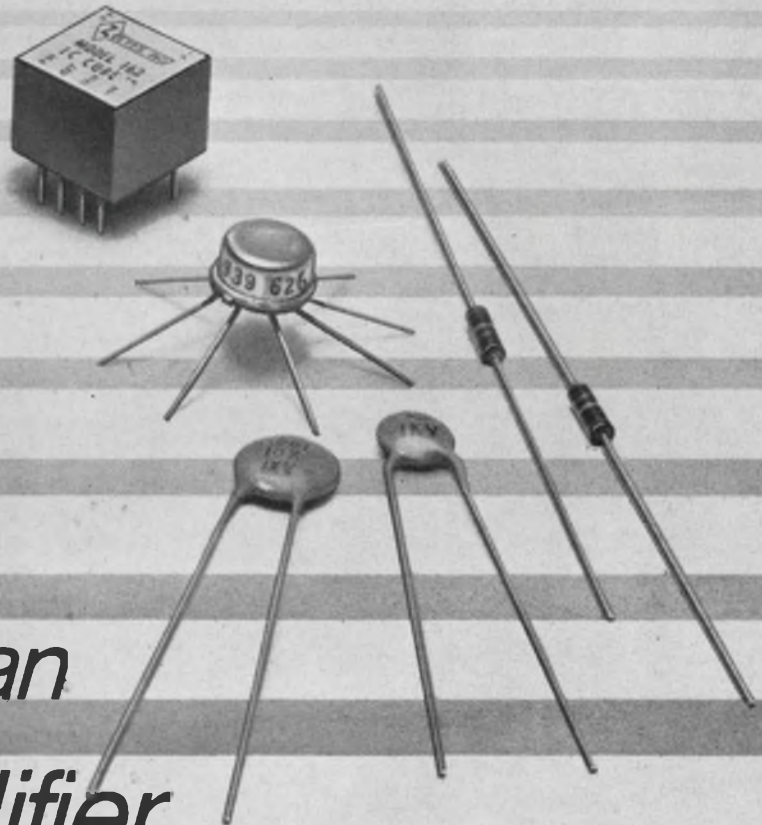

ON READER-SERVICE CARD CIRCLE 128

### Dipped caps to 150 $\mu$ F

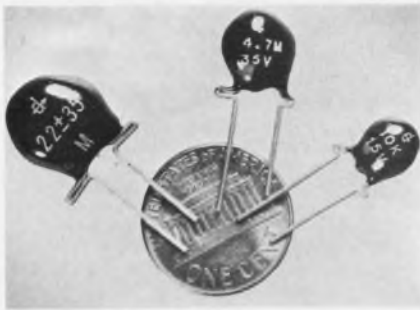

Dickson Electronics Corp., P. O. Box 1390, Scottsdale, Ariz. Phone: (602) 947-2231. Price: 32¢ to \$1.65.

These dipped epoxy solid-tantalum capacitors are available in three case sizes ranging from 0.47  $\mu$ F at 50 V to 150  $\mu$ F at 6 V. Construction provides moisture protection without the cost of hermetic sealing. The stand-off lead functions as a stress relief during handling. It also protects the capacitor from high-temperature damage during wave-soldering operations. The units are rated to operate from -55 to +85°C without deration. All have 0.025 in. diameter leads.

CIRCLE NO. 351

### Circuit connector works with 36 mates

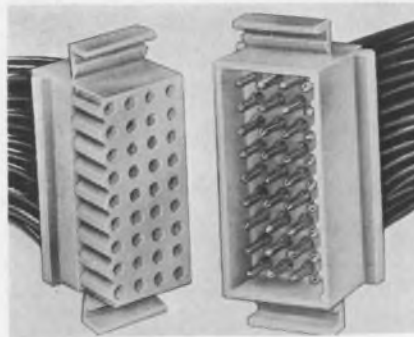

Molex Products Co., 5224 S. Kartrine Ave., Downers Grove, Ill. Phone: (312) 969-4550.

Requiring no soldering, 36 circuits can be assembled in production-line fashion. The design of the nylon housing provides protection for both male and female contacts. The wire leads may be crimped by an automatic machine to the contacts and then snap-locked into the housing with perfect alignment. The nylon housings feature integrally-molded mounting ears that snap-lock into panel securely. The plugs and receptacles are available in ten colors.

CIRCLE NO. 352

### Myler capacitors range to 75-V dc

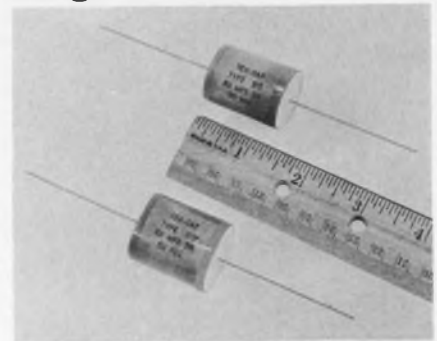

Texas Capacitor Co., Inc., 7830 Westglen Dr., Houston, Tex. Phone: (713) 782-9232.

The types 315 and 315F capacitors are available with a 75-Vdc rating, in addition to the standard 50-V dc. Designed primarily for transistor and other low-voltage applications, these epoxy-dipped units are capable of operating within a temperature range of -55 to +85°C at rated voltage, and up to +125°C with 50% derating. Standard tolerance is  $\pm 5\%$  with tolerances of  $\pm 10\%$ ,  $\pm 3\%$ ,  $\pm 2\%$  and  $\pm 1\%$  also available.

CIRCLE NO. 353

### PLASTIC SEALLESS PUMP

... no corrosion, no contamination, no leakage  
Standard capacities are from 1/3 to 40 gpm

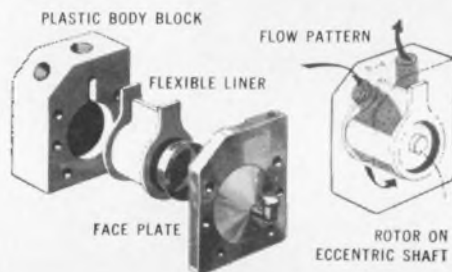

A rotor, mounted on an eccentric shaft in this plastic pump, rotates within a liner to create a progressive squeezing action on fluid trapped between the liner and the body block. All metal parts and mechanical action takes place inside the liner where fluid never reaches. This completely eliminates the need for stuffing boxes or shaft seals, guaranteeing no leakage.

The pump is self-priming, operates wet or dry and is suitable for extremely corrosive fluids, abrasive slurries or viscous materials. Applications include pumping of acids, alkalis, distilled water, diatomaceous earth slurries, electroplating solutions, ceramic tile glaze as well as shear sensitive emulsions.

Standard capacities are from 1/3 to 40 gpm with discharge pressure up to 50 psi. Materials of construction include Teflon, polypropylene, linear polyethylene, Bakelite or stainless steel for body blocks and Viton-A, Kel-F elastomer, Hypalon, Neoprene and Buna-N for the liner. These are the only parts in contact with the fluid.

For additional information, write Vanton Pump & Equipment Corporation, Hillside, New Jersey or telephone Area Code 201 926-2435.

"On display at the 31st Exposition  
Chemical Industries Booth No. 1229".

ON READER-SERVICE CARD CIRCLE 129

**MOTORS, MOTOR SPEED**  
Bodine fractional horsepower motors, many full horsepower  
**CONTROLS, GEARMOTORS,**  
motors, Superior Electric Co., Inc. Slo-Syn Motors, B & B  
**VARIABLE SPEED DRIVES,**  
Synchronous Motors, General Electric Motors, Geartronics  
**STEPPING MOTORS**  
Apcor Multi-Speed Gearmotors and Reducers, Zero Max Variable  
**TIMERS, CHRONOMETERS,**  
Speed Drives, Helland Mechanical Overload Couplings, Miller  
**SPEED INDICATING**

Rectifiers and Transformers, A.T.C. Timers and Counters,  
**SYSTEMS • ONE SOURCE**

Chronometric Speed Counters, Vis-count Tachometer Speed

**IMMEDIATE DELIVERY**

Indicating Systems, Heller Speed Controls. All in our new

**FACTORY LOW PRICES**

64 page catalog No. 14-67. Write for your copy.

**TECHNICAL ASSISTANCE**

**B&B MOTOR AND CONTROL CORP.**  
96 SPRING STREET  
NEW YORK, N.Y. 10012 (212) 966-5777

ON READER-SERVICE CARD CIRCLE 130

ELECTRONIC DESIGN 21, October 11, 1967

## Pulsed clock adds or subtracts

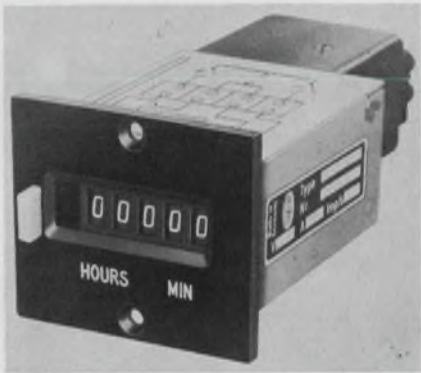

Kessler Ellis Products Co., 46 Center Ave., Atlantic Highlands, N. J. Phone: (201) 291-0500.

An electrically pulsed digital clock/counter reads out in minutes and hours or seconds and minutes is now available in an add-subtract version as well as the standard totalizer. An electrical pulse generated by a microswitch, relay, or read switch operates the counter causing it to count one count per pulse. When the first two digits reach 59 the next pulse registers 1.00. Available in any ac or dc voltage the unit can be equipped with either electrical or manual reset. Electrical connection is by means of screw terminals, solder lugs, or plug-in connectors.

CIRCLE NO. 354

## Titanium tubing strong and light

Superior Tube Co., Germantown Ave., Norristown, Pa. Phone: (215) 272-2070.

Small seamless tubing drawn from high-strength titanium alloy Ti-6Al-4V is being produced in a range of sizes up to 5/8-in. Tests indicate that stress-relieved 0.5 in. tubing has an ultimate tensile strength of 140,000 psi. High annealed strength is attained by the addition of 6% aluminum and 4% vanadium. Higher levels can be achieved by heat treatment. The alloy provides a high strength-to-weight ratio, as well as excellent resistance to corrosion and oxidation. It is stable over a temperature range of -423 to +1000°F. It also has excellent fatigue properties and fracture toughness.

CIRCLE NO. 355

# 1+1=3

## ...when You Calibrate AC Voltage, Current and Power with this RFL System



Model 100V  
Voltage  
Standard



Model 100C  
Current  
Standard

## ...or use our 100C and your present voltage standard

**The Model 100 System is the only AC Standard available which provides a complete calibration facility for voltage, current and power with variable frequency.**

**Unequaled Flexibility**—Either the voltage or current unit may be purchased and used independently. The other may be added and interconnected at any time for complete AC wattmeter calibration at power factors from 0 to 1, infinitely variable over the entire range.

**Wide Range**—The all-solid state system supplies ultra-precise, voltages from 1 mV to 1000 V at frequencies from 50 Hz to 10 kHz and current from 1 mA to 50 A at frequencies from 50 Hz to 3 kHz.

**Precision Accuracy**—Long term accuracy (one year), traceable to NBS better than .04%. Stability better than .01%. Resolution practically infinite.

**Automatic Operation**—Set digital dials and read directly, only instrument under test.

**Saves Time**—Direct reading of output deviation is a special feature which eliminates calculation of full and down-scale percent error.

**Other Features**—Safety interlocks protect operator and equipment under test. Built-in Standard Cell plus zener working source. Panel meter indicates burdens to 20 VA. Optional 10-line code for digital printout.

Phone Bill Jauch (201) 334-3100 for engineering evaluation loan or demonstration without obligation—or write for detailed specifications.



## RFL Industries, Inc.

FORMERLY RADIO FREQUENCY LABORATORIES, INC.

Instrumentation Division • Boonton, New Jersey 07005

Tel: 201-334-3100/TWX: 710-987-8352/CABLE: RADAIRCO, N.J.

ON READER-SERVICE CARD CIRCLE 131

# New Shorter READOUTS

We also make indicators, switches, keyboards, panel displays, in-line displays and CRT displays.

Actual size

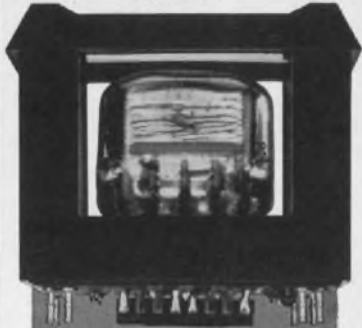

## NEED THIS SPACE?

Specify TNR-70A Digital  
Readout for I-C or  
Discrete Circuitry

## IT COSTS NO MORE!

Handles the job in  $\frac{1}{3}$  the  
depth. How?  
With this  
monolithic



silicon circuit. Complete de-  
coder/driver package, with  
NIXIE® tube and bezel, is  
only  $1\frac{1}{8}$ " deep. Accepts 1-  
2-4-8 binary coded decimal  
inputs and produces 10  
mutually exclusive outputs.  
Here's your answer where  
space is a critical factor.  
Prices as low as \$22.75  
without tube in 100-299  
quantities. Write for com-  
plete information.

©BURROUGHS CORP.

For complete information, contact  
your local TEC-Rep, or write direct.



INFORMATION DISPLAY AND CONTROL DEVICES

**TRANSISTOR ELECTRONICS  
CORPORATION**

Box 6191  
Minneapolis, Minnesota 55424  
Phone (612) 941-1100

# INDICATORS

We also make switches,  
readouts, keyboards, panel  
displays, in-line displays  
and CRT displays!

**FOR  
INTEGRATED  
CIRCUITS AND  
DISCRETE  
COMPONENT  
CIRCUITRY**

**VARIETY?**

Unlimited! Neon  
or replaceable  
incandescent  
lamps—optional  
integral switch.

**LOOKS?**

Go together,  
beautifully!

**CUSTOM  
DESIGNED?**

Yes, to fit your  
special  
requirements and  
usually at  
standard prices.

**MTL Series** Con-  
trols long life  
neon lamp from  
low level signals.  
Price: As low as  
\$3.00.\*  
**MMTL  
Series**  
for I-C.



**TBL  
Series**  
Adds  
integral  
isolated switch to  
**MTL Series**.  
Price: As low as  
\$4.35.\* **MTBL  
Series**  
for I-C.

**TIL Series** Bri-  
lliant incandes-  
cent lamp con-  
trolled by  
low level  
signals.  
Price: As  
low as  
\$4.76.\*  
**MTIL  
Series**  
for I-C.



**TIB  
Series**  
Integral,  
isolated  
switch plus TIL  
function. Price:  
As low as \$6.60.\*  
**MTIB Series**  
for I-C.



**Subminiature STL  
Series** .360" dia.  
body. Controls  
neon or  
incandescent  
lamp from  
logic levels.  
As low as  
\$7.45.\*  
**MSTL** for I-C.

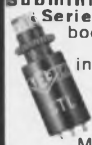

**TML  
Series**  
Turns on with a  
 $2\mu$ sec pulse, re-  
mains on until  
cleared. Integral  
clear switch op-  
tional. Price: As  
low as \$10.35.\*  
**MTML Series**  
for I-C.

\*in 100-499 quantities

For complete information, contact  
your local TEC-Rep or write direct.



INFORMATION DISPLAY AND CONTROL DEVICES

**TRANSISTOR ELECTRONICS  
CORPORATION**

Box 6191  
Minneapolis, Minnesota 55424  
Phone (612) 941-1100

# Design Aids

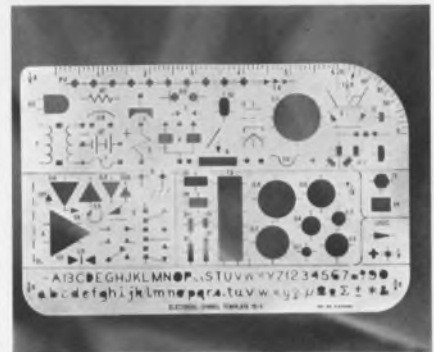

## Symbols template

Designed by electronic engineers,  
this template permits the drawing  
of graphic symbols for electronic  
and electrical schematic diagrams  
conforming in both appearance and  
size relationship with military spec-  
ification MIL-STD-15-1A. Based  
on a 0.2 in. grid, it allows adequate  
circuit line spacing when drawings  
are reduced, providing adequate  
clarity. The letter-guide portion  
will facilitate placing reference des-  
ignations, functional titles, nomen-  
clature, and notes on electrical  
drawings. The straight edges, cir-  
cles, round corners and scales on the  
template add to its utility. Its over-  
all size is 8-1/4 x 5-1/4 x 0.0025 in.

Available for \$3 from E. F.  
Thomey Co., 728 W. 10 Place, Los  
Angeles.

## Power supplies guide

The purpose of the 8-page design-  
er's guide is to help the system de-  
signer specify the power supply  
that exactly suits his needs and  
budget. In addition, it is intended to  
aid in writing specifications that  
are free from loopholes and bugs,  
thus enhancing system reliability.  
The cost factor is also covered, giv-  
ing the designer an understanding  
of cost distribution, and offering  
suggestions for minimizing ex-  
pense. The guide is divided into  
four sections: definitions; the  
checking of the specification for va-  
lidity; the protecting of the power  
supply and its load from one anoth-  
er; and detail consideration of size,  
heat, and money. Each section is il-  
lustrated with circuit and block di-  
agrams. Trio Laboratories, Inc.

CIRCLE NO. 357

# Adlake Mercury Wetted Relay — Application Data

## Capacitance of Adlake Mercury Wetted Contact Relays Applicable for Low Signal Applications

**Typical Capacitance in Picofarads** — Graphs illustrate typical capacitance values for Adlake AWCA-16000 series relays. Fig. 1 is for unshielded relays. Fig. 2: Electro-statically shielded switch brought out to a separate pin. Fig. 3: Electro-statically shielded switch with case and shield tied together at a common pin. Interelectrode capacitance across contacts of a bare switch, without external wires, is less than 1.0 picofarad.

Abbreviation COMM. stands for the Combination of the Armature and Normally Closed Contact. N.O. is the abbreviation for Normally Open Contact; whereas the symbol # is the mean average for the 5 relays. Graphs are available on other styles of Adlake Mercury Wetted Contact Relays upon request. (Please state wiring configuration.)

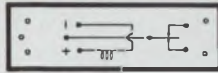

**AWCA 16011-S**  
Fig. 1

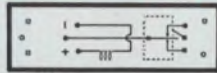
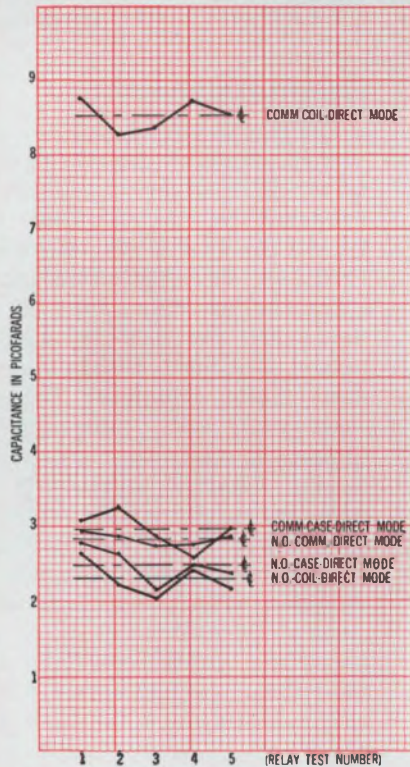

**AWCA 16016**  
Fig. 2

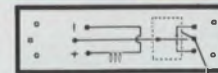
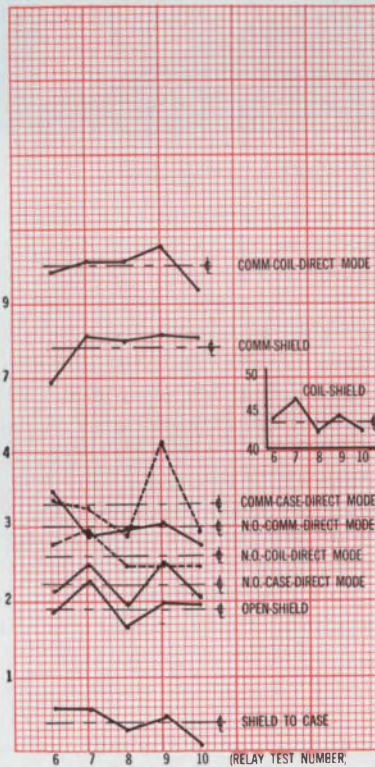

**AWCA 16018**  
Fig. 3

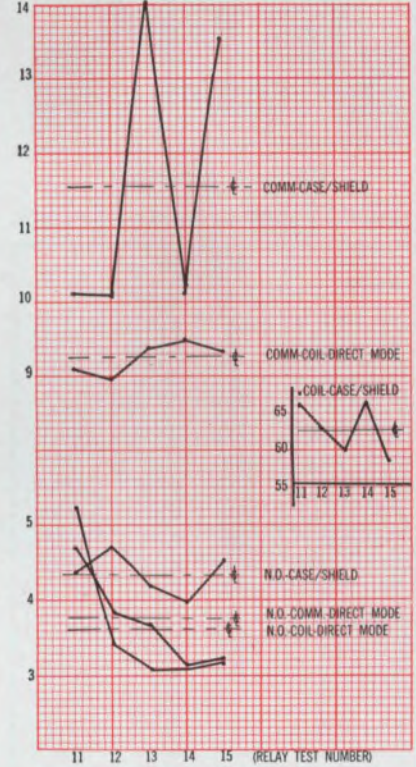

Data was obtained using a Boonton Electronics Corporation Capacitance Bridge, Model 75-A-S8 at 1MHz.

Backed by sound research and disciplined engineering, Adlake applies the industry's broadest line of mercury displacement and mercury wetted relays to the creative solution of design circuit problems. However unique or special your application, Adlake can assist you in

developing it. For prompt, personal and knowledgeable attention to your relay needs, contact the one source that is the complete source in the mercury relay field. Contact Adlake today for catalog and further information.



**THE ADAMS & WESTLAKE COMPANY**

A SUBSIDIARY OF ALLIED PRODUCTS CORPORATION

ELKHART, INDIANA 46514 • AC 219 • 264-1141

Dept. 1087

TRANSPORTATION EQUIPMENT • ARCHITECTURAL PRODUCTS • MERCURY RELAYS • DOORS AND ENTRANCES • CONTRACT MANUFACTURING

# CROSSOVER



Kepeco's original KS design offers true automatic crossover operation with real equality of performance for both voltage regulation and current regulation. VIX® equipped, too. Panel mode lights show at a glance just how the power supply is regulating (with signal provisions for remote alarms, process control, etc.).



## REGULATION 0.005% LINE — 0.01% LOAD

MODEL	DC OUTPUT RANGE		PRICE
	VOLTS	AMPS	
KS 8-15M	0-8	0-15	\$625.00
KS 8-25M	0-8	0-25	760.00
KS 8-50M	0-8	0-50	1,050.00
KS 8-100M	0-8	0-100	1,450.00
KS 18-10M	0-18	0-10	575.00
KS 18-15M	0-18	0-15	725.00
KS 18-25M	0-18	0-25	970.00
KS 18-50M	0-18	0-50	1,360.00
KS 36-5M	0-36	0-5	525.00
KS 36-10M	0-36	0-10	625.00
KS 36-15M	0-36	0-15	730.00
KS 36-30M	0-36	0-30	1,150.00
KS 60-2M	0-60	0-2	525.00
KS 60-5M	0-60	0-5	645.00
KS 60-10M	0-60	0-10	895.00
KS 60-20M	0-60	0-20	1,350.00
KS 120-1M	0-120	0-1	550.00
KS 120-2.5M	0-120	0-2.5	695.00
KS 120-5M	0-120	0-5	970.00
KS 120-10M	0-120	0-10	1,450.00



WRITE DEPT. K-5  
FOR LATEST CATALOG  
CONTAINING COMPLETE  
SPECIFICATIONS AND  
APPLICATIONS NOTES



131-38 SANFORD AVE. • FLUSHING, N.Y. 11352  
(212) 461-7000 • TWX #710-582-2631

ON READER-SERVICE CARD CIRCLE 134

# Application Notes



## Varactor amplifiers

A 23-page application note uses 7 technical illustrations to discuss fundamentals and applications of varactor-bridge operational amplifiers. The first 9-1/2 pages of the note discuss varactor bridge amplifier principles and use 3 schematics to show how ultra-low noise and drift are achieved. The next 2 pages show, with the aid of a circuit diagram and numerical examples, why low drift is more important than high input impedance for amplifiers working from multi-megohm sources. Three subsequent pages are devoted to an evaluation of the influence of noise versus drift upon circuit performance, and point out how one of the other predominates under different operating circumstances. Next, a 3-page section compares chopper-stabilized, FET input, transistor differential, and varactor-bridge amplifiers, using a comprehensive set of charts to plot noise and drift errors against circuit resistance. The error curves demonstrate the varactor-bridge unit's superiority over all other types when circuit resistance exceeds about 10 MΩ. Analog Devices, Inc.

CIRCLE NO. 358

## Testing

Testing is probably the last frontier of automation. This is not surprising because there is a tendency to feel that in this function, human judgment must be employed. This is true—but no more so than in many other automated processes. Human judgment is essential, but once something is programmed into the machine, it will remain thereafter. This note contains the ideas on testing for proper results. Problems and solutions are discussed. Slaughter Co.

CIRCLE NO. 359

## Electrical standards

The nineteenth biennial guide to current standards for a wide variety of electrical products has been published by the National Electrical Manufacturers Association (NEMA). The publication includes standards covering most of the products in the Association's seven major divisions: Building equipment, power equipment, industrial electronics and communications equipment, electrical insulating materials, lighting equipment and wire and cable. NEMA standards are adopted in the public interest. They define a product, process or procedure with reference to one or more of the following: dimensions, tolerances, safety, operating characteristics, performance, quality, rating, testing and the service for which the product is designed. NEMA

CIRCLE NO. 360

## Multiplexer modules

Applications described in the 12-page booklet include advance multiplexing, node grounding, submultiplexing, differential multiplexing, production testing, and ladder switching. Diagrams are provided as well as detailed specifications and operations data. Redcor Corp.

CIRCLE NO. 361



# NEW

*Cut down magnetic shielding problems with new full line of easy-to-use Netic Co-Netic Foils*

**In world-wide use for:**

**R & D • Prototypes • Evaluation • Production**

Valuable technical assistance to customers is a way of life with our engineers. Immediate delivery from stock in any length, in .002", .004", .006" and .010" thickness, and in any width up to 19 3/4". Standard widths are 4", 15" and 19 3/4". Full details in Catalog SG-1. Just ask for it.

**MAGNETIC SHIELD DIVISION/Perfection Mica Company**

1322 N. ELSTON AVENUE, CHICAGO, ILLINOIS 60622

**ORIGINATORS OF PERMANENTLY EFFECTIVE NETIC CO-NETIC MAGNETIC SHIELDING**

ON READER-SERVICE CARD CIRCLE 135



## **EASTMAN 910<sup>®</sup> Adhesive offers... reduced bonding costs in precision gaging instruments.**

EASTMAN 910 Adhesive reduces the component assembly costs of the Sheffield Electrojet<sup>®</sup> precision gaging transducer. Manufactured by Bendix Corporation's Automation and Measurement Division, this transducer, a mechanical contact type size sensing unit is widely used in the automo-



tive and machine tool industry.

Applied to junctions where pressure bonding is impractical, EASTMAN 910 Adhesive is used to bond acrylic to acrylic, to steel and to brass. Long lasting bonds are made in seconds, at room temperature with only contact pressure. With use of this adhesive, manpower and material costs have been reduced. Not one bond failure has been reported during five years of use.

EASTMAN 910 Adhesive will form bonds with almost any kind of material without heat, solvent evaporation, catalysts, or more than contact pressure. Try it on your toughest bonding jobs.

For technical data and information, write to Chemicals Division, EASTMAN CHEMICAL PRODUCTS, INC., subsidiary of Eastman Kodak Company, Kingsport, Tenn. EASTMAN 910 Adhesive is distributed by Armstrong Cork Company, Industry Products Division, Lancaster, Pa.

### **Here are some of the bonds that can be made with EASTMAN 910 Adhesive**

Among the stronger: steel, aluminum, brass, copper, vinyls, phenolics, cellulose, polyesters, polyurethanes, nylon; butyl, nitrile, SBR, natural rubber, most types of neoprene; most woods. Among the weaker: polystyrene, polyethylene (shear strengths up to 150 lb./sq. in.).

ON READER-SERVICE CARD CIRCLE 136

ELECTRONIC DESIGN 21, October 11, 1967

## **There is no adhesive like EASTMAN 910<sup>®</sup> Adhesive**



- SETS FAST**—Makes firm bonds in seconds to minutes.
  - VERSATILE**—Joins virtually any combination of materials.
  - HIGH STRENGTH**—Up to 5000 lb./in.<sup>2</sup> depending on the materials being bonded.
  - READY TO USE**—No catalyst or mixing necessary.
  - CURES AT ROOM TEMPERATURE**—No heat required to initiate or accelerate setting.
  - CONTACT PRESSURE SUFFICIENT.**
  - LOW SHRINKAGE**—Virtually no shrinkage on setting as neither solvent nor heat is used.
  - GOES FAR**—One-pound package contains about 30,000 one-drop applications. (Or in more specific terms, approximately 20 fast setting one-drop applications for a nickel.)
- The use of EASTMAN 910 Adhesive is not suggested at temperatures continuously above 175°F., or in the presence of extreme moisture for prolonged periods.

See Sweet's 1967 Product Design File 6a/Ea.

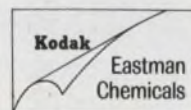



Please send me the latest Acopian catalog that lists

**62,000  
DIFFERENT  
POWER  
SUPPLIES**

available  
for shipment  
in 3 days.

Name \_\_\_\_\_

Title \_\_\_\_\_

Company \_\_\_\_\_

Address \_\_\_\_\_

City \_\_\_\_\_

State \_\_\_\_\_

ZIP \_\_\_\_\_

ACOPIAN CORP.  
EASTON, PENNSYLVANIA  
TEL: (215) 258-5441



ON READER-SERVICE CARD CIRCLE 137

## New Literature



### Transistor brochure

A 12-page supplement features the manufacturer's line of small signal npn and pnp transistors used for military, industrial and commercial applications. It includes small signal devices recently introduced by the company. The material in the catalog deals with silicon transistors constructed by alloy, epitaxial base and planar techniques. Among the types listed are discrete transistors, choppers, differential amplifiers, darlington amplifiers and duals. Complementary npn and pnp planar transistors are also discussed. Each transistor has a summary of its primary specifications for reference. Solitron Devices, Inc.

CIRCLE NO. 362

### Burr-Brown catalog

This catalog covers operational amplifiers including monolithic IC. Also function modules, including encapsulated quarter-square multipliers, sample/hold modules and active filters are described. With the product description is application information and technical specifications. Burr-Brown.

CIRCLE NO. 363

### Constant-force springs

Literature describing the design and application of constant-force springs and constant-force spring motors is available. It includes basic design principles and formulas developed. Associated Spring Corp.

CIRCLE NO. 364



### Dielectric materials

An illustrated folder is now available that describes dielectric products possessing high thermal conductivity. A chart shows adhesives, casting resins, surface coatings, transfer molding powders, silicones and a silicone mastic. Listed under each product are typical mechanical and electrical properties pertinent to the class, such as service temperature, strength, thermal conductivity and thermal expansion, together with dielectric strength, volume resistivity, dielectric constant and loss tangent. Each product is also separately described with emphasis on the handling characteristics of the uncured system, and the outstanding features of the cured system. Photographs illustrate applications for several of the materials. Emerson & Cuming, Inc.

CIRCLE NO. 365

### Where aluminum is used

A booklet entitled "Uses of aluminum" which details aluminum applications ranging from siding to the F-111 jet, describes applications in construction, transportation, electrical packaging, consumer durables, machinery equipment and the aerospace industry. The 32-page catalog is illustrated and is designed to give the reader an overall look at aluminum and its market. An introductory section gives information about basic aluminum characteristics and a brief history of its development. The Aluminum Association.

CIRCLE NO. 366

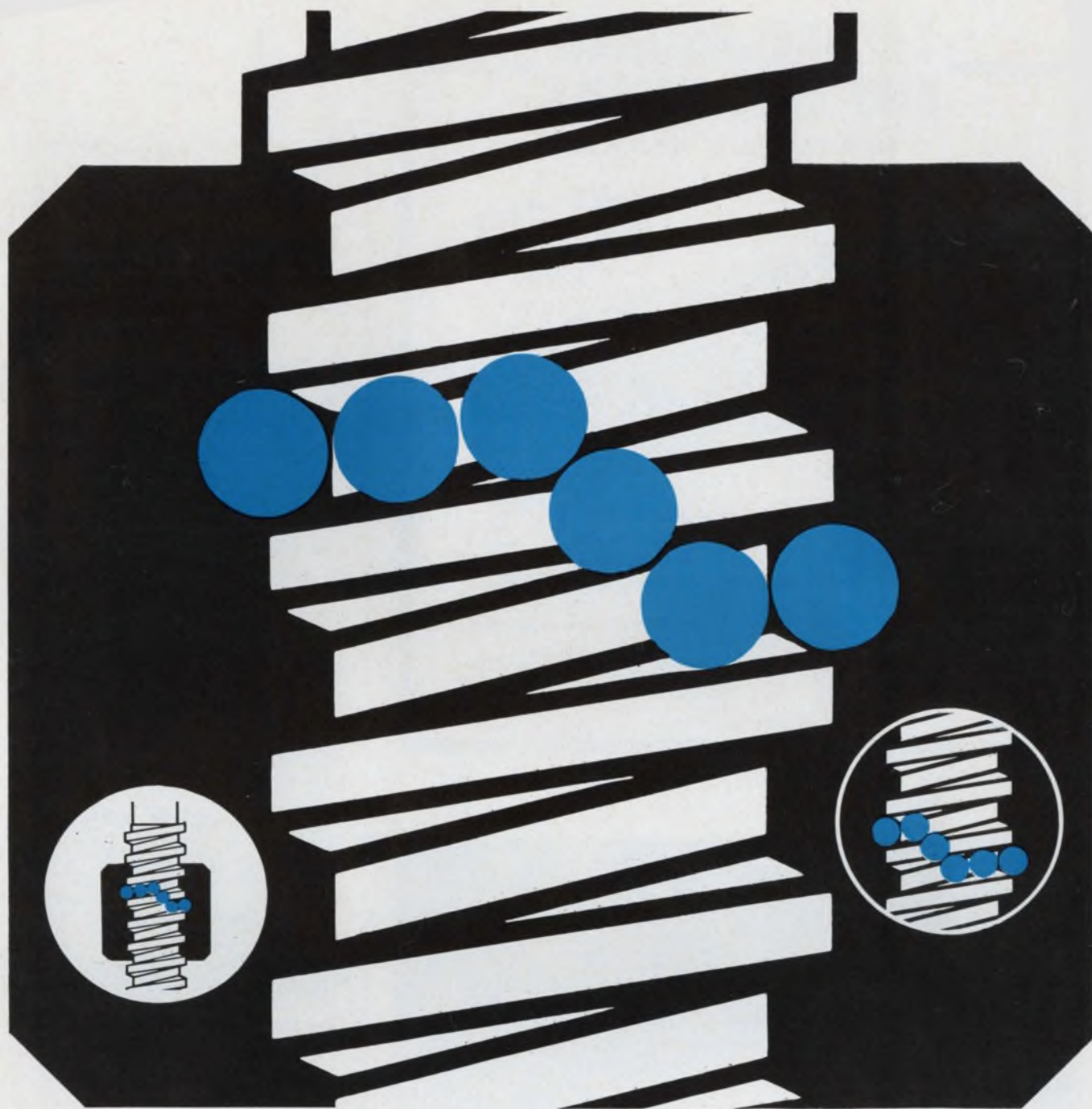

## Kidde Ballscrews

### SIZE AND WEIGHT PROBLEM SOLVERS

Kidde Ballscrews do more than solve friction problems of prime movers and drives. They can solve size and weight problems, too—and meet the demands for high efficiency transfer of motion and power. Here's why:

Their compact design results in smaller envelope dimensions. Weight is reduced because external tubes and fittings are eliminated. Kidde designs allow optimum usable power, due to extremely high efficiencies.

To solve these major problems, Kidde has designed a

wide range of Ballscrew sizes—from units less than 1" long to 32 foot custom assemblies. From 6" diameters down to 1/8"; sizes 3/16" to 1-1/2" (with various lead) are stocked.

Learn how Kidde Ballscrews can become your problem solver. Write for your free copy of "Standard and Precision Ballscrews." Walter Kidde & Company Inc., 675 Main Street, Belleville, New Jersey 07109.



ON READER-SERVICE CARD CIRCLE 138

# IC BREADBOARD AND TEST PANELS

TIME SAVING • FLEXIBLE

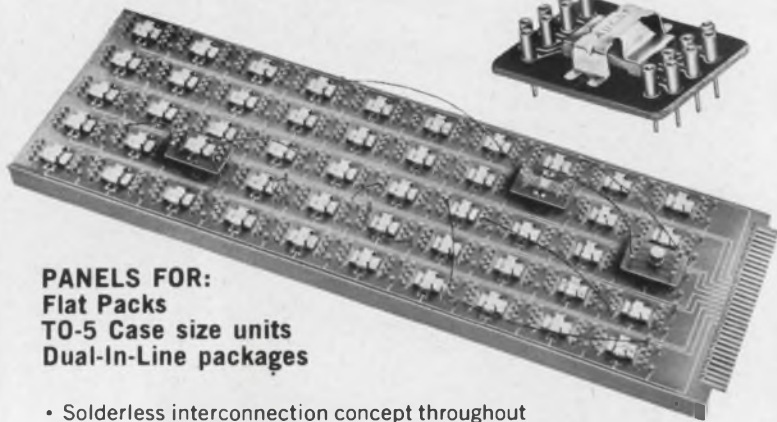

**PANELS FOR:**  
Flat Packs  
TO-5 Case size units  
Dual-In-Line packages

- Solderless interconnection concept throughout
- 10 to 50 patterns standard
- Fast loading and operation — easy IC interchangeability
- Single pattern units and wire jumpers provide unlimited flexibility
- Power and ground connection at each pattern
- Panel plugs into 36 position edge connector with contacts spaced on .156 centers
- 6" x 17" panels (50 patterns)

Request catalog 364

**AUGAT**  
INC.

31 PERRY AVE., ATTLEBORO, MASS. 02703

ON READER-SERVICE CARD CIRCLE 139

## WE'VE SIMPLIFIED PHOTOCCELL-LAMP DESIGN

New Clairex® PHOTOMODS® combine selected photoconductive cells and lamps into one compact module ready for use as noiseless pots, circuit isolators, automatic gain controls and for numerous other control applications. 11 standard PHOTOMODS are now available combining hermetically sealed CdS and CdSe photocells coupled to 500C hour lamps rated at 6, 12, 24, and 120 volts. Custom PHOTOMODS are also available based on your specific control and signal circuit parameters.



For additional design data request technical bulletin ITD 465.



INC. ■ 1239 BROADWAY, NEW YORK, N.Y. 10001

ON READER-SERVICE CARD CIRCLE 140

## NEW LITERATURE

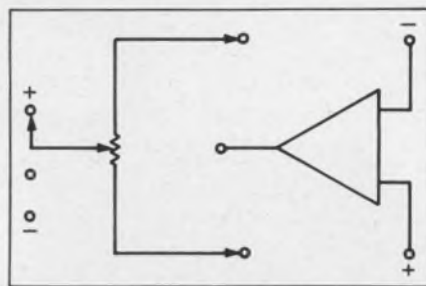

### Short form op-amp catalog

A brochure dealing with the manufacturer's two series of standard and FET-model operational amplifiers is available. Both series start with economy general-purpose units and span the entire spectrum of specifications to premium-quality models. The units may be ordered chopper stabilized and come in four-case sizes including flat-pack models. GPS Instrument Co., Inc.

CIRCLE NO. 356

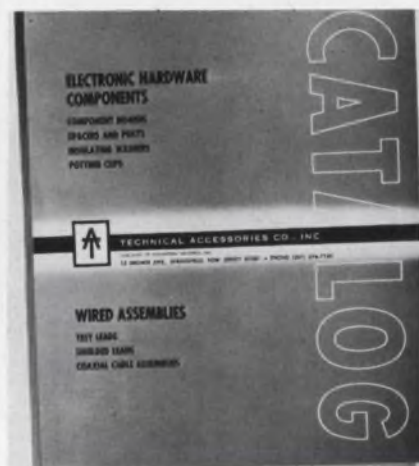

### Electronic components

A catalog which contains specifications, dimensions and pricing on the manufacturer's line of various electronic-hardware components is available. The brochure, which is designed for the designer and engineer, contains information on wired assemblies, test leads, shielded leads and coaxial cable assemblies. Technical Accessories Co.

CIRCLE NO. 367

### Lamp-base manufacture

A semi-automatic machine for solderless assembly of miniature-lamp socket-base contacts to wire leads is described. The machine, model NREC, increases production rates to as much as 2,500 units per hr by eliminating manual handling of small parts. Edward Segal, Inc.

CIRCLE NO. 368



### Etched metal parts

A brochure providing information on photoetching techniques employed in the production of precision parts for industrial and consumer products includes technical details on ease and speed of etching various materials. Special notes on designing parts for optimum results, and typical examples of close-tolerance, intricate parts possible are discussed. Tech-Etch, Inc.

CIRCLE NO. 369

### Opto-electronic relays

A 28-page catalog describing a line of solid state and reed relays including time delay, time interval and frequency-sensitive relays is available. The units utilize a miniaturized, ruggedized design and are recommended for military and industrial applications. Solid State Electronics Corp.

CIRCLE NO. 370

### Integrated power supplies

A twelve-page brochure entitled "Integrated power supplies using hi-pac<sub>(R)</sub> process" covers the unique features of the Hi-Pac<sub>(R)</sub> power supplies, provides technical information and illustrates product applications. Solitron Devices, Inc.

CIRCLE NO. 371

### Patchcord programing

A 24-page brochure entitled "Versatility in Patchcord Programing Systems," covers the manufacturer's line of products for patchcord programing. Included in the presentation are schematics and illustrations. Anderson Electric Corp.

CIRCLE NO. 372

# Yes.

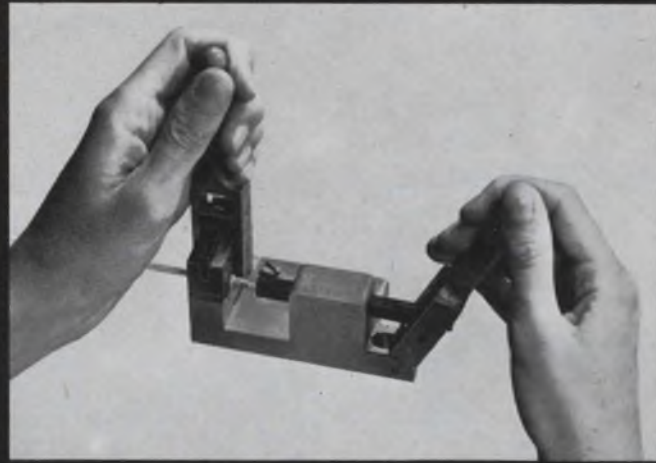

## Our Micon Emlock<sup>®</sup> connectors assemble just as fast as crimp types.

Speed of assembly used to be the supposed reason behind the specification of conventional crimp-type miniature connectors despite the fact that Emlock<sup>®</sup> compression fit connectors were generally recognized to be much more reliable. This situation is changed now. Emlock<sup>®</sup> compression fit connectors, thanks to our new T15 bench tool, are more than a match for crimp in assembly time. This is definitely not true of competitive compression types utilizing compliant braid gripping components rather than all metal elements, as we do.

With the new T15 tool, all you have to do to assemble an Emlock<sup>®</sup> connector,

after preparing the cable, is install a nut, wedge and washer, seat the ferrule against the braid and compress. It's that easy.

Prove it to yourself. One of our Technical Representatives will be happy to call on you for an actual demonstration of Emlock<sup>®</sup> assembly speed. While he is with you he will also show you that you simply can't pull the cable out of an Emlock<sup>®</sup> connector. Failure will be caused only by disintegration of the braid and never by pull-out of the compression.

Our new catalog has the whole story. Ask for Bulletin MMC, Issue 1.

Micon is now a part of

**PHELPS DODGE** ELECTRONIC PRODUCTS  
NORTH HAVEN, CONNECTICUT



ON READER-SERVICE CARD CIRCLE 141

## Beautiful Readout! and You'll Never Change a Lamp

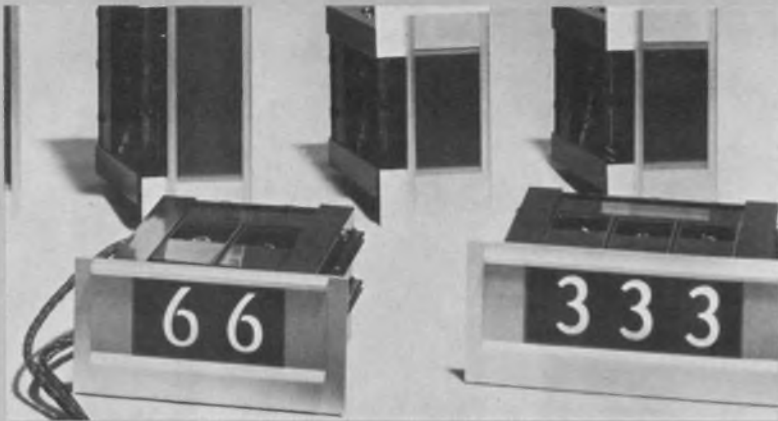

### Numex Decoding Readout Assemblies

Complete with decoding to work directly from 4-wire integrated circuit BCD. 6.3 volt transformer power supply—1½" numerals. 250 foot-lamberts

Single Assembly Prices: 6 digits \$334; 5 digits \$285; 4 digits \$236;  
3 digits \$187; 2 digits \$138. ALL FROM STOCK.

FOR INFORMATION & ORDERS CALL (617) 899-4040 or Write address below.

#### NUMEX Corporation

223 Crescent Street, Waltham, Massachusetts 02154

ON READER-SERVICE CARD CIRCLE 142

## NEW LITERATURE

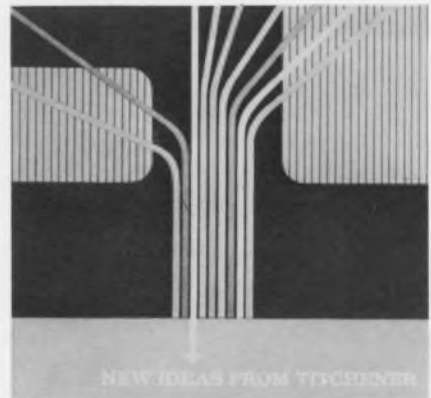

### Cut wire design costs

A brochure entitled "New Ideas from Titchener" discusses various ways to keep costs down when designing with steel wire. Included are 15 fastening and welding techniques used with wire forms and assemblies. E. H. Titchener & Co.

CIRCLE NO. 373



### Capacitor components

The catalog consists of 21 data sheets, either two or four pages a piece, which can be easily removed for updating and filing purposes. Each data sheet contains detailed specifications, typical curves, photos and diagrams. A handy capacitor selector locates the exact component you need. The vinyl-bound, three-hole catalog contains information on five new products and thin-line, high-current, high-voltage, chip, wafer, and high-reliability capacitors. Vitramon, Inc.

CIRCLE NO. 374

### Modular products

A 10-page catalog of modular products which includes price lists has been published. The booklet explains operational amplifiers, linear amplifiers, analog function modules and logarithmic amplifiers. Optical Electronics, Inc.

CIRCLE NO. 375

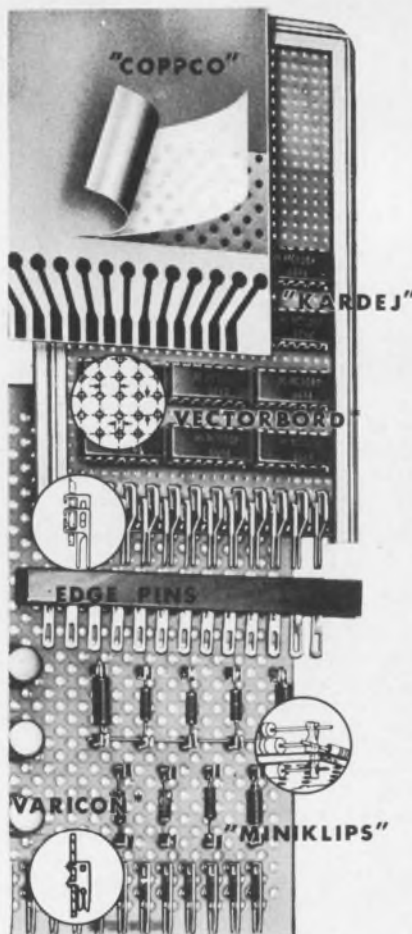

## VECTOR PLUGBORDS CUT CONSTRUCTION TIME

Why drill holes? Use prepunched Vector Plugboards to save time, work, and money.

- New "COPPCO"—Copper plus film plus Vectorbord\*. User "pokes" holes through.
- "KARDEJ"—Aluminum framing stiffens cards 1/32" to 1/16" thick.
- VECTORBORD: "P" Type—.042" holes, 0.1" grid for D.I.P.s; "M" Type—.025" holes on .050" grid for I.C.P.s; "G" Type—.062" holes, 0.2" x 0.1" grid for transistors and discrete components.
- EDGE PINS stake to card — fit New "VECTORCONN" receptacles.
- "MINIKLIPS"—Vector "Push Pins" and turned terminals for leads.
- ELCO VARICON\*, 12-47 contacts, or printed tabs.

\*Trademark

For complete information contact:

**Vector**

ELECTRONIC COMPANY, INCORPORATED  
1100 Flower Street, Glendale, California 91201

ON READER-SERVICE CARD CIRCLE 143



### Contact manufacturing

Facts on a recently-patented manufacturing process, which reduces the amount of silver in certain contacts by 70% are provided in this literature. In addition arcing and erosion have been reduced and improved mechanical life has resulted. Users of electrical contacts and contact sub-assemblies should find this information of interest. Deringer Metallurgical Corp.

CIRCLE NO. 376

### Balancing machines

A balancing-machine catalog, covering machines for use by the aircraft industry in manufacturing and maintaining of propellers, jets, landing gear, and helicopters, includes the manufacturer's pivot arrangement and compensator in an easily-read dial. Balancing machines for helicopter's tail-rotor assemblies, rotor assemblies and cooling fans are graphically displayed. Micro Poise Engineering.

CIRCLE NO. 377

### Reprints Available

The following reprints are available free and in limited quantities. To obtain single copies, circle the number of the article you want on the Reader-Service Card.

*Stop Wasting Design Time* (No. 466)

*Take a Fresh Look at Filters* (No. 467)

*Inductors Ups Crystals Bandwidth 2%* (No. 468)

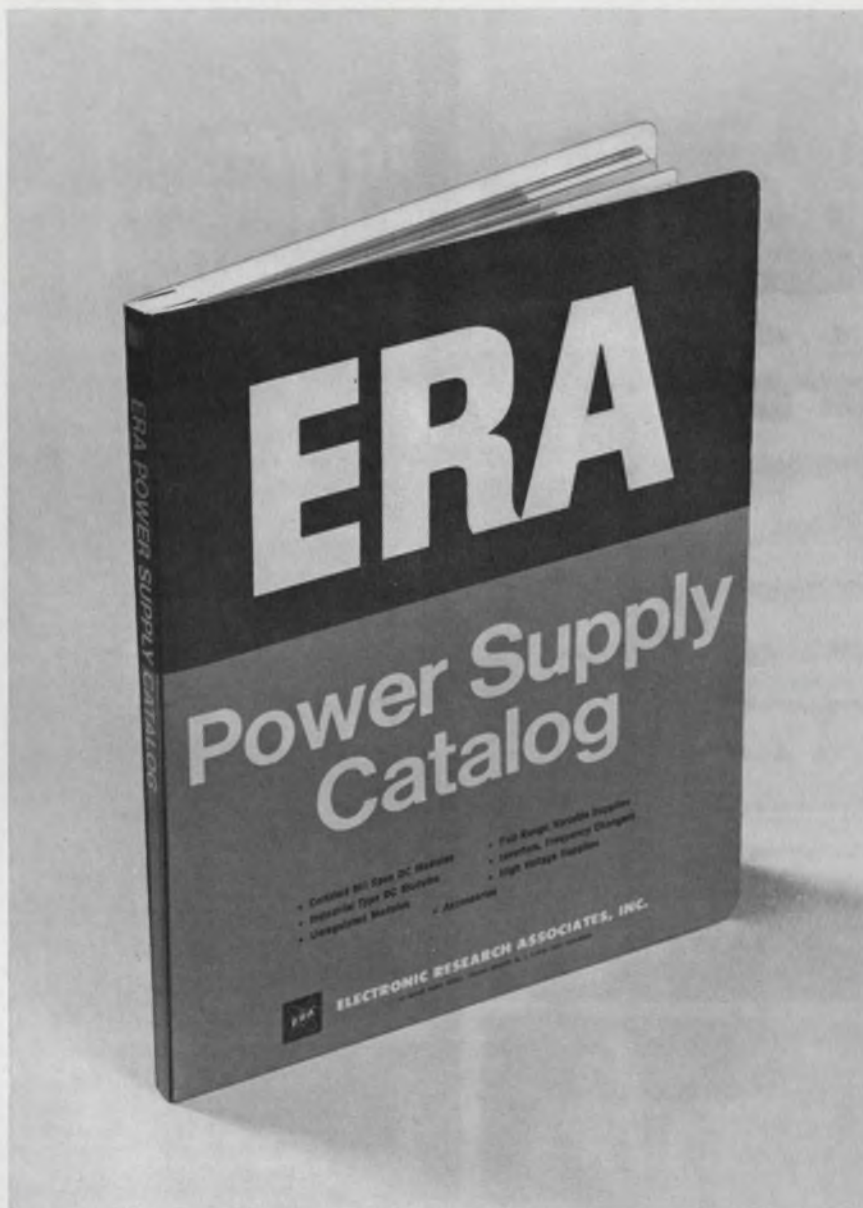

# Buying Power?

**Here's the new, single source for all your power needs.**

- *Certified Mil Spec Transpac® DC Modules*
- *New Low-Cost Silicon Transpac DC Modules*
- *Full-Range Variable Supplies*
- *Inverters, Frequency Changers*
- *High-Voltage Supplies*

**AC to DC • DC to AC • AC to AC • DC to DC**



**Send for Your Free Copy TODAY!**

**ELECTRONIC RESEARCH ASSOCIATES, INC.**

Dept. ED-10,67 Sand Park Road, Cedar Grove, N. J. 07009 • (201) 239-3000

**SUBSIDIARIES: ERA Electric Co. • ERA Acoustics Corp. • ERA Dynamics Corp. • ERA Pacific, Inc.**

ON READER-SERVICE CARD CIRCLE 144



# DIGITIZER

## BIGGEST NAME IN SHAFT ENCODERS

For proven reliability in shaft encoders, there is no substitute for genuine Coleman Digitizers®. Absolute decimal digital output. Patented dual brush technique eliminates ambiguity. Accurate within one count over full scale. Needs no decoding. High current capacity; up to 250 MA @ 24V DC, sufficient to directly operate a digital indicator, printer, relay or matrix data processor. Rugged design proved over 10 years. Send for full-line catalog.

Coleman Engineering Co., Inc. Box 1974, Santa Ana, California 92702

ON READER-SERVICE CARD CIRCLE 145

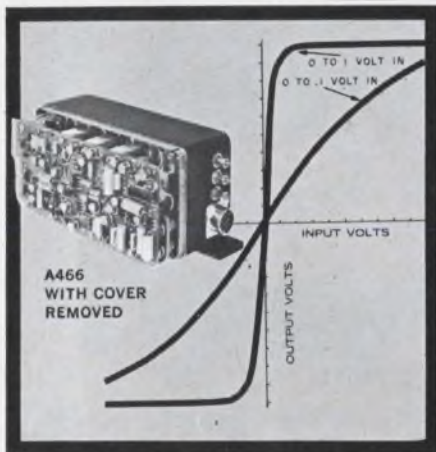

## 2 KW RFI FILTERED SERVO AMPLIFIER

Westamp servo amplifier model A466 is designed to drive DC motors from an AC line. This high power SCR amplifier is bi-directional and full wave. The A466 has high gain and high input impedance, provides for parallel summing of 3 signal inputs, and has adjustable current limiting. The A466 is designed to comply with requirements of MIL-I-16910A for RFI. For further data just send for our catalog.

HIGH POWER SERVO AMPLIFIERS

**WESTAMP**

1542 15TH STREET  
SANTA MONICA, CALIF. 90404  
PHONE: (213) 393-0401

ON READER-SERVICE CARD CIRCLE 146

180

# Advertisers' Index

Advertiser	Page	Advertiser	Page
ADC Products, A Division of Magnetic Controls Co.	157	Division	118
Acopian Corporation	174	Janco Corporation	112
Adams & Westlake Company, The	171	Janus Control Corporation	140
Allen-Bradley Co.	45	Johanson Manufacturing Corp.	46
Allied Electronics, a Subsidiary of Allied Radio	116	Kepeco, Inc.	172
American Lava Corporation	99	Kidde & Company, Inc., Walter	175
Augat, Inc.	176	Lamb Electric Division, Ametek, Inc.	124
Automatic Electric, A Subsidiary of General Telephone & Electronics	48, 145	Lambda Electronics Corp.	127
B & B Motor & Control Corp.	168	Leach Corporation	40
Ballantine Laboratories, Inc.	115	MacLean-Fogg Lock Nut Company	182
Beckman Instruments, Inc., Helipot Division	123	Mac Panel Company	165
Beckman Instruments, Inc., Electronic Instruments Division	143	Magnetics, Inc.	125
Bell Telephone Laboratories	85	Markel & Sons, L. Frank	142
Beman Mfg. Inc.	158	Master Specialties Company	96
Borden Chemical Co., The Mystic Tape Division	15	Measurements, A McGraw Edison Division	160
Bourns, Inc.	47	Memory Technology, Inc.	153
Brand Rex, Division of American Enka Corporation	155	Mepco, Inc.	105
Buckbee Mears Co.	164	Microdyne Instruments, Inc.	126
Buolva Electronics Division of Buolva Watch Company	150	MicroSwitch, A Division of Honeywell	163
Burdny Corporation	131	Microsonics, Inc.	166
Burr-Brown Research Corporation	110	Microwave Associates, Inc.	119
By-Buk Company	182	Motorola Semiconductor Products, Inc.	4
CTS Corporation	107	Mycalex Corporation of America	160
Cambridge Thermionic Corporation	42	National Semiconductor Corporation	8, 9
Clairex Electronics, Inc.	176	Nortronics Company, Inc.	146
Clare & Co., C. P.	147	Numex Corporation	178
Coleman Engineering Co. Inc.	180	Pamotor, Inc.	120
Conductron Corporation	152	Perfection Mica Company	73
Consolidated Electro-dynamics, A Subsidiary of Bell & Howell	84	Phelps Dodge Electronic Products	177
Coto Coil Company, Inc.	156	Power/Mate Corp.	183
Cutler-Hammer	39	Prentice-Hall, Inc.	181
Dale Electronics, Inc.	32 A-B	Prestape, Division of Prestype Inc.	138
Damon Engineering, Inc.	22	Princeton Applied Research Corp.	16
Datapulse, Incorporated	2	RCA Electronic Components and Devices	44, 77, 135, 159, Cover IV
Dayton Electronic Products Company	156	RF Division, Amphenol Corporation	34, 35
Deringer Metallurgical Corp.	137	RFL Industries, Inc.	169
Dialight Corporation	144	Radiation, Incorporated	109
Dow Corning Corporation	70, 71	Radio Cores, Inc.	134
Duncan Electronics, Inc.	20, 21	Redcor Corporation	83
Dzus Fastener Co., Inc.	183	Schweber Electronics	183
ESC Electronics Corp.	6	Sigma Division, Sigma Instruments, Inc.	76
ESI/Electro Scientific Industries, Inc.	152	Simpson Electric Company	31
Eastman Chemical Products, Inc.	173	Sperry Semiconductor, Division of Sperry Rand Corporation	121
Electro-Motive Mfg. Co., Inc., The	151	Sprague Electric Company	10, 12
Electronic Controls, Incorporated	133	Standard Condenser Corporation	136
Electronic Molding Corp.	94	Sylvania Electric Products, Inc., Electronic Tube Division	43
Electronic Research Associates, Inc.	179	Syntron Company	129
Electrovert, Inc.	148	TRW Semiconductors, Inc.	Cover II
Ellis and Watts Company	154	Tektronix, Inc., Oscilloscopes	50
Erie Technological Products, Inc.	27	Torngren Co., Inc., C. W.	33
Fairchild Memory Products	101	Transistor Electronics Corporation	170
G-V Controls, Inc.	64, 65	Trompeter Electronics, Inc.	181
General Electric Company	28	Union Carbide Corporation	25
General Instrument Corporation	41	U.S. Capacitor Corporation	130
General Radio Company	117	Unitrode Corporation	37
Globe Industries, Division of TRW, Inc.	164	Vanton Pump & Equipment Corporation	168
Hart/Advance Relay Division	148	Varian Associates	38
Hayden Book Company, Inc.	112	Vector Electronics Company	178
Heath Company	122	Victoreen Instrument Division	132
Hewlett-Packard	1, 5, Cover III	Waldom Electronics, Inc.	128
Hickok Electrical Instrument Co., Inc., The	162	Watkins-Johnson Company	32
Howell, Computer Control Division	56, 57	Westamp, Inc.	180
Howard Industries, A Division of MSL Industries, Inc.	144	Weston Instruments, Inc., Archbald Division	139
Hudson Lamp Company	103	Zeltex, Inc.	167
Hughes Aircraft Company	7	IMC Magnetics Corporation	161
IRC, Inc.	141	ITT Semiconductors, A Division of International Telephone and Telegraph Corporation	184
Industrial Electronic Engineers, Inc.	111	JFD Electronics Co./Components	

### Career Advertising

General Dynamics	97
LTV ElectroSystems, Inc.	95
Marathon Electric Manufacturing Corporation	94
Sylvania Electronic Systems	92



## Advertising Representatives

### New York 10022

Robert W. Gascoigne  
Thomas P. Barth  
Samuel M. Deitch  
Byron Adams  
850 Third Avenue  
(212) PLaza 1-5530  
TWX: 867-7866

### Philadelphia

William C. Repetto  
P. O. Box 206  
Merion Station, Pa. 19066  
(215) MO 4-1073

### Boston

Richard Parker  
7 Redstone Lane  
Marblehead, Mass. 01945  
(617) 742-0252

### Chicago 60611

Thomas P. Kavooras  
Berry Conner, Jr.  
720 N. Michigan  
(312) 337-0588

### Cleveland

(216) 247-7670

### Los Angeles 90303

Stanley I. Ehrenclou  
Terrence D. Buckley  
W. James Bischof  
2930 W. Imperial Highway  
Inglewood, Calif.  
(213) 757-0183

### San Francisco

Ashley P. Hartman  
175 South San Antonio Rd  
Ste. 243  
Los Altos, Calif. 94022  
(415) 941-3084

### Southwestern 75206

Tommy L. Wilson  
6200 North Central Express-  
way  
Dallas, Tex.  
(214) EMerson 1-2311

### London W. 1

Brayton C. Nichols  
44 Conduit Street

### Verviers, Belgium

Andre Jamar  
1, Rue Mallar, 1  
(087) 253.85

### Tokyo

Yoshihiro Takemura  
International Planning  
Service, Inc.  
Room 231 Tokyu-Mita Bldg.  
1, Shiba-Mita Koun-cho  
Minato-ku, Tokyo



# Design Data from Manufacturers

Advertisements of booklets, brochures, catalogs and data sheets. To order use Reader-Service Card.

## Get Quick Circuit Identification

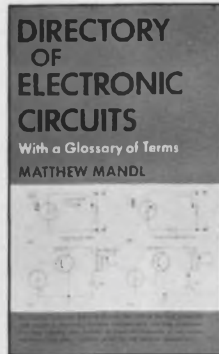

Directory Of Electronic Circuits With Glossary Of Terms, by Matthew Mandl, saves you time in experimental assembly or design with analyses of over 150 most commonly used circuits. Get quick, illustrated circuit identification, applications, description in every field of electronics including computers, communications, and industrial controls. Emphasizes solid-state components and circuit applications. An ideal fingertip guide for designing or improving an existing design to meet the exact performance characteristics you need. Pub. Sept. 1966, 226 pp., \$10.60. Order your free 15 day examination copy by circling the number to the right.

**Prentice-Hall Inc.**  
Englewood Cliffs, N.J. 07632

**171**

## Switching Circuits For Engineers

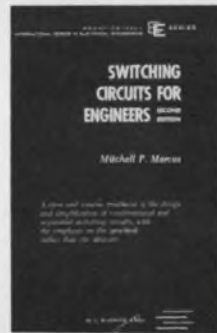

Save time and cost in design and simplification of combinational and sequential switching circuits with self-study features such as: Gives you "methods of attack"—clearly and quickly shows you how to recognize the applications of the theorems of Boolean Algebra (emphasizes sequential switching circuits in almost 50% of the book); Provides you with original methods for obtaining flip flop excitation expressions, minimizing relay and electronic trees, detection and identification of symmetric functions; plus an original approach to secondary assignment patterns. Written by Mitchell P. Marcus of I.B.M. Corp., Pub. April 1967, 338 pp., \$12.95. Order your free 15 day examination copy by circling the number to the right.

**Prentice-Hall, Inc.**  
Englewood Cliffs, N.J. 07632

**172**

## Video And Data Switching Systems



The switching systems presented in this catalog are a new concept designed to replace manual patching, programmed patch panels, and cross-bar switches, with matrices or multiple switching units for transferring low level-low frequency (audio, digital or analog) and high frequency (video, IF and RF) signals.

Matrices are capable of switching sine wave frequencies from zero hertz to 100 megahertz and fast rise time pulses for high megabit systems normally carried over shielded wire, coax, twisted pair shielded (twinax) or triax cables.

**Trompeter Electronics, Inc.**  
8936 Comanche Avenue  
Chatsworth, California 91311

**173**

ELECTRONIC DESIGN's function is:

- To aid progress in the electronics manufacturing industry by promoting good design.
- To give the electronic design engineer concepts and ideas that make his job easier and more productive.
- To provide a central source of timely electronics information.
- To promote two-way communication between manufacturer and engineer.

**Want a subscription?** ELECTRONIC DESIGN is sent free to qualified engineers and engineering managers doing design work, supervising design or setting standards in the United States and Western Europe. For a free subscription, use the postfree application form inside the back cover. If none is included, write to us direct for an application form.

If you do not qualify, you may take out a paid subscription for \$25 a year in the U.S.A., \$35 a year elsewhere. Single copies are \$1.50 each.

**If you change your address**, send us an old mailing label and your new address; there is generally a prepaid postcard for this inside the back cover. You will have to requalify to continue receiving ELECTRONIC DESIGN free.

**We strive for accuracy**, but despite our efforts, an occasional error does slip through. Whenever this occurs and it comes to our attention, we publish a correction. Corrections appear at the end of the Letters column.

**We will not knowingly accept** advertisements that make false claims. Readers are asked to bring any misleading or fraudulent data they see in advertisements in ELECTRONIC DESIGN to the attention of the Editor.

**Microfilm copies are available** of complete issues of ELECTRONIC DESIGN and of individual articles published since the beginning of 1961. Complete issues cost 4¢ a page, articles cost 50¢ a page; shipping and handling charges are extra. The minimum charge is \$3. For further details and to place orders, contact University Microfilms, Inc., 300 N. Zeeb Road, Ann Arbor, Mich. 48106; telephone (313) 761-4700.

**Want to contact us?** If you have any comments or wish to submit a manuscript or article outline, address your correspondence to:

Howard Bierman, Editor,  
ELECTRONIC DESIGN,  
850 Third Avenue,  
New York, N.Y. 10022.

## New "Tape Lift" Printed Circuit Drafting Aids



No engineer or draftsman should be without the most up-to-date cross-reference guide to better Printed Circuit Drafting Catalog. It is complete with prices and illustrations of over 1200 sizes of "Tape Lift" pads, shapes and other aids for faster, more accurate, distortion-free printed circuit master drawings.

Write for FREE catalog.

### By-Buk Company

4326 West Pico Blvd., Los Angeles, Calif. 90019  
Telephone: (213) 937-3511

# 174

## 48 Page Catalog of Lock Nuts



The MacLean-Fogg Lock Nut Company's new catalog No. 880 is the largest such book ever published to deal solely with locking fasteners. Each of the company's wide variety of products is treated comprehensively. The locking principle of each fastener is described. The advantages are stated and materials, finishes, sizes and shapes are covered in detail. Application sketches are given with each product to show how it is used in product assemblies. In addition to data on M-F Products there is a variety of technical information on threaded fasteners including torque-tension data, nut and bolt threads, and a bibliography of reference works on fastening.

### MacLean-Fogg Lock Nut Company

1060 Allanson Road  
Mundelein, Illinois 60060

# 175

## Engineers' Relay Handbook



A definitive work that is fast becoming a standard reference text for the relay user. Prepared and edited by the National Association of Relay Manufacturers, this book is a complete guide to the principles, properties, performance characteristics, application requirements, specifications, and testing of relays. Systems and product engineers will find the *Handbook* an indispensable help in determining the correct types of relays for their applications. For further information about this unique sourcebook, write Dept. ED.

### Hayden Book Co., Inc.

116 W. 14th Street  
New York, N. Y. 10011

# 176

# Manufacturers

Advertisements of booklets, brochures, catalogs and data sheets. To order use Reader-Service Card. (Advertisement)

## Op Amp Instrumentation By Fairchild



Specifications for 20 state-of-the-art amplifiers are given in this brochure. These are products of Fairchild Instrumentation, the leader in solid state technology, and offers a complete line of chopper stabilized and differential amplifiers. Schweber can ship these amplifiers from stock. Use phone number below. The brochure is yours by circling this number.

### Schweber Electronics

Westbury, N.Y. 11590  
Phone 516-334-7474

**177**

## Adjustable 0-34V, 1.5A Power Supply



Regulation: 0.005% or 1 MV  Ripple: 250  $\mu$ V  
 Output: Adjustable 0-34V, to 1.5A  Completely short circuit proof  Designed to meet environment MIL-E-5272  All silicon semiconductors  Operate to 71°C  Compact 3 1/4" x 3 7/8" x 6 7/8" size  Top quality components & construction  Units operate in series or parallel  Temp. Coef: 0.01%/°C  Response: less than 20  $\mu$ s  MTBF: greater than 100,000 hrs. per MIL HDBK 217  Remote sensing  Universal 3-position mounting  Three year warranty  Only \$88.00 F.O.B. Hackensack, N. J.  Write today.

### Power/Mate Corporation

163 Clay St., Hackensack, N. J. 07601  
(201) 343-6294

**178**

## Quality Fasteners For All Design Applications



This 8-page catalog provides design data on the complete group of DZUS 1/4-turn self-locking fasteners for standard, high speed and panel applications, as well as universal high strength multiple thread fasteners for high tensile and shear stresses. Dzus stud assemblies, wire forms and receptacles offer an exceptional, wide variety of combinations from stock to fit specific fastening requirements. Diagrams and tables give full details for rapid, unlimited design selection. Condensed Catalog No. S-2 or comprehensive Catalog No. D-3 are available on request.

### Dzus Fastener Co., Inc.

Division 32  
425 Union Boulevard  
West Islip, L. I., N. Y. 11795

**179**

# Designer's Datebook

OCTOBER						
S	M	T	W	T	F	S
1	2	3	4	5	6	7
8	9	10	11	12	13	14
15	16	17	18	19	20	21
22	23	24	25	26	27	28
29	30	31				

NOVEMBER						
S	M	T	W	T	F	S
		1	2	3	4	
5	6	7	8	9	10	11
12	13	14	15	16	17	18
19	20	21	22	23	24	25
26	27	28	29	30		

For further information on meetings, use Reader Service card.

### Oct. 23-27

**AIAA Meeting and Technical Display** (Anaheim, Calif.) Sponsor: American Institute of Aeronautics and Astronautics; A. G. Kildow, AIAA, 1290 Sixth Avenue, New York, N. Y. 10019.

CIRCLE NO. 469

### Oct. 23-25

**National Electronics Conference and Exhibition** (Chicago) Sponsor: IEEE; National Electronics Conference, 228 N. La Salle St., Chicago, Ill. 60601.

CIRCLE NO. 470

### Oct. 23-27

**Business Equipment Exposition and Conference** (New York) Sponsor: BEMA; L. C. Messick, BEMA, 235 East 42 St., New York, N. Y. 10017.

CIRCLE NO. 471

### Nov. 1-3

**Northeast Research and Engineering Meeting (NEREM)** (Boston) Sponsor: IEEE; IEEE Boston Office, 31 Channing St., Newton, Mass. 02158.

CIRCLE NO. 472

### Nov. 6-8

**Applied Superconductivity Conference and Exhibition** (Austin, Tex.) Sponsor: U.S. Atomic Energy Commission, University of Texas; G. D. Cody, RCA Laboratories, Princeton, N. J. 08540.

CIRCLE NO. 473

### Nov. 6-8

**Reliability Physics Symposium** (Los Angeles) Sponsor: IEEE; A. Coppola, Rome Air Development Center (EMERS), Griffiss Air Force Base, New York 13440.

CIRCLE NO. 474

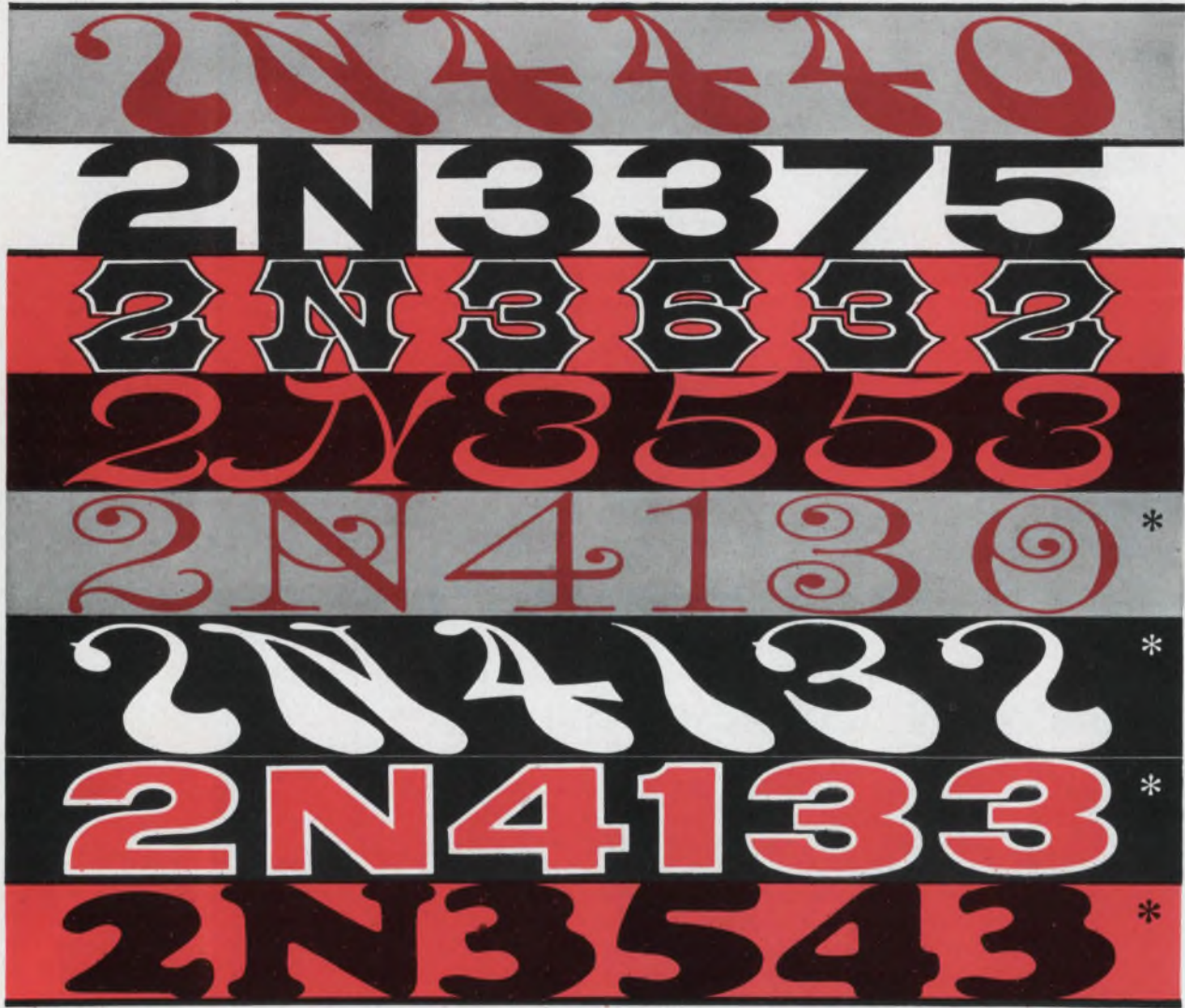

**ITT has eight instant solutions  
to your VHF/UHF  
power transistor procurement problems.**

Is there something missing from your procurement cycle for RF power transistors? Is it predictable delivery? Better-than-competitive pricing? Superior performance?

Let ITT "crack" your RF power vacuum. The eight popular part numbers listed above are in stock and

ready to go — at the ITT factory and at every one of ITT's distributors. Next time you send out an RFQ, send it to The Predictables, and fill your power vacuum.

ITT Semiconductors is a Division of International Telephone and Telegraph Corporation, 3301 Electronics Way, West Palm Beach, Florida.

\*New state-of-the-art devices, exclusive from ITT, 1 to 50 W, 30 to 70 MHz.

**semiconductors** **ITT**

FACTORIES IN WEST PALM BEACH, FLORIDA • PALO ALTO, CALIFORNIA • LAWRENCE, MASSACHUSETTS • ENGLAND • GERMANY • PORTUGAL • AUSTRALIA

ON READER-SERVICE CARD CIRCLE 147

1	2	3	4	5	6	7	8	9	10	11		
12	13	14	15	16	17	18	19	20	21	22		
23	24	25	26	27	28	29	30	31	32	33		
34	35	36	37	<b>NON-STOP</b>			39	40	41	42	43	44
45	46	47	48	<b>TO</b>			50	51	52	53	54	55
56	57	58	59	<b>135 MHz!</b>			61	62	63	64	65	66
67	68	69	70	71	72	73	74	75	76	77	78	
78	79	80	81	82	83	84	85	86	87	88	89	
89	90	91	92	93	94	95	96	97	98	99	100	
100	101	102	103	104	105	106	107	108	109	110	111	
111	112	113	114	115	116	117	118	119	120	121	122	
123	124	125	126	127	128	129	130	131	132	133	134	



- PLUS—ultra-stable, fast warm-up time base**
- PLUS—plug-in measurements to 18 GHz**
- PLUS—versatility as a frequency standard**
- PLUS—100 mV to 10V input range without adjustment**

The new Hewlett-Packard 5247M Electronic Counter makes direct frequency measurements 10 Hz to 135 MHz with no tuning, changing of accessories or adjustments of any kind. Further, it accepts signals over the wide input amplitude range of 100 mV to 10 V rms without any level adjustment. Additional plug-ins let you measure frequency to 18 GHz. Ultra-stable, fast warm-up time base increases accuracy of your measurements and extends the time between calibrations.

Typical warm-up is one hour to reach 5 parts in  $10^9$ ; aging rate is  $< 5$  parts in  $10^{10}/24$  hours. The spectrally pure 5 MHz time base output is available whenever the line cord is plugged in and serves as an excellent secondary frequency standard well buffered against line and load changes. Price: \$3000.

The 5247M is another addition to the popular HP plug-in electronic counters. For information on the 5247M call your local HP field engineer or write Hewlett-Packard, Palo Alto, California 94304; Europe: 54 Route des Acacias, Geneva.



**ELECTRONIC COUNTERS**  
ON READER-SERVICE CARD CIRCLE 148

# Caught with their ceramic-metal down



## all similarly rated tubes are not equal

Construction of the high-gain Cermolox<sup>®</sup> RCA-4628 is far superior. In SSB Communications and FM Broadcast service, particularly, the RCA-4628 delivers even more outstanding performance as a result of its compact coaxial structure, precision-aligned electronically-machined grids, and ceramic-to-metal seals.

RCA-4628, rated to 400 MHz, provides 10 Kw PEP output in the 2 to 30 MHz range with lower distortion and better gain than its nearest counterpart. In FM Broadcast service, it offers higher gain with non-critical broadband neutralization techniques.

From now on, look "inside" as well as outside when you need tubes. In the RCA-4628, you'll find ruggedness, compactness, and long-life reliability. Mechanically-induced noise is very low and, because of UHF capabilities, you have no need for complex neutralization circuits at HF. The RCA-4628 is your obvious choice.

For more information on this and other RCA Cermolox<sup>®</sup> tubes, see your RCA Representative. For technical data on specific tube types, write: RCA Commercial Engineering, Section J18-P, Harrison, N.J.

ALSO AVAILABLE FROM YOUR RCA INDUSTRIAL TUBE DISTRIBUTOR



RCA Electronic Components and Devices

THE MOST TRUSTED NAME IN ELECTRONICS