

Electronic Design 17

FOR ENGINEERS AND ENGINEERING MANAGERS

VOL. 15 NO. 17
AUGUST 16, 1967



**OPEN BEFORE
WESCON**

THIS SIDE UP



T 12004

TRW SPACE SAVING SOLID TANTALUM CAPACITORS

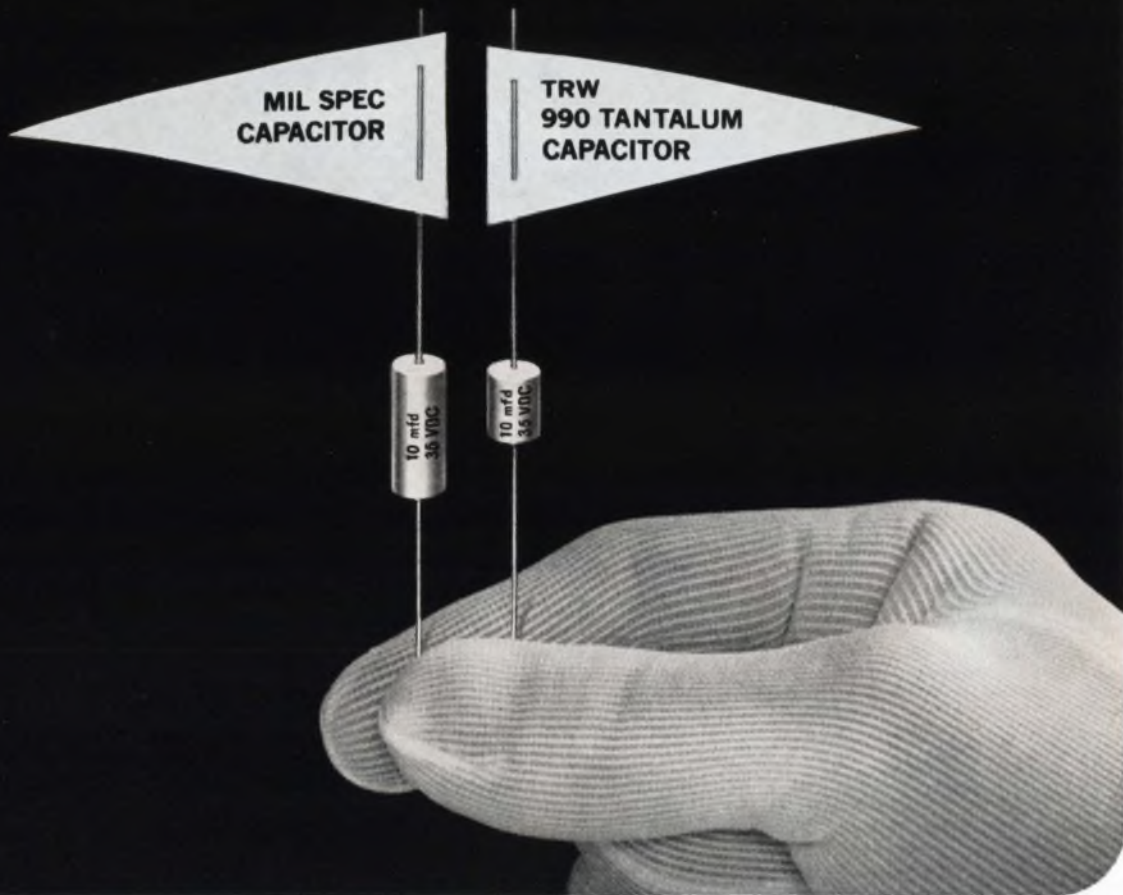

MIL spec performance...in half the space!

Type 990 miniature solid tantalums typify TRW's creative engineering. They're *designed* to fit in half the space. *Designed* to give better shock and vibration resistance. *Designed* to MIL

specs. They're *designed* to be the best hermetically sealed tantalums you can buy. Values from 8.2 to 330 mfd, 6 to 35 V.

Get the TRW tantalum story on space-savers like the 990,

on standard MIL types and tantalum hi rel capability. Contact TRW Capacitor Division, TRW INC., Box 1000, Ogallala, Nebraska. Phone (308) 284-3611. TWX: 910-620-0321.

TRW[®]

The only expense HP spared in making these versatile counters...



... is yours.

Only Hewlett-Packard offers the versatility-economy combination represented by the new 5221A and 5216A Electronic Counters, using integrated circuits. Wide frequency range, high input impedance and sensitivity, long-life readout tubes with display storage, six measuring functions (in 5216A)... all this at prices as low as *one-half* that of comparable electronic counters available today.

The HP 5221A Counter has 0.1 and 1 second gate times (power line frequency time base), 1 meg/30 pF input impedance and an input signal sensitivity of 100 millivolts. It is the lowest cost frequency counter with a 10 MHz counting rate available. 4-digit readout is standard, 5 or 6 digits optional.

The HP 5216A Counter is an extremely versatile, 7-digit, 12.5 MHz counter for measuring frequency, time interval, period, multiple period average (in

decade steps from 1 to 10^5), frequency ratio and totalizing. Gate times: 0.01/0.1/1.0/10 sec. Input sensitivity: 10 mV. Input impedance: 1 meg/50 pF. Time base: crystal with $< \pm 2 \times 10^{-6}$ /month maximum aging rate. BCD output for operating data printers and other system elements. The price, even though the 5216A's frequency range is greater, is 30% below counters with similar functions.

Both counters feature HP's exclusive zero blanking, which makes reading easier and faster by suppressing any zeros to the left of the most significant digit. This unique benefit results from specially designed Hewlett-Packard proprietary integrated circuits used in both of the new counters.

Call your local HP field engineer for more details, or write Hewlett-Packard, Palo Alto, California 94304; Europe: 54 Route des Acacias, Geneva.

Visit Hewlett-Packard at WESCON '67
San Francisco Cow Palace, August 22-25

HEWLETT  PACKARD

ON READER-SERVICE CARD CIRCLE 2



Unit Citation

We're honored! Not that we've won our crusade yet...just another battle ribbon. A while back we scored a military victory with our Model 880, the *first* solid state Mil Spec counter. This time it's a fully-militarized 5MHz all-silicon solid state universal counter-timer. Call it AN/USM-245, sir.

There's a good reason you should be interested. You see, the military model had its basic reliability well proved by our original commercial version, Model 607A. Now *there's* the one for you! It offers more features and capabilities than even the Admirals asked for. And it's available on-the-double.

Now hear this: Our lowest-bidder-type price is only \$1,575. (Check *that* saving against our competitor!) Then check these features: Model 607A is ideal for wide-range frequency measurements, frequency ratio determination, period and multiple period or time interval measurements, and pulse count totalizing. Time base is a 1 MHz crystal oscillator (for 1 microsec resolution). Display is six decade inline with display storage. BCD output transfers directly to CMC Model 410 tape printer, computer systems, etc. Automatically positioned illuminated decimal. Either ac or dc coupling of input signal. Front and rear A and B channel inputs. Rugged, compact (approx. 3½" high). Available for bench or rack.

THANKS

With all our pride and excitement over our AN/USM-245 award, and other new products, we haven't forgotten our fellow Crusaders who've made this success possible...YOU. A FREE Crusading Engineers medal is our fun-loving way of saying thanks. Get yours by writing for data so you can "Check the Specs" of our 607A. Your "chief" will be so proud of you at mail call!

12973 Bradley / San Fernando, California
Phone (213) 367-2161 / TWX 910-496-1487



State of the monolithic art



Electronic Design 17

VOL. 15 NO.

FOR ENGINEERS AND ENGINEERING MANAGERS

AUG. 16, 1967

NEWS

- 13 News Scope
- 17 **Systems approach to EMI sought**
- 23 **Plated wires cut ferrites to the core**
- 29 Washington Report
- 36 **Flying laboratory to study atmospheric heat**
- 42 **New uses for medical ultrasonics reported**
- 66 Letters
- 79 **Editorial: Let's raise our voices against noise pollution.**

WESCON USA—A special section Pages U81 to U216

TECHNOLOGY

- 220 **Design Directions:** Digital ICs eye markets where analogs fall short.
- 224 **Switch high loads with power transistors** by knowing all about secondary breakdown, device selection, and methods of analysis and design.
- 236 **Undercover signals are unmasked.** 'Aliasing' in sampled data systems is avoided by using a presampling filter and the correct sampling rate.
- 242 **An inexpensive character generator** built with commercially available integrated circuits displays characters of high quality.
- 246 **Pick plastics for high-speed circuits** by considering all properties. A low dielectric constant is only one part of the answer.
- 250 **Choose metals for compatibility** in packaged circuits to avoid RFI, poor grounds, ground loops and stray coupling.
- 254 **Use the signal flow graph technique** without the tedious flow graph reduction step to analyze active and passive networks.
- 260 **CRT displays antenna patterns** directly with the aid of a simple test setup. Picking the best pattern is then child's play.
- 264 Ideas for Design
- 278 NASA Tech Briefs

PRODUCTS

- | | |
|----------------------|--------------------|
| 292 Components | 311 Systems |
| 304 Test Equipment | 312 Microwaves |
| 310 Microelectronics | 314 Semiconductors |

Departments

- | | |
|-----------------------|-------------------------|
| 286 Book Reviews | 322 Reprints |
| 316 Application Notes | 324 Advertisers' Index |
| 317 Design Aids | 326 About the Magazine |
| 318 New Literature | 327 Designer's Notebook |
-

ELECTRONIC DESIGN is published biweekly by Hayden Publishing Company, Inc., 850 Third Avenue, New York, N. Y. 10022. James S. Mulholland, Jr., President. Printed at Poole Bros., Inc., Chicago, Ill., Controlled-circulation postage paid at Chicago, Ill., and New York, N. Y. Application to mail at controlled rates pending in St. Louis, Mo. Copyright © 1967, Hayden Publishing Company, Inc. 62,601 copies this issue.

**Logic function generator
is simplified with
Radiation's 5 x 5
Monolithic Diode Matrix**

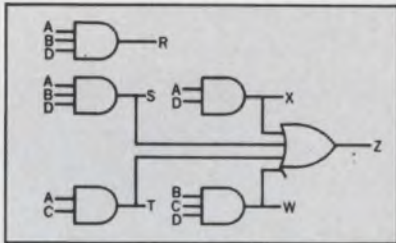

Radiation's RM-77 Monolithic Diode Matrix allows design engineers to: Generate logic functions for data transfer and operational control—Eliminate unnecessary logic gates—Reduce delay time—Save space by reducing package count—Increase speed of performance—Boost fan-out capability through duplicate function generation—Combine matrices to produce many AND/OR logic functions.

Radiation's 5 x 5 Matrix, at left, forms a two-level AND/OR logic array. The logic diagram above and circuit below clarify the functions

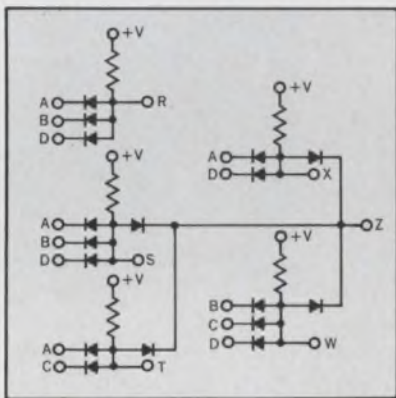

$$\begin{aligned} R &= A \cdot B \cdot D & S &= A \cdot B \cdot D \\ T &= A \cdot C & W &= B \cdot C \cdot D \\ X &= A \cdot D & Z &= X + S + T + W \end{aligned}$$

generated. The logic equations are listed below. This is only one of many applications in which Radiation's Diode Matrices offer the most reliable and the most economical approach to diode logic.

Radiation's popular dielectrically isolated matrices provide an unusual degree of flexibility. (1) RM-77 Matrices contain 25 active devices per chip. (2) A fusible link in series with each diode permits unlimited matrix patterns to be formed. And (3), circuits can be combined to produce an almost infinite variety of configurations.

In addition to flexibility, Radiation 5 x 5 Matrices offer the increased reliability of monolithic construction. Size and weight requirements are slashed through reduced package count. Further, cost of matching, testing and assembly of discrete diodes is eliminated.

Production has been expanded to guarantee fast shipment of matrices "customized" to your exact requirements. In fact, most orders are shipped on a 24-hour basis.

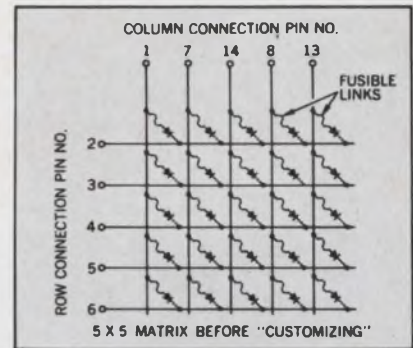

A new low-cost RM-177 design in ceramic dual in-line package is available in volume at a unit price of \$2.50—and can be supplied to any code configuration requested.

Write or phone for data sheets on the entire line of Radiation Monolithic Diode Matrices. Worst-case limits are included, as well as all information required by design engineers. We'll also be glad to supply our new manual, Monolithic Diode Matrix Technical Information and Applications. For your copy, write on your company letterhead to our Melbourne, Florida office.

Radiation 5 x 5 Monolithic Diode Matrices* (typical limits)

Characteristic	Symbol	RM-74	RM-75	RM-77 RM-177†	Unit	Test Conditions ($T_A = +25^\circ\text{C}$)
Forward drop	V_F	1.0 0.7	1.3 0.75	1.0 0.7	V	$I_F = 20 \text{ mA}$ $I_F = 1 \text{ mA}$
Reverse breakdown	BV_R	60	60	50	V	$I_R = 100 \mu\text{A}$
Reverse current	I_R	7	25	70	nA	$V_R = 25 \text{ V}$
Reverse recovery	t_r	7	11	30	ns	$I_F = 10 \text{ mA}$ to $I_R = 10 \text{ mA}$
Crosspoint capacitance	C_{cp}	1.9	1.9	2.0	pF	$V_R = 5 \text{ V}; f = 1 \text{ MHz}$
Coupling coefficient	I_{CL}	20	20	20	μA	See data sheet

*Supplied in TO-84 packages. †Supplied in ceramic dual in-line package.

All Radiation integrated circuits are dielectrically isolated.

VISIT US AT WESCON
BOOTH 5130-5131.



**RADIATION
INCORPORATED**
MICROELECTRONICS DIVISION

Sales offices: Suite 622, 650 North Sepulveda Blvd., El Segundo, Calif. (213) 772-6371—P.O. Box 738, Islington, Mass. (617) 762-3470
Suite 232, 600 Old Country Road, Garden City, N. Y. (516) 747-3730—Suite 704, 2600 Virginia Ave., N.W., Washington, D.C. (202) 337-4914
P.O. Box 37, Melbourne, Fla. (305) 723-1511, ext. 554

ON READER-SERVICE CARD CIRCLE 4



10 VARIETIES
AVAILABLE
IN THE NEW
TW
LINE.

SPDT

DPDT

- Maintained ON, Momentary ON
 - Maint. ON, Maint. ON
 - Mom. ON, OFF, Mom. ON
 - Maint. ON, OFF, Maint. ON
 - Maint. ON, OFF, Mom. ON

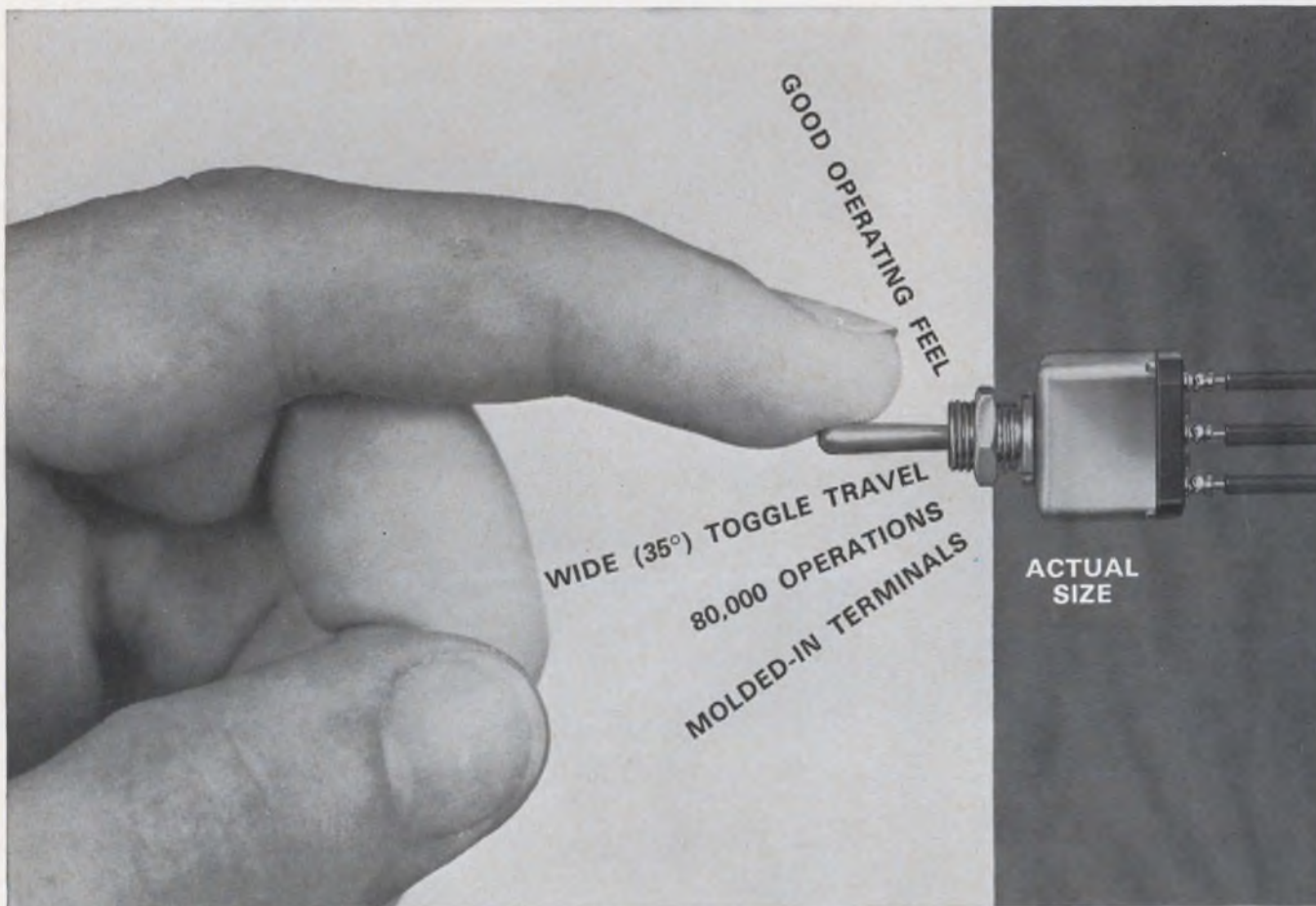

Biggest value yet in space-saving toggle switches

Here's the new little toggle that's big in the features you need. Space-saving size—only $\frac{5}{8}$ " behind the panel. Good operating feel—positive detents, optimum forces, positive return spring on momentary versions. Full versatility, too—ten versions offering SPDT or DPDT, 2 or 3 positions, maintained or momentary contact, 30 vdc or 115 vac, 5 amps resistive, 2 amps inductive.

Call a Branch Office or Distributor (Yellow Pages, "Switches, Electric"). Ask about TW switches. Or, write for Catalog 51.

MICRO SWITCH
FREEPORT, ILLINOIS 61032
A DIVISION OF HONEYWELL

HONEYWELL INTERNATIONAL—Sales and service offices in all principal cities of the world. Manufacturing in United States, United Kingdom, Canada, Netherlands, Germany, France, Japan.

ON READER-SERVICE CARD CIRCLE 5



Delusions of grandeur?

If the little 5-126 Recording Oscillograph were capable of emotion, we suspect that it would become quite insufferable.

And for these immodest reasons:

CEC's 5-126 is the first and only instrument that offers the basic capabilities of a light beam oscillograph at a cost-per-channel approaching that of a thermal writing recorder.

With CEC's new 7-380 Galvanometer, this portable unit will accurately record from dc to 1 KHz. (Strip chart recorders cry "uncle" around 150 Hz.)

Other advantages of the 5-126:

- *Tungsten light source* for optimum trace quality and lamp life, minimum cost and maintenance, instant operation and complete safety.
- *Nine distinct data traces* on 7-inch-wide paper.
- *Direct print-out records* upon exposure to ambient light eliminates the need for chemical processing.

■ *Simplicity of operation.* Due to CEC's automatic front-loading system, no spooling or threading is required.

■ *Single source responsibility.* Only CEC offers a complete range of data instrumentation products from transducers and signal conditioning equipment to recording papers and chemicals.

Who needs it?

Everyone who needs a low-cost, high-performance recording oscillograph. The list runs the gamut from automotive, railroad and mechanical component testers to medical science and aerospace. Chances are you're included.

To make sure, merely call your nearest CEC Field Office. Or write Consolidated Electrodynamics, Pasadena, California 91109. A subsidiary of Bell & Howell. Bulletin 5126-X11.

CEC
DATAGRAPH PRODUCTS

 **BELL & HOWELL**

ON READER-SERVICE CARD CIRCLE 6

5 x 10⁻¹⁰

**day stability
and rapid warm-up, too**



5245M COUNTER WITH NEW 5256A 8 TO 18 GHz FREQUENCY CONVERTER PLUG-IN



< 5×10^{-10} /day aging rate (long-term stability)

45-minute warm-up

5×10^{-11} /sec short-term stability (rms)

< $\pm 5 \times 10^{-11}$ /°C change with temperature

< $\pm 5 \times 10^{-11}$ change with $\pm 10\%$ line voltage change

< 2×10^{-11} change for load changes on 5 MHz output

Time base output so stable and spectrally pure you can use it as a standard.

The unique specifications on this new Hewlett-Packard plug-in counter belong at the top of the page. They're not mere footnotes, because they combine to offer counter time-base performance never before available.

The new HP 5245M Counter has all the features of the time-proven 50 MHz HP 5245L Plug-in Counter and, in addition, has a time-base with unprecedented accuracy and usefulness as a secondary frequency standard.

The new time-base increases measurement accuracy, particularly when making high-resolution frequency measurements with HP frequency converter plug-ins. There's less frequent need for calibration. The counter's 5 MHz output is present whenever the power cord is plugged in and serves as a secondary frequency standard with excellent stability and spectral purity. For example, spectra less than 1 Hz wide (half-power points) are obtainable when multiplied to X-Band (12.4 GHz). The fast warm-up saves time, too . . . the time-base typically comes to within 1×10^{-8} of its previous frequency within 45 minutes after a 24-hour absence of primary power under lab conditions. The long-term aging rate of 5×10^{-10} /day (max.) is achieved in a fraction of the time normally associated with such performance.

Other features include: the widest variety of high-performance front-panel plug-ins, 8-digit readout, BCD output for recorders, display storage, 1 meg/25 pf input impedance on all ranges.

The new 50 MHz counter is an all-purpose instrument. Use it for measuring frequency, period, multiple period average, ratio, multiples of ratio and for scaling by decades. And increase its versatility with the plug-ins, including the three new ones described below.

HP development of the small ultra-stable time-base for the 5245 Counter is evidence of the continuing engineering commitment that keeps the HP 5245 and 5246 Counter Series the most advanced and versatile in the industry. A steady stream of new high-performance plug-in accessories are compatible with the 5245L, 5245M and 5246L Counters.

NEW 8 TO 18 GHz FREQUENCY CONVERTER With the 5256A plugged into your HP counter you can measure from 8 to 18 GHz. Resolution is up to 1 Hz with only 4 seconds of counter operation, or 10 Hz resolution in 0.4 seconds, etc. Use is rapid and virtually fool-proof. Scheduled availability, October, 1967.

DC TO 12.4 GHz WITH ONLY TWO PLUG-INS Using only two plug-in frequency converters, the HP 5255A and 5254B, your counter measures frequencies DC to 12.4 GHz with 1 Hz resolution. The 5254B covers 200 MHz to 3 GHz, and the 5255A covers 1 to 200 MHz and 3 to 12.4 GHz—without spurious responses.

NEW PRESCALER FOR 1 mV SENSITIVITY The 5258A Prescaler gives you the most sensitive 1 to 200 MHz counting instrument available. It increases counter sensitivity to 1 mV and extends the direct readout range to 200 MHz. No tuning or arithmetic calculations. Combine it with the new 5254B Converter and your counter covers DC to 3 GHz.

For complete information on the advanced counter and plug-ins, call your local HP field engineer or write Hewlett-Packard, Palo Alto, California 94304; Europe: 54 Route des Acacias, Geneva.



5256A 8-18 GHz CONVERTER



5254B 0.2-3 GHz CONVERTER



5258A SENSITIVE PRESCALER

5245M and accessories (also compatible with HP 5245L and 5246L Counters)

- HP 5245M Counter without plug-ins, \$3200.
- HP 5255A 3 to 12.4 GHz Converter Plug-in, \$1650.
- HP 5254B 0.2 to 3 GHz Converter Plug-in, \$825.
- HP 5253B 50 to 500 MHz Converter Plug-in, \$500.
- HP 5251A 20 to 100 MHz Converter Plug-in, \$300.
- HP 5252A DC to 350 MHz Prescaler Plug-in, \$685.
- HP 5258A 1 to 200 MHz Prescaler Plug-in, \$825.
- HP 5261A Video Amplifier Plug-in, \$325.
- HP 5262A Time Interval Plug-in, \$250.
- HP 5264A Preset Unit Plug-in, \$650.
- HP 5265A DVM Plug-in, \$575.
- HP 5260A 0.3-12.4 GHz Automatic Frequency Divider, \$3450.
- HP 2590B 0.5-15 GHz Transfer Oscillator, \$2150.

PS: There's also a new, faster digital printer, the Model 5050A (20 lines/sec up to 18 columns), \$1750 + \$35/column.



ELECTRONIC COUNTERS

2562

ON READER-SERVICE CARD CIRCLE 7

Now from Sprague!

ECONOLINE* SILICON PLANAR PLASTIC TRANSISTORS

can save you **30 to 40%**
over metal-encased types

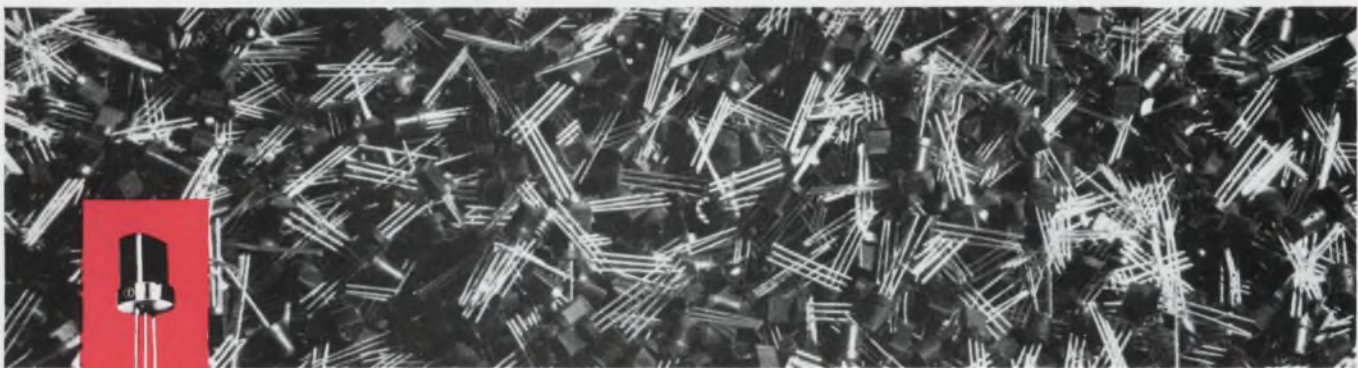

**56 POPULAR N-P-N TYPES IN VOLUME PRODUCTION
FOR OFF-THE-SHELF DELIVERY**

- Small-signal amplifiers
- Medium-speed switches
- Large-signal amplifiers
- High-frequency amplifiers
- Oscillators
- High-voltage indicator drivers

Sprague Econoline transistors . . . quality planar devices in plastic packages. You save the cost of metal cans. And with dual source back-up, too. For further information and prices call your local Sprague office today.



For comprehensive specifications write for catalog CN200 A to:

Technical Literature Service
Sprague Electric Company
347 Marshall Street
North Adams, Mass. 01247

*trademark

SPRAGUE COMPONENTS

TRANSISTORS
INTEGRATED CIRCUITS
THIN-FILM MICROCIRCUITS
CAPACITORS
RESISTORS

PULSE TRANSFORMERS
INTERFERENCE FILTERS
PULSE-FORMING NETWORKS
TOROIDAL INDUCTORS
ELECTRIC WAVE FILTERS

CERAMIC-BASE PRINTED NETWORKS
PACKAGED COMPONENT ASSEMBLIES
BOBBIN and TAPE WOUND MAGNETIC CORES
SILICON RECTIFIER GATE CONTROLS
FUNCTIONAL DIGITAL CIRCUITS

SPRAGUE
THE MARK OF RELIABILITY

*Sprague' and '®' are registered trademarks of the Sprague Electric Co.

ON READER-SERVICE CARD CIRCLE 8

News



Electromagnetic interference problems need a systems approach for a solution. Page 17

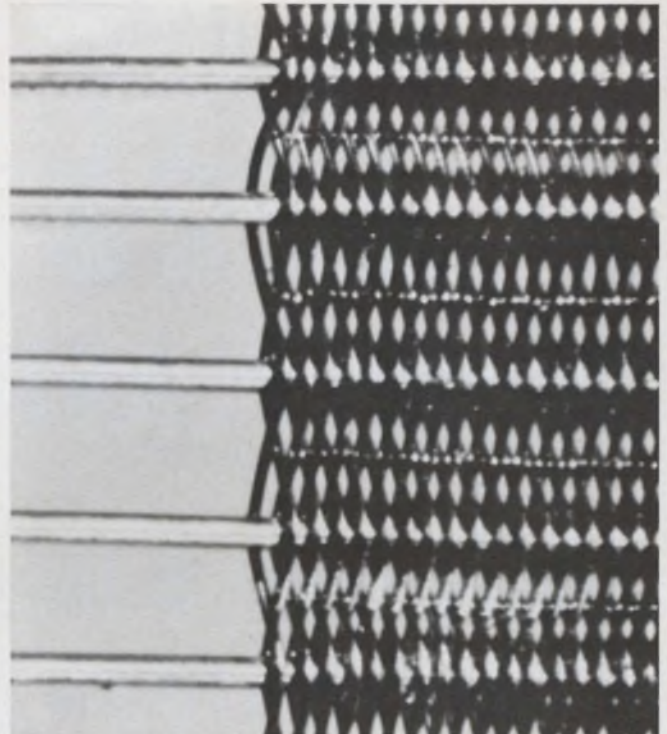

Thin magnetic films on wire substrates bid to preempt certain computer memories. Page 23

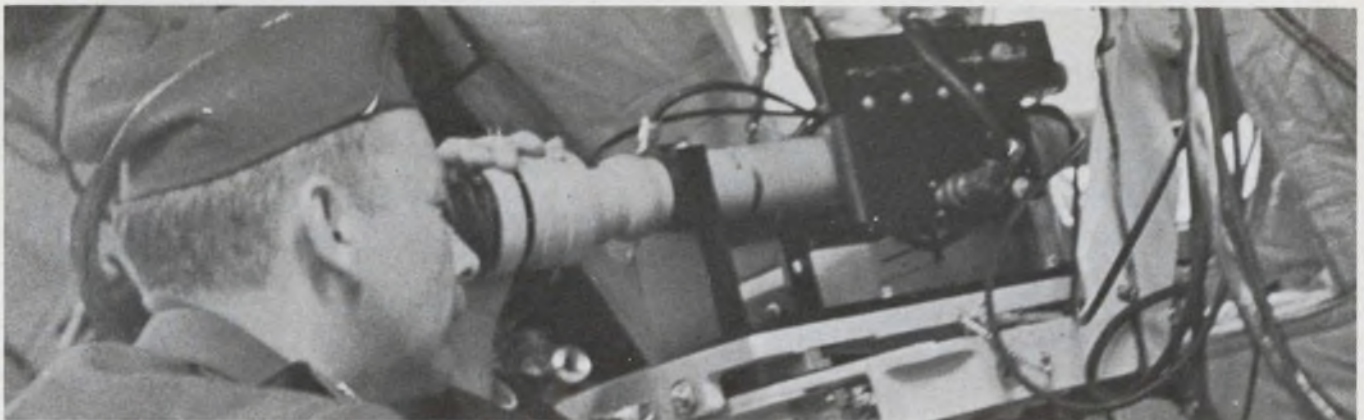

Airborne laboratory aboard a modified KC-135 is to begin worldwide flights to study

the variations in visible and infrared radiation and water vapor in the atmosphere. Page 36

Also in this section:

New uses for medical ultrasonics and ultrasonic holography described. Page 42

Quartz disk mixes and rectifies microwaves better than semiconductor diodes. Page 58

News Scope, Page 13... **Washington Report**, Page 29... **Editorial**, Page 79

Now from Sprague Electric!

241 LOGIC CIRCUITS IN PLASTIC DIP

Choose from 8 families of DTL and TTL
in low-cost plastic dual in-line packages

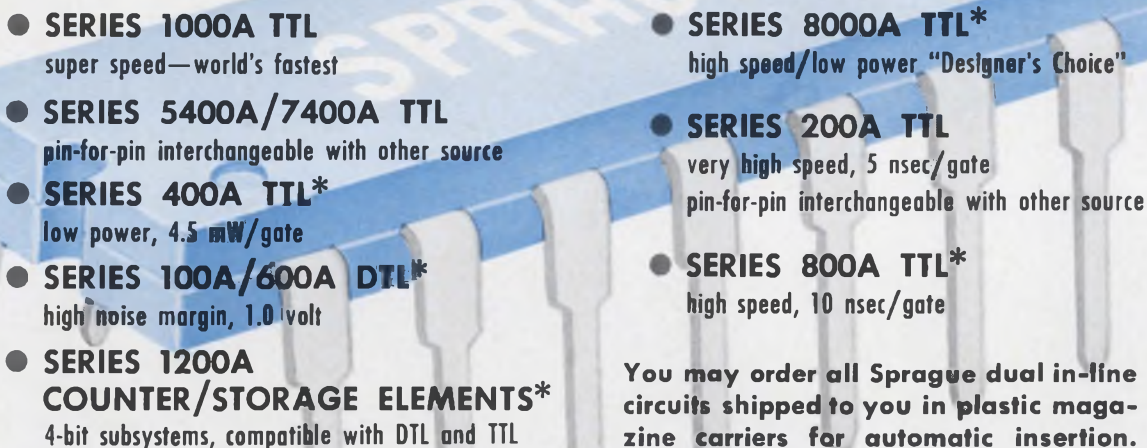
- 
- **SERIES 1000A TTL**
super speed—world's fastest
 - **SERIES 5400A/7400A TTL**
pin-for-pin interchangeable with other source
 - **SERIES 400A TTL***
low power, 4.5 mW/gate
 - **SERIES 100A/600A DTL***
high noise margin, 1.0 volt
 - **SERIES 1200A
COUNTER/STORAGE ELEMENTS***
4-bit subsystems, compatible with DTL and TTL
 - **SERIES 8000A TTL***
high speed/low power "Designer's Choice"
 - **SERIES 200A TTL**
very high speed, 5 nsec/gate
pin-for-pin interchangeable with other source
 - **SERIES 800A TTL***
high speed, 10 nsec/gate

You may order all Sprague dual in-line
circuits shipped to you in plastic maga-
zine carriers for automatic insertion.

*Circuits have pin-for-pin and spec-for-spec dual source availability through the Sprague/Signetics technology interchange.

*For complete technical data on the circuits in which you are
interested, write to Technical Literature Service, Sprague Elec-
tric Company, 347 Marshall Street, North Adams, Mass. 01247*

SPRAGUE COMPONENTS

INTEGRATED CIRCUITS
THIN-FILM MICROCIRCUITS
TRANSISTORS
CAPACITORS
RESISTORS

PULSE TRANSFORMERS
INTERFERENCE FILTERS
PULSE-FORMING NETWORKS
TOROIDAL INDUCTORS
ELECTRIC WAVE FILTERS

CERAMIC-BASE PRINTED NETWORKS
PACKAGED COMPONENT ASSEMBLIES
BOBBIN and TAPE WOUND MAGNETIC CORES
SILICON RECTIFIER GATE CONTROLS
FUNCTIONAL DIGITAL CIRCUITS



Sprague and ® are registered trademarks of the Sprague Electric Co.

ON READER-SERVICE CARD CIRCLE 9

U. S. moves to stem missile malfunctions

Revelations by the national press and trade publications in recent weeks of excessive Minuteman II guidance and control malfunctions appear substantiated in part, despite repeated denials by the Dept. of Defense. What still is not clear is how much the U.S. strategic retaliatory force structure is weakened whenever the ICBMs are removed from alert status for subsystem replacement.

Since the July 28 statement by Air Force Secretary Dr. Harold Brown in which he praised performance of the entire Minuteman operational force, a news embargo has been in force. The guidance system associate prime contractor, Autonetics Div. of North American Aviation, Inc., reportedly has been under a tight news clamp for over a year.

Repeated queries to the Pentagon, the Air Force Systems Command,



Minuteman II guidance section is installed atop third stage in silo at Vandenberg AFB.

and Autonetics for further clarification have revealed:

- That the deficiencies have been centered in microelectronic subsystems of the guidance system and usually in the D37 digital computer.

- That some of these are microelectronic circuit-board problems, most frequently involving electrical contacts between board layers.

- That others involve unsatisfactory resistors and capacitors.

- That failures have been random.

- And that Autonetics is solving its assembly problems through a general tightening of its in- and out-of-house quality assurance requirements.

One DOD spokesman, however, said that in his opinion a recent newspaper report that "defence officials fear Minuteman malfunctions undermine readiness" may have stemmed from a military official bent on attacking Defense Secretary McNamara's policy of reliance on ICBMs as the principal defense force. Some statements in the newspaper report bear striking resemblance to an *Aviation Week* article of a year ago (Aug. 22, 1966, p. 19).

At the present time, all 800 Minuteman Is are emplaced in hardened silos. An additional 200 Minuteman IIs, providing longer range and faster response time, are on station. Minuteman III is now in development. It will provide a multiple-warhead capability and a maneuverable reentry vehicle plus advanced penetration aids. A two-year retrofit program is underway to bring the Minuteman Is up to the II version capability.

Ninety-nine per cent of all on-board electronics, excluding the reentry vehicle, are represented by the Autonetics guidance and control system. The move from Minuteman

I to II required a complete redesign of this system and the broad use of integrated-circuit multilayer boards. As a result, the computer was reduced from 1.6 ft³ and 61.5 lb to 0.43 ft³ and 38.3 lb.

Conversely, the demands on the computer were greatly extended. The D37 memory, for example, carries a complete ground and airborne operational program, including all target data necessary for missile guidance to one of a number of targets. The particular target is selected remotely just prior to launch.

Systems checkout is performed continually in the silo, but no maintenance is attempted within the launch facility. Thus, at any given time some missiles must be down for maintenance and repair.

The Air Force states that its total number of weapons allows for a certain percentage (number classified) to be out of alert status. Dr. Brown asserts that the less mature Minuteman II guidance does have a higher than planned rate of repair but that component replacement is decreasing. Of the 39 live firings to date, he stated, 37 were successful.

He did not indicate, however, if these figures discount missiles that were shutdown prior to liftoff.

Israel invades U.S.; its goal—business

A major effort on the part of the Israeli government to break into the electronics market in the U.S. is now under way. Israel's aim is to improve its balance of payments with the U.S. Last year Israel imported \$220 million dollars worth of trade goods from the U.S.; it exported only \$80 million.

A joint venture between Aerodynamics Industries, Inc., Farmingdale, N. Y. and the government of Israel is designed to introduce the advanced technological, scientific and engineering skills of Israeli industries into the U.S. market. Aerodynamics Industries will market and service all Israeli equipment sold in the U.S.

There are 35 major electronics plants in Israel, manufacturing such products as transistors, meters, test equipment, communication equipment, radar, medical electronics supplies and uhf transceivers. One product to be marketed in the U.S.

News Scope

CONTINUED

that demonstrates Israeli electronic capabilities is a \$5000 table-top microelectronic digital computer that measures 18.8 by 17.6 by 12 in.

In 1966, some 1800 scientists graduated from Israeli universities—a very high percentage for a population of only 2.5 million. The number of professionals in the work force has been increasing by 10% a year for the last five years.

According to the Israeli Commerce Dept., Israel has the combined abilities of 15,000 engineers to field for this electronics invasion.

Navy satellites to be used by commercial shipping

Commercial ships and research vessels have been permitted to use the Navy's previously classified Navigation Satellite System.

Announcing the Government's decision, approved late last month by President Johnson, Vice President Hubert Humphrey said the Navy would shortly make available the information necessary for commercial contractors to build the receivers that would be required by nonmilitary shipping.

Humphrey said the Dept. of Transportation had been asked to draw up a plan for a more perma-



Navy satellites to aid commercial shipping navigation.

nent navigation system for use by commercial shipping. The Navy has made no commitment to maintain the present system indefinitely for nonmilitary use.

The three Navy satellites, which have been in use since 1964, are a key to guiding the U.S. Polaris-missile submarine fleet. They enable navigators to plot ships' positions to within 200 yards anywhere on the globe; the exact degree of accuracy has not been revealed.

The all-weather system was developed by the Applied Physics Laboratory of Johns Hopkins University, Baltimore, under the direction of Dr. Richard B. Kershner, head of the laboratory's space development division.

Ships of the Lamont Geological Observatory of Columbia University, New York, and the Woods Hole Oceanographic Institution, Mass., have used the system for recent marine surveys. Offshore oil-drilling companies and other concerns that require extremely accurate navigational and positioning information have expressed interest in access to the system.

The U.N. Committee on the Peaceful Uses of Outer Space is investigating the need for a navigation satellite system. Several other nations are also considering developing their capabilities in the field.

Testing time extended for tropospheric system

Selection of a winning contractor for the Air Force's new short-range, lightweight, tropospheric-scatter communications set may be delayed.

Competitive field testing at Eglin AFB, Fla., of the two systems under consideration—the AN/TRC-104, developed by Bell Aerosystems Co. in Buffalo, N.Y., and the AN/TRC-105, built by Motorola Inc.'s Government Electronics Div. in Chicago—was due to be completed in mid-August.

However, both contractors reported to have experienced equipment malfunctions (primarily burned out transformers) and testing has been extended to about Sept. 8.

The USAF project manager, Frank Zawislán, has now requested cost proposals from both contractors for 30-, 60- and 90-day follow-on tests.

The need for an under 500-lb tactical terminal for limited-warfare use has been demonstrated by the Vietnam conflict. The R&D effort grew out of the 407L program for air-transportable, fast-reaction communications to support tactical forward aircraft controllers, according to Air Force officials. Thus the terminals must be capable of being man-packed, use a single small antenna, and require minimum setup time (under 1 hour) and maintenance. To make the design task tougher, the set must use relatively low-power but ensure reliable operation through a fading medium.

Although each contractor selected a different design approach to achieve the desired 99.8% reliability under field conditions, both exceeded all Air Force design goals. These included a 500-lb maximum terminal weight, 80-mile minimum range, 5-kilo-watt maximum dissipated power, and a minimum of four channels (voice and digital data). Both systems came in under the weight limit and each contractor claims better than 120-mile operating range, 2-kW power need, and 12 channels for communications.

Bell employs an unusual coded-diversity transmission technique—a complex error-correction code with a multiplexed, eighth-order frequency-diversity fm signal. Motorola employs a sixteenth-order frequency-scan diversity technique. It continually checks the signal-to-noise level of all frequencies and selects the best frequency for use at any given time.

Low-cost electronic unit vies in business field

The accounting machine field, a \$500 million plum for equipment manufacturers, is being invaded even at the low-price end by electronic devices.

Burroughs Corp., Detroit, recently unveiled its E3500 Electronic Processor, which dispenses with mechanical components except for input-output functions. According to a Burroughs spokesman, there is nothing else in the \$12,000-to-\$17,000 range that compares to the E3500.

Computation is performed in milliseconds—well within the print cycle time. The operator can manually select preprogrammed subroutines.

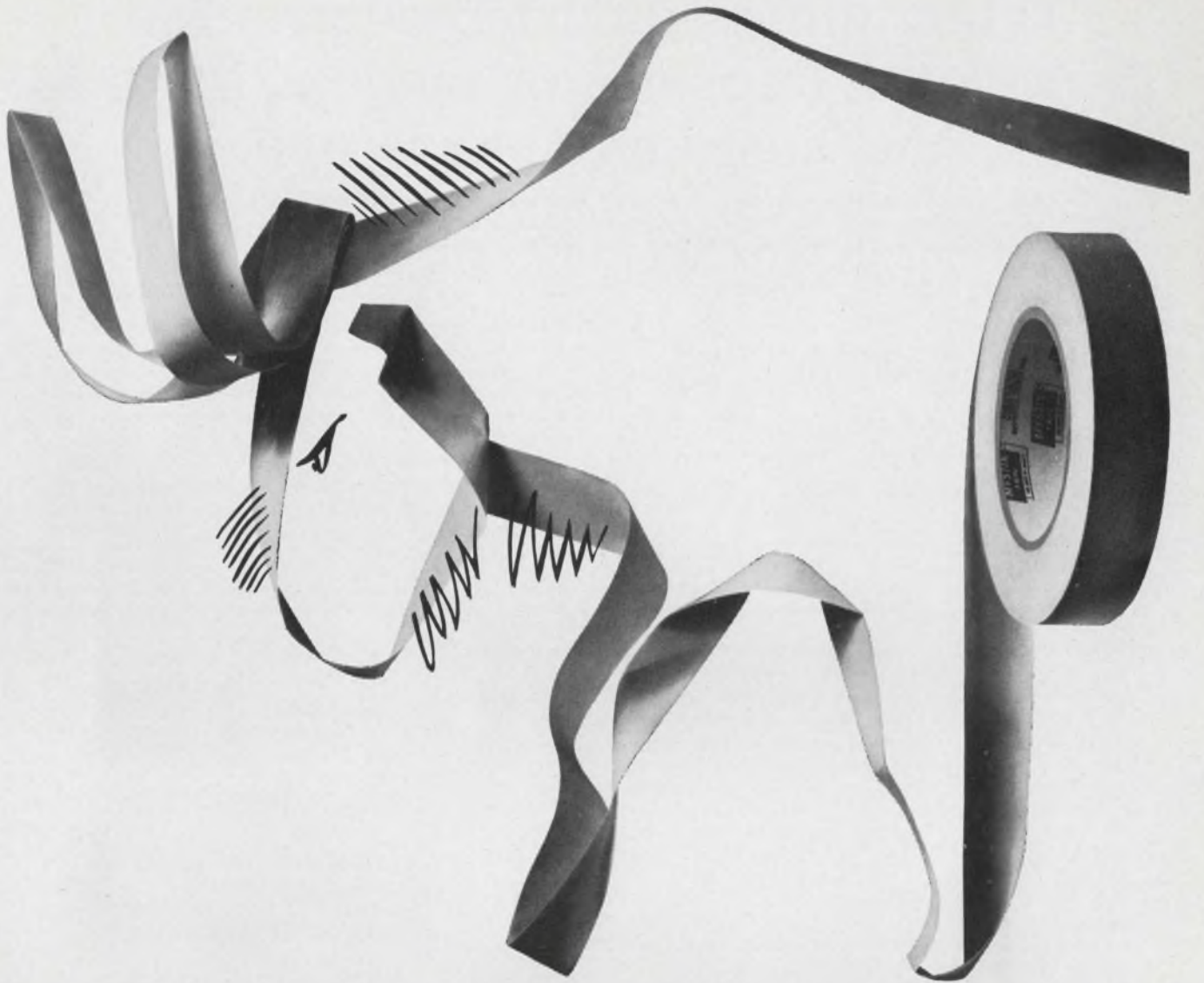

What's gnu? Mystik NOMEX[®], KAPTON[®] and TEDLAR[®], that's what!

**For more news . . .
see us at the
1967 WESCON
Booth #1719-1720
Cow Palace**

Mystik scores again by being the first to utilize three new materials . . . Nomex, Kapton and Tedlar . . . and add them to their already extensive line of pressure-sensitive tapes.

NOMEX —a highly conformable tape that offers excellent holding power and dielectric strength characteristics.

KAPTON—the featherweight of wire insulations . . . excellent high temperature applications which require low weight structures.

TEDLAR—ideal for electrical applications because of high dielectric strength combined with excellent weather and hydrolytic resistance.

If you would like more information on these or any other Mystik special-purpose tapes, contact your local Mystik distributor. He is listed in the yellow pages under "Tapes—Adhesive". Or, write Mystik Tape Division, The Borden Chemical Company, 1700 Winnetka Avenue, Northfield, Illinois 60093.

® DuPont registered trademark.



**BORDEN
CHEMICAL**

ON READER-SERVICE CARD CIRCLE 10

When information buried in noise is periodic, transient, or random, there is a *PAR*^{T.M.} instrument to recover it

PAR manufactures a complete line of signal processing equipment to measure signals of various types buried in noise. The choice of the most appropriate instrument depends upon the characteristics of the signals. The equipment falls into three general classes:

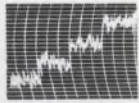

LOCK-IN AMPLIFIERS



Lock-In Amplifiers have application where the signal of interest is or can be made to appear at a single frequency and where a reference voltage related in frequency and phase to the signal can be obtained. These instruments employ phase-sensitive detection and narrow-band filtering techniques to provide a DC output signal proportional to the amplitude of the fundamental component of the signal being measured. The Lock-In Amplifier can be described as a tuned voltmeter, the response of which is "locked" to that particular frequency and phase at which the signal information has been made to appear. They operate typically in the frequency range of 1.5 Hz to 150 kHz with full scale sensitivities down to 10^{-9} volts.

Waveform Averagers are useful when, after processing, the actual waveform of the signal of interest must be maintained and the signals are repetitive waveforms or transients whose onset can be related to a trigger pulse. The application of a synchronized, repetitive waveform will result in an output that corresponds to the average value at each of the segments of the waveform being studied, whereas any non-repetitive (or un-synchronized) signals such as noise will be suppressed since their average after many occurrences will approach zero. PAR makes two instruments that perform this function: the Boxcar Integrator and the Waveform Eductor.^{T.M.} The Boxcar Integrator is a single point averager in which a single slice, as narrow as 1 microsecond, of the input waveform is averaged while the position of the slice is slowly scanned through the waveform. The Waveform Eductor simultaneously averages one hundred points of the waveform which can be distributed over periods varying from 100 microseconds to 10 seconds.

WAVEFORM AVERAGERS

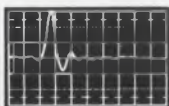
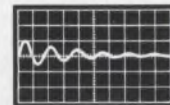

CORRELATION FUNCTION COMPUTERS



Correlation Function Computers are the most general form of signal processing equipment that can be constructed (Lock-In Amplifiers and Waveform Averagers are actually special cases of correlation equipment). Whereas a reference or synchronization signal is required in the other equipment discussed, autocorrelation analysis allows periodic and random signals to be defined without this restriction. An even more powerful technique is crosscorrelation which has the ability to describe the degree of conformity between two different signals as a function of their mutual delay. The PAR Signal Correlator simultaneously computes in real time 100 points of either the auto- or crosscorrelation function over total delay spans of 100 microseconds to 10 seconds.

A variety of instruments and associated peripheral equipment is available from PAR in each general class. Instrument prices range from \$765 to \$9500. Since PAR has wide experience in applying these systems to many situations in all fields of science and engineering (e.g.: aero- and hydrodynamics, spectroscopy, medical physics, geophysics, etc.), we welcome the opportunity to discuss your specific application. For additional information, or to arrange for a demonstration at your facility, contact Princeton Applied Research Corporation, Dept. E, P.O. Box 565, Princeton, New Jersey 08540. Telephone: (609) 924-6835.



PRINCETON APPLIED RESEARCH CORP.

ON READER-SERVICE CARD CIRCLE 11

Systems solution to EMI problem sought

DOD seeks to beat increasing interference by having compatibility designed into equipment

Neil Sclater

East Coast Editor

The systems approach is the best way to solve increasingly complex problems of electromagnetic interference (EMI). To this end, education, measurement and conservation are areas where immediate and extensive efforts are needed.

This was the consensus of speakers at a recent symposium sponsored in Washington, D. C., by the IEEE Group on Electromagnetic Compatibility. They emphasized that electromagnetic compatibility must in future be designed into equipment and systems, because attempts at correcting problems in the field have been largely unsuccessful.

During the symposium the Dept. of Defense gave a briefing on its projected program to combat electromagnetic interference. DOD and military spokesmen illustrated their plight with numerous examples of the military's failure to organize frequency allocation and squelch interference.

It was also brought out that not only was there a lack of knowledge

of the cause and effect of interference in many operational situations, but also there were numerous instances where even basic preventive specifications were not followed. Contract officers waived manufacturers' obligations to meet EMI requirements for cost or schedule reasons, only to find that solving problems in the field was much more complex and costly.

Among the bad cases cited were:

- A space capsule was lost because an explosive door bolt was fired prematurely by interfering radio signals.

- A taxi dispatcher's voice inadvertently launched a missile at a cost of millions of dollars and at serious risk to life.

- A piece of electronic equipment for checking out aircraft weapons systems passed all its factory tests but was found to be useless on an aircraft carrier. Several man-years of engineering time were required to redesign it so that it would work in its intended environment.

- An aircraft system developed with off-the-shelf electronic equipment to save time failed woefully during trials because of radio inter-

ference. A multimillion dollar contract was necessary after the aircraft was produced to overcome the difficulty.

Dept. of Defense and military spokesmen gave more specific details of equipment and frequencies involved in a separate, classified session held at the end of the conference. The news media were barred from this session because the data would "inform the enemy about weakness in our equipment."

An Army staff officer stressed the seriousness of the problem when he said that communications in Viet Nam were being carried on in a "electromagnetically dirty" environment. Maj. Gen. Dayton W. Eddy, Director J-6 (Communications-Electronics), Joint Chiefs of Staff, added that solutions to compatibility problems in Southeast Asia should also be applicable to electronic equipment operating in more sophisticated geographical locations like the continental United States or Europe.

The Pentagon's program* tackles the military's EMI problems on a systems basis. It calls for the assignment of specific electromagnet-

*See "DOD to put teeth into RFI program," ED 16, Aug. 2, 1967, p. 13.



Sensitivity and dynamic range of an amplifier are being measured by Atlantic Research engineers to determine its compatibility.



Cacophony of radio frequencies is present on the deck of the aircraft carrier "USS America" as engineers measure the radio frequency "noise floor." These data are necessary as steps to eliminating unwanted rf interference.

(EMI, *continued*)

ic-compatibility responsibilities to the Joint Chiefs of Staff and research elements of the Defense Dept. and the Air Force, Army and Navy.

Nearly 50 papers documented progress in interference prediction, analysis, measurement and control. All subscribed to the systems approach. Their topics included compatibility problems aboard an Apollo spacecraft-tracking ship; internal interference within integrated circuits; automated techniques for frequency control; and topographical studies for siting electronic equipment.

Apollo ship problems are typical

The electromagnetic-compatibility problems aboard an Apollo spacecraft-tracking ship were described by two engineers from General Dynamic's Convair Div., San Diego, Calif. Roger Henkel and Duane Mealey reported that many of the difficulties in operating shipboard electronics could be traced to standard deck hardware.

They said that bonding and grounding were very important in establishing shipboard electronic compatibility. But even when solved, they warned, problems can recur, especially as the ship and equipment age.

The three Apollo tracking ships are converted World War II tankers, 595 feet long with 75-foot beams. Each carries more than 455 tons of electronic equipment distributed among 11 major systems. The onboard electronics include an inertial navigator, digital computers, C- and S-band tracking, ranging and communications systems and telemetry installations. Hf, vhf, and uhf radio equipment permits ship-to-ship, ship-to-spacecraft and ship-to-shore communication.

The Convair engineers reported that serious problems occurred at the dockside when the high-frequency transmitters were fed from main-deck helical antennas. The high output power turned watertight doors into shock hazards and melted nylon rope hanging on safety cables. Once at sea, problems became even worse. When the hf transmitters were operating, ship-

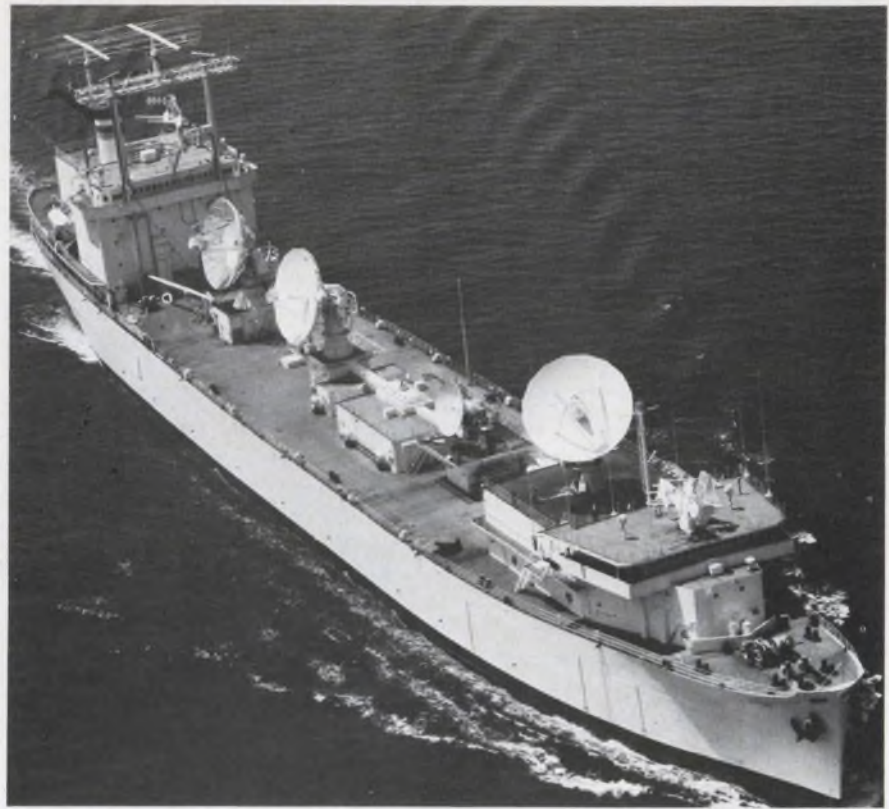

Forest of antennas on Apollo tracking and communications ship "Redstone" create electromagnetic "togetherness" problems. Interference can recur as ship and equipment age. Surveillance and continuous maintenance are necessary to keep all communication equipment at peak efficiency.



Communications electronics suffers from being too close to its neighbors.



Instruments for checking compatibility are lined up in Atlantic Research test van.

board receivers were inoperable.

High noise in the telemetry receivers was traced to slack safety chains, which prevent seamen from being washed overboard.

Where the chains were illuminated with rf, each link became an interference generator. Broad-band interference was detected in the 200-to-400-MHz region and harmonics as high as S band were detected. Replacing the chains with plastic line solved this problem. Correlation of variations in interference amplitudes with the ships

motion and the interference origin permitted the engineers to pinpoint the chains as offenders.

Another interference source was an antenna mount gear assembly that acted as an intermittent switch as the ship rolled. Rf leakage into the i-f of a C-band tracking radar caused it to malfunction. Soot deposits from the ship's stack was the probable offender in several cases of arcing on a logarithmic periodic antenna.

Electronic data processing is being used to predict the effects of

This is the only programmable curve tracer there is.



The Fairchild 6200B/P is the only programmable transistor curve tracer on the market. It has wide range sweeps from 20V at 5 Amps to 1000V at 100mA, and an extended base drive that goes down to 100nA for high-gain devices and up to 35V for FET's. It is all solid state, and costs \$2,350.00. When used with the optional programming unit (\$600 extra), the 6200B/P can subject each device to five separate tests, automatically, at speeds adjustable from 70 to 800msec. per test. High speed handling fixtures are available to facilitate high volume testing in such applications as device classification, quality assurance and receiving inspection. For complete information circle Reader Service Number 72.



FAIRCHILD
INSTRUMENTATION

(EMI, *continued*)

topography on electronic communications equipment compatibility. John Scott of the ITT Research Institute discussed the preparation and use of topographical maps for this purpose.

Intervening topography plays a major role in signal attenuation, according to Scott. Hitherto interference prediction has usually been made with free-space calculations that treat the world as a smooth sphere. Path loss values, if used, are based on data measured over rough terrain. He said that calculation was done in this manner because there had been no economical meth-

od of introducing topography into interference prediction calculations.

In a program sponsored by the Dept. of Defense Electromagnetic Compatibility Analysis Center, Annapolis, Md., numerical mapping techniques applicable to the solution of compatibility problems are now in use. Using data processing procedures, digitized topographic maps have been produced. Scott said that data covering approximately 25 per cent of the United States are now available.

Basic data for the maps are applied to two separate computer systems. The first, called the Site Analysis Model, provides clear acetate overlays which yield line-of-sight coverage information for siting

equipment when placed over scaled maps. The second, called the Power Density Model, delivers overlays that represent power density contours for selected equipment sites.

The Electromagnetic Compatibility Analysis Center also maintains data on the location, frequency and power of all major communications equipment in the continental United States. This information can be superimposed on regional maps to give complete information for siting new equipment or changing the output signatures of present equipment.

All information is available to civil and military personnel concerned with finding the best location for communications equipment.

EMC-Electronics living in harmony

Programs in electromagnetic compatibility (EMC) seek to eliminate interference caused by the close proximity of circuits to one another. Their aim is to have all electrical and electronic circuits live in harmony with themselves and their neighbors.

EMC seeks more than just the elimination of radio-frequency interference as a source or symptom of circuit malfunction and degradation. It seeks harmony in the total operating environment. It considers such topics as proper equipment siting, conservation of the electromagnetic spectrum and elimination of radiation hazards.

All authorities at the recent EMC symposium agreed that the total problem is becoming more difficult. Proliferation of operating systems—especially communications—and the general increase in background electromagnetic "contamination" were given as reasons.

EMC concerns everyone who uses electronic equipment, but the need to solve the problem is perhaps more critical in the military than in civil environments at present. The success of military operations, saving of lives and even national security depend on interference control.

Military ships and aircraft have dense circuitry radiating and receiving at many different frequencies. Ground-based equipment poses even more complex problems. Siting and distribution of equipment is random, de-

pending on tactical and strategic situations. The mobility of equipment and ever changing combat conditions call for frequency management.

Military officers report that it is often necessary to shut down some system in order to make use of others.

All EMC begins at the bench, or perhaps more accurately at the drawing board. Standards, specifications and directives purport to give guidance on design, construction, operation and maintenance. Prevention is evaluated by measurement and test.

But there are several nagging questions: Are the guidelines really effective and are they being enforced? Are all participants—designers, assemblers, operators and maintenance men—educated to the problem?

There is no shortage of documents, either civil or military, giving guidance on electromagnetic interference. Numerous civil and military specifications give the limits for allowable interference, methods for its measurement, and even definitions for terms or units.

Most specifications include tests for "interference" or "susceptibility." Interference tests are concerned with electromagnetic radiation from units under test, while susceptibility tests cover the vulnerability of the units being tested to external radiation.

Tests for offending conducted interference are made with vari-

ous receiving sets and analyzers. They concentrate on coupling through power lines, interconnecting leads between external housings, and antenna terminals. Instrument tests are also made for inadvertent radiation.

Susceptibility tests, on the other hand, are made with the test unit acting as its own response monitor. A degradation or malfunction shows up when the unit is exposed to a range of electromagnetic radiations. Conducted-susceptibility tests are essentially the reverse of conducted-interference tests.

So serious is the problem from the military point of view that the Dept. of Defense has split it into eight different areas of attack and charged various services and research groups with area responsibility.

The road will not be easy. Included in the tasks are such objectives as reviewing and improving specifications, guidelines, test instruments and techniques. The need for educational programs is seen and more basic information is sought on the over-all operating environment.

But even Pentagon officials realize that all this will go for naught if EMC specifications are not enforced contractually on manufacturers. They also foresee the need for new regulations covering deployment, use and maintenance of electronics by field personnel if any headway is to be made in reducing interference.

THESE LITTLE ERIE EMI FILTERS

ARE RESPONSIBLE FOR FILTERING
OUT NOISE IN THE GUIDANCE SYSTEM . . .



... ABOARD GRUMMAN'S LUNAR MODULE

ERIE — GRUMMAN'S CHOICE FOR EMI FILTERS

These superior EMI FILTERS passed Grumman's critical qualification requirements — including random vibration and high transient withstanding capability. Most of these very small filters weigh less than 10 grams, and their inherent reliability make Erie a natural selection as Grumman's filter source.

Bonded Filter Stock . . . inventories under lock and key in our Quality Control Department . . . is available for LM subcontractors or for other critical programs requiring Established Reliability Filters.

The typical 100 Vdc rated Erie Filter will provide an insertion loss of 67 db @ 150 kHz. A broad line of ERIE FILTERS is available — including MULTIPLE SECTION FILTERS and special configurations for STRIP LINE applications. Custom filters for your applications can be designed. Why not call in an Erie Filter specialist for your project?



Write for new catalog 9000 . . . ERIE ELECTRONIC FILTERS

Another Series of Components in Erie's Project "ACTIVE"
Advanced Components Through Increased Volumetric Efficiency



Erie, Pennsylvania

ON READER-SERVICE CARD CIRCLE 13



FREQUENCY STABILITY

TC/VCXO

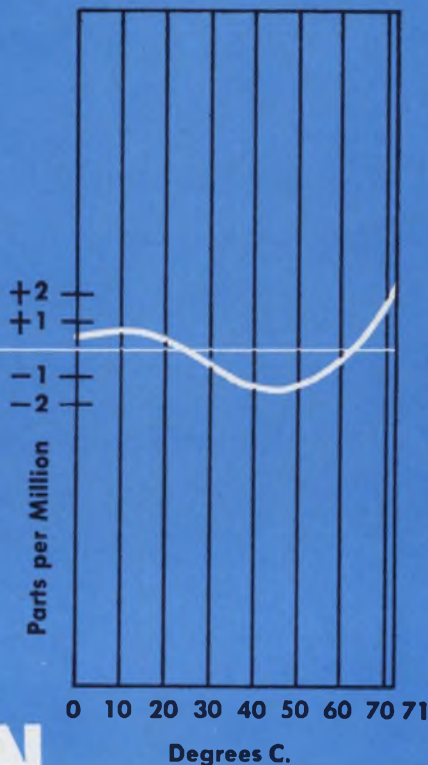

NO OVEN

TC/VCXO

Frequency Stability within $\pm 2 \times 10^{-6}$ over 0 to 71°C range



Typical TC/VCXO Model 5968WA
Center Frequency: 6.8 MHz
Size: approx. 2 1/2" L x 1 1/4" W x 3/4" H

If space and power are limited in your telecommunication system, consider the advantages of the Damon Temperature Compensated Voltage Controlled Crystal Oscillator (TC/VCXO). This rugged, miniaturized unit provides a frequency deviation of ± 100 Hz about center frequency and maintains a stability comparable to that of an "ovenized" unit without the need for added circuitry and power.

The illustration, above, shows a frequency stability curve for a simple Damon TC/VCXO. To achieve comparable frequency stability an "ovenized" unit would require more space and more power.

Tight temperature compensation is only one example of Damon VCXO capability. Low noise, small size and increased reliability are other Damon VCXO accomplishments. Perhaps your telecommunication system suggests new VCXO problems? Consultations between circuit designers and Damon engineers are the best route to proper VCXO selection. As a starter, may we invite you to write for the Damon VCXO Brochure. Damon Engineering, Inc., 240 Highland Avenue, Needham Heights, Mass. 02194 (617) 449-0800.

DAMON

On Reader-Service Card Circle 14

NEWS

(EMI, continued)

Considerable interest was shown in electromagnetic-interference test instrumentation. Several papers were delivered on the subject and manufacturers demonstrated their latest wares.

A general-purpose automatic spectrum surveillance system was described by David Smoller, chief engineer of Fairchild Electro-Metrics Corp., Amsterdam, N. Y. He said that until recently most RFI analysis had been "accomplished by laborious point-by-point data-taking." Measurement of RFI, he added, is complicated by the variety of transducers, nonstandard test setups and specification limits. The almost infinite variety of equipment under test also creates organization problems.

This situation, Smoler reported, has led to increasing use of automatic RFI/EMC measurement systems for testing a wide variety of equipment according to many different specifications. He said that many of the systems marketed to date have been massive and mechanically tuned, using combinations of commercial equipment designed for a narrow range of uses.

Fairchild Electro-Metrics demonstrated a spectrum surveillance system that included interference analyzers, an X-Y plotter and a spectrum display.

Smoler said that the system could survey part or all of a frequency from 20 Hz to 1 GHz, and plot spectrum profiles on the X-Y plotter. The two analyzers that cover the range are shielded superheterodyne receivers which use varactor tuning to eliminate mechanical sweeping.

Another automated data acquisition and analysis system was demonstrated by engineers from the Jansky and Bailey Depts. of Atlantic Research Corp., Alexandria, Va. They use a small computer programmed to control equipment being tested. It receives the measured data, performs the required data-processing and prints out the data in final form.

The 1967 IEEE Electromagnetic Compatibility Symposium Record is available from IEEE, Inc., 345 East 47 Street, New York, N. Y. 10017. The price is \$6 for members, \$12 for nonmembers. ■ ■

Plated wires cut ferrites to the core

Devices bid to preempt aerospace computer memories because of speed, ruggedness, NDRO

Richard N. Einhorn
News Editor

Plated-wire memories, mired since the early Sixties in production difficulties, are muscling their way into the main memories of third-generation commercial computers. They appear well on the way to monopolizing the aerospace computer field. The new generation of strategic missiles and counter missiles are all reportedly equipped with nondestructive readout (NDRO) memories. Many will contain plated-wire elements—including the inertial guidance computer of the Poseidon missile. And the National Aeronautics and Space Administration is reported to be considering them for the post-Apollo guidance computer memory.

Leading contender for the Poseidon memory is said to be the Univac Div. of Sperry-Rand, which under Air Force funding has built plated-wire modules of multimegabit capacity. Univac is also equipping its

9200 and 9300 lines of commercial computers with plated-wire memories. A spokesman for Univac says that a "considerable number" of 9000-series computers has been built, although none has been turned over to customers.

Eugene C. Maupin, an engineer in the computer group of the Avionics Laboratory of Wright-Patterson Air Force Base, Ohio, says that the immediate application of his group's research is space vehicles.

"If they're suitable for space vehicles," he said, "they're also suitable for missiles and aircraft, because one of the major advantages is the very low cost. Potentially, it could be down to fractions of a cent per bit."

There are several salient reasons for employing plated-wire memories in aerospace computers:

- Little power is consumed because of high-speed switching and short driving time.
- 250-ns cycle times are feasible.
- NDRO, which is easy to attain

with plated-wire memories, protects stored data, since the information never leaves the cell location. With destructive readout (DRO), the information must be fed to the electronics, where it is far more vulnerable to transients than it is in the storage elements.

■ The wire memories operate over a wide temperature range—plated-wire and planar thin films have a Curie temperature (the temperature at which the material loses its magnetic properties) of approximately 500°C, which is 100 degrees higher than that of the best ferrite core.

■ Wire memory elements do not themselves generate heat. Cores, on the other hand, get hot and add to system heat. In view of the heat-sink problem, spacing—and therefore density—is a limiting problem for cores but not for plated wires.

■ Wire memories are mechanically rugged. On one military program an array withstood 1000 g shock and 20 g vibration—equivalent to being dropped from the roof of a ten-story building.

NDRO becomes attractive

Up to now, NDRO was not feasible for aerospace use, despite the inherent possibility of high speed, because the cost in size, weight and power was prohibitive. There were exceptions: the Saturn computer, with its multiaperture devices (a "big, hairy, costly, beast," in the words of one aerospace manager), and the wired-in core memories of the Apollo equipment ("inflexible, terrible," says the same critic). Rather than accept these and such other NDRO devices as transfluxers and biax, which are big, heavy, expensive and chock full of components, aerospace planners tended to say: "All right, we'll live with cores and try to protect them from transients. But at least we can fly them."

But now this is all changed. With recent improvements in the production yield of plated-wire elements, they figure heavily in the plans of

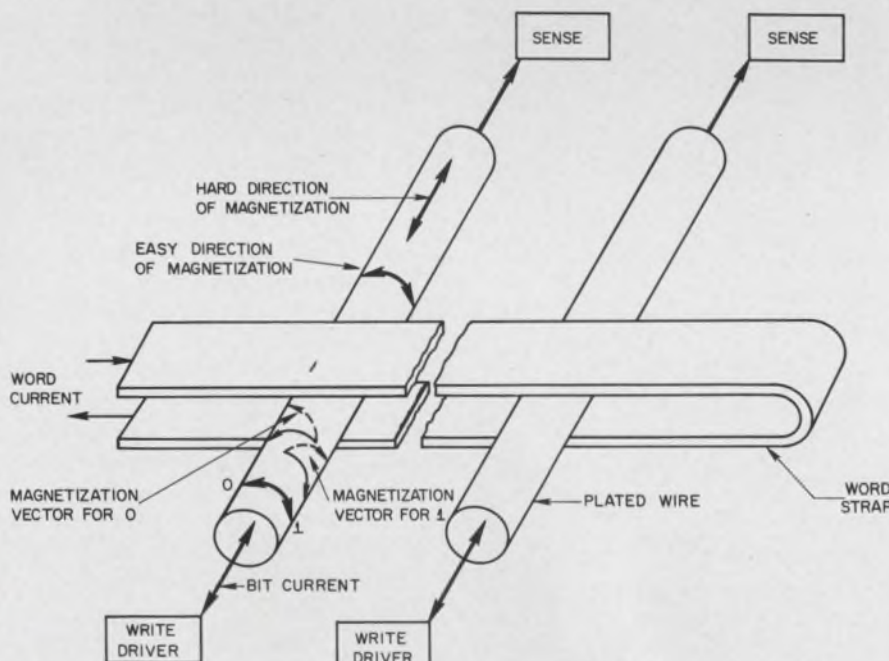

1. Plated-wire memory planes for Univac's 9000-series commercial computers are 144 bit lines by 256 word lines—36,864 bits in all. Planes are stacked for increased capacity, and multimegabit modules are feasible.

(plated wire, continued)

NASA and the Air Force. A few years ago production yield was as low as 2 per cent. Today the yield is reported to be much better than 50 per cent—and still improving.

How do plated-wire devices differ from other magnetic memory elements, such as ferrite cores and planar thin-film arrays?

Univac uses stripline

In the technique fostered by Univac, a moderately thin film of permalloy (10,000 to 20,000 Å) is electroplated onto beryllium copper wire substrates. Parallel lengths of this wire serve as digit lines in a matrix. The word lines are formed by word straps—copper ribbons wrapped around the bit lines like sugar tongs (see Fig. 1).

The plated-wire memory element is analogous to the planar thin film. It is anisotropic—oriented so that the easy direction (the preferred direction of the magnetic field) lies around the circumference of the film and the hard direction lies along the length of the wire. In the memory matrix the copper word strap is at right angles to the wires and encircles all of them with one turn. For Poseidon, Univac is reported to be using two turns for better coupling.

When current flows in the word strap, it produces a magnetic field that is along the axis of the wire—that is, in the hard direction. If, on the other hand, current flows along the wire, this produces a magnetic field around the circumference—the easy direction of magnetization. Application of both the word field and the bit field to a given storage location on the wire causes the bit to be stored. Writing is thus a coincident-current operation. The bit current must be large enough to partially rotate the magnetization vector, but not so large as to affect bit locations under adjacent word straps—the creep phenomenon.

Since the bit storage locations are not physically separated but are part of the same wire, there could be interference between bits. James P. McCallister, a Univac engineer, reported at the 1966 Fall Joint Computer Conference in San Francisco:

“This interference, which is reversible, occurs when information of the same polarity is repeatedly written into one bit cell. The bits under adjacent word straps may be reversed and caused the wrong information to be read out. An effective technique has been devised to prevent this interference. During a single write cycle, first the complement of the information is written and then the desired information. Thus, in every case, the magnetic history of a particular bit is balanced in ones and zeros, and no more than two write operations of the same polarity can occur consecutively at any one bit location.”

In reading, the word current is turned on and the wire serves as its own sense line. The word current creates a longitudinal magnetic field that rotates the magnetization vector toward, but not up to, the axis. This displacement induces a sense voltage that is detected by a sense amplifier in the bit lines. When the word current is removed, the bit location returns to previous orienta-

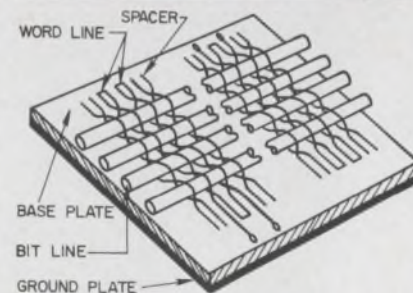
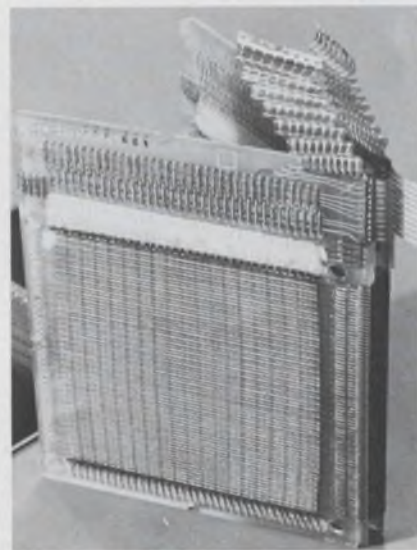

2. Word lines are woven in multiple turns around plated bit lines. Librascope expects new shuttle loom to weave one 64-word-by-64-bit plane (4096 digits) every 18 minutes continuously. Eventually weaving will be programed.

tion, thereby completing the read cycle. The speed of the plated-wire memory depends on the rapid rotation and snapping back of the magnetic domain. With cores, the domain is switched completely. This takes time and power, but by the same token, cores produce a larger output.

Univac incorporates a switching arrangement that permits selection of one out of each group of 16 word lines. This represents a great saving, in that it eliminates 15,000 of the 16,000 diodes in a single module, thus giving a square matrix. Switching doesn't introduce significant delay, because it is set up before interrogation of the stored data;

Another configuration is the woven wire approach used by Toko Coil of Japan and its licensee in the United States, General Precision's Librascope Group in Glendale, Calif. Here, the word lines consist of insulated wire woven about the plated bit lines (see Fig. 2). A machine much like a textile loom weaves the wires back and forth into multiple turns (the figure itself is simplified). Despite this, the goal is to have no more than two solder connections for each word line, as with the Univac method.

Woven wire favored

According to Dr. Richard H. Fuller, who directs R&D at Librascope, multiturn coils have one potential technical advantage over Univac's stripline method: Because the word wires wrap approximately 180 degrees around the plated wires, instead of being tangent to them at only two points, there is a greater ability to shape the word fields more precisely; they are strong and uniform at the bit and fall off away from the bit. This is said to permit greater packaging density and to afford better coupling. This, in turn, is said to permit the use of lower word current than the Univac device.

Librascope stacks individual memory planes to form a memory module of the required capacity, as does Univac.

Yield problems facing both Univac and Librascope stem from the condition of the substrate wires and the composition of the permalloy.

(continued on p. 26)

New CVC AutoMate™...The Decision Maker

Just Touch The Control... AutoMate Does The Rest

An AutoMate™ control system will handle your vacuum cycle for production—and do it automatically. AutoMate is engineered to make human decisions without human errors. Think what this means:

Finger-tip control on the AutoMate Decision Control Center...relieves operators from further machine attendance.

Automatic sequence operation...the cycling decision is made and carried out in response to actual pressure in the system.

Repeatable performance...get exactly the same results every time.

So let AutoMate make the vacuum decisions to free your operator for more important tasks in your production process. Use AutoMate in electronics, optics, ceramics, metallurgy.

AutoMate gives you a complete system with automatic control center, chamber, pumping system, and gauge. These elements have been human-engineered into a new design that makes AutoMate stand for the latest technological advances in high-vacuum automation. Write for details. Consolidated Vacuum Corporation, Rochester, N.Y. 14603. Subsidiary of Bell & Howell.



AutoMate Automatic Control Center as installed on CVC's new systems. Just touch the control—AutoMate does the rest. This Control Center introduces a whole new era of automated high-vacuum systems. Watch for more... from CVC.



(plated wire, continued)

Fuller says that scratches and die marks on the wire cause the easy direction of magnetization to follow the physical imperfections. Also, the alloy has to be carefully controlled to yield zero net magnetostriction of the film.

NDRO plated-wire memories provide the best protection for missile and space computers against radiation-induced transients, Fuller says. (Fluidic devices, which are inherently still safer, are too slow to be considered.) Semiconductor memories can be wiped out very easily. It is also easy to lose information with a core memory, because the process entails transfer to the associated electronics during readout.

The level of transient required to disturb the memory itself is several orders of magnitude higher than that required to disturb the electronics (with integrated circuits, the memory is just as vulnerable as the electronics). In a DRO memory, if the transient occurs while the data are in the electronics, information can be lost, or else it can be rewritten improperly. In a NDRO memory, loss of information in the electronics causes

only temporary dislocation, since the information remains in the bit locations. Thus, when the transient dies down, the computer can resume operation, provided that the electronics haven't been permanently damaged.

Asked whether it wouldn't be possible for the transients to introduce excessive current to the word straps or wires, so that the read currents would cause spurious writing, Fuller admitted that this could happen,

He explained that writing did not normally take place unless there was coincidence of the word and digit currents. By heavy overdrive—50 to 100 per cent—it would be possible to destroy information by writing with the word current alone. Such a transient would actually pull the flux current close to the axial direction of the wire. The flux would shatter and fall back randomly, and a great deal of it would be lost. As a result, the location could not be sensed unless it was rewritten. But rewriting might be impractical.

Fuller suggested several remedies to safeguard the plated-wire memories of missile computers. One might be the use of current-limiting devices. Depending on the energy, a fair amount could be dissipated in

terminating resistors. However, if the current were high enough, it could still destroy the stored information. At sufficiently high neutron flux densities, the transient could do physical damage to the wires.

Therefore the currents would be gated and normally limited. Flow would be through saturated switches, so that excessive current would pull the switches out of saturation, and they would become highly resistant.

It might also be possible to sense the rate of rise of the transients and to turn off power to the electronics before the damaging currents were applied. This switching could be set up to operate in tens of nanoseconds. Whether this would be fast enough is not known at present.

Other companies reported to be at least minimally engaged in research are Honeywell, Fabri-Tek, Melpar, and Fairchild Semiconductor. National Cash Register uses plated rods in its 315 RMC computer and is also developing plated wires. According to recently published papers, Bell Telephone Laboratories, Murray Hill, N. J., is still active after having pioneered this technology a decade ago under U. F. Gianola, head of the magnetic device department. ■ ■

Laser deposits wiring on a microcircuit chip

An unusual technique for direct deposition of microcircuit interconnection patterns on a single semiconductor substrate is reported by Standard Telecommunications Laboratories, Ltd., Harlow, England.

In their technique, a glass plate with a thin metal film on its underside is placed in contact with the processed semiconductor slice. A beam from a helium-neon laser—used with a micropositioning table—is focused through the pattern on the plate. The beam vaporizes the film material and deposits the interconnection pattern directly onto the slice.

A minimum line-width of 25 μ has been obtained, although the company says the process is still at an early stage of development. Local deposition is regarded as

particularly important, a company spokesman noted, because "it offers an elegant solution of multilayer

interconnection problems that will arise in future complex systems." ■ ■



Interconnection patterns are deposited directly onto a semiconductor substrate by means of a helium-neon laser.

bench accuracy at system speed



Cover protects 2402A controls for systems use.

Both in an integrating DVM with 1 microvolt resolution.

Take 40 readings per second, integrate and resolve the answers to a microvolt with the new Hewlett-Packard 2402A IDVM... get resolution never before available in this speed range. With the accuracy of a lab instrument (0.01% of reading $\pm 0.003\%$ of full scale), the 2402A is excellent for system applications... with full programmability and all the features you'd expect from a systems voltmeter. (Of course, it's an excellent lab instrument, too.)

Guarding and integration permit accurate measurement of low-level signals in the presence of common mode and superimposed noise—over 120 dB effective common mode rejection... even at 40 readings per second. Designed for low-cost multimeter expandability: AC, resistance and frequency measurement capabilities can be added easily with optional plug-in circuit cards. Five ranges

to ± 1000 Volts, including a 0.1 Volt range for high-accuracy millivolt measurements.

The 2402A: \$4800. Plug-in options are reasonably priced—AC, for example, only \$450.

For more information, call your local HP field engineer or write Hewlett-Packard, Palo Alto, California 94304; Europe: 54 Route des Acacias, Geneva.

HEWLETT  PACKARD

DIGITAL VOLTMETERS



SEMICONDUCTORS

NEW IDEAS IN APPLICATION AND DESIGN

■ **TRANSIENT-PROTECTED 1-AMP RECTIFIERS, HERMETICALLY SEALED IN SOLID GLASS, IN VOLUME PRODUCTION NOW**

You can use them to replace many kinds of older style rectifier diodes. General Electric's A14 rectifier diodes are encapsulated in solid glass and available in voltage ratings from 50 volts to 800 volts PRV.

Four popular types are the 1N5059-1N5062 rated from 200 volts through 800 volts PRV. These devices are tran-

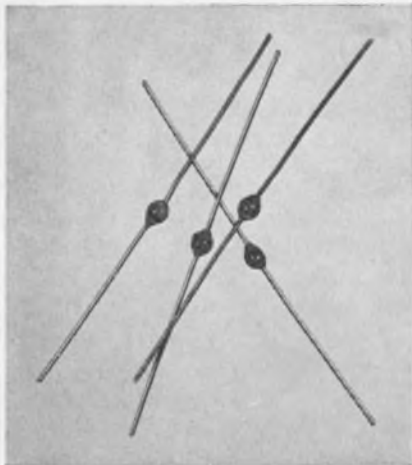

Actual size GE A14 rectifier diodes

sient voltage protected to dissipate up to 100 watts for 20 microseconds in the reverse direction.

A14's feature an all-diffused, glass passivated junction structure, high surge current capability, and low thermal impedance through dual heatsink design. The circuit protection offered by the A14, plus its stable performance, makes its use essential for both industrial and consumer applications where transient voltages may destroy conventional rectifier diodes.

For more information on General Electric A14's, just **Circle Number 96** on the magazine inquiry card.

PAIR 'EM UP...

110-Amp, 1000-Volt SCR Rated to 10,000 Hz

Ask for the General Electric C158. It features high di/dt (200 amps/ μ sec.), high dv/dt (200 volts/ μ sec. minimum), and very low switching losses. Available in both flexible lead (C158) and flag terminal (C159) packages, these GE SCR's are rated 1,000 volts, 10 kHz sine wave and 5 kHz square wave. Applications include use in choppers, inverters, regulated power supplies, induction heating, radio transmitters, cycloconverters, DC-to-DC converters, and high frequency lighting. **Circle Number 97.**

250-Amp, 1000-Volt Rectifier Diode with 1.5 μ sec. Recovery Time

For use in the same circuits with your C158/C159 SCR's, specify General Electric A96/A97 rectifier diodes. A96/A97's are rated up to 6.25 kHz and housed in a flexible lead package. The new rectifier diodes feature a recovery time of just 1.5 μ sec. Both forward (A96) and reverse (A97) polarities are available. Match them up with the C158/C159 or other SCR's and power transistors and try them in your own applications. Or **Circle Number 98** for specifications.

■ **ACCURACY UP, RFI DOWN WITH GE'S NEW LOW-COST A-C POWER CONTROL MODULE**

"Zero-voltage switching" is the key. GE's new S200 synchronous switch power control provides much lower RFI levels than are possible with electromechanical thermostats or phase-controlled semiconductors. And it has high accuracy with control point repeatability better than $\pm 0.5\%$ of sensor resistance. Keys to this high performance are a monolithic integrated firing circuit and a Triac power control device. Its user need only provide power, a resistive load (such as a resistance heater), a variable resistance sensor and a reference control resistor.

Potential uses include any resistive load application where a-c power control is needed. S200 power control modules are available in ratings of 10

and 15 amps RMS, at 120, 240 and 227 volts RMS, 50 to 60 Hz, for controlling resistive loads up to 4150 W. Use with General Electric's new Man-Made[®] diamond thermistor permits sensing and control of temperatures to 450 C. Housing dimensions of the S200 power control module are roughly 1 $\frac{1}{8}$ by 2 $\frac{1}{8}$ by 3 $\frac{1}{8}$ inches.

Circle Number 99 for full details on these new GE power control modules.

These are just a few examples of General Electric's total electronic capability. For more information on all GE semiconductor products, call your GE engineer/salesman or distributor. Or write to Section 220-59, General Electric Company, Schenectady, New York. In Canada: Canadian General Electric, 189 Dufferin St., Toronto, Ont. Export: Electronic Components Sales, IGE Export Division, 159 Madison Ave., New York, N. Y., U.S.A. 220-59

GENERAL  ELECTRIC



Navy seeks more bidders on hardware

The Navy is having trouble finding enough bidders for much of the hardware that it buys frequently. The Navy complains that there is "limited competition" and that in the past there have generally been no more than two bids or proposals on any item. In some cases, Navy officials admit, "competition has been limited by high setup investment and the need for specialized facilities or capabilities." But, they add, "for other items there are no known major factors which should inhibit additional competition."

To encourage more companies to bid—especially smaller companies that could provide much of the needed equipment—the Navy has compiled a long list of products that small firms could supply. Over half of them are electronic.

The list includes certain signal simulators, logarithmic periodic antennas, conical monopole antennas, radio transmitters (AN/FRT-72), motor generators, certain safety and arming devices, AN/PSM-4 multimeters, AM-2123/U amplifiers, AM-368 amplifiers, AN/PDR-43 radiation detection equipment. Also needed are permanent magnets for IC/SBA-4 and LS-444/WIH loudspeakers, control radio sets (C-1138B/UR), LS-386/SIC intercom stations, certain microphone stations, waveguide horns, head sets, roll gyros, signal simulators, frequency dividers, Mark-37 time-delay relays and coaxial cable.

Companies interested in bidding when these items come up for procurement should contact the Small Business/Labor Surplus Area Specialist at the Navy organization doing the buying. That official can also provide a list of the specialists at all other facilities, along with addresses and telephone numbers.

California receives most R&D funds

California has again taken the largest slice of the Federal research-and-development-funds

Washington Report

S. DAVID PURSGLOVE,
WASHINGTON EDITOR

pie. And to nobody's surprise, New York, Maryland, Massachusetts and Texas were again the runners-up. These five states accounted for 57 per cent of the funds spent by the eight Government agencies that handle 98 per cent of Federal R&D funds. The figures are published in the National Science Foundation's survey, *Geographic Distribution of Federal Funds for Research and Development*, for fiscal year 1965, the latest annual data available. The 188-page report is available for \$1.00 from the U.S. Government Printing Office, Washington, D. C. 20402.

The survey shows that 63 per cent of Federal research and development was performed by industrial firms, 21 per cent was "in house," and 8 per cent was carried out in colleges and universities. Of industry's share, 40 per cent was carried out in California, home of George P. Miller, chairman of the House Science and Astronautics Committee. The bulk of the work in California was space and military. The report shows that in New York and Texas, too, most of the work was space and military.

The Defense Department and the National Aeronautics and Space Administration together accounted for 82 per cent of the money spent on research and development. The others of the "Big Eight" agencies are the Atomic Energy Commission; Dept. of Health, Education and Welfare; Dept. of Agriculture; National Science Foundation; Dept. of the Interior; and Dept. of Commerce. The Pentagon and NASA were the major users of industrial laboratories; the Dept. of Health, Education and Welfare was the chief support of educational institutions; and the Atomic Energy Commission was the mainspring behind Federal contract research centers managed by educational institutions.

Between fiscal 1963 and 1965, the amount of money spent on Federal research and development rose by 17 per cent, the report shows, but the distribution of it among the various regions of the nation remained almost

unchanged. There were more noticeable changes on a state-by-state basis. In states getting the lion's share of Federal work, the impact of changes in contracting was slight; in states receiving less, the impact on their economy was quite significant.

Tactical comsats pass major test

Communications between air, ground, sea and undersea units of the Army, Navy and Air Force have been successfully performed with a new tri-service tactical communications satellite, LES-5. This completes a development phase that is expected to lead to production and the wide use of tactical communications satellites. The satellites are being developed by the tri-service Tactical Satellite Executive Steering Group.

Development of experimental ground terminals for the test program is an Army responsibility. The program so far includes two jeep terminals, two 3/4-ton-truck terminals and a 26-foot-van terminal, all developed by the Army Satellites Communications Agency, Fort Monmouth, N. J. During the experimental phase they have been used only in the Fort Monmouth area, but they are expected soon to be moved to other areas to test the "tac-comsat" system under different conditions. A voice network has been successfully operated among three of the ground stations.

The Navy has used 60-word-per-minute teletypewriters on a ship, a submarine, an airborne P-3 Orion aircraft and at three shore stations which took part in its experiments. The Naval Electronic Systems Command's Satellite Communications Project Office monitored development of the Navy terminals. The electronics for all six terminals was basically the same, but the antennas differed from one to another.

Air Force aircraft for the experiments were drawn from Systems Command and Strategic Air Command. Ground terminals were set up at the Air Development Center, Rome, N. Y.

Lincoln Laboratory at MIT built the LES-5 (Lincoln Experimental Satellite No. 5) as part of a program to provide rapid communications for highly mobile, lower-echelon (tactical) forces. The program aims to develop equipment

that is small and light in weight and offers maximum flexibility with minimum need for control.

New computer-library grants awarded

The U.S. Office of Education has begun to allocate \$3.5 million for 38 projects in a new program of library and information sciences research. The program is designed, U.S.O.E. says, "to devise better ways of coping with the 'information explosion.'" It is heavily computer-oriented and underscores the growing importance of computers for education and library works.

One \$64,408 project is being undertaken at the new Hampshire College, Amherst, Mass. The college will admit students in 1970 and is trying to use computers and dial-access communication systems to bring library services to dormitories. Under a \$293,000 grant, the Smithsonian Institution in Washington hopes to develop a computerized system to make its biological and geological specimens more readily accessible for students and specialists.

PHS looks into electron beams

Industrial electron-beam devices may become subject to Federal standards. The Public Health Service is eyeing the proliferation of neutron generators and electron accelerators used by industry to cure paint, pasteurize food and sterilize consumer products. Are there hazards to workers in plants where the devices are used? The PHS Bureau of Disease Prevention and Environmental control plans to find out. The Bureau seeks a contractor to assess the hazards. Data will then provide a basis for Federal guidelines on instrument design and operating procedures. The PHS also intends to study possible hazards from isotopic X-ray and Mossbauer devices.

Navy closes a chapter in missiles

The Navy has ended a chapter in the nation's undersea ballistic missile program, with the test-firing of a Polaris A-3 by the submarine Will Rogers. The new Will Rogers, scheduled to go on patrol in September, completes a planned fleet of 41 submarines, each armed with 16 undersea missiles. Future subs will be capable of carrying more missiles. The missiles themselves, beginning with Poseidon next year, will also be larger.

trouble-free selection...

1½% ACCURACY
MODEL 2750

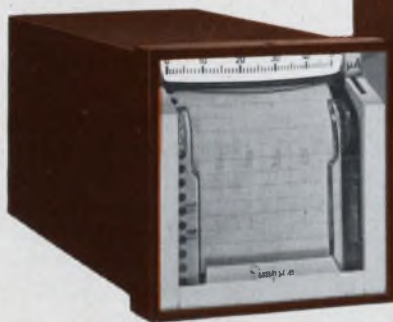

10 CHANNEL EVENT
MODEL 2755



22 BUILT-IN RANGES
MODEL 604

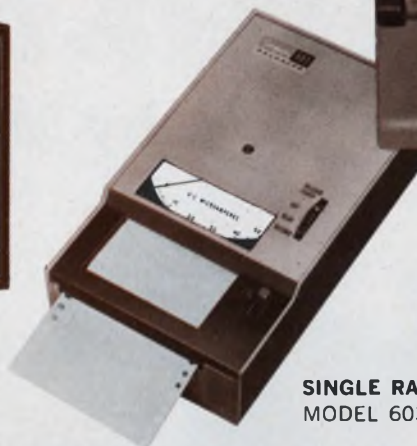

SINGLE RANGE—4 SPEED
MODEL 603

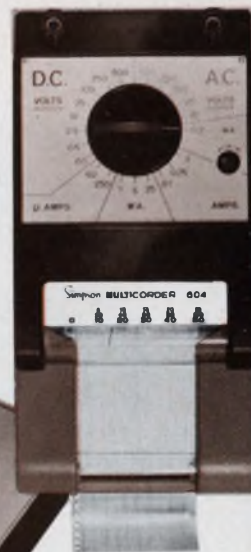

We build them only one way. Trouble-Free . . . with Simpson's inkless system for a clear record *every* time . . . with quick and easy paper changing . . . with ruggedness and portability. All our magnitude recorders use Taut Band movements to prevent shock and vibration damage. And speed changes can be made on all models while the chart is in motion, with the flip of a switch. High-quality construction throughout. Choose the recorder you need from the chart. All are Reliable. Convenient. Trouble-Free.

write for
further
information

SPECIFICATIONS	603	604	2750	2755
Accuracy of recording	DC models: ±2.5% FS AC models: ±4.0% FS	±2.5% FS on all ranges	±1.5%, any model	(Event channels only)
Number of ranges built-in	1	22	1	—
Ranges available from stock.	DC μ A: 0-50/100/250 DC mA: 0-1/5/50/500 DC A: 0-5 AC A: 0-5 DC mV: 0-50 DC V: 0-15/50/150 AC V: 0-5/150/300, 100-130	DC μ A: 0-50/250* DC mA: 0-1/5/25 DC A: 0-1/.25/1 AC mA: 0-2 DC V: 0-.1/.5/2.5/10/25/100/250/500 AC V: 0-10/25/100/250/500	DC μ A: 0-10/25/50/100/500 DC mA: 0-1/10/100 DC A: 0-1/5/10 AC μ A: 0-250/500 AC mA: 0-1/10/100 AC A: 0-5 DC mV: 0-50 DC V: 0-1/5/10/15/25/50/100/150/250/500 AC V: 0-10/15/25/50/100/150/250/500	—
Number of event channels built-in	1	none	none	10
Event indicator voltage	120 volts/60Hz.	—	—	120 volts/60Hz. (optional: 24VDC)
Built-in chart speeds	3/12/24/36" per hr.	1/3/12" per hr.	20/120 mm per hour	
Optional speeds	¼/1/2/3" per hr.**	30/60/90" per hr.***	30/180; 60/360; 100/600; 300/1800;*** 600/3600 mm per hr.	
Clamp rate	2 seconds	2 seconds	3 seconds	Continuous
Chart Paper	3" wide, pressure sensitive	2 1/16" wide, pressure sensitive		
Motor drive	Self-starting, synchronous. 120 volts @ 60 Hz.			
Price	\$90.00-\$120.00 From Electronics Parts Distributors	\$200.00	\$138.00-\$167.00 FROM YOUR SIMPSON REPRESENTATIVE	\$175.00

*Note: 604 has all ranges listed built-in one unit.

**Gearbox not interchangeable. Stocked in both low and high speed ranges.

***With interchangeable Gearboxes.

Simpson

ELECTRIC COMPANY

5200 W. Kinzie Street, Chicago, Illinois 60644 • Phone: (312) 379-1121

Export Dept: 400 W. Madison Street, Chicago, Illinois 60606, Cable, Simelco

IN CANADA: Bach-Simpson Ltd., London, Ontario

IN INDIA: Ruttonsha-Simpson Private Ltd., International House, Bombay-Agra Road, Vikhroli, Bombay

ON READER-SERVICE CARD CIRCLE 17

In goes schematic; out comes PC art

A computer service corporation, CEIR, Inc., Washington, D.C., has adapted a program, originally designed for the Atomic Energy Commission, to produce finished artwork used in the manufacture of printed-circuit boards from an engineer's schematic. The circuit is translated onto punch cards, which are then fed into the computer. In addition to the complete printed-circuit negative, the computer also produces a verified schematic, a parts list, an assembly drawing and a hole-drilling list.

The computer's input consists of three packs of punch cards. One set defines the location of each part on the schematic, which is divided into sections by a matrix of boxes. Each box contains one component—any device of four leads or less from a piece of connecting wire to a transistor. Another set of cards defines the board's size, the location of its corners, the conductor width and its pad and hole size. A third set locates and determines the connector terminal if it has one.

With these three sets of cards the computer attempts to lay out the wiring pattern of the printed-circuit board. If it cannot do this without crossing wires on the board, it indicates this impossibility with a crisp message to the operator. If it can lay out the printed circuit's plated wiring, without shorts, it does so on a graphic console. This console is equipped with a film, which, after development, is the negative that can be used directly in the production of the PC board.

A typical 3-by-5-in. board, crammed with components, takes about 20 minutes on an IBM 7090. CEIR charges \$400 to \$600 for this service, including the preparation of the punch cards and the time on their computer. The firm is now working on a version that will accept multileaded integrated circuits. The program will design boards with two layers of interconnection and should be ready in six months.

The original program was called ACCEL (Automated CirCuit-board Etching Layout) and it was developed jointly by the SANDIA Corp., and the Bede Foundation. ■ ■

SCOTCH COOLER

by McLean



McLEAN "COMPUTER AGE" RACK-MOUNTED BLOWER

Thr...r...r...riest Blowers in America!

The traditional key to economy is to make a little go a long way. But our problem at McLean is to make a great deal go by the shortest possible route.

In equipment cooling, this saves you money. By moving volumes of air through tight spaces — and doing it reliably, unflinchingly, with miniaturized units — McLean protects millions of dollars worth of electronic installations each year. But whether it be in the rack-mounted blower shown here, or in tonnage-volume units for industry, McLean delivers more for less.

And you pay less for more.

See us at Booth 3107 during the Wescon Show.

SEND FOR
NEW 1967
CATALOG



McLEAN ENGINEERING
LABORATORIES

Princeton Junction, N. J. 08550
Phone 609-799-0100 • TELEX 84-3422



Balloon telescope maps far-infrared

Two NASA astrophysicists who lofted an instrument-laden balloon to a height of 20 miles have conducted the first survey of the sky in the far-infrared region of the electromagnetic spectrum. In doing so, they may have discovered a way to gain valuable information on the formation of planets from the dust clouds surrounding newborn stars.

Their success was due to the balloon's ability to float over all but a few tenths of water vapor, the chief absorber of infrared energy in the atmosphere. The far-infrared, above 25 microns, is said to have been the last remaining unexplored region. Thus the gap between radio and optical astronomy has been bridged.

The astrophysicists, Drs. William F. Hoffmann and Neville J. Woolf, both of the Goddard Institute for Space Studies in New York City, placed a 1-mm chip of cryogenically cooled germanium, which served as a detector, at the focus of a 1-inch quartz lens. The balloon instrument package also included a recorder, a motor to rotate the package and and magnetometers.

The far-infrared, according to the two scientists, is normally filtered by the earth's atmosphere—along with the gamma-ray, X-ray and ultraviolet regions—and therefore is inaccessible from ground observation points. This region is said to be exceptionally difficult to detect and measure. At shorter wavelengths, such devices as photographic plates and infrared quantum detectors can be used. At longer wavelengths, radio receivers are available. But in the intermediate region, none of these methodologies can be applied successfully. The quanta of energy are too small for detection of the photoelectric effect, while the wavelength is too short for radio reception.

Hoffman and Woolf were able to take measurements that could place an upper limit on the amount of radiation from interstellar dust clouds. The composition of this dust could have important implications for theories on the origin of the solar system. Silicates would constitute an important ingredient in the formation of planets. ■ ■

KEITHLEY UNWRAPS *FIRST* MOS FET ALL SOLID-STATE ELECTROMETER



New Model 602 eliminates the need for frequent zero adjustment

Using Mos Fets at the input, this new Keithley solid state electrometer measures voltage, current, resistance and charge over 73 ranges. It is so stable the only discernible drift is with temperature. And only at a rate less than $300 \mu\text{V}/^\circ\text{F}$.

The 602 exhibits minimum zero shift from shock, vibration or voltage overloads up to 500 volts. Battery-operated, this versatile giant operates up to 1500 volts off ground and has battery life of 1000 hours, even when recording! Fast warm-up time, low 5×10^{-15} ampere offset current and freedom from microphonics make it truly unique!

Call your Keithley man for our technical engineering note. Ask for a free in-plant demonstration, too.

Model 602

- 1 mv f.s. to 10v, with 10^{14} ohms input resistance
- 100 ohms f.s. to 10^{13} ohms
- 10^{-13} to 10^{-6} coulomb
- 10^{-14} ampere f.s. to 0.3 amp.
- 500-volt overload protection

\$675, with input leads



KEITHLEY
INSTRUMENTS

28775 Aurora Road • Cleveland, Ohio 44139
EUROPE: 14 Ave. Villardin, 1009 Pully, Suisse

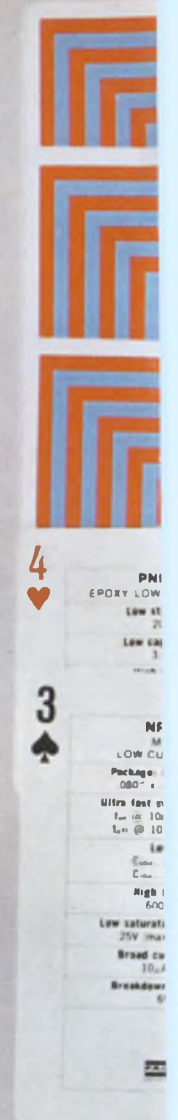
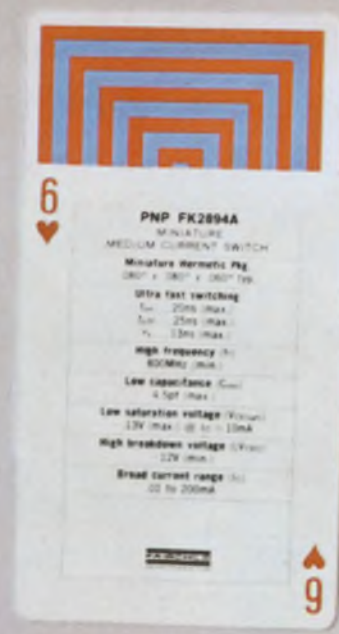

Get a whole new deck from Fairchild.

We now make silicon PNP complements for Fairchild NPN transistors. If you design complementary circuits, start fresh: you no longer have to use NPN's exclusively or settle for germanium PNP's. Fairchild now makes silicon PNP complements for the Fairchild NPN transistors you commonly use. And when we say complement we mean same performance specs, same silicon reliability, same low prices, same quick delivery. Everything matches except the polarity. To help you pick matching transistors we created a deck of attractive playing cards with our most popular complementary devices in complementary suits. We've even included abbreviated specs for each transistor. It's yours free for the coupon with our compliments. Or ask your Fairchild Distributor.



3 ♥

PNP FK4207
MINIATURE
LOW CURRENT SWITCH

Package: Miniature Hermetic
080" x 080" x 080" typ.

Ultra fast switching ($I_c = 10mA$)
 $t_{on} @ 10mA$ - 20ns (max.)
 $t_{off} @ 10mA$ - 15ns (max.)

2 ♠

NPN FT709
ULTRA FAST
LOW CURRENT SWITCH (METAL)

Fast switching
 t_{on} - 4ns (max.)
 t_{off} - 12ns (max.)
 t_{on} - 12ns (max.)

Current range (I_c)
 100 μA - 50mA

Low capacitance (C_{out})
 3pf (max.)

High frequency (f_t)
 600MHz (min.)

Low saturation ($V_{CE(sat)}$)
 0.25V (max.) @ $I_c = 10mA$

Package
 TO-18

2 ♥

3 ♦

PNP 2N4025
HIGH GAIN DUAL AMPLIFIER

Low noise (NF)
 10Hz - 5dB (max.)
 100Hz - 4dB (max.)
 1kHz - 2dB (max.)

High gain (β_{DC}) with excellent linearity
 @ $V_{CE} = 5.0V$
 $I_c = 1.0\mu A$ - 180 (min.)
 $I_c = 100\mu A$ - 250-550
 $I_c = 10mA$ - 200 (min.)

High gain (β_{AC}) match
 10% @ $I_c = 100\mu A$ - 1.0mA

Low $V_{BE} - V_{BE}$ match
 5.0mV @ $I_c = 10\mu A$

High frequency (f_t)
 50MHz (min.)

Low capacitance (C_{out})
 6pf (max.)

Low leakage (I_{CBO})
 10nA (max.) @ $V_{CE} = 50V$

3 ♣

Q ♣

NPN 2N3568
EPOXY HIGH CURRENT AMPLIFIER

High current gain (β_{DC}) with excellent linearity
 @ $V_{CE} = 10V$
 $I_c = 100\mu A$ - 40 (typ.)
 $I_c = 1.0mA$ - 55 (typ.)
 $I_c = 1.0A$ - 35 (min.)

PNP 2N3467
HIGH GAIN CORE DRIVERS

Fast switching at high current
 t_{on} - 40ns (max.)
 t_{off} - 90ns (max.)

Broad current range (I_c)
 1mA to 1.0A

High frequency (f_t)
 175MHz (min.)

Low saturation voltage ($V_{CE(sat)}$)
 5V (max.) @ $I_c = 500mA$

High voltage (V_{CE})
 80V (min.)

High gain (β_{DC})
 80 (min.) @ $I_c = 150mA$
 60 (min.) @ $I_c = 500mA$
 40 (min.) @ $I_c = 1A$

Package
 TO-5

J ♥

SWITCH
 (typ.)

SWITCH
 Hermetic
 07" typ.

$I_c = 10mA$
 t_{on} (max.)
 t_{off} (max.)

t_{on}
 t_{off}

$V_{CE(sat)}$
 10mA

I_c (typ.)
 A

$V_{CE(sat)}$

3 ♥

PNP 2N4358
AMPLIFIER

PNP 2N4249
EPOXY LOW NOISE AMPLIFIER

Low noise (NF)
 0.7dB (typ.)

High gain (β_{DC}) with excellent linearity
 @ $V_{CE} = 5.0V$
 $I_c = 10\mu A$ - 100-300
 $I_c = 1.0mA$ - 100 (min.)
 $I_c = 10mA$ - 100 (min.)

High voltage (V_{CE})
 60V (min.)

High frequency (f_t)
 600MHz (min.) @ $V_{CE} = 5.0V$
 500MHz (min.) @ $V_{CE} = 6.0V$

Low capacitance (C_{out})
 5.0pf (max.)

Low leakage (I_{CBO})
 10nA (max.) @ $V_{CE} = 60V$

Package
 TO-18 (70-18 (Epoxy))

2 ♦

PNP 2N4358
AMPLIFIER

PNP 2N4249
EPOXY LOW NOISE AMPLIFIER

Low noise (NF)
 0.7dB (typ.)

High gain (β_{DC}) with excellent linearity
 @ $V_{CE} = 5.0V$
 $I_c = 10\mu A$ - 100-300
 $I_c = 1.0mA$ - 100 (min.)
 $I_c = 10mA$ - 100 (min.)

High voltage (V_{CE})
 60V (min.)

High frequency (f_t)
 600MHz (min.) @ $V_{CE} = 5.0V$
 500MHz (min.) @ $V_{CE} = 6.0V$

Low capacitance (C_{out})
 5.0pf (max.)

Low leakage (I_{CBO})
 10nA (max.) @ $V_{CE} = 60V$

Package
 TO-18 (70-18 (Epoxy))

2 ♦

5 ♣

NPN 2N3823
HIGH VOLTAGE AMPLIFIER

High voltage (V_{CE})
 50V (min.)

High gain (β_{DC})
 30-120 @ $I_c = 20mA$

Low noise (NF)
 5dB (typ.)

Low capacitance (C_{out})
 7.4pf (typ.)

Excellent beta linearity
 10mA $V_{CE} = 10V$ - 65 (typ.)
 5mA $V_{CE} = 10V$ - 100 (typ.)

Package
 TO-5

5 ♣

Gentlemen: I am involved in complementary circuits design and want to get your new deck along with complete information on your PNP complements to NPN transistors.

Name _____

Title _____

Company _____

Address _____

City _____ State _____ Zip _____

Flying laboratory to study atmospheric IR

Neil Sclater, East Coast Editor

A flying laboratory equipped as an atmospheric infrared research platform will soon begin worldwide flights to investigate variations in visible and infrared radiation.

The airborne laboratory, a modified KC-135, is attached to the U.S. Air Force Cambridge Research Laboratories, Bedford, Mass. Air Force scientists will use it to obtain a better understanding of the production and propagation of visible and infrared energy. They say that the studies are of importance to the development of Air Force surveillance and reconnaissance systems.

Experiments are planned which will take the KC-135 from the north to the south magnetic poles, according to Hervey Gauvin, director of the project. He is chief of the Radiation Effects Branch within the Optical Physics Laboratory. He said that studies will begin this month in the following areas:

- Infrared aurora and airglow and their associated chemical and luminescent reactions.

- Atmospheric water vapor as a function of latitude, season and location.

- Evaluation of schemes for detecting low-level infrared emission from targets by Air Force planes.

- Test and evaluation of Air Force IR equipment

Gauvin said that infrared aurora and airglow will be studied in nor-

mal sky backgrounds in different latitudes and seasons. The project will also obtain statistical data on atmospheric water vapor between about 5 and 8 miles above the earth at various locations. The Air Force, he says, wants to know more about how water vapor absorbs infrared radiation and affects satellite reconnaissance.

Among the Air Force equipment to be evaluated, according to Gauvin, are systems that would identify IR signatures of aircraft, missiles, and reentry vehicles.

Nine newly developed instruments have been installed on the aircraft. One is an electronic scanning spectrometer able to scan the visible infrared region of 0.6 to 1 micron at rates up to 10,000 scans per second. It uses an image dissector photo-electron multiplier tube as a detector. Digital signals from the instrument are recorded on video magnetic tape in a format directly acceptable by a computer. The complete instrument package occupies less than one cubic foot.

The special equipment on the plane also includes a servo-controlled, trainable mount which permits up to seven separate instruments to be trained on one region of the sky at the same time.

The mount with its trainable periscope, Gauvin says, permits real-time correlation of data from a variety of instruments.

The other new instruments are

an infrared sky mapper, five Michelson interferometers and two infrared radiometers.

The conventional supporting instruments on the aircraft include a spectrometer and a sky mapper for visible light, a green-line photometer, and all-sky and documentary cameras.

Atmospheric research data may be recorded on any of five 14-channel magnetic-tape recorders and a video magnetic-tape recorder. The recording equipment has features that permit the data to be timed and indexed for ease of data reduction.

A liquid-nitrogen-cooled optical chopper, positioned outside a window of the aircraft, permits interferometer systems to make extremely low-level infrared measurements.

The aircraft is equipped with an MD-1 Astro Tracking System for navigating in parts of the world lacking adequate navigational aids.

The KC-135 was extensively modified for the installation of the instruments by Hayes International Corp., Birmingham, Ala. The internal framing was rebuilt to permit the installation of the many additional viewing ports in the pressurized cabin. The plane will be able to fly at altitudes greater than 40,000 feet but for long flights will cruise at about 37,000 feet. At that height it will be above 98 per cent of the earth's atmosphere. ■ ■

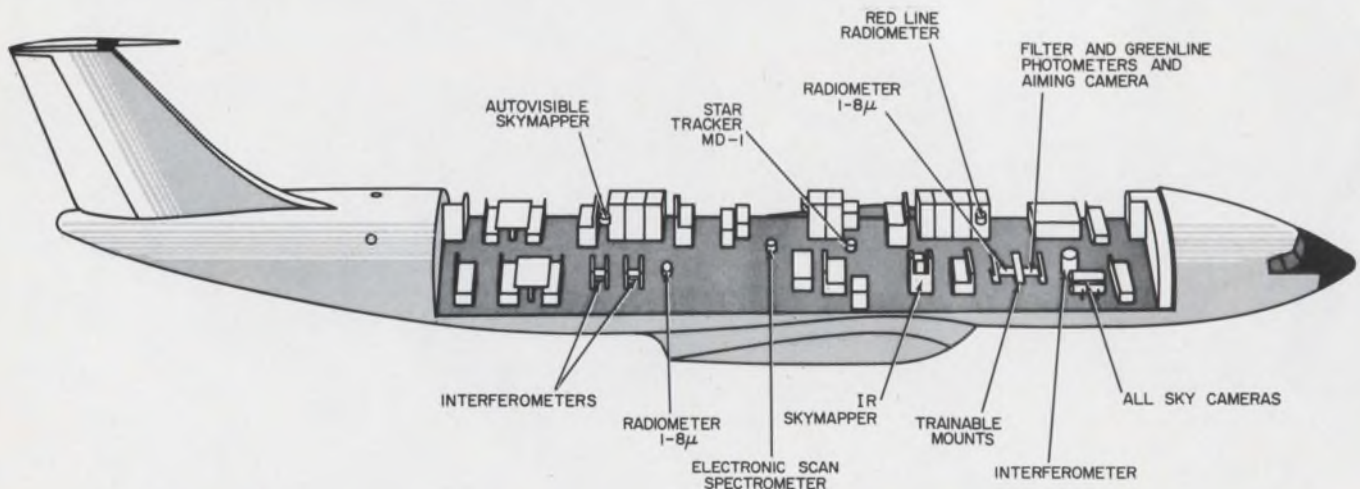

Nine newly developed scientific instruments and many conventional instruments, installed aboard this flying

thermal radiation laboratory, form a well equipped and versatile platform for the study of atmospheric radiation.



The servo-controlled master tracking station is positioned by Maj. William Grieder with a joystick control. Located on the mount is a 16-mm gun-sight camera, a narrow-band photometer and a wide-field telescope for aiming and tracking. Two other mounts are slaved to track with this station, permitting as many as seven instruments to be aimed simultaneously.



One of the two laser-referenced interferometer spectrometers is aimed by engineer Robert Pierce. Instruments are sensitive in 1- to 8-micron band and have nitrogen-cooled detectors.

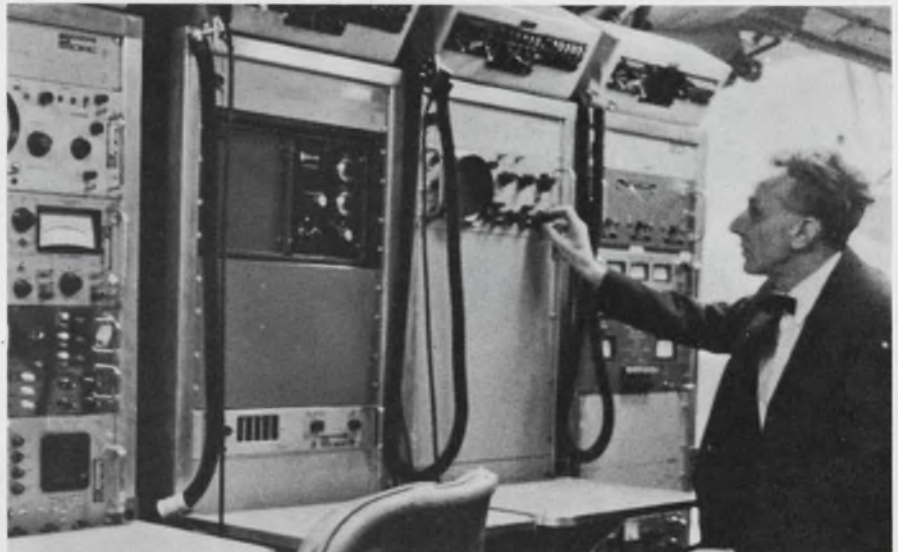

The remote-control monitor for an 8-to-14-micron-band filter radiometer is adjusted by Hervey Gauvin, the flying-laboratory project manager. The equipment racks before Gauvin also contain electronics for sweeping three 1-to-14-micron-band interferometer spectrometers and other devices that will monitor the radiometer.



The Air Force KC-135, recently modified at a cost of about \$329,000, will soon begin worldwide research flights.

The fuselage framing was built to permit the installation of many pressurized viewing windows.

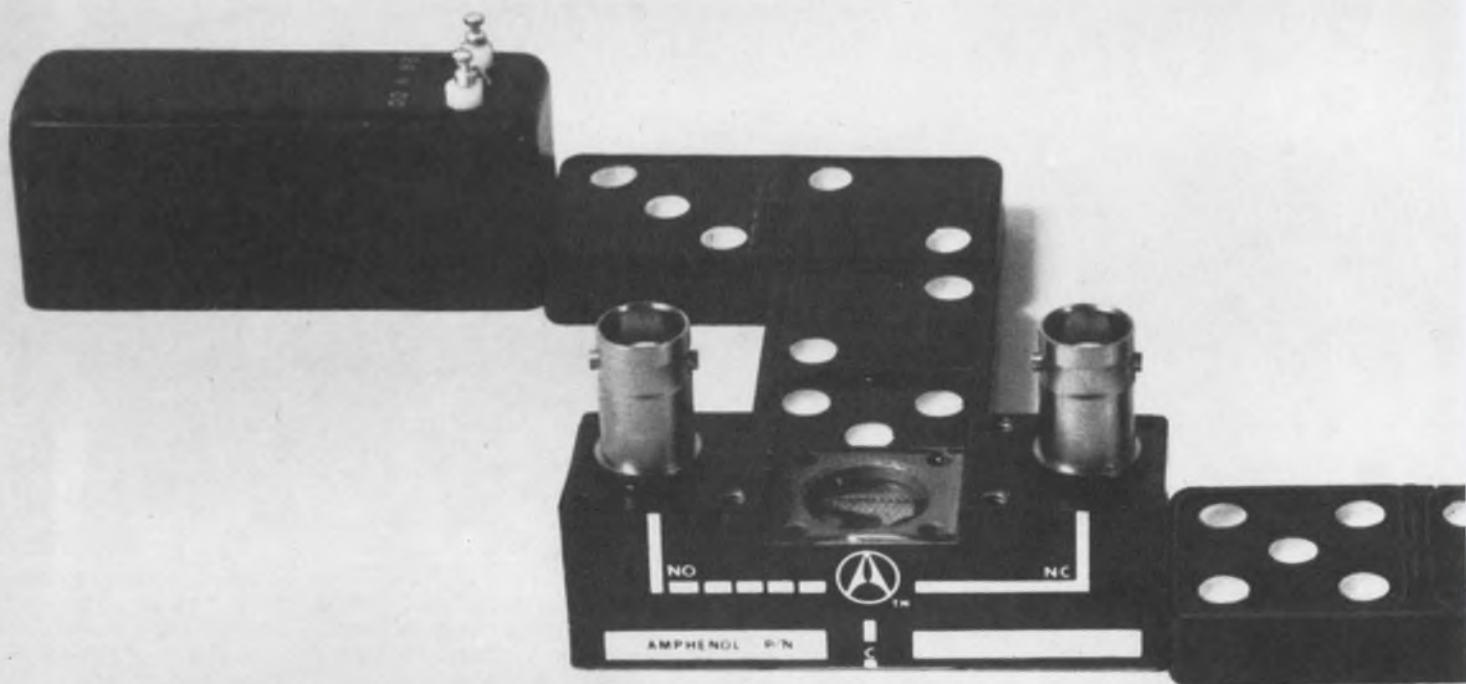

**For a switch,
try to stump Amphenol**

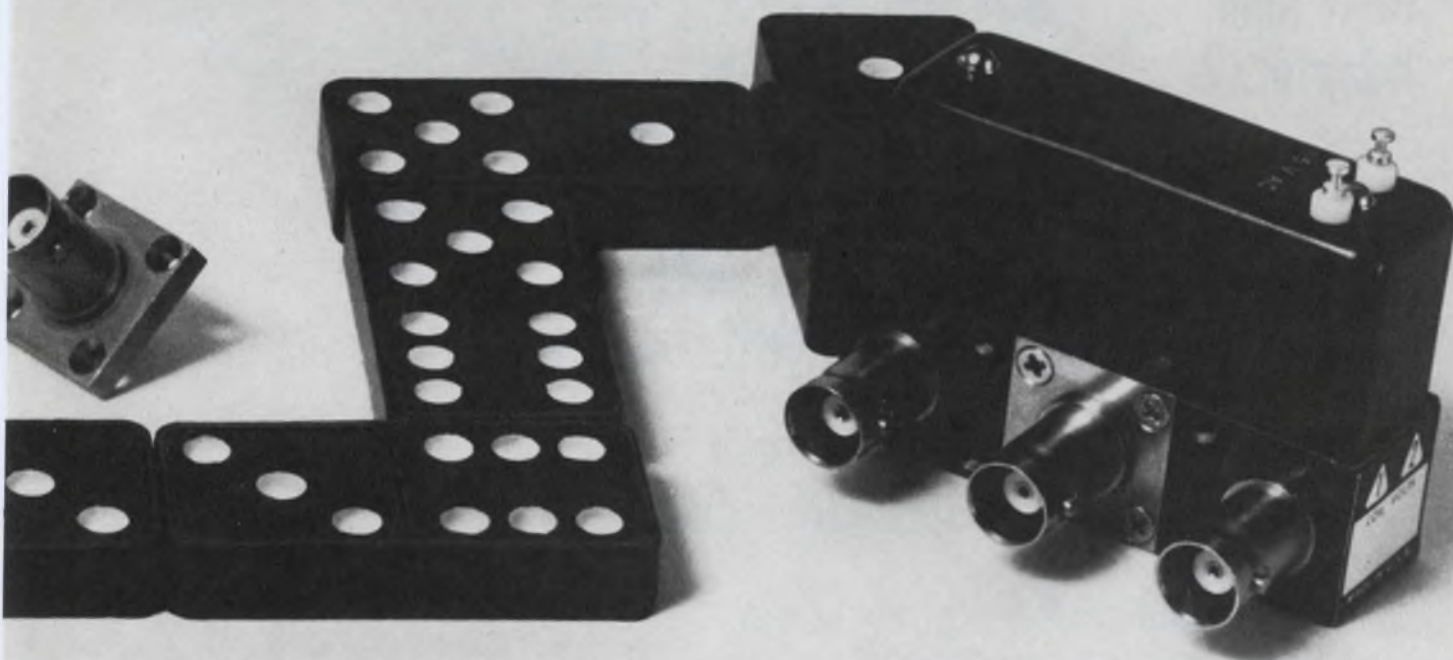

You can't. With our Dynaform* line, 23 standard modules go together like a set of dominoes to build any coaxial switch you like.

Over 300 variations. 1P2T, 2P2T or transfer. Shorting, non-shorting or resistor terminations. BNC, TNC or N type connectors. Same side or

opposite sides. Tell us what you need, and we'll put them together.

Design advances. Dynaform switches offer other advantages, too: aluminum shells for lighter weight, usable frequency ranges to 6 GHz, low crosstalk at all ranges, dust-proof construction, prompt delivery.

For price/delivery data, call your distributor or Amphenol Sales Engineer. For complete specs, write **Amphenol RF Division**, 33 E. Franklin Street, Danbury, Conn. 06810.



AMPHENOL

*Trademark

See the latest in Amphenol electronic components at WESCON. Booths 4501-4507.

ON READER-SERVICE CARD CIRCLE 21

**Transistor
Mounting
Pads?**

Clips?

**Heat Sink
Adapters?**

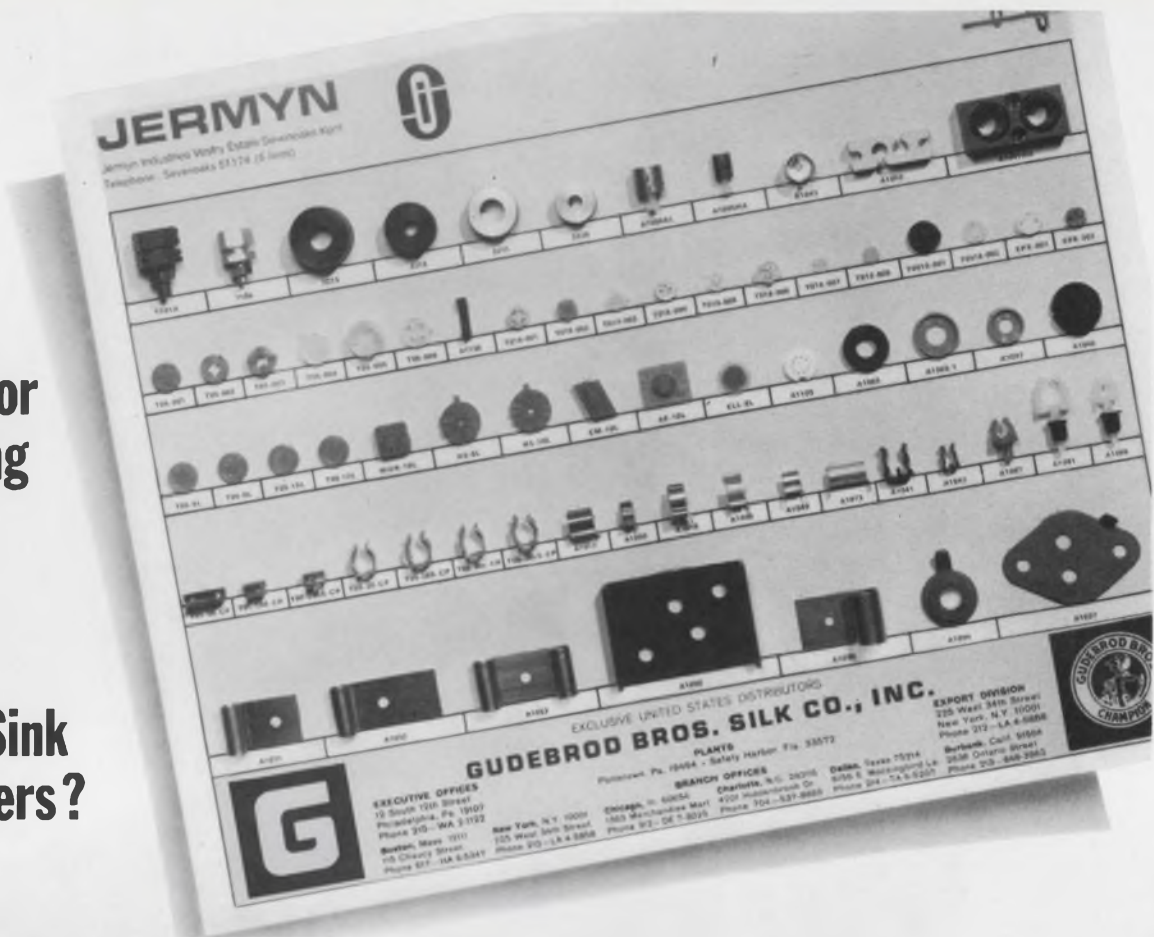

**GUDEBROD is your new, reliable source
for this important circuit hardware.**

**Precision made with traditional English
craftsmanship—by JERMYN Industries.**

**Stocked and sold exclusively in the
United States by GUDEBROD.**

**You ought to know more
about these products!**

Send for catalog now!

Gudebrod is now exclusive U.S. distributor for the electronic products manufactured by Jermyn Industries of Kent, England. Gudebrod feels it will be providing the industry with electronic hardware consistent with the high quality products manufactured by Gudebrod for nearly 100 years. Gudebrod will extend the same quality and depth of service it has become known for in lacing tapes. Write for the Catalog GJ100.



GUDEBROD BROS. SILK CO., INC.

FOUNDED IN 1870

Electronics Division

12 SOUTH 12th STREET, PHILADELPHIA, PENNSYLVANIA 19107

ON READER-SERVICE CARD CIRCLE 22

Area Code 215, WA 2-1122

Opens fresh design horizons...

microminiature solid cermet discrete resistor



Explore new design areas with these Ceradot[®] pellet resistor characteristics available only from CTS:

- ⑦ To $\pm 1\%$ tolerance.
- ⑦ 15 watts/cm³ power to size ratio.
- ⑦ Won't short out under any operating conditions.
- ⑦ Extreme stability under extreme environments.
- ⑦ 15 ohms to 200K ohms resistance range.
- ⑦ Not affected by radiation.
- ⑦ Operates at 175°C hot spot without leads.
- ⑦ Available with leads or terminating surfaces for soldering or welding.

Current CTS Ceradot applications include numerous aerospace, military and industrial microcircuits, such as discrete components inside transistor cans and flat packs, microwave loads, temperature compensated transistor circuits, load resistors, etc. How can Ceradot's unique characteristics help solve your design problem?

EXPERIMENT WITH CTS CERADOTS

Designers' Kit contains an assortment of pellet resistors in these sizes: .050" dia. x .030"; .050" dia. x .062"; .100" dia. x .030" and .100" dia. x .062" in random resistance values. Uses: in prototypes, development programs, testing and experimental microcircuits. Kit price \$10.00. Immediate delivery.



Founded 1896

CTS CORPORATION

Elkhart, Indiana

Sales Offices and Representatives conveniently located throughout the world.

Principal Products

Variable Resistors
Selector Switches
Loudspeakers
Trimming Potentiometers
Fixed Resistor Micromodules
& Microelectronic Circuitry
Crystals, Filters,
Oscillators & Ovens

Subsidiaries

CTS of Asheville, Inc., Skyland, N.C.
CTS of Berne, Inc., Berne, Indiana
CTS of Paducah, Inc., Paducah, Ky.
Chicago Telephone of California, Inc.,
South Pasadena, Calif.
CTS of Canada, Ltd., Streetsville, Ontario
CTS Microelectronics, Inc., Lafayette, Ind.
CTS Research, Inc., Lafayette, Ind.
CTS Knights, Inc., Sandwich, Ill.

ON READER-SERVICE CARD CIRCLE 23

New uses for medical ultrasonics reported

Stockholm meeting told ultrasound no risk to embryo or pregnant woman; ultrasonic holography described

Richard N. Einhorn
News Editor

Ultrasonics, a technology usually associated with the cleaning of watches and dentures and the detection of leaks and imperfections in materials, is assuming an important role in a variety of medical applications.

At the Seventh International Conference on Medical and Biological Engineering, now in progress in Stockholm, 17 papers are being presented on ultrasonics—and only one is on cleaning.

The conference is the largest of its type ever held. More than 500 papers, authored by scientists from over two dozen countries, are being presented between Aug. 14 and 19. To accommodate this activity, the conference is divided into 40 specialized sessions, in addition to general sessions. There is also an exhibit of the latest equipment.

Significant advances in medical ultrasonics reported at the confer-

ence include these:

- Imaging of the human body to supplement X-rays in diagnosis. The chief applications are gynecology and obstetrics, since, according to several of the speakers, ultrasound does not damage either the pregnant woman or the embryo.

- Mapping and measuring tissue, such as blood vessels.

- Detecting the sources and types of headaches.

- Locating tumors within the eye.

- Recording heart valve action.

Various therapeutic applications have also been tried. For example, ultrasonic surgery is reported to be used for clinical treatment of certain diseases—but not tumors, because it may cause malignancies to spread. And, according to Dr. H. W. Buschmann of Humboldt University, Berlin, who presented the general review of medical ultrasonics at Stockholm, it may be possible to move a detached retina back toward its original position with ultrasonic

waves, and hence improve the prospects for retinal surgery. However, he cautioned, this method needs further development.

The most promising application of ultrasonics is said to be imaging, including the production of ultrasonic holograms.

Frederick L. Thurstone, a scientist experimenting with ultrasound holography and reconstruction at the Bowman Gray School of Medicine, Winston-Salem, N. C., explains in his Stockholm paper¹ why there is a need for such techniques:

"The relative transparency of tissue structure to sonic energy and the reflectivity of soft tissue interfaces . . . have led to the development of numerous diagnostically useful imaging techniques." This means that the sound waves readily pass through soft tissue, but there is a distinct transition between parts—even between two adjacent tissue layers—because a portion of the energy travels forward as one wave through the second medium while another portion is reflected back into the first medium, usually with a phase change.² Thus the ultrasonic imaging of body sections provides good contrast of hard and soft tissue and no risk to patients.

Ultrasonic holograms tried

However, Dr. Thurstone reports that the characteristics of ultrasonic transducers limit the resolution of images, and that conventional scanning systems present only a cross-sectional image of the subject. This, he says, led him to investigate three-dimensional imaging.

Dr. Thurstone devised for experimental purposes a mechanical scanning system (see Fig. 1) that generates optical transparencies which are holographic reconstructions of sonic fields. The ultrasonic holograms could be illuminated with quasi-coherent light in the visible spectrum to produce three-dimensional images of the object.

As shown, a 5-MHz electrical output from the oscillator drives a pie-

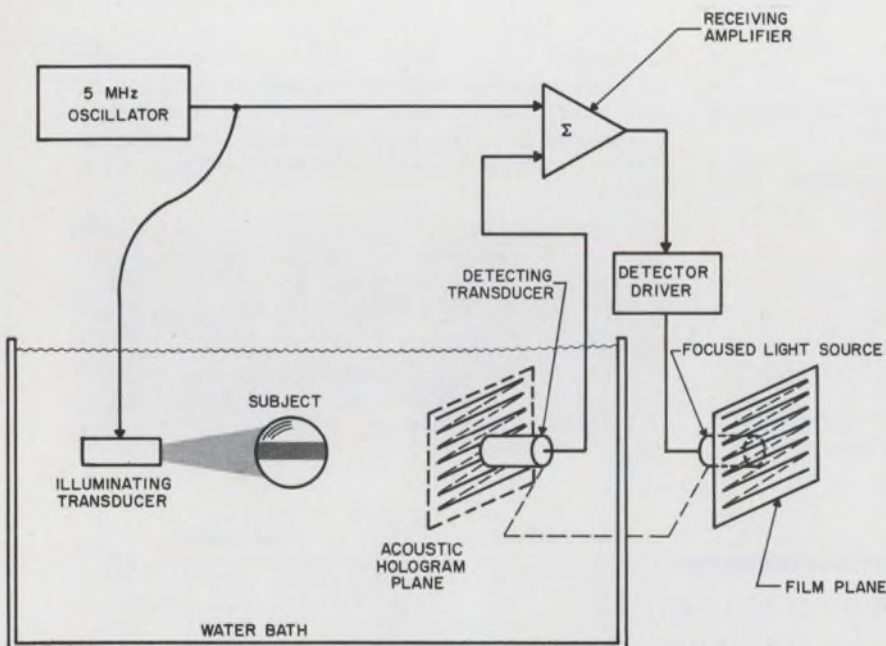

1. Ultrasonic holograms are formed on film by light scanned mechanically at same rate as detecting transducer. Nonlinear electronics are required for mapping magnitude and phase of a coherent sound field.

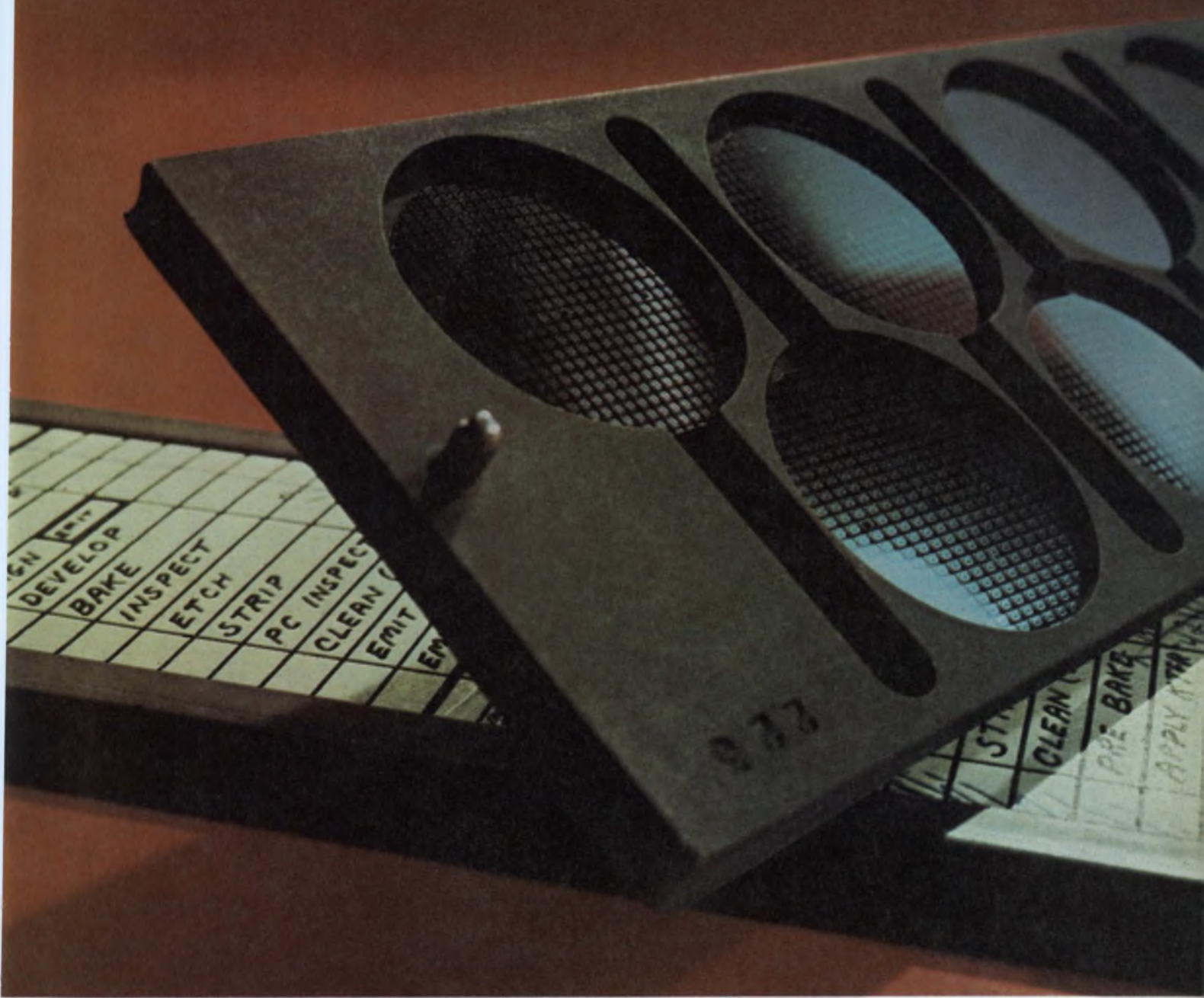

Even the biggest IC order you give us is made in small pedigreed batches.

Mistakes don't get far at Sylvania. By making ICs in small batches and logging their performance on charts that follow them through every step of production, we spot trends and make corrections early. You get reliable ICs, on time.

To assure reliability, vendors' materials must pass stringent tests. Parts made within Sylvania must pass the same tests.

For reliability, processing areas are designed to eliminate contamination. Ceilings, floors and

furnishings are impervious to dirt. Temperature, humidity and air are precisely-controlled.

We've virtually eliminated damage to chip substrates, metallizations and bond wires with mechanized handling equipment. And to make certain we achieve reliability, every IC must survive 100% testing in 12 steps during production. And 100% testing again at the very end.

Sylvania Semiconductor Division, Electronic Components Group, Woburn, Mass. 01801.

SYLVANIA
SUBSIDIARY OF
GENERAL TELEPHONE & ELECTRONICS **GTE**

zoelectric transducer, which is immersed in a water bath. The acoustical output of the transducer propagates in a narrow beam through the water and strikes the subject that is being recorded—a biological specimen, for example. (Ultrasonics generally requires a liquid medium because the losses in air would be too great.) The subject passes, absorbs or reflects the sonic energy, depending on its nature. The amount of absorption of ultrasound goes up with frequency.

A detecting transducer, which is also immersed in the bath in order to avoid diffraction effects at the air-water interface, is scanned mechanically at a constant rate through a two-dimensional plane that represents the plane of the sonic hologram in the sound field. This transducer has a very narrow aperture to give a good approximation of coherence. The mechanical scanning rate is completely independent of the oscillator frequency.

The electrical output of the detecting transducer is fed to an amplifier which has as its second input the direct output of the oscillator. A phase difference always exists between the two inputs because of the delays imposed in the water bath.

Since the subject lies in the acoustic path, its properties affect the magnitude and the phase difference.

The reference signal applied directly to the amplifier is analogous to a plane wave field in the water bath impinging directly on the plane of the sonic hologram with a normal angle of incidence. This is similar to the function of the reference beam in ordinary holography using a laser for illumination, so that an interference pattern is generated. The output of the amplifier is used to control the intensity of a focused light source through a non-linear system.

The light source, which has a narrow beam, is driven at the same rate as the detecting transducer, to which it is mechanically coupled. It scans a photographic emulsion placed in its path. In this way, the magnitude and phase of a quasi-coherent sound field are mapped into the photographic material to give a three-dimensional picture of the subject. The ultimate resolution of the optical image is said to be comparable to the sonic wavelength.

Ultrasonic holograms could be especially useful in analyzing tissue that is not highly differentiated, such as layers of muscle, he says. Dr. Thurstone hopes to experiment on animals in the coming academic year, and emphasizes that his results are only preliminary, and that

he does not foresee immediate medical applications.

Progress has been made in upgrading more conventional methods of diagnostic ultrasonics, too. According to scientists from the United States, the Netherlands and West Germany, the one-dimensional A-scan method is common in many hospitals because it requires relatively simple equipment. However, they point out that B-scan techniques, which give two-dimensional images, should be able to provide better information on soft biological tissue because the clinician would be able better to identify the part of the anatomy he is seeing.

Imaging uses sonar principles

A Dutch scientist, J. C. Somer of the Institute of Medical Physics TNO in Utrecht, says that previous attempts to implement B-scan ultrasonics generally involved a moving probe.³ The movement of the transducer is by means of translation (ordinary B-scan), rotation (sector scan) or a combination of the two (compound scan). He says that all of these have the following disadvantages:

- In contrast with A-scan, it is not possible to find the best position of the probe for every line in the picture.

- Acoustic coupling between probe and issue is erratic, especially when a water bath is not used.

The result is that the pictures are difficult to interpret and reproduce, he says. This is especially disadvantageous in examination of the brain.

He proposes as a solution a two-dimensional scanning technique without moving probe. His approach draws upon the array techniques of radar and sonar, in which many small elements are used instead of a large single element. Somer's elements are individually steerable, so that he has found it possible to generate ultrasound pulses in arbitrary directions within a sector.

The array consists of 21 elements, each 0.5 by 10 mm, arranged side by side to form a strip 11 by 10 mm (see Fig. 2). The elements resonate at 1.3 MHz.

Each element is fed by its own local oscillator, which is gated on and off by a monostable multivibra-

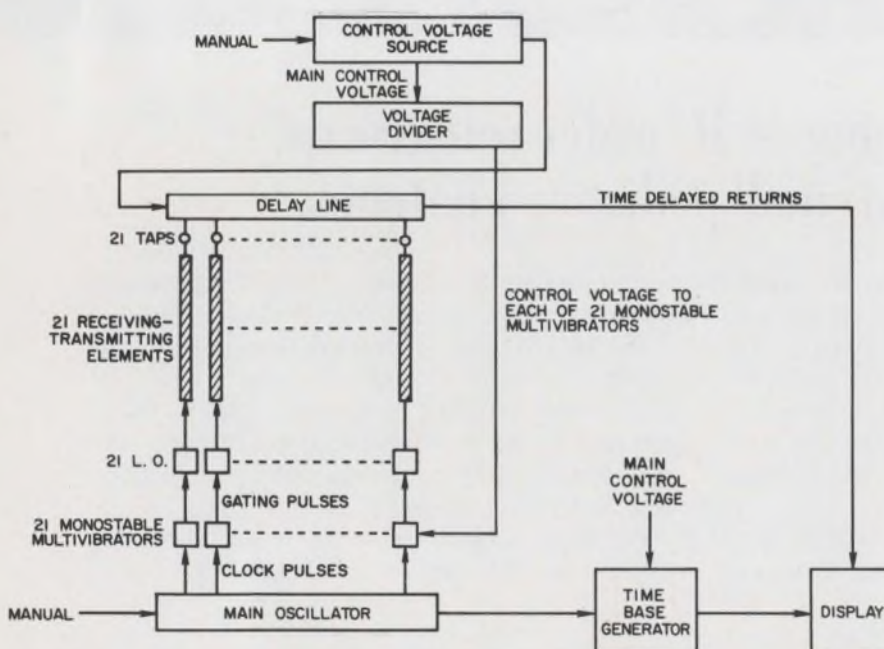

2. Electronic sector scanning is used to give two-dimensional image of tissue. Steerable array of transducer elements gives directionality.

New **ALSiBASE[®]** COMPOSITE SUBSTRATES

PROGRESS REPORT

ALSiBase Composite Substrates bury metal patterns in a monolithic high-alumina ceramic and provide ready access from any level to any other level. Planes can be stacked one on top of the other with each plane hermetically sealed. This gives far greater concentration in the same surface area since conductors can be very short or can cross over and under each other without destroying electrical integrity.

Advantages include:

- Circuit space savings.
- Device areas can be closer together.
- Short electrical paths are faster and have less resistance.
- Conductors may cross over and under each other.
- External wiring minimized.
- Provisions for discrete devices can be incorporated in design.
- Interconnections wherever desired.
- Maximum reliability and stability.
- Excellent heat dissipation
- Any number of levels or planes of tungsten or molybdenum metallized patterns.
- Fine line precision metal patterns as narrow as 4 mils on 8 mil centers can converge about the chip area.
- Line resistance down to 10 milliohms per square or better is often possible.
- Each plane separated by HIGH alumina ceramic.
- Thickness of insulating planes can be from .002" to .030".
- Each plane hermetically sealed.
- Provision for hermetic sealing of device areas or entire unit with mechanically sealed pins or leads.
- Ability to plate exposed metallized areas to facilitate chip attachment, wire bonding and hermetic sealing.

Prototype production is available. Designers are invited to explore with our Engineers the possibilities of Composites for their requirements.

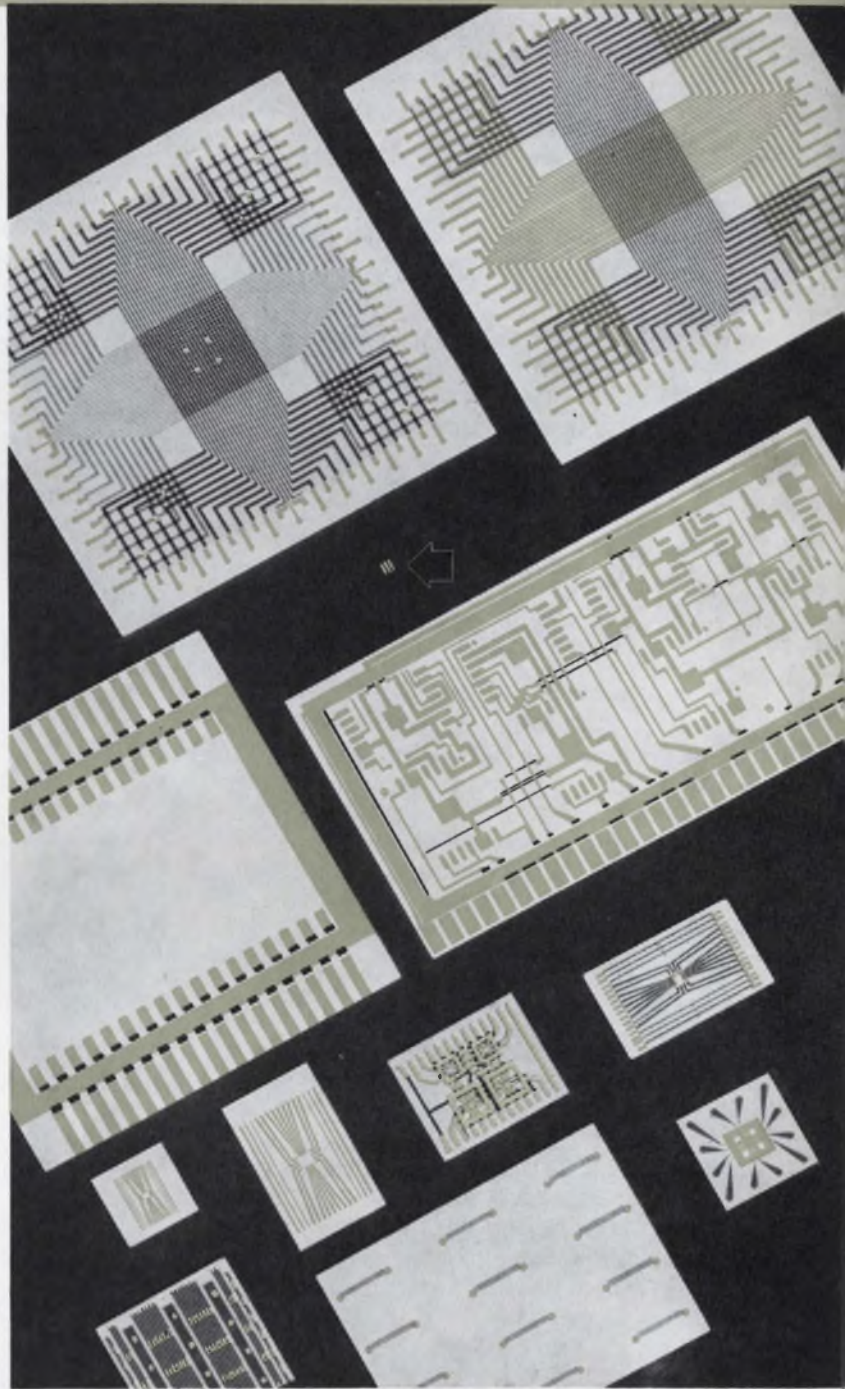

Illustrations about actual size.

CODE IDENT. NO. 70371

PHONE 615 265-3411, CHATTANOOGA, TENN. 37405

American Lava Corporation **3M**
A SUBSIDIARY OF COMPANY

66th
YEAR
OF
CERAMIC
LEADERSHIP

For service, contact American Lava representatives in Offices of Minnesota Mining and Manufacturing Company in these cities (see your local telephone directory): Boston: Needham Heights, Massachusetts • Chicago: Glen Ellyn, Illinois • Cleveland, Ohio • Dallas, Texas • Laurens, S. C. • Los Angeles, Calif. • Metropolitan New York: Ridgely, N. J. • Up-State New York and Canada: Baldwinsville, N. Y. • Orange, Conn. • Philadelphia, Penna. • Roanoke, Virginia • St. Louis: Lee's Summit, Missouri • So. San Francisco, Cal. • Troy, Mich. • 3M International: c/o American Lava Corp., Chattanooga, Tenn. 37405, U.S.A., 615/265-3411

NEW! Modular Integrated Circuit Digital-Analog Converters

Visit Us — WESCON
Booth Nos. 2209-2210

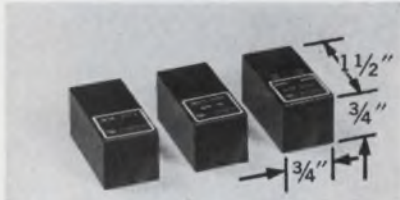

D/A/D Series is a group of compatible integrated circuit modules for Digital-to-Analog and Analog-to-Digital Conversion Systems. MODEL RM—2734 is a Jam Transfer Storage Register for up to 12 bits. On strobe command it will accept and store numbers. MODEL RSN—2698 is a Switching Resistor Network and Reference Source. It can be switched by micrologic input levels and provides output binary weighted currents to a summing point. MODEL AM—2612 is a Combination of Two Operational Amplifiers with Feedback Networks for converting currents from RSN—2698 to output voltages. The use of operational amplifiers provides a variety of output ranges at low impedance.



MODEL DAC-10_{ic} shown above is one of the many configurations in which the D/A/D Series Modules can be combined. It accepts 10 bit strobed parallel binary input in 1 microsecond slew time.

MODEL DAC-12_{ic} accepts 6, 7, 8, 9, 10, 11 or 12 bit strobed parallel binary inputs.

PASTORIZA
ELECTRONICS, INC.

385 Elliot St., Newton Upper Falls, Mass. 02134
(617) 332-2131

ON READER-SERVICE CARD CIRCLE 26

NEWS

(ultrasonics, *continued*)

tor. All 21 multivibrators are triggered simultaneously by a clock pulse from the main oscillator. The output pulse of each multivibrator can be varied individually by means of a control voltage. Somer derives the control voltages from a voltage divider which routes individual voltages from a voltage source to the 21 multivibrators.

The control voltages set the pulse widths of the multivibrators. Since the local oscillators are gated on when the multivibrator pulses end, the pulse width determines the phase of the corresponding element. The voltage-dividing action in effect controls the direction of the sound

beam. The array has a linear phase taper, and a sector is scanned by varying the main control voltage. The time intervals (hence phase differences) between the sonic pulses of adjacent elements are constant, but have different values for different directions.

The echoes are received by the 21 elements in the array, which are connected to taps of a delay network. This network consists of fixed and electrically variable delay lines that compensate for the time intervals with which a wave front arrives at the various elements. Therefore, the variable delay lines are controlled by the main control voltage. The echoes are received directionally in order to optimize angular resolution of the system.

The echoes are displayed at the
(*continued on p. 52*)

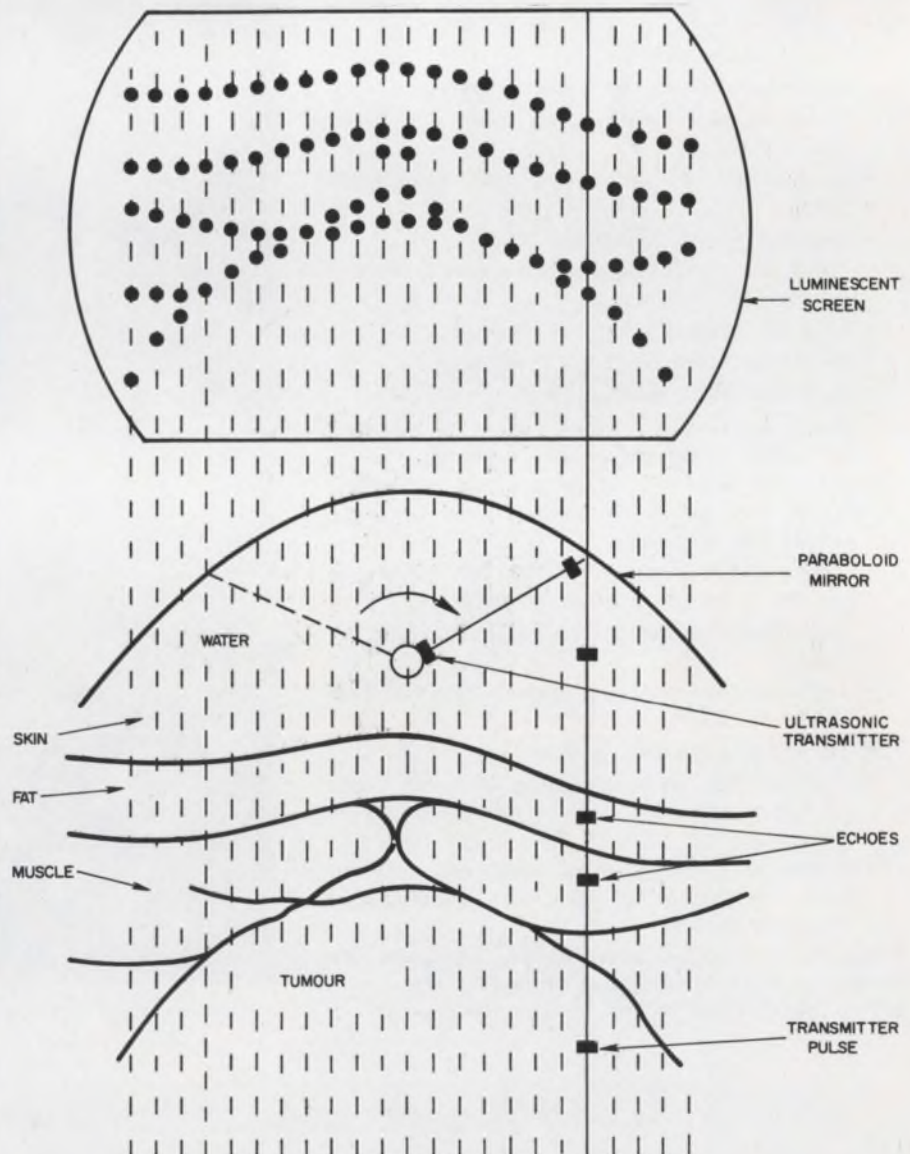

3. High-image-rate B-scanning is used for medical diagnosis. Ultrasonic scanning beam is displaced by rotation of directional transmitter.

Service beyond the call of duty

Those red and yellow ones at the left. They're for action, beyond the call of duty on a computer application. The little round one in the middle. Fighting at close quarters on a panel. The next two rows were on machine tools, office machines, guidance control and a few other items. We put the whole Licon® lighted switch story in a book. **It looks like this.**



Request your copy

**Join forces with LICON...
fastest growing full-line switch supplier**

i t LICON
DIVISION ILLINOIS TOOL WORKS INC.
6615 WEST IRVING PARK ROAD - CHICAGO, ILLINOIS 60634

'Remember, you're never more than a few feet away from a product of ITW' ®



ON READER-SERVICE CARD CIRCLE 27



Microwave Drive Power

Tung-Sol Electron Multiplier Tubes employ secondary emission multiplication to provide power suitable for driving microwave devices such as traveling wave tubes, lasers and hydrogen thyratrons. Operating from negligible input power, the tubes produce a positive or negative-going peak output pulse of up to 1000 volts at 4 amps. Output rise time is less than 10 nanoseconds. Total delay is under 20 nanoseconds. Write for complete information. Tung-Sol Division, Wagner Electric Corporation, One Summer Avenue, Newark, New Jersey 07104.

TYPICAL OPERATION	5-STAGE TYPES		2-STAGE TYPES
	8455	8428	DT1527A
Peak Pulse Output Voltage	1000v	600v	50v
Peak Pulse Output Current	4A	4A	1A
Peak Pulse Output Power	4.0kw	2.4kw	50w
Average Output Power	40w	24w	

TUNG-SOL®
ELECTRON MULTIPLIER TUBES

© REGISTERED TRADEMARK WAGNER ELECTRIC CORPORATION

ON READER-SERVICE CARD CIRCLE 28

ON READER-SERVICE CARD CIRCLE 29 >

Our I.C. digital modules reject more noise than anybody's.

Integrated flip-flops, inverters and buffer amplifiers in T Series modules are made to our proprietary design and hermetically sealed in TO-5 cans.

T Series input and load resistors, made to much tighter tolerances than can be attained with integrated components, are mounted outside the integrated circuit containers, eliminating power dissipation problems.

Full-width copper ground plane sandwiched between epoxy-glass boards minimizes circuit inductances and discourages noise spikes. Mounting cases also have full-width shield planes to retard noise coupling between logic wiring.

Discrete input diodes enable us to place the switching threshold right in the middle of the logic swing.

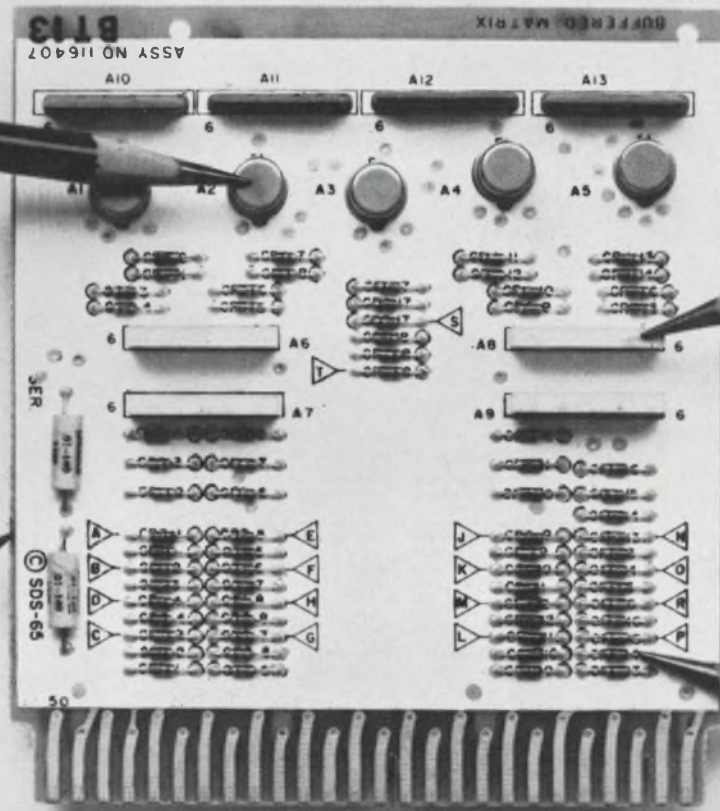

The payoff.

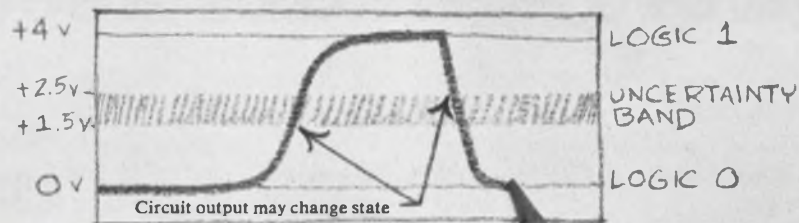

T Series logic levels are 0 and +4 volts, and noise rejection is 1.5 volts minimum, leaving a maximum uncertainty band only one volt wide within which noise can trigger the circuit output. This uncertainty band of 25% is far narrower than those of other I.C. modules on the market.

SDS
Scientific Data Systems,
Santa Monica, California

Back in 1964 we told you:

This is a super/reg™ synthesized zener diode.



**It enables you
to build a precision
power supply
in minutes using
any DC
power source.**

Typical super/reg zener impedances of 2 to 8 milliohms—lowest ever yet achieved—makes possible 01% regulation and 5mv ripple.

Voltage-adjustable as much as $\pm 10\%$, as small as a millivolt, with no derating or degradation. The "third terminal" lets you trim the output.

01% / C temperature compensation at high power levels; thermal stability 100-times greater than that of the standard zener.

Zener voltages from 5.6 to 56 V.

75 watts dissipation rating, 50% higher than any other available zeners.

Looks, mounts like any other diode. Standard TO-36 case.

Performance-proven reliability; patent-pending design. Suitable for MIL applications.

Write or call for complete data and application bulletin.

Semiconductor Division, Trio Laboratories, Inc., Dupont St., Plainview, L. I., N. Y.

(516) OVerbrook 1-0400

superreg

© 1964, TRIO LABORATORIES, INC. - PIONEERS IN BUILDING INSTRUMENTS AND CUSTOM POWER SUPPLIES

Now there are 104 super/reg® instant answers to your power regulator needs.

We figure if you've got something good, why stop there. Why not go ahead, expand the line, and give designers practically unlimited capability.

And that's what we've done — 104 times. No-body else comes close.

Super/regs come in shunt and series versions. Just connect rough DC from whatever source you have — semi-filtered, half-wave rectified transformer output, or even a battery — you get instant, precision DC power where you need it: at the load itself.

Super/reg precision miniature regulators are uniquely designed for maximum heat transfer and

power-handling capability. Ultra-compact configurations provide maximum flexibility over a wide range of voltage levels. Point-of-load installation eliminates distribution-line losses and cross-talk.

Write for complete data sheets and applications bulletins.

We've got 104. And if the mail is slow, we may have 105.

Trio Laboratories, Inc.,
Plainview, L. I., N. Y. 11803.
Tel: (516) 681-0400.

superreg®

New Ideas in Power Sources from

triolab®



Broad range of plug-in signal conditioners matched to the standard GPO galvos

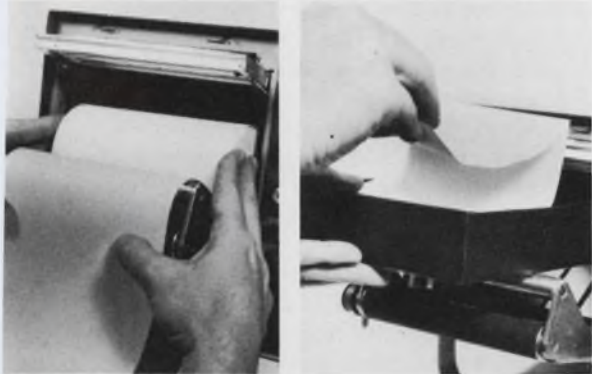

Use either roll or fanfold paper in the GPO



(Above) Front panel zero adjustments simplify operation. (Below) GPO is light in weight and easy to carry or store.

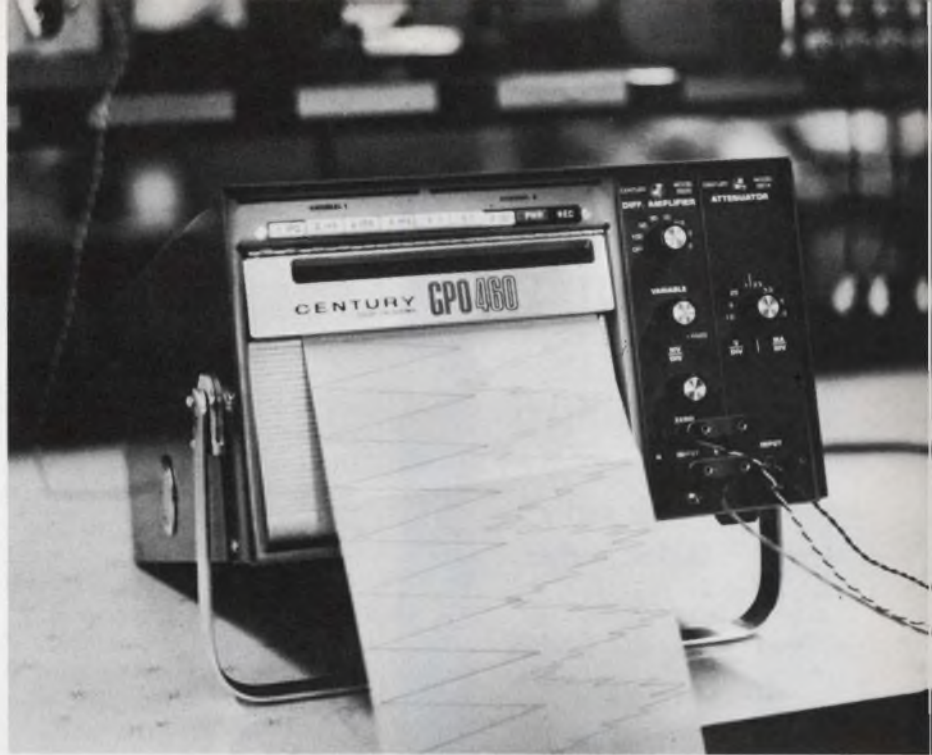
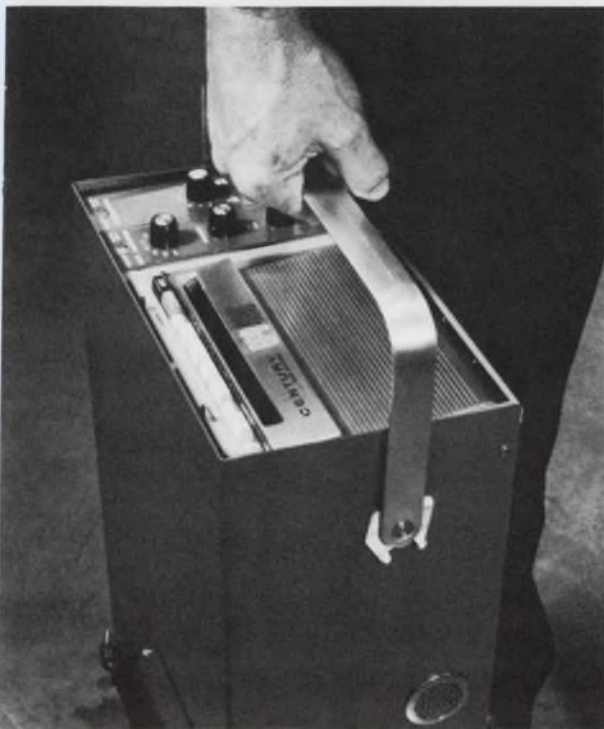

Now...less than \$1,000 buys a complete* light beam oscillograph recorder

We've just made design breakthroughs that have enabled us to cut oscillograph costs in half without sacrificing performance. The resulting new instrument is easier to operate, easier to set up, and easier to read than any previous oscillograph.

The new Century Model 460 GPO (general purpose oscillograph) is a two-channel light beam recorder that is competitive in price with high-quality pen-and-ink or hot stylus recorders... yet it will record high-frequency phenomena flat to 2000 Hz.

The GPO is expandable to six channels simply by adding an optional magnet and galvanometer assembly. Cost-per-channel goes down, of course, as the number of channels is increased.

Many design refinements — such as frontpanel zero adjustments and adaptability to fanfold paper — make the GPO more versatile and easier to use as well as more economical. High quality construction is assured since the unit is backed by one of the industry's leading manufacturers.

Get your free copy of the illustrated brochure which describes this revolutionary new oscillograph. Circle 248 on the Reader Service card... or write us direct!

*Complete with two galvanometers, two Model 567B signal conditioners, grid, and timing.

See the GPO at the Wescon Show. Booth number 3104A

CENTURY
ELECTRONICS & INSTRUMENTS, INC.
A SUBSIDIARY OF CENTURY GEOPHYSICAL CORPORATION
6540L East Apache Street • Tulsa, Oklahoma 74115
Phone: (918 TE 5-9951 • TWX 918-923-3407

YTTRIUM AND RARE EARTHS

High purity
oxides, metals,
salts

from the world's
largest
ion-exchange
facility

APPLICATIONS:

Phosphors
Electronic Ceramics
High Temperature
Refractories
Ceramic Control
Materials
Metallurgy
Coloring Agents
Permanent Magnets
Lasers
Catalysts
Glass, Lenses
Metal Halide Lamps

Like technical data on
any of the above oxides
or metals? Write, wire
or call us about your
specific interest.

**MICHIGAN
CHEMICAL
CORPORATION**



RARE EARTH SALES
2 North Riverside Plaza
Chicago, Illinois 60606
312-263-0580

Copyright 1987 by Michigan Chemical Corporation RE-67-1

ON READER-SERVICE CARD CIRCLE 32

NEWS

(ultrasonics, continued)

appropriate places on a cathode-ray tube. For synchronization purposes, the time base generator is under the control of both the main oscillator and the main control voltage. In the present design, the system scans 30 times a second. Each scan is constructed from 32 different beam directions within a 90 degree sector. Thus both instantaneous and continuous pictures are derived with a stationary transducer.

Somer says he has obtained good pictures of simple reflecting objects immersed in water. He points out that other scientists have recently reported useful diagnoses from mechanical sector scanning of the heart and brain. He predicts that by modifying his equipment to improve the beam shape and to suppress undesirable side lobes he should be able to get far better results with his electronic sector-scanning technique.

Tumors displayed ultrasonically

Two West German scientists at Stockholm report on another method of applying sonar principles to B-scan ultrasonic imaging to eliminate the time-consuming image buildup of conventional imaging. W. E. E. Krause and R. E. Soldner of Siemens AG, Erlangen, say that for the first time it is possible to display ultrasonic sections of the human body in short time intervals and in rapid sequence, so that it is possible to observe not only stationary conditions in real time, but also kinetic processes. They brought a photograph of an ultrasonic view of the abdomen of a woman suffering from a tumor. In the photograph the skin, fatty tissue, muscle and tumor stand out.⁴

Their method, too, takes advantage of the fact that sonic energy is reflected from each tissue interface through which the beam passes. The reflected echoes are converted into electrical pulses which are displayed on a cathode-ray tube as a brightness-modulated potential. The pulses form the image points of a vertical line on the screen that is traced in about 200 μ s. This interval

corresponds to a penetration of about 150 mm in soft tissue. The horizontal deflection of the electron beam is synchronized with the lateral displacement of the ultrasonic scanning beam and has a sweep time of approximately 70 ms. The picture frequency is about 15 Hz, just high enough to give the illusion of a stationary image.

About 140 vertical lines are traced for each image. The cross section is about 14 cm wide by 13 cm long. Rapid lateral parallel displacement of the ultrasonic scanning beam is achieved by means of a rotating ultrasonic directional beam transmitter in conjunction with ultrasonic mirror optics. As shown in Fig. 3, the transmitter is positioned in the focal path of a cylindrical paraboloid mirror. The transmitted sonic energy is reflected as a beam that is displaced laterally in a parallel manner. The echoes follow the same path, but in the opposite direction. The transmitter and the mirror are immersed in a water bath. The vessel containing the water is sealed by means of a plastic foil; the patient is coupled acoustically to this foil by a thin film of oil.

Krause and Soldner say that with this method it is possible to determine the position of the embryo and placenta in the uterus, the size of the infant's head and the presence of twins at an early stage. They estimate that the output has a mean ultrasonic power density of 10 mW/cm², a safe figure.

Three reports concern the use of Doppler-shifted ultrasound. One is on the measurement of blood pressure, another on the condition of blood vessels and a third on the location of clear scanning paths. ■ ■

References:

1. F. L. Thurstone, "Three-Dimensional Imaging by Ultrasound Holography," *Digest of 7th International Conference of Medical and Biological Engineering*, (Stockholm, Sweden: Organizing Committee of 7th ICMBE, 1967), p. 313. (Copies are available from Almqvist & Wilksell, 25 Gamla Brogatan, Stockholm 1, for 95 kronor.)
2. Benson Carlin, *Ultrasonics* (2nd ed.; New York: McGraw-Hill Book Co., 1960), p. 9.
3. J. C. Somer, "Electronic Sector Scanning for Ultrasonic Diagnosis," *Digest 7th ICBME*, p. 314.
4. W. E. E. Krause and R. E. Soldner, "Ultrasonic Imaging Technique (B-Scan) with High Image Rate for Medical Diagnosis," *Digest 7th ICBME*, p. 315.

ON READER-SERVICE CARD CIRCLE 33 ►

STOP BEING REJECTED

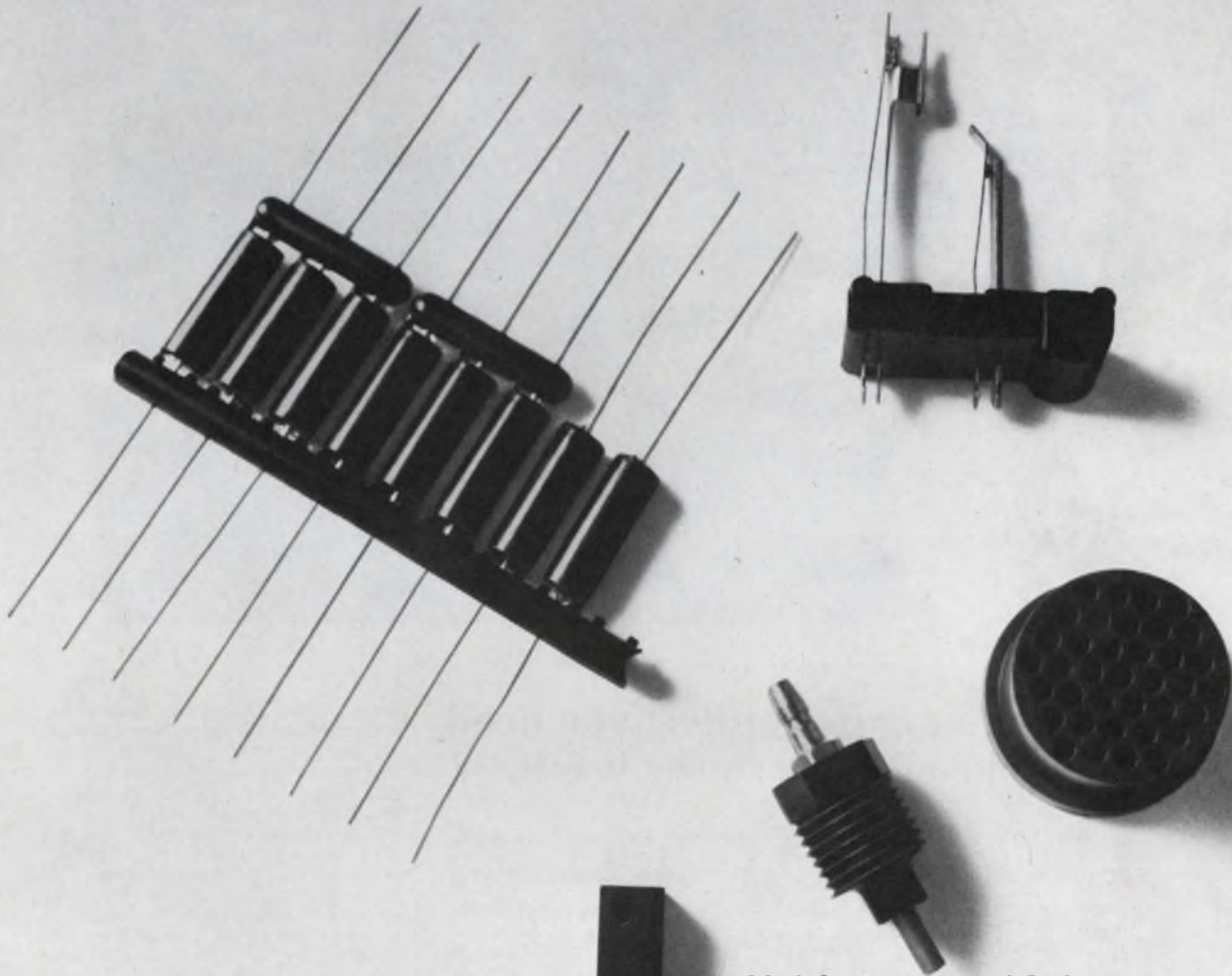

Achieve zero defects.

Use Plaskon® Epoxy molding compounds.

And minimize outgassing problems, even on the toughest, most exacting molding job.

Since system and component applications of epoxies operate in heat environments, outgassing is a critical factor. Outgassing can cause deposits to build up, which in turn cause failures.

Plaskon Epoxy molding compounds overcome this. Make your molding runs easy. Simple. Sure. So call Allied. Stop those rejects.

And here's something else of interest. We also carry a complete line of thermosets: Plaskon, Diall® DAP, alkyd, and amino molding compounds. One of them is sure to have the technical specs that makes it right for your job.

Mail the coupon and find out.

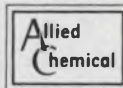

Allied Chemical, Plastic Division
Post Office Box 365, Morristown, N. J. 07960

Gentlemen:

Please send me complete information on Plaskon Epoxy Molding Compounds. I would also like technical data on the following thermoset molding compounds.

Diall DAP

Plaskon Alkyds

Plaskon Amino Compounds

Name _____

Title _____

Company _____

Street _____

City _____ State _____ Zip _____

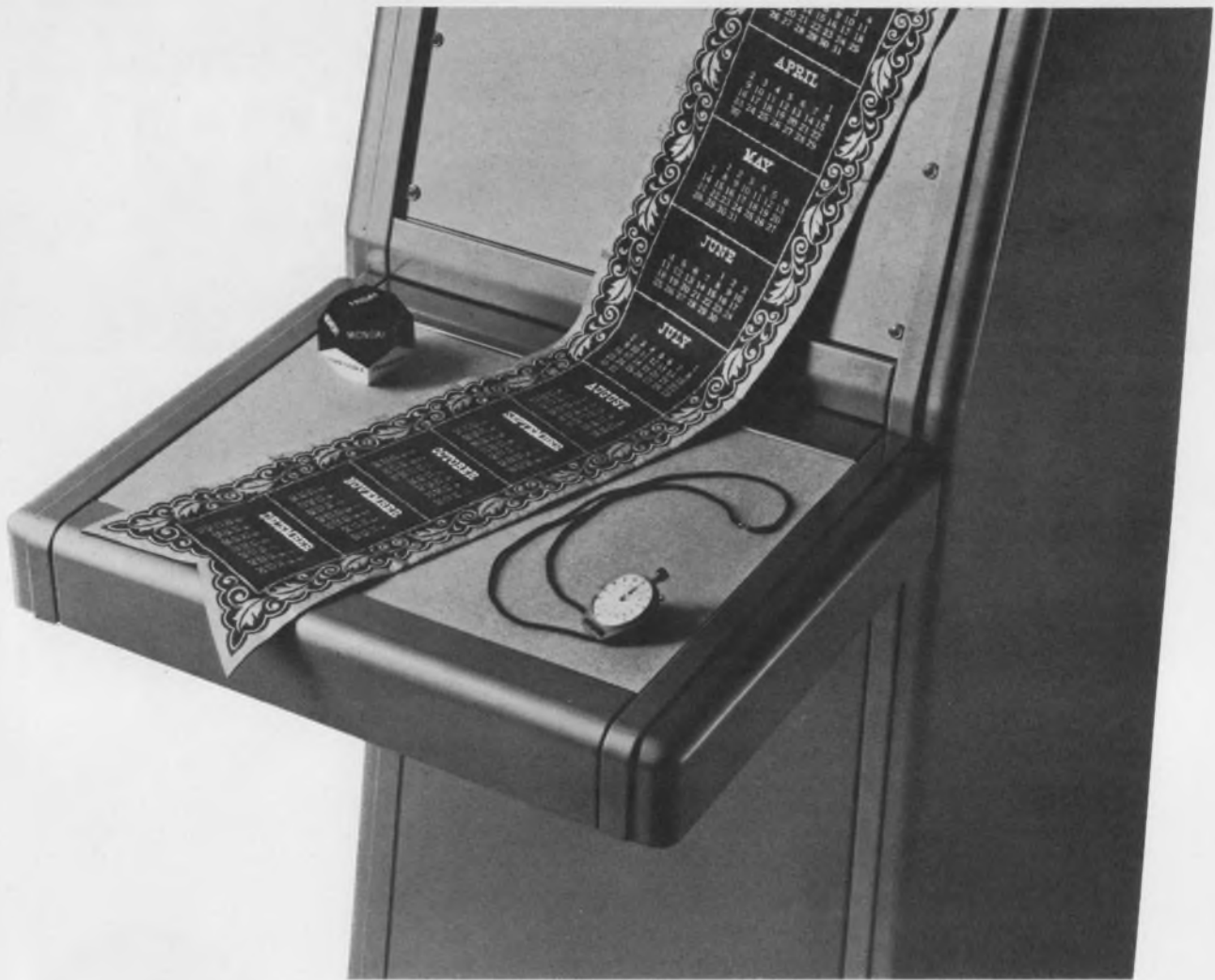

At whatever stage of your project you need a cabinet, your most reliable choice is EMCOR®

When you start designing your system, it's also the right time to think EMCOR cabinetry. Think how beautiful and precise the final package will look—and plan ahead.

But if time becomes vital, let EMCOR watch the clock for you. We've stepped-up production facilities to the

point where we can meet time deadlines head-on, and give you the same superb cabinetry in very short order.

If you have time to plan ahead and order early, great. If you need quick service, just ask us at EMCOR. Or call your local EMCOR Sales and Service Engineer listed on the right.

Albany: 436-9649; Albuquerque: 265-7766; Alexandria: 836-1800; Atlanta: 939-1674; Baltimore: 727-1999; Binghamton: 723-9661; Bridgeport: 368-4582; Chicago: 676-1100; Cleveland: 442-8080; Dallas: 631-7450; Dayton: 298-7573; Del Mar: 454-2191; Denver: 934-5505; Detroit: 357-3700; Fort Lauderdale: 564-8000; Ft. Lee (No. N.J.): 944-1600; Ft. Walton Beach: 243-6424; Houston: 526-2959; Huntsville: 539-6884; Indianapolis: 356-4249; Kansas City: 444-9494; Los Angeles: 938-2073; Minneapolis: 545-4481; Newport News: 245-8272; N.Y.C. area: 695-0082; Orlando: 425-5505; Palo Alto: 968-8304; Philadelphia: 242-0150; Pittsburgh: 884-5515; Phoenix: 273-1673; Rochester, N. Y.: 473-2115; St. Louis: 647-4350; Seattle (Bellevue): 454-5224; Syracuse: 471-7274; Tulsa: 742-4657; Utica: 732-3775; Valley Forge (So. N. J.): 265-5800; Wilmington, Mass.: 944-3930; Winston-Salem: 725-5384.
EMCOR Reg. U. S. Pat. Off.

EMCOR/distinguished cabinetry

Ingersoll Products 1025 West 120th St., Chicago, Illinois 60643

DIVISION OF BORG-WARNER CORPORATION

**electronic
equipment**



ON READER-SERVICE CARD CIRCLE 34

ELECTRONIC DESIGN 17, August 16, 1967



First full-range*
DC Voltage Calibrator
with .01% accuracy for under \$1000—

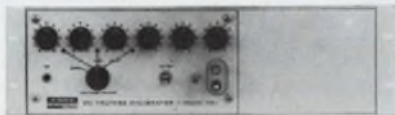

Cohu's new Model 324!

*Output voltage ranges: 10-V Range: 0 to 11.11110 volts (10 μ V steps)
 100-V Range: 0 to 111.1110 volts (100 μ V steps)
 1000-V Range: 0 to 1111.110 volts (1 mV steps)

Output current capability: 0 to 25 milliamperes nominal at any voltage setting.

Accuracy: 0.01% of setting.

Stability: Within 30 PPM for 24 hours, 50 PPM for 30 days.

Dimensions: Cabinet: 10½" W x 5¼" H x 15½" D.
 Rackmount: 19" W x 5¼" H x 15½" D.

Price: Cabinet (324): \$995. Rackmount (324R): \$1050.
 F.O.B. San Diego. Additional export charge.

Delivery: Immediate, from stock.

For full details, contact your Cohu engineering representative.

Cohu is looking for design engineers (in this area) with a degree. If you are interested, write to Chief Engineer J. L. Kimball in San Diego.



Box 623
 San Diego, California 92112
 Phone: 714-277-6700 See us at Wescon, Booth 3001.

ON READER-SERVICE CARD CIRCLE 35

Plugged. Down,

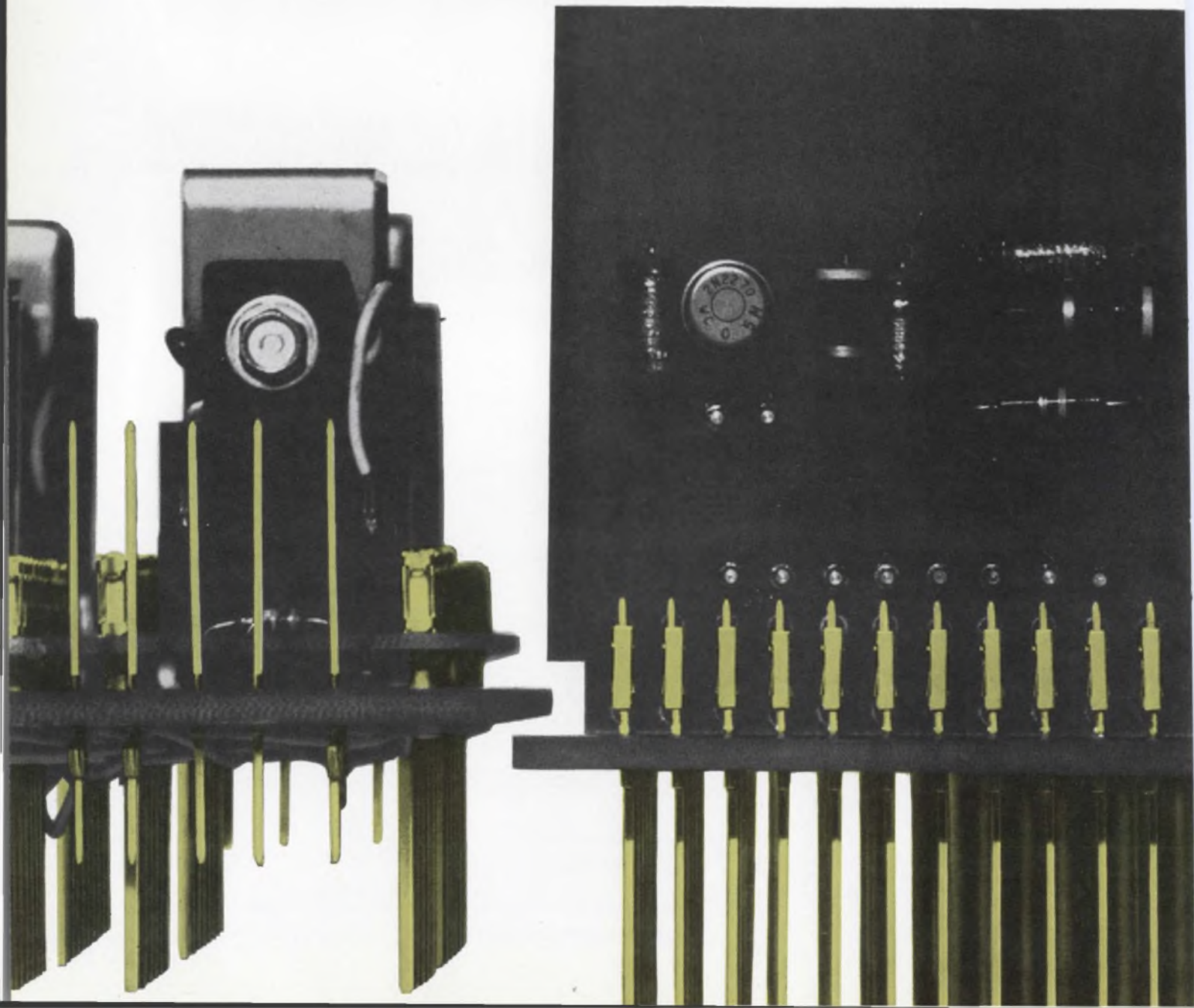

up or sideways.

Stake AMPMODU* posts to P. C. boards. Solder or wire by automation. Mount receptacles in any position, vertical or horizontal, even in a housing or crimped to a wire. Plug modules together. Test. Examine. Replug. Utter simplicity. For computers, TV, electronic organs, military electronics, industrial controls—any side up—anywhere circuit modules need stacking.

*Trademark of AMP Incorporated

PUT YOUR IDEAS INTO ACTION WITH THE HELP OF AMP ENGINEERING... WORLDWIDE.

AMP

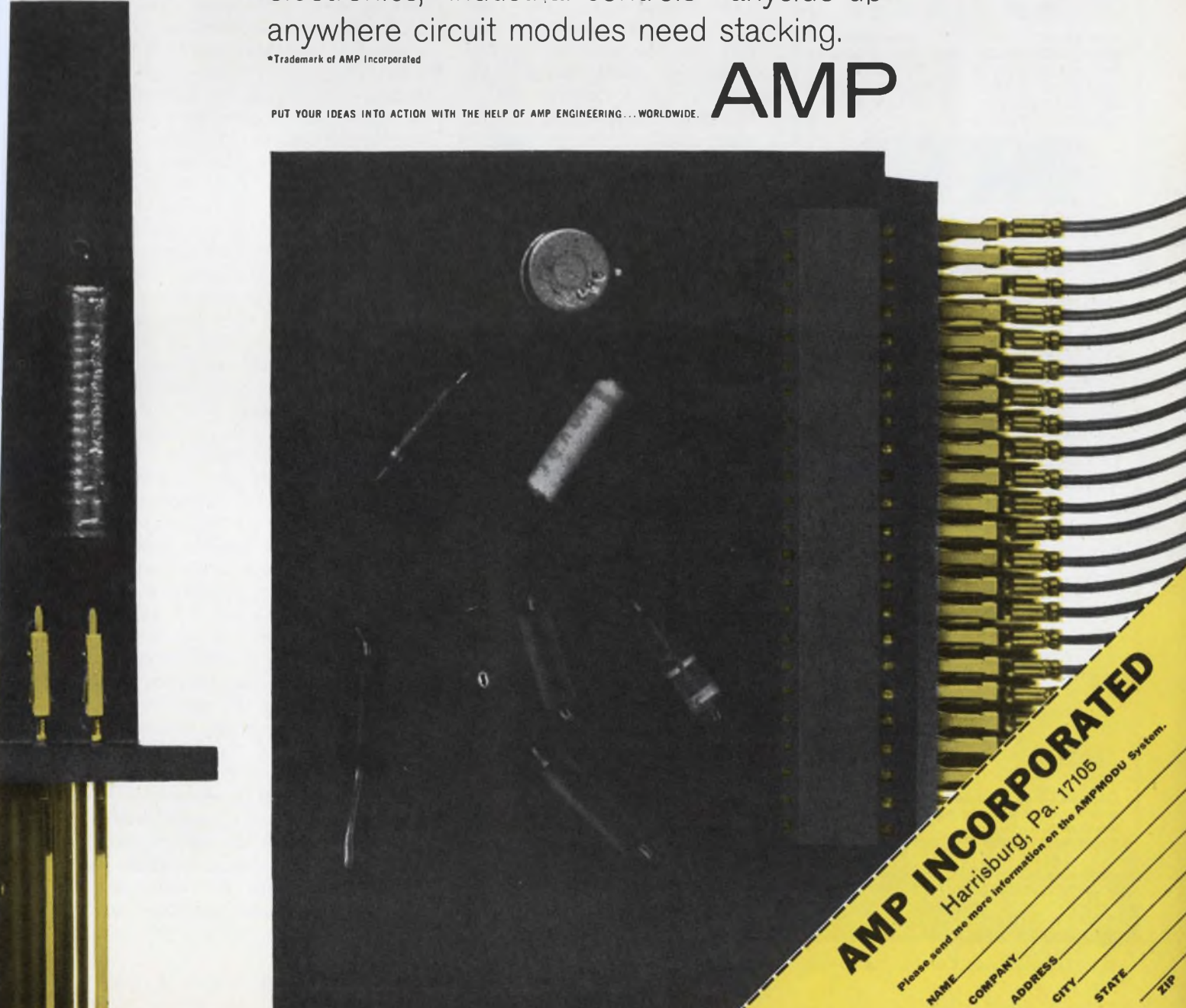

AMP INCORPORATED
Harrisburg, Pa. 17105

Please send me more information on the AMPMODU System.

NAME _____
COMPANY _____
ADDRESS _____
CITY _____
STATE _____
ZIP _____

STANDARD FREQUENCY RECEIVERS

FREQUENCY STANDARDIZATION TO THE
NATIONAL BUREAU OF STANDARDS



Model T-60 60 KHZ Time Code Receiver
Round The Clock WWVB 60 KHZ Binary Time
Code Broadcasts • Most Accurate Time Signal
Available • Can Be Recorded Continuously

Radio Station WWVB is broadcasting complete
time information using a level shift carrier
time code (10 db level changes). This code,
which is binary coded decimal (BCD) is
broadcast continuously and is synchronized
with the 60 khz carrier signal. \$480.00

Model T-60A Rack Model (3½" H x 19" W x 5" D)



Model SR-60 Price: \$850.00
Model SR-60. WWVB-60 khz. Will calibrate
any local standard up to $5 \cdot 10^{10}$ within a
short period. Can be easily operated by any
technician and performs in any part of the
Continental United States.



Model SFD-6R Modular Construction:
A complete system for distribution of stand-
ard frequency throughout a plant. All solid
State—fail safe—reasonably priced. Price
depends upon Modules selected (\$90.00
each). Several Modules available.



Model WVTR Mark II All Silicon Transistor
Five different models of Receivers for WWV
and WWVH are available. They receive all
frequencies transmitted by WWV and are
all crystal controlled double conversion
superheterodynes. \$590.00

Special Antenna Assemblies for
both VLF and HF are in stock.

Model WWVT \$590.00

Mark II
All Silicon Transistor
Over All Size
7¼" x 9½" x 5"
Approx. Weight
7 lbs.



Model 45 \$98.50
A pocket size battery
powered Time
Base Calibrator,
complete with in-
ternal battery.

Send for complete specifications. Prices and speci-
fications subject to change without notice. F.O.B.
Woodland Hills, Calif.

SPECIFIC PRODUCTS

P. O. Box 425 / 21051 Costanzo Street
Woodland Hills, California
Area Code: 213 340-3131



Quartz disk detects powerful microwaves

A virtually burnout-proof quartz disk able to rectify and mix higher-power microwave signals than conventional semiconductor diodes has been developed in a U.S. Air Force laboratory.

Two scientists in the Microwave Physics Laboratory of the Air Force Cambridge Research Laboratories, Bedford, Mass., demonstrated that a 0.1-mm-thick (0.004 inch) quartz disk has a burnout rating more than three times higher than a crystal diode.

The developers, Dr. Paul H. Carr and Andrew J. Slobodnik, Jr., have used the disk to absorb more than 30 ergs of input energy. The 1-watt input signal was square-wave modulated. The disk, mounted in a tunable resonant cavity, has a diameter of about 1/4 inch.

The piezoelectric quartz disk has a practical application in monitoring the performance of transmitters, according to Dr. Carr. He said that considerable attention must be given to handling and using diodes to prevent their burning out. Burnout is likely to occur when input power is about a tenth of a watt. He added, however, that the sensitivity of the quartz disk is much less than that of a diode.

The researchers evolved the technique during studies of the nonlinear microwave acoustic properties of dielectrics such as quartz. They

found that the output frequency depends on the disk surface quality and, if it is too rough, there will be no acoustic resonance.

In their experimental setup a quartz disk with a resonant frequency of about 29 MHz was located in a 3-GHz tunable reentrant cavity. Dr. Carr said that a dc voltage is produced across the disk by the radiation pressure or Maxwell-Faraday stress, nonlinearities in the material coefficients, and thermal effects.

The modulation envelope of the voltage across the disk, he says, is capacitively coupled to the two insulated halves of the cavity. Voltage is measured across these electrodes.

In order to obtain the largest rectified voltage, Dr. Carr said that the optically polished X-cut disks must be excited at an overtone acoustic resonance frequency. This, he said, occurs when the microwave frequency is an odd multiple of the fundamental acoustic frequency of the disk. He says that this property may be of use in microwave frequency-control applications.

The scientist said that the sensitivity of the disk is measurable in millivolts for each watt of input power. He predicted that 1 volt dc would be obtained if the input signal had a 1000-watt peak with a 2-microsecond duration, assuming a duty cycle of about 0.001.

Both researchers have also demonstrated that the piezoelectric disks permit mixing higher-power microwave energy than is possible with diodes. When a disk is used in a reentrant cavity excited by two separate microwave sources, an intermediate frequency is obtainable. Dr. Carr said that maximum output is observed when the difference in the frequencies of the two sources equals the fundamental frequency of the quartz disk. The bandwidth obtained when the disk with the 29-MHz fundamental frequency was used varied between 10 and 40 kHz. Dr. Carr said that the mixers may be of use in high-power radar systems, to eliminate the elaborate switches and attenuators used at present. ■ ■

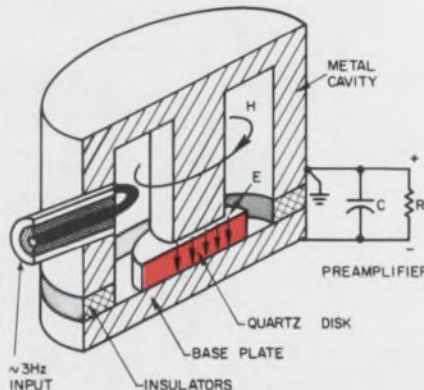

Thin quartz disk is microwave rectifier in Air Force experiment. Modulated signal is introduced into reentrant cavity and dc output appears across disk. It can withstand higher rf power than semiconductor diodes.

Audio to 100 MHz FILTERS

✓ **Active**
✓ **Passive**

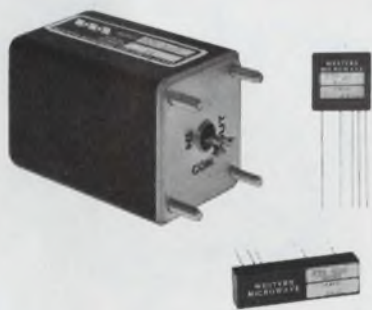

Here's the **complete** answer to your Filter problems!
Our **total filter capability** means one source for all of your filter needs.

Operational Filters are NEW; the most versatile, easiest-to-use active filter modules ever produced. Low Pass, High Pass, Band Pass (Q's to 500) and $j\omega$ Axis zeroes . . . all available from 100 Hz to 20 KHz.

Our new line of Active and Passive Telemetry Filters give you advantages you can't find anywhere else.

Active IRIG Channel and VCO Filters are the smallest in the industry; less than 0.5 cubic inches!

Passive Telemetry Filters maintain the highest standards obtainable, yet are the most economical you can find.



Write or phone for complete information.

Western Microwave Laboratories Inc.

1045 DiGiulio Avenue/Santa Clara, California 95050/(408) 241-6302/TWX 910-338-0032

Come see these units and get our Brochures and Applications Notes at Wescon Booth 3418.

ON READER-SERVICE CARD CIRCLE 38

keeping new ideas
for electrical energy moving

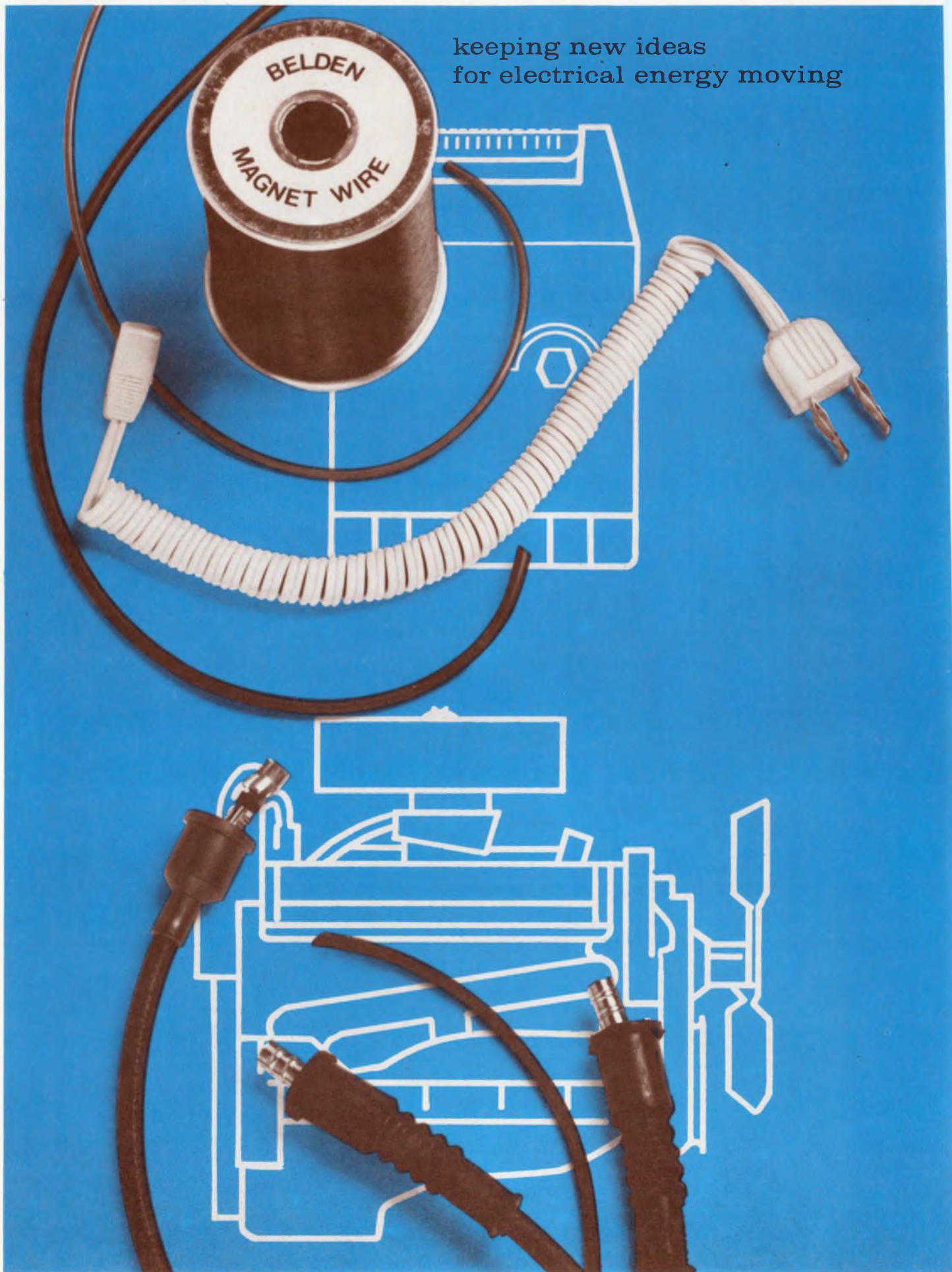

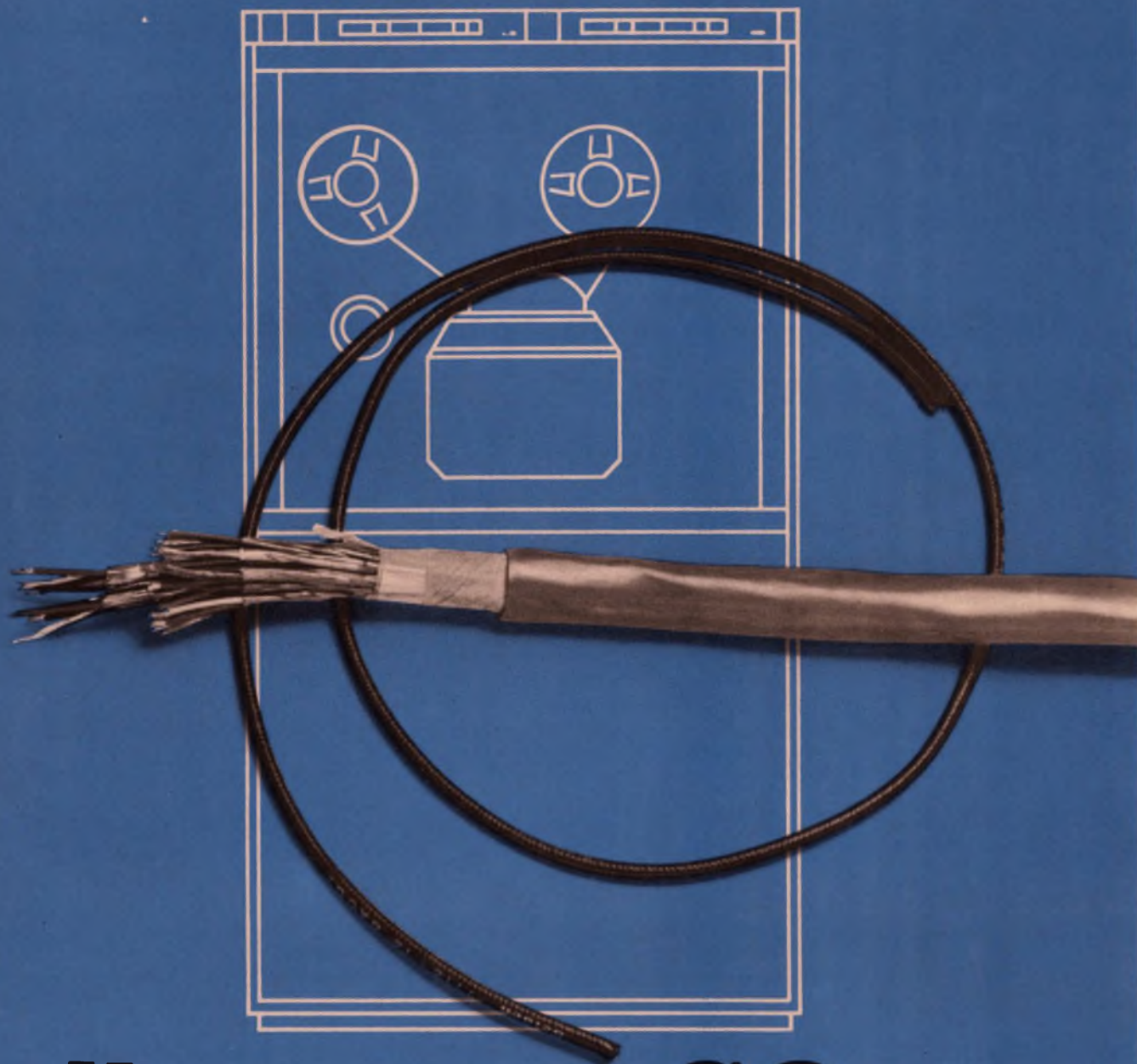

all systems GO

...when a Belden team of wire specialists shows you their dozen or so ways to wring out hidden values and costs. For example you can delve into design..maneuver with materials.. analyze assembly..pry into processing..pick different packaging..or a host of others. But success takes a supplier who is really perceptive—one who makes all kinds of wire for all kinds of systems. Want to join us in wringing out values and costs? Just call us in...Belden Manufacturing Company, P.O. Box 5070-A, Chicago, Illinois 60680.

Belden

ON READER-SERVICE CARD CIRCLE 39

Sweep 500 HZ to 25 MHZ.

One Unit Covers Audio-Video Range

The VS-20 solid state sweep signal generator can be centered at any frequency between 500 HZ and 25 MHZ and can sweep anywhere within this range. The sweep width is continuously adjustable from 500 HZ to 25 MHZ. It is also provided with a CW output mode. RF output is at least 1.0v rms into a 50 ohm load. Flatness is ± 0.25 db at maximum sweep width. Four sweep rate modes are provided: variable from 5 HZ to 60 HZ, 50/60 HZ line rate, manual sweep and external. Options available are a calibrated variable marker which covers the complete frequency range of the unit and the option of changing sweep rate range to 0.1 HZ to 10 HZ. Price: \$995.00.



Specialists In Electronic Instrumentation

Texscan
CORPORATION
tc
51 Koweba Lane
Indianapolis, Indiana 46207
Ph. (317) 632-7351

ON READER-SERVICE CARD CIRCLE 40

NEWS

Reading machine spells out aloud to the blind at 80 words a minute

A research version of a machine that can read aloud to a blind person from an ordinary printed page has been implemented by three scientists at the Massachusetts Institute of Technology. They predict that, when perfected, the reading machine will give the blind access to almost everything in a library, including newspapers and periodicals, instead of only Braille and talking books.

The device discriminates individual characters and spells them out at an average speed of approximately 80 words a minute, according to D. E. Troxel, F. F. Lee and S. J. Mason of MIT's Research Laboratory of Electronics. This rate is said to be comparable to that of Braille reading.

The system includes a document handler, a flying-spot opaque scanner, a special-purpose digital system known as a scanner controller, a data link to a medium-sized general-purpose digital computer, displays with which a sighted person can make adjustments of focus and threshold, and an audio system.

An oscilloscope, which has deflection voltages supplied by the scanner controller, serves as the light source for the opaque scanner. A dot of light from the cathode-ray tube is beamed onto the paper by a single lens, and the diffuse, reflected light is collected by two photomultiplier tubes. The beam is gated on and off when it is desired to interrogate the material. The absence of signal from the photomultiplier tubes indicates that a particular spot on the page, as specified by the

oscilloscope deflection voltages, is blank.

Once the machine has been initially adjusted, the blind person begins to "read." Under computer command the material is scanned, and the base and mid lines of a line of text are established as a reference for character discrimination. Next, the first letter of text is acquired, its contour is traced and a list of edgepoint coordinates is fed to the computer. Then the quadrants in which the character lies are mapped. Finally the computer, using both the height with respect to the mid and base lines and the horizontal extent of the contour, searches a code table, which is a summary of the machine's previous training.

The immediate applications of the reading machine program, which was supported by the National Institutes of Health, Bethesda, Md., are:

- Development of character-recognition algorithms.
- Determination of methods to enable the blind person to make his own adjustments.
- Investigation of alternative output formats, such as Braille or synthesized speech.

Prof. Troxel says he and his colleagues are devising algorithms that will enable the machine to read more than one type font, and perhaps even typewritten material. In tests, the machine typically performs at better than 99.5% accuracy. It is an improvement on the PRM-1, an earlier MIT reading machine for the blind. ■ ■



MIT reading machine for the blind has flying-spot scanner (left) that uses oscilloscope as light source. It reads type aloud, one letter at a time.

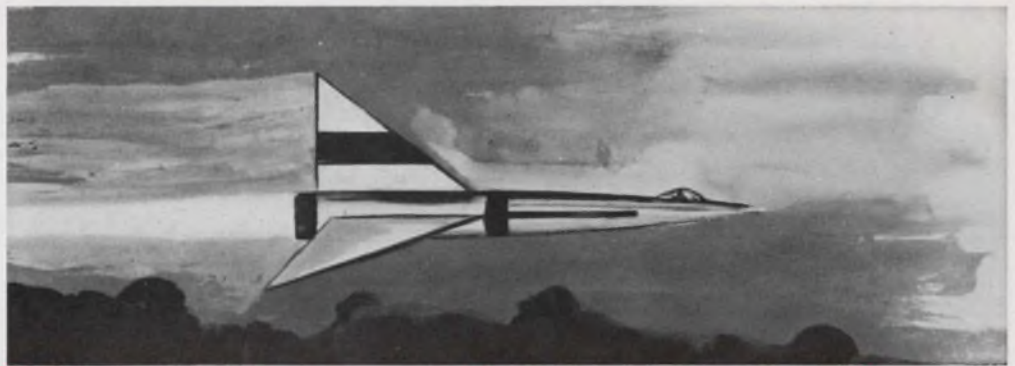
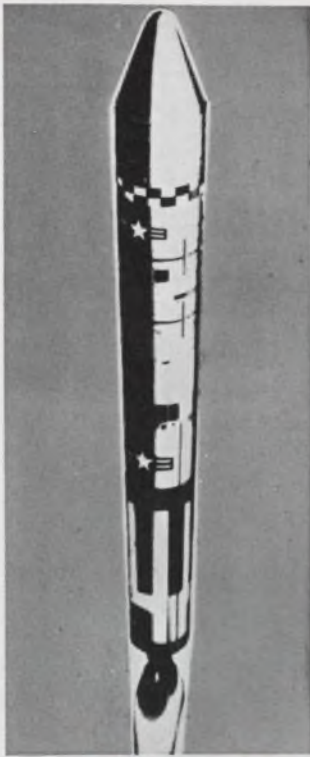

In any environment...

U.S.C.

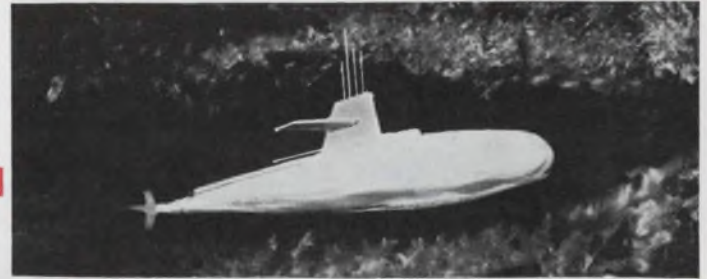

**ULTRAMINIATURE AND SUB-MINIATURE CONNECTORS
MAKE POSSIBLE HIGH DENSITY OF CIRCUITS IN LESS SPACE**

From the depths of the sea (Polaris) to the outermost reaches of space (Apollo), **U.S.C. Ultra Miniature and Sub-Miniature** connectors deliver reliability and versatility above and beyond the call of duty.

One of the reasons is the versatile U.S.C. standard and simulated closed-entry female contact that's designed for continuous reliability. Its unique flange assures positive re-entrancy of the male connector pin on each insertion because the wider countersink on its upper end aids connector pin alignment. And U.S.C. UMI and SMI four-slotted contact design minimizes any possibility of distortion, holds float between contact and molded body to .005 in. maximum in any direction, when mated.

Also available: a fully proved military version of our closed entry contact type—the U.S.C. CSMI and CUMI connector series; and RUMI, a new closed entry crimp removable contact type that offers full interchangeability with our UMI.

Whatever your sub-miniature and ultra-miniature connector needs are, advanced U.S.C. automated and semi-automated production capabilities are geared to meet them from our stock of 3000 catalog types. If custom-adapting to your spec's is required, our engineers will be glad to assist you.

Write for U.S.C. SMI and UMI connector catalogs.

U.S.C. Established Reliability stands ready to serve you!

Actual Physical size
UMI-34 (approx. 3/4
that of SMI-34).

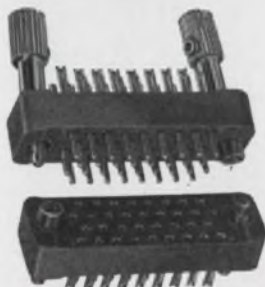

Actual Physical size
SMI-34



cross-section
4-slotted
flange
controlled entry
female contact
SMI
UMI

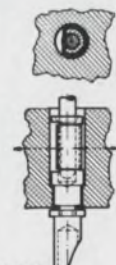

cross-section
closed
entry
female
contact
CSMI
CUMI

U.S. PAT. NOS. 2,761,108 & 3,030,602

U.S.C. Series
CONTACT SPACING
CURRENT RATING
NO. OF CONTACTS

VERSIONS

CONTACT DIA.

UMI	SMI
.093	.125
3 amps	7.5 amps
5, 7, 9,	5, 7, 11,
11, 14, 20	14, 20, 26
26, 29,	29, 34,
34, 44, 50	42, 50, 75
.030	.040



U. S. COMPONENTS, INC.
1320 ZEREGA AVENUE • BRONX, N.Y. 10462
or use TWX: 710-593-2141; TEL: 212-824-1600
TELEX: 01-2411; or Cable: COMPONENTS NYK.

VISIT US AT SAN FRANCISCO WESCON, BOOTH 5224

ON READER-SERVICE CARD CIRCLE 41

IBM. Circuit Design and Packaging Topics

General Radio relies on IBM reed switches

Suppression circuits extend reed switch life

General Radio relies on IBM reed switches

General Radio Company, West Concord, Mass., maker of test instruments, demands the best for their customers knowing that they can't tolerate equipment failure that will interrupt inspection or production routines.

That's why IBM reed switches go into General Radio's instruments.

General Radio uses reed switches in test instruments because they offer lower contact resistance than transistors, are smaller and more reliable than conventional relays.



General Radio confirms through its own vendor-component evaluation program that IBM reed switches show zero failures after 25 million operations.

GR's Service Department claims they can't afford anything less since tests prove that the IBM switch "just keeps on going."

As a result, General Radio relies on IBM reeds in nine varieties of instruments, including the GR 1680-A Automatic Capacitance Measuring Assembly, the 1770 Scanner Systems and four different models of Coherent Decade Frequency Synthesizers.

Suppression circuits extend reed switch life

The miniature dry reed switch possesses characteristics which make it applicable to an extremely wide range of low power switching applications.

The reed offers rapid response, low actuate power, small size and a contaminant-free, adjustment-free contact arrangement. All of this provides the switching circuit designer with a highly adaptable device for modern, low-power, high density applications.

However, the construction of the miniature reed, with its small air gap and low-release spring force, makes it more susceptible to failure from contact degradation than any previous common contact switching device. Ac-

cordingly, special precautions must be taken when applying the miniature reed switch.

IBM conducts a continuing study to learn as much as possible about the reasons for contact degradation. Once we know why, we can take steps to prevent it—and, in some cases, prolong switch life by a factor of 10 or more.

What causes a reed switch to fail after 20-million cycles in one application yet continue to function after several hundred million cycles in another?

Failure in the reed switch can be caused by material transfer which occurs each time the contact makes or breaks current. This material transfer, plus any magnetic particles caused by wear, form a mound in the contact area. The mound eventually causes failure by increasing the contact resistance or bridging the air gap.

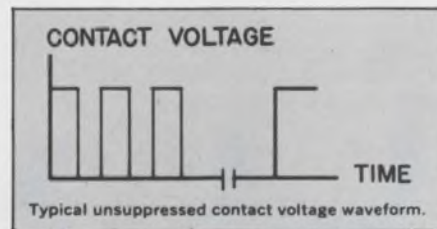

Bridge transfer occurs whenever two current-carrying conductors start to separate. The cross section of the contact point becomes increasingly smaller, giv-

ing rise to a constriction resistance that serves to heat the area. This heating effect first causes the metal to melt forming a bridge; then with further lever separation, to boil causing the bridge to rupture by vaporization.

fallacy to rely exclusively on volt-ampere ratings in estimating contact life. For any particular load condition, contact life can be considerably extended through the use of suppressive techniques.

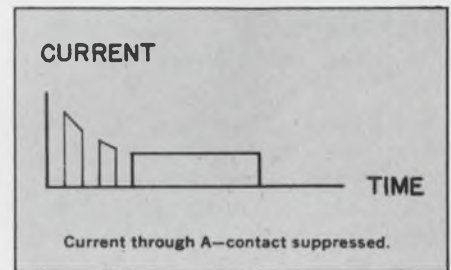
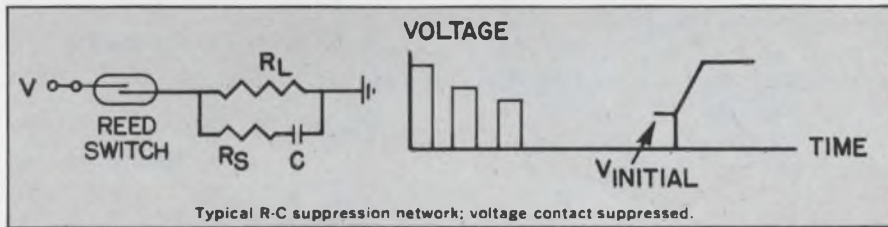

Another major process which causes material transfer in reed switches is arcing.

Arcing can occur both at the time the levers are first closing and at the time of the initial lever separation.

The arc on break is essentially the result of thermionic emission. It is caused by the heating of the levers, which in turn causes increasing constriction resistance at the time of lever separation.

The arc on make is caused solely by field emission and does not necessarily entail lever preheating. With open circuit voltages as low as 15 volts an arc can occur.

IBM studies to date indicate that major causes of contact degradation are a function of load conditions. It is a

On request, we will send you a detailed report on the design of typical R-C suppression circuits which can

maximize the life of your reed switches. Proper suppression techniques create new possibilities for circuit designers where speed, size and power are increasingly important.

Send in the coupon. IBM Industrial Products Marketing, 1000 Westchester Avenue, White Plains, New York 10604

**IBM Industrial Products Marketing Dept. T2
1000 Westchester Avenue
White Plains, New York 10604**

- IBM reed switch specifications
- Suppression circuits extend reed switch life

name _____
 position _____
 company _____
 address _____
 city _____ state _____ zip _____

IBM
INDUSTRIAL
PRODUCTS

Bidirectional counter is completely synchronous

Sir:

Most of Kay Smith's comments on my letter challenging his bidirectional-counter design ["Bidirectional counter said to have serious drawback," ED 10, May 10, 1967, pp. 46-50] are correct.

However, concerning the main point I made, i.e., the possibility of changing counting direction in a reversible counter regardless of the level at the *Advance* input if a synchronous scheme is adopted, Smith states that "a synchronous design would not solve the problem, and the only solution is to change directions while the *Advance* input is low."

It is true, as Smith writes, that I did not give any details concerning the carry from one decade to the next. The purpose of this letter is to fill this gap and to show that a synchronous design does indeed solve the problem.

Consider the reversible counter circuit below. This is essentially the same circuit printed and described in ED 10, pp. 46 and 50. Only slight modifications have been incorporated to obtain an inhibit input (*I*) to the decade. When this input is made high *all* the *J* and *K* inputs of *all* flip-flops go high, so that the decade

is inhibited.

Now the carry function is taken as:

$$carry = F \cdot Q_1 \cdot Q_4 + R \cdot Q_1 \cdot Q_2 \cdot Q_3 \cdot Q_4$$

This uses the opposite convention to that of Smith's original article ["IC bidirectional counters cost less," ED 2, Jan. 18, 1967, pp. 58-63], i.e., high = logic 1 and low = logic 0.

In a complete reversible counter made of several decades, the carry from each decade must be connected to the inhibit input of the next. All decades, and hence all flip-flops, have a common *Advance* input, so that the counter is completely synchronous.

Clearly, with this scheme, changing the counting direction does not affect any of the flip-flops, whatever the level at the *Advance* input.

Thinking about it, I should have been smarter: had I submitted the above solution as an "Idea for Design," I might have gotten twenty bucks out of it

S. Iannazzo

Applications Dept.
S.G.S. Fairchild
Milan, Italy

(ELECTRONIC DESIGN is pleased to send Mr. S. Iannazzo a check for

\$20.00 for what indeed would have been a fine Idea for Design.—Ed.)

The last word . . .

Sir:

It looks like Iannazzo has finally come up with a decent design, five months after my original design was published ["IC bidirectional counters cost less," ED 2, Jan. 18, 1967, pp. 58-63]. Iannazzo's second design is indeed synchronous. Of course, the price paid for a synchronous design is increased cost, since more logic is required compared with my original design.

I would also like to note that Iannazzo apparently has inadvertently omitted to synthesize the carry function. Also, his carry function should be:

$$carry = F \cdot a \cdot d + R \cdot a \cdot b \cdot c \cdot d$$

instead of:

$$carry = F \cdot Q_1 \cdot Q_4 + R \cdot Q_1 \cdot Q_2 \cdot Q_3 \cdot Q_4$$

Kay D. Smith

Sr. Design Engineer
General Instrument Corp.
Salt Lake City, Utah

(Letters continued on p. 70)

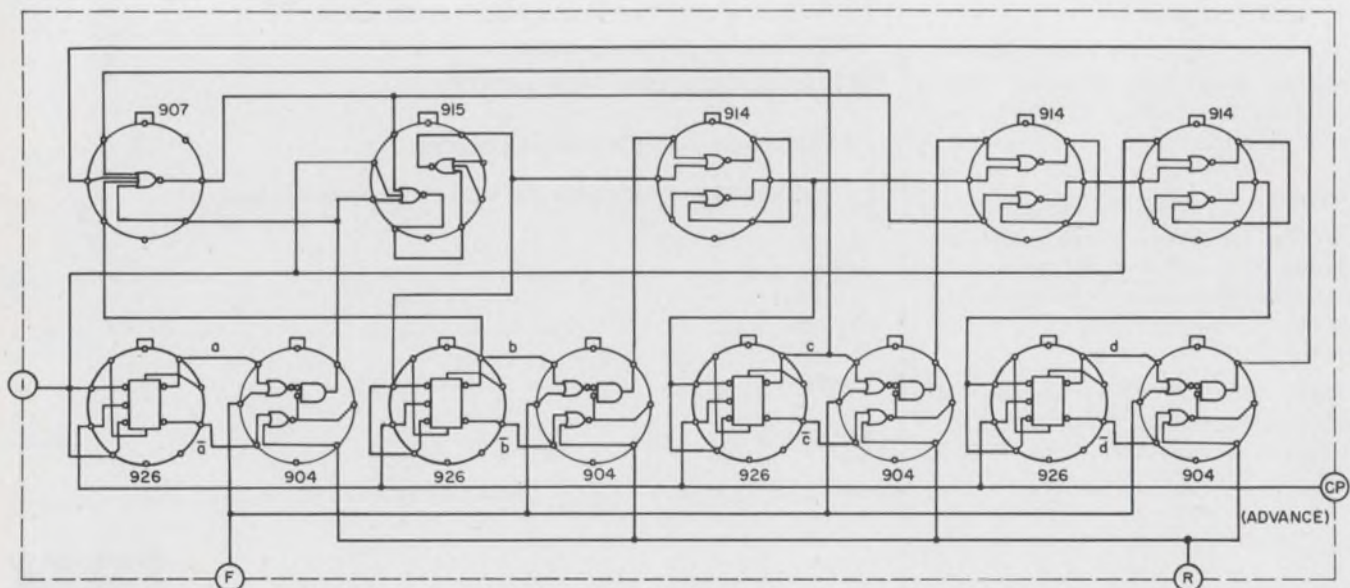

FORWARD: F HIGH; R LOW
BACKWARD: F LOW; R HIGH

Synchronous 1-2-4-8 decimal counter changes counting direction accurately regardless of Advance input level.

1.34 x 10⁵ COMBINATIONS

(ONE OF THEM HAS GOT TO WORK FOR YOU.)

When we say our Trim Trio has enormous application potential, we're not kidding. The combination of numbers surprised us too. For any of our three types of contacts—sub-min coax, machined or continuous formed strip—will work in any of nine connector blocks (14 to 152 positions). In any combination.

And if you wanted to count wire sizes, or figure the twisted pairs our sub-min coax can

accommodate, or leave some contact holes open, the possibilities would truly be endless. Probably most of them haven't been used yet. Surely some of them will

solve your problems.

And Burndy can make your installation problems easier, too. Whether you crimp one at a time on a hand tool or 3,000 per hour with a Hyfematic™ you can count on built-in quality control, save time and money. For the full story and details on the combination that will work for you—from breadboard to production—write for our Bulletin MS67.

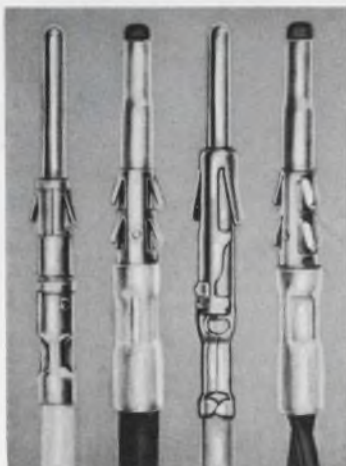

Machined Sub-min Coax Strip Hyfen Twisted Pair

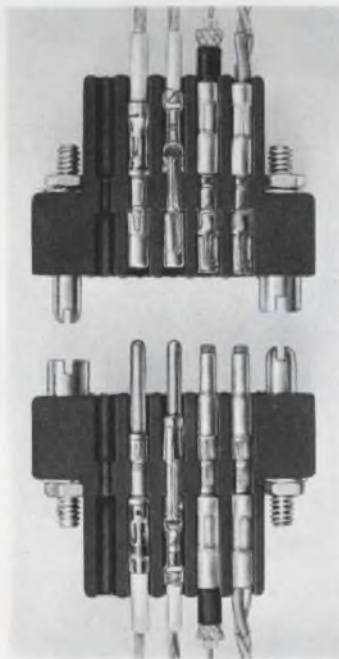

See more at
WESCON Booths 5344-6

 **BURNDY**
NORWALK, CONNECTICUT

INTERNATIONAL SALES HEADQUARTERS AND MANUFACTURING FACILITIES:
CANADA: Scarborough, Ontario / ENGLAND: St. Helens, Lancs. / BELGIUM: Mechelen / MEXICO: Naucalpan de Juarez
BRAZIL: Sao Paulo / JAPAN: Tokyo / Sales Offices in Other Major Cities



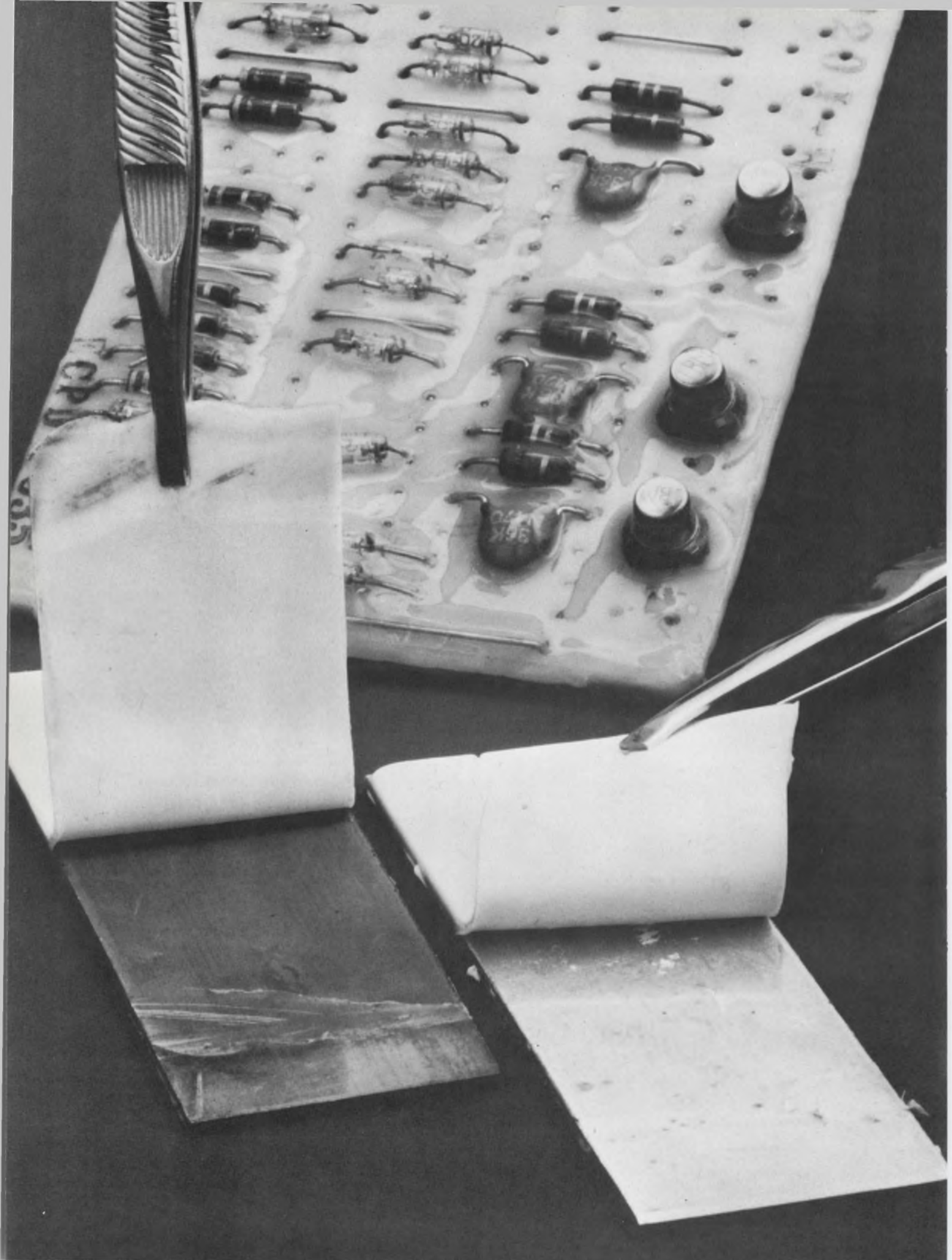

New, noncorrosive one-part RTV... tough silicone protection

Dow Corning® 3140 RTV coating and 3145 RTV adhesive/sealant are designed to be used in corrosion-sensitive equipment without harm to delicate electronic circuits and components.

Both are products of new silicone technology.

Dow Corning 3140 RTV coating is ideal for conformal protection of printed circuits . . . encapsulation of circuits, components and connectors. It is tough, translucent, self-leveling. Clarity of the coating allows easy visual inspection, identification, and faulty component removal. Repairs in the coating are easily made without loss of dielectric integrity.

Dow Corning 3145 RTV adhesive/sealant has high cured strength . . . is opaque, nonflowing . . . withstands long term exposure to temperature of 250 C — to 300 C for short periods. This *tough* material is excellent for bonding wires and terminals, mounting resistors, sealing electronic enclosures and providing a flexible adhesive for glass, ceramics, plastics and silicone rubber.

Dow Corning leads the way in making materials for the job you have at hand. For complete information on Dow Corning 3140 RTV coating and Dow Corning 3145 RTV adhesive/sealant, write Dept. 3921, Electronic Products Division, Dow Corning Corporation, Midland, Michigan 48640.

DOW CORNING

We're a materials producer exclusively. Let us tailor a material to your need.

No.



You cannot pull the cable out of our Micon Emlock[®] connectors.

No tricks. Our claim is that it is impossible to pull the cable out of one of our Emlock[®] compression fit, miniature connectors. Disengagement will be caused only by failure of the braid, not pullout of the compression. We believe this extraordinary capability beats crimped type connectors all hollow. Yes, and competitive compression types, too.

Prove it to yourself. Have one of our Technical Representatives call on you. He'll attach any one of our stock Emlock[®] connectors to a section of braided cable. Then, as he holds the connector body with a pliers, he'll hand you the chain nose, and you pull! The assembly will break away,

of course. He will then disassemble the connector and show you that there is still enough wire trapped to prove that Emlock[®] compression held and the braid failed!

Here's your chance to gain a new concept in miniature connector reliability. Remember, only Emlock[®] connectors offer this basic capability and only we have Emlock[®].

Write for the name of our Technical Representative in your territory. He'll phone for an appointment and give you a chance to prove it to yourself. *While you are about it, why don't you ask for Bulletin MMC, Issue 1 describing the complete line of Emlock[®] connectors?*

Micon is now a part of

PHELPS DODGE ELECTRONIC PRODUCTS
NORTH HAVEN, CONNECTICUT



ON READER-SERVICE CARD CIRCLE 45

LETTERS

(continued from p. 66)

How about publishing technical 'classics'?

Sir:

I read your editorial "It isn't the retrieval, it's what you retrieve" [ED 14, July 5, 1967, p. 59] with much interest, particularly because it hits very close to one of my pet peeves. How many times does the engineer reach into his file for information on a particular subject and come out with not one, but a half dozen articles on the subject, none of which is comprehensive in itself? The engineer must search out a little information from each of them for a complete picture.

I would like to invite ELECTRONIC DESIGN to sponsor a new series of articles, "classics" if you wish, on the subject they treat. Let each article be compiled from all known information about a particular subject and updated when the need arises to include information gathered from comments from readers. By "updated when the need arises," I don't mean simply publishing an addendum or "Accuracy is our policy" type of thing. I mean republishing the entire article, so that the engineer can throw everything else he has on the subject away, confident that the article is the best in existence on the subject.

The subject treated need not be revolutionary to be useful—just having all the information on a subject published in a handy form is sufficient reason for publication and would be a welcome aid in information retrieval. As an example, consider the article published in the November, 1964, issue of *EEE* by Mr. Geffe on the subject of resistive attenuators. This is one of the few articles in recent years that I consider a classic in its field. I do not know of anything of usefulness to add to Mr. Geffe's article. When I need a resistive attenuator, this is my sole source of reference. Unfortunately, it is one of the few subjects on which I am able to use a single reference.

Trade journals have advantages undreamed of by the textbook writer in publishing this type of information. Foremost among these is

(continued on p. 74)



Let's make waves!

EiD's Function Generator makes any wave you want a permanent wave.

As a general-purpose signal source, it's designed to make quite a splash: you get sinusoidal, square and triangular waveforms — simultaneously. Frequency is continuously variable from 0.005 Hz to 1 MHz in eight ranges. And you get dc offset controls.

Now, for a few interesting ripples. Selectable, 30-volt output, with continuously-variable level. (How's that for flexibility?) All outputs short-circuit proof. An output sync pulse is provided for precise triggering. Frequency can be externally voltage-controlled over a very linear 20/1 frequency range.

A few more. All silicon, solid-state. Compact. Rugged. Versatile. Easy to operate.

And finally: the price won't curl your hair. Comb your local EiD Sales Representative for all the facts... or write direct to our nearest regional office, listed at right.



EiD more than measures up.



INSTRUMENTS, INC.
ELECTRONIC INSTRUMENTS
DIVISION

2400 Harbor Blvd., Fullerton, Calif. 92634,
(213) 691-0841

7360 N. Lincoln Ave., Lincolnwood, Ill.
60646, (312) 583-1020

12051 Tech Rd., Montgomery Ind. Park,
Silver Spring, Md. 20904, (301) 622-2500

International Subsidiaries: Geneva;
Munich; Glenrothes, Scotland; Tokyo; Paris;
Capetown; London; Mexico City

ON READER-SERVICE CARD CIRCLE 46

DYNAMIC DUO!

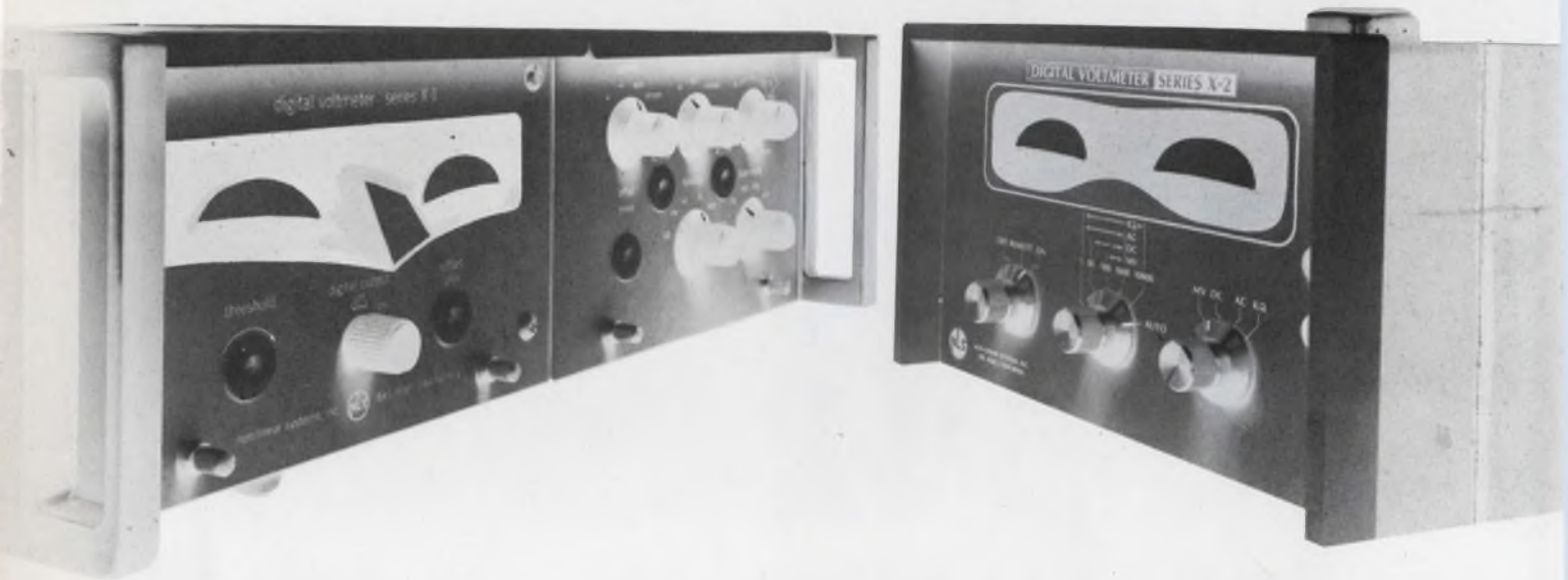

- X-2:** *Holy Accuracy, X-1, how do you do it? . . .*
- X-1:** Fear not, X-2, if you don't become a college dropout, you too, can achieve .005% Accuracy.
- X-2:** *You were designed to compete with those \$4,000 voltmeters, but I've got IC's.*
- X-1:** When I was in school, X-2, those IC's were costly and unavailable; however, with all your IC's, you can't give 23 millisecond readings!
- X-2:** *Well, X-1, I haven't had my logic courses yet. Can you integrate?*
- X-1:** I don't need to integrate, X-2, because I have an Active Filter that saves customers (who think they need a 5-digit integrator) \$1,700.
- X-2:** *You got me there, X-1, but if the customers don't need your .005% accuracy and high speed for \$2,450, they can buy me for \$980, and I'm half rack size too!*
- X-1:** Naturally, you're half rack size because you don't have Scan Counter, Range Memory, Range Hysteresis, Range and Polarity memory logic, and my Exclusive Threshold control.
- X-2:** *Holy features, X-1! Those other DVM's must be overpriced!*
- X-1:** We must not cast moral judgments on the integrity of our competition, X-2.
- X-2:** *You're such a good teacher, X-1 . . .*
- X-1:** Remember, X-2, that together, that is, you at \$980, and me at \$2,450, can conquer 80% of the requirements in DVM city.
- X-2:** *What do you think that joker is up to?*
- X-1:** It looks like he's trying to be a VTVM.

X-1 Check 237 Reader Service Card

X-2 Check 238 Reader Service Card



NON-LINEAR SYSTEMS, INC.
DEL MAR, CALIFORNIA 92014
[714] 755-1134/TWX: 910-322-1132

The Joker Replaces all (VTVM's)



NLS Introduces (X-3), a solid-state integrated circuit DVM (VTVM) with lots of tricks for \$695.00.

DC Volts:

10 mv to 10K v
.1% \pm 1 digit
100 Megohm input
impedance, entire range
10 Microvolts resolution

AC Volts:

200 Millivolts to 300 volts
10 Millivolts resolution
3% Accuracy
20 Hz to 500 MHz
10 Megohms Input
Impedance

Resistance:

10 Ohms to 2000 Megohms
.1% \pm 1 digit to 200K

Current:

10 Nano Amps to
200 Milliamps
.1% \pm 1 digit

It's No Joke . . .

LOOK AT THESE EXTRA TRICKS

100% Over-range Digit
Over-load Indicator
Over-load Protection
Automatic Polarity
Display Storage
High CMR
Unique Low, Medium, and
High Range Selector

Check 239 Reader Service Card

Yes, the Joker wins out. All these tricks for \$695 (including probes) . . . but wait, there's many more especially the one behind that ?.

See what's behind the ? at Booths 2808, 2809, 2810 and 2811, WESCON, or contact



Originator of the Digital Voltmeter

NON-LINEAR SYSTEMS, INC.
DEL MAR, CALIFORNIA 92014
[714] 755-1134/TWX: 910-322-1132

New from Dearborn!



FUZ-ION* Sealed Tubular Construction Sets New Size Standards for Metallized Polycarbonate-Film Capacitors

SMALL, LIGHTWEIGHT

Heat shrinkable plastic case construction reduces weight. Super-thin dielectric permits dramatic reductions in size. Volume efficiency as high as .04 cu. in./ μ F.

UNIQUE VAPOR SEAL

Plastic case is "Fuz-ion Sealed" to epoxy ends, ensuring maximum seal efficiency. Case is nonconductive, fungus-proof, corrosion-proof, humidity-resistant.

*Trademark

OUTSTANDING PERFORMANCE

Designed for -55 C to $+125\text{ C}$ operation. Superior operational reliability. High insulation resistance. Low dissipation factor. Low temperature coefficient. Excellent resistance to shock and vibration.

A-C AND D-C APPLICATIONS

Style LP88 Capacitors meet not only the most exacting d-c requirements, but are also ideally suited for a-c and r-f applications.

For complete technical information, write to Dearborn Electronics, Inc., Box 530, Orlando, Fla. 32802.

Dearborn Electronics, Inc.
(a subsidiary of the Sprague Electric Company)
FOREMOST IN FILM CAPACITORS

10-7100

ON READER-SERVICE CARD CIRCLE 49

LETTERS

(continued from p. 70)

thousands of critics to supply information for updating future editions of the article. In most cases, an article would have to "grow" from the contributions of the readers before it would truly become a classic in its field. It would even be desirable to publish a preliminary draft of the article for comments from the readers before final publication.

The responsibility for information retrieval belongs not only to the Federal Government, but also to readers, authors, and publishers. Will ELECTRONIC DESIGN do its part?

Vernon R. Cunningham
Design Engineer
Collins Radio Co.
Dallas

(Editor's Note: The sort of "classics" called for here would be nice to have, whether in trade-magazine or textbook format. Unfortunately there are few subjects narrow enough for such an approach to be feasible in a brief magazine article. We have published such articles, or series of articles, in ELECTRONIC DESIGN when the subject was appropriate. But many subjects require so much detailed discussion that books must serve as references. Nevertheless, we take our responsibility for clarity and completeness very seriously, and appreciate hearing from readers when we fall short.)

Accuracy is our policy

In "Make a filter out of an oscillator," ED 10, May 10, 1967, pp. 56-58, in the first paragraph after the first subhead, on p. 56, the sentence, "The transfer functions must have poles only on the negative real axis of the s plane," should be deleted.

In "Pulse oscillator puts out 35 kW," in the Microwaves listing of the Products section of ED 12, June 7, 1967, Applied Microwave Lab., Inc., points out that its device has an input power of -8.5 (not -85 , as printed) kV at 9 A (peak).

ELECTRONIC DESIGN 17, August 16, 1967



BETTER QUALITY AND RELIABILITY THROUGH CONTROL

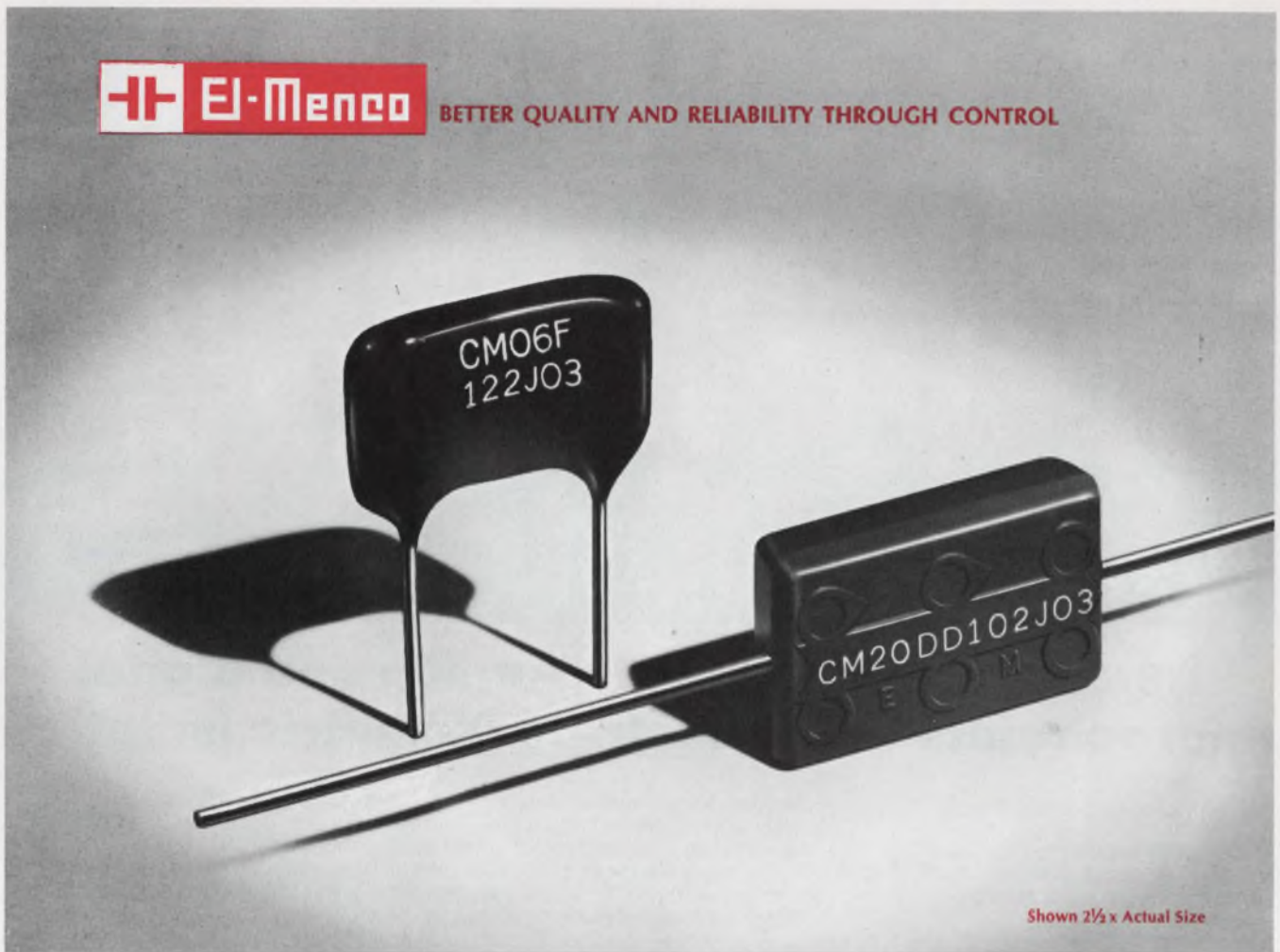

Capacitor Problems That Require A Lot Of Self-Control...Chemically Speaking

Problem 1: How to make sure the silver paste composition used for electrodes provides the best results for each electrical parameter in a given capacitor design?

Problem 2: How to improve the recognized moisture reliability of our dipped mica capacitors without adversely affecting life reliability?

Problem 3: How to upgrade the reliability of molded mica capacitors to equal that of dipped mica capacitors so designers can take advantage of body uniformity and axial lead design?

Solution: Chemical self-control! To do this we operate our own chemical manufacturing plant where we formulate silver pastes, phenolic dipping compounds, and epoxy molding compounds — all under strict controls.

Result: Dipped mica capacitors and molded mica capacitors of equally high reliability that operate up to 150°C. Send for technical literature and always insist on El-Menco brand capacitors . . . your assurance of better quality and reliability through control.

THE ELECTRO MOTIVE MFG. CO., INC.

WILLIMANTIC, CONNECTICUT 06226

Dipped Mica • Molded Mica • Silvered Mica Films • Mica Trimmers & Padders
Mylar-Paper Dipped • Paper Dipped • Mylar Dipped • Tubular Paper

Exclusive Supplier to Jobbers and Distributors
in the U. S. and Canada:
ARCO ELECTRONICS, INC., Community Drive.
Great Neck, L. I., New York

West Coast Manufacturers contact:
COLLINS & HYDE CO., 900 N. San Antonio Rd.,
Los Altos, California 94022
5380 Whittier Blvd., Los Angeles, California.

ON READER-SERVICE CARD CIRCLE 50

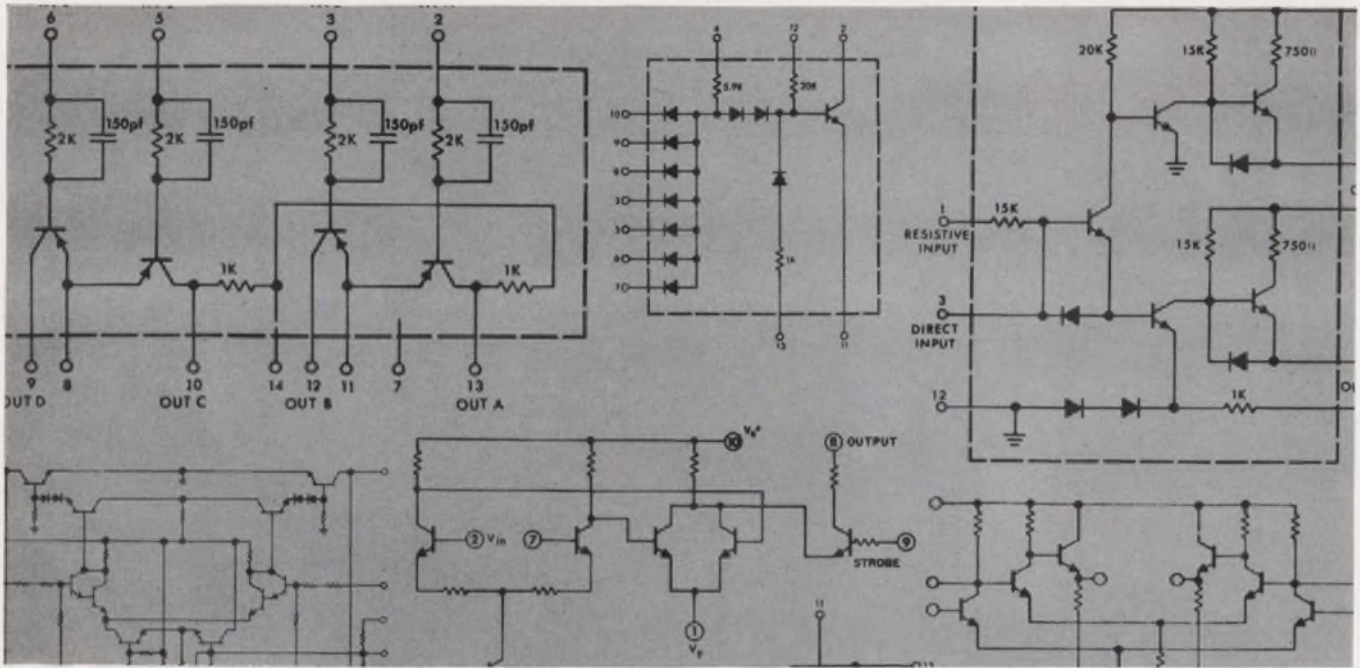

Now available from Norden **Analog and digital microcircuits with Glastrate dielectric isolation**

- NM 1032 General purpose amplifier
- NM 1038 Driver switch
- NM 4013 RS Flip flop
- NM 4014 Dual 4-input clocked DTL NAND/NOR gate
- NM 4015 Dual 4-input DTL NAND/NOR gate
- NM 4016 Driver amplifier
- NM 4017 7-input clock DTL NAND/NOR gate
- NM 4018 Triple high-level DTL NAND gate

Norden announces off-the-shelf availability of high-performance, dielectrically isolated analog and digital microcircuits produced to Minuteman specifications, guaranteeing you highest quality and reliability.

Norden's *Glastrate* process of dielectric isolation reduces leakage current and capacitance to substrate, prevents unwanted PNP action, eliminates "latching," and improves radiation resistance.

If you have special circuit design problems, use Norden's NM 3025 Master Dice Breadboard. Circuit interconnections can be made to your requirements, and your new circuit can be tested in a matter of days.

For more information about Norden's off-the-shelf circuits, or custom circuit service, write to Microcircuits Department, Norden Division of United Aircraft Corporation, Norwalk, Conn. 06856, Phone (203) 838-4471, TWX NWLK 21.

See us at WESCON, East Exhibit Hall, Booths 4901-4904.

Norden DIVISION OF UNITED AIRCRAFT CORPORATION
NORWALK, CONNECTICUT

U
A

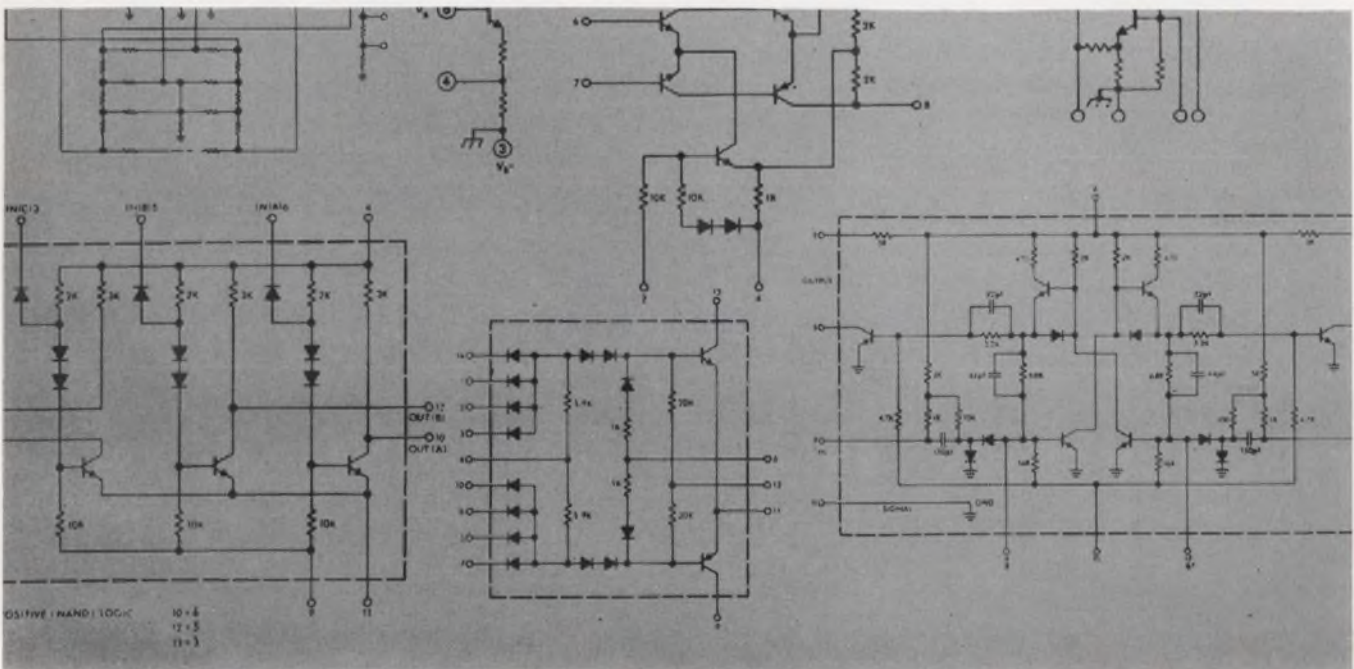

Tips on cooling off hot "plastic" transistors

See how circuit and packaging designers use new IERC heat dissipators to increase the efficiency of epoxy and ceramic semiconductors. Models are available for all TO-5, TO-18 and D-case sizes, with and without flanges.

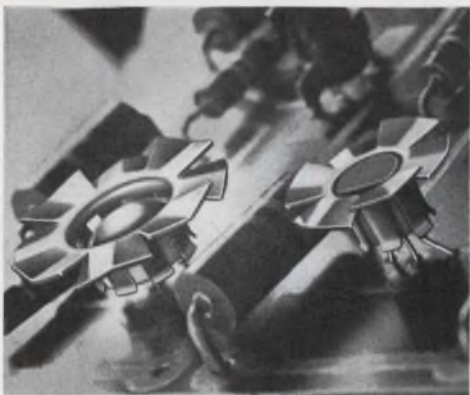

New, press-on "Fan Tops" fit all TO-5, TO-18 and D-case size devices. Need no board area; add virtually nothing to board height. An RO-97 with Fan Top dissipates 400 milliwatts at 65°C. compared to 200 milliwatts with no dissipator.

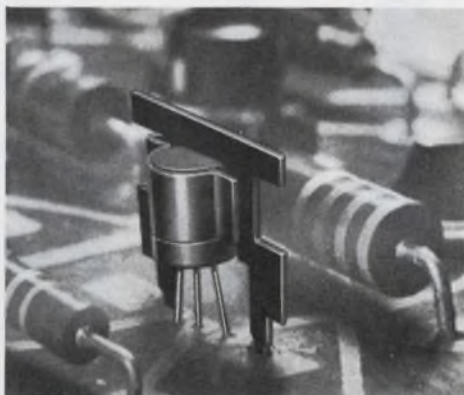

New "Universal" Spade types fit all D-case sizes, including the flanged type. Permit operating power of transistors to be increased 33%. Unique spring-clip retainer accommodates variations in case diameters. Single and dual models.

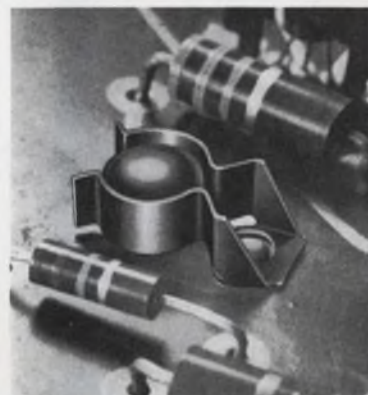

New Clip types are especially effective in high g environments. Hold TO-5 and TO-18 size devices securely; reduce load on leads. Allow 30% more operating power.

Unique new Spade types fit all TO-5, TO-18 and no-flange D-case sizes. Provide excellent retention and dissipation and are also valuable production aids. "Stand-off" legs give a positive 0.1" grid location for automatic insertion in p-c boards and hold transistors above the solder, preventing possible thermal damage. Single and dual models.

New PA and PB dissipators for medium power plastic devices accommodate the flat, rectangular shaped thyristors, transistors and SCR's. Patented, staggered-finger design and aluminum construction maximize dissipation. In natural convection a PA will permit a single X-58 or M332 case device to be operated with 80% more power. A PB type will allow matched pairs or larger devices to be operated with 200% more power.

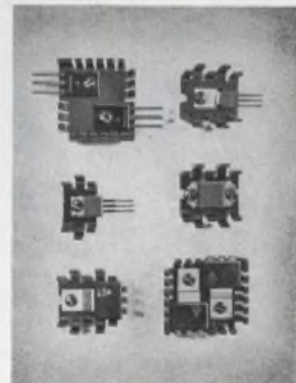
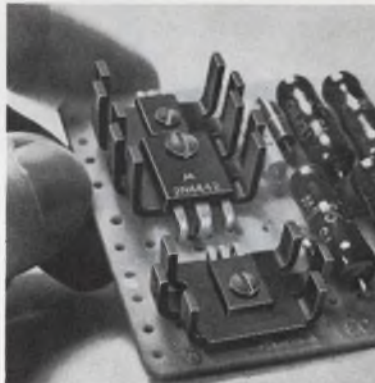
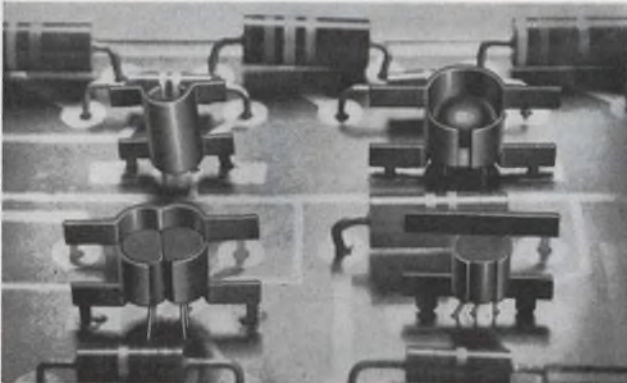

IMPROVED SEMICONDUCTOR PERFORMANCE FOR ONLY PENNIES

Epoxy and ceramic case semiconductors, like those in metal cases, have maximum allowable operating temperatures. Exceeding these limits can damage or destroy the component. Low cost IERC dissipators/retainers reduce operating temperatures, permitting semiconductors to be operated at power ratings up to 33% higher without increasing case temperatures. Their use also sharply reduces failures caused by excessive solder heat during assembly. **New SHORT FORM CATALOG** gives complete specifications and other helpful information for selecting transistors/dissipators. May we send you a copy?

Transistor dissipators/retainers • Forced air cooling packages • Fluid cooled heat sinks • Tube shields

INTERNATIONAL ELECTRONIC RESEARCH CORPORATION • A corporate division of Dynamics Corporation of America • 135 West Magnolia Ave. • Burbank, Calif. 91502

ON READER-SERVICE CARD CIRCLE 52

ierc
SEMICONDUCTOR
HEAT DISSIPATORS

New Model 3111 Relay by Bourns



{ SMALL
IN SIZE }



BIG IN SPECS

The Bourns Model 3111 TRIMPOT® Relay is a high performance, 0.5 amp, Double Pole Double Throw unit that answers the demand for higher reliability and greater miniaturization. It is hermetically sealed in a 1/6 size crystal can, with convenient 0.1" pin spacing.

The Model 3111 has an operating temperature range of -65°C to +125°C. Contact rating is 0.5 ampere resistive at 28 VDC, with a pick-up sensitivity of 130 MW. Operate and release time is 4 milliseconds maximum. Contact bounce is 2 milliseconds maximum. This model also features a self-damping return spring and balanced armature design assuring excellent shock (50G) and vibration (20G) performance. All requirements of MIL-R-5757 are met or exceeded by the Model 3111.

For further data and detailed specifications, contact your nearest Bourns sales office or representative, or write the factory direct.

TRIMPOT® AND PRECISION POTENTIOMETERS—RELAYS—MICROCOMPONENTS: TRANSFORMERS, INDUCTORS, RESISTORS AND CAPACITORS

Coil Operating Table

Standard Coil Resistance	Nominal Operating Voltage	VOLTAGE ADJUSTED		Drop-out Voltage Min.
		Maximum Pull-In Voltage at +25°C	at +125°C	
70	6.0	3.0	3.9	0.3
280	12.0	6.0	7.8	0.6
1500	26.5	14.0	18.0	1.4

Coil characteristics applicable at +25°C unless otherwise specified.
Various terminal types and mounting styles are available adding flexibility to fulfill your design requirements.



BOURNS, INC., TRIMPOT DIVISION • 1200 COLUMBIA AVE., RIVERSIDE, CALIF.
TELEPHONE (714) 684-1700 • TWX: 910 332-1252 • CABLE: BOURNSINC.

Co-Publishers

James S. Mulholland, Jr.
Hugh R. Roome

Editorial Director

Edward E. Grazda

Editor

Howard Bierman

Managing Editor

Robert C. Haavind

Technical Editors

Jeffrey N. Bairstow
Peter N. Budzilovich
Maria Dekany
Roger K. Field
David H. Surgan

Careers and Management Editor

Howard S. Ravis

News Editors

Ralph Dobriner, Chief
Richard N. Einhorn

East Coast Editor

Neil Sclater

West Coast Editor

Ron Gechman

New Products Editor

Steven B. Futterman

Copy Editor

Peter Beales

Directory Editor

William Alvarez

Washington Editor

S. David Pursglove

Editorial Production

Dollie S. Viebig
Marian Arkin
Anne T. Lombardi

Art Director

Clifford M. Gardiner

Art Assistant

William Kelly

Technical Illustrators

Cheh Nam Low
Sheila F. Ward
Richard Hartman

Production Manager

Thomas V. Sedita

Asst. Production Manager

Helen De Polo

Production Assistants

Bernard Wolinsky
Robert M. Henry
Murray Friedman

Circulation Manager

Nancy L. Merritt

Reader Service

Diane Mandell

EDITORIAL



Let's raise our voices against noise pollution

Did you ever hear a swallow burp?

Probably not.

You know why?

Because your neighborhood and your plant are gradually becoming polluted by noise. And noise pollution can be a problem if you have ears.

Noise pollution is what fills your ears when you open a window. It is the din of traffic, the chatter of a jackhammer, the blaring squawk of a neighbor's radio. It assaults us in every part of the audio spectrum: the rumble of a punch press, the painful bang of a riveting machine, a pressure nozzle's hiss.

Noise is not just annoying. Continued exposure to noise permanently impairs hearing. And an employer who fails to protect workers from hazardous noise environments can expect to pay workman's compensation for damages. Noise, just like uncaged gears, is now a hazard in the eyes of the law.

What can the designer do about noise pollution, you ask?

Four things:

- Learn about acoustics. The interaction between sound and the human ear is a complicated physiological and psychological matter. The editors of *ELECTRONIC DESIGN* suggest that you start with two books, *Acoustical Engineering* (Princeton, N. J.: D. Van Nostrand Co., 1957,) and *Music, Physics and Engineering* (New York: Dover Publication, 1967), both by the dean of acoustics, RCA's Harry F. Olson. A marvelous sound film on noise pollution is available free of charge from Wallace Waterfall, Secretary, Acoustical Materials Association, 335 East 45 Street, New York, N. Y. 10017. A booklet, *Acoustics and You*, which outlines career opportunities in acoustical engineering, is available from the same association.

- Include in your design of industrial equipment those shapes and materials that control and damp the most offensive portions of the audio spectrum. Use audible signaling devices only where there is no alternative. Design with your ears as well as your slide rule.

- Specify and purchase quiet production equipment. Don't look only at the specifications and the finish when you buy a machine—listen to it.

- Help the city nearest you control its noise pollution. *ELECTRONIC DESIGN* stands ready to assist and to report the efforts of any firm that will underwrite a project that aims to accomplish this goal.

There is no question that it will take effort and money to control noise pollution. But you'll sleep a lot sounder if the people whose lives are affected by your designs can hear their alarm clocks tick.

ROGER KENNETH FIELD

Reader's Choice

IEE bright, legible, wide-angle readouts:

Any characters desired
Any colors or combinations
Any input, BCD or decimal
Any input signal level
Any mounting, vertical or horizontal

Many sizes
Many configurations
Many lamp lives (to 100,000 hours)
Many brightness choices
Many options and accessories



Standard Readouts: Rear projection principle, like all IEE readouts. A lamp in the rear of the unit illuminates one of the 12 film messages, and projects it to the front viewing screen. Unbeatable readability and versatility.

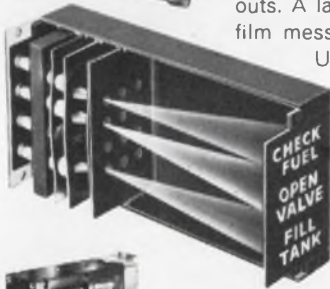

Large Screen Readouts: For reading distances up to 100 feet. Maximum character size 3 3/8".



Miniature Readouts: Only 1" wide x 1-5/16" high, yet can be read at 30 feet because of clarity of one-plane projection. Character size: 3/8".



Micro-Miniature Readouts: Only 1/2" wide x 3/4" high, but 20 foot viewing distance and maximum 175° viewing angle because of front-plane display. Character size: 3/8".



Hi-Brite Readouts: Special lens system increases character brightness 50%. Particularly good when high ambient light conditions exist.



Cue-Switch Readouts: Rear projection readout with push-button viewing screen. Combination switch and display device.



Bina-View Readout: Accepts binary or teletype code, decodes, and displays the proper character.



Status Indicator Readout: Displays up to 12 different messages, individually or in combination. Viewing screen only 3 sq. in.



Indicator Assemblies: Available with up to 11 rear projection readouts, for indicating seconds, minutes, hours, days, etc.



Driver/Decoder Module: Designed to work with IEE Readouts. Accepts a variety of binary codes for decimal conversion.

The new IEE Display Devices catalog gives complete information and specifications on these products, and their accessories. Ask for it.



"I-double-E", the world's largest manufacturer of rear projection readouts.
Industrial Electronic Engineers, Inc. 7720 Leona Avenue, Van Nuys, California

ON READER-SERVICE CARD CIRCLE 54

WESCON USA

Whether you're a showgoer or a 'no show,'
check this compact preview of the highlights



HURRY, HURRY...

It's called "Eight Shows in One." It runs from Aug. 22 through 25, and it features performances by more than 600 companies in 1100 booths.

WESCON, 1967, is open.

The Cow Palace at San Francisco has been transformed into a dazzling electronic spectacle that is expected to draw 40,000 engineers and managers.

Along the colorful aisles, products are grouped in eight broad categories. These are the eight shows of WESCON.



WESCON IS STARTING

And there's more in the wings. Technical sessions are planned on 20 subjects. In addition, the Eighth International Electronic Circuit Packaging Symposium opens Aug. 21 in the San Francisco Hilton. And a major symposium on microelectronic developments, "Microelectronics Comes of Age," starts Aug. 23 in the same hotel.

Join ELECTRONIC DESIGN's guided tour of the significant at this year's WESCON. Begin here:



Design trends in the major engineering disciplines, as reflected in new products on display and technical papers

Circuit Designer.....	U 88
Communications Engineer.....	U 90
Computer Engineer.....	U 91
Materials and Packaging Engineer..	U 96
Medical Electronics Engineer.....	U 97
Microcircuit Systems Designer.....	U 99
Microwave Engineer.....	U102
The engineer manager.....	U 84
When, where and what to hear, listed by engineering specialty.....	U112
Progress in fluidics.....	U108
As seen by the camera—	
Touring the exhibit areas.....	U120
Industrial design awards.....	U210
Outstanding new products	
Packaging & Production.....	U122
Computers & Data Processing.....	U136
Instruments & Control Systems.....	U148
Communication & Detection.....	U180
Circuit Components.....	U192

SUDDENLY, YOU'RE A MANAGER

And for the many engineers who find themselves unprepared, WESCON considers some remedies

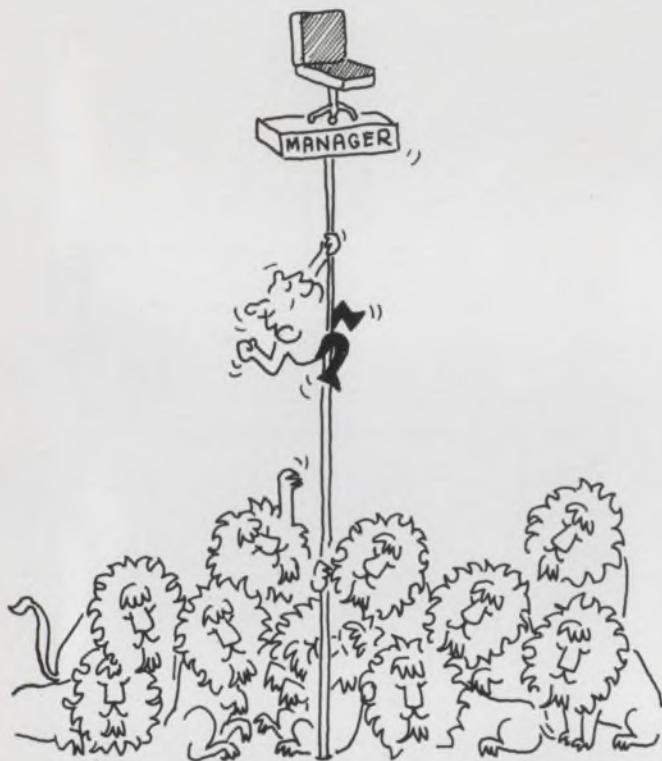

Manage or Perish: Many engineers must make the choice of moving into management or reaching the dead end!

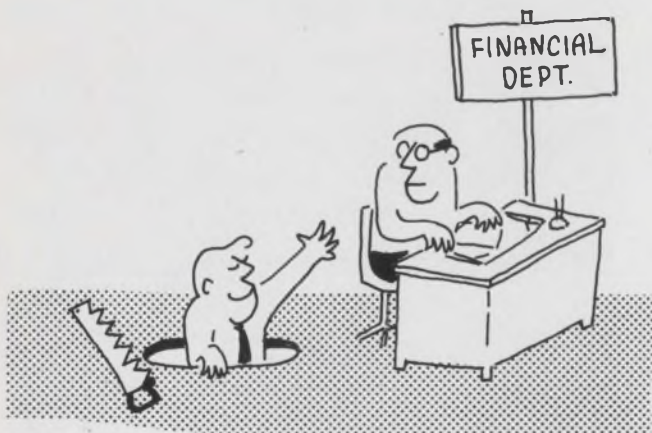

Meet the Financial Department: Many engineers move into management with little or no financial training. Personnel in the two departments should get to know each other.

Howard S. Ravis,
Careers & Management Editor

More and more engineers are moving into management positions, with little or no management training.

"It is a situation the engineering field has known for a long time," notes a WESCON official, "but no one wanted to talk about it. The industry is finally recognizing the fact that the technical man can no longer stay completely technical."

Engineering colleges have been partly to blame: they have trained future engineers to be engineers only. Several years after graduation from such schools, many have found themselves suddenly at a turning point in their careers. Like the professor in college who is commanded to "publish or perish," engineers in many instances face this prospect: "Manage or perish!"

Often with little or no preparation, the engineer must ask himself and must answer quickly: Am I qualified and will I be happy as a manager? Will I find myself spending most, if not all, of my time as an administrator instead of as a creative engineer? What will happen to me if I refuse the management position? Will the company let me go? Will I become professionally stagnant?

Recognizing the need for more engineering management discussion in the industry, WESCON this year is incorporating for the first time a section on the nontechnical side of engineering management. WESCON officials expect the subject to take on increased emphasis in future conventions.

"Business Management: The Engineer Becomes Manager" is the title of this year's session, designed to help both the engineer in management and the one who may make the move.

Managing people

"Once the engineer becomes a manager, he is part of the team which must manage the company resources in a manner that will ensure survival of the business," notes one of the WESCON panel-

ists, James F. Riley, president of Signetics Corp., Sunnyvale, Calif. He lists "technology, capital and people" as the three main company resources.

"There is more than enough emphasis on the technical and capital resources," Riley contends, "but less than adequate emphasis on people resources. More than anything else, the success of a manager depends on the functioning of his people and the direction and retention of them."

Riley is convinced that on-the-job training is best for developing managerial talent. "The home environment is the best training ground," he says. "The company can train the manager in the same environment in which he will manage. Thus top management sees him actually working with the people he also will work with in the future."

If the manager or potential manager attends an outside management session, Riley argues, he is dealing with people he has never seen before and probably will never see again: "Thus, how he works with and supervises these people is of limited value when he returns to his home plant."

Managing money

As the engineer becomes a manager, he becomes more directly involved in capital matters. He now is responsible for a budget; the costs of the project must be watched.

Another panelist, Daniel G. White, president of the Commonwealth National Bank of San Francisco, lists the "pitfalls in money management":

- Ideas alone have little real value. They will assume value only when the idea is translated into a product or service that fulfills a need.

- Avoid overoptimism. Confidence alone does not sell the product. Beware of the unexpected. Expect the worst—it may happen. Plan at the outset for a second line of defense.

- Bankers look at cost projections rather than sales projections. There is often a tendency to let costs get out of hand. Keeping them down will influence the later economic life of the product.

- Engineers must be motivated to the concept of making money. Too often the engineer is aloof to this aspect of the business. Idea must be translated into dollars and cents.

White admits there is no sure-fire way for an engineer to gain this economic education.

"A good way to start, however," he says, "is for closer correlation between the engineering and financial people of a company. Too often they are in different worlds within a firm. They're on different floors and never see each other, except perhaps for a chance meeting at a coffee break. The departments should know each other."

Managing technology

A third panelist, Charles H. Keller, president of

Illumination Industries, Inc., of Sunnyvale, Calif., says that company management must ask itself: "Why does the company exist?"

He continues: "A company cannot have technical superiority as a goal. This sounds very nice, but it is unreal, if not impossible. The electronics field is too vast for one company to achieve complete technical superiority, and the company management must realize this."

The answer, according to Keller, is that the company exists "to satisfy the demands that others make of it." He cites these six groups that make demands on a company: customers, employees, owners, suppliers, the Federal Government and the local community.

"A successful enterprise must utilize its demand-meeting capabilities to meet these demands in the stated order," Keller says. "When the demand-meeting resources are consistently misapplied, the enterprise will either fail or be set back until the proper order is established by pressure from the displaced group or recognition by management of the error of its ways."

Once the company knows the demands, it can manage its technology to meet these demands. "It is equally as dangerous to overestimate as to underestimate these demands," Keller adds.

Managing a turnaround

All three of the company's resources—people, money and technology—are put to the test when a company is forced into a major turnaround.

"The entire technological function of the company needs a change," notes Martin H. Dubilier, executive vice president of Friden, Inc., of San Leandro, Calif., who is also a panelist.

"Perhaps the most important thing a manager can do during this transition," says Dubilier, "is to keep the engineer completely informed when making the change. The management of most companies is reluctant to inform its engineers, fearing it will give away secrets, which the engineers in turn will give away."

"Management cannot afford to be reluctant, however. It is of greater significance to the company that their engineers be made part of the change so that they can conform or adapt to the new process."

Management must expect morale to drop during a changeover, Dubilier concedes. But he adds:

"By keeping your engineers informed, the drop can be lessened. And, finally, and perhaps more importantly, the engineer can be of great help to management—first, in recognizing the need for change and then in helping to achieve this change successfully."

Donald C. Hoefler, columnist for *Electronic News*, is the panel chairman of the WESCON session. ■ ■



The Kind of Knowledge that makes traffic control possible...

Every year more cars join the traffic scramble. As congestion thickens, bottlenecks occur more often. And traffic flow screeches to a halt.

How can we help keep the nation's expressway traffic moving from coast to coast? One way is with remote traffic control systems, like the one pictured above on the Kennedy Expressway in Chicago.

This system reverses lane directions as changes occur in traffic density during morning and evening rush hours. Through a system of gates, signal arrows and directional lights, an express lane can be changed from inbound to outbound—and vice versa. To date, this unique system is doing a great job helping keep Chicago traffic moving.

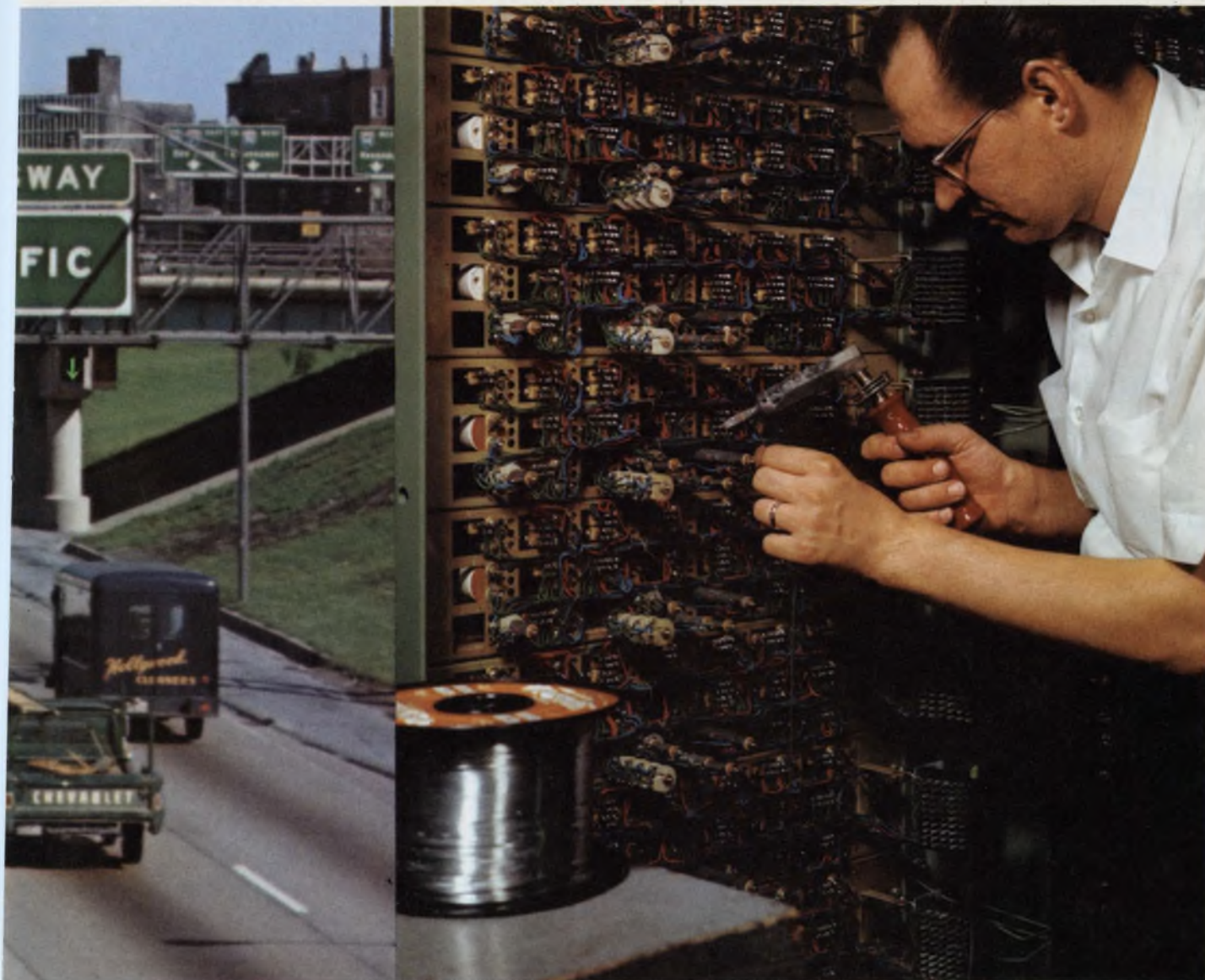

IS THE KIND OF KNOWLEDGE YOU GET FROM KESTER

Regulating such a complex control system takes hundreds of precision electromechanical relays and stepping switches. That means connections must be soldered for maximum reliability.

In assembling this traffic control system the manufacturer used Kester Solder. Both the solder and flux were specially formulated to meet stringent requirements.

The kind of knowledge that goes into traffic control systems is the kind of knowledge you get from Kester Solder. From formulating the finest solder and flux to expert assistance on soldering applications, Kester stands ready to serve you. Write, phone or wire for specific information.



KESTER SOLDER COMPANY 

DIVISION OF LITTON INDUSTRIES

4201 Wrightwood Avenue, Chicago, Illinois 60639 • Newark, New Jersey 07105 • Anaheim, California 92805 • Brantford, Ontario, Canada

1899-1967—68 years devoted to production of products of the highest reliability—solders and fluxes

ON READER-SERVICE CARD CIRCLE 55

ELECTRONIC DESIGN 17, August 16, 1967

U87

THE TECHNICAL SIDE OF WESCON

Here is a summary of the significant papers and trends evident at the show, arranged by engineering specialty

Circuit designer

FETs and plastic devices are finding wide use

Field-effect transistors, still relative newcomers to design, are now more practical than ever. This is evidenced by the fact that a complete session at WESCON (No. 8) is devoted to the design of rf circuits using FETs. Each paper presents practical design procedures and considerations, readily usable by a design engineer.

Of particular importance is the paper entitled "High-Frequency Power FETs," by J. B. Compton of Siliconix, Inc. He shows how the high input impedance and lack of secondary breakdown characteristic in FETs are used in the design of rf power amplifiers to get outputs of 0.5 watt.

A year or so ago one criterion for good circuit design was considered to be the number of active (transistor) devices used—the fewer the better. The major reason for this goal was the high cost of active devices.

This approach now appears to be obsolete. Plastic devices are rapidly coming down in price to the point where some compare favorably with the price of a resistor. Even such "sophisticated" devices as 400-MHz, 10-dB FETs can be bought for 95 cents. A unijunction transistor costs only about 65 cents. Silicon small-signal transistors sell for a dime or less.

Today the circuit designer need not worry about adding a transistor or two. He can achieve better reliability by increasing the number of active devices in the circuit, thereby avoiding the need to work a minimum of transistors at their highest limits. In fact, it is possible today for the designer to keep an assortment of his "pet" transistors in boxes (just as he would his resistors)

above the laboratory bench.

With the prices of plastic devices so low, the obvious question is will they make a reliable package? Two researchers from the Army Electronics Command at Fort Monmouth, N. J.—Edward B. Hakim and Roland Canepa—ask and partly answer this question in their paper, "A Preliminary Investigation of Plastic-Encapsulated Transistors," to be delivered at the Eighth International Electronic-Circuit Packaging Symposium. The paper presents a summary of various tests carried out on seven types of plastic-encapsulated transistors.

Several important conclusions have been reached by the authors as the result of their evaluation project. It was found that plastic devices pass present short-term military tests. The question of long-term effects, however—and whether plastics will introduce increasing failure rates, compared with metal packages—was not explored.

Two tests were found particularly helpful. One was a high-humidity and-temperature test, with an applied electric field across the device. In relatively short periods of time (less than four weeks) significant deterioration was observed in the plastic devices.

Another test, checking ionic contaminants, was the standard inversion layer test used on most pnp metal-encapsulated devices. It included high-temperature storage (150°–200°C) and 50 to 75 per cent of rated BV_{CRO} or BV_{CEO} of the transistor. The parameter measurements were made after the devices had cooled to room temperature and the voltage was removed. Again, deterioration was observed in the plastic devices.

Specifically, the following tests were performed:

- Temperature storage: +200° C.
- Temperature cycling (1/2 h at each temp.): -48°C to +200°C.
- -40°C and power cycle (1.5 min on, 30 min

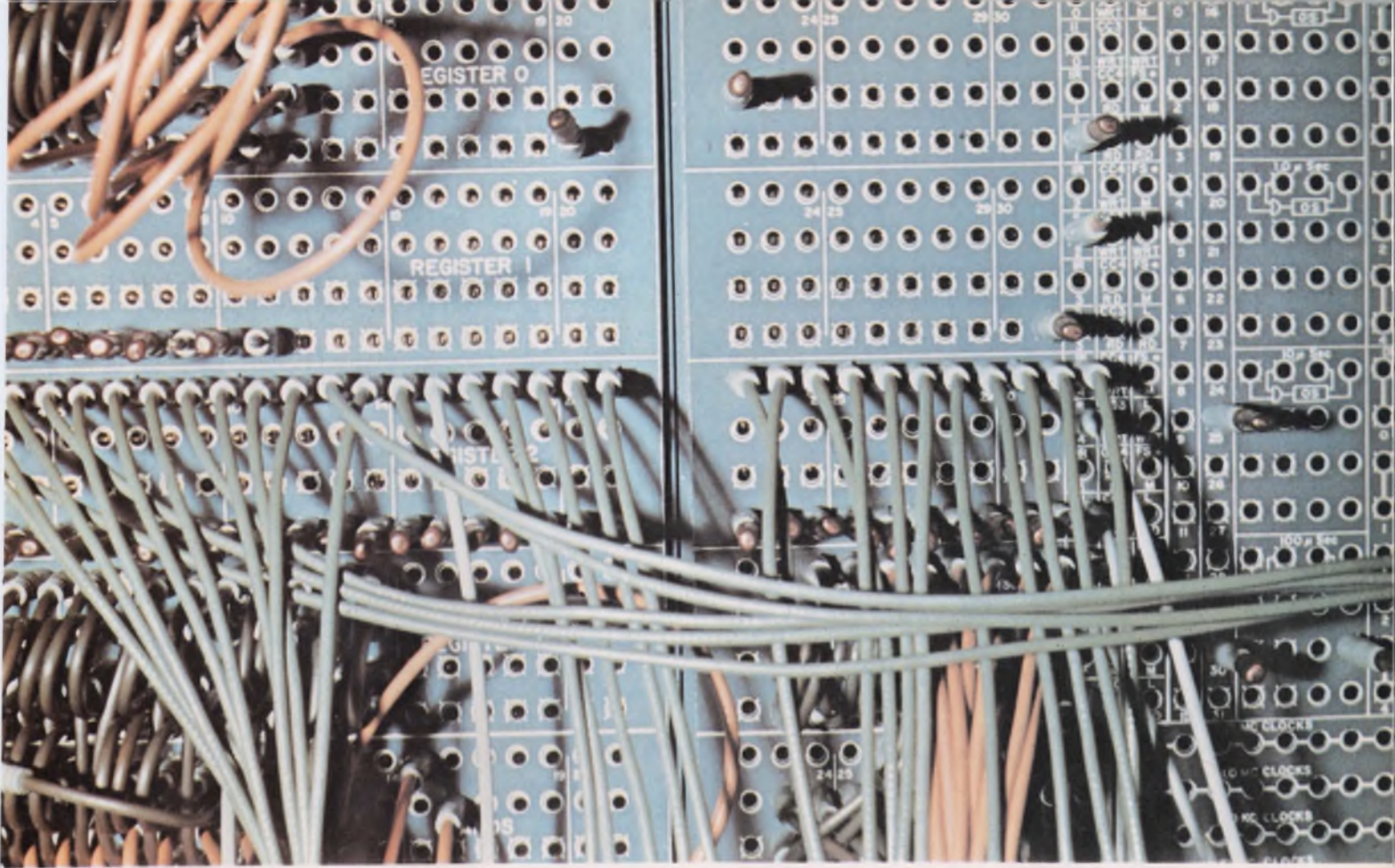

General-purpose interface, looking like a telephone switch-board, enables experimenters at Michigan University to

transfer digital or analog signals to and from a nuclear-physics laboratory and a computer. (Paper 16/2).

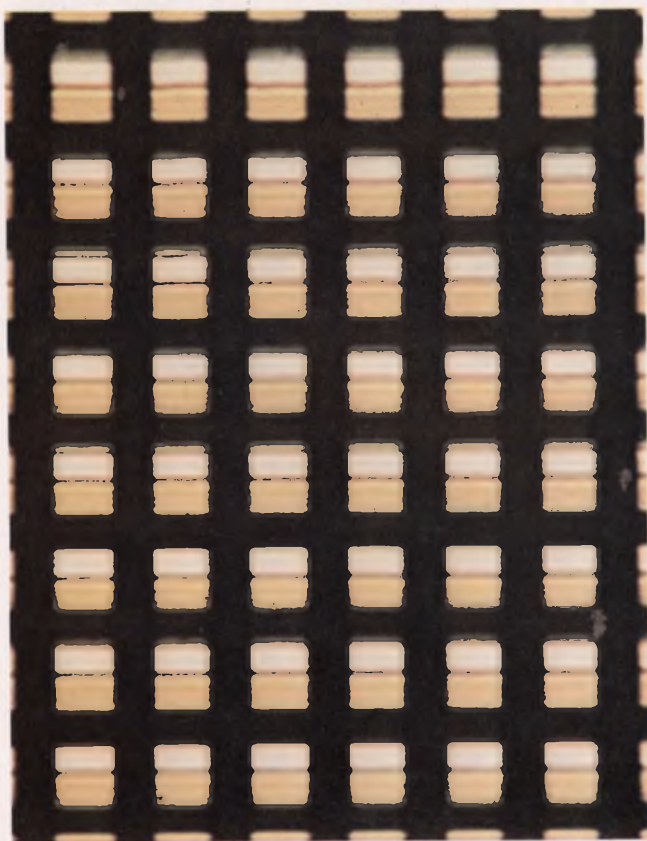

Photoconductor array at left contains 32,400 elements (180 by 180) and is part of a self-scanned image sensor

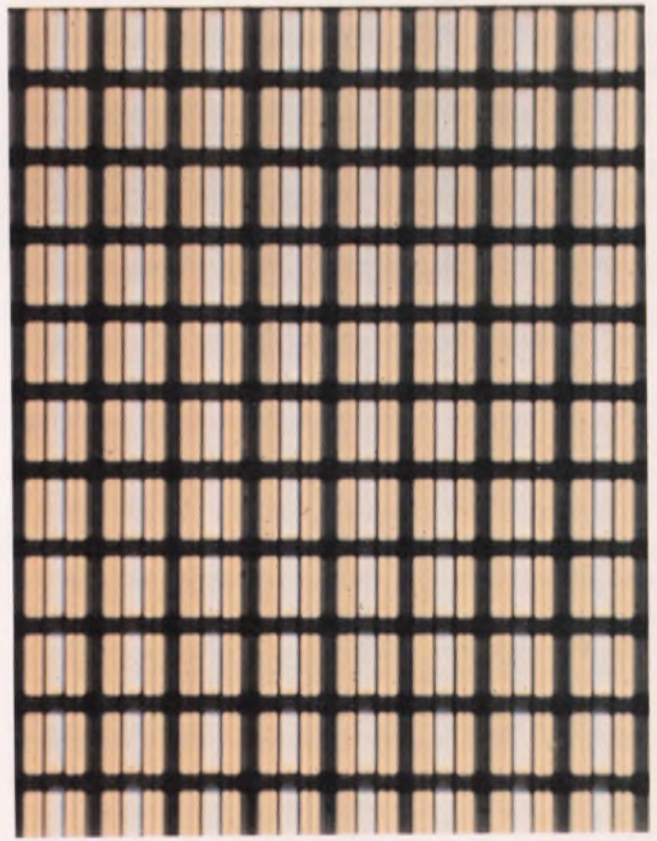

for an experimental, tubeless TV camera. A 360-by-360-element array is shown at the right (Paper 13/3).

off).

- -40°C and voltage cycle (1.5 min on, 30 min off).
- Humidity cycle and power: $+25^{\circ}$ to 65°C ; 80% to 98% relative humidity.

The report points to rapid improvements in plastic materials. Thus the authors state: "The testing of plastic-packaged transistors initially indicated that with plastics available at the start of this program silicone was more desirable than epoxy. However, epoxy devices are now available which appear as good as silicone in both high-temperature and moisture stability."

Communications engineer

Communicate, don't travel, is the goal of designers

A dozen or so years from now, the engineer too busy to travel to electronic shows across the country may pick up his picture phone and scan the exhibits. If a booth looks interesting, he may dial the engineer on duty and talk to him. Such are the possibilities envisioned by communications specialists.

The idea of substituting communication for transportation in many situations of daily life is not fancy, says Dr. Timothy Healy of the University of Santa Clara. It began, he notes, when telephone calls replaced trips across town. The questions now are how far and how fast.

According to Dr. Healy, the opportunities are virtually limitless. For example, attempts are being made today to eliminate the exchange of money through data links between a customer's bank and the places where he buys goods.

Psychological and economic problems

But there are formidable obstacles, Dr. Healy says. As he sees it, the two biggest are economic and psychological.

The most urgent problem is economic: data transmission is expensive. One minute on a video phone costs up to \$200 at present—out of reach of most would-be users. But Dr. Healy believes in the spirit of private enterprise. The cost of phone calls has dropped considerably over the years, he notes; video phones will follow suit.

The psychological problems are mostly long-range, Dr. Healy says. Can we really do without our work environment, for example? Can salesmen sell without face-to-face confrontation? Can housewives shop by television? Can executives give up the battles at round tables? There is no answer yet to these questions, but he will attempt

to shed light on ways to look at these problems in Session 9.

Curiously enough, Dr. Healy does not see any serious technological problems. He realizes that the expected increase in transmitted data will be astronomical, but he observes: "Obviously radio waves are out of question on the long range. Satellites will be a terrific boost for the next 10 to 15 years, but after that we'll have to use cable lines for data transmission. If you want to be really futuristic, then modulated light in cables may be the real answer."

For the next decade, he envisions "belts" of 15 or 20 satellites with highly directive antennas in S band, for instance, to handle data traffic with spatial multiplexing.

Cut cost of data compression

But before these ideas can be realized, designers must find more efficient ways of transmitting data. Already hardware capabilities are being strained. Straightforward approaches to increasing the capability of links run into trouble quickly because of cost, says a group of engineers at the Lockheed Missiles and Space Co., Sunnyvale, Calif. (Session 6).

At the transmitting end of systems, one solution

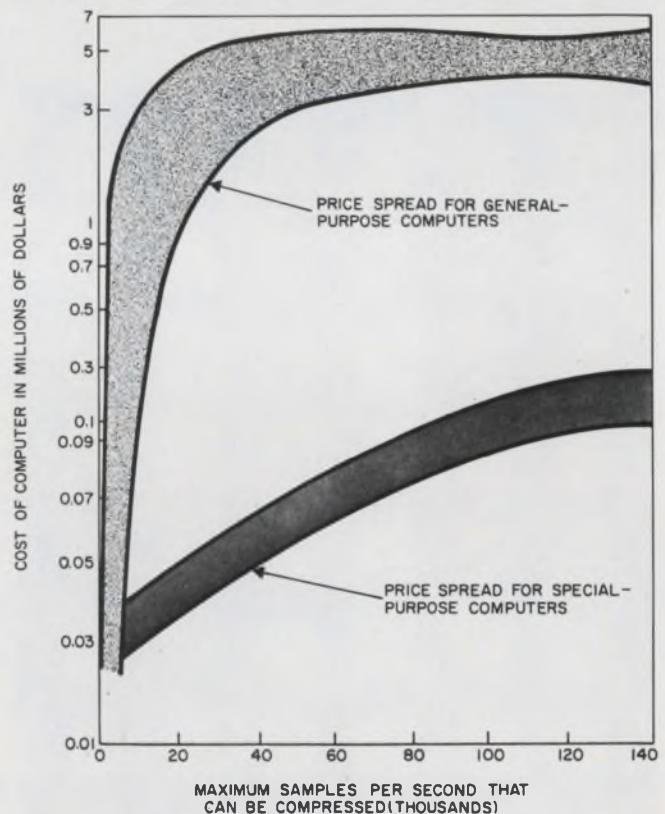

1. **Cost-performance trade-off** of computers for data compression clearly indicates the advantages of special-purpose types. Data-compressing computers are now developed that can handle many input types and allow the selection of processing that offers the best compression ratio.

lies in data compression—in the rejection of redundant data before transmission. The Lockheed group has come up with a hardware approach that can compress a variety of telemetry data, reconstruct the result when needed and display any selected two channels on a strip recorder. According to John J. Dowing, supervisor of the data-compression group, the technique avoids the need to design a special instrument for each application and manages to keep the cost far below that of a general-purpose computer (see Fig. 1 for cost comparison).

The compressor accepts 10-bit parallel digital input words that identify the channel and contain the data. This input may come directly from the telemetry multiplexer or from a decommutation station at a rate of more than 50,000 words a second. The experimental model can accept 1024 data channels, and separate tolerance levels can be established for each channel. To obtain the best compression ratios, each channel can be set for either averaging or exponential digital filtering and for one of several popular compression methods. The output is pulse-code modulated. It may be recorded and fed back to the machine, which then reconstructs the original uncompressed data.

How to predict fading

But even the most efficient data-compressing system will not do much good, if the data get lost in the propagation media. Robert F. Daly, a scientist at the Stanford Research Institute (Session 9), points out that theories abound on channels where the noise is assumed to be Gaussian or nearly Gaussian, but not much is available to help engineers deal with signal fading.

Fading, or signal distortion, becomes significant in high-speed digital data transmission, Daly says, since the loss of even a small data segment can be critical.

The communication problem in the presence of fading differs in several ways from the problem with additive noise only, but one difference is particularly important to system designers, according to Daly. With only additive noise in the channel, any desired small error can be achieved by increasing the transmitting power level, whether optimum or suboptimum receivers are used. This is important, says Daly, because it is easier to increase signal power than to obtain a better receiver.

But fading channels do not go by this rule. Without an optimum receiver, the transmission suffers an irreducible error, due to self-jamming. The channel distorts the signal so that some of the energy interferes with the desired transmission. Higher power levels increase both the signal and the interference, so nothing is gained, points out Daly. For the same reason, more sensitive receivers

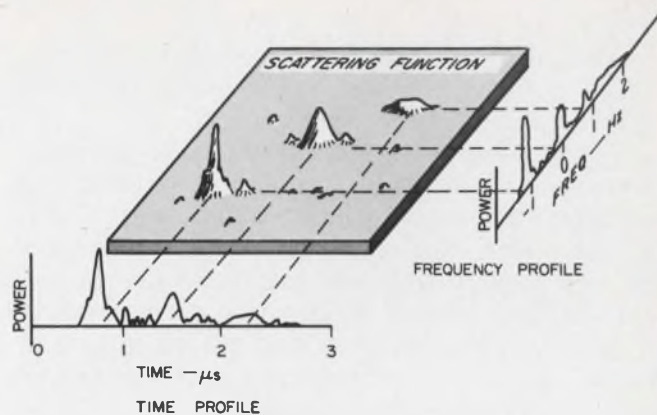

2. Time-frequency plane of scattering function in communication channel for hf signals show nodal nature of the function. It introduces both frequency and time variations in the signal.

ers do not help either.

Daly sets up a model for the fading channel that allows the accurate prediction of error rates over an hf link.

When setting up the model, he assumes that the signal undergoes both time dispersion and frequency dispersion, because of scattering in the channel.

The received signal is scattered by irregularities in the dielectric constant of the channel (particles, for example, are such irregularities). The energy from these scatterers arrives by a different path, causing a differential time delay, or time dispersion and resulting in frequency-selective fading. But the scatterers are in motion, which results in a Doppler shift. Since the Doppler shift is different for each scatterer, frequency dispersion is also introduced. Thus, both the time and frequency structure of the transmitted signal will become smeared out, and the transfer function of the channel displays both frequency and time dependence. Such a scattering function for an hf link is shown in Fig. 2.

He models this channel as a linear time-variant filter, and introduces some design points for optimum receivers that help reduce fading errors.

Computer engineer

Computers as components or will it be vice versa?

The computer engineer finds himself at a crossroads today: there is a wide road, along which computers are merely components, parts of a larger system; and there is a narrower road, along which components are computers, formed by large-scale integration (LSI). Which way does he

have to go?

Knowledgeable computer engineers are preparing to zigzag between the two paths, by adding to their skills along the way.

System design calls for the ability to integrate hardware and software, to optimize systems that use computers as components and to solve interface problems. Not only man-machine interfaces but also machine-machine interfaces are important, as, for example, in digital control systems. LSI requires an appreciation of the techniques of fabrication and, in particular, of the economics of large- and small-volume production.

Bob L. Ryle of the Planning Research Corp., Los Angeles, presents a strong case for considering software as another engineering discipline for the computer engineer (Session 16). He believes that the idea of software as an "esoteric art form" must be dispelled; it must be treated as a scientific discipline, he says. This will become even more necessary if, as seems likely, the software of operating systems is handled by hardware. An example of this is the use of LSI as a read-only memory storing an executive system.

Optimum design is needed

Maximum effectiveness of third-generation computers is the concern of authors David L. Stein and Joe L. Glaser of Scientific Data Systems, Santa Monica, Calif. They define third-generation computers as variable combinations of control units—memory and input/output units communicating freely with each other through standard interfaces.

Now a system designer can produce a whole range of systems to do a specific problem, according to the authors. The art is to find an optimum design, one that will do the job faster, more accurately or, perhaps more importantly, more cheaply. Although the criteria may be easy to determine, the effect of altering a system design may not. Simulation of proposed systems is likely to be one way out of this particular difficulty. The authors admit they do not have all the answers.

In the same session, Dr. J. V. Kane of Michigan State University shows how, as a nuclear physicist, he has had to solve an interface problem to use a third-generation time-sharing computer as a component of his laboratory. His general-purpose interface enables experiments to control not only a cyclotron but also several independent experiments. Dr. Kane cites the advantages of his system as follows:

- Experiments will be able to record and analyze data whenever they wish.
- The time required to set up and alter experiments will be reduced.
- Experiments may be operated remotely by researchers in distant or small institutions.

Computers help improve patient care

The computer as an element in the medical environment is the concern of Dr. Shannon Brunjes and his colleagues at the Los Angeles County Hospital. In their paper, the authors describe a system of out-patient prescription-information storage that uses remote CRT displays on line to the hospital's IBM 360/30. Envisaged is a larger information system, including in-patient drug orders and clinical information entered directly by the physician. Dr. Shannon notes that the hardware to do this is available now but that the programs are not. Specialized software is a necessary part of system design, he indicates. (If you want to hear more about the use of computers in medicine take a look at Session 7, where Dr. Donald C. Harrison of the Stanford University School of Medicine discusses on-line patient care.)

LSI is nearing reality

The effect of LSI on computer system design will be examined by a panel in Special Session B. Opening the discussion will be Richard Petritz of Texas Instruments, Dallas, who will be covering the state of LSI technology principally in monolithic integrated circuits, hybrid arrays and large arrays with discretionary wiring. Another enthusiastic proponent of LSI is Gordon Moore of Fairchild Semiconductor, Palo Alto, Calif. He predicts that LSI will be a reality by 1970, with costs of 5 cents a gate and memory costs of 2 or 3 cents a bit. He hopes to be able to establish a set of economic ground rules for the computer designer, in terms of quantities for feasible production runs and turn-around times for changes to designs in production. Debating the applications of LSI for large-scale systems will be Gene Amdahl of the International Business Machines Corp., San Jose, Calif., and covering small systems will be L. C. Hobbs of Hobbs Associates, Corona del Mar, Calif.

In the debate that will follow the presentations, some of the questions the computer engineer might like to hear answered could be these:

- When will there be some industry agreement on what constitutes LSI?
- When are the manufacturers of integrated circuits going to produce examples of LSI that are nontrivial and economic for the computer manufacturer?
- When and how is the problem of multilayer interconnection on a chip going to be solved?

Design automation will reduce costs

Both semiconductor and computer manufacturers agree that the problems of the design of LSI arrays will require automated design techniques to allow economic use. Thomas F. Prosser

(continued on page U96)

Engineers can design their own microcircuits by means of Norden's Master Dice Breadboard. The monolithic integrated layout contain 6 transistors, 33 resistors (Booth 5031).

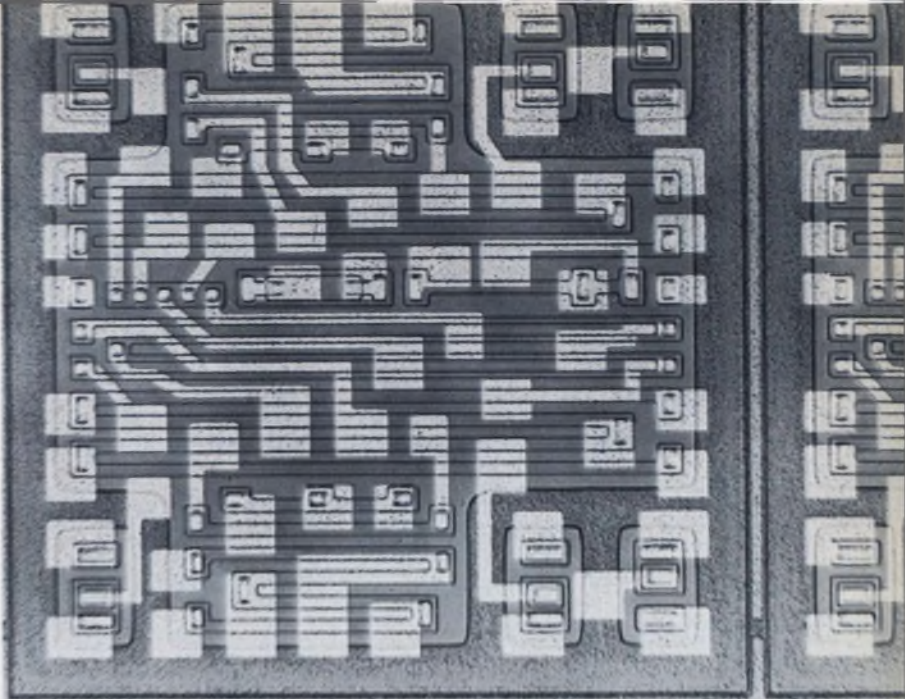

Fluidic control is used in Univac's pneumatically controlled document-handling system. A motion control track is shown (Paper 11/5).

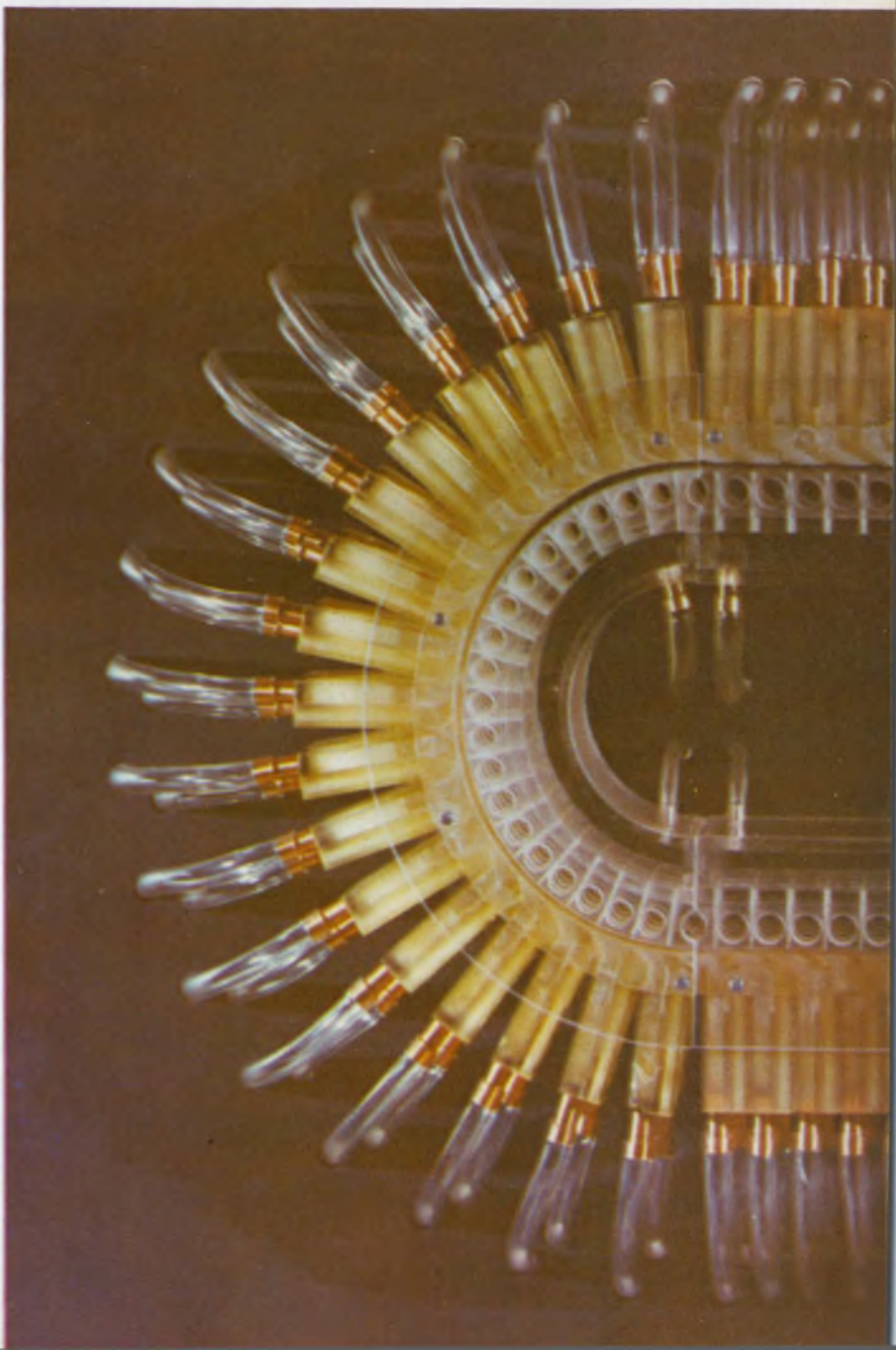



Reliable electrical connections

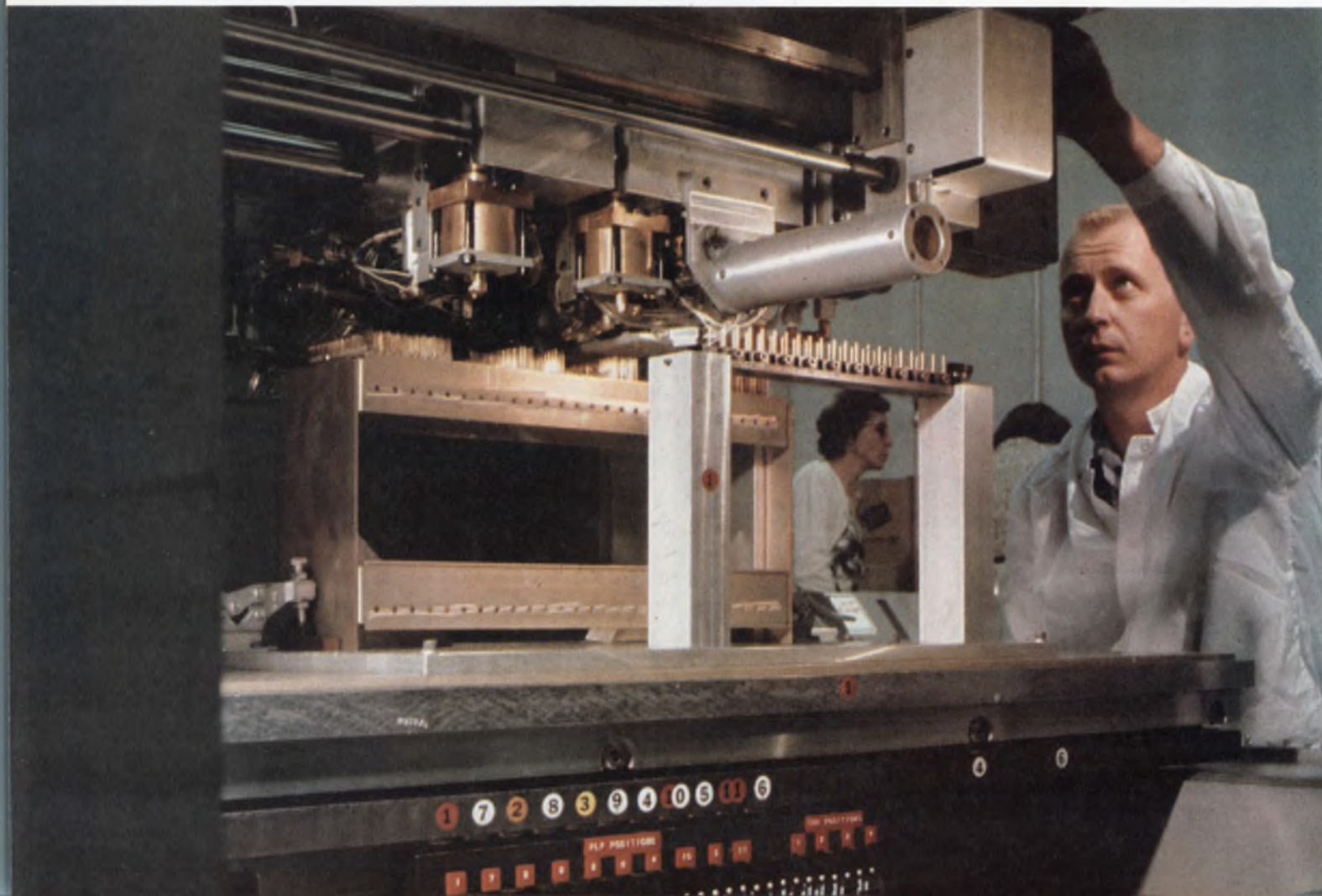

Your choice of power for hand "Wire-Wrap" tools . . . electricity, compressed air, or rechargeable battery. We also make manual tools for field servicing. Bulletins 14-1, 14-3 and 14-7.

Solderless electrical connections are wrapped to stay . . . wrapping time is less than one second each . . . Using Gardner-Denver "Wire-Wrap"[®] tools. You save hours of handwork. You save inspection and rework time as well, because "Wire-Wrap" tools make reliable connections, even in inexperienced hands. Widely used for wiring television, instruments, communications equipment, computer panels and missile guidance systems.

in less than one second each

Modular panels are quickly and securely wired on Gardner-Denver automatic "Wire-Wrap" machines, which are programmed with punched cards for maximum flexibility. Bulletin 14-121.

Reliable! More than 40 billion solderless wrapped connections have been made with "Wire-Wrap" equipment without a single reported electrical failure.



Film is scraped from wire and terminal at contact points. High pressure metal-to-metal contact invites solid state diffusion, maintaining low connection resistance.



Solderless wrapped connections remain gastight even when exposed to severe changes of temperature and humidity . . . so they're not affected by atmospheric corrosion.



Initial pressure may go as high as 100,000 psi. Pressure drops as wire relaxes, but stabilizes at a value greater than 29,000 psi.

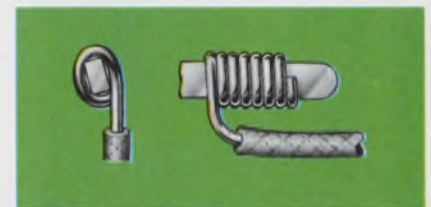

Flexible lead-off absorbs vibration and handling shocks . . . permits wrapped connection to stay tight and mechanically stable.



SEE WHAT AIR IS DOING NOW...SEE

GARDNER - DENVER

Gardner-Denver Company, Quincy, Illinois

ON READER-SERVICE CARD CIRCLE 56

(continued from p. U92)

of the Philco Ford Corp., Santa Clara, Calif., in a paper in Session 4 of the Eighth International Electronic-Circuit Packaging Symposium cites a component cost reduction factor of 10 or more through the use of computer-aided design. Proponents of LSI are painting a rosy future for it, by citing the advantage of tremendous computing power at very low cost. However, opponents are likely to retort that for large systems, the circuitry costs are likely to be only 5 per cent of the total, so that even a 50 per cent reduction in circuit costs will not significantly reduce the total system cost.

High-density recording packs them in

Bulk storage has always been important to computer users and designers. The cheapest bulk storage device is still the magnetic-tape unit (less than 0.001 cents a bit), although it is being hard-pressed by the other electromechanical storage devices, principally the magnetic disk (0.02 cents a bit). As a result there is considerable pressure on tape-unit manufacturers to improve the performance of their products.

Reporting on their work in Session 12 are Donald T. Best of the Ferroxcube Corp., Saugerties, N. Y., with a paper on magnetic head design, and Kermit Norris of the Leach Corp., Azusa, Calif. Norris describes a novel technique that uses a relatively simple one-track system, yet achieves a density of 10,000 bits an inch with an error rate of less than 1 in 10^8 bits. More unusual are the electron-beam and laser recording methods to be reviewed by Charles F. Spitzer of the Ampex Corp., Redwood City, Calif. These methods use modulated electron and laser beams on thermoplastic and silver halide films, which are developed and then coated with a plastic scintillator. When scanned with electron or light beams, the scintillator emits light that is detected with photomultipliers. Much of the work is still in the developmental stage, although a large computer manufacturer hopes to deliver an electron-beam system shortly. The author looks for a factor-of-10 improvement over magnetic tape and cites densities of the order of 10^7 bits a square inch.

Materials engineer

Microelectronic packages: The approaches fan out

The revolution in electronic components in the last decade has been accompanied by an upheaval in packaging and in the methods used to inter-

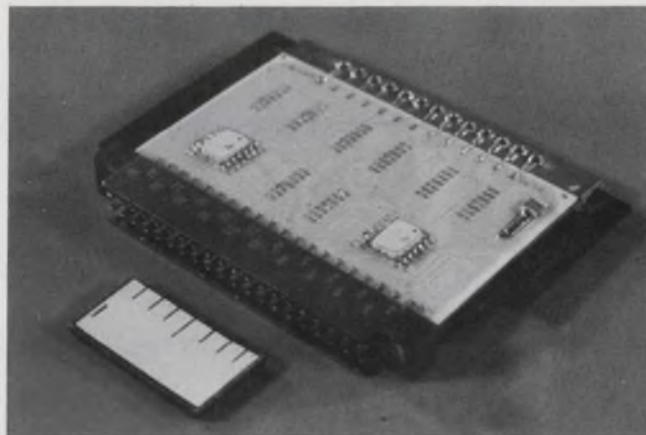

Four-layer digital logic module from Sylvania is formed by firing and screening metal and glass layers alternately on alumina substrate. Thermal characteristics are reportedly some 50 times better than glass-epoxy.

connect components.

The stamped metal chassis needed to hold tubes, and the wire, installed by women with soldering irons, have been superseded by printed-circuit boards with their plated interconnection patterns. Dip soldering fastens scores of components in place, allowing one worker with a tub of boiling peanut oil to do the work of a dozen girls with soldering irons.

Now, the popularity of integrated circuits makes even greater demands on packaging and interconnection techniques, and designers are meeting this challenge by creating multilayered interconnections in packages that can be batch-processed.

The simplest approach to multilayer interconnections is the double-sided printed-circuit board. Here, plated wires are photoformed on both sides of the printed-circuit board. Where current must flow from one side of the board to the other, eyelets, or plated holes in the board, provide the paths. Components can be mounted on either or both sides of the board.

More complex boards can contain several insulated layers of plated interconnections on one side. The additional interconnection density afforded by multilayered boards costs considerably more than lower-density wiring approaches.

Another approach to the solution of sophisticated wiring problems is the numerically controlled installation of ordinary, flexible wire. Here, a machine working under the direction of a set of programmed instructions automatically interconnects a rack of contact pins.

Designers encounter problems amenable to a similar solution in the pursuit of large-scale integrated arrays: LSI requires the development of a flexible, automatic interconnection method that can operate in a microscopic framework. At present the individual sub-circuits of a wafer are probe-tested and then interconnected by a special metalization pattern that is automatically gener-

ated by a computer. Unfortunately the computer time expended on the generation of a mask for one wafer is not applicable to the interconnection of the next wafer.

These and other aspects of interconnection and packaging technology are reported at WESCON's Technical Session 4.

Medical electronics engineer

Better cardiac monitors sought to cut death rate

The engineer attending the medical electronics session will hear that his efforts are needed to save the lives of 200,000 persons a year—cardiac-care patients who die from heart failure and shock because the doctors' stethoscopes cannot pick up the danger signs in time. Improved electronic monitoring must be developed to cut the toll.

Patient-monitoring systems are proliferating because their value in around-the-clock observation of persons who have been stricken with coronary occlusions—heart attacks—has been dramatically demonstrated. Already more than 300 of the approximately 7000 hospitals in the

United States are reported to be equipped with coronary-care wards—most in the last year or two. As Dr. Curtis E. Miller, head of medical research at Beckman Instruments, Inc., Fullerton, Calif., and chairman of the WESCON session, says: "Many people who have heart attacks are candidates for further trouble within two weeks after their attack."

Before electronic monitoring, about 40 per cent of the coronary patients admitted to hospitals died before medical help could be marshaled. Patient-monitoring systems are said to have cut this mortality in half.

Dr. Eliot Corday, a cardiologist at Cedars-Sinai Hospital in Beverly Hills, Calif., who will deliver the opening paper at the WESCON session, underlines the importance of these systems:

"We know that we are going to save the lives of 100,000 coronary patients a year when we get every patient who has a coronary monitored with electrocardiographic equipment minute by minute, and I read this into the *Congressional Record* in April," he told ELECTRONIC DESIGN.

"We are still losing 200,000 lives due to heart failure and shock, and it's obvious that to save those patients we're going to need other types of monitoring equipment to measure blood pressure, cardiac output and various pressures on the right

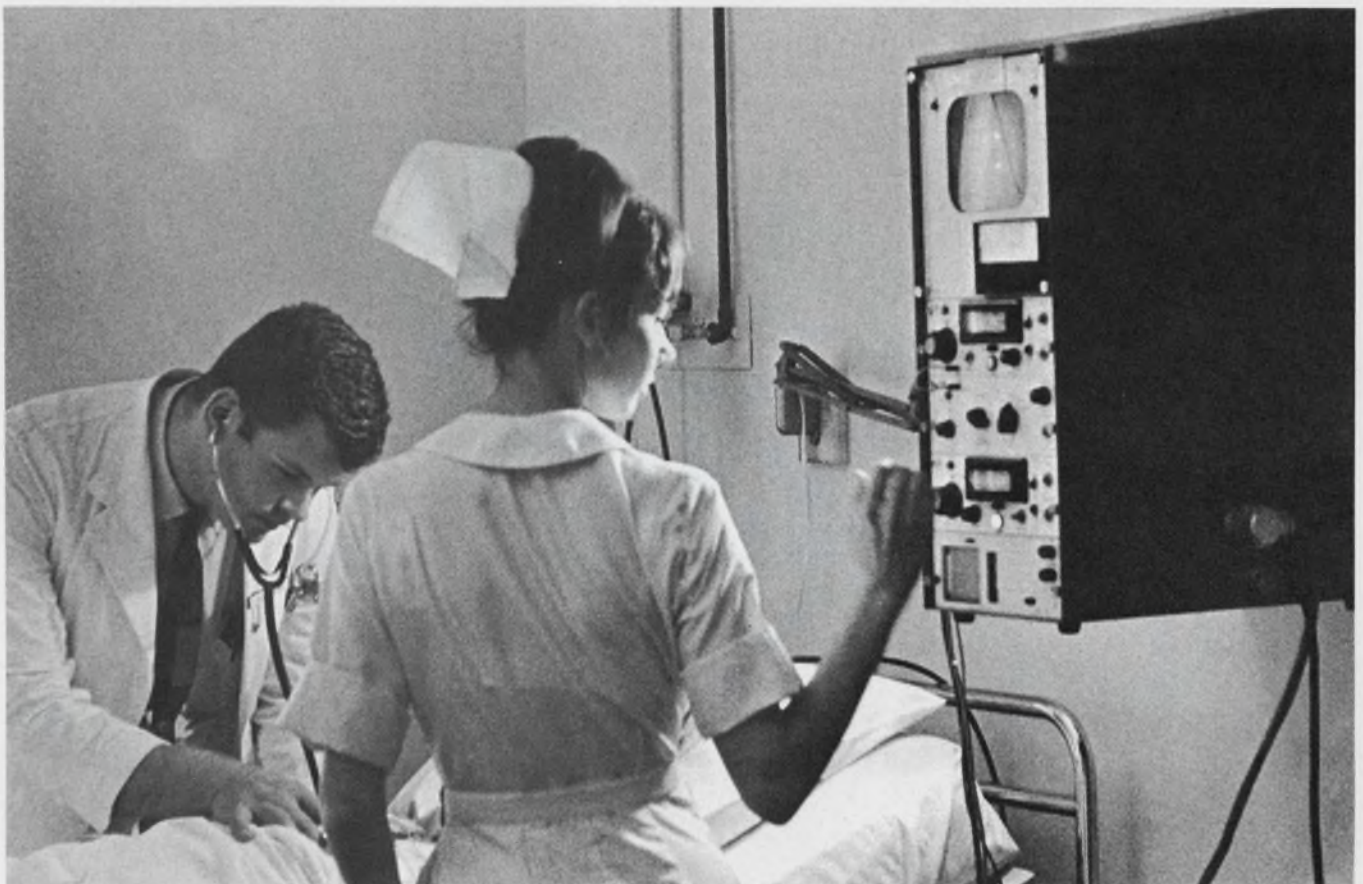

Cardiac parameters are displayed on oscilloscope at Columbia Presbyterian Medical Center, New York. Many

lives are saved, but more are lost because the ubiquitous stethoscope cannot reliably predict further trouble.

and left sides of the heart.”

Dr. Corday says that the greatest need right now is for a simple apparatus that can record blood pressure from within an artery from second to second (it would be left inside the patient), and for something that will measure cardiac efficiency externally (an indirect measurement which does not require anything to be implanted).

“This is what we’re shooting for,” Dr. Corday says, “and I hope we can have it in a few years. . . . We’re not recognizing the danger signs of heart failure and shock; we’re not picking them up on our stethoscopes.”

Another WESCON panel member, Dr. Donald Harrison, chief of the cardiology division at the Stanford Medical Center, says:

“It is useful to be able to measure cardiac output. One way of gaining some idea of this output is to measure the oxygen content of the central venous system by means of fiber optics. This gives an insight into how well the heart is functioning. The devices are not now practical for cardiac-care units, but I think they will be. The problem is one of size: it is necessary to get them small enough. I think that within a year or two they will be used widely.

“However, I have given up, after several years of intensive study and discussion with engineers, on getting useful indirect measurements. We’re going to have to live with catheters and tubes and fiber optic bundles. I don’t believe there is much capability in a year or two for indirect measure-

ments. In five years, perhaps.”

Dr. Harrison’s mention of catheters and tubes was a reference to the devices now being developed by such companies as Statham Medical Instruments, of Los Angeles, to measure blood pressure accurately. These involve the insertion of a tube into a blood vessel, so that a transducer can produce a continuous waveform output. In the fall Statham plans to introduce a subminiature blood-pressure transducer—less than 0.060 inch—that can be implanted for at least the duration of the patient’s stay in the cardiac-care ward. Present catheter-transducer devices must be replaced after a few days. However, transducers such as Statham’s are regarded as only an intermediate step.

The more general purpose of the WESCON session is to permit doctors who have had direct experience with patient-monitoring to give a critical review of this healing art: its problems, progress and prospects.

According to Dr. Miller, many hospitals think they need patient-monitoring systems but are uninformed about what they need. At WESCON the speakers will try to provide information both to the medical profession and to the instrument manufacturers.

For example, equipment should be designed with personnel in mind. Will engineers be in attendance in the hospitals? Or will the equipment be operated by nurses? What about maintenance?

There are other types of patient-monitoring



Cardiac pacemaker restores a patient’s heart beat when the monitor detects an irregularity. The unit is used in

the intensive care ward of University Hospital, NYU Medical Center, New York.

systems besides the cardiac units. Beckman Instruments is developing a device to protect premature babies against a common tendency for them to stop breathing. Nowadays a nurse walks around the incubators and checks. With the Beckman device, an alarm goes off when respiration stops.

Intensive care is another form of monitoring for patients who are seriously ill from a variety of causes: shock, traumatic surgery, brain damage, burns. These patients have to be checked extremely closely to detect the onset of difficulties that are secondary to the major illness.

Still other monitoring devices are used mainly in diagnosis. For example, a person may complain that his heart is fluttering or causing him pain. The electrocardiogram taken in the doctor's office may not show anything abnormal. But the physician knows from experience that patients have walked out of his office in similar circumstances, only to succumb to heart failure a day or two later. Now there are on the market portable tape recorders that, attached to a person, permit continuous recording of an electrocardiogram for up to 10 hours. The tape can be played back very rapidly under computer control to reveal pathological symptoms.

The computer itself has not yet begun to reach its full potential in patient-monitoring. In a very few hospitals time-shared computers are used for monitoring arrhythmia—irregular heartbeat—from electrocardiographic inputs. Dr. Harrison is confident that they will come into wider use, particularly when the number of parameters that have to be monitored increases.

"I think the next generation of time-sharing computers will lend themselves to monitoring," he says. "The data could be preprocessed on analog systems before they are run in the digital machines."

Publicity accorded the introduction of computers in the hospitals seems to have been misdirected, in the opinion of some experts. A spokesman for Montefiore Hospital in New York City says that the first things hospitals have done with the machines were the housekeeping chores—payrolls, purchase orders and the like. But many have been at a loss to use the computers in direct medical applications. Programming is said to be a problem. One doctor's description of symptoms might differ from another's.

Some of the computer applications instituted by Montefiore are:

- A daily printout on every floor of laboratory tests run for patients on that floor. Instead of laboriously copying reports by hand, a nurse could post the printout at the foot of the patient's bed.

- Storage of all X-ray records going back four years. Any time an unusual condition occurred,

records of similar conditions could easily be tuned up.

- Analysis of the results when two different radioisotopes are administered to the same patient. To separate the results, it is necessary to solve equations. The computer can accomplish in 2 minutes what it took a mathematician a day and a half to solve.

Microcircuit systems designer

MOS arrays and linears are reaching maturity

There are four important trends in microcircuits today: the proliferation of stable, producible MOS arrays; the explosion of linear microcircuits—monolithic circuits that perform analog functions; the tendency to perform these analog functions with inexpensive digital microcircuits; and the spiraling of microcircuit complexity. The latter trend, semiconductor manufacturers believe, will lead to development of large-scale arrays and will place in the manufacturers' hands responsibility for the design of a substantial portion of future electronic systems.

WESCON does not pretend to be a microelectronics show. Yet, its technical sessions and an accompanying two-day symposium touch on each of these four important areas. Unfortunately, two of the most interesting technical sessions 8B and 10 conflict with the two-day microcircuit symposium. There is, however, a profitable recourse.

The experienced designer can attend Session 1 ("Linear Integrated Circuits"), Session 8B ("Large-Scale Integration of Computer System Design") and Session 10 ("Digital Approach to Analog Functions").

The beginner can attend the two-day symposium, "Microelectronics Comes of Age."

Four of the five papers at Session 1 describe the design and application of a specific microcircuit made by the author's company. Ralph Seymour of Signetics, for example, discusses the application of a Signetics chip containing two transistor triads (driven by a small bias circuit) for i-f or rf amplification. Similarly Motorola's Leo Wisserman and Bill Ehrsam discuss a dual operational-amplifier microcircuit recently introduced by Motorola. Jerry Gibbs of Amelco Semiconductors, Mountain View, Calif., describes the marketing considerations that inspired Amelco to introduce an inexpensive version of the 709C operational amplifier, which it calls the 809C. He shows those

areas where the 809C performs adequately enough for the designer not to have to resort to the 709C, a chip of greater size and complexity. The 809C costs \$4.50, but Gibbs feels that its small size will allow the company to drop the price into the \$3 range in two to three years and still make a profit. Fairchild's μ A709C is presently selling for \$4.95.

Session 8B presents a panel of experts conversant in LSI (large-scale integration), that popular conversational gambit usually found at the other end of the digital microcircuit rainbow.

The electronics industry is about to witness a boom in linear microcircuits (see "Tiny exploding world of linear microcircuits," ED 15, July 19, pp. 49-72). The linears are, however, lagging several years in development behind their digital counterparts. Session 10 sheds some light on that area of systems design where it may well be easier to use digital microcircuits to perform analog functions, than to design linear microcircuits.

A paper to watch is the second presentation of the session. It is entitled "Four Digital Arrays Do All Algorithms," by George Sendzuk of General Electric, Binghamton, N. Y. He describes how four digital MOS arrays can simulate an analog filter of any frequency response. Hooking together the four arrays in the appropriate manner can save the designer of a digital system the trouble of converting a pulse train to an analog signal,

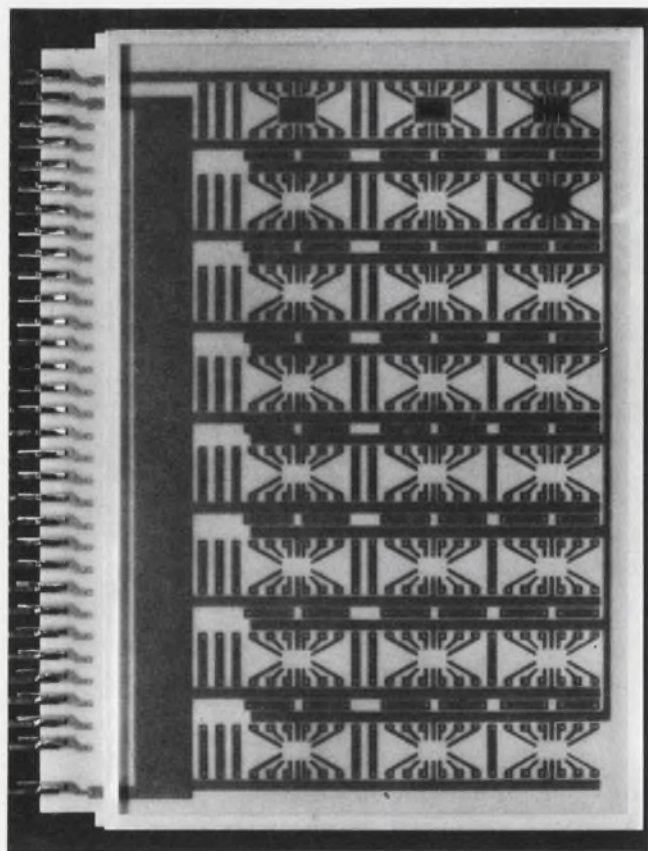

Interim approach to large-scale integration is exemplified by this card-sized ceramic board which is designed to carry 24 uncased circuit chips. Here only two are shown in place—one right side up and one flipped.

filtering it, and converting it back to a pulse train.

The two-day microelectronics symposium offers the designer who lacks experience with micro-miniaturization more than the technical papers offer the designer who has already acquired a good deal of microcircuit savvy. It covers the basics of every area of production, from thin and thick films to monolithic integrated circuits. It describes the basic theory of the devices of microcircuitry, from bipolar to MOS transistors, and from ordinary thick-film resistors to multilayered, thin-film capacitors. It presents basic applications information for both digital and linear integrated circuits. Packaging and wiring techniques as mundane as mechanical wiring are discussed right after those as esoteric as large-scale integration, which at the moment is an interconnection problem requiring computers for its solution.

The first day's symposium papers are divided, as is the field of microelectronics itself, into the hybrid (multichip) approach and the monolithic (single-chip) approach. A particularly interesting account of an automated hybrid production line is given by Mort Penberg of the Aerojet-General Corp., Azusa, Calif. Using an automatic vacuum deposition system developed at Aerojet-General, the automated production line deposits up to 40,000 thin-film circuits onto substrates in one pump-down; attaches transistors to the substrates automatically, with numerical control machines; and then checks each circuit on computer-controlled test equipment. The Aerojet-General system can manufacture and test a wide variety of thin-film circuits. In another paper, Wayne Moyers, head of microelectronics at the Lockheed Electronics Div., Lockheed Aircraft Corp., describes the design and manufacture of a mass-produced thin-film circuit used in touch-tone telephones. The circuit, developed at Bell Telephone Laboratories for the Bell System's manufacturing division, Western Electric, uses a beam-lead microcircuit as an oscillator.

The afternoon session delves into the monolithic approach to integrated circuits. Several papers deal with the basic theory-processing and design of bipolar microcircuits. Other papers explore those three new stars of monolithic integrated circuitry: the MOS array, the linear microcircuit and the microwave microcircuit. These are presented in papers 3/5, 3/6 and 3/7 by M. Sussman of the General Instruments Corp., Newark, N. J.; Jack Gifford of Fairchild Semiconductor, Mountain View, Calif., and V. Gelnovatch of the Army Electronics Command, Fort Monmouth, N. J. MOS arrays have been around for several years, but instability problems that have prevented their widespread use have been solved and sophisticated circuits that use four-phase logic and complementary transistors have been devel-



Variations in the output frequency of gas lasers—such as this helium-neon setup—may be caused by shifts in the

pressure of the constituent gases. Possible solutions to the problem are described in Paper 5/2.

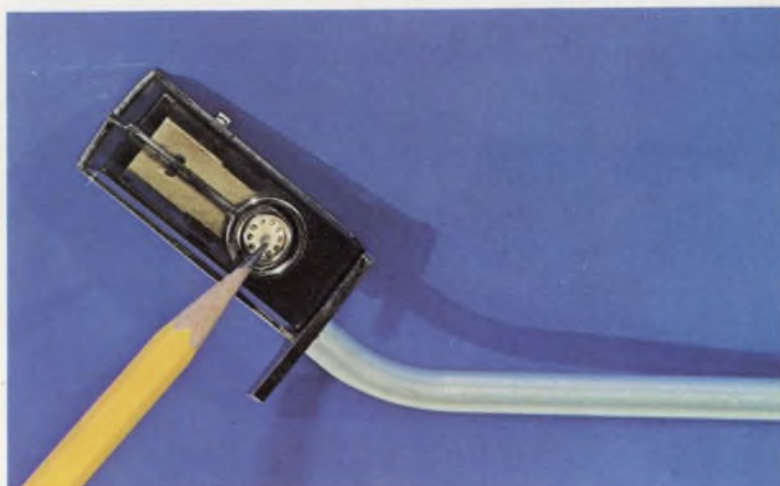

IC preamplifier by RCA replaces magnetic cartridge in phono arm. It's another example of the inroads ICs are making in the consumer products areas (Microelectronics symposium).

Improved communication with reentry space vehicles is the goal of researchers at Kirtland AFB, N. M. The visicorder output provides transmission data on various spacecraft window materials subjected to high temperatures by a 330-kW arc plasma generator in the background (Paper 5/2).

oped since the last WESCON.

Linear microcircuits, long the orphan of the semiconductor industry, are starting to come into their own. Their obvious home is the consumer market, where high volume helps offset the large development costs associated with linear microcircuits. Scores of linears for home entertainment products, like RCA's dual Darlington amplifier designed for a phonograph cartridge (see photo), are starting to appear on the market.

The use of high frequencies can exploit the limited size of capacitors that can be fabricated on a chip. Stripline techniques can even be used to make distributed inductors, which have usable values at microwave frequencies.

The key to microwave microcircuits is the development of good, high-frequency transistors, and that, in turn, requires extremely narrow emitter widths and shallow diffusions. One experimental approach to the fabrication of such fine geometries is Westinghouse's electron-beam etching machine. It operates on the principle that glass tends to etch faster when it is bombarded with electrons. Hence it uses the glass itself as a photoresist in the microcircuit production process.

Production techniques have progressed considerably faster than the education of the design community, says Glen Madland, president of the Integrated Circuit Engineering Corp., Phoenix, Ariz. Madland peers into his crystal ball at the symposium to spot trends in the integrated-circuit field.

The two-day symposium will not make an expert of an integrated-circuit novice, but for \$30 it offers working knowledge of the techniques and is a good place to start.

Microwave engineer

Phased-array makers consider mass output

The hottest topic in the microwave industry is phased arrays. If they make it, they can provide a much-needed new market for the microwave industry. The question is, will they? To hear the opinions of experts, drop in on Session 14 ("The Future of Solid-State Phased Arrays").

The problem is not R&D; it is the cost of production, according to at least one member of the session's panel, Malcom Vosberg of the Institute for Defense Analysis.

"We cannot afford the arrays we are building now; we've got to get the cost down," he says, "and mass production is the only way to do it."

Phased arrays are just about the only microwave system where mass-production techniques

are applicable, because they have many identical elements. (An element contains the steering circuit, or phase shifter; the drive circuit for the shifter; the transmitter; the duplexer and a low-noise receiver-preamplifier.)

A controversy arises at this point. How many elements should be used in phased arrays? One school of thought in industry leans toward arrays with 10,000 to 100,000 elements; the other favors the use of as few as possible—on the order of hundreds. Both sides will be represented on the panel.

The trade-off revolves around the power-aperture product of the antenna. "With many apertures, we can stop pushing for high powers in each element," says Vosberg, "but this means that their cost must come down to about \$100 to \$200 per element." If there are 100,000 elements, it does not matter much if 10 or 100 of them stop working; tolerances and reliability requirements can be relaxed. This reduces the cost.

With a few apertures, the power requirements go up, along with reliability and tolerances, thereby increasing the cost. One example of this approach is the radar designed by Bell Telephone Laboratories of Murray Hill, N. J., for the Nike X.

The lack of efficient assembly-line production techniques made the second approach the accepted solution, says Vosberg.

Where are the markets?

To find the market, the panel will examine the advantages and limitations of phased arrays, as well as three major applications areas that appear to be promising at this time.

The first area is, of course, where the electronically controlled scanning of phased arrays tops other antenna types in providing fast coverage. In ballistic missile radars, phased arrays are already replacing parabolic types.

The second area of promise for phased arrays is when the antenna becomes too large to be moved mechanically—for example, in space tracking. Phased arrays are installed permanently; hence their size is not limited. "You can make them the size of the Empire State Building," says Vosberg.

The third applications area may become the most significant in the long run. The idea is to put the array on the outer surfaces of aircraft and space vehicles. This design allows communication in all direction without swinging dishes around on gimbles, which comes in handy in satellite communications. The concept is aptly called conformal phased arrays.

Some members of the WESCON panel feel that these possibilities will hardly be sufficient to start a mad scramble among manufacturers. They estimate that only a few companies will end up in

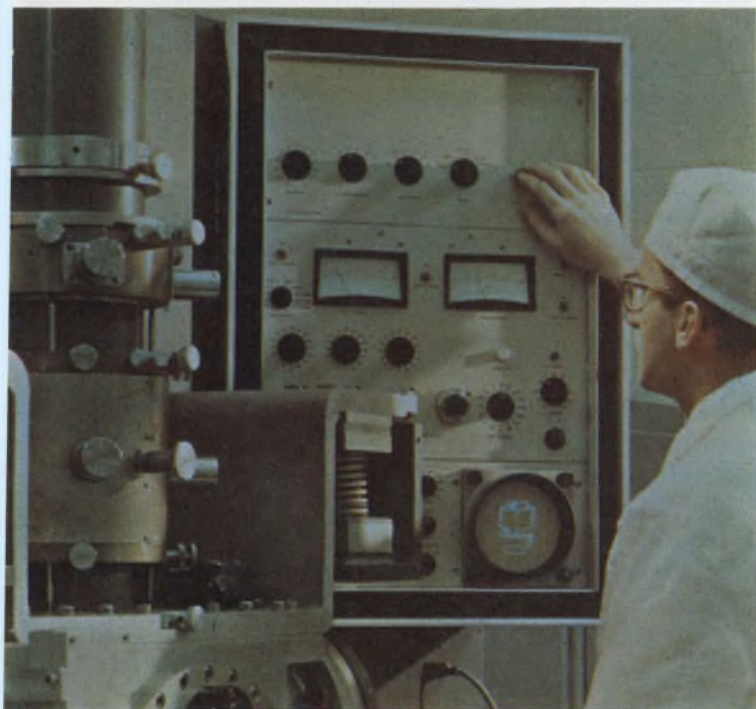

Electron-gun etching machine developed by Westinghouse can be used to etch glass coatings on microcircuits with no photoresist (Microelectronics Symposium Paper 3/1).



Noise figure measurements on an rf FET mixer are made by Siang Pink Kwok of Motorola Semiconductor, Inc. (Paper 8/1).

Arrays of silicon photo-transistors, operating in a photon flux integration mode, are reported to make it possible to obtain full frame storage at even commercial television rates. The linear array (above), developed by Fairchild Semiconductor, contains 200 phototransistors, although only 50 are hooked up (Paper 13/2).

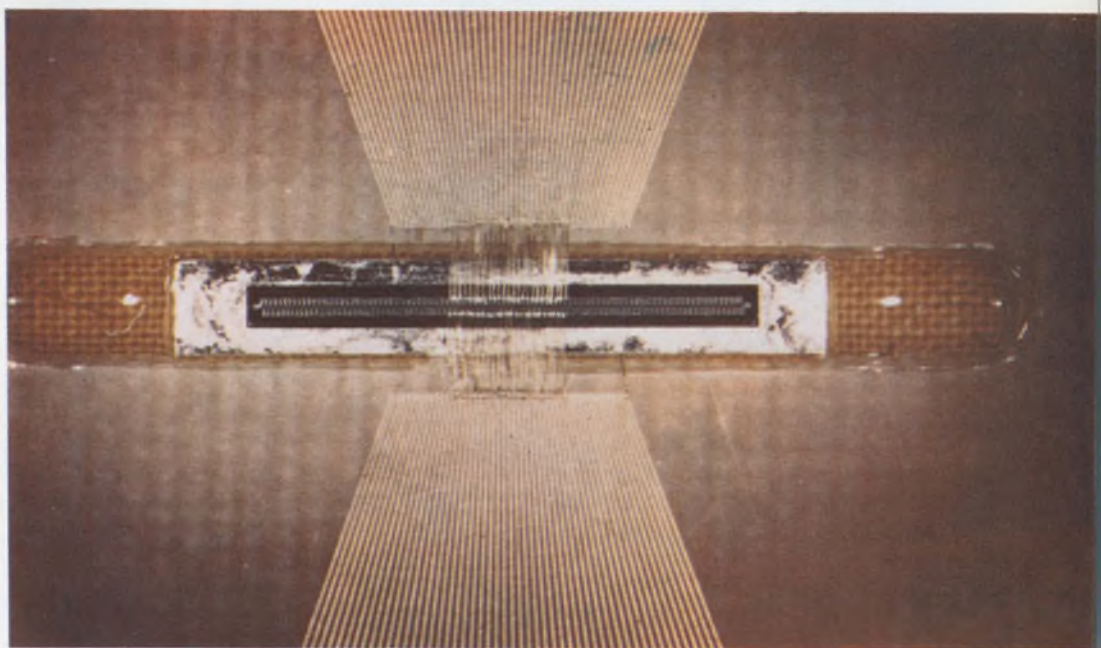

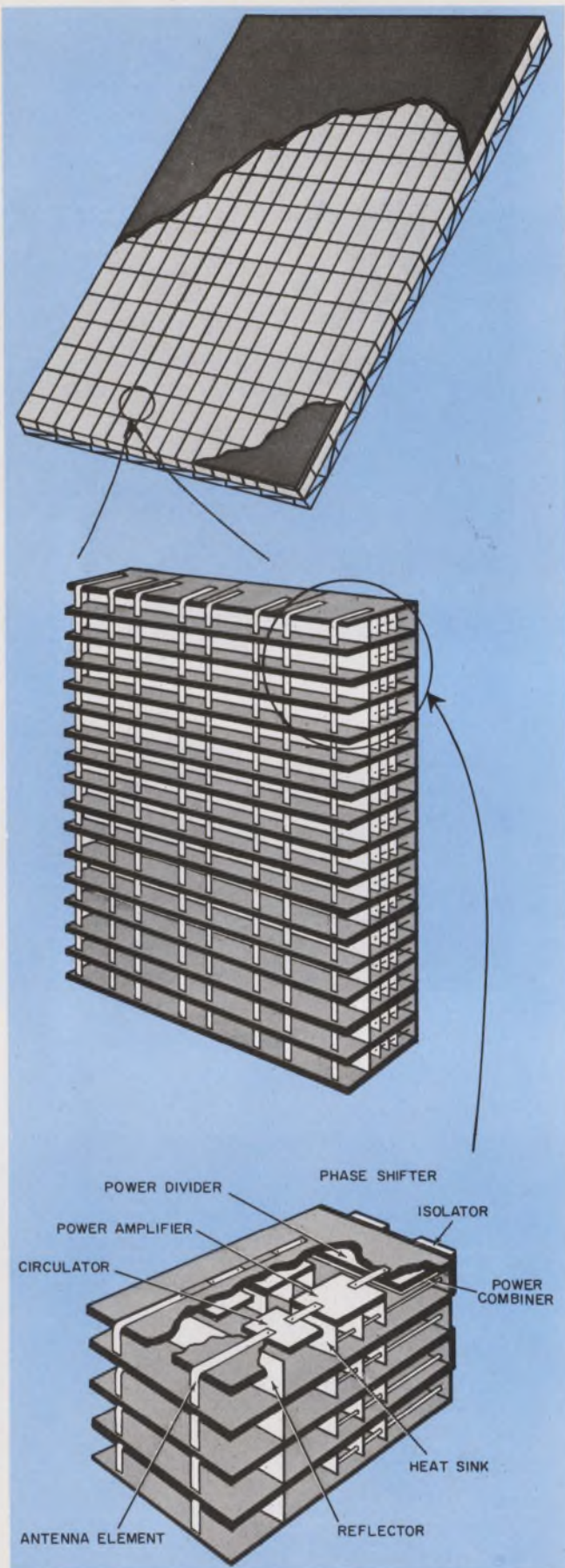

1. Design concept of solid-state phased arrays is based on a modular approach. The array face (top) has plug-in modules that provide 128 solid-state elements (center). Each plug-in unit (bottom) has eight amplifiers, radiating elements and transmitting and receiving circuitry.

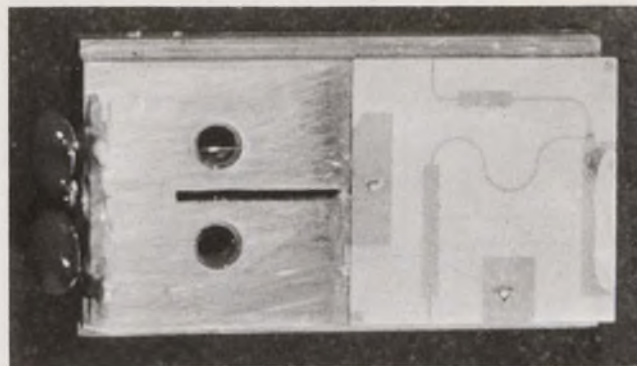

2. Integrated microwave receiver contains a miniature X-band ferrite circulator that leads to a tunnel-diode rf amplifier (not shown), a mixer, a wide-band i-f amplifier and circuits that generate an X-band local-oscillator signal. A four-times multiplier provides the X-band signal from an S-band input in this RCA unit.

this field. This centralization will change the component supply somewhat, experts say. At the moment, talents are scattered; the designer may want to go to Texas Instruments for a receiver transistor, to RCA for a power transistor and to Microwave Associates for a switching diode. But those who will get into the business of mass production will have to try to combine all these talents under one roof, to make their operation as efficient as possible.

Getting down to the finer points of engineering, the panel will try to establish guidelines for specific system parameters. Frequency and power levels for both solid-state and tube systems appear high on the agenda.

Solid state and the increased use of microwave integrated circuits are of interest, not only from purely engineering considerations but also because they help to reduce cost and facilitate mass production.

Most panel members agree that monolithic fabrication is just not suitable for microwave circuits at present. The transmission lines that constitute the inactive parts can be built only in a hybrid fashion. Microwave integrated circuits mean flat chips on a substrate, which may be ferrite for frequencies where ferrite devices are needed—mostly above S band. Below S band, semiconductor devices seem to take over all switching and beam-steering functions.

At least one panel member says that he would rather hold off the solid-state approach till transistors with 15 to 20 watts' output become available. "It does not make much sense to push development above L band, since we are just beginning to get transistors with a few watts of output in these frequencies and noise figures around 4 dB," says Vosberg, "and I'd like to see 10 or 20 watts before I can get serious about solid-state transmitters."

But it's an even bet that others on the panel will challenge him on this.

...and switch to the highest quality switches ever made: Shallcross!

These are the switches designed for function and performance, not to low price. Yet they're priced competitively!

They give you a quality "feel." A solid feel. The kind you don't get in cheaper switches.

Not surprising. Because we use only the best materials and conservative design standards in creating Shallcross rotaries. For both commercial ratings and switches designed to MIL-S-3786.

All this pays-off for you. With Shall-

cross switches, you get lower initial contact resistance. So you can use them on more exacting applications.

You get better contact-resistance stability, so your equipment holds calibration better.

And you get better voltage and current ratings for a given size. More switch per volume.

You get versatility, too. Select from 1" wafer, 1 3/4" deck, and 2 1/2" deck configurations, plus round and oval ceramics —for every rotary application.

Join our rotary club. Switch to the Number One rotary switch: Shallcross. See your local Cutler-Hammer Sales Office or Shallcross Stocking Distributor. Or write for catalog LA-163-0217.



Cutler-Hammer offers a complete selection of other quality switches. Commercial forms are covered in catalog LL-290, Military ratings in Catalog LL-291.



CUTLER-HAMMER
Milwaukee, Wisconsin 53201

Join our rotary club

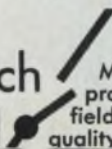

Switch to No. 1  More than just switches: prompt availability, field help, innovation, quality assurance too.

ONE COMPANY

has demonstrated the capability to design, produce and deliver the only broad line of complex **MTOS** arrays (LSI) available today...

MTOS MICROCIRCUIT ARRAYS ($T_A = -55^\circ\text{C}$ to $+85^\circ\text{C}$)

SHIFT REGISTERS		STATIC	DYNAMIC	FREQUENCY	NUMBER OF BITS	INPUT		OUTPUT		NUMBER OF CLOCKS	SUPPLY VOLTAGE (VOLTS)
TYPE	FUNCTION					PARALLEL	SERIES	PARALLEL	SERIES		
MEM 3005PP	5-BIT PARALLEL IN/ PARALLEL OUT	X		dc to 1.0 MHz	5	X	X	X		2	-27V \pm 1V
MEM 3005SP	5-BIT SERIAL IN/ PARALLEL OUT	X		dc to 1.0 MHz	5		X	X		2	-13V \pm 1V -27V \pm 1V
MEM 3008PS	8-BIT 2 ϕ PARALLEL IN/SERIAL OUT	X		dc to 1.0 MHz	8	X	X		X	2	-13V \pm 1V -27V \pm 1V
MEM 3012SP	12-BIT SERIAL IN/ PARALLEL OUT	X		dc to 1.0 MHz	12		X	X		1	-27V \pm 1V
MEM 3016-2	DUAL 16-BIT	X		dc to 1.0 MHz	32(16,16)		X		X	2	-13V \pm 1V -27V \pm 1V
MEM 3016-2D	DUAL 16-BIT		X	10 kHz to 1.0 MHz	32(16,16)		X		X	2	-13V \pm 1V -27V \pm 1V
MEM 3020	20-BIT	X		dc to 1.0 MHz	20		X		X	2	-13V \pm 1V -27V \pm 1V
MEM 3021	21-BIT	X		dc to 500 kHz	21(1,4,16)		X		X	1	-27V \pm 1V
MEM 3021B	21-BIT	X		dc to 250 kHz	21(1,4,16)		X		X	1	-27V \pm 1V
MEM 3032	6-1 ϕ BINARY WEIGHTED	X		dc to 1.0 MHz	32(1,1,2,4,8,16)		X		X	1	-13V \pm 1V -27V \pm 1V
MEM 3050	DUAL 25-BIT		X	10 kHz to 500 kHz	50(25,25)		X		X	2	-27V \pm 1V
MEM 3064	64-BIT SERIAL ACCUMULATOR		X	10 kHz to 5.0 MHz	64		X		X	4	NONE

plus these other exclusive MTOS devices...

MTOS SILICON P-CHANNEL ENHANCEMENT MODE FIELD EFFECT TRANSISTORS ($T_A = 25^\circ\text{C}$, BODY GROUND)									
TYPE	V_{GS1} (VOLTS TYP)	I_{D1} (DN) (mA TYP)	I_{DSS} (mA TYP)	I_{GSS} (nA TYP)	BV_{DSS} (VOLTS)	BV_{GSS} (VOLTS)	Y_{fs} (μmho TYP)	C_{gd} (pF TYP)	f_{os} DN (Ω TYP)
MEM 511	-4.0	-6	-0.5	-0.1	-30	-30	2500	2.0	150
MEM 517	-3.5	-60	-0.8	-0.1	-30	-25	12,000	10	30
MEM 517A	-3.5	-60	-0.8	-0.1	-30	-25	12,000	10	30
MEM 517B	-3.5	-60	-0.8	-0.1	-30	-25	12,000	10	30
MEM 520	-4.0	-6	-0.5	-0.03	-30	NA	2500	2.0	150
MEM 550	-4.0	-5	-0.1	-0.1	-30	-25	1400	1.1	250
MEM 551	-4.0	-5	-0.5	-0.03	-30	NA	1400	1.1	250
2N4353	-4.0	-6	-0.5	-0.1	-30	-30	2500	2.0	150

LOGIC CIRCUITS ($T_A = -55^\circ\text{C}$ to $+85^\circ\text{C}$)		POWER CONSUMPTION (mW)	SUPPLY VOLTAGE (VOLTS)	PROPAGATION DELAY (ns)	CAPACITANCE (pF) (TYP)	FREQUENCY (kHz)
TYPE	FUNCTION					
MEM 1000	DUAL FULL ADDER	< 70 TOTAL	-13V \pm 1V -27V \pm 1V	350 (TYP)	3.0	—
MEM 1002	DUAL 3-INPUT NOR GATE	< 40 (MAX)	-27V \pm 1V	200 (TYP)	3.0	—
MEM 1005	R-S-T FLIP-FLOP	< 80	-27V \pm 1V	950 (MAX)	3.0	dc to 500 kHz
MEM 1008	DUAL EXCLUSIVE OR/NOT GATE	50 (TYP)	-27V \pm 1V	500 (TYP)	3.0	—
MEM 1013	QUAD 2 INPUT NOR GATE	9 mW/circuit	-13V \pm 1V -27V \pm 1V	300 (TYP)	3.0	—
MEM 1014	QUAD 2 INPUT AND GATE	14 [Circ. (1,2,3)] 42 [Circuits 4,5]*	-13V \pm 1V -27V \pm 1V	300 (TYP)	3.0	—
MEM 1015	DUAL J K FLIP-FLOP	60	-13V \pm 1V -27V \pm 1V	—	3.0	dc to 1 mHz
MEM 1022	9-BIT PARALLEL PARITY DETECTOR	50	-27V \pm 1V	500 (TYP)	3.0	dc to 500
MEM 1050	4 STAGE BINARY UP-DOWN COUNTER	300	-27V \pm 1V	—	2.0	—
MEM 1051	BUFFERED D/A CONVERTER	25	-13V \pm 1.5V -25V \pm 3V	—	3.0	dc to 500 kHz

*The MEM 1014 provides Four 2-Input and Gates (Circuits 1, 2, 3, 4) plus One 2-Input N and Gate (Circuit 5)



WESCON BOOTHS 5401-5404

**at prices that reflect the
highest yields in the industry...**

LARGE DIGITAL SUBSYSTEMS		POWER CONSUMPTION	SUPPLY VOLTAGE (VOLTS)	CLOCK RATE	DESCRIPTION
TYPE	FUNCTION				
MEM 5014	A/D-D/A CONVERTER ELEMENT	135 mW	-27V ± 2V	dc to 200 kHz	Complete logic and analog switching for 10-bit successive approximation A/D converter.
MEM 5015	16 CHANNEL RANDOM ACCESS MULTIPLEXER	70 mW	-27V ± 1V	100 kHz	Sixteen Channel Multiplexer with address storage and decoding.
MEM 5021	DDA ELEMENT	100 mW	-13V ± 1V -27V ± 1V	500 kHz	Ternary type DDA performing rectangular integration.
MEM 5031	SERVO ADDER	25 mW	-13V ± 1V -27V ± 1V	dc to 1.0 MHz	Shift Register content decision unit
MEM 5035	SIGMA DELTA "Y" SUMMER	25 mW	-13V ± 1V	10 kHz to 1 MHz	2 Input Delta "Y" Summer used in conjunction with the MEM 5021
S-C-100	MINIATURE A/D CONVERTER SYSTEM	300 mW	-27V ± 2V -15V ± 2V +15V ± 2V REF. VOLT	100 kHz	Complete 10-BIT A/D Converter System

MULTIPLEXER CIRCUITS (T _A = -55°C to +85°C)		OFF RESISTANCE (Ω TYP)	ON RESISTANCE (Ω TYP)	CAPACITANCE (pF) Cgd	V _{OS11} (VOLTS)	V _{OS12} (VOLTS)
TYPE	FUNCTION					
MEM 2002	5 CHANNELS (4 Channels —Common Drain)	10 ¹⁰	200	1.1	-30	-30
MEM 2003	4 CHANNELS (Protective Diodes)	10 ¹⁰	200	1.1	-30	-30
MEM 2004	4 CHANNELS (No Diodes)	10 ¹⁰	200	1.1	-30	±60
MEM 2005	4 CHANNELS (Dual 2 Channel)	10 ¹⁰	200	1.1	-30	-30
MEM 2006	3 CHANNELS (2 Channels —Common Drain)	10 ¹⁰	200	1.1	-30	-30
MEM 2009	6 CHANNELS (Protective Diodes)	10 ¹⁰	150	1.9	-30	-30

SERIES SHUNT CHOPPER		OFFSET VOLTAGE	CLOCK φ	FREQUENCY (kHz)	ON RESISTANCE PER UNIT (SERIES OR SHUNT) (Ω TYP)	OFF RESISTANCE PER UNIT (SERIES OR SHUNT) (Ω TYP)	SIGNAL VOLTAGE HANDLING RANGE (TYP)
TYPE	FUNCTION						
MEM 2008	INTEGRATED SERIES SHUNT CHOP. CIRCUIT	0	1	100	6K	10 ¹²	1μV—10V

Contact your authorized General Instrument Distributor for off-the-shelf delivery. In Europe, contact General Instrument Europe, Via Turati 28, Milano, Italy. Write for complete data.

FLUIDIC LOGIC TAKES TO THE AIR

Control elements that use gases can guide missiles and stabilize helicopters

Roger Kenneth Field
Technical Editor

Despite the great flood of publicity about fluidics, designers find the new technology obscured by the shadow of electronics. Yet fluidic logic and control elements can reliably perform many intricate tasks, particularly where the equipment is expected to work in the face of temperature extremes, stifling humidity, chronic vibrations or violent shock.

Fluidics refers to a technology invented in 1958 in which streams of fluids—liquids or gases—are controlled by other streams of fluids. These fluids travel in channels and passageways that are gouged, etched, molded or milled in many materials, such as clays, glass, plastics, and ceramics as well as metal alloys like beryllium copper and tungsten steel. The reliability of fluidic systems hinges on the stability of the materials that comprise them, and the relatively simple fabrication requirements of fluidic elements allows the use of extremely tough materials.

The military needs a flip flop

Fluidics, like many other technologies, was spun off military research. The basic fluidic logic element, the flip-flop, was developed at what was then the Harry Diamond Ordnance Laboratory. For the Department of Defense in 1958, fluidics represented a rocket control system that was immune to radio-frequency jamming; it now represents a missile control system that is unaffected by ionizing X-ray radiation propagated in space by an enemy's anti-missile.

There are two pure fluid systems for the control of rocket engine exhaust. One is an analog system, which uses four proportional vortex amplifiers operating in a push-pull mode at the rocket's exhaust to control the direction of the tail. The other is a digital system which expels a portion of the exhaust through a giant fluidic flip-flop built into the tail. A fluidic guidance system in this missile determines the relative switching time for

each of the flip-flop outputs that keeps the missile on course.

The basic theory and design of the proportional system is revealed in a paper presented at the WESCON fluidics session (Session 11). Using a warm gas (2000°F) for the control of the engine's hot exhaust, four vortex amplifiers steer the missile. The injected stream pumped by an amplifier into the tail of the missile creates a shock wave that disturbs the laminar flow of the rocket's exhaust. This induces the cross section of the exhaust to be asymmetrical and the resulting force moves the tail of the missile in the direction of the vortex amplifier creating the shock. Jerome Rivard, head of propulsion controls, Bendix Research Laboratories, Southfield, Mich., describes the performance of this analog control system.

The digital missile control was developed by the Honeywell Aerospace and Defense Group, at Minneapolis. This fluidic control system controls the missile's spin by venting a portion of the exhaust through a giant flip-flop, to one side of the missile or the other. The Aerospace and Defense

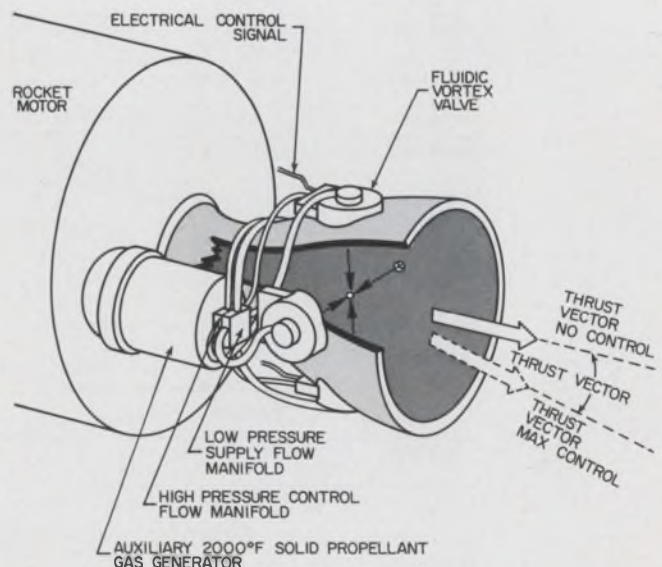

The Bendix analog rocket control uses four fluidic vortex valves to direct the tail.

Group is now developing an all fluidic control system to stabilize a helicopter. The firm hopes to test the system aboard a Navy CH-46A tandem-rotor helicopter at the Patuxent River Naval Air Station, Md., this fall. The system will sense the helicopter's attitude with three vortex rate sensors, amplify and process the information with fluid amplifiers, and adjust the helicopter's attitude by actuating conventional hydraulic control servos with fluidic-to-hydraulic transducers. Honeywell believes that this fluidic stabilizing system will be able to withstand the vibrations of the helicopter's jet engines far better than electronic controls, yet it will be able to respond to sudden instabilities more quickly and reliably than pneumatic and hydraulic control systems, which rely on moving mechanical parts.

Industrial uses for fluidics are hard on the heels of these military applications. The Sperry Utah Div. of Sperry Rand, Salt Lake City, Utah, has developed a fluidic proportional control system to regulate an important step in the extraction of gold. In another paper at WESCON's session 11, Sperry's Robert Blosser describes the operation and design of a system that his company put into service at the Carlin Gold Mine. He encountered two interesting problems: the response of the fluidic controls was so fast that the system oscillated about the ideal operating point and the valve that controlled the flow of gold slurry tended to cycle open and closed; and the slurry kept clogging a probe in the system.

The first problem was solved simply by the addition of sufficient damping to the feedback network. To solve the clogging problem, Sperry had to develop special probes that would sense the slurry level without clogging. One of the problems with fluidics at this early point in its development

is the fact that relatively few sensing devices have been designed, and, although there is a more than ample supply of logic elements for the design of many systems, most special sensing requirements almost inevitably demand the design of new transducers.

Though the designer of fluidic systems must contend with the dearth of sensors, transducers and interface equipment that accompanies the introduction of any logic technology, there is readily available a number of convenient systems for forming compact fluidic logic circuitry. The goal of these systems is to make it easy for the logic designer to string together the elements required by his design, and to be able to do so confident that it will work.

The latest approach is a system that will soon be announced by Corning Glass, Corning, N. Y. With it, each logic element is connected into the system by screwing it into a common manifold. Thus, rather intricate logic schemes can be implemented with preformed, standard logic elements such as gates, flip-flops and inverters. The final assembly is more than adequately compact for most industrial control applications, and it doesn't look like a prototype, which inevitably sports a maze of plastic tubes running in every conceivable direction.

With fluidics, as with microelectronics, the intraconnection of complex systems is a formidable problem. Already, fluidic manufacturers have developed various methods for integrating logic elements. Corning, for example, stacks glass slides into which fluidic channels have been etched and then fires the slides to fuse them into a solid ceramic-glass circuit.

Martin-Orlando does the same sort of stacking with etched, thin sheets of beryllium copper.

Fluidics' airy humor

For the electronic logic designer, fluidics offers a certain comic relief. After one grows accustomed to nanosecond delays, discussion of the millisecond response time of fluidic elements is often tinged with amusement. Fluidic designers discuss their systems in electrical terms, and it seems almost facetious to speak of the inductance of a long, fine air-tube or the capacitance of a bell jar. Yet just such analogies make it extremely easy for an electronic designer to feel at home in the airy field of fluidics. Sophisticated systems are being built. Fluidics now offers manufacturers of industrial controls a very quick alternative to pneumatics and hydraulics, the two technologies with which they have become thoroughly familiar. WESCON's session 11 sheds some light on to what is to many electronic designers the murky world of fluidics. ■ ■

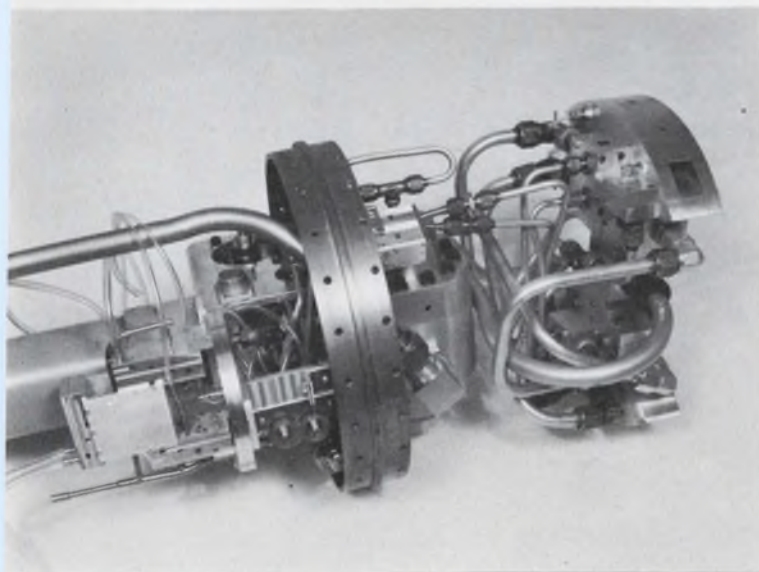

Honeywell's giant flip flop at the extreme left keeps a small test missile from spinning.

Look who's now

big in MOS.

Prodded by Dan Izumi, we now make the fastest, lowest-powered two phase shift register in the whole wide world.

We call it the MM400. He calls it the Izumi 400. Call it what you like, it's still the world's best dual 25 bit dynamic register. Primarily because it uses only -10 volt VDD and -16 volt clock voltage. That's at least a good 11 volts under any other. And guaranteed operation is at 1MHz over a temperature range that goes up to 125° centigrade.

There's also very little power dissipation — typically 40mw at 1 MHz operation — making it just perfect for ground systems, instrumentation, airborne computers and a variety of other applications. Price is an inscrutable \$40 in 100 lots. Send for details or get them off the shelves of our distributors. Ask for the Izumi 400. See if they know what you mean.

National Semiconductor Corporation, 2950 San Ysidro Way, Santa Clara, California 95051, (408) 245-4320.



National Semiconductor

ON READER-SERVICE CARD CIRCLE 59

WHEN, WHERE AND WHAT TO HEAR

Here's the complete technical program at the show, by session, including times and places for each paper.

1 Linear Integrated Circuits

(Tues./a.m./D)

Chairman: Jerry Eimbinder, *EEE Magazine*.

1/1 Applications for rf/i-f Integrated Circuit Amplifiers—*Ralph Seymour, Signetics Corp.*

1/2 Dual Integrated-Circuit Operational Amplifiers—*Leo L. Wisseman and Bill Ehsam, Motorola Semiconductor Products.*

1/3 The Trade-Off Between Cost and Performance in Operational-Amplifier Integrated Circuits:

Part 1—Designing for Industrial/Consumer Applications—*Jerry W. Gibbs, Amelco Semiconductor.*

Part 2—The Performance/Economics/Marketplace Interrelationships—*Jack Gifford, Fairchild Semiconductor.*

2 Business Management: The Engineer Becomes Manager

(Tues./a.m./T)

Chairman: Don C. Hoefler, *Electronic News*.

2/1 Management Is the Direction of People—*James F. Riley, Signetics Corp.*

2/2 Pitfalls in Money Management—*Daniel G. White, Commonwealth National Bank of San Francisco.*

2/3 A Model for Management Action—*Charles H. Keller, Illumination Industries.*

2/4 Managing a Major Turnaround—*Martin H. Dobilier, Friden, Inc.*

3 Radar Performance on Hyper- sonic Reentry Vehicles

(Tues./a.m./De)

Chairman: Lloyd M. Melick, *Sandia Corp.*

3/1 Microwave Transmission Studies through a Hypersonic Air Plasma—*D. W. Boyer, Cornell Aeronautical Lab.*

3/2 Effect of Reentry Vehicle Environment on Electromagnetic Transmission—*J. B. Chown, Stanford Research Institute.*

3/3 An Experimental Evaluation Technique for Reentry Vehicle Antenna Windows—*Lt. Bruce J. Benedict, Kirtland AFB.*

3/4 A Technique for Analyzing Antenna Pattern and Radar Return Effects on Spinning Vehicles—*James A. Cooper and C. D. Ouverson, Sandia Corp.*

4 Varactor Tuning of Receivers

(Tues./p.m./D)

Chairman: Johnnie Cochran, *Motorola Semiconductor.*

4/1 Designing around the Tuning Diode Inductance—*G. Schaffner, Motorola Semiconductor.*

4/2 Application of Electronic Tuning to Tactical Communications Equipments—*E. A. Janning, Avco Electronics.*

4/3 Voltage-Variable-Capacitor Tuning of Radio-Frequency Amplifiers—*Jorge E. Roza, General Dynamics Electronics Div.*

4/4 Varactor Tuning Applied to Radio Receivers—*Rinaldo DeCola, Warwick Electronics.*

4/5 Hyperabrupt Tuning Diode The-

ory and Application to a-m Radio—*Peter M. Norris, Motorola Semiconductors.*

A Special Session

Electronics and Meteorology

(Tues./p.m./De)

Chairmen: Bruce B. Lusignan, *Stanford University*, and Allen M. Peterson, *Stanford Research Institute.*

A/1 Feasibility and Utility of Satellite Lidar—*William E. Evans, Stanford Research Institute.*

A/2 Observations of Earth's Cloud Cover from Synchronous Satellite—*Dr. Verne Suomi, University of Wisconsin.*

A/3 Weather Experiments for Apollo Applications—*Dallas Evans, NASA.*

A/4 Meteorological Satellite Elec-

Code to abbreviations

The abbreviations used within this index are as follows:

a.m. — Morning sessions (10 a.m. to 12:30 p.m.)

p.m. — Afternoon sessions (2 p.m. to 4:30 p.m.)

All sessions will be held in the Cow Palace Convention Hall as follows:

D — DuBridge Hall

T — Terman Hall

De — Deforest Hall

E — Edison Hall

Numerals refer to sessions and to papers within a session — for example, 4/1 is paper 1 in session 4.



All components shown actual size



Only the new Allen-Bradley Type S cermet trimming resistors have all these features

Type S

shown twice actual size

for side adjustment



for top adjustment

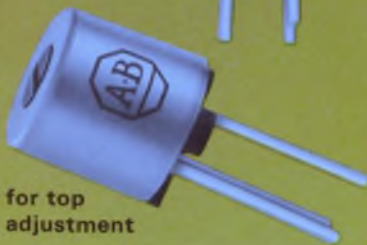

The Allen-Bradley Type S is a one turn cermet trimmer in which you will find incorporated a wider range of features than in any other trimmer now on the market. Here are a few of the more important features.

- **COMPACT**—body is $\frac{3}{8}$ " dia.
- **BUILT FOR EITHER TOP OR SIDE ADJUSTMENT**
- **50 OHMS THRU 1 MEGOHM**
- **THE SEALED UNIT** is immersion-proof
- **TEMPERATURE COEFFICIENT** less than 250 ppm/°C over all resistance values and complete temperature range
- **UNIQUE ROTOR DESIGN** provides exceptional stability of setting under shock and vibration
- **SMOOTH CONTROL**, approaches infinite resolution
- **PIN TYPE TERMINALS** for use on printed circuit boards with a 1/10" pattern
- **VIRTUALLY NO BACKLASH**
- **WIDE TEMPERATURE RANGE** from -65°C to +150°C
- **RATED $\frac{1}{2}$ watt @ 85°C**
- **EXCEPTIONAL STABILITY** under high temperature or high humidity
- **MEETS OR EXCEEDS ALL APPLICABLE MIL SPECS**
- **COMPETITIVELY PRICED!**

You'll find the new Type S trimmer equal to the traditional Allen-Bradley quality. You really ought to know more about the Type S. Won't you write for detailed specifications? Allen-Bradley Co., 222 W. Greenfield Ave., Milwaukee, Wis. 53204. In Canada: Allen-Bradley Canada Limited. Export Office: 630 Third Ave., New York, N. Y., U.S.A. 10017.



ALLEN-BRADLEY
QUALITY ELECTRONIC COMPONENTS

CERAMIC MAGNETS

Remington takes advantage of the high energy of Allen-Bradley ceramic permanent magnets to achieve the small size required for the ideal performance of their 500 *Selektronic* shaver

This custom designed ceramic magnet is the result of cooperative efforts by Remington and Allen-Bradley engineers. Despite the complex geometry of the magnets, Allen-Bradley was able to achieve high volume production at reasonable cost.

Allen-Bradley MO5-C ceramic permanent magnets are radially oriented and can be furnished in segments for d.c. motors measuring no more than $\frac{3}{4}$ " diameter up to a maximum rating of 10 hp. Coordinated and adequate manufacturing facilities at Allen-Bradley and tight quality control assure delivery in quantity —on time!

Allen-Bradley application engineers will be pleased to cooperate in the design of your motor magnets to obtain optimum performance. Allen-Bradley Company, 222 W. Greenfield Ave., Milwaukee, Wis. 53204. In Canada: Allen-Bradley Canada Limited. Export Office: 630 Third Ave., New York, N. Y., U.S.A. 10017.

A-B ceramic magnets
used in the 500 *Selektronic* shaver
shown actual size.

TYPE MO5-C CERAMIC PERMANENT MAGNETS Typical Characteristics—stated values have been determined at 25° C.

Property	Unit	Nominal Value
Residual Induction (B _r)	Gauss	3300
Coercive Force (H _c)	Oersteds	2300
Intrinsic Coercive Force (H _{ci})	Oersteds	2400
Peak Energy Product (B _r H _d max)	Gauss-Oersteds	2.6 x 10 ⁶
Reversible Permeability	—	1.09
Curie Temperature	+°C	450
Temperature Coefficient of Flux Density at B _r	%/°C	-0.20
Specific Gravity	—	4.85
Weight per Cu. In.	Lb.	0.175



The 500 *Selektronic* shaver features a unique dial which adjusts the shaving heads to four shaving positions for any combination of skin and beard, plus TRIM position for sideburn trimming and CLEAN position for instant cleaning. The shaver operates on its rechargeable energy cells or from an electric cord.



ALLEN-BRADLEY
QUALITY MOTOR CONTROL
QUALITY ELECTRONIC COMPONENTS

tronics Requirements of the Future—
Dr. Harry Press, NASA.

5

Gas Laser Stabilization

(Wed./a.m./E)

Chairman: D. E. Caddes, Sylvania Electronic Systems.

5/1 The Spectrum of a Laser Oscillator—A. E. Siegman, Stanford University.

5/2 Pressure Shifts and Related Effects in the He-Ne Laser—Arnold L. Bloom, Spectra-Physics, Inc.

5/3 Frequency Stabilization of Gaseous Zeeman Lasers—W. Culshaw, J. Kannelaud, and D. G. Peterson, Lockheed Missiles and Space Co.

5/4 A Frequency Stabilized fm Laser—Russell Targ and L. M. Osterink, Sylvania Electronic Systems.

6

Data Compression

(Wed./a.m./D)

Chairman: C. M. Kortman, Lockheed Missiles & Space Co.

6/1 Mechanization of a Digital Compressor for Biomedical Data—G. M. Loh, Lockheed Missiles & Space.

6/2 The Effect of Channel Errors on Data Compression—L. D. Davisson, Princeton University.

6/3 Adaptive Buffer Design for Data Compression Systems—G. R. Schwarz, IBM Federal Systems Div.

6/4 General-Purpose vs Special-Purpose Computers for Data Compression—D. Hochman, Adcom, Inc.

6/5 General-Purpose Telemetry Data Compression—J. J. Downing, W. E. Smith and J. E. Stubbles, Lockheed Missiles & Space Co.

7

Patient Monitoring Systems: Progress, Problems, Prospects

(Wed./a.m./T)

Chairman: Dr. Curtis E. Miller, Beckman



Instruments.

7/1 Dr. Eliot Corday, Cedars-Sinai Hospital, Los Angeles.

7/2 Dr. C. William Hall, Baylor University College of Medicine.

7/3 Dr. Donald C. Harrison, Stanford University School of Medicine.

7/4 John Mannes, Methodist Hospital, Houston,
(Paper titles to be announced)

8

Designing Radio-Frequency Circuits Using FETs

(Wed./a.m./De)

Chairman: Robert Dale, Motorola Semiconductor.

8/1 Field-Effect-Transistor rf Mixer Design Techniques—Siang Ping Kwok, Motorola Semiconductor.

8/2 Field-Effect-Transistor rf Power Design Techniques—J. B. Compton, Siliconix.

8/3 Field-Effect-Transistor rf Amplifier Design Techniques—Roy Hejhall, Motorola Semiconductor.

8/4 Field-Effect-Transistor Design Techniques at Broadcast Frequencies—Donald L. Wollesen, Philco Microelectronics Div.

8/5 Using Insulated-Gate Field-Effect Transistors as Versatile Oscillator Elements—George D. Hanchett, RCA.

B Special Session

LSI in Computer System Design

(Wed./p.m./E)

Chairman: W. H. Davidow, Hewlett-Packard.

B/1 The State of LSI Technology—Richard Petritz, Texas Instruments.

B/2 Present and Future Cost Factors in LSI—Gordon Moore, Fairchild.

B/3 Use of LSI in Future Large Computer Systems—Gene M. Amdahl, IBM Corp.

B/4 LSI in Small Systems: Practicality and Economic Considerations.—L. C. Hobbs, Hobbs Associates.

9

Recent Developments in Communications Systems

(Thurs./a.m./E)

Chairman: John V. N. Granger, Granger Associates.

9/1 Trends in Communications Systems Development—W. R. Vincent, Stanford Research Institute.

9/2 Limitations of Radio Propagation Media—Thomas Kailath and Paul Shaft, Stanford Research Institute.

9/3 Progress in Modulation and Demodulation Techniques—W. L. Hatton, Defense Telecommunications Establishment, Ottawa.

9/4 Transportation or Communications—Some Broad Considerations—Timothy Healy, University of Santa Clara.

10

Digital Approach to Analog Functions

(Thurs./a.m./D)

Chairman: James F. Kaiser, Bell Telephone Laboratories.

10/1 Why Use Digital ICs for Analog Functions?—Donald Breslow, Itek Corp.

10/2 Four Digital Arrays Do All Algorithms—George T. Sendzuk, General Electric Co.

10/3 A Comparison of Analog and Digital Integrated-Circuit Techniques for Sine and Cosine Generation—James R. Garvey, RCA Aerospace Systems Div. A brief summary by Dr. Kaiser will be followed by a panel discussion with audience participation.

11

Progress in Fluidics Applications

(Thurs./a.m./T)

Chairman: D. F. Folland, Sperry Utah Co.

11/1 Secondary-Injection Thrust Vector Control Using Fluidic Vortex Valves—Jerome G. Rivard, Bendix Research Laboratories.

11/2 Fluidic Time Optimal Adaptive Control System—Robert F. Turek, Bowles Engineering Corp.

11/3 Fluidic Device Testing—Harold L. Fox, Fluidonics Research Labs. Div. of Imperial Eastman Corp.

11/4 Proportional Control Systems in Industry—Robert L. Blosser, Sperry Utah Co.

11/5 A Pneumatically Controlled Document-Handling System—R. R. Coleman, Jr., and Richard S. Gluskin, Univac Div. of Sperry Rand Corp.

12

High-Density Recording Techniques

(Thurs./a.m./De)

Chairman: Roy D. Sturkie, Leach Corp. Controls Div.

12/1 High-Density Electron and Lightbeam Recording—Charles F. Spitzer, Ampex Corp.

12/2 Magnetic Heads for High-Density Digital Recording—Donald T. Best, Ferroxcube Corp.

12/3 A Technique for High-Density Digital Recording—Kermit Norris, Leach Corp. Controls Div.

12/4 Ultra-High Data-Packing-Density Recording Related to Manned Spacecraft—Donald Ray Smith, NASA.

C

Special Session

The Frequency Spectrum—An International Resource

(Thurs./p.m./E)

Chairman: James D. O'Connell, Executive Office of the President.

A panel of experts led by James D. O'Connell, Director, Telecommunication Management, Office of the President, will discuss various aspects of frequency spectrum management.

13

Solid-State Imaging—An Evolving Technology

(Fri./a.m./E)

Chairman: Carl Huggins, Marshall Space Flight Center.

13/1 100 x 128 Element Solid-State Imaging System—*D. E. Callahan, R. A. Anders, W. F. List, M. E. Wing, and D. H. McCann, Westinghouse Electric Corp.*

13/2 A Report on the Development at Fairchild Semiconductor of Integrated Arrays of Silicon Photodetectors of Image Sensing—*G. P. Weckler and R. H. Dyck, Fairchild Semiconductor Research and Development Laboratory.*

13/3 A Self-Scanned Solid-State Image Sensor—*P. K. Weimer, G. Sadasiv, J. E. Meyer, L. Meray-Horvath and W. S. Pike, RCA Laboratories.*

13/4 Solid-State Image Intensifier—*R. D. Stewart, General Electric.*

14 Panel Session The Future of Solid-State Phased Arrays

(Fri./a.m./D)

Chairman: Arthur S. Robinson, RCA Missile & Surface Radar Div.

Panelists:

- R. D. Alberts, Air Force Avionics Lab., Wright-Patterson AFB;
- Carl Blake, Lincoln Laboratories;
- Douglas Mather, Rome Air Development Center, Griffis AFB;
- Thomas Hyltin, Texas Instruments;
- Frank A. Brand, Electronic Components Laboratory, Fort Monmouth;
- Thomas Madigan, Bell Telephone Laboratories;
- Malcom Vosburg, Institute of Defense Analysis;
- Arthur S. Robinson, RCA Missile & Surface Radar Div.

15 Static Power Systems: Controls, Inverters, Rectifiers, Power Systems

(Fri./a.m./T)

Chairman: David W. Borst, International Rectifier Co.

15/1 Problems in Designing a dc Power Transmission System—*Stuart P. Jackson, Solid-State Controls, Inc.*

15/2 Current Regulators for Electrochemical Rectifier Systems—*R. P. DePuy and J. W. Luoma, General Electric Co.*

15/3 Application & Design Aspects of a 2.5-kVA Solid-State Frequency Converter for An Airborne Installation—*S. G. Campbell and T. H. Ussher, The de Havilland Aircraft Co. of Canada, Ltd.*

15/4 Static Stand-by Power Systems—*Chris F. Seyer, Fansteel Metallurgical Corp.*

15/5 Redundancy and Switching in Stand-by Systems—*Stuart P. Jackson and Dennis M. Swing, Solid-State Controls, Inc.*

16 The Computer as a System Component

(Fri./a.m./De)

Chairman: Pete England, Scientific Data Systems.

16/1 The Impact of Third-Generation Computers on System Design—*David L. Stein and Joe Glasier, Scientific Data Systems.*

16/2 A Third-Generation Computer in a Nuclear Physics Laboratory—*Richard F. Au, John V. Kane, and William E. Merritt, Michigan State University.*

16/3 Software as a Component in Computerized Systems—*Bob L. Ryle, Planning Research Corp.*

16/4 On-Line Computers and Patient Care—*Shannon Brunjes and Robert F. Maronde, University of Southern California; Stanley Seibert, Los Angeles County Hospital; John C. Soutter, IBM.*

D Special Session

Systems Approach to Natural Resources Control

(Fri./p.m./E)

Chairman: R. J. Pafford, Jr., Bureau of Reclamation, Sacramento, Calif.

D/1 Integrating Hydro and Thermal Generation—*E. F. Kaprielian, Pacific Gas and Electric Co.*

D/2 Systems Analysis Applications for the Future—*John Eichelman, Stanford Research Institute.*

D/3 Missouri Basin Flood Control and Water Conservation—*Tim Waara, Missouri River Div., U.S. Corps of Engineers.*

D/4 Bonneville Power Administration System Control—*Marvin Harris, Bonneville Power Administration.*

Exclusive Technical Session Order Form

Please send me the following WESCON technical session preprints at \$2.00 per session (average: four papers per session), plus \$1 mailing charge per complete order. I understand this order will be mailed to my address within two weeks after receipt. Offer good until November 1, 1967.

(Note: Papers bound by sessions; no individual papers available).

Session No.	Quantity
1	
2	
3	
4	
6	
8	
9	
10	
11	
12	
13	
15	
16	

Total Sessions x \$2.00 = \$ _____

Plus \$1.00 Mailing Charge = \$ 1.00

Total Cost = \$ _____

Make check payable to WESCON and mail with this form to:

WESCON
3600 Wilshire Blvd.
Los Angeles, Calif. 90005

DATE _____

NAME _____

FIRM _____

STREET ADDRESS _____

CITY, STATE, ZIP CODE _____

THE PACKAGING SYMPOSIUM

Here's a guide to the Electronic Packaging Symposium to be held Aug. 21 and 22 at the San Francisco Hilton.

1

Considerations for Joining Techniques

(Mon./a.m.)

Moderators: D. A. Beck, Bendix Research Labs., and E. C. Neidel, Sandia Corp.

1/1 Influence of Surface Structure on the Quality of Gold Electrodeposits—*J. B. P. Williamson and Morton Antier, Burndy Corp.*

1/2 Ultrasonic Soldering and Bonding Techniques—*Paul J. Bud, Electrovert, Inc.*

1/3 Nondestructive In-Process Weld Evaluation—*Forest C. Deal, Martin-Marietta Corp.*

1/4 Electromechanical Design of a Matched Impedance Connector—*H. H. Blonder and R. T. Evans, IBM.*

1/5 System Packaging At The Chip Level—*W. L. Doelp, Jr., Philco-Ford Corp.*

2

Advances in Packaging Techniques

(Mon./p.m.)

Moderators: H. J. Scagnelli, Bell Telephone Labs., and T. A. Telfer, General Electric Co.

2/1 A Preliminary Investigation of Plastic Encapsulated Transistors—*Edward B. Hakim and R. Canepa, U. S. Army Electronics Command.*

2/2 Development of Thin-Film Circuits with Thick-Film Conductor Networks and Crossovers—*Halle Abrams, Western Electric.*

2/3 Thick-Film Techniques and Design Criteria for Space-Vehicle Application—*A. Ottaviano and J. Thomas, General Electric.*

2/4 The Application of Thick-Film

Technology in Multilayered Circuitry—*W. O. Giesfeldt, Centralab.*

3

Linking the Electronics

(Mon./p.m.)

Moderators: W. J. Prise, Lockheed Missiles & Space Co., and G. E. Gless, University of Colorado.

3/1 Fabricating Reliable Multilayer Boards—*D. H. Rossi, Conductron-Missouri.*

3/2 A Flat-Pack Module Intraconnected by Molded Printed Circuits—*L. Eugene Jayden and Cornelius D. Flynn, Westinghouse Electric Corp.*

3/3 Equipment Design for Integrated-Circuit Packaging—*J. P. Focarlle and C. D. Irish, Bell Telephone Labs.*

3/4 Flexible Circuit Connections—*F. R. Sullivan, Lockheed Missiles & Space Co.*

4

The Computer and Electronic Packaging

(Tues./a.m.)

Moderators: E. J. Lorenz, IBM Corp., and T. G. Boe, *EDN Magazine.*

4/1 Packaging Aspects of Computer-Designed Multilayer-Interconnection Printed-Wiring—*Gerald L. Ginsberg, Philco-Ford.*

4/2 Large-Scale Integration—Computer Aids and Systems Aspects—*Thomas F. Prosser, Philco-Ford Corp., Microelectronics Div.*

4/3 Computer-Automated Design and Thermal Analysis of Printed Circuits—*B. Hyman and M. J. Merges, Bell Telephone Labs.*

4/4 Packaging Flat-Pack Integrated Circuits for Earth Satellites—*Robert C. Moore, Johns Hopkins University.*

5

Some Aspects of Thermal Design

(Tues./a.m.)

Moderators: R. C. Mayne, JPL, and J. R. Goodykoontz, TRW.

5/1 Thermal Design Considerations of a Very High-Speed Computer—*Kenji Taniguchi and Yuichiro Oya, Central Research Laboratory.*

5/2 Thermal Design for IBM System/360 Model 91—*V. W. Antonetti, R. C. Chu and J. H. Seely, IBM.*

5/3 Thermal Problems Encountered in the Design of the Electronics Packages of the LMS-Band Steerable Antenna and the Apollo High-Gain Antenna—*Allen L. Schmidt, Dalmo Victor.*

5/4 Temperature Predictions Within an Electronics Section of an Externally Mounted Aircraft Missile During Mach-4.0 Carry Flight—*S. A. Casazza, Raytheon Co.*

5/5 Simplified Transmitter Cooling System—*L. R. Paradis, Raytheon Co.*

6

Meeting the Challenge in Electronic Packaging

(Tues./p.m.)

Moderators: J. C. Rubin, Eastman Kodak Co., and S. Shuey, Sprague Electric.

6/1 Packaging Design of a Solenoid Array Correlator—*John G. Simon, Sylvania Electronic Systems.*

6/2 The Integration of Microelectronics and the Product—*J. F. Hinchey, Friden, Inc.*

6/3 Packaging Design of the Apollo-Lunar-Module Abort Computer—*Thomas B. Hibler, TRW, Inc.*

6/4 Packaging a Capacitor Read-Only Memory—*C. P. del Cano and H. E. Mayles, IBM.*

Latest in the line of Monsanto IC counter/timers.

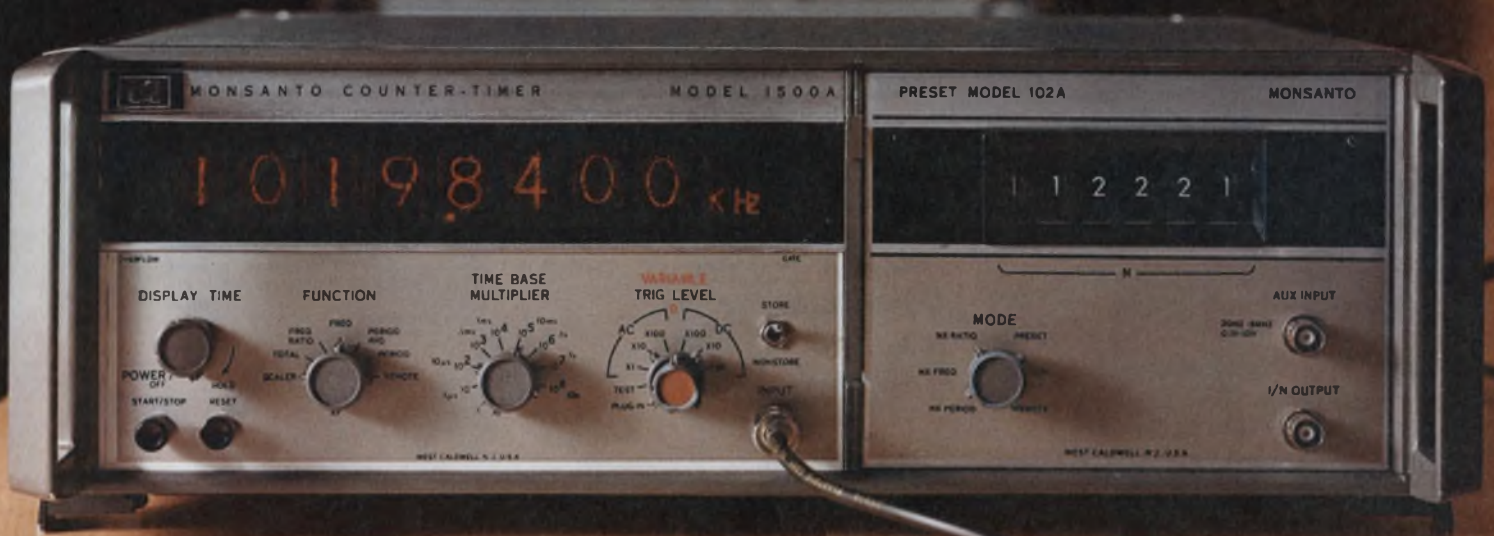

AVAILABLE PLUG-INS: TWO FREQUENCY CONVERTERS (50 MHz TO 500 MHz, 100 MHz TO 3 GHz); PRESCALER (dc TO 1 GHz); PRESET UNIT (20 Hz TO BEYOND 10 MHz); VIDEO AMPLIFIER (1 mV SENSITIVITY, 10 Hz TO 200 MHz); TIME INTERVAL UNIT (100 ns RESOLUTION); NON-COMMITTED PLUG-IN.

With 90% integrated circuit construction this new "4th generation" instrument is the most advanced plug-in counter/timer yet.

Our new model 1500A takes full advantage of IC capabilities to bring you: main-frame counting range from dc to over 125 MHz; to 3 GHz with a single plug-in. Remote programability by either contact closure or voltage level. Provision for external time base up to 10 MHz. And

naturally, the inherent stability and reliability of integrated circuit construction, as indicated by our two-year warranty. All this for only \$2,850 (U.S. dollars, FOB West Caldwell, N.J. exclusive of plug-ins). Circle the inquiry number for full technical details, or contact us directly

at: Monsanto Electronics Technical Center, 620 Passaic Avenue, West Caldwell, N.J. 07006. Phone: (201) 228-3800; TWX 710-734-4334.



ELECTRONICS

Technical Program

"MICROELECTRONICS COMES OF AGE"

Here's a guide to a special technical symposium to be held Aug. 23 and 24 at the San Francisco Hilton.

1

An Introduction to Microelectronics

(Wed./a.m.)

Keynote Address: Microelectronics in Perspective—*E. Keonjian, Grumman Aircraft Engineering Corp.*

1/1 Terminology and Classifications—*S. M. Stuhlberg, Raytheon.*

2

The Hybrid Approach

(Wed./a.m.)

Session Organizer: Wayne Martin—*RCA.*

2/1 Thin-Film Networks—*M. Penberg, Aerojet General Corp.*

2/2 Thick-Film Networks—*R. C. Early, General Electric Co.*

2/3 Microcomponent Parts and Assembly—*M. Ohanian, Raytheon Co.*

2/4 Microbonding—*R. Eggleston, Kulicke & Soffa, Inc.*

2/5 Microassembly Production Techniques Using Thin Films—*W. D. Moyers, Lockheed Electronics.*

2/6 Microassembly Production Techniques Using Multichips—*J. Welty, Amelco Co.*

2/7 Microassembly Production Techniques Using Thick Films—*R. Lia, IBM.*

3

The Monolithic Approach

(Wed./p.m.)

Session Organizer: Carl H. Worebrand, Adage, Inc.

3/1 Basic Theory—*H. C. Lin, Westinghouse Molecular Electronics.*

3/2 Processing—*C. Awad, Raytheon*

Semiconductor Operation.

3/3 Design Parameters—*R. E. Bohn, Sylvania Semiconductor.*

3/4 Bipolar Digital Circuit Applications—*W. R. Rhoades, Hughes Aircraft Co.*

3/5 MOSFET Circuit Applications—*M. Sussman, General Instruments Corp.*

3/6 Linear Circuit Applications—*J. Gifford, Fairchild Semiconductor.*

3/7 Microwave Circuit Applications—*V. Gelnovatch, U. S. Army Electronics Command.*

4

Interconnection and Packaging Technology

(Thurs./a.m.)

Session Organizer: Donald Sherman—*Raytheon Co.*

4/1 Current and Future Packaging Methods—*J. J. Staller, Sylvania Electric Co.*

4/2 Large-Scale Integration—*J. Lathrop, Texas Instruments.*

4/3 Mechanical Wiring Technology—*L. Katzin, Jet Propulsion Laboratory.*

4/4 Multilayer Wiring Technology—*A. Levy, RCA.*

4/5 Thermal Management—*J. R. Baum, Motorola Inc., Government Products Div.*

4/6 Future Manufacturing Methods—*Maurice Nelles, University of Virginia.*

5

Reliability and Cost Effectiveness

(Thurs./p.m.)

Session Organizer: Jules A. Rothman—*Ikor Inc.*

5/1 Microelectronics Reliability—*El-don Hall, MIT Instrumentation Labora-*

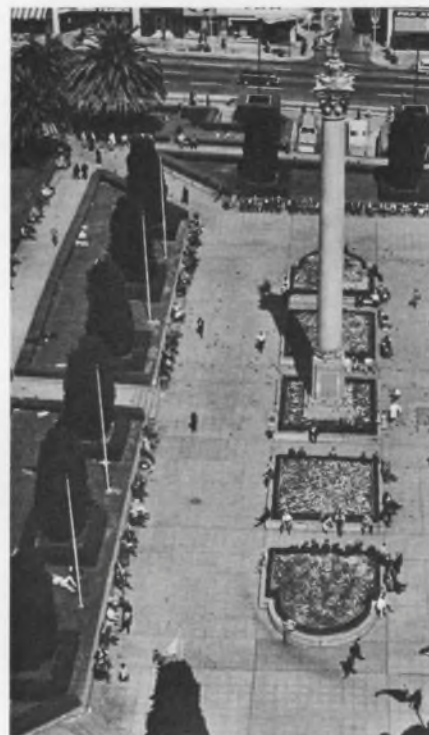

Union Square, near the Hilton, is the hub of San Francisco's shopping area.

tories.

5/2 Reliability Characteristics of Integrated Circuits—*D. I. Troxel, RCA.*

5/3 Cost Effectiveness—*H. Gunther Rudenberg, A. D. Little, Inc.*

5/4 The DOD View—*Ernest C. Wood, Department of Defense.*

6



A Look into The Future

(Thurs./p.m.)

Session Organizer: Jules A. Rothman—*Ikor Inc.*

6/1 Systems of the Future—*W. W. Gaertner, Gaertner Research, Inc.*

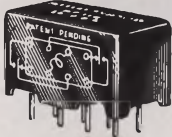
6/2 The Future of Integrated Circuits—*Glen R. Madland, Integrated Circuit Engineering Corp.*

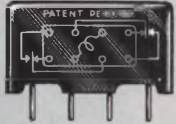
NEW! A commercial relay this  small with 2-ampere dpdt contacts. Printed circuit or socket terminals.  Has Lexan dust cover. This design bonus from our aero/space program is ideal for tape recorders, desk-top computers,  copying machines, television cameras, alarm systems, etc., etc., etc., etc., etc.

High density relay packaging becomes a reality with the low profile HP Series. Only one-fifth of a cubic inch is required for each relay. Seated height in socket or printed circuit board is 0.49". Mechanical life is placed at 10 million operations.

The DPDT contacts are rated from low level to 2 amperes at 30V DC resistive or 0.5 ampere maximum at 120V AC. Coil voltages range from 6V to 48V DC . . . with 12- and 24-volt models available from authorized electronic parts distributors.

These microminiature relays are direct descendants of our military, aero/space designs and have been engineered to perform with singular reliability in modern commercial equipment.

HP SPECIFICATIONS

GENERAL:

Temperature Range: -45°C to +70°C.

Dimensions: 0.49" x 0.88" x 0.48" max.

CONTACTS:

Arrangement: DPDT, 2 Form C.

Rating: Low level to 2 amps @ 30V DC, resistive;
0.5 amps max. @120V AC.

Contact Resistance: 50 milliohms before life
measured at maximum rated load.

COILS:

Power: Approximately .662 watts nominal @ 25°C.

1.0 watts max. @ 25°C.

Duty: Continuous.

Pick-up: 75% of nominal @ 25°C.

Operate Time: 5 milliseconds max. at nominal coil
voltage and 25°C.

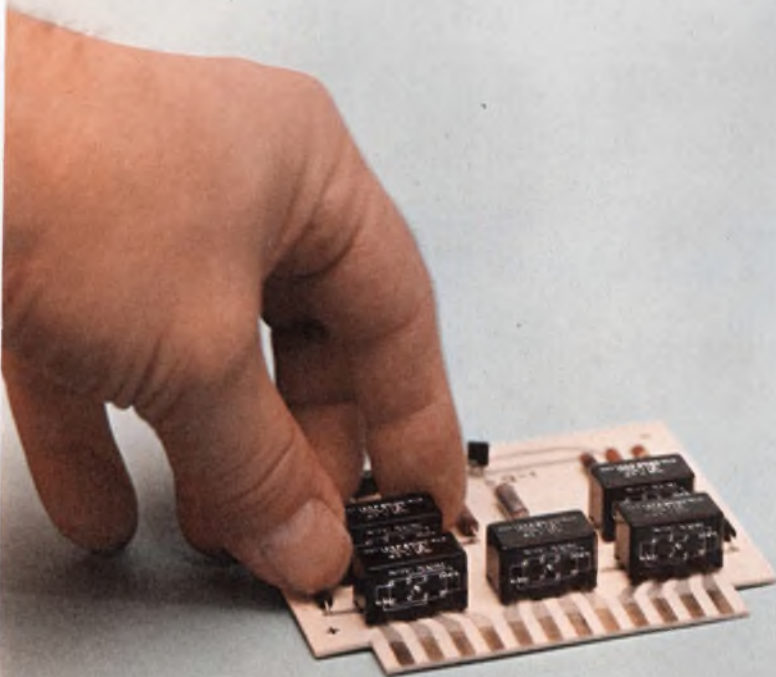

Call your electronic parts distributor



POTTER & BRUMFIELD

Division of American Machine & Foundry Co., Princeton, Ind. 47570
Export: AMF International, 261 Madison Ave., New York, N.Y. 10016

TOURING THE EXHIBIT AREAS

What's new? An electrostatic strip chart recorder, a microwave hybrid and the wares of some 600 exhibitors. Tour the aisles and then "shop the show" using the Reader Service card.

Packaging & Production..... U122
Computers & Data Processing... U136
Instruments & Control Systems... U148
Communication & Detection..... U180
Circuit Components..... U192

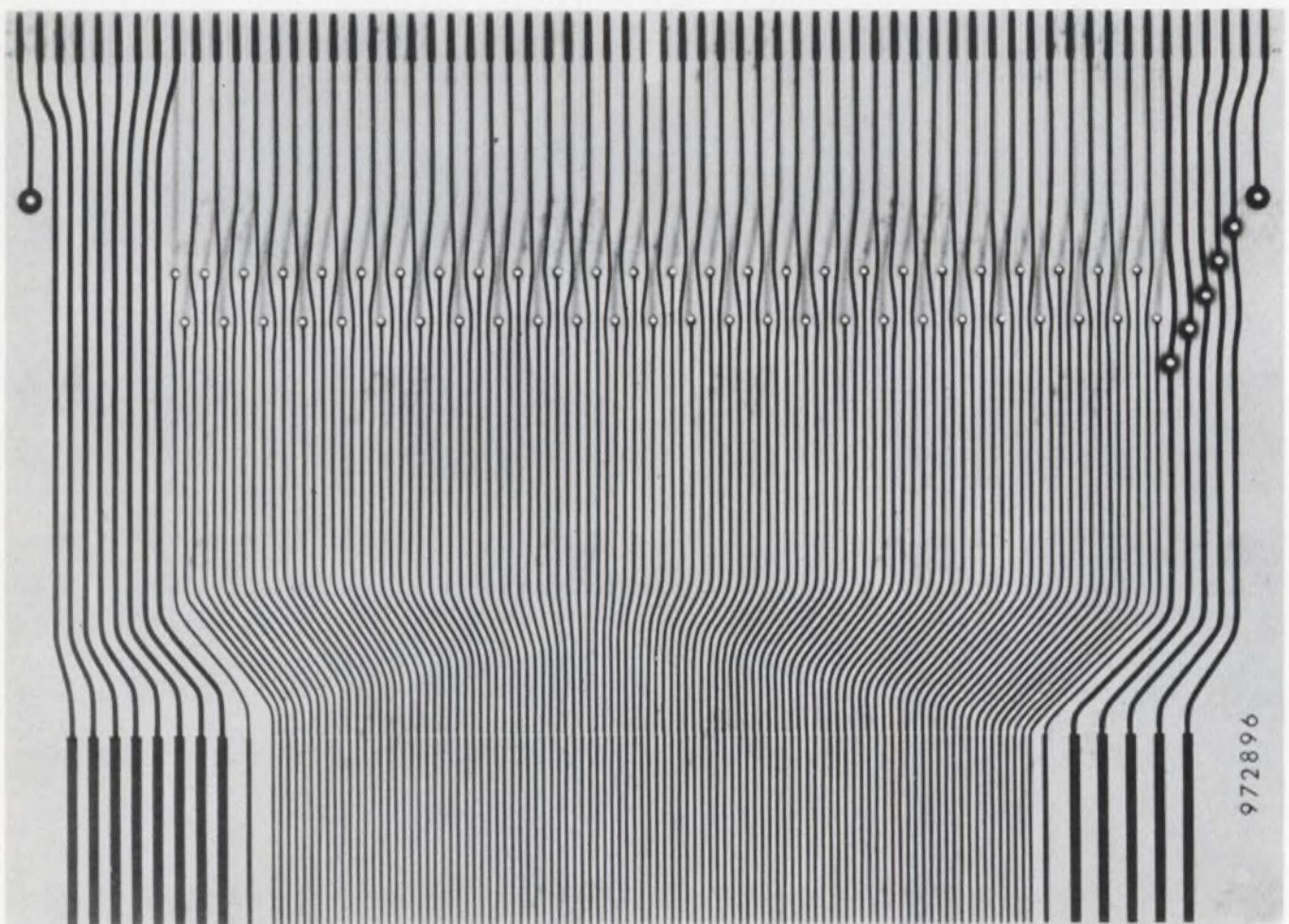

The electrostatic recorder writes as only the paper moves on. Event (left) and time-interval (right) styli flank the 100 fixed data styli in the recording head of Varian's electrostatic strip-chart recorders. With no moving parts

other than the transport, the units record dc-to-3-kHz data with a writing speed of better than 20,000 inches per second. Showgoers can see it at Booth 2309, stay-at-homes on p. U148.

Triple-barreled current probe makes dc, pulse and high-frequency measurements. Use it from dc to 50 MHz to evaluate a wide range of parameters in your semiconductor or SCR circuits. See it at Booth 2818 and on p. U152.

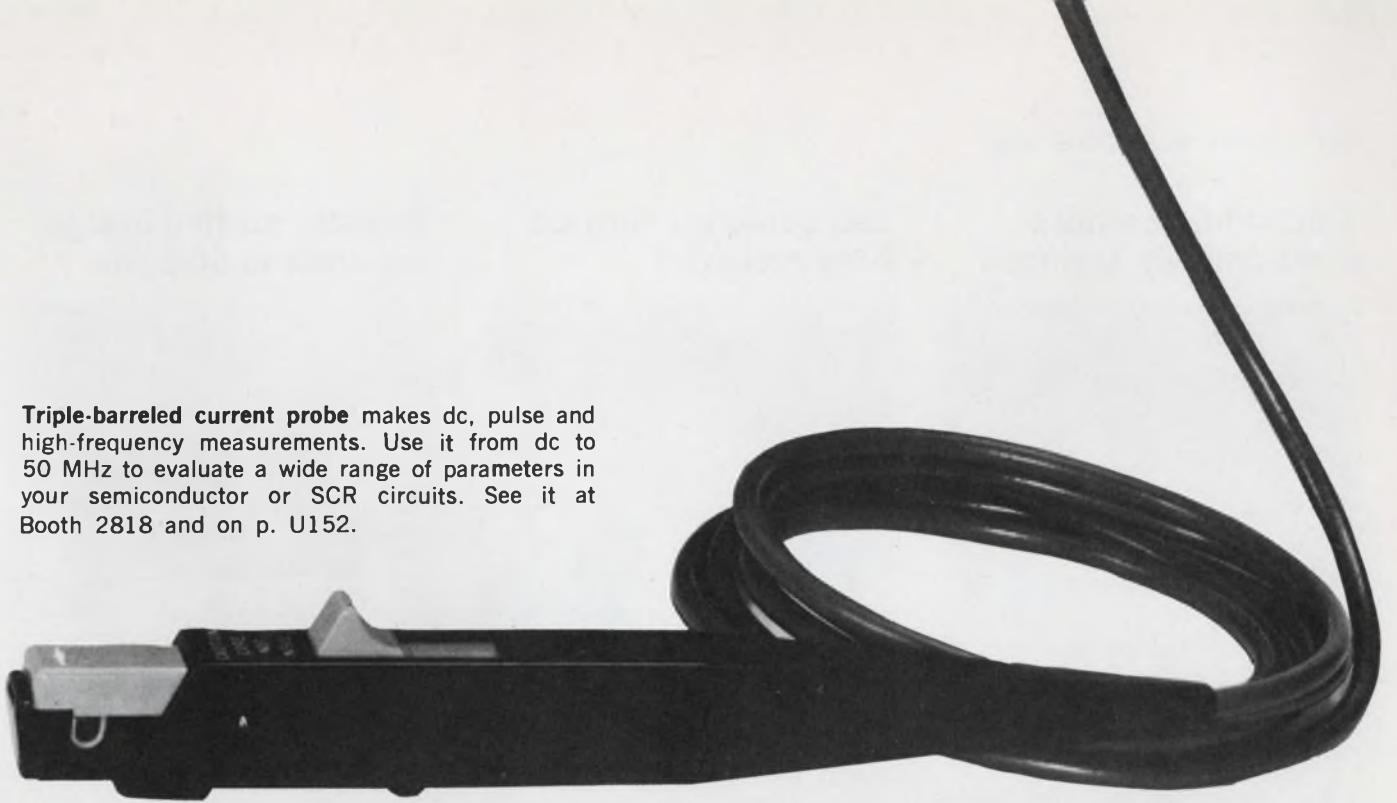

Long-lived ion laser is based on ring-discharge plasma excitation. Its high-power can be used in large-format information displays or to shorten exposure time in holography. At WESCON, it's at Booth 2922; or you can see it on p. U180.

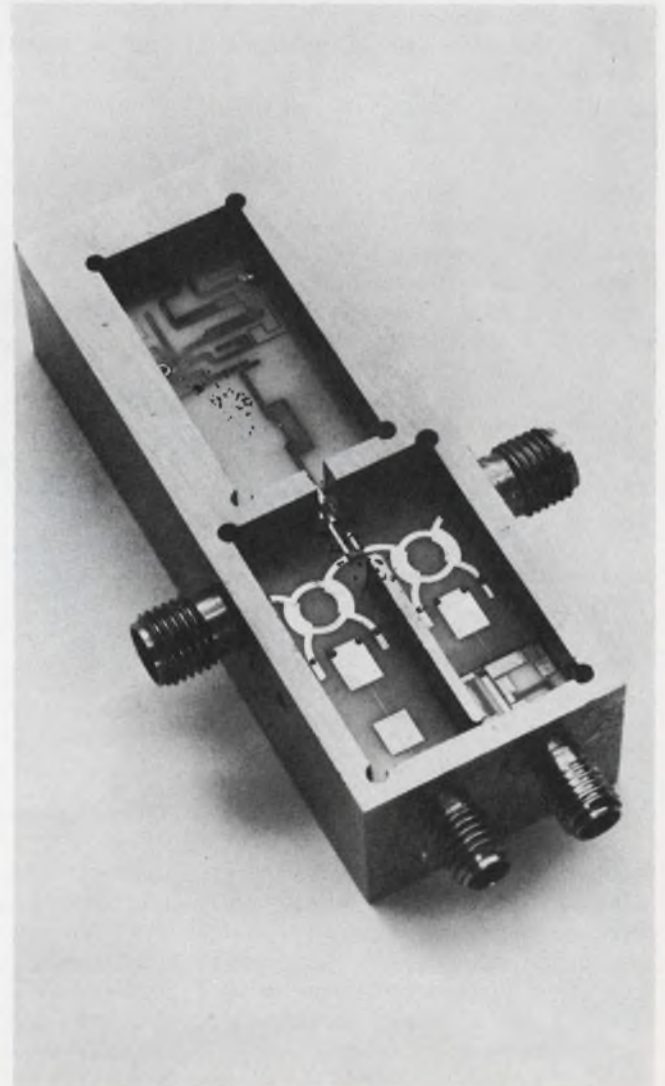

Hybrid integrated mixer and local oscillator assembly performs as well as waveguide and stripline units. Put its size and reliability to work in manpack or airborne pulsed and fm radar receivers. Microwave Associates can tell you about it at Booth 3723, or you can read about it on p. U194.

Thick-film resistors electronically trimmed

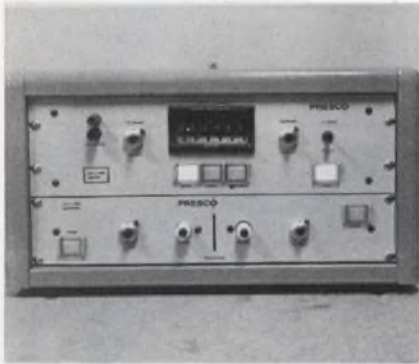

Precision Systems Co., Inc., U.S. Highway 22, P. O. Box 148, Somerville, N. J.

For adjusting thick-film resistors, this equipment uses a high-frequency field operating at high voltage and low current. The complete system consists of a generator and a monitor. The generator, using single or multiple-fixed probes, energizes the fired resistor causing a change in value. The process is clean, rapid, nondestructive, controllable and accurate. Once the unit is set up to adjust a run of resistors, time for each resistor adjustment can be set from a few milliseconds to several seconds. Because of the repeatability of the equipment, it is suited to automatic production applications.

The monitor is an electronic, chopper-stabilized bridge-amplifier circuit. The target resistance is preset into the monitor with two 10-turn pots. Tolerances from a fraction of a per cent to over 5% and target resistances from 1 Ω to 5 M Ω can be selected. The potentiometers may be calibrated externally with any accurate bridge or DVM plugged into calibrating jacks on the monitor panel.

Accessories available include a three-numeral digital ohmmeter to provide resistance readout. A simple, manually switched system is also available using a null-point bridge. This system depends on the operator to shut off the adjustment process. To adjust multiple resistors on the same substrate, the unit may be sequenced or two or more systems can be used, working simultaneously.

Booth No. 1210 Circle No. 341

Lab conveyor furnace fires resistors



Watkins Johnson Co., Stewart Div., Bean Creek Rd., Santa Cruz, Calif. Phone: (408) 438-2100. P&A: \$3975; 6 to 8 wks.

Designed specifically for thick-film firing of resistors, capacitors, and conductors, this lab conveyor furnace has four independently controlled temperature zones available with analog or digital set points and a straight-through quartz muffle. The controlled positive atmosphere flow assures uniform atmosphere quality and gives good binder and solvent removal.

Booth No. 1323 Circle No. 340

Floating insert prevents misalignment

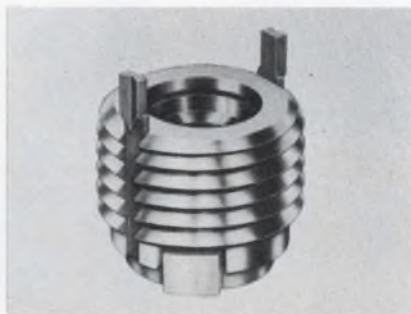

Newton Insert Company, 6500 Avalon Blvd., Los Angeles. Phone: (213) 753-4271.

These inserts simplify the assembly of curved surfaces and permit broader tolerances when using flat head screws. Incorporating "waveform" threads, the units roll their own threads in soft metals and plastics without creating chips. They compensate for misalignments up to 0.04 inches in mating parts.

Booth No. 1817 Circle No. 339

Resistor sorting bridge accurate to 50 ppm

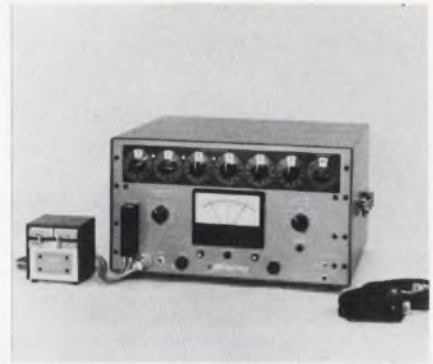

Electro Scientific Industries, Inc., 13900 N.W. Science Park Dr., Portland, Ore. Phone: (503) 646-4141. P&A: \$2595; stock to 30 days.

Designed for sorting or measuring resistors at production speeds, this guarded four-terminal Kelvin bridge design permits measurements from well under 1 Ω to more than 100 M Ω in six ranges. The front panel meter allows direct readout of percent deviation on any of the seven calibrated ranges from $\pm 0.01\%$ to $\pm 10\%$ end scale. Panel lights indicate go-no-go sorting.

Booth No. 2717 Circle No. 281

Low-noise blower delivers 150 cfm

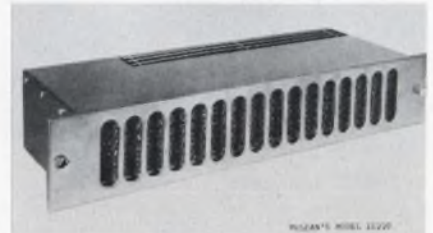

McLean Engineering Laboratories, Princeton Junction, N. J. Phone: (609) 799-0100.

This unit fits into a 3-1/2 inch slot in the front panel of an enclosure and forces a slot of air 12-1/2 inches wide to cool the equipment. Air is delivered in one long continuous discharge. The velocity and pressure ensure cooling of densely packed electronics. Each blower is equipped with an aluminum dust filter. The motor is a two-pole operating on 115-volt, 50/60-Hz single-phase power.

Booth No. 3107 Circle No. 316

For a clear picture of Centralab...

...keep an eye on our ripples

In our years of manufacturing miniature and subminiature components, we've made many ripples, and a few splashes, in the electronics industry:

Centralab designed and produced the world's first carbon composition potentiometer and for more than 40 years has been an industry leader. In 1936 we introduced the first temperature-compensating ceramic capacitor in America. We were first to offer dual controls and to add integral line switches to variable resistors. Our exclusive  integrated circuits have been key elements in the miniaturization of electronic equipment. During World War II days Centralab developed the ceramic disc capacitor design for military requirements. And our Ultra-Kap[®] ceramic disc capacitor has replaced millions of larger, more costly devices.

Centralab sales have increased substantially every year and our services have grown proportionately. Our products are sold, by separate sales groups and from separate warehouses, to original equipment and distributor markets.

Centralab's tested and proven products include capacitors, packaged circuits, rotary switches, potentiometers and technical ceramics. In October, 1966, we erected a push button switch manufacturing plant and in May, 1967, we acquired solar devices and semiconductor facilities.

Innovation, growth and stirring the waters are nothing new at Centralab; and we don't intend to stop. As technology advances and components become smaller, more complex and more sophisticated, we'll keep our feet wet.

To help keep abreast of Centralab developments, we'll be happy to send you our periodical "This Is Centralab." Write for future issues.



CENTRALAB

Electronics Division

GLOBE-UNION, INC.

5757 NORTH GREEN BAY AVENUE
MILWAUKEE, WISCONSIN 53201

ON READER-SERVICE CARD CIRCLE 68

Connect This New Over-Voltage Protector Wherever it's needed...

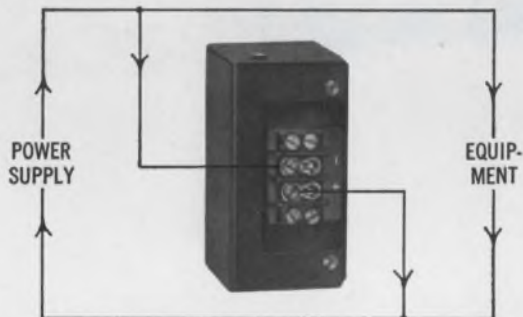

and get Maximum Protection

3 Big Advantages over "Built-In" Over-Voltage Protection

1. Connects at any location along DC supply bus. Provides full protection where needed such as directly at equipment terminals.
2. Completely independent of connected supply or source. Applicable to all types of power supplies and unaffected by the type of power supply failure.
3. Protects against all types of over-voltage conditions. Provides protection against inductive line spikes, switching transients, as well as power supply failure.

ERA Transpac "OV" over-voltage protectors are designed to protect electronic equipment against all types of over-voltage conditions. These units may be connected anywhere along the DC feed line, and offer complete protection, within microseconds, independent of the type of supply or source of transient over-voltage.

These new ERA units are two-terminal designs which may be connected at any location with no external power source connection. Since the units monitor only the voltage impressed across the two-terminal input, any type of power supply may be utilized including unregulated supplies, multiple supplies, or equipment with switching arrangements.

SPECIFICATIONS:

Trip Voltage Range: 4.5 to 40 VDC.
Trip Point Setting: Within 500 millivolts or 5% above output whichever is greater.
Shunt impedance, Tripped: Less than 10 milliohms.
Response: Within 10 microseconds after exceeding trip voltage.
Maximum Allowable Shunt Current (Peak): 200 amperes for 16 microseconds.

Maximum Shunt Current (Continuous): 10 amperes.
Resolution: Within 100 millivolts of trip point setting.
Operating Temperature Range: -40°C to +71°C
Type: Two-terminal.
Standby Current: 30 milliamperes max.
Temperature Coefficient: 5 millivolts/°C or 0.05%/°C, whichever is greater.

STANDARD MODELS

CURRENT	VOLTAGE	WEIGHT	SIZE (IN.)	MODEL	COST
0-8 amps	4.5-40 VDC	10 oz.	1 $\frac{1}{2}$ x 3 $\frac{1}{2}$ x 1 $\frac{1}{8}$	OV448	\$59.00
0-8 amps	4.5-40 VDC	10 oz.	1 $\frac{1}{2}$ x 3 $\frac{1}{2}$ x 1 $\frac{1}{8}$	OV448M*	\$95.00

*Military Component Type. Incorporates MIL Specification Parts Where Applicable.

Write for Catalog #152

ELECTRONIC RESEARCH ASSOCIATES, INC.

67 Sand Park Road, Cedar Grove, N.J. 07009 (201) CEnter 9-3000
 Subsidiaries: ERA Electric Co. • ERA Acoustics Co. • ERA Dynamics Corp. • ERA Pacific, Inc.



ON READER-SERVICE CARD CIRCLE 65

PACKAGING & PRODUCTION

Coil winding unit has many applications

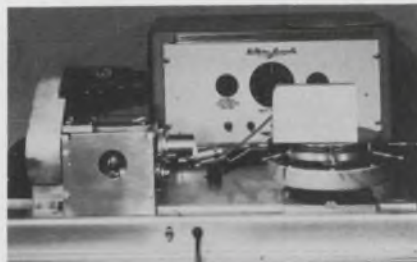

Coil Winding Equipment Co., Railroad Plaza, Oyster Bay, N. Y.
 Phone: (516) 922-5660

Lattice-wound, pi-wound and progressive universal windings are produced by this equipment. In addition, patterns that cannot be wound on conventional machines are possible. The wire is rapidly distributed across the face of the coil without the use of cams and reciprocating parts. The high winding speeds and free flow of the wire through the winding head is mated with a transfer mechanism so that both winding and transfer time are held down.

Booth No. 1802 Circle No. 344

Arc illuminator puts out 6500 W



Christie Electric Corp., Box 43187, 3410 W. 67th St., Los Angeles.
 Phone: (213) 750-1151.

High-intensity xenon arc illuminators have applications in photochemistry, semiconductor photorealist processes, high-speed photography and general research. The system includes the lamp, power supply, and lamp housing with optics and igniter. Systems are available in lamp ratings from 200 to 6500 watts with various types of optics and three performance classes of power supplies.

Booth No. 2523 Circle No. 321

"New I/C Dual Op Amp (Op Amp²)
Provides 36 Million
Voltage Gain!"

Naturally, you would have no need to use that much gain (right now) . . . yet, the fact remains that with a typical open-loop voltage gain of 6,000 in *each* of the two amplifier sections of the MC1535 (Op Amp²) – the total theoretical voltage gain of the pair in cascade is 36,000,000! Now, for a really large number from the industry's first I/C dual op amp, consider the power gain – where you square the above number . . .

Even more importantly, you can use whatever gain you need in practical applications without having to cascade. Since two operational amplifiers are constructed on a single

monolithic chip and contained within the same package – you can save on component costs – and, on assembly time, too! In addition, you save even more on the low initial cost of the MC1535 Op Amp² – priced at only \$8.50 (100-up) in the TO-100 package.

In addition to excellent gain characteristics, the MC1535 Op Amp² also offers excellent stability, with a minimum of external components; so, it functions well in summing amplifiers, integrators or other amplifiers where operating characteristics are a function of feedback. Some of the specifications that help to make possible the versatile and unusual

performance of the MC1535 Op Amp² are:

CHARACTERISTIC	SYMBOL	TYPICAL RATING	UNIT
Temperature Drift	$T_{c_{v_{io}}}$	10.0	$\mu V/^{\circ}C$
Output Voltage Swing	V_{out}	± 3.6	V
Input Offset Voltage	V_{io}	1.0	mV
Output Impedance	Z_{out}	1.7	$k\Omega$
Input Impedance	Z_{in}	45.0	$k\Omega$
Input Offset Current	I_{io}	0.05	μA
DC Power Dissipation	P_o	100.00	mW

The MC1535 Op Amp² is currently available, from stock, in both the 10-pin metal can and 14-pin ceramic flat pack. For complete details about this exciting, new integrated circuit, write for our data sheet.

where the priceless ingredient is care!



MOTOROLA Semiconductors

MOTOROLA SEMICONDUCTOR PRODUCTS INC. / P.O. BOX 955 / PHOENIX, ARIZONA 85001 / (602) 273-6900 / TWX 910-951-1334
ON READER-SERVICE CARD CIRCLE 63

To get
high energy
circuitry
at the
lowest cost:
start here.

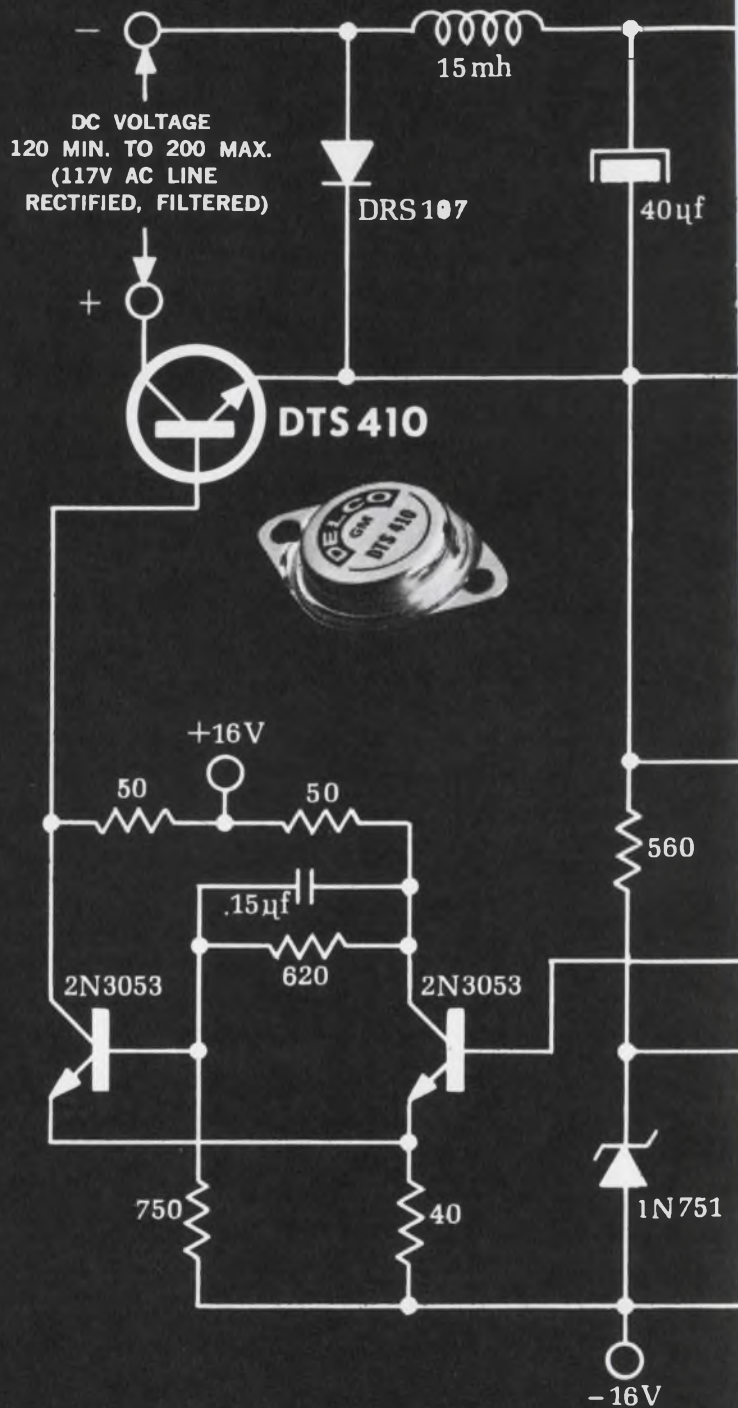

Application of Delco high voltage silicon power transistors:

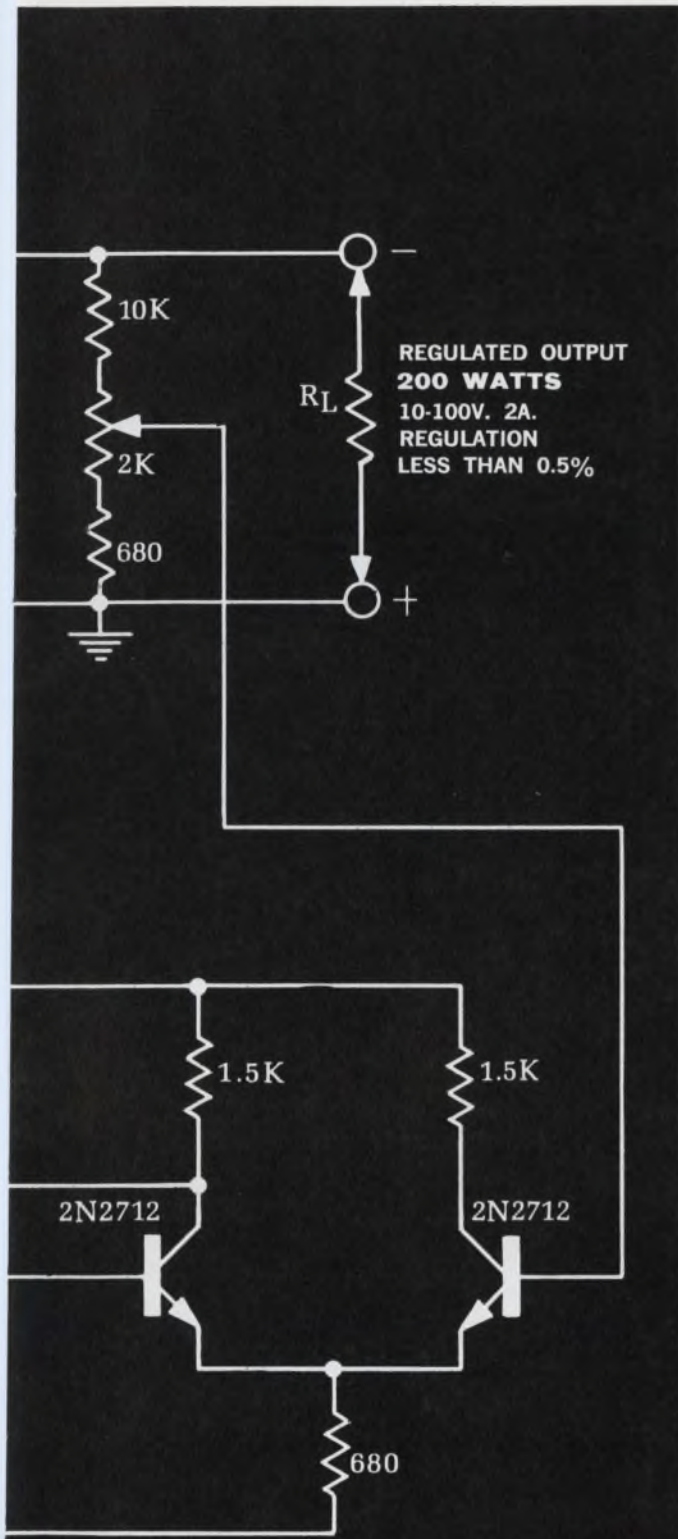

the switching regulator.

Start with circuit designs using Delco high voltage silicon power.

The simple switching regulator in the diagram at left turns out 200 watts (2 amps) output at efficiencies exceeding 85%. And it does it with just one series element working directly from rectified line voltage: the new Delco DTS-410 transistor at just \$1.95 each*.

Or if you need regulation of 250 volts DC and 400 watts output, the DTS-411 may be your answer. Cost? Just \$3.15 each*. And for extra-high voltage applications, there's the DTS-423, now priced at \$4.95 each*.

Now combine our new low prices with these other cost-cutting advantages of Delco high voltage silicon power transistors: you can reduce the number and complexity of input, output and filtering components. This means more compact circuitry, greater reliability and lower assembly costs.

These NPN silicon transistors are packaged in a rugged TO-3 case for low thermal resistance. Inside, they are mounted to withstand mechanical and thermal shock because of special bonding of the emitter to base contacts.

There's no need to be concerned about delivery. They are available right now in production quantities. Call us. Or order samples from your Delco distributor.

For details on the switching regulator circuit ask for application note number 39.

*Prices shown are for quantities of 1,000 or more.

TYPE	V _{CEO}	V _{CEO} (sus)	I _C Max	h _{FE} Min @ I _C V _{CE} = 5V	Power Diss Max
DTS-410	200V	200V (min)	3.5A	10 @ 2.5A	80W
DTS-411	300V	300V (min)	3.5A	10 @ 2.5A	100W
DTS-423	400V	325V (min)	3.5A	10 @ 2.5A	100W

FIELD SALES OFFICES
 UNION, NEW JERSEY** Box 1018 Chestnut Station (201) 687-3770
 DETROIT, MICHIGAN 57 Harper Avenue (313) 873-6560
 SANTA MONICA, CALIFORNIA** 726 Santa Monica Blvd. (213) 393-1465
 SYRACUSE, NEW YORK 1054 James Street (315) 472-2668
 CHICAGO, ILLINOIS** 5151 N. Harlem Avenue (312) 775-5411
 General Sales Office: 700 E. Firmin, Kokomo, Ind. (317) 459-2175

**Office includes field lab and resident engineer for applications assistance.

DELCO RADIO

Division of General Motors, Kokomo, Indiana



Portable tape preservers available in 2 sizes



Magnetic Shield Division, Perfection Mica Co., 1322 N. Elston Ave., Chicago. Phone: (312) 384-2122. P&A: \$50 to \$80, 2 to 4 wks.

Portable magnetic tape preservers measure 7-3/4 x 12 x 12 inches and hold 5 magnetic tapes 1 inch wide and 11-1/2 inches in diameter. The Model holds 3 similar magnetic tapes. The unit can be equipped with locks for additional security.

Booth No. 1602 Circle No. 372

Acid-gold solutions plate pure



Engelhard Industries, Inc., Chemical Div, 113 Astor St., Newark, N. J. Phone: (201) 242-2700.

Engelhard is offering a pair of new gold-plating solutions. Acid-gold electroplating process E 71 produces high-purity, relatively low-stressed, bright gold deposits of 140 to 200 Knoop hardness. Abrasion and wear resistance meets MIL-G-4520A, type II. Solution E-56 gives an ultra-pure deposit (99.99%) and meets all requirements of MIL-G-45204A, type I, and shows good resistance to heat and discoloration at high temperatures.

Booth No. 1617 Circle No. 343

Desolder components with hand-held tool

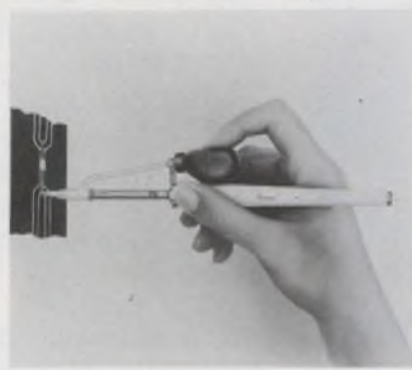

Ungar Electric Tools, 2701 El Segundo Blvd., Hawthorne, Calif. Phone: (213) 757-2151.

Nonclogging and nonsticking features are incorporated in this desoldering tool. Held in one hand, the operator has the other hand free for removal of IC chips and discrete devices during rework and repair. Clogging in the tip is eliminated by the stainless steel lining. The replaceable tip has an 0.033-inch aperture.

Booth No. 1604 Circle No. 361

Wire laying machine uses 2-axis control

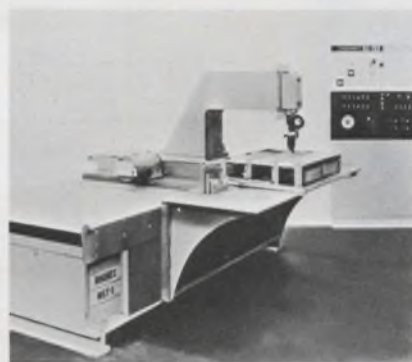

Hughes Aircraft Co., 5261 W. Imperial Hwy., Los Angeles. Phone: (213) 391-1711. P&A: \$45,000; 4 to 5 mos.

For jumper-wire connections, single-terminal connection and wire harness laying, this 2-axis machine uses solid-state logic. The table operates at a traverse speed of 400 inches per minute, with a resolution of 0.001 inches. Positioning accuracy per axis is ± 0.003 inches. The photoelectric tape reader reads 60 lines per second.

Booth No. 1704 Circle No. 381

Diffusion furnace for wafer makers

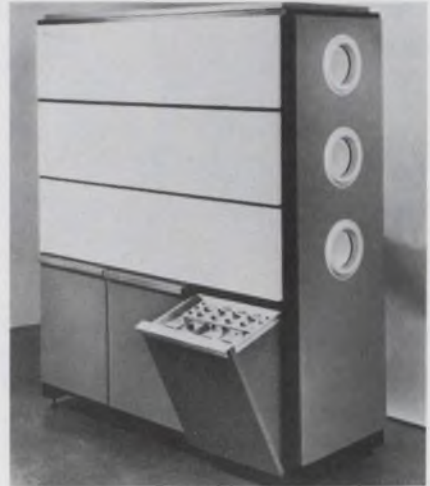

Electroglas, Inc., 150 Constitution Drive, Menlo Park, Calif. Phone: (415) 325-1536.

An all-solid-state controller, matched to the equipment, gives this furnace fast response and stability. The controller's high-gain amplifiers provide for narrow operating proportional bandwidths; as low as 1.5°C. All amplifier stages and thermocouple cold junctions are temperature-controlled within the controller to 65°C. Neither electrical nor mechanical choppers are required.

Booth No. 1915 Circle No. 338

1000-W power meter monitors cw lasers

Coherent Radiation Laboratories, 932 E. Meadow Dr., Palo Alto, Calif. Phone: (415) 328-1840.

This meter is capable of measurement and direct indication of intense cw laser radiation at the 10.6-micron wavelength. Model 203 consists of a direct-absorption water-cooled head with adjustable table-top stand and a control and indicator unit. The head is capable of dissipating up to 1.5 kilowatts on a continuous basis. The rear of the assembly is in intimate thermal contact with the water-cooled heat sink and the resultant longitudinal heat flow is sensed by an intermeshed system of thermocouples. The voltage thus generated by the thermopile is amplified in the control unit and indicated on the calibrated meter.

Booth No. 3214 Circle No. 313

The Innovator: Philco-Ford.

The Product: A 5-way better digital IC family. 1. Only our 9930 Series DTL is available in these three packages: E-line epoxy dual inline, ceramic flat packs, and ceramic dual inline packages. 2. For absolute minimum power dissipation, we've developed a unique MEL (Micro Energy Logic) family of medium-speed TTL integrated circuits (gate, buffer, and register flip flop elements). These circuits have a typical power dissipation of 440 μ W per gate function — lowest in the industry. 3. Super RTL is also available: high speed, medium power NAND/NOR log (8ns with 5.3 mW per function). 4. To date, our digital IC's have logged over 65 million device-hours; reliability data available on request. 5. Immediate delivery. Philco-Ford Corporation, Microelectronics Division, Santa Clara, California 95051.

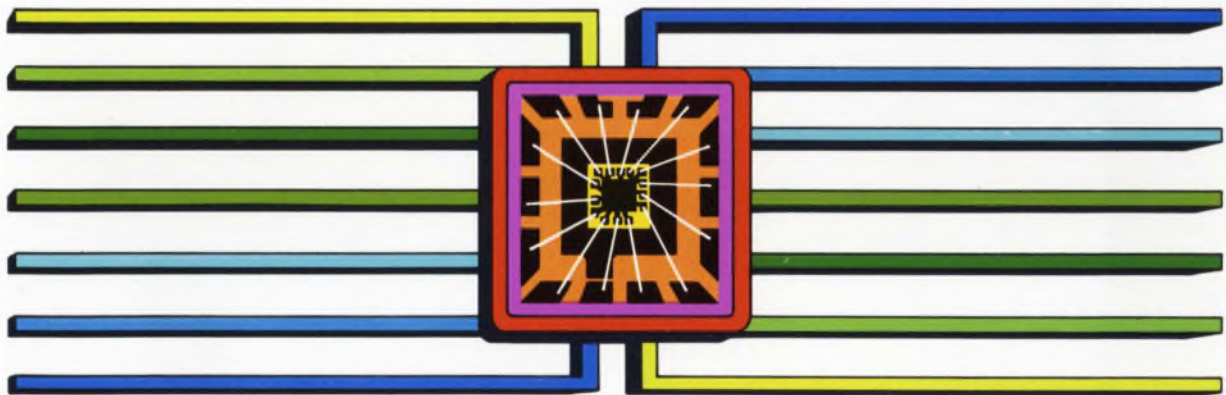
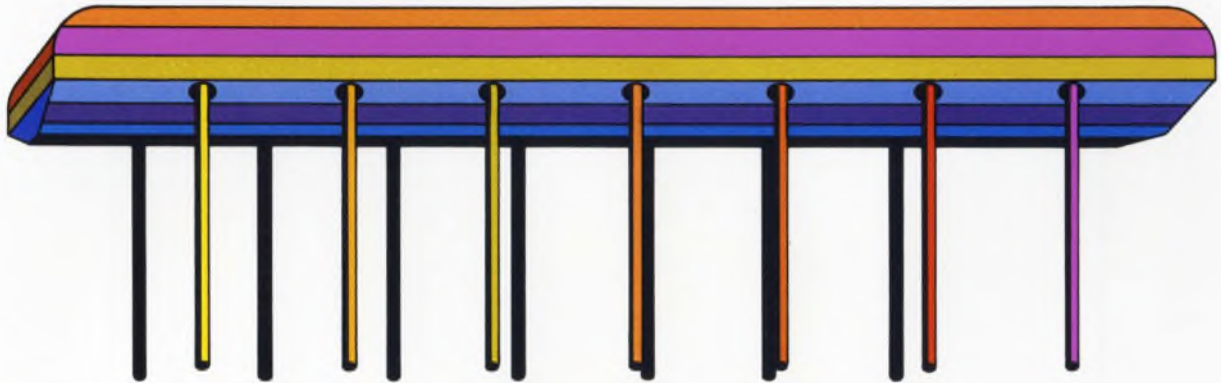

Hampton

MILG-22557



series **tmm**
(threaded coupling)



series **mmp**
(snap-on coupling)



series **mms**
(slide-on coupling)



Series
tmm, mmp
and mms
are compatible
with ConheX™
connectors

A complete line of MICRO and SUB MIN COAXIAL CONNECTORS

for semi-rigid and flexible cables, in both 50 and 75 ohm versions, offering a very wide selection of cable clamping and crimping techniques

Highly reliable and rugged, with excellent electrical characteristics, these versatile connectors offer complete design flexibility for today's critical miniaturization requirements.

Complete catalogs are available.
Write or phone today.

ConheX, Reg. TM Sealectro Corp.

automatic

METAL PRODUCTS CORPORATION
323 Berry St., B'klyn, N.Y. 11211 • Tel: (212) EV 8-6057

EXCLUSIVE CALIFORNIA DISTRIBUTOR
BELL ELECTRONICS
Northern California: Phone (415) 323-9431
Southern California: Phone (213) 321-5802

SEE US AT WESCON — BOOTH 4408

ON READER-SERVICE CARD CIRCLE 66
U130

PACKAGING & PRODUCTION

Marker plates for wire harnesses



Panduit Corp., 17301 Ridgeland Ave., Tinley Park, Ill. Phone: (312) 532-1800.

For identifying bundles up to 4-inch diameter, these markers are 3/4-inch wide and available in lengths of 1-1/2, 1-3/4, 2, 2-1/2 and 3-1/2 inches. They are nylon and can be hot-stamped or marked with a pen. All five sizes are easily secured to bundles using standard harness ties. The plates are available in packages of 100, bulk packages of 1000 and continuous rolls of 1000.
Booth No. 1902 Circle No. 347

Low-noise ion generator neutralizes charges

Controlled Environment Equipment Corp., 344 South Ave., Whitman, Mass. Phone: (617) 447-4436.

Laminar flow equipment is available with an air-ionizing unit to eliminate all electrostatic charges from the work area. Since statics are random, it is important to generate both positive and negative ions directly in the air stream. Thus, static charges of either polarity are neutralized. The ion generating unit does not generate ozone, nor is there radiation or shock hazard.

Booth No. 1917 Circle No. 355

For a complete listing of the technical papers at the show, see page U 112. For reprints of most of the papers, fill out the order form on page U 115.

Teflon cable covering zips closed



Zippertubing Co., 13000 S. Broadway, Los Angeles. Phone: (213) 321-3901.

Zippertubing, using Teflon fluorocarbon material, withstands environmental extremes of temperature and abrasion. Operable at temperatures to +500° and -425°F, the product comes with the zip-on, zip-off closure which permits easy jacketing application. The material is chemically inert, resistant to outdoor exposure, and has moisture absorption of less than 0.01%.

Booth No. 1505 Circle No. 353

Gas sputtering system modularly constructed



Consolidated Vacuum Corporation, 1775 Mt. Read Blvd., Rochester, N. Y. Phone: (716) 458-2550.

Each chamber of this system is a bolt-on module which can be fastened end-to-end to other chambers. Or, they can be joined to another chamber by means of a transport valve so that the two chambers can be operated at different pressures for multiple sequential processing of the same substrate. All materials now being sputtered in microelectronic circuit fabrication can be deposited in this system.

Booth No. 5228 Circle No. 354

ON READER-SERVICE CARD CIRCLE 222 ▶

The Innovator: Philco-Ford.

The Product: A 9-way better epoxy transistor. 1. PET TO-18's ambient power dissipation is typically greater than 400 mW (chip dependent). θ_{JC} is typically 105°C/W. 2. PET TO-5's ambient power dissipation is typically greater than 450 mW. θ_{JC} is typically 100°C/W. 3. PET packages have reliability factors equal to or exceeding that of metal cans. 4. PET's are immediately available in large volume production quantities. 5. PET's have a special deep-well interlock construction that insures hermeticity and reliability. 6. PET packages are permanently and legibly marked—lettered black on white. 7. PET's are packaged in our low-cost Taiwan production facility—to keep your cost low. 8. PET amplifiers operate on currents ranging from 10 μ A to 1 A; PET switches to speeds 8 ns turn on and 11 ns turn off. 9. PET's cover frequencies from 40 MHz to 1400 MHz. Philco-Ford Corporation, Microelectronics Division, Santa Clara, California 95051.



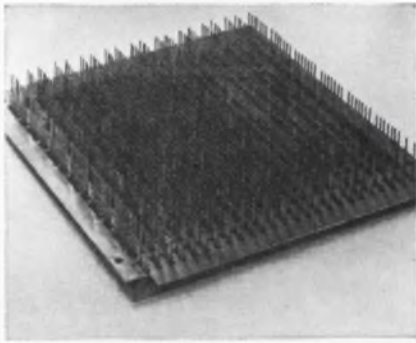

You're more productive with back-plane wiring

These new panels let you get the most out of wire-wrapping techniques. By combining specially drawn Wire-Wrap* terminals (for machine or hand-gun interconnection) with CAMBION®'s exclusive cage jack (for IC pluggability) you can have both packaging density and high production.

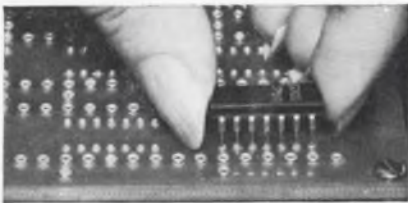

The concept of these panels allows you to order a size to meet your space or function requirements whether you're mounting 50 or 500 dual in-line IC's. If you are redesigning with integrated circuits, let CAMBION help you make the most of your design effort. For complete specifications on this reliable interconnection technique, contact: Cambridge Thermionic Corporation, Digital Products Division 433 Concord Avenue, Cambridge, Massachusetts 02138. Phone: (617) 491-5400.

REG. U.S. PAT. OFF.
*I. M. Gardner-Denver

CAMBION
CAMBRIDGE THERMIONIC CORPORATION

Standardize on CAMBION . . .

21,541 guaranteed electronic components

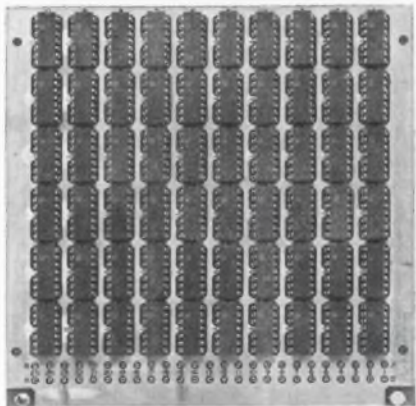

ON READER-SERVICE CARD CIRCLE 67

U132

PACKAGING & PRODUCTION

Solid-state programmer recovers in 1 ms

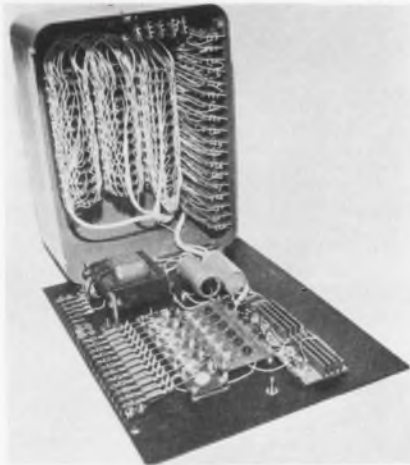

Leach Corp., Relay Div., 5915 Avalon Blvd., Los Angeles. Phone: (213) 232-8221.

This programmer uses ICs to perform logic and counting functions to control, in a selectable time sequence, the operation of semiautomatic machines, process control equipment, recording and tracking systems. The programmer initiates and terminates timing cycles, with durations as low as hundredths of a second, and up to 29.9 seconds. The input power required is 1 A at 115 V ac, 60 Hz. The unit operates over a temperature range of 15° to 55°C. Booth No. 3005 Circle No. 322

PC connector has wire-wrap terminals



Continental Connector Corp., 34-63 56th St., Woodside, N. Y. Phone: (212) 899-4422.

Printed circuit card-edge connectors feature terminations designed for wire-wrapping. They are available with 28 dual contacts providing 56 wiring terminals on 0.125-inch center-to-center spacing. Contact terminals are 0.025-inch square to permit wire-wrapping for up to three #26 AWG wires on each. Body material is glass-reinforced diallyl phthalate and contacts are gold-plated phosphor bronze.

Booth No. 3805 Circle No. 254

Circular connector mates simply



Viking Industries, Inc., 21001 Nordhoff St., Chatsworth, Calif. Phone: (213) 341-4330.

Miniature circular connectors for nonmilitary applications have crimp, removable high-density contacts. The entire plug/receptacle housing and insulators are molded in one unit eliminating costly separate metal housings and coupling devices. To mate, the user inserts the plug until it snaps to a locked position. By squeezing the finger grips on the plug housing, the plug releases and can be removed from the receptacle by pulling the plug. Booth No. 4001 Circle No. 251

Heat transfer devices cool off TO-92s

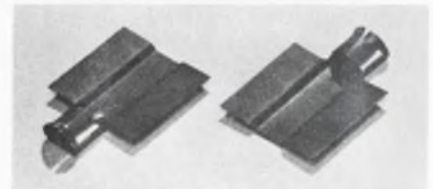

Wakefield Engineering, Inc., Wakefield, Mass. Phone: (617) 245-5900.

Two cooling devices are designed for TO-92 packages. The heat sink accommodates one TO-92 plastic transistor. It is made of aluminum with black immersion or irridite finish. For power dissipation of 0.2 watts, collector lead temperature rise above ambient is 18°C with black immersion or 20°C with irridite finish. The temperature equalizer for dual TO-92 units has three sizes to accept all different case size TO-92s. Material is aluminum or beryllium copper.

Booth No. 5332 Circle No. 264

ON READER-SERVICE CARD CIRCLE 223 >

The Innovator: Philco-Ford.

The Product: A 5-way better linear IC line. 1. Only linear line that covers the entire frequency spectrum from DC through VHF. 2. Our PA 7600 RF/IF video amplifier offers the highest gain bandwidth available in the industry (passband to 9000 MHz). 3. PA 7601 RF/IF bandpass amplifier offers extreme linearity with AGC. 4. PA 7713 RF/IF video amplifier: a special linear circuit featuring high gain bandwidth at low power (500 MHz at 18 mW). 5. Immediate delivery. Philco-Ford Corporation, Microelectronics Division, Santa Clara, California 95051.

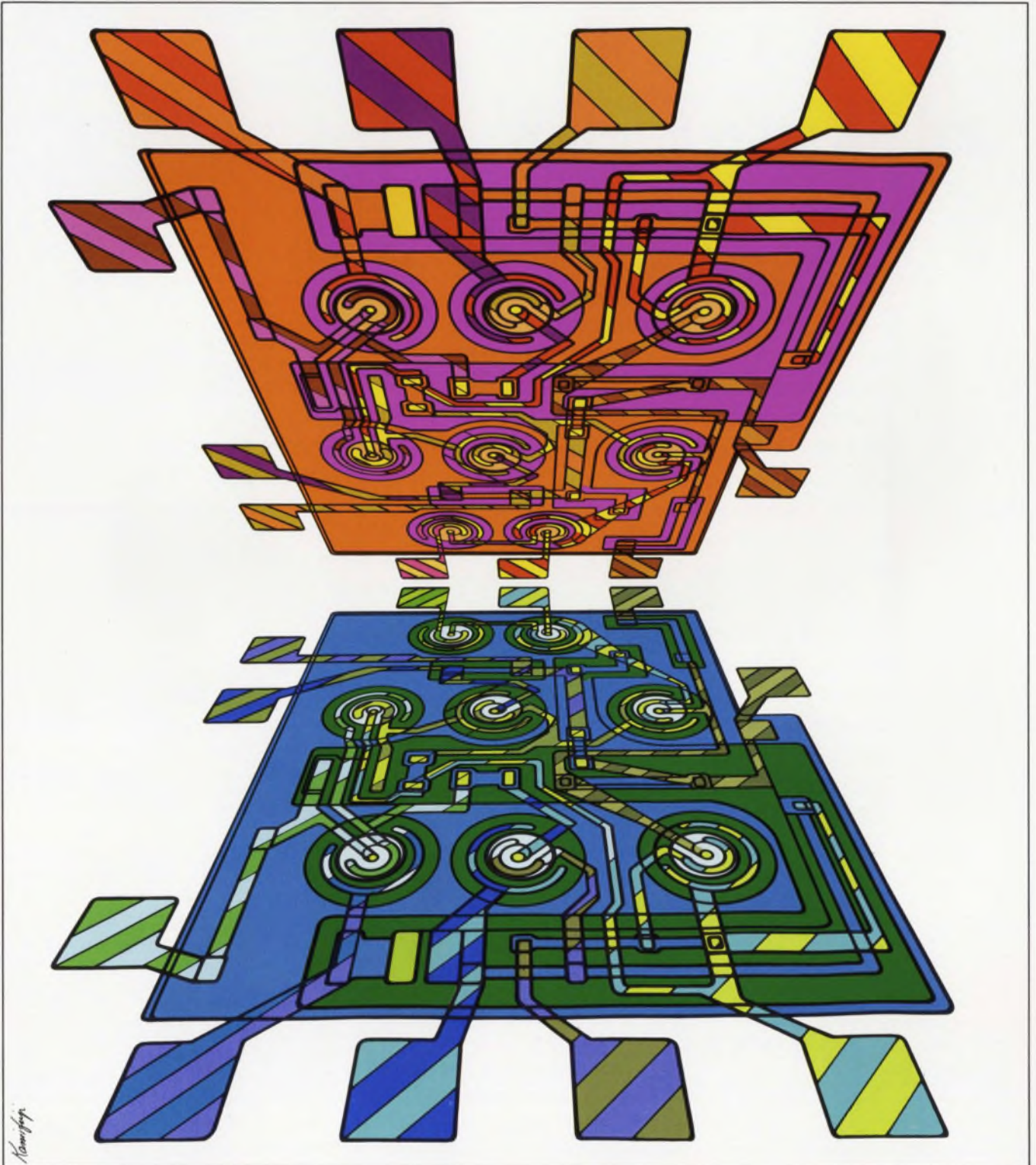

McQuay-Norris

We are No. 1 in RF Voltmeters

and you better believe it!

We have sold more sensitive RF Voltmeters than anyone else because we have been doing a lot of things right. We have given you 2% accuracy. We have given you the highest input impedance to make that accuracy meaningful. We have given you the highest AC and DC overload protection (probe diodes last longer that way). We have given you the fast response you need for peaking and nulling (sluggish sampling voltmeters can't make the grade). We have given you a well-mannered probe which works without any "backtalk" pulses pumped into your circuit (again, sampling voltmeters flunk out)! We have given you a clean, trouble-free design with a choice of features in three models ranging from \$495 to \$650. Check on the specs (we'll send them) that have made us No. 1.

**BOONTON
ELECTRONICS**
CORPORATION

ROUTE 287
PARSIPPANY, N.J. 07054
Telephone: 201-887-5110
TWX: 710-986-8241

ON READER-SERVICE CARD CIRCLE 69

PACKAGING & PRODUCTION

IC sealing system seams cold



*Solid State Equipment Corp., 4343
E. River Dr., Philadelphia. Phone:
(215) 844-3501. Price: \$8250.*

Designed to seal all types of hybrid and monolithic integrated circuits, from 1/8 to 3 inches, this system will accomplish sealing either by welding or reflow brazing. Only a small temperature rise occurs within packages being sealed, minimizing resistance shifts of thin- or thick-film resistors during sealing. Sealing may be accomplished in a wide variety of inert atmospheres such as nitrogen, helium or argon.

Booth No. 1014 Circle No. 337

Kynar sleeving cut to your spec

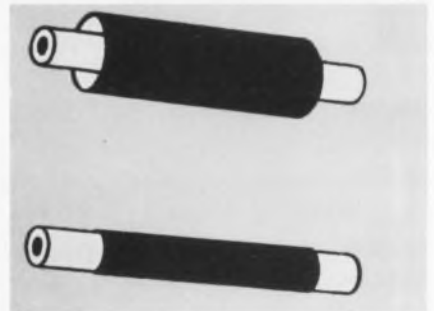

*Westline Products, 220 S. Rose St.,
P. O. Box 2980 Terminal Annex,
Los Angeles. Phone: (213) 627-
2641.*

Permanently printed tubular markers in heat-shrinkable Kynar can be used for identification of wires, cables, terminals, leads, connectors and component parts. Kynar is a clear, tough polyvinylidene fluoride which shrinks to 50% of its supplied diameter. Kynar will not cold-flow, does not burn, never melts and will not split over sharp or irregular surfaces. It has a continuous operating temperature from -55° to $+175^{\circ}\text{C}$.

Booth No. 1823 Circle No. 345

ON READER-SERVICE CARD CIRCLE 224 ➤

The Innovator: Philco-Ford.

The Product: MOS. 1. The first major manufacturer to take MOS from the theoretical to the practical. 2. Finest MOS manufacturing technique in the industry. 3. Most experienced MOS team in the industry: R&D, engineering, and systems know-how people. 4. Proven systems capability in MOS and large scale integration (LSI). 5. One of our Philco-Ford MOS circuit types has logged over 2.5 million device-hours; reliability data on MOS circuits available on request. Philco-Ford Corporation, Microelectronics Division, Santa Clara, California 95051.



Hamberg

Tape spooler feeds 1000 characters/second



Remex Electronics, 5250 W. El Segundo Blvd., Hawthorne, Calif. Phone: (213) 772-5321. Price: \$2195.

This all-solid-state spooling machine's speed is 1000 characters per second with a full 2000 feet of tape on 10-1/2-inch reels. Rewind speed is 2000 characters per second in either direction. Any input line frequency from 50 to 400 Hz at 115 volts can power the unit with 230-volt optionally available.

Booth No. 2011 Circle No. 336

Microlgic cards accept dc-to-10-MHz input

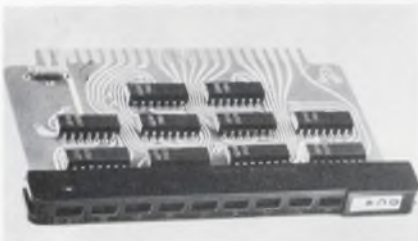

Control Logic, Inc., 3 Strathmore Rd., Natick, Mass. Phone: (617) 655-1170. Price: \$150 (4-stage card).

Four to 8 decade dividers connected in groups of 2 dividers each are provided on this card. The CDC-114 base card features two groups of 2 dividers, each providing two independent stages, or one 4-digit divider. Additional dividers, up to a maximum of eight, may be added to order. Each divider group has a separate count input. Each divider employs ripple carry with gated transfer and operates with dc-to-10-MHz inputs with less than 100-ns over-all delay.

Booth No. 2005 Circle No. 334

Stepped-up torque from small motor



IMC Magnetics Corp., 570 Main St., Westbury, N. Y. Phone: (516) 334-7195. Price: \$50 (over 500).

A 1.095-inch long, 50-gram permanent magnet step-servo motor, offers bidirectional operation with power consumption of 1.74 watts. Responding at rates of up to \$10 pps in 90° steps, the unit meets a variety of X-Y plotter, switch positioning, computer, remote control actuator and digital integrating requirements.

Booth No. 2118 Circle No. 342

High-speed reader operates bidirectionally



Remex Electronics, 5250 W. El Segundo Blvd., Hawthorne, Calif. Phone: (213) 772-5321. Price: \$3580.

This photocell punched-tape reader and spooler offers a 500-characters-per-second reader and a 50-inch-per-second spooler equipped with 10-1/2-inch diameter reels. Total height is 21 inches. It is all-solid-state with a choice of output signals. The spooler portion includes an independent high-speed, bidirectional rewind and soft take-up feature that precludes the possibility of breaking tapes.

Booth No. 2011 Circle No. 324

Digital calendar/clock advances automatically



Durant Manufacturing Co., Milwaukee. Phone: (414) 271-9300.

Continuous visual readout and remote electrical readout on command are provided by this clock for date/time information in six-figure form. It is designed for use in data reduction systems, to control batching, to aid in computing piece rates in all production processes, and in all types of data or material handling where a date/time base is required. Manual set-up switches on the front panel are provided to establish initial date and time.

Booth No. 2124 Circle No. 335

Digital printer totals 10 columns



Victor Comptometer Corp., 3900 N. Rockwell St., Chicago. Phone: (312) 539-8210.

Standard features of this device include 0 to 10 digits and print command, a choice of 24 V dc at 0.98 A or 48 V dc at 0.63-A solenoid voltage and choice of punctuation. Also on accumulators is a print command total and minus, all with signal-sector symbol printing. Nonadd and subtotal solenoid operation is optional.

Booth No. 2015 Circle No. 333

Replace 80% of all FET types with one!

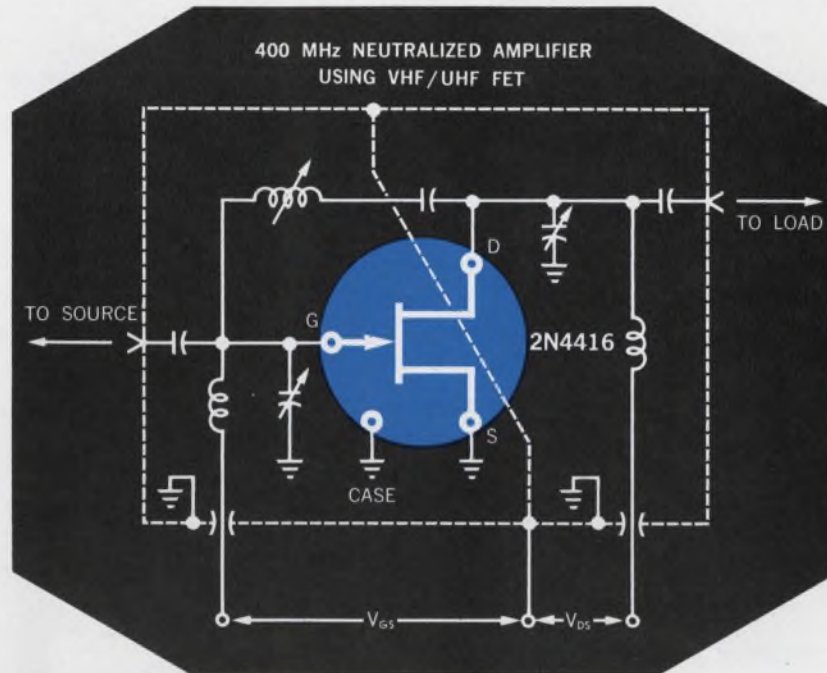

Here's how: Buy the Union Carbide 2N4416 universal FET in quantity, and you can select transistors over the entire frequency range covered by 80% of all field effect types. The 2N4416 is specified below as a VHF/UHF amplifier. However, from any class lot of this device you can select (1) general purpose, low noise, high gain amplifiers from D.C. to 900 MHz, or (2) ultra low noise devices for low frequency applications. This device is also available in a ribbon lead ceramic package (.138" dia.) as the low capacitance 2N4417. Use for TV tuners, FM sets, IF strips, mixers, oscillators, or even switches. Write for complete specifications.

CHARACTERISTICS Small Signal, Common Source @ 25°C	2N4416 T0-72	Frequency
Forward Transconductance $RE (Y_{r1})$ (min.)	4000 μ mhos	400 MHz
Input Capacitance, C_{in} (max.)	4.0 pf	1.0 MHz
Output Capacitance, C_{out} (max.)	2.0 pf	1.0 MHz
Reverse Transfer Capacitance, C_{r1} (max.)	0.8 pf	1.0 MHz
Spot Noise Figure (Neutralized), NF (max.)	4.0 dB	400 MHz
Spot Noise Figure, NF (max.) (Neutralized)	2.0 dB	100 MHz
Power Gain, G_{p1} (min.) (Neutralized)	10.0 dB	400 MHz

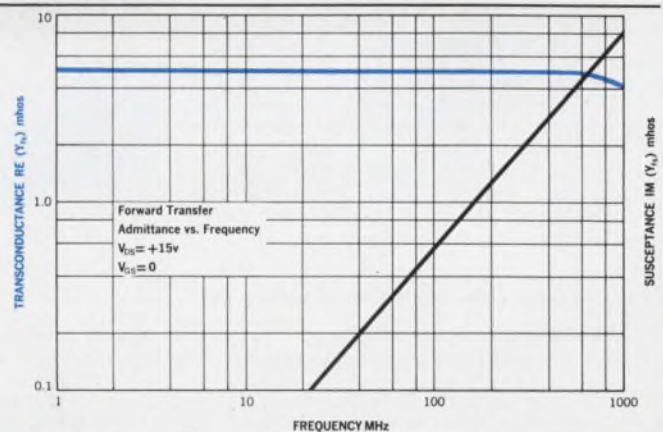

ELECTRONICS

Semiconductor Department / 365 Middlefield Road, Mountain View, California 94040 / Telephone: (415) 961-3300 / TWX: 910-379-6942

ON READER-SERVICE CARD CIRCLE 70

MAKING THE RIGHT CONTACTS...

for sequencing, data processing, programming, control and other industrial switching?

Ericsson offers an across-the-board selection of reliable, long-life and economical switching components for a broad spectrum of applications:

100-POINT PROGRAM BOARD

Multiple selection programmer for rapid circuit selection. 100 crosspoints in a 10 by 10 configuration, 2 1/4" square, 1-1/16" deep. Contact springs beryllium — copper bronze, gold-plated. Shorting pins color-coded in five colors. Solder-type terminals at bottom of board. Boards can be multiplied either horizontally or vertically.

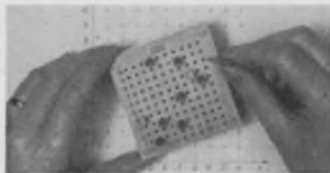

120-POINT SINGLE "CROSSBAR VERTICAL" MULTI-CONTACT RELAY

Replaces ten ordinary relays. Saves space, multiple wiring and complex wiring diagrams and circuitry. Silver alloy or gold bifurcated contacts. 8, 10 or 12 fixed contact strips, common to all ten (or split five and five) sub-relays and associated contact springs. 24 or 48 VDC coils. Special coils available. Life: 200 million operations.

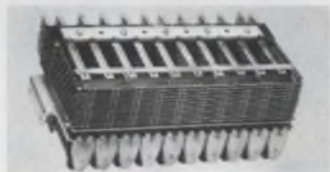

500 & 600-POINT CROSSBAR SWITCHES

Extremely high switching capacity, speed and reliability in an economical package. No rotary or sliding parts — minimum maintenance. Multipath selection by means of horizontal select bars and associated vertical contact strips. Silver alloy or gold contact strips and springs. 24 or 48 VDC coils. Special coils available.



1,000 & 1,200-POINT CROSSBAR SWITCHES

Same superior features as small size switches, with up to 1,200-point switching capacity. Mechanical life of all switches 25 million operations per vertical, 60 million per horizontal select bar, without maintenance or adjustment. 70 million operations per contact. Operate times from select to hold 35 to 75 milliseconds.

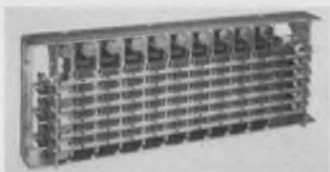

2,040-POINT BINARY CODE SWITCH

Compact switching matrix with wide range of input/output arrangements. Positive locked contacts — no sustaining power needed. Program will not change if power fails. New V-type positive-wipe copper/silver or silver/palladium contacts standard. Custom, built-in intermodular contact multipling. Quick-connect plug-in wiring.



Ericsson also offers similar values in:

- Telephone-Type Relays
- Rotary Switches
- Lighted Push-button Switches
- Test Cords

You can rely upon the proven experience and continuing advanced capabilities of Ericsson — a leader in worldwide communications and switching technology for more than 81 years.

SEE US IN BOOTH 3503 AT WESCON



ERICSSON CENTRUM, INC.
Component Products

16 E. 40th St., New York, N.Y. 10016



AVAILABLE IN CANADA — L. M. Ericsson Ltd., 2300 Laurentian Blvd., Montreal

ON READER-SERVICE CARD CIRCLE 74

COMPUTERS & DATA PROCESSING

Impulse counters
stack up small



Landis & Gyr, Inc., 45 W. 45th St.,
N. Y. Phone: (212) 586-4644.

A compact, low-wattage impulse counter is suited for multiple-counter installations where panel space is at a premium. Plug-in design provides for both surface and flush panel mounting. The counters are available with manual or electric reset or with no reset. Available counting speeds are 10, 25 or 60 Hz. Dimensions are 1.89 by 0.94 by 2.83 inches.

Booth No. 5340 Circle No. 258

Digital display
easy to read



Litton Industries, Aero Service
Div., 4219 Van Kirk St., Philadel-
phia. Phone: (215) 533-3900.

Consisting of two optical shaft transducers (one for X axis, one for Y axis), a power supply and a remote dual-axis, bidirectional display, this unit gives a 5-digit read-out with polarity sign to the nearest 0.001 inch. On-off switch and reset controls are mounted on the coordinate graph together with all cabling. The system eliminates the necessity of scale dials and tapes by permitting the operator to view the coordinate data directly on the remote display. It is available in three working area sizes and eight individual configurations.

Booth No. 4207 Circle No. 376

ON READER-SERVICE CARD CIRCLE 75 ➤

Polarad modular microwave signal instruments offer you new flexibility. Build the system you need now, rearrange or add new modules later.

Choose from 12 modules. Signal generators and sources cover a 0.95 to 11 GHz range. Doublers obtain frequencies to 21 GHz. Frequency stabilizers and a common modulator are available too. Rack, stack, or interchange in minutes.

Performance? Closely regulated power supplies, $\pm 0.5\%$ digital frequency readout accuracy, bimetallic cavity stabilization and other features assure lowest drift and incidental AM and FM, greatest freedom from spurious signals.

Polarad Signal Modules include:

Signal Generators	Frequency—GHz
1105	0.95 to 2.4
1106	2.0 to 4.6
1107	3.8 to 8.2
1108	6.95 to 11.0
Signal Sources	
1205	0.95 to 2.4
1206	1.95 to 4.2
1207	3.8 to 8.2
1208	6.95 to 11.0
Frequency Doublers	
1509	10.0 to 15.5
1510	15.0 to 21.0

Other Instruments

1001	Modulator
3815	Frequency Stabilizer

Let your Polarad field engineer demonstrate the flexibility and performance of these modular microwave instruments, and prove their economy too. Call him directly or contact Polarad Electronic Instruments, 34-02 Queens Boulevard, Long Island City, N. Y. 11101. Telephone: (212) 392-4500.



"Visit our booths 3101 and 3102 at Wescon"

**use these Polarad instruments
as an extended range
pulse modulated signal generator today...
give them separate assignments tomorrow**

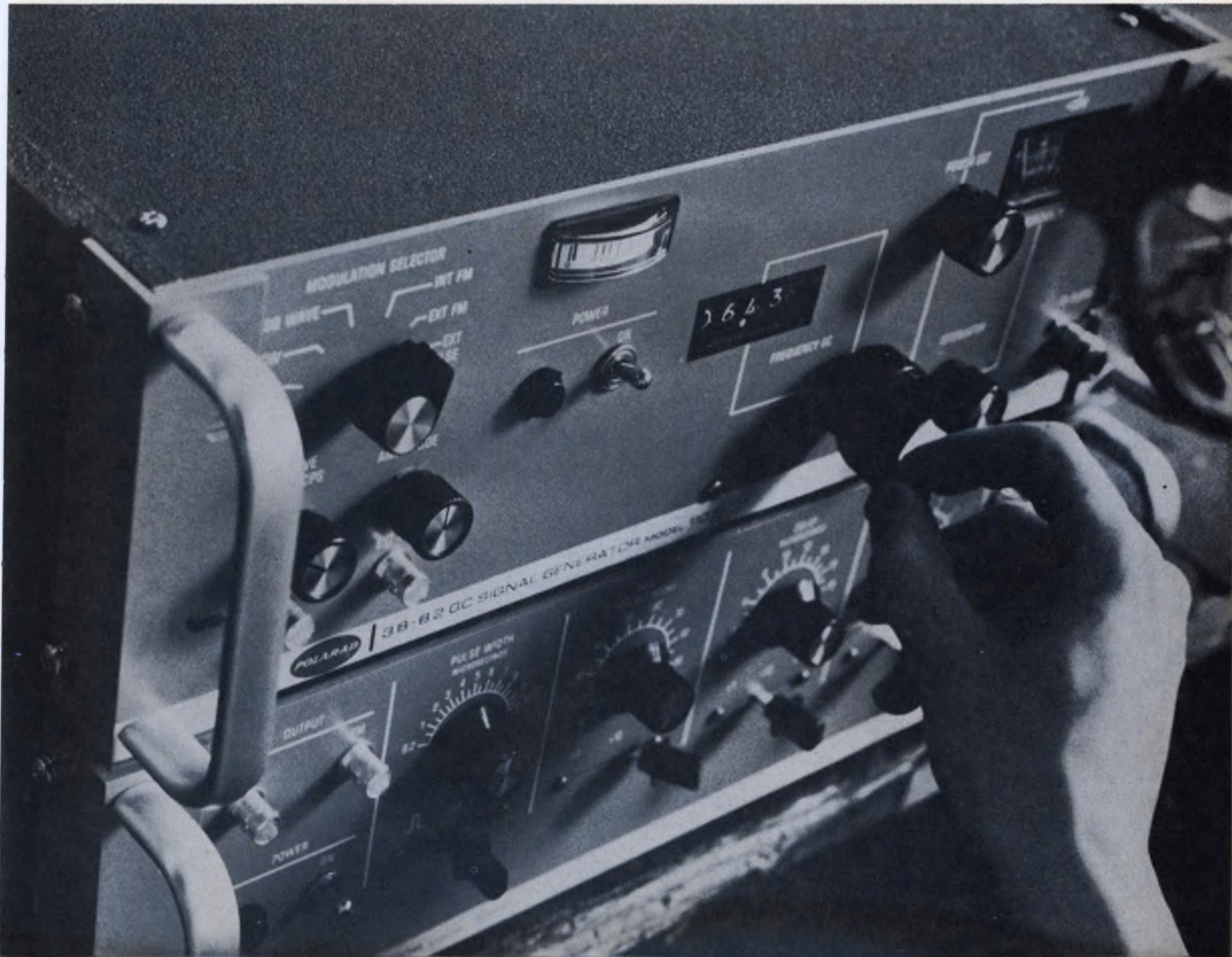

FLAT DRAWER CABLE

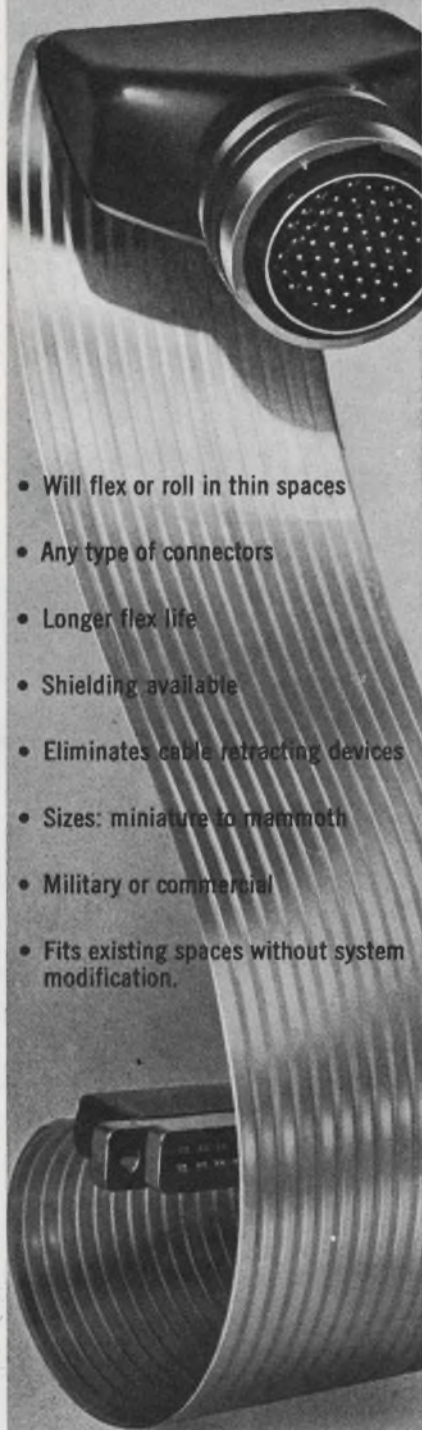

- Will flex or roll in thin spaces
- Any type of connectors
- Longer flex life
- Shielding available
- Eliminates cable retracting devices
- Sizes: miniature to mammoth
- Military or commercial
- Fits existing spaces without system modification.

 **FLEX-WELD**

DIGITAL SENSORS INC.
4127 N. Figueroa Street
Los Angeles, California 90065
(213) 223-2333 • TWX 213-226-1230

ON READER-SERVICE CARD CIRCLE 76

U140

COMPUTERS & DATA PROCESSING

Analog data processor plugs in functions

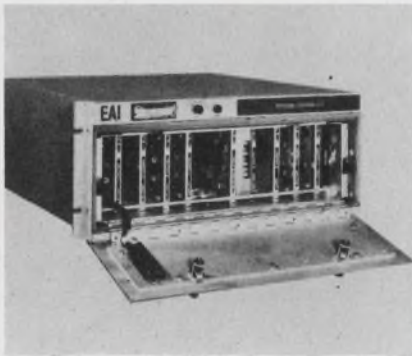

Electronic Associates, Inc., West Long Branch, N. J. Phone: (201) 229-1100. P&A: \$3000 to \$5000; 3 months.

A selection of plug-in components provides this analog data processor with a high degree of function flexibility. Depending on modular configuration, it can be used for operator guides, closed-loop control, signal conditioning and instrumentation. Modules now available include eight which have dual-function capability and one which can perform four functions. Each slot in the unit may be modified to dual function to provide up to 20 circuits per processor.

The module selection consists of three dual voltage-to-current and three dual current-to-voltage converters, a low-level wide-bandwidth diff amp, a dual amplifier resistor network which requires either one or two plug-in amplifiers and is the universal amplifier module, a time division multiplier, a variable diode function generator, a relay comparator, a dual integrator network which requires one or two FET high-input-impedance amplifiers and a quad coefficient network.

Power circuitry is built into each module. Test points and trimming potentiometers can be reached without removing the module from the housing. Modules may be cut out of the circuit for trimming purposes by turning a switch on the amplifier card.

Booth No. 2727 Circle No. 378

For a complete listing of the technical papers at the show, see page U 112. For reprints of most of the papers, fill out the order form on page U 115.

Satellite recorder operates unattended

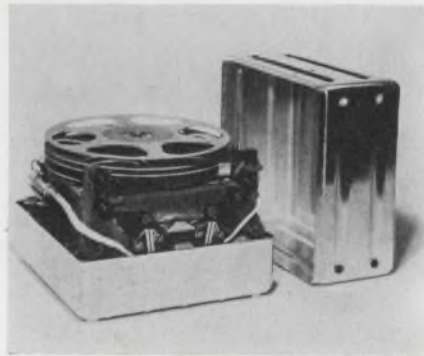

Leach Corp., 717 N. Coney Ave., Azusa, Calif. Phone: (213) 682-3506.

Capable of recording analog data over 1 kHz to 1 MHz, this unit is capable of providing a minimum of 1000 hours unattended operation in orbit. Measuring 7.1 x 8.1 x 5.25 inches, the recorder accommodates 280 feet of 1/2-mil tape using a packing density of 10 kHz per inch. Data can be recorded at 25, 50 or 100 inches per second.

Booth No. 3005 Circle No. 382

Ten-channel recorder changes paper simply

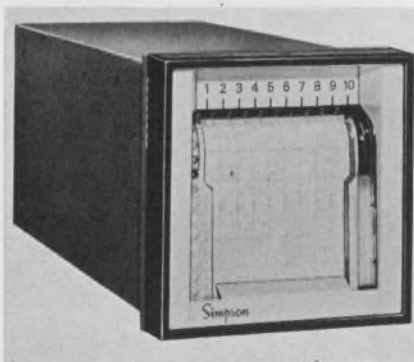

Simpson Electric Co., 5200 W. Kinzie St., Chicago. Phone: (312) 279-1121. Price: \$175.

The chart paper of this 10-channel event recorder can be quickly changed just by removing the front cover. If rack-mounted, this means that it is not necessary to remove the unit or go behind the panel. The unit is supplied with two chart speeds (20 or 120 mm per hour), which are switch-selected. Recording is on pressure-sensitive paper.

Booth No. 2501 Circle No. 363

No trace of overload problems



ACTUAL SIZE

withstand -100 V to +4 V signal surges

withstand 2:1 power supply surges

withstand -100 V to +100 V momentary signal transients

When you use RCA nuvistors

If you find it necessary to include overload protection in your solid-state circuit designs, look to RCA nuvistors. Nuvistors can withstand severe signal and power surges without catastrophic failure.

Nuvistors eliminate many other problems, too, through the benefits of their unique construction: demonstrated reliability of 99.901% per 1,000 hours out to 30,000 hours of operation; temperature stability, $\Delta gm \cong 4 \mu\text{mho}$ per degree C over the range -55°C to $+250^\circ\text{C}$; dependable performance in the presence of both pulse and steady state nuclear radiation; low RF and sub-audio noise; 1,000 g shock rating, and exceptional uniformity of electrical characteristics from tube to tube and throughout life.

For complete data on the entire RCA line of nuvistors for industrial and military applications, call your nearest RCA District Office or write RCA Commercial Engineering, Section H-18-DE, Harrison, N.J. 07029.

On Reader Service Card Circle 109

RCA DISTRICT OFFICES—OEM SALES: EAST, 2075 Millburn Ave., Maplewood, N.J. 07040, (201) 485-3900 • MID-ATLANTIC: 605 Marlton Pike, Haddonfield, N.J. 08034, (609) 428-4802 • MID-CENTRAL: 1600 Keith Bldg., 1621 Euclid Ave., Cleveland, Ohio 44115, (216) 241-3450; 2511 East 46th St., Bldg. Q2, Atkinson Sq., Indianapolis, Ind. 46205, (317) 546-4001 • CENTRAL: 446 East Howard Ave., Des Plaines, Illinois 60018, (312) 827-0033 • WEST: 6363 Sunset Blvd., Hollywood, Cal. 90028, (213) 461-9171 • INTERNATIONAL OPERATIONS, RCA International Division: Central and Terminal Aves., Clark, N.J. 07066, (201) 485-3900 • 118 Rue du Rhone, Geneva, Switzerland, 35 75 00

RCA Electronic Components and Devices, Harrison, N.J. 07029



The Most Trusted Name in Electronics

See RCA Nuvistors in Booths 3701/3705

These 14 New Devices Make RCA

the Triac Leader of the Industry

Now, RCA offers you the industry's broadest line of Triacs, with an unmatched choice of ratings and triggering characteristics in space-saving packages ... all at truly economical prices! Triacs are today's most modern, effective component for ac phase-control and load switching. Because they can perform the functions of two SCR's, Triacs make possible new economies in full-wave power circuit design and cost for industrial and commercial applications.

So for efficient, inexpensive solid-state control of motors, lighting, and heating, look to RCA, the Triac Leader. Your RCA Sales Representative will be happy to give you more details, including price and delivery. Also, ask him about RCA's complete line of SCR's. For additional technical data, write RCA Commercial Engineering, Section RG8-2, Harrison, N.J. 07029. See your RCA Distributor for his price and delivery.

*Priced in quantities of 1,000 and up.

On Reader Service Card Circle 107

Current Rating I_T (rms)	Low Voltage (100V)	120V Line (200V)	240V Line (400V)	Package
2.5A ($I_{GT} = 3$ mA max)	40525	40526	40527	modified 3-lead TO-5
2.5A ($I_{GT} = 10$ mA max)	40528	40529	40530	modified 3-lead TO-5
6A		40429	40430	TO-66
6A		40485	40486	modified 2-lead TO-5
6A		40431 (with integral trigger)	40432	modified 2-lead TO-5
15A		TA2834	TA2835	TO-66

RCA Electronic Components and Devices



The Most Trusted Name in Electronics

See us at WESCON, Booths 3701-05, 3718-22

Sensitive-Gate Triacs under \$1.00*

Extremely high gate sensitivity...rms (on-state) current = 2.5A...and a price level that makes possible a new generation of controls for small appliances, induction motors, and sensing circuits. Maximum gate sensitivities of 3 mA or 10 mA are actually many times greater than that of conventional Triacs! This means simplified triggering circuits and reduced component costs. The 100V versions (40525 and 40528) sell for \$0.95*; the 200V types (40526 and 40529) are priced at \$0.98*; and the 400V units (40527 and 40530) are available at \$1.40*!

6A Triacs in 2-lead TO-5 to Control up to 1440 Watts

With the new 40485 and 40486 6A Triacs, RCA doesn't have to use an expensive press-fit package to control a lot of power. Both types employ the low-cost TO-5 case which can be easily mounted on heat spreaders using mass produced pre-punched parts and batch soldering techniques for improved heat-sinking ability. The 40485 sells for only \$1.50* and controls 720 watts. The 40486 can control 1440 watts and sells for \$1.98*. And reliability is assured with surge current protection up to 100A!

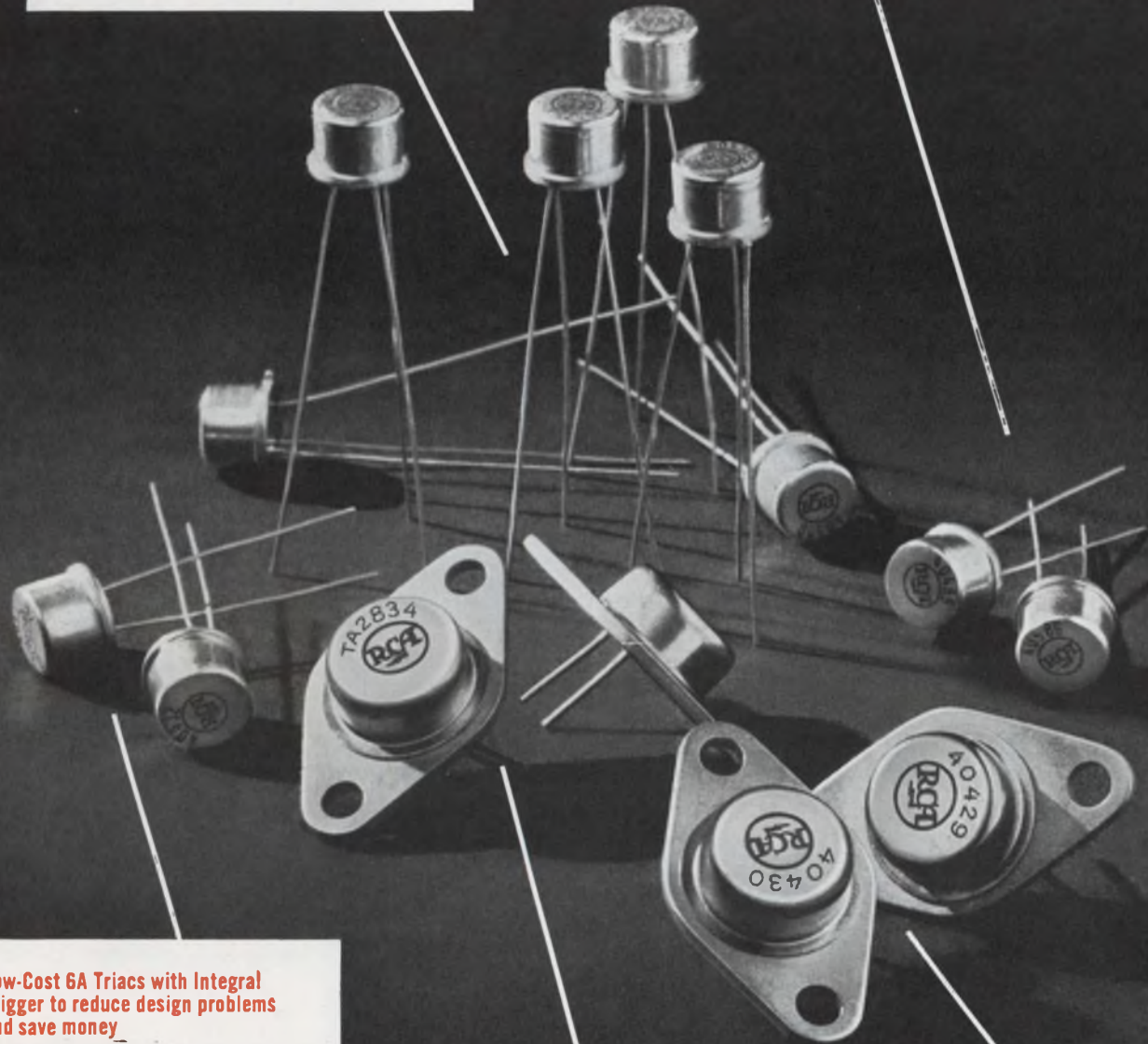

Low-Cost 6A Triacs with Integral Trigger to reduce design problems and save money

Because the triggering device and the firing characteristics of the 40431 and 40432 Triacs are coordinated inside a compact TO-5 case, you don't have to worry about designing in additional triggering components. You benefit further from reduced circuit and assembly costs, plus improved packaging densities! So if your ac-load control circuits require a trigger, why not have it built-in for you? The 40431 controls 720 watts at 120V and costs \$1.80*; the 40432 controls 1440 watts at 240V and costs only \$2.48*.

15A Triacs for Load Control up to 3600W

RCA developmental types TA2834 and TA2835 Triacs extend solid-state control way up into the kilowatt range. These powerful TO-66 units have surge current protection up to 100A, plus all of the other design benefits of RCA's lower current Triacs. Possible applications include power supplies, heating controls, motor drivers, and many other industrial and commercial usages.

6A Triacs in Popular TO-66 Package

Need full-wave control of up to 1440 watts in a TO-66 package? RCA 40429 and 40430 Triacs are your answer... they feature high gate sensitivity, symmetrical triggering characteristics ($I_{GT} = 25 \text{ mA max}$), and surge current protection up to 80A. The 200V 40429 costs \$1.50*, the 400V 40430 only \$1.98*.



NEW DIFFERENTIAL MULTIMETER.

Model 853A uses differential techniques to measure voltage, resistance and current to high accuracies. Range is 0 to 1100 volts AC/DC, 0 to 10 amps AC/DC, and 0 to 100 megohms. Price is a low, low \$445.

NEW RMS DIGITAL VOLTMETER.

Model 9500A offers true RMS response with fully automatic operation. Measures from 0-1100 volts RMS within $\pm(0.05\% + 0.015\%$ of range) digit and has options for remote control, printer output, and low capacity probe input. Price \$2,395.



NEW DC DIFFERENTIAL VOLTMETER.

Model 891A features infinite input resistance at null over entire 1100 volt range. Accuracy is $\pm 0.02\%$. Light weight and small, the new unit is priced at \$595. Battery option \$100.



NEW POWER SUPPLY.

Model 415A precision high voltage power supply offers up to 3 kv and 20 mils output in a 3 1/2" panel. Price is modest \$495.



NEW DC CALIBRATOR.

Model 335A combines a DC voltage standard with a high impedance voltmeter/null detector for ultimate versatility. The instrument performs as a 0-1100 volt $\pm 0.003\%$ voltage calibrator or infinite input resistance differential voltmeter; a 10 microvolt to 1100 volt voltmeter/null detector with 10 megohm and 100 megohm input resistance, or as a precision 50 ma source to drive a calibration system while separately detecting nulls. Price \$2,485.



NEW COMPARATOR. Fluke/Monotronics Model 103A performs short term stability measurements with no peripheral equipment. Priced at a low \$1,995. The Model 103A costs 40% less than competitive equipment.



NEW METER CALIBRATOR.

Model 760A does the work of five separate instruments for about half the cost and much more conveniently too. Use it to calibrate AC and DC voltmeters, ammeters and ohmmeters. Accuracy ranges from 0.1% to 0.25%. Price is \$2,485.

FOR WESCON '67, FLUKE EXPRESSES SEVEN GREAT IDEAS ABOUT MEASUREMENT IN SEVEN NEW PIECES OF HARDWARE.



See them all at the Fluke show, Wescon '67, Booths 3209, 3210, and 3211. Perchance you're one of the nine out of ten not going to the show, don't get shook! We'll be happy to send you full data and, if you like, arrange a visit from your full service Fluke sales engineer. Simply write or call us.

Fluke, Box 7428, Seattle, Washington 98133. Phone (206) 774-2211, TWX: (910) 449-2850. In Europe, address Fluke International Corporation, P.O. Box 5053, Ledeborstraat 27, Tilburg Holland. Telex: 844-50237.



COMPUTERS & DATA
PROCESSING

**IC logic modules
quiet to 10 MHz**

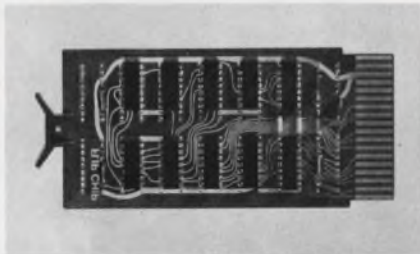

Digital Equipment Corp., 146 Main St., Maynard, Mass. Phone: (617) 897-8821.

High-speed, high-power TTL logic models are offered on 36-pin cards. In the logic 0 state (0 to 0.4 V), the driver sinks a maximum 1.6 mA from the driven load. In the logic 1 state (2.4 to 3.6 V), only the leakage current of the driven load must be supplied. Dc noise is 1 volt at either the logic 1 or logic 0 level. Absolute worst-case noise margin is 400 mV at either level.

Booth No. 2102 Circle No. 364

**Core memory system
cycles in microseconds**

Information Control Corp., 1320 E. Franklin Ave., El Segundo, Calif. Phone: (213) 322-6930.

For small data processing and data collection systems, these memory systems are available in two models. The ComRac 100 exhibits a cycle time of 1 μ s, an access time of 0.45 μ s, and is available in capacities up to 4096 words by 24 bits. The 150 exhibits a cycle time of 1.5 μ s, an access time of 0.7 μ s and is available in capacities up to 8192 words by 24 bits.

Both are organized as four-wire current systems and employ 20-mil lithium ferrite cores. They can be operated in standard modes of read/restore, clear/write, buffer read and buffer write. The entire memory, including power supply, is packaged in a 5-1/4-inch rack-mounted chassis.

Booth No. 2006 Circle No. 362

For a complete listing of the technical papers at the show, see page U 112. For reprints of most of the papers, fill out the order form on page U 115.

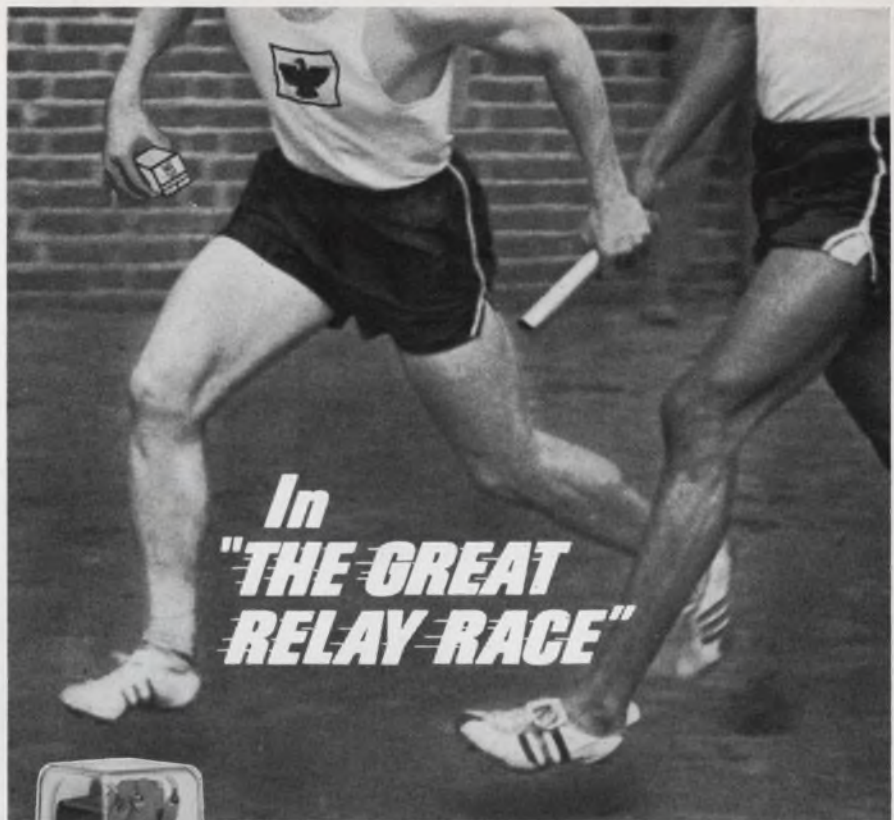

In
**"THE GREAT
RELAY RACE"**



A FREE RELAY IS YOURS . . . to run your own relay race (evaluation test) in your own plant . . . under your own conditions.

YOU BE THE OFFICIAL JUDGE! You'll find out what we already know (see our race results below). Eagle Relays run longer . . . and better. There's no premium in cost . . . and they're readily available.

YOU'LL BE A WINNER EVERY TIME! Send for your Official Judge's Entry Blank now by contacting: R. W. Emelander, Eagle Signal Division, E. W. Bliss Company, 736 Federal Street, Davenport, Iowa, 52808 or circle reader service number below.

CONTACTS	COMPETITIVE BRANDS						EAGLE RELAYS
	"A"	"B"	"C"	"D"	"E"	"F"	
Arrangement	3 PDT	3 PDT	3 PDT	3 PDT	3 PDT	3 PDT	3 PDT
Rating	5 Amp.	5 Amp.	5 Amp.	5 Amp.	5 Amp.	5 Amp.	5 Amp.
LIFE							
Mechanical	15,061,261 Operations	14,077,866 Operations	28,808,000 Operations	21,625,333 Operations	16,923,133 Operations	29,433,600 Operations	34,492,950 Operations
ELECTRICAL							
5 Amp. Resistive	295,466 Operations	490,433 Operations	129,600 Operations	235,700 Operations	778,200 Operations	921,400 Operations	948,675 Operations
1.6 Amp Inductive	488,666 Operations	1,071,666 Operations	496,000 Operations	284,333 Operations	3,529,466 Operations	1,842,000 Operations	3,102,200 Operations

FOR A FAST START in Eagle's "Great Relay Race" see us at the Wescon Show, San Francisco Cow Palace, Aug. 22-25. Booth No. 3401.



A DIVISION OF THE E. W. BLISS COMPANY

At Wescon, stop at Eagle's booth No. 3401 for the latest "race results"

ON READER-SERVICE CARD CIRCLE 80

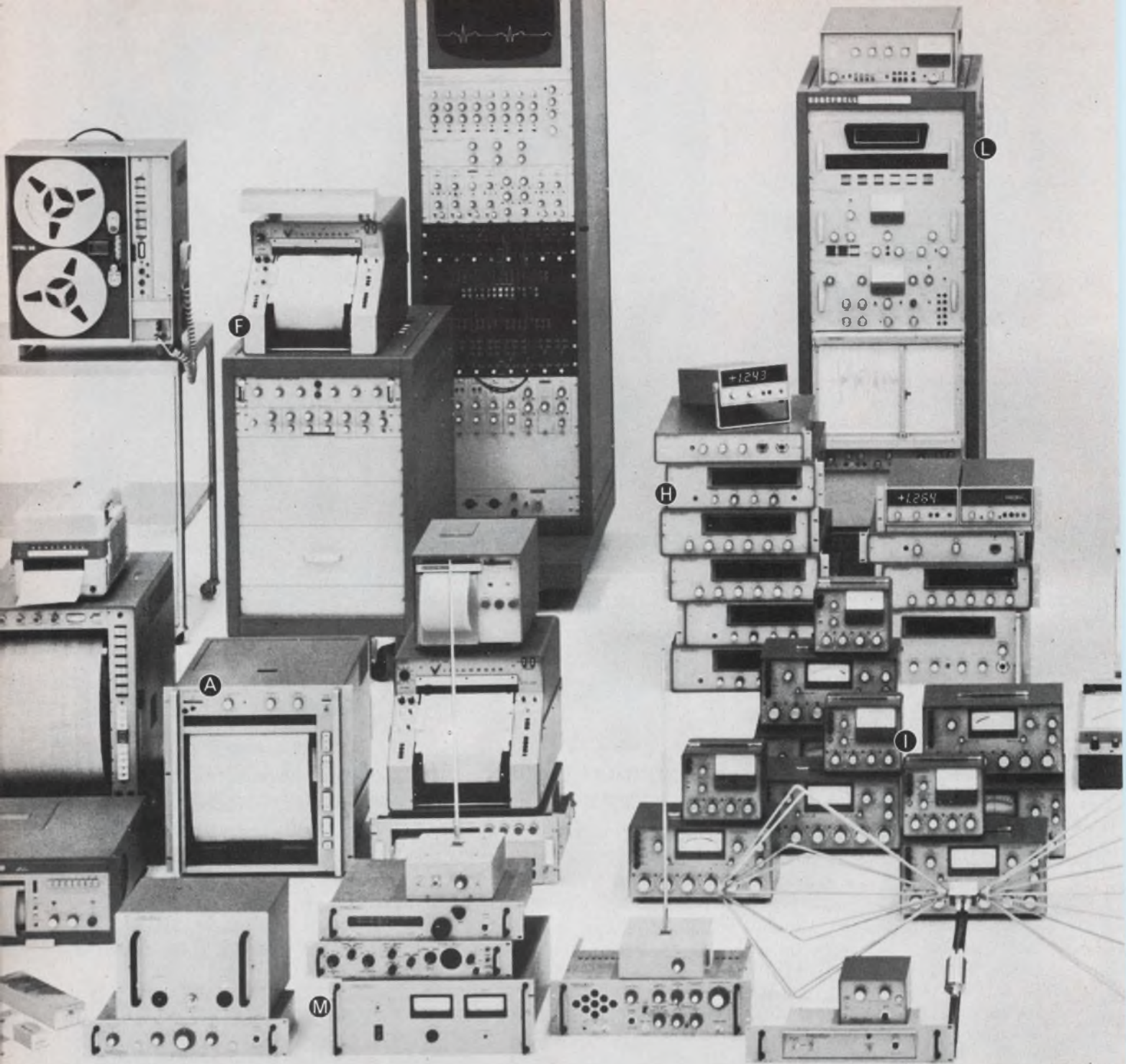

Here's just part of the full Honeywell line, which includes: **A** 117 Visicorder direct-recording oscillographs in 6", 8", and 12" models; **B** 2 Model 1806 fiber-optics CRT Visicorder oscillographs; **C** 26 magnetic tape systems, including the 7600 Series in 10½" and 15" reel versions; **D** 84 amplifiers and other signal-condi-

We build **847**
instruments to be sure we
have the exact **1** you need.



tioning units; **E** 78 analog recording systems; **F** 46 electronic medical systems; **G** 14 oscilloscopes; **H** 37 digital multimeters; **I** 29 differential voltmeters; **J** 179 precision laboratory standards and test instruments; **K** 128 data loggers; **L** 9 analysis systems; **M** 61 EMI products; **N** 37 X-Y graphic recorders.

Your Honeywell sales engineer can zero in on the *precise* solution to your instrumentation problems. Quickly and efficiently. You won't have to settle for "almost" what you need because the Honeywell sales engineer isn't handicapped by a limited line. He can choose from 847 basic instruments whose combinations and permutations approach the infinite.

The solution might be a Visicorder recording oscilloscope. Or one of our modular magnetic tape systems. Or an X-Y recorder, a digital multimeter, or a portable potentiometer. But whether it's a single instrument or a complete data system, you can be sure the solution will be the right one, carefully thought out with your future requirements considered as well as your current needs.

Local service and nationwide metrology facilities back up your Honeywell instrument or system. And, we can even provide factory training courses for *your* operating personnel. For the full story on how Honeywell can help you, call your local sales engineer or write: Honeywell, Test Instruments Division, Denver, Colorado 80217.

Honeywell

Honeywell engineers
sell solutions

The static recorder writes, only the paper moves on

Varian Associates, 611 Hansen Way, Palo Alto, Calif. Phone: (415) 326-4000. P&A: \$7100, late fall (Statos I); \$4700, early 1968 (Statos II).

An entirely new method of strip-chart recording combines electrostatic recording with integrated digital electronics. The result?

- A three-channel dc-to-3-kHz direct-writing strip-chart recorder with no moving parts, ink, arcing or heat elements in the writing.
- A writing speed of 20,000 in./s with less than 1% overshoot.
- Direct interface for computer readout or computer processing.
- Integral grid-chart imprinting with interchangeable grid patterns.
- Continuously variable chart speeds with correlated time-base logging.

Called the Statos I (high-frequency data recorder) and Statos II (50-channel event recorder), respectively, both units make analog records with digital accuracy.

Statos I has a fixed recording-head assembly which will simulta-

neously record two analog signals and one digital signal across 100 millimeters full-scale. With no moving pens, galvanometers, mirrors or other mechanical writing components, Statos I records three simultaneous signals, at either dc to 1.5 kHz (full-scale, 100-mm resolution) with 1% accuracy, or dc to 3 kHz (50-mm resolution) with 2% accuracy. The recorder also has 8 event-marker channels.

On/off, go/no-go or other binary events may be recorded by external contact closures or a 5-V dc change. Another function of the recorder head assembly is to imprint timing lines across the full width of the chart paper in exact relationship with the data signals. Five time-line intervals from 0.1 second to 10 minutes can be selected.

The chart grid-lines themselves are electrostatically printed on the paper. The Statos I system is supplied with two different chart grids selected by a switch. Any desired grid patterns can be supplied. The paper transport system has a 6000-to-1 speed range with 14 calibrated

chart speeds from 0.2 cm/min to 20 cm/s electronically selectable and continuously variable.

Basically, the technique involves using a fixed recording head to place electrostatic charges on dielectrically coated paper. The paper then passes through a toner and a permanent black image is formed immediately.

The 250-foot paper rolls are inexpensive (up to 50% less than light-sensitive or direct-write papers), insensitive to light and have excellent archival qualities. Continuous monitoring of any one of three data signals is provided by digital readout tubes, which indicate signal amplitude as a percentage of full scale.

Statos I has two plug-in differential analog preamplifiers with a sensitivity of 100 μ V and 13 ranges, from 1 mV/cm to 10 V/cm. In addition to the two analog input signals, a third signal in BCD format may be simultaneously recorded.

The companion product, Statos II, records up to 50 channels of two-level events by the same fixed-recording-head, electrostatic recording technique. The chart paper channels are preprinted in 250-foot-long rolls 7 inches wide. Events with a duration of 2 μ s or longer can be recorded. The time relationship between events can be resolved to 1-ms accuracy at a chart speed of 20 cm/s using the full-scale timing lines.

Booth No. 2903

Circle No. 318

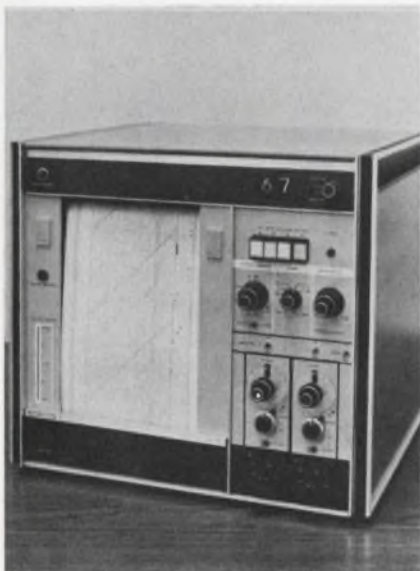

One hundred times faster than direct-writing processes, the electrostatic recorder writes at 20,000 inches per second, prints dc to 3 kHz data.

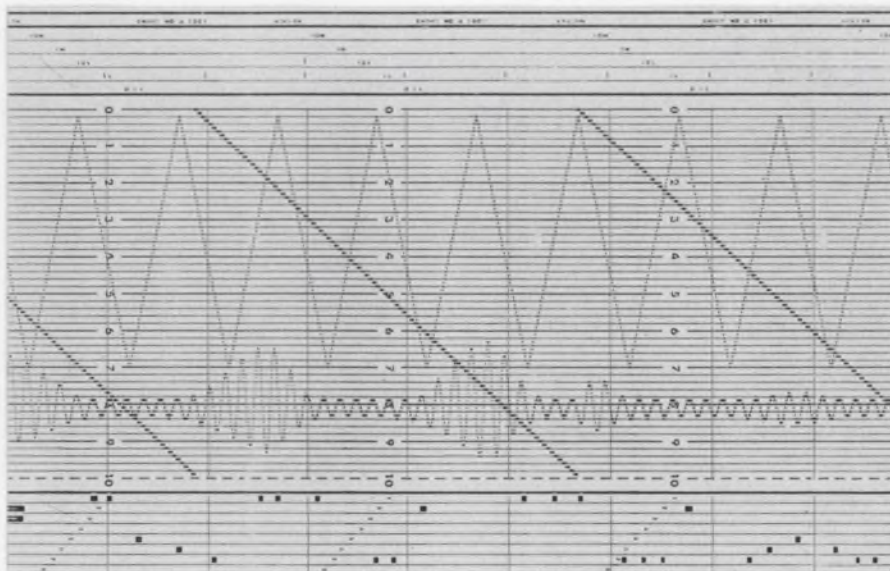

An analog presentation with digital accuracy, this 3-channel recording shows good clarity and resolution of both the grid pattern and the printed data. Note full-width time lines with time code at the top and event marks at the bottom of the 7-inch-wide paper.

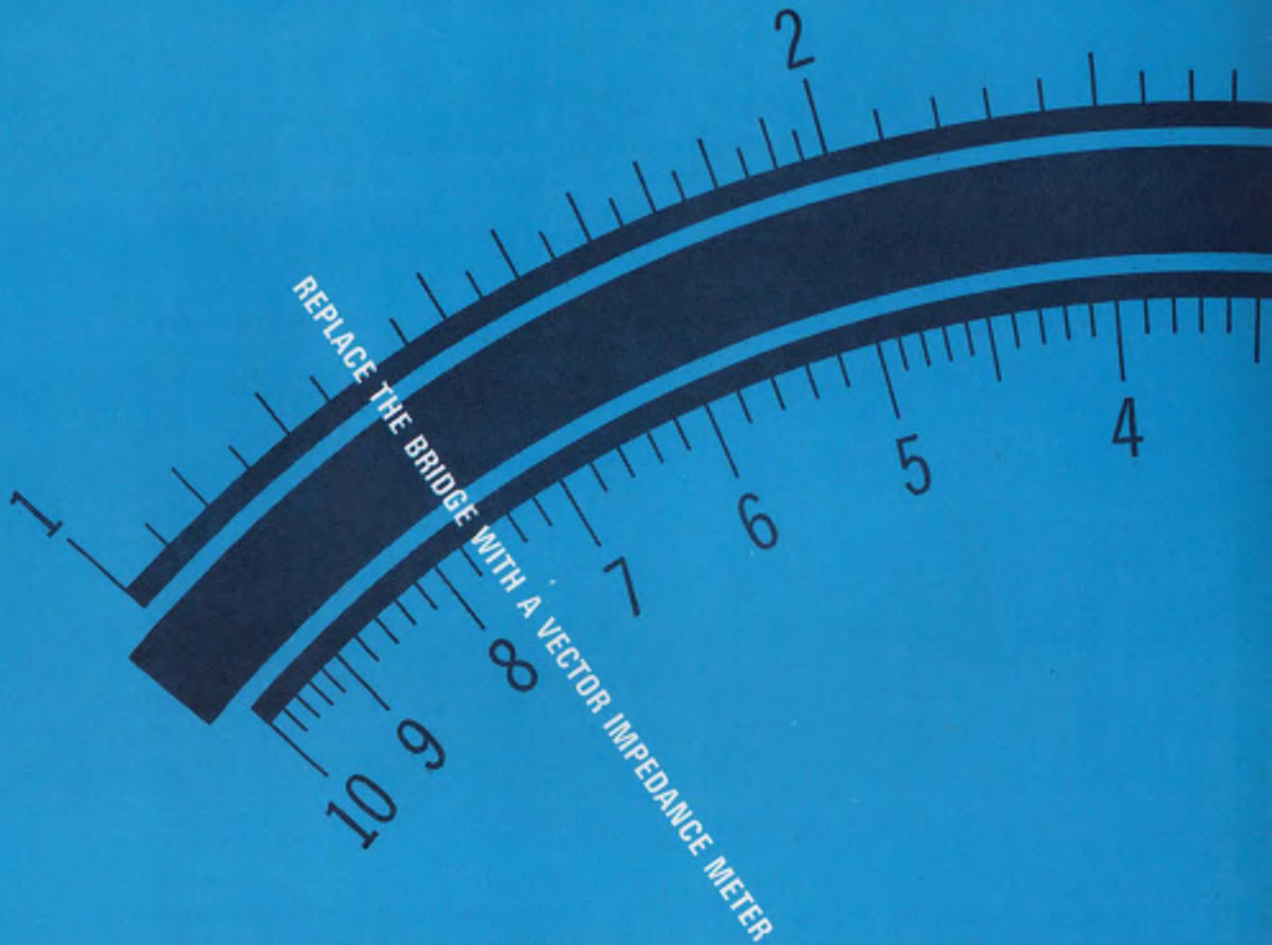

Vector Impedance Meter makes measurements in seconds



MODEL 4815A OFFERS DIRECT READOUT OF HIGH FREQUENCIES IN OPERATING CIRCUITS

The 4815A offers direct readout of impedance and phase angle measurements from 500 kHz to 108 MHz with continuous tuning. Probe on five-foot cable simplifies in-circuit measurements. Price: \$2,650.00. Complete specifications are yours on request.

Now there's no excuse for not making all the impedance measurements that previously have been too bothersome to make. The Hewlett-Packard 4800A Impedance Meter eliminates bridge balancing and nulling. It does for AC measurement what the ohmmeter does for DC testing. Just plug it in and read it. The 4800A may be mechanically swept to produce measurements over its full frequency range. You get direct readings of impedance and phase angle from 5 Hz to 500 kHz. Analog outputs of frequency, impedance and phase are available for X-Y recording.

The 4800A is an all solid-state integrated vector impedance *system* that reads out directly in Z and θ . Low-level signal strength prevents overloading of the test component. Price: \$1,650.00. For complete specifications, contact your local Hewlett-Packard field engineer or write: Hewlett-Packard, Green Pond Road, Rockaway, N.J. 07866.

HEWLETT  PACKARD

IMPEDANCE INSTRUMENTS

1071B

SERVO PACKAGE PROBLEMS?

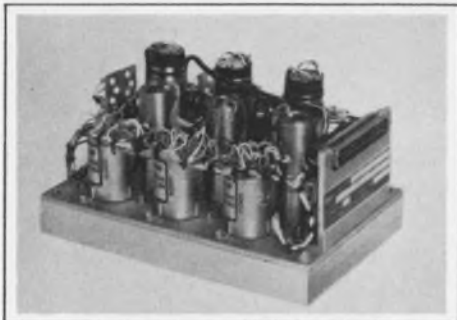

Three-Axis Coordinate Transformation Servo for airborne instrument landing system. Electrical inputs to CT's represent position in roll, pitch and yaw. Electrical outputs are a coordinate transformation of the aircraft's coordinates with respect to ILS coordinates.

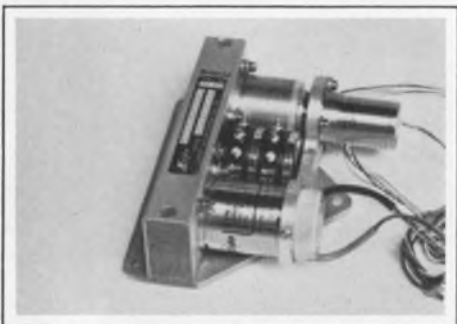

Inertial Navigation System Coupler for side-looking radar used in RF4B and RA4C aircraft. Vibration snubbers overcome 500 cps, 30 g vibration.

When it comes to servo packages, we've got the technical considerations licked. That goes for both components and packaging design.

We can give you the "tightest" job at the lowest price and meet your delivery requirements, too.

We have literally thousands of different servo components. Motors: stepper, synchronous, braked, viscous-damped and inertial-damped. Motor generators: rate, damping, integrating and high-signal-to-noise. Synchros and resolvers of all descriptions. Clutches, brakes and gearheads.

We design and build all the associated electronics: servo and buffer amplifiers, stepper-motor logic packages, phase-shifting capacitors, quadrature rejection circuits, electronic choppers and summing, isolation and switching networks.

Shown here are servo assemblies we've designed and produced to customer requirements using not-so-standard Kearfott elements and experience.

All you have to do to solve similar problems is call one single source—Kearfott. Write for our new brochure "Kearfott Servos." Address: Kearfott Products Division, General Precision, Inc., Aerospace Group, Dept. 1450, 1150 McBride Ave., Little Falls, N.J. 07424.

KEARFOTT PRODUCTS DIVISION

 **GENERAL
PRECISION INC.**

AEROSPACE GROUP

Little Falls, New Jersey 07424.

General Precision, Inc. is a subsidiary of General Precision Equipment Corporation.

ANSWER: KEARFOTT'S "ALL-UNDER- ONE-ROOF" SERVICES.

ON READER-SERVICE CARD CIRCLE 83

THE NEW GENERATION



SILVERLINETM

a new, superior line of Clifton Synchros

- Higher Accuracy. 5' standard
- Outstanding Repeatability of Calibration Pattern
- Stability of Calibration over Temp.
- 150°C Standard Operating Temp.

Keeping pace with the developing aerospace field, Clifton announces SILVERLINE, a new, superior line of standard synchros. □ These units, a natural evolution from our present line of quality synchros, embody certain new manufacturing techniques and space age materials. The result is a standard synchro which outperforms pres-

ent synchros in four distinct ways shown above. □ SILVERLINE synchros are in the field now. Call your local Clifton Sales Office for price, delivery and further information.

cppe **CLIFTON** 
DIVISION OF LITTON INDUSTRIES

Triple-barrelled probe spans dc to 50 MHz



Tektronix, Inc., P. O. Box 500, Beaverton, Ore. Phone: (503) 644-0161. Price: \$600.

This probe is useful for evaluating the performance of semiconductor and SCR circuits where a wide range of parameters exist. Fast switching transients, low-frequency response, and dc current level will be displayed simultaneously. Type P6042 has dc, pulse and high-frequency capability. Calibrated deflection factor ranges from 1 mA/div to 1 A/div in a 1-2-5 sequence (oscilloscope set at 50 mV/div). It has a bandwidth of dc-to-50 MHz and risetime of 7 ns. The output impedance is 50 Ω and is terminated into 50 Ω at the input of conventional oscilloscopes. When the probe is clipped around two wires carrying current in the same direction, the sum is displayed; when one of the wires is reversed, their difference is displayed. For increased sensitivity, several loops of one wire may be placed through the probe, increasing the sensitivity by the number of the loops.

Booth No. 2818 Circle No. 317

Get nanovolt sensitivity in dc testing



Keithley Instruments, Inc., 28775 Aurora Rd., Cleveland. Phone: (216) 248-0400. Price: \$1795.

A sensitive nanovolt amplifier extends the range of accurate dc voltage measuring systems. It can be used to obtain nanovolt sensitivity

with digital voltmeters, differential voltmeters, A-to-D converters and any digital data handling systems. Model 140 has selectable gains from 10^2 to 10^5 , allowing a choice of sensitivity. Its maximum output of 10 volts is more than sufficient to be accurately measured with a DVM. Since only two instruments are used, interface and connection problems within the system are minimized. Accuracy is between $\pm 0.005\%$ and 0.01% depending upon measurement conditions. A choice of three rise times is available: 5 seconds for low-noise measurements, and 0.5 or 0.05 seconds for fast measurements with little additional noise. To minimize circuit loading errors in the recording instrument, output resistance is less than 0.2 Ω . Battery operation permits maximum isolation from power lines and ground. The battery will be charged automatically when the model 140 is connected to the line, whether it is turned on or off. When battery operated, the line is internally disconnected.

Booth No. 3008 Circle No. 325

Amplifier finds signals 51 dB below noise



Princeton Applied Research Corp., P.O. Box 565, Princeton, N. J. Phone: (609) 924-6835 P&A: \$765; 60 days.

The lock-in amplifier operates as an amplifier, detector and filter combination with an equivalent noise bandwidth of less than 0.0083 Hz. The operating frequency is locked to the input signal, eliminating drift problems encountered when narrow-banding to eliminate noise. With a signal channel input impedance of 10 M Ω shunted by 30 pF and a noise figure of less than 3 dB at 1 kHz, the amplifier has minimum full-scale sensitivity of 100 μ V for low level signal detection.

Booth No. 2706 Circle No. 299

Integrating DVM holds its calibration



Cohu Electronics, Inc., Box 623, San Diego, Calif. Phone: (714) 277-6700. P&A: \$1495 to \$2750; 28 days.

This integrating digital voltmeter has an accuracy of 0.01% of reading ± 1 digit in four ranges from 1.5 to 1000 volts dc. Features include five-digit readout with over-ranging digit, polarity and decimal, manual and automatic range selection and constant 10-M Ω input impedance. No zero adjustment is required between six month calibration periods.

Booth No. 3001 Circle No. 287

Integrating DVM takes 40 readings per second



Hewlett Packard, 1501 Page Mill Rd., Palo Alto, Calif. Phone: (415) 326-7000. P&A: \$4800; 2 months.

Five measurement ranges, from ± 0.1 V to ± 1000 V full scale are featured in this voltmeter. Resolution on the 0.1-V range is 1 μ V, enabling the voltmeter to measure millivolt signals accurately without a preamp. The measurement linearity is 0.003%. Accuracy is $\pm 0.01\%$ of reading $\pm 0.005\%$ of full scale. The instrument automatically opens the input circuit when overloaded, and resets itself at the start of the next measurement cycle. Input resistance is 10 M Ω shunted by 200 pF on all ranges.

Booth No. 2909 Circle No. 297



The wrapped tubular explosion!

When you think of wrapped mylar capacitors, you naturally think of Cornell-Dubilier. Over the years, our type WMF has become an industry standard.

But our wrapped mylars are just a small part of the biggest selection of wrapped tubular capacitors made. The CDE line also includes type MFP pressed mylars, military grade type CTM mylars, type MMW metal-

lized mylars and two brand new types. WCR polycarbonates and MCR metallized polycarbonates.

All are SPRINT stock standards. All are available through CDE's Authorized Industrial Distributors.

CDE **CORNELL-DUBILIER**

— STOCK STANDARDS — WRAPPED TUBULAR CAPACITORS —

WMF — GENERAL PURPOSE MINIATURE

STANDARD STOCK RATINGS

‡ Tolerance ±20% or ±10%

Cap. Mfd.	100V DCW			200V DCW			400V DCW			600V DCW			Cap. Mfd.	100V DCW			200V DCW			400V DCW			600V DCW		
	†Type WMF—	Size D x L (In.)	Lead Size	†Type WMF—	Size D x L (In.)	Lead Size	†Type WMF—	Size D x L (In.)	Lead Size	†Type WMF—	Size D x L (In.)	Lead Size		†Type WMF—	Size D x L (In.)	Lead Size	†Type WMF—	Size D x L (In.)	Lead Size	†Type WMF—	Size D x L (In.)	Lead Size	†Type WMF—	Size D x L (In.)	Lead Size
.001	1D1	.156 x 1/2	—	2D1	.156 x 1/2	—	4D1	.156 x 3/8	—	6D1	.170 x 3/4	—	056	1S56	.265 x 3/4	—	2S68	.350 x 3/4	—	4S68	.390 x 1	—	6S68	.500 x 1	—
.0012	1D12	.156 x 1/2	—	2D12	.156 x 1/2	—	4D12	.156 x 3/8	—	6D12	.170 x 3/4	—	068	1S68	.280 x 3/4	—	2S88	.375 x 3/4	—	4S88	.465 x 1	—	6S88	.575 x 1	—
.0015	1D15	.156 x 1/2	—	2D15	.156 x 1/2	—	4D15	.156 x 3/8	—	6D15	.170 x 3/4	—	082	1S82	.270 x 3/4	—	2P1	.410 x 7/8	—	4P1	.465 x 1	—	6P1	.520 x 1 1/2	—
.0018	1D18	.156 x 1/2	—	2D18	.156 x 1/2	—	4D18	.156 x 3/8	—	6D18	.170 x 3/4	—	1	1P1	.290 x 3/4	—	2P15	.410 x 7/8	—	4P15	.465 x 1	—	6P15	.520 x 1 1/2	—
.0022	1D22	.156 x 1/2	—	2D22	.156 x 1/2	—	4D22	.156 x 3/8	—	6D22	.187 x 3/4	—	.12	1P12	.315 x 7/8	—	2P15	.410 x 7/8	—	4P15	.465 x 1	—	6P15	.520 x 1 1/2	—
.0027	1D27	.156 x 1/2	—	2D27	.156 x 1/2	—	4D27	.156 x 3/8	—	6D27	.187 x 3/4	—	.15	1P15	.335 x 7/8	—	2P15	.410 x 7/8	—	4P15	.465 x 1	—	6P15	.520 x 1 1/2	—
.0033	1D33	.156 x 1/2	—	2D33	.160 x 1/2	—	4D33	.190 x 3/8	—	6D33	.203 x 3/4	—	.18	1P18	.350 x 1	—	2P22	.500 x 1 1/8	—	4P22	.565 x 1 1/8	—	6P22	.660 x 1 1/2	—
.0039	1D39	.156 x 1/2	—	2D39	.160 x 1/2	—	4D39	.190 x 3/8	—	6D39	.203 x 3/4	—	.22	1P22	.385 x 1	—	2P22	.500 x 1 1/8	—	4P22	.565 x 1 1/8	—	6P22	.660 x 1 1/2	—
.0047	1D47	.156 x 1/2	—	2D47	.170 x 1/2	—	4D47	.200 x 3/8	—	6D47	.234 x 3/4	—	.27	1P27	.380 x 1 1/8	—	2P33	.550 x 1 1/8	—	4P33	.600 x 1 1/8	—	6P33	.687 x 2	—
.0050	1D5	.156 x 1/2	—	2D5	.156 x 1/2	—	4D5	.156 x 3/8	—	6D5	.170 x 3/4	—	.33	1P33	.415 x 1 1/8	—	2P33	.550 x 1 1/8	—	4P33	.600 x 1 1/8	—	6P33	.687 x 2	—
.0056	1D56	.156 x 1/2	—	2D56	.175 x 1/2	—	4D56	.200 x 3/8	—	6D56	.225 x 3/4	—	.39	1P39	.460 x 1 1/8	—	2P47	.600 x 1 1/4	—	4P47	.700 x 1 1/4	—	6P47	.855 x 2	—
.0068	1D68	.175 x 1/2	—	2D68	.200 x 1/2	—	4D68	.250 x 3/8	—	6D68	.265 x 3/4	—	.47	1P47	.475 x 1 1/4	—	2P47	.600 x 1 1/4	—	4P47	.700 x 1 1/4	—	6P47	.855 x 2	—
.0082	1D82	.175 x 1/2	—	2D82	.200 x 1/2	—	4D82	.250 x 3/8	—	6D82	.265 x 3/4	—	.50	1P5	.500 x 1 1/4	—	2P5	.600 x 1 1/4	—	4P5	.700 x 1 1/4	—	6P5	.855 x 2	—
.01	1S1	.200 x 1/2	—	2S1	.230 x 1/2	—	4S1	.300 x 3/8	—	6S1	.290 x 3/4	—	.56	1P56	.525 x 1 1/4	—	2P56	.650 x 1 1/4	—	4P56	.750 x 1 1/4	—	6P56	.900 x 1 1/2	—
.012	1S12	.215 x 1/2	—	2S12	.230 x 1/2	—	4S12	.300 x 3/8	—	6S12	.290 x 3/4	—	.68	1P68	.570 x 1 1/4	—	2P68	.650 x 1 1/4	—	4P68	.750 x 1 1/4	—	6P68	.970 x 2	—
.015	1S15	.235 x 1/2	—	2S15	.290 x 1/2	—	4S15	.360 x 3/8	—	6S15	.312 x 3/4	—	.82	1P82	.585 x 1 1/2	—	2W1	.750 x 1 3/4	—	4W1	.875 x 2	—	6W1	1.165 x 2 1/2	—
.018	1S18	.255 x 1/2	—	2S18	.290 x 1/2	—	4S18	.360 x 3/8	—	6S18	.312 x 3/4	—	1.0	1W1	.625 x 1 1/2	—	2W1P25	.825 x 1 3/4	—	4W1P25	.950 x 2	—	6W1P25	1.340 x 2 1/2	—
.022	1S22	.275 x 1/2	—	2S22	.260 x 3/8	—	4S22	.320 x 3/4	—	6S22	.335 x 3/4	—	1.25	1W1P25	.690 x 1 1/2	—	2W1P5	.900 x 1 3/4	—	4W1P5	.975 x 2 1/4	—	6W1P5	1.275 x 3	—
.027	1S27	.300 x 3/8	—	2S27	.270 x 3/4	—	4S27	.350 x 3/8	—	6S27	.350 x 1	—	1.5	1W1P5	.770 x 1 3/4	—	2W2	.980 x 1 7/8	—	4W2	1.250 x 2 1/4	—	6W2	1.460 x 3	—
.033	1S33	.300 x 3/8	—	2S33	.270 x 3/4	—	4S33	.350 x 3/8	—	6S33	.350 x 1	—	2.0	1W2	.955 x 1 3/4	—	2W2	.980 x 1 7/8	—	4W2	1.250 x 2 1/4	—	6W2	1.460 x 3	—
.039	1S39	.245 x 3/4	—	2S47	.320 x 3/4	—	4S47	.400 x 7/8	—	6S47	.415 x 1	—	3.0	1W3	1.100 x 2 1/16	—	2W3	1.250 x 2.500	—	4W3	—	—	6W3	—	—
.047	1S47	.265 x 3/4	—	2S47	.320 x 3/4	—	4S47	.400 x 7/8	—	6S47	.415 x 1	—	4.0	1W4	1.250 x 2.500	—	2W4	—	—	4W4	—	—	6W4	—	—
.050	1S5	.265 x 3/4	—	2S5	.320 x 3/4	—	4S5	.400 x 7/8	—	6S5	.415 x 1	—	—	—	—	—	—	—	—	—	—	—	—	—	—

† Order by complete type no.; e.g., WMF1D68 Type numbers listed are ±10%; Available to 1.0 mfd in ±20% tolerance. To specify ±20% add -20

MFP — FLAT MYLAR® WRAP

STANDARD STOCK RATINGS

‡ Tolerance ±20% or ±10%

Cap. Mfd.	†Type MFP—	100V DCW		200V DCW		400V DCW		600V DCW	
		L x W x T (Inches)	Lead Size	L x W x T (Inches)	Lead Size	L x W x T (Inches)	Lead Size	L x W x T (Inches)	Lead Size
.01	★	—	—	★	—	★	—	★	—
.015	★	—	—	2S15	.500 x .312 x .187	4S15	.625 x .437 x .312	6S15	.750 x .343 x .218
.022	1S22	.625 x .343 x .218	—	2S22	.625 x .312 x .187	4S22	.750 x .375 x .250	6S22	.875 x .406 x .281
.033	1S33	.625 x .312 x .187	—	2S33	.750 x .343 x .218	4S33	.875 x .406 x .281	6S33	1.000 x .406 x .281
.047	1S47	.750 x .312 x .187	—	2S47	.750 x .375 x .250	4S47	.875 x .500 x .343	6S47	1.000 x .468 x .343
.068	1S68	.750 x .343 x .218	—	2S68	.750 x .437 x .250	4S68	1.000 x .437 x .312	6S68	1.000 x .562 x .406
.1	1P1	.875 x .343 x .218	—	2P1	.875 x .500 x .312	4P1	1.000 x .531 x .375	6P1	1.375 x .593 x .406
.15	1P15	.875 x .406 x .250	—	2P15	.875 x .562 x .375	4P15	1.250 x .562 x .406	6P15	1.375 x .687 x .531
.22	1P22	1.000 x .468 x .281	—	2P22	1.125 x .562 x .406	4P22	1.375 x .625 x .500	6P22	1.625 x .750 x .531
.33	1P33	1.125 x .500 x .312	—	2P33	1.125 x .625 x .500	4P33	1.625 x .656 x .500	6P33	2.000 x .781 x .562
.47	1P47	1.250 x .531 x .375	—	2P47	1.250 x .656 x .500	4P47	1.625 x .781 x .593	6P47	2.000 x .937 x .718
.68	1P68	1.250 x .687 x .468	—	2P68	1.625 x .718 x .531	4P68	2.000 x .875 x .687	6P68	2.000 x 1.062 x .843
1.0	1W1	1.500 x .718 x .500	—	2W1	1.750 x .812 x .625	4W1	2.000 x .937 x .750	6W1	2.500 x 1.250 x 1.062
1.25	1W1P25	1.500 x .718 x .562	—	2W1P25	1.750 x .960 x .687	4W1P25	2.000 x 1.062 x .843	6W1P25	2.500 x 1.437 x 1.218
1.50	1W1P5	1.750 x .843 x .656	—	2W1P5	1.750 x 1.000 x .781	4W1P5	2.250 x 1.062 x .843	6W1P5	3.000 x 1.406 x 1.093
2.0	1W2	1.750 x 1.062 x .843	—	2W2	1.875 x 1.062 x .843	4W2	2.250 x 1.312 x 1.125	6W2	3.000 x 1.593 x 1.281

★ Covered by Parent Case size. Use next higher voltage for same case size. † Order by complete type no.; e.g., MFP1S22 ‡ Type numbers listed are ±20%; to specify ±10% add -10 to type no.

MMW — MINIATURE MYLAR WRAP — METALLIZED

STANDARD STOCK RATINGS

Tolerance ±20%

Cap. Mfd.	200V DCW			400V DCW			600V DCW			Cap. Mfd.	200V DCW			400V DCW			600V DCW		
	Type† MMW—	Size D x L (Inches)	Lead Size	Type† MMW—	Size D x L (Inches)	Lead Size	Type† MMW—	Size D x L (Inches)	Lead Size		Type† MMW—	Size D x L (Inches)	Lead Size	Type† MMW—	Size D x L (Inches)	Lead Size	Type† MMW—	Size D x L (Inches)	Lead Size
.01	★	—	—	4S1	.180 x 3/16	—	6S1	.200 x 3/4	—	.22	2P22	.340 x 1 1/16	—	4P22	.400 x 1 1/4	—	6P22	.575 x 1 1/4	—
.015	★	—	—	4S15	.180 x 1/16	—	6S15	.250 x 3/4	—	.33	2P33	.390 x 1 1/16	—	4P33	.450 x 1 1/2	—	6P33	.560 x 1 3/4	—
.022	★	—	—	4S22	.210 x 3/16	—	6S22	.300 x 3/4	—	.47	2P47	.370 x 1	—	4P47	.520 x 1 1/2	—	6P47	.675 x 1 3/4	—
.033	2S33	.180 x 3/16	—	4S33	.250 x 1/16	—	6S33	.370 x 3/4	—	.68	2P68	.420 x 1	—	4P68	.625 x 1 1/2	—	6P68	.800 x 1 3/4	—
.047	2S47	.200 x 3/16	—	4S47	.300 x 1/16	—	6S47	.325 x 1 1/16	—	1.0	2W1	.500 x 1	—	4W1	.675 x 1 3/4	—	6W1	.950 x 1 3/4	—
.068	2S68	.200 x 1/16	—	4S68	.350 x 1/16	—	6S68	.400 x 1 1/4	—	1.5	2W1P5	.540 x 1 1/4	—	4W1P5	.825 x 1 3/4	—	6W1P5	.950 x 1 3/4	—
.1	2P1	.240 x 1/16	—	4P1	.325 x 1	—	6P1	.450 x 1 1/4	—	2.0	2W2	.620 x 1 1/4	—	4W2	.950 x 1 3/4	—	6W2	—	—
.15	2P15	.280 x 1/16	—	4P15	.375 x 1	—	6P15	.475 x 1 1/4	—	—	—	—	—	—	—	—	—	—	—

★ Use next higher voltage rating. † Order by complete type number; e.g., MMW2S33.

MCR — FILM WRAP METALLIZED POLYCARBONATE

STANDARD STOCK RATINGS

Tolerance ±20%

Cap. Mfd.	200V DCW			400V DCW			600V DCW			Cap. Mfd.	200V DCW			400V DCW			600V DCW		
	†Type MCR—	Size D x L (In.)	Lead Size	†Type MCR—	Size D x L (In.)	Lead Size	†Type MCR—	Size D x L (In.)	Lead Size		†Type MCR—	Size D x L (In.)	Lead Size	†Type MCR—	Size D x L (In.)				

**S-band klystrons
give 500 kW cw**

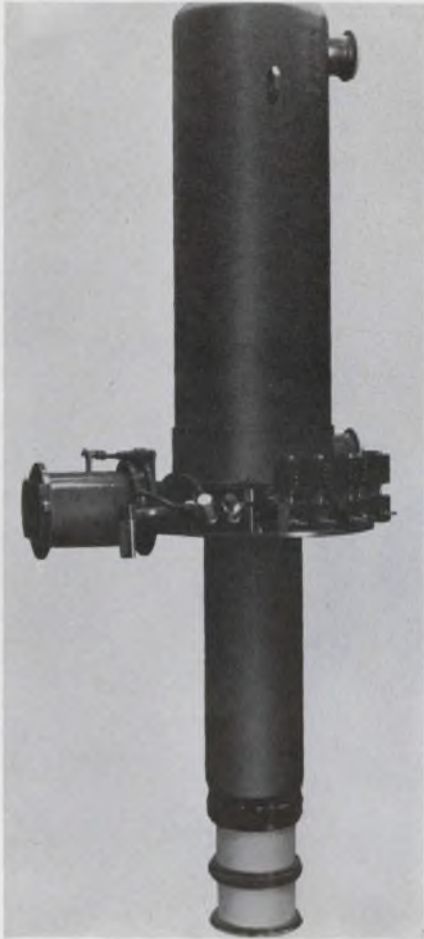

EIMAC Division of Varian, 301 Industrial Way, San Carlos, Calif. Phone: (415) 592-1221.

Producing over 500-kW continuous wave power at S-band, this tube is reportedly the highest power klystron yet delivered. The five-cavity klystron features 56% efficiency and 56-dB gain, and has an instantaneous bandwidth of 20 MHz. The tube may be operated in any attitude, including antenna mounting. The collector is rated at a megawatt, allowing amplitude modulation of the drive level or full removal of drive without overheating. Digital counters are provided to facilitate tuning.

Beam voltage may be varied from 45 kV (130-kW output) to 63 kV (500-kW output) without retuning. The output window is a single beryllium oxide structure in a half-wave circular configuration. The magnet requires only a single power supply at a fixed current for all operating conditions and powers.
Booth No. 2309 Circle No. 285

... IT's the MOST ...
EXCEPT FOR PRICE

NEW **KH** ALL-SILICON

R-C OSCILLATOR
holds PERFORMANCE but
LOWERS PRICE

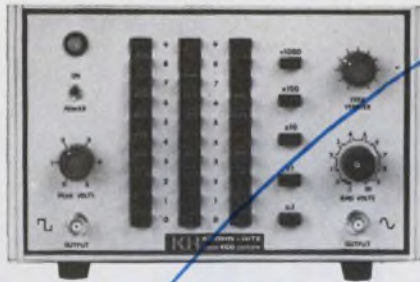

MODEL 4100, brand new R-C Oscillator with push-button frequency control. Sine- and Square-Wave simultaneously from 0.01 Hz to 1 MHz. Price \$550. Provides performance of higher priced units. 5 3/4" H x 8 3/4" W x 14 1/2" D.

Using advanced circuit techniques, Krohn-Hite has produced a new R-C Oscillator, at a medium price, with traditional K-H Quality.

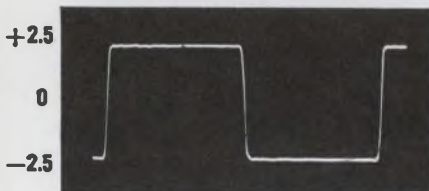
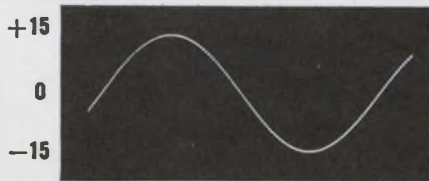

SIMULTANEOUS SINE AND SQUARE-WAVE outputs pack real power (up to 1/2 watt into 50 ohms). Photos show open circuit output voltages at 1 MHz.

These outputs typify the performance of the Model 4100. Add to this half-watt output, 0.5% frequency accuracy, 0.03% distortion, 0.02% hum and noise, 0.02 db frequency response and 0.02%/hr. amplitude stability and you get a clearer picture of what we're talking about.

There's much more in KH Data Sheet 4100

Write for a copy

KH KROHN-HITE
CORPORATION
580 Massachusetts Avenue, Cambridge, Mass. 02139
Telephone: 617/491-3211

That's what they all say!

But K-H really means it!

Puts out Both Sine and Square Waves?

Sure... and with power

That's a great 1 MHz Square Wave

As they said... it's the Most Except for Price

Where's the Bingo Card? Go SEE it at WESCON booth 3307

Only \$5,000

for the most powerful, longest-lasting pulsed argon-ion laser on the market

Compare our new Model 3041H with any other pulsed argon-ion laser that's available.

Compare it for performance. The 3041H has a peak power output (multimode) of 20 watts minimum . . . produces 4½ million single pulses in six or more wavelengths simultaneously in the blue-green "easy vision" portion of the spectrum. Its unique

mirror-prism unit lets you select the one you want to use.

Then compare it for price. You'll soon discover that units with considerably lower power, less versatility, and much shorter lives have price tags 40% to 75% higher than the 3041H's modest \$5,000. (And a smaller, lower peak power

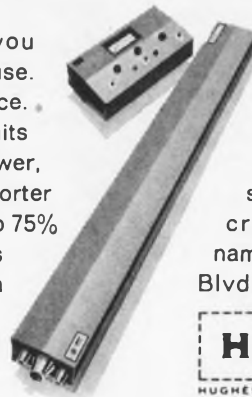

Model 3040H is available for even less.)

Does this grab you? Then write for our spec sheet. Special questions about your setup? Fire away! Hughes Aircraft Company, Electron Dynamics Division, 3100 W. Lomita Blvd., Torrance, California 90509.

HUGHES

HUGHES AIRCRAFT COMPANY
ELECTRON DYNAMICS DIVISION

Transistor Parameter Measurements with the hp 8405A Vector Voltmeter

Measurement of transistor h, y or z parameters becomes increasingly difficult above 100 MHz through an inability to obtain consistently good open- and short-circuits. Tedious adjustment of tuning stubs is usually required for each measurement frequency, and unwanted circuit oscillations often occur.

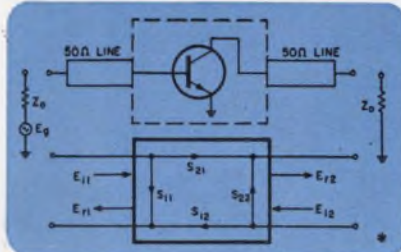

With the 8405A Vector Voltmeter, however, it is easy to measure a slightly different set of parameters—the "s" or scattering parameters. Measurement is simple over a wide frequency range and since the parameters are measured with a Z_0 load, there is little chance for oscillation. The measured s parameters can be plotted directly on a Smith Chart and easily manipulated to establish optimum gain with matching networks. Or the s parameters can be translated into h, y, or z parameters if desired.

Free Application Data

Hewlett-Packard has prepared an application note on s parameter measurements. Write today for your copy of Application Note #77-1, "Transistor Parameter Measurement", to Hewlett-Packard, Palo Alto, California 94304. Europe: 54 Route des Acacias, Geneva.

The hp 8405A Vector Voltmeter is a new, wideband, 2-channel RF millivoltmeter-phasemeter. With the 8405A, measurements that were formerly difficult or impossible can now be made quickly, easily and accurately.

Major Specifications, HP 8405A Vector Voltmeter

Frequency Range is 1 to 1000 MHz in 21 overlapping octave bands; automatic tuning within each band.

Voltage Range for Channel A (synchronizing channel), 300 μ v to 1 v rms (10-500 MHz), 500 μ v to 1 v rms (500-1000 MHz), 1.5 mv to 1 v rms (1-10 MHz).

Voltage Range for Channel B (input to Channel A required), 100 μ v to 1 v rms, full scale. Full-scale meter ranges from 100 μ v to 1 v in 10 db steps. Both channels can be extended to 10 v rms with 11576A 10:1 Divider.

Phase Range of 360° indicated on zero-center meter with end-scale ranges of $\pm 180^\circ$, $\pm 60^\circ$, $\pm 18^\circ$, $\pm 6^\circ$. Phase meter OFFSET of $\pm 180^\circ$ in 10° steps permits use of $\pm 6^\circ$ range for 0.1° phase resolution at any phase angle.

Price: \$2750.

•NPN Transistor in common emitter configuration and its equivalent 2 port scattering diagram.

A NEW TIME-SAVING TECHNIQUE



HEWLETT  PACKARD

1697R

ON READER-SERVICE CARD CIRCLE 88

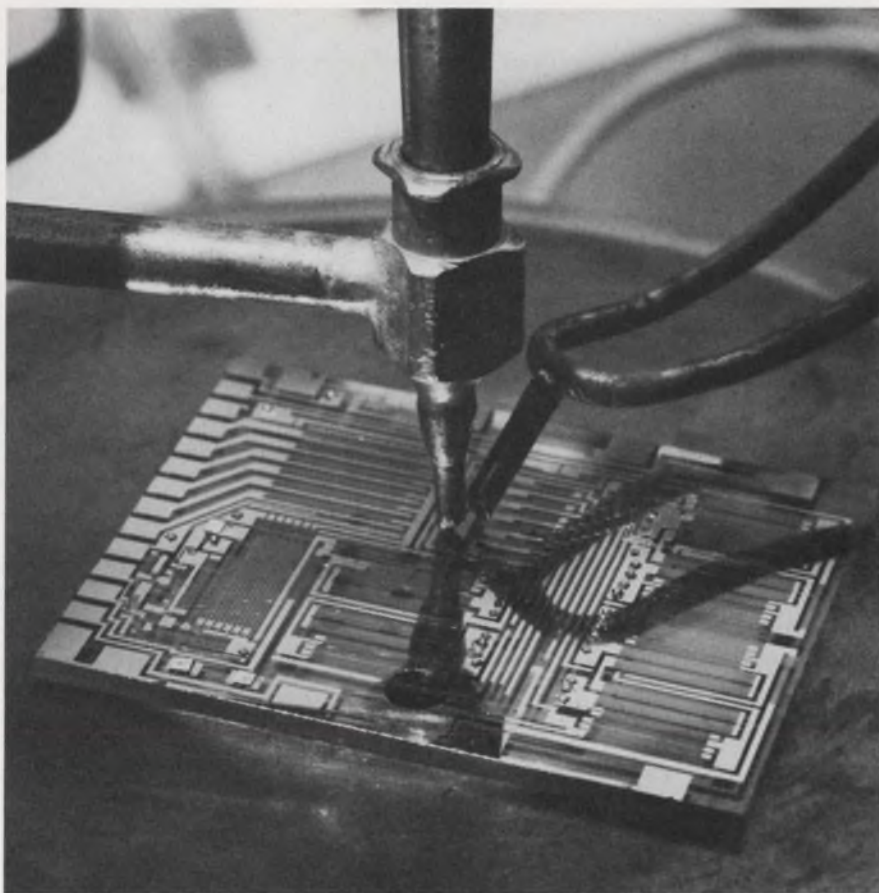

UNUSUAL REQUIREMENTS CALL FOR UNUSUAL TALENTS

In the seven years we've been in business we've concentrated on providing the best technical performance in certain specialized areas.

For instance, using a proprietary process we trim resistors to .01%. We specialize in meeting unique function and packaging requirements by combining chips, LIDS, and flip-chips on thin-film substrates with a variety of discrete components. And we adjust and match the temperature coefficient of resistance to track to within $\pm 5\text{ppm}/\text{C}^\circ$. Complete environmental facilities allow us to test your finished circuit under almost any required environmental conditions.

Naturally we have the latest equipment, but so does everybody else who is really serious about being in the hybrid microcircuit business. What we're offering you is the unique technical know-how that allows you to get exactly the precision you want in the package that meets your needs. And that means we don't cut corners on costs at the expense of performance. Why not give us a call. We'll be glad to tell you more about our approach to hybrid microcircuit technology.

Contact Joe Crist, Sales Manager, Microelectronics Operation, (213) 346-6000, Extension 546, or write to:



THE BUNKER-RAMO CORPORATION
DEFENSE SYSTEMS DIVISION
8433 FALLBROOK AVENUE • CANOGA PARK, CALIFORNIA 91304
ON READER-SERVICE CARD CIRCLE 89

INSTRUMENTS & CONTROL

Precision phase standard accurate to 0.015°

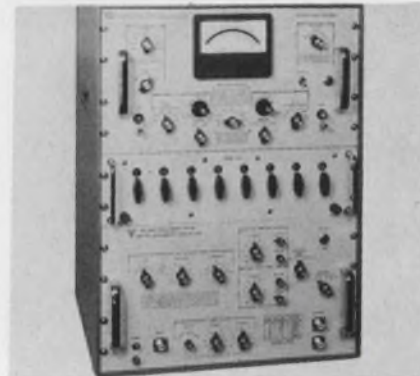

Ad-Yu Electronics Inc., 249 Terhune St., Passaic, N. J. Phone: (201) 472-5622. Price: \$4365.

This device features self-calibration and self-checking by means of fundamental bridge balancing, without the use of an external standard. Its phase shift can be set from 0° to 360° with 7-digit resolution. The instrument accepts a stable sine wave and produces two output signals. Type 209 can be used over the range of 50 Hz to 10 kHz. It does not require interpretation of patterns on a scope, or electrical sampling of many cycles.

Booth No. 3302 Circle No. 294

Frequency synthesizer spans dc to 100 kHz



Measurements, McGraw Edison Div., Boonton, N. J. Phone: (201) 334-2131. Price: \$2850.

This instrument spans dc to 100 kHz with digital selection of 0.01 cycle. A variable oscillator provides continuous frequency selection over the range of any digit except the 10 kHz. The unit operates on the direct synthesis principle, avoiding the problems common to phase-locked oscillators. Frequency generation is under control of a 1-MHz quartz oscillator with short-term stability of one part in 10^8 . Digital assemblies may be omitted with a price reduction of \$170 per digit.

Booth No. 2803 Circle No. 283



We've Pushed Signal-Generator Performance to the Limits

An innovation in signal-generators brings about 10-to-1 better frequency stability and improved accuracy and resolution, without sacrificing other performance features. The key to this performance is the frequency-generating system — a single-range, optimally designed oscillator followed by frequency dividers to provide the successively lower ranges. Thus, the stability of one range is the stability of all, and range switching is accomplished without transient instability. After warmup, drift is typically less than 1 ppm per ten minutes, at least 10 times better than that of any other generator. Because of all-solid-state circuitry, total warmup drift is less than 150 ppm in three hours. Frequency changes caused by band switching or variations in line voltage, load, or level are virtually nonexistent.

The 1003 covers a 67-kHz-to-80 MHz frequency range, and tuning this instrument is as much fun as it is convenient and fast. You can coarse-tune by motor over the main slide-rule dial to within 0.25% at a rate of about 7% per second, and fine-tune manually with a large control whose dial divisions correspond to 0.01% of the main scale. For greater resolution, a " ΔF " control provides electronic, backlash-free settability to 2 ppm. The motor-driven frequency control is fully utilized in the model containing the auto-control unit, which lets you preset frequencies. The preselected frequencies are useful either as limits for automatic sweeping or for programmed frequency selection (repeatable to 0.1%).

Frequency, incremental frequency, and automatic sweeping can all be pro-

grammed, as can output level and modulation-percentage. A crystal calibrator with 1-MHz, 200-kHz, and 50-kHz outputs is also supplied with the model containing the auto-control unit. This calibrator allows you to calibrate to within 0.002 percent.

The 1003 requires only 20 watts and delivers 180 milliwatts of leveled CW power into a 50-ohm load (6 volts behind 50 ohms). Envelope distortion is less than 2% at 70% a-m, with the modulating signal of 400 Hz or 1 kHz provided. Incidental phase modulation is less than 0.1 radian with 30% a-m. The highly accurate, 10-dB-per-step attenuator and a continuously adjustable carrier-level control give an over-all 155-dB dynamic range.

This instrument must be seen to be appreciated. A demonstration will show that very-narrow-bandwidth measurements can be made in 10 seconds with a 1003 signal generator and an oscilloscope. Try that with any other signal generator.

Price of the 1003 is \$2995 (\$2795 without the auto-control unit and crystal calibrator). For complete information, write General Radio Company, 22 Baker Avenue, W. Concord, Massachusetts 01781; telephone (617) 369-4400; TWX (710) 347-1051.

GENERAL RADIO

See the Type 1003 Standard-Signal Generator at WESCON, Booths No. 3015-3018.

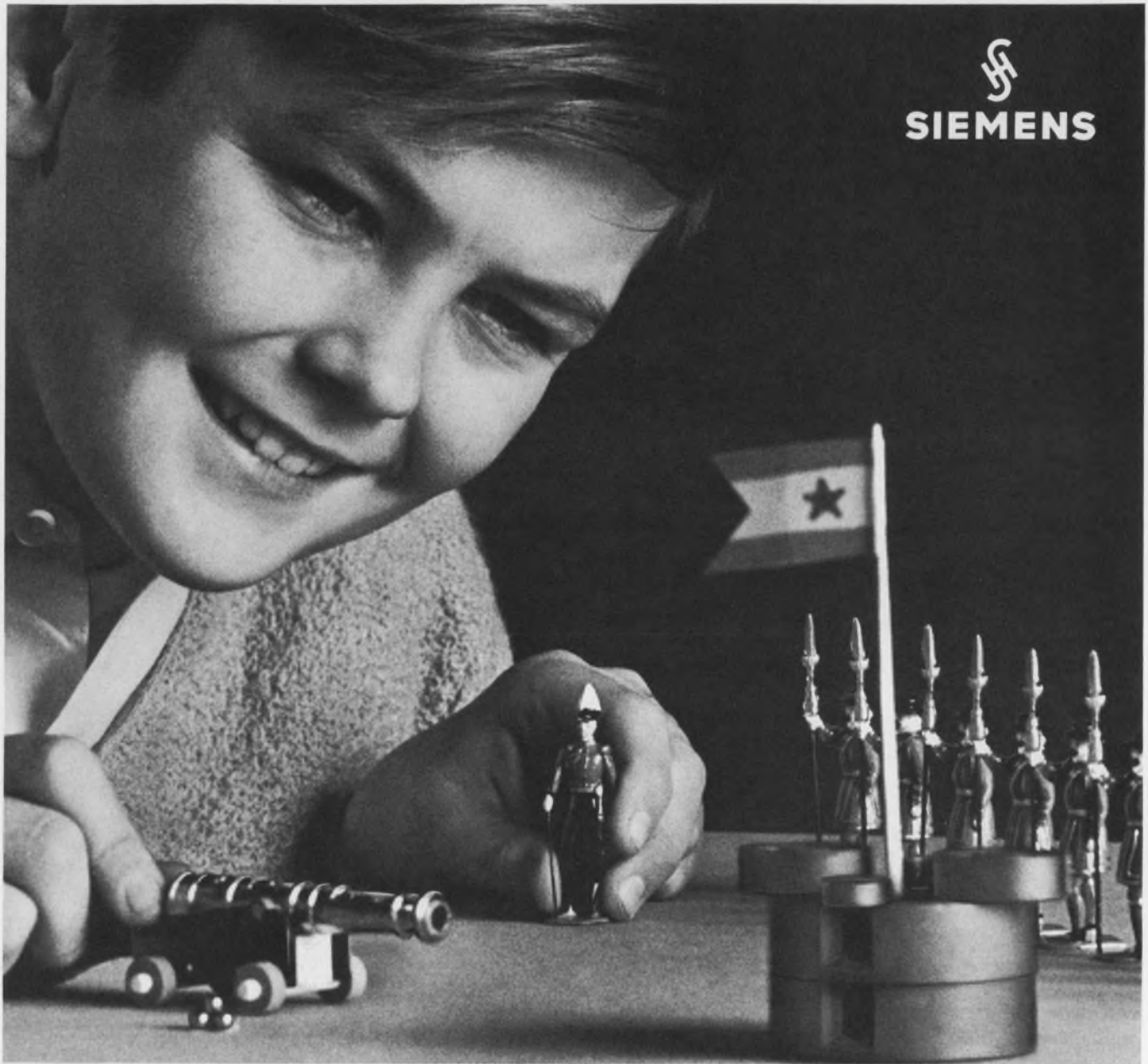

uniformity

Month after month, the electrical characteristics of Siemens pot cores are consistent. Precision engineered for adjustable high stability, high-Q coils, they meet the most critical requirements for filters used in multiplex and other carrier-frequency applications. Low distortion and self-shielding are two important plus features. Available out of stock, too. Let a Siemens engineer show you how Siemens pot cores fit into your application. It's child's play.

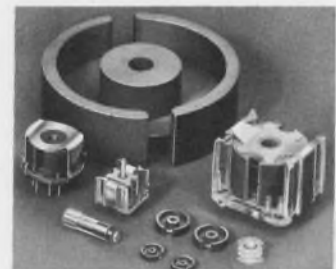

SIEMENS FERRITE POT CORES

8 different materials, 18 different sizes (.22 to 2.75 inches diameter) and more than 250 standard types afford optimum properties for all filter, oscillator and transformer applications. High Q value with high stability is typical: a 26 x 16 core of N22 or N28 material AL 315 at 100 kc/s shows a Q value of approx. 950. Siemens components include ferrite materials, metallized polyester and polystyrene capacitors, all electronic and microwave tubes, rectifiers and a complete line of semi-conductors.

SIEMENS AMERICA INCORPORATED

VISIT BOOTH 5027/28 WESCON SHOW

Components Division • 230 Ferris Avenue, White Plains, N.Y. 10603

U158

ON READER-SERVICE CARD CIRCLE 121

ELECTRONIC DESIGN 17, August 16, 1967

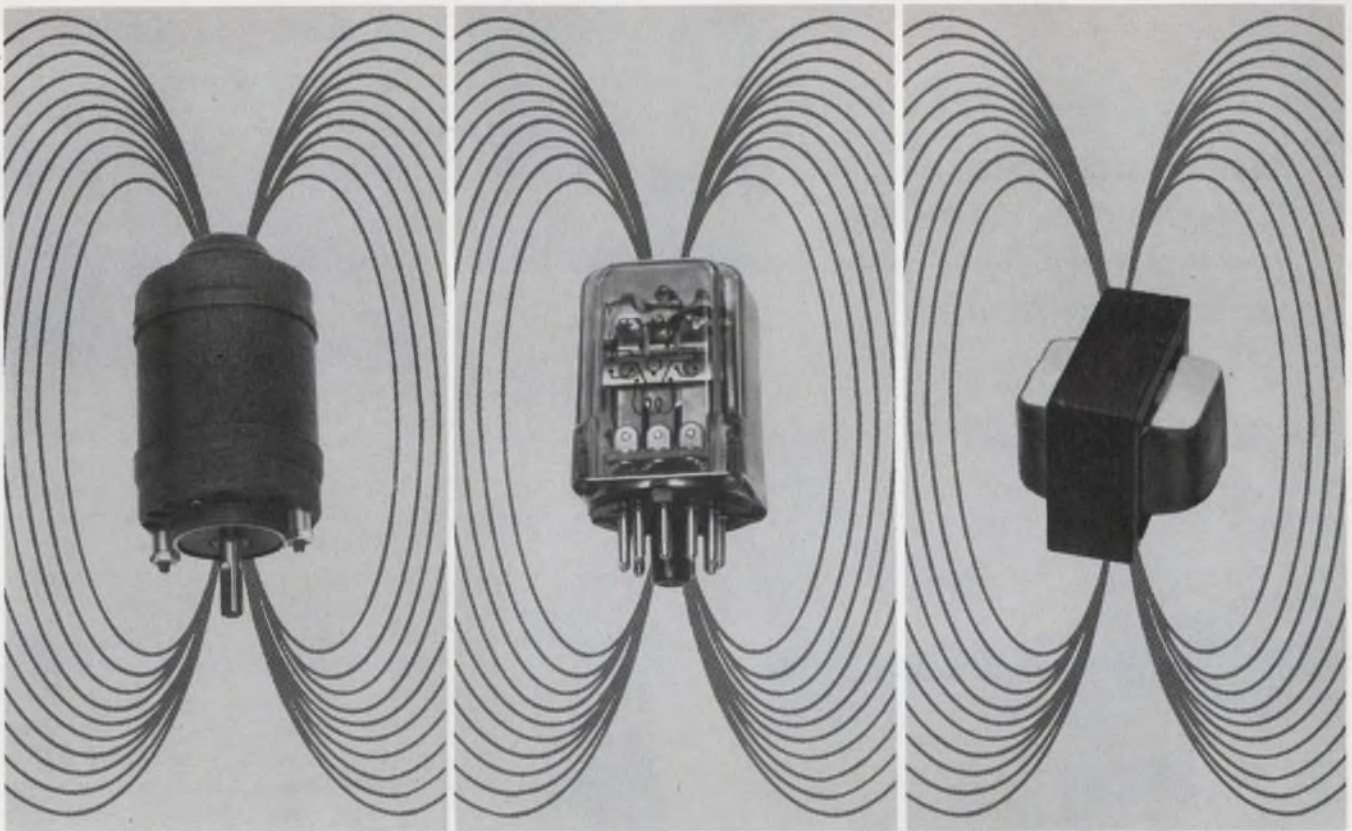

Now, Get 6 Volts Noise Immunity For Your Digital Control System With New MHTL Integrated Circuits!

You'll get the "right" signal every time in your numerical control, supervisory control and computer peripheral equipment with the new Motorola-developed high threshold integrated circuit logic series. Called MHTL, it's the first family of integrated circuits to offer a noise margin of 6 volts (typ) and a 15 volt ($\pm 1V$) operating voltage. And, it's priced, packaged, and specified for application in equipment designed for use in high noise industrial environments.

MHTL combines high noise immunity with a voltage swing of 13 volts, broad operating temperature range, large fan-out and a 35 mW power dissipation rating. In short, it offers you discrete circuit characteristics PLUS the price, size, and reliability advantages of integrated circuitry.

Here are some of the MHTL specifications:

CHARACTERISTICS	MHTL
Operating Voltage	15 \pm 1 Volts
Noise Immunity	6 Volts (typ)
Fan-out (Gate)	10 (min)
Clock Rate (Flip-Flop)	4 MHz (typ)
Operating Temperature Range	-30°C to +75°C

Offered in the 14-pin dual in-line plastic Unibloc* package, the circuit functions and prices for the MHTL family are as follows:

TYPE	DESCRIPTION	PRICE (1,000 UP)
MC660P	Dual 4-Input Gate	\$3.50
MC661P	Dual 4-Input Gate (Passive Pull-Up)	\$3.50
MC663P	Dual J-K Flip-Flop	\$6.10
MC664P	Master Slave R-S Flip-Flop	\$4.05

Other functions planned for the immediate future include a Dual 4-Input Line Driver, Triple Input Interface, Quad Output Interface, Dual Monostable Multivibrator, and Quad 2-Input Gate.

To find out how easily your designs can conquer high-noise-environments with MHTL, write for our data sheets. We'll also send you our latest application note on how MHTL solves your noise problems. For circuits you can try right now — call your nearby franchised Motorola Semiconductor distributor. He has high-noise-immunity MHTL in stock!

*Trademark of Motorola Inc.

- where the priceless ingredient is care!



MOTOROLA Semiconductors

MOTOROLA SEMICONDUCTOR PRODUCTS INC. / P. O. BOX 955 / PHOENIX, ARIZONA 85001 / (602) 273-6900 / TWX 910-931-1334

ON READER-SERVICE CARD CIRCLE 122

ELECTRONIC DESIGN 17, August 16, 1967

U159

Get a complete Electronic Package from Chassis-Trak of Indianapolis



C-300 to 50 lbs.

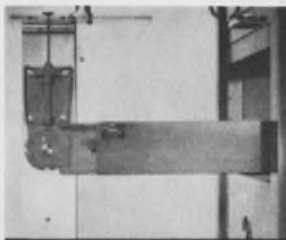

C-230 to 100 lbs.



CTB to 175 lbs.



CB to 1000 lbs.

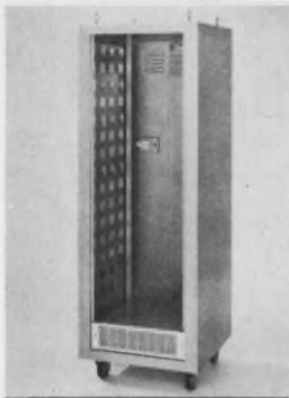

3000 Series



5000 Series



D-600 to 125 lbs.



VENT-RAK Modular Chassis

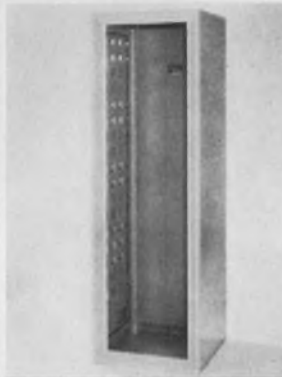

1000 Series



5050 Series

See you at
WESCON



Whatever your electronic packaging needs, military or commercial, light-weight or heavy-duty, Chassis-Trak offers a complete line of slides in capacities from 50 lbs. to 1,000 lbs., hardware, and cabinets in a wide range of styles, sizes and materials. The *Chassis-Trak* of Indianapolis name on your electronic package is your assurance of quality and economical *versatility*.

To learn more about *total electronic packaging* write Chassis-Trak, Inc.

525 South Webster Avenue, Indianapolis, Indiana 46219

ON READER-SERVICE CARD CIRCLE 123

INSTRUMENTS & CONTROL

Thin-line counter spans 0.3 to 12.4 GHz

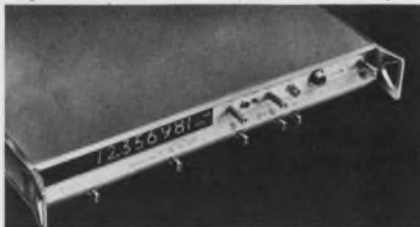

Systron-Donner Corp., 888 Galindo St., Concord, Calif. Phone: (415) 682-6161. Price: \$4650.

A new integrated circuit counter has been added to Systron-Donner's "Thin-line" (ED 5, Mar. 1, 1967, p. 114). Featuring automatic measurements from 300 MHz to 12.4 GHz and a direct 100-MHz counting range, the unit combines a built-in Acto (automatic computing transfer oscillator) with a 100-MHz frequency counter for the wide range and automatic operation.

The Acto technique performs phase lock and selection of the proper harmonic automatically. Readout of measurements in the 0.3-to-12.4 GHz range appear instantaneously in 8 digits (9 digits optional) and with a "lok" annunciator that appears only when the Acto has achieved a phase lock with the unknown input. Designed principally of ICs, the unit offers such features as a 1-3/4-inch panel height, slide switches, an optional high-stability oscillator (5 parts in 10^{10} per 24 hrs) and 9-digit readout.

Booth No. 2402 Circle No. 288

Audio phase meter ranges 10 Hz to 2 MHz



Wiltron Co., 930 E. Meadow Dr., Palo Alto, Calif. Phone: (415) 321-7428. P&A: \$995; 10 wks.

Covering 10 Hz to 2 MHz, this audio phase meter has a dynamic range of 60 dB and a swept frequency capability. A 1-millivolt sensitivity in both channels eliminates the need for external or plug-in preamplifiers which may introduce phase error of their own.

Booth No. 2711 Circle No. 293

Adlake Mercury Wetted Relay — Application Data

Measurement of "Dynamic Contact Noise" for Low Level Signal Applications



**Adlake AWCS
26000 Series Relay—
2 Switch Form C**

In small signal applications, such as computers, telemetric systems, strain gauges, etc. generated emf. within the system's relays must be taken into account.

Dynamic Contact Noise is a "coined" phrase used to indicate an undesired generated emf. upon contact closure. It is the result of mechanical oscillation of the armature—caused by the impact of the armature on the stationary contacts — sweeping the coil flux.

Typical illustrations of this noise are shown in the oscillograms, with the relay being driven at nominal voltage in the test circuit shown below. The frequency and amplitude are integral functions of system bandwidth and coil drive conditions.

The slight ripple seen at the end of each trace is not noise, but due to resolution of test equipment and test circuit.

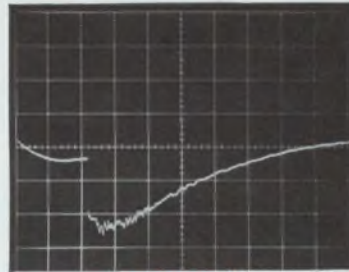

FIGURE 1

Horizontal Deflection 1.0 ms/cm
Vertical Deflection 20 μ V/cm
Systems Bandwidth .06–60 Hz.

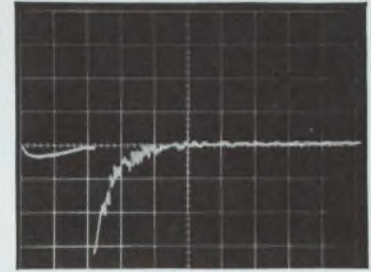

FIGURE 2

Horizontal Deflection 1.0 ms/cm
Vertical Deflection 100 μ V/cm
Systems Bandwidth .06–600 Hz.

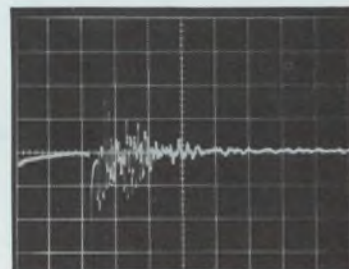

FIGURE 3

Horizontal Deflection 1.0 ms/cm
Vertical Deflection 200 μ V/cm
Systems Bandwidth .06–6K Hz.

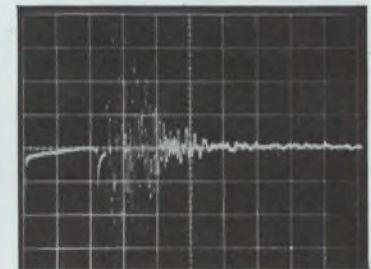

FIGURE 4

Horizontal Deflection 1.0 ms/cm
Vertical Deflection 200 μ V/cm
Systems Bandwidth .06–60K Hz.

TEST CIRCUIT

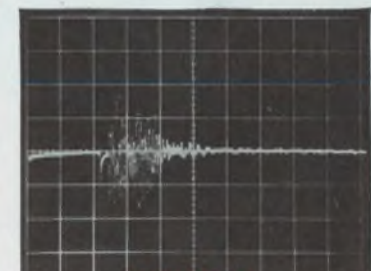
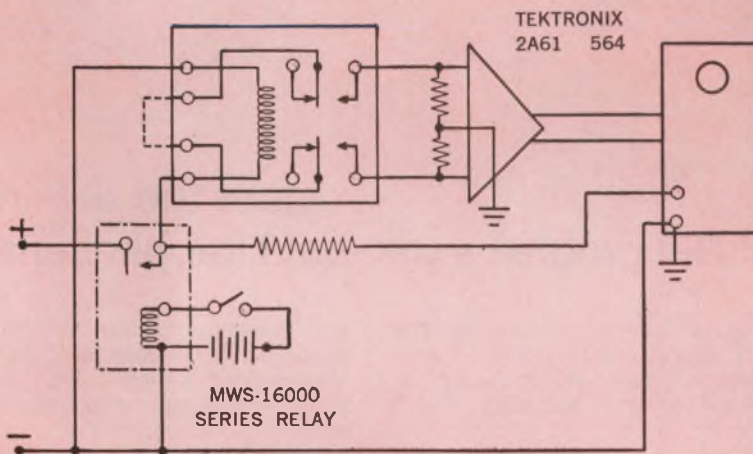

FIGURE 5

Horizontal Deflection 1.0 ms/cm
Vertical Deflection 500 μ V/cm
Systems Bandwidth .06–100K Hz.

***** If you have a problem regarding relay applications to a particular system our engineering staff is ready to help you. Contact Mr. Le Roy Carlson, Chief Project Engineer.

Backed by sound research and disciplined engineering, Adlake applies the industry's broadest line of mercury displacement and mercury wetted relays to the creative solution of design circuit problems. However unique or special your application, Adlake can assist you in

developing it. For prompt, personal and knowledgeable attention to your relay needs, contact the one source that is the complete source in the mercury relay field. Contact Adlake today for catalog and further information.



THE ADAMS & WESTLAKE COMPANY

A SUBSIDIARY OF ALLIED PRODUCTS CORPORATION

ELKHART, INDIANA 46514 • AC 219 • 264-1141

Dept. 1087

TRANSPORTATION EQUIPMENT • ARCHITECTURAL PRODUCTS • MERCURY RELAYS • DOORS AND ENTRANCES • CONTRACT MANUFACTURING

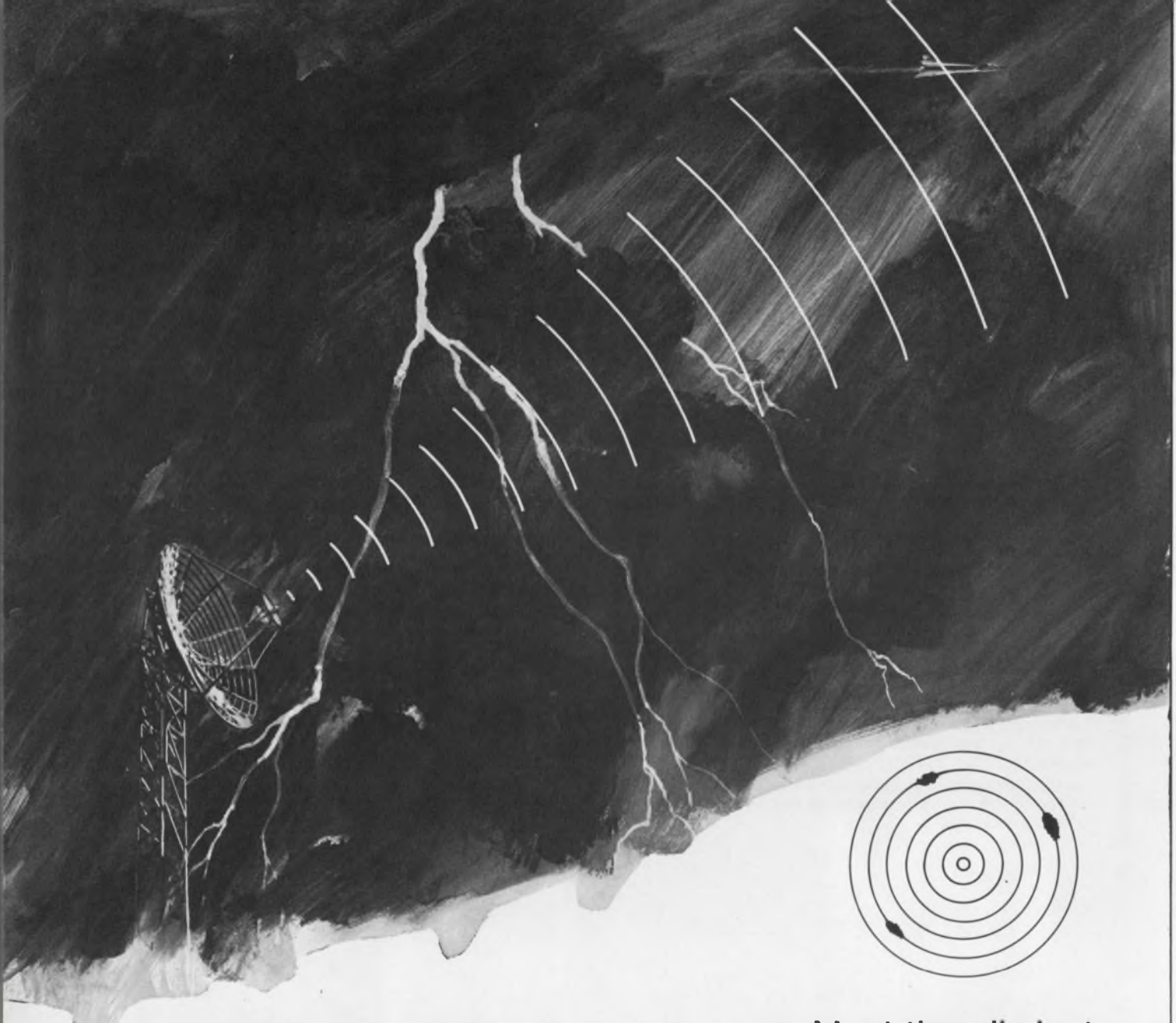

Meet the eliminator.
Make a clean sweep of RFI problems with our filter pin contacts.

When RFI started giving trouble, we did something about it. ITT Cannon developed filter pin contacts to achieve optimum RFI rejection in the connector assembly. And because our filters are an integral part of the connector—and terminated like standard contacts—they also eliminate filter boards and all the attendant expenses of engineering, assembly, wiring, inspection and testing of separate filter units.

Even crowded corners are no longer an obstacle to RFI filtering. CANNON®

Plugs with filter pin contacts are up to 75% *smaller* and 62% *lighter* than connectors with separate clusters of filters—and up to 500 times more effective.

This better idea in RFI-resistant connectors is available in many shapes and























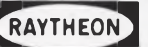

sizes: miniature circular connectors designed to MIL-C-26482 and NAS1599 specifications, miniature and sub-miniature rectangular rack and panel, and RF coaxial connectors.

For further information and literature, write to ITT Cannon Electric, 3208 Humboldt Street, Los Angeles, California 90031.

A division of International Telephone and Telegraph Corporation.

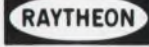

CANNON **ITT**

HLT²L  HLT²L  HLT²L  HLT²L 
 HLT²L  HLT²L  HLT²L  HLT²L
 HLT²L  HLT²L  HLT²L  HLT²L 
 HLT²L  HLT²L  HLT²L  HLT²L
 HLT²L  HLT²L  HLT²L  HLT²L 
 HLT²L  **50 MHz DUAL J-K FLIP-FLOP**

Now – Raytheon completes the line!

Raytheon's 50MHz Dual J-K Flip-Flops (RF120 Separate Clock and RF130 Common Clock) are available for delivery now.

As with all Raytheon MIL Spec IC's, our HLT²L line features —55°C to 125°C temperature range, true hermetic seals guaranteed to 5x10⁻⁸ cc/sec Helium, and a complete battery of electrical and physical quality assurance tests and inspections.

Raytheon HLT²L evaluation samples and data sheets are ready for immediate delivery. Raytheon Company, Semiconductor Operation, 350 Ellis Street, Mountain View, California 94040.

See us at Wescon. Booth #4421



ON READER-SERVICE CARD CIRCLE 126



NEWS

from Mr. MAGNETICIAN™



SPECIALISTS IN MAGNETIC MATERIALS



PERMANENT MAGNETS

Custom-engineered to size, shape and specific magnetic properties for sophisticated applications from a complete range of permanent magnet alloys. Production availability of new high energy product Columax 9 and ultra-high coercive force Alnico 8-C.

Write for Bulletin M-304-C.



LAMINATIONS

Punchings of various shaped Silicon Iron laminations for use as stacked magnetic cores for electro-magnetic devices such as transformers, solenoids, rectifiers, chokes, etc. Most shapes and sizes available from stock.

Write for Catalog L-523.



MAGNETIC INSTRUMENTATION

Precise measuring and testing equipment for laboratory and production operation. Includes Magnetchargers, Demagnetizers, Magnetic Stabilizer, Permanent Magnet Charger, Magnetic Pole Indicator, and Balanced Magnetic Bridge Recording Permeameter.

Write for Bulletin A-930.



TAPE WOUND CORES

Orthosil® "C", "E", "Y" and Toroidal transformer cores using thin gauge (1 through 4 mil) oriented silicon iron for single phase and three phase applications.

® Orthosil is a registered trademark of Thomas & Skinner, Inc.

Write for Catalog W-102-C.

NEW PRODUCTS ON DISPLAY AT WESCON 67

Be sure to visit Mr. Magnetician at Booth 4008, South Exhibit Hall, Cow Palace, San Francisco during Wescon 67.



Thomas & Skinner, Inc.

Box 102, 1120 East 23rd Street, Indianapolis, Indiana 46205
Phone 317-923-2501

ON READER-SERVICE CARD CIRCLE 127

INSTRUMENTS & CONTROL

Impedance plots made with pulsed rf



Wiltron Co., 930 E. Meadow Dr., Palo Alto, Calif. Phone: (415) 321-7428. P&A: \$3900; 6 wks.

A pulse adapter extends the capabilities of Wiltron's circuit analyzer so it can operate on pulsed signals from 2 MHz to 4 GHz. It is possible to make impedance plots with very short pulses. This is essential in checking mixers whose characteristics change with input level and duty cycle. An important application for this pulse capability is in the testing of the phase shift through microwave tubes where testing can be done with pulses as short as 0.2 μ s and phase resolution of better than 1° over the whole range. A dynamic range of 20 dB is automatically handled and can be extended by choice of signal levels.

Booth No. 2711 Circle No. 320

C-band amplifier hits 1 MW peak

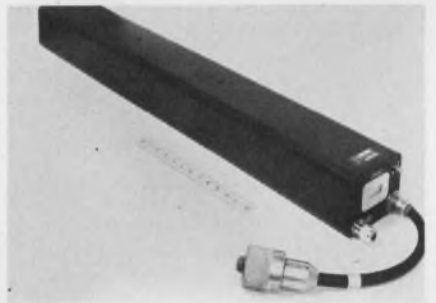

Litton Industries, Electron Tube Div., 960 Industrial Rd., San Carlos, Calif. Phone: (415) 591-8411.

With excellent phase and gain characteristics as well as high power outputs over wide bandwidths, this cold-cathode device requires only a dc power supply for operation. At the end of the rf input pulse it automatically ceases operation within a few nanoseconds. Between pulses, there is no current drawn from the supply. No complicated pulse circuitry is required to amplify pulse trains with varying pulse widths and repetition rates.

Booth No. 4207 Circle No. 279

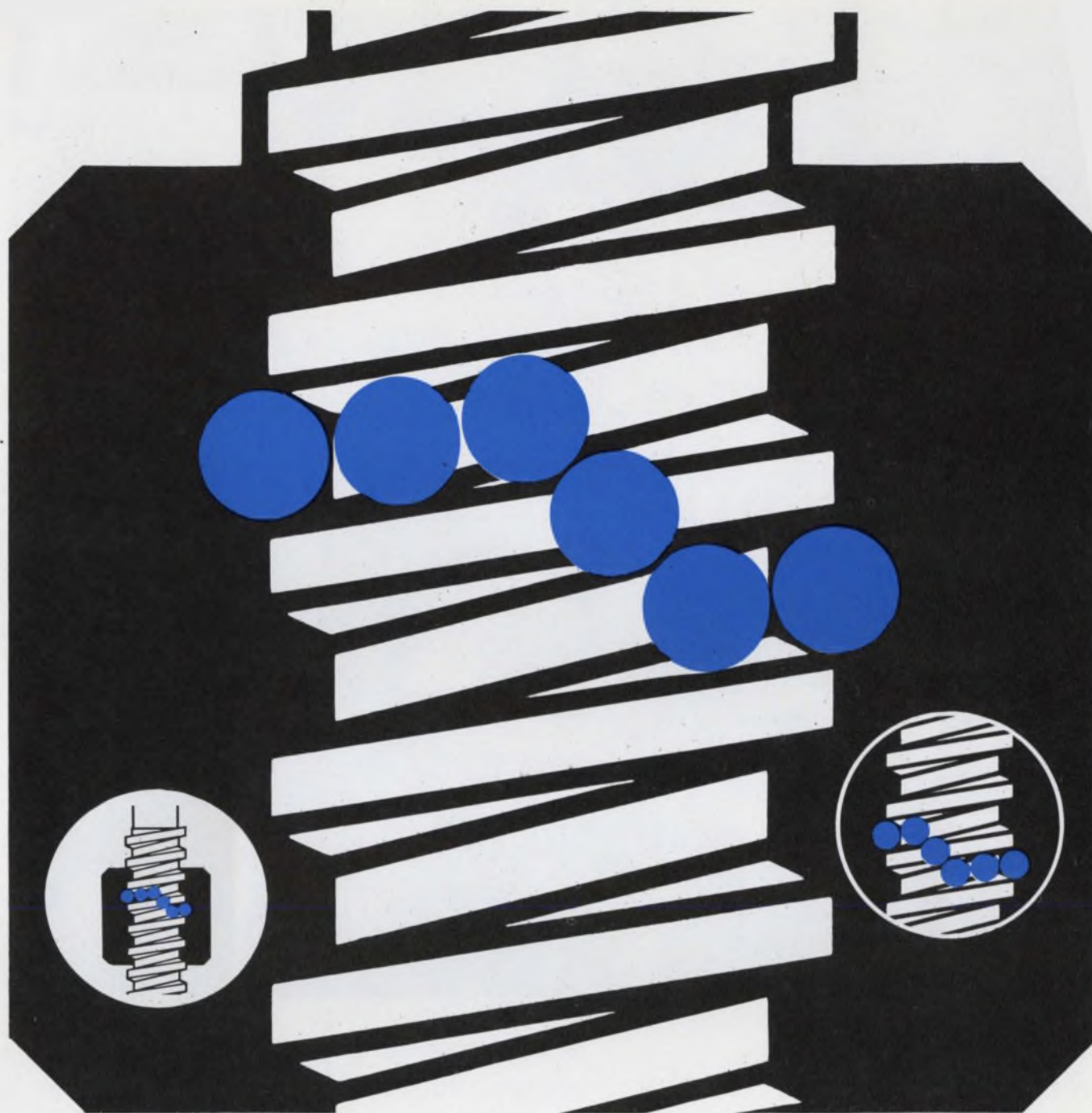

Kidde Ballscrews

SIZE AND WEIGHT PROBLEM SOLVERS

Kidde Ballscrews do more than solve friction problems of prime movers and drives. They can solve size and weight problems, too—and meet the demands for high efficiency transfer of motion and power. Here's why:

Their compact design results in smaller envelope dimensions. Weight is reduced because external tubes and fittings are eliminated. Kidde designs allow optimum usable power, due to extremely high efficiencies.

To solve these major problems, Kidde has designed a

wide range of Ballscrew sizes—from units less than 1" long to 32 foot custom assemblies. From 6" diameters down to 1/8"; sizes 3/16" to 1-1/2" (with various lead) are stocked.

Learn how Kidde Ballscrews can become your problem solver. Write for your free copy of "Standard and Precision Ballscrews." Walter Kidde & Company Inc., 675 Main Street, Belleville, New Jersey 07109.



ON READER-SERVICE CARD CIRCLE 128

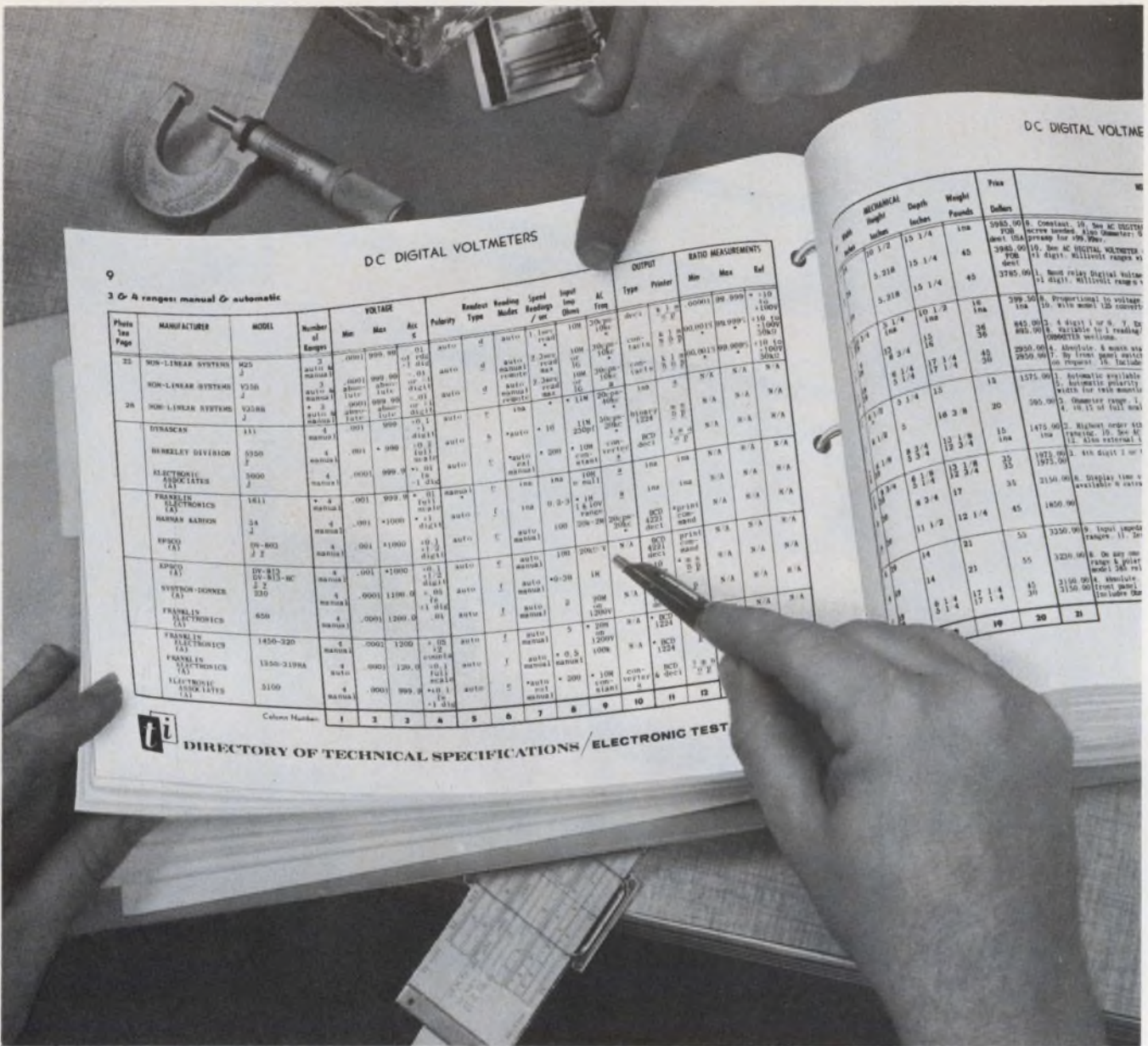

9
3 & 4 ranges manual & automatic

Plate No Page	MANUFACTURER	MODEL	Number of Ranges	VOLTAGE			Polarity	Readout Type	Reading Modes	Speed Readings /sec	Input Imp (Ohm)	AC Freq	OUTPUT			RATIO MEASUREMENTS		
				Min	Max	Acc							Type	Printer	Min	Max	Rel	
22	NON-LINEAR SYSTEMS	425	2	0.001	999.99	0.1	auto	d	1	100	200	50	0.0001	99.999	+10	N/A	N/A	N/A
26	NON-LINEAR SYSTEMS	V250	3	0.001	999.99	0.1	auto	d	2	100	200	50	0.0001	99.999	+10	N/A	N/A	N/A
26	NON-LINEAR SYSTEMS	V250R	3	0.001	999.99	0.1	auto	d	2	100	200	50	0.0001	99.999	+10	N/A	N/A	N/A
	DYNASCAN	311	4	0.01	999	0.1	auto	c	1	100	200	50	0.0001	99.999	+10	N/A	N/A	N/A
	HARVEY DIVISION	5350	4	0.01	999	0.1	auto	c	1	100	200	50	0.0001	99.999	+10	N/A	N/A	N/A
	ELECTRONIC INSTRUMENTS	5000	4	0.001	999.9	0.1	auto	c	1	100	200	50	0.0001	99.999	+10	N/A	N/A	N/A
	FRANKLIN ELECTRONICS (A)	1411	4	0.01	999.9	0.1	auto	c	1	100	200	50	0.0001	99.999	+10	N/A	N/A	N/A
	HARMAN KATHON	54	4	0.001	999.9	0.1	auto	c	1	100	200	50	0.0001	99.999	+10	N/A	N/A	N/A
	EPSON (A)	09-803	4	0.001	999.9	0.1	auto	c	1	100	200	50	0.0001	99.999	+10	N/A	N/A	N/A
	EPSON (A)	09-810	4	0.001	999.9	0.1	auto	c	1	100	200	50	0.0001	99.999	+10	N/A	N/A	N/A
	SYSTEM-DOZER (A)	22	4	0.001	999.9	0.1	auto	c	1	100	200	50	0.0001	99.999	+10	N/A	N/A	N/A
	FRANKLIN ELECTRONICS (A)	650	4	0.001	999.9	0.1	auto	c	1	100	200	50	0.0001	99.999	+10	N/A	N/A	N/A
	FRANKLIN ELECTRONICS (A)	1450-320	4	0.001	999.9	0.1	auto	c	1	100	200	50	0.0001	99.999	+10	N/A	N/A	N/A
	FRANKLIN ELECTRONICS (A)	1350-3196	4	0.001	999.9	0.1	auto	c	1	100	200	50	0.0001	99.999	+10	N/A	N/A	N/A
	ELECTRONIC INSTRUMENTS (A)	5100	4	0.001	999.9	0.1	auto	c	1	100	200	50	0.0001	99.999	+10	N/A	N/A	N/A

Columns Number: 1 2 3 4 5 6 7 8 9 10 11 12

ti DIRECTORY OF TECHNICAL SPECIFICATIONS / ELECTRONIC TEST

If you are buying or selling **Digital Voltmeters, Signal Generators, Receivers, Microwave Equipment or Oscilloscopes**, a Directory of Technical Specifications will allow you comparative and current analysis of manufacturer's pertinent specifications... *at your fingertips.*

A one year subscription for \$300 contains 47 categories bound in 47 separate sections (includes six storage binders).



TECHNICAL INFORMATION CORP.
P.O. BOX 514 SMITHTOWN, N.Y. 11787 (516) 234-0100
SEE US AT WESCON BOOTHS 3616 AND 3617

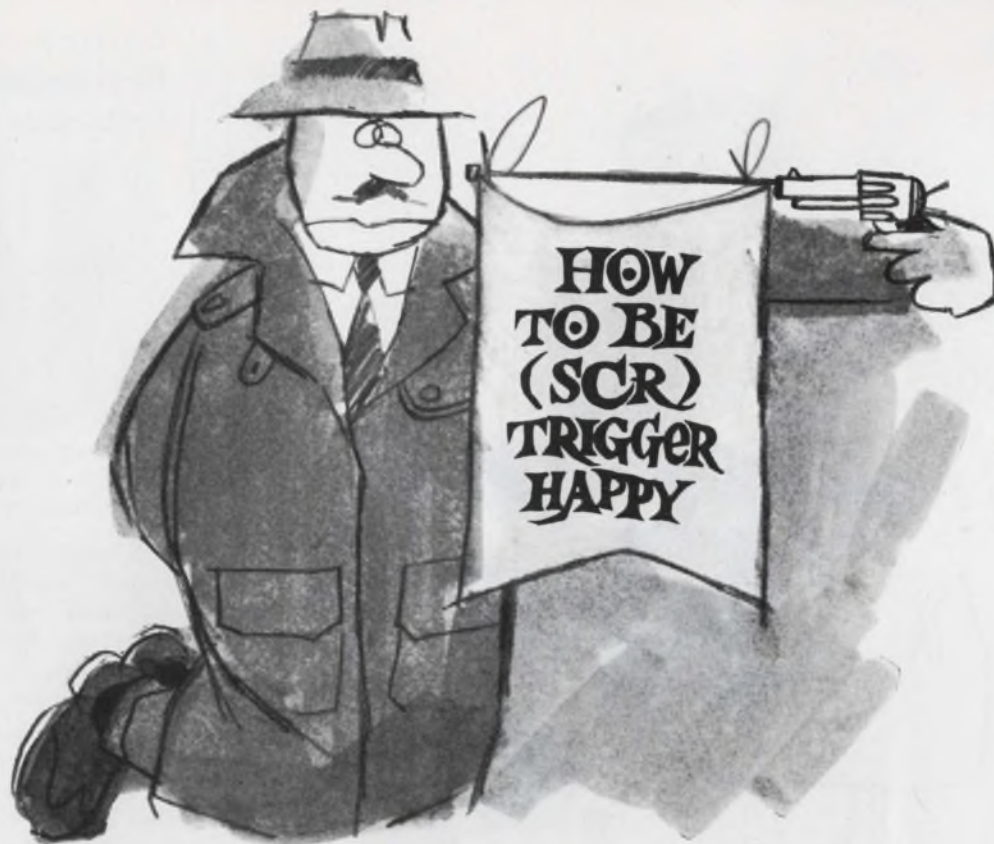

fire them this flexible, economical, precise, fail-safe way

... with Aladdin pulse transformers ... allows triggering from a high impedance control circuit ... provides isolation from the trigger source; permits triggering through the use of fewer components (reducing overall circuit cost). Applicable to both closed and open loop systems; gate isolation permits use of both AC and DC circuits. Precise firing depends on characteristics of the pulse transformer and semiconductor elements—the extensive Aladdin transformer line affords maximum “trading” of characteristics for optimum results. Readily available—the chart lists some of the most common ratios of 1:1 and 1:1:1.

For other applications, consult our applications engineers. Meanwhile send for bulletin 195 listing other standard SCR transformers and additional performance data.

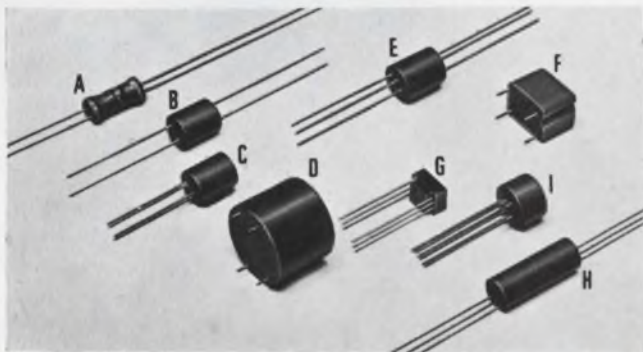

Part Number	Package Style	OCL (mh)	Turns Ratio ($\pm 10\%$)	High Potential Test Voltage
307-102	A	.2 min.	1:1	1600
90-2569	B	1.3 min.	1:1	550
306-136	C	1.3 min.	1:1	550
314-162	D	3.5 min.	1:1	550
90-2510	B	5.0 min.	1:1	550
72-2040	F	5.0 $\pm 20\%$	1:1	1750
314-141	D	6.6 $\pm 20\%$	1:1	1000
02-1864	E	6.0 $\pm 20\%$	1:1	700
90-1055	B	6.0 $\pm 20\%$	1:1	700
90-2364	B	8.5 $\pm 20\%$	1:1	700
90-2555	B	24.0 $\pm 20\%$	1:1	700
314-142	D	41.0 $\pm 20\%$	1:1	1000
314-143	D	162 $\pm 20\%$	1:1	1000
307-101	H	.045 $\pm 10\%$	1:1:1	700
78-2028	G	.7 min.	1:1:1	1000
90-2397	B	1.3 min.	1:1:1	550
312-114	I	1.3 min.	1:1:1	550
90-2398	B*	5.0 min.	1:1:1	550
90-2362	B*	6.0 $\pm 20\%$	1:1:1	700
02-2062	E*	6.0 $\pm 20\%$	1:1:1	1250
314-144	D*	6.6 $\pm 20\%$	1:1:1	1000
02-2066	E*	14.0 min.	1:1:1	1000
02-1861	E*	15.0 $\pm 20\%$	1:1:1	700
314-139	D*	21.0 $\pm 20\%$	1:1:1	700
314-170	D*	28.0 $\pm 20\%$	1:1:1	1000
314-145	D*	41.0 $\pm 20\%$	1:1:1	1000

Aladdin Electronics can custom design to individual needs for higher interwinding voltage strengths.
*Package configuration are same as shown except for the additional leads required for 1:1:1 transformers.

where the magic of magnetics is a science...

Aladdin
electronics

Nashville 10, Tennessee

ON READER-SERVICE CARD CIRCLE 130



Meet The Anadex Freq Family

Pictured above is a portrait of the Anadex family of high-performance, low-cost frequency instruments for **measuring, generating, converting, and manipulating frequencies** in the 0-200 KC range. There is a member of the Anadex "Freq" Family especially designed for each of these functions and many more:

- $V_o = KF_i$ Frequency-To-DC Conversion
- $F_o = KV_i$ DC-To-Frequency Conversion
- $F_o = KF_i$ Frequency-To-Frequency Conversion
- $V_i = KF_i$ Frequency Limit Detection
- $\theta_m = KF_i$ Frequency Meter Indication
- plus F_i / F_2 , $F_i \times F_2$, $F^{1/2}$, and Frequency Generators

Complete literature on the "Anadex Freq Family" containing detailed specifications is available. Send for it today.



... THE NAME YOU CAN COUNT ON

7833 HASKELL AVENUE, VAN NUYS, CALIFORNIA 91406
PHONE 213-873-6620 • TWX 213-781-6811

Visit our Booth 3303 at WESCON August 22-25

ON READER-SERVICE CARD CIRCLE 131

INSTRUMENTS & CONTROL

Picosecond pulser tests sampling scopes



Tektronix, Inc., P. O. Box 500, Beaverton, Ore. Phone: (503) 644-0161. Price: \$525.

Available outputs of this pulser include all the signals required to check the risetime, vertical deflection factors and horizontal sweep rates of sampling systems. The repetition rate of the pulse generator is 50 kHz with a pulse duration of 1 μ s and a flatness of $\pm 3\%$ or better. A pre-trigger is available that occurs either 5 ns or 50 ns before the pulse output. Rise time is 50 ps. Squarewave outputs with a period of 10 μ s, 1 μ s or 100 ns and amplitudes of 1 V, 100 mV or 10 mV into 50 Ω may be selected. Sinewave outputs of 10 ns or 1 ns period are available for checking fast sweep rates.

Booth No. 2818 Circle No. 315

Directional rf wattmeter accurate to 100 W



Bird Electronic Corp., 30303 Aurora Rd., Cleveland. Phone: (216) 248-1200. Price: \$895.

With all components assembled in an 11 x 9-1/2 x 6-3/8-inch case, this rf wattmeter remains accurate to 100 watts. A section of machined 50- Ω reference line for insertion into the users coax system is connected to a 5-1/2-inch taut-band meter, which permits readings without residual jewelfriction. Five 100-watt plug-in elements cover a continuous frequency range from 2 to 1000 MHz.

Booth No. 2601 Circle No. 329

ON READER-SERVICE CARD CIRCLE 91,92

It tests all digital integrated circuits & costs only \$60,000

per dozen.

1. REDCOR's new IC tester does everything 100,000 testers do. Except cost \$50,000. True, it's somewhat slower than expensive units, but as it costs only one-tenth as much, perhaps you could manage with less than overwhelming speed.

2. The 990 IC tester has to be the perfect tester for small run production, incoming inspection, and laboratory analysis. It performs both pulse and dc parameter tests as well as functional tests without external equipment. Measurement accuracy is 1%. (For an extra thousand bucks we build in a digital readout that gives an accuracy of 0.1% on all ranges.)

3. The 990 is easy to operate. You can train a bright girl to be a proficient operator in half a day. Test programming is accomplished with thumbwheels and requires less than 60 seconds for most IC's.

4. Power supply accuracy is 0.1% ± 1 mv. All supplies have adjustable current or voltage limiting and will both source and sink. Kelvin connections are provided to the device under test.

5. For more information on the 990, flip the page.



An outlined guide to testing IC's

cheap

start here

8 7.
1.

BRILLIANT PERFORMANCE

The 990 stimulates and measures all dc parameters without additional equipment. In combination with an oscilloscope it measures ac parameters.

FETCHING MODULARITY

The standard complement of modules is three voltage supplies, one current supply, one swept voltage supply, one dual loads module, and one dual output pulse generator. All modules are individually powered from ac line and are floating. Current and voltage are continuously variable with indication when limits are reached.

STUNNING ACCURACY

The 990's metering capability is comparable to that of testers ten times its cost. With the optional DRO, accuracy is $0.1\% \pm 1$ mv. Kelvin referencing means that the actual voltage or current at the lead is just what it should be. (Greater accuracy in low-level current measurements.)

RATHER SWIFT PROGRAMMING

Test programming for any available device can be set up in less than sixty seconds. Thumbwheel/pushbutton programming gives instantaneous verification of testing conditions. A complete line of device adaptors is available.

CRASHINGLY SIMPLE OPERATION

From the programming to the actual testing, the model 990 can be operated by nearly anyone (even salesmen). Why don't you call one of ours and see.

DELIVERY

Immediate.

3 FURTHER INFORMATION

Call collect to Dick Barr, our sales manager for this product.

10

Ka-band oscillators pump paramps

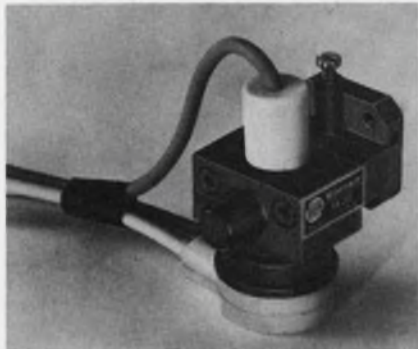

Varian Associates, 611 Hansen Way, Palo Alto, Calif. Phone: (415) 326-4000.

Reflex klystron oscillators covering the frequency range between 26.5 and 35 GHz are designed for use as pump tubes in parametric amplifiers. Tuning over a 1-GHz range, the tube delivers 150 mW at a beam voltage of 550 V. Mechanical tuning range is 700 MHz and the tube delivers 500 mW at 26 GHz and 250 mW at 35 GHz.

Booth No. 2309 Circle No. 286

Frequency program unit presents slim profile



General Radio Co., West Concord, Mass. Phone: (617) 369-4400.

Designed for use with GR frequency synthesizers with remote digit programming, this frequency program unit can be preset to select up to 40 seven-digit frequencies. A single contact closure is required for complete selection of each frequency. The digit-programming switches are contained in plug-in trays which can be changed quickly if more than one program of 40 frequencies is needed. Manual control of any or all digits of the synthesizer overrides the preset program.

Booth No. 3015 Circle No. 292

ON READER-SERVICE CARD CIRCLE 132 >

◆ ON READER-SERVICE CARD CIRCLE 91, 92

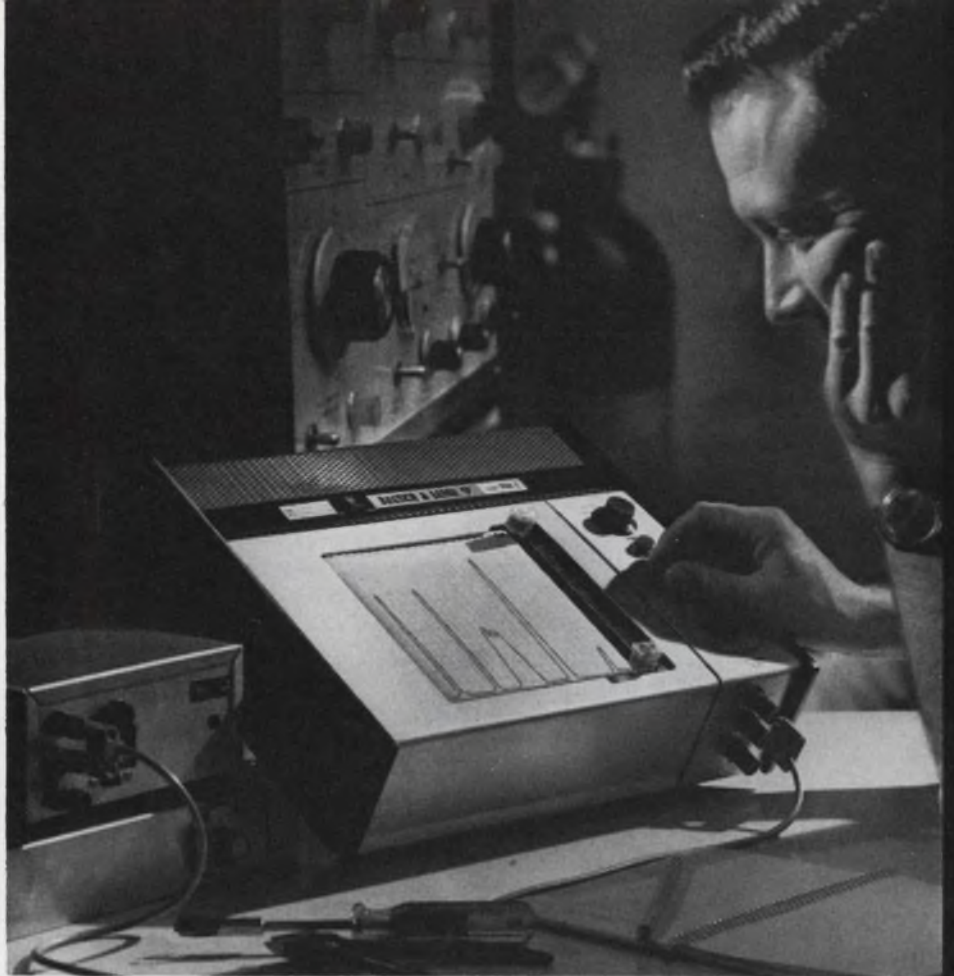

SO MUCH FOR SO LITTLE...

Can the price be right?

There's no mistake.

At Bausch & Lomb we know electronics. We've come up with a remarkable line of recorders . . . the V.O.M. They have more of the features you want, *built-in*, than units costing up to twice as much. They're uniquely able to directly measure and record D.C. volts, ohms and milliamps. They are extremely accurate and sensitive, have high off-balance impedance.

At no extra charge there's an event marker. There are five chart speeds—the same instrument can be used for short term, intermediate or long term recordings. Nothing has been spared to assure top performance. We use a zener diode reference supply, a photoelectric modulator and a durable, smooth-writing sapphire-tipped pen.

Choose the model having the sensitivity you need. Get the right recorder without paying a premium price or buying expensive options.

And for any special applications . . . we can modify to suit your needs. Send for our Catalogs 37-2174 and 37-2194. Write Bausch & Lomb, Electronics Division, 91544 Bausch Street, Rochester, New York 14602.

	V.O.M.-5	V.O.M.-6	V.O.M.-7	V.O.M.-8
Voltage range:	10 mv-500v D.C.	2.5 mv-125v D.C.	0.5 mv-10v D.C.	Absorbance/ Transmittance Measurement (voltage, current, resistance range same as V.O.M.-5)
Current range:	10 ma-100 ma	2.5 ma-25 ma	1 μ a-10 ma	
Resistance range:	1 ohm-100 K ohms	0.25 ohms-25 K ohms	1 ohm-100 K ohms	
Weight:	18 lbs.	18 lbs.	20 lbs.	16 lbs.
Prices: (suggested list)	\$675 COMPLETE	\$745 COMPLETE	\$910 COMPLETE	\$995 COMPLETE

BAUSCH & LOMB 
ELECTRONICS DIVISION

In Canada, Bausch & Lomb Optical Co., Ltd., 16 Grosvenor St., Toronto.

See them at the Woscon Show, Booth No. 3306

You'll find two types of relay manufacturers around today.

**Group A: those who care.
Group B: those who don't.**



Group A consists of that very select, very rare bunch who make you feel like *you're* the customer. Group B contains the losers. You know them. You come across them 95% of the time you want something done that requires a little effort.

Line Electric belongs to group A.

We manufacture the best relays in the business. Every unit is put through nine performance tests before you get it. Our sales force is courteous and qualified. Our prices are the best in the industry. And we guarantee delivery in six weeks, not eight like other companies.

To service you properly, we have a sales office in every state and one in Milano, Italy; we have stocking distributors in 68 cities in 28 states, with one in Ottawa, Canada.

Proof of performance? Oh, yes. Our sales have increased by over 400% in the past six years and this year shipments are 80% ahead of last year. And that doesn't happen if your in group B.



But you'll have to try us to believe us. Talking about it won't prove a thing.



The Line Electric Company, Manufacturers of Relays and the best service in the business. Subsidiary of  General Precision Equipment Corporation. Send for 64 page catalog:

305 U.S. Highway 287, Parsippany, N.J. 07054
"See us at WESCON. Booth 5020"

ON READER-SERVICE CARD CIRCLE 133

INSTRUMENTS & CONTROL

Inductor analyzer spans micro to kilohenries

Marconi Instruments, 111 Cedar Lane, Englewood, N. J. Phone: (201) 567-0607. P&A: \$1485; stock.

Twenty-seven controls and a CRT provide ease of balance on this inductance bridge. With a range from 0.3 μ H to 21,000 H, this true inductor analyzer incorporates a low and medium-current bridge and the nucleus of a complete high-power inductor test assembly. It can be used from 20 Hz to 20 kHz and has internal frequencies of 10 kHz, 1 kHz and 60 Hz line. The display gives a positive indication of direction of inductor balance and tells if the inductor is capacitive at the test frequency.

Booth No. 2619 Circle No. 291

Random data generator weighs 25 pounds



Datapulse, Inc., 10150 W. Jefferson Blvd., Culver City, Calif. Phone: (213) 836-6100.

This 10-stage shift register operates in a closed loop with feedback into the first stage selectable from any two of the stages in the register. It provides a pattern up to 1023 bits long, two units provide over a million bits, three over a billion bits. On pseudo-random operation, the unit may generate the pseudo-random sequence under internal control or synchronize the sequence to a selected sync pattern in external data. Or, it uses the content of preceding bits in external data to generate the proper next bit in the sequence.

Booth No. 2719 Circle No. 282

Amperex

FETS, Zeners & Dual Isolated Diodes, RF & IF Amplifiers and Switches Now Available in



**VERY HIGH FREQUENCY
RF AMPLIFIER (NPN)**
LDA 407
functionally replaces types:
2N2857, 2N5053/4

**HIGH GAIN, LOW CAPACITY
IF AMPLIFIER (NPN)**
LDA 410
functionally replaces type A473

**VERY HIGH SPEED SWITCH
(NPN)**
LDS 205
functionally replaces type 2N709

**LOW "ON" RESISTANCE
D/A SWITCHES (NPN)**
LDS 206
LDS 208

**LOW NOISE FETs
(N-CHANNEL JUNCTION)**
LDF 603/604/605
functionally replace types:
2N5103/4/5

**PLANAR ZENER DIODES
(4 to 10 Volts, 5%)**
LDZ 70 SERIES

**HIGH SPEED
LOGIC/SWITCHING DIODES**
SINGLE TYPE LDD5
DUAL ISOLATED TYPE LDD15
functionally replaces type 1N914

Other types

HIGH SPEED SWITCHES (NPN)
LDS 200/201
functionally replace types:
2N706, 2N708, 2N743/4,
2N834/5, 2N914, 2N2368/9

**GENERAL PURPOSE
AMPLIFIERS (NPN)**
LDA 402/403
functionally replace
general-purpose amplifiers
operating from
1 to 100 ma, such as:
2N696/7, 2N1613, 2N2218/9,
2N3390/1

**MEDIUM CURRENT
AMPLIFIER AND SWITCH (NPN)**
LDA 404/405
(Complement to LDA 452 and
LDA 453)
functionally replaces types:
2N2217/8/9, 2N2220/1/2, 2N1613,
2N1711, 2N718A, 2N871

**HIGH FREQUENCY
RF AMPLIFIER (NPN)**
LDA 406
functionally replaces type 2N918

**GENERAL PURPOSE
AMPLIFIER AND SWITCH (PNP)**
LDA 450/451
functionally replaces types:
2N2604/5

**HIGH GAIN, LOW LEVEL
AMPLIFIERS (NPN)**
LDA 400/401
functionally replace types:
2N929/30, 2N2483/4

**MEDIUM CURRENT
AMPLIFIER AND SWITCH (PNP)**
LDA 452/453
(Complement to LDA 404 and
LDA 405)
functionally replaces types:
2N2904/5/6/7

**DUAL, GENERAL PURPOSE AND
HIGH SPEED SWITCHING DIODES**
COMMON CATHODE TYPE LDD10
COMMON ANODE TYPE LDD50

To meet any hybrid I.C. application

Amperex's expanded line of LID semiconductors now can satisfy all your design requirements for hybrid IC's. First introduced by Amperex early in '66, the LID, an all-ceramic microelectronic package for semiconductors, has proven to be the answer for high yield, low cost production of hybrid integrated circuits.

Evaluation level quantities of LIDS are available now from your local franchised Amperex distributor. Mechanized production techniques now in full swing have resulted in price reductions across the board. For data, write: Amperex Electronic Corp., Semiconductor & Receiving Tube Div., Dept. 371, Slatersville, R. I. 02876.

Amperex
TOMORROW'S THINKING IN TODAY'S PRODUCTS



The Industry Standard Semiconductor Package For Hybrid IC's.

ON READER-SERVICE CARD CIRCLE 134

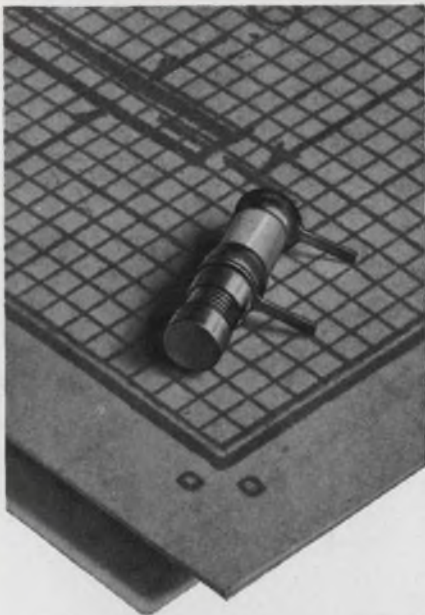

Sub-Miniature Low-Inductance Capacitor

High Q > 1500 @ 500 mc

10:1 capacitance ratio in micro miniature size — extra fine tuning <.35 pF per turn. High Q, (greater than 1500 at 500 mc).

Specifications

- Size:** 1/8" diameter, 1/2" length
- Capacitance Range:** 0.35 pF to 3.5 pF
- Working Voltage:** 250 VDC (test voltage, 500 VDC)
- Q @ 100 mc:** >5000; @ 250 mc, >2000
- Insulation Resistance:** >10⁶ Megohms
- Temperature Range:** -55°C to 125°C
- Temperature Coefficient:** 50 ± 50 ppm/°C

Features 570° Solder. Prevents distortion. Not affected by conventional soldering temperatures.

Call or write for complete information.

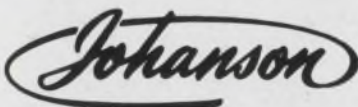

MANUFACTURING CORPORATION

400 Rockaway Valley Road
Boonton, N.J. 07005 • (201) 334-2676
Electronic Accuracy Through Mechanical Precision
ON READER-SERVICE CARD CIRCLE 135

U172

Digital measuring system fully modular



Hickok Electrical Instrument Co., Cleveland. Phone: (216) 541-8060. Price: \$320 (main frame), \$175 to \$240 (plug-ins).

The main frame of this all-solid-state system (with digital readout) accepts any of five plug-ins. It measures dc voltage, frequency or period, resistance, capacitance, or performs event counting. The flexible system features wide measurement ranges for each plug-in.
Booth No. 3002 Circle No. 328

Portable VTVM uses no filters



Industrial Test Equipment Co., 20 Beechwood Ave., Pt. Washington, N. Y. Phone: (516) 767-9190.

The unit measures in-phase voltage, quadrature voltage, true rms voltage and phase angle. It operates over a 50-Hz-to-10-kHz frequency range and rejects noise and harmonics (40-dB down) without the use of filters. For field use where suitable power sources may not be available, D cells may be used.
Booth No. 2304 Circle No. 314

Stock panel meters customized to suit

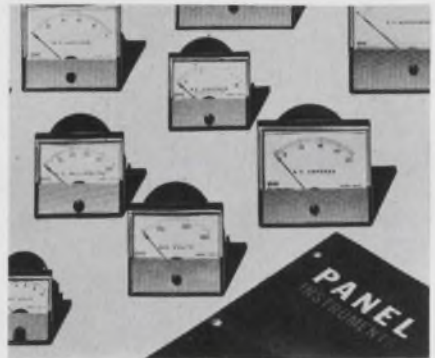

Triplet Electrical Instrument Co., Bluffton, Ohio. Phone: (419) 351-4912.

These panel meters give the user a dial design that provides an area for multiple scales and other special applications. The instruments are available in five sizes from the four ounce 1-1/2-inch to the 2-1/2, 3-1/2, 4-1/2 and 5-1/2 inch units. Accuracy is 2% for all types, 3% for the ac rectifier type.
Booth No. 3013 Circle No. 330

Economy DVM accurate to 0.01%

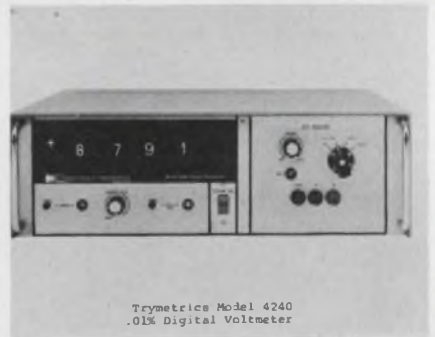

Trymetrics Corp., 204 Babylon Turnpike, Roosevelt, N. Y. Phone: (516) 378-5020. Price: \$595.

Capable of 10 samples per second with a readout accuracy of 0.01% over three dc voltage ranges, this 4-digit DVM operates without display blinking or running numbers. IC counter circuits and a temperature-stabilized pulsed oscillator voltage-to-time conversion system maintain the accuracy and display stability. The unit has ranges of 0.999, 9.999, 99.99 and 999.9 volts full scale.
Booth No. 3112 Circle No. 311

ON READER-SERVICE CARD CIRCLE 136 ➤



TAKE A
CLOSE
LOOK AT
**HUDSON'S
ELECTRI-CITY**

- OF
- ENCLOSURES
 - STAMPINGS
 - ASSEMBLIES

**WESCON SHOW
BOOTHS 1302-1303**

Our particular specialty is Deep Drawn Electronic Enclosures. We've solved the nation's housing problems for more than twenty-seven years . . . with over 5,000 varied shape units in a variety of materials.

Looking at our Electri-City, you can see that we stress individuality. So, if you can't find the exact accommodations for your housing problems, we'll alter the skyline . . . just for you!

**HUDSON
TOOL & DIE
COMPANY, INC.**

*Enclosures, Stampings
and Assemblies*

NEWARK, N.J. 07105 U.S.A.



**What do Hewlett-Packard •
Kimball Systems • Auto-Trol •
Systron-Donner • Berkeley
Scientific Laboratories • Vidar •
Calma • Victoreen Instrument •
Bisset-Berman • Baird-Atomic •
and Raytheon Computer have
in common?**



US

The outstanding firms listed above, and many others, include Kennedy incremental magnetic recorders in their data gathering systems because of the simplicity, reliability, and easy handling designed into every Kennedy recorder.

See them at WESCON 67—San Francisco at Booth 2416.

We may have a lot in common with you.

THINK
INCREMENTAL **Kennedy Co.**

Altadena, California 91001 • (213) 681-9314 • TWX 910-582-3203
ON READER-SERVICE CARD CIRCLE 137

INSTRUMENTS & CONTROL

**Time interval counter
features dc gating**

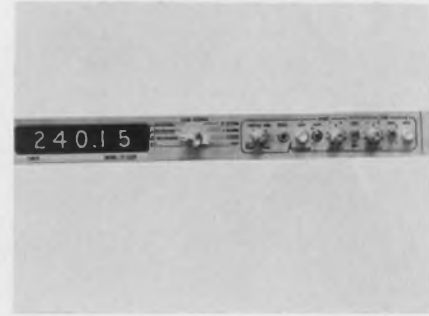

*Anadex Instruments, Inc., 7833
Haskell Ave., Van Nuys, Calif.
Phone: (213) 782-9527.*

Interval measurements such as pulse length, pulse spacing and time between electrical events are provided by this counter. It has start/stop dc levels which are adjustable from +30 to -30 V with slope control. A switch is provided for single line or two line gate inputs. Measurements from 10 μ s to 100,000 seconds are possible. Digital readout may be displayed for an adjustable interval or the display may be held indefinitely until reset.
Booth No. 3303 Circle No. 331

**Nanovolt galvo accepts
any source impedance**



*Electro Scientific Industries, Inc.,
13900 N.W. Science Park Dr., Port-
land, Ore. Phone: (503) 646-4141.
P&A: \$2595; stock to 30 days.*

This galvanometer-type null detector operates from any source impedance without changes in response or damping characteristics. The unit has infinite common-mode rejection and multiple calibrated ranges. It measures voltage or current from 10 nV (10 pA) to 3 mV (3 μ A). Noise is less than 2 nV or 2 pA p-p.

Booth No. 2717 Circle No. 280

CHEMICALLY MILLED MAGNETIC LAMINATIONS & SMALL METAL PARTS

Chemical milling permits faster delivery of prototypes and far lower re-designing costs. The process produces flat, thin, burr-free, close tolerance parts which are too thin to produce by normal stamping methods.

Typical precision metal parts in gages from 0.0002" to 0.020" include miniature transformer and recording head laminations, mechanical and semiconductor strain gages, micromodules with integrated circuitry used in the new flat packs, metal and glass masks used for semiconductor product manufacturing, electrical motor laminates and electrical contacts. Other precision devices made by this process are tube grids and CRT screens, alpha-numeric symbols and letters for electronic display tubes and devices, light attenuation masks (optical filters) and photographic shutters. The process also lends itself to fabrication of small metal parts using non-magnetic materials such as Beryllium Copper, Tungsten, Kovar and Alloy 52.



THE ARNOLD ENGINEERING COMPANY, Main Office: MARENGO, ILL.
BRANCH OFFICES and REPRESENTATIVES in PRINCIPAL CITIES

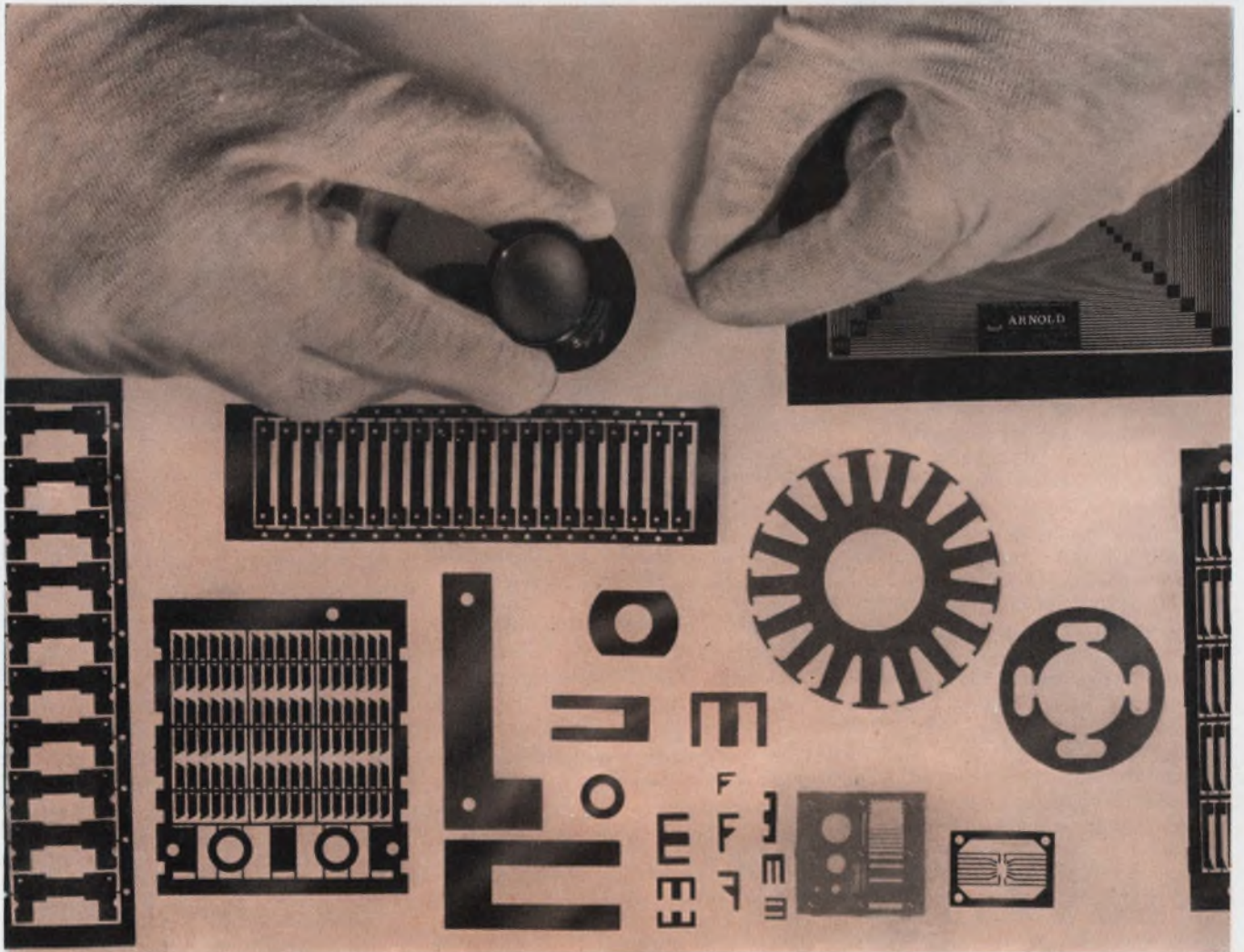

ON READER-SERVICE CARD CIRCLE 138

**What stays
anchored
better than a
headed lead?**

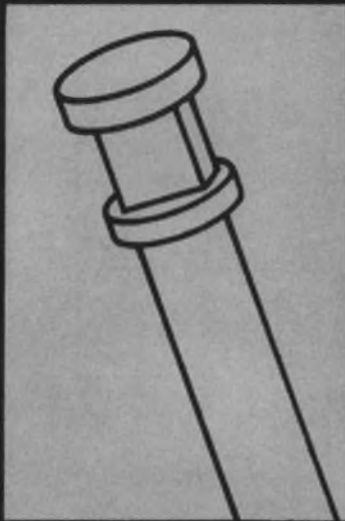

**... a double
upset lead
with
Torque-Lock flat!**

If you can't meet mechanical strength specs with your present epoxy or glass sealed headed leads, get in touch with Art Wire. We have developed high speed automatic machines that can produce double upsets as close as .030" apart, with a flat between, on .015" to .090" diameter wire. The flat eliminates twisting. The second upset at the seal surface improves mechanical bonding and eliminates flashing.

Cost is surprisingly low, not much more than single headed leads. Find out. Send a part or a drawing and we'll quote on it.

Write for catalog.

ART WIRE & STAMPING COMPANY
14 Boyden Place, Newark, N. J. 07102

ON READER-SERVICE CARD CIRCLE 139

U176

**Dc-to-freq converter
linear to 0.01%**

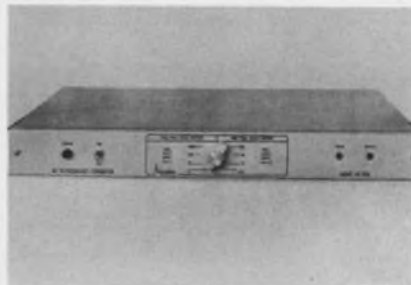

Anadex Instruments, Inc., 7833 Haskell Ave., Van Nuys, Calif. Phone: (213) 782-9527. P&A: \$450; 1 month.

An output frequency directly proportional to the input voltage is provided by this converter. By means of a range switch, the user may select any of four input voltage ranges from 10 mV to 10 V full scale with a 10-kHz output, or four input voltage ranges from 100 mV to 100 V with a 100-kHz output. Front-panel controls provides a 0-to-50-kHz output frequency for zero input on any range. The output changes less than $\pm 0.01\%$ for any $\pm 10\%$ change of line voltage.

Booth No. 3303 Circle No. 332

**Turret attenuators
operable to 12.4 GHz**



Narda Microwave Corp., Plainview, N. Y. Phone: (516) 433-9000.

Model 710 turret attenuator provides a 0-to-60-dB attenuation range in 10-dB steps, model 711 ranges 0 to 10 dB in 1-dB steps and model 712 is a dual-turret device combining both attenuation ranges. Turrets are mounted in a cast-aluminum housing, and all units are equipped with type N female connectors. Positive attenuator rf mating is ensured by spring-loaded inner and outer conductors.

Booth No. 2704 Circle No. 319

**Solid-state monitor
displays X-Y-Z**



Hewlett Packard, 1501 Page Mill Rd., Palo Alto, Calif. Phone: (415) 326-7000. P&A: \$1900; September.

A CRT monitor with an 8×10 -inch display area has 20-MHz response on all 3 axes. The CRT writing rate is faster than 20 inches/ μ s. The power consumption is 175 W (the unit has a self-contained power supply). Input sensitivity of the X and Y amplifiers is 0.1 V/inch and a 2.5:1 vernier amplitude control is included on each axis.

Booth No. 2909 Circle No. 312

**Frequency distribution
unit accepts 8 plug-ins**



Tracor, Inc., 6500 Tracor Lane, Austin, Tex. Phone: (512) 926-2800.

This unit features modular construction, adjustable gain, low distortion, output level monitoring, short-circuit protection and instantaneous switchover to an external dc standby supply should ac power fail. The modules, which plug in from the rear of the unit, are available in frequencies of 5 MHz, 1 MHz and 100 kHz. There are two outputs available from each module, with either output capable of delivering a minimum of one volt rms to a 50- Ω load at the end of a 300-foot length of RG 58/U cable.

Booth No. 2205 Circle No. 296

**WORLD'S LARGEST SELLING
AND WORLD'S NEWEST**

Hand Size V-O-M's

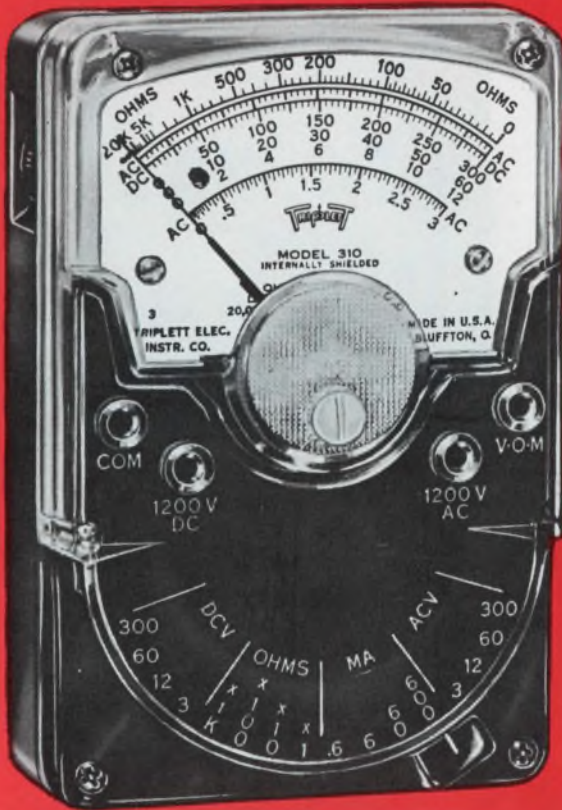

MODEL 310
World's Largest Selling
Volt-Ohm-Milliammeter

MODEL 310-C
World's Newest
Volt-Ohm-Milliammeter



**BOTH TESTERS
SHOWN
ACTUAL SIZE**

- 1** HAND SIZE AND LIGHTWEIGHT, but with the features of full-size V-O-M's.
- 2** 20,000 OHMS PER VOLT DC; 5,000 AC (310)—15,000 AC (310-C).
- 3** EXCLUSIVE SINGLE SELECTOR SWITCH speeds circuit and range settings. The first miniature V-O-M's with this exclusive feature for quick, fool-proof selection of all ranges.

SELF-SHIELDED Bar-Ring instrument; permits checking in strong magnetic fields. FITTING INTERCHANGEABLE test prod tip into top of tester makes it the common probe, thereby freeing one hand. UNBREAKABLE plastic meter window. BANANA-TYPE JACKS—positive connection and long life.

Model 310—\$42.00 Model 310-C—\$53.00 Model 369 Leather Case—\$4.00

ALL PRICES ARE SUGGESTED U.S.A. USER NET, SUBJECT TO CHANGE

THE TRIPLET ELECTRICAL INSTRUMENT COMPANY, BLUFFTON, OHIO

310-C PLUS FEATURES

1. Fully enclosed lever range switch
2. 15,000 Ohms per volt AC (20,000 O/V DC same as 310)
3. Reversing switch for DC measurements

MODELS 100 AND 100-C

Comprehensive test sets. Model 100 includes: Model 310 V-O-M, Model 10 Clamp-on Ammeter Adapter; Model 101 Line Separator; Model 379 Leather Case; Model 311 leads. (\$78.00 Value Separate Unit Purchase Price.)

MODEL 100—U.S.A. User Net...\$74.00
MODEL 100-C—
Same as above, but
with Model 310-C,
Net.....\$84.00



USES UNLIMITED: FIELD ENGINEERS • ELECTRICAL, RADIO, TV, AND APPLIANCE SERVICEMEN • ELECTRICAL CONTRACTORS • FACTORY MAINTENANCE MEN • ELECTRONIC TECHNICIANS • HOME OWNERS, HOBBYISTS
THE WORLD'S MOST COMPLETE LINE OF V-O-M's • AVAILABLE FROM YOUR TRIPLET DISTRIBUTOR'S STOCK

THE MOST ACCURATE and SIMPLEST WAY:

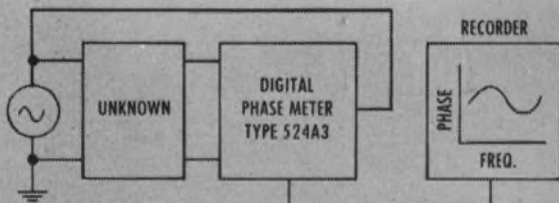

Read phase angle in 4-digits and automatically plot phase curve vs. frequency from 10 Hz to 500 KHz.

DIGITAL PHASE METER Type 524A3

Phase angle in degrees directly represented in four digits. No amplitude adjustment. No frequency adjustment. Analog output available for external recorder or programmable systems. Accuracy $\pm 0.03^\circ$. Phase response from 5 Hz to 500 KHz.

Write for free technical bulletin—
"DIGITAL PHASE MEASUREMENT"



WORLD FAMOUS IN PHASE-TIME MEASUREMENT

ADYU

ELECTRONICS, INC.
249 TERRINE AVE., PASSAIC, N. J.
PHONE: (201) 472-5622
CABLE: ADYU PASSAIC

"See our Booth No. 3302 at the Wescon Show"
ON READER-SERVICE CARD CIRCLE 141

Narrow marker plug-in triples in brass



Kay Electric Co., Maple Ave., Pine Brook, N. J. Phone: (201) 227-2000.

Essentially a fancy marker plug-in unit using ICs, this device is a complex frequency marking system consisting of:

- a direct reading variable pulse marker a few Hz wide and accurate to $\pm 0.05\%$.
- a slave pulse marker that can be accurately and simultaneously set a few Hz away.
- a mixer-amplifier providing all marker coupling and 30-dB preamplifier gain.

Designed to operate in Kay's sweep generator, the plug-in covers a frequency range from 100 kHz to 70 MHz, providing pulse markers whose width is approximately 0.5% of total sweep display over a wide range of sweep widths and sweep rates. It is narrow enough to mark filters a few Hz wide. A three-digit, ten-turn dial provides readability of an Hz from 100 kHz to 1 MHz, of 10 Hz from 1 to 10 MHz and of 100 Hz from 10 to 70 MHz. Accuracy increases linearly on each of these ranges from the $\pm 0.05\%$ spec to $\pm 0.005\%$ at the high frequency end.

Incremental dial accuracy (and the accuracy of the spacing between markers) is better than 2%. The 30-dB gain mixer-amplifier provides input impedance of 100 M Ω , variable gain and an output of 4 volts peak to peak into a 500- Ω load.

Booth No. 2804 Circle No. 284

why should you buy a relay that promises less ?

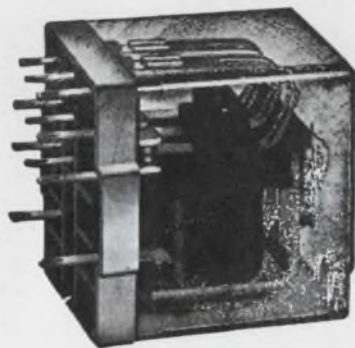

Because this one—the Guardian 1220—promises less of the things you *don't* want. Like wasted space, breakdowns, and high cost. The

1220 is an extremely compact relay. It has a new "Uni-Guard" one-piece switch that eliminates many internal solder connections.

The terminal panel is used as the male plug, dispensing with radio-type plug, extra wiring, and sub-assembly. This advanced design boosts dependability, because with fewer parts, there are fewer reasons for breakdown. The U.L. recognized, 10 amp. DPDT or 3PDT 1220 is tightly enclosed (so, no problems from dust or moisture), and it's available from stock. Price? Only \$1.85 in quantities. Write today for our free Bulletin B4—it includes full technical specs, dimensions, mounting variations.

GUARDIAN  **ELECTRIC**

1550 West Carroll Avenue, Chicago, Illinois 60607

ON READER-SERVICE CARD CIRCLE 142

Argon ion laser based on rf induction



Spectra-Physics, 1255 Terra Bella Ave., Mountain View, Calif. Phone: (415) 961-2550.

This unit is based on Spectra-Physics' method of rf induction excitation of ion-laser discharges. In this method, a radio frequency H field is air-coupled to a closed-circuit laser tube so that the plasma forms the equivalent of a one-turn secondary winding of an rf transformer. This ensures a long life time of the plasma tube, far in excess of the dc cathode type of plasma excitation.

Booth No. 2922 Circle No. 295

Transmit-receive pair for fm relay links

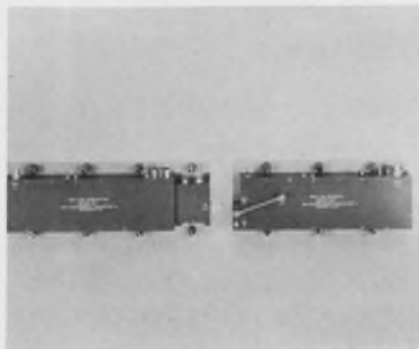

RHG Electronics Laboratory, Inc., 94 Milbar Blvd., Farmingdale, N. Y. Phone: (516) 694-3100. P&A: \$5900; 8 wks.

Fm transmitter and receiver combinations are intended to be used as basic modules in relay links. They provide a microwave relay capability in a volume of 75 cubic inches each. Standard units are available from 1.4 to 2.3 GHz and offer baseband response to 4.5 MHz. System performance is compatible with EIA and CCIR standards for monochrome TV.

Booth No. 3607 Circle No. 277

Vhf-uhf varactors break down at 120 V



Alpha Industries, Inc., 381 Elliot St., Newton Upper Fall, Mass. Phone: (617) 969-8480.

A high power varactor suitable for vhf and uhf multipliers has high input and output power levels. The type 1210 of the 1200 series exhibits the following specifications: minimum and maximum junction capacitance of 5 to 10 pF, maximum series resistance of 3.5 Ω , maximum thermal resistance of 15°C/W and breakdown voltage of 120 V minimum.

Booth No. 3615 Circle No. 274

Pre-TR/TR tube protects TWTs

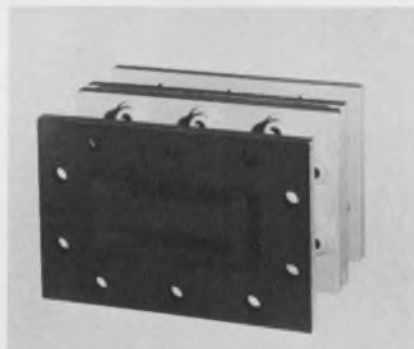

Microwave Associates, Burlington, Mass. Phone: (617) 272-3000.

A dual pre-TR/TR tube provides positive receiver protection for traveling wave tubes. The S-band tube covers a frequency range of 3.35 to 3.65 GHz and operates at a maximum peak power of 750 kW with a maximum recovery time of 30 μ s. The compact package provides for an insertion loss of 0.5 dB. It is designed for use in air search radar systems.

Booth No. 3723 Circle No. 269

Solid-state oscillators for fm relay links

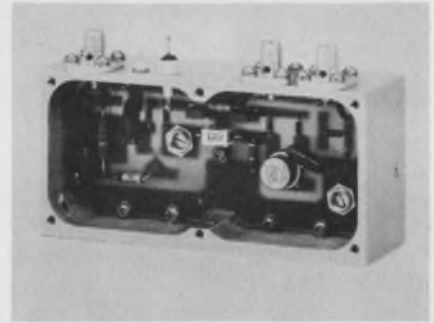

RHG Electronics Laboratory, Inc., 94 Milbar Blvd., Farmingdale, N. Y. Phone: (516) 694-3100. P&A: \$995; 30 days.

Capable of being frequency modulated at baseband rates to 12 MHz, this oscillator is used as the basic exciter unit in wideband microwave relay systems. Oscillators are available from 250 to 380 MHz, and can be deviated over 9 MHz with linearity of 2%.

Booth No. 3607 Circle No. 271

Voice, data recorder weighs five pounds



Leach Corp., 717 N. Coney Ave., Azusa, Calif. Phone: (213) 334-8211.

A cartridge-loaded voice and data recorder/reproducer measures only 7 x 4.5 x 4.5 inches and weighs five pounds. The 4-channel cartridge-load unit eliminates complicated tape threading and assures simple tape changes. Each cartridge holds 260 feet of 1/4-inch magnetic tape. The unit will record and reproduce at speeds up to 30 ips.

Booth No. 3005 Circle No. 270

Nexus devises
6 new operational
amplifiers...each
of which may bring
a little happiness
into the life of a
hard-pressed
engineer



3 low-cost, high-performance OP AMPS

These three nifty little modules give better temperature characteristics and lower input bias currents than you would believe possible for the price. Just try to find anything else in the ballpark that comes close to these typical specifications:

TYPICAL PERFORMANCE @ 25°C

	Q-101	Q-102	Q-103
Output	$\pm 11V/\pm 5.5mA$	$\pm 11V/\pm 5.5mA$	$\pm 11V/\pm 2.5mA$
Input \bar{z} Diff.	1 Megohm	1 Megohm	5 Megohms
Input Bias Current	$\pm 3nA$	$\pm 3nA$	$\pm 5nA$
Bias Current Drift	$\pm 0.4nA/^{\circ}C$	$\pm 0.4nA/^{\circ}C$	$\pm .05nA/^{\circ}C$
Initial Offset Voltage (Ext Trim)	$\pm 0.2mV$	$\pm 0.2mV$	(Ext Trim)
Max. Drift vs Temp.	$15\mu V/^{\circ}C$	$15\mu V/^{\circ}C$	$15\mu V/^{\circ}C$
-A Version	$5\mu V/^{\circ}C$	$5\mu V/^{\circ}C$	$5\mu V/^{\circ}C$
List Price	\$22	\$25	\$22
-A Version	\$25	\$28	\$25

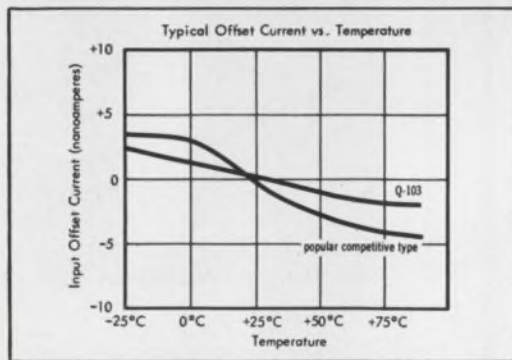

1 lowest-cost FET OP AMP

FET prices have gone ffft with the new Nexus QFT-5 which sells for \$22 in moderate quantities.

TYPICAL PERFORMANCE @ 25°C

Output	$\pm 11V/\pm 5.5mA$
Input Impedance	10^{10} ohms
Gain	100,000
Drift	$50\mu V/^{\circ}C$
Gain-bandwidth	2MHz
Slewing rate (full output)	$5.0V/\mu s$

2 ultra-fast differential OP AMPS

Both these new units, the FSL-4 and FSL-5 can handle inverting, non-inverting or differential functions with full output at frequencies up to 1 MHz.

- Smooth Loop Dynamics: 6dB/Octave Rolloff
- $60V/\mu s$ Slewing, Either Inverting Or Non-Inverting
- $4\mu s$ Settling Time To 0.1% With 20 Volt P-P Square Wave Output
- $\pm 0.2nA/^{\circ}C$ Maximum Input Bias Current Drift (FSL-5)
- $\pm 10\mu V/^{\circ}C$ Maximum Offset Voltage Drift (FSL-5)
- ± 10 Volt @ $\pm 20mA$ Output

The following test photos compare FSL-4 performance with a typical competitive (Brand X) unit.

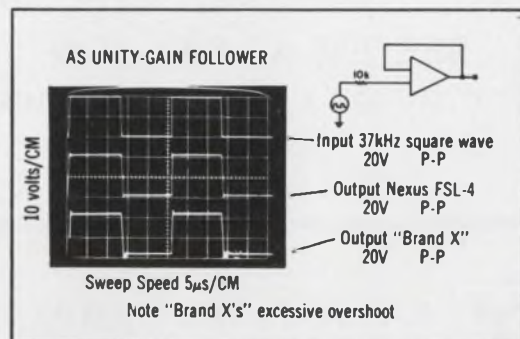
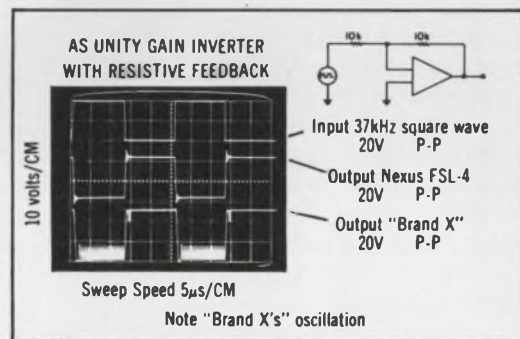

SEE ALL THESE GREAT NEW
OP AMPS AT WESCON BOOTH 2420

Prices F. O. B. Canton, Mass. U.S.A.

NEXUS
A TELEDYNE COMPANY

480 Neponset St., Canton, Mass. 02021, Tel: (617) 828-9000 TWX (710) 348-1323

Johnson Introduces Two NEW Components to save space, cut costs!

1. Save space with new, horizontal-mounting, printed circuit, type "U", machined-plate capacitors. Available in various sizes, with capacity values ranging from 1.2 pf to 24.5 pf, these tiny trimmers provide tuning accessibility from edge of board. Printed circuit boards can be close-spaced, resulting in compact equipment designs. TC—plus 45 ± 15 PPM/°C. "Q"—greater than 1500 at 1 MHz. All metal parts silver plated. Famous Johnson quality throughout.

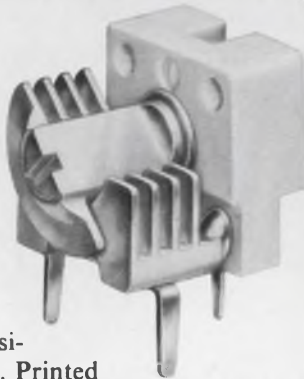

2. Cut costs with new, Johnson RIB-LOC™ Tip Jacks that save production line time with *press-in* design. No mounting hardware to assemble or handle. Simple insertion tool presses Tip Jack into pre-drilled chassis hole for a secure mount that resists loosening and turning. Jack accepts 0.080" tip plug in a recessed, closed-entry type contact. Insulating body is molded of low-loss polyamide. Brass solder terminal is silver-plated and Iridited. Low cost.



**SEE 'EM AT WESCON
BOOTH 5326 AT THE COW PALACE**

*Stop in for details and specifications
on all Johnson Components*



E. F. JOHNSON COMPANY
3346 Tenth Ave. S.W., Waseca, Minnesota 56093

ON READER-SERVICE CARD CIRCLE 145

COMMUNICATION & DETECTION

Beacon magnetron compact, powerful

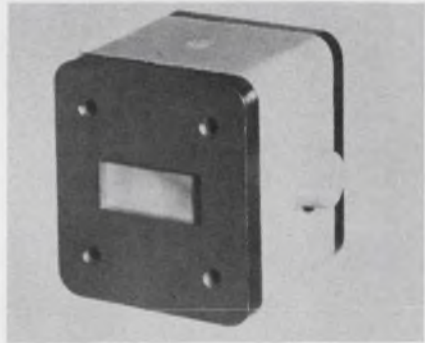

*Microwave Associates, Burlington,
Mass. Phone: (617) 272-3000.*

A compact 7-kW fixed-frequency X-band beacon magnetron weighs 21 ounces. It is designed to operate at a fixed frequency in the 8.5-to-9.6-GHz range with a 0.5 μ s pulse width and an 0.005 duty ratio. Input connections are made through flexible leads or solder lugs and the output connector mates with a UG-3/9U cover flange. This unit is designed for beacon and navigation systems, radar detection applications, missile ground support equipment, transponders and airborne radar applications.

Booth No. 3723 Circle No. 268

Glass tuning varactors have Q to 1000



*American Electronic Laboratories,
Inc., Colmar, Pa. Phone: (215) 822-
2929.*

DO-7 glass tuning varactors are designed for electronic tuning applications in equipment operating at frequencies up to 3 GHz. The units display a Q of 1000. They are suited for hand-solder or stripline insertion. The capacitance ratios, up to 5.2:1, make it possible to design resonant circuits which are tunable over octave bands. The varactors are available in a capacity range from 4 to 27 pF.

Booth No. 5106 Circle No. 276

POWER SUPPLIES UNLIMITED

at WESCON Booth 2218.



See 15 NJE power supplies.
Get the lowdown on 216 more.

There's no guessing when you select a power supply from NJE's huge line. No "goofs"! The NJE line covers any conceivable power requirement you may have, so you don't have to underbuy or overbuy. What's more, NJE's slotted supplies narrow the ranges, so you don't have to pay extra for power you can't use. To see just how easy power supply selecting can be, visit us at WESCON Booth 2218.

IMMEDIATE DELIVERY

NJE CORPORATION
Electronic Development & Manufacturing

Kenilworth, New Jersey 07033 / (201) 272-6000
Telefax: FFP • TWX: (201) 276-7630

A SUBSIDIARY OF  CORPORATION

See these NJE power supplies at WESCON Booth 2218.

SVC line NJE all-silicon power supplies provide voltage and/or current regulation for lab or system use. Available in Lab-Rak laboratory bench units, rack adaptable, or full rack construction. 0-40 VDC/0-5 Amps/.01% Reg./1 mv RMS Ripple.



Model SVC 40-5-M

NJE's custom capabilities include design and manufacture of multiple output power supplies for use in systems requiring more than one voltage simultaneously. SIX 20 VDC/0-1.5 Amps/.01% Reg./1 mv RMS Ripple.



Model C6S-20SR1.5

SY "system" NJE power supplies provide the regulation and ripple usually only found in high-cost lab equipment. Unique design provides the maximum power at the lowest dollar-per-watt ratio, but still incorporating "wide slot" adjustment range. 10-36 VDC/0-30 Amps/.01% Reg./1 mv RMS Ripple.



Model SY 36-30-M

312

ON READER-SERVICE CARD CIRCLE 146

THE FIRST

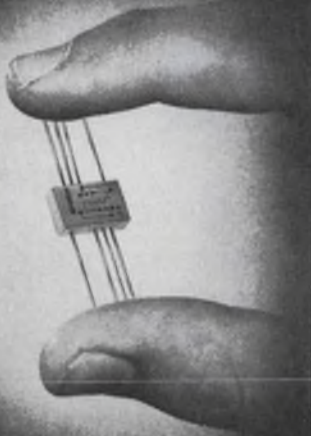

FLAT PACK RELAY

NEW from BRANSON - TO-87 RELAY

This TO-87 size relay creates new design flexibility and capability in low profile applications including circuit boards, packaging with semiconductors, part of integrated circuits and hybrid devices, etc. The TO-87 DPDT relay, rated at 1/4 amp. at 28 volts, measures 3/8" x 1/4" x 1/10" and weighs 1 gram. It is hermetically sealed and exceeds all applicable MIL specifications.

Send For Complete Detailed Specifications

OTHER BRANSON PRODUCTS . . .



SOLID STATE TIME DELAY RELAY



4 POLE 1/6 SIZE RELAY



6 POLE DT CRYSTAL CAN RELAY



1/2 CRYSTAL CAN 4 PDT RELAY

*Relays...
Our Only Business*

BRANSON CORP.

VANDERHOOF AVENUE
DENVER, NEW JERSEY
(201) 625-0600

SEE US AT WESCON—BOOTH 4104
ON READER-SERVICE CARD CIRCLE 147

Multiplier varactors cover vhf to Ku band



Microwave Associates, Burlington, Mass. Phone: (617) 272-3000.

High-efficiency multiplier varactors cover vhf to Ku-band. The all-silicon epitaxial diffused junction devices have a multiple junction feature, obtained by the series connection of two diodes. Each diode junction is mounted in its own ceramic package and then welded into a single assembly. A typical unit is useable over 5 to 8 GHz with typical output power of 3.5 W.

Booth No. 3723 Circle No. 266

Vacuum coax relay accepts 12 inputs

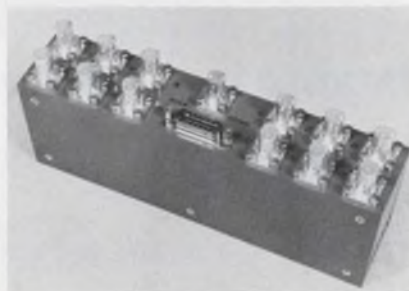

ITT Jennings, P. O. Box 1278, San Jose, Calif. Phone: (408) 292-4025.

A 12-input, common-output vacuum coax relay uses vacuum relays as the interrupting elements. The maximum power switching is limited directly by the BNC type rf connectors. The vacuum construction keeps insertion losses and contact resistance low and isolation of input to input and output to any input high. VSWR at 30 MHz is less than 1.2. In a typical application, a telemetry receiver receives information from 12 separate antennas in any order. Switching speed is 10 ms.

Booth No. 5807 Circle No. 257

Recorder features 8-speed transport



Consolidated Electrodynamics Corp., 1500 Shamrock, Monrovia, Calif. Phone: (213) 796-9381.

A 15-inch reel capacity and recording rates convertible from 100 kHz to 1.5 MHz give this recorder large capacity. All eight bi-directional speeds are automatically selected by one rotary switch, and no adjustments are required throughout the speed range. The electronic capstan control features automatic fail safe operation, assuring continuous recording even in the event of signal loss or minor component failure. The VR-3400 offers direct response to 600 kHz at 120 ips and a low end response of 50 Hz at 1-7/8 ips. Fm electronics permit operation with standard fm (20 kHz at 60 ips) or wideband fm (80 kHz at 120 ips) interchangeably.

Booth No. 3113 Circle No. 323

Now AE gives you complete PC Correed logic modules



The Automatic Electric PC Correed (dry reed switch) is now available as an integral part of a complete printed circuit board assembly. It's made up of type G10 epoxy-glass laminate, 1/16 inch thick, with the necessary PC Correeds and associated components mounted and soldered. The assembly is a complete circuit package—ready for direct insertion into an edge-type connector.

The high-reliability epoxy-glass cards feature copper-nickel-gold circuit paths and standard 0.800 inch card spacing. They're rigidly inspected and tested before shipment.

You give us your circuit—and we'll take it from there! We do the entire packaging to your specifications—including circuitry and artwork.

You get a completely wired circuit module, which eliminates the need to design, assemble and

wire discrete components.

AE's type PC logic modules give the system designer flexibility, reliability and economy. They provide isolation between input and output, and high immunity to electrical noise. Packaged logic circuits are particularly suited for supervisory and telemetering equipment, process controls, check-out and ground support equipment, test equipment and engineering models.

There's a lot of helpful, detailed information in our new 8-page brochure. To get your copy, just write for Circular 1113 to the Director, Electronic Control Equipment Sales, Automatic Electric, Northlake, Illinois 60164.



AUTOMATIC ELECTRIC
SUBSIDIARY OF
GENERAL TELEPHONE & ELECTRONICS **GTE**

ON READER-SERVICE CARD CIRCLE 148

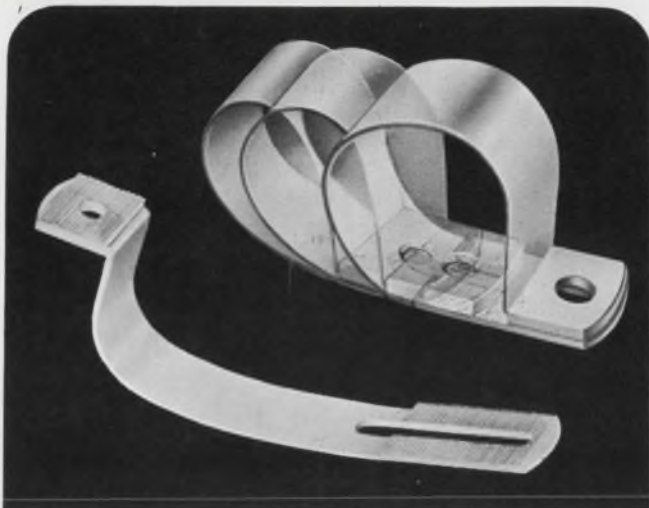

ADJUSTABLE P-CLIPS

Only nine sizes provide controlled tension for all bundle and cable diameters from 1/8" thru 2". Add or remove wires and the same clip can be adjusted to the new bundle diameter. Molded nylon ratchet teeth provide positive locking action — no slip, no slide — even under vibration or shock. Adjustable P-Clips simplify work, ordering, and inventories.

Send for Free Samples

ELECTROVERT INC.

Components Division
86 Hartford Ave., Mt. Vernon, N. Y. 10553
Milwaukee, Wis. • Burbank, Calif.



SOLD COAST-TO-COAST THROUGH AUTHORIZED DISTRIBUTORS

See us at Booth 1111
ON READER-SERVICE CARD CIRCLE 149

REGULATED POWER

FOR SENSITIVE EQUIPMENT



INVERTERS
DC to Quality AC



FREQUENCY CHANGERS
Inferior AC to Quality AC

For mobile and emergency operation of electronic instruments, video tape recorders or other sensitive equipment. Field-proven and available from stock.

- Output: 115 V \pm 5%; 60 \pm .03 sine wave, maximum 6% harmonic distortion
- Input: Inverters—11-15 or 22-30 VDC
Changers—95-125 VAC, 50-500 cps
- 1000, 500, 250 and 125 VA models
- All-transistorized for high reliability, low acoustic noise and instant turn-on
- Used by Industry and Military

SEND FOR
COMPLETE CATALOG



TOPAZ, INCORPORATED
3800 HOUSTON STREET
SAN DIEGO, CALIF. 92110

ON READER-SERVICE CARD CIRCLE 150

COMMUNICATION & DETECTION

C-band magnetron yields 0.5 to 3 MW

Raytheon Co., Waltham, Mass.,
Phone: (617) 862-6600.

Model QKS1343 is an integral magnet tube with waveguide input and output. It covers 5.4 to 5.9 GHz without electrical or mechanical adjustment when used with a modulator having proper load-line characteristics. In typical operation, peak power is 0.5 MW with 15-kW average power output. At 0.03 duty, pulse duration is 200 μ s.

Booth No. 4418 Circle No. 385

Line terminations withstand 10 kW cw

Bird Electronics Corporation, 30303
Aurora Rd., Cleveland. Phone: (216)
248-1200.

Line terminations weighing 6.5 lbs can be bolted to the end of a line in any position. Model 8736 with a 1.625-inch flange and model 8732 with a 3.125-inch flange have cw power ratings of 10 kW with 4 gal/min water cooling. Fifty- Ω units have 1.1 VSWR to 1 GHz and 1.14 VSWR to 1.4 GHz.

Booth No. 2601 Circle No. 386

Circulator tunes 400 MHz to 1.2 GHz

Scientific-Atlanta, P. O. Box 13654,
Atlanta. Phone: (404) 938-2930.
P&A: \$1000; 1 month.

Electrically tunable from 400 MHz to 1.2 GHz, this circulator has an instantaneous bandwidth of greater than 30 MHz. VSWR is below 1.35. The circulator is furnished with a variable-voltage dc power supply and tuning control with linear, direct readout of frequency from 500 MHz to 1 GHz. Tuning from 400 to 500 MHz and 1 to 1.2 GHz is by calibration chart. An external voltage source permits the circulator to be tuned or swept at rates to 60 Hz.

Booth No. 2305 Circle No. 387

DCL*

DESIGNER'S CHOICE LOGIC

Signetics puts IC systems design decisions back in the hands of the systems designer.

Some IC families put severe limits on the decisions the systems designer can make. He's often held back by the speed, power, and noise immunity trade-offs built into the family by the IC manufacturer. Now Signetics Designer's Choice Logic changes all that. Signetics DCL* Series 8000 includes high speed TTL circuits, slower low power TTL circuits that offer high AC noise immunity, and low power DTL circuits that provide high DC noise margins. The series also includes large functional arrays for counting and storage applications. All elements in the 8000-Series are specified compatibly. And we've got a 46-page data

handbook — the most complete one of its kind ever offered — to guide you in using these flexible circuits. In designing with DCL* you can optimize your system performance without drawn-out calculations, expensive and time-consuming ground-plane designs, or extensive use of outboard discrete components. The handbook provides special sections directed to systems, evaluation and design engineers. Find out fast what can be done with our DCL* series, and how to loosen constraints on your designs. Write Signetics for your DCL* handbook: 811 East Arques, Sunnyvale, California 94086.

*SIGNETICS TRADEMARK

**SIGNETICS
INTEGRATED
CIRCUITS**



A SUBSIDIARY OF CORNING GLASS WORKS

SIGNETICS SALES OFFICES: Metropolitan New York (201) 992-3980; Upper New York State (315) 469-1072; Southwestern (214) 231-6344; Western Regional (213) 272-9421; Eastern Regional (617) 245-8200; Mid Atlantic (609) 858-2864; Southeastern (813) 726-3734; Midwestern Regional (312) 259-8300; Northwestern (408) 738-2710.

DISTRIBUTORS: Compar at all locations listed below. Semiconductor Specialists, Inc. (312) 279-1000; Terminal Hudson Electronics (212) 243-5200; Wesco Electronics (213) 684-0880; Wesco Electronics (405) 968-3475; Hammond Electronics (305) 241-6601; Avnet Electronics Corp. of Massachusetts (617) 272-3060.

DOMESTIC REPRESENTATIVES: Jack Pyle Company (415) 349-1266; Compar Corporation at the following locations: Alabama (205) 539-8476; Arizona (602) 947-4336; California (203) 245-1172; California (415) 697-6244; Colorado (303) 781-0912; Connecticut (203) 288-9276; Florida (305) 855-3964; Illinois (312) 775-5300; Maryland (301) 484-5400; Massachusetts (617) 969-7140; Michigan (313) 476-5758; Minnesota (612) 922-7011; Missouri (314) 428-5313; New Jersey (609) 429-1526; New Mexico (505) 265-1020; New York (518) 436-8536; New York (607) 723-8743; New York (716) 684-5731; New York (201) 471-6090; North Carolina (919) 724-0750; Ohio (216) 333-4120; Ohio (513) 878-2631; Texas (214) EM 3-1526; Texas (713) 649-5756; Washington (206) 725-7800.

INTERNATIONAL SALES: France, Germany, Italy, Belgium, Holland, Luxemburg, Spain — Sover Electronique, 11, Chemin de Ronde, Le Vesinet, (S.-&D.) France. United Kingdom, Ireland, Sweden, Denmark, Norway, Switzerland, Austria, Portugal — Electrotil Ltd., Lakeside Estate, Colnbrook By Pass Slough, Buckinghamshire, Great Britain. Australia — Corning, 1202 Plaza Building, Australia Square, Sydney, N.S.W. 27-4318. Canada — Corning Glass Works of Canada, Ltd., Leaside Plant, Ontario, Canada (416) 421-150. Israel — Optronix, P.O. Box 195, Ramat-Gan, Israel 724-437. Japan — ASAMI Glass Co., Ltd., Corning Products Sales Dept. No. 2, 3-Chome Marunouchi, Chiyoda-ku, Tokyo, Japan.

ON READER-SERVICE CARD CIRCLE 151



MEASUREMENTS



MODEL 500A STANDARD FREQUENCY SYNTHESIZER

- 0 to 100 Kcs
- Smallest digital step .01 cps
- Stability 1 part in 10^9
- Output 0 to 2 volts
- Harmonics below 40 db
- Spurious outputs below 60 db
- Vernier oscillator for continuous frequency sweep
- Provision for remote control
- Modular construction
- All solid-state design

PRICE: \$2850.00 f.o.b. Boonton, N. J.

Laboratory Standards



MEASUREMENTS

A McGraw-Edison Division

P.O. Box 180, Boonton, N. J. 07005

Phone: 201-334-2131

ON READER-SERVICE CARD CIRCLE 152

U188

COMMUNICATION & DETECTION

Four-arm connectors combine rf signals

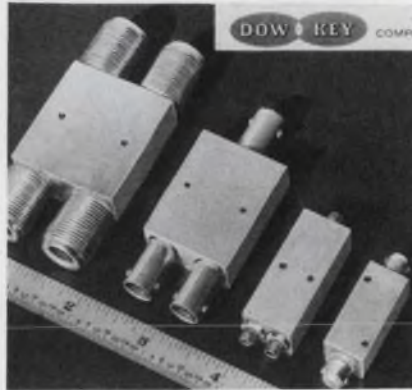

Dow Key Co., 2260 Industrial Lane, Broomfield, Colo. Phone: (303)466-7303.

Matched or standard connectors are used to connect 3 or 4 coax transmission lines. They are commonly used to divide or combine rf signals with any connector used as input or output. They are offered in two basic types: parallel wired similar to standard tee adapters, and resistive match power dividers, where each arm is matched when the other arms are terminated. They are useful up to 1 GHz with VSWR at 1.1 up to 500 MHz and 1.2 to 1 GHz. Power rating is 0.5 W cw, 5 kW peak.

Booth No. 4917 Circle No. 272

Tapped delay line has 5-ns rise time

Bel Fuse, Inc., 198 Van Vorst St., Jersey City, N. J. Phone: (201) 432-0463.

This unit has a total delay of 15 ns with taps every nanosecond and a rise time of less than 5 ns. Designed for printed circuit mounting, the line is available in impedance values of 93, 200 and 500 Ω . The delay line is suitable for many computer applications.

Booth No. 4910 Circle No. 273

For a complete listing of the technical papers at the show, see page U 112. For reprints of most of the papers, fill out the order form on page U 115.

Compact unit converts digital to synchro



Astrosystems, Inc., 6 Nevada Dr., New Hyde Park, N. Y. Phone: (516) 328-1600. P&A: \$1000 to \$2500; 6 to 8 wks.

This unit accepts a parallel 10-bit binary angle and provides a synchro output equivalent to the digital input. Inputs are compatible with microelectronic logic levels at updating speeds to 10,000 words per second. The conversion technique uses toroidal transformers and solid state ac switches to drive a load without the use of amplifiers. The unit provides a standard 3-wire synchro output signal of 11.8 volts at 400 Hz completely isolated from ground and input. Serial and parallel interfaces can be accommodated. Accuracy from no load to full load is 0.5° . The unit mounts in a RETMA rack.

Booth No. 4522 Circle No. 275

Switching modules drop into coax line

Hewlett-Packard, 1501 Page Mill Rd., Palo Alto, Calif. Phone: (415) 326-7000. P&A: \$100 to \$175; stock.

Hermetically sealed switching modules in HP's 3600 series are packaged as coax sections that can be inserted as part of a coax line. The units have a dc-to-18-GHz bandwidth, 0.5-to-2.2-dB loss and 1.5-to-2.3 VSWR. They can be brazed, clamped or pressed into place and match semirigid lines with 0.141- and 0.188-inch ODs. They can be adapted to 0.276-inch OD lines. Switching speed runs 10 to 50 ns.

Booth No. 2909 Circle No. 384

NEW

NPN / PNP

HI-QUALITY! HI-VOLTAGE!

SILICON TRANSISTORS

...Attention Designers! Satisfy Your Most Demanding High Voltage Requirements with the Following Premium Devices From...



NPN

TO-5 OUTLINE	V_{CER} V_{CBO}	V_{CEO}	I_{CBO}	$V_{CE(SAT)}$
2N5092	400V	350V	500NA	0.5V
2N5095 2N5101*	500V	400V	500NA	0.5V
2N5097	600V	450V	500NA	0.5V
2N5098	700V	500V	500NA	0.5V
2N5099	800V	550V	500NA	0.5V

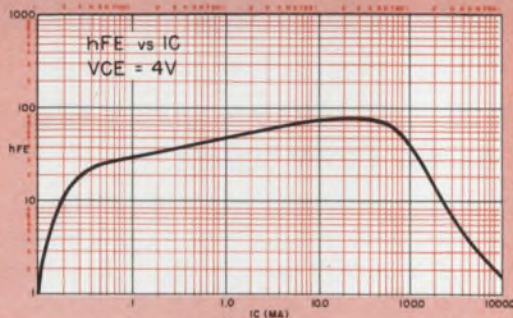

$h_{FE} > 25$ from $I_C = 1.0$ MA to I_C 100 MA
*MD-14 OUTLINE

PNP

TO-5 OUTLINE	V_{CER} V_{CBO}	V_{CEO}	I_{CBO}	$V_{CE(SAT)}$
2N5091	350V	300V	500NA	3.0V
2N5093	400V	350V	500NA	3.0V
2N5094 2N1510*	450V	400V	500NA	3.0V
2N5096	500V	450V	500NA	3.0V

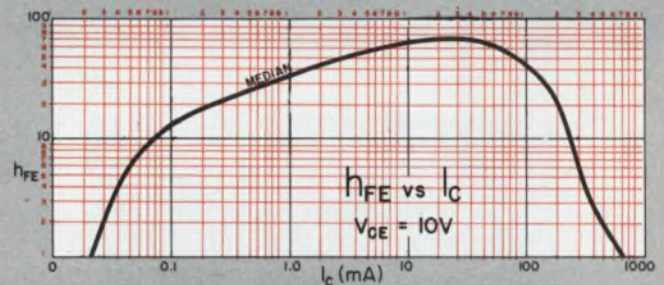

$h_{FE} > 20$ from $I_C = 1.0$ MA to I_C 100 MA
*MD-14 OUTLINE



INDUSTRO TRANSISTOR CORP.

35-10 36th Avenue • LONG ISLAND CITY, NEW YORK 11106

TELEPHONE (212) 392-8000

ON READER-SERVICE CARD CIRCLE 153



This is the fastest clutch or brake in the world!

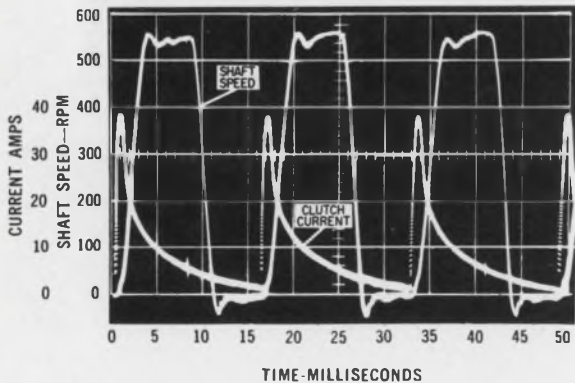
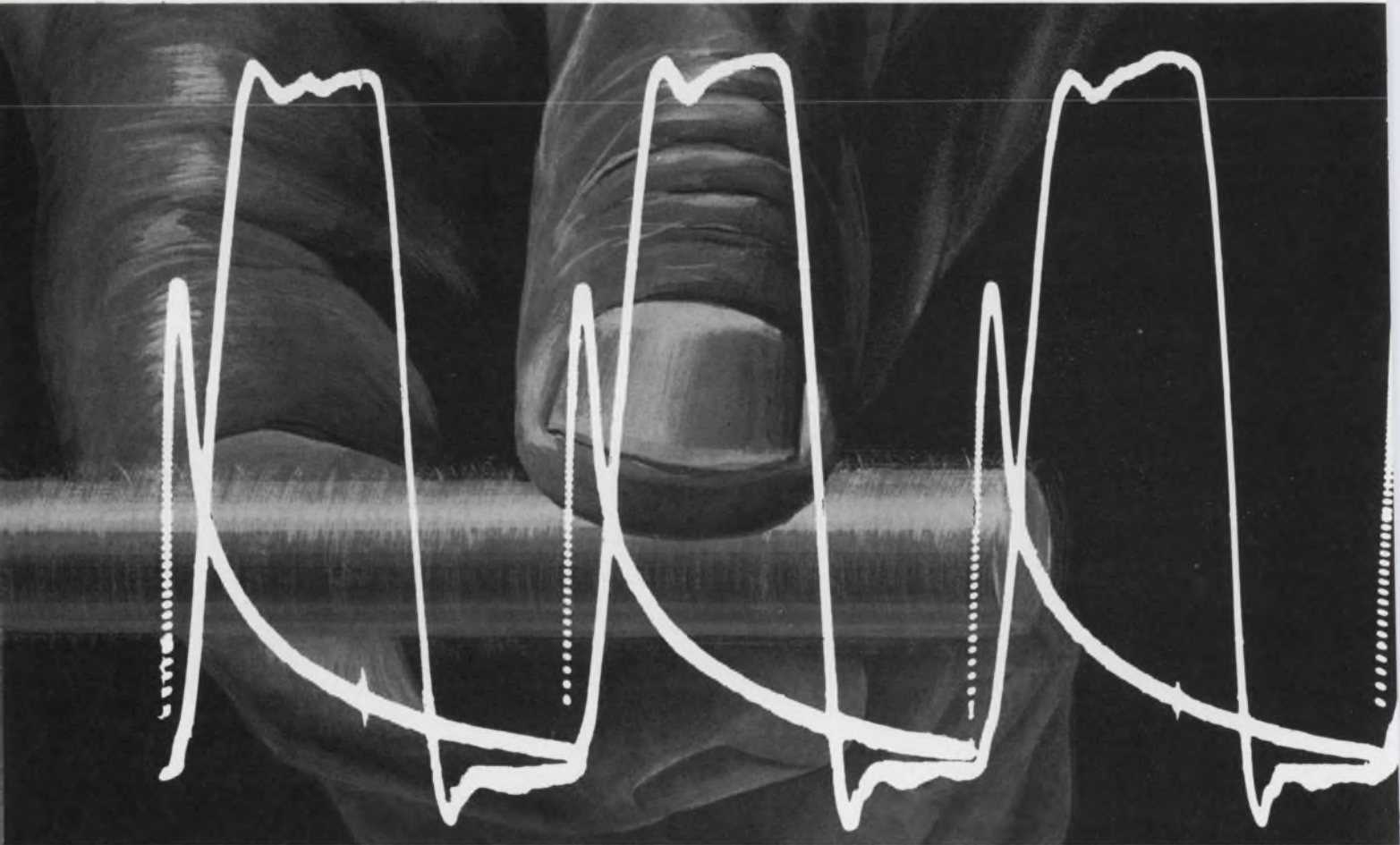

The **FASTEP** offers the fastest response on the market today. This scope picture illustrates the capability of a **FASTEP** clutch and brake to perform a high speed indexing function. The rate is 60 steps per second and the external inertial load is 100×10^{-5} lb. in. sec.². When the slope of the shaft velocity trace becomes a straight line, full torque has been achieved. In this case, it is less than $1\frac{1}{2}$ milliseconds from signal for constant acceleration, or full torque.

**RESPONSE SO FAST YOU CAN HARDLY FEEL IT . . .
PROVE IT ON YOUR OWN SCOPE!**

LSI's **FASTEP** clutch represents a new state-of-the-art in Magnetic Particle units. Used as either a clutch or a brake, it attains fast response yet it doesn't sacrifice the inherent advantages of soft starts and stops. Its capabilities include long life and repeatability. In fact, customer tests have substantiated life expectancy of over 500 million cycles. LSI magnetic particle clutches and brakes are used in a variety of applications including tape drives, numerical control, printers, remote actuation, tensioning devices and business machines.

LEAR SIEGLER, INC.



POWER EQUIPMENT DIVISION
P.O. BOX 6719 • CLEVELAND, OHIO 44101
Phone 216—662-1000

**You've
got to
see it
to believe it!**

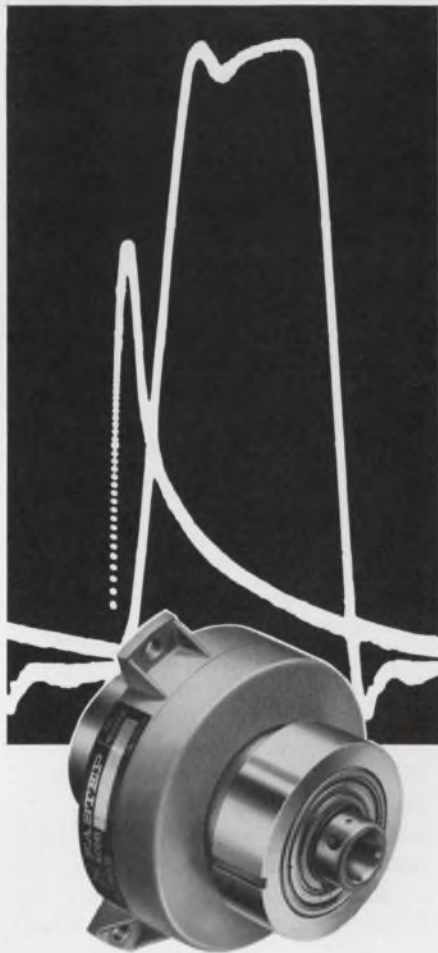

You can, because we'll have our *fastest* Magnetic Particle units in operation at our booth during the WESCON Show. So come in and see for yourself this amazing performance.

WESCON SHOW

AUGUST 22-25

SAN FRANCISCO

BOOTH 2013



ON READER-SERVICE CARD CIRCLE 154
ELECTRONIC DESIGN 17, August 16, 1967

COMMUNICATION & DETECTION

**Latching switches
carry 500 V rms**



Microwave Associates, Burlington, Mass. Phone: (617) 272-3000.

Specs of this 500-V latching switch include 60-dB interposition isolation from dc to 12.4 GHz, VSWR of 1.5 and insertion loss of 0.5 dB. Units can be stacked side-by-side for multichannel double-throw and other multiple switching uses. Latching is advantageous in applications in which switching power drain must be limited.

Booth No. 3723 Circle No. 374

**X-band multipliers
for fm transmitters**

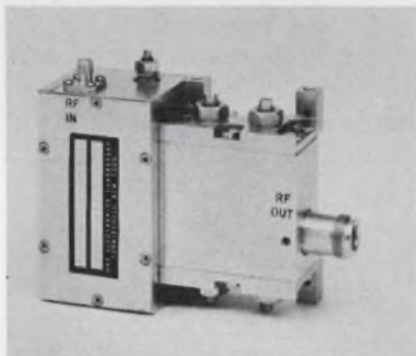

RHG Electronics Laboratory, Inc., 94 Milbar Blvd., Farmingdale, N.Y. Phone: (516) 694-3100. P&A: \$1495; 6 to 8 wks.

These units provide output powers to 2 watts in S band, 1 watt in C band, and 1/2 watt in X band. The use of step-recovery varactor multiplier diodes, coupled with an integral cavity filler assembly, provides efficiency with low spurious content.

Booth No. 3607 Circle No. 377

**Amersil
Fused Quartz
Tubing
Quality
Ensures
Dependability**

Use Amersil fused quartz for furnace muffles in temperatures up to 1400°C for

**DIFFUSION
·
CALCINING
·
SINTERING
·
DEPOSITION**

Economical operation is possible because of low inclusion content, high purity, and resistance to devitrification.

Sizes

Transparent
.040" to 9" dia.

Opaque
.125" to 25" dia.



885 RAMSEY AVENUE
HILLSIDE, NEW JERSEY 07205

ON READER-SERVICE CARD CIRCLE 155

U191

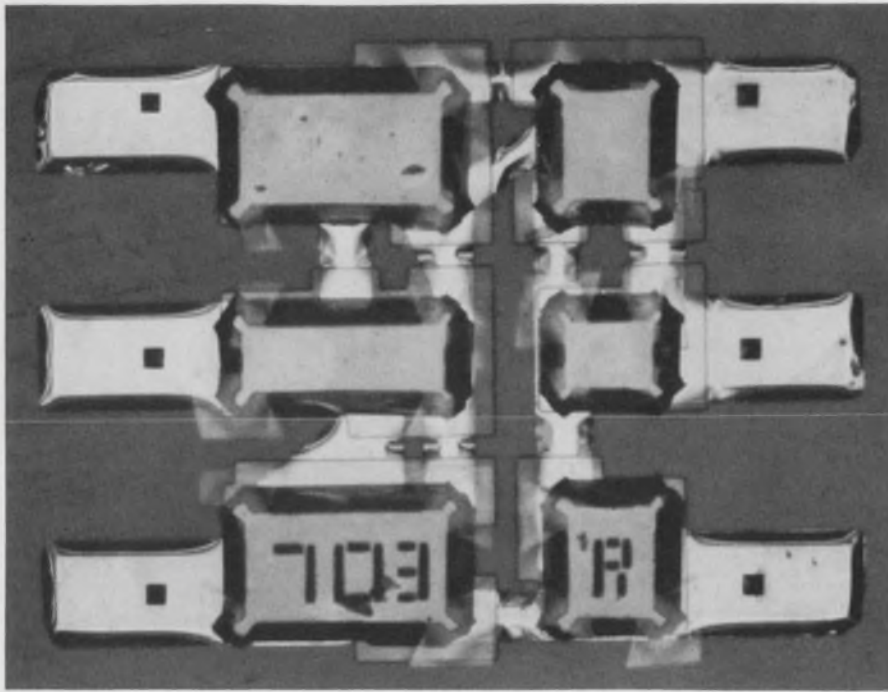

Beam leads, air isolation push 703 past 1 GHz for unity gain

Raytheon Semiconductors, 350 Ellis St., Mountain View, Calif. Phone: (415) 968-9211. P&A: about \$5 for military market; 8 wks (sample quantities).

A beam-lead version of the standard 703 rf-i-f amplifier has been developed by Raytheon Semiconductors. Using air-isolation to reduce parasitics, the circuit's unity-gain

frequency is pushed past 1 GHz.

The microcircuit's four resistors and two transistors are isolated from each other by air. Each component occupies its own little island of silicon, and the silicon islands are held together by thick gold leads, which also form the contacts.

The isolation of its components allows the rf amplifier a substantially higher frequency response

than its p-isolated counterpart. The latter's gain, for example, falls off to unity at about 100 MHz; the beam-lead version reaches 1 GHz.

Though the gold leads themselves are electroformed in the same way as the Bell Labs' beam leads (ED 4, Feb. 15, 1967, p. 17) the metallurgy that bonds the leads to the chip and makes good ohmic contact with the silicon is somewhat different. Where the Bell Labs method uses layers of platinum, titanium, and platinum between the gold lead and the glass, the Raytheon method uses a single layer of chromium. Where the Bell Labs method forms platinum silicide in the contact hole to insure low resistance between the silicon and the gold lead, Raytheon substitutes a different metal, which they choose not to reveal.

The advantage of the Raytheon system is that it does not require the use of sputtering or back-sputtering in the production of the chip. Instead, metal can be vapor deposited just as in the production of an ordinary circuit. Raytheon feels that the simplified production requirements of its metallurgy make it a natural for the development of high-volume, high-performance microcircuits.

The primary market for the new devices is expected to be in the area of military or satellite communications equipment. Since the air-isolation eliminates the substrate leakage currents, the beam-lead devices are much more resistant to high-radiation environments than are standard units.

Booth No. 4418

Circle No. 461

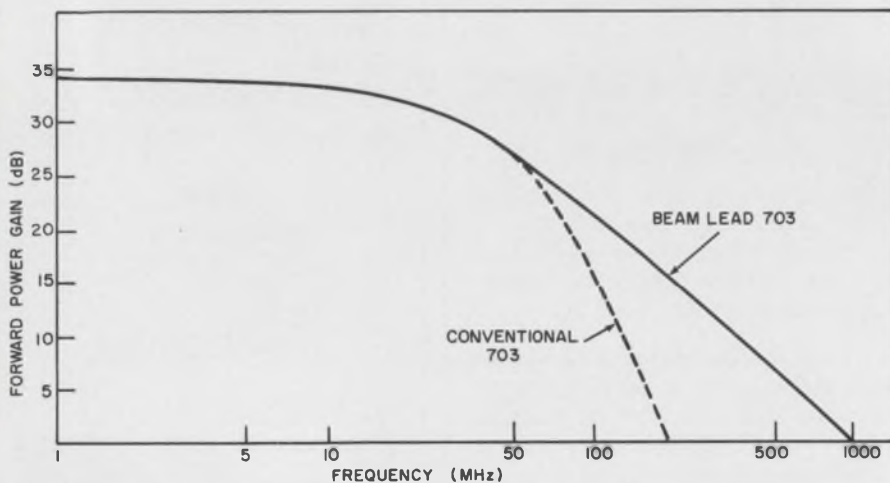

Reduced parasitics associated with air isolation improve roll-off of the 703. The 0-dB gain frequency moves from less than 200 MHz to past 1 GHz with 6-dB/octave roll-off. Component geometry itself is unchanged from the standard 703 layout.

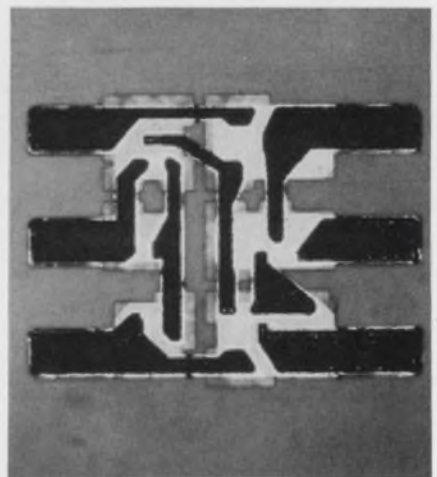

'Bottom' view of the 703 shows thick gold leads (dark areas). Corresponding light areas on chip photo above are chromium.

Support your local Resistance.



	Multi-purpose instruments			Resistance Bridges			Ratio/Deviation Bridges		
Model	250 DE	292	300	231	232	242	122	500	261
Range	.1 Ω -12M Ω	.1 Ω -1.2M Ω	.01 Ω -500M Ω	.01 Ω -12G Ω	.1 Ω -500M Ω	.001 Ω -120M Ω	.001 Ω -100M Ω	.1 Ω -111M Ω	10 Ω -2M Ω
Accuracy	.1%	.05%	.02%	.01%	.01%	50ppm	0.2ppm	.01%	.1%
Price	\$475	1380	875	2050	1075	3500	4000	2595	Appr. 350
Comments	R, C and L	R, C, L and G	R, E, I and Ratio			Ratio and deviation ranges	1:1, 10:1 ratios	Deviation ranges \pm 10% to \pm .01%	1:1 ratio \pm 1%, 5%, 20% ranges

Resistance measurement is very much a local matter, requiring resistance measuring instruments designed to match your local needs. Whether the job is production testing, on-line inspection, or laboratory calibration and certification—you want an instrument specifically tailored to the task.

The chart illustrates the wide range of approaches ESI can offer to meet your resistance measuring needs. Among them, you're sure to find the ranges, accuracies and special features that suit your particular application. In many cases, you may be able to answer a number of different electronic measurement requirements in a single multi-purpose instrument.

It's not by chance that every major manufacturer of precision resistors uses an ESI measuring instrument. You'll find, as they have, that ESI instruments are fast and easy to use. And they give you the greatest reliability and accuracy for your dollar. That's a good local cause to be supporting, ESI, 13900 NW Science Park Drive, Portland, Oregon 97229.

Electro Scientific Industries Inc. **esi**[®]
WESCON Booths 2717-18

ON READER-SERVICE CARD CIRCLE 156

NOW! Narrowband active filters with 20 and 24 Hz spacing from 350 to 3500 Hz.



Bundy's active filters makes available more frequencies for more channels.

Active bandpass filters in channel spacings of 20 Hz from 385 to 3495 Hz and 24 Hz from 353 to 3503 Hz. The 20 Hz active filter has a bandwidth of 5 Hz and a crossover attenuation of 12 db. The 24 Hz active filter has a 10 Hz bandwidth and 18 db crossover attenuation. That's a lot of performance in a package just 2" x 1 1/2" x 3/4".

Write for technical bulletin No. B-101.

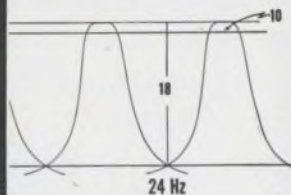
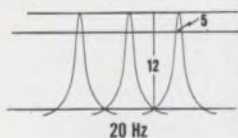

Bundy
ELECTRONICS
CORPORATION



Fadem Road • Springfield, N. J. 07081
Telephone: (201) 376-8150

CIRCUIT COMPONENTS

Hybrid mixer/LOs shrink receiver size

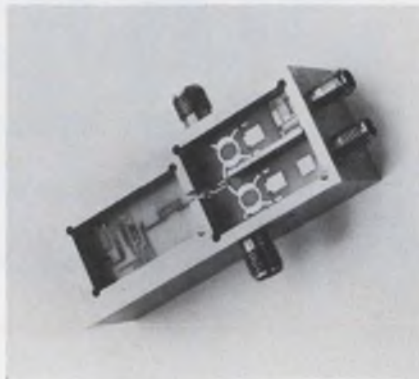

Microwave Associates, Burlington, Mass. Phone: (617) 272-3000.

A solid-state hybrid integrated mixer and local oscillator assembly using microstrip circuitry weighs 2 ounces with dimensions of 1 x 2.3 x 0.75 inches. Incorporated in the device are two Schottky-barrier diode balanced mixers and a transistor preamp in addition to an integrated microstrip local oscillator. This portion of the microwave receiver front end performs all of the mixing functions for the signal and afc channels, signal channel i-f preamplification and local oscillator generation. The two balanced mixers utilize two-element branch line couplers for the 3-dB power dividers and passivated silicon Schottky diode chips are mounted as the semiconductor device element. The balanced mixers have a 9-dB noise figure with an rf-to-i-f gain of 20 dB. The i-f frequency is 150 MHz with a 50-MHz bandpass. The LO module consists of an L-band transistor oscillator that has an output power of 200 mW. The oscillator feeds a X6 varactor multiplier and subsequently a bandpass filter for spurious rejection. The oscillator module has an output of approximately 10 mW at X-band with all spurious signals 30-dB down. An electronic tuning range of over 100 MHz is possible for electronic frequency control in an afc circuit.

The circuits use alumina substrates with the center conductors fired onto the alumina. The conductor is composed of silver, copper and gold. The coupling from substrate to substrate is made by a ribbon jumper soldered between the 50-Ω center conductors.

Booth No. 3723 Circle No. 259

Buy this ten dollar Philbrick Operational Amplifier

...and let everyone think
you paid twenty.
They'll believe it,
when they see
its performance.

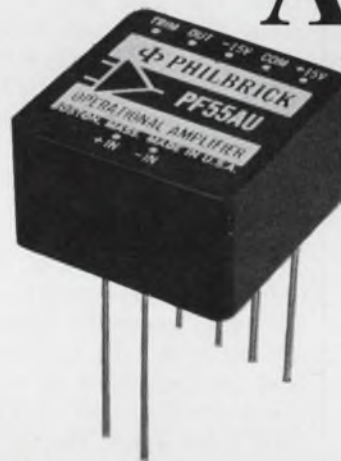

Plain language—our low prices come from volume-production savings and new packaging efficiencies. Others achieve them by cutting corners—thereby making your design job more expensive, more difficult, and more restricted.

Here's what we mean—Economy-Grade Philbricks give you *design resilience* the others don't have. Things like:

Safe, conservative operation at any supply voltage between ± 7.5 V and ± 22 V; a full ± 11 V output swing with a ± 15 V supply (even more at higher supply levels); gain to spare—enough to let you take full advantage of their low offset drifts; remarkably low quiescent power; exceptionally wide stability margins.

We know—that nine times out of ten, you would save money if you paid *twenty* dollars for a resilient Philbrick—but we don't ask you to; just pay what you would for a narrow-margin stiff one. Call us—we've

got what you want, at low prices you'll be surprised to find.

EXAMPLE: This new PF55AU preformed-case epoxy encapsulated miniature has open-loop gain of 40,000 driving $10k\Omega$, 1.5 MHz bandwidth, CMR of at least 1000:1, will slew at 1.5 V/ μ sec, 20 μ V/ $^{\circ}$ C offset limit, and all the resilience described above. It outperforms the cut-spec cheapies, yet it's a genuine Philbrick, through and through. PF55AU price: In lots of 1,000 . . . \$10.00 (even less in larger quantities.)

Send for new Operational Amplifiers price list and 12 page brochure: Bulletin 6111. Philbrick Researches, Inc., 46-G Allied Drive at Rte. 128, Dedham, Mass. 02026.

Phone: (617) 329-1600 TWX: (617) 326-5754.



GOING THE MICROCIRCUIT ROUTE? There's a resilient easy-to-stabilize Philbrick in a modified TO-5 package, too—at only \$6.95 (less in 100-lot quantities or more).

ELECTRONIC ANALOG COMPUTING EQUIPMENT for MODELLING, MEASURING, MANIPULATING and MUCH ELSE



PHILBRICK
A TELEDYNE COMPANY

ON READER-SERVICE CARD CIRCLE 158

The more you need from crystal filters, the more you need Bulova!

Today's sophisticated systems call for filters with "difficult" characteristics. Difficult, that is, for everyone but Bulova! Bulova has had so much experience with crystal filters, there's hardly anything we don't know about them;

Take single side-band filters, for example: Attenuation figures alone are not enough to adequately describe today's military communication filters. More and more filters require limitations on envelope time delay, while others must follow a precise time-delay envelope curve.

Bulova has been testing for these parameters — providing measurements both in terms of phase linearity and, in many cases, directly in envelope time-delay readings. As a result,

Bulova can engineer and produce to the exact measurements you specify. And at a realistic price!

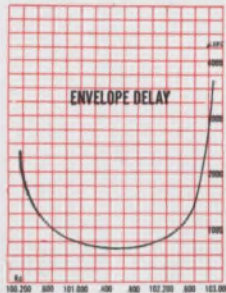

Proof: Here are the actual curves and specs for just one Bulova filter, Model 562.

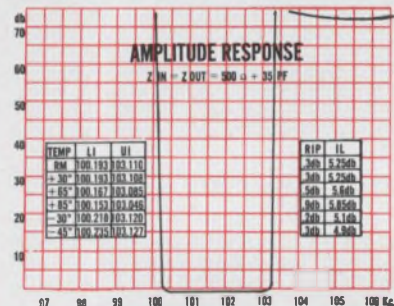

- Bandwidth (1db) 100.255 to 103.035 Kc
- Bandwidth (60 db) 99.990 to 103.260 Kc
- Carrier frequency — is 100 Kc
- Loss at carrier — 55 db min.
- Ultimate attenuation — 70 db
- Max. insertion loss — 6 db
- Max. ripple — 1 db max.
- Operating temperature— -40° to +65°C
- Impedance — 500Ω (in and out)
- Differential envelope time delay — 500 μsec max. over 80% of pass band

With specs like these you can see why we say — the more you need from a filter, the more you need Bulova! Call or write Dept. ED-21.

Try Bulova first!

FREQUENCY CONTROL PRODUCTS

ELECTRONICS DIVISION
OF BULOVA WATCH COMPANY, INC.

61-20 WOODSIDE AVENUE
WOODSIDE, N.Y. 11377, (212) DE 5-6000

ON READER-SERVICE CARD CIRCLE 159
U196

CIRCUIT COMPONENTS

Silicon transistor amplifies to 4 GHz

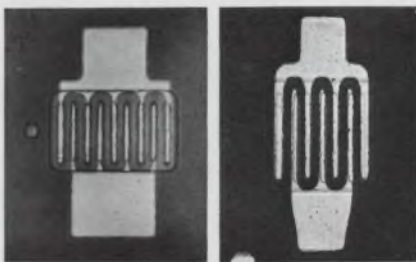

Texas Instruments, Inc., 13500
North Central Expressway, Dallas.
Phone: (214) 238-3741.

A pair of microwave silicon transistors are designed for practical oscillator applications above 4 GHz with a third device useful as an amplifier to 4 GHz, with guaranteed noise and gain performance at 2 GHz. The L-187 and 187A are fundamental oscillators with typical power output (at 4 GHz) of 40 and 75 mW. Both can be tuned over octave ranges, attaining maximum frequency of oscillation of approximately 6 GHz.

The amplifier, L-186, features a typical noise figure of 5 dB at 2 GHz. Common-emitter unneutralized gain under the same operating conditions is 8 dB. Higher gain with a slight increase in noise figure can be obtained by operating the device at 8 V and 5 mA. The 187 and 187A oscillators are also useful as amplifiers, delivering a somewhat higher saturated output than the 186. Gain is similar but noise figure is higher because of the higher operating current.

All three devices are npn double-diffused, epitaxial planar transistors, and all are available in a pill-type package for use in stripline circuitry. The package has common-lead inductance of 0.16 nH, and feedback capacitance of 0.02 pF. The oscillators are connected in a common-base configuration, and the amplifier common-emitter.

Booth No. 4105 Circle No. 357

For a complete listing of the technical papers at the show, see page U 112. For reprints of most of the papers, fill out the order form on page U 115.

Recirculating memory compatible with DTL

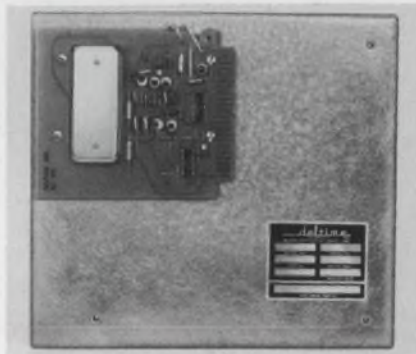

Sealectro Corp., Mamaroneck, N. Y.
Phone: (914) 698-5600.

Fully compatible with ICs, (DTL 930), this recirculating delay line memory module accepts a variety of delay lines to provide storage capabilities between 20 and 10,000 bits and delays between 20 and 15,000 μs. Applications include sequential information storage for CRT displays, buffer memories for teletype information and programing for numerically controlled machines. The module operates on -10 V dc at 20 mA, +10 V dc at 21 to 56 mA, +5 V dc at 35 mA, and includes trigger, inhibit and clock inputs.

Booth No. 4309 Circle No. 256

Rf power transistors designed 'fail-safe'

Amperex Electronic Corp., Slatersville, R. I. Phone: (401) 762-9000.

Silicon npn rf power transistors feature high power output and high power gain with excellent fail-safe characteristics. The low-voltage devices are intended for use in 12-V battery-operated 175-MHz mobile communication systems. The units are designed to withstand higher current surges without going into secondary breakdown. This minimizes the effects of short or open-circuit antenna or load mismatch.

Using the A200 as a low-power stage driver, the transistors produce 36 watts from a 0.12-W input source with a 3-device series-parallel arrangement.

All are single-chip devices, with the A200 packaged in a TO-39 case and the A201 and A202 enclosed in a TO-60 stud package.

Booth No. 3912 Circle No. 356

WHO'LL make the next breakthrough in EDP design?

Could be YOU: with Mosaic's Fiber Optics!

EDP systems design engineers are only beginning to tap the potential of fiber optics. Yet, after a brief acquaintance with this broad, new technology, they have made breakthroughs already . . . obsolescing "standard" EDP design solutions. Advances like greater speeds. Design freedom. New capabilities. Reliability and lower costs.

Did you hear about the oscillograph equipped with a fiber optic cathode ray tube? The CRT tube's electron beam is the writing device. Printout is nearly 100 times faster (1 million inches per sec.) than any direct-writing system in existence!

Do you know the story on Mosaic's Fiber Optic systems? In new EDP readers, printers, punched tape and card verifiers . . . in keypunch and teletype equipment, they're more dependable, less complicated, less costly and over 4 times faster than heat, wear and friction-prone mechanical systems!

Mosaic's fiber optics can help you make breakthroughs to advance the EDP state-of-the-art, too. Give those specific design problems of yours a hard look now. Then get going with the solution. Start by contacting Mosaic Fabrications, the people who know fiber optics inside-out . . . the largest single source of fiber optics technology, capability and productivity on earth!

Mosaic will work with you to solve your EDP design problems now . . . will help you design and develop,



from prototype to production, the specific EDP fiber optic hardware to put you way ahead!

Call or write Mosaic Fabrications, Inc.,
Galileo Park, Sturbridge, Mass. 01518,
(617) 347-9191 for descriptive literature today!

Bendix **Electronics**

ON READER-SERVICE CARD CIRCLE 160

WANTED

YOUR CLEANING PROBLEMS

**FREE LABORATORY
"CLEAN-TEST"***

Right now stubborn contaminants and faulty cleaning procedures are causing rejects, downtime and labor waste in your plant. Unnecessarily. There is an optimum way to remove every known contaminant . . . and L & R's laboratory will find it for you. Hardened greases, oils, fluxes, impacted waxes, finishing compounds, dust specks — anything — can resist ordinary cleaning techniques and adversely affect product performance.

***To have your components "clean-tested", simply send them to L & R just as they would come off the production line. After testing we will recommend the correct cleaning equipment, specific cleaning solutions and ideal cleaning procedures in detail. There is absolutely no cost or obligation for this service. Isn't it just plain good sense to use our experience in this vital aspect of your production? When sending samples for cleaning, please include brief description of present cleaning methods and production requirements.**

L & R
Ultrasonic
Cleaning
Unit,
Model 430 . . .

just one of many L & R Industrial
Cleaning Systems available from
1 pint to 5 gallon capacity.



L & R Manufacturing Company

577 Elm Street • Kearny, New Jersey 07032
(201) WY 1-5330

55 E. Washington St., Chicago 60602
215 W. 5th St., Los Angeles 90013
L & R Ultrasonics, Ltd., 20 Northburgh St.
London, E. C. 1, England

952 A

"See us at Booths 1001 & 1002, WESCON Show"

CIRCUIT COMPONENTS

Monolithic regulators give 2-A output

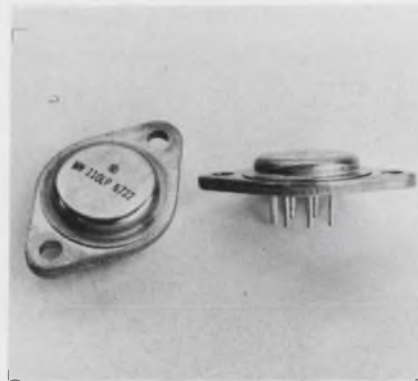

*Westinghouse, Molecular Electronics
Div., Elkridge, Md. Phone: (301)
796-3666. P&A: \$25 (over 50);
stock.*

The 2-A output of this unit is sufficient to drive 10-to-50-A power transistors to outputs from 5 to 25 A. For additional power-handling, a discrete power transistor can be added. The additional transistor will make the output stage a triple Darlington. The power transistor's heat sink must be isolated from the monolithic circuit's heat sink, and the power limitations of the IC must be observed. As a power supply regulator, it can produce 0 to 2 A from 8 to 48 V. An additional lead is provided so that external Zener references may be used. This permits the unit to be used for outputs less than 8 V. The case is at ground potential and it is possible in some systems to bolt the package to chassis or structural members for heat sinking without resorting to mica washers or other substances that impair the heat removal path. With a 5-mA constant current source, the WM 330 will deliver regulation of 0.1 to 0.2% for input variations of 20% and load variations of 0 to 1 A.

Short circuit protection is available by using a small series resistor at pin 2. This resistor connected to a transistor could cut the bias of the monolithic's Darlington and shut it down. The units can be used in systems as local regulators for noise isolation rather than one central power supply. The circuits can be inconspicuously spotted right onto the PC boards and mother boards for which they supplied the regulated power.

Booth No. 5205

Circle No. 383

INTRODUCING!



- **TINY-T® is the first relay of its kind**
- **.340" off-the-board height**
- **1000V. Interrupt**
- **10 Milliohms or less contact resistance**
- **Switches 150W. per contact**
- **100-Million operating cycles**
- **Inexpensive cost and operation**

OPERATIONAL SAMPLES AVAILABLE!

At last . . . here's the four-pole flatpack relay that everyone has asked for! Offering the ideal dimension off-the-board (.340"), the Tiny-T® features a standard .100 x .100 grid terminal layout, making it ideal for printed circuit board applications. ■ We'll gladly send you a sample at a special \$4.00 introductory price so you can put Tiny-T® to the test. Our representatives are ready for your orders in all quantities. So are we! ■



electronic controls, inc.

T-Bar Switch/Relay Div. • Danbury Road, Wilton, Conn.

phone (203) 762/8351

. . . See us at BOOTHS 5113-5114—WESCON '67 . . .

ON READER-SERVICE CARD CIRCLE 162



Electronic Controls, Inc.
Switch/Relay Division
Danbury Road
Wilton, Connecticut 06897

- Enclosed is our Purchase Order for \$4; please rush a Tiny-T Relay Sample.
- Have a representative call with more details.
- Send Bulletin #TB401 on the Tiny-T.

I anticipate using the Tiny-T Relay for _____

NAME _____ TITLE _____

DIVISION _____

FIRM _____

STREET _____

CITY _____ STATE _____ ZIP _____

Compare the
All-New PAMOTOR
Model 4500 with
the miniature
axial fan
you're now using!



COMPACT SIZE

Only 4 1/16" x 4 1/16" x 1 1/2". Weighs just 1 1/4 lbs. Interchangeable with similar, less reliable 4 1/16" fans.

POWERFUL MOTOR

Dependable shaded-pole motor operates with low internal heat rise. Efficient inside-out design.

ALL-METAL CONSTRUCTION

Precision die cast housing, hub, impellers. Corrosion resistant. Natural heat sink. Warp-free, unlike conventional plastic fans.

**115 CFM WITH LESS
THAN 37.5 dB SIL***

*Speech Interference Level

- Lubrication-free life in excess of 20,000 operational hours, continuous duty at 55° C.
- Delivers more air at a lower noise level, yet priced under similar conventional plastic fans.
- Model 4500 designed for 117V/50-60 Hz operation. Model 4550 operates at 230V/50-60 Hz.
- Now available for immediate delivery through leading electronic distributors or directly from factory stock.
- Has Underwriters' Laboratories Inc. Yellow Card Component Recognition Number E41168.

Write to
PAMOTOR, INC., 312 Seventh St.
San Francisco, California 94103.

PAMOTOR, INC.

ON READER-SERVICE CARD CIRCLE 163

U200

CIRCUIT COMPONENTS

Pulse transformers trigger xenon lamps

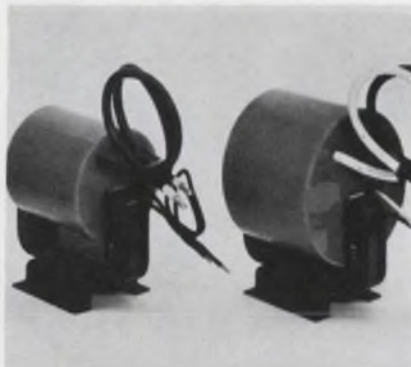

Pek, Inc., 825 E. Evelyn Ave., Sunnyvale, Calif. Phone: (408) 245-4111. P&A: \$125, \$175, \$250; stock.

Designed for series-triggering xenon flash lamps, these trigger pulse transformers have special applications in flash photolysis and high-performance pulsed laser operation. The three models feature long term secondary rms current ratings of 20, 30 and 40 A with peak secondary current ratings of 10, 14 and 12 kA. Saturated secondary inductance is 16 μ H and secondary resistance is 2.5 M Ω .

Booth No. 4414 Circle No. 261

Economy hybrid isolator has infinite Z_{in}



Nexus Research Laboratory, Inc., 480 Neponset St., Canton, Mass. Phone: (617) 828-9000. P&A: \$24 (1 to 9); stock.

This unity-gain noninverting isolation amplifier features very high input impedance and wide bandwidth. The amplifier has unity gain to an accuracy of typically 0.02%. Its impedance at dc is 10¹² M Ω . Output voltage range is \pm 10 V into a 5-k Ω load.

Booth No. 2420 Circle No. 327

Silicon power transistor sustains 80 volts

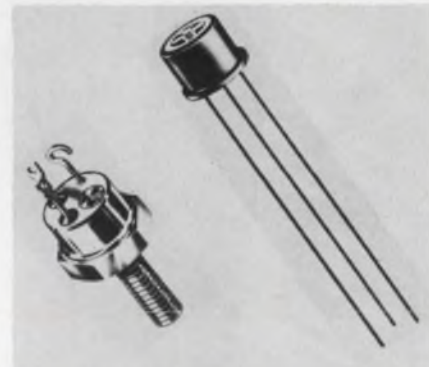

Silicon Transistor Corp., East Gate Blvd., Garden City, N. Y. Phone: (516) 742-4100. P&A: \$8 to \$16 (100 lots).

A line of pnp silicon single-diffused power transistors offers sustaining voltages of 40 volts for the 2N5110 and 80 volts for the 5111. Both are offered in the TO-5 package. The equivalent 2N5112 and 5113 are packaged TO-59. All are designed with a 1-A collector current and dissipate 5 W at 25° C in the TO-5 package, 34 watts in the TO-59 package.

Booth No. 5323 Circle No. 349

Dc regulators give 1-A outputs

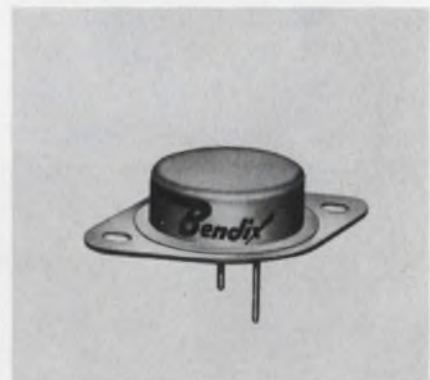

Bendix Corp., Semiconductor Div., Holmdel, N. J. Phone: (201) 747-5400. Price: \$4 (1000 up).

Low cost 1-A dc voltage regulator modules are contained in a JEDEC TO-3 package and fit all standard heat sinks. They are available in units rated at 5, 6, 12, 18 or 25 volts, \pm 10% setting tolerance. Load regulation is \pm 2% from minimum to maximum load. Temperature coefficient is 0.1%.

Booth No. 2812 Circle No. 260

What has the little red school house got to do with engineering?



In the context of the Little Red School House, our publication serves as a "blackboard" for the communication of knowledge . . . knowledge that is vital to the creative force within the electronics industry, specifically the 155,000 engineering and engineering manager readers of Electronic Design. The communicators of this knowledge are our editors. They are engineers who find enjoyment and satisfaction

discovering, analyzing, interpreting, reporting and teaching through the pages of Electronic Design.

If you've ever thought about teaching, consider communicating in another dimension as an editor of Electronic Design. The rewards can be many. Call or write Howard Bierman, our Editor, or drop by our booth at Wescon.



Hayden Publications
850 Third Avenue
New York, N.Y. 10022

Who makes specialized card packaging hardware? Scanbe does!

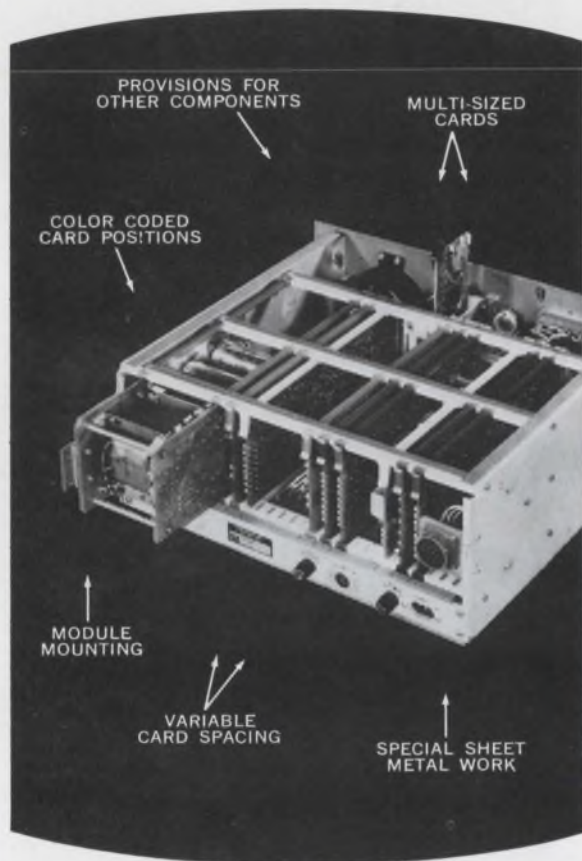

The design and manufacture of special card packaging configurations to your specifications is our business.

- **Specialized design and engineering** capability ready to assist you.
- **Specialized Factory facilities** equipped to handle high volume production as well as prototypes and small runs.
- **Specialized components** for high density, unusual shapes, and environmental applications.

Look to one source for all your card packaging requirements. Contact Scanbe, the specialist for electronic packaging hardware.

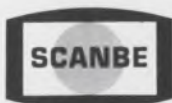

SCANBE MANUFACTURING CORP.

1161 MONTEREY PASS RD., MONTEREY PARK, CALIF. 91754

TELEPHONE (213) 264-2300

TWX 910-321-4336

Distributor Inquiries Invited

CIRCUIT COMPONENTS

Economy op amp has FET input

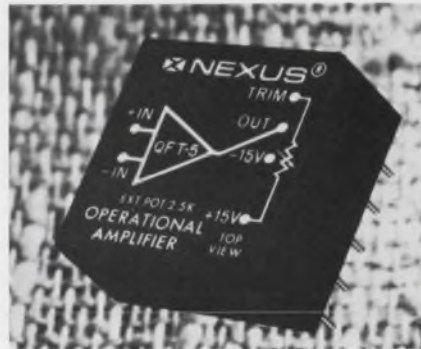

Nexus Research Laboratory, Inc.,
480 Neponset St., Canton, Mass.
Phone: (617) 828-9000. P&A: \$29;
stock.

The QFT-5 provides $10^{10} \Omega$ differential and common-mode impedances, less than 1-nA of input offset current, and high tolerance to capacitive loads. Its output voltage range is ± 11 V at ± 5.5 mA. The supply voltage is ± 15 V. The unit rolls off at 6 dB/octave.

Booth No. 2420 Circle No. 326

Molded MIL chokes available to 1000 μ H

Cambridge Thermionic Corp., 445
Concord Ave., Cambridge, Mass.
Phone: (617) 491-5400. P&A: 22¢
to 33¢ (100 to 249); stock.

Molded chokes in 3 series conform to MS 75052, 75053 and 75054 respectively. The first covers inductance values from 47 to 150 μ H in a 0.25-inch diameter by 0.56-inch long package. Q ranges from 18 to 75. The second covers 180 to 390 μ H in a configuration of 0.31-inch diameter by 0.56-inch long. Q values span 80 to 75. Another series spans 470 to 1000 μ H and measures 0.375-inch diameter by 0.625-inch long. Q values are 80 through 70. All chokes are hot molded using epoxy and are color-banded.

Booth No. 4103 Circle No. 265

For a complete listing of the technical papers at the show, see page U 112. For reprints of most of the papers, fill out the order form on page U 115.

An engineering forum is supposed to be a discussion. Somehow I get the feeling that Switchcraft is going to be doing all the talking.

We sincerely hope not. We want the Forum to be truly an interchange of ideas on the technical aspects of the products we make, let the chips fall where they may. A "switch craft" forum as well as a "Switchcraft Forum."

We hope that, with a lively response from design engineers in the field, we can develop enough questions and ideas so that a future Forum might examine, for example, all sides of a single aspect of a single type of switch, whether you agree with our viewpoint or not.

(Obviously, as we are paying for the space, we will make a solid attempt to convert you to our viewpoint.)

For this, our first edition, we will have to start the ball rolling, which means we will be doing most of the talking.

We thought a good place to start would be a discussion of stack switches and, naturally, why our stack switches are best.

Naturally. But why lead off with stack switches? Why not one of the newer, more exotic circuit controls?

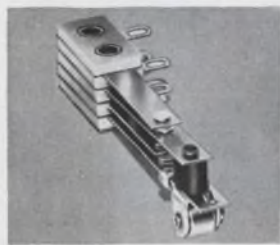

Typical stack switch assembly

large silver contacts solidly staked to the spring. This forms a pointed contact which mates with a flat contact. The result is higher unit pressure and lower contact resistance. (See figure).

For dry circuit or low level applications, palladium, silver or gold contacts are welded, rather than riveted, to the spring for low contact resistance and bond strength uniformity.

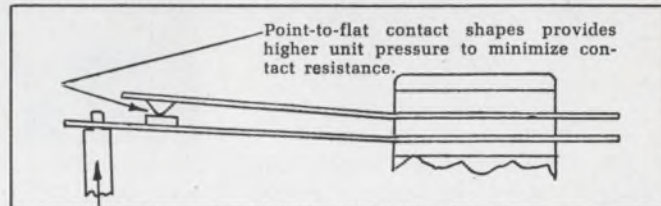

Sounds good so far, but what other engineering factors are involved?

And you were worried that we would be doing all the talking. We don't have space here to even get into all the engineering parameters involved.

But we do have a comprehensive engineering article and a catalog we would be happy to send you. (Check the Reader Service Number below).



Just briefly, we could cover one more point. Insulation. XP and XXP Phenolic fibre insulators have about the same breakdown voltage.

XXXP has better insulation resistance, less leakage current. We use nothing but the XXXP.

In a nutshell, Switchcraft offers a well-designed, quality-constructed stack switch for just about every application an engineer would ever have for a stack switch. And Switchcraft prices are competitive, right down the line.

SWITCH CRAFT FORUM

Versatility can be pretty exotic. And that's what stack switches are. You have a wide selection of contact materials, insulation, mounting and actuation methods. Versatility is an integral part of stack switches and a quality line such as ours should be a basic component in every engineer's design arsenal. **Impressive. But how about some specifics?**

Quality is very specific. It is definitely related to materials and manufacturing techniques. Switchcraft quality is easy to explain.

For instance, all of our stack switches use a special nickel silver alloy for the contact and actuator springs. This material is fabricated to our specifications on hardness to assure proper characteristics for long switch life. We gain a 10% improvement in tensile strength over switches made with other spring materials.

Let's talk about contact assemblies. For typical medium level stack switch applications, we offer

I'm beginning to think your Forum idea will work. But how are you going to get more engineers to join in? Ask the right questions? Come up with ideas?

That's what we're doing right here. If you have anything to ask, or say, about any type of switch we make, or for that matter any type of product we make, send us your questions or comments. If your questions are loaded, or controversial, so much the better. This is where product development comes from.

We're waiting to hear from you.

SWITCHCRAFT
INC.

5529 N. Elston Ave.
Chicago, Ill. 60630

Time-delay relays fixed or adjustable



Potter & Brumfield, Princeton, Ind. Phone: (812) 385-5251. Price: \$12.50.

Low-cost time-delay relays are designed for delay on operate applications in machine tool controls, coin-operated machines or process controls. Two versions, fixed time delay on operate and resistor adjustable, are offered in ac and dc models. Timing ranges of 1, 5, 10, 30, 60 and 120 seconds are available. Timing tolerance is $\pm 5\%$, reset time is 100 ms. Relay contacts are rated at 10 A at 28 V dc or 120 V ac.

Booth No. 4101 Circle No. 255

Tubular feedthrough accepts 2 leads



Seaelectro Corp., 225 Hoyt, Mamaroneck, N. Y. Phone: (914) 698-5600.

With dual tubular lugs mounted in a single Teflon bushing, this two-pin feedthrough terminal is designed for multiconnection applications. Component leads come up from beneath the chassis, through holes in the lugs and are then soldered in place. Circuit wiring can then be attached to the outer lugs, completing the package. The unit is made of Teflon and has gold flash over silver-plated brass lugs measuring 0.207 inch and lugs with soldered areas 0.045 inch in diameter.

Booth No. 4309 Circle No. 263

Time delay relays withstand line changes

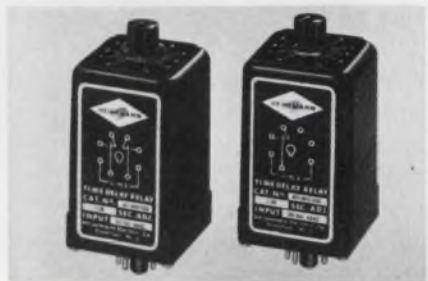

Heinemann Electric Co., Magnetic Dr., Trenton, N. J. Phone: (609) 882-4800. Price: \$20 and \$26.

Using a solid-state timing circuit, this relay's delay time, within the total range, is adjusted by a self-contained pot and is not subject to extreme time variations caused by changes in line voltage. A time interval repeatability of $\pm 2\%$ at 70°F and 115 V ac is not affected by line variations from 100 to 135 V ac. The unit is available in two models: delay-on-make and delay-on-break. Corresponding ranges are 1 to 60 and 1 to 30 seconds.

Booth No. 3921 Circle No. 262

EASTMAN 910[®] Adhesive offers... reduced bonding costs in precision gaging instruments.

EASTMAN 910 Adhesive reduces the component assembly costs of the Sheffield Electrojet[®] precision gaging transducer. Manufactured by Bendix Corporation's Automation and Measurement Division, this transducer, a mechanical contact type size sensing unit is widely used in the automo-



Here are some of the bonds that can be made with EASTMAN 910 Adhesive

Among the stronger: steel, aluminum, brass, copper, vinyls, phenolics, cellulose, polyesters, polyurethanes, nylon; butyl, nitrile, SBR, natural rubber, most types of neoprene; most woods. Among the weaker: polystyrene, polyethylene (shear strengths up to 150 lb./sq. in.).

tive and machine tool industry.

Applied to junctions where pressure bonding is impractical, EASTMAN 910 Adhesive is used to bond acrylic to acrylic, to steel and to brass. Long lasting bonds are made in seconds, at room temperature with only contact pressure. With use of this adhesive, manpower and material costs have been reduced. Not one bond failure has been reported during five years of use.

EASTMAN 910 Adhesive will form bonds with almost any kind of material without heat, solvent evaporation, catalysts, or more than contact pressure. Try it on your toughest bonding jobs.

For technical data and information, write to Chemicals Division, EASTMAN CHEMICAL PRODUCTS, INC., subsidiary of Eastman Kodak Company, Kingsport, Tenn. EASTMAN 910 Adhesive is distributed by Armstrong Cork Company, Industry Products Division, Lancaster, Pa.

There is no adhesive like EASTMAN 910[®] Adhesive



- SETS FAST**—Makes firm bonds in seconds to minutes.
 - VERSATILE**—Joins virtually any combination of materials.
 - HIGH STRENGTH**—Up to 5000 lb./in.² depending on the materials being bonded.
 - READY TO USE**—No catalyst or mixing necessary.
 - CURES AT ROOM TEMPERATURE**—No heat required to initiate or accelerate setting.
 - CONTACT PRESSURE SUFFICIENT.**
 - LOW SHRINKAGE**—Virtually no shrinkage on setting as neither solvent nor heat is used.
 - GOES FAR**—One-pound package contains about 30,000 one-drop applications. (Or in more specific terms, approximately 20 fast setting one-drop applications for a nickel.)
- The use of EASTMAN 910 Adhesive is not suggested at temperatures continuously above 175°F., or in the presence of extreme moisture for prolonged periods.

See Sweet's 1967 Product Design File 6a/Ea.

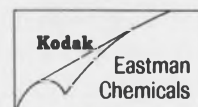

Take a close look at the total area your present Monolithic Integrated Circuit Differential Amplifiers are using, and compare with the new ZELTEX 161/162 Hybrid Circuit family. These high-reliability devices are truly universal. They flush mount in less space than splayed-lead TO cans and require no external components to insure stability in all modes of operation. ■ Performance? Model 162, for example, is the only FET IC Diff Amp on the market and, like the rest of the family, it's burnout-proof! ■ So, take a close look at ZELTEX integrated Circuit Amplifiers now. The price is as small as the size — totally!



Key Specifications — Model 162

- Input Impedance 10^{11} ohms
- DC Gain 200,000
- Input Current 25pa
- Fully Stabilized (-6db/octave)
- Output $\pm 10v$ @ 4ma
- Drift $10\mu v/^{\circ}C$
- Common Mode Voltage 10v
- Short Circuit Proof

Zeltek Inc., 1000 Chalomar Road, Concord, California 94520, Phone (415) 686-6660

*total
size
is what
makes an
IC amplifier
universal*

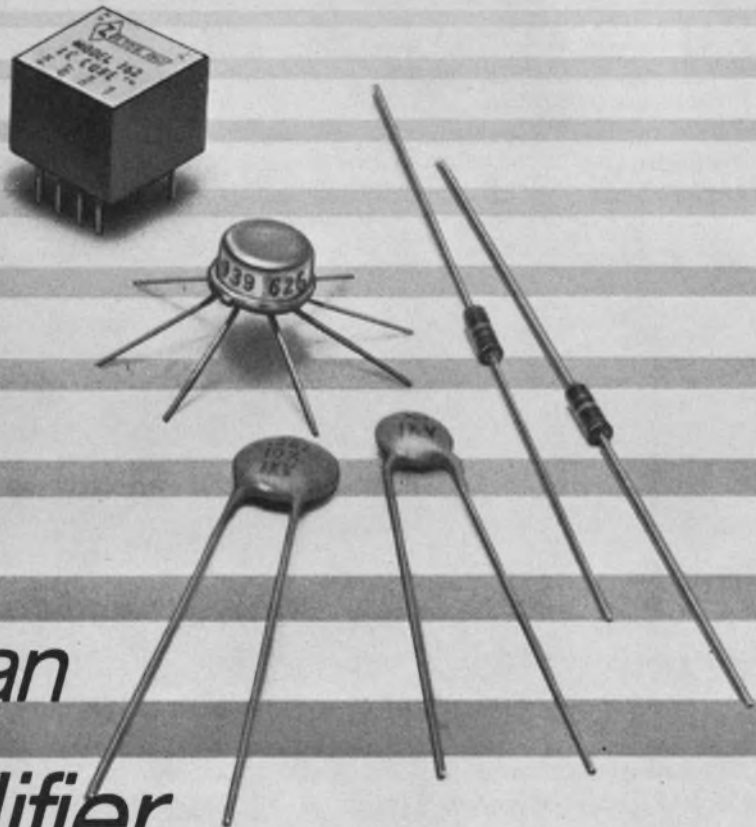

ON READER-SERVICE CARD CIRCLE 169

it costs you nothing to call on experience:

Reeves-Hoffman design and manufacture
is 100% custom . . .
let us quote your needs!

★ quartz crystals

★ crystal filters

★ oscillators

★ discriminators

★ standards

★ ovens



400 WEST NORTH STREET, CARLISLE, PENNSYLVANIA 17013
Telephone 717-243-5929

Md., Del., D.C., Va., W.Va., N.C.
Valley Electronics, Inc.
Baltimore, Maryland
(301)668-4900; (202)659-1760

New England
Howard Jappe Company
Wakefield, Mass.
(617)245-9359

Pa. (except Pittsburgh), So. N.J.
Eastern Components, Inc.
Philadelphia, Pa.
(215)927-6262

New York (except N.Y.C.)
Midstate Research Sales Co.
Syracuse, New York
(315)478-8314; (315)478-0715

New York City, No. N.J.
G M Moch Company
Ridgefield, New Jersey
(201)945-0080; (212)279-6758

So. California
Ash M. Wood Company
Arcadia, California
(213)283-1201; (213)287-0449

No. California
L & M Engineering
Santa Clara, Cal.
(408)243-6661

Ill., Ind., Wisc., Minn.
PGM Sales, Inc.
Chicago, Illinois
(312)622-8183

Ohio, W.Pa., Mich., Ky.
Tri-State Marketing, Inc.
Cincinnati, Ohio
(513)631-5060

Texas, Okla., Ark.
Carter Associates, Inc.
Garland, Texas
(214)276-7151

Ariz., N.M., Las Vegas
Carter Associates, Inc.
Scottsdale, Arizona
(602)947-4355

ON READER-SERVICE CARD CIRCLE 182



"I DON'T MIND PAYING A LITTLE LESS"

With An Airways Businessman's Credit Card He'll Save Even More Money

Being a practical man and a business traveler, this man knows he qualifies for a special Rent-A-Car discount by presenting his AIRWAYS BUSINESSMAN'S CREDIT CARD at any of over 200 AIRWAYS offices. He knows AIRWAYS regular rates are lower than other rent-a-car companies including their 20% corporate discounts. With an AIRWAYS BUSINESSMAN'S CREDIT CARD he knows he'll enjoy even greater savings. He knows AIRWAYS provides 1967 Chevrolets, Buicks, Pontiacs—even Cadillacs. He also knows he'll save time because he simply calls when he arrives at the airport and AIRWAYS will probably arrive before his luggage. We have downtown offices, too. **He knows it — AIRWAYS knows it — now YOU know it.**

Send for your free AIRWAYS BUSINESSMAN'S
CREDIT CARD now. Write to: Dept. 6ED

AIRWAYS RENT-A-CAR

8405 Pershing Drive
Plaza Del Rey, California 90291

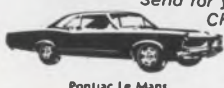

Pontiac Le Mans



ON READER-SERVICE CARD CIRCLE 183

CIRCUIT COMPONENTS

Rotary switch ends knob twirling

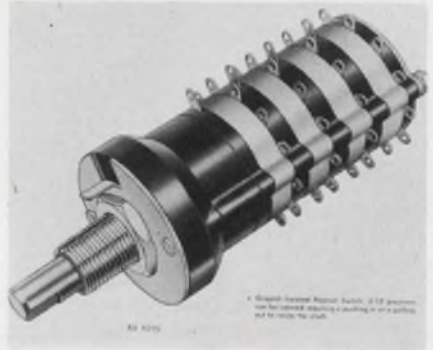

Grayhill Inc., P. O. Box 373, La-
grange, Ill. Phone: (312) 354-1040.

An isolated-position rotary switch prevents knob twisters from turning on or turning off one or more circuits. Any combination of switch positions can be isolated by requiring either a push or pull of the rotary switch shaft by the operator before the isolated position can be reached. Typical applications include equipment that requires an off or calibrate position and/or a stand-by position. Externally, the isolating mechanism appears as an additional switch deck without terminals located immediately behind the detent system. This feature is available with up to 4 decks with 30° angle of throw.

Booth No. 4111 Circle No. 252

Vacuum fixed caps rated at 12 kV



ITT Jennings, P. O. Box 1278, San
Jose, Calif. Phone: (408) 292-4025.

With capacities ranging 1 through 5 pF, these fixed capacitors combine a high-strength ceramic housing and low-loss copper plates with vacuum dielectric. The capacitors are 0.77 inch in diameter and 3.25 inches in length. Peak voltage is 30 kV at 60 Hz. Current ratings are as high as 12 A rms at 20 MHz. Operating temperatures are up to 125°C.

Booth No. 3807 Circle No. 267

Comar doesn't shy away from the tough one's



Anyone can handle the easy relay applications, but it takes a company with engineering knowhow, manufacturing superiority and just plain "guts" to take on the tough one's.

The engineers at Comar have an enviable record of rolling up their sleeves and burning the midnight oil to meet stringent relay specifications . . . shock, vibration, miss testing, humidity, special operating characteristics.

The next time someone tells you "it can't be done," call Comar. No miracles, just technical experience and the finest relay test laboratory in the world!



Comar electric company

3349 Addison Street
Chicago, Illinois 60618

TELEPHONE TYPE RELAYS • SUBMINIATURE RELAYS •
RELAY ASSEMBLIES • SOLENOIDS • SOLENOID ASSEMBLIES

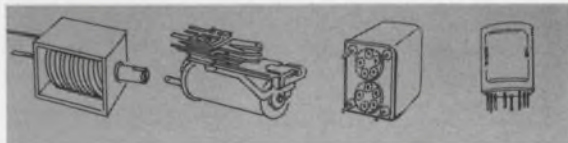

ON READER-SERVICE CARD CIRCLE 184



MEET THE HEAD

that solved the problem
for \$41.75

Double, multi-diameter heads with nib for precision positioning040", 18 gauge copper wire . . . nominal tolerances: $\pm .0003$ " wire diameter . . . $\pm .002$ head concentricity . . . $\pm .001$ distance between heads . . . $\pm .001$ nib length . . . 8 times actual size.

What's your problem . . . design . . . material . . . plating . . . production . . . For precision formed wire heads that withstand . . . pulling . . . bending . . . twisting, contact . . .

EMPORIUM SPECIALTIES INC.
Wire Forms Division

Plant and Engineering: Austin, Pennsylvania
General Sales Office: 2800 East 116th Street
Cleveland, Ohio 44120
Telephone: (216) 795-1640

ON READER-SERVICE CARD CIRCLE 185

TERMINAL BLOCKS

CURTIS

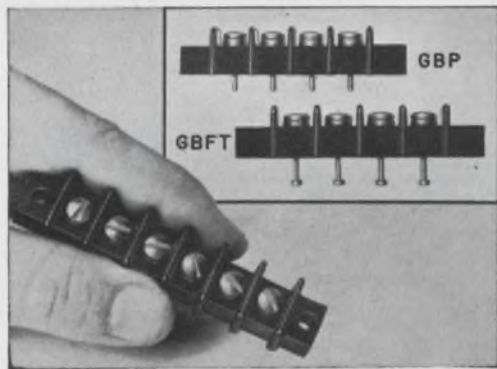

FEED-THRU GB-SERIES

Versatile flat base feed-thru terminal blocks with choice of interior turret-type solder terminals or .062 dia. printed circuit pins. Inserts are bright tin plated for excellent solderability, conductivity, and long shelf life.

Rated — 20 amps, 300 volts.

Available — 1 to 18 terminals, $\frac{3}{16}$ " center-to-center terminal spacing. #6-32 screw connections accept up to #12 AWG wire.

FREE! Full details, descriptions and prices in new Curtis 24-page illustrated catalog.

CURTIS DEVELOPMENT & MFG. CO.
3236 N. 33rd St. • Milwaukee, Wis. 53216



SEE US AT WESCON, BOOTH 1013
ON READER-SERVICE CARD CIRCLE 186

CIRCUIT COMPONENTS

One-piece carrier for 1/4-inch flat packs

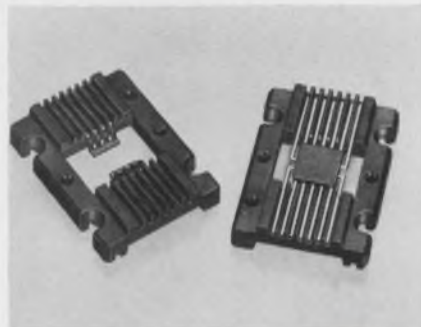

Barnes Development Co., 213 West Baltimore, Lansdowne, Pa. Phone: (215) 622-1525. P&A: 1¢ to 10¢; stock to 10 days.

For 1/4 x 1/4 inch flat packs, this carrier uses an integrally molded device retention feature that protects the IC. The carriers are molded of polysulfone for continuous operation from -65°C to 150°C . They are designed for automated and semiautomated testing and handling, including handling in both magazines and bowl feeders.
Booth No. 4905 Circle No. 358

Turbine-impeller blower outdoes squirrel-cage



Rotron Manufacturing Co., Inc., Woodstock, N. Y. Phone: (914) 679-2401.

This turbine-impeller blower delivers more air with greater efficiency than conventional squirrel-cage units. The unit delivers up to 250 cfm at free delivery from a substantially smaller, maintenance-free package. No centrifugal starting switches or relays are used, eliminating the cause of most single-phase motor failures. The blower is designed for electronic cabinets requiring large volumes of cooling to be delivered against high static pressures.

Booth No. 4415 Circle No. 253

The Victor Digital Printer, just \$335. \$335?

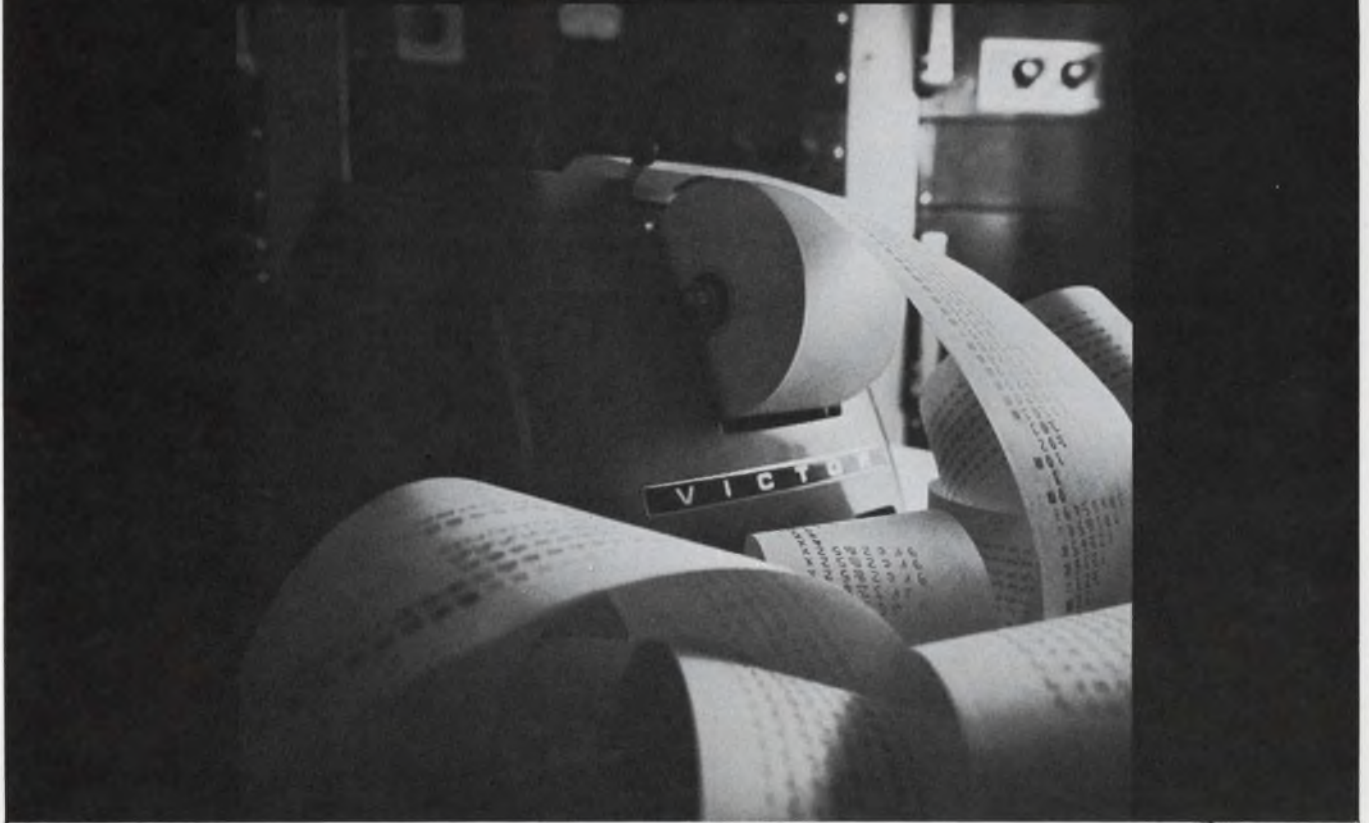

That's right; the Victor Digit-Matic does what any high quality serial entry printer does. And for less money. The Digit-Matic lists 8-column figures from remote sources, on either 24 or 48 volt solenoids. Printing press action reduces wear, eliminates parts, and assures clear, uniform print-out under all conditions.

For just \$50 more, the Digit-Matic will also add and subtract. Ten-column capacity, just \$20 more!

Factory-trained service representatives located across the country. OEM and quantity discounts available.

Wherever clear print-out is required, call for a Victor Digit-Matic specialist. Write: Victor Comptometer Corporation, Business Machines Group, 3900 N. Rockwell St., Chicago, Ill. 60618.

**Call on Victor
and you're in business.**



VICTOR CALCULATORS • ADDING MACHINES • CASH REGISTERS • TEMPORARY HELP • ELECTROWRITER COMMUNICATIONS

ON READER-SERVICE CARD CIRCLE 187

THE BEST IN PRODUCT DESIGN

Here are the six winners of WESCON's 1967 industrial-design awards of excellence and the 10 other finalists that competed against them. All these products will be on display at the show.

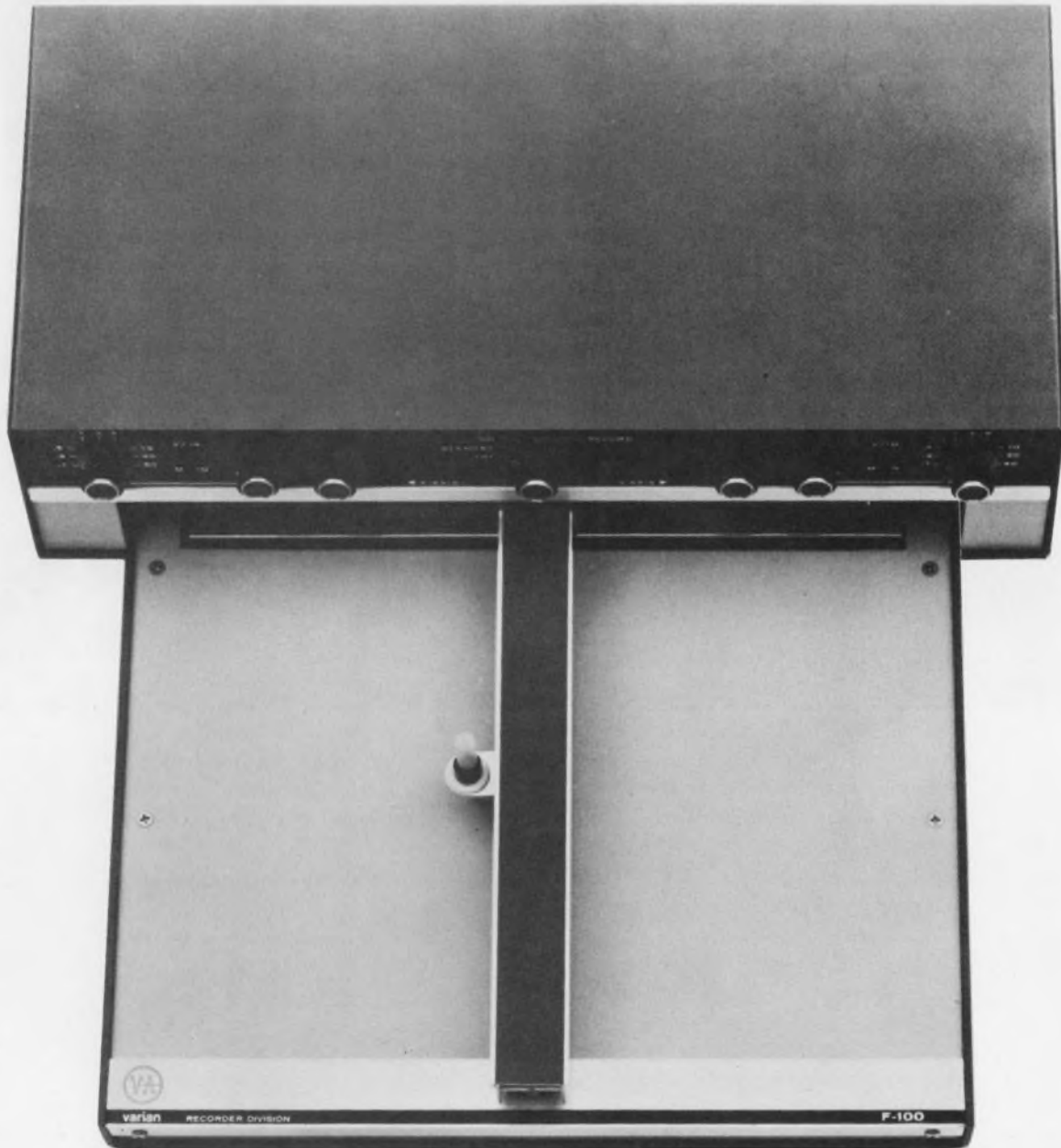

X-Y graphic recorder contains no moving parts; the reverse side of the chart paper is coated with a passive iron ink that holds the paper down on the platen, which acts as a large magnet. Nonmagnetized paper can be held down simply by throwing a paper clip on top.

Company: Varian Associates
Designer: Anthony P. H. Chan

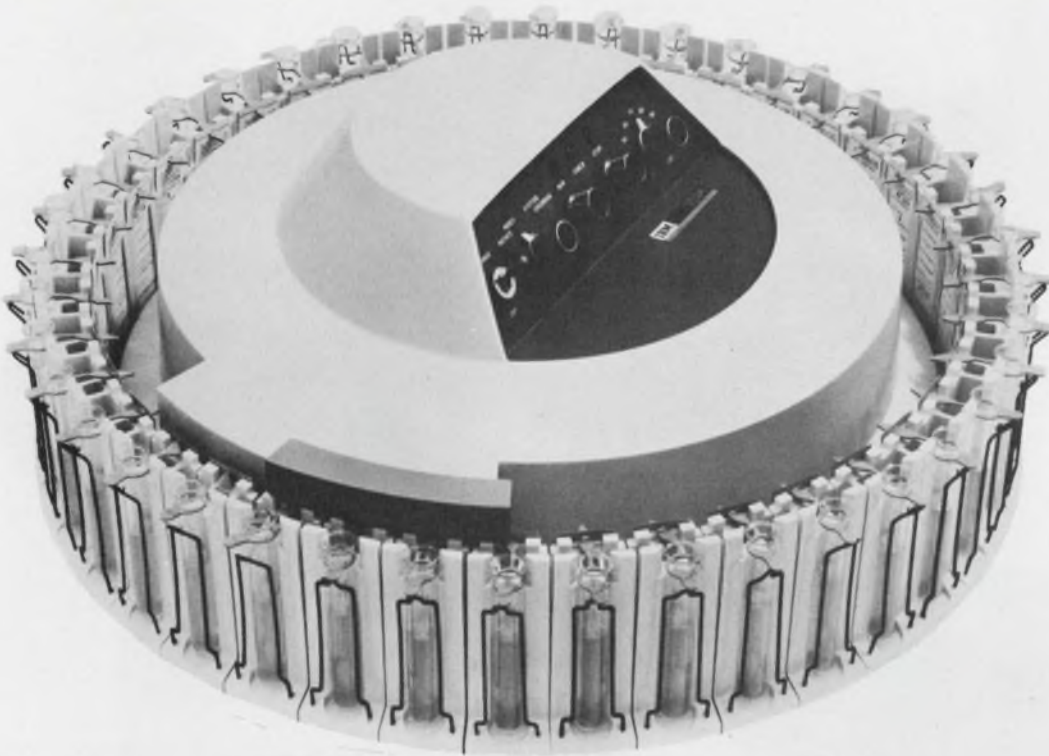

Award-winning sampler reader automatically analyzes and records medical specimens, such as blood or urine. The sophisticated self-cleaning package is used in conjunction with the IBM 1080 data acquisition system and Technicon analytical equipment.

Company: IBM/Systems Development Div.
Designers: Donald H. Wood, Donald A. Moore
Consultant: Eliot Noyes

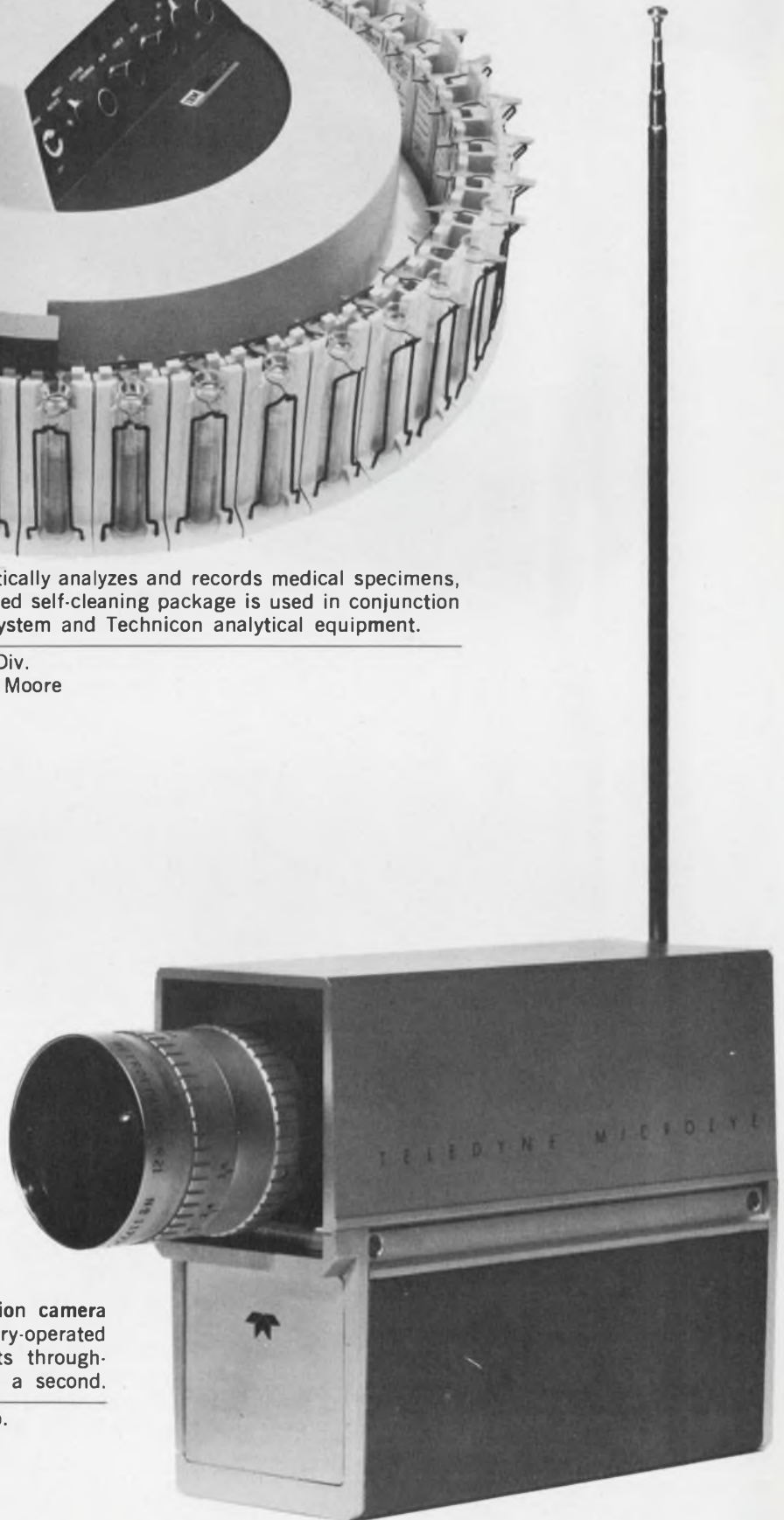

Award-winning microeye television camera weighs just 4 pounds. It is battery-operated and contains integrated circuits throughout. Its scan rate is 525 lines a second.

Company: Teledyne Systems Co.
Designer: H. E. Shanks



Portable video camera is part of a battery-powered videotape-recorder-and-camera combination. It weighs less than 50 pounds and is designed primarily for remote high-speed taping of news events by a single operator.

Company: Ampex Corp.
Designer: Gene Bozarth, F. T. Walsh

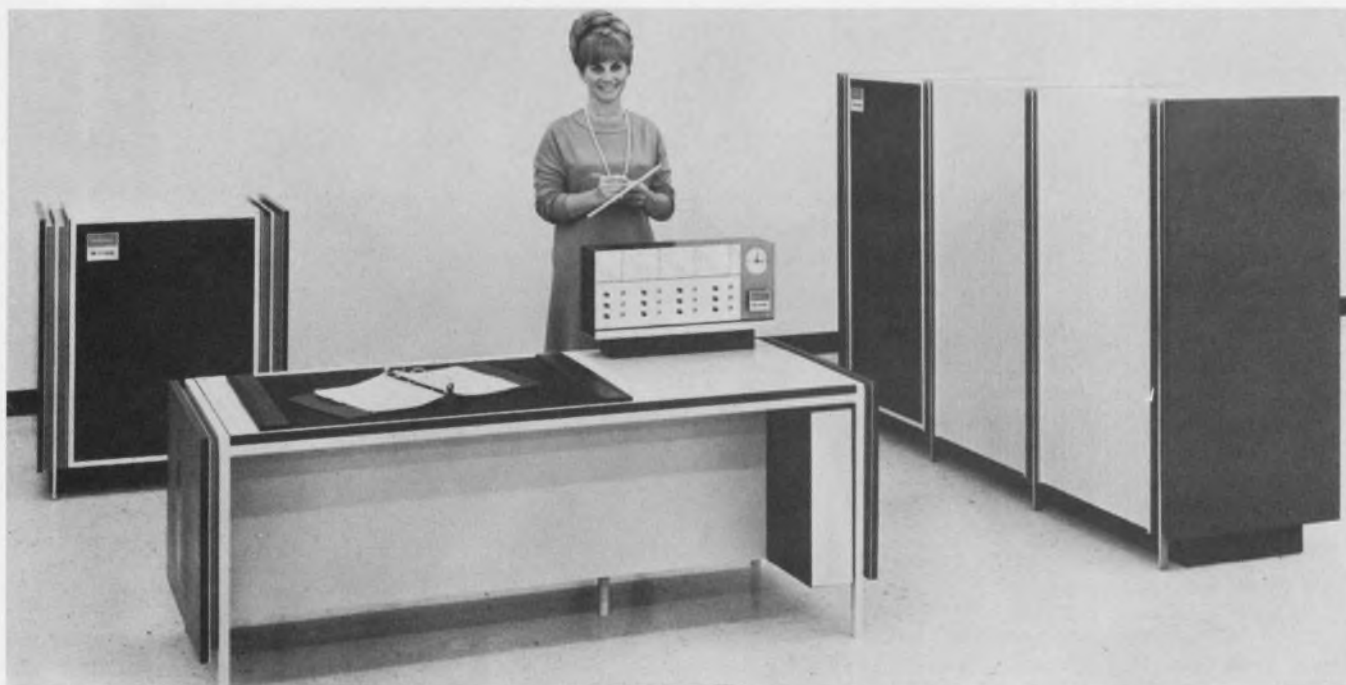

Data communications system is designed to handle complete communications problems, including message protection and error control. The general-purpose system can handle inputs up to 400 characters per second and interfaces with a variety of terminal devices.

Company: Marshall Communications, Inc.
Designers: Clarence Zierhut, Moro Shimano, Robert Noyer

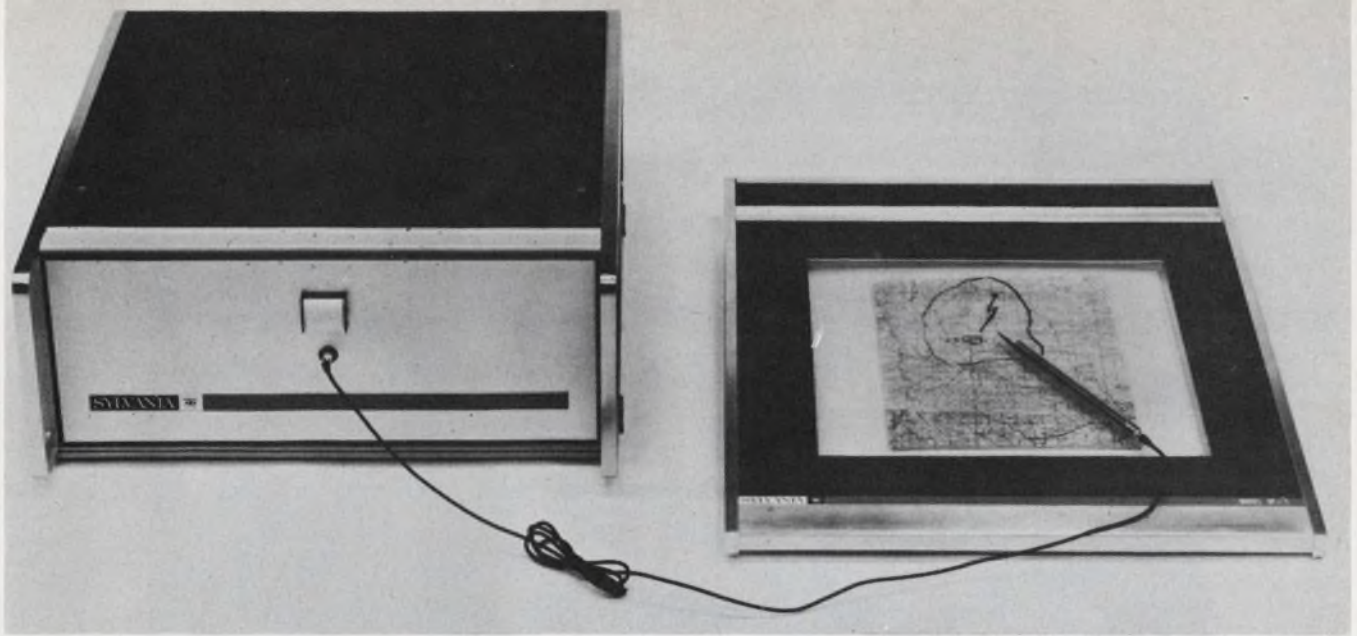

Computer graphical input system comprises an electronic pen and transparent conductive data tablet. Handwritten information is sampled and converted for computer storage and processing. Both analog and digital outputs are available.

Company: Sylvania Electronic Systems
 Designer: Oskar Heininger

Multiple-beam interferometer used in surface microtopology (measurement of surface irregularities) can measure the thickness of film depositions down to 20,000 Å or 0.00008 inch.

Company: Varian Associates, Vacuum Products Div.
 Designer: Anthony P. H. Chan

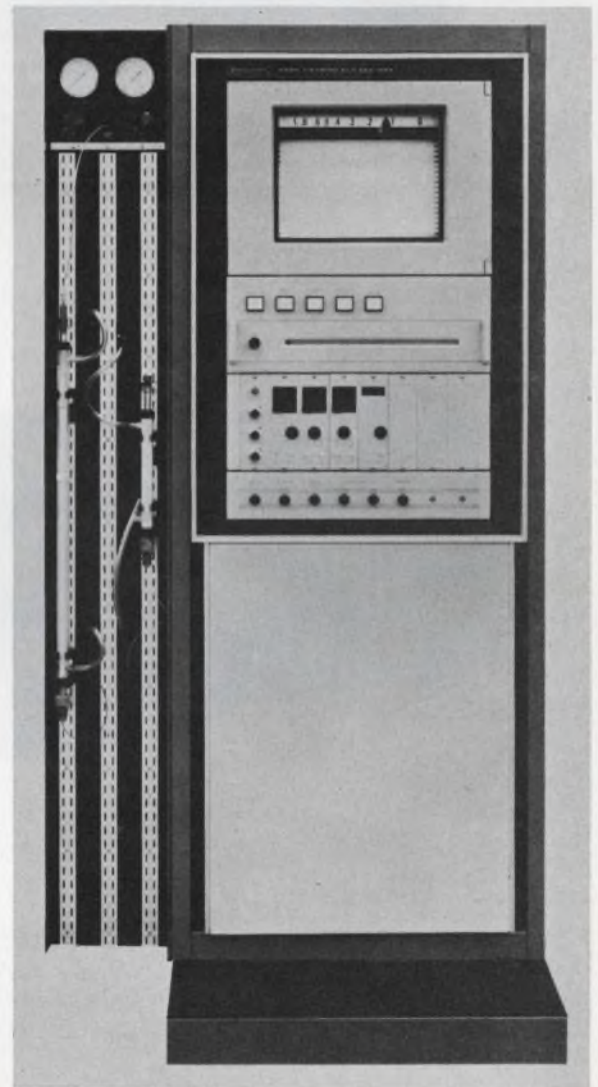
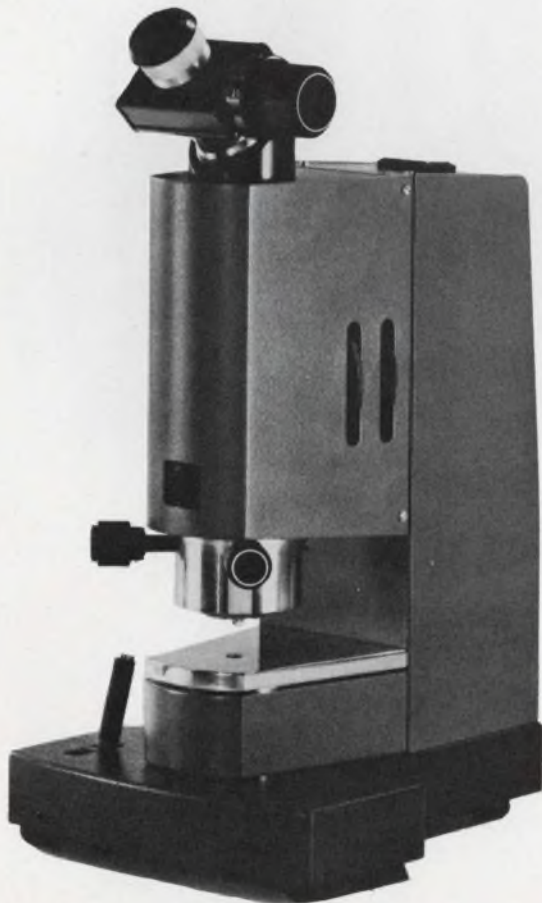

Amino acid analyzer identifies and analyzes amino acids and peptides for medical and pharmaceutical research by means of ion exchange chromatography. It is completely automated, so that the chemist needs only to start it.

Company: Beckman Instruments, Inc., Spinco Div.
 Designer: Charles W. Dodge

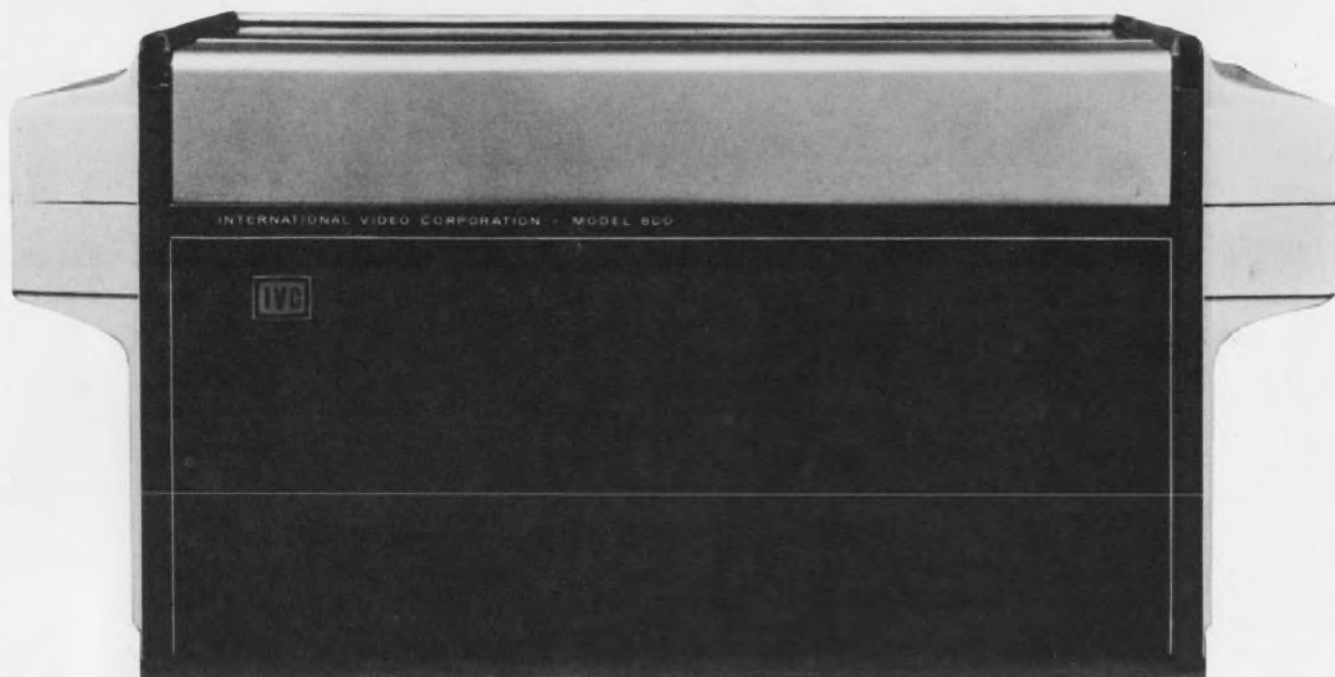

Award-winning video tape recorder for closed-circuit color television can record with any standard camera and play back with any standard monitor or television receiver. It has a 5-MHz bandwidth and operates at 6.9 in./s to save tape.

Company: International Video Corp.
Design consultant: Gruye-Vogt-Opperman, Inc.



Award-winning infrared thermometer, carried in a holster, can measure temperatures of objects without physical contact. It comes in seven models with a total range of 60°F to 3000°F. One model, the Circuit Ryder, is specifically designed to measure the temperature of PC-board components.

Company: Raytek, Inc.
Designer: J. Budd Steinhilber (Tepper/Steinhilber Associates)



Remote control unit and timer is part of an instant-replay color-TV recording system. It can play TV action back almost immediately at normal, fast and slow speeds and is capable of frame-by-frame stop action.

Company: Ampex Corp.
Designers: R. W. Borschlegel, F. T. Walsh

Studio camera is a highly flexible, low-cost unit capable of easy modification to suit customers' needs. It accommodates four lenses of any type, with front or rear zooms, and vidicon or plumbicon tubes. The modular circuitry is readily accessible through side housings locked in place by simple thumb screws.

Company: Ampex Corp.
Designers: Donald E. Leman, Stanley E. Lenhart, Mervin LaRue, Arden Farey, Rein Norma

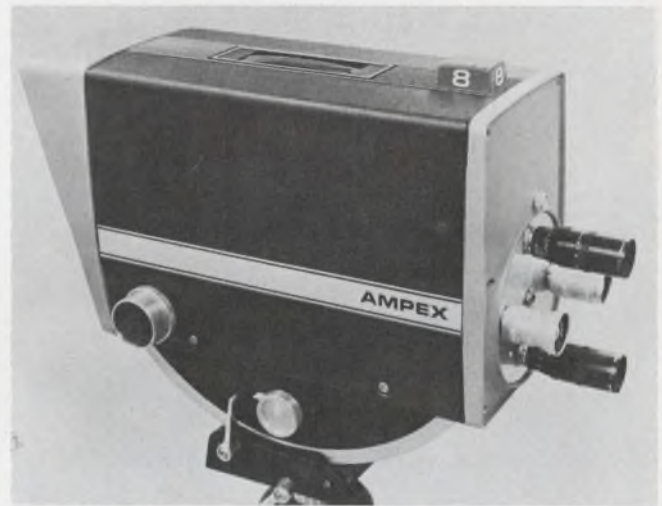

Microspec infrared spectrophotometer uses simplified monochromator optics to print out precise graphs of chemical compounds' absorbance or reflectance of IR wavelengths. Characteristic signatures of compounds are identified for clinical and industrial research.

Company: Beckman Instruments, Inc.
Designers: Robert L. Greene, Hugh O. Brown

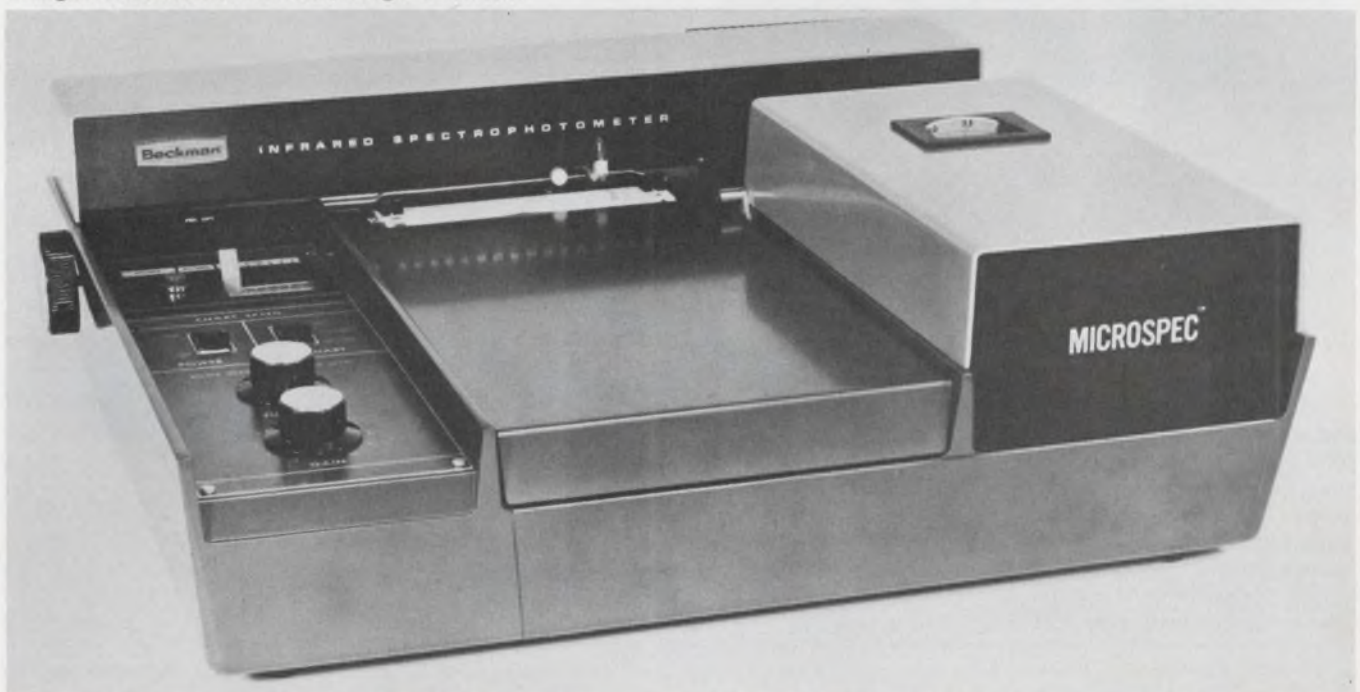

Award-winning CO₂ gas laser system is specifically designed as a self-contained unit for industrial applications. It emits approximately 100 watts of continuous power at a wavelength of 10.6 microns, and is capable of some 200 hours of continuous operation on a single bottle of CO₂.

Company: Coherent Radiation Laboratories
 Designers: W. Mefford, R. Rorden, S. Jarrett, C. Nunes
 Consultants: Gruye-Vogt-Opperman, Inc.

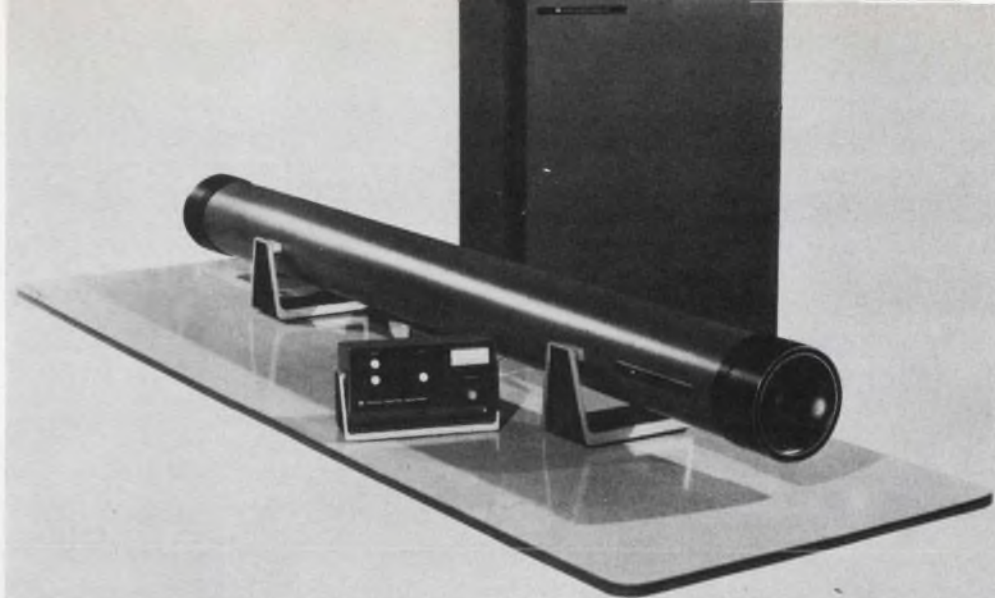

Award-winning ultracentrifuge for biochemical research is capable of 65,000 r/min, generating up to 420,000 g. Indicator lights on the well-grouped display panel pinpoint the location of any malfunction. Rotor temperatures can be precisely controlled from 5° below ambient to 0°C. The whole unit is enclosed in a vacuum chamber.

Company: Beckman Instruments, Inc., Spinco Div.
 Designer: Charles W. Dodge

Induction ion laser provides 2-W cw output in the yellow-green-to-blue-violet spectrum. The closed glass ring containing argon or krypton serves as the secondary of an rf transformer. Excitation is applied through a coil.

Company: Spectra-Physics
 Designer: Carl J. Clement

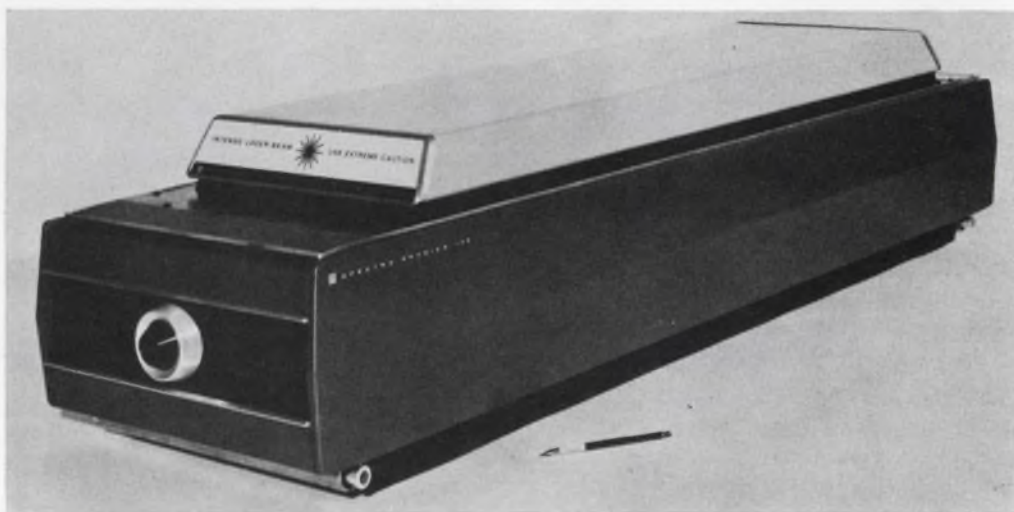

Only new Lambda LP Series lab power supplies provide all these big system features in a small, low-cost package.

Starting at only \$114.

- High power output—up to 28 watts.
- Wide voltage range versatility—0-10 VDC up to 0-250 VDC.
- Bench or rack use—without adapters.
- Unusually wide automatic current limiting—from 1% (or 5 MA) to 105% of rated output current.
- Two meters for voltage and current.
- Both coarse and fine adjustment of voltage and current.
- Over-temperature protection by thermal relay—prevents overheating.
- Convection cooled—no blower failures.



You can mount up to 4 units in a standard LRA-1 or LRA-2 rack adapter.

Other features

- Regulation (line or load): .01% + 1 MV.
- Ripple: 500 μ V RMS, 1.5 MV p-p
- Temperature coefficient: .015% + .5 MV/°C.
- CV/CC with automatic crossover.
- A-C input: 105-132 VAC 45-440 Hz (ratings based on 57-63 Hz operation).
- All Lambda power supplies are guaranteed for 5 years.

Select from six models

Model	Voltage Range	MAX. CURRENT AT AMBIENT OF:				Price ¹
		30°C	40°C	50°C	60°C	
LP 410	0-10 VDC°	2A	1.8A	1.6A	1.4A	\$129
LP 411	0-20 VDC°	1.2A	1.1A	1.0A	0.8A	119
LP 412	0-40 VDC°	0.70A	0.65A	0.60A	0.50A	114
LP 413	0-60 VDC°	0.45A	0.41A	0.37A	0.33A	129
LP 414	0-120 VDC	0.20A	0.18A	0.16A	0.12A	149
LP 415	0-250 VDC	80MA	72MA	65MA	60MA	164

* Overvoltage Protection available as an accessory—\$40.00 each.

¹ Prices are for non-metered models. For metered models, add suffix (FM) and add \$10.00 to price.

 **LAMBDA**
ELECTRONICS CORP.
515 BROADHOLLOW ROAD • MELVILLE, L.I., NEW YORK 11746 • (516) 694-4200
A VEECO SUBSIDIARY

VEECO HIGH VACUUM EQUIPMENT/LAMBDA POWER SUPPLIES

new Tektronix plug-in simplifies

reflectometry measurements

Type 1S2 Sampling Unit for time domain reflectometry and general-purpose sampling

You can test transmission lines, cables, connectors, broad-band devices with ease and accuracy with the new Type 1S2 Sampling Plug-In Unit. It can be used in any Tektronix oscilloscope that accepts letter and 1-series plug-ins.

The ≤ 90 -ps risetime of the vertical channel, and deflection factors to 5 mV/div make the Type 1S2 useful in many general-purpose sampling measurements. For this general-purpose use, a pretrigger or delay line is required. System risetime as a reflectometer is ≤ 140 ps.

The illustration shows a Type 1S2 in a Tektronix Type 549 Storage Oscilloscope being used to test a 50- Ω delay line. Information obtained from the upper trace includes electrical length of the line, nominal impedance, location and type of discontinuities. Lower trace is magnification of the discontinuity shown near the center of the upper trace. Deflection factors:

Upper trace — Vertical 0.25 p/div
Horizontal 20 ns/div
Lower trace — Vertical 0.025 p/div
Horizontal 5 ns/div

The Type 1S2 Manual Scan display mode was used in storing both traces to obtain optimum resolution.

With the Type 1S2, positions of discontinuities in a line under test can be read directly from a dial in units of time or distance. Accuracy of round-trip time readings is within $\pm 1\%$ of full scale.

Dual, full-scale 10-division horizontal calibration is in distances of 10 m, 100 m, and 1 km, and in times of 0.1 μ s, 1 μ s, and 10 μ s. The display can be expanded by a 7-step, calibrated, X1 through X100 magnifier for detailed examination of any discontinuities.

Illuminated readout of the horizontal scale factor, including any magnification, adds to the operating ease. And testing of either short or long lines is facilitated by internal generators that provide a 50-ps, 250 mV pulse and a 1-ns, 1-V pulse.

A front-panel switch provides for matching the horizontal calibration to the types of lines most commonly tested—air, TFE, and polyethylene. A variable control permits matching the calibration to lines using other dielectrics.

Vertical calibration is in both ρ (rho) and in volts, from 0.005/div to 0.5/div, in 7 steps, with an accuracy within $\pm 3\%$. It is also variable between steps, uncalibrated. A ± 2 -V offset voltage, monitorable at the front panel, allows amplitude measurements, using slide-back techniques, with an accuracy within $\pm 1\%$.

Vertical and horizontal outputs of 1 V/div of displayed signal are available at front-panel connectors.

Type 1S2 \$1300
Includes: 2X and 5X attenuators, 50- Ω termination, 20-cm airline, 5-ns RG 8/AU cable, 2 GR elbows, 18" patch cord, and 2 manuals.

U. S. Sales Price f.o.b. Beaverton, Oregon

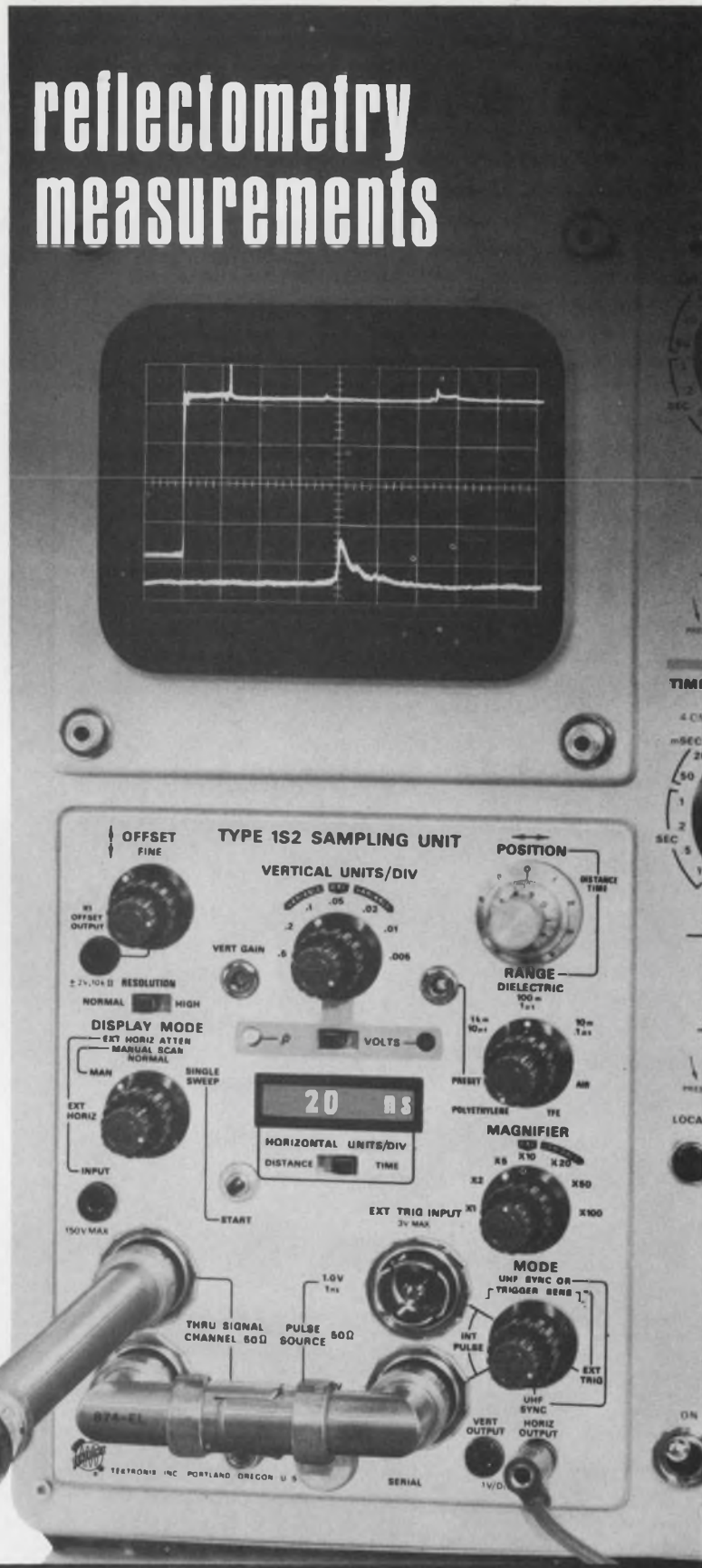

Tektronix, Inc.



For complete information, contact your nearby Tektronix field engineer or write: Tektronix, Inc., P.O. Box 500, Beaverton, Oregon 97005

SEE THE LATEST TEKTRONIX INSTRUMENTS AT WESCON

ON READER-SERVICE CARD CIRCLE 189

Technology



Ease the design of power-transistor circuits for switching high-inductive loads. Page 224

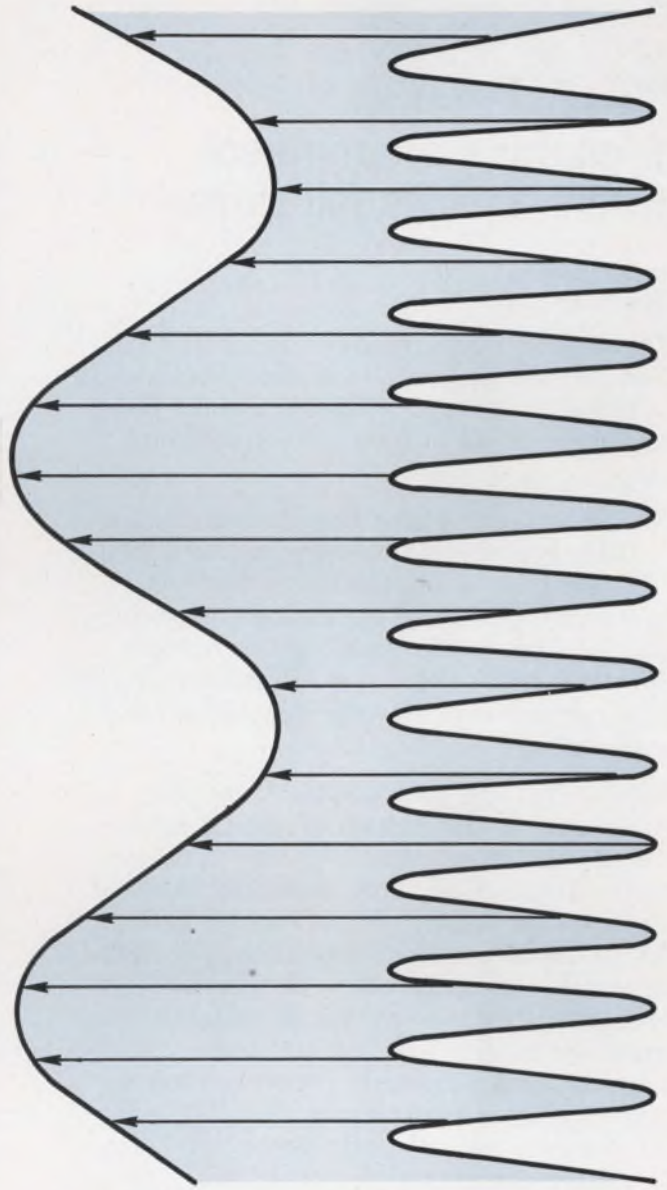

Beat "aliasing" in sampled data systems with the right filter and sampling rate. Page 236

Also in this section:

Digital ICs prepare to move into areas where analog units fall short. Page 220

Quality character generator is made with inexpensive, off-the-shelf ICs. Page 242

Consider all properties when choosing plastics for high-speed circuits. Page 246



Design Directions

... AN EDITOR'S COMMENTARY

Digital ICs eye markets where analogs fall short

Maria Dekany
Technical Editor

Digital integrated circuits are beginning to cost less than the phone call that places the order. In addition, clever fabrication is shrinking their size every day by putting more circuits on a chip.

The advantages of low cost and small size are enticing engineers to find new uses for digital ICs. Attention is now turning to functions previously performed by analog components. The basic intent is to realize analog transfer functions with some sort of incremental process that can be performed with digital integrated circuits.

Digital ICs will permanently claim some areas now in the domain of analog devices, despite the phenomenal advances of linear microcircuits (see "Tiny exploding world of linear microcircuits," ED 15, July 19, 1967, p. 49 ff.). Besides the cost advantages, the digital approach sometimes offers performance characteristics that cannot be matched with linear devices—at least not with those available now. But even if linear microcircuits improve significantly in performance and cost, some trouble spots such as drift seem to be inherent in analog elements.

"Analog" functions, as referred to here, are continuous or, at worst, piecewise continuous. In the usual design analysis, these signals, or functions, are decomposed into their Fourier-series components in the frequency domain. The analog system that operates on these components is characterized by its transfer function in the frequency domain, $H(j\omega)$.

Digital signals are discrete, and are therefore more conveniently described in the time domain. The data appear as bits, one after another. The digital system that operates on this sequence of bits assigns some degree of significance to each bit; in short, it weights the

input data.

The link between the two approaches— analog and digital—is a transfer function of a numerical operator, which meets a specified response characteristic in the frequency domain, and accounts for the quantization process of the digital operation.

Analog networks are troubled by frequency and phase distortion. They also often need compensation for possible instability. Digital circuits, on the other hand, suffer from quantizing errors and round-off errors. But these digital system errors can be limited to a large degree, without much added complexity.

These two points indirectly help to answer the question of linear integrated circuits. Even if linear ICs were available at comparable costs, these fundamental error sources would still exist in analog circuits. In addition, digitalized systems share other advantages:

- **Digital systems are more accurate than analogs, and their accuracy is predictable.** Their precision depends on the controlling crystal clock and on the word length.
- **They don't have the component tolerance problems that plague analog designs.** In high-order filters, for example, the analog approach needs many, and very accurate, capacitances and inductances, which are expensive. In addition, their stray reactances still cause special problems.
- **Some functions cannot be approximated to any useful degree with analog systems.** An

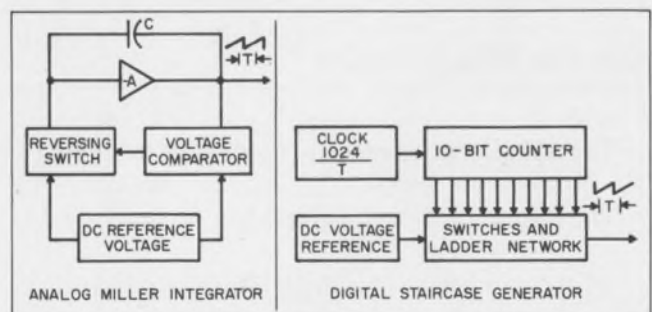

Analog and digital versions of precision integrator.

averaging filter with a sharp, steep window can only be built by the digitalized approach— analog R-C types have a long “tail.”

- **There is no dc drift.** The lack of dc drift with the digital approach makes possible systems like precision integrators.
- **With a little experience, the designer can avoid the breadboard stage,** which is imperative in most analog circuits. He may run into debugging problems in the software, but the cost is still generally less.

All of these “digitalized” systems may be called computers, but the name is misleading in a certain sense. Most engineers hearing the word “computer” envision a huge, all-purpose monster, which must be talked to in a special language and which, after some mysterious happenings inside, spews out answers on tons of paper or on cards with little holes.

But these “computerized” approaches can be grasped without extensive background in computer design and software, and the solution is usually in the form of an electrical response. For example, digitalized filters provide the same frequency-vs-gain-response curves as analog types (after a D/A conversion, of course).

The idea of a digitalized approach to analog functions is not new. Integration and differentiation with digital computers were worked out on paper some time ago. Simple transfer functions like $1/s$ and $1/(s + a)$ were shown to be realizable with digital circuits. But at that time the necessary hardware for widespread design was not available. Large-scale integration had to come along first before digitalized techniques could compete meaningfully with conventional analog techniques. A two-pole digitalized filter, for example, may need up to 40 to 50 flip-flops. With discrete components, it would mean just as many cans resulting in an expensive and large system. Now two flat packs can do the job, at reasonable cost.

A typical example of LSI is a MOS array for multiplication which contains 123 devices on a 0.049-in.-by-0.55-in. chip.

Familiarization with these techniques may take some time for engineers, but the rewards are worth it. Imagine working without large capacitors at very low frequencies. Or getting long sweeps with errors less than 0.1% with a couple of flat packs. There is no need for careful component selection and testing, to keep the dc and component drift within bounds; no dielectric saturation of the sweep capacitor;

there are no transients, and no hysteresis effects.

Integrator has better accuracy

Consider, for example, a typical case when digital techniques offer definite advantages, according to an analysis performed at RCA Aerospace Systems Div., Burlington, Mass.—a precision integrator. This sweep function is basic in many radar operations and sweep accuracy is a prime criterion.

The analog Miller integrator and its digital version are shown in the sketch below. If the required tolerances of the time constant must be better than 5% in periods exceeding 1 second, the capacitances become very large in the analog system. Maintaining 5% accuracy with a digital system in a small package is well within reach. The main sources of errors are the resistors in the ladders, the voltage reference and quantization errors, that can be kept within bounds easily. The attractiveness of the digital system is further increased by the fact that the several hundred gates needed to perform the function of the operational amplifier can be obtained in a single chip.

Engineers at Collins envision a digitalized filter-computer that can be placed in the front end of a receiver.

By pushing a button on its control panel, the engineer can select the frequency of interest in the incoming signal and reject all others. The filter would have zero attenuation at the frequency of interest and infinite attenuation at all others; thus finally making the ideal filter a reality. Tuning may be accomplished by changing the delay in a subroutine of the computer that performs cross correlation between the incoming signal and the stored information. This computing filter could be placed right up at the receiver, in front of the mixer and amplifier stages.

These examples are only a few of the cases where the digital approach is gaining ground. Do you know of some other design problems that would warrant this approach? If you do, why don't you give us a call, or drop us a note, to talk over your idea? “The Digital Approach to Analog Functions” is the theme of WESCON's technical session No. 10 on Thursday morning, August 24, sponsored by ELECTRONIC DESIGN. We will publish a special report on this field in our September 1 issue that will examine the mathematical design tools and trace the design of several widely applicable circuits, such as ramp generators, filters and sine-cosine generators. We welcome any follow-up articles—pro or con. ■ ■

23 new TTL circuits from TI

Series 54/74 features three levels of speed and power dissipation

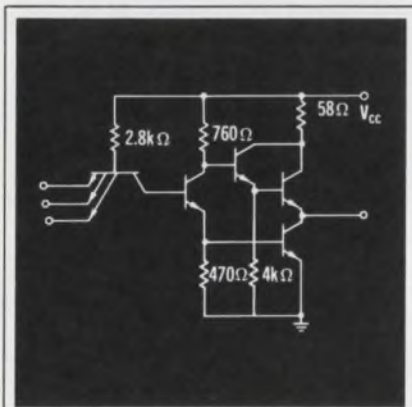

Typical Characteristics	Gate	Flip Flop
Propagation delay	6 nsec	17 nsec
Power dissipation	22 mW	80 mW
Noise immunity	1 V	1 V
Fan-out		
Standard loads	12	12
High-speed loads	10	10

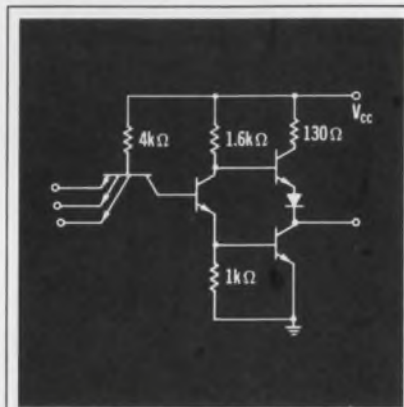

Typical Characteristics	Gate	Flip Flop
Propagation delay	13 nsec	40 nsec
Power dissipation	10 mW	60 mW
Noise immunity	1 V	1 V
Fan-out	10	10

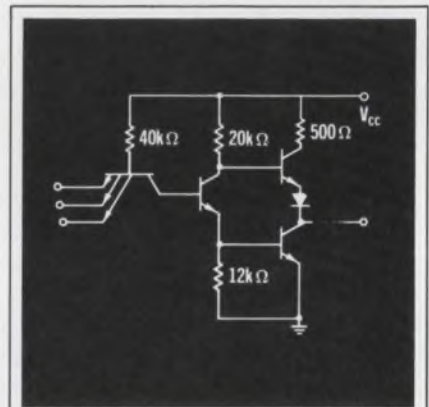

Typical Characteristics	Gate	Flip Flop
Propagation delay	33 nsec	47 nsec
Power dissipation	1 mW	3.8 mW
Noise immunity	1 V	1 V
Fan-out		
Standard loads	1	1
Lower-power loads	10	10

16 Series 54H/74H high speed circuits feature 6 nsec propagation delay

This line offers the highest speed available in saturated logic... six nanoseconds per gate. Applications include critical portions of digital systems such as high speed computation and data processing sections.

Series 54H/74H circuits may also be combined with standard and low-power TTL circuits in a single system... giving you the advantage of speed where it is required while keeping system power consumption low.

Sixteen circuit functions include AND gates as well as NAND so you can design simpler less costly systems.

Circle 210 for data sheets.

27 standard Series 54/74 circuits include 3 new devices for added versatility

Standard Series 54/74 integrated circuits offer a combination of speed and power dissipation best suited for most applications. When used with the new high-speed and low-power circuits, they provide today's system designer with unprecedented flexibility... in selecting speed and power requirements.

Twenty-seven circuits are offered in the standard line, including many complex-function devices that perform up to forty gate functions. These complex-function circuits enable you to cut costs while simplifying system design and improving reliability.

Circle 211 for data sheets.

New series 54L low-power circuits feature 1 mW per gate power drain

This line of four circuits features power requirements less than one-tenth that of standard circuits... yet speeds are approximately twice as fast as other circuits with similar power dissipation.

TI's Series 54L/74L circuits are specifically designed for space systems, avionic systems and other applications where power consumption and heat dissipation are critical. They may be combined with standard and high-speed Series 54/74 circuits to provide almost any desired speed/power dissipation combination the system designer requires.

Circle 212 for data sheets.

New standard-line additions reduce cost, improve performance of systems using Series 54/74 TTL

With three speed ranges, three power dissipation levels, two lead arrangements, two packages, and two temperature ranges, TI's Series 54/74 family of 47 TTL integrated circuits is industry's most versatile and complete logic line. All circuits use the same 5 Volt supply voltage and all use the same familiar TTL design rules.

Here are three new additions to the standard line that open the way to further cost reductions and improvements in performance.

SN7475 quadruple bistable latch replaces four flip flops

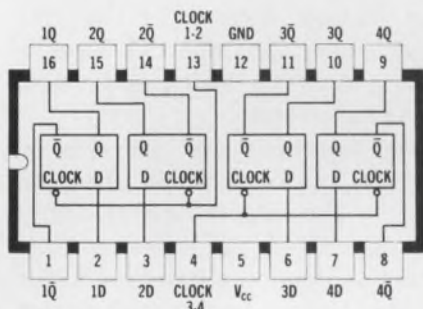

This specialized circuit was designed for readout tube applications. When used with the SN7490 decade counter and the SN7441 decoder/driver, the SN7475 will enable you to realize substantial savings in overall system costs.

This latest addition to TI's growing group of complex-function circuits features a propagation delay of 30 nanoseconds. Power dissipation is 40 milliwatts per latch.

Circle 213 for data sheet.

SN5401 NAND gate features open collector output for "Wire-OR" logic

This circuit enables designers to employ the economical "Wire-OR" logic function to simplify system designs. With the open collector output, the "collector-OR" function is built-in, permitting outputs to be connected directly.

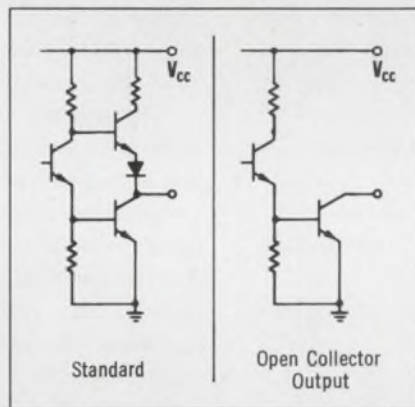

Before this circuit was developed, "Wire-OR" logic could only be used with DTL and RTL circuits. Now system designers can take advantage of this simplification and still benefit from the speed, economy and noise immunity of TTL.

Circle 214 for data sheet.

SN5402 NOR gate reduces package count and propagation delays

Here is a quadruple 2 input NOR gate that performs the "Not-OR" logic function directly. It eliminates the need for three or four NAND gates, making possible a 100 percent speed improvement as well as a 67 percent reduction in gate count.

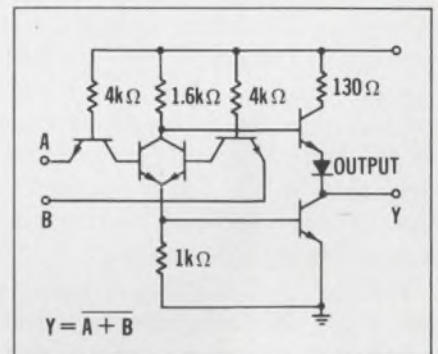

Designers may use the SN5402 with other Series 54/74 circuits... including complex-function types... to reduce overall system costs significantly below that possible with any other logic types.

Circle 215 for data sheet.

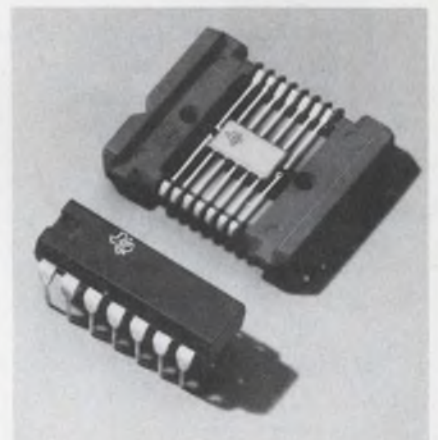

No other high-performance IC family is as complete, versatile and economical as Series 54/74 TTL from Texas Instruments. For more information, contact your nearest TI field sales engineer or authorized distributor, or write P. O. Box 5012, Dallas, Texas 75222.



TEXAS INSTRUMENTS
INCORPORATED

Switch high loads with power transistors

by knowing all about secondary breakdown, device selection, and methods of analysis and design.

How many engineers can design a power switching circuit for inductive loads, breadboard it, and then cut in the supply and put it through its operating cycle with complete confidence? There are a few, but most of us would have some qualms once the test data began to call for higher device ratings. More than once a puff of smoke from a power transistor has been sad and belated evidence of a minor oversight in the calculations.

This detailed analysis of power switching circuit design and device selection is the outcome of a study undertaken to put an end to such situations. The need was to switch high-inductive currents (tens of amperes) in a dc motor armature control system for tape drives.

To explain the behavior of these switching circuits fully, these areas were explored:

- Germanium vs silicon devices.
- Mechanism and prevention of secondary breakdown.
- Explanation of power transistor specifications given by manufacturers.
- Detailed design examples.
- Heat sink considerations.

Selecting the power transistor

The power circuit designer must first choose the transistor most suitable for his requirements. Two important criteria are maximum current and voltage. Maximum current can be defined as the largest current that the transistor must handle before the gain falls below some specified value. Maximum voltage is the largest reverse voltage that can be applied across each junction before breakdown occurs. Pnp germanium transistors are generally capable of handling much higher currents than npn silicon transistors, but the breakdown voltages of the npn devices are larger than those of equivalent pnps. Table 1 shows the representative relative capabilities of these devices.

Another important design consideration is the maximum power that will be dissipated. The maxi-

imum power rating of the device is a function of the junction temperature. In general, germanium transistors operate safely with a junction temperature of 100°C; silicon devices can tolerate temperatures up to 150°C. The higher junction temperature of silicon devices does not mean, however, that their dc current capability is higher than that of germanium devices. Rather, the reverse is true, because the junction saturation voltages in silicon devices are often twice as large as those in germanium devices for the same chip size. Typical values are shown in Table 2. Thus, a silicon npn device with a 50 per cent higher power rating than a germanium pnp unit may have an over-all lower dc current capability.

The leakage currents for silicon devices are considerably lower than for pnp devices. Typical values are shown in Table 3.

Leakage current is temperature-dependent and approximately doubles for every 10°C rise in junction temperature for Ge and 7°C rise for Si. So at 100°C the collector leakage current for the germanium devices may exceed 150 mA. This could seriously affect current-sensitive loads, and cause excessive dissipation in the off state.

Reverse-biasing the base-to-emitter junction to prevent such conduction can be difficult when the emitter is referenced to the largest circuit supply available. One way to put the device into a nonconducting state is to short-circuit the base-to-emitter junction. However, the leakage current is greater for a short-circuited base-to-emitter junction (I_{CES}) than for a reverse-biased junction (I_{CEX}). This is because collector leakage current flowing in the base lead produces a transverse voltage drop in the base region. The transistor may become forward-biased and cause the leakage current to increase significantly. At low temperatures, this voltage drop may be tolerable, but higher temperatures cause larger leakage currents.

Table 1. pnp and npn comparison.

	npn (Si)	pnp (Ge)
Max dc current	30 A	60 A
Max reverse voltage (BV _{CEO})	120 V for a 30-A device	60 V for a 60-A device

These values do not include special devices such as 750-V, 2-A npn units.

Henry S. Smith, Associate Engineer, IBM, Systems Development Div., Poughkeepsie, N. Y.

Table 2. npn—pnp sat. voltages.

	npn (Si)	pnp (Ge)
$V_{BE_{sat}}$ at 15 A	1.5 to 3.0 V	0.5 to 1.5 V
$V_{CE_{sat}}$ at 15 A	0.7 to 2.5 V	0.2 to 0.4 V

Table 3. npn-pnp leakage currents.

	npn at $T = 100^{\circ}\text{C}$	pnp at $T = 55^{\circ}\text{C}$
	$V_C = +80\text{ V}$ $V_{BE} = -1\text{ V}$	$V_C = -80\text{ V}$ $V_{BE} = +1\text{ V}$
Leakage Current (I_{CEX})	100 μA	10 mA

Table 4. Ge and Si devices.

Transistor	Advantages
Ge (pnp)	<ol style="list-style-type: none"> 1. Lower cost. 2. Higher current capability. 3. Lower V_{BE} and V_{CE} saturation voltages.
Si (npn)	<ol style="list-style-type: none"> 1. Higher junction temperature. 2. Lower leakage currents. 3. Can be turned off without reverse bias. 4. Higher breakdown voltages.

The net result is a greater voltage drop across the base resistance and more forward bias to the device. Usually this will not be a problem with silicon devices because of their lower leakage currents and the higher base-to-emitter forward voltages needed for conduction. But, a germanium device may actually go into a conducting state when its junction is short-circuited. For this reason a germanium transistor should not be used if a reverse bias is not available.

Besides the electrical characteristics, the price of the device will influence the choice. Pnp devices are now considerably cheaper than comparable npn devices; where 30 A npn prices range from \$25 to \$50, a 60 A pnp sells for \$4 to \$10. The relative merits of silicon and germanium devices are compared in Table 4.

Understand secondary breakdown

After choosing the transistor, the designer faces problems not normally encountered in low-power circuit design. The biggest is that of secondary breakdown, which is usually the result of switching inductive loads. Because secondary breakdown is normally a catastrophic failure and does irreparable transistor damage, the causes and solution of the problem must be thoroughly understood. Often sec-

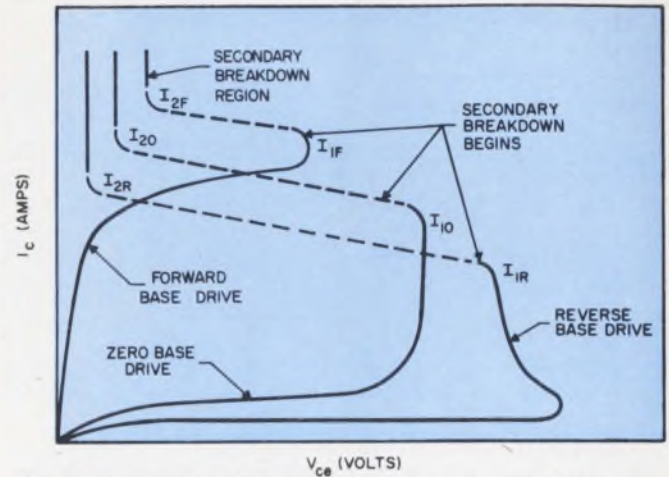

1. **Secondary breakdown** can occur at various base-drives and is energy-dependent.

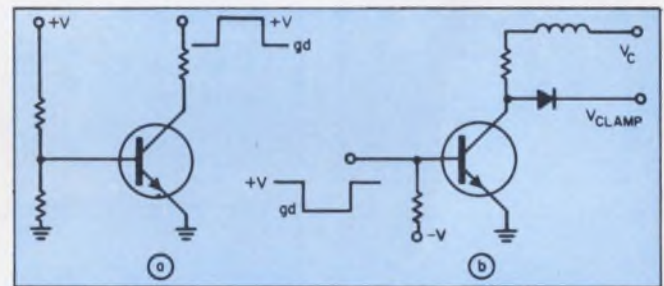

2. **Secondary breakdown testing** can be done either by applying a pulse to the collector through a current-limiting resistor (a), or by applying a pulse to the base of a transistor (b) and switching off an inductive load.

ondary breakdown can be avoided only by external modification of the circuit to shift the load line.

Secondary breakdown is a condition that makes the transistor output impedance change instantaneously to a small positive value. This is shown in Fig. 1 for various base-drive conditions.

The most obvious characteristic of secondary breakdown is an abrupt decrease in collector-to-emitter voltage and an increase in collector current. It is similar to avalanche breakdown* with two exceptions:

- The final limiting voltage is much less than the avalanche condition.
- Secondary breakdown seems to be energy-dependent.

Testing for secondary breakdown

Two pulse methods can be used to observe secondary breakdown. One is to apply—under the desired forward base-drive conditions—a rectangular voltage pulse to a current-limiting resistor in series with the collector of a transistor, as in Fig. 2a. The other method is to apply a rectangular voltage pulse

*Negative resistance region where large changes in current accompany small changes in applied voltage.

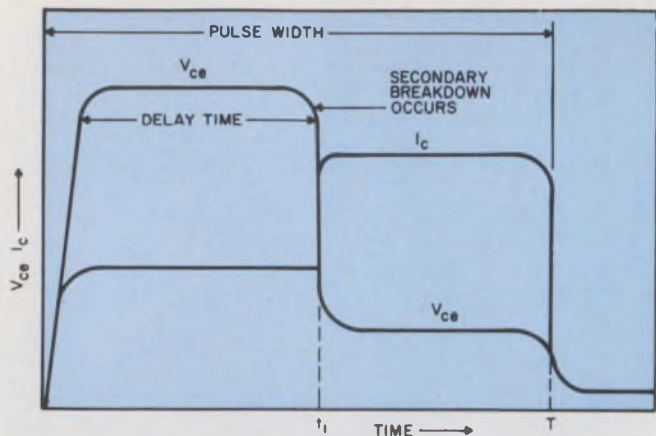

3. Secondary breakdown occurs at t_1 in the circuit of Fig. 2a during a forward base-bias condition. Note the drop in voltage and jump in current.

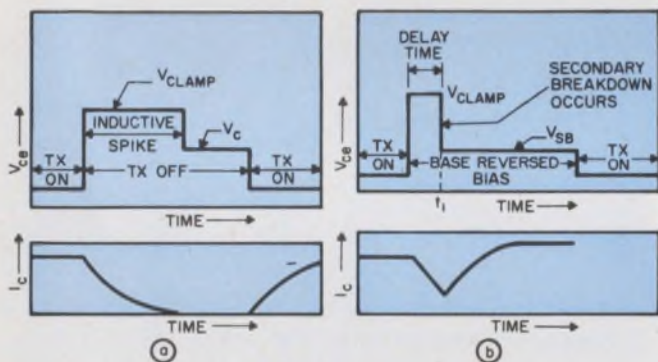

4. Switching an inductive load with the circuit of Fig. 2b with no secondary breakdown results in waveforms (a). Voltage and current waveforms during the secondary breakdown are shown in (b).



5. Results of secondary breakdown are seen on an npn silicon chip. The damaged area is indicated by the arrow.

to the base and to switch off an inductive load in series with a current-limiting resistor, as in Fig. 2b. In both cases, the collector voltage and current are monitored as a function of time.

Figure 3 shows secondary breakdown occurring at t_1 during a forward base-bias condition. The waveforms correspond to those that would be observed at the collector of the circuit in Fig. 2a.

Figure 4a shows the normal waveforms that would appear at the collector of the circuit in Fig. 2b when no secondary breakdown occurs.

Figure 4b shows secondary breakdown occurring at t_1 during a reverse base-bias condition. The waveforms are what would be observed at the collector of the circuit in Fig. 2b.

What causes secondary breakdown?

In both pulse methods, there is always a delay time before the collector voltage decreases and the collector current increases. Hence the theory that the transistor must dissipate some energy before secondary breakdown can occur. Some portion of the transistor must therefore reach a critical temperature before the process is started. Physically, then, secondary breakdown appears to be caused by a local thermal runaway induced by severe current concentrations. These current concentrations may be caused by:

- Defects in the transistor structure.
- Application of a reverse base drive.

That is, when the base current is flowing in the reverse direction, potential gradients may reverse-bias the periphery of the base but forward-bias its center. The injected current from the emitter flows in a small area toward the center of the base and causes a concentration of current.

The high current density increases the temperature of the area; the temperature increases the current. The condition, if allowed to continue, will result in a local thermal runaway. This will usually cause a collector-to-emitter short circuit or alter the transistor characteristics, such as lowering the device's BV_{CE0} . The magnified view of an npn silicon transistor chip after secondary breakdown in Fig. 5 shows the destruction of the emitter due to a concentration of current in a small area (the arrow indicates this area). When tested, the transistor was found to have a typical collector-to-emitter short circuit.

Manufacturers will usually supply safe-operating-area curves that indicate the energy ($I_C \times V_{CE} \times t$) limits below which the device will not go into secondary breakdown. Two examples of such curves are given in Fig. 6.

Switching inductive loads

Since secondary breakdown occurs most often when

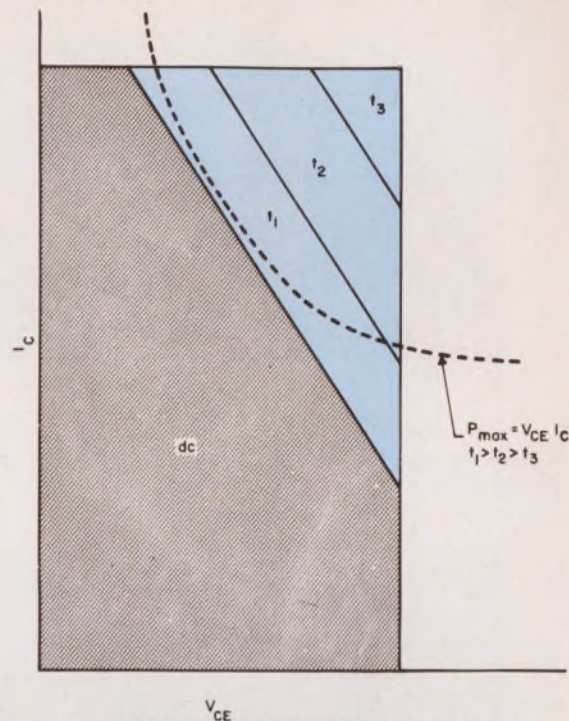
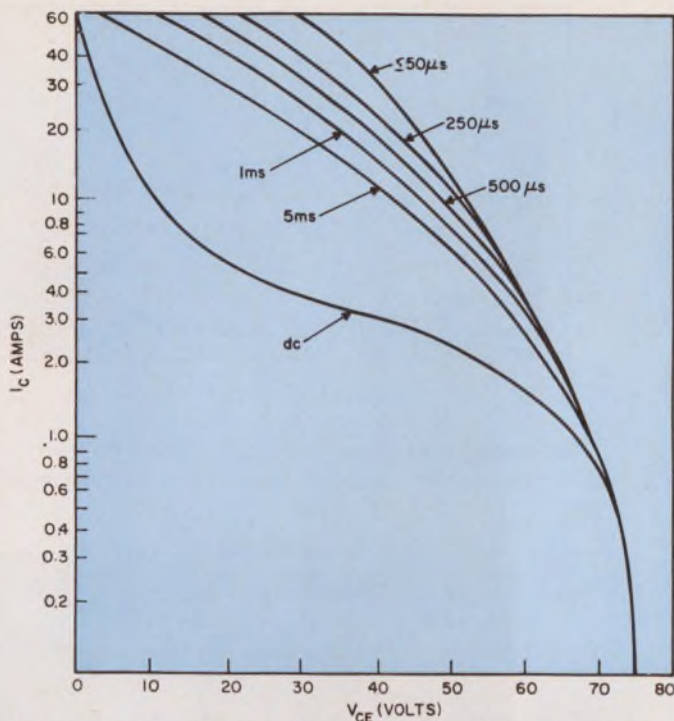

6. Safe operating limits for a power transistor are usually specified by the manufacturers in graphs like these two.

switching inductive loads, this area will be examined in detail. Figure 7 shows the characteristic output curve of a transistor when the base is reverse-biased.

In Region I, the transistor is cut off and has a high resistance. At voltage V_a , the transistor exhibits a negative resistance (avalanche breakdown condition). When the current reaches I_1 , a sharp breakdown occurs, and the characteristics jump into Region III, the low-positive-resistance region. This is referred to as the second breakdown. If reduced, the current jumps back into Region II at the point $I = I_2$.

On the same set of curves, the forward-bias output characteristic of the transistor can also be plotted (Fig. 8). $I_0 V_0$ is the quiescent operating point of the device. Point I_0 is below breakover point I_2 . If the transistor is suddenly reverse-biased and switches off an inductive load, the turn-off path will resemble that in Fig. 9.

The turn-off path will depend on the L/R time constant of the load and transistor, and the amount of energy that was stored in the inductor. The initial jump in voltage occurs because the inductor current cannot change instantaneously. For the case shown in Fig. 9, no transistor damage occurs if the turn-off path is within the safe operating area. With a different turn-off path, as in Fig. 10, the energy stored in the inductive load is so large that the initial jump in voltage causes the turn-off path to hit the negative-resistance region. If the energy delivered by the inductor is greater than the maximum energy that can be dissipated by the transistor, the device will be destroyed.

A second condition that can cause catastrophic failure appears in Fig. 11. In this instance, point

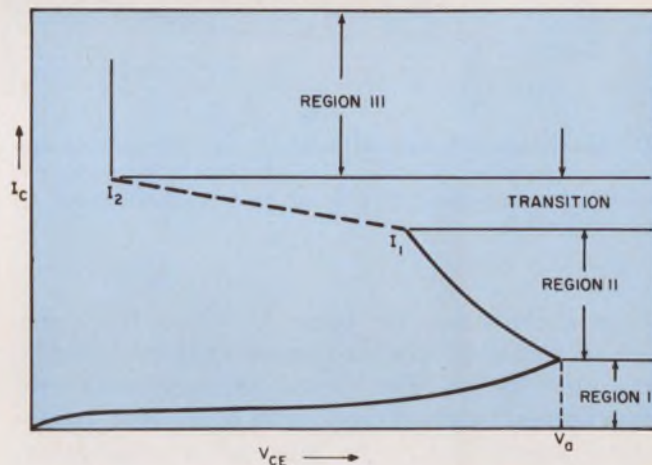

7. Characteristic output curve of a power transistor with base reverse-biased pinpoints safe operating areas.

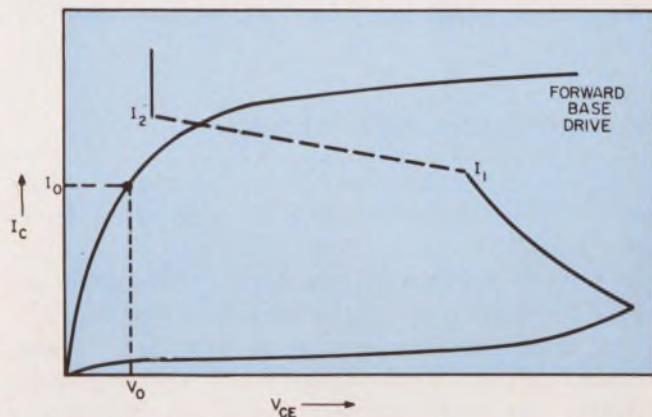

8. Characteristic output curve with base forward-biased, superimposed on the curves of Fig. 7, shows the relationship of two biasing modes to the secondary breakdown current value.

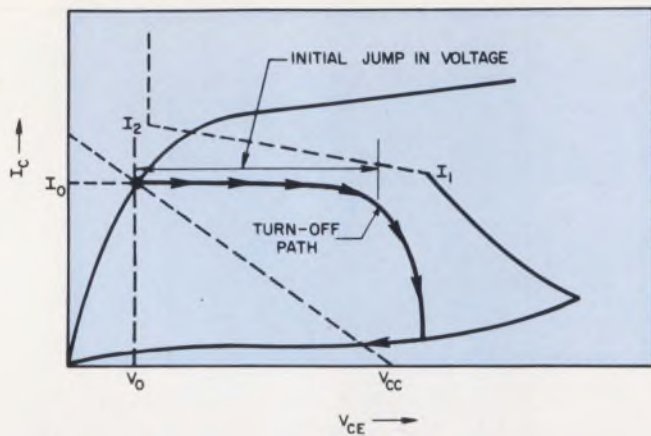

9. **Safe turn-off path** for an inductive load must lie within the forward- and reverse-biased curves.

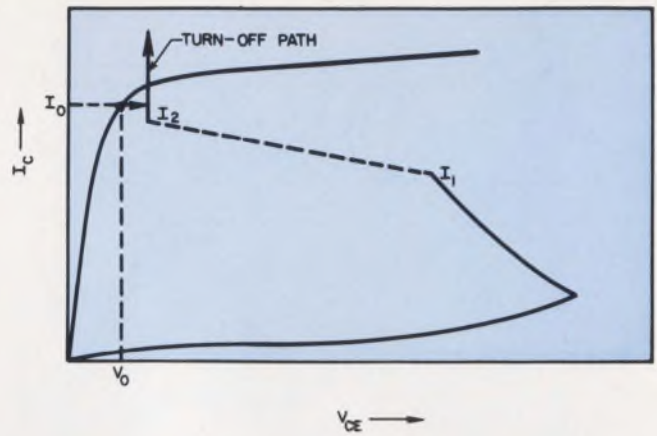

11. **Secondary breakdown** will occur during the turn-off when the quiescent current I_0 is near the positive resistance region.

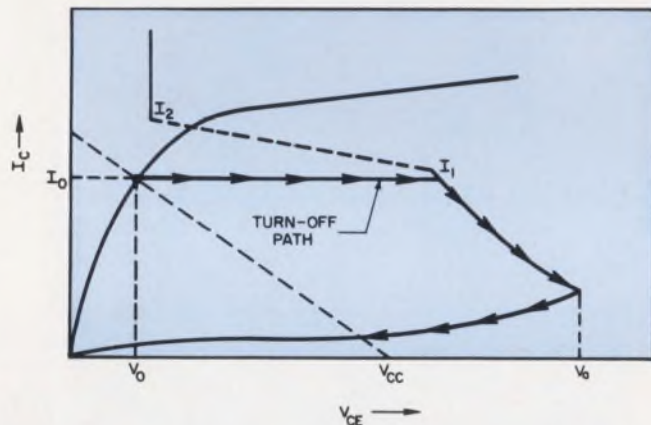

10. **Maximum safe turn-off path** follows the reverse-bias curve. If the energy delivered by the inductive "kick" exceeds the transistor dissipation, the transistor will be destroyed.

I_0 is above breakover point I_2 . When the transistor is turned off, the load line hits the low-positive-resistance region. The current then increases until it is limited by the dc resistance of the load. In this state, energy dissipation may again cause transistor destruction. The higher the limiting voltage in the negative-resistance region, the more rapid the transistor destruction. And in any case, destruction will usually result in a collector-to-emitter short circuit.

Preventing secondary breakdown

How can the designer prevent secondary breakdown? The simplest method is to choose a device that has:

- An I_2 breakover point higher than maximum collector current I_0 at the maximum temperature. The maximum temperature is specified because breakover point I_2 decreases with increasing temperature. At room temperature, I_2 may be above I_0 , but at maximum junction temperature, I_2 will have fallen below I_0 and will cause the transistor to be destroyed when it is turned off.

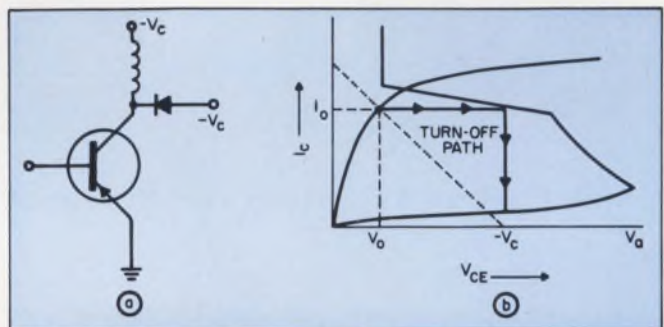

12. **Diode clamping** (a) prevents secondary breakdown in switching an inductive load (b).

■ A large enough first breakover point V_0 for the inductive load line not to hit this part of the characteristic. This point is also temperature-dependent and will move to the left with increasing temperature.

Either of the above criteria can be used in choosing a device to fit the application. They may not always be feasible, however, and an external-load-line modification—such as a conventional diode clamp, Zener diode clamp, capacitor-resistor network, or paralleling devices—may be necessary to protect against secondary breakdown.

Figure 12a illustrates the simplest of these techniques. A diode is connected from the collector to voltage $-V_C$. The turn-off path never reaches the negative resistance region if $-V_C$ is less than the avalanche breakdown voltage. The turn-off path resembles that in Fig. 12b. When the transistor is on, the diode is reverse-biased and has no effect on circuit operation.

Although the voltage is clamped to $-V_C$, the turn-off path may still be outside the safe operating area and the transistor may go into secondary breakdown. One method to correct this is shown in Fig. 13.

Zener diode $D1$ and conventional diode $D2$ are series-connected from the collector to ground. When the transistor is turned off, the collector voltage will be clamped to V_Z , the Zener breakdown voltage which is usually considerably less than $+V_C$. The

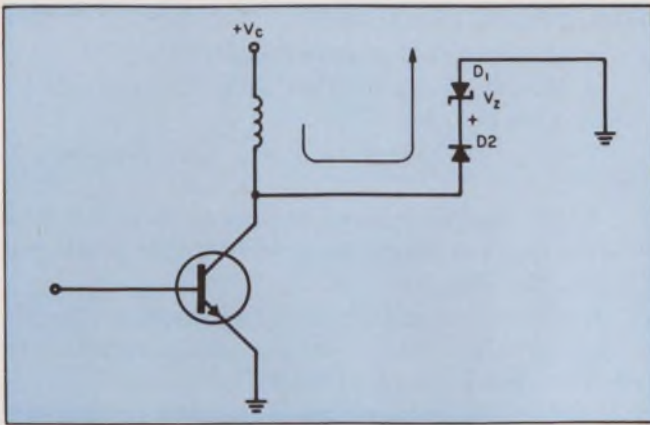

13. **Zener-diode clamping** reduces the possibility of the secondary breakdown even further.

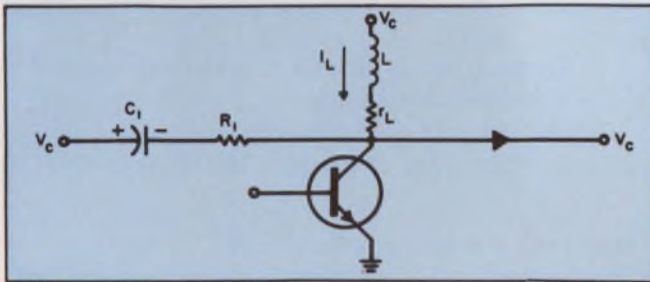

14. **An RC network** can also be used to prevent the secondary breakdown where the energy dissipated during the turn-off is too high for the transistor involved.

conventional diode prevents any current from flowing in the forward direction through the Zener diode when the transistor is on. Since the turn-off voltage has been reduced, a smaller amount of power is dissipated, and the transistor can safely operate in this region for a longer period of time.

In many cases it is impractical to use a Zener diode or the energy dissipated during turn-off may still be too high for the transistor involved. Then an RC network may be placed in the collector circuit (Fig. 14).

During the time the transistor is conducting, $C1$ will charge to a voltage $V_C - V_{CE}$. The inductor will be conducting a current I_L . When the transistor attempts to turn off, the current through the inductor and the voltage across the capacitor cannot change instantaneously. Current I_L will be used to discharge $C1$ and the collector-to-emitter voltage will not reach V_C until the capacitor has completely discharged. This turn-off path is shown in Fig. 15. $R1$ limits the collector current during turn-on and determines how long it will take $C1$ to charge to $V_C - V_{CE}$.

It is possible to bypass $R1$ during turn-off by placing a diode across it (Fig. 16). $R1$ still limits the turn-on current, but it is shorted by the diode during turn-off. The values of $R1$ and $C1$ can be chosen so that the turn-off path falls inside the safe operating area.

If the maximum collector current is so large that none of these methods will protect the transistor, it is necessary to parallel two or more transistors. This

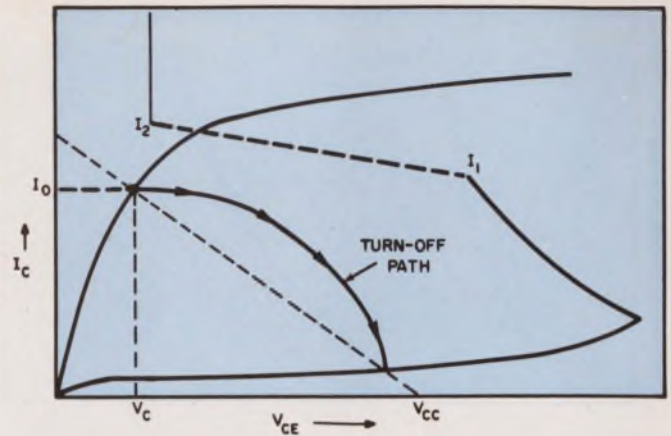

15. **Turn-off path** for the RC network of Fig. 14 is well within the safe limit.

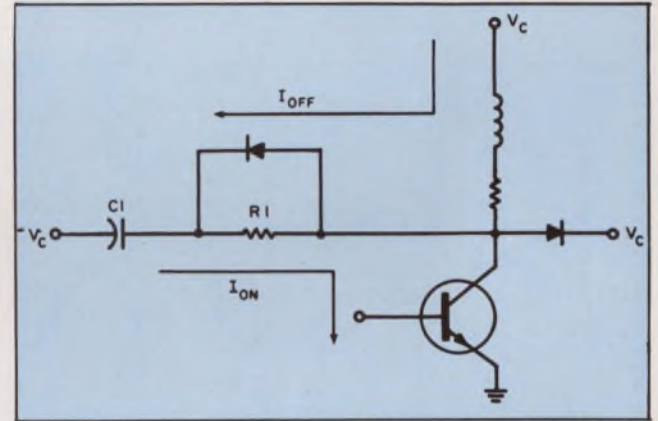

16. **Quick transfer of energy** from the inductive load into the capacitor can be enhanced by a shunting resistor with a diode due to its very low forward resistance which is used in this mode.

reduces the collector current that each device will have to handle. At first sight, one might expect the current to split equally between the two devices. This is not so. Transistors of the same type do not always have identical characteristics and may not accept equal portions of the load. It may even be possible for one of the transistors to carry the entire load. This can readily be seen from the I_C -vs- V_{BE} curves of the devices as in Fig. 17.

Owing to the spread of the V_{BE} characteristics, one transistor may be fully on while the other is off. This is because TX_1 clamps the base-to-emitter potential to a value below the knee of the characteristics of TX_2 . A small resistor should be placed in the emitters of both transistors, to compensate for the variations in the characteristics. The value of the resistor will depend on the desired ratio of current-sharing. A numerical example demonstrates a graphical solution to determine the resistor value.

How to parallel power transistors

Emitter resistors for parallel transistors are to be

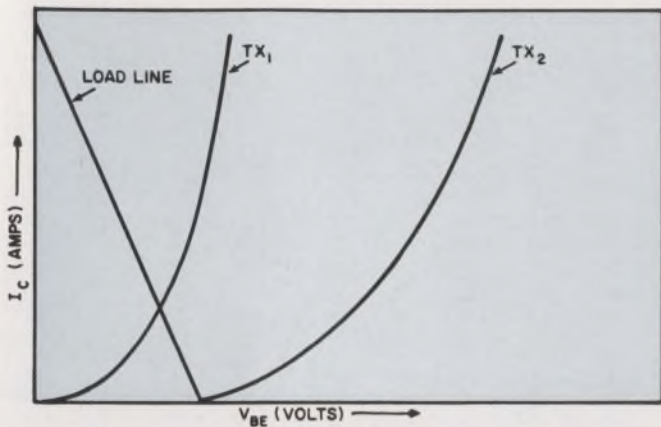

17. In paralleling two power transistors, differences in the I_C -vs- V_{BE} characteristics may result in one transistor carrying all the load, unless some compensation is provided.

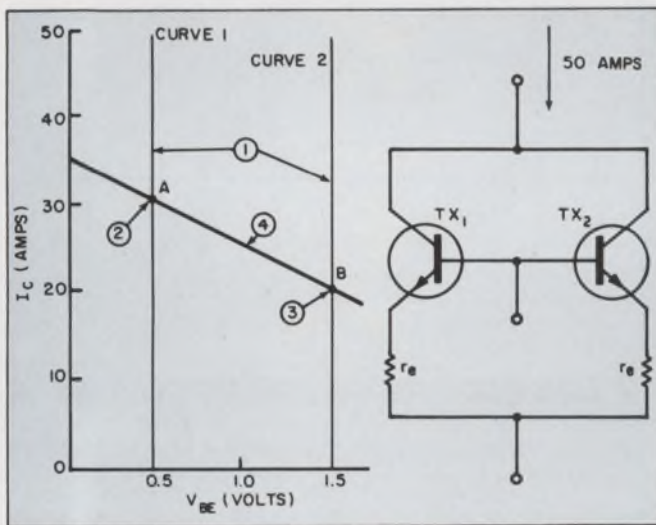

18. Dividing the load current between two transistors involves selecting the proper emitter resistors (see text).

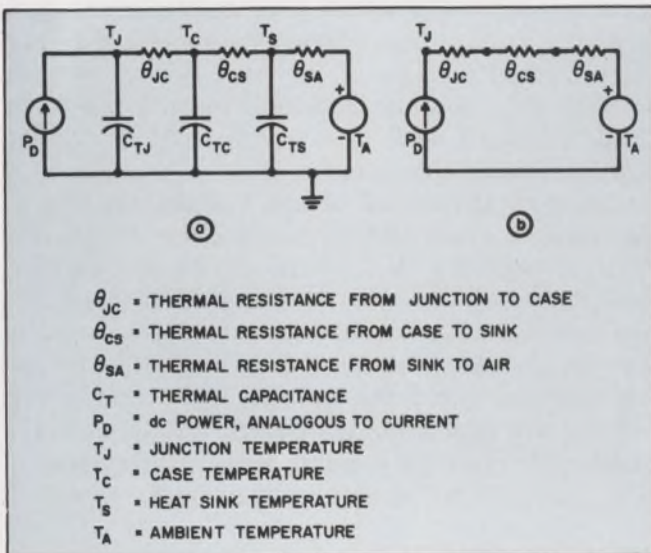

19. Electrical analogs of general (a) and steady-state (b) thermal models of a transistor pinpoint all the parameters involved in calculating transistor power dissipation.

chosen for these conditions:

- Maximum total current equals 50 A.
- Maximum current that each device is capable of handling is 35 A.
- $V_{BE\ sat}$ is guaranteed to fall between 0.5 and 1.5 V.
- The desired current-sharing ratio is 3:2. This means that the maximum current either device will have to handle is 30 A.

The procedure is as follows (see steps in Fig. 18):

1. Plot the ideal I_C -vs- V_{BE} characteristics for the best- and worst-case device.
2. Mark the point on curve 1 that corresponds to 30 A (point A). This is the maximum current that one device has to handle.
3. Mark the point on curve 2 that corresponds to 20 A (point B). This is the current that the other device has to carry.
4. Connect points A and B with a straight line. This is the emitter load line.
5. The value of the emitter resistor will equal the inverse of the slope of the line. In this case $r_e = 0.1\Omega$.

Understand device power ratings

For a complete understanding of power transistors, the designer must know how to interpret and use the device power ratings. These include maximum steady-state and peak power, and maximum junction temperature.

The average or steady-state power dissipated in a transistor is:

$$P_D = I_B V_{BE} + I_C V_{CE}, \quad (1)$$

which is the sum of the base and collector power. This expression can be better understood by writing it as the sum of the power dissipated in each junction:

$$P_D = V_{BE}(I_B + I_C) + V_{CB}(I_C). \quad (2)$$

If an analogy between heat and current is made, then an equivalent thermal circuit can be drawn for any transistor (Fig. 19a). (The values used in this figure will be used throughout the analysis.)

In the steady-state condition ($C_T = \text{open circuit}$), the equivalent thermal circuit can be simplified to look like that in Fig. 19b. The total thermal junction-to-air resistance is:

$$\theta_{JA} = \theta_{JC} + \theta_{CS} + \theta_{SA}. \quad (3)$$

The steady-state or dc junction temperature can be calculated as:

$$T_J = P_D \theta_{JA} + T_A. \quad (4)$$

If the maximum allowed junction temperature, T_J , is specified (100°C for germanium and 150°C for silicon), the maximum allowable dc power can be found from:

$$P_{D\ max} = (T_{J\ max} - T_A) / \theta_{JA}. \quad (5)$$

The formulas are somewhat more complex for the transient case because the pulse power dissipation effects now depend on the thermal capacitance as well as the thermal resistance. Before an attempt is made to solve for a repetitive power pulse, look at a single

rectangular pulse of width t_1 . Assume that there is an infinite heat sink.

This means that the case temperature is equal to the ambient temperature. The equivalent circuit and power pulse are shown in Fig. 20.

The junction temperature at the end of the pulse is:

$$T_J = T_C + P_p \theta_{JC} [1 - \exp(-t_1/\tau_{JC})], \quad (6)$$

where τ_{JC} represents the junction-to-case thermal time constant, which is equal to $\theta_{JC} \times C_{TJ}$. This can be defined as the time required for the junction temperature to rise to 63 per cent of its final value. τ_{JC} will usually be specified by the manufacturer. The term $[1 - \exp(-t_1/\tau_{JC})]$ is usually represented by $1/C_{PJC}$.

C_{PJC} is referred to by manufacturers as the transistor coefficient of power. The coefficient of power may be plotted (Fig. 21) as a function of the ratio of power pulse width, t_1 , to the thermal time constant of the device, τ_{JC} , for a single nonrepresentative pulse.

From Fig. 21 it can be seen that, if the pulse width is less than approximately one-third of the time constant, the relationship between the coefficient of power and pulse width is almost linear. Thus, for the linear portion of the curve:

$$1/C_{PJC} \approx t_1/\tau_{JC}.$$

The same relationship may be obtained by expanding $[1 - \exp(-t_1/\tau_{JC})]$ into a power series:

$$\epsilon^{-t_1/\tau_{JC}} = 1 - \frac{t_1}{\tau_{JC}} - \left(\frac{t_1}{\tau_{JC}}\right)^2 - \left(\frac{t_1}{\tau_{JC}}\right)^3 - \dots - \left(\frac{t_1}{\tau_{JC}}\right)^n. \quad (7)$$

If t_1 is much smaller than τ_{JC} , the high-order terms in the series are insignificant and $\exp(-t_1/\tau_{JC})$ can be approximated by $1 - t_1/\tau_{JC}$.

Therefore:

$$1/C_{PJC} = 1 - \epsilon^{-t_1/\tau_{JC}} \approx 1 - (1 - t_1/\tau_{JC}) = t_1/\tau_{JC},$$

which is the relationship obtained from the curve, t_1/τ_{JC} can now be substituted into the expression for junction temperature. Equation 6 now becomes:

$$T_J = T_C + P_p \theta_{JC} t_1/\tau_{JC}. \quad (8)$$

The term $P_p t_1$ is equal to the energy contained in the pulse E_p so that the change in temperature, $T_J - T_C$, can be represented as:

$$T_J - T_C = \theta_{JC} E_p/\tau_{JC}. \quad (9)$$

Equation 9 leads to an important conclusion. For short pulses, the change in temperature depends only on the total energy of the pulse, not on its shape. This means that the temperature change due to a narrow, irregularly shaped pulse could be calculated by integrating the area under the curve to get the total energy, E_p , and converting it to an equivalent rectangular pulse with the same energy. A good approximation for the original wave shape can be obtained by making the height of the rectangular pulse equal to the maximum amplitude of the original pulse. The width is then equal to the total energy divided by the height.

Now suppose that repetitive power pulses with

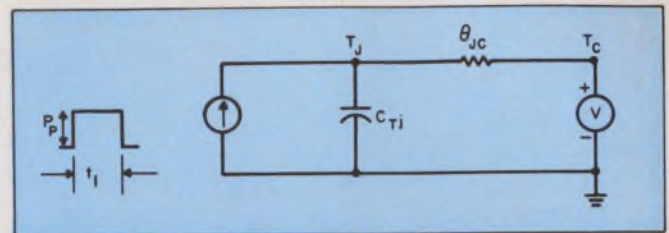

20. Junction temperature of a transistor in the case of a single applied pulse can be computed with this equivalent circuit.

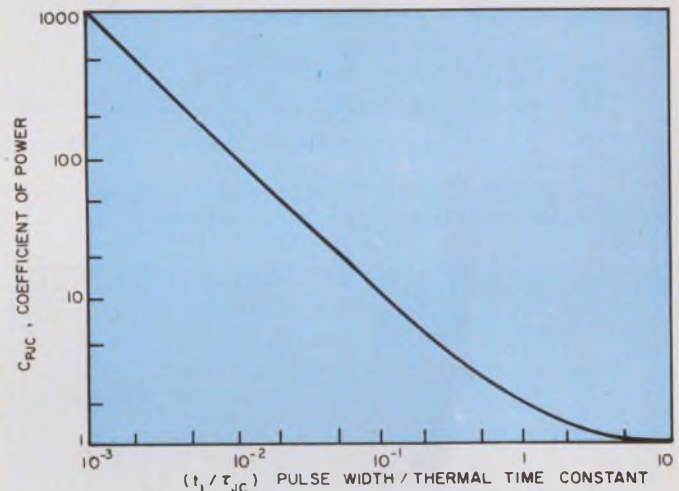

21. Coefficient-of-power characteristic supplied by manufacturers can be used to calculate junction temperature for a simple nonrepetitive pulse.

period T and width t_1 are applied to the device, with an infinite heat sink. With the same electrical analog as for the rectangular pulse, the expression for the rise in temperature is:

$$T_J - T_C = P_p \theta_{JC} \left[\frac{1 - \epsilon^{t_1/\tau_{JC}}}{1 - \epsilon^{T/\tau_{JC}}} \right]. \quad (10)$$

This expression is obtained from linear network analysis by methods of steady-state responses to periodic excitations. The term $\left\{ \frac{1 - \exp(-t_1/\tau_{JC})}{1 - \exp(-T/\tau_{JC})} \right\}$ now represents $1/C_{PJC}$ and C_{PJC} can now be plotted as a function of t_1/τ_{JC} for various duty cycles, as shown in Fig. 22. Once C_{PJC} is obtained from the curves, the equation for the change in junction temperature is:

$$T_J - T_C = P_p \theta_{JC} (1/C_{PJC}),$$

and:

$$P_{max} = C_{PJC} (T_{Jmax} - T_C) / \theta_{JC}. \quad (11)$$

If there is no infinite heat sink, there will be some thermal resistance and capacitance between the case and ambient. Usually the thermal time constant of the case and heat sink is very large in comparison with the time constant of the transistor and the width of the applied pulse. The case-to-air coefficient of power, C_{PCA} , where $1/C_{PCA} = \left[\frac{1 - \exp(-t_1/\tau_{CA})}{1 - \exp(-T/\tau_{CA})} \right]$, can be approximated by T/t_1 for repetitive, short pulses (letting τ_{CA} approach infinity), and by τ_{CA}/t_1 for non-repetitive, short pulses (letting T approach infinity).

The rise in case temperature for short, repetitive

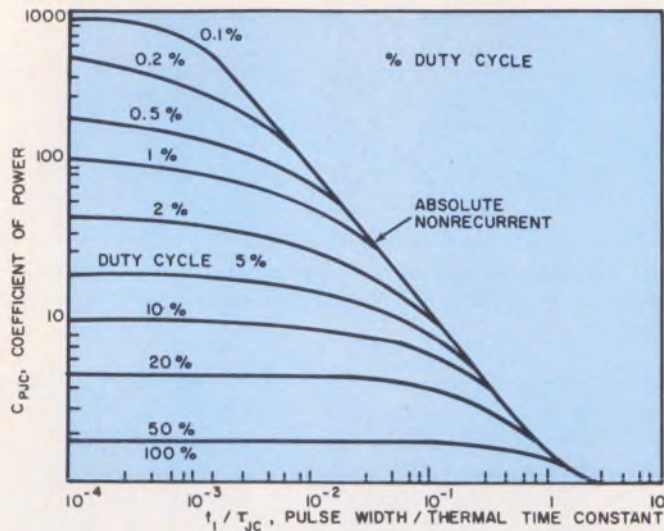

22. Coefficient-of-power characteristic for repetitive pulses takes into account various duty cycles.

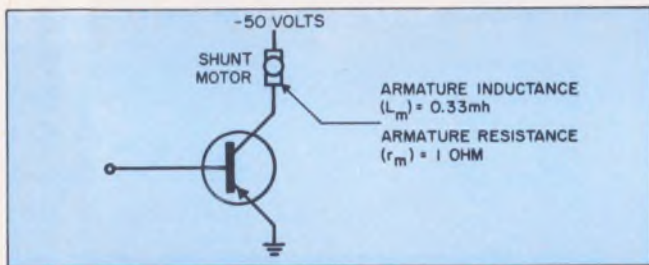

23. Practical motor switching circuit can be made with a single power transistor. See text for design details.

pulses can be found on the basis of the case-to-air coefficient of power:

$$T_C = T_A + P_p \theta_{CA} / C_{PCA} = T_A + P_p \theta_{CA} / (T/t_1). \quad (12)$$

If this combined with the equation for maximum peak power for an infinite heat sink, Eq. 11, the result is:

$$P_{p \max} = [T_{J \max} - T_A] / [(\theta_{JC} / C_{PJC}) + \theta_{CA} (t_1 / T)]. \quad (13)$$

This is the allowable peak power for a finite heat sink on the assumption of no steady-state power. Generally, however, there will be some steady-state power and this will reduce the amount of tolerable peak power. The steady-state power results in a certain junction temperature when no pulse power is present. This can be introduced into the equation by representing this steady-state junction temperature as an increase in ambient temperature. The peak power can now be calculated as:

$$P_{p \max} = \frac{T_{J \max} - T_A (\theta_{JC} / C_{PJC}) + \theta_{CA} (t_1 / T)}{(\theta_{JC} / C_{PJC}) + \theta_{CA} (t_1 / T)}. \quad (14)$$

It is very important to note that the peak allowable power is based solely on the maximum junction temperature that the transistor can tolerate. The calculated power value must be compared with the power values given in the safe operating area (Fig. 6). If the maximum temperature is exceeded, the transistor will go into secondary breakdown. Thus,

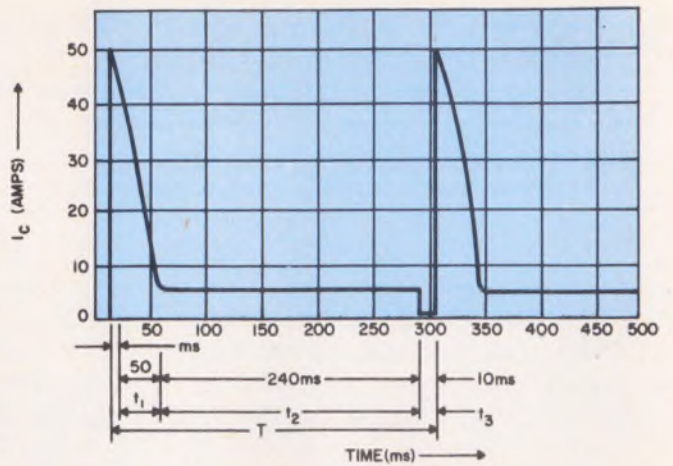

24. Transient and steady-state collector current for the circuit of Fig. 23 shows this waveform.

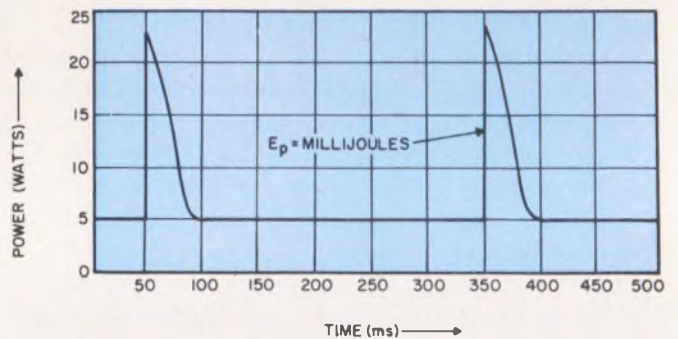

25. First step in the motor control circuit design is to convert the current waveform of Fig. 24 into this power-vs-time plot.

both safe areas and allowable power limits must be observed when designing a power circuit.

Calculating maximum junction temperature

Suppose that a power transistor is being used to drive a dc shunt-field motor (see Fig. 23). The motor can be represented by an inductor in series with a resistor. When the transistor is turned on, the current will increase to a maximum of $50 - V_{CE \text{ sat}} / r_m$ with a time constant L_m / r_m . As the motor speed increases, a back emf builds up and opposes the flow of current. The current decreases until the motor reaches its steady running speed. At this point, the current is equal to $(50 - V_{CE \text{ sat}} - V_{emf}) / r_m$ and remains at this value until the transistor is turned off.

The waveform of the collector current appears in Fig. 24. It is assumed that the transistor always operates in the safe operating area. The problem of secondary breakdown during turn-off is not to be considered.

The problem is to determine if the maximum junction temperature will be less than the value specified by the manufacturer. The following data are available.

$$\begin{aligned} I_{ce0} &= 10 \text{ mA} \\ V_{CE \text{ sat}} &= 0.4 \text{ V max} \end{aligned}$$

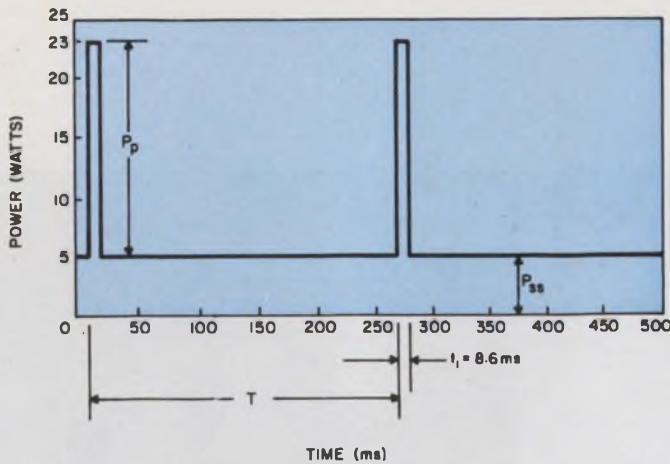

26. To simplify analysis an equivalent power-vs-time plot is obtained. Note the rectangular pulses.

$$\begin{aligned}
 V_{BE\ sat} &= 1.5\text{ V max} \\
 h_{FE} &= 25\text{ min at } 50\text{ A} \\
 \theta_{JC} &= 0.5^\circ\text{ C/W} \\
 \theta_{CS} &= 0.75^\circ\text{ C/W} \\
 \theta_{SA} &= 1.25^\circ\text{ C/W with an air flow of } 100\text{ ft/min} \\
 \tau_{JC} &= 50\text{ ms}
 \end{aligned}$$

Ambient Temperature = 55° C max

C_P vs t_1/τ_{JC} is shown in Fig. 22.

The design procedure is as follows:

1. Convert the current waveform into an equivalent power dissipation waveform (Fig. 25):

$$P_{on} = I_C V_{CE\ sat} + I_B V_{BE\ sat}$$

If the turn-on transition, which is very small compared with the total on-time and the transistor time constant, is neglected $I_C V_{CE\ sat}$ can be plotted by multiplying all points on the curve by $V_{CE\ sat}$. To this curve, add a constant $I_B V_{BE\ sat} = 2(1.5) = 3.0\text{ W}$. Under worst-case conditions, assume that 2 A of base current are supplied continuously, i.e.:

$$I_B = I_C/h_{FE} = 50/25 = 2\text{ A.}$$

In the off state:

$$\begin{aligned}
 P_{off} &= I_{CEO} V_{CE} + I_{EBO} V_{BE} \\
 &= (10 \times 10^{-3})(50) + (\approx 0) = 0.5\text{ W}
 \end{aligned}$$

To simplify the waveform, neglect the power dissipated during the off time and extend the on time for 10 ms. This gives a condition that is worse than would actually exist but it simplifies the calculations. Thus the simplified power-vs-time curve shown in Fig. 25 is obtained.

2. Calculate the energy under the pulses in Fig. 25 and convert them into equivalent rectangular pulses with the same energy value. This is done simply by counting the squares underneath the pulses. This value is approximately 197 mJ. The height of the rectangular pulse is made equal to the maximum height of the original pulse. This value is 23 W. The width is found to be equal to:

$$E_p/\text{height} = 197\text{ mJ}/23\text{ W} = 8.6\text{ ms.}$$

The waveform is shown in Fig. 26.

3. Calculate the steady-state power:

$$P_{ss} = I_C V_{CE\ sat} + I_{BE\ sat} V_{BE\ sat} = 5(0.4) + 2(1.5) = 5\text{ W.}$$

4. Find C_{PJC} from the curve of Fig. 22. First, calculate the duty cycle, which is:

$$t_1/T = 8.6\text{ ms}/258.6\text{ ms} = 3.3\%$$

and then:

$$t_1/\tau_{JC} = 8.6\text{ ms}/50\text{ ms} = 0.172.$$

The value of C_{PJC} is approximately 9.

5. Solve for $T_{J\ max}$ by rearranging the peak power equation:

$$T_{J\ max} = P_p \theta_{JC}/C_{PJC} + \theta_{CA} t_1/T + T_A + \theta_{JA} P_{ss}$$

Substituting all the values, $T_{J\ max} = 70.2^\circ\text{ C}$, which is below the maximum allowable temperature specified by the manufacturer. Thus, the transistor can safely be used in this application.

Choose proper heat sink

The maximum power that could be dissipated has been determined on the basis of a given thermal resistance. Often, the maximum power that can be dissipated is given and a choice of the proper packaging and cooling to keep the junction temperature below the specified limit must be made. Since the internal thermal impedance from junction to case is a function of the device package, maximum performance can be obtained only by reducing the thermal impedance from case to sink and sink to ambient. The device mounting will determine θ_{CS} and the choice of heat sink and air flow will determine θ_{SA} . ■ ■

Bibliography:

- Chang, Z. F., and Turner, C. R. *Characterization of Second Breakdown in Silicon Power Transistors*. RCA Application Note, 1963.
- Eisler, Paul. "How to Measure Transistor Thermal Characteristics," *EEE*, XIII, No. 8 (August, 1965), 78-81.
- Forrest, M. L. N. "Avalanche Carrier Multiplication in Junction Transistors and Its Implications in Circuit Design," *Jour. IERE* (London), XX, No. 6 (June, 1960), 429-439.
- Goldman, Wayne E. "How to Measure Heat-Sink Characteristics for High-Power Applications," *EEE*, XIII, No. 7 (July, 1965), 71-72.
- Greenburg, Ralph (ed.). *Motorola Power Transistor Handbook* (1st ed.). Phoenix, Ariz.: Motorola Semiconductor Products Div., Inc., 1960.
- Lin, H. C., Hlavacek, A. R., and White, B. H. "Transient Operation of Transistor with Inductive Load," *IRE Trans. on Electron Devices*, Vol. ED-7, No. 3 (July, 1960), 174-178.
- Scarlett, R. M., and Shockley, W. *Secondary Breakdown and Hot Spots in Power Transistors*. Shockley Laboratory Rpt.
- Schafft, H. A., and French, J. C. "Second Breakdown in Transistors," *IRE Trans. on Electron Devices*, Vol. ED-9, No. 2 (March, 1962), 129-136.
- . "Breakdown Characteristics of Semiconductor Materials," *Electro-Technology*, LXXV, No. 6 (June, 1965).
- Schiff, P. *Second Breakdown in Transistors under Conditions of Cutoff*. RCA Application Note, August, 1964.
- Wechsler, Reuben. "Designing SCR Circuits for High Inrush Loads," *EEE*, XIV, No. 3 (March, 1966), 86.



Data Display Devices from Raytheon

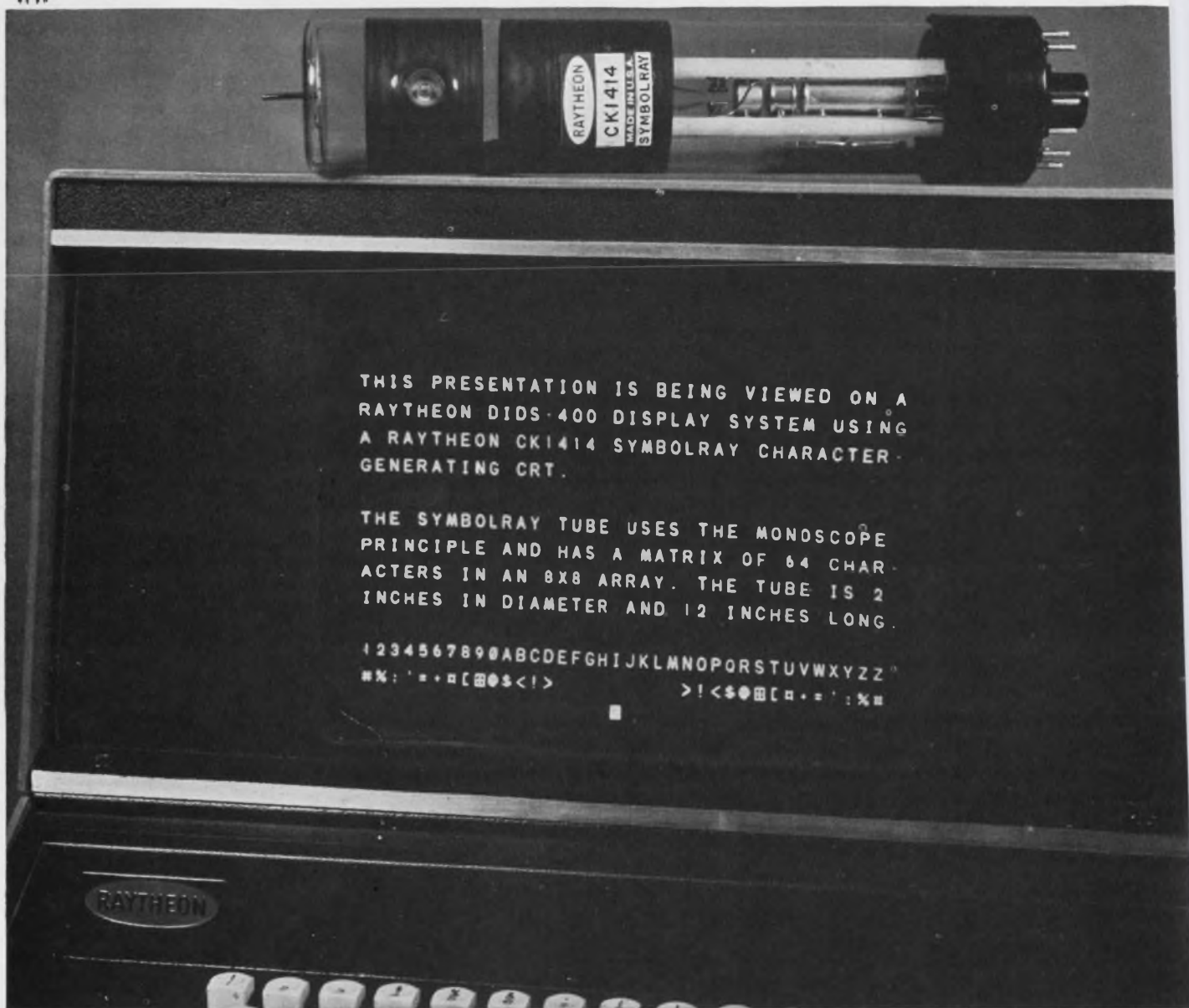

The presentation you see above was generated by a Symbolray* Cathode Ray Tube identical to the one lying on the console. A new type of monoscope, the Symbolray can generate alphanumeric characters from electrical signals for cathode-ray display or for hard copy print-out. The presentation here is shown on a Raytheon tube (CK1415) used in a Raytheon DIDS-400 display system.

An economical method of generating characters. Priced at less than \$100 in quantities of 1,000, the Symbolray provides a more economical method of generating

electronic displays than using large numbers of circuit cards.

The output of the Symbolray operating as a monoscope is obtained by electrically deflecting the electron beam to desired characters on the target and scanning them sequentially with small raster. The display cathode ray tube on which this output is viewed is scanned in synchronism. When the Symbolray method is used in conjunction with buffer-memory techniques, full messages can be displayed—as shown above. The Symbolray tube uses electrostatic deflection and

focus, and is available in designs with 64 and 96 character matrices.

Raytheon's wide range of Data-ray* CRTs cover the screen sizes from 7 to 24". Electrostatic, magnetic and combination deflection types are available for writing alphanumeric characters while raster scanning. Raytheon also offers combination deflection or "diddle plate" types and all standard phosphors. Or, Raytheon can meet your special CRT design requirements.

For more information—or a demonstration—call or write your Raytheon regional sales office.



New Raytheon Projectoray* Tube produces more than double the light output of standard projection-type cathode ray tubes. The tube's light output is 30,000 foot lamberts, which results in a light level of 15-foot lamberts on a 3' x 4' lenticular screen.

The tube's expected minimum operating life is 500 hours—20 times the life of a standard projection tube.

The Projectoray's high light output and long life are due to its novel design. The design incorporates liquid cooling of the phosphor backplate. This allows the phosphor to be energized with a very intense electron beam. At high beam levels, very high peak light output is obtained. The light image is projected through a 5" optical window in the face of the tube. The electron gun is set at an angle to the phosphor and the deflection system compensates for keystone effects.

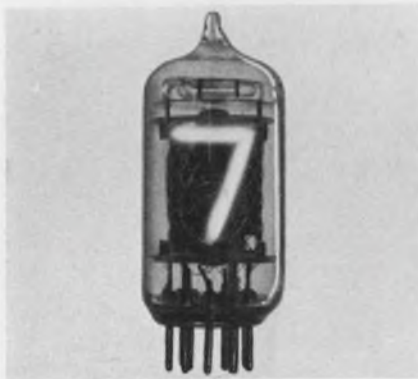

Datavue* Side-View Tubes. New Type CK8650, with numerals close to the front, permits wide-angle viewing. These side-view, in-line visual readout tubes display single numerals 0 through 9 or preselected symbols such as + and - signs. Their 3/8"-high characters are easily read from a distance of 30 feet. Less than \$5 each in 500 lots, they also cost less to use because the bezel and filter assembly can be eliminated and because their mating sockets are inexpensive.

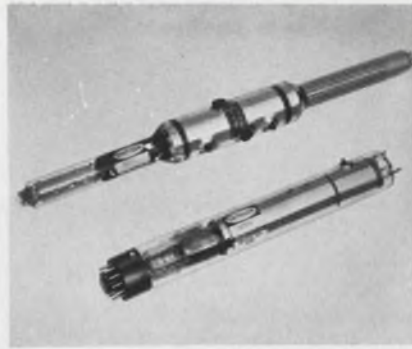

Recording Storage Tubes. The miniature tubes shown here are Raytheon's single-gun (CK1518) and dual-gun (CK1519). They provide high resolution, long storage, and fast erase capability.

Raytheon electronic input-output storage devices feature the above capabilities and immediate readout. Information can be written and stored by sequential techniques or by random-access writing. Complete, gradual or selective erasure is possible.

Raytheon storage tubes are readily available for applications in radar scan conversion, slow-down video, signal processing, signal enhancement, time delay, and stop motion.

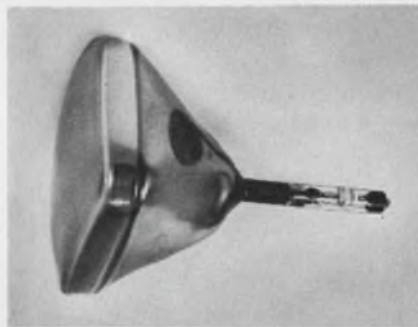

Dataray* Cathode Ray Tubes. Raytheon makes a wide range of industrial CRTs—including special types—in screen sizes from 7" to 24". Electrostatic, magnetic, and combination deflection types are available for writing alphanumeric characters while raster scanning. All standard phosphors are available and specific design requirements can be met. Combination deflection or "diddle plate" types include CK1395P (24" rectangular tube), CK1400P (21" rectangular), and CK1406P (17" rectangular).



Datavue* End-View Tubes. Raytheon makes round (CK8421) and rectangular (CK8422) Datavue indicator tubes on automated equipment capable of high production rates and top quality. The CK8422 rectangular tube is also available with decimal point, ± symbols, and in other special versions. Both round and rectangular types fit existing sockets and conform to EIA ratings. These ultra-long-life tubes are designed for 200,000 hours or more of dynamic operation.



Send Reader Service Card for literature on the:

Symbolray CRT	101
Projectoray CRT	102
Datavue Indicator Tubes	103
Recording Storage Tubes	104
Dataray CRTs	105

Or call your Raytheon regional sales office. Or write to *Raytheon Company, Components Division, Quincy, Mass. 02169.*

*Trademark of Raytheon Company

**SEE THESE DEVICES AT
WESCON—RAYTHEON
BOOTHS 4418-4422**



Industrial Components Operation—A single source for Circuit Modules/Control Knobs/Display Devices/Filters/Hybrid Thick-Film Circuits/Industrial Tubes/Optoelectronic Devices/Panel Hardware

Undercover signals are unmasked

'Aliasing' in sampled data systems is avoided by using a presampling filter and the correct sampling rate.

Telemetry systems often require digital transmission of continuous inputs. Reconstituting digital information can occasion incorrect waveforms due to "aliasing." An example of this problem is shown in Fig. 1b. Choosing the correct sampling rate and presampling filter can prevent this from happening.

A sampled data system using periodic sampling of a continuous input signal must have a sampling rate that fulfills two criteria, if the recovered signal is accurately to portray the input:

- The sampling must be instantaneous, that is, be an impulse function.
- The sampling rate, f_s , must be more than twice the highest signal-base-band frequency. One-half the sampling frequency is often called the Nyquist frequency, $f_s/2$.

Neither of these conditions can be satisfied completely. Realizable sampled-data links use non-zero sampling durations because of circuit or response limitations. The second condition implies that the input signal is band-limited, an ideal characteristic that is physically impossible to attain.

A realizable signal will have a spectrum that contains energy at frequencies greater than the Nyquist frequency. This energy is transposed downward in frequency by the sampling process and may appear in the output—a mechanism known as aliasing. As an extreme example, consider a sinusoid, sampled at a rate eight times its frequency (Fig. 1a), from which a good reconstruction can be achieved. A higher-frequency signal (Fig. 1b) sampled at a rate that is eight-sevenths of its frequency gives identical sampled data, which will lead to a reconstructed signal identical to the first. Such an error may arise in a time-division multiplex link (Fig. 2).

The magnitude of this aliasing error is a function of the input signal spectrum and of the filter network interposed between the sampling device and the signal source.

The presampling filter should have a sharp cutoff at the Nyquist frequency, so that spectral components higher than the Nyquist frequency

will produce a negligible aliasing error.

Calculating the aliasing error

The mean square aliasing error is given by the mean power that exists over signal spectral frequencies greater than the Nyquist frequency.¹ Then the power spectrum presented to the sampler, $G^2(f)$, is given by:

$$G^2(f) = S^2(f)H^2(f),$$

where $S^2(f)$ is the signal power spectral density, and $H(f)$ is the presampling filter amplitude response.

The aliasing error is obtained by integrating over the filtered signal spectrum, from the Nyquist frequency to infinity:

$$P_a = \int_{f_s/2}^{\infty} G^2(f) df \text{ (watts).}$$

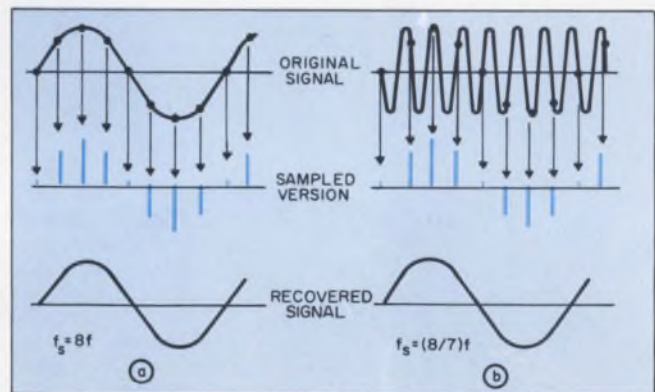

1. Sine wave has good reconstruction where sampling rate is eight times its frequency as in (a). Higher frequency signal, sampled at 8/7 its frequency, gives reconstructed signal (b) identical to (a). Process is known as aliasing.

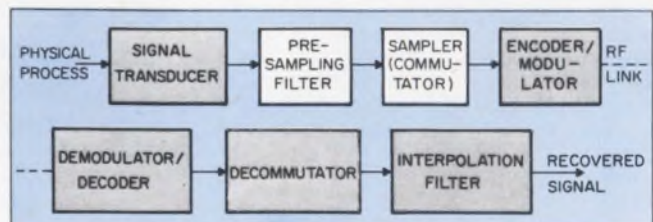

2. Typical time-division multiplex link uses a presampling filter to minimize signal components above the Nyquist frequency.

R. J. Rechter, Head of Signal Analysis Group, Hughes Aircraft Co., Los Angeles, Calif.

This can be normalized by taking a ratio of aliasing power to signal power. The mean signal power is given simply by:

$$P_s = \int_0^{\infty} S^2(f) df \text{ (watts).}$$

The rms aliasing error can then be defined by the square root of the power ratio of aliasing power to signal power:

$$\epsilon_a = (P_a/P_s)^{1/2}.$$

An example of this technique has been worked out² for a presampling spectral density given by the Butterworth power transfer function. In this example, the filtered signal spectral density, $G^2(f)$, can be assumed to be identical to the Butterworth power transfer function:

$$G^2(f) = K/[1 + (f/f_c)^{2m}],$$

where:

- K = constant,
- f_c = the -3-dB bandwidth,
- m = the order of the function.

This spectrum would be obtained if a uniform spectral density signal were filtered by an m^{th} -order Butterworth low-pass presampling filter. The shaded region in Fig. 3 is proportional to the aliasing power. The maximally flat spectral characteristic may be approximated by:

$$G^2(f) \approx K(f_c/f)^{2m},$$

when $f_s/2 \gg f_c$.

Then the aliasing power is given by:

$$\begin{aligned} P_a &= \int_{f_s/2}^{\infty} G^2(f) df = \int_{f_s/2}^{\infty} K (f_c/f)^{2m} df \\ &= [2^{2m-1} K f_c / (2m-1)] (f_c/f_s)^{2m-1}. \end{aligned}$$

Similarly, the total signal power is:

$$\begin{aligned} P_s &= \int_0^{\infty} G^2(f) df = \int_0^{\infty} \{K df / [1 + (f/f_c)^{2m}]\} \\ &= (\pi K f_c / 2m) \csc(\pi/2m). \end{aligned}$$

Finally, the rms aliasing error is:

$$\begin{aligned} \epsilon_a &= (P_a/P_s)^{1/2} \\ &= 2^m \{ [m/\pi(2m-1)] [f_c/f_s]^{2m-1} \sin(\pi/2m) \}^{1/2}. \end{aligned}$$

This aliasing error can be plotted against a normalized sampling-rate/presampling-bandwidth factor for a family of Butterworth filters of various orders (Fig. 4).

It has already been stated that the presampling filter should have a sharp cutoff at the Nyquist frequency if a low value of aliasing error is to be achieved. Consider an example which uses a first-order RC filter ($m = 1$). A uniform signal spectral density is assumed. Now, even if the sampling rate is as high as 100 times the filter cutoff frequency, Fig. 4 shows that an aliasing error of 8% will occur! Most physical signals, of course, do not exhibit uniform spectra, as for example, in television cameras where the signal spectral density is inversely proportional to the signal frequency. But the point is clear: very se-

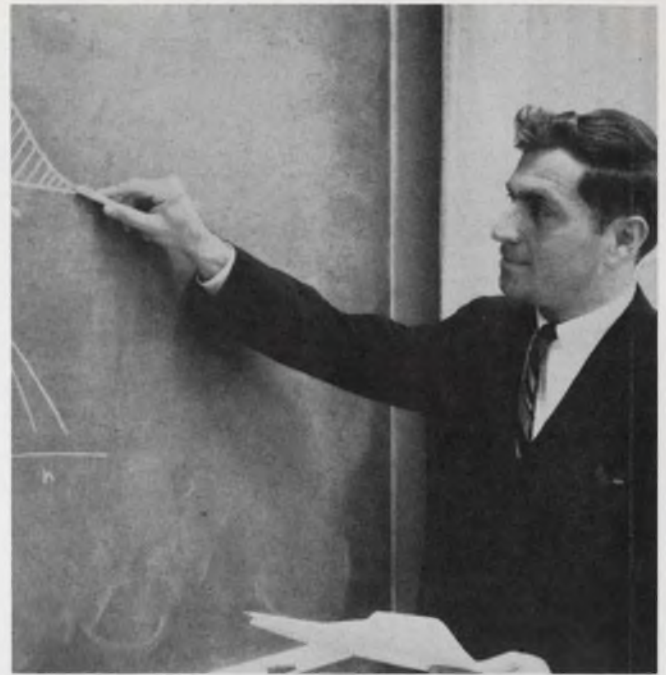

Author Rechter gets the message through to his colleagues on reducing aliasing errors.

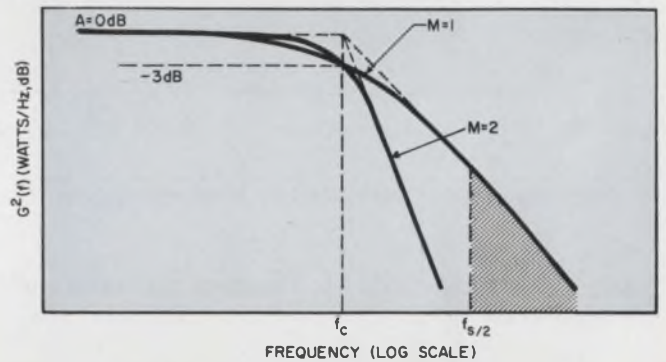

3. Butterworth low-pass presampling filter of second order may be designed to achieve sharp cutoff at less than twice the sampling frequency. Shaded region is aliasing power obtained with first-order filter.

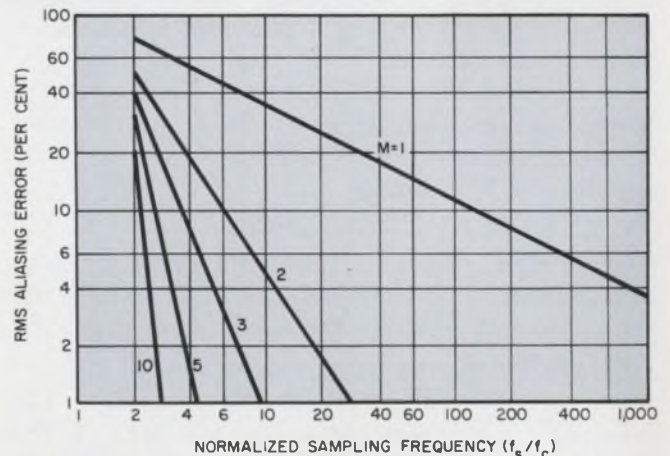

4. Percentage aliasing error for family of filter orders with a normalized sampling frequency enables error to be estimated. For example, RC ($m=1$) filter and f_s 100 times f_c will result in rms aliasing error of 8%.

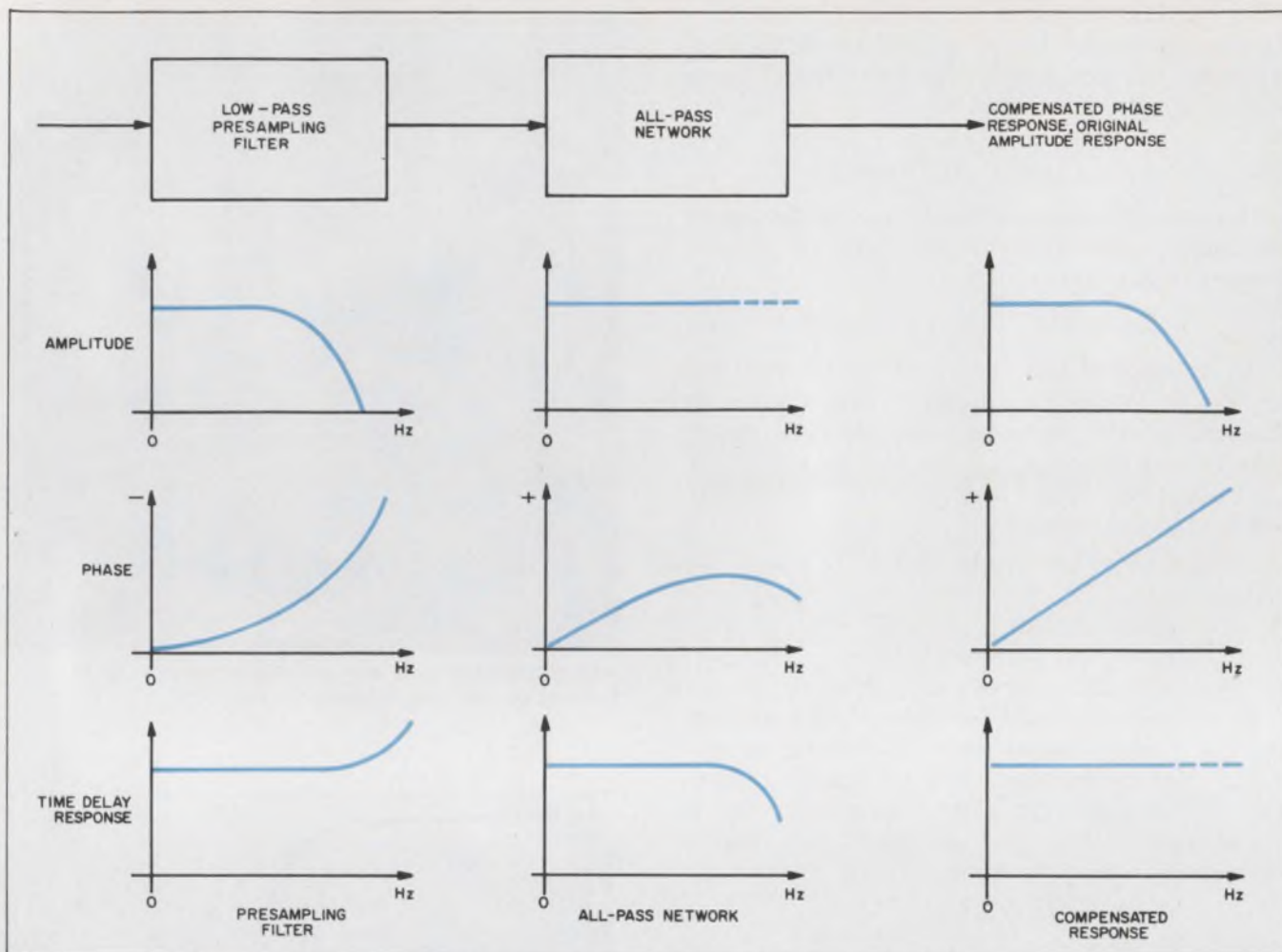

5. Phase distortion is introduced by presampling filter but addition of an all-pass network may be used to compensate.

lective filters are needed to ensure small values of aliasing error.

Transmission link requirements

The transmitter power required for a PCM, FM, phase-modulated link is directly dependent on the predetection signal-to-noise ratio and sampling rate specified. The following analysis of basic parameters for such a system shows how this dependence is derived.

In a typical PCM/FM/PM link, if a non-return-to-zero pulse train is assumed, a predetection threshold signal-to-noise ratio, S_T , must be satisfied. For the i^{th} channel:

$$P_{sc_i} / N_{sc_i} \geq S_T, \quad (1)$$

where P_{sc_i} is the signal power present in the i^{th} subcarrier predetection bandwidth, and N_{sc_i} is the noise power present in the same bandwidth. The signal power is:

$$P_{sc_i} = P_R M L_{sc_i}, \quad (2)$$

where P_R is the received power and $M L_{sc_i}$ is the modulation loss of the i^{th} channel. The noise power is:

$$N_{sc_i} = k T B_{sc_i}, \quad (3)$$

where k is Boltzmann's constant, T is the effective

system temperature in degrees Kelvin, and B_{sc_i} is the i^{th} subcarrier bandwidth in hertz. If P_R is expressed as αP_T , where α is a constant determined by transmitter and receiver antenna and circuit losses, and P_T is the transmitter power, then Eq. 1 can be written as:

$$\alpha P_T M L_{sc_i} / k T B_{sc_i} \geq S_T, \quad (4)$$

or $P_T / B_{sc_i} \geq r$, where $r \equiv S_T k T / \alpha M L_{sc_i}$.

Since $k T / \alpha M L_{sc_i}$ is a constant for a particular system, r is dependent on the desired threshold signal-to-noise ratio. Hence, for a given threshold S/N ratio, the transmitter power is dependent on the subcarrier bandwidth. Since this is a sampled-data system, B_{sc_i} is given by:

$$B_{sc_i} = \gamma N, \quad (5)$$

where N is the total number of bits per second and γ is a factor relating the equivalent noise bandwidth to -3-dB bandwidth ($\gamma \leq 1.08$ for most bandpass functions). N is given by:

$$N = L R f_m, \quad (6)$$

where L is the number of bits per word, R is the number of samples per hertz, and f_m is the data base-band. The transmitter power is thus:

$$P_T \geq r \gamma L R f_m. \quad (7)$$

Since $\gamma L f_m$ is an assumed constant, m , for a

given design situation:

$$P_T \geq r m R.$$

Thus an increase in sampling rate, R , will require an increase in transmitter power. The pre-sampling-filter characteristics are significant in reducing the sampling-rate requirements and thereby either lowering transmitter power levels or improving the transmission link performance by increasing the subcarrier predetection signal-to-noise ratio.

Filtering causes distortion

It should be noted that a presampling filter that has a sharp cutoff also exhibits nonlinear phase. Since the group (or time) delay is the derivative of the phase, it will also be nonlinear with frequency. This can be seen by a comparison of various filter functions³ (Fig. 5).

Because sampled-data systems require linear phase and time delay, all-pass networks may be used for compensation (Fig. 5).

Analyze aliasing error by computer

Aliasing error may be analyzed by computer in the following way:

- The signal (transducer) spectral density is encoded, point by point, as input data to a program, which then operates on this spectrum with a given presampling-filter power transfer response.
- A routine numerically integrates that portion of the modified spectrum which lies beyond the Nyquist frequency. This sum represents the mean aliasing power.
- Another numerical integration, over the entire unmodified signal spectrum, results in the mean signal power.
- Finally, the routines take the square root of the ratio of these two powers and present it as the rms aliasing error.
- In addition, the sampling problem can be attacked directly, in the time domain, by use of an IBM program, ECAP (Electronic Circuit Analysis Program)* (Fig. 6).

This program computes and plots the time function at any node in a system represented by R , L , C , voltage and current source, and switch elements. This transient analysis routine is known as ECAPTR. ■ ■

*ECAP is available from the International Business Machines Corp., Greenbelt Space Flight Center, Greenbelt, Md. 20770 (contact Roger Cliff).

Acknowledgment:

This work was partially prepared under contract No. 950056 to the Jet Propulsion Laboratory and NASA.

References:

1. H. Stilitz (ed.), *Aerospace Telemetry* (Englewood Cliffs, N. J.: Prentice-Hall, Inc., 1961), Chap. 4, pp. 87-90.
2. *Ibid.*
3. H. S. Black, *Modulation Theory* (Princeton, N. J.: D. Van Nostrand Co., Inc., 1953), pp. 181-233.

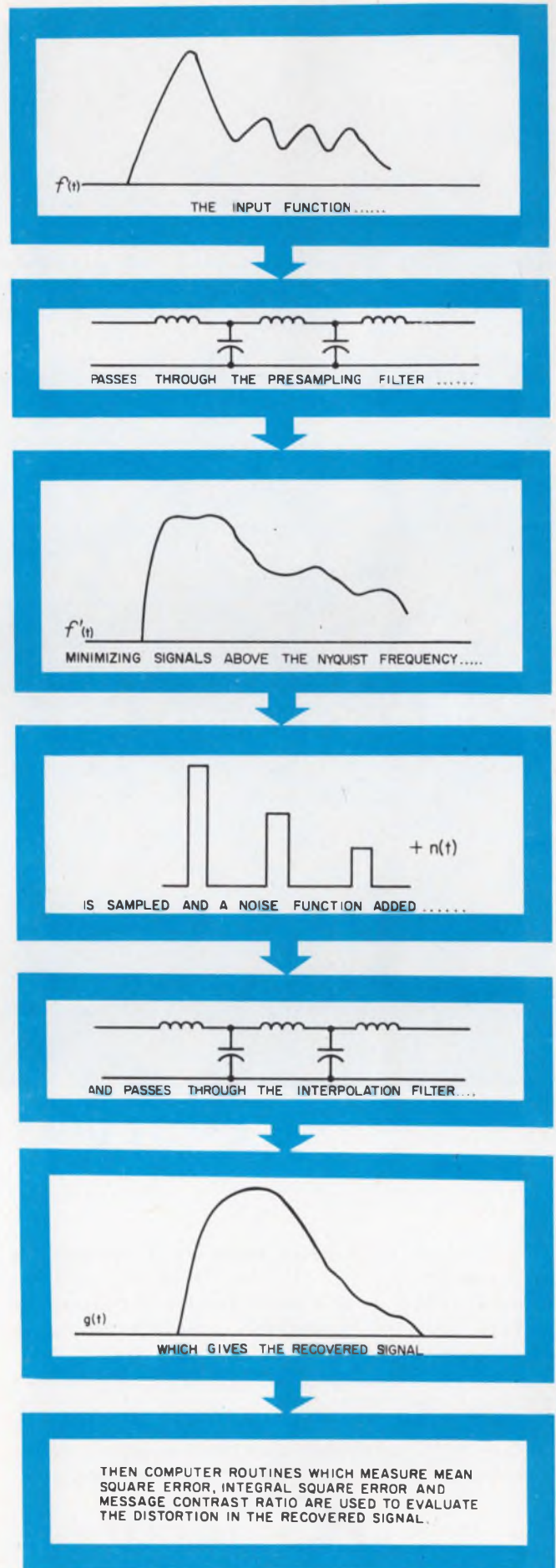

6. Computer simulates multiplex link using ECAP.

**COULD YOU SLICE THIS ANGLE
INTO 300 EQUAL PARTS?**

OR MAKE A CRYSTAL FILTER HAVING 0.1% PHASE LINEARITY



OVER 1500° PHASE SHIFT?

M^{CC}COY DOES IT EVERY DAY!

M^{CC}Coy makes the most complete line of crystal filters in the world, from 5 KHz to 125 MHz...precision assemblies that do an outstanding job of passing the desired range of frequencies while attenuating all others. Can be designed to withstand severe shock and vibration conditions under extreme changes in ambient temperature.

Options in electrical components, particularly the M^{CC}Coy tight parameter-controlled quartz crystals, permit wide choice of narrow, intermediate and wide-

band filter types for every circuit need.

M^{CC}Coy filters have low insertion loss, minimum ripple, and excellent passband characteristics over temperature ranges of -55 to $+105^{\circ}\text{C}$.

Such filter precision is made possible by the use of M^{CC}Coy-made quartz crystals having the proper combination of inductance, capacitance, Q and frequency stability. When you specify M^{CC}Coy crystal filters, you are going to get the highest quality available.

For full details, write for our new catalog.



M^{CC}COY ELECTRONICS COMPANY

A Subsidiary of OAK ELECTRO/NETICS CORP
Mt. Holly Springs, Pennsylvania 17065

ON READER-SERVICE CARD CIRCLE 191

There's no faster delivery of Heinemann circuit breakers than across-the-counter...



...and we've got 43 counters:

AUTHORIZED HEINEMANN STOCKING DISTRIBUTORS

Alabama

Electro-Tech, Inc.
Huntsville
(205) 539-1250

Arizona

Kierulff Electronics, Inc.
Phoenix
(602) 273-7331

California

Wesco Electronics
Palo Alto
(415) 968-3475

Wesco Electronics
Pasadena
(213) 795-9161

Colorado

Kierulff Electronics, Inc.
Denver
(303) 825-7033

Connecticut

MarLe Company
Stamford
(203) 348-2645

Florida

McDonald Distributors
of Florida Inc.
Fort Lauderdale
(305) 563-1255

Industrial Electronics
Associates, Inc.
West Palm Beach
(305) 848-8686

Parts Service Corp.
Winter Park
(305) 647-5343

Georgia

Electro-Tech, Inc.
Hapeville
(404) 758-7205

Kansas

Hall-Mark Electronics
Kansas City
(913) 236-4343

Kentucky

E & H Electric Supply Co.
Louisville
(502) 587-0991

Marine Electric Co., Inc.
Louisville
(502) 587-6511

Louisiana

Poulan's Electrical Co.
Monroe
(318) 323-7701

Hall-Mark Electronics
New Orleans
(504) 242-7581

Maine

Stanley J. Leen Co., Inc.
Portland
(207) 774-6266

Maryland

Lee Electric Co.
Baltimore
(301) 752-4080

Pytronic Industries Inc.
Baltimore
(301) 727-5100

Massachusetts

Apparatus Service Co.
Allston
(617) 787-1300

Electrical Supply Corp.
Cambridge
(617) 491-3300

T. F. Cushing, Inc.
Springfield
(413) 788-7341

Mississippi

Ellington Electronic
Supply, Inc.
Jackson
(601) 355-0561

New Jersey

Valley Electronics, Inc.
Cherry Hill
(609) 662-9337

Federated Purchaser, Inc.
Springfield
(201) 376-8900

New Mexico

Kierulff Electronics, Inc.
Albuquerque
(505) 268-3901

New York

Federal Electronics Inc.
Vestal
(607) 748-8211

Schweber Electronics
Westbury, Long Island
(516) 334-7474

North Carolina

Electro-Tech, Inc.
Charlotte
(704) 333-0326

Ohio

Midwest Equipment Co.
Cincinnati
(513) 821-1687

Radio & Electronic Parts
Cleveland
(216) 881-6060

Oklahoma

Hall-Mark Electronics
Tulsa
(918) 835-8458

Oregon

Platt Electric Supply
Portland
(503) 222-9633

Pennsylvania

West Chester Electric
Supply Co.
West Chester
(215) 696-7500

Rhode Island

William Dandreta & Co.
Providence
(401) 861-2000

Texas

G. E. Jones Electric Co.
Amarillo
(806) 372-5505

Warren Electric Co.
Beaumont
(713) 833-9405

Hall-Mark Electronics
Dallas
(214) 231-6111

Nelson Electric Supply
Dallas
(214) 741-6341

Hall-Mark Electronics
Houston
(713) 781-0011

Warren Electric Co.
Houston
(713) 225-0971

Messner Electric Supply
Longview
(214) 753-4484

The Perry Shankle Co.
San Antonio
(512) 223-1801

Washington

Kierulff Electronics, Inc.
Seattle
(206) 725-1550

HEINEMANN ELECTRIC COMPANY



Trenton, New Jersey 08602

ON READER-SERVICE CARD CIRCLE 192

An inexpensive character generator

built with commercially available integrated circuits displays characters of high quality

A task that frequently faces a designer is to modify or add to an existing system to meet new needs. His ability to do this with available hardware and without changing the over-all system is an important factor in holding down the cost of new devices.

In the following instance, a character generator had to be built to operate with an existing graphic display. The system already included analog sources capable of generating circles, line segments and similar geometric shapes. The focus, then, was on designing a character generator that could use analog function generators to provide a variety of character elements.

Additional requirements for the character generator were:

- Good character quality.
- Minimum bandwidth.
- High rate of character generation
- Low cost.

All the design goals were met. A comparison of this method with several other approaches showed that what at first seemed to be a constraint—the use of analog sources—proved to be an advantage. The method used was the least costly and was compatible with the rest of the system.

Compare other methods

Other methods of character generation include dot-raster schemes, straight-line-segment generators, monoscopes, and beam-shaping. These techniques are illustrated in Fig. 1.

The quality of straight-line-segment and dot-raster methods is poorer and the bandwidths they require are larger by a factor of two to three than what was selected. Beam-shaping could have been used, for its character quality is excellent, but beam-shaping CRTs run about \$3000 apiece in small quantities—an excessive price. Monoscope tubes can be purchased for around \$100 in small quantities, but like beam-shaping equipment require a decode matrix, which will substantially increase the cost of most character generators.

Analog methods are employed to form line seg-

Harvey L. Morgan, Senior Systems Engineer, General Electric Co., Phoenix, Ariz.

Table: Character building waveforms

1. Sine wave
 2. Cosine wave
 3. Sine-sawtooth
 4. Cosine-sawtooth
 5. Sine-square wave
 6. Cosine-square wave
 7. High level
 8. Zero level
 9. Low level
 10. Negative sine wave
 11. Negative sine-sawtooth
 12. Negative cosine-sawtooth
- Half-amplitude waves**
13. Positive-biased cosine wave
 14. Negative-biased negative cosine-sawtooth
 15. Positive-biased negative cosine-sawtooth
 16. Negative cosine-sawtooth
 17. Negative-biased cosine wave

ments needed for full alphanumeric display. Binary switching and timing serve to display the waveforms successively.

The table lists the necessary waveforms. Combinations of sine waves, sawtooths, cosine waves, and constant levels are used, as well as full and half-amplitude versions of the basic waveforms, and inverted waveforms. All in all, 17 different forms are required to generate a full repertoire of characters.

The capital letter A, for example, requires starting from the lower, left-hand corner of the alphanumeric block simultaneously with a half-amplitude cosine-sawtooth on the horizontal plates of the electrostatic deflection system and a full-amplitude cosine-sawtooth on the vertical plates. Figure 2 shows the waveforms and timing. This can be followed by negative-going sawtooths to draw the line from the top of the block to the lower, right-hand corner. The bar in the middle requires a constant (zero) voltage on the vertical axis and a half-amplitude cosine-sawtooth on the horizontal axis. Between line-drawing operat-

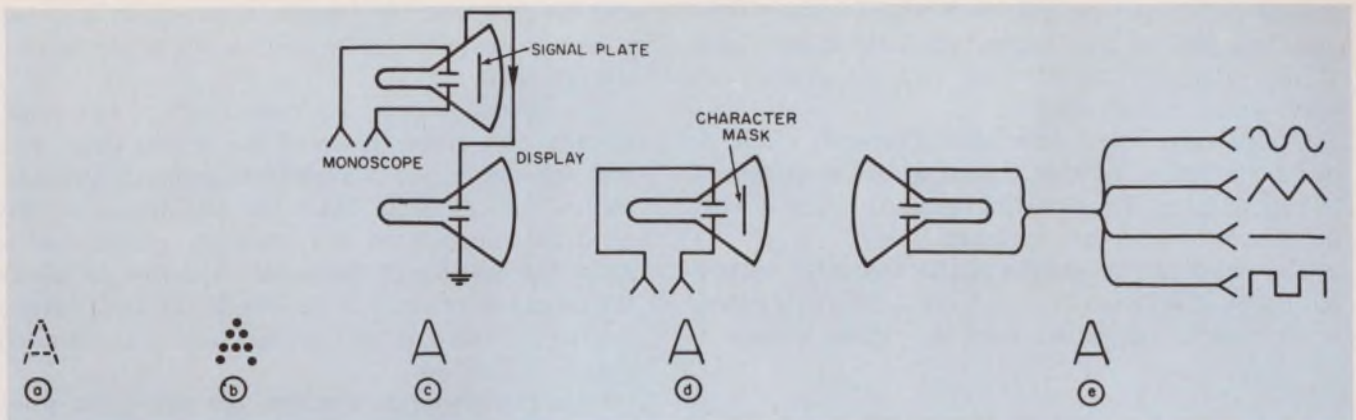

1. Various approaches to forming characters for the CRT display are possible. Straight-line-segment (a) and dot-raster (b) methods do not give good quality and require large bandwidths. Monoscope (c) and beam-shaping (d) methods include costly CRTs. (In a monoscope the char-

acters are printed on the cathode "signal plate." The electrical TV signal is obtained by scanning the signal plate.) The selected method (e) using combinations of basic analog functions gives characters of good quality and is inexpensive.

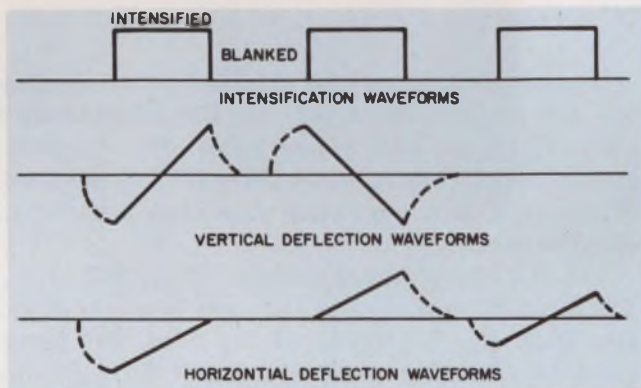

2. Letter A is formed by simultaneously applying a half-amplitude cosine-sawtooth to the horizontal deflection plates and a full-amplitude cosine-sawtooth to the vertical plates. The bar in the middle requires a constant (zero) voltage on the vertical plates and a half-amplitude cosine-sawtooth on the horizontal axis. Other letters are formed in similar fashion.

ions (when intensity is on full), blanking is required to hide the spot movements to new starting positions.

The operations illustrated for a capital A are basically the same for all the alphanumeric characters, and various other symbols. A maximum of six lines is required to delineate any character or symbol; the average is three.

How the generator works

A free-running multivibrator, followed by triggered flip-flops which are driven from opposite sides of the multivibrator (see Figs. 3 and 4), generates the signals for the various waveforms. This gives a two-phase square-wave clock. To obtain sinusoids, an LC low-pass filter with 90° phase delay is driven off each flip-flop. Sawtooths are obtained by integrating the square waves with Miller integrators (Fig. 5). Phase inverters yield positive and negative versions of both sinusoidal waves and sawtooths. Voltage dividers provide the half-amplitude waves. Clamps to

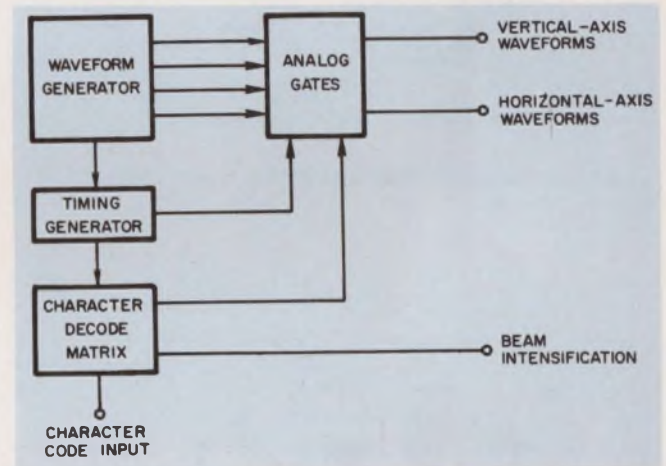

3. Character generator block diagram illustrates its functional simplicity. The generated waveforms are selected by the character decode matrix and applied to the display device through analog gates.

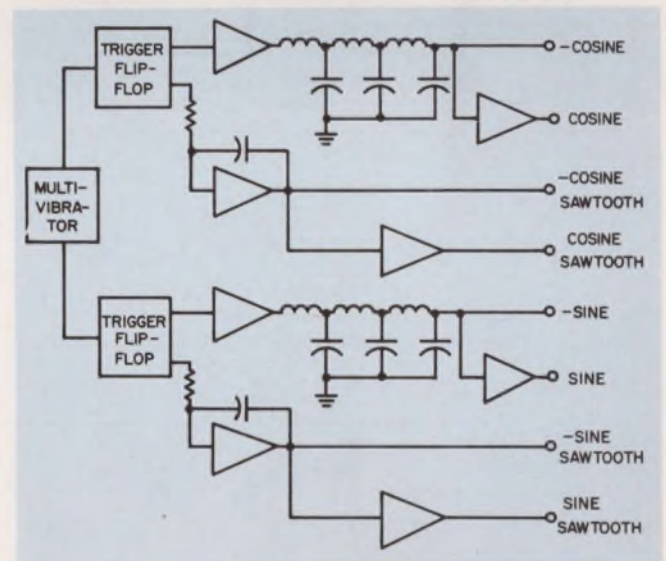

4. Waveform generator comprises ICs and passive pulse-shaping networks. To obtain sinusoids, an LC low-pass filter with 90° phase delay is driven off each flip-flop. See text for the component values.

ground and plus and minus voltages supply constant voltages for lines across top, bottom, and sides of the character block. Bias voltages applied to waveforms also play a part.

Timing comes from the basic character clock. A counter wired to provide timing pulses at equal intervals of intensification and blanking is gated with waveforms to draw the characters (Fig. 6).

The heart of the system is the character decode matrix built principally with 8-input 957 AND gates. It receives timing pulses from the timing generator

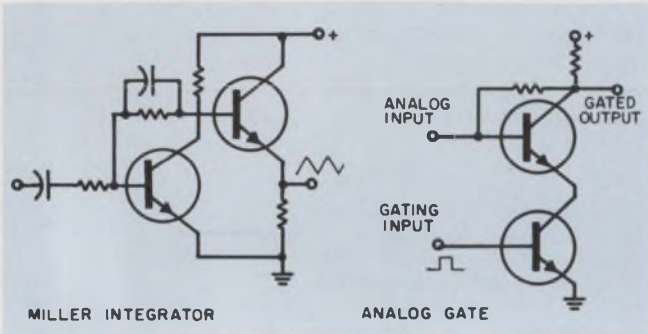

5. Analog signal-shaping and gating is accomplished with simple circuits.

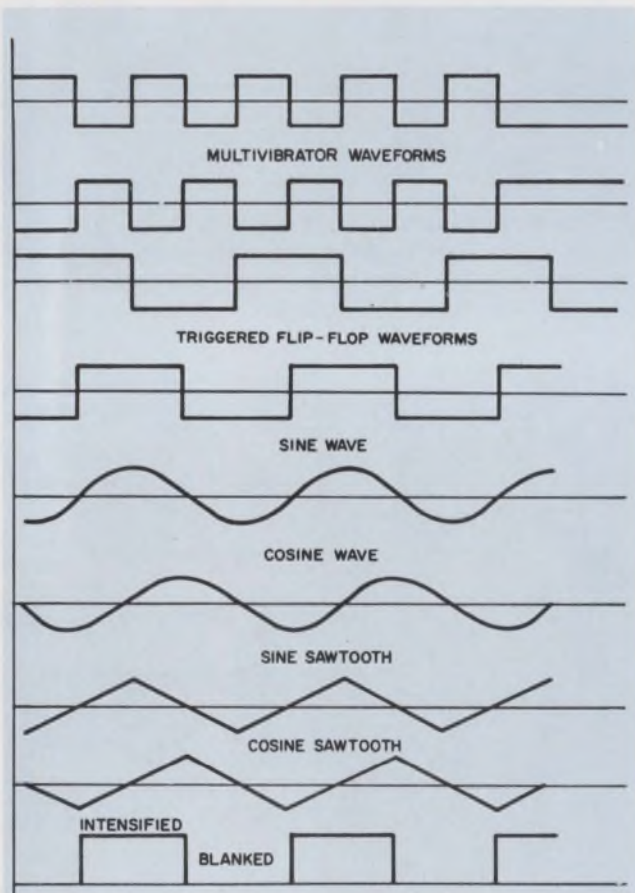

6. Waveform timing is given by the character clock. A combination of character requirements, waveforms, timing pulses, and intensification provides the right waveforms to delineate any desired character. Only a few basic waveforms are illustrated.

and the character code input. A binary six-bit code is used to enter character information from the central processor.

The decode matrix, on recognizing a character, actuates the proper gates of the analog gate unit. Simultaneously, it determines appropriate intensification and blanking. Since the waveforms are applied continuously to the normally closed analog gates, the opening of the gates in succession allows the proper waveforms to appear at the electrostatic plates of the display unit. In this fashion the desired character is drawn.

Character decoding matrices are simplified when it is remembered that many characters have lines in common. For example, a line down the left side of the character block is used by the capital letters B, D, E, F, H, K, L, M, N, P, and R. Groupings of this type allow considerable logic simplification.

Circuit tips

In implementing the character generator, integrated circuits are employed for the multivibrator clock; flip-flops, and binary gates. For waveform gating, analog two-transistor gates (Fig. 5) are used. The signal to pass the analog waveforms is binary in either on or off.

The ICs are of the Fairchild CT μ L 950 series. The multivibrator used as the clock is a pair of 952 gate packages. For triggered flip-flops, 957 power gates drive integrator and phase-shift filter circuits which not only provide sine waves but also 90° phase shifts. The transistors are 2N697 silicon units, except for the CRT deflection drivers (not shown) for character display. Character decode networks are built mostly with the 8-input 957 AND gates.

The transistor circuits use +12 volts; 4.5- and -2-volt supplies drive the logic circuits. The Miller integrator has a 1.5-k Ω collector load resistor, a 10-pF feedback capacitor, a 1.5-k Ω series base resistor, and 0.6-k Ω emitter-follower load resistor. The analog gate uses a 1.5-k Ω collector load resistor and a 90-k Ω base bias resistor.

The clock rate (multivibrator frequency) is 2 MHz. Sine-wave frequency is half that—1 MHz. Character generation rate is one per 8 microseconds, or 125,000 characters per second. A video bandwidth of 5 MHz is used for horizontal and vertical electrostatic deflection.

A recent look at integrated circuit prices with regard to the requirements of this generator revealed that the cost of building it is only a small fraction of the cost of buying one on the market.

All in all, this approach resulted in a simple, versatile system fully utilizing the existing hardware. In addition to its low cost, the system could be easily changed without going to some outside vendor as would be the case if any of the approaches mentioned in the beginning of the article were used. ■ ■

Plugboard programming systems? MAC ships off-the-shelf!

Compatibility is the difference between components and systems. Because we match plugboards, plugwires and receivers for such characteristics as conductivity, crosstalk, shielding and convenience, we can actually say that we ship simple systems off-the-shelf. But if you're thinking of a system that is *really*

different, that may take us a little longer . . . a matter of weeks, maybe. We are constantly exercising our ingenuity and engineering expertise in the creation of new systems, to order. If you're thinking now, and want delivery anytime soon, we should be talking. Or designing. Would tomorrow be too soon?

MAC O.E.M. DIVISION

MAC Panel Co., Box 5027, High Point, N. C. 27262

On Reader Service Card Circle 194



Pick plastics for high-speed circuits

by considering all properties. A low dielectric constant is only one part of the answer.

The electrical parameters and construction materials of a high-speed digital circuit influence the circuit's "speed." Theoretically it should take no time to turn a switch from off to on, or to change the voltage at some point in the circuit from, say, 0 to +3 volts. But not only do the active circuit elements cause delay, so too do the plastics used to separate, support and protect the circuit.

These plastics are important circuit-design parameters—critical factors that determine the performance of the final, packaged circuit. They affect two important elements:

- Component values.
- Heat transfer properties.

The major factor that limits the use of a particular material in high-speed circuitry is its dielectric constant. The dielectric constant alone, however, is not the sole criterion for selecting a material—even for high-speed applications. Other factors must also be taken into account. Many low-dielectric plastics have questionable insulation resistance, moisture absorption, mechanical strength, and handling and processing qualities, which make them poor choices in many applications. The logical approach to high-speed circuitry is to choose as low-dielectric a material as will satisfy all other requirements.

Mind your Ls and Cs

At present, typical propagation delays are on the order of tens of nanoseconds, but a great deal of development work is going on in the nanosecond and subnanosecond region. Here the placement of components is as critical as the components themselves. The geometry of and spacing between components become critical factors in determining the value of components. As a rule of thumb, it is convenient to remember:

- One inch of wire has an inductance of about 20 nanohenries.
- Two adjacent one-inch-long insulated wires have a capacitance of about 0.1 picofarad.

These inductances and capacitances are addi-

tional to the inductors and capacitors that are intentionally placed in a circuit (interconnecting wires, pin connections, cables, etc.). They constitute real Ls and Cs, however, which, because they must be charged and discharged, affect propagation delay.

Dielectric constant affects parasitics

The material between conductors affects the parasitic capacitance between the conductors. Parasitic capacitance comprises parallel-plate capacitance and fringe capacitance (Fig. 1).

Parallel-plate capacitance is given by:

$$C = k \epsilon_r A/d, \quad (1)$$

where:

- k = a constant which depends on the units of measure,
- ϵ_r = relative dielectric constant,
- A = plate area,
- d = distance between the plates.

Fringe capacitance does not lend itself to a simple analytical expression. It is generally the dominant term in parasitic capacitance, however, since the parallel areas are usually very small. It, too, is a strong function of ϵ_r .

At a bare minimum, the substrate on which all the devices are mounted will increase the parasitic capacitance relative to air. If the conditions under which the circuit must operate require its encapsulation, the dielectric constant of the particular encapsulant will further increase the parasitic capacitance. Whether or not the parasitic capacitance is desirable (it might be used to cancel a stray inductance, for instance), it inevitably exists in a circuit. And plastics modify capacitances.

Another source of capacitance is the connectors and cables that join various circuits. The capacitance between adjacent wires in a cable and between pins in a connection is determined to a large extent by the insulating plastics.

The choice of the right plastic is further complicated by the fact that the relative dielectric constant of some materials is a function of frequency. Therefore, not only must the plastic itself be considered, but also the particular frequency at

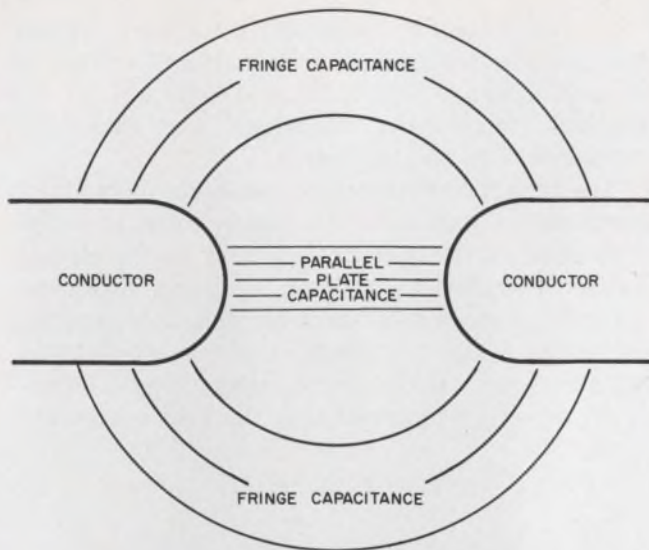

1. Parallel-plate and fringe capacitances are inherent in any material. Both components of parasitic capacitance are strong functions of the material dielectric constant.

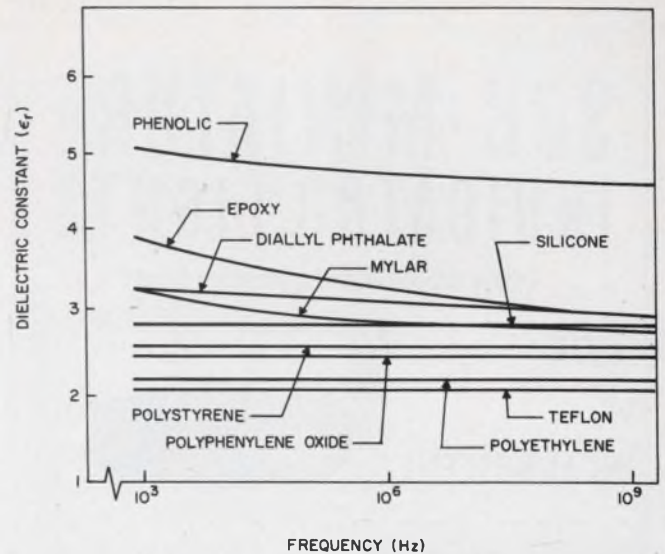

2. Dielectric constant is a function of the frequency of circuit operation. Merely choosing the lowest dielectric constant, however, is not the full answer.

which the circuit is to be operated. Figure 2 shows the frequency dependence of ϵ_r for several plastics.

Failure to consider the effect of a plastic on component values early in the breadboard phase may lead ultimately to a circuit package that has substantially less than the desired capability.

Plastics form a thermal circuit

Modification of component values is not the only problem to be considered in selecting plastics for high-speed circuits. While components may be shrunk smaller and smaller, heat dissipation will place a practical limit on packaging density.

All components dissipate heat, and this heat

must eventually be transferred to the ambient environment. As higher switching speeds are achieved, the thermal power density increases, and the problem of cooling circuits becomes more critical. This is because higher switching speeds demand smaller components, placed more closely together in order to reduce propagation delay.

Reducing the power level is an obvious solution. For reliable operation, however, there is a minimum power level beyond which it is impractical to go. Therefore, as smaller components are placed closer together, the thermal power density has to increase for operation to take place at a specified power level. It is this thermal power that has to be dissipated. And, plastics play a part.

Table. Comparative properties of plastics (25° C)

	Specific gravity (dimensionless)	Heat distortion temperature (°F)	Coefficient of linear expansion (in./in. °F)	Thermal conductivity (W/°C·m)	Water absorption (% at 24 h)	Dielectric strength (V/mil)	Volume resistivity (Ω·cm)
Phenolic	1.5	350	30×10^6	0.30	0.9	350	10^{12}
Epoxy	1.5	300	30×10^6	0.17	0.04	400	10^{15}
Diallyl phthalate	1.5	310	40×10^6	0.30	0.09	450	2×10^{16}
Silicone	1.8	900	30×10^6	0.36	0.15	350	5×10^{13}
Polyphenylene oxide	1.1	375	29×10^6	0.19	0.06	450	10^{17}
Mylar*	1.4	300†	15×10^6	0.14	0.8	5000‡	10^{18}
Polyethylene	0.94	110	100×10^6	0.35	0.01	500	10^{16}
Polystyrene	1.1	170	40×10^6	0.12	0.04	500	10^{17}
Teflon*	2.1	132	55×10^6	0.25	0.01	500	10^{17}

NOTES:

* DuPont trademark

† Maximum service temperature

‡ 1-mil film

DIALCO

SUB-MINIATURE INDICATOR LIGHTS

make difficult display applications easier!

NEON
OR
INCANDESCENT



Dialco has the widest selection of sub-miniature indicator lights to choose from ...off the shelf for quick delivery!

Designed to meet or exceed the environmental and operational requirements of MIL-L-6723 and MIL-L-3661, Dialco Incandescent units may be had for 1.35 to 28V circuits; Neon indicators for 105-125V AC-DC or 110-125V AC only. Units mount in 15/32" or 17/32" clearance hole—and lens caps unscrew from front of panel for easy lamp replacement.

Choose from a wide array of lens shapes and colors (with or without hot-stamped or engraved legends)—dimming or non-dimming features; assemblies with or without watertight construction.



Ask for new 12 page catalog today. Get all the facts!

...and choose with the satisfaction of knowing you are getting the best. Dialco has been the standard of the industry for over a quarter of a century!

SAMPLES ON REQUEST—AT ONCE—NO CHARGE

Foremost Manufacturer of Indicator Lights

DIALIGHT CORPORATION

60 STEWART AVE., BROOKLYN, N.Y. 11237 • AREA CODE 212 497-7600

Booths 5239-5240 at WESCON
ON READER-SERVICE CARD CIRCLE 195

(Illus. approx. actual size)



137-8836-0931-552



174-8430-0131-203



162-8430-0931-502



134-8430-0351-201



101-3830-0971-201



177-8430-0931-503

As in the case of component-value modification, the plastics used in high-speed circuitry affect its thermal characteristics. They form part of the thermal circuit that transfers heat from the components to the ambience.

The exact relationship between component temperature and ambient temperature is highly dependent on the specific geometry of the circuit. Proper thermal analysis of a circuit ordinarily requires experimental data as well as theoretical calculation. The temperature difference between ambience and a particular component will, however, be directly proportional to the heat conductivity:

$$\theta_A - \theta_C = k P_T / \lambda, \quad (2)$$

where:

θ_A = ambient temperature,

θ_C = components temperature,

k = a constant which depends on the particular geometry,

P_T = thermal power,

λ = heat conductivity of the intervening material.

Since the component temperature may approach 200°C, the heat conductivity of the particular plastics used is important for the efficient transfer of heat to the external environment.

Thus at each stage of the final packaging of a typical high-speed digital circuit, the electrical and thermal properties of the plastics must be taken into consideration since they help to determine the performance of the final system.

The table indicates important electrical, thermal, and physical properties of plastics which lend themselves to use in high-speed circuits. Depending on the particular application and environment, trade-offs have to be made between desirable characteristics. For example, Teflon has the lowest dielectric constant. However, if the dielectric constant of polyphenylene oxide can be tolerated, it has excellent mechanical and thermal properties. One other parameter not listed has also to be considered: the cost of the material selected.

This article has been confined to high-speed digital circuits, but its findings apply similarly to high-frequency linear circuits. ■ ■

Bibliography:

Andreotti, J. "Development of Formulas for Predicting Changes in Parameters of Electronic Components Due to Embedding," *Insulation*, XII, No. 3 (March, 1966).

Molzon, A. E. "Advances and Trends in Electronic Encapsulation," *Proc. 6th IEEE Electrical Insulation Conf., Sept., 1965* (Paper No. 32C3-38).

Schlabach, T. D. "Insulating Substrates for Data Processing Equipment," *Proc. 6th IEEE Electrical Insulation Conf., Sept., 1965*, (Paper No. 32C3-54).

Tenzer, M. "Dielectrics in Microcircuitry for Communications," *Proc. 6th IEEE Electrical Insulation Conf., Sept., 1965* (Paper No. 32C3-49).

Von Hippel, A. *Dielectrical Materials and Applications*. New York: John Wiley & Sons, 1954.

SPECTROL STOCKING DISTRIBUTORS

- ALABAMA**
HUNTSVILLE—Radio Electronic Service Co. (205) 539-5156
- ARIZONA**
PHOENIX—Sterling Electronics, Inc. (602) 258-4531
- CALIFORNIA**
GLENDALE—R. V. Weatherford Company (213) 849-3451
INGLEWOOD—Newark Electronics Co., Inc. (213) 678-0441
LOS ANGELES—Kierulff Electronics (213) 685-5511
PALO ALTO—Kierulff Electronics (415) 968-6292
REDWOOD CITY—Fortune Electronics (415) 365-4000
SAN DIEGO—Kierulff Electronics (714) 278-2112
- CANADA**
MONTREAL—CESCO Electronics, Limited (514) 861-2411
OTTAWA—CESCO Electronics, Limited (613) 729-5118
QUEBEC—CESCO Electronics, Limited (418) 524-3518
TORONTO—CESCO Electronics, Limited (416) 538-5250
VANCOUVER, B. C.—L.A. Varah, Limited (604) 736-6411
- COLORADO**
DENVER—Newark-Denver Electronics (303) 757-3351
- CONNECTICUT**
NORWALK—Arrow Electronics (203) 838-4851
- DELAWARE**
WILMINGTON—Wholesale Electronics (302) 652-3221
- FLORIDA**
ORLANDO—Hall-Mark Electronics (305) 855-4020
- GEORGIA**
ATLANTA—Jackson Electronics Supply Co., Inc. (404) 355-2223
- ILLINOIS**
CHICAGO—Newark Electronics (312) 638-4411
- LOUISIANA**
BATON ROUGE—Ralph's of Baton Rouge (504) 344-3761
NEW ORLEANS—Sterling Electronics (504) 522-8726
- MARYLAND**
BALTIMORE
 Radio Electric Service Co. of Baltimore (301) 539-3835
HYATTSVILLE—Milgray/Washington, Inc. (202) 864-6330
- MASSACHUSETTS**
BOSTON—DeMambro Electronics (617) 787-1200
- MICHIGAN**
DETROIT—Newark-Detroit Electronics (313) 548-0250
- MINNESOTA**
ST. PAUL—Gopher Electronics Co. (612) 645-0241
- NEW JERSEY**
SPRINGFIELD—Federated Purchaser, Inc. (201) 376-8900
- NEW MEXICO**
ALBUQUERQUE—Kierulff Electronics (505) 268-3901
- NEW YORK**
BINGHAMTON—Stack Industrial Electronics, Inc. (607) 723-6326
BUFFALO—Summit Distributors (716) 884-3450
LONG ISLAND—Arrow Electronics (516) 694-6800
 Schweber Electronics (516) 334-7474
NEW YORK CITY—Terminal Hudson Electronics, Inc. (212) 243-5200
- NORTH CAROLINA**
GREENSBORO—Carolina Radio Supply Company (919) 273-6358
- OHIO**
CINCINNATI—Newark Herrlinger (513) 421-5282
CLEVELAND—Winteradio Electronic Supply Corp. (216) 621-9383
COLUMBUS—Electronics Marketing Corporation (614) 299-4161
- SOUTH EUCLID**
 Winteradio Electronic Supply Company (216) 382-7676
- OKLAHOMA**
TULSA—Hall-Mark Electronics (918) 835-8458
- PENNSYLVANIA**
PHILADELPHIA—Milgray/Delaware Valley (215) 228-2000
PITTSBURGH—Barco Radio Company (412) 462-7575
- SOUTH CAROLINA**
GREENVILLE—Carolina Radio Supply Company, Inc. (803) 239-5125
- TENNESSEE**
KINGSPORT—Radio Electric Supply (615) 247-8111
NASHVILLE—Electra Distributing Co. (615) 255-8444
- TEXAS**
DALLAS—Contact Electronics, Inc. (214) 631-9530
EL PASO—Midland Specialty Company (915) 533-9555
HOUSTON—Busacker/Hamilton (713) 528-6383
SAN ANTONIO—Busacker/Hamilton (512) 223-5517
- UTAH**
SALT LAKE CITY—Kimball Electronics (801) 328-2075
- VIRGINIA**
RICHMOND—Meridian Electronics, Inc. (703) 353-6648
- WASHINGTON**
SEATTLE—Kierulff Pacific Northwest (206) 725-1550
- WEST VIRGINIA**
CHARLESTON—Charleston Electrical Supply Co. (304) 346-0321
- WISCONSIN**
MILWAUKEE—Electronic Expeditors (414) 871-3000

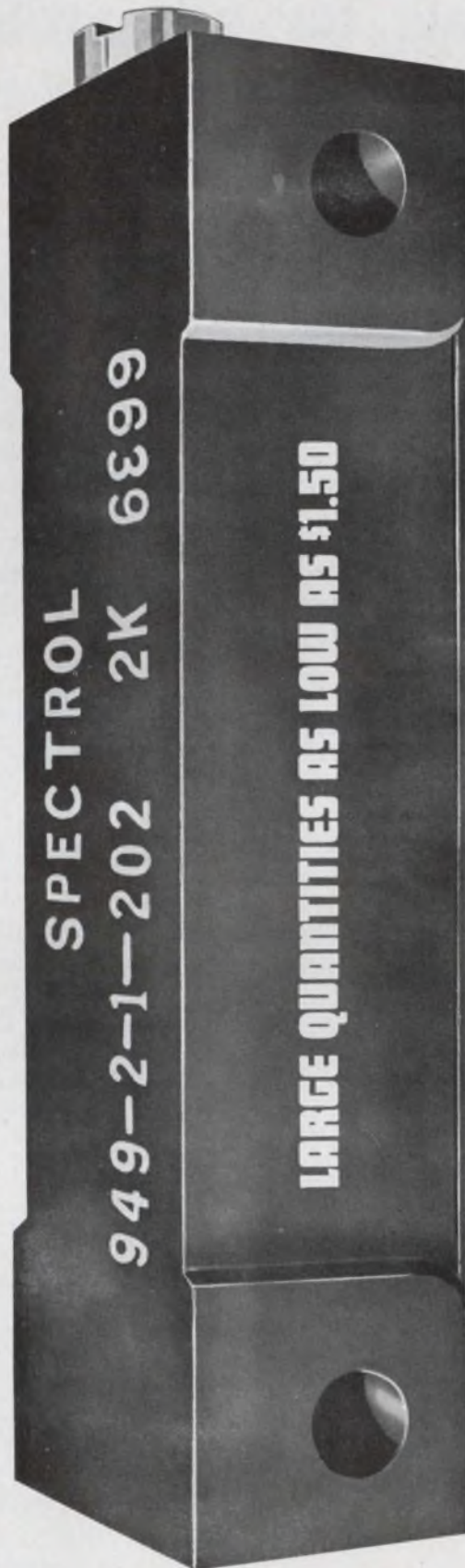

But the proof is in the product. You'll find it on the shelves of your local Spectrol distributor. Its performance will prove to you that our published specs are conservative. (We like it that way.)

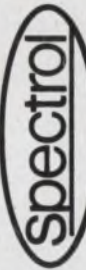

Better Components for Better Systems

And at these prices, what other non-wirewound can beat these specs?

- Resistance Range: 100Ω to 1 megohm.
- Power Rating: 0.75W @ 70°C.
- Temperature Range: -25°C. to +125°C.
- Resistance Tolerance: ±20%
- Tempo: ±300 ppm/°C. max.
- Element: Cermet
- Packages: RJ11 size with 5 mounting options

Biggest cermet value at lowest prices!

Here is the lowest priced cermet trimmer you can buy in an RJ11 package! Even if the Spectrol design was not better (and we think it is) could you afford to ignore the prices?

SPECTROL ELECTRONICS CORPORATION / 17070 E. GALE AVENUE, CITY OF INDUSTRY, CALIFORNIA 91745 / PHONE: (213) 964-6565 • TWX: (910) 584-1314

Choose metals for compatibility

in packaged circuits to avoid RFI, poor grounds, ground loops and stray coupling.

A little knowledge of metallurgy is a useful adjunct for the designer who is packaging his electronics in a metal chassis. An ill-chosen finish for a package can lead to poor grounds, ground loops, stray coupling and RFI. The wrong protective coating for this finish can introduce noise. Metal hardware performing interconnection, support, readout and read-in functions must be selected with care. And in general, the smaller a package of linear or nonlinear circuitry, the greater the problems of metal compatibility tend to become. Only the proper choice of compatible hardware, materials and finishes can alleviate these problems. Here then are some hints on how to achieve this end.

Metallic materials must be galvanically similar

For much of today's equipment, an aluminum alloy is used as the chassis material. When this is the case, feed-through insulators and similar hardware that is in contact with the chassis should be plated with finishes that do not form galvanic couples with aluminum. As the table shows, these finishes would need to be of zinc, cadmium, tin or stainless steel.

If the designer were to choose hardware that was

William A. Melanson, Vice President, Cambridge Thermionic Corp., Cambridge, Mass.

nickel-plated, for example, undesirable contacts between dissimilar metals could occur. Many oxides and sulfides that might result are semiconductors and could form nonlinear ground paths or loops in which a nonlinear element is present. This could lead to faulty rectification and reradiation.

The table, taken from MIL-Std-454A, groups together metals that are considered galvanically similar. Any metal within a group may be used in intimate contact with any other metal in the same group. All the metals listed are for surface application and can be an electrodeposited plate, hot dip or spray.

Extra protective coatings are added to many finishes to increase corrosion resistance. These coatings can be in the form of organic dips, chromate conversion coatings or anodizes. If care is not taken, these coatings can interfere with good grounding and bonding, thus introducing noise. If the coatings are used in structural hardware or as grounding hardware, devices such as lock washers or bonded jumpers should be used to ensure that the surface film is broken and metal-to-metal contact is made. One useful rule of thumb is that the resistance of chromate conversion coatings increases in direct proportion to the depth of the color of the coating.

Electronic hardware is commonly made of a copper alloy base metal, which is either electroplated or coated with another metal, both to give the character-

Table: Galvanically similar metals

Group I	Group II	Group III	Group IV
Magnesium alloys (all) Aluminum alloys 5052, 5056, 5356, 6061 and 6063 Tin	Aluminum Aluminum alloys (all) Zinc Cadmium Tin Stainless steel Tin-lead (solder)	Zinc Cadmium Steel Lead Tin Stainless steel Nickel Nickel alloys (all) Tin-lead (solder)	Copper Copper alloys (all) Nickel Nickel alloys (all) Chromium Stainless steel Gold Silver

istics desired for the end use and to provide greater corrosion protection. Unfortunately, there exists no universal finish for all electronic hardware that will satisfy all requirements for solderability, weldability, appearance, corrosion resistance and conductivity. Here's a rundown of the more commonly used metal finishes.

Many trade-offs in choosing a finish

Silver-plate finishes are best for hard-wiring and soldering. Silver is an excellent conductor and does not amalgamate so readily with commonly used base metals as some other finishes. Unprotected silver, however, tarnishes rapidly in the presence of sulphur contaminates and may migrate under appropriate conditions of moisture, heat and voltage. Like all other finishes, it will suffer surface contamination by atmospheric pollutants. This surface contamination may be delayed by a protective coating of a chromate or lacquer.

Gold plate is widely used for hand-soldered terminals and hardware as well as for connectors. Gold has a very high resistance to corrosion in relation to film thickness. Even gold, however, requires to be at least 0.0001 inch thick in order to withstand a 100-hour salt-spray test when plated over free-machining brass. Obviously, gold platings this thick can be expensive. Precautions may be necessary when wave-soldering gold or silver to prevent contamination and/or scavenging of the solder bath.

Electro-tin, electro-tin alloy and centrifuge coatings are extensively used for hardware that is to be wave-soldered. For these finishes, stearic acid coatings should be used for protection against atmospheric contaminates. In addition, zinc migration and consequent amalgamation have to be prevented when tin coatings are used on such zinc-bearing alloys as brass. This amalgamation will produce an unsolderable finish. Normally, an intermediate barrier plate is used to guard against migration and amalgamation.

Cadmium plating is used on both ferrous and non-ferrous material. Cadmium as a protective finish is sacrificial; that is, its own corrosion products protect the base metal. To prevent eventual exposure of the base metal, the cadmium corrosion can be retarded with surface chromate conversion coatings. For example, 0.0003 inch of cadmium on brass with colored-chromate treatment will withstand 100 hours' salt spray. Cadmium is highly suitable for interior hardware applications.

Finally, many finishes on electronic hardware are used for their appearance as well as to prevent corrosion. These include nickel plate, chromium plating, black oxide treatments, and anodizing treatments for aluminum. ■ ■

Bibliography:

Miller, Myron. *The Engineer's Plating Manual*. Los Angeles: Interlock Publications, Inc., 1966.



**Our electron multipliers
are sensitive to
just about everything
but ambient atmosphere
and 350°C.**

That's right, there's absolutely *no* deterioration of performance from ambient atmospheric exposure with Bendix® magnetic electron multipliers. Their remarkable sensitivity covers the most extreme ends of the electromagnetic spectrum: for photon and particle counting, far ultraviolet and soft x-ray detection, high-altitude solar radiation, nuclear radiation and ion detection, and even the hard ultraviolet range—something unattainable in other types of detectors.

What's more, the Model 310B is bakeable to 350°C. And there are several other models to choose from—each with the most compact, rugged, lightweight multiplier of its kind. *All with current gains of 10⁸.*

And to power them, our compact Model 1122 power supply was made to order. Its dependable solid state operation assures constant voltage differentials through extreme level variations. And minimum maintenance as well.

Bendix scientific instruments—including mass spectrometers, atomic absorption and flame spectrophotometers, polarimeters, polarographic systems and electron multipliers—are used in over 100 areas of research and analysis. For more information, write: **The Bendix Corporation, Scientific Instruments Division, 3625 Hauck Road, Cincinnati, Ohio 45241. Or phone (513) 772-1600.**

Specifications	Model M 306	Model M 308	Model M 310/310B
Direction of view	side	end	side
Aperture (in mm)	18.3 x 15.5	10.4 x 5.3	12.5 x 12.5
Spectral response	10 ⁸	10 ⁸	10 ⁸
Operating press. max. torr	5 x 10 ⁻⁴	1 x 10 ⁻⁴	1 x 10 ⁻⁴
Length, max. inches	4	2½	2½
Height, max. inches	.81	.93	.80
Width, max. inches	1.32	1.29	.69
Weight, nom. oz.	4½	2	2½



DEAR ENGINEER,

I AM A SYNCHRO TO
SINE/COSINE CONVERTER.*



I AM HERE TO SOLVE YOUR INSTRUMENTATION/CONTROL INTERFACE PROBLEMS, LIKE HOW DO YOU GET FROM A 3 WIRE SYNCHRO OUTPUT TO A SINE/COSINE RADAR DISPLAY OR COMPUTER.

AND BEST OF ALL I SOLVE THEM MORE ACCURATELY (± 3 MIN. OF ARC), MORE RELIABLY, AND IN LESS SPACE THAN YOU CAN IMAGINE. YOU SEE I AM ALL SOLID STATE, NOT ELECTRO MECHANICAL LIKE THE SYSTEMS I REPLACE. AND IN ADDITION, I AM INSENSITIVE TO ROTOR VOLTAGE. IF YOU THINK I AM BRAGGING, DON'T YOU AGREE THAT WITH MY MEASUREMENTS 1.03" X 2.03" X 3.03", I HAVE JUST A LITTLE RIGHT TO BE PROUD?

FOR INFORMATION ON SOME OF MY OTHER VITAL STATISTICS WRITE FOR COMPLETE TECHNICAL LITERATURE TO NATEL ENGINEERING CO., OR IF YOU ARE IN A HURRY, CALL 213-782-4161.

YOUR FRIEND,
SS/CC*

P.S. I AM ONLY PART OF A GROWING FAMILY OF SYNCHRO CONVERSION EQUIPMENT. JUST WAIT TILL YOU SEE MY BIG SISTER.



NATEL ENGINEERING CO., INC.
7129 Gerald Ave. • Van Nuys, California 91406 • (213) 782-4161

ON READER-SERVICE CARD CIRCLE 198

ELECTRONIC DESIGN 17, August 1978

NEW! ECONOMY + HIGH RELIABILITY

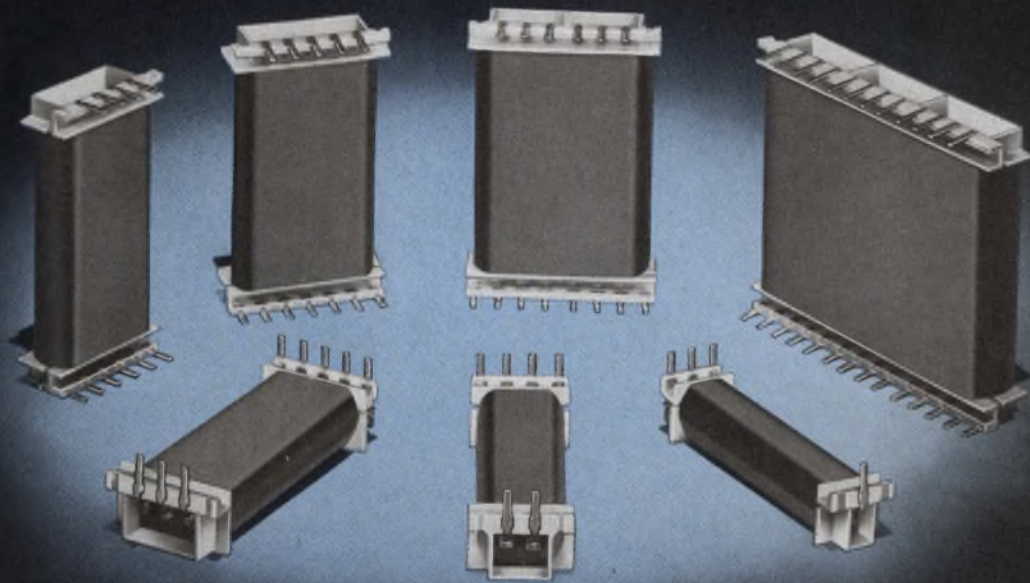

RBM

CONTROLS

Open Construction Bi-Reed Relays

This new family of standard size Bi-Reed relays offers true economy with RBM's industry-recognized high reliability. They feature straight, unstressed contact leads which prevent damage to capsule seals, and the contact terminals are welded (or soldered) to the printed circuit terminals which are on 2.5" centers with .218" terminal spacing. Standard 1 thru 6-pole and 12-pole forms are available with coil voltages thru 48 volts D.C.

Of course, RBM makes the complete unit . . . including the switch . . . with automatic equipment in "white room" facilities. This single source responsibility means consistent characteristics and total reliability in every RBM Bi-Reed you use! Call your local RBM Controls sales engineer or write for Technical Bulletin 2020.

ESSEX
WIRE CORPORATION

CONTROLS DIVISION • 131 GODFREY STREET • LOGANSPORT, INDIANA

ON READER-SERVICE CARD CIRCLE 199

Use the signal flow graph technique

without the tedious flow graph reduction step to analyze active and passive networks.

The solution to network problems is usually obtained by writing down the set of simultaneous equations that describe the network and solving them by substitution or by the matrix method. The flow graph method, first introduced by S. J. Mason,¹ however, can often significantly reduce the work involved. Many problems that might not even be attempted by lengthy equations are often solved with ease by the signal flow graph method.

Moreover, the signal flow method itself can be further simplified if the graph reduction step normally required is omitted.

What is a signal flow graph?

The signal flow graph method is a transformation from the matrix method to a topological method when a set of simultaneous equations is under consideration. The flow graph illustrates the passage of a signal through a network and indicates feedback paths present in the network. Once the flow graph has been constructed, the network solution can be obtained either by the rules of reduction or with Mason's general-gain equation.² Applying reduction rules to a flow graph generally cuts down the number of dependent variables associated with a set of simultaneous equations but is not necessary when the general gain equation is used.

A signal flow graph consists of junction points called nodes which represent network variables. The nodes are connected by paths which are called branches. The branches have direction with a signal traveling along a branch in the direction of the arrow. The flow graph for the expression:

$$x_2 = T_1 x_1 \quad (1)$$

is shown in Fig. 1a. Nodes x_1 and x_2 represent variables and the branch direction shows the dependence of x_2 on x_1 . The coefficient T_1 is called the transmittance.

At this point it is well to define the terms illustrated in Fig. 1b:

<i>Input node</i>	A node with only outgoing branches (e.g., node x_1).
<i>Output node</i>	A node with only incoming branches. When this condition is not met, an additional branch of unity transmittance and an additional variable (e.g., node x_0) are introduced.
<i>Path</i>	A continuous succession of branches.
<i>Forward path</i>	A path connecting the input node to the output node where no node is encountered more than once (e.g., x_1, x_2, x_4, x_5, x_0). A flow graph may have more than one forward step.
<i>Feedback loop</i>	A path originating and terminating on the same node where no node is encountered more than once (e.g., x_2, x_4, x_3, x_2 or x_4, x_3, x_4).
<i>Self loop</i>	A branch originating and terminating on the same node (e.g., x_3, x_3 through T_5).
<i>Path gain</i>	The product of transmittances encountered along the path.
<i>Loop gain</i>	The product of transmittances of the branches forming the loop.

How to write network equations

There are many ways of writing a set of independent equations describing a network. With the

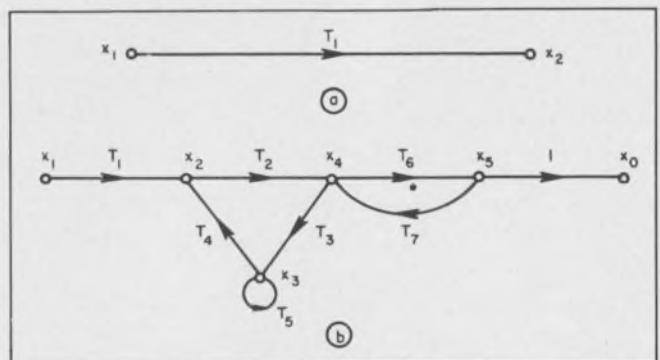

1. Elements of a signal flow graph can be best defined through a sketch. A flow graph for one branch (a) has an input node, x_1 , transmission path, T_1 , and an output node, x_2 . Other elements appear in (b).

Glenn B. De Bella, Project Engineer, Hewlett-Packard Co., Palo Alto, Calif.

signal flow graph method, it is unnecessary to minimize the number of equations. It is advisable, however, to follow a systematic procedure for writing the network equations such as the following:

1. Define the variables. Except for situations where a network output is desired for many independent driving sources, there is one independent variable and n dependent variables.
2. For $(n+1)$ variables, use n independent equations.
3. Do NOT write an equation for the independent variable.
4. Write one equation for each dependent variable. This results in at least one branch entering every dependent node.

Once the signal flow graph has been constructed from the network equations, the solution T (the ratio of output variable to input variable) can be written down by inspection through use of Mason's general gain equation. This equation is:

$$T = \sum_k T_k \Delta_k / \Delta, \quad (2)$$

where:

T_k = path gain of the k^{th} forward path,

$\Delta = 1 - \text{sum of all individual loop gains} + \text{sum of the loop gain products of all possible combinations of two nontouching loops} - \text{sum of the loop gain products of all possible combinations of three nontouching loops} + \dots$

Δ_k = value of Δ not touching the k^{th} forward path.

Note that two loops are considered nontouching when they have no common nodes.

Ladder network analyzed

Consider the problem of finding the voltage transfer ratio, v_0/v_1 , for the ladder network in Fig. 2a. In this figure v_1 is the independent variable and $i_1, v_2, i_2, v_3, i_3, v_4, v_0$ are the dependent

variables. The network equations are:

$$\left. \begin{aligned} i_1 &= (v_1 - v_2)/Z_1, \\ v_2 &= Z_2(i_1 - i_2), \\ i_2 &= (v_2 - v_3)/Z_3, \\ v_3 &= Z_4(i_2 - i_3), \\ i_3 &= (v_3 - v_4)/Z_5, \\ v_4 &= Z_6 i_3, \\ v_0 &= v_4. \end{aligned} \right\} \quad (3)$$

From Eqs. 3 the signal flow graph can be constructed, as shown in Fig. 2b. The only forward path has a path gain:

$$T_1 = Z_2 Z_4 Z_6 / Z_1 Z_3 Z_5. \quad (4)$$

The individual loop gains are:

$$\begin{aligned} &-(Z_2/Z_1), -(Z_2/Z_3), -(Z_4/Z_3), \\ &-(Z_4/Z_5), -(Z_6/Z_5). \end{aligned} \quad (5)$$

The loop gain products of all possible combinations of two nontouching loops are:

$$\begin{aligned} &Z_2 Z_4 / Z_1 Z_3, Z_2 Z_4 / Z_1 Z_5, Z_2 Z_6 / Z_1 Z_5, \\ &Z_2 Z_4 / Z_3 Z_5, Z_2 Z_6 / Z_3 Z_5, Z_4 Z_6 / Z_3 Z_5. \end{aligned} \quad (6)$$

The loop gain product of the only possible combination of three nontouching loops is:

$$-(Z_2 Z_4 Z_6 / Z_1 Z_3 Z_5). \quad (7)$$

Now, substituting Eqs. 4 through 7 into Mason's general gain equation (Eq. 2) yields a voltage transfer ratio:

$$v_0/v_1 = \frac{Z_2 Z_4 Z_6 / Z_1 Z_3 Z_5}{\left\{ \begin{aligned} &1 + Z_2/Z_1 + Z_2/Z_3 + Z_4/Z_3 + Z_1/Z_5 \\ &+ Z_6/Z_5 + Z_2 Z_4 / Z_1 Z_3 + Z_2 Z_4 / Z_1 Z_5 \\ &+ Z_2 Z_6 / Z_1 Z_5 + Z_2 Z_4 / Z_3 Z_5 \\ &+ Z_2 Z_6 / Z_3 Z_5 + Z_4 Z_6 / Z_3 Z_5 \\ &+ Z_2 Z_4 Z_6 / Z_1 Z_3 Z_5 \end{aligned} \right\}}, \quad (8)$$

which could be rearranged to give a more pleasing form.

If, for example, the input impedance to the ladder network were desired, i_1 would be the independent variable, resulting in little change in the signal flow graph shown.

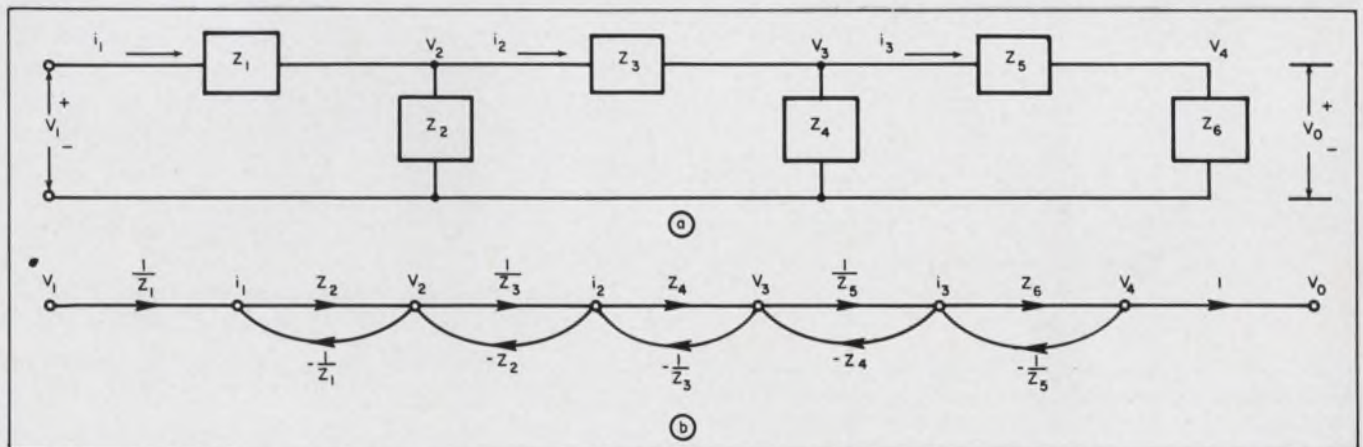

2. A ladder network (a) and its flow graph (b) demonstrate how voltage transfer ratio, v_0/v_1 , can be determined.

Finding the voltage transfer ratio of an amplifier

As another example, consider the common-emitter transistor amplifier in Fig. 3a. The voltage transfer ratio, $v_o(s)/v_i(s)$ has to be found. From the small-signal equivalent circuit in Fig. 3b,³ it is seen that v_1 is the independent variable and $i_1, v_{b'e}, i_2, v_2, v_o$ are the dependent variables.

The network equations are:

$$\left. \begin{aligned} i_1 &= (v_1 - v_{b'e})/R, \\ v_{b'e} &= [(i_1 - i_2)/C_{ob}s] + v_2, \\ i_2 &= v_{b'e}/Z_E, \\ v_2 &= [(i_1 - i_2)/R_L] - [\alpha_o R_L v_{b'e}/r_\epsilon], \\ v_o &= v_2, \end{aligned} \right\} (9)$$

where:

$$R = R_s + r_b$$

and:

$$Z_E = r_{b'e}/(r_{b'e} C_E s + 1).$$

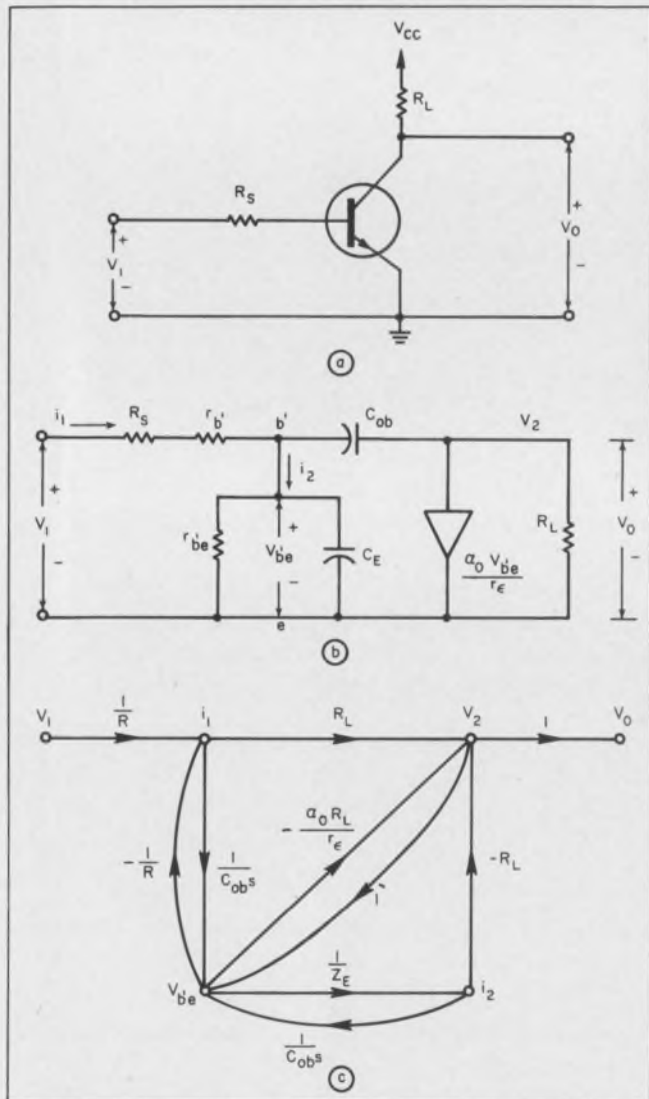

3. A common emitter amplifier (a) is first redrawn in its equivalent form (b) and the flow graph is then prepared (c). Determination of its voltage transfer ratio, v_o/v_i is now a simple matter.

From Eq. 9, the signal flow graph is constructed as in Fig. 3c. There are three forward paths; their respective path gains are:

$$\left. \begin{aligned} T_1 &= R_L/R, \\ T_2 &= -\alpha_o R_L/R r_\epsilon C_{ob} s, \\ T_3 &= -R_L/R C_{ob} s Z_E. \end{aligned} \right\} (10)$$

The individual loop gains are:

$$\begin{aligned} &-(\alpha_o R_L/r_\epsilon), -(1/R C_{ob} s), \\ &-(1/Z_E C_{ob} s), -(R_L/Z_E), -(R_L/R). \end{aligned} (11)$$

There are no nontouching loops. The loop with gain $-(1/Z_E C_{ob} s)$ does not touch the forward path given by T_1 in Eqs. 10.

The voltage transfer ratio is found by substituting Eqs. 10 and 11 into Mason's general gain equation:

$$\frac{v_o(s)}{v_i(s)} = \frac{\frac{R_L}{R} \left[1 + \frac{1}{Z_E C_{ob} s} \right] - \frac{\alpha_o R_L}{R r_\epsilon C_{ob} s} - \frac{R_L}{R C_{ob} s Z_E}}{1 + \frac{\alpha_o R_L}{r_\epsilon} + \frac{1}{R C_{ob} s} + \frac{1}{Z_E C_{ob} s} + \frac{R_L}{Z_E} + \frac{R_L}{R}} (12)$$

Note that $\alpha_o = \beta_o/(\beta_o + 1)$ and $r_{b'e} = (\beta_o + 1)r_\epsilon$. Then substituting for Z_E enables Eq. 12 to be rearranged to give the more familiar:

$$\frac{v_o(s)}{v_i(s)} = \frac{-\frac{\beta_o R_L}{R + r_{b'e}} \left[1 - \frac{C_{ob} r_\epsilon}{\alpha_o} s \right]}{s^2 \left[\frac{R r_{b'e}}{R + r_{b'e}} R_L C_{ob} C_E \right] + s \left[\frac{R r_{b'e}}{R + r_{b'e}} \left\langle C_{ob} \left(1 + \frac{\alpha_o R_L}{r_\epsilon} \right) + C_E \right\rangle + R_L C_{ob} \right] + 1} (13)$$

In this example, as in the previous one, the network equations and the path and loop gains were written out before the general gain equation was applied. It is not unreasonable to expect, however, that with a little practice it would be possible to construct the flow graph directly from the network and to obtain the solution by inspection through use of Mason's general gain equation. ■ ■

References:

1. Mason, "Feedback Theory: Some Properties of Signal Flow Graphs," *Proc. IRE*, XLI, No. 9 (Sept., 1953), 1144-1156.
2. ———, "Feedback Theory: Further Properties of Signal Flow Graphs," *ibid*, XLIV, No. 7 (July, 1956), 920-926.
3. G. B. DeBella, "Stability of Capacitively Loaded Emitter-Followers: A Simplified Approach," *Hewlett-Packard Jour.*, XVII, No. 8 (April, 1966), 15-16.

ulano is the leading manufacturer
of screen process stencil film

...any kind!

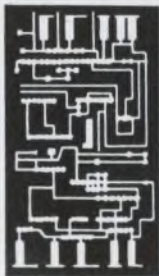

*In screen processing
of complex printed circuitry ...
there's no margin for error!
That's why Ulano offers
a complete line of
Screen Process Stencil Films
especially designed for
the Electronics Industry.*

ulano

^{T.M.}

610 DEAN STREET, BROOKLYN, N.Y. 11238

NEW YORK • CALIFORNIA • CHICAGO • ZURICH

In Europe: ULANO A. G., Untere Heslibachstrasse 22, Kusnacht 8700, Switzerland

*For free working samples, write today
on your letterhead for Kit No. 5827*

When you hold a MINIVERTER™ in your hand

... You'll have a 16-channel multiplexer, sample-and-hold and 10-bit, 100 KHz analog-to-digital converter for under \$2,000.

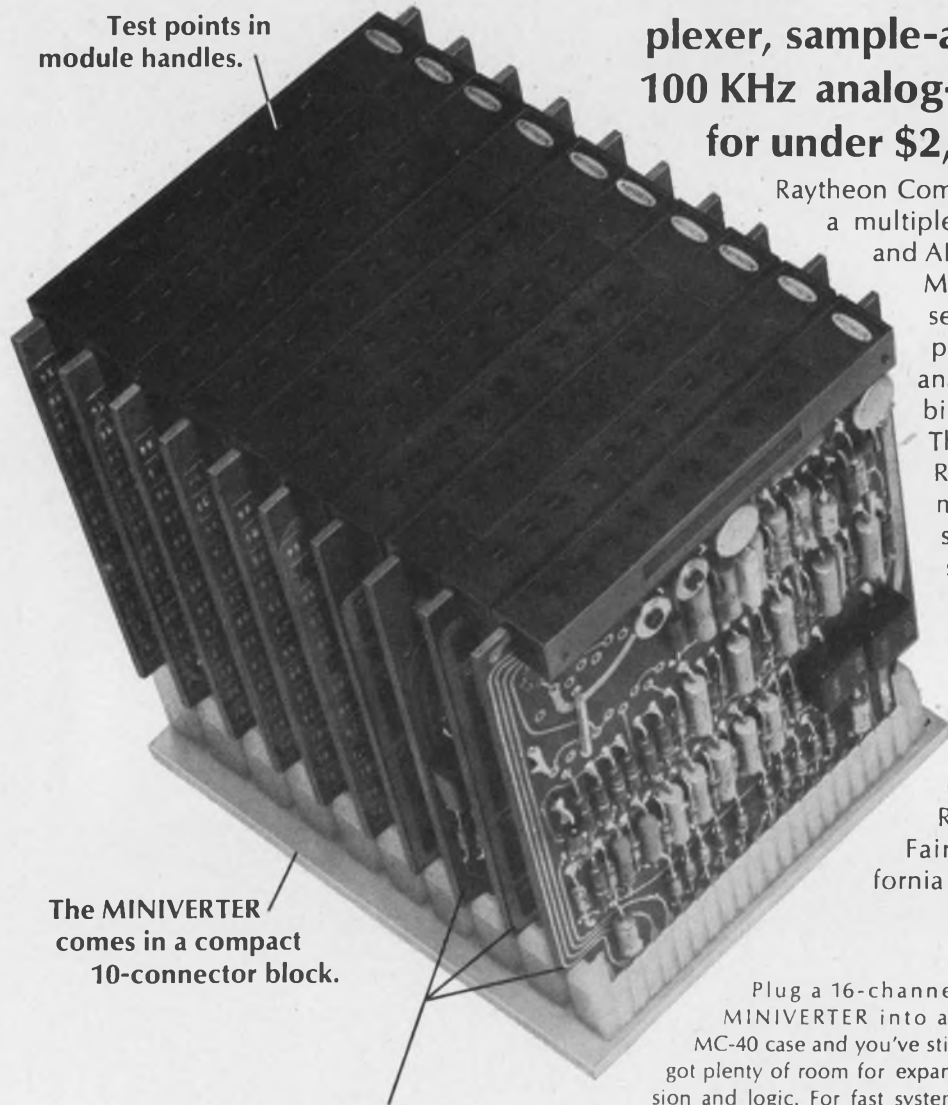

Test points in module handles.

The MINIVERTER comes in a compact 10-connector block.

These three cards make up the ADC. An optional fourth card is a DC power supply that runs on +5 volts and provides all necessary ADC power.

Raytheon Computer's new MINIVERTER packs a multiplexer, sample-and-hold amplifier and ADC into just ten IC modules. The MINIVERTER (or the ADC) is assembled and pre-wired, ready to plug in and use. ■ Two more new analog IC modules make up a 10-bit digital-to-analog converter. ■ These instruments are built from Raytheon's standard M-Series IC modules and there's a whole stockroom full of compatible systems hardware. More than 40 analog and digital modules, power supplies, three different chassis—all so thoroughly engineered all you do is design your logic. ■ Our literature is almost as exciting as our products. Write or call today. Raytheon Computer, 2700 South Fairview Street, Santa Ana, California 92704. Phone: (714) 546-7160.



Plug a 16-channel MINIVERTER into an MC-40 case and you've still got plenty of room for expansion and logic. For fast system assembly, module connectors come in blocks of 10, 30 and 40. Power and analog and digital ground are available in module cases via laminated bus bars. And you can have automatic wire wrap if you want it.

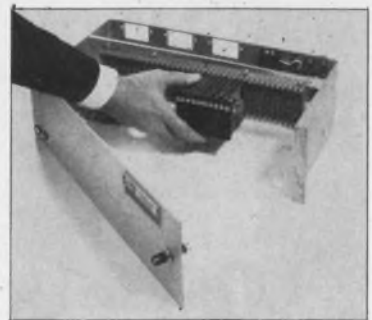

Hold a MINIVERTER in your hand at WESCON, Booths 2001-2002.

Report from

**BELL
LABORATORIES**

See a computer talk

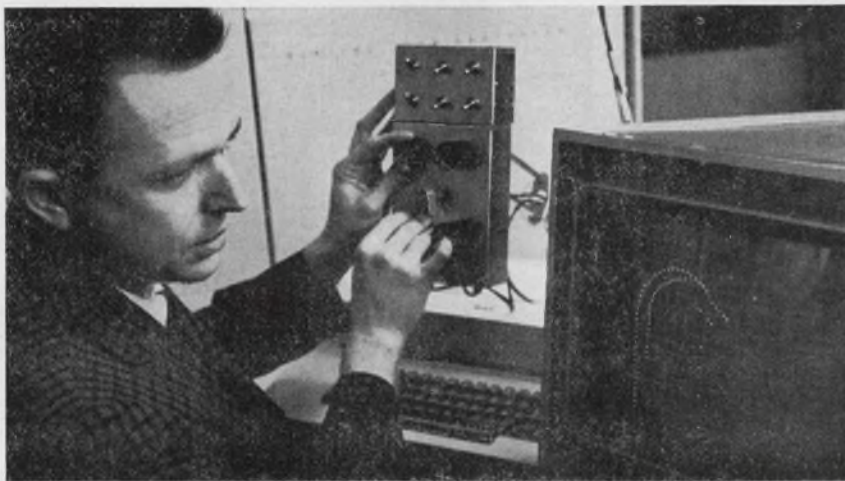

C. H. Coker adjusts controls which change the outline of the "vocal tract" simulated on the oscilloscope. At the same time, he hears the sound corresponding to the displayed shape. Desired vocal-tract shapes (representing sounds) can be stored in the computer memory.

Bell Laboratories' computerized vocal-tract model. (Head outline added.) The various parts can be positioned to imitate any speech sound. The model displays tract length versus cross-sectional area. It is based on anatomical measurements of the vocal tract made by a number of acousticians.

A feature of the model is that it reproduces the transition sounds between word fragments. The nonsense word eedah, for example, consists of ee plus d plus ah. But the d is not the same as in, say, eedee. That is, the d is noticeably affected by context. Coker handles this by storing dynamic properties of the vocal articulators (the tongue, lips and jaw). The program automatically incorporates these properties in assembling word fragments.

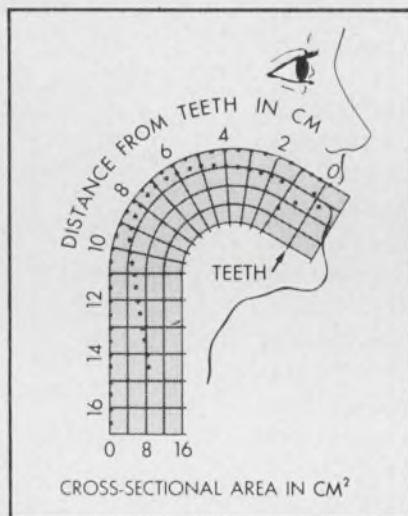

ee d ah



ee d ah



Comparison of nonsense word "eedah," pronounced by a human (left) and by Coker's program. These speech spectrographic patterns represent time (horizontal scale), frequency (vertical), and intensity (line density). The dark bars are called "formants" and are characteristic of speech sounds. The technique for making these diagrams was conceived and developed in the early 40's at Bell Telephone Laboratories.

Speech, one of the most complex of human activities, is studied as part of the continuing communications research at Bell Telephone Laboratories. But the speech mechanism has always been difficult to analyze: vocal-tract movements—crucial to the formation of meaningful acoustic signals—are mostly obscured from sight and are not easily measured. Now our understanding of speech is being advanced through a computerized simulation of the vocal tract devised by Cecil H. Coker of Bell Laboratories and Osamu Fujimura of the University of Tokyo, who worked at Bell Labs as a consultant.

The model (displayed on an oscilloscope, left) resembles the actual vocal tract and shows its principal parts. The parts can be moved either automatically by the computer program or by manual controls on the computer panel. The program calculates speech data corresponding to the displayed vocal-tract shape and delivers these data to an electronic speech synthesizer, designed by Coker. The synthesizer then generates a sound corresponding to the tract shape. Hence the researcher can hear the synthetic output at the same time he sees the tract motion.

The model accurately reproduces not only individual speech sounds but, for the first time, the subtle transitions that connect these sounds. It also demonstrates that these transitions are vital to clarity and realism.

The system produces patterns of frequency and energy (spectrograms) very like a human's (left). And it passes a more difficult test: pronouncing speech sounds which are understandable even when taken out of context.



Bell Telephone Laboratories
Research and Development Unit of the Bell System

CRT displays antenna patterns

directly with the aid of a simple test setup. Picking the best pattern is then child's play.

A new type of antenna pattern recorder, which can be built with components readily available in most laboratories, shows the pattern in polar form on a cathode-ray oscilloscope.

Besides giving a better "feel" for the pattern shape through the polar coordinates, the device eliminates the need for paper recording. For permanent recordings, a scope camera can be used, thus reducing storage space: instead of piles of paper, the selected patterns are photographed and filed away in a 4-inch-by-4-inch cabinet.

The basic form of the recording system is shown in Fig. 1. The antenna pedestal drive can be any variable speed drive. The antenna under test is attached to the antenna mast.

The signal received by the antenna under test is detected conventionally, and routed to the antenna recorder for display on a conventional pattern recorder.

The present system differs from the usual method, however, in that a synchrotransmitter is attached to the antenna mast in a 1:1 drive arrangement—that is, one revolution of the antenna mast produces one revolution of the synchrotransmitter shaft. The output of the synchrotransmitter is fed to a synchro-follower, located in the antenna pattern facility. The synchro-follower, in turn, drives a two-phase resolver on a 1:1 basis. The detected signal is fed into the rotor winding of this resolver. The two stator windings channel the components of the resolved signal into the plates of the cathode-ray tube, where they are recombined. Thus, assuming linear detection and amplification, the displayed pattern on the CRT will be a replica of the antenna pattern. A typical polar display (Fig. 2a) gives a much better and quicker understanding of a radiated pattern than a flat version (Fig. 2b).

The only unit that is not standard in Fig. 1 is the detector preamplifier.¹ The preamplifier (see Fig. 3) offers voltage gain of about 74 dB—a useful value in view of the fact that most crystal detectors have a

linear dynamic range only on the order of 30 dB. The bandwidth of the preamplifier is limited on the low side by C_5 and on the high side by C_2 . With the components specified in Fig. 2, for example, the bandwidth is from 2.5 to 250 Hz. If C_2 is removed, the range extends up to 7 kHz.

To record antenna patterns at different frequencies, the frequency setting on signal generator has only to be changed. Thus, a swept-frequency source makes octave-bandwidth testing possible. ■ ■

Reference:

1. Nathan Buitenkant, "Infrared System Preamplifier Design," *EDN*, III, No. 8 (August, 1958), 36-45.

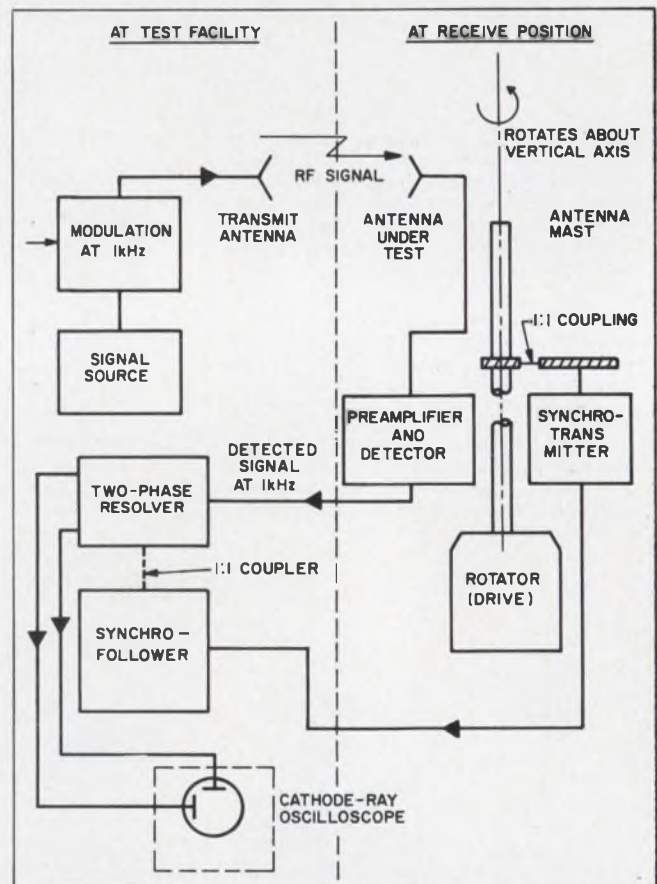

1. Antenna-pattern display uses a cathode-ray tube to show the actual polar pattern. Instead of storing the paper recording of conventional setups, the photos of the appropriate patterns can be put away in a 4-by-4-in. file cabinet.

George J. Monser, Head, ECM Antenna Section, Raytheon Co., Goleta, Calif., and Joseph Miller, Engineering Specialist, American Electronic Laboratories, Inc., Colmar, Pa.

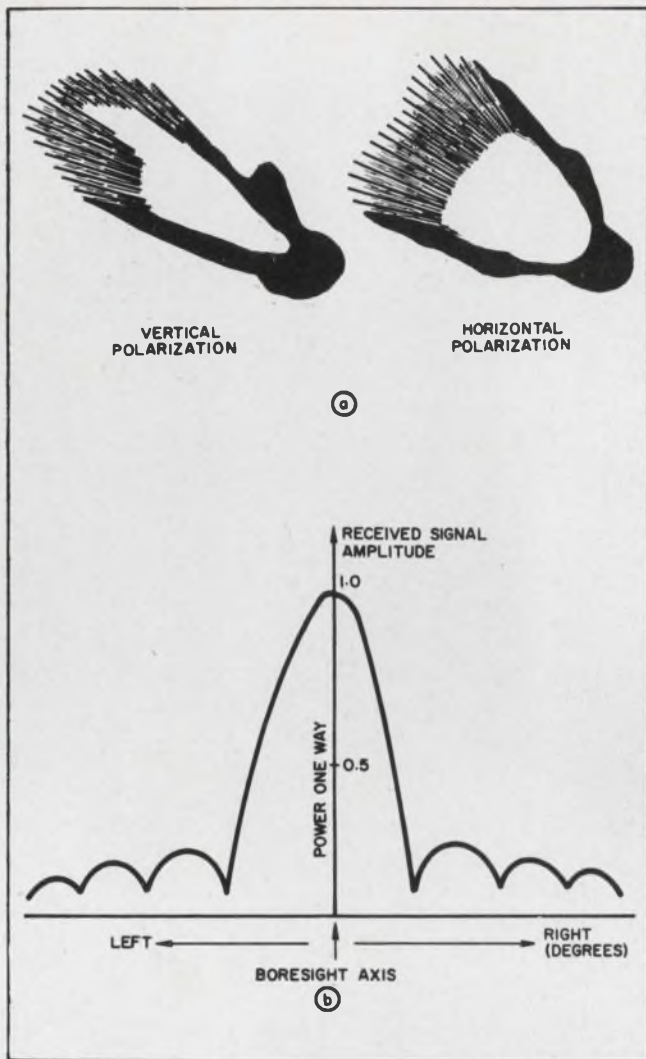

2. **Typical polar pattern** immediately shows the directivity of the antenna and the relative energy radiated through the side-lobes (a). Strip-chart recording of the same pattern (b) is less clear.

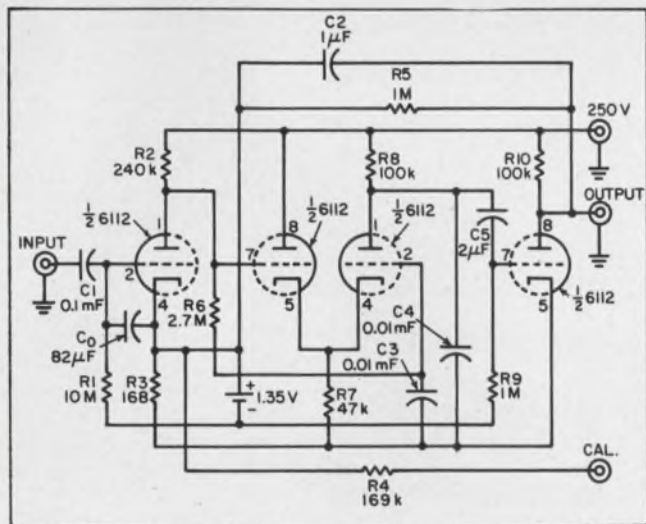

3. **Only nonstandard circuit is the detector preamplifier**, which offers a gain of about 74 dB. Its bandwidth is limited by C5 at the lower end and by C2 at the upper. With the given components, the circuit has a bandwidth from 2.5 to 250 Hz. Removal of C2 ups the range to 7 kHz.

These two heat-shrinkables are hungry for tough mil-spec insulation problems.

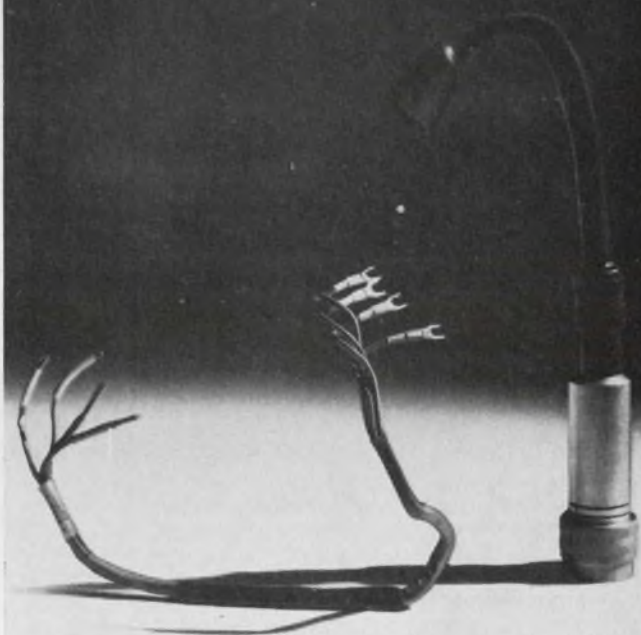

Feed them.

New Insultite® SR-350 eats up shock, strain and vibration like only a semi-rigid, irradiated polyolefin can. It combines superior dielectric characteristics with high structural strength. From 3/64" to 1" I.D.

Insultite FP-301, on the other hand, has a flexible polyolefin appetite that devours mil-spec applications. Quickly. Totally. From 3/64" to 4" I.D.

SR-350 meets classes 3 and 4 of MIL-I-23053A and NASA 276A. FP-301 meets classes 1 and 2.

Both are available in ten standard colors. Write today for free samples. (Specify diameters, please.)

ELECTRONIZED CHEMICALS CORPORATION

A subsidiary of High Voltage Engineering Corporation
Burlington, Mass. 01803, Area Code 617-272-2850

E.C.C. heat shrinkables are recognized under UL component file E39100.

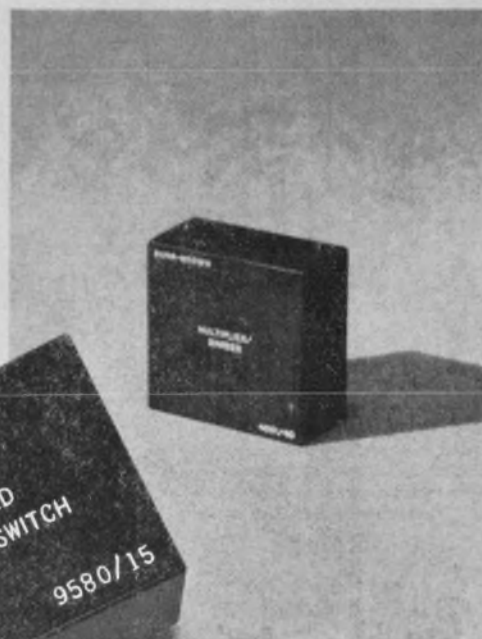
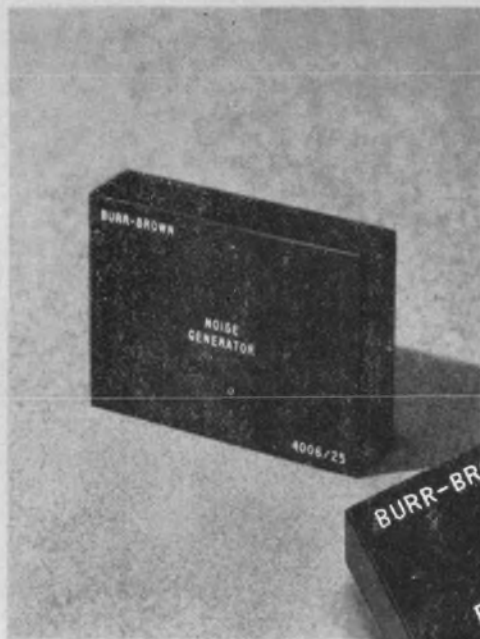

for Instant Analog Systems

Burr-Brown Encapsulated Function Modules

Cut costs, simplify design, and achieve maximum performance from your analog and hybrid circuits by utilizing Burr-Brown encapsulated function modules. These compatible sub-systems are designed to mount and work side by side with operational amplifiers. You save money on component and assembly costs, design time is reduced to an absolute minimum, and you gain the performance advantage of Burr-Brown's specialized experience in analog applications.

Currently, Burr-Brown is supplying thirteen 10V, encapsulated function modules from stock. Each one provides the type of performance you'd expect from the company that "wrote the book" on operational amplifier applications. Available units include: Quarter Square Multiplier — Fast, $E_o = -E_i E_i / 10$. Squaring Modules —

Four separate units are offered. Noise Generator — Random digital output. Logarithmic Amplifiers — Both 40 db and 60 db log units. Adaptive Analog Comparator — Switched hysteresis. Electronic Switches — Including Fast Sample/Hold, Sample/Hold, Integrate/Hold, and Reset/Integrate/Hold units.

Rack Mounting Units — For your rack-mounting applications, Burr-Brown offers thirteen modules. These pre-engineered circuits are ready for you to plug in, wire together, and put to use immediately.

FOR COMPLETE INFORMATION on these maximum value units, contact your nearest Burr-Brown Engineering Representative and ask him for a copy of the new 16-page Burr-Brown catalog. He also has demonstrator units available for your immediate evaluation.

BURR-BROWN

RESEARCH CORPORATION

International Airport Industrial Park • Tucson, Arizona 85706
TELEPHONE: 602-294-1431 • TWX: 910-952-1111 • CABLE: BBRCORP



*Operational Amplifiers
Instrumentation Amplifiers
Function Modules
Analog Simulators
Geophysical Instruments*

ENGINEERING REPRESENTATIVES: ALABAMA, HUNTSVILLE (205) 534-1648 / ALASKA, ANCHORAGE (907) 272-5231 / ARIZONA, PHOENIX (602) 254-6085 / CALIF., LOS ANGELES (213) 665-5181, SAN FRANCISCO (408) 245-3321 / COLO., DENVER (303) 388-4391 / CONN., MILFORD (203) 874-9222 / D.C., WASHINGTON (SEE MARYLAND) / FLORIDA, ORLANDO (305) 425-2764 / ILLINOIS, CHICAGO (312) 286-6824 / LA., NEW ORLEANS (504) 834-6598 / MD., SILVER SPRING (301) 588-8134 / MASS., BOSTON (617) 245-4870 / MICH., DETROIT (313) 353-3822 / MINN., MINNEAPOLIS (612) 781-1611 / MO., ST. LOUIS (314) 524-4800 / N.C., GREENSBORO (919) 273-1918 / N.J., CAMDEN (609) 365-2450 / N.M., ALBUQUERQUE (505) 255-1638 / N.Y.,

ALBANY (518) 436-9649, BINGHAMTON (607) 723-9661, BUFFALO (716) 632-2727, MT. VERNON (914) 968-2200, NEW HARTFORD (315) 732-3775 / OHIO, CINCINNATI (513) 761-5432, CLEVELAND (216) 884-2001, DAYTON (513) 277-8911 / OKLA., TULSA (918) 835-2481 / OREGON, PORTLAND (503) 292-8762 / PENN., PHILADELPHIA (SEE CAMDEN, N.J.), PITTSBURGH (412) 243-6655 / TEXAS, DALLAS (214) 363-1671, HOUSTON (713) 928-5251 / UTAH, SALT LAKE CITY (801) 466-8709 / VIRGINIA, (SEE MARYLAND) / WASH., SEATTLE (206) 622-0177 / CANADA, TORONTO (416) 293-7011, VANCOUVER (604) 736-6377

LET THERE BE LIGHT OR TELL ME ABOUT THE FREE \$50 SWITCH

It's yours absolutely, unconditionally free. All we ask is that you give us \$50 for it. Why do we call it "free" when we are earnest about getting paid for it?

Two reasons:

First of all, when you throw the mechanical switch on, nothing happens until a teeny solid-state device senses that the voltage passes through zero. Then the switch turns the circuit on. When you throw the mechanical switch off and the current passes through zero, the circuit is turned off.

That means that the on-off switching is done at the point of minimum energy.

And that means no step function voltage to generate high-frequency components. And that means that the switch is *free* from radio frequency interference. *Quod est demonstrandum.*

The second reason we call it "free" is we thought that if you thought you could get a \$50 switch for nothing you'd probably be greedy enough to read this ad. There appears to be some justification for this assumption.

Circle reader service # 831

OUR TELEMETRY GEAR WILL NEVER GET OFF THE GROUND

Because we manufacture only equipment associated with checking out telemetry transmission while the transmitter is still nice and accessible.

For example, our new, compact FM Discriminator for playback in FM/FM telemetry systems. The pulse average design has 0.1% linearity. The Model 71-282 operates on all IRIG channels, 1-21, and A through H, with an input sensitivity of 20 mV. Accommodates any center frequency from 300 Hz to 300 KHz. Each one weighs less than a pound. Disgustingly inexpensive, too.

Circle reader service # 832

HOW WE INVENTED THE SANDWICH

To make the ruggeddest possible field portable tape recorder we suspended the entire tape transport mechanism between two parallel flat plates. This gives double support to all members, and as the tape contacts only the primary drive mechanism, reel hubs, two turn rollers and the head surfaces, its oxide coating gets maximum protection.

As you know, the flanges on tape reels are cantilevered members which can be supported against extreme shock and vibration only at the cost of a substantial increase in the rotational inertia of a system. So we got rid of them. The tape can't slip off the reel because hoop tension



forces resulting from normal pulling of the tape provide great compressive forces within the reel stack. It would take in excess of 300 g's for slippage to occur.

The result of our Sandwich and Flangeless design approaches (plus a few other neat ideas): a rugged, high performance field portable tape system. Request full information.

Circle reader service # 833

OUR RATE-OF-TURN TABLE LAUGHS AT ABUSE

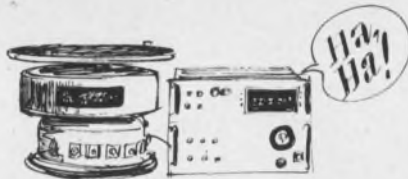

Our new Model 1147 maintains high precision performance regardless of rough handling and transportation. (One reason it's used as the AGE gyro test table for F-111 Aircraft System.) Hydrostatic bearings give precise dimensional stability, excellent alignment, low runout and eccentricity, low mechanical noise and long life. The bearing is capable of smooth rotation at less than siderial rates (.004°/sec.). And up to 1500°/sec.

The Model 1147's compactness makes it ideal for field or bench checking. Its ruggedness makes it ideal in case you just happen to feel like kicking hell out of a fine piece of equipment.

Circle reader service # 834

OUR COMPUTER CAN BEAT UP YOUR COMPUTER

Filled with supreme confidence the engineer plugs in his newly designed gem of a system. Then discovers that it's too noisy. So off to the supplier for a custom filter. It's expensive and its weird configuration makes it almost impossible to maintain a hermetic seal under the stresses of high pressures and extreme temperature variations.

We can help you avoid the what-need-a-filter syndrome. Give us a work statement. For free, we'll crank the system parameters into our computer and it will design the Perfect Filter. It will do the job right, and cost you about 40% less than one that must be produced downstream.

Out of the hundred or so companies in the industry only two or three use computers. We're better at it than they are, and besides our salesmen know good jokes. Come on, give us a break.

Circle reader service # 835



GENISCO TECHNOLOGY CORPORATION
18435 SUSANA ROAD
COMPTON, CALIFORNIA 90221

Matched bipolars replace FETs in a simple squaring circuit

The squaring circuit shown in the figure is very similar to that described by Theodore F. Bogart, Jr., in *ELECTRONIC DESIGN*.^{*} The main difference is the use of a matched pair of transistors instead of FETs. The transistors are forced to assume square-law characteristics by the use of small unbypassed resistors $R1$ and $R2$ in the emitter circuits. These resistors not only shape the square-law function but, in addition, by slightly unbalancing them, they can compensate for phase errors at low frequency, such as that due to insufficient or unbalanced emitter-bypass capacity. In this manner the frequency response may be extended downward. If high-frequency response is not important, $R1$ and $R2$ may be replaced by potentiometers.

To adjust this circuit, an input signal of 1000 Hz is used. The 250-ohm potentiometer is adjusted so that the outputs as measured at the collector and emitter of the 2N2219 are equal. Then the 1000-ohm potentiometer is adjusted so that the inputs at the two bases of the 2N2640 are equal. Looking at the output on an oscilloscope at nearly maximum output level, a 2-kHz signal should be

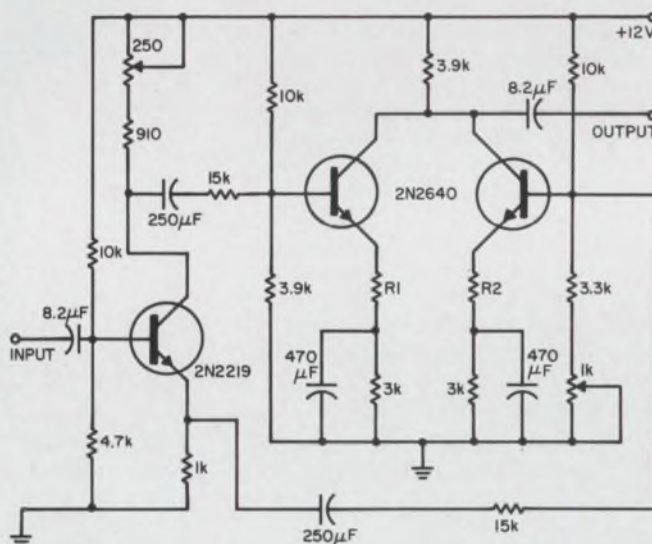

True square-law response is obtained with the circuit shown. $R1$ and $R2$ are approximately 22 ohms and can be potentiometers if high-frequency operation is not required.

seen with unequal successive peaks. The 250-ohm and 1000-ohm potentiometer are now alternately adjusted, with the output signal first at maximum level and then at minimum readable level, to equalize the peaks so that a pure 2-kHz sine wave is seen on the scope at all levels.

After this is done, record the maximum and minimum input and output levels to see if the circuit truly has the square-law characteristics. If not, readjust $R1$ and $R2$ until it is obtained. In this circuit, 22 ohms was found to be satisfactory with several transistors tried.

If low-frequency operation is required, readjust either $R1$ or $R2$ at the desired low frequency until a perfect sine wave is obtained at the lowest expected level of operation. This should have only a second-order effect on the square-law characteristic.

The circuit will operate with an open-circuit output of about 10 volts peak to peak and has a range of almost 60 dB.

It has not been thoroughly investigated espe-

^{*}"Matched Transistors Passé for FET Squarer," *op. cit.*, XIII, No. 23 (Nov. 8, 1965), 36-41.



VOTE! Go through all Idea-for-Design entries, select the best, and circle the appropriate number on the Reader-Service-Card.

SEND US YOUR IDEAS FOR DESIGN. You may win a grand total of \$1050 (cash)! Here's how. Submit your IFD describing a new or important circuit or design technique, the clever use of a new component or test equipment, packaging tips, cost-saving ideas to our Ideas-for-Design editor. You will receive \$20 for each accepted idea, \$30 more if it is voted best-of-issue by our readers. The best-of-issue winners become eligible for the Idea Of the Year award of \$1000.

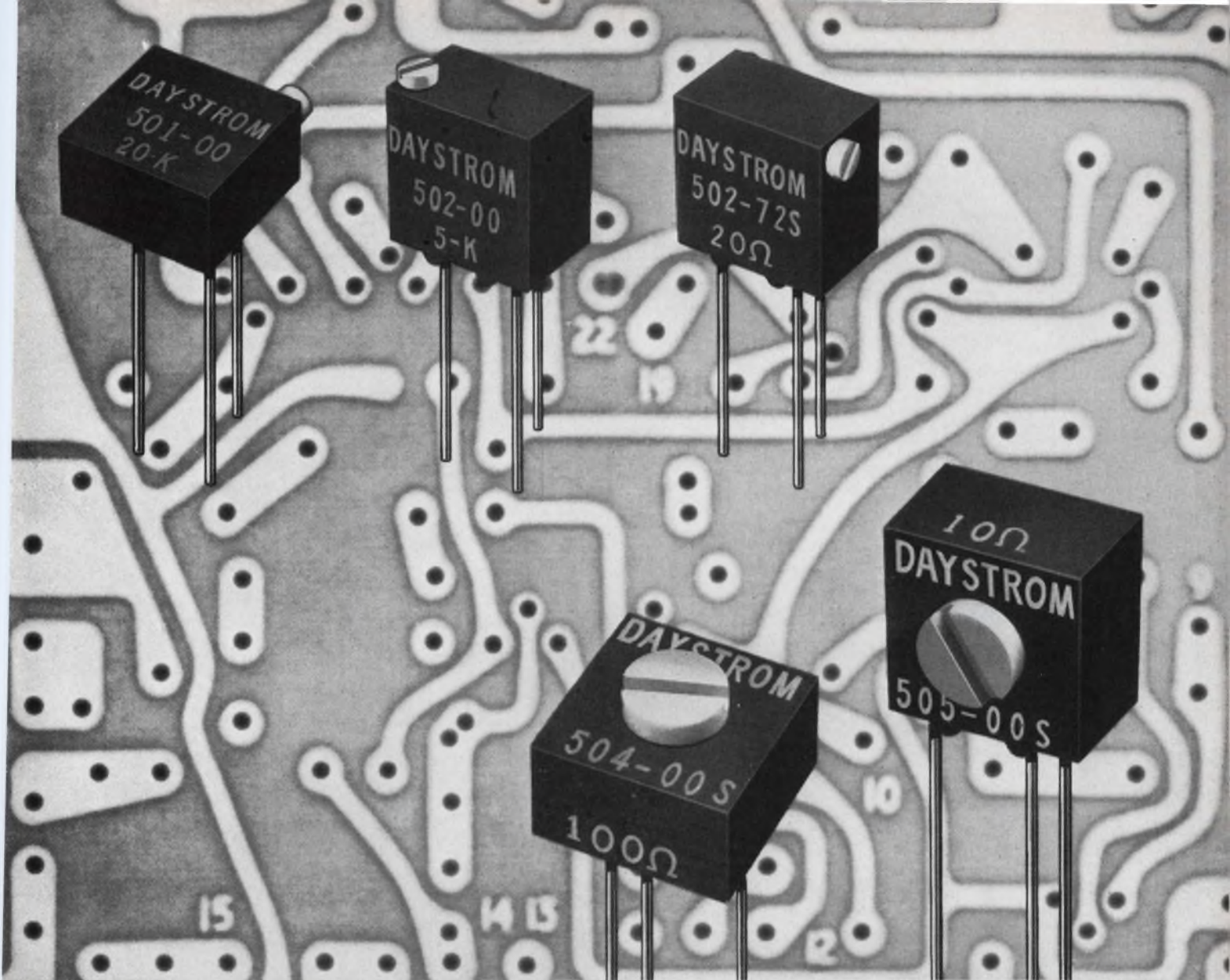

Savings across the board just took a new turn

DAYSTROM Commercial Squaretrim[®] potentiometers now include single-turn types. New models 504 and 505 are fully adjustable with just one turn. Models 501 and 502 are 15-turn types. They all clear up to 80% more PC board space—at no extra cost. But the trim .02 cubic inch size is only one reason why these commercial 500 Series pots are proving so popular. They also feature Weston's exclusive wire-in-the-groove design, and all these performance extras:

Convenience 5 different configurations with adjusting screw on top, side or end • **Tolerance** $\pm 5\%$ • **Adjustability** 15 turns or single turn • **Slip Clutch** eliminates wiper damage, cuts production delays • **Suregard[™] Terminations** for better protection against vibration, shock and humidity—no pressure taps • **Superior Resolution** 0.125% or less • **Wide Range** 10 Ω to 20K (higher values on request) • **High Power** 0.6 watt in still air at 70°C • **Wide Temperature Range** -55°C to 150°C • **Low Temperature Coefficient** 70 ppm max. • **Low Noise** 100 Ω max. ENR • **Small Size** $\frac{5}{16}$ " x $\frac{5}{16}$ " x $\frac{3}{16}$ " • **Low Cost** \$2.10 each for 501/502 in 500 lot quantity, \$1.95 each for 504/505 in 500 lot quantity.

Daystrom potentiometers are another product of:

Weston Instruments, Inc. • Weston-Archbald Division • Archbald, Pa. 18403

WESTON[®] prime source for precision . . . since 1888

cially with respect to temperature. It does demonstrate, however, that a square-law characteristic can be obtained practically with transistors. When four different 2N2640 transistors were successively inserted in this circuit, only a slight readjustment of the two potentiometers was necessary. This circuit may also be used as a low-distortion, low-frequency doubler with or without $R1$ and $R2$ in the circuit

(This work was performed for the Quality Control Laboratory at Marshall Space Flight Center, Huntsville, Ala.)

Richard L. Phares, Project Engineer, Spaco, Inc., Huntsville, Ala.

VOTE FOR 110

Foolproof dc regulator uses minimum of components

During normal operation diode $D2$ in Fig. 1 is kept in conduction by the current flow in $R1$, so that changes in the output voltage arrive unattenuated at emitter of $Q2$. This compares the output with the Zener voltage of $D1$ and amplifies the difference. The difference signal is used to make series transistor $Q1$ a constant-voltage source.

When the output current increases, transistor

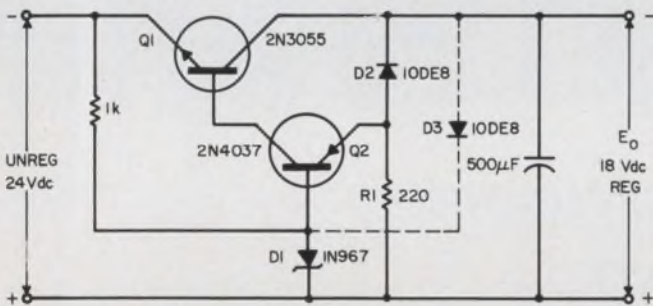

(a)

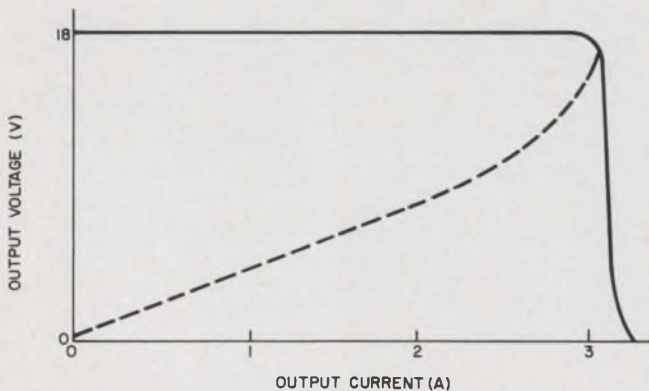

(b)

Output current remains constant (b) by the action of $D2$ (a). $D3$ keeps $Q1$ "cool" during a short.

$Q2$ has to deliver more current to $Q1$. On overload, the current in $Q2$ will make the voltage drop across $R1$ so large that $D2$ is cut off. Now the feedback loop is broken, and $Q2$ becomes a constant-current source. Hence the output current remains constant.

Excessive dissipation in $Q1$ during overload can be prevented by adding diode $D3$. Normally $D3$ is biased off. But when E_o drops below the Zener reference voltage, $D3$ conducts and shorts Zener diode $D1$. This causes a drop in the emitter current of $Q2$ and a consequent decrease of the output current.

The value of resistor $R1$ determines the output current, I_o , at which diode $D2$ turns off. It can be calculated as follows, if the β of $Q1$ at I_o is known:

$$R1 = \beta(E_o - 0.5)/I_o.$$

H. L. Han, Staff Member, Technological University, Delft, Netherlands.

VOTE FOR 111

Electronic bailing circuit is all solid state

This design for an electronic bailing circuit requires only two interconnecting leads between selector circuits, and selector circuits are not restricted in location with respect to each other.

Bailing circuits are used in electronic equipment where there is a need to select one of several circuits at a time. When a circuit is selected, any previously selected circuit is automatically turned off. The most usual bailing methods utilize mechanical devices or multicontact switches or relays to perform the bailing function. Multicontact methods require several interconnecting leads between selector switches. Mechanical methods require that the individual selector switches be located in the same assembly.

A typical application of the electronic bailing circuit is shown in Fig. 1. The circuit is used to gate on or off the output of two binary-coded-data (BCD) sources to a common read-out and ensures that only one of the two data sources is connected to the common read-out at a time. Although only two data sources are shown, additional data sources could be added in parallel with them.

The main element of the circuit is a J-K flip-flop in each data source. This device changes state on the leading edge of a positive-going signal at the clock (C) input. The J input is activated only when J is logical 1; likewise, the K input only when K is logical 1. A truth table for the J and K input is shown in Fig. 1. Data source gates $A1$ and

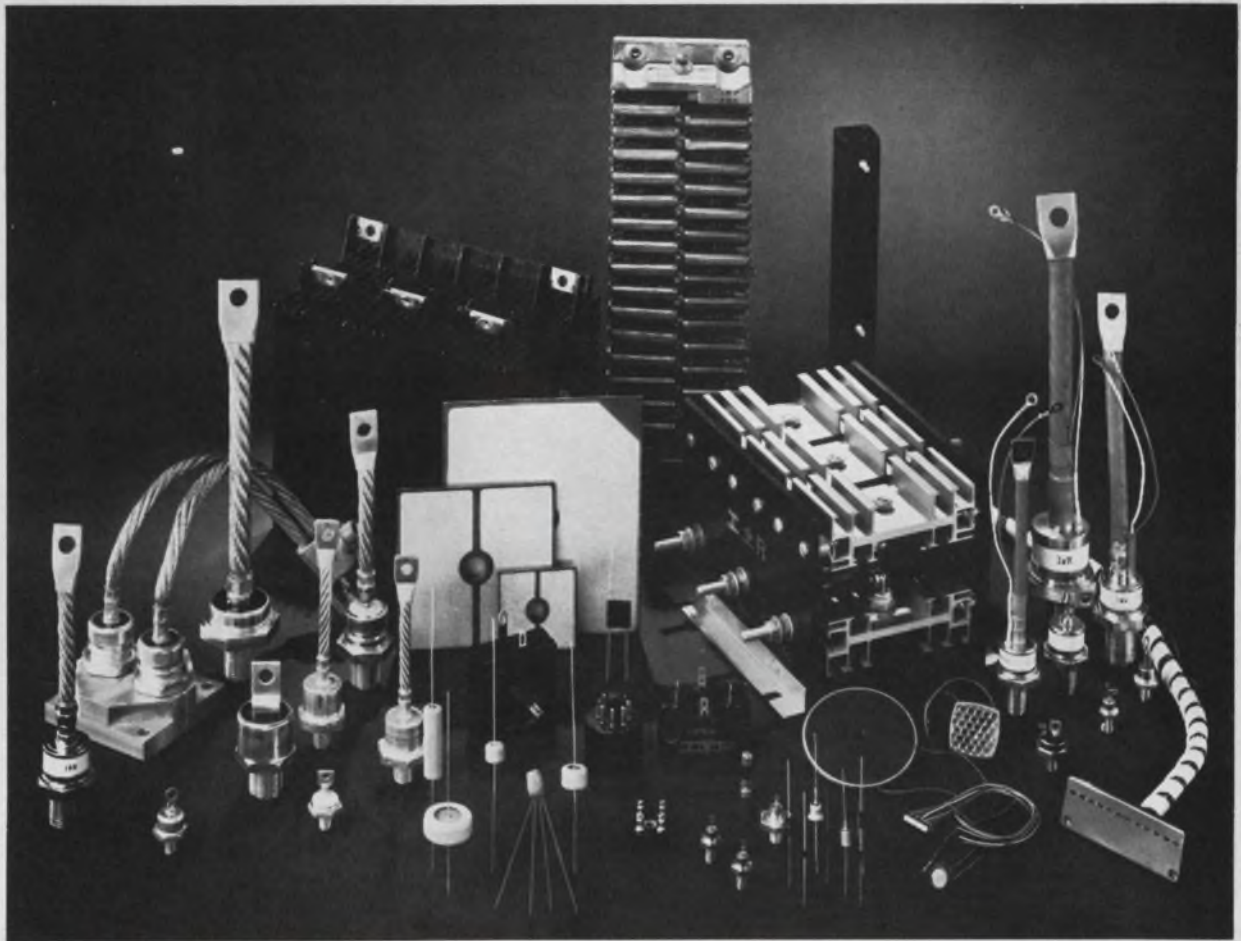

The great IR family portrait

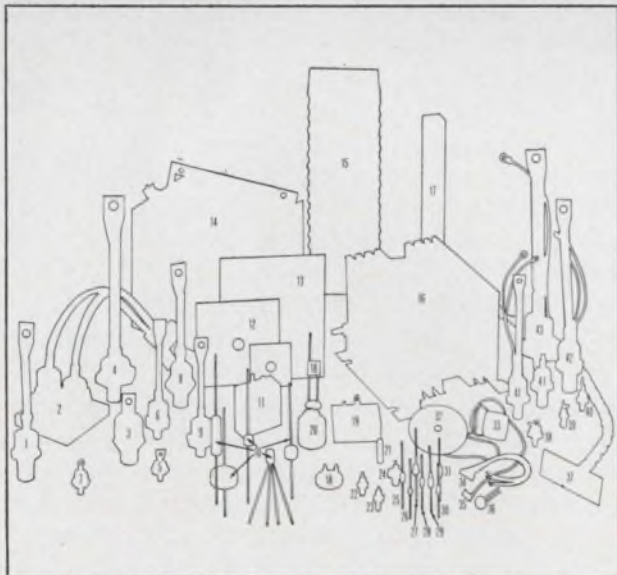

How many do you know? SILICON POWER RECTIFIERS. 1. High-Voltage 300-Amp Rectifier. 2. 500-Amp Rectifier. 3. 200-Amp Economy Rectifier. 4. 450-Amp Rectifier. 5. 70-Amp Rectifier. 6. 150-Amp Rectifier. 7. 15- to 60-Amp Rectifier. 8. 250- to 300-Amp Rectifier. 9. 150-Amp Rectifier. SELENIUM RECTIFIERS AND ASSEMBLIES. 10. Selenium Cartridges. 11. Klip-Sel Voltage Transient Suppressor. 12. Single Selenium Split Cells. 13. Single Selenium Cells. 14. Selenium Stack Assembly. SILICON RECTIFIER ASSEMBLIES. 15. Silicon High-Voltage Column. 16. Silicon Stack Assembly. 17. Encapsulated High-Voltage Assembly. 18. General Purpose Molded Circuits. 19. Medium Current Molded Circuit. 20. Silicon Tube Replacement. 21. Silicon Plug-In Rectifier. ZENER REGULATORS, VOLTAGE REFERENCES, AND LOW POWER RECTIFIERS. 22. 10-Watt Zener Regulator. 23. 12-Amp Silicon Rectifier. 24. 50-Watt Zener Regulator. 25. 1-Amp Silicon Rectifier. 26. 1-Amp Silicon Rectifier. 27. 1.3-Amp Silicon Rectifier. 28. Low-Power DO-7 Glass Zener Regulator. 29. 2.0-Amp Silicon Rectifier. 30. Low-Current DO-7 Glass Zener Regulator. 31. 1-Watt Zener Regulator. LIGHT SENSITIVE DEVICES. 32. Selenium Photovoltaic Cell. 33. Silicon Photovoltaic Cell (mounted). 34. Silicon Readout Array. 35. Silicon Photovoltaic Cell (unmounted). 36. Cadmium Sulfide Photoconductive Cell. 37. Custom Silicon Readout Array. SILICON CONTROLLED RECTIFIERS. 38. 63-Amp RMS SCR. 39. 4.7- to 7.4-Amp RMS SCR. 40. 16- to 35-Amp RMS SCR. 41. 55- to 110-Amp RMS SCR. 42. 160- to 235-Amp RMS SCR. 43. 400- to 550-Amp RMS SCR. We'll gladly send you information about any of the above. Write.

INTERNATIONAL RECTIFIER



SEMICONDUCTOR DIVISION □ 233 KANSAS STREET, EL SEGUNDO, CALIF. 90245 □ PHONE (213) 678-6281
FIELD OFFICES AND DISTRIBUTORS IN MAJOR CITIES AROUND THE WORLD

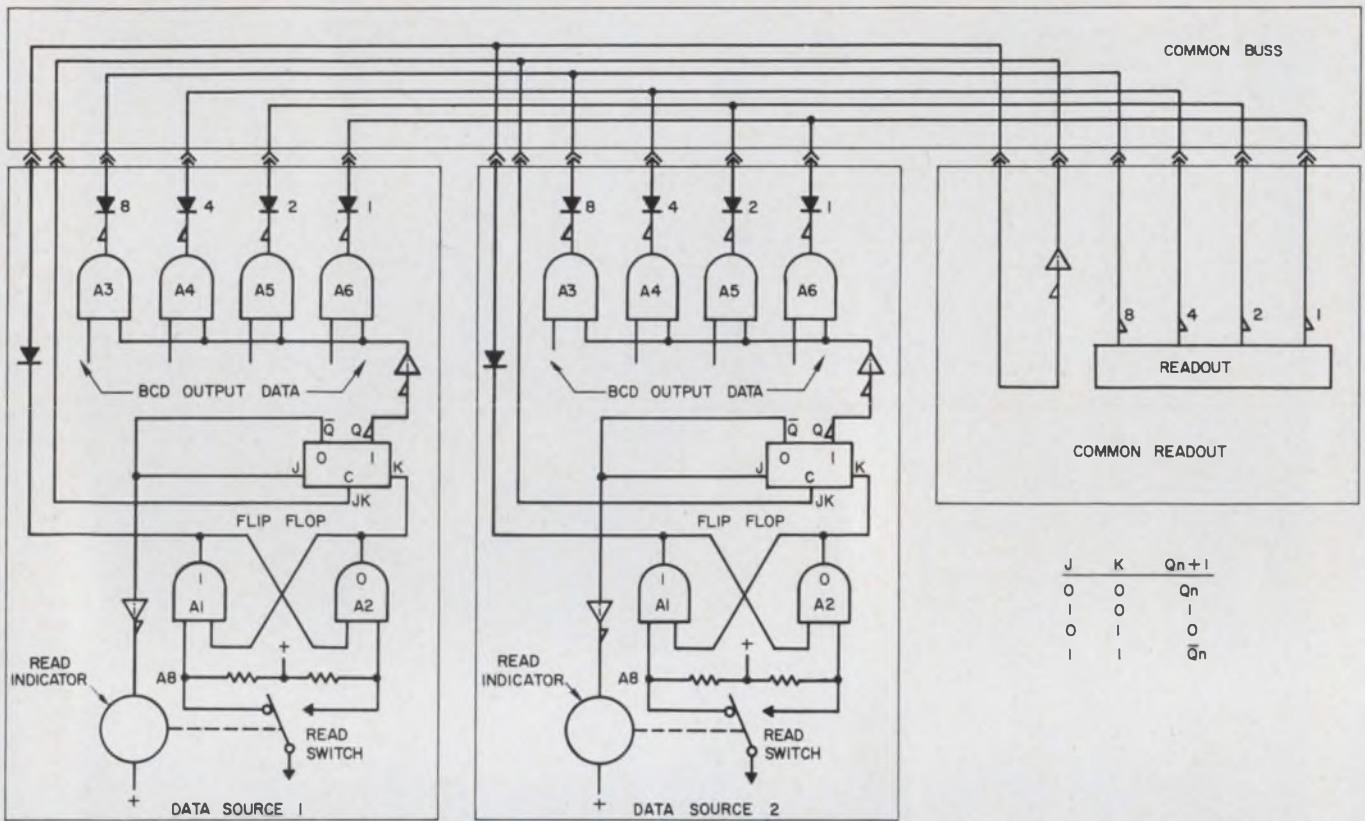

Exclusively selective solid-state switching circuit (so-called bailing circuit) uses J-K flip-flops and several gates to connect data from any desired source to the common

read-out, simultaneously disconnecting other sources. While only two data sources are shown, additional sources can be added in parallel.

A2 eliminate the effects of the contact bounce of the READ switch. Gates A3 through A6 gate the data source output, through the common bus, to the common read-out.

When the READ switch/indicator unit of data source 1 is operated, the output at gate A2 goes to a logical 1 and the output at gate A1 goes to a logical 0. At this instant, the K input of the flip-flop is a logical 1 and the J input is a logical 0. The negative or zero-going pulse at gate A1 is inverted by the current amplifier of the common read-out and the positive-going output of this current amplifier is connected back to the clock input of the flip-flop. These input conditions will result in point Q of the flip-flop changing to a 0 level, its active state.

The positive-going output of the data-source current amplifier is also connected to the clock input of the flip-flop in data source 2. But since both the J and K inputs of this flip-flop are at 0 the flip-flop will not change state. With point Q of the flip-flop in data source 1 at a 0 level, the BCD output gates that connect data from data source 1 to the read-out are activated. Point Q of the flip-flop is also at a 1 level, which, when inverted at current amplifier A8, will result in the READ switch/indicator being lighted. When the

READ switch/indicator is released, the level at gate A2 returns to a logic 0 and gate A1 returns to a logic 1. At this instant, the K input of the flip-flop is a logic 0, and because the flip-flop is now in the active state ($\bar{Q} = 1$), the J input is then a logic 1.

The positive-going pulse at gate A1 is inverted at the read-out-module current amplifier, resulting in a negative-going signal at the flip-flop clock input. Since the flip-flop changes state only on a positive-going signal, the flip-flop remains in the active state until either the READ switch/indicator of data source 1 is operated again or until the READ switch/indicator of data source 2 is operated.

With the flip-flop of data source 1 in its active state and the READ switch/indicator released, the K input of the flip-flop is a logic 0 and the J input is a logic 1. If the READ switch/indicator of data source 2 is then operated, data source 2 output data will be gated to the common read-out in the same manner as for data source 1. In addition, the positive-going output of the common-read-out current amplifier will cause the flip-flop of data source 1 to change from the active to the inactive state.

If a data source is connected to the common

GLOBE

KABOOM!

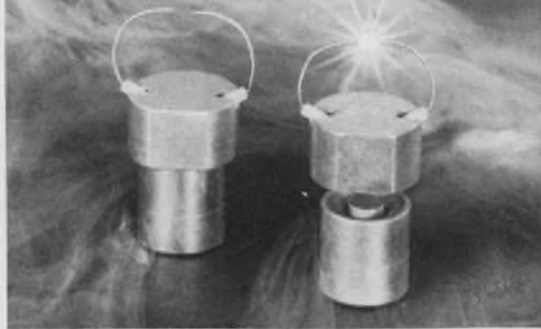

Globe's magnetic induction generator is less than an inch long and weighs slightly more than one ounce, yet it packs a 0.001 joule wallop. Designed as a detonator, it has a variety of potential applications. A pulse voltage, induced when the magnetic assembly is displaced, can trigger relays, signals, fail-safe devices, or explosives. Globe can provide the generator separately in varied sizes, configurations, and outputs, or as a complete actuator designed for your specific application. Write for specifications.

Suprel Operations, Globe Industries Div. of TRW Inc.
1784 Stanley Ave., Dayton, Ohio 45404, Tel: 513 222-3741

ON READER-SERVICE CARD CIRCLE 205

ANOTHER WORLD'S SMALLEST Soshin's Dipped Mica Capacitors/DM05

Developed by SOSHIN ELECTRIC, the only mica capacitor maker in Japan with MIL-C-5C qualifications. This newest and its bigger brothers will meet all your requirements. Volume orders accepted.

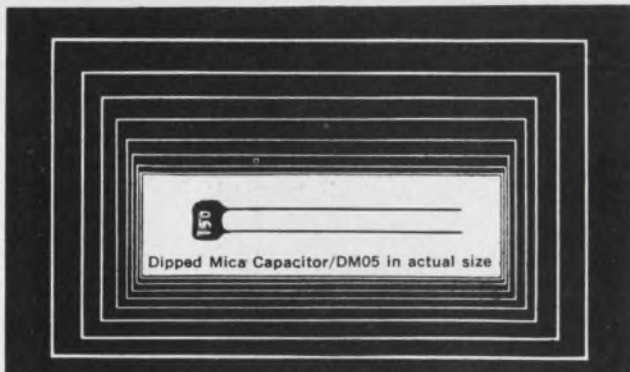

Types	Max Allowable Capacitance (pF)			Dimension (mm)								
	100 WV	300 WV	500 WV	100 WV			300 WV			500 WV		
Standard				L Max	W Max	T Max	L Max	W Max	T Max	L Max	W Max	T Max
DM 05	200	130	—	7.0	5.0	3.5	7.0	5.0	3.5	—	—	—
DM 10	400	300	330	8.5	5.5	3.5	8.5	5.5	3.5	8.5	5.5	3.5
DM 15 (C.MOS)	7000	1700	310	13.0	11.0	6.5	12.5	10.5	6.0	12.0	10.0	5.5
DM 19 (C.MOS)	10000	6800	5100	18.0	15.0	8.5	18.0	15.0	8.0	17.5	15.0	7.5

For further information, write to

SOSHIN SOSHINELECTRIC CO., LTD.
18-18, Nakamagome 1-chome, Ohta-ku, Tokyo, Japan
Cables: SOSHINCAPACITOR TOKYO

ON READER-SERVICE CARD CIRCLE 206

ELECTRONIC DESIGN 17, August 16, 1967

the search goes on

... from South Africa to other far corners of the world,
Karl Lambrecht still searches for even finer calcite
and crystal quartz deposits.

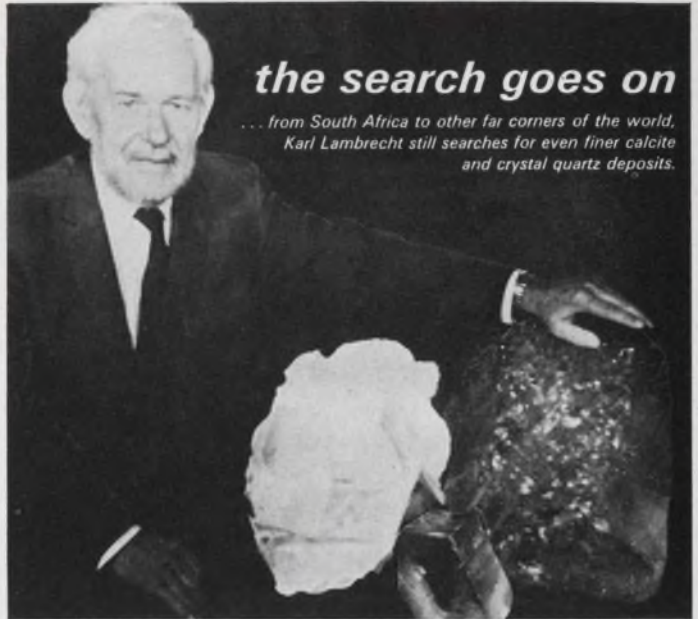

Polarized Optics for your Laser Program

Crystal Optics supplies a special series of Glan-Laser polarizers which provide efficient polarization at higher energy levels with even greater reliability. Interface angle of Type A Glan Prism has been modified to further minimize the reflection losses, length to aperture ratio was increased to permit sealing of the air space with cemented black glass side plates, eliminating the need for a blackening paint. Maximum durability is insured by hard single layer anti-reflection coatings applied to entrance and exit faces.

For some higher energy levels, including those generated by Ruby Lasers, a modified version of the Glan-Laser prism is available. In this, the totally reflected polarized beam is allowed to escape through one polished, anti-reflection coated prism side.

Superior transmission crystal quartz wave plates available for practically all wave lengths.

PRECISION POLARIZING PRISMS

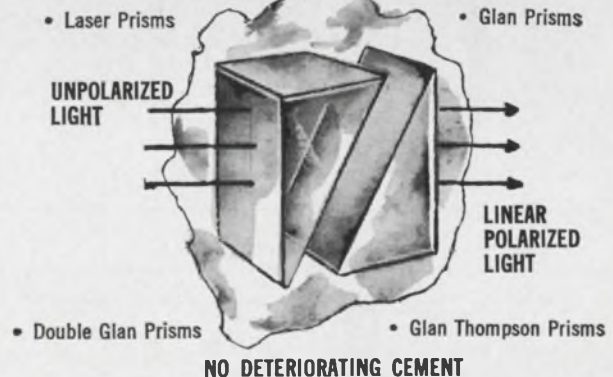

All prisms available mounted in precision divided circles.

Write for further information on Laser products and special components for the Ultraviolet. If possible, give details on your specific requirements.

Crystal Optics

3959 North Lincoln Ave., Chicago, Illinois 60613
Area 312 472-5442

ON READER-SERVICE CARD CIRCLE 207



Dial Direct – and Save

Introducing the direct-dialing Bourns KNOBPOT® Model 3650 — a digital dial, knob, and 10-turn precision potentiometer in a single assembly. At \$25, this integrated unit costs you less than a precision potentiometer and digital dial bought separately, yet gives you greater accuracy. Correlation between dial and wiper output is guaranteed accurate to 0.1 per cent! There are no phase-it-yourself problems with the Model 3650, either. Each unit is phased at the factory. You save time, trouble and expense!

Settings are fast and easy, thanks to the large, clear numerals that show turns, tenths of turns and hundredths of turns. Calibration marks beside hundredth-turn numerals allow settings as fine as 1/1000 turn or 1/10,000 of the total applied voltage.

Reliability is enhanced by extensive in-process inspection, 100 per cent final inspection, the Bourns Reliability Assurance Program, and by such outstanding construction features as the exclusive SILVERWELD® termination — the strongest in the industry. For value you can count on, specify Model 3650. Write today for complete technical data.

MODEL 3650 1 1/4" dia., 10-turn STANDARD SPECIFICATIONS

Dial accuracy (correlation of dial reading and output, including linearity)	±0.1% (50K and above)
Repeatability of dial reading	±0.05%
Power rating	2.5W at 25°C
Humidity	MIL-STD 202 Method 103
Resistance Range	100Ω-500K



unit shown 1/4 actual size



BOURNS, INC., TRIMPOT DIVISION, 1200 COLUMBIA AVE., RIVERSIDE, CALIF.
PHONE 684-1700 • TWX: 714-682 9582 • CABLE: BOURNSINC.

TRIMPOT® AND PRECISION POTENTIOMETERS — RELAYS — MICROCOMPONENTS: TRANSFORMERS, INDUCTORS, RESISTORS AND CAPACITORS

accomplished with a voltmeter and a depth micrometer. An accurate plot of displacement vs voltage can be obtained for the load piston. Input voltage is set to 28 volts dc. The output is checked with the piston at the bottom of the cylinder, and set to 1 volt by adjusting the position of the lamp. The rate of change of output is then 0.023 volt per 0.010 inch, which can vary if the photocell is changed.

The greatest time resolution on the oscilloscope can be obtained if it is triggered by the bridge-wire-to-case ionization of the explosive motor. Triggering is done with 200 volts dc and a 0.22- μ F capacitor. The scope is set for 0.2 ms/cm sweep with the vertical sweep set to give the maximum display of 1-volt pk-pk signal. It is of interest to

note that the completion of motor piston travel can be seen on the displacement trace as a discontinuity. This is the point of separation of the motor and load pistons. This point can also be detected on the force trace.

The force-vs-time output is obtained with a ceramic piezoelectric washer, 0.625 inch in diameter and 0.035 inch thick, with a 0.321-inch hole in the center. A "sandwich" is made with the crystal, contact leaves on either side of the crystal, mylar insulators, and a steel anvil washer. The bottom of the explosive motor sits on the anvil washer. When the piston is fired up the cylinder, the reaction force is transduced by the crystal and displayed on the scope.

The crystal can be calibrated with a static load and an electrometer, voltmeter or charge amplifier. Calibration can also be accomplished with a dynamic force such as that generated with a pendulum. The force is then easily calculated.

The output of the crystal is not linear; but with proper calibration, this is no problem. The force on the crystal may be as high as 600 pounds with a corresponding output of over 300 volts. There is some attrition due to breakage, but crystals are easily changed and are made to such tolerances that recalibration is unnecessary.

J. M. Phillips, J. K. Shane, R. M. Bleakney, Component Test Equipment, Development Div., Sandia Corp., Albuquerque, N. M.

VOTE FOR 114

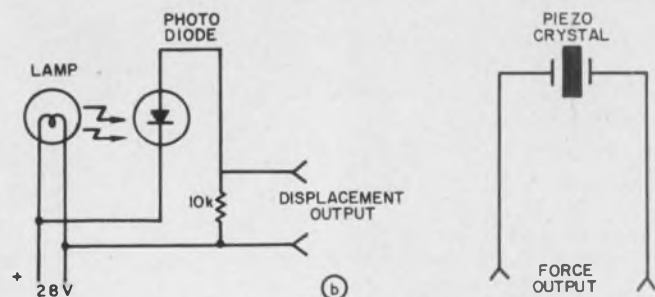
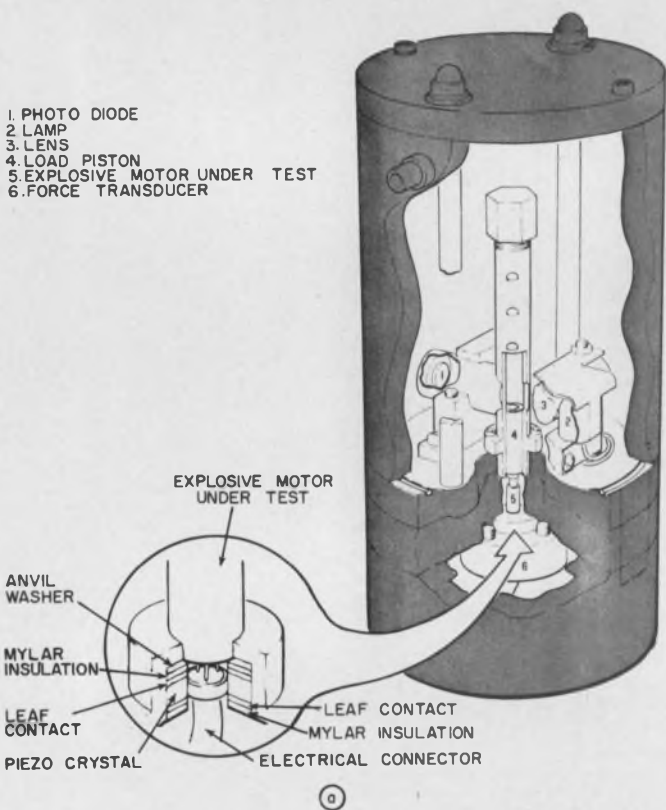

Force and displacement vs time of an explosively actuated linear motor are measured by "looking" at the load piston with the photocell and by measuring the reaction force of the motor with the piezoelectric washer (a). The test circuit is simple (b).

FET buffers output of voltmeter or counter

A field-effect transistor (FET) may be used as an impedance buffer and level inverter between four-line binary-coded-decimal (BCD) printer output and negative-potential diode-transistor logic.

A specific problem was to gate the four-line BCD printer output of a Dymec 2401C voltmeter. The logical 1 level consisted of a 0- to -5-volt dc level; the logical 0 level of a level of -24 to -35 volts dc. These voltages are isolated by a 100-k Ω resistor.

The FET buffer circuit of Fig. 1a solved the problem. The 2N4303 is an n-type industrial-grade FET. The main characteristics exploited here are:

Min saturation current (I_{DSS})	4 mA
Max pinch-off voltage (V_p)	6 V

The 4-mA minimum saturation current provides an output voltage of about -10 volts dc for a 0-to-5-volt dc input (logical 1).

The 6-volt maximum pinch-off voltage guaran-

MINIATURE, SUB-MINIATURE, ULTRA-MINIATURE ELECTRONIC COMPONENTS

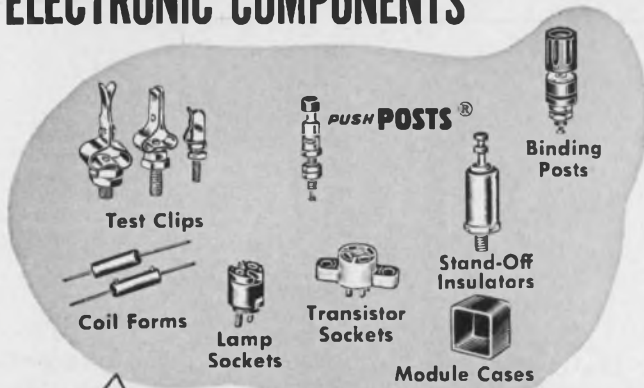

... the Difference Between
Excellent and Adequate

Select Materials

Metal Parts — Steel, SS, Brass,
Beryllium, Copper
Finishes — Silver Plate, Nickel
Plate, Gold Plate
Contacts—Fine Silver
Insulating Material — Molded
Phenolic, Diallyl, Epoxies to
MIL-M-14

Typical Specifications

All Grayhill Components are designed for long life and high reliability under extreme environmental and operating conditions. Excellence, competitively priced.

Engineering Catalog G304 presents a full range of Miniature Components—Write



565 Hillgrove Avenue
LaGrange, Illinois 60525
Area Code 312, Phone 354-1040

"PIONEERS IN MINIATURIZATION"
ON READER-SERVICE CARD CIRCLE 225

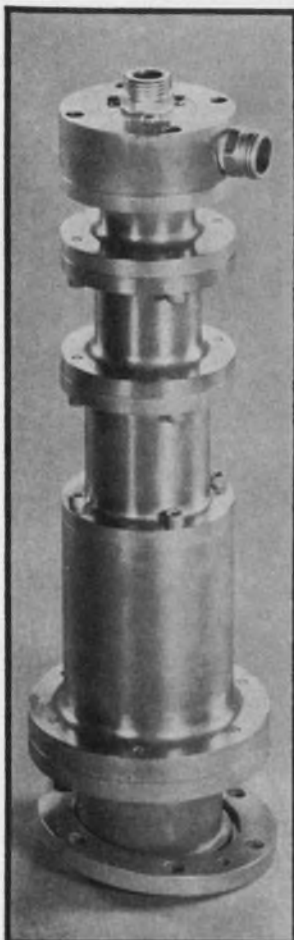

... total weight only 16½ lbs.

OMEGALINE LOAD RESISTORS 50 KW — 2000 mc DIRECT WATER-COOLED Model 5750

An Altronic "First:" The combined use of water as a dielectric medium and as a coolant to provide a compact dummy load in the frequency range up to 2000 mc.

Transmitter, power tube and microwave component manufacturers, and transmitting stations requiring absorption of power up to 50 KW can install the Omegaline Model 5750 for continuous operation in any position. Minimum water-flow rate: 10 gpm, in open or closed systems, for maximum power input.

Resistor in patented enclosure provides an almost reflection-free termination and can be easily replaced in the field in a few minutes. Maximum input VSWR is 1.1 to 1000 mc; 1.15 to 1500 mc; and 1.25 to 2000 mc.

Compare and Save

\$1275.00

with 3¼" EIA flanged connector
F.O.B. Cleveland, Ohio

CALL OR WRITE FOR COMPLETE SPECIFICATIONS

**ALTRONIC
RESEARCH CORPORATION**

13710 Aspinwall Avenue
Cleveland, Ohio 44110
216-851-3220

ON READER-SERVICE CARD CIRCLE 226

ELECTRONIC DESIGN 17, August 16, 1967

TIME/ FREQUENCY is a unique dimension!

<p>WE MEASURE IT (Frequency Standards)</p>	<p>WE CONTROL IT (Crystal Oscillators)</p>
<p>WE CONTROL ITS ENVIRONMENT (Proportional Ovens)</p>	<p>WE PIPE IT (Distribution Amplifiers)</p>
<p>WE COMPARE IT (Phase Comparators)</p>	<p>WE EXERCISE IT (Voltage Controlled Oscillators)</p>
<p>WE COMPENSATE FOR ITS ENVIRONMENT (Temperature Compensated Oscillators)</p>	<p>WE CONTROL ITS ENVIRONMENT WITH MINIMAL ENERGY (Low Power Oscillators)</p>
<p>WE SOMETIMES CARRY IT (High Stability Portable Clocks)</p>	<p>WE EVEN CONVERT IT (Linear Discriminators)</p>



SEND FOR OUR
COMPLETE CATALOG ED

FREQUENCY ELECTRONICS, INC.

No Compromise with Quality

3 Delaware Drive, New Hyde Park, New York 11040 (516) 328-0100

ON READER-SERVICE CARD CIRCLE 227

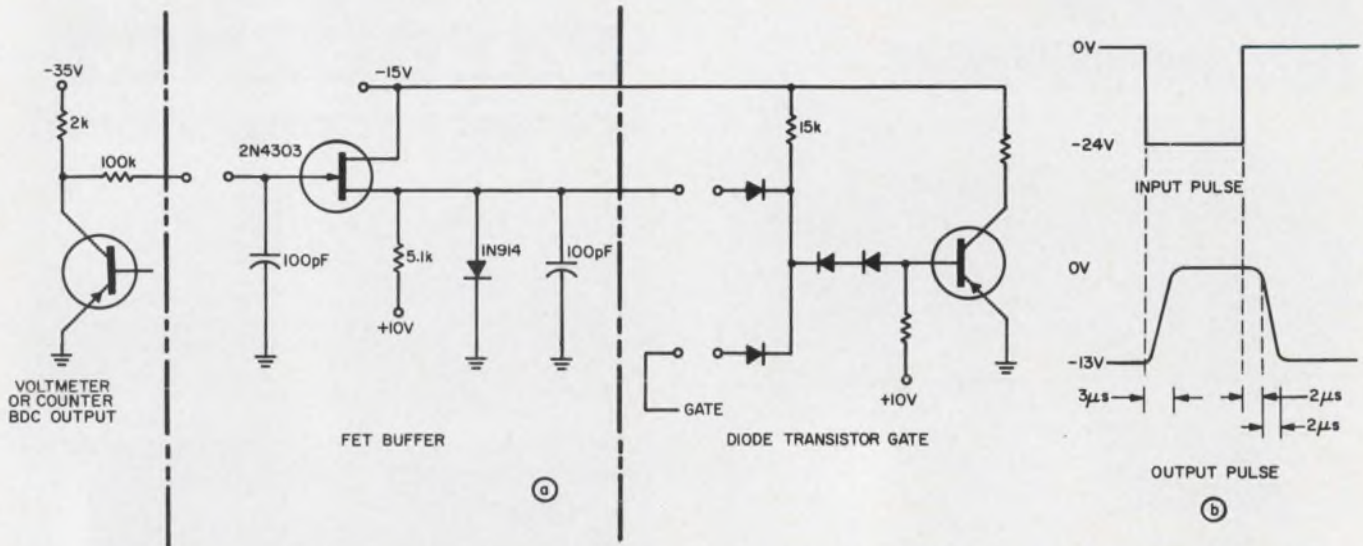

FET impedance buffer and level converter solves the problem of coupling output of a digital voltmeter to a DTL AND

gate (a). Input-output waveforms are shown in (b) together with the two-input DTL gate.

tees turnoff of the FET for a 24-volt (logical 0) input.

The logic inversion is such that the buffer circuit will work directly into a negative-potential diode-transistor-logic (DTL) two-input AND gate, which in this case was the desired end result.

Sketches of turn-off and turn-on time are shown in Fig. 1b. For an input of a -24-volt pulse with 30-nanosecond rise and fall times, the output pulse had about a three-microsecond rise time (FET

turn-off) and a two-microsecond delay plus two-microsecond fall time (FET turn-on). In the breadboard circuit, a 100-pF capacitor was added at the input and output to simulate wiring capacitance.

J. H. Smelser and D. M. Morrison, Product Tester Design Div., Sandia Corp., Albuquerque, N. M.

VOTE FOR 115

Go-no-go digital comparator uses complementary addition

Two binary numbers can be compared by subtraction. This may be performed and more easily implemented by complementary addition.

In general, when any two numbers in the same binary form (straight binary, excess three, Gray, and any form of BCD.) are compared by complementary addition, the final carry term will be a 1 if the unknown is greater than the limit, and a 0 if the unknown is less than or equal to the limit.

Determining whether a binary number, X , lies between two limits, H (high) and L (low), requires two comparisons. When X is compared with H , the carry term should be 0; when X is compared with L , the carry term should be 1. Therefore, by making two comparisons and storing the resulting carry terms, a below-limits, in-limits, or above-limits condition can be recognized.

The schematic for an n -bit, dual-limit comparator is shown in the figure. Standard half-adder and full-adder circuits compare first digits $X_0 - X_n$ with digits $L_0 - L_n$ (low limit), and then $X_0 - X_n$ with $H_0 - H_n$ (high limit). Each resulting final

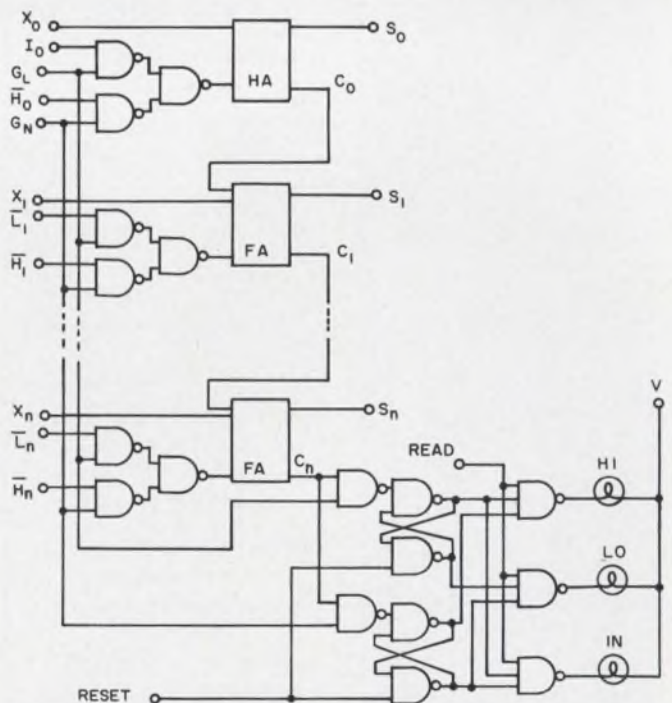

Comparator stores the final carry from the separate high and low limit checks. The two carries are decoded to give in- or out-of-limits signals.

narda SOLVES YOUR Peak Power PROBLEMS – With less Equipment, Time and Expense and Improved Accuracy

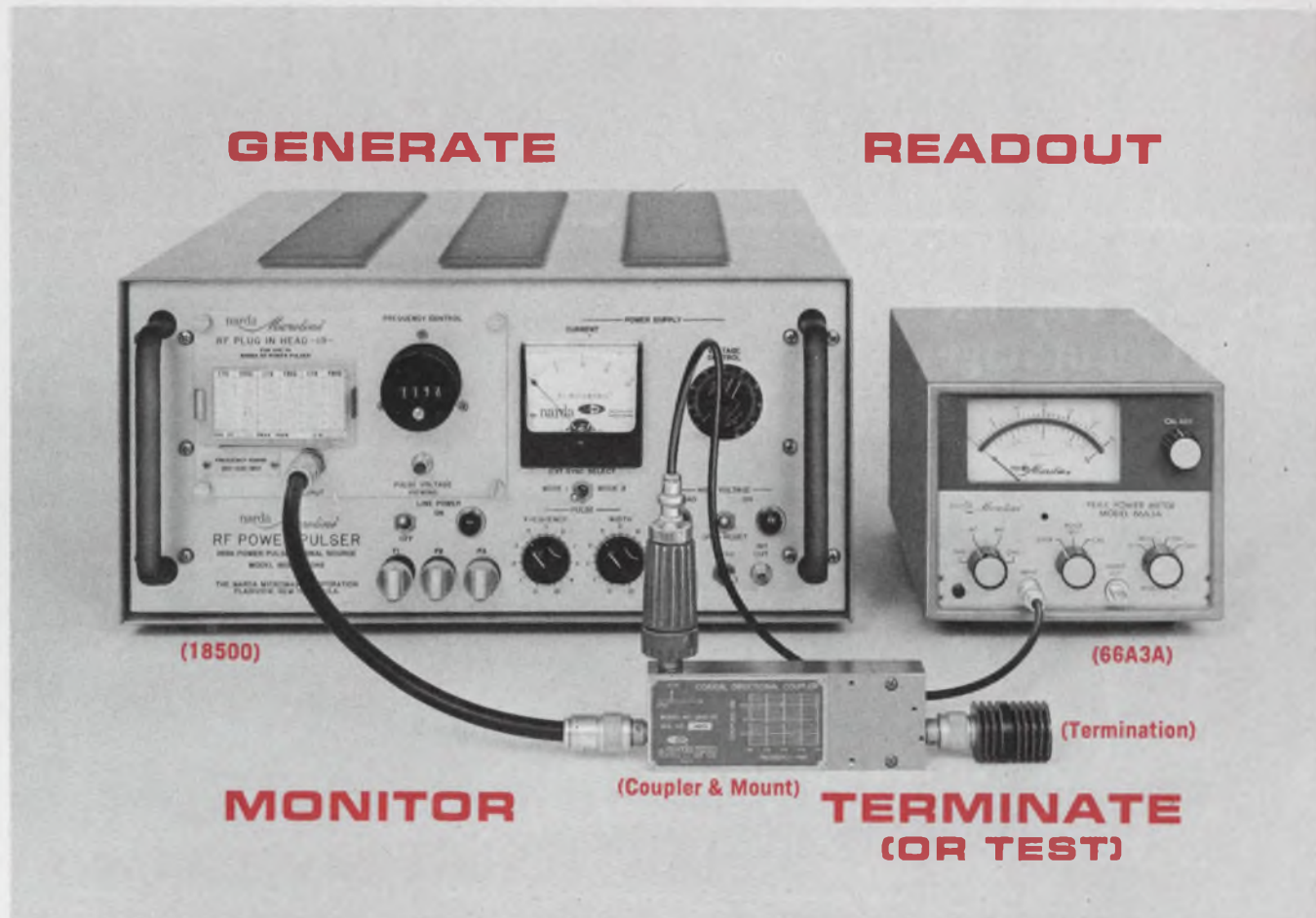

Narda's total capability for power measurements can satisfy any system or component test requirement with catalog test devices. This means convenience and economy to you. Give us your problem and we will help you solve it with a complete measuring set-up. The above peak power measurement set-up shows one of Narda's answers to a measurement problem.

NARDA MICROLINE 18500 RF POWER PULSER

- From 200 to 9500 MHz with 11 plug-in- r-f heads
- Continuously variable peak power to 5 KW depending on r-f heads
- Internal pulse generator
- Variable pulse width from .25 to 6.0, μ sec depending on r-f head
- Continuously variable PRF from 150 to 4000 pps built-in DC to 4000 pps external
- External pulse viewing capability
- Multipulse capability

NEWLY IMPROVED PEAK POWER METER 66A3A — 33B3 BOLOMETER MOUNT

- New shielding effectiveness now permits power meter operation in high Peak Power environments
- Peak power output read directly from 0 to 300 mw. over frequency range of 0.5 to 12.4 GHz with Narda bolometer mounts
- Accuracy of $\pm 5\%$ of full scale
- Transistorized, battery-operated, immediately operative
- Calibration accuracy of Narda bolometer mounts traceable to NBS

MAXIMALLY FLAT COAXIAL COUPLER — 3040 SERIES

- Frequency: from 0.125 to 12.4 GHz
- Flatness: ± 0.2 db over octave ranges
- Directivity: 20 DB
- Coupling: 10, 20, 30 db values (special on request) calibrated and permanently marked at 5 frequencies

MEDIUM POWER COAXIAL TERMINATIONS 370 SERIES

- Cover entire frequency range of DC to 12.4 GHz
- Power levels up to 40 watts average
- Small, lightweight — low cost

Call our factory or local representative for demonstration of this system or its catalog components.

narda *Microline*[®]

THE NARDA MICROWAVE CORPORATION • PLAINVIEW, L.I., NEW YORK 11803

516 - 433 - 9000 • TWX: 510 - 221 - 1867 • CABLE: NARDACORP PLAINVIEW NEWYORK

ON READER-SERVICE CARD CIRCLE 228

carry term, C_n , is stored and appropriate logic circuits provide an output as shown in the truth table.

The main feature of this comparator is that it is a universal-decision element, providing automatic accept-reject information on any parameter which

can be digitized. Digital comparison accuracy is absolute so that total system accuracy depends only on the analog-to-digital converter used in the measuring equipment, which is commonly $\pm 0.1\%$.

J. Lopper and R. Stinson, Engineering Research Center, Western Electric Co., New York.

VOTE FOR 116

Mini-noise amplifier has FET input stage

This device can be used where noise, temperature stability, dynamic range, gain requirements, and physical size are critical.

The circuit (see figure) is basically a two-stage FET amplifier with a Darlington output stage. The advantages of using FETs are twofold: they give an internal noise threshold of -112 dBV over a bandwidth from 60 Hz to 24 kHz, and they provide the high input impedance. In addition, the current drain in the stand-by mode is very small which is important in any battery-operated equipment.

Each amplifier stage provides 20-dB gain for an over-all gain of 40 dB. The first stage is operated

in the self-biased mode to provide greater stability.

It has been found that the signal variation is ± 1 dB over the frequency range. Negative feedback can be added to improve stability with a corresponding increase in noise level.

The Darlington output stage reduces the effective output impedance to 40 ohms in order to operate into low-impedance cables.

The use of tantalum capacitors and metal-oxide-film resistors makes for a small package which can easily be encapsulated along with its battery supply. The addition of resistors R_x and R_y allows for the calibration of the entire system.

William Martin Keane, Electronics Engineer, U. S. Navy, Office of Naval Research, Bermuda.

VOTE FOR 117

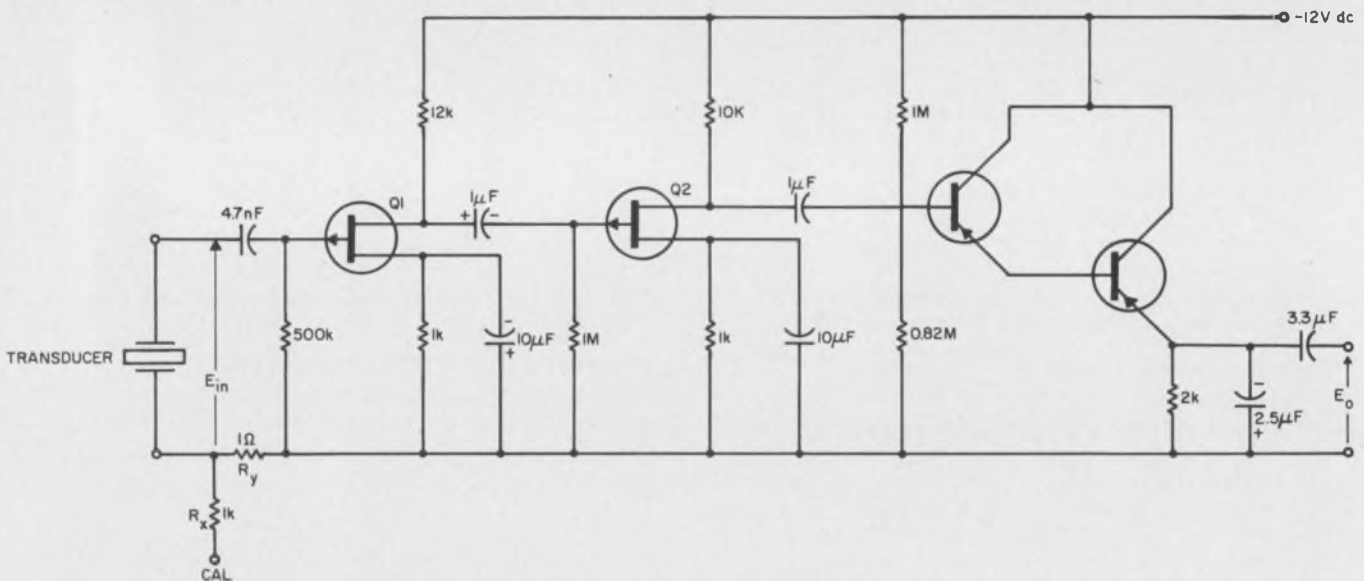

Low-noise amplifier with high input impedance uses two FET input stages. The output of the amplifier is flat within

± 1 dB from 60 Hz to 24 KHz. A Darlington pair at the output gives 40 ohms' output impedance.

IFD Winner for May 10, 1967

Les Toth, Project Engineer, Diamond Electronics, Lancaster, Ohio.

His Idea, "IC and four resistors compose inexpen-

sive voltage regulator," has been voted the \$50 Most Valuable of Issue Award.

Cast Your Vote for the Best Idea in this Issue.



SS motor



SS governed



SS planetary

FAMILY OF 7/8" D.C. MOTORS

Basic Type SS p.m. motor produces up to 0.3 oz. in. @ 10,000 rpm continuous; 19 standard windings plus specials can meet your speed, torque, and power requirements. Size; 7/8" dia. x 1 3/8"; weight is 2 oz. Voltages 4 through 50 v.d.c. or more. MIL specs. Mechanically governed SS motors can regulate speed within 2%; electronic governors, within a few parts per million. Gear reducers further extend usefulness to 300 oz. in. torque; 21 standard planetary ratios, 28 standard spur gear ratios. If you need a still smaller motor, ask about Type SD (3/4" dia.) or VT (5/8" dia.). Request Bulletin SS from

GLOBE

GLOBE INDUSTRIES
DIVISION OF TRW INC.
2275 Stanley Ave., Dayton, Ohio 45404, Tel: 513 222-3741
Booth 4220 WESCON Show



ON READER-SERVICE CARD CIRCLE 229

EMI/RFI Shielding

COMBINED WITH
AIR/FLUID SEALING FOR
Total Shielding Effectiveness Up To 120 dB

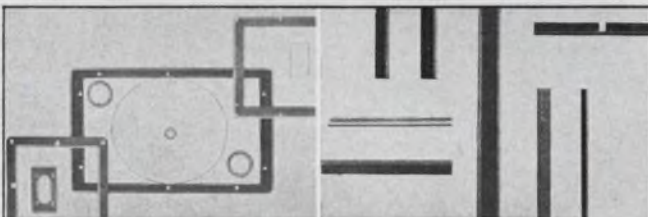

DUOGASKET

DUOSTRIP

- **SHIELD** with Tecknit's SN/CU/FE, Monel, Aluminum or Brass, Silver Plated.
- **SEAL** with solid or sponge elastomers such as Silicone, Neoprene, Buna or Butyl Rubber.

These single, dual purpose components save space . . . keep design and installation costs down. Also available with pressure sensitive adhesive back. Write today for information #109.



Technical Wire Products, Inc.
EASTERN PLANT
129 Dermody St., Cranford, N.J. 07016
WESTERN DIVISION
427 Olive St., Santa Barbara, Calif., 93101

ON READER-SERVICE CARD CIRCLE 230

ELECTRONIC DESIGN 17, August 16, 1967



waldom solderless terminals & connectors

You can be sure of neater, stronger, more positive terminations if you use Waldom Solderless Terminals and Connectors. Though designed primarily for sophisticated quality circuitry, more and more economy circuits now use Waldom Solderless Terminals for savings in assembly time. From any angle, Waldom is the Industry's fastest growing line.

- * Broad selection including Quick Disconnects
- * All construction styles
- * Absolute dependability
- * Saves time and labor
- * Easier servicing
- * All types made to military specs.

Fast delivery from your electronics or electrical distributor. Write for FREE Waldom catalog listing more than 3000 electronic hardware items.



waldom
ELECTRONICS, INC.

4643 West 53rd Street, Chicago, Illinois 60632

ON READER-SERVICE CARD CIRCLE 231

DIGITAL SYSTEMS DESIGNERS

Recent expansion in the Switching Systems Laboratory has created several challenging opportunities for electronic logic systems designers and evaluation engineers to develop solid state switching and communications systems utilizing both general and special purpose computers. Experience desired in the area of small signal techniques, stored program design and applications of memory devices in solid state switching logic. B.S.E.E degree desired, however will consider applicants with all levels of compatible industrial experience.

CIRCUIT DESIGN ENGINEERS

Creative opportunities in the field of digital computer circuits employing both integrated and discrete components are open to circuit design engineers. Responsibilities of these positions will include the analysis and development of circuit techniques for operational features of automated central office test equipment common control switching systems and electronic (I.C.) and E.C. and electromechanical Local Toll or Toll Ticketing equipment. Requirements for consideration include all levels of design experience in the areas of Machine Control, Automatic Process Control Equipment, and telephone circuit development. B.S.E.E. or equivalent.

We offer a professional atmosphere, excellent benefit program and attractive salary. Please send resume detailing education, experience, present and expected salary requirements:

Mr. W.R. Kaplinski
Professional Employment

Automatic Electric Laboratories
400 North Wolf Road
Northlake, Illinois 60164

*an equal opportunity employer
member of the G.T.&E. Family
of Companies.*

ON CAREER INQUIRY FORM CIRCLE 900

transistor circuits engineer

to work in Industrial Controls
with Marathon's new R&D
division in Southern Connecticut.

If you want the freedom to
tinker, designing generator
voltage regulators and variable
speed drives for both AC and DC
motors, and industrial control
applications, like logic functions,
etc. . . . then you're our man.
There are no limitations on salary
. . . . because the man we seek
must be good.

This is the ground floor
opportunity you've been seeking
. . . . to work in green New England
and see your plans and ideas
come to life at the start of
this new division.

Interested? Write today with
complete resume and
your salary needs.

*Mr. A. Guterman

Marathon
Electric
MANUFACTURING CORPORATION
Control Development Group
533 Pacific St., Shamford, Conn. 06902

ON CAREER INQUIRY FORM CIRCLE 901

NASA TECH BRIEFS

Solid-state converter combines two functions

Problem: Design a circuit capable of producing an output pulse with an amplitude directly proportional to the time interval between two input pulses. A single circuit must be capable of operating under two separate and distinctly different input conditions:

- It must measure the time interval between two pulses which occur in very rapid succession. This time interval is generally of shorter duration than that of the pulse lengths themselves.

- It must measure the time interval between the starting point and the end point of a continuous "beam"-type pulse. The circuit in this instance receives not two pulses, but one in the form of burst energy.

Usual methods of obtaining time-to-pulse-height conversion require that separate circuits be used for each type of input condition.

Solution: Incorporate selected circuit options into one solid-state circuit, to achieve variable mode operation. A tunnel diode, used as a bistable element, controls the charging time of a capacitor in proportion to the time interval being measured for either randomly or periodically occurring pulses.

The device achieves time-to-pulse-height conversion by controlling the on time of a bistable

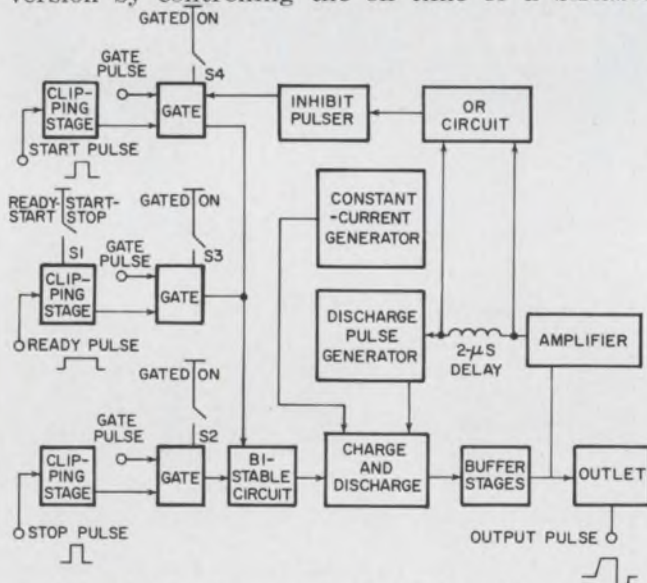

circuit which charges a capacitor. The voltage developed across the capacitor is thus proportional to the time interval. After a short time interval, the capacitor is discharged so that the circuit is ready for a new conversion. The conversion is accomplished by five basic circuit functions:

- Wave-shaping circuits and gates.
- Converter circuits.
- Capacitor discharge circuit.
- Start pulse inhibit circuit.

Free Career Inquiry Service

Absolutely Confidential

Respond to the career opportunities advertised in this issue. Fill out and send us this handy resume. **Electronic Design** will do the rest – neatly typed copies of this form will be mailed to the companies of your choice, indicated by the circled Career Inquiry Numbers at the bottom of this page.

17

Name		Home Phone	
Home Address (Street)		City	State ZIP Code
Age	<input type="checkbox"/> U.S. Citizen <input type="checkbox"/> Yes <input type="checkbox"/> No	Security Clearance	
Prime Experience		Secondary Experience	

Desired Salary	Availability Date
-----------------------	--------------------------

Employment History – present and previous employers

Company			
City, State			
Dates	to	to	to
Title			
Specialty			

Education – indicate major if degree is not self-explanatory

Degree			
College			
City, State			
Dates	to	to	to

Additional Training – non-degree, industry, military, etc.

Professional Societies

Published Articles

Career Inquiry Numbers:

900	901	902	903	904	905	906	907	908	909
910	911	912	913	914	915	916	917	918	919

ELECTRONIC DESIGN
 850 Third Avenue
 New York, New York 10022

▪ Isolating and output stages.

The system permits two modes of operation: ready-start and start-stop.

The ready-start mode measures the time interval between two pulses occurring at a random rate. By switching *S1* in the ready-start position, the circuit turns on the bistable element whenever a start pulse appears coincidentally with a ready pulse. The ready pulse, of a duration fixed by a delay cable, switches the bistable element off.

With *S1* in the start-stop position, a ready current is always present at the bistable circuit, and the bistable circuit is turned on by a start pulse. The circuit remains on until either a stop pulse or a negative ready pulse is applied. This mode of operation is used for experiments where one pulse occurs at a periodic rate, i.e., pulsed-beam experiments.

The wave-shaping circuits and gates first shape the input pulses (start, ready, and stop) in size and duration. The start and stop pulses, which must be positive, are clipped to a duration of 7 μ s. The ready pulse is clipped to a time longer than the true interval of interest. The start pulse is delayed so that for isochronous pulses it arrives later than the start of the ready pulse.

The capacitor discharge is controlled by the pulse generator and the charge and discharge circuitry. A normally cut-off transistor amplifier is brought into conduction and discharges the capacitor after a 2- μ s delay. The discharge current of the capacitor produces an output pulse of an amplitude that is directly proportional to the time interval between input pulses.

The OR and inhibit pulser circuits close the gate to the start pulse regardless of the position of *S4*. This is to ensure that a new start pulse will not enter when a cycle is in progress. A 2- μ s delay line between the discharge pulse generator and the OR circuit provides a flat-topped pulse suitable for use with a multichannel pulse-height analyzer.

The isolation and output section uses three cascaded emitter-followers to present a very high impedance to the charging capacitor, thus minimizing capacitor leakage current and maintaining system accuracy.

The input pulses must have a rise time of less than 10 ns and an amplitude of at least 1.5 volts.

Ready pulses appearing at the input of the device must have a time duration greater than the time lag between the pulses under observation. This is to ensure that clipping of the ready pulse at the ready clipping line will not impair the complete coincidence condition which must occur between ready and start pulses.

Inquiries concerning this innovation may be directed to: Office of Industrial Cooperation, Argonne National Laboratory, 9700 South Cass

Avenue, Argonne, Ill. 60439 (B67-10053).

Inquiries about obtaining rights for commercial use of this innovation may be made to: Mr. George H. Lee, Chief Chicago Patent Group, U.S. Atomic Energy Commission, Chicago Operations Office, 9800 South Cass Avenue, Argonne, Ill. 60439.

Multiply width of pulse in two easy steps

Problem: Provide a simple means to multiply the width modulation of a pulse train by some constant factor.

Solution: A modulation multiplier that operates directly on a pulse-width-modulated input signal, to generate an output pulse train that has a greater degree of width modulation than the input signal.

Pulses from the pulse-width modulator are applied to the input of the modulation multiplier. The modulation multiplier consists of an RC low-pass filter followed by a level-sensing trigger

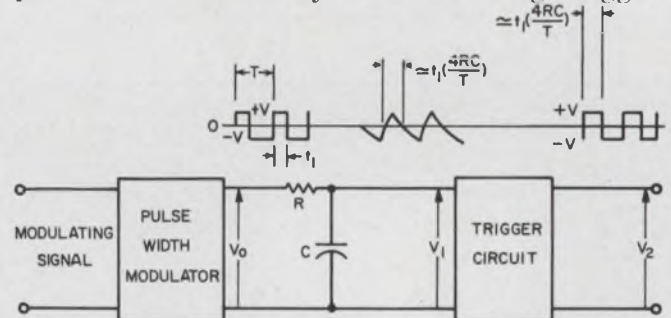

circuit. The latter circuit responds to its exponential sawtooth input voltage, V_1 , by switching to output level $+V$ when V_1 is positive, and to $-V$ when V_1 is negative. In this way the circuit generates the pulse-width-modulated output, V_2 .

When the RC time constant is equal to or greater than the period T of the pulses V_0 (the input to the modulation multiplier), the multiplication is linear (within 2 per cent when RC is equal to the input pulse period, and better as the RC time constant increases) over the whole range of operation. The output modulation is greater than the input modulation by approximately $4RC/T$.

The modulation multiplication method also applies to input-pulse switching between $+V_0$ and 0 volts. However, the level at which the trigger circuit changes state must be adjusted to compensate for the additional dc level of the input pulse.

Inquiries concerning this invention may be directed to: Technology Utilization Officer, Headquarters, National Aeronautics and Space Administration, Washington, D. C. 20546 (B67-10055). Inquiries about rights for the commercial use of this invention may be made to NASA, Code GP, Washington, D. C. 20546.



the course of tomorrow

Tomorrow does not merely happen — it is created. Scientists and engineers, like you, are working now on tomorrow's globe-spanning satellite communications networks . . . on miniature transceivers that are used today by downed airmen in Vietnam, and tomorrow will be pocket-sized communications links for doctors, businessmen . . . on laser systems that offer new possibilities for information handling.

As you help to shape technology's future, you build your own tomorrow. At Sylvania Electronic Systems, you'll find first-rate engineers, scientists and technical managers who span the complete communications spectrum of research, systems development, product and field engineering.

Join the tomorrow-builders. Send your resume in strict confidence to Mr. Kimball Shaw, Professional Staffing, Sylvania Electronic Systems, Division of Sylvania Electric Products Inc., Box 805, 40 Sylvan Road, Waltham, Mass. 02154.

*Opportunities in suburban Boston,
Buffalo or San Francisco.*

GT&E
GENERAL TELEPHONE & ELECTRONICS
Total Communications from a single source through

SYLVANIA ELECTRONIC SYSTEMS

RESEARCH • SYSTEMS DEVELOPMENT • PRODUCT & FIELD ENGINEERING

An equal opportunity employer

ON CAREER INQUIRY FORM CIRCLE 903

EE openings on SRAM, Minuteman and other Boeing programs

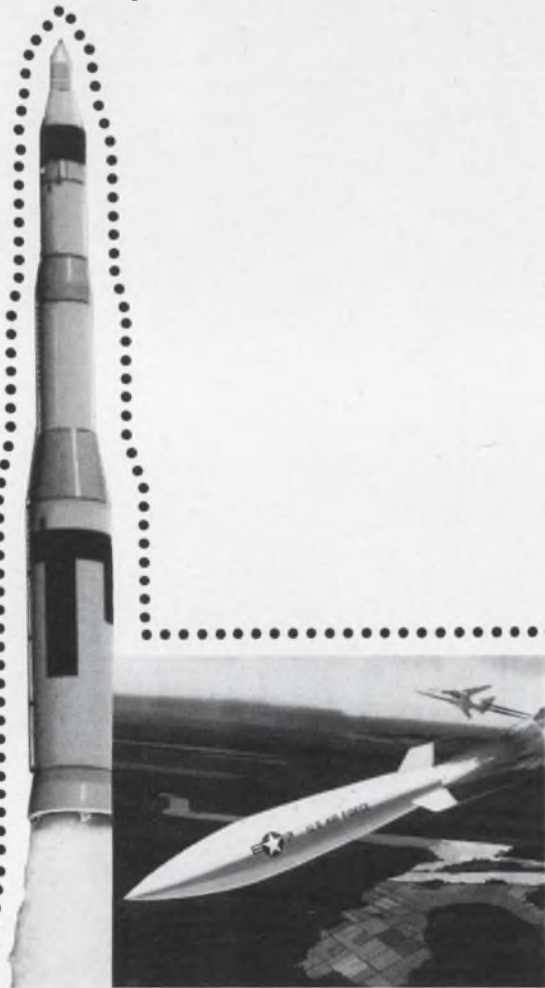

I'm interested in a Boeing career; please contact me with details.

Name _____

Address _____

Phone (incl. area code) _____

City _____ State _____ Zip _____

I'm usually home between _____ and _____ (hours) on _____ (days)

Degree/Field of Interest _____

Please mail to the location of your choice and qualifications: SEATTLE: Mr. R. R. Laurie, The Boeing Company, P.O. Box 3999-EDF, Seattle, Washington 98124. HUNTSVILLE: Mr. Lee Batt, The Boeing Company, P.O. Box 1680-EDF, Huntsville, Alabama 35807. KENNEDY SPACE CENTER: Mr. G. S. McDaniel, The Boeing Company, P.O. Box 1698-EDF, Cocoa Beach, Florida 32931.

Boeing's deep involvement with the nation's major missile and space programs provides immediate career opportunities for electrical/electronic engineers at Seattle, Huntsville, and Kennedy Space Center.

Boeing is system integration contractor for SRAM, the U.S. Air Force's new Short-Range Attack Missile. The company also is weapon system integrator for the USAF advanced Minuteman II ICBM. In space, Boeing is prime contractor for the National Aeronautics and Space Administration's Lunar Orbiter, the moon-circling spacecraft which is helping NASA scientists select the best landing sites for Apollo astronauts. In addition, Boeing is a major mission-support contractor to NASA on the Apollo/Saturn V program, and is building the first stage of the Saturn V launch vehicle.

Immediate openings exist at Seattle on the SRAM, Minuteman and Lunar Orbiter programs. Assignments in test technology include data systems and instrumentation and test data handling and processing. Qualifications include a B.S. or M.S. in electrical engineering and two to five years applicable experience. Flight technology positions are available in flight control and flight mechanics. Qualifications include a B.S. or M.S. in electrical engineering with two to five years experience.

Additional Seattle openings exist in developmental design and electronic packaging. Design assignments are in airborne control systems, ground system electrical power systems, and environmental control, and require a B.S. degree in an applicable discipline plus related experience. Electronic packaging qualifications include a B.S. in electrical engineering plus applicable experience.

A number of openings also exist on the Apollo/Saturn V program. At Huntsville, assignments in flight mechanics and flight evaluation include operational trajectories, mission analysis, trajectory analysis, post-flight trajectories, flight simulation development, and flight dynamics. Qualifications include a B.S., M.S. or Ph.D. in electrical engineering. Openings also exist for electrical/electronic engineers at Kennedy Space Center.

Salaries are commensurate with experience and educational background. Moving and travel allowances are paid to newly employed personnel. Boeing is an equal opportunity employer.

Please fill in and mail the coupon to the location of your choice and qualifications. A Boeing representative will get in touch with you.

BOEING

MISSILE & INFORMATION SYSTEMS DIVISION
SPACE DIVISION

Other Divisions: Commercial Airplane • Vertol • Wichita
Also, Boeing Scientific Research Laboratories

A FET model for computer design

Problem: Provide a computer simulation for a field-effect transistor (FET). Existing computer programs for automated electrical-circuit analyses and syntheses are only able to simulate resistors, voltage and current sources, diodes, capacitors, inductors, and conventional transistors.

Solution: Form an equivalent circuit for the field-effect transistor with circuit elements that can be simulated by existing computer programs.

The equivalent circuit of a FET consists of a conventional transistor (T), a resistor (R_g), and a constant-current source (I). The terminals S , G and D correspond to the source, gate and drain terminals of the FET.

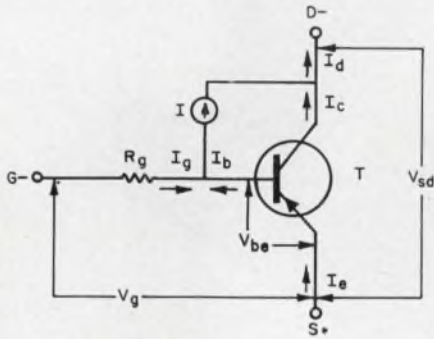

The value of R_g is equal to the gate input resistance. The value of I must be calculated from the electrical characteristics of the FET.

Transistor T will be a pnp type for a p-type channel FET, and an npn type for a n-type channel. Because computer programs simulate transistors by the I_c -vs- V_{be} characteristic curve, the values for I_v , V_{be} and β must be calculated for the transistor.

Depending on the accuracy required by the application, the model may be improved by in-

young engineers

-speed up your professional development in the advanced ship design program of the world's largest shipbuilding complex

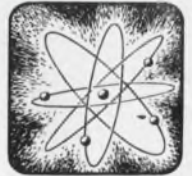

If you are a naval architect, a marine, mechanical, structural, electrical, electronics, architectural, general, or civil engineer, we urge you to consider the unusual opportunities that exist for you at the San Francisco Bay Naval Shipyard.

Here you can work in design, development, testing, installation, check-out and evaluation on all systems for naval ships including submarines, destroyers, frigates, cruisers, aircraft carriers, and special projects such as the deep submergence program and the design of bathyscaphs and sea labs.

Programs include developments on weapons systems, radar and communications, nuclear power systems, hydraulics, ventilation and air-conditioning systems, high-strength steel structures, preliminary design, new material development.

San Francisco Bay Naval Shipyard has two work sites located 40 miles apart: San Francisco and Vallejo, California. Each location has ready access to the full cultural advantages of San Francisco and the mild year-round climate of the Bay Area. All types of recreation from ocean surfing to skiing on the slopes of the Sierras are within easy driving distance.

Openings exist at Grades GS-5, GS-7, GS-9 and GS-11. Salaries range from \$6,400 to \$10,500. These are career Civil Service positions with regular salary increases, generous benefits. Financial support for continued education available.

Send resume or Standard Form 57, Application for Federal Employment, to:

**Coordinator, Professional and Technical Recruitment
Employment Division (Code 174A40)
San Francisco Bay Naval Shipyard
Vallejo, California 94592**

An Equal Opportunity Employer

Must be a U. S. Citizen

Lockheed's electronics engineers have a lot of fingers in the...



It figures. The scope of production, development and study programs now under way at Lockheed-California range from "A" (ASW)...to "V" (V/STOL); with many stops in between, such as Military Rotary Wing Aircraft; Commercial Aircraft; Fighter/Bombers and Hypersonic Aircraft. They all have one thing in common: sophisticated electronic systems...and you can help to provide them.

The variety of projects at Lockheed have created openings for Electronics Engineers in the areas of Sensors; Data Processing; Navigation; Communications; Armament and Electrical Installation. □ If you're an electronics engineer equally at home with a formula or an idea...look into Lockheed-California. Send your resume to Mr. E. W. Des Lauriers, Professional Placement Manager, Department 1308 2402 North Hollywood Way, Burbank, California 91503. Lockheed is an equal opportunity employer.

LOCKHEED-CALIFORNIA COMPANY

A group division of Lockheed Aircraft Corporation

cluding some or all of the factors that influence performance characteristics of the field-effect transistor. For example:

- Adjust the characteristics of the base-collector junction to improve the drain current curve in the pinch-off region.
- Vary the value of R_g with variation in V_g to cause the slope of the drain current curve to vary with gate voltage.

- Vary both R_g and β with temperature.

- Vary β with drain current. These factors may also be described by curves in the computer program instead of by fixed parameters.

For further information, contact: Technology Utilization Officer, Marshall Space Flight Center, Huntsville, Ala. 35812 (B66-10690).

Dual-range device measures RF phase

Problem: Devise a mechanical instrument to help measure RF phase differences in either vhf or uhf ranges accurately.

Solution: Build a dual-range, linear measurement device with a coarse range, extending to 30 cm, readable to 1 mm and any fine-range portion of 2.5 cm readable to 0.01 mm.

ened, the line stretcher and rod are made integral with the tube, which impinges against the dial indicator. By turning the fine adjustment nut, the line stretcher can be adjusted in length within the limits of the dial indicator, with the change in adjustment readable to 0.01 mm on the dial indicator.

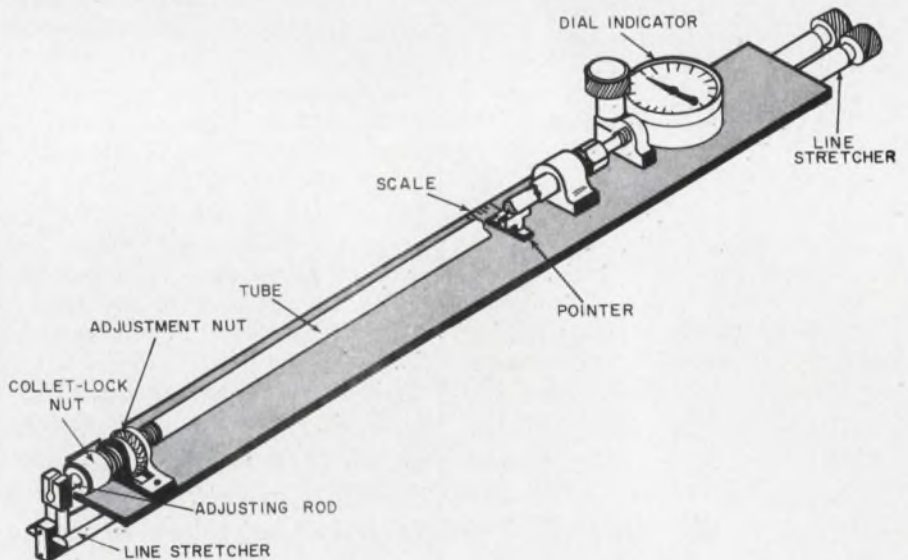

With the collet-lock nut released, the RF line stretcher can be adjusted to different lengths by sliding the coarse adjusting rod, with an attached pointer, within the tube and then reading the change in adjustment in millimeters on the scale.

With the collet-lock nut tight-

The device can measure the phase differences of radio frequency outputs of power dividers or hybrid junctions.

For further information, contact Technology Utilization Officer, Marshall Space Flight Center, Huntsville, Ala. 35812 (B66-10694).

We're constantly drumming up new business.



Even though we have a staff of nearly 2,000, do business in the tens of millions, and occupy 264,000 gross square feet of floor space for our research, engineering, manufacturing and other activities, we enjoy a reputation for technical excellence and on-time—or ahead of schedule—delivery. Our company pride wouldn't let us have it any other way.

All things considered, that's saying quite a lot when you think that Conductor pioneers in the design, development and manufacture of special-purpose electromechanical systems, interface equipment and components, including micro-miniaturized circuits. We're a volume hardware producer of avionics and ground support checkout equipment. We're involved in advanced communications and micro-electronic circuitry. And we've just entered the institutional field with PARAMETRON®, the most flexible bio-medical critical monitoring device yet offered to hospitals.

For our customers, who range from companies in the defense and space industries to those in the commercial and institutional markets, Conductor engineers developed and produced such diverse items as McDonnell Mercury and Gemini simulators for training our astronauts, and the Orbital Timing Device—standard equipment in all Gemini space capsules.

At the present time, Conductor is producing flight training simulators for the Boeing 747, 737, 727, Douglas DC8, DC9, and Lockheed C5A. Customers include Eastern, United and Piedmont Airlines and Lockheed for the U.S. Air Force. We are also putting our know-how to work for other customers in the areas of data systems, communications and a wide spectrum (140 separate checkout systems) of aerospace ground support equipment. Then, too, we're producing visual and radar landmass training simulators and developing holo-

graphic techniques to produce a three dimensional aspect for pilot training.

We like our work. So do our customers. We think you will too.

Conductor-Missouri's facilities are located in suburban St. Charles, Mo., just 22 Freeway miles from Downtown St. Louis and close to excellent cultural, educational and recreational facilities.

If you are a graduate engineer with 2 to 5 years' experience, who is interested in an outstanding growth opportunity with a leader in the electronics industry, we have current openings in these categories:

**SYSTEMS, ELECTRONIC or ELECTRICAL ENGINEERING
MATH MODELING • SCIENTIFIC PROGRAMMING
LOGIC DESIGN • MECHANICAL, RELIABILITY or
MAINTAINABILITY ENGINEERING • MANUFACTURING
ENGINEERING • OPTICS • COMMUNICATIONS
ENVIRONMENTAL TESTING • AERODYNAMICS
VALUE ENGINEERING**

Send your résumé in complete confidence to Mr. Thomas Walenga, Professional Employment Office, Dept. _____.



CONDUCTRON-MISSOURI

Division of Conductor Corporation

2600 N. Third Street, Box 426, St. Charles, Missouri 63301

For WESCON Interviews contact Jim Hoose at the Thunderbolt Hotel, 101 Bayshore Freeway, Milbrae, Calif. Telephone: 415-697-7700

We are and always have been an equal opportunity employer.

ON CAREER INQUIRY FORM CIRCLE 906

Book Reviews

Practical logic circuit design

Switching Circuits for Engineers, Mitchell P. Marcus (Prentice-Hall, Inc., Englewood Cliffs, N. J.), 338 pp. \$12.00.

Here is a designer's handbook that is filled with practical information from beginning to end. Although the result of this compression is an often staccato presentation, the practicing logic designer will find this a valuable reference.

As might be expected from an author actively engaged in the computer industry, much of the emphasis is on the design of sequential circuits. One result is that coding and error detection and correction are well treated but code conversion, surprisingly, is omitted.

In this second edition the author has taken the opportunity to add further problems and some solutions. These together with an extensive bibliography should increase the book's usefulness for the student.

Jeffrey N. Bairstow

Printed circuits

Printed Circuits Handbook, Clyde F. Coombs, ed. (McGraw-Hill Book Co., New York), 536 pp. \$15.00.

This is a "how-to-do-it" reference to printed circuits, their assembly, fabrication, design and testing. Each portion of the subject is treated by a specialist in that particular field. The book aims to be both technical enough to be of value to the engineer and practical enough for use in production.

It opens with practical discussion of layout and design and goes on to laminate selection and specification. Following this is a section on transforming the artwork into a finished image on the PC card. Both manual and automatic assembly of electronic components onto the printed-circuit board are dealt with as well as plastic encapsulating materials and conformal coatings. The volume is rounded out with soldering techniques and materials, and methods for testing, inspection and quality control.

Optimization methods

Recent Advances in Optimization Techniques, Abraham Lavi and Thomas P. Vogl, eds. (John Wiley & Sons, New York), 656 pp. \$12.50.

This collection of articles discusses recent analytical studies and presents new practical methods of optimization. The results of the application of these methods to real-life problems are presented, actual working programs are described and their operation is discussed. The articles cover two broad areas. The first involves design optimization of "static" systems, leading to nonlinear programming problems. The other involves performance optimization of dynamic systems, leading to problems in the calculus of variations and dynamic programming. An extensive bibliography of optimization techniques is included.

Introduction to transistors

Transistor Basics: A Short Course, George C. Stanley, Jr. (Hayden Book Co., New York), 102 pp. \$2.75.

Beginning with the introduction of the necessary terms, and then describing diode and transistor behavior, this simplified approach to transistor circuit analysis will enable the reader to determine values to an accuracy adequate for most practical situations. In anticipation of changes in the technology, a table of exact expressions plus a set of rule-of-thumb formulas are given in appendices.

Noise measurement

Handbook of Noise Measurement, Arnold P. G. Peterson and Ervin E. Gross (General Radio Company, West Concord, Mass.), Sixth Edition, 282 pp. \$1.

This revised edition contains new charts and tables, a bibliography of references on sound and vibration, and a catalog of General Radio sound instruments. It includes a detailed discussion of noise and vibration and their effect on humans, and a description of noise measuring techniques, instruments and accessories.

Introduction to engineering

Engineering: An Introduction to a Creative Profession, George C. Beakley and H. W. Leach (The Macmillan Company, New York), 548 pp. \$9.95.

Beginning with a brief history of engineering developments, the authors construct an elementary text useful to the uninitiated and the new engineering student. Qualifications and basic tools for a career in engineering and the various branches of engineering are discussed, as are methods of problem-solving, analysis and design. Of particular value to the novice are a chapter on technical sketching and appendices containing a review of logarithms, trigonometry and geometric figures, and tables and formulas. Several chapters include problems and exercises; all have bibliographies.

Bridge to radio astronomy

Introduction to Radio Astronomy, R.C. Jennison (Philosophical Library, Inc., New York), 160 pp. \$4.75.

Bridging the gap between comprehensive textbook and oversimplified popular treatment is this short treatise on radio astronomy. It contains a reasonable amount of detail on the techniques of the science and is directed to those who are not specialists but are interested in understanding the subject.

Some mathematics are incorporated in the text, but the substance of the book is discussed verbally so that the less mathematical should have little difficulty in grasping it.

Measurement guide

Handbook of Electronic Instruments and Measurement Techniques, Harry E. Thomas and Carole A. Clarke (Prentice-Hall, Inc., Englewood Cliffs, N. J.), 398 pp. \$12.

The illustrated handbook is a ready reference to information about electronic instruments, measurements and techniques, including a rundown on transducers and read-out devices. Bridge circuits, display devices and digital instrumentation are covered in detail.



EE'S

with military communications
equipment experience

call us collect

area code 317/459-2808

Rapid expansion of our ground based and airborne military communications capability has created urgent requirements for electrical engineers (B.S. or M.S.) at Delco Radio.

Opportunities at all levels—beginning, through supervisory, with 2-10 years experience—in the following areas:

Digital communications in the HF, VHF, and UHF bands

Single side band design, HF, and VHF

Frequency synthesizer techniques in all frequency ranges

Wide range electronic tuning

Retransmission techniques

Secure communications techniques

Man-portable and vehicular battle area communications equipment

Acoustic transducers, antennas, and micro-electronics applications.

Call us collect for an interview or more information. Area Code 317/459-2808. Ask for C. D. Longshore. Or send your resume to Mr. Longshore, Supervisor, Salaried Employment, Dept. 203, Delco Radio Division of General Motors, Kokomo, Indiana.



DELCO RADIO

DIVISION OF GENERAL MOTORS • KOKOMO, INDIANA

An equal opportunity employer

Discrete physical systems

Analysis of Discrete Physical Systems, Herman E. Koenig, Yilmaz Tokad, Hiremaglur K. Kesavan and Harry G. Hedges (McGraw-Hill, New York), 447 pp. \$13.75.

Electrical networks, electronic circuits, mechanical systems and control systems—all receive specialized treatment in most engineering schools. This book develops a single discipline for analyzing these and other systems. The book comprehensively explains the general theory for system modeling and presents state-space concepts and numerical solutions before introducing more conventional Laplace transform models and solutions. The problem of modeling and the problem of evaluating the performance characteristics of the system as reflected by the model are recognized as two fundamental aspects of general system theory. The modeling theory is based on generalizations of Kirchhoff's voltage and current laws and the performance characteristics are presented primarily in terms of state-space concepts. These two aspects of system theory are integrated to establish the relationship between the state model and the structure of the system.

Device physics

Large-Signal Transistor Circuits, Donald T. Comer (Prentice-Hall, Inc., Englewood Cliffs, N. J.), 268 pp. \$10.50.

This treatment of device physics and equivalent circuits is divided into nine sections. These deal respectively with transistor physics, small-signal equivalent circuits, large-signal graphical techniques, miscellaneous R-C circuits, static and transient considerations in transistor switching, multivibrator circuits, time base generation and transformer-coupled pulse circuits.

The book is not intended as a reference work, but as a tutorial treatment addressed to the student. It tries to get away from the more usual "black box" piecemeal linear methods by stressing circuit analysis rather than circuit design. Thus it subordinates exact design equations to physicomathematical descriptions of circuit operation.

Microwave communications

Microwave Systems Planning, Kenneth L. Dumás and Leo G. Sands (Hayden Book Co., New York), 143 pp. \$8.00.

This book defines and explains, in a semitechnical manner, the important criteria involved in the planning, engineering and installation of microwave equipment for communications purposes. The authors have confined the discussion to point-to-point FM systems. The book begins with the theoretical aspects of the field, from frequency and wave theory, including propagation, to hardware theory. Following this is a thorough investigation of the practical aspects of establishing a microwave path with a high probability of good performance.

Electron theory of solids

An Introduction to the Electron Theory of Solids, John Stringer (Pergamon Press, New York), 246 pp. \$6.00, hard cover; \$4.50, soft-bound.

This text deals with the behavior of electrons in solids, particularly in relation to semiconductors. Some knowledge of second-order differential equations and elementary crystallography is assumed. Beginning with a discussion of classical theory, the author proceeds to discuss the uncertainty principle; quantum theory, with physical models to illustrate quantum mechanical results; statistical mechanics; and the band theory of solids. Theoretical manipulations are related to real problems.

Basic industrial metrology

Handbook of Industrial Metrology, Publications Committee of the American Society of Tool and Manufacturing Engineers, eds. (Prentice-Hall, Inc., Englewood Cliffs, N. J.), 492 pp. \$15.00.

This guide to ultraprecise measurement combines both theory and principles for all types of discrete measurements, with strong emphasis on applications. The introduction outlines the principles for estimating and achieving accuracy; systematic and constant errors; sensitivity and readability, and elements of a generalized measuring

system. The general principles of measurement are dealt with in detail for such areas as setup and datum definition, datum deformation, stress and strain, basic units and quantities and master standards.

The book also describes the design and application of direct measuring equipment, optical projectors, radiological instruments, surface texture equipment and optical alignment devices. It concludes with a section on gauging equipment, gauge control, quality control management, test function and machine tool alignment.

Residue arithmetic

Residue Arithmetic and Its Applications to Computer Technology, Nicholas S. Szabo and Richard I. Tanaka (McGraw-Hill, New York), 236 pp. \$12.50.

This summary of the whole field of residue arithmetic includes an annotated bibliography which lists the literature in the field, together with comments on each of the references cited.

A form of carry-free arithmetic, the residue number system permits addition, subtraction and multiplication to be performed in one step. This makes it possible to perform these operations in a digital system at a higher rate than is practical with conventional number systems. The book discusses the advantages and uses of the system, giving careful attention to the troublesome areas of determining algebraic sign dividing, and determining the magnitude of a number.

Mathematical physics

Equations of Mathematical Physics, G. N. Polozhiy (Hayden Book Co., New York), 543 pp. \$14.50.

This first English edition of Polozhiy's comprehensive text (first published in the U.S.S.R. in 1964) is a valuable reference to the field of mathematical physics for those involved in engineering and physics. The author departs from the traditional by investigating the general properties of elliptical equations before dealing with parabolic and hyperbolic equations. In each case there is an introductory discussion of their physical interpretation.

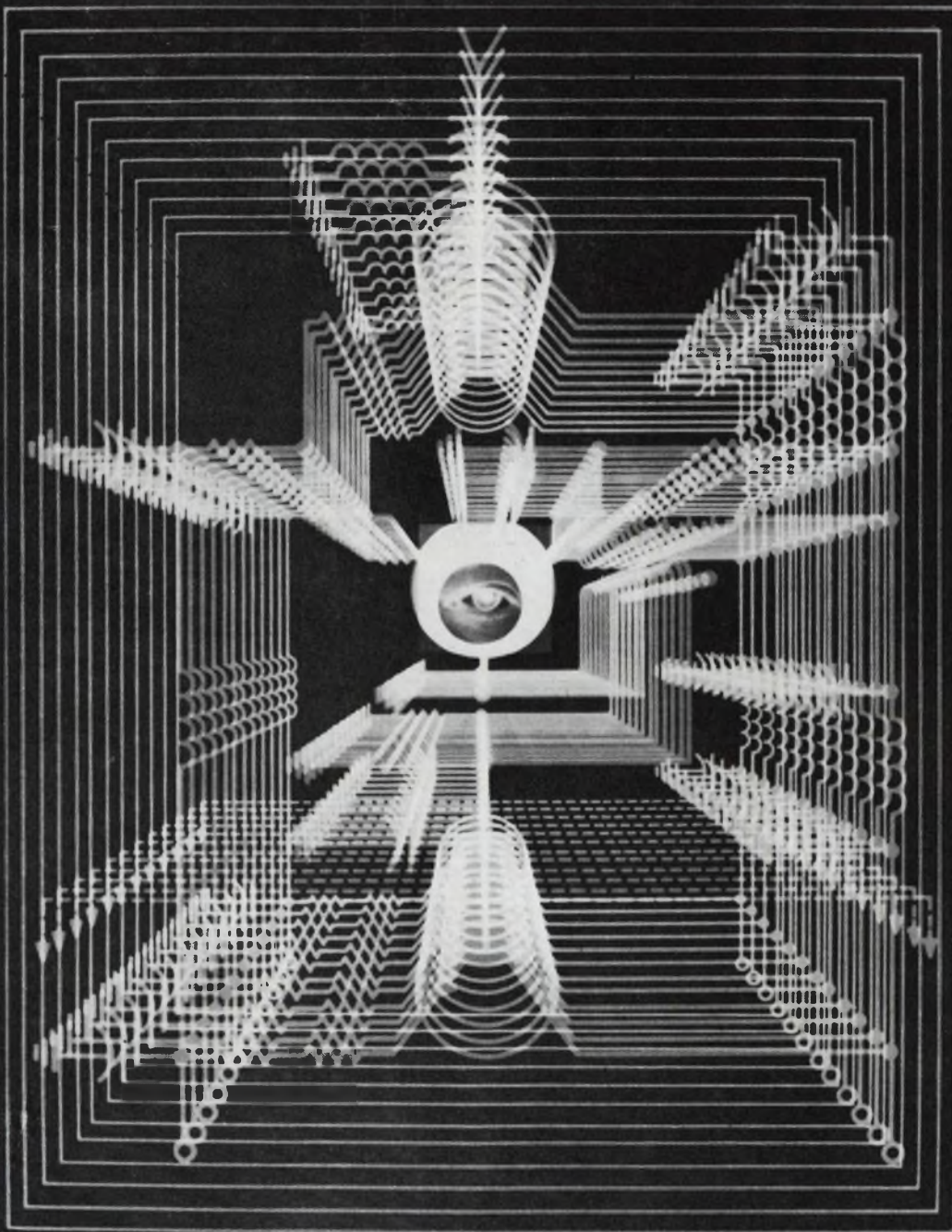

Look into the vehicles of opportunity at Lockheed...for circuit designers.

Opportunity broad enough to interest every circuit designer, that's the sweep of electronics assignments at Lockheed. Big, wide-ranging programs that extend from deep sea to deep space. And with ever-growing commitments comes an increasing need for new concepts and major technical advances in flight controls, communications, antennas and state-of-the-art electronics checkout equipment in both spacecraft and fleet ballistic missiles. In addition to its major vehicle programs... Agena, Poseidon, and Polaris, Lockheed is involved in deep submersibles; unique advanced land vehicles; information systems for states and hospitals; and many other technically alluring programs. For complete information, write Mr. R. C. Birdsall, Professional Placement Manager, P.O. Box 504, Sunnyvale, California. Lockheed is an equal opportunity employer.

LOCKHEED
MISSILES & SPACE COMPANY
A GROUP DIVISION OF LOCKHEED AIRCRAFT CORPORATION
ON CAREER INQUIRY FORM CIRCLE 908

In California or anywhere in the world, when you need an encoder, you need Norden.

California is building the largest complex of dams and aqueducts in the history of the world. At hundreds of points from Oregon to San Diego water flow will be measured and controlled with great precision. Norden encoders have been chosen for the first of the new control systems.

Encoders of the Norden BCD 360-count-per-turn family will convert analog information about depth of water and rate of flow into digital data for transmission via telephone lines to on-site computers and to the central control system in Sacramento. These encoders not only generate exactly the type data needed in the California Water Resources Development Program, but are rugged and reliable, too.

Whatever your encoder requirement, wherever you are, you can depend on Norden for a complete selection of encoders — Optical, Magnetic, Contacting — in many sizes and codes. They can be designed into your navigation or stabilization system, your industrial instrumentation or your automated control system. Norden also makes servo modules that incorporate Norden encoders to provide a complete encoding package.

For more information about Norden encoders, call or write Norden Division, United Aircraft Corp., 1475 Barnum Ave., Bridgeport, Conn. 06610. Phone (203) 366-4531. TWX 710/468-0788.

Norden DIVISION OF UNITED AIRCRAFT CORPORATION

U
A
C



See us at Booths 4901-4904, East Exhibit Hall, WESCON.

ON READER-SERVICE CARD CIRCLE 232

Products

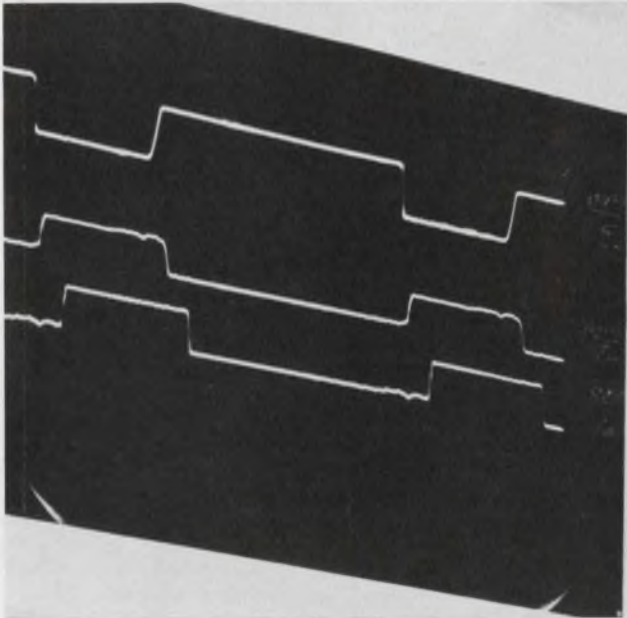

Line receiver logic card prevents reflections and standing waves caused by mismatches in

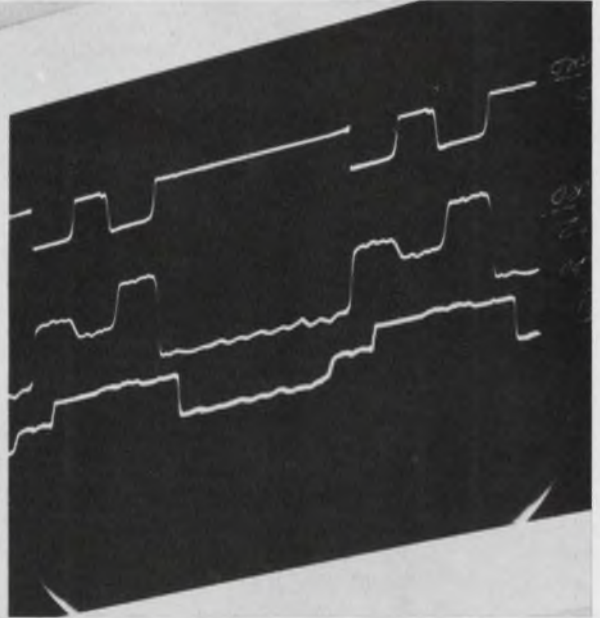

long signal paths. The card has circuitry for four separate transmission lines. Page 292

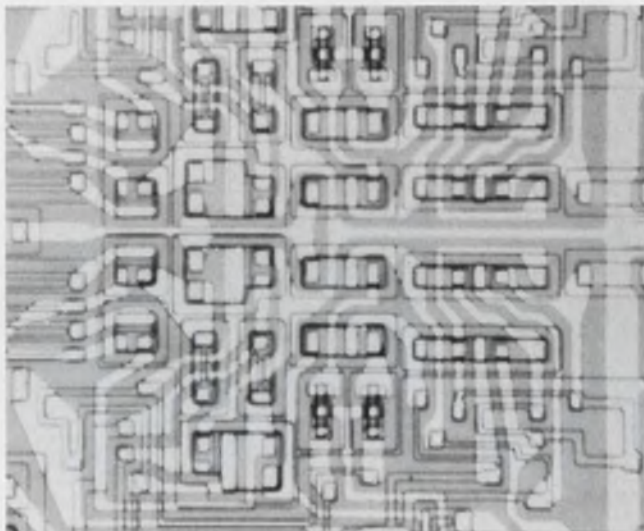

A pair of cross-coupled J-K flip-flops in a single package halves your can count. Page 310

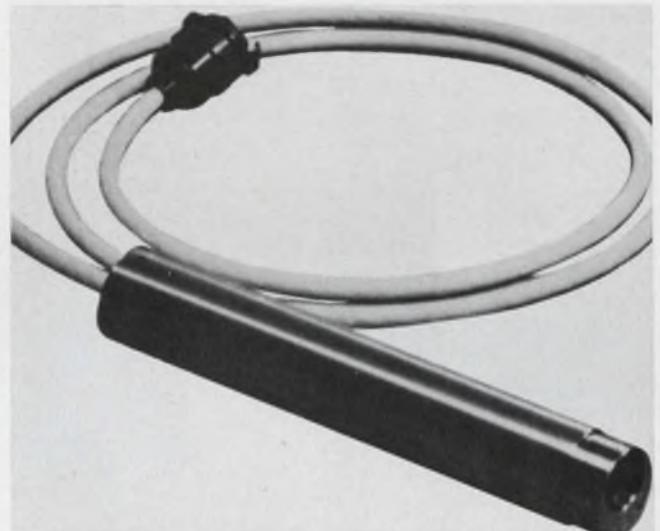

Solid-state light pen responds in nanoseconds without fiber optics or multipliers. Page 304

Also in this section:

Flip-flops speed up. This ECL toggles at 120 MHz. Page 310

Tiny teraohm resistors fit under your thumbnail. Page 294

Design Aids, Page 317 . . . Application Notes, Page 316 . . . New Literature, Page 318

Line receiver card cuts reflections

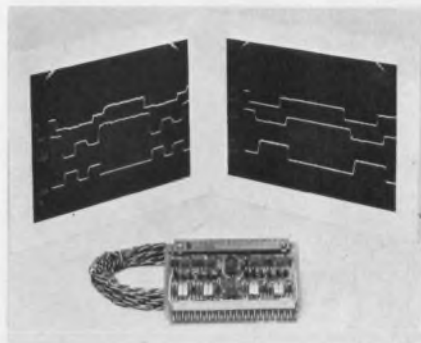

Monitor Systems, Inc., Fort Washington, Pa. Phone: (215) 646-8100.

Designed for use where long signal paths cause transmission difficulties, this digital logic card eliminates reflections and standing waves brought about by impedance mismatches together with erroneous pulses generated by these reflections. The problem of reflections is particularly difficult in the case of TTL equipment. Here faster switching time gives rise to higher frequency components which cause the most trouble. Each of the cards carries line receiver circuits for four separate lines.

CIRCLE NO. 392

Generator calibrates scope sweeps



Accutronics, Inc., 12 South Island, Batavia, Ill. Phone: (312) 879-1000. P&A: \$59.50; stock.

Used for calibrating the sweep of scopes, this 1-MHz battery-powered, time-mark generator provides an output of 1 V p-p with an output impedance of 50 Ω . The Micro/marker uses silicon transistors and provides better than $\pm 0.01\%$ stability over 0° to $+60^\circ\text{C}$. It has connectors for both UHF or BNC type oscilloscopes.

CIRCLE NO. 393

Isolated-input VCO keeps output a-m low



International Electronic Research Corp., 135 W. Magnolia Blvd., Burbank, Calif. Phone: P&A: \$300; 45 days.

An isolated power supply provides a high degree of isolation from power, input and output terminals in this VCO. Common-mode rejection is 120 dB at dc and 60 dB at 1 kHz. A miniature transformer-coupled output stage provides for floating in single-ended output connections. Output distortion is less than 1% and a-m is under 1 dB.

CIRCLE NO. 394

Voltage time integrators measure battery charge

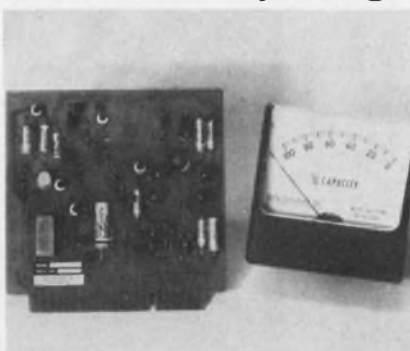

Curtis Instruments, Inc., Mt. Kisco, N. Y. Phone: (914) 666-8051.

With an output scaled to provide a microampere output, this integrator is an analog of battery state-of-charge. A 100% charge is equal to 10 μA . The lightweight, solid-state unit provides a direct indication of remaining battery capacity. The unit features a linearity of 0.5%, drift of 0.2% per day powered and zero unpowered, zero input threshold and infinite storage.

Booth No. 4611 Circle No. 359

Module detects analog coincidence

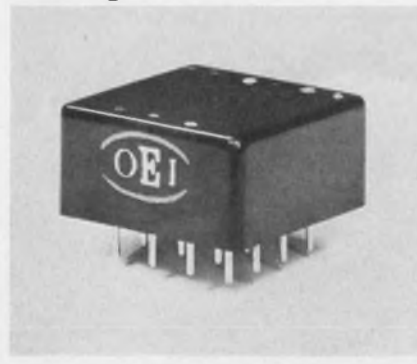

Optical Electronics, Inc., P. O. Box 11140, Tucson, Ariz. Phone: (602) 624-3605. P&A: \$50 (3 to 9); stock.

Only at the coincidence of two analog input voltages does this detector have a digital output of 1. Regardless of the relationship of the two input voltages, the output is at 0 at noncoincidence. Using the Model 5185 and a voltage comparator, an unknown voltage may be determined to be above, equal to or below a reference voltage.

CIRCLE NO. 395

High-current op amp drifts $\pm 10 \mu\text{V}/^\circ\text{C}$

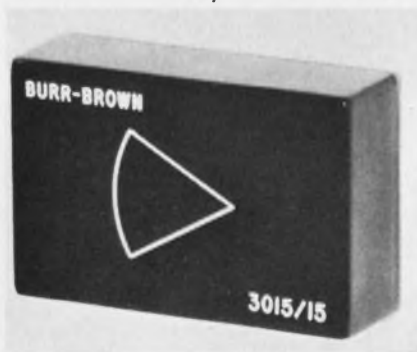

Burr-Brown Research Corp., 6730 S. Tucson Blvd., Tucson, Ariz. Phone: (602) 294-1431. P&A: \$65 (1 to 9); stock to 3 wks.

This unit packs a $\pm 50\text{-mA}$ output current in a package 1.8 x 1.2 x 0.6 inches. The unit is useful for comparator or go/no-go applications in which the amplifier is required to drive a relay. Other specifications include a rated output voltage of $\pm 10\text{ V}$, open loop gain of 100 dB, small-signal response of 1.5 MHz and full-power response of 20 kHz.

Booth No. 3212 Circle No. 380

JFD's Capacitor Progress Report '67 - '68

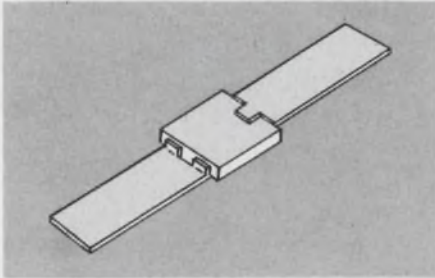

up to 7.5 KV RF, 10 KVDC
up to 12 amps RF, 24 KVAR
Solid Silver terminals

Uniceram
MINIATURE RF POWER CERAMIC CAPACITORS

up to 2500 V peak @ 2 MHz & 200°C
0.5 to 5.0 pf
Q > 2000 @ 1 MHz

**JFD Precision — HIGH VOLTAGE
QUARTZ VARIABLE CAPACITORS**

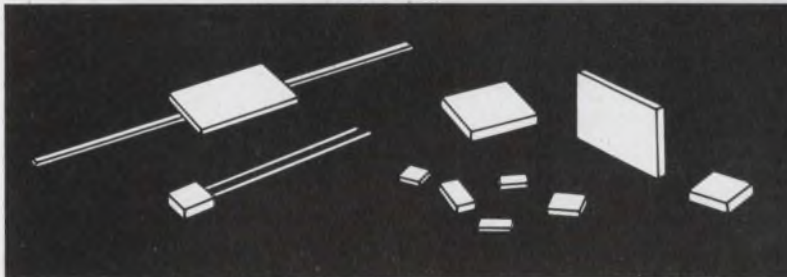
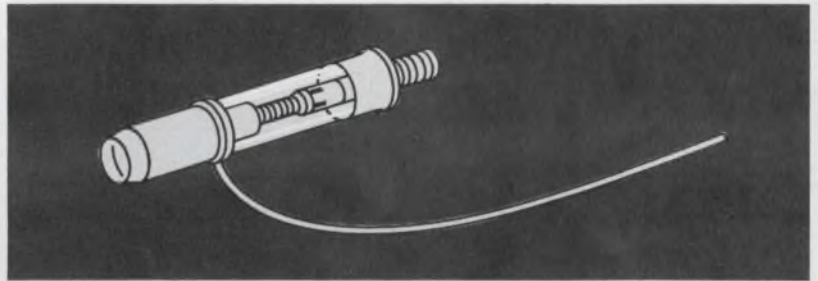

.001 to 1.5 Mfd
25 to 200 WVDC
T.C.: ± 15% (—55°C to +125°C)

**Uniceram — HIGH K
CERAMIC CAPACITORS**

0.1 to 50.0 Mfd
Epoxy-dip coat
Quality @ low cost

Stangard
MINIATURE SOLID TANTALUM CAPACITORS

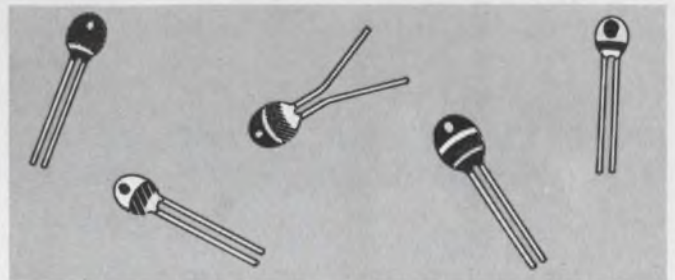

NEW Standardized drive
4 & 8 element models
wide choice of capacitance

JFD Long Life
Modular COMPACTUNERS

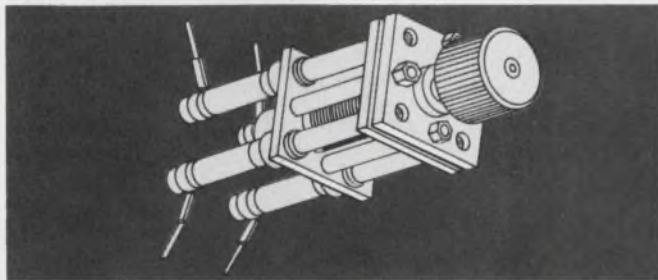

Write for your JFD/CCS. A one stop components reference file!

"TODAY'S COMPONENTS BUILT FOR TOMORROW'S CHALLENGES"

JFD JFD ELECTRONICS CO. / COMPONENTS DIVISION • 15th Avenue at 62nd Street • Brooklyn, New York 11219 / Phone 212-331-1000
Sales Offices — Arcadia, California / Chicago, Illinois / Baltimore, Maryland / Saxonville, Massachusetts / Brooklyn, New York
New Hartford, New York / Cincinnati, Ohio / Philadelphia, Pennsylvania / Pittsburgh, Pennsylvania / Paris, France / Azor, Israel
VISIT JFD'S WESCON BOOTH 4015

ON READER-SERVICE CARD CIRCLE 233

COMPONENTS

Teraohm resistors in tiny package

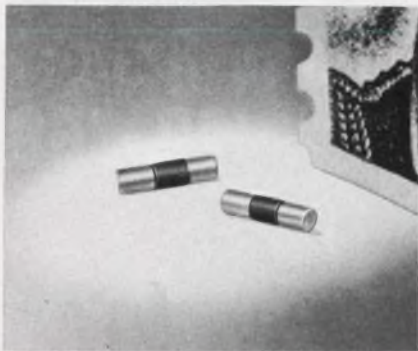

Pyrofilm Resistor Co., Inc., Cedar Knolls, N. J. Phone: (201) 539-7110.

Tiny enough to fit under your fingernail these resistors are operative from 10^8 to $10^{12} \Omega$ with a normal tolerance of $\pm 25\%$. The sub-miniature component is 0.04-inch in diameter and 0.13-inch long. It is usable at temperatures of up to 100°C and can be encapsulated. The ends of the resistor serve as terminals for soldering to boards or other components.

CIRCLE NO. 439

Crystal oscillators compatible with ICs

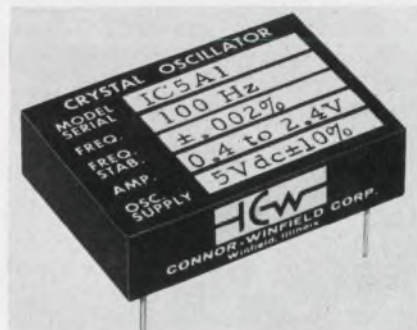

Connor-Winfield Corp., Winfield, Ill. Phone: (312) 231-5270.

Fully compatible with integrated circuitry, these oscillators span 1 Hz to 400 kHz in any of eight models. Duty cycle is 50% and output is square wave. Zero voltage is less than 0.4 and logic one is greater than 2.4 V. Power supply requirement is 5 V dc $\pm 10\%$.

CIRCLE NO. 396

GENTAPE — where great ideas are generated

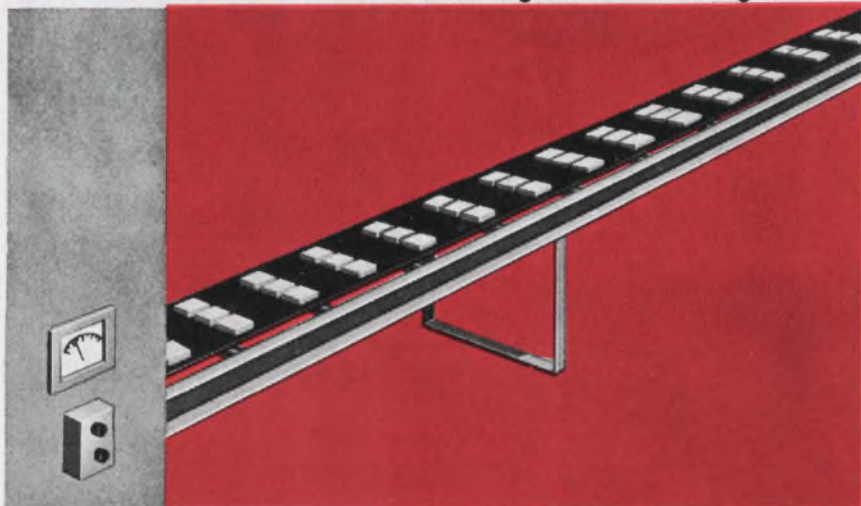

When Moving Miniature Parts is a Particular Problem . . . or Driving Fine Instruments Demands Dimensional Stability,

GENTAPE CONVEYOR and DRIVE BELTS DELIVER REMARKABLE QUALITY and FLEXIBILITY

Highly sophisticated electronic components seemingly become more minuscule by the minute — while precision standards soar. And assembly line methods and materials must keep pace.

Gentape's TO-412 Series of conveyor and drive belts fully take the measure of today's demanding miniaturization. They're available in widths as meager as $\frac{1}{8}$ " up to 6" — in any color — with or without sprocket holes.

Highly flexible, dimensionally stable, they're more accurate and last longer.

SPLICE — AND GO!

In addition, TO-412 Series loops may be quickly, easily spliced — cuts downtime — secures the exact loop length right on the job.

Have we conveyed to you why you should check into Gentape without delay?

GENTAPE CORPORATION

A DIVISION OF GENERAL PLASTICS CORPORATION
51A LA FRANCE AVE., BLOOMFIELD, N. J. (201) 748-5506

Mfrs. of Precision Printed Tapes, Lighted Dials, Masks and Other Critical Instrumentation Parts

ON READER-SERVICE CARD CIRCLE 234

Tiny delay lines housed in flat pack

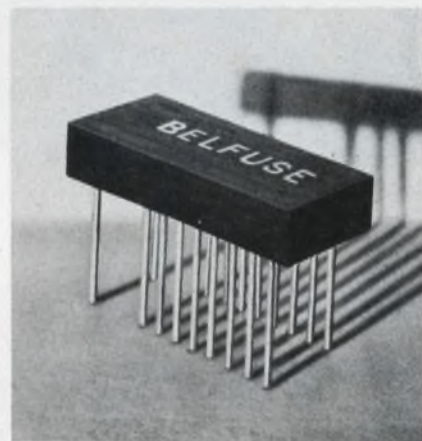

Bel Fuse, Inc., 198 Van Vorst St., Jersey City, N. J. Phone: (201) 432-0463.

Designed for flat-pack applications where compact size is required, these delay-line modules measure 0.8 by 0.35 by 0.25 inch. The delay line can be single or multisectioned with delays up to 20 ns. Characteristic impedance is 100Ω with output rise times of less than 4 ns. The units are suitable for computer and instrumentation applications where high-density packaging is required.

Booth No. 4910 Circle No. 250

Reversible counter cards operable to 5 MHz

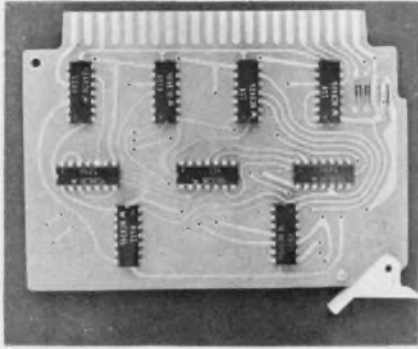

Wyle Products Div., 133 Center St., El Segundo, Calif. Phone: (213) 678-4251.

A pair of DTL counter cards are offered: Model MRC-ID contains one reversible BCD decade counter, and model MRC-1B one reversible 4-bit binary counter. Both operate at up to 5 MHz. Operating from a single counting input, the counters are equipped with "enable" gates for forward or reverse control. Carry outputs are provided for tandem connection.

CIRCLE NO. 397

Tiny wirewound pot weighs 1/2 ounce



Duncan Electronics, Inc., 2865 Fairview Rd., Costa Mesa, Calif. Phone: (213) 754-2931. P&A: \$4; stock.

Measuring 7/8-inch in diameter, 3/4-inch long, and weighing one-half ounce, Duncan's Pixie pot has $\pm 5\%$ tolerance over 100 Ω to 100 k Ω . Linearity is $\pm 0.25\%$ and resolution for a 1-k Ω unit is typically 0.022. The pot features gold-plated terminals and is rated at 2 watts at 25°C.

CIRCLE NO. 398

McDonnell Phantom: the hot one



Eastern keeps its radar cool

Each day of flight operation continues to confirm the McDonnell "Phantom" as the most advanced all-around fight aircraft in the world today. But high density electronics and the heat loads of high speed flight would soon put the radar nose of the Phantom out of business.

That's where Eastern Industries' cooling systems come in. A liquid-to-air heat exchanger and hydraulic pack combine to remove over 8 KW from the radar, keeping it within safe temperature limits under all flight conditions. For all its performance, the total system weighs less than 17 lbs. and is remarkably compact (hydraulic pack: 3 $\frac{3}{16}$ " x 6 $\frac{1}{16}$ " x 11" and exchanger: 6 $\frac{5}{8}$ " x 8" x 17").

Other Eastern cooling systems are now under development or in production for such aircraft as the Lockheed AH-56A, North American RA5C and F-104.

Write for new literature on Eastern capabilities in thermal control — or for the answer to your particular problem. We may have some cool answers.



EASTERN INDUSTRIES

A Division of Laboratory For Electronics, Inc.
100 Skiff Street • Hamden, Connecticut

ON READER-SERVICE CARD CIRCLE 235

COOL

KLYSTRONS • MAGNETRONS • TRANSFORMERS
TRAVELING-WAVE TUBES • SWITCH TUBES
WAVE GUIDES • DUMMY LOADS • LASERS

with New **ELLIS and WATTS**
Liquid-to-Air Heat Exchangers*

One of the new Ellis and Watts Heat Exchangers may be the answer to a need for tailoring a cooling system to your type of electronic equipment. Minimum space, low noise level and optimum performance have been achieved in each of a wide range of designs which include indoor/outdoor types in ratings from 5 to 300 KW. Proved in military, aerospace and commercial applications, these designs offer flexibility for quick modification to meet any specific cooling requirements.

Why not put the widely recognized Ellis and Watts custom-cooling "know-how" to work for you. Write us at the address below.

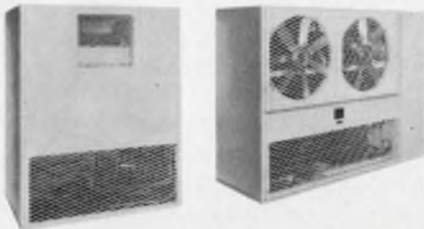

*Liquid-to-Liquid Heat Exchangers also available.



ELLIS AND WATTS COMPANY
Ellis and Watts Company, P.O. Box 36033
Cincinnati, Ohio 45236

ON READER-SERVICE CARD CIRCLE 771
296

COMPONENTS

Ceramic plate capacitors range 1 to 150 pF

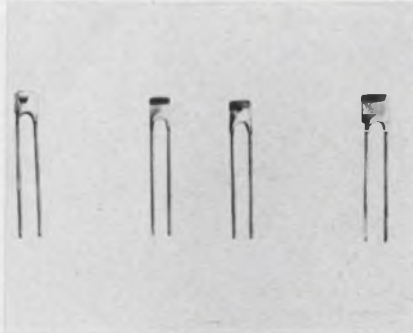

Mepco, Inc., Columbia Rd., Morristown, N. J. Phone: (201) 539-2000.

Less than 0.197 inches wide, these capacitors range from 1 to 150 pF. Class II capacitors are available in capacitances ranging from 1000 to 10,000 pF and from 18 to 1800 pF in two size configurations. Both Class I and II capacitors have a maximum working voltage of 40 V dc and are available with 0.024-inch rigid leads, or 0.016-inch flexible leads, for mounting on PC boards.

CIRCLE NO. 399

Silver-cadmium cells overpower NiCads

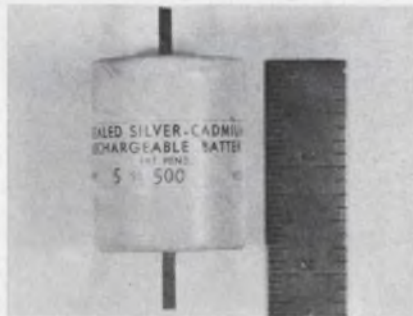

Electrochimica Corp., 1140 O'Brien Dr., Menlo Park, Calif. Phone: (415) 323-0283.

With about twice as large an energy density in Wh/lb and Wh/in³, silver cadmium cells offer higher discharge rate capabilities and longer charge retention than Ni-Cads. The S-500 (500 mA-hr) measures 1.34-inches OD and 0.25-inch high and offers twice the capacity of a NiCad cell of the same dimensions. The batteries are suitable for microelectronics, communication transceivers, test instruments, telemetry, and other commercial, space and military applications.

CIRCLE NO. 400

Sense and hold module remembers peaks



Optical Electronics Inc., P. O. Box 11150, Tucson, Ariz. Phone: (602) 624-3605. P&A: \$360 to \$400; 30 days.

In operation, this module stores the peak positive or negative value of an input waveform and presents it as a dc output signal. The output is changed by a higher level input signal or by a reset signal applied to the module. The modules can be used to measure the amplitude of transients, to obtain a peak noise voltage level and to measure the peak of a complex waveform.

CIRCLE NO. 401

Analog multipliers keep error down



GPS Instrument Co., Inc., 188 Needham St., Newton, Mass. Phone: (617) 969-9405.

A pair of analog multipliers are offered. One accepts two signals in the range of 0 to ± 5 V and delivers $1/5$ their algebraic product. The other accepts signals of 0 to ± 10 V and gives $1/10$ the algebraic product. Error is less than 50 mV. Both are quarter-square type multipliers and use diode-shaping networks and four wide-bandwidth op amps.

CIRCLE NO. 402

Two-position toggles RFI-shielded

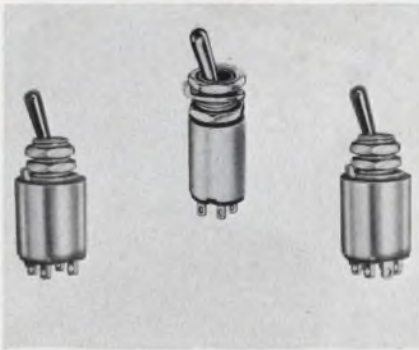

Control Switch Div. of Controls Company of America, 1420 Delmar Dr., Folcroft, Pa. Phone: (215) 586-7500. Price: \$7.56.

With minimal RFI emission, these switches are for airborne, shipboard, military, and commercial electronic equipment that operate in shielded systems. The shielded switches attenuate conduction and radiation in the 0.14-to-200-MHz range. The switches meet MIL-I-6181D and MIL-STD-826A requirements for radiation-free components and are designed for use in radiation-free airborne equipment conforming to MIL-I-26600.

CIRCLE NO. 403

PC coil forms fully shielded

Cambridge Thermionic Corp., 445 Concord Ave., Cambridge, Mass. Phone: (617) 491-5400. P&A: 82¢ and 87¢ (100 to 249); stock.

Mounting pins for these units are located on 0.2-inch grid spacing for printed circuit layout and mate with 0.025-inch jacks. Coil forms are available in six types for operating frequencies from 0.2 to 300 MHz. Inductances range from 0.022 to 1200 μ H with Qs of approximately 60 and 40 respectively. The package is 0.4 inches square and offers a low profile above the printed circuit. Booth No. 4103 Circle No. 379

For a complete listing of the technical papers at the show, see page U 112. For reprints of most of the papers, fill out the order form on page U 115.

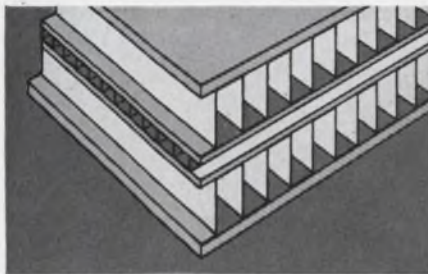

Westinghouse cools hot electronics in Janitrol cold box

Westinghouse Aerospace Div. designed advanced electronic gear into small space for the AWG-10 missile control system on the F-4J. To solve the heat problem, they called on Janitrol's new structural heat exchanger.

The walls of the sealed housing provide mounting and heat exchange surfaces. Walls are only $\frac{5}{8}$ " thick and contain two air circuits straddling a sealed oil cooling circuit.

Janitrol designs and fabricates special structural heat exchanger shapes for your specific heat dissipation requirements. In general, these will handle 10 watts per cubic inch, although higher capacities are possible. For more information write: Janitrol Aero, 4200 Surface Road, Columbus, Ohio 43228.



JANITROL AERO DIVISION
Midland-Ross Corporation

ON READER-SERVICE CARD CIRCLE 772

Ceramic chip caps range 10 pF to 1.5 mF

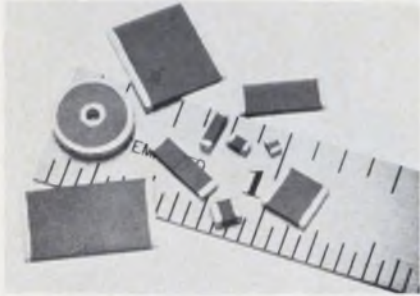

Monolithic Dielectrics, Inc., P. O. Box 647, Burbank, Calif. Phone: (213) 848-4465.

Space-saving, high-stability monolithic ceramic chip capacitors have a high capacitance-to-volume ratio. Available in 51 models, the series ranges from 10 pF to 1.5 mF in small rectangular, large rectangular, square and disc feedthrough configurations. All models are available with dc working voltages of 50, 100 and 200. Standard tolerance is $\pm 20\%$, with models also available at $\pm 5\%$, $\pm 10\%$ and guaranteed minimum value.

CIRCLE NO. 404

Narrow-band filters cut off sharply



Bundy Electronics Corp., Fadem Rd., Springfield, N. J. Phone: (201) 376-8150.

Narrow-band active filters are offered covering 385 to 3495 Hz (20-Hz spacing) or 353 to 3503 Hz (24-Hz spacing). The 20-Hz filters can divide the frequency spectrum into 155 channels, with a bandwidth of 5 Hz and attenuation of 12 dB at crossover. The 24-Hz filter produces 131 channels, with a bandwidth of 10 Hz and 18-dB attenuation at crossover. The filters come in a hermetically sealed module with solder or plug-in termination.

CIRCLE NO. 405

High-gain op amp gives 2 mA at 20 V



Data Device Corp., 240 Old Country Rd., Hicksville, N. Y. Phone: (516) 433-5330. P&A: \$71 (10 to 24); stock.

With a gain of 200,000, this op amp has an output of 20 mA and 20 V, and stability of $5 \mu\text{V}/^\circ\text{C}$, $0.3 \text{ nA}/^\circ\text{C}$. The unit has a current off-set of 10 nA. It provides a frequency for full output of 25 kHz. Applications include servo/resolver systems, solenoid drivers, automatic test equipment and signal conditioning systems. The all-silicon device is fully encapsulated and designed for PC board mounting.

CIRCLE NO. 406



Will the "real" Magnetic Shield please stand up!

Define "real" this way:

- 1) Not significantly affected by dropping, shock or vibration.
- 2) Never needs periodic re-annealing . . . no maintenance problems, no downtime.
- 3) Minimal retentivity.

Such "real" performance is delivered only by shields with the Yellow Netic Co-Netic label . . . fabricated by MSD Shielding Specialists. That's why Netic & Co-Netic shields are the accepted world standard for industrial, military and commercial applications.

Available fabricated to your specs or in Sheet Stock for your fabrication.
Delivery 3-4 weeks. Request Short Form Catalog No. 67.



MAGNETIC SHIELD DIVISION

Perfection Mica Company
1322 N. ELSTON AVENUE • CHICAGO, ILLINOIS 60622
Phone 312. EV 4-2122 • TWX 910 221-0105

High noise immunity in DTL cards

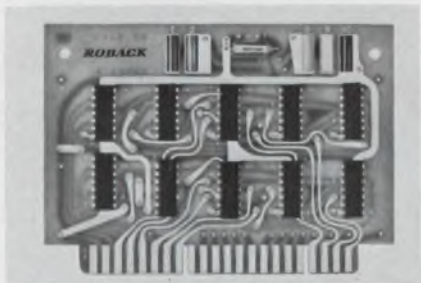

The Roback Corp., 601 Buck Rd., Huntingdon Valley, Pa. Phone: (215) 676-4000. P&A: \$9.50 (flip-flop), \$2.50 (gate); stock.

Low-cost DTL logic cards provide high noise immunity with a dc-to-5-MHz operating speed. Available in commercial and military versions, the cards combine monolithic ICs and discrete hybrids on a 4.5 by 3.25-inch glass-epoxy board. High noise immunity, typically 1.2 volts over 0° to 70°C is achieved with local power line filtering.

CIRCLE NO. 407

Module delays pulses up to 30 μ s

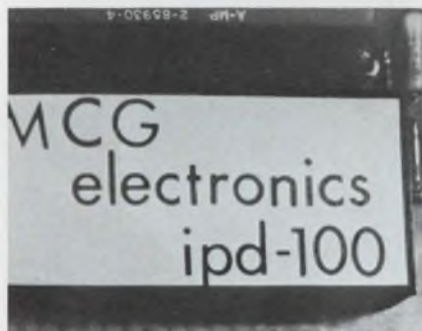

MCG Electronics, 11-22 Joselson Ave., Bay Shore, N. Y. Phone: (516) 586-5125.

This module accepts a logic 0 (negative 0-V pulse from 2 to 5-Vdc level) input pulse and delays it up to 3 μ s with a delay tap resolution of 50 ns. The output is a logic pulse with a fan out of 20 and with rise and fall times of approximately 30 ns. The delayed output pulse is stable, exhibiting a time delay variation of 50 ns (at the 3- μ s setting) when the temperature is varied from +25° to +75°C.

CIRCLE NO. 408

Like one of Lamb Electric's complete line of motors. They turn your products on and keep them going with exceptional reliability. Whatever your product has to do—scrub, polish or vacuum—Lamb Electric has the motor with just the right combination of performance, life and cost. If necessary, we'll even custom build a gear motor from standard Lamb parts.

So whatever your design is, Lamb Electric has the power. The power with performance and durability enough to turn your product on and give it extra sell.

If you'd like a better motor for your better floor-care product, write us. We'll send you details and performance curves that will turn you on about Lamb. Address: Ametek, Inc., Lamb Electric Division, Kent, Ohio 44240. In Canada: Sangamo Company, Ltd., Toronto.

**FOR A
TOUGH,
LONG-
LASTING
FLOOR-CARE
PRODUCT,
PUT A LITTLE
LAMB IN IT!**



AMETEK Lamb Electric
AMETEK

ON READER-SERVICE CARD CIRCLE 774

Get the Components You Need... from Austron!



CRYSTAL OSCILLATORS

Output frequencies from 50 Hz to 10 MHz. Stabilities from 1×10^{-6} to 1×10^{-10} per day. High frequency stability over operating ranges as great as -55°C to $+85^{\circ}\text{C}$.

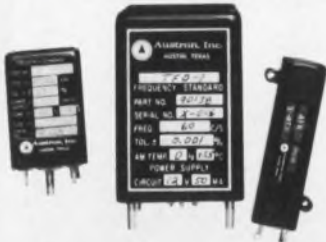

TUNING-FORK OSCILLATORS

Packaged units include basic resonators or complete oscillator units. Range of frequencies, stabilities and mechanical configurations available.



POWER MODULES

5 VA to 1 KVA, AC output with AC or DC input, square or sine-wave output, 50 Hz to 5 kHz, frequency tolerances to $\pm 0.00005\%$, output regulation to $\pm 2\%$.

See these, and other Austron components, at our WESCON booth No. 5243.



AUSTRON INC.

10214 NORTH INTERREGIONAL HIGHWAY,
AUSTIN, TEXAS 78753
TELEPHONE (512) 454-2581

COMPONENTS

Thermocouple reference converts mV recorders

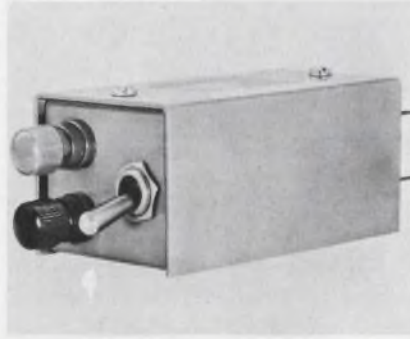

Consolidated Ohmic Devices, 115 Old Country Rd., Carle Place, N. Y. Phone: (516) 741-1500. P&A: \$92.50; stock to 4 wks.

Millivolt recorders can be converted to thermocouple recorders with this plug-in thermocouple reference junction. The device has banana plugs on 3/4-inch spacing to plug in directly to the 5-way binding posts of the millivolt recorder. The device is activated by an off-on switch. The plug-in, set at 0°C reference, can measure any temperature with any thermocouple. Over the 55° to 90°F range, accuracy is guaranteed at $\pm 1/2^{\circ}\text{F}$.

CIRCLE NO. 409

Tiny pressure transducer weighs in at 0.06 oz



Servonic Instruments, 1644 Whittier Ave., Costa Mesa, Calif. Phone: (714) 642-2400.

The Miniducer, measuring 0.5-inch in diameter and 1-inch long, is available in pressure ranges from 0 to 500 to 0 to 10,000 psia and psig. Used for airborne telemetry and control, overall accuracy is better than $\pm 1.75\%$ including the combined effects of linearity, friction, hysteresis, resolution and repeatability. It withstands 100-G shock and 50-G vibration.

Booth No. 5314 Circle No. 373

Wideband multiplier phase-controlled

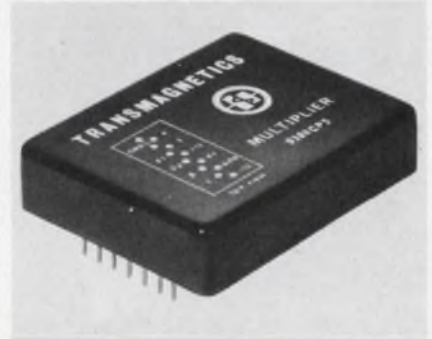

Transmagnetics, Inc., 134-25 Northern Blvd., Flushing, N. Y. Phone: (212) 539-2750. P&A: \$278 (1 to 9); stock to 4 wks.

Flat to 0.1 dB from dc to 25 kHz, this true analog multiplier has a phase shift not exceeding 1.5 degrees. Applications are in precision modulation or dc-to-ac compensation, variable gain control, wideband power measurement, weighted gating and signal sampling and analog multiplication. Specifications include 0.5% full-scale linearity and $0.02\%/^{\circ}\text{C}$ stability over -55° to $+85^{\circ}\text{C}$.

CIRCLE NO. 410

Stable inverter gives ripple-free output



MIL Associates, Inc., Dracut Rd., Hudson, N. H. Phone: (603) 882-5193. P&A: \$375 (1 to 9); 10 days.

For use with airborne, synchronous servo equipment where accuracy of operation is dependent upon frequency stability, this inverter gives a 400-Hz output stable to $\pm 0.25\%$. A 28-V dc input provides 115 ± 5 V rms output. Ability to adjust the output frequency by $\pm 1\%$ or ± 4 Hz allows compensation for mechanical tolerances in clock or servo equipment such as airborne tape recorders.

CIRCLE NO. 411

**Synchro-to-dc converter
accurate to 3 minutes**



Nutel Engineering Co., Inc., 7129 Gerald Ave., Van Nuys, Calif. Phone: (213) 782-4161. P&A: from \$250; 4 to 5 wks.

All solid-state synchro-to-dc sine/cosine converters offer ± 3 -minute accuracy independent of rotor excitation voltage ($\pm 10\%$). Sine/cosine tracking accuracy is $\pm 0.02\%$ of full scale and repeatability is $\pm 0.01\%$. The converters accept the output of a standard 3-wire ungrounded synchro stator and provide dc voltage outputs corresponding to sine and cosine of synchro shaft angle.

CIRCLE NO. 412

**Log amplifier modules
temp compensated**



Burr-Brown Research Corp., 6730 S. Tucson Blvd., Tucson, Ariz. Phone: (602) 294-1431. Price: \$275 (1 to 9).

Temperature compensation gives this log amp an accurate log characteristic over a range of temperatures (0° to 60°C). Input signals range from 10 mV to 10 V. Applications include signal compression, analog computation, industrial and scientific instrumentation. Balancing and zeroing controls are external and optional.

Booth No. 3212 Circle No. 370

**Looking for
hitherto impossible connections
of solid or stranded lead wires to
pins, posts, tabs, etc. (of any metal and any shape)?
Come see the revolutionary**

aci
SIGMAPoint T.M.

POST TERMINATIONS

See it
demonstrated!

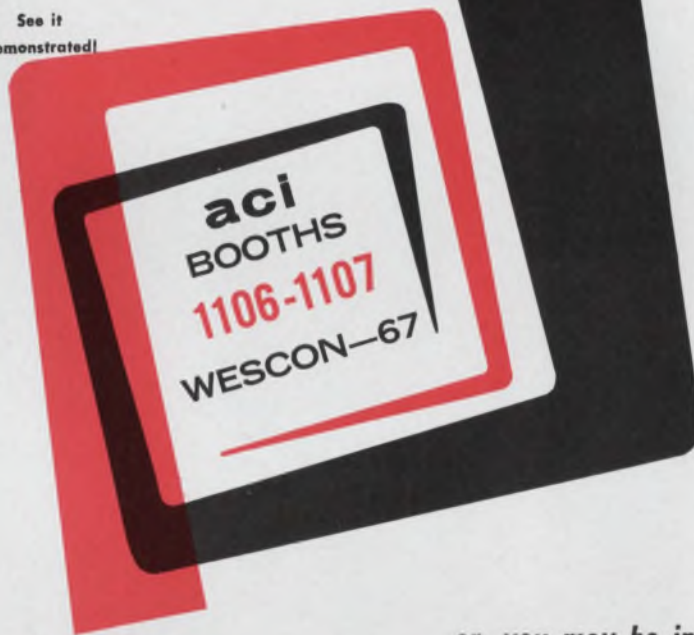

or, you may be interested in

aci
SIGMAFLO T.M.

I/S SYSTEMS

Interconnection and
Structural
Systems for
Memory Devices

which include tunnel structures, word lines, keeper, planar thin film memory sense-digit lines (everything but the electronics and magnetics).

These new, never-before-shown products will be displayed along with the latest developments in aci Signaflo wiring systems and Signaflo signal transmission line wiring systems. If you don't make the show, we'll gladly rush literature to you.

SIGMAFLO T.M.
wiring systems

"Visit ACI Booth 1106-1107"

aci DIVISION OF KENT CORPORATION
206 Industrial Center, Princeton, N. J. 08540
Telephone 609-924-3800 TWX. 609-921-2077



"Acknowledged leader in flat cable systems."

ON READER-SERVICE CARD CIRCLE 776

Five-amp logic relays take microamp inputs

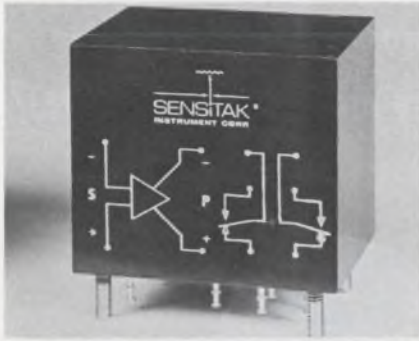

Sensitak Instrument Corp., 531 Front St., Manchester, N. H. Phone: (603) 627-1432. P&A: \$9.90; stock.

Microamp-sensitive dpdt logic relays consist of a silicon npn amplifier driver and a magnetic relay, epoxy encapsulated for immunity to shock and vibration. Signal input impedance of 1 M Ω and large over-voltage capability suit for sensing over a 100:1 dynamic range.

CIRCLE NO. 413

Load-absorb resistor has no self-inductance



The Carbone Corp., 400 Myrtle Ave., Boonton, N. J. Phone: (201) 334-0700.

Practically independent of applied voltage and ambient temperature, these load-absorbing resistors return to their normal ohmic values after overload if overload is not too high or too protracted. The material absorbs large transient energy impulses. The resistors are used in the same applications as wire-wounds but in circuits where self-inductance must be zero or where overloading is anticipated. Uses are as surge-limiting resistors, protection resistors in dust-precipitator circuits, dummy-load resistors, surge-dampening devices in short-wave transmitters, resistors for alternator ground connections and discharge resistors for condenser banks.

Resistance values range from 2 to 40,000 Ω . Maximum energy dissipation in still air is from 175 to 250 joules per cubic centimeter, depending on discharge time. The upper limits can be raised by forced cooling with air, water or oil. Maximum voltage gradient is about 1200 V/cm. Maximum load is about 200 watts, without forced cooling.

CIRCLE NO. 414

does your design require precious metal pot wire?

Secon produces high quality, precision — *precious metal* — potentiometer wire. We offer quick delivery for your production requirements, as well as FREE prototype samples.

You get the precious metal alloy wire you need, engineered to meet your exact requirements — from 37 to over 610 ohms/cm; low temperature coefficient of resistance — with excellent roundness and linearity.

This high tensile strength wire is engineered to facilitate uniform winding — available to .0004" diameter. Supplied bare or enameled.

If your requirements are for high quality, fine potentiometer wire you should write for a copy of our comprehensive brochure on wire for the potentiometer industry.

Please write on your letterhead; no obligation of course.



7 INTERVALE STREET, WHITE PLAINS, N. Y. 10606 ■ (914) 949-4757
ON READER-SERVICE CARD CIRCLE 777

Short 5-A connectors hold 85 conductors

Matrix Science Corp., 3311 Winona Ave., Burbank, Calif. Phone: (213) 845-8434.

With six shell sizes from 8 through 18, these connectors accommodate from 7 to 85 conductors. Mated pairs meet operating requirements through a temperature range of -67° to $+392^{\circ}$ F. All contacts are rated for 5-A continuous duty, rated at 1500 V dc.

CIRCLE NO. 415

Improved Nixies shorter, faster

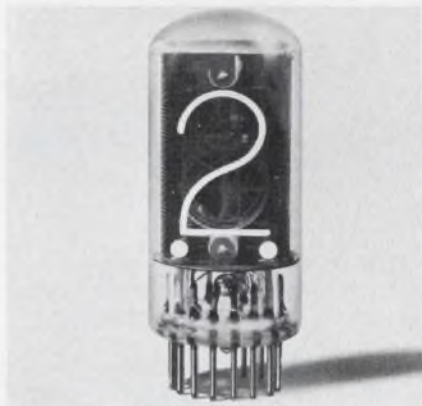

Burroughs Corp., Electronic Components Div., Plainfield, N. J.
Phone: (201) 757-5000.

An improved version of Burroughs B-5440 Nixie is electrically and mechanically interchangeable with the old standard. The tip-off, which is at the top of the tube in the B-5440, has now been brought out in the base so that overall seated height is cut by 17%. An optional "keep alive" feature is used when rapid ionization is required, in dark environments, in photographic applications, and in time sharing or strobe applications. The "keep alive" feature enables ionization to occur in normal ambient light in less than 100 μ s in contrast to 10 μ s required by standard tubes.

Booth No. 2816 Circle No. 360

PC reeds packed for sensitivity

Automatic Electric Co., Chicago.
Phone: (312) 562-7100.

This printed circuit dry reed switch is a miniature reed capsule within a relatively large bobbin for greater sensitivity. Due to its low self-inductance and high-speed operation, the Correed is reportedly an ideal output device, providing complete isolation between the coil drive and output contacts. The metallic output contacts have a low closed-circuit resistance (about 60 m Ω) and a very high open-circuit resistance (about 500,000 M Ω).

Booth No. 4221 Circle No. 351

NEW VECTOR \longrightarrow POWER CHAIN DELIVERS 25 WATTS @ 400 MHz!

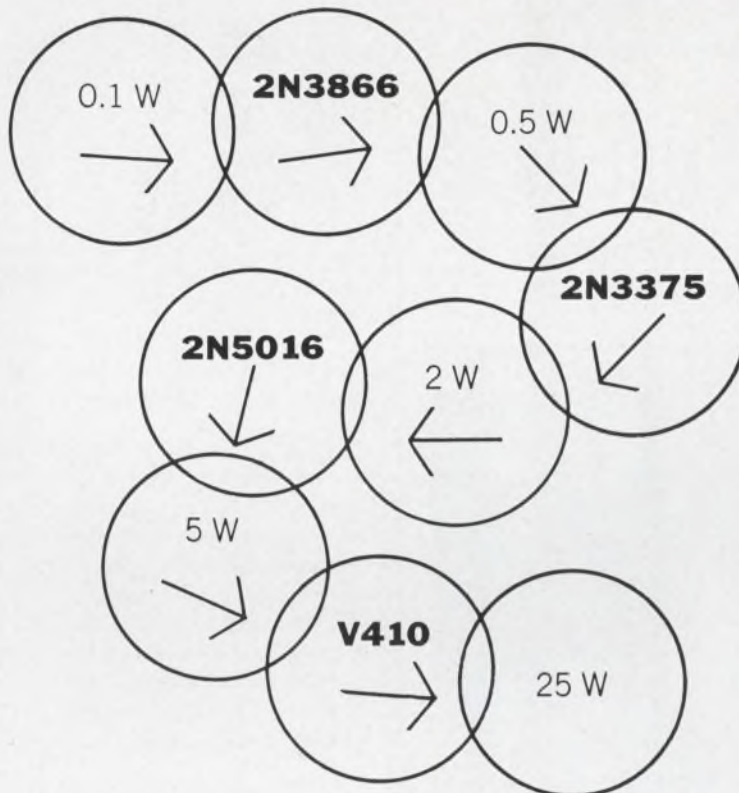

You can get 25 watts (typical) at 400 MHz from a high-gain amplifier using the four silicon transistors shown above. And, conservative per-stage power gain allows you greater design bandwidths and higher temperature operation.

All this is possible because of Vector's new family of V410 and 2N5016 high-frequency silicon epitaxial NPN transistors designed for large-signal, high-power oscillator/amplifier applications in the 200—500 MHz region.

Each of these transistors has over 400 emitters, 2½ microns wide. These provide greater output, gain, efficiency, frequency capability and linearity.

Packaging variations are offered to permit either internally grounded emitter operation or complete electrode isolation in the TO-60 package.

TRANSISTOR CHARACTERISTICS

	f_o	P_o	Eff. (min.)	f_T (typical)	Package
V410	400 MHz	25 W	50%	650 MHz	TO-60
2N5016	400 MHz	15 W	50%	600 MHz	TO-60
2N3375	400 MHz	3 W	40%	500 MHz	TO-60
2N3866	400 MHz	1 W	45%	800 MHz	TO-39

All four of the transistors shown in the above power chain are available from stock. For data sheets and price quotations, call Vector Solid State Laboratories, (215) 355-2700. TWX 510-667-1717.

Vector DIVISION OF UNITED AIRCRAFT CORPORATION
SOUTHAMPTON, PENNSYLVANIA 18966

See us at Booths 4901 — 4904, East Exhibit Hall, WESCON.

NEW MAGNETIC RELAY plugs into your PC board!

NO Springs, NO Wiring,
NO Sockets, NO Soldering,
NO Mechanical Linkage

Printact®

Standard Series G
Latching Series LS/LD

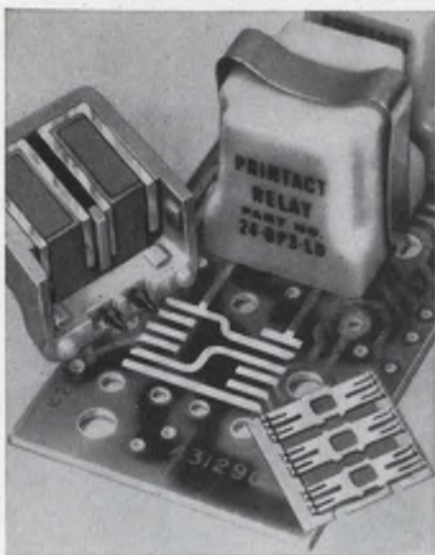

(actual size)

Plated Conductors on Your PC Board are the Fixed Contacts

Save SPACE, MONEY and MANHOURS with these new small, lightweight, highly reliable Standard and Latching PRINTACT Relays.

Available with Bifurcated Palladium or Gold Alloy contacts for more than 10 million cycle 2 to 4* pole switching. Handles up to 2 amp. res. loads. Coils for 6, 12, 24 and 48 vdc at 500 mw. Operating temperature -30°C to $+95^{\circ}\text{C}$. Operate time 7 ms. The little gem is an 0.8 oz. $\frac{7}{8}$ " cube.

Quality features include: double-break contacts; balanced armature, enclosed housing, plug-in application; encapsulated coil; self-wiping contacts and inherent snap-action — saves sockets soldering, and wiring and the cost is lower than you think!

*Switches up to 4 form A plus B, or 4 form C.

For data and prices write or call:
212-EX2-4800

Executone

PRINTACT RELAY DIVISION

47-37 Austell Place

Long Island City, N.Y. 11101

ON READER-SERVICE CARD CIRCLE 779

TEST EQUIPMENT

Solid-state light pen responds in nanoseconds



Information Control Corp., 1320 E. Franklin Ave., El Segundo, Calif. Phone: (213) 322-6930.

Sensitive to brightness changes of 10^{-6} mW/cm², this light pen exhibits less than a 300-ns response time. Acceptance area of the pen is $\frac{1}{8}$ inch, defined by an illuminated solid finder circle projected on the CRT phosphor. To aid the operator in positioning, the pen projects an illuminated solid finder circle on the CRT phosphor illuminating the exact area to be sampled by the detector.

CIRCLE NO. 416

Fm discriminator sits in 5-1/4-inch rack



Geotech, Div. of Teledyne, 3401 Shiloh Rd., Garland, Tex. Phone: (214) 278-8102.

For multiple-channel, low-frequency, fm data telemetering, this 14-channel demodulator system is housed in a 5-1/4-inch rack. Input signal threshold is adjustable from 0.05 to 10 V p-p. Carrier center frequency is 1500 Hz with $\pm 45\%$ deviation. Dynamic range is 80 dB on an rms-rms basis and provision is made for filter configurations. Noise level is 1 mV p-p.

CIRCLE NO. 417

Self-powered op amps drift-free, quiet



Julie Research Laboratories, Inc., 211 W. 61st St., N. Y. Phone: (212) 245-2727. P&A: \$800; 30 days.

Designed for precision dc applications, these low-noise, drift-free op amps feature input stability of $0.1 \mu\text{V}$ and typical gains from 10^6 (120 dB) to 10^8 (160 dB). They are suited for driving and control elements in high-stability and high-linearity current and voltage generating (feedback) systems and as standard cell emf buffers and amplifiers and as drive units for dialable voltage current sources. Overall noise (short-term) is ± 100 nV p-p, stability is less than $1 \mu\text{V}/\text{wk}$.

CIRCLE NO. 418

Calibration standards span wide ranges

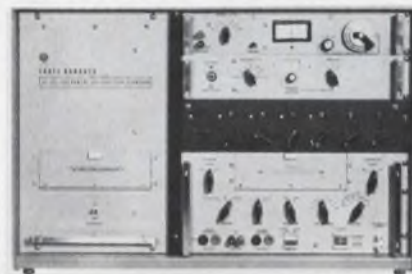

RFL Industries, Boonton, N. J. Phone: (201) 334-3100. Price: \$9000.

Solid-state calibration standards offer wide ranges of current, voltage, power and frequency output. Accuracy is 0.1% dc, 0.15% ac. Go-no-go logic circuitry protects against misoperation and overloads. Automatic operation senses the dialed quantity and corrects for any deviation. The output deviation control facilitates direct percent calibration. Voltage ranges from 0.01 mV to 1000 V ac and dc, currents from $0.02 \mu\text{A}$ to 20A, dc watts from 0.01 to 4000 and dc resistance from 0.01Ω to $11.11 \text{M}\Omega$.

Booth No. 2307 Circle No. 290

Comparator-converter NBS-accurate

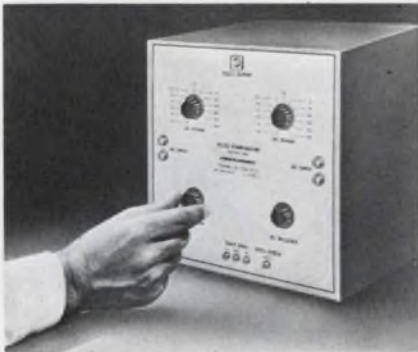

Engelhard Industries, Inc., 113 Astor St., Newark, N. J. Phone: (201) 242-2700.

A comparator and companion coax thermal converter set offer high accuracy for electronic and aerospace metrology. The comparator is a stable, accurate transfer standard with an ac/dc differential of 10 ppm or less, which can be certified by NBS to an accuracy of 50 ppm in the audio range. The converter set determines the ac/dc difference of the comparator for complete calibration accuracy.
Booth No. 1671 Circle No. 369

Volt/frequency meters have digital readout



Wavetek, 8159 Engineer Rd., San Diego, Calif. Phone: (714) 279-2200. Price: \$1095.

With a 5-digit readout, this unit measures dc voltages from 0 to 1000, and frequency from 5 Hz to 100 MHz. A null meter with full-scale deflection sensitivity of 100 μ V provides a voltage accuracy of 0.01%. Frequency can be measured to 0.01% of reading \pm 0.001% of full scale. A recorder connector provides for continuous analog output of either frequency or voltage.
Booth No. 2417 Circle No. 368

control / alarm shortcut

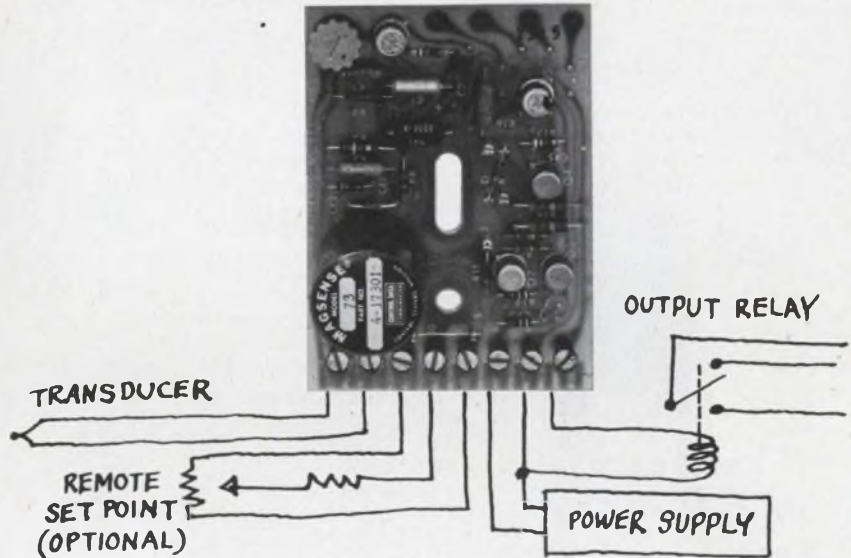

MAGSENSE®

control / alarm for temperature, pressure, speed, flow

Here's a fast, easy way to design a solid-state control/alarm circuit you can depend on. Just connect sensor, load and power source to the standard MAGSENSE model that meets your specific requirements. That's it. Your circuit is complete. You'll save time and money by using MAGSENSE, and you'll be taking advantage of accuracy and reliability proven in hundreds of temperature, pressure, speed, position, liquid level and flow applications.

All 11 Magsense models offer 100-billion power gain and accept inputs as low as 1 microamp or 10 microvolts *directly* without preamplification. Continuous overload capability is 1,000 times nominal full-scale input without damage. Trip point is unaffected by common mode voltages as high as 110 VAC, 60 Hz because input is full floating with respect to the

output circuit.

Single or dual setpoints and hysteresis are easily adjusted internally or remotely. You can specify latching, non-latching or pulse control/alarm action. Non-latching and pulse units have adjustable differential gap and proportional band capabilities.

Transducer excitation voltage is available from all MAGSENSE units, and cold junction and copper compensation are standard in models for thermocouple applications.

Priced from \$35 in quantity, all MAGSENSE modules are available from stock.

For data sheets or a quote, contact MAGSENSE Sales, Dept. 201, La Jolla Division, Control Data Corporation, 4455 Eastgate Mall, La Jolla, California 92037. For immediate action, phone (714) 453-2500.

LA JOLLA DIVISION

CONTROL DATA

CORPORATION

4455 Eastgate Mall, La Jolla, Calif

ON READER-SERVICE CARD CIRCLE 780



Apollo Wiring Assemblies

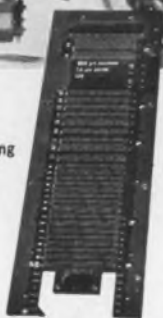

**SPACE
to UNDERSEA
Instrumentation**

TSC

THE SHIPPAN CORPORATION

Concepts • Engineering
Manufacturing

Contact: W. J. Lavery, Programs Manager,
Marion, Massachusetts 02738
Tel. 617 748-1160.



Expendable BT System (AN/SSQ-56)



ON READER-SERVICE CARD CIRCLE 781

TEST EQUIPMENT

**Slot supply system
mixed and matched**

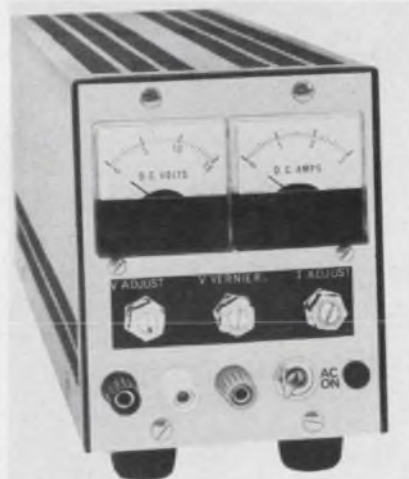

Trygon Electronics, Inc., 111 Pleasant Ave., Roosevelt, N. Y. Phone: (516) 378-2800.

Sub-rack slot power supplies offer combinations of half-rack and quarter-rack, modules and metered models. The power supplies in the series feature slot voltage ranges from 2.5 to 4.5 V dc at 3.6 A to 24 to 32 V dc at 8 A. Versatility is achieved with a series of rack adapters permitting the designer to mix and match units to obtain up to eight different outputs in a 19-inch wide rack configuration.

Booth No. 2618 Circle No. 298

**MIL-spec DVM
environment-resistant**

Dana Laboratories, Inc., 2401 Campus Drive, Irvine, Calif. Phone: (714) 833-1234.

Designed to meet all of the significant requirements of MIL-T-21200F, class 2 and 3, this DVM is a 5-digit (with sixth-digit over-range) null-balance instrument with a dc accuracy of $\pm 0.005\%$ of reading $\pm 0.001\%$ of full scale, and a minimum measuring speed of 12 ms. The unit meets MIL-temperature requirements with continuous operation from -40° to $+55^{\circ}\text{C}$, storage temperature from -62° to $+85^{\circ}\text{C}$ and intermittent operation possible at $+71^{\circ}\text{C}$. Humidity may run to 100%, with condensation in and on the equipment. The rack-mount unit also meets shock, sand, fungus, salt, explosion and vibration requirements.

Booth No. 2406 Circle No. 289

**Portable counters
for ac or dc**



Amark Corp., 31 Commercial St., Plainview, N. Y. Phone: (516) 938-3322. P&A: \$595 to \$890; 2 to 4 wks.

Ability to operate from 12 V dc gives these counters a field service capability. Model TSA-3334 has a four-digit readout, model TSA 3436 a six-digit readout. Frequency ranges are 15 Hz to 1.2 MHz and dc to 1.2 MHz. The counters function with inputs ranging from 100 mV to 250 V with accuracy of ± 1 count. The counters are self checking and have an automatic reset.

CIRCLE NO. 419

**MIL power modules
range 3 to 250 V**



Deltron, Inc., Wissahickon Ave., North Wales, Pa. Phone: (215) 699-9261. P&A: \$65 to \$470; stock.

There are 299 units in this line ranging from 3 volts, 36 A to 250 volts, 2.1 A. Units provide an MTBF of to 100,000 hours, and meet military shock, vibration, humidity, altitude, RFI, marking, and component standards. The units have 0.02% regulation, convection cooling to 71°C , thermal cutout with automatic reset, remote sensing and programing and automatic series and parallel operation.

CIRCLE NO. 420

Digital voltage source fully programmable



Electronic Development Corp., 423 W. Broadway, Boston. Phone: (617) 268-9696. P&A: \$1650; stock.

The sign and each decade of this voltage source are independently selected. Outputs are 0 to 111.11 Vdc. Programming is either serial by decimal digit, 8421 code or full parallel entry. The memory feature will preserve the contents of the internal register after the transfer busses have been de-energized. Punch tape, punch card, incremental magnetic tape readers, or pin board, programmer drum, stepping switch programming may be used.

CIRCLE NO. 421

Prescaler plug-in ups counter specs



Hewlett-Packard, 1501 Page Mill Rd., Palo Alto, Calif. Phone: (415) 326-7000. P&A: \$825; 10 wks.

For use in HP plug-in counters, this prescaler extends the direct counting rate to 200 MHz. At the same time, the plug-in increases counter sensitivity, enabling counter operation with signals as small as 1 mV rms at frequencies between 1 and 200 MHz. The prescaler works with HP models 5245L, 5245M, 5246L and 5247M. The plug-in's digital circuits divide input sine waves or pulse trains by a factor of four, bringing signal frequencies as high as 200 MHz within the basic counting rate.

Booth No. 2909 Circle No. 367

This is the smallest optical encoder that can resolve 14 bits in one revolution under avionics conditions. It's one example of what Datex offers you in optical encoders. We'll send you others in return for your name and address. Write:

Datex Division / Conrac Corporation
1911 Walker St., Monrovia, California
(213) 359-5381

Dallas, Texas (214) EM 3-6417
Dayton, Ohio (513) 253-1104
Des Plaines, Illinois (312) 827-8141
Huntsville, Alabama (205) 539-9396
New York, New York (212) 661-4070
Pasadena, California (213) 681-7152
Washington, D.C. (202) 244-8700



Model 01-809
Actual Size

**in Mercury
or Xenon**

PEK

**is the standard of
reliability in
High Intensity
Light Sources**



Across a power range of 35 watts to 30KW in xenon, and 100 to 500 watts in mercury, PEK high intensity arc lamps are

noted for long life, maximum arc stability, dependable glass-to-metal seals. These are the qualities that have made PEK arc lamps the standard of reliability in applications ranging from photography to solar simulation, from microscope illumination to long-range projection.

PEK'S off-the-shelf line of arc lamps is the most comprehensive in the industry. Send for our new Product Reference Guide, or tell us what your special requirements are. There's a PEK lamp to fit your application.

PEK

PEK / 825 E. Evelyn Avenue
Sunnyvale, California
(408) 245-4111 / TWX 910-339-9214

TEST EQUIPMENT

Photomultiplier supply delivers 15 kv

Venus Scientific Inc., 25 Bloomingdale Rd., Hicksville, N. Y. Phone: (212) 867-6062. P&A: \$178; stock.

Using all silicon components, the K15 is a dc-dc converter capable of delivering up to 1 mA with ripple of 0.1% or less for inputs ranging from ± 3 to 15 V dc. Output voltages vary from ± 300 to 1500 V. Input and output circuits are fully isolated from each other. The unit provides complete protection against damage from shorts or reversal of polarity. Measuring 1 inch in diameter and 2-1/4 inches long, the unit can be incorporated into closed-loop systems.

CIRCLE NO. 427

Rear-projection readout weighs 1-1/2 ounces



Shelly Associates, Inc., 111 Eucalyptus Dr., El Segundo, Calif. Phone: (213) 322-2374.

Smaller than a roll of pennies, this readout contains 12 separate message projection systems. Each of the optical systems will project anything that can be put on film into images as large as 0.45 inches. The design permits messages to be displayed vertically or horizontally with minimum blank areas or image blockages. It will readout symbols, characters or up to four-line messages 0.1-inch high. The front dimensions are 0.65 x 0.46 inch. The SRO-90 uses an unbased, replaceable lamp unit, easily replaced.

CIRCLE NO. 428

Digital frequency meter measures to 12.4 GHz



Hewlett-Packard, 1501 Page Mill Rd., Palo Alto, Calif. Phone: (415) 326-7000. P&A: \$4750; Sept.

This unit measures microwave frequencies between 0.3 and 12.4 GHz with 8-digit resolution. Other than selection of the appropriate one of two frequency ranges, the operator needs to make no tuning adjustments or calculations. The correct readout is obtained automatically. A "no-lock" monitor causes the display to read all zeroes until the instrument is locked onto an input signal.

CIRCLE NO. 429

Guidance receiver all-solid-state



Electronic Specialty Co., Colorado Blvd., Los Angeles. Phone: (213) 246-6761.

Intended for use in pilotless target aircraft and missiles, this command guidance receiver uses all-solid-state circuitry and operates in the 406-to-550-MHz band. It operates from the aircraft's 28-V dc power source and contains its own voltage regulator and line filter. A low-impedance audio output is provided to drive an external decoder.

CIRCLE NO. 430

ON READER-SERVICE CARD CIRCLE 783

Generator synthesizes low-frequency noise



Hewlett-Packard, 1501 Page Mill Rd., Palo Alto, Calif. Phone: (415) 326-7000. P&A: \$2650; stock.

Gaussian noise waveforms whose power density is exactly known are generated by this instrument. Maximum amplitude is 3.16 V rms with an upper cutoff frequency selectable in 18 steps from a high of 50 kHz to a low of 0.00015 Hz. Output power remains constant regardless of bandwidth selected. An advantage of the synthesizing technique is that noise waveforms can be repeated exactly as they occurred at an earlier time.

Since the amplitude of the binary waveform can be controlled precisely, the noise output of the generator is known precisely and is highly stable in amplitude (dc drift is less than 5 mV per 10°C change between 0 and 55°C). An attenuator provides 30 steps down to 0.1 V rms output. The instrument's output impedance is matched to 600 Ω when the attenuator is used (a second output supplies a fixed-level 3.16-V output from a 1-Ω source).

The instrument generates a sync pulse, for triggering an oscilloscope or other equipment, each time the noise pattern repeats. When desired, the patterns can be gated and set to run once, twice, four or eight times and then stop. The gating waveform is available at rear panel connectors for operating any external equipment.

CIRCLE NO. 431

For a complete listing of the technical papers at the show, see page U 112. For reprints of most of the papers, fill out the order form on page U 115.

LET'S TALK ECONOTAN[®] MINIATURE SOLID TANTALUM CAPACITORS

LET'S TALK — SIZE

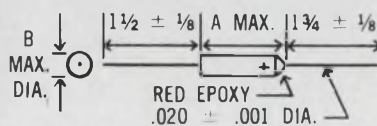

SERIES	A MAX.	B MAX.	VOL. CU. IN.
CT	.260	.095	.00184
CM	.320	.133	.00444
CL	.345	.180	.00877

LET'S TALK — RATINGS

ECONOTAN capacitors are available in 3 case sizes and 41 different ratings from 2 to 35 WVDC and from .0047 MFD to 68 MFD. Ask for our complete technical data folder containing detailed specifications, A size reproducible master, and standard reel pack information.

LET'S TALK — PERFORMANCE

ECONOTAN capacitors will operate reliably from -55°C to +85°C without derating. Maximum leakage is .01uA/mfd-volt. Dissipation factor is below 6% for 6 to 35 WVDC ratings. Surge voltage specification is 130%. Withstand over 25,000 G's mechanical shock.

LET'S TALK — DELIVERY

Same day shipment on prototypes. Production quantities one week. We have the BEST DELIVERY IN THE INDUSTRY.

LET'S TALK — APPLICATIONS

FILTERING — BYPASSING —
COUPLING — TIMING.

ECONOTANS are ideal for volume commercial applications requiring minimum space, high stability, reliability, and machine insertability.

LET'S TALK — PRICE . . .

We're very competitive whether your requirements are for 2 units or 2,000,000 units. It takes only one phone call to find out we mean business—dial 207-284-5956, SALES DEPARTMENT COMPONENTS INC., BIDDEFORD, MAINE

LET'S TALK ECONOTAN —

BOOTHS 5009-5010 WESCON



COMPONENTS, INC.

MAINE DIVISION



SMITH STREET, BIDDEFORD, MAINE 04005 / AC 207-284-5956

ON READER-SERVICE CARD CIRCLE 784

Microsonics

State of the Art Design in Filters Oscillators and Delay Lines



Continuously
Variable Delay
Systems
Bulletins 4301 and 4302



Broad Bandwidth
Highly Selective
Crystal Filters
Bulletin 6350

Comb. Filter Sets
Bulletin 6350



Broad Bandwidth
Delay Lines
Bulletin 4300



Highly Stable
Oscillators — Bulletin 6350



Voltage Controlled
Crystal Oscillators
Bulletin 6350



High Density
Digital Storage
Systems
Bulletin
5350

Send for literature.



MICROSONICS, INC.
60 Winter Street
Weymouth, Mass. 02188
Tel: 617 337-4200

A subsidiary of the Sangamo Electric Company

MICROELECTRONICS

ECL flip-flops toggle at 120 MHz

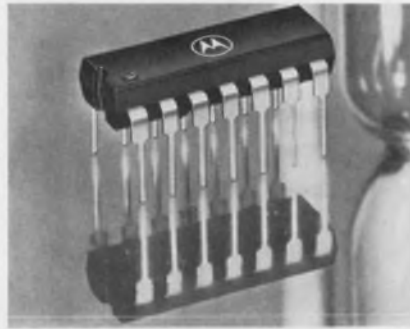

Motorola Semiconductor Products, Inc., P. O. Box 955, Phoenix. Phone: (602) 273-6900. P&A: \$6.50 and \$7.40 (over 1000); stock.

Flip-flops keep getting faster. Designed for high-frequency counters, frequency synthesizers and extremely high-speed registers, Motorola's J-K flip-flop features a typical toggle frequency of 120 MHz. Known as the MC1027P, it is an ac-coupled J-K flip-flop with 4 J and 4 K inputs as well as direct set and reset inputs. The unit operates with the same logic levels and is fully compatible with other members of Motorola's emitter-coupled logic series. The 120-MHz toggle frequency of the MC1027P is reportedly more than twice as fast as any saturated logic flip-flop. The MC1027P offers a typical propagation delay of 4 ns. Dc fan out is 25 minimum with maximum recommended ac fan out of 15 for high speed operation. Both the companion high-speed clock driver and the flip-flop are packaged in a 14-lead plastic package.

CIRCLE NO. 422

Ferrite circulator completely integrated

Texas Instruments, 13500 N. Central Expwy., Dallas. Phone: (214) 238-3741.

These symmetric-junction integrated circulators operate in the X-band frequencies, from 8.7 to 9.9 GHz. Isolation is 20 dB and insertion loss is 0.4 to 0.6 dB. With a 450-MHz bandwidth centered at 9.2 GHz, the unit exhibits 25 to 37-dB isolation and 0.4-dB insertion loss. The integrated circulator is intended for stripline circuitry, but it is also adaptable to coaxial packaging. Booth No. 4105 Circle No. 366

Dual J-K flip-flop cuts external wiring

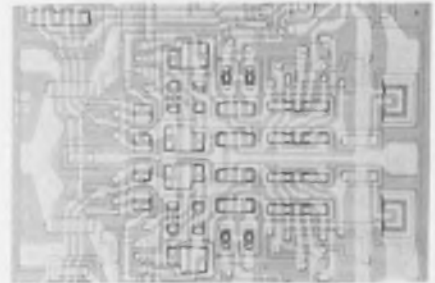

Stewart-Warner Microcircuits, Inc. 730 E. Evelyn Ave., Sunnyvale, Calif. Phone: (408) 245-9200. P&A: \$10.10 (100 to 999); stock.

Dual J-K flip-flops are now available consisting of two cross-coupled, J-K flip-flops in a single package. The circuits are built as a single passivated die measuring 56 x 56 mils. Two DTL 948 flip-flops are offered in two logic configurations, one with separate clock inputs, and the other with common clock and common reset in temperature ranges from -55° to $+125^{\circ}$ C or 0° to 75° C.

The circuits meet dc and dynamic specs of the DTL 930 series logic elements and with TTL logic elements. Their use can cut the package count in half in counters and shift registers; and since they are already J-K connected, the required external wiring is reduced significantly. All circuits are available in ceramic flat or dual in-line packages.

CIRCLE NO. 423

Core driver assemblies give 1-A pulses

Microsemiconductor Corp., 11250 Playa Court, Culver City, Calif. Phone: (213) 870-2974. P&A: 25¢ to 50¢ per junction; stock.

Core driver assemblies are offered in 1 x 4, 2 x 4, 1 x 8 and 2 x 8 silicon diode matrices. They are produced on 0.025-inch centers. Electrical characteristics of individual silicon diode junctions are compatible with microsecond read and write mass memories. Trapezoidal pulses with amplitude in excess of 1 A driving current can be achieved.

CIRCLE NO. 424

SYSTEMS

Disc drum memories hold 15 megabits

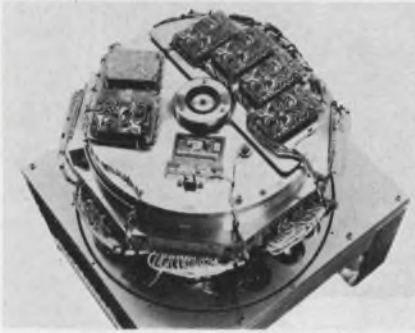

Digital Development Corp., 5575 Kearny Villa Rd., San Diego, Calif. Phone: (714) 278-9920.

Capacity of this system is 1536 million bits with an access time of 8.5 ms. Each disc has a capacity of 3.84 million bits on its 128 data tracks of recording surface. With four discs, 512 data tracks are available in a single unit. Recording heads are organized into groups and each group services one disc surface.

CIRCLE NO. 425

Simulators generate PCM, PDM, PAM

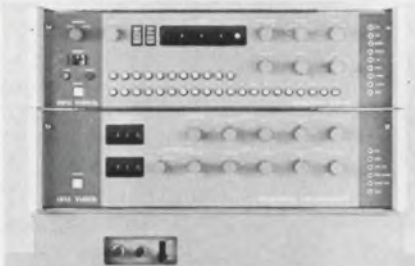

Electro-Mechanical Research, Inc., Box 3041, Sarasota, Fla. Phone: (813) 958-0811.

Serial PAM, PDM, and PCM telemetry signals and parallel computer words are generated by these simulators. Format content and signal characteristics are programmed and can be instantly changed under computer, paper tape or manual control. To simulate distortion occurring in the transmission system, they will insert selectable blanking, noise, bit-rate jitter, baseline offset and wow. The core memory has 2- μ s cycle time, and is capable of storing 1024 16-bit words. Up to seven instantly addressable complex formats can be stored in memory and modified in real time.

CIRCLE NO. 426

TENSILE-FLEX®

**EXTRAORDINARY FLEX LIFE
HIGH STRENGTH
AND CONDUCTIVITY**

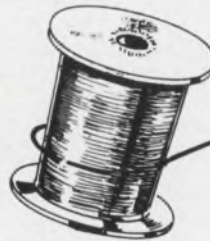

TENSILE-FLEX

**FOR ALL APPLICATIONS
THAT ARE CRITICAL**

Tensile-Flex is a copper base alloy developed specifically for applications where high tensile strength, high flex life, and high electrical conductivity are required.

Tensile-Flex combines the desirable qualities of cadmium copper, chromium copper, and zirconium copper into one material. Typical physical properties include: tensile strength—60,000 to 80,000 p.s.i.; elongation—6% to 12%; and conductivity—84% to 90%.

Tensile Flex is available plated with silver or nickel, in both singled-end and all stranded constructions. Its uniform physical properties remain absolutely stable throughout normal high temperature insulation curing.

A comparison of Tensile-Flex with other high flex alloys having similar heat treatment indicates far greater flex life with Tensile-Flex.

Technical bulletin on request

FREE SAMPLE

An actual sample of Tensile-Flex® is available upon request . . . we urge you to put it through your own tests . . .



INTERNATIONAL WIRE PRODUCTS CORP.

West Main Street, Wyckoff, New Jersey

Telephone: 201-891-5800



BOBBINS

...if you need them,
PERMACOR®
has them!



Name your size . . . select your shape . . . if it's Bobbins you want, we have them. As the world's largest maker of cores, we have the designers and production facilities to answer your every need, be it Bobbins or any other standard or special powdered iron cores.

IRON CORES... Plain, Hollow, Threaded, Insert, Tuning, Cup, and Toroidal Iron Cores, Iron Coil Forms, Sleeves, Flexible Magnetic Shielding, Bobbins and special shapes.

PERMACOR®

A Division of Radio Cores, Inc.

9540 Tulley Ave., Oak Lawn, Ill. 60454
Phone: 312-422-3353

MICROWAVES

Equalize gain in broadband TWT amps

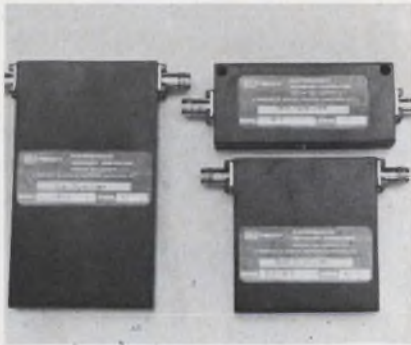

American Electronic Laboratories, Inc., P. O. Box 552, Lansdale, Pa. Phone: (215) 822-2929.

A passive, self-contained gain equalizer provides a method for removing undesirable gain variations in broadband TWT amplifiers. Either terminal can serve as the input, and the band-edge loss can be limited to 1/2 dB. A peak attenuation of 6 dB is normal at the center of the frequency band, but can be shifted as much as $\pm 10\%$. Units are available in ranges of 1 through 5 GHz to accommodate power levels up to 10 watts.

CIRCLE NO. 432

Rf voltage detector keeps VSWR low



Telonic Instruments, 60 N. First Ave., Beech Grove, Ind. Phone: (317) 787-3231. P&A: \$95; 45 to 60 days.

Designed for cw and swept applications as well as general-purpose use, this voltage detector covers 10 kHz to 3000 MHz. In addition to its low VSWR and the broadband characteristics, the model 8029 is a sensitive detector; square-law sensitivity is 0.3 mV/ μ W. It also exhibits flatness of ± 0.5 dB over its operating range. Input impedance is 50 Ω .

Booth No. 3126 Circle No. 365

Water-cooled load dissipates 25 kW

Aetronic Research Corp., 13710 Aspinwall Ave., Cleveland. Phone: (216) 851-3220. Price: \$875.

Designed to terminate 50- Ω coax lines, this dummy load handles 25 kW from 60 Hz to 2.2 GHz. Maximum VSWR is 1.1 to 1 GHz; 1.15 to 1.5 GHz; and, 1.2 to 2.2 GHz. This unit uses water both as a dielectric and as a coolant. It may be operated in any condition. Construction is brass and aluminum, finished in nickel plate.

CIRCLE NO. 433

Passive limiters protect detectors

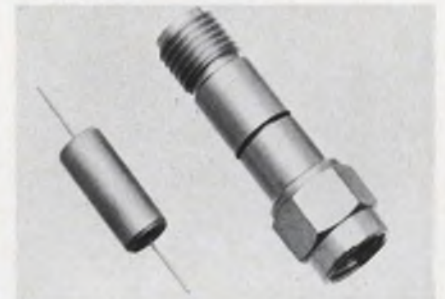

Hewlett Packard, 1501 Page Mill Rd., Palo Alto, Calif. Phone: (415) 326-7000. P&A: \$100 to \$125; stock.

Passive limiters reflect excess microwave power on coax transmission lines. The limiters protect detectors and other sensitive elements by attenuating power at levels above 10 mW. Signals with lower power levels pass with little attenuation. Frequency range of the limiters is 0.4 to 12.4 GHz. Maximum cw power input can be 1 W, derated linearly above 25°C to 0 watts at 150°C. Maximum permitted pulse power input is 75 W for 1- μ s pulses with a 0.001 duty factor. The limiters consist of two silicon pin diodes in parallel between the center and outer conductors of a coax line. The limiters are supplied in two forms. One, type 3701, is a short section of coax line that can be mounted directly into semirigid 0.141-inch OD or 0.188-inch OD coax line by brazing or soldering. The other limiter, type 3711, has miniature 3-mm coaxial connectors.

CIRCLE NO. 434

Insertion loss tester sweeps 0.05 to 12.4 GHz

Weinschel Engineering Co., Inc.,
Clopper Rd., Gaithersburg, Md.
Phone: (301) 948-3434.

With accuracy the same as that of a single-frequency dual-channel system, this swept insertion loss test set has resolution of 0.01 dB up to 20 dB. A single sweep of the components under test provides a permanent record of insertion loss vs frequency over the band. Stability of reference lines is better than 0.01 dB. In application, twenty unknown items having nearly the same value and frequency sensitivity can be readily tested using the same set of reference lines. A choice of insertion loss measurement heads are available in ranges of 0.05 to 2 GHz, 1.7 to 4.2 GHz, 3.7 to 8.2 GHz and 7 to 12.4 GHz.

Booth No. 4606 Circle No. 278

Coherent transponder ups radar resolution



Control Science Corporation, 4810
Beauregard St., Alexandria, Va.
Phone: (703) 354-1500.

For missile or aircraft applications where precise velocity measurements are required, this C-band, pulse coherent transponder is used in conjunction with such radars as the AN/FPS-16, AN/FPQ-6 or AN/TPQ-18 which have been modified for coherent signal processing. The resolution of target velocity can be improved by two orders of magnitude in comparison with conventional transponder tracking. Receiver sensitivity is -65 dBm with the 100-watt peak minimum transmitted response pulse identical in frequency and coherent with the received signal. Frequency is 5.4 GHz to 5.9 GHz.

CIRCLE NO. 435

All the necessary controls and supervisions may be performed by you alone!

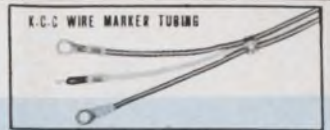

Principles

This switchboard, being equipped with multifarious standardized indications, and with the flow sheet applicable in accordance with the development of the plant construction is capable of constantly supervising all such factors as the working conditions of the generator for the electric circuit, the working conditions of the branching system or an apparatus related thereto, the height and the direction of flows of filled materials in the vessel, and many other operational characteristics as a whole.

It is possible to mutually interchange the standardized constituents. Moreover, the range of indications by means of illumination is quite wide; the Lumiblock diagram is peculiarly well fit for numerous applications in various fields of industries.

In other words Lumiblock may be advantageously used for the purpose of controls of power plants, mining industries, railroads, metallurgy, air fields, chemical plants, water-line pumps, etc.

Methods of Applications.

The switchboard of this company is completely wired within, and is provided with the terminals, by means of which it is coupled with the exterior wirings.

This is an instrument furnished independently, not attached to other implements, or else it is provided by arranging it in the shape of a board and in the form of a table.

These switchboards of this company are favorably received by the the company customers in France, England, Germany, Belgium, Italy, Switzerland and many other countries of the world to their entire satisfaction.

For further details of the company's products, you are welcome to apply for a catalog.

See us at WESCON SROB, Booths 4714-4715

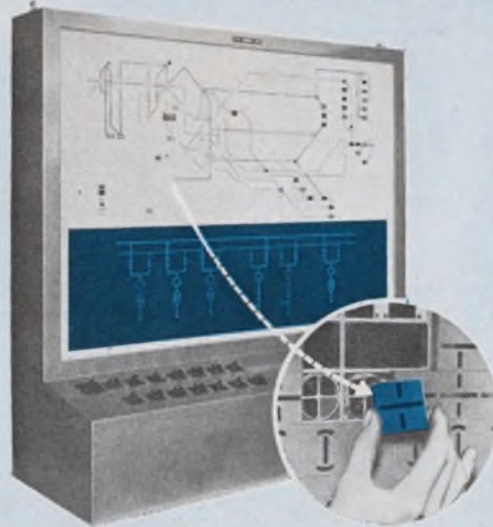

LUMIBLOCK
MOSAIC PANEL

K.C.C. SHOKAI LTD.
Head Office: No. 71, 4-chome, Nada-1-chu, Nada-ku, Kobe, Japan
Tokyo Office: Nanyo Bldg., Hanzonon-cho, Shinjuku-ku, Tokyo, Japan
Lahr: WANKO KUIE, Telephone: Kobe: 87-0271-3 Tokyo: 356-2591
American Liaison Office: 31 Kuruda 1367 33rd Avenue San Francisco
Representative: Western Switch-Board Co., Ltd. San Francisco

ON READER-SERVICE CARD CIRCLE 788



MICRO-MINIATURE COAXIAL RELAY WITH INTEGRAL CONNECTORS - switches up to 75 watts RF

DPDT RF contacts; or SPDT RF contacts with a SPDT auxiliary.

Here's the RF characteristics:

USES FAMILIAR CRYSTAL CAN

An AEMCO first - a micro-miniature coaxial relay offering the convenience of integral connectors. Mate with Microdot ultra-miniature LEPR/CON connectors. Usable cables are RG178 or RG196.

Call or write for brochure today.

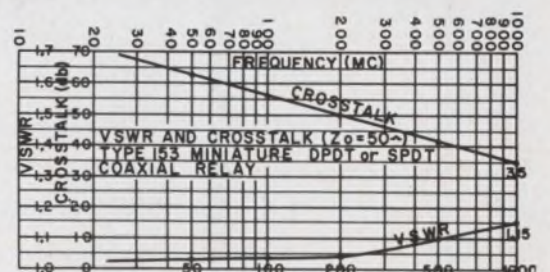

PROTOTYPES AVAILABLE FROM STOCK with 26.5 vdc coils. Other coils and mountings available on special order.

AEMCO DIVISION

MANKATO, MINNESOTA 56001
PHONE A/C 507-388-2985



ON READER-SERVICE CARD CIRCLE 789



**dv/dt 500 volts
per microsecond**

SCR's
manufactured
by
NATIONAL[®]

- ⊕ 12 to 20 microseconds turn-off time available.
- ⊕ 16 amp thru 110 amp.
- ⊕ Immediate delivery.

NATIONAL

*Request
bulletin*

ELECTRONICS, INC.
a varian subsidiary

PHONE: (312) 232-4300 • GENEVA, ILLINOIS 60134

VISIT US AT WESCON BOOTHS 2309-2317
ON READER-SERVICE CARD CIRCLE 790

If you are attending WESCON, and we hope you are, please be sure to pick-up your free copy of Electronic Design's WESCON EXTRA at booth 3622 in the Cow Palace's South Exhibit Hall. The EXTRA contains all the Show news you need to know.

The Editors

SEMICONDUCTORS

Integrated rectifier recovers in 200 ns



Varo, Inc., 2203 Walnut St., Garland, Tex. Phone: (214) 272-3561. P&A: \$5.05 to \$6.85 (100); stock to 3 wks.

Peak reverse voltage ratings of this rectifier are 100, 200 and 400 volts. The full-wave bridge output current is 10 A at 75°C case temperature. The package is 0.75-inch diameter by 0.8-inch high and has a hermetic seal. The circuit is electrically insulated from the base for direct mounting to chassis or heat sink.

Booth No. 5342 Circle No. 371

Power rectifiers use modular design

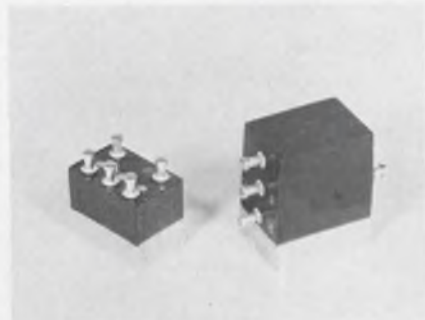

Solitron Devices, Inc., 256 Oak Tree Rd., Tappan, N. Y. Phone: (914) 359-5050.

Mounted on an insulated aluminum heat sink, these rectifiers overcome insulation problems. The rigid metal substrate provides a low thermal resistance path to the heat sink. Units available are a center tap, doubler, single-phase half or full-wave bridges and three phase half or full-wave bridges.

CIRCLE NO. 436

Photodiode detector sees the light

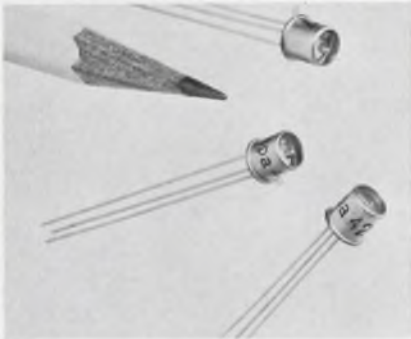

Hewlett Packard, 1501 Page Mill Rd., Palo Alto, Calif. Phone: (415) 326-7000. P&A: \$35 (1 to 9); stock.

When these pin diodes are reverse-biased, usually at 10 volts, changes in illumination intensity modulate the diode current. One of the advantages is the extremely fast response to changes in illumination—less than 1 ns with a 50- Ω load resistance. Dark current is 1 nA at 10 V reverse bias and at 25°C. Typical response is 0.5 $\mu\text{A}/\mu\text{W}$ into 1-M Ω load at a wavelength of 0.77 micron and reverse bias of 10 volts.

CIRCLE NO. 437

Npn switches rated 30 V emitter-to-base



Crystalonics, Div. of Teledyne, 147 Sherman St., Cambridge, Mass. Phone: (617) 499-9156. P&A: \$10.80; stock.

Emitter-to-base voltage of the 2N5066 silicon npn switching transistors is a healthy 30 volts. Offset voltage is 1 mV and saturation voltage is a maximum of 8 Ω . The 2N5066 is a direct complement of the 2N3677 and the pair can be used in high-accuracy ac switching applications.

CIRCLE NO. 438

IT'S HARD TO CONTACT YOU IF YOU DON'T CONTACT US.

It isn't that we don't have a phone or men out beating the bushes. It's just that, if you don't let us know about any electrical contact or sub-assembly problem you might have, we may not find you. And that would be a shame. You'd be depriving yourself of the opportunity of dealing with people who have seen enough contact problems to realize that yours may well be different from all the others. And, people who know what to do about your problem!

Once a solution is reached, it is executed with the finest, most modern, and in many cases, exclusive facilities in our industry. That's another reason it would be a shame not to get in touch with us. Two more are service (and our eager approach to it) and delivery (we break our necks to be prompt). So do us a favor by doing yourself a favor. Next time the subject of contacts comes up, contact Deringer. It's your best bet for quick, economical service.



METALLURGICAL CORPORATION

1250 Town Line Road - Mundelein, Illinois 60060
ON READER-SERVICE CARD CIRCLE 791

You name the meter. Ideal has it.

(or we'll make it for you)

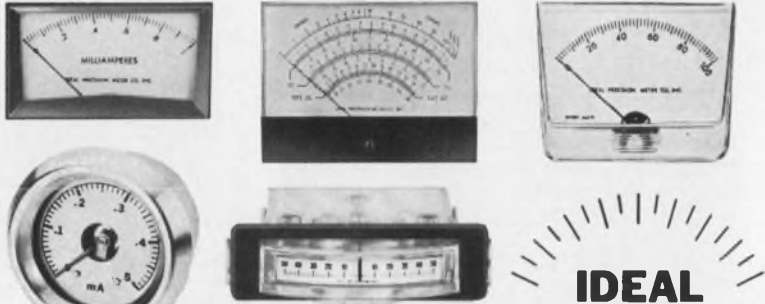

If one concentrates long and hard enough on panel meter development and engineering, one becomes expert.

IDEAL meters are used by all the Military and by leaders in defense and industry. For everything in meters—ruggedized or commercial, custom and stock, 1/2" to 7"—you can count on IDEAL, the proven leader.

Write for free 32-pg. catalog. Ideal Precision Meter Co., Inc., 218 Franklin St., Brooklyn, N.Y. 11222. (212) EVergreen 3-6904.

ON READER-SERVICE CARD CIRCLE 792

ACTIVE FILTERS

TUBE: Plug-in feedback amplifier-network combinations for single-tuned or higher order band pass responses as illustrated. Center frequencies down to 0.005 cycle. Q's to 75. Widely used where LC filter sections are impractical. High pass, low pass and narrow notch response characteristics available.

TRANSISTOR: Integral transistorized amplifier-network units for single-tuned band pass responses. No external components required. Units will cascade for higher order responses. Center frequencies down to 0.01 cycle. Q's to 40. High pass, low pass and narrow notch response characteristics available.

PASSIVE FILTERS

LC FILTERS: Stable toroidal LC's—low, high, band pass and reject over wide impedance ranges in the audio frequency spectrum.

RC TWIN-T NETWORKS: Null frequencies 0.005 cycle to 50 kc in wide range of impedance levels. Useful for low pass filtering, harmonic rejection, feedback circuit.

- STANDARD FILTERS AND NETWORKS HERMETICALLY SEALED
- SPECIAL ENCAPSULATIONS AVAILABLE
- PLUG-IN OR STUDS FOR MOUNTING (OR BOTH)
- EARLY DELIVERIES—MODERATE PRICES
- PROMPT ENGINEERING ON INDIVIDUAL PROBLEMS

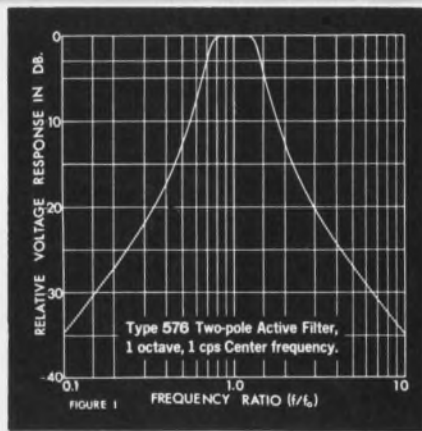

Write for technical bulletins describing filters in the audio spectrum and below, active and passive; Network Notes containing filter selection and application suggestions. Much performance information not yet published available on request. Ask about low-frequency spectrum analyzers.

White
instruments, incorporated

Phone Area 512 892-0752
P. O. Box 698 Austin, Texas 78767

ON READER-SERVICE CARD CIRCLE 793

Application Notes

QUALITY CONTROL CHECK CHART
FOR ALL ELECTRONIC PACKAGES . . . ROUND, SQUARE, ETC.
STRIVE FOR "ZERO-DEFECTS"

18 CHECKS

- 1 Check overall size and all dimensions with drawings
- 2 Check for presence of "ZERO-DEFECTS" TAG
- 3 Check for correct markings
- 4 Check for correct polarity and correct name markings
- 5 Check for correct dimensions and correct markings
- 6 Check for correct dimensions and correct markings
- 7 Check for correct dimensions and correct markings
- 8 Check for correct dimensions and correct markings
- 9 Check for correct dimensions and correct markings
- 10 Check for correct dimensions and correct markings
- 11 Check for correct dimensions and correct markings
- 12 Check for correct dimensions and correct markings
- 13 Check for correct dimensions and correct markings
- 14 Check for correct dimensions and correct markings
- 15 Check for correct dimensions and correct markings
- 16 Check for correct dimensions and correct markings
- 17 Check for correct dimensions and correct markings
- 18 Check for correct dimensions and correct markings

GENERAL DEFECTS CHECK

- 19 Check for correct dimensions and correct markings
- 20 Check for correct dimensions and correct markings
- 21 Check for correct dimensions and correct markings
- 22 Check for correct dimensions and correct markings
- 23 Check for correct dimensions and correct markings
- 24 Check for correct dimensions and correct markings
- 25 Check for correct dimensions and correct markings
- 26 Check for correct dimensions and correct markings
- 27 Check for correct dimensions and correct markings
- 28 Check for correct dimensions and correct markings
- 29 Check for correct dimensions and correct markings
- 30 Check for correct dimensions and correct markings
- 31 Check for correct dimensions and correct markings
- 32 Check for correct dimensions and correct markings
- 33 Check for correct dimensions and correct markings
- 34 Check for correct dimensions and correct markings
- 35 Check for correct dimensions and correct markings
- 36 Check for correct dimensions and correct markings
- 37 Check for correct dimensions and correct markings
- 38 Check for correct dimensions and correct markings
- 39 Check for correct dimensions and correct markings
- 40 Check for correct dimensions and correct markings

RESDEL CORPORATION

Epoxy package checklist

A two-part data sheet and checklist on electronic packages aims at "at-a-glance" quality control. The front of the sheet shows two photomicrographs of cross sections of epoxy tube walls. The reverse side is a thorough checklist which describes the various defects which occur in packages. Resdel Corp.

CIRCLE NO. 441

Switching speed up

This note describes an application of the 2N2580 transistor to a switching circuit with improved decay time, without the use of a despike diode. Delco Radio.

CIRCLE NO. 442

Power amplifier design

Delco's audio power amplifier design exhibits ± 1 dB flatness from 20 Hz to 20 kHz. One application is in a commercial home entertainment system. Schematics and specifications are available in a 4-page guide. Delco Semiconductors.

CIRCLE NO. 443

Integrated DTL circuits

In twelve pages of notes on the Signetics 600 series of integrated DTL circuits, NAND gates and their uses are described. Design considerations are mentioned, and schematics and graphs are given. Signetics Corp.

CIRCLE NO. 444

Design Aids

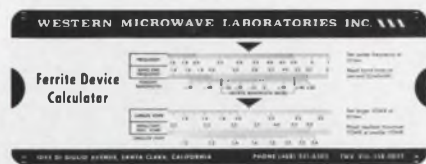

Ferrite device calculator

This pocket-sized calculator aids in the specification of ferrite components. In addition, the calculator is a handy aid to systems designers in solving commonly encountered transmission line problems. The rule gives band limits given center frequency, resultant max VSWR given larger and smaller VSWR and isolation given the VSWR of the terminated port. Western Microwave Labs, Inc.

CIRCLE NO. 445

Mold release chart

Molders of epoxy resins will find helpful information in this chart describing parting agents for castings and laminates. It describes application, surface of the finished part, method of applying, temperature resistance and film thickness. Also included are step-by-step instructions for the preparation of porous and nonporous surfaces prior to casting or lamination. Marblette Corp.

CIRCLE NO. 446

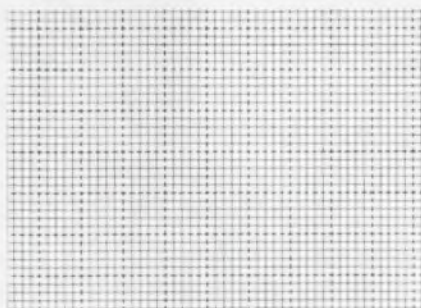

Designer's Mylar grid

Samples of a five-line designer's grid in Mylar are offered. Every fifth line is broken to allow for easier interpretation of dimensions. The grid is accurate to ± 0.001 and is offered in black-line or nonreproducible blue line in a range of sizes. Capitol Reproductions, Inc.

CIRCLE NO. 447

NEED A 3000 VOLT ZENER DIODE?

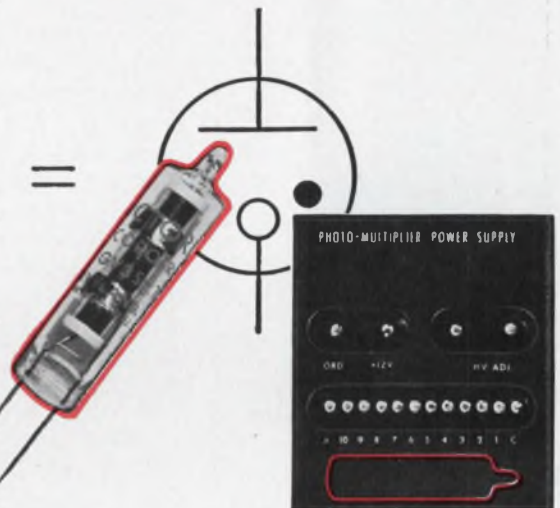
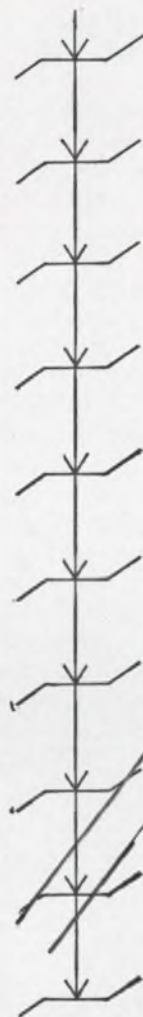

Corotron actual size: Photo-multiplier power supply, showing Corotron location, $\frac{1}{2}$ size.

You could string together several hundred zeners. Or you could specify one Victoreen Corotron. It is the gaseous equivalent of the zener with all the advantages of an *ideal* HV zener diode.

For space research and other rugged applications requiring absolute power supply stability, GV3S Series, shown, provide the ideal reference voltage anywhere in the range of 400 to 3000 volts. They enable circuitry to maintain constant high voltage regardless of battery source voltage or load current variations. Cubage and weight (GV3S Corotron weighs only 4 gm.) are important considerations. So is temperature variation (Corotrons operate from 200°C down to -65°C). Ruggedized versions withstand shock to 2000 G, vibration 10 to 2000 cps.

If you're trying to simplify circuits . . . to cut cost, size and weight . . . to upgrade performance—you need Corotron high voltage regulators. Models are available now from 400 to 30,000 volts. A consultation with our Applications Engineering Dept. will speed up the countdown.

8501-A



VICTOREEN INSTRUMENT DIVISION
10101 WOODLAND AVENUE • CLEVELAND, OHIO 44104
IN EUROPE: GROVE HOUSE, LONDON RD., ISLEWORTH, MIDDLESEX, ENGLAND

ON READER-SERVICE CARD CIRCLE 794

Got a 30 MHz counter headache?



Count on Janus for speedy relief!

If your counter instrument or system designs have been a bit sluggish and out of spec, lately, you may have a 30 MHz Counter Headache! Reach for a Janus UC-300 Series 30 MHz BCD Counter-Display, WITH TTL, and get speedy relief! This Series accepts periodic and aperiodic signals to 30 MHz. Important features: BCD outputs, preset to non-zero numbers, external count control and bright in-line display. Input and output levels are compatible with DTL and TTL integrated circuit logic levels. Also available with latch storage for "blur-free" display and BCD data storage. For slower-speed headaches use Janus 5 MHz Counter-Display Modules.

See your local Janus Representative or write for clinical data.



296 Newton St., Waltham, Mass. 02154
Phone (617) 891-4700

ON READER-SERVICE CARD CIRCLE 795

New Literature

Logic modules manual

A 24-page illustrated booklet, "Logic Modules: Make? Buy?" identifies and analyzes factors management should consider in making decisions. Long and short-range production costs, effects of time loss or gain on competitive position, risk involved with short market life or possible obsoleted performance, and optimum utilization of capital investment (both human and financial resources) are considered. These factors and others are related to each other in the framework of present trends and past experience in the IC logic module field. Charts, graphs and worksheets included in the report are structured so that individual companies can "plug in" pertinent information for analysis. Data Technology Corp.

CIRCLE NO. 448



Components compendium

A reference manual entitled "Essential Characteristics" contains 360 pages of data on receiving tubes, five-star tubes, special-purpose tubes, picture tubes, capacitors, photoconductive cells, photoconductive cell-lamp combinations and reed switches. This single-source reference has been updated and includes 300 receiving and television picture tubes. It is directed at helping technicians, design engineers and hobbyists.

Available for \$2 from General Electric, 2100 Gardiner Lane, Louisville, Ky.

For a complete listing of the technical papers at the show, see page U 112. For reprints of most of the papers, fill out the order form on page U 115.



Electrolytic capacitor guide

A 32-page cross reference covers electrolytic capacitors used in color TV chassis. The listing is intended to aid interchangeability of high-quality electrolytic capacitors. Included in the presentation is a section on printed-circuit replacements by capacity/voltage for single, double, triple and quadruple section units. Cornell-Dubilier Electronics.

CIRCLE NO. 450

Microelectronics manual

A product reference guide of Philco/Ford microelectronic products lists such products as bipolar linear and digital ICs, MOS ICs, epoxy transistors and MOSFETs. The brochure contains instructions for logic diagrams and packaging. Basic parameters are given for all ICs. Additional information is given on LSI, hybrids, microwave components and devices and infrared components. Philco-Ford Corp.

CIRCLE NO. 451

Monolithic subsystems

The second edition of "MOS Monolithic Subsystems: A Revolution in Microelectronics," is an introduction to MOS ICs. Included in the presentation are a historical sketch of the individual MOS transistor, descriptions of the arrays now in production, explanations of the fundamentals of device and circuit operation, circuit advantages and descriptions of the basic digital and analog circuit design techniques developed at Philco-Ford. Philco-Ford Corp.

CIRCLE NO. 452

DTL/TTL modules

Compatibility, interfacing and performance characteristics of DTL and TTL integrated circuit logic modules are discussed in a reference chart. The table lists propagation time, power dissipation (maximum and typical), fan in, fan out, and other operating parameters including interfaces. The 4-page chart folds into an 8-1/2 by 11 booklet for easy notebook filing. Data Technology Corp.

CIRCLE NO. 453

Instrumentation applications

The Spectrum Scanner, published bi-monthly, describes the manufacturers instrumentation and their various applications. Covered in the booklet are emission spectroscopy, atomic absorption spectroscopy, instrumentation for research in the physical sciences and X-ray diffraction. The bulletin is fully illustrated with photos and schematics. Jarrell-Ash Co.

CIRCLE NO. 454

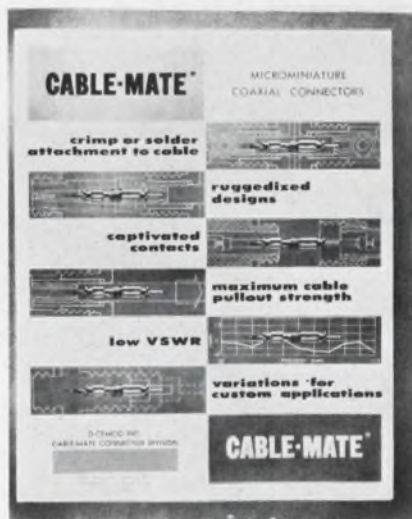

Coax connector catalog

A 32-page volume provides engineering data for standard and custom designed microminiature coaxial connectors, including plugs, jacks, adaptors and PC receptacles. Many of the designs described are interchangeable with other nationally available microminiature, sub-miniature and ultraminiature coax connectors. D-Cemco, Inc.

CIRCLE NO. 455

**This is our 3 step.
Give us a call and see all
the steps in our routine.**

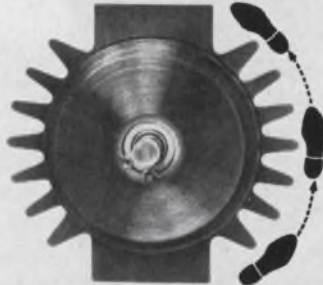

If you really want to swing you can also step 4, 8, 12, 24, 48, and 200 increments without gears.

Or to Indicate, Measure and Control using flag and remote angle indicators, synchros, resolvers, steppers, or solenoids. They are in stock at IMC Magnetics Corp., Western Division. For quick service contact the Applications Section at Western Division, 6058 Walker Ave., Maywood, Calif. 90270. Phone 213 583 4785 or TWX 910 321 3089.

If you need data sheets for references or consideration for future projects, write IMC's Marketing Division at 570 Main Street, Westbury, New York 11591.



ON READER-SERVICE CARD CIRCLE 796

The New Mini Boxer



**dressed or undressed,
fits places too small for the
full-size Boxer fan.**

Small and vigorous. Measures only 3.625 square by 1.5 inches deep, yet the Mini Boxer delivers a lusty 46 cubic feet of air per minute.

Durable. Ball bearing models survive difficult environments for five years and more, due to patented extra-large lube reservoir. Sleeve type Grand Prix (pat. pending) bearings run cool and reliably, offering exceptional life at low cost. Rugged metal frame won't crack under stress like plastic.

Versatile too, in skeleton or venturi version it flips to reverse airflow, mounts easily anywhere. Special skeleton version fits within 3.5-inch square for standard racks.

Available. It's at your nearest distributor.



IMC Magnetics Corp., New Hampshire Division
Route 16B, Rochester, N.H.03867. Tel: (603) 332-5300

ON READER-SERVICE CARD CIRCLE 797



NEW / FROM NORTRONICS



FIRST COMBO HEAD FOR 8-TRACK STEREO

MODEL Z-B2L

ELIMINATES: ASSEMBLY TOLERANCE, TRACK ALIGNMENT AND PRESSURE PAD PROBLEMS

This new Nortronics Z-Combo head — a major engineering accomplishment — reduces the spacing between erase and playback gaps from the conventional .250" to an extremely small .050"!

Because of the close tolerances required in 8-track stereo, the conventional gap-to-gap spacing creates serious problems.

A 1° azimuth correction of the R/P gap in conventional combo heads creates a vertical displacement of .004" of the erase gap. As a result, the erase gap may incompletely erase the proper tracks and at the same time erase unwanted material on adjacent tracks. With the Nortronics Z-Combo heads, the equivalent displacement is less than .001".

The new head also permits simplified circuitry in the recorder, since it features internal automatic biasing.

The new Z-Combo head displays the quality, engineering, ingenuity, and responsiveness to every recording need that have made Nortronics the world's largest manufacturer of laminated core tape heads and the standard-setter for the industry.

Complete technical data is available on request.

Nortronics
COMPANY, INC.

8101 Tenth Avenue North
Minneapolis, Minnesota 55427

NEW LITERATURE

Relay contamination

The paper that won first prize at the 1967 NARM (National Association of Relay Manufacturers) Conference is offered in reprint form. It describes contact resistance as the principal parameter for determining the reliability of relay operation and applies this concept directly to the influencing and affecting internal and external causes of instabilities. The paper describes the various sources of contamination and their alleviation. Part of the report focuses on the residual gas analyzer, a device which permits the relay manufacturer to locate and localize the sources of residual gas within the relay package for removal. Another section discusses intermediate contact life which describes some of the relays which exhibit high and erratic contact resistance only after a period of service life. The 14-page paper is illustrated with photos, graphs and schematics. Filtors, Inc.

CIRCLE NO. 456

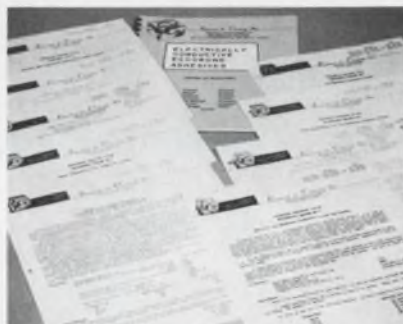

Conductive adhesives

A new brochure describes in detail the use and performance characteristics of electrically conductive adhesives, and coatings. Their volume resistivity varies from 0.0002 to 50 Ω -cm. One-part systems requiring elevated temperature curves are described, as well as two-part room temperature curing systems. Emerson & Cuming, Inc., Dielectric Materials Div.

CIRCLE NO. 457

For a complete listing of the technical papers at the show, see page U 112. For reprints of most of the papers, fill out the order form on page U 115.

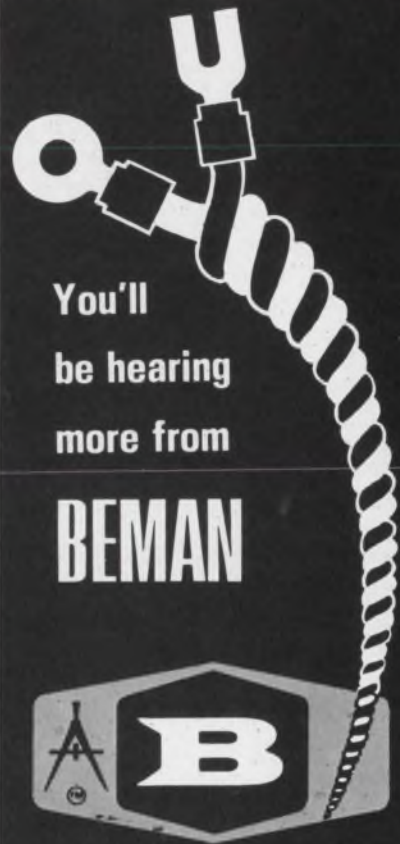

You'll
be hearing
more from

BEMAN

Already there is much favorable comment regarding this alert and aggressive company, a vigorous offspring of our dynamic electronic age, founded in 1961. Industry leaders are entrusting Beman with important assignments in cable and termination manufacture, custom molding and die stamping, and various types of electrical and mechanical assembly work. There is also a growing demand for the creative capabilities displayed by Beman's versatile designers and engineers. A modern, new engineering facility is strategically located in Harrisburg, a few miles from the main plant.

QUALITY, DEPENDABILITY, INGENUITY

Whether asked to follow iron-clad specifications, or to work from scratch on an outline of new requirements, Beman is vitally aware of its responsibilities. Research and development talents are applied to a customer's project with the same all-out effort that is put into one of Beman's own original products. Perhaps your company can benefit from the specialized training and experience which are carrying Beman forward. An illustrated brochure just off the press will be mailed on request. Beman is able ... and ready ... to serve you.



BEMAN MFG., INC.

P. O. Box 370 New Cumberland, Pa., 17070

Phone: (717) 774-0210

ON READER-SERVICE CARD CIRCLE 805

Rf instrumentation

Jerrold's new short form catalog gives capsule information on their line of rf test equipment, including sweep systems. Also included is detailed information on amplifiers, measurement comparators, marker generators, precision attenuators, tuned rf voltmeters, and general-purpose test sets. Accessory equipment in the form of detectors, bridges, matching pads and rotary coaxial transfer switches is also included. Jerrold Electronics Corp.

CIRCLE NO. 458

Solder-plated wire

A technical information bulletin covers tin and solder-plated wire and ribbon. The brochure describes wires capable of being plated, the range of plating thickness, the types of baths available, spooling sizes and the ability of plated wire to retain its uniformity after curing. It shows how to analyze the thickness, continuity, solderability and the tin lead ratio of solder-plated copper. Sylvania Products Inc.

CIRCLE NO. 459

Core wire optimization

"How to Determine Optimum Wire Sizes" is a two-page data sheet which describes a graphic technique to determine the optimum wire size for a given ferrite core. Electronic Memories, Inc.

CIRCLE NO. 462

Trimmer cap selection

A 4-page brochure, "Eighteen Things to Look For in Precision Trimmer Capacitors" shows pictorially how the internal construction of precision trimmers affects their performance. It shows how typical trimmers are made, how rotating and non-rotating piston designs work. It demonstrates how linearity, Q, rf current capacity, life and self-resonance are affected by the internal mechanism. The bulletin graphically indicates the differences in resolution, seal integrity, size and performance under vibration. Voltronics, Inc.

CIRCLE NO. 460

a calibrated AC voltage standard/source



The EDC Model AC 200 has been especially designed for simplicity of operation and intended as a "work horse" standard for laboratory, production line, or field applications. It is a calibrator for meters, VOMs, VTVMs and DVMs. Circuit designers can use this Precision AC Source in the development and evaluation of amplifiers, converters, filters, rectifiers, regulators, demodulators, transformers, and inductors, even at low impedances. It is also a stable power source for servo applications. The Model AC 200 sells for \$2490, F.O.B., Boston.

Other features of the **Model AC 200** include:

Readout: 6 decimal digits in true RMS volts	Frequency: audio frequency range
Output Voltages: 10 mV to 211.110 volts AC RMS	Frequency Stability: 0.1% 8 hrs.
Resolution: 1 mV	Size: 19" x 7" x 13 ³ / ₄ "
Voltage Accuracy: ±0.2% of setting, traceable to NBS	Weight: 35 lbs.
Voltage Stability: ±.01% 8 hrs.	Power Output: 50 VA
Overload Protection: automatic trip, push-button reset	Also DC Standards from 1 μ V to 1100 Vdc.

For further information please write or call



ELECTRONIC DEVELOPMENT CORPORATION

423 West Broadway, Boston, Massachusetts 02127 Tel: (617) 268-9696

ELECTRO-MAG LO-HI FREQUENCY SHIELD

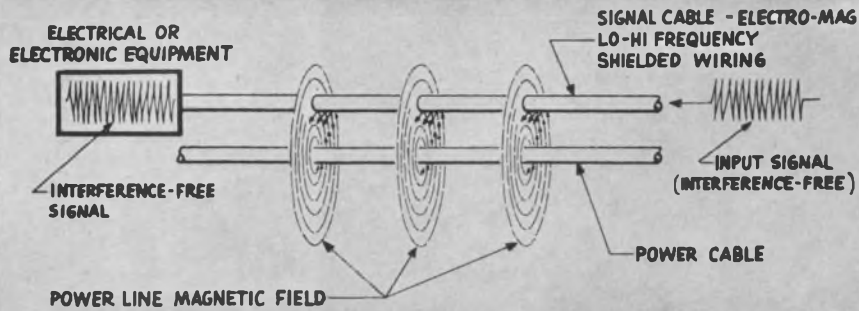

A new method of attenuating electro magnetic interference over an extremely wide frequency range 60 CPS to 10 KMC. Can be applied over power cable and assemblies to reduce noise. Write for literature and test report.



Manufacturers of Electronic wire, cable, cable assemblies and custom products.

B&B

ELECTRONICS CORP.

17360 S. Gramercy Place, Gardena, California
SEE US AT BOOTH 1522

ON READER-SERVICE CARD CIRCLE 800

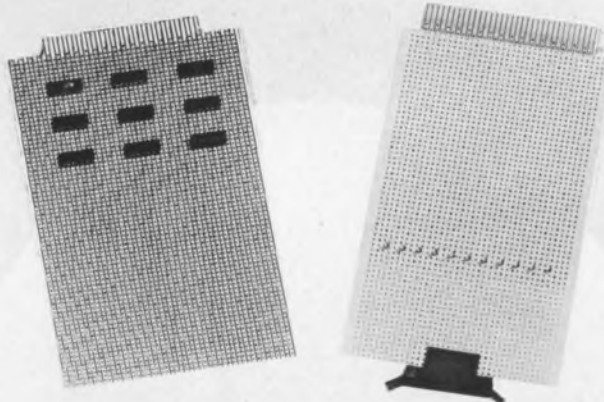

VEROBOARD* AND VERO "FINGER BOARD" NOW OFFER TOTAL FLEXIBILITY FOR ALL PROTOTYPE AND PRODUCTION REQUIREMENTS

FEATURES INCLUDE:

VEROBOARD*

Hole Patterns — .050 x .050,
.1 x .1, .150 x .150, .156 x .1,
.2 x .2, .2 x .1
Over 200 Standard Sizes —
Single and Double Sided x-y
pattern
Material—XXXP and FR-4 Epoxy
Glass.
*Patented

VERO "FINGER BOARDS"

Hole Patterns—.1 x .1, .052 dia.
Material— $\frac{1}{16}$ Epoxy Glass, FR-4.
Connector Fingers — 22 x .156,
44 x .156, 16 x .1, 32 x .1

OFF THE SHELF IN SIZES TO
FIT ALL CARD FILE SYSTEMS

VERO

VERO ELECTRONICS INC.

176 Central Avenue, Farmingdale, New York 11703
Tel. 516 MY 4-6550 TWX 510-224-6425

ON READER-SERVICE CARD CIRCLE 801

NEW LITERATURE

Reliability evaluation

A 67-page booklet describing methods for evaluating contractor reliability programs describes the key factors which make a reliability assurance program effective. It gives specific criteria for evaluating each of fourteen reliability program areas. The description of criteria for evaluating each reliability task is directed toward fundamentals and should be of use to contractors and subcontractors in aerospace and other industries which employ reliability assurance programs.

Available for \$3 (NASA SP-6501) from Clearinghouse, Springfield, Va. 22151.

Radar standards

Minimum performance standards for airborne weather and ground mapping pulsed radar are set forth in this report by the Radio Technical Commission for Aeronautics. The recommended standards were coordinated internationally with the European Organization for Civil Aviation Electronics and an RTCA group. The 40-page document, RTCA DO-134, meets the international standardization needs of users and manufacturers of airborne electronic equipment.

Available for \$2.50 from RTCA Secretariat, 2000 K Street, N. W., Washington, D. C.

For a complete listing of the technical papers at the show, see page U 112. For reprints of most of the papers, fill out the order form on page U 115.

Reprints Available

The following reprints are available free and in limited quantities. To obtain single copies, circle the number of the article you want on the Reader-Service card.

Solid state competes with lasers
(No. 490)

Maintainability specs bothering you? (No. 491)

Suppress harmonics at the source
(No. 492)

Don't pay too much for stability
(No. 493)

Advertising Representatives

New York 10022
 Robert W. Gascoigne
 Thomas P. Barth
 Samuel M. Deitch
 Byron Adams
 850 Third Avenue
 (212) PLaza 1-5530
 TWX: 867-7866

Philadelphia
 William C. Repetto
 P. O. Box 206
 Merion Station, Pa. 19066
 (215) MO 4-1073

Boston
 Richard Parker
 7 Redstone Lane
 Marblehead, Mass. 01945
 (617) 742-0252

Chicago 60611
 Thomas P. Kavooras
 Berry Conner, Jr.
 720 N. Michigan
 (312) 337-0588

Cleveland
 (216) 247-7670

Los Angeles 90303
 Stanley I. Ehrenclou
 Terrence D. Buckley
 W. James Bischof
 2930 W. Imperial Highway
 Inglewood, Calif.
 (213) 757-0183

San Francisco
 Ashley P. Hartman
 175 South San Antonio Rd.
 Ste. 243
 Los Altos, Calif. 94022
 (415) 941-3084

Southwestern 75206
 Tommy L. Wilson
 6200 North Central Express-
 way
 Dallas, Tex.
 (214) EMerson 1-2311

London W. 1
 Brayton C. Nichols
 44 Conduit Street

Verviers, Belgium
 Andre Jamar
 1, Rue Mallar, 1
 (087) 253.85

Tokyo
 Yoshihiro Takemura
 International Planning
 Service, Inc.
 Room 231 Tokyu-Mita Bldg.
 1, Shiba-Mita Koun-cho
 Minato-ku, Tokyo



VACTEC

announces a new line of

VACTROL Lamp-Cell Controls

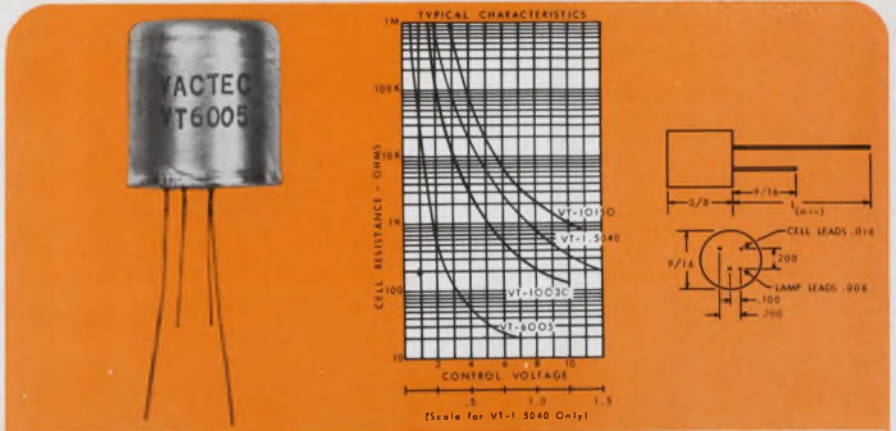

Now 1.5v, 6v, and two 10-volt Vactrols are available for electronic amplifier applications. Combines a dependable Vactec photocell with the proper long-life incandescent lamp in a complete low-cost module. Provides noiseless, trouble-free volume and

tone control for TV, radio, guitars, organs, and other musical instruments. Unit is protected by an epoxy sealed metal enclosure. Leads are spaced on .100" centers for circuit board mounting. Special characteristic designs available for unique applications. Write for Vactrol Bulletin PDC-4C 1.



VACTEC, INC.

2423 Northline Ind. Blvd. • Maryland Hts., Mo. 63042 • AC 314.432-4200

See Vactec's listing in EBG under "Semi-Conductors," and in EEM, Sec. 3700.

ON READER-SERVICE CARD CIRCLE 802

New high efficiency, high frequency Photochopper Modules

- High stability from -25 to +75C, efficiency varies less than 5% over temperature range
- 50% efficiency at 1000 Hz
- Internal electrostatic shielding
- CdS cells for fast warm up

Write for new Bulletin 201/ITD3-67

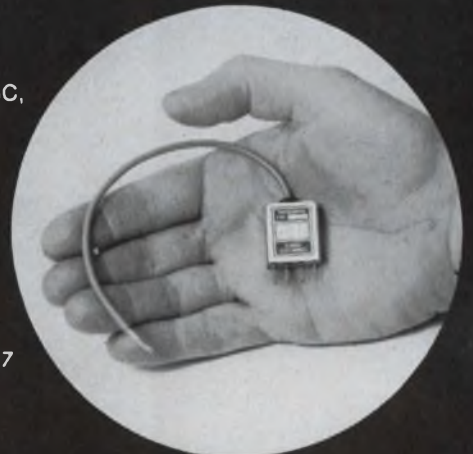

CLAIRES ELECTRONICS, INC. ■ 1239 BROADWAY, NEW YORK, N.Y. 10001

ON READER-SERVICE CARD CIRCLE 803

Advertisers' Index

Advertiser	Page	Advertiser	Page	Advertiser	Page
ACI Division of Kent Corporation	301	Erie Technological Products, Inc.	21	Nortronics Company, Inc.	320
AMP, Incorporated	56, 57	Executone, Inc.	304	PEK	308
Adams & Westlake Company, The	U161	Fairchild Instrumentation,		Pamotor, Inc.	U200
Ad-Yu Electronics, Inc.	U178	A Division of Fairchild Camera and		Pastoriza Electronics, Inc.	46
Aemco Division, Midtek Corporation	313	Instrument Corporation	19	Perfection Mica Company	298
Airways Rent-A-Car	U206	Fairchild Semiconductor,		Phelps Dodge Electronic Products	70
Aladdin Electronics	U167	A Division Fairchild Camera and		Philbrick, A Teledyne Corporation	U195
Allen-Bradley Co.	U112 A-B	Instrument Corporation	34, 35	Philco-Ford	
Allied Chemical, Plastic Div.	53	Fluke Mfg. Co., Inc. John	U144	Corporation	U129, U131, U133, U135
Altronic Research Corp.	273	Frequency Electronics, Inc.	273	Polarad Electronic Instruments, Polarad	
American Lava Corporation	45	Gardner-Denver Company	U94, U95	Electronics Corporation	U139
Amersil, Inc.	U191	General Electric Company	28	Potter & Brumfield Division of	
Ametek, Inc. Lamb Electronic Division	299	General Instrument Corporation	U106, U107	American Machine & Foundry	
Ampex Electronic Corporation	U171	General Precision, Kearfott Products		Company	U119
Ampelton Corporation, RF Division	38, 39	Division	U150	Princeton Applied Research Corp.	16
Anadex Instruments, Inc.	U168	General Radio Corporation	U157	RBM Controls Division	253
Arnold Engineering Company, The	U175	Genisco Technology Corporation	263	RCA Electronic Components and Devices	
Art Wire and Stamping Co.	U176	Gentape Corporation	294	U141, U142, U143, Cover IV	
Austron, Inc.	300	Globe Industries, Division of TRW, Inc.	277	Radiation, Incorporated	4, 5
Automatic Electric, A Subsidiary of		Grayhill, Inc.	273	R-dio Cores, Inc.	312
General Telephone & Electronics	U185	Gudebrod Bros. Silk Co., Inc.	40	Raytheon Company, Components	
Automatic Metal Products Corporation	U130	Guardian Electric Manufacturing		Division	234, 235
B & B Electronics Corp.	322	Company	U179	Raytheon Company, Computer	258
Barry Instrument Corporation	326	Hammel Riglander & Co. Inc.	326	Raytheon Company, Semiconductor	
Bausch & Lomb Electronics Division	U169	Hayden Publishing Company, Inc.	U201, 325	Division	U163
Beckman Instruments, Inc.	71	Heinemann Electric Company	241	Redcor Corporation	U168 A-B
Beman Mfg. Inc.	320	Hewlett-Packard		Reeves Hoffman Division of DCA	U206
Belden Manufacturing Company	60, 61	1, 8, 9, 27, U149, U155, Cover III		Scanbe Manufacturing Corp.	U202
Bell Telephone Laboratories	259	Honeywell Test Instrument Division,		Schweber Electronics	327
Bendix Corporation, The Scientific		U146, U147		Scientific Data Systems, Inc.	49
Instruments Division	251	Hudson Tool & Die Company, Inc.	U173	Secon Metals Corporation	302
Boonton Electronics Corp.	U134	Hughes Aircraft-Company, Electronic		Siemens America, Incorporated	U158
Borden Chemical Co., The Mystic Tape		Dynamics Division	U154	Signetics Integrated Circuits, A	
Division	15	IBM Industrial Products Marketing	64, 65	Subsidiary of Corning Glass Works	U187
Bourns, Inc.	78, 271	IMC Magnetics Corporation	319	Simpson Electric Company	31
Branson Corp.	U184	ITT Cannon Electric, A division of		Sippican Corporation, The	306
Bulova, Electronics Division of Bulova		International Telephone and Telegraph		Soshin Electric Co., Ltd.	269
Watch Company	U196	Corp.	U162	Specific Products	58
Bundy Electronics Corporation	U194	ITT Semiconductors, A Division of		Spectrol Electronics Corporation	249
Bunker Ramo Corporation, The	U156	International Telephone and Telegraph		Sprague Electric Company	10, 12
Burndy Corporation	67	Corporation	328	Suprel Division, Globe Industries, TRW,	
Burr-Brown Research Corporation	262	Ideal Precision Meter Co. Inc.	316	Inc.	269
By-Buk Company	327	Industrial Electronic Engineers, Inc.	80	Switchcraft, Inc.	U203
CTS Corporation	41	Industro Transistor Corporation	U189	Sylvania Electric Products, Inc.,	
Cambridge Thermionic Corporation	U132	Ingersoll Products, Division of Borg		Semiconductors-Components	43
Century Electronics & Instruments, Inc.	51	Warner Corporation	54	TRW, Inc., Capacitor Division	Cover II
Centralab, the Electronics Division of		International Electronic Research		Technical Information Corp.	U166
Globe-Union, Inc.	U123	Corporation	77	Technical Wire Products, Inc.	277
Chassis-Trak Inc.	U160	International Rectifier	267	Tektronix, Inc., Oscilloscopes	218
Clairex Electronics, Inc.	323	International Wire Corporation	311	Texas Instruments Incorporated,	
Clifton, Division of Litton Industries	U151	JFD Electronics Co./Components		Semiconductors- Components	
Cohu Electronics, Inc.	55	Division	293	Division	222, 223
Comar Electric Company	U207	Janitrol Aero Division	297	Texscan Corporation	62
Components, Inc.	309	Janus Control Division	318	Thomas & Skinner, Inc.	U164
Computer Measurements Company	2	Johanson Manufacturing Corp.	U172	Topaz Transformer Products, Inc.	U186
Consolidated ElectroDynamics, A		Johnson Company, E. F.	U182	Trio Laboratories, Inc.	50
Subsidiary of Bell & Howell	7	K.K.C. Shokai Ltd.	313	Triplet Electrical Instrument Company	U177
Consolidated Vacuum Corporation	25	Keithley Instruments	33	Tung-Sol Division, Wagner Electric	
Control Data Corporation	305	Kennedy Co.	U174	Corporation	48
Cornell-Dubilier Electronics	U152 A-B	Kester Solder Company	U86, U87	Ulano	257
Crystal Optics	269	Kidde & Company, Inc. Walter	U165	Union Carbide Corporation	U137
Curtis Development & Mfg. Co.	U208	Krohn-Hite Corporation	U153	United Aircraft Corporation, Norden	
Cutler-Hammer	U105	L & R Manufacturing Company	U198	Division	76, 290
Damon Engineering, Inc.	22	Lambda Electronics Corp.	217	United Aircraft Corporation, Vector	
Datex Corporation	307	Lear Siegler Inc.	U190, U191	Division	314
Dearborn Electronics, Inc.	74	Licon, Division Illinois Tool Works, Inc.	47	U.S. Components, Inc.	63
Delco Radio, Division of General Motors	U126, U127	Line Electric Company	U170	Vactec Inc.	323
Deringer Metallurgical Corp.	315	McCoy Electronics Company	240	Vero Electronics, Incorporated	322
Dialight Corporation	248	McLean Engineering Laboratories	32	Victor Comptometer Corporation	U209
Digital Sensors, Inc.	U140	Mac Panel Company	245	Victoreen Instrument Company, The	317
Dow Corning Corporation	68, 69	Measurements, A McGraw-Edison		Waldom Electronics, Inc.	277
Dynage, Inc.	326	Division	U188	Western Microwave Laboratories, Inc.	59
ESI/Electro Scientific Industries, Inc.	U193	Michigan Chemical Corporation	52	Weston Instruments, Inc.	265
Eagle Signal, A Division E. W. Bliss		MicroSwitch, A Division of Honeywell	6	White Instrument, Incorporated	316
Company	U145	Microsonics, Inc.	310	Zeltex, Inc.	U205
Eastern Industries, A Division of		Monsanto	U117	Career Advertising	
Laboratory for Electronics, Inc.	295	Mosaic Fabrications, Inc.	U197	Automatic Electric Laboratories	278
Eastman Chemical Products, Inc.	U204	Motorola Semiconductor Products, Inc.		Boeing Company, The	282
Electro-Motive Mfg. Co., Inc., The	75	U125, U159		Conductron-Missouri	285
Electronic Controls, Incorporated	U199	NJE Corporation	U183	Delco Radio, Division, of General	
Electronic Development Corporation	321	Narda Microwave Corporation, The	275	Motors	287
Electronic Research Associates, Inc.	U124	Natel Engineering Co., Inc.	252	Lockheed-California Company	284
Electronized Chemicals Corporation	261	National Electronics, Inc.	314	Lockheed Missiles & Space Company	289
Electrovert, Inc.	U186	National Semiconductor		Marathon Electric Mfg. Corp.	278
Ellis and Watts Company	296	Corporation	U110, U111	San Francisco Bay Naval Shipyard	283
Emporium Specialties, Inc.	U208	Nexus Research Laboratory, Inc.	U181	Sylvania Electronic Systems	281
Ericsson Centrum, Inc.	U138	Non-Linear Systems, Inc.	72, 73		

Want to benefit from a Hayden Happening?

Attend the Hayden "Write-In" at Wescon!

It's for engineers who want practical advice on how to write a technical article.

It's for engineers who have written articles and want them evaluated.

It's for engineers who have ideas for technical articles and want to discuss them with editors.

It's for engineers who have ideas (or even a completed manuscript) for a technical book and want a publisher's reaction.

It's for engineers who would like to meet editors over coffee and danish to discuss the benefits of writing for publication.

It's at the North Continental Parlor 7 of San Francisco's Hilton. Please feel free to drop in anytime between 8 A.M. and 10 A.M., Tuesday, Wednesday, Thursday or Friday.



Hayden Publishing Co., Inc.
Publishers of Electronic Design and
MicroWaves magazines...Hayden,
Ahrens and Rider books.

Electronic Design

ELECTRONIC DESIGN's function is:

- To aid progress in the electronics manufacturing industry by promoting good design.
- To give the electronic design engineer concepts and ideas that make his job easier and more productive.
- To provide a central source of timely electronics information.
- To promote two-way communication between manufacturer and engineer.

Want a subscription? ELECTRONIC DESIGN is sent free to qualified engineers and engineering managers doing design work, supervising design or setting standards in the United States and Western Europe. For a free subscription, use the postfree application form inside the back cover. If none is included, write to us direct for an application form.

If you do not qualify, you may take out a paid subscription for \$25 a year in the U.S.A., \$35 a year elsewhere. Single copies are \$1.50 each.

If you change your address, send us an old mailing label and your new address; there is generally a prepaid postcard for this inside the back cover. You will have to requalify to continue receiving ELECTRONIC DESIGN free.

We strive for accuracy, but despite our strenuous efforts, an occasional error does slip through. Whenever this occurs and it comes to our attention, we publish a prompt correction. Corrections appear at the end of the Letters column.

Microfilm copies are available of complete issues of ELECTRONIC DESIGN and of individual articles published since the beginning of 1961. Complete issues cost 4¢ a page, articles cost 50¢ a page; shipping and handling charges are extra. The minimum charge is \$3. For further details and to place orders, contact University Microfilms, Inc., 300 N. Zeeb Road, Ann Arbor, Mich. 48106; telephone (313) 761-4700.

Want to contact us? If you have any comments or wish to submit a manuscript or article outline, address your correspondence to:

Howard Bierman, Editor,
ELECTRONIC DESIGN,
850 Third Avenue,
New York, N.Y. 10022.

Your New Electronics Hand Tool Catalog



The finest Peer Swiss made tweezers for all micro-miniature work. 42 different patterns in all alloys. SWEDISH PLIERS that feature the "Box Joint" construction by Lindstrom, for all your precision work.

CUTTING TWEEZERS, NIPPERS AND SCISSORS for special wire cutting problems in different areas.

Many other useful tools.

Write today—for your Catalog 167.

Hammel, Riglander & Co., Inc.

P. O. Box 222
New York, N. Y. 10014

174

Here's the new Barry Springboard!

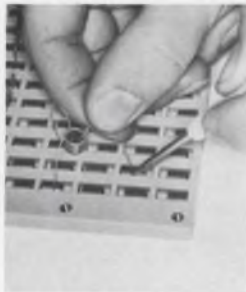

In fact, the Barry Springboard provides positive connections for 1080 leads—without soldering! The versatility of a Barry Springboard offers 120 springs which are individually pocketed, and each spring accommodates up to nine leads. Barry Springboards can be linked or bracketed to provide a limitless variety of circuits. Circuits are easily assembled, rearranged, optimized, and disassembled. The Springboards are reusable over years of service. For quick, economical, and positive circuits, please contact:

Barry Instrument Corporation

P.O. Box 252
Los Alamitos, California 90720
(213) 430-4913

175

Total System Power Supply Capability



Dynage manufactures three different standard styles of equipment. The voltage references and standards are packaged for circuit board and chassis mounting. The low current power supplies (Dynage "D" series up to 1.0 amperes) are packaged for chassis mounting in Mil-T-27A cans. The highest current power supplies (H series up to 60 amperes) are racked type modules.

The advantages to the Dynage approach are repairability, service, cost, delivery, (72 hours on standard D & H series power supplies), flexible packaging, color coordination and an extremely wide selection of voltages and currents.

Dynage, Inc.

1331 Blue Hills Avenue
Bloomfield, Connecticut 06002

176

Manufacturers

Advertisements of booklets, brochures, catalogs and data sheets. To order use Reader-ServiceCard.
(Advertisement)

Schweber's Guide To RCA

Schweber

Semiconductors



Guide to RCA
Semiconductor
Products

This is a product guide to RCA semiconductors and integrated circuits. It is intended for use as a handy quick-reference handbook to facilitate selection of RCA products. A table of contents lists the major categories of devices: AF, RF, Switching, Rectifiers, Thyristors, Photocells, Integrated Circuits. The unique feature of this guide is the arrangement of the significant ratings and characteristics of all devices into uniform data charts supported by a numerical index for easy location of desired chart. Circle number below for your copy—hot off the press—published August 1967.

Schweber Electronics

Westbury, New York 11590
516/334-7474

177

New "Tape Lift" Printed Circuit Drafting

Aids



No engineer or draftsman should be without the most up-to-date cross-reference guide to better Printed Circuit Drafting Catalog. It is complete with prices and illustrations of over 1200 sizes of "Tape Lift" pads, shapes and other aids for faster, more accurate, distortion-free printed circuit master drawings. Write for FREE catalog.

By-Buk Company

4326 West Pico Blvd., Los Angeles, Calif. 90019
Telephone: (213) 937-3511

178

Engineers' Relay Handbook



A definitive work that is fast becoming a standard reference text for the relay user. Prepared and edited by the National Association of Relay Manufacturers, this book is a complete guide to the principles, properties, performance characteristics, application requirements, specifications, and testing of relays. Systems and product engineers will find the Handbook an indispensable help in determining the correct types of relays for their applications. For further information about this unique sourcebook, write Dept. ED.

Hayden Book Co., Inc.

116 W. 14th Street
New York, N. Y. 10011

179

Designer's Datebook

AUGUST						
S	M	T	W	T	F	S
		1	2	3	4	5
6	7	8	9	10	11	12
13	14	15	16	17	18	19
20	21	22	23	24	25	26
27	28	29	30	31		

SEPTEMBER						
S	M	T	W	T	F	S
					1	2
3	4	5	6	7	8	9
10	11	12	13	14	15	16
17	18	19	20	21	22	23
24	25	26	27	28	29	30

For further information on meetings, use Reader Service card.

Aug. 28-30

Technical Conference on Electronic Materials (New York City) Sponsor: AIME; L. R. Weisberg, Electronic Materials Committee, The Metallurgical Society of AIME, 345 E. 47 St., New York, N. Y. 10017

CIRCLE NO. 494

Aug. 29-31

Association for Computing Machinery Conference (Washington, D. C.) Sponsor: ACM; M. J. Healy, c/o Association for Computing Machinery, Box 6, Annandale, Va. 22003

CIRCLE NO. 495

Sept. 6-8

IEEE Computer Conference (Chicago) Sponsor: IEEE; S. S. Yau, Northwestern University, Dept. of Electrical Engineering, Evanston, Ill. 60201

CIRCLE NO. 496

Sept. 11-14

ISA Conference and Exhibit (Chicago) Sponsor: ISA; Instrument Society of America, 530 William Penn Place, Pittsburgh, Penn. 15219

CIRCLE NO. 497

Sept. 11-16

International Congress on Magnetism (Cambridge, Mass.) Sponsor: American Institute of Physics; Dr. J. S. Smart, Secretary, 1967 ICM, IBM Watson Research Center, Yorktown Heights, N. Y. 10598

CIRCLE NO. 498

Sept. 21-22

Microelectronics Applications Symposium (Garden City, N. Y.) Sponsor: IEEE; L. I. Kent, Executive Secretary, c/o Airborne Instruments Laboratory, Commack Road, Deer Park, N. Y. 11729

CIRCLE NO. 499



24 x ACTUAL SIZE

Order ITT 4-layer diodes— they're big for simplifying oscillator, protective and switching circuits

An ITT 4-layer diode stays "off" until the voltage across it reaches a specified level. Then it switches "on" in nanoseconds and remains so until current through it falls below a specified minimum. Because gating components are eliminated, the device is ideal when circuit simplification is the goal. You can specify it in glass DO-7 or top hat packages, with firing voltages from 20 to 100.

For application notes that will help you simplify your own circuits, as well as specification sheets and prices, use the coupon at right. ITT Semiconductors is a division of International Telephone and Telegraph Corporation, 3301 Electronics Way, West Palm Beach, Florida.

ITT SEMICONDUCTORS
3301 Electronics Way, West Palm Beach, Fla.

NAME _____

TITLE _____ COMPANY _____

ADDRESS _____

CITY _____ STATE _____ ZIP _____

ON READER-SERVICE CARD CIRCLE 804

semiconductors **ITT**

FACTORIES IN WEST PALM BEACH, FLORIDA • PALO ALTO, CALIFORNIA • LAWRENCE, MASSACHUSETTS • ENGLAND • GERMANY • PORTUGAL • AUSTRALIA



new disciplines in DC



take the models that MEMORIZE YOUR VOLTAGE SETTING

0.01% resettability featured in 8 precision-regulated all-silicon supplies

Set the five front panel dials to any desired voltage; output will be within 0.1% of setting. Change to another setting. Later, return to the first setting—output voltage will be within 0.01% \pm 200 μ V of original value, in spite of any changes (within rating) of line voltage and load current, ambient temperature changes up to 3°C, and elapsed time up to 8 hours.

All eight highly-stable STB Series instruments have performance at least an order of magnitude better than well-regulated laboratory supplies. Typical specs include: Regulation, Load or Line, 0.001%; Ripple and Noise 40 μ V RMS; **Controlled Environment Stability, 0.0005% \pm 10 μ V for eight hours** (constant load, line, and ambient temperature).

Can be used as a precision general purpose bench supply, as a portable DC reference or calibrator with high output current capability, as an adjustable reference or master supply for systems applications. Model 6110A also serves as an exceptionally stable photomultiplier supply.

All models except 6110A have Remote Programming, Remote Sensing, and four-position Multiple Range Meter Switch which sets full scale voltmeter and ammeter values at either 100% or 10% of nominal output rating.

Short-Circuit-Proof • Continuously Variable Current Limit Control
No Overshoot on Turn-On, Turn-Off, or AC Power Removal • Floating Output,
Ground Either Positive or Negative Terminal • Rack Mounting Hardware Available.

Contact your nearest Hewlett-Packard Sales Office for full specifications.

100 Locust Ave., Berkeley Heights, New Jersey 07922

Telephone 201-464-1234 TWX 710-984-7972

ON READER-SERVICE CARD CIRCLE 243

5-DIGIT FRONT PANEL DECADE CONTROL 5¼" H, Half Rack Width		
DC OUTPUT	MODEL	PRICE
0 - 10V, 0 - 2A	6113A	\$375.
0 - 20V, 0 - 1A	6111A	375.
0 - 40V, 0 - 500MA	6112A	375.
0 - 100V, 0 - 200MA	6116A	375.
0 - 3000V, 0 - 6MA	6110A	495.

10-TURN FRONT PANEL OUTPUT CONTROL 3½" H, Half Rack Width		
DC OUTPUT	MODEL	PRICE
0 - 20V, 0 - 1A	6101A	\$265.
0 - 40V, 0 - 500MA	6102A	265.
0 - 100V, 0 - 200MA	6106A	265.



POWER SUPPLIES

The "non-plastic" plastic transistors



So reliable you'd think they were hermetic

We're big enough to realize that with any plastic transistor, you're bound to have questions concerning reliability.

So...long before RCA announced this family of "Hometaxial-Base" silicon power plastic devices (10 transistors with ratings of 36W or 83W), our reliability engineers devised a most rigorous new-product testing program. RCA

subjected hundreds of units to stresses beyond device ratings and the results are so impressive that, frankly, you'd think the transistors were hermetic.

We thought it would be appropriate for you to see our reliability manager's comment on the tests to date.

Here's what he had to say: "...sure we've had failures to our end points. But take a close look at them. Out of 376 units totalling 410,000 device hours at 175°C (versus an actual transistor rating of 150°C) only 3 failed. There were 2 failures from 119 units subjected to 25 temperature cycles of -65°C to 175°C (device rating is 5 cycles of -65°C to 150°C). In all, our actual unit hours on all life tests, including storage, operating, and reverse bias, total over 1,600,000 with a failure rate of 1.7% per 1,000 hours. And if you adjust for the fact that all these tests were essentially at over-stress conditions, the result is an estimated failure rate of less than 0.1% per 1,000 hours."

Why not evaluate the facts behind RCA's "non-plastic" plastic transistors yourself? We documented all of the details in a no-nonsense brochure (HBT-600A) which we'll be glad to send you. Just write RCA Commercial Engineering, Section IG8-3, Harrison, N.J. 07029, or see your local RCA representative.

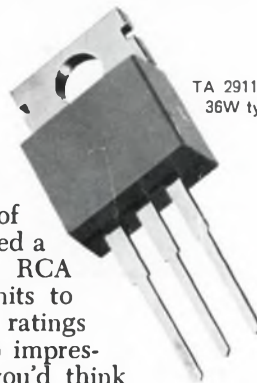

TA 2911
36W type for printed-circuit boards

TA 7155
36W type for TO-66 sockets



2N 5035
83W type for printed-circuit boards



2N 5034
83W type for TO-3 sockets

On Reader Service Card Circle 108

RCA Electronic Components and Devices



The Most Trusted Name in Electronics

See us at WESCON, Booths 3701-05, 3718-22