

Electronic Design 16

VOL. 15 NO.

FOR ENGINEERS AND ENGINEERING MANAGERS

AUG. 2, 1967

Digital computers go 'on stream,' signaling the wide acceptance of direct digital control—DDC—by a variety of industries—chemicals, steel, cement, power and others.

As system complexity goes up, the price of the computer itself is overshadowed by the cost of "software." For what this means to design engineers, see p. 17.

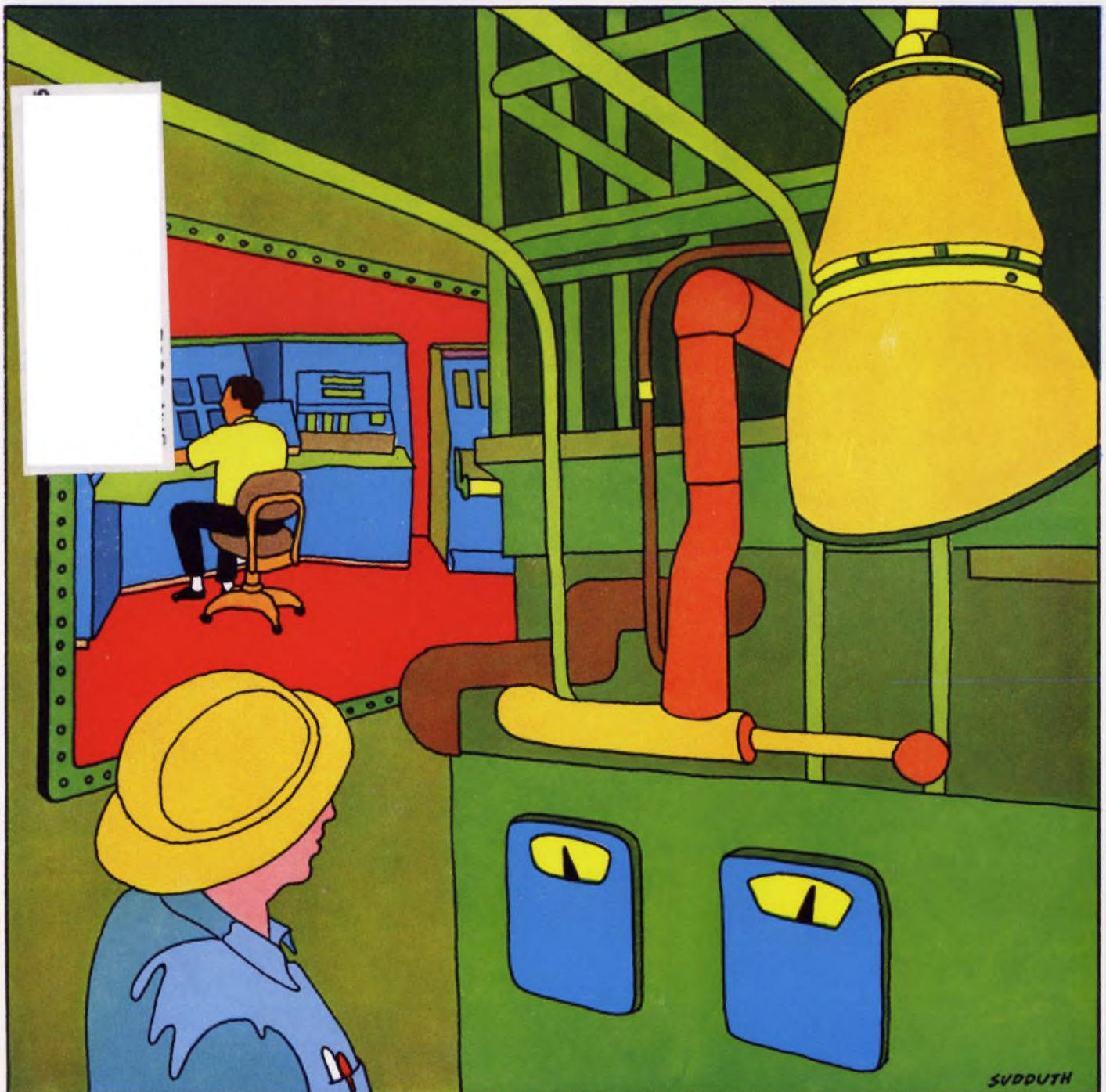

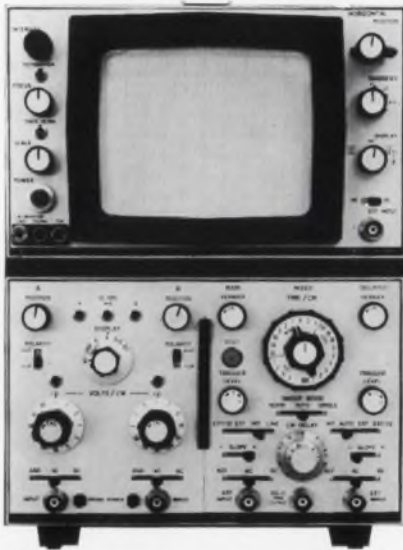

hp 180A Oscilloscope

RUGGED

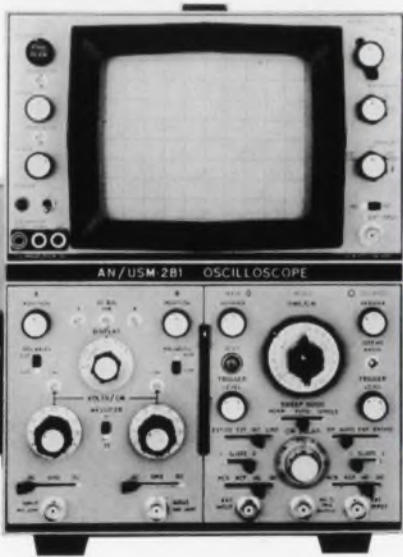

hp 180E Military Version Oscilloscope

RUGGEDest

Our grammar may not be correct . . . but the description is!

The standard hp 180A Oscilloscope is a RUGGED scope. Take its environmental specs, for example. The 180A scope with plug-ins operates in temperatures from -28 to +65°C—and at altitudes to 15,000 feet. It operates in a steamy 95% relative humidity up to 40°C. It operates after being vibrated in three planes for 15 minutes each with 0.010" excursion from 10 to 55 Hz. It's rugged enough to take rough treatment in field trucks—and rugged enough to take being banged around your laboratory . . . without affecting electrical performance!

Take the already rugged 180A, further ruggedize its step-ahead circuitry and wrap it in a splash-proof case. The result is the "RUGGEDEST" scope—the 180E (AN/USM-281, FSN 6625-053-3112) Military Version Oscilloscope. In fact, it is the *ruggedest scope in the world!*

We battered the 180E with a 400-pound hammer. We subjected it to spray. We checked it for RFI. We steamed it in 95% humidity at temperatures up to 65°C while operating. Some of

the other significant military specifications met by the 180E are listed in the table. It met these specifications—and our own exacting electrical specifications—with no ifs, buts or maybes—NO COMPROMISE!

If you're looking for a 50 MHz, 30-pound, solid-state, plug-in scope with a large easy-to-read 8 x 10 cm CRT, 7 nsec rise time and 5 mV/cm sensitivity get the rugged hp 180A. If you're working in extreme environments, get the "ruggedest"—the hp 180E Oscilloscope!

Ask your hp field engineer for the data sheet on the 180A and for the 180E data sheet which gives test results and a cross reference to military specifications, plus full electrical specifications. Or, write to Hewlett-Packard, Palo Alto, California 94304. Europe: 54 Route des Acacias, Geneva.

Price: For the hp 180A Oscilloscope, \$825; hp 180AR (rack mount), \$900; hp 1801A Dual Channel Amplifier, \$650; hp 1820A Time Base, \$475; hp 1821A Time Base and Delay Generator, \$800. For the hp 180E Oscilloscope, \$1215; hp 180ER (rack mount), \$1205; hp 1801E, \$800; hp 1820E, \$570; hp 1821E, \$920, hp 10164A Accessory Kit and Front Cover, \$165; hp 180E Military Oscilloscope System (AN/USM-281, FSN 6625-053-3112), \$3100.

	MIL-E-16400F Class 2 & 4	MIL-E-4158C outdoor equipment	MIL-E-4158C indoor equipment	MIL-E-4970A PROC III	MIL-F-18870C Class 4	MIL-S-8512B PROC 3
Temp. oper.	●	*	●	●	●	●
Altitude oper.	▲	●	●	●	●	●
Humidity	●	●	●	●	●	●
Shock	●	▲	▲	●	●	●
RFI	●	●	●	▲	▲	●
● Passed *Not tested ▲ Indicates test not required						

087/29

HEWLETT  PACKARD

OSCILLOSCOPE SYSTEMS



RF OUTPUT
 $Z_0 = 50 \text{ OHMS}$

1026 STANDARD-SIGNAL GENERATOR
GENERAL RADIO COMPANY
CONCORD MASSACHUSETTS USA
SERIAL 100

RF output: 1/2 watt

We've used an ordinary pilot lamp to prove a point: Our new Type 1026 Standard-Signal Generator puts out lots of power — $\frac{1}{2}$ watt into 50 ohms, 10 volts behind 50 ohms (5 volts when modulated). It also puts out as little as 0.1 μV and anything in between these limits.

The 1026 also has true single-dial tuning over its entire 9.5- to 500-MHz frequency range. There is no output trimmer control to adjust every time you change frequency. Output of the 1026 is *automatically* leveled; you can change frequency within a range or even switch ranges and maintain output level within ± 0.2 dB to 110 MHz and within ± 0.5 dB to 500 MHz. The carrier is leveled whether modulated or unmodulated. Amplitude modulation up to 95% can be imposed on the carrier from an internal, highly stable 1-kHz oscillator or from an external audio source. There are also provisions for external modulation to 1.5 MHz and for pulse modulation.

Other specifications are as much as an order of magnitude better than those of

any other signal generator you can buy. For example, envelope distortion is less than 1% for 1-kHz, 50% modulation; incidental fm accompanying this a-m is less than 1 ppm, peak; residual fm is less than 0.05 ppm, peak; residual a-m is at least 70 dB below carrier level in CW, internal 1 kHz, and external audio modes.

This instrument is made to order for a-m receiver testing, and its high-level output makes it most suitable for antenna-pattern and impedance measurements, receiver overload and cross-modulation tests, and measurements of large insertion losses. The ease of operation and outstanding performance of the 1026 in the most critical applications must be experienced to be appreciated.

For complete information or a demonstration of the 1026, write General Radio Company, W. Concord, Massachusetts 01781; telephone (617) 369-4400; TWX (710) 347-1051.

ON READER-SERVICE CARD CIRCLE 3

GENERAL RADIO



Type 1026 Standard-Signal Generator, \$6500 in U. S. A.



king me!

Outwit Your Data Simulation Problems

Crown the Datapulse Model 201 16-Bit Data Generator with a pulse generator and solve your data simulation problems economically.

For only \$680.00, the 201 provides these superior features: 16-bit cycle lengths, bit rates to 10 MHz (from an external clock), NRZ outputs to 10V, variable baseline offset to $\pm 10V$, and continuous or command recycle.

To king the 201 simply add a Datapulse 101 Pulse Generator — \$395.00 — or any other async-gated pulse generator with the output characteristics you need.* The result: a system capable of producing variable parameter RZ formats — ideal for a host of simulation tests on components, circuitry, memory elements, or data transmission links — the perfect programmer for developing time related sequential signals to command systems operations.

Interconnect several 201's for longer serial words or additional parallel channels. Then set up programs for core testing, drive any gate array from zero to +10V, produce true complimentary outputs to drive adders, etc.

There's one more thing about the 201. It's small. Two units can be mounted in just 3½ inches of rack panel height.

If the 201 doesn't solve all your data simulation problems, pick up a copy of our catalog! We offer more off-the-shelf digital test instrumentation than any other manufacturer in the world, so if you don't have our catalog, do something about it!

Your move!

*Datapulse Model 111 for ultra-fast linear rise times; Datapulse Model 108 for 50V outputs; Datapulse Model 110A for fully controllable fast pulses, etc.



SEE THEM ALL AT WESCON, BOOTHS 2719-21



Datapulse Incorporated — A Subsidiary of Systron Donner Corporation, 10150 West Jefferson Blvd., Culver City, California 90230. Telephone: (213) 836-6100, 871-0410. TWX: 910-340-6766. CABLE: Datapulse • Microwave Division: DeMornay-Bonardi.

NEWS

- 13 News Scope
- 17 **DDC is prospering despite \$500,000 prices**
Third-generation computers spur applications and cut programing.
- 22 **There's solid-state pressure on transducers**
Mass-produced semiconductors may displace most electromechanical devices.
- 29 Washington Report
- 33 Airborne system forms instant maps.
- 36 Satellite to film Earth's profile in color TV.
- 40 Letters
- 51 **Editorial: Who says technical parleys must be a waste of time?**

TECHNOLOGY

- 54 **Evaluate operational-amplifier errors** using standard manufacturers' data, an actual op-amp model, and a few simple equations.
- 60 **Zener diodes are not enough** when the heat is really on in a voltage regulator. Try checking loop gain and other figures of merit.
- 66 **Here's a dc-to-pulse-width converter** that's simple to put together, allows zero offset control, and stays linear over an 80°C swing.
- 72 **Core buffer sizes are defined rapidly** with this simple nomograph which also specifies magnetic-tape record separation.
- 76 **Pit your engineering management skill** against these actual problem situations. Then find out what the "men on the spot" did.
- 86 Ideas for Design

PRODUCTS

- 98 **Components:** Lighted pushbutton switches ease mounting and maintenance.
- 102 **Semiconductors:** Epoxy encapsulant replaces photoamplifier can and lens.
- 108 Plastic-encapsulated FET reaches 400 MHz with 10-dB gain.
- 110 **Microelectronics:** Dual monolithic op amp: one header is better than two.
- 114 **Test Equipment:** Take your eye off the needle: panel meters go digital.
- 124 Materials
- 126 Microwaves
- 130 Systems
- 132 Production Equipment

Departments

- 82 Book Reviews
- 134 Application Notes
- 136 New Literature
- 140 Advertisers' Index
- 142 About the Magazine
- 143 Designer's Datebook

Cheap son-

That's the LM 201. Our new, low priced Op Amp designed as a limited temperature range replacement for the 709.

It was Bob Dugan who discovered the market for this one. He said that you could really use a 101 type Op Amp with a 0° to 70° range. If, of course, it sold for much, much less than the LM 101. It does. And the pin configuration's the same as the 709, so no need to change PC boards. The minimum 15,000 voltage gain can be compensated by only one 30 pF capacitor. The $\pm 30V$ differential input range

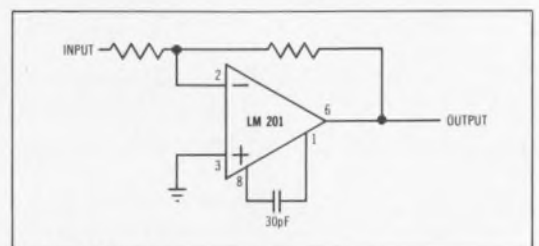

INVERTING AMPLIFIER

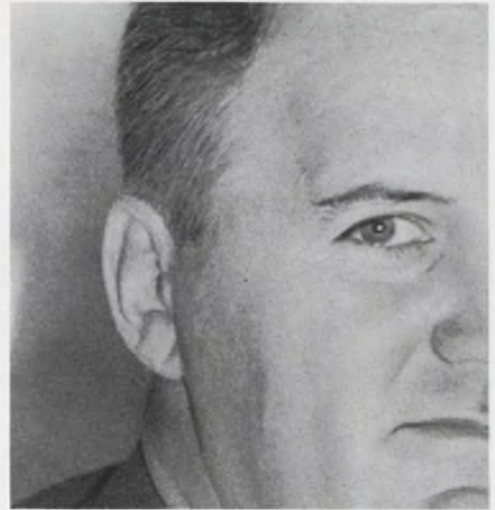

Cheap son-of-a-101 market discoverer, Dugan.

of-a-101

reduces your chance of burnout from overload. It also has a class-B output — with continuous short-circuit protection — giving at least a $\pm 10V$ output swing with a $2K\Omega$ load. And, operation's specified from $\pm 5V$ to $\pm 20V$, with power dissipation less than 100 mW at $\pm 20V$ supplies.

Sound familiar?

In spite of the low price, we'll also guarantee: 7.5mV offset voltage, 500 nA offset current and a $\pm 12V$ common mode range.

Ready? So are our distributors. They're delivering 1-24 at \$13.10; 25-99 at \$10.50 and 100-999 at \$8.80. That's National Semiconductor Corporation, 2090 San Ysidro Way, Santa Clara, California 95051 (408) 245-4320.

National Semiconductor

ON READER-SERVICE CARD CIRCLE 5

RCL OFFERS "OFF-THE-SHELF" SHIPMENTS! 1/2" ROTARY SWITCHES

INDUSTRY'S BEST DELIVERY

Up to 12 positions per deck . . . up to 6 poles per deck . . . shorting and non-shorting poles can be grouped in any combination on one deck . . . individual deck parts self-contained and permanently molded into place. Extremely low and uniform contact resistance: $.004\Omega$ average. Life expectancy: 200,000 mechanical operations.

RCL

Write for complete engineering information

ELECTRONICS, INC.

General Sales Office: 700 So. 21st St., Irvington, New Jersey 07111



Available With:

- ..Adjustable Stops
- ..Coned Terminals
for critical space
requirements.

Pat. Pend.

This CKR capacitor's price is right.

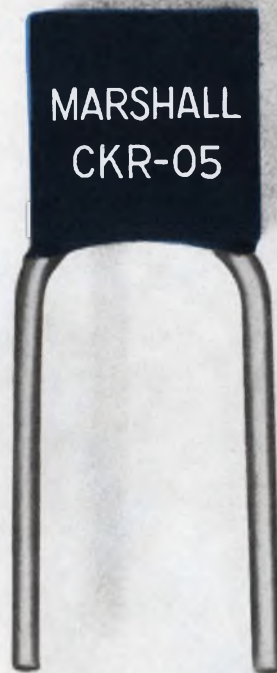

it's free.

We'd like to give you a free CKR ceramic capacitor. No strings attached. After you temperature-cycle it, drop-test it, and generally mistreat it, we don't think you'll let any other capacitor near your circuitry.

Marshall set out about two years ago to make the industry's finest ceramic capacitor. We think we've succeeded. Here's why: First, we developed a unique proprietary process that virtually eliminates the pin-holes that may occur in competitive devices. And this process provides a dielectric with an amazing density for its thinness.

But we didn't stop there. We made the dielectric strength of our material so high that it withstands four times the rated voltage. (That's well beyond existing test and operat-

ing requirements.) This superior dielectric also means Marshall capacitors do not require de-rating.

Programs like Apollo and Minuteman III demand extraordinary performance and reliability. That's why they specify Marshall capacitors.

This may be the one time you'll ever get something for nothing. Go ahead, take advantage of us.

For your free ceramic capacitor, circle inquiry no. 248.

MARSHALL INDUSTRIES



CAPACITOR DIVISION

formerly Electron Products

1960 Walker Ave., Monrovia, Calif. 91016

Take the line of least resistance



Now there's a line of hermetically sealed connectors that can significantly reduce the circuit resistance build-up normally associated with hermetically sealed inter-connections.

The line is the Deutsch HP Series. And its unique feature is the result of a brand new type of contact, designed to lower electrical impedance to a minimum.

In applications where a low milli-volt drop is required, it's a good line to take.

Unique compression glass inserts, molded into the connector shells, with the contacts fused right in, give true hermetic sealing against extreme environmental conditions. This new group of Deutsch receptacles is interchangeable with existing receptacles. It incorporates the ruggedness, precision and reliability you expect from all Deutsch hermetics.

Contacts are available in sizes #22, #20 and #16. Receptacles come in a wide variety of shell sizes and styles to mate with Deutsch push-pull or bayonet coupling plugs, in miniature and subminiature configurations. Layouts meet MIL-C-26482.

Call your local Deutschman and tell him your needs for hermetically sealed connectors with low resistance contacts.

It's your line of least resistance.

For an HP Series brochure, write to Deutsch, Electronic Components Division, Municipal Airport, Banning, California.

 **DEUTSCH**

LOW RESISTANCE HERMETICALLY SEALED CONNECTORS

you get a choice,

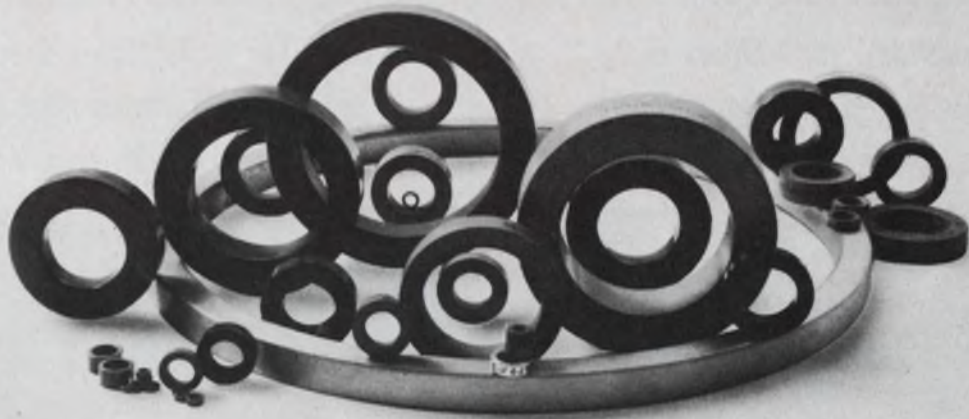

not a challenge



Most complete line of high quality tape wound cores available from any manufacturer

Magnetics' selection of tape wound cores encompasses eight material types, in a range of sizes from 0.050" to 12" inside diameter. For frequencies from DC through 500 kc, materials are produced in thicknesses ranging from 1/8 mil through 14 mils. All core sizes are available boxed in phenolic or plastic, aluminum or GVB- coated

aluminum. Magnesil[™], less sensitive to external stresses, is also available unboxed or epoxy encapsulated.

In addition to offering this broad range of tape wound cores, Magnetics has improved its production of raw materials, using the most advanced testing devices to control quality in metals, winding, annealing, potting compounds, boxing processes and the application of encapsulating

materials. This across-the-board control assures you of getting what you pay for in performance.

If you have an application for tape wound cores, why settle for an approximation of your specifications? With Magnetics, you don't have to "make do"—you get a choice, not a challenge. For further information on our complete line of tape wound cores, write for Catalog TWC-300, Magnetics Inc., Butler, Pennsylvania 16001



New from Sprague!

This Resistor has 5 Times the Resistance of a Conventional Metal-Film Resistor of Equal Size!

This Resistor is 21 Times Smaller than a Conventional Metal-Film Resistor with Equal Resistance Value!

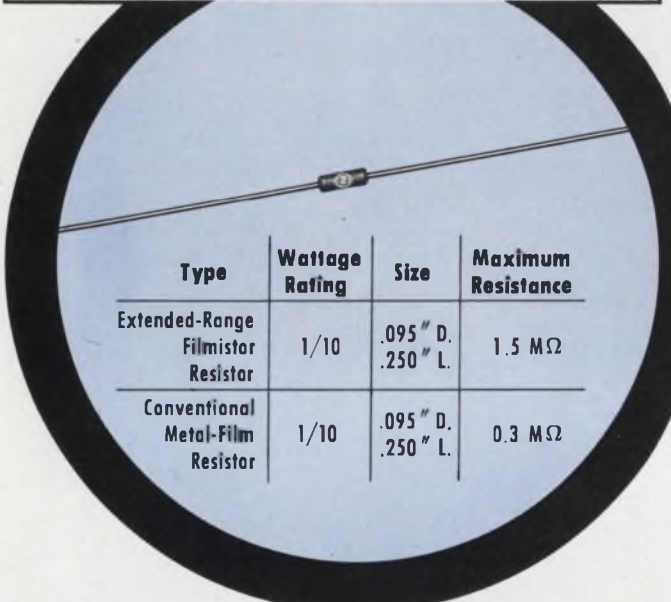

Type	Wattage Rating	Size	Maximum Resistance
Extended-Range Filmistor Resistor	1/10	.095" D. .250" L.	1.5 MΩ
Conventional Metal-Film Resistor	1/10	.095" D. .250" L.	0.3 MΩ

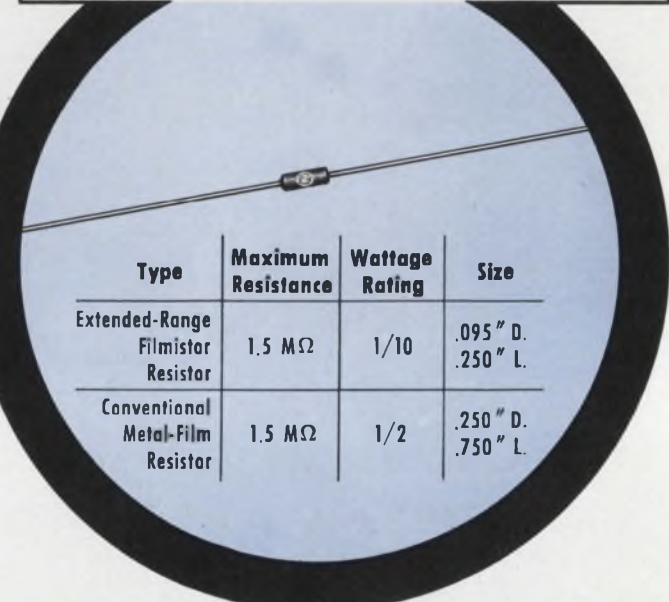

Type	Maximum Resistance	Wattage Rating	Size
Extended-Range Filmistor Resistor	1.5 MΩ	1/10	.095" D. .250" L.
Conventional Metal-Film Resistor	1.5 MΩ	1/2	.250" D. .750" L.

Both Resistors are one and the same...they're Sprague's new **EXTENDED-RANGE FILMISTOR® METAL-FILM RESISTORS**

Substantial saving of space in all wattage ratings—1/20, 1/10, 1/8, 1/4, 1/2, and 1 watt—with absolutely NO SACRIFICE IN STABILITY!

New manufacturing techniques at Sprague Electric have made possible a major breakthrough in resistance limits for metal-film resistors. Extended-Range Filmistor Resistors now offer, in addition to accuracy . . . stability . . . reliability . . . extended resistance values in size reductions which were previously unobtainable. Size and weight advantages of Filmistor Resistors now make them the ideal selection for applications in high-impedance circuits, field-effect

transistor circuits, etc., where space is at a premium. Many designs which previously had to settle for the higher temperature coefficients of carbon-film resistors in order to obtain required resistance values can now utilize the low and controlled temperature coefficients of Filmistor Metal-Film Resistors.

Other key features are $\pm 1\%$ standard resistance tolerance, low inherent noise level, negligible voltage coefficient of resistance, and tough molded case for protection against mechanical damage and humidity.

For complete technical data, write for Engineering Bulletin 7025C to Technical Literature Service, Sprague Electric Company, 347 Marshall Street, North Adams, Massachusetts 01248.

SPRAGUE COMPONENTS

RESISTORS
CAPACITORS
TRANSISTORS
THIN-FILM MICROCIRCUITS
INTEGRATED MICROCIRCUITS

PULSE TRANSFORMERS
INTERFERENCE FILTERS
PULSE-FORMING NETWORKS
TOROIDAL INDUCTORS
ELECTRIC WAVE FILTERS

CERAMIC-BASE PRINTED NETWORKS
PACKAGED COMPONENT ASSEMBLIES
BOBBIN and TAPE WOUND MAGNETIC CORES
SILICON RECTIFIER GATE CONTROLS
FUNCTIONAL DIGITAL CIRCUITS



'Sprague' and '®' are registered trademarks of the Sprague Electric Co.

News



Direct digital control (DDC) is taking over in many big plants like this oil refinery. Page 17



Mass-produced solid-state transducers likely to oust most electromechanical units. Page 22

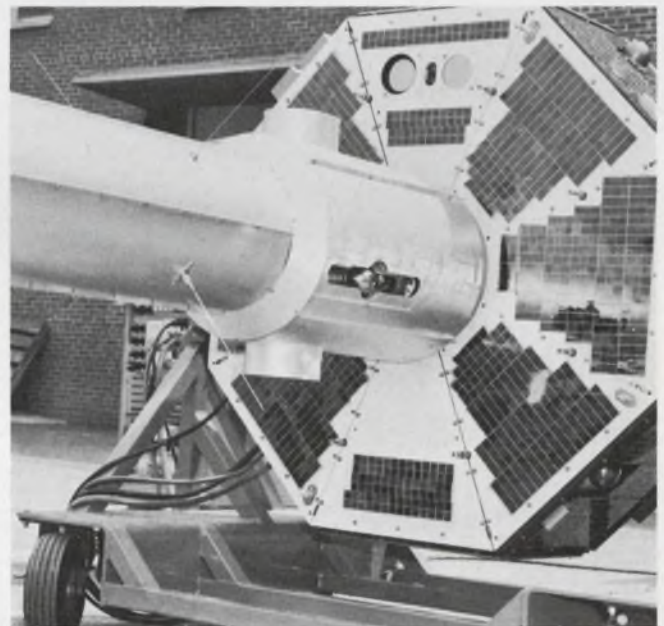

Dodge satellite about to transmit first color TV pictures of Earth from outer space. Page 36

Also in this section:

In-flight recorder drafts instant, permanent maps. Page 33

News Scope, Page 13. . . Washington Report, Page 29. . . Editorial, Page 51

Bendix LJT Connectors— first and only to be fully scoop-proof.



No mismating, damaged pins or short circuits.

The Scoop Test is a pretty tough test to give a connector. To pass, you can't damage or short the pins, no matter how much you misalign the plug and receptacle during mating.

Bendix® LJT Connectors *pass* the Scoop Test—and scoop the rest. And it doesn't matter if the pins are in the plug or the receptacle! Because all contacts are totally recessed. They're stronger, too. And mismating is a thing

of the past. Five-key polarization assures it.

But that's not half the story. Hard, glass fiber-filled epoxy inserts improve electrical and thermal characteristics, are impenetrable by pins and probes. Plug shells are provided with grounding fingers for EMR and RFI shielding. Safer, too, because the shell is grounded before contacts engage. Insert assemblies are staked and bonded for a sturdy

moisture-proof seal. You can specify shell sizes from 9 to 25. Get from 3 to 67 contacts in 16, 20 and 22M sizes, with solder terminations. Select flange mount, line mount, straight plug, jam nut or hermetic types. All built as rugged as you can find.

Write today for complete information on our LJT connectors. The Bendix Corporation, Electrical Components Division, Sidney, New York 13838.

Bendix  **Electronics**

DOD to put teeth into RIF program

The Defense Dept.'s concern with radio interference has prompted it to put out a sweeping directive, aimed at parceling the responsibility for solving the problem squarely among the military services and the Joint Chiefs of Staff.

The objective is to ensure that the military forces are equipped with electronics that have radio compatibility "designed in."

At a conference in Washington D.C., officials of the Defense Dept. and the military services explained the electromagnetic compatibility program.

The speakers at the meeting indicated that the electromagnetic interference problem was increasing with time, despite long-standing official concern. The military services are receiving ever-increasing quantities of electronic equipment, all of it making new demands on available frequencies.

There were references to numerous problems in the field and to makeshift solutions. Often, the conference was told, some equipment must be shut down before other units can be used, thus endangering the success of operations.

While design guides for equipment and knowledge of local frequency assignments is a necessity, such information alone has proved ineffective. Design construction and test responsibility must be fixed as part of component and system procurement. And tests must be performed in actual or realistically simulated environments.

At present contract specifications aim to do this, but they are uncoordinated and often not enforced by contracting officers.

The conference speakers recognized that all the regulations would be worthless, unless they were enforced and backed up by a bank of

useful engineering data.

Edgar G. Shelor, assistant director of communication and electronics in the Defense Dept.'s Office of Defense Research and Engineering, told the conference that the Electromagnetic Compatibility Analysis Center, in existence since 1960, would now concentrate more on the solution of real design problems and less on analyzing electromagnetic environments.

He said that the center, jointly supported by the military services, was established to analyze electromagnetic compatibility situations and complement the efforts of the services in solving their own unique problems. The change in emphasis was brought about, he said by the seriousness of the problems encountered.

"We must consider electromagnetic equipment and systems rather than waiting to find problems during service test or even worse, after deployment," Shelor stated. Fixing problems at that point is usually expensive, time delaying and often less than fully satisfactory," the official added.

Explorer 35 reports on Moon's environment

Information vital to the safety of the first United States Moon-landing astronauts may be gathered from the flight of a small satellite in the Explorer series.

The second Anchored Interplanetary Monitoring (AIM) satellite was launched on July 19 into an orbit around the Moon. It will collect data and report back continuously on the Earth's interplanetary wake.

Designated the Explorer 35, it was captured by the Moon's weak gravitational field in interplanetary

space three days after launching.

The satellite weighs 148 pounds and packed an 82-pound retro motor to slow down so that it could be captured in lunar orbit. The spent motor casing was jettisoned two hours after it burned out.

Instrumentation aboard the craft will measure characteristics of interplanetary dust distribution, solar and galactic cosmic rays and the magnetohydrodynamic wake of the earth.

Among the radiation experiments on the satellite are an energetic-particle-flux experiment, an electron and proton experiment and a plasma probe.

Two magnetometer experiments of different design will measure the interplanetary magnetic field. Engineering experiments will determine the effects of interplanetary radiation on solar cells and monitor contamination accumulated on the thermal coatings and surfaces of the spacecraft.

An earlier AIM failed to achieve the proper, anchored Moon orbit after launching last year but is nevertheless returning valuable data as it crosses through the Moon's wake.

Westinghouse's Aerospace Div. in Baltimore built the integrated spacecraft system for NASA's Goddard Space Flight Center, Greenbelt, Md., the project manager.

Meanwhile, NASA scientists are trying to determine the exact fate of Surveyor 4 launched a week earlier. About three minutes before the spacecraft was to reach the Moon's surface, controllers at the Jet Pro-



Explorer 35 now circles the moon.

pulsion Laboratory lost telemetry contact with it. It was not immediately known whether the craft had landed softly and upright, or had crashed.

Telecommunications face growth problems

Telecommunications technology is growing so rapidly that it is outstripping the national capacity to harness it effectively, according to James D. O'Connell, the White House Director of Telecommunications Management.

In a report to the Independent Offices Subcommittee of the Senate Appropriations Committee, he said that increased funds and a major overhaul of the laws regulating communications were essential. The most urgent need, he said, is to tackle the problem of allocation of the rf spectrum. "Our time for study, consultation and review has about run out," he warned.

O'Connell cited three steps that he said would pave the way to optimum use of the spectrum:

- Establishment of a computer data center for storing information on all rf authorizations made by the Federal Communications Commission and Mr. O'Connell's own office.

- An analysis of the value of those sectors that presently compete for use of the spectrum.

- Setting standards to determine how much use the allocated portions of the spectrum receive.

These steps, he noted, are not only vital but also costly. He therefore urged the committee to restore the \$300,000 cut from his office's \$2,245,000 budget request for 1968. He warned that if the problem of rf management were not tackled at once, it might become necessary to capitalize the spectrum and allocate bands to the highest bidder.

To help meet the challenge, O'Connell's office, the Brookings Institution and Resources for the Future are sponsoring a symposium on "Values of the Spectrum" in September in Warrenton, Va.

The President's Special Assistant

told the subcommittee that as the importance of world communications grew, "the structure of U.S. international communications should be at its best." At present, he said, it is not—it contains serious flaws." The laws that set the guidelines for the six international common carriers in the U.S. need a thorough revision, O'Connell insisted. He singled out the 1934 Communications Act as "seriously limiting the role of international communications and hampering U.S. international common carriers." The law's distinction between record and voice telecommunications is obsolete, he said; so, too, is its bar on mergers by the carriers.

O'Connell complained that lack of funds was also obstructing satellite communications.

Transistor radio makers must give honest count

Reforms in deceptive transistor radio advertising are the aim of a new rule issued by the Federal Trade Commission.

The new addition to the Federal Trade Commission Act reads:

"In connection with the sale of radio sets in commerce. . . , it is an unfair method of competition and an unfair and deceptive act or practice to represent, directly or by implication, that any radio set contains a specified number of transistors when one or more of such transistors are either dummy transistors or do not perform the recognized and customary functions of radio set transistors in the detection, amplification and reception of radio signals."

Any objections to or comments on the rule can be filed in writing before Nov. 3, 1967, with the Chief, Division of Trade Regulation Rules, Bureau of Industry Guidance, FTC, Pennsylvania at 6th St., Wash., D.C. 20580.

EIA publishes standards for quality assurance

Quality assurance within the electronic-components industry moves toward greater standardization with a set of guidelines published July 19 by the Electronic Industries Association.

The guidelines include a standard

questionnaire which allows systems or equipment manufacturers to obtain quick answers on quality assurance from their component suppliers. Previously costly plant surveys were often required for each individual customer. Under the new system a vendor will know exactly what kind of questions he will be asked by his customers.

The standard, *Electronic and Electrical Part Suppliers' Quality and Reliability Assurance Standard Procedure and Questionnaires*, is available for \$1 from the EIA, 2001 Eye St., NW, Washington D.C. 20006, Attn. EIA-1000.

EZA and AEM merger comes to nothing

The Association of Electronic Manufacturers, Inc., and the Electronic Industries Association have called off their merger negotiations.

Ira Landis, AEM president, and Robert Galvin, EIA president, said it had proved impossible at the present time to realign the bylaws of the two national associations so as to effect a combination.

The presidents indicated that the two groups plan to continue as independent but cooperative bodies.

ITT-ABC merger hits new stumbling block

The proposed merger of the International Telegraph & Telephone Corp. and the American Broadcasting Co. has been delayed again by the Justice Dept.

The FCC approved the merger proposal after reconsidering an earlier go-ahead that had been challenged by the Justice Dept. One major issue—whether ITT would influence ABC news coverage—resulted in assurances by ITT that it would keep hands off the ABC news operations.

The Justice Dept. filed its challenge of the latest FCC approval with the Federal Court of Appeals in Washington, D. C., on July 21.

The court will probably not make a final decision on whether to allow the merger before the end of the year. But the merger agreement runs out Dec. 31. Thus it would have to be reconsidered by both parties before final consummation even if the court approves.

**if you're ready to buy
the smallest, fastest
military memory available,
put on the coffee and call us.
we'll be right over.**

Our SEMS 5 weighs less than 7 pounds, operates on 60 watts maximum at a data transfer rate of 16,000,000 bits per second. It has a 2 μ sec cycle time and stores 4096 words of 32 bits. Capable of taking a bruising 30g's vibration, it meets all applicable portions of MIL-E-5400, MIL-E-4158 and MIL-E-16,400.

Our number: (213) 772-5201. That's black, one sugar.

EM electronic memories

12621 Chadron Avenue, Dept. 3E,
Hawthorne, California 90250

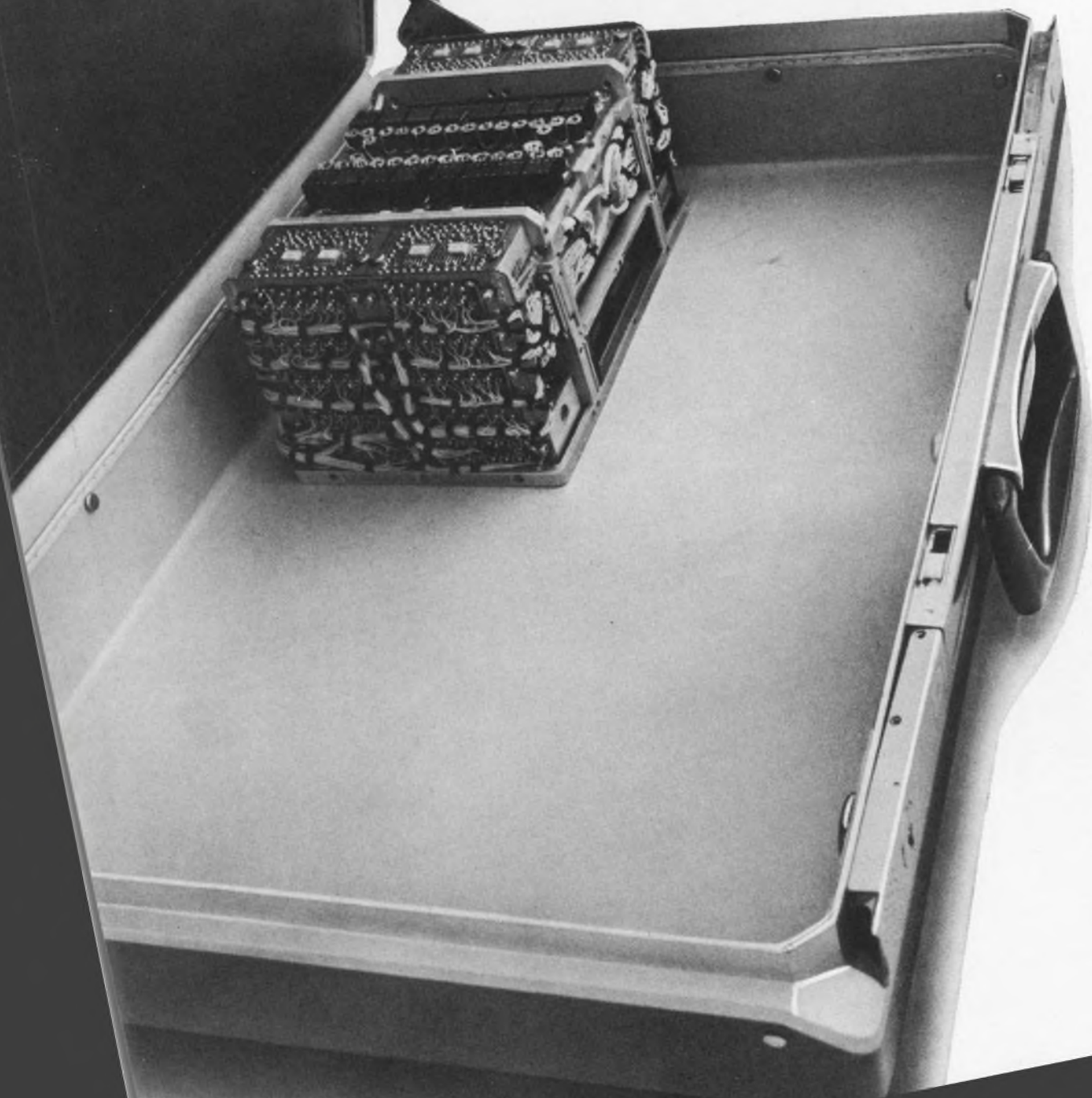

DDC is prospering despite \$500,000 prices

Third-generation computers spur applications of new techniques and reduce programing chores

Peter Budzilovich
Technical Editor

The installation rate of direct digital control (DDC) systems has tripled in the last three years as the engineering emphasis has shifted from hardware to software. About nine systems a week are now being installed, according to unofficial estimates, despite price tags in the \$500,000 range. In fact over 1500 DDC systems are now "on stream" in the world despite the brief nine-year history of the technology.

Designers in this field have available to them a third generation of computers built with microcircuits and far more powerful than pre-

vious systems. The trick now is to apply the added computing ability to achieve more sophisticated control of processes in the chemical, oil, metals and other industries.

Reliable electronic devices—sensors, actuators, scanners, AD and DA converters—are readily available to the systems designer. He also has a choice of high-speed, large-storage-capacity, highly reliable central computers. His problem has been summarized by Rodney Burns, programmer analyst of Control Data Corp.: "No longer are we worried about adjusting the pneumatic valve or wiring our system; we're now worried about communicating our control philosophy in a

language not too far from the control engineer's language."

Involving practical applications of most modern mathematical techniques, DDC—in effect, automation within automation—is being used to mix ingredients, conduct measurements or monitor processes with a degree of precision heretofore unobtainable by either analog or manual control.

But there are obstacles to really widespread expansion of DDC, to the point where any small factory can afford an installation. An engineering kibitzer suggested recently that DDC seemed to be at about the same point in its evolution that DDT was shortly before World War II: well on its way to becoming a "household" abbreviation, but with some bugs to be knocked out first.

The formidable obstacles are these:

- The software costs more than the hardware. Since each plant is unique, a new large-scale systems problem must be solved each time.

- Though the system is digital, practically all the controlled processes in industry and their parameters are analog in nature.

The programing language problem has been met in part by the application of such languages as FORTRAN, ASSEMBLER and, more recently, PROSPRO to DDC systems. Wider use of floating-point computers is also easing the chore of programing. But the hardware costs are higher, as a result.

What is a DDC system?

To illustrate why software is so important, let's look at the accompanying block diagram of a typical DDC system. It consists of a controlled process, analog-to-digital

The DDC man-process interface overshadows the familiar attributes (in the background) of an analog control room. Here the DDC operator adjusts the computer controlling a petroleum processing unit at the Mobil Oil refinery in Paulsboro, N. J., as the refinery manager, Richard P. Medlin, looks on.



(DDC, *continued*)

(AD) and digital-to-analog (DA) converters, a computer, and an operator's console. (Supervisory control, data logging, reporting and other functions are left out, for the time being, for the sake of clarity.)

This diagram, simplified as it is, serves well to define some of the software tasks confronting the DDC system installation team. Its job includes:

- Specifying the required process performance.
- Creating a mathematical model of the process.
- Selecting characteristic process variables.
- Specifying transducers and actuators.
- Specifying the interfaces.
- Specifying operators' functions.
- Programing the computer.
- Checking out the system.

The next step: 'control attitudes'

But so far the picture is of only one—and really the less important—of two DDC functions: the control function. By far the more important use of a DDC system lies in the area of supervisory control. This taking over of managerial functions by the machine has a more direct bearing on a company's profit-and-loss record. Supervisory control comprises long-range programs that tell the process control computer how to run the process for optimum (economical) results.

This DDC aspect has no counterpart in an analog system. It is the added ability not only to control the process but also to determine and carry out what may be termed "control attitudes." In many cases the ability to perform the supervisory control justifies the purchase of a DDC system.

An example of such an approach is the use of a DDC system in an electric utility to make hourly decisions on whether to buy power from other utilities or to cut in more generators in the local plant.

Many industrial plants have already used automation to reduce their crews to the minimum needed for emergencies. So why use DDC?

The answer is higher efficiency

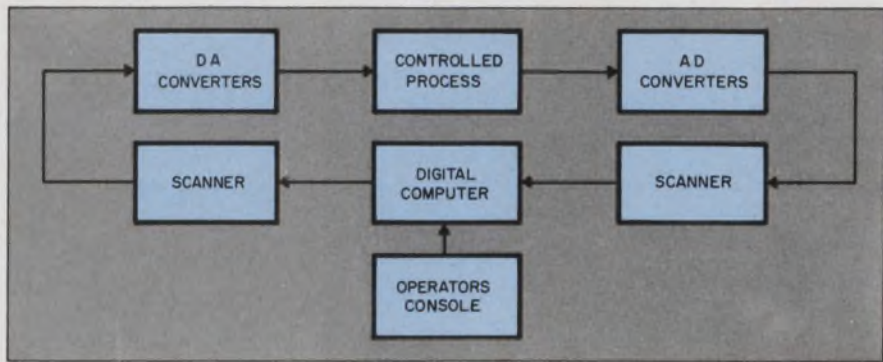

Simplified DDC system schematic gives an idea of the system operation. Analog process variables are digitized, scanned and processed by the computer, and the resulting control signals are applied to the process.

Characteristics of some third generation machines

Model	Mfr.	Memory Access Speed (μ s)	Memory Size (words x 000)	Price (\$ x 000)
1800	IBM	2 to 4	4 to 32	125-368
GE/PAC 4020	GE	1.6	4 to 32	60-130
Sigma 7	SDS	0.85	4 to 130	250-1,000
PRODAC 250	Westinghouse	2.25	65	120-400
855	Bailey Meters	—	—	350-650
PDP 8 PDP 8 S	Dig. Equ. Lab.	1.5	32	18
1700	CDC	1.1	4-32	37.5 and up
840	Syst. Eng. Lab.	1.75	4-164	54.5 and up
516	Honeywell	0.96	4-32	23.5 and up

that pays off in the long run. Specifically, it means pushing the process hard against whatever constraints may be present. In a chemical plant, for instance, the inability of an analog or manual controller to sense parameter changes and apply corrections rapidly may require operating the plant at, say, 60 per cent of its theoretical efficiency for safety reasons. Using DDC in a fully automated scheme may permit the plant to run the same process safely at, say, 75 per cent of the theoretical efficiency.

In a Ford Motor Co. glass manufacturing plant in Dearborn, Mich., a DDC system is expected to increase the production of windshield glass 5 per cent, according to Kenneth E. Coburn, manager.

The high cost of the software is illustrated by Jay C. Nelson, an engineer with the Union Carbide Corp., in a simple manpower curve. It shows that 20.5 man-years were required to put a DDC system "on

stream" to control a major plastics plant—one with over 2000 control loops. The over-all software cost is estimated at about \$512,500!

Watch your language

The cost of the software being what it is, and since most of this effort is in the programing (10.5 man-years in the case of Union Carbide), the machine that is favored is one that uses simple language.

"Use a simple language like FORTRAN and a floating-point machine," says Burns. "While both of these are costly, compared to a computer using machine language and a fixed point, the time savings for the operating personnel will well justify the initial outlay."

A new program developed by the Humble Oil and Refining Co. of Texas, in cooperation with IBM, has been designated as PROSPRO 1800. It permits the control engineer to make any changes in the program simply by entering new

NIKON HASN'T MADE MICRO-CIRCUIT MASK-ALIGNMENT EASY.

JUST EASIER.

Mask alignment is still the painstaking visuo-mechanical procedure it always was. The Nikon Mask-Alignment Microscope hasn't changed that. But it has reduced the element of human error to where relatively unskilled personnel, with minimum training, can be relied upon for higher registration accuracy in less time.

The reasons are inherent in the basic design of the Nikon Mask-Alignment Microscope. First, the quality of optics: the use of special, high-resolution lenses which give maximum visual acuity with minimum distortion, eyestrain and fatigue. Second, the use of an integrated, point light source on the optical axis of each objective system for optimum illumination efficiency. And third, the degree of flexibility provided by the operating controls.

The optical head, for example, is equipped with two objective lenses and a split-field prism. This prism has a push-pull rod control which permits the user to blank out the image of either of the objectives, or to observe both adjacent to each other in any ratio of field coverage he may desire. Furthermore, the distance between the two objectives can be continuously varied from 0.475" to 1.535", axis to axis.

The binocular eyepiece head, furnished as standard equipment, is inclined at an angle of 45° to the optical axis. It can be rotated 360° to any position most favorable for viewing, and is supplied with matched wide-field, high-eye-point oculars. It also offers facilities for interpupillary adjustment and diopter compensation. Monocular and trinocular heads can be interchanged for photographic and other special applications.

Four interchangeable eyepieces are available (5X, 10X, 15X and 20X), and three interchangeable pairs of objectives (4X, 10X, 13X and 20X) for an overall magnification range from 20X to 400X. A ball bearing, rack-and-pinion focusing mount is also available, where required. In addition, the left objective can also be individually adjusted for focus to provide precise tracking of both objectives.

Price of the basic Nikon Mask-Alignment Microscope is \$806 including step-down transformer equipped with power switch and pilot light. For complete details, write: Nikon Inc., Instrument Division, Garden City, N.Y. 11533 Subsidiary of Ehrenreich Photo-Optical Industries, Inc. (In Canada: Alcanphoto Ltd., Instrument Division, Ont.)

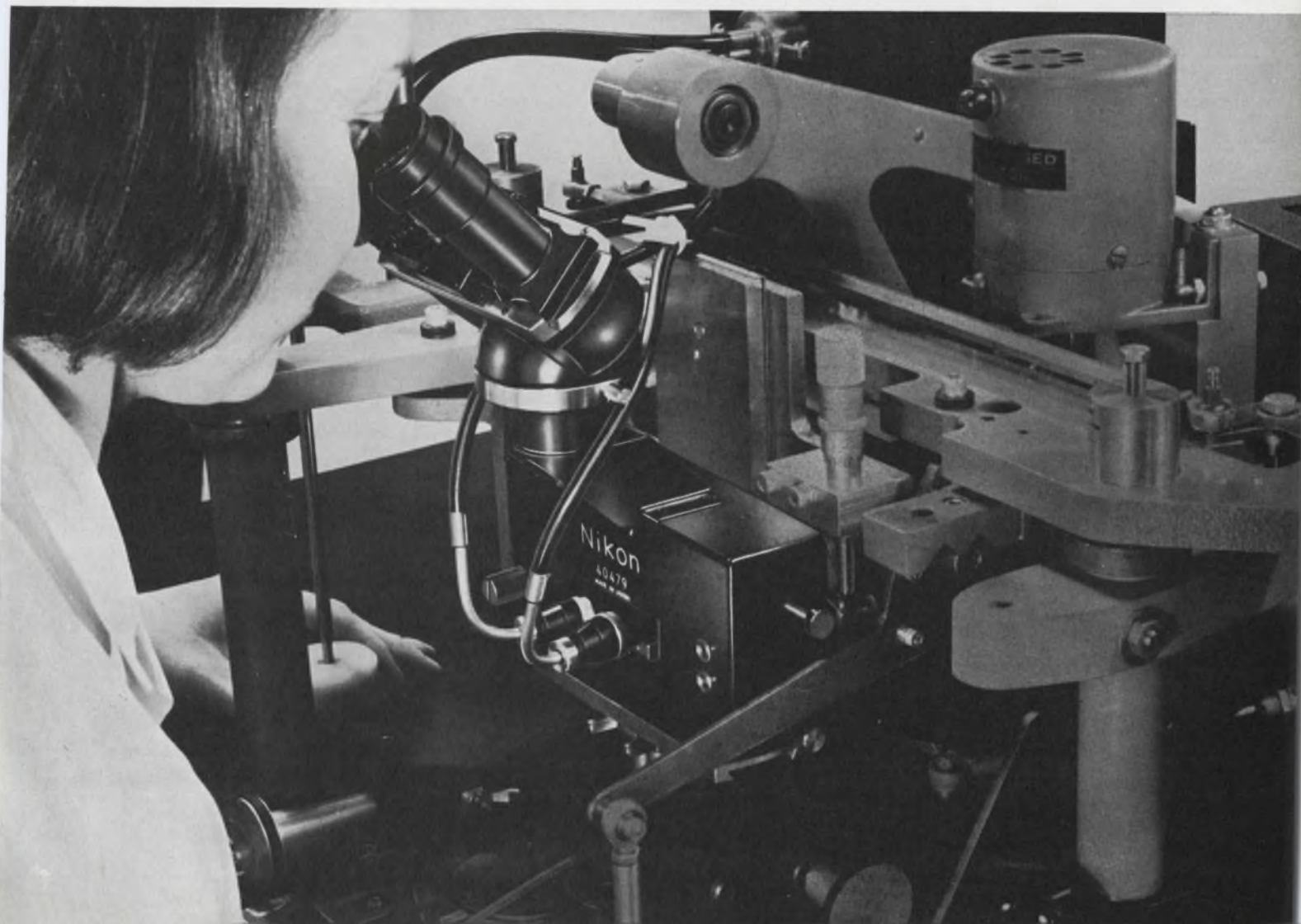

(DDC, *continued*)

data on special blanks or forms in FORTRAN and ASSEMBLER languages. These entries (retained as program documentation) are then transferred to cards and used with the IBM 1800 system. The computer uses these inputs, in accordance with its supervisory program, to change the control function.

The biggest advantage of PROSPRO is that a control engineer relatively inexperienced in programming can make the required program changes with ease without affecting the rest of the program.

Third-generation takes over

Third-generation DDC computers are generally considered to be those using microcircuits rather than discrete transistors.

"The outstanding characteristic of a third-generation machine is its speed," says Gary K. L. Chien, manager of a mathematical analysis group at IBM.

"An IBM 1800, for instance, can gather information at rates up to 24,000 signals per second, which is an order of magnitude improvement over a second-generation machine such as an IBM 1710."

The ability of the digital computer to handle a variety of variables in a fraction of a second has resulted in the application of new control techniques.

"Statistical control, 'bang-bang' control, and optimization are now becoming very realistic and practical," says Burns.

One new technique—adaptive learning control—is particularly interesting. It is being used in some plants to control valve actuators, widely used in the chemical and petroleum industry. The adaptive learning control system in this case stores in a computer memory the characteristics of the actuators as the computer learns them by observation. The optimum control commands are then derived, based on these observations. Such control provides not only continuous on-line adaptation to the changing characteristics of the valve actuators but also adaptation to characteristics that cannot be measured.

According to Chien: "Adaptive

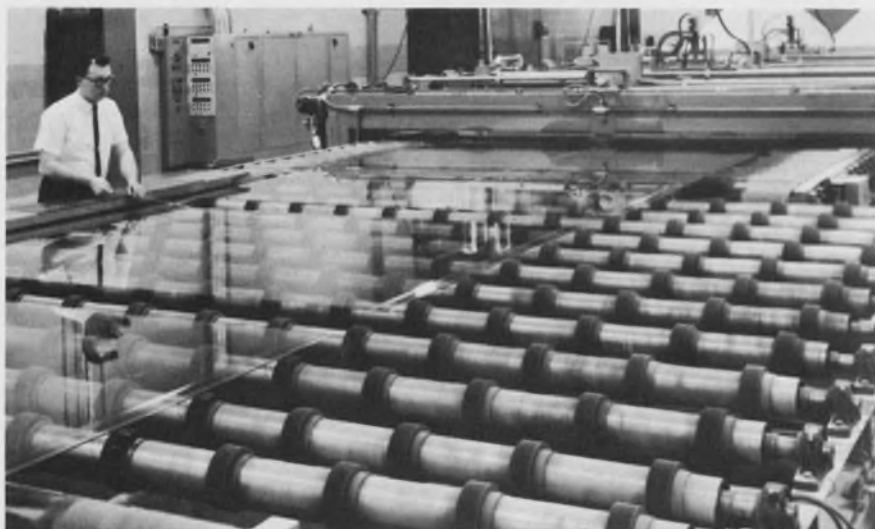

Windshield glass in a continuous ribbon rolls off the line at a Ford Motor Co.'s computer-based plant. A five-per-cent increase in glass production is expected with the DDC system.

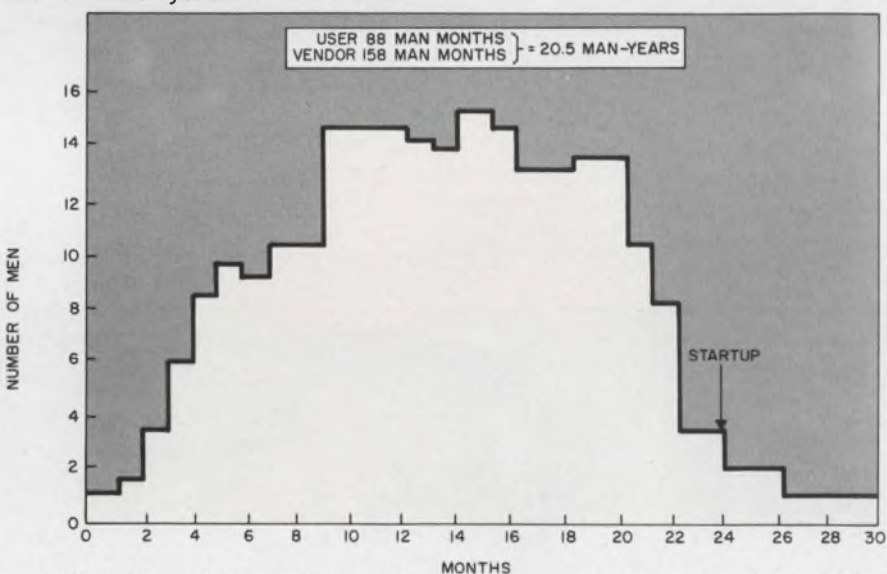

Roughly half a million dollars can be spent on the software to place a DDC system "on stream." This figure is derived by assigning a \$25,000 price for each man-year to the 20.5 man-years required to install the system.

learning control should be used wherever either process or load characteristics vary widely and the gain of the control system must vary by a factor of two or more."

An obvious advantage of adaptive learning control is that it permits one to use "sloppier" components and to diagnose their wear. Since the actuators' characteristics are monitored continuously, it is an easy task to compare them with some fixed limiting values and to signal an operator, or supervisory computer, whenever the limits are approached or exceeded.

Much of the peripheral equipment in a DDC system is electromechanical. Since the failures of the computer itself can be monitored relatively easily, and the reliability

of a modern all-solid-state machine is quite high compared with that of the interfacing hardware, it is the hardware that is of concern.

The major obstacles to reliability of the DDC system are found in the output hardware. They include, according to Burns, "relay multiplexers, typewriters, electromechanical operator displays, pushbuttons." In this sense, failure of even a simple, back-lighted pushbutton, if its purpose is to alert the operator to some critical condition, is crucial.

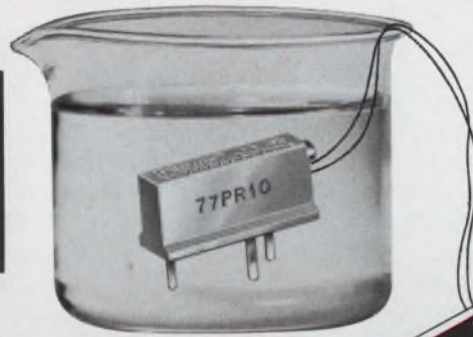

The general reliability of DDC systems has been so good and has improved so rapidly that "back-up" systems are now in the form of a second DDC system. And in some cases they are even being completely eliminated. ■ ■

Designed Sealed Delivered



Helipot's New Model 77P Cermet Trimming Potentiometer

Here's the new Model 77P, the first low-cost, general purpose trimmer with a sealed housing and cermet resistance element! DESIGNED to wider performance parameters than any other adjustment potentiometer in its price range. It is directly interchangeable with competitive Models 3067 and 3068—SEALED to permit p.c. board solvent cleaning and potting without trimmer contamination or failure—DELIVERED from local stock at the low list price of \$1.95. In large quantities, Model 77P sells for as little as \$1.10. ■ Compare Model 77P specifications with those of unsealed trimmers, then call your local Helipot representative for an evaluation sample.

	 Helipot Model 77P	 Model 3067 Wirewound	 Model 3068 Carbon
Resistance Range, ohms	10 - 2 meg	50 - 20K	20K - 1 meg
Resolution	Essentially Infinite	1.7 (100) to 0.3 (20K)	Essentially Infinite
Sealing	Yes	No	No
Power Rating, watts	0.75	0.5	0.2
Maximum Operating Temp. °C	105	85	85



Beckman INSTRUMENTS, INC.
HELIPOT DIVISION
FULLERTON, CALIFORNIA • 92634

INTERNATIONAL SUBSIDIARIES: GENEVA; MUNICH; GLENROTHES, SCOTLAND; TOKYO; PARIS; CAPETOWN; LONDON; MEXICO CITY

ON READER-SERVICE CARD CIRCLE 14

There's solid-state pressure on transducers

Mass production of semiconductor sensors may displace virtually all electromechanical devices

Ron Gechman
West Coast Editor

The electromechanical transducer may be approaching the end of its useful life in the electronics industry. Smaller semiconductor transducers are surging out of their prototype stages. When they become mass-produced, they will not only be much cheaper than electromechanical devices but far more reliable.

These are the expectations of major transducer manufacturers, according to an industry sampling. One estimate of the time it will take to complete the revolution is three to five years.

A big reason for the swing to semiconductor transducers is cited by Harold Gordy, general manager of the Instrument Div. of the Conrac Corp., Duarte, Calif.: "The future of aerospace measurement is solid-state, and all signs point to a

technological revolution in transducers similar to the impact of integrated circuitry on electronics."

Computer need apparent

Gordy has ample reason for backing the revolt. One solid-state computer developed by his company is only three times the size of one of the electromechanical pressure transducers that feeds it information. Two such transducers are used as inputs to the computer. The obvious evolutionary step is to reduce the size of the transducer.

Except for the really low-cost, high-volume electromechanical transducers, such as those used in automotive and industrial applications, Gordy predicts that all transducers will be solid state by 1970, or, at the latest, 1972.

In general, solid-state transducers are now more expensive than electromechanical ones, he notes,

but he expects costs to drop as yields rise. The signal-conditioning circuitry in solid-state transducers will consist of linear integrated circuits, with only a few discrete components, Gordy says, and linear integrated circuits are beginning to follow the same downward price trend as digital ICs have recently.

Hank Heller, senior scientist at Conrac, points out that the material costs for semiconductor transducers are minimal and that the transducers can be easily mass-produced. On the other hand, the biggest single cost factor in turning out electromechanical transducers—labor—cannot be cut much lower. The transducers do not lend themselves to mass production; a great deal of time-consuming hand labor is generally required to assemble each device.

Conrac has already begun to diffuse the entire electronics package directly into a thin film transducer. According to Heller, about 25 per cent of the development program for such a device has been completed, and a prototype program is being set up.

By incorporating an analog-to-digital converter into the electronics package in a transducer, a direct digital output device would be achieved. Such a device is desired where the transducer feeds into a computer.

Materials advances awaited

Just what constitutes a semiconductor transducer has been the cause of some confusion. Solid state implies no moving parts. However, movement—even though extremely minute in many cases—does exist in all transducers. The force-summing device that converts an applied force into a displacement is the portion of the transducer that actually moves.

This displacement is applied to the pickoff point, which measures the displacement and produces an output voltage that is proportional to the displacement.

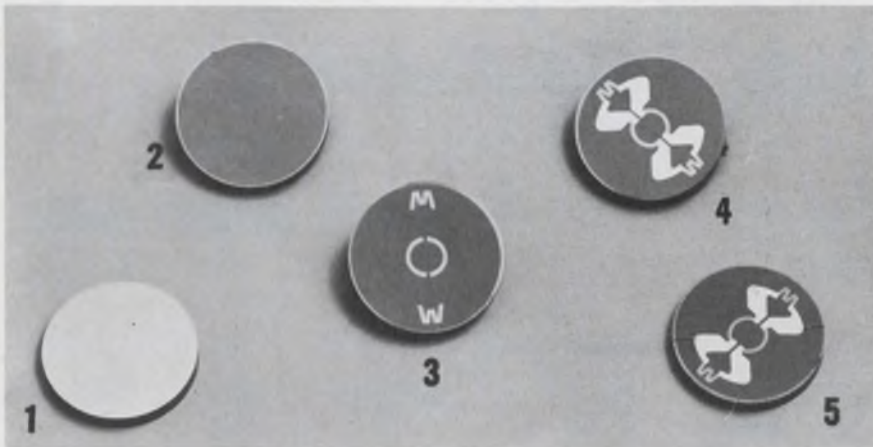

Thin-film transducer is made by vacuum-depositing a ceramic substrate (2) over a metal diaphragm (1). Silicon strain gauges are deposited on the substrate (3). Interconnecting leads are then deposited to form the bridge circuit (4), and lead wires are attached directly to the film by electronic welding or thermocompression bonding (5). Inset shows partially assembled unit. Device is made by Stat-ham Instruments.

Semiconductor transducers, therefore, are devices that use a semiconductor material as the pickoff element, instead of a slide wire, a vibrating wire or other type of pickoff.

The major semiconductor sensors in use, according to Gordy, are the silicon-diffused or metallic-deposited strain gauges, used for pressure measurement; the heavily diffused silicon junction, for temperature measurement; piezoelectric sensors, for measuring vibration; and lithium-drift sensors, for measuring radiation.

A piezoelectric transducer uses the self-generating effects of a quartz crystal. When force is applied against a piezoelectric crystal, a charge develops across the crystal, and this charge is in proportion to the applied force.

Among their advantages, piezoelectric transducers have a high-output, high-frequency response, are self-generating (no external power needed), have a negligible phase shift, are small in size and rugged.

Their disadvantages include high sensitivity to temperature changes and cross accelerations, inability to measure static conditions, high impedance output, noise or spurious responses occur-



Implantable blood pressure biomedical transducer made by Electro-Optical Systems uses four semiconductor bonded strain gauges.

1970

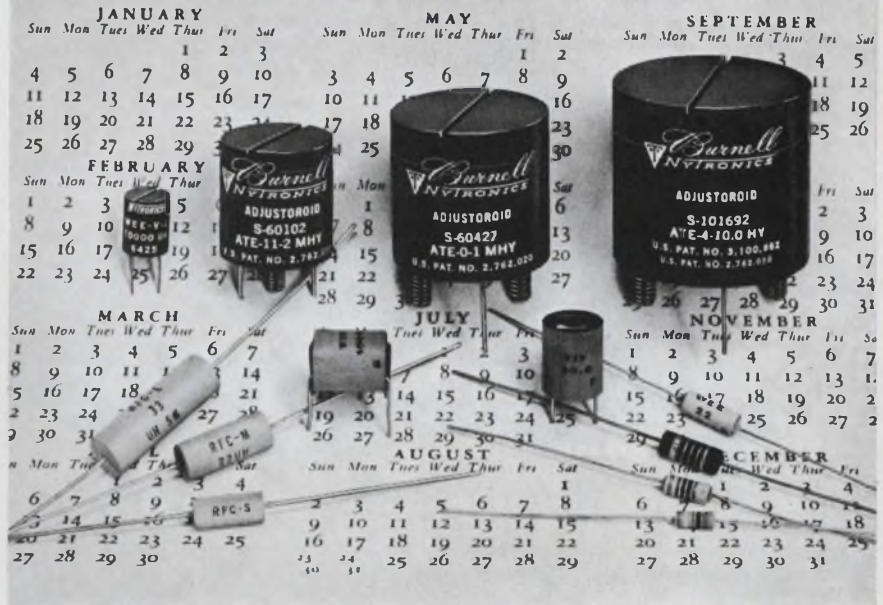

Nytronics Inductors are ahead of their time!

Nytronics continuous research and development have produced standardized quality inductors with the superb precision and stability to meet the demanding requirements of tomorrow's circuitry. Yours *today* — delivered off the shelf from a large inventory. Pioneering is a Nytronics speciality!

WEE-DUCTOR — Magnetically shielded with inductance range 0.1 to 180,000uH, designed to MIL-C-15305, Grade 1, Class B. Encapsulated Envelope: 0.157" diameter x .450" length.

SUPER WEE-DUCTOR/90537 TYPE — Manufactured in accordance with MS90537, Molded Magnetically shielded with inductance range 0.1 to 100,000uH $\pm 10\%$ tolerance. Molded Envelope: 0.163" diameter x 0.410" length.

WEE WEE-DUCTOR — Magnetically shielded with inductance range 0.1 to 10,000uH. Designed to MIL-C-15305. Encapsulated Envelope: 0.125" diameter x 0.335" length.

DECI-DUCTOR — Subminiature with inductance range 0.1 to 1000uH. Designed to MIL-C-15305, Grade 1, Class B. Molded Envelope: 0.100" diameter x 0.250" length.

S-M-L INDUCTORS — Non-shielded with inductance range 0.1 to 10,000uH. Designed to MIL-C-15305, Grade 1, Class B. Molded Envelope: "S" Type — 0.188" diameter x 0.44" length, "M" Type — 0.25" diameter x 0.60" length, "L" Type — 0.31" diameter x 0.90" length.

VARIABLE INDUCTOR — Unshielded with adjustable range 0.1 to 4700uH. Designed to meet MIL-C-15305, Grade 1, Class B. Encapsulated Envelope: 0.400" diameter x 0.500" length. Vertical or Horizontal mounting.

WEE V-L — Magnetically shielded adjustable range 0.1 to 100,000uH. Designed to MIL-C-15305, Grade 1, Class B. Epoxy Molded 0.300" diameter x 0.400" length.

ADJUSTOROID — Adjustable toroid available in nominal values from 0.01Hy to 12Hy. This unit provides stepless adjustment in a completely hermetically sealed package.

Nytronics off-the-shelf inventory also includes a wide range of capacitors, delay lines, and resistors. Write today for complete engineering data.



NYTRONICS®

...for Precision Electronic Components

550 Springfield Ave., Berkeley Heights, N.J. 07922 ■ (201) 464-9300 ■ TWX: 710-984-7977

ON READER-SERVICE CARD CIRCLE 15

(transducers, *continued*)

ring in long cable runs, and the inability to return to a previous reference output after extreme shock.

In a piezoresistive type of transducer, the applied force changes the internal resistance of a silicon crystal. The use of an external electrical power source enables this change in resistance to be measured.

The advantages and disadvantages of the piezoresistive transducer are about the same as those of the piezoelectric device, except that it is not self-generating; an external power source is needed. The use of an external power source, however, allows the piezoresistive transducer to measure static conditions.

One of the most popular solid-state transducers is the silicon strain gauge, used for pressure and temperature measurements. Silicon strain gauges usually are constructed in a bonded configuration, in which the entire gauge is attached by an adhesive directly to the element of which the strain is to be measured. Four gauges are commonly used in a balanced Wheatstone bridge configuration.

A measure of the gauge's sensitivity is represented by its gauge factor. This is determined by the unit change in resistance per unit change in length. Gauges using strain-sensitive wire or foil have gauge factors from 50 to 200, developmental gauges have yielded gauge factors as high as 10,000.

The advantages of strain gauges over other semiconductor transducers are their high accuracy, low sensitivity to temperature, response to both static and dynamic measurements, and low sensitivity to shock and vibration.

Their disadvantages include a rather low output, except that a higher output is available if silicon is used, with some compromise of thermal and stability characteristics and a low range limitation for the bonded type.

A recent development in strain gauges in the thin-film transducer. One such device is being manufactured by Statham Instruments, Inc., of Los Angeles. It is made by vacuum-depositing a ceramic film on a metal sensor and then vacuum-depositing four strain gauges on the ceramic film. Interconnecting leads are deposited, to form a bridge circuit, and lead wires are attached by thermocompression welding.

Versatile configurations possible

Peter Perino, chief engineer at Statham, says that the sensing element can have any configuration; the strain gauges can be deposited on diaphragms, beams, columns and other sensing elements.

In operation, thin-film transducers are similar to wire strain gauges, Perino says, in that applied pressure causes tension stress in one pair of the bridge legs and compression in the opposite pair. Temperature compensation is an integral part of the transducer bridge, and it minimizes the need for separately placed compensating resistors.

An important role of transducers in aerospace applications has been the measurement of acceleration. One of the most recent transducers to be announced is a three-axis, solid-state accelerometer, developed by the Conrac Corp. According to Gordy, the device uses the piezoresistance effect to provide three axes of acceleration. It is packaged in a half-inch cube that weighs 3 ounces—far smaller and lighter than any conventional single-axis accelerometer.

Three cylinder-shaped masses are positioned orthogonally and drilled, so they can pass through

State of development of some semiconductor transducers

Type	In production	In pre-prod. development	In R & D	Present cost, compared with similar E/M device	Typical applications
Pressure	X			More costly but more accurate	Reentry vehicles, launch vehicles, avionic systems, process control
Acceleration	X			About the same cost	Reentry vehicles, low-grade inertial platforms, cruise missiles
Gyroscopic position		X	X	Projected cost higher than E/M devices	Future: High-grade inertial platforms
Gyroscopic rate			X	Projected cost higher than E/M devices	Future: Control systems, reentry vehicles
Temperature	X			No similar E/M device	All aerospace systems, process control

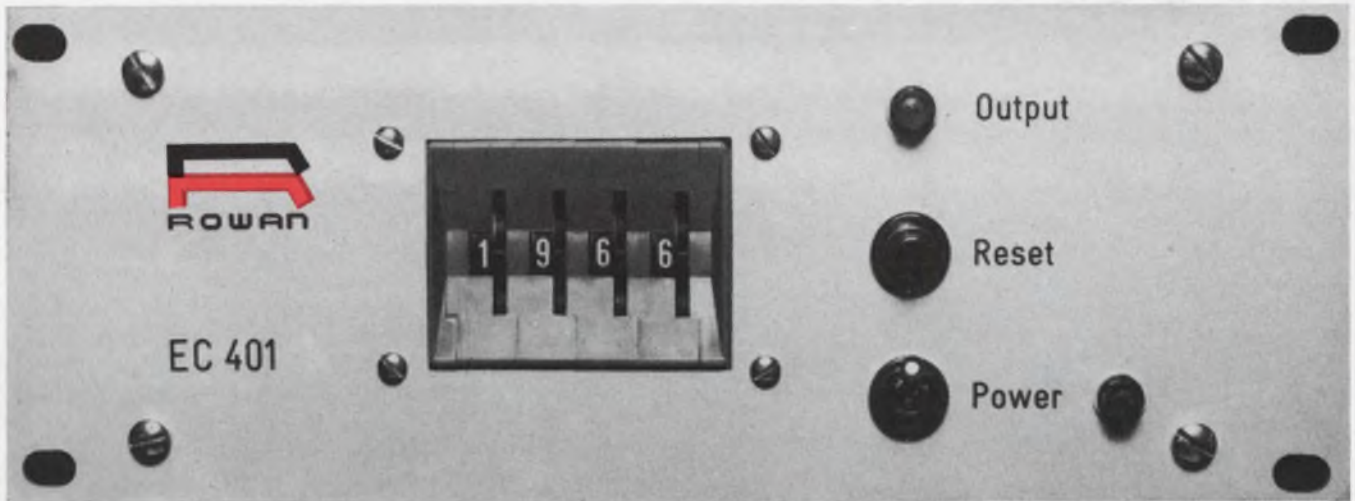

Model EC 401 - HALF RACK

ROWAN'S NEW **EC SERIES**
ELECTRONIC COUNTER...
OFFERED IN 15 MODELS—

10 KHz COUNTING SPEED

FULL AND HALF RACK

4,5,6 DIGITS

SOLID STATE/SILICON

HIGH NOISE IMMUNITY

TOTALIZING—SINGLE OR DUAL PRESET

MANUAL, REMOTE OR AUTOMATIC RESET



For more information, call or write

THE ROWAN CONTROLLER COMPANY

OCEANPORT, NEW JERSEY 07757

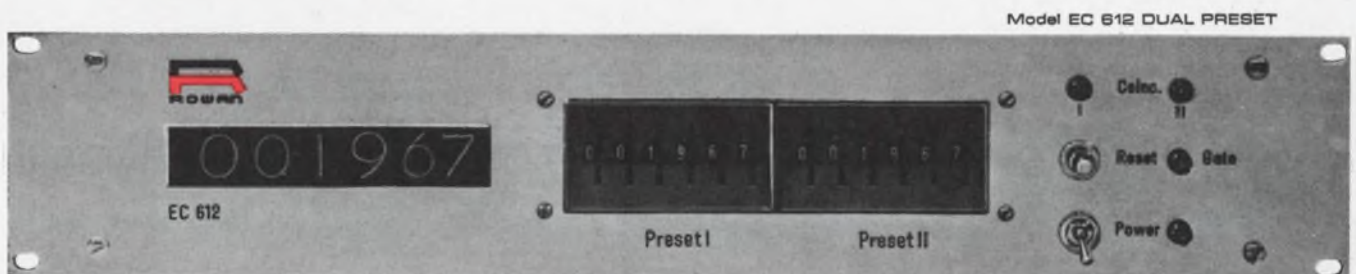

Model EC 612 DUAL PRESET

(transducers, continued)

one another at the coincidence point. The holes are oversized, so that each sensor mass would be able to move axially if it were not restrained at the ends. The orthogonal assembly of three sensor masses is mounted in a hollow cube and held in position by two silicon beams, one at each end of the cylinder. Piezoresistive elements are diffused onto these beams.

Whenever any axis is accelerated, the sensor mass exerts a proportional force on the restraining beam. This stresses the beam, causing piezoresistive changes in the bridge circuit and producing

an output voltage.

The acceleration sensitivity in each axis is determined by the stiffness of the two silicon beams in that axis. Therefore each axis may have a different sensitivity. Units can be built that produce a full-scale output of 1 g in one axis and 75 g in another.

Prototype units are now in final test and will soon be delivered to support a Navy missile program. Conrac expects to market the unit as a standard line before too long.

Pressure and temperature both affect the output of a strain-gauge transducer, and in most applications efforts are made to minimize the effect of one phenomenon (such as temperature) when the other (such as pressure) is being measured. Electro-Optical Systems of Pasadena, Calif., has applied the

simultaneous effects of both properties to develop a strain gauge to measure the quantity of propellant remaining in the storage tanks of lunar space vehicles.

The sensor in the Electro-Optical device is a piezoresistive pressure transducer that measures the pressurizing gas in the propellant tank. The transducer output is directly proportional to the pressure and inversely proportional to the temperature. By measuring the gas volume that has replaced the propellant, the gauge gives an indirect reading of the volume remaining in the propellant tank. Accuracies of 5 to 8 per cent are obtained, but accuracies as high as 1 to 2 per cent are possible with the use of two transducers, one in the propellant tank and another in the gas-supply tank. ■ ■

Common transducer types and how they work

Transducers employ numerous electrical principles to convert energy into an electrical signal. Some of these principles include the effects of capacitance, induction, ionization, magnetostriction, ohmstriction and oscillation. Vacuum tubes, vibrating wires, velocity generators and differential transformers are also used. The most common transducer types include these:

Potentiometric transducers

A force is transferred through a force-summing device to a movable slider, which is in contact with a resistive element. The motion of the slider results in resistance changes that may be linear, sine, cosine, logarithmic, hyperbolic, exponential, etc., depending on the manner in which the resistive wire is wound. Deposited carbon or platinum film are often used for the resistive element. Although

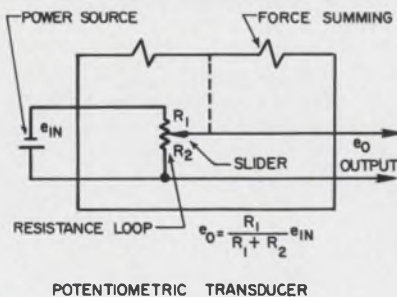

widely used, it has many disadvantages, such as limited life, sensitivity to vibration, finite resolution and high mechanical friction. In addition it is usually large. It does, however, provide sufficient output to permit control operations without further amplification. And it is relatively inexpensive to construct and easily serviced.

Strain-gauge transducers

The force being measured is transferred through a force-summing device to the strain gauge, causing the active element to expand or compress. This produces a change in the element's resistance. These gauges are usually arranged as a Wheatstone bridge circuit, with one to four of the bridge legs active.

Strain gauges are classified into two general categories: unbonded and bonded. The unbonded gauge has one end fixed and

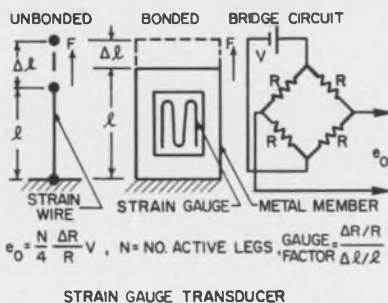

the movable end attached to a force collector. The bonded gauge is entirely attached by an adhesive to the member whose strain (elongation or contraction) is to be measured.

Strain gauges are generally made from metal alloys in wire or foil form, from semiconductor material (usually silicon) or from thin-film materials. By controlling the materials and deposition processes, thin-film gauges can be made to produce a wide range of characteristics. No matter what material is used, the operating principle for all strain gauges is basically the same.

Piezoelectric transducers

Asymmetrical crystalline materials produce an electrical potential upon application of strain or stress. The most widely employed piezoelectric crystals are quartz, tourmaline, Rochelle salt and barium titanate.

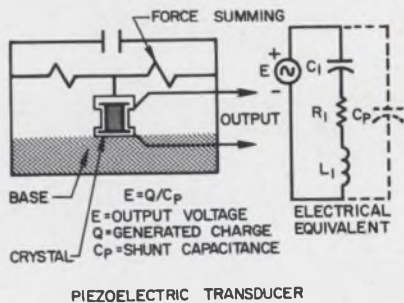

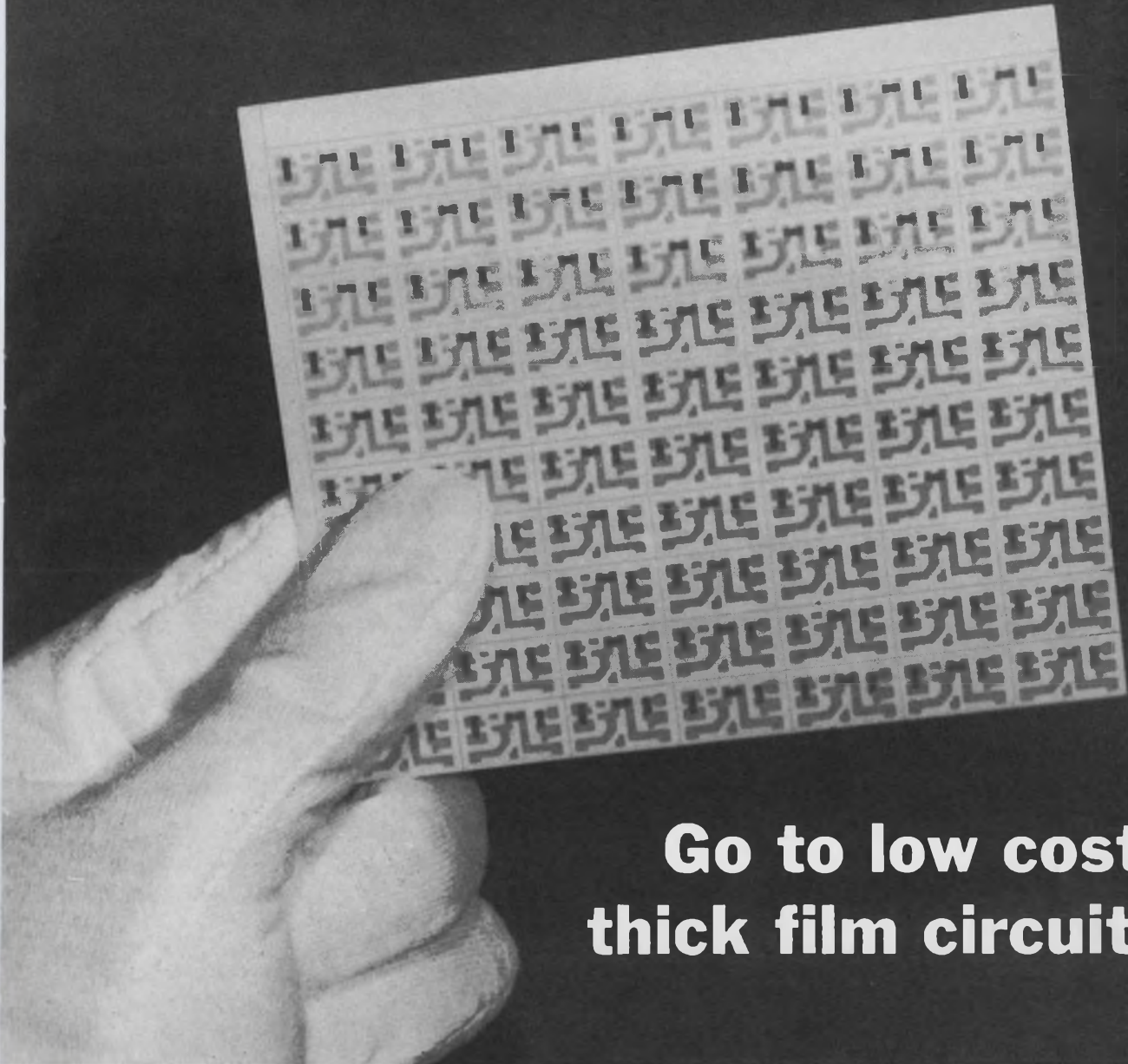

Go to low cost thick film circuitry!

Coors can help you get into the thick film business for low cost microcircuitry and packaging. With new technology, air fired pastes make low cost conductors, resistors and dielectrics. These open up a wide possibility of circuit networks for solid state and high density packaging. Coors can make up complete thick-film-on-ceramic circuit boards—and take the load off your production facilities. Or, Coors can furnish you the ceramic substrates for your in-house operation, plus giving you technical assistance on application techniques. Coors facilities can accommodate fast delivery on orders for thousands or millions. If you are thinking about going to low cost, thick film circuit boards, let's talk. Coors can also help you make the best choice in high temperature, brazed packaging. Get on-the-spot answers. Dial Coors—303/279-6565, Ext. 374. For complete facilities and capabilities, write for Coors Metallizing Data.

*consider
Coors
ceramics*

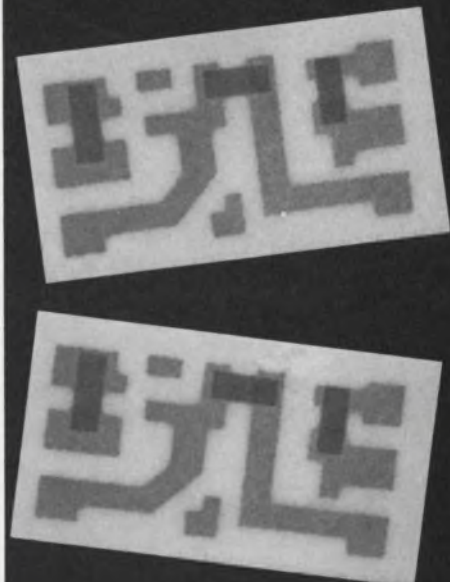

Coors

CERAMICS

ALUMINA • BERYLLIA • MAGNESIA • SPECIAL OXIDES
Coors Porcelain Co., Golden, Colo.



30-60 day delivery ...

**...helps you
meet tight schedules
when you use I/C
 μ -STORE core memories**

Our submicrosecond μ -STORE memories are ready now to meet your tightest delivery schedule — 60 days or less on standard models with capacities of 4,096, 8,192, 16,384 and 32,768 words.

If you've drawn a block marked "core memory" recently, let us show you μ -STORE speeds, capacities, and fast delivery capability. You'll find that both our ICM-40 and ICM-47 (670 nanosecond full cycle time) have been designed to offer a custom solution to your memory problems. Write for our new brochure. It sums up all the facts. Honeywell, Computer Control Division, Old Connecticut Path, Framingham, Massachusetts 01701.

Honeywell

 **COMPUTER CONTROL**
DIVISION

Congress may get new insight in technology



Congress to beef up science role

House Science and Astronautics Committee chairman George P. Miller (D-Calif.) is making headway on the groundwork for a new organization to increase Congress's competence to deal with science and technology (see "Washington Report," ED 26, Nov. 22, 1966, p. 26). He has hinted that definite steps will be taken later this year to set up a technology assessment panel to examine the pros and cons of new technologies. To illustrate the need for it, he has pointed to pesticides and detergents as substances of unquestioned value, which have had serious side effects, polluting water and killing useful fish and bird life.

Miller's hint that the long-discussed panel should soon be created came in a new report from the Science, Research and Development Subcommittee headed by Emilio Q. Daddario (D-Conn.). Daddario's report documents instances where Congress could have done with increased science and technology advice. During the 89th Congress of 1965-66, Daddario's group listed "76 nondefense areas involving science or technology as ingredients of the first magnitude—and more than 100, if subareas are included." In two years, Congress had to deal with each of them by hearings or reports, by legislation or by overseeing. And, says Daddario, "the tempo is not slackening, but is picking up."

But Congress in an age of technology has not been legislating in a vacuum, Daddario says. He points out that in the past three years several steps have been taken to enhance Congressional understanding of science and technology. The Science Policy Research Div. of the Library of Congress Legislative Reference Service has been set up. The science staffs of many Congressional committees have been increased. The House Science and Astronautics Committee has a direct contract with the National Academy of Sciences for major reports. But, say Daddario and Miller, none of these is an effort specifically to enable Congress to foresee the consequences of new technologies. "We have had warnings," they say "but the Torrey

Washington Report

S. DAVID PURSGLOVE,
WASHINGTON EDITOR

Canyons, the great electrical blackouts, the water shortages, the Donora plagues, the impassable highways and deluged airports are only beginning symptoms. We must find ways of forecasting and avoiding these things because—without perceptive technological management—they are going to get much worse."

Technology assessment can stifle progress

Miller and Daddario acknowledge that their plan for a national panel is not without critics. Many critics have pointed to results of past efforts to forecast the effects of nascent technologies. Researchers have been pessimistic about the effectiveness and value of the task (see "Washington Report," ED 25, Nov. 28, 1966, p. 31). Members of the Science and Astronautics Committee now are talking in terms of attempting to assess technologies after they have evolved to a reasonable degree.

In their public statements, both Miller and Daddario seem aware that the biggest opposition to their proposed panel will come from scientists and engineers, who fear that critical examination of innovations will slow and sometimes block development. In statements that seem to respond to such criticism, Miller has emphasized that the panel must elicit both the positive and the negative aspects of new technologies, and Daddario has declared: "We have to find ways to do it without stifling industry or private initiative."

Transatlantic exchanges flounder

The White House is starting to implement its alternative to a "Technological Marshall Plan" sought by some Europeans as a means to close the so-called technology gap between the U. S. and Europe. The Administration clearly rejected the idea of a technology aid program when Commerce Secretary Trowbridge told the American Chamber of Commerce in Paris that only Europe itself can redress any technology gap or "brain drain," which, he said, was caused

Washington Report

CONTINUED

not by technological incompetence but by problems of management, environment and productivity (see "Washington Report," ED 14, July 5, 1967, pp. 29-30).

Presidential science adviser Donald F. Hornig has just returned from a fact-finding mission to Europe, where he explored ways to promote better use of technology by Europe and the U.S. He headed a team of specialists who conferred with their counterparts in Rome (where Technological Marshall Plan advocates have been most vocal), Paris, Brussels, The Hague, Bonn and London. The White House is known to feel that Europe will have to settle for an increase in more traditional types of information through conferences and journals, largely on the science rather than the technology level.

A high official in the Commerce Dept., where any technological aid program was most likely to have been operated, admitted that the Administration had two reasons for its eventual coolness toward the Technological Marshall Plan first proposed by Italian Foreign Minister Amintore Fanfani. One was pressure from U. S. business on the grounds that it would give more than it received. "The opposition of business to an aid plan was pretty open," the official said. "Trowbridge as much as acknowledged this in Paris when he told them pretty bluntly that even if the Government wanted to, it couldn't give away American technology because it's largely private property."

The other reason is the trouble already experienced in the U. S. with institutionalized idea exchanges that carry new technology into the marketplace—such as the Commerce Dept.'s programs to provide the states with new technology information. There is no reason to believe such exchanges would fare better abroad. They are off to a slow start at home, are groping for their proper arena and having to buck established Federal, state and university bureaucracies.

Industry cool to idea exchanges

The Commerce Dept., which played a greater role in shaping the Administration's technology aid decision than did the White House Office of Science and Technology, has been working closely with an increasing number of

Congressional committees, that are seeking ways to channel defense- and space-generated technology into civilian areas. It has learned that potential users of technology information centers and programs are far from universally enthusiastic about formalized idea exchanges.

Recently, the Senate Small Business Committee's subcommittee on science and technology published industry responses to questions on formalized technology transfer programs. Respondents, largely from the aerospace-defense industry, which both generates and uses most of the technology involved, generally approved the concept but felt it would break down in practice. They cited proprietary and patent problems, problems in developing formats applicable to all types of technology and usable by all companies, and the dilution of useful information with trivia by those unfamiliar with industrial needs.

Hughes Aircraft Co. was one of several firms reporting a problem that would be greatly magnified by a big national or international effort to communicate new technologies developed in association with government contracts. Reported Hughes: "We do sometimes encounter difficulty in establishing just which contract supported which invention to our own satisfaction. The problem is not one of accounting, but is rather related to the intrinsic problem of identifying the precise time of an invention vis-à-vis contractual charging and the collateral contributions of various contributors, many of whom may be carrying multiple responsibilities."

'Innovations' not new, not used

Westinghouse Electric, referring to existing government programs such as the NASA technology utilization program, reported: "Westinghouse has used, to a limited extent, some of the technical innovations that have been reported, but we have not found many applications for the results of the technology utilization programs. . . . Perhaps one of the weaknesses in past utilization programs is the great difficulty of effectively demonstrating the usefulness of the technological achievement in a manner that excites interest for industrial and commercial applications. . . ."

Grumman Aircraft Engineering Corp. reported that it receives NASA Tech Briefs and bulletins of other government technology transfer efforts, but "much of the material received, and possibly the major portion thereof, has not been new to Grumman."

GREGARIOUS!

The tighter you cram little Turbowrap™ wires together, the happier they are. Kynar and polysulfone insulation make them as tough in tight spots as much bigger wires.

Think of the opportunities that Turbowrap 312 (with Kynar) and Turbowrap 412 (with polysulfone) open up for higher-density wiring. Made in sizes as small as 30 AWG, with walls as thin as .004" — these wires zip through automated wire-wrap operations with never a jam, skip, nick, short or break. And they perform faithfully, once in place.

Special thin-wall extruding techniques, plus the fine electricals and mechanicals of the insulation, have made it possible for Brand-Rex to produce small O.D. wires with excellent cut-through resistance.

Looking for ways to put more wire into less space? Call on our tough little extroverts, Turbowrap 312 and 412.

AMERICAN ENKA CORPORATION

BRAND-REX DIVISION

WILLIMANTIC, CONNECTICUT 06226
PHONE 203 423-7771

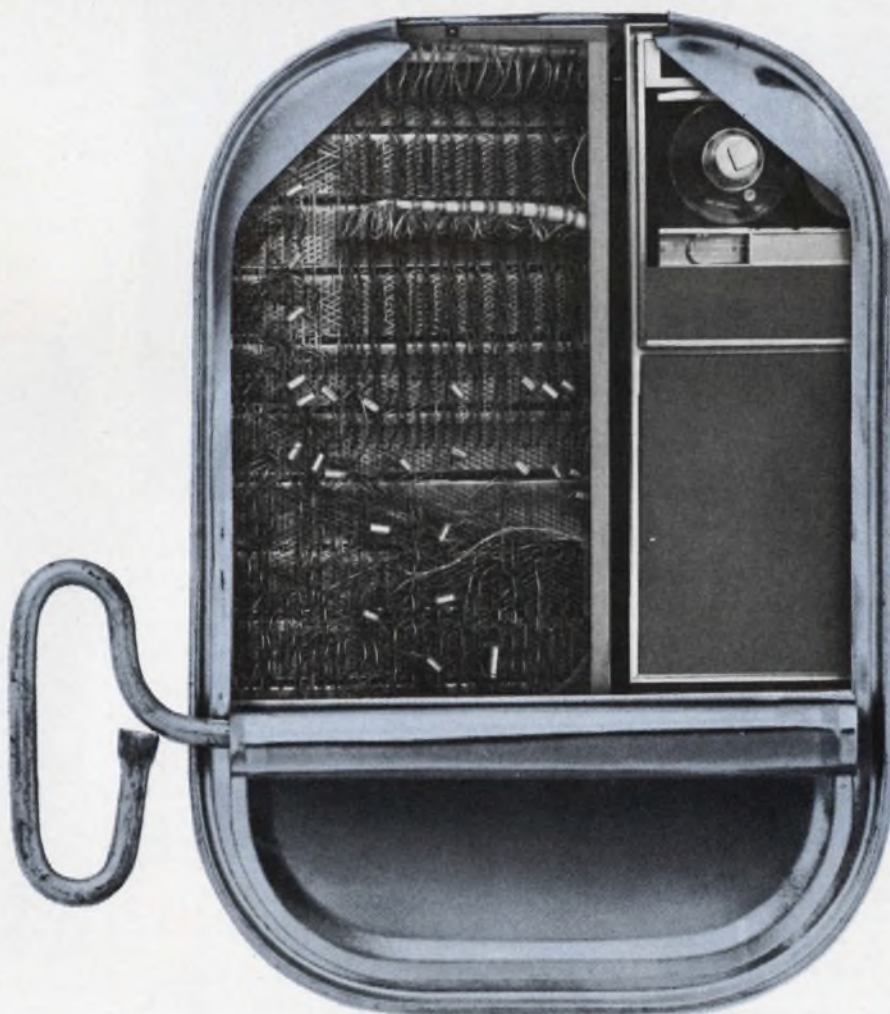

No.

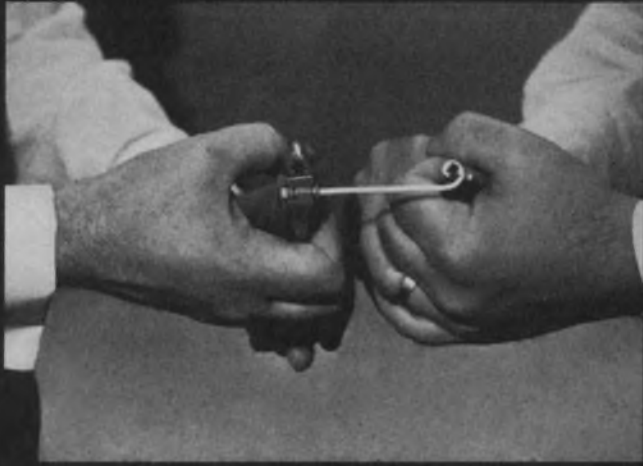

You cannot pull the cable out of our Micon Emlock[®] connectors.

No tricks. Our claim is that it is impossible to pull the cable out of one of our Emlock[®] compression fit, miniature connectors. Disengagement will be caused only by failure of the braid, not pullout of the compression. We believe this extraordinary capability beats crimped type connectors all hollow. Yes, and competitive compression types, too.

Prove it to yourself. Have one of our Technical Representatives call on you. He'll attach any one of our stock Emlock[®] connectors to a section of braided cable. Then, as he holds the connector body with a pliers, he'll hand you the chain nose, and you pull! The assembly will break away,

of course. He will then disassemble the connector and show you that there is still enough wire trapped to prove that Emlock[®] compression held and the braid failed!

Here's your chance to gain a new concept in miniature connector reliability. Remember, only Emlock[®] connectors offer this basic capability and only we have Emlock[®].

Write for the name of our Technical Representative in your territory. He'll phone for an appointment and give you a chance to prove it to yourself. *While you are about it, why don't you ask for Bulletin MMC, Issue 1 describing the complete line of Emlock[®] connectors?*

Micon is now a part of

PHELPS DODGE ELECTRONIC PRODUCTS
NORTH HAVEN, CONNECTICUT



ON READER-SERVICE CARD CIRCLE 20

NEWS

Neon illuminates aircraft display

The principle behind the famed neon sign has been put to use in an experimental "gas tube" flight display.

Developed by Sperry Rand Corp.'s Phoenix Div., the display consists essentially of a glass plate on which metallic segments have been deposited. Each segment forms a separate cathode and is individually connected to solid-state driving circuitry. A second glass plate with a transparent anode coating is mounted in front of the cathode glass plate, with neon gas sealed in the intervening space.

When voltage is applied between the anode coating and automatically selected cathode segments, glowing neon gas forms numerals or letters in the four center patterns, when viewed through the anode plate. Supplementary data, such as "miles" or "x10," are illuminated in the rectangular blocks. The outer segments represent heading pointers when lit.

Since the display has no moving parts, it is expected to have a high degree of reliability. ■ ■



Cathode plate portion of "gas tube" display is checked by technician. The segments are connected to driving circuitry.

ON READER-SERVICE CARD CIRCLE 21 ➤

Miniature A-B Type BB hot molded resistors
provide over 1,300,000 units per cu. ft.*



...your answer to high packaging density
with discrete components

Faced with a severe space limitation for your electronics equipment, the miniature Allen-Bradley Type BB is just the "ticket." Its extremely high packaging density (over 1,300,000 per cu. ft. *) enables a drastic size reduction—with no sacrifice in reliability!

These tiny Type BB resistors are made by the identical exclusive hot molding process as the larger Allen-Bradley resistor. Using precision automatic machines—developed and perfected by Allen-Bradley—the human element is completely eliminated. The resulting uniformity from one resistor to the next—million after million and year after year—is so exact that long term resistor performance can be accurately predicted. And during the twenty-five years this exclusive hot molding process has been in operation, no Allen-Bradley resistor is known to have failed catastrophically.

Allen-Bradley Type BB resistors are available in standard resistance values from 2.7 ohms to 100 megohms with tolerances of $\pm 5\%$, $\pm 10\%$, and $\pm 20\%$. Maximum rated wattage is $\frac{1}{8}$ watt at 70°C and can be derated linearly to zero watts at 130°C. The maximum continuous rated voltage is 150 volts RMS or DC. For complete specifications on the Type BB resistor, please write for Technical Bulletin B-5005. Allen-Bradley Co., 222 W. Greenfield Ave., Milwaukee, Wis. 53204. In Canada: Allen-Bradley Canada Limited. Export Office: 630 Third Ave., New York, N.Y., U.S.A. 10017.

**Theoretical packaging in cordwood arrangement.*

actual size

of Allen-Bradley Type BB
hot molded resistors



ALLEN - BRADLEY

QUALITY ELECTRONIC COMPONENTS

WAVETEK uses Allen-Bradley Type F variable resistors exclusively because of their

- * Quality performance
- * Excellent stability
- * Infinite resolution

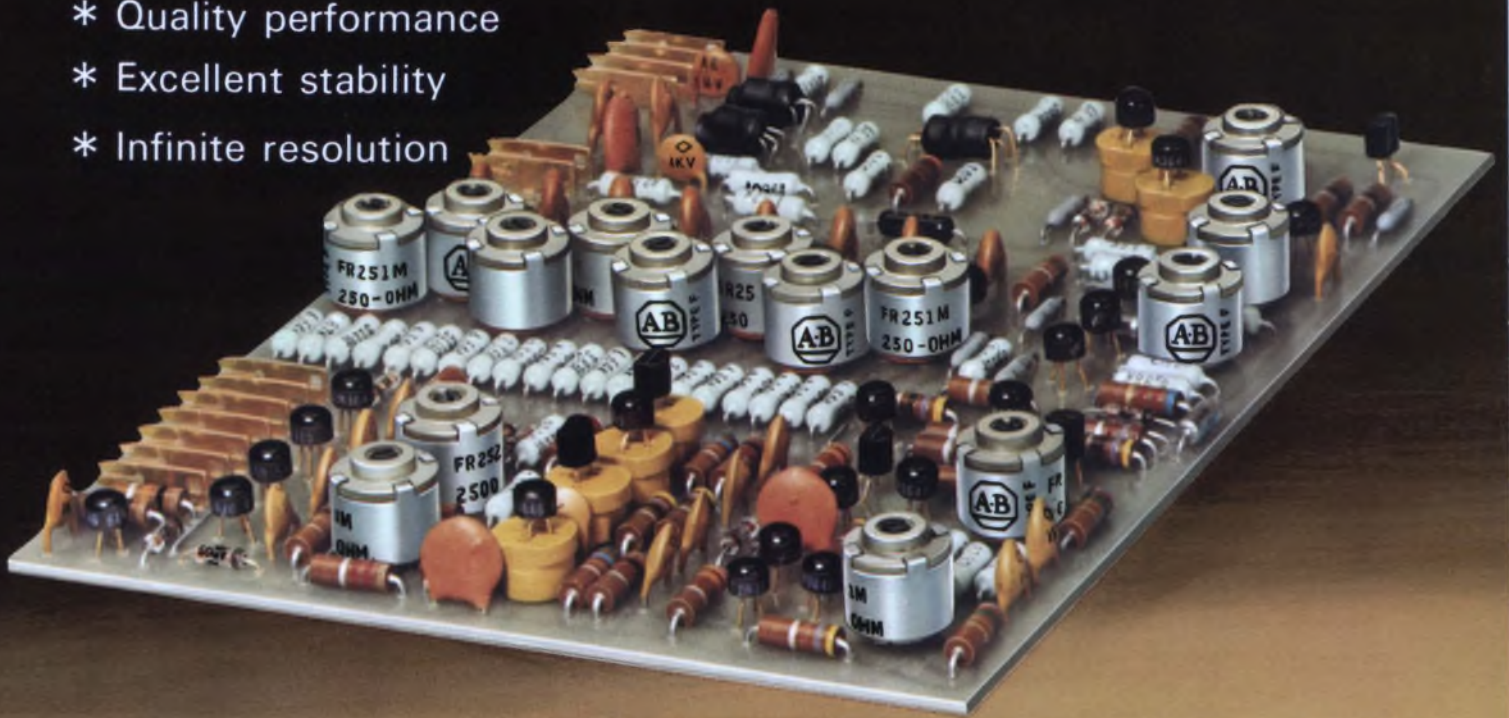

One of the 5-inch by 6½-inch Wavetek printed circuit cards, showing 15 of the 25 Allen-Bradley Type F hot molded variable resistors and numerous hot molded fixed resistors used in the Model 111 VCG function generator.

Type F variable resistor with pin type terminals for mounting directly on printed wiring boards. Rated ¼ watt at 70°C. Total resistance values from 100 ohms to 5 megohms.



Actual Size



Wavetek Model 111 VCG generates sine, square, triangle, and ramp waves from 0.0015 Hz to 1 MHz, and offers precision control of the frequency of the waveforms by external voltage.

■ The precision waveforms generated by Wavetek's Model 111 VCG place exacting demands on the large number of variable resistors used to set amplitudes to very precise values and assure symmetry of all functions. They must provide velvet smooth control, and quiet operation. And since this is a Wavetek adjustment, it is essential that the variable resistors, once adjusted, will stay "put".

Allen-Bradley Type F variable resistors satisfy all of these requirements, because they have the same solid hot molded resistance track as the famous Type J and Type G variable resistors. There's velvet smooth control at all times—never the problem of discrete steps com-

mon to all wire-wound units. And since Type F variable resistors are essentially noninductive and have low distributed capacitance, they can be used at high frequencies where wire-wound controls are useless.

When a manufacturer like Wavetek has standardized on the quality of A-B electronic components, you can be sure of the superior performance of such equipment.

For more details on the complete line of Allen-Bradley quality electronic components, please write for Publication 6024. Allen-Bradley Co., 222 W. Greenfield Avenue, Milwaukee, Wis. 53204. In Canada: Allen-Bradley Canada Limited. Export Office: 630 Third Avenue, New York, N.Y., U.S.A. 10017.



ALLEN - BRADLEY

QUALITY ELECTRONIC COMPONENTS

Airborne system forms instant maps

A recorder-display system for the U.S. Air Force uses radar, infrared and electro-optical signals to form instant, permanent strip maps without chemical processing.

Milliseconds after the information becomes available from the receiver electronics, it is displayed on rear-projection screens ready for in-flight viewing. A development of General Electric's Electronic Laboratory, Syracuse, N. Y., the system is based on a thermoplastic recording technique.

What is projected on the screen is a display of the terrain under the aircraft as seen by the aircraft's sensor. The continuous strip map rolls from top to bottom; the aircraft's current position is represented by the top line.

Information is recorded on a moving thermoplastic tape by an electron beam that scans a two-inch width. The recorded image is then projected onto the screen.

High resolution is achieved by means of the system's ability to form approximately 8000 by 5000 picture elements on a 3-by-2-inch area of tape. Sixteen levels of gray are said to be measurable, giving a dynamic brightness range of better than 100 to 1.

The airborne recorder display console contains all recording, opti-

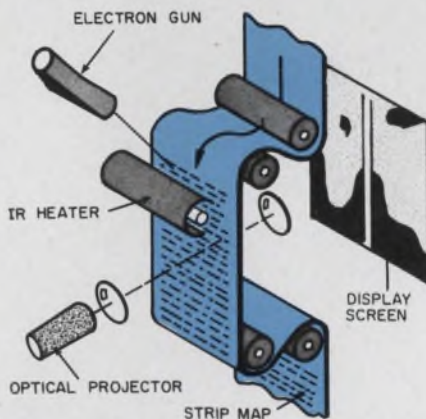

Airborne-recorder display forms instant maps for reconnaissance aircraft. The infrared heater softens the thermoplastic layer of recording tape while the electron beam forms grooves corresponding to radar, IR or electro-optical video signals. The optical projection system then forms the map on the screen.

cal and test components and electronics. Two 10-by-15-inch display screens permit the simultaneous display of large terrain areas at 5× magnification and small areas at 20× magnification.

Selection of the terrain for 20× magnification is done manually. A tracking feature enables the operator to "freeze" a selected area of the 5× display, so that the image remains temporarily motionless. This area can then be magnified and inspected in detail.

The electron beam in the recorder is intensity-modulated by the sensor video signal and scans the width of the recording tape synchronously with the sensor. The tape moves at a rate proportional to the velocity of the aircraft at all altitudes.

The recording tape has three layers: a base film, a conductive coating, and a surface film of thermoplastic. Locally applied heat liquefies the thermoplastic layer, permitting electrons to be deposited on the conductive layer.

Grooves, varying in depth and slope, are formed by the action of the modulated electron beam as the infrared heater liquefies the surface of the moving tape. As the tape cools, the grooves solidify in the tape surface.

A schlieren optical system beams light through the groove, to project the moving map, which is based on the intensity of the sensor video signal. The only time delay is the few milliseconds required to form the grooves in the tape surface.

A ground-based display, delivered with the airborne equipment, permits Air Force personnel to replay the airborne tapes and make detailed postflight evaluations.

The project sponsor, the Air Force Avionics Laboratory, Wright-Patterson AFB, Dayton, Ohio, says the system has many advantages over current photographic-film systems for tactical reconnaissance missions. It is said to offer higher resolution and wider dynamic range than existing cathode-ray-tube systems. Moreover, it makes a permanent record while the plane is in flight and eliminates chemical film-processing. ■ ■

"9 years ago we had a great idea that put us in the high-rel relay business.



It's still a great idea, and now we've put it in a one-inch package!"

Wedge-action* was the great idea. By combining long precious-metal contact wipe with high contact force, it gives Electro-Tec relays the highest dry-circuit confidence level ever reached. (90%, based on a failure rate of only .001% in 10,000 operations.)



Packing wedge-action into a one-inch envelope wasn't easy. But it was worth it. It gives you maximum reliability in minimum space. And it's available for both 8PDT and 4PDT operations, in relays that exceed all requirements of MIL-R-5757/1 and /7.

The one-inch relay is just one of our family of wedge-action relays, which cover almost every dry-circuit to 2 amp application. When you need a high-rel relay that really works, remember our great idea, and put it to work for you.

*U.S. Patent No. 2,868,046 and others pending.



Electro-Tec Corp.

SLIP RINGS • RELAYS • SWITCHES • OPTICS

P. O. Box 887 • Ormond Beach, Florida
(904) 877-1771 • TWX 810-857-0305

Manufacturing Facilities:
Ormond Beach, Fla. • Blacksburg, Va.

ON READER-SERVICE CARD CIRCLE 22



**You can get an
integrated circuit
universal counter
almost as good
as the Fairchild
8200 for only
\$100 more. Or you
can circle Reader
Service No. 71
and get our specs
free.**

FAIRCHILD
INSTRUMENTATION

Satellite to film earth's profile in color TV

The first satellite color-television pictures of the earth are now being taken by the Dodge (for Department of Defense Gravity Experiment) satellite.

The 430-pound Dodge, launched from Cape Kennedy last month into a 20,700-mile-high orbit, is intended primarily to demonstrate the practicability of using gravity-gradient stabilization at near-synchronous-orbit altitudes. A secondary goal is to take pictures of the earth's profile in color television.

The advantages of color observations have not yet been established, according to the head of the television project, Thomas Thompson of the Johns Hopkins University Applied Physics Laboratory, where the Dodge was designed and built. "There are various theories," he says. "For example, you're supposed to be able to judge the height of clouds better, and different colors may give you different information about the horizon." Thompson also believes that the color pictures will lead to more meaningful observations of auroras. NASA's ATSC meteorological satellite, due to be launched this fall, will relay color photographs of cloud formations to ground stations.

Other observers believe that color

television will improve military reconnaissance. Another possible application is surveying remote areas for potentially arable land; the color of the soil is a clue to its chemical content.

In the Dodge gravity experiment, stabilization will be achieved by 10 weighted masts that can be extended and retracted. The main boom is 150 feet long, and it extends from a 62-inch mast on the bottom of the octahedral satellite.

Two vidicon cameras have been installed on the Dodge satellite—one color and one black-and-white. They serve the double function of observing the thermal bending of its extendable booms and sensing the attitude of the satellite with respect to Earth. This versatility saved the use of a separate attitude sensing system.

The color camera photographs the Earth with a 22-degree field of view; the other takes black-and-white pictures over a 60-degree field of view. The narrower-angle camera also transmits in black- and-white.

According to an Applied Physics Laboratory spokesman, both cameras appeared to be functioning normally during the first three weeks after launch, but no pictures were taken until the satellite had settled.

The face of the narrow-field-of-view camera is calibrated with a bull's-eye reticle to permit rapid measurement of the satellite's attitude. A color filter wheel is incorporated in the shutter mechanism. Three of the eight positions are used for the additive primary colors—red, green and blue. The others are haze filters used to improve picture contrast.

The scientists selected a frame-sequential camera scheme, rather than a dot-sequential or three-head system with electronic switching, because of its simplicity. It is feasible because there is hardly any motion of the satellite in a near-synchronous orbit. Greater relative motion would warrant the use of one of the two other color techniques.

In the scheme used, three successive frames, each making use of a different color filter, are transmitted. Thus, three frames are required to arrive at a composite color picture. The ground station produces three color-separation negatives from a direct, high-quality cathode-ray-tube readout that exposes a black-and-white film plate. The negatives are processed into a composite color print or transparency.

The wide-angle camera permits the scientists to see what they are doing when they "rock the boat"—perturb the satellite by means of gravity-gradient and magnetic devices. They can observe how long it takes the satellite to damp excursions of 30 degrees on each side of the axis.

The scan of both cameras is stabilized by means of a digital technique that steps the scan electron beam to 512 positions along each of 512 lines. Thus, beam modulation results in a sampling rate of once per scan step. By using the satellite's stable oscillator as the clock for the camera electronics, it is possible to eliminate separate transmission of the clock frequency to the ground station while preserving good picture synchronization.

Other experiments planned with Dodge include measuring the earth's magnetic field at near-synchronous-orbit altitude and measuring the output of various types of solar cells. ■ ■



The Dodge satellite undergoing sunlight tests at the Applied Physics Laboratory of Johns Hopkins University before being shipped to Cape Kennedy.

Our 500MHz counter has integrated circuits. (Where they count.)



The Fairchild 8220 is a counter made for communications equipment checkout. It measures frequency to 500MHz at 100 mV sensitivity. It's built with silicon Planar transistors and integrated circuits, so it's smaller, lighter (12 lbs.), less expensive (\$1500.00), and more reliable than the germanium transistor models in the same frequency range. Get the complete story. Simply circle Reader

Service
No. 72.

FAIRCHILD
INSTRUMENTATION

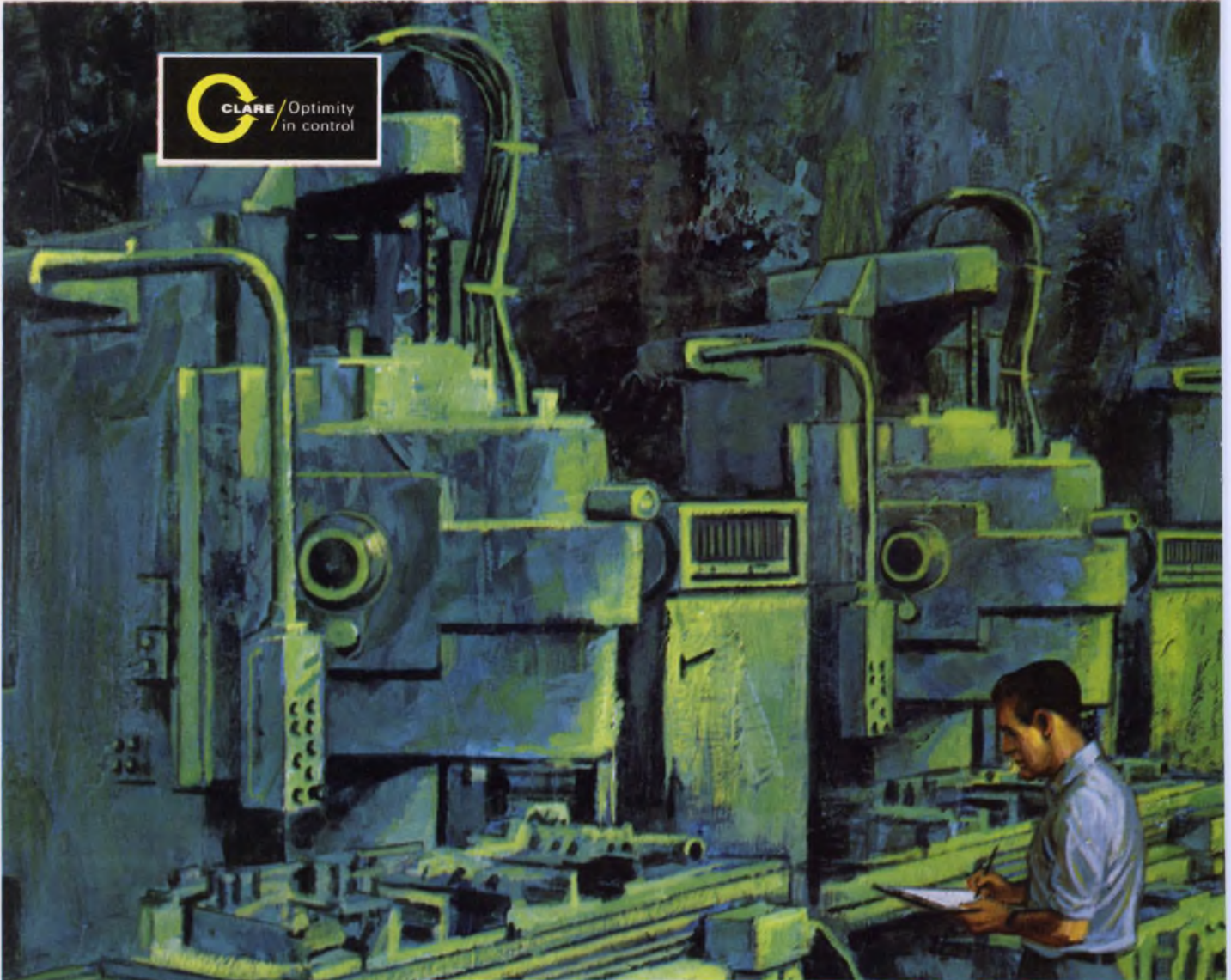

Clare provides maximum variety in Reed Relays

CLAREED RELAYS
(2.1" switch)



MICROCLAREED RELAYS
($\frac{1}{8}$ " switch)

Open Coil
pcb Module



Enclosed
pcb Module



handles them all ...large and small,

matches design versatility to the speed, reliability and long life demands of industrial process control systems !

CLAREED and MicroClareed Sealed-Contact Reed Relays are fast—speeds in the low millisecond range serve advanced system requirements. And no matter what's around them, there's virtually no falsing, no sequence disruption—these relays are insensitive to transient electrical noise !

Sealed-in-glass contacts never need adjustment, stay clean whatever the location. Use 'em singly or in combinations up to 12 contacts, for switching millivolt low level signals or up to 15 va (ac or dc) loads. Count on long service, up to 100 million operations at full rated loads, in pcb applications and wired assemblies.

Send for full facts. Circle Reader Service Number, or ask Clare for Clareed Bulletin 951A, and MicroClareed Data Sheet 961...write Group 8A4,

C. P. Clare & Co., Chicago, Illinois 60645

Four Different Switches

2.1"—General Purpose,
Mercury-Wetted,
High Voltage
(available in models illustrated, and in plug-in and solder-type for wired chassis)

7/8"—MicroClareed

- Switching speeds in low millisecond range
- Immunity to transient electrical noise
- Life : 20×10^9 or 100×10^6 (depending on switch)
- 1 to 12 contacts—Clareed
1 to 5 contacts—MicroClareed
- Complete input/output isolation

CLAREED® SEALED-CONTACT REED RELAYS

for industrial control, data logging and instrumentation, communication switching, ground control and check-out systems

ON READER-SERVICE CARD CIRCLE 23

FREE 16-PAGE SHORT COURSE

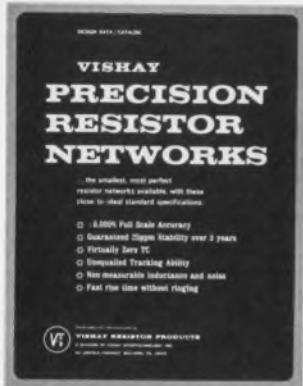

The standard specs on the cover above tell you these are networks with total performance never before available. The other pages tell you the how and where . . . how and where this performance is needed and important...how and where Vishay (and only Vishay) achieves it...how simple network design can be and where you can get experienced assistance. There's even a streamlined Design Check List that'll bring you an immediate quote.

About the only thing we've left out it just how much less this total performance can cost . . . and how much time you'll save (in design and delivery).

To find out, send for your copy of this Design Data/Catalog today. Return the Checklist with your application's specs (we're used to meeting the tightest). We promise a quick response (and quick delivery when you order).

Write to Vishay Resistor Products, 71 Lincoln Highway, Malvern, Pa. 19355

VISHAY RESISTOR PRODUCTS



a division of
Vishay
Intertechnology, Inc.

ON READER-SERVICE CARD CIRCLE 26

Letters

Engineers support plea for prices

Use before Aug. 15, 1967

NAME C. W. WOLFE TITLE Sr. Eng
 COMPANY XEROX CORP M S
 ADDRESS _____ CITY ROCHESTER
 STATE N.Y. ZIP CODE _____ PHONE NO _____ EXT _____

Circle the reader service number of the items in which you are interested

25	50	75	100	125	150	175	200	225	250	275	300	325	350	375	400	425	450	783	828	900	
1	26	51	76	101	126	151	176	201	226	251	276	301	326	351	376	401	426	451	784	851	901
2	27	52	77	102	127	152	177	202	227	252	277	302	327	352	377	402	427	452	785	852	902
3	28	53	78												378	403	428	453	786	853	903
4	29	54	79												379	404	429	454	787	854	904
5	30	55	80												380	405	430	455	788	855	905
6	31	56	81												381	406	431	456	789	856	906
7	32	57	82												382	407	432	457	790	857	907
8	33	58	83												383	408	433	458	791	858	908
9	34	59	84												384	409	434	459	792	859	909
10	35	60	85												385	410	435	460	793	860	910
11	36	61	86												386	411	436	461	811	884	911
12	37	62	87												387	412	437	462	812	885	912
13	38	63	88												388	413	438	463	813	886	913
14	39	64	89												389	414	439	464	814	887	914
15	40	65	90												390	415	440	465	815	888	915
16	41	66	91	116	141	166	191	216	241	266	291	316	341	366	391	416	441	466	816	889	916
17	42	67	92	117	142	167	192	217	242	267	292	317	342	367	392	417	442	467	817	890	917
18	43	68	93	118	143	168	193	218	243	268	293	318	343	368	393	418	443	468	821	891	918
19	44	69	94	119	144	169	194	219	244	269	294	319	344	369	394	419	444	469	822	892	919
20	45	70	95	120	145	170	195	220	245	270	295	320	345	370	395	420	445	470	823	893	920
21	46	71	96	121	146	171	196	221	246	271	296	321	346	371	396	421	446	471	824	894	921
22	47	72	97	122	147	172	197	222	247	272	297	322	347	372	397	422	447	472	825	895	922
23	48	73	98	123	148	173	198	223	248	273	298	323	348	373	398	423	448	473	826	896	923
24	49	74	99	124	149	174	199	224	249	274	299	324	349	374	399	424	449	474	827	897	924

For employment ads give home address

City _____ State _____ Zip Code _____

Why do manufacturers refuse to cite prices?

Sir:
Manufacturers who refuse to send printed price lists with their catalogs bug me more than anything else in this industry.

AMEN

Sir:

The letter from John Cone regarding pricing information ["Why do manufacturers refuse to cite prices?" ED 13, June 21, 1967, pp. 46-48] does not begin to express the frustrations which are heaped upon the designer.

As a consulting engineer, I face this problem constantly. I currently have over 16 meters' worth of manufacturers' literature; yet less than one per cent of it is covered by adequate pricing information.

It may well be that there exist some companies with CPFF [cost-plus-fixed-fee contracts] for whom pricing information holds little value, but my clients are very concerned with costs in prototype, preproduction and production quantities. How can I give them the best design at the lowest cost without adequate data? Even when one calls a company on the telephone, it is like pulling hens' teeth to obtain enough information.

In my case, it is perhaps harder to get pricing information than for a designer affiliated with a "company" name. For ethical reasons I do

not reveal the identity of my clients, so many people who are unfamiliar with what a consulting engineer does believe that I *must* be a competitor.

I have been told by a few companies that the publication of price sheets and keeping them up to date are too expensive. They will spend copious amounts of money on brochures and data sheets with the finest art and layout, yet a mimeographed price sheet would be "too expensive."

The subject could be discussed at length, but my intent is not to write an article but to say "Amen" to Mr. Cone's letter and to plead for your support.

Carl David Todd
Electronics Consulting Engineer
Costa Mesa, Calif.

Sir:

I must concur with John Cone. I believe, however, that part of the problem is the fact that companies are accustomed to components
(continued on p. 44)



**Remember
The Whisker
Contact?
It Was Before
The S-Bend.**



**Remember
The S-Bend?
It Was Before ...**



RamRod

**The First New Zener Diode Construction In 9 Years ...
Gives You Safe, Sure, Lead-To-Die Contact!**

A new reliability "plus" has been added to 250 mW and 400 mW zener diodes . . . called RamRod® zener diodes! Now, with RamRod devices you get:

- straight-through lead alignment that prevents S-bend mismatches, shorts to substrates and parameter shift due to contact resistance and pressure change
- increased power dissipation through direct, more massive lead-to-metal-over-oxide-die soldered contact
- continuous device operation when subjected to shock or vibration

The reasons are state-of-the-art:

RamRod design is simplicity itself which yields increased reliability and non-variability of assembly; thermal expansion coefficients are closely matched and a perfected final seal process achieves, simultaneously, a glass-to-glass hermetic seal and metallic solder bond of the lead to die with less than *half* the compressive load on the die as that required for sealing S-bends.

Reliability and electrical stability of RamRod units are so superior that not one device selected at random from production runs has failed above-and-beyond Mil-S-19500-type tests like 10,000 G step stress shock, 225°C, liquid-environment, thermal shock excursions at 25°C/

sec change and 100 G variable frequency vibration at 100 to 2000 Hz.

Motorola has supplied reliability-proven RamRod types since 1965:

MILITARY TYPES		
1N746 Series	400 mW, 2.4 to 200 V	MIL-S-19500/127
1N962 Series		MIL-S-19500/117
1N4370 Series		MIL-S-19500/127

INDUSTRIAL TYPES		
¼ M2.4AZ Series	250 mW, 2.4 to 200 V	±5% to ±20% Tolerance
1N4099 Series	250 mW, 6.8 to 100 V	±5% Tolerance

Send for a new RamRod reliability report and data sheets today: Box 955, Phoenix, Arizona 85001. Contact your franchised Motorola distributor for evaluation units.

*Trademark of Motorola Inc.

-where the priceless ingredient is care!



MOTOROLA
Semiconductors

Where to begin...what equipment to select
...what pitfalls to guard against in

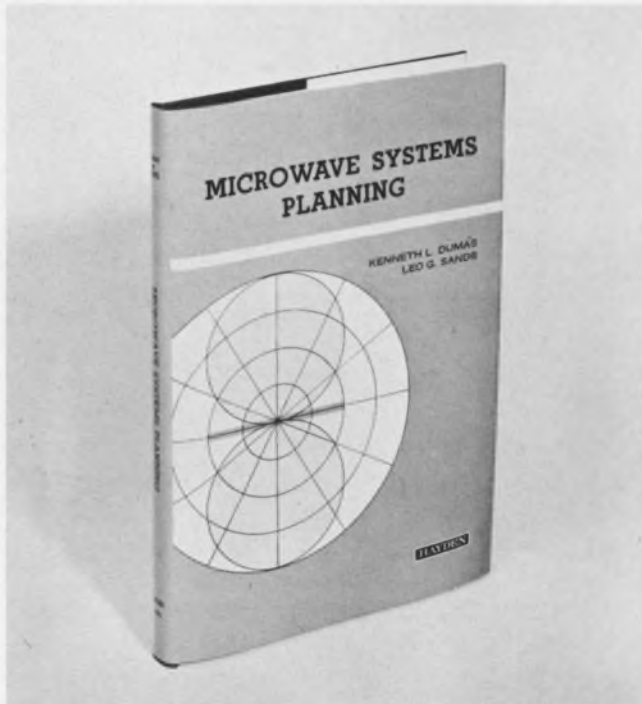

Microwave Systems Planning

KENNETH L. DUMAS, and
LEO G. SANDS

Here is an authoritative introduction to microwave systems, presenting for the first time in a single volume needed information that has been scattered up to now among many books, articles, and manufacturers' catalogs. With this convenient sourcebook at hand, managers, engineers, and technicians — all participants in the spiralling growth of communications facilities — have a comprehensive view of the theoretical and practical considerations of installing and operating point-to-point FM communication systems.

Written in a semi-technical manner, the book uses terms, phrases, and symbols commonly employed in the telephone industry, the greatest user of micro-

wave systems. It begins by providing a thorough groundwork in fundamental principles, from frequency and wave theory — including propagation — to hardware theory. The balance of the book is concerned with a thorough, objective investigation of the practical aspects of establishing a microwave path with a high probability of good performance.

Chapters: Fundamentals of Microwave Theory. Microwave Propagation Theory. Characteristics of Transmission Paths. Transmission Performance. Microwave System Performance. Microwave Communications Equipment Loading. Fundamentals of Antenna Systems. Microwave Equipment. Microwave Path Engineering. Antenna Orientation and System Measurement. **143 pages, illustrated, clothbound. \$8.00.**

Dept. JC-6, Hayden Book Company, Inc., 116 West 14 St., New York, N.Y. 10011
Send me MICROWAVE SYSTEMS PLANNING for a free examination. At the end of ten days,
I will either remit \$8.00 plus postage or return the book with no further obligation.

Name _____ Title _____

Company _____

Address _____

City _____ State _____ Zip _____

Check here if payment enclosed. Publisher pays postage with same return guarantee.
(Foreign orders, except Canada, must include payment in \$ U.S.)

Nothing makes it work better.

Our customers tell us nothing makes their equipment work better than our vacuum components! That's because nothing else has all the advantages of the vacuum dielectric: high voltage ratings • high rf current ratings • long contact life • no contact maintenance • impervious to environment • faster operation • high capacity change ratios • compact design... and many others.

You just can't compare anything else with ITT Jennings vacuum

components for reliable solutions to high-voltage switching and control applications. Moreover, ITT Jennings offers industry the broadest range of vacuum products available: Our new diaphragm vacuum relays which ounce for ounce control more power for more applications than any other relays in the world • Complete coaxial switching matrices for communication control in satellite tracking stations • The widest selection of vacuum capacitors • Efficient, compact vacuum contactors.

The next time you need a reliable relaying or capacitive device for controlling high voltage or current let us show you how easily a vacuum component will solve your problem... even if you only have a crowded corner to put it in. Chances are our more than 24 years of experience with the vacuum dielectric has already provided an answer.

For information on any of the products shown, or for our complete catalog, write to ITT Jennings, a division of International Telephone and Telegraph Corporation, 970 McLaughlin Avenue, San Jose, California 95108.



Vacuum Contactors for the most reliable means available for the remote control of high voltages from 60 cycle through rf and in applications ranging from antenna switching to motor controls.

High Voltage Measuring Equipment for the measuring and testing of high voltage circuits from 60 cycle to rf frequencies.



Vacuum Coaxial Relays for automatic, remotely controlled coaxial switching in antenna and transmitter equipment for communication systems.

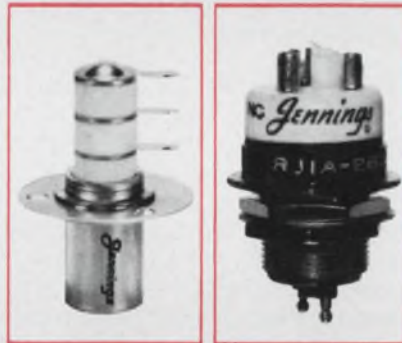

Vacuum Relays for high-voltage switching applications in airborne, mobile, or marine communication systems, and many industrial and commercial applications.

Vacuum Capacitors for the utmost in performance in rf generating devices such as high power transmitters and dielectric heating equipment.

JENNINGS ITT

ON READER-SERVICE CARD CIRCLE 29

AMPERITE

GLASS ENCLOSED Thermostatic DELAY RELAYS



Offer true
hermetic
sealing —
— assure
maximum
stability
and life!

Delays: 2 to 180 seconds

Actuated by a heater, they operate on A.C., D.C., or Pulsating Current . . . Being hermetically sealed, they are not affected by altitude, moisture, or climate changes . . . SPST only — normally open or normally closed . . . Compensated for ambient temperature changes from -55° to $+80^{\circ}\text{C}$. . . Heaters consume approximately 2 W. and may be operated continuously. The units are rugged, explosion-proof, long-lived, and inexpensive! TYPES: Standard Radio Octal and 9-Pin Miniature . . . List Price, \$4.00 PROBLEM? Send for Bulletin No. TR-81.

AMPERITE

BALLAST REGULATORS

Hermetically sealed, they are not affected by changes in altitude, ambient temperature (-50° to $+70^{\circ}\text{C}$), or humidity . . . Rugged, light, compact, most inexpensive.

List Price, \$3.00

Write for
4-page
Technical
Bulletin
No. AB-51

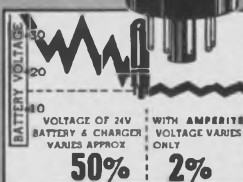

AMPERITE

600 PALISADE AVE., UNION CITY, N.J.

Telephone: 201 UNION 4-9503

In Canada: Atlas Radio Corp., Ltd.,
50 Wingold Ave., Toronto 10

LETTERS

(continued from p. 40)

being used on military contracts, where cost is secondary to specifications. But there are some of us who do no government work; all of our production is aimed at the man in the street. In our case, cost is extremely important. It is impossible to sell an item for \$100 if one component alone costs \$30.

Another thing that bothers me is the company that sends information on everything but what is asked for. Some time ago I wrote to a leading manufacturer for information on his line of 455-kHz ceramic transfilters. I received information on everything in his line except the transfilters.

Two subsequent letters produced no better results. At the time of writing I still have not received this information. I am importing my 455-kHz ceramic filters from Japan.

W. R. Eade

General Manager
Borderline Electronics
San Diego, Calif.

Sir:

Please allow me to second John Cone's complaint about catalogs without prices. My standing rule is: "No prices, into the wastebasket"—although occasionally I am forced to break the rule. Our corporate policy specifically calls for prices to be printed in all the catalogs that we put out.

Price is at least as important a design parameter as power output, β , etc. An engineer who can design without component cost in mind is working under very unusual conditions. If there are two catalogs at hand for comparable items, the one with prices will receive preferential attention.

I think that a general rule should be: Whenever reasonable, print the prices. However, whenever complex equipment is described for nontechnical people, lack of a price may get the salesman in to explain application limitations and so forth that nontechnical people tend to misread or read around.

George F. Quittner
Research Director
API Instruments Co.
Chesterland, Ohio

Engineers' conservatism may not be their fault

Sir:

It seems to me that K. H. Sueker in his letter, "Older engineers are too conservative" [ED 11, May 24, 1967, p. 54], is not entirely correct. His statement, "older engineers tend to become . . . unable to accept management decisions which run counter to what they 'know' is right," is very true. But this is not always due to the conservatism of the engineer. It is not always that they like to change *nothing*, but rather that they think that a change must *really* improve conditions.

Management, heavily burdened with too much administrative work and anxious to build a personality "image" for advancement purposes, finds no time to take everything into account and hear other opinions before it makes a decision. Thus older, "subordinate" people adopt one of two attitudes: either they become immobile, that is, conservative; or like me they become very bitter in their criticism. The manager should always bear in mind: resourcefulness must be stimulated and encouraged by the boss or it will die out. Yet more often than not, management puts obstacles in the way of young men because they make it feel uneasy. I have often seen fresh, young people come in bursting with new ideas only to become stultified over the years as their suggestions are one after another turned down. That's what generates conservatism.

As for me, I am 43 and have been a design engineer since 1952 at the Central Laboratories of the world-famous Siemens AG. But I am very much too progressive and must hope that no member of our management ever reads this letter!

Rudolf L. Zorn
In-house Design Engineer
Siemens AG Zentrallaboratorium
Munich, West Germany

Accuracy is our policy

In "Pulse generator uses IC logic," in the Ideas for Design section of ED 10, May 10, 1967, p. 94, author Richard Belanger draws attention to two errors in the figure. In

(continued on p. 48)

Good, old-fashioned, Scottish thrift.

We've become so thrifty at Honeywell that we've pared the prices of taut-band meters down even lower than the prices of pivot-and-jewel meters. (About 10% lower, on the average.)

Now, if your shrewd business sense tells you we've left something out, you're right.

We've left out half



the parts. (All the unnecessary ones.) Which doesn't make the meter less sophisticated. Just less complicated.

This taut-band meter is so ingeniously simple, there's hardly anything to go wrong.

There's no friction in the moving system, so the pointer doesn't stick. (Better readout accuracy and repeatability.) And the meter's self-shielded.



The low-cost taut-band meter from Honeywell. It comes in just about any style you'd like. Write Honeywell Precision Meter Division in Manchester, N.H. 03105 and we'll send you a brochure with all the sizes, styles and prices.



What's the secret of Honeywell's taut-band meter success?



Think
vertically.

Get your
functional
circuit
designs
stacked
in a
MicroCircuit
Pack™...
ready to
mount.

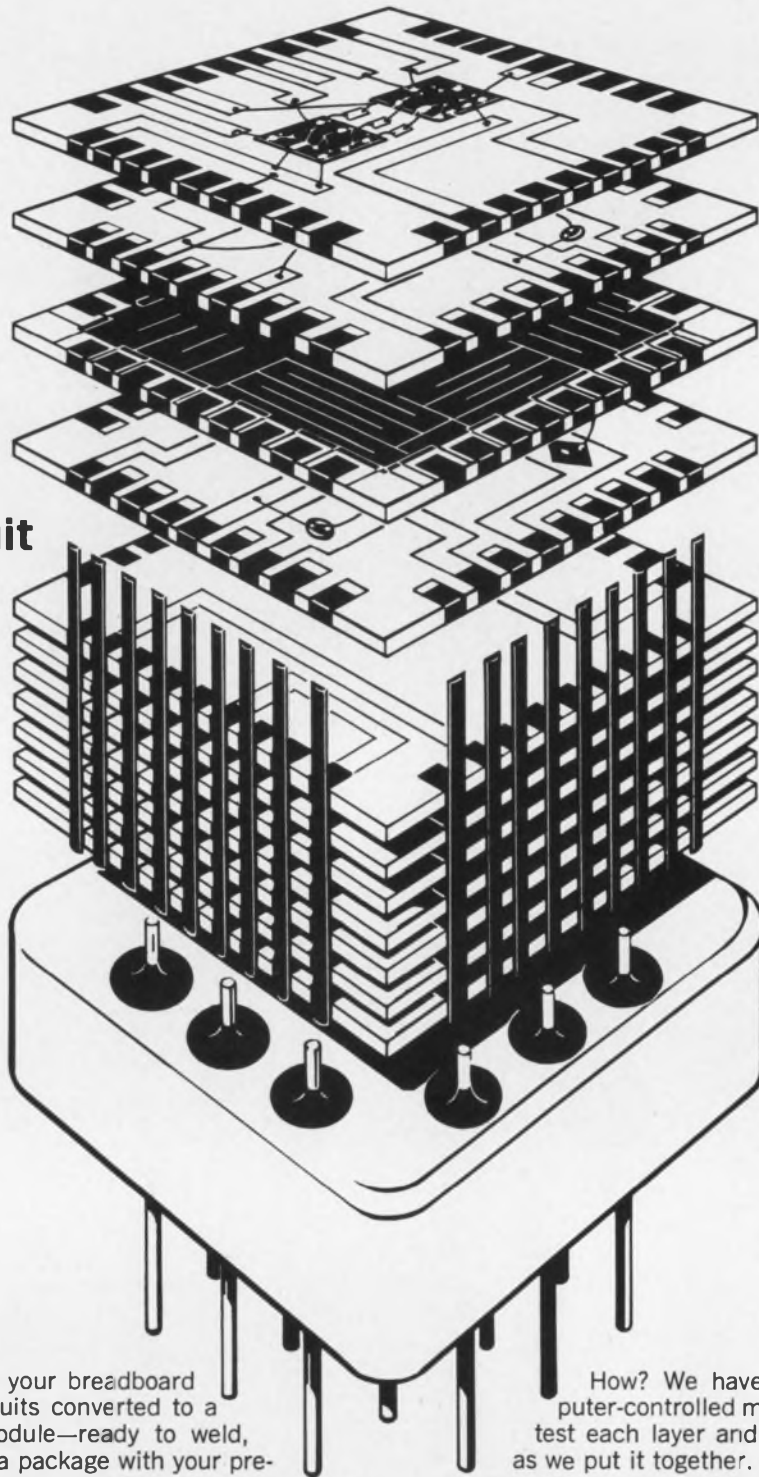

SEE US
AT
WESCON

Wouldn't you like to see your breadboard model of functional circuits converted to a fully microelectronic module—ready to weld, solder, or plug in? Want a package with your preferred mix of semi-conductors, monolithic integrated circuits, thin film and discrete devices ready to perform a number of system functions, either analog or digital—one that combines all the advantages of vertical, multilayer stacking, welded interconnections, hermetically-sealed enclosure, and uniform modular assembly?

That's no pipe dream with Hamilton Standard's MicroCircuit Pack technology. We can deliver a custom-built module of up to 15 ceramic wafers, pretested to meet your design, in either evaluation or production quantities. And it will cost far less than you would think.



Actual size

How? We have developed flexible, computer-controlled methods of manufacture. We test each layer and each module step-by-step as we put it together. And we use electron-beam scribing, welding and sealing under ultraclean vacuum conditions. Results? Your packaged module is strong and reliable, will resist moisture and radiation, and will operate over a wide temperature range.

Whatever your system requirements might be, investigate going to MicroCircuit Packs direct. Consider all the in-between expenses you can save. For more information, price quotations, or assistance in component selection and system layout, contact the Marketing Manager, Electronics Department, Hamilton Standard, Windsor Locks, Conn., 06096. Phone (203) 623-1621, ext. 2012. TWX 710-420-0586.

Hamilton Standard DIVISION OF UNITED AIRCRAFT CORPORATION
WINDSOR LOCKS, CONNECTICUT

U
A

ON READER-SERVICE CARD CIRCLE 32

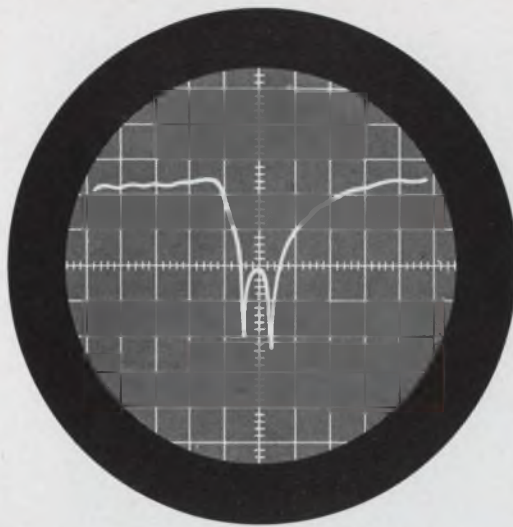

**First you look at the big picture*...
then...presto...zoom...**

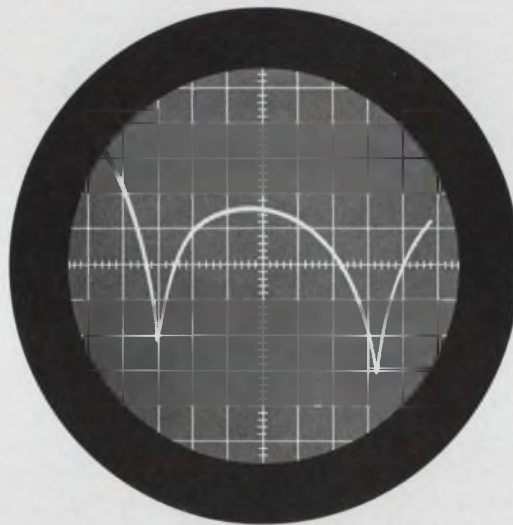

see all the fine detail!

Alfred Sweep Analyzers speed and simplify microwave measurements including insertion loss or gain, return loss (VSWR) or gain, and absolute or relative levels of CW power over a 60 db dynamic range with direct db or dbm readout.

It's not too much to say that Alfred Sweep Network Analyzers, Models 8000/7051 and 8000/7052, present a new dimension to microwave metrology. They take the agony out of designing and testing microwave instruments and components. Do in minutes what used to take hours.

The Model 8000/7051 Sweep Network Analyzer provides three signal channels to permit simultaneous, independent ratio measurements. It compares any two signal input levels with a common reference signal which eliminates the need for a leveled source. When the rf test loop is driven by a leveled sweeper, the lower cost single-chan-

nel Model 8000/7052 measures performance response directly.

Price of the Model 8000/7051 is \$1680. The Model 8000/7052 costs \$1250.

New Catalog Ready

For complete information ask your full service Alfred Sales Engineer for a copy of the Alfred '67 catalog just off the press. Or, if you prefer, you may address us at 3176 Porter Drive, Palo Alto, California 94304. Phone (415) 326-6496.

ALFRED ELECTRONICS

Upper and lower photos display, respectively, transmission characteristics of a passive microwave device examined by an Alfred Sweep Network Analyzer with wide sweep (10 db/div sensitivity) and then automatically zooming in with a narrow sweep (5 db/div).

Project responsibility opportunities exist for qualified engineers on our technical staff. An equal opportunity employer.

"See us at WESCON, booths 2606. & 2607"

ON READER-SERVICE CARD CIRCLE 33

Check here for free new GE lamp catalogs.

More than 1,200 listings, lots more application information in General Electric's revised new illustrated catalogs. Complete electrical and physical specifications, now easier to read. Lamps are grouped by bulb size to simplify selection, plus each catalog contains an index by lamp number for easy reference. Check the catalogs you need, then mail the coupon to:

GENERAL ELECTRIC COMPANY, MINIATURE LAMP DEPARTMENT,
M7-2, Nela Park, Cleveland, Ohio 44112.



MINIATURE LAMPS

Comprehensive 40-page booklet lists all miniature lamps larger than T2. Includes flasher lamps, Christmas lamps, electric discharge lamps, too. Complete with filament and base drawings of all lamps, plus a handy table that groups lamps by primary application.

SUB-MINIATURE LAMPS

Filament and base descriptions, selection factors and completely updated listings of more than 150 sub-miniature lamps (T2 and smaller).

GLOW LAMPS

GE glow lamps are rugged, long-lasting and inexpensive tools for electrical designers. Here are more than 50 for indicator and circuit component applications with photos and typical circuits. Argon and Helium-Argon descriptions, too.

SEALED BEAMS

Lists all sealed beam lamps—automotive, aircraft, marine, and tractor. Includes features of GE headlamps, information on Heavy Duty lamps, beam pattern descriptions, filament and base information.

ELECTROLUMINESCENT LAMPS

You specify the shape. General Electric will design and fabricate an electroluminescent lamp for your low-brightness lighting or luminous product application. Catalog gives product uses, operating characteristics, selection data.

INDEX OF ALL LAMPS

Lists all the above mentioned lamps by number, with reference to the appropriate catalog and line number.

Name _____ Title _____
Please Print

Company _____ Address _____

City _____ State _____ Zip _____

SERVING YOU WITH GENUINE GE SEALED BEAMS • MINIATURE LAMPS • TIRE STUDS • SILICONE PRODUCTS

Miniature Lamp Department

GENERAL  ELECTRIC

ON READER-SERVICE CARD CIRCLE 34

LETTERS

(Accuracy . . . continued from p. 44)

the circuit, $R7$ has the value 100 ohms (not 50, as printed). In the waveform, intervals t_R and t_F are both <10 nanoseconds (not <10 milliseconds, as printed).

In "Use a good switching transistor model," ED 12, June 7, 1967, pp. 54-59, coauthor Nathan Sokal has drawn attention to an inaccuracy in the equation at the foot of the right-hand column on p. 57. In the second line of this equation, the denominator should be $I_{EF} + [I_{ES}/(1 - \alpha_N \alpha_I)]$, not $I_{EF} + [I_{EF}/(1 - \alpha_N \alpha_I)]$, as printed.

In the second part of this article, "Assign the proper numerical values," published in ED 13, June 21, 1967, pp. 60-66, Mr. Sokal draws attention to further inaccuracies:

In Eq. 2, p. 62, the divisor should be: $(I_{C3} - I_{C1})$, not $(I_{CE} - I_{C1})$, as printed.

In Eq. 3, a square bracket should close the denominator; it was omitted in printing.

In Eq. 9, p. 63, the element V_{BE} in the denominator should be V_{BE2} .

In Eq. 18, p. 65, the last element in the denominator should be β_N , not β_N , as printed.

In Fig. 2, p. 61, the caption should read: ". . . readings must be readable and repeatable to ± 1 mV" (not \pm mV, as printed).

In Fig. 5, p. 63, the caption should read: ". . . variation is 7% for a base current of 0.06 mA" (not 0.6 mA, as printed).

Mr. Sokal suggests that the following should be added to the end of the paragraph preceding the sub-head on p. 66, to clarify the method by which the correct value of F_n is found:

"The computed rise times can be plotted against the values used for F_n in calculating the test circuit transient response, and a curve drawn between the plotted points. The correct value of F_n is read off the curve as that which corresponds to the measured or specified performance."

This same explanation may also be inserted at the end of the next to last paragraph of the article, with F_i substituted for F_n , and "storage times" substituted for "rise times."

ON READER-SERVICE CARD CIRCLE 35 ➤



Don't risk it!

These wires were subjected to a transient current overload in a normal atmosphere. The insulation smoked, then burst into flame. This won't happen with insulation of Du Pont TEFLON® fluorocarbon resins.

TEFLON will not propagate flame. It is *nonflammable*... by all recognized vertical and horizontal flame tests. The point is simply this: for proven reliability you need the combined benefits offered *only* by TEFLON. Nonflammability is just one. Among others: • *TEFLON is rated for continuous use from -450°F. to +500°F. (TFE)* • *Inert to virtually all chemicals and corrosives* • *Provides space and weight savings without sacrificing performance or long-term reliability.*

It comes as no surprise, then, that when reliability is considered, TEFLON answers the need. Its reliability has been proven in use for more than 20 years.

We'd like to send you detailed performance data on nonflammability. Write Du Pont Company, Room 5268, Wilmington, Del. 19898.

TEFLON®...for an extra measure of reliability!



Better things for better living
...through chemistry

If suddenly you're unhappy with your present recorder...



**blame
CEC's
new VR-3400.**

For the VR-3400 was created for malcontents—people who have wanted an advanced laboratory recorder at a budget price. Fact is, the full-ranged VR-3400 costs little more than some conventional portables.

There are a few “laboratory” recorders presently available in its price range. But there are none which offer all, or even most, of its advantages. Namely...

- **Magnetic recording heads guaranteed to exceed 1000 hours.** CEC's unique, solid metal pole-tip design has eliminated the inherent deficiencies of lamination and rotary head design.
- **Failsafe DC Capstan Drive** assures dramatically-improved flutter and TDE performance.
- **All-Electronic Tension Control.** Solid state amplifiers for improved linear tension control and greater reliability.
- **15-inch reel capacity.**
- **Automatic 8-speed transport** with electrically selectable electronics.
- **Modularized capstan control electronics** for ease of maintenance and system updating.
- **Convertible from mid to wideband recording.** New plug-in heads offer easy interchange of headstacks up to 42-channel capacity.

Obviously, we're rather impressed with the new VR-3400. We believe you will be too.

For complete information, call or write Consolidated Electrodynamics, Pasadena, California 91109. A subsidiary of Bell & Howell. Bulletin 3400-X2.

CEC
DATATAPE PRODUCTS

 **BELL & HOWELL**

See the VR-3400 at WESCON—Booths 3113-3115 and National ISA—Booth 801.

ON READER-SERVICE CARD CIRCLE 36

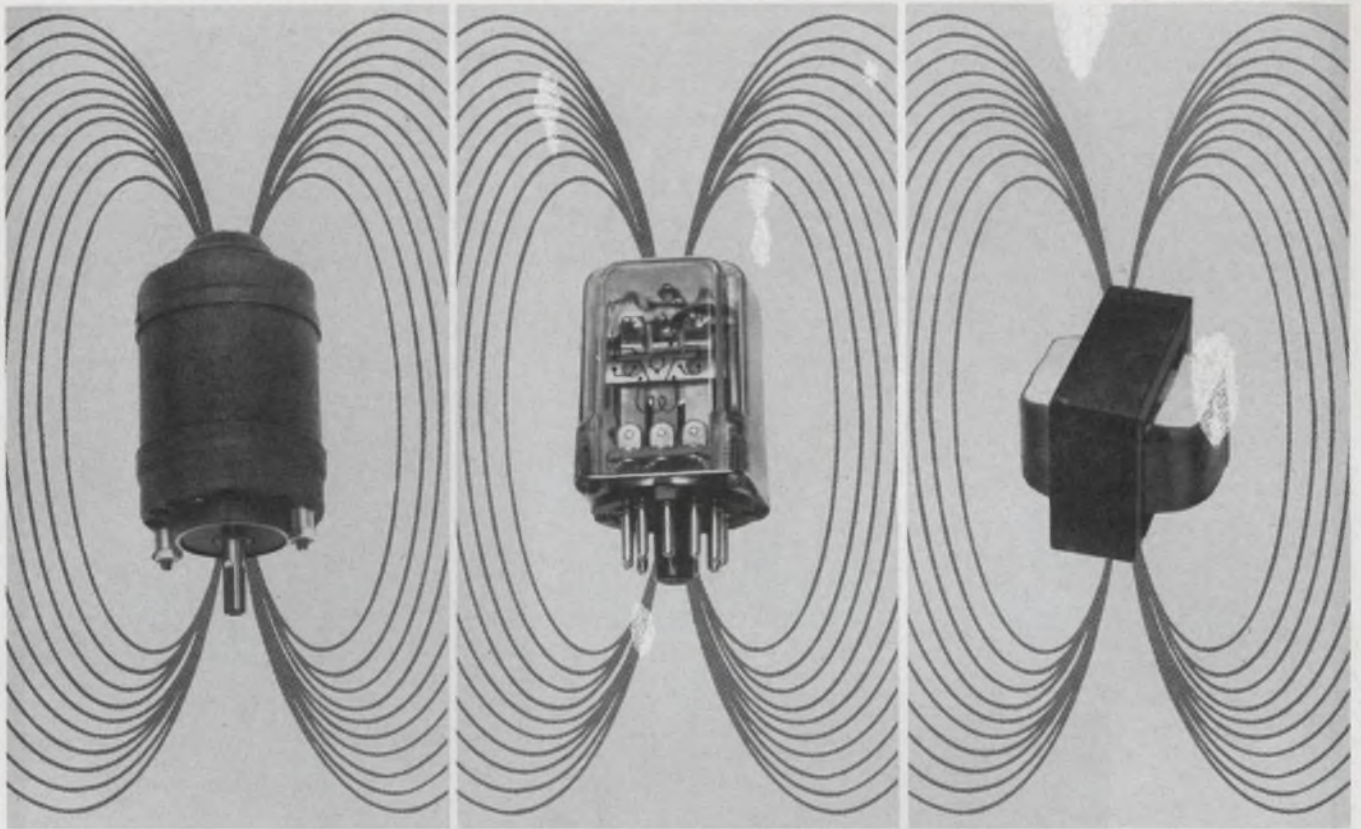

Now, Get 6 Volts Noise Immunity For Your Digital Control System With New MHTL Integrated Circuits!

You'll get the "right" signal every time in your numerical control, supervisory control and computer peripheral equipment with the new Motorola-developed high threshold integrated circuit logic series. Called MHTL, it's the first family of integrated circuits to offer a noise margin of 6 volts (typ) and a 15 volt ($\pm 1V$) operating voltage. And, it's priced, packaged, and specified for application in equipment designed for use in high noise industrial environments.

MHTL combines high noise immunity with a voltage swing of 13 volts, broad operating temperature range, large fan-out and a 35 mW power dissipation rating. In short, it offers you discrete circuit characteristics PLUS the price, size, and reliability advantages of integrated circuitry.

Here are some of the MHTL specifications:

CHARACTERISTICS	MHTL
Operating Voltage	15 \pm 1 Volts
Noise Immunity	6 Volts (typ)
Fan-out (Gate)	10 (min)
Clock Rate (Flip-Flop)	4 MHz (typ)
Operating Temperature Range	-30°C to +75°C

Offered in the 14-pin dual in-line plastic Unibloc* package, the circuit functions and prices for the MHTL family are as follows:

TYPE	DESCRIPTION	PRICE (1,000 UP)
MC660P	Dual 4-Input Gate	\$3.50
MC661P	Dual 4-Input Gate (Passive Pull-Up)	\$3.50
MC663P	Dual J-K Flip-Flop	\$6.10
MC664P	Master Slave R-S Flip-Flop	\$4.05

Other functions planned for the immediate future include a Dual 4-Input Line Driver, Triple Input Interface, Quad Output Interface, Dual Monostable Multi-vibrator, and Quad 2-Input Gate.

To find out how easily your designs can conquer high-noise-environments with MHTL, write for our data sheets. We'll also send you our latest application note on how MHTL solves your noise problems. For circuits you can try right now — call your nearby franchised Motorola Semiconductor distributor. He has high-noise-immunity MHTL in stock!

*Trademark of Motorola Inc.

— where the priceless ingredient is care!



MOTOROLA Semiconductors

MOTOROLA SEMICONDUCTOR PRODUCTS INC. / P. O. BOX 955 / PHOENIX, ARIZONA 85001 / (602) 273-6900 / TWX 910-931-1334

ON READER-SERVICE CARD CIRCLE 37

ELECTRONIC DESIGN 16, August 2, 1967

49

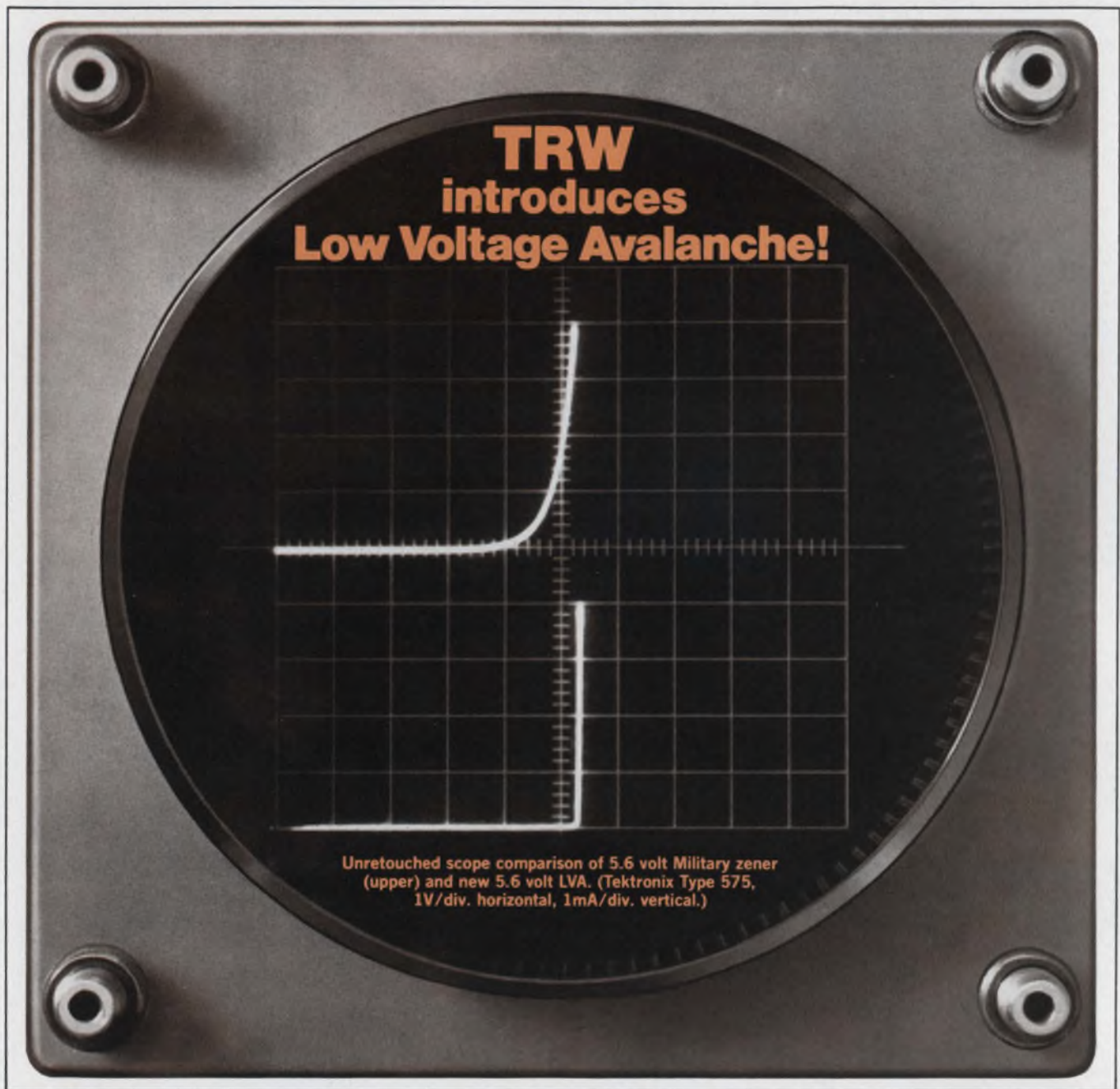

Sharpest Breakdown Below 10 Volts!

The LVA™ is more than just a new diode: it represents a major breakthrough in low voltage regulators (patent pending). Wherever you need a zener below 10 volts, the LVA will significantly improve circuit performance with its avalanche breakdown characteristics.

With the LVA you can design better low current circuits, battery-operated circuits, and operational

amplifier clamping networks. And now for the first time, you can make zero TC reference below 5 volts!

The LVA is available in 10 values from 10 volts down to 4.3 volts. Delivery is off-the-shelf from factory or authorized distributors.

If you'd like to compare, write for test samples and applications data on company letterhead to

TRW Semiconductors, Ray Koch, 14520 Aviation Boulevard, Lawndale, California 90260. Phone (213) 679-4561. TWX 910-325-6206. *TRW Semiconductors Inc. is a subsidiary of TRW INC.*

TRW

ON READER-SERVICE CARD CIRCLE 38

ELECTRONIC DESIGN 16, August 2, 1967

Co-Publishers

James S. Mulholland, Jr.
Hugh R. Roome

Editorial Director

Edward E. Grazda

Editor

Howard Bierman

Managing Editor

Robert C. Haavind

Technical Editors

Jeffrey N. Bairstow
Peter N. Budzilovich
Maria Dekany
Roger K. Field

Careers and Management Editor

Howard S. Ravis

News Editors

Ralph Dobriner, Chief
Richard N. Einhorn

East Coast Editor

Neil Sclater

West Coast Editor

Ron Gechman

Copy Editor

Peter Beales

New Products Editors

David H. Surgan

Directory Editor

William Alvarez

Washington Editor

S. David Pursglove

Editorial Production

Dollie S. Viebig
Marian Arkin
Anne T. Lombardi

Art Director

Clifford M. Gardiner

Art Assistant

William Kelly

Technical Illustrators

Cheh Nam Low
Sheila F. Ward
Richard Hartman

Production Manager

Thomas V. Sedita

Asst. Production Manager

Helen De Polo

Production Assistants

Bernard Wolinsky
Robert M. Henry
Murray Friedman

Circulation Manager

Nancy L. Merritt

Reader Service

Diane Mandell

EDITORIAL



Who says technical parleys must be a waste of time?

Too many technical conferences are boring. Worse yet, they fail to inform fully. They offer the same tiresome format over and over. You know the system: a dry-voiced talk, a few slides and graphs, a narrow viewpoint—"How I built. . . ." Some so-called lectures at these conferences are nothing more than reading classes; the "lecturer" merely reads, word for word, the paper as it is published in the official proceedings—as if most engineers cannot read.

Gary K. L. Chien, manager of IBM's Mathematical Analysis Group at White Plains, N. Y., had a different idea earlier this summer. As program chairman of the Joint Automatic Control Conference, he enlisted a crew of knowledgeable devil's advocates for the technical sessions. He called them "discussers." Their job: to review, without consultation with the authors, all the technical papers and to critique them after the authors had presented them at the conference. Each discussor received one technical paper to assay.

The audience gained from this approach in several ways. The discussors put the spotlight on obscure points in the papers and helped to clarify them. In many cases they added substantially to the content of the papers. And in some cases they offered alternative approaches to solving the problem. In at least one instance, the discussor suggested that the author's approach was both impractical and unnecessarily complex.

Another good idea that Dr. Chien pressed in running the conference was the use of comprehensive night sessions, where a selected panel could discuss a "hot" topic in an informal atmosphere with wide audience participation. Sometimes more ground was covered at such sessions in an hour than in several hours of formal paper presentations.

Needless to say, both of these approaches place an additional burden on the paper selection committee and the program chairman. And it is important to choose discussors who will call the shots as they see them and offer truly constructive criticism. This means selecting outspoken authorities who have enough expertise to express their opinions with confidence.

Another way to improve technical conferences is to print the proceedings and distribute them to the prospective attendants at least a week in advance. This gives the audience a better chance to participate in the discussion.

Let's hope that more technical conference organizers will realize that the purpose of presenting papers is to enlighten rather than to confuse, that pompousness should not be mistaken for brilliance. And, moreover, that all it takes to make an interesting as well as a serious conference is a little imagination and drive.

PETER N. BUDZILOVICH

New! 100 MHz in a ruggedized oscilloscope with 3.5-ns risetime at the probe tip

DC-to-100-MHz bandwidth at 10 mV/cm
is NOW AVAILABLE
in a plug-in oscilloscope
with solid-state design . . .
the Tektronix Type 647A and R647A.

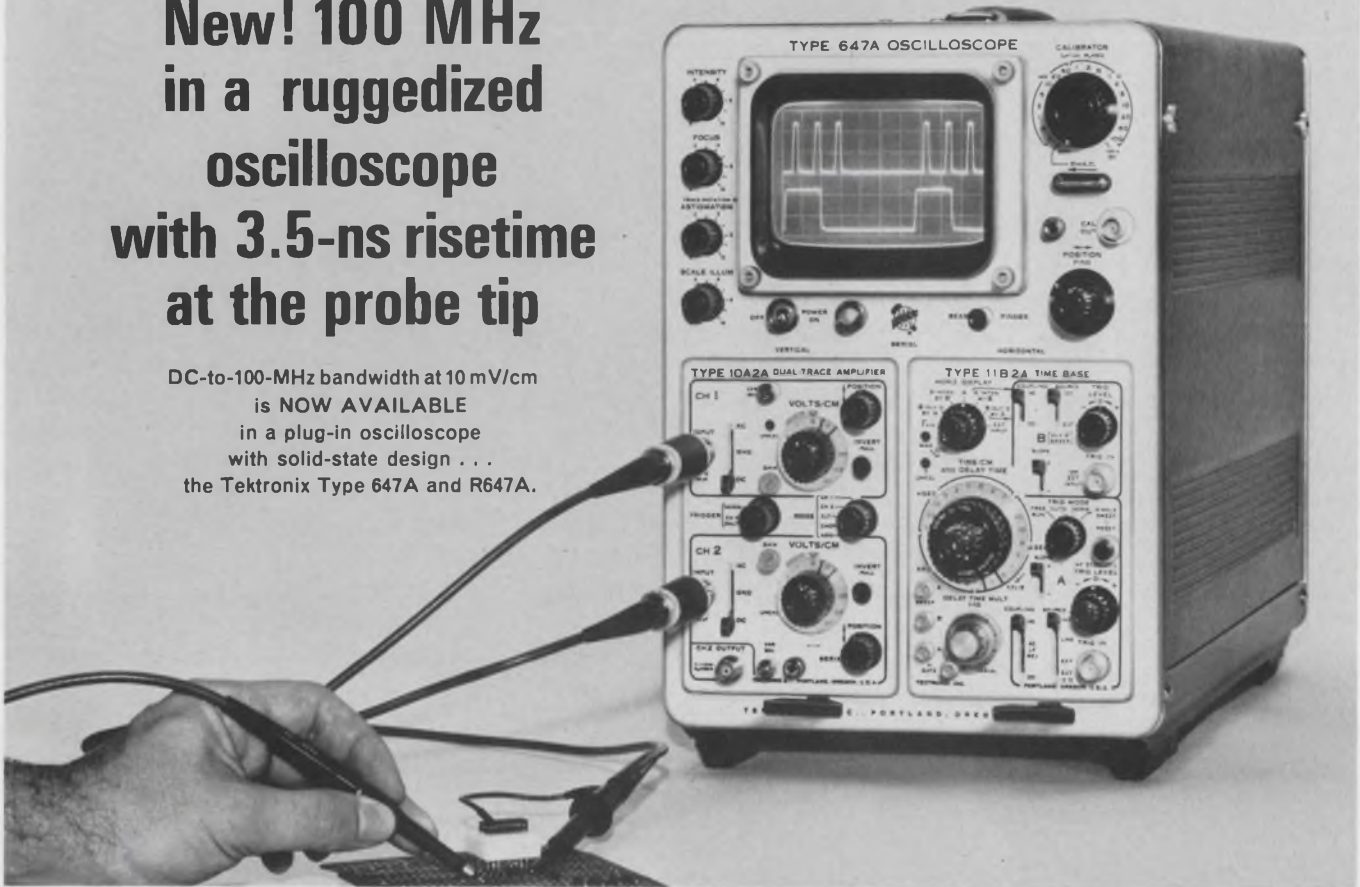

New Type 10A2A Dual Trace Amplifier. The risetime and bandwidth are specified where you use it — at the probe tip. The vertical system performance with or without the new miniature P6047 10X Attenuator Probe is DC-to-100 MHz bandwidth with 3.5-ns risetime at ambient temperatures of 0° C to +40° C (+32° F to +104° F). Bandwidth is DC-to-90 MHz with 4.1-ns risetime over its entire operating range, —30° C to +65° C. The calibrated vertical deflection range (without probe) is from 10 mV/cm to 20 V/cm.

Bright Displays. The Tektronix CRT provides bright displays with its advanced design and 14-kV accelerating potential. It has a 6-by-10 cm viewing area and a no-parallax, illuminated, internal graticule.

New Type 11B2A Delayed Sweep Time Base. The Type 11B2A triggers to above 100 MHz internally and provides a calibrated delayed sweep. Calibrated sweep range is from 100 ns/cm to 5 s/cm, extending to 10 ns/cm on both normal and delayed sweeps with X10 magnification. Calibrated sweep delay is from 1 μ s to 50 s and the plug-in also provides single sweep operation.

Rugged Environmental Capabilities. These instruments are capable of accurate measurements in severe environments and offer an extra margin of dependability and even greater accuracy in normal environments. Temperature: Operating —30° C to +65° C. Non-Operating —55° C to +75° C. Shock: Non-Operating 20 G's max, 2 shocks, each direction, along each of the 3 major axes. Vibration: Operating or Non-Operating 0.025" p-to-p, 10-55-10 Hz, (4 G's) 1 min cycles, 15 min each major axis. Humidity: Non-Operating meets MIL-STD-202B, Method 106A, except freezing and vibration, through 5 cycles (120 hours). Altitude: Operating 15,000 ft. Non-Operating 50,000 ft.

New Type R647A Rack Mount. The same DC-to-100 MHz performance also is available in a 7-inch-high rack mount oscilloscope, the Type R647A. Additional plug-ins include the Type 10A1 Differential Amplifier and the Type 11B1 Time Base.

Type 647A Oscilloscope (includes 2-P6047 Probes)	\$1500
Type R647A Oscilloscope (includes 2-P6047 Probes)	\$1625
Type 11B2A Time Base	\$ 850
Type 10A2A Dual Trace Amplifier	\$ 775

U. S. Sales Prices FOB Beaverton, Oregon

For complete information, contact your nearby Tektronix Field Engineer or write: Tektronix, Inc., P. O. Box 500, Beaverton, Ore. 97005.



Environmental testing



*. . . part of the Tektronix commitment
to technical excellence*

Technology

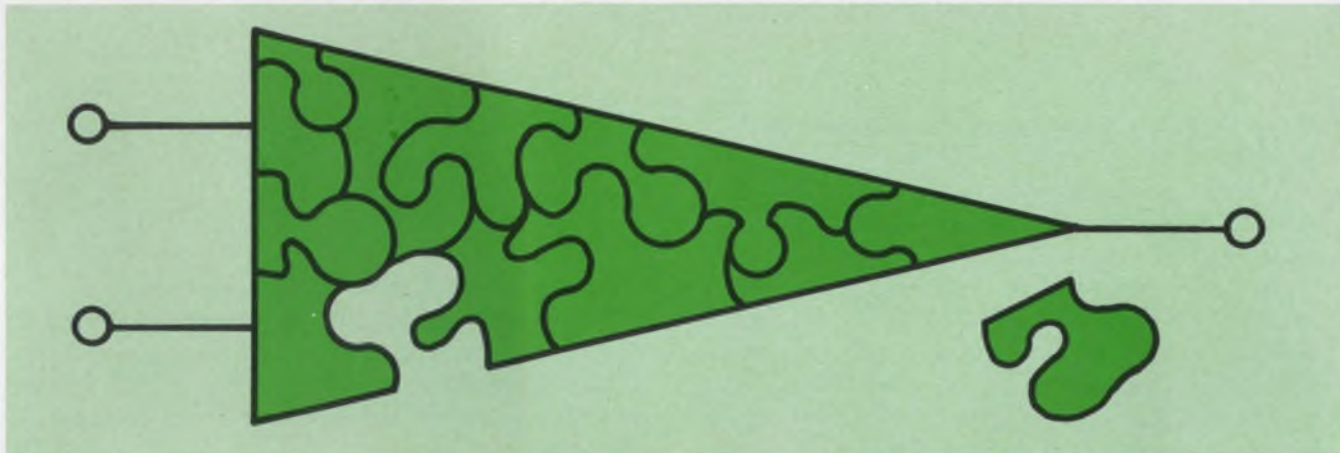

The puzzle of operational-amplifier design is easy to solve if you bear in mind inherent

sources or error and do not base calculations exclusively on an ideal device. Page 54

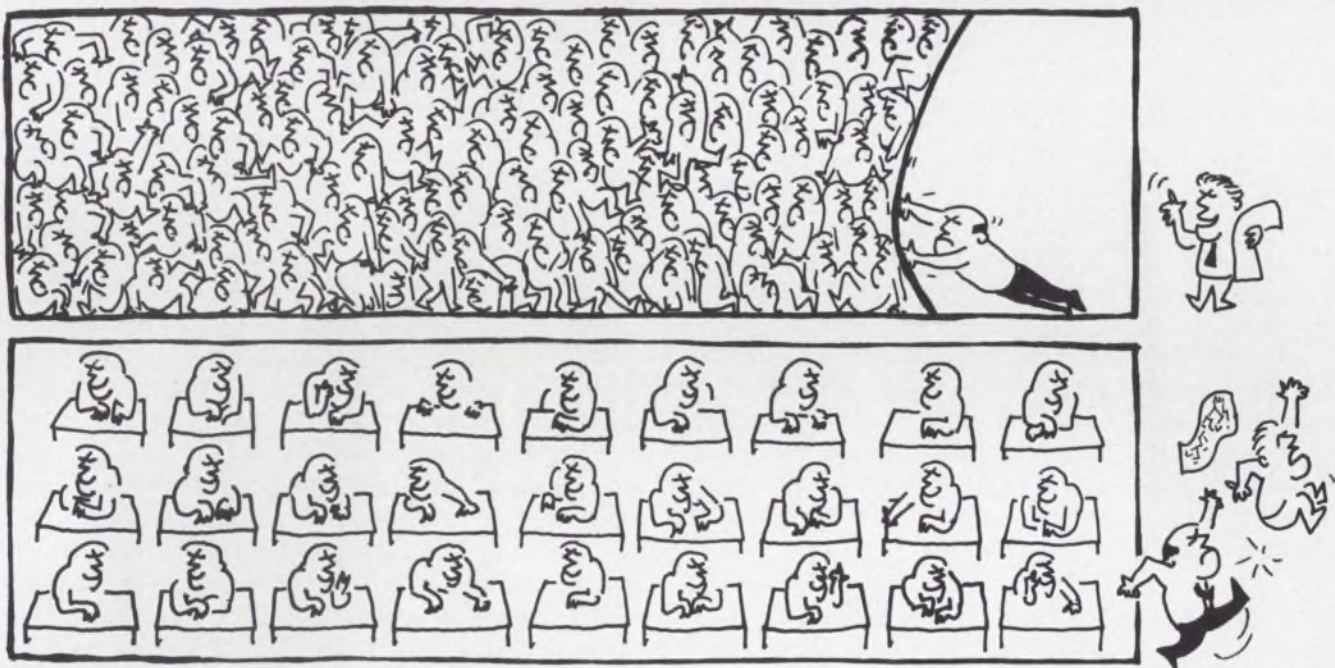

Try your hand at engineering management by considering 6 typical real-life problems. When

you have decided what you would do, see what the men on the spot did. Page 76

Also in this section:

Zener diodes alone cannot cope with all the heat in a voltage regulator. Page 60

Simple dc-to-pulse-width converter has zero offset control and wide linearity. Page 66

Core buffer sizes and magnetic-tape record separation are fixed by a nomograph. Page 72

Evaluate operational amplifier errors

using standard manufacturer's data, an actual op-amp model, and a few simple equations.

Most of the literature describing the use of operational amplifiers in feedback loops assumes an "ideal" amplifier. A quick look at the specifications of typical amplifiers, however, will convince the designer that most of these devices are far from ideal. Not only do they not have infinite gains and input impedances, they also have inherent input offsets and internal noise sources. The designer must know how these nonideal characteristics will affect circuit operation.

A model of the nonideal operational amplifier will therefore be constructed and expressions for calculating the resulting output error developed. Since these expressions employ the values usually provided by the operational-amplifier manufacturers, a designer can quickly establish the suitability of any unit to his needs.

Consider major nonideal characteristics

The main nonideal characteristics of an operational amplifier are internal noise sources, input voltage offset, input bias current, finite gain, and finite input impedance. The method of specifying each of these parameters is shown in block diagram form in Fig. 1.

The internal noise sources become significant whenever an operational amplifier is used for low-level work, such as the amplification of strain-gauge or photocell output signals. The familiar method of specifying noise has certain disadvantages when applied to operational amplifiers. The noise figure of a device is given by the equation:

$$F_o \text{ (dB)} = 20 \log \left[\frac{N_o}{A (4kTBR_g)^{1/2}} \right] \quad (1)$$

where:

- F_o = noise figure
- N_o = noise output voltage,
- A = gain of the device,
- k = Boltzmann's constant ($1.38 \times 10^{-23} \text{ J/}^\circ\text{K}$),
- T = temperature in $^\circ\text{K}$,
- B = noise bandwidth in Hz,
- R_g = source resistance in Ω .

It can be seen from this equation that noise figure is a function of both bandwidth and source re-

sistance. There is a method of specifying noise performance that makes the noise characteristics of the device independent of the circuit in which they are measured. It can be shown that any noisy amplifier can be represented by an equivalent noiseless amplifier plus two noise generators.

One generator is a constant-current noise generator in parallel with the input, the other is a constant-voltage noise generator in series with the input. To determine the value of the constant-voltage generator, the input is short-circuited and the output noise is compared with the output that results from a small, known input signal voltage. To determine the value of the constant-current noise generator, the input terminals are open-circuited and the output noise is compared with the output that results from a small, known input current.

The voltages \bar{e}_n and current \bar{i}_n are rms values and are usually specified per unit bandwidth measurement. The relationships between e_n , i_n and F_o are given by:

$$F_o = 1 + (1/4kTBR_g)(\bar{i}_n^2 R G^2 + \bar{e}_n^2 + 2\alpha \bar{e}_n \bar{i}_n R_g), \quad (2)$$

where F_o (dB) = $10 \log F_o$ and α = correlation coefficient ≈ 1 .

When $\bar{e}_n/\bar{i}_n = R_g$ Eq. 2 reduces to:

$$F_o' = 1 + (e_n \bar{i}_n / kTB), \quad (3)$$

which is the optimum noise figure of the device.

The input voltage offset, V_{os} , is caused by an imbalance of the input stage, usually by the difference in the base-to-emitter junction voltage, V_{be} , of the two input transistors. The value of V_{os} for a good amplifier is about 1 mV over a limited range. Most manufacturers supply circuits to compensate for V_{os} , but such a circuit adjustment will change with temperature. The voltage offset can be measured by observing the input voltage needed to reduce the amplifier output to zero volts.

The bias currents I_1 and I_2 are caused either by transistor or FET leakage currents. These currents can be matched fairly closely and the difference or offset current is typically 150 nA for an uncompensated amplifier and 100 pA for a compensated one.

The finite gain of an operational amplifier is restricted to the limits of physical realizability. The best that can be hoped is that the gain is high enough for the error introduced in the output to be

less than a specified value. Although Fig. 1 shows the gain measurement in block form without input and feedback resistors, most practical amplifiers have such high gain that the amplifier would saturate and make a meaningful measurement impossible. The best method of measuring gain is to ground the signal end of the input resistor, open the connection of the feedback resistor to the output, and feed the signal end into the feedback resistor. The range of typical operational amplifier gains is from 10,000 to 1,000,000.

The input impedance is normally a complex impedance in parallel with the input. Typical values are 200 kΩ and 7 pF, although units with input impedances as high as 10¹¹ ohms and 3 pF are available for electrometer and similar uses.

From the information in Fig. 1, a model of the amplifier can be constructed using internal voltage and current generators. This model is included in the feedback network of Fig. 2. Since the output voltage is equal to the input voltage multiplied by the gain of the amplifier, a generator $-Ae_i$ is used to develop output voltage e_o . The noise voltage, \bar{e}_n , and the voltage offset cause an output even when the input is shorted; therefore, these error voltage generators are placed in series with the input. The noise current generator, \bar{i}_n , is in parallel with the input, as is input impedance R_1 (a resistance in this case). I_1 and I_2 are added to the model by means of two equal current generators that generate the average current $I_b = (I_1 + I_2)/2$. The difference between I_1 and I_2 is accounted for by adding offset current generator I_{os} . This completes the model.

Computing the errors

The voltages and currents shown in Fig. 2 enable the following equations to be written directly:

$$(e_1 - e_3)/R_1 = (e_3 - e_o)/R_2 + e_i/R_i + \bar{i}_n + I_b; \quad (4)$$

$$e_4/R_3 = e_i/R_i + \bar{i}_n + I_{os} - I_b; \quad (5)$$

$$e_3 - e_4 = \bar{e}_n + V_{os} + e_i; \quad (6)$$

$$e_o = -Ae_i. \quad (7)$$

Solving Eqs. 5 and 6 and substituting this and Eq. 7 into Eq. 4 yield:

$$e_o = \left\{ -Ke_1 + I_b \left[R_2 - (K+1)R_3 \right] + (K+1) \right. \\ \left. (V_{os} + R_3 I_{os}) + \bar{i}_n \left[R_2 + R_3(K+1) \right] + (K+1)\bar{e}_n \right\} \\ / \left\{ 1 + (1/A) \left[(R_2/R_i) - (K+1)(1 + R_3/R_i) \right] \right\}, \quad (8)$$

where $K = R_2/R_1$.

The first term in the numerator is the usual expression for the output of an ideal amplifier. The terms:

$$I_b \left[R_2 - (K+1)R_3 \right] + (K+1)(V_{os} + R_3 I_{os}) \quad (9)$$

represent the errors due to dc bias and offset. It should be noted that the expression can be minimized by letting $R_2 = R_3(K+1)$ or substituting $R_3 = R_2 R_1 / (R_2 + R_1)$ for K .

The terms:

$$\bar{i}_n \left[R_2 + R_3(K+1) \right] + (K+1)\bar{e}_n \quad (10)$$

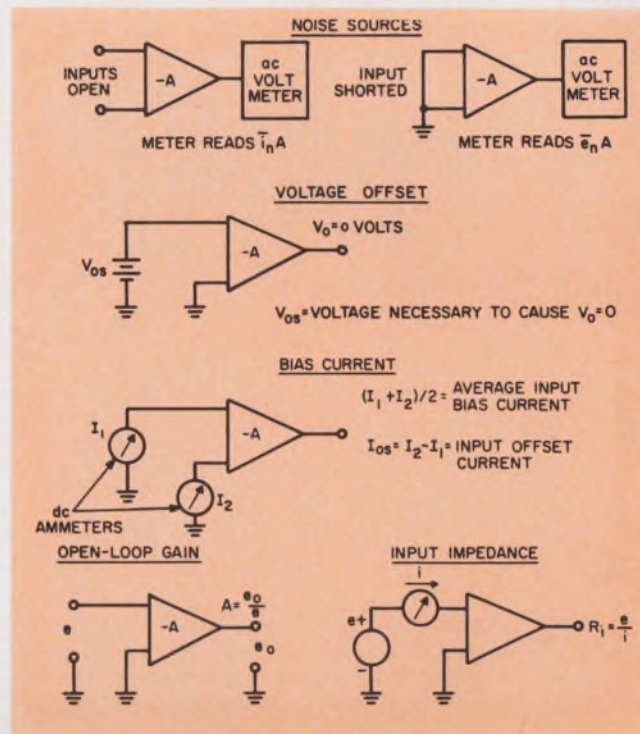

1. Several error sources contribute to the nonideal operational amplifier characteristics. Here they are defined and measurement methods given. The notation of the figure is used throughout the text.

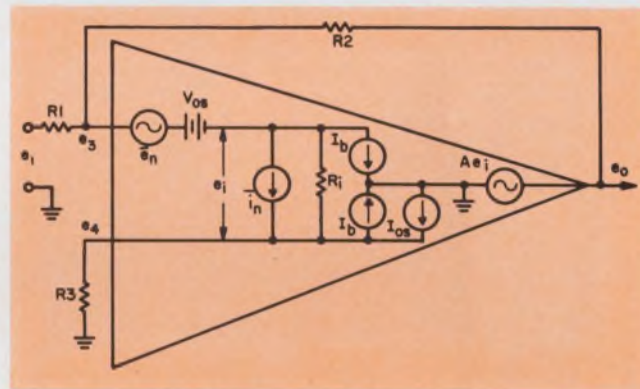

2. A practical operational amplifier model is used to determine performance in an actual application. Equations 4 through 7 describe the model.

represent the output error due to ac noise sources in the amplifier and are a function of the noise figure of the amplifier; \bar{i}_n and \bar{e}_n are rms values and are usually specified as per unit bandwidth measurements. In most amplifiers the dc error defined in Eq. 9 is many orders of magnitude greater than the ac error term. Therefore, the ac error term would be significant only for a low-signal ac-coupled case.

The denominator of Eq. 8:

$$1 + (1/A) \left[(R_2/R_i) - (K+1)(1 + R_3/R_i) \right] \quad (11)$$

represents the error in the output due to the fact that the gain and input impedance of the amplifier are finite.

The analysis can easily be extended to feedback elements other than resistors. Replacing the feed-

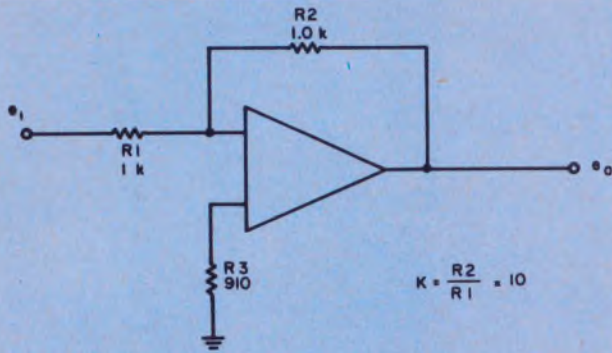

TYPICAL AMPLIFIER SPECIFICATIONS

VOLTAGE GAIN 40,000
 INPUT IMPEDANCE 22 kΩ IN PARALLEL WITH 6 pF
 INPUT VOLTAGE OFFSET 100 nA
 INPUT NOISE VOLTAGE 1 μV rms
 INPUT NOISE CURRENT 60 pA rms

3. Operational amplifier performance in a dc configuration with an over-all gain of 10 indicates, on the basis of typical manufacturer's data, that with the values shown a dc drift of 17.6 mV will be present. Clearly, such drift is significant.

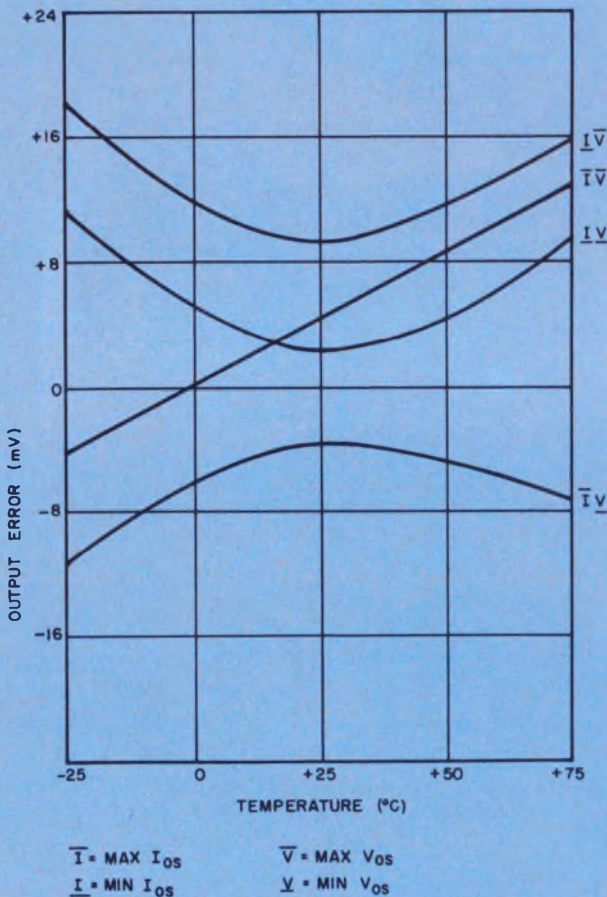

4. Methods for reducing input offset voltage and current usually recommended by the operational amplifier manufacturers are often valid for only one temperature. A designer should construct his own plot of the V_{os} and I_{os} temperature with Eq. 9.

back resistors in Eq. 8 by impedances Z_n gives an expression for output voltage e_o as a function of complex variable s :

$$e_o(s) = \frac{-K(s)e_1(s) + \bar{i}_n [Z_3(s)]}{1 + 1/A(s) [Z_2(s)/Z_i(s) - (K(s) + 1)] + [K(s) + 1] \bar{e}_n} \quad (12)$$

$$+ \frac{I_b [Z_2(0) - (K(0) + 1)Z_3(0)]}{1 + (1/A(0)) [Z_2(0)/Z_i(0) - (K(0) + 1)] + [K(0) + 1] [V_{os} + Z_3(0)I_{os}]}$$

$$\frac{1}{(1 + Z_3(0)/Z_i(0))}$$

How to use error equations

The use of the error equations can be illustrated with Fig. 3, which shows a typical amplifier specification and a circuit configuration for an over-all gain of 10.

The gain error term is examined first. Substituting the values from Fig. 3 into Eq. 11 gives:

$$(1 + (1/40,000) [(10k\Omega/220k\Omega) - (10 + 1)] (1 + 910/220k\Omega)) = 1 + 0.000275.$$

This error, then, is negligible in this circuit.

Since the amplifier is being used in a dc configuration, the ac error term (Eq. 10) may be neglected. The dc drift term will be much greater. The magnitude of the dc drift can be calculated with Eq. 9. Since $R_2 = (K + 1)R_3$, Eq. 9 reduces to:

$$\text{dc drift} = (K + 1)(V_{os} + R_3 I_{os});$$

substituting the given values gives:

$$\text{dc drift} = (11) [1.5 \text{ mV} + 910(100 \times 10^{-9})] = 17.6 \text{ mV}.$$

Most application notes supplied by the manufacturers of operational amplifiers show circuits for reducing or balancing the input offset voltage and the input offset current. It is important to realize that these networks only reduce the error at one temperature. Typically, V_{os} and I_{os} are nonlinear functions of temperature. To find the bounds on the error voltage over the temperature range of interest, the specifications have to be studied carefully to determine both the V_{os} and I_{os} versus temperature characteristic. A plot of output error versus temperature can then be made by calculating the error at a series of temperature values with Eq. 9. Figure 4 shows such a plot. Both maximum and minimum I_{os} and V_{os} values are used.

For the circuit of Fig. 3 the predominant error is the dc drift term. Different circuit arrangements can cause other error terms to be significant but the equations developed above allow the designer to calculate easily the total output error for the circuit. ■

ADVANCE

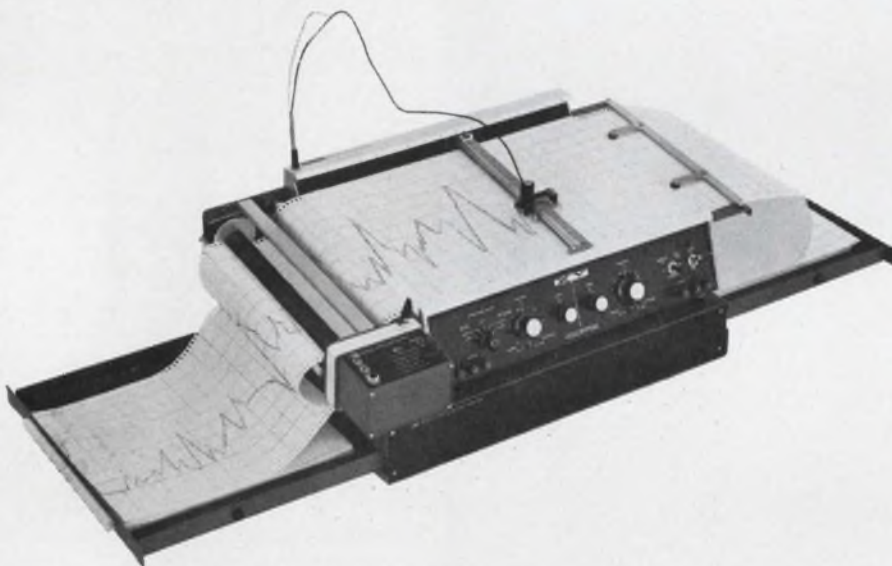

new X-Y
accessory
offers
unique
recorder
flexibility

The new 17005A Incremental Chart Advance turns your Moseley X-Y recorder into a more flexible lab and production tool. It provides this added versatility and high performance by converting your X-Y into a strip-chart recorder. It offers incremental advance for multi-channel pulse height analysis with resolution between channels—and accepts both positive- and negative-going signals to advance the appropriate increment in the advance mode.

Designed for remote control operation. Will adapt to most 11x17 Moseley Recorders. Powered by the recorder itself. Uses roll chart or Z-fold paper. Price: Model 17005A, \$895.

For complete information, contact your local HP field engineer, or write Hewlett-Packard, Palo Alto, California 94304; Europe: 54 Route des Acacias, Geneva.

SPECIFICATIONS:

Incremental advance mode

Plot density (plots/inch):
200, 100, 50, 20, 10

Increment size (in./advance):
0.005", 0.01", 0.02",
0.05", 0.10"

Frame advance mode

Advance distance: 24"
Accuracy:
±0.005" (non-accumulative)
Advance time: <20 sec.

Time base mode

Chart speeds:
1, 5, 10, 50, 100 sec/in.
Accuracy: ±2%

Major division advance mode

Advance distance:
Major divs. in 3" increments
Accuracy:
±0.005" (non-accumulative)
Advance time: 2½ sec.
Other advance increments available

**HEWLETT
PACKARD**  **MOSELEY
DIVISION**

ON READER-SERVICE CARD CIRCLE 40

11701

Five new op amps from TI expand your linear IC spectrum

Operational Amplifier Selection Guide

Typical Characteristics	SN523A SN5231L	SN524A SN724	SN525 SN725	SN526 SN726	SN5510	NEW				
						SN5511	SN52702	SN52709	SN52710	SN52711
Open-loop voltage gain, dB	72	63	90	66	40	65	68	93	64	64
Bandwidth (-3 dB), kHz	180	140	45	120	40,000	4000	-	-	-	-
Input impedance, k Ω	15	1000	140	1000	6	5	25	400	-	-
Input capacitance, pF	55	60	250	50	7	-	-	-	-	-
Differential-input offset voltage, mV	2.2	12	1	3	3	1	2	3	2	1
Differential-input offset current, μ A	0.5	0.02	0.016	0.006	3	3.2	0.7	0.05	1	0.5
Differential-input offset voltage temperature coefficient, μ V/ $^{\circ}$ C	9	25	5	10	10	2	5	-	5	5
Maximum common-mode input voltage range, V	\pm 5	\pm 5	\pm 7	\pm 7	\pm 1	\pm 2.6	0.5 to -4	\pm 10	-	-
Common-mode output offset voltage, V	0.5	-	0.25	0.22	3.1	.35	-	-	-	-
Output impedance, Ω	200	200	10k	-	35	770	200	150	200	200
Maximum peak-to-peak output voltage, V	24	15	18	11.7	4.0	5.0	10.6	26	-	-
Common-mode rejection ratio, dB	90	55	100	77	85	95	80	90	-	-
Total Power dissipation, mW	100	120	100	132	165	170	70	80	110	130
Input current, μ A	5	0.08	0.45	0.05	40	3.2	4	0.2	25	25

With the addition of five new IC operational amplifiers, Texas Instruments provides linear system designers with the broadest range of performance characteristics available today. Now you can select an IC amplifier suited to your particular requirements of performance and price. Some of the new circuits challenge the finest discrete-component amplifiers in performance. Others cost less than a third as much as discrete-component equivalents. All offer the advantages of smaller, simpler, more economical systems and vastly increased reliability.

New video differential amplifier offers unsurpassed stability

The new SN5511 differential video amplifier provides excellent operational amplifier performance at frequencies extending into the low VHF range. It offers a flat 30 dB closed loop gain from dc to 30 MHz, an extremely low offset voltage of 300 mV typical, and a minimum of 80 dB common mode rejection.

Stability and versatility are enhanced by provisions for external compensating networks and gating, to clock the circuit on and off under minimal interface conditions. The external compensating networks may also be used to adjust frequency response and offset.

Circle 181 for data sheet

New general-purpose operational amplifier costs 30% of discrete equivalent

The SN52702 is a high gain band-

width IC amplifier that offers distinct size and reliability advantages over discrete component counterparts, at about one-third the cost.

Matching of components within the chip assures excellent thermal stability. Drift is only $5 \mu\text{V}/^\circ\text{C}$ and offset is typically 6 mV. Further stability is provided by both lead and lag external compensation.

Circle 182 for data sheet.

New "premium" op-amp offers superior performance for critical applications

The SN52709 IC has nearly twice as many components on the chip as conventional amplifiers... and correspondingly superior electrical characteristics. When compared with earlier IC amplifiers, differential input offset is an order of magnitude lower, output voltage is $2\frac{1}{2}$ times higher, and large signal voltage gain is 20 times higher. Input impedance is ten times higher and output impedance is 50 percent lower. Two frequency compensating arrangements are provided.

The SN52709 is the new standard of performance for analog computer and other critical applications.

Circle 183 for data sheet.

New differential comparator features fast response

High speed is the big advantage of the SN52710. It responds in 40 nsec when a 5 mV overdrive is supplied. Low offset (6 mV max), high voltage gains (typically 1500), and high output level (4 V), are other features.

Circle 184 for data sheet.

New dual comparator can stretch output pulses and sense amplitude variations

The SN52711 is more than just two differential comparators in a single package. It can stretch output pulses and function as an amplitude-discriminating sense amplifier with an adjustable threshold. Despite these capabilities the cost is less than two comparable differential comparators.

Circle 185 for data sheet.

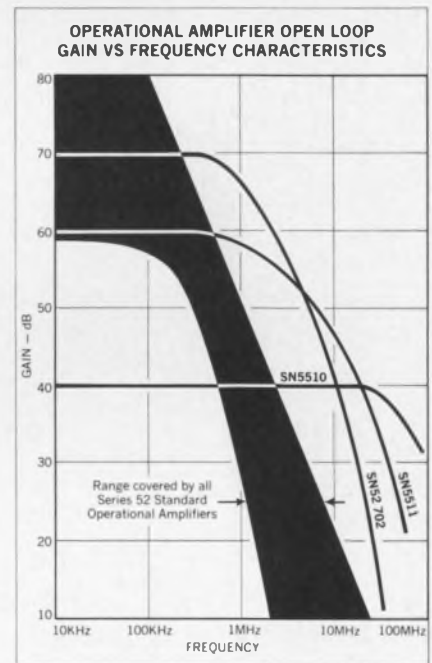

To learn more about these and other linear integrated circuits, contact your local TI sales engineer or authorized distributor... or write us at P. O. Box 5012, Dallas, Texas 75222.



TEXAS INSTRUMENTS
INCORPORATED

Zener diodes are not enough

when the heat is really on in a voltage regulator. Try checking loop gain and other figures of merit.

Try designing electronic gear that must function flawlessly under a desert sun, and you'll end up convinced that the usual reliance solely on temperature-compensated reference elements, such as Zener diodes, is inadequate.

This was the experience in the design of a 15-volt dc 0.5-ampere voltage regulator. Analysis showed that the temperature compensation of the Zener diode was insufficient when the loop-gain change due to heat was larger than the Zener's temperature-induced voltage changes.

Thus a detailed analysis of other figures of merit, such as output resistance and regulation change factor, was undertaken to pinpoint the components contributing to the temperature-induced errors.

Figures of merit defined

The adequacy of any regulator is expressed by certain figures of merit, such as (see box for symbol definitions):

Temperature coefficient:

$$T_c = \left. \frac{\Delta V_o / \Delta T}{R_L, V_s = \text{constants.}} \right|$$

Output resistance:

$$R_o = \left. \frac{\Delta V_o / \Delta I_L}{V_s, T = \text{constants.}} \right|$$

Regulation change factor:

$$C_F = \left. \frac{\Delta V_o / \Delta V_s}{R_L, T = \text{constants.}} \right|$$

Calculating loop-gain changes

Before these figures of merit are calculated, the loop-gain of the regulator is found. To do this, the loop is opened anywhere—for example, at the base of Q1 (Fig. 1). Assuming:

$$i_{b1} \ll I_{R3},$$

$$R_{in} \text{ of common emitter} = r_b + r_e (1 + \beta) = r_e \beta, \\ \beta + 1 \approx \beta$$

yields:

$$A = \Delta V / \Delta e, \quad (1)$$

$$\Delta V = \Delta V_o R3 / (R3 + R4) = \Delta V_o / \alpha \quad (2)$$

Z. Peled and N. Freiman, Research Engineers, Ministry of Defense, Tel Aviv, Israel.

Since both Q3 and Q4 act as emitter followers:

$$\Delta V_2 = \Delta V_o; \quad (3)$$

$$\Delta V_2 = \Delta i_2 R1 \approx \beta_2 \Delta i_1 R1; \quad (4)$$

$$\Delta i_1 = \Delta i_{b1} \beta_1 = (\Delta e / 2\beta_1 r_e) \beta_1 = \Delta e / 2r_e. \quad (5)$$

Inserting Eq. 5 into Eq. 4 yields:

$$\Delta V_2 = \beta_2 (\Delta e / 2r_e) R1 = \Delta V_o. \quad (6)$$

Equation 2 then becomes:

$$\Delta V = \beta_2 (\Delta e / 2r_e) (R1 / \alpha), \quad (7)$$

and hence:

$$A = (\beta_2 R1 / 2r_e) / \alpha. \quad (8)$$

For the voltage regulator of Fig. 1:

$$1/\alpha = R3 / (R3 + R4) = 0.4;$$

$$R1 = 3.3 \text{ k}\Omega;$$

$$r_e \approx 26 / I(\text{mA}) = 260 \Omega;$$

$$\beta_{typ} \approx 40;$$

$$\therefore A \approx 100,$$

$$\Delta A / A = \Delta \beta_2 / \beta_2 = 0.7\% / ^\circ\text{C}.$$

Temperature coefficient computed

The variation of $\Delta V_o / V_o$ with a temperature change of $\Delta T = 1^\circ\text{C}$ is:

$$\Delta V_o / V_o = \Delta V / V \approx (1/A) (\Delta A / A) \\ = (1/100) (7 \times 10^{-5}) = 7 \times 10^{-5}; \\ \therefore \Delta V_o / \Delta T = 1.05 \text{ mV} / ^\circ\text{C}.$$

In the circuit (Fig. 1), 1 mV/ $^\circ\text{C}$ was measured, giving a figure of merit of 1 mV/15,000 mV = 6.67 x 10⁻⁵. There is thus little point in using a Zener diode temperature-compensated to within a few parts per million for a regulator of the type in Fig. 1. Instead it is important to control the loop gain—in this configuration the β of Q2. Zener diodes, above 6.2 volts usually require compensation because their change in temperature is larger than that of the loop gain.

The loop gain in A cannot be increased indefinitely because of stability considerations. In fact, unless one is prepared to insert a stabilizing network, the loop gain is limited to the value already calculated.

Find the output resistance

The output resistance is defined as:

$$R_o = \left. \frac{\Delta V_o / \Delta I_L}{V_s, T = \text{constants.}} \right|$$

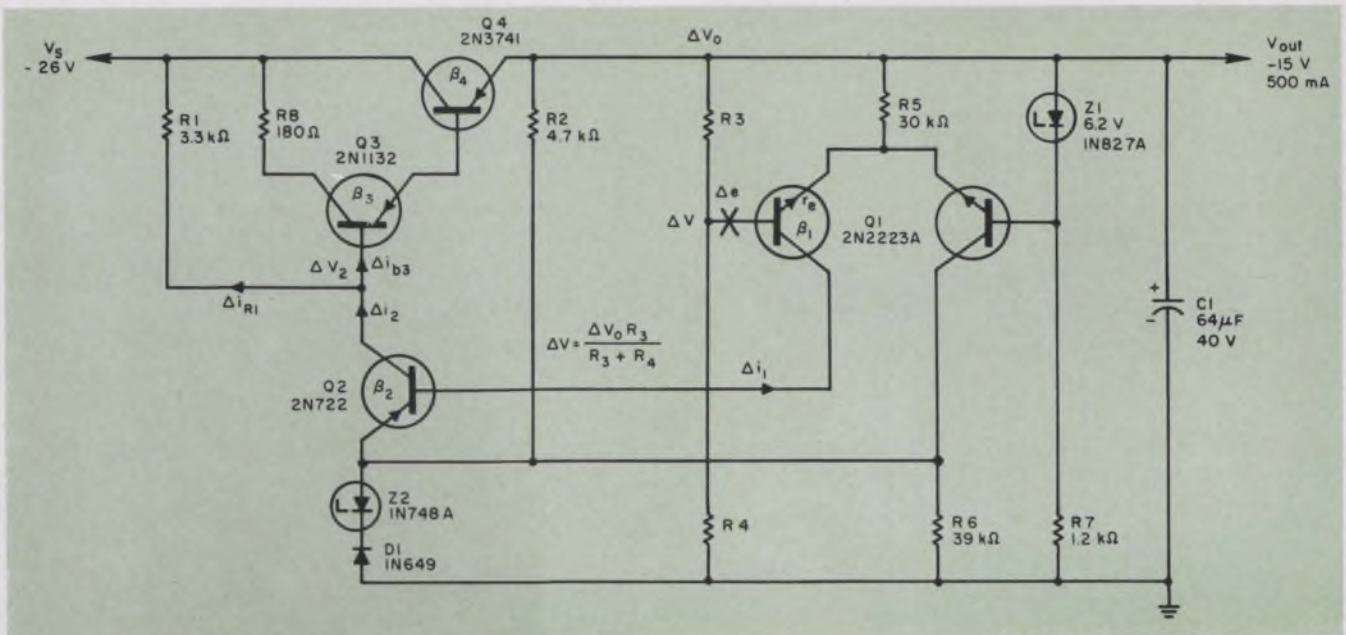

1. **Effects of temperature** on the performance of this voltage regulator can be estimated only by computing the loop-gain changes, not by assuming that the over-all temperature coefficient will be determined by the temperature coefficient of the reference element, Z1. The

loop-gain changes are computed by opening the loop in any convenient place, such as the base of Q1. The analysis shows that β of Q2 is the major factor in temperature performance of the unit. The analysis, as shown in the text, is not very involved.

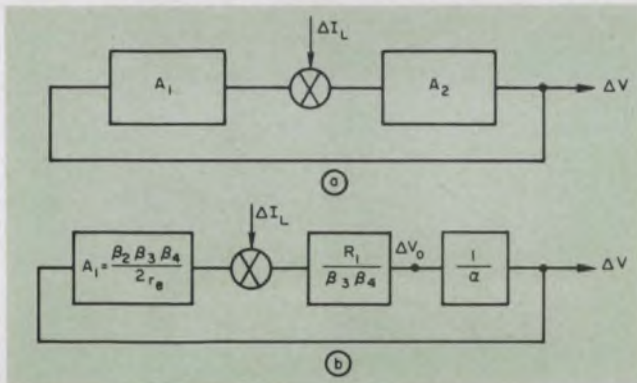

2. **Regulator output resistance**, $\Delta V / \Delta I_L$, is computed with help of a general block diagram (a) and a more detailed one (b). Equations 9 through 19 give the step-by-step derivation.

ΔI_L can be considered as a disturbance in the loop. This then gives the scheme of Fig. 2a. If $A_1 \times A_2 = A$ and $A \gg 1$, then:

$$\begin{aligned} \Delta V / \Delta I_L &= A_2 / (1 + A_1 A_2) \\ &= [A / (1 + A)] A_1 \approx 1 / A_1. \end{aligned} \quad (9)$$

For a change in the load current, ΔI_L , the change in the base current of Q3 is:

$$\Delta i_{b3} \approx \Delta I_L / \beta_3 \beta_4; \quad (10)$$

$$\Delta i_2 = \Delta i_{b3} + \Delta i_{R1} = (\Delta I_L / \beta_3 \beta_4) + (\Delta V_o / R1); \quad (11)$$

$$\Delta V_o = \alpha \Delta V \approx \alpha (\Delta i_2 / \beta_2) 2r_e. \quad (12)$$

Inserting Eq. 11 into Eq. 12 yields:

$$\Delta V_o = \alpha (2r_e / \beta_2) | \Delta I_L / \beta_3 \beta_4 + (\Delta V_o / R1) |; \quad (13)$$

$$\Delta V_o / \Delta I_L = \alpha 2r_e / \beta_2 | (1 / \beta_3 \beta_4) + (\Delta V_o / R1 \Delta I_L) |; \quad (14)$$

$$(\Delta V_o / \Delta I_L) = [1 - (\alpha 2r_e / \beta_2 R1)] = \alpha 2r_e / \beta_2 \beta_3 \beta_4; \quad (15)$$

$$\alpha 2r_e / \beta_2 R1 = (2.5 \times 2 \times 0.26) / (40 \times 3.3)$$

$$\approx 1/100 \gg 1.$$

Table of symbols

A	Gain
C_F	Regulation change factor
Δe	Error voltage at base of Q1
Δi_b	Change of base current
Δi_1	Change in the collector current of Q1 due to Δe
Δi_2	Change in the collector current of Q2
I_L	Load current
I_{R3}	Current through R3 and R4
R_o	Output resistance
R_L	Load resistance
r_e	Small-signal resistance of the forward-biased emitter-base junction
r_b	Base resistance
T	Temperature in $^{\circ}C$
T_c	Temperature coefficient
V_s	Unregulated input voltage
V_o	Regulated output voltage
ΔV_o	Change of output voltage
ΔV_2	Change of collector voltage of Q2
ΔV	$= \Delta V_o R3 / (R3 + R4) = \Delta V_o / \alpha$
α	$= (R3 + R4) / R3$ (see Fig. 1)
β	= Dc forward current-transfer ratio in common-emitter configuration



This is still a reliable timepiece

... and our precision frequency oscillators are just as reliable and enduring . . . engineered to meet your specific size and performance requirements. Take a look at our advanced time reference devices.



FREQUENCIES: 1 Hz to 1 MHz
ACCURACIES: 0.1 to 0.005%
TEMPERATURE RANGES: -55°C to +125°C

**SELECTED BY GOVERNMENT AND INDUSTRY FOR
WIDE-RANGING APPLICATIONS:**

For a solution to your frequency requirements—get the full story from your Melpar representative, call or write,

Attention: Product Marketing Department

**WABCO
MELPAR INC**

A Subsidiary of Westinghouse Air Brake Company

7769 ARLINGTON BLVD. • FALLS CHURCH, VA. • (703) 534-6000

ON READER-SERVICE CARD CIRCLE 41

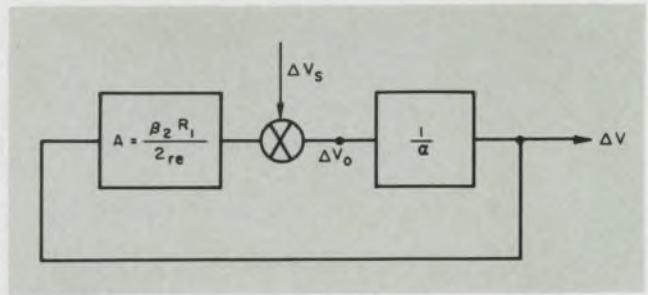

3. **Regulation change factor**, $\Delta V_o/\Delta V_s$, is computed from this block diagram. Equations 20 through 23 show the detailed analysis.

Therefore:

$$\Delta V_o/\Delta I_L \approx \alpha 2r_e/\beta_2\beta_3\beta_4. \quad (16)$$

Since $\Delta V_o = \alpha \Delta V$, Eqs. 9 and 16 yield:

$$\Delta V_o/\Delta I_L \approx \alpha \cdot 1/A_1. \quad (17)$$

Therefore:

$$A_1 = \beta_2\beta_3\beta_4/2r_e; \quad (18)$$

$$A_2 = A/A_1 = R1/\alpha \cdot \beta_3\beta_4, \quad (19)$$

since from Eq. 8, $A = \beta_2 R1/2r_e \alpha$.

The loop therefore has the configuration shown in Fig. 2b, so that:

$$\begin{aligned} R_{o, typ.} &= \Delta V_o/\Delta I_L = \alpha 2r_e/\beta_2\beta_3\beta_4 \\ &= (2.5 \times 2 \times 260)/(40^2 \times 20) \approx 40 \text{ m}\Omega. \end{aligned}$$

Compute regulation change factor

The regulation change factor is defined as:

$$C_F = \Delta V_o/\Delta V_s \Big|_{R_L, T = \text{constants.}}$$

If the block diagram of Fig. 3 is used and $I_L = \text{constant}$, the change in the collector current of Q2 is:

$$\Delta i_2 = (\Delta V_s - \Delta V_o)/R1, \quad (20)$$

or:

$$\begin{aligned} \Delta i_2 &= \beta_2 \Delta i_1 = \beta_2 (\Delta V/2r_e) \\ &= (\beta_2/2r_e) \left[R3/(R3 + R4) \right] \Delta V_o \\ &= (\beta_2/2r_e) (\Delta V_o/\alpha). \end{aligned} \quad (21)$$

Substituting Eq. 21 into Eq. 20 yields:

$$(\Delta V_s/R1) - (\Delta V_o/R1) = (\beta_2/2r_e) (\Delta V_o/\alpha), \quad (22)$$

and thus:

$$\begin{aligned} C_F &= \Delta V_o/\Delta V_s \\ &= (1/R1)/\left[(1/R1) + (\beta_2/2r_e \alpha) \right] \\ &= 1/\left[1 + (\beta_2 R1/2r_e \alpha) \right] = 1/(1 + A) \approx 1/A. \end{aligned} \quad (23)$$

Since loop gain A is 100:

$$\Delta V_o \approx (1/100) (\Delta V_s).$$

Therefore, where $\Delta V_s = 1$ volt:

$$\Delta V_o = 10 \text{ mV.}$$

In the actual circuit ΔV_o was measured as 8 mV when $\Delta V_s = 1$ volt.

The good agreement of the experimental data with the calculated figures confirms the validity of a number of the simplifying assumptions made. Thus it is possible to completely describe the regulator's performance in terms of accurate figures of merit — temperature coefficient, output resistance, and the regulation change factor. ■ ■

Your 1967 Catalog Enclosed

DC Power Supply Modules
**GUARANTEED
FOREVER**

acdc electronics inc.

If you'll circle Reader Service #25,
we'll send you one by return mail.



Name _____

Company _____

Address _____

City _____

State _____ Zip _____

adc electronics inc.

2975 North Ontario Street • Burbank, California 91504

Name your failure rate

this
G-E
sealed
relay
will give
it to you

But you have to let us establish:

- level of confidence
- operating conditions
- what constitutes a failure

By varying these conditions, we can give you any failure rate you want.

Doesn't make sense, does it? You're supposed to set the conditions. Not us.

That's why we don't establish failure rates till you give us application information.

If we did, we'd hurt you. And us.

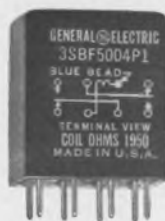

You, because you might buy the wrong relay.

Us, because we might hurt our reputation and lose you—a valued customer.

Want realistic failure rate data and the best relay for your next project? Contact your G-E Electronic Components Sales Engineer. Or for latest catalog information, write General Electric Company, Section 792-40, Schenectady, New York 12305.

GENERAL  **ELECTRIC**

ON READER-SERVICE CARD CIRCLE 42

The Hewlett-Packard 4204A Digital Oscillator in one instrument gives you an accurate frequency source of measured amplitude. It provides 0.2% frequency accuracy in highly stable test signals for both lab and production applications. Low distortion, 0.01% frequency repeatability and a flat frequency response of 0.3% variation add to your dollar value.

The 4204A allows you to select any frequency between 10.0 Hz and 999.9 kHz to four significant figures... 36,900 discrete frequencies are available. One vernier

control provides infinite resolution and extends the upper frequency limit of the 4204A Oscillator to 1 MHz.

This oscillator also has a built-in impedance voltmeter to measure output. It is calibrated to read volts or dBm into a matched 600 ohm load. The output attenuator has an 80 dB range and is adjustable in 10 dB steps with a 20 dB vernier. Price is \$695.

Call your local HP field engineer for more information, or write Hewlett-Packard, Palo Alto, California 94304. Europe: 54 Route des Acacias, Geneva.

Stable and repeatable signal accuracy

HEWLETT  PACKARD
S I G N A L S O U R C E S

18701



ON READER-SERVICE CARD CIRCLE 43

Here's a dc-to-pulse-width converter

that's simple to put together, allows offset control, and stays linear over an 80 ° C swing.

The simple-minded approach often leads to the best results. How, for instance, does one design a circuit to convert a dc, or slowly varying, input voltage to a train of pulses of a width proportional to the input? The most obvious approach is a circuit that can put out pulses that have an on time controlled by the dc voltage.

Based on this unsophisticated idea, a circuit was developed that uses a complementary monostable flip-flop and a constant-current generator to control its output-pulse width. The addition of a few components to make the output of the constant-current generator proportional to the dc input signal completes the design.

The circuit is particularly useful for telemetry and other systems where analog-to-digital conversion is required. Tests have shown it to be linear over a temperature range of from +60° to -20°C. The slope of its transfer characteristic curve (output pulse width versus dc input voltage) can easily be adjusted for any desired zero

input offset by changing a couple of resistors, without adverse effects on stability.

How it works

The schematic diagram of the analog dc-voltage-to-pulse-width converter is shown in Fig. 1. With no trigger pulse applied, transistors *Q3* and *Q4* are off, diode *D1* is reverse-biased, and capacitor *C_T* is charged to the input analog voltage.

When an input trigger pulse is applied to the base of transistor *Q8*, the complementary monostable flip-flop switches to its opposite state, initiating the linear discharge of *C_T* through the constant-current generator, *Q1*. Since the discharge rate of *C_T* is constant, the time required for the flip-flop to return to its original state is proportional to the voltage across *C_T*. This in turn is proportional to the input analog dc voltage.

Transistor *Q7* is a constant-current generator. It supplies a bias current to the input circuitry to overcome the diode and base-emitter voltage drops of *D2*, *D3*, *Q2* and *Q6*. This enables the converter to handle small dc input voltages. Transistor *Q2* is an emitter-follower that prevents the input circuitry from loading the converter.

Warren R. Crockett, Engineer, NASA, Goodard Space Flight Center, Greenbelt, Md.

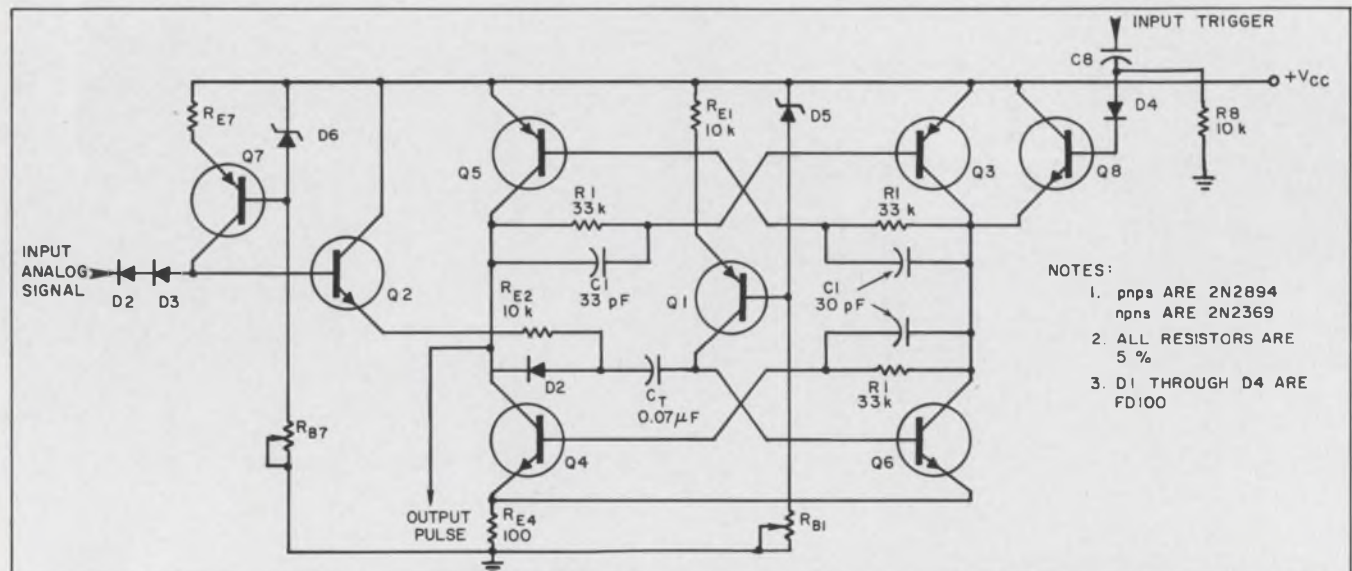

NOTES:

1. npns ARE 2N2894
npns ARE 2N2369
2. ALL RESISTORS ARE
5 %
3. D1 THROUGH D4 ARE
FD100

1. Analog dc-voltage-to-pulse-width converter consists basically of a complementary flip-flop (Q3, Q4, Q5, Q6)

and a constant-current generator (Q1, D5). The circuit is stable over +60°C to -20°C.

Designing the digital circuitry

The schematic diagram of a complementary flip-flop is shown in Fig. 2. Any flip-flop may be made into a monostable by unbalancing the circuit. In Fig. 2, if the $R1$ and $C1$, associated with transistor $Q4$, are replaced by a timing network, a complementary monostable flip-flop results. The parameters to be determined are $R1$, $C1$, R_L , and the minimum h_{FE} that is required to secure reliable operation.

Assume that $Q3$ and $Q4$ in Fig. 2 are on, and that $Q5$ and $Q6$ are off. The design equations for the parameters under worst-case conditions are:

$$R1 = (V_{CC} - V_{BE(Q3)} - V_{CE(Q4)}) / i_b; \quad (1)$$

$$R_L = (V_{CC} - V_{CE(Q3)}) / i_c; \quad (2)$$

$$C1 = [(R1 + R_S) / R1 R_S] / f_{t(max)}; \quad (3)$$

$$h_{FE} = [(V_{CC} - V_{CE(Q3)}) R1 / R_L] / [V_{CC} - V_{BE(Q3)} - V_{CE(Q4)}]; \quad (4)$$

where:

$V_{BE(Q3)}$ = base-to-emitter voltage drop at saturation of $Q3$,

$V_{CE(Q4)}$ = collector-to-emitter voltage drop at saturation of $Q4$,

$V_{CE(Q3)}$ = collector-to-emitter voltage drop at saturation of $Q3$,

$V_{BE(Q4)}$ = base-to-emitter voltage drop at saturation of $Q4$,

R_S = combined saturation resistance of $Q3$ and $Q4$,

f_t = triggering frequency.

Designing the constant-current generator

The function of the constant-current generator (Fig. 3) is to supply a constant current to capacitor C_T . This constant-current source employs a Zener diode for temperature compensation. The

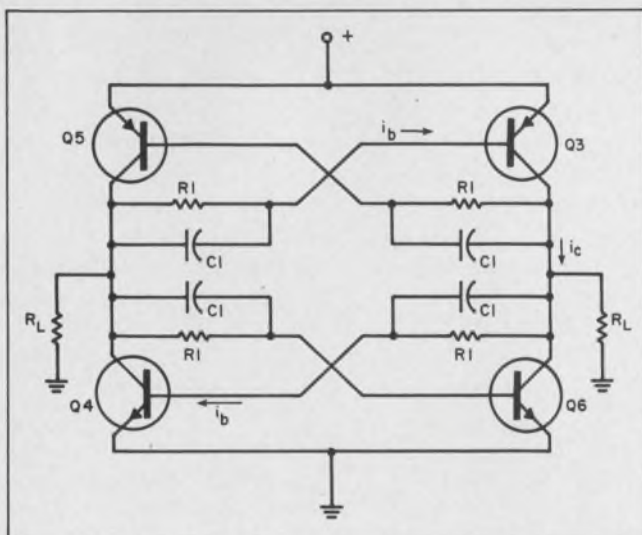

2. A complementary monostable flip-flop results when the circuit is unbalanced. See text for equations determining the component values.

Zener diode characteristics must be similar to the base-emitter diode characteristics of $Q1$. If diode $D5$ of Fig. 3 is properly selected, the voltage across the Zener diode may increase, decrease, or remain constant with temperature. The equation to be satisfied for proper Zener diode selection is:¹

$$\partial i_b / \partial t + (\delta R + \delta F) / R_E = 0, \quad (5)$$

where:

δR = temperature coefficient of reverse breakdown voltage,

δF = temperature coefficient of forward bias function of the Zener diode.

Evaluating the performance

Figure 4 shows a block diagram of the test setup used to check the converter circuit. These tests comprise:

- Output linearity of the converter.
- Stability of the converter as temperature is varied over a temperature range of $+60^\circ\text{C}$ to -20°C .
- Control of the output slope of the converter.

Linearity is defined as the percentage deviation from the best-fit straight line. Table 1 shows the output pulse width in microseconds as a function of analog dc input voltage over the range from zero to 5 volts dc. The equation for the line that best represents these data may be obtained by the

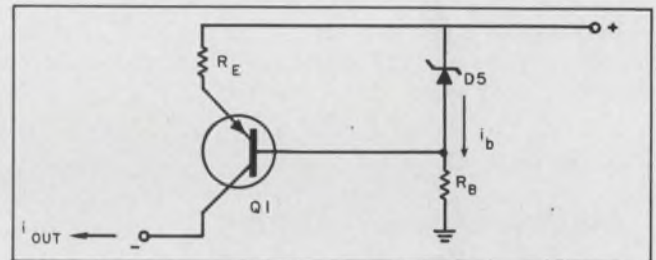

3. A simple constant-current generator uses a Zener diode ($D5$) and a transistor ($Q1$). The base-emitter diode characteristics must be similar to those of the Zener diode for good temperature compensation.

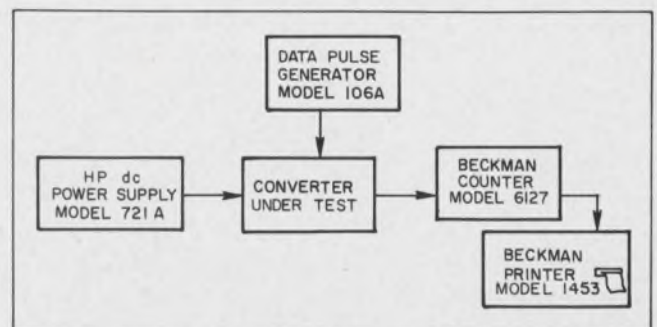

4. Test circuit for the converter uses few standard laboratory instruments. Input dc voltage is provided by the 721A power supply, input trigger pulses come from the 106A pulse generator and the output is monitored by the 6127 counter and 1453 printer.

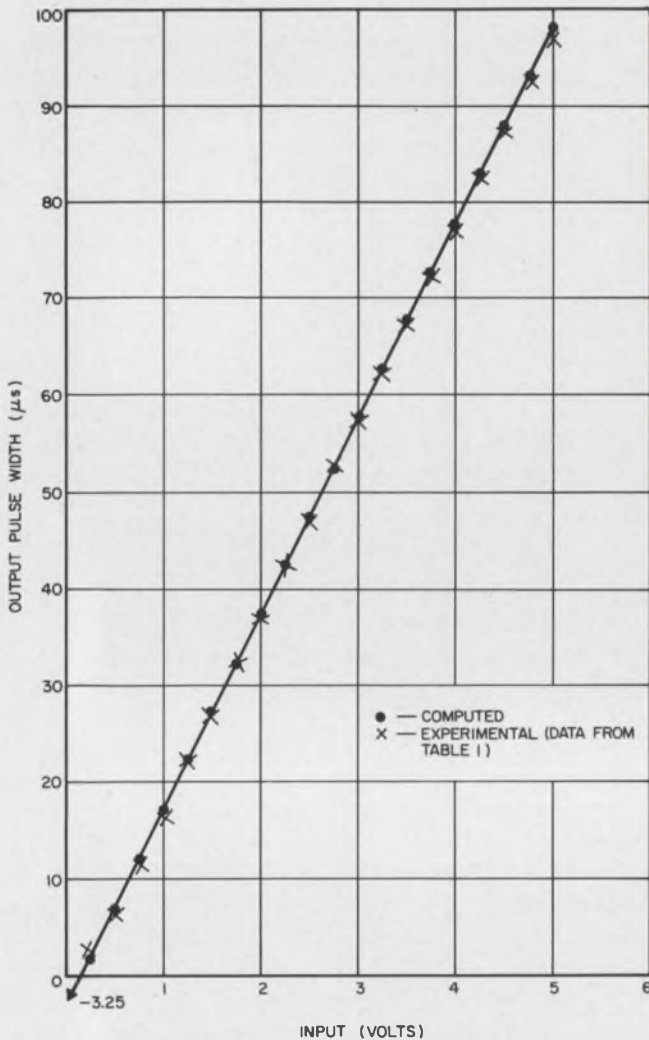

5. Linear pulse-width variation is obtained when dc input voltage is changed. Note that the Y intercept is -3.25 when $R_{H1} = 80 \text{ k}\Omega$.

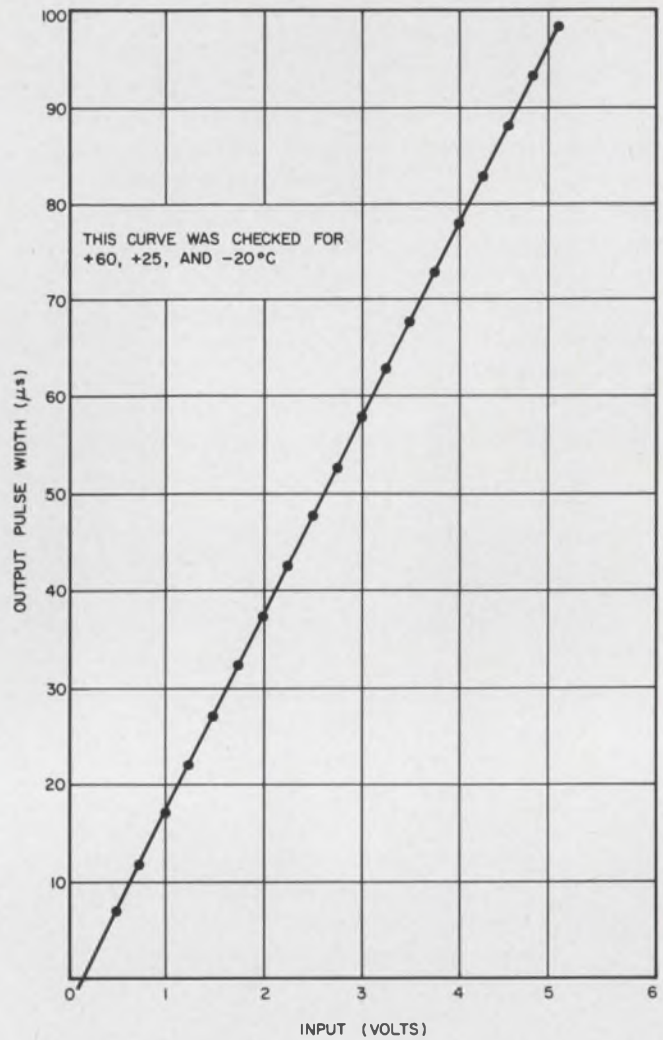

6. Temperature variations from $+60^\circ\text{C}$ to -20°C have very little effect on the linearity of the output pulse-width changes vs input dc voltage.

Method of least squares

The method of least squares is used to test the dc-to-pulse-width converter. For a straight line that comes close to fitting all the experimentally observed points, deviations will be both positive and negative. Their squares, however, will all be positive. If the equation is:

$$Y_{obs} = K + MX_{obs}$$

where K and M are constants to be determined and Y_{obs} and X_{obs} are experimentally observed points, then the deviation at any point is:

$$d = Y_{obs} - (K + MX_{obs})$$

The expression:

$$f(K, M) = (Y_1 - K - MX_1)^2 + (Y_2 - K - MX_2)^2 + \dots + (Y_n - K - MX_n)^2$$

sums all deviations $\pm d$.

The constants for the best-fit straight line can be found from the solution of two simultaneous equations:

$$\partial f(K, M) / \partial K = 0 \quad \text{and} \quad \partial f(K, M) / \partial M = 0$$

Further details of this technique can be found in most good texts on elementary calculus.

method of the least square line (see box). With the data from Table 1, the analog input voltage represented by X and the output pulse width by Y , the least-square-line equation is:

$$Y = -3.25 + 20.25 X \quad (6)$$

Figure 5 compares the theoretical data for this equation with experimentally derived figures. The root mean square deviation is found to be 0.5 per cent.

The converter was tested over a temperature range of $+60^\circ$ to -20°C . The data obtained from these tests are plotted in Fig. 6. The least-square-line equations at the temperature extremes, using the notations of Eq. 6, are:

$$Y_{+60^\circ\text{C}} = -3.82 + 20.43 X, \quad (7)$$

and

$$Y_{-20^\circ\text{C}} = -3.41 + 20.37 X. \quad (8)$$

The maximum rms pulse-width deviation due to temperature variation (Fig. 7) is 0.6 per cent.²

In the portion of the characteristic curve in Fig. 5 that is below 0.5 volt dc, the Y intercept can be made to approach zero by adjusting R_{H1} and R_{H7} .

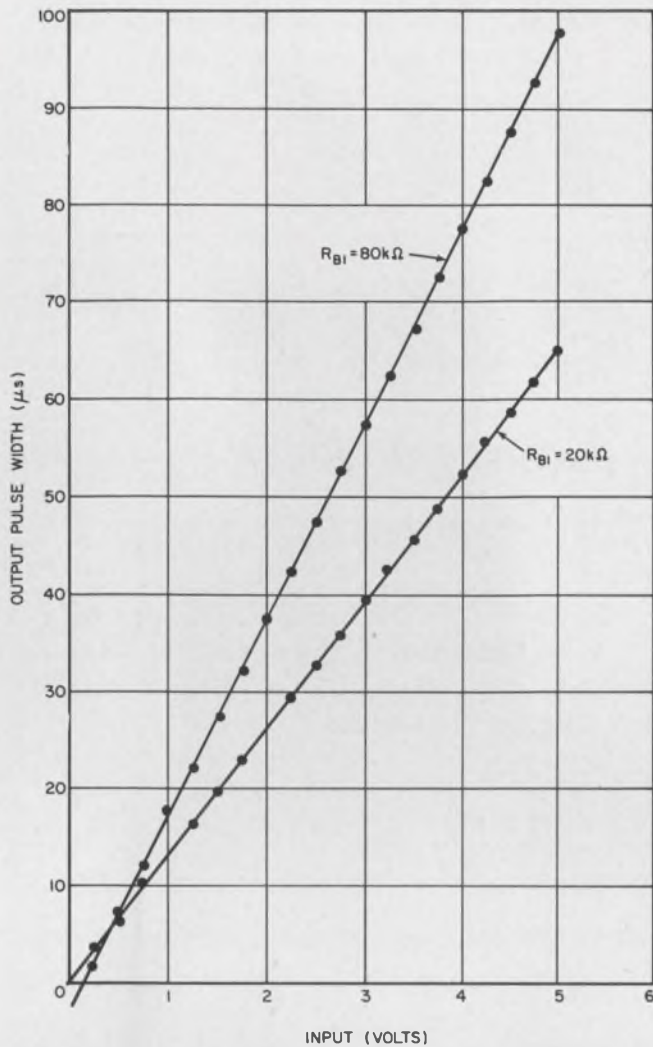

Effect of R_{B1} on the slope of the transfer characteristic curve shows that the Y intercept can be adjusted to equal zero when $R_{B1} = 20 k\Omega$.

of Fig. 1. R_{B1} also controls the output pulse width at high input analog dc voltages.

Figure 7 shows how the slope of the output characteristic curve is changed by varying resistor R_{B1} . When R_B is equal to $20 k\Omega$, the output from the converter is linear over the input voltage range from zero to 5.0 volts dc, and the Y intercept approaches zero. From Table 2 the least-square-line equation is:

$$Y = 0.333 + 12.92 X. \quad (9)$$

Note that the Y intercept has changed from -3.25 to 0.333 . From these calculations it follows that the Y intercept can be made equal to zero if care is taken in selecting R_{B1} and R_{B7} .

The rms deviation over the input voltage range is 0.5 per cent. ■ ■

References:

1. D. F. Hilbiber, "A New Dc Differential Transistor Amplifier," 1961 International Solid-State Circuits Conference Digest of Technical Papers (New York: Lewis Winner, 1961), pp. 44-45.
2. W. R. Crockett, "The Linearity Evaluation of a Dc Voltage-to-Pulse-Width Converter," Unpublished report, Goddard Space Flight Center, Md., 1966.

Table 1: Linearity data ($R_{B1} = 80 k\Omega$)

Input (X) (volts)	Output (Y) Pulse width (μs)
0.00	1.25
0.25	3.00
0.50	6.25
0.75	11.50
1.00	16.50
1.25	22.00
1.50	26.25
1.75	32.00
2.00	36.75
2.25	42.25
2.50	47.00
2.75	52.50
3.00	57.00
3.25	63.00
3.50	67.00
3.75	72.00
4.00	77.00
4.25	82.25
4.50	87.15
4.75	92.80
5.00	97.25

Table 2: Linearity data ($R_{B1} = 20 k\Omega$)

Input (X) (Volts)	Output (Y) Pulse width (μs)
0.00	0.00
0.25	3.60
0.50	6.90
0.75	10.10
1.00	13.25
1.25	16.50
1.50	19.90
1.75	23.00
2.00	25.95
2.25	29.25
2.50	32.70
2.75	36.00
3.00	39.10
3.25	42.25
3.50	45.30
3.75	48.80
4.00	52.10
4.25	55.45
4.50	58.60
4.75	61.80
5.00	65.00

circuit problems?

***Signalite Glow Lamps have
solved problems in these areas:***

- Voltage Regulation & References • Photo-Cell Drivers • SCR Triggering
- Timing • Photo Choppers • Oscillators • Indicator Lights • Counters
- Voltage Dividers • Surge Protectors • Logic Circuits • Flip-Flops
- Memory • Switching • Digital Readouts

Signalite glow lamps combine long life, close tolerance and economy, and are manufactured with a broad range of characteristics to meet individual application requirements. For a creative approach to your design problem . . . contact Signalite's Application Engineering Department.



VOLTAGE REGULATORS BETTER THAN 1% ACCURACY These subminiature voltage regulators are used in regulated power supplies, as reference sources, photomultiplier regulators, oscilloscope calibrators, etc. They are available in voltages from 82 to 143 V. They are used in multiples as regulators in KV ranges.

SEE Signalite Application News Vol. 3 No. 2 for TYPICAL APPLICATIONS.



NEON LAMPS WITH TRANSISTORS The A079 is recommended as an indicator light for transistor circuits, transistorized flip-flops, and other general low voltage operations. The advantages result from the low current and low voltage requirements, the absence of heat generated and extremely long life.

SEE Signalite Application News Vol. 2 No. 5 for TYPICAL APPLICATIONS.

SIGNALITE APPLICATION NEWS

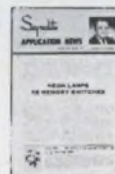

is used to communicate new and proven techniques and applications of Signalite's neon lamps and gas discharge tubes. Signalite Application News provides a forum for an exchange of ideas to keep the design engineer aware of the versatility of neon lamps and their many applications. Copies are available from your Signalite representative or by contacting Signalite.

Reader Service No. 193



TRIGGER LAMPS FOR OPERATION OF SCR'S AND TRIACS The A057B lamp is recommended for use as a triggering device for both SCR'S and TRIACS in motor speed controls and light dimmer circuits. Its properties of stable operation and high current capabilities qualify it for this application.

See Signalite Application News Vol. 2 No. 4 for TYPICAL APPLICATIONS.

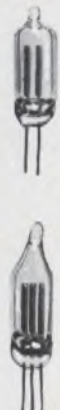

MEMORY SWITCHES Neon lamps have proven to be an excellent memory switch since they store information and provide visual indication. The properties of neon lamps provide a large differential between breakdown and maintaining voltages, stable electrical characteristics and high "off" resistance (20,000 meg ohms). Other applications include switching, information storage, timing circuitry, etc.

SEE Signalite Application News Vol. 4 No. 3 for TYPICAL APPLICATIONS.

Signalite

**INCORPORATED
NEPTUNE, NEW JERSEY 07753
(201) 775-2490**



SUBSIDIARY OF GENERAL INSTRUMENT

Flaming resistor failure used to be a catastrophic danger.

So Corning changed resistor failure.

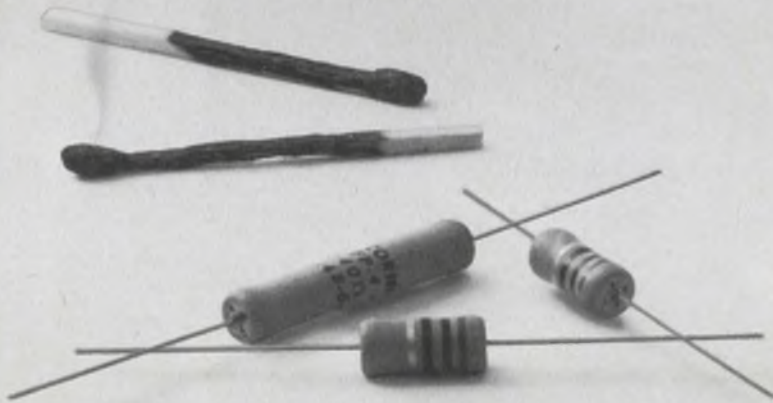

The fact is, new CORNING® FP Resistors just won't burn. Even if a circuit smacks one with an overload of a hundred times or more, it won't burn. It knows how to fail gracefully. It will open up, but no flame and no short. But don't just take our word. Test this new resistor yourself.

FP resistors come in 2, 3, 4, 5, 7 and 10 watt sizes, from 9 ohms to 90K.

Just write for free samples and complete data.

Meanwhile, we're looking for more changes that will improve resistors. That's how our line of glass tin oxide film resistors has grown to be one of the most extensive and useful. That's how we've earned our qualifications for exceptional stability and reliability.

Corning Glass Works, 3904 Electronics Drive, Raleigh, N.C.

CORNING
ELECTRONICS

Core buffer sizes are defined rapidly

with this simple nomograph which also specifies magnetic-tape record separation.

In the design of digital data acquisition systems, particularly in continuous-input—intermittent-output applications, it is often necessary to determine the minimum core buffer size required for sequential interlaced operation. This nomograph enables magnetic-tape record gap time and minimum buffer size to be determined rapidly from a knowledge of record length and core input and output data rates.

As an example, suppose the buffer input rate (R_i) is 30 kHz, the output rate (R_o) 60 kHz and

Barrett W. Reese, Senior Systems Engineer, Leach Corp., Azusa, Calif.

the record length (n) 600 bytes. Line *A* is shown at a buffer input rate of 30 kHz. The horizontal line *B* is taken from the intersection of *A* and the 60-kHz buffer-output-rate curve over to the record-length line, $n=600$ bytes. The vertical projection of this point gives a record gap time (G) of 10 ms (line *C*).

Minimum buffer size K is determined by returning to line *A* and its intersection with the 10-ms record-gap-time line. Horizontal projection *D* from this point yields the minimum buffer size, $K=300$ bytes. In practice, this would require a 512-address core buffer.

The results are accurate within the limits given on the nomograph. ■ ■

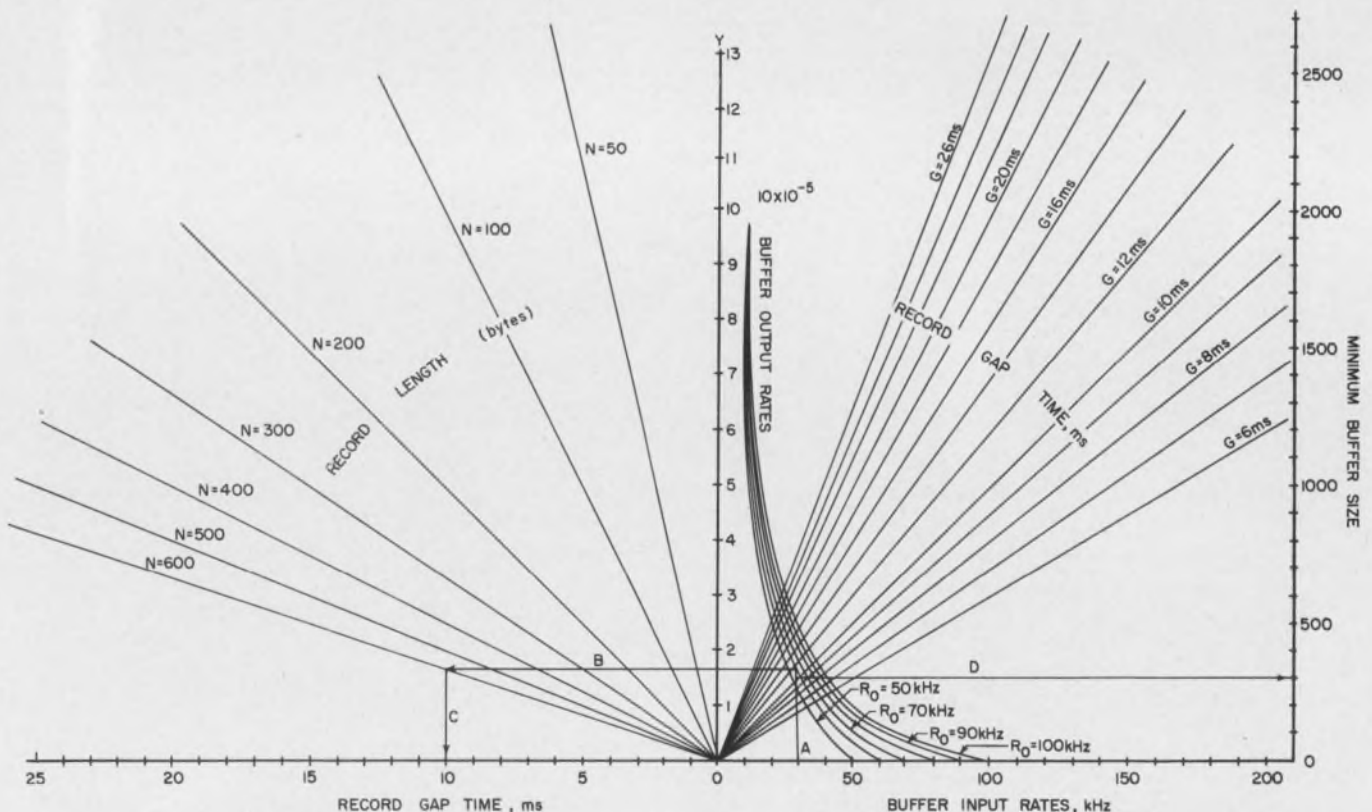

The buffer input rate (A) together with the output rate and record length (B) are used to find the record gap time.

(C). The intersection of the input rate and record gap time lines gives the minimum core buffer size (D).

**Design with
confidence ...**



**with
Centralab's
"Little Giant"
Zeners
up your sleeve**



- Microminiature • High Rel
- High Wattage • Competitively priced

With Centralab Little Giant 1 watt zeners up your sleeve, regulators will be the least of your problems in circuit design. Though microminiature in size (actual size in above illustration), Centralab's Little Giant replaces larger zeners*, in entertainment, industrial and high reliability applications. Rugged tests the Little Giant is subjected to and passes include acceleration,

mechanical shock, vibration, lead and body strength, temperature, thermal shock, humidity, salt spray and altitude. If you need a tough zener regulator, drop us a line on your letterhead and we'll send you complete specifications and a sample *free*, which is better than on-the-cuff.

Centralab's Little Giant is available from the factory and through our Semiconductor Products Distributors. Use the readers service card for location of your nearest distributor and additional technical data.

*The Centralab 1 watt zener regulator (HW6.8 through HW91.0) will replace any zener regulator that has a wattage rating of 1 watt or less within zener voltage breakdown of 6.8 to 91.0 volts, including aluminum can units, epoxies or other glass units. Here are the JEDEC types it will replace and outperform:

150mW	400mW	400mW	¼ watt	¼ watt	1 watt	1 watt
1N1313	1N754	1N957	1N710	1N764	1N1767	1N3016
through	through	through	through	through	through	through
1N1326	1N759	1N984	1N737	1N769	1N1794	1N3043

NOTE: Also available in 1.5 watt, in solderable and weldable lead styles.



CENTRALAB

Electronics Division
GLOBE-UNION INC.

5757 NORTH GREEN BAY AVENUE
MILWAUKEE, WISCONSIN 53201

M-6722

ON READER-SERVICE CARD CIRCLE 45

Want to benefit from a Hayden Happening?

Attend the Hayden "Write-In" at Wescon!

It's for engineers who want practical advice on how to write a technical article.

It's for engineers who have written articles and want them evaluated.

It's for engineers who have ideas for technical articles and want to discuss them with editors.

It's for engineers who have ideas (or even a completed manuscript) for a technical book and want a publisher's reaction.

It's for engineers who would like to meet editors over coffee and danish to discuss the benefits of writing for publication.

It's at the North Continental Parlor 7 of San Francisco's Hilton. Please feel free to drop in anytime between 8 A.M. and 10 A.M., Tuesday, Wednesday, Thursday or Friday.



Hayden Publishing Co., Inc.
Publishers of Electronic Design and
MicroWaves magazines...Hayden,
Ahrens and Rider books.

INDICATORS

We also make switches, readouts, keyboards, panel displays, in-line displays and CRT displays.

FOR INTEGRATED CIRCUITS AND DISCRETE COMPONENT CIRCUITRY!

VARIETY?

Unlimited! Neon or replaceable incandescent lamps—optional integral switch.

LOOKS?

Go together, beautifully! Mount on 19/32" centers.

CUSTOM DESIGNED?

Yes, to fit your special requirements—and usually at standard prices.



SUBMINIATURE
STL Series (Actual Size) .360" dia. body. Mounts on 3/8" centers. Neon or incandescent lamp internally controlled from low level signals. As low as \$7.45*. MSTL for I-C.



MTL Series
Controls long life neon lamp from signals as small as 2 volts. Price: As low as \$3.00*. MMTL Series for integrated Circuits (I-C).

TBL Series
Adds integral isolated switch to MTL Series. As low as \$4.35*. MTBL Series for I-C.

TIL Series
Brilliant, replaceable incandescent lamp operated by signals as low as 0.3 ma. As low as \$4.76*. MTIL Series for I-C.

TIB Series
Integral, isolated switch plus TIL function. As low as \$6.60. MTIB Series for I-C.

TML Series
Turns on with a 2 μ s pulse, remains on until cleared. Integral clear switch optional. As low as \$10.35*. MTML Series for I-C.

LVN Series
For discrete component circuits only—use where high voltage not available. Internally amplifies low voltage D.C. supply to fire neon lamp. LVB Series adds isolated switch. LVN Series as low as \$6.25*. LVB Series as low as \$8.90*.

*in 100-499 quantities

For complete information, contact your local TEC-Rep, or write direct.



Box 6191 • Minneapolis, Minnesota 55424 • Phone (612) 941-1100

ON READER-SERVICE CARD CIRCLE 46

SWITCHES

We also make indicators, readouts, keyboards, panel displays, in-line displays and CRT displays.

ISN'T THIS WHAT YOU WANT?

Million-cycle reliability! Low standard prices. Compact design! Match-mate appearance with TEC-LITE Indicators!

HERE THEY ARE:



TBL Series—Combines neon lamp indicator with integral isolated 100 ma. SPDT switch. For I-C or discrete component circuitry. As low as \$4.35*.

TIB Series—Same as TBL but with replaceable incandescent lamp. As low as \$6.60*.

ABL-ABS Series—Alternate action two circuit, double break, 100 ma. switch for controlling separate circuits. Switch only, or with replaceable neon or incandescent lamp. As low \$5.40*.



RBL Series—Independent SPDT momentary contact switch combined with replaceable neon or incandescent lamp. As low as \$2.60*.

MBS Series—SPDT momentary 100 ma. switch. MBL Series has neon or incandescent lamp. MBS as low as \$1.45; MBL as low as \$1.88*.



SBS Series—Subminiature (.360" body) SPST n.o. momentary contact switch. SBL Series offers integral incandescent T-1 lamp with switch. SBS as low as \$1.26; SBL as low as \$3.10*.

For complete information, contact your local TEC-Rep or write direct.

*in 100-499 quantities



INFORMATION DISPLAY AND CONTROL DEVICES
TRANSISTOR ELECTRONICS CORPORATION

Box 6191
Minneapolis, Minnesota 55424
Phone (612) 941-1100

ON READER-SERVICE CARD CIRCLE 47

Pit your engineering management skill against these actual problem situations. Then find out what the "men on the spot" really did.

A growing and dynamic business requires steady change. Each step along the way represents a challenge to management at all levels. One wrong decision can undo a company unless it is recognized soon enough and corrected. At the same time, taking no action at all can be just as destructive. Steps *must* be taken to modify procedures and organization as each department takes on more work, more people join the company, and facilities expand.

These problems are particularly serious in the electronics industry, which has been growing at an annual rate of about 15%. This is three to four times the growth rate of industry in general. A static position in the electronics industry is usually a losing position. Because of the industry's dependence on technology, an engineering department's ability to adapt to each new situation can boost or blight the company's future. Engineering managers cannot afford to bury their heads in design problems. They must be alert to new techniques, the total company situation, and to each impending problem.

Six managers on the firing line

Following are six real situations that have occurred in actual companies. In each case the engineering manager was the one who had to come up with the right answer at the right time. In some cases, proper action was taken and success was the result. In others, the wrong thing was done and the company suffered—in one instance, bankruptcy. In the other instances, the trouble engendered by improper decisions was spotted early enough for corrective action to be taken and the companies recovered.

To give the reader an opportunity to test his own managerial skills against those of the men who actually faced these situations, the problems will first be presented without solutions. Then the actual solution that succeeded, or the one that should have been applied, is given.

Robert B. MacAskill, Product Manager, The Hallicrafters Co., Chicago.

Problem No. 1: The booming-business dilemma

A well-established microwave company was receiving orders faster than the shop could put them out and slow deliveries were becoming a way of life. The chief engineer found that, however hard his group worked, it never caught up with its schedule. Also, because of the slow deliveries, income was insufficient to keep pace with the need for new parts and supplies. Thus there were periods when the shop was not working at full capacity despite the heavy work backlog. The re-

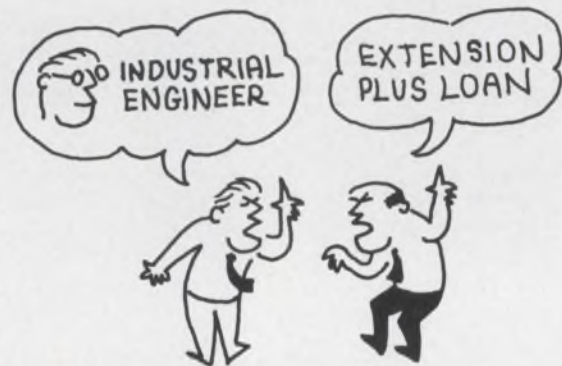

sult of all this was that production and engineering costs were quite high, and profits were negligible.

The chief engineer went to management and admitted that the production operation, for which he was responsible, was working inefficiently. He asked for permission to hire an industrial engineer to straighten out the scheduling and ordering.

Management agreed that the troubles needed to be cleared up, but thought that hiring another man in the engineering department was no solution. They suggested that, if they borrowed some money, a stock of parts and materials could be accumulated and an extension could be built onto the plant. This would surely cure the trouble, they felt.

Should the chief engineer accept this solution? (Solution, p. 78.)

Problem No. 2: The overburdened engineering group

A small Midwestern firm that had grown easily for several years found that, no matter what new products or sales efforts it attempted, it could not make more than \$1 million annually. The bottleneck appeared to be the engineering department. Hiring more technical people did not help the situation. The engineering department head worked long and hard and was so busy staffing new programs and putting out little fires that he found no time to plan lasting solutions. Business was being stifled by the department's apparent inability to develop profitable products.

Markets, customers and profits were dwindling. No matter how hard the engineers tried, they seemed unable to catch up with the problems of existing product lines or the production difficulties of new lines.

Clearly something had to be done or the company would turn from meager profits to actual losses.

What should the chief engineer do? (Solution, p. 80.)

* * * *

Problem No. 3: The perfect products plan

An audio components company was falling behind its sector of the industry. Competitors' technology had outstripped its own, so a new engineering head was hired. He was brought in on the understanding that only top-quality products in each line would be put into the field, so that the firm could reestablish its place in the consumer equipment industry.

The manager agreed to this plan, and immediately set up a system to accomplish management goals. He set up a rigid set of controls for new product development, ranging all through the selection, development and testing cycles. There was to be no room for mistakes.

After six months, the company was coming out with very few new products. Those that were introduced were slow getting into production. Although the products were good, the competition was taking an even larger share of the market and prospects were bleak.

What should the engineering head do? (Solution, p. 80.)

* * * *

Problem No. 4: The new plant caper

The engineering department of a small instrument company was becoming overcrowded and inefficient because it was outgrowing its working space. Management agreed to build a plant extension with a large section for the engineering group to move into. The old space would be turned over to production.

The chief engineer estimated the space he would require for the next two years, but then decided that it would be necessary at this time to buy the office furniture, drafting tables, and other equipment needed only for the first year's expansion. Thus the cost of the additional equipment for the second year could be deferred. He decided to divide the floor space allotted to him into two

sections: one for the first year, the extra space for storage until it was needed for the additional expansion.

Then he assigned one of his good design engineers, who was momentarily not needed on any design project, to work out the details of the layout. These, of course, would be approved by the chief engineer once the design engineer had completed them.

In the space of a few weeks he was able to inform management that all his planning was completed, and the building program began.

Did the chief engineer handle this job correctly? Do any of his plans seem faulty? If so, how should the situation have been handled? (Solution, p. 80.)

* * * *



Problem No. 5: The price of glory

A well-known electronics company prospered early in its history by restricting its line and becoming an outstanding manufacturer of its select products. It gained an enviable reputation for sophisticated work and grew to many times its original size. A competent production capability was established, nourished by many product innovations from the engineering department.

After a decade of profitable growth it became apparent that many of its products would be supplanted by equivalent solid-state models. A shift in techniques was obviously necessary if the firm was to maintain its leading position. The shift began, but after several months' concerted effort new product development still had not reached the production stage. Meanwhile, competitors' products were gaining wider acceptance. Obviously the company was in a dangerous technological situation. A consultant was called in to help.

The consultant found that the company's managers were all experienced engineers with years in the business. They were past masters at every phase of the technology involved in the particular type of products being manufactured. But these men were now pretty much removed from detailed product development work. The younger engineers had been trained to take the place of the more experienced men who had trained them and they were floundering.

What should the consultant recommend? (Solution, p. 81.)

* * * *

Problem No. 6: Riding herd on rising costs

The product manager of a fast-growing automatic-controls company found that his engineering costs were rising faster than the business warranted. These costs were beginning to endanger the firm's competitive bidding position. Accounting, purchasing and payroll records shed little light on the problem. Only after the manager had followed several contracts from quotation through delivery was the problem apparent.

His analysis indicated that slight variations in the design of the company's products were being introduced into each job.

The solution seemed clear. A product standardization program was instituted. The product manager called all the engineers together to discuss the new policy. They expressed strong doubts about the new approach. "We tried it that way before," they claimed, "but it failed." But the manager insisted that the new policy be followed.

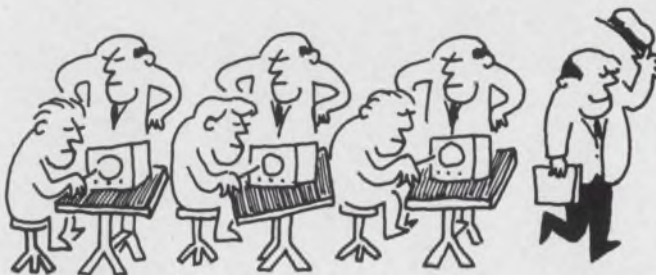

Thereafter he kept an eye on the cost records, and for a time it appeared that the problem had vanished. Meanwhile, a growing number of installations kept the manager on the road working with individual customers for much of the time.

A year later, the manager realized that profits had picked up very little and the cost problem was as grave as ever.

Where did he go wrong, and what should he do now? (Solution, p. 81.)

* * * *

CAUTION: These situations have of necessity been simplified. Situations in your own company that may bear a superficial similarity could be quite different. Many other factors are involved in every company's business. Each situation must be studied separately and carefully, with full consultation between all departments before acting.

SOLUTIONS

Solution No. 1: The booming business dilemma

The chief engineer should not accept the solution offered by management. Any department head who cannot keep his costs down and efficiency up soon becomes a drag on a company. When such a situation arises, its causes must be dealt with directly and immediately. The new extension would bring with it serious new problems—installing new equipment, setting up new operations—while existing shortcomings would remain unchanged. The chief engineer himself would be too busy to straighten out the scheduling and ordering problems.

This is a common case in industry. The cost-saving aid appears to management simply as a new expense. Yet a good industrial engineer, especially in a situation like this, can save his salary many times over. The chief engineer should estimate what savings might be achieved so he can present management with a convincing case.

In this particular instance, the chief engineer
(continued on p. 80)

GOOD THINGS COME IN SMALL PACKAGES

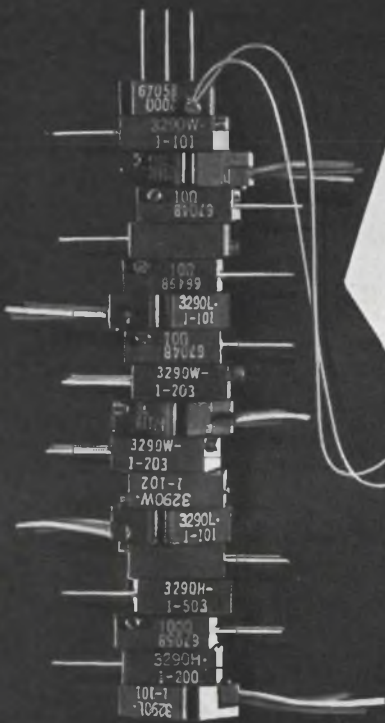

**THINNER
3/8" SQUARE
POTENTIOMETER
NOW AVAILABLE**

It's an old saying . . . but truer today than ever before with the Model 3290 TRIMPOT® Potentiometer. This outstanding high-quality unit measures only $\frac{3}{8}$ " x $\frac{3}{8}$ " x less than $\frac{1}{32}$ " thick, yet offers specifications available in larger units—all at the competitive price of \$5.48*.

Available with leads and three printed circuit-pin mounting styles, the Model 3290 meets or exceeds requirements of MIL-R-27208 . . . is rated at 1 watt at 70°C, and has a temperature range of -65°C to +175°C. The all-plastic case is sealed against liquids and potting compounds and a resistance range of 10Ω to 50K gives you plenty of selection for your projects.

When your designs and programs call for the very best in potentiometer quality and small size, at competitive prices . . . test and then specify the Model 3290! Write today for complete technical data or contact your nearest Bourns office or representative.

*100-piece price



SPECIFICATIONS

Size	$\frac{3}{8}$ " x $\frac{3}{8}$ " x .150"
Standard Resistance Range	10Ω to 50KΩ
Resistance Tolerance	±5% Standard
Resolution	1.01% to 0.10%
Power Rating	1 watt at 70°C
Operating Temperature Range	-65°C to +175°C
Temperature Coefficient	50 PPM/°C max.
Moisture Resistance (MIL-R-27208)	100 megohms min. insulation resistance
Mechanical Adjustment	25 turns



BOURNS, INC., TRIMPOT DIVISION • 1200 COLUMBIA AVE., RIVERSIDE, CALIF.
TELEPHONE (714) 684-1700 • TWX: 910 332-1252 • CABLE: BOURNSINC.

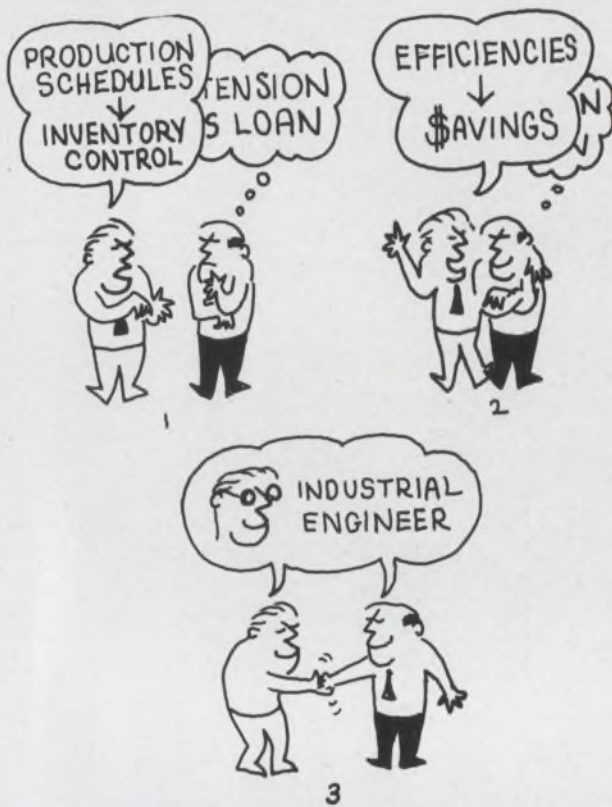

accepted management's advice without argument. The money was borrowed, the new extension built. Soon afterwards the company went out of business. It is highly probable that this company would have survived, even without the loan, if they had employed the services of an industrial engineer to attack the immediate cost problem.

* * * *

Solution No. 2: The overburdened engineering group

This firm's most valuable resource, engineering talent, was being wasted. Designers were being used to get products out of the door instead of being assigned to develop products that would ensure a successful future.

Fortunately, in this case, the engineering manager paused in his treadmill activities long enough to recognize the problem. He saw his responsibility clearly. He had to reorganize his department to meet company goals better. He consulted with management to assess the financial potential of each program. Top men were assigned to products with the best prospects.

A new criterion was established in the selection of new products. All things being equal, the product with the lowest ratio of engineering to nonengineering time was selected for continuing development. Other products were dropped. Thus engineering resources were freed for other, more profitable new-product programs.

This honest appraisal of the problem and the determination to achieve a solution corrected the company's growth pattern. The company has been successful and the engineering department, now applying its resources properly, is a dynamic force in this growth and progress.

* * * *

Solution No. 3: The perfect products plan

In attempting to delegate the responsibility for getting results, management sometimes fails to delegate the right to make mistakes. Both these must be delegated if the company is to be dynamic and grow.

In this situation the fear of making a mistake was stifling initiative and slowing progress. The engineering department had so many restrictions on new-product development that a negative attitude had evolved. Of course, it is bad for an engineering manager to be surrounded by unshakable optimists. But it is equally bad to have a group of engineers who are expert at showing only why any idea will not work. This sort of thinking inflates minor problems and impedes progress.

This engineering head understood the problem and took the correct course. He lifted his rigid restrictions and encouraged ideas for new products. Stringent testing procedures were relaxed. Controls were still applied to major specifications, but there were more compromises on minor specifications for a particular product. Mistakes were no longer blasted.

This company has gradually recovered. Now its growth rate is better than that of the industry as a whole.

* * * *

Solution No. 4: The new plant caper

This chief engineer made serious errors, and his department's morale and efficiency suffered as a result. He started out on the wrong foot. He should have viewed the expansion as an opportunity to save money, increase efficiency and earn better profits. Instead, he handled the whole matter rather casually.

After minimal planning on his own part, the chief engineer assigned laying out the new section to the first available person, regardless of qualifications. The trouble with the plan that was the outcome did not become evident for about a year. Then it was clear that each subdepartment within the group was outgrowing its assigned space. New equipment and furniture was indeed needed, but within each of these smaller units



it refuses
to let go...

...until you
can see these
Shure-Stake[®]
integrity
dots*



PATENTED

NEW, LIGHT WEIGHT, SHURE-STAKE[®] TOOL MUST MAKE ZERO DEFECTS
CRIMP AND INSPECT IT BEFORE IT WILL RELEASE STA-KON[®] TERMINAL

From the moment you pick up a T&B tool, you know it's different from any other. With the Shure-Stake technique an experienced operator **can't** make a faulty crimp. T&B's million dollar tooling techniques correctly match tools, wire size, and insulated terminal to produce optimum mechanical and electrical performance. More than a million dollars in Shure-Stake tooling research gives you T&B connector reliability. See other side how you can lower installed costs and increase reliability

*A feature of the Elliptical Crimp Type Tools.

250.1

FIRST CLASS
PERMIT NO. 2016
ELIZABETH,
NEW JERSEY

BUSINESS REPLY MAIL

NO POSTAGE NECESSARY IF MAILED IN THE UNITED STATES

POSTAGE WILL BE PAID BY

The Thomas & Betts Co., Incorporated
36 Butler Street
Elizabeth, New Jersey 07207



THESE STA-KON TERMINALS ARE MATCHED TO SHURE-STAKE® TOOLING FOR OPTIMUM PERFORMANCE

Wire range: insulated #26 to #10 AWG, non-insulated #22 to #10 AWG.



PATENTED

These are typical of hundreds of Sta-kon terminals

- | | | |
|--|---|---|
| 1. RB-250
Female Snap-On
Nylon Self-Insulated | 7. RB863
Nylon Self-Insulated Ring | 15. C39
Non-Insulated
Rectangular |
| 2. RA-23
Wristlock Disconnect
Nylon Self-Insulated | 8. RA1123
Nylon Self-Insulated Fork | 16. C-482
Non-Insulated
Rectangular L80 |
| 3. RAA23
Nylon Self-Insulated
Aircraft Splice | 9. RC1643
Nylon Self-Insulated
Rectangular | 17. B-1103
Non-Insulated
Elipti-Grip(TM) Fork |
| 4. RA15
End Caps | 10. RA-482
Nylon Self-Insulated
Rectangular L80 | 18. B132G
Insulation Grip Ring |
| 5. RAA-217
Butt Splice
Vinyl Self-Insulated | 11. RB857
Vinyl Self-Insulated Ring | 19. B116G
Insulation Grip Fork |
| 6. RB4
One-Piece Wire Joint
Nylon Self-Insulated | 12. RC1147
Vinyl Self-Insulated Fork | 20. AB53
Non-Insulated Flag |
| | 13. C26
Non-Insulated Ring | 21. NW52
Non-Insulated Ring
Up to 1900°F |
| | 14. C120
Non-Insulated Fork | |

I am interested in learning how STA-KON® tools and terminals can reduce costs and improve reliability.

- Please send me product literature.
 Please have T&B terminal specialist call for appointment.
 My interest is: immediate future general

NAME TITLE

COMPANY DEPT.

ADDRESS PHONE

CITY STATE ZIP

SOLD COAST-TO-COAST THROUGH AUTHORIZED T&B DISTRIBUTORS

NEW

LIGHT WEIGHT
STA-KON®
WT-400 & 500
SERIES
HAND TOOLS
WITH
SHURE-STAKE®
RELIABILITY



SHURE-STAKE
INTEGRITY

The Shure-Stake ratchet and pawl assembly releases the terminal only after dies close completely, thus assuring that specified compression has been produced. Dies close along a straight line.



NEW
ELLIPTIGRIP™
TERMINAL

This cross section shows T&B's confined Elipti-grip crimp which provides a large contact area for high conductivity and low resistance. Exceeds pull-out values of MIL-T-7928E.



NEW FLOATING
LOCATOR

Holds terminal in proper position for crimp and acts as a positive wire stop. Locator also swings away to accommodate splices and end caps.



PATENTED

NEW PORTABLE
AUTO-FEED TOOL

Both bench and hand models utilize tough mylar belt to hold STA-KON terminals — over 1000 installations per hour are now practical. Other features are — Shure-Stake integrity, interchangeable snap-in dies, only 5 moving parts, quick feed safety guide and Shure-Stake automatic advance. Air operated by foot or hand.

THE THOMAS & BETTS COMPANY, INC.
36 Butler Street • Elizabeth, N. J. 07207
In Canada, Thomas & Betts Ltd. • Iberville, P.Q.



THOMAS & BETTS

where no room had been left for it! It was obvious that the total space should have been laid out to cope with the full two years' expansion. Now it was necessary to tear down most of the partitions and restructure the entire space once again. Work slowed down, schedules slipped and people groused about the need to shuffle around again only a year after a big move.

The answer here is that qualified advice must be sought when expansion plans are made. These situations can be forecast, and the plant layout adjusted to minimize inconveniences. The engineering business, like any other, must view problems as potential cost centers and treat them from the beginning as opportunities for future savings and profits.

* * * *

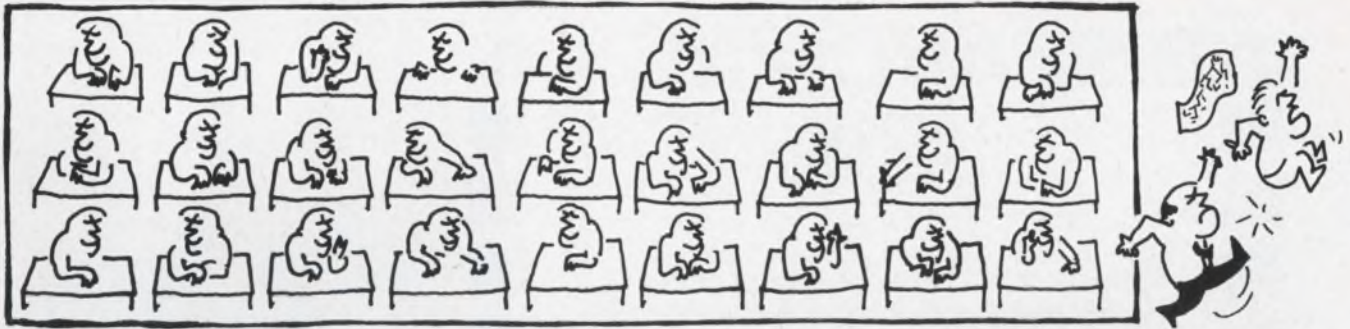

Solution No. 5: The price of glory

Since past achievements are no assurance of future progress, an engineering firm can be misled by the image it has of its capabilities. That is what happened to this company. Although engineering management had the foresight to realize the need for a change, it did not recognize the technical limitations.

The consultant pointed out that the older engineers, who were responsible for training the younger ones, were experienced in tube design but had had little experience with semiconductors. Since the old products had earned a high reputation, these managers had resisted any major innovations. The younger engineers were kept busy filling the design gaps left by the older engineers who moved into management, and they were given little encouragement to gain new knowledge. Thus the engineering department was almost obsolete, and a rigorous training program in solid-state techniques was required. It was also obvious that several experienced solid-state design engineers had to be hired.

There would be a time lag between this learning process and effective application of the new knowledge, the consultant pointed out. Therefore, management would have to be prepared to see business suffer unless it was willing to put an intermediate program into effect. Although this program promised to be financially rewarding, it would be an affront to the engineering department's pride.

The course would be to forget about innovation for at least a couple of years, and produce instead variations on solid-state developments that had already gained market acceptance. To be a follow-

er after so many years of leadership was a bitter pill to swallow. But management recognized that this would be transitory, and that during this time all operations of the company—production, marketing, administration—would be fully employed. The total plan was accepted with the result that the company survived and now makes a unique line of solid-state products.

* * * *

Solution No. 6: Riding herd on rising costs

The trouble here was lack of follow-through. The product manager's analysis of the problem and his solution were correct, but he evolved no system of control to see that his program was being effected. A plan cannot run by itself. And if the people who are implementing it do not really believe in it, a manager can expect it to run into trouble. This possibility must be recognized in advance, and steps taken to counter it.

In this specific case the weakness was to assume that the engineers would stop their experiments on the standard line without some sort of continuing discipline. Fortunately, the product manager recognized his failure and added a new element to the program. He assigned his most economy-minded and experienced engineers to manage each project, and then periodically reviewed the standardizing situation with them. He approved changes only when the need warranted them. After another year with these controls, standard designs became the backbone of each quotation, putting the company in a solid competitive bidding situation. The engineering time thus conserved permitted the company to widen its range of activity and to progress handsomely. ■ ■

RF CIRCUIT ENGINEERS
SYSTEMS ANALYSIS ENGINEERS
SYSTEMS INTEGRATION ENGINEERS
INDUSTRIAL ENGINEERS
DIGITAL ENGINEERS

SEARCHING FOR

OPPORTUNITY instead of promises?

We can't promise you'll realize all your career objectives at ECI, but we will give you every opportunity. And we'll help you every way we can. The rest is up to you.

CHALLENGE instead of a chance?

Challenges lead to accomplishments. Chances don't necessarily lead to anything. If you like the satisfaction of accomplishing things, you'll like working at ECI. We're objective oriented.

GROWTH instead of a groove?

In our business you can't afford to stop learning . . . to stop growing. At ECI you'll be pushing the state-of-the-art. There are few confining grooves when you explore the unknown.

And LOCATION too?

If you're going to like your job, you might as well like where you're living. We'll pit the St. Petersburg area against anyplace in the U.S. for stimulating, comfortable living.

INVESTIGATE ECI!

We have immediate openings in design and supervision. You'll work on systems and equipment in satellite communications, multiplexing, electronic switchboards, and advanced VHF/UHF communications using microcircuitry and state-of-the-art techniques.

Send your resume, in confidence, to K. S. Nipper, Supervisor of Professional Placement, Electronic Communications, Inc., Box 12248D, St. Petersburg, Florida 33733. (An equal opportunity employer.)



St. Petersburg Division
Electronic Communications, Inc.

ON CAREER-INQUIRY FORM CIRCLE 901

Book Reviews

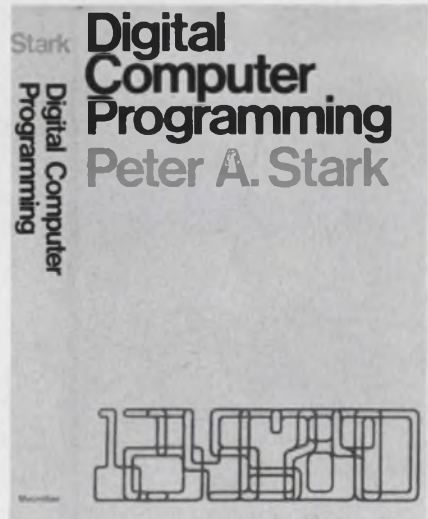

Programing without tears

Digital Computer Programming, Peter A. Stark (The Macmillan Co., New York), 525 pp. \$9.95.

The ever expanding field of computers is relentlessly producing what amounts almost to a paper explosion. An apparently increasing part of this consists of books on how to use the machines whose appetite for programs and, by implication, for programmers, is not yet satiated.

As an instructor Mr. Stark is well aware of the high demand for programmers and has produced a sizable textbook for an obviously sizable audience. However, others have been there before. The question is: Does Stark say better what has already been said? Unfortunately, the answer is less than affirmative.

The student and perhaps the hard pressed instructor will find this book helpful in explaining the intimacies of debugging or relocatable programing, but will hardly pause over a 16-page list of computer manufacturers and their products or the usual obligatory pages on Pascal, Babbage, *et al.*

This textbook concentrates on machine language and symbolic programing together with a subset of FORTRAN IV. Many scientific users will be concerned only with the higher-level languages, such as ALGOL and FORTRAN. The engineer who is faced with a specific

Free Career Inquiry Service

Absolutely Confidential

Respond to the career opportunities advertised in this issue. Fill out and send us this handy resume. **Electronic Design** will do the rest – neatly typed copies of this form will be mailed to the companies of your choice, indicated by the circled Career Inquiry Numbers at the bottom of this page.

16

Name		Home Phone	
Home Address (Street)		City	State
		ZIP Code	
Age	U.S. Citizen	Security Clearance	
	<input type="checkbox"/> Yes <input type="checkbox"/> No		

Prime Experience	Secondary Experience

Desired Salary	Availability Date
-----------------------	--------------------------

Employment History – present and previous employers

Company	City, State	Dates	Title
		to	
		to	
		to	

Education – indicate major if degree is not self-explanatory

Degree	College	City, State	Dates
			to
			to
			to

Additional Training – non-degree, industry, military, etc.

Professional Societies

Published Articles

- Career Inquiry Numbers:**
- | | | | | | | | | | |
|-----|-----|-----|-----|-----|-----|-----|-----|-----|-----|
| 900 | 901 | 902 | 903 | 904 | 905 | 906 | 907 | 908 | 909 |
| 910 | 911 | 912 | 913 | 914 | 915 | 916 | 917 | 918 | 919 |

ELECTRONIC DESIGN
850 Third Avenue
New York, New York 10022

Electromagnetic Compatibility Engineers:

CAREER OPPORTUNITIES WITH IBM IN ENDICOTT, NEW YORK

Experienced EMC Engineers are needed to help develop electromagnetic compatibility technology with:

Digital Computers
Input/Output Equipment
Microelectronics
Digital Communications

Development activity includes design techniques for control of radiation and susceptibility characteristics in

advanced data processing systems.

Applicants should have a BS or MSEE and 1 to 5 years' experience in commercial, military or space EMC programs. Please send your resume to: **I. E. Rosenbarker, Department QB5H, EMC Laboratory, IBM Corporation, Endicott, New York 13760.**

IBM

An Equal Opportunity Employer

ON CAREER INQUIRY FORM CIRCLE 902

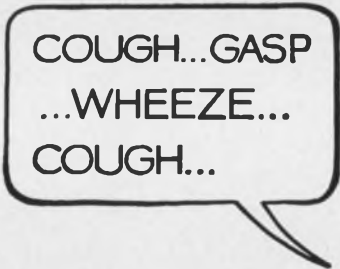

Sound familiar?

Many people have breathing problems—shortness of breath, persistent cough, too much phlegm—and they brush them off. They hardly notice—until their fun and work are interrupted, their happiness threatened, even their lives. Don't let it happen to you. It might be emphysema or some other respiratory disease. See your doctor. Use the coupon.

Paste on postcard

NTA, GPO, Box 2400, New York, N. Y. 10001

Send me the free booklet, "Your Breathing Troubles"

Name _____

Address _____

City _____ State _____ Zip Code _____

Published by National Tuberculosis Association, paid for by Christmas Seals.

BOOK REVIEWS

language would be better advised to turn to a text on that particular language.

For the budding systems programmer this book is perhaps of rather more value, even though such interesting concepts as indirect addressing and macroinstruction programming are given only cursory treatment. However it is a far cry from being able to use an assembly language to being able to write an assembler.

Jeffrey N. Bairstow

RC network synthesis

Synthesis of RC Networks, Hun H. Sun (Hayden Book Co., New York), 150 pp. \$7.50.

This textbook covers the material needed for a one-term course in RC network synthesis at graduate or senior level. Its topics include the basic theory and practical design procedures needed for one-port and two-port synthesis, controlled-source devices, and general RC active-network design. Particularly thorough treatment is given to continued fractions, real roots of polynomials, and polynomial decomposition.

Semiconductor devices

Theory of Semiconductor Junction Devices, J. H. Leck (Pergamon Press, New York), 164 pp. \$4.75.

This book describes in simple but adequate form the theory of operation of an important range of semiconductor devices. It is limited to junction devices in common use in the engineering industry; discussion of basic solid-state theory is avoided. In the first chapters, the results of the application of band theory to the special case of semiconductors, both intrinsic and extrinsic, are presented as a necessary introduction to a study of the devices. An examination of the electrical properties of semiconductors, conductivity, Hall effect, and other basic topics then leads to the central topic, p-n junction theory. There follow descriptions of the rectifier, the tunnel diode, avalanche and Zener diodes and the variable capacitor, and also of the multijunction elements, injection and field-effect transistors and the pnpn switch.

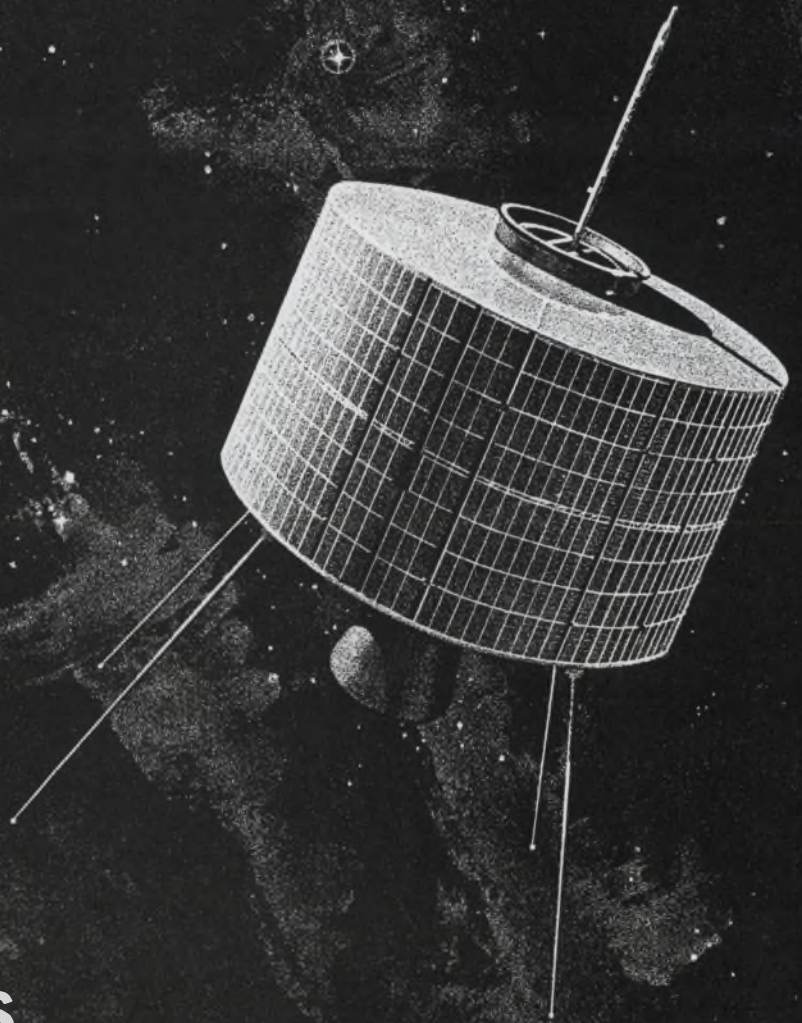

CIRCUIT DESIGNERS... is your appointment in space with Hughes?

Today, Hughes is one of the nation's most active aerospace/electronics firms: Projects include: F-111B PHOENIX Guided Missile System, TOW Anti-Tank Missile System, Communication Satellites, ATS-Advanced Technology Satellites, VATE, Hard Point Defense and others.

This vigor will assist the qualified engineers and scientists towards more and better opportunities for both professional and personal growth.

Many immediate openings exist. The engineers selected for these positions will be assigned to the following design tasks: the development of high power airborne radar

transmitters, the design of which involves use of the most advanced components; the design of low noise radar receivers using parametric amplifiers; solid state masers and other advanced microwave components; radar data processing circuit design, including range and speed trackers, crystal filter circuitry and a variety of display circuits; high efficiency power supplies for airborne and space electronic systems; telemetering and command circuits for space vehicles, timing, control and display circuits for the Hughes COLIDAR (Coherent Light Detection and Ranging).

If you are interested and believe that you can contribute, make your appointment today.

For immediate consideration, please airmail your resume to:

Mr. Robert A. Martin
Head of Employment, Dept. 54
Hughes Aerospace Divisions
11940 W. Jefferson Blvd.
Culver City, California 90230

Creating a new world with electronics

HUGHES

HUGHES AIRCRAFT COMPANY

AEROSPACE DIVISIONS

An equal opportunity employer.

U.S. CITIZENSHIP REQUIRED

Burroughs eliminates a sizable point

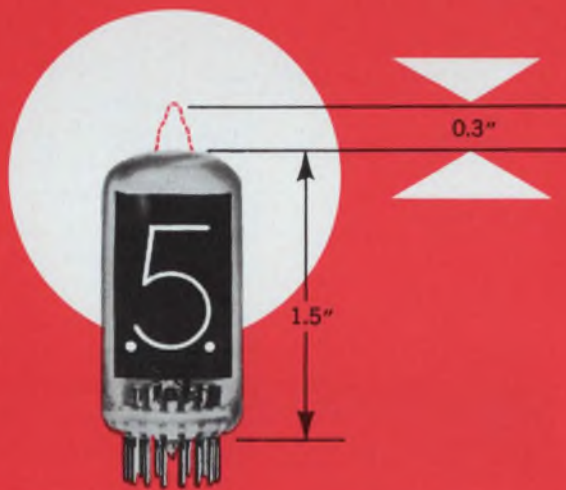

The B5440A series NIXIE® tubes are real space savers.

Now, you can shrink your instruments in both height and cost and assure the highest reliability. Burroughs has improved their side viewing NIXIE tube by rounding off the bulb to save you 16 $\frac{2}{3}$ % panel height and to reduce the possibilities of breakage. Burroughs design with extra stem pins and "hidden" tubulation offer these additional advantages:

- Smallest side-viewing tube in low cost category
- Pins directly solderable to PC boards
- Smallest sockets for every type of mounting

- Ultra long life and high reliability characteristics
- Built-in "keep alive" for rapid ionization - particularly useful in strobe applications (optional)
- Fine mesh wrap-around screen for better readability
- Two decimal points left and right (optional)
- Electrically interchangeable with Burroughs B-5440 series

For further information contact: Burroughs Corporation, Electronic Components Division, P.O. Box 1226, Department N1, Plainfield, N.J. 07061. Tel: (201) 757-5000

"WESCON Booth 2816"

Only Burroughs manufactures NIXIE Tubes



Burroughs Corporation

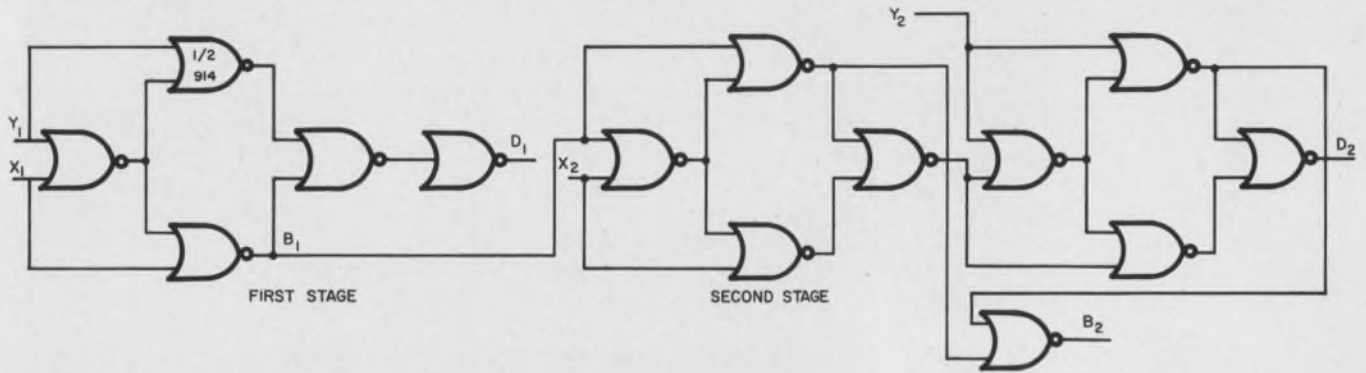

Borrow pulse is generated by combining signals in difference logic in a single state.

$$X = X_n, X_{n-1}, X_{n-2}, \dots, X_1$$

$$Y = Y_n, Y_{n-1}, Y_{n-2}, \dots, Y_1$$

where the least significant bit has a 1 subscript and the most significant bit an n subscript. 2's complement number representation is used.

The logic equations for the first stage of the subtracter are derived from Table 1. They are:

$$D_1 = X_1 \bar{Y}_1 + \bar{X}_1 Y_1 = X_1 \oplus Y_1,$$

$$B_1 = \bar{X}_1 Y_1.$$

The logic equations for the second stage are derived from Table 2. They are:

$$D_2 = \bar{X}_2 Y_2 B_1 + \bar{X}_2 Y_2 \bar{B}_1 + X_2 \bar{Y}_2 \bar{B}_1 + X_2 Y_2 B_1$$

or:

$$D_2 = X_2 \oplus Y_2 \oplus B_1$$

and:

$$B_2 = \bar{X}_2 B_1 + Y_2 B_1 + \bar{X}_2 Y_2.$$

In general, for the n^{th} stage, the difference and borrow are given by:

$$D_n = X_n \oplus Y_n \oplus B_{n-1}$$

$$B_n = (\bar{X}_n + Y_n) B_{n-1} + \bar{X}_n Y_n.$$

The equation for the borrow for the second stage can be expressed as:

$$B_2 = \bar{X}_2 B_1 + Y_2 B_1 + \bar{X}_2 Y_2$$

$$= (\bar{X}_2 + B_1) (Y_2 + X_2 \oplus B_1)$$

$$= (X_2 \bar{B}_1) + \bar{Y}_2 (X_2 \oplus B_1).$$

The two terms that are NORed together in the above equation are available at intermediate points in the difference-generating logic.

The logic for the first and second stages of the subtracter is shown in the figure. The remaining stages, except for the last, are identical to the second stage. The gate that forms the borrow is not required for the last stage.

This simple example points up a facet of logic reduction, or simplification, that is too often overlooked by logicians. They fail to examine their logic at intermediate points in the generation of one function to see whether certain signals can be used to simplify the generation of other functions.

Bruce Wenniger, Industrial Applications Engineer, Fairchild Semiconductor, Mountain View, Calif.

TABLE 1: FIRST STAGE TRUTH TABLE

X ₁	Y ₁	D ₁	B ₁
0	0	0	0
0	1	1	1
1	0	1	0
1	1	0	0

TABLE 2: SECOND STAGE TRUTH TABLE

X ₂	Y ₂	B ₁	B ₂	D ₂
0	0	0	0	0
0	0	1	1	1
0	1	0	1	1
0	1	1	1	0
1	0	0	0	1
1	0	1	0	0
1	1	0	0	0
1	1	1	1	1

VOTE FOR 111

Switching circuit has hysteresis

The circuit shown in Fig. 1a operates a normally open and a normally closed solid-state switch simultaneously. The range of input voltage over which it operates and the circuit's hysteresis characteristic are adjustable. Peak triggering voltages from 6 to 12 volts have been used. Lower peak voltages (V_1 of Fig. 1b) are possible but the circuit will tend to become unstable as V_1 approaches V_{sat} , which is the combined valley

voltage of unijunction transistor Q2, the base-to-emitter drop of Q3, and the drop across R6. This value of V_{sat} determines the turnoff voltage.

The circuit operates as follows. Assume the input is anywhere below the upper triggering level. Since very little current flows in the emitter of Q2, the base and emitter of Q3 are at the same potential and Q3 is cut off. Q4 is saturated through R7 and the 22-volt Zener diode, D1. When the input voltage reaches the triggering level, the emitter voltage of Q2 and, consequently, the emitter voltage of Q3 drop to the saturation value;

Some of our FET's are "me too's"

Some of our FET's are "me only's"

(THREE NEW JEDEC TYPES FOR LOW NOISE AT LOW FREQUENCY)

Our "me too's" include the 2N3823 and 2N4416, the industry's very popular, high performance, n-channel junction FETs. They're in everybody's line, including ours.

But our "me only's" are something special; they have lower noise—at low frequency—than any n-channel junction FET in the entire JEDEC list. They are available now—from stock—at volume prices.

If you need a really low noise, high gain FET for low frequency applications, you need our 2N5105. It has an equivalent noise voltage of only 40 nV/ $\sqrt{\text{Hz}}$ at 10 Hz and transconductance of 5,000 to 10,000 μmhos .

It's ideal for small signal circuits from 10Hz to 200MHz:

- Low level operational amplifiers
- High impedance instrument inputs (scope/voltmeter probes, recorder pickups)
- IF and RF linear stages
- Wideband amplifiers

As a group, the 2N5103, 2N5104 and 2N5105 have the highest figure of merit (g_m/I_{DSS}) of all n-channel junction FETs available today, whether high or low frequency. And all three offer low feedback capacity, low input capacity, and small leakage currents.

KEY PARAMETERS: AMPEREX "ME ONLY" N-CHANNEL, JUNCTION FET'S*

CHARACTERISTICS	SYMBOL		2N5103	2N5104	2N5105	UNITS
EQUIVALENT NOISE VOLTAGE	e_N		100 @ 100 Hz	50 @ 10 Hz	40 @ 10 Hz	nV/ $\sqrt{\text{Hz}}$
TRANSCONDUCTANCE AT 1 KHz	$ Y_{fi} $	Min. Max.	2000 5000	3500 7500	5000 10,000	μmhos
DRAIN TO SOURCE CURRENT	I_{DSS}	Min. Max.	0.5 3.0	2.0 6.0	5.0 15.0	mA
INPUT CAPACITY	C_{iis}	Max.	1	1	1	pf
FEEDBACK CAPACITY	C_{rfs}	Max.	5	5	5	pf

*In TO-72

For complete data and applications assistance on Amperex n-channel junction FETs, write: Amperex Electronic Corporation, Semiconductor and Receiving Tube Division, Department 371, Slatersville, Rhode Island 02876.

Amperex

Tomorrow's Thinking In Today's Products

ON READER-SERVICE CARD CIRCLE 51

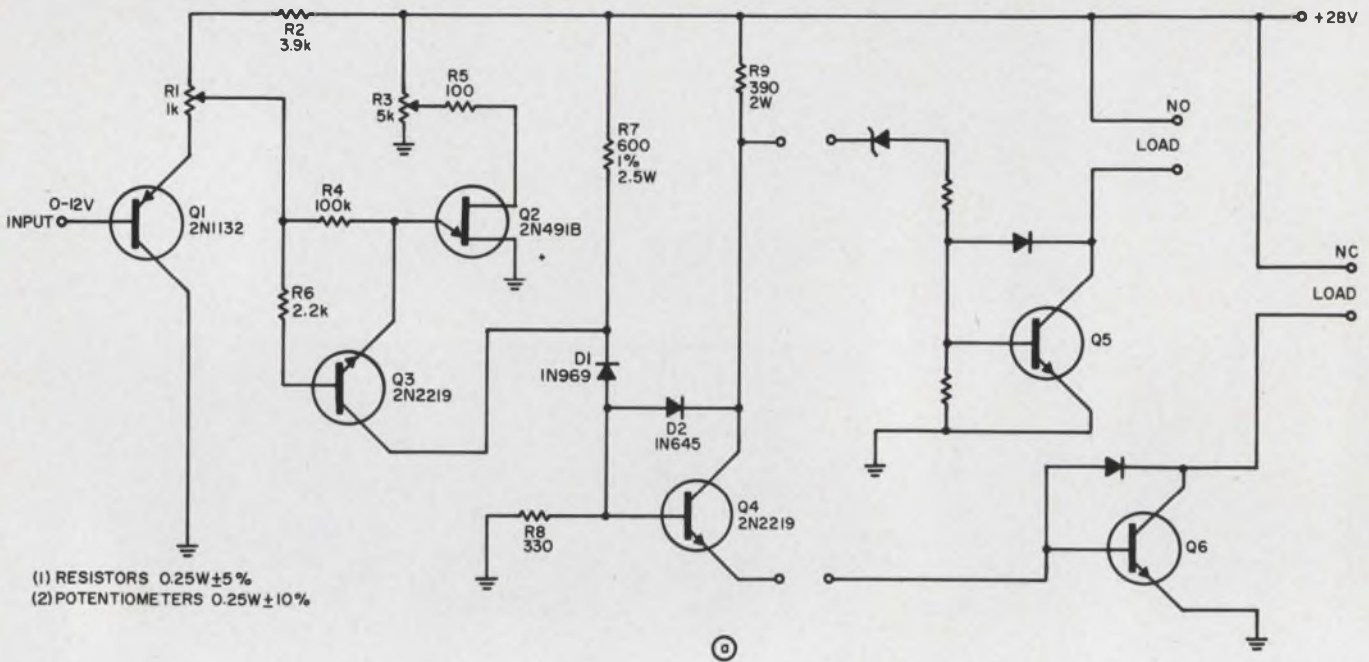

(1) RESISTORS 0.25W ±5%
(2) POTENTIOMETERS 0.25W ±10%

Q3 saturates, cutting off base current to Q4. Q4 remains cut off until the input voltage drops to the point where Q3 will no longer supply valley current to Q2; it then switches to the saturated state. A capacitor added across R6 will speed switching time.

Some modifications may be made to this circuit, but extreme care must be taken to ensure that instability does not result. The saturation voltage, V_{sat} , may be increased somewhat by adding a small resistor in the base 1 of circuit of Q2. It may be increased without fear of instability by returning base 1 to a small positive voltage. This will reduce the input voltage range accordingly. Connecting a resistance from the base of Q3 to ground will increase the upper triggering level. In the circuit of Fig. 1a the operating range was increased from 0-12 volts to 0-20 volts by this method.

Connecting the collector of Q1 to a negative voltage enables the circuit to be set to turn off at a negative input voltage (Fig. 1b). This would require changing R1 and R2. The same result may be obtained by returning base 1 of Q2 to a negative voltage.

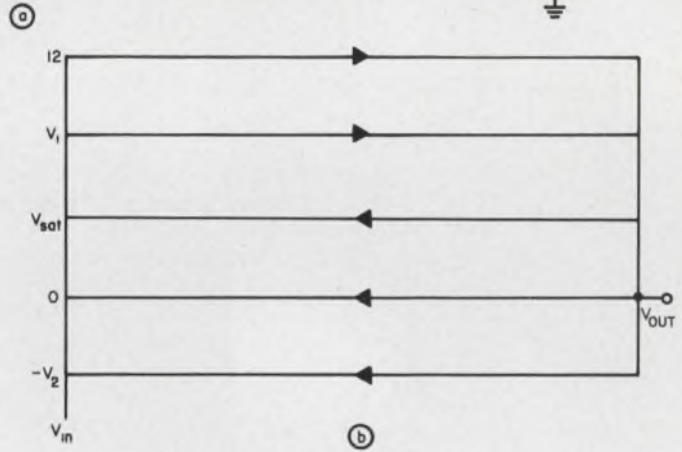

1. Solid state switches, Q5 and Q6, can be connected as shown to the switching circuit (a) having hysteresis characteristics as in (b).

While this circuit was designed to operate over the complete range of values of the components used, including the unijunction transistor, no temperature requirements were included in the design. The circuit was developed at the Quality Laboratory, Marshall Space Flight Center.

Richard L. Phares, Spaco, Inc., Huntsville, Ala.
VOTE FOR 112

UJTs generate quasi-random pulses

There is a number of waveform distortions encountered in the transmission of teletype (TTY) signals. One type of distortion is of a random nature and is commonly known as fortuitous distortion. Its cause is random equipment

disturbances that lead to the breaking up or dropping out of the transmitted TTY signal.

The problem was to develop a circuit that would simulate this type of distortion on a TTY line.

The solution was provided by designing a quasi-random data interrupter. When combined with the random TTY character bits 1 through 5 (Fig. 1a), it became a fortuitous-distortion generator.

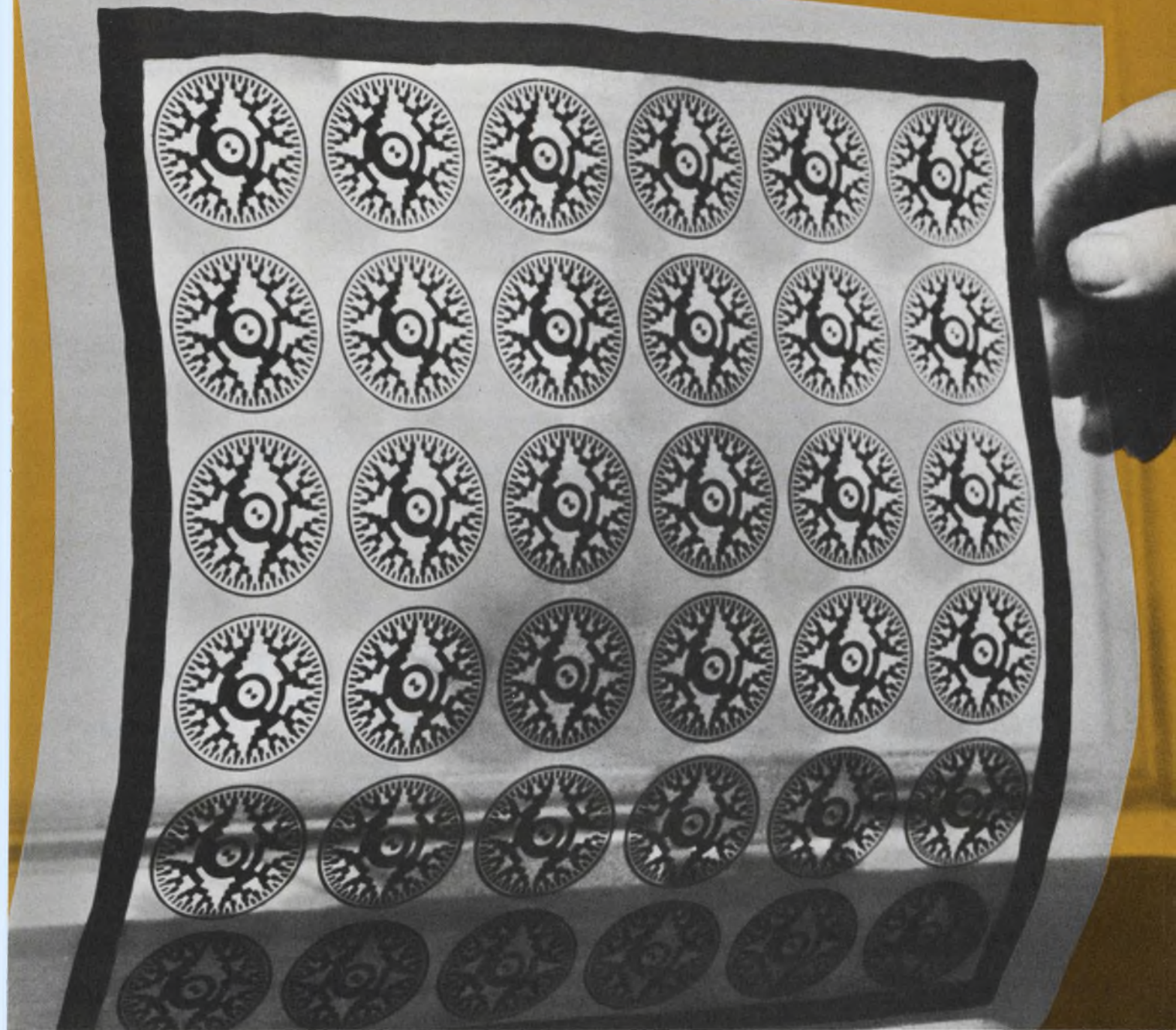

For 14 years now, the pattern
has been firmly established...

Librascope is No. 1 in shaft encoders

1952: Librascope coins the word "encoder", a year later develops the V-scan. 1962: Librascope's hybrid magnetic-brush encoder takes on radar-picket-ship duty. (No failure to date.) 1964: our hybrid was adopted for the Apollo mission and F-111 simulator systems. Today: our advanced-concept hybrid brings magnetic encoder reliability at lower system cost to a widening range of *industrial* as well as military/aerospace applications. In the interim, we've designed and built hundreds of standard model encoders to serve any need. Right now, we'd like an opportunity to quote on *your* application—and to send you our new capability brochure (on request).



The Librascope hybrid encoder: built to rigid military specs with a life-factor 64 times greater than that of a brush encoder.

**GENERAL
PRECISION INC.**

LIBRASCOPE GROUP
808 WESTERN AVENUE • GLENDALE, CALIFORNIA 91201

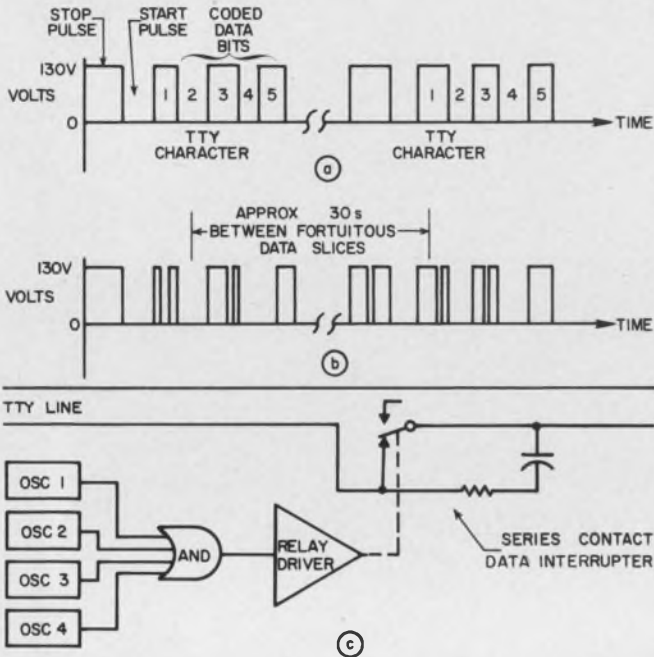

The outputs of the four unijunction transistor relaxation oscillators in Fig. 1c are ANDed together and the gated output drives a relay, the contacts of which interrupted the serial data flow.

The timing capacitor voltage (see Fig. 1d) of the four oscillators are diode-coupled to the base of *Q5*. Only when all oscillator capacitor outputs are in synchronism will all the diodes (*CR1* through *CR4*) be reverse-biased and allow all the current supplied through *R15* to drive the base of *Q5*. This coincident gating results in a *Q5* output that drives *Q6* and *Q7* which, in turn, cause the contacts of *K1* to interrupt the data signal, as shown in Fig. 1b. The voltage on the emitter of *Q5* may be adjusted by *R17* to vary the point on the

Quasi-random data interruptor (d) uses four UJT oscillators of different frequency. Functional block diagram is shown in (c). Normal teletype signal (a) combined with the output of the interruptor results in waveform (b).

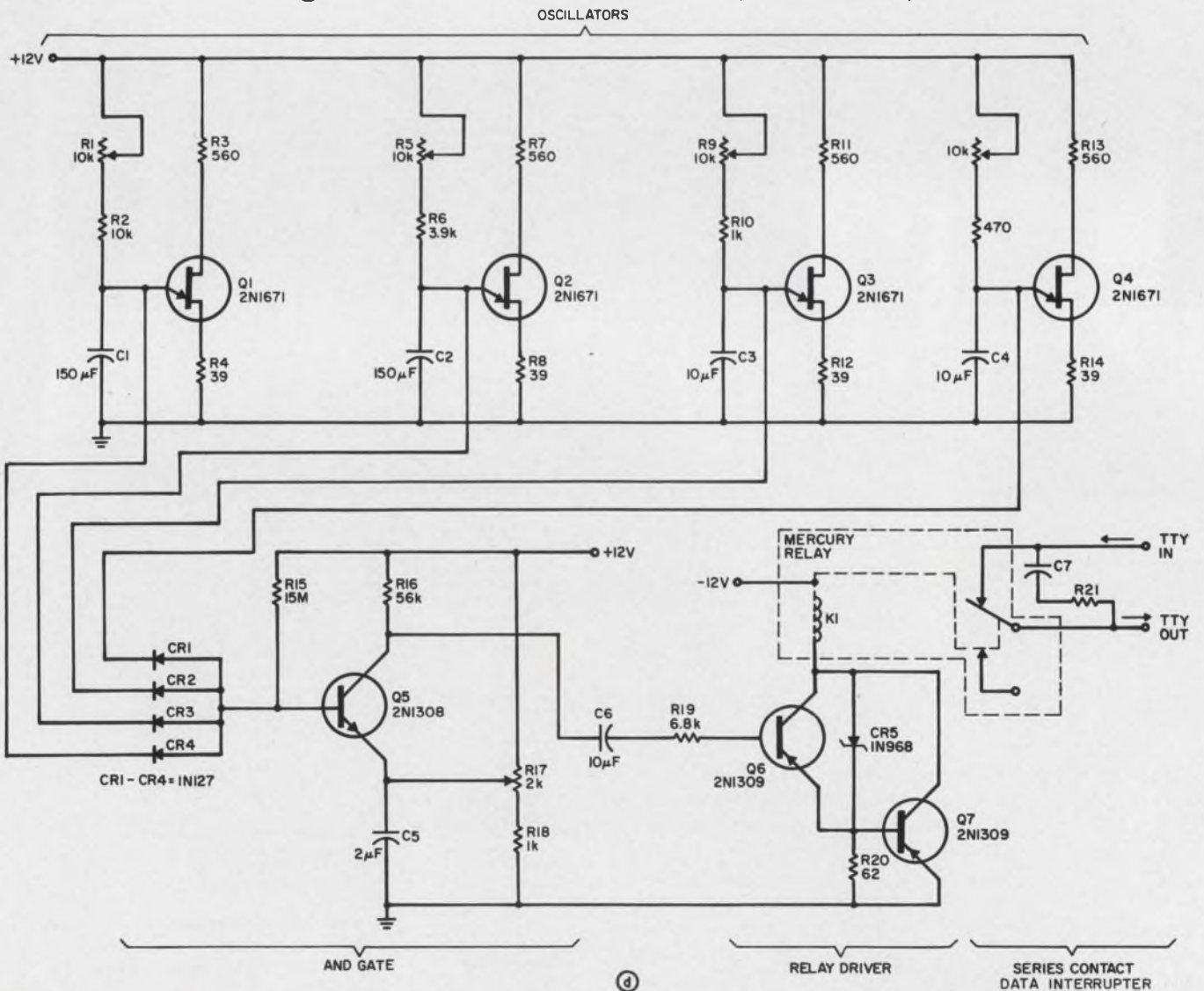

What a line!

The broadest, most complete array of perforated tape readers available.
25 to 1000 char/sec....mechanical and photoelectric.

Model 500 R
1000 char/sec search
500 char/sec synch.
200 char/sec asynch.

Model R150
150 char/sec

Model 424
60 char/sec

Model 464
120 char/sec

Model 500 RF/10
Ruggedized
1000 char/sec search
500 char/sec synch.
150 char/sec asynch.

Model HR150
High Reliability
150 char/sec

Model R30
30 char/sec

Model 625
25 char/sec

And that's no line!

Not shown, Models 500 RM, 500 RF, and 500 T photoreaders which operate at up to 1000 char/sec in the search mode, 500 char/sec synchronously and 200 char/sec asynchronously. Model 500 RM is a full MIL-SPEC reader. Model 500 T requires external reeling. All photoreaders work without pinch rollers, friction brakes or solenoids. For complete information, call your full-service Tally sales engineer (see EEM) or write Tom Tracy, Tally Corporation, 1310 Mercer Street, Seattle, Washington 98109. In the U.K. and Europe, address Tally Europe, Ltd., Radnor House, 1272 London Road, London, S.W. 16, England.

TALLY

exponential capacitor voltage at which the diodes are reverse-biased.

The oscillator frequencies were set in this design for two long periods ($\tau = 1.37$ s and $\tau = 0.7$ s) and two short periods ($\tau = 75$ ms and $\tau = 60$ ms). This resulted in a 30-second period between fortuitous data slices, as shown in Fig. 1b. This dead time between outputs is caused by the attempt of the two long-term pulses to synchronize.

More oscillators may be added and their frequencies chosen to provide other gated output pulse sequences. The output of the circuit may be used as a source of quasi-random pulses, and circuit output pulse frequency can be increased by replacing the relay with a transistor switch.

A. R. Campbell, Senior Engineer, Philco-Ford Corp., Communications & Electronics Div., Philadelphia.

VOTE FOR 113

Grounded-load current source uses one operational amplifier

A frequent need is for a current source as part of a subsystem. The classical approach to a high-quality current source is to use an operational amplifier connected as in Fig. 1a.

In this figure the load is floating. When, however, a grounded load (one side grounded) is required, two operational amplifiers are usually connected as in Fig. 1b. Here the current-sam-

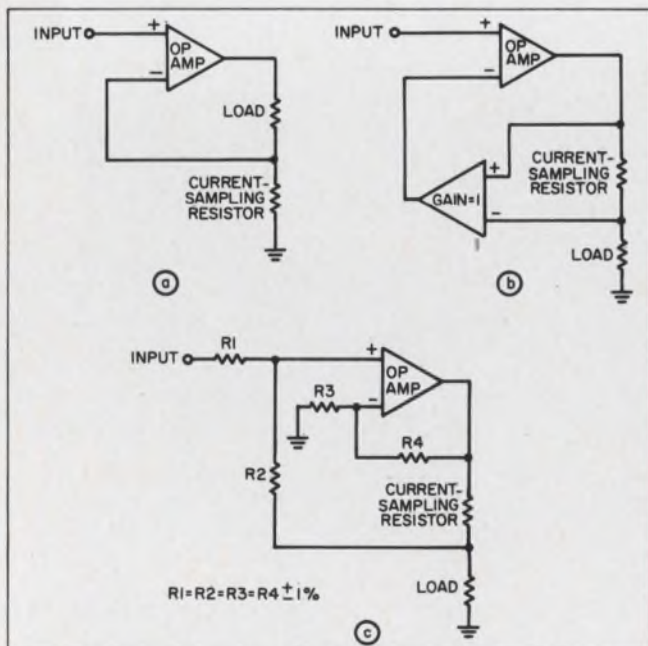

Grounded-load current source can be made with only one operational amplifier (c). In the standard circuit (a) the load floats, while (b) uses two amplifiers.

pling resistor is floating. This necessitates a differential signal pick-off amplifier with gain of 1.

Figure 1c shows how a grounded-load current source can be obtained with just one operational amplifier. The differential input capability of the single amplifier is exploited by resistive positive and negative feedback networks. For high output impedance, network resistors R_1 , R_2 , R_3 , and R_4 must be equal to each other within $\pm 1\%$.

James M. Loe, Project Engineer, Communications & Electronics Div., Philco-Ford Corp., Blue Bell, Pa.

VOTE FOR 114

Adhesive foil electrodes aid biomedical applications

The recent introduction of a conductive adhesive foil with conductive backing* suggests its application not only for shielding purposes—its original intended use—but also as a versatile disposable electrode material for a variety of electrobiological studies.

It has been found that the foil will readily adhere to alcohol-cleaned skin, and that the conductive adhesive will establish a reliable low-impedance contact with the skin. The foil, which is available in rolls of various widths, may be cut to any desired shape, and is flexible enough to adapt to any body contour. Lead attachment to the electrode can be readily made by sandwiching the exposed and flared wire ends between the upper surface of the electrode and a small tab made from the same conductive foil.

Electrocardiograms and other bioelectric phenomena have been successfully recorded with this technique; the only drawback is that electrodes may only be used once, since the backing appears to lose its adhesive properties after one application. Once in place, however, the material has remained essentially unchanged and securely attached, even after more than 8 hours of continuous use on a mobile and active subject.

R. Michel Zilberstein, Engineer, Microsonics, Inc., Weymouth, Mass.

VOTE FOR 115

*Minnesota Mining & Manufacturing Co., Tape No. X-1181.

IFD Winner for April 26, 1967

Curtis Sewell, Jr., Electronic Engineer, Lawrence Radiation Laboratory, Livermore, Calif. His Idea, "One power supply does the work of two," has been voted the \$50 Most Valuable of Issue Award. Cast Your Vote for the Best Idea in this Issue.

Look what's happened to the sweep generator. Telonic has designed the new 2003 "all-modular" for instant adaption to your swept frequency applications. The 2003 is essentially an

ULTIMATE SWEEP SYSTEM

consisting of a basic chassis and plug-in modules that permit selection of frequency range, attenuation, frequency marking, RF detection, and display processing.

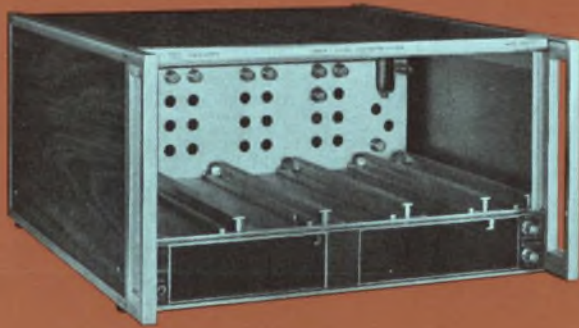

The sweep oscillator modules cover frequencies from

DC to MICROWAVE,

attenuation units range to 109 dB, markers are of both fixed, harmonic and variable types, passive and active detectors are available, and display outputs are provided for oscilloscope or X-Y recording. Useful power available ranges from .35 to .5 VRMS, and is frequency stable without additional isolation. The system may also be phase-locked externally.

Then consider bonus features such as marker tilt control, three sweeping modes, interference-free, time-shared markers, with center frequency and end-point tuning, and the 2003 Sweep System becomes the essential instrument for swept frequency measurement.

Write for Catalog 70, complete with descriptions, specifications, and Sweep Generator Applications.

Telonic INSTRUMENTS
A DIVISION OF TELONIC INDUSTRIES, INC.

60 N. First Avenue, Beech Grove, Indiana 46107
Tel. (317) 787-3231 TWX-810-341-3202

Representatives throughout the U.S., Canada, and overseas. Branch offices in Maidenhead, England; Frankfurt, Germany; and Milan, Italy.
"SEE TELONIC INDUSTRIES, INC. AT WESCON, BOOTHS 3124-3128"

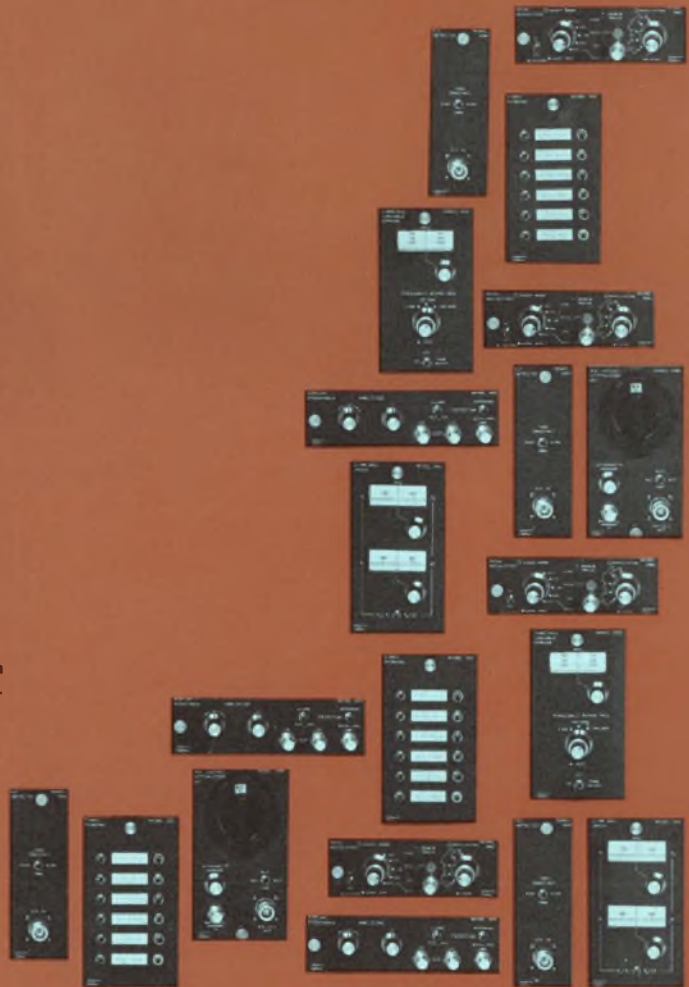

A LOW-COST 4PDT 3 AMP RELAY CAN OUTPERFORM THE HIGHER PRICED ONES.



If it's the new
Sigma Series 67.

New Sigma Series 67 4PDT 3 amp AC-DC relays are not only priced lower than competitive types but will outperform them four ways:

In Life Expectancy: Slots in contact base between fixed contacts eliminate build-up of vaporized contact material and leakage paths. This feature alone can double relay life expectancy.

In Adjustment Stability: The contact base and movable contact support of the new Series 67 is made of diallyl phthalate. This material does not deform under mechanical and thermal stresses.

In Thermal Resistance: The Series 67 enclosure is made of high heat resistant polycarbonate instead of less resistant nylon. This assures stable operation at high temperatures.

In Fast, Easy Installation: Series 67 solder ter-

minal socket can be installed in seconds, with no need for screws or fasteners. It simply snaps into the face of the panel and four spring clips lock it.

We'd like to give you a new Sigma Series 67—or any of our other standard relays. Test and compare it against the brand you may now be using. It's the best way we know to prove what we say about Sigma relay performance. Just circle our reader service number on the reader service card. We'll send you the new Sigma relay catalog and a "free relay" request form. Return the form to us and your Sigma representative will see that you get the relay you need.

Need fast delivery? The Series 67 is available off-the-shelf from your Sigma distributor.

SIGMA DIVISION  SIGMA INSTRUMENTS INC
Assured Reliability With Advanced Design/Braintree, Mass. 02185
Sigma Instruments (Canada) Ltd., P.O. Box 43, Toronto 18

ON READER-SERVICE CARD CIRCLE 55

ELECTRONIC DESIGN 16, August 2, 1967

Products

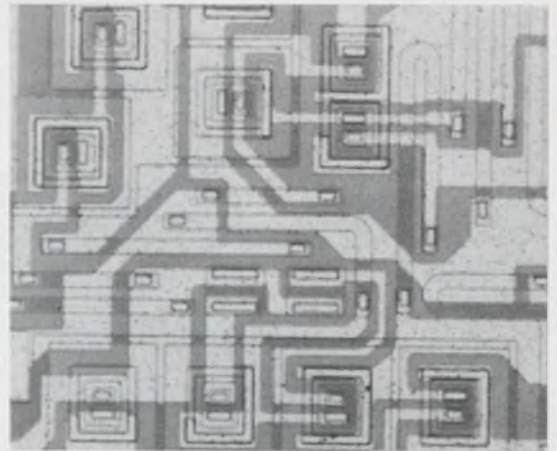
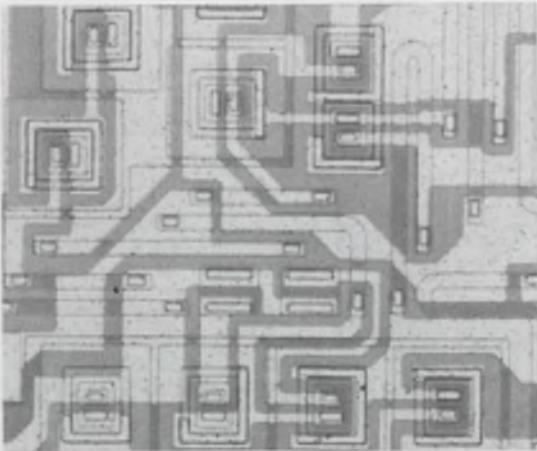

One header is better than two. A pair of monolithic operational amplifiers are built on a

single chip, housed in a single can and cost a little more than a single op amp. Page 110



Lighted pushbutton switch is simple to use. Page 98



Clear epoxy replaces can and lens in Darlington photoamplifier. The 'optical' epoxy cuts unit cost to under a dollar. Page 103

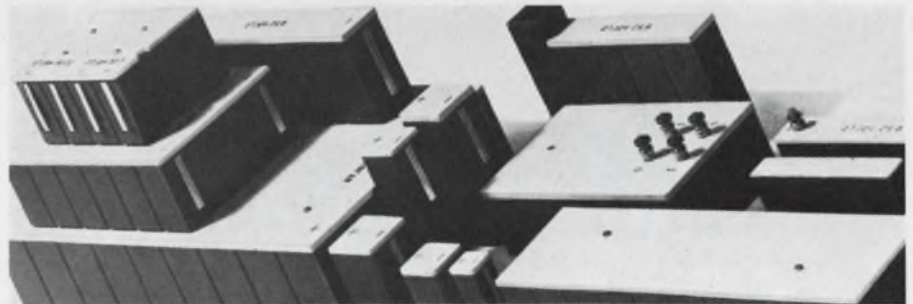

Rechargeable NiCad batteries are packaged as building-block modules. Custom-build your battery to your specs. Page 100

Also in this section:

Take your eye off the needle: panel meters go digital. Page 114

Low-cost plastic FET operable to 400 MHz with 10-dB gain. Page 109

Handling of silicon dice simplified with 'egg crate' trays. Page 132

Application Notes, Page 134 . . . **New Literature**, Page 136

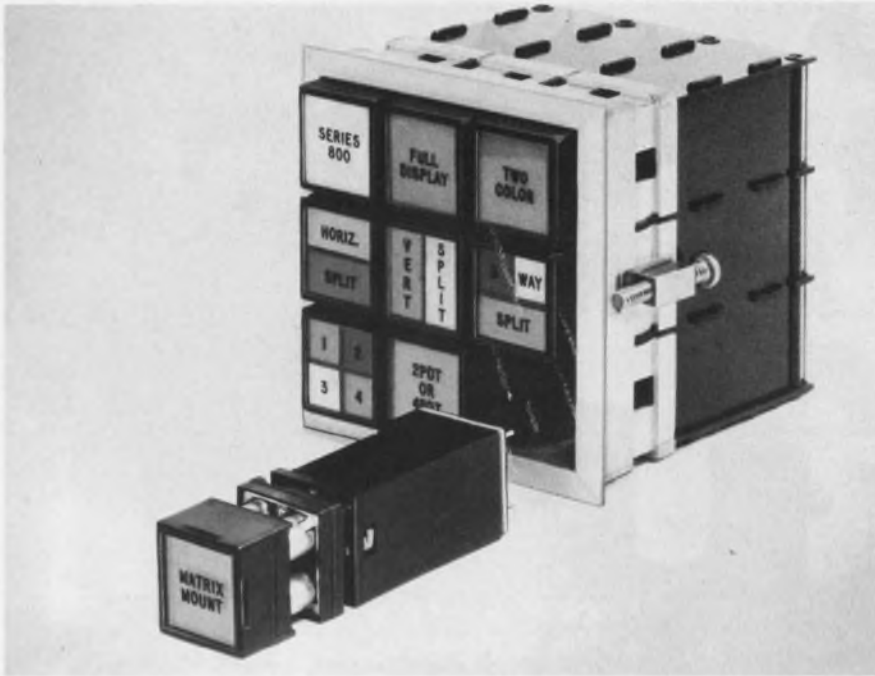

Lighted pushbuttons simplify mounting and maintenance

Master Specialties Co., 1640 Monrovia Ave., Costa Mesa, Calif. Phone: (714) 642-2427. P&A: from \$15 (single-channel basic unit; lens, color, legend options extra) to \$3 (larger matrices); stock to 4 wks.

Lighted pushbutton switches are a major operator-equipment interface. Yet their installation, mounting, modification and maintenance can be bothersome, at best. Master Specialties Co. has made these functions simple ones in their Series-800 rack-mounted switch. Advantages include:

- A modular mounting rack for multiple-unit assemblies which is installed through a single cutout.
- Solderless crimp terminals.
- Simplified mounting by means of a slot and mounting fastener.
- Easy replacement of lamp bulbs from the panel front without the need to use special tools.

The units are four-lamp (T-1-3/4 base) switches with display face-up for four lines of legend. Depressing the display face actuates the switch contacts. Contacts are available in momentary or alternate action, 2pdt

or 4pdt. A choice of holding coils is available to provide electrical interlock. The front lens is available as a full display, or as a split display for more than one message indication. Each of the four lamps may be individually controlled.

The switches weigh about 50% less than conventional units—a 12-by-12 channel unit weighs 1.5 oz per channel.

The mounting-rack and terminal-block assembly is preassembled at the factory. Any number of channels can be specified from a single unit to a 12-by-12 or 5-by-20 matrix. Crimp solderless terminals (Fig. 1) are used for bench wiring of the terminal blocks before the panels are installed. A standard crimping tool is used. Each terminal will hold one #20, 22, or 24 AWG wire or two #24 AWGs.

Installing the mounting rack is easy. A single panel cutout is all that is needed. Once the rack has been inserted through the panel cutout from the front, mounting fasteners are slipped into slots on the rack frame and tightened (Fig. 2). A slot is provided at each channel position (horizontal and vertical) along the mounting-rack frame.

Lamp replacement is accomplished from the panel front without tools (Fig. 3). Finger pull slots are provided on the top and bottom of the display-screen housing for each unit. Simply by pulling outward on the slots, the entire screen lamp assembly swings to one side.

Units are available for 6, 12 and 28-V dc operation, or, with a neon lamp with built-in current-limiting resistor, for 115 V ac. Displays are available with any of four different lens types, eight lens retainers, six colors and any specified legend.

CIRCLE NO. 250

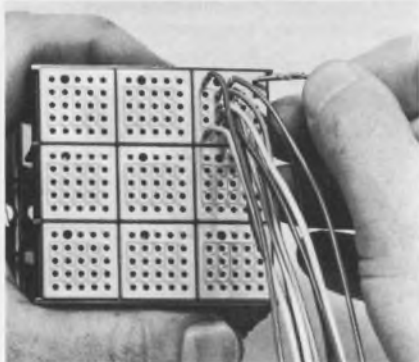

1. Crimp-type solderless terminals simplify wiring. Wire leads are merely inserted. Soldering may be used if desired.

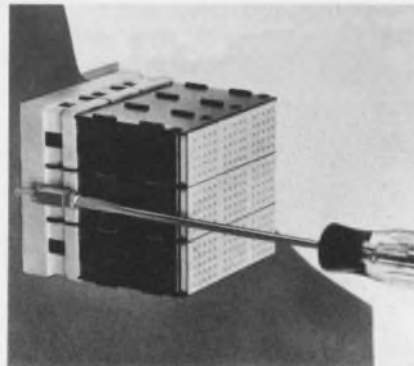

2. Mounting screws fix the entire assembly through a single panel cutout. No mounting hardware is visible from the panel front.

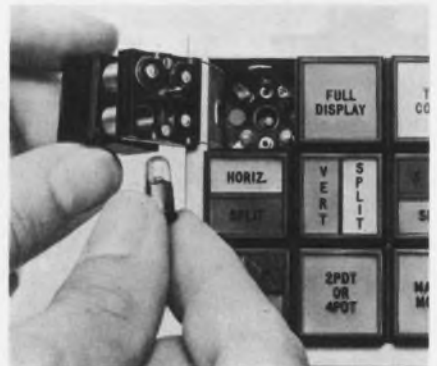

3. Lamp replacement is easy. The screen/lamp housing swings away right from the panel front for quick accessibility.



Name your need in triggers, timers, ring counters, and oscillators

Whatever your problem, GE's very broad line of small signal, regenerative switching semi-conductors has at least one device that can solve it. Interested in developing a threshold voltage proportional to the supply voltage? Specify a GE unijunction transistor (UJT). Or do you need a device that gives you temperature and frequency stability with opposite polarity from a regular UJT? Our newest innovation, the Complementary UJT, gives you this. Silicon Unilateral Switches (SUS's) and Silicon Bilateral Switches (SBS's) serve as exceptionally stable low-voltage trigger diodes, compatible with integrated circuits. And GE Silicon Controlled Switches (SCS's) have achieved excellent results performing as 4-lead SCR's that feature high voltage capability and versatility.

All 5 of these GE types of devices are capable of generating an output current pulse in excess of 1 ampere from an input signal as low as $1\mu\text{A}$. Just name your triggering device need, then circle magazine inquiry card **Number 90** for GE's full line information.

For aircraft and ground power applications: thin-sintered plate nickel-cadmium batteries



Meets military specifications

- Extremely reliable over a very wide temperature range.
 - Quick, full recharge within one hour.
 - Long life—with constant, dependable service.
 - Peak power at level voltage rate.
 - Constant voltage output 90% of the time.
 - Operational in temperatures from sub-zero to tropic.
 - Many years' storage life without harm.
 - Up to two-thirds lighter than conventional lead-acid batteries.
 - Extremely rugged—proved in tests up to 5,000 G's.
 - No modifications required with existing aircraft electrical systems.
 - Economical in operation through long life, little maintenance, and excellent performance.
- Circle **Number 91** for all the facts.

Tiny 5-amp relay in 2-amp model price range

Weight: just 0.7 ounce maximum. Now, the proven magnetic motor design of GE's 3SAF microminiature relay, featuring all-welded construction, is combined with new, heavy-duty contacts and terminal leads. Result: 5-amp switching capability in a microminiature gridspace package. We call it the 3SBK. Electron-beam welding eliminates the need for solder flux, adding greater strength and delivering more trouble-free performance. Circle magazine inquiry card **Number 92**.

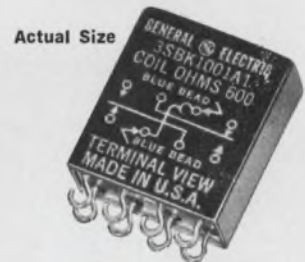

Actual Size

Highest power VTM's in industry



Electronically tunable at rates as high as 20,000 mc per microsecond.

GE Voltage Tunable Magnetrons—available at power levels of 100 watts and higher over electronically tuned bandwidths of 20% in L, S, and C bands—meet system requirements from 1,000 to 6,000 mc in:

- noise generators for electronic countermeasure systems.
- drivers for frequency diversity transmitters.
- other applications requiring high-efficiency, self-excited oscillators.

As developers of the VTM, GE engineers continually improve their uniformity and quality in quantity production. And GE integral isolator know-how helps alleviate tube-equipment interface problems. These VTM's feature electronic tuning, linear tuning characteristic, magnetic shielding, and rapid modulation. Conversion efficiencies exceed 60% in many high-powered types. Circle **Number 93** for more details.

COMING YOUR WAY—GE's MICROWAVE TUBE VAN. CIRCLE NUMBER 94.

WE MAY NOT OFFER EVERYTHING YOU WANT FROM ONE COMPONENTS SUPPLIER. BUT WE DO COME A LITTLE CLOSER THAN ANYONE ELSE.

Rechargeable NiCad cells packaged as modules

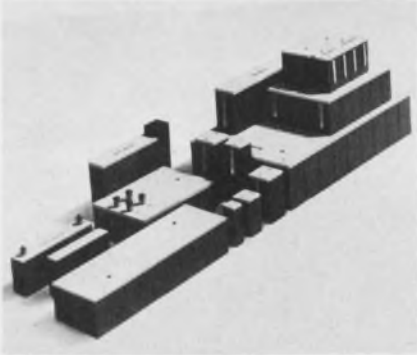

Sonotone Corp., Elmsford, N. Y.
Phone: (914) 592-9600.

A single rechargeable nickel-cadmium cell is housed in an individual polystyrene container and insulated. Sonotone then joins this battery with others until a battery package is formed to desired physical and electrical specs. The concept is fast and convenient. Voltage tap-offs can be made from any position and many varieties of contacts can be used. Present cell sizes are AA, 19/32 x 1.92 inch (oversize AA), sub-C, C and D.

CIRCLE NO. 251

Low-torque wirewound weighs five grams

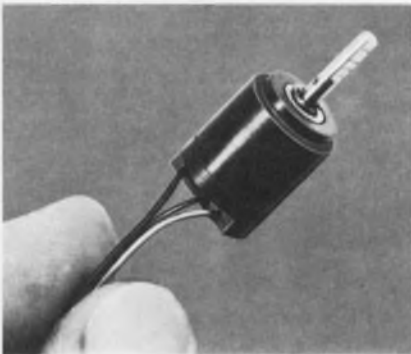

Humphrey Inc., 2805 Canon St., San Diego, Calif. Phone: (714) 223-1654.

Weighing only five grams, this wirewound pot is designed for applications in servo units, or as a feedback device on miniature actuators where low-torque outputs are available. The instrument has a ball-bearing-mounted shaft and measures 0.5 inch diameter and 0.68 inch long with available resistance values from 5 to 20 k Ω . Torque is 3 gm-cm, and resolution is 0.6 $^\circ$.

CIRCLE NO. 252

Proportional controller completely noiseless

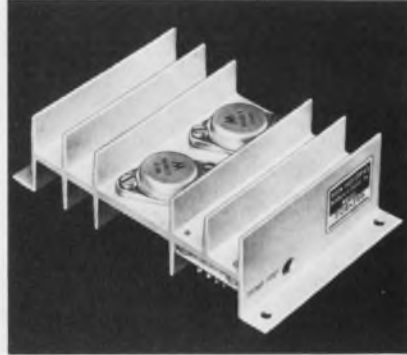

Oven Industries, Div. of Greenray Industries, Inc., E. Simpson Rd., Mechanicsburg, Pa. Phone: (717) 766-0721. P&A: \$185 (1 to 10); 3 to 4 wks.

A completely noiseless ac proportional controller uses no SCRs, switches or relays of any type. The unit will withstand overvoltage transients of 300 V peak for two seconds. Output is 98 to 128 V pulsating dc (120 Hz ripple content) into a 100-W maximum resistive load. The unit uses a thermistor sensor that will control temperature to within $\pm 0.01^\circ\text{C}$.

CIRCLE NO. 253

Four-quadrant multiplier fast and accurate



Burr-Brown Research Corp., 6730 Tucson, Tucson, Ariz. Phone: (602) 294-1431. Price: \$675.

Static accuracies of 0.25% of full scale and bandwidths of 1 MHz (1% error at 50 kHz) are achieved by this multiplier module. Phase shift is less than 0.5 $^\circ$ at 50 kHz. Four-quadrant multiplication is achieved using bipolar diode squaring circuits driven by external high-speed inverters. Repetitive operation is possible at speeds as high as 1000 computations per second.

CIRCLE NO. 254

Tiny 28-V dc switch transient-free

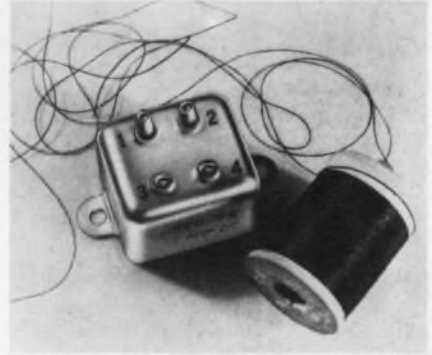

Genistron Div., Genisco Technology Corp., 18435 Susana Road, Compton, Calif. Phone: (213) 774-1850. Price: \$4.94 (1 A), \$6.75 (5 A).

A small dc transient-free switch for 28-V dc service is offered in 1 and 5-A configurations. The 1-A switch measures 0.87 by 1.12 by 1-inch with the 5-A version at 1 by 1.75 by 1.25. The switch limits the rate of change of voltage in an attached load to levels which permit switching while conforming to the EMI limits of MIL-Std-826A.

CIRCLE NO. 255

Coax connectors handle kilovolts



Reynolds Industries, Inc., 2105 Colorado Ave., Santa Monica, Calif. Phone: (213) 451-1741.

Miniature coaxial cable connectors rated at 10 kV dc for limited pulse applications have dielectric seals to provide rated voltage stand-off when mated. The connector has a maximum plug diameter of 1/4 inch, considered a minimum for reliability at voltages as high as 10 kV dc. The high voltage capability and the small size suit the connector to limited pulse applications.

CIRCLE NO. 256

Comparator module has speedy response

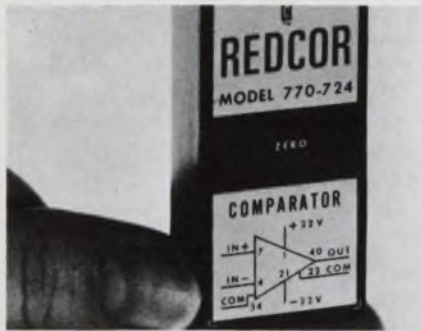

Redcor Corp., 7800 Deering Ave., Canoga Park, Calif. Phone: (213) 348-5892. Price: \$52.50 (over 50).

Designed for applications requiring fast response and high sensitivity, this comparator module features a resolution-speed-product of 2 mV/2 μ s. It also offers fast overload recovery guaranteed over a full 10-V input range. Input impedance is 100 k Ω differential, 10 M Ω common-mode. Package size is 1.4 cubic inches.

CIRCLE NO. 257

Miniature relays combined in packages



Branson Corp., Vanderhoof Ave., Denville, N. J. Phone: (201) 625-0600.

High-density, multipole relay packages combine Branson's tiny relays in a single package. A 40pdt relay package with 2-A, 28-V dc resistive contacts is available. The packaging technique allows for easy replacement of individual switching units, eliminating replacement of the complete unit. Coil voltages of 6, 12, 24 and 48 are offered with a choice of hook terminals, wire leads or plug-in headers.

CIRCLE NO. 258

99% Fewer Cavities With Cinch-Graphik



10X MICROPHOTOS OF MULTILAYER THRU-HOLE CROSS SECTIONS

Cinch-Graphik's advanced multilayer production techniques eliminate voids in thru-hole plating and intra-layer lamination. This is why Cinch-Graphik circuits have greater electrical reliability (complete interface bond between plated thru-hole and individual circuit layers), better final assembly quality (good component contact) and increased physical integrity (no delamination under wave soldering). For a brighter smile, use Cinch-Graphik multilayer circuitry. Write for our illustrated brochure.



DIVISION OF UNITED-CARR



200 South Turnbull Canyon Road, City of Industry (Los Angeles), Calif. 91744 - Phone (213) ED 3-1201. Sales offices in 33 principal cities throughout the United States, Great Britain, Canada, Australia and West Germany.

CONSISTING OF CINCH MANUFACTURING COMPANY, CINCH GRAPHIK, CINCH-MONADNOCK, CINCH-NULINE, UCINITE (ELECTRONICS) AND PLAXIAL CABLE DEPT.

ON READER-SERVICE CARD CIRCLE 56

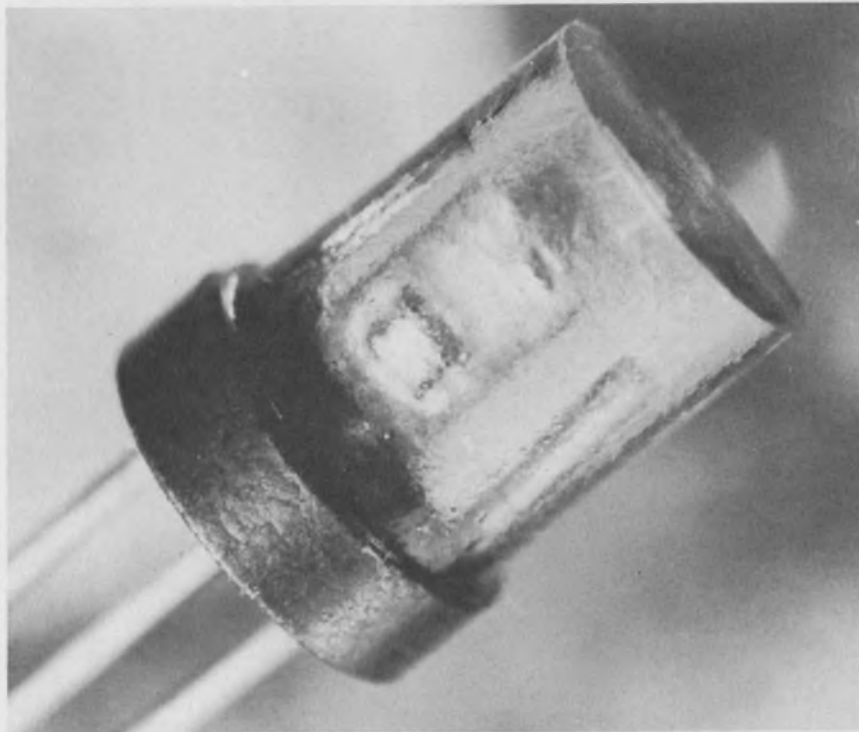

Clear epoxy acts as can and lens in Darlington photoamplifier

General Electric Co., Semiconductor Products Dept., 1 River Rd., Schenectady, N. Y. Phone: (518) 374-2211. P&A: under \$1 (100 to 999); stock.

An economy phototransistor eliminates the need for a focusing lens mounted in the package, as well as eliminating the metal can itself as the package. The device, designated the L14B by its manufac-

turer, General Electric, is an npn silicon Darlington photoamplifier that is packaged in a clear epoxy encapsulant. Unit price is well under \$1 in large volume.

Some of the possible applications are in vending machines to replace actuating switches and in automotive circuits, also to replace switches. In headlight monitoring devices, the L14B could receive the output

from a headlamp and send an indicating signal to the dashboard to remind the driver to turn off his lights after driving through daylight, rain, snow or fog. Many commercial applications are seen, such as limiting detectors for conveyor belts, hoist limiting, level sensing in liquid operations and counting circuits.

The unit is a Darlington amplifier transistor configuration, all of which is potted in a clear epoxy. There is no need for the relatively expensive lens system that was previously found in most phototransistors since the sensitive device operates without an optical focusing arrangement. For many applications, only the collector and emitter leads are used. A base lead is furnished to control sensitivity and gain of the unit.

The curved side of the JEDEC TO-98 package outline functions as a lens, with a 75% light response at a 40° angle from the center of the curvature of the package. The spectral response is centered near 0.9 microns, with a relative response of 75% from 0.73 to 0.98 microns. The allows the L14B to have a broad operating range of light response from infrared to unfiltered tungsten lamps.

The maximum light current value is 100 mA with a power dissipation of 150 mW at 25°C, derating at 2 mW/°C above 25°C ambient. Storage temperature range is -65° to 100°C. Rise time is 250 μs. Full specifications on the unit are given in the Table.

CIRCLE NO. 259

Table: Darlington photoamplifier specs (25°C)

Parameter	Test conditions	Specification
Light current (I_L)	$V_{CE}=5\text{ V}, H^*=2\text{ mW/cm}^2$	0.5-2 mA
Dark current (I_D)	$V_{CE}=5\text{ V}, I_B=0$	100 nA
Breakdown (BV_{CEO})	$I_C=10\text{ mA}, H=0$	12 V
Breakdown (BV_{CBO})	$I_C=100\text{ nA}, H=0$	18 V
Breakdown (BV_{EBO})	$I_E=100\text{ nA}, H=0$	8 V
Delay time† (t_d)	$\left\{ \begin{array}{l} V_{CE}=10\text{ V} \\ I_L=1\text{ mA} \\ R_L=1\text{ k}\Omega \end{array} \right\}$	60 μs
Rise time† (t_r)		250 μs
Storage time† (t_s)		0.5 μs
Fall time† (t_f)		150 μs
Junction temp. (T_j)		85°C

*H is radiation flux density. Source is an unfiltered tungsten filament bulb at 2780°K color temperature.

†Radiant source is a GaAs light-emitting diode.

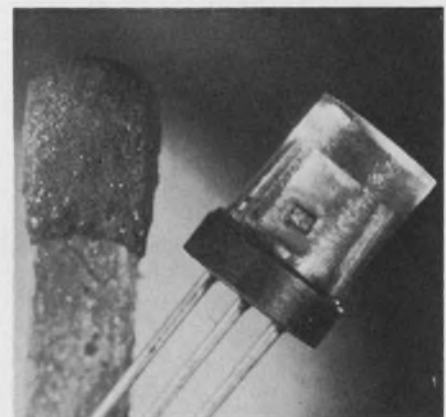

No bigger than this light source, the photoamplifier uses its clear epoxy package as its lens. For some applications, only collector and emitter leads are used; the base controls gain and sensitivity.

high performance motors

By Wright Division of Sperry Rand Corporation

High Density DC Motors with clutch-brake

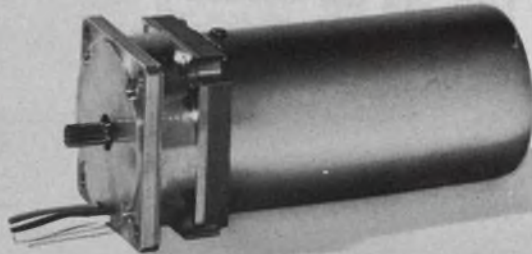

Enormous power is provided in small packages 2" to 4" in diameter. Offered in shunt, series, compound, and permanent magnet types.

Synchronous Motors

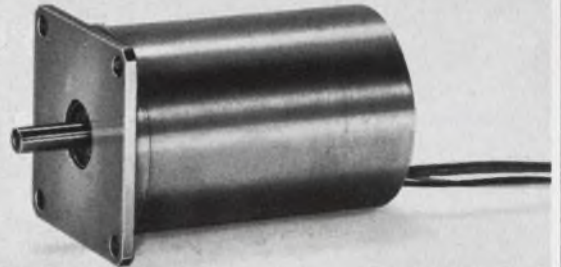

High efficiency designs available in single phase and polyphase types. They feature low noise and flutter. Six different speeds available in one unit.

Brushless DC Torque Motors



Torque motors with a response of four hundred millionths of a second for incremental rotation. Diameter 1 inch to 10 inches.

Gyro Motors



This new type of gyro motor features low power, high torque, and fast acceleration. Synchronous and induction. Half inch to seven inches in diameter.

AC Drive Motors



Recommended for continuous drive duty in antenna, optical, stabilizing systems. Available with synchronous or servo characteristics. Inverted or conventional. Wide variety of windings and sizes.

Power Stepper Motors



Powerful, permanent magnet stepper motors open whole new fields of application for the direct drive of all types of mechanical systems. Up to 600 ounce-inches torque at 15° step angle.

WRIGHT 
Division of Sperry Rand Corporation

DURHAM, NORTH CAROLINA □ TELEPHONE 919/682-8161 □ TWX 919/682-8931

ON READER-SERVICE CARD CIRCLE 57

Selenium rectifiers outlive silicon units

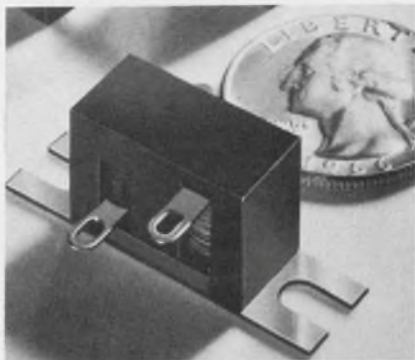

Sarkes Tarzian Inc., 415 N. College Ave., Bloomington, Ind. Phone: (812) 332-1435. Price: 50¢ to 82¢ (4-arm bridge).

Miniature single-phase bridge rectifiers are made from a superconductive selenium material. The rectifier is approximately the size of equivalent silicon devices yet reportedly withstands momentary overloads and voltage transients where a silicon device would fail. Life expectancy is over 100,000 hours when operated at full load at 35°C. The device is rated at 6 mA and 230 V rms.

CIRCLE NO. 260

Low-frequency FETs amplify quietly

Amperex Electronic Corp., Semiconductor and Receiving Tube Div., Slatersville, R. I. Phone: (401) 762-9000.

This series of n-channel field-effect transistors, 2N5103, 2N5104 and 2N5105, have low-noise, low-frequency characteristics. Designed primarily for low-power dc and audio amplifier applications, all three offer 5-pF feedback capacity, 1-pF input capacity and low leakage. The 2N5105 is designed for low-frequency applications where low-noise and high-gain characteristics are required. It has an equivalent noise voltage of $40 \text{ nV}/\sqrt{\text{Hz}}$ at 10 Hz and transconductance of 5000 to 10,000 μmho . Applications are in such small-signal circuits as low-noise operational amplifiers, high-impedance instrument inputs, i-f/rf linear stages and wideband amplifiers.

CIRCLE NO. 261

Direct Reading Precision Phase Measurements to 1MHz



The Aerometrics Model PM-720 Phase Meter covers from 0 to 180 degrees in four ranges. For measurements above 180 degrees, the PM-720 utilizes automatic lead-lag indicator lights to give direct reading capability to 360 degrees. The amplitude ratio of the two input signals can be as high as 5000 to 1 with sensitivity of 100 mv (p-p) to 500 v (option available to 1 mv). For direct meter readings the accuracy is $\pm 2\%$ but increase accuracy of $\pm .2\%$ can be obtained by utilizing the DC voltage output which reads directly in degrees on a DVM. The compact, all solid state construction offers true portability (total weight 7 pounds). Aerometrics also offers Model PM-730 which covers 0 to 360 degrees in four ranges. The frequency is extended to 1 MHz. The PM-730 also offers the unique advantage of measuring phase relationship between dissimilar wave forms.

Do you have Phase Measurement Problems to 750 MHz?

The PM-730 can be used with the Aerometrics Model SA-300 pulse sampler to give precision phase measurements to 750 MHz. For further information, write or visit us at the ISA and WESCON Shows.

See us at WESCON Exhibit Booth Nos. 3304-A & 3305-A and at ISA Exhibit Booth No. 544



AEROMETRICS

San Ramon, California 94583 • P.O. Box 216

See us at ISA Exhibit Booth No. 544

750 MHz Sampling Oscilloscope for \$995



If your present oscilloscope has a minimum band width of 50 KHz, you can convert it into a high speed sampling oscilloscope using the Aerometrics dual channel pulse sampler. The Model SA-300 may also be used with an inexpensive X-Y recorder for permanent recording of fast computer wave forms, radar pulses, semiconductor characteristics, etc. The all solid state Aerometrics sampler offers rise time of typically one nanosecond and sweep speeds from 10 nanoseconds to 5 microseconds per full sweep. Like other Aerometrics instruments, the SA-300 features portability through compactness and light weight.

Multimeters, Pulse Generators & Electronic Counters

A full range of instruments which excel in precision, compactness, ruggedness, portability and flexibility—the most dependable instruments you'll ever use—and all in competitive price ranges. Be sure and check Aerometrics' specifications before investing in test equipment.



See us at WESCON Exhibit Booth Nos. 3304-A & 3305-A and at ISA Exhibit Booth No. 544

AEROJET
GENERAL TIRE
GENERAL

AEROMETRICS

San Ramon, California 94583 • P.O. Box 216

See us at ISA Exhibit Booth No. 544

Npn power planars radiation-resistant



Bendix Corp., Semiconductor Div., Holmdel, N. J. Phone: (201) 946-9400.

Radiation-resistant silicon planar npn power transistors feature a continuous collector current of 20 A. The transistors' ability to withstand neutron radiation without excessive gain degradation is due to the narrow base width in construction of the transistor element. The devices withstand levels as great as 5×10^{14} nvt. Power dissipation is 50 W and V_{CE0} runs 40 to 74 V.

CIRCLE NO. 262

Silicon power transistors rated 650 V, 5 A



Bendix Corp., Semiconductor Div., Holmdel, N. J. Phone: (201) 946-9400. P&A: \$2.95 to \$26 (100 to 999); stock.

Twenty-two 650-V, 5-A silicon power npn transistors are available in the TO-3 package. Designed for use in high-voltage inverters, regulators, converters and deflection circuits, all transistors are Safe Operating Area specied for second breakdown protection. Electrical characteristics include P_T of 50 watts at 100° C, 20 V and 2.5 A.

CIRCLE NO. 263

The naked truth!

Now for the first time ever! The unexpurgated Redcor/Module's complete 10-channel multiplexer facts are laid bare! A lascivious thrill will run down your spine when you learn of its voluptuous 100 kc throughput rate! Its luscious 5 μ sec settling time! Your blood will thunder through your veins, your mind reel, at the wildly exciting possibility of eliminating multiplexer

modulations and offset! All this and more are yours in a bold new data sheet, "Sex & Specs & our Multiplex", available to all red-blooded engineers at **no cost!** Engineers under 18 must have a note from mommy.

REDCOR 7800 DEERING AVENUE
CANOGA PARK,
CALIFORNIA 91304

(213) 348-5892 • TWX 910-494-1228

ON READER-SERVICE CARD CIRCLE 58

SEALED / POWER MODULES

NUCOR NPS POWER MODULES are sealed to provide absolute assurance from dust, humidity, salt spray—uniquely designed, they will operate under the severe military environment of MIL-E-16400, MIL-E-5400, MIL-T-21200, MIL-E-4158.

- **TEMPERATURE TO 100° C**
No Derating
- **MTBF 100,000 HOURS**
Mean Time Between Failure
- **RIPPLE 250 μ v RMS**
Typical
- **REGULATION 4 mv**



NUCOR POWER SUPPLIES ARE
DIRECT RETROFITS IN
YOUR EQUIPMENT.

485 standard models available



Write today to
NUCLEAR CORPORATION OF AMERICA
2 RICHWOOD PLACE, DENVER, NEW JERSEY 07834

ON READER-SERVICE CARD CIRCLE 59

SEMICONDUCTORS

Small-signal npns useful to 1 GHz

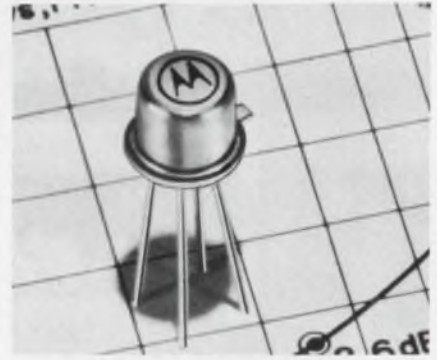

Motorola Semiconductor Products, Inc., P. O. Box 955, Phoenix. Phone: (602) 273-6900. Price: \$4.50, \$6.90, \$13.50 (100 up).

Silicon npn transistors for high-gain, low-noise amplifiers and mixers and other vhf/uhf small-signal applications to 1 GHz offer maximum noise figures as low as 3 dB. Minimum power gains range to 17 dB at 450 MHz in the common-emitter configuration. At 1 GHz, the 2N4957 delivers a typical common-emitter power gain of 13 dB.

CIRCLE NO. 264

MOSFET switches protected by Zener

Siliconix, Inc., 1140 W. Evelyn Ave., Sunnyvale, Calif. Phone: (408) 245-1000. P&A: \$6.70 and \$16.40 (100 lots); stock.

P-channel enhancement-type MOSFET in single and dual versions are designed for analog and digital switching applications. The potential problem of oxide breakdown, due to static-charge accumulation on the gate, is eliminated by a built-in Zener between gate and body. Gate protection is assured because the 90-V diode breakdown is much lower than the oxide destructive voltage. Drain leakage current (I_{DSS}) is 0.2 nA at room temperature. Drain-to-source on-resistance (r_{DS}) is 150 Ω at a gate-to-source bias of -20 V. Breakdown voltages are all 30 V. Gate threshold voltage (V_{GS}) is 6 V. The M103 is a single MOSFET packaged in a TO-72, the M106 is a dual M103 with common source, packaged in a TO-99.

CIRCLE NO. 265

Photodevice pair turn on quickly

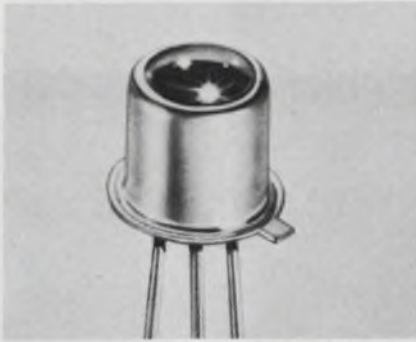

Motorola Semiconductor Products, Inc., P. O. Box 955, Phoenix. Phone: (602) 273-6900. P&A: \$6.75 (500 up); stock.

A photodetector and phototransistor mark Motorola's entry into the field of optoelectronics. The detector is a 0.06-inch diameter, two-terminal device for use where mechanical mounting requires high-density positioning such as in high-speed tape and card readers and rotating shaft information encoders. It exhibits a collector-emitter radiation sensitivity of 0.5 mA/mW/cm². Maximum turn-on/turn-off is 6.5 μs.

The transistor is housed in a TO-18, with external connections for added control. It has a higher sensitivity (1.6 mA/mW/cm²) than the detector and responds to modulation well above the audio spectrum providing a useful means of information transfer from laser light sources. Low-leakage permits the devices to be used in direct-coupled circuitry at low signal levels.

CIRCLE NO. 266

Photocell/lamps mount PC boards

National Semiconductors Ltd., 2150 Ward St., Montreal, Canada. Phone: (514) 744-5507

Photoconductive cell/incandescent lamp assemblies using a 10-V 15-mA incandescent lamp mount on PC boards. Maximum illuminated photocell resistance is 100 Ω for one type, 400 Ω for the other. Minimum dark resistance is 10 and 100 MΩ. Insulation between lamp and photocell terminals is 3000 V. Typical applications include audio switching, volume expanders and high-voltage decoupling.

CIRCLE NO. 267



Build reliability into every connection with GARDNER-DENVER Wire-Wrap® tools

Reliability is an inherent characteristic of solderless wrapped connections made with Gardner-Denver "Wire-Wrap"® tools. It does not depend on the skill and judgment of the operator . . . or on complex quality control procedures.

Proof: More than 37 billion such wrapped connections have been made . . . without a reported electrical failure.

Why? "Wire-Wrap" tools are simple to use. Connections are permanently tight . . . withstand severe temperature changes, atmospheric corrosion and vibration.

Send for Bulletins 14-1, 14-3, and 14-5 on Gardner-Denver "Wire-Wrap" tools. Air- or electric-powered models.



SEE WHAT AIR IS DOING NOW...SEE

GARDNER - DENVER

Gardner-Denver Company, Quincy, Illinois

ON READER-SERVICE CARD CIRCLE 60

Cinch
Creative
Problem
Solving

to reduce gold requirements...



An important breakthrough in electroplating technique, the work of the Cinch Electrochemical Laboratories, backed by the R & D activities of the United-Carr Exploratory Development Laboratory, permits the control of both thickness and selective location of gold deposits on connector contacts.

RESULT: Substantial cost savings with no decrease in connector reliability, durability or electrical performance. This achievement in precious metal deposition has even greater significance when combined with Cinch capabilities in contact and insulator design.

In addition to this unique process, Cinch utilizes other, more conventional, selective plating methods, when appropriate. "Gold Button" welding is another Cinch-developed method for reduction of gold usage and connector costs.

Here is another demonstration of the extra dimension in Cinch's engineering and developmental skills. Beyond this ability to design fine products, we offer in-depth production engineering capabilities, including tool, die, mold and equipment design and fabrication.

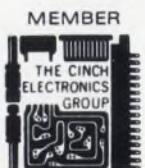
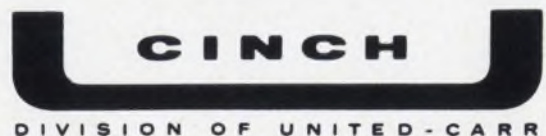

CONSISTING OF CINCH MANUFACTURING COMPANY, CINCH-GRAPHIK, CINCH-MONADNOCK, CINCH-NULINE, UCINITE (ELECTRONICS) AND PLAXIAL CABLE DEPT.

60%

develop
a unique
selective
plating
process

Our skills and services are available to you. For Cinch creative problem solving assistance, contact Cinch Manufacturing Company, 1501 Morse Avenue, Elk Grove Village, Illinois 60007

Plastic high-frequency FETs priced under a dollar

Texas Instruments, Inc., 13500 N. Central Expressway, Dallas. Phone: (214) 235-3111. P&A: 95¢ (100 to 999); stock.

A plastic package for the 2N4416 400-MHz silicon FET has cut its price to under \$1. Thus, Texas Instruments' TIS88 has double the frequency of any other FET in its price range. The unit can be operated at up to 400 MHz with a usable power gain of at least 10 dB (18 dB at 100 MHz). Transconductance is high ($\text{Re } Y_{fs} = 4000 \mu\text{mho}$ at 400 MHz), and feedback capacitance is low ($C_{rss} = 1 \text{ pF}$). The ratio of the two shows a favorable figure of merit for high-frequency FET operation.

At a drain-to-source voltage of 15 volts, a drain current of 5 mA and a generator resistance of 1 k Ω , spot noise figure is a comfortable 2 dB at 100 MHz, 4 dB at 400 MHz.

Absolute maximum ratings at 25°C free-air temperature include drain-to-gate and drain-to-source voltages of 30 V. Reverse gate-to-source voltage is -30 V. Continuous forward gate current is 50 mA.

Full specifications of the TIS88 are tabulated below.

The n-channel, epitaxial, planar

device is useful in a variety of consumer, industrial and military applications. TI cites advantages in fm rf amplifiers, cascode-connected TV vhf amplifiers and sonobuoy input amplifiers. The device is suited for rf amplifier and mixer applications because of its high-frequency capability, and also because of its square-law transfer characteristic, which minimizes undesirable cross modulation.

It is available in TI's plastic package with a TO-18 pin circle. The drain and gate leads are separated in a drain-source-gate lead configuration for reduced feedback capacitance and higher maximum stable gain.

The plastic case has compromised none of the device's mechanical properties. The case withstands soldering temperatures without deformation. The device itself remains stable under high-humidity conditions and meets hermeticity requirements of MIL-Std-202C, method 106B. The device is light-insensitive. Storage temperature range is -65° to 150°C. Continuous device dissipation at 25°C free-air is 360 mW, derating at 2.88 mW/°C to 150°C.

CIRCLE NO. 268

Table. Electrical characteristics at 25° C

Parameter	Test Conditions	Specification
$V_{(BR)GSS}$	$I_G = -1 \mu\text{A}, V_{DS} = 0$	-30 V
I_{GSS}	$V_{GS} = -20 \text{ V}, V_{DS} = 0$ Same at $T_A = 100^\circ\text{C}$	-1 nA -0.5 μA
$V_{GS}^{(OFF)}$	$V_{DS} = 15 \text{ V}, I_D = 10 \text{ nA}$	-1 to -6 V
I_{DSS}	$V_{DS} = 15 \text{ V}, V_{GS} = 0$	5 to 15 mA
Y_{fs}	$V_{DS} = 15 \text{ V}, V_{GS} = 0, f = 1 \text{ kHz}$	4.5 to 7.5 mmho
Y_{os}	As above	0.005 mmho
C_{iss}	$V_{DS} = 15 \text{ V}, V_{GS} = 0, f = 1 \text{ MHz}$	4.5 pF
C_{rss}	As above	1 pF

when you specify
SWITCHCRAFT
"TELEVER"
 TELEPHONE TYPE
SWITCHES

...smile



SERIES 16000

...you've done
 your product
 a favor

1. OUTSTANDING QUALITY

Virtually indestructible "T-Beam" frame. Proved and preferred Leaf-type switch stacks go on-and-on after other types wear out. Materials and finishes meet Mil specs . . . overall design meets rigid telephone company standards (but with lots more uses).

2. CHANGEABLE FUNCTIONS

Insert for
 non-locking
 operation . . .

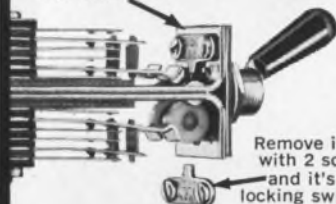

Now it locks—now it doesn't. Exclusive removable inserts converts it either way—even in the field. Can be locked in any one or all positions.

3. TOPS IN VERSATILITY

Incomparable flexibility in contact arrangements (up to 8-pole, double throw). Two and three position. Palladium or fine silver contacts. Unsurpassed for any critical switching function—telephone companies, communications and test equipment, computers, ground support equipment, etc.

Write for bulletin S-302, or see your authorized Switchcraft distributor for immediate delivery at factory prices.

SWITCHCRAFT[®]

5543 Elston Avenue, Chicago 30, Illinois

ON READER-SERVICE CARD CIRCLE 62

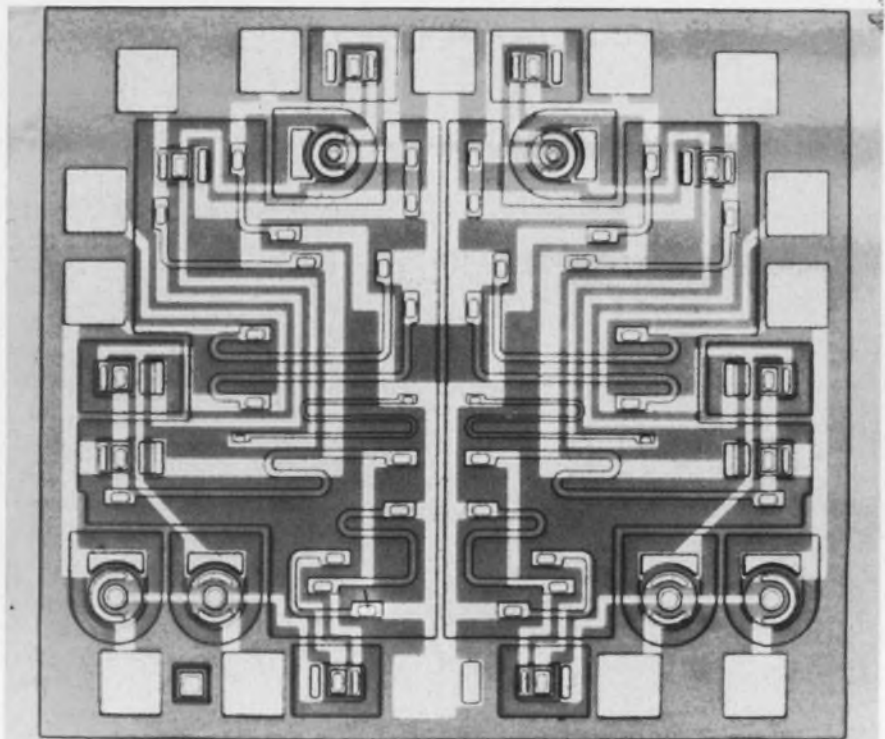

Two op amps on one chip: one header is better than two

Motorola Semiconductor Products, Inc., P. O. Box 955, Phoenix. Phone: (602) 273-6900. P&A: \$8.50 (100-up); stock.

Two for the price of one? Just about—with Motorola's new dual operational amplifier. You can now buy two MIL-range operational amplifiers on a single chip in a single can. Motorola considers its move "the way to go" in linears and is planning the same treatment for other devices in its line.

The situation in linear-circuit packaging parallels that in the digital field a few years ago: one package, one gate. Today, however, we see quad 2-input gates, dual flip-flops and others. Linear circuits are now leaving the one-circuit, one-package stage with this new operational amplifier.

Within the 10-pin metal can or the 14-pin ceramic TO-85 flat pack are two complete op amps. Each of the amplifier channels has a healthy open-loop voltage gain of 77 dB, an input offset voltage of 1 mV and an output voltage swing of ± 3.6 V with a ± 6 -V power supply voltage. Operating range is -55° to 125° C.

Operation is quiet. Input noise voltage is $0.5 \mu\text{V}$.

In addition, the separate amplifiers are quite closely matched. Open-loop gains are within ± 1 dB, input offset voltages within ± 0.1 V and input offset currents within $\pm 0.02 \mu\text{A}$. Separation between the channels is 60 dB.

The MC 1535 chip can be used in either of two ways:

- As two parallel amplifiers, or even as unrelated amplifiers for multichannel applications.
- In cascade, where the resulting higher gain is desirable.

A natural application would be a zero-drift amplifier. Since both of the op amps exhibit the same drift characteristics, all the designer has to do is generate a feedback configuration which will effectively cancel the drift of the two operational amplifiers.

The major advantage of the dual, aside from the reduction in can count, is the cost. Since Motorola has cut its own packaging costs, you pay less. The 100-up price of the MC1535 is \$8.50—or \$4.25 for each op amp.

CIRCLE NO. 269



**Happiness is an Acopian power supply . . .
because it's shipped in only 3 days.**

Whether your application is op amps, ICs, logic circuits, relays, lamps or electronic measuring equipment, look to Acopian to meet your needs for AC to DC plug-in power supplies. Acopian's new catalog lists over 62,000 different supplies . . . all available for shipment within 3 days. Get your 16 pages of happiness by writing or calling Acopian Corp., Easton, Pennsylvania (215) 258-5441.

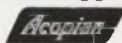

Sample and hold. Sample and hold. Do dah. Do dah.

The closed-loop performance of Redcor/Modules' new Sample-and-Hold will put a smile on your face and a spring in your step. The 770-715 has an accuracy of 0.01%. If that don't get you, try a settling time of 5 microseconds for 20V step input. Or how about an input impedance of 10 megohms at 1 kc? Maybe a frequency response of DC to over 50 kHz? This performance, friends, is yours for a mere \$250 in quantities of 50. Redcor makes equally appealing comparators,

dynamic bridge and buffer amplifiers, 8-channel multiplexers, plus 0.1% Sample-and-Holds. They all have a great new pin layout that for the first time lets you easily interconnect modules with dual in-lines. So quit clapping your hands long enough to request complete data.

REDCOR 7800 DEERING AVENUE
CANOGA PARK,
CALIFORNIA 91304
(213) 348-5892 • TWX 910-494-1228

ON READER-SERVICE CARD CIRCLE 64

Mini who?

Mini-Coax. Just an easier way of saying Micro-Miniature Coaxial Connector. And it really is mini. Measuring only 0.103 inches in diameter, it's the smallest connector of its kind on the market today. The Mini-Coax is an in-line, push-on connector that's ideal for joining RF signal lines in tight places. So if you're cramped for space, write for complete specs on the Mini-Coax. **WAVELABS CO.** Get the connection?

1925 Euclid Ave., San Diego, Calif. 92105
Tel. (714) 263-2171 or TWX 910-335-2018

ON READER-SERVICE CARD CIRCLE 65

MICROELECTRONICS

Beckman hybrids bow with dc regulator

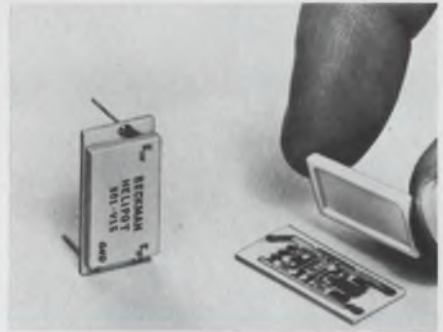

Beckman Instruments, Inc., Helipot Div., 2500 Harbor Blvd., Fullerton, Calif. Phone: (714) 871-4848. P&A: \$30; stock.

Hybrid circuits are now available from a large potentiometer house. Beckman's Helipot Div. has applied its cermet know-how to hybrids. Their thick-film regulator provides both line and load regulation to within $\pm 0.05\%$, current handling capability of up to 0.5 A and power rating of 1.8 watts at 25°C free-air. The units are available in five standard models with fixed outputs of 9, 12, 15, 18 and 21 volts. Output-power-to-load ranges from 4.5 V for the 9-V model to 10.5 V for the 21-V model. The regulators measure 0.17-inch high and occupy 0.5 in² of board space. They are sealed for immersion solvent cleaning and potting and operate over -55° to $+125^{\circ}$ C. Cermet passive elements and chip semiconductors bonded to an alumina substrate are used. Interconnections are made by thermocompression lead bonding. The solder-coated copper terminal pins are located on standard 0.1-inch grids. CIRCLE NO. 270

Thin-film resistor ladder a bit more accurate

Halex, Inc., 139 Maryland St., El Segundo, Calif. Phone: (213) 772-2545. Price: \$40 (100-up).

A ladder network for D/A and A/D conversion has five-bit capacity in a voltage mode and six-bit capacity in a current mode. Two units can be combined for ten-bit capacity in either mode. Maximum input in voltage mode is 40 V, 2 mA in current mode. Overall accuracy for ten bits at 25°C is $\pm 1/2$ least significant bit. CIRCLE NO. 271

Low-drift IC op amps span MIL temperatures

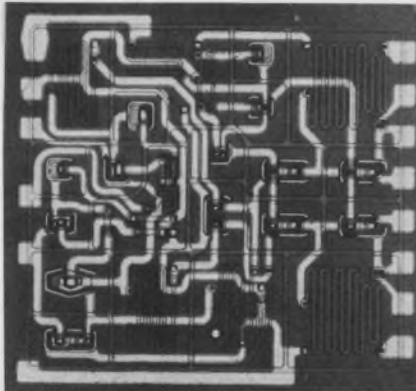

Union Carbide Electronics, 365 Middlefield Rd., Mountain View, Calif. Phone: (415) 961-3300. P&A: \$17 (1 to 24); stock.

This silicon planar IC offers low current offset and current offset drift vs temperature. Offset voltage is adjustable to zero with an external pot and common-mode voltage is ± 10 V. The unit offers a 15-nA differential input offset current, 175-pA/ $^{\circ}$ C differential input offset current drift and 10- μ V/ $^{\circ}$ C input offset voltage drift. The op amps are packaged in a TO-101, and operate over a temperature range of -55° to $\pm 125^{\circ}$ C. CIRCLE NO. 272

Tiny pulse transformers go dual-in-line

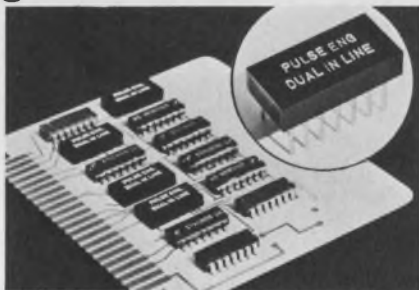

Pulse Engineering, Inc., 560 Robert Ave., Santa Clara, Calif. Phone: (408) 248-6040. P&A: \$14 (1 to 9); stock.

While certainly not integrated, these pulse transformers are IC-compatible. The dual-in-line module consists of three transformers which provide dc isolation, impedance-matching, signal inversion, current or voltage gain and common-mode rejection. The modules find application as memory line drivers, common-mode chokes and floating switches. CIRCLE NO. 273

Spdt hybrid has low on-resistance

Amelco Semiconductor, Div. of Tel-edyne, Inc., 1300 Terra Bella Ave., Mountain View, Calif. Phone: (415) 968-9241. Price: \$25.10 (100-up).

This hybrid analog switch is used for high-level multiplexing, A/D conversion, telemetry, and chopper applications and may be driven from TTL, DTL, RTL or SUHL logic. It features 1.5- μ s switching

speeds and has the capability of handling ac signals with frequencies in excess of 1 MHz. Storage temperature range is -65° to $+150^{\circ}$ C and operating temperature spans -55° to $+125^{\circ}$ C. Static drain to source on resistance (r_{DS}) is 65 Ω at a 1-mA drain current. The circuit is useful as a direct replacement for many relay applications. Operating voltage is ± 18 volts. Packaging is in the G-package.

CIRCLE NO. 326

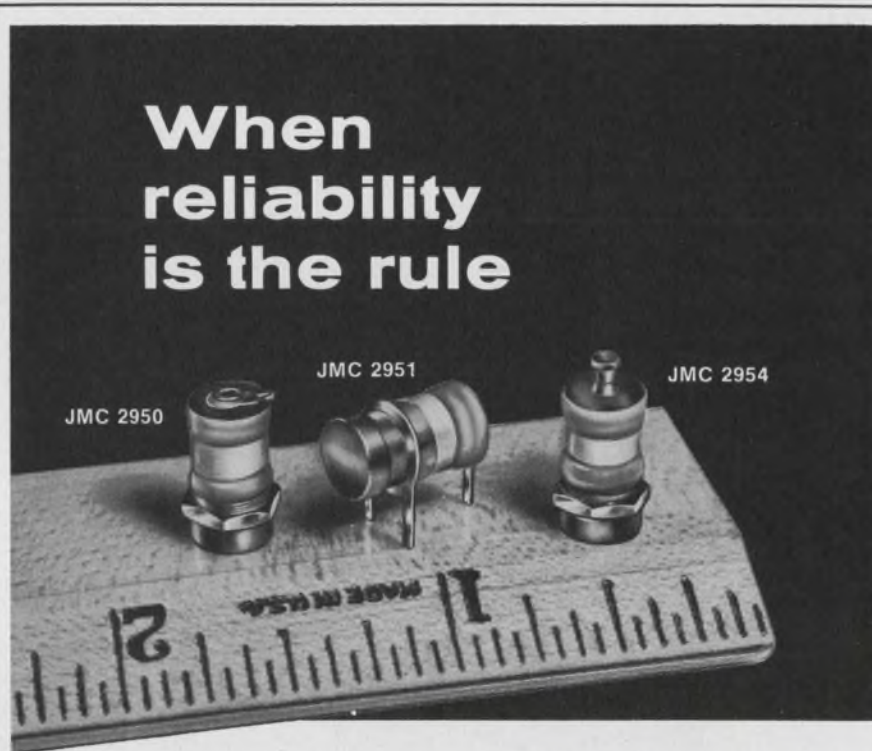

... specify *Johanson*

HIGH Q, HIGH FREQUENCY VARIABLE AIR CAPACITORS

This versatile series provides, in miniature size, exceptionally high Q, superior ruggedness for protection against shock and vibration, -55° to $+125^{\circ}$ C operating temperature range, protection against fungus, salt spray and humidity... plus all the other construction and performance features that have made Johanson capacitors the industry standard for excellence.

Specifications

- Capacitance Range: 0.8 — 10.0 pF
- Dielectric Withstanding Voltage: Rating 250 VDC breakdown >500 VDC
- Insulation Resistance: $>10^6$ megohms @ 500 VDC
- Q: >2000 @ 100 mc
- Temperature Coefficient: 0 ± 20 ppm/ $^{\circ}$ C
- Rotational Life: >800 revolutions

Write Today for Complete Catalog, Prices.

Johanson MANUFACTURING CORPORATION
400 Rockaway Valley Rd., Boonton, N.J. 07005, (201) 334-2676
Electronic Accuracy Through Mechanical Precision

ON READER-SERVICE CARD CIRCLE 66

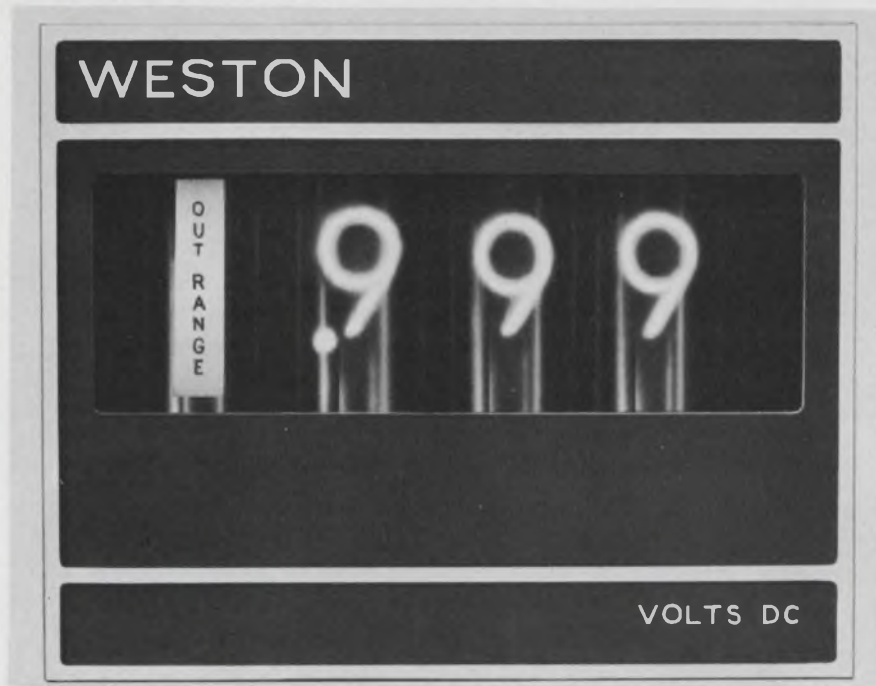

Take your eye off the needle: panel meters go digital

Weston Instruments, Inc., Weston-Newark Div., 614 Freylinghuysen Ave., Newark, N. J. Phone: (201) 243-4700. P&A: \$249.60 (over 25); October.

A compact panel meter provides a stable, 3-digit readout. With more than half its circuits integrated and dual-slope-integration A/D conversion, Weston's meter can be adapted to many applications, and can even update existing panels.

Only three PC cards make up the meter and all lift right out of the 4-1/2-inch-deep package—the power supply, the digital display driver circuitry, and the A/D converter.

The meter gives 0.1% ± 1 -digit accuracy with Nixie display simplicity for voltage and current measurements (10 ranges). It can be used with a variety of transducers and can be adapted to work with shunts, tachometers or thermoelectric elements.

The choice of a dual-slope-integration conversion technique, with sensing intervals related to power frequency, provides true average output readings and avoids series-mode interference problems. The approach is independent of the value of the integrating capacitor and

the clock frequency and thus ensures freedom from drift. A resistive ladder is not used; the unit maintains its accuracy by a controlled ratio between two stable resistors and Zeners. Thus, resistor aging does not upset the established ratio and the meter remains stable.

Given its small size, the meter rates high in versatility. It provides a 1.5-V pulse as a print command once conversion is complete. Weston will supply it to original-equipment manufacturers to operate with any printer. Weston is even investigating production of its own economy printer to mate with the meter. The meter can be sectioned into sub-units at the customer's choice. The readout can be removed and the converter and supply circuitry can be used as a front end for a computer. Or, if there is an available power source, the supply can be eliminated altogether. The slope adjustment can be changed up to 50% internally and by ± 8 counts by a front-panel screw. The conversion may also be adjusted over ± 8 counts for a 1-V dc input without sacrificing stability, linearity or precision of control.

CIRCLE NO. 274

Double-barrelled pulser quick on the draw

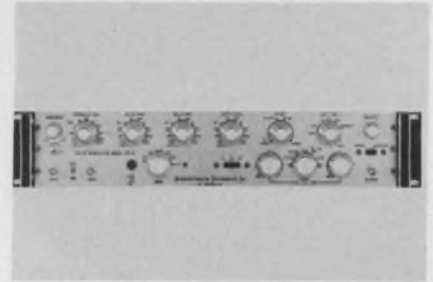

Intercontinental Instruments, Inc., 500 Nuber Ave., Mt. Vernon, N. Y. Phone: (914) 699-4400. Price: \$1800.

Rep rate capability to 100 MHz, a 2-ns rise and fall time and 100% duty cycle are featured in this all-silicon pulse generator. The unit provides current (to ± 400 mA) or voltage (to ± 20 V into 50 Ω) single or double pulses with sync pulse. All output parameters are continuously variable over dynamic ranges of at least 100:1. These include pulse repetition frequency, amplitude, rise and fall time (separately variable), delay width (of each pulse independently in double pulse modes) and dc offset. Outputs can be of either polarity or their complements. The instrument may be triggered and/or gated and provision is made for manual single-shot operation.

Output waveforms are clean: frequency jitter is 0.1% of period +0.1 ns, width and delay jitter are 0.2% +0.1 ns, linearity and distortion (preshoot, overshoot, undershoot, droop) are better than 5%.

CIRCLE NO. 275

Pyroelectric unit meters cw, pulse laser outputs

Barnes Engineering Co., 30 Commerce Rd., Stamford, Conn. Phone: (203) 348-5381.

This broadband laser energy meter uses a pyroelectric detector to measure the energy from cw or pulse lasers. The device measures radiation anywhere in the spectral region from the visible to beyond 40 microns in the far infrared. Meter readout is direct in watts and joules. Operating range is from 100 mW to 1000 W for cw lasers, and from 10 millijoules to 100 joules for pulse lasers. Accuracy is within 5%.

CIRCLE NO. 276

Dual-trace samplers span 7-GHz bandwidth



E-H Research Laboratories, Inc.,
163 Adeline St., Oakland, Calif.
Phone: (415) 834-3030. Price:
\$6215.

A 7-GHz sampling oscilloscope is offered as a complete unit consisting of main frame, vertical and horizontal plugins. Specifications on the dual-trace SAS 5009A include a 7-GHz bandwidth, 7-GHz trigger bandwidth, 20-ps trigger jitter, 50-ps risetime and noise of less than 10 mV peak-to-peak.

CIRCLE NO. 277

Oven-controlled Zener keeps voltmeter accurate



Precision Standards Corp., 911
Westminster Ave., Alhambra, Calif.
Phone: (213) 289-2453.

An integral proportional-controlled oven for the Zener reference of this ac/dc voltmeter gives good accuracy and stability. Ranges are ± 1100 , ± 110 and ± 11 V and 1100 and 110 mV with 6-digit in-line readout. Rated dc accuracy is $\pm(0.005\%$ of reading $+2$ ppm of range $+5 \mu\text{V})$ from 65° to 85°F , 0 to 1100 V dc. Ac accuracy of reading is $\pm(0.1\% +25 \mu\text{V})$, 10 to 20 kHz.

CIRCLE NO. 278

Ballantine Model 355 AC-DC Digital Voltmeter



Measures Full Scale ac to 10 mV... ac & dc from 0 to 1,000 V

Ballantine's Model 355 is the only digital voltmeter of its type in the U.S.A. . . . with a versatility that makes it ideal for production line and quality control applications.

Use the 355 in place of analog instruments, for example, in reducing personnel errors, for speeding up production. You can depend on Ballantine's high standards of accuracy, precision, and reliability to reward you with savings of time and money the first day you place it in service.

The instrument features a servo-driven, three-digit counter with over-ranging . . . combines many virtues of both digital and analog voltmeters in one small, compact, economical package. Its large, well-lighted readout with illuminated decimal point, range and mode information allows fast, clear readings, while the indicator can follow and allow observation of slowly varying signals. An optional foot-operated switch for retaining voltage readings enables you to cut the time between successive readings materially.

Voltage Range	AC	DC
	0 to 1000	0 to 1000
Full scale, most sensitive range . . .	10 mV	100 mV

Frequency Range	30 Hz to 250 kHz	DC
------------------------	------------------	----

Accuracy in % of Full Scale	AC	DC
$\frac{1}{4}\%$, 50 Hz to 10 kHz		$\frac{1}{4}\%$
$\frac{1}{2}\%$, 30 Hz to 50 kHz		
1%, 50 kHz to 250 kHz		

Power Requirements . . . 115/230 V, 50-60 Hz, 52 W

Relay Rack Version . . . Model 800 rack mounting kit is optional

Optional Model 600 Resistors are available for measuring current directly in volts

Price: \$620

Write for full details

— Since 1932 —
BALLANTINE
LABORATORIES INC.
Boonton, New Jersey

ON READER-SERVICE CARD CIRCLE 67

Ballantine Model 345 DC/AC Voltmeter/Ohmmeter



Features Accuracy not available in any other Volt/Ohmmeter for both ac and dc volts . . . and ohms

A single five-inch logarithmic scale of Ballantine's Model 345 is used for all ac and dc voltage measurements except very low voltages, where red scales are used to reach zero. This single scale can be read with no confusion compared to the four scales commonly used on volt/ohmmeters on which there are two scales for ac and two more for dc.

Ballantine's single scale results in faster measurements, with the possibility of fewer reading errors. Its logarithmic scale spreads out the readings over the full five inches with the same resolution and accuracy in % of reading at the very bottom of the scale as at the top. The same features apply to the ohms scale.

Use of a Sola® regulating power transformer provides exceptionally high stability as a function of power line voltage changes that are commonly experienced in many locations. This feature speeds up accuracy measurements.

Voltage Range . . . 0 to 1000 V dc; 0 to 350 V ac

Resistance Range 0 to 5000 M Ω

Accuracy . . . 1% of indication, 1 V to 1100 V dc;
2% of indication, 1 V to 350 V ac,
50 Hz to 100 MHz; 3% of indication,
1 Ω to 100 M Ω

Power Supply 115/230 V,
50 or 60 Hz as specified

Optional Accessories Includes T Adapter,
N/BNC Adapter, and 10,000 volt dc probe

Price \$395

Write for full details

— Since 1932 —
BALLANTINE
LABORATORIES INC.
Boonton, New Jersey

ON READER-SERVICE CARD CIRCLE 68

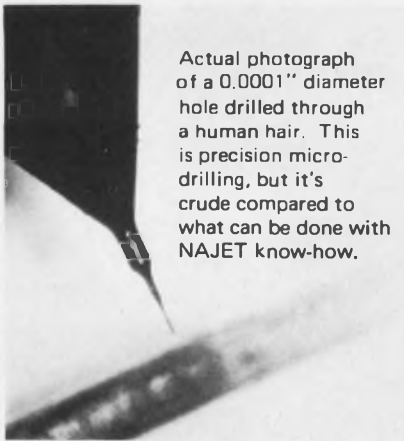

Actual photograph of a 0.0001" diameter hole drilled through a human hair. This is precision micro-drilling, but it's crude compared to what can be done with NAJET know-how.

DRILL ULTRA-SMALL HOLES

If you have a requirement for small and ultra-small holes in any phase of circuit or component fabrication, take a look at the capabilities National Jet can give you. NAJET is the only firm in the world that supplies both drilling machines and drills for microtechnology, featuring standard catalog equipment that lets you drill virtually any material with holes from 0.0001-inch to 0.125-inch diameter, and with size and location tolerances unmatched by any other method.

MICRODRILLING SERVICE !

If drilling volume is too low to warrant the purchase of micro-tooling equipment, NAJET will drill your products to your own specifications at its factory—another exclusive in the microminiature drilling field.

WORK UP, NOT DOWN.

Consider carefully this basic concept: you can cut design time drastically, reduce rejects to practically zero, and eliminate "trial-and-error" drilling completely by **WORKING UP** to your size requirements with NAJET equipment, rather than painstakingly working down to your requirements with other equipment.

**write today
for details**



**NATIONAL
JET
COMPANY**

10 CUPLER DRIVE, LAVALE,
CUMBERLAND, MARYLAND 21502

ON READER-SERVICE CARD CIRCLE 69

TEST EQUIPMENT

Bridge amplifier aids medical recording



Statham Instruments, Inc., 12401 W. Olympic Blvd., Los Angeles. Phone: (213) 272-0371. P&A: \$95; stock.

Designed for use with commercial and medical data recording systems and compatible with most data recording systems, this bridge amplifier has an output of 10 V. The output current of 5 mA can drive most galvanometers directly without need for additional amplification. Other features include instant warmup, signal output power isolation and continuously adjustable linear gain of $\pm 0.5\%$ from 0 to 10 V.

CIRCLE NO. 279

Rf power bridge measures absolutes



Narda Microwave Corp., Plainview, N. Y. Phone: (516) 433-9000. P&A: \$975; stock.

This temperature-compensated rf power bridge allows the measurement of absolute power with 0.15% accuracy with automatic temperature compensation. The unit combines the attributes of the single-bridge configuration with the added accuracy introduced by dual-bridge temperature compensation. Two dc self-balancing bridges and a regulated supply make up the unit.

CIRCLE NO. 280

Passive meters deflect 50 nA full scale



Greibach Instruments Corp., 315 North Ave., New Rochelle, N. Y. Phone: (914) 633-7900.

Full scale deflection of 50 nA without amplification is offered by this passive dc meter with an accuracy of 0.5%. The meter features a bifilar suspension system with a weightless light-beam pointer projecting a sharp hairline for direct readout without parallax. The entire movement is virtually frictionless, providing reading resolution of better than 0.1%.

CIRCLE NO. 281

Dc slot supplies from 2.3 to 41 volts

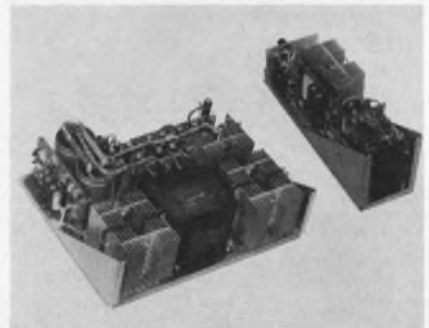

Darcy Industries, Behlman Div., 1723 Cloverfield Blvd., Santa Monica, Calif. Phone: (213) 393-9611. P&A: \$186 to \$530; stock to 22 wks.

All silicon, open module dc slot supplies in 1/4, 1/2, 3/4 and full-rack widths are available from 2.3 to 41.0 V dc in 414 separate models. All are repairable and feature self-contained heat sinks. Up to 6 output currents per voltage range are available, and each voltage range is adjustable over 5 to 10%.

CIRCLE NO. 282

**Dc/ac servo analyzer
computer-programmable**

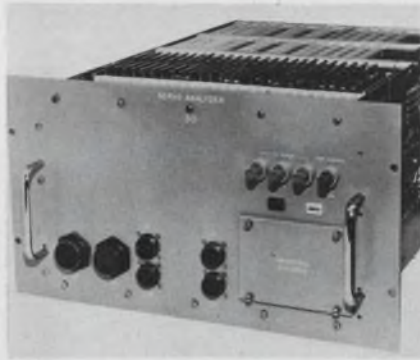

Canoga Electronics Corp., Canoga Div., 8966 Comanche Ave., Chatsworth, Calif. Phone: (213) 341-3010.

This computer-programmable servo analyzer has automatic ranging, high input impedance, dc rejection of up to 100% of analyzed signal, self-test capability and internal fault isolation. The unit provides both amplitude and phase information for preparation of Bode and Nyquist diagrams for network or system evaluation.

CIRCLE NO. 283

**General-purpose pulser
remotely programmable**



Advanced Automation Corp., 13724 Prairie Ave., Hawthorne, Calif. Phone: (213) 675-0331. P&A: \$1000; 30 days.

For use in automatic and semiautomatic test systems, this general-purpose pulser is remotely programmable. Rep rate is programmable by external trigger to 20 MHz or by internal oscillator from 10 Hz to 10 MHz, delay, from 30 ns to 10 ms and width from 30 ns to 1 ms. Amplitude is from 0 to 15 volts into 50 Ω either polarity.

CIRCLE NO. 284

Low Cost **4 DIGIT**
400 SERIES
INTEGRATING DC
DIGITAL VOLTMETER



Extended Range Measurements: Fifth digit over-range.

Precise Measurements: With accuracies to 0.05%.

Input Flexibility: Four voltage ranges and a micro-current input for measuring in "Engineering Units" (psi, degrees, etc.)

System Compatibility: BCD Outputs and Remote Programming.

High Noise Rejection: Differential input and integration techniques provide common mode rejection greater than 120 db at 60 Hz.

Economical: 3 and 4 digit models range from \$349.50 to \$495.50.

These DVM's are not only **NEW**, they're **AVAILABLE** from Janus representatives from coast to coast!

CALL OR WRITE FOR A DEMONSTRATION.



296 NEWTON STREET • WALTHAM • MASSACHUSETTS 02154 • TEL: (617) 891-4700
ON READER-SERVICE CARD CIRCLE 70

Multichannel counter has variable time base



Anadex Instruments Inc., 7833 Haskell Avenue, Van Nuys, Calif. Phone: (213) 782-9527. P&A: \$1245; 4 wks.

With two to six independently adjustable time bases, this counter has an integral channel selector switch for readout of any one of the input channels. Each channel has an independently adjustable time base and can be set from 0.0001 to 100 seconds by means of four thumb-wheel switches and a three-position range multiplier switch. Frequency range is 1 Hz to 200 kHz and input sensitivity is 10 mV rms, 3 Hz to 200 kHz.

CIRCLE NO. 285

Portable freq meters easy-to-use, accurate



Wavetek, 8159 Engineer Rd., San Diego, Calif. Phone: (714) 279-2200. Price: \$745 and \$945.

Portable frequency meters combining analog and digital techniques allow frequency or rep rates to be measured with extremely high accuracy. Model 701 Hertzmeter reads from 5 Hz to 1 MHz in four ranges. Frequency range of the 702 is 5 Hz to 100 MHz. Both feature a sensitive null meter and five-digit readout, allowing measurements to 0.01% of reading $\pm 0.001\%$ of range on all ranges. A recorder output furnishes an analog voltage proportional to frequency.

CIRCLE NO. 286

Dual discriminator takes 200-MHz random pulses

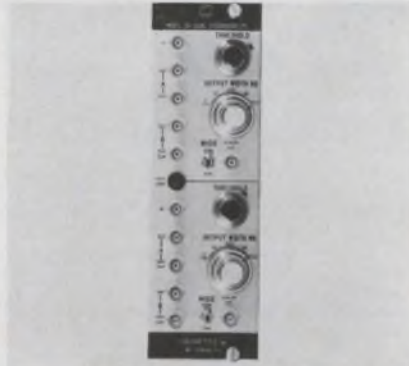

Chronetics, Inc., 500 Nuber Ave., Mt. Vernon, N. Y. Phone: (914) 699-4400. P&A: \$825; 30 days.

Accepting asynchronous (random rate) pulses to better than 200 MHz, this dual discriminator provides two standardized logic pairs and a scaler driver output at the same rate. The dc-coupled input to the voltage-sensitive discriminator is via a ten-turn pot, allowing threshold to be continuously variable over a 50-mV-to-1-V range. Duty cycle is 100%, dead-timeless.

CIRCLE NO. 287

A-to-D converter needs no preamp

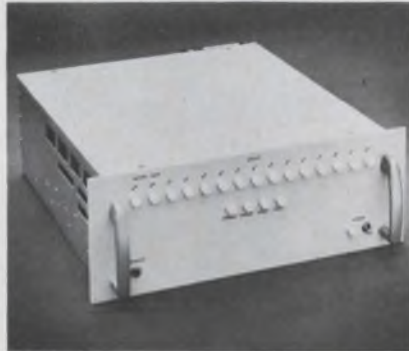

Control Data Corp., 4455 Eastgate Mall, La Jolla, Calif. Phone: (714) 453-2500.

A low-level 15-bit integrating A-to-D converter with high series and common-mode rejection needs no preamplification or individual point filtering. Common-mode rejection is 10 million-to-1 at dc to line frequency, and series mode rejection is more than 4000-to-1 at multiples of line frequency. Standard full scale input voltage is 50 mV with linearity of $\pm 0.01\%$ and long term accuracy of $\pm 0.05\%$ full scale.

CIRCLE NO. 288

Discriminator calibrator remotely programmable

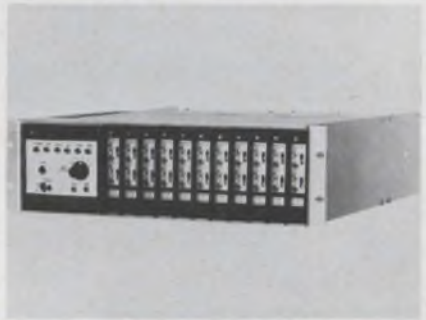

Vidar, 77 Ortega Ave., Mountain View, Calif. Phone: (415) 961-1000.

Used to test and calibrate subcarrier discriminators operating at IRIG constant-bandwidth frequencies, this calibrator is inserted between the telemetry receiver or data recorder and the discriminators to permit quick calibration without patching connections. The calibrator generates all 21 constant-bandwidth channel frequencies and a reference frequency simultaneously and applies the resulting frequency-multiplex group to the discriminator system. Deviation bandwidths for each channel can be individually set at ± 2 , ± 4 , or ± 8 kHz. Reference frequencies are 240, 100 and 50 kHz. Pushbutton or remote programming selects any one of five band positions, or the positions can be stepped automatically.

CIRCLE NO. 289

Signal generator stable to a few ppm

General Radio Co., West Concord, Mass. Phone: (617) 369-4400. Price: \$2995.

An all-solid-state standard-signal generator covers 67 kHz to 80 MHz with calibrated output of $0.1 \mu\text{V}$ to 6 V behind 50 Ω . Total warm-up drift is typically 150 ppm in three hours and drift after the warm-up period is typically 1 ppm per 10 minutes. The effects of line-voltage changes, loading, level changes and range switching are typically 1 ppm or less. The slide-rule dial is calibrated logarithmically to $1/4\%$ with vernier calibration and to 0.01% frequency change per dial division.

CIRCLE NO. 290

MEAN DISTANCE: 238,857 MILES.
HIGH-RELIABILITY, QUALITY PRODUCTS NEEDED
EVERY MILE OF THE WAY



The Model 2600 Push-Button Rotary Switch is designed for only those applications requiring the highest of reliability and quality.

UNIQUE

Several interesting engineering accomplishments have made this push-button switch unique.

It is totally enclosed . . . and explosion proof.

It has a readout that can display numbers, symbols, color, and binary codes.

It even has its own light.

No other push-button switch has had so much designed into so little a package.

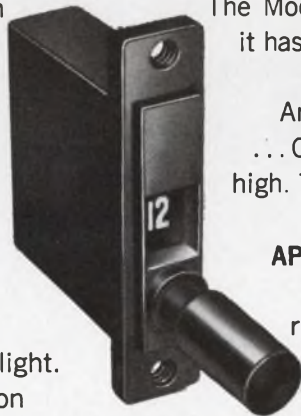

The Model 2600 is so small it has been nicknamed the "Space-Saver." And a Space-Saver it is . . . Only .350 wide x 1.00 high. This adds up to panel space savings.

APPLICATIONS

The Space-Saver represents tomorrow's push-button state of the art today.

It was designed for only those applications needing the finest

quality push-button switch. *It was designed for applications where function and performance outweigh all other criteria.*

When your project calls for nothing but the finest, high-reliability, push-button rotary switch manufactured, you can rest assured that it is available at Janco Corporation.

And we mean available . . . even for the mean distance and back!



JANCO
CORPORATION

3111 Winona Avenue, Burbank, California 91504

ON READER-SERVICE CARD CIRCLE 73

NOW 2 REED RELAY SERIES



ACTUAL SIZE

ULTRA MINIATURE REED RELAYS SERIES 442

- Smallest multi-pole relays in industry (1-4 poles Form A)
- P.C. Board Mount
- Contacts rated at a full 4 watts
- Occupies 0.055 cu. in. per pole

**SMALL
ENOUGH
TO
CHANGE
YOUR
DESIGN
IDEAS!**

MIL QUALITY AT
COMMERCIAL PRICES



ACTUAL SIZE

ULTRA MINIATURE NEEDLE REED RELAYS SERIES 373

- Occupies only 0.02 cu. in.
- Operates on only 50 mw of power
- Operate time 190 microseconds (typical)
- Insulation resistance as high as 1×10^{14}
- Contacts rated at a full 4 watts

BY *Wheelock* OF COURSE

Contact Wheelock first for any of your relay design problems.

Write for new literature on Wheelock's big family of small relays!

WHEELOCK SIGNALS, INC.
273 Branchport Avenue • Long Branch, N. J.
(201) 222-6880



ON READER-SERVICE CARD CIRCLE 74

TEST EQUIPMENT

Dc amplifier drives light-beam galvos

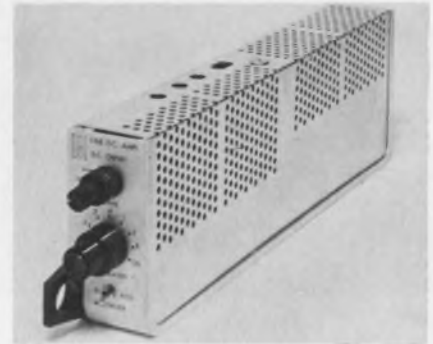

Consolidated Electrodynamics Corp.,
Data Instruments Div., 360 Sierra
Madre Villa, Pasadena, Calif.
Phone: (213) 796-9381. P&A:
\$380; 30 days.

With voltage gain positions down to 0.1, this wideband differential dc amplifier can drive high-frequency light-beam galvanometers. A four-terminal device provides isolation between input and output and between circuitry and ground. Voltage gain ranges from 0.1 to 500, with a vernier control for continuous adjustment between gain steps.

CIRCLE NO. 291

Display 100 channels on profile monitor scope



ITT, Industrial Products Div.,
15191 Bledsoe St., San Fernando,
Calif. Phone: (213) 367-6161.

With 10-mV full-scale detection, this profile monitor oscilloscope displays up to 100 channels of information. The instrument is designed for real-time transducer output displays. The 17-inch aluminized screen tube gives a flicker-free display. The instrument has interlocking capacity, individual channel gain control and an automatic warning system and shut down.

CIRCLE NO. 292

Uhf sweep generator eases testing

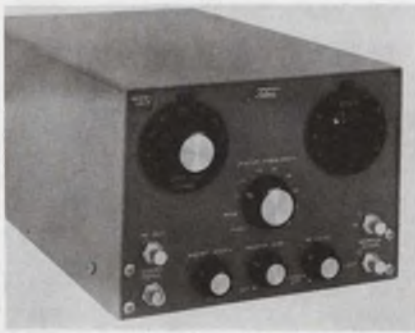

Telonic Instruments, 60 N. First Ave., Beech Grove, Ind. Phone: (317) 787-3231.

For TV tuner alignment, filter testing or attenuator measurements, this uhf sweep generator covers 450 to 910 MHz with continuously variable tuning. The sweep width is variable from 5 to 50 MHz, and the instrument's output is 0.5 V rms. The Autotrack frequency tuning system permits the user to change the frequency of the unit under test, without having to change the sweeper setting.

CIRCLE NO. 293

Solid-state supplies deliver 500 watts



Electro Products Laboratories, Inc., 6125 Howard, Chicago. Phone: (312) 647-8744. Price: \$375 to \$395.

All-solid-state regulated dc supplies feature silicon rectifiers, SCR regulation and pi-type filters. They deliver a continuously variable 500-watt output with line or load regulation of less than 1%, no load to full load. Ripple is less than 1% at maximum rated current. Three models, all operating from an ac input of 105 V, 60 Hz, are available.

CIRCLE NO. 294

POT SHOT OF THE MOON

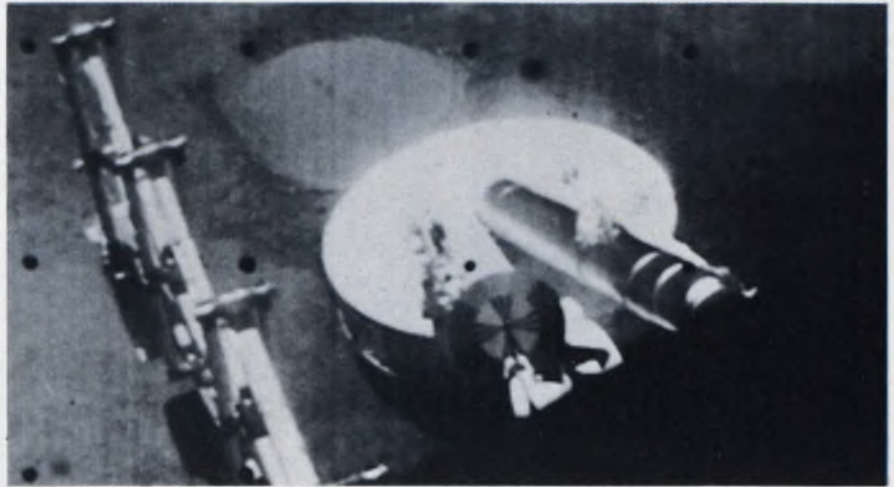

Less than an hour after Surveyor 3 settled itself on the lunar surface, the first photos from its TV camera were being processed at Jet Propulsion Laboratories. They have continued coming through at a rate of better than 300 per day.

Six Duncan Electronics precision potentiometers in the camera lens assembly built by Bell & Howell help to assure that the photos are being continuously transmitted. These wirewound linear pots control and monitor the TV camera's variable focal length lens, the mirror angle, and the color wheel position.

As in Surveyor 1, the Duncan pots are operating in temperatures ranging from -149°F to $+302^{\circ}\text{F}$ and in a vacuum estimated at only 10^{-13}mm of Hg. Their perfect performance in both missions is testimony to the exacting care used in their design and manufacture.

Whether or not you're shooting for the moon, you'll find we can solve your potentiometer problems — be they linear, non-linear, wirewound, or conductive plastic.

Call us today — we'll help you get off the ground.



(photographs courtesy
Hughes Aircraft Company)



DUNCAN electronics, inc.

2865 Fairview Rd., Costa Mesa, California • Tel: (714) 545-8261 • TWX: 910-595-1128
ON READER-SERVICE CARD CIRCLE 75

HE'S telling YOU about Heart Attack

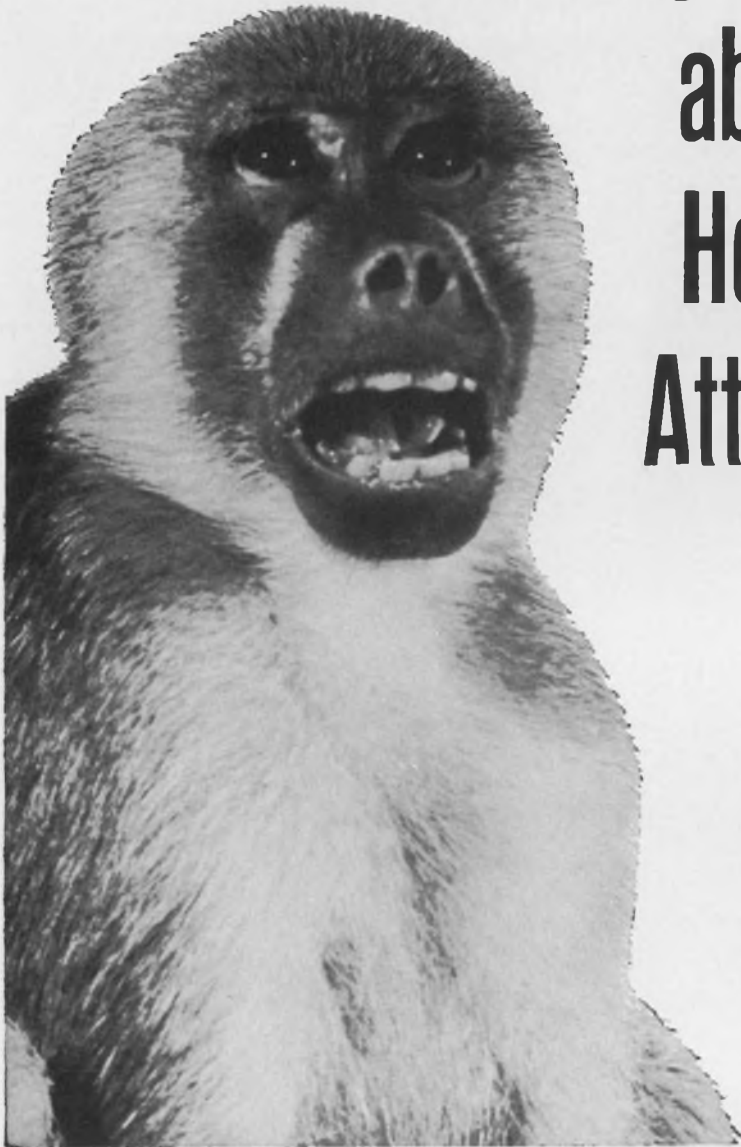

Like man, baboons are susceptible to hardening of the arteries. Research investigators are studying them in the search for ways to control this major cause of heart attack and stroke, responsible for 750,000 U.S. deaths a year. Your Heart Fund dollars support vital research studies . . . and make possible important education and community action programs designed to protect all hearts.

GIVE...
so more will live
HEART FUND



Contributed by the Publisher

TEST EQUIPMENT

Ramp generator for large-screen CRTs



ITT, Industrial Products Div.,
15191 Bledsoe St., San Fernando,
Calif. Phone: (213) 367-6161.

An auxiliary time-base generator for any large-screen CRT application provides all waveforms necessary to produce a triggered time base for a CRT display. For other precision timing applications, the instrument offers accuracy, stability, and $\pm 0.1\%$ linearity. Sensitivity is 250 mV to 5 V. The instrument has full lockout for completely stable triggering.

CIRCLE NO. 295

Battery operated preamp quiet to 10 μ V



AGAC-Derritron, Inc., 600 N. Henry St.,
Alexandria, Va. Phone: (703) 836-4641. Price: from \$95.

Portable preamplifiers use a noise-cancelling circuit for an rms integrated broadband noise level below 10 μ V. Special low-noise versions can be provided with noise figures as low as 400 nV. Input impedance is 1000 M Ω and frequency range is 0.2 Hz to 100 kHz. Models are available in fixed gains of 0, 10, 20, 40 and 60 dB and variable gains of 0 to 20 and 20 to 40 dB.

CIRCLE NO. 296

Digital freq meter compares standards

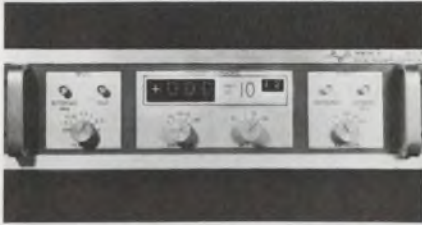

RMS Engineering, Inc., 486 Fourteenth St. N. W., Atlanta. Phone: (404) 873-5257.

A rapid, digital comparison of two frequency standards is provided by this meter. It is useful in the setting-on or calibration of secondary standards, and in short- and long-term frequency stability measurements. The instrument consists of a frequency offset multiplier (error expander) with a built-in frequency counter. Independent selection of multiplication factor and count period permits direct digital reading of frequency difference from 999 parts in 10^5 to one part in 10^{13} .

CIRCLE NO. 297

Lab i-f amplifier offers two bandwidths



General Radio Co., West Concord, Mass. Phone: (617) 369-4400. Price: \$675.

A solid-state 30-MHz laboratory i-f amplifier features two bandwidths (0.5 and 4 MHz) and a noise figure of 2 dB. Its 6-inch meter has an expanded meter range of 1 dB full scale and a 50 dB compressed scale, as well as conventional decibel and crystal-current scales. The unit features a continuously adjustable gain control, video and i-f outputs, regulated amplifier power supply, a regulated LO supply adjustable from the front panel, and an attenuator with a range of 70 dB in 10-dB steps.

CIRCLE NO. 298

A standard fastener from the WORLD'S MOST COMPLETE LINE will save you TIME and MONEY



Instead of a special, perhaps one of our standard fasteners can meet your requirements.

We make a tremendous variety of eyelets, grommets, rivets, washers, snap fasteners, ferrules, hole plugs, terminals, and other similar fasteners. Tell us what you need and let us submit a standard fastener.

Send for our general catalog which illustrates over 1000 metal articles.



Stimpson



70 FRANKLIN AVENUE,
BROOKLYN, NEW YORK 11205

ULster 5-3131

1515 S.W. 13th COURT,
POMPANO BEACH, FLA. 33060

WEbster 3-3355

Deposit Any Thin Film



New RF Plasma Sputtering Systems

- High deposition rates: up to 1200 Å / minute
- High uniformity of deposition
- Elimination of heated filaments increases reliability and film purity
- Low operating pressure: down to 2×10^{-4} Torr
- Bakeable to 200° C
- Easy to use
- Complete system, nothing more to buy

Write for complete information. Varian Vacuum Division, Palo Alto, California; Zug, Switzerland; Georgetown, Ontario.



varian
vacuum division

ON READER-SERVICE CARD CIRCLE 77

MATERIALS

Heat dissipators for D-case transistors

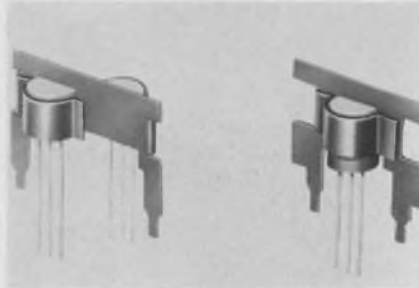

International Electronic Research Corp., 135 W. Magnolia Blvd., Burbank, Calif. Phone: (213) 849-2481. P&A: 2-1/2¢ to 3-1/2¢ (single mount), 3-1/2¢ to 5-1/2¢ (dual mount); stock.

Two heat dissipators/retainers for D-case plastic transistors have efficiencies such that the operating power range of the transistors can be increased approximately 33%. Both feature a spring clip retaining device which accommodates variations in case diameters. This feature permits the dissipators to fit transistors such as TO-98, RO-67, TO-92 and X 20. All models are available in brass or beryllium copper, unplated or with a black chemical oxide or black cadmium finish.

CIRCLE NO. 314

Organic PC coating conserves solder

Alpha Metals, Inc., 56 Water St., Jersey City, N. J. Phone: (201) 434-6778.

An organic coating for use on laminates and printed circuit boards reduces the amount of solder used per board, prevents excess contamination of solder from metal solution, eliminates bridging of adjacent conductors and permits closer spacing between lands. Fast-curing and silk-screenable, the coating is selectively applied to minimize the metal area exposed to solder during final assembly. The coating is non-conductive, nonhygroscopic and noncorrosive to both boards and components. The fully-cured material forms a protective coating on the bottom of a printed circuit board, eliminating the hazard of accidental shorts due to contamination. Current leakage because of high humidity is also reduced.

CIRCLE NO. 315

Low-loss laminate based on PPO

General Electric Co., Laminated Products Dept., Coshocton, Ohio. Phone: (614) 622-5310.

A low dielectric loss laminate based on polyphenylene oxide is for use in stripline circuits for microwave equipment operating from 300 MHz to 30 GHz. The PPO laminate reportedly offers a better balance of properties than any other material presently available for stripline application. These include irradiated polyethylene, polystyrene, Teflon, polystyrene-glass and Teflon-glass. Because the thermal coefficient of expansion of PPO is closer to copper than other polymers now being used in this type of circuit, the new laminate, after etching, more accurately conforms to design specifications. It shows little change in dielectric constant over a wide range of temperatures (-300° to $+300^{\circ}$ F) and frequency (1 MHz to 12 GHz). The heat distortion temperature is 380°F. Sheets are available in sizes between 7 by 9 and 36 by 36 inches, clad with copper, aluminum foil or unclad (nonadhesive).

CIRCLE NO. 316

Aluminum braze alloy accepts plate, anodize

Jensen Alloys, 3630 E. Indian School Rd., Phoenix. Phone: (602) 955-0180. Price: \$4.99 (trial kit).

A low-temperature brazing material for joining aluminum and its alloys is geared to brazing or welding of parts which must later be plated or anodized. Alloy 601 closely matches aluminum in color and physical properties. Joints made with this material are claimed to be as strong as aluminum, flexible and resistant to corrosion. They may be heat treated, anodized or plated. The melting temperature of the alloy is approximately 1031°F, almost 200° below the melting temperature of pure aluminum. It is applied with an acetylene torch in conjunction with flux. The alloy is furnished in 15-inch long extruded rods in diameters of 1/16, 3/32 and 1/8 inch.

CIRCLE NO. 317

160V

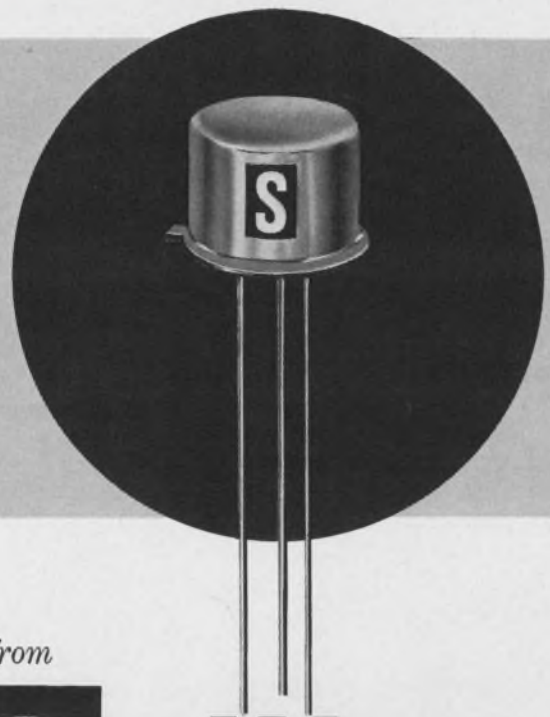

pnp silicon chopper transistors

from

Solitron

Solitron, now in full production of small signal transistors, has a complete line of PNP Silicon Choppers with voltage capabilities up to 160 Volts. Identified as the SSS 1001-4 Series, these devices are available in the TO-5 package. They offer high reliability, low saturation voltages and can be purchased as pairs with offset voltages matched to $100 \mu\text{V}@T_A=25^\circ\text{C}$. A few of their many circuit applications include modulators, servos, telemetry and multiplexing.

Type Number TO-5	Power Dissipation $T_A = 25^\circ\text{C}$ (mW)	Rated Breakdown Voltages			I_{ECX}			I_{pI}		$V_{CE(ISO)}$		C_{obo}	
		V_{IBKBO} (Volts)	V_{IBKTO} (Volts)	V_{IBKSO} (Volts)	Max (na)	V_{EC} (Volts)	V_{EC} (Volts)	Max (na)	V_{EC} (Volts)	Max (mV)	I_B (μa)	Max (pf)	V_{CE} (Volts)
2N 1920	250	-40	-18	-40	-2.5	10	-15	-1.5	10	3.0	-500	14	-6
2N 1921	250	-50	-50	-50	-10	10	-30	-2.0	10	4.0	-750	14	-6
2N 3345	250	-50	-50	-50	—	—	—	—	—	3.0	-1000	25	-0
2N 3346	250	-50	-50	-50	—	—	—	—	—	1.5	-1000	25	0
2N 1922	250	-80	-80	-80	-10	10	-50	-2.0	10	4.0	-750	14	-6
SSS 1001	400	-100	-100	-100	-10	10	-60	-3.0	10	2.0	-750	30	-6
SSS 1002	400	-120	-120	-120	-10	10	-70	-3.0	10	2.0	-750	30	-6
SSS 1003	400	-140	-140	-140	-10	10	-80	-3.0	10	2.0	-750	30	-6
SSS 1004	400	-160	-160	-160	-10	10	-90	-3.0	10	2.0	-750	30	-6

*Emitter Offset Current **Emitter Offset Voltage

DIAL 1- 800-327-3243 FOR A NO CHARGE TELEPHONE CALL AND FURTHER INFORMATION

Solitron DEVICES, INC.

1177 BLUE HERON BLVD. / RIVIERA BEACH, FLORIDA / (305) 848-4311 / TWX: (510) 952-6676

Leader in Germanium and Silicon Transistors, Cryogenic Thermometers, High Voltage Rectifiers, Hot Carrier Diodes, Temperature Compensated Zeners, Voltage Variable Capacitors, Random/White Noise Components, Microelectronic Circuits, and Power-Sink Interconnection Systems.

ON READER-SERVICE CARD CIRCLE 78

X-band circulator economizes a port



Airtron, Div. of Litton Industries, Morris Plains, N. J. Phone: (201) 539-5500. P&A: \$350; 60 to 90 days.

With a peak power of 300 kW and an average power of 300 W, this 3-port junction circulator operates in X band in WR-112 waveguide. The unit is claimed to be 10 times smaller than a 4-port with comparable power-handling capacity. Used as a circulator, isolator or duplexer, it features an insertion loss of 0.3 dB and isolation of 20 dB.

CIRCLE NO. 318

Noise-temp calibrator NBS - accurate

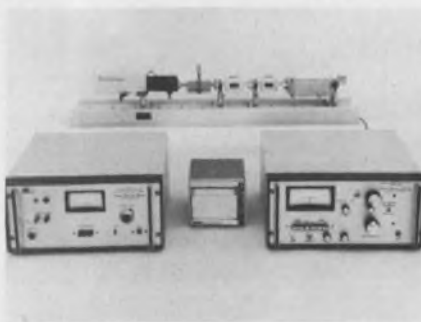

Airborne Instruments Laboratory, Div. of Cutler-Hammer, Deer Park, N. Y. Phone: (516) 595-5823.

Used to calibrate gas-discharge noise sources, this microwave noise temperature calibrator includes an i-f switched radiometer that compares the output of an unknown noise source to that of a reference standard noise source. The difference (in dB) between the relative excess noise temperatures of the unknown and the standard is read from a digital drum dial.

CIRCLE NO. 319

Coax bandpass filter spans 2.2 to 2.3 GHz



Microlab/FXR, 10 Microlab Rd., Livingston, N. J. Phone: (201) 992-7700. P&A: \$275; stock.

Covering 2.2 to 2.3 GHz for use in telemetry receivers and down converters, this coax filter provides the necessary image rejection when employed in the rf stage of a dual-conversion receiver such as results when a 200 to 300 MHz receiver is used in conjunction with a 2.2 to 2.3 GHz down converter. The filter offers high rejection band characteristics—50 dB at 2040 and 2460 MHz—with 80 dB minimum image rejection.

CIRCLE NO. 320

Slotted line keeps residual VSWR down



Alford Manufacturing Co., 299 Atlantic Ave., Boston. Phone: (617) 426-2150. P&A: \$1140; stock to 30 days.

This 7-mm coaxial slotted line with APC-7 output connector is operable through 18 GHz. Compensated dielectric pins instead of a conventional bead are used to support the inner conductor. Rated residual vswr is under 1.005 to 3 GHz, 1.008 to 6 GHz, 1.013 to 11 GHz and 1.025 to 18 GHz. The slotted line is equipped with a type N jack connector and probe output.

CIRCLE NO. 321

Mixer/modulators span dc to 1 GHz



Relcom, 2164 E. Middlefield Rd., Mountain View, Calif. Phone: (415) 961-6265. P&A: \$120 (1 to 4); stock.

Using matched hot-carrier diodes, this double balanced mixer spans dc to 1 GHz with 40-dB isolation for improved switching ratio and low intermodulation products. The mixer is used for frequency conversion, phase code modulation, pulse modulation, current-controlled attenuation and phase detection. Specifications include 40-dB LO isolation, 7-to-9-dB SSB noise figure and 7-to-9-dB SSB conversion loss.

CIRCLE NO. 322

Microwave tuning unit spans 2 to 75 GHz



Polarad Electronic Instruments, 34-02 Queens Boulevard, Long Island City, N. Y. Phone: (212) 392-4500. Price: \$2750 (tuning unit), \$3100 (receiver).

Covering the 2-to-75-GHz range, this microwave tuning unit plugs into Polarad's general-purpose antenna-pattern receiver. Two features provide maximum sensitivity: variable local oscillator injection and a 1-kHz modulated first LO operating with a 1-kHz video output filter. Operating modes include a-m, fm, cw, pulse and mcw.

CIRCLE NO. 323

Coax magnetron gives 250 kW at X-band



SFD Laboratories, Inc., 800 Rahway Ave., Union, N. J. Phone: (201) 687-0250.

A mechanically tuned coaxial magnetron for airborne and ground-based radar systems develops 250 kilowatts peak power over a frequency range of 8.5 to 9.6 GHz. The 19-pound, air-cooled tube can be used in systems now using the 6249 tube family in any mounting position. The low pushing factor (50 kHz/A) permits a high quality rf spectrum.

CIRCLE NO. 324

Rf balanced mixer mounts PC boards

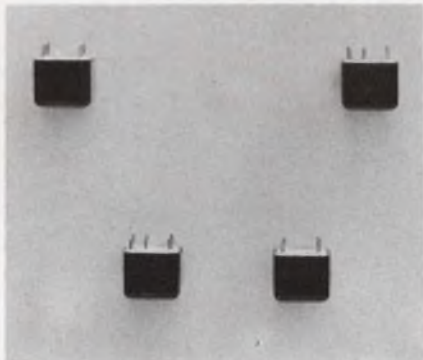

Comdel Inc., Beverly Airport, Beverly, Mass. Phone: (617) 468-3541. P&A: \$42; stock.

For use in communication and data transmission systems, these broadband rf mixers have a noise figure of 6 dB, SSB. Maximum signal input is 1 volt behind 50Ω. Input and output are transformer-coupled for 50-Ω systems. Applications are in SSB rf transmitters where low intermodulation distortion, wide bandwidth and good balance are required.

CIRCLE NO. 325



Methode makes all styles and types

It makes no difference what your quantity or delivery requirements may be: Methode Electronics has the stock, and the production capacity to supply your needs right now!

Dependable, precise Methode fork contacts, receptacles, contact strips and disposable contact strips are available in all sizes and configurations; fully interchangeable and compatible; featuring the originally designed split leg construction which saves you money.

Connectors available with 3 to 51 contacts in all popular termination styles.

We invite your inquiry.

Connector Division
Methode Electronics, Inc.
 7447 W. Wilson Ave.
 Chicago, Illinois 60656 • 312/867-9600

Avnet stocks Methode's full line of connectors across the country... order today!

Licensed under Elco patents

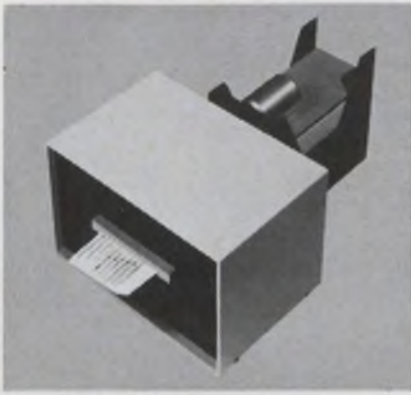

TAURUS

"SERIAL" CARD READER

Taurus Model 600 reads standard 80-column, 12-row cards, serially, column by column, 10 or 40 columns per second. (8 to 30 cards per min.) Alpha-numeric or other symbols accepted. For industrial control, remote transmission, interfaced with typewriter, or for card duplication or correction. Automatic card feed available for sequential feeding of up to 350 cards.

Send for 1967 Catalog



TAURUS Corporation

Academy Hill, Lambertville, N. J. 08530

Also teflon terminals and PC board traks.
ON READER-SERVICE CARD CIRCLE 80

If you are attending WESCON, and we hope you are, please be sure to pick-up your free copy of Electronic Design's WESCON EXTRA at booth 3622 in the Cow Palace's South Exhibit Hall. The EXTRA contains all the Show news you need to know.

The Editors

MICROWAVES

L-band filter attenuates harmonics

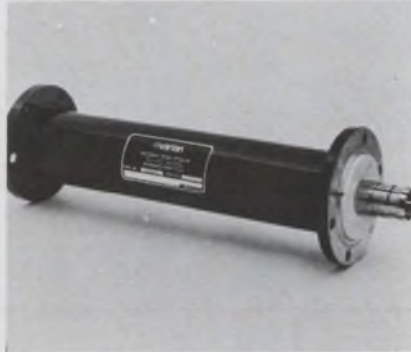

Varian Associates, 611 Hansen Way, Palo Alto, Calif. Phone: (415) 326-4000.

This coax low-pass, reactive filter attenuates the harmonic outputs of a high-power transmitter operating in the range of 820 to 890 MHz. It consists of alternating high- and low-impedance coax line segments in series. This permits the transmission of the operating band power while reflecting its harmonics. VSWR is 1.2 and losses are 0.1 dB.

CIRCLE NO. 327

S-band transmitter delivers 20 watts

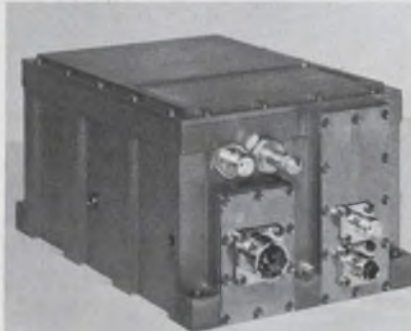

EMR, Telemetry Div., Box 3041, Sarasota, Fla. Phone: (609) 924-9100.

Designed for aerospace telemetry applications, this uhf fm transmitter is capable of delivering 20 watts minimum signal at S-band frequencies in the 2200-to-2300-MHz range. Center frequency stability is within $\pm 0.003\%$ under all environmental conditions and for up to $\pm 1\%$ fluctuations in supply voltage. Frequency response is within ± 1 dB for modulation frequencies in the range of dc to 350 kHz. At deviations up to 350 kHz the transmitter experiences less than 0.5% non-linearity.

CIRCLE NO. 328

Low-cost log i-f amp can be gain matched

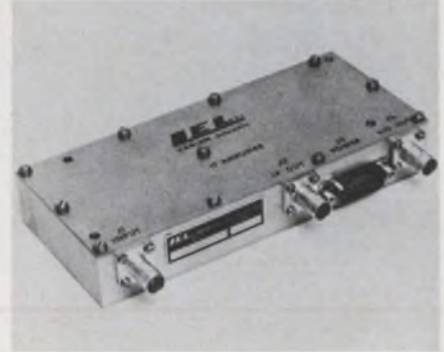

Varian Associates LEL Div., Akron St., Copiague, N.Y. Phone: (516) 264-2200. P&A: \$325; stock to 30 days.

For use in microwave receivers, this log amp provides a logarithmic video output with a 70-dB input dynamic range. When used in place of an agc i-f amplifier, improved performance is achieved in reception of high-speed pulses. Video output is proportional, within ± 2 dB, to the logarithm of the input over a range of -60 to $+10$ dBm. Standard models are available at 30 or 60-MHz center frequency, 4 or 8-MHz bandwidth. The amplifier operates in a 50- Ω i-f system. Output is a 25-mV/dB pulse, delivered to a 1-k Ω load. Amplifiers may be ordered as matched pairs, with log video amplitude matched to 1 dB.

CIRCLE NO. 329

Fm transmitter gives 0.5 W to 7 GHz

RHG Electronics Laboratory, Inc., 94 Milbar Blvd., Farmingdale, N. Y. Phone: (516) 694-3100. P&A: from \$6900; 10 to 12 wks.

A missile-grade, solid-state fm transmitter has output powers of 1 watt to 2.4 GHz and 0.5 watt to 7 GHz. The lightweight (under 10 lbs), transmitter is applicable in missile environments for the transmission of fm-TV, multichannel telephony or high-speed telemetry data. The transmitter consists of a temperature-compensated varactor-tuned oscillator feeding a power amplifier-multiplier chain. An RF filter and a ferrite isolator are provided, along with a video amplifier, preemphasis and modulator circuitry.

CIRCLE NO. 330

Direct-read attenuators range to 90 GHz

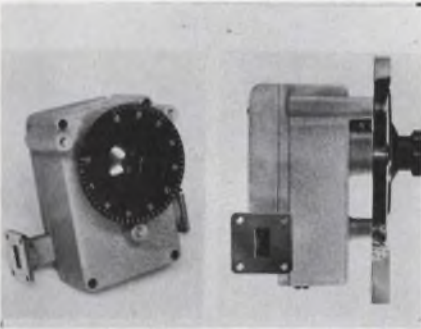

Demornay-Bonardi, Div. of Data-pulse Inc., 1313 N. Lincoln Ave., Pasadena, Calif. Phone: (213) 681-7416. P&A: \$350 to \$700; 30 to 45 days.

Eight direct-reading attenuators for 7.05 to 90 GHz each have an attenuation range of 0 to 50 dB. VSWR is 1.15, accuracy is ± 0.5 dB and maximum insertion loss is 0.5 dB. Short insertion length (6 inches for X-band) permits use in systems where compactness is of major importance. Insertion length for Ku band is 5 inches.

CIRCLE NO. 331

Miniature TWT gives 1 watt at 2 GHz



Eimac, Div. of Varian, 301 Industrial Way, San Carlos, Calif. Phone: (415) 592-1221.

Producing 1-watt output power at 1 to 2 GHz, this TWT measures 8 inches in length and weighs one pound. The gridded TWT features 30-dB minimum gain, is ppm-focused, and meets MIL-E-5400 environmental specifications. Construction is ceramic/metal. The tube is available in a serrodynable configuration, or with depressed collector.

CIRCLE NO. 332

Fm calibrator spans 10 MHz to 16 GHz

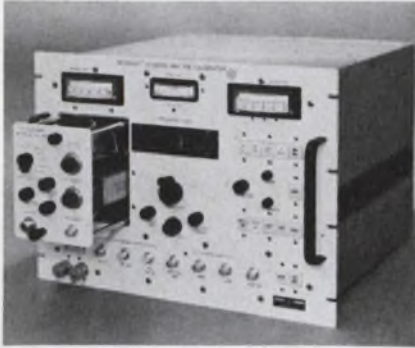

Microdot, Inc., 220 Pasadena Ave., South Pasadena, Calif. Phone: (213) 799-9171.

A dual-purpose fm calibrator and signal generator, this unit calibrates and evaluates frequency-modulated characteristics on transmitters, signal sources and receivers. It covers 10 MHz to 16 GHz by using six plug-in modules. Power up to 20 mW (available to drive klystrons and TWT amplifiers) is obtainable over the entire frequency range. Accuracy and stability of frequency and for generating elements are independent of the plug-in heads and are maintained over the entire frequency range to within 3% on transmitters, receivers and fm indicator devices.

Provision is made for reading frequency with an external counter and for setting accuracies of deviation with reference to an electronic digital readout. Measurements can be made of carrier shift as a result of modulation, incidental fm of high-level signal generators and bandwidth characteristics of fm receivers. Automatic band change is available with each plug-in module.

CIRCLE NO. 333

Flexible waveguide in continuous lengths

Andrew Corp., P. O. Box 807, Chicago. Phone: (312) 349-3300.

Heliac flexible elliptical waveguide for the 1.95-to-2.7-GHz band is available in splice/free continuous lengths. Waveguide characteristics for lengths up to 200 feet are: attenuation of 0.39 dB per 100 feet from 2.5 to 2.7 GHz, average power of 23.5 kW and VSWR of 1.17 to 1.1.

CIRCLE NO. 334

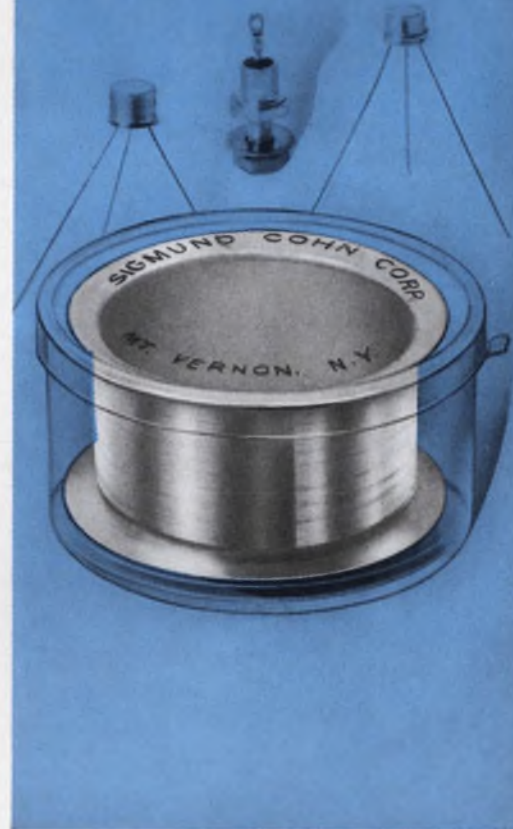

Sigmund Cohn Corp. Offers Fine Sizes in High Quality

Aluminum Alloy Bonding Wires

for Thermo-Compression and Ultrasonic Bonding

- Good bonding characteristics
- Excellent reproducibility
- Maximum homogeneity

In a variety of alloys, such as Aluminum 1% Silicon; Aluminum 1% Magnesium; No. 1100 Aluminum

Write for New Engineering Bulletin

Sigmund Cohn Corp. 121 So. Columbus Ave., Mount Vernon, N.Y. 10553



Since 1901

NEW FREEDOM SHARES

**What are they?
Who may buy them?**



Americans have put their savings to work for freedom through U. S. Savings Bonds for many years. New Freedom Shares do the same job... plus. Read how.

Freedom Shares are U. S. Savings Notes. They pay a higher return than Savings Bonds, 4.74% when held to maturity. And they mature in just four-and-a-half years.

For regular Bond buyers only

These new Freedom Shares — which are not redeemable for the first year — are offered on a one-for-one basis with E Bonds, but only to people who belong to the Payroll Savings Plan where they work or the Bond-a-Month Plan where they bank.

There are four denominations of Freedom Shares, each of which may be paired with a Series E Bond of the same or larger denomination, as a "package."

For instance, for \$39 total, you can purchase a Savings Bond that matures at \$25 and a Freedom Share that matures at \$25.

America needs your help

When you buy Savings Bonds and Freedom Shares, you do an important job for freedom, backing our men in Vietnam and helping to keep our country economically strong. The need is urgent. What you do counts.

Sign up

Tell your supervisor or the Payroll Department where you work (or any officer where you bank) that you'd like to join a Bond purchase plan. Decide how much you'll save... whether you want Freedom Shares as well as Bonds... and just sign the authorization card.

You'll be helping your country as you help yourself. And the country needs your help.



The U. S. Government does not pay for this advertisement. It is presented as a public service in cooperation with the Treasury Department and The Advertising Council.

SYSTEMS

Drum memory system expands computers



Vermont Research Corp., Precision Park, North Springfield, Vt. Phone: (802) 886-2255. Price: \$9950.

Complete with interface hardware and drum routine software, this drum memory system adds 131,072 words to the 4096-word core memories of PDP-8, 8/S and other small computers. The 1104S drum system, coupled with an 8/S, permits extremely long or complex programs in machine or process control applications. As a peripheral computer, the 1104S-8/S can monitor and control up to 62 I/O devices, with complex processing. Used as a substitute for a time-sharing terminal, it is competitive in cost and does not require transmission lines or special programming for security.

The software package includes routines which transfer data between core memory and drum in one-page bites, under program control. These routines transfer all but the last page of core (used for counters and tape loaders), all but the last two pages or selected pages with program interrupt active or disabled. To permit processing between interrupts, word transfer rate (for 8/S systems) is set at one word per millisecond. For use with PDP-8 data break systems word rate may be set as high as one word every 17 μ s.

The system provides X32 enlargement of total capacity, with average access time of 8.3 ms. A number of assemblers, editors, object programs and subroutines can be stored for use by program or manual call-out. The maximum transfer of 31 pages requires less than 4.4 seconds. Commonly used programs may be exchanged in a few seconds.

CIRCLE NO. 337

Decom data formatter accurate to 0.025%



Stellarmetrics, Inc., 416 E. Cota St., Santa Barbara, Calif. Phone: (805) 963-3566. P&A: \$7500; 30 days.

This decommutation data formatter has accuracies of 0.025%. The unit handles signal conditioning, sampling and holding, channel and frame synchronization and frame sync detection. It operates at any rate from one to 10,000 pps on signals with up to 999 channels per frame, and will handle all time-shared analog telemetry wave trains conforming to IRIG or industrial formats.

CIRCLE NO. 338

Digital interpolator cuts data costs



Boston Digital Corp., Ashland, Mass. Phone: (617) 881-1600. Price: \$6500.

Digital interpolation, when used in numerical control systems and computer-controlled systems, can reduce the volume of data and computing capacity required for a given control problem, lower the cost of data preparation, increase control accuracy (resolution) and rate and provide better system reliability by decreasing volume data transmission. This special-purpose digital interpolator is capable of

controlling two axes or variables accurately with a minimum of input data. Standard input interfaces are manual thumbwheel, punched paper tape and on-line computer. Output is in the form of logic level pulses representing the incremental changes of the input variables. The pulse output is particularly adaptable to digital step motor control.

CIRCLE NO. 339

PCM system transmits way-out data

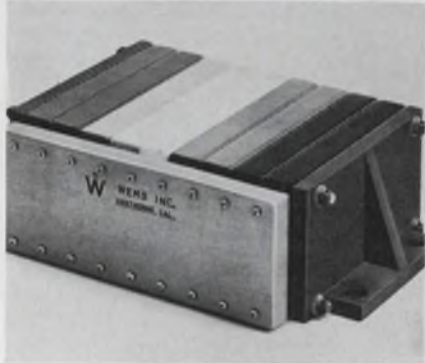

Wems, Inc., Electronic Products Div., 4650 West Rosecrans Ave., Hawthorne, Calif. Phone: (213) 679-9181.

A low-speed PCM system is capable of transmitting reliable telemetry data from deep space probes. Because of the low bit rate of the PCM telemeter, greater transmission distance is possible, eliminating garbled or lost data common in high-speed systems. In addition to high reliability, the telemeter features simplified A/D conversion. The solid state SSM-141 telemeter converts 104 channels of analog data into a synchronization NRZ digital output format of 125 eight-bit words. Sixty channels are sampled at 0.1 per second from analog sources of 0.125 V, while an additional 40 channels are sampled at 0.1 per second from data sources of zero to 5 volts.

Bilevel channels are sampled at a rate of one each second and a sampling rate of 125 times per second to provide for an additional bilevel channel. A serial time word is sampled twice each second. Each of the 125 word frames (excluding the 8th bit) is a digital representation of an analog input. The eighth bit monitors a bilevel input data channel.

CIRCLE NO. 340

Multiplier actual size
3" x 2" x 5/8"



3.75 Cubic Inch Analog Multiplier Requires No External Amplifiers

Advanced design makes possible this solid state DC voltage multiplier that performs multiplication, squaring, division, and square rooting. The multiplying function is accomplished without the use of special non-linear or magnetic devices.

Major features include DC differential inputs with common mode capability, mode selection by shorting pins, no critical supply regulation requirements, and no zero adjustments. The new four quadrant Intronics M 101 costs less than \$500, requires no external amplifiers and gives systems designers a compact, rugged answer to multiplier problems.

Features

Input Voltage	± 10 volts differential maximum	Operating Temperature	-25°C to $+85^{\circ}\text{C}$
Input Impedance	75,000 ohms minimum	Frequency Response (-3db)	DC to 1 KHz
Output Voltage	± 10 volts at 5 ma maximum	Supply Voltage	+ 15 to + 16 volts DC - 15 to - 16 volts DC at 50 ma maximum
Output Impedance	less than 1.0 ohm	Package	3" x 2" x 5/8" Solid Epoxy Encapsulated Module with 0.25" Long, .040" Diam. Gold Plated Pins
Linearity	0.25% full scale	Mil Specs:	Meets MIL Standards.
Output Offset (both inputs zero)	0 ± 10 mv DC max.		
Temperature Stability of Output Offset	0.5 mv/ $^{\circ}\text{C}$ -25°C to $+85^{\circ}\text{C}$		

Write or call Intronics 617-332-7350 for more information and a quotation.



intronics

I N C O R P O R A T E D

57 CHAPEL ST., NEWTON, MASSACHUSETTS 02158

ON READER-SERVICE CARD CIRCLE 82

EXCLUSIVE!

Now Measure Your Controlled Temperatures to 0.01°C



Model 390

EXPANDABLE SCALE THERMOMETER

with Expanded 1°C increment
Scale over 0 to 100° Range.

Solid state and direct-reading, the 390 features two modes, 0 to 100°C, with 1°C increments and 1-0-1°C range with 0.02°C increments — permitting for the first time, monitoring of temperatures directly to within 0.01°C resolution.

In ovens and baths, the 390 permits direct temperature measurement of material being treated or tested.

With second probe, temperature gradients or differential temperature measurements are possible in air, gas or fluids.

Large, easy-to-read meter, high stability, tilt-top meter housing, battery operated.

Other ranges available at no extra charge from -100°C to +500°C. in spans of 100°.

Price: \$690.00, less batteries, FOB Boonton (with one probe).



For Technical Data or
Free Evaluation Loan —
Write or Call John Carson

RFL Industries, Inc.

FORMERLY RADIO FREQUENCY LABORATORIES, INC.

Thermocontrol Div. • Boonton, N. J. 07005

Tel: 201-334-3100 / TWX: 710-987-8352 / CABLE RADARCO, N. J.

"See us at Booth No. 2307
and 2308 WESCON"

ON READER-SERVICE CARD CIRCLE 83

PRODUCTION EQUIPMENT

Silicon dice handled free of contaminants

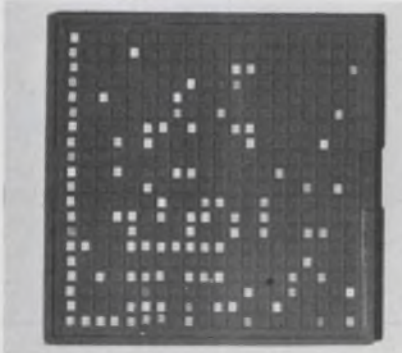

Quality Control Corp., Route 6, P. O. Box 477, Mahopac, N. Y. Phone: (914) 628-4554.

The handling and shipping of silicon dice poses several problems. Current techniques involve coating with wax, individual loading in capsules or sandwiching between polyurethane foam for protection during transit. After arrival, however, the dice require dewaxing with special chemicals or individual sorting and examination prior to use. Such excessive handling can produce a 20% to 30% rejection rate.

These molded Traypaks are a die casting of multicavity dimples with a coating of room-temperature vulcanizing silicon rubber. The silicon rubber acts as a cushion between a clear glass plate that is placed on top of the tray and the chips that are in the cavities. The entire unit can then be sealed with a heat-shrinkable plastic, thus providing a carrier completely safe from external contaminants and physical damage caused by intermingling. The units come in four sizes with 0.05 and 0.1-inch cavities containing from 200 to 900 dice.

CIRCLE NO. 341

IC test set expands capabilities

Birtcher Instrument Div., 1200 Monterey Pass Rd., Monterey Park, Calif. Phone: (213) 264-6610.

A larger version of Birtcher's IC test system provides 35 inches of vertical panel space for the incorporation of additional instrumentation. Analog tests and ac measurements such as rise time, propagation time, delay time and device limit may be made with internally-mounted units.

CIRCLE NO. 342

ICs tested, sorted TO-5 or dual-in-line

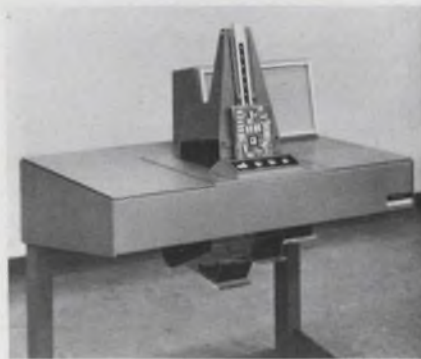

Daymarc Corp., 40 Bear Hill Rd., Waltham, Mass. Phone: (617) 894-2105.

Automatic testing and binning of flat pack, dual in-line or TO-5 integrated circuits is performed by this tester at rates of 7000 per hour for circuits with 150 ms test time, mounted in standard type carriers. Circuits are either bowl-fed or hand-fed and presented to test probe, then binned according to test results. Dc tests are performed with Kelvin connection, 28 contacts for 14-lead packs.

CIRCLE NO. 343

Ultrasonic unit cleans components



Bulova Watch Co., Inc., Chemical & Ultrasonic Products, Bulova Park, Flushing, N. Y. Phone: (212) 335-6000. P&A: \$165; stock.

Designed to clean electronic components before final quality control and before encapsulation, this transistorized system has an instant-starting solid-state self-tuning generator controlled by an external 1-to-15-minute timer. At the primary 60-kHz frequency, the unit cleans in both aqueous and solvent type solutions.

CIRCLE NO. 344

Drill ICs and PCs to 1-mil diameter

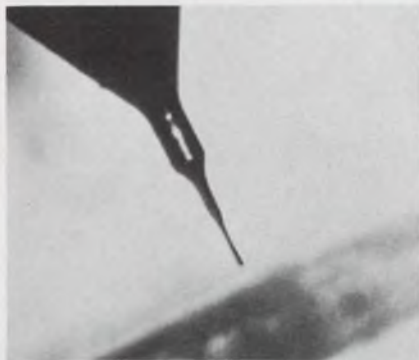

National Jet Co., 10 Cuyler Dr., La
Vale Cumberland, Md. Phone:
(301) 729-2300.

For microminiature drilling, this tooling system features optional automatic electronic and fluidic controls. Holes less than one-thousandth of an inch diameter can be drilled on a production basis, and simultaneous drilling of many holes per square inch can be done. Whether single or multihole drilling is used, the system permits holes to be located to within one-ten-thousandth of an inch. Roundness, run-out, and sizing tolerances are within the same range.

CIRCLE NO. 345

Magnetic stabilizer charges alloy magnets



Thomas & Skinner, Inc., 1120 E.
23rd St., Indianapolis, Ind. Phone:
(317) 923-5201.

A fully automatic high-speed system, this stabilizer is capable of magnetizing and stabilizing metallic alloy magnets to a predetermined value of flux density. The unit will fully charge and stabilize magnetic alloy magnets up to 1/4 lb with a stabilization accuracy within 2%. It is capable of up to 1000 charging cycles per hour.

CIRCLE NO. 346

Sample and hold. Sample and hold. Do dah. Do dah.

The closed-loop performance of Redcor/Modules' new Sample-and-Hold will put a smile on your face and a spring in your step. The 770-715 has an accuracy of 0.01%. If that don't get you, try a settling time of 5 microseconds for 20V step input. Or how about an input impedance of 10 megohms at 1 kc? Maybe a frequency response of DC to over 50 kHz? This performance, friends, is yours for a mere \$250 in quantities of 50. Redcor makes equally appealing comparators,

dynamic bridge and buffer amplifiers, 8-channel multiplexers, plus 0.1% Sample-and-Holds. They all have a great new pin layout that for the first time lets you easily interconnect modules with dual in-lines. So quit clapping your hands long enough to request complete data.

REDCOR 7800 DEERING AVENUE
CANOGA PARK,
CALIFORNIA 91304
(213) 348-5892 • TWX 910-494-1228

ON READER-SERVICE CARD CIRCLE 84

SMALLEST RELAMPABLE T-1 CONFIGURATIONS

new from Eldema



actual size

H-Lites, a new Eldema series of indicator lights, offer the smallest relampable lamp housings and lens caps for the T-1 flange base lamp size. Features: both grounded and ungrounded housings. Lamps replaceable from the front. RFI shielding. 5/16" mounting hole for two-

terminal style; 1/4" for single-terminal style. Designed to MIL-L-3661.

Available in a variety of lens styles and colors. Waterproof versions available. Write for complete data on the H series from Eldema, where innovation is a way of life.

ELDEMA

A Division of Genisco Technology Corporation
18435 Susana Road / Compton, California / (213) 774-1850

ON READER-SERVICE CARD CIRCLE 85

new, low cost!

Reliable Circuit Breaker



Model 375 at 90¢ (prod. qty.) designed with the famous TAYLOR Bi-metal patented Blade for unsurpassed repeatability and reliability.

Write for Data Sheet 375.



WOOD ELECTRIC CORPORATION

244 Broad Street, Lynn, Mass. (617) LY8-5313

ON READER-SERVICE CARD CIRCLE 86

PLASTIC SEALLESS PUMP

... no corrosion, no contamination, no leakage
Standard capacities are from 1/3 to 40 gpm

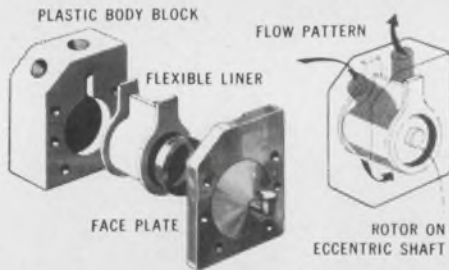

A rotor, mounted on an eccentric shaft in this plastic pump, rotates within a liner to create a progressive squeezing action on fluid trapped between the liner and the body block. All metal parts and mechanical action takes place inside the liner where fluid never reaches. This completely eliminates the need for stuffing boxes or shaft seals, guaranteeing no leakage.

The pump is self-priming, operates wet or dry and is suitable for extremely corrosive fluids, abrasive slurries or viscous materials. Applications include pumping of acids, alkalis, distilled water, diatomaceous earth slurries, electroplating solutions, ceramic tile glaze as well as shear sensitive emulsions.

Standard capacities are from 1/3 to 40 gpm with discharge pressure up to 50 psi. Materials of construction include Teflon, polypropylene, linear polyethylene, Bakelite or stainless steel for body blocks and Viton-A, Kel-F elastomer, Hypalon, Neoprene and Buna-N for the liner. These are the only parts in contact with the fluid.

For additional information, write Vanton Pump & Equipment Corporation, Hillside, New Jersey or telephone Area Code 201 926-2435.

ON READER-SERVICE CARD CIRCLE 87

Application Notes



(a) PHASE REVERSAL



(b) PSEUDORANDOM CODE



(c) SPREAD SPECTRUM

Phase modulator design

The phase modulator and multiplexing amplifier described in this 6-page note consist of two amplifiers in parallel, both gated to provide an output from either amplifier. In the phase modulator, a common signal is fed to both amplifiers and the outputs are connected to be out of phase. Gating from one to the other gives an output phase reversal of 180°. A phase modulator for use in a pseudorandom coder illustrates the application. The modulator's output signal is shifted in phase by 180° every time a trigger is applied (a). If a nonperiodic trigger waveform (b) is applied to the phase modulator in conjunction with a single frequency carrier, the output spectrum is spread from a single line to a noise-like spectrum (c). Design specifics, schematics and test results are given in the discussion. Westinghouse, Molecular Electronics Div.

CIRCLE NO. 347

Voltage comparator uses

Signetics 518 is a monolithic, medium-gain, high-frequency diff amp with an output stage suitable for driving digital circuits. It is ideal for applications in interfacing analog and digital systems. A typical application for the voltage comparator is in analog-to-digital converters similar to the one shown above. Design procedures for this and other circuits are given in this 8-page illustrated note. Signetics.

CIRCLE NO. 348



a TCXO that fits almost anywhere

and offers exceptional frequency stability between -55°C and $+85^{\circ}\text{C}$

Only about $\frac{1}{2}$ of a cubic inch in size, this TCXO (temperature compensated crystal oscillator) offers excellent frequency stability; 5 ppm over a temperature range of -55°C to $+85^{\circ}\text{C}$. It's one of four new miniature TCXO's from Motorola. The slightly larger models offer stabilities as low as ± 1 ppm. Zener diode regulated compensating circuits provide on-frequency operation the instant they're turned on. All-silicon solid-state construction provides exceptional reliability. Take a look at these facts.

See it at Booths 3116 & 7 at WESCON



MOTOROLA
PRECISION
INSTRUMENT
PRODUCTS

SMALL SIZE: Sizes range from 0.58 cubic inch to 3.4 cubic inches.

WIDE TEMPERATURE RANGE: From -55°C to $+85^{\circ}\text{C}$.

HIGH FREQUENCY STABILITY: Available as low as ± 1 ppm.

WIDE FREQUENCY RANGE: From 1 MHz to 30 MHz.

LOW POWER CONSUMPTION: As low as 100 milliwatts.

NO WARM-UP TIME: Adjusts instantly to temperature conditions.

FOR MORE INFORMATION contact your Motorola representative. Or write for bulletin TIC-3213.

MOTOROLA COMMUNICATIONS AND ELECTRONICS INC.
Dept. ED, 4900 West Flournoy Street
Chicago, Illinois 60644. A subsidiary of Motorola Inc.

ON READER-SERVICE CARD CIRCLE 88



“Bring me your resistors, your capacitors, your other component parts.

(And I will lead you to a measurement accuracy of 0.05%.)”

Let our new Model 292 usher you into the promised land of high accuracy impedance measurement. Here in one system you have the capabilities to measure resistance and conductance to $\pm 0.05\%$, inductance and capacitance to $\pm 0.1\%$.

We've designed it to give you easy access to each circuit element for individual use and ease of calibration. This package “laboratory” of six high accuracy bridge circuits will handle 99% of the measurement requirements of the average inspection, quality control or calibration department. It's so easy to operate you don't need an instruction manual (although one is provided for those who like to read!)

Earlier models of this system have been living up to specifications for eight years now. If you haven't heard about the ESI Impedance Measuring System before this, remember: it took Moses 40 years to discover his promised land. ESI® 13900 NW Science Park Drive, Portland, Oregon (97229).

Model 292 Universal Impedance Measuring System

Resistance and Conductance

Range: 0 to 1200 kilohms — (R)
0 to 1200 milliohms — (C)

Accuracy: $\pm 0.05\%$ + 1 dial division

Capacitance and Inductance (Series & Parallel)

Range: 0 to 1200 microfads — (C)
0 to 1200 Henrys — (L)

Accuracy: $\pm 0.1\%$ + 1 dial division

Sensitivity:

DC — 5 microvolts
AC — 20 microvolts

Frequency: 1 KC supplied (others available)

Price: \$1380

Note: For related capability in a proven, portable design, inquire about our Model 250 DA at \$550.

New Literature



Rf communications designs

A comprehensive rf circuit design library booklet containing circuit design and testing information from Motorola's rf applications engineering staff has been compiled. The 150-page volume includes 10 authoritative application notes which describe the use of basic techniques for rf design, plus specific rf applications. The guidebook includes specifications for rf amplifier transistors to assist the design engineer in selection. Some of the topics covered in this guide include: “Whats and whys about Y-parameters,” “Systemizing rf power design,” “Rf small signal design using admittance parameters,” and “A 50-watt, 50-MHz solid state transmitter.” Motorola Semiconductor Products, Inc.

CIRCLE NO. 349

Data on indicating devices

Sixteen models of indicating devices are detailed in this bulletin. It includes microminiature “bite” indicators, which monitor circuit or system performance, military and industrial elapsed time indicators and events counters, sweep scale and digital stop clocks and a laboratory stop clock. A. W. Haydon Co.

CIRCLE NO. 350

Materials for motors

A 50-page catalog of standard electrical insulating materials for the motor repair and maintenance industry is now available. It features illustrations, descriptions, prices and ordering information on products used for motor repair and maintenance. Insulation Manufacturers Corp.

CIRCLE NO. 351

Glass-to-metal seals

A revised issue of Airpax's ninety-page glass-to-metal seals indexed catalog is available. The volume describes a line of standard compression and matched seals and includes a special and custom seal components section and pin layout diagram data. The brochure contains dimensional drawings, test voltage ratings and current capacities. Airpax Electronics.

CIRCLE NO. 352



Basics of adhesive use

A 10-page illustrated booklet entitled “How to Make Adhesives Work for You” tells why and where adhesives should be used. Answers on how to select an adhesive and what tests to use to determine its effectiveness, temperature considerations, joint designs, and how to adapt adhesives for assembly-line use are contained in the presentation. Armstrong Cork Co.

CIRCLE NO. 353

Magnetic tape maintenance

A 32-page booklet entitled “Magnetic Tape Maintenance for Computer Managers” combines the following individual publications into one: The Tape Management Program, The Technology of Tape Preventive Maintenance, The Tape Preventive Maintenance and Rehabilitation Process and Why is Tape Preventive Maintenance Needed? The presentation deals with tape problems faced by computer tape users and offers a program to reduce operating cost and tape procurements. General Kinetics Inc.

CIRCLE NO. 354

Electro Scientific Industries **esi**®

ON READER-SERVICE CARD CIRCLE 96



Does Ford Make Automobiles ?



Does IBM
Make Computers ?

Does Boeing Make Airplanes ?



Does CLIFTON Make Servo Packages ?

Sure, it's a Big part of our Business !

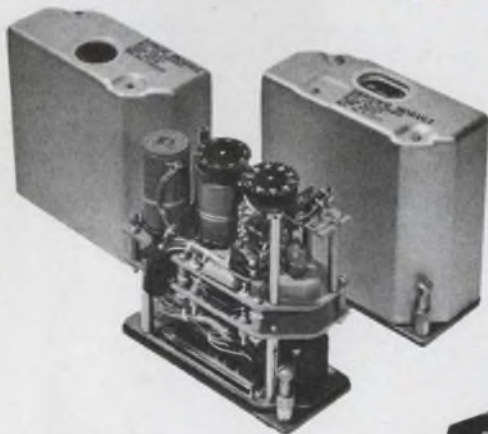

TACAN
RANGE AND
BEARING COUPLERS

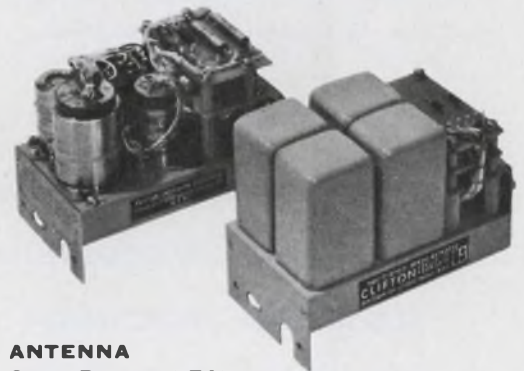

ANTENNA
CONTROL REPEATER
ELECTRO-MECHANICAL or SOLID STATE

DISCRETE MESSAGE INDICATOR
DATA LINK SYSTEMS



AUTOMATIC
STABILIZATION
ACTUATOR—SEA KNIGHT

Our Special Devices Group for the past 10 years has designed, developed, and manufactured an extremely wide variety of electro-mechanical and electronic packages for aircraft and ground support equipment. We are also well versed in the solid state technology which is replacing electro-mechanics in some instances. We are flying in the F-111, A7A, CH47A, 727 and dozens of our country's most important aircraft.

In your next "make or buy" situation, let Clifton engineering solve your problem—and with CLIFTON QUALITY built in!

For further information call your local Clifton Sales Office or Ed Fisher 215 622-1000; TWX 215 623-1183.

CLIFTON 
DIVISION OF LITTON INDUSTRIES



Thumbwheel Switches For Industrial Control

These panel-mounted thumbwheel switches offer you convenient control devices for presetting digital information. A visual indication of the setting is provided by easily-read characters on each thumbwheel.

You can use these switches for binary decimal coding or decoding, or for straight decimal circuitry. They are available for special functions, and the use of four independent contact wipers and built-in diode gates make them readily adaptable to individual circuit requirements. The thumbwheel switches can be used in single pole, double pole and four pole switch applications.

For mounting, standard facades are available to accommodate from 1 to 9 switches on $\frac{1}{8}$ " centers. Send for technical data now.

AWHAYDON
THE COMPANY

232 North Elm Street
Waterbury, Conn. 06720

4060 Ince Boulevard
Culver City, Calif. 90231

Timing & Stepper Motors • Electromechanical & Electronic Timing Devices & Systems

ON READER-SERVICE CARD CIRCLE 98

**YOUR POSTMASTER RECOMMENDS
THE USE OF ZIP CODE NUMBERS
IN RETURN ADDRESSES—
THEY WILL PERMIT LARGE MAILERS
SUCH AS BANKS,
INSURANCE COMPANIES
AND MAGAZINE PUBLISHERS
TO UTILIZE THE ZIP CODE
MORE EFFECTIVELY WITH A RESULTANT
FASTER SERVICE FOR ALL.**

NEW LITERATURE



MIL-spec cases

A design manual for transportation, operating and combination cases meeting military specifications contains complete design information for cases meeting MIL-T-945, MIL-T-21200, MIL-C-4150 and MIL-T-4734 along with information on molded fiberglass cases. An analysis of panel structures and materials for meeting various shock and vibration absorbing requirements is included as is technical information on protective materials for equipment protection within the case. Specifications and drawings are included. Skydyne, Inc.

CIRCLE NO. 355

Computer technology briefs

Three separately-bound reprints on computers are contained in an attractive folder. The articles deal with analog, hybrid and iterative computer technology. The first, entitled "General Purpose, Tabletop Analog and Hybrid Computers," describes and compares popular analog computers presently on the market. The second reprint, "General Purpose Scientific Analog and Hybrid Computers," covers the computer market. A comparative chart of twelve manufacturer's product lines is included. The third booklet is a technical description of how an iterative analog computer has been used to investigate methods of efficiency of a signal representation system by combining analog measurements with digital control and storage. GPS Instrument Co., Inc.

CIRCLE NO. 356



Transformer catalog

This 32-page publication lists a line of transformers, inductors and toroids in MIL-T-27B construction. The catalog features a section which compiles commercial/industrial transformers and reactors for use in instrumentation and automation applications. Charts, graphs, applications, schematics and notes for transformer specification are included. Microtran Co., Inc.

CIRCLE NO. 357

Beryllium alloy products

A comprehensive 15-page review of beryllium alloys features beryllium copper and includes discussions of beryllium nickel and beryllium aluminum. Forms of these alloys which are available from the manufacturer are also dealt with. Charts describing chemical compositions and physical and mechanical properties complete the presentation. The Brush Beryllium Co.

CIRCLE NO. 358

Semiconductor price list

Contained in a 54-page stock and price volume are such products as ICs, SCRs, Zeners tunnel diodes, silicon rectifiers, silicon transistors, germanium diodes and transistors, four-layer diodes, ceramic filters, tantalum capacitors and heat-sink assemblies. The catalog features products from houses such as Fairchild, GE, Motorola and RCA. Engineering testing such as transistor and Zener testing, FET matching and testing, reliability testing and diode and rectifier testing are also dealt with. Semiconductor Specialists, Inc.

CIRCLE NO. 359



1 1/2 in. AM-1 (actual size)

Distinctively Styled high torque, self-shielded panel meters

Smart, sophisticated styling . . . easy reading scale . . . sizes 1 1/2 to 4 1/2". Rugged, high torque mechanism offers 1% linearity, 2% accuracy and sensitivity to 20 ua. Completely shielded to eliminate error from magnetic panels. Mounts bezel-to-bezel on any material without interaction or effect on calibration. Choice of colors or finishes, custom dials — ASA/MIL 4-stud mounting.

AMMON

AMMON INSTRUMENTS, INC.
345 Kelley St., Manchester, N.H. 03105

ON READER-SERVICE CARD CIRCLE 99

FREE CATALOG!

NEARLY 4,500 BUYS FOR INDUSTRY

OPTICS! SCIENCE! MATH!

GIANT 148 PAGES

Many on-the-job Helps . . . Quality Control Aids! Write for this completely new, 1967 Catalog. New items, new categories, new illustrations. 148 easy-to-read pages packed with hundreds of charts, diagrams, illustrations. A treasure-house of optical and scientific information . . . unusual bargains galore. Optics for industry, research labs, design engineers, experimenters, hobbyists! Instruments for checking, measuring—to speed work, improve quality, cut production costs. We give you facts: what it is—how it works—where it's used.

Comparators, Magnifiers, Microscopes

Hard-to-get war surplus bargains—ingenious scientific tools—imported—domestic. Thousands of components: lenses, prisms, wedges, mirrors, mounts, accessories of all descriptions. Dozens of instruments: magnifiers, stereo microscopes, telescopes, binoculars, infrared equipment, photo attachments. Shop by mail. No salesman will call. Use the Catalog of America's greatest Optics—Science—Math Mart. Known for reliability. Mail the coupon below for Catalog "DA."

EDMUND SCIENTIFIC CO., BARRINGTON, N. J.

Mail Coupon for FREE Catalog "DA"

EDMUND SCIENTIFIC CO., Barrington, N. J. 08007

Please send FREE Giant 148-page Catalog "DA"

NAME

ADDRESS

CITY..... STATE..... ZIP.....

ON READER-SERVICE CARD CIRCLE 100

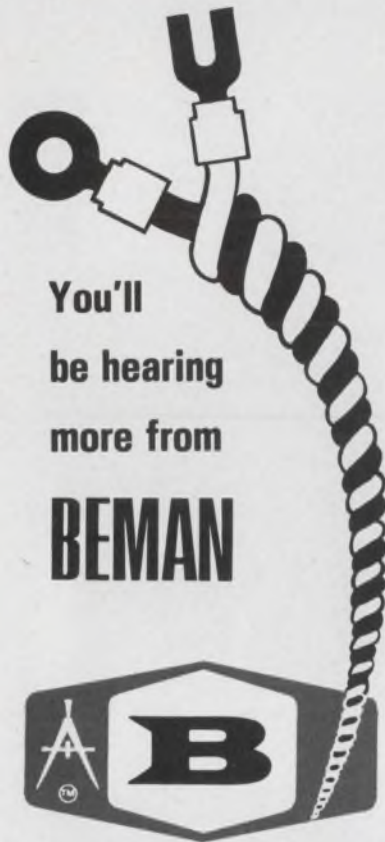

You'll
be hearing
more from
BEMAN

Already there is much favorable comment regarding this alert and aggressive company, a vigorous offspring of our dynamic electronic age, founded in 1961. Industry leaders are entrusting Beman with important assignments in cable and termination manufacture, custom molding and die stamping, and various types of electrical and mechanical assembly work. There is also a growing demand for the creative capabilities displayed by Beman's versatile designers and engineers. A modern, new engineering facility is strategically located in Harrisburg, a few miles from the main plant.

QUALITY, DEPENDABILITY, INGENUITY

Whether asked to follow iron-clad specifications, or to work from scratch on an outline of new requirements, Beman is vitally aware of its responsibilities. Research and development talents are applied to a customer's project with the same all-out effort that is put into one of Beman's own original products. Perhaps your company can benefit from the specialized training and experience which are carrying Beman forward. An illustrated brochure just off the press will be mailed on request. Beman is able ... and ready ... to serve you.



P. O. Box 370 New Cumberland, Pa., 17070
Phone: (717) 774-0210

ON READER-SERVICE CARD CIRCLE 101

Advertisers' Index

Advertiser	Page	Advertiser	Page
ACDC Electronics, Inc.	63	ITT Semiconductors, A Division of International Telephone and Telegraph Corporation	144
Acopian Corporation	111	Intronics, Inc.	131
Aerojet General Corporation	104, 105	Janco Corporation	119
Alfred Electronics	47	Janus Control Division	117
Allen-Bradley Co.	32 A-B	Johanson Manufacturing Corp.	113
Ammon Instruments, Inc.	139	MacLean-Fogg Lock Nut Company	142
Amperex Electronic Corporation	89	Magnetics, Inc.	9
Amperite	44	Marshall Industries, Capacitor Division	7
Augat, Inc.	112 A-F	Melpar, Inc.	62
Ballantine Laboratories, Inc.	115	Method Electronics, Inc.	127
Beckman Instruments, Inc., Helipot Division	21	Motorola Communications & Electronics, Inc.	135
Beman Manufacturing, Inc.	140	Motorola Semiconductor Products, Inc.	41, 49
Bendix Corporation, The. Electronic Components Division	12	National Jet Company	116
Bourns, Inc.	79	National Semiconductor Corp.	4, 5
Brand Rex, Division of American Enka Corporation	31	Nuclear Corporation of America	106
Burroughs Corporation	87	Nytronics, Inc.	23
Centralab, Electronics Division of Globe-Union, Inc.	73	Phelps Dodge Electronic Products	32
Cinch, Division of United Carr	101, 108, 109	Prentice-Hall, Inc.	141
Clare & Co., C. P.	38, 39	RCA Electronic Components and Devices	Cover IV
Clifton, Division of Litton Industries	137	RCL Electronics, Inc.	6
Cohn Corp., Sigmund	129	RFL Industries, Inc.	132
Consolidated Electrodynamics, A Subsidiary of Bell & Howell	48B	Redcor Corporation	106, 112, 133
Coors Porcelain Co.	27	Rowan Controller Co., The	25
Corning Electronics, Division of Corning Glass Works	71	Sigma Instruments, Sigma Instruments, Inc.	96
Curtis Development & Mfg. Co.	142	Signalite, Incorporated	70
Dakota Engineering, Inc.	142	Solitron Devices, Inc.	125
Dale Electronics, Inc.	Cover III	Sprague Electric Company	10
Datapulse, Incorporated	2	Stimpson	123
Deutsch Electronic Components Division	8	Switchcraft, Inc.	110
Duncan Electronics, Inc.	121	TRW Semiconductors, Inc.	50
Du Pont Company	48A	Tally Corporation	93
Dzus Fastener Co., Inc.	143	Taurus Corporation	128
ESI/Electro Scientific Industries, Inc.	136	Tektronix, Inc., Oscilloscopes	52
Ehrenreich Photo Optical Industries, Inc.	19	Telonic Instruments, A Division of Telonic Industries, Inc.	95
Edmund Scientific Company	139	Texas Instruments Incorporated, Semiconductors- Components Division	58, 59
Eldre Components, Inc.	143	Thomas & Betts Co. Incorporated, The	80 A-B
Electro Tec Corp.	33	Transistor Electronics Corporation	75
Electronic Memories, Inc.	16	Trompeter Electronics	143
Fairchild Instrumentation, A Division of Fairchild Camera and Instrument Corporation	34, 35, 37	Union Carbide Corporation	15
Gardner-Denver Company	107	Vanton Pump & Equipment Corporation	134
General Electric Company	64, 99	Varian Associates, Vacuum Division	124
General Electric Company Miniature Lamp Dept.	48	Vishay Resistor Products, A Division of Vishay Intertechnology, Inc.	40
General Precision, Librascope Group	91	Wavelabs Co.	112
General Radio Company	1	Wheelock Signals, Inc.	120
Genisco Technology Corporation, Eldema Division	133	Wood Electric Corporation	134
Hamilton Standard, Division of United Aircraft Corporation	46	Wright/Division of Sperry Rand Corporation	103
Hayden Book Company, Inc.	42	Career Advertising	
Hayden Publishing Company, Inc.	74	Electronic Communications, Inc.	82
Haydon Company, A. W.	138	Hughes Aircraft Company	85
Hewlett-Packard, Moseley Division	57	IBM Corporation	84
Hewlett-Packard	Cover II, 65	ITT Jennings, a subsidiary of International Telephone and Telegraph Corporation	43
Honeywell, Computer Control Division	28		
Honeywell, Precision Meter Division	45		

Electronic Design Design Data from Manufacturers

Advertisements of booklets, brochures, catalogs and data sheets. To order use Reader-Service Card.
(Advertisement)

Advertising Representatives

New York 10022
Robert W. Gascoigne
Thomas P. Barth
Samuel M. Deitch
Byron Adams
850 Third Avenue
(212) PLaza 1-5530
TWX: 867-7866

Philadelphia
William C. Repetto
P. O. Box 206
Merion Station, Pa. 19066
(215) MO 4-1073

Boston
Richard Parker
7 Redstone Lane
Marblehead, Mass. 01945
(617) 742-0252

Chicago 60611
Thomas P. Kavooras
Berry Conner, Jr.
720 N. Michigan
(312) 397-0588

Cleveland
(216) 247-7670

Los Angeles 90303
Stanley I. Ehrenclou
Terrence D. Buckley
W. James Bischof
2930 W. Imperial Highway
Inglewood, Calif.
(213) 757-0183

San Francisco
Ashley P. Hartman
175 South San Antonio Rd.
Ste. 243
Los Altos, Calif. 94022
(415) 941-3084

Southwestern 75206
Tommy L. Wilson
6200 North Central Express-
way
Dallas, Tex.
(214) EMerson 1-2311

London W. 1
Brayton C. Nichols
44 Conduit Street

Verviers, Belgium
Andre Jamar
1, Rue Mallard, 1
(087) 253.85

Tokyo
Yoshihiro Takemura
International Planning
Service, Inc.
Room 231 Tokyu-Mita Bldg.
1, Shiba-Mita Koun-cho
Minato-ku, Tokyo



Large Signal Transistor Circuits

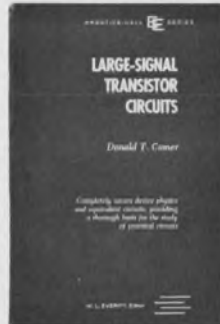

Gives you quick, accurate assistance in solving pulse circuit problems and shows you the latest methods for using transistor and semiconductor devices. You'll discover applications for circuits in many different fields besides radar and digital computing. Equips you to create circuits operating under large-signal conditions and generating nonsinusoidal waveforms. Brings you up-to-date on pulse and digital circuits. Written by Donald T. Comer of IBM Corp., Pub. May 1967, 268 pp., \$10.50. Order your 15 day examination copy by circling the number to the right.

Prentice-Hall, Inc.
Englewood Cliffs, N.J. 07632

171

Transistor Design "How-To" Tips



Modern Transistor Electronics Analysis and Design, by Fred K. Manasse, Charles R. Gray, & John A. Ekiss, brings you a modern approach with practical "how-to" tips for transistor and integrated circuit design. Contains original material on two-terminal active devices, tunnel diode, p-n avalanching diodes, and Gunn effect diodes. Gives you a detailed examination of linear tuned amplifiers with practical analysis of design approach. Also covers transistor switching circuits, noise in transistors, choppers, and multiplexing. Pub. Sept. 1967, 512 pp., \$12.95. Order your 15 day examination copy by circling the number to the right.

Prentice-Hall, Inc.
Englewood Cliffs, N.J. 07632

172

Covers Silicon Integrated Devices



Fundamentals Of Silicon Integrated Device Technology, Volume 1: Oxidation, Diffusion, and Epitaxy, edited by R.M. Burger & R.P. Donovan, brings together the latest information related to silicon integrated devices. Includes detailed data, techniques, and phenomenological descriptions. Generously illustrated with sketches, graphs, photographs, and tables. Emphasizes capabilities and limitations of the present technology. Discusses practical implementation of diffusion in considerable detail. Pub. Feb. 1967, 495 pp., \$15.00. Order your 15 day examination copy by circling the number to the right.

Prentice-Hall, Inc.
Englewood Cliffs, N.J. 07632

173

ELECTRONIC DESIGN's aim is fourfold. It aids progress in the electronics manufacturing industry by promoting good design. It gives the electronic design engineer concepts and ideas that will make his job easier and more productive. The magazine serves as a central source of timely, up-to-the-minute electronics information. And finally it seeks to encourage two-way communication between manufacturer and engineer.

Want a subscription? ELECTRONIC DESIGN is circulated free of charge to qualified engineers and engineering management doing design work, supervising design or establishing standards in the United States, Western Europe and the United Kingdom. If you think that you are entitled to a free subscription, use the postfree application form that you will generally find inside the back cover. When it is not included, write to us direct for an application form.

If you are not qualified, you may take out a paid subscription at the following rates: \$25 a year if you live in the U.S.A. or \$35 a year if you live elsewhere. Single copies may be purchased for \$1.50 each.

If you change your address, send us an old mailing label and your new address; there is generally a prepaid postcard for this inside the back cover. If you have been receiving ELECTRONIC DESIGN free of charge, you will have to requalify to continue doing so.

We strive for accuracy. We take the utmost pains to ensure the highest standard of accuracy throughout the magazine. A single mistake in practical design information can have serious consequences. But to err is human, and for all the care we take, an occasional error slips through. Whenever this occurs, we publish a correction at the earliest opportunity. You will find these corrections printed at the end of the Letters column. If you should spot an error, be sure to let us know. You may save your colleagues heartaches.

Microfilm copies are available of complete issues of ELECTRONIC DESIGN that have been published since the beginning of 1961, and of single articles. Complete issues cost 4¢ a page, individual pages cost 50¢ each; shipping and handling charges are extra. The minimum charge is \$3; delivery time runs from 10 days for single pages to five weeks for complete issues. For further details and to place orders, get in touch directly with University Microfilms, Inc., 300 N. Zeeb Road, Ann Arbor, Mich. 48106; telephone (313) 761-4700.

Want to contact us? If you have any inquiries about these or other matters, or if you have a manuscript outline or article idea, address your correspondence to:

Howard Bierman, Editor,
ELECTRONIC DESIGN,
850 Third Avenue,
New York, N.Y. 10022.

Design Data from

Clamp or Tie Wire Bundles In Seconds!



Six-page catalog contains complete ordering information for CAB-L-TITE® clamps and BUND-L-TITE® straps, devices which provide a fast and reliable means of securing wires and wire bundles. Units withstand loadings greater than 50 G's, are removable in seconds for re-routing wires, and are self-locking—no tying, no knots, no hitches to come loose. Lightweight Du Pont Zytel meets MIL-P-17091 and MIL-P-20693. Proved in aircraft and missiles. Photos, dimensional drawings, tables, physical properties, specifications, price list. Request catalog A.

Dakota Engineering, Inc.
4315 Sepulveda Blvd.
Culver City, California 90230

174

Laminated and Molded Bus Bars For Power Distribution



A 16 page Technical Bulletin is now available, describing a new concept in power distribution. Basic mechanical and electrical design principles, along with descriptive pictures and diagrams, are included in this bulletin. These compact buses can replace bulky cable harnesses and repetitive wiring for computer or modular application. This method of construction satisfies the demanding requirements of low inductance and resistance of high speed, solid state systems, while controlling electrical noises.

Eldre Components, Inc.
1239 University Avenue
Rochester, New York 14607

"see us at WESCON Booth 1313-1314"

175

Terminal Block Selector



A new 24-page, completely illustrated catalog contains photos, descriptions, ratings, engineering drawings, and prices of the complete line of Curtis terminal blocks. Included are printed circuit, insulated feed-thru, quick disconnect, track type, and high current terminal blocks. Handy selection chart quickly locates the perfect block for your particular requirements. Send today for your free copy. See us at WESCON, Booth 1013

Curtis Development & Mfg. Co.
3236 North 33rd Street
Milwaukee, Wisconsin 53216

176

Manufacturers

Advertisements of booklets, brochures, catalogs and data sheets. To order use Reader-ServiceCard Advertisement

Video And Data Switching Systems

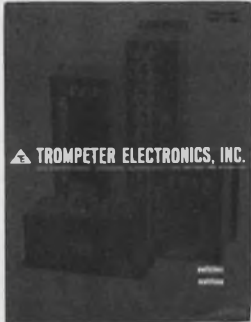

The switching systems presented in this catalog are a new concept designed to replace manual patching, programmed patch panels, and cross-bar switches, with matrices or multiple switching units for transferring low level-low frequency (audio, digital or analog) and high frequency (video, IF and RF) signals.

Matrices are capable of switching sine wave frequencies from zero hertz to 100 megahertz and fast rise time pulses for high megabit systems normally carried over shielded wire, coax, twisted pair shielded (twinax) or triax cables.

Trompeter Electronics, Inc.

8936 Comanche Avenue
Chatsworth, California 91311.

177

M-F Nylon Insert Lock Nuts

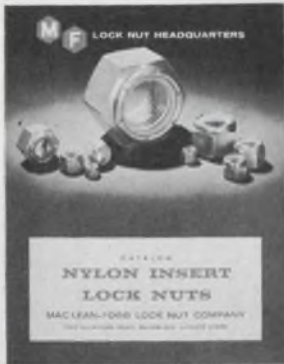

This book can be a valuable guide to the engineer who must specify dependable locking fasteners. It contains sixteen pages and describes all aspects of MacLean-Fogg's complete line of Nylon Insert Lock Nuts. There are tables which outline principal features and applications of the nuts. Other tables list physical properties, chemical properties, and data on tensile strength requirements. Charts on each of the company's eight styles of Nylon Insert Lock Nuts include dimensional data, weights, and part numbers. Circle number on reply card.

MacLean-Fogg Lock Nut Company

1060 Allanson Road
Mundelein, Illinois 60060

178

Quality Fasteners For All Design Applications



This 8-page catalog provides design data on the complete group of DZUS 1/4-turn self-locking fasteners for standard, high speed and panel applications, as well as universal high strength multiple thread fasteners for high tensile and shear stresses. Dzus stud assemblies, wire forms and receptacles offer an exceptional, wide variety of combinations from stock to fit specific fastening requirements. Diagrams and tables give full details for rapid, unlimited design selection. Condensed Catalog No. S-2 or comprehensive Catalog No. D-3 are available on request.

Dzus Fastener Co., Inc.

Division 32
425 Union Boulevard
West Islip, L. I., N. Y. 11795

179

Designer's Datebook

AUGUST						
S	M	T	W	T	F	S
	1	2	3	4	5	
6	7	8	9	10	11	12
13	14	15	16	17	18	19
20	21	22	23	24	25	26
27	28	29	30	31		

SEPTEMBER						
S	M	T	W	T	F	S
						1 2
3	4	5	6	7	8	9
10	11	12	13	14	15	16
17	18	19	20	21	22	23
24	25	26	27	28	29	30

For further information on meetings, use Reader Service card.

Aug. 22-25

Western Electronic Show and Convention (San Francisco)
Sponsor: WEMA; Ted Shields, WESCON, 3600 Wilshire Blvd., Los Angeles, Calif. 90005

CIRCLE NO. 469

Aug. 29-31

Conference on Engineering Applications of Electronic Phenomena (Ithaca, N. Y.) Sponsor: Cornell University, IEEE, ONR; Conference Committee, School of Electrical Engineering, Philips Hall, Cornell University, Ithaca, N. Y. 14850

CIRCLE NO. 470

Aug. 28-30

Technical Conference on Electronic Materials (New York City)
Sponsor: AIME; L. R. Weisberg, Electronic Materials Committee, The Metallurgical Society of AIME, 345 E. 47 St., New York, N. Y. 10017

CIRCLE NO. 471

Aug. 29-31

Association for Computing Machinery Conference (Washington, D. C.) Sponsor: ACM; M. J. Healy, c/o Association for Computing Machinery, Box 6, Annandale, Va. 22003

CIRCLE NO. 472

Sept. 6-8

Computer Conference (Chicago)
Sponsor: IEEE; D. Jacobsohn, Argonne National Laboratories, 3700 S. Cass Ave., Argonne, Ill. 61061

CIRCLE NO. 473

Sept. 11-14

Instrumentation-Automation Conference and Exhibit (Chicago)
Sponsor: ISA; W. V. Halle, Public Relations Dept., Instrument Society of America, 530 William Penn Place, Pittsburgh, Pa. 15219

CIRCLE NO. 474

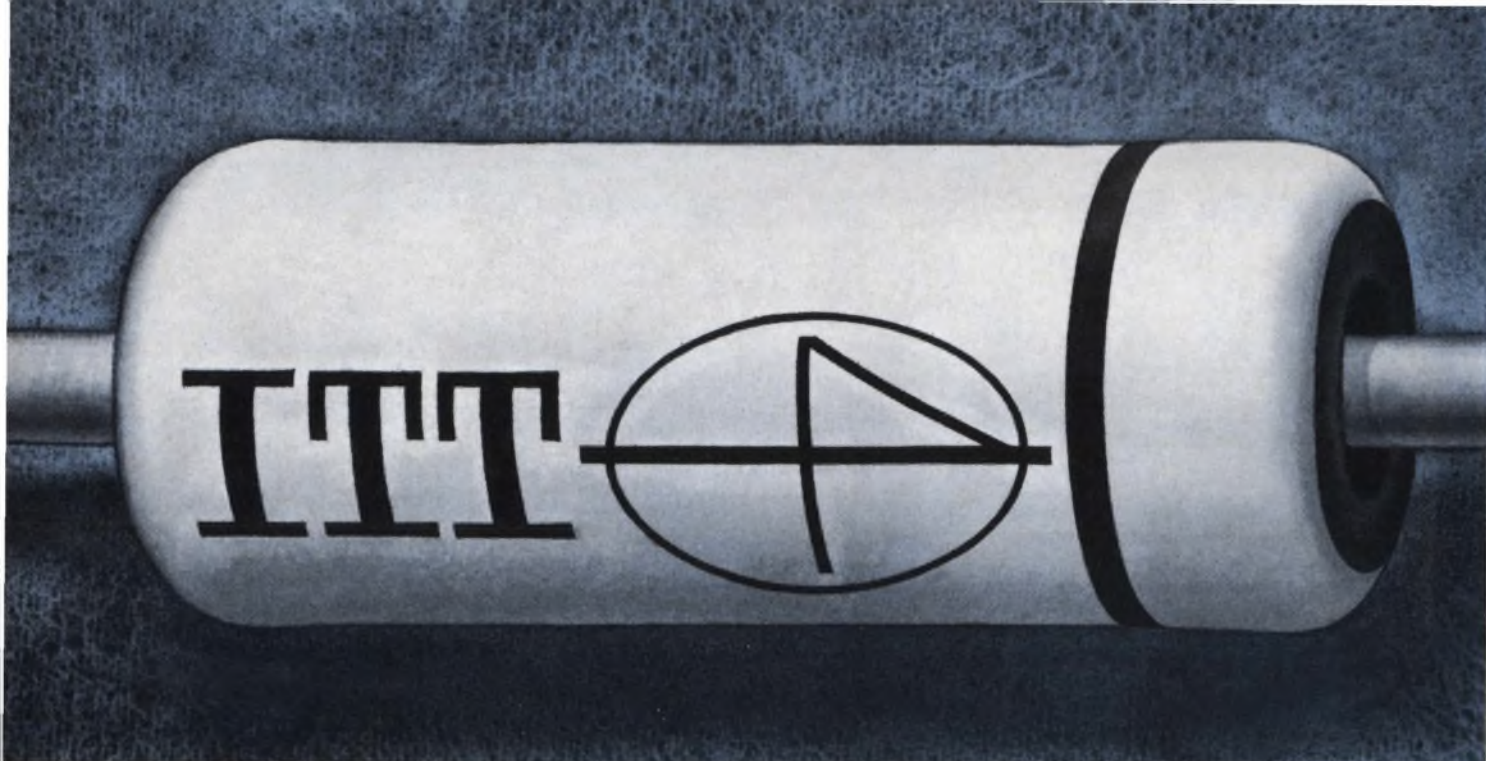

24 x ACTUAL SIZE

Order ITT 4-layer diodes— they're big for simplifying oscillator, protective and switching circuits

An ITT 4-layer diode stays "off" until the voltage across it reaches a specified level. Then it switches "on" in nanoseconds and remains so until current through it falls below a specified minimum. Because gating components are eliminated, the device is ideal when circuit simplification is the goal. You can specify it in glass DO-7 or top hat packages, with firing voltages from 20 to 100.

For application notes that will help you simplify your own circuits, as well as specification sheets and prices, use the coupon at right. ITT Semiconductors is a division of International Telephone and Telegraph Corporation, 3301 Electronics Way, West Palm Beach, Florida.

ITT SEMICONDUCTORS 3301 Electronics Way, West Palm Beach, Fla.		
NAME _____		
TITLE _____	COMPANY _____	
ADDRESS _____		
CITY _____	STATE _____	ZIP _____

ON READER-SERVICE CARD CIRCLE 102

FACTORIES IN WEST PALM BEACH, FLORIDA • PALO ALTO, CALIFORNIA • LAWRENCE, MASSACHUSETTS • ENGLAND • GERMANY • PORTUGAL • AUSTRALIA

semiconductors **ITT**

DALE**RELIABILITY**TOTAL CAPABILITY IN
PRECISION RESISTANCE

Call our hand on reliability*

These two precision power wirewounds are the most reliable you can buy anywhere. Now, they're joined by a third, the ARH Series, to give Dale the only complete line of housed and coated resistors with established reliability. Most of our customers don't need this much reliability—but they assume it should lend our standard parts an edge in quality and performance. They're right.

NOW AVAILABLE!



ARH Power Wirewounds for chassis mounting. Meets MIL-R-39009. Made on the same line, under the same high reliability standards as ARS and AGS resistors.

ARS, AGS & ARH RESISTOR DATA		
	ARS & AGS	ARH
FAILURE RATE: Per 1,000 hours	ARS: .00038% (60% confidence level). AGS: .000125% (60% confidence level) GARD Screening Available. Estimated failure rate after GARD screening is .00009%.	1%* (60% confidence level) *Expect to achieve failure rate goal of .1% approx. April 1, 1967
FAILURE DEFINITION:	$\Delta R > 0.5\%$ (1000 hours)	$\Delta R > 1\%$ (2000 hours)
OPERATING CONDITIONS:	50% rated power 25° C ambient	100% rated power 25° C ambient
SPECIFICATIONS:	ARS: 3 models; 2, 5, 10 watts. Resistance range — .1 Ω to 40K Ω . Standard tolerance 1%. AGS: 4 models; 1, 2.25, 4, 7 watts. Resistance range — .1 Ω to 12.4K Ω . Standard tolerance 1%.	4 models; 5, 10, 15, 30 watts. Resistance range — .1 Ω to 39.2K Ω . Standard tolerance 1%.
MIL-SPEC.:	Meets MIL-R-39007	Meets MIL-R-39009
COMPARATIVE SIZE:	ARS-2 (2 watts) .812" L. x .187" D. AGS-3 (2 1/4 watts) .400" L. x .090" D.	N/A

LOT ACCEPTANCE TESTING BEING CONDUCTED ON SCHEDULED BASIS

* Write for ■ ARS, AGS & ARH Test Reports
■ Resistor Catalog A



DALE ELECTRONICS, INC.

1328 28th Ave., Columbus, Nebr. 68601
In Canada: Dale Electronics Canada, Ltd.



ON READER-SERVICE CARD CIRCLE 142

We're ready for you now!

RCA's popular "Under \$1" sensitive-gate Triacs are now immediately available in mass production quantities... and what a combination of low-cost and exceptional performance!

Over a year in the field has demonstrated the unmatched advantages of RCA sensitive-gate Triacs for ac phase control, load switching, and solid-state replacement for relays. And now we're ready for mass production orders. Just check these circuit benefits:

High gate sensitivity—10 mA max. gate current is many times more sensitive than conventional Triacs...and types as low as 3 mA are also available for designs where critical heat-sinking is not an important consideration.

Low current—2.5A (rms) is ideal for many 110V or 220V appliances and motors... plus surge current protection to 25A.

Convenient size—popular TO-5 package combines the advantages of a compact, hermetically sealed metal case with the Triac's inherent ability to perform the full-wave functions of 2 SCR's.

Your RCA Field Representative can give you complete information on RCA's six different versions of sensitive-gate Triacs, including price and delivery. For additional technical data, write RCA Commercial Engineering, Section RC8-1, Harrison, N.J. 07029. See your RCA Distributor for his price and delivery.

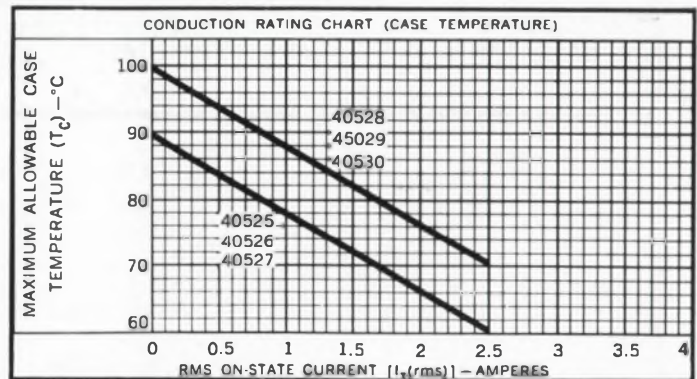

$I_T(rms)$	I_{GT}	Low Voltage ($V_{DRM}=100V$)	120V Line ($V_{DRM}=200V$)	240V Line ($V_{DRM}=400V$)
2.5A	3 mA Max	40525 (0.95*)	40526 (0.98*)	40527 (1.40*)
	10 mA Max	40528 (0.95*)	40529 (0.98*)	40530 (1.40*)

*Prices in quantities of 1,000 and up

RCA Electronic Components and Devices



The Most Trusted Name in Electronics

ON READER-SERVICE CARD CIRCLE 143