

Electronic Design 13

VOL. 15 NO.

FOR ENGINEERS AND ENGINEERING MANAGERS.

JUNE 21, 1967

Let the computer be your guide to better circuit design. Try the parameter sensitivity approach to get optimum performance in your control systems. Such a method

can be applied in either the time or frequency domain (page 54). But success in any design hinges on the device model which you feed to the computer (page 60).



TRW introduces Low Voltage Avalanche!

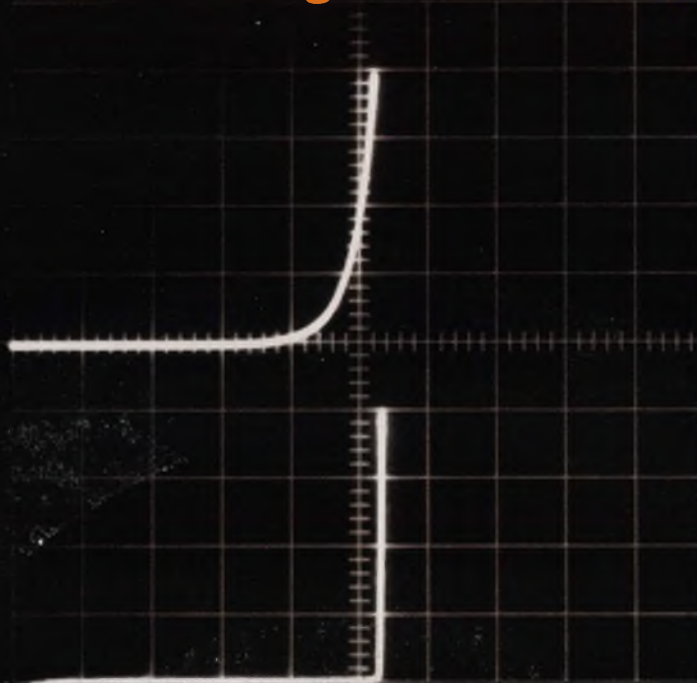

Unretouched scope comparison of 5.6 volt Military zener (upper) and new 5.6 volt LVA. (Tektronix Type 575, 1V/div. horizontal, 1mA/div. vertical.)

Sharpest Breakdown Below 10 Volts!

The LVA™ is more than just a new diode: it represents a major breakthrough in low voltage regulators (patent pending). Wherever you need a zener below 10 volts, the LVA will significantly improve circuit performance with its avalanche breakdown characteristics.

With the LVA you can design better low current circuits, battery-operated circuits, and operational

amplifier clamping networks. And now for the first time, you can make zero TC reference below 5 volts!

The LVA is available in 10 values from 10 volts down to 4.3 volts. Delivery is off-the-shelf from factory or authorized distributors.

If you'd like to compare, write for test samples and applications data on company letterhead to

TRW Semiconductors, Ray Koch, 14520 Aviation Boulevard, Lawndale, California 90260. Phone (213) 679-4561. TWX 910-325-6206. *TRW Semiconductors Inc. is a subsidiary of TRW INC.*

TRW®

MICROWAVE SWEEP OSCILLATORS

And
Now
RF
0.1-110 MHz

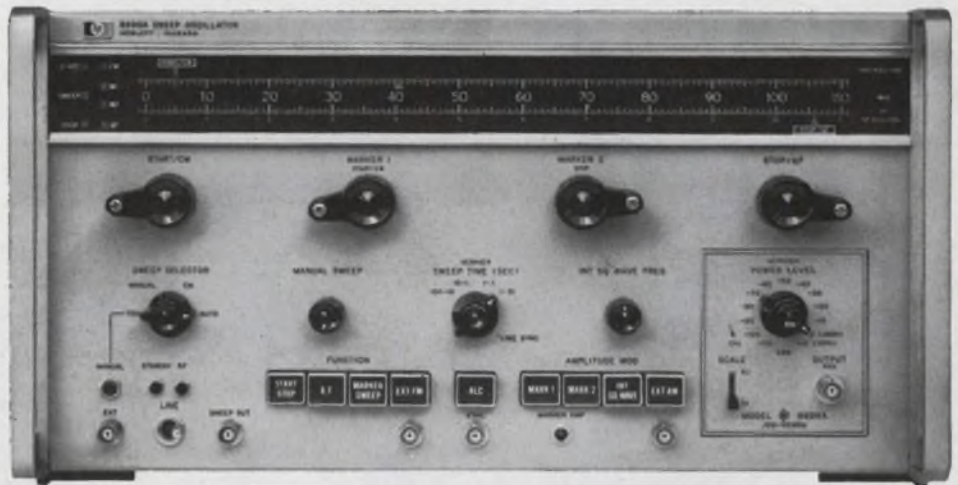

Extend your sweeper coverage into the Video/IF/RF frequency range with the new Hewlett-Packard 8698A RF Sweeper-Generator plug-in for the HP 8690A Sweep Oscillator. □ Frequency range is 0.1-110 MHz with 0.5% linearity for any sweep, wide or narrow. Low residual FM, 1% frequency accuracy, calibrated power output.

Sweep Oscillator/ RF Unit*	Frequency Range	Price	Sweep Oscillator/ RF Unit*	Frequency Range	Price
8698A	0.1-11 and 1-110 MHz	\$ 950	8694A	8-12.4 GHz	\$1575
8691A	1-2 GHz	1875	H01-8694A	7-12.4 GHz	1850
8691B	1-2 GHz	2175	H02-8694A	7-11 GHz	1600
8692A	2-4 GHz	1675	8694B	8-12.4 GHz	1925
8692B	2-4 GHz	1975	H01-8694B	7-12.4 GHz	2200
H01-8692B	1.7-4.2 GHz	2275	H02-8694B	7-11 GHz	1950
8693A	4-8 GHz	1575	8695A	12.4-18 GHz	1700
8693B	4-8 GHz	1900	8696A	18-26.5 GHz	2500
H01-8693B	3.7-8.3 GHz	2200	8697A	26.5-40 GHz	4300

*Models with "B" suffix feature PIN diode modulation and leveling.

The HP 8690A Sweep Oscillator contains power supplies, control and modulation circuitry, function selectors and operating controls. Accepts 8691A through 8698A RF Units. Price, \$1550.

For more information see your Hewlett-Packard field engineer or write Hewlett-Packard, Palo Alto, California 94304, Tel. (415) 326-7000; Europe: 54 Route des Acacias, Geneva.

HEWLETT  PACKARD

ON READER-SERVICE CARD CIRCLE 2



Unit Citation

We're honored! Not that we've won our crusade yet...just another battle ribbon. A while back we scored a military victory with our Model 880, the *first* solid state Mil Spec counter. This time it's a fully-militarized 5MHz all-silicon solid state universal counter-timer. Call it AN/USM-245, sir.

There's a good reason you should be interested. You see, the military model had its basic reliability well proved by our original commercial version, Model 607A. Now *there's* the one for you! It offers more features and capabilities than even the Admirals asked for. And it's available on-the-double.

Now hear this: Our lowest-bidder-type price is only \$1,575. (Check *that* saving against our competitor!) Then check these features: Model 607A is ideal for wide-range frequency measurements, frequency ratio determination, period and multiple period or time interval measurements, and pulse count totalizing. Time base is a 1 MHz crystal oscillator (for 1 microsec resolution). Display is six decade inline with display storage. BCD output transfers directly to CMC Model 410 tape printer, computer systems, etc. Automatically positioned illuminated decimal. Either ac or dc coupling of input signal. Front and rear A and B channel inputs. Rugged, compact (approx. 3½" high). Available for bench or rack.

THANKS

With all our pride and excitement over our AN/USM-245 award, and other new products, we haven't forgotten our fellow Crusaders who've made this success possible...YOU. A FREE Crusading Engineers medal is our fun-loving way of saying thanks. Get yours by writing for data so you can "Check the Specs" of our 607A. Your "chief" will be so proud of you at mail call!

12973 Bradley / San Fernando, California
Phone (213) 367-2161 / TWX 910-496-1487



Computer Measurements Company is a Leading Designer and Manufacturer of Electronic Instrumentation to Count, Measure, and Control.

ON READER-SERVICE CARD CIRCLE 3

Electronic Design 13

VOL. 15 NO.

FOR ENGINEERS AND ENGINEERING MANAGERS.

JUNE 21, 1967

NEWS

- 13 News Scope
- 17 **Microwave tubes hold their own**
Despite inroads by solid-state devices, tubes have a promising future.
- 24 **Organic devices advance as energy sources**
Air Force scientists optimistic about future usefulness of these units.
- 29 Washington Report
- 34 Plasma display panel writes with computer signals.
- 38 Low-cost tape transport records 50 MHz.
- 42 Portable chargers on way for battlefield use.
- 46 Letters
- 51 **Editorial: We can take a lesson from Europe on trade shows.**

TECHNOLOGY

- 54 **Computer-analyze your circuit** by applying the principle of sensitivity of active circuits to parameter variations.
- 60 **Assign the proper numerical values** to transistor models for best results when you simulate switching circuits with a computer program.
- 70 **Ease resistor-thermistor network design** with this direct approach. It's faster and far more accurate than the commonly used approximation techniques.
- 76 **'Spectral purity' can hide a lot of sins** since test methods and definitions lack standards. Sidestep the pitfalls by looking beyond the specification sheets.
- 84 **Delay distortion can be eliminated** from instrumentation systems by exploiting the inverse response of all-pass networks.
- 90 **Design reliable printed switches** by considering not only electrical parameters but manufacturing and materials requirements as well.
- 96 Ideas for Design
- 108 NASA Tech Briefs

PRODUCTS

- 120 **Semiconductors:** Avalanche Zeners show sharper knees in low-voltage range.
- 134 **Materials:** Electroless copper PC boards ease soldering and cut costs.
- 144 **Production Equipment:** Trimmer pots tested for 7 parameters in 5 seconds.
- 124 Microelectronics
- 126 Components
- 136 Test Equipment
- 148 Microwaves

Departments

- 115 Book Reviews
- 153 Design Aids
- 154 Application Notes
- 156 New Literature
- 164 Advertisers' Index
- 167 Designer's Datebook

ELECTRONIC DESIGN is published biweekly by Hayden Publishing Company, Inc., 850 Third Avenue, New York, N. Y. 10022. James S. Mulholland, Jr., President. Printed at Poole Bros., Inc., Chicago, Ill. Controlled-circulation postage paid at Chicago, Ill., and New York, N. Y. Application to mail at controlled postage rates pending in St. Louis, Mo. Copyright © 1967. Hayden Publishing Company, Inc. 62,529 copies this issue.



**Here's Amphenol's new
square version of the
low cost 2600 trimmer**

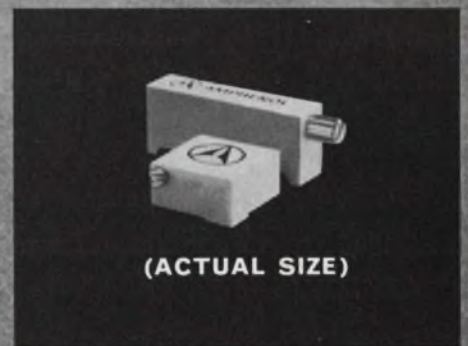
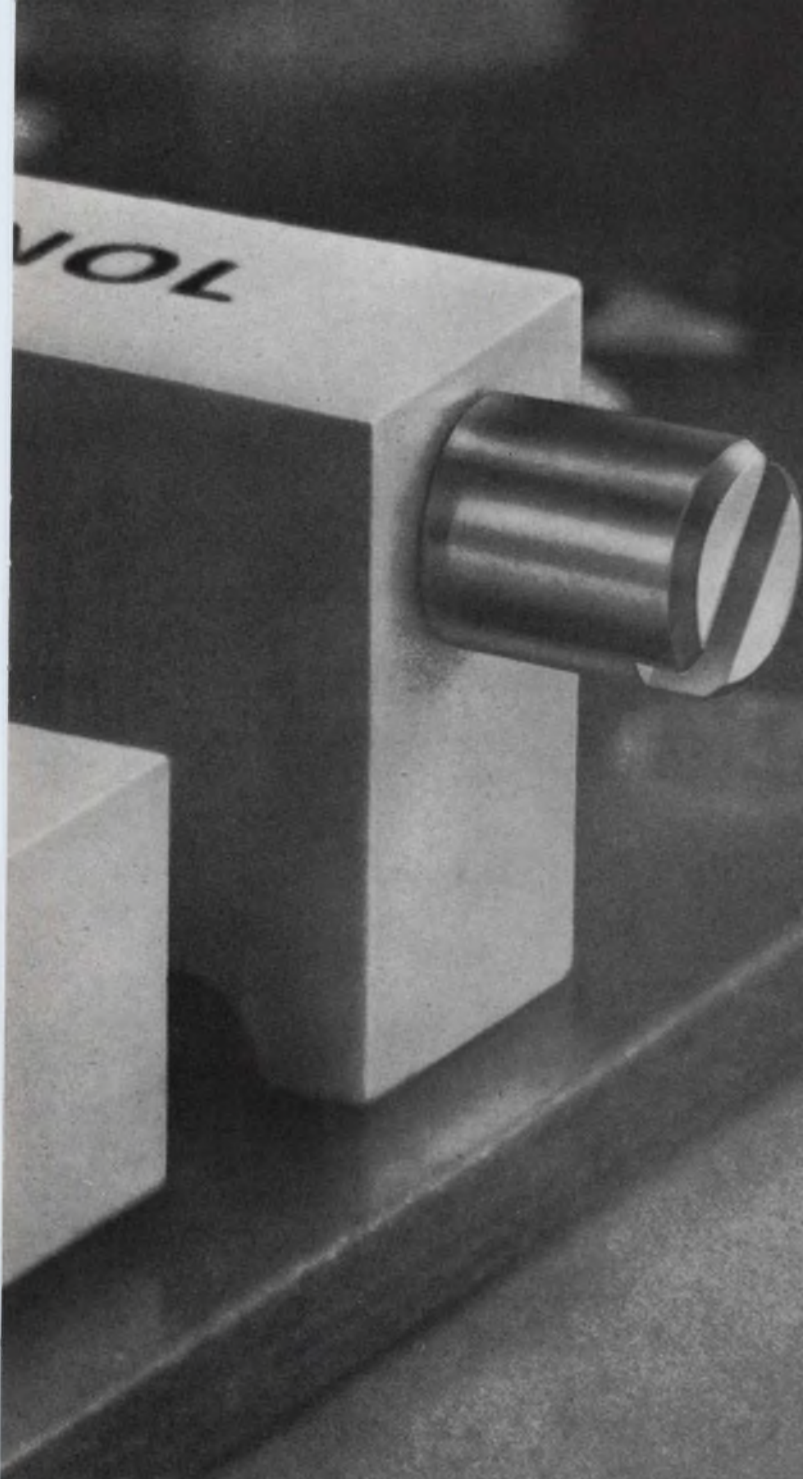

Amphenol's new $\frac{3}{8}$ " square commercial trimmer offers you half the height of our renowned 2600 trimmer above, and half the cost of any $\frac{3}{8}$ " square trimmer—less than \$2.00 each in production quantities.

REPLACES $\frac{3}{8}$ " OR $\frac{1}{2}$ " SQUARE TRIMMERS The PC pins of the new

3600 trimmer fit the cards of any standard $\frac{3}{8}$ " or $\frac{1}{2}$ " square trimmer. And, it's only .200" high for low card space applications. It's also available in a humidity-proof model, the 3610.

SAME 2600 QUALITY SPECS The 3600 performs like the 2600 with 85% better resolution than MIL-

R-27208B, RT24. Order the 2600 or 3600 from your Amphenol Distributor or Sales Engineer. **Amphenol Controls Division**, Janesville, Wis.



AMPHENOL

ON READER-SERVICE CARD CIRCLE 4

Specify Amphenol . . . the leading name in cable, connectors, assemblies, RF switches, potentiometers, motors, microelectronics

WAVETEK uses Allen-Bradley Type F variable resistors exclusively because of their

- * Quality performance
- * Excellent stability
- * Infinite resolution

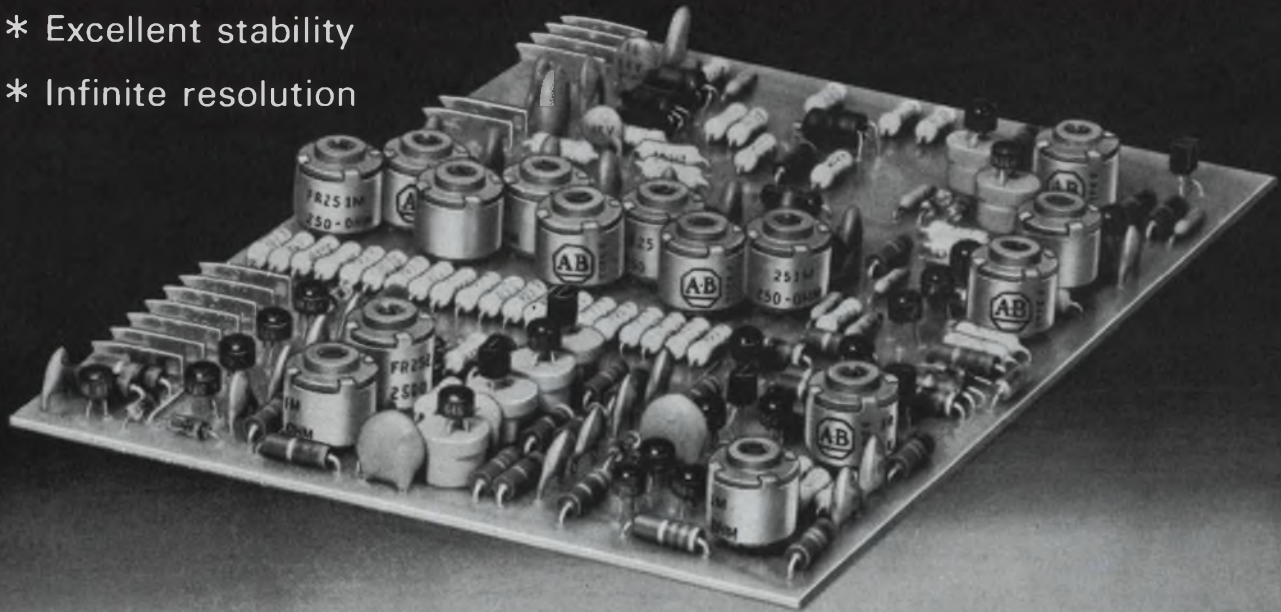

One of the 5-inch by 6½-inch Wavetek printed circuit cards, showing 15 of the 25 Allen-Bradley Type F hot molded variable resistors and numerous hot molded fixed resistors used in the Model 111 VCG function generator.



Type F variable resistor with pin type terminals for mounting directly on printed wiring boards. Rated ¼ watt at 70°C. Total resistance values from 100 ohms to 5 megohms.

Actual Size



Wavetek Model 111 VCG generates sine, square, triangle, and ramp waves from 0.0015 Hz to 1 MHz, and offers precision control of the frequency of the waveforms by external voltage.

■ The precision waveforms generated by Wavetek's Model 111 VCG place exacting demands on the large number of variable resistors used to set amplitudes to very precise values and assure symmetry of all functions. They must provide velvet smooth control, and quiet operation. And since this is a Wavetek adjustment, it is essential that the variable resistors, once adjusted, will stay "put".

Allen-Bradley Type F variable resistors satisfy all of these requirements, because they have the same solid hot molded resistance track as the famous Type J and Type G variable resistors. There's velvet smooth control at all times—never the problem of discrete steps com-

mon to all wire-wound units. And since Type F variable resistors are essentially noninductive and have low distributed capacitance, they can be used at high frequencies where wire-wound controls are useless.

When a manufacturer like Wavetek has standardized on the quality of A-B electronic components, you can be sure of the superior performance of such equipment.

For more details on the complete line of Allen-Bradley quality electronic components, please write for Publication 6024. Allen-Bradley Co., 1344 South Second Street, Milwaukee, Wis. 53204. In Canada: Allen-Bradley Canada Limited. Export Office: 630 Third Avenue, New York, N.Y., U.S.A. 10017



ALLEN-BRADLEY

QUALITY ELECTRONIC COMPONENTS

ON READER-SERVICE CARD CIRCLE 5

TWO NEW FET IDEAS FROM MOTOROLA!

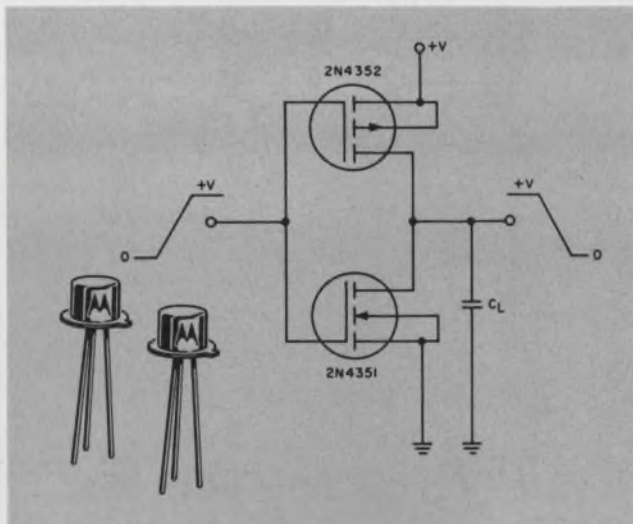

1 "Zero Power" Switching Complementary MOSFETs

Now, you can design ultra low-power complementary switching circuits, or circuits with switching times in the nanoseconds region using Motorola types 2N4351 (n-channel) and 2N4352 (p-channel) MOSFETs. In addition to exhibiting leakage currents of only 10 pA, they also show very low capacitance values. The combination provides a very high input impedance resulting in a large fan-out capability and almost no loading of the driving source. Both units are designed for enhancement-mode, or normally "off" operation.

Available in the standard TO-72 package, each device is 100-up priced at just \$4.50 (compared with prices in the \$7.00 range for most of today's MOSFETs). Here are more detailed specifications for these two new state-of-the-art devices:

CHARACTERISTICS (2N4351-2N4352)	SYMBOL	MIN	MAX	UNIT
Switching Time (Total)	t	—	270	ns
Forward Transfer Admittance	$ y_{fs} $	1000		μmhos
Reverse Transfer Capacitance	C_{rss}	—	1.3	pF
Input Capacitance	C_{iss}	—	5.0	pF
"ON" Drain Current	$I_{D(on)}$	3.0	—	mAdc
Gate Leakage Current	I_{gss}	—	± 10	pAdc
Zero-Gate-Voltage Drain Current	I_{DSS}	—	10	nAdc
Drain-Source "ON" Voltage	$V_{DS(on)}$	—	1.0	Vdc

*Trademark of Motorola Inc.

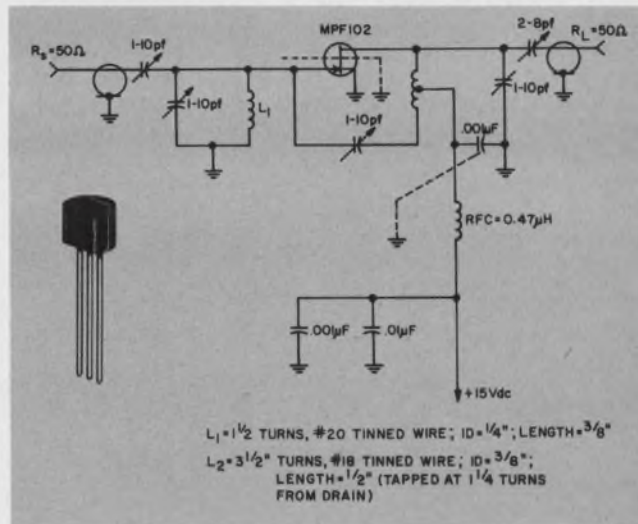

2 Low-Cost, Low-Noise Plastic RF FET

Here's a new low-cost junction FET (type MPF102) that's priced at just 45 cents each (1000-up), making it economical for FM-tuner front-ends, yet with such high quality performance it's also well suited for a variety of sockets in industrial communications equipment — for both mixer and amplifier applications! The MPF102, housed in Motorola's reliable Unibloc* plastic package, combines a low 200-MHz typical noise figure of only 2.5 dB with exceptionally high gain — prime qualities for all RF applications! Here are other top specs that show the all-around performance of the MPF102:

CHARACTERISTICS (MPF102)	SYMBOL	MIN	MAX	UNIT
Gate Reverse Current	I_{gss}	—	-2.0	nAdc
Zero-Gate-Voltage Drain Current	I_{DSS}	2.0	20	mAdc
Input Capacitance	C_{iss}	—	7.0	pF
Reverse Transfer Capacitance	C_{rss}	—	3.0	pF
Forward Transfer Admittance	$ y_{fs} $	2000	—	μmhos
Noise Figure	NF		2.5 (typ)	dB

ON READER-SERVICE CARD CIRCLE 6

Write for complete data sheets on the MPF102 and 2N4351-52. We'll also send you our latest application notes on complementary FET switching and RF FET circuit design. Then, for sample devices you can try right now, contact your nearby franchised Motorola Semiconductor distributor or district sales office.

- where the priceless ingredient is care!



MOTOROLA
Semiconductors

MOTOROLA SEMICONDUCTOR PRODUCTS INC. / P. O. BOX 955 / PHOENIX, ARIZONA 85001

Our I.C. digital modules reject more noise than anybody's.

Integrated flip-flops, inverters and buffer amplifiers in T Series modules are made to our proprietary design and hermetically sealed in TO-5 cans.

T Series input and load resistors, made to much tighter tolerances than can be attained with integrated components, are mounted outside the integrated circuit containers, eliminating power dissipation problems.

Full-width copper ground plane sandwiched between epoxy-glass boards minimizes circuit inductances and discourages noise spikes. Mounting cases also have full-width shield planes to retard noise coupling between logic wiring.

Discrete input diodes enable us to place the switching threshold right in the middle of the logic swing.

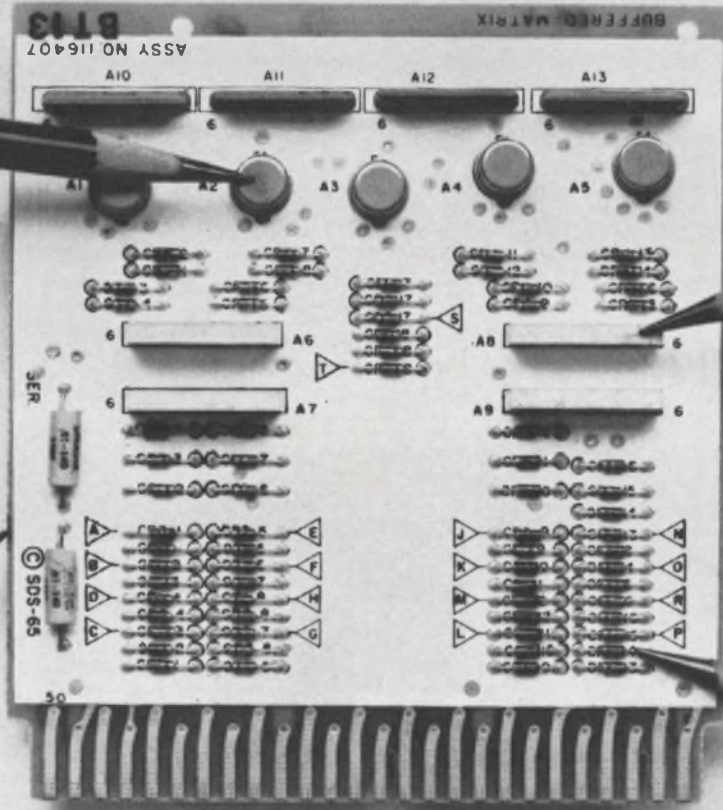

The payoff.

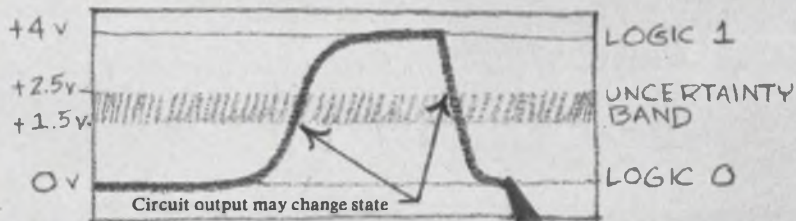

T Series logic levels are 0 and +4 volts, and noise rejection is 1.5 volts minimum, leaving a maximum uncertainty band only one volt wide within which noise can trigger the circuit output. This uncertainty band of 25% is far narrower than those of other I.C. modules on the market.

SDS

Scientific Data Systems,
Santa Monica, California



**ACKNOWLEDGED as the MOST TEMPERATURE STABLE
MINIATURE CAPACITORS in the ELECTRONICS INDUSTRY . . .
SUPERIOR to GLASS and MICA CAPACITORS**

If your circuits require capacitance stability, high Q, and close tolerance, there's only one line of miniature capacitors to consider . . . ERIE NPO High Stability Ceramic Capacitors. These ultra-stable ceramic dielectrics are considerably superior to glass and mica . . . for ERIE produces the most nearly perfect ceramic in the industry.

NPO (temperature coefficient) miniature capacitors are available in a variety of physical types as illustrated at right. Capacitance range and capacitance tolerance (as close as $\pm 1\%$ or $\pm .1$ pf.) to suit your circuit requirements. Units are conservatively rated . . . flash test 3 times WVDC, life test 2 times WVDC.

In addition to these NPO High Stability Ceramic Capacitors, Erie offers a full line of Temperature Compensating types (P100 through N5600) and General Purpose type capacitors . . . all produced from the most nearly perfect ceramic in the industry.

Write for information TODAY about Erie NPO High Stability Ceramic Capacitors. A helpful Erie Field Sales Engineer will be happy to discuss your specific requirements . . . no obligation of course.

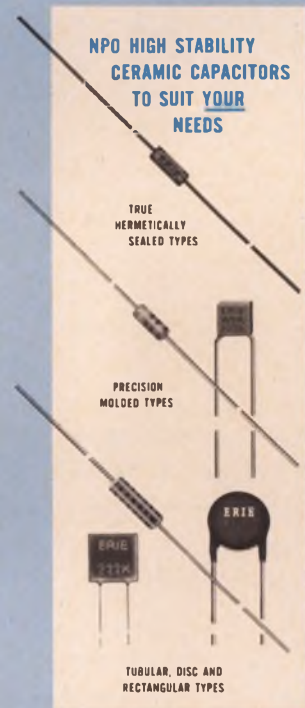

ERIE

TECHNOLOGICAL

PRODUCTS, INC.



Erie, Pennsylvania

CAPACITANCE CHANGE VS. TEMPERATURE

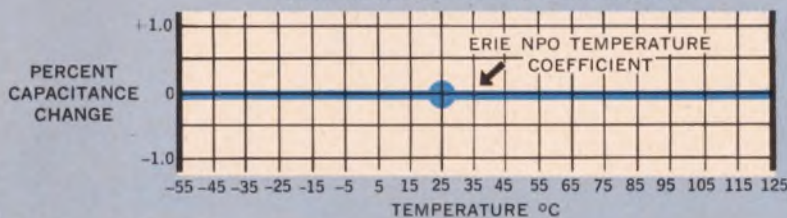

Another Series of Components in Erie's Project "ACTIVE" . . .
Advanced Components Through Increased Volumetric Efficiency

ON READER-SERVICE CARD CIRCLE 8

ON READER-SERVICE CARD CIRCLE 7

New from Sprague Electric!

bandwidth

50 MHz

voltage gain

40 dB



This is an outstanding performance characteristic of **Sprague UC-1514A Ceracircuit® Amplifiers**. They also feature excellent stability of gain and d-c output operating point, in addition to providing complete short-circuit protection.

The first of a new series of Ceracircuit® amplifier modules, Type UC-1514A is well-suited for video and audio, as well as communications applications.

Manufactured by the hybrid thin-film technique, Ceracircuit® Amplifiers offer substantial size and weight

reduction in addition to reliable, stable operation over the entire operating range of -55 C to $+100\text{ C}$. Their precision planar metal-film resistors have an extremely low noise level and excellent load-life stability. Semiconductor devices are mounted on small ceramic wafers which, in turn, are bonded in a leadless configuration to the basic thin-film circuit.

Type UC-1514A Ceracircuit® Amplifiers are encapsulated in low-loss, resilient resin-filled, pre-molded epoxy cases which provide rugged mechanical protection as well as dimensional consistency.

For complete technical data, write for Engineering Bulletin 22111 to Technical Literature Service, Sprague Electric Company, 347 Marshall Street, North Adams, Mass. 01247

SPRAGUE COMPONENTS

THIN-FILM MICROCIRCUITS
INTEGRATED CIRCUITS
TRANSISTORS
CAPACITORS
RESISTORS

PULSE TRANSFORMERS
INTERFERENCE FILTERS
PULSE-FORMING NETWORKS
TOROIDAL INDUCTORS
ELECTRIC WAVE FILTERS

CERAMIC-BASE PRINTED NETWORKS
PACKAGED COMPONENT ASSEMBLIES
BOBBIN and TAPE WOUND MAGNETIC CORES
SILICON RECTIFIER GATE CONTROLS
FUNCTIONAL DIGITAL CIRCUITS

SPRAGUE®
THE MARK OF RELIABILITY

Sprague® and ® are registered trademarks of the Sprague Electric Co.

News

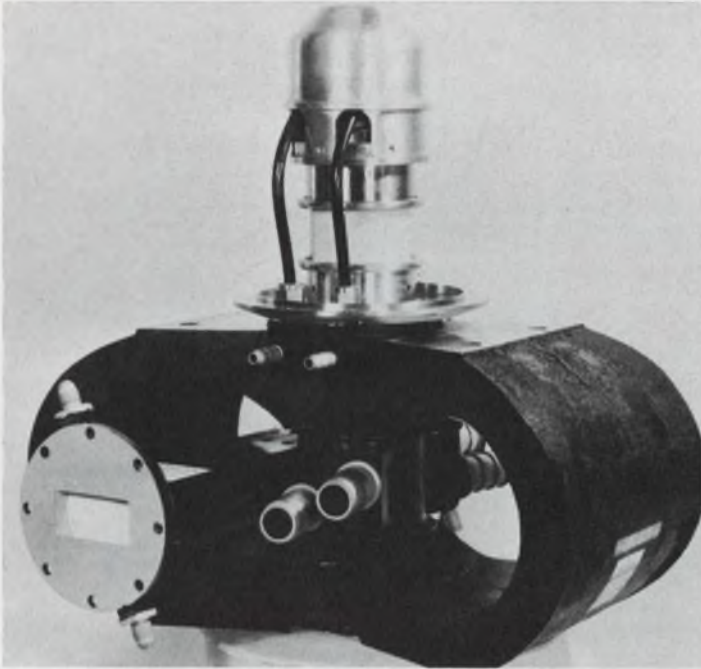

Microwave tubes hold their own in high-power, hf regions despite solid-state units' inroads. Page 17

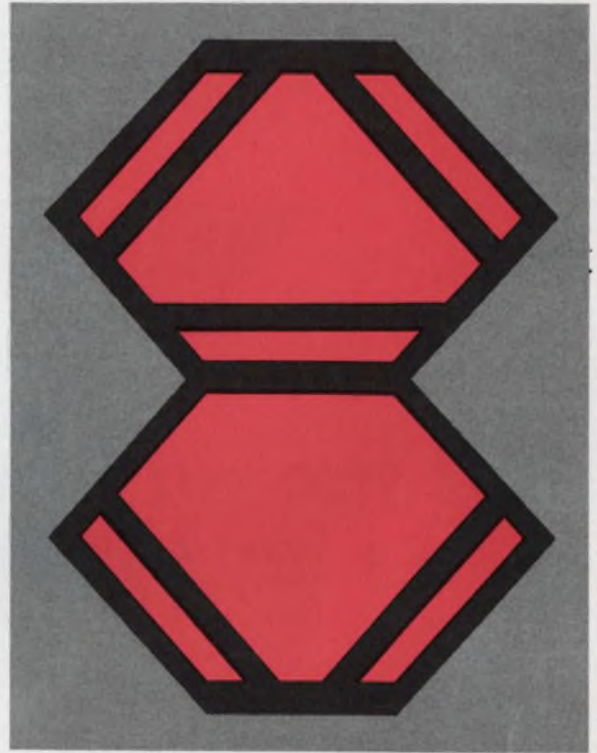

Organic photovoltaic devices make great strides toward practical future. Page 24

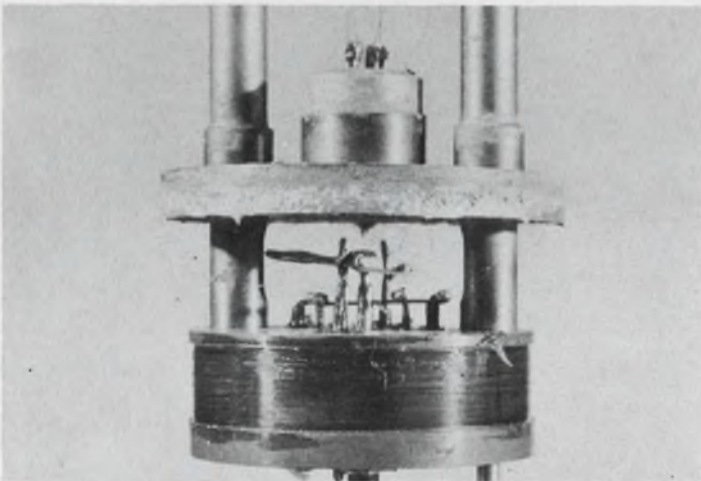

Self-calibrating thermometer uses binary logic for precise measurement from 10° to 25°K. Page 22

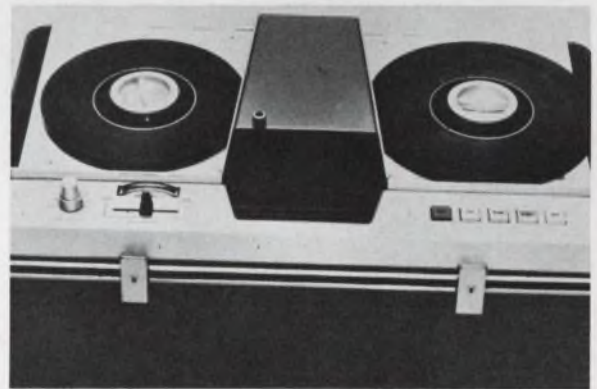

High-speed, low-cost tape transport has bandwidth greater than 50 MHz. Page 38

Also in this section:

Plasma panel may oust CRTs for displaying computer digital signals. Page 34

Family of automatic battery chargers developed for battlefield use. Page 42

News Scope, Page 13 . . . **Washington Report**, Page 29 . . . **Editorial**, Page 51

Now from Sprague!

QUALITY
STABILITY
RELIABILITY
SMALL SIZE

All the advantages of tantalum in one **LOW COST** capacitor!

EPOXY-DIPPED TANTALEX® CAPACITORS...

For industrial, commercial, and entertainment electronic applications where tantalum capacitors were previously too expensive!

— High stability—very little capacitance change, even at outer limits of operating temperature range.

— Type 196D Solid-electrolyte Tantalum Capacitors have special epoxy-dip coating which keeps costs down without sacrifice in dependability. Positively seals capacitor section while providing excellent electrical insulation. Protects against mechanical damage in handling.

— Radial lead design for plug-in mounting on printed wiring boards. The .250" lead spacing will fit standard .125" grids.

— High stability—very little capacitance change, even at outer limits of operating temperature range.

— Low dissipation factor of these capacitors permits higher ripple currents.

— Meet environmental test conditions of Military Specification MIL-C-26655B.

— Prime capacitance and voltage ratings. Based on rating popularity of other types of solid tantalum capacitors.

— Designed for continuous operation at temperatures from -55°C to $+85^{\circ}\text{C}$.

For complete technical data, write for Engineering Bulletin 3545 to Technical Literature Service, Sprague Electric Company, 347 Marshall Street, North Adams, Massachusetts 01247.

Now available for fast delivery from your Sprague Industrial Distributor

SPRAGUE COMPONENTS

CAPACITORS
TRANSISTORS
RESISTORS
INTEGRATED CIRCUITS
THIN-FILM MICROCIRCUITS
45C-4138R1

PULSE TRANSFORMERS
INTERFERENCE FILTERS
PULSE-FORMING NETWORKS
TOROIDAL INDUCTORS
ELECTRIC WAVE FILTERS

CERAMIC-BASE PRINTED NETWORKS
PACKAGED COMPONENT ASSEMBLIES
BOBBIN and TAPE WOUND MAGNETIC CORES
SILICON RECTIFIER GATE CONTROLS
FUNCTIONAL DIGITAL CIRCUITS

SPRAGUE®
THE MARK OF RELIABILITY

Sprague® and ® are registered trademarks of the Sprague Electric Co.

Global electronic patent search system proposed

By 1975 it may be possible to set up a global electronic patent search system that would contain "instantly available data on every existing patent and patent application, accessible to every inventor or potential user of his invention."

This is the view of perennial prognosticator, RCA board chairman, David Sarnoff, during an address before an international patent conference in Frankfurt, West Germany.

Nearly 350 years after the introduction of the first patent law, according to Sarnoff, "we are still burdened with a fragmented territorial concept of patent coverage." (see "News Scope," ED 1, Jan. 4, 1967, pp. 13-14).

"An inventor is still compelled to go through separate and often widely different procedures in nearly every nation where he seeks to establish title to his work," he commented.

Sarnoff described several technological advances which, he said, had brought a world patent search system into the "realm of imminent

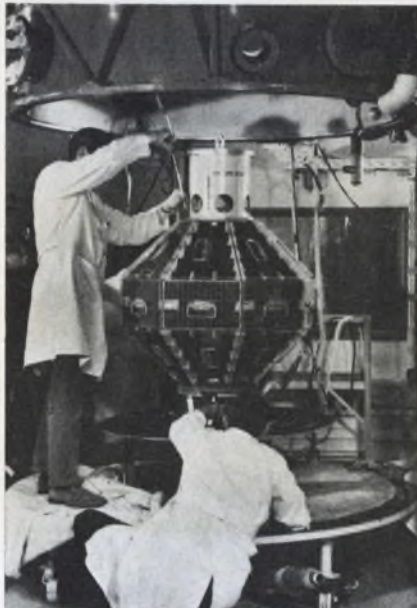

Communications satellites, such as this Philco-Ford version, could help link worldwide patent offices.

reality." Included were:

- New generations of communications satellites with vastly increased capacities, and new cable facilities.

- Advances in laser holography that may permit, for example, the transfer of all the information on 100,000 standard typewritten pages to a single card about the area of an automobile license plate.

- Computers now in planning that will be able to store up to 100 million bits of information in their main memory units and retrieve them at the rate of a million bits per second. Cryogenic memories reportedly would be used (see "Cryogenics promises a billion bit memory," ED 8, April 12, 1967, p. 13).

- High-speed electronic printers currently in development that will be able to reproduce computer data at thousands of lines per minute.

- New electronic systems now coming into use that can compose images, print diagrams and write text a hundred times more rapidly than conventional manual and mechanical methods. With the latest of these, a 600-page book could be made up in any desired type face in only an hour.

Sarnoff envisions a World Patent Search Center that could be the nucleus of a unified system for determining the originality of an invention anywhere in the world.

The search system would comprise a network of national and regional patent offices linked by satellite, cable and overland circuits to a central computer. Each of the national and regional offices would maintain laser hologram files of all existing patents and patent applications in its area.

Whenever an inventor filed a patent application in any country in the system, the information would be flashed over the world network to the computer. From the computer, an automatic call would go to all

offices in the network for information in their hologram files needed to determine the novelty of the invention.

The whole process, from start to finish, would be automatic and practically instantaneous, and the inventor would know within hours whether he could obtain a world patent on his idea.

Despite the technical feasibility of such a system, Sarnoff said, important operational questions must be resolved: Who should have access to the data in the search system, and under what conditions? What procedures should be followed in adding new information to the files? How will outdated material be eliminated?

Army blasts industry for late deliveries

The head of the U.S. Army's Electronics Command has blistered the electronics industry for tardy delivery of equipment for the Vietnam war. Maj. Gen. William B. Latta, commander of Fort Monmouth, N. J., said that for over a year the Army has been "plagued by unacceptable shortages" of materials and components.

Latta complained that electronic test equipment now took 3 times as long to deliver as formerly, magnet wire 5 times, other wire and cable 9 times, and switches 5 times.

"By far the largest share of the blame for contractor production delinquency must rest on the industry contractors themselves," he insisted.

He said that, while the Army was not wholly free from criticism in the matter of setting unrealistic schedules, "We try to have a continuing review of production lead times to assure that the schedules we require of industry are consistent with the vendor and production facts of life."

He said that delivery shortcomings were caused by:

- Failure of prime contractors to locate suppliers.

- Failure to secure alternative sources.

- Failure to order all needed materials and components.

- Inefficient negotiation of purchase orders and delivery schedules.

The remedy would be a "more conscientious effort by contractors,"

Latta declared.

When asked to compare the performance of industry now and during the Korean conflict, Latta said: I was in charge of procurement then, and it was definitely better." Was there any one missing ingredient this time, he was asked. "Yes, there is," he said. "Patriotism."

Pressed for comment, he said that there was too much emphasis by industry on luxury consumer goods like color television, which bring larger financial rewards than military electronics.

TV sets burgeon with miniature components

Getting a jump on the competition, Motorola's Consumer Products Div. has displayed the first line of all solid-state color-TV sets in the U.S. All-transistor black-and-white sets have been on the market for sometime.

Two versions of the 23-inch sets were shown, both identical in their electronics but different in chassis construction. The sets feature modular construction with 10 plug-in circuit boards. Each set contains 62 transistors, 28 diodes and an IC chip in the audio system in addition to the rectifier and picture tube. The deluxe version model TS-915 is built on a vertical plane and the entire chassis slides out from the front of the set for ease of servicing. The model TS-919 has more conventional horizontal-chassis construction.

A Motorola spokesman said the sets will be on the market sometime in late July and will be priced somewhat higher than tube color-TV models. Prices will begin at about \$600, he said.

In April, Thorn Electrical Industries, Ltd., of England, announced that it had developed a fully transistorized chassis for its 25-in. color TV sets. Thorn said the set—priced from \$870 to \$970—contains 90 transistors and may not be marketed in Europe before 1968.

Meanwhile, Texas Instruments displayed what it said was the first hybrid integrated circuit for TV ap-

plication—a dime-sized 30-component fm-sound-system module. It was shown at the recent IEEE Spring Conference on Broadcast and Television receivers. The TI hybrid integrated circuit contains a wide-band i-f amplifier, and fm detector and an audio preamplifier. Construction is with discrete semiconductors combined with thick-film-resistor fabrication techniques.

First tariff-cut details leaked by Japanese EIA

A Japanese electronic trade association has published details of some of the tariff cuts that were adopted in the Kennedy Round of tariff talks recently concluded at Geneva (see "News Scope," ED 12, June 7, 1967, p. 73). The U.S. Government still has not formally released these figures. The official announcement will be made in Washington in July.

Apparently a 50% slash will be effected on the following items (the present levels are shown in parentheses):

- Transformers (12%)
- Switches (17.5%)
- Transistor radios (12.5%)
- Television receivers (10%)
- Transceivers (12.5%)
- TV picture tubes (30%)
- Electron tubes (30%)
- Test equipment (12%)
- Capacitors (12.5%)
- Phonographs and attachments (11.5%)

Excluded from negotiations were tape recorders (11.5%) and electronic musical instruments 17.5%.

The final level of reduction is due to be reached gradually over a five-year period. The President, however, still has not signed the treaty, nor has Congress ratified it.

Navy sets new guidelines for electronics packaging

During the past two years the U.S. Naval Material Command has been working to develop preferred packaging and enclosure approaches for future Naval electronic systems and equipment. These approaches are described in a new 248-page *Navy Systems Design Guidelines Manual for Electronic Packaging* (NAVMAT P3940, May, 1967). The concepts in the manual

include packaging of microelectronic devices, printed-wiring plug-in boards and functional modules, and basic external housings in combination with alternative rack configurations. Standard connectors and wiring alternatives are also covered.

Rear Admiral F. L. Pinney, Jr., Deputy Chief of Naval Material for Development, in the foreword of the manual, states that its use is "mandatory in planning the development of future naval electronic systems and equipment." It is understood that the Navy Department may soon issue an internal directive implementing the manual's guidelines. This could have a direct impact within the electronics industry in terms of responses to requests for proposals in about a year, according to industry sources.

A copy of the manual may be obtained free by writing to Naval Material Command (Code MAT-0325), Dept. of the Navy, Washington, D. C. 20360.

Newspaper delivery by TV to be tested by RCA

A system that would print out an electrostatic facsimile newspaper in the home through regular TV channels is to be tested by Radio Corp. of America.

The company filed an application with the Federal Communications Commission for permission to make off-hour, on-the-air tests for six months between RCA Laboratories at Princeton, N. J., and New York City—possibly using RCA-owned WNBC-TV, Channel 4.

The transmission of printed material into the home is accomplished by a system of "electronic hitchhiking" by blending signals at the transmitter with those of regular TV programs.

Dr. James Hillier, RCA vice-president, said: "The blended signal is broadcast for reception by standard TV home antennas. The signal is fed from the antenna to the facsimile printer without affecting home TV reception in any way." The experimental system, he pointed out, would require no additional rf spectrum nor would its use limit present television services. Dr. Hillier emphasized it might be several years before an operating system were publicly available.

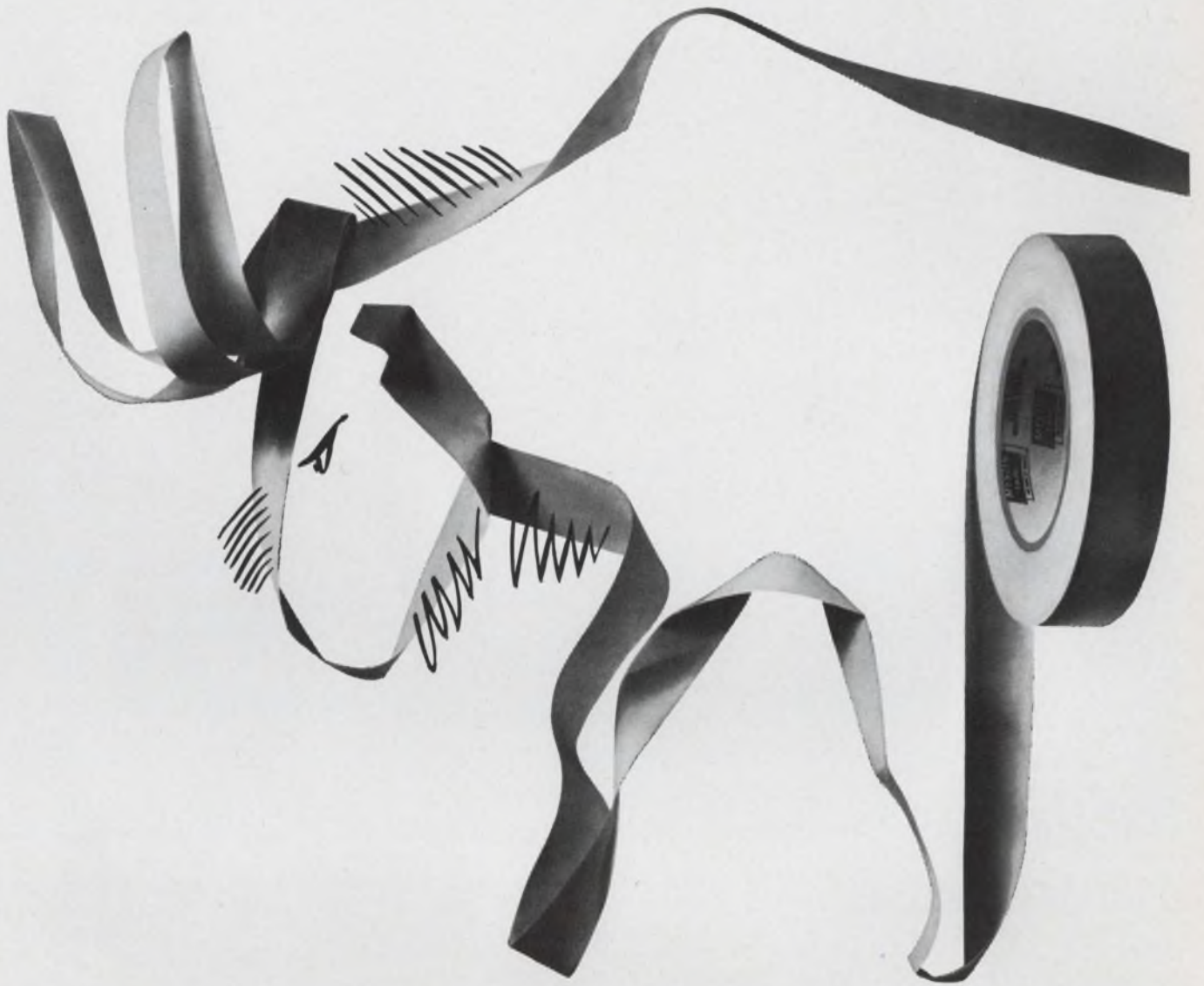

What's gnu? Mystik NOMEX[®], KAPTON[®] and TEDLAR[®], that's what!

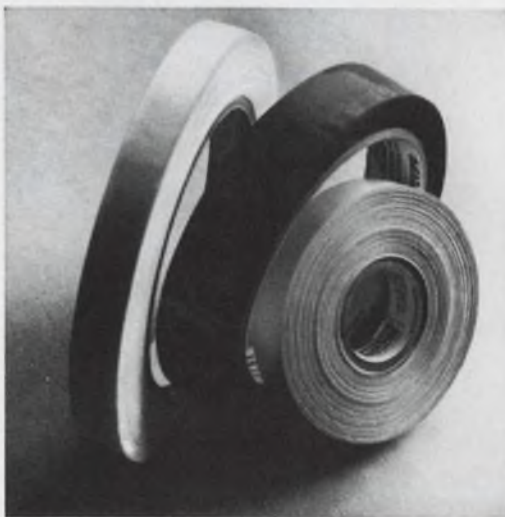

Mystik scores again by being the first to utilize three new materials ... Nomex, Kapton and Tedlar ... and add them to their already extensive line of pressure-sensitive tapes.

NOMEX —a highly conformable tape that offers excellent holding power and dielectric strength characteristics.

KAPTON—the featherweight of wire insulations... excellent high temperature applications which require low weight structures.

TEDLAR—ideal for electrical applications because of high dielectric strength combined with excellent weather and hydrolytic resistance.

If you would like more information on these or any other Mystik special-purpose tapes, contact your local Mystik distributor. He is listed in the yellow pages under "Tapes—Adhesive". Or, write Mystik Tape Division, The Borden Chemical Company, 1700 Winnetka Avenue, Northfield, Illinois 60093.

® Du Pont registered trademark



**BORDEN
CHEMICAL**

ON READER-SERVICE CARD CIRCLE 10

FROM PAR Detection, Measurement or Comparison of Noisy Signals



New Signal Correlator

PERFORMS AUTO- OR CROSSCORRELATIONS IN REAL TIME

CORRELATION FUNCTION COMPUTED FOR 100 DELAY POINTS SIMULTANEOUSLY

The PAR Model 100 Signal Correlator, a general purpose, high accuracy instrument of wide dynamic and delay range, computes the auto- or cross-correlation function of input signals and makes them available for continuous display. This system computes 100 points of the correlation function over total spans from 100 microseconds to 1 second. It operates by simultaneously multiplying one input signal by 100 separate delayed replicas of the second input signal. The resulting 100 products are individually averaged and stored in analog memory elements. Readout, which may be performed continuously as the correlation function is being computed, is accomplished by scanning the memory bank at a rate consistent with the speed of the external readout device, e.g., an oscilloscope or x-y recorder.

Correlation analysis — an extremely powerful signal processing technique in many areas of science and engineering — has heretofore been neglected, largely due to a lack of availability of suitable equipment. The

PAR Model 100 Signal Correlator will be useful in such diverse fields as aero- and hydrodynamics, plasma physics, vibration analysis, radio astronomy, radar, lasers, medical physics and geophysics.

**PAR Model 100—
Hundred Point Time Delay Correlator
SPECIFICATIONS IN BRIEF:**

Total Delay Range: 100 μ Sec to 10 Sec in 1, 2, 5 sequence.

Input Signal Levels: Peak-to-peak signals of 0.4 volts to 200 volts are accommodated without overload in each channel.

Correlator Gain Factor: At gain of 1 in each channel, 1 volt into each input will give 1 volt of correlated output. Gain for each channel is .01 to 5, in 1, 2, 5 sequence.

Noise and Dynamic Range: Base line noise with no signals, 10^{-3} volts peak-to-peak. Maximum correlated output, ± 3.5 volts.

Frequency Response and Resolution: Channel amplifiers flat to 1 megacycle. Resolution: 100 sampling points on output function.

Averaging Time - Constant: Nominally 20 seconds: May be changed to any value from 0.1 to 100 seconds.

Accuracy: Better than 1%.

Readout: 0-3.5 volts at sweep rates of 20 per Sec, 1 per 10 Sec, 1 per 50 Sec.

Price: \$8500.00. Export price approximately 5% higher, except Canada.

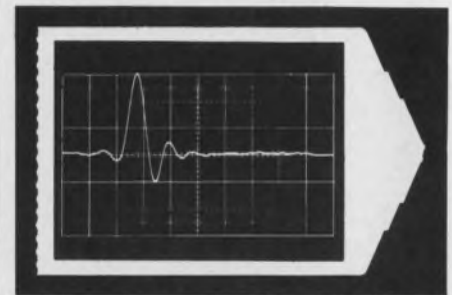

Typical Photograph of Crosscorrelation Function of Input and Output Signals of Complex Passive Network Driven by White Noise.

For more information call (609) 924-6835 or write Princeton Applied Research Corp., Dept. E, P.O. Box 565, Princeton, N. J. 08540.



PRINCETON APPLIED RESEARCH CORP.

ON READER-SERVICE CARD CIRCLE 11

ELECTRONIC DESIGN 13, June 21, 1967

Microwave tubes hold their own

Despite inroads by solid-state units, tubes still have an important place in systems

Neil Sclater
News Editor

Microwave tubes will hold their own for many years to come, and be joined by newer versions in advanced systems. This view was expressed by a panel of microwave-tube engineers from industry and government at the recent Microwave Exposition held at New York's Coliseum.

The engineers stated that there are definite regions in the power-frequency spectrum where microwave tubes will continue to predominate in the foreseeable future. This region is characterized by high power and high frequency—generally above 1 GHz with average power greater than 10 watts.

In the region where solid-state devices and tubes overlap (see shaded area in illustration), tubes will continue in use and perhaps find new and expanding applications, they predicted. The tube engineers, aware of improvements in solid-state devices, said that tube technology is being continually advanced in a seesaw contest for applications.

They cautioned against direct comparison of solid-state devices and tubes in the region of overlap because of the fundamental differ-

ence in their mode of operation. The varying requirements imposed on microwave devices, relative cost, size, weight and available power supply were all factors to be considered, they added. The designer has a far wider selection of power sources and amplifiers in the microwave region than formerly, they claimed, because of advances being made in both classes of device.

In the overlap region, today's solid-state devices are transistors, or make use of internal or external varactor-diode frequency multipliers. In this same region reflex klystrons, traveling-wave tubes and gridded tubes operate also. These tubes are expected to remain useful because of their proven high reliability, long life, generally low cost, and ability to dissipate the heat associated with power generation.

One speaker, Willis Yocom, of Bell Telephone Laboratory, Murray Hill, N. J., said that Bell was not committed to either solid-state or tube devices. While it intends to use transistorized amplifiers in the receivers of a projected microwave transmission system, it still has faith in traveling-wave tubes for communications systems.

He said that the low noise figure of about 5 dB obtained in one proto-

type 4-GHz amplifier and its ability to operate from an approximately 10-volt power supply justified use of solid state. Its 500-MHz bandwidth was adequate for the intended application, he noted.

He added, however, that the record of reliability for traveling-wave tubes was impressive in the same power and frequency range. Bell expects to continue using TWTs because of their high efficiency (40 to 50%), extremely wide bandwidth, and life that in many cases exceeds 50,000 hours.

The case for gridded triodes was stated by George Taylor of the U.S. Army's Ft. Monmouth Signal Laboratory, N. J. Taylor said that the triodes have been improving continuously since they first appeared more than 25 years ago. New designs and improved materials and construction techniques have extended their usefulness as amplifiers to 5 GHz and as oscillators to 10 GHz. He said that within the last 10 years output power has jumped to about 10 watts—a tenfold increase at 5 GHz—and efficiency has jumped to 30 per cent, a fivefold improvement. In the last two years alone, their life expectancy at the upper range has been increased from 100 to 1000 hours.

Taylor reported that gridded tubes give performance equal to many reflex klystrons, yet they are

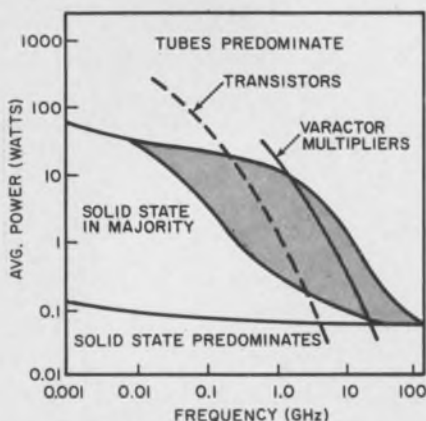

Power-frequency domain of tubes and solid-state devices shows area of overlap (shaded) where solid-state devices are challenging tubes. In the upper region, tubes are expected to dominate for years to come.

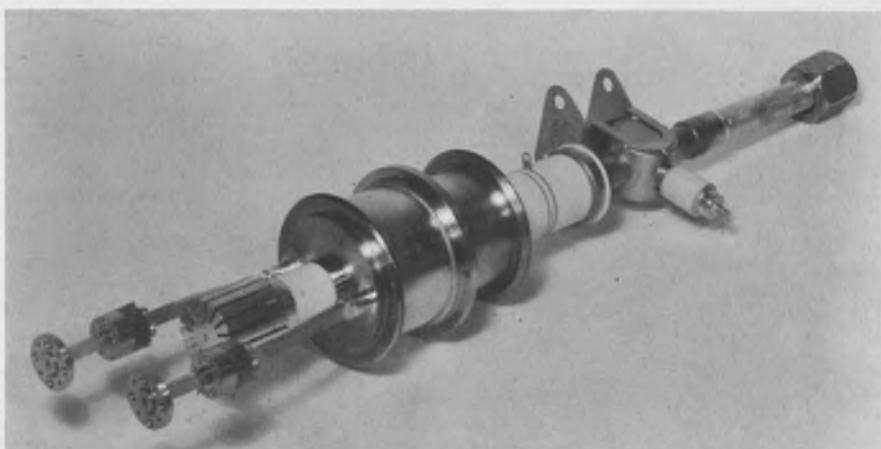

Millimeter-region traveling-wave amplifier represents one application where tubes dominate. Hughes device (without focusing magnet) can produce 100 cw at 94 GHz. Small-signal gain is 20 dB at 20% efficiency. Space communications are encouraging mm development.

cheaper and require less complicated power supplies. The regions in which they once were dominant, however, have been invaded by solid-state devices.

The Army, according to Taylor is now looking to hybrid devices, combining the best features of the grid-tube devices with those of solid-state devices.

The future of microwave tubes at millimeter waves was discussed by Donald Forster, an engineering manager at Hughes Aircraft Corp.'s research laboratories in Malibu, Calif. He said that average power in excess of 5 kW has been achieved at 55 GHz with a forward-wave traveling-wave-tube amplifier, giving about 30 dB gain. Bandwidths of one GHz and efficiencies of greater than 30% have been observed. Forster said that the state of the art in continuous-wave sources at millimeter frequencies (20 to 160 GHz) has advanced from about 20 watts to its present level in only six years.

The interest in high-power millimeter sources, he said, had been spurred by Air Force and NASA programs in space communications.

Here, he commented, millimeter-wave communication was competing with lasers.

The high-power millimeter tube which Forster took as typical of the state of the art was built by Hughes for use at the Oak Ridge National Laboratory for heating magnetically confined plasma in experiments. He said it was not applicable to radar or communications because the frequency selected suffers from high atmospheric absorption. The tube design, however, could readily be scaled up or down in the millimeter-wave spectrum.

Forster said that there was little doubt that greater output power could be obtained at millimeter wavelengths. Basic development was needed on guns and collectors. Greater beam compression would also be welcome with high-current-density guns, he added.

The future of high-power linear and crossed-field tubes in the L, S and X bands (1.0 to 12.0 GHz) was discussed by Dr. Philip Hess, a scientist at Littion's Electron Tube Div. San Carlos, Calif., and Armand Staprans, an engineering manager at Varian Assoc., Palo Alto, Calif.

Dr. Hess spoke for crossed-field

devices, which include magnetrons, backward-wave oscillators and Amplitrons; Staprans covered the future of super-power linear traveling-wave tubes and high-power multicavity klystrons capable of more than 500-kW average power.

Magnetrons and Amplitrons will continue to be useful for generating high-peak, pulsed power for radar, Dr. Hess believed. The primary role for M-type backward-wave oscillators and amplifiers will still be in military communications and electronic counter measures, he said.

Linear TWTs will go on being used for radar long-range communications and as power sources for linear accelerators, he said.

He said that manufacturers of high-power TWTs in this region were refining present beam optics, waveguide-window technology and RF circuit design as well as improving efficiency. He predicted that within five years the efficiencies of these tubes will be increased from their present 50% to 70%.

Staprans and Dr. Hess noted the trend toward the use of high-power tubes for industrial heating, and even saw a brighter future for tubes in microwave cooking. ■ ■

Solid-state vs tubes (0.5-2 GHz)

	Solid-state		Tubes		
	Transistor oscillator	Crystal oscillator (controlled chain)	Reflex klystron	Pencil-tube triode	Backward wave oscillator
Temperature stability (ppm/°C) Uncompensated Compensated	100 10	1 0.1 (Oven-controlled)	5 0.5	10	10
Voltage stability Plate or collector (±5% ΔV) Filament (±3% ΔV)	±1.2-1.5 MHz	Includes 5% ΔV	±7.5 MHz	±0.4 MHz ±0.2 MHz	±35 MHz
Tuning Mechanical: 0.5-1 GHz 1-2 GHz Electrical: 0.5-1 GHz 1-2 GHz	Octave 30-50% 12% 12%		30%		Octave
AM sideband noise	Fair	Fair (harmonic generator by itself, good)	Good (2-cavity klystron, best)	Fair; comparable to uncompensated reflex klystron	Fair
FM noise (relative)	Poorest	Good (lowest near carrier)	Fair, when unstabilized Good, when stabilized Best, 2-cavity klystron		Poor
Courtesy of RCA					

**SPECIFY
UNION CARBIDE'S
2N4044 SERIES
FOR THE BEST AVAILABLE
IN INTEGRATED DUALS!**

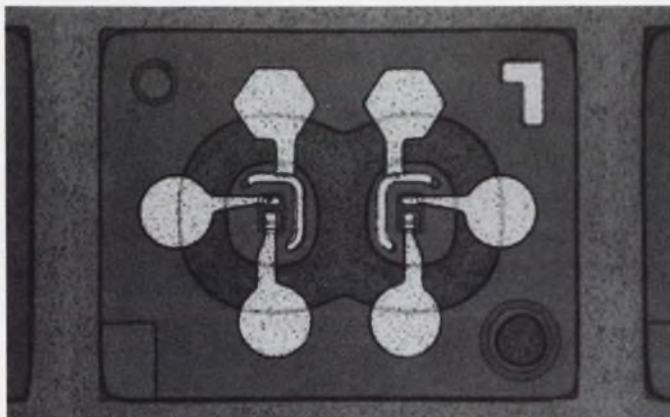

MONOLITHIC INTEGRATED dual transistors with dielectric isolation. Common substrate for better thermal and electrical characteristics.

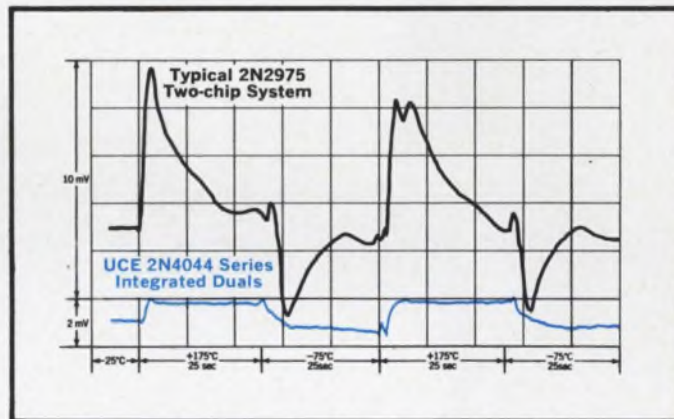

THERMAL RESPONSE COMPARISON. UCE integrated duals are very closely matched and track within narrow voltage band over entire temperature range. Typical two-chip system varies widely in response under the same conditions.

LOWER UNIT COST. UCE integrated duals will cost you less per unit than matched pairs of discrete transistors.

CHECK THE SPECS for yourself, and then sample these devices. You'll find the dielectric process for true isolation, and Union Carbide Electronics' device design yields

low noise transistors with the lowest voltage and current drift, highest betas at low collector current, and high f_r 's.

USE THESE DUALS for low level front end amplifiers, differential amplifiers, comparators, operational amplifiers, integrators, sample and hold and A/D converters.



Semiconductor Department / 365 Middlefield Road, Mountain View, California 94040 / Telephone: (415) 961-3300 / TWX: 910-379-6942

ON READER-SERVICE CARD CIRCLE 12

Russian lunar TV simple but sharp

A simple electro-mechanical device in the Soviet Luna 9 and Luna 13 spacecraft permitted the Russians to obtain TV pictures of the moon with resolution that matched that of the human eye.

The weight of the assembly was 2.7 pounds, and it consumed 2.5

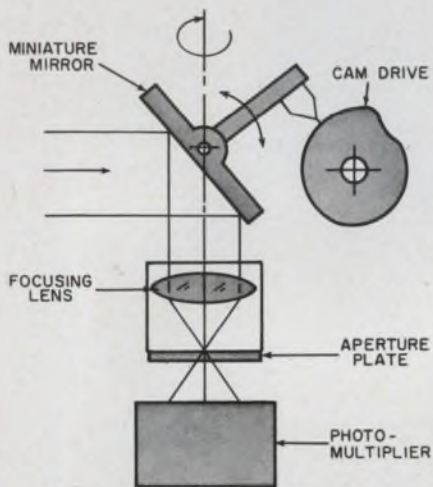

1. Russian camera used in Luna 9 and Luna 13 spacecraft uses a simultaneously rotating and oscillating mirror. The image falls on the lens, passes through the aperture that determines the size of each picture element, and then reaches the photomultiplier.

watts of power, according to a description by I. Khodarev and A. Selivanov in a recent issue of *Aviation and Cosmonautics*, (Issue 4, 1967, p. 12).

The functional schematic of the camera is shown in Fig. 1. It consists of a miniature mirror, cam drive, focusing lens assembly, aperture plate and photomultiplier.

The mirror rotates slowly about the vertical axis (horizontal scan), while the cam drive causes it to move up and down (vertical scan). The light reflected by the mirror falls onto the lens, passes through the aperture and is received by the photomultiplier. The resulting electrical signal is fed to the transmitter, which sends it to the earth receiving stations.

The vertical angle of vision of the camera (α in Fig. 2) is about 30° , and the camera can look around it for the full 360° angle (β). The full scan consists of 6000 vertical lines, each line having 500 TV-like elements. Consequently the resolution of the camera is 0.06° , or 3.6 angular minutes, which is roughly the resolution of the human eye.

The scan speed was one line (500 elements) per second. In this fash-

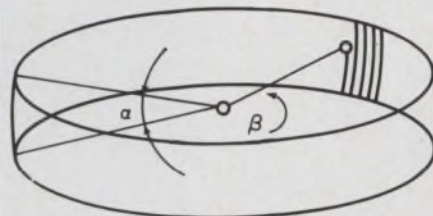

2. Wide views are available with the lunar camera. The vertical viewing angle (α) is about 30° . The horizontal viewing angle (β) can be a full 360° and can be controlled from the earth. The required bandwidth is only 250 Hz.

ion, then, the full 360° view was obtained in 100 minutes. This permitted use of a low-bandwidth system of about 250 Hz, which in turn allowed the use of low-power transmitters and omnidirectional antennas.

This electro-mechanical system met the weight, power and environmental requirements of the lunar landing craft. The slowness of the scanning mechanism had no adverse effect on the quality of the pictures, since the observed objects were stationary and shadows on the surface of the moon were also approximately stationary over the time of the scan. ■ ■

Electronic monitor warns doctors before symptoms appear

An electronic "early warning" system is being used to alert hospital physicians to impending changes in the condition of patients "hours before clinical signs appear."

The system was recently put into operation in the cardiopulmonary intensive-care unit at San Francisco's Presbyterian Medical Center. It is being used primarily in the post-operative treatment of open-heart surgery patients.

Developed jointly by the hospital's Institute of Medical Sciences, under grants from the National Institutes of Health and the International Business Machines Corp., the computer-monitor system measures up to 25 vital factors involved in the patient's progress. It displays the accumulated findings on a television screen near the patient and signals

attending physicians if an abnormal condition begins to develop.

The circumstances under which an alarm will be sounded and emergency information displayed are prescribed in advance for each patient by his physician and entered into the system.

The operation of the system was described by the institute's president, Dr. Frank Gerbode, as follows:

Minutes after a patient enters the cardiopulmonary intensive-care unit, sensors begin to measure blood pressures, heart action, respiratory functions and body temperatures. The data are continuously and automatically fed to an IBM 1800 in a nearby computer room, which processes the factors useful to the physician in diagnosing the

patient's condition.

Some factors are monitored continuously for alarm conditions; others are processed every 10 minutes for routine closed-circuit TV display for doctors in the intensive-care unit. These factors are stored in the patient's history file and are printed out each day or on command. The doctors can also ask the system to produce a strip-chart record.

Future displays for the system, expected soon, will provide an even earlier warning for doctors, Dr. Gerbode said. The TV summaries of a patient's condition will be automatically interrupted by a special "suspect" message whenever a complication begins to develop. At the same time a soft alarm will sound and a red light will flash on. ■ ■

PRECISION

RODS AND TUBES

METALLIZED

SUBSTRATES

PACKAGES

PROGRESS REPORT **ALSiMAG** BERYLLIA CERAMICS

Where heat dissipation is important, ALSiMag beryllia offers a great advantage. At low temperatures, this ceramic has the thermal conductivity of aluminum plus the favorable electrical characteristics of ALSiMag alumina ceramics.

Close Tolerances "As Fired"

It is often said that close tolerances on beryllia ceramics are difficult, if not impossible. Five years of continuous progress now permits close dimensional control of small precision "as fired" ALSiMag beryllia ceramics. They are being produced regularly and in volume to close tolerances normally associated with the finest precision metal work.

Substrates and Snap-Strates

ALSiMag beryllia substrates have an "as fired" working surface of 8 microinches CLA or better. They have controlled small crystal sizes and low internal porosity. Their electrical properties parallel those of alumina substrates and their physical properties are adequate for usual substrate requirements. ALSiMag beryllia substrates may include a plurality of precision holes, serrations or indexing notches. Prototype quantities of ALSiMag beryllia substrates are stocked

in a thickness of .025" in sizes 1/2" x 3/4", 1" x 1", 1" x 2" and 2" x 2".

ALSiMag beryllia substrates, modified to separate accurately along clean straight lines, were originated by American Lava Corporation and are called SNAP-STRATES. They offer substantial savings in the finished component in some designs. Film and circuit work can be completed on the larger SNAP-STRATE and then divided into smaller controlled individual sizes.

Rods and Tubes

The great thermal conductivity of ALSiMag beryllia has led to wide use in rod and tube form, especially for resistors. Prior consultation on sizes and tolerances of beryllia rods and tubes can be especially rewarding.

Metallized Beryllia

American Lava has broad experience in a wide range of metallized beryllia ceramics and offers single source re-

sponsibility and economy in production time. Single plane precision metallized patterns on beryllia are also available. Pattern sizes up to 3" square are practical with line widths of 7 mils on 14 mil centers and, on short length converging lines, 4 mil widths on 8 mil centers. Line resistance down to 10 milliohms per square or better is possible.

Packages

ALSiPak® packages with an ALSiMag beryllia ceramic base can solve certain problems of heat dissipation. The use of these packages has steadily increased.

Beryllia Bulletin 675 sent on request.

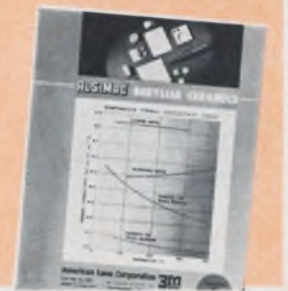

CODE IDENT. NO. 70371

American Lava Corporation **3M**

PHONE 615 265-3411, CHATTANOOGA, TENN. 37405

A SUBSIDIARY OF **3M** COMPANY

For service, contact American Lava representatives in Offices of Minnesota Mining and Manufacturing Company in these cities (see your local telephone directory): Atlanta, Ga. • Boston: Needham Heights, Mass. • Chicago: Glen Ellyn, Ill. • Cleveland, Ohio • Dallas, Texas • Laurens, S.C. • Los Angeles, Calif. • Metropolitan New York: Ridgefield, N.J. • Up-State New York and Canada: Baldwinsville, N.Y. • Orange, Conn. • Philadelphia, Penna. • Roanoke, Virginia • St. Louis: Lee's Summit, Missouri • So. San Francisco, Cal. • Troy, Mich. • 3M International: c/o American Lava Corp., Chattanooga, Tenn. 37405, U.S.A., 615/265-3411

66th
YEAR
OF
CERAMIC
LEADERSHIP

Si device measures 10° to 25° K accurately

A low-temperature thermometer that uses binary logic and is inherently self-calibrating has been developed by National Bureau of Standards scientists. The device is said to provide absolute accuracies of 0.1° K in the range of 10° to 25 K°—ordinarily an awkward region in which to make measurements.

The device is essentially a silicon detector that is irradiated by a small mass of radioactive bismuth or polonium. Output pulses from the detector are routed over coaxial cable to a temperature-indicating circuit. The pulses are amplified, discriminated according to pulse height, and counted by a scaler. This readily gives binary logic—the measurement is above or below a given temperature. In this fashion, a series of selected detectors provide a multivalue thermometer.

According to Dr. William R. Dodge, one of the four developers of the device, when the temperature is sufficiently lowered, the product kT becomes much less than the ionization energies of the impurities in the silicon. This results in a sharp, well-defined transition in the detector depletion depth for all bias fields greater than 100 V/cm. Since transition temperature depends on impurity concentration and ionization energy, and not on the usual thermodynamic variables, pulse height is directly related to temperature.

One application could be temperature detection and control in low-temperature servo systems. Dodge comments: "If one wanted to maintain a constant temperature of, say, 15°K, this might well be the way to do it, since, if the temperature signal output is above or below this level, corrections could be made."

The conventional method for measuring temperatures in this range is to monitor the resistance of carbon. The resistance of an intrinsic semiconductor varies exponentially with temperature: the lower the temperature, the higher the resistance. However, the resistors must be calibrated each time. Codevelopers of the new device were W. R. Dodge, S. R. Doman, D. D. Hoppes and A. L. Hirshfeld of NBS. ■ ■

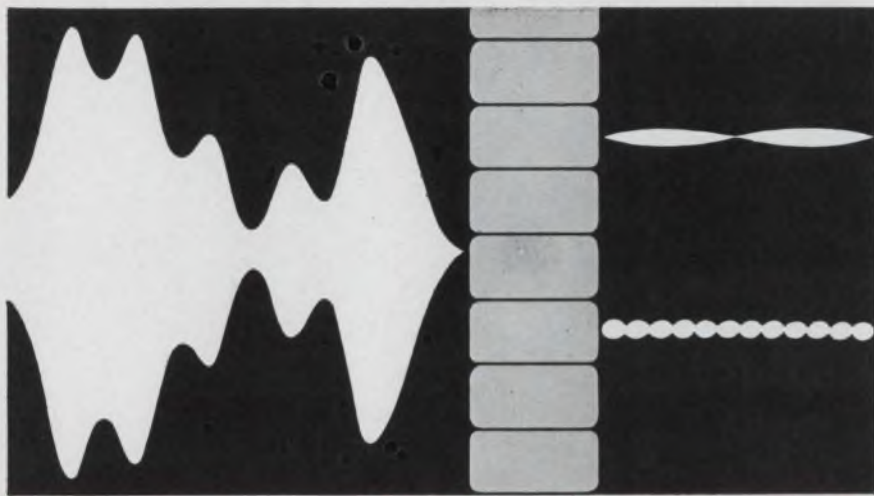

121 TIMES

LESS DRIVE POWER

with Contiguous Comb Filter Sets by Damon

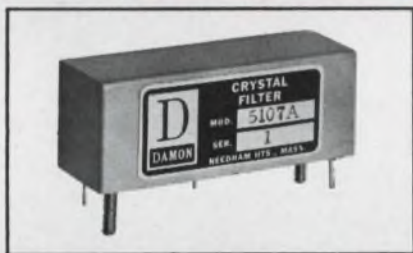

Typical Contiguous Comb Crystal Filter, Model 5107A is 1 1/8" L x 3/8" W x 7/8" H.

Damon has produced a bank of 200 contiguous comb crystal filters that requires a total of 6.6 watts of drive power to obtain 10 milliwatts from each of the Gaussian (non-overshoot) response filters. This is only 1/121 of the 800 watts of drive power normally required to achieve the same output using conventional resistive padding techniques.

This significant achievement is the result of two advances in crystal filter technology: high efficiency contiguous comb crystal filters combined with new synthesis techniques. These advances permit the adherence to both frequency and time response specifications and offer a

new concept in the design of radar and other spectrum-based systems. Contiguous comb crystal filter banks are also the most reliable, efficient, compact and economical precision systems available for multichannel signal processing of all kinds.

Write for data on Gaussian Response Contiguous Comb Crystal Filters to Damon Engineering, Inc., Needham Heights, Mass. 02194, Tel. (617) 449-0800.

DAMON

ON READER-SERVICE CARD CIRCLE 14



Bourns H-490 Turns-Counting Dials

Units shown actual size

Would You Believe \$5.74?*

Yes it is true—for just \$5.74 you can buy the most attractive turns-counting dial in existence—one that will compliment any panel! Priced below any 1" precision turns-counting dial available, the new H-490 offers excellent readability and ease of installation.

You can specify H-490 dials in either clear or black anodized body finish—with or without brake—and to fit $\frac{3}{32}$ ", $\frac{1}{8}$ " or $\frac{1}{4}$ " shaft diameters. Mounting is sim-

ple too, you do not have to drill special panel holes. Delivery—from stock!

Based on price, appearance, readability and ease of installation, the new H-490 is your best buy. Write today for complete data!

**Unit price in quantities of 100*



BOURNS, INC., TRIMPOT DIVISION, 1200 COLUMBIA AVE., RIVERSIDE, CALIF.
PHONE 684-1700 • TWX: 714-682 9582 • CABLE: BOURNSINC

TRIMPOT® AND PRECISION POTENTIOMETERS — RELAYS — MICROCOMPONENTS: TRANSFORMERS, INDUCTORS, RESISTORS AND CAPACITORS
ON READER-SERVICE CARD CIRCLE 15

Organic devices advance as energy sources

Air Force scientists optimistic about future of organic units as detectors and solar cells

U. S. Air Force researchers are exploring the possible use of thin-film, organic photovoltaic devices as selective detectors for certain wavelengths and as solar power sources.

Research on the organic devices is being carried out at the Air Force Cambridge Research Laboratories, Bedford, Mass., under Dr. Aleksandar Golubović. Results so far indicate that the photovoltaic devices are practical for specialized applications even though they are not yet such efficient power sources as inorganic solar cells.

Experimental cells are formed by high-vacuum vapor deposition and sublimation techniques. Organic photoconductor materials are sandwiched between thin-film aluminum and gold electrodes deposited on a transparent glass substrate.

Dr. Golubović says that his space physics laboratory group is examining a wide variety of organic materials to find the best combinations for building desired properties into the devices.

He explains that the electronic properties of organic compounds

have been studied for more than 10 years but results have hitherto been inconclusive. The devices' low power output and the tendency of organic materials to decompose under high temperatures or radiation had frustrated attempts to put them to practical use.

The scientist is optimistic that these handicaps can now be overcome. The power output from the devices, he reported, has been improved within the last year.

At present, power has not exceeded three microwatts; photocurrent has not exceeded four microamperes and is typically about one microampere. But Dr. Golubović prefers to emphasize their potential as detectors for certain spectral-wavelength regions and their possible use as inexpensive, versatile photovoltaic cells on plastic substrates.

According to Dr. Golubović, the resistivity of organic materials resembles that of both inorganic semiconductors and inorganic insulators. He said that resistivities vary from as low as 10^{-2} Ω/cm —about the same as germanium—up

to 10^{18} Ω/cm —comparable to porcelain and quartz insulators. He said, however, that many of the photoconductive materials he is using have resistivity values of about 10^{14} Ω/cm in darkness and about 10^9 Ω/cm when illuminated. There are some differences in the mechanism of conduction, he adds, because organic compounds are molecular crystals whereas inorganic semiconductor compounds are valence-bonded.

He says that the devices do not operate like inorganic photoconductive devices. Inequality in electronic work function between the thin-film metal electrodes and the organic materials creates the cell voltage.

Thin-film cells are made by depositing semitransparent aluminum-film electrodes by high-vacuum deposition on to Pyrex glass substrates. The organic compounds are sublimed on the aluminum electrode and a second electrode of gold film is deposited over the organic compounds, also under high-vacuum conditions. The organic materials are sublimed at 200° to 300° C at a pressure of 1 to 2×10^{-6} torr.

Two classes of organic materials are used: photoconductive and non-photoconductive. Among the photoconductive compounds are anthracene, tetracene, phthalocyanine. Nonphotoconductive materials include tetracyanoquinodimethane (TCNQ) and chloranil.

Some cells have been fabricated with photoconductive material in a single layer; others were formed with both photoconductive and non-photoconductive materials in a double layer. The photoconductor is the first deposition on the aluminum in the double-layer cells.

The power output of the cells is improved by addition of the second layer, which serves as an electron acceptor.

Cells are illuminated for tests through the semitransparent aluminum electrodes by a quartz-iodine light source. Photovoltages of one half volt have been recorded when the cell was connected to a 10-megohm load. ■ ■

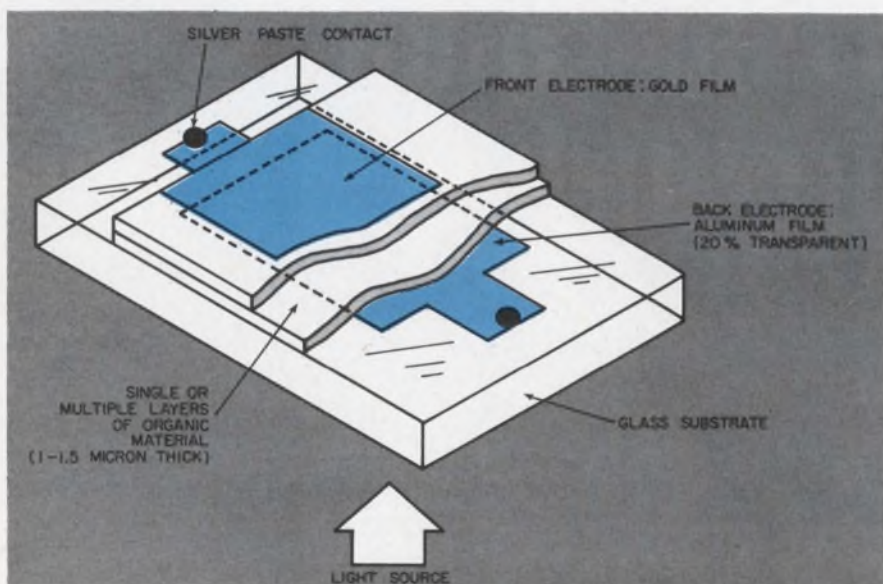

Photovoltaic device is used to test organic materials for use in detectors and solar cells. The Air Force is trying to obtain a better understanding of the electronic properties of organic materials.

100 μ v resolution auto polarity-display storage overrange digit



[\$595]

The new Hewlett-Packard 3430A Digital Voltmeter is a high-performance utility instrument ideal for production line work, repair or inspection stations, in the lab or for quality control. It offers the highest value available today in terms of price and performance.

- 100 μ v sensitivity for low-level measurements
- Auto polarity
- Non-blinking display, ideal for faster, easier, less vulnerable measurements
- 60% overrange with an extra digit
- Floating measurement with 10 Meg input impedance
- Fast (half second) response
- Analog dc output from amplifier, useful as a 100:1 voltage amplifier
- RATIO measurement option

Nowhere else can you get these extra "luxury" features at such a low cost. High-speed measurement, 100 mv-1000 v, accuracy 0.1% of full scale ± 1 digit, plus the 4th digit for over-ranging. Measure to ± 500 v dc with respect to ground. No worry about circuit loading with the high input impedance. High stability with the voltage accuracy guaranteed to 3 months, one-year warranty on the instrument. The only DVM of its type available with ratio measurement capability, at an accuracy of $\pm 0.15\% \pm 1$ digit. With the ratio option 01 (\$80), you can normalize transducer dc outputs without taking time for recalculation. It offers all polarity combinations. The bonus amplifier output, $\pm 0.1\%$ accuracy, increases testing flexibility.

Call your Hewlett-Packard field engineer for a demonstration or write for complete specifications: Hewlett-Packard, Palo Alto, California 94304, Tel. (415) 326-7000; Europe: 54 Route des Acacias, Geneva.

Data subject to change without notice. Price f.o.b. factory.

HEWLETT  PACKARD
An extra measure of quality

ON READER-SERVICE CARD CIRCLE 16

1648

Next to our 709 is ancient

That's what Widlar says. And we figure he should know. He designed the 709. For somebody else. Then we got Widlar and locked him in a room with some parameters and he came out later with some curves, a data sheet and a new operational amplifier. The 709's Successor. For the catalog, we call it the LM-101.

He calls it out of sight. Here's why:

It has a minimum voltage gain of 50,000, yet it can be compensated for by only one 30 pF capacitor. That makes it stable for all feedback configurations. Even with capacitive loads.

A Class B output—with continuous short circuit protection—provides at least a $\pm 10V$ output swing with a $2K\Omega$ load. There's no erratic operation when the common mode range is exceeded. And the $\pm 30V$ differential input range reduces the chance of burnout from overload. It's specified for operation from $\pm 5V$ to $\pm 20V$. With a power dissipation less than 100mW at $\pm 20V$ supplies.

new LM101, the history.

Also guaranteed: 5mV offset voltage, 200nA offset current and a $\pm 12V$ common mode range. Even though fewer compensation components are used, the LM-101 still has the same pin configuration as the LM-709. No need to change printed circuit boards.

It's on our distributors' shelves. In quantity. So call them.

Start bringing your designs up to date. Write for our application notes. National Semiconductor, 2950 San Ysidro Way, Santa Clara, California 95051. (408) 245-4320.

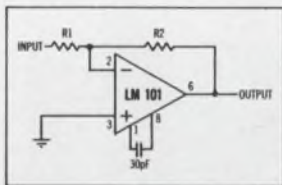

VOLTAGE FOLLOWER

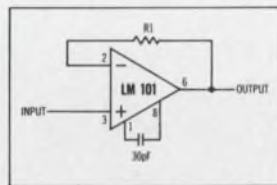

INVERTING AMPLIFIER

National Semiconductor



*The ever-moving
Mr. Widlar.
What's he
up to now?*

Smaller, even, than our DHD silicon diodes

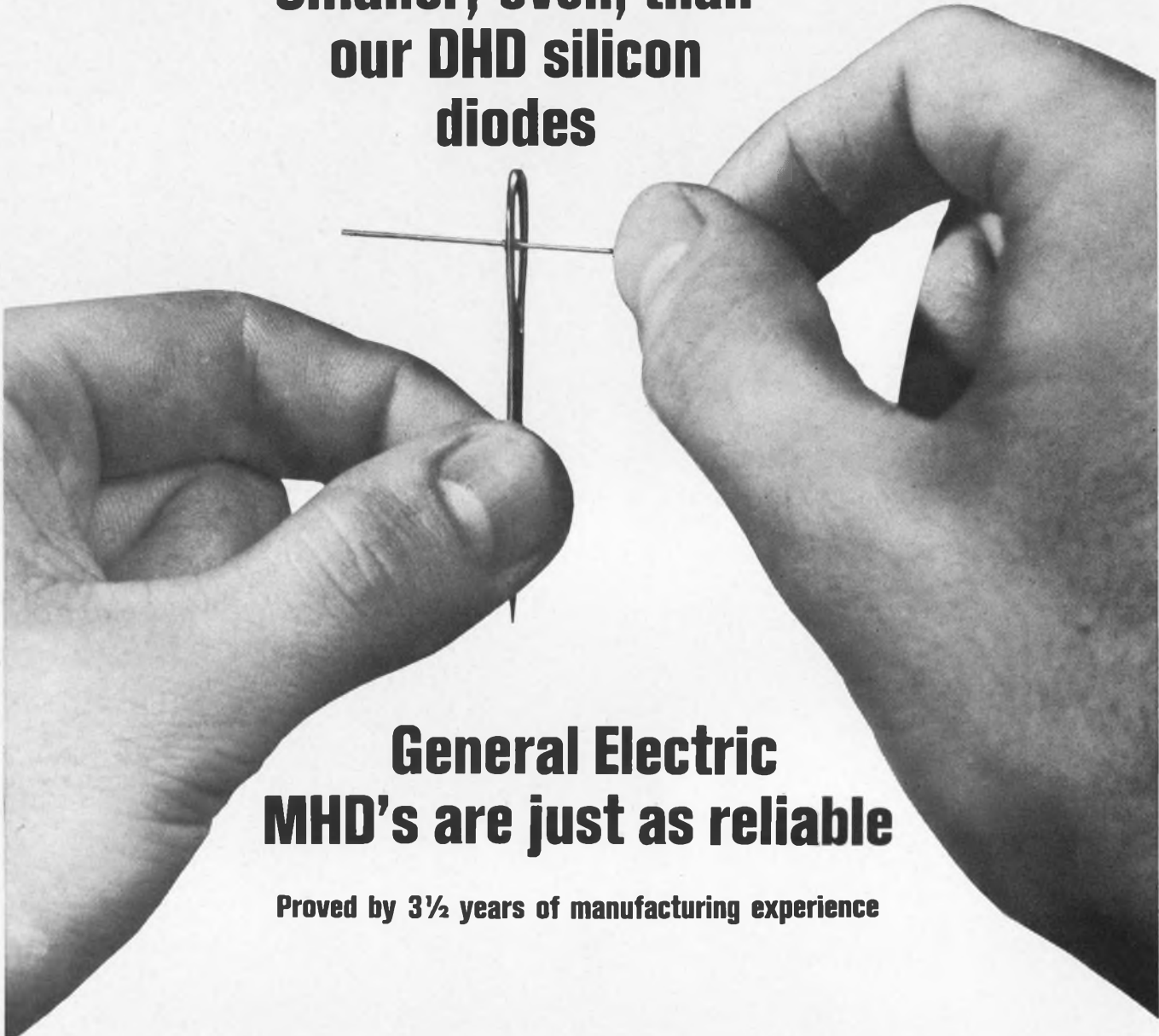

General Electric MHD's are just as reliable

Proved by 3½ years of manufacturing experience

■ They're the next logical step forward in GE signal diode innovations. Nearly 40% smaller than the DHD we introduced 5 years ago, tiny GE Milli-Heatsink diodes feature the same "springless" construction . . . the same proved, inherent reliability. MHD's are perfect for high-density circuit card and memory applications, and for "cordwood" construction. Each Milli-Heatsink diode features high conductance and nano-

second switching time. New General Electric MHD's are available in JEDEC types 1N4531-34 and 1N4536.

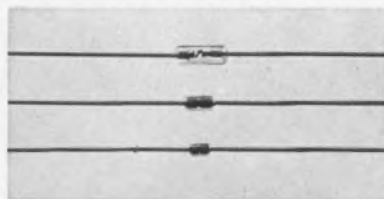

Signal diode packages shown actual size. From top to bottom: old DO-7 spring construction, General Electric DHD package, and General Electric MHD planar epitaxial silicon signal diode package.

MHD's are just one more example of the total electronic capability you get only from General Electric. For more information, call your GE engineer/salesman or authorized distributor. Or write: General Electric Company, Section 220-56, Schenectady, New York, 12305. In Canada: Canadian General Electric, 189 Dufferin St., Toronto, Ontario. Export: Electronic Component Sales, IGE Export Division, 159 Madison Ave., New York, N. Y., U.S.A.

SEMICONDUCTOR PRODUCTS DEPARTMENT

GENERAL  ELECTRIC

ON READER-SERVICE CARD CIRCLE 18

Minuteman foiled by capacitors



Washington Report

S. DAVID PURSGLOVE,
WASHINGTON EDITOR

Capacitors blamed for Minuteman II failures

A rumored series of Minuteman missile launching test failures has been confirmed by the Director of Defense Research and Engineering. Dr. John F. Foster, Jr., lays the blame for the failures at the door of the electronics industry, thus, some Capitol Hill observers believe, bringing Congress a step closer to including defense and space contractor performance penalties in appropriations acts.

Foster was prodded into the admission by Rep. William E. Minshall (R-Ohio) during closed-door hearings by the House Defense Appropriations Subcommittee. The test project, Long Life II, conducted near Grand Forks, N. D., late in 1966, was designed to determine the launching readiness and reliability of Minuteman II. Foster reported three failures of in-silo operational missiles. In one case, Foster said, failure was due to a substandard resistor. In both other cases he ascribed failure to a defective new type of capacitor. Foster said an engineering change has been proposed to eliminate the problem and indicated that all Minuteman II missiles would be retrofitted with new components.

Subcommittee members had been concerned mostly because the rumored failures were not developmental testing failures. The missiles siloed in North Dakota are operationally on station. However, Foster pointed out, only "a small portion of the force" of Minuteman II missiles was fitted with the faulty components.

'Mr. Laser' moves up at ARPA

Dr. Peter Franken, who joined the Defense Department's Advanced Research Projects Agency (ARPA) as Deputy Director only last January, has been promoted to Acting Director. He fills the vacancy created by Dr. Charles M. Herzfeld's appointment as Technical Director of ITT's Defense-Space Group at Nutley, N. J.

When Franken joined ARPA, followers of

military R&D trends anticipated a Pentagon speed-up in laser technology (see "Washington Report," ED 5, March 1, p. 31). Franken, formerly of the University of Michigan, is a laser specialist and was a member of a research team that made pioneering laser studies and later developed laser applications in communications, measurement and weapons aiming. Pentagon press officers made a special point of Dr. Franken's laser experience and implied that it would be fully exploited at ARPA.

Jungle radio R&D guide due

Before he left ARPA, Dr. Herzfeld told a closed-door session on Capitol Hill that several years' study in Southeast Asian rain forests by ARPA were about to bear fruit in the form of a technical report to guide the design and development of new military communications equipment. The report will be made available "for immediate use by the scientific-industrial-government community," Herzfeld said in late March. His comments have just been cleared and released for publication by the Pentagon.

At the time he spoke, Herzfeld said that the studies, primarily under Project AGILE (ARPA's program of basic research into problems of remote-area conflict and counter-insurgency), were concentrated in a rain forest in Southern Thailand that has the same influence on radio waves as does much of the terrain in Vietnam. He stated that results of the study "so far have been encouraging," and indicated that the forthcoming report would contain a large amount of data that would practically dictate new radio-set designs.

Crime Commission affirms electronics role

The President's Crime Commission has issued an eagerly awaited report—prepared in cooperation with the Institute for Defense Analyses—on the role of science and technology in the prevention and control of crime. Eagerly

Washington Report

CONTINUED

awaited—certainly by the electronics industry—because the Commission's first general report, *The Challenge of Crime in a Free Society*, loudly trumpeted the roles that the Commission expected a more detailed study to pinpoint for communications equipment, data processing and other computer applications, and many other electronics devices (see "Washington Report," ED 6, March 15, p. 31).

The Commission, formally entitled The President's Commission on Law Enforcement and Administration of Justice, is headed by former Attorney General Nicholas deB. Katzenbach, now Undersecretary of State. He declares: "Heretofore, science has limited itself mainly to solving individual crimes; now—through the use of computers, integrated communications systems, better command and control systems and systems analysis—science can begin to seek solutions to the over-all problems of controlling crime."

For the electronics industry, the gist of the study is a recurring recommendation that the Federal Government finance R&D on many electronic systems, and help states and cities to make major capital investments in electronic hardware. The report points out that "it costs about \$100,000 per year to cover a two-man police beat on a 24-hour basis, but the capital investment in equipment to do that job better rarely exceeds the \$3,000 cost of a police car." The report argues that "reasonable investments in equipment would only be a small part of the cost of patrolling." Some of that equipment:

- Radios that would tie every patrolman to his department, whether or not he is in a car. There should be Federal funds for the development of them.
- Television frequencies allocated for police use and tied into area-wide networks. Radio channels are congested in most large cities, and the Government should support the development and installation of equipment to take advantage of TV channels.
- Patrol car locator equipment. Government support should be given to the development of systems that would show the location of all cars continuously on a dispatcher's board.
- Pocket radio transmitters to trigger remote

robbery alarms. These should be developed and made available to such vulnerable persons as gas station attendants and liquor store employees.

- Fingerprint recognition systems. Semiautomatic systems, especially those that would help to identify latent and smudged prints, need to be developed.

The report admits that with today's available technology, "most reasonable requests can be met with sufficient time and money; the more difficult problem is deciding how to invest the limited available budgets." The report stresses the application of systems analysis, and states that the technique has already been applied in a number of instances. Says the Commission: "The single technological development that can have the greatest impact is the electronic computer."

FCC blasted by senior employee

In the midst of one of the most trying periods in its history, the FCC has just been shaken by an accusatory bomb tossed as a parting gesture by one of its own senior staff members. Already much out of favor with both the Administration and Congress over the proposed ITT-ABC merger and over its in-house investigation and clearance of Commissioner Robert E. Lee, accused of conflict of interest, the FCC now has to explain charges hurled by D. E. Winslow, a senior economist.

As part of an act of resignation, Winslow sent a "personal memorandum on the sad state of the regulatory art as presently practiced by the FCC" to each of the seven Commissioners. The concern it caused mushroomed into what one staff member called "real furor" when a Washington newspaper got hold of a copy and printed excerpts. Many observers believe that the timing of the denunciation will affect future regulations and goad the FCC into a tougher stance at forthcoming hearings, such as those on "computer utilities."

Winslow, who has been involved in much of the commission's present examination of AT&T operations, directed most of his fire at what he called the commission's inability to regulate such bodies as AT&T, Western Union and Comsat on a "rational basis." He attributed this inability to inadequate information and failure to lay plans to deal with the nation's future communications requirements. He hit hard on points that a number of Congressmen were also making late last year, urging a communications R&D organization within the FCC.

NOW...a full-sized **VOM** in a palm sized "package"



160 Volt-Ohm-Milliammeter
Complete with alligator clip
leads and operator's manual.
..... \$50.00



Carrying Case—
Cat. No. 2225..... \$ 9.50
Accessory Leads—
Probe Tip Lead—
Cat. No. 2055..... \$ 2.75

Simpson 160 Handi-VOM[®]

Simpson Handi-VOM gives you the ranges, the time-saving conveniences and the sensitivity of a full-sized volt-ohm-milliammeter—yet it's only 3-5/16" wide, weighs a mere 12 ounces. Recessed range-selector switch never gets in the way . . . polarity-reversing switch saves fuss and fumble. Self-shielded taut band movement assures high repeatability and freedom from external magnetic fields. Diode overload protection prevents burn-out—permits safe operation by inexperienced employees and students. The demand is BIG, so get your order in to your electronic distributor, TODAY!

RANGES

ACCURACY: $\pm 3\%$ FS DC, $\pm 4\%$ FS AC
DC VOLTS: 0-0.25, 1.0, 2.5, 10, 50, 250, 500, 1000 @ 20,000 Ω/v
AC VOLTS: 0-2.5, 10, 50, 250, 500, 1000 @ 5000 Ω/v
DC MICROAMPERES: 0-50
DC MILLIAMPERES: 0-1, 10, 100, 500
DB: -20 to +10, -8 to +22, +6 to +36, +20 to +50
"0" REFERENCE: 1 MW into 600 Ω
RESISTANCE: Rx1, Rx10, Rx100, Rx1K, Rx10K (30 Ω center)



DIVISION



SIMPSON ELECTRIC COMPANY

5200 W. Kinzie Street, Chicago, Illinois 60644

Phone: (312) 379-1121

Export Dept: 400 W. Madison Street, Chicago, Illinois 60606, Cable, Simelco

IN CANADA: Bach-Simpson Ltd., London, Ontario

IN INDIA: Ruttonsha-Simpson Private Ltd., International House, Bombay-Agra Road, Vikhroli, Bombay

Representatives in Principal Cities
... See Telephone Yellow Pages

WORLD'S LARGEST MANUFACTURER OF ELECTRONIC TEST EQUIPMENT
ON READER-SERVICE CARD CIRCLE 19

Slide projector helps aircraft land

A simple, modified slide projector that sends out varying light patterns from the ground is being used to guide Navy pilots to night landings at the Patuxent River Naval Air Station, Md.

The projector is the key component in a new visual landing aid called the Altitude Rate Command System. It was developed by the Naval Research Laboratories and is currently undergoing evaluation tests at Patuxent River.

The system provides highly sensitive rate-of-descent information to approaching aircraft by varying the light intensities projected from the landing area. The patterns that a pilot sees depend upon the interaction between his aircraft's motion and the light beam's motion. He thus receives error information without the aid of electrical or mechanical sensors in either the aircraft or on the ground and without a data link between the aircraft and the display.

Varying light checks descent

When the pilot sees the light gradually becoming brighter in a cyclic or repetitive manner, he knows that his rate of descent is too great and that he should add power. When he sees the light gradually growing dimmer, he knows that his rate of descent is insufficient and that he should reduce the power.

A steady amber light indicates that the aircraft is on the glide path with the proper rate of descent.

The system also tells whether the aircraft is above or below the glide path. A green light indicates that it is above the path; red, that it is below. Any number of aircraft can utilize the system at the same time.

The basic equipment consists of the modified slide projector, a rotating drum on which a patterned transparency is superimposed, and standard condensing and objective lenses. The rotating drum serves as the slide, or object, for projection. Its rotation, together with the pattern superimposed on it, forms the moving beam pattern. ■ ■



Program wiring patterns from A to Z with automatic *Wire-Wrap* machines

Only automatic "Wire-Wrap" machines provide the flexibility required for point to point wiring of modular electronic panels. Just program the circuit with punched cards or tape. Then "Wire-Wrap" machines take over—connecting wires at an average of 5 seconds per wire—as much as 25 times faster than hand soldering in most applications.

Reliability—These solderless wrapped connections are permanently tight—unaffected by temperature changes, atmospheric corrosion, vibration. More than 37 billion such connections are in use today without a single reported failure.

Economy—Cost savings in excess of 92% are common when compared to soldering and other techniques. Additional benefits include: No thermal damage to heat-sensitive materials . . . elimination of fire hazards . . . connections that are easily removed in plant or in the field.

Write for Bulletins 14-1, 14-121.

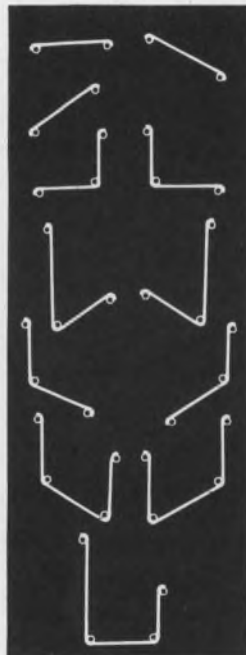

Typical wiring patterns made with automatic "Wire-Wrap" machines.



SEE WHAT AIR IS DOING NOW...SEE

GARDNER - DENVER

Gardner-Denver Company, Quincy, Illinois

ON READER-SERVICE CARD CIRCLE 20

from SYLVANIA Electronic Components Group

CRTs

Display information the new way, with one-gun two-color CRTs

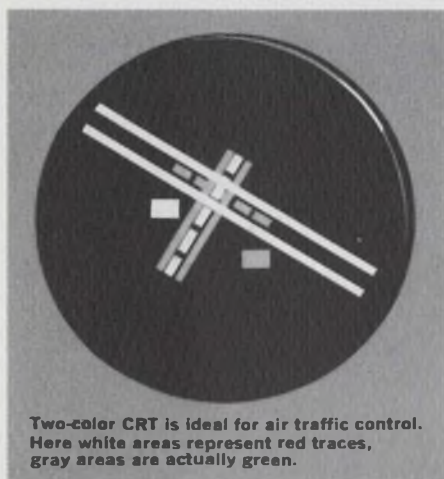

Two-color CRT is ideal for air traffic control. Here white areas represent red traces, gray areas are actually green.

It's a truism that applications for a new CRT are limited only by the designer's imagination. And this fact is well illustrated by the introduction of what Sylvania believes to be the most versatile CRT ever devised—a one-gun, two-phosphor, two-color display component. Conventional three-gun color cathode ray tubes designed for consumer TV receivers seldom meet the stringent performance and environmental demands placed on military, industrial and commercial displays. Until now, this meant either foregoing the use of a color display

or living with degraded performance. Sylvania's new one-gun multi-color tubes overcome the limitations of the three-gun shadow-mask tubes through a new construction technique employing multilayer phosphors.

For the first time, designers of displays have a practical multi-color CRT for equipment requiring quick and positive recognition of the different information being displayed. Getting red or green with Sylvania's new one-gun color tube is as simple as switching the voltage on the anode to a higher or lower level. The extra two guns and precise shadow-mask control needed with conventional color CRTs are eliminated.

In the new type tube, multilayer phosphors of red and green produce the two-color outputs on the tube face. Because the three dots of different phosphors required for each information point in the three-gun tube are eliminated, the new tube has very high resolution. Thus, more information can be displayed in a given area.

This new CRT is ideal for applications requiring discrete-color information. In aircraft control displays,

colors could be used to indicate different altitudes to provide quick and positive information on stacked aircraft. Or, colors could be used to indicate various runways. In computer displays, color can be used to indicate particularly significant data or newly deleted, changed or added data. In short, applications are limited only by the designer's imagination.

Using red and green phosphors provides the high contrast and color separation needed for readily and accurately readable displays. The red phosphor, the famous europium developed by Sylvania for TV color tubes, is an example of the continuing improvements in CRT design which are incorporated in the new tube.

Typical of these multi-color tubes is Sylvania's type SC-4689. It features excellent color separation from red to green by switching the voltage on anode No. 3 from 6,000 to 12,000 V.

Using a 5" diameter screen and a high resolution gun, the SC-4689
(continued)

This issue in capsule

Integrated Circuits — Solve your high current drive problems with the right IC.

Manager's Corner—A new approach to low cost fabrication of microwave ICs.

Diodes—An array made up of 13 diodes in a single plug-in package.

Photoconductors — Now you can drive 300 mW loads with a new 250-ohm device; also, news on TO-18 PCs customized to your needs.

Microwave Semiconductors — How you can design broadband systems around a single diode and holder.

SPECTRAL ENERGY DISTRIBUTION (PHOSPHOR TYPE "PSO")

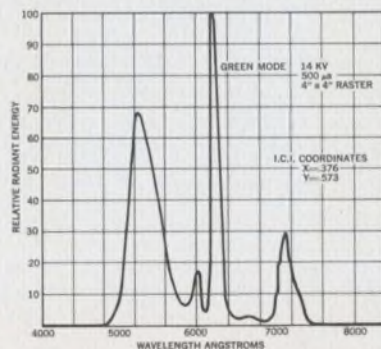
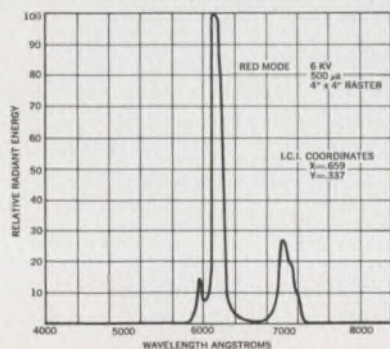

offers spiral post deflection acceleration to minimize the changes in deflection sensitivity and pattern linearity as anode No. 3 is switched.

Sylvania can apply the same principles used in the SC-4689 to other sizes and to other types, such as a two-gun device, to meet users' specific needs.

CIRCLE NUMBER 300

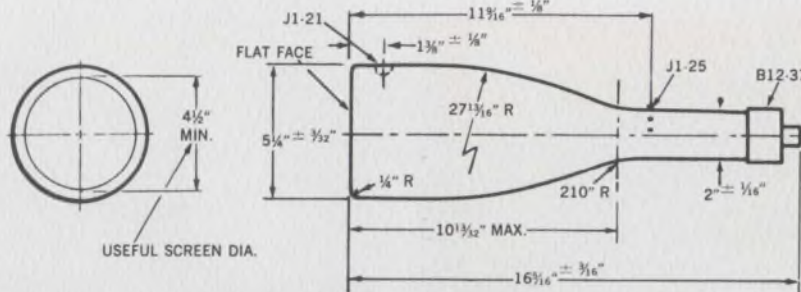

MAXIMUM RATINGS (Absolute Maximum Values)		TYPICAL OPERATING CONDITIONS		
Anode No. 3 Voltage	13,000 Volts dc		Red Operation	Green Operation
Anode No. 2 Voltage ⁽¹⁾	7,000 Volts dc	Anode No. 3 Voltage	6,000	12,000 V. dc
Anode No. 1 Voltage	1,100 Volts dc	Anode No. 2 Voltage	3,000	3,000 V. dc
Grid No. 1 Voltage		Anode No. 1 Voltage for Focus	150-400	150-400 V. dc
Negative Bias Value	220 Volts dc	Grid No. 1 Voltage Required for Cutoff ⁽²⁾	-30 to -70	-30 to -70 V. dc
Positive Bias Value	0 Volts dc	Deflection Factor		
Positive Peak Value	2 Volts	Deflecting Plates 1-2 ⁽³⁾	70-90	95-115 V. dc/in.
Peak Heater-Cathode Voltage		Deflecting Plates 3-4 ⁽⁴⁾	65-85	90-110 V. dc/in.
Heater Negative		Line Width "A" @ I _{a3} = 25 μA	.012	.010 in.
with Respect to Cathode	140 Volts dc	Brightness, 2"x2" raster		
Heater Positive		I _{a3} = 25 μA (approx.)	4	35
with Respect to Cathode	140 Volts dc	Anode No. 3 Current		
Peak Voltage Between Anode No. 2 and Any Deflection Plate	550 Volts	@ E _{g1} = cutoff (approx.)	7-30	21-90 μA dc
Post Deflection Spiral Resistance	100-400 Megohms			
SC-4689 CHARACTERISTICS		CIRCUIT VALUES		
Focusing Method	Electrostatic	Grid No. 1 Circuit Resistance	1.5 Megohms Max.	
Deflect on Method	Electrostatic	Deflection Circuit Resistance ⁽⁵⁾	5 Megohms Max.	
Heater Voltage	6.3 Volts			
Heater Current	0.6 Ampere			
Minimum Useful Screen Diameter	4.5 Inches			
Weight (approx.)	2.5 Pounds			
Mounting Position	Any			

NOTES: 1. The product of the Anode No. 2 Voltage and the Average Anode No. 2 Current should be limited to 6 Watts.
 2. Visual extinction of undeflected focused spot.
 3. Deflecting Plates 1-2 are nearer the screen.
 4. Deflecting Plates 3-4 are nearer the base.
 5. It is recommended that the deflecting electrode resistances be approximately equal.

MANAGER'S CORNER

Microwave ICs—New approach to low cost fabrication

A great deal of effort has been expended over the past few years to develop "Integrated Microwave Circuits". A great many interpretations have been placed on this term, but, in general, the resulting circuits have been limited to a single functional component, usually a ceramic microstrip structure with semiconductor devices bonded or epoxied in place.

The resulting components usually have a "handmade" look to them; this may be an asset in a wool sweater or a piece of fine furniture, but is no virtue in a microwave component. As with clothing and furniture, hand labor costs a lot of money. What is needed is a technique of fabrication which is adaptable to batch processing with most of the work performed by machines. In this way, large numbers of microwave components and systems could be produced at a cost that would make possible the economical construction of phased array radars and other large scale military systems, as well as open the door to many non-military markets for which microwave components are too expensive today.

One approach to this problem is to apply the techniques of monolithic integrated circuitry. Automation in monolithic circuits has already reached a high level at Sylvania in the manufacture of digital and low frequency linear circuits. However, monolithic techniques have not been extensively used at microwave frequencies because of the difficulty of working with the very high resistivity semiconductor material required for low loss transmission lines.

Sylvania's Beam-Lead Technology

Sylvania has pioneered an exciting new approach to the problem of functionally integrating microwave circuitry with a technique that is compatible with automated manufacturing.

The beam-lead technology is a new and powerful technique for fabrication and mounting of semiconductor devices in microwave integrated circuits. Compared with conventional chip fabrication and mounting, the beam-lead approach offers the following advantages:

■ The assembly operations of scribing, chip mounting and wire bond-

ing are replaced by the single step of precise beam-lead welding. Beam leads are also far stronger than ribbon or wire leads.

- Complete uniformity of device and lead geometry is assured from unit to unit through photolithographic definition of the unified structure. This permits accurate characterization and repeatability of device and parasitic parameters.
- Economy in fabrication is realized through batch processing of large numbers of devices.
- Economy in assembly of circuits is realized through the ease and simplicity of device mounting. The process readily lends itself to automation and mass production.

This process creates a device in which individual chips of silicon contain the active areas and are interconnected and mechanically supported by rather thick gold "beams". This type of device, therefore, contains all the advantages of a discrete chip circuit as regards completeness of isolation, while maintaining the batch fabrication process and small size which are the unique advantages of

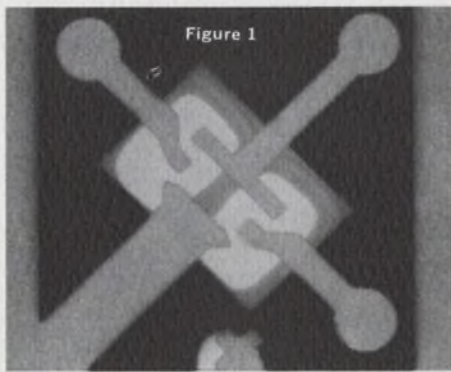

Figure 1

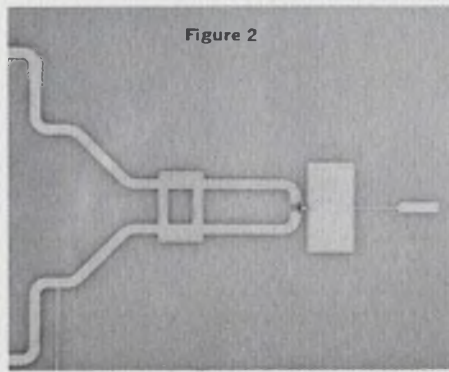

Figure 2

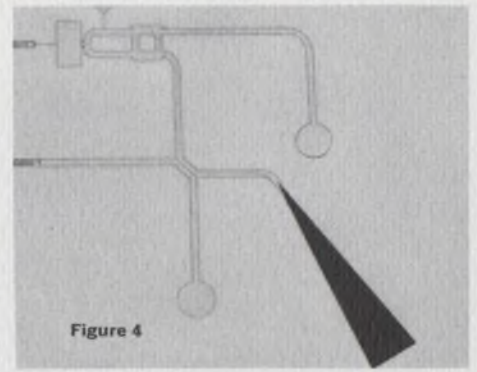

Figure 4

integrated circuits. The interconnection leads are strong and are much less likely to prove unreliable than the alloyed or ribbon leads normally used in standard devices.

Further, the external leads now project beyond the edges of the circuit area for several mils, and are precisely located with respect to one another. This facilitates the assembly of the device onto a premetallized circuit substrate which has a properly prepared metallization pattern which "mates" with the leads. The gold beam leads are excellent for bonding or welding to a microstrip conductor. The reliability of such a bond is as great as that of the lead itself.

One may reasonably compare beam-lead microwave integrated circuitry with monolithic circuitry in which semiconductor devices are fabricated integrally with a semiconductor transmission line substrate. In the latter process, one is restricted to devices which are compatible with the monolith; with beam-leading, devices of different starting materials may be used in the same circuit. In monolithic circuits, transmission line losses are higher than in ceramic microstrip circuits with which beam-lead devices are used.

The usually-quoted monolithic circuit advantages of cost, reliability and size may be fairly challenged by beam-lead hybrid circuits. Since the fabrication and mounting of de-

vices is so well suited to automation, large volume costs of beam-lead circuits should not greatly exceed those of monolithic circuits, and may in fact be lower, especially where yield is critical. Reliability of welded beam-lead circuits should be comparable to that of monolithic circuits, and units made by the two processes are comparable in size.

Perhaps most important is that beam-lead hybrid microwave integrated circuits are here now, have been proven in performance and are far simpler to fabricate and develop than monolithic circuits using silicon transmission lines. In addition, the potential exists for comparable low cost and reliability in automated large scale production.

Sylvania's beam-lead technology has been applied to produce a unique microwave mixer circuit configuration. Two silicon Schottky barrier diodes are fabricated monolithically and beam-lead in series, with a center beam between them. The resultant diode pair is as shown in Figure 1. The complete mixer is shown in the photograph of Figure 2.

Here, the diodes are bonded to the arms of a quarter-wavelength branch line hybrid, and the IF signals are combined at the center tap of the diode pair and fed out through a low pass filter. This mixer has successfully performed at X-band with a noise figure of 7 db. Continuing development

programs will extend the application of beam-lead technology to other microwave devices, leading to the development of complex microwave sub-systems on ceramic substrates for radar and communications applications which are reliable, reproducible, and adaptable to automated fabrication.

As an illustration of what can be done, Sylvania has recently constructed a simple demonstration model of a CW integrated doppler radar. This simple system, shown in block diagram form in Figure 3, consists of a 9.5 GHz avalanche diode oscillator, which serves as transmitter and local oscillator (the system operates at zero IF frequency), a directional coupler, separate transmit and receive antennas, a Schottky diode balanced mixer, low pass filter, audio amplifier and loud-speaker. A moving target produces a doppler-shifted return signal, which is downconverted to an audio frequency, amplified and fed to the speaker.

The portion of the circuit shown within the dotted lines has been integrated in alumina microstrip, as in the photo of Figure 4. Shown here are the balanced mixer, which uses a beam-lead Schottky diode series pair, low pass filter, directional coupler with termination, and two slot antennas. Radiation is from the ground plane side of substrate through slots which are not visible in the picture.

The avalanche oscillator used is a miniature coaxial cavity circuit which is directly coupled to the microstrip circuit without a coaxial connector. It produces approximately 40 milliwatts CW power. This system was demonstrated at the 1967 IEEE International Convention.

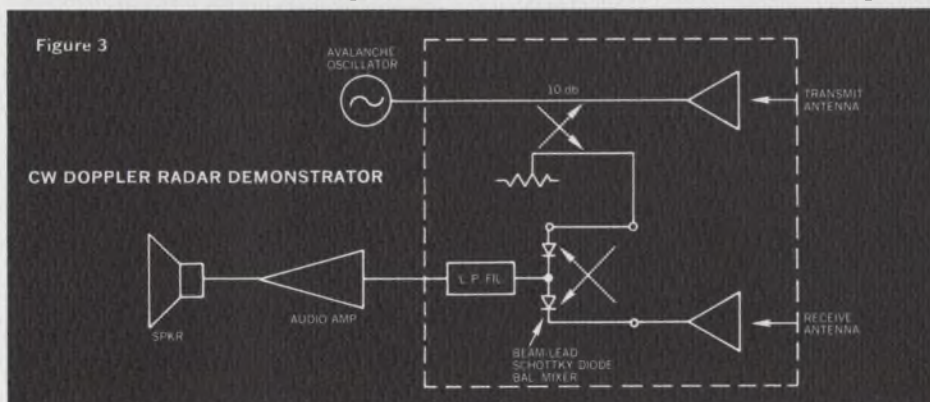

Figure 3

CW DOPPLER RADAR DEMONSTRATOR

Art Solomon
 ARTHUR H. SOLOMON
 HEAD, SOLID STATE MICROWAVE COMPONENTS

ICs to solve your high current drive problems

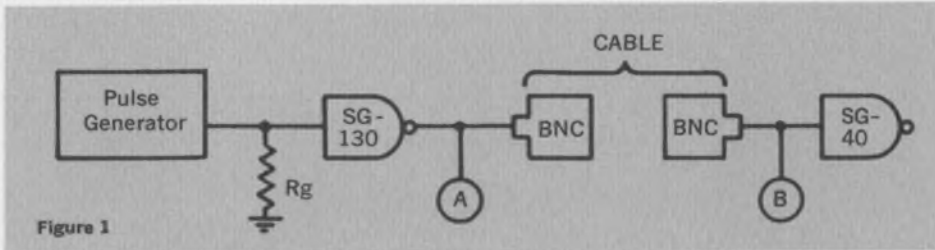

Figure 1

"Output Drive Capability" are the key words describing the type of IC often needed to translate the output of a logic operation into a useable power signal. Ideally, these ICs should be able to drive high fanout and high capacitive loads without sacrificing speed, logic swing or noise immunity. Sylvania's SG-130 series of SUHL™ dual gate drivers meets these device requirements, and they're usually the best choice in line and cable drivers, lamp drivers and other interface applications.

The SG-130 series of SUHL high fanout dual drivers solves the problems associated with many interface applications which require gate outputs with high current drive capability when the output is at "0" and/or "1." They overcome these problems by providing the necessary power without degrading the speed and

noise immunity of the system.

Typical of the output drive capability of units in the SG-130 series are:

A line driver "0" output of 0.45 V max. when sinking up to 40 mA, guaranteed over the applicable temperature range of the device.

"0" output of 0.8 V (nominal) when sinking up to 100 mA (min.) at 25°C.

"1" output of 2.8 V (min.) when supplying up to 3.0 mA, guaranteed over the temperature range.

"1" output of 3.4 V (typical) when supplying up to 20 mA.

Values of the output current at logic "1" and at room temperature show this typical range:

$I_{out} @ 0V = 110 \text{ to } 140 \text{ mA}$

$I_{out} @ 0.5V = 95 \text{ to } 125 \text{ mA}$

$I_{out} @ 1.0V = 85 \text{ to } 110 \text{ mA}$

One use of the drive capability out-

CIRCLE NUMBER 301

lined by these device specifications is in cable or line driver applications. Figure 1 gives the test setup used to check performance of the SG-130 units in such applications. A number of different cables, both short and long lengths, were connected between the SG-130 under test and a SG-40, a NAND/NOR gate in the SUHL family. Cables used included: RG58U (Z_o of 50 ohms), RG62U (Z_o of 93 ohms), twisted wire (Z_o of about 100 ohms), and single wire. Lengths ranged from 2.5 ft. to 37 ft.

Test results for various conditions are given in Figures 2 to 5.

In most cases, a termination of Z_o to ground or to +3.5 volts on the receiving end gives the best matching. In lower power applications, a resistor in series with the SG-130 output can be used at a slight decrease in noise immunity.

The SG-130 series is available in four versions – Military Prime, Military Standard, Industrial Prime, and Industrial Standard – with fan-outs ranging from 12 to 30. Each package uses two four-input AND gates followed by an inverting amplifier to get a NAND function in positive logic.

Figure 2

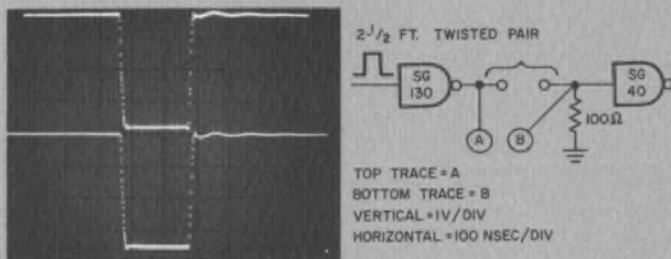

Figure 3

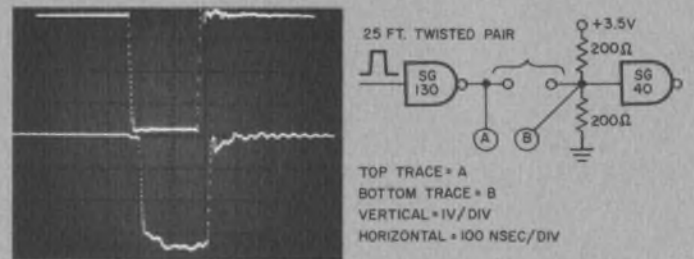

Figure 4

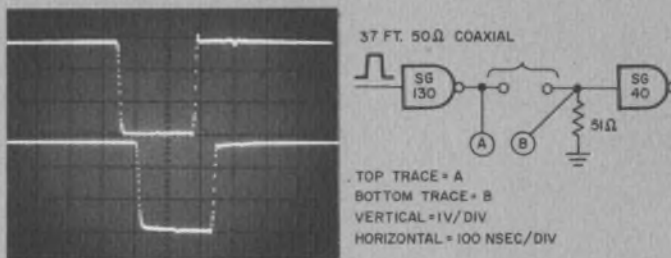
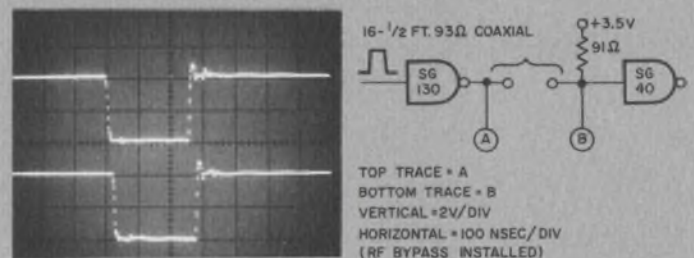

Figure 5



Now, design broadband systems around a single diode and holder

A new family of Sylvania microwave diodes uses an improved coaxial cartridge package to bring the microwave designer a host of benefits. Now, each diode can be used over a much broader frequency range, operation at higher temperature limits is possible, and diode holder design is simplified. In addition, these hermetically sealed units can withstand more severe environments.

Sylvania's new line of microwave mixers and detectors employs a new design glass bead to overcome the frequency limitations found in conventional ceramic-beaded coaxial cartridge microwave diodes. These glass-beaded units provide a much flatter frequency response over a much broader range; each Sylvania unit is designed for a frequency range, not just one specific center frequency. Because the improved process permits better sealing of the diodes, the new devices can be used in any atmosphere at temperatures up to 150°C; therefore, the need for elaborate sealing procedures by the diode user is eliminated.

All these performances and environmental advantages are a result of using a glass bead to support the center conductor in the coaxial package. In conventional coaxial diodes for use above S-band, the center conductor which is attached to the diode's active element is supported by an insulating bead whose length is one-half wavelength at the design frequency. In this way, the desired rf impedance of the rectifying contact will be transformed to the input end of the coaxial diode. Variations in the rf impedance at the terminals of a coaxial diode with a half wavelength bead depends on how far away from the design fre-

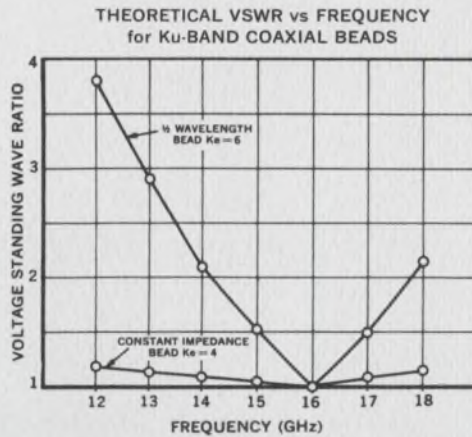

quency the diode is to be operated. A relatively large frequency sensitivity exists for these beads. This can introduce large mismatches capable of degrading overall diode performance.

Because of the large mismatch presented by a half-wavelength bead when operating off the design frequency, it is difficult to design broadband systems utilizing this type of diode. To enable the coaxial diode to be used across a band of frequencies with only minimum mismatch, Sylvania now uses a bead with little or no frequency sensitivity.

The length of the dielectric bead is no longer a half-wave at the design frequency, but is chosen to compensate for the small capacitances which now occur at each end of the bead. The relative frequency insensitivity of this type of bead is illustrated by Figure 1 which compares Ku-band operation for both bead types. The mismatch introduced by the improved bead is very much less than that of the old bead design.

In the past, special diode holders with various tuning and matching adjustments were necessary when a coaxial diode was used at other than the design frequency. The holder re-

EQUIVALENCY CHART

TRI-POLAR		
New Type	Old	Application
D5632	1N1132	3-12.4 GHz Mixer
D5638	1N358	1-12.4 GHz Detector
D5634	1N630	1-12.4 GHz Detector
STANDARD COAXIAL		
D5392	1N2510	8.2-12.4 GHz Mixer
D5391	None	10-16 GHz Mixer
D5282	1N78	12.4-4.18 GHz Mixer
D5326	1N26	18-26.5 GHz Mixer
D5353	1N53	25.6-40 GHz Mixer

quired retuning when frequencies shifted or when another diode was installed. The new device eliminates these tuning devices which used to be part of the diode holder. This means not only is the usefulness of the diode increased across a band of frequencies, but also installation costs are reduced, because a much simpler holder is required and diodes may be replaced without retuning.

In the new construction, high temperature bead materials are now being utilized. Previously, high dielectric constants restricted their use. The result is an integral glass-to-metal seal which can withstand extremes of temperature and mechanical stresses, and still maintain its hermetic integrity.

These new detectors are ideally suited for broadband ECM and test equipments. They are available in singles, matched pairs and matched quads to meet the users' specific needs.

The new bead construction is also used in a tripolar coaxial diode, with input/output termination at different ends. This further simplifies construction of the diode holder.

CIRCLE NUMBER 302

TYPICAL RESPONSE FOR BROADBAND VIDEO DETECTOR (D5634-D5638)
VOLTAGE OUTPUT vs FREQUENCY

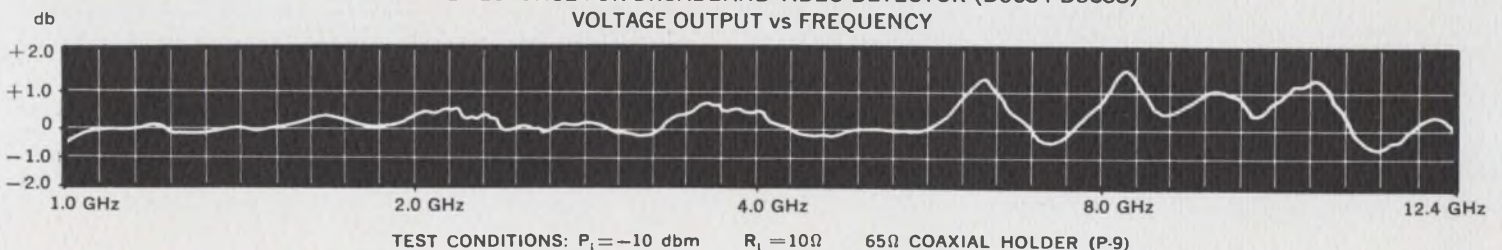

Arrays: now 13 Sylvania diodes in one dual-in-line plug-in package

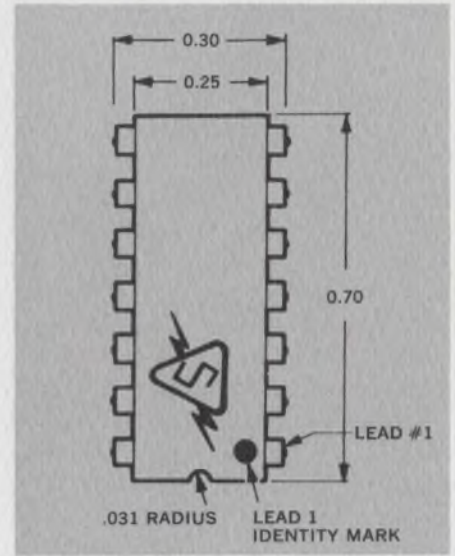
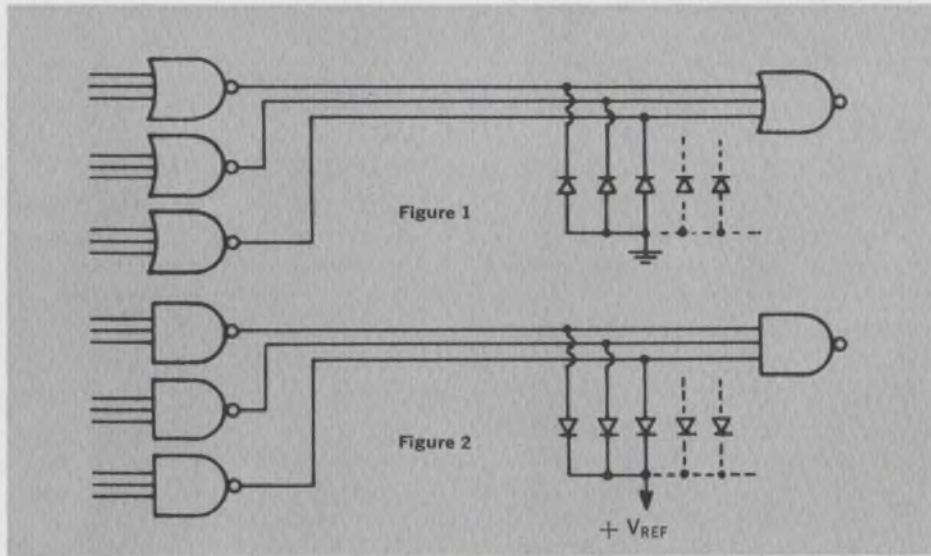

We've gone about as far as we can go. In designing diode arrays which can be mounted in the popular dual-in-line plug-in package (DIP), Sylvania has been an industry pacesetter. There are only 14 leads on standard DIPs and we use all of them to provide 13 diodes and a common connection. And not just 13 ordinary diodes, but monolithic silicon epitaxial diodes with uniform electrical characteristics. These DIP devices are the latest addition to an already broad line of diode arrays which include units packaged in a TO-46 can or in molded epoxy.

Sylvania's diode arrays containing 13 individual silicon junctions per assembly are versatile circuit design tools. Because these arrays are available in both common cathode and common anode versions, they are ideally suited for a wide variety of applications. Applications include systems using integrated circuits as well as those made with discrete components or a combination of ICs and

discrete components.

But the multiple diode feature is only one of the advantages with these units. Use of Sylvania's dual-in-line plug-in package offers significant improvement over other package types. The Sylvania plug-in package lends itself more easily to automated insertion on printed circuit boards, takes up less stacking space and has lead spacing which permits conductive printed circuit paths to be carried under the package without any spidering of leads. And you get these advantages in a package with a true hermetic seal.

Each individual diode in the monolithic array mounted in this superior package is an epitaxial device with the excellent electrical characteristics outlined in the table. The SID13A-1 is a device having a common cathode configuration and the SID13B-1 is a common anode device. Both operate over a range of -55°C to $+150^{\circ}\text{C}$ and are relatively inexpensive.

Typical of the many uses of these

multiple devices is a clamp to reduce ringing from mismatched system elements. One example: when driving fast edges through long coaxial lines, twisted pairs or open wire, the terminating circuit may not be matched to the characteristic impedance of the line. The result is ringing and generation of spurious signals. This ringing travels back and forth along the line to interfere with logical operations.

This noise can be squelched by using these diode arrays as clamps which absorb the energy and reduce ringing. With NOR type emitter coupled logic this would be done with a common anode device as shown in Figure 1. Here the diodes keep the lines from going more negative than one diode drop.

The same principle applies to other logic forms. In some cases it's desirable to clamp positive excursions. Figure 2 shows how this can be accomplished in NAND logic using a common cathode array.

CIRCLE NUMBER 303

SCHEMATIC		SPECIFICATIONS (each diode):	
		Forward voltage @ 1.9 mA @ 25°C:	0.875V max.
		Reverse current @ 5V @ 25°C:	0.25 μA max.
		Reverse current @ 5V @ 70°C:	10 μA max.
		TYPICAL CHARACTERISTICS (each diode):	
		Forward voltage @ 10 mA @ 25°C:	1.0V max.
		Reverse current @ 20 V @ 25°C:	0.1 μA max.
		Reverse current @ 20 V @ 100°C:	100 μA max.
		Breakdown voltage @ 100 μA @ 25°C:	30V min.
		Capacitance @ 0V, f = 1 MHz:	6 pf. max.
		Reverse recovery, $I_f = I_r = 10$ mA, recover to 1 mA:	50 nsec.
		Operating & Storage Temp. Range:	-55°C to $+150^{\circ}\text{C}$

Individually or in arrays, TO-18 PCs are customized to meet your needs

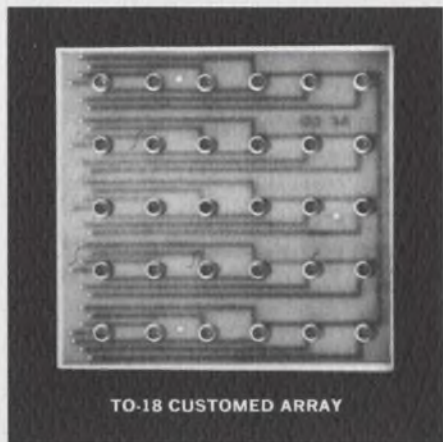

TO-18 CUSTOMED ARRAY

TO-18 cells are among the latest additions to Sylvania's varied line of photoconductors. These miniature, end-viewed cells in transistor-type packages offer the circuit designer stable electrical properties coupled with long life and high reliability. And with Sylvania's customizing capability, you can get the precise cell characteristics dictated by your requirements; or on special order, you can get TO-18 customized arrays.

Sylvania's custom capability in photoconductors isn't limited to arrays or

matrices only. When your requirements make it practical, even the response time and other characteristics of TO-18 devices can be customized. In this way the user gets all the physical advantages of the TO-18 device—small volume, low profile, hermetic sealing, end-viewing, better heat dissipation—in the precise array configuration he wants with the electrical characteristics he needs.

Improved photosensitive material used in Sylvania's standard TO-18 yields response times which are about twice as fast as those obtained with standard cadmium sulfide types. The basic photosensitive material used in the TO-18 can be altered to vary characteristics when required. For example, various peaks in spectral response can be obtained over a wavelength of 5300 to 6300 Angstroms; and cell resistance at 2 foot-candles can be tailored within a range of 10 K to 100 K ohms.

In addition to the obvious space savings, these TO-18s offer other advantages which make them ideal for

use in PC arrays. The glass window sealed in the top of the TO-18 metal container means they are made for end-viewed operations. Thus, there's less chance of stray light influencing them as they can be directed toward the particular light source they are designed to "see." This means they can be stacked closer together than other types.

Hermetic sealing and welded construction insure that the TO-18 cells won't degrade with time, and the metal base acts as a heat sink which keeps the photosensitive substrate cooler.

At Sylvania, the TO-18 is manufactured using the proven processes of transistor technology including dry box atmosphere, projection welding and vacuum bake out. The package measures 0.155 inches maximum height (excluding leads) with a diameter of 0.215 inches. Half-inch leads provide for soldered circuit connections or the leads may be clipped for insertion into conventional transistor sockets. The photosensitive material is formed on a rugged ceramic substrate which aids in heat dissipation and makes possible the 50 mW ratings for these cells.

CIRCLE NUMBER 304

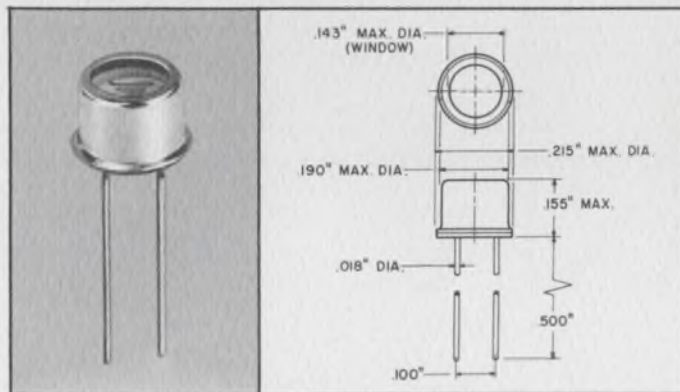

OPTICAL DATA

Wavelength of Maximum Spectral Response.....5300 to 6300 Angstroms
 Various Peaks can be Obtained Within the Above Response Range.

RATINGS (Absolute Maximum Rating System)

Breakdown VoltageUp to 200 Volts
 Dissipation
 T-Amb. = 25°C..... 50 Mw
 T-Amb. = 75°C..... 0 Mw
 Derate linearly from 25°C to 75°C
 Ambient Temperature Range..... -40 to +75°C

CHARACTERISTICS

Cell Resistance at 2FC..... Various Values Available From 10K to 100K Ohms
 Dark ResistanceIn Megohm Range
 Ratio (2FC to Dark)..... Minimum Ratio 100:1
 Average Ratio 1000:1

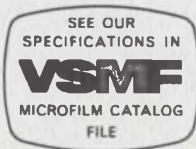

FIRST CLASS
 Permit No. 2833
 Buffalo, N.Y.

BUSINESS REPLY MAIL
 No Postage Stamp Necessary if Mailed in the United States

POSTAGE WILL BE PAID BY

SYLVANIA ELECTRONIC COMPONENTS GROUP

Sylvania Electric Products Inc.
 1100 Main Street
 Buffalo, New York 14209

Dept. B6 6 6

Use Sylvania's "Hot Line" inquiry service, especially if you require full particulars on any item in a hurry. It's easy and it's free. Circle the reader service number(s) you're most interested in; then fill in your name, title, company and address. We'll do the rest and see you get further information almost by return mail.



Now, drive 300 mW loads with a new 250-ohm PC

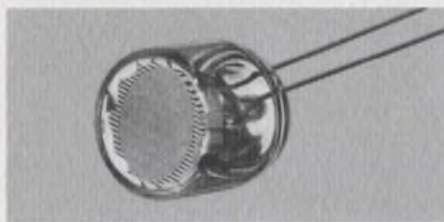

Sylvania's broad line of photoconductors already contains many T-4 devices capable of handling 300 milliwatts. Now the T-4 series is expanded with the introduction of another unit. The extreme sensitivity of this newest low-resistance photocell allows the design and construction of detection circuits to be simplified. Here's how.

A low cell resistance of 250 ohms at 2 footcandles (FC) means Sylvania's newest T-4 photoconductor can directly drive sensitive relays in a wide variety of applications and eases circuit requirements in others. Because the Type 8760 cell supplies more useful power at lower light levels than previously available from units of a similar size, associated circuits are simplified or eliminated. This lower-resistance cell allows the use of less sensitive and more economical relays and can even eliminate stages of amplification. The result is a significant cost advantage in detector design.

The increased sensitivity characteristics of the 8760 at low light levels

comes from the type of photoconductor pattern and material used. A significant decrease in the pattern spacing placed on the $\frac{1}{2}$ "-diameter face of the cell represents a significant improvement in device construction. In the new device, the use of cadmium sulfide as the detector material gives stable operation as ambient temperatures vary.

Typical of the applications for the 8760 are fire and smoke detection systems. One system now being developed uses this improved photoconductor to detect ignition in gas-fired furnaces. With ordinary photocells, the light output of the gas burner is too low to be detected reliably. Of course, the new cells can also be used in oil ignition detection systems.

The 8760 can operate a relay directly at the same low light levels at which other detectors would require

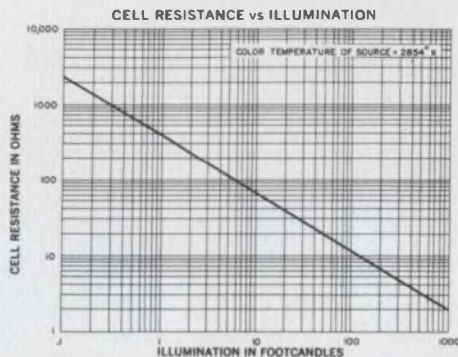

an additional stage of amplification. In addition, this new low impedance device adapts better to switching applications. Impedance of the 8760 approaches zero at even relatively low light levels while showing extremely high values in the dark. Resistance ratio of dark to 2 FC is at least 200:1, with typical values of 500:1. Minimum value for 2 FC to 100 FC resistance ratio is a high 15 to 1.

Despite an intricate finger pattern, plus a low resistance in light (12.5 ohms at 100 FC) and a high dark resistance (100,000 ohms), the 8760's voltage rating is high. In the dark, the new unit can take up to 175 VAC without damage.

All of Sylvania's T-4 devices can take 300-g impact shocks and 2.5-g vibrations. With the addition of the newest devices, light resistance values now cover the range from 250 ohms to 9 K ohms. Sylvania can also supply higher resistance cells on special order. Minimum dark/light resistance ratio for any unit in the line is 100:1 and voltage ratings for these $\frac{1}{2}$ "-diameter end-view cells are as high as 400 volts.

CIRCLE NUMBER 305

8760 CHARACTERISTICS

Cell Resistance	Resistance Ratio
At 100 FC 12.5 ohms	Dark to 2 FC, min. 200:1
At 2 FC 250 ohms	Dark to 2 FC, typ. 500:1
At Dark 0.1 Megohm	2 FC to 100 FC, min. 15:1
Cell Voltage 175 VAC	2 FC to 100 FC, typ. 20:1

This information in Sylvania Ideas is furnished without assuming any obligations.

SYLVANIA

SUBSIDIARY OF
GENERAL TELEPHONE & ELECTRONICS GTE

NEW CAPABILITIES IN: ELECTRONIC TUBES • SEMICONDUCTORS • MICROWAVE DEVICES • SPECIAL COMPONENTS • DISPLAY DEVICES

NAME _____

TITLE _____

COMPANY _____

ADDRESS _____

CITY _____ STATE _____

Circle Numbers Corresponding to Product Item

300 301 302 303 304
305

Please have a Sales Engineer call



HOT LINE INQUIRY SERVICE

Need information in a hurry? Clip the card and mail it. Be sure to fill in all information requested. We'll rush you full particulars on any item indicated.

You can also get information using the publication's card elsewhere in this issue. Use of the card shown here will simplify handling and save time.

Switch unit senses landing gear status

Are the wheels down and locked? This question nags aircraft pilots frequently as they head toward a landing. For there is always the possibility that the indicator switches are not working or are giving false readings.

To help take some of the worry out of landing, Electro-Optical Systems, Inc., Pasadena, Calif., has developed a solid-state proximity switch that is said to be superior to existing mechanical switches in signaling positive wheel lock on both military and commercial aircraft.

The new units have no moving parts, do not depend on metallic contact and are not subject to contact bounce or contact arcing, the company says.

All the switch's electronics are contained in a single, matchbox-size, hermetically sealed unit. The switch includes a sensor head, an oscillator, an electromagnetic interference filter, a solid-state switch and an output switching transistor.

Electro-Optical explains that eddy currents are set up within a metal target, such as an aircraft strut, when the sensor head approaches it. As the detector nears the target, a change in inductance is seen by the solid-state switch. At a preset threshold level, a signal actuates the output switching transistor. This transistor, capable of switching 100 mA from the system's 12-V dc power supply, flashes a status light on a remote panel indicator.

Unlike the mechanical switch, the proximity switch is said to be able to function without interference from snow, ice or dust. It has a built-in "fail-safe" mode which turns the remote indicator to "off" in the event of a short- or open-circuit condition of the excitation electronics.

Initially developed to indicate wheel position on Navy aircraft, the switch is being adapted for use as aircraft flap and door position indicators and as a tachometer for other military aircraft, the company says. The device is also reported to be under evaluation for landing-gear and gear-door position indicators for a jet airliner. ■ ■

another  solution

TEFLON* SPACER/BUSHINGS FOR MOUNTING P.C. BOARDS TO METAL PANELS OR CHASSIS

Completely eliminate nuts, bolts, lockwashers, insulators, metal stand-offs and spacers, with Sealectro's new and unique Press-Fit® Teflon Spacer/Bushings. Simply drill or punch a hole in a chassis, panel, or other mounting area . . . pop in a spacer bushing . . . drill or punch a mating hole in the P.C. board . . . snap them together . . . that's all there is to it. They can't be shaken apart but can be unsnapped at will for service, test or modification

Press-Fit Spacer/Bushings are precision machined from pure Teflon. Stand-off heights from .125" to .750" with a standard diameter of $\frac{3}{16}$ " are included in the complete line.

If you need a fast, reliable and inexpensive means to mount P.C. boards, consider Sealectro's new Spacer/Bushings. Sealectro is your No. 1 source for all types of electronic hardware. Complete information and drawings are yours for the asking.

*Registered Trademark E. I. DuPont De Nemours & Co.

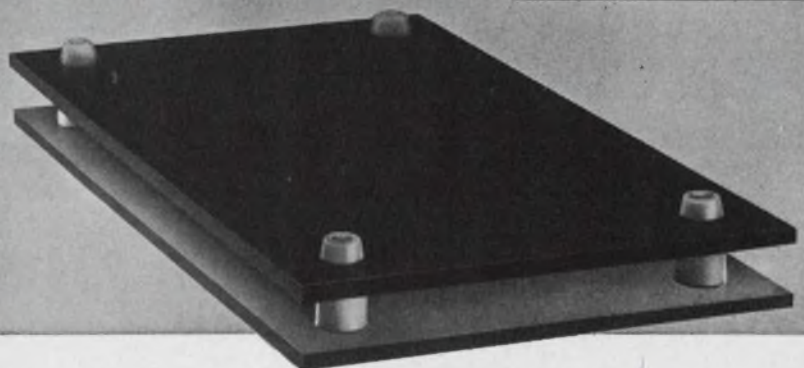
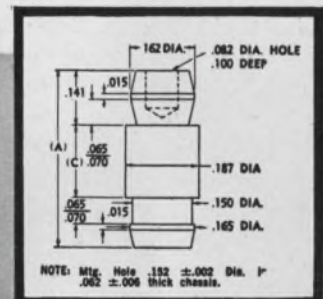
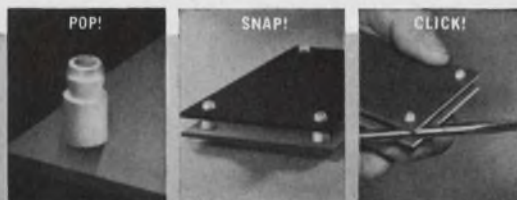

CIRCUIT HARDWARE DIVISION

SEAELECTRO
CORPORATION

MAMARONECK • NEW YORK

PHONE: 914 698 - 5600 TWX: 710-566-1110

Sealectro Ltd., Portsmouth, Hants, England

ON READER-SERVICE CARD CIRCLE 21

Plasma display writes with computer signals

A new device is threatening the dominance of the cathode-ray tube in computer displays. The plasma panel, a rectangular array of bistable gas discharge cells, can present words and numbers directly from a computer's digital signals and retain its images without continuous refreshing.

The possible cathode-ray substitute was evolved by researchers at the Coordinated Science Laboratory of the University of Illinois' Urbana campus. Associate Prof. Donald Bitzer and Dr. Gene Slottow, a senior research engineer, were the inventors of it.

In a paper presented to the eighth National Symposium of the Society for Information Display, in San Francisco recently, Dr. Slottow described the panel as an economical device for information display that combines the properties of memory, display, and high bright-

ness in a simple structure.

Dr. Slottow explained that the basic element of the display, the bistable gas discharge cell, is constructed so that charges can be stored on its glass insulating walls, thus forming a memory element. Its operation is similar to a magnetic memory plane in that the state of each cell can be changed by placing appropriate voltages across two conductors that intersect at each cell. The individual 0.015-inch-diameter cells discharge and glow as dots of bright light when they are in the on state. Because of the close spacing of the cells, clear letters or numbers can be drawn with high resolution.

The arrays are made up of a pattern of holes in a glass sheet sandwiched between two other thin glass panes. Transparent gold conducting strips are deposited on the outer surfaces of the glass covers.

The strips, which conduct the voltage to the cells, are orthogonal to one another directly over the cell holes. Air is evacuated from the cells and neon-nitrogen mixture is admitted.

An alternating voltage of 500 kHz, called the sustaining voltage, is maintained on the conductors at all times that the display is operating. When it is desired to turn a cell on, the appropriate switching signal is placed across the intersecting conductors. After the cell has fired, the switching signal is removed, but the cell remains on owing to the wall charges that have built up as a result of the firing.

In the zero or off state, the sustaining cell voltage is insufficient to create a discharge. In the on state a brief glow discharge occurs once each half cycle of the sustaining voltage (50 nanoseconds).

The charge can be removed to switch the cell off with another appropriate switching signal. A light source can be used for both writing and erasure.

The capacitive reactances between cells and the electrodes not only couple the signals to the cell, but also isolate the cells from each other electrically.

The inventors of the device say that display technology has not kept pace with the increasing speed and larger memories of advanced computers. While they admit that TV storage tubes and other cathode-ray tubes perform well in present systems, they say that there is now no display device available that performs well and is sufficiently inexpensive for use with large-scale central computing facilities with hundreds of display stations.

As objections to cathode-ray tubes, the inventors list:

- The short memory of CRTs which make it necessary to regenerate characters to avoid flicker.

- The requirement for digital-to-analog conversion at video bandwidths to work with digital signals, calling for expensive, complex circuitry.

- High voltage and excessive space requirements. ■ ■

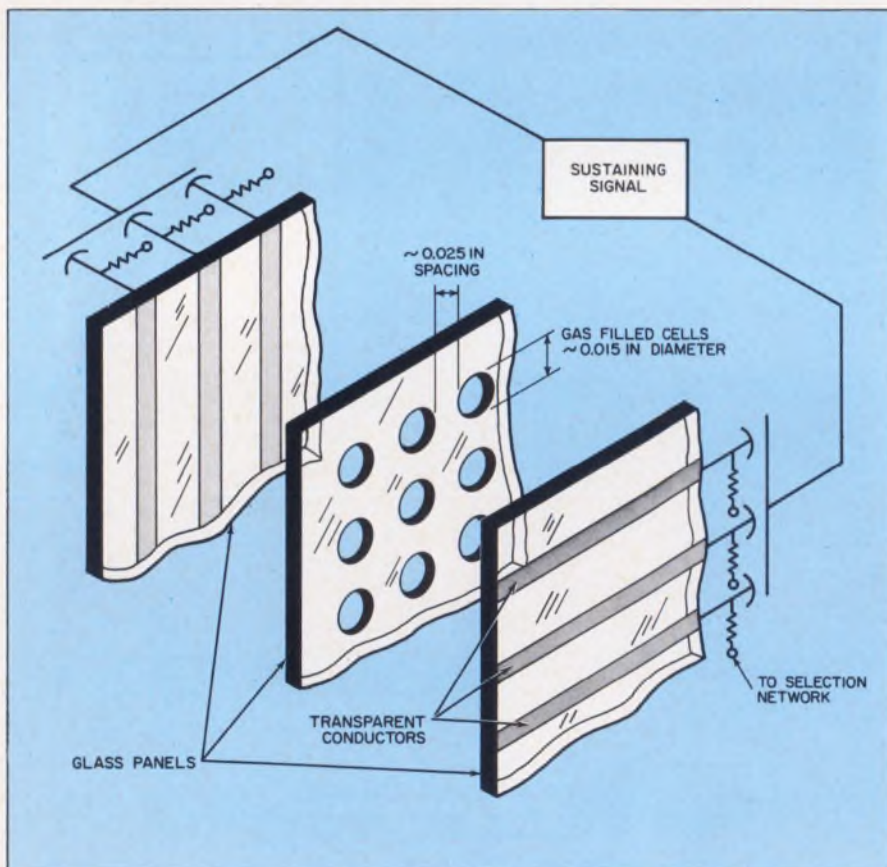

The plasma display panel (shown exploded) is a possible substitute for the CRT in computer displays. Signals directly from the computer combine with the sustaining signal to fire gas cells and form characters.



Spice of life...

... means Drake has almost an unlimited variety of these "MF" — midget flange — indicator lights. Adapts to many commercial or military requirements, including aerospace, missile, automation, instrumentation, panel read-out, safety equipment, heavy duty controls, office equipment and specialties.

Choose from many shapes, styles and sizes . . . For a starter, we have Press-to-Test, variable intensity and waterproof, types; neons, incandescents; front or rear mounting — all have front lamp replacement; lampholder bodies are corrosion resistant black or natural finish.

Color, shape or style . . . You name it, Drake's got it.

Readily available from authorized distributors, and you'll find Drake's personal service to be valuable throughout every phase of your project. Call today, Drake's 35 years' experience will prove helpful.

Ask for a brochure, too.





Shown actual size.

Our operational amplifiers start at \$9.75. We have compensated μ A709's, FET-IC's, and a full line of high-gain, low drift, compact modules. Try one on a small signal. You'll make it big.

FAIRCHILD
INSTRUMENTATION

Low-cost tape transport records 50 MHz

A simplified tape transport with only three moving parts permits tape speeds of 4000 ips and a bandwidth greater than 50 MHz for instrumentation purposes. The transport, reportedly, may also lead to lower cost home audio and video tape systems.

The main feature of the new transport is a large drive capstan that is in contact with the outer rim of both reels of tape. A single motor drives the capstan which, in turn, transmits its rotational force to both tape rolls. The two spindles which make up the remaining moving parts are freewheeling and have no direct contact with a power source.

To compensate for the varying tape roll diameters as tape is passed from one roll to the other, both spindles move laterally in addition to rotating. A spring attached to each spindle keeps the tape in constant contact with the capstan.

Speed without hazards

Rapid acceleration and deceleration as high as several thousand inches per second are achieved, without the danger of stretching or cinching the tape, according to the developer, Chester W. Newell of Newell Associates, Sunnyvale, Calif. Tape travel can be reversed from full speed forward to full speed backward in a fraction of a second. At 120 ips, reversal time is typically 240 ms, Newell says.

The tape is wound by compression of the capstan against the take-up roll in a sort of squeegee action that removes all the air between layers of tape. With the air removed, the tape rolls are literally

solid disks of plastic, Newell says. This eliminates the need for conventional flanged reels. Instead, the tape is wound on center hubs.

Newell says the new transport has attained tape speeds of 4000 ips and a bandwidth greater than 50 MHz for instrumentation purposes. He added that the transport has reduced by an order of magnitude such limiting factors as flutter, wow and tape skew. High information-packing densities have also been achieved, with as many as 50 channels recorded per half inch of tape width.

Newell reports that life tests run on the ferrite heads used in the system resulted in little or no tape wear after passing 100 million feet of tape past the heads at 240 ips. This is made possible by the unusually light head-to-tape pressure required to ensure contact.

The initial product using the transport is expected to be a 40-channel, high-performance instrumentation recorder using half-inch tape. It will have a tape speed of 1000 ips, a bandwidth greater than 10 MHz and be completely self-threading.

The first home color-TV recorder using the transport is expected to retail around \$1250 with ultimate price reductions to below \$500 as mass production levels are reached within the next few years, Newell predicts.

A high-performance stereo tape playback system costing less than \$300—comparable to medium-quality systems using record changers or conventional tape decks—will also be produced. The price includes the complete playback electronics. Tapes could be changed automatic-

ally by means of lever settings—something like a jukebox.

The stereo will use tiny "reel-ettes" of tape, 2 inches in diameter. The 8-track tape will have 44 minutes of playing time, equivalent to a complete LP album. Prerecorded "reel-ettes" could be priced competitively with conventional pressed discs.

Licenses have been granted to a number of firms to manufacture the equipment and tapes. Among the licenses so far announced are Borg-Warner Controls, of Santa Ana, Calif., for the manufacture of instrumentation recorders; and General Recorded Tape, Inc., of Sunnyvale, Calif., for the manufacture of LP tape albums and prerecorded video tapes for playback on home video recorders. This means that the user could buy a tape of his favorite program—commercials and all.

Manufacturers of other consumer products have not yet been announced. According to Newell, these companies will be making their product announcements before the end of this year.

Other products due

Various products using the Newell tape transport principle will be introduced at staggered intervals during the next few years, either by licensees or by Newell's own company. Newell projects the schedule as follows:

- 1967—monochrome and color video tape recorders, industrial audio and video recorders, home tape systems and instrumentation recorders
- 1968—data processing, storage and retrieval equipment, and broadcast studio sound recorders
- 1969—other broadband recorders

Some eight patent applications have been filed by Newell, a former Ampex engineer.

Newell predicts that the cost of full-length color movies using his tape transports would be less than half that of conventional helical-scan recording. ■ ■

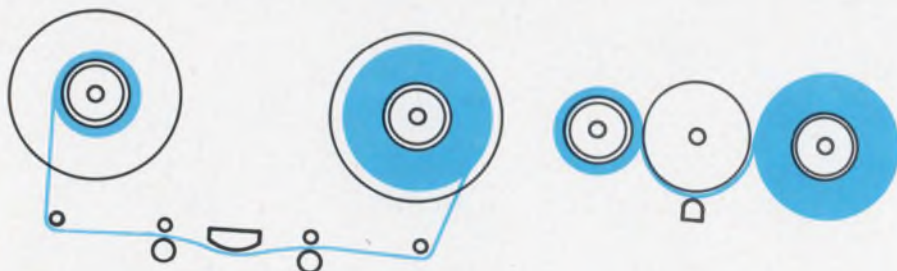

High-speed transport capstan is located between tape rolls. Unlike conventional transports, tape is continuously supported as it changes from one roll to the other.



Operational amplifiers

Check the specifications of our compensated μ A709's, FET-IC's and economy modules. Check our prices: they start at \$9.75. Check with us for complete information and applications assistance. Then check out one of our modules. Try it on a small signal. You'll make it big.



Typical Specifications	Economy Solid-State Modules		Compensated ICs μ A709C μ A709		FET-IC Modules		FET Input Modules	
	ADO-44	ADO-45	ADO-49C	ADO-49A	ADO-29	ADO-26	ADO-25	ADO-24
Open Loop Gain	10,000	100,000	40,000	40,000	140,000	140,000	50,000	50,000
Bandwidth	550KHz	1.5MHz	1MHz	1MHz	1.5MHz	1.5MHz	10MHz	10MHz
Slew Rate	0.2V/ μ s	1.4V/ μ s	0.2V/ μ s	0.2V/ μ s	2V/ μ s	2V/ μ s	15V/ μ s	15V/ μ s
Difference Current	10nA	10nA	100nA	100nA	10pA	10pA	10pA	10pA
Input Impedance	300Kohm	300Kohm	250Kohm	250Kohm	10 ¹¹ ohm	10 ¹² ohm	10 ¹² ohm	10 ¹² ohm
Drift	20 μ V/ $^{\circ}$ C	10 μ V/ $^{\circ}$ C	5 μ V/ $^{\circ}$ C	5 μ V/ $^{\circ}$ C	25 μ V/ $^{\circ}$ C	1 μ V/ $^{\circ}$ C	10 μ V/ $^{\circ}$ C	10 μ V/ $^{\circ}$ C
Output Voltage	10V	10V	10V	10V	10V	10V	10V	10V
Output Current	1mA	5mA	5mA	5mA	5mA	5mA	2.5mA	20mA
Price (1-9)	\$9.75	\$15.00	\$29.00	\$80.00	\$45.00	\$98.00	\$85.00	\$105.00
(100 pcs)	\$9.00	\$13.00	\$18.00	\$55.00	\$37.00	\$75.00	\$69.00	\$ 80.00

For the supplier nearest you, and/or for technical information and assistance, call Gaylon Patterson at Fairchild (415) 962-2030 or 962-2086, or TWX 910-379-6944.



MICRO SWITCH Precision Switches

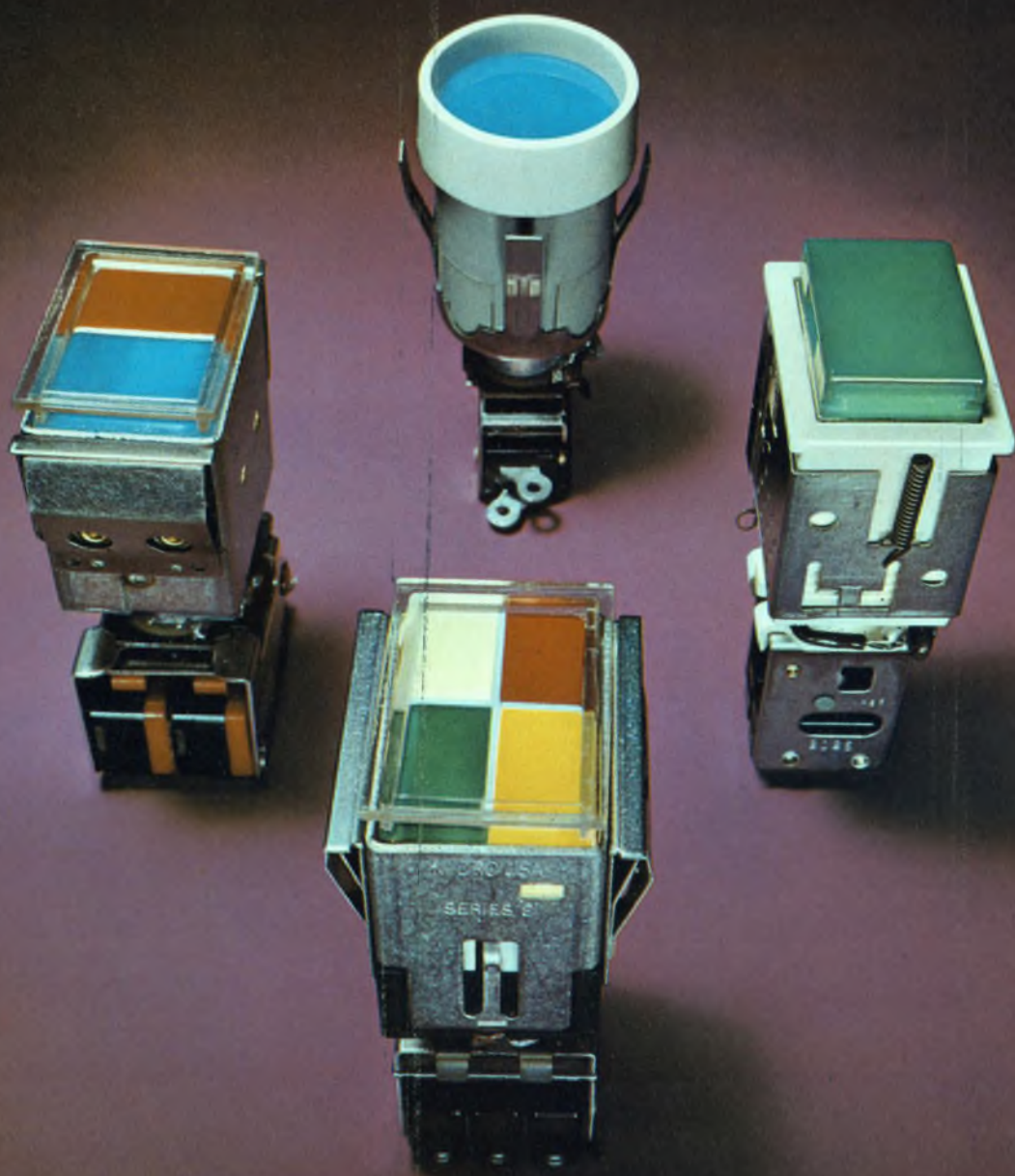

How to make sure you are not in the dark on the latest in Lighted Pushbutton Switches

Take a new look into the complete line available from MICRO SWITCH.

Ever since MICRO SWITCH introduced the first modular pushbutton switch with lighted legends, the line has been expanding. New modules, new assemblies, new ideas now offer you more opportunities to work out custom answers to today's panel requirements.

In addition to the popular Series 2 which started the modular trend, the line now includes Series 2N and Series 2C200. All three offer unequalled freedom of design—in

sheer number of possible control and display combinations—in ease of installation—and in panel appearance.

MICRO SWITCH gives you another bonus: application experience. Our specially trained field engineers will be glad to discuss your requirements. They are backed by the industry's most elaborate research and development facilities.

For information, contact a Branch Office or Distributor (see Yellow Pages, under "Switches, Electric") or write for literature.

MICRO SWITCH—the line providing unequalled freedom of design with all this versatility

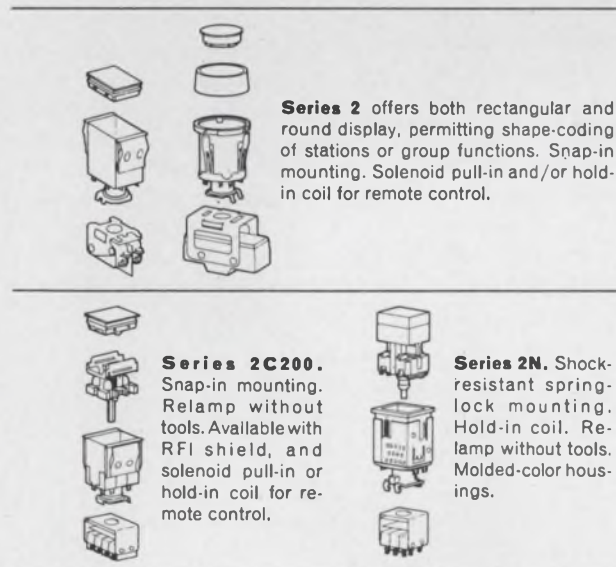

in BUTTONS—Choice of 1, 2, 3, or 4-section buttons.

in COLOR—Wide selection of transmitted and projected (filtered) color schemes, and 1 to 4 lamps for up to 4-color display.

in CIRCUITRY—Up to 4-pole double-throw and 2-circuit double-break contact arrangements.

in RATINGS—Wide selection of modules for handling low energy to heavy duty electrical loads.

in WIRING—Solder, screw or quick connect wiring terminations.

in MOUNTING—Snap-in flange and barrier mountings or spring-lock panel attachment.

in REMOTE CONTROL—Only MICRO SWITCH has both remote actuation and release of switching contacts.

MICRO SWITCH
FREEPORT, ILLINOIS 61032
A DIVISION OF HONEYWELL

Portable chargers for battlefield use on way

Electronic systems for today's infantry combat soldier are destined to grow rapidly in the next few years. To keep pace with the progress, the Army is developing a family of portable automatic battery chargers that operate from available power sources, such as a vehicle's electrical system. The first charger has already been built.

The need and the challenge to designers were outlined at the Power Sources Conference, sponsored at Atlantic City, N. J., by the Army Electronics Command.

Present demands for battlefield power are being filled by rechargeable secondary batteries, Frank Wrublewski of the Army's Power Sources Div. said. The batteries have low internal impedance and can provide high discharge rates for relatively long periods of time. Vented nickel-cadmium batteries offer long cycle life, ruggedness on recharge and reasonable energy density, Wrublewski noted; silver-zinc oxide batteries, while they have a shorter cycle life and are expensive, provide higher energy density and thus lightweight power.

However, a serious problem with secondary batteries is lack of recharging capability at forward areas, Wrublewski continued. If plans call for batteries to be shipped from the battlefield to rear areas for recharging, logistic support must be arranged to provide several batteries to cover each single use cycle—one for the functioning equipment, one on its way to the rear area, one in the process of charge, and one on

its way back to the combat area, he explained. The portable chargers should help overcome this logistic jam.

The first such lightweight unit can automatically charge nickel-cadmium, cadmium-silver oxide, zinc-silver oxide, or lead-acid batteries. Designated the FP-4126, the charger can handle 6-, 12- or 24-volt assemblies up to 320 watts and can be used as a voltage-regulated power supply to operate equipment directly from 12 to 30 volts dc.

As shown in the accompanying block diagram, logic circuits in the voltage window accept a variety of inputs but prevent charger operation if the operator has not set the controls properly. Dc power, set by the mode control, is fed to the dc-dc converter, which uses SCRs for power switching. The blocking oscillator and drive circuits provide pulses to trigger the SCR commutating circuits. The current sense stage samples the output current and provides a signal that sets the blocking oscillator frequency; the feedback loop thus causes output current to be proportional to the operating frequency of the blocking oscillator. The voltage-sense circuit provides information for automatic charge control, based on the end voltage of the battery under charge. The reverse battery circuit prevents operation with a reversed battery.

A 500-watt fuel cell power source to provide primary power for the battery charger is under development. The combined fuel cell-battery charger package will come in back pack and skid configurations. ■

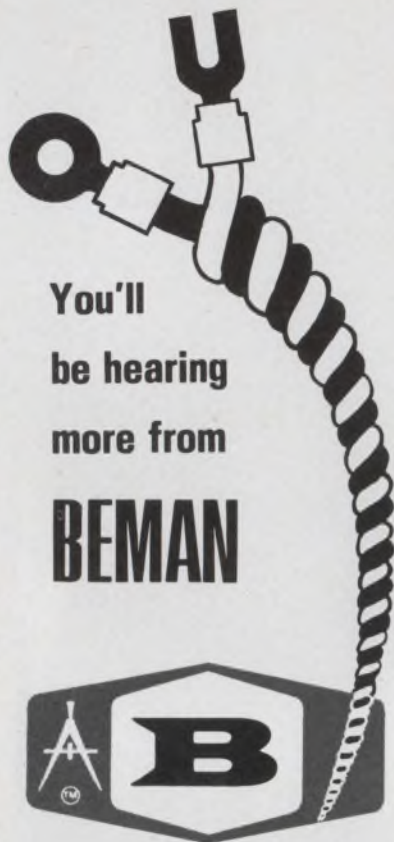

You'll
be hearing
more from
BEMAN

Already there is much favorable comment regarding this alert and aggressive company, a vigorous offspring of our dynamic electronic age, founded in 1961. Industry leaders are entrusting Beman with important assignments in cable and termination manufacture, custom molding and die stamping, and various types of electrical and mechanical assembly work. There is also a growing demand for the creative capabilities displayed by Beman's versatile designers and engineers. A modern, new engineering facility is strategically located in Harrisburg, a few miles from the main plant.

QUALITY, DEPENDABILITY, INGENUITY

Whether asked to follow iron-clad specifications, or to work from scratch on an outline of new requirements, Beman is vitally aware of its responsibilities. Research and development talents are applied to a customer's project with the same all-out effort that is put into one of Beman's own original products. Perhaps your company can benefit from the specialized training and experience which are carrying Beman forward. An illustrated brochure just off the press will be mailed on request. Beman is able ... and ready ... to serve you.



P. O. Box 370 New Cumberland, Pa., 17070
Phone: (717) 774-0210

ON READER-SERVICE CARD CIRCLE 25

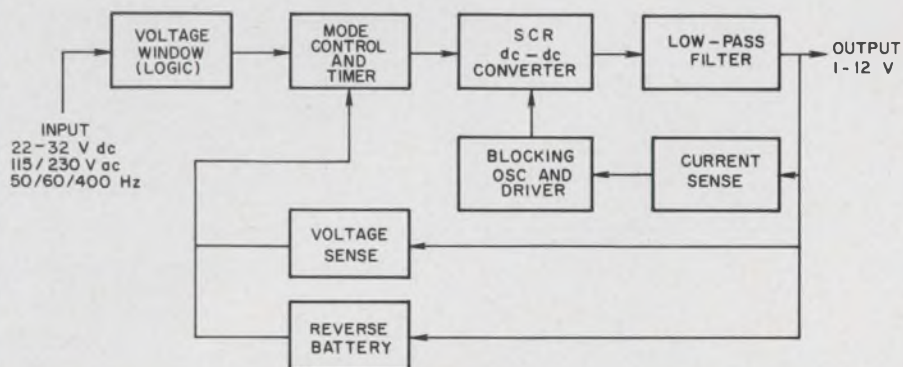

Lightweight battery charger can automatically recharge sealed or vented batteries and can also be used as a voltage-regulated power supply.

Now—the broadest line of convection-cooled, all silicon, .015% regulated power supplies

For test equipment and lab use 0-10,-20,-40,-60,-120 VDC, from 0-.5 amp to 0-66 amps

Features and Data

- Rack or bench use
- Full five year guarantee on materials and labor
- Convection Cooled
- Remote Programming
- Regulation—.015% or 1 MV (Line or Load)
- Temp. Coef. .015%/°C
- Completely Protected—Short circuit proof—Continuously adjustable Automatic current limiting
- Remote Sensing
- Constant I./Constant V. by automatic crossover
- Series/Parallel Operation
- No Voltage Spikes or Overshoot on "turn on", "turn off" or power failure
- Ripple—LK models—500 μ V RMS
LH models—250 μ V RMS, 1 MV P-P
- Meet MIL Environment Specs

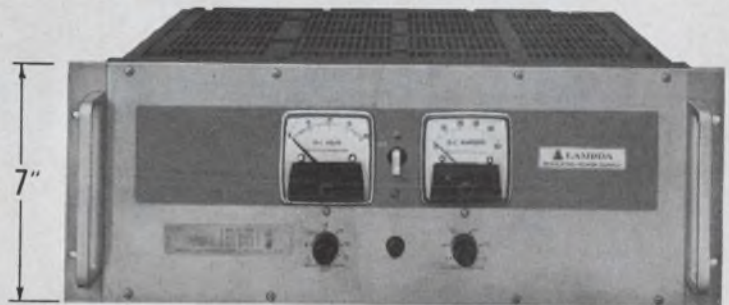

Full Rack 7" LK Series



1/4 Rack LH Series



1/2 Rack LK Series-LH Series



Full Rack 5 1/4" LK Series

3 Full-rack Models — Size 7" x 19" x 18 1/2"

Model ²	Voltage Range	CURRENT RANGE AT AMBIENT OF: ¹				Price ²
		40°C	50°C	60°C	71°C	
LK 360 FM	0-20VDC	0-66A	0-59A	0-50A	0-40A	\$995
LK 361 FM	0-36VDC	0-48A	0-43A	0-36A	0-30A	950
LK 362 FM	0-60VDC	0-25A	0-24A	0-22A	0-19A	995

3 Full-rack Models — Size 5 1/4" x 19" x 16 1/2"

Model ²	Voltage Range	CURRENT RANGE AT AMBIENT OF: ¹				Price ²
		40°C	50°C	60°C	71°C	
LK 350	0-20VDC	0-35A	0-31A	0-26A	0-20A	\$675
LK 351	0-36VDC	0-25A	0-23A	0-20A	0-15A	640
LK 352	0-60VDC	0-15A	0-14A	0-12.5A	0-10A	650

5 Quarter-rack Models — Size 5 3/8" x 4 3/8" x 15 1/2"

Model ²	Voltage Range	CURRENT RANGE AT AMBIENT OF: ¹				Price ²
		30°C	50°C	60°C	71°C	
LH 118	0-10VDC	0-4.0A	0-3.5A	0-2.9A	0-2.3A	\$175
LH 121	0-20VDC	0-2.4A	0-2.2A	0-1.8A	0-1.5A	159
LH 124	0-40VDC	0-1.3A	0-1.1A	0-0.9A	0-0.7A	154
LH 127	0-60VDC	0-0.9A	0-0.7A	0-0.6A	0-0.5A	184
LH 130	0-120VDC	0-0.50A	0-0.40A	0-0.35A	0-0.25A	225

11 Half-rack Models — Size 5 3/8" x 8 3/8" x 15 1/2"

Model ²	Voltage Range	CURRENT RANGE AT AMBIENT OF: ¹				Price ²
		40°C	50°C	60°C	71°C	
LK 340	0-20VDC	0- 8.0A	0- 7.0A	0- 6.1A	0-4.9A	\$330
LK 341	0-20VDC	0-13.5A	0-11.0A	0-10.0A	0-7.7A	385
LK 342	0-36VDC	0- 5.2A	0- 5.0A	0- 4.5A	0-3.7A	335
LK 343	0-36VDC	0- 9.0A	0- 8.5A	0- 7.6A	0-6.1A	395
LK 344	0-60VDC	0- 4.0A	0- 3.5A	0- 3.0A	0-2.5A	340
LK 345	0-60VDC	0- 6.0A	0- 5.2A	0- 4.5A	0-4.0A	395

Model ²	Voltage Range	CURRENT RANGE AT AMBIENT OF: ¹				Price ²
		30°C	50°C	60°C	71°C	
LH 119	0-10VDC	0- 9.0A	0- 8.0A	0- 6.9A	0-5.8A	\$289
LH 122	0-20VDC	0- 5.7A	0- 4.7A	0- 4.0A	0-3.3A	260
LH 125	0-40VDC	0- 3.0A	0- 2.7A	0- 2.3A	0-1.9A	269
LH 128	0-60VDC	0- 2.4A	0- 2.1A	0- 1.8A	0-1.5A	315
LH 131	0-120VDC	0- 1.2A	0- 0.9A	0- 0.8A	0-0.6A	320

¹ Current rating applies over entire voltage range.

² Prices are for non-metered models (except for models LK360FM thru LK362FM which are not available without meters). For metered models, add suffix (FM) and add \$25 to price of LH models; add \$30 to price of LK models.

³ Overvoltage Protection: add suffix (OV) to model number and add \$60 to the price of LH models; add \$70 to price of half-rack LK models; add \$90 to price of 5 1/4" full-rack LK models; add \$120 to price of 7" full-rack LK models.

⁴ Chassis Slides for full rack models: Add suffix (CS) to model number and add \$60 to the price.



LAMBDA ELECTRONICS CORP.

515 BROAD HOLLOW ROAD • MELVILLE, L.I., NEW YORK 11746 • (516) 694-4200 A Veeco SUBSIDIARY

Total monolithic integration of analog subsystems:

When?

Now.

Big things are happening in Linear Integrated Circuits. And they're happening where they've always happened — at Fairchild (that's why we supply more LIC's off-the-shelf than all other manufacturers combined). We've got a pile of new data that belongs in your hands. Take a look:

NEW, IMPROVED PERFORMANCE

We've done new things with old products. The original 702 and 710 circuits have powerful new specifications:

μ A702 — Wideband DC Amplifier			μ A710 — High Speed Differential Comparator		
Typical Parameters	New	Former	Typical Parameters	New	Former
V_{os}	0.5mV	2.0mV	V_{os}	0.6mV	2.0mV
I_{os}	180nA	700nA	I_{os}	750nA	1.0 μ A
A_{vo}	3,600	2,600	t_{on}	40nS	40nS
$V_{os}/\Delta T$	2.5 μ V/ $^{\circ}$ C		A_{vo}	1,700	1,500
			$V_{os}/\Delta T$	2.5 μ V/ $^{\circ}$ C	

NEW PRODUCTS

We've introduced three completely new circuits to allow you even greater design flexibility:

μ A716 — Low Distortion Medium Power Amplifier		μ A726 — Temperature Stabilized Transistor Pair		μ A730 — Differential Output Amplifier	
Typical Characteristics		Typical Characteristics		Typical Characteristics	
A_{vc}	10, 20, 100, 200	$\Delta V_{be}/T$	0.2 μ V/ $^{\circ}$ C	A_{vo}	145
THD	0.05% @ 150mW	$\Delta I_b/T$	10pA/ $^{\circ}$ C	V_{os}	1mV
I_{out}	100mA pk	h_{FE}	400 \pm 5%	I_{os}	0.5 μ A
V_{out}	13V p-p	h_{FE} (-55 to +125 $^{\circ}$ C) ($I_c = 100\mu$ A)		V_{out}	8 V p-p
		V_{ce0}	30V	R_{out}	70 Ω

TOTAL LINEAR CAPABILITY

Fairchild volume production gives you the quantity you need of the circuit you need, when you need it. Choose from the improved 702 and 710; the all-new 716, 726 and 730; or from these field-proven standards:

μ A703 — RF-IF Limiting Amplifier		μ A709 — High Gain Operational Amplifier		μ A711 — High Speed Dual Comparator	
Typical Characteristics		Typical Parameters		Typical Parameters	
G_m	35 mmbos	V_{os}	1mV	V_{os}	1.0mV
Y_{12}	.001 mmbos	I_{os}	50nA	I_{os}	0.5 μ A
I_{out}	4mA p-p	A_{vo}	45,000	t_{on}	40nS
R_{in}	3K Ω	V_{out}	\pm 14V	A_{vo}	1,500

NEW, LOWER PRICES

Fairchild sells more so Fairchild sells for less. Our high volume allows us to again reduce your costs, across the board. For instance, look at these new prices:

702C	\$ 5.50	711C	\$16.00
703E	1.50	716C	5.75
709C	5.95	726C	12.50
710C	4.95	730C	3.85

(all prices are 1000-quantity, industrial grades)

FREE, NEW APPLICATIONS HANDBOOK

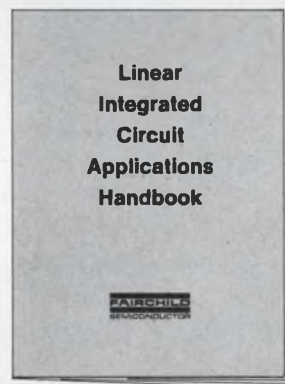

For a limited time, we'll send all inquirers our new 150-page Fairchild Linear Integrated Circuit Applications Handbook (just off the press). It's crammed with new design ideas, new applications, and new information on how to cut costs and improve performance utilizing Total Monolithic Integration (we'll also include complete specification data on the entire Fairchild LIC line). Along with this information, you receive complete rules and entry forms for our Special LIC Contest (see below).

CONTEST



Win a new Pontiac Firebird for a year

We've even developed a personal incentive for you to up-date your knowledge of the Fairchild LIC line and the benefits of designing with Total Monolithic Integration. It's an Analog Subsystem Design Contest. If you're a winner, we'll put you behind the wheel of a brand new Pontiac Firebird. Complete contest rules and entry forms are included with your LIC Handbook Data Kit (all you need to do is write us or call your Fairchild Distributor or Sales Office). You can enter as often as you want. But hurry: The contest closes on September 30.

CIRCLE READER SERVICE NUMBER

FAIRCHILD
SEMICONDUCTOR

INLAND dc DIRECT-DRIVE TORQUE MOTOR

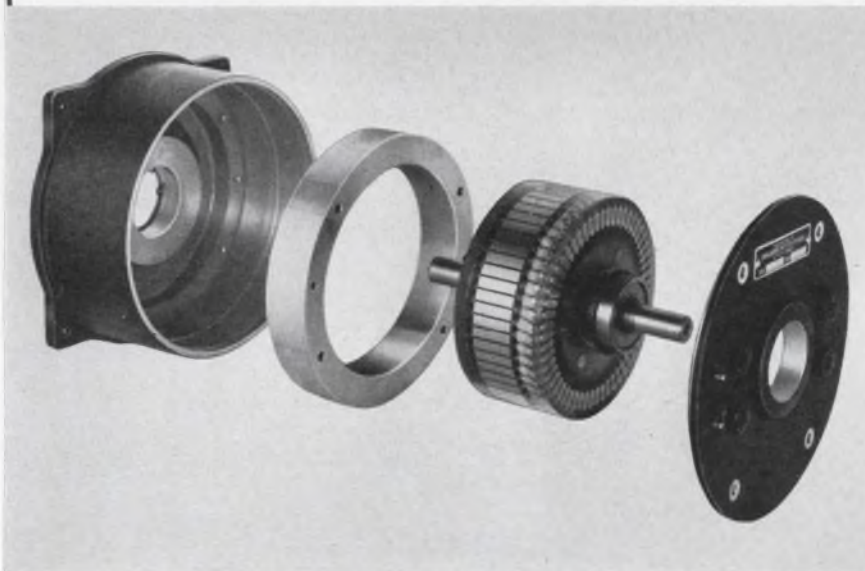

PRECISELY POSITIONS ALL TUNING STAGES IN AUTOMATICALLY TUNED LINEAR POWER AMPLIFIERS

Inland's unique configuration breaks a systems bottleneck by permitting precise positioning of the driver output tuning stage, the final output tuning stage and the final loading tuning stage. Direct-drive mounting of the torque motor on each shaft eliminates gears and "dead zones" — no backlash error. High coupling stiffness gives fine resolution and high positional accuracy, accuracy that is practically limited only by the error detecting transducing system.

The basic simplicity and absolute minimum of moving parts make a torque motor inherently reliable. Extensive design and production experience have put Inland torque motors in most major defense programs of the past 15 years. This wealth of experience is now available to help solve your drive problems.

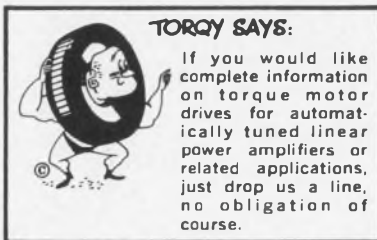

INLAND MOTOR

**CORPORATION
OF VIRGINIA**
RADFORD, VIRGINIA
703-639-3973

SUBSIDIARY OF **KOLLMORGEN**

ON READER-SERVICE CARD CIRCLE 28

Letters

Wanted: Information on laser modulation

Sir:

I am interested to know what hardware is required to modulate and demodulate a cw He-Ne laser beam (voice and TV). I particularly want information on the cheapest method to do the job, as the modulation and demodulation method is to be used in a high-school project.

Edwin C. Aldridge, Jr.

Technical Staff
TRW Systems
Houston

(ELECTRONIC DESIGN will be happy to receive and pass on any suggestions that readers may have for Mr. Aldridge.—Ed.)

Why do manufacturers refuse to cite prices?

Sir:

Manufacturers who refuse to send printed price lists with their catalogs bug me more than anything else in this industry.

My first impression is that something shady is involved, and further dealings with one such manufacturer recently strengthened that impression considerably. Even if it is unfair to tar all companies with the same brush, they can be suspected of a desire to quote different prices to different buyers.

I don't think anyone objects to "negotiated" prices when quantities are really large, but I've never been offered any acceptable explanation of the refusal to furnish printed price lists up to 999 pieces.

At the very least, there seems to be a desire to enable a salesman to get a foot in the door and deliver a sales pitch while quoting prices "in person." But that's the least—I'm still convinced I've encountered situations a lot closer to outright dishonesty than that.

Now if I'm all wet, let your readers jump on me; but if I'm right, perhaps something can be done.

I realize that most of the sugges-
(continued on p. 48)

ON READER-SERVICE CARD CIRCLE 29 ➤



You don't have to be Scottish to go for this.

We're so thrifty-minded at Honeywell that we've been able to put the taut-band meter's price down even lower than the price of a pivot-and-jewel meter. (About 10% lower, on the average.)

Maybe that sounds to you like we've left something out.



We have.

We've left out half the parts, in fact. (All the unnecessary ones.) This doesn't make the meter less sophisticated. Just less complicated.

It's a very different kind of meter. It costs less, for one thing — for us to make and for you to buy. It's simpler and more reliable.

There's no friction in the moving system, so you get better readout ac-



curacy and repeatability. And it's self-shielded.

Honeywell's new taut-band meter. It comes in just about any style you like.

Write Honeywell Precision Meter Division in Manchester, N. H. 03105 and we'll send you a brochure.

Honeywell

**We've put the
taut-band meter's price
where you want it.**

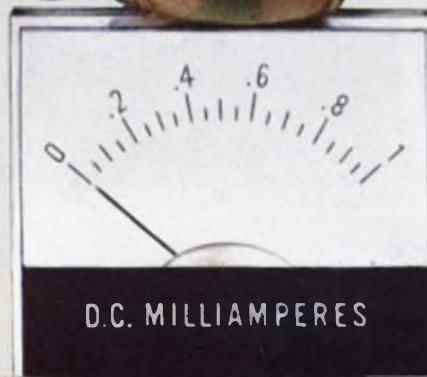

RFI and EMI DETECTION BEGINS AT



For help in solving RFI and EMI detection problems in the frequency range from 30 MHz to 1 GHz, may we direct your attention to the following CEI equipment:



TYPE 975A VHF RECEIVER . . .
an ultra-sensitive 30-300 MHz receiver for AM, FM, CW and Pulse detection.



TYPE FE-103 HF FREQUENCY EXTENDER . . .
may be used with VHF receiver above; converts signals in the 10-30 MHz range to a 60 MHz IF output.



TYPE FE-25-1 UHF FREQUENCY EXTENDER . . .
also designed for use with receivers tuning to 60 MHz; covers the 235 MHz to 1 GHz range in two bands.

Together, these three units span the MF/HF/VHF/UHF range of 10 MHz to 1 GHz. Each occupies just 3½" of rack space. For complete information, please contact:

COMMUNICATION ELECTRONICS INCORPORATED

6006 Executive Blvd., Rockville, Md. 20852 • Phone: (301) 933-2800 • TWX: 710-824-9603

CEI SETS THE PACE in surveillance, spectrum monitoring, and EMI/RFI detection. When only the highest possible performance is acceptable, look to the leader.

ON READER-SERVICE CARD CIRCLE 30

LETTERS

(continued from p. 46)

tions you seek are ways to improve your own magazine, and you are to be congratulated on the promptness with which such suggestions have been adopted. My pet peeve is not so easily within your control, yet a strong editorial (if you agree with me) might work wonders.

I cannot recall ever having encountered a product which didn't meet specifications, and that's a remarkable achievement for any industry, even if the specifications are sometimes a bit tricky in their wording. Now let's see if somebody, and perhaps a large group of somebodies, can put pressure on the handful of manufacturers who won't be equally honest about prices.

John H. Cone

General Manager
Electronic Enterprises
Pasadena, Calif.

(Despite Mr. Cone's belief to the contrary, ELECTRONIC DESIGN is interested in all valid commentary or criticism concerning any aspect of the electronics industry, not just in suggestions applicable to the magazine.—Ed.)

Needed: More support for anticrime R&D

Sir:

Since both [J. Edgar] Hoover and [S. David] Pursglove agree that updating the antiquated fingerprint system is a vital necessity [Letters, ED 9, April 26, 1967, pp. 54 & 60], I thought I would add my fuel to the fire.

In 1960, 1961 and 1962 an inkless fingerprinting system known as Proof was developed by Vought Electronics, now a part of the LTV complex. This system was offered to many law enforcement agencies but with no success in marketing it. LTV sought a buyer for the system in order to recover some of the development costs. While I am not aware of the final outcome of this venture, I do know that:

- The system successfully reproduced better fingerprints optically than could be obtained with conventional inking.

- Even badly burned fingers

ON READER-SERVICE CARD CIRCLE 181 ►

Dale stacks up better in industrial wirewounds



Scientific Data Systems uses Dale HLM Wirewounds in the power supply for its new Sigma 2 Computer

You can sell a lot of resistors if the price is right. Dale does. But price alone won't keep your name on the blueprint. Reliability will. The broad HL industrial wirewound line uses the same precision wirewinding and silicone coating techniques which—at MIL-R-39007 levels—have earned outstanding reliability records for Dale resistors. It pays off. Over 1,800,000 unit hours of testing has proven the maximum failure rate of HL resistors to be .05% per 1,000 hours. This is extra assurance that an inexpensive resistor won't shut down a costly piece of equipment. It's also extra value for the price. Get it from Dale.

CHECK DALE'S HL LINE • Tubular, flat, adjustable, tapped and non-inductive styles • Power: 1.25-225 watts
• Maximum resistance to 1.3 megohms depending on size • Tolerance $\pm 5\%$ or $\pm 10\%$ depending on value, specials to .05% • Lug and lead terminals • Meet MIL-R-26 and MIL-R-19365C.



FOR FAST INFORMATION CALL 402-564-3131 OR CIRCLE NO. 181



for optimum value in industrial resistors

DALE ELECTRONICS, INC., 1300 28th Ave., Columbus, Nebraska 68601

In Canada: Dale Electronics Canada, Ltd.

Printed in U.S.A.



Here's where to find a good industrial trimmer!

Western Electric makes wide use of Dale's 2100 Trimmer in circuit packs for Electronic Switching Systems

Western Electric's complex ESS #1 uses Dale 2100 Series Wirewound Trimmers in various circuit packs. Each of these circuit designs requires a trimmer with good stability, fine resolution and stable temperature characteristics—items which the 2100 can deliver easily at industrial price levels.

By using one simple, highly reliable design throughout its trimmer line, Dale has earned the confidence of industry leaders. This concept makes

performance no problem at any price level—and it means that value analysis techniques really pay off when you apply them to the Dale trimmer line.

For example, the 2100 Series—offering 1 watt at 70°C—is the commercial counterpart of RT-11, MIL-R-27208A. For pennies more it becomes a low-priced humidity-proof model equal to the mil spec everywhere but temperature. Similar values are available throughout the Dale trimmer line. For help in finding them, call 402-564-3131 today.

Circle No. 201 for Catalog B



for optimum value in trimmer potentiometers

DALE ELECTRONICS, INC., 1300 28th Ave., Columbus, Nebraska 68601
In Canada: Dale Electronics Canada, Ltd.



LETTERS

not in a state of total disintegration could yield usable prints.

■ Prints could be telecast across the nation while the person's fingers were actually being fingerprinted and could also be recorded on both film and tape for later viewing if necessary. It was suggested that electronic scanning techniques could be developed to aid in rapid identification and recovery of stored data from such fingerprints.

If those educated men in law enforcement would let the nation's engineers and scientists know what types of products they needed, or just give them a rudimentary idea of such equipment and willingly work with them to develop these ideas into usable hardware, everyone would benefit. Until then markets for equipment for these agencies must necessarily be conceived as an outgrowth of other ventures because of the large cost of development programs and when there is no surety that the product can be sold once it has been developed.

Richard H. Englert
Northridge, Calif.

Accuracy is our policy

In "Capacitive voltages are found easily," ED 6, March 15, 1967, pp. 266-267, author Arvid Rosenboom calls attention to two errors.

On p. 266, the equation in col. 2 should read:

$$T = (18 \times 10^{-9}) / (10 \times 10^{-9}) \\ = 1.8.$$

The "s" (for seconds) after 1.8 should be omitted; T is a multiplier; it is not a dimensioned quantity.

Similarly, the x axis of the graph on p. 267 should be labeled "Time constants (T)," not "(ns)." " T " is t/RC as defined in text.

In "Aluminum bumps bond DTL ICs," in the Microelectronics listing of the Products section of ED 11, May 24, 1967, p. 148, Fairchild Semiconductor points out that their Fairpak package has an alumina ceramic substrate, not an aluminum substrate as printed.

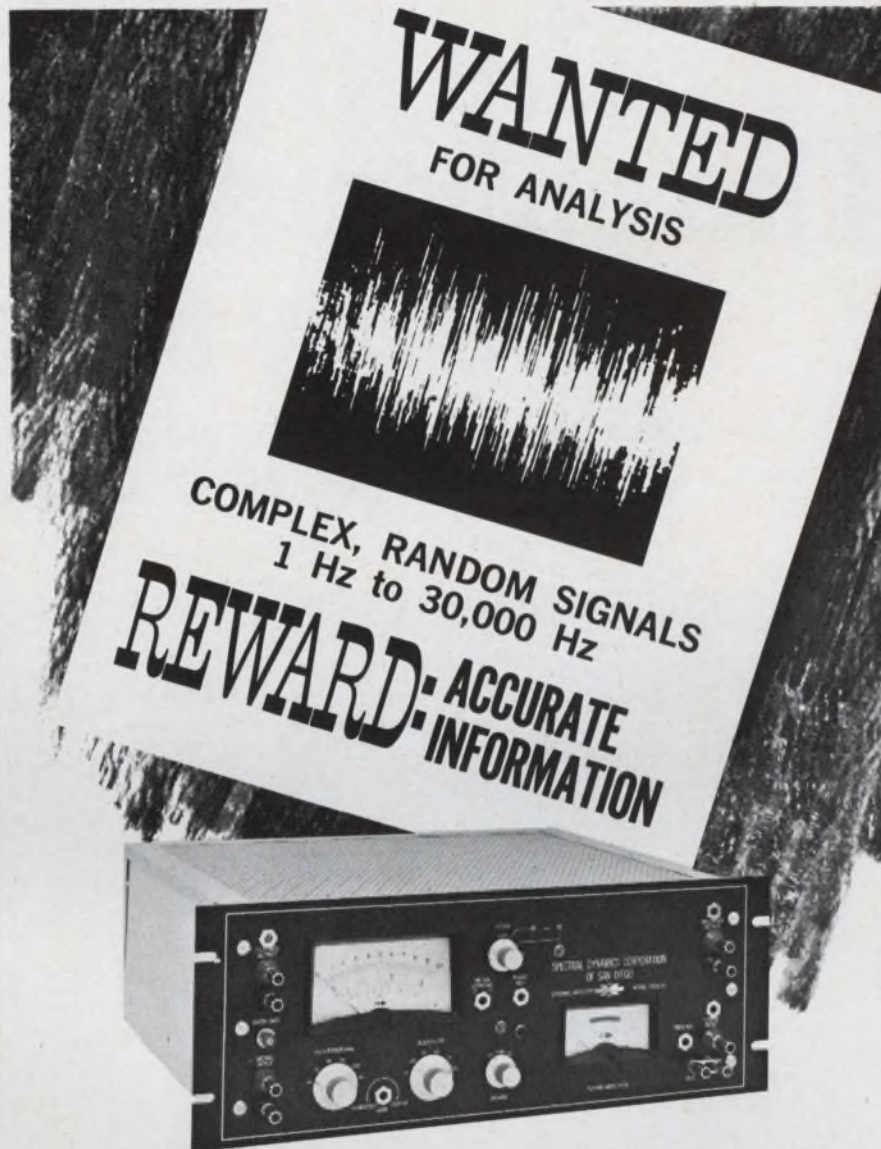

Feed the SD101A Dynamic Analyzer — *the world's most widely used tracking filter/analyzer* — any oscillating phenomenon convertible to an electric signal. Accurately, automatically and rapidly the SD101A will "sort out" the phenomenon's components, providing magnitude as well as phase information at each discrete frequency. Information can be recorded for detailed study.

How can you use talent like that? For determining Power Spectral Density. For analyzing seismic, acoustic, vibration and oceanographic data. For reducing taped data. For measuring Mechanical Impedance (Transfer-Function Analysis). For analyzing Rotating Machinery. Just to name a few.

The SD101A operates as a *frequency-tuned bandpass filter*. It tracks an external sine tuning source, such as an oscillator or tachometer, and places the center frequency of its constant-bandwidth filter (plug-in filter bandwidths are selectable from 1.5 to 200 Hz) anywhere you wish between 1 and 30,000 Hz. Then, as the Analyzer is tuned or swept through the signal, it passes *only* that portion within the filter bandwidth. (For example, with the SD101A tuned by an external signal of 100 Hz, a 10-Hz bandwidth plug-in filter will pass the spectrum between 95 and 105 Hz.) With accessories, you can switch automatically between as many as five plug-in filters for successive bandwidth cuts at the significant *information* buried in your data.

BECAUSE THE SD101A OPERATES ON A TOTALLY UNIQUE CONCEPT, BETTER SEND FOR THE DATA SHEET . . . IT TELLS THE ENTIRE STORY.

SPECTRAL DYNAMICS CORPORATION
OF SAN DIEGO



P.O. BOX 671 • SAN DIEGO, CALIFORNIA 92112 • (714)-278-2501 • TWX 910-335-2022

ON READER-SERVICE CARD CIRCLE 31

The Alfred 650: The only anti-confusion, utterly reliable sweep oscillator.

All controls, indicators, and r.f. plug-in on front panel.
Alfred "total protection" circuitry used throughout.

Unique Alfred three story slide rule dial with 5 CW frequencies and 3 markers.

Internal or external leveling... PIN diode or grid leveling.

11 plug-ins cover total 250 MHz to 40 GHz. Plug-ins covering intermediate ranges available.

Front plug-in convenience eliminates additional wasteful handling and useless accessories required with now obsolete rear plug-in sweepers.

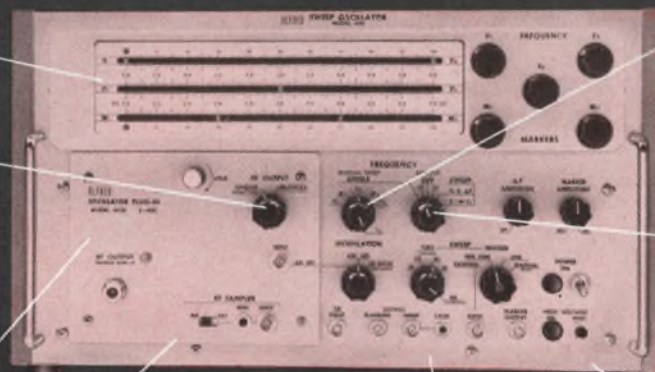

Unique F_0 control which serves as a frequency marker, the center of the symmetrical sweep, and as a single frequency.

Broad band $F_1 F_2$ sweep and narrow band symmetrical sweep, $F_0 \pm F$.

Operates from 50 to 400 Hz 115/230 volt power for convenient air, sea, or ground application.

Rugged construction. There is no sturdier sweeper on the market. Ask your Alfred sales engineer to demonstrate the 4" drop test.

Ask for the six-page data pack.

A six-page data pack describing the Alfred 650 Sweep Oscillator and associated plug-ins is yours for the asking. Ask your full service Alfred sales engineer for a copy or write to Alfred Electronics, 3176 Porter Drive, Palo Alto, California 94304. Phone (415) 326-6496.

Project responsibility opportunities are available for qualified engineers on Alfred Electronics' growing technical staff. An equal opportunity employer. See us at Wescon, Booths #2606 & 2607

ALFRED ELECTRONICS

ON READER-SERVICE CARD CIRCLE 32

Co-Publishers

James S. Mulholland, Jr.
Robert E. Ahrendorf

Editorial Director

Edward E. Grazda

Editor

Howard Bierman

Managing Editor

Robert C. Haavind

Technical Editors

Jeffrey N. Bairstow
Peter N. Budzilovich
Maria Dekany
Roger K. Field

News Editors

Ralph Dobriner, Chief
Richard N. Einhorn

East Coast Editor

Neil Sclater

West Coast Editor

Ron Gechman

Copy Editor

Peter Beales

New Products Editors

David H. Sorgan
Daniel R. Butterly

Directory Editor

William Alvarez

Washington Editor

S. David Pursglove

Editorial Production

Dollie S. Viebig
Karen L. Sherman

Art Director

Clifford M. Gardiner

Art Assistant

William Kelly

Technical Illustrators

Cheh Nam Low
Sheila F. Ward

Production Manager

Thomas V. Sedita

Asst. Production Manager

Helen De Polo

Production Assistants

Bernard Wolinsky
Robert M. Henry

Circulation Manager

Nancy L. Merritt

Reader Service

Diane Mandell

EDITORIAL



We can take a lesson from Europe on trade shows

European electronic exhibitions are better than those in the United States.

That's a challenging statement, but from the standpoint of the foot-weary design engineer touring these shows, the European show wins out. Technical programs are another matter. Despite the defects of many of the technical sessions in the U.S., the content and communications effectiveness seem better. But in exhibiting products, U.S. companies can learn a lot from Europe.

Why do we think European shows are better? The first reason is the construction of the booths. Each booth, or stand as the Europeans call them, of any size has a little back room; or even a series of rooms. These are set up with tables, chairs, couches, and sometimes even a refrigerator and a bar. Here the visiting designer can sit down with an applications engineer and work out his device or equipment needs, or with a marketing man to talk prices. In some booths one room is used for serious design discussions while others are alive with vendor-customer chatter. Drinks offered to the visitor range from fruit juice to much stronger spirits. Adding to this atmosphere of comfortable homeyness is an occasional floral display, or a few plants. Also, the "gee whiz" approach of so many U.S. exhibitors is rare.

Yet even these touches are not enough. One West German manufacturer cited a number of European exhibits put on by the U.S. Government. "Sure, they had the European stands and the drinks and all," he commented. "But our engineers didn't think much of them. They left out the most important thing: a man at each booth who could get down to the details of doing business."

He said that he had visited U.S. shows and found floods of literature and information cards to fill out. But seldom did he find well-informed personnel at a booth so that business could be transacted.

There are, of course, exceptions to this general picture. Hewlett-Packard, for example, does a fine job at exhibitions in both the U.S. and Europe. H-P engineers familiar with the equipment are well-rehearsed before manning the booth at a show, so that when a designer stops by he finds out what he wants to know.

But the other side of the picture exists, too, and it is beginning to receive attention. International Rectifier has stayed out of the IEEE Show the last two years and rented a large hotel suite instead. A major reason was that in the hotel the company's applications engineers could sit down and chat with valued customers without interruption. In a busy booth with heavy traffic this was difficult to do.

At the 1967 Wescon show in San Francisco in August there will be a group of European-type booths to allow this type of detailed interchange right at the show, rather than at a nearby hotel.

Let's hope that this trend toward better shows continues.

ROBERT HAAVIND

150 MHz, 2.4 ns

New performance from probe tip to CRT!

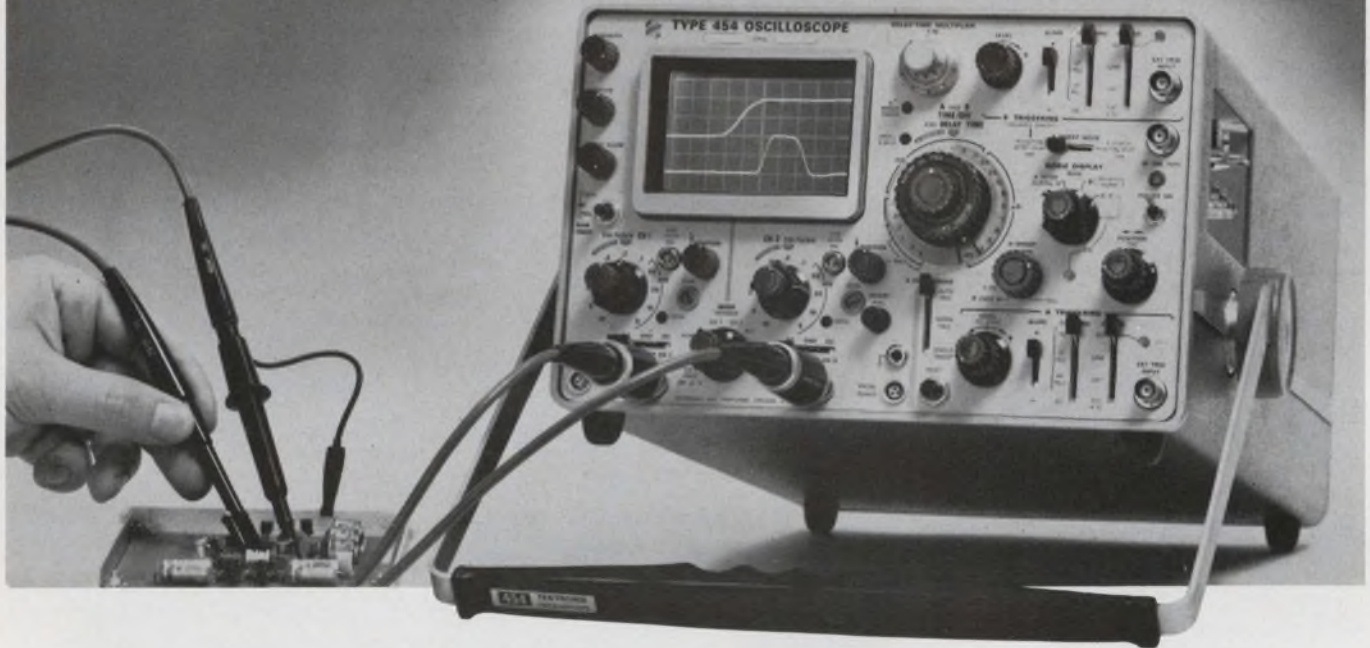

The Tektronix Type 454 is an advanced new portable oscilloscope with DC-to-150 MHz bandwidth and 2.4-ns risetime performance where you use it — at the probe tip. It is designed to solve your measurement needs with a dual-trace vertical, high performance triggering, 5-ns/div delayed sweep and solid state design. You also can make 1 mV/div single-trace measurements and 5 mV/div X-Y measurements.

The vertical system provides the following dual-trace performance, either with or without the new miniature P6047 10X Attenuator Probes:

Deflection Factor*	Risetime	Bandwidth
20 mV/div to 10 V/div	2.4 ns	DC to 150 MHz
10 mV/div	3.5 ns	DC to 100 MHz
5 mV/div	5.9 ns	DC to 60 MHz

*Front panel reading. With P6047 deflection factor is 10X panel reading.

The Type 454 can trigger internally to above 150 MHz. Its calibrated sweep range is from 50 ns/div to 5 s/div, extending to 5 ns/div with the X10 magnifier on both the normal and delayed sweeps. The delayed sweep has a calibrated delay range from 1 μ s to 50 seconds.

For further information, contact your nearby Tektronix field engineer, or write: Tektronix, Inc., P. O. Box 500, Beaverton, Oregon 97005.

- Type 454 (complete with 2 P6047 and accessories) \$2550
- Rackmount Type R454 (complete with 2 P6047 and accessories) \$2635
- New Type 200-1 Scope-Mobile® Cart \$ 60

U. S. Sales Prices FOB Beaverton, Oregon



Coordinated research,
design and manufacturing



... part of the Tektronix commitment
to progress in the measurement sciences

Pulse fidelity

This double-exposure photograph shows the same 12-ns-wide pulse displayed on the Type 454 (upper display) and on a 7-ns, 50-MHz oscilloscope (lower display). Note the difference in detail of the pulse characteristics displayed on the Type 454 with its 2.4-ns risetime performance.

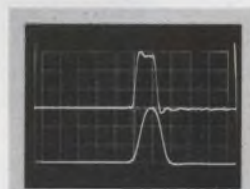

10 ns/div

5 ns/div delayed sweep

The delayed sweep is used to measure individual pulses in digital pulse trains. The Type 454 with its 1 μ s-to-50 s calibrated delay time, 5-ns/div sweep speed and 2.4-ns risetime permits high resolution measurements to be made. Upper trace is 1 μ s/div; lower trace is 5 ns/div.

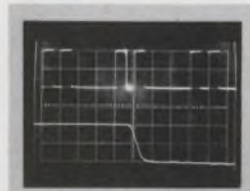

Double Exposure

X-Y

The upper display is a 150-MHz signal that is 50% modulated by a 2 kHz signal. The lower display is an X-Y trapezoidal modulation pattern showing the 150-MHz AM signal vertically (Y) and the 2 kHz modulation signal horizontally (X). Straight vertical line is the unmodulated carrier. Multiple exposure.

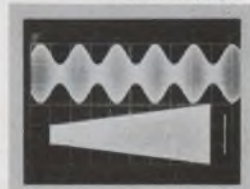

150 MHz AM

Technology



Root sensitivity is a prime consideration in computer analyses of active circuits. Page 54

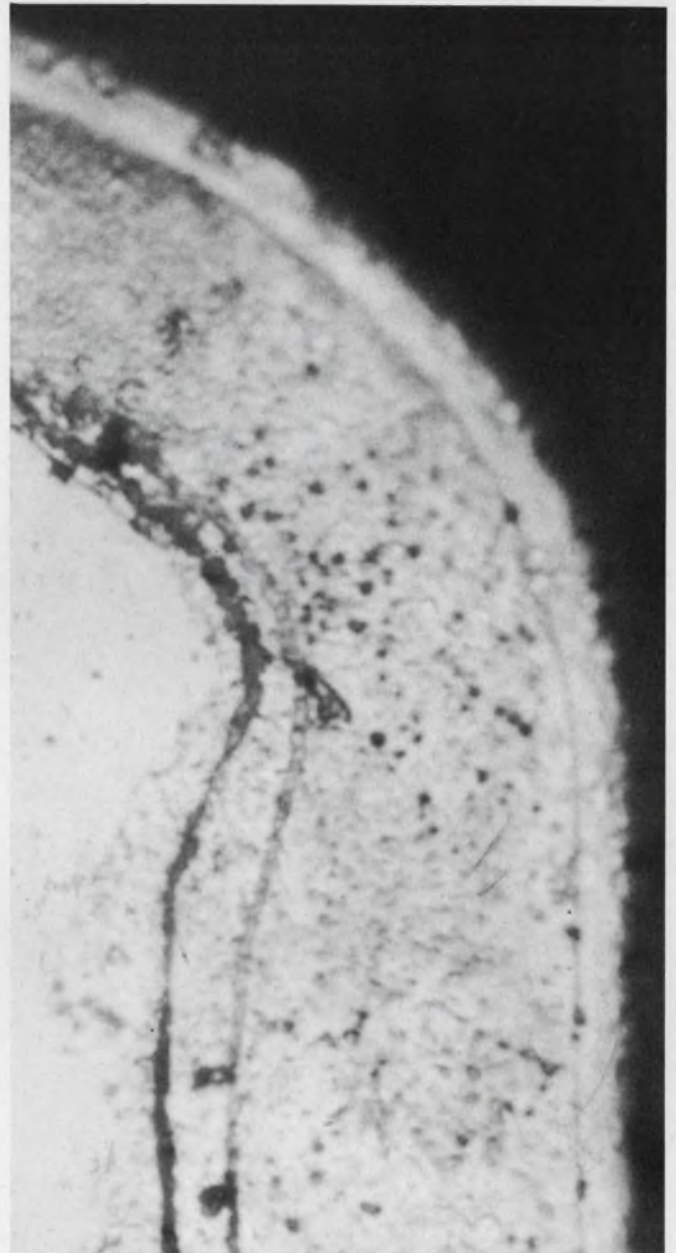

Reliable design of PC rotary switches is based on materials and processing. Page 90

Also in this section:

Properly valued transistor models secure best results from computer analyses. Page 60

Resistor-thermistor network design is simplified by the direct approach. Page 70

Measure and specify spectral purity of oscillators meaningfully. Page 76

Delay distortion is eliminated by using the inverse response of all-pass networks. Page 84

Computer-analyze your circuit

by applying the principle of sensitivity of active circuits to parameter variations.

The sensitivity of an active circuit to parameter variations is a major consideration in the analysis and design of modern solid-state circuits. Several useful sensitivity indices are to be discussed and illustrated here. It will be shown that the root sensitivity calculated on the basis of the state vector differential equation is particularly suitable for digital-computer calculations.

An active circuit, whatever its nature, can be affected by changing environment, aging, component tolerances and other natural factors. Variation of the parameters of a circuit will often have a significant effect on its performance. Thus, a circuit's sensitivity to parameter variations is of prime importance.

What is sensitivity?

The sensitivity of a circuit is defined as the effect of parameter variations on the performance of the circuit. Hence, the sensitivity is:

$$S_{\rho_i}^{I_j} = \Delta I_j / \Delta \rho_i, \quad (1)$$

where I_j is the j th performance index and ρ_i is the i th parameter. For example, if the focus of interest is on the node voltage e_1 and the effect of the resistance R_1 , the equation is:

$$S_{R_1}^{e_1} = \Delta e_1 / \Delta R_1, \quad (2)$$

where ΔR_1 is the variation in the resistance R_1 . Alternatively, the normalized sensitivity measure may be used. This is defined as:

$$S_{\rho_i}^{I_j} = (\Delta I_j / I_j) / (\Delta \rho_i / \rho_i). \quad (3)$$

In active circuit analysis, the performance indices of interest include node voltages, transient response, ac response, gain, and the circuit transfer function. For computer-aided circuit analysis and design, sensitivity measures that are readily calculated with a digital computer are usually selected.

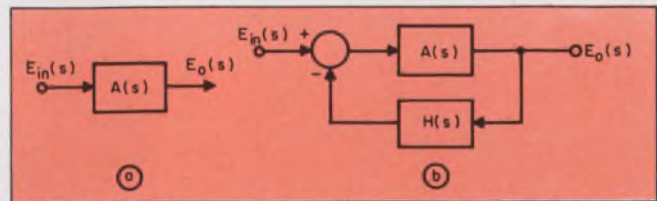

1. Effect of parameter variations on circuit or system performance is illustrated for the case of an open-loop (a) and a closed-loop (b) circuit.

To illustrate the effect of parameter variations, consider the open-loop circuit of Fig. 1a and the feedback circuit of Fig. 1b. The effect of a change in the circuit of Fig. 1a, $A(s) + \Delta A(s)$, results in:

$$E_o(s) + \Delta E_o(s) = [A(s) + \Delta A(s)] E_{in}(s)$$

or:

$$\Delta E_o(s) = \Delta A(s) E_{in}(s). \quad (4)$$

Thus, a change in the circuit results in a proportional variation in the output. For the closed-loop feedback system of Fig. 1b, the equation is:

$$E_o(s) + \Delta E_o(s) = \frac{A(s) + \Delta A(s)}{1 + [A(s) + \Delta A(s)]H(s)} E_{in}(s). \quad (5)$$

Then, the change in the output is approximately:

$$\Delta E_o(s) = \{ \Delta A(s) / [1 + AH(s)] \} E_{in}(s). \quad (6)$$

Comparing Eqs. 4 and 6 brings out the fact that the change in the output has been reduced by the factor $[1 + AH(s)]$.

Sensitivity as defined by Bode

The definition of sensitivity attributed to Bode is stated in terms of the transfer function of a circuit, $T(s) = E_o(s)/E_{in}(s)$, to be:

$$S_{\Delta A}^T = [\Delta T(s)/T(s)] / [\Delta A(s)/A(s)]. \quad (7)$$

In the limit it is:

$$S_{\Delta A}^T = [dT/T(s)] / [dA(s)/A(s)]. \quad (8)$$

Equation 8 serves to show that the sensitivity

Richard C. Dorf, PhD, Professor and Chairman, Dept. of Electrical Engineering, University of Santa Clara, Calif.

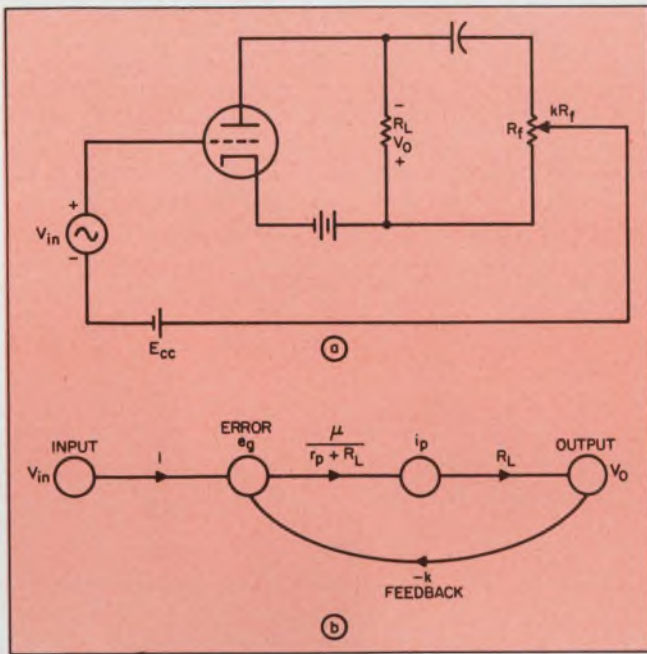

2. Sensitivity of an electronic circuit (a) to parameter variations can be reduced by introducing a feedback loop. Signal flow graph is shown in (b).

of the open-loop circuit of Fig. 1a is equal to 1. The sensitivity of circuit of Fig. 1b is:

$$S_{dA}^T = 1/[1 + AH(s)]. \quad (9)$$

Similarly, the sensitivity of the transfer function to the feedback network is:

$$S_{dAH(s)}^{T(s)} = -AH(s)/[1 + AH(s)]. \quad (10)$$

Therefore, the sensitivity of an active circuit S_{dA}^T may be reduced by establishing $AH(s) \gg 1$. However, the sensitivity S_{dAH}^T of the circuit to the feedback network then becomes approximately 1. Consequently, the feedback circuit must be constructed of reliable components which will not vary with environmental changes.

To illustrate the effectiveness of feedback in reducing the sensitivity of an electronic circuit, consider the simple circuit in Fig. 2a. The signal flow graph of the amplifier appears in Fig. 2b. Clearly, the gain without the feedback is $A = \mu R_L / (r_p + R_L)$. The sensitivity of the open-loop system to changes in μ is equal to 1. The sensitivity of the closed-loop circuit is:

$$S_{d\mu}^T = (\partial T/T) / (\partial \mu/\mu) = 1/(1 + Ak), \quad (11)$$

where $T = A/(1 + Ak)$. If A has a typical value of 20 and $k = 0.5$, then $S_{d\mu}^T = 1/11 = 0.091$.

Characteristic roots and sensitivity

The sensitivity index employed by Bode is useful for illustrating the concept of sensitivity and the value of introducing feedback to reduce the sensitivity of an electronic circuit. It is not a particularly useful index, however, for

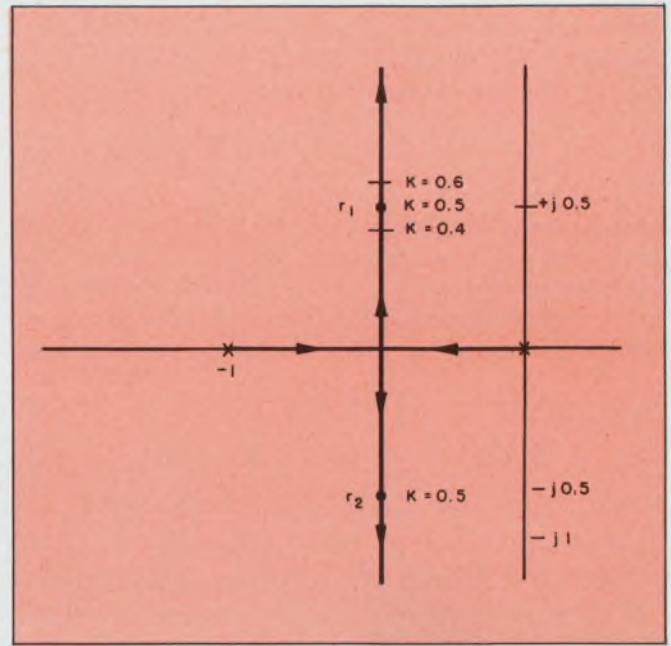

3. Root locus for K (gain) of the feedback circuit of Fig. 1b illustrates the root (r_1) sensitivity to variations in K . See Eq. 15 for the sensitivity expression.

computer analysis or design. Another potentially more useful index is defined in terms of the characteristic roots of the circuits as:

$$S_{p_j}^{r_i} = \partial r_i / (\partial p_j / p_j). \quad (12)$$

In this definition, r_i is the i th characteristic root, p_j is the j th parameter, and the circuit transfer function is written as:

$$T(s) = \left[K \prod_{m=0}^M (s + z_m) \right] / \left[\prod_{i=1}^n (s + r_i) \right]. \quad (13)$$

The sensitivity index $S_{p_j}^{r_i}$ is defined as the root sensitivity of the circuit. Root locus methods² are used to evaluate a circuit's root sensitivity. As an example, consider the feedback circuit of Fig. 1b, where $A(s) = K/[s(s + \beta)]$ and $H(s) = 1$. The characteristic equation of this circuit is $s^2 + \beta s + K = 0$, or, written in root locus form:

$$1 + \{K/[s(s + \beta)]\} = 0. \quad (14)$$

Where the nominal value of $K = 0.5$ and $\beta_0 = 1.0$, the resulting characteristic roots are $r_1 = -0.5 + j0.5$ and $r_2 = r_1^*$. The locus of roots for this circuit as a function of the gain K appears in Fig. 3. For a $\pm 20\%$ change in K , the root locations are evaluated by root locus methods, as in Fig. 3. Thus the root sensitivity for r_1 is:

$$\begin{aligned} S_{+\Delta K}^{r_1} &= \Delta r_1 / (\Delta K/K) \\ &= +j0.09/0.2 = 0.45 \angle +90^\circ. \end{aligned} \quad (15)$$

The pole β may also vary as a result of environmental changes, so that $\beta = \beta_0 + \Delta\beta$. Then the effect of $\Delta\beta$ is represented as:

$$s^2 + s + \Delta\beta s + 0.5 = 0, \quad (16)$$

since the nominal value of β is $\beta_0 = 1$ and the nominal value of gain is $K = 0.5$. Rewriting Eq. 16 in root locus form yields:

$$1 + [\Delta\beta s / (s^2 + s + 0.5)] = 0. \quad (17)$$

The denominator is equal to the unchanged characteristic equation when $\Delta\beta = 0$. The root locus for changes in $\Delta\beta$ is shown in Fig. 4. For small changes in β , the departure vector may be used as an approximation to the locus of roots. Evaluating the root sensitivity yields:

$$S_{+\Delta\beta}^r = (0.16 \angle -131^\circ) / 0.20 = 0.80 \angle -131^\circ; \quad (18)$$

$$S_{-\Delta\beta}^r = (0.125 \angle 39^\circ) / 0.20 = 0.625 \angle 39^\circ. \quad (19)$$

The angle of the root sensitivity is as important a factor as the magnitude, since the direction of movement indicates a change in the relative stability of the circuit. Comparing the sensitivity of the roots associated with K and β makes it clear that the root associated with pole β is more significant because of the larger magnitude of $S_{-\Delta\beta}^r$ and because of the β roots' direction, which is toward lower damping for a reduction in β .

Sensitivity in the time domain

A sensitivity measure that is particularly useful for computer evaluation of nonlinear circuits is defined in terms of the sensitivity coefficients in the time domain as:

$$v_i(t) = [\partial x_i(t) / \partial p], \quad (20)$$

where $x_i(t)$ is the i th state variable and p is the parameter that is varying because of environmental changes. For a set of n state variables, the sensitivity vector may be defined as:

$$\mathbf{v}(t) = \partial \mathbf{x} / \partial p, \quad (21)$$

where $\mathbf{x} = (x_1, x_2, \dots, x_n)^T =$ state vector.³ (Bold-face lower-case letters denote vector quantities, bold-face capital letters denote matrices.) The state variables are commonly selected as the capacitor voltages and the inductor currents for an active circuit. The state vector differential equation for the circuit is written as:

$$\dot{\mathbf{x}} = \mathbf{f}(\mathbf{x}, \mathbf{u}, t), \quad (22)$$

where \mathbf{u} is the vector of input signals. Equation 22 may be written as:

$$\mathbf{F}(\dot{\mathbf{x}}, \mathbf{x}, \mathbf{u}, t) = 0, \quad (23)$$

and the derivative of \mathbf{F} with respect to p is:

$$\frac{\partial \mathbf{F}}{\partial p} = \frac{\partial \mathbf{F}}{\partial \dot{\mathbf{x}}} \frac{d\dot{\mathbf{x}}}{dp} + \frac{\partial \mathbf{F}}{\partial \mathbf{x}} \frac{d\mathbf{x}}{dp} + \frac{\partial \mathbf{F}}{\partial p} \frac{dp}{dp} = 0. \quad (24)$$

Then, for example, for the linear system, the following is obtained:

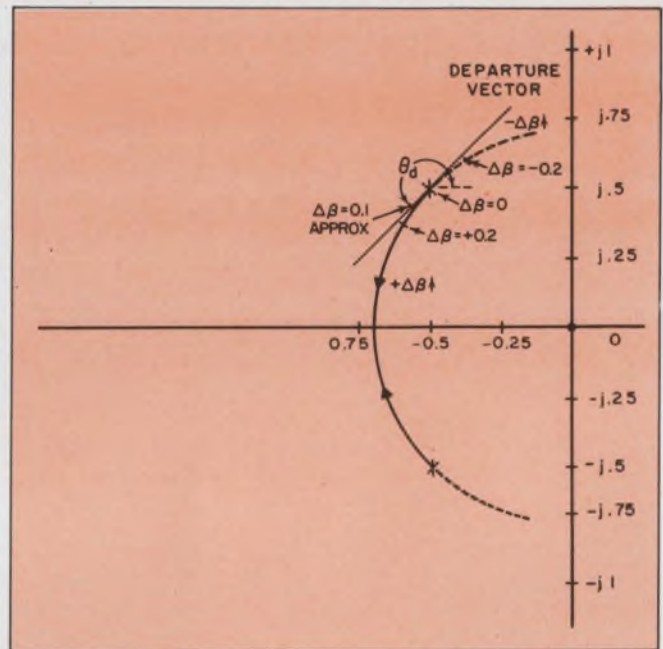

4. Effect of changing β can be seen from the root locus for the parameter β .

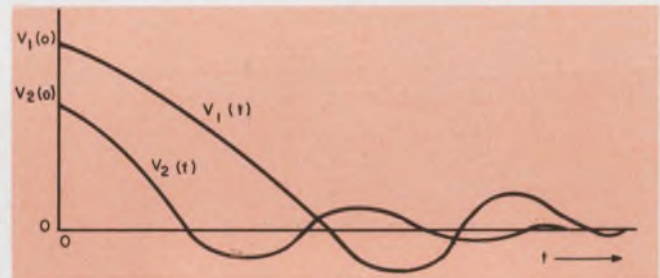

5. Typical transient response of the two sensitivity coefficients (see Eq. 31).

$$\partial \mathbf{F} / \partial \dot{\mathbf{x}} = -\mathbf{I}, \quad \partial \mathbf{F} / \partial \mathbf{x} = \mathbf{A},$$

$$\partial \mathbf{F} / \partial p = (\partial \mathbf{A} / \partial p) \mathbf{x} = \mathbf{Dx},$$

and thus:

$$d\mathbf{x} / dp = \mathbf{A} (d\mathbf{x} / dp) + \mathbf{Dx}. \quad (25)$$

For the definition of the sensitivity coefficients $\mathbf{v} = \partial \mathbf{x} / \partial p$, Eq. 25 becomes:

$$\dot{\mathbf{v}} = \mathbf{A} \mathbf{v} + \mathbf{Dx}(t). \quad (26)$$

The solution of this linear sensitivity equation may be obtained by computer methods.⁴ The solution of Eq. 26 may also be written as:

$$\mathbf{v}(t) = \Phi(t) \mathbf{v}(0) + \int_0^t \Phi(t - \tau) \mathbf{D} \mathbf{x}(\tau) d\tau, \quad (27)$$

where $\Phi(t)$ is the transition matrix, $e^{\mathbf{A}t}$. Consider, for example, the second-order system described by the linear state vector differential equation:

$$\dot{\mathbf{x}} = \mathbf{A} \mathbf{x} + \mathbf{B} \mathbf{u}, \quad (28)$$

where $\mathbf{A} = \begin{bmatrix} 0 & 1 \\ -p & -3 \end{bmatrix}$ and the nominal value of

$p = -2$. Then, the matrix D is:

$$D = dA/dp = \begin{bmatrix} 0 & 0 \\ -1 & 0 \end{bmatrix}, \quad (29)$$

and the sensitivity vector is:

$$\mathbf{v}(t) = \Phi(t) \mathbf{v}(0) + \int_0^t \begin{bmatrix} \phi_{12} & (t-\tau) \\ \phi_{22} & (t-\tau) \end{bmatrix} [-x_1(\tau)] d\tau. \quad (30)$$

The typical transient response of the two sensitivity coefficients is shown in Fig. 5.

To obtain a suitable sensitivity measure using the sensitivity coefficients, one might use:

$$S = \int_0^\infty (\mathbf{v}^T \mathbf{v}) dt = \int_0^\infty [v_1^2(t) + v_2^2(t)] dt. \quad (31)$$

Using the measure of Eq. 31, the designer could include the effect of sensitivity in a computer-aided design procedure.

Root sensitivity and state vector formulation

The root sensitivity of a linear system represented by the time-domain vector differential equation (Eq. 28) may be determined by a digital-computer program.⁵ The change in any root r_i for a change in the parameters of A is:

$$dr_i = \frac{\mathbf{R}(s) * dA}{\text{tr } \mathbf{R}(s)} \Big|_{s=r_i} \quad (32)$$

where $\mathbf{R}(s)$ is the adjoint matrix, dA is the differential change in A , tr denotes the trace of a matrix (that is, the sum of the terms in the main diagonal), and $*$ indicates the inner product of two matrices (that is:

$$A * B = a_1 b_1 + a_2 b_2 + \dots + a_n b_n, \quad (33)$$

where a_i is the i th row of A and b_i is the i th column of B .) Equation 32 is obtained by using an algorithm for the characteristic roots and the characteristic matrix that is best suited to digital-computer calculation.^{6,7} Hence:

$$\mathbf{R}(s) = \mathbf{I}s^{n-1} + \mathbf{R}_1 s^{n-2} + \mathbf{R}_2 s^{n-3} + \dots \quad (34)$$

The algorithm for generating $\mathbf{R}_k(s)$ is:

$$\mathbf{R}_k = \mathbf{A}\mathbf{R}_{k-1} - d_k \mathbf{I}, \quad (35)$$

where $d_k = 1/k \text{tr } \mathbf{A}\mathbf{R}_{k-1}$ and $\mathbf{R}_0 = \mathbf{I}$.

As an example of this method, consider again the feedback circuit of Fig. 1b with a transfer function (see Eq. 14):

$$T(s) = 0.5/(s^2 + \beta s + 0.5) \quad (36)$$

and the nominal value of β is 1.0. The resulting characteristic root of interest is $r_1 = -0.5 + j0.5$ and the aim is to determine the root sensitivity of r_1 due to a small change in β . The circuit with the transfer function of Eq. 36 may be repre-

sented by the state vector equation (Eq. 28):

$$\begin{aligned} \dot{\mathbf{x}} &= \begin{bmatrix} 0 & 1 \\ -0.5 & -\beta \end{bmatrix} \mathbf{x} + \begin{bmatrix} 0 \\ 1/2 \end{bmatrix} e_{in} \\ &= \mathbf{A} \mathbf{x} + \mathbf{B} \mathbf{u}. \end{aligned} \quad (37)$$

Therefore:

$$\begin{aligned} dA &= \begin{bmatrix} 0 & 0 \\ 0 & -1 \end{bmatrix} d\beta; \\ \mathbf{R}_0 &= \mathbf{I}; \\ d_1 &= \text{tr } \mathbf{A} = -\beta = -1; \\ \mathbf{R}_1 &= \mathbf{A}\mathbf{R}_0 - d_1 \mathbf{I} = \begin{bmatrix} 1 & 1 \\ -0.5 & 0 \end{bmatrix}. \end{aligned} \quad (38)$$

Thus Eq. 35 becomes:

$$\mathbf{R}(s) = \mathbf{I}s + \mathbf{R}_1 = \begin{bmatrix} (s+1) & 1 \\ -0.5 & s \end{bmatrix}. \quad (39)$$

Using Eq. 32 to evaluate the root change yields:

$$\begin{aligned} dr_1 &= \frac{\mathbf{R}(s) * dA}{\text{tr } \mathbf{R}(s)} \Big|_{s=r_1} \\ &= \frac{\begin{bmatrix} (s+1) & 1 \\ -0.5 & s \end{bmatrix} * \begin{bmatrix} 0 & 0 \\ 0 & -1 \end{bmatrix} d\beta}{(2s+1)} \Big|_{s=r_1} \\ &= (-r_1 d\beta)/(2r_1 + 1). \end{aligned} \quad (40)$$

Since $r_1 = -0.5 + j0.5$, the root sensitivity is:

$$S_{+\beta}^{r_1} = dr_1/(d\beta/\beta) = 0.707 \angle -135^\circ \quad (41)$$

This root sensitivity calculation may be compared with that obtained in Eq. 18 for incremental changes in the parameter β . This method of calculating the root sensitivity of an active circuit which is based on the time-domain equations describing that circuit is exceptionally useful for digital-computer calculation. A program for it is currently available. ■ ■

References:

1. H. W. Bode, *Network Analysis and Feedback Amplifier Design* (Princeton, N. J.: D. Van Nostrand Co., Inc., 1945).
2. R. C. Dorf, *Modern Control Systems* (Reading, Mass.: Addison-Wesley Publishing Co., 1967).
3. ———, *Time Domain Analysis and Design of Control Systems* (Reading, Mass.: Addison-Wesley Publishing Co., 1965).
4. ———, "System Sensitivity in the Time Domain," *Proceedings of the Third Allerton Conference on Circuit and System Theory* (Chicago: University of Illinois Press, 1965), pp. 46-62.
5. B. S. Morgan, Jr., "Computational Procedures for Sensitivity Coefficients in Time-Invariant Multivariable Systems," *Proc. 3rd Allerton Conf. on Circuit and System Theory* (Chicago: University of Illinois Press, 1965), pp. 252-258. Also available as Report SRL 65-004, F. J. Seiler Research Lab., U.S. Air Force Academy, Colo.
6. D. K. Faddeev and V. N. Faddeeva, *Computation Methods of Linear Algebra* (San Francisco: Freeman and Co., 1963), p. 229.
7. Dorf, *Modern Control Systems*.
8. B. S. Morgan, Jr., *op. cit.*

Let's take an engineer's look at TTL from TI

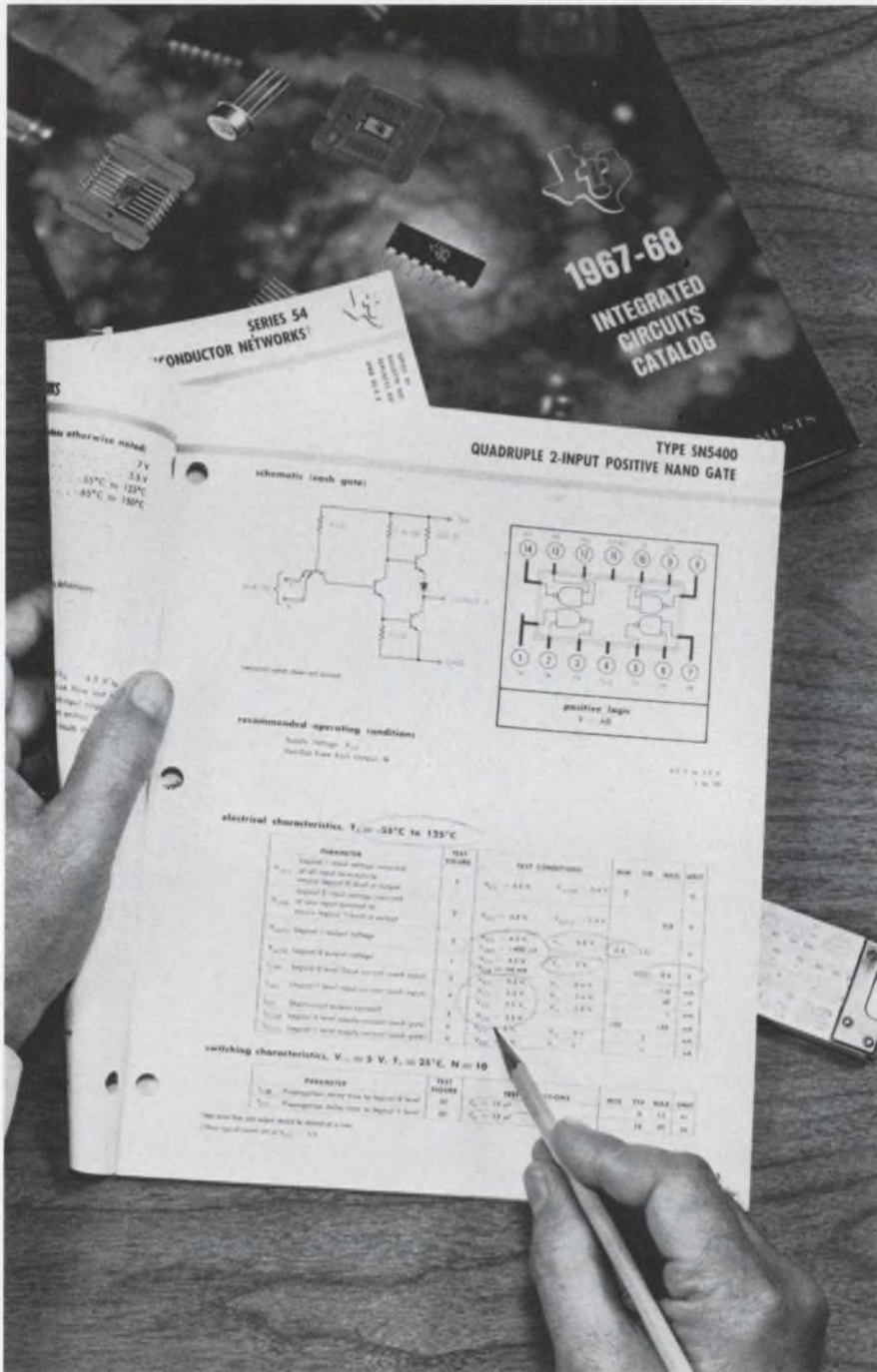

Many key TTL performance characteristics are not readily understood. What do the specifications really mean? How were they determined?

Answers to these questions are important to engineers involved in designing digital systems. Here are some of the reasons why we "spec" Series 54/74 TTL circuits the way we do. It's all part of our efforts to assure reliable, high-performance system operation.

Logical zero DC noise immunity

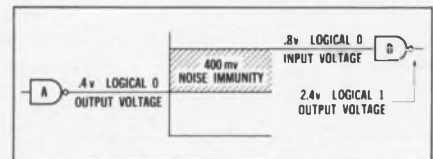

The noise required to false trigger a gate is typically more than one volt. However, TI's guaranteed logical zero noise immunity is 400 mV. Here's how this is determined:

The logical zero input test condition (voltage at which the output does not fall below its 2.4 volt logical one minimum) is 0.8 V. However, guaranteed maximum logical zero output voltage is 0.4 V. Thus, the difference (400 mV) becomes guaranteed noise immunity.

Logical one DC noise immunity

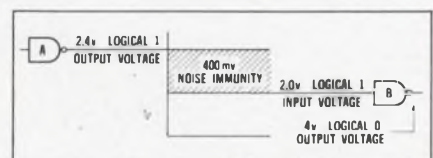

Similarly, guaranteed logical one noise immunity is 400 mV. In this case it's the difference between guaranteed minimum logical one

output voltage (2.4 V) and logical one input test condition of 2.0 V.

Here again, it typically takes more than one volt of noise before a gate actually false triggers.

**Low logical one
AC noise susceptibility**

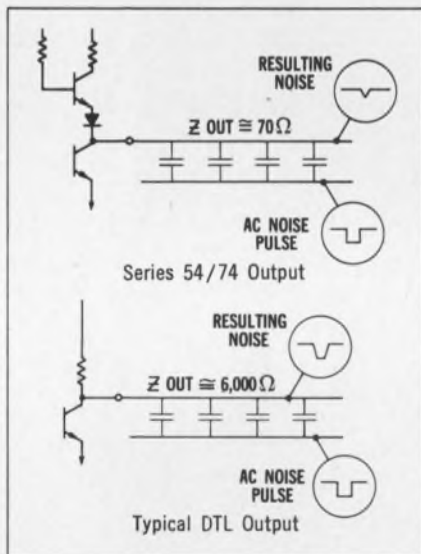

Series 54/74 TTL has a high immunity to signal line noise. It also exhibits a low susceptibility to noise getting there in the first place. Here is an example:

Low output impedance results in a low susceptibility to capacitively-coupled noise... and Series 54/74 logical one output impedance is only 70 ohms. This is far better than for DTL, which typically has a 6000-ohm logical one output impedance.

**Worst-case
Supply voltage conditions**

TI uses the worst-case voltage test condition when testing input current and output voltage. The low supply voltage is critical when

testing output voltage, so the minimum 4.5 volt supply is used. For logical zero, a lower supply voltage reduces the base drive to the lower output transistor... thus creating a worst-case condition.

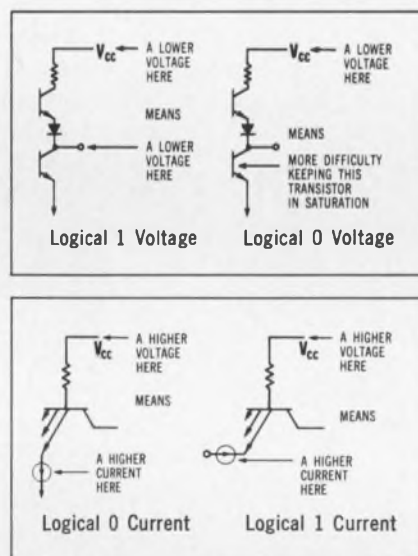

On the other hand, when testing input current, the high supply voltage is critical, since a higher supply voltage means a higher input current. For these measurements, TI uses the worst-case high supply voltage of 5.5 volts.

Worst-case loading conditions

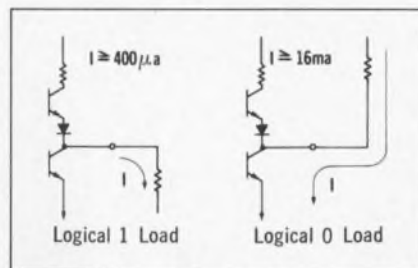

TI measures output voltages while output current is at least the value

required for a fan-out of 10. For logical one, this value is 400 μA, while for logical zero, it is 16 mA.

Worst-case temperature conditions

Since all circuit parameters vary with temperature, many look better at 25°C than at temperature limits (for example -55°C or +125°C). However, TI guarantees all Series 54/74 DC parameters over the full temperature range.

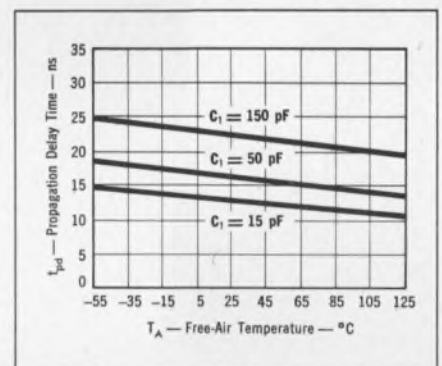

Furthermore, propagation delay of TTL circuits — an important measure of AC performance — is only minimally affected by temperature changes (see chart).

New TTL Brochure

Want to know more about TI's family of TTL circuits? A new 48-page brochure is just off the press and provides in-depth information on all Series 54/74 ICs. For your copy, circle 212 on the Reader Service card or write us directly at P.O. Box 5012, Dallas, Texas 75222.



Assign the proper numerical values to transistor models for best results when you simulate switching circuits with a computer program.

Part 2 of a three-part series

The quality of a computer-generated design depends on the relevance of the transistor models used. But these models can be only as good as the numerical values assigned to them. The modeling procedures for switching transistors were discussed in the first part of this series ("Use a good switching transistor model," ED 12, June 7, 1967, p. 54). Attention is now to be turned to how to determine the numerical values that make switching transistor models display the electrical characteristics that are appropriate.

All of the data presented assume the use of the NET-1 program for design analysis. The description of the model derived in Part 1 was taken from the users' manual of Malmberg, Cornwall and Hofer, *Net-1 Network Analysis Program 7090/94 Version*, (Report No. LA-3119, Los Alamos Scientific Lab., N. M., 1964). Here's how the values to be used in the model are obtained.

Dc measurement procedure

In saturated switching circuits, the constants R_{CC} , R_{EE} , R_{BB} , M_E , M_C , I_{ES} , I_{CS} , β_I and β_N have to be considered because they control the values of $V_{BE(sat)}$ and $V_{CE(sat)}$. Usually all these constants except β_N have only minor effect on circuit operation in the cutoff region and in the active region. They should therefore be fitted to the transistor characteristics in the saturation region, where they have most importance. The remaining constant, β_N , is obtained from h_{FE} data in the active region.

To determine these constants, it is necessary to measure voltages at various values of collector current. For saturating transistors, the most convenient and representative conditions are at a fixed value of forced circuit gain, $\beta_F = I_{C(sat)}/I_{B(sat)}$ over a range of $I_{C(sat)}$ determined by the particular design requirement. β_F usually varies over a range of 10 to 20. It is suggested that, with a low β_F of, say, 10, three sets of values of $V_{BE(sat)}$ and $V_{CE(sat)}$ should be measured, one at a high

value of $I_{C(sat)}$, one at a medium value, and one at a low value. β_F must be low enough for $V_{CE(sat)}$ always to increase directly with $I_{C(sat)}$. If $V_{CE(sat)}$ decreases with increasing $I_{C(sat)}$, the β_F used is too high and should be reduced. The fourth set of values of $V_{BE(sat)}$, $V_{CE(sat)}$ and $I_{C(sat)}$ should be taken at a high value of β_F , called β_{F4} , for instance at $\beta_{F4} = 20$.

The transistor characteristics, then, are fitted over a range of collector currents and a range of forced circuit gains. The three readings of $V_{BE(sat)}$ and $V_{CE(sat)}$ vs $I_{C(sat)}$ at forced circuit gain β_F are labeled V_{BE1} , V_{CE1} , I_{C1} ; V_{BE2} , V_{CE2} , I_{C2} ; and V_{BE3} , V_{CE3} , I_{C3} . The fourth set of values at forced circuit gain β_{F4} is labeled V_{BE4} , V_{CE4} and I_{C4} . It is convenient but not essential to have $I_{C4} = I_{C3}$. The characteristics could be fitted at points approximately as shown in Fig. 1.

Read transistor junction voltages directly

The direct-reading method of Fig. 2 can be used when readings are readable and repeatable

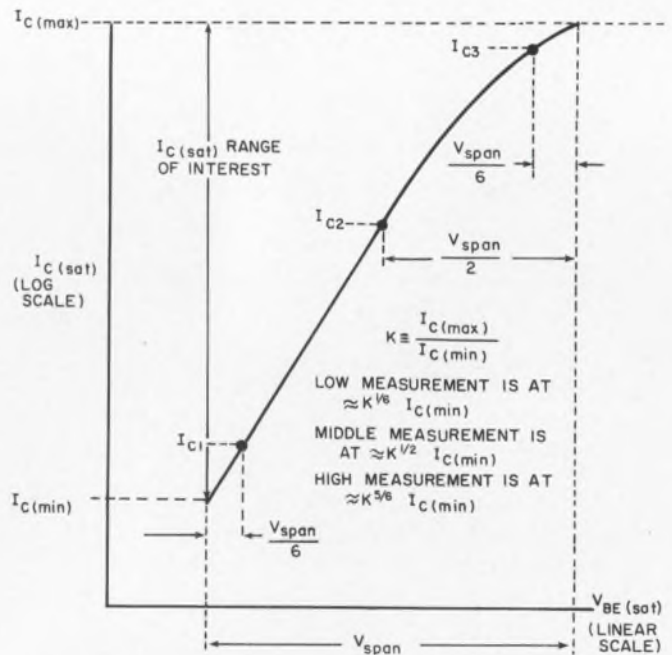

1. Nonlinear junction characteristics can be measured at three values of saturation voltage and current spaced over the range of interest of $I_{C(sat)}$.

Nathan O. Sokal, President, and **Joseph J. Sierakowski**, Senior Engineer, Design Automation, Inc., Lexington, Mass., and **Jonathan J. Sirota**, Vice-President, Memory Technology, Inc., Waltham, Mass.

Table: Transistor constants and variables

Symbol	Brief description	Symbol	Brief description
C_C	Average collector-base transition capacitance plus stray collector-to-base capacitance	M_E	Emission constant for emitter-base diode
C_L	Collector-to-ground capacitance	N_C	Collector-base junction grading constant
C_{dc}	Collector-base diffusion capacitance	N_E	Emitter-base junction grading constant
C_{de}	Emitter-base diffusion capacitance	q	Electron charge
C_{mc}	Measured collector-base transition capacitance	R_{BB}	Base ohmic series resistance
C_{me}	Measured emitter-base transition capacitance	R_C	Collector-base junction ohmic leakage resistance
C_{tc}	Collector-base transition capacitance	R_{CC}	Collector ohmic series resistance
C_{te}	Emitter-base transition capacitance	R_E	Emitter-base junction ohmic leakage resistance
D_1	Emitter-base transition capacitance proportionality constant	R_{EE}	Emitter ohmic series resistance
F_i	Average inverted-mode intrinsic gain-bandwidth product	R_L	Collector load resistance
F_i'	Apparent inverted-mode gain bandwidth product	T	Junction absolute temperature
F_n	Average normal-mode intrinsic gain-bandwidth product	T_S	Measured storage time
F_n'	Apparent normal-mode gain-bandwidth product	t_r	Measured 10%-to-90% collector-current rise time
f_T	Normal-mode gain-bandwidth product	V_{BE}	Base-to-emitter dc voltage
h_{FE}	Common-emitter forward-current transfer ratio	$V_{BE(sat)}$	Base-to-emitter saturation voltage
$I_{B(sat)}$	Base saturation current	V_{CB}	Collector-to-base dc voltage
$I_{C(sat)}$	Collector saturation current	V_{CC}	Collector dc supply voltage
I_{CF}	Current emitted from collector	V_{CE}	Collector-to-emitter dc voltage
I_{CS}	Collector-base diode saturation current at the operating junction temperature	$V_{CE(sat)}$	Collector-to-emitter saturation voltage
I_{EF}	Current emitted from emitter	V_{TC}	Collector transition capacitance test voltage
I_{ES}	Emitter-base diode saturation current at the operating junction temperature	V_{TE}	Emitter transition capacitance test voltage
k	Boltzmann's constant	V_{ZC}	Collector-base junction contact potential
M_C	Emission constant for collector-base diode	V_{ZE}	Emitter-base junction contact potential
		α_I	Common-base inverted-mode dc current gain
		α_N	Common-base normal-mode dc current gain
		β_F	Forced circuit gain
		β_I	Common-emitter inverted-mode dc current gain
		β_N	Common-emitter normal-mode dc current gain

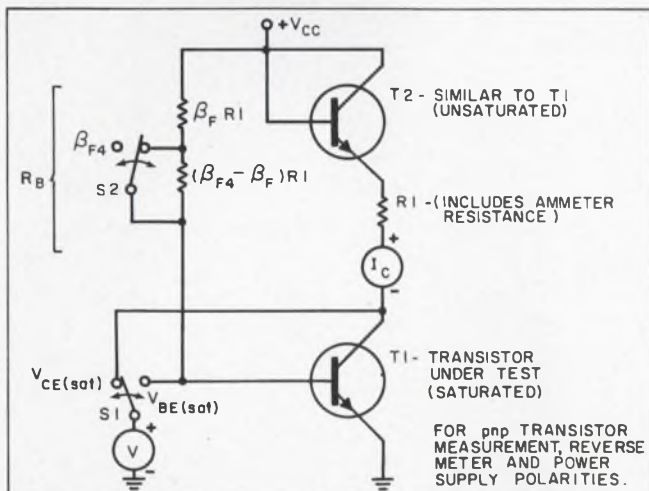

2. Transistor dc characteristics are given directly by a simple circuit, but readings must be readable and repeatable to \pm mV. Transistor T2 keeps $I_{C(sat)} / I_{B(sat)}$ constant over the range of V_{CC} .

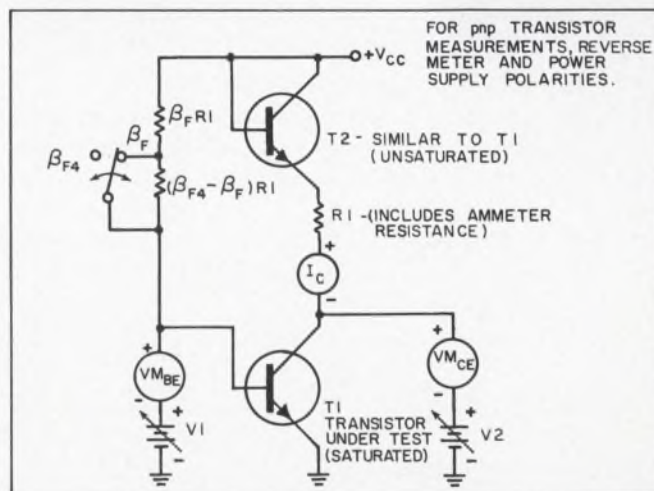

3. Null measurement gives transistor characteristics precisely. Difference voltages are read off for direct substitution into the model equations. Voltmeter should be a DVM with a resolution of 1 mV or similar instrument.

to about ± 1 mV. A direct-coupled oscilloscope of 5-mV/cm sensitivity or a digital voltmeter with a resolution of 1 mV or better should be used. V_{CC} should be ≥ 5 volts. Transistor T_2 keeps the ratio $I_{C(sat)}/I_{B(sat)}$ nearly constant as V_{CC} is varied. The collector and base currents of T_1 are:

$$I_{B(sat)} = (V_{CC} - V_{BE(sat)})/R_B;$$

$$I_{C(sat)} = [V_{CC} - (V_{BE2} + V_{CE(sat)})]/R_1.$$

If $V_{BE(sat)}$ and $(V_{BE2} + V_{CE(sat)})$ are small in comparison with V_{CC} , then the ratio $I_{C(sat)}/I_{B(sat)}$ will be determined by R_1 and R_B and will be constant. Typically, $V_{BE(sat)}$ and V_{BE2} have a range of 0.6 to 0.8 volt, and $V_{CE(sat)}$ of 0.1 to 0.2 volt. If V_{CC} is small, 5 volts for example, the difference in the numerators of the two equations will give an error in $I_{C(sat)}/I_{B(sat)}$ of 3%. A variation of $\pm 1.5\%$ over a range of V_{CC} from 5 to ∞ is satisfactory for most purposes. If T_2 were not used, the V_{BE2} term would not appear and the error at low values of V_{CC} would be three or four times greater.

For most devices it will be sufficient to vary V_{CC} from 5 to 100 volts to cover a 20:1 range of I_C upward from $I_{C(min)}$. To cover a wider range, change to a new set of lower-value resistors after taking the low-current data. Care should be taken not to exceed the V_{CE} rating. This can occur if β_F is inadvertently chosen to be larger than h_{FE} at any test condition. To avoid this, use a value of β_F that is lower than the lowest anticipated h_{FE} , or select a new set of lower-value resistors when the V_{CE} rating is approached. Use resistors of 1% tolerance, or smaller, and of sufficient power rating for the desired test conditions. The value for R_1 is:

$$R_1 \approx (V_{CC(min)} - V_{BE(sat)} - V_{CE(sat)})/I_{C(min)},$$

where $I_{C(min)}$ is the minimum I_C for which a valid model is desired. I_C , V_{BE} and V_{CE} are read over the desired I_C range.

A null measurement procedure for junction voltages

The null measurement method shown in Fig. 3 nulls the fixed component of voltage, so that a more sensitive instrument can be used. Precise measurements can be made even if the instrument can be read to only two significant digits. This is how it is done:

- Read voltmeters at collector current I_{C1} with $V_1 = V_2 = 0$. These readings are V_{BE1} and V_{CE1} .
- Adjust stable voltage sources V_1 and V_2 for zero readings on the voltmeters at collector current I_{C1} .
- Leave V_1 and V_2 at this zero setting and read the voltmeters at collector currents I_{C2} and I_{C3} . These readings are $(V_{BE2} - V_{BE1})$ and $(V_{CE2} - V_{CE1})$, and $(V_{BE3} - V_{BE1})$ and $(V_{CE3} - V_{CE1})$. These difference terms are used in the equations that follow.
- V_{BE2} is needed later, and is found as $(V_{BE2} -$

$V_{BE1}) + V_{BE1}$. In the same way V_{CE2} , V_{CE3} and V_{CE3} can all be found.

Transistor dc parameters using complete data

The model used is the one described in Part 1 of this series. The dc portion is shown in Fig 4. The measurement methods and equations result in all measured quantities normally being positive for both npn and pnp transistors. All measured quantities go directly into the equations that follow. If any value calculated according to these equations falls substantially outside the "usual range" given for that quantity, the calculations and the validity of the input data should be checked. Manual calculations are greatly simplified if it is taken that α_N and α_I are approximately constant as I_C varies. This is usually a safe assumption and is used in the equations.

Some of these complex calculations may be bypassed by short-cut techniques which will be developed later. For many applications the accuracy of the model will not be impaired by using simpler equations and some approximations.

$$q/k = 1.161 \times 10^4.$$

$$T = \text{Absolute temperature } (^{\circ}\text{K}) = ^{\circ}\text{C} + 273.2.$$

$M_E =$

$$\frac{(V_{BE3} - V_{BE1}) \left(\frac{I_{C2} - I_{C1}}{I_{C3} - I_{C1}} \right) - (V_{BE2} - V_{BE1})}{\left(\frac{kT}{q} \right) \left[\left(\frac{I_{C2} - I_{C1}}{I_{C3} - I_{C1}} \right) \ln \left(\frac{I_{C3}}{I_{C1}} \right) - \ln \left(\frac{I_{C2}}{I_{C1}} \right) \right]} \quad (1)$$

The usual range for M_E is 1.0 to 2.2.

$$R_X = \frac{(V_{BE3} - V_{BE1}) - M_E \left(\frac{kT}{q} \right) \ln \left(\frac{I_{C3}}{I_{C1}} \right)}{(I_{CE} - I_{C1})} \quad (2)$$

$$M_C = \frac{\left\{ \begin{array}{l} [(V_{BE3} - V_{BE1}) \\ - (V_{CE3} - V_{CE1})] \left(\frac{I_{C2} - I_{C1}}{I_{C3} - I_{C1}} \right) \\ - [(V_{BE2} - V_{BE1}) - (V_{CE2} - V_{CE1})] \end{array} \right\}}{\left(\frac{kT}{q} \right) \left[\left(\frac{I_{C2} - I_{C1}}{I_{C3} - I_{C1}} \right) \ln \left(\frac{I_{C3}}{I_{C1}} \right) - \ln \left(\frac{I_{C2}}{I_{C1}} \right) \right]} \quad (3)$$

The usual range for M_C is the same as for M_E , 1.0 to 2.2.

$$R_Y = \frac{\left\{ \begin{array}{l} [(V_{BE3} - V_{BE1}) - (V_{CE3} - V_{CE1})] \\ - M_C \left(\frac{kT}{q} \right) \ln \left(\frac{I_{C3}}{I_{C1}} \right) \end{array} \right\}}{(I_{C3} - I_{C1})} \quad (4)$$

β_N can be read from a curve of h_{FE} vs I_C . A value averaged over the current range of interest should be used for the calculations to find the other constants. In the computer calculations, β_N can be made a function of the emitter current, I_{EF} ,

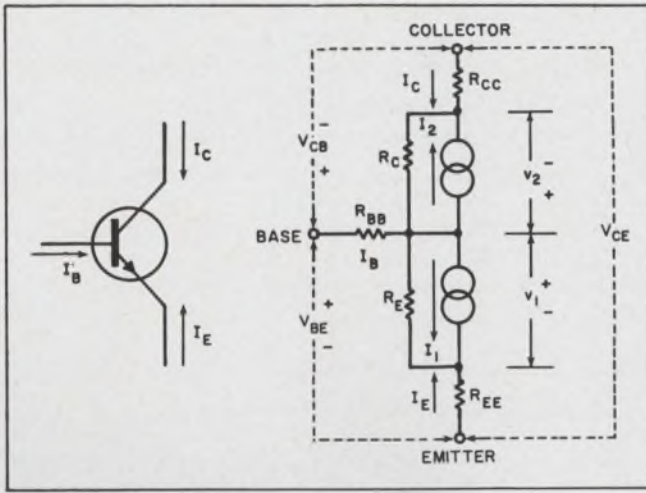

4. Transistor dc model is used for npn. For pnp transistor polarities are reversed.

if desired, as in Eq. 7 of Part 1 of this series.

In order to average β_N , n values of β_N are read from a curve of h_{FE} vs I_C at equally spaced values of current over the range from $I_{C(min)}$ to $I_{C(max)}$. These are labeled $\beta_{N1}, \beta_{N2}, \dots, \beta_{Nn}$.

Then:

$$\beta_N = (\beta_{N1} + \beta_{N2} + \dots + \beta_{Nn}) / n. \quad (5)$$

Then:

$I_{CS} =$

$$\frac{I_{C2} [1/(\beta_N + 1)] [(\beta_N/\beta_F) - 1]}{\exp [(q/M_c k T) (V_{BE2} - V_{CE2} - I_{C2} R_Y)] - 1} \quad (6)$$

$$\beta_I = \frac{\left(\frac{I_{C3}}{I_{C4}}\right) \left(\frac{\beta_{F4}}{\beta_F}\right) (\beta_F + 1) e^{C_5} - (\beta_{F4} + 1)}{\left[1 - \left(\frac{I_{C3}}{I_{C4}}\right) \left(\frac{\beta_{F4}}{\beta_F}\right) e^{C_5}\right]}; \quad (7)$$

$$C_5 = \frac{q}{M_E k T} \left[(V_{CE4} - V_{CE3}) + \frac{M_c k T}{q} \ln \left\{ \frac{I_{C4} \left(\frac{1}{\beta_N + 1}\right) \left(\frac{\beta_N}{\beta_{F4}} - 1\right) + I_{CS}}{I_{C3} \left(\frac{1}{\beta_N + 1}\right) \left(\frac{\beta_N}{\beta_F} - 1\right) + I_{CS}} \right\} - (I_{C4} - I_{C3}) (R_X - R_Y) \right]; \quad (8)$$

$$I_{ES} = \frac{I_{C2} \{ [1/(\beta_I + 1)] + (1/\beta_F) \}}{\exp [(q/M_E k T) (V_{BE} - I_{C2} R_X)] - 1} \quad (9)$$

The usual range of I_{ES} is 10^{-14} to 10^{-6} mA at 25°C for silicon and 10^{-8} to 10^{-2} mA for germanium. I_{CS} is usually about an order of magnitude larger than I_{ES} , such that $I_{CS} \approx I_{ES} (\alpha_N/\alpha_I)$.

$$R_{X4} = \left\{ M_E \left(\frac{kT}{q}\right) \ln \left[\frac{I_{C3} \left(\frac{1}{\beta_I + 1} + \frac{1}{\beta_F}\right) + I_{ES}}{I_{C4} \left(\frac{1}{\beta_I + 1} + \frac{1}{\beta_{F4}}\right) + I_{ES}} \right] - (V_{BE3} - V_{BE4}) + \left(\frac{I_{C3}}{I_{C4}}\right) R_X \right\} / I_{C4}; \quad (10)$$

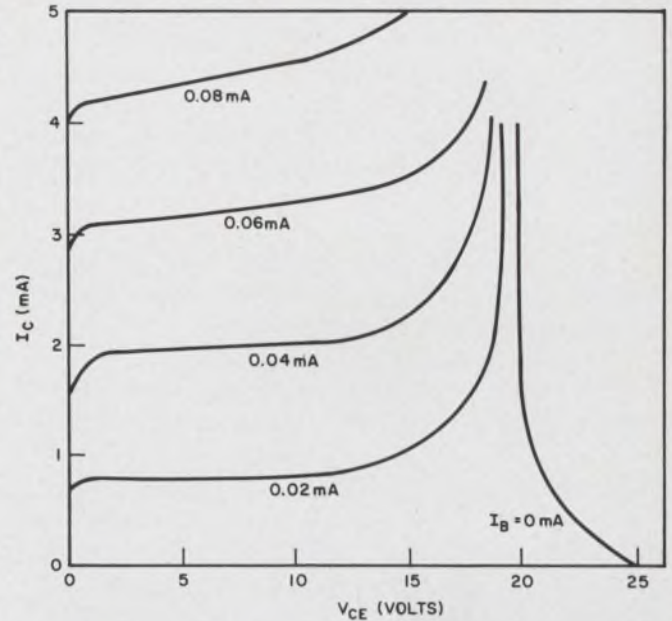

5. Variation in current gain, h_{FE} , is small in comparison with other transistor variations. For a typical transistor, e.g., Fairchild 2N708, variation is 7% for a base current of 0.6 mA.

$$R_{EE} = [R_X - (\beta_{F4}/\beta_F) R_{X4}] / [1 - (\beta_{F4}/\beta_F)]; \quad (11)$$

$$R_{BB} = \beta_F R_X - (\beta_F + 1) R_{EE}; \quad (12)$$

$$R_{CC} = (R_{BB}/\beta_F) - R_Y. \quad (13)$$

The usual ranges are 10^{-5} to 10^{-2} k Ω for R_{EE} and R_{CC} , and 10^{-1} to 10^1 k Ω for R_{BB} . All resistances are expressed in kilohms for the sake of consistency in the set of units, as explained in Part 1.

Emitter and collector leakage resistances

h_{FE} varies somewhat with V_{CE} . This is a result of base width modulation and is illustrated in Fig. 5, which shows a set of typical common-emitter collector characteristics for a Fairchild 2N708. h_{FE} is seen to be $\pm 7\%$ over a voltage range of 0 to 15 volts along the curve of $I_B = 0.06$ mA.

In most applications the effect of this small variation is negligible in comparison with other transistor variations. Thus, β_N can be chosen as h_{FE} at a median value of V_{CE} for active-normal applications, for instance, amplifiers, or as h_{FE} at $V_{CE} \approx V_{BE}$ for applications where the transistor is to be saturated, for instance, saturated switches.

When the transistor model does not explicitly provide for modeling the base width modulation effects, as is the case with NET-1, R_C can be chosen to model either this variation of h_{FE} with V_{CB} or to model the collector-base junction leakage resistance.

In most small, silicon transistors (in TO-5 packages or smaller), the reverse leakage, R_C , is usually so high that it has little effect on most circuits, and is a "don't care" parameter: almost

any value larger than a megohm will suffice.

If it is desired to model this leakage, however, a plot of leakage current, I_C , vs reverse V_{CB} should be made at the temperature of interest with the emitter open. A straight-line approximation is taken over the reverse voltage range of interest. Then $\Delta V_{CB}/\Delta I_R = R_C$.

Similarly, with the collector open, a plot of leakage current, I_E , vs reverse V_{BE} will result in a value of R_E for modeling emitter leakage.

If R_C is chosen to model the variation in β_N vs V_{CB} , it will accurately model this variation at only one value of I_C . Therefore a curve approximately in the middle of the range of interest of collector current should be chosen for use in modeling. To determine the value of R_C , find the ΔI_C along a curve of constant I_B over the V_{CB} range of interest (i.e., edge of saturation to maximum V_{CB} for switching transistors); then $R_C = \Delta V_{CB}/\Delta I_C$. ΔV_{CE} can be substituted for ΔV_{CB} , because V_{BE} is approximately constant. A plot of the same parameters with the transistor in the inverted mode can give a value of R_E for modeling a variation in β_I with emitter-base junction voltage, if desired. This, however, is rarely necessary.

Short-cut techniques with limited data

If only two points are available for $V_{BE(sat)}$ vs I_C , assume a value of R_X and use Eq. 14 to find M_E :

$$M_E = \frac{(V_{BE3} - V_{BE1}) - R_X (I_{C3} - I_{C1})}{(k T/q) \ln (I_{C3}/I_{C1})}. \quad (14)$$

Equation 9 is then used to find I_{ES} .

If only one point of $V_{BE(sat)}$ vs I_C is known, assume values for R_X and M_E and use Eq. 9 to find I_{ES} .

In either case, a reasonable value to assume for R_X is 2 ohms for transistors like the 2N914. To represent a low- V_{BE} transistor, assume an M_E of about 1 to 1.5. For a high- V_{BE} device, assign a value of about 1.5 to 2.0 to M_E .

Similarly, if only two points of $V_{CE(sat)}$ and $V_{BE(sat)}$ vs I_C are known for finding M_C , R_Y and I_{CS} , assume a value for R_Y and use Eq. 15 to find M_C :

$$M_C = \frac{(V_{BE3} - V_{BE1}) - (V_{CE3} - V_{CE1}) - R_Y (I_{C3} - I_{C1})}{(k T/q) \ln (I_{C3}/I_{C1})}. \quad (15)$$

Then use Eq. 6 to find I_{CS} .

If only one point is known, assume values for R_Y and M_C , then use Eq. 6 to find I_{CS} .

A reasonable value to assume for R_Y is 1 ohm. For a low $V_{CE(sat)}$, use a high M_C , bearing in mind that usually $1.0 < M_C < 2.2$. For a high $V_{CE(sat)}$, use a low M_C . Too large a value of M_C can result in a negative $V_{CE(sat)}$.

Where insufficient data are available to find R_Y , M_C and I_{CS} accurately, use $I_{CS} = 10 I_{ES}$ and $M_C =$

M_E . This gives quite reasonable values for $V_{CE(sat)}$.

If β_I is not found from Eq. 7, it can be measured directly or assumed as follows:¹

Transistor type	Typical β_I
Planar, silicon epitaxial	0.2
Alloy, uniform base	4
Alloy, diffused base	1
Mesa, diffused base	0.4

Transistor transition capacitances

The transition capacitance parameters for the nonlinear transistor model are obtained from a graph or a set of three values for capacitance vs junction voltage over the range of interest, usually reverse bias. The emitter-base capacitance will be used as an example; the collector-base capacitance is handled similarly. The capacitance being modeled is the sum of the junction transition capacitance plus the linear header and lead capacitances. If possible, capacitance measurements should be made with a three-terminal capacitance bridge, with unused device terminals, such as the collector and case, guarded to minimize the effects of other capacitances on the measurements. The measured data are fitted to the equation:

$$C_{te} = D_1 / (V_{ZE} - v_1)^{N_E}, \quad (16)$$

where v_1 , the emitter-base junction voltage, is a negative number for reverse bias on the junction. The procedure is as follows:

- A value for V_{ZE} is assumed: start with 0.9 volt for silicon, or 0.4 volt for germanium.
- C_{te} vs $(V_{ZE} - v_1)$ is plotted on log-log paper, with C_{te} along the y axis.
- The result should be a straight line. If it is not, and the low-voltage end is bent low, V_{ZE} is too small; V_{ZE} is increased and the graph replotted. If the low-voltage end of the curve is bent high, V_{ZE} is too large; V_{ZE} is decreased and a replot is made. The V_{ZE} which gives a straight line over the range of interest is the proper one to use.
- The slope of the straight line is $-N_E$. N_E is usually in the range of about 0.3 to 0.5, depending on the type of semiconductor junction.

V_{ZE} must be larger than the largest expected forward junction voltage. If it is not, the denominator will go through zero at $v_1 = V_{ZE}$, yielding an infinite capacitance. Or if v_1 approaches but does not equal V_{ZE} , the capacitance will be less than infinite, but large. This capacitance is in parallel with the emitter diffusion capacitance; it makes the total capacitance appear to be larger than intended and decreases the apparent f_T of the transistor. This is often why computer transistor response is unexpectedly slow. (Similarly, V_{TE} more positive than V_{ZE} is prohibited; in NET-1 it will cause a computer halt.) If V_{ZE} comes out



NET-1 may be run on several computers, IBM 7040/44, 7090/94 (as shown) and 360/65 with 7094 emulator.

smaller than the largest expected forward junction voltage, assume a value of V_{ZE} that is, say, 10% greater than the largest expected forward voltage and calculate N_E from:

$$N_E = \log(C_{te1}/C_{te2}) / \log[(V_{ZE} - v_{12}) / (V_{ZE} - v_{11})], \quad (17)$$

where C_{te1} and C_{te2} are values of emitter-base transition capacitance at two values of junction voltage, v_{11} and v_{12} , respectively. The values can be chosen near the ends of the voltage range of interest. If C_{me} and V_{TE} are then specified at approximately the midpoint of the voltage range of interest, the computed curve of C_{te} will pass through the chosen midpoint value, and will have the desired slope over the range of interest.

Similar procedures apply to the collector-base transition capacitance, C_{tc} . The usual range of N_C is from 0.1 to 0.5. Typical values of N_C are 0.1 for an epitaxial collector-base junction, 0.3 for a graded junction, and 0.5 for a step junction.

Transistor normal-mode intrinsic cutoff frequency

F_n is the average f_t (normal-mode gain-bandwidth product or cutoff frequency) for the *intrinsic* transistor (the transistor with transition and stray capacitances and series resistances removed) over the range of voltage and current that the transistor will traverse in circuit operation. The observed switching time is governed by F_n , plus circuit constants and stray parameters. Direct observation of the intrinsic cutoff frequency is obscured by the effect of C_{te} shunting C_{de} , both of which are varying during the rise-time transient. The *apparent* gain-bandwidth product,

F_n' is less than the *intrinsic* F_n because of this shunting effect of C_{te} on C_{de} . F_n' is calculated first and then corrected to F_n by an approximate hand calculation.

For a switching transistor, apparent gain-bandwidth product F_n' can be calculated from a measurement or specification of t_r , the 10% to 90% rise time of collector current in a grounded-emitter constant-base-drive switching test. If turn-on time (delay plus rise time) alone is given, the delay time should be subtracted out to obtain the rise time. The apparent gain-bandwidth product is:

$$F_n' = \frac{1}{\left\{ 2\pi \left\{ t_r / [(\beta_N + 1) \ln X] - [R_L + R_{CC}] [C_C + (C_L / \beta_N)] \right\} \right\}}, \quad (18)$$

where:

t_r = the measured rise time of collector current from the 10% to 90% values of $I_{C(sat)}$,

R_L = collector load resistance,

C_C = collector-base transition capacitance plus stray collector-to-base capacitance, averaged over the voltage range traversed by the collector-base junction during the switching from 10% to 90% of $I_{C(sat)}$,

C_L = collector-to-ground capacitance, i.e., wiring, scope, etc.,

β_N = h_{FE} averaged over the voltage and current range traversed during the switching test,

I_B = constant value of base turn-on current,

$I_{C(sat)}$ = value of collector current at the edge of saturation, where $V_{CB} = 0$ or $V_{CE} = V_{BE}$,

$$X = [I_B - 0.1(I_{C(sat)} / \beta_N)] / [I_B - 0.9(I_{C(sat)} / \beta_N)]. \quad (19)$$

The following simplification is valid if $(\beta_N + 1) \geq 3 I_{C(sat)} / I_B$:

$$t_r / [(\beta_N + 1) \ln X] \approx 1.25 I_B t_r / I_{C(sat)}.$$

If C_{te} is small in comparison with C_{de} , the apparent F_n' is close to the intrinsic F_n . The shunting effect of C_{te} can be accounted for approximately by hand calculations, if desired:

The normal-mode intrinsic cutoff frequency is:

$$F_n \approx F_n' / (1 - F_n' / F_e), \quad (20)$$

where:

$$F_e = q [I_{EF} + I_{ES} / (1 - \alpha_N \alpha_I)] / [2\pi M_E k T C_E], \quad (21)$$

$$q/k = 1.161 \times 10^4,$$

T = temperature in °K,

C_E = emitter transition capacitance averaged over the range of forward bias voltage traversed during the 10% to 90% rise-time test.

$$C_E \approx C_{me} [(V_{ZE} - V_{TE}) / (V_{ZE} - V_E)]^{N_E}, \quad (22)$$

where V_E is the emitter-base voltage at a collector

current of $I_{C(sat)}/2$. A value of $I_{C(sat)}/2$ can be used for I_{EF} in Eq. 21.

Once the parameters for the transition capacitances, the test circuit parameters, and all the transistor parameters but F_n are known, the F_n calculated from approximate Eqs. 20-22 can be further refined by having the transient analysis program calculate the test circuit transient response for a few values of F_n in a narrow range about the approximate value. The correct value is that which gives a calculated performance that best duplicates the measured or specified performance that is being modeled. The computer calculations take account of the fact that both C_{te} and C_{de} vary during the transient.

Transistor inverted-mode intrinsic cutoff frequency

F_i is the inverted-mode gain-bandwidth product for the intrinsic transistor. As with F_n , direct observation of F_i is obscured by the shunting effect of transition capacitance on diffusion capacitance, both of which vary during the storage-time transient. The apparent gain-bandwidth product, F_i' , can be found from the storage time, T_s , by means of the base turn-on and turn-off currents and collector current in the expected range of operation:

$$F_i' = \frac{1}{2 \pi \tau_x (1 - \alpha_N \alpha_I) - 1/F_n}, \quad (23)$$

where:

$$\tau_x = T_s / \ln[(I_{B1} - I_{B2}) / (I_{C(sat)} / h_{FE}) - I_{B2}], \quad (24)$$

I_{B1} = base on current before turn-off (Positive sign is turn-on polarity),

I_{B2} = base current during turn-off (The same sign convention applies; therefore reverse base drive has a negative numerical value),

$I_{C(sat)}$ = value of collector current at the edge of saturation, where $V_{CB} = 0$ or $V_{CE} = V_{BE}$,

h_{FE} = value at the edge of saturation,

T_s = measured storage time.

The base current is assumed to be a step from the constant value of I_{B1} to I_{B2} . T_s is measured as the time interval from the step transition to the time the transistor leaves saturation when $V_{CB} = 0$. The latter is the time at which the base voltage and collector voltage waveforms cross, when both are displayed on an oscilloscope, at the same gain and zero settings for both amplifier inputs. If the input is not a step transition, the zero time can be taken at approximately the midpoint of the transition.

Note that the common definition of storage time to the 10% point of the collector voltage transition is not correct for use here. By that definition, storage time usually includes a portion of the fall-time transient. The fraction of the fall time which

is included depends on the magnitude of the collector voltage swing, which varies from one test circuit to another. Values of 2 to 100 volts are common. If the storage time includes some of the fall time, the amount that is included should be subtracted to find the true storage time.

If C_{tc} is small in comparison with C_{dc} , the observed F_i' is close to the intrinsic F_i . The shunting effect of C_{tc} can be accounted for approximately by hand calculation, if desired. The intrinsic inverted-mode cutoff frequency is:

$$F_i = F_i' / (1 - F_i' / F_c), \quad (25)$$

where:

$$F_c = q [I_{CF} + I_{CS} / (1 - \alpha_N \alpha_I)] / [2 \pi M_c k T C_C], \quad (26)$$

C_C = the collector-base transition capacitance averaged over the voltage range traversed during the storage-time interval.

C_C can be taken as the value at a forward bias of approximately $V_C \equiv V_{BE(sat)} - V_{CE(sat)}$. This value is:

$$C_C = C_{mc} [(V_{ZC} - V_{TC}) / (V_{ZC} - V_C)]^{N_c}. \quad (27)$$

I_{CF} is found as:

$$I_{CF} = I_C [(\beta_N / \beta_F - 1) (\beta_I + 1) / (\beta_N + \beta_I + 1)], \quad (28)$$

where:

β_N = h_{FE} at the edge of saturation,

β_F = I_C / I_B ,

β_I = dc current gain of the transistor in the inverted connection at $V_{BE} = 0$.

An average value of I_{CF} can be used, averaged between the value at the beginning and the end of the storage time interval, if there is a substantial change in I_C during that time. Some test circuits use a supply voltage that is not large with respect to $V_{BE} - V_{CE(sat)}$. In this case, I_C changes appreciably during the storage-time interval. In most cases, $I_{CS} / (1 - \alpha_N \alpha_I)$ is much smaller than I_{CF} and can be neglected. Hence:

$$F_i = \frac{F_i'}{1 - [F_i' 2 \pi M_c (kT/q) C_C] / I_{CF(avg)}}, \quad (29)$$

where F_i' is obtained from measured storage time and Eqs. 23 and 24.

This approximate allowance for transition capacitance can be refined, if desired, by having the computer calculate the transient response of the given transistor in the given test circuit with a few values of F_i that range around the value obtained from Eqs. 25 through 29. In the computer calculations the variations in C_{te} , C_{tc} , C_{de} and C_{dc} during the switching transient are taken into account. The F_i that gives performance closest to that being modeled is the correct value.

The third and final part of this series, to appear in the next issue, will detail the diode model and parameters. ■ ■

Reference:

1. *Motorola Switching Transistor Handbook* (1st ed.; Phoenix, Ariz.: Motorola Semiconductor Products Div., Inc.), p. 56.

**WE STOPPED
AT NOTHING
TO BRING YOU
THE WORLD'S
MOST VERSATILE RELAY**



SHOWN ACTUAL SIZE

Ounce for ounce, our new vacuum relay controls more power for more applications than any other relay in the world.

We're talking about the wholly new ITT Jennings RFI relay, the relay that gives you a low cost, high quality solution to almost any relay application!

Now, for the first time, the advantages and reliability of vacuum relays are available for an almost unlimited number of switching applications in a package that occupies less than $\frac{1}{2}$ cubic inch . . . weighs less than $\frac{3}{4}$ of an ounce. Yet they cost no more than other relays of their power level.

No other relay comes close to providing all these advantages for so many fields:

COMMUNICATIONS—*Switching Radar Transducers, Antenna Switching, RF Coil Tapping, Switching in RF Circuits.*

- 2 kv peak operate voltage at 16 mc
- Carries 4 amps rms at 16 mc • 020 ohms maximum contact resistance at 32 mc remains permanently low.

AIRCRAFT/MISSILES/SATELLITES — *Switching Grid and Plate Circuits, Switching Ground Control Equipment.*

- Resists 10 g to 2000 cps vibration
- Impervious to environmental conditions

INDUSTRIAL CONTROLS—*Motor Controls, Railway Signal Controls, Machine Tools, Lighting Controls.* • In-

terrupts 1 kw dc power • Interrupts inductive loads • Rapid operation (10 ms maximum)

PROCESS INDUSTRY—*Computer/Control Panel Interface.* • Long life. 2,000,000 mechanical operations • No contact maintenance • High reliability

Let ITT Jennings introduce you to the reliable world of vacuum relays; there's no one more experienced or more qualified. For complete information on the RFI; and our new relay catalog, write to ITT Jennings, a division of International Telephone and Telegraph Corporation, 970 McLaughlin Avenue, San Jose, Calif. 95108.

JENNINGS ITT

ON READER-SERVICE CARD CIRCLE 34

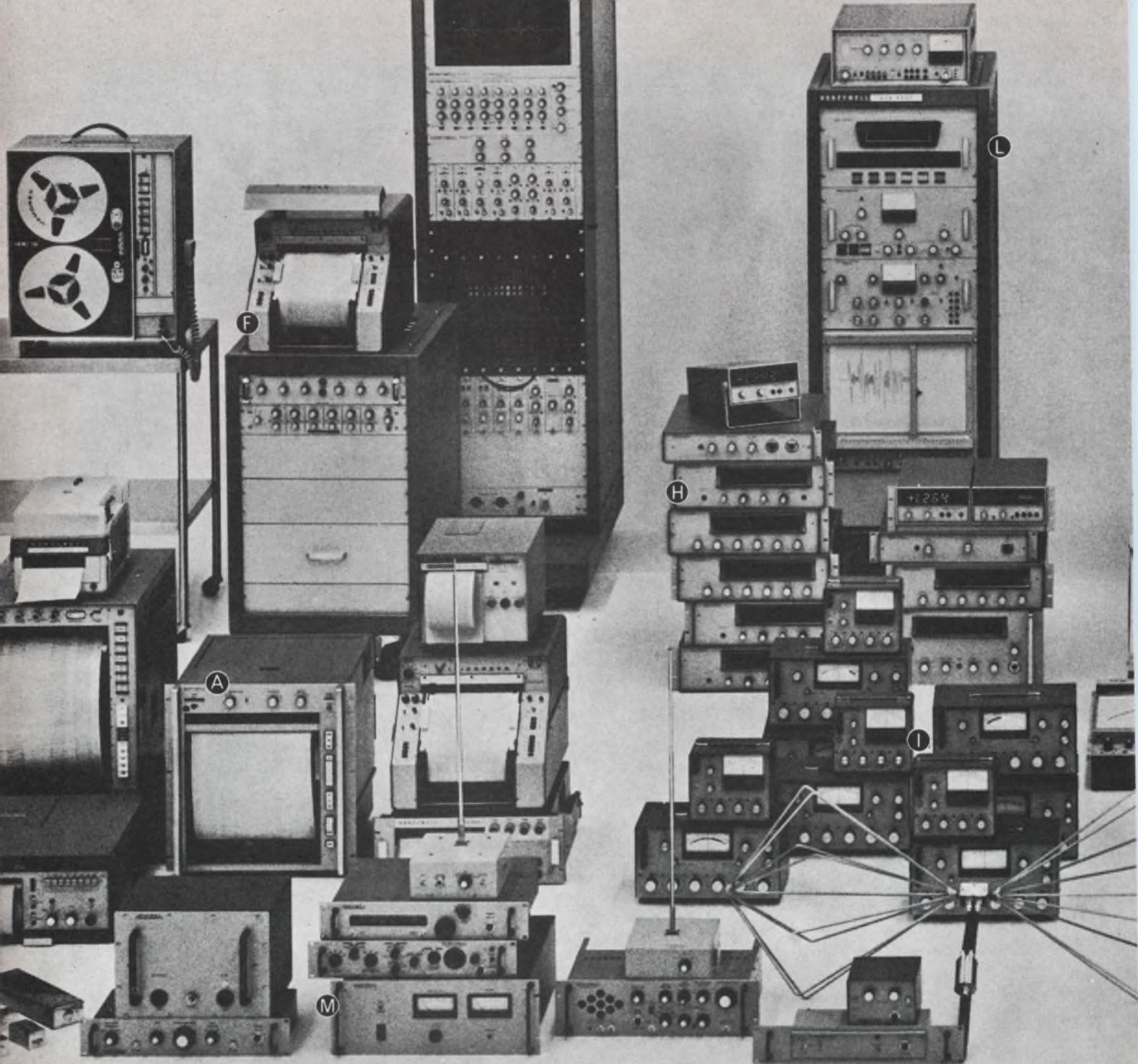

Here's just part of the full Honeywell line, which includes: **A** 117 Visicorder direct-recording oscillographs in 6", 8", and 12" models; **B** 2 Model 1806 fiber-optics CRT Visicorder oscillographs; **C** 26 magnetic tape systems, including the 7600 Series in 10½" and 15" reel versions; **D** 84 amplifiers and other signal-condi-

We build **847**
instruments to be sure we
have the exact **1** you need.

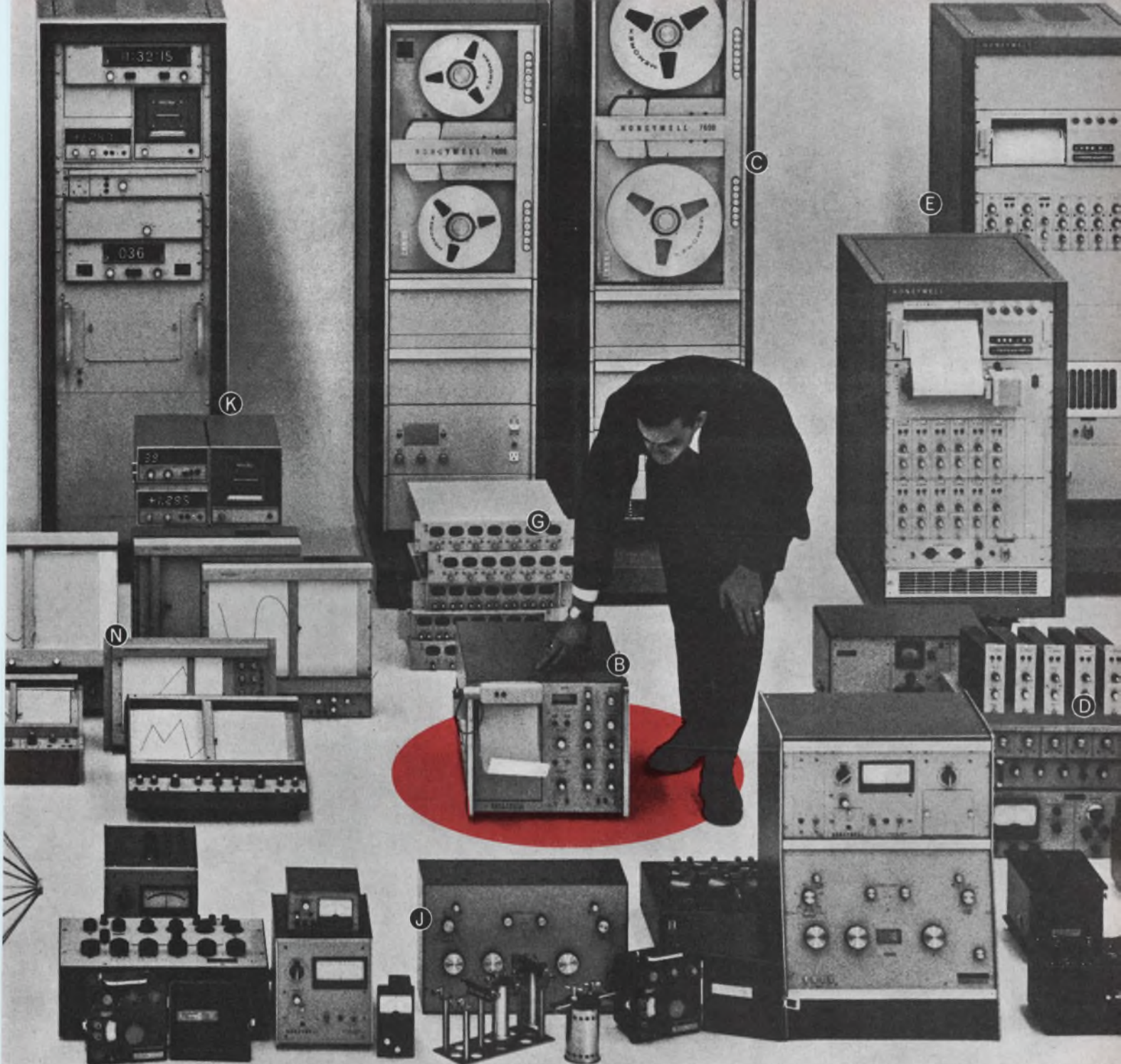

tioning units; **B** 78 analog recording systems; **F** 46 electronic medical systems; **G** 14 oscilloscopes; **H** 37 digital multimeters; **I** 29 differential voltmeters; **J** 179 precision laboratory standards and test instruments; **K** 128 data loggers; **L** 9 analysis systems; **M** 61 EMI products; **N** 37 X-Y graphic recorders.

Your Honeywell engineer can zero in on the *precise* solution to your instrumentation problems. Quickly and efficiently. You won't have to settle for "almost" what you need because the Honeywell engineer isn't handicapped by a limited line. He can choose from 847 basic instruments whose combinations and permutations approach the infinite.

The solution might be a Visicorder recording oscillograph. Or one of our modular magnetic tape systems. Or an X-Y recorder, a digital multimeter, or a portable potentiometer. But whether it's a single instrument or a complete data system, you can be sure the solution will be the right one, carefully thought out with your future requirements considered as well as your current needs.

Local service and nationwide metrology facilities back up your Honeywell instrument or system. And, we can even provide factory training courses for *your* operating personnel. For the full story on how Honeywell can help you, call your local representative or write: Honeywell, Test Instruments Division, Denver, Colorado 80217.

Honeywell

ON READER-SERVICE CARD CIRCLE 35

Honeywell engineers
sell solutions

Ease resistor-thermistor network design

with this direct approach. It's faster and far more accurate than the commonly used approximation techniques.

Part 1 of a two-part article

Networks of thermistors and resistors are frequently used to compensate for the effects of ambient temperature variations on passive or active circuit elements. Thermistor networks are also used in temperature-measuring and -sensing devices such as bolometers and thermometers.

Variations of parameters and operating points of transistors, of the resonant frequency of oscillators and of the Q and inductance of coils with temperature are the more obvious examples of the need for accurate thermistor networks. They even find application in the measurement of gas concentrations.

In most applications either a resistance-vs-temperature characteristic or a certain voltage-or current-ratio-vs-temperature characteristic is specified. A network to synthesize the characteristic is then required.

Many approximation procedures can be used to design such a thermistor-resistor network. These procedures, however, are very time-consuming and usually result in gross errors, which may or may not be tolerable. In fact, in some cases the thermistor that is calculated does not exist and is not even manufacturable.

The following direct design technique yields faster and much more accurate results. In the development of the network synthesis procedures, the thermistor is used as a linear circuit element with a resistance that varies nonlinearly with temperature.

Two basic types of thermistors used

There are two types of thermistors available commercially: the negative-temperature-coefficient type (NTC) and the positive-temperature type (PTC). The NTC has a resistance that decreases with increasing temperature over a wide temperature range; the PTC has a resistance that decreases, increases, and finally decreases again with increasing temperature over a limited

temperature range.

The resistance-vs-temperature characteristic of the negative-temperature-coefficient thermistor is described by the exponential function:

$$R = R_{\infty} \exp B/T, \quad (1)$$

where:

R_{∞} = asymptotic value of R ,

B = a constant that is a function of the thermistor's composition.

T = temperature in degrees Kelvin.

An equation that is more useful for design purposes can be established by letting R_0 be the resistance at a reference temperature, T_0 . Then from Eq. 1:

$$R_0 = R_{\infty} \exp B/T_0. \quad (2)$$

Dividing Eq. 2 into Eq. 1 eliminates the asymptotic limit (R_{∞}) of R , yielding:

$$R = R_0 \exp [B(1/T - 1/T_0)]. \quad (3)$$

Instead of specifying R_{∞} , which may be measured at a temperature far from the temperature of interest, R_0 can be specified at temperature T_0 , which is well within the region of interest. In view of the fact that Eq. 1 will not be followed by the thermistor exactly, it seems reasonable that a specification of R_0 at T_0 within a temperature region T_n will lead to a more precise description than if R_{∞} at an end-point temperature were specified.

If Eq. 3 is divided by R_0 , a normalized thermistor characteristic, $r(T)$, is obtained:

$$R/R_0 = r(T) = \exp[B(1/T - 1/T_0)]. \quad (4)$$

In Eq. 4, $r(T)$ is a function of T and the thermistor constant B . Thus a set of curves, $r_i(T)$, that are independent of R_0 can be drawn for the corresponding B_i representing the range of available B . A typical set of such universal curves is shown in Fig. 1. These curves are used to determine which B would be the most useful for a specific application.

The positive-temperature-coefficient thermistor, also called a posistor, falls into one of two groups, according to its resistance-vs-temperature characteristics. Those of group SW¹ have a negative temperature coefficient at low temperatures, a positive coefficient at higher temperatures

Victor Weisenbloom, Electronic Engineer, Raytheon Co., Sudbury, Mass.

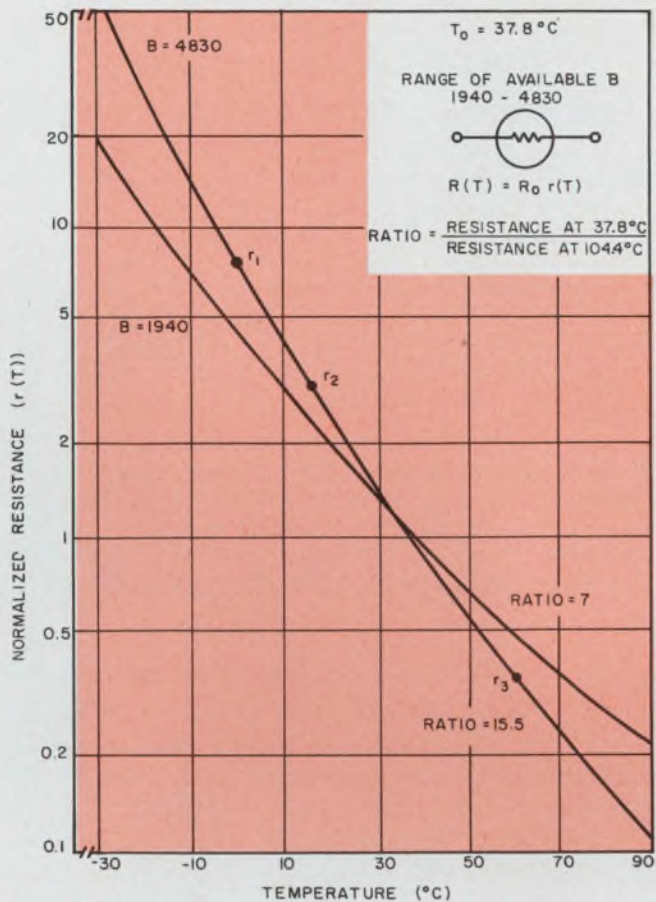

1. Range of available thermistor constant (B) is shown on the thermistor manufacturers' universal curves. From these curves the designer determines which value of B is most useful for a specific application.

and finally a negative coefficient at yet higher temperatures. Those of group TC² have a positive temperature coefficient over a larger range of temperatures than the SW type. Their coefficients, however, still go negative at extreme values of temperature.

The posistor's resistance-vs-temperature characteristic is shown in Fig. 2. Between temperatures T_p and T_n , the resistance is described approximately by:

$$R = R_0 \exp AT, \quad (T_p < T < T_n)$$

where:

$$R_0 = \text{resistance at } T = T_p,$$

$$A = \text{posistor constant.}$$

Below T_p and above T_n the posistor has a characteristic which is approximately:

$$R = R_0 \exp B/T,$$

where B is the thermistor constant of conventional thermistors.

Because of the approximation involved in the defining equation for the posistor, its specifications are based on empirical data supplied by the manufacturer. The designer must therefore decide on his tolerance requirements in conjunction with the typical posistor characteristic that is shown in Fig. 2.

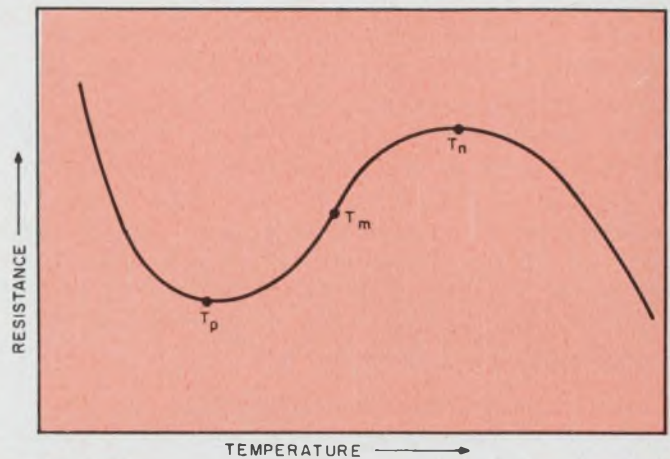

2. Variable R-T characteristic is exhibited by positive-temperature-coefficient thermistors. They have a negative coefficient at low temperatures, a positive coefficient at higher temperatures and a negative coefficient again at even higher temperatures.

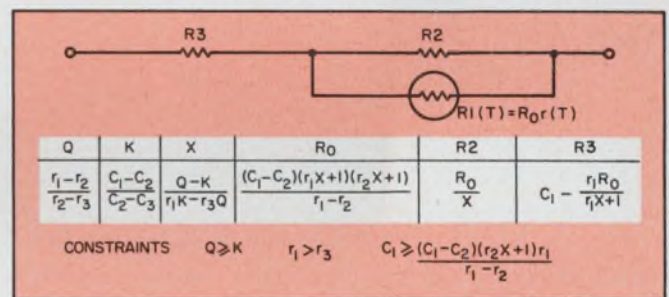

3. Desired resistance-vs-temperature characteristic can be matched by use of this series-parallel resistor-thermistor configuration. The three unknowns are R_2 , R_3 and R_0 .

For most design purposes the negative-coefficient thermistor is preferred and used more commonly than the posistor. There is a wider range of nominal values (R_0 at ambient) and of thermistor constants for NTC types. The posistor, however, is useful in certain applications where the NTC cannot be used and where the desired characteristic or functional relationship requires thermistors of opposite type.

The effects of thermistor self-heating are assumed to be negligible.

Direct method applied to series-parallel circuit

In applying the direct method of resistor-thermistor network synthesis, assume that a given resistance-vs-temperature characteristic is to be synthesized. To reproduce this characteristic, the series-parallel configuration in Fig. 3 is chosen and the elements R_2 , R_3 and R_0 solved for as functions of points on the given R-T characteristic. From Fig. 3 the total resistance, $R_T(T)$, is found to be:

$$R_T(T) = R_3 + R_2 R_1(T) / [R_1(T) + R_2] \\ = R_3 + R_2 R_0 r(T) / [R_2 + R_0 r(T)]. \quad (5)$$

If the normalized thermistor characteristic, $r(T)$, is chosen from among available thermistors

(as it should be), then Eq. 5 has three unknowns: R_2 , R_3 and R_0 . To solve for the three unknowns, three resistance values, $R_T(T_1)$, $R_T(T_2)$ and $R_T(T_3)$, are chosen at T_1 , T_2 and T_3 , respectively, from the given characteristic and the corresponding $r(T_1)$, $r(T_2)$ and $r(T_3)$ are taken from the manufacturer's universal thermistor curves (see Fig. 1). If for convenience $R_T(T_1)$ is defined as equal to C_1 , and $R_T(T_2) = C_2$, $R_T(T_3) = C_3$, $r(T_1) = r_1$, $r(T_2) = r_2$ and $r(T_3) = r_3$, three equations can be generated from Eq. 5:

$$\left. \begin{aligned} C_1 &= R_3 + R_2 r_1 R_0 / (r_1 R_0 + R_2), \\ C_2 &= R_3 + R_2 R_0 r_2 / (r_2 R_0 + R_2), \\ C_3 &= R_3 + R_2 R_0 r_3 / (r_3 R_0 + R_2). \end{aligned} \right\} \quad (6)$$

Solving for R_0 , R_2 and R_3 yields:

$$\left. \begin{aligned} R_0 &= (C_1 - C_2)(r_1 X + 1)(r_2 X + 1) / (r_1 - r_2), \\ R_2 &= R_0 / X, \\ R_3 &= C_1 - [r_1 R_0 / (1 + r_1 X)], \end{aligned} \right\} \quad (7)$$

where:

$$\begin{aligned} X &= (Q - K) / (r_1 K - r_3 Q), \\ K &= (C_1 - C_2) / (C_2 - C_3), \\ Q &= (r_1 - r_2) / (r_2 - r_3). \end{aligned}$$

Equations 7 give in simple form the elements of the series-parallel arrangement as functions of points on the required curve and the normalized thermistor curve. Since C_1 , C_2 , C_3 and r_1 , r_2 and r_3 were chosen at the respective temperatures T_1 , T_2 , T_3 , a quick and simple slide-rule calculation will give the element values, and the network design is complete.

This design method is much faster and much more accurate than any approximation scheme. Moreover, the synthesized network has an R - T characteristic which is guaranteed to pass through the points $R_T(T_1)$, $R_T(T_2)$ and $R_T(T_3)$ on the required curve (assuming zero tolerances on all elements).

Network must be realizable

When this method is used, it is important to determine whether the thermistor characteristic chosen is capable of yielding realizable element values for the points picked from the given R - T characteristic. In other words, is the network to be synthesized realizable? The network is realizable if all the elements found from Eqs. 7 are positive. From Eq. 7 it can be seen that where $X > 0$, R_0 and R_2 are each greater than zero, if:

$$Q \geq K \text{ and } Q < (r_1 / r_3) K,$$

or equivalently:

$$Q \geq K \text{ and } r_1 > r_3. \quad (8)$$

The inequalities in Eq. 8, if satisfied, will ensure positive values for R_0 and R_2 . The realizability of R_3 can be checked with the equation:

$$C_1 \geq [(C_1 - C_2)(r_2 X + 1)r_1] / (r_1 - r_2).$$

This realizability condition for R_3 is not very

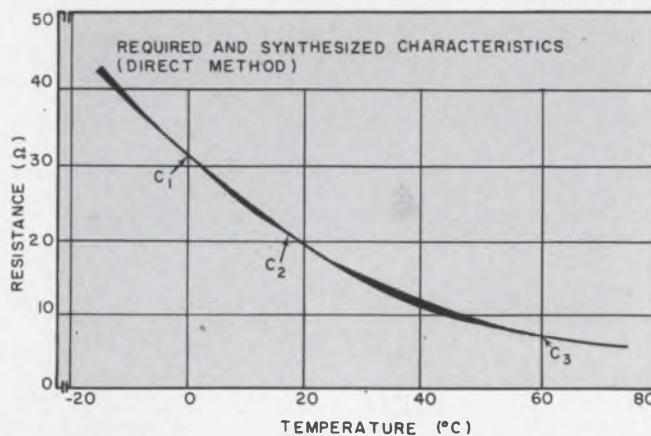

4. Three points on required R - T characteristic are chosen as the starting point in developing the synthesized network. These points yield the needed equations. The R - T characteristic of the synthesized network is shown to coincide almost exactly with the desired characteristic.

useful, however, since in order to carry out the check most of the synthesis procedure must be performed. It is therefore usually best to try to synthesize the network completely, as long as the constraints on R_0 and R_2 are satisfied.

Under these constraints, the step-by-step procedure can be summarized as follows (see Fig. 3):

- From the given R - T characteristic choose three suitable points, C_1 , C_2 and C_3 , at temperatures T_1 , T_2 and T_3 , respectively. Then calculate K .

- Find the proper normalized thermistor characteristic, $r(T)$, by calculating Q from the manufacturer's universal curves (Fig. 1). Make sure the constraints on realizability are satisfied.

- Calculate the values of R_0 , R_2 and R_3 from Fig. 3.

Design example illustrates direct method

As an example of applying the direct method, consider the case where the resistance-vs-temperature characteristic shown in Fig. 4 is to be synthesized. The points C_1 , C_2 and C_3 to be matched are chosen by determining the slope, $\Delta R / \Delta T$, of the given characteristic at various temperatures within the region of interest. Since there are three points to pick, one should be chosen where the slope is the greatest and the other two should each be chosen in a region where the rate of change of slope is a maximum.

In this case, each of the latter points are picked on the opposite sides of the greatest-slope point. If the curve is matched where the acceleration is a maximum, and at the point where the slope is a maximum, the errors involved in the match should be reduced.

In Fig. 4, at $T = 15^\circ$ the slope is at a maximum, and at $T = 0^\circ$ and $T = 60^\circ$ the acceleration is at a maximum. The latter determination can also be

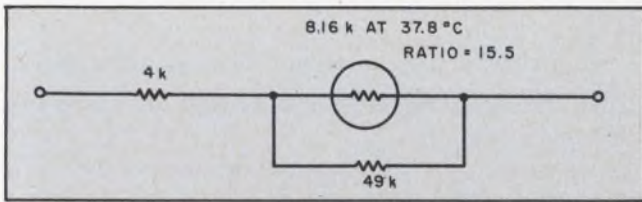

5. Component values produced by the design example in order to reproduce the R-T characteristic of Fig. 4.

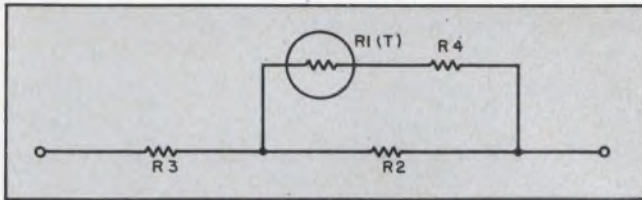

6. Modified series-parallel network permits the direct method to be used for off-the-shelf thermistors.

made by calculating $\Delta \text{slope}/\Delta T$ for various points on the graph.

An NTC thermistor of ratio 15.5 is chosen arbitrarily and the required data for the solution are tabulated. The normalized thermistor curve yielding r_1 , r_2 and r_3 can be seen in Fig. 1.

The constraints for realizability should now be checked. From Eq. 8, the following must be satisfied:

$$K \leq Q \text{ and } r_1 > r_3,$$

where:

$$K = (C_1 - C_2) / (C_2 - C_3),$$

$$Q = (r_1 - r_2) / (r_2 - r_3).$$

Substituting the values from the graphs:

$$K = (31.7 - 21.4) / (21.4 - 6.75) = 10.3 / 14.65 = 0.703$$

$$Q = (7.77 - 3.3) / (3.3 - 0.36) = 4.47 / 2.94 = 1.52$$

$$r_1 / r_3 = 7.77 / 0.36 = 21.6.$$

Hence:

$$0.703 \leq 1.52 \leq (21.6)(0.703) = 15.2.$$

Thus the thermistor appears to be adequate. Instead of checking the constraint on R_3 , which may take as long as the solution, continue with the actual solution. From Fig. 3:

$$X = R_0 / R_2 = (Q - K) / \{r_3 [K(r_1 / r_3) - Q]\}$$

$$= (1.52 - 0.703) / [0.36(15.2 - 1.52)]$$

$$= 0.166.$$

Finding R_0 :

$$R_0 = (C_1 - C_2)(r_1 X + 1)(r_2 X + 1) / (r_1 - r_2)$$

$$= (10.3)(2.29)(1.55) / 4.47$$

$$= 8.18 \text{ k}\Omega.$$

Therefore:

$$R_2 = R_0 / X = 8.16 / 0.166 = 49 \text{ k}\Omega.$$

Finally:

$$R_3 = C_1 - [R_0 r_1 / (r_1 X - 1)]$$

$$= 31.7 - [(8.16)(7.77) / 2.29]$$

$$= 4 \text{ k}\Omega.$$

The complete synthesized network appears in

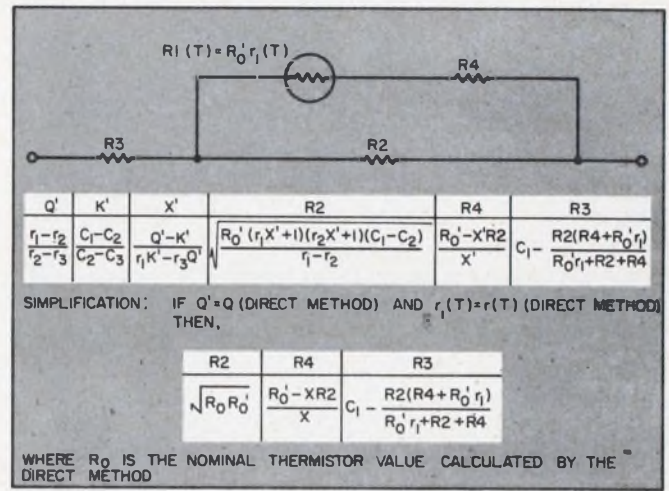

7. Off-the-shelf thermistor-resistor network design is an expanded version of the direct method. It is performed with the above circuit configuration and equations.

Fig. 5. When its resistance-vs-temperature characteristic is drawn on the same graph as the desired characteristic (Fig. 4), the error is seen to be essentially zero.

From the procedure described above, it is clear that the direct method is more accurate, easier to execute and more practical than other approximation procedures.

Method extended for off-the-shelf thermistors

The values of resistors R_2 and R_3 derived by the direct method generally pose no procurement problem. The nominal thermistor resistance, R_0 , may not, however, be available off the shelf from any manufacturer. In this case, the derived R_0 for the chosen $r(T)$ characteristic may have to be custom-made. If the network is going to be used repeatedly, in, say, one thousand systems, this may be an economical proposition. On the other hand, for limited or "one shot" applications where accuracy, expediency and economy all count, it is advantageous to use an off-the-shelf thermistor.

The direct method can then be extended to incorporate an off-the-shelf unit in the following manner:

- Design the thermistor-resistor network by the direct method as described.

- If the calculated value of R_0 is not available off the shelf, choose a thermistor, $R_1(T)$, from those that are available off the shelf. It must be one that has a nominal value, R_0' , close to the calculated R_0 and an identical or similar normalized characteristic, $r_1(T)$.

- Use the network in Fig. 7 and determine values of R_2 , R_3 and R_4 such that the chosen off-the-shelf thermistor may be used, where:

$$R_1(T) = R_0' r_1(T).$$

The equations for R_2 , R_3 and R_4 are derived

similarly to those for the direct method. From Fig. 6 the total resistance is:

$$R_T(T) = R3 + R2[R4 + R_1(T)] / [R2 + R4 + R_1(T)].$$

The three equations that are needed to solve for the unknowns are generated by choosing three points, $R_T(T_1)$, $R_T(T_2)$, $R_T(T_3)$, to be matched from the required characteristic, and by selecting the respective $r(T)$ values from the normalized thermistor curves. Letting $R_T(T_1) = C_1$, $R_T(T_2) = C_2$, $R_T(T_3) = C_3$, $r(T_1) = r_1$, etc. and solving the three generated equations yield:

$$R2 = [R_0'(r_1X' + 1)(r_2X' + 1)(C_1 - C_2) / (r_1 - r_2)]^{1/2},$$

$$R3 = C_1 - [R2(R4 + R_0'r_1) / (R_0'r_1 + R2 + R4)],$$

$$R4 = R_0'/X' - R2,$$

where:

$$X' = (Q' - K') / (r_1K' - r_3Q'),$$

$$Q' = (r_1 - r_2) / (r_2 - r_3),$$

$$K' = (C_1 - C_2) / (C_2 - C_3).$$

The equations for $R2$, $R3$ and $R4$ can be simplified somewhat if the chosen points C_1 , C_2 and C_3 and the normalized thermistor characteristic $r_1(T)$ are the same as those selected for the basic direct method. In this case, the equations become:

$$R2 = (R_0 R_0')^{1/2},$$

$$R3 = C_1 - [R2(R4 + R_0'r_1) / (R_0'r_1 + R2 + R4)],$$

$$R4 = (R_0' - X R2) / X,$$

where R_0 is the value found by the direct method and X is the value defined earlier and found by

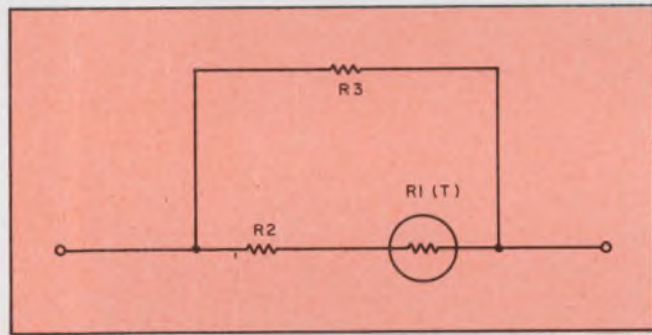

8. Alternative circuit configuration can be used when applying the direct method to resistor-thermistor networks.

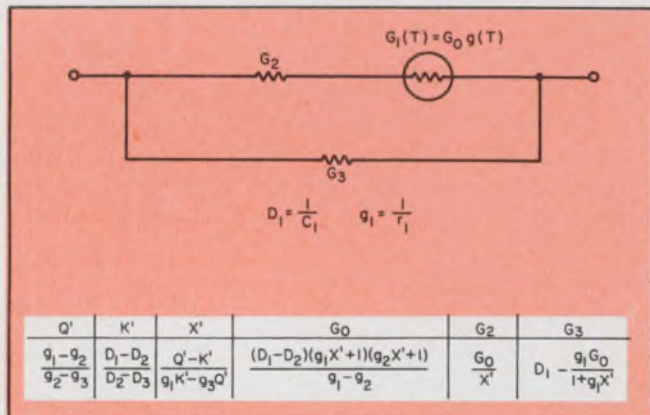

9. Admittance form can also be used to express the equations needed to carry out the direct method of design.

the direct method.

This technique for expanding the direct method to accommodate off-the-shelf thermistors is summarized in Fig. 7.

Alternative configuration possible

Instead of the series-parallel circuit configuration of Fig. 3, the designer may prefer to synthesize a given resistance-vs-temperature characteristic with the configuration of Fig. 8.

The component values in this case are derived in the same manner as those for the arrangement in Fig. 3. To show the analogy, the pertinent equations can be derived in admittance form. From Fig. 9:

$$G_T(T) = G_3 + G_2 G_1(T) / [G_2 + G_1(T)],$$

where:

$$G_3 = 1/R3,$$

$$G_2 = 1/R2,$$

$$G_1(T) = G_0 g(T) = 1/R_0 r(T).$$

Hence, for three temperature points on a given temperature characteristic and the corresponding three points on the universal thermistor curves, the component values can be found. The results are summarized in Fig. 9. The constraints noted for the configuration of Fig. 3 apply equally to that of Fig. 9.

The application of the direct method for synthesizing networks to match voltage- or current-ratios-vs-temperature characteristics will appear in Part 2 of this article, in the next issue. ■ ■

References:

- O. Saburi and K. Wakino, "Processing Techniques and Applications of Positive-Temperature-Coefficient Thermistors," *IEEE Trans. on Comp. Parts*, Vol. CP-10, No. 1 (March, 1963), 53-67.
- Ibid.*

Bibliography:

- Adler, Richard B., et al. *Introduction to Semiconductor Physics*. New York: John Wiley & Sons, 1964
- Del Toro, Vincent, and Parker, Sidney. *Principles of Control Systems Engineering*. New York: McGraw-Hill Book Co., 1960
- Farhi, Sivy, and Groves, Stanley. "Design of Resistive Temperature Compensation by Single and Multiple Thermistor Networks," *AIEE Trans.*, LXXX, Pt. 1, July, 1961, 246-253.
- Joyce, Maurice V., and Clarke, Kenneth K. *Transistor Circuit Analysis*. Reading, Mass.: Addison-Wesley Pub. Co., 1961.
- Kedson. "Thermistor Compensation Simplified," *EEE*, X, No. 7 (July, 1962).
- Saburi, O., and Wakino, K. "Processing Techniques and Applications of Positive Temperature Coefficient Thermistors," *IEEE Trans. on Comp. Parts*, Vol. CP-10, No. 1 (March, 1963), 53-67.
- Scarr, R. W. A., and Settingington, R. A. "Thermistors, Their Theory, Manufacture and Applications," *IRE Trans. on Comp. Parts*, Vol. CP-8, No. 1 (March, 1961), 6-22.
- Stern. *Theory of Non-Linear Networks and Systems*. Reading, Mass.: Addison-Wesley Pub. Co., 1965.
- Truxal, J. G. *Automatic Feedback Control System Synthesis*. New York: McGraw-Hill Book Co., 1955.
- Volz. "Temperature Compensation of Transistor Circuits." Research report conducted by the Dept. of Electrical Engineering of Pennsylvania State University for Keystone Carbon Co., Feb., 1965.
- Weinberg, Louis. *Network Analysis and Synthesis*. New York: McGraw-Hill Book Co., 1962

RCA
integrated
circuits

RCA CA3020 LOW COST "UNIVERSAL" AMPLIFIER

- High gain • Low level to $P_{out} = 1/2 w$
- DC to 6MHz • Price \$1.75 (1,000+)

Here's a new answer to economics, packaging, and performance for a broad spectrum of audio and RF applications—RCA-CA3020, a multi-stage, multi-purpose amplifier on a single monolithic silicon pellet. CA3020 is useful in portable and stationary sound systems; in military, industrial, and commercial

communications equipment; in servo-control systems and elsewhere. Available now for evaluation—and production line use. Write for Technical Bulletin and Application Note to Commercial Engineering, Sec. ICG6-3 RCA Electronic Components and Devices, Harrison, New Jersey 07029.

Specification Highlights

- 58 db typical gain in audio applications
- -3 db bandwidth 25 Hz to 6 MHz (typ)
- Operates with single power supply +3 to +9 VDC
- Built-in temperature tracking with voltage regulator—stabilized operation over -55°C to +125°C range
- Single-ended input at 40k Ω (typ); push-pull differential input at 600 Ω (typ)
- High maximum power output 550 mW (typ) @ $V_{cc} = +9V$
- Push-pull output
- Squelch flexibility—three methods for applying squelch

ASK YOUR RCA DISTRIBUTOR FOR HIS PRICE AND DELIVERY

RCA Electronic Components and Devices



The Most Trusted Name in Electronics

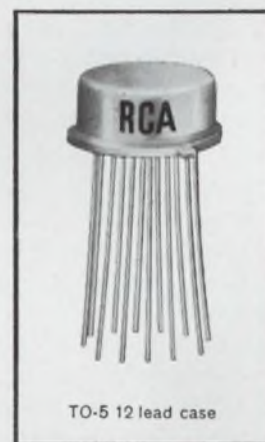
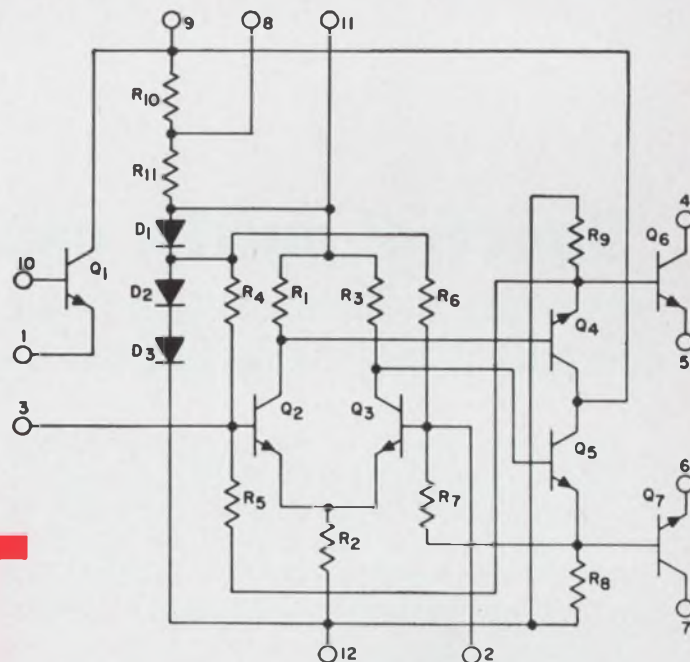

'Spectral purity' can hide a lot of sins

since test methods and definitions lack standards. Sidestep the pitfalls by looking beyond the spec sheet.

The specification and testing of the spectral properties of oscillators is obscured by a maze of nomenclature that varies from manufacturer to manufacturer. Since industry is not about to standardize, here is an attempt to cut through the confusion and to specify and measure properties meaningfully.

Short-term stability differentiates changes in the spectrum occurring at a rate of up to seconds from those resulting from aging and measured in terms of days, months or years.

The factors that affect short-term stability are the thermal noise, shot noise and $1/f$ noise (flicker noise) associated with quartz crystal oscillators and their circuitry. These three factors cause frequency modulation, which appears as a spectrum centered around the carrier frequency. This spectrum is the result of perturbations in the phase of the carrier.

To establish the concept of short-term stability, to perform meaningful measurements and to achieve good stabilization, consider first a "picture" of a fractional frequency offset and an observation interval in the time domain.

A frequency of f_0 is desired, but, because of tiny phase disturbances, this carrier is seldom instantaneously on the desired frequency, although the average offset over long intervals may be exceedingly small. Figure 1a is a plot of instantaneous frequency in a given time interval. It shows that the averaged frequency error with time is very closely related to an observation interval.

If the short-term excursions are averaged over a relatively long time period, as is the case for T_1 in Fig. 1a, the value of $\Delta f/f$ will be small. When the observing interval is shortened, however, as it is for T_2 and T_3 , there is insufficient time for an averaging effect to take place and $\Delta f/f$ becomes larger. The increase in $\Delta f/f$ with decreasing T is continued until a further decrease in observation time reveals no further change in $\Delta f/f$. At this point, the true rms short-term stability, or σ , of an oscilloscope may be determined:

Robert J. Munn, Manager of Engineering, Motorola, Inc. Chicago, Ill.

$\sigma = (\sigma_1^2 + \sigma_2^2 + \dots + \sigma_n^2)^{1/2}$, where $\sigma_1, \sigma_2, \dots, \sigma_n$ are the individual observed excursions.

If a system relies on the frequency as a time base, there is ample room for error. Suppose a reference for a timing or navigation system is established at t_1 . At t_2 this reference has shifted by some $\Delta f/f$. If the offset is large enough, there may be serious system inaccuracy.

Spectrum needed in frequency domain

To appreciate the detrimental effect of short-term stability in the frequency domain, the concept must be reconstructed in terms of frequency, or more specifically, power density versus frequency. A plot of this is usually called a spectrum or spectral-density curve (Fig. 1b).

If in the original time-domain plot of Fig. 1a the frequency were a straight, horizontal line extending out from f_0 with no $\Delta f/f$ disturbances, the corresponding spectral-density plot would be a vertical line extending upward from ω_0 . Frequency perturbations do exist, however, as the time-domain model shows, and they give rise to the sidebands seen in the frequency-domain plot. These sidebands constitute the spectrum.

In most oscillators the power contained in these sidebands is small compared with the carrier power. Therefore it is valid within practical limits to treat the modulation as narrow-band; the principle of superposition is then applicable. For the frequency-modulated case where the modulation can be expressed in the general form, $Kf(t)$, where K is the maximum amplitude of modulation, the instantaneous angular frequency is given as: $\omega_i = \omega_c + Kf(t)$. The amplitude and phase of the sidebands can be found by integrating this expression to find $\theta(t)$, the angular displacement at time t :

$$\theta(t) = \int \omega_i dt = \omega_c t + \theta_0 + K \int f(t) dt,$$

where θ_0 is the angular displacement at $t = 0$. Letting $\theta_0 = 0$ and substituting $g(t)$ for $f(t)$ makes $F_c(t) = \cos [\omega_c t + K g(t)]$, which is the real part, or the amplitude, of the sidebands.

In practical, low-frequency, high-stability oscillators, the value of K is so small that it is difficult

to measure directly. But if ω_c is multiplied by some factor n , $F_c(t)$ becomes $\cos [n \omega_c t + n K g(t)]$. In other words, the maximum amplitude of the original noise sideband increases directly with the multiplication ratio. The signal-to-noise ratio of a 1-MHz oscillator, multiplied up to 1 GHz, for example, becomes 1000 times worse than that of the original 1-MHz oscillator.

Thus short-term stability is a factor to be reckoned with in all oscillator applications that are sensitive to S/N ratio or spectral line width. In the case of Doppler radar, the target return line width directly affects the sensitivity and velocity resolution of the system and determines the minimum useful filter bandwidths. Maximum subclutter visibility is also dependent on noise sidebands generated by the transmitter and local oscillators.

Improved short-term stability and consequent smaller line width are a deciding factor in the design of spacecraft communications systems. This is because bandwidths may be lowered and communications distances increased with the same power, when narrower spectra are achieved.

In view of the severe problems caused by poor spectral purity, what can be done about it is a vital question.

What to do for a clean spectrum

Multiplication of a signal, it has been shown, leads to greater noise. One logical approach to a noise-free spectrum, therefore, would be to start off with a frequency so high that little or no multiplication would be necessary. Since oscillators with high long-term stability are best designed in the region between 1 MHz and 5 MHz, this would be an inadequate solution whenever both good aging characteristics and a "clean" spectrum were desired at, say, 1 GHz.

Another approach would be to improve the oscillator's signal-to-noise ratio. The short-term stability of a quartz crystal can be equated with the signal-to-noise ratio of the source:

$$\Delta f/f = 2\pi/(t f SN),$$

where t is the averaging time, f the frequency, and SN the signal-to-noise ratio. Raising the oscillator's power level would improve SN , but this, too, has limitations. Quartz crystals have power-level-versus-frequency-offset characteristics similar to those in Fig. 2. The level must be held near point O in order to take advantage of as high a power as possible without encroaching on the region where $\Delta f/f$ increases sharply with the power level.

A third method involves combining the first two approaches (Fig. 3). The output of a low-frequency, good-aging oscillator is multiplied and phase-compared with that of a high-frequency, high-power oscillator. The high-level one may have inherently poor long-term stability, but it is

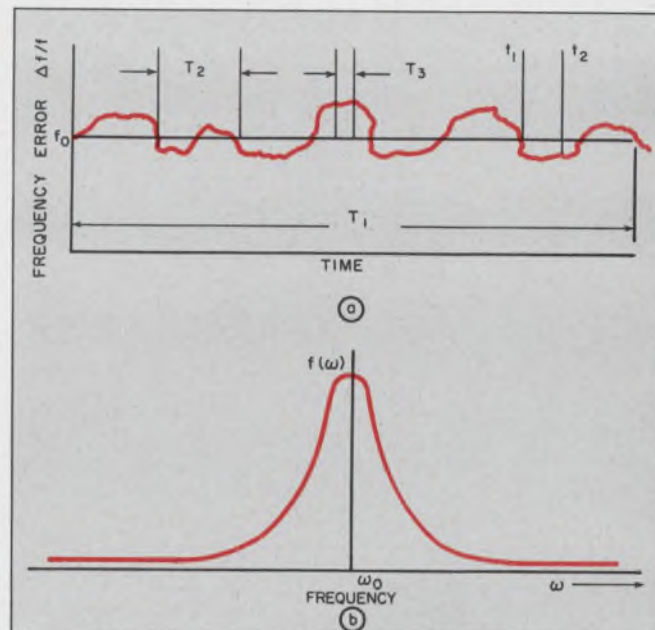

1. Random plot of frequency error variation with time (a) shows dependence of the averaged frequency error, $\Delta f/t$, on the observation intervals T_1 , T_2 , T_3 . In the frequency domain, a spectral density curve (b) must be constructed. The frequency perturbations give rise to sidebands.

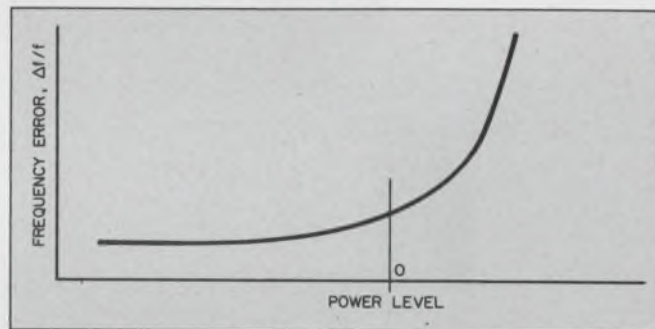

2. Typical power level vs frequency offset of quartz crystals shows why it is futile to try to improve spectral purity by increasing the power level. Beyond the output power at point O the frequency error increases sharply.

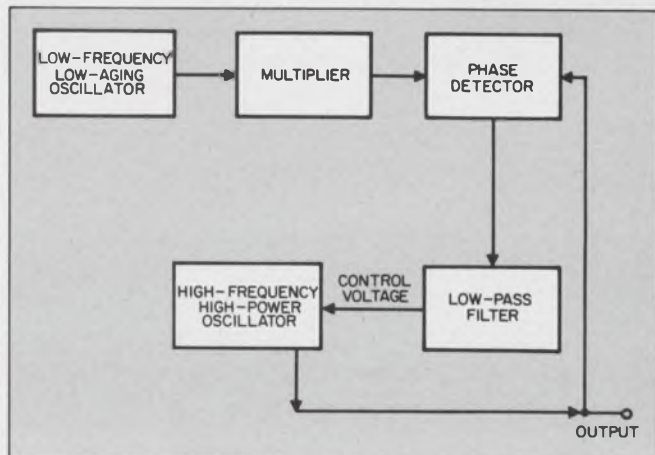

3. Complex frequency-correction scheme uses a high-power oscillator, the phase of which is controlled by a low-frequency, very stable oscillator.

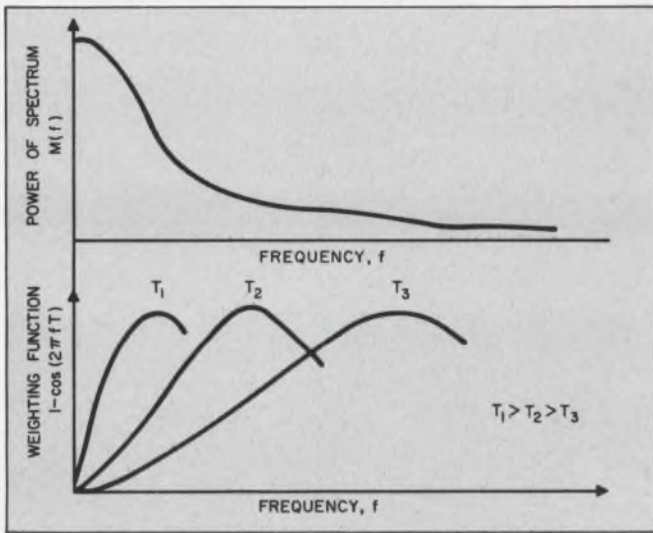

4. Short-term stability is related to the power spectrum through a weighting function, $[1 - \cos(2\pi fT)]$, which depends on the observation intervals. This relationship permits the use of filters at the output of the oscillator to clean up the spectrum. Larger observation times make lower frequencies more important; short intervals emphasize high-frequency contributions.

continuously corrected by the detector output.

Filtering simplifies design

A much simpler and more practical scheme is to filter the output of an oscillator that has poor spectral characteristics. Short-term stability is related to the power spectrum by the autocorrelation function, which supplies the average of the total ensemble of noise sources:

$$\sigma^2 [A_f(T)] = (1/\pi^2 T^2) \int_0^\infty M(f) [1 - \cos(2\pi fT)] df,$$

where $\Delta f/f = \{\sigma^2 [A_f(T)]\}^{1/2}/f$ and $M(f)$ is the power associated with the spectrum, such that $M(f) df$ is the power in a narrow band of frequencies of width df . (It must be specified, however, that $M(f)$ does not include the carrier at $f = 0$.) The integrand can be thought of as the power spectrum weighted by a $[1 - \cos(2\pi fT)]$ function, as shown in Fig. 4.¹

As observation time T is increased, the spectral components that result from the lower frequencies are weighted more heavily. As time T is decreased, the contribution of the higher frequencies to the spectrum becomes more pronounced. On this basis it is possible to specify filter bandwidths according to short-term stability requirements.

Consider a practical situation where short-term stabilities in the region of 1×10^{-10} are required for 10-ms observation intervals, and in the region of 5×10^{-10} for 1-ms intervals. The unfiltered output of the oscillator in question appears as curve A in Fig. 5. Short-term stabilities at 10 ms and 1 ms for this oscillator are found to be about two orders of magnitude too high. What can be done to the spectrum to reduce the 10-ms and 1-ms short-term figures? Qualitatively, Fig. 5 shows that the large spectral frequencies at 100 and 1000 Hz from the carrier are the major contributors to the 10-ms and 1-ms instabilities, respectively, and have to be reduced. Unfortunately, there is no easy way to predict that if, for instance, the spectrum at a particular point were reduced by 20 dB the short-term would be improved by an order of magnitude. Indeed, this just does not happen. In Fig. 4 the weighting is certainly greatest for frequencies equal to $1/T_1$, $1/T_2$ and $1/T_3$ at T_1 , T_2 and T_3 , respectively, but the weighting interacts to some extent over the entire spectral range and obviates a simple solution. The oscillator, then, is filtered to attenuate the 100-Hz and 1000-Hz components to a greater degree to reduce their reciprocal time-domain counterparts, even though this relationship is quantitatively neither simple nor direct. The result, however, is spectrum B in Fig. 5, which has considerably better short-term stabilities. The final sideband characteristics of

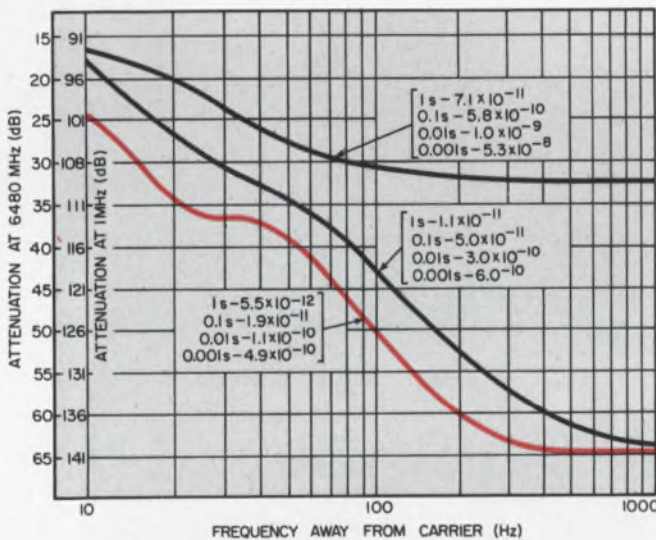

5. Filtering improves the short-term stability. Unfiltered output (curve A) was filtered to attenuate the 100- and 1000-Hz components (B). Final sideband characteristic (C) shows considerable improvements. The bandwidth is 6 Hz.

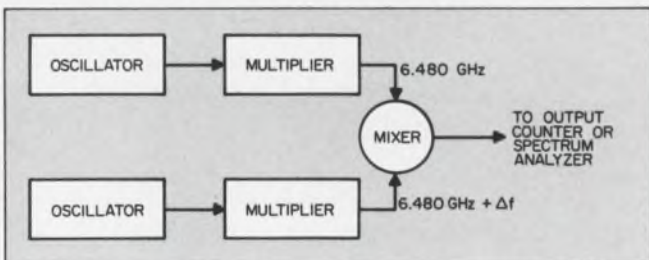

6. Multiply the output frequency until its spectrum can be conveniently examined with this type of setup. The data in Fig. 5 were obtained with this way. One oscillator may be offset for a beat frequency.

Short-term stability computed from power spectrum

The method is based on the autocorrelation function. The basic equation expresses short-term stability in terms of the autocorrelation function of the oscillator's instantaneous frequency:

$$\sigma^2 [A_f(T)] = (1/2 \pi^2 T^2) \sum_{n=1}^{\infty} A_n^2 (1 - \cos \omega_n T),$$

where:

$\sigma^2 [A_f(T)]$ = variance in the average frequency over T ,

T = observation interval,

A_n^2 = true sideband-component-to-carrier power ratio, where A_n is defined as the voltage ratio of the sideband to the carrier level,

ω_n = frequency of the discrete component with respect to the carrier.

The coefficients of the function can be determined by approximating the spectrum in question by a set of discrete components. Figure 8 shows the dimensions and position of a component within a typical spectrum. The spectrum is first divided into a number of convenient bands with the dimensions: Hz \times (relative watts/Hz) = relative watts (power).

To simplify the process, the spectrum should be normalized to a standard-bandwidth spectrum of 1 Hz. A 6-Hz-bandwidth spectrum, for example, becomes a 1-Hz-bandwidth spectrum simply by reducing all sidebands by 8 dB. The true power ratio of a given band can be obtained directly from the square of the measured voltage ratio terms, A_n . Since spectrum symmetry is assumed, only one side of the spectrum need be analyzed. Consequently, the total spectrum contribution would be raised by 3 dB over the value obtained by observing one side alone. While this must be borne in mind, the 3 dB to be added for the other side of the spectrum is very often subtracted because of the assumed equal contribution due to two oscillators.

While for maximum accuracy the spectrum should ideally be divided into 1-Hz increments, this in fact is impractical as each would have to be processed into the computer separately. Since

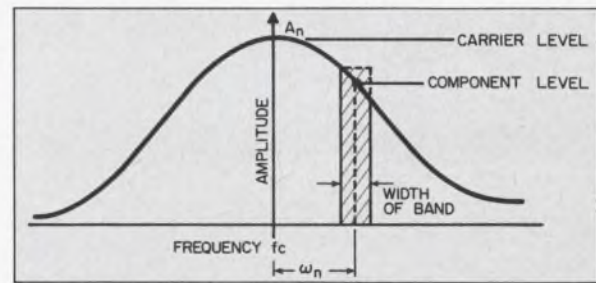

8. A typical spectrum may be decomposed into a set of discrete components. It helps in the calculation of the expression that relates the short-term stability and the instantaneous frequency.

the spectrum in this region is not changing rapidly, a value of, say, 66 dB average over the region can be assumed and 500 processes converted into a single one with no appreciable loss of accuracy. Thus a spectrum with a half bandwidth of examination of 1 kHz can be divided into about 25 segments with widths of from 2 to 500 Hz each. The choice of segment width depends on the segment's position in the spectrum. Where the spectral component level is changing slowly, large segments can be taken; where the spectrum is changing rapidly, a larger number of narrower segments is required.

Two identical oscillators were tested by the method illustrated in Fig. 6. Compare the short-term stabilities measured by taking the rms value of the inverted beat period offsets with values calculated by the method just described:

T	Measured $\Delta f/f$	Calculated $\Delta f/f$
0.001 s	4.94×10^{-10}	4.05×10^{-10}
0.01 s	1.10×10^{-10}	1.85×10^{-10}
0.1 s	1.87×10^{-11}	3.06×10^{-11}
1.0 s	5.50×10^{-12}	4.27×10^{-12}

Even estimates of the very low-frequency spectral components are well within an order of magnitude of actual measurements. Shorter observation times, however, increase the difficulty of measuring short-term stabilities. In these cases, the method of calculating the standard deviation of the average stability for various observation times becomes a powerful analytical tool especially where T is very small.

curve C , arrived at empirically, provide the degree of attenuation of spectral components necessary to yield the short-term stabilities desired.

Four terms associated with spectral purity

Small disturbances that generate noise spectra can be specified several ways. A good grasp of the meaning of the terms commonly associated with spectral purity helps the user to know what to expect of an oscillator and to specify accurately what is wanted.

Spectrum—This permits the fullest description

of the purity of a signal source. From the spectrum, short-term stability may be derived for observation intervals as long as the inverse of the spectrum frequency limit. That is to say, spectral information at a frequency that is 1 kHz away from the carrier may be translated into 1-ms short-term stability or longer (see box for the proof).

Signal-to-noise ratio—This is usually expressed as a ratio in decibels within a specific bandwidth. It is in fact the integral of the power spectrum, limited by the plus and minus bandwidths. It does not, however, give any information about the

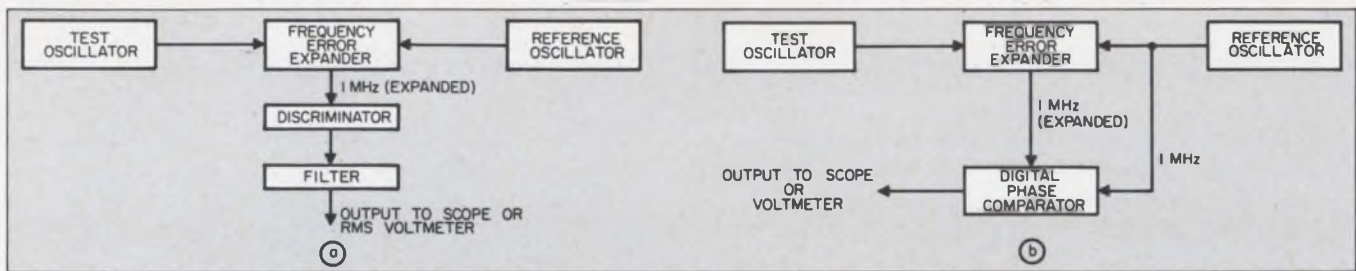

7. Error expander can measure short-term frequency stability (a) or phase stability (b). It accepts the input (between 250 kHz and 5 MHz), converts it to 1 MHz and

expands frequency or phase deviations at 1 MHz. Peak or rms values appear at the output. The transfer characteristics of the discriminator must be known.

distribution of the spectral components within the band of interest, so it is impossible to determine short-term properties from this specification.

Short-term stability—This information is of real value only if the number of stabilities are given along with observation intervals. Although it is virtually impossible to reconstruct a spectrum from a few pieces of short-term information, an approximate picture can be developed by relating one spectrum to another (see Fig. 5). If specifications are given for the smallest time interval, the stabilities for longer intervals will always be better, or at least at the outset, no worse. This, nonetheless, takes no account of aging.

Phase jitter—This is mathematically related to short-term stability and similar limitations apply.

How to measure stability

There are several measurement techniques to check whether the oscillator meets the specifications. They will solve most problems.

The maximum amplitude of the noise sidebands of an oscillator increases in direct relation to the multiplication ratio. One method of checking would therefore be simply to multiply the frequency of the oscillator until its spectrum could be conveniently viewed. This was how the data in Fig. 5 were obtained. A practical system is shown in Fig. 6, where the output frequencies of two 1-MHz oscillators are multiplied 6480 times. This effectively raises the spectral components by 76 dB over their values at 1 MHz.

In typical test, one of the test oscillators is offset in frequency such that a convenient beat frequency is obtained from the mixer. An audio analyzer may then be used to examine the spectrum. Alternatively, the beat note may be fed into a period counter. The variation in the resulting periods measured over a particular time interval will, when inverted, provide the variance of the average frequency during this interval. The rms value of $\Delta f/f$ may then be calculated as:

$$\sigma = (\sigma_1^2 + \sigma_2^2 + \sigma_3^2 + \dots + \sigma_n^2)^{1/2},$$

where $\sigma_1, \sigma_2, \dots, \sigma_n$ are the individual frequency excursions (part per part). Furthermore, if the two oscillators make identical contributions to the

spectrum, the spectral contribution of a single oscillator can be assumed to be 3 dB less than the measured value.²

A less complicated system of measurement, shown in Fig. 7a, employs a frequency error expander, such as the Motorola S1061BR. It accepts any of eight commonly used standard frequencies between 250 kHz and 5 MHz, converts it to 1 MHz, expands phase or frequency deviations by 10, 100 or 1000, and provides an output at 1 MHz. This obviates the ticklish task of working with microwave frequencies. The error expander's output is fed into a 1-MHz crystal-controlled discriminator which translates it into a varying voltage. If the transfer characteristics or the slope of the discriminator is known in volts per hertz, peak or rms values of the short-term stability can be determined. The bandwidth of the Motorola unit accommodates observation intervals as small as 100 μ s. Longer intervals can be observed simply by use of a narrower filter following or preceding the discriminator.

To measure phase jitter rather than frequency instability, the system in Fig. 7b can be used. Once again the transfer characteristics of the phase comparator (which should be linear) must be known in volts per degree or volts per radian in order to calibrate the system. If, for instance, this ratio were 1 volt per radian, the maximum system sensitivity would be 1 volt per milliradian with the Motorola S1061BR's expansion capability.

Phase or frequency instabilities measured by either of the foregoing systems can be converted one into the other by means of the relationship: $\Delta\phi/2\pi f = \Delta f T/f$, where $\Delta\phi$ is the phase jitter and T is the observation time. Hence:

$$\Delta\phi = 2\pi f(\Delta f T/f)$$

and

$$\Delta f/f = \Delta\phi/2\pi f T.$$

The observation interval must be specified for meaningful data. ■ ■

References:

1. J. Schloemer and D. Sullivan, "The Relation between the Short-Term Stability and the Power Spectrum of a High-Stability Oscillator" (unpublished Motorola report).
2. Roy L. Chafin, "A Technique for Short-Term Oscillator Stability Measurements," *Proc. IRE*, XLVIII, Nov., 1960, 1914-1915.

CERMET



POTENTIOMETERS

IMMEDIATE DELIVERY FROM FACTORY OR DISTRIBUTOR STOCKS!

Complete stocks are now available of TRIMPOT® cermet element potentiometers in the full range of 10Ω to 1 Megohm.

Models 3012 and 3052 are in the familiar rectangular configurations, while the Model 3282 is a 3/8" square unit available in five mounting configurations . . . all three units are rated at 1 watt. All PALIRIUM® cermet potentiometers are designed and built to the usual Bourns high quality standards. They meet all the requirements of MIL-R-22097 and are ideal for applications requiring top performance under the most stringent environmental conditions.

Remember, Bourns is your best single source for the industry's widest selection of wirewound, cermet and carbon potentiometers. For detailed technical data sheets on these cermet units, contact your nearest Bourns office, representative or write the factory direct.

These units are stocked in depth, in all resistances and mounting configurations at the factory and by your local Bourns authorized distributor!

SPECIFICATIONS

	3012	3052	3282
Size	1 1/4 x 3/2 x 3/16"	1 1/4 x 3/16 x 3/16"	3/8 x 3/8 x 1/4"
Mechanical Adjustment	22 Turns	22 Turns	25 Turns
Resistance Range		10Ω to 1 Megohm	
Resistance Tolerance		±10% Standard	
End Settings		10Ω to 200Ω, 0.5% 500Ω to 1 Megohm, 0.1%	
Temperature Range		-65°C to +175°C	
Power Rating		1.0 watt at 70°C	
Temperature Coefficient	+25°C to +175°C	{ 10Ω to 200Ω, 0 to +500 PPM/°C 500Ω to 1 Meg, ±100 PPM/°C	
	+25°C to -65°C	{ 10Ω to 200Ω, +500 to -100 PPM/°C 500Ω to 1 Meg, +100 to -250 PPM/°C	
Humidity		100 Megohms minimum insulation resistance after removal from chamber	



BOURNS, INC., TRIMPOT DIVISION • 1200 COLUMBIA AVE., RIVERSIDE, CALIF.
TELEPHONE 714 684-1700 • TWX: 910 332-1252 • CABLE: BOURNSINC.

TRIMPOT® and Precision Potentiometers - Miniature Relays - Electronic Modules - Microcomponents.

10 amp subminiature relays at less than a buck an amp

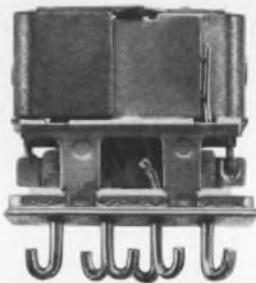

It's a new design. Not a short cut, but an instrumentation quality device that is built to MIL-R-5757.

(Seems we've built them so good, so long, we can't do it any other way, at any price.)

These 10 amp 2PDT relays come up to the 50 G shock and 15 G vibration specs and pass the 100K life cycling test.

They just aren't built to go through all those extreme space environ-

ments, so why pay the missile price? You get them by ordering our Series D. In several mounting and terminal configurations. And, of course, the under-a-buck-an-amp part does mean in quantity.

Get all the details by phoning us at Leach Corporation, Relay Division (213) 323-8221.

Or write: 5915 South Avalon Boulevard, Los Angeles 90003. Export is Leach International S.A.

LEACH

Ever need plug-in power supplies in a hurry?
 Send for our 1967 catalog.
 It lists 62,000 different types.
 The one you need will be shipped in 3 days.
 (We've never failed to make good on this promise)

Waim DUAL OUTPUT SOLID STATE REGULATED POWER SUPPLIES (400 MA MAX.) Ambient temperature rating 0 to 85°C.

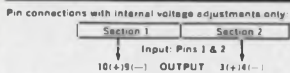
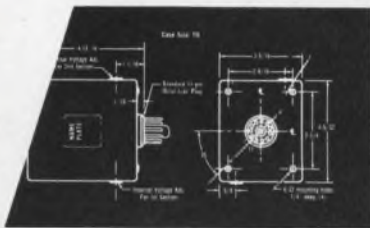

Pin connections for models with provisions for both internal and remote adjustment. (Models with prefix "E" See optional feature: Remote output adjustment.)

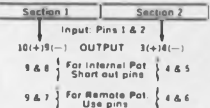

SPECIFICATIONS
 INPUT VOLTAGE: 105-125V AC, 50 to 400 cycle single phase.
 OUTPUT VOLTAGE SEE SECTIONS
 OUTPUT CURRENT SPECIFIC SECTIONS
 REGULATION SPECIFIC SECTIONS
 RIPPLE SPECIFIC SECTIONS
 OUTPUT VOLTAGE ADJUSTMENT: ±1 volt, adjustment provided for each section.
 POLARITY: Outputs are floating. Each individual section may be connected as a separate power supply. Either negative or positive side of one section may be grounded irrespective of the other section.
 IMPEDANCE: Approximately 2 ohm at 10KC.
 TEMPERATURE: Continuous duty at full load from 0 to 55°C ambient.
 INSTALLATION: Plugs into standard 11 pin octal type socket. Mounting holes (6-32) provided at each corner for installation in any position.
 WEIGHT: 2 1/2 to 3 lbs., depending on model.

FEATURES
 Identical or different sections may be selected • Short circuit protection • No additional heat sinking required • May be used in series • Not encapsulated.

HOW TO ORDER
 Select two sections desired. The Model Number is the combination of the two sections selected. Example: Section 6B10DL and section 12A40D is Model 6B10DL 12A40D. Always assign the lower voltage section first.
 For pricing purposes, add the cost of the individual sections selected. Example: Model 6B10DL 6B10DL - Price: \$120.00.

OPTIONAL FEATURES
REMOTE OUTPUT ADJUSTMENT - All standard dual power supplies are provided with accessible internal voltage adjustments. For remote internal adjustments, add prefix "E" to model number and add \$7.00 to price. Example: 6B80DL 12B20DL "E" power supplies will have provisions for both internal and remote adjustments in both sections.
REMOTE SENSING - Provision for remote sensing of the output voltages so as to compensate for drops in the load lines can be furnished at an additional charge of \$20.00 per model. Add prefix "R" to model number when ordering. "R" power supplies will also have provisions for both internal and remote output adjustment.

216 VOLT INPUT - All standard units can be furnished to accept an input of 210 to 250V. Add suffix "230" to model number. Additional cost: \$10.00.

Model Number	Output Voltage	Output Current (amp)	REGULATION (Line %)	Regulation (Load %)	Ripple (mV)	Price (100's of Dollars)	Section (1st Order)
21.5	200	1	0.5	0.5	1	1.40	21B10DL
21.5	100	1	0.5	0.5	1	1.40	21B20DL
22.5	200	1	0.5	0.5	1	1.40	22B10DL
22.5	100	1	0.5	0.5	1	1.40	22B20DL
4	200	1	0.5	0.5	1	1.40	4B10DL
4	100	1	0.5	0.5	1	1.40	4B20DL
5	200	1	0.5	0.5	1	1.40	5B10DL
5	100	1	0.5	0.5	1	1.40	5B20DL
6	200	1	0.5	0.5	1	1.40	6B10DL
6	100	1	0.5	0.5	1	1.40	6B20DL
7	200	1	0.5	0.5	1	1.40	7B10DL
7	100	1	0.5	0.5	1	1.40	7B20DL
8	200	1	0.5	0.5	1	1.40	8B10DL
8	100	1	0.5	0.5	1	1.40	8B20DL
9	200	1	0.5	0.5	1	1.40	9B10DL
9	100	1	0.5	0.5	1	1.40	9B20DL
10	200	1	0.5	0.5	1	1.40	10B10DL
10	100	1	0.5	0.5	1	1.40	10B20DL
11	200	1	0.5	0.5	1	1.40	11B10DL
11	100	1	0.5	0.5	1	1.40	11B20DL
12	200	1	0.5	0.5	1	1.40	12B10DL
12	100	1	0.5	0.5	1	1.40	12B20DL
13	200	1	0.5	0.5	1	1.40	13B10DL
13	100	1	0.5	0.5	1	1.40	13B20DL
14	200	1	0.5	0.5	1	1.40	14B10DL
14	100	1	0.5	0.5	1	1.40	14B20DL
15	200	1	0.5	0.5	1	1.40	15B10DL
15	100	1	0.5	0.5	1	1.40	15B20DL
16	200	1	0.5	0.5	1	1.40	16B10DL
16	100	1	0.5	0.5	1	1.40	16B20DL
17	200	1	0.5	0.5	1	1.40	17B10DL
17	100	1	0.5	0.5	1	1.40	17B20DL
18	200	1	0.5	0.5	1	1.40	18B10DL
18	100	1	0.5	0.5	1	1.40	18B20DL
19	200	1	0.5	0.5	1	1.40	19B10DL
19	100	1	0.5	0.5	1	1.40	19B20DL
20	200	1	0.5	0.5	1	1.40	20B10DL
20	100	1	0.5	0.5	1	1.40	20B20DL
21	200	1	0.5	0.5	1	1.40	21B10DL
21	100	1	0.5	0.5	1	1.40	21B20DL
22	200	1	0.5	0.5	1	1.40	22B10DL
22	100	1	0.5	0.5	1	1.40	22B20DL
23	200	1	0.5	0.5	1	1.40	23B10DL
23	100	1	0.5	0.5	1	1.40	23B20DL

Acopian DUAL OUTPUT SOLID STATE REGULATED POWER SUPPLIES (400 MA MAX.) Ambient temperature rating 0 to 85°C.

Model Number	Output Voltage	Output Current (amp)	REGULATION (Line %)	Regulation (Load %)	Ripple (mV)	Price (100's of Dollars)	Section (1st Order)
24	200	1	0.5	0.5	1	1.40	24B10DL
24	100	1	0.5	0.5	1	1.40	24B20DL
25	200	1	0.5	0.5	1	1.40	25B10DL
25	100	1	0.5	0.5	1	1.40	25B20DL
26	200	1	0.5	0.5	1	1.40	26B10DL
26	100	1	0.5	0.5	1	1.40	26B20DL
27	200	1	0.5	0.5	1	1.40	27B10DL
27	100	1	0.5	0.5	1	1.40	27B20DL
28	200	1	0.5	0.5	1	1.40	28B10DL
28	100	1	0.5	0.5	1	1.40	28B20DL
29	200	1	0.5	0.5	1	1.40	29B10DL
29	100	1	0.5	0.5	1	1.40	29B20DL
30	200	1	0.5	0.5	1	1.40	30B10DL
30	100	1	0.5	0.5	1	1.40	30B20DL
31	200	1	0.5	0.5	1	1.40	31B10DL
31	100	1	0.5	0.5	1	1.40	31B20DL
32	200	1	0.5	0.5	1	1.40	32B10DL
32	100	1	0.5	0.5	1	1.40	32B20DL
33	200	1	0.5	0.5	1	1.40	33B10DL
33	100	1	0.5	0.5	1	1.40	33B20DL
34	200	1	0.5	0.5	1	1.40	34B10DL
34	100	1	0.5	0.5	1	1.40	34B20DL
35	200	1	0.5	0.5	1	1.40	35B10DL
35	100	1	0.5	0.5	1	1.40	35B20DL
36	200	1	0.5	0.5	1	1.40	36B10DL
36	100	1	0.5	0.5	1	1.40	36B20DL
37	200	1	0.5	0.5	1	1.40	37B10DL
37	100	1	0.5	0.5	1	1.40	37B20DL
38	200	1	0.5	0.5	1	1.40	38B10DL
38	100	1	0.5	0.5	1	1.40	38B20DL
39	200	1	0.5	0.5	1	1.40	39B10DL
39	100	1	0.5	0.5	1	1.40	39B20DL
40	200	1	0.5	0.5	1	1.40	40B10DL
40	100	1	0.5	0.5	1	1.40	40B20DL
41	200	1	0.5	0.5	1	1.40	41B10DL
41	100	1	0.5	0.5	1	1.40	41B20DL
42	200	1	0.5	0.5	1	1.40	42B10DL
42	100	1	0.5	0.5	1	1.40	42B20DL
43	200	1	0.5	0.5	1	1.40	43B10DL
43	100	1	0.5	0.5	1	1.40	43B20DL
44	200	1	0.5	0.5	1	1.40	44B10DL
44	100	1	0.5	0.5	1	1.40	44B20DL
45	200	1	0.5	0.5	1	1.40	45B10DL
45	100	1	0.5	0.5	1	1.40	45B20DL
46	200	1	0.5	0.5	1	1.40	46B10DL
46	100	1	0.5	0.5	1	1.40	46B20DL
47	200	1	0.5	0.5	1	1.40	47B10DL
47	100	1	0.5	0.5	1	1.40	47B20DL
48	200	1	0.5	0.5	1	1.40	48B10DL
48	100	1	0.5	0.5	1	1.40	48B20DL
49	200	1	0.5	0.5	1	1.40	49B10DL
49	100	1	0.5	0.5	1	1.40	49B20DL
50	200	1	0.5	0.5	1	1.40	50B10DL
50	100	1	0.5	0.5	1	1.40	50B20DL
51	200	1	0.5	0.5	1	1.40	51B10DL
51	100	1	0.5	0.5	1	1.40	51B20DL
52	200	1	0.5	0.5	1	1.40	52B10DL
52	100	1	0.5	0.5	1	1.40	52B20DL
53	200	1	0.5	0.5	1	1.40	53B10DL
53	100	1	0.5	0.5	1	1.40	53B20DL
54	200	1	0.5	0.5	1	1.40	54B10DL
54	100	1	0.5	0.5	1	1.40	54B20DL
55	200	1	0.5	0.5	1	1.40	55B10DL
55	100	1	0.5	0.5	1	1.40	55B20DL

ELECTRONIC DESIGN 13, June 21, 1967

ON READER-SERVICE CARD CIRCLE 39

Acopian Corp., Easton, Pennsylvania (215) 258-5441



Delay distortion can be eliminated

from instrumentation systems simply by exploiting the inverse response of all-pass networks.

Data-transmission and storage systems are subject to several forms of distortion. Frequency distortion (the variation in transmission gain or loss with frequency) and amplitude distortion (described by harmonic and intermodulation products) are well known and are corrected by conventional techniques. A third form of distortion that is receiving increasing attention is delay distortion. This can cause serious impairment of complex waveforms and misinterpretation of recorded data.

Delay distortion, sometimes called phase distortion, is caused by differences in the transmission time of frequency components and harmonics of complex waveforms as they travel through a transmission system. Take, for instance, a tape recording and reproducing system. This is a time-delay system, where the delay time may be anything from a fraction of a second to several years. So long as all the recorded frequency components take exactly the same transmission time, there is no delay distortion.

In many cases, however, multiple generation copies are made between the original master recording and the end product. Each generation of equalization and head/tape characteristic produces delay errors. These time-delay errors are generally not random but directly additive. This is because the delay errors are generated by identical mechanisms for each of the multiple recordings. One result is deterioration of the rise time of steep wave fronts. In the case of a modulated carrier such as in AM and FM recording, the upper and lower sidebands may be delayed by unequal amounts. This causes nonlinear shifts in the carrier-axis intercepts and quadrature distortion of the demodulated output signals.

Experiments were carried out with a 1.5-MHz system. The results and corrective methods to be described are applicable to other instrumentation, and video and audio recording and reproducing systems.

The recording amplifiers and record head driv-

ers used were designed for uniform flux-versus-frequency recording characteristics. This means that the frequency response and time delay of the recorded flux pattern on the magnetic tape should have been essentially constant for all frequencies within the system passband. An exception to this was the high-frequency pre-emphasis in the record head driver. This was to compensate for magnetic circuit losses in the record head.

Along with the pre-emphasis was a phase lead at 1.5 MHz which caused a slight increase in high-frequency envelope delay. The result was an essentially constant recorded flux as a function of frequency up to 1.5 MHz. The increase in delay at high frequencies did not appear significant in comparison with the variations in delay caused by record bias level.

Phase and frequency determine delay

Delay may be defined as the transmission time for a single frequency component of a waveform through a system, that is, $T_d = \phi/\omega$, where ϕ is phase shift in radians and ω is frequency in radians per unit time. Where the original signal is not available for a comparative measurement of frequency and phase, the term envelope delay is used. Envelope delay is the slope of the phase-shift curve at the frequency of interest:

$$T_e = d\phi/d\omega \approx \Delta\phi/\Delta\omega = (\phi_2 - \phi_1)/(\omega_2 - \omega_1).$$

Envelope delay as a function of recorded frequency for three bias-current levels measured at the output of the reproduce preamplifier is plotted in Fig. 1. These response curves may be divided roughly into three regions.

In the low-frequency region, the reproduce head output increases at a rate of approximately 6 dB per octave and is accompanied by decreasing envelope delay. This is the result of the differentiating action of the reproduce head on the recorded tape flux pattern. This differentiating action is offset by the integrating action of the reproduce equalizer.

In the mid-frequency region, the 6-dB-per-octave rise is offset by the self-demagnetization or thickness losses, which cause a 6-dB-per-octave decrease in output. This is the range where the

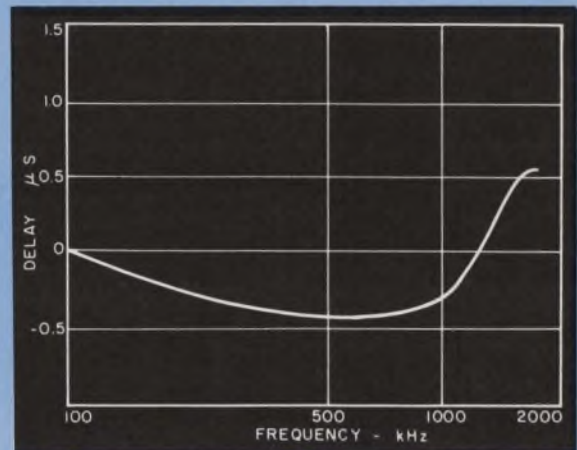
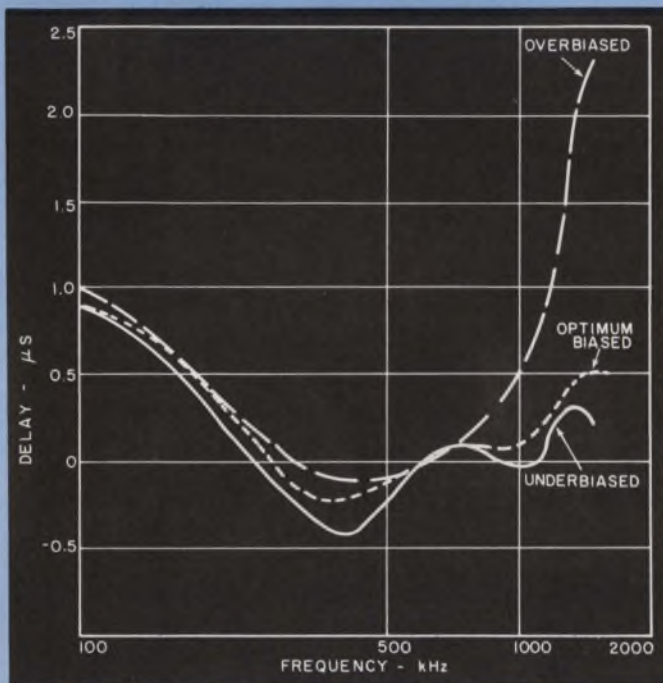

2. Most envelope delay of reproduce signals occurs at high frequencies because of the rapid increase in high-frequency equalizer gain.

1. Rapid increase occurs in envelope delay of high-frequency signals as record bias current is increased above its optimum value. This is shown by these curves of envelope delay at the preamplifier output.

dimension of the recorded wavelength approaches that of the thickness of the magnetic oxide. Frequency and delay response are relatively uniform in this region, subject to mid-frequency adjustment of the reproduce equalizer.

In the high-frequency region, the reproduce head output is attenuated at a rapidly increasing rate by several factors. These include:

- Spacing loss.
- Azimuth misalignment loss.
- Gap loss (aperture effect).
- Magnetic circuit losses.

Although these combined losses result in considerable attenuation of signal level as the reproduced frequency increases, they do not cause appreciable change in the envelope delay.

The response curves of Fig. 1 show that the

envelope delay of short-wavelength signals increases rapidly as the record bias current is increased above optimum value. Tests indicate that minimum envelope-delay distortion occurs at record and bias levels that magnetize only the surface layer of the magnetic oxide. Excessive penetration of the magnetic oxide by the recording field causes loss of high frequencies, apparently due to demagnetization, and time-delay distortion due to the virtual recording point's shifting with wavelength. These effects seem insignificant at wavelengths longer than the thickness of the magnetic oxide layer.

The reproduce signal, when properly biased and equalized for uniform frequency response, has a typical delay response similar to that in Fig. 2. Most of this delay error is at the high-frequency

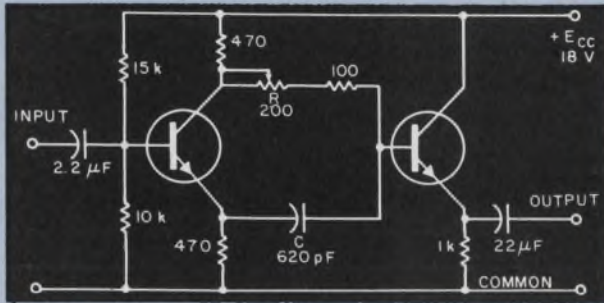

3. Adjustment of resistor R controls the frequency at which maximum delay occurs in this delay equalizer.

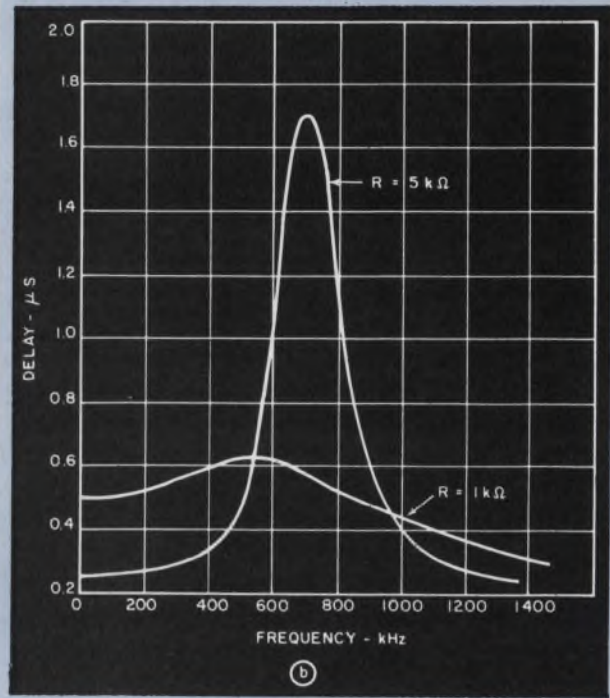
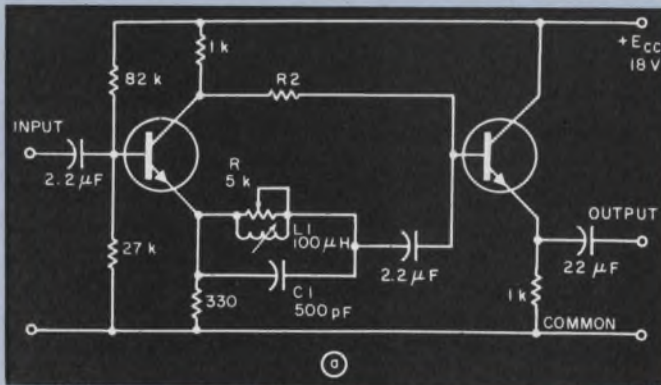

4. Two adjustments are used in this more complex delay equalization network (a). Coil L1 adjusts the frequency of maximum delay and resistor R controls the bandwidth of the delay peak. The delay vs frequency of the network is shown in (b).

end of the passband and is a result of the rapid increase in high-frequency equalizer gain.

Since the amount of high-frequency postequalization needed depends on record and reproduce head/tape conditions, the amount of resulting envelope-delay error is highly variable. These delay variations are not necessarily related to frequency response and so are best compensated for separately from the amplitude equalization.

Inverse response cures distortion

Envelope-delay distortion is corrected by the addition of a delay-versus-frequency characteristic that is the inverse of that to be corrected. A negative delay cannot be added, for a signal cannot leave a network before it has entered. Therefore, it is necessary to add all-pass networks that have delays such that the sum of the delays which the signal encounters is nearly constant at all frequencies within the passband. The amount of delay correction necessary depends on adjustment of the amplitude equalizer and on the record/reproduce conditions. The delay equalizer has thus to be adjustable, both in frequency and in magnitude of delay, at staggered frequencies within the passband. The delay equalizers to be discussed are those which theoretically introduce either zero or a fixed amount of attenuation at all frequencies within the passband. Hence they can

be added to existing circuits for delay correction without distorting gain characteristics.

All-pass networks may be classified as either passive or active. The passive networks usually considered for distortion correction are constant-resistance, recurrent structures designed to match a line impedance. The relatively large number of reactive elements in passive networks makes adjustment of the frequency and amplitude of delay rather difficult.

A simple type of active delay equalizer is shown in Fig. 3. It consists of a split-load phase inverter with equal collector and emitter load resistances. The emitter and collector signals are equal in amplitude but 180° out of phase with each other. Both signals are summed together, one through a resistance and the other through a reactance. As the signal frequency changes from the lower to the upper limits of bandwidth, the phase change approaches 180° at the summing point. Adjustment of the summing resistance controls the frequency at which maximum delay is obtained. The component values shown are for the 1.5-MHz instrumentation system.

Another type of delay equalization network is shown in Fig. 4a. This network consists of a balanced signal applied to resistive and reactive arms. The signals from the two arms are summed at a common high-impedance point.

Two adjustments per stage are used in this

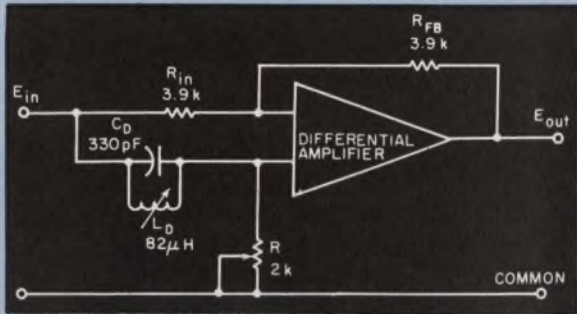

5. Differential amplifier network has distinct advantages for delay equalizer use. Phase inversion is not required and direct coupling of stages is possible.

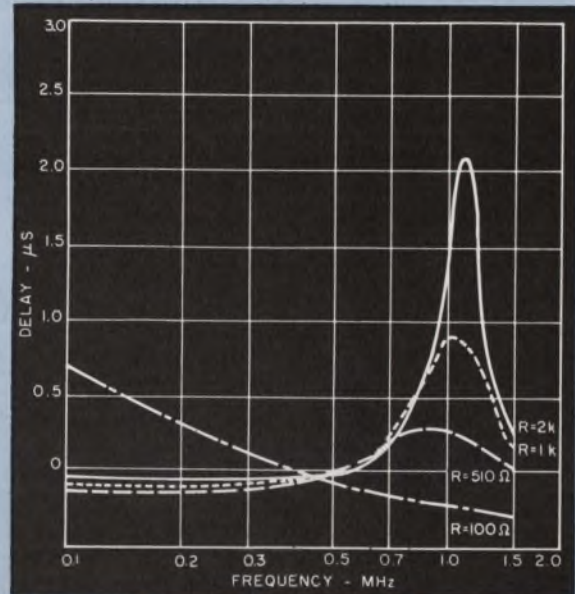

6. Delay in differential amplifier network is controlled by variable resistor (Fig. 5). The frequency of the delay peak is controlled by the variable inductance. These adjustments are not interacting.

network. Variation of L_1 is used to adjust the frequency of maximum delay. R is used to adjust the tuned-circuit Q and thus control the bandwidth of the delay peak. R_2 is selected to balance the out-of-phase signal amplitude at the summing point in order to minimize variations of output signal amplitude with frequency.

A phase rotation approaching 360° is obtained at the signal summing point as the signal frequency is changed from the lower to the upper limits of bandwidth. The rate of change with respect to frequency is the delay determined by resonant-circuit Q (see Fig. 4b).

The block diagram in Fig. 5 illustrates a third type of active delay equalizer. This circuit uses a differential operational amplifier that has balanced input and single-ended output. The output signal is proportional to the difference between the two input signals:

$$E_{out}/E_{in} = (R - jx)/(R + jx).$$

This circuit's advantages become evident when it is compared with the circuits of Figs. 3 and 4a. The latter two require a phase inverter with biasing networks and large tantalum capacitors for dc blocking. The differential input of the circuit in Fig. 5 eliminates the need for phase inversion and its low dc offset allows a number of stages to be directly coupled. The high open-loop gain gives a large amount of negative feedback

and makes it possible to approach the desired transfer function more closely. Relatively low impedances are used in the reactive network so that loading effects and stray capacitances do not appreciably disturb the frequency and phase characteristics. Figure 6 shows the measured response for a single stage. The adjustable resistor controls the amount of delay and the adjustable inductance controls the frequency of the delay peak. These adjustments are not interacting. A typical delay equalizer consists of a number of all-pass sections in tandem, each of which inserts a controlled amount of delay at a selected frequency. Larger amounts and larger bandwidths of delay require more delay sections. The advent of integrated circuits makes this operational-amplifier approach to delay equalization practical. ■ ■

Reference:

1. W. E. Stewart, *Magnetic Recording Techniques* (New York: McGraw-Hill Book Co., Inc., 1958), Appendices I, V and VI.

Bibliography:

Bennett and Davey. *Data Transmission*. New York: McGraw-Hill Book Co., Inc., 1965. Chap. 15.
 Cannon, W. D. "Delay Distortion Correction," *Communications and Electronics*, March, 1956 pp. 55-61.
 Geffe, P. R. *Simplified Modern Filter Design*. New York: John F. Rider, Inc., 1963. Pp. 70-75.
 Star, Jack. "Envelope Delay in a Tape Recorder System," *Solid State Design*, VI, No. 6 (June, 1965), 27-33.
 Storer, J. E. *Passive Network Synthesis*. New York: McGraw-Hill Book Co., Inc., 1957.
 Weinberg, L. *Network Analysis and Synthesis*. New York: McGraw-Hill Book Co., Inc., 1962.

After you've placed an important order for silicon power transistors, can you sit back and relax, confident that everything will proceed smoothly and on schedule?

Or is that when you have to haul out a big whip and start cracking it to keep your semiconductor supplier in line?

If you're like many others in our industry today, you've probably been wondering about what ever happened to the idea of a "buyer's market," where the supplier bends over backwards to satisfy your requirements. Instead, you've had to become a whip-wielder to defend yourself against broken delivery promises, unexplained delays, costly paperwork, phone calls, telegrams and constant expediting—not to mention spiraling prices and problems of technical service and quality control.

Well, get ready to put away that whip, because there is an easier way!

Our Semiconductor Division is now in production on a selection of the most popular types of silicon power transistors, with power ratings from 5 watts to 85 watts. We'll be adding other types soon, but here's the starting line-up:

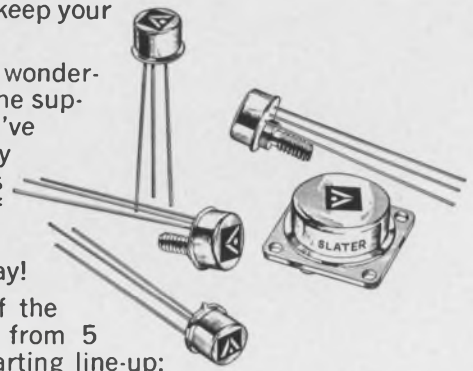

TYPE	POWER	PACKAGE	TYPE	POWER	PACKAGE	TYPE	POWER	PACKAGE	TYPE	POWER	PACKAGE
2N389	85 w	TO-53	2N1048	40 w	TO-57	2N1050A	40 w	TO-57	2N1769	40 w	TO-57
2N389A	85 w	TO-53	2N1048A	40 w	TO-57	2N1050B	40 w	TO-57	2N2032	85 w	TO-53
2N424	85 w	TO-53	2N1048B	40 w	TO-57	2N1116	5 w	TO-5	2N2033	8.75 w	TO-5
2N424A	85 w	TO-53	2N1049	40 w	TO-57	2N1117	5 w	TO-5	2N2034	8.75 w	TO-5
2N1047	40 w	TO-57	2N1049A	40 w	TO-57	2N1690	40 w	TO-57	2N2858	8.75 w	TO-5
2N1047A	40 w	TO-57	2N1049B	40 w	TO-57	2N1691	40 w	TO-57	2N2859	8.75 w	TO-5
2N1047B	40 w	TO-57	2N1050	40 w	TO-57	2N1768	40 w	TO-57	2N2911	8.75 w	TO-5

The next time you need any of these types, in any quantity, try the easy way—the Slater way. Delivery? Immediate, thanks to unique production break-throughs that give us the highest quality yield rates ever attained. Prices? Very, very competitive—which is a polite way of saying that we really mean business. Service? The kind you deserve, but haven't had in many years. As a starter, we invite you to lay down your whip and call us collect today for quotes, tech data or anything else that will help make your job easier.

SEMICONDUCTOR DIVISION, SLATER ELECTRIC INC., 45 SEA CLIFF AVE., GLEN COVE, N.Y., 516-671-7000



**There must be
an easier way to buy
silicon power transistors.**





BETTER QUALITY AND RELIABILITY THROUGH CONTROL

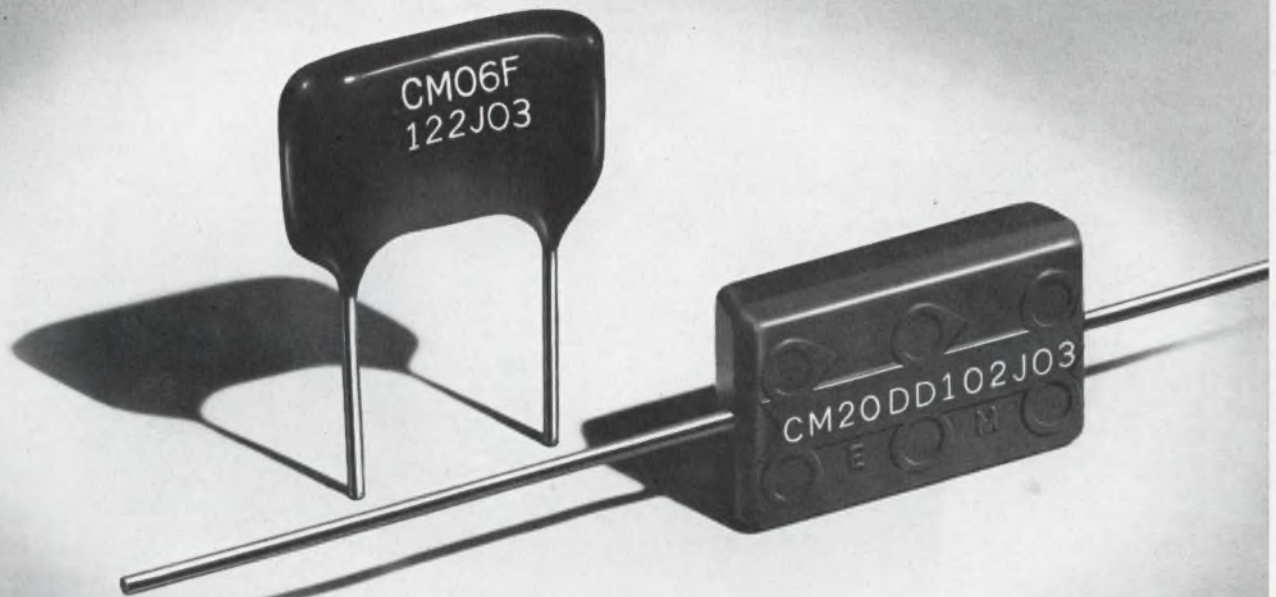

Shown 2½ x Actual Size

Capacitor Problems That Require A Lot Of Self-Control...Chemically Speaking

Problem 1: How to make sure the silver paste composition used for electrodes provides the best results for each electrical parameter in a given capacitor design?

Problem 2: How to improve the recognized moisture reliability of our dipped mica capacitors without adversely affecting life reliability?

Problem 3: How to upgrade the reliability of molded mica capacitors to equal that of dipped mica capacitors so designers can take advantage of body uniformity and axial lead design?

Solution: Chemical self-control! To do this we operate our own chemical manufacturing plant where we formulate silver pastes, phenolic dipping compounds, and epoxy molding compounds — all under strict controls.

Result: Dipped mica capacitors and molded mica capacitors of equally high reliability that operate up to 150°C. Send for technical literature and always insist on El-Menco brand capacitors . . . your assurance of better quality and reliability through control.

THE ELECTRO MOTIVE MFG. CO., INC.

WILLIMANTIC, CONNECTICUT 06226

Dipped Mica • Molded Mica • Silvered Mica Films • Mica Trimmers & Padders
Mylar-Paper Dipped • Paper Dipped • Mylar Dipped • Tubular Paper

Exclusive Supplier to Jobbers and Distributors
in the U. S. and Canada:
ARCO ELECTRONICS, INC., Community Drive.
Great Neck, L. I., New York

West Coast Manufacturers contact:
COLLINS & HYDE CO., 900 N. San Antonio Rd.,
Los Altos, California 94022
5380 Whittier Blvd., Los Angeles, California.

ON READER-SERVICE CARD CIRCLE 41

Design reliable printed switches

by considering not only electrical parameters but manufacturing and materials requirements as well.

Reliability is always a major design consideration for producers of military and space electronic hardware. And one area where high reliability is extremely important is printed-circuit rotary switches (Fig. 1). Because of the many different causes of switch failure, and consequent system and program failure, military specifications usually spell out very exact design limitations and test criteria for switches. They may be specified in detail or by product definition, but in either case, to produce a suitable end product, it is essential for the designer to be familiar with the problems inherent in switch design and manufacture.

The function of printed-circuit rotary-switch assemblies is to route signals from point to point in a system and to interrupt these signals when required. An acceptable switch assembly should have no other appreciable effect on the signal. To prevent signal modification and extend the reliability of contact assemblies, it is necessary to consider a number of switch parameters during the design stage, including contact materials, contact configuration, contact pressure, torque, contact resistance, and noise.

Contact materials and contact configuration are determined by the particular design, and are basic to an acceptable product. Contact pressure and torque, while primarily dependent on design parameters, are widely influenced by fabrication procedures and the materials used. A prime consideration in contact design is the choice of electroplating and the specification of cleaning procedures. This is because the metal-to-metal wiping action of the switch may cause rapid assembly failure if cleaning and electroplating are not properly performed.

Contact considerations are important

Printed-circuit switches usually consist of two rotary wipers, the printed-circuit board, and a spacer to separate the contacts (Fig. 2). Since the wiper arm makes a point contact with the printed-circuit switch, there is a much larger surface area

of the printed-circuit board than of the contact to affect performance. Nevertheless, it is the combined effect of the contact characteristics and the printed-circuit characteristics that determines the performance of the assembly. It is important, therefore, that each of these items be given careful consideration.

The contact pressure on the track area of the printed switch is determined by the physical characteristics of the wiper arm, the disk thickness, and the printed-circuit-board thickness. Some of the physical characteristics of the wiper arm that influence contact pressure are sweep radius from center of rotor to contact point, width of arm, thickness of arm, contact alloy, thickness and nature of electrode-deposited material, and deflection of contact arm before assembly. In addition, the heat treating of the contact arm, which can be adjusted, may alter the deflection pressure.

Several materials are satisfactory for contact

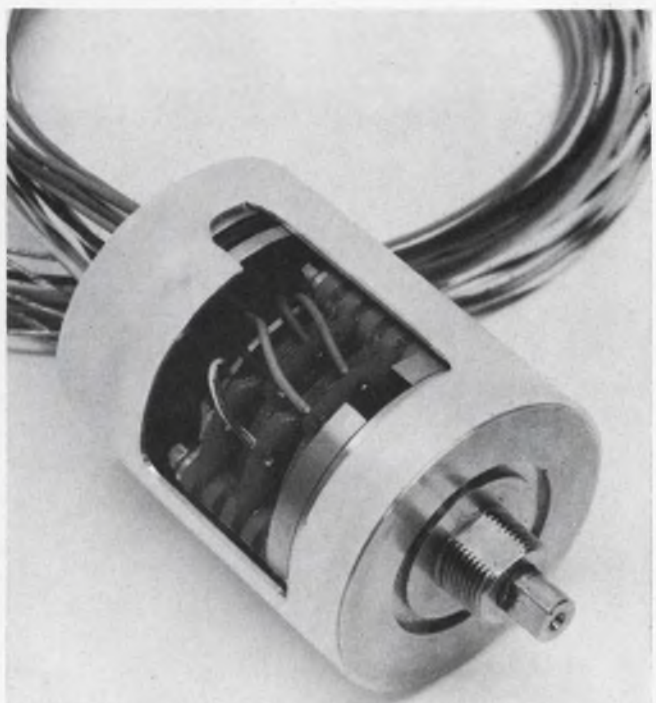

1. Construction of high-reliability PC rotary switch is shown in cutaway. Such assemblies are widely used in military and space electronics systems.

Fred W. Kear, Engineer, Sparton Southwest, Inc., Albuquerque, N. M.

fabrication. Some of the most widely used are proprietary alloys manufactured by firms specializing in switch materials. Although most of these require no electroplating, they also do not offer as wide a choice of contact characteristics as do beryllium-copper contacts. Beryllium-copper contacts, however, must usually be electroplated.

Usually, nickel and rhodium are electroplated on the beryllium-copper to provide wear and oxidation resistance. A copper underplate is also specified to provide good adhesion for the nickel.

Beryllium-copper is much less expensive than proprietary alloys, even with the rhodium overplate. Moreover, it offers wide design variations through heat treating, and different wiper-arm widths and thicknesses. Nevertheless, in cases where the thermal coefficient of expansion of the switch material must be compatible with stainless steels or similar materials, it may be better to use Paliney or some other alloy for the wiper.

The contact pressure of a rotary-switch assembly and frictional forces determine the torque required for operation. Both factors are subject to variations, resulting from manufacturing tolerances and processing, throughout wiper travel.

In general, there are two manufacturing methods for contacts: they can be either blanked or chemically milled. From a design standpoint, there is little to choose between the methods, but it is much less expensive to design tooling and produce small quantities by chemical milling. If several thousand of the contacts are to be produced, though, it is cheaper to produce them by blanking. In either case, tooling will have to be provided to dimple the contact. It is extremely important for the contact dimple to be produced at the proper radius of rotation, for the dimple to be smooth, and for its size to be correct.

The designer should make allowance for wiper arms to be wider if they are to be chemically milled than if they are to be blanked. This will compensate for the chemical undercut that occurs during etching.

Another good practice is to provide for tumble deburring of contacts, especially if they are blanked from coil stock. Deburring not only removes blanking burrs, but provides dimple surfaces that are lower in torque than nontumbled contacts. This is because surface pits tend to become burnished during tumbling.

Two basic switch varieties used

There are two basic types of rotary printed-circuit switch: the break-before-make type and the make-before-break type. Physically, the commutator track of the break-before-make configuration has an isolated segment that separates active segments (Fig. 3a). In riding over this isolated segment, the wiper breaks from one

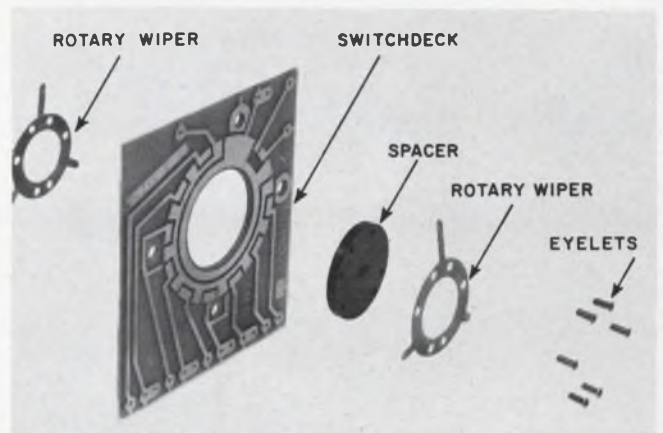

2. Exploded view shows relationship of printed-circuit rotary switch parts.

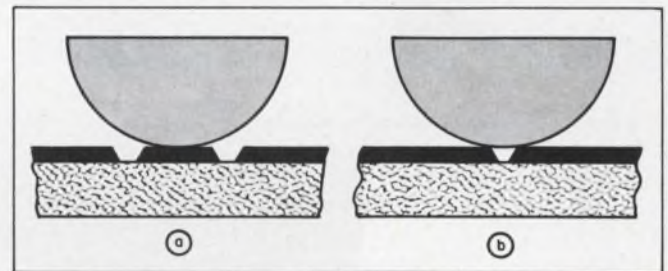

3. Two basic configurations are used in rotary switches. In the break-before-make type (a), an insulated island breaks contact before the wiper makes contact with the next segment. In the make-before-break type (b), the wiper makes contact with the next segment before it leaves the previous segment.

active portion of the track before it reaches the next. The make-before-break configuration, on the other hand, allows the wiper to contact two active portions of the track at the break point (Fig. 3b).

In many switch designs, the starting and stopping points of active segments serve timing functions. It is therefore important for the track dimensions to be carefully controlled on the printed-circuit artwork. Timing-switch segments perform such functions as charging capacitors in integrating circuits, providing logic functions, and arming squibs. Sometimes these functions require the break-before-make switch and sometimes they require the make-before-break switch. In either case, where timing accuracy is important, the thinnest possible copper-clad laminate should be used to allow greater accuracy in etching. Thicker laminates cause wider variations in circuit widths, and therefore greater timing variations.

Usually, the current rating of the switch is not a limiting factor in laminate thickness; but if the thinner copper on the laminate material is going to produce a marginal switch, there are two design recourses. The switch segments and the dimple contour on the wiper can both be made larger, or the segment can be electroplated with copper to provide greater current-carrying capability. In

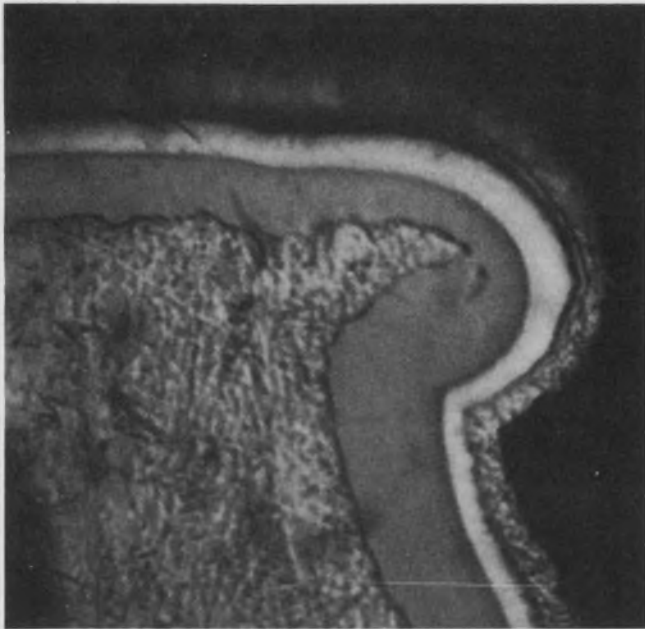

(a)

4. Edges of switch segments should be polished prior to plating to prevent segment degradation under wiper-arm pressure. An unpolished segment edge is shown in (a) after use. A polished edge used under the same pressure is shown in (b).

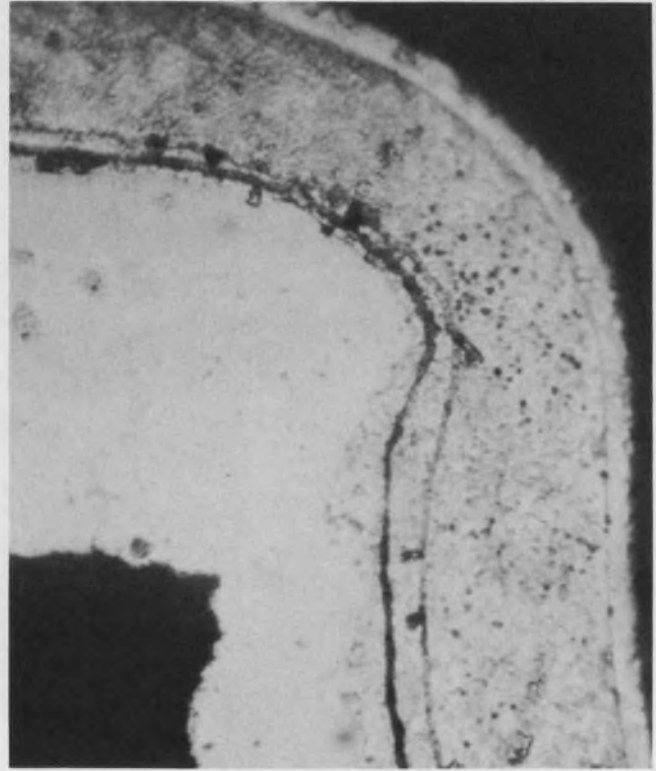

(b)

any case, the contact point between the wiper and the switch segment will probably limit current more than the conductor segment itself.

For the greatest reliability in rotary switches—and most military specifications are written around these requirements—the printed-circuit switch segments should be plated with nickel and rhodium, just as the wiper contact is. This provides exceptionally good wear-resistance, as well as good thermal-coefficient-of-expansion matching between the wiper and the switch segments. It also prevents switch deterioration from galvanic action. To reduce torque and electrical noise, most specifications call for the switch segments to be overplated with a gold flash. The plating thicknesses on the wiper and printed-circuit board are usually: nickel—0.0001 in. to 0.0003 in.; rhodium—0.00004 in. to 0.00008 in.; and gold—0.00002 in. to 0.00007 in.

Design for reliability

Two major factors govern the reliability of rotary-contact assemblies: assembly contamination and assembly wear. The amount of wear and contamination, in turn, are determined by the switch's manufacture and the environment in which it is used. The switch designer must therefore make allowance for both of these factors by understanding both manufacturing procedures and the effect of environments on materials.

At one time, for example, it was thought that flush circuits might greatly reduce switch degradation because of the lessened contact wear. But

experience proved that the carry-over of epoxy by the contact caused greater deterioration than contact wear. Now that this is understood, it is easier to design a reliable switch.

There are other factors that must be considered in switch design that are also highly important to reliability. For instance, it is essential for the edge of the switch segments to be polished before plating. Figure 4 shows the effects of polishing. Figure 4a is an unpolished switch edge after use under wiper pressure; Fig. 4b is a switch edge that has been polished and subjected to the same wiping action. These two examples demonstrate the advantages of polishing printed switch decks before plating.

Most military switch programs call for quality assurance steps to verify control of plating thicknesses and edge conditions. This can be done by sectioning the printed-circuit boards and wiper contacts on a lot control basis, and microinspecting the sections. This inspection may be recorded photographically or written in the test records.

Wiper profiles are usually checked on optical comparators to verify dimple geometries and the correct deflection. Staging fixtures fix the wiper location during these checks, and optical gauges offer a rapid means of determining product acceptability. Final switch torques, contact pressure and current rating may be traded off more effectively after switch performance has been tested. But none of these is of importance if the switch life and environmental characteristics are unacceptable. And only performance tests can definitely establish these facts. ■ ■

have you noticed how everybody's just introducing big, fast, core-memory systems that we've been delivering for more than a year?

When we first introduced our NANOMEMORY™ 900 at the 1964 Fall Joint Computer Conference, we claimed an access time of 350 nanoseconds and a memory capacity of 16,384 words of 84 bits. A little later we developed the NANOMEMORY 650. Same capacity but with an access time of 300 nanoseconds.

Soon after we started shipping, reports came in calling our claims, if anything, too conservative. Operating margins were indeed wider. And with the stack connections reduced by 80%, the reliability gave maintenance managers no end of pleasure.

But more gratifying than the compliments were the re-orders. Of the many systems being assembled on the floor right now, 80% are engaged. If you want to stay ahead of your competition, call or write us about the 20% that are still unattached. Ask for Litpak 6E.

EM electronic memories

12621 Chadron Avenue, Hawthorne, California 90250
Telephone (213) 772-5201



The Victor Digital Printer, just \$335. \$335?

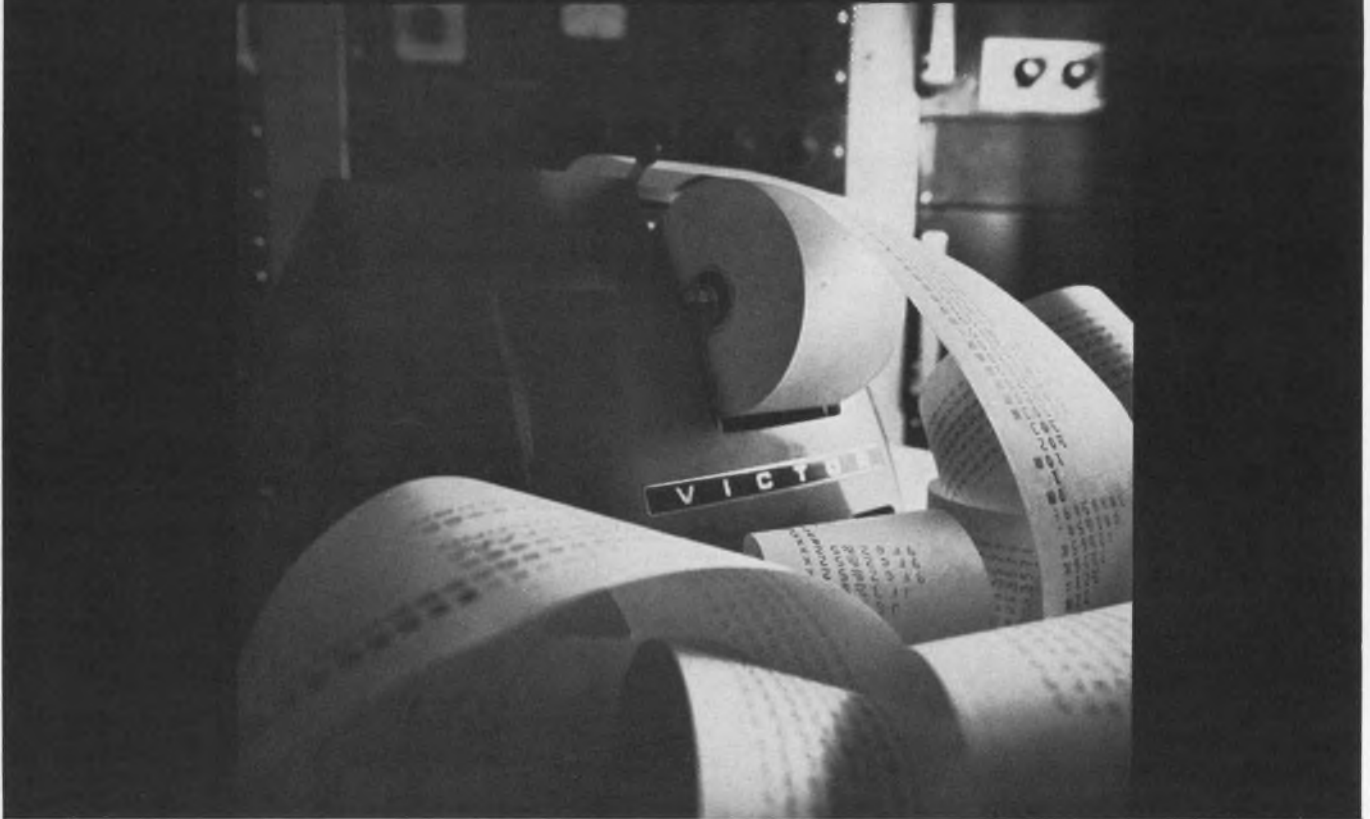

That's right; the Victor Digit-Matic does what any high quality serial entry printer does. And for less money. The Digit-Matic lists 8-column figures from remote sources, on either 24 or 48 volt solenoids. Printing press action reduces wear, eliminates parts, and assures clear, uniform print-out under all conditions.

For just \$50 more, the Digit-Matic will also add and subtract. Ten-column capacity, just \$20 more!

Factory-trained service representatives located across the country. OEM and quantity discounts available.

Wherever clear print-out is required, call for a Victor Digit-Matic specialist. Write: Victor Comptometer Corporation, Business Machines Group, 3900 N. Rockwell St., Chicago, Ill. 60618.

**Call on Victor
and you're in business.**



TAKE ONE



If your work has anything to do with visual readout, there's something in this IEE Catalog for you. It contains the most complete, up-to-date information available on rear projection readouts. If you design, manufacture, market or use products requiring visual display, you should become familiar with current developments in rear projection display. It's in this catalog. The catalog explains the operating principles of rear projection readouts. It also describes the unique results you get with this product.

You will easily see why it is specified for applications requiring readability, appearance and versatility. One of these applications could be yours. In addition to specifications on the complete line of IEE projection readouts, the catalog includes information on displays, assemblies, accessories, lamps and prices. It's complete.

Ask us for a copy now.

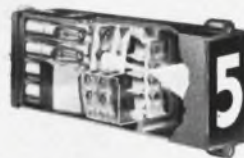

The Rear Projection Readout: When one of the 12 lamps at the rear of the readout is lighted, it illuminates one of 12 film messages, focuses it through a lens system, and projects it onto the non-glare viewing screen at the front.

The displayed message is clearly and distinctly projected on a single plane, with no obstruction from unlighted filaments. There is a wide viewing angle and a minimum of interference from ambient light. It is extremely versatile, since anything that can be put on film can be displayed on an IEE readout. That includes any combination of colors, symbols, numbers, letters and words. A total of five different models offering character sizes ranging from $\frac{1}{8}$ " to $3\frac{3}{8}$ ".

"I double-E," the world's largest manufacturer of rear projection readouts.
Industrial Electronic Engineers, Inc., 7720 Lemona Ave., Van Nuys, Calif.



ON READER-SERVICE CARD CIRCLE 44

Ideal rectifier uses equal-value resistors

Operational amplifiers can be combined with diodes and resistors to perform nearly ideal rectification, satisfying $e_o = |e_i|$. The diodes are situated within the feedback loop, so that the diode forward voltage drop is reduced at the output by the feedback factor. Figure 1a shows a commonly used full-wave rectifying circuit which gives a positive output, e_o , for bipolar input at e_i . This circuit has the following disadvantages:

- Output e_o due to plus input at e_i is obtained by bucking out the plus current from $R5$ with the negative (rectified) current through $R3$. The tolerance of this difference voltage can be three times resistor tolerance, since it is obtained by subtraction.
- Non-zero input impedance. If a summing junction is required at the input node, another operational amplifier is required.
- Increased drive requirements. The input at

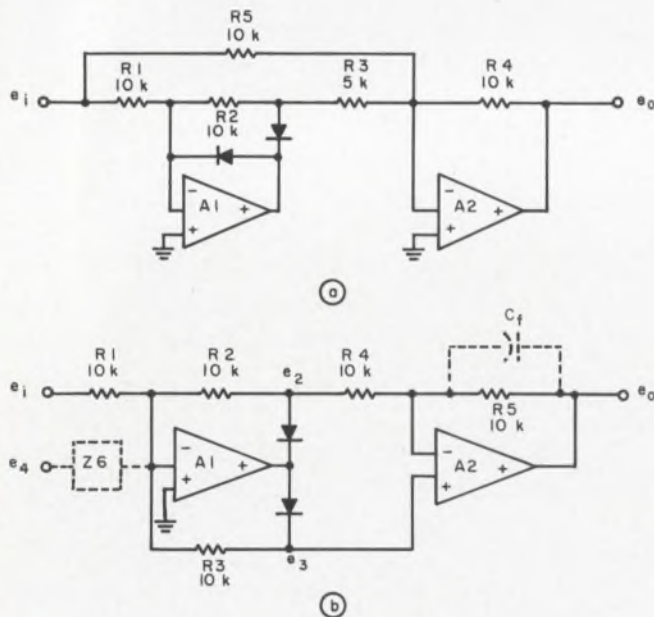

An improved, 'ideal' full-wave rectifier (b) is achieved by modifying a standard circuit (a).

VOTE! Circle the Reader-Service-Card number corresponding to what you think is the best Idea-for-Design in this issue.

SEND US YOUR IDEAS FOR DESIGN. Submit your IFD describing a new or important circuit or design technique, the clever use of a new component, or a cost-saving design tip to our Ideas-for-Design editor. If your idea is published, you will receive \$20 and become eligible for an additional \$30 (awarded for the best-of-issue Idea) and the grand prize of \$1000 for the Idea of the Year.

e_i drives two amplifiers in parallel.

- Unequal resistor values. $R3$ is half of $R5$. Figure 1b shows an "ideal" rectifier configuration which has the following advantages:
 - All resistors are of the same (arbitrary) value.
 - Output voltage tolerance is an additive function of resistor tolerance. Equal-value resistors are easy to select for high accuracy.
 - Zero input impedance. The single summing junction at n allows extra isolated inputs to be connected, as shown dotted for e_4 and $Z6$.

It may be necessary to connect a small capacitor, C_f , in parallel with $R5$ in order to prevent high-frequency oscillations. Rectified voltages e_2 and e_3 are unequal in this circuit.

Allan G. Lloyd, Project Engineer, Avion Electronics, Inc., Paramus, N. J.

VOTE FOR 110

Pulse peak detector uses matched dual-input transistor

A pair of inexpensive matched-input transistors is the key to a signal amplitude detector that can easily handle either square- or sine-wave pulses. The circuit, shown in the figure, is capable of sampling and holding for short periods, and of demodulating the pulse amplitude of low-frequency signals.

Matched transistors $Q3$ and $Q4$ form the circuit's threshold, with the input applied to the base of $Q4$. The signal from the collector of $Q4$ is capacitively coupled into an inverter, npn $Q1$, and then is applied to an npn inverter, $Q5$. The collector of $Q5$ is connected to the base of $Q6$ which discharges the storage capacitor, $C3$.

$C2$ and $R6$ should be selected so that the threshold of $Q6$ is not reached for approximately five input pulses. As long as the input to the circuit does not change in amplitude, $Q1$ will receive a pulse input. When the input amplitude decreases, $Q4$ stops conducting, allowing $Q1$ and $Q5$ to remain off. Resistor $R6$ charges $C2$ up to the value of the threshold of $Q6$, which turns on the discharges capacitor $C3$. As soon as the base voltage of $Q3$ reaches that of the input signal, $Q4$ again



GET FAST SIX-WAY RELIEF.....

from irritation due to
circuit design problems

New NEXUS QFT capsules give "best-you-can-buy" op amp performance

1. FET input . . . 10^{11} ohms Z, differential and common-mode
2. High output in small package . . . $\pm 10\text{mA}$ @ $\pm 11.5\text{V}$
3. Low input bias current . . . 10pA, typical
4. High common-mode rejection — 86dB
5. Fast slewing . . . $10\text{V}/\mu\text{s}$ (gives full output to 200kHz)
6. Low temperature drift . . . $5\mu\text{V}/^\circ\text{C}$ max. (for the QFT-2B)

Here is a new FET op amp series guaranteed to relieve pains caused by typical marginal "general-purpose" operational amplifiers.

In addition to the unique combination of characteristics above, the three QFT models provide dc open-loop gain (full output) of 150,000 min., fast settling time ($5\mu\text{s}$ to 0.1%), extremely smooth

loop dynamics, and high tolerance to capacitive loads. The QFT-2, QFT-2A, and QFT-2B have maximum temperature coefficients of 35, 10, and $5\mu\text{V}/^\circ\text{C}$ respectively.

And best of all, prices for the QFT series are extremely soothing. Write today for complete specifications and price information on the QFT series.

The QFT-2 lists at only \$45 (1-9). The QFT-2A, \$70 (1-9) and QFT-2B, \$85 (1-9). Prices F. O. B. Canton, Mass. U. S. A.

NEXUS
RESEARCH LABORATORY, INC.
480 NEPONSET STREET, CANTON, MASS. 02021
TEL: (617) 828-9000 TWX (710) 348-1323

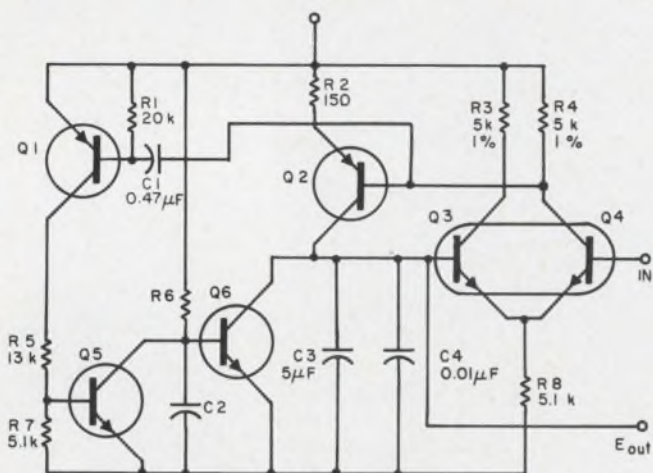

R6 - C2 CHOSEN BY FREQUENCY OF OPERATION
 Q1, Q2 - 2N3673
 Q3, Q4 - MATCHED DUAL UNIT 2N3729
 Q5, Q6 - 2N2846

Pulse peak detector for either square or sine waves uses an inexpensive dual matched transistor, Q3 and Q4, at the input.

activates Q1 and Q5. This turns Q6 off and the charge on the storage capacitor is again stable at the peak of the input signal.

Storage capacitor C3 should be a 5-10- μ F electrolytic capacitor. Q3 and Q4 are matched closely for V_{BE} and β . A dual transistor was used for this application.

Orville L. Lykins, Systems Engineering, Fairchild Semiconductor, Mountain View, Calif.

VOTE FOR 111

Two SCRs form pulse generator

Two SCRs can produce pulses at power-line repetition frequency (see figure). The pulse position and width are controlled by potentiometers R4. The pulse width is adjustable from 10 microseconds to several milliseconds. The pulse shape is a slice of a sine wave, which for short pulses approaches a square wave, and for longer periods

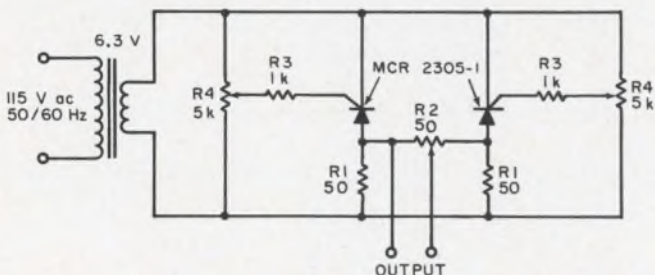

Variable width pulses are obtained at the output by changing settings of R4 potentiometers. Pulse width can be varied between 10 μ s to several milliseconds.

can produce sawtooth or trapezoid shapes. The pulse starts when the first SCR conducts and stops when the second SCR turns on.

The generator can also be designed for high-power output, but its main use is in synchronization circuits. The reason is its low efficiency: the power at R2 is less than 10% of the power dissipated in the two R1s and R2.

Juval Mantel, Certified Engineer, Munich, West Germany.

VOTE FOR 112

High voltages switched with a single transistor

To generate output voltage signals on the order of 800 volts peak-to-peak, transformers and vacuum tubes are generally used. High-voltage transistors, however, make it possible to obtain high-voltage outputs without transformers.

Figure 1a shows a typical, simple Class-A circuit used for a high-voltage output. The collector of the MSP80 is at approximately 400 volts, with a quiescent current of 10 mA. The circuit will have a high voltage gain and low input impedance. Of great importance is the fact that the Miller capacitance will be large, since the voltage gain will be over 400 and will thus multiply the collector-to-base capacitance by approximately 400. The high capacitance will cause loading on the input and attenuation of undesirable frequencies and input-to-output coupling.

Use of a low-voltage, high-beta and usually low-cost transistor will further improve circuit performance. Figure 1b shows the circuit of Fig. 1a modified with such transistors, in this case a silicon npn type, 2N2219A. The collector of the 2N2219A drives the emitter of the MSP80 directly; there are no interstage networks to add losses. Essentially the 2N2219A is a grounded emitter, driving the MSP80 in a grounded-base configuration. The circuit of Fig. 1b gives the same phase reversal as that of Fig. 1a. The circuit is generally called the "cascode" configuration after its vacuum-tube counterpart. The 2N2219A transistor provides the current gain, while the MSP80 contributes the voltage gain. The input signal is applied to the base of the 2N2219A, which does not see the large, 800-volt swing; the collector of the 2N2219A actually sees less than a one-volt variation.

The circuit has some advantages which are not readily apparent. One of them is the fact that the high-voltage transistor is biased under ideal conditions as far as stability due to leakage current and beta changes is concerned. The stability

1967
AUGUST
1
TUESDAY



Better monolithic I. C. modules: Sometimes it pays to wait.

Even DIGITAL waited. Until now, despite the technological accomplishment, there was just no way to get the cost and performance of I.C. modules significantly less than the cost and performance of discrete component modules.

But things have changed. DIGITAL will deliver, in August, a new line of integrated circuit modules — functional logic arrays of high speed TTL's in dual in-line packages, designed to operate from dc to 10 MHz. The module line encompasses every basic system function, and features high fan out, high capacitance drive capabilities, and excellent noise margins.

Waiting has had these advantages: the I.C.'s are the latest,

best, least expensive. Cost vs. performance are now vastly improved for the first time. Lowest cost per gate, for example. The technology of dual in-line TTL's has assets not available in previous I.C. modules.

The boards are identical in size to the FLIP CHIP™ modules, but with 36, rather than 18, pins. Pin sockets and mounting panels, as well as other standardized hardware, are available. All new hardware is compatible with the other FLIP CHIPS™.

We call the new line: M series. Write for further details now. Delivery in August.

digital
MODULES · COMPUTERS

DIGITAL EQUIPMENT CORPORATION, Maynard, Massachusetts 01754. Telephone: (617) 897-8821 • Cambridge, Mass. • New Haven • Washington, D.C. • Parsippany, N.J. • Rochester, N.Y. • Philadelphia • Huntsville • Pittsburgh • Chicago • Denver • Ann Arbor • Houston • Los Angeles • Palo Alto • Seattle • Carleton Place and Toronto, Ont. • Reading, England • Paris, France • Munich and Cologne, Germany • Sydney and West Perth, Australia • Modules distributed also through Allied Radio

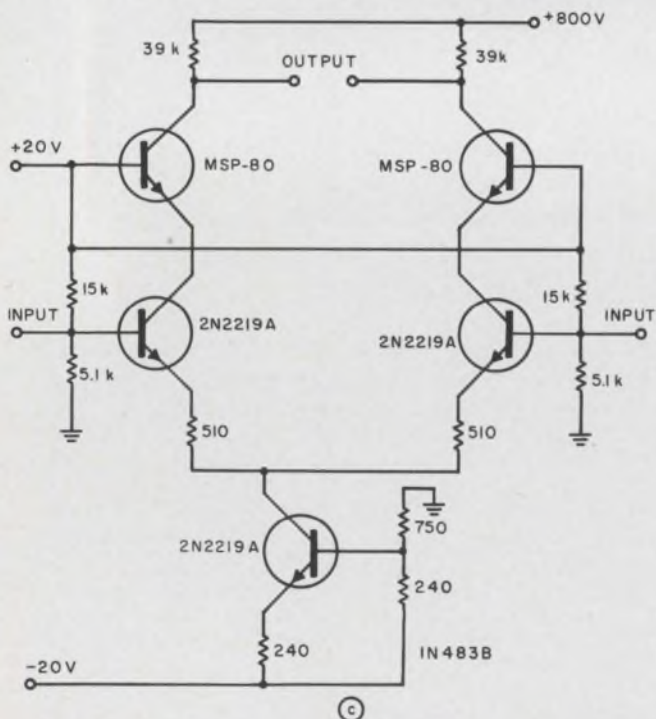
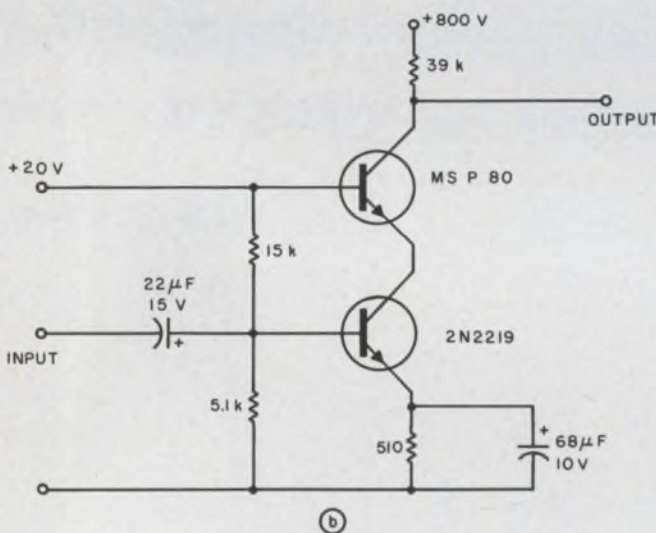
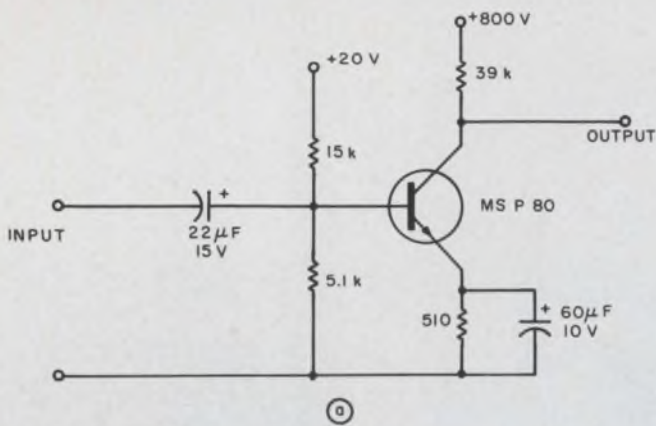

Simple high-voltage switch (a) is improved by the addition of a low-cost transistor (b). The circuit in (c) can directly drive CRT deflection plates.

factor is close to one, since the base is biased with a constant-voltage source and the emitter is biased with the collector of the 2N2219A, a good constant-current source. The voltage breakdown of the high-voltage transistor is also optimized, since essentially the V_{CBO} rating can be used for computations because of the constant-voltage source drive to the base.

Figure 1c shows how two stages of the circuit of Fig. 1b can be used to generate a differential output signal of approximately 1600 volts peak-to-peak. It is dc-coupled and is useful for driving CRT deflection plates for wide-band operation.

D. G. Aivazian, MS Transistor Corp., New York.

NOTE FOR 113

Build a square-wave generator with \$3 worth of components

Although a circuit as straightforward as the Schmitt trigger would hardly seem subject to further simplification, it has been found that eliminating all the capacitors yields significant benefits in certain applications. The circuit shown (Fig. 1a) can be used from 10 Hz to well over 100 kHz without adjustment. It displays excellent waveforms (Fig. 1b) at all frequencies, with both rise and fall times under 18 ns (Fig. 1c). It can be driven by an inexpensive audio oscillator (e.g., Heathkit) to perform most of the functions of a costly square-wave generator.

The commonly used speed-up capacitors shorten the storage time, and are thus of value in logic systems. They do not alter rise or fall times, but make it considerably more difficult to obtain good waveforms over a wide range of frequencies.

Aside from eliminating these capacitors, the present circuit is unusual in having the load resistor at the end of the output cable; conventional methods, however, did not seem to achieve comparable results. Belden 8421 cable is specified because it has the lowest capacitance of any commonly available flexible cable. Eighteen inches may appear short, but has proved perfectly adequate during several months' use on the test bench.

Lead dress and layout are not critical, but cable length is; so after the cable has been cut, the exact values of R_1 and R_3 should be determined while observing the descending waveform (fall time). The best value of R_4 is then chosen while studying the rise time. R_4 should be a 1-watt noninductive resistor (ordinary composition). R_1 is set to give symmetrical square waves and usually requires no



Converts BCD to printed form.



Produces strip chart record of digital data



Compares measured values with preset limits



Selects C and D (or G) range, balances, presents visual and BCD outputs



Sequentially connects capacitors to bridge.

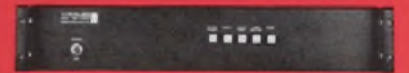

Makes parallel-to-serial conversion for data processing and analysis

Push for Automatic Measurements

These are the basic building blocks for a variety of automatic capacitance-measuring systems that can test capacitors at rates as high as 120 per minute. Such systems are used for production testing and sorting, incoming inspection, zero-defects quality-assurance programs, and environmental-test runs for design evaluation. Cost analyses by owners of 1680 systems indicate savings of up to 80% or more on the per-unit cost of component inspection over manual methods.

The heart of each system is GR's 1680 Automatic Capacitance Bridge, which automatically selects C and D (or G) range, balances, and displays measurements in digital form. Measurement range is 0.01 pF to 1000 μ F and basic accuracy is 0.1% of reading for C and G, 1% of reading ± 0.001 for D. Price is \$4975 in U.S.A.

Other system components designed around the 1680 bridge are shown below:

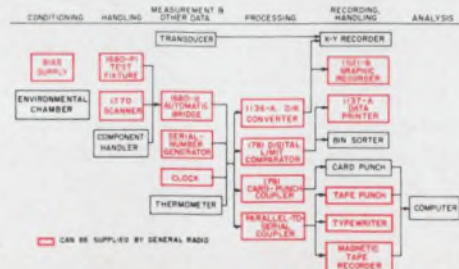

Three of these instruments are new: *Type 1770 Scanner System*, for sequential connection of many capacitors to the bridge; modular construction permits up to 100 input channels; guarded connection; six operating modes; visual display and BCD output of channel number. Price dependent upon requirements; about \$3500 for a guarded, 50-channel model.

Type 1781 Digital Limit Comparator, makes possible fully automatic capacitor sorting; compares BCD output of the 1680 bridge with limits of C and D (or G), preset on the 1781 front panel; GO/NO-GO visual indication and relay-contact output. Price, \$1625 in U.S.A.

Type 1791 Card-Punch Coupler, a parallel-to-serial converter for driving an IBM 526 Card Punch from the BCD output of the 1680 bridge and other digital instruments; 22-digit capacity. Price on request.

For additional information, write General Radio Company, W. Concord, Massachusetts 01781; telephone (617) 369-4400; TWX (710) 347-1051.

GENERAL RADIO



An automatic capacitor-test system produced by General Radio.

further adjustment unless input voltages are changed. Lower input voltages give even faster rise time and may be used where less output is acceptable.

Q1 and Q2 are Fairchild 2N4275 or TI 2N4418. These are both epoxy equivalents of the 2N2369. Motorola 2N3903/4 are a trifle slower, but will switch more power. For pnp try 2N3638A, 2N3905/6 or 2N4258.

John H. Cone, General Manager, Electronic Enterprises, Pasadena, Calif.

VOTE FOR 114

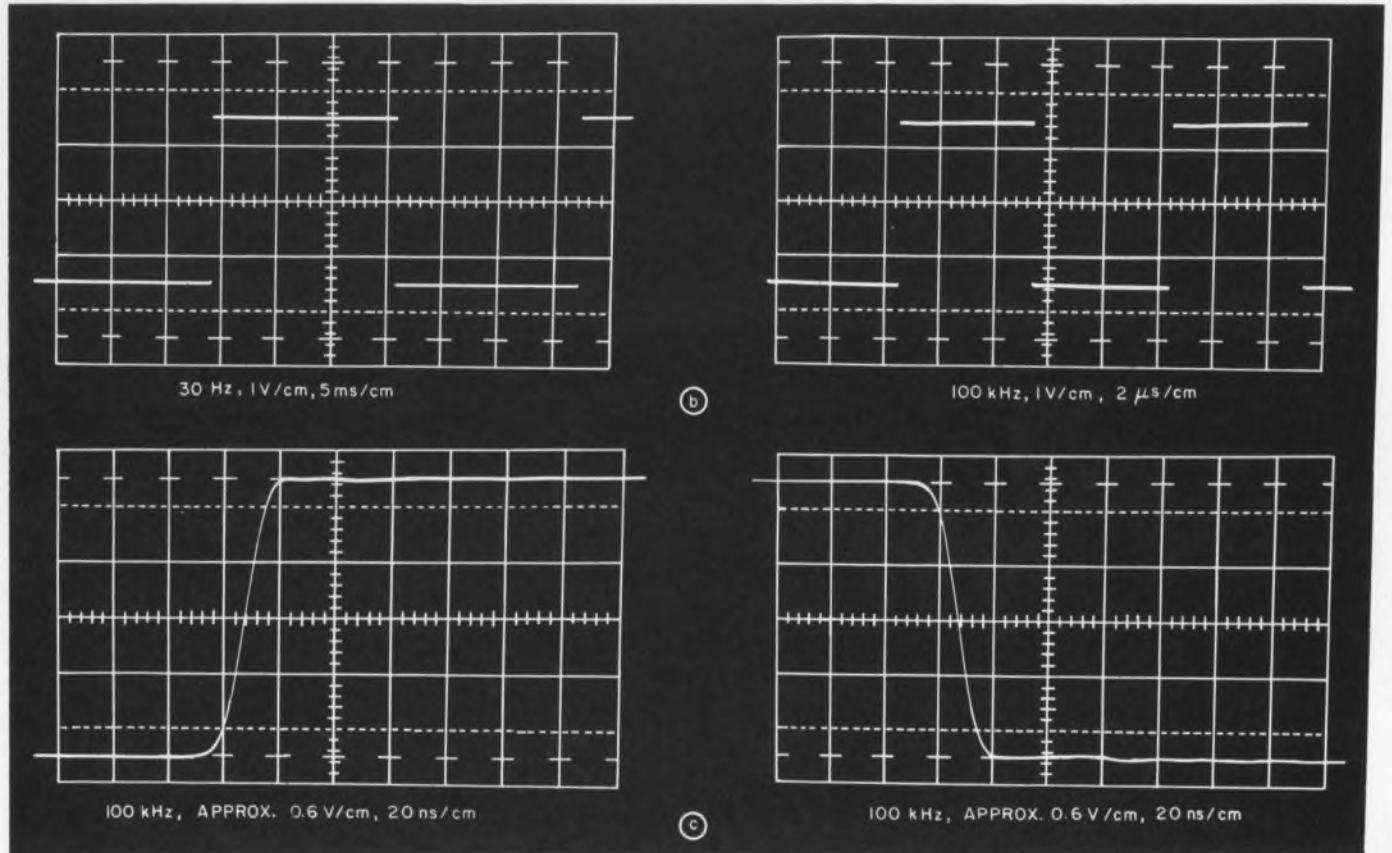
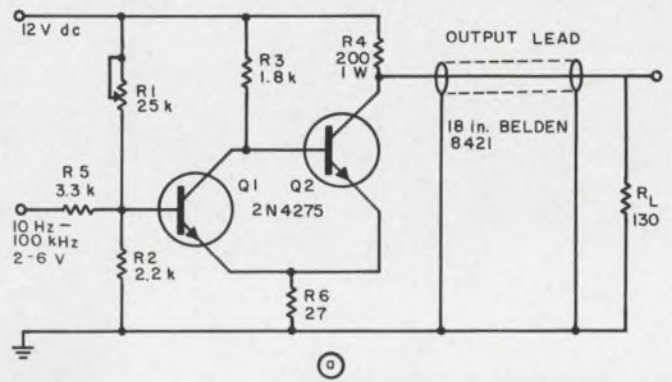

Sharp square waves (b) are obtained with the simplified Schmitt trigger (a). Rise and fall times of 18 ns are shown

in (c). Note the absence of speed-up capacitors and use of 18-in. cable.

Bidirectional dc drive circuit has ac preamplifier

The illustrated circuit is useful as a demodulator-driver for a two-wire dc load, such as a dc motor or hydraulic servo valve, that must be driven in two directions. The circuit offers the advantage of allowing the preamplifier to be an ac device, which is inherently more stable than the conventional dc preamplifier. Since no bias voltages are applied to the transistors, there will be no drift or null shift.

The operation of the circuit is as follows. If the

input voltage at the secondary of T1 is zero, the reference voltage supplied through T2 will not be applied to the load, ZL, because none of the transistors will be turned on.

If the phase of the input voltage is as shown, transistors Q1 and Q4 will be turned on when the reference voltage is positive, and the current will be allowed to flow through ZL from A to B. The input voltage of this phase and the positive half cycle applied to Q2 and Q3 will keep these transistors open.

If the input voltage is of the opposite phase, transistors Q2 and Q3 will be turned on when the

The Unbeatable IC System:

Your logic design and Raytheon Computer modules and hardware.

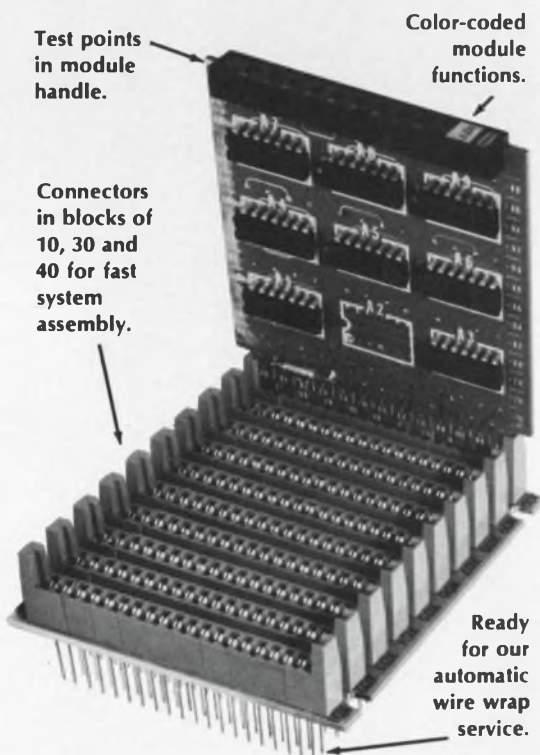

Laminated power bus bars installed and wired in each module case. Reduces noise, eliminates power inter-connections, cuts hours from assembly and test time.

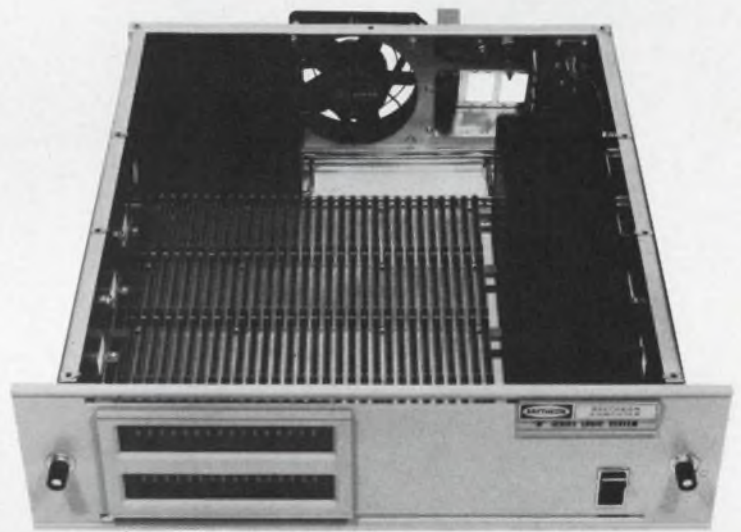

Indicator lights display system operation.

This case holds 120 modules. There's also one for 40; another for 400.

Raytheon Computer's M-Series — more than 30 modules—connectors, cases, power supplies and power distribution are so thoroughly engineered you can concentrate on logic and electronic design, not mechanical details. Every step—design, assembly, test, check-out, troubleshooting—is easier than you thought it could be.

We'll even help you design your logic. Call or write today for a visit from a helpful applications engineer or for the whole story in print. Ask for Data File M-136. Raytheon Computer, 2700 S. Fairview St., Santa Ana, Calif., 92705, Phone: (714) 546-7160.



ON READER-SERVICE CARD CIRCLE 48



**Our electron multipliers
are sensitive to
just about everything
but ambient atmosphere
and 350°C.**

That's right, there's absolutely *no* deterioration of performance from ambient atmospheric exposure with Bendix® magnetic electron multipliers. Their remarkable sensitivity covers the most extreme ends of the electromagnetic spectrum: for photon and particle counting, far ultraviolet and soft x-ray detection, high-altitude solar radiation, nuclear radiation and ion detection, and even the hard ultraviolet range—something unattainable in other types of detectors.

What's more, the Model 310B is bakeable to 350°C. And there are several other models to choose from—each with the most compact, rugged, lightweight multiplier of its kind. *All with current gains of 10⁸.*

And to power them, our compact Model 1122 power supply was made to order. Its dependable solid state operation assures constant voltage differentials through extreme level variations. And minimum maintenance as well.

Bendix scientific instruments—including mass spectrometers, atomic absorption and flame spectrophotometers, polarimeters, polarographic systems and electron multipliers—are used in over 100 areas of research and analysis. For more information, write: **The Bendix Corporation, Scientific Instruments Division, 3625 Hauck Road, Cincinnati, Ohio 45241. Or phone (513) 772-1600.**

Specifications	Model M 306	Model M 308	Model M 310/310B
Direction of view	side	end	side
Aperture (in mm)	18.3 x 15.5	10.4 x 5.3	12.5 x 12.5
Spectral response	10 ⁸	10 ⁸	10 ⁸
Operating press. max. torr	5 x 10 ⁻⁴	1 x 10 ⁻⁴	1 x 10 ⁻⁴
Length, max. inches	4	2½	2½
Height, max. inches	.81	.93	.80
Width, max. inches	1.32	1.29	.69
Weight, nom. oz.	4½	2	2½



ON READER-SERVICE CARD CIRCLE 49

IDEAS FOR DESIGN

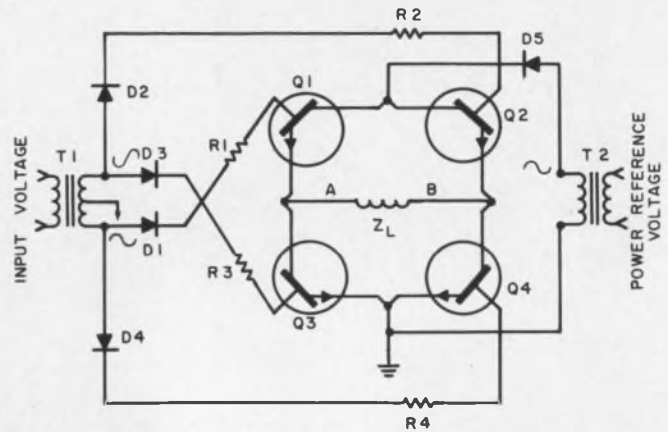

Simple demodulator-driver circuit for a two-wire dc load can provide bidirectional drive, depending on the phase of the input voltage.

reference voltage is positive. The current will flow from B to A.

For proportional control it is necessary for only two of the transistors to be operated linearly; the other two may act as switches. Thus for low-impedance drive, R3 and R4 are small so that Q3 and Q4 act as switches and Q1 and Q2 as emitter-followers. For a higher-impedance drive, R1 and R2 are made small so that Q1 and Q2 act as switches and Q3 and Q4 as common-emitter amplifiers.

The switching transistors in either circuit configuration could be replaced by SCRs.

B. A. Rogers, Senior Engineer, Guidance Systems Dept., Electrodynamics Div., Bendix Corp., North Hollywood, Calif.

VOTE FOR 115

Diode and battery form low-voltage Zener diode

High-current Zener diodes are generally not readily available below a 6.8-volt nominal value. Lower-voltage Zeners can be simulated inexpensively by connecting a blocking diode in series

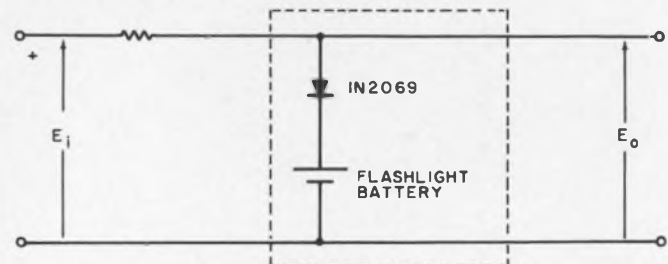

2.4-V, 100-mA Zener diode with the dynamic impedance of 1 ohm is made with a diode and a D-cell combined as shown.

ON READER-SERVICE CARD CIRCLE 50 ➤

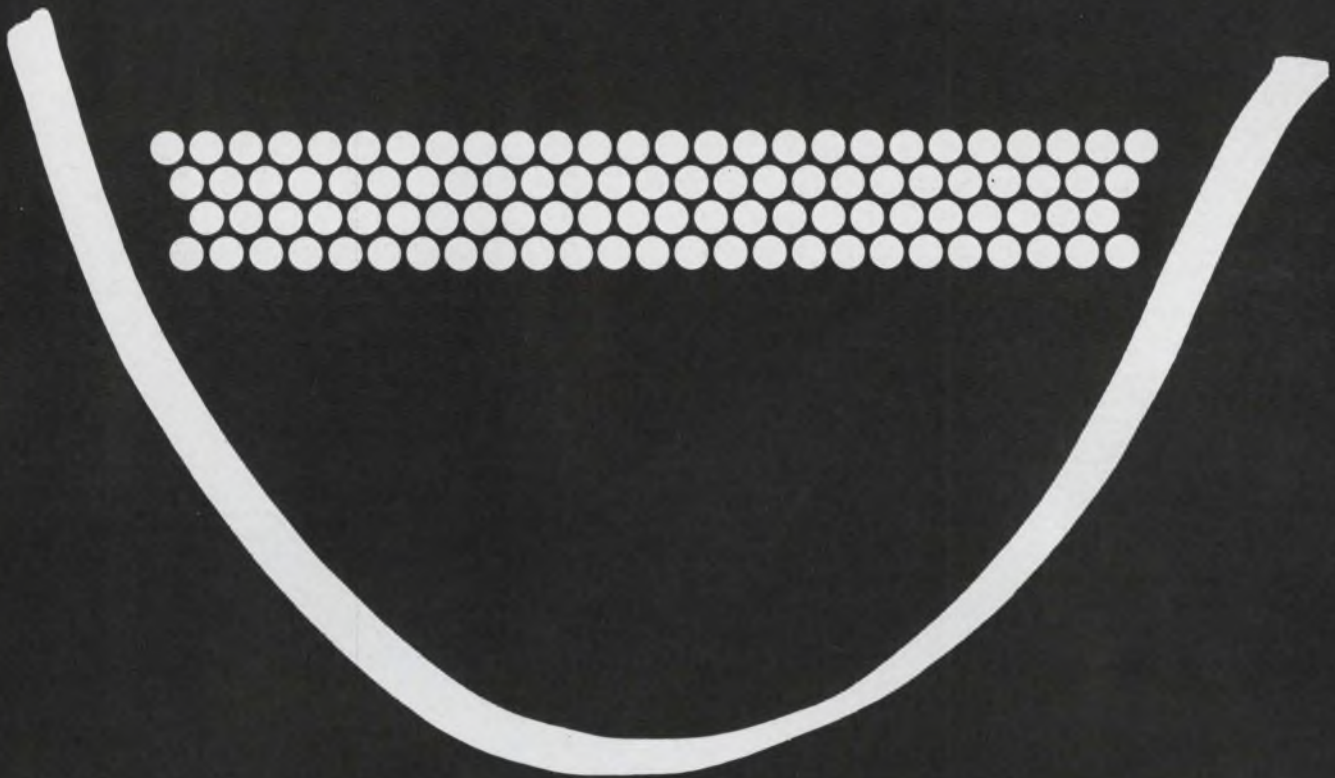

Now you can smile at weight and space problems...
 We doubled the density of our D Subminiature connectors.

You can get out of a tight spot fast by specifying crimp, removable snap-in contacts in ITT Cannon's popular D Subminiature shell configurations with double the contact density!

You get two for the space of one in five different shell sizes. For instance, 100 contacts instead of 50. Also available in 19, 31, 52



and 79 contact arrangement sizes — all on .075" centers.

The Double Density D is intermountable with our D Subminiature series, and uses the same wide range of accessories. The new series incorporates highly reliable CENTI-PIN® contacts which assure positive contact alignment and reduce contact bending, as well as providing a low noise level and electrical continuity even under severe vibration and shock.

These new Double Density D connectors are available in quantity now from your nearby ITT Cannon factory authorized distributor. For complete information write for Catalog 2D-1.

ITT Cannon Electric,
 3208 Humboldt Street,
 Los Angeles, California 90031.

A division of International Telephone and Telegraph Corporation.



with one or more dry cells.

In the example shown, a silicon diode and a standard D-size flashlight battery have an apparent Zener voltage of 2.4 volts at 100 milliamperes. The dynamic impedance at the current specified is on the order of 1 ohm.

The diode keeps the battery from biasing the output and also prevents the discharge of the battery between operations.

Ernest A. Preuss, Section Head, Aircraft Radio Corp., Boonton, N. J.

VOTE FOR 116

Ac level indicator lights a lamp

A two-transistor amplifier can function as a 4-Hz oscillator that flashes a lamp when input signal levels exceed the set threshold.

In the figure, point A is at +3 volts, which reverse-bias diodes D1 and D2. When the ac signal at Q2 collector is large enough to cause D2 to conduct, positive feedback is applied to the base of Q1. Q1 and Q2 now become a saturating oscillator at about 4 hertz. The circuit continues to oscillate as long as the signal level at the input is above the set threshold.

The threshold can be adjusted from 0.3 to 14 volts peak-to-peak at the input.

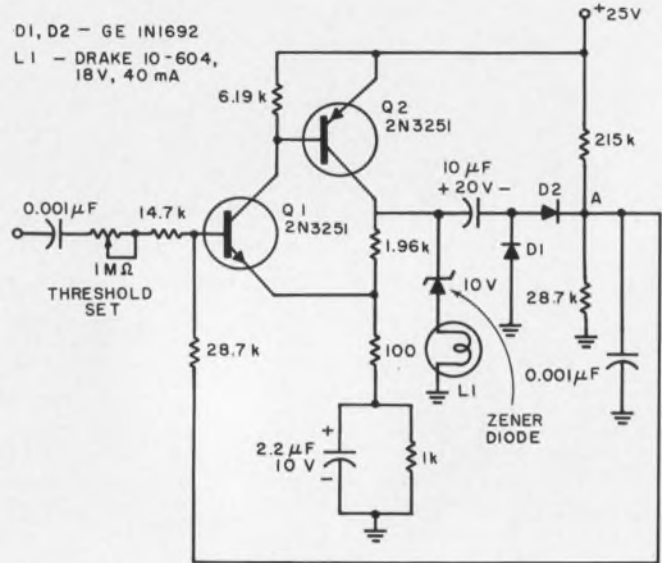

Excessive ac input signal levels cause the amplifier (Q1 and Q2) to become a slow oscillator flashing the lamp, L1, at about 4 Hz.

The signal frequencies that this circuit was designed for ranged from 50 kHz to 2 MHz. The circuit was used to indicate when signal levels out of a phase detector were approaching the limiting level of the detector.

Rudy Stefenel, Design Engineer, Microwave Laboratory, Hewlett Packard, Palo Alto, Calif.

VOTE FOR 117

Ac time-delay relay uses unijunction transistor

This single-UJT ac time-delay relay, capable of better than 300-s delays, is both inexpensive and accurate.

The delay is set by the 2-MΩ potentiometer. The relay is energized when the voltage across C3 reaches the firing voltage of the UJT. The voltage

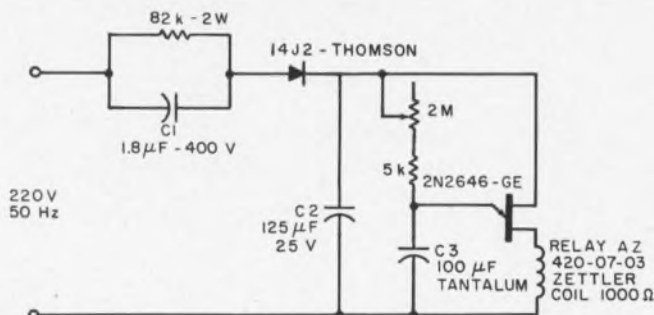

Time delays of about 300 s are achieved with this simple circuit. One-hour delay is possible by increasing values of the pot and C3.

applied to the relay coil at that instant is about 9 volts. Thereafter it remains at about 4 volts, keeping the relay closed.

The time delay is fairly independent of temperature and supply voltage. The repetition accuracy is 1% between +10° and +50°C with supply voltage variations of ±10%.

Time delays of up to one hour are possible with a 10-MΩ potentiometer and a 1000-µF capacitor. The repetition accuracy, however, suffers.

Paolo Redi, Engineer, Officine Galileo, Florence, Italy.

VOTE FOR 118

IFD Winner for Mar. 15, 1967

Milton Dickfoss, Grumman Aircraft Engineering Corp., Bethpage, L. I., N. Y.

His Idea, "Protect your panels from scratches and burrs," has been voted the \$50 Most Valuable of Issue Award.

Cast Your Vote for the Best Idea in this Issue.

AN UNBIASED GUIDE TO TEFLON WIRE AND CABLE AND WHERE TO GET IT

MIL-W-16878D TEFLON WIRE TYPE E—EXTRUDED (600 VOLTS)

2850 Size #32...Alpha Distributors
2851 Size #30...Alpha Distributors
2852 Size #28...Alpha Distributors
2853 Size #26...Alpha Distributors
2854 Size #24...Alpha Distributors
2855 Size #22...Alpha Distributors
2856 Size #20...Alpha Distributors
2857 Size #18...Alpha Distributors
2858 Size #16...Alpha Distributors
2859 Size #14...Alpha Distributors
2859/12 Size #12...Alpha Distributors
2859/10 Size #10...Alpha Distributors

MIL-W-16878D TEFLON WIRE

TYPE EE—EXTRUDED (1000 VOLTS)

2874 Size #24...Alpha Distributors
2875 Size #22...Alpha Distributors
2876 Size #20...Alpha Distributors
2877 Size #18...Alpha Distributors
2878 Size #16...Alpha Distributors
2879 Size #14...Alpha Distributors
2879/12 Size #12...Alpha Distributors
2879/10 Size #10...Alpha Distributors
2879/8 Size #8...Alpha Distributors

MIL-W-16878D SHIELDED TEFLON CABLE; NO OUTER COVERING OVER SHIELD

2809 1 cond., size 24...Alpha Distributors
2809/2 2 cond., size 24...Alpha Distributors
2809/3 3 cond., size 24...Alpha Distributors
2809/4 4 cond., size 24...Alpha Distributors
2812 1 cond., size 22...Alpha Distributors
2812/2 2 cond., size 22...Alpha Distributors
2812/3 3 cond., size 22...Alpha Distributors
2812/4 4 cond., size 22...Alpha Distributors
2815 1 cond., size 20...Alpha Distributors
2815/2 2 cond., size 20...Alpha Distributors
2815/3 3 cond., size 20...Alpha Distributors
2815/4 4 cond., size 20...Alpha Distributors
2818 1 cond., size 18...Alpha Distributors
2818/2 2 cond., size 18...Alpha Distributors
2818/3 3 cond., size 18...Alpha Distributors
2818/4 4 cond., size 18...Alpha Distributors
2807 1 cond., size 16...Alpha Distributors
2807/2 2 cond., size 16...Alpha Distributors

MIL-W-16878D SHIELDED TEFLON CABLE; TEFLON IMPREGNATED BRAID OVER SHIELD:

2811 1 cond., size 24...Alpha Distributors
2811/2 2 cond., size 24...Alpha Distributors
2811/3 3 cond., size 24...Alpha Distributors
2811/4 4 cond., size 24...Alpha Distributors
2814 1 cond., size 22...Alpha Distributors
2814/2 2 cond., size 22...Alpha Distributors
2814/3 3 cond., size 22...Alpha Distributors

2814/4 4 cond., size 22...Alpha Distributors
2817 1 cond., size 20...Alpha Distributors
2817/2 2 cond., size 20...Alpha Distributors
2817/3 3 cond., size 20...Alpha Distributors
2817/4 4 cond., size 20...Alpha Distributors
2819 1 cond., size 18...Alpha Distributors
2819/2 2 cond., size 18...Alpha Distributors
2819/3 3 cond., size 18...Alpha Distributors
2819/4 4 cond., size 18...Alpha Distributors
2820 1 cond., size 16...Alpha Distributors
2820/2 2 cond., size 16...Alpha Distributors

MIL-W-16878D SHIELDED TEFLON CABLE; TEFLON TAPE WRAP JACKET OVER SHIELD:

2821 1 cond., size 24...Alpha Distributors
2821/2 2 cond., size 24...Alpha Distributors
2821/3 3 cond., size 24...Alpha Distributors
2821/4 4 cond., size 24...Alpha Distributors
2824 1 cond., size 22...Alpha Distributors
2824/2 2 cond., size 22...Alpha Distributors
2824/3 3 cond., size 22...Alpha Distributors
2824/4 4 cond., size 22...Alpha Distributors
2827 1 cond., size 20...Alpha Distributors
2827/2 2 cond., size 20...Alpha Distributors
2827/3 3 cond., size 20...Alpha Distributors
2827/4 4 cond., size 20...Alpha Distributors
2829 1 cond., size 18...Alpha Distributors
2829/2 2 cond., size 18...Alpha Distributors
2829/3 3 cond., size 18...Alpha Distributors
2829/4 4 cond., size 18...Alpha Distributors
2826 1 cond., size 16...Alpha Distributors
2826/2 2 cond., size 16...Alpha Distributors

MIL-W-16878D SHIELDED TEFLON CABLE; TEFLON FEP EXTRUDED JACKET OVER SHIELD:

2831 1 cond., size 24...Alpha Distributors
2831/2 2 cond., size 24...Alpha Distributors
2831/3 3 cond., size 24...Alpha Distributors
2834 1 cond., size 22...Alpha Distributors
2834/2 2 cond., size 22...Alpha Distributors
2834/3 3 cond., size 22...Alpha Distributors
2837 1 cond., size 20...Alpha Distributors
2837/2 2 cond., size 20...Alpha Distributors
2837/3 3 cond., size 20...Alpha Distributors
2839 1 cond., size 18...Alpha Distributors
2839/2 2 cond., size 18...Alpha Distributors
2839/3 3 cond., size 18...Alpha Distributors
2836 1 cond., size 16...Alpha Distributors
2836/2 2 cond., size 16...Alpha Distributors

MIL-W-7139B CLASS 1 TEFLON* AIRFRAME LEAD WIRE

6494 Size #22...Alpha Distributors
6495 Size #20...Alpha Distributors
6496 Size #18...Alpha Distributors
6497 Size #16...Alpha Distributors
6498 Size #14...Alpha Distributors
6499 Size #12...Alpha Distributors

*T. M. Dupont

ALPHA WIRE

A Division of Loral Corporation
Elizabeth, New Jersey 07207

ON READER-SERVICE CARD CIRCLE 51

Coaxial cable on toroid yields wide-band transformer

Problem: Design a high-frequency, wide-band transformer with a high turn ratio, a high coupling coefficient, and a flat, broad-band response.

It is difficult to obtain efficient coupling in standard high-frequency transformers with turn ratios above 2:1. Moreover, flat, broad-band frequency response is not readily available in transformers with very high turn ratios.

Solution: A toroidal core is wound spirally with a single coaxial cable. The inner conductor of the coaxial cable functions as the primary winding and the outer coaxial shielding is segmented to form the secondary winding.

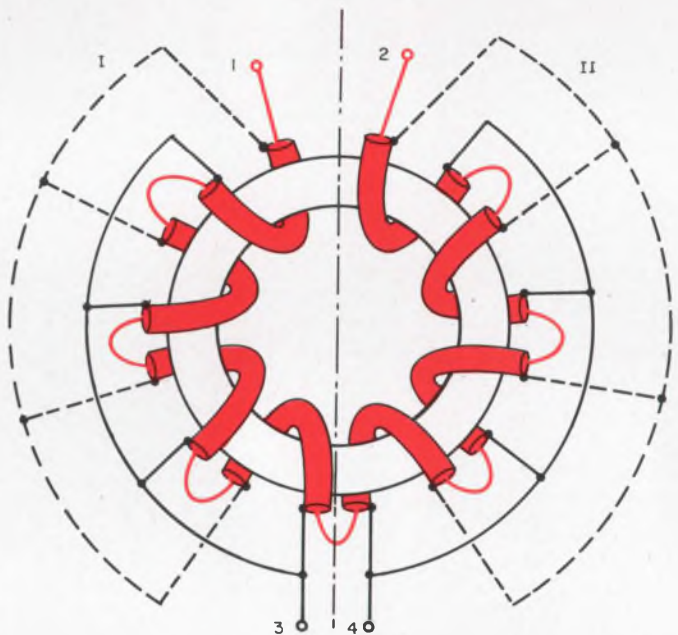

The center-tap push-pull transformer configuration shown in the figure consists of a helical winding of coaxial cable on a ring of ferrite core material. The ferrite inner conductor, with input terminals 1 and 2, corresponds to the primary winding. The outer shielding, with output terminals 3 and 4, corresponds to the secondary winding.

The cable is initially wound on the core at a 1:1 ratio.

To obtain a 4:1 stepdown ratio, for each half of the transformer (I and II), four primary windings are coupled magnetically to one secondary winding. The effect of reducing the number of turns in the secondary is accomplished by sectionally discontinuing the outer shielding and rewiring the resulting sections into four parallel networks. Thus, the secondary is electrically equivalent to a single turn of a conductor about a magnetic core wound with four primary turns.

Specific performance data of this design indi-



How many kinds of plugwires do you need next week?

MAC ships off-the-shelf!

Getting a signal from P to Q—or from P₁, P₂, P₃ to Q, or from P to Q₁, Q₂, Q₃, etc.—is the function of the plugwire. MAC maintains a programmer's paradise of plugwires in inventory: single conductor, coaxial, dual conductor, two conductor shielded twisted pair, Y-type with 3, 4, 5 or 6 pin common, just to start the list. Color coded, 6" to 36". Bring order out of chaos. Off-the-shelf. You supply the order, we'll take care of the chaos.

MAC

O.E.M. DIVISION

MAC Panel Co., Box 5027, High Point, N. C. 27261

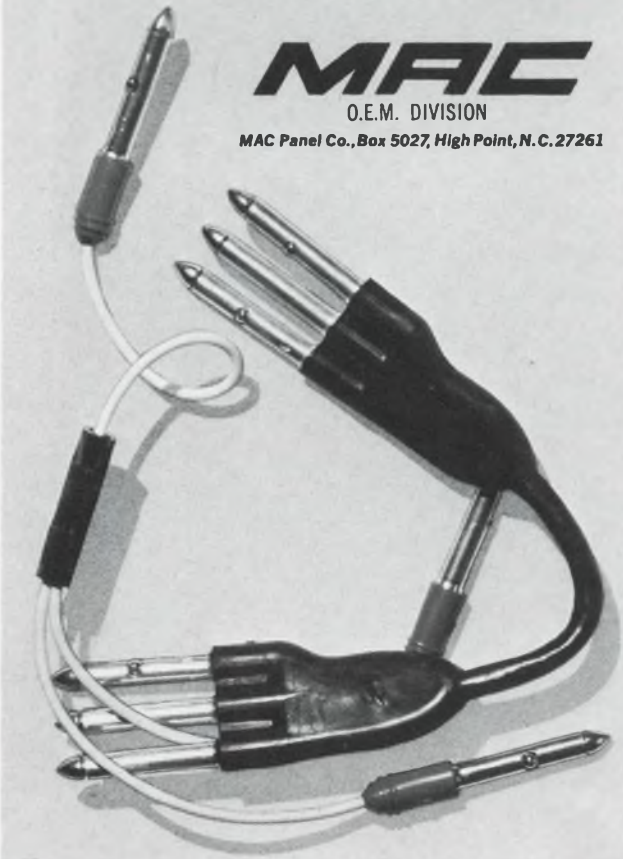

ON READER-SERVICE CARD CIRCLE 52

SOLID STATE



featuring
AUTOGRIP*
electric
holddown

All the advantages of solid-state design and construction are yours in a wide variety of Hewlett-Packard 8½" x 11" and 11" x 17" x-y recorders. Compact, rugged construction; solid-state reliability and long life; all with optional metric calibration and unprecedented performance characteristics. Check the list, then talk to your Hewlett-Packard field engineer about the models most useful for your task. Or write for complete information: Hewlett-Packard, Palo Alto, California 94304, Tel. (415) 326-7000; Europe: 54 Route des Acacias, Geneva.

Data subject to change without notice. Prices f.o.b. factory.

***EXCLUSIVE, CARE-FREE, DEPENDABLE PAPER HOLDDOWN.**

8-1/2" x 11" X-Y RECORDERS

- Bench/rack model in one, portable, 0.5 mv-5 v/in., X-axis time base; Model 135, \$1650.
- 2-pen version of 135, 0.5 mv-50 v/in.; Model 136A, \$2650.
- High-sensitivity model, 1 MΩ input impedance, time base either axis, 0.1 mv-20 v/in.; Model 7030A, \$1895.
- Economy model, 1 mv-10 v/in.; Model 7035A, \$895.

11" x 17" X-Y RECORDERS

- Versatile recorder, X-axis time base, 0.5 mv-50 v/in., high-impedance, computer reference models available; Model 2D Series, from \$1950.
- Economy model of 2D Series, 0.5 mv-10 v/in.; Model 2D-4, \$1490.
- 2-pen version of 2D Series; Model 2FA, \$3375.
- High-sensitivity ac/dc recorder, time base either axis, 0.1 mv-20 v/in. dc, 5 mv-20 v/in. ac; Model 7000A, \$2495 (also available without ac input, Model 7001A \$2175).
- Automatic data plotting system, null detector and character printer built in, 0.5 mv-10 v/in.; Model 7590C, \$1985.

**HEWLETT
PACKARD**  **MOSELEY
DIVISION**

ON READER-SERVICE CARD CIRCLE 53

1790

QUO VADIS

age old question...

WHERE ARE
YOU GOING?



The Infrared Engineer of today wants to know where he's going ... try Aerojet-General's Von Karman Center. Programs for the future in ...

Night Vision, Fire Control Systems, Ballistic Missile Defense, Guidance, Lethal Defense, Penetration Aids, Pattern Recognition, Satellite Systems, Measurement Programs.

Where are you going? ... we hope with us

- **INFRARED SPECIALISTS** to perform research and development in new types of infrared detectors.
- **DATA SYSTEMS ENGINEERS** for the development of techniques for storing and processing optical data for advanced sensor systems.
- **SENSOR SYSTEMS SPECIALISTS** for the development of advanced sensor concepts for acquisition and processing of optical and infrared information.
- **PATTERN RECOGNITION SCIENTISTS** for investigating techniques for recognition of geometric patterns involving optical coding, classification and correlation.

U.S. CITIZENSHIP REQUIRED

Please submit resume, including salary requirements, to:



R. S. Lawrence, Scientific & Engineering Placement

**P. O. Box 303 . . . Dept. E. D. . . .
Azusa, Calif. 91702**

A subsidiary of The General Tire & Rubber Co.

An equal opportunity employer

NASA TECH BRIEFS

cate that the coupling coefficient between primary and secondary approaches 1. Stray inductance loss is lowered by this configuration. The amount of coupling and/or stray inductance loss may be varied as a function of the conductors' diameters.

Empirical studies of the frequency response of this transformer indicate a completely flat response from 100 Hz to 10 MHz.

The networks in parallel need not be single turn, as illustrated, but may be any number as required to meet specific requirements.

For more information, contact Office of Industrial Cooperation, Argonne National Laboratory, 9700 South Cass Avenue, Argonne, Ill. 60439 (B66-10600).

Plastic cap protects thermocouple connector

Problem: Design highly reliable thermocouple connectors for use in test operations. Commercially available steel sheath types tend to become highly unreliable because of electrical shorts that develop at the connection of the cable and the thermocouple.

Solution: Fit the thermocouple into a plastic (polycarbonate) insulator that is molded in half sections. It can be assembled mechanically, and electrical shorting is eliminated.

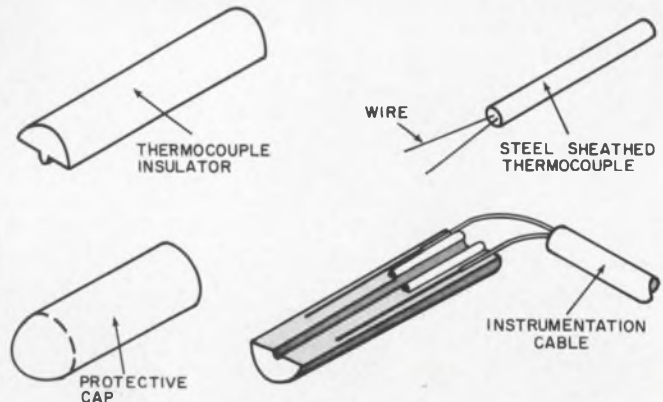

The thermocouple insulator and protective cap enclose the steel-sheathed thermocouple which contains two wire leads. The steel-sheathed thermocouple with its bare wire leads is placed in one of the insulator halves so that the wires are separated. The instrumentation cable wire leads are soldered or laid against the thermocouple leads and the other insulator half is mated together.

The protective cap is press-fitted over the insulator halves, and the unit is then dipped in methylene chloride to bond the entire unit together.

For further information, contact Technology Utilization Officer, AEC-NASA Space Nuclear Propulsion Office, U.S. Atomic Energy Commission, Washington, D. C. 20545 (B66-10709).

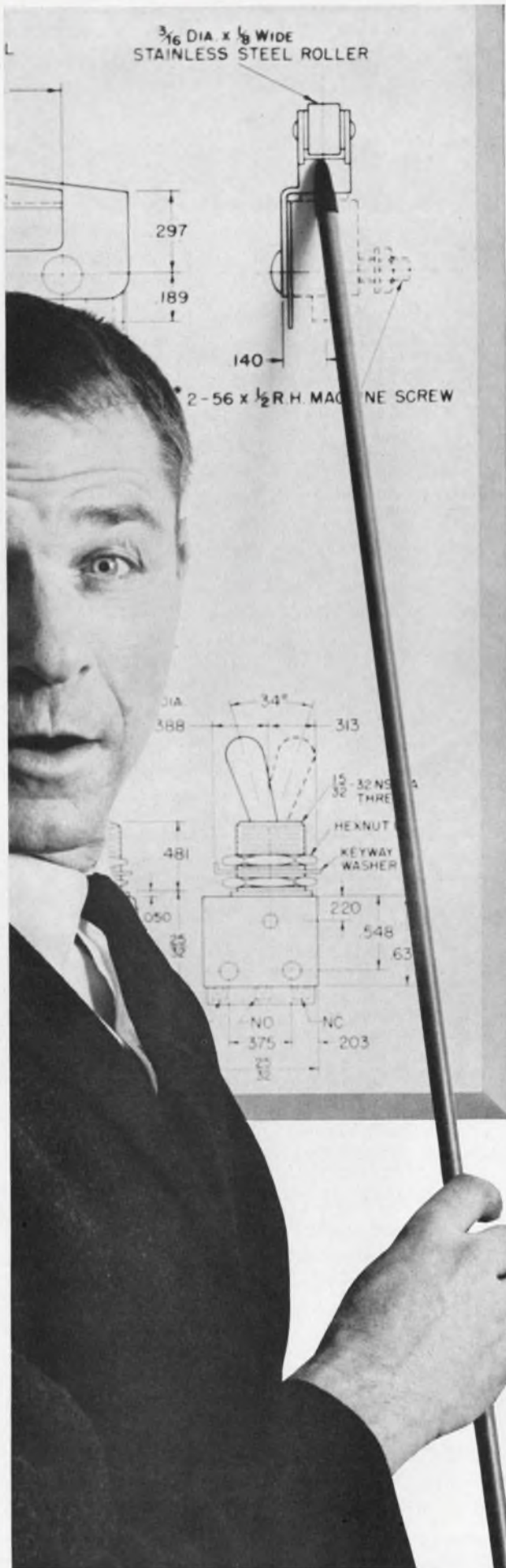

Mapping out Your Plans

The enemy is smart. He knows your weaknesses.

Hits you where it hurts. You need greater reliability, longer life, and lower cost in switches.

That'll get him, and put your product out in front. Licon® general purpose commercial and industrial switches fit right into the engineering map. **Read about**

them in this book.

Copies sent on request.



**Lay out your plans with
LICON ... fastest growing
full-line switch supplier**

itw LICON

DIVISION ILLINOIS TOOL WORKS INC.
6615 WEST IRVING PARK ROAD - CHICAGO, ILLINOIS 60634

*Remember, you're never more than a few feet away from a product of ITW®

When you're as busy as we are, it's hard to toot your own horn.

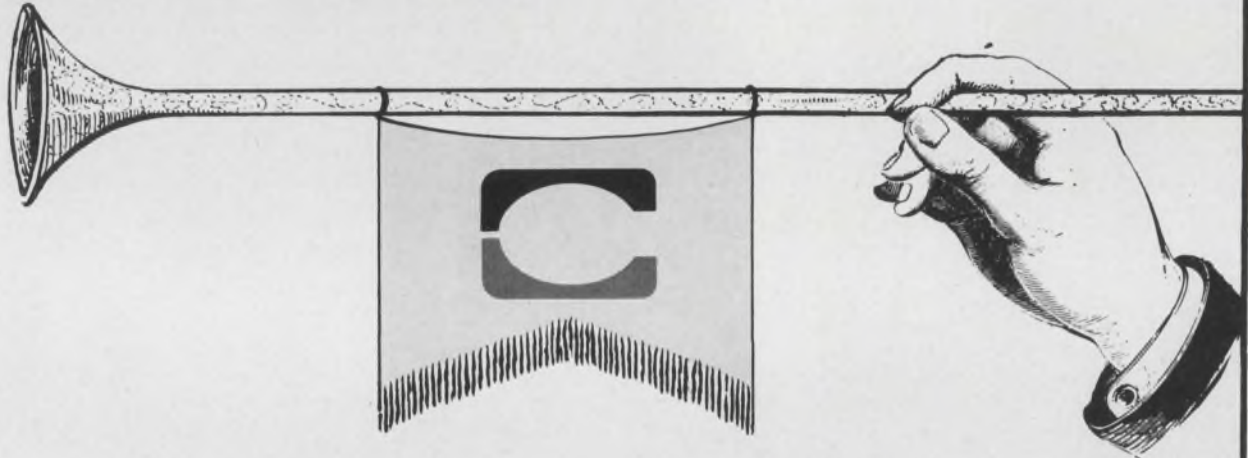

It's not as though we couldn't. We have plenty to be proud of.

It wasn't long ago that the astronauts trained in Mercury and Gemini Simulators that were developed and produced by Conduction engineers, for McDonnell. Aboard the Gemini flights, they used our Orbital Timing Device. Very soon, commercial and Air Force pilots will be training in Boeing 727, 737; Douglas DC8, DC9; and Lockheed C5A Simulators produced by the St. Louis-based Conduction-Missouri.

But this is just one aspect of our electronic capabilities. Conduction pioneers in the design, development and manufacture of a wide range of special-purpose electromechanical systems; interface equipment; and components, including microminiaturized circuits.

To provide our ever growing list of customers with electronic products for defense, space, commercial and institutional markets, Conduction is expanding its horizons. Right now, we are active in communications, data systems, microelectronics, avionics and aerospace ground support systems. Conduction is also producing landmass and radar operator training simulators.

We have nearly \$2 million invested in the most modern test equipment for the use of our engineers. With 383 engineers and scientists and the need to double this professional force in just three years, you can foresee the opportunity we offer for promotion.

Located in suburban St. Charles, just 22 freeway miles from downtown St. Louis, Conduction-Missouri is just minutes from the outstanding cultural, educational, and recreational activities of the Gateway City.

If you are a graduate engineer with 2 to 5 years experience, who is interested in an outstanding growth opportunity with a leader in the electronics industry, we have current openings in these categories:

**SYSTEMS, ELECTRONIC or ELECTRICAL
ENGINEERING • MATH MODELING • SCIENTIFIC
PROGRAMMING • LOGIC DESIGN • MECHANICAL,
RELIABILITY or MAINTAINABILITY ENGINEERING
MANUFACTURING ENGINEERING • OPTICS
COMMUNICATIONS • ENVIRONMENTAL TESTING**

Send your résumé in complete confidence to Mr. Thomas Walenga, Professional Employment Office, Dept. ED



CONDUCTION-MISSOURI

Division of Conduction Corporation

2600 N. Third Street • Box 426 • St. Charles, Missouri 63301

We are and always have been an equal opportunity employer

Free Career Inquiry Service

Absolutely Confidential

Respond to the career opportunities advertised in this issue. Fill out and send us this handy resume. **Electronic Design** will do the rest – neatly typed copies of this form will be mailed to the companies of your choice, indicated by the circled Career Inquiry Numbers at the bottom of this page.

13

Name				Home Phone	
Home Address (Street)			City		State
					ZIP Code
Age	U.S. Citizen		Security Clearance		
	<input type="checkbox"/> Yes	<input type="checkbox"/> No			
Prime Experience			Secondary Experience		
Desired Salary			Availability Date		
Employment History – present and previous employers					
Company					
City, State					
Dates	to	to	to		
Title					
Specialty					
Education – indicate major if degree is not self-explanatory					
Degree					
College					
City, State					
Dates	to	to	to		
Additional Training – non-degree, industry, military, etc.					
Professional Societies					
Published Articles					

Career Inquiry Numbers:

- | | | | | | | | | | |
|-----|-----|-----|-----|-----|-----|-----|-----|-----|-----|
| 900 | 901 | 902 | 903 | 904 | 905 | 906 | 907 | 908 | 909 |
| 910 | 911 | 912 | 913 | 914 | 915 | 916 | 917 | 918 | 919 |

ELECTRONIC DESIGN
 850 Third Avenue
 New York, New York 10022

**LOOKING FOR
GROWTH?**

**INVESTIGATE
3C NOW!**

Net sales have increased an average of 50% each year over the past 10 years; personnel has grown from less than 200 people to 1700 in the same period.

3C offers, to its customers, a total digital capability; to our professional engineers we offer a dramatic, dynamic growth potential. Continued market acceptance of our new DDP-516, DDP-416, and DDP-124 computers, I/C logic modules and core memory systems has created key opportunities for professional design engineers with experience in integrated circuits, high speed switching circuits and A/D-D/A circuitry to work on our next generation of digital equipment.

If you want growth, in a challenging atmosphere, call or wire collect, Mr. Martin Dorfman (617) 235-6220, or send your current resume to Honeywell, COMPUTER CONTROL DIVISION, Old Connecticut Path, Framingham, Massachusetts 01701.

Honeywell

 **COMPUTER CONTROL
DIVISION**

To explore professional opportunities in other Honeywell locations, coast to coast, send your application in confidence to Mr. Fred G. Laing, Honeywell, Minneapolis 55408. An Equal Opportunity Employer

ON CAREER-INQUIRY FORM CIRCLE 902

ELECTRONIC DESIGN 13, June 21, 1967

Book Reviews

LAURENCE G. COWLES

ANALYSIS AND DESIGN OF TRANSISTOR CIRCUITS

A refreshingly new and direct treatment of transistor circuit principles primarily concerned with practical circuit design. It is the first work to recognize the tremendous improvement in circuit performance and the simplification of circuit design brought about by the development of the planar transistor.

Transistor circuit design

Analysis and Design of Transistor Circuits, Laurence G. Cowles (D. Van Nostrand Company, Inc., Princeton, N. J.), 309 pp. \$9.75.

Here is a book on transistor circuit design and analysis that, instead of wasting chapters on the movement of holes and electrons, goes directly to the heart of the matter—how to design circuits. The mathematics is kept simple and to a minimum, and most theoretical material is backed up with the detailed circuit examples. Many include step-by-step design procedures making the book particularly desirable for the practicing engineer.

Special attention must be called to the fact that the book covers circuit design with planar transistors, J-FETs and MOS-FETs.

The practicality of the book is demonstrated by the fact that, in addition to numerous references throughout the text, there is a whole chapter on thermal considerations, including discussion on heat sinks.

All in all, this book seems to be one of the few written for the practicing engineer. It is a real bargain.

—Peter N. Budzilovich

Antenna handbook

Frequency Independent Antennas, Victor Rumsey (Academic Press, New York), 150 pp. \$7.50.

This book discusses current practical and theoretical work on frequency-independent antennas. The characteristics of these antennas, such as radiation pattern, polarization and impedance, are practically constant for a ten- or hundredfold change of frequency. The first six chapters are written on a senior undergraduate level; the final two chapters, which deal with mathematical solutions of Maxwell's equations, are slightly more advanced.

Servo design techniques

Modern Analytical Design of Instrument Servomechanisms, Bruce A. Chubb (Addison-Wesley, Reading, Mass.), 228 pp. \$11.95.

The purpose of this book is to help with the design of optimized instrument servomechanisms. For the practicing engineer, the book has new and useful material, including the latest analytical techniques for instrument servo design. The design and analytical techniques presented lend themselves directly to programing on the digital computer. One section deals with automated design and optimization theory using the principle of steepest descent.

Plasma physics

Electrodynamics of Plasmas, R. Jancel and Th. Kahan (John Wiley & Sons, New York), 633 pp. \$19.60.

The aim of this book is to give a comprehensive view of the theoretical fundamentals of plasma physics. It begins with a discussion of general properties of plasmas and elementary processes. The authors then proceed to treat more advanced aspects of plasma theory, including Boltzmann's integro-differential equation, Maxwell's transport equations and the properties of the Maxwellian state of plasmas, macroscopic relations, and the H theorem. When reference is made to certain classical theories, they are developed or summarized.

ENGINEERS

Univac Twin Cities is a young exciting place to work!

Univac is an exciting, big league company in a young, big league city. *We like it here.*

We like the choice of colorful major league football, baseball or hockey. We like to pick and choose from dozens of fine restaurants with big league flavor.

We like to swim, ski, skate, fish and hunt. We like to choose from over 10,000 lakes.

We like to live in the leisure of suburbia—minutes driving time from our offices.

We like the challenge and career growth that comes from belonging to the finest hardware/software manufacturer in the computer field.

We'd like to have you join us. Do you have experience in the following areas?

- Computer Logic Design
- Computer Graphics and Displays
- Advanced Manufacturing Techniques
- Reliability and Failure Analysis
- Industrial Engineering

If you do, write and tell us your goals for today and tomorrow. Write R. K. Patterson, Employment Manager, Dept. 113, address below:

UNIVAC

DIVISION OF SPERRY RAND CORP.

FEDERAL SYSTEMS DIVISION
2750 WEST SEVENTH BLVD.
ST. PAUL, MINNESOTA 55118

An equal opportunity employer M/F



Microwave communication systems serving much of the free world.

Data processing and communication systems used by government and industry.

Specialized aerospace and military systems.



What Does an EE Do at Collins?

He designs some of the most advanced communication equipment and systems in the world. Examples: all weather systems allowing aircraft to land under reduced minimums, microwave radio systems providing vital communication links across the United States and many foreign countries, data systems used by airlines and railroads, complete earth stations for satellite communications, automatically tuned single sideband maritime systems.

EE's find professional challenge and advancement in Collins' highly diversified technical environment. Collins' continuing growth provides openings for qualified EE's in a wide range of disciplines such as those listed.

- Flight Control Systems Engineers
- Communications Research Engineers
- Circuit Designers
- Process Engineers
- Electronic Packaging Designers
- Systems Engineers
- Microcircuit Designers
- Instrumentation Engineers
- Spacecraft Systems Engineers
- Reliability Engineers
- Field Support Engineers
- RF Systems Engineers
- Antenna Design Engineers
- Microwave Design Engineers
- Quality Engineers
- Transmitter Design Engineers
- Training Instructors
- Crystal Filter Engineers
- Maintainability Engineers
- Component Evaluation Engineers
- Data Systems Analysts
- Computer Programmers/Analysts
- Solid State I.C. Engineers (MOS)
- Data Communications Engineers

For additional information about careers at Collins, send your resume in confidence to Manager of Professional Employment, Collins Radio Company, Dallas, Texas, Cedar Rapids, Iowa, or Newport Beach, California.



AM-FM broadcast systems from microphone to antenna.

Avionic systems used by more than 50 commercial airlines.



COMMUNICATION/COMPUTATION/CONTROL

an equal opportunity employer



COLLINS RADIO COMPANY / DALLAS, TEXAS • CEDAR RAPIDS, IOWA • NEWPORT BEACH, CALIFORNIA • TORONTO, ONTARIO
Bangkok • Beirut • Frankfurt • Hong Kong • Kuala Lumpur • Los Angeles • London • Melbourne • Mexico City • New York • Paris • Rome • Washington • Wellington

ON READER-SERVICE CARD CIRCLE 904

TI offers temperature stabilization for components at half the cost.

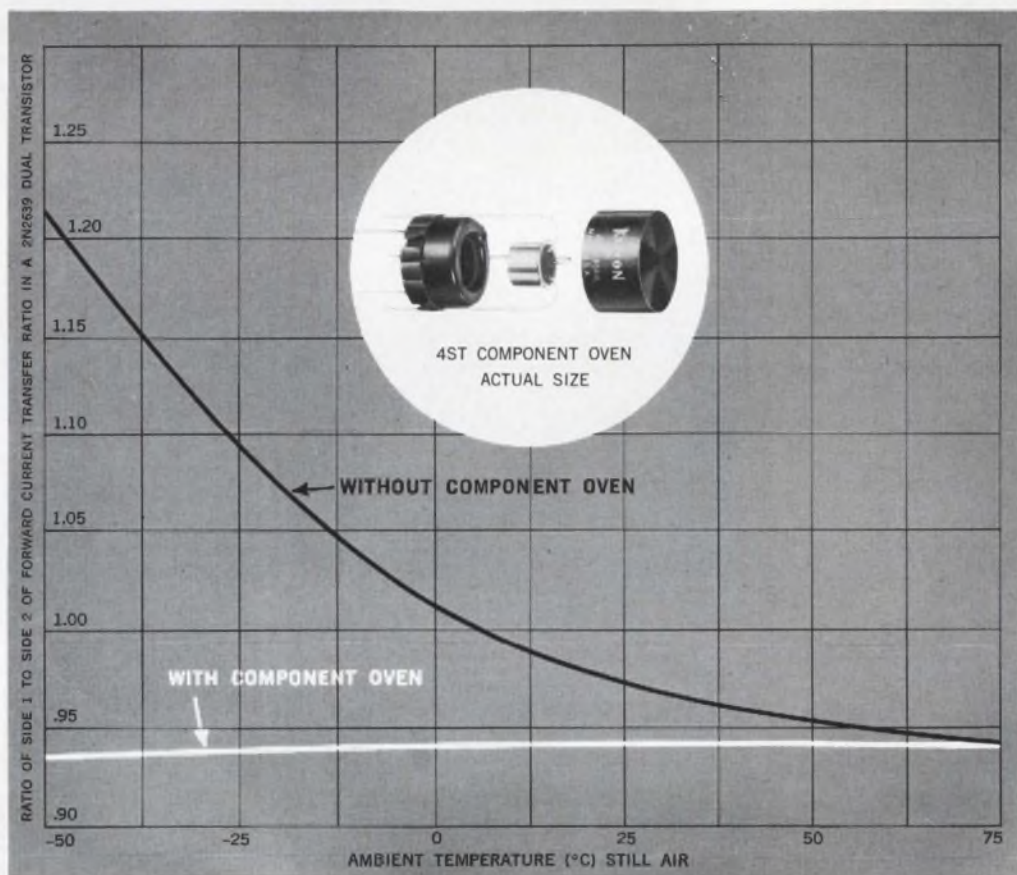

TI component ovens use the self-regulating characteristics of a polycrystalline material to provide a stable thermal environment for semiconductor components. This precise control, for example, can increase the performance of lower priced components so significantly they can be used to replace components costing five to thirty times as much . . . Even with the component oven cost, there's a savings of at least 50% . . . and this

in the smallest ovens available on the market today.

TI ovens are available in two options: one with a control temperature of 80°C, the other with a control temperature of 115°C. Power requirement at room temperature is about one watt. Warm up time from -55°C at an air velocity of 100 ft./min. is two minutes, maximum. Control temperature shift with voltage variation from nominal is 0.4°C to

0.6°C per volt.

We offer a complete line of component ovens, precision thermostats, other electromechanical switches, solid state switches, thermal and magnetic circuit breakers, cooling effect detectors, proportional temperature controllers and power storage systems.

For complete information on a product in any of these lines, write to TI Control Products Group, Attleboro, Mass. 02703.



TEXAS INSTRUMENTS
INCORPORATED

Products

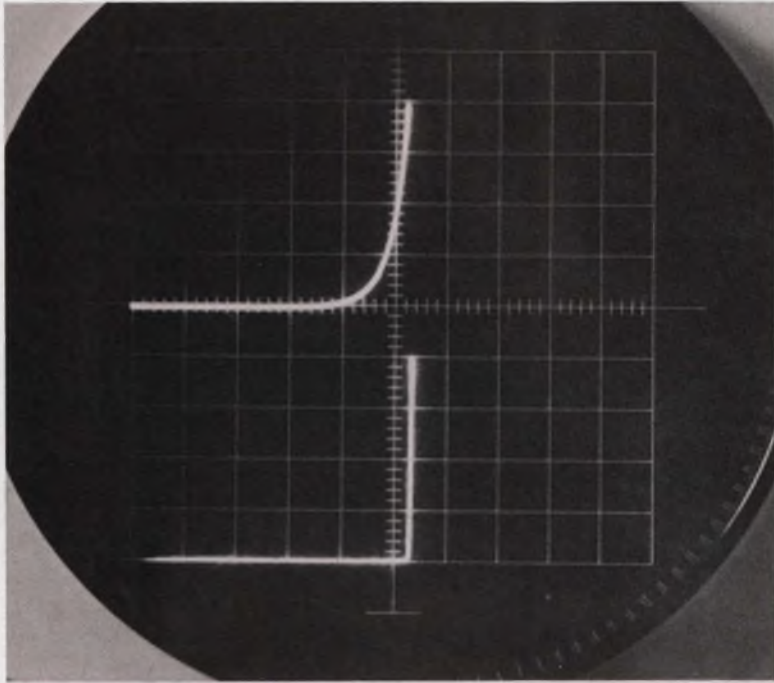

Sharper knees at lower voltages with new avalanche diodes. Upper trace is equivalent 1N752A. Page 120



Trimmer potentiometers automatically tested for seven operating parameters at 5 seconds/pot. Page 144

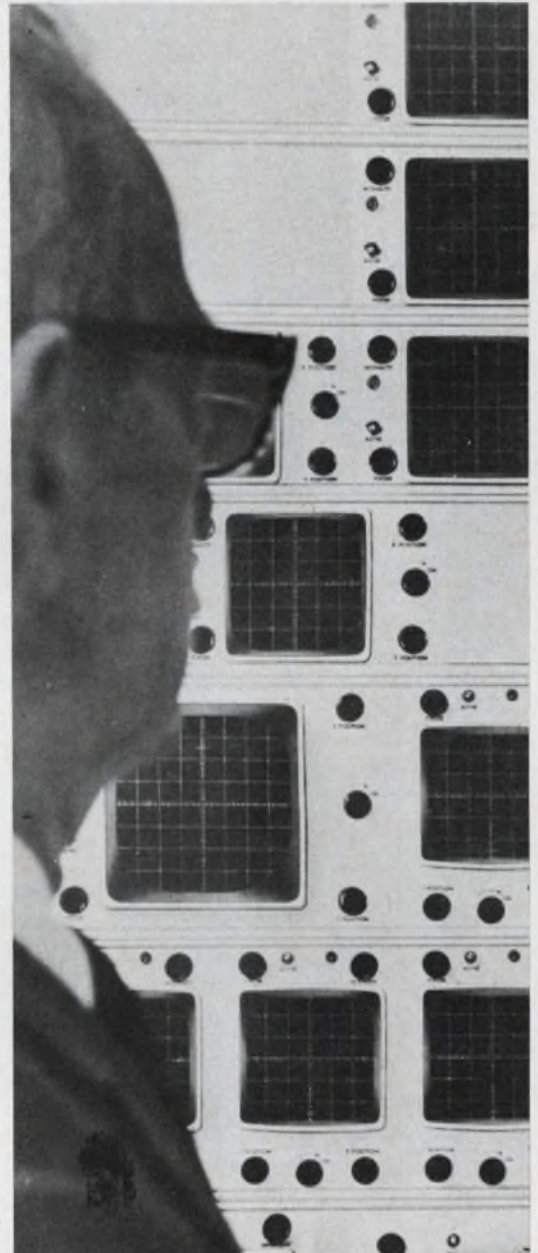

Custom CRT displays from 4 modules, hundreds of options. Page 136

Also in this section:

MOS-FET flip-flops operate at DTL voltage levels. Page 124

Electroless copper PC boards ease soldering, cut costs. Page 134

Dummy loads dissipate 50 kW. Water doubles as coolant and dielectric. Page 148

Design Aids, Page 153 . . . **Application Notes**, Page 154 . . . **New Literature**, Page 156

Avalanche diode exhibits sharp low-voltage breakdown

TRW Semiconductors, Inc., 14520 Aviation Blvd., Lawndale, Calif. Phone: (213) 679-4561. P&A: under \$1 in large quantity; stock.

With avalanche characteristics in the low-voltage field-emission range, TRW Semiconductors' family of low-voltage avalanche (LVA) Zeners has considerably sharper breakdown than field-emission types. Leakage, knee impedance and regulation are much better than the MIL-spec for the equivalent JAN 1N749A through 758A series.

The sharp breakdown (photo, p. 119) makes the LVA much more effective as a clip, clamp or low-current regulator. In addition, good stability of the diode could eliminate the need for an additional dc reference voltage in power supplies. Other applications could be in wave-shaping and agc threshold circuits, operational and IF amplifiers.

The new diode has noticeably sharper breakdown characteristics than Zeners in the 4-to-10-volt range. Above 10 volts, the break-

down mechanism of Zener regulators is avalanche, which produces a very sharp knee and provides good voltage regulation. Below 10 volts, the field-emission phenomena start, and as the operating voltage decreases, field emission accounts for an increasingly higher percentage of the breakdown mechanism. This produces the soft knee in low-voltage Zener regulators. In the LVA diode, the field-emission breakdown mechanism is suppressed, producing a predominantly avalanche breakdown in the low-voltage range.

Below approximately 7 volts, the sharp knee offers the circuit designer a much better regulator at wider current spreads than was previously available. For instance, the 5.6-volt diode in the regulator circuit of Fig. 1 has 5% typical regulation over three decades of current (50 μ A to 50 mA). The regulation of an equivalent Zener, over the same range of currents, is 19%.

Above approximately 7 volts, because the LVA diode is further into avalanche, there is less bulk or field-

emission "leakage" in the breakdown mechanism. This decrease in bulk leakage combined with clean junction surfaces produces the lowest-leakage device available, according to TRW.

In the series regulator circuit of Fig. 2, the lower impedance of the LVA serves to keep output ripple an order of magnitude less than the 1N751A. The impedance is much lower than MIL types at Zener voltages less than 6 to 7 volts and is not significantly changed above this voltage. The reverse leakage is improved at all breakdown voltages. Since impedance is an important factor in regulator applications and reverse leakage is important in clamp and clipping applications, the LVA diode makes it possible to build better regulators below 7 volts and better clamps below 10 volts.

The diodes also shift the uncompensated zero TC point from the normal 5.4-to-5.6-volt point down to 4.7 volts, allowing lower voltage references than ever before. Another benefit is a relatively constant TC as a function of operating current. This allows construction of 6.4-volt TC Zeners which operate as low as 50 μ A and hold a very low TC from 50 μ A to 10 mA.

The family of diodes is available rated at 4.3 to 10 volts at 20 mA. Packaging is DO-18 or DO-14. It is also available as a chip on a substrate.

CIRCLE NO. 250

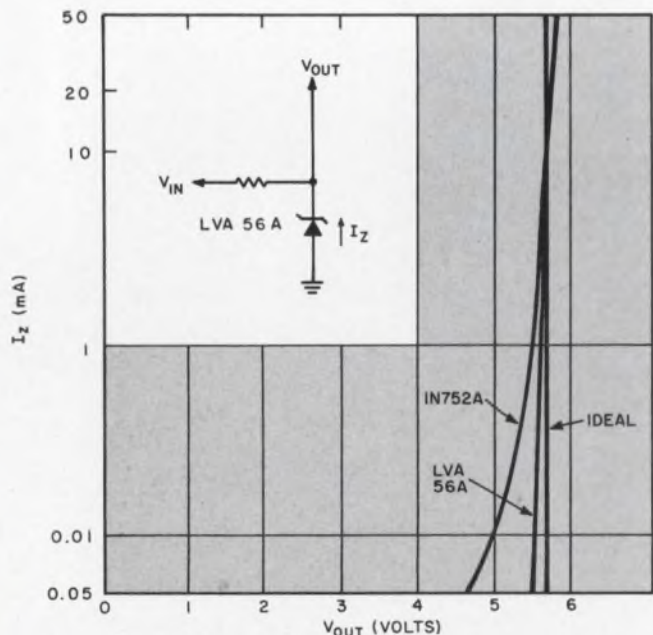

1. In basic regulator circuit, LVA 56A exhibits 5% regulation from 50 μ A to 50 mA. JAN 1N752A shows 19% regulation over the same current spread.

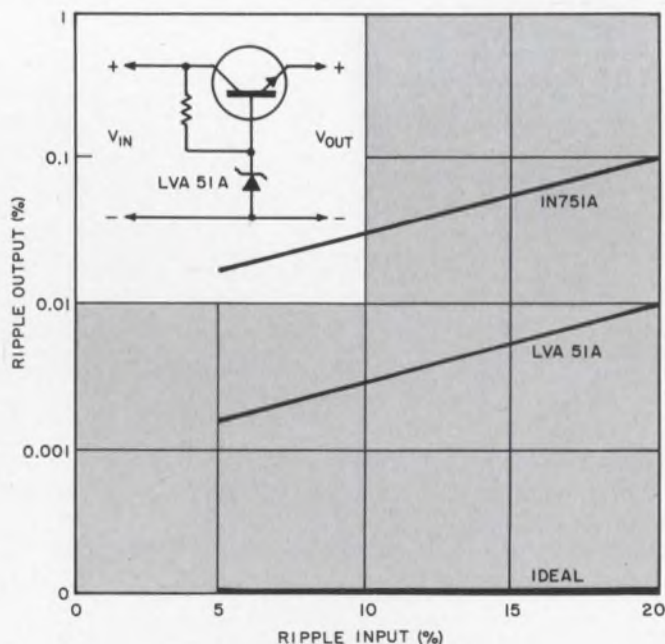

2. In series regulator circuit, LVA 51A cuts output ripple by an order of magnitude over JAN 1N751A. Zener impedance of LVA is lower at less than 6 or 7 volts.

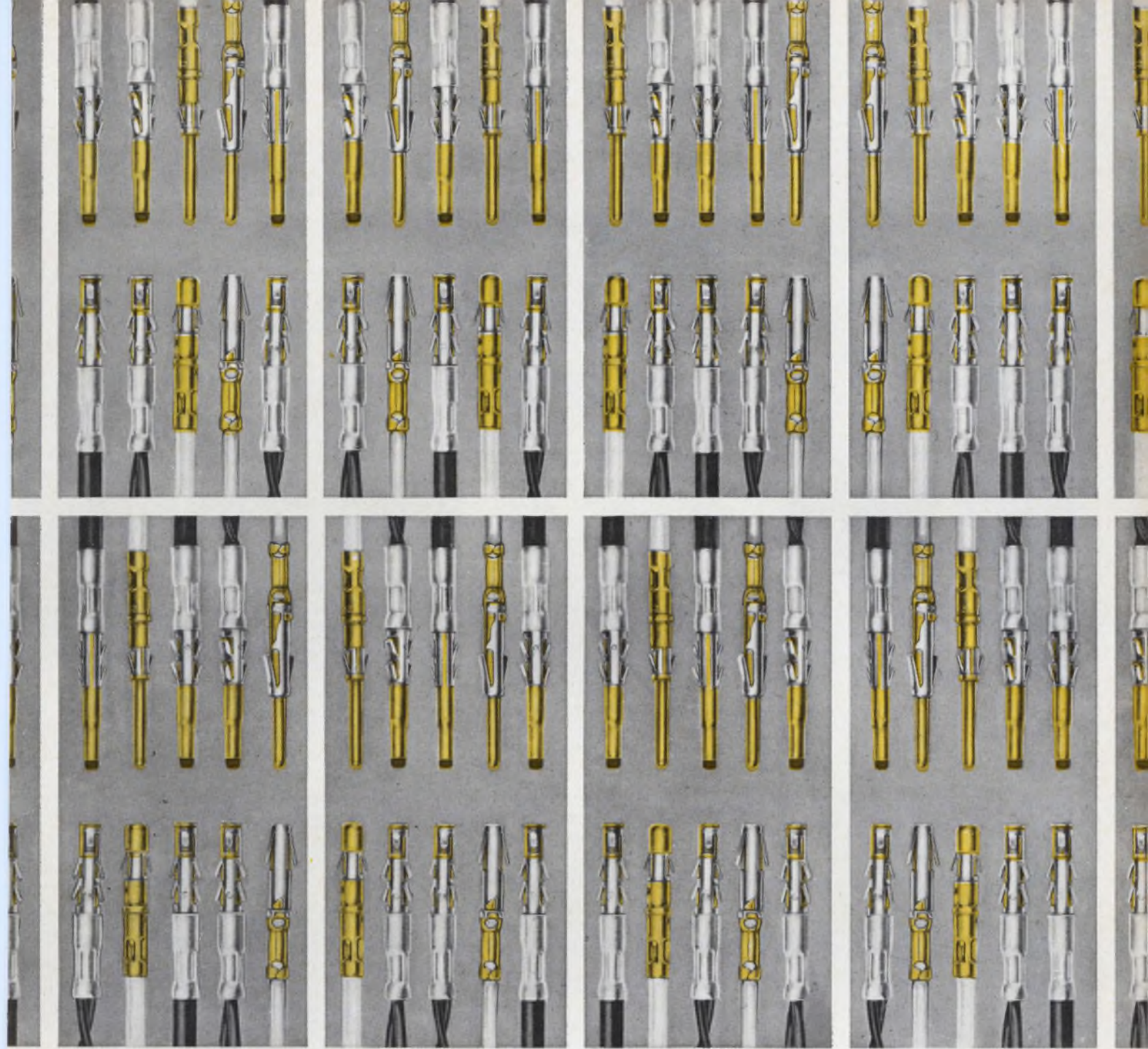

Mix these signal, power and coax leads in any combination.

Burndy Trim Trio Connectors—available in many shapes—accept three contact styles, all crimp-removable, for signal and power leads #16 thru #24, twisted pair #24 and #26, and subminiature coaxial cables.

Changing conductors is fast and simple, whether for lower voltage drop or better shielding or mechanical reasons. This makes Trim Trio Connectors ideal for breadboard and prototype work as well as

production. For large production runs you can take advantage of the economies offered by the automatic Burndy Hyfematic™ with a crimp rate of up to 3000 contacts per hour.

Get more details on how you can take advantage of the Burndy Trim Trio System—THE ACCEPTED METHOD OF INTERMIXING CONTACTS.

BURNDY
Norwalk, Connecticut

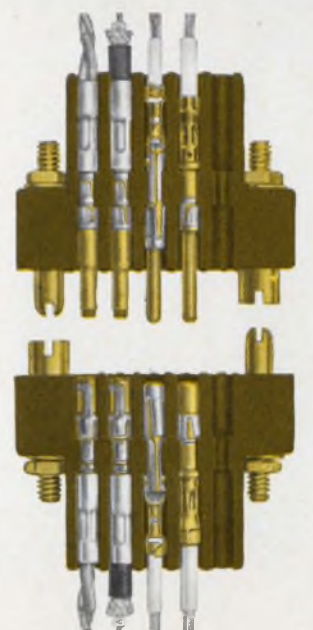

MODEL SR-60 60 KHZ PHASE COMPARATOR RECEIVER

• Measurement Accuracies To Parts in 10¹⁰ • Low Cost • Easy To Operate

The Model SR-60 is the first low cost VLF Phase Comparison Receiver designed to permit phase comparison measurements between a local oscillator and the National Bureau of Standards transmitted 60 KHz from WWVB. The receiver is a straight-forward Tuned Radio Frequency receiver and can be used in any location in the United States with highly satisfactory results.

The SR-60 permits accuracy measurements to parts in 10¹⁰ with relative short measurements. Phase difference is displayed on a front panel meter, an integral 2" oscilloscope or on a strip chart when more precise measurements are made over a long period of time. **MODEL SR-60 \$850.00**

Rack panel: 5 1/4" H x 19" W x 17 1/2" D



SEE OUR SPECIFICATIONS IN VSMF MICROFILM CATALOG FILE

Write, wire or phone for complete catalog information.

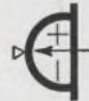

SPECIFIC PRODUCTS

P. O. Box 425 / 21051 Costanzo Street / Woodland Hills, California 91364 / Phone: (Area Code 213) Diamond 0-3131

ON READER-SERVICE CARD CIRCLE 56

SEMICONDUCTORS

Turn on thyristors with 3-layer triggers

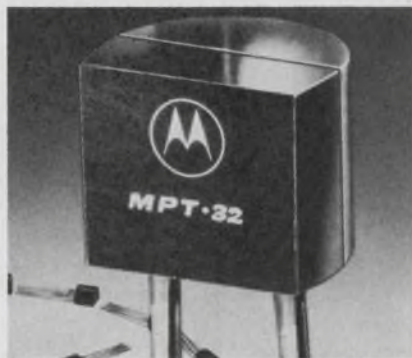

Motorola Semiconductor Products, Inc., P. O. Box 955, Phoenix. Phone: (602) 273-6900. P&A: 48¢ (100 to 999); stock.

Space-saving 3-layer trigger devices for turning on thyristors in phase-control circuits are intended to replace older trigger types such as neons that have higher voltage requirements, 4-layer diodes, Zeners and other unilateral triggering devices. Known as 3-layer bilateral triggers, the two-terminal units have a high internal resistance until the voltage reaches the switching level causing internal breakover. Beyond this level of applied voltage the device switches into the negative resistance region, producing a current pulse for thyristor triggering. Switching occurs during the application of either positive or negative polarity permitting simplified full-wave phase control. The plastic units are available with typical breakover voltage of 28, 32 and 36 V and a typical breakover current rating of 20 μ A.

CIRCLE NO. 251

Silicon planar SCRs block up to 400 V

Transitron Electronic Corp., 168 Albion St., Wakefield, Mass. Phone: (617) 245-4500. P&A: \$6 (1 to 99), \$4 (100 to 999); stock.

High-voltage silicon planar SCRs are for use in switching circuits where blocking voltage capability of up to 400 volts is required. Packaged in a TO-5, the devices have dc gate trigger current and voltage of 200 μ A, 0.8 V. Holding current is 10 mA.

CIRCLE NO. 252

High-Q varactors packaged whiskerless



MSI Electronics, Inc., 34-32 57th St., Woodside, N. Y. Phone: (212) 672-6500. P&A: \$3 to \$10 (1 to 99); stock.

High-Q voltage-variable capacitance diodes ranging from 3 to 18 pF are available in a whiskerless DO-35. Qs are greater than 500 measured at 50 MHz. Series inductance is less than 0.5 nH and package capacitance is 0.2 pF. Power dissipation of 300 mW is made possible by the built-in heat sink construction of the double plugs; the total device dissipation may be derated linearly to 100°C free air temperature at the rate of 3.5 mW/°C. The capacitance swing is typically 2:1 from zero to 4 V bias. The high Q suggests applications in FM and TV tuners, as well as in military applications for use in afc, FM and selective tuning.

CIRCLE NO. 253

Power transistor socket accepts TO-66 base

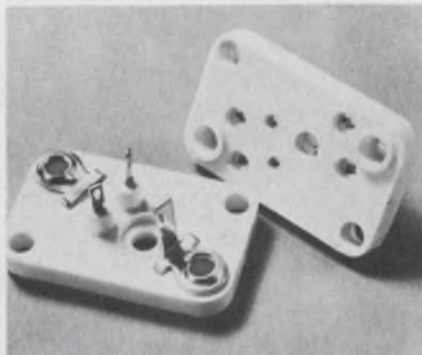

Industrial Electronic Hardware Corp., 109 Prince St., New York. Phone: (212) 617-1881.

All-molded power transistor sockets accept the TO-66 base. The socket has a polypropylene casting, brass cadmium-plated contacts and steel cadmium-plated ground lug. It is also available for printed circuit mounting.

CIRCLE NO. 254

Varactor diodes for TV tuning

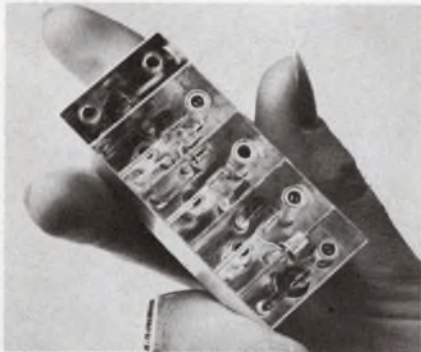

STC Semiconductors, Ltd., Footscray, Sidcup, Kent, England. Phone: Footscray 3333.

Two variable-capacity diodes, the BA 141 and BA 142, are designed for use at frequencies up to 1000 MHz. Mainly intended for TV/uhf and vhf/FM tuners, they are JEDEC DO-7 devices with a capacitance range of 4.5:1. The BA 141 is suitable for continuous tuning over each of TV bands I, II and III, and over bands IV and V combined; the BA 142 is suitable for bands I, II and III only. Tracking of both diodes is better than 3% and Q varies from 300 at 47 MHz to 75 at 800 MHz. For television use, the BA 141 is supplied in matched sets of four, and the BA 142 in matched sets of three. Both are also suited for afc and remote tuning in vhf equipment and can be used in FM control systems.

CIRCLE NO. 255

Transistor amplifies at 250 MHz

TRW Semiconductors Inc., 14520 Aviation Blvd., Lawndale, Calif. Phone: (213) 679-4561. P&A: \$5.25 (1 to 99), \$3.50 (100 to 999); stock.

A new transistor is designed for high-level applications in 250-MHz output amplifiers, 100-MHz high-level amplifiers and broadband amplifiers. Features of the unit, type PT3760, are 30-V collector-to-emitter voltage, 460-MHz gain-bandwidth product, 100-mA collector current and 10-dB gain at 232 MHz (120 mW out). Package is TO-18.

CIRCLE NO. 256

POT SHOT OF THE MOON

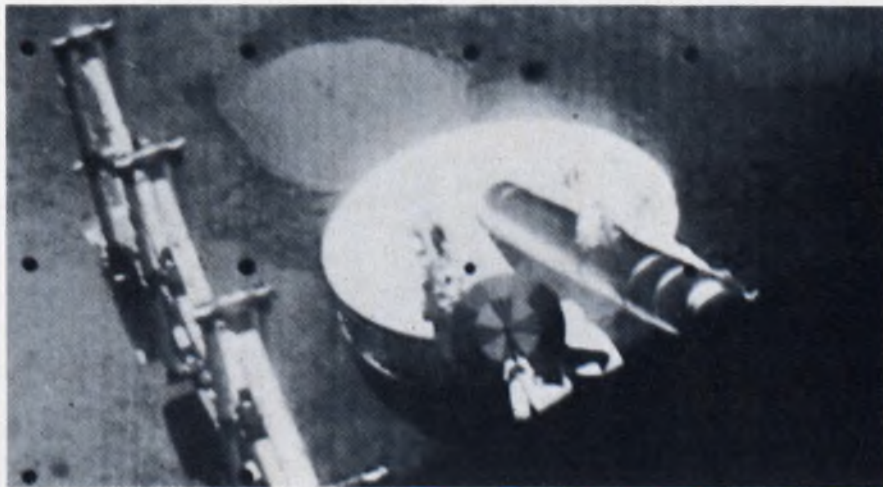

Less than an hour after Surveyor 3 settled itself on the lunar surface, the first photos from its TV camera were being processed at Jet Propulsion Laboratories. They have continued coming through at a rate of better than 300 per day.

Six Duncan Electronics precision potentiometers in the camera lens assembly built by Bell & Howell help to assure that the photos are being continuously transmitted. These wirewound linear pots control and monitor the TV camera's variable focal length lens, the mirror angle, and the color wheel position.

As in Surveyor 1, the Duncan pots are operating in temperatures ranging from -149°F to $+302^{\circ}\text{F}$ and in a vacuum estimated at only 10^{-13} mm of Hg. Their perfect performance in both missions is testimony to the exacting care used in their design and manufacture.

Whether or not you're shooting for the moon, you'll find we can solve your potentiometer problems — be they linear, non-linear, wirewound, or conductive plastic.

Call us today — we'll help you get off the ground.



(photographs courtesy Hughes Aircraft Company)



DUNCAN electronics, inc.

2865 Fairview Rd., Costa Mesa, California • Tel: (714) 545-8261 • TWX: 910-595-1128

ON READER-SERVICE CARD CIRCLE 57

COOL

KLYSTRONS • MAGNETRONS • TRANSFORMERS
TRAVELING-WAVE TUBES • SWITCH TUBES
WAVE GUIDES • DUMMY LOADS • LASERS

with New **ELLIS and WATTS**
Liquid-to-Air Heat Exchangers*

One of the new Ellis and Watts Heat Exchangers may be the answer to a need for tailoring a cooling system to your type of electronic equipment. Minimum space, low noise level and optimum performance have been achieved in each of a wide range of designs which include indoor/outdoor types in ratings from 5 to 300 KW. Proved in military, aerospace and commercial applications, these designs offer flexibility for quick modification to meet any specific cooling requirements.

Why not put the widely recognized Ellis and Watts custom-cooling "know-how" to work for you. Write us at the address below.

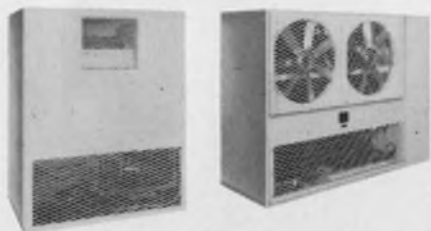

*Liquid-to-Liquid Heat Exchangers also available.



ELLIS AND WATTS COMPANY
Ellis and Watts Company, P.O. Box 36033
Cincinnati, Ohio 45236

ON READER-SERVICE CARD CIRCLE 58

Hybrid IC amplifiers gain 58 dB into 600 Ω

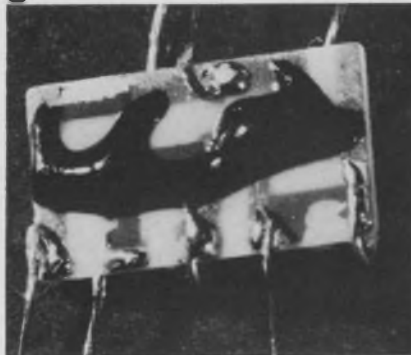

*The Head Line Co., 17220 N. W.
2nd Court, N. Miami Beach, Fla.
Phone: (305) 624-5031. P&A: \$8.50
(100-up); 4 wks.*

Hybrid integrated circuit amplifiers are designed for use in portable equipment requiring high gain and low power consumption. The HL-50 provides a voltage gain of 58 dB into a 600- Ω load. Power consumption is 0.7 mA at a 1.5-Vdc supply. No external components other than a gain control and a load resistance are required. Size is 0.175 x 0.095 x 0.285 inch with 6 stranded flexible insulated lead wires.

CIRCLE NO. 257

MOS flip-flop operates at DTL voltages

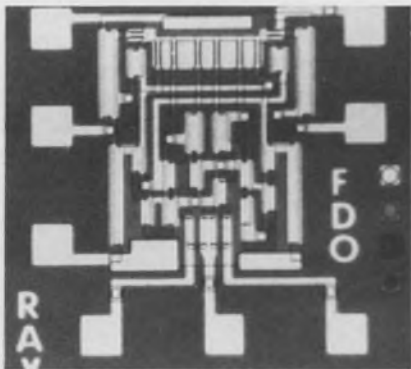

Raytheon Co., Semiconductor Operation, 350 Ellis St., Mountain View, Calif. Phone: (415) 968-9211. P&A: \$2.60 (over 1000); stock.

A complex MOS-FET logic array is capable of operating at DTL voltage levels. The device, an asynchronous low-power J-K flip-flop and counter element, consists of a num-

ber of p-channel enhancement mode MOS-FETs on a chip measuring 0.033 x 0.03 inch. It employs direct-coupled NOR logic to produce a basic flip-flop which operates from dc to 200 kHz. The three inputs, J, K, and counter, allow the device to operate as a J-K flip-flop or as a counter element with preset and reset capability.

The device operates with two power supplies, whose voltages may be varied for trade-offs in the areas of power dissipation, speed and noise immunity. Current requirement is less than 0.5 mA at 6 V. When operated with the principal power supply at -6 V, the 0 and 1 logic levels are -0.25 and -5 V. The array is produced in low profile, 8-lead TO-5 packages.

CIRCLE NO. 258

Monolithic breadboard dielectrically isolated

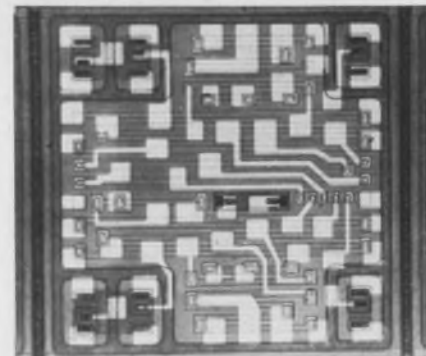

United Aircraft Corp., Vector Div., Southampton, Pa. Phone: (215) 355-2700.

A dielectrically isolated master monolithic breadboard is available for production quantities of custom-designed circuitry. The IC chips are available with tantalum nitride thin-film or diffused resistors. Economies result from the elimination of the production steps of masking and diffusion with each design change. Resistors applied to the master breadboard have a range from 75 Ω to 50 k Ω and the transistors have a minimum beta of 50 with an f_t of 400 MHz. There are normally 30 resistors and 6 transistors on the basic master breadboard chip.

CIRCLE NO. 259

In Making Masks for Electronic Components there's no Margin for Error!

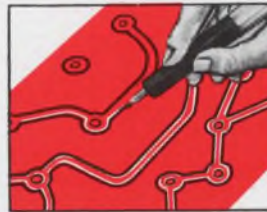

With sharp blade, outline the areas to be masked. Do not cut through the backing sheet. The Ulano Swivel Knife does the job quickly, easily.



Now carefully peel off the film as outlined leaving a completed photo mask, positive or negative, that corresponds exactly to the desired pattern.

**THAT'S WHY EXPERIENCED DESIGNERS
AND ENGINEERS ALWAYS INSIST ON...**



RUBYLITH™

HAND-CUT MASKING FILM FOR THE GRAPHIC ARTS

**THE KNIFE-CUT, LIGHT-SAFE MASKING FILM
LAMINATED TO A STABLE POLYESTER BASE**

The most versatile line of hand-cut masking films, including

**.0075—RUBYLITH 75 DR* .005 RUBYLITH 5 DR
.005 AMBERLITH 5 DA**

These new, thick Ulano films provide the positive answers where exact register assumes a critical importance.

** Available in sheets only, cut to your specifications.*

by

Ulano™

ulano™

610 DEAN STREET, BROOKLYN, N. Y. 11238

NEW YORK • CALIFORNIA • CHICAGO • ZURICH

In Europe: ULANO A. G., Untere Heslibachstrasse 22, Kusnacht 8700, Switzerland

Write on your letterhead for special electronic test kit (no charge) No. 4127

ON READER-SERVICE CARD CIRCLE 59

Microsonics

State of the Art Design in Filters Oscillators and Delay Lines



Continuously
Variable Delay
Systems

Bulletins 4301 and 4302



Broad Bandwidth
Highly Selective
Crystal Filters
Bulletin 6350

Comb. Filter Sets
Bulletin 6350



Broad Bandwidth
Delay Lines
Bulletin 4300



Highly Stable
Oscillators — Bulletin 6350



Voltage Controlled
Crystal Oscillators
Bulletin 6350

High Density
Digital Storage
Systems

Bulletin
5350



Send for literature.



MICROSONICS, INC.
60 Winter Street
Weymouth, Mass. 02188
Tel: 617 337-4200

A subsidiary of the Sangamo Electric Company

COMPONENTS

FET diff-amp ups common-mode specs



Analog Devices, 221 Fifth St. Cambridge, Mass. Phone: (617) 491-1650. P&A: \$110, \$120, \$135; stock to 3 wks.

This FET operational amplifier overcomes a problem that has plagued FET types: poor common-mode performance. Previously, the best FET amplifiers were limited to a common-mode-rejection ratio of about 5000:1. Model 147C is rated at 300,000:1.

In addition, current-drift performance has been raised. Initial bias current is 15 pA, compared with 100 pA max for competitive types. Voltage drift is 2 $\mu\text{V}/^\circ\text{C}$. The 0.1-pA maximum noise figure reportedly is 100 fold better than comparably-priced chopper-stabilized amplifiers, enabling model 147C to replace chopper amplifiers in many high-impedance circuits. The 10-V/ μs slewing rate makes the amplifier good for fast A-D converters and sample-and-hold amplifiers.

Three models are offered, differing in voltage drift and bias current. Voltage drift for models A, B and C are 15, 5 and 2 $\mu\text{V}/^\circ\text{C}$.

CIRCLE NO. 260

PC board fasteners eliminate solder ground

Palnut Co., Glen Rd., Mountainside, N. J. Phone: (201) 233-3300.

These spring steel fasteners snap into mounting holes in a PC board where they are secured by normal solder dips. The board is then pushed down on the tabs bent upright from the sheet metal chassis. They provide a positive electrical ground that eliminates the need for hand-soldered connections.

CIRCLE NO. 261

Liquid-cooled heat sinks for semiconductors

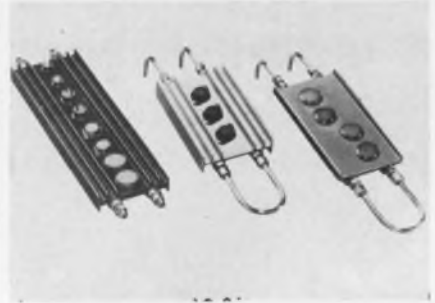

International Electronics Research Corp., 135 W. Magnolia Blvd., Burbank, Calif. Phone: (213) 849-2481.

Liquid-cooled heat dissipators incorporating integrally-extruded coolant passages are designed for high-power dissipation in small spaces. Utilizing any normal coolant, type E4 requires 42 in³ for dissipation of 1000 watts while the E5 performs similarly in less than 45 in³. Extruded in a pattern of two fins plus liquid passages, the E4 has an outside cross section 3-1/2 inches wide by 1 inch high; the E5, with 6 fins, is 3-3/4 inches by 1 inch. Standard lengths for both units run from 6 inches to 4 feet in 1-1/2-inch increments.

CIRCLE NO. 262

Dc-to-dc converter puts out 2.25 kV

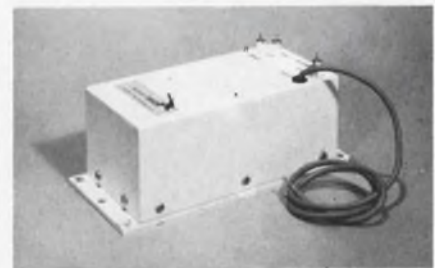

Terra Corp., Albuquerque, N. M. Phone: (505) 255-0157.

With high- and low-voltage outputs, this dc-to-dc converter is input-regulated and temperature-compensated. Input voltage is +28 volts; dc outputs are +2.25 kV, +20 V, +6.3 V and -80 V. The unit is designed primarily as a triode microwave oscillator power supply but is applicable to any system requiring bias, filament, logic and high voltage from a single converter.

CIRCLE NO. 263

ON READER-SERVICE CARD CIRCLE 60

From RCA "overlay" ... 8 great RF-Power transistor advances!

new:



Industry's Best Performing
RF-Power Plastic Transistor

**RCA
2N5017**

$P_{out} = 15 \text{ W (Min.) @ 400 MHz}$

Low emitter and base inductances (0.1 nH and 0.2 nH respectively)... rugged "terminal block" structure permits choice of stripline, printed circuit, or lumped circuit mounting.

On Reader Service Card Circle 191

new:



Microwave Coaxial Package!

**RCA
TA 7003**

$P_{out} = 1 \text{ W (Min.)}, 5 \text{ dB Gain @ 2 GHz}$
 $P_{out} = 2 \text{ W (Min.)}, 10 \text{ dB Gain @ 1 GHz}$

New low-inductance package for UHF and microwave oscillator, frequency-multiplier, and rf-amplifier service.

On Reader Service Card Circle 192

new:



**RCA
2N 5016**

$P_{out} = 15 \text{ W (Min.) @ 400 MHz}$

Formerly TA2675, this type uses the same chip as in RCA's new 2N5017 plastic-stud package, but in the popular hermetically sealed TO-60 case.

On Reader Service Card Circle 193

new:



High power version of
RCA's new 2N5016 transistor!

**RCA
TA 7036**

$P_{out} = 20 \text{ W (Min.) @ 400 MHz}$

For Class B or C VHF-UHF Military & Industrial Communications.

On Reader Service Card Circle 194

new:



For Class-A Wideband applications
in VHF Equipment!

**RCA
TA 2800**

$f_t = 1200 \text{ MHz (Min.) @ } I_c = 50 \text{ mA}$
Large dynamic range
 $NF = 3 \text{ db (Typ) @ 200 MHz}$

For top performance in CATV and MATV line amplifiers and low-noise linear amplifiers.

On Reader Service Card Circle 195

new:



High-gain Class-C amplifier
type for UHF service!

**RCA
TA 2710**

$P_{out} = 1 \text{ W (Min.) } 5 \text{ dB Gain @ 1 GHz}$
 $= 0.3 \text{ W (Typ) @ 1.68 GHz}$

On Reader Service Card Circle 196

new:



Class-B and -C amplifier type
for 24-V FM communications!

**RCA
2N 5071**

As narrowband amplifier:
 $P_{out} = 24 \text{ W Min. @ 76 MHz with } P_{in} = 3 \text{ W}$
As broadband amplifier:
 $P_{out} = 15 \text{ W (Min.) @ 30-76 MHz with } P_{in} = 3 \text{ W}$

On Reader Service Card Circle 197

new:



Class-A and -B amplifier type for
Single-Sideband Transmitters!

**RCA
2N 5070**

$P_{out} = 25 \text{ W (PEP) Min.}$
13 dB gain @ 30 MHz, $V_{cc} = 28 \text{ V}$
Intermodulation Distortion = 30 dB (Max.)

On Reader Service Card Circle 198

For information on these and other RCA "overlay" transistors, see your RCA Representative. For technical data on specific types, write: RCA Commercial Engineering, Section IG6-3, Harrison, N.J. 07029



RCA Electronic Components and Devices

The Most Trusted Name in Electronics

NEW!

High RF Voltage



Quartz Trimmer Capacitor

The new Johanson GQ 11115 quartz trimmer capacitor permits a working voltage of 2500 VDC and 2500v peak RF at 30 mc with a dielectric strength of 7000 VDC. It bridges the application gap between the low power handling capabilities of conventional piston trimmer capacitors and the extremely high power handling capabilities of vacuum capacitors.



Tubular Electrodes

- Low losses and low inductance at microwave frequencies.
- Components can be attached to the capacitors utilizing shorter leads.
- Higher voltages (RF) and higher Q are a result of the "gripping" action of bands on glass.

Call or write for complete information.

Johanson

MANUFACTURING CORPORATION

400 Rockaway Valley Road
Boonton, N.J. 07005 • (201) 334-2676

Electronic Accuracy Through Mechanical Precision

ON READER-SERVICE CARD CIRCLE 61

COMPONENTS

Plug-in detector card linear to 0.1%

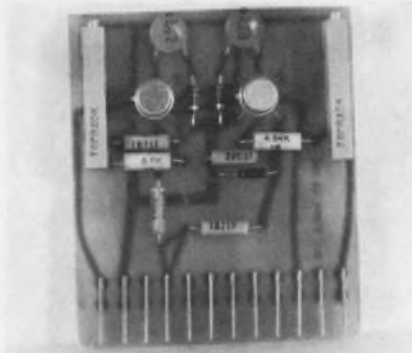

M. L. Stern Co., Inc. P. O. Box 17826, Charlotte, N. C. Phone: (704) 375-6961. Price: \$90.

A plug-in detector card using operational amplifiers accepts ac signal inputs from 0 to 500 mV and delivers full-wave rectified dc proportional to the input signal. Linearity is better than 0.1% to 8 kHz over a 60-dB range. Adjustable feedback potentiometers control the gain of the card so various input levels can be accepted. Temperature range is -55° to $+125^{\circ}$ C.

CIRCLE NO. 264

Matching transformer shielded to 65 dB



Microtran Co., Inc., 145 E. Mineola Ave., Valley Stream, N. Y. Phone: (516) 561-6050. P&A: \$7.25 (over 100); stock.

Low-level matching transformers are double high nickel alloy shielded, to provide approximately 65-dB shielding to minimize stray magnetic field pick-up. They are available in a range of impedance-matching ratings for applications such as chopper, microphone and line-matching applications. The units measure 1-17/32-inch high by 1-1/16-inch diameter.

CIRCLE NO. 265

Knob-adjust trimmer stands 0.35-inch tall



Reon Resistor Corp., 155 Saw Mill River Rd., Yonkers, N. Y. Phone: (914) 965-9850.

A molded-composition 1/2-inch-diameter trimming pot features infinite-resolution knob adjustment over 100Ω to $5 M\Omega$ in a 0.35-inch-high sealed unit. Model CK is easily adjusted from the side after mounting. The unit has very low end resistance (less than 5Ω each end) and high power dissipation capability. Nominal power rating is 0.25 watts at 70° C.

CIRCLE NO. 266

Bipolar log amp ranges dc to 10 kHz



Optical Electronics, Inc., P. O. Box 11140, Tucson, Ariz. Phone: (602) 624-3605. P&A: \$350; 30 days.

Utilizing monolithic ICs, this amplifier provides a bipolar logarithmic output with dc-to-10-kHz frequency response. Applications include dc voltage compression for telemetry, X-Y and strip-chart recording and general measurement. Ac applications include acoustic measurements, ambient noise measurements and telemetry. Dynamic range is 80 dB.

CIRCLE NO. 267

LET THERE BE LIGHT OR TELL ME ABOUT THE FREE \$50 SWITCH

It's yours absolutely, unconditionally free. All we ask is that you give us \$50 for it. Why do we call it "free" when we are earnest about getting paid for it?

Two reasons:

First of all, when you throw the mechanical switch on, nothing happens until a teeny solid-state device senses that the voltage passes through zero. Then the switch turns the circuit on. When you throw the mechanical switch off and the current passes through zero, the circuit is turned off.

That means that the on-off switching is done at the point of minimum energy. And that means no step function voltage to generate high-frequency components. And that means that the switch is *free* from radio frequency interference. *Quod est demonstrandum.*

The second reason we call it "free" is we thought that if you thought you could get a \$50 switch for nothing you'd probably be greedy enough to read this ad. There appears to be some justification for this assumption.

Circle reader service #121

OUR TELEMETRY GEAR WILL NEVER GET OFF THE GROUND

Because we manufacture only equipment associated with checking out telemetry transmission while the transmitter is still nice and accessible.

For example, our new, compact FM Discriminator for playback in FM/FM telemetry systems. The pulse average design has 0.1% linearity. The Model 71-282 operates on all IRIG channels, 1-21, and A through H, with an input sensitivity of 20 mV. Accommodates any center frequency from 300 Hz to 300 KHz. Each one weighs less than a pound. Disgustingly inexpensive, too.

Circle reader service #122

HOW WE INVENTED THE SANDWICH

To make the ruggedest possible field portable tape recorder we suspended the entire tape transport mechanism between two parallel flat plates. This gives double support to all members, and as the tape contacts only the primary drive mechanism, reel hubs, two turn rollers and the head surfaces, its oxide coating gets maximum protection.

As you know, the flanges on tape reels are cantilevered members which can be supported against extreme shock and vibration only at the cost of a substantial increase in the rotational inertia of a system. So we got rid of them. The tape can't slip off the reel because hoop tension



forces resulting from normal pulling of the tape provide great compressive forces within the reel stack. It would take in excess of 300 g's for slippage to occur.

The result of our Sandwich and Flangeless design approaches (plus a few other neat ideas): a rugged, high performance field portable tape system. Request full information.

Circle reader service #123

OUR RATE-OF-TURN TABLE LAUGHS AT ABUSE



Our new Model 1147 maintains high precision performance regardless of rough handling and transportation. (One reason it's used as the AGE gyro test table for F-111 Aircraft System.) Hydrostatic bearings give precise dimensional stability, excellent alignment, low runout and eccentricity, low mechanical noise and long life. The bearing is capable of smooth rotation at less than sidereal rates (.004°/sec.). And up to 1500°/sec.

The Model 1147's compactness makes it ideal for field or bench checking. Its ruggedness makes it ideal in case you just happen to feel like kicking hell out of a fine piece of equipment.

Circle reader service #124

OUR COMPUTER CAN BEAT UP YOUR COMPUTER

Filled with supreme confidence the engineer plugs in his newly designed gem of a system. Then discovers that it's too noisy. So off to the supplier for a custom filter. It's expensive and its weird configuration makes it almost impossible to maintain a hermetic seal under the stresses of high pressures and extreme temperature variations.

We can help you avoid the what-me-need-a-filter syndrome. Give us a work statement. For free, we'll crank the system parameters into our computer and it will design the Perfect Filter. It will do the job right, and cost you about 40% less than one that must be produced downstream.

Out of the hundred or so companies in the industry only two or three use computers. We're better at it than they are, and besides our salesmen know good jokes. Come on, give us a break.

Circle reader service #125



GENISCO TECHNOLOGY CORPORATION
18435 SUSANA ROAD
COMPTON, CALIFORNIA 90221

WHEN YOU ATTEND*
WESCON
 STOP BY FOR SOME



BIG
NEWS
ABOUT OUR
MINIATURE
MICRO
REED
RELAY

ACTUAL
SIZE

*
IF YOU DON'T SEE US AT WESCON
WRITE OR CALL

HATHAWAY
INSTRUMENTS, INC.

3250 EAST EVANS AVENUE
DENVER, COLORADO 80222
(303) 756-8301 • TWX 292-2935
Distributed Nationally by
COMPAR CORPORATION

ON READER-SERVICE CARD CIRCLE 62

COMPONENTS

Contactless reed has
near-infinite life

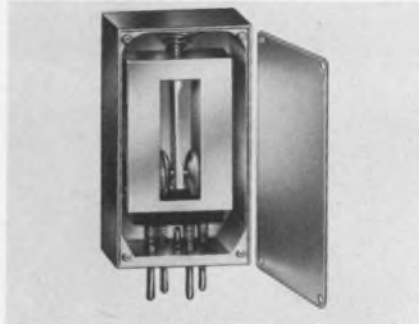

Bramco Controls Div., Ledex, Inc.,
College and South Sts., Piqua, Ohio.
Phone: (513) 773-8271. P&A: \$9.50
to \$25; stock.

As an audio tone filter with sharp selectivity ($\pm 0.35\%$) or as a frequency source for stable ($\pm 0.15\%$) audio tone generators, this resonant reed weighs 1/2 ounce. Since it does not use mechanical relay contacts, it offers near-infinite life, even in continuous tone applications. Frequency range is 80 to 3000 Hz. This range expands the number of permissible tone channels in a system to over 100. The unit employs isolated input and output coils coupled by a high-Q resonant reed.

CIRCLE NO. 270

Integrated crystal filters
attenuate 40 dB



Piezo Technology, Inc., 2400 Diversified Way, Orlando, Fla. Phone: (305) 425-1574. P&A: \$10 to \$25 (1000 lots); 2 to 3 wks.

For IF filtering applications, three integrated crystal filters are centered at 10.7, 21.4 and 70 MHz. All three models feature 2-pole response characteristics with a 3-dB bandwidth of 19 kHz. Ultimate attenuation is greater than 40 dB. Units are furnished in small crystal can packages.

CIRCLE NO. 271

Ten-turn pots live
to be 200 million

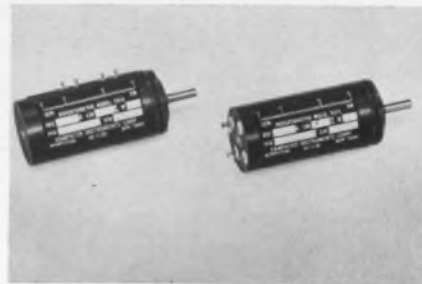

Computer Instruments Corp., 92 Madison Ave., Hempstead, N. Y. Phone: (516) 483-8200.

Multiturn pots provide one-second resolution with output smoothness levels to 0.01% and operating lives to 200 million revolutions. The model 7813 with rear terminals and the model 7814 with radial terminals incorporate a helical plastic-film resistive element, multiple-fingered precious metal wipers, gold-plated slip rings and ball bearings at both ends of the 7/8-inch case. Resistance range is 5 k Ω to 1.5 M Ω with linearity of 0.05%.

CIRCLE NO. 272

Low-drift op-amp
chopper-stabilized



Burr-Brown Research Corp., 6730 S. Tucson Blvd., Tucson, Ariz. Phone: (602) 294-1431. P&A: \$175; stock.

Maximum input voltage drift of $\pm 0.5 \mu\text{V}/^\circ\text{C}$ over the range of -25° to $+85^\circ\text{C}$ and maximum input bias current drift of $\pm 1 \text{ pA}/^\circ\text{C}$ are features of this chopper-stabilized op-amp. Slewing rate is 60 V/ μs and minimum full power response is 1 MHz. The model 3010/25 is particularly useful as an integrator.

CIRCLE NO. 273

High Current Regulated Power Supply Adjustable Output Voltage, 27-28 V.D.C. 1% Regulation 50-60 Cycle Operation Substantial Overload Capability

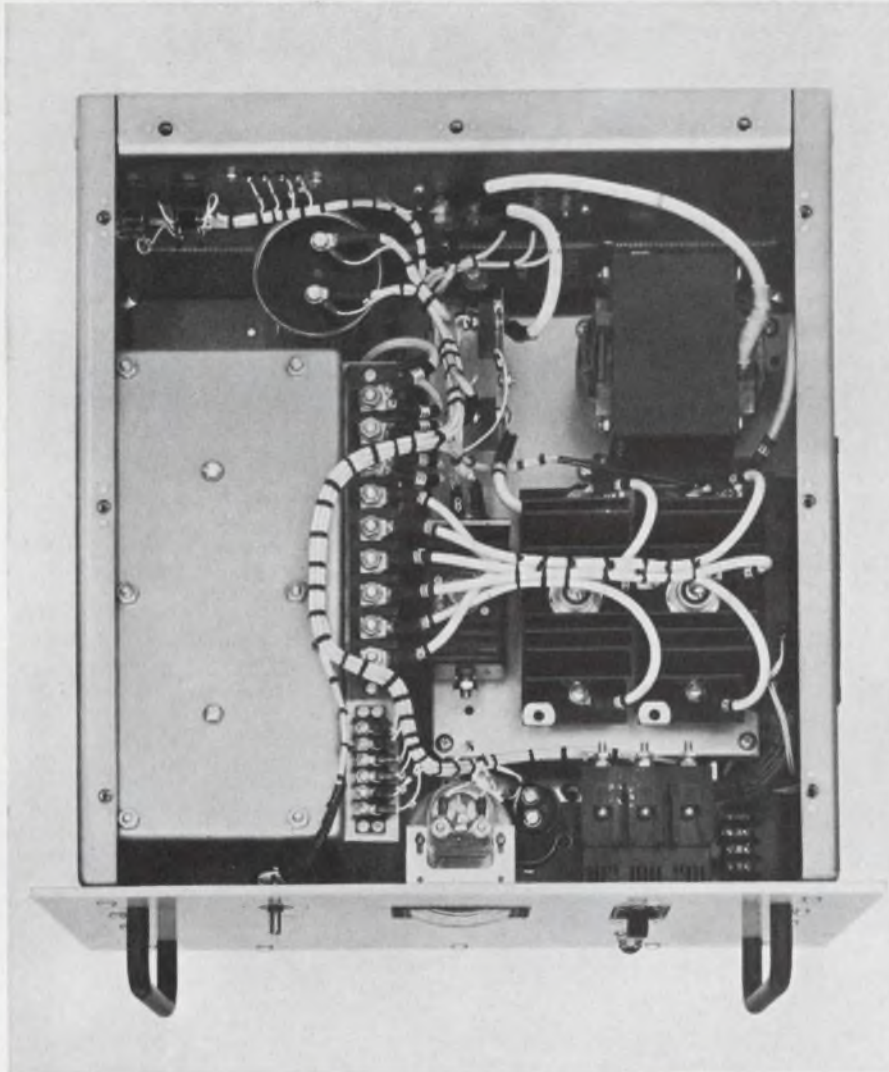

This unit was designed for communications equipment and is available in 25 amp. stages from 25 to 150 amps. It can be operated in parallel, has a remote sense feature, an inverse time circuit breaker and internal fan cooling. Overload capacity is 200% for 5 minutes; 400% for 4 seconds. Environmental capability encompasses a temperature range of -20° to $+130^{\circ}$ F. This equipment is designed for standard rack mounting and is compatible with the system into which it will be designed.

Like other Tung-Sol designed and built power supplies, this one meets precise performance requirements and high reliability standards. The price doesn't sound as though it was custom built.

If you are interested in this, or a power supply to meet other specs, we would like the opportunity to demonstrate that a Tung-Sol designed unit would be your best buy.

CHATHAM PRODUCTS

Tung-Sol Division

Wagner Electric Corporation

LIVINGSTON, N.J. 07039 TWX 710-737-4421

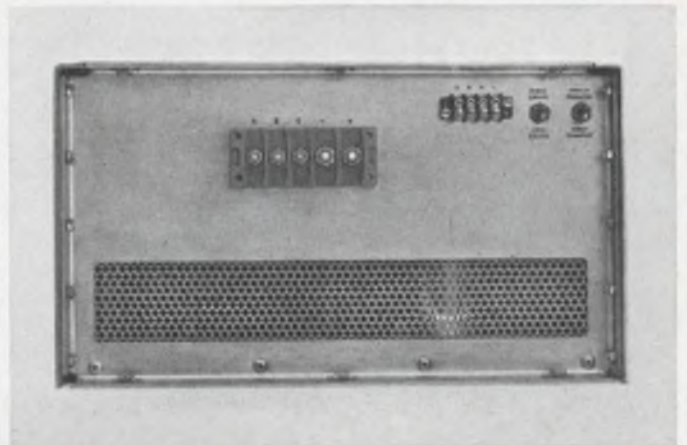
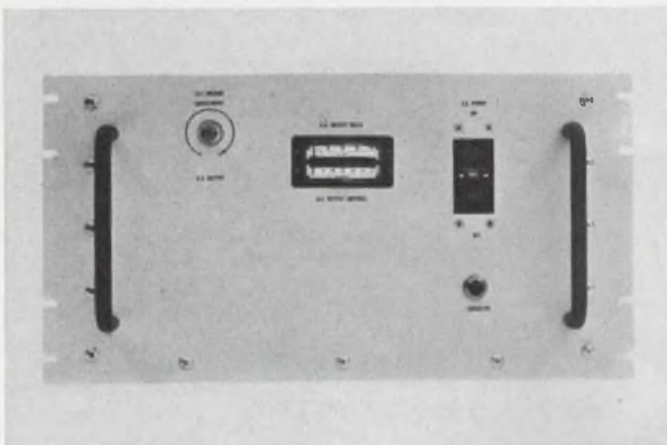

ON READER-SERVICE CARD CIRCLE 63

Variable delay line linear to 0.3%

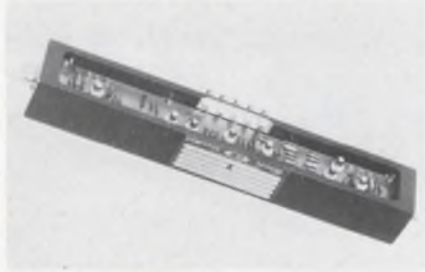

Computer Devices Corp., 63 Austin Blvd., Commack, N. Y. Phone: (516) 543-4220. P&A: \$275 (100 up); 6 to 8 wks.

Variable magnetostrictive delay lines have linearity of better than 0.3%. They can exactly reproduce the input pulse of 0.4- μ s width and -5 to -6 V amplitude. The line requires 1 W of power from a \pm 12-Vdc supply. Built for continuous operation, its delay can be varied between 4 and 30 μ s with temperature coefficient of less than 30 ppm/ $^{\circ}$ C. One turn of the shaft gives approximately 4- μ s delay.

CIRCLE NO. 274

Toroidal inductors usable to 30 MHz



Bulova Watch Co., Electronics Div., 51-20 Woodside Ave., Woodside, N. Y. Phone: (212) 335-6000. P&A: \$6.50; 4 wks.

High-frequency miniature molded toroidal inductors have peak Q above 100 at optimum frequencies. The usable frequency range of models in the line varies from 400 kHz to 30 MHz, and the package used is designed for mounting on PC boards. Models are offered in any value of inductance from 0.10 to 500 μ H.

CIRCLE NO. 275

Power supply modules range to 136 V, 6 A



Power/Mate Corp., 163 Clay St., Hackensack, N. J. Phone: (201) 343-6294.

Assemble a rack-mounted power supply with variable voltage ranges from 0 to 136 V and current outputs from 1.5 to 6 A with these modules. By using one or more of the supplies in series, parallel or series/parallel a large number of voltage ranges are available in outputs up to 6 A. Each rack can accommodate up to 4 modules and up to 4 metered control panels.

CIRCLE NO. 276

NPO chip capacitors available to 80 μ F

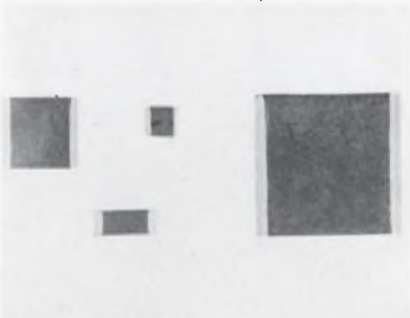

San Fernando Electric Mfg. Co., 1509 First St., San Fernando, Calif. Phone: (213) 365-9411.

Nonpolar dielectric chip capacitors are available in 25 configurations ranging from 0.05 \times 0.05 \times 0.03 to 0.69 \times 0.275 \times 0.1 inches. Capacitance values from 10 pF to 80 μ F in voltage ratings of 25, 50 and 100 wVdc are available in tolerances from \pm 0.5%. Temperature range is -55 $^{\circ}$ to +125 $^{\circ}$ C. Standard termination bands are silver, with platinum/gold available.

CIRCLE NO. 277



SIX GOOD REASONS FOR SPECIFYING LIGHT, SMALL, ECONOMICAL SEMCOR SILICON MOLDED DIODES

- Broad application** from a single package design. A uniform package through four power ratings with consecutive 5% tolerance types from 3.3 V to 200 V.
- Guaranteed performance** through time-proven process control techniques, including 100% oscilloscope testing.
- Complete final testing** to registered parameter requirements plus additional in-house screen on quality-reference parameters.
- Demonstrated capability** to surpass DOD operating life requirements placed on high-rel, space quality parts.
- Replace higher cost devices** in non-critical applications with Semcor's fully tested X-version. Minimum cost for performance-proven, higher-tolerance units.
- Less than 5% tolerance special devices** available on order for quick delivery to meet critical applications.

Obtain complete details on high quality, attractively priced Semcor molded zeners by writing: 3540 W. Osborn Road, Phoenix, Arizona 85019. 602 272 1341.





Lighter, smaller,
competitive
replacements for
glass and metal zeners

Semcor Silicon Molded Diodes

Before you order or specify another glass or metal zener, you'll find it well worth your while to look over Semcor's outstanding line of molded zener diodes. You'll probably identify a direct replacement that slashes the weight, size and cost of its counterpart. Semcor molded zeners are available in 400-mW, $\frac{3}{4}$ -W, 1-W and 2-W ratings from 3.3 through 200-V operation. Major features include an epoxy body which meets MIL-S-19500 environmental requirements, thermal exercising before a complete final test, and critical lot acceptance inspection by QA before shipping. Suitable for a broad range of consumer and commercial applications, these economical silicon molded diodes are produced by Semcor Division of Components, Inc.—your finest assurance of fair pricing, prompt delivery and superior reliability in electronic components. For more information and data, see your nearest dealer or write: 3540 W. Osborn Road, Phoenix, Arizona 85019, 602-272-1341.



ON READER-SERVICE CARD CIRCLE 65

Electroless copper PC boards ease soldering, cut costs

Photocircuits Corp., 31 Sea Cliff Ave., Glen Cove, N. Y. Phone: (516) 676-8000. P&A: about \$3.25 in medium quantity; stock.

Plated-through printed-circuit boards incorporating three new techniques are aimed at boosting reliability and cutting cost, according to the manufacturer, Photocircuits Corp. The conventional electroplating step is eliminated in the NT-1 boards.

The developments are:

- Use of an inert catalyst in the laminate.
- Use of electroless deposited copper for plated-through holes.
- Application of a nonregistered solder mask of noncatalytic epoxy.

In the manufacturing sequence the pattern of conductors is printed and etched from the foil-clad base laminate. Then the patterns on both sides of the board are protected with a permanent conformal epoxy (non-registered-solder) mask. Finally the holes are drilled. A cross section of a finished board is shown in Fig. 1.

Since the laminate has been impregnated with the copper-receptive catalyst, surfaces exposed after etching and hole fabrication and not protected by the conformal coating

receive the deposited copper well. The deposition forms a fine-grain, pure, ductile copper surface uniformly deposited in the hole. In addition, the copper forms a "bead" (photomicrograph, Fig. 2) over the surface of the foil copper to facilitate soldering. Thus, large "land" areas on the board are not necessary. The epoxy coating also serves double duty. Impervious to cleaning solutions, it provides mechanical, electrical and moisture protection as well as serving as a solder mask to eliminate bridging during solder operations.

Elimination of electroplating cuts the costs of boards. Photocircuits quotes 30% as a typical cost saving. Other advantages are:

- Fine lines and spacing (small diameter holes on 50-mil centers with conductors between holes).
- Virtually limitless hole-diameter-to-depth ratio (10:1 easily attained).
- No solder bridging.
- Elimination of "slivers" from plating overhang around holes.
- A "built-in" conformal coating.

The first use of the NT (New Technology) boards was in General Electric's recently announced integrated clock radio.

CIRCLE NO. 268

Multilayer circuitry incorporates crossovers

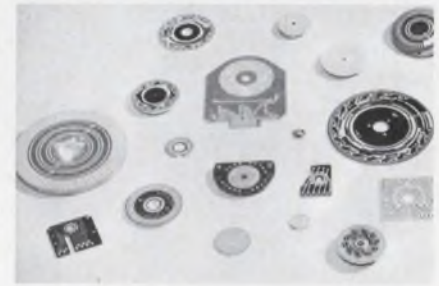

Intellux, Inc., 26 Coromar Dr., Goleta, Calif. Phone: (805) 968-3541.

A multilayering technique enables the incorporation of interconnections and crossover circuitry within a supporting substrate for use in complex commutating and switching devices. Precision Flush Circuitry is designed for high-bit encoding systems and other noise-free angular or segmented switching systems. Terminations can be located in any convenient area on either the front or rear surface of the disc. Subsurface circuitry can be interconnected without interference with the connecting surface.

CIRCLE NO. 278

Delay line coils electrically trimmed



Times Wire & Cable, 358 Hall Ave., Wallingford, Conn. Phone: (203) 269-3385.

Delay line coils are offered trimmed to precise electrical lengths with an absolute accuracy of ± 1 degree. The coils feature a phase temperature coefficient of 20 ppm/ $^{\circ}$ C. Relative electrical length is ± 0.5 degrees. The cable has an OD of 0.086 inch, TFE dielectric and is jacketed with tubular copper sheath. Solder-on splices and connectors are available.

CIRCLE NO. 279

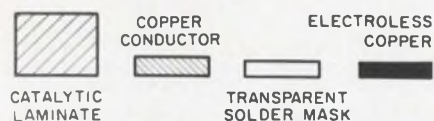
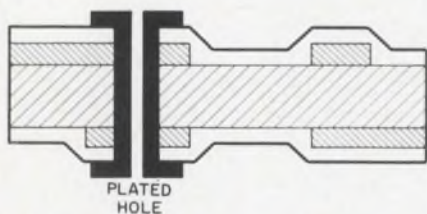

1. Cross section of 2-sided board. Plated copper extends over surface to ease soldering. Transparent coating doubles as solder mask to prevent bridging across contacts.

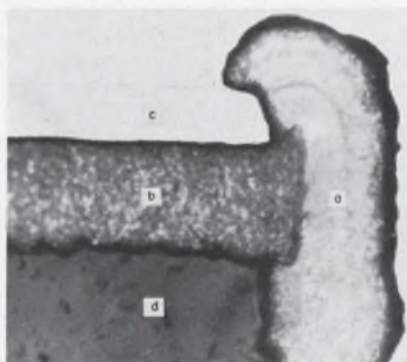

2. Plated (a) and foil (b) copper interface shows copper "bead" above surface of solder mask (c). Base laminate (d) contains copper-receptive catalyst.



***I suppose you might say we're proud
and maybe a little conceited about our position!***

For years we have supplied the basic ceramic elements to most manufacturers of capacitors, mainly because we are one of the original developers of the technique. This tremendous technological experience and production capability is now available to you directly from EMC in the form of finished capacitors.

HIGH-Q

HIGH-K

TIGHT TOLERANCE

MIL-C-11015

HI-REL



RADIAL LEAD
encapsulated
or dipped



AXIAL LEAD
encapsulated
or dipped



**"CHIP"
CAPACITORS**



**COAXIAL
FEED-THRU
CAPACITORS**

WRITE FOR OUR COMPLETE CATALOGUE

"Remember, you're never more than a few feet away from a product of ITW®"



ELECTRO MATERIALS CORP.

SUBSIDIARY ILLINOIS TOOL WORKS INC.

11620 SORRENTO VALLEY ROAD • SAN DIEGO, CALIFORNIA 92121

TEL. (714) 459-4355 • TWX. 910 322-1130

Distributed by  **COMPAR**

ON READER-SERVICE CARD CIRCLE 66

LC Filters?

We'll try anything!

If you have a tough, tricky or unusual problem in LC filters, try Bulova first! Bulova has built a reputation for being willing to "try anything". Even jobs that other companies "can't be bothered with"!



Are we crazy? Like foxes! Fact is, we can do things others can't—and that's the way we win friends and customers!

We'll custom-design units to solve your unique problems. We'll supply prototypes when you need them—in 2 weeks or less! We'll schedule production units to meet your schedule—and give you solid proof we can do it!

And what a range! High pass, low pass, band pass, lumped constant delay lines, IRIG filters—you name it! Frequencies from DC to 50MHz! Sharpest shape factors! Just tell us your requirements—when you need it—and let us tackle it. Our hot engineering group will show you why you should "Try Bulova first"!

For more information, write to us at Dept. ED-25.

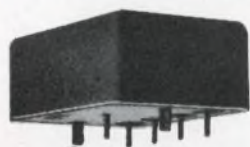

Try Bulova First!

FREQUENCY CONTROL PRODUCTS

ELECTRONICS DIVISION
OF BULOVA WATCH COMPANY, INC.

61-20 WOODSIDE AVENUE
WOODSIDE, N.Y. 11377, (212) DE 5-6000

ON READER-SERVICE CARD CIRCLE 67

TEST EQUIPMENT

Power supplies tested for six parameters



Pacific Measurements, Inc., 940 Industrial Way, Palo Alto, Calif. Phone: (415) 328-0300. Price: \$1100.

A power supply test set with an integral regulation monitor permits measurement of transient response, output impedance, loop stability, microvolt ripple and short and long-term drift. Model 1004 contains a regulated electronic load capable of pulse loading a power supply to 20 A and 70 V. The scope display of the resulting output waveform is a measurement of transient response and dc output impedance and an indication of proper regulation and loop stability. The regulation monitor allows the measurement of power supply drift and regulation against line and load.

The instrument can be operated in both the pulse and dc mode. In the pulse mode, the load current switches in less than 5 μ s. Load duty cycle is 10% and rep rate is some 200 Hz to insure a flicker-free scope display. In the dc mode, the load is capable of dissipating 200 W at up to 45 V. Maximum voltage across the electronic load is 70 V. In either mode, load current is regulated and is continuously adjustable with a 10-turn pot and is monitored by a front panel meter. The regulation monitor meter is calibrated directly in ranges of 10%, 1%, 0.1%, and 0.01% full scale.

A ripple amplifier with a differential guarded input and a low-impedance output makes possible the measurement of ripple in the microvolt region with an ordinary low-gain scope. Amplifier bandwidth is greater than 1 MHz, but may be switched to 10 kHz for high-sensitivity ripple measurements where noise reduction is necessary.

CIRCLE NO. 280

Customize CRT displays with standard options

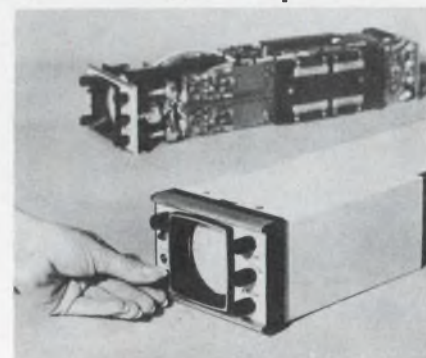

Benrus Technical Products, Div., Benrus Watch Co., Inc., 30 Cherry St., Waterbury, Conn. Phone: (203) 756-4621.

Packaged CRT display units give the equipment designer choice among more than 100,000 different combinations for application in communication, data-processing, aero-space, and industrial processing and control systems.

Previously, equipment designers needing CRT displays faced the choice either of selecting a rack-mounted version of a lab scope which occupied more panel space, required more controls and had more functions than needed, or, of designing and building his own.

The selection offered features 3- and 5-inch CRTs, and amplifiers capable of operation into the 20-MHz range. A total of 310 standard amplifier combinations provide various bandwidth and gain tradeoffs. Other options range from sensitivity, screen phosphor, input impedance and attenuator to panel markings and panel finish.

CIRCLE NO. 281

Ac frequency converters handle 1 kVA

Microdot, Inc., 5960 Bowcroft St., Los Angeles. Phone: (213) 870-7491.

Low-power frequency converters have power outputs ranging from 125 VA to 1 kVA. The series provides outputs of 50, 60 or 400 Hz, one-phase from a 60-Hz, one-phase input. Voltage regulation is $\pm 0.5\%$ line and load, frequency stability is $\pm 0.25\%$, maximum harmonic distortion is 5% and overloads of 110% at any power factor are tolerated for one minute.

CIRCLE NO. 282

SEMICONDUCTORS

NEW IDEAS IN APPLICATION AND DESIGN

■ WHY NOT USE

G-E PNP SILICON PLANAR TRANSISTORS TO COMPLEMENT YOUR G-E NPN'S?

Specify 2N2904,A—2907,A; 2N3485,A—3486,A; and 2N3502—3505 for collector saturation voltage as low as -0.4 volts (at $I_C = -150$ mA, $I_B = -15$ mA) and outstanding frequency characteristics. These low cost devices are ideal complements to G.E.'s 2N2217—2N2222 NPN devices.

General Electric epitaxial passivated PNP's give you excellent Beta control from 100 microamps to 500 milliamps, frequency capability to 200 MHz, and switching in nanoseconds.

They're available in the TO-18 and TO-46 packages, and the TO-5 configuration with a solid header for better heatsinking. You can choose between epoxy or hermetically sealed packages. Both withstand moisture as well as high ambient or junction temperatures.

For logic circuits, drivers, or peripheral equipment in computers, or in general purpose amplifiers and power supplies, General Electric PNP transistors belong in your circuits. Circle number 811 for more details.

■ HAVE YOU BEEN WAITING FOR A MORE ECONOMICAL HIGH CURRENT SCR?

With the new General Electric C178 type SCR, high performance now costs less than ever.

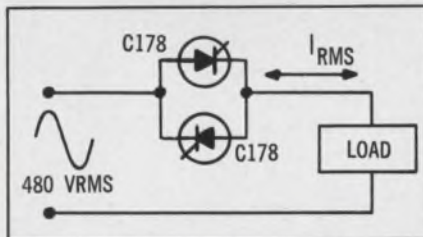

Sample circuit using two GE C178 high current SCR's.

Two inverse-parallel C178's can now control up to 280 amperes (RMS) economically. The C178 is available with blocking voltage capability to 1200 volts. Therefore, operation from 480 volts (RMS) allows power control to the tune of 135 kilowatts. Using

Now lower cost

G-E A28 rectifier diodes

pull a fast one on reverse voltage

Here's reverse recovery as fast as 100 nanoseconds for up to 20% less than you might expect to pay.

You'll get better overall performance from your circuits with A28 rectifiers. The A28's fast recovery reduces recovery transients to a minimum, giving you better total performance from all circuit components in either high or low frequency applications.

In addition to faster switching and less reverse power dissipation at high frequencies, this diode produces less RFI and transient voltage generation.

In choppers, inverters, sonar

power supplies, ultrasonic systems, and other applications, the A28 offers performance to match the high frequency capability of G.E.'s new high speed SCR's.

Besides the 100 nanosecond A28, four other G-E fast recovery rectifier diodes with 200 nanosecond recovery time are available in these current ratings: 6 amps average (1N3879,R—3883,R), 12 amps average (1N3889,R—3893,R), 20 amps average (1N3899,R—3903,R), and 30 amps average (1N3909,R—3913,R). All offer blocking capability up to 400 volts. For further details circle number 813 on the Reader's Service Card.

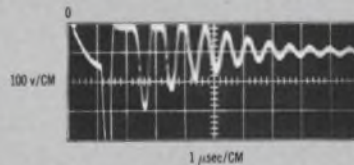

Commutation transient of conventional rectifier diode.

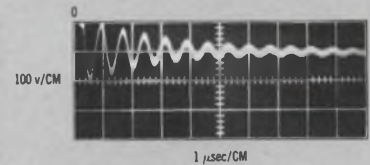

Commutation transient of fast-recovery (A28) rectifier diode.

Commutation conditions: Forward current just prior to commutation, $I_F = 5$ amps; reverse di/dt , $-I_F = 10$ amps/ μ sec; steady state reverse voltage, $E_C = 100$ volts.

1000 volt C178 SCR's the price per kilowatt of switching capability is less than \$2.00.*

As a bonus you can get the same high degree of dynamic performance that's characteristic of General Electric's unmatched C100 series all-diffused, high-power SCR's.

- Minimum dv/dt withstand capability—200 volts/ μ sec.
- Maximum rate of rise of anode current at turn-on (di/dt)—75 amps/ μ sec (from 1000 volts).

Furthermore, the C178 SCR has no peak forward voltage limitation. It offers unusual immunity to forward

*In quantities of 100 and up

voltage destruction at breakover provided that switching and follow-through currents are kept within limits.

For more information on the C178 economy, high current SCR circle number 812.

These are just a few examples of General Electric's total electronic capability. For more information on all G-E semiconductor products, call your G-E engineer salesman or distributor. Or write to Section 220-52, General Electric Company, Schenectady, N.Y. In Canada: Canadian General Electric, 189 Dufferin St., Toronto, Ont. Export: Electronic Components Sales, IGE Export Division, 159 Madison Ave., New York, N.Y., U.S.A.

GENERAL  ELECTRIC

Diode switching speeds quickly measured



B-Line Electronics Corp., 4 Music Hall Ave., Waltham, Mass. Phone: (617) 899-3880. Price: \$3250.

Measurements of diode switching speeds are made by this stored charge detector at rates up to 10,000 diodes an hour. Since stored charge measurement can be performed in series with dc tests, one pass through an automatic diode handler will provide all the necessary diode parameter measurements. As compared to the more expensive sampling scope measurement, stored charge measurements offer higher rates of testing, higher accuracy and reproducibility, and interfacing with a diode handler. Measurement ranges are 10, 100 and 1000 pC, and forward current bias levels are 0.1, 1 and 10 mA. Pulse rep rate is 100 kHz, amplitude is 5 V and width is 50 ns.

CIRCLE NO. 283

Digital oscillator puts out 2 VA to 100 kHz



California Instruments Corp., Elin Div., 3511 Midway Dr., San Diego, Calif. Phone: (714) 224-3241.

Operating over a range of 10 Hz to 100 kHz, this oscillator combines 1% frequency accuracy and 0.5% stability with simple operation. Frequency is both dialed and displayed directly. Output voltage ranges to 50 V at 2 VA. It is determined by a front-panel control which provides ranges of 0 to 50 mV, 0 to 500 mV, 0 to 5 or 0 to 50 volts.

CIRCLE NO. 284

Spectrum analyzer is two-in-one



Federal Scientific Corp., 615 W. 131 St., New York. Phone: (212) 286-4400. P&A: about \$49,000; 4 to 6 months.

Fractional and constant-bandwidth operation are combined in a single real-time spectrum analyzer. Fractional bandwidths can be selected down to 0.4% in any of 13 octave bands. Switching to the constant bandwidth mode provides 500-element resolution in any of 13 low-pass ranges. The unit uses digital delay-line techniques to achieve real-time analysis. Octave ranges are from 1 to 2 Hz to 4096 to 8192 Hz, with bandwidths variable in any range from 0.4% to 25.6% in 7 binary steps.

CIRCLE NO. 285

Sweep gen plug-in spans 10 to 270 MHz



Telonic Instruments, 60 N. First Ave., Beech Grove, Ind. Phone: (317) 787-3231.

Capable of sweeping from 10 to 270 MHz for applications requiring high stability and narrow sweep output, this plug-in oscillator operates with Telonic's SM-2000 chassis. It has a sweep width capability permitting coverage as narrow as 200 kHz or as wide as 70 MHz. In addition, the oscillator may be set to sweep at rates continuously variable from 0.01 to 100 Hz.

CIRCLE NO. 286

Low-cost supply digitally settable



SRC, 2309 Pontius Ave., Los Angeles. Phone: (213) 477-4573. P&A: \$275; 4 wks.

A completely isolated, all-silicon power supply, with both constant voltage and constant current modes, offers digital settability to 0.05%. Called the Digi-Mite, model 3561 has variable output voltage from 0 to 50 Vdc at 0.5 A in the constant-voltage mode. Line and load regulation is 0.01%, ripple is 100 μ V p-p, time stability is 0.002% of full scale per day and temperature coefficient is 0.001%/°C. In the constant-current mode, output current is 0 to 500 mA at a compliance voltage of 0 to 50 V. Regulation is 0.05% and ripple is 25 μ A. By combining a range switch and a 3-decade digital pot, the unit eliminates the necessity of using a digital or differential voltmeter for set up.

CIRCLE NO. 287

Measure RF noise from 1 MHz to 2 GHz



Teltronics, Inc., P. O. Box 466, Nashua, N. H. Phone: (603) 889-6694. P&A: \$2395; stock to 30 days.

An RF noise measuring set permits quantitative comparisons between unknown noises and a reference noise over the range from 1 MHz to 2 GHz. The unit provides accuracy of 1 dB and is capable of measuring down to a level of 10^{-12} W. Measurement bandwidth is 200 kHz. The basic unit covers 1 to 100 MHz and is extendable to 2 GHz.

CIRCLE NO. 288

Today \$1495 buys you immediate delivery of our new 540 Series Integrating Digital Voltmeter.

Stability: within specs for six months. No zero adjust. It automatically corrects for zero offset as a part of each computation. Reliability: at least an order of magnitude better than our competitors' most reliable IDVM.

How come? Because 90% of the design is done with integrated circuits. No vacuum tubes or mechanical choppers. No wonder it delivers specs like these:

Accuracy: 0.01% of reading ± 1 digit in four ranges from 1.0000 to 1000.0 volts dc. Automatic and manual ranging via illuminated, inter-

locking pushbuttons, with automatic polarity selection. Input impedance: 10 megohms on all ranges. Normal mode rejection: ≥ 80 dB at 60-Hz without the use of an input filter. Speed: 1.5 readings per second.

For \$2750 you can get immediate delivery on the 540 Integrating Digital Multimeter. It measures dc millivolts, dc volts, ac volts, dc current, and resistance.

Prices FOB San Diego. Additional export charge. Full details are available from your nearest Cohu engineering representative, or from Ken Walker, Manager, Instruments and Systems. Telephone: 714-277-6700. Box 623, San Diego, Calif. 92112.



While everybody else is still talking about using integrated circuits to design the most stable and *reliable IDVM* ever...

Cohu ships it.

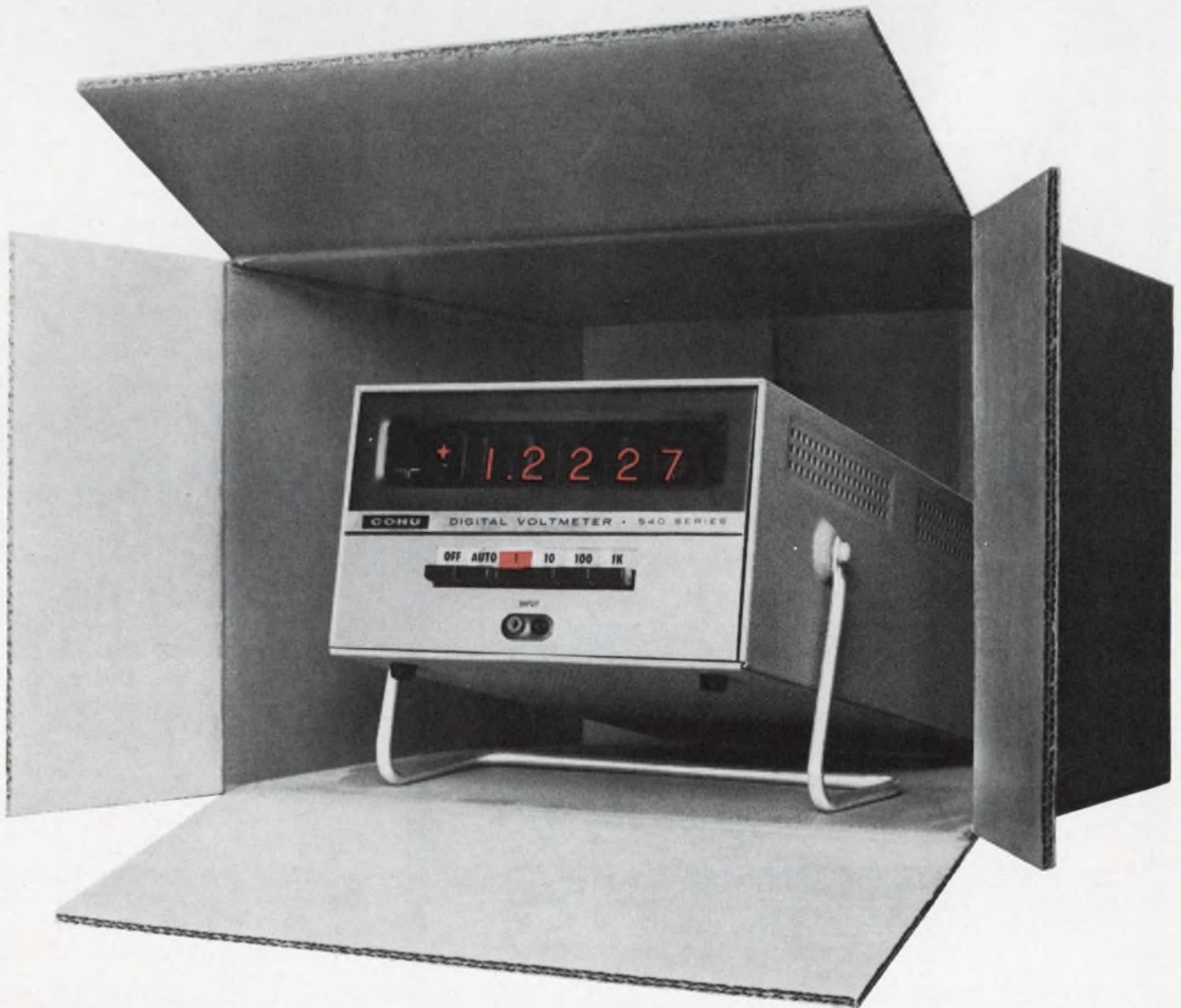

See Us At WESCON, Booth 3001

ON READER-SERVICE CARD CIRCLE 69

IN-LINE DISPLAYS

We also make panel displays, CRT displays, readouts, switches and indicators.

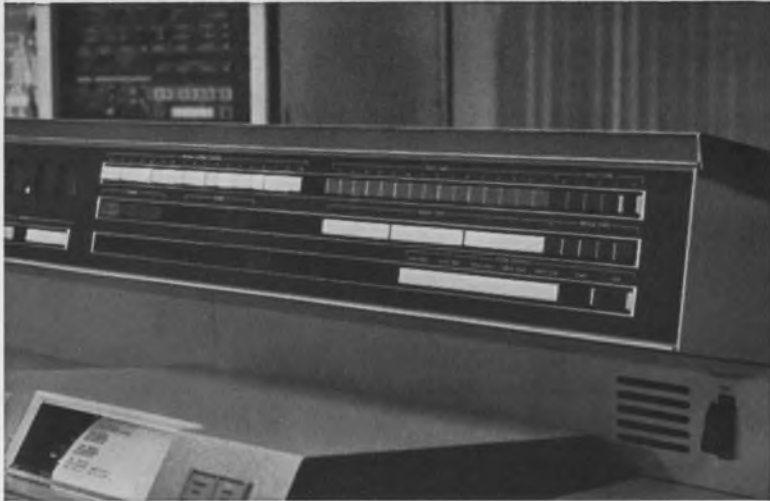

DATA-LINE DISPLAY BRINGS A TOTALLY NEW MEANING TO THE WORD VERSATILITY!

■ Combine basic switch, indicator and message display functions in this new, in-line modular package. Handsome! And a practical approach to display, compatible with today's demand for human engineered, high density packaging. Permits intermixing of message display, neon or incandescent indicators, switch-indicators or switch functions on .700" centers in frame lengths up to four feet—and functions may be arranged in any sequence! Mechanically and electrically, DATA-LINE Display is as versatile as your needs. Makes a lot of dollar sense, too.

Price of DATA-LINE Display's switch indicator function compares favorably with other multi-pole lighted push button switches. Its appearance and design flexibility is unexcelled!



For complete information, contact your local TEC-Rep, or write direct.

TEC LITE INFORMATION DISPLAY
AND CONTROL DEVICES
TRANSISTOR ELECTRONICS CORPORATION

Box 6191 • Minneapolis, Minnesota 55424 • Phone (612) 941-1100

ON READER-SERVICE CARD CIRCLE 70

TEST EQUIPMENT

Electronic commutator samples 64 channels



Santa Rita Technology, Inc., 1040 O'Brien Dr., Menlo Park, Calif. Phone: (415) 324-4701. P&A: \$995 (32 channels); 60 to 90 days.

Variable rate commutators can sample as many as 64 channels of analog data at rates as high as 200,000/second. Applications include scope displays of multiband spectrum analyzer or transducer outputs, multiplexing, counting, or code and function generation. The commutator is internally stepped at 1000, 10,000 and 100,000 samples/second, and may be externally stepped from dc to the maximum rate. Both 50% and 100% duty cycle outputs are provided.

CIRCLE NO. 289

Digital ohmmeter spans 0.001Ω to 10 MΩ



California Instruments Corp., 3511 Midway Dr., San Diego, Calif. Phone: (714) 224-3241. P&A: \$1145; 30 days.

A low-level digital ohmmeter offers 0.1% accuracy and 1-mΩ resolution with a total of 7 ranges providing coverage from 0.001 Ω to 10 MΩ. The digital readout provides 4-digit presentation with 10% over-ranging. Display time is variable from one to ten seconds and can be adjusted through a front-panel rate control or by a manual switch.

CIRCLE NO. 290

Large-screen scope linear to 1%

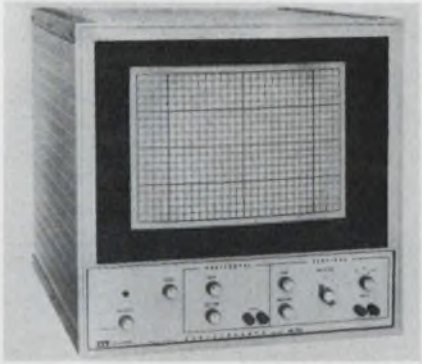

ITT, Industrial Products Div.,
15191 Bledsoe St., San Fernando,
Calif. Phone: (213) 367-6161.

A solid-state, large-screen monitor scope has 40 lines per centimeter resolution on a 17-inch CRT. The instrument displays low-frequency phenomena and complex data in applications such as telemetry, analog computer readout, data acquisitions, systems readout, high speed X-Y plotting, sweep generations, data sampling and envelope detection. It provides 1% linearity.

CIRCLE NO. 291

Low-cost X-Y monitor packaged compactly

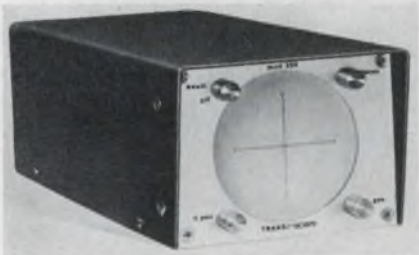

Measurement Control Devices, Inc.,
2445 Emerald St., Philadelphia.
Phone: (215) 426-8602. P&A:
\$139.50; 60 to 90 days.

Completely solid state, this X-Y monitor is a compact 3-1/2 × 4-1/2 × 14-inch package with four controls and identical dc amplifiers. Plug-in PC boards and magnetic shielding on the CRT and between the power transformer and the boards are incorporated. The polaroid-filtered 3-inch round CRT has a 1-kV accelerating potential and a P1 phosphor. Deflection sensitivity on both amplifiers is 1 V/inch and response is dc to 500 kHz (-3 dB).

CIRCLE NO. 292

Lamb Electric engineering turns your product on.



Example: the whole world of floor care

If your product has got to vacuum, scrub or polish, you need Lamb engineering. Lamb products turn on the whole range of equipment that cares for floors.

For example, you might be interested in our gear motors customized from standard Lamb parts . . . or one of our many vacuum motors that assure you of the right combination of performance, life and cost. Whatever floor care product you manufacture, Lamb Electric has the motor that will do the job for you.

Let Lamb engineers turn your product on. Write for motor details and performance curves. Put us to the test. We'll turn your product on . . . with exactly the motor that you need. Ametek, Inc., Lamb Electric Division, Kent, Ohio 44240.

AMETEK / Lamb Electric

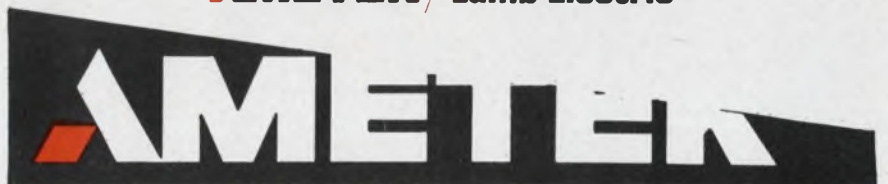

ON READER-SERVICE CARD CIRCLE 71



Apollo Wiring Assemblies



SPACE to UNDERSEA Instrumentation

TSC

THE SIPPICAN CORPORATION

Concepts • Engineering
Manufacturing

Contact: W. J. Lavery, Programs Manager,
Marion, Massachusetts 02738
Tel. 617 748-1160.



Expendable BT System (AN/SSQ-56)



ON READER-SERVICE CARD CIRCLE 72

Time delay unit tests freq translation devices



Rantec Div. Emerson Electric Co.,
24003 Ventura Blvd., Calabasas,
Calif. Phone: (213) 347-5446.

For measuring RF and microwave time delay (group delay), this instrument is insensitive to attenuation variations and signal source characteristics, thereby allowing frequency translation devices to be tested. Multioctave swept measurements of time delay and amplitude response are provided for scope display or recorder presentation. Modulation at 200 kHz and 1 MHz may be selected to optimize time delay indicator performance for the bandwidth of the test device. Typical accuracy at 1 MHz modulation is ± 0.1 ns $\pm 2\%$ of reading fixed, and ± 0.3 ns $\pm 2\%$ swept. A common solid-state indicator unit mates with four interchangeable modulators and three detectors to provide coverage from 20 MHz to 18 GHz.

CIRCLE NO. 293

Low-power bipolars tested go-no go

Electro Techniques Co., Inc., P.O.
Box 101, Haverhill, Mass. Phone:
(617) 373-0031.

This semiautomatic test set sorts transistors in 8 categories, read out by lamps and recorded on counters. All limits and test conditions are programmed by digital thumbwheel switches. Tests can be sequenced to occur automatically or manually. The set measures the dc characteristics of npn or pnp low-power transistors on a go-no go basis. It measures I_{CBO} , I_{EBO} , BV_{CBO} , BV_{EBO} , BV_{CEO} , BV_{ECO} , LV_{CEO} and h_{FE} . Additional modules may be substituted which permit the measurement of BV_{CES} , I_{CES} , BV_{CER} and I_{CER} .

CIRCLE NO. 294

Two-color readout from one-gun CRT



Sylvania Electric Products, Inc.,
Electronic Tube Div., Seneca Falls,
N. Y. Phone: (315) 568-5881.

A high-resolution one-gun, two-color information display tube is the first of its kind, according to its manufacturer, Sylvania, Electronic Tube Div. The tube, which can be read easily under high ambient light conditions, should prove useful in airborne or surface electronic systems for air traffic control where flight corridors or the positions of other planes must be clearly defined. The tube uses red, "rare earth" Europium-activated phosphor and an improved green phosphor to provide high-resolution, high-contrast displays. It utilizes a five-inch round faceplate coated with two layers of phosphor: red and green. The two phosphor layers are separated by a barrier layer. By switching the final anode voltage, the intensity of the electron beam is controlled to excite the first phosphor layer only, creating one color, or to penetrate the barrier and excite both phosphor layers, creating a second color. By high-speed voltage switching, the tube produces a two-color display that appears continuous to the observer.

Since the tube does not have a shadow mask nor the combination phosphor dot pattern common to entertainment color TV tubes, greater brightness and finer resolution is possible. Using the same basic principle, tubes ranging in size from one to 27 inches in either round or rectangular versions could be developed.

Anode number one voltage is 150 to 400 Vdc and anode two is 3000 Vdc for red and green. Anode three voltage is 6000 Vdc red, and 12,000 Vdc green.

CIRCLE NO. 295

Influence the acceptance of your product...generate increased sales

CLASSIC CABINETS

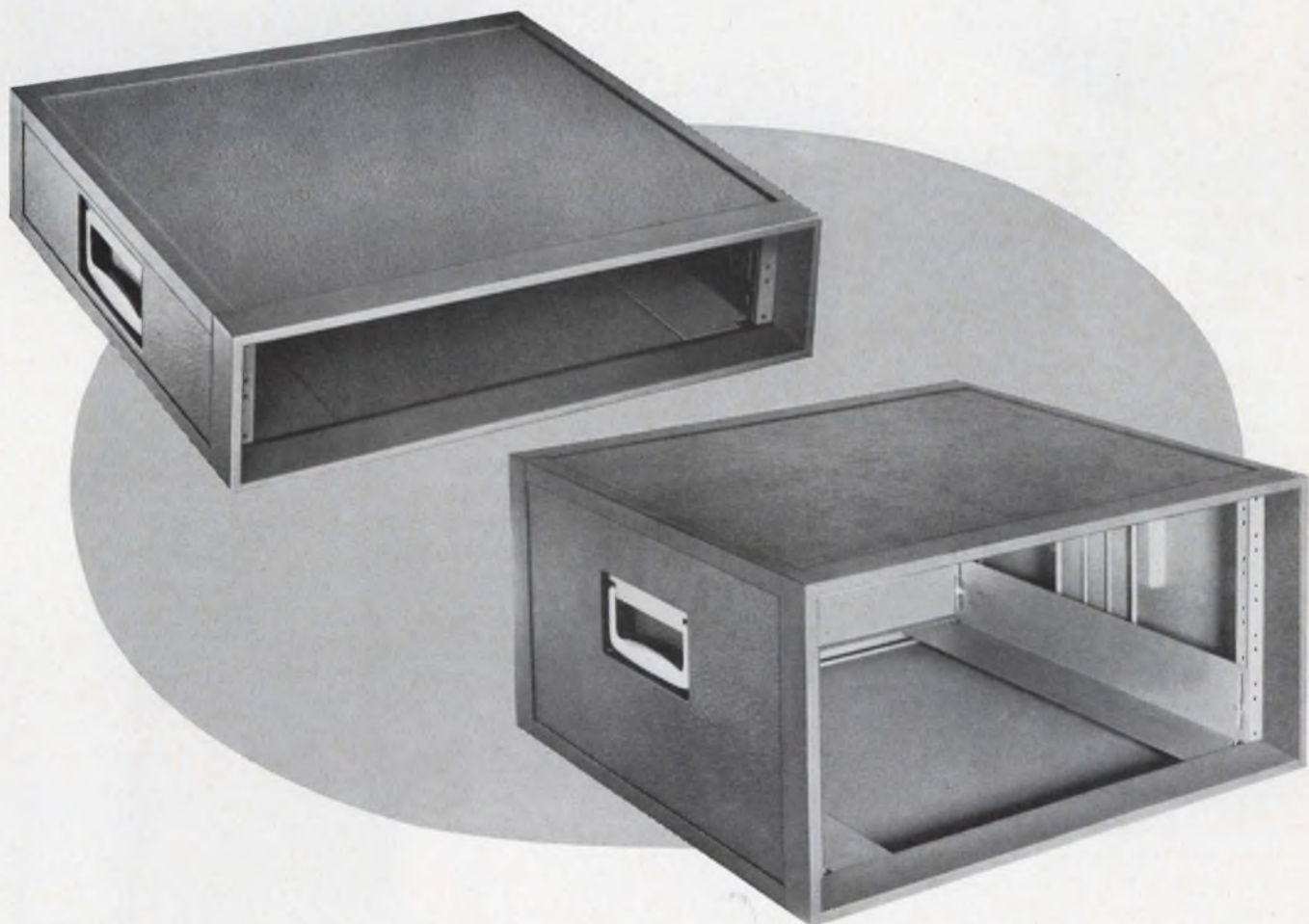

Classic Cabinets provide extra sales appeal by presenting an image designed to enhance the value of the contents. They are the most distinguished enclosures for electronic instrumentation and systems.

Uniquely designed and fabricated with a welded aluminum frame to which is affixed

patterned aluminum paneling. Classic Cabinets are available from stock in a selection of 15 practical sizes and two colors.

Write us for descriptive literature or see the Classic Cabinets at your authorized Bud Distributor's showroom. We'll be glad to supply his name to you.



BUD RADIO, INC.

WILLOUGHBY, OHIO

ON READER-SERVICE CARD CIRCLE 73

NEW! Modular Miniature Precision Dual Power Supplies

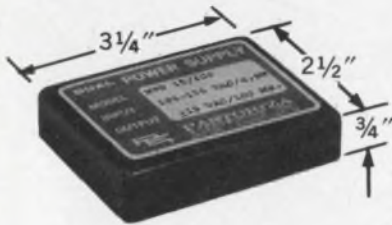

MODEL MPD 15/100 is designed for use with operational amplifiers, instruments and systems. It provides ± 15 VDC @ 100 Ma output from 110 VAC input, in a package only $3/4$ " high including the power transformer. MPD 15/100 represents the first significant step in power supply miniaturization. The systems designer can now take full advantage of the comparable reductions in his circuits brought about by hybrid techniques.

Specifications include: 0.02% regulation (no load to full load), 0.005% regulation against line, complete short circuit protection and ambients from -25°C to $+65^{\circ}\text{C}$. There are pin connectors for socket or printed circuit board mounting.

MODEL MPD 5/150 is a miniature card mounting power supply specifically designed for micrologic systems and instruments. It provides 5 volts at 600 Mas to power conventional DTL and TTL logic as well as 150 volts for neon or nixie readout lights.

This compact unit contains the entire power supply including power transformer, filtering, regulators and adequate heat dissipating surface. Input power is 5.5 watts, 105 to 125 VAC and 50 to 450 Hz.

PASTORIZA
ELECTRONICS, INC.

385 Elliot St., Newton Upper Falls, Mass. 02164
(617) 332-2131

ON READER-SERVICE CARD CIRCLE 75

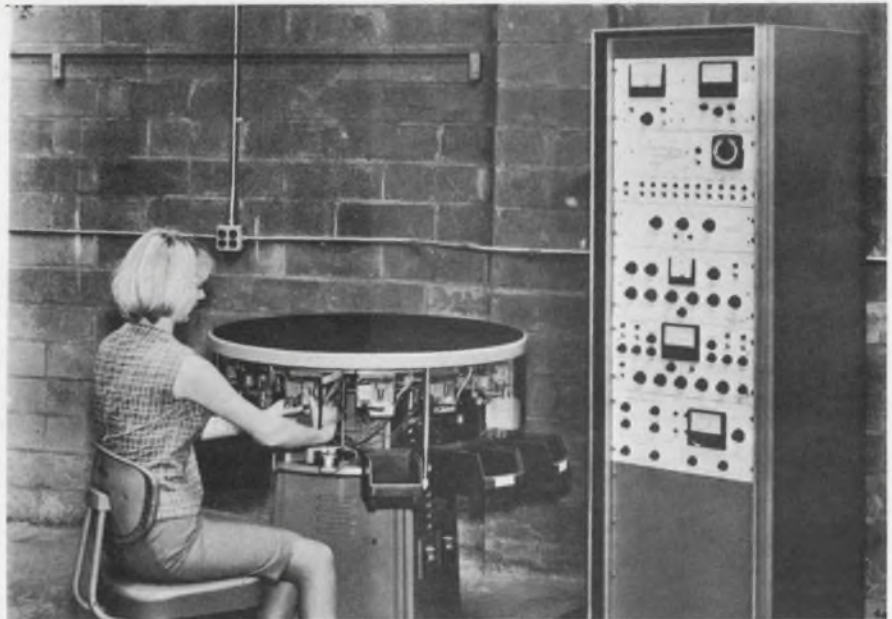

Test trimmer pots automatically for seven parameters

Solatron Enterprises, 4079 Glencoe Ave., Venice, Calif. Phone: (213) 391-6662. P&A: \$25,000; 6 months.

Manual measurement of the performance parameters of trimmer potentiometers is a laborious, time-consuming and expensive job. With one operator, this trimmer tester, reportedly the only one of its kind, can inspect as many as 720 potentiometers per hour for total resistance, end resistance, contact resistance variation and/or absolute contact resistance (noise), dielectric withstanding voltage, insulation resistance, effective travel and continuity. With these tests the unit verifies conformance of all of the critical parameters of the pot to the requirements of either MIL-R-27208 or MIL-R-22097.

The tester consists of a 12-station rotary table for handling, driving and sorting the pots and an associated console of test equipment to perform the required inspections. An operator, sitting in front of the rotary table, installs the pots into test fixtures as the machine positions fixtures in the load station.

In the first station following loading, the pot shaft is rotated to one end of its travel to establish a rotation reference. Every 5 seconds the rotary table advances the pots

in their test fixtures, to subsequent test stations where they are inspected. If any of the parameters exceed allowable limits, the pot is rejected at the particular station into a corresponding bin. All pots advancing to the last station are ejected by the tester as good parts.

A variety of test fixtures can be provided to enable testing of any type of trimmer potentiometer; rectilinear, square, single-turn, printed-circuit lead, wire-lead and solder-pin lead.

CIRCLE NO. 269

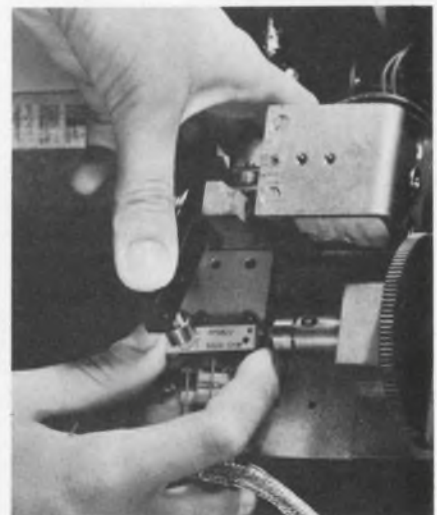

Operator positions pot in test fixture and machine takes over. Seven tests are made every 5 seconds.

The Authority.

Free.

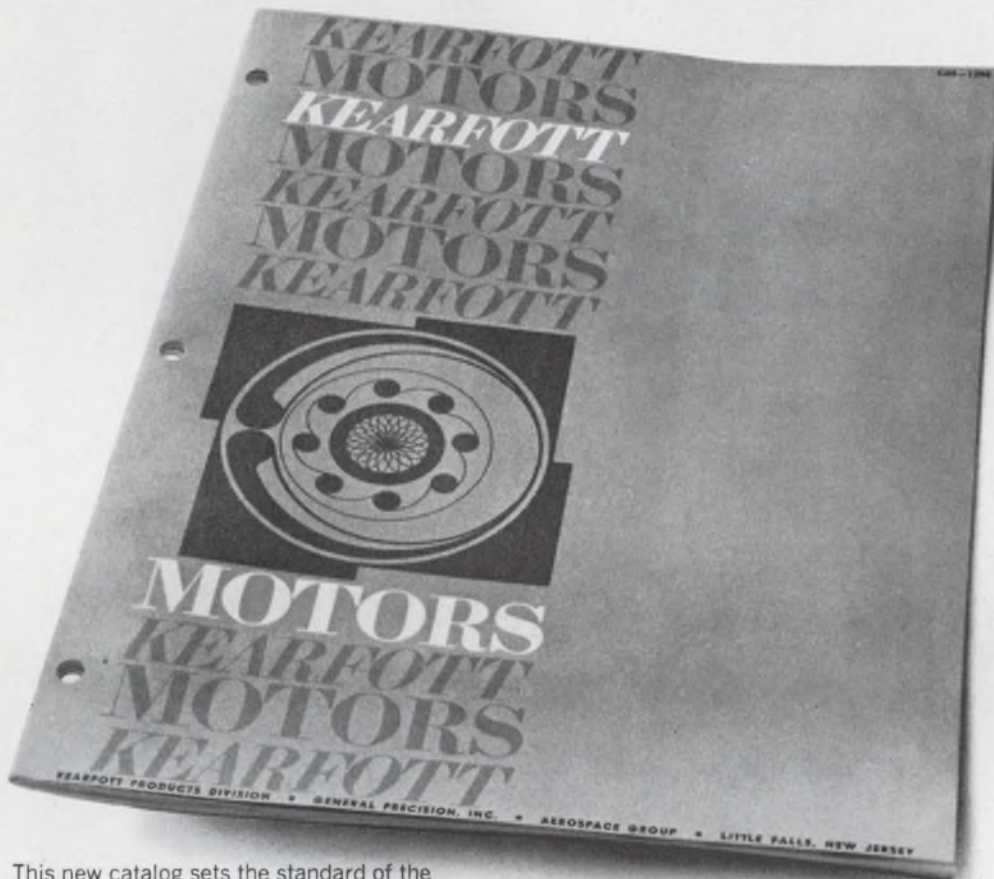

This new catalog sets the standard of the industry.

It thoroughly describes the finest motors you can buy. All types of Kearfott motors.

Open it and look at the listing. We offer stepper motors, drivers and logic. Synchronous motors. Viscous-damped, inertial-damped and braked servo motors in sizes 5 through 23. Special-purpose AC motors that meet some really way-out application needs.

Some of the designs we call standard others might call extraordinary.

Take our permanent magnet stepper motors. They're as much as 40% shorter than conventional units with no sacrifice in torque. Which means you can keep your designs small.

Our variable reluctance stepper motors are the shortest per unit torque

available. They require the least power for rated operation, and they're non-resonant without using external resistive or mechanical damping circuits.

Our standard hysteresis synchronous motors are the most stable for those applications where hunting and jittering can't be tolerated.

No other source offers such a complete variety of motors providing precision and reliability developed during 20 years of experience.

You'll find all the details in our comprehensive 32-page brochure. Pictures. Descriptions. Tables of characteristics. Dimensional drawings. Wiring schematics. Even a summary of design formulas.

Free. Write for it today. Kearfott Products Division, General Precision, Inc., Aerospace Group, Dept. 1450, 1150 McBride Avenue, Little Falls, New Jersey 07424.

KEARFOTT PRODUCTS DIVISION

 **GENERAL
PRECISION INC.**

AEROSPACE GROUP

LITTLE FALLS

NEW JERSEY

A SUBSIDIARY OF GENERAL PRECISION EQUIPMENT CORPORATION

ON READER-SERVICE CARD CIRCLE 76

What do we know about switches and military relays? We wrote the "books"!

Free: four new catalogs from Cutler-Hammer—
covering the most versatile line
of switches and relays in the industry.
Order the ones you want!



Military Switches

Here is complete descriptive data on the Cutler-Hammer switch line, designed especially for military applications—everything from push-buttons to "Positive Action" switches (nearly everything that flies uses Cutler-Hammer "Positive Action" switches!).
Reader Service No. 202



Commercial Specialty Switches

New 36-page catalog is filled with detailed information on hundreds of switches for every application . . . appliances . . . power and hand tools . . . photo equipment . . . business machines . . . you name it! Truly a buyer's guide for quality switches.
Reader Service No. 203



Power Relays

Here is the book on performance-tested relays designed for electrical control on aircraft, space vehicles, ordnance, ground-support equipment. Contains illustrative photos, engineering data, drawings and ratings on our full line of power relays.
Reader Service No. 204



Shallcross Rotary Switches

A brief but complete booklet on all Shallcross rotary switches. Series 1 (1-inch deck), Series 2 (1 3/4-inch deck), Series 4 (2 1/2-inch deck) round ceramic switches and oval ceramic switches. Includes description, design characteristics and selection tables.
Reader Service No. 205

CUTLER-HAMMER

Milwaukee, Wisconsin 53201



PRODUCTION EQUIPMENT

Vacuum encapsulator for 2-part epoxies

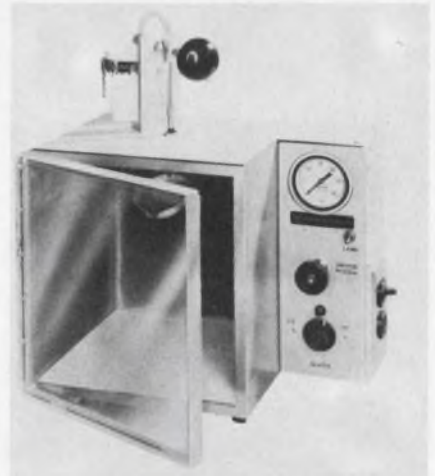

Warlock Systems, Inc., 81 Newton Rd., Danbury, Conn. Phone: (203) 744-0686. P&A: \$575; 4 wks.

For use with two-part epoxy systems, this chamber eliminates air completely during the encapsulating process. The mold is completely voided of air before the epoxy is poured. The epoxy is heated automatically as it is used. Inside dimensions of the chamber are 9 x 10 x 8 inches. Power required is 115 Vac, 60 Hz, 10 A. Air evacuation time is approximately 60 seconds.

CIRCLE NO. 296

Desolder components with hand-held tool



Edsyn, Inc., Box 868, Arleta Station, Pacoima, Calif. Phone: (213) 893-1688. P&A: \$11.95; stock.

A hand-held self-contained desoldering tool facilitates component rework through rapid removal of unwanted solder from solder joints. The tool incorporates self-cleaning features and swift vacuum action. Molten solder is drawn into the receiving chamber with a high impulse vacuum stroke by a simple thumb release of the spring-loaded piston.

CIRCLE NO. 297

Photoresist coating unit fully automated

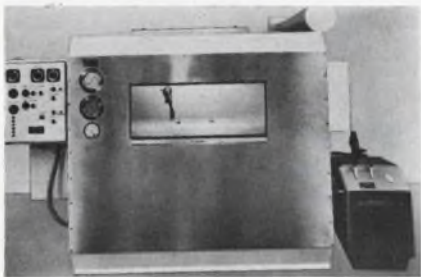

Zicon Corp., 63 E. Sanford Blvd., Mt. Vernon, N. Y. Phone: (914) 667-1260. P&A: \$9500 to \$26,500; 8 to 10 wks.

Silicon wafers, glass, ceramic and thin-film substrates requiring fine line definition can be automatically coated with 5000-A photoresist with this coating system. Whereas photoresist spinning is generally limited to round substrates not exceeding 2-inch diameters, the system produces pure, uniform pinhole-free coatings regardless of the substrate size or shape. In addition, through-hole plated PC boards can be coated without puddling or plugging of the holes and without wedging effects.

CIRCLE NO. 298

Contact chatter checked with solid-state unit

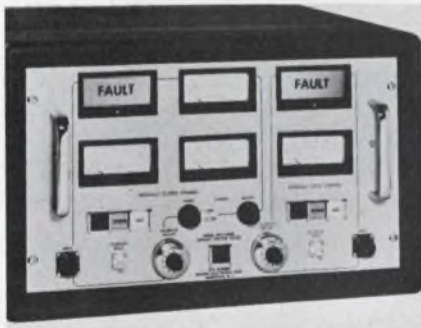

Artisan Electronics Corp., 5 Eastmans Rd., Parsippany, N. J. Phone: (201) 887-7100.

Model EPC-10492 monitors contact chatter per MIL-Std 202, method 310. The unit is adjustable from 1 to 100 μ s for both NC and NO channel testing. NC contacts may be subjected to 1 A in ranges from 0 to 100 mA and 100 mA to 1 A, while NO contacts have a fixed 100-Vdc applied across them. When set at 10 μ s, the detection accuracy is \pm 500 ns with a chatter accumulation rejection of 500 ns.

CIRCLE NO. 299

Columbia Components Thick-film hybrids.

Send us your specs for fast action.

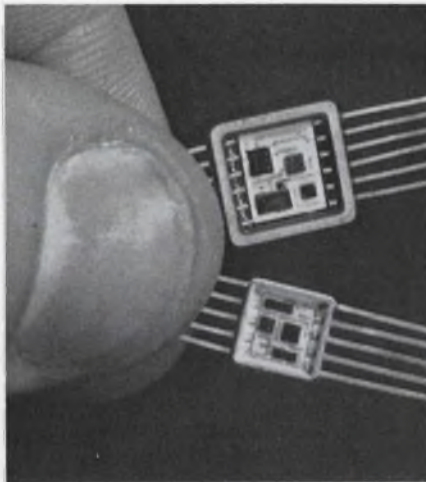

The answers to your micro-packaging problems are as close as this coupon.

The hybrid circuit is a versatile tool in the hands of the design engineer faced with problems in high power ratings, thermal tracking, precision component tolerances, intermixing monolithic IC's and other interfacing circuitry and components. In applications where the design may undergo changes up to the first production article, the hybrid offers the designer freedom to institute necessary changes with minimal cost and time.

Columbia Components Corporation's Thick-Film Hybrid Circuits are capable of reproducing any given circuit without degradation in circuit functions. These hybrids also present the most economical approach to most problems.

Please sketch schematic (or print, if available) and attach.						<table border="1"> <thead> <tr> <th>R</th> <th>Value</th> <th>Tol.</th> <th>T.C.</th> <th>Wattage</th> <th>Q</th> <th>Generic Type</th> <th>Tol.</th> </tr> </thead> <tbody> <tr><td>R1</td><td></td><td></td><td></td><td></td><td>Q1</td><td></td><td></td></tr> <tr><td>R2</td><td></td><td></td><td></td><td></td><td>Q2</td><td></td><td></td></tr> <tr><td>R3</td><td></td><td></td><td></td><td></td><td>Q3</td><td></td><td></td></tr> <tr><td>R4</td><td></td><td></td><td></td><td></td><td>Q4</td><td></td><td></td></tr> <tr><td>R5</td><td></td><td></td><td></td><td></td><td>Q5</td><td></td><td></td></tr> <tr><td>R6</td><td></td><td></td><td></td><td></td><td>Q6</td><td></td><td></td></tr> <tr><td>R7</td><td></td><td></td><td></td><td></td><td></td><td></td><td></td></tr> <tr><td>R8</td><td></td><td></td><td></td><td></td><td></td><td></td><td></td></tr> <tr><td>R9</td><td></td><td></td><td></td><td></td><td></td><td></td><td></td></tr> <tr><td>R10</td><td></td><td></td><td></td><td></td><td></td><td></td><td></td></tr> </tbody> </table>			R	Value	Tol.	T.C.	Wattage	Q	Generic Type	Tol.	R1					Q1			R2					Q2			R3					Q3			R4					Q4			R5					Q5			R6					Q6			R7								R8								R9								R10							
R	Value	Tol.	T.C.	Wattage	Q	Generic Type	Tol.																																																																																									
R1					Q1																																																																																											
R2					Q2																																																																																											
R3					Q3																																																																																											
R4					Q4																																																																																											
R5					Q5																																																																																											
R6					Q6																																																																																											
R7																																																																																																
R8																																																																																																
R9																																																																																																
R10																																																																																																
Application _____						<table border="1"> <thead> <tr> <th>C</th> <th>Value</th> <th>Tol.</th> <th>Rated Voltage</th> <th>CR</th> <th>Generic Type</th> <th>Tol.</th> </tr> </thead> <tbody> <tr><td>C1</td><td></td><td></td><td></td><td>CR1</td><td></td><td></td></tr> <tr><td>C2</td><td></td><td></td><td></td><td>CR2</td><td></td><td></td></tr> <tr><td>C3</td><td></td><td></td><td></td><td>CR3</td><td></td><td></td></tr> <tr><td>C4</td><td></td><td></td><td></td><td>CR4</td><td></td><td></td></tr> <tr><td>C5</td><td></td><td></td><td></td><td>CR5</td><td></td><td></td></tr> <tr><td>C6</td><td></td><td></td><td></td><td>CR6</td><td></td><td></td></tr> <tr><td>C7</td><td></td><td></td><td></td><td></td><td></td><td></td></tr> <tr><td>C8</td><td></td><td></td><td></td><td></td><td></td><td></td></tr> <tr><td>C9</td><td></td><td></td><td></td><td></td><td></td><td></td></tr> <tr><td>C10</td><td></td><td></td><td></td><td></td><td></td><td></td></tr> </tbody> </table>			C	Value	Tol.	Rated Voltage	CR	Generic Type	Tol.	C1				CR1			C2				CR2			C3				CR3			C4				CR4			C5				CR5			C6				CR6			C7							C8							C9							C10																	
C	Value	Tol.	Rated Voltage	CR	Generic Type	Tol.																																																																																										
C1				CR1																																																																																												
C2				CR2																																																																																												
C3				CR3																																																																																												
C4				CR4																																																																																												
C5				CR5																																																																																												
C6				CR6																																																																																												
C7																																																																																																
C8																																																																																																
C9																																																																																																
C10																																																																																																
Customer Print # _____																																																																																																
Rev: _____ Lead Forming _____																																																																																																
Is qualification acceptance required? _____																																																																																																
Is lot acceptance required? _____																																																																																																
Package style & size: _____																																																																																																
Body Material: _____																																																																																																
Lead materials: _____																																																																																																
MAXIMUM RATINGS																																																																																																
Storage Temp. Range _____ Operating Temp. _____						Environmental Specifications _____																																																																																										
Ambient Temp. _____ Power Dissipation of 25°C _____						Military Specs., if any _____ Frequency _____																																																																																										
<input type="checkbox"/> Have your engineer call. <input type="checkbox"/> Send descriptive literature.						Other applicable specs _____																																																																																										
Name _____ Title _____						Voltages _____																																																																																										
Company _____																																																																																																
Address _____ Telephone _____																																																																																																
City _____ State _____ Zip _____																																																																																																
 COLUMBIA COMPONENTS CORP. A Subsidiary of Computer Instruments Corp., Woodside, N. Y. 11377. Tel: (212) 726-2600																																																																																																

ON READER-SERVICE CARD CIRCLE 74

μsec/millisecc delays

VIDEO

TRIPLE

5-500MHz

MULTI-CHANNEL

TRAVEL

PROPORTIONAL CONTROL

analog

ISOTHERMAL

WIDEBAND

LOW LOSS

AMPLIFIERS

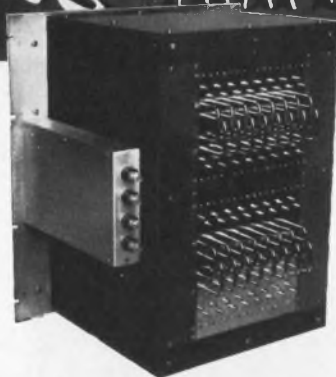

In a word, LFE

for quartz or glass ultrasonic delay lines

You'll find the complete text — applications information — theory — technical data — specifying information for standard and custom delay lines for your application — in these authoritative LFE Catalog-Handbooks. Get them, now!



ELECTRONICS DIVISION

Laboratory For Electronics, Inc.
WALTHAM, MASSACHUSETTS 02154
Tel: 617-894-6600 • TWX: 710-324-0681

ON READER-SERVICE CARD CIRCLE 77

MICROWAVES

Dummy load uses water as dielectric, coolant



Altronic Research Corp., 13710 Aspinwall Ave., Cleveland. Phone: (216) 851-3220. P&A: \$1275; stock.

A lightweight 50-Ω RF coaxial load resistor dissipates up to 50 kW. Using tap or distilled water as the dielectric and the coolant, the unit can serve as a dummy load during transmitter designing, testing adjusting and aligning in the frequency range up to 2 GHz and as a dummy load for RF power tube manufacturers or transmitting stations. The power is dissipated in a film-type cylindrical resistor which can be replaced in the field. The resistor is contained in an enclosure which provides an almost reflection-free termination. Maximum input vswr is 1.1 to 1 GHz, 1.15 to 1.5 GHz and 1.2 to 2 GHz.

Ordinary tap or distilled water flow may be used in either open or closed water systems. Rate of flow at 9 gallons per minute enables the absorption of power up to 50 kW. All components exposed to water are noncontaminating. The units weigh 16-1/2 lbs.

CIRCLE NO. 438

Balanced mixer ranges 4.2 to 4.4 GHz

Microlab/FXR, 10 Microlab Rd., Livingston, N. J. Phone: (201) 992-7700.

Balanced mixers covering 4.2 to 4.4 GHz are capable of handling IF frequencies from 0.5 to 100 MHz without tuning. Present models provide LO isolation of 20 dB with 5 to 15 mW LO power. Maximum RF input power is at least -12 dBm, and the mixer operates over a temperature range of -300° to +60°C. Hot carrier diodes are employed exclusively. Noise figure is typically 7 dB with an IF noise figure of 1.5 dB.

CIRCLE NO. 439

S-band generator doubles as LO, receiver



Polarad Electronic Instruments, 34-02 Queens Blvd., Long Island City, N. Y. Phone: (212) 392-4500. Price: \$1900.

Covering 2 to 4.6 GHz, this signal generator can be used alone or racked or stacked with other modules. A frequency stabilizer module can be added for phase-locking the generator over its entire range to crystal stability. Full FM, square-wave and pulse modulation is obtainable by the addition of a modulator. This permits testing broad and narrow-band antennas, attenuators, beacons, crystal mounts, hybrid junctions, preselectors, radars, receivers and TWT amplifiers. Specific measurements can be made of bandwidth, attenuation, alignment, frequency dial calibration, image rejection, sensitivity, power gain and vswr.

CIRCLE NO. 440

Line stretcher spans dc to 12.4 GHz

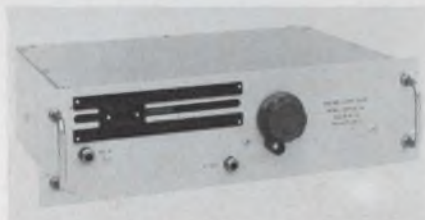

Wiltron Co., 930 E. Meadow Dr., Palo Alto, Calif. Phone: (415) 321-7428. P&A: \$750; 5 wks.

Phase shifters calibrated in degrees per GHz and millimeters of line length can be used as line stretchers for phase measurements, as a reference for calibrating phase meters or for introducing fixed line-length changes into systems. Calibration is accurate to $\pm 0.1^\circ$ at 1 GHz and vswr is 1.25 to 2 GHz and 1.4 to 12.4 GHz. Line length variation is 60 centimeters.

CIRCLE NO. 441

Versatility and simplicity in variable, regulated power supplies

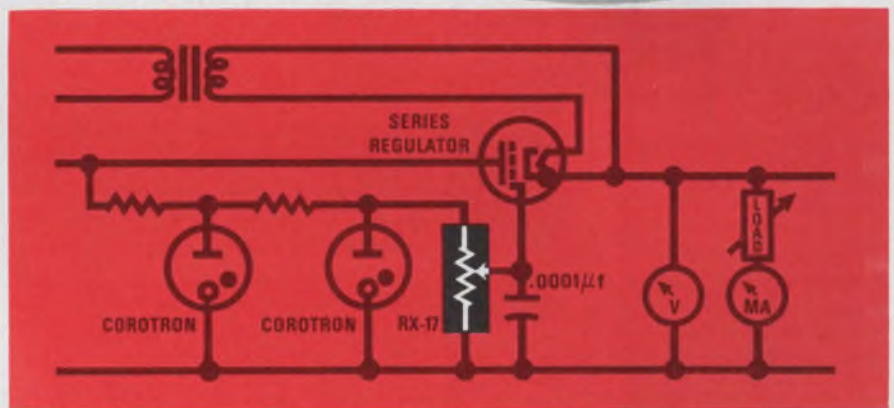
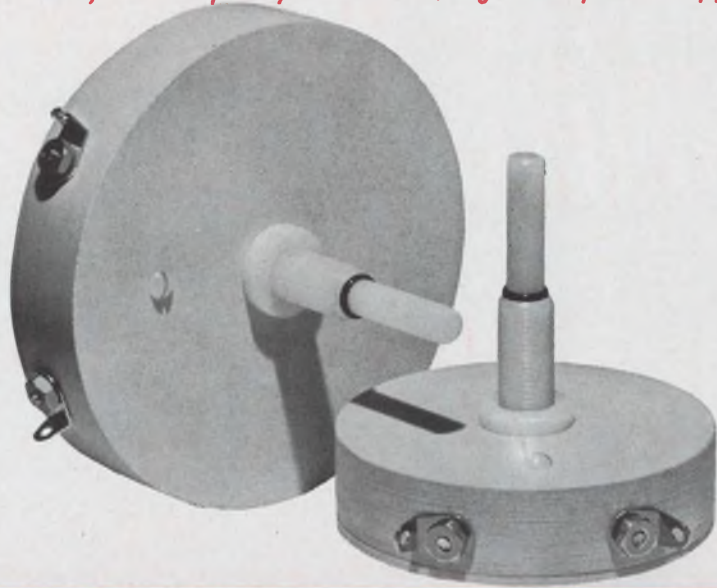

POTENTIOMETERS TO 10 KV

New Victoreen RX-17 series ceramic potentiometers, when used across a well-regulated high-voltage source, provide reference adjustment with a degree of simplicity never before available to circuit designers.

Long life, resistance stability and panel insulation capability to 20 kv make Victoreen RX-17 series potentiometers ideal for reference adjustment for variable, regulated HV supplies in CRT's, TWT's, Klystrons, GM tubes, proportional counters, etc.

Two RX-17 series are available: One for operation to 5 kv rated at 3 w, the other for 10 kv rated at 5 w. RX-17 series ceramic potentiometers are normally supplied with nominal resistance range of 1 Meg to 5000 Meg, with a linearity of $\approx 2\%$. Full technical details on request to Applications Engineering Department.

6976-A

VICTOREEN INSTRUMENT DIVISION
10101 WOODLAND AVENUE • CLEVELAND, OHIO 44104
IN EUROPE: GROVE HOUSE, LONDON RD., ISLEWORTH, MIDDLESEX, ENGLAND



ON READER-SERVICE CARD CIRCLE 78

GLASS ENCLOSED

AMPERITE

Thermostatic DELAY RELAYS

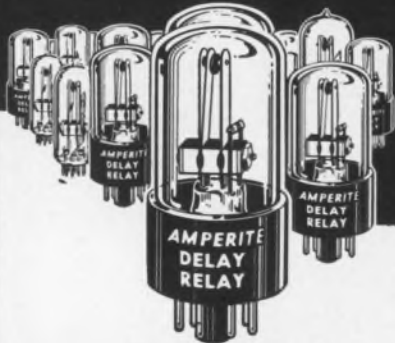

**Offer true hermetic sealing
-assure maximum stability and life!**

Delays: 2 to 180 seconds . . . Actuated by a heater, they operate on A.C., D.C., or Pulsating Current . . . Being hermetically sealed, they are not affected by altitude, moisture, or climate changes . . . SPST only—normally open or normally closed . . . Compensated for ambient temperature changes from -55° to +80° C . . . Heaters consume approximately 2 W. and may be operated continuously . . . The units are rugged, explosion-proof, long-lived, and—inexpensive!

TYPES: Standard Radio Octal, and 9-Pin Miniature.
List Price, \$4.00

PROBLEM? Send for Bulletin No. TR-81

AMPERITE

BALLAST REGULATORS

Hermetically sealed, they are not affected by changes in altitude, ambient temperature (-50° to +70° C.), or humidity . . . Rugged, light, compact, most inexpensive.

List Price, \$3.00

Write for 4-page Technical Bulletin No. AB-51

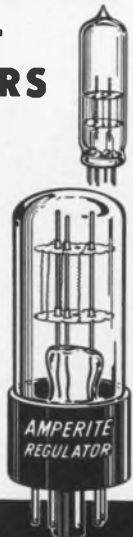
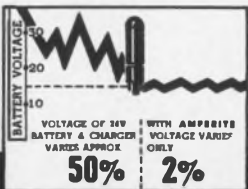

AMPERITE

600 PALISADE AVE., UNION CITY, N.J.
Telephone: 201 UNion 4-9503
In Canada: Atlas Radio Corp., Ltd.,
50 Wingold Ave., Toronto 10

ON READER-SERVICE CARD CIRCLE 79

MICROWAVES

Three-plug-in receiver spans 2 to 12 GHz



Rohde & Schwarz, 111 Lexington Ave., Passaic, N. J. Phone: (201) 773-8010. P&A: About \$7500; stock.

With three plug-ins, this test receiver covers 2 to 12.1 GHz. It has preselection, klystron oscillator, switch-selected IF bandwidth and automatic phase control. Uses are as a broadband monitoring receiver with IF output for PM and FM signals and with phones and video output for AM signals or as a narrow-band lab receiver with an IF output.

CIRCLE NO. 442

Lightweight RF loads dissipate 10 kW

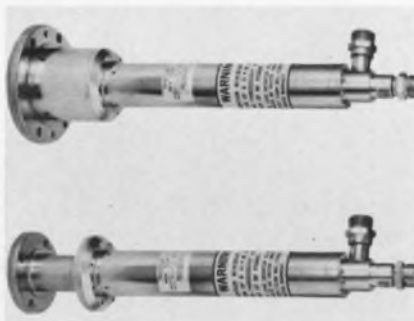

Bird Electronic Corp., 30303 Aurora Rd., Cleveland. Phone: (216) 248-1200.

Instead of heavy built-in terminating resistors, these line terminations are simply connected to the line wherever needed. At 6-1/2 pounds, they are light enough to bolt to the end of the line in any position. Both units have a continuous power rating of 10 kW with 4 gallons per minute cooling water. Vswr of the 50-Ω loads is 1.1 to 1 GHz and 1.15 to 1.4 GHz.

CIRCLE NO. 443

S-band switch-driver based on hybrids

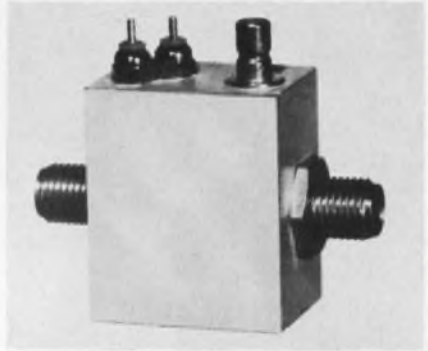

Microwave Associates, Burlington, Mass. Phone: (617) 272-3000.

S-band spdt integrated switch-driver assemblies achieve their small size and 0.5-oz weight by using hybrid circuits mounted on a ceramic base. Diode chips are mounted directly on the transmission line, eliminating interconnecting elements. Reduction in the number of diodes to two pin diodes results in a 20-ns switching speed with 45-dB isolation. The unit operates in the 1-to-4-GHz range.

CIRCLE NO. 444

Broadband circulator electrically tunable



Scientific-Atlanta, Inc., Box 13654, Atlanta. Phone: (404) 938-2930. P&A: under \$1000; 30 days.

Tunable over a range of 400 to 1200 MHz, instantaneous bandwidth of this circulator is greater than 30 MHz. Vswr is below 1.35. The circulator is furnished with a variable voltage dc supply and tuning control with linear, direct read-out of frequency from 500 to 1000 MHz. Tuning from 400 to 500 and 1000 to 1200 MHz is by calibration chart. Power is 260 mA, 10 V.

CIRCLE NO. 445

*The Scionics Corporation
is proud to announce
a New addition to its
broad line of
Microminiature Ceramic
Capacitors
The S-Cap 500 Series*

Phone: 213-341-5500

a NEW Ceramic Capacitor

The new Scionics **S-Cap 500** series ceramic capacitors offer a wide range of values in a single small package. Permitting 100% packaging compatibility with all discrete components, the **S-Cap 500** has a uniform molded case (.260" length and .100" diameter) with a wide range of capacitance values from 10 pf to 22000 pf.

New and improved capacitor elements used in the **S-Cap 500** series, provide even greater margins of reliability and better overall electrical and temperature characteristics. Improved lead attachment, superior moisture immunity, and improved ceramic formulations guarantee a superior capacitor. **S-Cap 500** series meet and exceed all electrical and environmental requirements of MIL-C-11015C and MIL-C-39014.

Write today for descriptive **S-Cap 500** literature. Also available, our general catalogue describing the complete line of Scionics ceramic capacitor products; pellets, chips, and higher capacitance values through 1 mfd.

THE SCIONICS CORPORATION — 8900 Winnetka Avenue, Northridge, California/213-341-5500/TWX 213-341-7559

SCIONICS[®]

SCIONICS — SCIENCE AND ELECTRONICS FOR INDUSTRY AND DEFENSE
CAPACITOR DIVISION • INSTRUMENT DIVISION • INFORMATION SYSTEMS DIVISION

Job #2513 Prepared by Burrell Advertising

ON READER-SERVICE CARD CIRCLE 80

NEW SOLID STATE CYCL-FLEX® TIMER



CE300

YOUR BROADEST SCOPE

RENOWNED ELECTROMECHANICAL CYCL-FLEX TIMER



HP5

The Man from E.A.G.L.E.* offers you a range of accurately controlled Cycl-Flex time delays that run all the way from 1/20 second to 60 hours. These timers, housed in their now famous plug-in cases, may in fact be interchanged. The HP5 Cycl-Flex is a synchronous, motor driven, precision instrument providing accurate delay between control-circuit actuation in the operation of load circuits. Maximum settings range from 5 seconds to 60 hours with minimum settings from 1/6 second to 2 hours. The CE300 Cycl-Flex is a solid state timer that overlaps the HP5 in the lower time ranges. The 300 series offers dial ranges of 10 seconds and shorter, with minimum settings from 1/20 second to 1/2 second. Depending on contact load, average mechanical life is more than 10,000,000 operations.

Whether you need short time cycles at a fast repetitive rate, or longer but still precisely-controlled delays, the Cycl-Flex Series will give you exactly the right answer... for specifications, get our HP5 Series Bulletin 125 and our CE300 Series Bulletin 155. Write Eagle Signal Division, E. W. Bliss Company, 736 Federal Street, Davenport, Iowa 52808; or call (319) 324-1361.

BLISS  **EAGLE SIGNAL**

A DIVISION OF THE E. W. BLISS COMPANY

*E.A.G.L.E.—Engineering Assistance Given Locally—Effectively.

For Information on CE300 Timer Circle Reader Service Card Number 106

For Information on HP5 Timer Circle Reader Service Card Number 107

Design Aids



Varactor diode calculator

A "Varicap" slide rule aids the design engineer in making rapid calculations relating to voltage-variable capacitor functions. The user can make instant calculations by interrelating voltage-variable capacitance diode parameters at other than standard operating conditions. Relationships such as capacitance or Q vs frequency, voltage or temperature can be obtained. The rule optimizes catalog selection of voltage-variables by relating such design criteria as tuning ratio capability to device capacitance/voltage maxima and minima.

Available free of charge from any TRW Semiconductor authorized distributor.

Diallyl phthalate selector

A diallyl phthalate materials selector covers 10 molding compounds and 12 materials. Materials are conveniently listed by grade code and MIL-spec. Thirty-one key characteristics are thoroughly covered, including mechanical, thermal, moisture and electrical parameters. U. S. Polymeric, Inc.

CIRCLE NO. 446

Dc clutches and brakes

This 6-page article briefly discusses operating principles of dc clutches and brakes. Emphasis is placed on the factors involved in selecting the proper unit for a particular application: torque, load, service factors, thermal capacity, heat absorption. "Rules of thumb" and formulas are listed as working guides to proper application. Also contained in the article is a discussion on the range of electrical and mechanical design modifications possible with clutches and brakes. Stearns Electric Corp.

CIRCLE NO. 447



INSTANT EAGLE RELAYS

Test Them Immediately...Get Production Quantities In Two Weeks!

That's right . . . Eagle challenges you to compare them with any relay on the market. NOW you can get immediate delivery on these general-purpose or medium-power relays. Test results prove they're the finest of their kind in the world. Eliminate your relay delivery problems. Call your "Man from E.A.G.L.E." . . . listed below. You'll find he has full details and specifications on Eagle relays.

YOUR "MAN FROM E.A.G.L.E."

Distributors

Burlingame, California 415-697-6244	Albuquerque, New Mexico 505-265-1020
Glendale, California 213-245-1172	Albany, New York 518-436-8536
Englewood, Colorado 303-781-0912	Depew, New York 716-684-5731
Hamden, Connecticut 203-288-9276	Endwell, New York 607-723-8743
Orlando, Florida 305-855-3964	Fairborn, Ohio 513-878-2631
Baltimore, Maryland 301-484-5400	Fairview Park, Ohio 216-333-4120
Newton Highlands, Mass. 617-969-7140	Dallas, Texas 214-363-1526
Minneapolis, Minnesota 612-922-7011	Houston, Texas 713-649-5756
Clifton, New Jersey 201-471-6090	Seattle, Washington 206-725-7800
Haddonfield, New Jersey 609-429-1526	

Representatives

Scottsdale, Arizona 602-947-4336	Hackensack, New Jersey 201-342-2602
Pasadena, California 213-681-4421	Latham, New York 518-785-5032
Jacksonville, Florida 305-388-7656	Rochester, New York 716-436-4410
Orlando, Florida 305-422-4295	Skaneateles, New York 315-685-6172
Roswell, Georgia 404-993-6498	Fairfield, Ohio 216-333-4120
Chicago, Illinois 312-775-5300	Havertown, Pennsylvania 215-528-6640
Chicago, Illinois 312-784-7314	Dallas, Texas 214-748-7788
Baltimore, Maryland 301-276-1505	Houston, Texas 713-224-9715
Norwood, Massachusetts 617-769-3600	Bellevue, Washington 206-454-5200
Minneapolis, Minnesota 612-922-0243	Charleston, West Virginia 304-342-2211
St. Louis, Missouri 314-428-5313	

BLISS



EAGLE SIGNAL

A DIVISION OF THE E. W. BLISS COMPANY

736 Federal Street, Davenport, Iowa

ON READER-SERVICE CARD CIRCLE 108

Application Notes

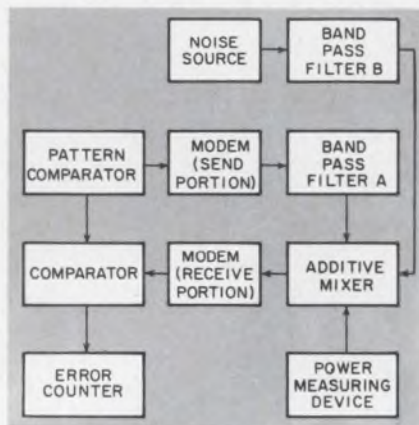

Modem noise measurement

Noise on data communication circuits causes errors. A modulator-demodulator's ability to tolerate this noise is an important measure of its performance. This 8-page bulletin is concerned with the testing of modems to measure their performance in the presence of communications circuit noise. The types of noise and the bit error rate as a performance measure are discussed. The note helps the engineer to understand, correlate, and use published data on modem performance relative to noise. The block diagram of signal-to-noise test set-up shown above is used for measuring modem performance in the presence of white gaussian noise. Rixon Electronics.

CIRCLE NO. 448

Wideband transformer uses

Wideband (100 kHz to 1 GHz) transformer applications are discussed in a 6-page fold-out note. A description of characteristics, mechanical and environmental notes and matching requirements precede the circuit diagrams. Schematics and component selection accompany each of the applications. Applications include a wideband amplifier, microwave diode mixer, 2- and 4-way power divider, frequency doubler and double-balanced mixer. Vari-L Company.

CIRCLE NO. 449

Spectrum analyzer displays

Techniques for improving wide-band spectrum analyzer displays by use of a wide-range, electrically tunable preselector are given in this 8-page note. The preselector functions as a tunable RF stage for the spectrum analyzer to remove undesired image and harmonic responses.

The note presents the theory of operation of the preselector, which uses a YIG filter tunable over 1.8 to 12.4 GHz. It describes the multiple-response characteristic of wideband spectrum analyzers and shows how the filter separates the responses to obtain a more easily interpreted display. Hewlett-Packard.

CIRCLE NO. 450

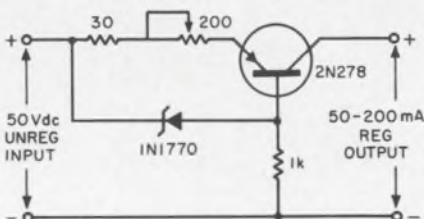

Current regulator design

The current regulator shown above is basically a grounded base circuit. The collector current is essentially equal to the emitter current because of the high current gain characteristics of the 2N278. This application note details the design of the regulator using a 2N278 and a 1N1770 Zener. Delco Semiconductors.

CIRCLE NO. 451

Analog dialogues

Are you interested in a periodical covering operational amplifier technology? The first Analog Dialogue, published by Analog Devices, covers the technique for multiplying magnetoresistive elements. Also included is a section on single amp current sources and operational integrated amps. A qualification post card will be sent to those interested. Analog Devices.

CIRCLE NO. 452

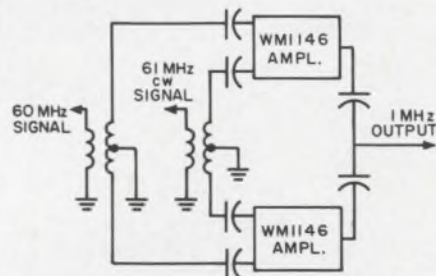

60-MHz mixer using ICs

The mixer above is a double-balanced down converter, mixing a 60-MHz input signal with a 61-MHz local oscillator to give a 1-MHz output frequency. The design utilizes only simple fixed networks for balancing. Input and local oscillator signals are suppressed at the output by at least 20 dB. The mixer uses two Westinghouse WM1146 wide-band amplifiers. Performance, circuit description and design are detailed in this 4-page note. Westinghouse, Molecular Electronics Div.

CIRCLE NO. 453

Wideband amplifier design

Philco/Ford's PA7600 silicon monolithic microcircuit is a wide-band amplifier suitable for linear amplifier or oscillator service from audio to RF frequencies in excess of 160 MHz. It exhibits a gain-bandwidth product of 9 GHz. As a video amplifier, the IC provides an insertion gain of 43 dB at a bandwidth of 65 MHz. Gain is easily traded for bandwidth by the connection of internal or external feedback networks. The bandpass flatness is readily controlled by use of external equalization capacitors. It can be used with external frequency selective elements to provide bandpass amplification for RF or IF applications. The amplifier provides sufficient output power for driving mixer or detector circuits. These and other applications are discussed in an 8-page application note. Philco/Ford Microelectronics.

CIRCLE NO. 454

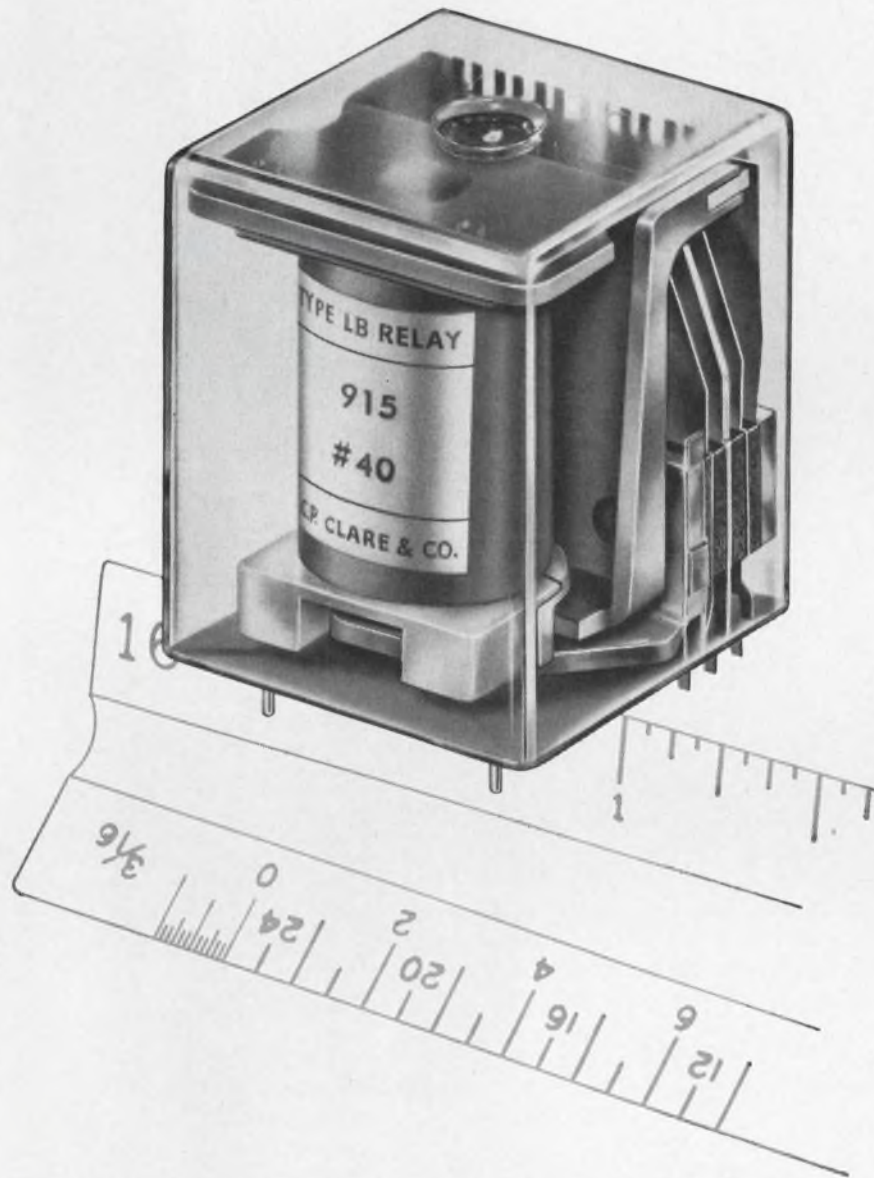

industrious

Small wonder the Clare LB Telephone Type Relay is kept busy—at 1.33 cu. in., it is unmatched for switching capacity and contact versatility—realistically priced!

You can design around 2 amp. to low level operation . . . using up to six Form C contacts . . . or Forms A, B, or D. Twin contacts assure reliable performance . . . with no adjustment needed. Use Type LB for direct pcb mounting . . . Type LBP for mounting with socket. With completely automatic manufacture and adjustment, you can depend on these industrious relays for consistent high quality...maintenance-free, long life operation.

For design information, circle reader service number—or ask Clare for Data Sheet 552B . . . Write Group 6A5.

C.P. Clare & Co., Chicago, Illinois 60645

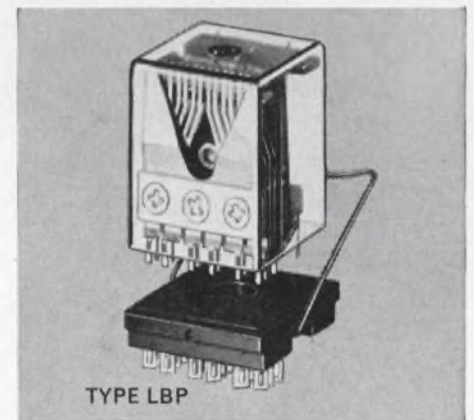

- Long life: up to 50×10^8 operations
- Contact Versatility: 2 amp. to low level . . . twin contacts for reliability . . . up to 6 Form C with A, B and D available
- Stable, adjustment-free operation
- Variety of terminals—pcb, direct plug-in, solder

CLARE MINIATURE TELEPHONE TYPE RELAYS

for process control, computer peripheral equipment, communications,
digital instruments, business machines, ground support equipment

ON READER-SERVICE CARD CIRCLE 81

New Literature

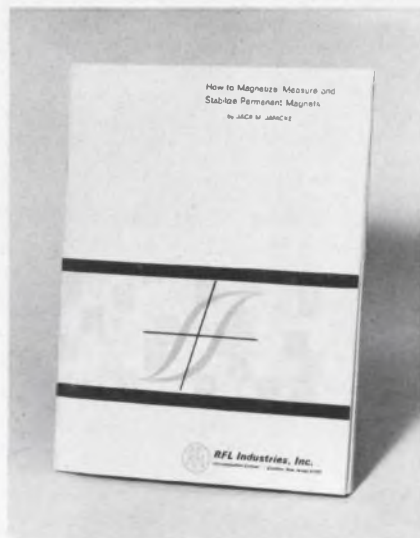

Magnet measurement

"How to Magnetize, Measure and Stabilize Permanent Magnets" is a 26-page illustrated booklet for engineers in the field of magnetics and magnetic measurement. It contains up-to-date magnetic terms and definitions as well as new equipment available for charging, treating and measuring. Chapter one covers the selection and use of magnet charging and treating equipment with chapter two describing Hall-effect gaussmeters. The presentation concludes with a system approach. RFL Industries, Inc.

CIRCLE NO. 455

Production brazing booklet

A 16-page catalog "positions" brazing as a production metal-joining method, compares brazing to other metal joining techniques and points out where brazing is advantageous. The booklet explains the basic idea of brazing and demonstrates how the flexibility of the process permits automation at different production levels. The presentation discusses the role of service conditions in the choice of a joining method, and describes techniques for automating the heating cycle and placement of alloy and flux. Handy & Harman.

CIRCLE NO. 456



Drafting aids

This catalog lists standard and special electrical/electronic engineering and drafting aids. Listed in the 28-page catalog are electronic component symbols for ICs, PCs, micrologic, welded modules, flat packs and transistors. Also included in the presentation are several pads, elbows, corners, tees, ells, tapes, connector strips, reference numbers, letters and schematic symbols. Bishop Industries Corp.

CIRCLE NO. 457

High-power antennas

This 8-page illustrated short-form catalog describes high-power antenna switching matrices with manual and remote control for coaxial and balanced transmission lines and antenna coupling units with manual and remote servo control. Also included in the presentation are operating impedance bridges, rotary variable inductors, tunable notch filters and multicouplers, and receiving antenna systems. Delta Electronics, Inc.

CIRCLE NO. 458

IC bulletin

Radiation's integrated circuits are listed in a bulletin with typical characteristics, schematics and logic diagrams. Dielectrically isolated DTL circuits, operational amplifiers and diode matrices are covered. Radiation, Inc.

CIRCLE NO. 459

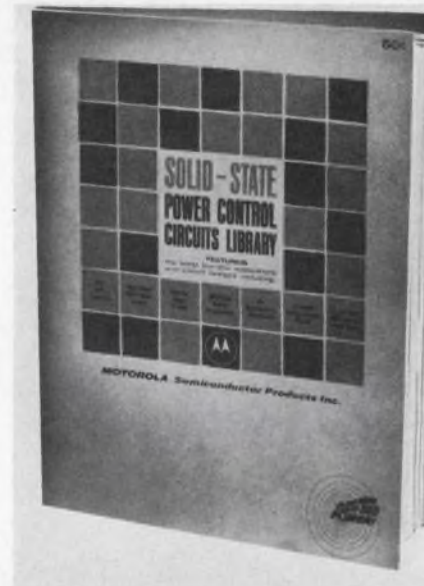

Control circuits guide

An applications-oriented power control circuits guide compiled from Motorola application notes is available. The booklet contains ideas that will ignite design thinking in consumer/light industrial solid-state power control circuitry. Titled, "Solid-State Power Control Circuits Library," the volume presents new solutions to today's common thyristor control problems in thirteen titled sections.

Available on company letterhead from Motorola Semiconductor Products, Inc., P. O. Box 955, Phoenix, Ariz.

Insulation materials

Bulk, fabricated and machined electrical insulation materials are covered in a 10-page brochure. The presentation is directed at designers and manufacturers of electrical apparatus, appliances and heavy-duty equipment. Materials include glass-based polyesters, glass-supported Teflon laminates, tapes and extrusions, monolithic asbestos, Benelex, mica and vulcanized fibres for NEMA Classes B, F and H service. Wisconsin Gasket & Manufacturing Co., Inc.

CIRCLE NO. 460

who says
the shoemaker's
son
always goes
barefoot?



not us!

Let's admit it: electronic engineers sometimes dedicate time and energy to everyone's problems — *except* their own! Those "color ghosts" that haunt their color TV reception, for example. Very unscientific! And very unnecessary when all it takes to clear up the situation is the time it takes to install an Alliance Tenna Rotor.

Tenna Rotor is designed to eliminate "color ghosts", brighten up color pictures or improve black and white reception and even sharpen up FM-Stereo. All scientifically . . . simply by aiming your antenna in the direction of the strongest signal.

So, if the shoe fits . . . see your local dealer or send this coupon for further information.

Send me additional information about Alliance Tenna Rotor and names of nearby dealers.

The Alliance Manufacturing Co., Inc.
Alliance, Ohio

Name _____

Address _____

City and State _____ Zip _____

ED-21



the **ALLIANCE** Manufacturing Co., Inc., Alliance, Ohio 44601
(Subsidiary of Consolidated Electronics Industries Corp.)

® MAKER OF GENIE® AUTOMATIC GARAGE DOOR OPENER SYSTEM

ON READER-SERVICE CARD CIRCLE 82

Boxer fans speak softly, but carry away loads of hot air.

(They're durable, efficient, versatile and immediately available.)

Durable.
Ball bearing models withstand high temperature for long periods of time, due to a patented extra-large lube reservoir. Sleeve type Grand Prix (pat. pending) bearings run cool and reliably, offering exceptional life at low cost. Rugged metal frame won't crack under stress like plastic.



Efficient.
Five-bladed aerodynamic impeller delivers maximum flow against high back pressures.

Versatile.
Standard modular size fits almost anywhere, flips to reverse airflow, has seven useful accessories.

Available.
In stock at your nearest distributor.



IMC Magnetics Corp., New Hampshire Division
Route 16B, Rochester, N.H. 03867.
Tel: (603) 332-5300

ON READER-SERVICE CARD CIRCLE 83

This was the result of an IMC reducing plan.



Moves more than 11,000 times
its own volume of air each minute.

For spot cooling of miniaturized equipment.

Cools micro-circuits, transistor heat sinks, airborne computers and instrumentation . . . de-fogs radomes and optical equipment.

Delivers 6.5 cubic feet of cooling air per minute, yet this precision engineered vaneaxial fan weighs only 1 ounce and measures just 1 inch on a side.

Meets demanding environmental,

performance, and reliability specifications, operating efficiently for 1000 hours at 125° C, much longer at lower temperature ranges.

Standardized, for low cost and easy mounting, IMCube fans are readily placed throughout a system, whether it's already completed, or still in design stage.

IMCube fans with cylindrical housing optionally available.



IMC Magnetics Corp., Eastern Division, 570 Main St., Westbury, N.Y. 11591
Phone (516) 334-7070 or TWX 510 222-4469

ON READER-SERVICE CARD CIRCLE 84

NEW LITERATURE



Be-Cu components

More than 50 beryllium copper components are described in this 24-page manual. Twelve pages of standard stock items of finger stock, clips and rings are accompanied by tables of sizes and lengths. H. Braun Tool and Instrument Co., Inc.

CIRCLE NO. 461

Al conductor standards

This 24-page booklet lists reel and coil sizes for bare and covered aluminum conductor and aluminum cable steel-reinforced and neutral supported secondary and service drop cable. Weight and length of conductor that each reel or coil can accommodate are also given. The catalog replaces four previously published packaging standards and incorporates data on large ACSR reels and aluminum alloy conductors fabricated from 5005 and 6201 alloys. Aluminum Association.

CIRCLE NO. 462

Connector catalog

A 12-page, two-color catalog covers miniature high-voltage RF coax connectors, receptacles and adapters. It provides descriptions, photographs, part numbers, sizes and construction. The brochure contains a cable and cross-reference chart, mounting diagrams and a description of cabling procedures. Kings Electronics Co., Inc.

CIRCLE NO. 463

Test equipment references

A pair of directories aid both users and sellers of test equipment. They fill the need for quick and easy comparison of standard equipment on the market. The first three-volume directory lists 7000 microwave instruments manufactured by 200 companies, in 29 individually bound sections. Dealt with are signal generators, sweep generators, directional couplers, isolators, attenuators, slotted lines, vswr meters, frequency meters, counters and power meters.

A second 3-volume directory is aimed at audio-RF test equipment users. Contained in the volume are 5000 instruments manufactured by 200 companies in 26 individually bound sections. Some of the categories covered are: oscillators, pulse generators, amplifiers, receivers, multimeters, VTVMs, digital voltmeters, frequency counters, oscilloscopes and spectrum analyzers. The subscription price of \$150 each includes the 3-volume set plus the periodic up-dating service to keep information complete and current.

Available from *Technical Information Corp., P. O. Box 514, Smithtown, N. Y.*

Diallyl phthalate compounds

Twelve data sheets cover a full line of diallyl phthalate molding compounds. Each data sheet contains complete specifications, including compound properties, molding procedures, molded properties and electrical properties. Materials included are certifiable to MIL-M-14F or P-19833B. Parr Molding Compounds Corp.

CIRCLE NO. 464

Semi and tube buyer's guide

A pair of 4-page 2-color brochures pertaining to semiconductors and tubes are available. They both allow purchasing agents or buyers to analyze sources and costs for more than 70 brands of electronic tubes and semiconductors. TRX Electronic Corp.

CIRCLE NO. 465

Waters INDUSTRIAL TRIMMER PT 3/4C

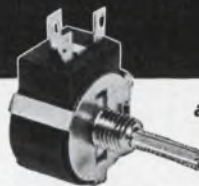

actual size

**When a lot in a little
is a must..!**

Because so much potentiometer performance must so often be packed into small space, we developed the PT $\frac{3}{4}$ C Trimmer to do this job for you. And to do it well . . . all half-ounce of it!

Conforming to Waters exacting standards, you can depend on the PT $\frac{3}{4}$ C to deliver stable resistance control with military reliability over a long operational life. And at commercial cost level.

You'll want the whole story on this versatile potentiometer. We'd like to send it to you.

NEED A PARTICULAR POT . . . ?

If you have a worthwhile need for the potentiometer that doesn't exist . . . could be Waters has the engineering know-how to do something about it.

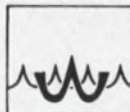

WATERS
MANUFACTURING INC.
WAYLAND, MASSACHUSETTS

EXPORT: Charles H. Reed, Export Director, Waters Manufacturing, Inc.,
Wayland, Mass. 01778 U. S. A.

HART/ADVANCE QUALITY INDUSTRIAL RELAYS



MK

Ultra-small and feather-light, these DC relays occupy less than $\frac{1}{2}$ " mounting space. Silicone dielectrics are used throughout, and all switching is above ground. Stable performance under vibration and shock is assured by beryllium-copper armature hinges. Contact rating 1 amp 115 V AC resistive, 0.6 amp inductive. Size: $\frac{51}{64}$ " H x $\frac{41}{64}$ " W x $\frac{53}{64}$ " L. Weight only 11 grams. Units supplied with single 2-56 NC-2 mounting machine screw.



12

Low-cost, long-life general purpose relay with multiple contacts used widely for vending, communications, and automatic control equipment. Available in resistances up to 12,000 ohms, voltages up to 230 AC or DC. Coil dissipation 4 W, max. Size: (6 C version) $2\frac{3}{16}$ " H x $1\frac{23}{32}$ " L x $1\frac{1}{8}$ " W. $\frac{3}{16}$ " medium power silver contacts (5 & 10) rated amp resistive at 115 VAC. Also latching version.



GH

A low cost, general purpose, continuous duty relay available in open, dustite or hermetically sealed enclosures. Enclosed types, SPDT and DPDT use plug-in bases. Open types use solder lugs, printed circuit or plug mounting. Contacts rated at 10 amp resistive load. UL approval granted on types GH1-C and GH2-C. Latching version (LGA) available.



2

Dependable and versatile, the Type 2 is the work-horse of relays. It operates millions of times with reliability and requires little attention during its long life. Operating voltage up to 750 VDC—up to 440 VAC, 60 cps. Contacts rated up to 8 AMP in either single or bifurcated. Available in a wide range of contact assemblies, materials, mountings, and coil adjustments.



4C

Compact design and specifications similar to Type 2. Armature, coil core, and heel piece are of magnetic iron. Long-life armature pivot bearings assure constant pick-up and drop-out adjustment. Available with either solder lug, P.C. or taper tabs. Contacts rated up to 5 amp at 115 VAC.



8

A versatile and fast acting compact series of telephone types available in many coil, contact, mounting, and terminal variations. Tempered nickel-silver contact blades give true single or twin-contact operation. Coil operating voltage up to 300 VDC, 230 VAC, 60 or 400 cycle. Resistance up to 20,000 ohm, single or double wound. Standard twin palladium contacts rated 4 amps, 115 VAC resistive.



67

Designed for industrial applications requiring 1 to 8 form C where space, weight, and cost are important. Single and bifurcated contacts rated at 3 and 5 amps are available. Mechanical life expectancy is in excess of 100,000,000 operations. One-piece frame and core provide for unusually precise adjustment. Printed circuit or solder type socket mountings available.



W

Series W is a DPDT relay available either with socket for plug-in mounting or with standard quick-connect terminals for simplicity and ease of wiring. Rated to 1 HP at 120 V and 2 HP at 240 V, this popular unit offers highest quality, dependable performance, and long life. The Series W relay measures only $1\frac{1}{2}$ " x $1\frac{1}{2}$ " x $1\frac{1}{8}$ " and weighs less than 10 ounces.



K1A03

Series K1A03 is typical of the high quality standards designed and built into the Hart Reed Relay line. For maximum reliability and extended life, the reed is suspended in silicone rubber, and entire relay is encapsulated in .005 (min.) epoxy coating. Features include electromagnetic shielding, rhodium contacts, and less than one mill-second operating time, including bounce.



For further information about these and other industrial, commercial, and military relays, send for condensed DSC-2 catalog or individual product data sheets.



HART MANUFACTURING CO.
110 BARTHOLOMEW AVE. HARTFORD, CONN 06101
A SUBSIDIARY OF OAK ELECTRO/NETICS CORP.

NEW LITERATURE



Thermoplasts for electronics

A 12-page, 2-color bulletin which describes GE's thermoplastic resin for electrical/electronics applications is available. The catalog details the physical, mechanical, thermal and electrical properties of the resin. Property comparisons between Noryl and competitive materials are included. The bulletin centers around the application advantages and presents various typical applications. General Electric Co., Polymer Products Operation.

CIRCLE NO. 466

Electrical contacts catalog

A guide to electrical contacts is contained in a 20-page, illustrated booklet discussing points to be considered in the design, specification and purchase of rivet, disc, tape, laminated and crossbar contacts. Other sections of the brochure are devoted to an explanation of the contact manufacturing process and to the production of complete contact assemblies. Charts provide data on disc, rivet and crossbar contacts in the most common configurations and alloys. Tricon Manufacturing Co.

CIRCLE NO. 467

Test equipment catalog

A quick-reference catalog describing the manufacturer's line of electronic test equipment is available. Contained in the 8-page brochure are illustrations and descriptions on products complete with price information. Hickok Electrical Instrument Co.

CIRCLE NO. 468



Want
to try
Something
New?

COMPLETE
PHOTO ELECTRIC
PACKAGE

Many other configurations of photo detectors
and electronic packages available.
WHY NOT ASK FOR A CATALOG?

SKAN-A-MATIC
CORP.

P.O. Drawer 68, Skaneateles, N.Y. 13152 • Phone 315-685-3473

ON READER-SERVICE CARD CIRCLE 87

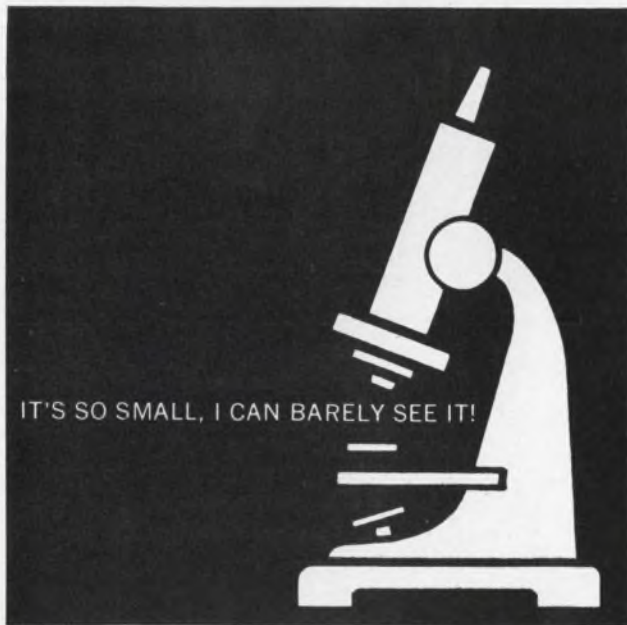

The world's smallest fuse—Picofuse. 1/8 thru
5 amps . . . weight 1/5 gram each . . . 125 v.
Standard or high reliability line.

LITTELFUSE
DES PLAINES, ILLINOIS

ON READER-SERVICE CARD CIRCLE 88

ELECTRONIC DESIGN 13, June 21, 1967

UP TO
2.1
KW OUTPUT
that's what you get
from Deltron's new
"big brute" . . .

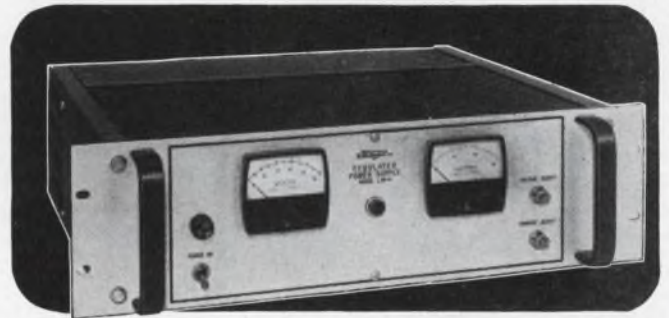

L SERIES SILICON **SYSTEMS
POWER
SUPPLIES**

Choose from 720 models that give you the most comprehensive coverage of voltage and current ratings ever to be offered to the power supply user. Here are just a few features:

- Voltages up to 200 . . . amp ratings to 86.
- Overload protection — adjustable current CUTBAC circuit reduces voltage and current — protects both power supply and load — recovers automatically when fault is cleared.
- 0.01% regulation. ■ Remote sensing.
- Operates up to 71°C.
- Ideally suited for unattended operation.
- No overshoot on turn on, turn off, or power interruption.
- Multiple stacking through unique design — requires no external fans.

For more information . . . or to arrange a demonstration, write to . . .

Deltron inc.

D 106

WISSAHICKON AVENUE, NORTH WALES, PENNSYLVANIA 19454
PHONE: (215) 699-9261 TWX: 510-661-8061

ON READER-SERVICE CARD CIRCLE 89



RESISTANCE MEASUREMENT SYSTEM

±.001% ACCURACY

- RESISTANCE RANGE - 1 OHM TO 1111.11 MEG OHMS
- OVER 8 YEARS OF PROVEN LONG TERM STABILITY,
- GO/NO GO OPERATION
- AUTOMATICALLY PROGRAMS CORRECT MEASUREMENT VOLTAGE AND DETECTOR SENSITIVITY
- AUTOMATIC PERCENT DEVIATION READOUT-LINEAR METER DISPLAY
- DAMAGE-PROOF CIRCUITRY
- 8 DECADE RESOLUTION FROM 6 DECADES PLUS OVERRANGING & LINEAR ANALOG METER DISPLAY



THE GENERAL RESISTANCE MODEL 6003EB IS A TOTALLY SELF-CONTAINED RESISTANCE MEASUREMENT SYSTEM, CONSISTING OF A WHEATSTONE BRIDGE, SOLID STATE NULL DETECTOR, REGULATED SUPPLY AND AN AUTOMATIC GO/NO GO PERCENT SELECTOR PROGRAMMER. OVER 600 RESISTORS PER HOUR CAN BE MEASURED AND SORTED TO BETTER THAN 1 PPM RELATIVE OR ±10 PPM ABSOLUTE ACCURACY.

THE GO/NO GO METER READS ERROR IN PERCENT OR PARTS PER MILLION OF THE COMPONENT UNDER TEST. THE LINEAR METER OF THE GENERAL RESISTANCE BRIDGE IS AUTOMATIC AND REQUIRES ONLY THE MOVEMENT OF A SINGLE PERCENT SELECTOR KNOB TO THE DESIRED LIMIT, WITHOUT REGARD TO THE OTHER DIAL SETTINGS.

Price range - \$3450.00 to \$3750.00. Write for Bulletin #710



GENERAL RESISTANCE, INC
430 Southern Blvd. • Bronx, New York 10455 • Tel.: 212-292-1500 • TWX 212 824-4880

ON READER-SERVICE CARD CIRCLE 90



Write for bulletin describing

New CDS type 6C Photochopper Cells

- High Efficiency
- Low Temperature Coefficient
- Resistance Tolerance ±50%
- Internal Electrostatic Shielding
- Dumet Leads



CLAIREX ELECTRONICS, INC. ■ 1239 BROADWAY, NEW YORK, N.Y. 10001

ON READER-SERVICE CARD CIRCLE 91

Electronic Design

Advertising Representatives

New York 10022

Robert W. Gascoigne
Thomas P. Barth
Samuel M. Deitch
William C. Repetto
850 Third Avenue
(212) PLaza 1-5530
TWX: 867-7866

Philadelphia

P. O. Box 206
Merion Station, Pa. 19066
(215) MO 4-1073

Boston

Richard Parker
7 Redstone Lane
Marblehead, Mass. 01945
(617) 742-0252

Chicago 60611

Thomas P. Kavooras
Berry Conner, Jr.
720 N. Michigan
(312) 337-0588

Cleveland

(216) 247-7670

Los Angeles 90303

Stanley I. Ehrenclou
Terrence D. Buckley
W. James Bischof
2930 W. Imperial Highway
Inglewood, Calif.
(213) 757-0183

San Francisco

Ashley P. Hartman
175 South San Antonio Rd.
Ste. 243
Los Altos, Calif. 94022
(415) 941-3084

Southwestern 75206

Tommy L. Wilson
6200 North Central Expressway
Dallas, Tex.
(214) EMerson 1-2311

London W. 1

Brayton C. Nichols
44 Conduit Street

Verviers, Belgium

Andre Jamar
1, Rue Mallar, 1
(087) 253.85

Tokyo

Yoshihiro Takemura
International Planning
Service, Inc.
Room 231 Tokyu-Mita Bldg.
1, Shiba-Mita Koun-cho
Minato-ku, Tokyo



Save with NEG'ATOR[®] counter- balances

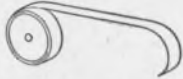

Save space, save weight, save more on production costs too, with Hunter's NEG'ATOR springs in your products. A strip of spring steel forming a pre-stressed coil, the NEG'ATOR resists uncoiling with uniform pull, thus providing the same rated force at any extended length. So with the NEG'ATOR constant-force spring, you'll eliminate deadweights and linkages, and simplify mountings. For complete information on the cost and design advantages of the NEG'ATOR spring write Ametek, Inc., Hunter Spring Division 27 Spring Street Hatfield, Pennsylvania 19440.

AMETEK / Hunter Spring



ON READER-SERVICE CARD CIRCLE 92

**THE BEST
DRY TRANSFER
LETTERING COSTS
LESS THAN ANY
OTHER POPULAR
BRAND**

ONLY

\$1.25
per sheet

\$2.25 / two sheets

SPECIFY



Look in the Yellow Pages
under Drafting Supplies
or Art Supplies for your
dealer's name.



That's the cost of a sheet of DECA-DRY Transfer Lettering. It's the lowest priced of all the popular brands of dry transfer lettering. But some people go right on paying more, and for less quality. It must be because they don't know DECA-DRY is the best transfer lettering you can buy. One way to find out is to try DECA-DRY. It's easy to use . . . all you do is rub it on for quick, reproduction quality lettering. We'll be glad to send you a sample, or better still, buy a sheet at your dealer today. People who have bought DECA-DRY have found better quality does cost less.

CHART-PAK, INC.

A Subsidiary of Avery Products Corp. □
3460 River Road, Leeds, Mass. 01053

Send free sample and catalog showing complete DECA-DRY line.

Name Title

Company

Address

City State Zip

Application

ON READER-SERVICE CARD CIRCLE 93

ELECTRONIC DESIGN 13, June 21, 1967

MAKES EVERYONE LOOK
GOOD...



**waldom
solderless
terminals &
connectors**

From any angle, a wired assembly with solderless terminations by Waldom is better, stronger, neater and easier to assemble. Everyone gains . . . the pretty assembler on the line, her foreman, the company officers and stockholders and, most of all, the user of the completed product.

Waldom Solderless Terminals and Connectors make positive connections, are vibration and temperature proof and they will never wear out or lose their grip. If that's not enough, check these other benefits. . . .

- * Broad selection including Quick Disconnects. * All construction styles. * Absolute dependability. * Saves time and labor. * Easier servicing. * All types made to military specs.

Fast delivery from your electronics or electrical distributor. Write for FREE Waldom catalog listing more than 3000 electronic hardware items.



waldom ELECTRONICS, INC.

4643 West 53rd Street, Chicago, Illinois 60632

ON READER-SERVICE CARD CIRCLE 94

**80%
SMALLER!**



NEW **LEL** LOG AMPS

- 80 dB Dynamic Range
- Gain Matching (in pairs) to 1 dB
- 20 mV/dB Sensitivity
- Accuracy ± 1 dB

These miniature log amplifiers are especially well suited for use in microwave receivers where small size and weight must be achieved without sacrificing performance.

The ITL-4 units actually improve performance levels for reception of high speed pulses when substituted for the normal AGC'd IF amplifier.

Where size and weight are secondary, excellent performance is readily available with LEL's ITL-2 log amps listed at \$670.

SPECIFICATIONS

Center Frequency	30, 60 or 70 MHz
Bandwidth	10 MHz
Input	50 Ohms
Output	Video Det.
Dimensions	6 $\frac{3}{8}$ x $\frac{3}{4}$ x 1 $\frac{1}{2}$
Connectors	OSM
Power Requirement	-15V @ 90 mA
Price	\$975
Delivery	Stock to 30 days

More than 100 other standard IF Amplifiers are available many with such special characteristics as broad bandwidth, gain-and-phase-match, low noise, extremely low power drain.

Send now for complete data book including full specifications and performance curves.





AKRON ST., COPIAGUE, L. I., NEW YORK 11726
(516) AMityville 4-2200/(516) PYramid 9-8200
TWX Code 516-691-5085

ON READER-SERVICE CARD CIRCLE 95

Advertisers' Index

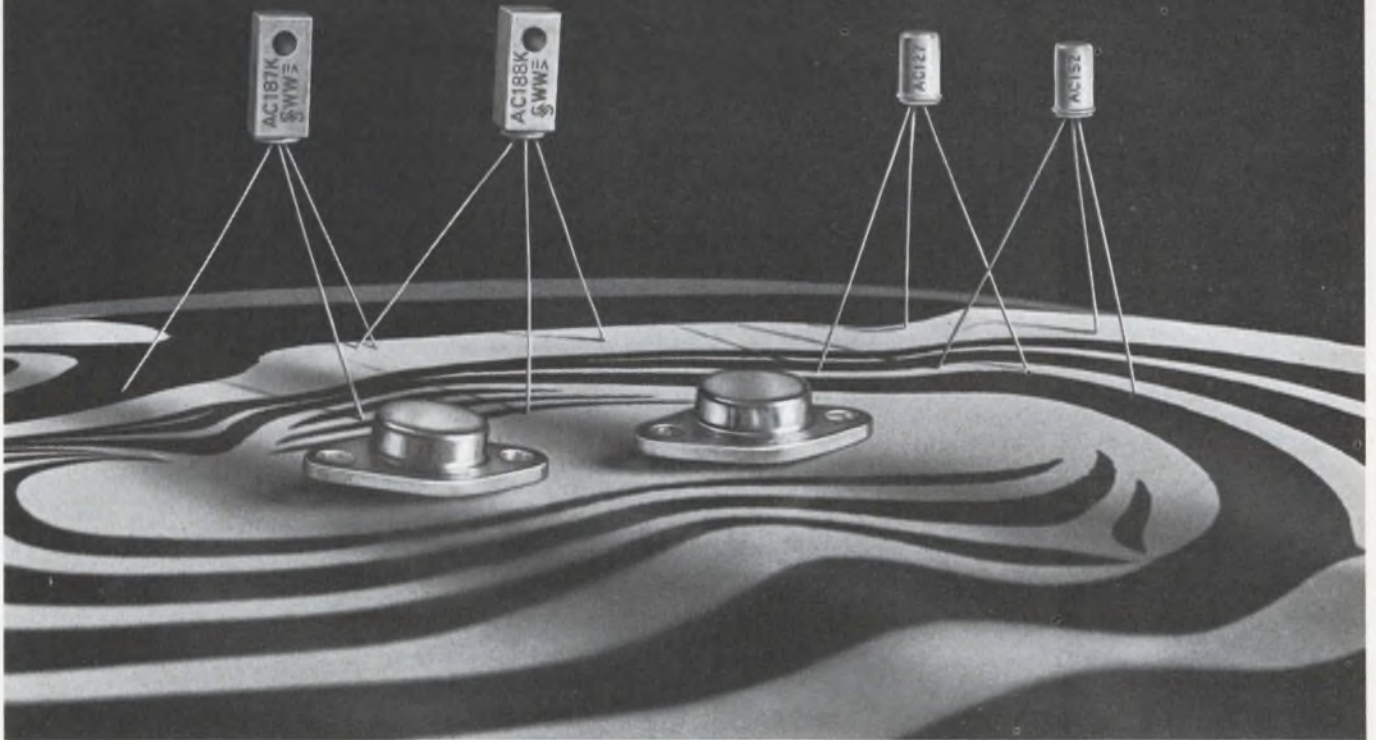
Advertiser	Page	Advertiser	Page
Acopian Corp.	83	ITT Cannon Electric, A division of International Telephone and Telegraph Corp.	105
Alfred Electronics	50	ITT Jennings, a subsidiary of International Telephone and Telegraph Corporation	67
Allen-Bradley Co.	6	ITT Semiconductors, A Division of International Telephone and Telegraph Corporation	168
Alliance Manufacturing Co., Inc., The	157	Industrial Electronic Engineers, Inc.	95
Alpha Wire, a Division of Loral Corporation	107	Inland Motor Corporation of Virginia	46
American Lava Corporation	21	Johanson Manufacturing Corp.	128
Ametek/Hunter Spring	163	LFE Electronics, Division of Laboratory of Electronics, Inc.	148
Ametek Inc., Lamb Electric Division	150	L E L Division, Varian Associates	164
Amperite	150	Lamb Electric Division, Ametek, Inc.	141
Amphenol Controls Division, Amphenol Corporation	4, 5	Lambda Electronics Corp.	43
Beman Manufacturing, Inc.	42	Leach Corporation	82
Bendix Corporation, The, Scientific Instruments Division	104	Licon, Division Illinois Tool Works, Inc.	111
Borden Chemical Co., The, Mystic Tape Division	15	Littelfuse	161
Bourns, Inc.	23, 81	Mac Panel Co.	108
Bud Radio, Inc.	143	MicroSwitch, A Division of Honeywell	40, 41
Bulova Electronics Division of Bulova Watch Company	136	Microsonics Inc.	126
Burndy Corporation	121	Motorola Semiconductor Products, Inc.	7
By-Buk Company	166	National Semiconductor Corporation	26, 27
Ceramagnetics, Inc.	167	Nexus Research Laboratory, Inc.	97
Chart-Pak, Inc.	163	Pastoriza Electronics, Inc.	144
Clairex Electronics, Inc.	162	Platronics, Inc.	167
Clare & Co., C. P.	155	Power/Mate Corp.	166
Cohu Electronics, Inc.	139	Princeton Applied Research Corp.	16
Columbia Components Corp.	147	RCA Electronic Components and Devices	75, 127, Cover III
Communication Electronics, Incorporated	48	Raytheon Computer	103
Components, Inc. Sencor Division	132, 133	Scan-a-Matic Corp.	161
Computer Measurements Company	2	Scientific Data Systems, Inc.	8
Cutler-Hammer	146	Scionics Corporation, The	151
Dale Electronics, Inc.	48 A-B	Sealectro Corporation	33
Damon Engineering, Inc.	22	Siemens America, Incorporated	165
Deltron, Inc.	161	Simpson Electric Company	31
Digital Equipment Corporation	99	Sippican Corporation, The	142
Drake Manufacturing Company	35	Slater Electric, Inc.	88
Duncan Electronics, Inc.	123	Specific Products	122
Eagle Signal, A Division E. W. Bliss Company	152, 153	Spectral Dynamics Corporation of San Diego	49
Eldre Components, Inc.	167	Sprague Electric Company	10, 12
Electro Materials Corp.	135	Sylvania Electric Products, Inc. Electronic Components Group	32 A-H
Electro-Motive Mfg. Co., Inc., The	89	TRW Semiconductors, Inc.	Cover II
Electronic Memories, Inc.	93	Tektronix, Inc., Oscilloscopes	52
Ellis and Watts Company	124	Texas Instruments Incorporated	118
Erie Technological Products, Inc.	9	Texas Instruments Incorporated, Semiconductors- Components Division	58, 59
Fairchild Instrumentation, A Division of Fairchild Camera and Instrument Corporation	36, 37, 39	Transistor Electronics Company	140
Fairchild Semiconductor, A Division Fairchild Camera and Instrument Corporation	44, 45	Tung-Sol Division Chatham Products	131
Federal Tool Engineering Company	166	Ulano	125
Gardner-Denver Company	32	Union Carbide Corporation	19
General Electric Company, Electronic Components, Sales Operation	137	Victor Comptometer Corporation	94
General Electric Company, Semiconductor Products Department	28	Victoreen Instrument Division	149
General Precision, Kearfott Products Division	145	Waldom Electronics, Inc.	163
General Radio Company	101	Waters Manufacturing, Inc.	159
General Resistance Inc.	162	Career Advertising	
Genisco Technology Corporation	129	Aerojet General	110
Hart Manufacturing Co., The	160	Collins Radio Company	116, 117
Hathaway Instruments, Inc.	130	Conductron-Missouri	112
Hewlett-Packard, Harrison Division	Cover III	Honeywell, Computer Control Division	114
Hewlett-Packard, Moseley Division	109	Univac, A Division of Sperry Rand Corporation	115
Hewlett-Packard	1, 25	IMC Magnetics Corporation	158
Honeywell, Precision Meter Division	47		
Honeywell Test Instrument Division	68, 69		



Siemens Semiconductors:

Germanium Transistors
Silicon Transistors
Germanium Diodes • Tunnel Diodes
Silicon Diodes
Silicon Zener Diodes
Photo Diodes • Photo-Voltaic Cells
Negative Temperature
Coefficient Thermistors
Positive Temperature
Coefficient Thermistors

transistors

Siemens Transistors for transformerless
output stage with complimentary pairs

*Write for further information,
or tell us your application and
we will suggest specific items.*

SIEMENS AMERICA INCORPORATED

Components Division • 230 Ferris Avenue, White Plains, N. Y. 10603

ON READER-SERVICE CARD CIRCLE 96

Electronic Design

ELECTRONIC DESIGN's aim is fourfold. It aids progress in the electronics manufacturing industry by promoting good design. It gives the electronic design engineer concepts and ideas that will make his job easier and more productive. The magazine serves as a central source of timely, up-to-the-minute electronics information. And finally it seeks to encourage two-way communication between manufacturer and engineer.

Want a subscription? ELECTRONIC DESIGN is circulated free of charge to qualified engineers and engineering management doing design work, supervising design or establishing standards in the United States, Western Europe and the United Kingdom. If you think that you are entitled to a free subscription, use the postfree application form that you will generally find inside the back cover. When it is not included, write to us direct for an application form.

If you are not qualified, you may take out a paid subscription at the following rates: \$25 a year if you live in the U.S.A. or \$35 a year if you live elsewhere. Single copies may be purchased for \$1.50 each.

If you change your address, send us an old mailing label and your new address; there is generally a prepaid postcard for this inside the back cover. If you have been receiving ELECTRONIC DESIGN free of charge, you will have to requalify to continue doing so.

We strive for accuracy. We take the utmost pains to ensure the highest standard of accuracy throughout the magazine. A single mistake in practical design information can have serious consequences. But to err is human, and for all the care we take, an occasional error slips through. Whenever this occurs, we publish a correction at the earliest opportunity. You will find these corrections printed at the end of the Letters column. If you should spot an error, be sure to let us know. You may save your colleagues heartaches.

Microfilm copies are available of complete issues of ELECTRONIC DESIGN that have been published since the beginning of 1961, and of single articles. Complete issues cost 4¢ a page, individual pages cost 50¢ each; shipping and handling charges are extra. The minimum charge is \$3; delivery time runs from 10 days for single pages to five weeks for complete issues. For further details and to place orders, get in touch directly with University Microfilms, Inc., 300 N. Zeeb Road, Ann Arbor, Mich. 48106; telephone (313) 761-4700.

Want to contact us? If you have any inquiries about these or other matters, or if you have a manuscript outline or article idea, address your correspondence to:

Howard Bierman, Editor,
ELECTRONIC DESIGN,
850 Third Avenue,
New York, N.Y. 10022.

Design Data from

Small Electronic Parts Automation



New brochure describes an exclusive new system which permits the complete automation of small electronic parts manufacturing operations, at a fraction of the cost of custom built equipment. Illustrations show the standard universal power tables and production modules which perform each manufacturing operation. System can be assembled so simply that small runs can be automated economically and modules are interchangeable to meet changing requirements.

Federal Tool Engineering Company

1384 Pompton Avenue
Cedar Grove, N. J. 07009

171

New "Tape Lift" Printed Circuit Drafting



Aids

No engineer or draftsman should be without the most up-to-date cross-reference guide to better Printed Circuit Drafting Catalog. It is complete with prices and illustrations of over 1200 sizes of "Tape Lift" pads, shapes and other aids for faster, more accurate, distortion-free printed circuit master drawings.

Write for FREE catalog.

By-Buk Company

4326 West Pico Blvd., Los Angeles, Calif. 90019
Telephone: (213) 937-3511

173

Equipment Under Test Sign



Bright red and white signs to attach to equipment while it is under test to forestall accidental interference are available from POWER/MATE CORP., Hackensack, N. J. The company is offering these heavy cardboard signs along with their new Power Supply Module Catalog No. 117. The Catalog lists all of the many supplies available from PMC. The package will also include information about their new Uni-88—a 0-34 volt, 1.5 amp. supply that sells for only \$88.00. Racks and other accessories are also available. Write today.

Power/Mate Corp.

163 Clay St.
Hackensack, N. J. 07601

175

Manufacturers

Advertisements of booklets, brochures, catalogs and data sheets. To order use Reader-ServiceCard
(Advertisement)

Ferrites For Electronics

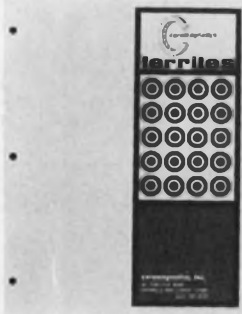

This new catalog provides detailed engineering information pertaining to ferrite materials, their inherent magnetic characteristics and recommended applications for their optimum usage. Offered are specific materials designed for:

- Low and Medium Frequency Small Signal Devices.
- Medium to High Frequency Devices.
- High and V.H.F. Devices.
- U.H.F. Microwave and Millimeter Wave Devices.
- Magnetostrictive and Electromechanical Transducers, Couplers and Filters.

Ceramagnetics, Inc.
87 Fairfield Road
Fairfield, New Jersey 07006

172

Laminated and Molded Bus Bars For Power Distribution



A 16 page Technical Bulletin is now available, describing a new concept in power distribution. Basic mechanical and electrical design principles, along with descriptive pictures and diagrams, are included in this bulletin. These compact buses can replace bulky cable harnesses and repetitive wiring for computer or modular application. This method of construction satisfies the demanding requirements of low inductance and resistance of high speed, solid state systems, while controlling electrical noises.

Eldre Components, Inc.
1239 University Avenue
Rochester, New York 14607

174

How To Plate Electronic Parts



Details step-by-step procedures for plating electronic components — particularly with precious metals — to maintain functional reliability in the most severe environmental and end-use conditions. Provides a pictorial tour through the country's largest plating facility designed for electronics—from pilot plant operations, to modern volume production techniques and stringent quality control procedures. Also describes prototype sample plating service, to specifications, which the company offers at no cost or obligation.

Platronics, Inc.
500 Commerce Road
Linden, New Jersey 07036

176

Designer's Datebook

JULY						
S	M	T	W	T	F	S
2	3	4	5	6	7	8
9	10	11	12	13	14	15
16	17	18	19	20	21	22
23	24	25	26	27	28	29

AUGUST						
S	M	T	W	T	F	S
6	7	8	9	10	11	12
13	14	15	16	17	18	19
20	21	22	23	24	25	26
27	28	29	30	31		

For further information on meetings, use Reader Service card.

June 28-30

Joint Automatic Control Conference (Philadelphia) Sponsor: IEEE; L. Winner, 152 W. 42 St., New York, N. Y. 10036.

CIRCLE NO. 469

July 17-19

Reliability and Maintainability Conference (Cocoa Beach, Fla.) Sponsor: SAE, AIAA, EIA *et al.*; E. J. Folkman, General Electric Co., Cape Kennedy, Fla. 32920.

CIRCLE NO. 470

July 18-20

Electromagnetic Compatibility Symposium (Washington, D.C.) Sponsor: IEEE; J. S. Hill, P. O. Box 7405, Benjamin Franklin Station, Washington, D. C. 20044.

CIRCLE NO. 471

July 24-28

Design Course on Automatic Electronic Test Equipment (New York City) Sponsor: New York University; D. M. Goodman, N. Y. U. School of Engineering and Science, 401 W. 205 St., New York, N. Y. 10034.

CIRCLE NO. 472

August 7-11

Computer-Aided Circuit Design Institute (Columbia, Mo.) Sponsor: University of Missouri; Prof. G. W. Zobrist, College of Engineering, Univ. of Missouri, Columbia, Mo. 65201.

CIRCLE NO. 473

August 17-19

Joint Automatic Control Conference (Seattle) Sponsor: AIAA, ASME, *et al.*; A. E. Bryson, Jr., Univ. of Washington, 327 Lewis Hall, Seattle, Wash. 98105.

CIRCLE NO. 474

The Predictables.

**Some computer
manufacturers
inspect every
incoming diode.**

**The others order
from ITT.**

**We do it for them. ITT inspects every diode
100% three different times before it's
shipped. Any part number, silicon or ger-
manium, double plug or DO-7. Make us
prove it. RFQ: The Predictables.**

diodes ITT

ITT SEMICONDUCTORS IS A DIVISION OF INTERNATIONAL TELEPHONE AND TELEGRAPH CORPORATION
FACTORIES IN WEST PALM BEACH, FLORIDA; PALO ALTO, CALIFORNIA; LAWRENCE, MASSACHUSETTS; HARLOW AND FOOTSCRAY, ENGLAND; FREIBURG AND NURENBERG, GERMANY



new disciplines in DC

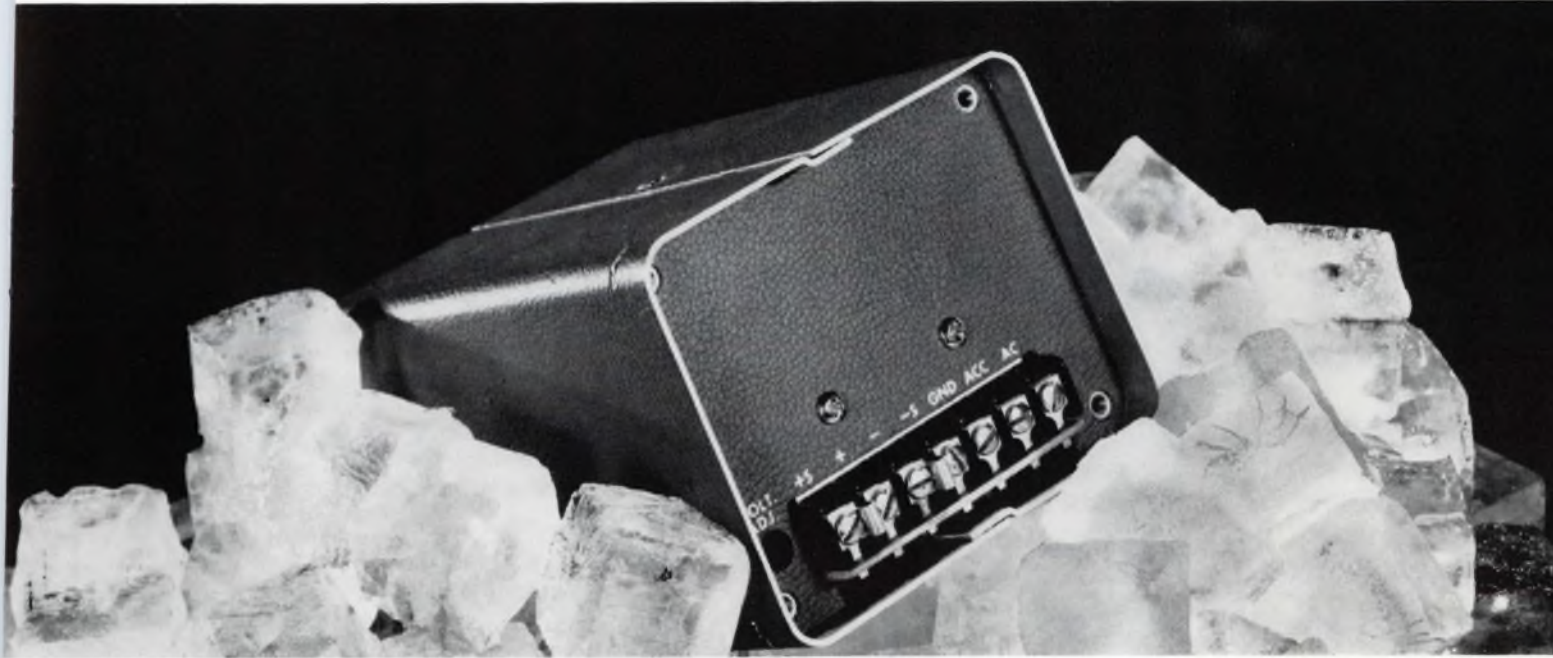

take the **COOL** slot supplies

No need to put 'em on ice • no need for added heat sinks

All Silicon • Fully Serviceable • No Encapsulated Components

HP's new SLOT Series of DC Regulated Power Supplies have a constant voltage output, screwdriver adjustable $\pm 10\%$. Using four nuts imbedded in end plate, modules can be mounted inside instrument or on standard 19" rack panels available from hp. Barrier strip has terminals for AC input, DC output, and remote sensing.

Design insures operation to 50°C without derating or added heat sinks. Internal construction employs no cables, hand-soldered connections, or component encapsulation — units are fully serviceable. Stock models, available on a short-delivery basis, are listed below. The area below each curve at the right indicates limits of ratings available on special order.

STOCK MODELS

Voltage	Output Current	Package Size	Model Number	Price Qty. 1-9
6V $\pm 10\%$	0-3A	5	60065A	\$100.
12V $\pm 10\%$	0-1A	3	60123A	79.
12V $\pm 10\%$	0-2.2A	5	60125A	100.
24V $\pm 10\%$	0-1A	4	60244A	88.
28V $\pm 10\%$	0-1.5A	5	60285A	100.

DIMENSIONS

Module Size	Mounting Surface	Length
2	3 $\frac{3}{8}$ " x 4 $\frac{1}{8}$ "	4 $\frac{1}{8}$ "
3	3 $\frac{3}{8}$ " x 4 $\frac{1}{8}$ "	6"
4	3 $\frac{3}{8}$ " x 5 $\frac{1}{8}$ "	6"
5	3 $\frac{3}{8}$ " x 5 $\frac{1}{8}$ "	7 $\frac{3}{8}$ "
6	4 $\frac{1}{4}$ " x 5 $\frac{1}{8}$ "	11"

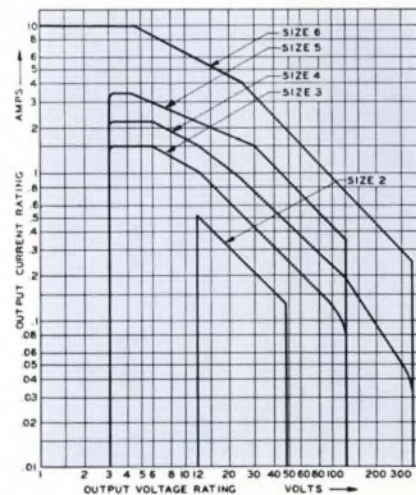

Load Regulation, 0.05%; Line Regulation, 0.05%; Ripple, less than 0.006% or 1 MV RMS, whichever is greater • Transient Recovery Time, less than 25 μ sec to within 10 MV • Short-Circuit-Proof, Current-Limited Output • No Overshoot on Turn-On, Turn-Off, or AC Power Removal • Operating Temperature, 0°C to 50°C; Storage — 40°C to +85°C

Contact your nearest Hewlett-Packard Sales Office for full specifications.

**HEWLETT
PACKARD**  **HARRISON
DIVISION**

(H13B)

100 Locust Ave., Berkeley Heights, New Jersey 07922 • Telephone 201-464-1234 TWX 710-984-7972

ON READER-SERVICE CARD CIRCLE 223

Detect single photons with RCA BIALKALI photomultipliers



Here's a light-sensing achievement so remarkable it enables you to measure the properties of a star. RCA Bialkali Photomultipliers are capable of detecting single photons to improve measurement capability. They all use RCA Bialkali Photocathodes with 24% quantum efficiency at 4,000 Å and low noise—with the added benefit of low cost.

This family of RCA Photomultipliers is intended for systems for scintillation counting, spectroscopy and other applications where pulse counting and low-light-level detection and measurement are important.

A few of the typical characteristics of these Photomultipliers are summarized in the chart. All have copper-beryllium dynodes and feature low dark current and good time-resolution characteristics.

For technical assistance on these and other RCA Photomultipliers, see your RCA Representative. For comprehensive literature on RCA's full line of photomultipliers, contact your RCA Industrial Tube Distributor or Commercial Engineering, Section ICG6-3, RCA Electronic Components and Devices, Harrison, N.J. 07029

Also Available From Your RCA Industrial Tube Distributor

Type	4516	4517	4518	4523	4524	4525
Size (inches)	¾	1½	2	2	3	5
Dynode Structure	In-Line Electrostatically Focused	Circular Cage Electrostatically Focused	Circular Cage Electrostatically Focused	Venetian Blind	Venetian Blind	Venetian Blind
Anode Dark Current: 10 A/lm and 22°C	$2.6 \times 10^{-10}A$	$3.9 \times 10^{-10}A$	$3.1 \times 10^{-10}A$	$3.85 \times 10^{-10}A$	$0.77 \times 10^{-9}A$	$1.15 \times 10^{-9}A$
Dark Noise: 32 photoelectrons $\Sigma = 1$ photoelectron	2.4×10^4	1.5×10^4	7.7×10^4	2×10^4	5×10^4	1.5×10^5
Electron Transit Time (ns @ 1500 V)	20	27	27	59	65	110
Anode Pulse Rise Time (ns @ 1500 V)	1.8	2.3	2.3	12	14	18
Pulse Height Resolution (%)	8.5	8.5	9	7.5	7.5	7.5



The Most Trusted Name
in Electronics