

Electronic Design 11

VOL. 15 NO.
MAY 24, 1967

THE MAGAZINE OF ESSENTIAL NEWS, PRODUCTS AND TECHNOLOGY

Electrical brain stimulation plays tricks on a monkey's eyes, can even modify his social behavior. Such studies will ultimately lead to better diagnosis and treatment

of human ailments. Advances in miniaturization are bringing about button-sized implants which will further brain research. For details, see the report starting on p. 36.

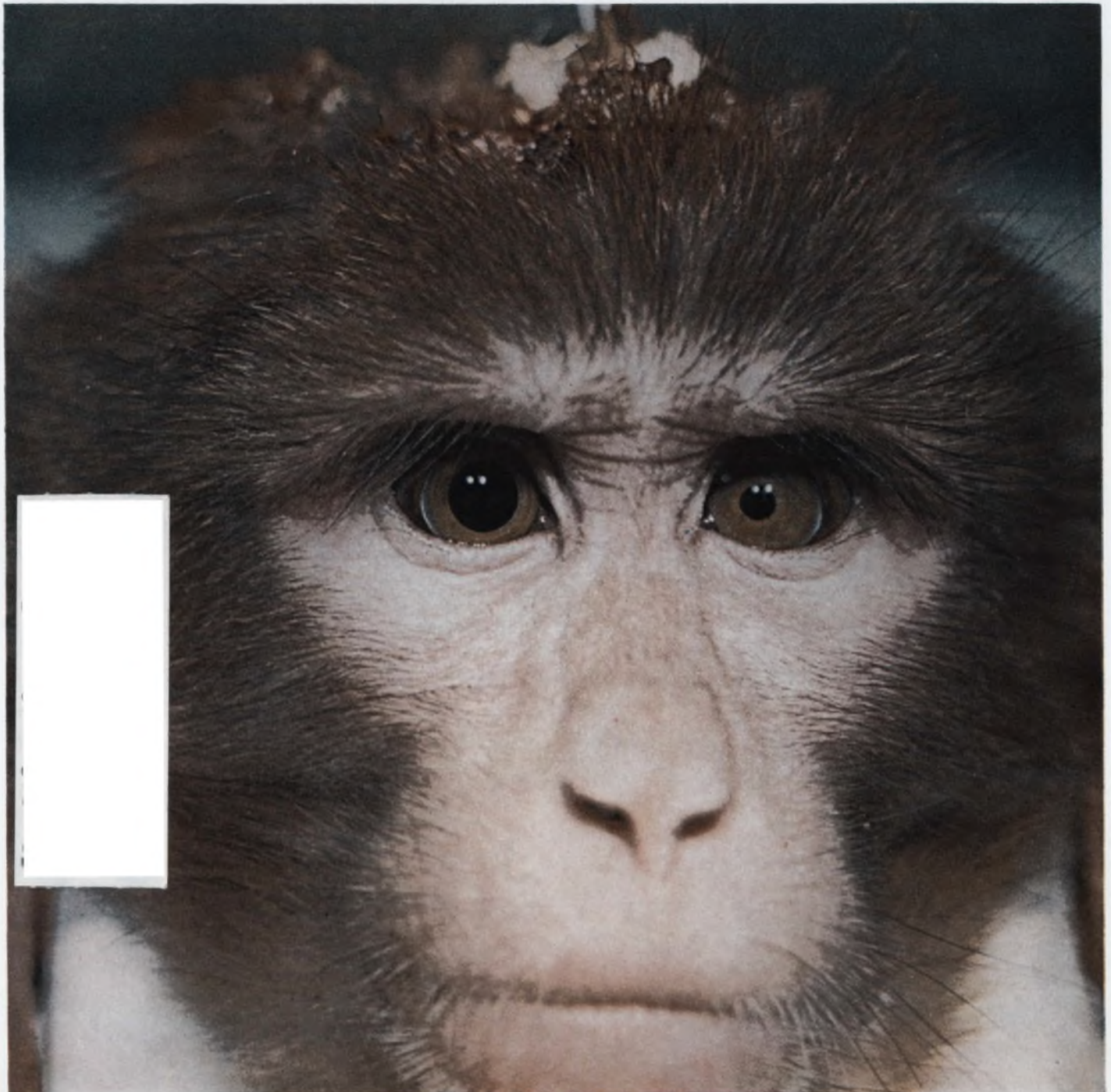



NEW

DO-T200™ SERIES

**ULTRAMINIATURE TRANSISTOR TYPE
AUDIO TRANSFORMERS**

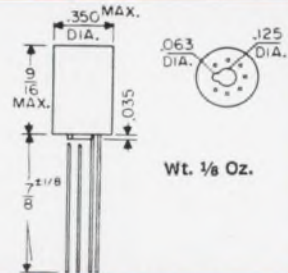

Wt. 1/8 Oz.

U. S. PAT. NO. 2,949,391; others pending.

This DO-T200 series of transistor transformers and inductors has been newly added to the UTC lines of stock items available for immediate delivery. These transformers provide the unprecedented power handling capabilities and the inherent reliability found only in the basic structural design of the UTC DO-T Family of miniature transformers. This reliability has been dramatically proven in the field.

Leads are 7/8" long, .016 Dumet wire, gold plated, and may be either welded or soldered. They are uninsulated and are spaced on a .1" radius circle, conforming to the termination pattern of the "TO-5" cased semiconductors and micrologic elements.

DO-T200 series of transformers are designed for Class R application. On special order they may be designed to Class S Specifications. No additional life expectancy is gained by using Class S insulation systems at Class R temperatures.

In pulse coupling impedance matching applications, (when measured with a 30 microsecond input pulse voltage wave), typical values for these transformers are: 5% or less droop, zero overshoot, and less than 10% backswing.

Special unit modifications, such as additions and deletions of leads, changed lead lengths, different impedance ratios and incorporation of electrostatic shields, etc., are available in these constructions.

• Manufactured and successfully tested to complete environmental requirements of MIL-T-27B

- Most Ruggedized MIL Structure, Grade 4, Metal Encased
- Hermetically Sealed
- Immediate Delivery From Stock
- Straight Pin Terminals
- Full Conformance to MIL Mounting Requirements
- Excellent Response
- Solderable and Weldable Leads
- High Efficiency
- Low Distortion

Type No.	MIL Type	Pri. Imp.	D. C. ma† in Pri.	Sec. Imp.	Pri. Res.	Mw Level	Application
DO-T255	TF4RX13YY	1K/1.2K CT	3	50/60	115	100	Output or matching
DO-T275	TF4RX13YY	10K/12K CT	1	1.5K/1.8K CT	780	100	Interstage
DO-T277	TF4RX13YY	10K/12K CT	1	2K/2.4K split	560	100	Interstage
DO-T278	TF4RX13YY	10K/12.5K	1	2K/2.5K CT	780	100	Driver
DO-T283	TF4RX13YY	10K/12K CT	1	10K/12K CT	975	100	Isol. or Interstage or Pulse
DO-T288	TF4RX13YY	20K/30K CT	.5	.8K/1.2K CT	830	50	Interstage
DO-T297	TF4RX16YY	200,000 CT	0	1000 CT	8500	25	Input and Chopper
DO-T200SH	Drawn Hipermalloy shield provides 15 to 20 db shielding through side of case						

†DCma shown is for single ended usage. For push pull, DCma can be any balanced value taken by .5W transistors. Where windings are listed as split, 1/4 of the listed impedance is available by paralleling the winding.

THE DO-T FAMILY OF COMPONENTS



These items manufactured and successfully tested to complete environmental requirements of MIL-T-27B, Grade 4, Class R, Life X. Except PIP: to MIL-T-21038B, Grade 6, Class R, Life X. Grades 4 and Grades 6 of MIL-T-27B & MIL-T-21038B respectively, are identical.

DO-T Flexible leads. Freq range 300 CPS—10KC & up. Power up to 1/2 W. Size 3/16 dia x 1 1/32" h. Wt approx 1/10 oz.

DI-T Flexible leads. Freq range 400 CPS—10KC & up. Power up to 1/2 W. Size 3/16 dia x 1/4" h. Wt approx 1/15 oz.

DO-T200 Series: See above

DI-T200 Series Straight pin gold plated. Dumet leads. Freq range 400 CPS—100KC. Power up to 500 mw. Size 3/16 d x 3/16" h. Wt approx 1/15 oz.

PIL Inductors range from .025 hy to .8 hy, DC 0 to 10 ma. Transformers from 500 ohms to 10,000 ohms impedance. Freq range 800 cps—250 KC; power up to 100 MW. Size 3/16 dia x 3/16" h. Wt 1/20 oz.

PIP (Pulse) Flexible leads. Wide application pulse transformers, to MIL-T-21038B specifications. Size 3/16 dia x 3/16". Wt 1/20 oz.

DO-T400 (Power) Flexible leads, power transformer. Power output 400 mw @ 400 cycles. Size 3/16 dia x 1 1/32". Wt 1/10 oz.

AND SPECIAL, CUSTOM BUILT COMPONENTS TO YOUR SPECIFICATIONS

Write for catalog of over
1,300 UTC TOP QUALITY
STOCK ITEMS
IMMEDIATELY AVAILABLE
from your local distributor.



UNITED TRANSFORMER CO.

DIVISION OF TRW INC. • 150 VARICK STREET, NEW YORK, N. Y. 10013

What makes the new 0.002% dc calibrator practical?

NEW

BESIDES—1 ppm resolution on 1 to 1000 v ranges...up to 50 ma output current...MIL RFI specs...\$2350 price

A 0.002% dc calibrator should have the "stability" necessary to keep the calibration cycle at 30 days or longer...otherwise, it will require frequent calibration. (Stability of the new Hewlett-Packard 740B insures rated accuracy for 30 days.)

A 0.002% dc calibrator should be "self-aligning"...otherwise, it will require extra time to calibrate. (With a standard cell and screwdriver, the new hp 740B can be calibrated in 15 minutes. Check this against your present or proposed techniques.)

A 0.002% dc calibrator should have remote sensing terminals "at the load"... otherwise, the voltage drop in the connecting leads will degrade the accuracy.

A 0.002% dc calibrator should have a zero control... otherwise, the thermals and dc offset, sometimes generated in the equipment under test, cannot be balanced out.

PERFORMANCE

The hp 740B has six digit resolution with discrete steps of 1 ppm at full scale from 0 to 1000 volts dc. It complies with MIL-I-6181D on RFI. Noise and hum from 0.01 Hz to 1 Hz is less



New hp 740B DC Calibrator

than 1 ppm of range.

The specified accuracy of $\pm 0.002\%$ of setting $+0.0004\%$ of range is ideal for calibrating digital and differential voltmeters, potentiometers, precision voltage dividers and other production and lab usages.

MULTIPLE USES

You also can use the 740B as a 0.005% dc differential voltmeter, a 0.01% precision dc amplifier and a high impedance voltmeter.

DC STANDARDS

Used in conjunction with the Hewlett-Packard 419A DC Nullmeter and the 735A Transfer Standard, it lets

you carry precise standards anywhere you need them. The portable Hewlett-Packard 735A Transfer Standard with typical 5 ppm/mo. stability allows you to do calibration and standards work out of the standards lab. Application Note 70 explains the use of this unique combination of instruments that provides you with a new measurement concept. Ask your Hewlett-Packard field engineer for your copy and for complete information on the 740B and related instruments. Or write to Hewlett-Packard, Palo Alto, California 94304, Tel. (415) 326-7000; Europe: 54 Route des Acacias, Geneva.

Data subject to change without notice. Prices f.o.b. factory.

HEWLETT  PACKARD
An extra measure of quality

1367



Sorry about that, Big, Bad B.
And prepare thyself, H-P.

Your guts made us number two

Pardon the frank language. But you must be used to our bluntness by now. And we just don't know how else to say we appreciate what you've done for us. Golly, only three years ago CMC counters were almost never found on anybody's purchase order. Frankly we were pretty discouraged. We knew our equipment was as good as anybody's. But you didn't. That's when we asked for help from all Crusading Engineers with guts. And look at what happened!

Over 54,000 of you earned Crusading Engineers medals by checking our specs against H-P and B. We introduced new or improved counters at a rate of about one per month. One was the first all-silicon, solid state counter. Our Motherboard design was another first. We added pulse and time delay generators by acquiring Rutherford. Then you helped us pull off two military coups: Model 880, the first all solid state Mil Spec frequency counter (AN/USM-207); and our 5MHz all-silicon universal counter-timer (AN/USM-245). Next our new 10 lines/sec. digital printer. We're even working with you on systems development.

The result of all this, fellow Crusaders, is that you've pulled us up into Number 2 position. Friends, spies, and industry authorities report that your support has moved our sales ahead of brand B and

right behind brand H-P. And does that feel good! Need we say we think you're the greatest? Keep wearing your Crusading Engineer medal (write for one today if yours was stolen), and we'll do our best to keep deserving your loyalty.

Now the question is: flushed with success as a giant-killer, should we go into the car rental business and shake up Hertz and Avis?

12973 Bradley/San Fernando, California
Phone (213) 772-6321/TWX 901-496-1487



Thanks



ON READER-SERVICE CARD CIRCLE 3

NEWS

- 13 News Scope
- 17 **Common Market lures U.S. instrument makers**
'Made in Europe' to be commoner on U.S. goods as European tariffs tumble.
- 21 **Europe adopts integrated-circuit coding scheme**
Thirty-eight firms agree on code to be used for ICs; U.S. sticks to 6N numbers.
- 29 Washington Report
- 32 Rugged mirrors lift CO₂ laser's output.
- 36 **Special Feature: Probing the mind's 'computer'**
Reseachers seek to modify behavior by electrical stimulation of the brain.
- 48 Photodetectors calibrated in minutes.
- 50 **Building-block units aid computer designers**
'Macromodular' concept permits tryout of novel systems before manufacture.
- 54 Letters
- 59 **Editorial:** Brain research is no threat to man's individuality.
-

TECHNOLOGY

- 62 **Design a log amp with tunnel diodes** to combine high speed with temperature and phase stability. Hybrid techniques make it easy.
- 68 **Disregard load impedance** in SCR inverter design. Use a unique swinging LC turn-off circuit operating as a gate-controlled switch.
- 75 **Stop wasting design time.** Keep a neat notebook of basic circuits; you will reap the benefit every time you need a handy reference.
- 84 **Cut the size of your vhf attenuators** with a simple circuit. Other virtues are fast response time and continuously variable attenuation.
- 90 **Automate microelectronic soldering** with prealloyed solder/flux creams. This also increases uniformity and reliability.
- 96 **Make your proposal sell** the services and products you offer. Many an award has been lost by garbled language.
- 106 NASA Tech Briefs
- 110 Ideas for Design
-

PRODUCTS

- 122 **Components:** Electrochemical timing cells available in three different forms.
- | | |
|----------------------|--------------------------|
| 142 Test Equipment | 154 Production Equipment |
| 148 Microelectronics | 158 Systems |
| 150 Materials | |
-

Departments

- | | |
|-----------------------|-------------------------|
| 100 Book Reviews | 164 New Literature |
| 160 Design Aids | 172 Advertisers' Index |
| 162 Application Notes | 175 Designer's Datebook |
-



All the CANNON® connectors
made in the last 40 years would
reach to the moon.

In fact, some have.

ITT Cannon Electric has made more electrical connectors for more applications than anyone in the world. More than 40 years ago a specially designed CANNON Plug helped introduce talking pictures. Today, some of our connector designs rest on the moon.

Generation after generation of CANNON connectors have solved every conceivable electrical and electronic connection problem.

From the aircraft industry's infancy of the early thirties to the most modern military and commercial jet . . . to the challenge of outer space and the ocean's depths to the rapidly expanding needs of commercial and industrial electronics — CANNON connectors have always been first to meet the most exacting requirements, whether size, shape or environmental extremes.

Today, ITT Cannon Electric offers the broadest connector line available. You have a complete choice of standard, miniature, subminiature, microminiature — in cylindrical and rack/panel configurations—for every aircraft, ground support, satellite, marine, commercial, and industrial application.

This is ITT Cannon Electric.

When you need electrical connectors, an old standby or a breakthrough design, look first to the imaginative engineering of ITT Cannon, the world's most experienced manufacturer of electrical connectors. ITT Cannon Electric, 3208 Humboldt Street, Los Angeles, California 90031.

A division of International Telephone
and Telegraph Corporation.



CANNON ITT

EIMAC

now has three new miniature planar triodes for airborne and space applications

EIMAC's new line of miniature planar triodes is specifically designed for use in advanced airborne and space applications. They are rugged and reliable, and feature larger contact areas for improved electrical paths. EIMAC 8755, 8756, and 8757 triodes are miniaturized versions of the well-known 8533, 7815, and 7698 tubes. You're assured of excellent tube-to-tube uniformity because of our more than 20 years experience with planar triode design and manufacture. Cooling is by forced air or heat sink. All tubes have arc-resistant cathodes, and provide good high-frequency efficiency through S-band. Write Power Grid Tube Marketing for more details, or contact your nearest EIMAC distributor.

TUBE TYPE Description	CHARACTERISTICS						
	8755 Miniature, high voltage pulse triode stable anode		8756 Miniature, high current, stable anode		8757 Miniature, high current, stable anode		
Anode dissipation (watts)	100		100		100		
Maximum Frequency (MHz)	3000		2500		2500		
Transconductance (micromhos)	30,000		25,000		30,000		
TYPICAL OPERATION	8755		8756		8757		
	grid pulsed	plate pulsed	CW	CW	grid pulsed	CW	CW
Frequency (MHz)	1550	3000	500	2500	1100	500	2500
Amplifier or Oscillator	AMP	OSC	AMP	OSC	AMP	AMP	OSC
Output Watts (minimum)	2000	2500	40	17	1500	65	25

EIMAC
Division of Varian
San Carlos, California 94070

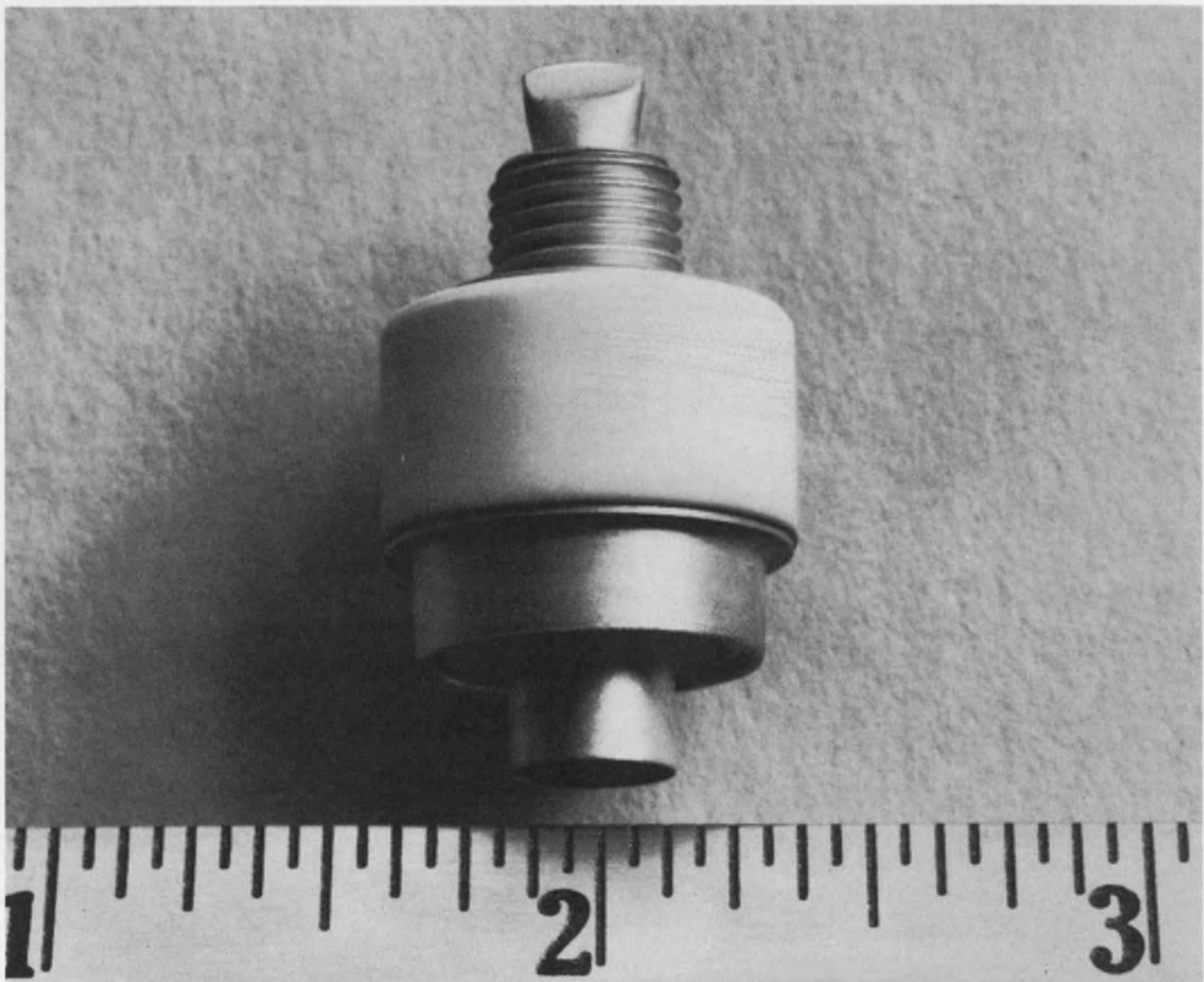

ON READER-SERVICE CARD CIRCLE 5

ELECTRONIC DESIGN 11, May 24, 1967

RCA Engineers strive to give you better tube performance at lower cost

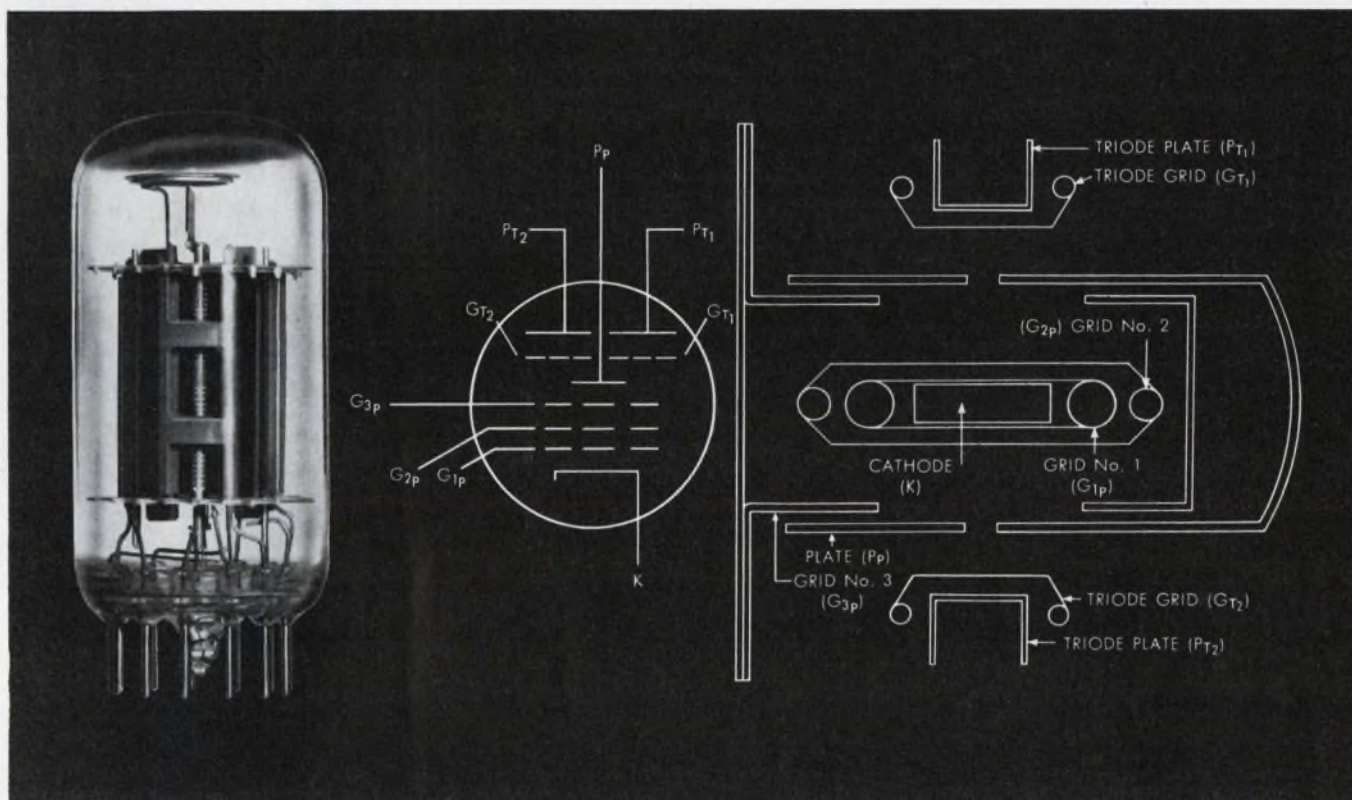

Never satisfied with existing performance, RCA Engineers are intent on improving receiving tube designs. For example, consider the unique RCA developmental A55280 tube—with three individually-controllable outputs from a single cathode in a pentode-triode-triode configuration. Far more significant to you than the development of this particular tube, however, is the dedication that lies behind it: a determined and continuing effort to give circuit designers products that provide ever better performance at the lowest possible cost.

For more information on RCA's developmental A55280, contact your nearest RCA District Office. For complete information on RCA's Commercial and Industrial Receiving Tubes, write RCA Commercial Engineering, Section E18DE, Harrison, New Jersey 07029.

Advantages of RCA's developmental A55280 include:

- Frame-grid pentode in series with two triodes... and all in one envelope
- Very high pentode-unit transconductance (45,000 μ mo)
- Noise-immune sync automatically obtained from one of the triode units
- High-gain bandwidth product

RCA DISTRICT OFFICES—OEM SALES: EAST, 2075 Millburn Ave., Maplewood, N.J. 07040, [201] 485-3900 • MID-ATLANTIC, 605 Marlton Pike, Haddonfield, N.J. 08034, [609] 428-4802 • MID-CENTRAL, 2511 East 46th St., Bldg. Q2, Atkinson Square, Indianapolis, Ind. 46205, [317] 546-4001 • CENTRAL, 446 East Howard Ave., Des Plaines, Ill. 60018, [312] 827-0033 • WEST, 6363 Sunset Blvd., Hollywood, Cal. 90028, [213] 461-9171 • INTERNATIONAL OPERATIONS, RCA International Division: Central and Terminal Aves., Clark, N.J. 07066, [201] 485-3900 • 118 Rue du Rhone, Geneva, Switzerland, 35 75 00.

RCA Electronic Components and Devices, Harrison, N. J. 07029



The Most Trusted Name in Electronics

ON READER-SERVICE CARD CIRCLE 6

IF YOU CHECK THE PRICE OF OUR NEW PLASTIC UNIJUNCTION TRANSISTOR, YOU'LL FIND IT'S ONLY 40¢*



If You Check What It Does, You'll Wonder Why.

Here's a new plastic unijunction transistor that's not only priced to extend the inherent economy of UJT circuitry but offers significant advantages in many existing and new consumer and industrial circuit designs!

For example, you can now select from *two* narrower-range eta spreads, reducing the necessity of tight-tolerance resistor/capacitor selection and *two* valley current characteristics allowing you wider latitude in sawtooth oscillator and frequency divider circuit design.

A low leakage current, resulting from the Motorola developed and patented oxide-passivated Annular † structure, reduces pulse width variations due to the undesirable charging current to the timing capacitor in oscillator circuits.

And low (2.5 V) typical emitter saturation voltage allows greater output to the following circuit stage, particularly in triggering applications.

Rugged Unibloc** unijunction packages are easy to plug into existing "base-one, emitter, base-two" metal TO-18 pin circles, too... *without* confusing lead-crossing common to other plastic units.

Use it in: ■ time delays ■ lamp dimmers & flashers ■ sawtooth generators ■ motor-speed controls ■ level sensing ■ temperature & process control ■ ring counters ■ military fuse circuits ■ regulator, motor & lamp operator circuits ■ pulse generators ■ photoelectric sensors ■ frequency dividers ■ TV deflection ■ automotive ignition ■ multivibrators ■ oscillators

Check the specs and prices — then contact your franchised Motorola distributor for evaluation units or your Motorola factory representative for production quantities. Write Box 955, Phoenix, Arizona 85001, for data sheets and two just-off-the-press unijunction technical publications!

CHARACTERISTICS					
Type	Peak Point Current (typ)	Emitter Reverse Current (typ)	Intrinsic Standoff Ratio (η)		Valley Current (Min)
			Min.	Max.	
2N4870	1 μ A	0.05 μ A	0.56	0.75	2.0 mA
2N4871			0.70	0.85	4.0 mA

*Large Volume. †Annular semiconductors are patented by Motorola Inc.
**Trademark of Motorola Inc.

- where the priceless ingredient is care!



MOTOROLA

Semiconductors

ANNOUNCING . . .

The *WORLD'S* most compact *QUALITY*

CERAMIC TRIMMER CAPACITOR

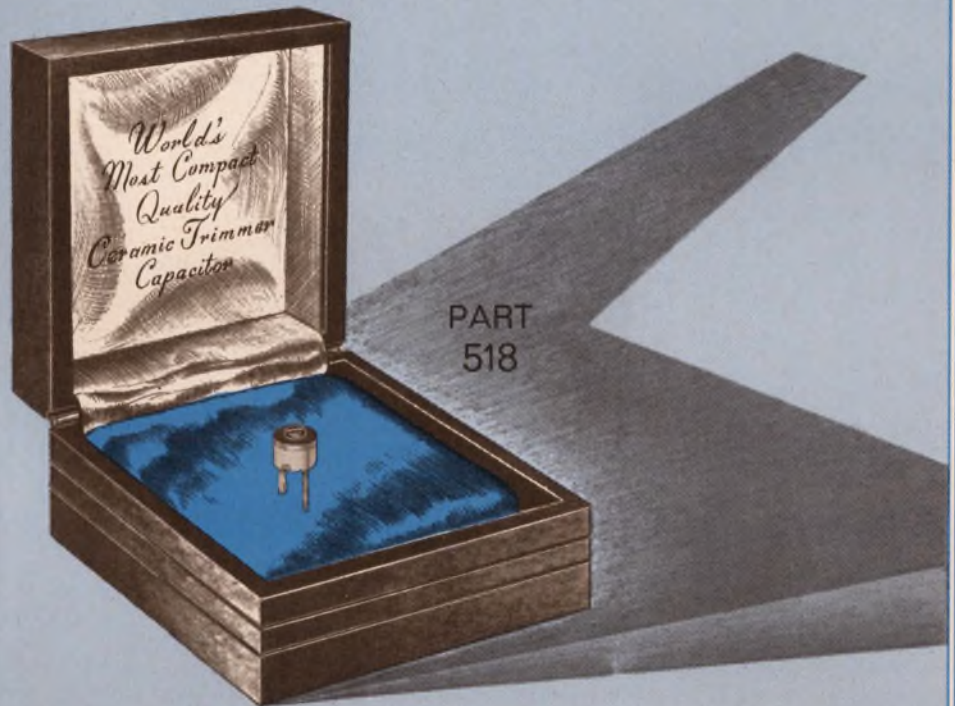

AMAZING 5 to 25 pF. CAPACITANCE RANGE IN LESS THAN .007 CUBIC INCH

A precious jewel? Not at all . . . This is a new subminiature Ceramic Trimmer Capacitor. It represents the most significant development in variable capacitors in more than a decade . . . and again Erie leads the State of the Art. The tiny 518 occupies only .007 cubic in. . . and has an incredible capacitance range of 5 to 25 pF. Operating temperature range: -55°C to 125°C . — Working voltage 100 WVdc to 85°C ; 50WVdc to 125°C . The unit exhibits remarkable ruggedness, being a development from Erie's exclusive Monobloc Process[®]. The Monobloc rotor with its sealed electrode provides stability under extreme environmental conditions. The 518 permits rigid mounting in both printed circuit and point to point wiring applications. Tuning linearity is assured by precision lapped bearing surfaces.

This compact little trimmer is the ultimate in volumetric efficiency . . . after all, it's only .218" in diameter — almost the size of a precious jewel.

ERIE OFFERS THE MOST COMPLETE SUBMINIATURE TRIMMER CAPACITOR LINE IN THE INDUSTRY . . .

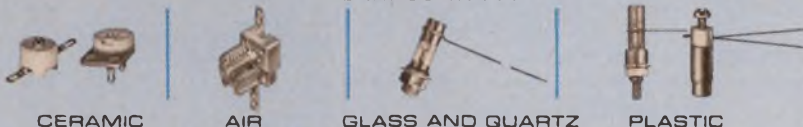

Another Series of Components in Erie's Project "ACTIVE"
Advanced Components Through Increased Volumetric Efficiency

ERIE

TECHNOLOGICAL

PRODUCTS, INC.

ERIE

Erie, Pennsylvania

ON READER-SERVICE CARD CIRCLE 8

RESISTORS FOR PERSPICACIOUS DESIGN ENGINEERS

FILMISTOR® PRECISION METAL-FILM RESISTORS

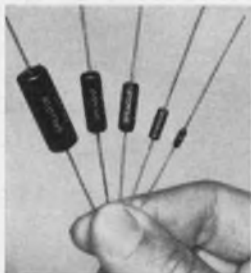

Extended-range Filmistor Resistors now give you dramatic space savings in all wattage ratings — 1/20, 1/10, 1/8, 1/4, 1/2, and 1 watt — with absolutely *no sacrifice in stability!*

Filmistors offer extended resistance values in size reductions previously unobtainable. For example, you can get a 4.5MΩ resistor in the standard 1/4 watt size, which had conventionally been limited to 1 MΩ. Filmistor Metal-Film Resistors are now the ideal selection for "tight-spot" applications in high-impedance circuits, field-effect transistor circuits, etc.

Other key features are ±1% resistance tolerance, low and controlled temperature coefficients, low inherent noise level, negligible coefficient of resistance, and rugged molded case.

Filmistors *surpass* the performance requirements of MIL-R-10509E.

**Write for Engineering
Bulletin 7025C**

ACRASIL® PRECISION/POWER WIREWOUND RESISTORS

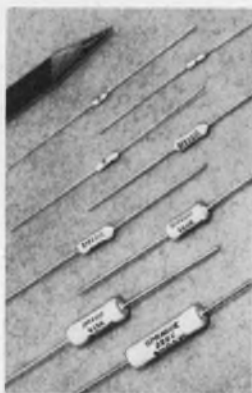

These silicone-encapsulated resistors combine the best features of both precision and power wirewound types, giving them unusual stability and reliability.

Acrasil Resistors are available with tolerances as close as .05%, in power ratings from 1 to 10 watts. Resistance values range from 0.5 ohm to 66,000 ohms.

Their tough silicone coating, with closely matched expansion coefficient, protects against shock, vibration, moisture, and fungus.

Acrasil Resistors meet or exceed the requirements of MIL-R-26C.

**Write for Engineering
Bulletin 7450**

BLUE JACKET® VITREOUS ENAMEL PRECISION/POWER WIREWOUND RESISTORS

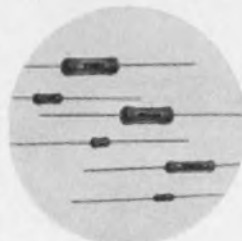

Axial-lead resistors available in ratings from 1 to 11 watts, with resistance tolerances to ±1%. Non-inductive windings available to ±2% tolerance.

All welded end-cap construction securely anchors leads to resistor body. Vitreous coating and ceramic base have closely matched expansion coefficients.

**Write for Engineering
Bulletins 7410D, 7411A**



Tab-terminal Blue Jacket Resistors can be had in a wide selection of ratings from 5 to 218 watts, with several terminal styles to meet specific needs.

Tab-terminal as well as axial-lead Blue Jacket resistors can be furnished to meet the requirements of MIL-R-26C.

**Write for Engineering
Bulletins 7400B, 7401**

KOOLOHM® CERAMIC-SHELL POWER WIREWOUND RESISTORS



Koolohm Resistors are furnished in axial-lead, axial-tab, and radial-tab styles, in a broad range of ratings from 2 to 120 watts. Both standard and non-inductive windings are available.

Exclusive ceramic-insulated resistance wire permits "short-proof" multilayer windings on a special ceramic center core for higher resistance values. The tough non-porous ceramic shell provides complete moisture protection and electrical insulation. Koolohms can be mounted in direct contact with chassis or "live" components.

Axial-lead Koolohm Resistors to MIL-R-26C are available in MIL styles RW55 and RW56.

**Write for Bulletins
7300, 7305, 7310**

STACKOHM® POWER WIREWOUND RESISTORS



Sprague Stackohm Resistors are especially designed for equipment which requires power wirewound resistors of minimum height. Their flat silhouette permits stacking of resistor banks in close quarters.

Aluminum thru-bars with integral spacers act as mounting means and also conduct heat from within the resistance element. Resistance windings are welded to end terminations for maximum reliability. An outstanding vitreous coating protects the assembly against mechanical damage and moisture. Ceramic core, end terminations, and vitreous enamel are closely matched for coefficient of expansion.

Stackohm Resistors are available in both 10-watt and 20-watt ratings, and can be furnished with resistance tolerances as close as ±1%. Resistance values range from 1 ohm to 6000 ohms.

Both 10- and 20-watt types meet the stringent requirements of MIL-R-26C.

**Write for Engineering
Bulletin 7430**

Send your request to Technical Literature Service, Sprague Electric Co., 347 Marshall St., North Adams, Mass. 01247, indicating the engineering bulletins in which you are interested.

ON READER-SERVICE
CIRCLE 821

ON READER-SERVICE
CIRCLE 822

ON READER-SERVICE
CIRCLE 823

ON READER-SERVICE
CIRCLE 824

ON READER-SERVICE
CIRCLE 825

SPRAGUE COMPONENTS

RESISTORS
CAPACITORS
TRANSISTORS
THIN-FILM MICROCIRCUITS
INTEGRATED MICROCIRCUITS

PULSE TRANSFORMERS
INTERFERENCE FILTERS
PULSE-FORMING NETWORKS
TOROIDAL INDUCTORS
ELECTRIC WAVE FILTERS

CERAMIC-BASE PRINTED NETWORKS
PACKAGED COMPONENT ASSEMBLIES
BOBBIN and TAPE WOUND MAGNETIC CORES
SILICON RECTIFIER GATE CONTROLS
FUNCTIONAL DIGITAL CIRCUITS

SPRAGUE®
THE MARK OF RELIABILITY

Sprague and ® are registered trademarks of the Sprague Electric Co.

News



Permanently implantable microcircuit stimulators aid research into workings of the brain. Page 36

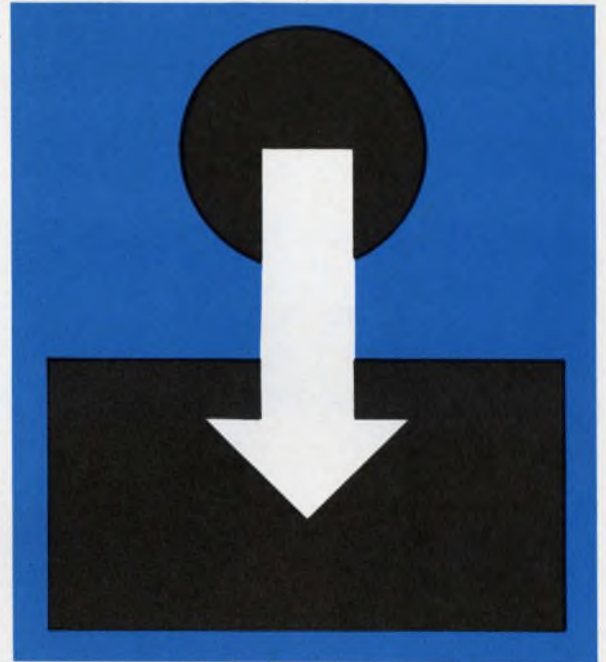

'Macromodular' building blocks ease the design of new computer setups. Page 50



U.S. instrument makers take steps to expand their market in Western Europe. Paris show

points up the extent of their influence, now felt even by Polish manufacturers. Page 17

Also in this section:

Europe adopts coding system for microelectronic devices. Page 21

Pen and transparent tablet feed drawings to computer. Page 26

News Scope, Page 13 . . . **Washington Report**, Page 29 . . . **Editorial**, Page 59

First from Sprague Electric!

Do you use the  2N2222 for Industrial Amplifiers or for Switching?

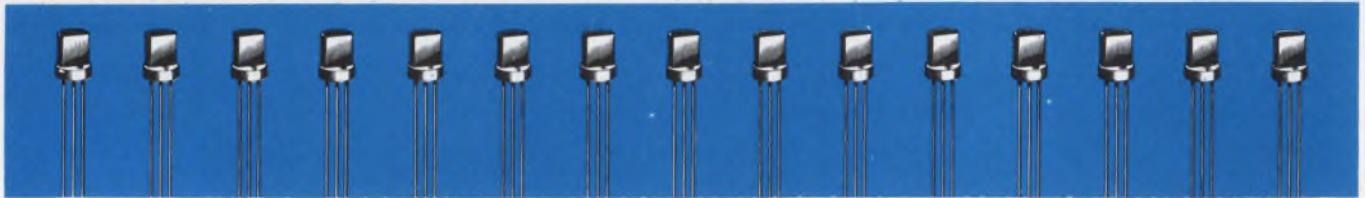

Switch to the Econoline* 2N4951 SERIES and cut costs 40%

Econoline transistors offer an improved, low cost version of the industry-standard 2N2222 family. Automated assembly and plastic packaging save you money over comparable metal can types. Types available in volume quantities for immediate delivery are:

2N4951 — A high gain replacement for the 2N2221

2N4952 — A low-sat replacement for the 2N2222

2N4953 — A high gain replacement for the 2N2222

2N4954 — A 40V ultra-low cost device

Call your nearest Sprague sales office today for specifications and prices—or mail the coupon for free samples. 

*Trademark

SPRAGUE COMPONENTS

TRANSISTORS

INTEGRATED CIRCUITS

THIN-FILM MICROCIRCUITS

CAPACITORS

RESISTORS

455-7121

PULSE TRANSFORMERS

INTERFERENCE FILTERS

PULSE-FORMING NETWORKS

TOROIDAL INDUCTORS

ELECTRIC WAVE FILTERS

CERAMIC-BASE PRINTED NETWORKS

PACKAGED COMPONENT ASSEMBLIES

BOBBIN and TAPE WOUND MAGNETIC CORES

SILICON RECTIFIER GATE CONTROLS

FUNCTIONAL DIGITAL CIRCUITS

SEND FOR FREE SAMPLES OF THE 2N4951 SERIES

Marketing Dept., Semiconductor Div.
Sprague Electric Co., Concord, N.H. 03302

My application is
Please send samples and Engineering Bulletin on Type Number

I would like to discuss my application problems with a sales engineer.

Name

Title

Company

City State Zip

(Business Address Only, Please)

SPRAGUE®
THE MARK OF RELIABILITY

Sprague® and ® are registered trademarks of the Sprague Electric Co.

ON READER-SERVICE CARD CIRCLE 9

NASA invites industry to design for future

At a two-day briefing at the Massachusetts Institute of Technology, NASA put it on the line to industry: It needs new equipment and foresees millions of dollars' worth of potential business for communications, guidance and control manufacturers.

But the equipment must be reliable. Unless a system "can operate reliably over periods of years, encountering radiation fields and temperature extremes ranging from -200° to $+1200^{\circ}\text{C}$," one NASA official indicated, it's no sale.

The U.S. space agency, in discussing its plans for the future, disclosed that not only was it envisioning a more ambitious assault on space; it also intends to direct more of its efforts toward solving civil-aviation problems.

To the 500 industry representatives at the briefing in Cambridge, Mass., earlier this month, NASA speakers pointed to these potential orders for space equipment:

- A threefold increase in the use of microcircuits in systems over the

next five years.

- Miniature on-board computers.
- More powerful lasers in the visible region and improved optical and infrared filters, modulators and detectors.

- Better display techniques, including cathode-ray tubes, motion pictures as well as three-dimensional systems.

In civil aviation, NASA said it was particularly interested in areas that are not now being investigated by the Defense Dept. They include:

- Attitude control systems—probably "fly-by-wire" type.
- Display concepts and their integration with control systems.
- Approach and landing guidance.
- Aircraft collision-avoidance systems.

Dr. W. Crawford Dunlap, assistant director for components research at the NASA Electronics Research Center in Cambridge, noted that the Apollo program computer being built by United Aircraft was one of the most advanced microcircuit applications. Used for kick-

stage guidance, the computer contains 5600 micrologic gates, equivalent to 39,000 discrete components. Dr. Dunlap said that by the year 2000, NASA would need a miniature, cognitive, multiprocessor computer capable of processing nearly all the raw data on a spacecraft. The computer for an unmanned planetary vehicle may have as many as 10^{10} logic elements and 10^9 memory bits and still have a volume of one cubic foot.

Dr. Dunlap reported that the center had sponsored the development of a space-charge-limited, thin-film transistor to operate reliably in temperatures above 400°C . The device, developed by Hughes Research Laboratories of Malibu, Calif., is an analog of the vacuum tube. With the use of silicon-on-sapphire techniques, the device is not suited for really high temperatures, Dr. Dunlap said, but it is a step in the right direction and overcomes the 175°C limit for silicon monolithic structures.

Jack Fischel of NASA's Flight Research Center at Edwards, Calif., said that electrical "fly-by-wire" systems were the best means of controlling high-performance aircraft like the SST. These systems, he explained, use electrical signals originating at the aircraft's manual controls. The signals, transmitted over wires, actuate hydraulic or electric drive mechanisms at the rudder, ailerons or other control surfaces. Fischel said that the X-15 and several lunar-landing simulators had demonstrated the effectiveness of the concept.

The electronics industry must, he went on, provide reliable, low-cost, easily maintained systems for more exacting flight control. He also emphasized the need for new landing displays that could show several variables to the pilot at once.

"The need to improve and simplify pilot displays has been recognized for many years," Fischel said. "Anyone entering the cockpit of an aircraft would be awed by the array of single-parameter instruments. The lack of cockpit space, the increased information required by the pilot, has resulted in indicators being installed in window sills, on the cockpit ceiling, floor and, in some instances, behind the pilot. An obvious solution is the use of integrated displays."

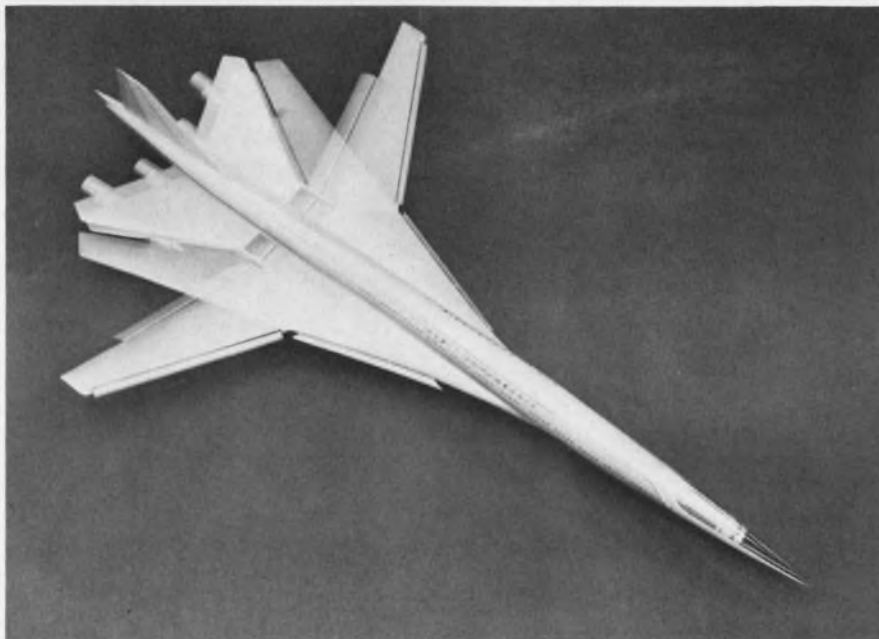

NASA proposes fly-by-wire control and integrated displays for SST

X-ray missile defense may get U.S. go-ahead

Is the United States pushing to deploy an antimissile defense system? Or does the Administration still believe, as Defense Secretary Robert S. McNamara has indicated in the past, that such a system would be of questionable military value? The questions are being asked anew in the light of recent Congressional testimony by the Pentagon's Director of Defense Research and Engineering, Dr. John S. Foster, Jr.

Dr. Foster has indicated that the U.S. is looking into the use of the enormous X-ray energy released by thermonuclear explosion to destroy incoming missiles. In heavily censored testimony, the defense official is said to have confirmed that such use of X-rays is a key element in the proposed Nike-X missile defense system.

An X-ray defense would make possible an "area defense," in which it would no longer be necessary to aim defense missiles directly at incoming warheads. Since the destructive effects of X-rays extend for miles in outer space, defensive missiles could be effective merely by firing them at high altitudes in the vicinity of intruding missiles.

Dr. Foster said that a nationwide defense system, costing as much as \$20 billion, was not technically justified because changes in the enemy's offense could rapidly outdate it. He noted, however, that a "thin-defense" Nike-X system, costing \$3 to \$4 billion, could be effective against a Communist Chinese nuclear threat.

As reported in *ELECTRONIC DESIGN* last Feb. 15 (News Scope, ED 4, p. 13), modifications of U.S. ICBM offensive warheads has been under way for some time in the wake of speculation that the Soviet antimissile system is relying on X-ray to stop any incoming hardware.

However, Secretary McNamara is on record as saying that the enormous cost and questionable performance of any antimissile defense

would make it impractical for a nation as large as the U.S. to build a fully effective system.

According to Dr. Foster's testimony, the Defense Dept. decided in 1964-65 to make a fundamental change in its approach to a ballistic-missile defense. Prior to that time the Pentagon had been developing the Nike Zeus missile for long range interception of attacking warheads. The Nike Zeus however suffered from two fundamental defects.

First, it had to be guided relatively close to its target to be able to destroy the warhead. Secondly, because of its interception requirement, it was incapable of handling a large-scale attack in which warheads were mingled with decoys.

As a result, Dr. Foster explained, the Pentagon shifted toward the concept of providing "area defense" by using larger warheads with X-rays which would have to be exploded only in the general vicinity of incoming warheads.

French telemetry system checks car crash victims

In order to improve the chances of survival of persons injured in automobile crashes, doctors at Purpan Hospital in Toulouse, France, are using a new patient telemetry scheme.

The ambulance crew carries an FM/FM telemetry system with appropriate transducers. These are attached to the injured victim before he is removed from the automobile. The telemetered heartbeat, respiration and like parameters are monitored by a specialist back at the hospital. By this means, doctors can advise on the correct method of handling the patient in the hope of increasing his chances of survival.

The monitoring continues while the patient is in the ambulance, and correct equipment is therefore on hand when the patient is admitted to the hospital.

Ford opens new lab for advanced research

The Philco-Ford Corp. has underlined electronics' growing role in the automobile industry by establishing a research facility in Blue Bell, Pa.

George C. Crowley, a corporation vice-president, has announced that

the Automotive Electronic Development Laboratory will be equipped with the latest electronic apparatus and instrumentation.

The laboratory's function will be to undertake advanced research and development work aimed at the economic application to the automobile industry of innovations coming out of the Philco-Ford laboratories in Dearborn, Mich.

It is expected to work with a three-to-five-year lead time on the refinement of basic research for the solution of automotive problems. Its main responsibility will be to develop electronic controls, communications and entertainment devices for use in cars.

U.S. contract shakeup follows Apollo fire

The first major reforms in the U.S. Moon-exploration program are being pressed by NASA in the wake of the Apollo spacecraft fire that killed three astronauts at Cape Kennedy last Jan. 27. The revisions call for:

- Less responsibility for North American Aviation, Inc., manufacturer of the capsule.

- New contracts to other companies to fill the void.

Testifying this month before the Senate Space Committee, NASA administrator James E. Webb said that the \$2.8 billion Apollo contract with North American, along with \$75 million in engineering changes, was being renegotiated.

The contract changes will bring the Boeing Co. into the program as checkout specialist for the spacecraft before it is launched. This role was formerly performed by North American itself.

In addition, Webb said, another contractor will take over preparation of the Apollo craft for missions after its first lunar landing.

And "other forms of contractor assistance" are being considered, the space administrator went on, to help North American with management and test procedures.

The changes followed blunt criticism in a report last month by a special board that investigated the Apollo fire. The board found "major deficiencies in design and engineering, manufacture and quality control" (see News Scope, ED 9, April 26, 1967, p. 13).

new!

versatile, solid state time delay relays



It's all in the Ohmite "Answer Book," Bulletin 709



New from Ohmite! Convenient, plug-in, time delay relays for obtaining delays or intervals with accuracy and repeatability superior to pneumatic and geared devices. Dependability and long life are assured with maintenance-free, solid state timing circuits and rugged Ohmite electro-mechanical relays which serve as the power switching elements.

Lots of options make these time delay relays highly adaptable. You can choose from three continuously variable delays of 0.1 to 10 seconds, 0.6 to 60 seconds, 1.8 to 180 seconds... or seven fixed delay ratings from one to 180 seconds. Fixed delay models are factory set, but you can easily reduce delay in the field by installing a fixed or variable resistance across terminals. All are available for AC or DC operation in various voltages. There is also a choice of three methods of actuation: (1) on the closing of a switch, (2) on the opening of a

switch, (3) on the momentary closing of a switch. Plug-in timing modules are available for some types, and are used with an external electro-mechanical relay. Write for Ohmite "Answer Book," Catalog 709. Ohmite Manufacturing Company, 3643 Howard Street, Skokie, Illinois 60076. Phone: (312) ORchard 5-2600.

...and don't overlook Ohmite's general purpose relays. You'll find them in the Ohmite "Answer Book," Catalog 700.



OHMITE
MANUFACTURING COMPANY

RHEOSTATS ■ POWER RESISTORS ■ PRECISION RESISTORS ■ VARIABLE TRANSFORMERS ■ RELAYS
TAP SWITCHES ■ TANTALUM CAPACITORS ■ SOLID STATE CONTROLS ■ R. F. CHOKES

ON READER-SERVICE CARD CIRCLE 10



Tuned Amplifier/Oscillator is Six Instruments in One

- LOW-NOISE AMPLIFIER
- WAVE ANALYZER
- DISTORTION ANALYZER
- LOW-DISTORTION OSCILLATOR
- SENSITIVE AC VOLTMETER
- ALLPASS DELAY PHASE SHIFTER

The PAR Model 110 Tuned Amplifier/Oscillator is a versatile high-gain, low-noise, low-distortion frequency selective amplifier operating over the frequency range of 1 Hz to 110 kHz with Q variable from 1 to 100 with no gain change. It provides four outputs simultaneously: a second order (resonance) bandpass; a second order band-reject (notch) providing rejection of the center frequency in excess of 100 dB; a second order allpass characterized by an amplitude response which is flat with frequency and a phase lag which increases monotonically with frequency; and a flat output. Each of the 600 ohm outputs is capable of providing 5 volts rms into a 5K ohm load. A front panel AC voltmeter permits measurement of any one of the four outputs.

The instrument can function as a wave analyzer with bandwidth adjustable from 1% to 100%; as a flat

or selective AC voltmeter with sensitivity ranging from 10 microvolts to 5 volts rms full scale; as a distortion analyzer to measure distortion levels as low as 0.1% (as low as 0.001% when used in conjunction with a second Model 110); as a low-noise amplifier (typical noise figure of 1 dB) with voltage gain ranging from 1 to 10⁴; as a stable general-purpose low-distortion oscillator providing up to 5 volts rms into 600 ohms, capable of being synchronized by an external signal; and as an AC-DC converter with ground-based output.

Price: \$1195. Export price approximately 5% higher (except Canada).

For additional information, write for Bulletin T-140 to Princeton Applied Research Corporation, Dept. E P.O. Box 565, Princeton, New Jersey 08540. Telephone: (609) 924-6835.



PRINCETON APPLIED RESEARCH CORP.

At Mesucora 67

Common Market lures U. S. instrument makers

“Made in Europe” will be commoner on American units as tariffs tumble; even Poland follows U.S. lead

Robert Haavind
Managing Editor

PARIS

U.S. test equipment manufacturers, despite a powerful position in the European marketplace, are not standing pat. They are organizing to take fuller advantage of falling Common Market trade barriers.

The degree of their European involvement varies widely, as was evident from exhibits at the mammoth Palais de la Défense here, where Mesucora, a quadrennial European instruments and controls exhibition, was held April 14-21.

Three items at the show pointed up different facets of the situation.

First was a display of instruments shown by Metronex, the Polish export-import agency which controls all electronics goods moving into or out of this Eastern European nation. The labels on the equipment were in English, and English descriptions and specification sheets were available.

“A few years ago, German was usually used on instruments,” a Polish representative explained, “But

today, European engineers know English best.”

Many other aspects of European-designed equipment also followed patterns pioneered in the U.S. in the last few years—plug-ins, dual-trace capability in oscilloscopes, for instance. Even Eastern European nations must, somewhat apologetically, follow this trend in order to compete in the Western Europe market.

A second pointer was the fact that the John Fluke Manufacturing Co., Inc., of Seattle, plans to set up manufacturing facilities in Amsterdam next year. A Fluke representative pinpointed the reason: instruments shipped from the Netherlands to other members of the European Common Market next year will be subject to 5% duty; from the U.S., 25%. The pressure on instrument makers to “go European” is even stronger than on the component makers (see “Europe girds for battle with Goliaths of U.S.,” ED 9, April 26, 1967, p. 24 ff), because the tariffs for their more complex equipment are higher. Although

France is keeping U.S. instrument makers at arm's length, other Common Market nations—like Belgium and the Netherlands—are spreading the welcome mat.

A third indication came from a company which has probably gone furthest in integrating its efforts into the European scene: Hewlett-Packard Co. It was a new sound loudness analyzer completely designed by engineers at H-P's Böblingen, West Germany, plant. Another H-P instrument at the booth was a 10-Hz-to-1-MHz digital oscillator, completely designed in Japan by HP-Yokogawa.

Some European sales representatives accounted for American success here by pointing out that the much larger electronics industry in the U.S. allowed manufacturers to design for a sizable market. Since more units can be sold, development costs can be spread over a larger production run. But a second important factor was apparent at Mesucora: design innovation. The variety of instruments shown and use of the latest technology, such as microcircuits—both stood out in U.S. exhibits.

The former was evident in a Gertsch synthesized signal genera-

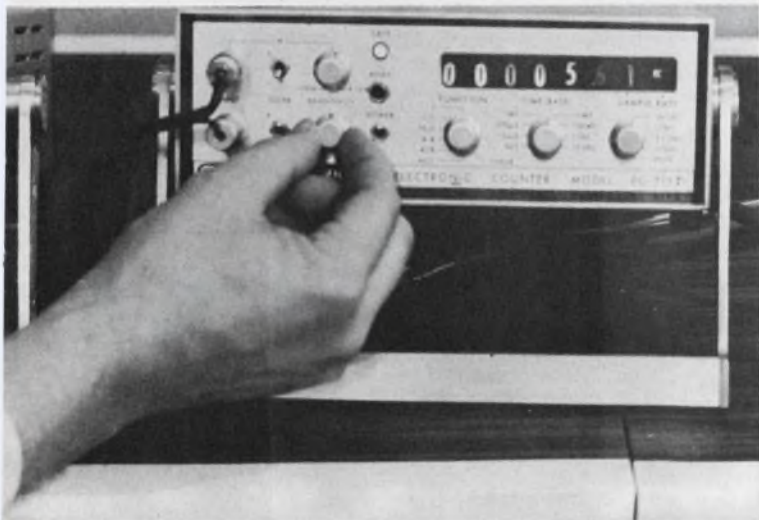

A contrast in design is evident in Aerometric's 10-MHz counter (above) and the Polish 10-MHz digital frequency time meter. The 8-digit version of the U.S. instrument sells for \$1925. The Polish instrument, with markings in English, costs about \$3000.



(Mesucora 67, continued)

tor, the model SSG-1. It covers 5 Hz to 500 MHz, in 1-Hz steps to 50 MHz and in 10-Hz steps thereafter. It is priced at \$12,500.

"The total market for this kind of instrument in France might be 20 or 30, not enough to make it economically sound for a French manufacturer," explained Pierre Challande, sales engineer for SERIEL, the French representative for Singer Metrics, Gertsch's parent firm.

The microcircuit trend was noticeable among U.S. digital instruments. Linear circuits, however, are still usually implemented with discrete devices, because linear-microcircuit performance has not yet reached desired levels.

Tiny 10-MHz counter

Aerometrics showed 0-10-MHz microcircuit counters that, it claims, are the smallest on the market. Prices range from \$1250 for a four-digit model to \$1925 for an eight-digit version in the EC715 series introduced by the Aerojet-General subsidiary.

Two of the units will fit side by side in a standard 19-inch rack, taking up 3-1/4 inches in height. Sensitivity is 100 mV rms. This instrument is about 80% IC. The power supply and some linear circuits are not integrated. It weighs seven pounds.

The Poles were also showing what they called a digital frequency time meter—the 55-pound Zopan type PFL-4, priced at about \$3000. Over a glass of Polish vodka in a private room within the booth, the Polish representatives explained how difficult it was for them to move into world electronic-instrument markets.

"One of our biggest difficulties is your embargo. Many of the things we need are on the embargo list. We can get most of them—through contacts in Holland and Belgium—but it costs us about 40% more that way."

This was stated by one of the Polish representatives who did not wish to be identified. He also cited difficulties with Polish transistors. "We make only pnp transistors in Poland, and their quality is low," he said.

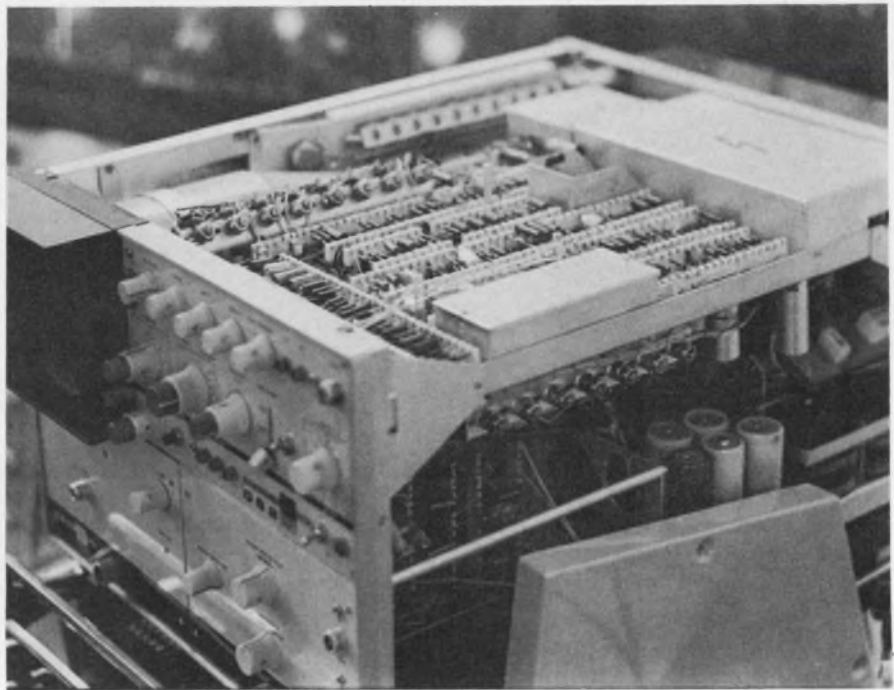

Interior of a Polish 60-MHz oscilloscope shows the large components and side-by-side packaging used. The OSA601 has passive devices suspended between two ceramic strips with slots for the leads to be soldered into.



Floral display brightens the scene as a visiting engineer inspects a new Gertsch synthesized signal generator. Booths at European shows include sections at the back where business can be transacted.

The counter that was on display uses eight types of Polish transistors, one Soviet and one Dutch. It uses four Polish diodes and one Dutch. An eight-digit nixie read-out uses Philips digit indicators.

The Poles were also showing a 60-MHz oscilloscope, type OSA601, which sells for about \$3000. It comes with a carrying cart and plug-ins, including a sampler that covers 0-1 GHz. Triggering to 100 MHz is possible in the real-time scope by means of tunnel-diode cir-

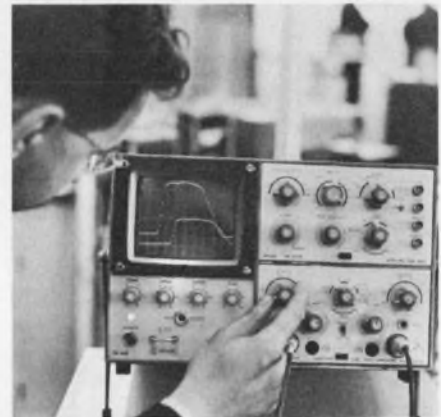

One European manufacturer that seems to run neck and neck with U.S. developments is Philips of Eindhoven, which introduced this 1-GHz two-channel sampling scope priced at about \$4100.

cuitry. The 95-pound instrument uses large components, soldered side by side between two ceramic pieces. In view of the handicaps faced by Polish designers, both instruments are a credit to their ingenuity.

The representative explained also that the Poles would not sell instruments unless they were able to make a profit.

"The vodka," he commented, "is one thing we make better than the Russians." And it was good. ■ ■

you get a choice,



not a challenge

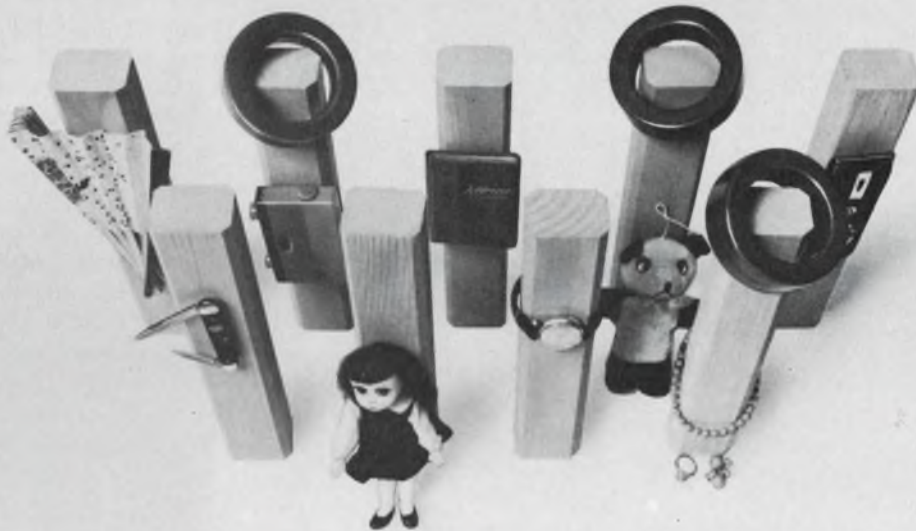

Industry's widest selection of powder cores gives you greater design flexibility

The trend toward smaller circuits and higher density packaging has posed a compaction problem for electrical design engineers—finding quality components small enough to do the job. Magnetics gives the designer more “elbow room” by providing the industry's most complete line of moly-permalloy powder cores—sizes as small

as 0.110" I.D. in the widest range of permeabilities and stabilizations.

We also give the designer involved with highly critical inductor stability factors more latitude with guaranteed temperature stabilization in miniature powder cores. All of these types are designed so they can be wound on present miniature toroidal winding equipment. The “M” type limits the change in inductance to $\pm 0.25\%$ from -65 to $+125^\circ\text{C}$. The “D” type limits the









change to $\pm 0.1\%$ from 0 to 55°C . The “W” type limits the change to $\pm 0.25\%$ from -55 to $+85^\circ\text{C}$. These stabilizations are available in all sizes and permeabilities.

If condensing a circuit design is your bugaboo, check Magnetics' powder core line—the one that gives you a choice, not a challenge. For the complete story, write Magnetics Inc., Butler, Pa. 16001



All from Sprague!

TWELVE OF OUR MOST POPULAR METALLIZED CAPACITOR TYPES

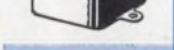
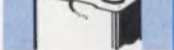
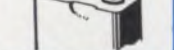
SPRAGUE TYPE	Case And Configuration	Dielectric	Temperature Range	Military Equivalent	Eng. Bulletin
 680P	hermetically-sealed metal-clad tubular	metallized Metfilm* 'A'	-55 C, +85 C	no specification	2650
 431P	film-wrapped axial-lead tubular	metallized Metfilm* 'E' (polyester film)	-55 C, +85 C	no specification	2445
 155P, 156P	molded phenolic axial-lead tubular	metallized paper	-40 C, +85 C	no specification	2030
 218P	hermetically-sealed metal-clad tubular	metallized Metfilm* 'E' (polyester film)	-55 C, +105 C	CH08, CH09 Characteristic R	2450A
 260P	hermetically-sealed metal-clad tubular	metallized Metfilm* 'K' (polycarbonate film)	-55 C, +105 C	no specification	2705
 121P	hermetically-sealed metal-clad tubular	metallized paper	-55 C, +125 C	no specification	2210C
 118P	hermetically-sealed metal-clad tubular	metallized Difilm® (polyester film and paper)	-55 C, +125 C	CH08, CH09 Characteristic N	2211D
 143P	hermetically-sealed metal-clad "bathtub" case	metallized paper	-55 C, +125 C	no specification	2220A
 144P	hermetically-sealed metal-clad "bathtub" case	metallized Difilm® (polyester film and paper)	-55 C, +125 C	CH53, CH54, CH55 Characteristic N	2221A
 284P	hermetically-sealed metal-clad rectangular case	metallized paper	-55 C, +105 C	no specification	2222
 283P	hermetically-sealed metal-clad rectangular case	metallized Difilm® (polyester film and paper)	-55 C, +125 C	CH72 Characteristic N	2223
 282P (energy storage)	drawn metal case, ceramic pillar terminals	metallized paper	0 C, +40 C	no specification	2148A

*Trademark

For additional information, write Technical Literature Service, Sprague Electric Company, 347 Marshall St., North Adams, Mass. 01247, indicating the engineering bulletins in which you are interested.

SPRAGUE COMPONENTS

CAPACITORS
TRANSISTORS
RESISTORS
THIN-FILM MICROCIRCUITS
INTEGRATED CIRCUITS
INTERFERENCE FILTERS

PACKAGED COMPONENT ASSEMBLIES
FUNCTIONAL DIGITAL CIRCUITS
MAGNETIC COMPONENTS
PULSE TRANSFORMERS
CERAMIC-BASE PRINTED NETWORKS
PULSE-FORMING NETWORKS



Sprague and ® are registered trademarks of the Sprague Electric Co.

NEWS

FM unit monitors whirling turbine

A self-contained transmitter the size of a shotgun shell broadcasts the condition of turbochargers spinning at 100,000 revolutions per minute.

The FM station, built by the Schwitzer Div. of Wallace-Murray Corp., Indianapolis, is said to be the world's smallest. It is mounted on the hollow impeller shaft of the supercharger and is used to relay signals from strain gauges on the impeller blades.

Schwitzer laboratory technicians developed the tiny transmitter when they found that the former method of picking up the strain gauge signals by commutation was no longer practical. Electrical impulses were picked up directly from contacts on the shaft at speeds to 50,000 rpm but were unable to keep up at the higher speeds.

The miniature transmitter is powered by the same battery as that used to power an electric wristwatch. Schwitzer says that the milliwatt output power is modulated by the output signals from the strain gauges. The strain gauges are cemented to selected locations on the impeller blades. The receiver can interpret variations to indicate impeller stress. ■ ■



Tiny FM transmitter mounted on a turbocharger impeller is able to relay strain gauge signals when the shaft is rotating at 100,000 rpm.

Europe adopts integrated-circuit coding scheme

Thirty-eight firms agree on code to be used for ICs; U.S. sticks to 6N numbers

European manufacturers have begun using a new, meaningful coding system to identify microelectronic devices. The system is similar to coding schemes already in use in Europe for tubes, transistors and

diodes.¹

The system was developed by the Association Internationale à But Scientifique, Pro Electron, headquartered in Brussels, Belgium. Members of the organization in-

clude 38 European semiconductor manufacturers, including all the major ones of France, the Netherlands and West Germany, according to Jan Haantjes, director of the organization. The first meeting was held in Brussels last Feb. 21 and was attended by representatives from Belgium, France, Italy, the Netherlands, Spain, Sweden, the

New code for integrated circuits.

FAA101*

The first two letters: Family, respectively solitary type	Third letter: Group of circuit functions	Two first figures: Running serial number	Third figure: Temperature range
Family types: FA, FB, . . . GA, GB, . . ., etc. Solitary types: T followed by letter A, which may change to B, C, etc., if running serial number is exhausted.	A Linear amplification. B Frequency conversion/demodulation. C Oscillating/generating (continuous). D Multiple of dissimilar linear networks. G Multiple of noninterconnected discrete devices when belonging to a family of networks. H Logic. J Storage (continuous). K Timing (including temporary storage). L Digital level conversion. Y Miscellaneous.	10-99	1) 0° to +75°C. 2) -55° to +125°C. 0) Other temperature ranges.

* Linear amplifier, the first device in the FA series, for use in a temperature range from 0 to 75°C.

Special code for Zener diodes.

BZY99 - C4V7R*

Basic part of the type designation	Letter indicating the nominal tolerance of the Zener voltage in %	Typical Zener voltage in volts	Polarity
Assigned in accordance with the code described in Table 1.	A 1% B 2% C 5% D 10% E 15%	The typical Zener voltage is related to the nominal current rating for the whole range. The letter V is used in place of the decimal point when this occurs.	Normal polarity, which is with cathode connected to case, and symmetrical executions are not specially indicated. Reverse polarity, which is with anode connected to case, is indicated by the letter R.

* Silicon voltage reference diode for use in professional equipment. Second group says this is a 4.7-volt, 5% tolerance device with reverse polarity (anode connected to case).



FREQUENCY STABILITY

TC/VCXO

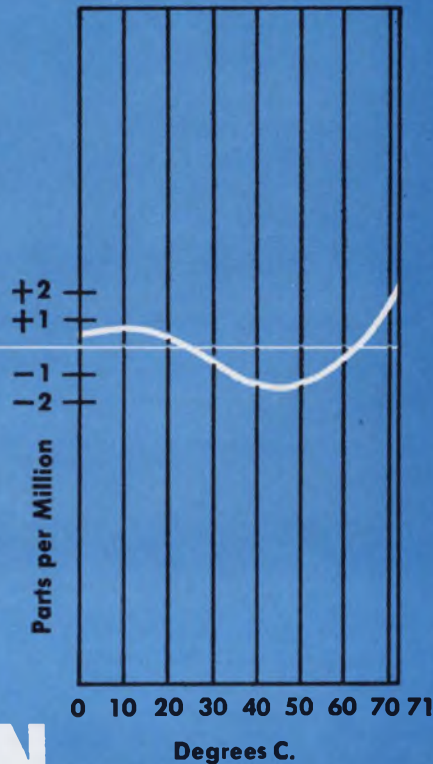

NO OVEN

TC/VCXO

Frequency Stability
within $\pm 2 \times 10^{-6}$
over 0 to 71°C range



Typical TC/VCXO Model 5968WA
Center Frequency: 6.8 MHz
Size: approx. 2½" L x 1½" W x ¾" H

If space and power are limited in your telecommunication system, consider the advantages of the Damon Temperature Compensated Voltage Controlled Crystal Oscillator (TC/VCXO). This rugged, miniaturized unit provides a frequency deviation of ± 100 Hz about center frequency and maintains a stability comparable to that of an "ovenized" unit without the need for added circuitry and power.

The illustration, above, shows a frequency stability curve for a simple Damon TC/VCXO. To achieve comparable frequency stability an "ovenized" unit would require more space and more power.

Tight temperature compensation is only one example of Damon VCXO capability. Low noise, small size and increased reliability are other Damon VCXO accomplishments. Perhaps your telecommunication system suggests new VCXO problems? Consultations between circuit designers and Damon engineers are the best route to proper VCXO selection. As a starter, may we invite you to write for the Damon VCXO Brochure. Damon Engineering, Inc., 240 Highland Avenue, Needham Heights, Mass. 02194 (617) 449-0800.

DAMON

ON READER-SERVICE CARD CIRCLE 14

(coding scheme, continued)

United Kingdom and West Germany. The group will continue to use the tube, semiconductor and diode coding developed previously by the now dissolved Association Pro Electron of Luxembourg.

Many characteristics of the tube coding scheme used in Europe for the past 30 years have been carried over into the codes for semiconductor devices. For example, a small-signal diode is always identified by the second letter "A", whether it is a semiconductor type or a high-vacuum or gas-filled tube. The first letter tells which of these it is.

The basic principles of coding are similar for all devices in the European system. The first letter—or in the case of integrated circuits, two letters—indicates the category and group, series or family of devices. The second, or third, letter indicates the circuit function of the device. In some cases additional information is coded in, or a serial number is added to identify specific devices.

The new integrated circuit code is shown in the table. A comparison with Table 1, for discrete semiconductor devices, shows the similarity between the systems. The following example will help to clarify the system and illustrate some of its present limitations.

A device designated "FYH121" is a digital logic microcircuit (from the "H") in the "FY" family. It will work compatibly with other "FY" devices. That is, it will use the same supply voltages, work with the same input and output levels, operate at the same speed, etc. It is the third device in the series (series numbers go from 10-99, therefore the "12" gives this information). The "1" at the end indicates that it operates over a temperature range of 0°-75°C.

The logic type—DTL, RCTL, E²CL—is not given by the code. Haantjes says that there is some interest among European semiconductor makers in adding this information, and a means to do so may be developed.

At present six manufacturers have already started using the new code and the remaining 32 manufacturers in the organization intend

Table 1. Designation code for semiconductor devices.

AA100*

First letter: Distinguishes between junction and nonjunction devices and gives an indication of the material.	Second letter: Indicates primarily the main application, respectively main application and construction if a further differentiation is essential.	Serial number:
<p>Junction devices:</p> <p>A Devices with one or more junctions, using material with a band gap of 0.6 to 1.0 eV, such as germanium.</p> <p>B Devices with one or more junctions, using material with a band gap of 1.0 to 1.3 eV, such as silicon.</p> <p>C Devices with one or more junctions, using material with a band gap of 1.3 eV and more, such as gallium arsenide.</p> <p>D Devices with one or more junctions, using material with a band gap of less than 0.6 eV, such as indium antimonide.</p> <p>Nonjunction devices:</p> <p>R Devices without junction, using materials such as those employed in Hall generators and photoconductive cells.</p>	<p>A Detection diode, high-speed diode, mixer diode.</p> <p>B Variable-capacitance diode.</p> <p>C Transistor for af applications (thermal resistance between crystal and mounting base more than 15°C/W).</p> <p>D Power transistor for af applications (thermal resistance between crystal and mounting base equal to or less than 15°C/W).</p> <p>E Tunnel diode.</p> <p>F Transistor for RF applications (thermal resistance between crystal and mounting base more than 15°C/W).</p> <p>G Multiple of dissimilar devices. †</p> <p>H Field probe.</p> <p>K Hall generator in an open magnetic circuit, e.g. magnetogram or signal probe.</p> <p>L Power transistor for RF applications (thermal resistance between crystal and mounting base equal to or less than 15°C/W).</p> <p>M Hall generator in a closed, electrically energized magnetic circuit, e.g., Hall modulator or multiplier.</p> <p>P Radiation-sensitive device.</p> <p>Q Radiation-generating device.</p> <p>R Electrically triggered controlling and switching device having a breakdown characteristic (thermal resistance between the crystal and mounting base more than 15°C/W).</p> <p>S Transistor for switching applications (thermal resistance between crystal and mounting base more than 15°C/W).</p> <p>T Electrically, or by means of light, triggered controlling and switching power device having a breakdown characteristic (thermal resistance between crystal and mounting base equal to or less than 15°C/W).</p> <p>U Power transistor for switching applications (thermal resistance equal to or less than 15°C/W).</p> <p>X Multiplier diode, e.g. varactor, step recovery diode.</p> <p>Y Rectifying diode, booster diode, efficiency diode.</p> <p>Z Voltage reference or voltage regulator diode.</p>	<p>Three figures for semiconductor devices designed for use primarily in consumer goods.</p> <p>One letter and two figures for semiconductor devices designed for use primarily in professional equipment.</p>

* Germanium small-signal diode (either detection, high speed or mixer) for use in consumer equipment.

† A multiple device is defined as a combination of similar or dissimilar active devices, contained in a common encapsulation that cannot be dismantled, and of which all electrodes of the individual devices are accessible from the outside. Multiples of similar devices as well as multiples consisting of a main device and an auxiliary device are designated according to the code for discrete devices described above. Multiples of dissimilar devices of other nature are designated by the second letter G.

Special code for rectifiers and thyristors.

BYY99 - 100R*

BTY99 - 100R

Basic part of the type designation	Rated maximum value of the repetitive peak reverse voltage in volts	Polarity
Assigned in accordance with the code described in Table 1.	In case of thyristors the rated maximum value of the repetitive peak reverse voltage in volts or the repetitive peak off-state voltage, whichever value is lower.	Normal polarity, which is with cathode connected to case, and symmetrical executions are not specially indicated. Reverse polarity, which is with anode connected to case, is indicated by the letter R.

* Silicon diodes, a rectifier in the case of the "BY" and a thyristor in the case of the "BT," for use in professional equipment. Both have 100-volt PRV and reverse polarity.

(coding scheme, *continued*)

to adopt it as they go into off-the-shelf microcircuit production, according to Haantjes.

European engineers and European representatives of U.S. firms expressed mixed feelings about the new coding system.

Interviews at the International Electronic Components Exhibition, held in Paris April 5-10, indicated that the European design engineer appreciates the meaningful coding of devices. Several years of using the U.S. system, however, has accustomed him to dealing with the serial registration numbering of devices. He feels that the much better data supplied by U.S. firms than European or Japanese suppliers, particularly in the form of application notes, partly compensates for the system's shortcomings. He would welcome the application of the European code to U.S. devices, but a still different code would lead to too much confusion.

European representatives of U.S. firms are generally satisfied with JEDEC numbers, 1N and 2N des-

ignations: there has been little recoding of devices for the European market. The fine job done by JEDEC in getting uniformity of characteristics for devices with the same type number from different manufacturers was praised. Two devices with the same numbers from two different European manufacturers may be quite different, they said.

Meanwhile, the EIA committees on microelectronics have settled on the 6N system for all integrated devices. There has been considerable agitation over the past year for at least the addition of a 7N designation for nondigital microcircuits, according to C. E. Coon, EIA staff engineer for active devices. Contacted in Washington, he said that this possibility was rejected early this month. Among the many reasons for this, he explained, is the problem of where to put devices such as A-D converters and future LSI chips that include both analog and digital circuits. The decision was reached by the EIA's MED-2 committee (Microelectronic Devices) and approved by the seven member MED Engineering Panel. This panel, which includes representatives of manufacturers of

semiconductors, parts and government products, voted unanimously against expanding the 6N system, according to Coon.

The formation of the newly constituted Pro Electron group in Brussels was undertaken for two main reasons. When the Luxembourg group was started, it was split into founding members and normal members. Since the founding members carried more weight in the organization, manufacturers who joined later were dissatisfied with their weaker position. The new group has only normal members, all with an equal voice in decisions. The previous organization registered only devices from member companies, so some European devices went unregistered. The new Brussels group will register devices from nonmember firms as well. The address of the new organization is:

Association Internationale à But Scientifique, Pro Electron,
10, Avenue Hamoir,
Brussels 18,
Belgium. ■ ■

Reference:

1. W. A. Rheinfelder, "Why Not Sensible Coding for Transistors?" *ELECTRONIC DESIGN*, XII, No. 23 (Nov. 9, 1964), 64-69.

Air Force gyro: a nimble thimble



The DART gyro for aerospace use.

The Air Force has developed a hardy gyro the size of a thimble.

The gyro is relatively insensitive to shock, yet it can measure a wide range of angular velocities from one revolution an hour to 78 a minute. It is for use in stabilizing aircraft, missiles and spacecraft.

Called DART (Dual Axis Rate Transducer) the new gyro is a result of collaboration between the Air Force's Materials Laboratory and its Flight Dynamics Laboratory.

The heart of the DART is a half-inch sphere, filled with mercury, and an assembly of piezoelectric crystal sensing rods. When the vehicle accelerates, the mercury presses against the rods and a voltage appears across their length. The sphere rotates on ball bearings at 24,000 rpm. This rotation is sustained by a tiny electric motor, mounted in the gyro case. ■ ■

On the beam at Expo



An infrared light beam carries data between an IBM System/360 computer in the Canadian Government pavilion at Expo 67 and a receiving unit and graphic display terminal (above) in the Man the Producer pavilion half a mile away. The path of the beam has been simulated by photographic retouching.

Polarad modular microwave signal instruments offer you new flexibility. Build the system you need now, rearrange or add new modules later.

Choose from 12 modules. Signal generators and sources cover a 0.95 to 11 GHz range. Doublers obtain frequencies to 21 GHz. Frequency stabilizers and a common modulator are available too. Rack, stack, or interchange in minutes.

Performance? Closely regulated power supplies, $\pm 0.5\%$ digital frequency readout accuracy, bimetallic cavity stabilization and other features assure lowest drift and incidental AM and FM, greatest freedom from spurious signals.

Polarad Signal Modules include:

Signal Generators	Frequency—GHz
1105	0.95 to 2.4
1106	2.0 to 4.6
1107	3.8 to 8.2
1108	6.95 to 11.0
Signal Sources	
1205	0.95 to 2.4
1206	1.95 to 4.2
1207	3.8 to 8.2
1208	6.95 to 11.0
Frequency Doublers	
1509	10.0 to 15.5
1510	15.0 to 21.0

Other Instruments

1001	Modulator
3815	Frequency Stabilizer

Let your Polarad field engineer demonstrate the flexibility and performance of these modular microwave instruments, and prove their economy too. Call him directly or contact Polarad Electronic Instruments, 34-02 Queens Boulevard, Long Island City, N. Y. 11101. Telephone: (212) 392-4500.



**use these Polarad instruments
as an extended range
pulse modulated signal generator today...
give them separate assignments tomorrow**

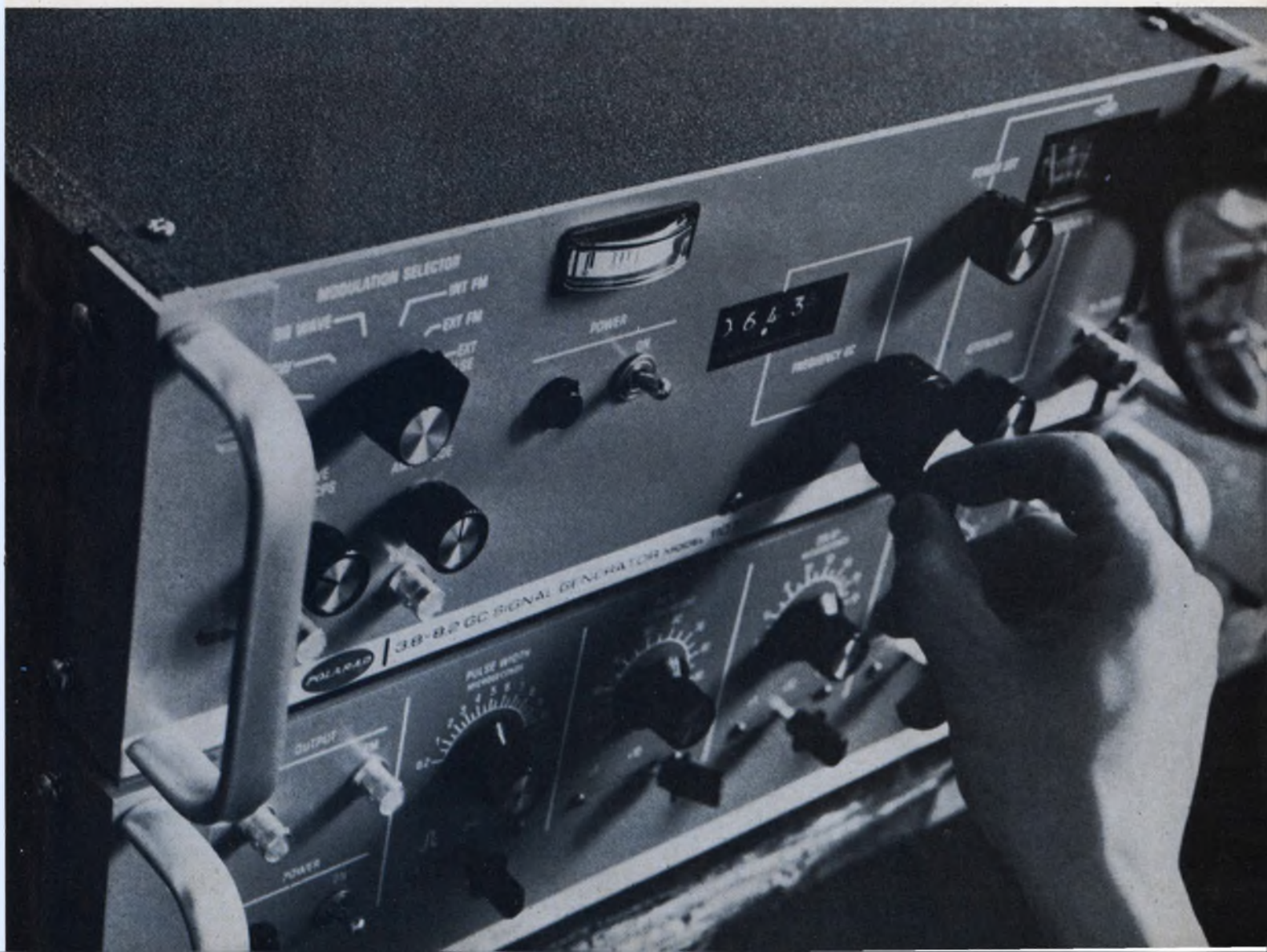

Input for a computer: A pen and transparent table

Hand-drawn information can be converted easily for computer storage and processing with a new computer input system. The operator merely marks the information with an electronic pen on a transparent conductive plate, and the system converts the result to digital and analog signals.

Reported to operate more simply than other graphic input devices, it depends on phase detection to convert the written information to electronic data.

A development of the Applied Research Laboratory of Sylvania's Electronic Systems Div., Waltham, Mass., the electronic "note pad" permits the operator to work directly on an oscilloscope face or to trace directly over maps or drawings. The transparent tablet eliminates the guess work in locating precise coordinates. The ball point pen can make permanent copies on translucent paper.

The Rand tablet, another input device, uses an opaque surface that cannot be used for tracing. If a correction on a CRT face is desired, the operator must, by trial and er-

ror, find the corresponding point on the display before he can make the change.

The light pen, on the other hand, calls for more complex circuitry than either the Rand or Sylvania tablet, and it does not give the operator a copy of his drawing.

The writing area in the Sylvania system is a conductive surface with ac fields across the x (horizontal) and y (vertical) directions. As the pen passes over the writing surface, its position is sampled 200 times a second, by measurement of the phase of the x and y signals corresponding to the pen's position.

Sylvania engineers say that the phase-detection technique is less susceptible to error than earlier voltage-gradient-surface stylus and capacitance-surface stylus techniques. They say that pen movements as small as 0.003 inch can be measured.

In addition to the x and y measurements, the system has a z-axis capability. Variations in the height of the pen above the tablet will produce differences in the z digital output that can be used to introduce additional data to the computer.

Sylvania says its system can be used with military command and control equipment, machine-aided design displays, training devices and for the reduction and processing of maps and charts.

The system has a transparent conductive film that is sandwiched between transparent glass sheets. Signals of about 100 kHz are introduced across the 11-by-11-inch writing surface at points along the edges of the tablet.

Time-varying modulating signals of 1 kHz are impressed on the 100-KHz signal at the input points. Coordinate information at any point on the surface is obtained by detecting the phases of the signals at that point. Signals are sensed by the pen through its capacitive coupling with the tablet surface.

Both digital and analog outputs are available simultaneously from the x and y axes; only digital information is available from the z axis.

Digital output in x and y, encoded as 12-bit words, are updated every 5 ms. Three bits of z-axis information are available. ■ ■

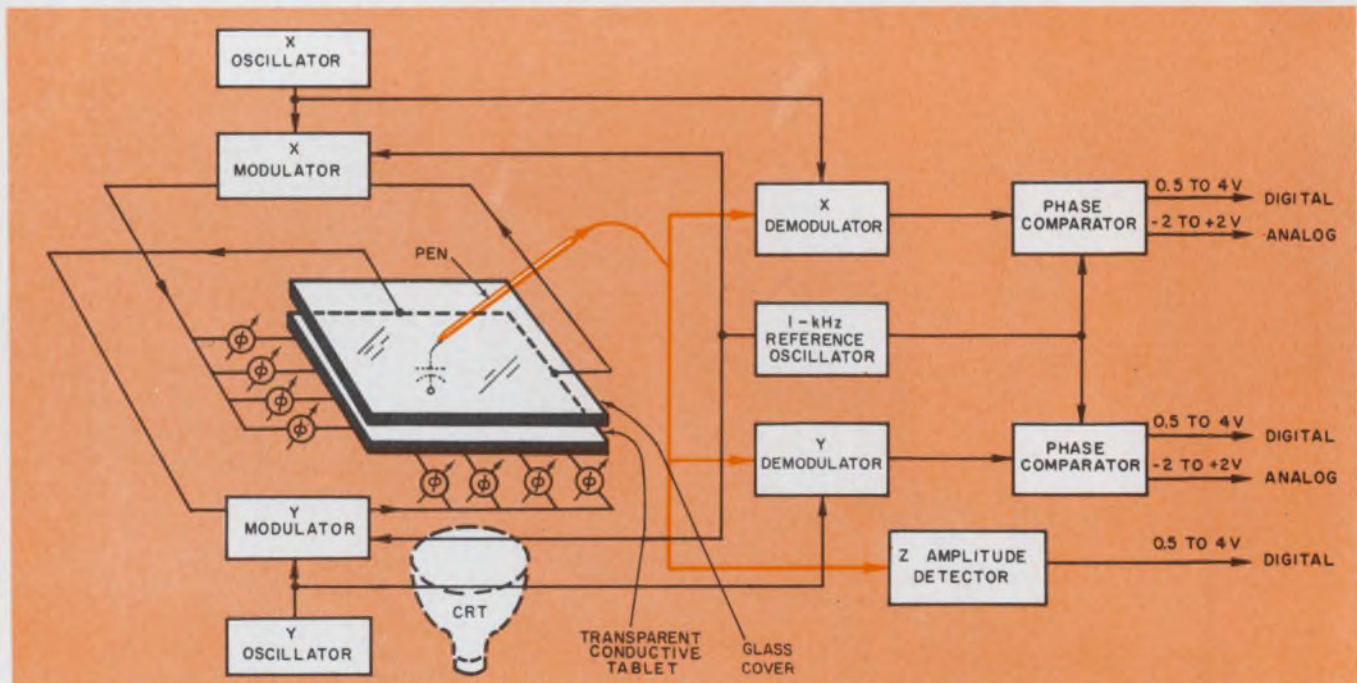

Computer graphical input system uses an electronic pen and a transparent conductive tablet. The pen makes capacitive contact with the conductive layer, and its co-

ordinates are sampled 200 times a second by means of a phase detection technique. Both analog and digital output are available.

SPERRY

DIVISION OF
SPERRY RAND
CORPORATION

CAIN & CO. OFFICES

★ LOS ANGELES, 213 / 783-4700

★ BOSTON, 617 / 665-8600

★ CHICAGO, 312 / 253-3578

★ DALLAS, 214 / 369-2897

★ DAYTON, 614 / 861-2119

★ NEW YORK, 914 / 337-3445

★ PHILADELPHIA, 215 / 664-3797

★ SAN FRANCISCO, 415 / 948-6533

★ SYRACUSE, 315 / 437-2933

★ WASHINGTON, 202 / 296-8265

★ SOUTH AMBOY, 201 / 727-1900

★ HUNTSVILLE, 205 / 859-3410

★ ORLANDO, 305 / 422-3460

★ SAN DIEGO, 714 / 278-1031

★ MONTREAL, 514 / 844-0089

(See the full Sperry line at Booth 200 in the Microwave Exposition.)

If you would like a simpler way to select and specify microwave components, Sperry has the answer, and the answer is your Cain & Co. representative. He now serves as your single source for such outstanding Sperry products as:

ISOLATORS • CIRCULATORS

MICROWAVE SOURCES • BWO — klystron — solid-state

AMPLIFIERS • Klystron — traveling wave — parametric

MICROWAVE ACOUSTIC DELAY LINES
PHASE SHIFTERS

Why not speed up your job by talking to the Cain man? He has the products, the technical knowledge and the close factory liaison it takes to help you build a better system faster.

Write for your free catalog. It shows the whole family of microwave components designed, developed and manufactured by:

SPERRY MICROWAVE ELECTRONICS CO.
Clearwater, Florida

SPERRY ELECTRONIC TUBE DIVISION
Gainesville, Florida

Now it's easier to buy any Sperry microwave component because you can buy them all from one man.

Your Cain & Co. man.

ON READER-SERVICE CARD CIRCLE 16



SEMICONDUCTORS

NEW IDEAS IN APPLICATION AND DESIGN

■ ACCURACY UP, RFI DOWN WITH GE'S NEW LOW-COST A-C POWER CONTROL MODULE

"Zero-voltage switching" is the key. GE's new S200 synchronous switch power control provides much lower RFI levels than are possible with electromechanical thermostats or phase-controlled semiconductors. And it has high accuracy with control point repeatability better than $\pm 0.5\%$ of sensor resistance. Keys to this high performance are a monolithic integrated firing circuit and a Triac power control device. Its user need only provide power, a resistive load (such as a resistance heater), a variable resistance sensor and a reference control resistor.

Potential uses include any resistive load application where a-c power control is needed. S200 power control modules are available in ratings of 10 and 15 amps RMS, at 120, 240 and 227 volts RMS, 50 to 60 Hz, for controlling resistive loads up to 4150 W. Use with General Electric's new Man-Made[®] diamond thermistor permits sensing and control of temperatures to 450 C. Housing dimensions of the S200 power control module are roughly $1\frac{1}{8}$ by $2\frac{1}{2}$ by $3\frac{1}{4}$ inches.

Circle Number 811 for full details on these new GE power control modules.

■ NEW ECONOMY POWER TRANSISTOR

Thermal dissipation....1.2W (free air)
Beta holdup.....to 500 mA

It's GE's D28A.

■ P_T1.2 W at 25 C (ambient)

■ h_{FE} 75-225 and
180-540 at 2 mA, 4.5 V
20 min. at 400 mA, 1 V

■ BV_{CEO} ... 25 and 50 V

■ $V_{CE(SAT)}$... 0.05 typical
0.3 V (max.) at $I_C/I_E =$
50 mA/3 mA

Other characteristics closely match those of the 2N3414-17.

All of this comes in a low-cost plastic package with three in-line leads that can easily be formed to a TO-5 pin circle. Price: less than 30¢ in volume.

Try D28A medium power silicon transistors for output stages in stereos and other phonographs, TV's, radios and other kinds of audio equipment. Or for oscillators, amplifiers, buffers and as drivers for very high power amplifiers. Circle Number 812 on the magazine inquiry card.

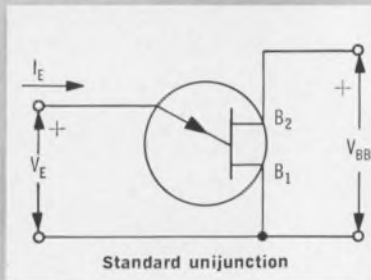

Standard unijunction

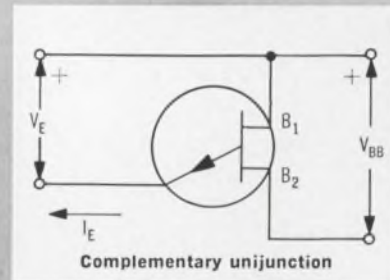

Complementary unijunction

Introducing the Complementary UJT for Improved Stability and Accuracy in Oscillator and Timer Circuits

It's an entirely new kind of unijunction called the D5K. General Electric's D5K has superior temperature stability and product uniformity through utilization of planar processing techniques. Its characteristics are like those of a standard unijunction transistor except that the currents and voltages applied to it are of opposite polarity.

With GE's D5K you can build oscillator and timer circuits with better than 0.5% accuracy from -40 to $+120$ C. Its intrinsic stand-off ratio (η) is just 0.58-0.62 or $\pm 3\%$. You save

test costs by determining your best compensating resistor for temperature stability at room temperature. And the D5K gives you a low base 1 to emitter voltage drop at high current... permits generation of high output pulses with low base-to-base voltages.

GE D5K's are priced at \$4.64 in 100-lot quantities. Take advantage of GE's continuing UJT leadership and superior application help. D5K's are available for both military and industrial uses. Circle Number 813 for more information.

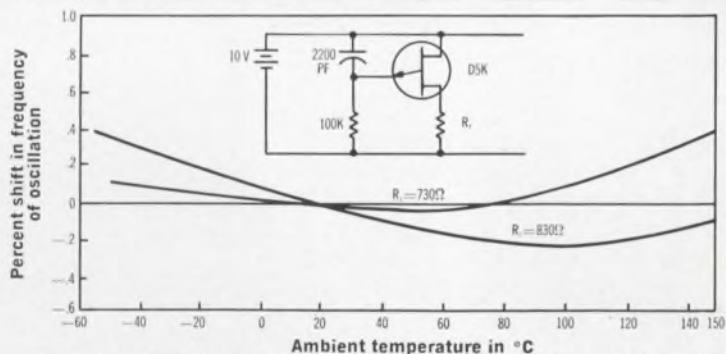

Frequency stability demonstrated by relaxation oscillator test circuit (CUJT only subjected to temperature change.)

These are just three more examples of GE's total electronic capability. For more information call your GE engineer/salesman or distributor. Or write to Section 220-55, General Electric Company, Schenectady, New York. In Canada:

Canadian General Electric, 189 Dufferin St., Toronto, Ont. Export: Electronic Components Sales, IGE Export Division, 159 Madison Ave., New York, N.Y., U.S.A.

GENERAL  ELECTRIC

The search for talent is chronic



Washington Report

S. DAVID PURSGLOVE,
WASHINGTON EDITOR

Hiring of aliens urged

Is there a shortage of scientists and engineers in the United States? Acting Commerce Secretary Alexander Trowbridge says there is. As a result, Senator Warren G. Magnuson (D-Wash.) has introduced a bill that would permit the Commerce Dept. to hire aliens in scientific or technical capacities when U.S. citizens with the needed skills could not be found.

Trowbridge has told Magnuson that a number of times Commerce Dept. agencies engaged in scientific or technical work "have found that the only persons qualified and available for certain highly specialized positions are not citizens of the United States." In general, only U.S. citizens can be paid with Federal funds, although many exceptions are made.

A significant assertion by Trowbridge—one that swings considerable weight in recurrent argument over whether there is a shortage of scientists and engineers—is this passage from his letter to Magnuson: "The need to utilize the services of these talented foreigners is due in part to the general shortage of scientists and engineers in this country."

But more important to the Commerce Dept. right now is "the fact that some of the department's technical programs are outside the popular, or currently fashionable, areas of modern science, and therefore are not particularly attractive to American students and scientists." Trowbridge cites as an example the difficulty that the National Bureau of Standards has had for several years in recruiting physicists trained in atomic spectroscopy. The lack of trained Americans, combined with the increasing demands on the bureau for precise data on atomic properties obtainable only through spectroscopic studies, have created a near crisis, according to Trowbridge. He points out that the information is essential in interpreting astrophysical data associated with the space program; in measuring and understanding plasmas in thermonuclear fusion research, and in

furthering our grasp of rocket propulsion. Yet, he says, present law prohibits hiring atomic spectroscopists from Sweden, where large numbers have been trained.

The Acting Secretary says similar problems exist in applied mathematics and numerical analysis, and in such undertakings as the Weather Bureau's atmospheric ozone study program and the Bureau of Standards' oceanography program. He says the requested law would not jeopardize U.S. scientists and engineers, because it would require an unsuccessful search of the various talent rosters before an alien could be hired. Further, Trowbridge points out, such organizations as the Smithsonian Institution, NASA, the Defense Dept. and Agriculture Dept. already have authority to hire non-citizen scientists and engineers under compelling circumstances.

The bill (S. 1663) has White House support. However, a staff member of the Senate Commerce Committee, which will conduct the hearings, wondered aloud what the State Dept. would have to say about its "brain drain" implications.

Computer supply setup criticized

The Army's new computer-based Pacific supply system is largely useless at present, the General Accounting Office has concluded after a year's review. The watchdog arm of Congress says, however, that it's the Army supply system—not the computers—that is at fault. Comptroller General Elmer B. Staats says he is not recommending abandonment of the computers, because "they are essential for effective management of large inventories and great numbers of supply transactions." However, he reports, they won't do the Army any good until the basic supply system and the data fed to the computers are improved.

These conclusions represent a major rewrite of the General Accounting Office report from its draft form, which did not differentiate as clearly between computer failings and Army failings. In its earlier form, computer industry

Washington Report

CONTINUED

representatives in Washington felt, the report could have given large computer-based systems a black eye and might have cost the industry several years in its efforts to win new Government business. Investigators found two chief reasons behind the alleged failure of the Pacific system. One is that "inventory procedures were not adequate to insure accuracy of inventory and warehouse location records." The other is that "management practices led to excesses of some supply items and critical shortages of others." The report says the Army failed to prepare for installation of its computers by correcting long-standing supply-management problems and by adapting the operation to data processing. Even after more than a year of operation with the computers, the Government study team found, a large percentage of Pacific supply transactions could not be processed routinely by computers; they still had to be researched, edited and reprocessed manually, just as in the old days.

Under a contract to scrutinize the system and suggest changes, the Computer Science Corp. made some short-term improvements. However, according to the Comptroller General, the Army found it was in such bad shape that it had to rewrite its contract with Computer Science, at a cost of \$1.6 million, to redesign the entire system. The system consists of four computer sites. Three batteries of computers are at each. At the Army's Pacific headquarters in Hawaii, the groupings are: IBM 7010-100K/7010-80K; IBM 1460/1401C/1401E; IBM 1302-2/1302-2/1302-1. At other points, the computers used, all IBM, are 7010, 1460, 1302-2 and 1410 in groupings less sophisticated than those on Hawaii. The annual rental fee for the supply system is about \$2.5 million. In addition, General Accounting Office figures, the Army owns and maintains equipment that would amount to about \$600,000 in annual rental at current rates.

Needed: A sonic boom silencer

Transportation Secretary Alan Boyd has indicated a sometimes-overlooked role for the electronics industry in the planned SST (supersonic transport) development program. The ultra-high-speed craft obviously will require new navigation and collision-avoidance

electronics that the industry already has discussed. But Boyd is publicly indicating research programs in the offing, aimed at reducing sonic boom. A Federal Aviation Administration official admits that the FAA has no concrete ideas on how such an apparent natural phenomenon as a sonic boom might be curtailed, but he assumes early approaches will center on electronics. At the very least, he told ELECTRONIC DESIGN, the mere studying of sonic booms will be an electronics research project.

Electronic maintenance codified

The struggle of maintenance departments to keep up with galloping progress in electronic equipment is no less a problem for Government than it is for industry. Various approaches of Government agencies to meet this problem have been brought together in one publication that the Commerce Dept. is offering to industry. Ten maintenance concepts, described as new, have been analyzed for the Army by E. L. Shriver and R. C. Trexler of the Human Resources Research Office of George Washington University.

The research team attempted to identify the common elements of the 10 maintenance concepts and to indicate which aspects of each might be combined to fit new situations. One common element discovered was that of having experts generate trouble-shooting strategy rather than attempting to give each maintenance trainee sufficient technical background to generate his own strategy. According to the researchers, all of the concepts can reduce trouble-shooting time and can result in a higher degree of success in finding the causes of trouble, compared with conventional approaches.

In the Human Resources Research Office publication, an analysis of a system is followed by samples of the instructions and graphics used in the system. The publication, "A Description and Analytic Discussion of Ten New Concepts for Electronics Maintenance," is available at \$3 (65¢ in microfiche) from the Commerce Dept. Clearinghouse, Springfield, Va. 22151. Order AD-647-229.

Among the concepts discussed are FORECAST, JOBTRAIN and MAINTRAIN, developed by the Human Resources Research Office; BAMAGAT, the trademark of a system developed by the Hughes Aircraft Co. and MDS (Maintenance Data System), which is under development by Bell Telephone Laboratories.

NOW...a full-sized **VOM** in a palm sized "package"

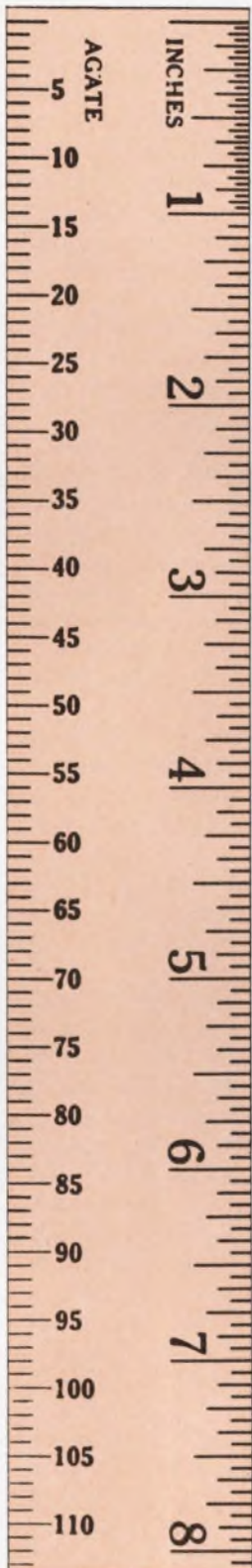

160 Volt-Ohm-Milliammeter
Complete with alligator clip
leads and operator's manual.
..... \$50.00



Carrying Case—
Cat. No. 2225 \$ 9.50
Accessory Leads—
Probe Tip Lead—
Cat. No. 2055 \$ 2.75

Simpson 160 Handi-VOM[®]

Simpson Handi-VOM gives you the ranges, the time-saving conveniences and the sensitivity of a full-sized volt-ohm-milliammeter—yet it's only 3-5/16" wide, weighs a mere 12 ounces. Recessed range-selector switch never gets in the way . . . polarity-reversing switch saves fuss and fumble. Self-shielded taut band movement assures high repeatability and freedom from external magnetic fields. Diode overload protection prevents burn-out—permits safe operation by inexperienced employees and students. The demand is BIG, so get your order in to your electronic distributor, TODAY!

RANGES

ACCURACY: $\pm 3\%$ FS DC, $\pm 4\%$ FS AC
DC VOLTS: 0-0.25, 1.0, 2.5, 10, 50, 250,
500, 1000 (@ 20,000 Ω/v)
AC VOLTS: 0-2.5, 10, 50, 250, 500, 1000
(@ 5000 Ω/v)
DC MICROAMPERES: 0-50
DC MILLIAMPERES: 0-1, 10, 100, 500
DB: -20 to +10, -8 to +22, +6 to
+36, +20 to +50
"0" REFERENCE: 1 MW into 600 Ω
RESISTANCE: Rx1, Rx10, Rx100, Rx100,
Rx10K
(30 Ω center)



DIVISION



SIMPSON ELECTRIC COMPANY

5200 W. Kinzie Street, Chicago, Illinois 60644 • Phone: (312) 379-1121
Export Dept: 400 W. Madison Street, Chicago, Illinois 60606, Cable, Simelco
IN CANADA: Bach-Simpson Ltd., London, Ontario
IN INDIA: Ruttonsha-Simpson Private Ltd., International House, Bombay-Agra Road, Vikhroli, Bombay

Representatives in Principal Cities
... See Telephone Yellow Pages

WORLD'S LARGEST MANUFACTURER OF ELECTRONIC TEST EQUIPMENT

ON READER-SERVICE CARD CIRCLE 17

which pot... has infinite resolution?

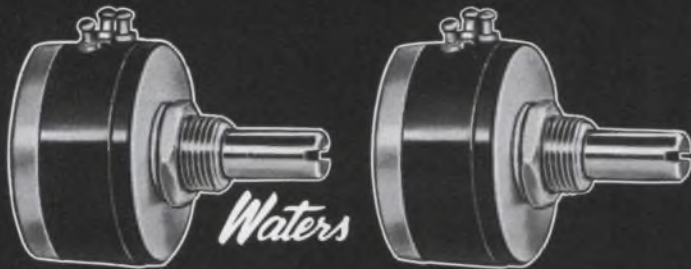

PT/112 SERIES POTENTIOMETERS

Alike as the proverbial peas in a pod, you'd need X-Ray vision to tell which of these potentiometer-twins can resolve to infinity.

But one of them does. And we turn this neat trick with the use of our own exclusive MystR[®] as the resistance element. Excellent stability and low noise levels are dividends.

The resistance element in its companion PT/112 is Waters continuous thermo-welded extruded wire winding.

The PT/112's make a pretty versatile pair of potentiometers for just about any of your ground-environment potentiometer applications. Perfectly matched, they can be ganged (up to 3 cups) in combination or separately. With Waters ball bearing bushings, the PT/112M (MystR[®]) has a rotational life in excess of 2,000,000 cycles.

You'll want the whole story on the PT/112 series. We'd like to send it to you.

NEED A PARTICULAR POT..?

If you have a worthwhile need for the potentiometer that doesn't exist . . . could be Waters has the engineering know-how to do something about it.



WATERS
MANUFACTURING INC.
WAYLAND, MASSACHUSETTS

EXPORT: Charles H. Reed, Export Director, Waters Manufacturing, Inc.,
Wayland, Mass. 01778 U. S. A.

NEWS

Rugged mirrors lift CO₂ laser's output

A multilayer film deposited on germanium makes almost lossless, rugged reflectors for CO₂ laser systems.

Philip Heinrich, president of Laser Optics, Inc., Danbury, Conn., where the new coating technique was developed, says that lasers that formerly delivered 100 watts now put out 150 to 170 with the new reflectors.

He declined to reveal the material of the film, except that it is an unusual one, and "competitors would not be able to analyze it readily."

Vacuum evaporation is used to deposit the film. He considers the control of the critical parameters during deposition the key factor in achieving the improved performance. His list of factors includes the temperature of the germanium substrate, the evaporation rate and the composition of the residual background gases.

"Our aim was to combine low loss with durability and stability in the reflectors," Heinrich says, "and we did it. The loss of the mirrors is about 0.3%, and they are waterproof, resist acids and tolerate wide temperature ranges—like from room temperature to 250°C and back in 15 seconds."

The technique is said to combine the two major advantages of conventional mirror coatings: the ruggedness of germanium and the low loss of NaCl and BaF₂. But in conventional designs, the losses of germanium hover around 2%, and NaCl and BaF₂ are water-soluble, so that on a humid day, the failure of an air-conditioner can be ruinous.

Encouraged by its success with the CO₂ laser, Laser Optics is working on a reflecting system for ruby lasers. As radar or range finders, ruby lasers should provide high pulse rates and high power levels, but the high energy densities and the resulting rapid temperature rise (several hundred °C in 10⁻⁶s) explode the available film systems. Heinrich's aim is to find materials for lasers that have up to 50 MW output power and 10 or more pulses per second. ■ ■

Integrated Circuit

SYLVANIA
Electronic Components Group

IDEAS

Sylvania's ceramic-pack ICs, for unexceeded reliability

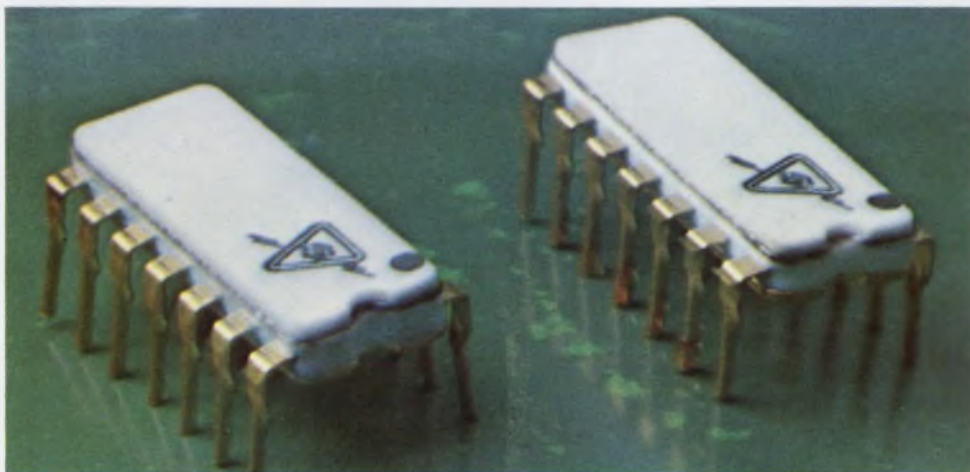

Ceramic-packaged SUHL ICs use fastest TTL logic available.

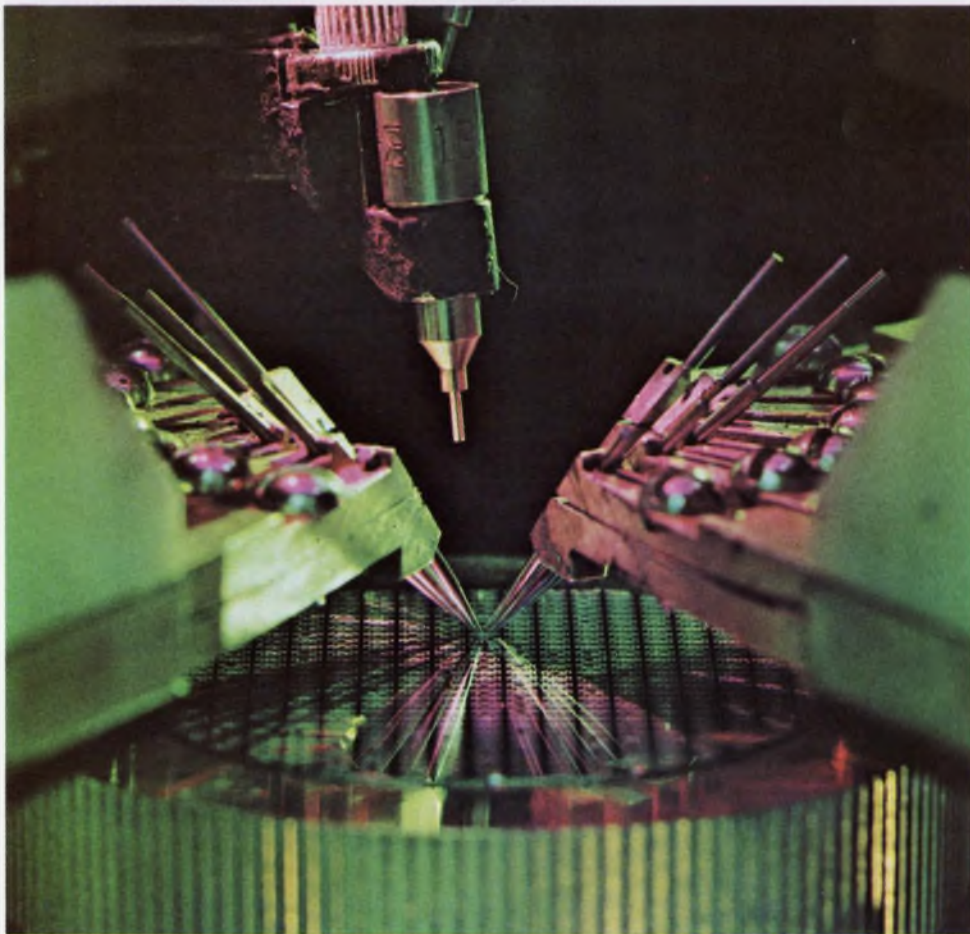

Mechanized wafer-level testing with this 14-point probe.

Sylvania's ceramic-packaged TTL integrated circuits provide greater reliability and higher performance levels.

Ceramic packaging offers the finest environmental protection for integrated circuits. Therefore, the ICs operate at peak design efficiency since the package insures that the circuits are never exposed to moisture or other performance degrading environments. Also, consistent reliable operation under varying temperatures is assured because all parts of Sylvania's package, including the IC chip, have matched temperature coefficients of expansion.

But reliable operation depends on more than an excellent package; a good logic approach, a properly designed semiconductor chip, precisely controlled manufacturing, proper testing, quality auditing and a continuous reliability improvement program assure high reliability.

All Sylvania integrated circuits

(Continued)

This issue in capsule

Power supply

You can customize performance by tailoring the supply voltage.

Flip-flops

How designers can implement just about any function calling for flip-flops.

SUHL I & SUHL II; Arrays

A guide to the industry's largest high-level TTL line: 48 functions, 380 types.

Who's MR. ATOMIC?

How Sylvania can assure the IC performance you want.

Interfacing problems

A simple way to overcome them.

I-Hz generator

You can build an accurate, but inexpensive one whose input is the power line frequency.

(Continued)

go through extensive testing during and after manufacturing. Once packaged, they are thermally and mechanically stressed, then tested for hermeticity. After a high-temperature stabilization period, they are ready to be tested for static and dynamic characteristics by "MR. ATOMIC", Sylvania's automatic IC tester.

Additional quality checks on each IC lot supplement the 100 percent testing program.

Typical of the continuing effort devoted to reliability improvement is an extensive wire bonding program just completed. The result was an improved ultrasonic bonding process. In the first tests of this new technique, over 1200 ICs were subjected to accelerated temperature cycling from -65°C to 200°C for 400 cycles. The result: out of 16,800 connections, only one bond on one circuit failed. That's high reliability!

CIRCLE NUMBER 300

You can customize SUHL performance by tailoring the supply voltage

Designers can't always use ICs at their rated supply voltage. Here's what you gain (and lose) when SUHL™ circuits are not operated at their nominal value.

SUHL integrated circuits by Sylvania provide maximum speed, highest noise immunity, greatest fan-out with a minimum of power. To accomplish this, a 5.0 volt nominal power supply is needed for proper drive to the outputs in the "0" state and for a high logic "1" for negative noise immunity.

SUHL devices are designed for power supply variations of $\pm 10\%$ retaining good circuit performance over the range of 4.5 to 5.5 volts.

Below 4.5 V the performance, speed and noise immunity are degraded, particularly at low temperatures. Supplies larger than 5.5 volts may be used with a resultant increase in speed and an increase in negative noise immunity, but this causes a disproportionate increase in power consumption. Supply voltages greater than 6.0 V are not recommended for normal operation. The increased power causes an internal temperature rise of about $0.3^{\circ}\text{C}/\text{mW}$ in free air. This temperature rise degrades the positive noise immunity about $4\text{mW}/^{\circ}\text{C}$, or $1.2\text{mV}/\text{mW}$. A higher power supply of 6.0 would normally have a tolerance of $\pm 10\%$ which would cause even greater degradation.

The degradation is not in the junctions or in reliability, but in a heating effect which restricts logical performance. This is the reason for the maximum

supply voltage rating of 8.0 V and a maximum operating supply voltage of 4.5 to 6.0 V. At 8.0 V, the circuits are not destroyed but probably won't operate logically.

The best results are obtained by keeping within the optimum design value for the power supply, 5.0 to 5.25 volts.

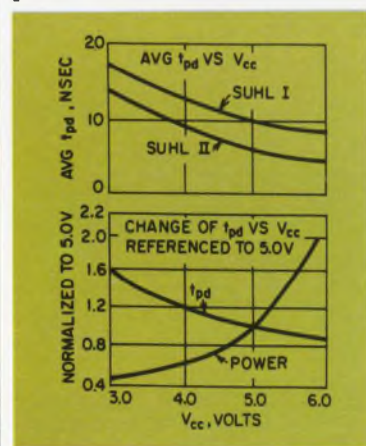

CIRCLE NUMBER 301

If the problem can be solved with flip-flops, Sylvania has the solution

What can designers do with Sylvania's line of TTL flip-flops? They can implement just about any circuit function calling for flip-flops.

Because Sylvania has the most flexible line of TTL flip-flops, designers are finding it easier to solve a host of circuit problems. They can choose from many flip-flop types—SR, two-phase SR, single-phase SRT, J-Ks with AND inputs, J-Ks with OR inputs, dual J-Ks with common or separate clocks. Frequency ratings for these units are as high as 50 MHz. All these flip-flops are available in military or industrial versions, packaged in the TO-85 flat pack or in Sylvania's dual-in-line plug-in pack.

Here are a few typical applications for SUHL™ flip-flops.

The lowest power approach to flip-flop register applications is offered by Sylvania's set-reset SF-10 series (Figure 1). The SF-10 units are useful for a variety of register applications where high speed word transfer is required. In the method illustrated in Figure 1, the reset line clears the central register and permits the clock line to transfer word information from the buffer register.

The SF-20 series of SR clocked flip-flops are particularly useful for application in dual rank or 2-phase systems or as half shift registers. Figure 2 gives the interconnections for a dual rank shift register.

How a synchronous binary counter can be implemented with the SF-30 series of single-phase SRT flip-flops is shown in Figure 3. The SF-30 devices are particularly useful in applications requiring a simple ac coupled flip-flop.

The advantages of multiple J and K inputs are seen in the synchronous binary counter of Figure 4 which uses only four SF-50 series J-K flip-flops. Because gating is internal, this circuit has no external gate delays and counts at 14 MHz. The counting rate can be upped to 38 MHz by using SF-200 flip-flops which otherwise display the same functional characteristics.

Figure 5 shows how OR input J-Ks can be used for parallel to serial conversion. The flip-flops are Sylvania's SF-60 series (14 MHz) or SF-210 (38MHz).

Dual J-Ks with separate clock input terminals for each flip-flop are used in the high-speed ripple-type binary counter of Figure 6. This configuration offers both minimum wiring and minimum package count.

You can choose 35 MHz (SF-100 series) or 50 MHz (SF-120 series) devices for this application. These same dual J-K devices are also excellent for systems where multiple J-K flip-flops are needed for separate, unrelated processing activities.

The way that the SF-110 (35 MHz) and SF-130 (50 MHz) dual J-Ks with a common clock can be used in a semi-ripple counter is seen in Figure 7. Decoding rate of this circuit is 25 MHz.

These are just a few of the circuit problems which can be solved effectively and efficiently with the wide range of flip-flops in completely compatible SUHL I and SUHL II.

CIRCLE NUMBER 302

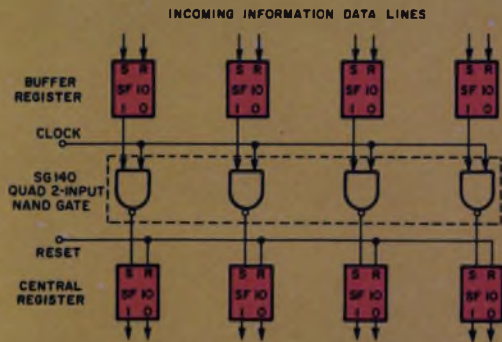

Fig. 1—Flip-flop register application.

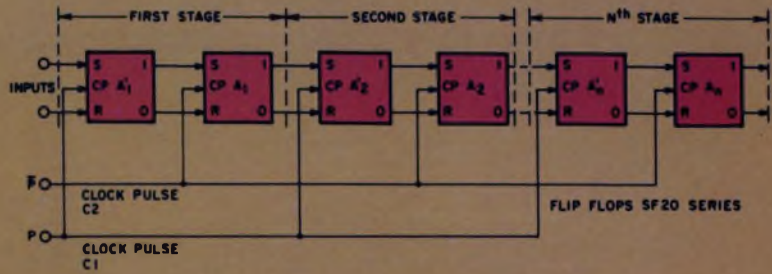

Fig. 2—Shift register—dual rank.

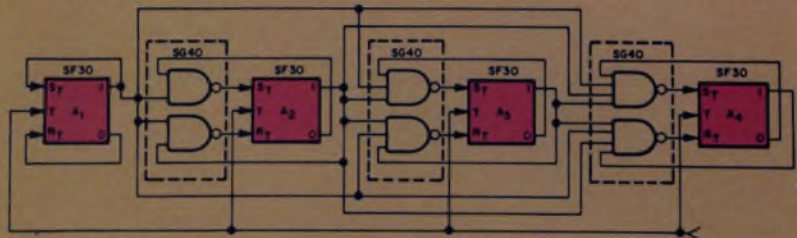

Fig. 3—Synchronous binary counter with SRT flip-flops.

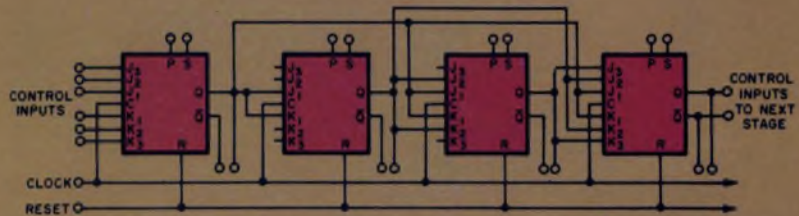

Fig. 4—Synchronous binary counter takes advantage of multiple J and K Inputs.

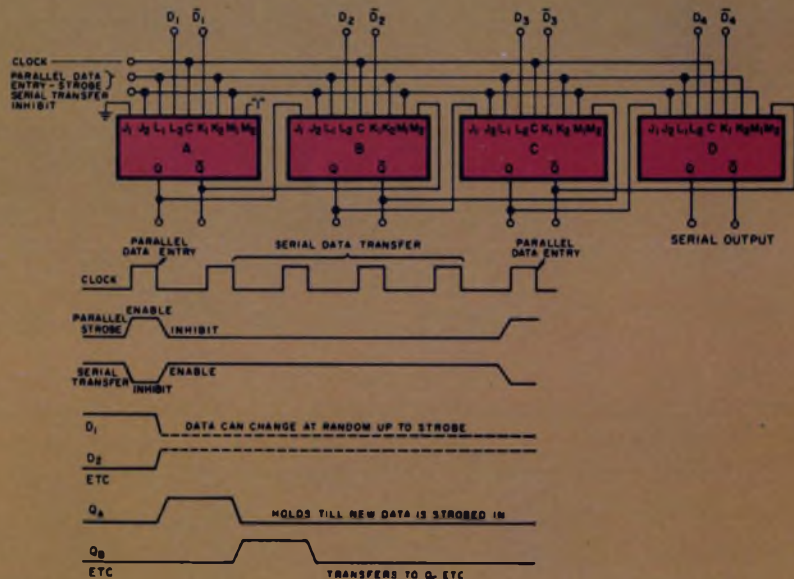

Fig. 5—In parallel to serial converter data is inserted through one set of 0Red inputs on each flip-flop.

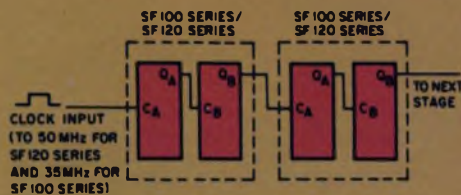

Fig. 6—High-speed ripple counter can be clocked at up to 50 MHz.

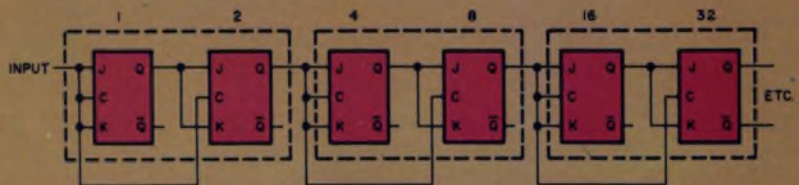

Fig. 7—Semi-ripple counter employs dual J-Ks with common clock.

380 circuit types in Industry's largest TTL line

SUHL I TYPICAL CHARACTERISTICS (+25°C, +5.0 Volts)										
Function	Type Nos.	t_{pd} (nsec)	Avg. Power (mw)	Noise Immunity +(volts)-		**Military (-55°C to +125°C) Prime FO Std. FO		**Industrial (0°C to +75°C) Prime FO Std. FO		
NAND/NOR Gates										
Dual 4-Input NAND/NOR Gate	SG-40, SG-41, SG-42, SG-43	10	15	1.1	1.5	15	7	12	6	
Single 8-Input NAND/NOR Gate	SG-60, SG-61, SG-62, SG-63	12	15	1.1	1.5	15	7	12	6	
Expandable Single 8-Input NAND/NOR Gate	SG-120, SG-121, SG-122, SG-123	18	15	1.1	1.5	15	7	12	6	
Dual 4-Input Line Driver	SG-130, SG-131, SG-132, SG-133	25	30	1.1	1.5	30	15	24	12	
Quad 2-Input NAND/NOR Gate	SG-140, SG-141, SG-142, SG-143	10	15	1.1	1.5	15	7	12	6	
Triple 2-Input Bus Driver	SG-160, SG-161, SG-162, SG-163	15	15	1.1	1.5	15	7	12	6	
Triple 3-Input NAND/NOR Gate	SG-180, SG-181, SG-182, SG-193	10	15	1.1	1.5	15	7	12	6	
AND-NOR Gates										
Expandable Quad 2-Input OR Gate	SG-50, SG-51, SG-52, SG-53	12	30	1.1	1.5	15	7	12	6	
Expandable Dual Output, Dual 2-Input OR Gate	SG-70, SG-71, SG-72, SG-73	12	20/gate	1.1	1.5	15	7	12	6	
Exclusive-OR with Complement	SG-90, SG-91, SG-92, SG-93	11	35	1.1	1.5	15	7	12	6	
Expandable Triple 3-Input OR Gate	SG-100, SG-101, SG-102, SG-103	12	25	1.1	1.5	15	7	12	6	
Expandable Dual 4-Input OR Gate	SG-110, SG-111, SG-112, SG-113	12	20	1.1	1.5	15	7	12	6	
Non-Inverting Gates										
Dual Pulse Shaper/Delay-AND Gate	SG-80, SG-81, SG-82, SG-83	11	30/gate	1.1	1.5	15	7	12	6	
Dual 4-Input AND/OR Gate	SG-280, SG-281, SG-282, SG-283	11	38/gate	1.0	1.5	10	5	8	4	
AND Expanders										
Dual 4-Input AND Expander	SG-180, SG-181, SG-182, SG-183	< 1	0.9/gate	1.1	1.5					
Dual 2 + 3 Input AND/OR Expander	SG-290, SG-291, SG-292, SG-293	7	15/gate	1.0	1.5					
OR Expanders										
Quad 2-Input OR Expander	SG-150, SG-151, SG-152, SG-153	4	20	1.1	1.5					
Dual 4-Input OR Expander	SG-170, SG-171, SG-172, SG-173	3	5	1.1	1.5					
Flip-Flops										
Set-Reset Flip-Flop	SF-10, SF-11, SF-12, SF-13	20MHz*	30	1.1	1.5	15	7	12	6	
Two Phase SR Clocked Flip-Flop	SF-20, SF-21, SF-22, SF-23	20MHz*	30	1.1	1.5	15	7	12	6	
Single Phase SRT Flip-Flop	SF-30, SF-31, SF-32, SF-33	15MHz*	30	1.1	1.5	15	7	12	6	
J-K Flip-Flop (AND Inputs)	SF-50, SF-51, SF-52, SF-53	20MHz*	50	1.1	1.5	15	7	12	6	
J-K Flip-Flop (OR Inputs)	SF-60, SF-61, SF-62, SF-63	20MHz*	55	1.1	1.5	15	7	12	6	
Dual 35MHz J-K Flip-Flop (Separate Clock)	SF-100, SF-101, SF-102, SF-103	35MHz*	55/FF	1.0	1.5	11	6	9	5	
Dual 35MHz J-K Flip-Flop (Common Clock)	SF-110, SF-111, SF-112, SF-113	35MHz*	55/FF	1.0	1.5	11	6	9	5	

FUNCTIONAL ARRAYS, TYPICAL CHARACTERISTICS (+25°C, +5.0 Volts)										
Function	Type Nos.	t_{pd} (nsec)	Avg. Power (mw)	Noise Immunity +(volts)-		**Military (-55°C to +125°C) Prime FO Std. FO		**Industrial (0°C to +75°C) Prime FO Std. FO		
Full Adder	SM-10, SM-11, SM-12, SM-13	sum 22 carry 10	90	1.0	1.0	20	10	20	10	
Dependent Carry Fast Adder	SM-20, SM-21, SM-22, SM-23	sum 22 carry 10	125	1.0	1.0	20	10	20	10	
Independent Carry Fast Adder	SM-30, SM-31, SM-32, SM-33	sum 22 carry 10	125	1.0	1.0	20	10	20	10	
Carry Decoder	SM-40, SM-41, SM-42, SM-43	2	25	1.0	1.0					
Decade Frequency Divider	SM-50, SM-52	30 MHz	120	1.0	1.0	15		15		
Four Bit Storage Register Bus Transfer Output	SM-60, SM-61, SM-62, SM-63	t_{pd}	30/bit	1.0	1.0	20	10	20	10	
Four Bit Storage Register Cascade Pullup Output	SM-70, SM-71, SM-72, SM-73	20	30/bit	1.0	1.0	20	10	20	10	
16-Bit Scratch Pad Memory	SM-80, SM-81, SM-82, SM-83	25	250	1.0	1.0	40	20	40	10	

*Minimum toggle frequency **Minimum fan-out CIRCLE NUMBER 303

The performance you ask for, assured by MR. ATOMIC

IC users expect to get the performance they specify. This means every IC made by Sylvania undergoes extensive dynamic testing before delivery.

At Sylvania, a unique IC tester called MR. ATOMIC permits comprehensive and accurate testing of every integrated circuit produced, and it does this with complete assurance that each individual test has been precisely performed. Hence, all possibility of human error has been eliminated.

MR. ATOMIC (Multiple Rapid Automatic Test Of Monolithic Integrated Circuits) includes four temperature controlled dc test chambers, one each for +75°C, 0°C, +125°C, and -55°C, as well as a 25°C switching station. This tester features automatic mechanical feed and precise control by a digital process computer and magnetic drum memory.

Prior to testing, individual circuits in special plastic pallets are stack-loaded into MR. ATOMIC'S dispensing rack, which automatically dispenses a new circuit to the tester every two seconds. As each IC enters the first control chamber (75°C ambient temperature), it is automatically inserted into a large rotary holding device which moves the circuit to the test position. Holder and chamber are designed to insure that the time required for the IC to travel the 180 degrees to the test position is such that the entire device (chip, case and junction) has stabilized at the test temperature.

The test probe block for the IC package is arranged so that two probes make contact with each lead on the package. One probe performs the actual testing; the other is a sensing probe which allows MR. ATOMIC to determine that electrical contact has indeed been established with each lead. Any IC failing the contact



Fifth testing station tests 30 switching parameters at 25°C.

sensing test at any test station is automatically sorted into a special bin for retesting.

Once electrical contact has been verified for all 14 leads, up to 100 parameters are checked at the rate of 17 milliseconds

per test. The result of each test is stored in the computer memory for use in final circuit sorting.

After the first chamber tests are completed, each IC is fed automatically to the second, third and fourth chambers where it is tested at 0°C, +125°C, and -55°C respectively. Again, the result of each test at each temperature is stored in the computer memory.

After completion of the dc tests, the IC moves to the fifth test station where dynamic switching tests are performed at 25°C. Here, as in dc testing, the integrated circuit is "worst case" tested for switching performance. Rise time (t_r), fall time (t_f), turn on delay (t_{on}), and turn off delay (t_{off}) are verified to the specification for each IC.

In this test, each input is individually checked through its appropriate gate structure for all parameters. Each input is verified; i.e., it is more than testing just one input of a multiple input gate and then assuming that all other inputs will function identically.

After each integrated circuit emerges from the switching test station, the complete history of that integrated circuit's electrical performance, stored in the computer memory, is reviewed and a decision made on sorting it. The package then is automatically placed into one of 20 sort bins where it is stored for packaging for shipment.

CIRCLE NUMBER 304

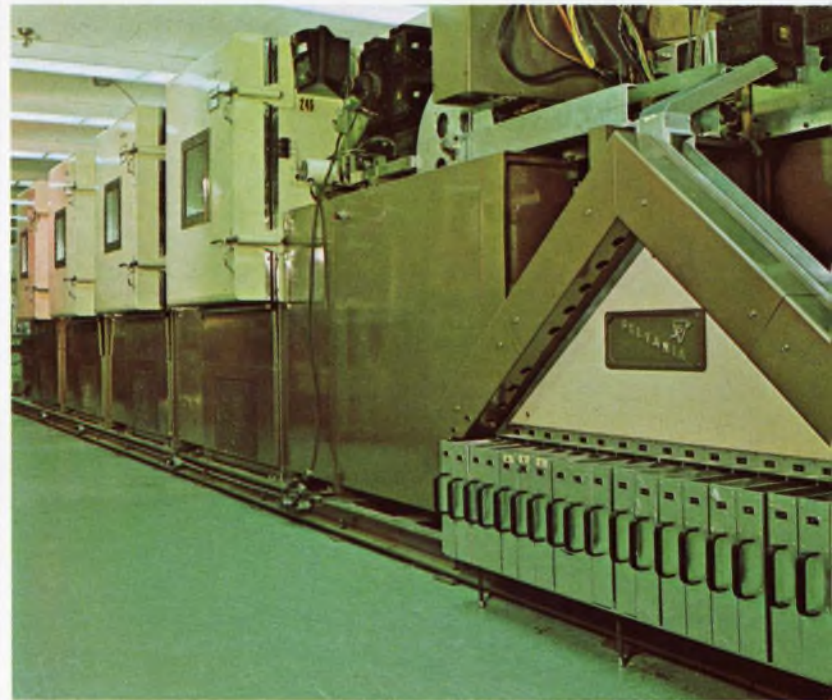

MR. ATOMIC tests each Sylvania IC in four temperature-controlled chambers.

You can overcome IC interface problems this simple way

There's no need to give up the superior performance of SUHL™ circuits due to logic interface problems. Simple circuits overcome most of these problems.

Often, system requirements make it necessary to interface SUHL devices with other types of logic or other types of circuit functions. This is easily done.

One technique for interfacing SUHL circuits with RTL or other logics with similar restrictions is shown

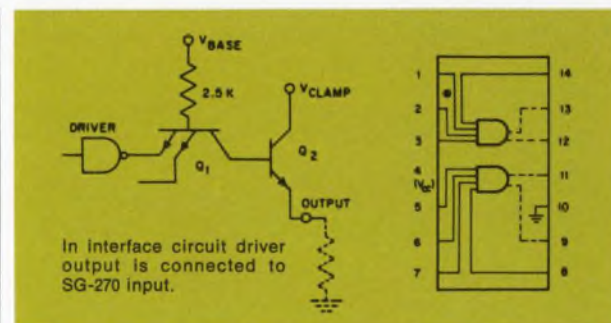

in the Figure. Here, the driving gate (or gates) is connected to the input of an SG-270 dual 4-input OR expander.

When the driver output is at logic "0", Q₂ is OFF and the output is at logic "0" (or ground). As the

(Continued)

driver gate output goes to logic "1" (3.2V), the emitter of Q_2 follows. When the input of Q_1 gets to $V_{\text{clamp}} + V_{\text{BE}}$ of Q_2 , the collector-base and base-emitter of Q_2 become forward biased and the output is essentially V_{clamp} . Further increases in the input have no effect on the output emitter of Q_2 .

Impedance of the load determines the current in Q_2 . This current should be no greater than 10 mA, as the transistor is designed to operate at a nominal value of about 5 mA.

To get sufficient drive at the base of Q_2 , the current through the base resistor of Q_1 should be calculated

for a beta of 5 for the temperature range of -55°C to $+125^\circ\text{C}$, or a beta of 8 for 0°C to $+75^\circ\text{C}$.

Base drive can be adjusted by the V_{base} supply. For 1 mA drive to the base of Q_2 :

$$V_{\text{base}} = V_{\text{clamp}} + 2 V_{\text{BE}} + (2.5 \text{ K}\Omega \times 1 \text{ mA})$$

$$\text{or, } V_{\text{base}} = V_{\text{clamp}} + 2 V_{\text{BE}} + 2.5 \text{ V}$$

Since the voltage on the load will be V_{clamp} and the input must rise to $V_{\text{clamp}} + V_{\text{BE}}$, the maximum clamp voltage using a 5-V supply would be 2.5 volts. When higher clamp voltages are desired, a resistor is tied from the driver gate output to the B^+ supply.

CIRCLE NUMBER 305

An accurate 1-Hz generator doesn't need to be expensive

Here's how to build an inexpensive 1-Hz generator with an accuracy of better than 0.1% and which uses the power line frequency as its input.

A 1-Hz generator can be made with four Sylvania ICs: one SM-50 decade frequency divider and three SF-50 J-K flip-flops. The circuit uses the 60-Hertz line frequency as a P.R.R. control. Since power companies hold the power line frequency between 59.95 and 60.02 Hertz, this results in an accuracy of better than 0.1%.

In the circuit (Figure 1) the 60-Hertz line frequency is fed into the SM-50 and divided by ten. The resulting 6-Hz signal is put into three SF-50s connected in a synchronous divide-by-six configuration, giving an output of 1 pulse per second.

Because there is an emitter-follower on the SM-50 chip, the 60-Hertz sine wave can be fed directly into the SM-50. Output of the emitter-follower, which is essentially a rectified half-sine wave, serves as the

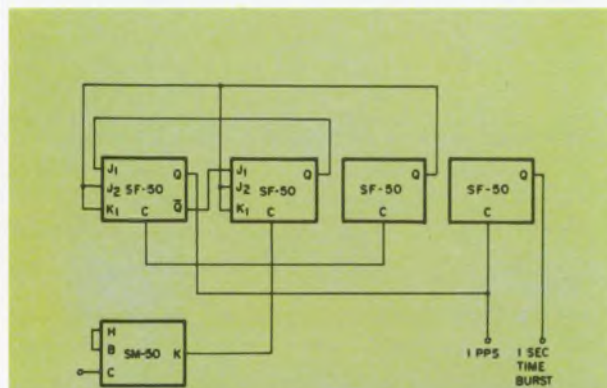

Fig. 1—Simple, accurate 1-Hertz generator using SUHL ICs.

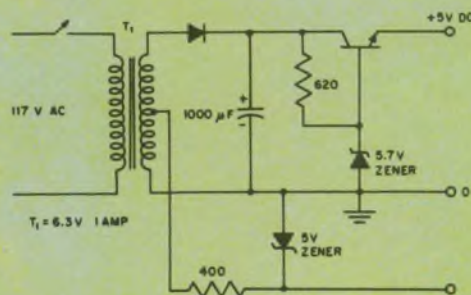
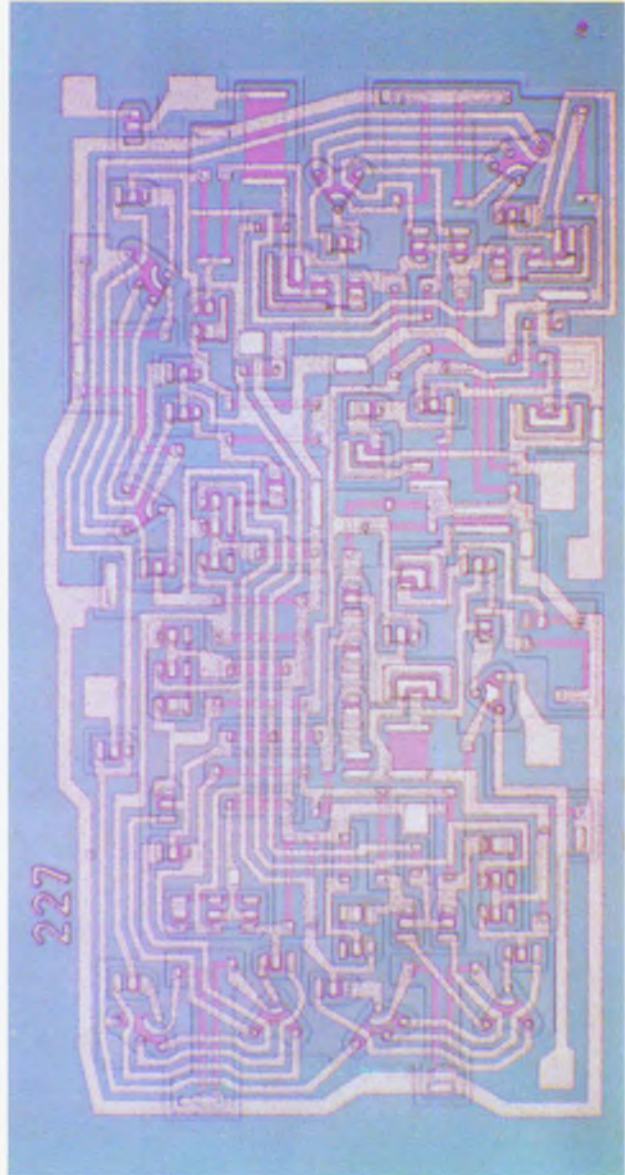

Fig. 2—Power source for low-frequency generator.



SM-50, Decade Frequency Divider

input to the divide-by-ten circuit. The output of the SM-50 is compatible with the circuits in the SF-50 and with the other devices in the SUHL family.

When a one second time burst is desired, output of the divide-by-sixty goes into another SF-50. This produces an output voltage which will be ON for one second and OFF for one second.

With proper gating, the basic circuit can be used to make an accurate timer. The time-burst configuration can be used to open and close a gate to a counter so that accurate counts per second can be made, such as is used in frequency counting.

Figure 2 gives the details of a simple power supply to power this 1-Hz generator circuit.

CIRCLE NUMBER 306

How to error-check with SUHL NAND/NOR gates

When processing binary data, it's important that errors be immediately detected. The practical way to detect such errors is to use IC gates for parity checking.

Parity checking can insure that errors do not creep into information being processed in a computer or being transferred from a computer to other equipment. Essentially an error detection method, parity checking is based on checking the total number of 1s present in a computer word at various stages within the computer or after data is transferred. This is done by including an extra binary digit (parity bit) in the word so that the total number of 1s in the computer word (including the parity bit) is always odd or always even.

If a system uses ODD parity checking, then an error is indicated any time there is a single error or an odd number of errors in a computer word. In Figure 1, Row 1 shows an 8-bit word having ODD parity, there are five 1s. In Row 2, there is a change of one bit (the 8th bit went from "1" to "0"). Now there is an even number of 1s and an error signal would be produced by the ODD parity checker. Row 3 has an odd number of errors (bit positions 8, 6, & 5) are different from the original word). In this case, an error signal would be produced by the ODD parity checker because, again, there is an even number of 1s.

	8	7	6	5	4	3	2	1
1. Original word	1	1	0	0	1	0	1	1
2. Single error	0	1	0	0	1	0	1	1
3. ODD # of errors	0	1	1	1	1	0	1	1

Fig. 1—Eight-bit data word showing parity checks.

In a similar manner, in an EVEN parity checker the total number of 1s in a computer word (including the parity bit) is always EVEN. Thus, EVEN parity is the complement of ODD parity.

How parity checking is implemented with SUHL devices is shown in Figures 2 & 3. Figure 2 shows the ease of implementing ODD/EVEN parity checking with only 1 1/4 SG-140 packages for 2 bits. Each SG-140 has four 2-input NAND/NOR gates. With the units shown, the typical propagation delay for EVEN parity is 36 nsec; for ODD parity, 48 nsec.

An 8-bit binary ODD/EVEN parity checker consisting of 7 1/4 SG-140 packages is outlined in Figure 3. An advantage of this method is that only the uncomplemented inputs are necessary, and wiring interconnects are straight forward and repetitive.

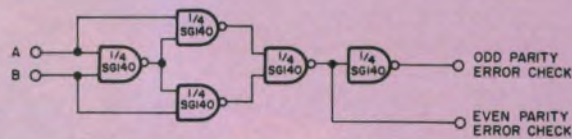

Fig. 2—ODD/EVEN parity checking for two bits.

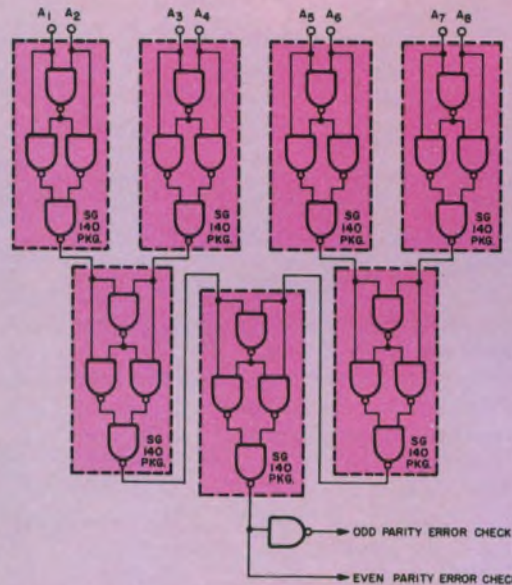
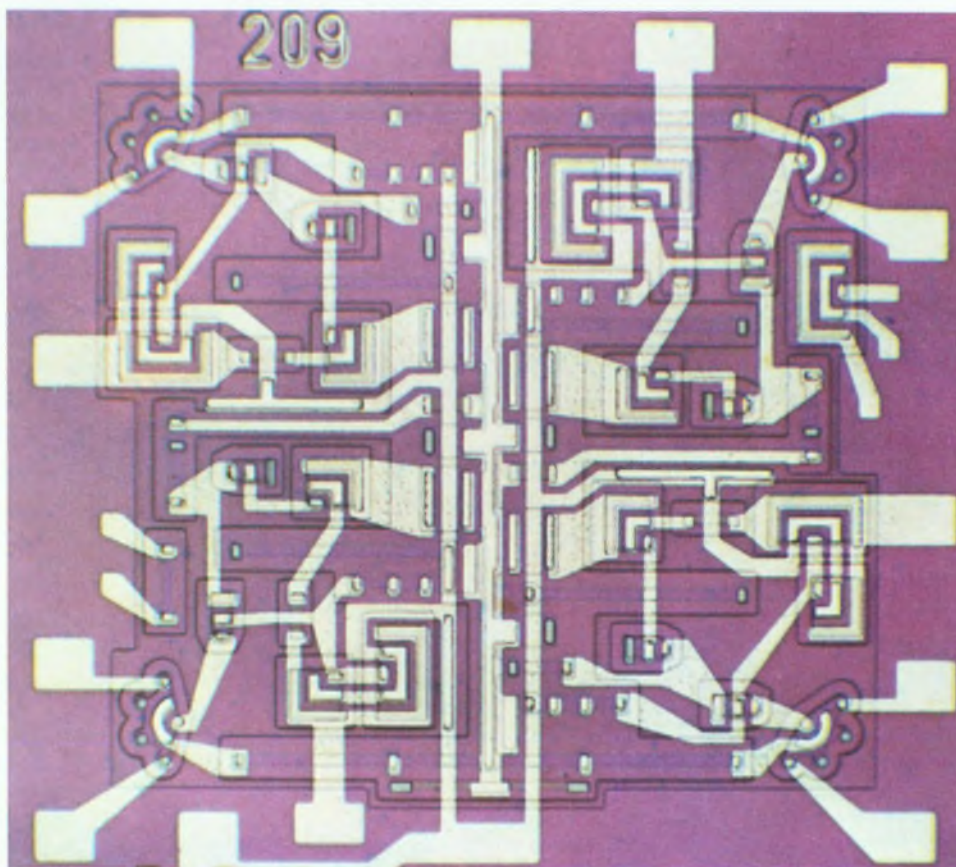

Fig. 3—Parity checking for 8-bit binary word which includes the parity bit.



SG-140, Quad 2-Input NAND/NOR Gate

Good specification sheets can both simplify and maximize IC utilization

You're cheating yourself if you're using inadequately specified integrated circuits.

Let's take a closer look at the problem. First of all, say that an IC spec sheet's purpose in life is to transmit technical information about a particular circuit to all parties who will be involved in its usage and application.

Next, add to this basic description certain other essentials:

- It must be readable, i.e., well organized and written in the simplest appropriate style.**
- It must be easy to understand, i.e., all technical data presented in an orderly manner, with all information in logical groups.**
- It should provide the greatest number of guarantees over the broadest range of practical considerations, i.e., give realistic results of product tests. By keeping within practical limits, the user may be assured of the results as stated on the sheet.**

While the specification sheet should be descriptive, the description is of the greatest practical benefit to the user when it relates to and assists in the actual use of the circuit in a system. A specification can be quite elaborate, yet be unrelated to the end application.

The specification sheet will provide the packaging engineer with package dimensions, thermal characteristics, conductivity, orientation. It provides the logic designer a description of the logical operation and rules for applying that particular logic element. Application notes also give ideas on optimizing logic capability.

The specification provides all details on the circuit and pertinent standards. For component engineers the sheet offers a description of the circuit, its opera-

tion and parameters—as well as information on how these parameters are effected by pertinent conditions (capacitance, frequency and temperature).

The actual "specification of electrical characteristics" portion of the spec sheet is generally the most difficult portion for the manufacturer to provide. Often it gets the greatest amount of his consideration, and also the user's. It's here that parameter limits and conditions of measurement are specified.

Parameters, limits, and conditions must be derived from:

- Circuit analysis and calculations**
- Product distribution**
- Application or system requirements**

A good specification is a combination of these criteria. All are valid and necessary and effect the acceptability of the product, either by limiting its usefulness or its cost. The electrical specification should be developed under conditions that duplicate those of the circuit's eventual application.

Sylvania integrated circuits specifications combine all these criteria to provide well defined circuit input, output, and transfer characteristics which are directly translatable into system parameters and design rules. Parameters are not only specified over the temperature range, but are verified by actual testing at specified temperatures before shipment.

To make it easier to use the product and maximize the utility of the circuits, all Sylvania specifications provide circuit and logic diagrams plus a description of the circuit function and its operation. In addition, to assist you in using the circuits under conditions other than those specified, (data such as typical characteristics vs. temperature, power supply, loading, etc.) are specified. Our specification sheet also assists in system design by giving applications ideas which we feel highlight the circuit's special capabilities.

SUHL circuits make system design easy, and SUHL specification sheets make it easy to use SUHL.



JOHN RIENZO

SYLVANIA
SUBSIDIARY OF
GENERAL TELEPHONE & ELECTRONICS GTE

This information in Sylvania Ideas is furnished without assuming any obligations.

NEW CAPABILITIES IN: ELECTRONIC TUBES • SEMICONDUCTORS • MICROWAVE DEVICES • SPECIAL COMPONENTS • DISPLAY DEVICES

Need IC information in a hurry?

You can get full information on any integrated circuit or application shown in this special issue of Sylvania IDEAS.

The quickest way is to drop us a line at the address shown here. Be sure to give us your name, title, company, address, and tell us the names of the products on which you'd like

to receive more information. And if you have a particular design problem, just let us know. We'll rush you full particulars. Please write to:

Dept. No. B 5 5 5
 Sylvania Electronic Components Group
 1100 Main Street
 Buffalo, New York 14209

You can also get information using the publication's card elsewhere in this issue.

Indicate the items you're most interested in and circle the appropriate reader service numbers.



TWO-SLIT SPOT ANALYZER

FOR DETERMINATION OF CRT SPOT CHARACTERISTICS

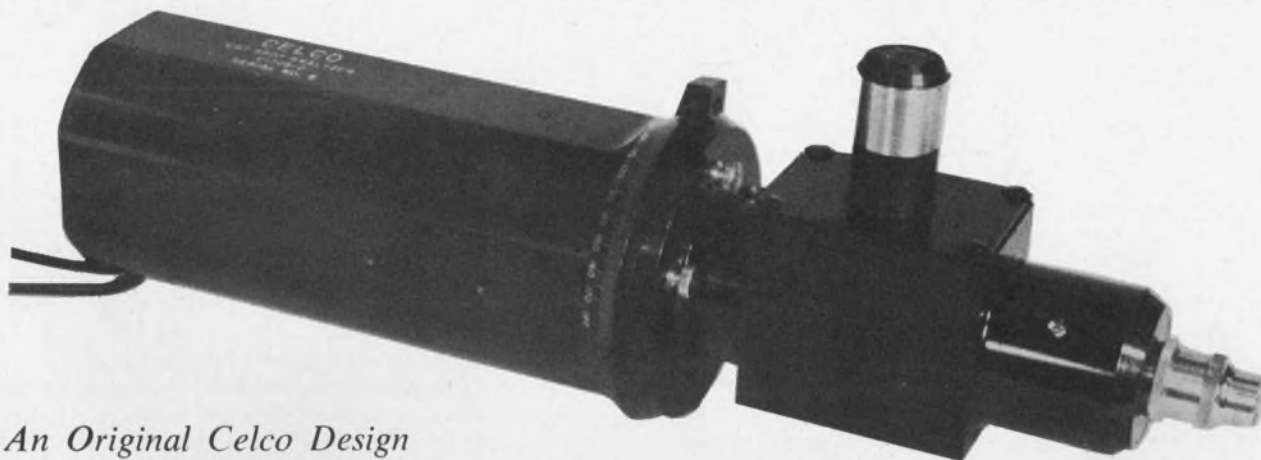

An Original Celco Design

SPOT MEASUREMENTS ON 5" HIGH RESOLUTION CRT

Spot Diameter at 2" to Left of Center

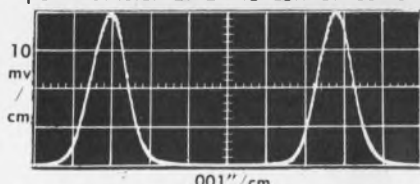

Half Amplitude Spot Diameter = .001"

Phosphor or Face Noise

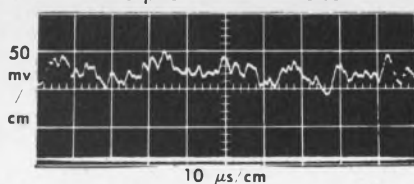

Contrast Ratio Bar Chart

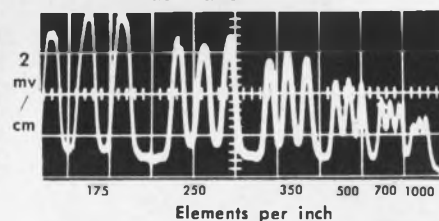

- SPOT SIZE AND PHOSPHOR NOISE
- GAUSSIAN SPOT — HALF AMPLITUDE POINTS
- SPATIAL FREQUENCY DISTRIBUTION
- MODIFIED LINE WIDTH — SINGLE SLIT
- SINE WAVE RESPONSE
- ABBERATION MEASUREMENT
- CONTRAST RATIO METHOD
- LINEARITY DETERMINATION

The CELCO Two-Slit Spot Analyzer is a complete system for measuring spot characteristics on the face of high resolution Cathode Ray Tubes under dynamic conditions and without the customary dependence on operator decisions. This device, calibrated in our laboratories, enables the user to make spot size measurements using a standard oscilloscope for the read-out of half amplitude points or other resolution references.

The Analyzer lens systems focuses the CRT spot on a pair of slits mounted in the goniometer and the unmodulated spot is scanned across the calibrated slits. Variations in light output are picked up by the photo-multiplier and this output fed to an oscillo-

scope. A pair of Gaussian distribution curves are presented on the face of the scope using an appropriate time base as determined by the analyzer calibration. The slits may be rotated to examine the spot for astigmatism or other aberrations.

Spot sizes of .0002" to .020" can be measured using various lenses, slits and bar charts.

This versatile instrument has become an invaluable aid in research and development as well as in production testing and inspection of CRT's. Phosphor research, phosphor characteristics and other photoelectric measurements may be carried out. Ask our engineering staff for full details.



Constantine Engineering Laboratories Company

MAHWAH, N. J.
201-327-1123
TWX 201-327-1435

UPLAND, CAL.
714-982-0215
TWX 714-556-9550

ON READER-SERVICE CARD CIRCLE 19



Philbrick

Probing the mind's 'computer'

Medical scientists seek to modify behavior by planting permanent microcircuit stimulators in the brain.

Richard N. Einhorn
News Editor

At hospitals and medical schools across the United States, scientists are using electrical impulses to gain new insights into that most marvelous of all computers, the human brain. Through electrical stimulation they are laying bare the fears, the motivations, the social adjustments and the learning processes.

This work with humans has been going on for 15 years, and micro-miniaturization, integrated circuitry, telemetry and other electronic advances promise to help accelerate it. New types of power supplies are urgently needed.

Thus far the work with humans has been with the ill—epileptics, Parkinson's disease sufferers, persons seeking relief from intractable pain and, in some cases, schizophrenics and other psychotics. Using electrode implants in the brain as a diagnostic tool, neurosurgeons have evoked in patients sensations of pleasure or pain, recall of long-forgotten experiences, and hallucinations, depending on how the electrodes were positioned.

One neurosurgeon recounts: "A patient even reached out from the operating table to catch the flitting butterfly created in his brain by the play of electrons."

All of the work so far has been in the realm of diagnosis and research. No cures have resulted from electrical stimulation of the brain, though that is the ultimate goal of clinicians. The most promising results to date have been the temporary relief of pain and the control of involuntary movements for a while.

The research, the progress, make many people uneasy. They accept the necessity of implanting electronic cardiac pacemakers, and they know that scientists are working on artificial organs, but the brain is

something else again. Every sensation, every emotion, every concrete or abstract thought, every artistic impulse that man experiences depends upon the workings of his brain.

Like atomic energy, it raises a spate of ethical questions: Have the doctors the right to evoke artificial responses in people they are treating? Is nothing sacrosanct? Will the biomedical engineer become the liberator or the unwitting jailer of humanity?

Yet the work was bound to happen. Experimental work with animals had been going on fairly quietly for nearly a century. With their fine electrical pointers inserted in the depths of the brain, neurophysiologists (specialists in the mechanisms of the nervous system) have discovered such specialized structures as pain and pleasure centers, memory banks, automatic regulators of blood pressure, respiration and the flow of digestive juices, and many other bodily functions most people never even stop to think about. In one series of experiments each eye of a monkey reacted differently to light of the same intensity (see cover photo).

At a session of this spring's IEEE International Convention in New York, Prof. José M. R. Delgado of the Yale University School of Medicine called upon the electronic designer to add his skills to the interdisciplinary research on the brain. He described his own work and that of others and mentioned some of the limitations in present equipment: awkward hard-wire connections to the brain, bulky electronics, the inadequacy of present batteries.

Dr. Delgado predicted that micro-miniaturization and integrated circuit technology would soon make possible a stimulator "small enough to be implanted as a button in the skull, completely underneath the

skin." It would operate without batteries, avoiding both toxic reactions and the need for surgery to replace them. The device would both receive and transmit electrical information over a telemetry link: stimulating waveforms with exactly controllable parameters in, EEG (electroencephalographic) signals out.

This stimulator would be a boon both to scientific investigation of the animal brain and to the art of diagnosing and treating human ills.

For legal and moral reasons, experiments purely for the sake of knowledge are not performed on humans. However, starting about 1952, neurosurgeons began to apply some of the experience gained with animals to hospital patients. They used implanted electrodes to pinpoint sites in the brain where epileptic seizures took place. Once this was determined, only the bare minimum of tissue was destroyed by surgery to eliminate the seizures.

Telemetry link sought

Early this spring Dr. Delgado visited Prof. Wen H. Ko, director of the Microelectronic Laboratory for Biomedical Sciences at the Case Institute of Technology in Cleveland. The neurophysiologist and the electronics expert had at least one interest in common—the telemetry of biological information.

Dr. Delgado had a problem, and he stated it something like this: "I want a completely encapsulated signal generator the size of an aspirin tablet. It must be batteryless, yet draw its power without leads that pierce the skin."

As the Yale professor spoke, Ko listened intently. He was used to being asked for state-of-the-art information on medical electronics.

Dr. Delgado continued: "My system must be activated by a telemetry link, you know."



Electrical pulse to inhibitory center in brain causes monkey to lose interest in fruit it contemplates so fondly.



Radio-controlled stimulator weighs 28 grams, consumes 1.2 mA and operates at 100 MHz. Leads run to electrodes.



Monitoring signals from the brain is valuable with or without stimulation. Here monkey undergoes EEG reading.

(**brain stimulation, continued**)

But there was more, much more, to his problem. Every pulse had to be exactly controllable in current amplitude, polarity, duration and frequency. The intended application: electrical stimulation of the brains of monkeys in a large cage or in a large outdoor compound.

"Do you think this is feasible?" Dr. Delgado asked.

Ko told him, in effect: "Engineering-wise, everything can be done, but not right away."

In a recent interview, the Case professor explained his reply.

"The design of a pulse generator the size of an aspirin tablet has been accomplished—for example, at our laboratory," he told *ELECTRONIC DESIGN*.

As for powering the brain stimulator without batteries or external leads, Ko noted: "At Tokyo in 1965, I discussed some of my results on the radio pulsing of power to implants. At Case we have transmitted about 50 mW maximum over half an inch in muscle, using a coil about an inch in diameter.

"Another way of powering it might be to implant biological power sources, such as piezoelectric crystals, in body cavities. However, these are a long way off, because

there are still many problems to be solved."

As for the telemetry link:

"There are many ways you can telemeter medical information," Ko said. "If you are interested in EEG signals from the brain, first you transmit from the brain to the outside. Then you use a relay transmitter hanging on the animal's collar. You can transmit a few miles rather easily that way.

"To send brain-stimulation signals to the animal, you modulate a transmitter with the pulses. You use a simple, short antenna on the animal and load the antenna. The receiver can be small, and you can use batteries with that."

Ko concluded:

"All the pieces exist, or at least have been proven feasible, but no one has engineered them into a system."

Major design objectives

The design objectives for an implantable telestimulation system would depend on the end use: animal experiments or clinical work with humans. For example, a neurosurgeon could remove just enough bone from the skull of a sufferer from intractable pain to permit the insertion of a "button." Emanating from the button would be an RF pickup coil placed under the skin.

A precise transport mechanism clamped to the skull would settle the electrodes accurately within a fraction of a millimeter.

Ironically, the brain, the master receptor of every sensation from a stubbed toe to a maiden's blush, itself feels no pain. Nor does drilling through the bone occasion much discomfort. Once implanted, the electrodes can be left in place for years without ill effect. The surgeon merely pulls the scalp flap back over the implant, so the skin can heal. Eventually there is no way of telling from the appearance of the head that a delicate brain operation was performed.

A few days after button-implant surgery, the doctors would wheel up a console containing a pulse generator and a transmitter. Activation of preselected electrodes would send dribbles of current into the brain to give remission from pain, perhaps for a few hours. It is much less drastic than cutting nerve endings.

Further microminiaturization might permit a Parkinson's disease victim, for example, to control tremors of his arms and legs with pushbuttons on a portable device attached to his belt. He could thus remain out of the hospital for long periods. The only maintenance required would be replacement of the batteries in his belt pack.

With experimental monkeys in an

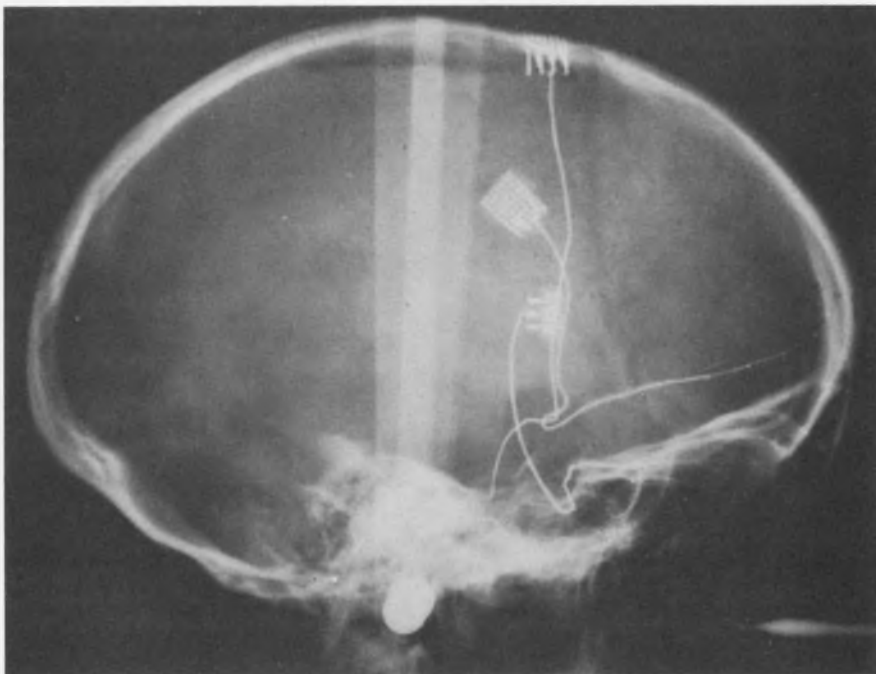

Electrodes implanted in human brain are shown in lateral X-ray photograph (from Mahl et al., *Psychosomatic Medicine*, No. 26 (1964), p. 340; reprinted by permission of Hoeber Medical Division, Harper & Row).

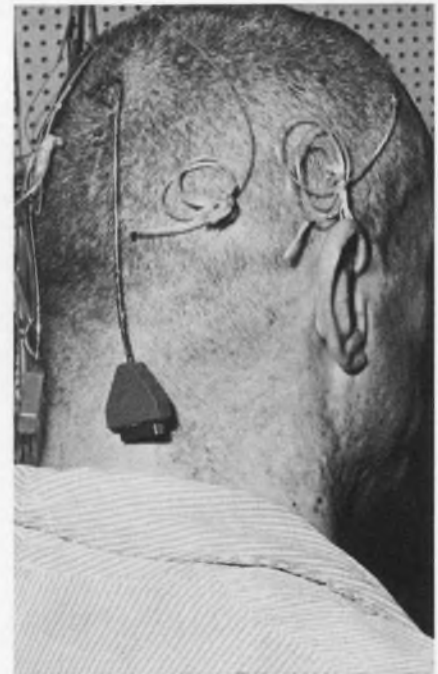

Hospital brain stimulator mates with connectors protruding from scalp to pinpoint sites of abnormalities.

outdoor colony, however, the engineering criteria are entirely different. Here the idea is to observe animals in a social setting and to attempt to modify their behavior.

With humans who are in the hospital for treatment, the control console is close by; with monkeys, it may be a quarter of a mile away. The monkey experiments require a telemetry link.

Engineering problems apparent

There is much for the engineer to know before he attempts to design an electrical brain-stimulating system. Any material implanted in the body must be nontoxic and essentially nonreactive with body fluids. Thus the stimulator must be encapsulated in a biologically acceptable plastic. The electrodes are generally fashioned from stainless steel. All but the tips are insulated with Teflon or nylon, although in clinical work it is not uncommon to deliberately strip away patches of insulation, so that each electrode has several points of stimulation.

Form factor, too, is important. The implanted device must not chafe or compress parts of the body. Once in place, it must be secured. Dr. Delgado has suggested screwing or cementing his button to the skull. Teflon or nylon screws might be used, since they are nontoxic; the same would have to be true of any bonding agent.

And, naturally, the implanted device must be built to last forever. The mere notion of mean-time-between-failures is unthinkable.

Weight is not a great problem with humans, particularly if everything possible is microminiaturized. However, for a 10-pound rhesus monkey, the implant should weigh a few grams, the entire animal-borne equipment a few ounces.

If the implanted stimulator is imbedded in the skull, there are constraints upon the size. Monkey skulls are about a quarter to a half inch thick, and the smaller figure should be used as the design goal if the device is not to put pressure on the brain.

Recently the rhesus monkey has become the preferred animal for brain stimulation experiments, because it more closely resembles the human in intelligence, mannerisms and structure than either the dog or

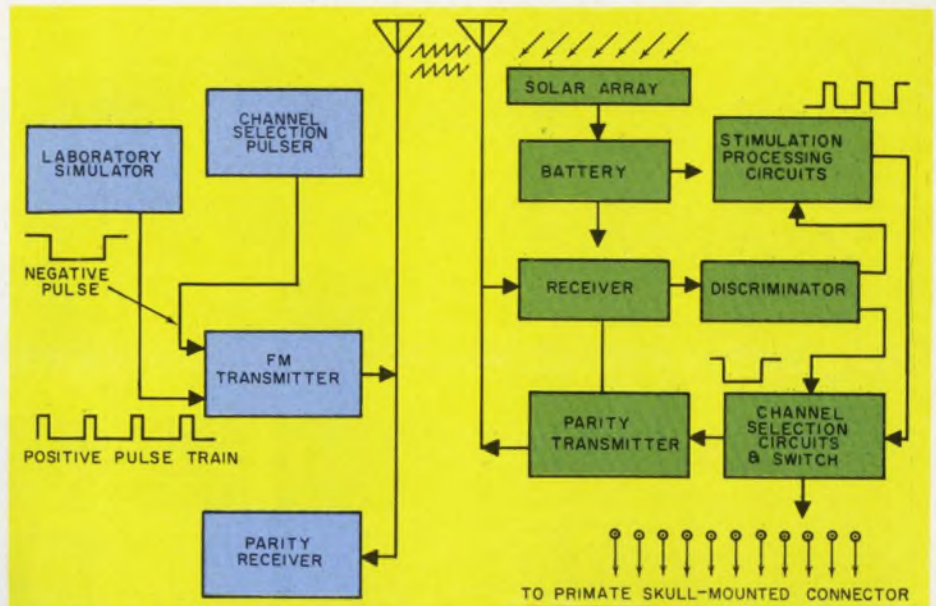

1. General Electric Mark II telestimulator permits remote stimulation of more than one monkey in outdoor primate colony. Miniaturized switch steps output pulses through 11 electrodes.

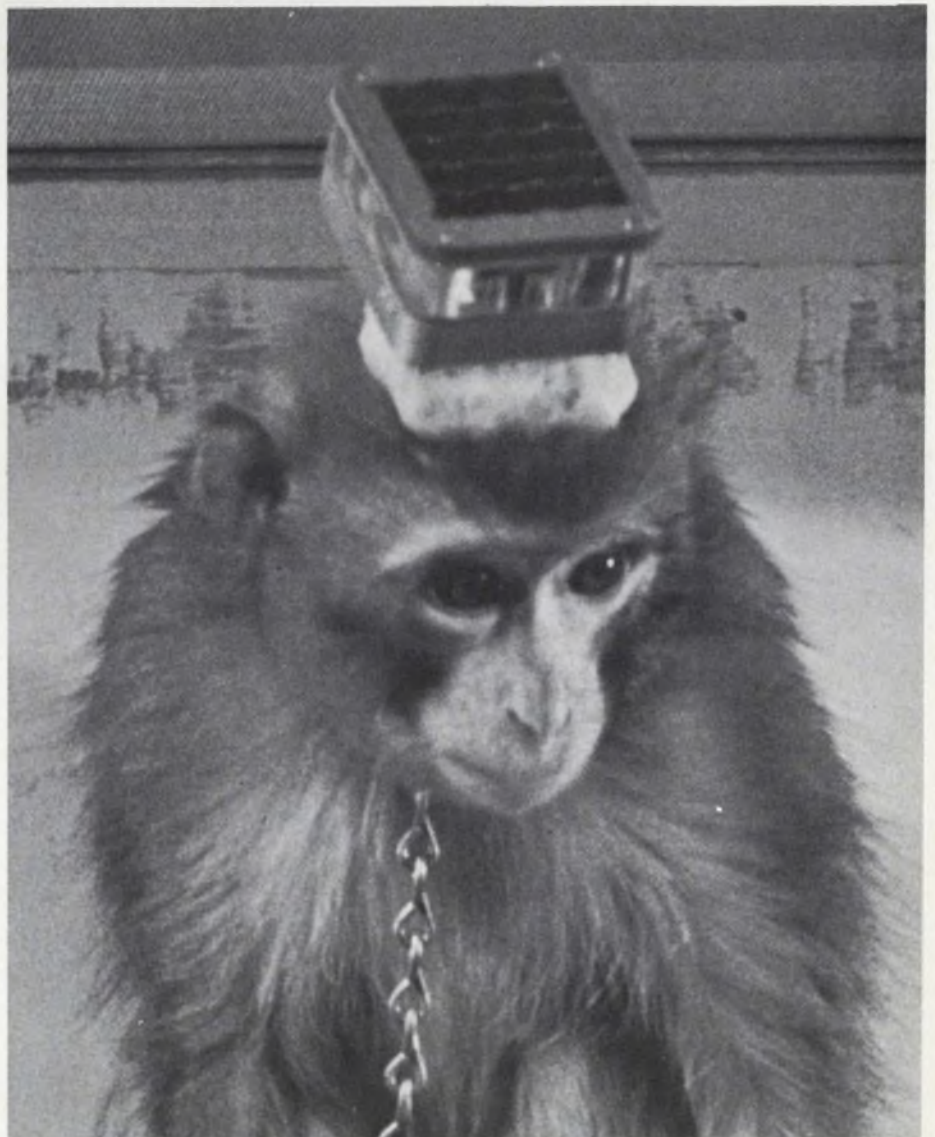

Solar array powers receiver-stimulator developed by General Electric Co. for Dr. Bryan Robinson. Head-mounted unit weighs 200 grams and measures 7 x 6 x 3 cm.

(brain stimulation, continued)

cat. However, monkeys are naturally curious, destructive animals and tend to tear apart any loose piece of equipment or wiring they can lay their hands on. The design must be "monkey-proof."

The nonimplantable portion of the monkey-borne equipment can be mounted on a collar or on a harness. It must be shock-resistant and designed to withstand opening by, say, a muscular 15-pounder—a heavyweight among rhesus monkeys. The receiving antenna can be imbedded in the harness or collar. The antenna is horizontally polarized.

Dr. Bryan Robinson, a neurophysiologist at Emory University, Atlanta, Ga., experiments on monkeys by means of a telestimulation system designed by Harold Warner of the General Electric Company's Missile and Space Div., Valley Forge, Pa. Dr. Robinson has dispensed with a receiving antenna entirely: he uses the body of the animal to approximate one-quarter wavelength of a vhf carrier. Furry but effective!

The control console should provide the neurophysiologist with the means for varying the parameters of stimulation: current amplitude, polarity, duration, frequency, and length of pulse train. It should also permit the selection of more than one animal for stimulation. Finally, it should permit the monitoring of EEGs; for this purpose it should provide output connections to a six- or eight-track chart recorder, and perhaps an EEG magnetic tape recorder.

A free-ranging monkey can run, jump, swing from trees, stand on its head or lie down. This would wreak havoc on wide-dynamic-range AM transmission, which requires a gc. How can the investigator possibly know what signals he is applying to the simian? Because of animal ambience, the transmitting antenna should be circularly polarized and mounted on a mast.

Biotelemetry is usually conducted in the vhf band. Dr. Delgado operates at about 100 MHz at Yale, and Dr. Robinson used 130 to 140 MHz when he was working at the National Institute of Mental Health,

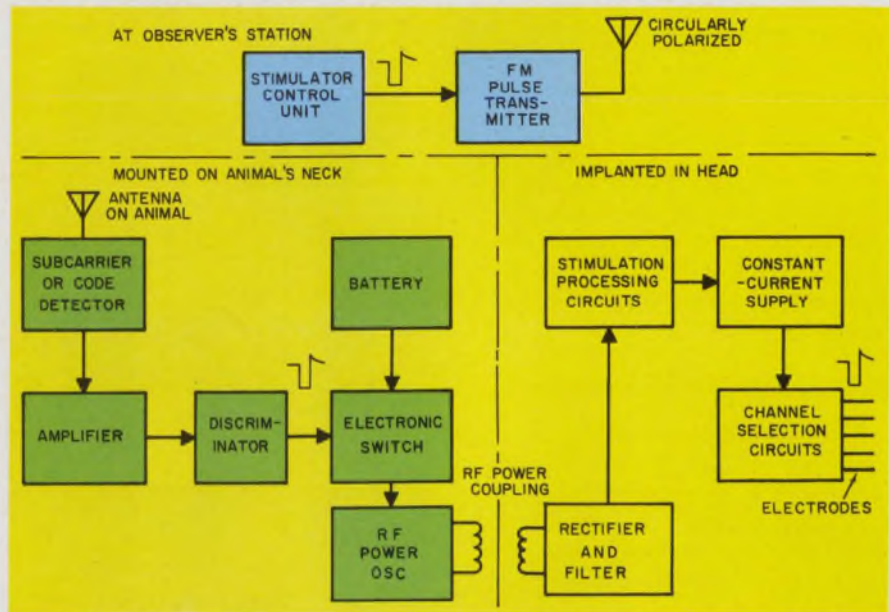

2. Microminiaturized implantable stimulator would draw power from electronics pack mounted on animal without using leads that pierce the scalp. Integrated circuits and biological power source might permit implantation of receiver and antenna as well.

Bethesda, Md. Of course, it is necessary to obtain the permission of the Federal Communications Commission to operate such a transmitter. Not only is there the problem of not interfering with the outside world, but in addition, it is also necessary to avoid spurious signals from outside transmitters. You don't want a satellite to stimulate your monkeys, but neither do you want a test missile to home on your laboratory.

Multi-stimulation methods outlined

In observing social behavior in a primate colony, it is desirable to stimulate several animals simultaneously. This can be accomplished in several ways, Ko says.

"You can use subcarriers or you can change the carrier frequency," he suggests. "As you finish with one animal, you change your tuning circuit and transmit at another frequency."

Another way is to use pulse-coded transmission.

"Give each animal its own address, like the radio control of missiles of space ships," Ko says. "You can send out a coding signal to turn on a particular animal's circuit, then turn it off with a closing code."

The animal-borne receiver is not particularly difficult to design. However, it must be able to reject stray signals that might cause spu-

rious stimulation, while offering high sensitivity to the modulated carrier. Over-all signal-to-noise ratio should be high.

The implanted stimulator delivers the current needed to stimulate nerve centers. Two technical approaches seem feasible.

One is the so-called passive stimulator, which has already been employed in cardiac pacemakers. With the pacemaker, a transmitter loaded with a coil is mounted on the patient's chest. Just inside the chest wall is a tuned receiving coil that is aligned with the transmitting coil. A preset timing circuit that is synchronized with the patient's heart-beat triggers an oscillator that modulates the output of the transmitter. Inside, a diode detector demodulates the signal and applies a pulse to the heart. For brain stimulation, a passive stimulator could be implanted in the neck.

Better yet would be a microminiaturized signal generator, encapsulated in a button seated in the skull. This, too, would be activated by inductive RF coupling from the external electronics. It would faithfully reproduce the waveforms introduced by the experimenter at the control console. Thus it is particularly suitable for medical application. Also, the absence of hard-wire connections would eliminate ground loops that might cause spurious stimulation.

The parameters of stimulation play an important role in determining the complexity of the entire brain stimulation system.

Most investigators use rectangular pulses, because they are easy to generate, measure, count and describe. Dr. Delgado uses negative-going pulses, to which he intentionally adds a positive-going overshoot on the trailing edge. A gradual return to the baseline yields zero net current, which, he says, is necessary to avoid electrolytic action in brain tissue.

Another neurophysiologist, Dr. John Roth of the Oregon Regional Primate Research Institute, has been using sine waves for seven years. He says:

"We are not in a position to argue about whether one waveform stimulates more effectively than another. However, a large part of the impedance is not of the tissue but of the tissue-electrode interface. We feel that this distorts a square wave into something that doesn't even approach a square."

He goes on to say that because the impedance of the tissue varies, a constant-current device is superior to a constant-voltage device. Besides, it would appear that sine waves also operate with zero net current.

Frequency is critical

Sidestepping this controversy entirely is Dr. Blaine Nashold of Duke University, who is performing extensive clinical work on humans.

"Much more important than the shape of the waveform is the stimulation rate," he says. "We've tried just about every shape, and it doesn't make any difference."

He hastens to add that his work is cruder than animal research, because he is in no position to stimulate his patients over and over as neurophysiologists do in the laboratory. For example, Dr. John C. Lilly reports that sine waves are unsuitable for intensive, long-term stimulation (up to 18 hours a day for months).

Experience with both animals and humans has confirmed the importance of frequency. Stimulating the same site with different frequencies can yield completely different results.

"There are very definite re-

sponses related to frequency," Dr. Nashold says. "There are responses you don't see at 5 cps that you do at 100; there are those you don't at 60 but do at 300."

Dr. Nashold also discounts the importance of voltage, provided it does not result in excessive current.

"Going from 5 volts to 10 will give you a stronger response," he says, "but the pattern will be the same."

There is general agreement on pulse duration: experimental waveforms are normally less than 1 millisecond, because increasing the duration doesn't produce different effects, and it adds unnecessarily to the amount of current applied to the brain.

The duty cycle of brain stimulation is generally short. It is unlikely that humans would be permitted to remain out of the hospital if their conditions demanded constant stimulation. Constraints are imposed by the fatigability of various structures in the brain: The motor cortex, which controls movement, fatigues in seconds; the amygdala (in the area of the brain stem), in minutes; portions of the hypothalamus, in days.

Dr. Delgado cautions designers and experimenters alike: "If you stimulate too much, you would produce convulsions. If you increase the intensity and use very long pulses, you could burn tissue. If you apply too high a milliamperage in one direction, you cause electrolysis."

The crux of the implantation problem is how to get power to the implanted device without also implanting batteries. If a suitable power source were available right now, the implantable telestimulation system could be a reality within a year.

The ideal solution, everyone agrees, would be to use biological power sources. By this is meant a scheme for tapping the chemical, mechanical and thermal processes of the body to provide electrical energy for the implanted device.

Blood flow, for example, abounds in energy. Engineers talk of placing Lilliputian turbomotors into the aorta or other large artery. Thus far no one appears to have developed them.

Most engineers, after a few moments of thought, would suggest piezoelectric crystals. In fact, a

numbers of papers have been published on them. There appear to be two main problems:

Since piezoelectric crystals are basically high-output-impedance devices, they can be short-circuited by body fluids seeping around them. The body itself is not rigid. It flows, changes its shape under stress. If pressure is applied, the body tends to deform to avoid the pressure. Eventually the output of the crystal decreases, because the motion of the stress becomes smaller.

Ko says he has found a way to avoid these problems. However, the power output attainable at present would not be sufficient to power a device with many stages.

Another idea is the so-called biological battery, which has been investigated both at the General Electric Company and at Drexel Institute. Published results indicate that it would be possible to develop about 0.6 volt by placing electrodes fabricated from such dissimilar metals as platinum-black and high-speed steel into the body. This can furnish as much as 50 μ W for a few months—adequate for some cardiac pacemakers.

Ko, for one, is skeptical. He says: "They simply report on whether it will work. But I don't believe I've seen any data published on the dangers to the body."

"As everyone who has taken a high-school physics course knows, putting two different metals into a conductive fluid is enough to create a chemical cell. However, one of the electrodes will dissolve in the process. What happens to ions like the tungsten and cobalt, which are given off by the General Electric and Drexel batteries?

"Hopefully, these ions would be absorbed by the kidneys and discharged from the body in the form of urine. But in practice, many of them—I am speaking of micrograms—are trapped by the liver, the pancreas, the brain. What then? These organs are very sensitive to ions."

The Microelectronics Laboratory at Case Institute is experimenting with a biological battery containing silver chloride and zinc. Ko says it delivers a full volt, and at a much higher power density than the others—a milliwatt, instead of microwatts, per square centimeter. He and his associates are evaluating the

(brain stimulation, continued)

AgCl-Zn battery in animals to observe the rate of trapping of ions by the organs.

Perhaps the best idea of all would be the use of fuel cells, particularly one that metabolizes the glucose in the bloodstream. This is the body's own way of developing energy reserves to meet the demands placed on it by physical activity. The simple act of eating replaces all the fuel consumed.

The catch is in finding some catalyst that simulates the body's method of converting glucose into energy. The device would be completely nontoxic, since the poles and the catalyst would be inert and the by-products would be water, hydrogen and oxygen, which the body can certainly tolerate.

Like the other biological power sources, the glucose-metabolizing fuel cell is far from a reality. To gain some "feel" for such a device, Ko conducted a laboratory experiment in which he put some yeast into a glucose solution, using a semipermeable membrane, and thereby generated electricity. Unfortunately the body cannot tolerate the presence of yeast.

Thus, with biological power sources ruled out at least for the next few years, the candidates for powering the implant are narrowed down considerably. Dr. Delgado mentions as a possibility the implantation of atomic batteries with a long half-life. Such a battery could be shielded, so that radiation would not be a problem, but there is the problem of bulk. No atomic source in sight seems to provide enough power in a package small enough for implantation.

This seems to leave only one more route to batteryless operation: the induction of power into the device. An external coil excited by electronics mounted on the animal or human would radiate energy across the air-and-tissue gap to an implanted receiving coil—in effect, an RF transmitter with primary and secondary windings separated.

Biomedical engineers have been working with RF inductive coupling for a number of years. With the type of cardiac pacemaker described previously, it is foolproof in its simplicity. The only reasons for

concern are whether alignment of the two coils is critical and whether RF radiation is harmful to tissue.

Published studies show that with close coupling of the coils, power transfer at RF frequencies can attain efficiencies up to 95%. Also, there have been no apparent ill effects. Radiating about 50 watts of power through the chest doesn't seem to raise local body temperature.

When asked about the inductive coupling of RF power to energize an implanted brain stimulator, Ko replied that it was feasible.

He made an interesting observation: "If you use an implanted stimulator which merely requires power to operate, then transmitter and receiver alignment are not critical. But if you want to supply signal as well as power, then the coils must be properly aligned, since signal amplitude will be affected."

This would appear to support the design approach that calls for an implanted signal generator to recreate the waveforms.

It would be appropriate to modify the method used to power cardiac pacemakers, since the brute power radiated across the chest wall is much too high to apply to the head. It is up to the systems engineer to refine the power oscillator and to scale down the power requirements.

At this point, designers may ask: Why do neurophysiologists need such sophisticated telestimulation systems? After all, they have logged some impressive results with the hardware already on hand.

A look at their methodologies should provide the answer.

Most experimenters who stimulate animals—cats, rats, bats, dogs, dolphins, baboons—use hard-wire systems. This is all right, provided that the animal is inactive and isolated from other animals. Imagine the tangle that would result if three monkeys with long leads protruding from their heads were all in one cage.

The choice of animal is important to the experimental results. Monkeys not used to handling can be a real trial. "Rhesus monkeys" says Dr. Delgado "are usually aggressive, and . . . it is dangerous to put a hand within reach of their teeth." Ten trained persons have died in about as many years from encephalitis

after having been bitten in the laboratory.

Dr. Robert Doty, a neurophysiologist at the University of Rochester, says that scientists have to choose between keeping the animals in a restraining chair or staging a daily monkey roundup, with a greater risk of being bitten.

Dr. Doty, when asked whether he would use a completely microminiaturized, totally implantable stimulator, replied:

"That would be delightful. But it would consume a great deal of experimental time to work out the engineering problems, and I'm not interested in becoming the supervisor of a Manhattan Project to do this."

Thus neurophysiologists would be happy to use the latest innovations of electronic technology, if only the engineers would fabricate and market them.

In a compromise between hard-wire systems with animals under restraint and the yet-to-be-built implantable telestimulation system, stimulating signals are being transmitted via an RF link to receivers mounted on the animal. All of the electronics is external, but secure cabling is run from the signal generator to the socket to which the implanted electrodes are attached. The first system affording remote control of brain stimulation was developed in 1934, but it took the invention of the transistor to grant the radio-controlled stimulator parity with the hardwire systems.

Dr. Delgado has achieved many of his most impressive results with a unit built for him by Per Hals, an associate at the Yale University Medical School. Hals is an electronics engineer who custom-builds devices for the staff.

The best radio-controlled system now in operation is considered to be the General Electric Mark II telestimulator (Fig. 1), built for Dr. Robinson. It consists of a pulse-modulated transmitter, four receiver-stimulators for mounting on rhesus monkeys, a communications receiver with converter, and a directional antenna at the control station.

Solar power is used

To permit sequential stimulation of several monkeys in an outdoor colony, the transmitter delivers an

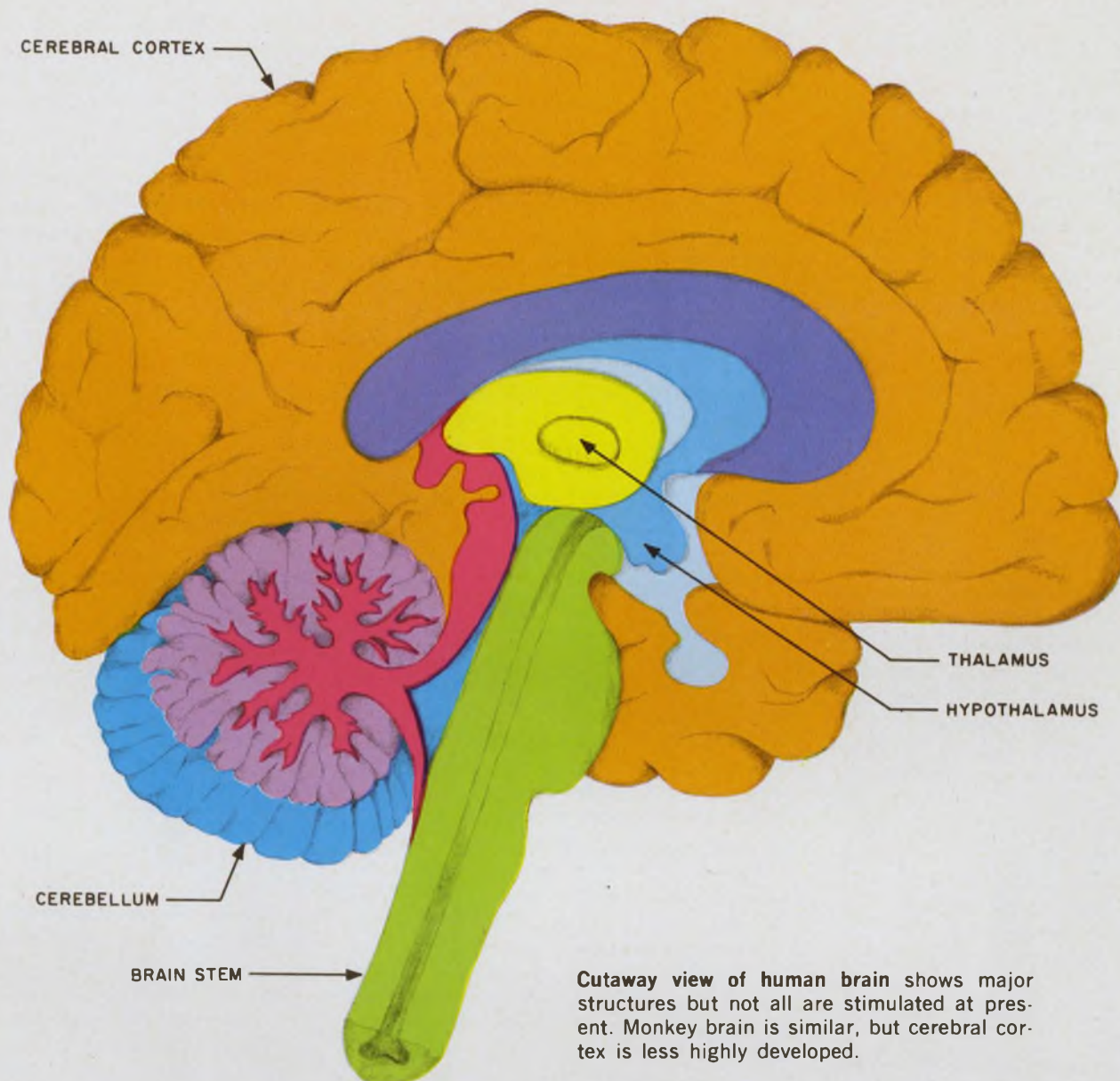

Cutaway view of human brain shows major structures but not all are stimulated at present. Monkey brain is similar, but cerebral cortex is less highly developed.

FM carrier on any one of four frequencies in the vicinity of 140 MHz. However, the use of additional transmitters would permit the simultaneous stimulation of more than one animal.

The Mark II permits a duty cycle of 0.05 at full power and 0.15 at reduced power. Inputs to the stimulation system are furnished by a standard laboratory pulse generator. A positive pulse train modulates the transmitter, which delivers FM carriers to the antenna. The channel selection pulser selects the electrode channel, which is also displayed at the console.

A crystal-stabilized superheterodyne receiver interprets the information modulated on the carrier as brain-channel selection, pulse width,

repetition rate and constant current amplitude.

The stimulation processing circuits apply the original pulse train to any one of 11 electrodes through a miniature electromagnetic stepping switch. The stepping switch also pulses a tiny parity transmitter, which produces an audible "beep" on the communications receiver. This verifies that the switch has been stepped to the proper brain-stimulation channel.

The novel feature of the Mark II, which sits astride the monkey's head like a scholar's mortarboard, is an array of 40 solar cells that recharge Ni-Cd storage batteries. Even artificial light from the laboratory is sufficient for continuously charging the storage batteries.

Thus uniform power can be maintained should the level of incident light decrease.

The unit, which measures 3 x 6 x 7 cm and weighs 200 grams, is mounted on a platform that is screwed onto the monkey's head. Fastening the receiver-stimulator to the socket automatically seats pins that make contact with the electrodes.

In practice, the Mark II works quite satisfactorily. Animals tested do not seem to object to the presence of the devices on their heads. They can be allowed to prowl their compound or cages for months without any need for adjustment.

But good as they are, the radio-controlled stimulators used by Dr. Robinson and Dr. Delgado have sev-

(brain stimulation, continued)

eral disadvantages. For one, there are leads that pierce the skin, with the risk of infection at the skin-lead interface, as well as the possibility of breakage or dislocation. These hazards would be annoying for animal research but really serious for human patients. And they would disfigure a person.

Fig. 2 illustrates one concept of an implantable stimulator intended for studying animals in an outdoor enclosure. There are three subsystems: a stimulator control unit and transmitter, electronics mounted on the animal's neck or back, and a surgically implanted stimulator.

Waveforms selected at the control unit are multiplexed on subcarriers which modulate the output of an FM transmitter. A circularly polarized antenna array beams the carrier fairly directionally.

A subcarrier detector in each animal's receiver ensures that the desired animal is stimulated. The detected signal is amplified and reconverted to the original control pulses.

The control signal, together with power, is inductively coupled to the implanted stimulator at radio frequencies. An electronic switch routes power and signal to the oscillator only when a stimulating waveform is present.

The transmitting coil is coupled to a receiving coil in the neck. A rectifier and filter apply dc to the stimulation processing circuits. Pulses from this stage trigger a constant-current supply. Channel selection circuits route stimulating current to the electrodes in accordance with the control pulses.

Research gains support

The modern era of brain-stimulation experimentation began in the 1930s, when W. R. Hess developed the technique of implanting electrodes in the brains of unanesthetized cats. He was the first to show that functions of the lower brain, which govern our more primitive emotions, as well as posture, equilibrium and sleep, could be influenced by electrical stimulation. For this work, Hess received the Nobel Prize in 1949.

Other neurophysiologists were

soon attracted to the technique. Brain-stimulation experiments on animals are now conducted at hundreds of laboratories around the world. A leading center is the Yale University School of Medicine, where Dr. Delgado is famed for a research stunt he performed in Spain—facing a brave bull in a corrida, armed only with a hand-held RF transmitter. As the beast charged, he pressed a button on his transmitter, thereby actuating an electrical stimulator in the bull's brain. Immediately it stopped its charge. But when the effects of the stimulus wore off, it remembered it was a fighting bull. Once again it charged, and once again it was stopped, like a radio-controlled model auto. While El Toro had not been turned into Ferdinand, Delgado had succeeded in inhibiting its aggression.

In another experiment, Dr. Delgado stimulated the brain of a monkey. Each eye reacted differently to light of the same intensity, because different current levels were applied to two electrodes in its brain. Experimenters like Dr. Delgado can control the diameter of the eye pupils like a photographer setting the f-stops on his camera. A human wired in this fashion would react the same way.

Movements, emotions and hallucinations have also been produced artificially. Fear, hunger, rage and sexual drives can be influenced by electrical stimulation. Dr. Delgado has even temporarily overridden the maternal instinct in monkeys.

Of all his results, Dr. Delgado considers the most important to be the discovery of a functional bias. He says that when he stimulates certain structures, the electrical inputs merely bias the normal sensory inputs. For example, when he stimulates a monkey to aggression, the animal seeks as victims the ones it usually picks on anyway.

Dr. Delgado has even rigged a monkey cage with a lever that permits the Casper Milquetoasts of his primate colony to inhibit the aggressiveness of the "boss" monkey. Here we have a case of a monkey learning to stimulate the brain of one of its companions.

Despite the experimentation to date, scientists still have only a fragmentary grasp of what goes on in the brain. It is like trying to follow a motion picture when only a

frame or two is projected every few minutes. Less than 20 per cent of the monkey's brain has been "mapped" with electrical probes. And even that is critically re-evaluated as new data are published.

From years of further studies of animals, neurophysiologists hope eventually to derive a methodology suitable for routine clinical work with humans. Dr. Reginald Bickford of the Mayo Clinic, Dr. Robert Heath of Tulane, Dr. Nashold of Duke and Dr. William Sweet of the Massachusetts General Hospital have studied the onset of epileptic seizures by means of electrical stimulation. However, much more research is needed before these and other diagnostic techniques are refined.

Dr. Heath has reported short-lived relief of the symptoms of schizophrenia by electrically inducing pleasure in the brains of the patients. In addition he has diagnosed the disease by detecting an abnormal spiking of spontaneous electrical activity in the brain.

One gnawing suspicion that is always going to be voiced whenever the subject of brain stimulation comes up is the Svengali-like domination of individuals by means of electrical pulses. When experimenters who have spent years in the field can be drawn into speculative conversation, they uniformly reject the notion. The brain, they say, has its own built-in controls, and the subject can recognize artificially evoked behavior.

The future course of electrical brain stimulation appears likely to follow the lines of gaining more knowledge about how the brain works. This in turn may lead to advances in the diagnosis and treatment of disorders of the brain. It may also suggest superior ways in which to educate people.

Dr. Delgado wrote in 1965:

"I am not so naive as to think that cerebral research holds all the answers to mankind's present problems, but I do believe that an understanding of the biological bases of social and antisocial behavior and of mental activities, which for the first time can now be explored in the conscious brain, may be of decisive importance in the search for intelligent solutions to some of our present anxieties, frustrations and conflicts." ■ ■

among other things...

This P&B relay can save you up to \$2.40* per relay installed

*Compared with ordinary 3-pole dust-covered relays using an octal socket.



The KU series is available in many variations to fit your requirements

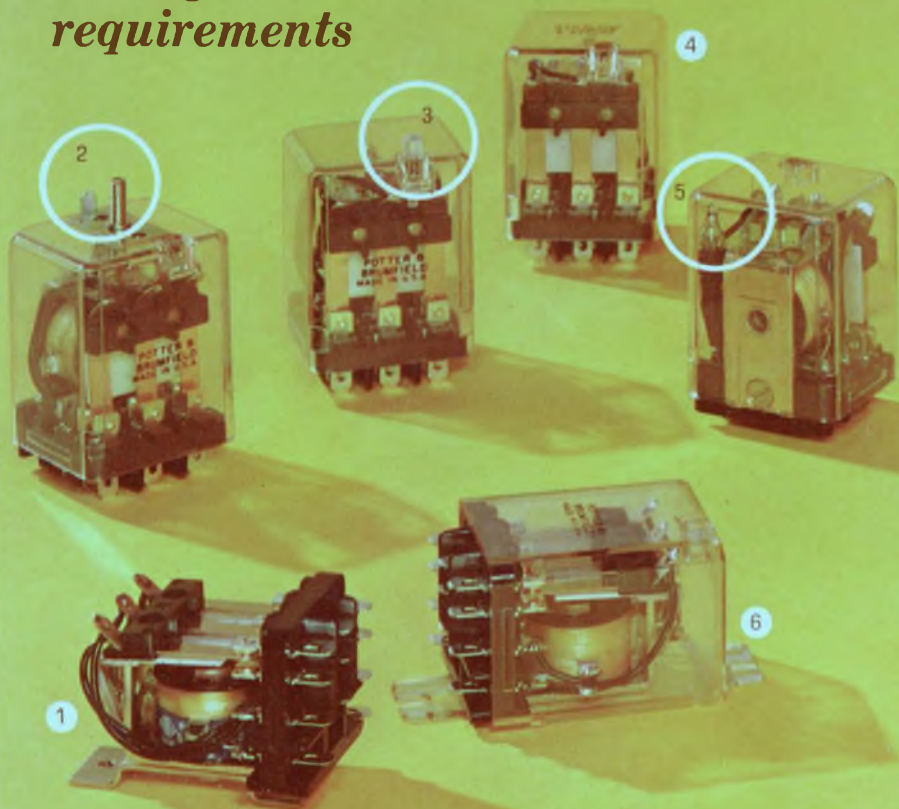

1 Open relays can be mounted with stud and locating tab, tapped core or bracket as shown.

Five or ten ampere contact ratings. AC or DC.

.187" quick connect/solder terminals standard (.205" available).

2 Stud and locating tab on top of cover may be ordered.

3 Built-in push-to-test button is available.

4 High impact polycarbonate dust cover.

5 Optional neon lamp shows if power is reaching coil.

6 Flanged dust covers for direct chassis mounting are available.

7 True 10 ampere nylon socket.

The KUP can save you up to \$2.40 (including socket costs) over similar relays with factory wired octal plugs. A true 10 ampere nylon socket can be supplied to receive the quick-connect terminals. Standard KU/KUP relays are covered by Underwriters' Laboratories Component Recognition Program.

Quick-connect terminals mean faster installation on your production line . . . easier replacement in the field. Standard models have .187" terminals, but .205" may be ordered. All terminals are punched for those who prefer solder connections.

Long life, improved reliability, exceptional versatility and, in the case of covered relays, substantially lower costs are all part of the KU Series. Call your P&B sales representative today, or get in touch with us direct.

KU SERIES SPECIFICATIONS

GENERAL:

Description: 5 or 10 amp. General Purpose Relay.
Expected Life: 10,000,000 cycles, Mech.
Breakdown Voltage: 1,500V rms 60 Hz
between all elements;
500V rms 60 Hz between open contacts.

CONTACTS:

Arrangements: Up to 3 Form C.
Rating: 5 or 10 amps @ 28V DC or 120V AC.

COILS:

Voltage: DC to 110V; AC to 240V 60 Hz.
Power: DC 1.2 W; AC 1 and 2 poles 2.0 VA;
AC 3 poles 2.7 VA.
Resistance: 16,500 ohms max.

MOUNTING:

(open relay) 6-32 mtg. stud, $\frac{7}{32}$ " locating tab
on $\frac{7}{16}$ " centers. Socket available.

STANDARD P&B RELAYS ARE AVAILABLE AT
LEADING ELECTRONIC PARTS DISTRIBUTORS



POTTER & BRUMFIELD

Division of American Machine & Foundry Company, Princeton, Indiana
Export: AMF International, 261 Madison Avenue, New York, New York

Why do conscientious engineers buy the X-1?



Simple. To save \$540

Buy any other digital voltmeter at \$2450 and you're short changing yourself on features, functions and accuracy. Buy the *capabilities* of the X-1 in any other DVM and you'll pay at least \$540 more. *Only* the X-1 offers this combination of features and price:

- Response—Digitizing time 6 ms
- Resolution—5 digits with 6th digit (20%) overranging
- Versatility—Functions include AC, ohms, preamp and ratio
- Reliability—All solid-state construction (no mechanical choppers)
- Availability—Delivery 2 weeks
- Price—\$2450 (basic DC instrument)

There are also features such as the active filter, floating input, isolated output and autoranging with all functions. And the capability of adding functions with additional or substitute circuit boards protects you against obsolescence. With the X-1 you can have the precise, versatile measuring instrument you need and still make the grimmest budget-watcher happy.

Take a closer look at the X-1. Fill out and mail the coupon, or write directly to Non-Linear Systems, Dept. 902, Del Mar, California 92014. For fast action call us at (714) 755-1134.

I'd like more information on the X-1

Send me a data sheet

Have a representative call

Name _____

Title _____

Company _____

Address _____

State _____

Phone _____

Ext. _____

Zip _____



Originator of the Digital Voltmeter

non-linear systems, inc.

DEL MAR, CALIFORNIA

ON READER-SERVIC CARD CIRCLE 143

Tired of 4th digit bobble?



Try the new X-2 (small, fast, integrating, DVM with multimeter capability: \$980)

Now you can get a low cost, small size integrating digital voltmeter with multimeter capabilities. With the new X-2 you can have AC, ohms, preamp and ratio functions in one compact package just by plugging in the appropriate circuit boards. And the X-2 has the exclusive NLS *anti-bobble* circuit. Unlike other low cost DVMs, the right hand (least significant) digit in the X-2 behaves as it would in a scan logic instrument . . . stays put, doesn't jump around.

Compare these features:

- Response—10 readings per second
- Resolution—4 digits with 5th digit (20%) overranging
- Versatility—Functions include

AC, ohms, preamp and ratio—add functions as desired, and protect yourself against obsolescence

- Reliability—Integrated circuit construction meets Milspec standards
- Availability—Delivery 30 days
- Price—\$980 (basic DC instrument)

The X-2 also offers display storage and the space saving *half rack* size. It all adds up to a new capability at a price that will make the grimmest budget-watcher happy.

Take a closer look at the X-2. Fill out and mail the coupon, or write directly to Non-Linear Systems, Dept. 904, Del Mar, California 92014. For fast action, call us at (714) 755-1134.

I'd like more information on the X-2

Send me a data sheet

Have a representative call

Name _____

Title _____

Company _____

Address _____

State _____

Phone _____

Extension _____

Zip _____



Originator of the Digital Voltmeter

non-linear systems, inc.

DEL MAR, CALIFORNIA

ON READER-SERVICE CARD CIRCLE 144



MEASUREMENTS



MODEL 500A STANDARD FREQUENCY SYNTHESIZER

- 0 to 100 Kcs
- Smallest digital step .01 cps
- Stability 1 part in 10^6
- Output 0 to 2 volts
- Harmonics below 40 db
- Spurious outputs below 60 db
- Vernier oscillator for continuous frequency sweep
- Provision for remote control
- Modular construction
- All solid-state design

PRICE: \$2850.00 f.o.b. Boonton, N. J.

Laboratory Standards



MEASUREMENTS

A McGraw-Edison Division

P.O. Box 180, Boonton, N. J. 07005

Phone: 201-334-2131

Photodetectors calibrated in minutes

Scientists at the National Bureau of Standards have developed an instrument that permits photodetectors to be calibrated in the visible spectrum (0.38μ to 0.8μ) in minutes instead of hours.

The new calibrator-recorder illuminates the photodetector under test with light from a monochromator swept across the desired portion of the visible spectrum. It records the output as a function of wavelength. Its circuitry holds the illuminating energy at a fixed level to make possible measurement precisions of 2 per cent. The instrument automatically scans and records photodetector response across the visible spectrum in about four minutes, according to its developers, M. Kuder and H. Hammond III of the bureau's Metrology Div. This speed, they point out, makes the instrument especially well suited to calibrating large numbers of photodevices with moderate accuracy.

In the past, the spectral response of the photosensitive devices has been determined by measuring their output at selected wavelengths of monochromatic illumination at constant energy, using a calibrated thermopile as intensity reference.

Values obtained by this method were used to plot a curve of response.

Although the reference thermopiles used have essentially flat spectral responses, they are extremely sensitive to ambient temperature.

According to the scientists, the NBS spectral calibrator is freed of temperature instabilities and resulting inaccuracies by use of a constant-light source as a reference and the thermopile as an intensity difference-sensing device. It compares the reference and monochromator output 13 times a second by a light-chopping method, to eliminate thermal drift and to stabilize monochromator output.

The bureau describes its instrument as a specialized one, intended for running fast plots of photocell response for varying wavelength, where 4 per cent accuracy is acceptable. The bureau's photometry laboratory is now reported to be developing an equally specialized photoresponse instrument. It is expected to yield values for a succession of wavelengths from which points of the response curve can be plotted, and is expected to have an accuracy within 1 per cent but with increased running time. ■ ■



Photoelectric cell is plugged into new photodetector response recorder by National Bureau of Standards engineer David Goebel. A plot, representing a 4-minute scan of a photoelectric device, is shown on the x-y recorder. The monochromatic light source is in the background.

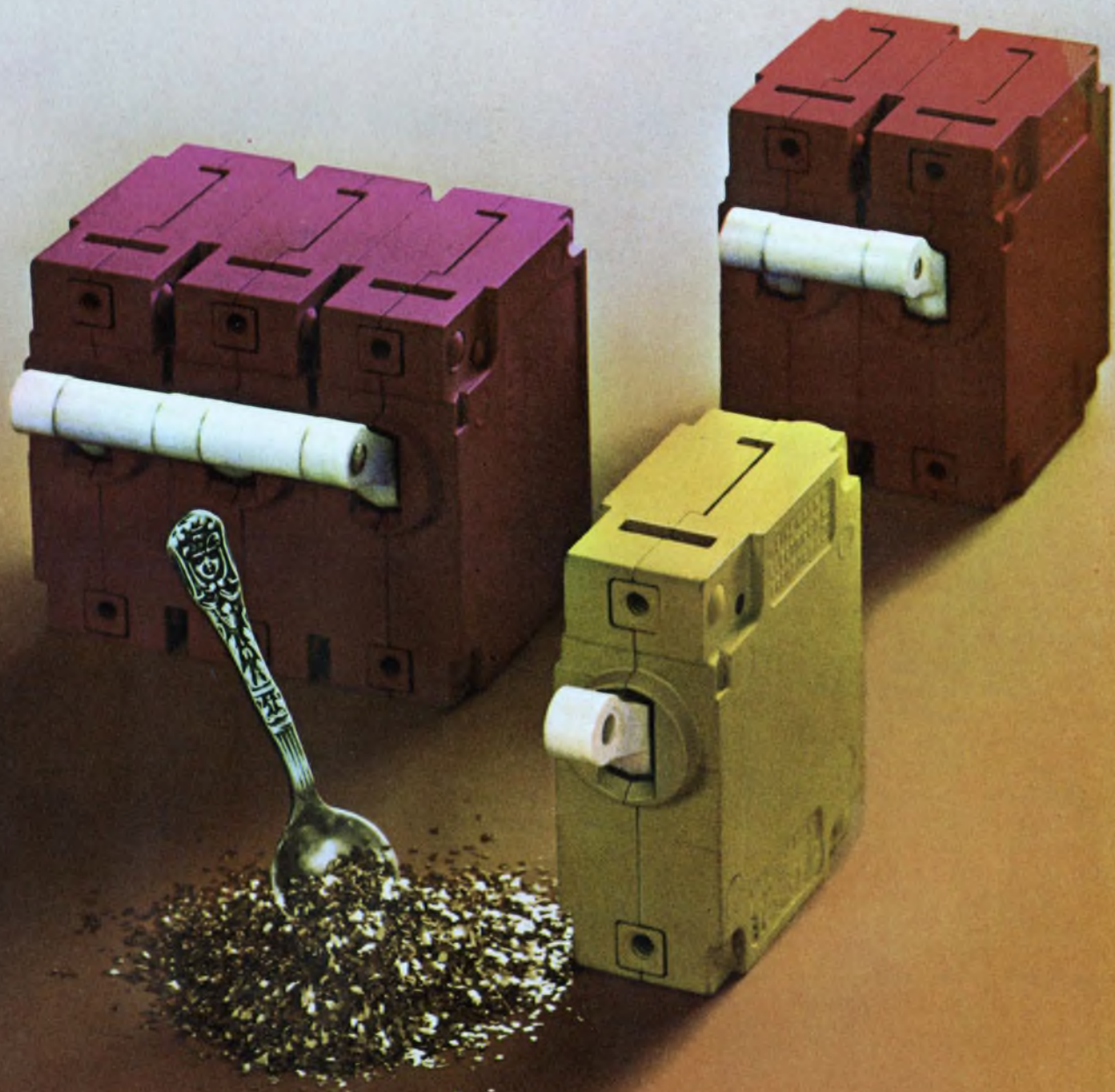

Our 'instant color' circuit breakers.

(The second surprise is that they don't cost a lot of gold.)

Nobody has ever accused Heinemann of being down in the bargain basement of the circuit breaker world. (But almost everyone will admit that our performance well justifies our price.)

The Series JA is a breaker of a somewhat different stripe. The usual Heinemann features are all there—temperature-stable trip-points, precise current ratings, choice of time delays, optional special-function internal circuits. But they cost less in the JA wrapper.

And you can have color, too. Not all over the breaker, of course—just in the part that shows. The mounting boss.

A very simple arrangement of color caps lets you change the boss from basic black to any of eight other colors. You can thereby instantly color-code the breakers to pilot lights, operational sequences, or anything else you might have in mind. Or, you can use them just because they dress up a panel handsomely.

The JA can be had in any integral or fractional current rating from 0.100 to 30 amperes. Standard maximum voltage ratings are 250vac, 60 or 400 Hz; 65vdc. Our Bulletin 3350 will give you complete specs and catalog data. A copy is yours for the asking, of course. Heinemann Electric Company, 2700 Brunswick Pike, Trenton, New Jersey 08602.



HEINEMANN

Building-block units aid computer designers

Washington U. 'macromodular' concept permits tryout of novel systems before manufacture

Neil Sclater
East Coast Editor

A building-block scheme, much like a Tinker Toy set, is permitting engineers to assemble custom computers with relative ease.

The concept for the "macromodular" computer systems was disclosed at the recent Spring Joint Computer Conference in Atlantic City, N. J. It was developed by the Computer Research Laboratory at Washington University, St. Louis.

Dr. Wesley Clark, director of the laboratory, explained that the scheme permits designers and users to devise computer systems for novel applications without the expense and time involved in ordering a system from a manufacturer.

Macromodules, according to Dr. Clark, are self-contained blocks, including registers, adders, memories and control devices, designed for assembly on special wiring frames. Program flow diagrams can be used as plans to assemble the modules.

While making clear that macromodules would be of greatest

benefit in laboratories, where computational requirements are highly variable, Dr. Clark also cited advantages for computer manufacturers. He said that experimental systems could be adjusted and improved with macromodules before a system was sold for general use.

"Once a design has been realized and its value established", Dr. Clark said, "it could then be reworked into tighter engineering form, for maximum efficiency and for production by automatic wiring and fabrication techniques."

Prototypes of the macromodules are in use at Washington University, and some small, initial systems are planned for the next few months, Dr. Clark indicated. He said that design work had so far indicated that the functions selected for the module scheme were reasonable and convenient.

The macromodules are being selected from a set of 20 to 40 basic designs. Central processor modules, such as register and memory units, range in logical complexity from as few as 50 to as many as 400 gate

circuits. Emitter-coupled integrated circuits have typical rise times of 6 nanoseconds. There are also modules for power, signal conditioning, input-output buffering, and control. Some input-output devices are also built as macromodules.

All parts of the system will be reusable and capable of reorganization into a wide variety of configurations. The assembly frame already built contains ducts for standard cables that connect the modules. New modules can be added without disturbing the existing system.

Data modules have been designed to process twelve-bit word segments, but greater word lengths can be obtained by interconnecting modules. The memory modules hold 4096 segments of 12 bits each. Interconnection permits the formation of larger arrays.

The control signals for computer processes have been routed along the cables of a control network the layout of which is an analog of the flow diagram of the process.

Dr. Clark said that two principal problems were encountered in the logical design of macromodules:

- Physical separation of the modules within a system created interference and signal propagation time delays.

- The process of modeling flow diagrams ruled out synchronous timing.

To solve these problems, all control signals were made self-timing and data validation signals were routed through wires parallel to the data paths to ensure that control does not precede data.

A set of basic logic elements capable of operating without a common time clock was designed. Macromodules depend on this logic rather than the traditional gates and flip-flops.

The logic circuits are high-speed, low-level and dc-coupled, and therefore are subject to noise problems. This problem, Dr. Clark said, is solved by transmitting data and control signals over twisted wire pairs. Shielding around all system components and cables, he said, is used to reduce signal pickup from outside sources. ■ ■

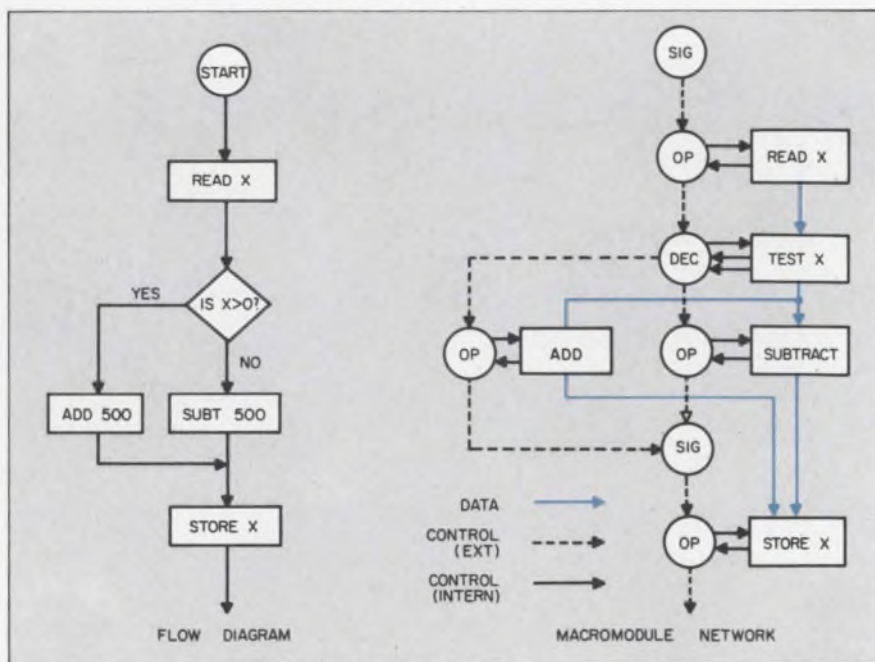

Macromodule concept (circles and blocks above) permits flow diagram (left) to be translated easily into a hardware data-processing network (right).



You don't have to be Scottish to go for this.

We're so thrifty-minded at Honeywell that we've been able to put the taut-band meter's price down even lower than the price of a pivot-and-jewel meter. (About 10% lower, on the average.)

Maybe that sounds to you like we've left something out.



We have.

We've left out half the parts, in fact. (All the unnecessary ones.) This doesn't make the meter less sophisticated. Just less complicated.

It's a very different kind of meter. It costs less, for one thing — for us to make and for you to buy. It's simpler and more reliable.

There's no friction in the moving system, so you get better readout ac-



curacy and repeatability. And it's self-shielded.

Honeywell's new taut-band meter. It comes in just about any style you like.

Write Honeywell Precision Meter Division in Manchester, N. H. 03105 and we'll send you a brochure.

Honeywell

**We've put the
taut-band meter's price
where you want it.**



Differential Multiverter[®]

Register indicator lights, mode and channel select controls for random and sequential addressing (on front panel)

Sample and hold with 50 nanosecond aperture

Multiplexing differential inputs with 100db common mode rejection

A to D conversion (17 choices of word length and conversion speed)

Digitized data... 10-15 bits precision at up to 40kHz comes out here

Up to 48 differential analog inputs go in panel

For Differential Signals

In one drawer and for a lot less money, the Differential Multiverter gives you the functional equivalent of a differential amplifier for each of your input channels. The Differential Multiverter switches the high and low sides of each signal simultaneously, neatly handling analog signals of ± 10 volts, common mode voltages of ± 1 volt, and providing common mode rejection of up to 100db.

All other Multiverter specs apply, including the important ones: \blacksquare 100 megohms input impedance \blacksquare linearity and drift within 0.01% \blacksquare systems accuracy within 0.025% \blacksquare temperature coefficient of 15 ppm/ $^{\circ}$ C.

It's all covered in Data File E-137. Write or call today. Raytheon Computer, 2700 So. Fairview Street, Santa Ana, California 92704. Phone: (714) 546-7160.



ON READER-SERVICE CARD CIRCLE 23

Can You Imagine A PNP Silicon Power Transistor That Gives Faster, More Efficient Performance Than Any Other Type? WE DID! Meet the 30-Amp 2N4398.

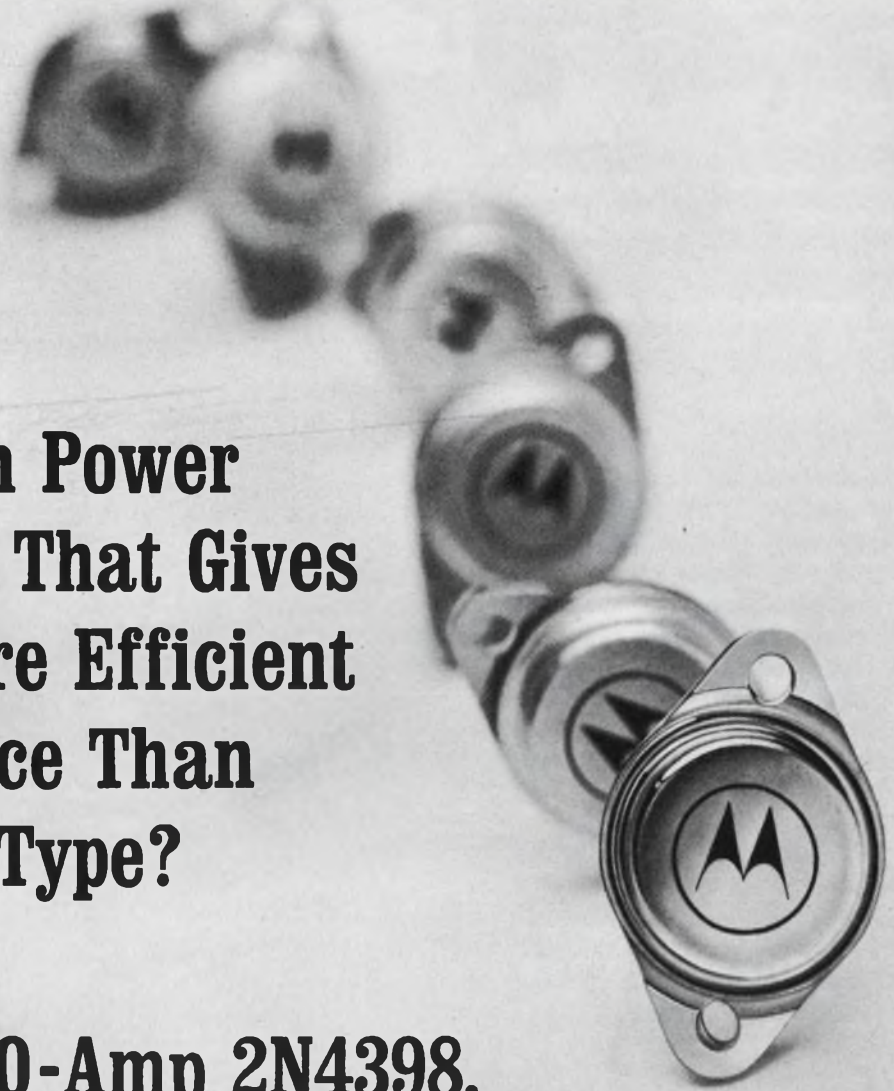

Now, you can specify state-of-the-art power, speed and efficiency with a true industry first: the Motorola 30-ampere PNP silicon power transistor! Here's what's in it for you:

1. 200 watts of dc power to 30 volts V_{CE} .

The best PNP silicon power-handling capability in the business! Use them to replace germanium devices in those "extra tough" industrial/military high-power audio and servo amplifiers, voltage regulators and modulator applications. And you realize lighter, simpler, less-costly heat sinking in all designs through low thermal resistance — θ_{JC} of 0.875° C/W max.

2. 400 nsec rise time at 10 amperes.

There's no power/speed trade-off with the 2N4398-99 devices. At 10 amperes I_C and 30 volts V_{CE} , the delay and rise time is only 400 nsec maximum . . . an unmatched figure of merit that affords minimum switching losses.

3. 0.75 volt max $V_{CE(sat)}$ at 10 amperes.

Ensure efficient, low power loss performance in all your applications . . . plus, have the added capability to swing down in voltage without loss of current gain to 1 volt @ 10 amperes — important in low-distortion audio amplifiers.

Add excellent gain linearity over a 5 to 20-ampere range, 50-ampere peak current, a low-silhouette TO-3 package, *low price* — and you've got the answer to superior silicon power circuit performance in many of today's demanding circuit designs!

Available in both premium and economy types:

PREMIUM TYPES

Type	V_{CE} Volts	I_C Amps	$P_o @$ $T_c 25^\circ C$	h_{FE} @ I_C, V_{CE}	$V_{CE(sat)}$ @ I_C	Price 100 999
2N4398	40	30	200 W	15-60 @ 15 A, 2 V	0.75 V @ 10 A	\$7.50
2N4399	60	30				9.05

ECONOMY TYPE

MJ450	40	30	175 W	20 min. @ 10 A, 2 V	1.0 V @ 10 A	6.35
-------	----	----	-------	---------------------	--------------	------

Contact your franchised Motorola distributor now for evaluation units or write Box 955, Phoenix, Arizona 85001 for complete 30-ampere state-of-the-art silicon power technical data!

— where the priceless ingredient is care!



MOTOROLA Semiconductors

ON READER-SERVICE CARD CIRCLE 24

COOL

KLYSTRONS · MAGNETRONS · TRANSFORMERS
TRAVELING-WAVE TUBES · SWITCH TUBES
WAVE GUIDES · DUMMY LOADS · LASERS

with New **ELLIS and WATTS**
Liquid-to-Air Heat Exchangers*

One of the new Ellis and Watts Heat Exchangers may be the answer to a need for tailoring a cooling system to your type of electronic equipment. Minimum space, low noise level and optimum performance have been achieved in each of a wide range of designs which include indoor/outdoor types in ratings from 5 to 300 KW. Proved in military, aerospace and commercial applications, these designs offer flexibility for quick modification to meet any specific cooling requirements.

Why not put the widely recognized Ellis and Watts custom-cooling "know-how" to work for you. Write us at the address below.

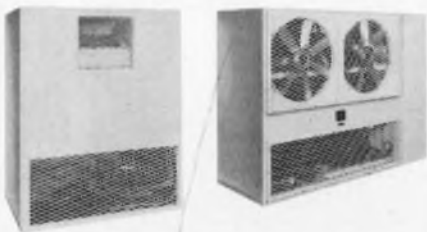

*Liquid-to-Liquid Heat Exchangers also available.



ELLIS AND WATTS COMPANY
Ellis and Watts Company, P.O. Box 36033
Cincinnati, Ohio 45236

Letters

Positioning not critical for AUTODIN hardware

Sir:

Your article on the AUTODIN system which appeared in the Feb. 1 issue of *ELECTRONIC DESIGN* ["Centers to handle 32,000 messages an hour," ED 3, pp. 17-20] was excellent. We were very much impressed by the quantity and quality of the information.

I would like to clarify a possible misinterpretation of a point in the article concerning the positioning of hardware [p. 17, fourth para.]. Installation of hardware within a "one-third of an inch" tolerance is *not* a requirement and the failure to stay within one-third of an inch will *not* result in intolerable crosstalk and signal loss. It so happens that installation is being accomplished very accurately relative to installation drawings (usually within one-third of an inch), but the system performance is by no means affected by emplacements that vary from drawings by more than that amount.

M. Gelman

Manager
System Design and Analysis
Philco-Ford Corp.
Willow Grove, Pa.

Engineers must form professional group

Sir:

I have enjoyed reading your recently published editorial ["Needed: A way to tame the gypsy in us," ED 4, Feb. 15, 1967, p. 75] concerning engineers and their professional status. I am of the opinion that engineers, especially in electronics, must begin to form associations that will benefit them as a group, since the individual is completely powerless when dealing with management. This, in my opinion, is the only way to maintain a proper professional status in the eyes of management.

I hope that *ELECTRONIC DESIGN* will continue to emphasize the engineer's social and professional status as well as his technical contributions to society.

N. Paul Galluzzi

Electrical Engineer
Beverly, Mass.

Older engineers are too conservative

Sir:

Your editorial, "Life Begins at 40 . . . Will it for you?" [ED 8, April 12, 1967, p. 51] was quite thought-provoking. In my own experience with engineers, I find they tend to become too conservative—regardless of their ability or education. For some reason, older engineers tend to become set in their ways and unable to accept management decisions which run counter to what they "know" is right. Perhaps the problem is intrinsic to the engineering mind. I hope not.

K. H. Sueker

Marketing Manager
Semiconductor Div.
Westinghouse Electric Corp.
Youngwood, Pa.

CATV is less bad than portrayed

Sir:

A copy of your November 8 editorial ["Wasteland revisited: Must CATV be an electronic 'rubber stamp'?" ED 25, p. 51] has just come to my attention. Let me congratulate you on your concept of services that can be provided by CATV.

My first tendency is to blush a little at the fact that the present activities of many CATV operators have received so little publicity that they are in effect unknown to a publication of the stature of yours. However, since a great many of our CATV systems operate in and for people of small communities, which are served by newspapers and other publications of limited circulation, it is entirely possible that our activities in the field of origination have received a minimum of attention.

(continued on p. 57)



Nearly everything that flies... flies with Cutler-Hammer power relays!

You've made us Number One. And we thank you.

For years, you've been buying more Cutler-Hammer power relays for your airborne projects than anybody else's.

Probably because our relays combine the utmost in small size, light weight and resistance to severe environmental conditions.

Now, we'd like to tactfully remind you that more and more of your fellow engineers are using our relays in ground support as well. And in ordnance and shipboard electronics, too.

Like in the tank above, and in trucks, radar, power systems and fire-control systems.

We're delighted. But not surprised. Because the relays are very much the same.

Same proved reliability under severe environmental conditions. Same in-process inspection and rigid quality control.

On your next project—ground, marine or airborne—specify Cutler-Hammer power relays. Call our local stocking distributor, or write for new Catalog LL-292-I217.



Typical of Cutler-Hammer's full line are these 25-, 50-, and 100-amp hermetically sealed power relays (front), our new 175-amp hermetically sealed generator contactor, and a 400-amp environmentally sealed relay.

Switch
to No. 1

More than just products:
prompt availability,
field help, innovation,
quality assurance too.



CUTLER-HAMMER

Milwaukee, Wisconsin 53201

Union Carbide's New Integrated Circuit Operational Amplifier

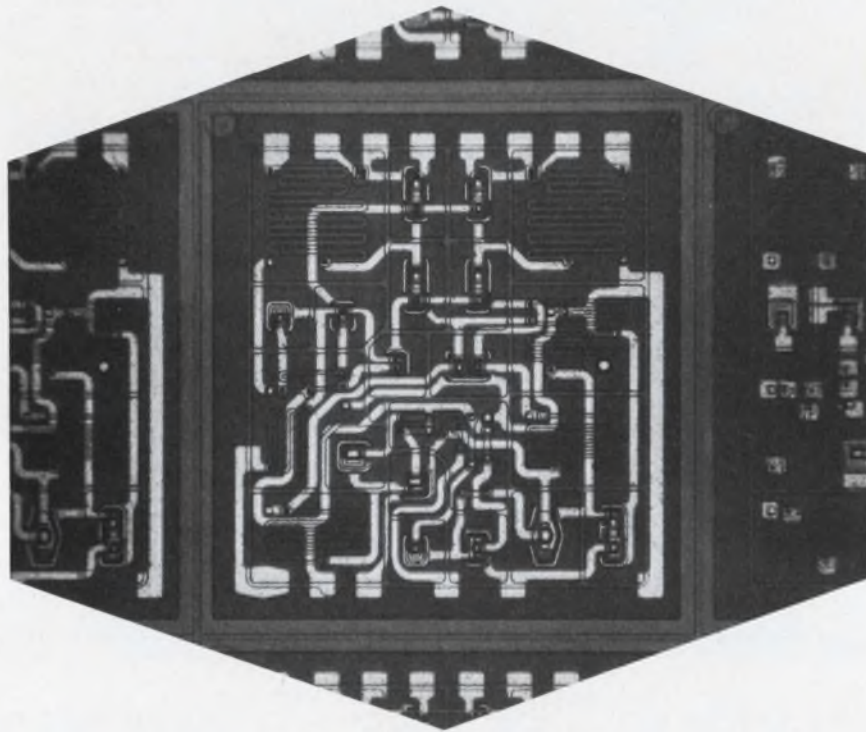

The 15nA Operational Amplifier

ADVANCED DATA SHEET FOR YOUR USE



- 15nA differential input offset current (max)
- 175pA/°C differential input offset current drift (max)
 - 5mV input offset voltage (max)
- 10 μ V/°C input offset voltage drift (max)
 - 50nA input biasing current (max)
 - ± 10 V common mode voltage (min)
 - ± 10 V output voltage swing (min)
 - 2mA output current drive (min)
 - 20,000 open loop voltage gain (min)
- -55°C to $+125^{\circ}\text{C}$ operating temp. in TO-101
- Offset Voltage adjustable to zero with external potentiometer
 - Off the shelf delivery

applications: A to D converter • Bridge amplifier • DC amplifier • Differential amplifier
Integrator (DC to AC) • Sample and hold amplifier



ELECTRONICS

ON READER-SERVICE CARD CIRCLE 27



ELECTRONICS

MONOLITHIC OPERATIONAL AMPLIFIERS

LINEAR INTEGRATED CIRCUITS

UC4000/UC4001/UC4002

The UC4000 series of operational amplifiers are constructed on a single silicon chip. The amplifier has the following features:

- Offset voltage adjustable to zero with external potentiometer • $\pm 10V$ common mode voltage • 15 nA differential input offset current • 100 pA/ $^{\circ}C$ differential input current drift • 10 $\mu V/^{\circ}C$ input offset voltage drift

MAXIMUM RATINGS

$T_A = 25^{\circ}C$ (UNLESS OTHERWISE NOTED)

	UC4000/UC4001/UC4002
Supply Voltage	± 18.0 Volts
Internal Power Dissipation 125 $^{\circ}C$ Ambient Temp.	200 mW
Output Short Circuit Duration	5 sec
Differential Input Voltage	± 10.0 Volts
Input Voltage, Common Mode	± 10.0 Volts
Storage Temperature Range	-65 $^{\circ}C$ to +200 $^{\circ}C$
Operating Ambient Temperature Range	-55 $^{\circ}C$ to +125 $^{\circ}C$
Lead Temperature Soldering for 60 seconds	+300 $^{\circ}C$

ELECTRICAL CHARACTERISTICS

@ 25 $^{\circ}C$ and Supply Voltage ± 15.0 Volts in Test Circuit Figure No. 4 (UNLESS OTHERWISE NOTED)

SPECIFICATION	Sym.	UC4000			UC4001			UC4002			Unit	TEST CONDITIONS
		Min.	Typ.	Max.	Min.	Typ.	Max.	Min.	Typ.	Max.		
Large Signal, Open Loop Voltage Gain	A_v	20K		80K	20K		80K	20K		80K		$V_{IN} = 100 \mu V$ rms $R_L = 10 K$ ohms $f = 100$ Hz
Large Signal, Open Loop Voltage Gain	A_v	15K		15K			15K					$V_{IN} = 100 \mu V$ rms $R_L = 10 K$ ohms, $f=100$ Hz ($T_A = -55^{\circ}C$ to +125 $^{\circ}C$)
Differential Input Impedance	R_{in} C_{in}	0.8	3.0		0.8	3.0		0.8	3.0		M Ω pF	$V_{out} = 7 V$ rms $f = 1 KHz$
Open Loop Output Resistance	R_{out}		100			100			100		ohm	$V_{out} \leq 1 V$ p-p $f = 100$ Hz
Output Voltage Swing	V_{out}	± 10		± 10			± 10				V	$R_L = 10 K$ ohms ($T_A = -55^{\circ}C$ to +125 $^{\circ}C$)
Output Current	I_{out}	± 2		± 2			± 2				mA	$R_L = 5 K$ ohms
Equivalent Input Offset Voltage (1)	V_{os}		3.0	5.0		5.0	10.0		7.0	10.0	mV	$R_L = 10 K$ ohms
Equivalent Input Offset Voltage Change with Temp.	ΔV_{os}			1.8			3.6			7.2	mV	$R_L = 10 K$ ohms ($T_A = -55^{\circ}C$ to +125 $^{\circ}C$)
Equivalent Average Offset Voltage Drift	ΔV_{os}			10			20			40	$\mu V/^{\circ}C$	$R_L = 10 K$ ohms ($T_A = -55^{\circ}C$ to +125 $^{\circ}C$)
Offset Voltage Change with Power Supply Variation	ΔV_{os}		25	150		25	150		25	150	$\mu V/V$	$R_L = 10 K$ ohms, $V_{out} = 0$ $\Delta V_{PS} = 1 V$ rms, $f = 100$ Hz
Offset Voltage Drift with Time	ΔV_{os}		40			100			160		$\mu V/24$ hr	$V_{os} = 0$ at start, $t = 24$ hrs.
Differential Input Offset Current	I_{os}			15			30			50	nA	$V_{out} = 0$, $R_L = 10 K$ ohms
Differential Input Offset Current Change with Temp.	ΔI_{os}			31.5			63.0			126	nA	$V_{out} = 0$, $R_L = 10 K$ ohms ($T_A = -55^{\circ}C$ to +125 $^{\circ}C$)

ELECTRICAL CHARACTERISTICS

@ 25°C and Supply Voltage ± 15.0 Volts in Test Circuit Figure No. 4 (UNLESS OTHERWISE NOTED)

SPECIFICATION	Sym.	UC4000			UC4001			UC4002		Unit	TEST CONDITIONS	
		Min.	Typ.	Max.	Min.	Typ.	Max.	Min.	Typ.			Max.
Average Differential Input Offset Current Drift	ΔI_{os}			175			350			700	pA/°C	$V_{out} = 0, R_L = 10\text{ K ohm}$ ($T_A = -55^\circ\text{C}$ to 125°C)
Differential Input Offset Current Change with Power Supply Variation	ΔI_{os}		500			500			500		pA/V	$V_{out} = 0, R_L = 10\text{ K ohms}$ $\Delta V_{PS} = 1\text{ V rms}, f = 100\text{ Hz}$
Differential Input Offset Current Change with Time	ΔI_{on}		1			3			5		nA/24 hr	$V_O = 0$ at start, $t = 24\text{ hrs.}$ $R_L = 10\text{ K } \Omega$
Common Mode Rejection	CMR	90	100		90	100		90	100		dB	$e_{in} = 1\text{ V rms}, f = 100\text{ Hz}$
Common Mode Voltage Range (Note 2)	V_{CM}	± 10			± 10			± 10			V	$R_L = 10\text{ K}, R_f = \infty$ $f = 100\text{ Hz},$ $V_{out} = 7\text{ V rms}$
Common Mode Input Resistance	R_{CM}		400			400			400		M Ω	$V_{out} = 7.0\text{ V rms}$ $V_{CM} = 7.0\text{ V rms}$
Input Bias Current	I_{Bias}		40	50		60	100		80	150	nA	$V_{out} = 0$
Input Bias Current	I_{Bias}		150	250		300	400		500	600	nA	$V_{out} = 0$ ($T_A = -55^\circ\text{C}$)
Input Spot Noise Voltage	e_n		200			200			200		nV/ $\sqrt{\sim}$	$f = 100\text{ Hz}$ $R_L = 10\text{ K}\Omega$
Small Signal Bandwidth—(Note 2)	BW	1.0	2.0	1.0	2.0	1.0	2.0	1.0	2.0		MHz	$R_f = 0, R_{in} = \infty,$ $e_{in} \leq 100\text{ mV}$
P.S. Current Drain, +15 V				7.0			7.0			7.0	mA	$V_{out} = 0$
P.S. Current Drain, -15 V				8.0			8.0			8.0	mA	$V_{out} = 0$
Slewing Rate (Note 2)	$\Delta V/\Delta t$	1.0		1.0		1.0		1.0			V/ μs	$R_L = 10\text{ K}$ $-10\text{ V} < V_{out} < +10\text{ V}$ $t_r = 10\text{ ns}, \text{PRR} = 1\text{ KHz}$
Full Power Frequency (Note 2)		15		15		15		15			KHz	$R_L = 10\text{ K}, V_{out} = 7\text{ V rms}$ $R_i = R_f = 100\text{ K}\Omega$

- Notes: 1) Adjustable to zero by external 20 K Ω potentiometer.
 2) With compensation to provide 6 dB per octave roll-off (see Figure 3).
 3) If balance potentiometer is not used, connect pins 7 and 12 through 10K ohm resistors to pin 6 (see Figure 5).

4) Case connected to negative supply pin 2.

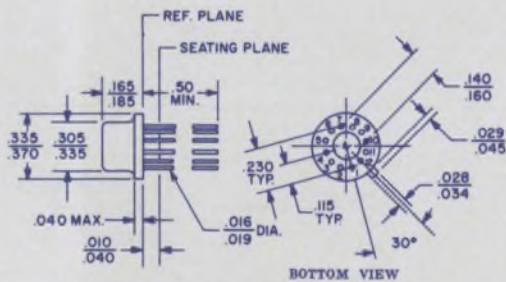

JEDEC OUTLINE TO-101.
PHYSICAL DIMENSIONS
FIGURE 1

- (1) Common
- (2) Negative Supply (Ref: Note 4)
- (3) Output Compensation (Fig. 3 & 5)
- (4) Output Compensation (Internal Resistor)
- (5) Output
- (6) Positive Supply
- (7) Balance Potentiometer
- (8) Input Compensation (Fig. 3 & 5)
- (9) Input (Inverting)
- (10) Input (Non-inverting)
- (11) Input Compensation
- (12) Balance Potentiometer (Fig. 3 & 5)

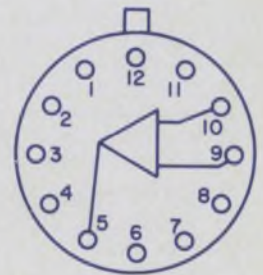

CONNECTION DIAGRAM
FIGURE 2

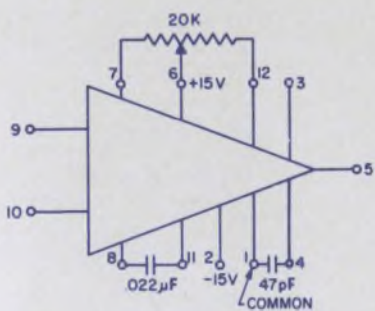

FREQUENCY COMPENSATION CIRCUIT FOR
6 dB/OCTAVE ROLLOFF (Ref: Note 2)
FIGURE 3

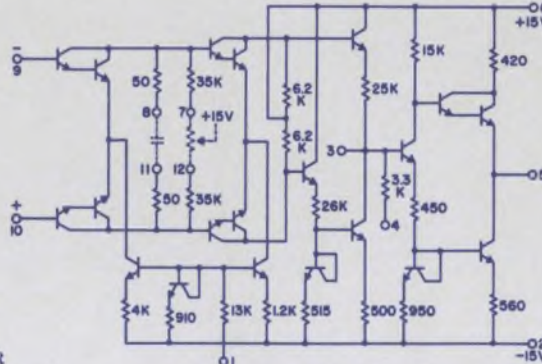

CIRCUIT DIAGRAM
FIGURE 4

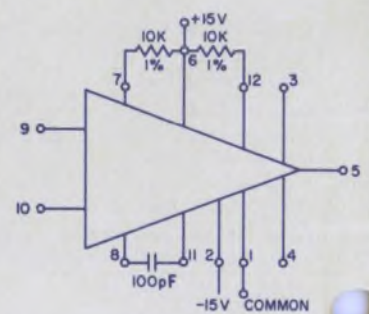

STANDARD TEST CIRCUIT
(Ref: Note 3)
FIGURE 5

LARGE SIGNAL CHARACTERISTIC

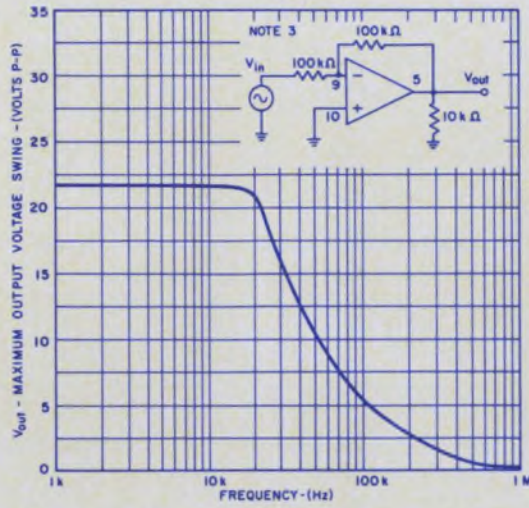

MAXIMUM OUTPUT VOLTAGE SWING VS FREQUENCY

FIGURE 18

SMALL SIGNAL CHARACTERISTIC

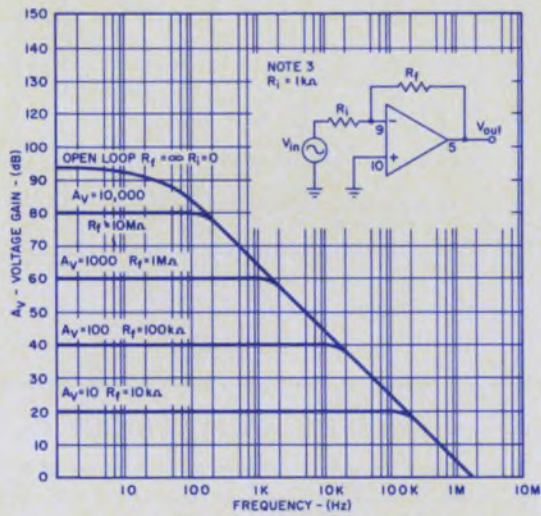

VOLTAGE GAIN VS FREQUENCY

FIGURE 19

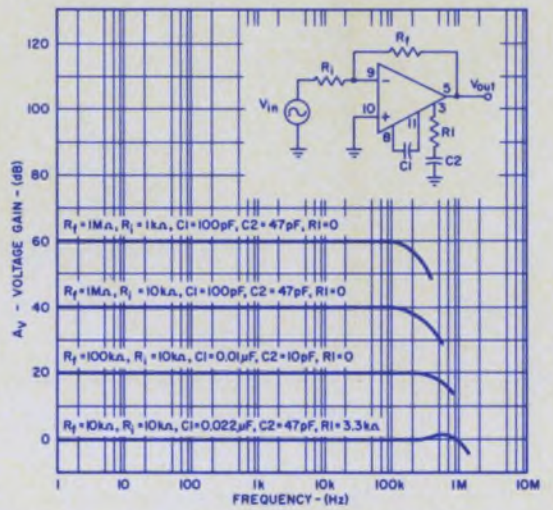

VOLTAGE GAIN VS FREQUENCY

FIGURE 20

POWER SUPPLY CHARACTERISTICS

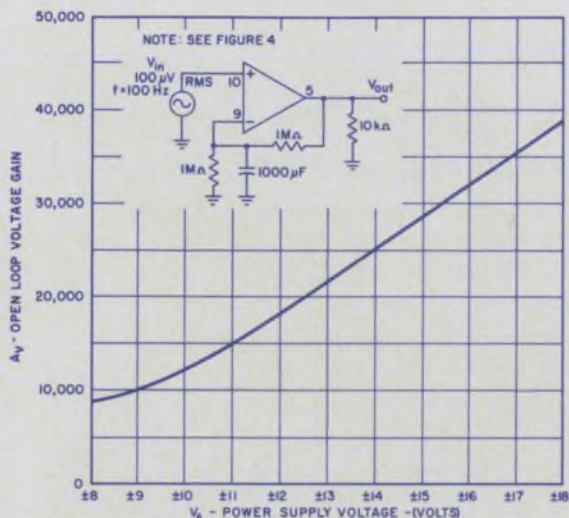

OPEN LOOP VOLTAGE GAIN VS POWER SUPPLY VOLTAGE

FIGURE 12

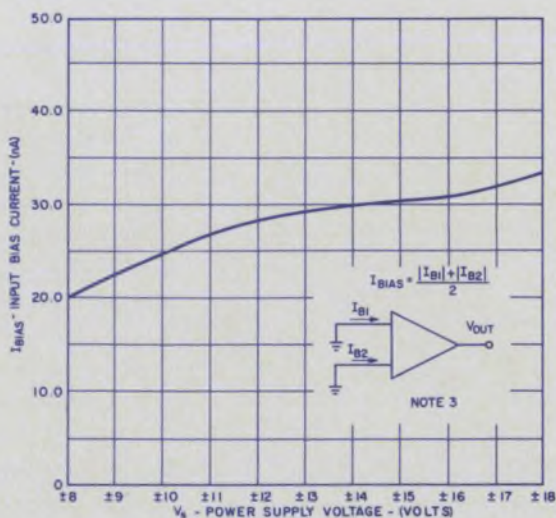

INPUT BIAS CURRENT VS POWER SUPPLY VOLTAGE

FIGURE 13

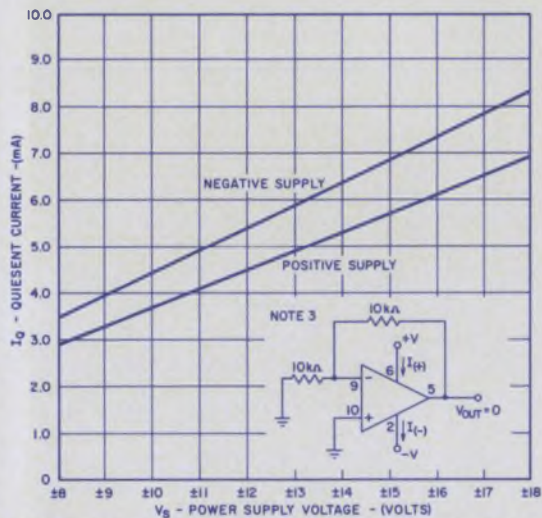

QUIESCENT CURRENT VS POWER SUPPLY VOLTAGE

FIGURE 14

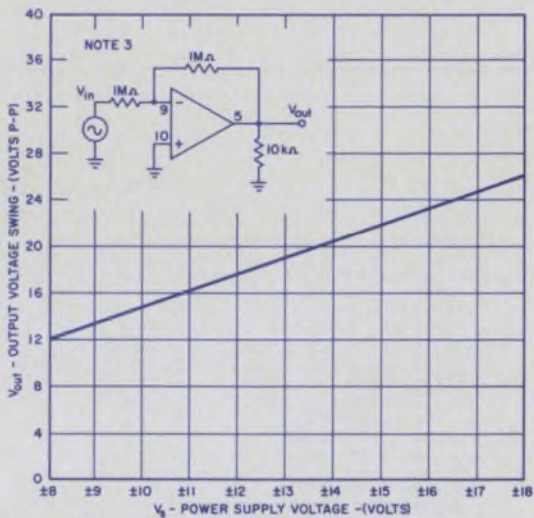

OUTPUT VOLTAGE SWING VS POWER SUPPLY VOLTAGE

FIGURE 15

TRANSFER CHARACTERISTIC

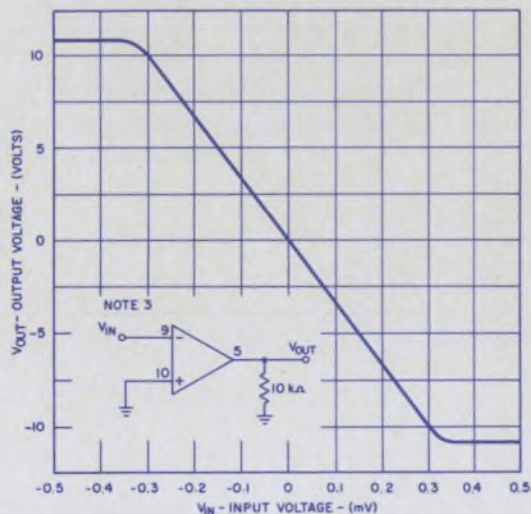

OUTPUT VOLTAGE VS INPUT VOLTAGE

FIGURE 16

NOISE CHARACTERISTIC

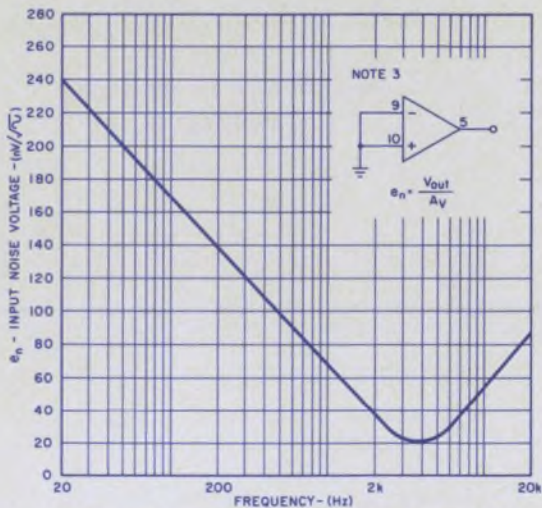

INPUT NOISE VOLTAGE VS FREQUENCY

FIGURE 17

TEMPERATURE CHARACTERISTICS

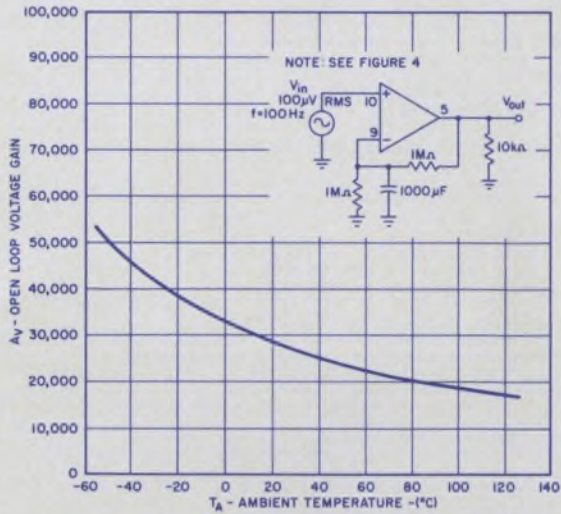

UNION CARBIDE SALES OFFICES

CALIFORNIA 92633, Fullerton • 2736 W. Orangethorpe
 Union Carbide Electronics • (213) 691-0958 • (714) 871-5073
 • TWX: 910-592-1255

CALIFORNIA, Mtn. View • 2680 Bayshore Frontage Road
 Union Carbide Electronics • (415) 969 9390 • TWX: 910-379-6444

ILLINOIS 60068, Park Ridge • 2 Talcott Road
 Union Carbide Electronics • (312) 825-7181 • TWX: 910-253-4081

NEW JERSEY, Englewood Cliffs • 320 Hudson Terrace
 Union Carbide Electronics • (201) 567-6730 • TWX: 710-991-9744

MASSACHUSETTS, Needham • 300 First Avenue
 Union Carbide Electronics • (617) 444-5400 • TWX: 710-325-1329

TEXAS, Dallas • Preston Forest Towers, 5925 Forest Ln.
 Union Carbide Electronics • (214) 239-0221 • TWX: 910-860-5000

REPRESENTATIVES / EASTERN:

ALABAMA, Huntsville • 2805 Governors Drive
 Bohman Associates • (205) 534-1355

CONNECTICUT, Milford • 662 Bridgeport
 Vector Sales, Inc. • (203) 874-2112

FLORIDA, Orlando • 7040 Lake Ellenor Drive
 Bohman Associates • (305) 855-0274

MARYLAND, Towson • 206 W. Washington Avenue
 Wm. I. Duncan Assoc., Inc. • (301) 823-2506

MASSACHUSETTS, Belmont • 774 Pleasant St.
 Vector Sales, Inc. • (617) 489-1400

NEW JERSEY, Wayne • 18 Sunny Ridge Road
 Unicomp • (201) 696-2888 • TWX: 201-835-5444

NEW YORK, Ithaca • 714 W. Clinton St.
 Bob Dean, Inc. • (601) 272-2187 • TWX: 510-255-5876

NORTH CAROLINA, Bethania •
 Candor Company • (919) 924-1480

PENNSYLVANIA, Philadelphia • 5452 Charles St.
 Wm. I. Duncan Assoc., Inc. • (215) 744-8110

CENTRAL:

ILLINOIS, Chicago • 7448 North Harlem Avenue
 Carlson Electronic Sales Co. • (312) 774-4812 • TWX: 910-221-5017

INDIANA, Indianapolis • 4010 Washington Blvd.
 Leslie M. Devoe Co. • (317) 283-1395 • TWX: 810-341-3284

MICHIGAN, Detroit • 16239 Wyoming Avenue
 Carter, McCormick and Peirce • (313) 863-4600 • TWX: 810-243-4067

MINNESOTA, Minneapolis • 7400 Lyndale Avenue South
 Stan Clothier Co., Inc. • (612) 869-3231 • TWX 910-576-3415

MISSOURI, Kansas City • 7916 Paseo St.
 Harris-Hanson Company • (816) 444-9494 • TWX: 910-771-2160

MISSOURI, St. Louis • 2814 So. Brentwood
 Harris-Hanson Company • (314) 647-4350 • TWX: 910-760-1650

OHIO, Cleveland • 3691 Lee Road
 Carter, McCormick and Peirce • (216) 921-1360

OHIO, Dayton • 3406 N. Main Street
 Carter, McCormick and Peirce • (513) 278-5873

TEXAS, Garland • 400 Forest Gate Lane, Suite 102 P. O. Box 87
 Carter Associates • (214) 276-7151

TEXAS, Houston • 1401 S. Post Oak Road, Suite 105
 Carter Associates • (713) 622-0844 • TWX: 910-881-2600

WESTERN:

ARIZONA, Scottsdale • 201 West 1st Street, P.O. Box 99
 Carter Associates • (602) 947-4355 • TWX: 910-950-0080

CALIFORNIA, Costa Mesa • 2956 Randolph
 Williams, Hedge and Martin • (714) 540-3244

CALIFORNIA, Los Altos • 175 So. Antonio Road
 W. W. Posey Co. • (415) 948-7771

CALIFORNIA, Van Nuys • 13615 Victory Blvd.
 Dorado Electronics, Inc. • (213) 873-4124

COLORADO, Denver • 2654 So. Krameria St.
 Lindberg Company • (303) 757-6489 • TWX: 910-931-2579

OREGON, Beaverton • 200 N.E. Canyon Road
 Arneson Associates • (503) 646-3416

WASHINGTON, Seattle • 5950 Sixth Avenue, So.
 Arneson Associates • (206) 762-7664

DISTRIBUTORS / EASTERN:

ALABAMA, Huntsville • 2805 Governors Drive
 Hall-Mark Electronics • (205) 536-9627

ALABAMA, Huntsville • Clinton Building, 2109 Clinton Ave.
 Schweber Electronics • (205) 539-2756 • TWX 510-579-2245

FLORIDA, Orlando • 7233 Lake Ellenor Drive
 Hall-Mark Electronics • (305) 855-4020 • TWX: 810-850-0183

MARYLAND, Baltimore • 5 North Howard Street
 Radio Electric Service Co. • (301) 539-3835 • TWX: 710-234-1050

MARYLAND, Silver Springs • 8720 Georgia Ave.
 Schweber Electronics • (310) 587-2900

MASSACHUSETTS, Burlington • 207 Cambridge Street
 Avnet Electronics • (617) 272-3060 • Telex: 94-6530

MASSACHUSETTS, Waltham • 400 Wyman Street
 Schweber Electronics • (617) 891-8484

NEW JERSEY, Clifton • 312 Clifton Avenue
 Eastern Radio • (201) 471-6600 • TWX: 710-484-4828

NEW YORK, Binghamton • P.O. Box 1208
 Federal Electronics • (607) 748-8211

NEW YORK, Buffalo • 916 Main Street
 Summit Electronics • (716) 884-3450

NEW YORK, New York •
 Eastern Radio • (212) 244-8930

NEW YORK, Westbury, L.I. • Jericho Turnpike
 Schweber Electronics • (516) 334-7474 • TWX: 510-222-3660

NORTH CAROLINA, Winston-Salem • 938 Burke Street
 Electronic Wholesalers, Inc. • (919) 725-8711

PENNSYLVANIA, Philadelphia • 5908 Torresdale Ave.
 Buyers Electronic Distributors, Inc. • (215) 744-3242

CENTRAL:

ILLINOIS, Elk Grove Village • 75 Gaylord Street
 Arco Electronics • (312) 487-0500

ILLINOIS, Franklin Park • 10130 West Pacific
 Avnet Electronics • (312) 678-8160 • TWX: 910-227-0795

KANSAS, Kansas City • 2707 W. 43rd Street
 Precision Electronics Devices, Inc. • (913) 236-4343

MINNESOTA, Minneapolis • 4940 Viking Drive, Suite 208
 Avnet Electronics • (612) 920-5866

MISSOURI, St. Louis • 2605 S. Hanley Road
 Electronic Components for Industry • (313) 647-5505
 • TWX: 314-556-0584

OHIO, Cleveland • 20950 Center Ridge Road
 Schweber Electronics • (216) 333-7020

OKLAHOMA, Tulsa • P.O. Box 15565, Admiral Station
 Hall-Mark Electronics • (918) 835-8458 • TWX 910-845-2246

TEXAS, Dallas • 9100 Markville Drive
 Hall-Mark Electronics • (214) 231-6111

TEXAS, Houston • 8000 Westglen
 Hall-Mark Electronics • (713) 781-0011 • TWX: 910-867-4717

TEXAS, Houston • 1616 McKinney
 Sterling Electronics • (713) 225-1321 • TWX: 713-571-3327

WESTERN:

ARIZONA, Phoenix • 1739 North 28th Avenue
 Avnet Electronics • (602) 272-6821 • Telex: 66-750

CALIFORNIA, Culver City • 10916 Washington Blvd.
 Avnet Electronics • (213) 870-6141 • TWX: 910-340-6753

CALIFORNIA, Los Angeles • 5645 E. Washington Blvd.
 K-Tronics • (213) 685-5888 • TWX: 910-580-3152

CALIFORNIA, Mtn. View • 344 Middlefield Road
 Avnet Electronics • (415) 961-7700

CALIFORNIA, Newport Beach • 4301 Birch Street
 Western Electronic Components • (714) 540-1322 (213) 631-6119

CALIFORNIA, Palo Alto • 3969 E. Bayshore
 Kierulff Electronics, Inc. • (415) 968-6292 • TWX: 910-379-6430

CALIFORNIA, Redwood City • 695 Veterans Blvd.
 Fortune Electronics • (415) 365-4000
 (312) 439-8100

CALIFORNIA, San Diego • 7969 Engineer Road
 Avnet Electronics • (714) 279-1550 • Telex: 69-515

CALIFORNIA, San Diego • 8133 Engineer Road
 Kierulff Electronics • (714) 278-2112 • TWX: 910-335-1182

COLORADO, Denver • 2170 So. Grape Street
 Newark-Denver Electronics • (303) 757-3351 • TWX: 910-931-0479

WASHINGTON, Seattle • 2217 Third Avenue
 Washington Electronics, Inc. • (206) 682-8981

INTERNATIONAL SALES

NEW YORK, New York • 270 Park Avenue
 Union Carbide International

AUSTRALIA, Sydney N.S.W. • 167 - 187 Kent Street
 Union Carbide Australia Limited

BELGIUM, Brussels 8 • 134 Boulevard Leopold II
 J. P. Lemaire

CANADA, London Ontario • 1255 Brydges St.
 Welwyn Canada Ltd. • (519) 451-9490

CANADA, Montreal 11, Quebec • 1505 Louvain St. W.
 Avnet Electronics of Canada • (514) 381-9126 • Telex: 01-20678

CANADA, Toronto 19, Ontario • 87 Wingold Avenue
 Avnet Electronics of Canada • (416) 789-1838 • Telex: 02-29195

FRANCE, Clichy (Seine) • 19-21 Rue Madame de Sanzillon
 Tranchant Electronique

SWEDEN, Solna 3 • Gardsvagen 10B
 John C. Lagercrantz

UNITED KINGDOM • 31 Camden Road, London N.W. 1, Eng.
 Livingston Components Limited

UNITED KINGDOM • 8 Grafton Street, London W 1, Eng.
 Union Carbide Limited

WEST GERMANY, Munich 19 • Nymphenburger Strasse 164
 Omni-Ray GmbH

WEST GERMANY, Munich 90 • Chiemgaustrasse 109, 8000
 Sasco, GmbH

PRINTED IN U.S.A. 567



365 Middlefield Road, Mountain View, California 94040/Tel: (415) 961-3300; TWX: 910-379-6942

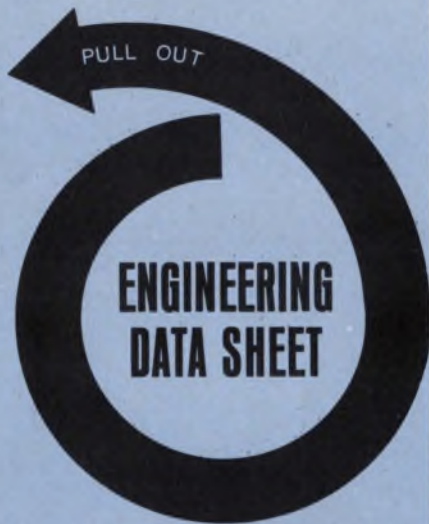

If somebody beat
you to it, write to:
**Union Carbide
Electronics**
or call your UCE
distributor
IN THE WEST

ARIZONA, Phoenix
Avnet Electronics • (602) 272-6821

CALIFORNIA,
Culver City
Avnet Electronics • (213) 870-6141
Los Angeles
K-Tronics • (213) 685-5888
Mountain View
Avnet Electronics • (415) 961-7700
Newport Beach

Western Electronic Components •
(714) 540-1322 (213) 631-6119
Palo Alto
Kierulff Electronics, Inc. • (415) 968-6292
San Diego
Avnet Electronics • (714) 279-1550
San Diego
Kierulff Electronics • (714) 278-2112

COLORADO, Denver
Newark-Denver Electronics •
(303) 757-3351

WASHINGTON, Seattle
Washington Electronics • (206) 682-8981

Factory Sales Offices
CALIFORNIA

Mountain View
(415) 969-9390
Fullerton
(213) 691-0958



ELECTRONICS

ON READER-SERVICE CARD CIRCLE 27

LETTERS

(continued from p. 54)

At present we estimate over 200 systems in the country are providing 24-hour time and weather service and a substantial number of these systems are providing a 24-hour news channel utilizing the news wire services of Associated Press and United Press International. Partly as a result of demands by local communities, approximately 100 CATV systems are presently engaged in some additional form of local origination (cablecasting is apparently the term that will be applied to this activity) geared to the needs of the communities they serve.

I would offer one disclaimer on the content of your editorial. You refer to "between 50 and 100 per cent" profits. We have sought, unsuccessfully, to document reports of such profits which have appeared in various articles over the past five years. We are justifiably enthusiastic about our industry and its future, but tend to regard it as a very good business rather than one in the spectacular category in which it has been depicted.

Wally Briscoe
Administrative Assistant
National Community Television
Assoc.
Washington, D. C.

MAYBE gate performs better in new mode

Sir:

A further improvement in the performance of the MAYBE gate described in *ELECTRONIC DESIGN* [Letters, ED 4, Feb. 15, 1967, p. 49] can be obtained by making slight modifications in the circuitry.

While operation in the FOR-SURE mode, as recently discussed

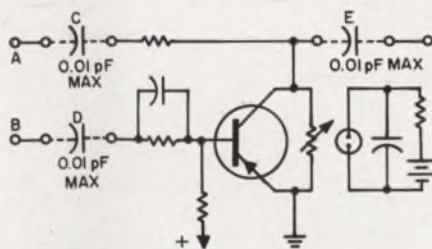

WHYBOTHER mode improves gate

[Letters, ED 7, April 1, 1967, p. 33], provides reliable results, guaranteed performance can be obtained by modifying the circuitry to allow operation in the WHYBOTHER mode (see figure).

In this configuration, the output is affected neither by the input nor by the bias on the transistor, and there can thus never be any question of its magnitude. Additional savings allowed by the elimination of the bias supply are unfortunately decreased, however, by the necessity for careful quality control in circuit construction to minimize capacitance at points C, D and E.

Jud B.Flato
Senior Research Chemist
Leon Szmauz
Senior Development Engineer
Princeton Applied Research Corp.
Princeton, N. J.

Fawkes' nomograph makes its mark

Sir:

Genius fills me with awe and envy. I marvel at its process and wish that I, a journeyman engineer, could duplicate it.

The fruits of genius are the salvation of hacks like me. They also bring immortality to the discoverers, to wit, Newton and fluxions, Steinmetz and complex algebra, Heaviside and operational calculus, Shannon and Boolean algebra, and now at last, Guy Fawkes and his hertz-cps nomograph [see "Nomograph accurately converts Hz into cps" ED 7, April 1, 1967, p. 37]. A new immortal!!

William Rosenstein
Project Engineer
Development and Product Engineering Dept.
Varityper Corp.
Newark, N. J.

Accuracy is our policy

In "Digital multimeter has push-button control," ED 6, March 15, 1967, p. U168, the pricing is incomplete. Cohu Electronics' basic device costs \$1495, but the "full-house" version described is listed at \$2750.

TRW announces the
Hyper Abrupt
Junction
Varicap™

**HYPER
ABRUPT
JUNCTION**

...first available on the domestic market!

Here is the first of a series of TRW hyper-abrupt junction voltage-variable capacitance diodes designed for UHF and VHF telemetry, mobile and airborne equipment.

With this remarkable new Varicap you can increase tuning range up to 4 times . . . assure

linear loop sensitivity in VCO design and achieve substantially greater efficiency in frequency multipliers.

PHV Varicaps are available in 3pF and 20pF values (PHV3R0 and PHV200) and are packaged in D0-19 cases.

Contact any TRW distributor

or TRW Semiconductors, 14520 Aviation Blvd., Lawndale, Calif. 90260. Phone: (213) 679-4561, TWX: 910-325-6206. TRW Semiconductors Inc., is a subsidiary of TRW INC.

TRW®

ON READER-SERVICE CARD CIRCLE 28

Co-Publishers

James S. Mulholland, Jr.
Robert E. Ahrensford

Editorial Director

Edward E. Grazda

Editor

Howard Bierman

Managing Editor

Robert C. Haavind

Technical Editors

Jeffrey N. Bairstow
Peter N. Budzilovich
Maria Dekany
Roger K. Field

Careers & Management Editor

Archimedes Doria

News Editors

Ralph Dobriner, Chief
Richard N. Einhorn

East Coast Editor

Neil Sclater

West Coast Editor

Ron Gechman

Copy Editor

Peter Beales

New Products Editors

David H. Sorgan
Daniel R. Butterly

Washington Editor

S. David Pursglove

Editorial Production

Dollie S. Viebig
Karen L. Sherman

Art Director

Clifford M. Gardiner

Art Assistant

William Kelly

Technical Illustrators

Cheh Nam Low
William Alvarez
Sheila F. Ward

Production Manager

Thomas V. Sedita

Asst. Production Manager

Helen De Polo

Production Assistants

Bernard Wolinsky
Robert B. Lichtig

Circulation Manager

Nancy L. Merritt

Reader Service

Diane Mandell

EDITORIAL

Brain research is no threat to man's individuality

Electrical stimulation of the brain has many connotations to scientists. To the clinician, it is a tool for diagnosing such abnormalities as epileptic seizures. To the physiologist, it is a method of gaining new insight into the functioning of an extremely complex organ. To the psychologist, it is a means to understand behavior of animals and men.

A layman freshly confronted with the concept lacks a sound basis for deciding whether this research is benign or malevolent. It is natural that he should be troubled at the idea of intrusion into his privacy at least, total domination at worst.

Fear of enslavement is as old as man himself. Forced-labor camps are a reality in our age. Nor is government interference with our biology novel. We submit to blood tests before marrying, to inoculation before traveling abroad. We eat iodized salt, drink fluoridated water.

Prof. José M. R. Delgado of the Yale University Medical School commented in 1965:

"These intrusions into our blood, teeth, and glands have been legally introduced, are useful for the prevention of illness, and do generally benefit society and individuals, but they have established a precedent of official manipulation."

"Fortunately," he added, turning individuals into robots is "remote, if not impossible."

Unfortunately, much nonsense has been written on this subject. An advertisement for a sensational book on the assassination of John F. Kennedy hints that Oswald, Ruby and others were controlled by means of receivers implanted in their brains.

When Dr. Delgado and other researchers say this is impossible, these are their reasons:

- There are anatomical and functional differences between individuals. Each person would have to be studied for a long time before the effects of implanted electrodes were known.

- Stimulation of the human brain evokes limited responses, but would not control the totality of behavior.

- The human brain has built-in controls of its own and resists manipulation. Stimulation can modify existing behavior; it cannot create personality.

Scientific discoveries and technology cannot be shelved because of real or imaginary dangers, but their progress should be in the open. Nothing dispels unfounded fears better than knowledge.

RICHARD N. EINHORN

Tektronix Type 491

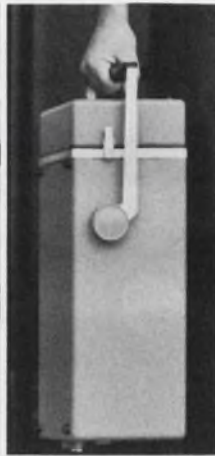

... PACK IT UP ... PICK IT UP ... SET IT UP

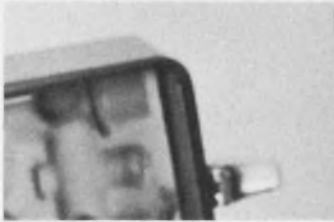

... START IT UP

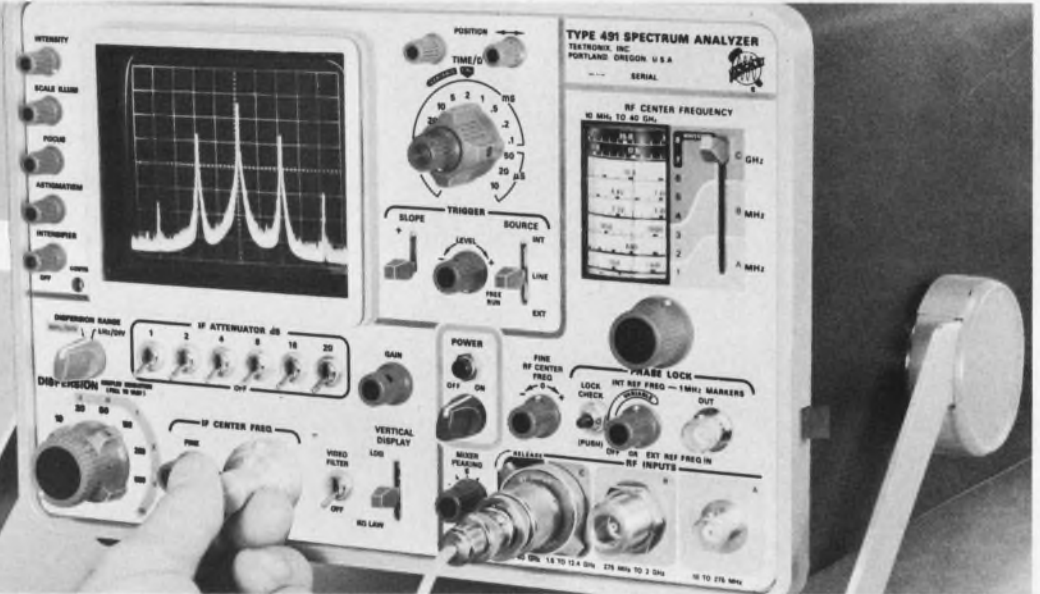

New 10 MHz-TO-40 GHz spectrum analyzer

The Type 491 is only 7" high by 12" wide and 22" deep, weighs less than 40 pounds and requires only 55 watts. Yet it has the broad frequency range and high performance you need for most applications. And setup is easy even at waveguide frequencies—just mount one of the three included external waveguide mixers to your source and couple it to the Type 491 with a flexible cable.

You can judge its performance by these features . . . internal phase lock for stable displays even at 1 kHz/div dispersion . . . resolution range of 1 kHz to 100 kHz coupled to calibrated dispersion for operational simplicity . . . dispersion range of 10 kHz (1 kHz/div) to 100 MHz (10 MHz/div) for direct readings of relative frequency from the display . . . CW sensitivity of -110 to -70 dBm depending on frequency . . . and display flatness of ± 1.5 dB over 100 MHz dispersion.

With oscilloscope-type triggering and sweep circuitry, you can trigger from internal, external or line sources, and have

wide choice of sweep rates from 0.5 s/div to 10 μ s/div in a 1-2-5 sequence.

Other features include EMI (RFI) suppression . . . trace intensification of high speed segments of the waveform . . . camera compatibility with the Tektronix Type C-30 for easy, high quality photographs . . . bright display, small spot size, long persistence (P-7) phosphor on a new 4-inch rectangular CRT with 8x10 div (1 div equals 0.8 cm) display . . . and DC-coupled recorder output.

As shown, the carrying handle adjusts for various tilt positions and provides a sturdy support stand. The front panel cover serves as a storage case for the included accessories such as adapters, cables, waveguide mixers and coax attenuators. And the rugged construction of the Type 491 lets you carry laboratory performance to the job.

Type 491 (with accessories) \$4200

U.S. Sales Price f.o.b. Beaverton, Oregon

Tektronix, Inc.



For complete information, contact your nearby Tektronix field engineer or write: Tektronix, Inc., P.O. Box 500, Beaverton, Oregon 97005

ON READER-SERVICE CARD CIRCLE 29

Technology

RAPID DESIGN OF PRACTICAL
CLASS A, SINGLE-ENDED

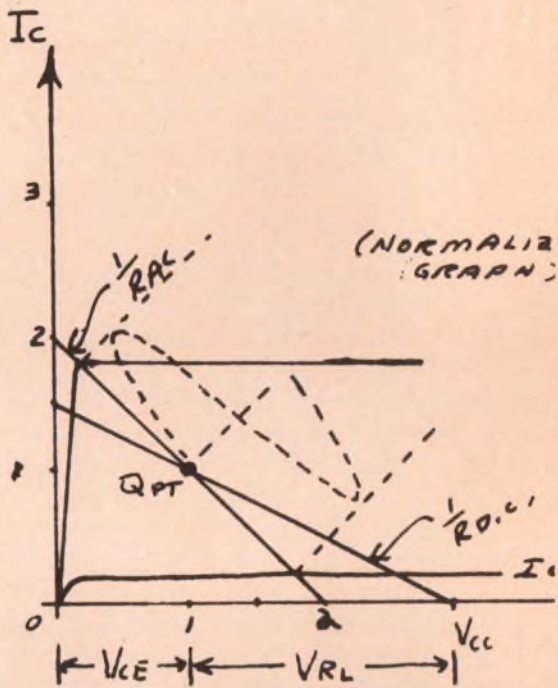

KNOWN: V_{CC} , Z_{OUT} , \bar{z}

OBJECTIVE: MAX. SIGNAL

METHOD: STAGE EFFICIENT
POINT WHICH RES
THE Q POINT
SWING BETWEEN

1. ASSUMING $V_D > Z_{OUT}$
 I_c .
2. $R_4 + R_5 = R_3$

A neatly kept notebook of basic circuit designs is an invaluable and handy reference. Page 75

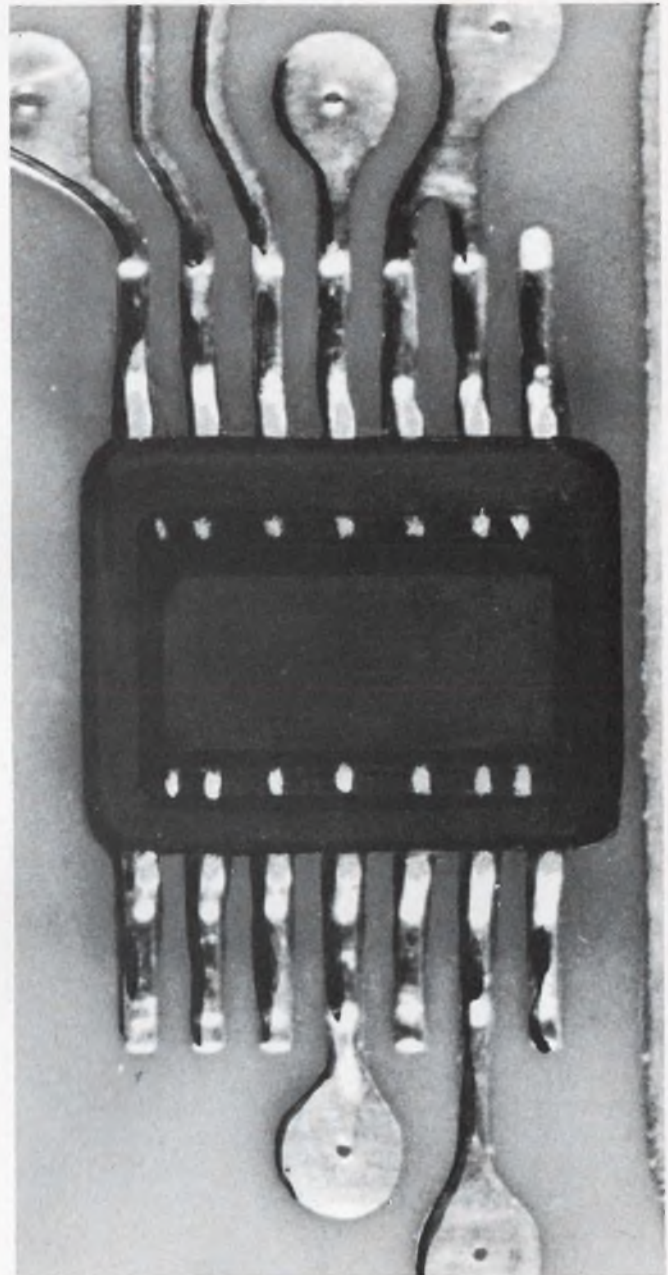

Prealloyed solder-and-flux creams improve quality of microelectronic soldering. Page 90

Also in this section:

A high-performance logarithmic amplifier is designed with tunnel diodes. Page 62

Load impedance may be ignored in SCR inverters if an LC swinging circuit is used. Page 68

The size of vhf attenuators is cut by a simple circuit with good characteristics. Page 84

Design a log amp with tunnel diodes

to combine high speed with temperature and phase stability. Hybrid techniques make it easy.

Logarithmic amplifiers designed with tunnel diodes can perform at frequencies above 1 GHz with bandwidths greater than 100 MHz. They dissipate one-twelfth the power of conventional logarithmic amplifiers that use ordinary diodes; they are twice as phase-stable; and they are four times more temperature-stable.

Such high-performance amplifiers can be made with thin-film passive components, tiny inductors and available tunnel diodes. They are especially useful in high-resolution radar systems or any system that requires very stable logarithmic amplification of extremely high frequencies.

The effective bandwidth of commonly used successive-detection logarithmic amplifiers is limited to about 10 MHz because they require IF decoupling at the video output of each stage. On the other hand, cascaded duo-gain logarithmic amplifiers that use conventional diodes as nonlinear feedback or load are limited—in frequency as well as bandwidth—by the capacitance and speed of their diodes.

The tunnel diodes offer these benefits to the logarithmic-amplifier circuit:

- They can operate in the microwave region. The circuit is limited primarily by the speed of available transistors, which is now routinely up to 1 GHz. A stripline logarithmic amplifier, however, would probably be better at speeds of 10 GHz.

- They have low forward impedance of about 50 ohms. The amplifier thus has more small-signal gain than conventional logarithmic amplifiers. Fewer cascaded stages are required for a specific input dynamic range when tunnel diodes are used.

- They have extremely low junction capacitance—around 1 picofarad—and excellent matching characteristics. This results in less phase shift than conventional logarithmic amplifiers.

- They have excellent current-temperature

characteristics. The circuit's drift is within 2% over a wide temperature range.

How the basic circuit works

The basic tunnel-diode logarithmic-amplifier circuit is shown in Fig. 1. This circuit is a common-emitter stage with the tunnel-diode network in the emitter leg. Transistor *Q1* is a microwave transistor; hence its input and output capacitances can be neglected up to a frequency of some 10 GHz—the present state of the art of microwave transistors. R_L is the load resistance and includes the equivalent collector resistance of *Q1*. R_{in} is the input resistance and includes the equivalent transistor input resistance. R_e is the emitter bias resistor. C_{in} is the input feedthrough capacitor, C_o is the output feedthrough capacitor, and C_e is the emitter bypass capacitor.

Parallel resistors R_{D1} and R_{D2} are matched to



Author Harry Fumea zeroes in on one of his hybrid tunnel-diode logarithmic amplifiers.

Harry J. Fumea, Jr., Technical Director, Eastern Technical Center, Bunker-Ramo Corp., Silver Spring, Md. This work was done while the author was employed at Westinghouse Defense and Space Center, Baltimore.

the tunnel diodes, *TD1* and *TD2*, to produce the characteristic curve shown in Fig. 1. Resistor R_x is used to control the gain of region 3, which is held at unity.

The equivalent circuit (Fig. 2) for the tunnel-diode-resistor network shows:

$$R_s = R_D || R_R = R_D R_R / (R_D + R_R), \quad (1)$$

where:

R_s = series resistance,

R_R = reverse resistance of the tunnel diodes.

From Fig. 2 (left):

$$\begin{aligned} Z_1 &= (R_s + R_x) + Z_{D1} || R_{D1} \\ &= (R_s + R_x) + [Z_{D1} R_{D1} / (Z_{D1} + R_{D1})], \end{aligned} \quad (2)$$

where Z_{D1} = impedance of tunnel diode *TD1*. From Fig. 2 (right):

$$\begin{aligned} Z_2 &= (R_s + R_x) + Z_{D2} || R_{D2} \\ &= (R_s + R_x) + [Z_{D2} R_{D2} / (Z_{D2} + R_{D2})], \end{aligned} \quad (3)$$

where Z_{D2} = impedance of tunnel diode *TD2*.

If the tunnel diodes are matched:

$$Z_D = Z_{D1} = Z_{D2}, \quad (4)$$

and if R_{D1} and R_{D2} are chosen so that $R_D = R_{D1} = R_{D2}$, then Eqs. 2 and 3 are identical and become:

$$\begin{aligned} Z &= Z_1 = Z_2 = (R_s + R_x) + Z_D || R_D \\ &= (R_s + R_x) + [Z_D R_D / (Z_D + R_D)], \end{aligned} \quad (5)$$

where Z = total impedance of the tunnel-diode network.

Equation 5 shows that bipolar operation is obtained. The voltage output of Fig. 1 is given as:

$$e_o = e_{in} (Z_c / Z_e), \quad (6)$$

where:

Z_c = total collector impedance,

Z_e = total emitter impedance:

$$Z_e = R_e || Z = R_e Z / (R_e + Z). \quad (7)$$

If bias resistor R_e is made large in relation to Z , the total emitter resistance becomes:

$$Z_e \approx Z. \quad (8)$$

Since $Z_c = R_L$, Eq. 6 becomes:

$$\begin{aligned} e_o &= e_{in} (R_L / Z) \\ &= e_{in} \{ R_L / [(R_s + R_x) + Z_D || R_D] \}. \end{aligned} \quad (9)$$

This equation describes the curves of Fig. 1 (right). Z_D is nonlinear and can be broken into four approximately linear regions (Fig. 3):

In region 1, Z_D is positive and small = Z_{1D} ;

In region 2, Z_D is negative and small = Z_{2D} ;

In region 3, Z_D is positive and large = Z_{3D} ;

In region 4, Z_D is positive and small = Z_{4D} .

Throughout region 1, the small-signal region, Eq. 9 becomes:

$$e_o = e_{in} \{ R_L / [(R_s + R_x) + Z_{1D} || R_D] \}. \quad (10)$$

Since Z_{1D} is small and positive, the voltage gain is maximum, as shown in Fig. 1. A typical small-signal gain is 10 dB.

In region 3, Eq. 9 becomes:

$$e_o = e_{in} \{ R_L / [(R_s + R_x) + Z_{3D} || R_D] \}. \quad (11)$$

Since Z_{3D} is positive and large, $Z_{3D} || R_D$ is approximately equal to Z_{3D} . Since Z_{3D} and R_s are deter-

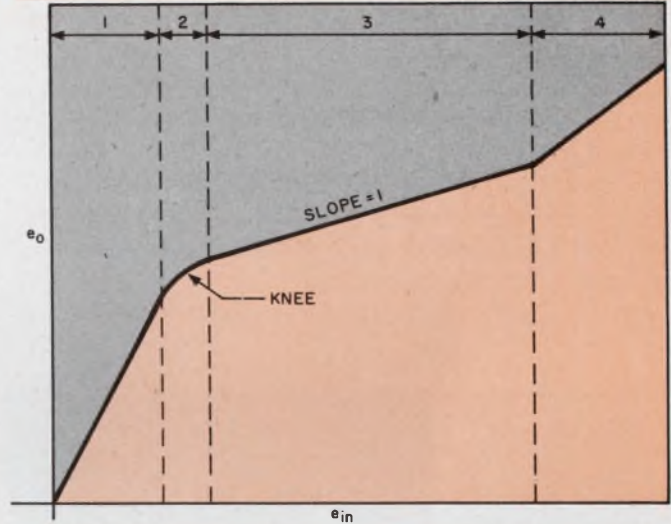
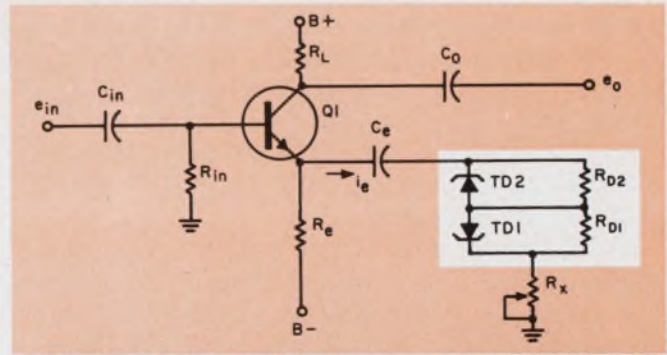

1. The basic circuit for a tunnel-diode log-amp stage (top) produces duo-gain characteristics (bottom). The circuit exploits regions 1 and 3. Region 2, the curve's knee, is minimized by selection of R_x . Region 4 is not used.

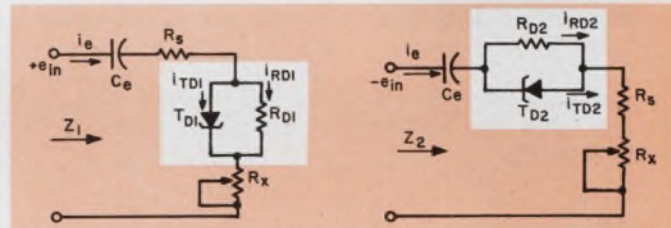

2. Equivalent circuits for the tunnel-diode-resistor network show positive excursions of the input (left) and negative excursions (right).

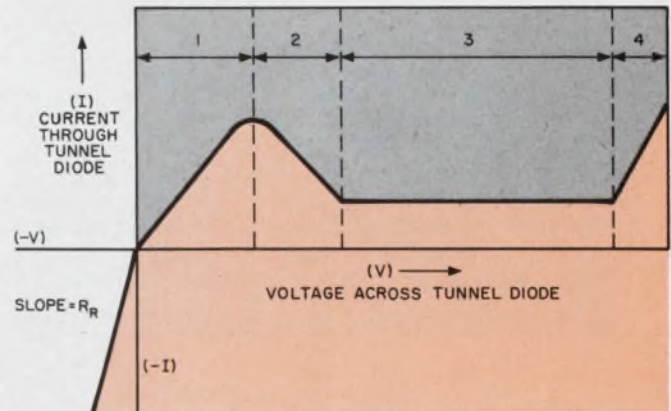

3. Four approximately linear regions make up the characteristic curve of a tunnel diode.

mined by characteristics of the tunnel diodes, R_x is adjusted for a given load, R_L , to give a voltage gain of unity throughout this region. While it would be possible to delete resistor R_x and vary either load resistor R_L or emitter bias resistor R_D , this method would affect the dc operating point of the transistor.

In region 2, since Z_D is negative, the tunnel-diode current, i_{TD} , decreases as e_{in} increases. Normally the total emitter current, i_e , would remain constant or dip slightly if the R_D current did not rise enough to counteract the tunnel-diode current drop. But the temperature-dependent current characteristic of R_D is so chosen that the current through the resistors always increases faster than the tunnel-diode current drops. In this manner the current in R_D swamps out the decrease in tunnel-diode current, so that the total current through the loop increases and causes the output voltage to increase.

This effectively expands regions 1 and 3, as

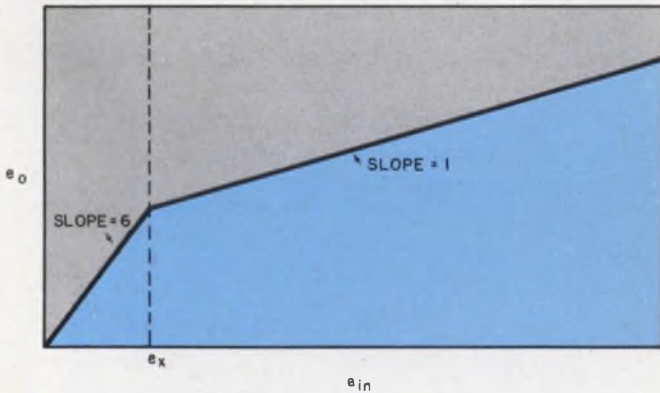

4. Duo-gain characteristic shows small-signal gain = 6 ($e_{in} < e_x$) and large-signal gain = 1 ($e_{in} > e_x$). e_x is the voltage across R_x .

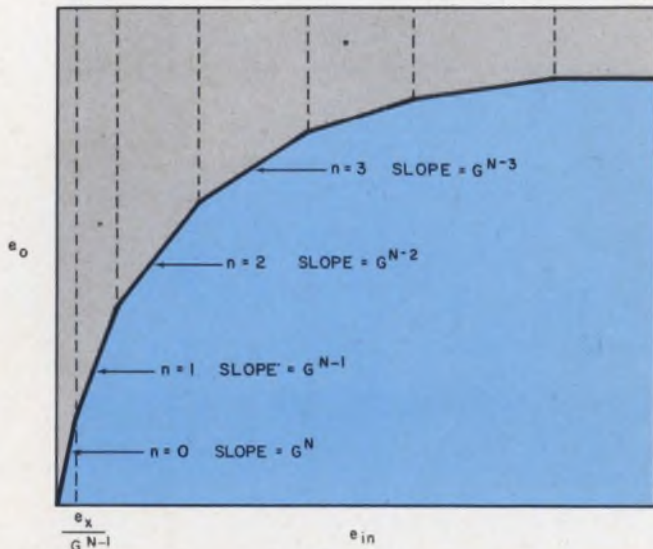

5. Cascading many stages yields an amplifier with a linear response for small signals and a logarithmic response for large signals.

shown in Fig. 1. At the same time region 2 is reduced to a knee. If R_D is made too small, however, the tunnel-diode action will be shorted out; if R_D is made too large, the knee region will expand, destroying the desired response.

Region 4 is similar to region 1, but is not exploited because it would destroy the desired logarithmic characteristic. Therefore, when stages are cascaded to produce an over-all logarithmic response, the input voltage of each stage is confined below region 4.

Curve is key to logarithmic response

Having explained how the circuit of Fig. 1 produces its output-vs-input curve, it is necessary to explain why this curve is needed to produce a logarithmic response. The curve of Fig. 1 approximates the duo-gain curve—a curve made up of two linear regions with different slopes—in Fig. 4.

If N stages of Fig. 4 are cascaded, the output of

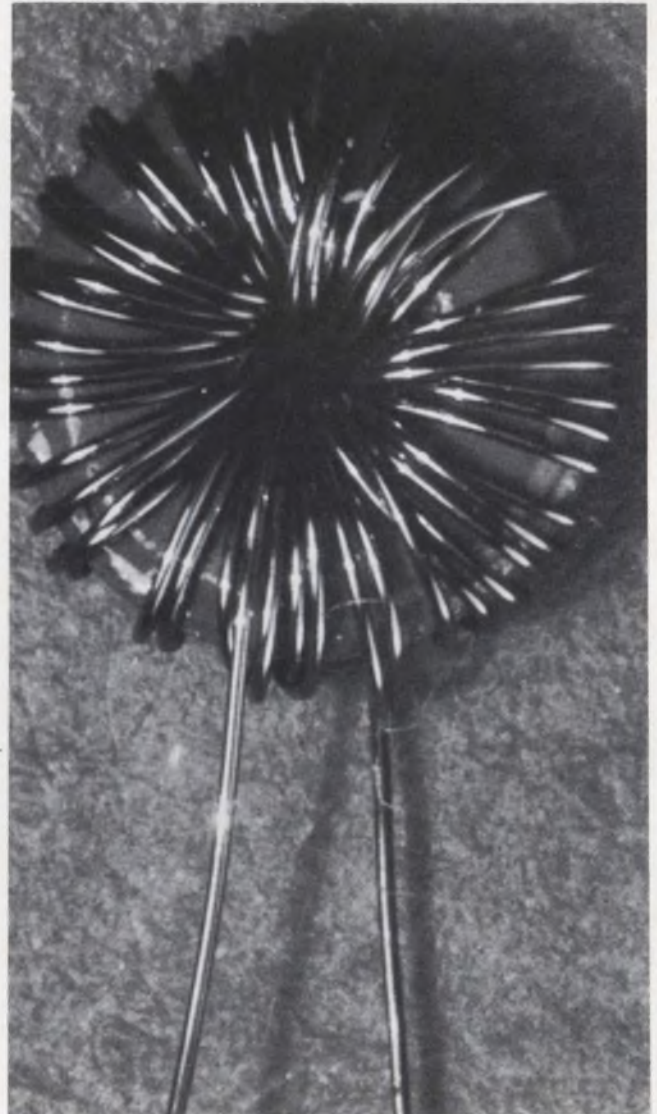

This miniature inductor is used to tune the circuits to the proper center frequency.

the N th stage is given as:

$$e_{o(N)} = n(G-1)e_x + G^{N-n}e_{in}$$

for $e_x/G^{N-n} \leq e_{in} \leq e_x/G^{N-n-1}$, (12)

where $N = n + 1$ = the number of cascaded stages. If Eq. 12 is plotted, the resulting logarithmic response is that shown in Fig. 5.

When many stages are cascaded (i.e., when N is large), the curve of Fig. 5 approximates a linear-logarithmic characteristic. A linear-logarithmic characteristic is one that has a linear small-signal region. The first segment ($n = 0$) is the small-signal, or linear, region where the over-all gain, or slope, is G^N . The following segment has a slope of G^{N-1} , the next a slope of G^{N-2} , and so forth. The input dynamic range is equal to the over-all small-signal gain, G^N . Since straight-line approximations are used, the maximum error or deviation from the true linear-logarithmic curve increases as the gain per stage increases.

In the case of the duo-gain curve, the small-signal region, the region between $e_{in} = 0$ and $e_{in} = e_x$, has a slope of G ; the large-signal region, the region between $e_{in} = e_x$ and $e_{in\ max}$, has a slope of unity.

Design example illustrates technique

A design example that uses typical practical values shows the use of the derived equations. Assume that the small-signal gain, K_v , of a stage and the value of its R_i have to be found where:

$$\begin{aligned} R_R &= 11 \Omega, \\ R_D &= R_{D_i} = R_{D_o} = 150 \Omega, \\ Z_{3D} &= 3 \text{ k}\Omega, \\ Z_{1D} &= 50 \Omega, \\ R_L &= 160 \Omega. \end{aligned}$$

From Eq. 1 the value of R_s required to produce the desired logarithmic response is:

$$\begin{aligned} R_s &= R_D || R_R = R_D R_R / (R_D + R_R) \\ &= (150)(11) / (150 + 11) = 10 \Omega. \end{aligned}$$

The voltage gain of region 3 must be unity.

From Eq. 11:

$$\begin{aligned} e_o/e_{in} &= R_L / [(R_s + R_x) + Z_{3D} || R_D] = 1; \\ \therefore R_x &= R_L - Z_{3D} || R_D - R_s \\ &= 160 - 143 - 10 = 7 \Omega. \end{aligned}$$

The small-signal gain is:

$$\begin{aligned} K_v &= e_o/e_{in} = R_L / [(R_s + R_x) + Z_{3D} || R_D] \\ &= 160 / [(10 + 7) + (50 || 150)] \\ &= 2.78 \text{ or } 8.9 \text{ dB}. \end{aligned}$$

Cascading ten such stages would produce a logarithmic amplifier with 89 dB of logarithmic dynamic range.

Thin films used for passive components

A vacuum-deposited thin-film technique can be used for the passive elements (resistors and capacitors) and interconnections within the circuit (Fig. 6). Miniature powdered-iron toroid

cores produce the coils in the tuned circuit wafers for frequency tuning.

The thin-film wafer is composed of four thin films and a glass substrate. Glass is used because it has the highly polished surface needed for coherent films. The substrate is a 0.41-inch square. The thin film is placed in a hermetically sealed encapsulation. The final thin-film wafer is 0.5 in. long, 0.5 in. wide and 0.1 in. high. Resistors, conductors, lead attachment pads, and capacitor bottom plates are formed by photoetching continuous films of copper and chromium. The capacitor dielectric and top plate are formed by deposition through thin, metal masks.

Circuit offers stable hf log amplification

Six-stage, seven-stage, eight-stage and nine-stage tunnel-diode logarithmic-amplifier units have been built according to the schematic in Fig. 7. The 1.3- μ H coils are decoupling coils, the capaci-

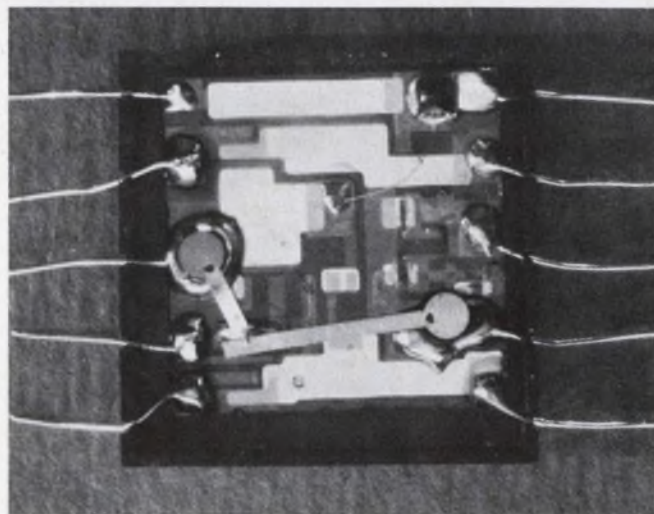
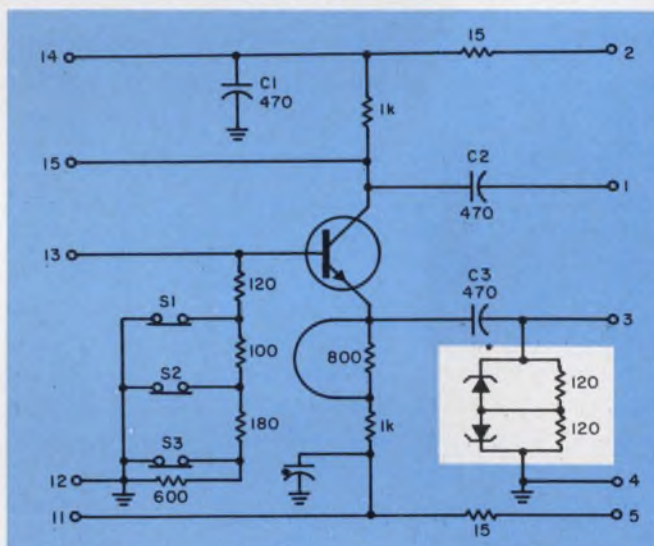

6. In the schematic for a single stage, S1, S2, and S3 are shorts that can be opened to adjust input impedance (above). The stage is made on glass (below).

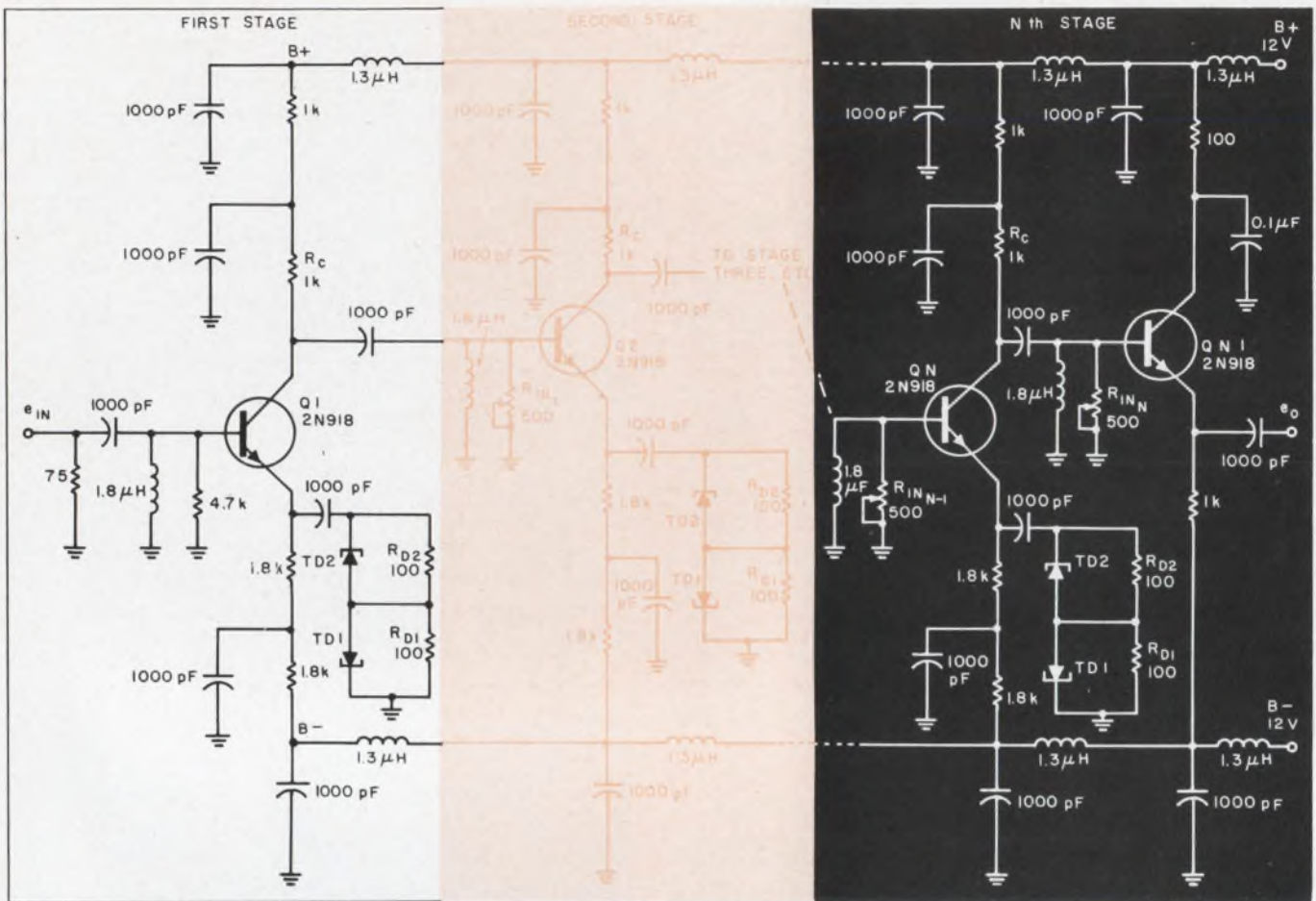

7. Complete schematic shows input stage, output stage and Nth stage. All capacitor values are in pF. Transistors

Q1, Q2 . . . QN are 2N918. Tunnel diodes are 1N3713. Five stages produce dynamic range of 60 dB.

tors on the power supply lines are decoupling capacitors, and coils L are tuning coils. (When tuning coils are chosen to be $1.8 \mu\text{H}$, the circuit tunes at 30 MHz.) The output stage is an emitter-follower stage, which permits heavy loading of the multistage units. The load impedance of each stage is composed of collector resistor R_c , the output capacitance of each stage, coupling capacitor C , tuning coil L , input resistor R_{IN} , the input capacitance of the following stage, and all other stages. Since coil L forms a tuned circuit with all parallel capacitances and collector resistor R_c is made much larger than input resistor R_{IN} , however, input resistor R_{IN} can be considered the total effective load impedance.

To maximize the small-signal gain, resistor R_c was made zero, and the effective load resistance of each stage, R_{IN} was adjusted to produce unity large signal gain. For different load R_{IN} values, resistors R_{D1} , R_{D2} in parallel with the tunnel diodes $TD1$, $TD2$ must be changed to minimize output variations in the large-signal region.

With 2N918 transistors and 1N3713 tunnel diodes, the maximum dynamic range obtained was 60 dB. The minimum number of stages needed to produce 60 dB of range was five. Tunnel diodes with larger valley-to-peak voltage ratios would

improve the dynamic range beyond 60 dB.

The best error obtained was ± 0.5 dB maximum over 60 dB of range. This error was minimized by matching the effective load resistors to the tunnel-diode parallel resistors. The optimum effective load resistor value was 120Ω and the optimum parallel resistor value was 75Ω . Conventional logarithmic amplifiers can produce errors of less than ± 0.25 dB over 90-dB ranges and are therefore superior in this respect.

The maximum input signal that the tunnel-diode logarithmic amplifier was capable of handling was 100 mV, which is at least 20 dB below that which conventional logarithmic amplifiers can handle. This is very good for microminiature applications where efficient operation is important, but can be a disadvantage if large input signals are anticipated.

The measured bandwidth of the tunnel-diode logarithmic amplifier with 2N918 transistors was 100 MHz per stage. A five-stage unit would therefore have an over-all bandwidth of 39 MHz. Based on an R_{IN} stage of 120Ω , bandwidths of 250 MHz a stage or larger can be obtained, if microwave transistors are used. This would be equivalent to a five-stage unit with a 100-MHz or larger over-all bandwidth. ■ ■



SINE 90°



COSINE 90°



SINE 180°



COSINE 180°



SINE 360°



COSINE 360°



SINGLE SIDED SQUARE

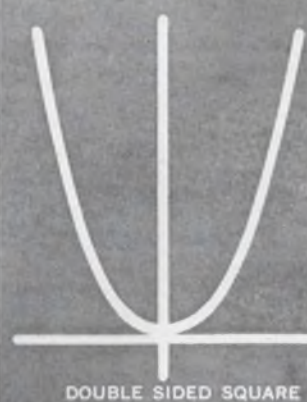

DOUBLE SIDED SQUARE



SIN-COS 360°



20 db LOG



40 db LOG

**A
FEW
LINES
ABOUT
NONLINEARS**

Bourns offers you a wide selection of single and multiturn nonlinear potentiometers . . . available in either bushing or servo mount styles. The curves shown on this page illustrate standard nonlinear functions available from Bourns.*

If these standard functions do not meet your needs, many others can be provided by Bourns to satisfy your most exacting requirements. When it comes to that "out-of-the-ordinary" need, call Bourns . . . where total-value is a reality. Contact your nearest Bourns office, representative, or write the factory direct, outlining your requirements . . . let us help you save time and cut costs.

*Write for our 4-page bulletin "Nonlinear Functions" for data on capabilities, resistance ranges, conformity, etc.



BOURNS, INC. TRIMPOT DIVISION • 1200 COLUMBIA AVE., RIVERSIDE, CALIF.
TELEPHONE 714 684-1700 • TWX: 910 332-1252 • CABLE: BOURNSINC.

Disregard load impedance in SCR inverter design. Use a unique LC swinging turn-off circuit operating as a gate-controlled switch.

In the design of an SCR-controlled inverter the most difficult problem is to turn the SCRs on and off. The ideal control system is one where this action is not influenced by the load. Such a system, using an LC swinging circuit switched by an auxiliary SCR, has been designed to achieve forced commutation of the load-carrying SCR in a configuration that bypasses the load impedance.

With these features, the turn-off circuit functions as a gate-controlled switch capable of handling the power levels of SCRs. This renders the circuit particularly applicable to bridge-type single-phase and three-phase inverters that rely on SCRs.

Turn-off circuit swings into operation

The basic operation of the turn-off circuit can be explained with the low-voltage chopper shown in Fig. 1.

The turn-off circuit is enclosed in the dashed lines. When the auxiliary rectifier *SCR2* is turned on, the voltage across capacitor *C* is applied across diode *D1* and load-carrying rectifier *SCR1*. If the voltage across *C* is initially negative, *SCR1* will be turned off.

At this point, the swinging circuit consisting of capacitance *C* and inductance L_T (the transformer primary) will come into play, to provide a positive voltage across *C* to turn *SCR2* off. When *SCR2* is off, the swinging circuit consisting of *L1* and *C* will return the voltage across *C* to its initial negative state, and this will then be used again to turn *SCR1* off.

In turning *SCR2* off, the transformer, consisting of coils n_1 and n_2 , is made to operate first with its secondary open and then with it closed. When n_2 is open, a voltage swing to turn off *SCR2* is started. To prevent this swing from becoming excessive, the voltage is clamped when secondary winding n_2 is closed by the conduction of *D3*.

This transformer action takes place as follows: when *SCR1* is first turned off, secondary n_2 is open with *D3* back-biased. Therefore at this time L_T consists of primary leakage inductance, L_p , plus mutual inductance, L_m . When the $L_T C$

swinging circuit reaches the point where V_c attains a positive magnitude such that the voltage across *D3* becomes somewhat positive, forward conduction occurs in *D3*. Since the output impedance of voltage source V_{dc} can be considered as a dynamic short across secondary n_2 , the mutual-inductance portion of L_T is shorted out, leaving only the smaller leakage-inductance portion, L_p . This action clamps the voltage swing. At this point, the swinging circuit will consist of the leakage inductance L_p and capacitor *C*, and oscillation will continue until the current tries to reverse through *SCR2*. This will turn *SCR2* off and clamp the voltage across capacitor *C*. *SCR2* will now be back-biased by a voltage equal to $V_c - V_{dc}$. Then, *L1* comes into action and returns V_c to its initial negative value—ready to turn off *SCR1* again.

The important feature of this circuit is the fact that the load impedance is not part of the turn-off circuit.

Turn-off circuit analyzed

Detailed discussion of the commutation performed by the turn-off circuit shown in Fig. 1 involves the following definitions:

- V_c = voltage across commutating capacitor *C*,
- V_{SCR2} = voltage across *SCR2*,
- i = current in primary n_1 (this equals the load current until the beginning of commutation),
- i_{SCR2} = current through *SCR2*,
- i_2 = current in secondary n_2 , and
- I_L = magnitude of load current at the beginning of commutation.

If *SCR1* is turned on and V_o is equal to V_{dc} initially, diode *D1* is back-biased. On the assumption that $V_c \approx -[(1 + r)V_{dc} + \Delta V]$, where r is the ratio of transformation, n_2/n_1 , and ΔV is the voltage increase across capacitor *C* produced by swinging circuit L_p , L_s and *C* when turning *SCR2* off, then it will be possible to turn *SCR1* off through forward-biased diode *D1* when *SCR2* is turned on. Product $L_T C$ is designed large enough to hold the voltage across capacitor *C* negative until *SCR1* recovers. Note particularly that the transient through L_T , *C*, *SCR1* bypasses load Z_L , and is therefore unaffected by the character of

Thomas Weisz, Research Engineer, Phillips Laboratories, Briarcliff Manor, N. Y.

Z_L , that is, by the load power factor. The magnitude of Z_L , however, will have an effect on the turn-off of *SCR1* through the current it produces in L_T .

In Fig. 1, inductor L_1 is much larger than L_T so that its influence can be neglected at this point. After *SCR1* recovers, i.e., turns off fully, capacitor C would charge up in the positive direction to approximately $3V_{dc}$, if it were not clamped at a voltage of approximately $(1 + r)V_{dc} + \Delta V$. This clamping action is accomplished by L_T , which, as stated, consists of primary leakage inductance L_p plus mutual inductance L_m as long as voltage V_L across it is less than approximately $(n_1/n_2)V_{dc}$. As soon as $V_L = (n_1/n_2)V_{dc}$, diode D_3 in series with secondary winding n_2 is forward-biased, the L_m portion is shorted out, and L_T consists of primary and secondary inductance, $L_p + L_s$, thus clamping the voltage swing. The swinging circuit of $L_p + L_s$ and C will then turn *SCR2* off. At this time,

$$V_c \approx V_{dc} + (n_1/n_2)V_{dc} + \Delta V \approx (1 + r)V_{dc} + \Delta V,$$

where ΔV is the voltage increase across capacitor C produced by swinging circuit $L_p + L_s$ and C while *SCR2* is being turned off.

Voltage V_c reverses through the swinging circuit consisting of inductor L_1 and capacitor C , and is clamped by diode D_2 at approximately $V_c = -(1 + r)V_{dc} + \Delta V$. This swinging circuit is much slower than the one that consists of L_T and C . The ratio L_1/L_T is chosen so that $\omega_1 = 1/(L_1C)^{1/2} \ll \omega_2 = 1/(L_TC)^{1/2}$. Meanwhile, inductor L_T discharges into the supply, and the circuit is back to its initial state and ready to turn *SCR1* off again.

The transformer nature of L_T is an important characteristic of the circuit. Without this, the voltage across capacitor C would increase indefinitely. Every time *SCR1* is turned off, energy is put into the circuit, and without a return path into the supply, energy—apart from losses—would accumulate in the capacitor.

To clamp the voltage across the capacitor at a

level not much above V_{dc} , the ratio of transformation, r , has to be high. Since the voltage across diode D_3 when *SCR2* is turned on is approximately $2(1 + r)V_{dc}$, a large r will lead to extremely high voltages; therefore, the circuit in Fig. 1 is practical for low input voltages only.

A way to avoid high voltages across diode D_3 , when higher input voltages are involved, is shown in Fig. 2. Here L_2 is a pure inductor and the transformer action is taken over by a separate transformer, T . So long as capacitor voltage $V_c < [1 + (n_1/n_2)]V_{dc}$, the transformer is disconnected from the circuit by diode D_4 . But when the voltage reaches this value, it is clamped by the transformer, which feeds magnetic energy stored in L_2 back to the supply. Since diode D_4 prevents reverse voltages from being impressed on the transformer, the voltage across diode D_3 is never higher than V_{dc} . In a practical circuit, however, transients will occur and produce high voltages across D_3 . Simple RC circuits placed across the diode can quench these.

It is of interest to note how the circuits in Figs. 1 and 2 operate with reactive loads. The voltage across an inductive load will reverse when *SCR1* is turned off and be clamped by diode D_1 . The load current will circulate in the D_1 - Z_L loop until *SCR1* is turned on again.

A capacitive load will cause *SCR1* to be turned off before *SCR2* is turned on, when the half period of the swinging circuit formed by L_2 and the capacitive Z_L is less than the time between turning *SCR1* on and *SCR2* on. If the capacitive load is larger than its critical value determined in this manner, *SCR1* will be switched off by the turn-off circuit as in the case of a resistive load.

Design equations for circuit parameters

An expression for the commutating capacitor C in Fig. 2 may be obtained in the following manner. If $t = 0$ is taken to be the beginning of the turn-off process, i.e., when *SCR2* is turned on, and V_c

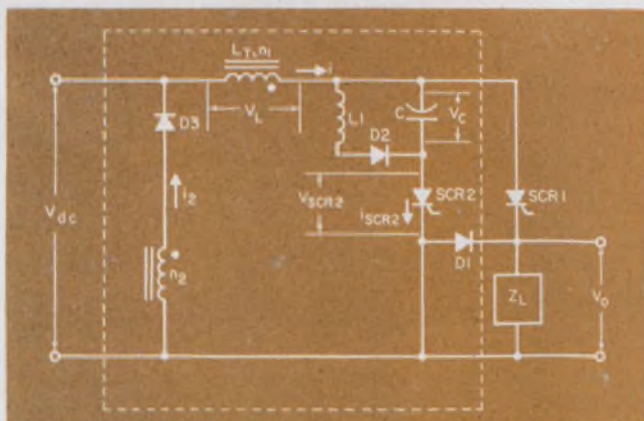

1. SCR swinging turn-off circuit to control power *SCR1* is built with the components enclosed by the dashed lines. Load impedance has no effect on its operation.

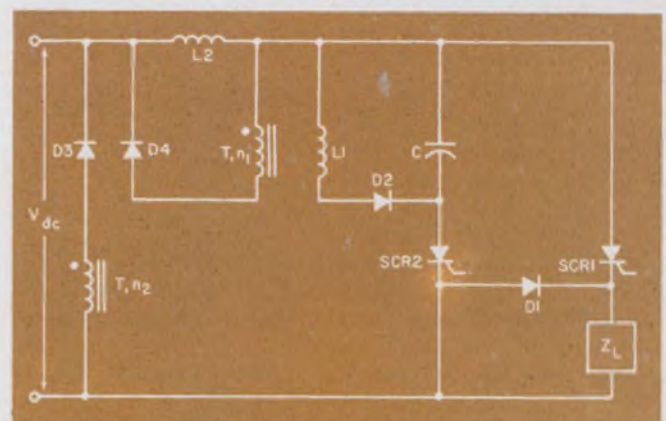

2. High voltages across diode D_3 can be avoided by modifying the basic turn-off circuit of Fig. 1; diode D_4 was added and the components were slightly rearranged.

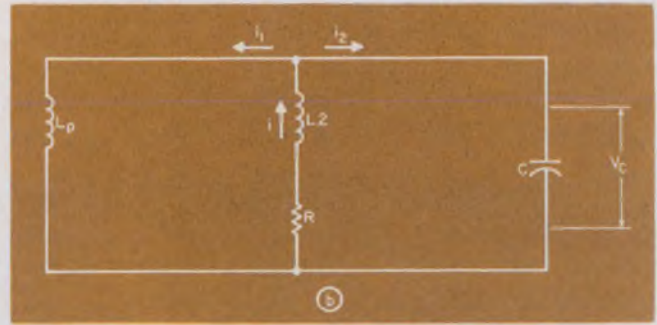
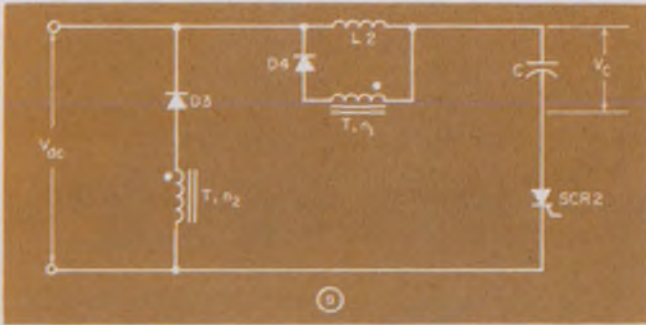

3. The active portion of the circuit of Fig. 2 is shown in (a). Its equivalent circuit appears in (b).

is negative, the voltage V_c across capacitor C may be expressed as:

$$V_c = -[(1+r)V_{dc} + \Delta V] \cos \omega t + V_{dc}(1 - \cos \omega t) + V_{L2} \sin \omega t, \quad (1)$$

where:

r = transformer turns ratio,

ΔV = voltage increase across capacitor C produced by swinging circuit $L_p + L_s$ and C while turning $SCR2$ off,

V_{L2} = voltage drop across $L2$ due to the load current.

Since it is known that:

$$\omega = 1/(L2C)^{1/2},$$

and that:

$$V_{L2} = (L2/C)^{1/2} I_{load}$$

(from the relationship $(L2 I_{load}/2)^2 = (C V_{L2}/2)^2$), an expression for C at full load may be obtained. If V_c is set equal to zero and t = the maximum

turn-off time of $SCR1$ as specified by the manufacturer, and on the assumption that $(L2/C)^{1/2} \approx V_{dc}/I_{FL}$ yields a small value for C with a reasonably short cycling time, then:

$$C \cong \{I_{FL}/[V_{dc}(1+r)]\} t_{off}, \quad (2)$$

where I_{FL} = the magnitude of full load current at the beginning of commutation.

Once the value of C has been determined from Eq. 2, $L2$ can be calculated from the relationship:

$$(L2/C)^{1/2} \approx V_{dc}/I_{FL}:$$

$$L2 = (V_{dc}/I_{FL})^2 C.$$

Swinging circuit $L1C$ is chosen so that it has negligible influence on the operation of swinging circuit $L2C$. Therefore:

$$(L1C)^{1/2} = 5(L2C)^{1/2},$$

$$\therefore L1 = 25 L2.$$

Now that the circuit parameters are established, it is possible to check whether the circuit provides a suitable turn-off time for $SCR2$.

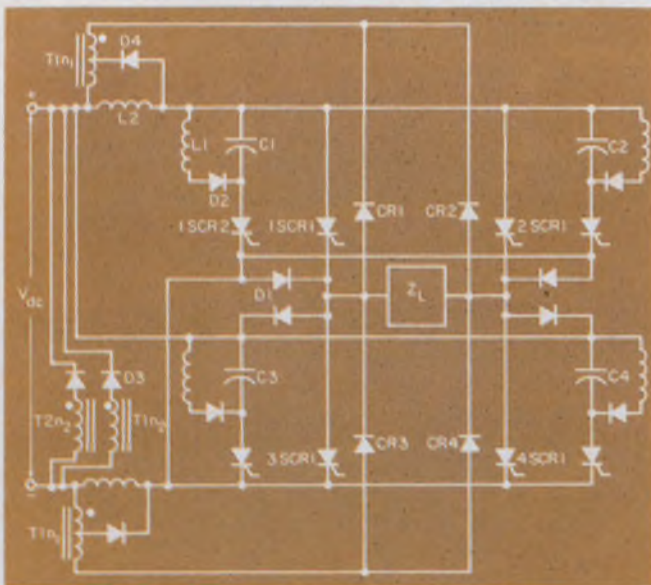

4. Simplified schematic of a 1.5-kVA inverter using the swinging turn-off circuit is shown without high-voltage suppressing and balancing networks. SCR1s form a bridge to provide a square-wave voltage across the load Z_L . Turn-off circuit for 1SCR1 consists of $L1$, $D2$, $C1$, 1SCR2, $D1$, $D3$, $T1$, $L2$, $D4$. $CR1$, $CR2$, $CR3$, $CR4$ provide current paths to discharge inductive loads into supply. See box for the component values.

Single-phase bridge-type inverter

Operating characteristics

Output power	1.5 kVA
Input voltage	150 V dc
Output voltage	148 V square wave zero-to-peak
Frequency	50-1000 Hz, adjustable
Efficiency	92% at 400 Hz and full power (only slightly affected by power factor)

Circuit parameters

SCR1	Type C40C
SCR2	Type C20D
D4, CR1, CR2,	
CR3, CR4	1N3495R
D1, D2	1N2070
D3	1N2071
L1	3 mH
L2	190 μ H
C1, C2	2.2 μ F
C3, C4	2 μ F
T1, T2	Transformers with 2-mH primary magnetizing inductance, 12:1 secondary-to-primary ratio, r , and 1.2:1 primary tap ratio.

Calculating the turn-off time of SCR2

That portion of the circuit of Fig. 2 that plays an active part in turning SCR2 off is redrawn in Fig. 3a and the corresponding equivalent circuit is shown in Fig. 3b. Both are valid after SCR1 is turned off and may be represented by an open circuit. In Fig. 3b, L_p represents the leakage inductance reduced to the primary of transformer T , and R is the equivalent loss resistance of $L2$.

The equivalent circuit assumes that:

- The forward voltage drops across SCR2, $D3$ and $D4$ are zero.
- The winding resistance of transformer T is negligible.
- $L1$ is so large that the current it draws while SCR2 is being turned off is negligible.

Solving the proper differential equation based on the equivalent circuit of Fig. 3b gives:

$$i_2 = I_o(L_p/L2)\epsilon^{-t/\tau}(\cos \omega t + RC \omega \sin \omega t), \quad (3)$$

where:

$t = 0$ when the combination of $D3$ and n_2 just begins to clamp the capacitor voltage,

$$\tau = L_m/R,$$

$$\omega = \frac{1}{C[L_p L2/(L_p + L2)]^{1/2}},$$

I_o = the current flowing in $L2$ when transformer T just begins to clamp the capacitor voltage.

I_o approximately equals the load current flowing in $L2$ just before SCR1 is turned off and therefore:

$$I_o \approx 2I_L.$$

SCR2 will turn off when $i_2 = 0$. With this condition, the time t_1 necessary to accomplish this can be computed from Eq. 3. Then the voltage rise across capacitor C , ΔV_c , by current i_2 is:

$$\Delta V_c = (1/C) \int_0^{t_1} i_2 dt.$$

Solving this integral gives:

$$\Delta V_c \approx 2(L_p/L2)V_{dc}. \quad (4)$$

At time t_1 , when the increase in capacitor voltage reaches ΔV_c , SCR2 turns off and is reverse-biased by ΔV_c . This is because the rest of the capacitor voltage is balanced by voltage drops across the primary of transformer T and diode $D3$.

The capacitor voltage will reverse through swinging circuit $L1$ and C , diminishing ΔV_c . The length of time t_2 during which SCR2 is reverse-biased may be calculated from the equation for V_{dc} :

$$V_{dc} = [(1+r)V_{dc} + \Delta V_c] \cos \omega_2 t_2, \quad (5)$$

where:

$$\omega_2 = 1/(L1C)^{1/2}.$$

Assuming $L_p/L_m = 0.02$, $L_m/L2 = 10$ and $0.1 < r < 0.2$, substituting V_c from Eq. 4 into Eq. 5, and solving for t_2 yield:

$$t_2 \approx 0.8(L1C1)^{1/2};$$

since $L1 \approx 25 L2$, then:

$$t_2 \approx 4(L2C)^{1/2}. \quad (6)$$

A large $L_m:L2$ ratio is necessary in order for magnetic energy stored in $L2$ to be fed into the supply instead of into L_m . Even with infinite $L_m/L2$, however, there will still be some buildup of magnetic energy in L_m , which will produce over-voltages unless dissipated in surge suppressors.

Now, substituting the relationship $L2/C \approx V_{dc}/I_{FL}$ into Eq. 2 and solving for $(L2C)^{1/2}$ yield the following relationship:

$$t_{off} = (L2C)^{1/2}/(1+r),$$

or:

$$(L2C)^{1/2} = (1+r)t_{off}. \quad (7)$$

Substitution of Eq. 7 into Eq. 6 gives an expression for the circuit turn-off time, t_2 , of SCR2 in terms of the maximum turn-off time of SCR1:

$$t_2 \approx 4(1+r)t_{off} \approx 4.5 t_{off1}, \quad (8)$$

assuming $r \approx 0.1 \rightarrow 0.2$.

Because the circuit turn-off time for SCR2 is greater than that for SCR1 by a factor of 4.5, it can be seen that no stringent requirements govern the selection of a silicon-controlled rectifier for SCR2.

The turn-off circuit used in an inverter

A schematic of a single-phase bridge-type inverter that uses the turn-off circuit of Fig. 2 appears in Fig. 4. This novel turn-off circuit lends itself particularly well to this type of inverter.

Some of this inverter's interesting features are:

- Commutation—that is, turn-off of the load-carrying SCRs—is independent of load power factors.
- Starting is easy.
- It has inherent overload protection.
- The inverter output voltage can be controlled and regulated by pulse width modulation.

The design philosophy for this single-phase inverter is especially applicable to multiphase inverters. This, too, is because of the unique turn-off characteristics of the turn-off circuit.

Controlled rectifiers 1SCR1, 2SCR1, 3SCR1 and 4SCR1 form a bridge circuit to produce a square-wave voltage across the load Z_L . Components $L1$, $D2$, $C1$, SCR2, $D1$, $D3$, $T1$, $L2$ and $D4$ constitute the turn-off circuit for 1SCR1, as in Fig. 2. The other three main SCRs in the bridge have similar turn-off circuits. $T1$, $D4$, $L2$ and $D3$ serve the turn-off circuits of both 1SCR1 and 2SCR1. The same applies to $T2$ in relation to the bottom half of the circuit. Rectifiers CR1, CR2, CR3 and CR4 provide current paths to discharge inductive loads into the supply as in the McMurray-Bedford inverter.¹

Control and regulation of the inverter output voltage is made possible by varying the time interval between turn-on pulses to the load-carry-

RCA SEMINARS IN AUTOMATION AND COMPUTER TECHNOLOGY

A series of complete 5-day programs researched by RCA Institutes, Inc., for engineers and other technical personnel faced with the challenging new areas of expanding technologies and systems refinements.

LOGIC DESIGN	Los Angeles	3/6
	San Francisco	3/13
	Cherry Hill	4/3
	Denver	4/17
	Detroit	5/8
	Seattle	5/15
	Long Island	5/22
	Boston	6/5
	Atlanta	6/19
	Minneapolis	7/10
	Dallas	7/31
Washington, D.C.	8/7	
DIGITAL SYSTEMS ENGINEERING	Dallas	3/13
	Palm Beach	4/17
	New York City	5/8
	Albuquerque	5/15
	Rochester	6/5
	Washington, D.C.	6/12
	Detroit	6/19
	Seattle	7/10
Cherry Hill	7/24	
DIGITAL ELECTRONICS	New York City	3/6
	Washington, D.C.	7/10
DIGITAL COMMUNICATIONS	Boston	4/3
	Washington, D.C.	4/10
	New York City	4/24, 7/10
	Los Angeles	5/8, 8/7
	San Francisco	5/15, 8/14
	Palm Beach	6/5
	Chicago	6/19
Denver	7/17	
INTEGRATED CIRCUITS	New York City	8/7
	Chicago	8/21
	Washington, D.C.	9/11

Dates shown are seminar starting dates. Schedules are subject to change and additions.

Special in-plant seminars can be arranged. For full information and registration, call Mr. Bradford Daggett, 212, 247-5700 or use coupon below.



Bradford Daggett, Director of Seminar Programs
RCA Institutes, Inc., Dep't ELD-57
 49 West 45th Street, New York, N. Y. 10036
 Please send me complete information on RCA's 5-day seminars, and keep me informed on future programs.

Name _____ Title _____

Company _____

Address _____

City _____ State _____ Zip Code _____

ON READER-SERVICE CARD CIRCLE 31

ing SCRs and their associated auxiliary SCRs. To secure proper voltage across the capacitors when starting up the inverter, pulses to the gates of the auxiliary SCRs are applied first.

The only difference between individual SCR turn-off circuits in Fig. 4 and the turn-off circuit in Fig. 2 is that in Fig. 4 transformers $T1$ and $T2$ have tapped primary windings (the primaries are autotransformers) with feedback rectifiers $CR1$, $CR2$, $CR3$ and $CR4$ connected to them. This design feature is necessary in case of inductive loads. Magnetic energy trapped in the load when the main SCRs are turned off (e.g., $2SCR1$, $3SCR1$) will drive current into the dc supply through the feedback rectifiers (e.g., $CR1$, $CR2$). When the next two main SCRs ($1SCR1$ and $4SCR1$, in this instance) are turned on, however, any magnetic energy trapped in inductor $L2$ will cause a circulating current to flow in the loop $L2$, $1SCR1$, $CR1$, $T1$. This can become a cumulative process and cause failure of either $1SCR1$ or $CR1$.

Tapping the primary of the transformer produces a back emf which prevents these circulation currents from flowing. The value of this back emf should be larger than the sum of the forward voltage drops through an SCR and a rectifier, that is, the sum of the voltage drops across $1SCR1$ and $CR1$, when forward-biased. For example, the tapped portion of $T1$ opposite feedback rectifiers $CR1$, $CR2$ will prevent current from flowing in the loop consisting of $L2$, $1SCR1$, $CR1$ and $T1$ by putting out about 3 volts.

Internal short circuits due to overloads can be prevented by gating the turn-on pulses to the load-carrying SCRs. If, for some reason, the two SCRs conducting during a half cycle are overloaded and, as a result, do not open when the next half cycle begins, a short circuit will result. The gating will involve sensing the voltage across the lower main SCRs, i.e., $3SCR1$ and $4SCR1$. To prevent the upper two main SCRs from not turning off on account of a short circuit, their commutating capacitors are selected to have a somewhat larger capacitance than the other two commutating capacitors.

The system will automatically keep trying to resume normal operation until the overload disappears. When this happens, the main SCR that failed to turn off will recover, and the inverter output voltage will reappear.

For clarity's sake, a number of high-voltage suppressing and balancing networks, necessary for proper inverter operation, are not shown. Practical circuit parameters and operating characteristics for a single-phase bridge-type inverter are listed in the box. ■ ■

Reference:

1. McMurray and D. P. Shattuck, "A Silicon-Controlled Rectifier Inverter with Improved Commutation," *AIEE Trans.*, LXXX, Pt. 1, Nov., 1961, 531-542.

if you design the best for others... you'll want the best for yourself.

When you know your designs and specifications can be improved, you improve them. You have to.

Insist on the same standards for yourself. Don't put up with poor color TV reception.

You know how important it is to aim your antenna. Direct signals produce sharp, clear pictures by reducing "color ghosts", snow, and interference. Directional control also makes it possible to pull in more stations — even from fringe areas. Put this knowledge to work for yourself.

An Alliance Tenna Rotor® gives you the directional control you need at your finger tips. It's designed and engineered the way you

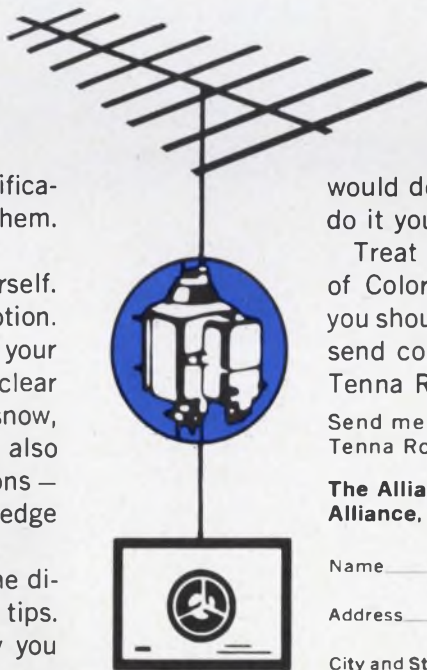

would do it. And it's easy to install. You can do it yourself, if you wish.

Treat yourself and your family to the kind of Color and B&W TV reception you know you should be getting. See your local dealer or send coupon for information about Alliance Tenna Rotor.

Send me additional information about Alliance Tenna Rotor and names of nearby dealers.

The Alliance Manufacturing Co., Inc.
Alliance, Ohio

Name

Address

City and State Zip

ED-24

ALLIANCE TENNA ROTOR® • "TV'S BETTER COLOR GETTER!"



the **ALLIANCE** Manufacturing Co., Inc., Alliance, Ohio 44601

(Subsidiary of Consolidated Electronics Industries Corp.)

MAKER OF GENIE® AUTOMATIC GARAGE DOOR OPENER SYSTEM

ON READER-SERVICE CARD CIRCLE 32

Uniring® grounds a shielded cable in less time than it takes to heat a soldering iron.

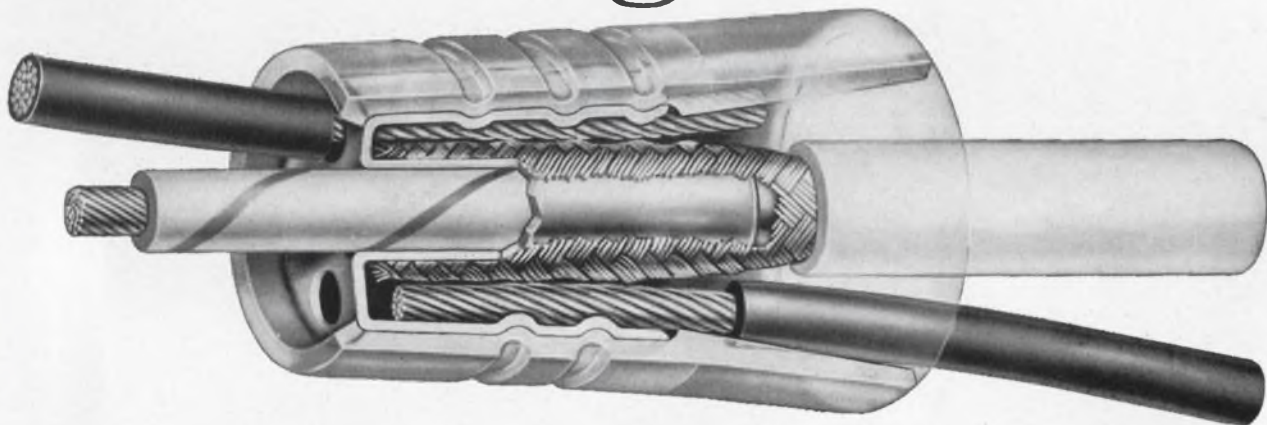

Uniring combines inner and outer ferrules in unitized construction. Simply insert a stripped conductor and tap wire, then crimp. One crimp does it. No heat. No burnt cables. Result: A vibration-resistant, noise-free connection that is mechanically and electrically stable. A uniform connection that takes virtually no time to make.

Uniring terminations are color coded for fool-proof size selection. And the insulated Uniring employs a nylon sleeve that's flared for fast, easy insertion of the shielding braid and tap. (These connectors are also available uninsulated.) No other type of connector is as fast, as reliable, or as low in cost to use. Time and labor savings offered

by the compression method of grounding and terminating shielded cable are recognized by the military and referred to in MIL-E-16400 and MIL-I-983. Burndy Uniring terminations conform in all details to MIL-F-21608 (dated 1/5/59). Send today for a free sample and catalog.



BURNDY

Norwalk  Connecticut

Stop wasting design time. Keep a good notebook of basic circuits, and the next time you need one, it will be ready for instant reuse.

1117-73rd Street
Brooklyn, N. Y.

Electronic Design
850 Third Avenue
New York, N. Y.

Dear Sirs:

It's a curious fact that many engineers waste hours doing design work that they need not do. They design a basic circuit, only to discard the paperwork when they are finished. Weeks or months later, when they need the same circuit for another application, they go through the tedious procedure of working out the design again.

Having faced the necessity of designing basic transistor circuits over and over, I have learned that much time can be saved by recording and keeping all the pertinent design information in neat, concise form.

Here are several pages from my own design notebook that show how data on several basic circuits can be recorded for future use.

I do not claim anything original in the design procedures; they are well tried. However, I would have appreciated finding this material in one place, nicely summarized, years ago when I was a struggling, young engineer.

Every engineer who designs for a living should have a handy, well-stocked notebook. Anyone can start such a reference source with the designs worked out on the pages that follow.

Sincerely yours,

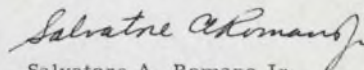

Salvatore A. Romano Jr.
Consultant

RAPID DESIGN OF PRACTICAL AMPLIFIERS

CLASS A, SINGLE-ENDED, RC COUPLED, LOW DISTORTION

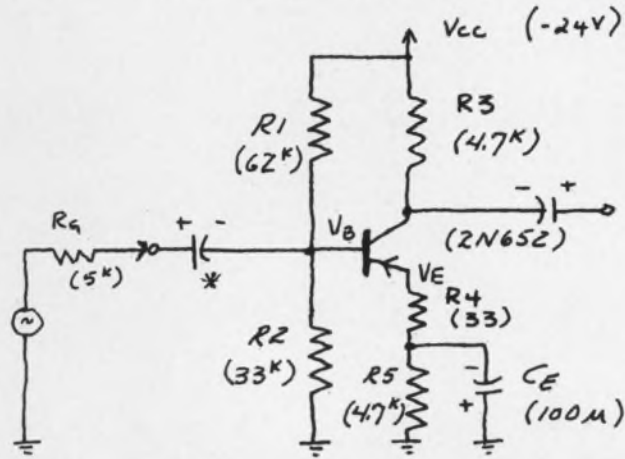
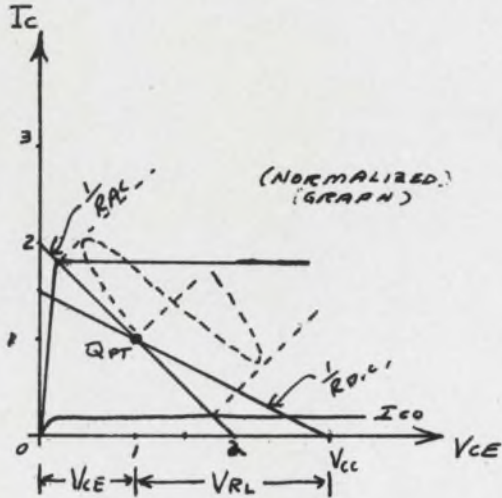

* CHOICE OF Coupling Cap. left TO DESIGNER USING CONVENTIONAL METHODS

KNOWN: V_{CC} , Z_{OUT} , Z_{IN} , APPROX. VOLTAGE GAIN (V.G.)

OBJECTIVE: MAX. SIGNAL WITH MIN. DISTORTION, TEMPERATURE STABILITY - 60°C AMB.

METHOD: STAGE EFFICIENCY WILL BE SACRIFICED TO ACHIEVE AN OPERATING POINT WHICH RESULTS IN MINIMUM DISTORTION. THE Q POINT WILL BE PLACED FOR EQUAL HALF CYCLES OF SIGNAL SWING BETWEEN I_{CO} & I_{SAT} .

1. ASSUMING $V_d > Z_{OUT}$; $Z_c \approx 100K$ SET $R_3 = Z_{OUT}$

2. $R_4 + R_5 = R_3$

3. D.C. LOAD LINE $I_m = \frac{V_{CC}}{R_3 + R_4 + R_5}$

4. CHOOSE $I_Q = \frac{2}{3} I_m$; $\therefore V_E = V_{CC} = \frac{V_{CC}}{3}$

OR $V_{RL} = \frac{2}{3} V_{CC}$; $R_L = R_3 + R_4 + R_5$

5. CHOOSE $R_4 > V_e$; where $V_e \approx 30\Omega$

$I_B \approx \frac{V_E}{R_4 + R_5}$; $V_e @ 1ma = 30\Omega$

WITH V_e KNOWN & VOLT. GAIN DESIRED R_4 MAY BE GOTTEN FROM

$V.G. \approx \frac{R_3}{R_4 + V_e}$

6. $R_5 = (R_4 + R_5) - R_4$ SINCE $R_4 + R_5 = R_3$

7. R_1 & R_2 CHOSEN SO CURRENT STABILITY FACTOR, S , < 5 FOR GERMANIUM

AND < 10 FOR SILICON

CHOOSE: $R_1 || R_2 = 4(R_4 + R_5)$ FOR GERMANIUM

neglect V_{cc} THEN $V_E \approx \frac{R_2}{R_1 + R_2}$

$\therefore R_1 = 2R_2$

CHOOSE: $R_1 || R_2 = 8(R_4 + R_5)$ FOR SILICON

8. CHOOSE $X_{CE} \leq \frac{R_4 + R_{IN}}{10}$;

where $R_{IN} = \frac{R_B + Y_b + Y_e}{\beta}$; R_B = TOTAL SOURCE IMPEDANCE

V_b may be determined from h parameters at Q pt current OR APPROXIMATED FROM base characteristics curves as $\Delta V_{BE} / \Delta I_B$ about the operating pt.

9. $P_{DISSIP} = V_{CE} I_Q$; $P_{OUT} = \frac{V_{CE} I_Q}{4}$

$P_{IN BATTERY} = V_{CC} I_Q$; $V_m = V_{CC}$

$P_{DISSIP MAX SIGNAL} = \frac{3}{4} V_{CE} I_Q$

10. STAGE EFFICIENCY $\eta = \frac{P_o}{P_{in}} = \frac{\frac{V_m I_m}{18}}{\frac{2}{3} V_m I_m} = 8.3\%$

SAMPLE DESIGN

$Z_{OUT} \approx 5K$; $V_{CC} = -24V$; 2N652 ; V.G. = 100

1. $R_3 = 5K$ USE 4.7K

2. $R_4 + R_5 = R_3 = 4.7K$

3. $I_m = \frac{24}{9.4K} = 2.56mA$; $I_Q = 1.7mA \approx I_E$

$V_E = \frac{V_{CC}}{3} = 8 \text{ VOLTS} = V_{CE} = V_{p-p} \text{ MAX. POSSIBLE}$

5. $V_e \approx \frac{30}{1.7ma} = 17.7 \text{ OHMS}$

V.G. $\approx \frac{R_3}{R_4 + V_e}$; $\therefore R_4 \approx 30\Omega$ USE 33 Ω

6. $R_5 = R_3 - R_4 = 4.7K - 33$ IN THIS CASE NEGLECT R_4

$\therefore R_5 = 4.7K\Omega$

7. $\frac{R_1 R_2}{R_1 + R_2} = 4(4.7K) \approx 20K$ 9 SINCE $R_1 = 2R_2$
 $R_2 = 30K$ USE 33K
 $R_1 = 60K$ USE 62K

8. X_{CE} : $R_B = R_1 || R_2 || R_G$; $R_G = 5K$
 $\therefore R_B \approx 4K$; $V_b \approx 1K$ ($\beta = 100$)

$\therefore X_{CE} = 10$ TAKING $f_{low} = 200cps - 10B$

$C_E = \frac{1}{2\pi f X_{CE}} \approx 80mfd$ USE 100mfd

BECAUSE STANDARD VALUES OF RESISTANCE HAVE BEEN USED & V_{be} NEGLECTED V_E WILL BE SLIGHTLY LESS THAN $\frac{V_{CC}}{3}$ & I_Q SLIGHTLY DIFFERENT. WHERE NECESSARY THESE INACCURACIES CAN BE DONE AWAY WITH BY NOT NEGLECTING V_{be} , $I_C = \alpha I_E$ ETC. WHERE ACCURATE Z_{OUT} NECESSARY DO NOT NEGLECT V_d

9. $P_{DISSIP} = 13.6 \text{ milliwatts}$; $P_{OUT} = 3.4 \text{ m.w.}$

$P_{IN} = 24(1.70m) = 40.7 \text{ m.w.}$

$P_{DISSIP MAX SIG} = \frac{3}{4} (13.6 \text{ m.w.}) = 10.2 \text{ m.w.}$

$\eta = \frac{3.4 \text{ m.w.}}{40.7 \text{ m.w.}} = 8.3\%$

CLASS A SINGLE-ENDED TRANSFORMER COUPLED

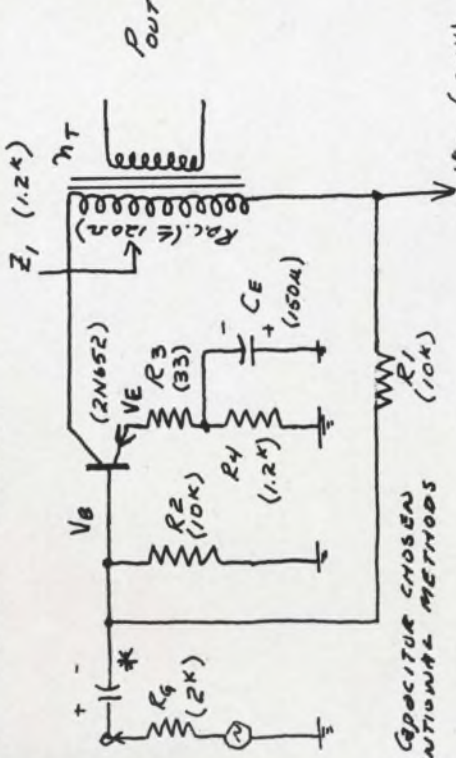
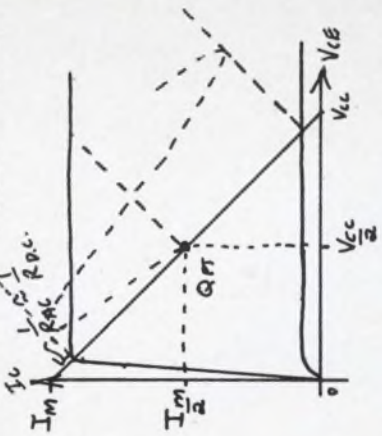

* COUPLING CAPACITOR CHOSEN BY CONVENTIONAL METHODS

KNOWN: $R_g, P_{OUT}, V_{CC}, \eta$ (TRANSF EFFIC.)

OBJECTIVE: MAX. SIG. SWING. WITH MIN. DISTORTION IN AS HIGH AS PRACTICAL

METHOD: A PRACTICAL COMPROMISE ACHIEVED BY MAKING THE AC LOAD LINE 2 D.C. LOAD LINE

1. $P_{STAGE} = \frac{1}{2} P_{\beta} = \frac{V_{CE} I_{Q}}{2}$; CHOOSE $V_{CE} = \frac{V_{CC}}{2}$
2. $I_{Q} = \frac{2 P_{\beta}}{V_{CE}}$; $R_{LAC} = \frac{V_{CE}}{I_{Q}}$
3. D.C. TRANSF $\leq \frac{R_{LAC}}{10}$ FOR MILLIWATT TRANSF.
4. CHOOSE: $R_3 + R_4 = R_{LAC}$

SINCE $R_3 \ll R_4 \text{ \& } R_{LAC}$ $R_{A.C.} \approx R_{D.C.}$ LOADLINE

$V_{CE} = \frac{V_{CC}}{2}$ neglecting RAC. TRANSF.

ASSUME $I_E \approx I_Q$

CHOOSE: $R_3 > V_{CE}$; $V_{CE} \approx \frac{30}{I_E}$

TRY $R_3 \approx 10 V_{CE}$ IN ACCORDANCE WITH R_3 & THE R_{IN} THAT MUST BE CREATED NOT TO LOAD IT EXCESSIVELY

$R_{IN} = R_1 || R_2 || V_b + \beta(V_{CE} + R_3)$

$\therefore R_4 = \frac{V_{CE}}{I_E} - R_3$; OR $(R_4 + R_3) = R_3$

R_1, R_2 chosen so current stability factor S_{I_C} is ≤ 5 FOR GERMANIUM ≤ 10 FOR SILICON

$\therefore R_1 || R_2 = 4(R_3 + R_4)$ FOR GERMANIUM

$R_1 || R_2 = 8(R_3 + R_4)$ FOR SILICON

CHOOSE $V_{CE} \approx \frac{R_3 + R_{INE}}{10}$; where $R_{INE} = R_3 || V_b + \beta$

$R_B = R_1 || R_2 || R_g$

V_b determined from transistor characteristics

$P_{DISSIP} NO SIG = V_{CE} I_Q$; $P_{OUT} STAGE = \frac{V_{CE} I_Q}{2}$

$P_{IN} BATTERY = V_{CC} I_Q$

$P_{DISSIP} MAX SIG = P_{DISSIP} NO SIG - P_{OUT} STAGE = \frac{V_{CE} I_Q}{2}$

STAGE EFFICIENCY $\eta_s = \frac{P_{OUT}}{P_{IN BATT}} = 25\%$ BEFORE TRANSFORMER

$\eta_o = 18.8\%$ including transformer

STAMPLE DESIGN

OUT req'd = 45 milliwatts
 $V_{CE} = 24$ VOLTS
 2N652 $\eta_{TRANSF} = 75\%$
 $R_g = 1.2k$
 $P_{\beta} = \frac{P_o}{\eta} = 60$ m.w.
 $V_{CE} = 24 = 12$ VOLTS
 $I_{Q} = \frac{P_{\beta}}{V_{CE}} = \frac{60}{24} = 2.5$ mA
 $R_{LAC} = \frac{V_{CE}}{I_{Q}} = \frac{24}{2.5} = 9.6$ OHMS

1. $R_{LAC} = \frac{12}{2.5} = 4.8$ OHMS = Z_1

2. RAC. TRANSF $\leq \frac{1.2k}{10} \leq 120$ OHMS

3. $R_3 + R_4 = 1.2k$

4. $V_E = 12$ V. ASSUME $I_E = I_Q = 10$ mA

5. $V_E = \frac{30}{10} = 3$ OHMS

6. $R_3 = 10(3) = 30$ OHMS USE $1.2k$ OHMS IN THIS CASE

7. $\therefore R_4 = 1.2k - 30 = 1.17k$

8. $R_g = 1.2k$

9. $\frac{R_1 R_2}{R_1 + R_2} = 4(1.2k) = 4.8k$ USE $5k$

SINCE $V_E \approx 12$ V & NEGLECTING V_{BE}
 $V_B = 12$ V. $\therefore R_1 = R_2$

$\therefore R_1 = R_2 = 10k$

10. $R_B = \frac{5k(2k)}{7k} \approx 1.4k$; $R_B = 2k$

$R_{INE} = \frac{1.4k + 1k + 3 + 33}{80} = 66$ OHMS

$\beta = 80$ FROM CHARACTERISTICS

$\therefore V_{CE} = \frac{66}{10} = 6.6$ OHMS; $C_E = \frac{1}{2\pi(100)6.6}$

USING $f_{LOW} = 200$ CPS USE 150 mF.

10. $P_{DISSIP} NO SIG = 12(10$ mA) = 120 mW.

$P_{IN} BATTERY = 24(10$ mA) = 240 mW

$P_{OUT} = 60$ mW

$P_{DISSIP} = 120$ mW - 60 mW = 60 mW

11. STAGE EFFICIENCY $\eta_s = \frac{60}{240} = 25\%$ EXCLUDING TRANSF.

$\eta_o = \frac{60}{240} \times 25\% = 18.8\%$ OVERALL

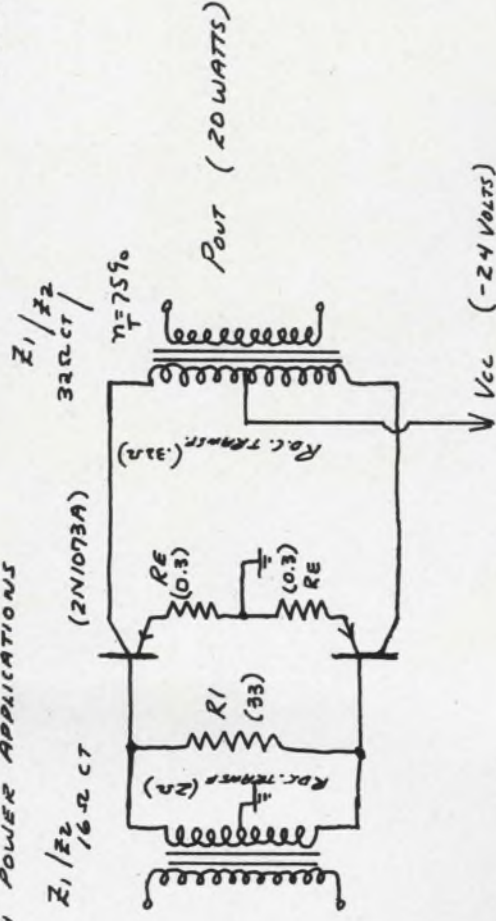

- $P_1 = \frac{P_o}{\eta_T}$
- $P / \text{TRANS} = \frac{V_m I_m}{4}$
allowing 2 volts for anticipated drops through R_E & $1/2$ TRANS.
- $I_m = 4 P / \text{TRANS}$
- $I_{D.C.} = 2 \frac{I_m}{\pi}$
- $R_L / \text{TRANS} = \frac{V_m}{I_m}$; $\therefore R_{L \text{ TOTAL}} = 4 R_L / \text{TRANS}$ SINCE CLASS B
- $P_{IN} / \text{TRANS} = V_{CE} \frac{I_m}{\pi}$ FROM BATT
- $P_{LOSS} / \text{TRANS} = P_{IN} / \text{TRANS} - P_o / \text{TRANS} - \frac{1}{2} P_{LOSS}$
 $R_E \approx \frac{V}{I_m}$
- BASE DRIVE $I_{BM} = I_m$
 V_{BM} FROM CHOICE FOR I_{BM}
- $V_{BM} = V_{BE} + V_{EM}$
- $P_{IN} / \text{TRANS} = \frac{V_{BM} I_{BM}}{\pi}$
- $P_{N \text{ TOTAL}} = 2 P_{IN} / \text{TRANS}$
- $R_B / \text{TRANS} = R_B + \beta (R_E + V_E)$
 R_B FROM $\frac{\Delta V_{BE}}{I_B}$ AT OPER. PT ON BARE CHOC. V_E SMALL NEGLECT.
AS ABOVE $R_E \approx \frac{V}{I_m}$
- $\therefore R_{IN \text{ TOTAL}} = 4 R_{IN} / \text{TRANS}$: CLASS B
- R_1 CHOICE EQUAL TO R_{IN} OF TRANSISTORS TO CREATE 2 MORE CONSTANT INPUT IMPED FOR THE BARE OTHER STAGE.
- $\therefore Z_2 = R_{IN} // R_1$; $R_1 = R_{IN}$
 $\therefore Z_2 = \frac{R_{IN}}{2}$
- $\theta_{JA} \text{ REQ'D} = \frac{T_J - T_A}{P_D}$ MAX. ALLOWED
 $\theta_{SA} = \theta_{JA} - \theta_{JC} - \theta_{CS}$ MAX. REQ'D THERMAL RESIST. OF HEAT SINK
- $\eta_{overall} = \frac{P_o}{P_{IN \text{ BATT}}} \eta_T = \frac{V_m I_m}{2 V_{CE} I_m} \approx 75\% \eta_T$

SAMPLE DESIGN

- $P_o = 20 \text{ WATTS}$ $\eta_T = 75\%$ $V_{CC} = -24 \text{ V}$ $T_A = +55^\circ \text{C}$
 $P_1 = \frac{20}{.75} = 26.6 \text{ WATTS}$ USE 30 WATTS
- $P / \text{TRANS} = \frac{30}{2} = 15 \text{ WATTS}$
- $V_m = 24 - V_E = 22 \text{ VOLTS}$
- $I_m = \frac{4(15)}{2} = 2.72 \text{ AMPS}$
- $I_{D.C.} = 2 \left(\frac{2.72}{\pi} \right) = 1.73 \text{ AMPS}$
- $R_L / \text{TRANS} = \frac{22}{2.72} = 8.1 \text{ OHMS}$ USE 8 OHMS
- $\therefore R_{L \text{ TOTAL}} = 4(8) = 32 \text{ OHMS}$
 $R_{D.C.} \leq \frac{32}{100} = 0.32 \text{ OHMS}$
- $P_{IN} / \text{TRANS} = \frac{24(2.72)}{\pi} = 20.75 \text{ WATTS}$
- $P_{LOSS} / \text{TRANS} = 2.72(R_E + R_{D.C.})$
 $R_E \approx \frac{V}{I_m} = 0.3 \Omega$ $\therefore P_{LOSS} / \text{TRANS} = 1.23 \text{ WATTS}$
- $P_{LOSS} / \text{TRANS} = P_{IN} / \text{TRANS} - P_o / \text{TRANS} - P_{LOSS} / \text{TRANS}$
 $= 20.75 - 15 - 1.23 = 4.52 \text{ WATTS}$ USE 5 WATTS
- BASE DRIVE $I_{BM} = I_m$
AT THIS TIME TRANSISTOR CHOSEN 2N1073A
($\beta = 20$ MIN AT I_{MAX})
 $\therefore I_{BM} = 2.72$ AT I_{BM} FROM BARE CHOICE.
- $V_{BM} = V_{BE} + V_E = 0.56 + 0.816 = 1.376 \text{ VOLTS}$
- $P_{IN} / \text{TRANS} = \frac{1.376(136 \text{ mm}^2)}{4} = 4.2 \text{ mW}$
(SINCE $R_E \approx \frac{V}{I_m} = 0.3 \Omega$; $R_{D.C.} = \frac{V_E}{I_m} = 0.11 \Omega$)
- $R_{IN} / \text{TRANS} = 2 + 20(0.3) = 8 \text{ OHMS}$
- $\therefore R_{IN \text{ TOTAL}} = 4(8) = 32 \Omega$: CLASS B
- LET $R_1 = 33 \Omega$
- $Z_2 = 16 \Omega$
- $\theta_{JA} = \frac{100 - 50}{5} = 9^\circ \text{C/W}$
- $\theta_{SA} = \theta_{JA} - \theta_{JC} - \theta_{CS} = 9.0 - 1.8 - 1.4 = 7.8^\circ \text{C/W}$
USE AN AVERAGE HEAT SINK WITH $\theta_{SA} = 6^\circ \text{C/W}$
- $\eta_o = \frac{20}{21.5} \approx 46\%$

FORMULA DERIVATIONS

CLASS A QPT AT $V_{CC} = \frac{V_m}{2}, I_Q = \frac{I_m}{2}$

$$P_{out} = \frac{1}{2\pi} \int_0^{2\pi} \left[\int_{-\frac{V_m}{2}}^{\frac{V_m}{2}} \frac{V_m}{2} \cos^2 \omega t d\omega t \right]$$

$$= \frac{V_m I_m}{8\pi} \left\{ \frac{2}{\pi} - 0 + 2\pi - \frac{2}{\pi} \right\} = \frac{V_m I_m}{8}$$

$$P_{inBATT} = V_{CC} I_Q = 2V_{CC} I_Q = \frac{V_m I_m}{2}$$

$$\therefore \eta = \frac{P_o}{P_{in}} = \frac{8}{2} = 25\% \text{ Max}$$

CLASS A QPT AT $V_{CC} = \frac{3}{2} V_m, I_Q = \frac{3}{2} I_m$

$$P_{out} = \frac{1}{2\pi} \int_0^{2\pi} \left[\int_{-\frac{3V_m}{2}}^{\frac{3V_m}{2}} \frac{3V_m}{2} \cos^2 \omega t d\omega t \right]$$

$$= \frac{3V_m I_m}{2\pi} \left(\frac{2}{\pi} - 0 + 2\pi - \frac{2}{\pi} \right) = \frac{3V_m I_m}{2}$$

$$P_{inBATT} = V_{CC} I_Q = \frac{3}{2} V_m \cdot \frac{3}{2} I_m = \frac{9}{4} V_m I_m$$

$$\therefore \eta = \frac{P_o}{P_{in}} = \frac{2}{9} = 22.2\% \text{ Max}$$

CLASS B QPT AT $V_{CC} = V_m, I_Q = 0$

$$P_{out} = \frac{1}{2\pi} \int_0^{2\pi} \left[\int_{-V_m}^V V_m \cos^2 \omega t d\omega t \right]$$

$$= \frac{V_m I_m}{2\pi} \left(\frac{2}{\pi} - 0 + 2\pi - \frac{2}{\pi} \right) = \frac{V_m I_m}{\pi}$$

$$P_{inBATT} = V_{CC} I_Q = 0$$

$$\therefore \eta = \frac{P_o}{P_{in}} = \frac{\pi}{\pi} = 100\%$$

CLASS A PUSH-PULL QPT AT $V_{CC} \approx V_m, I_Q = \frac{I_m}{2}$

$$P_{out} = \frac{1}{2\pi} \int_0^{2\pi} \left[\int_{-V_m}^V V_m \cos^2 \omega t d\omega t \right]$$

$$= \frac{V_m I_m}{2\pi} \left(\frac{2}{\pi} - 0 + 2\pi - \frac{2}{\pi} \right) = \frac{V_m I_m}{\pi}$$

$$P_{inBATT} = V_{CC} I_Q = V_m \cdot \frac{I_m}{2} = \frac{V_m I_m}{2}$$

$$\therefore \eta = \frac{P_o}{P_{in}} = \frac{2}{1} = 50\% \text{ Max}$$

CLASS A PUSH-PULL QPT AT $V_{CC} \approx V_{CE}$

$$P_{out} = \frac{1}{2\pi} \int_0^{2\pi} \left[\int_{-V_{CE}}^V V_{CE} \cos^2 \omega t d\omega t \right]$$

$$= \frac{V_{CE} I_Q}{2\pi} \left(\frac{2}{\pi} - 0 + 2\pi - \frac{2}{\pi} \right) = \frac{V_{CE} I_Q}{\pi}$$

$$P_{inBATT} = V_{CC} I_m = 2V_{CC} I_Q$$

$$\therefore \eta = \frac{P_o}{P_{in}} = \frac{1}{2} = 50\% \text{ Max}$$

CLASS B PUSH-PULL

$$P_{OUT/TRANS} = \frac{1}{2\pi} \left[\int_0^{\pi} V_m I_m \sin^2 \omega t \sin^2 \omega t d(\omega t) + \int_{\pi}^{2\pi} 0 \right]$$

$$= \frac{V_m I_m}{2\pi} \left[\frac{\pi}{2} - 0 \right] = \frac{V_m I_m}{4}$$

$$P_{OUT} = \frac{V_m I_m}{2}$$

$$P_{IN BATT} = V_m \cdot 2 \frac{I_m}{\pi} = 2 \frac{V_m I_m}{\pi}$$

$$\eta = \frac{P_O}{P_{IN}} = 78.5\%$$

~

VOLTAGE FEEDBACK TO CREATE A DESIRED Z_{OUT}

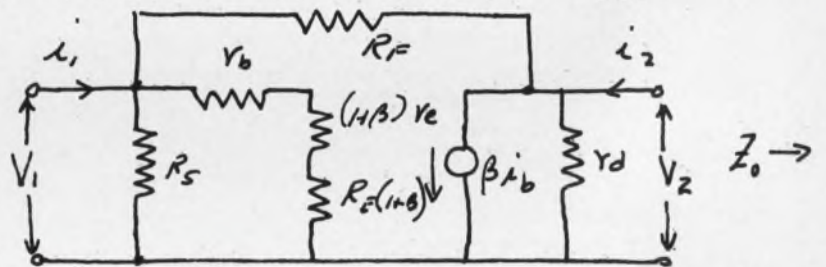
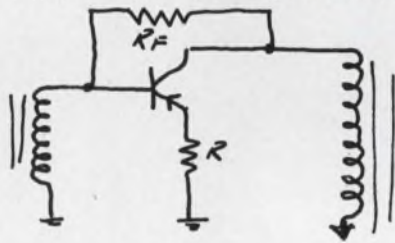

$$Z_0 = \frac{\Delta + Z_{22} Z_g}{Z_{11} + Z_g}$$

$$\Delta = Z_{11} Z_{22} - Z_{12} Z_{21}$$

BY MATRIX DERIVATION

$$Z_0 = \frac{Y_D (\beta R_E + R_F)}{R_F - Y_D}$$

OR TO DETERMINE R_F FOR DESIRED Z_0

$$\therefore R_F = \frac{Y_D (Z_0 + \beta R_E)}{Z_0 - Y_D}$$

FOR ^{PUSH-PULL} CLASS B SINGLE-ENDED CLASS A

FOR CLASS A PUSH-PULL DOUBLE R_F CALCULATED

The actual value of R_F will have to be found experimentally. As much as 30% error has been noted however this ^{may} have been due to inaccurate data available to determine Y_D from.

DESIGN PROCEDURE FOR MULTIPLE DIODE, HIGH-VOLTAGE
DIODE POWER SUPPLY.

RECOVERY TIME EQUALIZATION, REV. VOLTAGE EQUALIZATION
P.I.V. PROTECTION

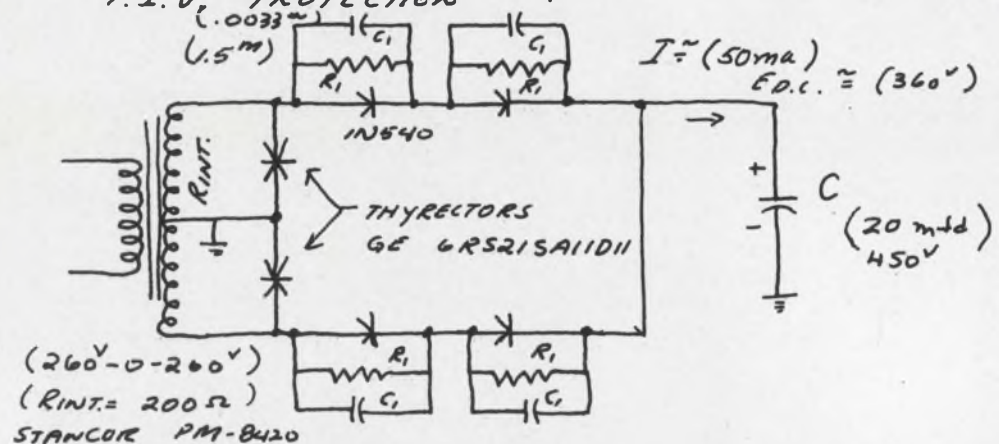

1) R_1 - EQUALIZES VOLTAGE DIVISION - REVERSE - WHICH MAY OCCUR DUE TO DIFFERENCES IN THE BACK RESISTANCE OF DIODES

$$R_1 = \frac{1}{2} \frac{E_{MAX} \text{ D.C. - REV. RATING}}{I_{MAX} \text{ REV. CURRENT AT MAX. OPER. TEMPERATURE JUNCTION}}$$

2) USING JUNCTION TEMP = $\theta \times P_D = \Delta T_{JMAX}$
 $\therefore T_J = T_{AMAX} + T_{JMAX}$

3) $C_1 = \frac{\tau t}{R_L}$ $R_L = \text{EQUIV. LOAD RESISTANCE}$
 $n = \text{NO. OF RECTIFIERS}$

$\tau = \text{REV. RECOVERY TIME OF RECTIFIER USED.}$

4) MIN SERIES RESISTANCE REQUIRED IN SERIES WITH RECTIFIERS TO REDUCE FWD SURGE.

CALL: $\frac{C_S E_m}{\sqrt{3 I^2 t}}$ 3) $C_S = C + 200\% C$

USE $E_m = 1.1 \text{ EPK OF SUPPLY VOLTAGE}$

REFERENCE: GE. RECT. COMP. MANUAL

$I^2 t$ FROM RECTIFIER SPEC. FOR DIODE USED.

FOR VALUE OF $\frac{C_S E_m}{3 I^2 t}$; DET. RC *

* FROM CHART IN REFERENCE P. 36.

5) $R = \frac{RC}{C_S}$ NOW IF TRANSFORMER HAS THIS MIN. NO ADDITIONAL NEED BE ADDED.

6) CHOOSE THYRECTORS TO LIMIT REV. VOLTAGES FROM EXCEEDING RECTIFIERS TOTAL RATING

EXAMPLE

1) 360V D.C. OUTPUT AT 50mA DESIRED

\therefore P.I.V. ACROSS EACH LEG AT LEAST 720V

CHOOSING IN540 WITH 600V AV USING TWO IN SERIES

2) TO DET $I_{MAX} \text{ REV}$
 $T_J = T_A + T_{JMAX}$ $\theta = 100^\circ \text{C/WATT}$
 $\Delta T_J = 100^\circ \text{C/WATT} \times 400 \text{ mW}$
 $= 40^\circ \text{C}$

$\therefore T_J = 55^\circ \text{C} + 40^\circ \text{C} = 95^\circ \text{C}$ USE 100°C
 AT 100°C $I_{MAX} \text{ REV.} \approx 100 \text{ mA}$

$\therefore R_1 = \frac{1}{2} \frac{400}{100 \text{ mA}} \approx 2 \text{ m}\Omega$ USE 1.5M Ω

3) $C_1 = \frac{\tau t}{R_L}$ $R_L = \frac{360 \text{ V}}{50 \text{ mA}} = 7.2 \text{ K}$

$n = 2$; $\tau = \text{REV. RECOV. TIME} = 10 \mu\text{SEC.}$
 $\therefore C_1 = \frac{2(10 \mu)}{7.2 \text{ K}} = 2.775 \text{ m}\mu\text{F}$ USE 3 $.0033 \mu\text{fd}$

4) $\frac{C_S E_m}{\sqrt{3 I^2 t}} = \frac{60 \mu (400)}{\sqrt{2.7}} = .0146$
 \uparrow IRT FOR IN540 = .93 amp²-sec
 $t \leq .008 \text{ sec.}$

5) FOR .0146 FROM CHART = $RC = 5 \times 10^{-3}$
 $R = \frac{5 \times 10^{-3}}{60 \mu} = 83.3 \Omega$

TRANSFORMER CHOSEN HAS 100 Ω /LEG
 \therefore NO ADDITIONAL REQUIRED.

6) THYRECTORS CHOSEN
 SINCE AC 260V - 0 - 260V
 USE 275V RMS, 385V PK UNITS

Free reprints
 Single copies of a reprint of these "Pages from an Engineer's Notebook" will be sent free of charge to readers who circle Reader Service card no. 250.

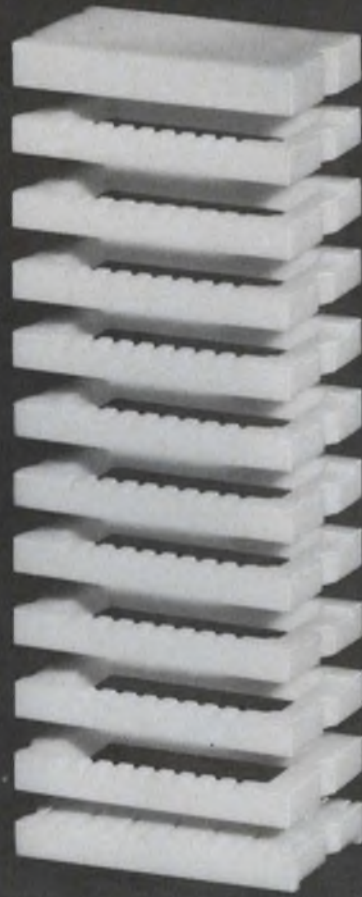

For reliable High Density Packaging

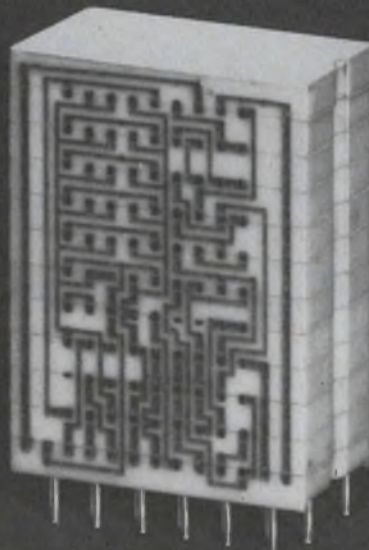

If you are working with a single chip or with complex circuit networks, Coors micro-ceramic modules offer you high reliability packaging. In the example above, the design engineer utilized base, frame, and lid modules to form a universal stacked package that can grow to fit any circuit density required. Each module is approximately 5/16" wide, 11/16" long and .050" high - indexed for high speed assembly. Because of the unique properties of Coors Ceramics, modules can be joined by epoxy, glass, low temperature solder, or high temperature brazes. Thin film or thick film technique can be used. The high mechanical strength, high surface resistivity and high thermal conductivity of Coors Ceramics combine to make the package reliable under widely varying operating conditions. Precision tolerances can be held even on complex designs. Whether your requirements call for thousands a week, or millions a week, Coors has complete facilities to offer you on-time delivery of alumina or beryllia packaging modules. Faced with a packaging decision? Get on-the-spot answers. Dial Coors - 303/279-6565, Ext. 361. For complete design criteria, write for Coors Alumina and Beryllia Properties Handbook No. 952.

*consider
Coors
ceramics*

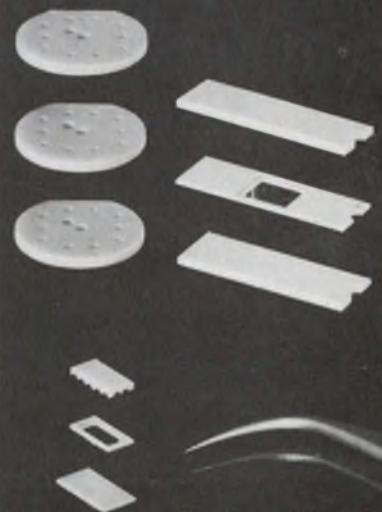

Coors

CERAMICS

ALUMINA • BERYLLIA • MAGNESIA • SPECIAL OXIDES
Coors Porcelain Co., Golden, Colo.

ON READER-SERVICE CARD CIRCLE 34

Cut the size of your vhf attenuators

with a simple circuit. Other virtues are fast response time and continuously variable attenuation.

A design approach that uses a bridge-type circuit with pin diodes makes it possible to fit uhf and vhf attenuators into small packages. The technique makes allowance for the requirements of both variable and fixed attenuations at power levels up to 100 watts cw over bandwidths up to 25%. Its upper frequency limit is some 2 to 3 GHz.

In many systems a practical attenuator at uhf and vhf frequencies must both be compact and provide for fixed and variable attenuation. It must, furthermore, remain matched to the system over its whole range. Above 500 MHz these requirements pose no problems; a matched multidiode attenuator or a ferrite isolator in conjunction with a reflective diode attenuator are among the devices available to the systems engineer. At lower frequencies, however, their size makes them incompatible with most system requirements.

The bridge-type diode circuit in Fig. 1 not only overcomes the size problem (it is about half the size of the devices mentioned above) but also meets the other requirements. Its major areas of application include modulation of RF signals over broad power and frequency ranges, remote gain control of RF amplifiers, protection of receivers by RF power-leveling, and the control of radiated power.

The major factor in the design is selection of the diodes. Attenuation range, insertion loss and input power have all to be considered at once when the choice is made.

Diodes are merely resistances

The basic circuit of Fig. 1 may be used to establish the design criteria. It is assumed that the RF impedance of diode 1 can be represented as Z_1 and that of diode 2 as Z_2 . To ensure a matched condition, the RF input impedance of the attenuator must be R_0 , where R_0 is the system's characteristic impedance. The load is simply the rest of the system, so it, too, has a value of R_0 . Neglecting

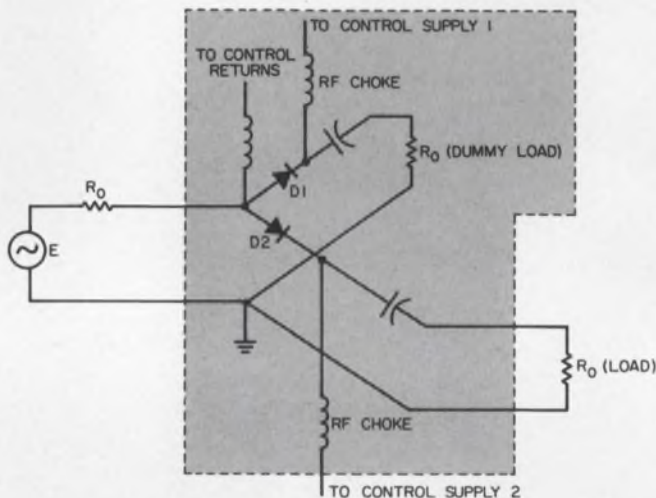

1. Basic attenuator circuit is built around two RF diodes. Both the generator and load impedances are assumed to be equal to R_0 . The diodes are pin type and have resistive impedances through their bias range. The attenuation is continuously variable through the bias of the diodes, which varies their impedances from about 0.5 to 5000 ohms.

transmission-line effects, this requires that:

$$R_0 = [(Z_1 + R_0)(Z_2 + R_0)] / [Z_1 + Z_2 + 2R_0] \quad (1)$$

If Z_1 , the impedance of diode 1, equals $R_1 + jX_1$, and Z_2 , the impedance of diode 2, equals $R_2 + jX_2$, then Eq. 1 becomes:

$$R_1R_2 - X_1X_2 + j(R_1X_2 + R_2X_1) = R_0^2 \quad (2)$$

Since R_0^2 is a real number, the imaginary part of Eq. 2 must be zero: $R_1X_2 = -R_2X_1$. This is easily realizable on condition that:

$$R_1 + jX_1 = (R_2 - jX_2)C^2 \quad (3)$$

for then $Z_1 = C^2Z_2^*$, that is, Z_1 is proportional to the complex conjugate of Z_2 . (C is a constant and $*$ denotes the complex conjugate.) Using Eq. 3 in the real part of Eq. 2 gives:

$$R_2^2 + X_2^2 = (R_0/C)^2 \quad (4)$$

In other words, the impedance of diode 2 must be controlled so that it has a magnitude equal to:

$$(Z_2Z_2^*)^{1/2} = (R_2^2 + X_2^2)^{1/2} = R_0/C,$$

and simultaneously the impedance of diode 1 must be equal to $C^2Z_2^*$. However, if Z_1 equals R_1 and Z_2 equals R_2 (that is, $X_1 = X_2 = 0$), Eq. 2 is sat-

Hugh R. Malone, Electrical Engineer, and Donald E. Allen, Sr. Engineer, Motorola Government Electronics Div., Scottsdale, Ariz.

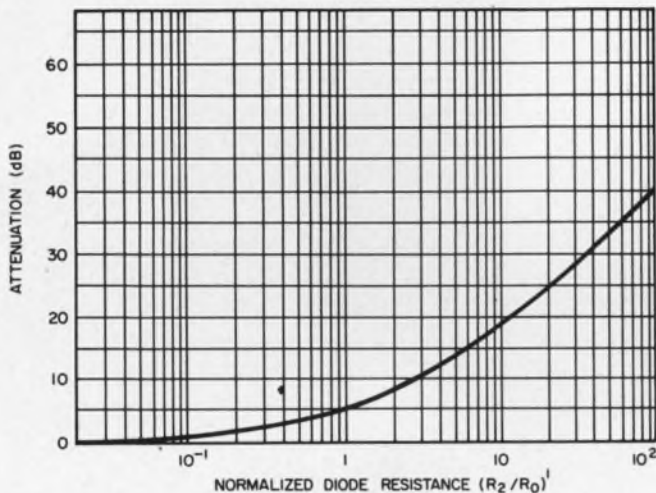

2. **Continuously variable attenuation** is achieved by changing the diode's resistance. Here the resistance is normalized with respect to the system's impedance, R_0 . It is assumed that both diodes in Fig. 1 have the same resistances; which vary from 0.5 to 5000 ohms. The range of the attenuator is greater than 40 dB, and its insertion loss is less than 0.1 dB.

ified by:

$$Z_1 Z_2 = R_1 R_2 = R_0^2. \quad (5)$$

A matched attenuator (or variable power divider) can then be achieved by controlling the diodes' impedances.

Loss in passband is down to 0.1 dB

The two remaining parameters are the insertion loss and the maximum permissible power dissipation. The insertion loss determines the attenuation range of the circuit and dissipated power affects the amount of attenuation.

The insertion loss is defined as the ratio of power delivered to a matched load to the power available to a matched load. For real diode impedances, it is given by:

$$\text{Insertion Loss} = [(R_1 + R_0)/(R_1 + R_2 + 2R_0)]^2, \quad (6)$$

where R_2 is related to R_1 by Eq. 5.

The diode's impedances may be normalized for simplicity: $R_n' = R_n/R_0$, where $n = 1, 2$. When the loss is expressed in decibels, Eq. 6 becomes:

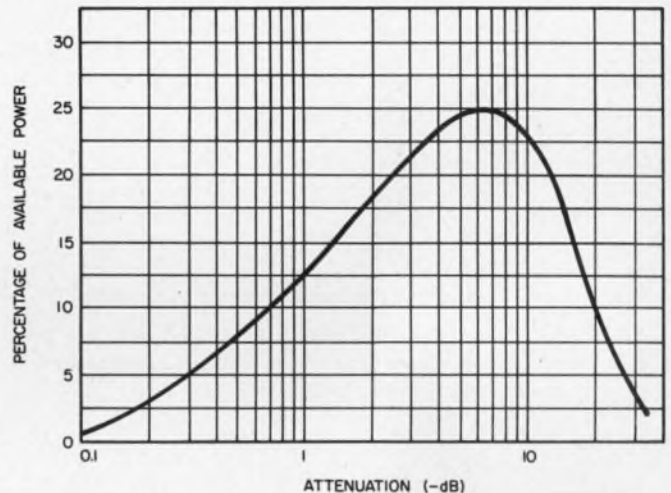

3. **Dissipation in the diodes reaches its peak** at the 6-dB attenuation level. The absorbed power is expressed as a percentage of the total input power. Each diode must therefore be rated to dissipate one-fourth of the controllable power. However, if $R_1 R_2 = R_0^2$, then even a larger percentage of the input can be dissipated in a diode. Diodes can dissipate 1 to 5 watts with good heat sinks.

$$\text{Insertion Loss}_{dB} = 20 \log_{10}[1 + R_2']. \quad (7)$$

The achievable attenuation is plotted in Fig. 2 as a function of R_2/R_0 , with the implicit condition that $R_1 R_2 = R_0^2$. Note that in a 50-ohm system impedance level, an attenuator with less than 0.1-dB insertion loss and a range of attenuation greater than 40 dB can be implemented with diodes with resistances that can be varied from 0.5 to 5000 ohms. The measured swr at the input of the attenuator is 1.0 when $R_1 R_2 = R_0^2$.

Diodes should share power equally

The power dissipated in each diode depends on the impedances of the generator and the load and, of course, on the diodes' impedance. If Eq. 5 is valid (i.e., $R_1 R_2 = R_0^2$) and both the load and the generator impedances are equal to R_0 , then the two diodes absorb equal amounts of power. The percentage of dissipated power in each diode, P_d , is therefore:

$$P_d = [R_2'/(1 + R_2')^2] \times 100\%, \quad (8)$$

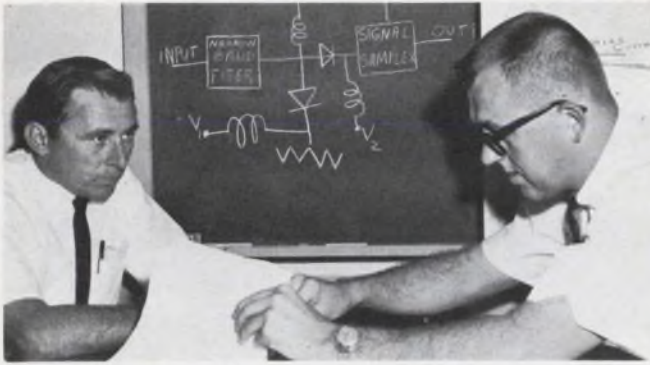

A simple block diagram and a Smith chart help authors Allen (left) and Malone to come up with the right devices.

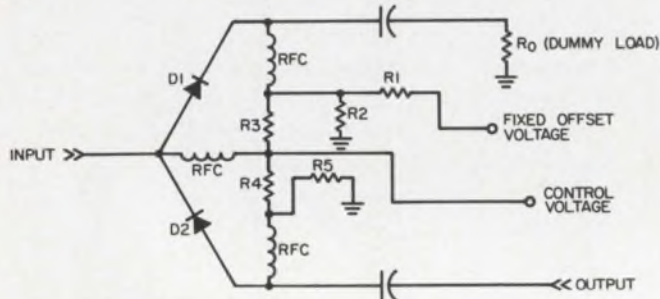

4. A single control source may bias both diodes if one of the diodes is reversed. Here diode D2 is reversed with respect to its original direction in Fig. 1.

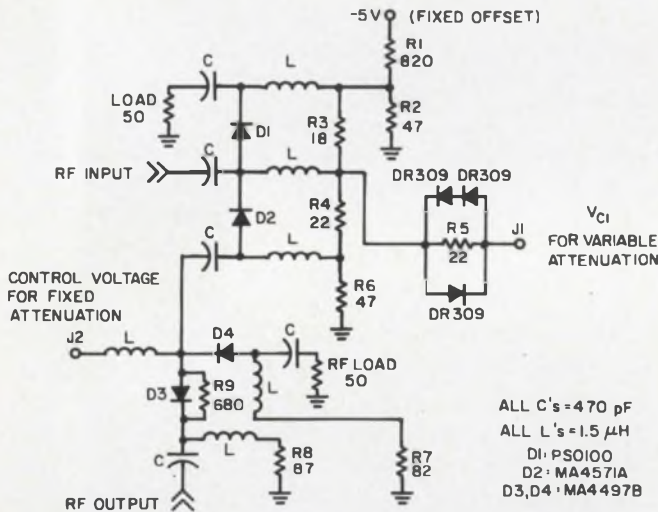

(a)



(b)

5. Power attenuator is designed for 200 MHz. A spdt diode switch (D3 and D4) has been added to provide a fixed attenuation of 23 dB. The variable attenuation of 28 dB is controlled by V_{C1} , as shown in (a). The size of the prototype package is about 4 x 2.5 x 1 inches (b).

where the primed symbols again represent diode impedances normalized to R_0 . The relative power dissipated by each diode, as a function of the attenuation level, is plotted in Fig. 3. The maximum power is absorbed by each diode at the 6-dB attenuation point. At this attenuation value, one quarter of the available power is dissipated in each diode, the power load and the external load, respectively. To prove that maximum power absorption occurs at the 6-dB point, the derivative of Eq. 8 is taken and set equal to zero:

$$\frac{\partial P_d}{\partial R_2'} = \frac{(1 + R_2')^2 - R_2' 2(1 + R_2')}{(1 + R_2')^4} = 0.$$

Hence $R_2' = 1$ when maximum power is absorbed in either diode. Substituting $R_2' = 1$ into Eq. 7 yields the attenuation value of 6 dB.

If the condition that $R_1 R_2 = R_0^2$ does not hold, then an even higher percentage of the available power can be dissipated in a diode than is predicted by Eq. 8.

In view of all that has been discussed, it is clear that the diodes are completely specified by these three conditions:

- The attenuation range determines their maximum and minimum impedances (Eqs. 5 and 7 and Fig. 2).
- One quarter of the input power determines their power-dissipating capability.
- The RF impedances of the diodes should be real over the entire bias range.

Typical pin diodes appear to be the best choice for wide attenuation ranges and medium power levels. They have RF impedances that can be varied with the bias and are nearly real in the vhf and uhf bands.^{1,2} Their typical minimum value during forward bias is less than 1 ohm. These diodes are normally rated as capable of dissipating 2 to 5 watts, when provided with a sufficient heat sink.

Passive components have low impedances

Once the diodes are selected, the circuit design becomes mostly empirical; common sense will help the designer more than mathematical formulas.

In the circuit in Fig. 1, the RF chokes provide a means of injecting the diode bias. The chokes must provide sufficient reactance at the RF frequency to ensure a low-loss attenuator. The dc blocking capacitors, which isolate the bias paths, the dummy load, and the external attenuator load, must have low RF impedances.

Several variations are possible in the bias circuitry. As an example, one of the diodes can be reversed and both diodes can be biased by a single control source. A typical circuit of this type is shown in Fig. 4. The selection of bias circuit is mostly determined by available voltages.

Since, when the attenuation is 6 dB, a quarter of the available RF power to a matched load is dissipated in each diode, the major thermal problem is that of providing a sufficient heat sink for each diode.

If a coaxial transmission line is used within the attenuator, the problem is to provide a high-thermal-conductivity - low-electrical-conductivity path between the inner and outer coaxial conductors. Simultaneously, a high thermal-conductivity path is required between the diode package and the coaxial inner conductor.

Experiments show that a beryllium oxide loaded transmission line satisfies both criteria. An assembly of this type has been designed to control 10 watts of average RF power with MA 4571 diodes over ambient temperature ranges of -50°C to $+50^{\circ}\text{C}$. This attenuator, shown in Fig. 5, operates at 200 MHz. Its continuously variable attenuation ranges are from 1.0 to 28 dB, with a maximum swr of 1.6 when used in a 50-ohm system. The maximum control power is 0.6 watt. A response time (not considered a minimum) of less than $0.3\ \mu\text{s}$ was measured.

Add switch for fixed attenuation

An additional spdt diode switch has been added, so that both fixed and variable attenuation can be obtained. Some additional bias circuitry is also included to linearize partially the continuously variable portion of the attenuation with control voltage.

Resistors $R1$ through $R6$ and the DR309 diodes were selected empirically so that the attenuation-vs-control curves were sufficiently linear. Resistors $R7$ and $R8$ are current-limiting resistors. Their values are determined by the maximum desirable bias currents of RF diodes $D3$ and $D4$. $R9$ limits the attenuation achievable by RF diode $D3$. It would not even be used in most instances.

All capacitances are chosen for minimum RF impedance and compatibility with switching requirements. As the values of capacitances are increased, RF losses drop. The switching time of the attenuator, however, will be increased with increasing values of C . The values shown in Fig. 5 reflect a compromise between these two criteria. The inductances are selected in a similar manner. All chokes are $1.5\ \mu\text{H}$ and all capacitors are 470 pF. An offset voltage of $-5\ \text{V}$ and a control voltage of $\pm 5\ \text{V}$ at $J2$ provide a step (fixed) attenuation of 23 dB. A second control voltage, V_{C1} , provides the continuously variable 28-dB range of attenuation. Applied at $J1$, it is continuously variable from -5 to $+5$ volts. Hence, a total attenuation of 51 dB is available.

The continuously variable portion of the attenuation depends on control voltage V_{C1} , as shown in

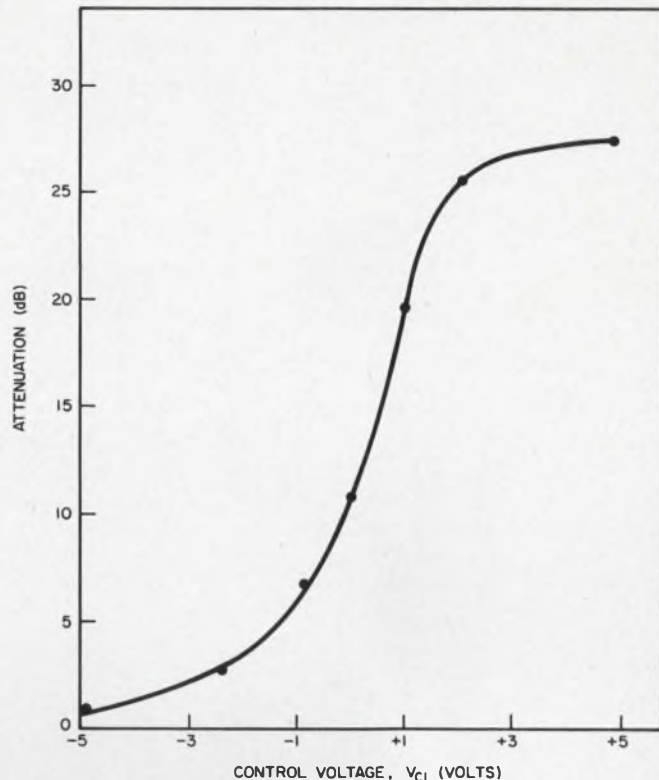

6. Measured variation of continuously variable attenuation with control voltage V_{C1} shows rapid control. The switching time of the device over the entire attenuation range is less than 300 ns.

Fig. 6. The maximum swr measured over the entire attenuation range is 1.6:1, with typical values of less than 1.3:1. The device, evaluated over an RF bandwidth of 25% and an ambient temperature range of -50°C to $+50^{\circ}\text{C}$, shows only negligible variations from the data of Fig. 7. The switching time of the device over the entire range of attenuation is less than 300 ns.

The operational frequency and maximum power-handling capability of the attenuator design are very difficult to calculate. Exact diode impedances, exact thermal properties, exact diode impedances, and exact thermal properties of the diode mounts must be known. The estimated upper limit of operating frequency is about 2 to 3 GHz, for the circuit in Fig. 5. Careful design can push up the maximum power-handling capability to about 100 watts. Diodes would have to be carefully selected and a good thermal design would be imperative. In the vhf and uhf ranges, bandwidths of 25% are estimated as feasible for the mean frequency. ■ ■

References:

1. A. Uhlir, "The Potential of Semiconductor Diodes in High-Frequency Communications," *Proc. IRE*, XLVI (June, 1958), 1099-1115.
2. Donald E. Allen, "An Investigation of the Microwave Equivalent Circuit of the pin Diode" (Master's thesis. Arizona State University, June, 1965).

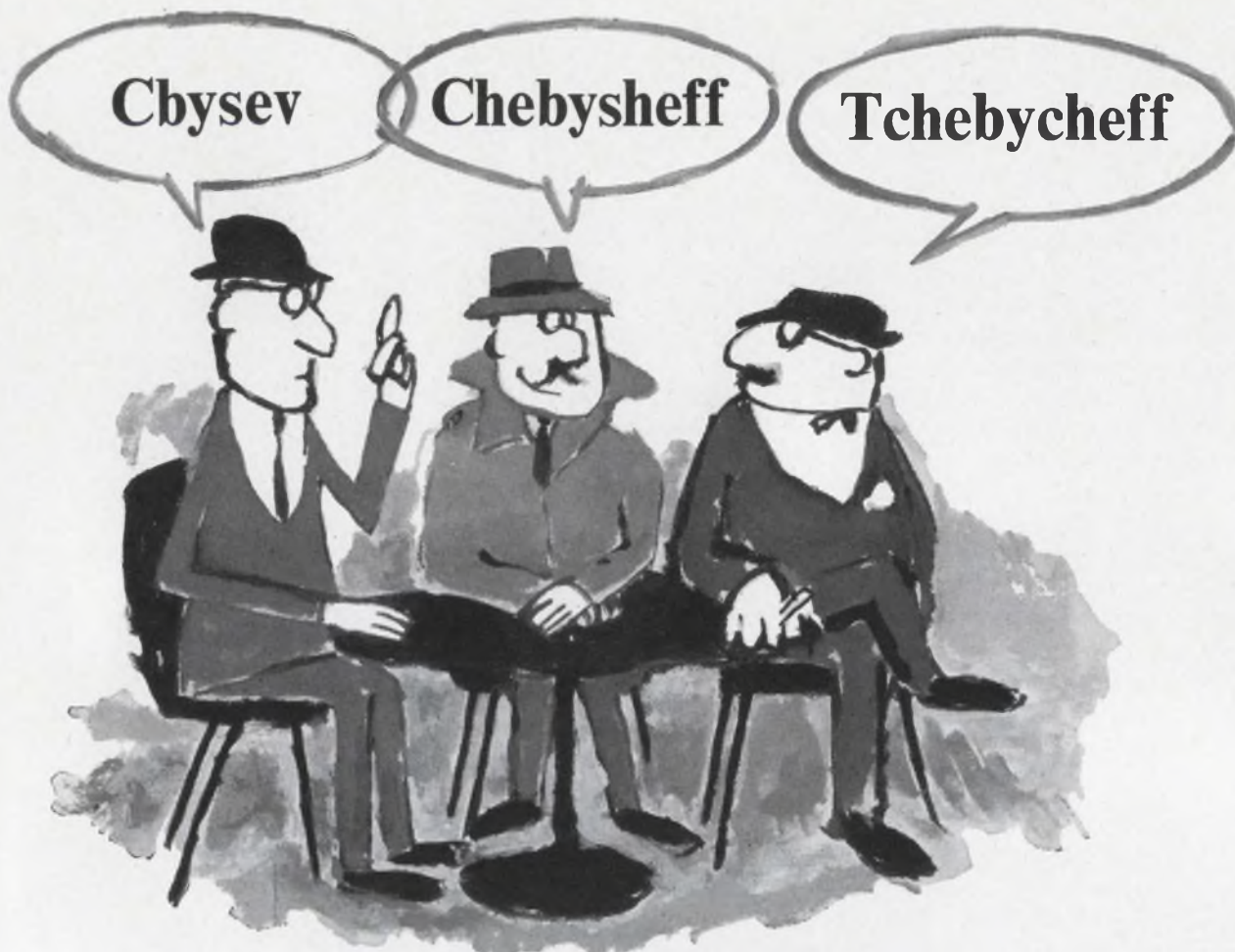

SCHMEBICHEFF???

WHO CARES as long as you get attenuation!
 If you are tired of maintaining the Status Kuo
 If, when it comes to filter design, you are a Cauer-d
 If, you are worried about the Worth of Butter . . .

Ask Aladdin for a QFS*

We not only know how to design and build filters, we handle your problems in a businesslike, straight-forward way.

Here are the steps in the plan that goes into action as soon as you send us a description of your requirements.

First, the feasibility study. A free service. It amounts to a computerized analysis that tells whether one of Aladdin's "standard" types will meet your specs, *using stock components*.

Second, if the feasibility study is affirmative, you receive a quotation on a sample lot of Aladdin filters which *will meet your specs*.

Third, along with your quote and before we even make the samples—a quote on production quantities just like the samples. In short, we are not going to hem and haw and weasel word our estimate of the quote, even on a prototype design we have never made before. You know before you test the samples that if they turn out to be what you want you have a firm price on production quantities.

Fourth—if you order the sample lot—quick service . . . because we combine stock components and hardware with Aladdin tailored inductance values.

where the [★]magic of magnetics is a science...™

Aladdin[®]
electronics /

703 Murfreesboro Road,
 Nashville, Tennessee

*Quick Feasibility Study

ON READER-SERVICE CARD CIRCLE 35

ELECTRONIC DESIGN 11, May 24, 1967



Here's your answer
to shock and
vibration problems

■ Allen-Bradley Type R adjustable fixed resistors are unexcelled for holding precise settings through extreme conditions of shock and vibration. This unusual ruggedness is the result of a manufacturing process—perfected and used only by Allen-Bradley—which hot molds the resistance and collector elements, terminals, and insulating material into an almost indestructible component. Thus, the controls can be mounted by their own rugged terminals *without* additional support.

The solid resistance track assures such smooth control that it approaches infinite resolution. Its smoothness cannot be compared with the abrupt wire-wound turn-to-turn resistance changes which may cause circuit transients. Since Type R controls are essentially non-inductive and have low distributed capacity, they can

be applied in high frequency circuits where wire-wound controls are impractical. The Type R molded enclosures are both dustproof and watertight, permitting encapsulation after adjustment.

Allen-Bradley Type R controls are suitable for use from -55°C to $+125^{\circ}\text{C}$ and are rated $\frac{1}{4}$ watt at 70°C , 300 volts max. RMS. Available as standard in total resistance values from 100 ohms to 2.5 megohms with tolerances of $\pm 10\%$ or $\pm 20\%$. As special, can be furnished down to 50 ohms. Technical Bulletin B5205 contains complete specifications. Please send for your copy today: Allen-Bradley Co., 1344 S. Second Street, Milwaukee, Wisconsin 53204. In Canada: Allen-Bradley Canada Limited. Export Office: 630 Third Ave., New York, New York, U.S.A. 10017.

Allen-Bradley Type R Adjustable Fixed Resistors—Shown actual size

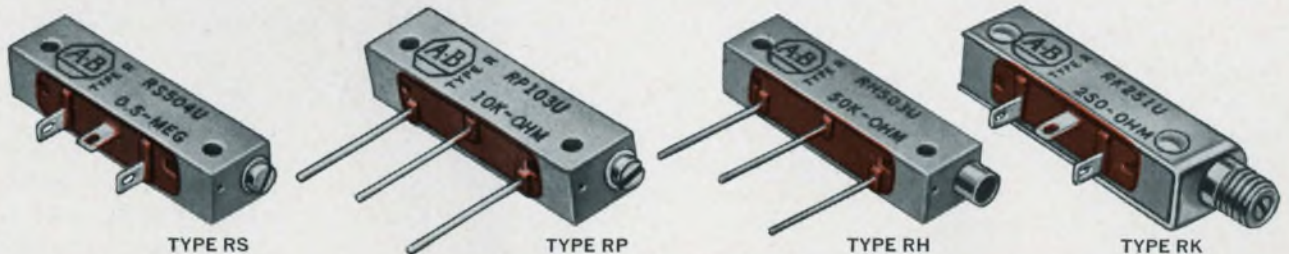

ALLEN - BRADLEY
QUALITY ELECTRONIC COMPONENTS

266-2AB

ON READER-SERVICE CARD CIRCLE 36

Speed microelectronic soldering

by using prealloyed-solder/flux creams. This also increases uniformity and reliability.

Soldering minute parts in high-density electronic packages presents problems uncommon to other joining methods. The amount of solder and flux required for adequate joining is extremely small. Excessive solder and flux will result in a bridge that will cause the assembly to short. Space is at a premium and the location where the solder and flux should be placed must be closely controlled. In addition, the heat from the soldering operation and the residues from the soldering materials cannot be permitted to affect the rest of the assembly adversely. When soldering many joints on one assembly, remelt must not occur. Solder creams or pastes offer a solution to many of these problems.

Choice depends on application

Solder creams are flux and solder combinations made from prealloyed solder powder and fully activated, mildly activated or nonactivated flux, according to the application. The composition of the prealloyed solder powder itself depends on the specific use to which it is to be put.

Two factors govern choice of the proper solder alloy:

- Soldering temperature—An alloy that solders at a low temperature will help minimize thermal damage to the assembly. This is an important consideration when dealing with temperature-sensitive components. Table 1 lists the melting points and plastic temperatures of common alloys.

- Solder joint strength—Physical and mechanical stresses that an assembly must withstand have to be borne in mind.

Storage requirements dictate selection of a curable or of a noncurable solder. Curable creams are used if the assembly is to be handled or stored after application. Noncurable creams are used when handling and storage are unnecessary and soldering can be accomplished immediately.

Unlike roll solders, exact amounts of solder

pastes may be precisely located. A specific volume can be selectively screened or masked onto the assembly surface. It can also be extruded onto the assembly surface with an air syringe to provide close control over the volume of cream deposited.

Controlling the amount of solder and flux used to make the joint by preplacing the solder cream eliminates bridging problems resulting from excessive solder (see Fig. 1). It also cuts out the possibility of using too little solder. Dependence on an operator's technique for making solder joints in an exact location, using the proper amount of solder, and handling a soldering iron is overcome. Reliability is increased by the fact that each joint is made with a premeasured amount of solder and flux. Rejects and the need to repair inadequate joints are reduced.

When soldering many joints on one assembly, remelt can occur. If the joints are made one at a time, the heat required to bring one joint to soldering temperature may be sufficient to remelt those joints already made. With the automatic application of a solder cream to all joints at once and a single application of heat, the joints are soldered simultaneously and there is no possibility of remelt.

Solder applicable by several methods

Once the volume of solder has been calculated¹ and this calculation has been corroborated by prototype soldering, preplacement of solder cream onto the assembly can be automated, even when dealing with microminiature assemblies. Although the methods of applying solder cream can be varied, the underlying techniques fall into the broad categories of screening, masking, or using automated equipment.

Screening is usually appropriate for very thin deposits—generally no greater than 0.001 inch thick. The screening process permits the deposition of solder cream in custom amounts and configurations to meet specific needs. Since heavier deposits may present registration problems, another application method should be employed when the required thickness exceeds 0.001 inch.

H. H. Manko, Director, Solder Research & Development, Alpha Metals, Inc., Jersey City, N. J.

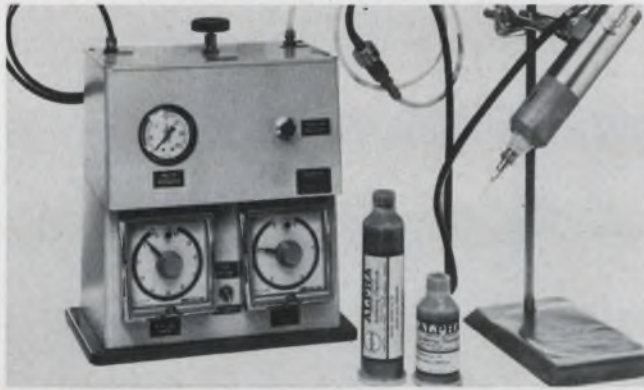

2. **Extrusion-type automatic dispensing unit** applies solder. The shot timer, Kenics model 500 SIFM, pulses air into the dispensing hopper. The dispenser, Pyles model 950-60X, is outfitted with a needle nozzle which dispenses solder in response to the pulses. Tubing is standard Polyflow plastic.

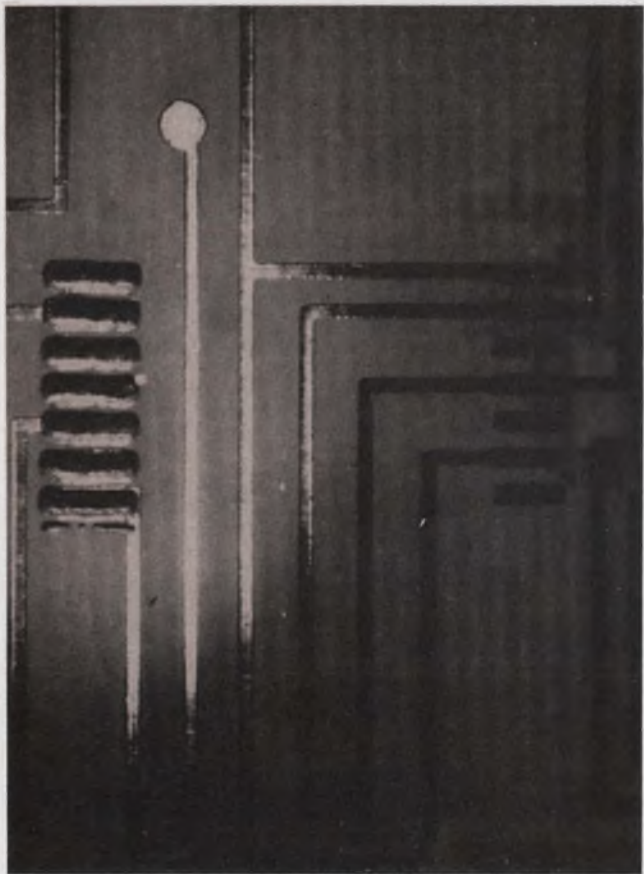
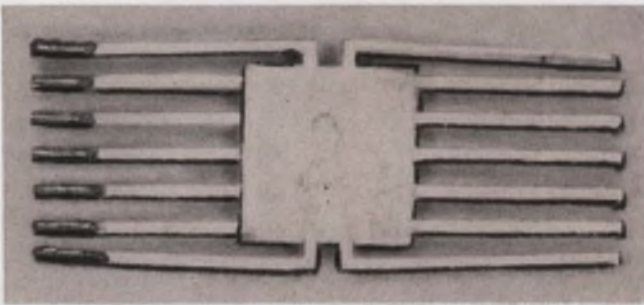

3. **Two methods for joining flat packs to PC boards.** On the flat pack above, solder cream is directly applied to the leads. On the board below, solder cream is deposited straight onto the bonding pads.

Masking or extrusion is appropriate.

Masking is used for heavier deposits of solder cream. The cream is applied in any configuration through a stainless-steel mask or pre-etched stainless-steel template. The thickness of the stainless-steel mask determines the thickness of the deposited layer of solder cream.

Continuous conveyors and automatic extrusion devices can be effectively adapted to automate the application of solder cream (see Fig. 2). A technique similar to that used to paint silver on ceramics or a combination extrusion and stamping procedure may also be used.

If handling or storage is required, the solder cream should be cured in an oven or with hot-air blasts. Table 2 shows some typical curing times and temperatures for patches up to 2 square inches in area. A typical curing criterion would be 10 to 15 minutes' exposure in an oven at a temperature of 200°F, assuming that the solder cream is of medium thickness. The assembly may then be stored, if necessary. Assemblies containing cured solder cream have been subjected to atmospheric conditions and humidity-chamber conditions for 18 months without showing deterioration of solderability. This means that the base material containing a cured coating of solder cream can be stored for prolonged periods prior to soldering without detriment. After curing, the solder takes on a dry, gray, paint-like appearance and is hard to the touch. It adheres well to the assembly surface. A strip of copper containing a 0.008-inch-thick deposit of solder cream can be bent to a 30° angle without any flaking of the solder. Even when the copper strip is bent farther, flaking does not occur, although the solder cream deposit does crack. This cracking does not impair the assembly's solderability; it simply means that the coating is no longer uniform. The cured solder coating not only permits handling and storage, but also protects the surface that is to be soldered against oxidation.

When the solder cream is used with ceramic substrates, perfect registration of the cured solder cream is not essential. It will climb back onto the metallic area of the substrate once it has been reheated for soldering. The soldering operation may be accomplished by any conventional means. Soldering irons, conduction heaters, resistance tools, light banks, torch flames, infrared radiation, hot air and many other methods are all applicable. Although soldering time and temperature depend on the alloy used, in general the soldering temperature should be approximately 100°F above the liquidus or total melting point of the alloy.

The flux residues left after soldering with the cream are nonconductive and nonhygroscopic and therefore considered noncorrosive for most applications. If desired, the flux residues can be

removed with most commercial cleaners and rosin flux removers.

Two techniques for microelectronic soldering

With solder cream, flat packs can be uniformly soldered to printed-circuit boards and still be very easy to inspect. Two methods are available. By one, the solder cream is applied to the printed-circuit-board pads immediately after board manufacture when the pads are still simple to solder. The flat packs with solderable leads are simply placed where desired and, when heat is applied to the solder cream, a fillet is formed. The other approach involves placing the solder cream on the flat-pack leads. The leads are then placed on the PC-board pads. In this instance, the process is in effect reversed. Moreover, whereas in the first approach little solder is present on top of the lead, in the second, the solder completely encompasses it. Thus from an inspection standpoint, the first approach is more desirable. Figure 3 shows both

Table 2. Curing time and temperature

Temperature	Time	Thickness
210°F (99°C)	20 minutes	0.010 inch
230°F (110°C)	20 minutes	0.018 inch
250°F (121°C)	25 minutes	0.030 inch

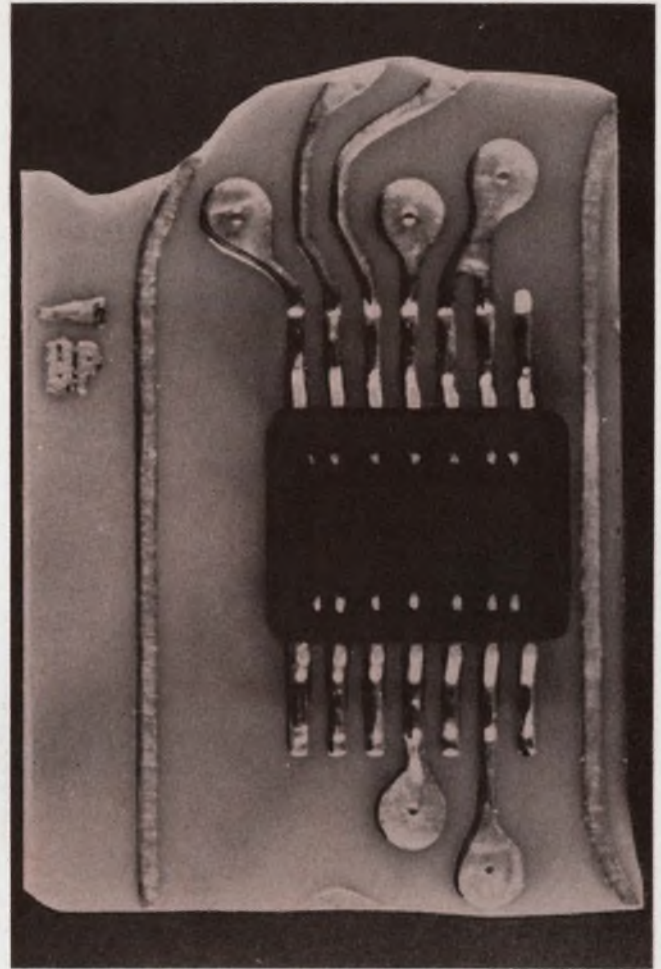

4. Completed assembly using solder cream on the bonding pads. Note the absence of bridging.

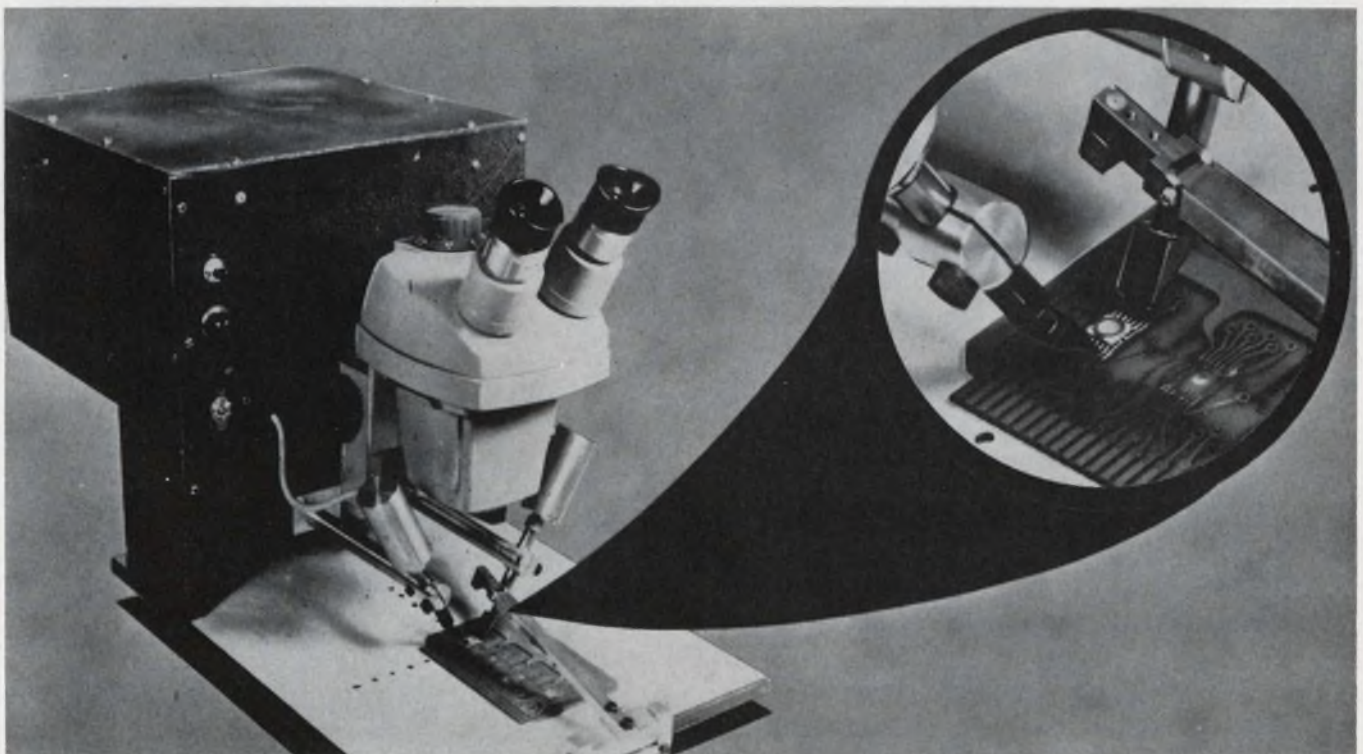

5. Typical resistance soldering setup. A Weller Electric Corp. unit is used. Soldering temperature is about 100°F

above total melting point of the alloy. Blow-up area of photo shows actual soldering operation.

approaches graphically. Figure 4 shows an actual flat pack that was soldered to a printed-circuit board with solder cream on the pad, not on the lead. Focused infrared light was used as the heat source and all solder joints were made in a period of four seconds.

Another system used successfully is the resistance equipment shown in Fig. 5. Here, two blocks containing the heating element and a large heat sink are used to generate a high current to provide enough heat for the soldering operation. The heat sinks on top of the heating elements help cool the solder immediately after it becomes molten, thus shortening the cycle. The microscope enables the operator to position the flat packs precisely.

Applications are not limited to soldering leads and joining microcircuitry. The material can also be used to join active devices to microcircuit systems. Figure 6 shows an application of this type. The solder cream (containing a 10 Sn/90 Pb alloy and water-white rosin) was used to solder the tiny chips to a hybrid microcircuit.

Solder cream can be used to attach leads to metallized ceramic surfaces when manufacturing inexpensive integrated circuits. In this application, metallized chips are first screened with solder cream. A continuous length of ribbon, to be used as leads, is brought into contact with the solder cream. When heat is applied, the ribbon is soldered in place and then cut to the appropriate lead length. This process is then repeated for the next device. The solder cream itself is not a metallizing material and may not be used as such. It can only adhere to solderable metallic surfaces.

Another area of interest is in the manufacture of computer memory core arrays. Figure 7 shows

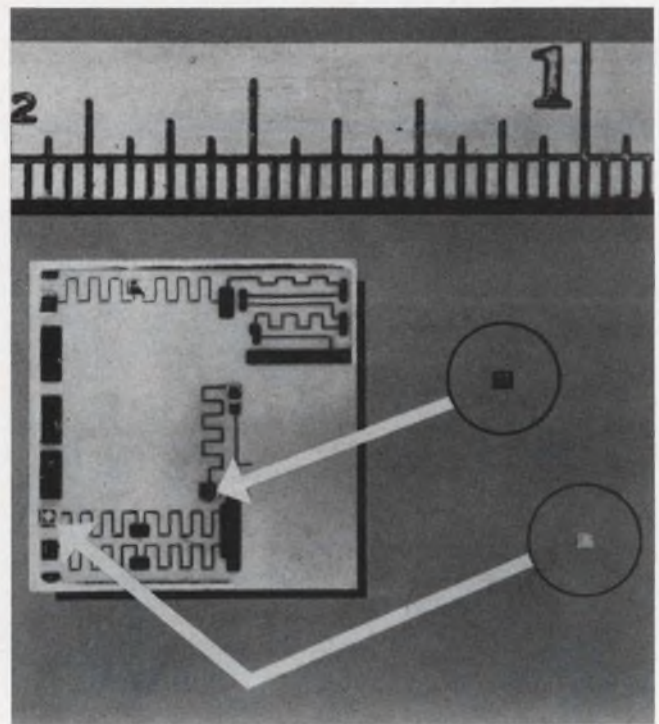

6. Active devices joined to a hybrid microcircuit. The same soldering techniques as for flat packs may be used.

how to locate insulated magnet wire over a frame containing cured solder cream, after the matrix has been woven. In a single operation, the application of heat from above forms the solder fillet while simultaneously stripping the insulation from the copper wire without weakening the wire. ■ ■

Reference:

1. Howard H. Manko, *Solder and Soldering* (New York: McGraw-Hill Book Co., Inc., 1964), chap. 5.

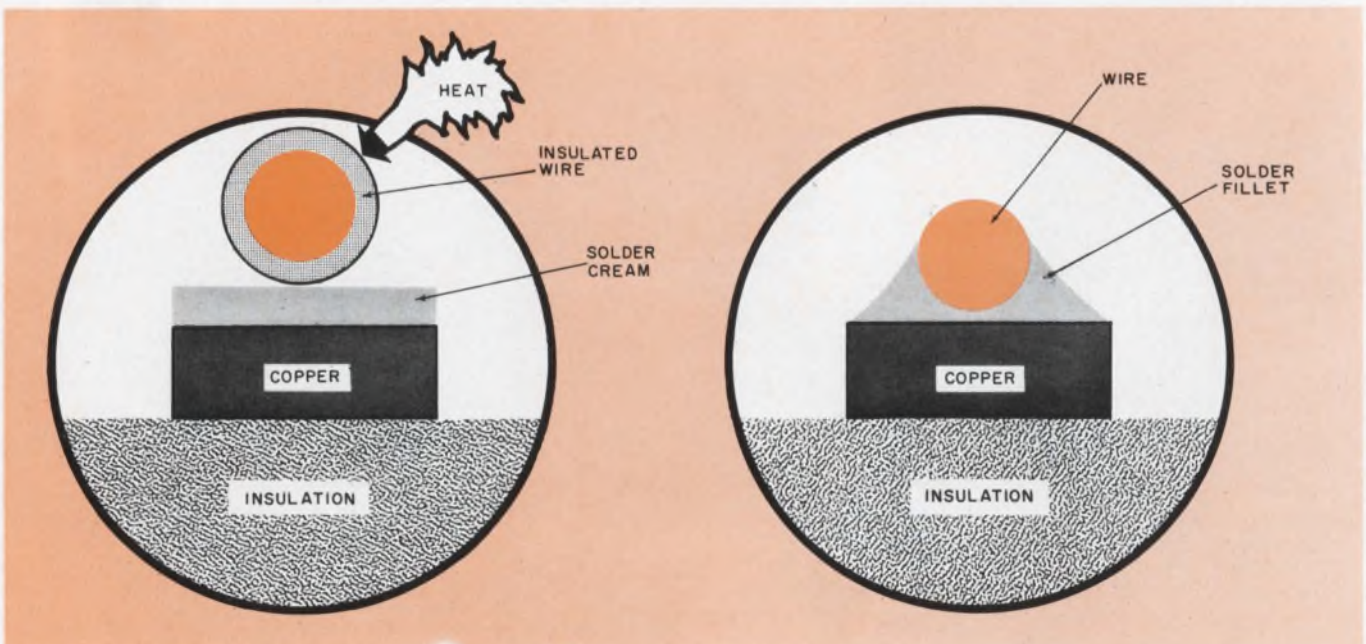

7. Insulated magnet wire is located over a computer memory array frame containing cured cream after the

matrix has been woven. The application of heat forms the solder fillet and strips the wire simultaneously.

Why take pot luck for reliability?

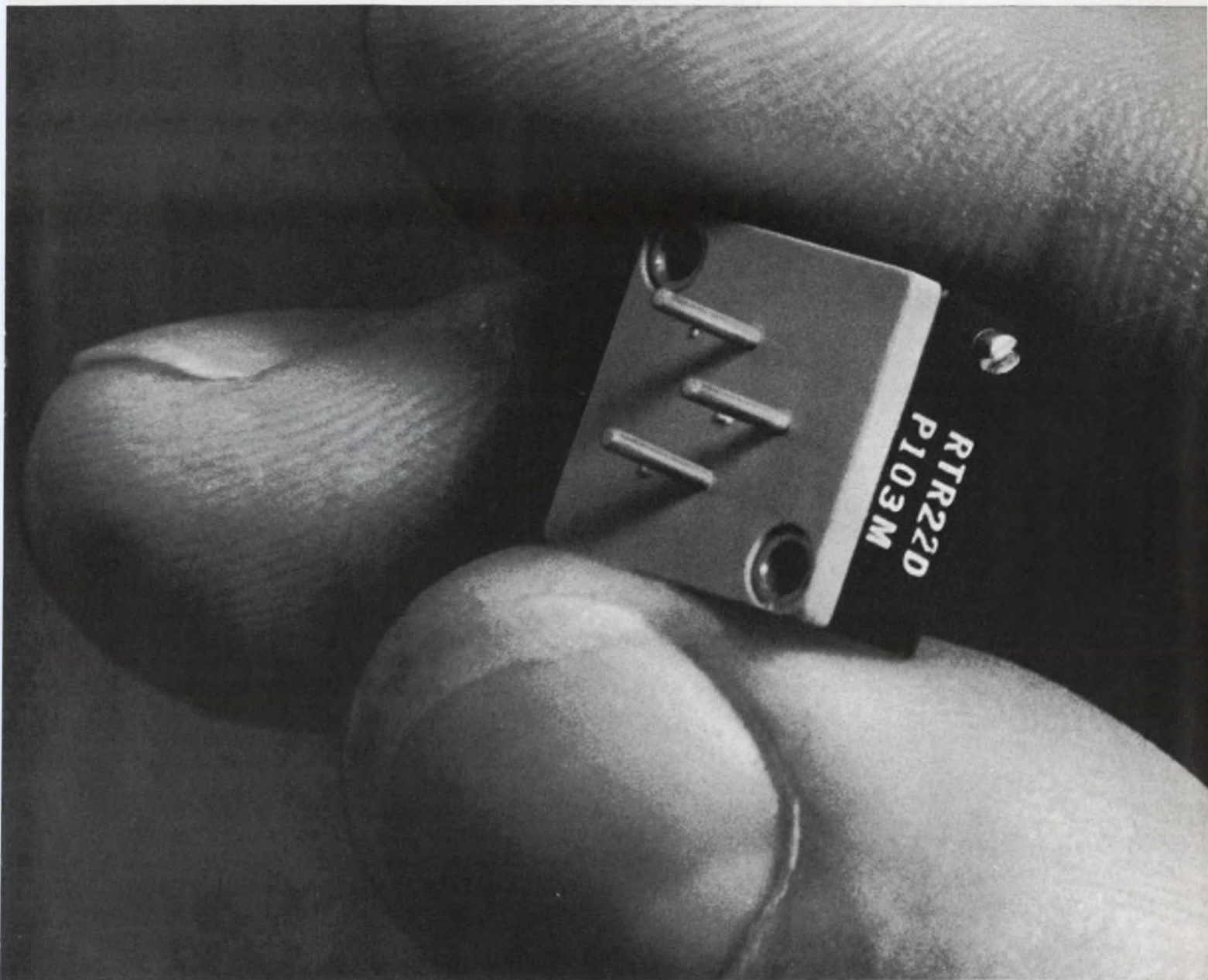

**DAYSTROM HI-RELIABILITY SQUARETRIM® POTS
ARE MANUFACTURED AND TESTED TO MIL-R-39015**

The Daystrom Squaretrim 318-160HS is designed, manufactured and tested in complete accordance with MIL-R-39015. This means you no longer have to resort to costly unmonitored programs when you need high reliability potentiometers.

The 318-160 Series Squaretrim potentiometers not only give you the best design and materials, but are manufactured with piece part traceability, in-process controls, and

the stringent QC program defined in this Specification.

So . . . don't trust to luck. Order Daystrom Hi-Reliability Squaretrim pots. They're available in values from 10 ohms through 20K. Prompt delivery on orders. Write or phone today.

*Daystrom potentiometers are another product of:
Weston Instruments, Inc. • Weston-Archbald Division,
Archbald, Pennsylvania 18403 • Phone 717-876-1500*

WESTON® *prime source for precision . . . since 1888*

Make your next proposal sell

the services and products you offer. Many an award has been lost by garbled language.

"We have the lowest price, the fastest delivery, a good technical proposal and look what happened—that fly-by-night outfit ran away with the award!"

Sound familiar? Relax. Don't start howling about payola and customer ignorance until you see the other company's proposal.

Your own proposal may not have been as good as you thought. Clearly, if your price was rock-bottom, your delivery the speediest, you were well on your way to landing the job. Now ask yourself what went wrong. Did you explain your proposal satisfactorily?

Provided that the proposal's technical approach was sound, it's likely that your trouble lay in the explanation—you failed to get your point across. It didn't sell. The customer may even have had trouble understanding it.

Let's face it at the outset of this discussion: the object of any technical proposal is to sell. As in any selling campaign, you must display your product in its most favorable light.

Before you begin, be sure you can answer yes to the following questions:

- Do you know your customer?
- Are you certain you understand the customer's needs?
- Have you made sure that all people associated with the contract award can appreciate the details in it, even details that do not directly concern them?
- Is the proposal responsive to the customer's request?

Know your customer

Your customer may be a government agency, another company or, sometimes, a division of your own corporation. Always try to gather as much information about the customer as possible. Such information may include the following:

- The customer's past experience with bidders on the program, with particular stress on pitfalls to avoid. What past technical approaches have left

him high and dry, for example?

- The points that are most important to the customer—on-time delivery, cost, technical ingenuity, or whatever.

Remember, after the job is lost, it is too late to blame your marketing people for not supplying you with the information. If you write the technical proposal, it is up to you to obtain information from the marketing staff, salesmen and others who have dealt with the customer.

Understand the customer's needs

More often than not, a request for a proposal



Know your customer

Peter N. Budzilovich, Technical Editor, ELECTRONIC DESIGN.

contains a mixture of specifications, some of which are important, some superfluous, some even contradictory. Whenever time permits, draw up a set of working specifications by meeting with the customer and resolving all gray areas. In most cases, agreement can be reached by pointing out that a better product at a lower cost may result from a thorough understanding of the specifications. Depending on the nature of the contract—CPFF (cost plus fixed fee), CPIF (cost plus incentive fee), FP (fixed price) or any other^{1,2}—get together with your contract administrators and ask for advice before talking to the customer. Whenever possible, ask the administrator to come along when you meet with the customer. Under all circumstances, make sure that you understand every request of the customer.

Write for the proposal evaluators

A contract award usually depends on several evaluations. In the case of government agencies, a proposal is read by contract personnel, program managers, efficiency experts and technical specialists. If you have fulfilled the first basic requirement (know your customer), you should know who will evaluate your proposal. The next basic step is to summarize all your data in tidy sections, so that every reader will find exactly what he needs to know in one place.

There are eight main sections to the average technical proposal, ranging from "Introduction" and "Statement of the Problem" to "Experience" and "Facilities." The contract administrator, for example, who may well not be an engineer, is interested in your program organization and how you propose to meet schedules and costs. Don't bore him in these sections of your proposal with flowery descriptions of the company's technical prowess. Technical qualifications and methods are stated in the engineering section.

In preparing your proposal, make sure that all points raised by the customer are answered. Ask yourself how you would react if someone ignored your questions. Simple or complex, pertinent or irrelevant, all customer's questions must be conclusively answered. To facilitate reading by the customer, the answers to such questions may even appear as headings or subheadings in the outline of your technical section. In any case, don't substitute your own jargon for the customer's definitions. For example, if the customer asks for a "flat frequency response to 100 kHz," make sure that there is a title exactly like this. Don't hide it someplace in reams of pages entitled "Improved Amplifier Performance."

Remember, the customer had certain reasons for asking specific questions. They must all be answered.

In preparing the proposal, start with an outline,

such as the one below:

1. Introduction to the Company.
2. Statement of the Problem.
3. Program Summary.
4. Program Organization.
5. Technical Approach.
6. Key Personnel.
7. Company Experience.
8. Company Facilities.

This general form will cover a wide variety of proposals.

Bear in mind that the written proposal will represent you, your colleagues and your company to the customer; it will be the only way a customer can judge whether or not to give you the award. The place to begin, then, is by introducing yourself to the customer.

Introduce your company

In preparing this first section, think how you introduce yourself at a business visit: "My name is so-and-so, I represent Awfully Big Laboratories (call me ABL, for short). We are making such-and-such, and the reason for my call is as follows."

These, in a nutshell, are the essentials of an

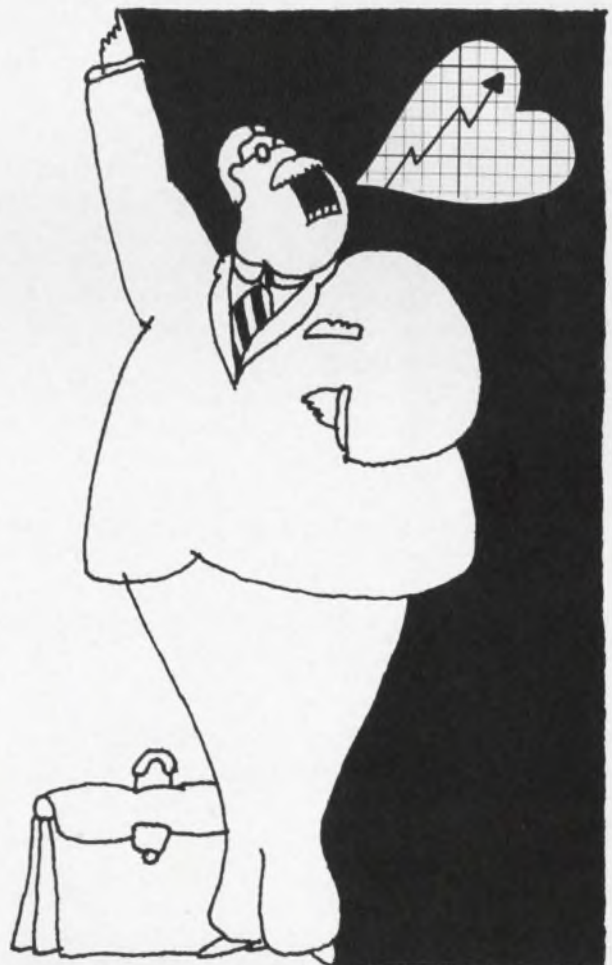

Don't sing praises to your company

introduction section. Try this approach:

"Awfully Big Laboratories, hereinafter referred to as ABL, is pleased to submit this proposal in response to the request for proposal XYZ. ABL proposes to furnish personnel, equipment, facilities (with the exception of _____) required to carry out the development of new molecular mousetraps.

"In the last several years ABL has gained considerable experience in this field. Our personnel have been involved in all phases of design and production of a variety of mousetraps.

"The deliverable items are listed in Section 3, 'Program Summary,' and organization of the program is outlined in Section 4, 'Program Organization.' Section 5 details our technical approach to the problem.

"To demonstrate that ABL possesses suitable talent for successful performance of the contract, we list the key personnel in Section 6.

"Our pertinent experience is summarized in Section 7, 'Company Experience.'

"Section 8, 'Company Facilities,' lists our specialized facilities, which will be available for the project."

That is all there is to it; there is no more to the introduction. Don't start singing praises to yourself and your company. Just tell the customer who you are, why you should get the job, and where to look for various details.

State the problem

Next, you want to be sure that you and the customer see eye to eye on the object of the program. This is done in the section called "Statement of the Problem."

In defining the problem, state it as clearly and concisely as you can, without any technical detail. For our mousetrap problem, for example, the statement should read:

"The problem is to design, develop and produce X prototypes of a molecular mousetrap."

This is the problem. How you are going to lure the mice, or how you are going to catch them, is not a problem. These are design details that will be treated in the section called "Technical Approach." State the problem in one sentence!

Let's review briefly at this point. After reading only two sections of your proposal, your customer should know:

- Who you are.
- Why you feel you should get the job.
- Where to look for detailed information.
- The object of the program.

Summarize your proposal

"Program Summary," the next section, tells the customer in easily understood language exactly what he gets for what he pays. Tell him that the

program will culminate in delivery of X prototypes, drawings, reports and manuals. Tell him, for example, that the mousetraps will be small (if this is important), light, reliable and inexpensive. Once again, don't bore him with details. If your device is really outstanding, one page of tentative specifications (alongside the customer's specifications) may be included.

Organization of the program

The section on "Program Organization" is one of the most important. Be sure to state all details that affect the success of the program. Your proposed organization, with all its key personnel, must be shown. Include details on program management (a staff with suitable technical backgrounds), documentation, cost control, reporting, production control, purchasing. Enclose easy-to-follow milestone schedules.

PERT charts can also be included, but for easy understanding by nonengineers, simpler charts should be prepared. List the assignments for personnel responsible for various phases of the program. In short, convey to the customer that if you get the job, you are ready to "jump in and grind with both feet." He is dealing with a responsible, business-like organization that knows very well how to produce.

Present the technical meat

You have now summarized fairly well most of the key points except your company's technical excellence. The reader, at this point, knows all about the job, except the details of various systems that are needed to produce what is promised. In fact, the presentation, being largely nontechnical, may even stir the interest of nonengineers. An elated customer contract man may wonder: "So far I understand everything about this highly complex technical program. Maybe these fellows will keep it this way in their technical section."

Try not to disappoint him. Do your best in the "Technical Approach" section to state your method in a simple, understandable way. If the Special Theory of Relativity can be explained to high-school students, you can explain your system to a contract man. No one will be taken in if you lard your proposal with incomprehensible jargon. If you want to say, "The building is very high," don't say, "The vertical extension of the edifice is considerable." Naturally there will be highly technical aspects that will leave a nontechnical reader gasping. But he is prepared for this, to a certain extent. Just keep in mind that if he succeeds in understanding the broad concept clearly, you have won another vote on the proposal evaluation board.

Roughly, the style of the technical section

should be that practiced by the news reporter. Begin with a general description of the system. (A set of preliminary specs should appear at this point, and the most important parameters should be emphasized.) Follow with a detailed, block-by-block system description, down to the circuit schematics.

Use simple examples: "Previously this was done with 100 components. Our approach will use only 10 with equal or better results." The illustrations will show your ingenuity, creativeness and knowledge of the field.

Write the 'boiler plate'

Now that you have told how you will do the job, both in general and in detail, provide more back-up information. Thus, in the section on "Program Organization," you listed the persons who will be responsible for the program. The customer, however, does not know these people. So provide a section entitled "Key Personnel." This states broadly the skills, education, and experience of those assigned to the program and demonstrates that they are technically competent.

Next, to demonstrate your readiness to start, list various facilities that will be needed to carry out the job. These facilities must be pertinent. Don't submit pages and pages of descriptions of electron microscopes, mass spectrographs and complex instrumentation just to impress the customer; he isn't apt to be misled. Give him a clear listing of facilities that relate directly to the job. If you want to show the general prominence of your company in other fields, make two facilities sections—one called "Specialized Facilities" and the other "General Facilities."

The experience section should be treated in identical fashion. Don't list your participation in a Mars landing program if you are bidding on a mousetrap development.

Make one final check

And now that you have finished drafting your proposal, check it. Remember these cardinal rules:

- Make sure that each section is complete and deals with one topic at a time.
- Be certain that every proposal evaluator finds the facts he needs in one place and that they are not obscured by irrelevant statements and references.
- Answer all questions raised by the customer.
- Use simple, everyday language in place of specialized jargon.

Good luck. At least you have a fighting chance now. ■ ■

References:

1. John A. Bianchini, "Learn the basics of contracts," ELECTRONIC DESIGN, XIV, No. 22 (Sept. 27, 1966), 100-105.
2. George O. Thogerson, "Pinpoint your profits," ELECTRONIC DESIGN, XV, No. 4 (Feb. 15, 1967), 104-106.

RCL power wire wound resistors



- Standard Temperature Coefficient ± 10 PPM
- Standard Tolerance $\pm 1\%$
— available to $\pm .01\%$
- Sub-Miniature Series available at no extra charge
- 23 Special Temperature Coefficients available from -50 PPM to $+5900$ PPM . . . an industry exclusive
- Available in Standard Wattages $\frac{1}{2}$ Watt through 50 Watts
- Resistance Values from .01 ohms to 275K
- Special Silicone Coating impervious to all cleaning solutions without exception!
- **DELIVERY — IN QUANTITY WITHIN TWO WEEKS**

RCL

Main Office and Plant
RCL ELECTRONICS, INC.

700 South 21st Street
Irvington, New Jersey 07111

ON READER-SERVICE CARD CIRCLE 38

ENGINEERS:
UNIVAC and you:
words to program
a career by . . .

"Bootstrap"



"BOOTSTRAP" (noun).

To a programmer this word has its standard technical meaning, of course. In terms of your career outlook too, the first steps are a bootstrap kind of an operation. You've got to pull yourself up and make the first move.

You probably know that UNIVAC is the number one technical leader in the computer field. You may also have heard that we are on the grow and looking for top flight engineers and technicians right now in . . .

- Advanced Electronic Circuit Studies
- Integrated Circuits and Thin Film Studies
- Ultra-High Speed Integrated Circuit Interconnections
- Computer Manufacturing Engineering
- Advanced Mechanical Design Engineering—Rotating Apparatus

But the bootstrap effort has to come from you. If you have the initiative to write us outlining your qualifications and experience, as well as what you hope to grow into in the future, we'll do our part and tell you everything we can about opportunities here. Write: John D. Hallenberg, Employment Manager, Dept. 507.

Write today and make an appointment with tomorrow.

UNIVAC
DIVISION OF SPERRY RAND CORPORATION

data processing division
2276 highcrest drive
roseville, minn. 55113
telephone 612-633-6170

An equal opportunity employer M/F

Book Reviews

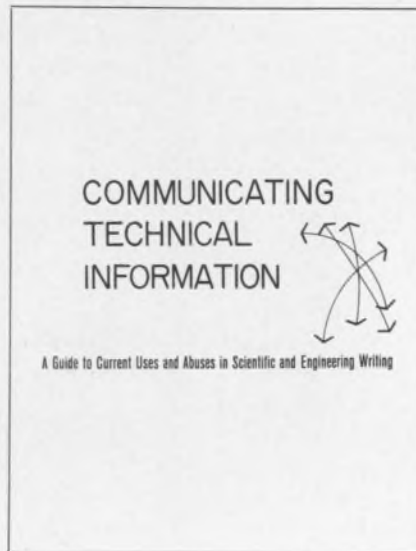

Technical writing guide is both handy and helpful

Communicating Technical Information, Robert R. Rathbone (Addison-Wesley Pub. Co., Reading, Mass.), 104 pp. \$1.95.

Many nonprofessional authors write in a manner that is stupefyingly dull. This little book—a couple of hours' reading—is therefore welcome. It is intended as a self-help reference for engineers and scientists on the job and in the classroom. Sections cover the writing of abstracts, titles, technical descriptions, and conclusions and recommendations. Other chapters deal with organization of material, editing, and "noise"—obstacles to clear presentation and easy understanding of written matter.

The book contains a wealth of suggestions and hints that all technical writers would do well to heed. Rathbone's style is itself a little patchy: some passages are bright and cogent; others induce boredom. But then, few things are harder to write about consistently interestingly than how to write. Nevertheless, the book can safely be recommended to all those faced with the need to write technical matters. In the final analysis, though, as Rathbone says, "You will have to do more than just read about writing—you will have to write, write, write."

—Peter J. Beales

Transform and state variables

Transform and State Variable Methods in Linear Systems, Someshwar C. Gupta (John Wiley & Sons, New York), 426 pp. \$12.75.

This book is an in-depth survey of eigenvalues and eigenvectors in control and circuit problems. Transform methods are used and developed systematically, and time-varying systems are treated by both transform and matrix methods. The book's features include a full outline of simple, multiple and complex eigenvalues, and an exhaustive treatment of networks by state variable methods; a reasonably elementary development of higher-order delta functions, including Fourier series and networks by the delta-function approach; and a comprehensive description of the time convolution and the determination of limits of integrals for the time convolution.

Marketing guide to R&D

Marketing Guide to U.S. Government Research and Development, Robert Rickles (Noyes Development Corp., Park Ridge, N. J.), 229 pp. \$20.00.

This book offers an introduction to the research and development activities of the U.S. Federal Government, the largest performer and financier of research and development in the world. It is intended as a guide to the two important markets that exist in the Federal R&D structure: contract research and development, and the market for knowledge. For each Government department or agency that performs or finances research and/or development in the physical sciences, the following information is given: mission of the agency with regard to research and development, its R&D funds, location of its facilities, the officials to contact, its personnel, the nature of its extramural contracts and restrictions on them, the nature of its intramural research, and organizational charts.

Free Career Inquiry Service

Absolutely Confidential

Respond to the career opportunities advertised in this issue. Fill out and send us this handy resume. **Electronic Design** will do the rest – neatly typed copies of this form will be mailed to the companies of your choice, indicated by the circled Career Inquiry Numbers at the bottom of this page.

11

Name		Home Phone	
Home Address (Street)		City	State ZIP Code
Age	U.S. Citizen <input type="checkbox"/> Yes <input type="checkbox"/> No	Security Clearance	
Prime Experience		Secondary Experience	

Desired Salary	Availability Date
-----------------------	--------------------------

Employment History – present and previous employers

Company			
City, State			
Dates	to	to	to
Title			
Specialty			

Education – indicate major if degree is not self-explanatory

Degree			
College			
City, State			
Dates	to	to	to

Additional Training – non-degree, industry, military, etc.

Professional Societies

Published Articles

- Career Inquiry Numbers:**
- | | | | | | | | | | |
|-----|-----|-----|-----|-----|-----|-----|-----|-----|-----|
| 900 | 901 | 902 | 903 | 904 | 905 | 906 | 907 | 908 | 909 |
| 910 | 911 | 912 | 913 | 914 | 915 | 916 | 917 | 918 | 919 |

ELECTRONIC DESIGN
850 Third Avenue
New York, New York 10022

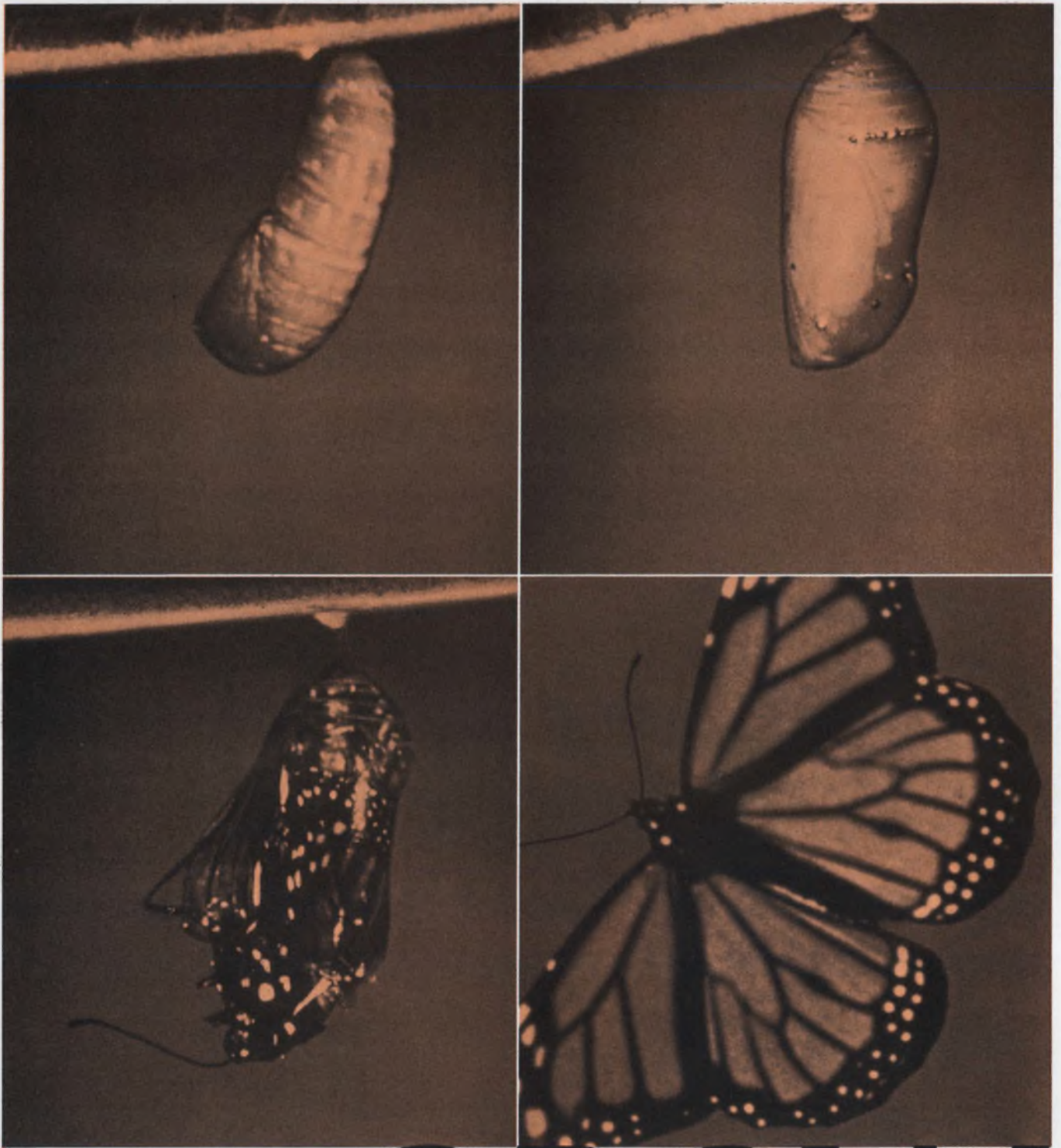

let yourself **GROW**



at NCR's expanding electronics division in los angeles

Ready to metamorphose? Look into NCR Electronics Division *now*. This is the largest, fastest-moving commercial computer manufacturing facility in Southern California and one of the most advanced in the world. The company's record backlog of orders continues to grow, and to meet it the Division has just doubled in size. *You'll* grow, too—contributing to a vigorous business automation program that covers more than 120 countries. The combination is unusual: non-defense stability, front-line EDP action, wide-open creative opportunity. How about it? Southern California's a great place to stretch your wings.

ON CAREER-INQUIRY FORM CIRCLE 902

Circuit analysis

Transistor Circuit Analysis and Design, John J. Corning (Prentice-Hall, Inc., Englewood Cliffs, N. J.), 466 pp. \$14.65.

Here is a thorough yet easy-to-read presentation of the principles of circuit analysis and the application of these principles to the design of circuits with specific performance attributes. The material is divided into four general areas: an introduction to semiconductor physics and its relation to junction behavior in diodes and transistors; a concentrated coverage of transistors from the device viewpoint; the analysis and design of transistor circuits (the major portion of the book); and a series of laboratory experiments. The circuit design engineer will find this a useful reference work.

Pulse generators

High-Power Semiconductor-Magnetic Pulse Generators, Godfrey T. Coate and Laurence R. Swain, Jr. (M.I.T. Press, Cambridge, Mass.), 136 pp. \$7.50.

This monograph fills a long-standing need to augment and update vacuum- and gas-tube pulse-generator techniques evolved during and shortly after World War II. Describing a solid-state circuit technique for generating repetitive high-power pulses, the authors present a flexible design procedure for adapting the technique to a broad range of specific pulse-generator applications. Radar pulse-modulator designers and those concerned with the design of particle accelerators and similar repetitive high-power pulse circuits will be especially interested in this book.

Random-process techniques

Random-Process Simulation and Measurements, Granino A. Korn (McGraw-Hill, New York), 234 pp. \$12.50.

This presentation of random-process simulation and measurement with emphasis on computer techniques will be useful to many engineers and scientists involved in

control, guidance, communication, detection and instrument design. The book describes new hybrid analog/digital techniques for Monte Carlo simulation of linear and non-linear, stationary and nonstationary random phenomena, and treats new techniques that permit savings in instrumentation, circuitry, and operating time. At the same time, the author outlines all relevant theory.

Computer-aided analysis

System Analysis by Digital Computer, Franklin F. Kuo and James F. Kaiser (John Wiley & Sons, New York), 438 pp. \$8.95.

A comprehensive and carefully-detailed exposition of the computer's role in engineering problems, this book is concerned mainly with computers' application to the analysis and synthesis of electric networks and systems. The first chapter is an introductory survey of network analysis techniques and programs; the remainder of the book deals with the application of computer techniques to actual problems of engineering analysis and design.

Electromagnetic theory

The Plane Wave Spectrum Representation of Electromagnetic Fields, P. C. Clemmow (Pergamon Press, New York), 185 pp. \$7.50.

The purpose of this book is to explain how general electromagnetic fields can be represented by the superposition of plane waves traveling in diverse directions. It illustrates the use of this plane-wave-spectrum representation in characteristic problems relating to the classical theories of radiation, diffraction and propagation. The reader is assumed to be familiar with integration in the complex plane, but otherwise the discussion is virtually self-contained. Although this book can furnish the student of electromagnetic theory with a useful technical tool, its pedagogic style does not make for easy reading.

digital systems

opportunities at NCR electronics division in los angeles

SYSTEMS FORMULATION & ANALYSIS ENGINEERS

For assignments in commercial on-line computer applications with emphasis on communications interface. Extensive experience required in hardware specifications and advanced systems, including multiprogramming and list processing. Requires B.S. in engineering, business or related field.

- SOFTWARE PROGRAMMER
- DIAGNOSTIC PROGRAMMER
- PROJECT ENGINEERS

Computing Systems
Peripheral Equipment
Discs & Controllers
Packaging

- SENIOR CIRCUIT DESIGN ENGINEERS
- ELECTRICAL & MECHANICAL LIAISON ENGINEERS
- PACKAGING ENGINEERS (ALL LEVELS)
- MACHINE DESIGN ENGINEER
- SYSTEMS TEST ENGINEERS
- LOGIC DESIGN ENGINEERS
- RELIABILITY ENGINEERS
- Q.C. ENGINEERS
- PROCESS ENGINEER—ELECTRONIC
- TEST EQUIPMENT DESIGN ENGINEERS
- MEMORY DESIGN—RESEARCH
- OPTICS/LASER RESEARCH
- MECHANISMS SPECIALIST—Ph.D.
- MECHANICAL/OPTICS DESIGN ENGINEER
- MAGNETIC RECORDING ENGINEERS
- SERVO SYSTEMS ENGINEERS

ARRANGE NOW FOR AN INTERVIEW IN YOUR AREA

Confidential interviews will be held soon in various parts of the country. To arrange an appointment, please send your resume, including experience, training and salary history, to Tom E. Lyon, Technical Placement, at the address below, or call collect.

The National Cash Register Company



ELECTRONICS DIVISION
2817 W. El Segundo Blvd., Hawthorne, Calif.
Telephone: Area Code (213) 777-7296
An equal-opportunity employer

ON CAREER INQUIRY FORM CIRCLE 902

Spacecraft Power Conditioning Engineers

Assignments currently exist in Hughes Radar & Space Electronics Laboratory for power conversion engineers to work in the following project areas: Communications Satellites, Lunar & Planetary Probes, Laser Systems, Radar & Missile Systems and TV Systems.

PRODUCT DESIGN ENGINEERS.

Project assignments include responsibility for the product design of power sub-system assemblies for spacecraft and airborne systems. Duties will include the direct supervision of technicians and design draftsmen and coordination with engineers responsible for the circuit, structural, thermal and test equipment design. Requires at least two years of experience in packaging electronic circuits.

SR. CIRCUIT ENGINEERS.

Duties include: establishment of preliminary function requirements through contact with company-wide circuit design areas; assignment of senior and junior-level engineers to required design tasks; responsibility for technical monitoring and design review and establishment of communication with product design engineers. Desirable background would include: linear voltage/current regulator design, switching mode circuit design, magnetic component specifying and semiconductor/integrated circuit technology.

REQUIREMENTS: an accredited Engineering or Scientific degree, a minimum of two years of applicable, professional experience and U.S. citizenship.

For immediate consideration, please airmail your resume TODAY to:

Mr. Robert A. Martin
Head of Employment
HUGHES Aerospace Divisions
Dept. 32.
11940 W. Jefferson Blvd.
Culver City, Calif. 90230

HUGHES

HUGHES AIRCRAFT COMPANY
AEROSPACE DIVISIONS

An equal opportunity employer—M&F



BOOK REVIEWS

Electromagnetic theory

Electronic and Magnetic Behavior of Materials, Allen Nussbaum (Prentice-Hall, Inc., Englewood Cliffs, N. J.), 156 pp. \$5.95.

Contained in this relatively short electronics book is a brief but very ample review of the nature of fields inside materials and a basic treatment of quantum theory. An understanding of modern physics and a familiarity with the vector differential operators is assumed.

A thorough introduction to the qualitative and quantitative aspects of the theory of semiconductor materials and devices, magnetic materials, dielectrics and quantum electronics is developed almost from "scratch." Concise reviews of the necessary background in electromagnetic and quantum theory contribute to making this book a complete source for the engineer. All theories dealt with are developed on the basis of atomic physics.

The primary thesis of Nussbaum's book is that the behavior of materials is determined by their atomic, molecular, crystallographic and microscopic structure. As such, it provides a broad selection of reference material in the major areas of interest to physical metallurgists, ceramists and other materials-oriented electronic engineers. Principal disciplines dealt with and emphasized are those of structure, thermodynamics, kinetics of reactions, mechanical properties and physical properties.

Using transformers

Transformers for Electronic Circuits, Nathan R. Grossner (McGraw-Hill, New York), 321 pp. \$14.00.

Here is a comprehensive guide for all engineers using transformers in electronic circuits. In a simple, logical style, the book concentrates on basic principles and fundamental relationships, avoiding complicated equations and masses of design data on the realistic assumption that most users today select their transformers rather than design them. The discussion of design considerations is planned to

give the user an understanding of the logic and methods of the transformer specialist. This book will aid the practicing engineer to obtain optimum, limit-of-the-art performance from his transformers, to write specifications with greater confidence of obtaining a desired performance, and to consult and understand certain practical charts and tables directly useful in his work.

Tunnel diode circuits

Analysis and Synthesis of Tunnel Diode Circuits, J. O. Scanlan (John Wiley & Sons, New York), 274 pp. \$9.75.

Beginning with an introductory approach to the early material and proceeding to advanced treatment in the later pages, this book aims to treat completely all sinusoidal aspects of tunnel diodes in an integrated and practical manner. The book sets out clearly the principles of operation of the tunnel diode, and from this basis develops both small- and large-signal representations. The design principles of narrow- and broad-band amplifiers are discussed, and the applications of the diode in general network synthesis techniques as well as its nonlinear applications are covered.

Electron motion

Electron Dynamics of Diode Regions, Charles K. Birdsall and William B. Bridges (Academic Press, New York), 270 pp. \$10.00.

The motion of charged particles in time-varying fields between two electrodes is the subject of this monograph. The models analyzed are simplified versions of parts of practical devices, primarily active microwave devices, tubes and semiconductor amplifiers. Detailed development of widely applicable linear analyses and nonlinear computer experiments with charged sheets is given. Model construction is also presented in detail in order to help the reader to develop his physical insight and to progress to more complex models.

Transistor amplifiers

Transistor Bandpass Amplifiers and Designing Transistor I. F. Amplifiers, W. Th. Hettterscheid (Philips Technical Library, Springer-Verlag, New York), 314 pp. and 330 pp. \$11.40 and \$11.25.

Transistor Bandpass Amplifiers deals theoretically with the analysis and design of selective amplifiers as used in the IF parts of radio, television and radar receivers, with special reference to the application of transistors. Use is made of a four-terminal network representation of the transistors or vacuum tubes. This facilitates mathematical description of the performance of the complete amplifier by means of a single determinant. Single-stage amplifiers as well as multistage amplifiers, with arbitrary types of interstage or terminating networks, are treated in detail.

The design and construction of IF amplifiers with transistors for radio, television and radar receivers is the subject of *Designing Transistor I.F. Amplifiers*. A survey of the theory is presented, from which a practical design procedure is developed, making use of a large number of normalized design charts. The design procedures described are elucidated by means of six fully worked-out examples.

Circuit design

Semiconductor Circuit Design, J. Watson (D. Van Nostrand, Co., Inc., Princeton, N. J.), 318 pp. \$19.75.

This text on circuit design with discrete semiconductor components concentrates on the amplification and switching of audio-frequency and direct currents. The treatment is thus in somewhat greater depth than would be possible in a more widely based volume. Discussion also covers semiconductor devices other than bipolar transistors, such as field-effect transistors. Particular emphasis is placed on the photoelectric family and its usefulness in general circuit design. Throughout the text, the author stresses the importance of design rather than analysis.

design engineers

NAVAL ARCHITECT • MARINE • MECHANICAL
STRUCTURAL • ELECTRICAL • ELECTRONICS
ARCHITECTURAL • CIVIL

Investigate your opportunities in the world's largest ship- building complex

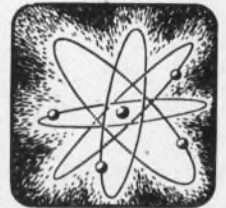

The San Francisco Bay Naval Shipyard provides service to surface and underwater ships and deep submersibles. Assignments include new construction of Polaris nuclear submarines and guided missile frigates; and the repair, overhaul and conversion of all classes of ships. Other projects include research on noise reduction, ASW, replenishment-at-sea, Trieste II and Sea Lab II and III.

Openings exist at all levels in these program areas:

Ship Structure Development

Ship Weight Control

Structural Mechanics

**Nuclear and Conventional
Propulsion Systems**

**Navigation and Communication
Systems**

Sound and Vibration Control

**Cargo Replenishment-at-Sea
Development**

Shipboard Mechanization

Plant Facilities

**Ordnance, Guided Missile, Fleet
Ballistic Missile and
Electronic Systems**

**Shipboard Aeronautical Material
and Equipment**

**Shipboard Electrical and Power
Systems**

Naval Tactical Data Systems

Job Locations: San Francisco Bay Naval Shipyard has two work sites located 40 miles apart: San Francisco and Vallejo, California. Each location has ready access to the full cultural advantages of San Francisco and the mild year-round climate of the "Bay Area." All types of recreation from ocean surfing to skiing on the slopes of the Sierras are within easy driving distance.

Send resume or Standard Form 57, Application for Federal Employment, to:

**Coordinator, Professional and Technical Recruitment (Code I74A4)
Employment Division**

**San Francisco Bay Naval Shipyard
Vallejo, California 94592**

AN EQUAL OPPORTUNITY EMPLOYER

MUST BE A U.S. CITIZEN

Would you like
to be one of these

PROBLEM SOLVERS?



Pilots Rely On This Solution For All-Weather Landings

PROBLEM: To provide highly accurate altitude information for use in all-weather landing systems. An instrument providing this information is used only during approach and landing phases of the flight. The pilot, however, must be assured in advance that the instrument will function properly when it's called upon for its vital information. Accuracy alone is not enough. The instrument must be capable of "knowing" throughout the flight whether it will function properly at the critical moment.

APPROACH: Two separate but interdependent investigations were conducted to determine: 1) The best possible technique to measure altitude displacements ranging from zero to 2,500 feet, with accuracy suitable for use in an aircraft low approach system, and 2) what must be done to give the necessary assurance of both performance and "anticipated" performance.

Selection of a measurement technique was made at the conclusion of a systematic study of areas such as radar characteristics of terrain, adaptability of various forms of modulation, dynamic errors that could be produced as a result of information processing or by geometric situations of flight, and operational characteristics resulting from the embodiment of the possible techniques.

Along with the study necessary to select the measurement technique, other studies were directed toward means of providing

constant evaluation of equipment status before and during the phase of flight where operation is required. Special consideration was given to areas such as aircraft flight procedures, component failure modes, display techniques and human factors. With a clear and complete understanding of the objectives and techniques, the designers exercised their judgement to provide optimum performance and integrity monitoring with minimum complexity.

SOLUTION: Altitude is measured through use of a solid-state 4-GHz FM-CW transmitter modulated by a linear triangular waveform in conjunction with a wide bandwidth receiver which detects the frequency shift proportional to altitude. The altitude information is presented to the pilot via a visual display and supplied to the autopilot or landing system. Repeatable altitude accuracy exceeds the standards required for Category II and Category III landing systems.

Performance integrity is monitored by a comprehensive system of checks and cross checks of each essential parameter. This complete monitoring provides assurance of performance during the critical approach period as well as a check of anticipated performance throughout other phases of the flight profile. A unique system of antenna monitoring was devised to verify antenna integrity continuously, even at high altitudes where a normal ground return signal was not available for this purpose. A self-test feature further augments the monitoring to give added confidence in accuracy and system integrity by exercising all circuits and requir-

ing a proper indication on command of the pilot.

This equipment is now in use in many types of aircraft which have been certified for Category II landings and is currently being used in Category III test programs.

Custom Crystal Filters Designed As Standard Items

THE PROBLEM: Meet widespread need for custom crystal filter designs in less than the three-month period normally required.

THE APPROACH: Develop computer-assisted design techniques which permit Collins to offer "special design" filters as standard product line items.

THE SOLUTION: Data on a wide range of filter applications may be programmed into Collins' computer, which analyzes customer's parameters, furnishes bill of materials, and produces a performance curve. A tested prototype is delivered to the customer in one-third the time formerly required.

Controlling The Antenna For Launch Control

THE PROBLEM: Design a receive antenna for Minuteman Missile Weapon System. It will be stored underground and automatically erected after nuclear attack for use by Launch Control communications. It must be erected from 28 feet below ground level to full height instantaneously.

The mast is driven by instantaneous release of high pressure air, which acts as an inefficient piston. Maximum erection velocity is 66'/sec. It must be stopped at a given height $\pm 3\frac{1}{4}$ inches.

THE APPROACH: Many energy absorbing methods were considered. Trade-off studies were performed taking into account the advantages and disadvantages of each technique. Finally tests were performed to verify the selected solution to the problem.

THE SOLUTION: A crushable aluminum honeycomb absorber was selected. This material has a predictable crushing strength, an area of 62.4 sq. ins. and a maximum crushing distance of 6.75 inches.

COMMUNICATION/COMPUTATION/CONTROL



COLLINS RADIO COMPANY

Collins is looking for
Problem Solvers in these

AREAS

Instrumentation Engineers
Communications Research
Engineers
Flight Control Systems
Engineers
Circuit Designers
Process Engineers
Electronic Packaging Designers
Systems Engineers
Microcircuit Designers
Production Plastics Engineers
Spacecraft Systems Engineers
Stress Analysis Engineers
Mechanical Engineers
Reliability Engineers
Technical Writers
Field Support Engineers
RF Systems Engineers
Antenna Design Engineers
Microwave Design Engineers
Scientific and Software
Programmers
Industrial Engineers
Quality Engineers
Transmitter Design Engineers
Training Instructors
Crystal Filter Engineers
Maintainability Engineers
Component Evaluation Engineers
Assembly Foremen
Computer Instructors
Data Systems Analysts

If you'd like to help solve problems in any of these areas, we welcome your inquiry. Write to Manager of Professional Employment, Collins Radio Company, in Cedar Rapids, Iowa; Dallas, Texas, or Newport Beach, California.

An equal opportunity employer

Simple logic reads out during counting

Problem: Devise a digital frequency counter that can be read out accurately at one-second intervals without interrupting or disturbing the counting process. This counter is to be used to monitor the frequency of a programmed exciter that serves as a local oscillator capable of providing frequencies from 0 to 50 MHz/s in steps of 0.01 Hz. Previous counters required an inordinate amount of gating logic and high circuit speed.

Solution: Incorporate a master counter and a slave counter with novel logic interconnections.

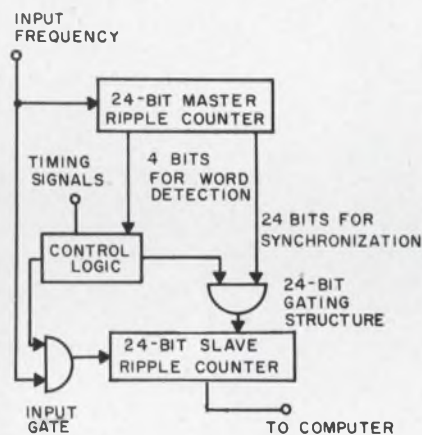

Two 24-bit ripple counters are used, one a master, the other a slave. Both counters count the input frequency, but in addition, the slave counter may either be synchronized with the master counter, or disconnected from the input frequency by the control logic.

Sometime before the count value is desired, both the input signal from the input gate and the synchronizing signals from the master counter are connected to the slave counter. The synchronizing signals are fed directly into the dc inputs of the

slave counter flip-flops, which are represented by the 24-bit gating structure.

When a carry ripple is propagating down the master counter, the slave counter is in an indeterminate state because of possible interference between the synchronizing signals and the slave internal ripple signals.

When no ripple is present in the master counter, the state of the slave counter is exactly that of the master counter. At this time the control logic disconnects the synchronizing signals from the slave counter, for the ripple in the slave counter occurs at the same time as the ripple in the master counter.

The condition of no-ripple exists when the first four least-significant-bit positions of the master counter are equal to 1. This indicates that 15 counts of the input frequency have occurred since the previous major carry bit was propagated. Sufficient time has thus been allowed for all carries to have been completely propagated. At this time both counters are counting the same signal and contain the same count, but otherwise are completely independent of each other.

When the instantaneous count value is desired, the input signal is disconnected from the slave counter. After any carry ripples have finished propagating in the slave counter, the individual slave counter flip-flops may be read by the computer.

The counter can be readily adapted to provide frequency readouts at 0.1-second intervals.

For more details, contact: Technology Utilization Officer, Jet Propulsion Laboratory, 4800 Oak Grove Drive, Pasadena, Calif. 91103 (B66-10658).

We believe if there's one thing in the world you don't need it's a headache.

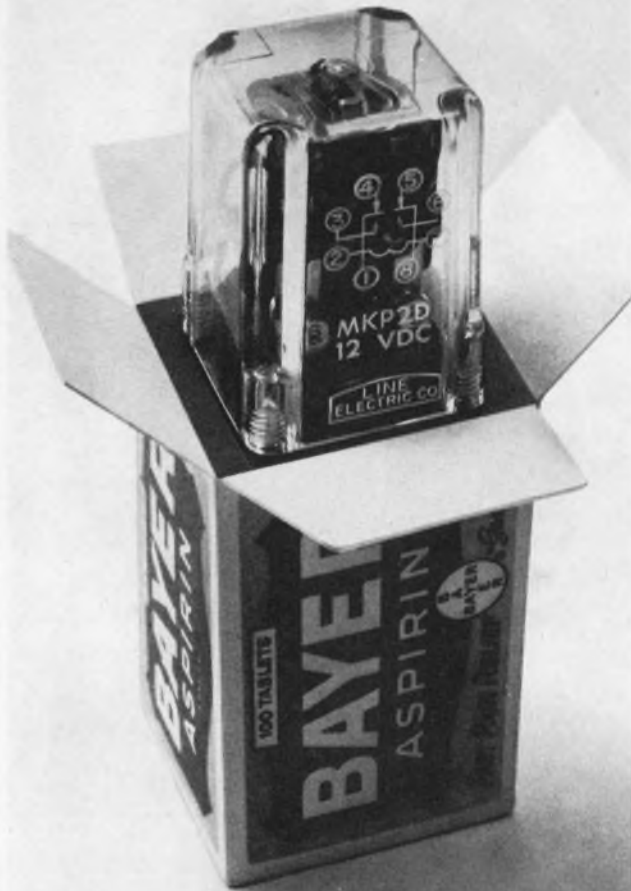

90% of all our orders are shipped ahead of their due date. And normal delivery for us is six weeks, not eight like most companies. We guarantee it.

Every relay we manufacture is put to nine performance tests before it's shipped out. And we're rough: We flunk one out of every 50 produced.

Our sales have quadrupled in the past six years, and this year shipments are 80% ahead of last year. You don't grow that fast by giving people headaches.

So give us a call when you need relays. Without the headaches.



The Line Electric Company
Division of Industrial Timer Corp.
Manufacturers of Relays
and the best service
in the business.
Send for 64 page catalog:

305 U.S. Highway 287, Parsippany, N.J. 07054
ON READER-SERVICE CARD CIRCLE 39

RC bandpass filter is adapted to miniaturized construction

Problem: Design a sixth-order unsymmetrical bandpass filter suitable for use in integrated circuits.

Solution: Replace LC networks with RC ones in filters.

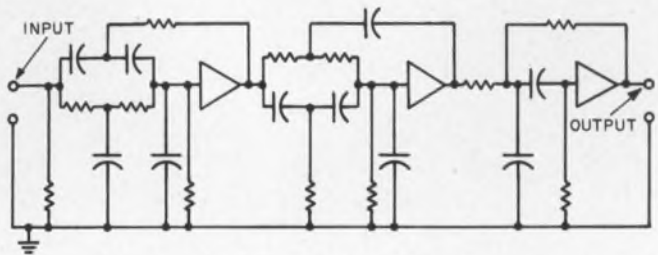

Three stagger-tuned stages are used in the circuit shown as the basic structure with modifications to allow for the asymmetric infinite attenuation points. Each stage uses passive RC components and an amplifier that acts as an ideal voltage-controlled voltage source of low gain. Parallel ladder networks in two of the stages provide the finite zeros and the feedback to realize the desired complex conjugate poles. These networks permit completely independent selection of the pole and zero positions. A somewhat simpler RC network in the third stage yields the zeros at the origin and at infinity, and the third set of complex conjugate poles.

The amplifiers are suitable for cascade connection, without coupling or bypass capacitors. In addition, they have very high gain stability, an input impedance exceeding 20 megohms, and an output impedance less than 20 ohms. Each amplifier uses three transistors and five resistors. In its present form, the amplifier has a frequency response of dc to 5 MHz. The networks require gains of between 1 and 4, and the amplifier provides an open-loop voltage gain of greater than 1,000, thereby allowing excellent stability, as a result of the feedback.

The RC circuit has exceeded a comparable LC circuit in notch rejection at 5 and 15 kHz, and produced a gain of 500 in the pass band, which is 2 kHz wide, centered at 10 kHz. Temperature tests have shown less than 1% overall system gain change from room temperature to 100°C.

The primary advantages of the active RC filter network are in the reduction in size and weight and in the elimination of magnetic materials. The latter advantage is particularly important in instruments used for measuring very weak magnetic fields.

Even without using integrated circuitry techniques, this complete filter-amplifier could be packaged in a 1-inch cube using off-the-shelf, discrete components.

For further information, contact: Technology Utilization Officer, Ames Research Center, Moffett Field, California 94035. Refer to: B66-10309.

Look what's happened to the sweep generator. Telonic has designed the new 2003 "all-modular" for instant adaption to your swept frequency applications. The 2003 is essentially an

ULTIMATE SWEEP SYSTEM

consisting of a basic chassis and plug-in modules that permit selection of frequency range, attenuation, frequency marking, RF detection, and display processing.

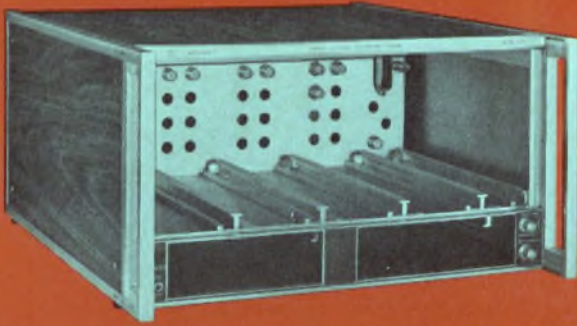

The sweep oscillator modules cover frequencies from

DC to MICROWAVE,

attenuation units range to 109 dB, markers are of both fixed, harmonic and variable types, passive and active detectors are available, and display outputs are provided for oscilloscope or X-Y recording. Useful power available ranges from .35 to .5 VRMS, and is frequency stable without additional isolation. The system may also be phase-locked externally.

Then consider bonus features such as marker tilt control, three sweeping modes, interference-free, time-shared markers, with center frequency and end-point tuning, and the 2003 Sweep System becomes the essential instrument for swept frequency measurement.

Write for Catalog 70, complete with descriptions, specifications, and Sweep Generator Applications.

Telonic **INSTRUMENTS**
A DIVISION OF TELONIC INDUSTRIES, INC.

60 N. First Avenue, Beech Grove, Indiana 46107
Tel. (317) 787-3231 TWX-810-341-3202

Representatives throughout the U.S., Canada, and overseas. Branch offices in Maidenhead, England; Frankfurt, Germany; and Milan, Italy.

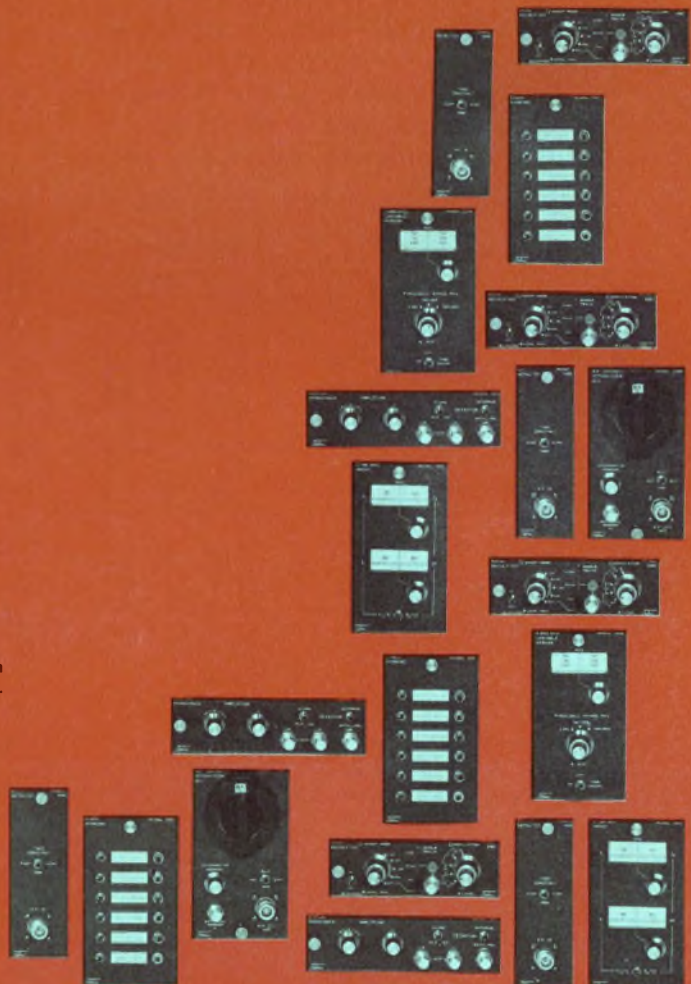

Astable multivibrator has timing interval as long as one cycle per 6.7 minutes

The astable multivibrator shown in the figure was designed for a laboratory instrument which required relatively long timing intervals of variable frequency and duty cycle. With the values shown, the frequency is variable from 0.0025 hertz (one cycle per 6.7 minutes) to 0.006 hertz (one cycle per 3 minutes). The duty cycle may be varied continuously from 66% to 3% at the 0.006-hertz setting and from 33% to 1.5% at 0.0025 hertz.

Q1 operates as a conventional UJT oscillator and sets the frequency of operation, while Q4, also operating as a UJT oscillator, determines the duty cycle. Q2 is a relay driver and Q3 is a switch biased in the on condition by the voltage divider, R5 and R6. R1 is the frequency control and R9 is the duty cycle control.

When power is applied to the circuit, C1 charges through R1 and R2 until the voltage at the emitter of Q1 reaches the peak point and Q1 fires. The resulting positive pulse developed across R4 is applied to the gate of Q2 turning it on; this, in turn, operates the relay, K1. Q2's

simultaneous firing results in application of voltage across Q4 and its associated circuitry. Thus C3 begins to charge through R9 and R10. When the emitter of Q4 reaches the peak point, Q4 fires. A positive pulse developed across R8 is applied to the base of Q3, momentarily turning it off. This also turns off Q2 and subsequently Q4. In the meantime C1 has been charging and will fire Q1 when its voltage reaches the peak point of Q1. The cycle is then repeated.

The long timing intervals are due to the low peak-point triggering current of the 2N4853: 0.4 μ A. The B1 resistor of Q1, R4, is kept low in order to prevent erratic triggering of SCR Q2 which has an extremely sensitive gate. The B1 resistor of Q4, R8, has a relatively large value to ensure a sufficient pulse to turn Q3 off. The relay used was a New Product Engineering No. 822-0111-506 but a Sigma 65P1 or 11F series worked equally well.

George W. Barrowcliff, Zeta Engineering Co., Euless, Tex.

VOTE FOR 110

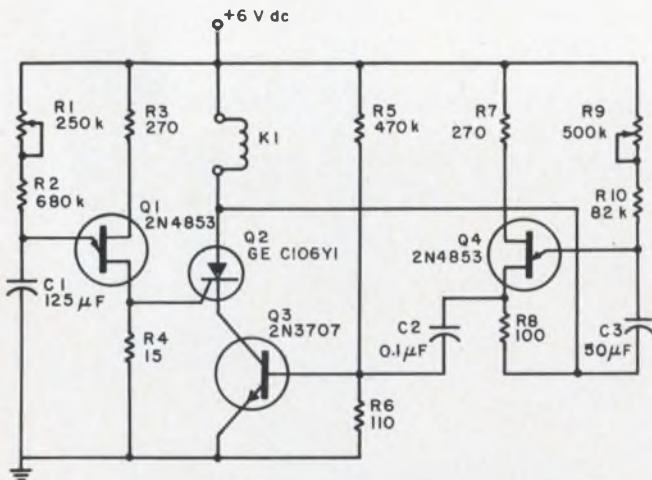

Very slow astable multivibrator uses separate timing circuits, Q1 and Q4, to turn the relay K1 on and off. Both the frequency and duty cycle can be varied independently.

VOTE! Circle the Reader-Service-Card number corresponding to what you think is the best Idea-for-Design in this issue.

SEND US YOUR IDEAS FOR DESIGN. Submit your IFD describing a new or important circuit or design technique, the clever use of a new component, or a cost-saving design tip to our Ideas-for-Design editor. If your idea is published, you will receive \$20 and become eligible for an additional \$30 (awarded for the best-of-issue Idea) and the grand prize of \$1000 for the Idea of the Year.

Fire SCRs directly from integrated circuits

It is possible to fire fairly large SCRs directly from some integrated circuit gates. The figure shows a 16-amp, 400-volt SCR fired by a standard Westinghouse Series 200 DTL gate. The Series 200 gates are particularly useful in this application, for they are available without collector resistors. This enables the designer to use external collector resistors that are lower than normal. The gate can thus deliver sufficient current to turn a large SCR on. These gates' 6-volt operating level, moreover, helps them to deliver more gating current to the gate lead of large SCRs.

A capacitor has to be placed between the logic gate and the SCR gate because the SCR gate jumps to about 1.5 volts when the device is turned on. Should the gate then for some reason lose the 0-state input signal that turned the SCR on in the first place, the NAND nature of the gate would try to turn the SCR on and would burn it out.

This logic-gate-to-SCR arrangement makes it possible to go from the milliwatt levels of integrated circuits to kilowatt powers in a single step.

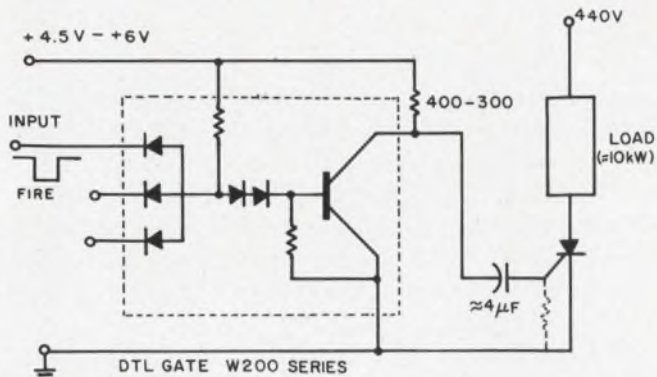

SCR firing circuit uses single IC and two discrete components.

This is made even easier by the high voltage ratings of today's SCRs. When a 1000-volt SCR is controlling 10 amps, for instance, the going is from the 100 milliwatts of the DTL gate to the 10 kilowatts of the load.

This approach could be applied to industrial control systems where IC logic has to govern power loads like heating ovens, motors or lighting. It could also be used in SCR systems where advantage can be taken of the IC's counting, timing and delay (if a delay monostable is developed from integrated modules with external capacitors).

Robert Cushman, Chief Engineer, Cybiotronics, Port Washington, N. Y.

VOTE FOR 111

Simple circuit measures impedances at af

The illustrated circuit offers a simple and reasonably foolproof means for the quick measurement of impedances at audio frequencies. It is particularly useful where a large reactive component is combined with resistive and ac-resistance components like magnetic transducers. Only an oscillator, VTVM, decade box and dpdt switch are required.

In operation the switch is used to compare voltage drops across Z_x and R ; the latter is adjusted until the voltage readings are equal. The value of $|Z|$ can then be read off the decade box

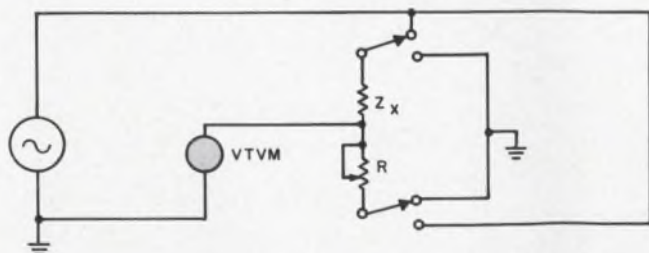

Real part of Z is determined by adjusting R until voltages across Z_x and R are equal. The value is then read off the dial of the decade box, R .

used as R . R should be noninductive.

The switch can be built into a small box with suitable terminals for connection to other circuit elements. If high impedances—greater than 10 k Ω —are to be measured, internal wiring should be shielded.

Harry Teder, Chief Engineer, Advanced Development, Acoustic Products Div., Telex Corp., Minneapolis.

VOTE FOR 112

Af oscillator uses crystal and neon bulb

A simple oscillator (see figure) can be made with a crystal and a neon bulb.

When switch S_1 is closed and the pulse repetition rate of the neon bulb oscillator is near the resonant frequency of the crystal, two things happen. First, the crystal is shock-excited into mechanical vibration at its resonant frequency. Secondly, the emf generated by the crystal pulls the relaxation oscillations into step. When this synchronism occurs, the crystal vibrates even more energetically and assumes control of both frequency and waveshape; sine-wave oscillation then results.

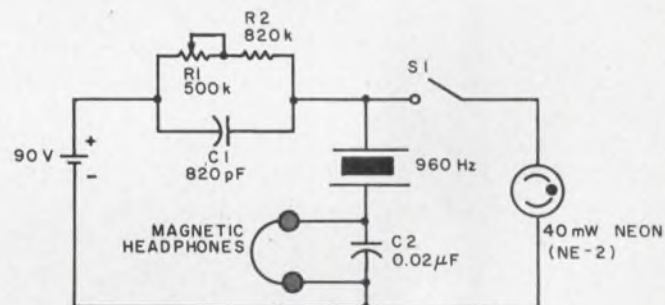

Versatile relaxation oscillator results when a neon bulb is combined with an audio crystal.

The oscillator configuration makes use of the capacitor in parallel with the resistance rather than the more common connection in which the capacitor is connected across the neon bulb. Although better operation is secured in this way, this is not the salient feature of the oscillator. Relaxation oscillation of about the same frequency obtains for either connection, when the crystal is absent. For use with the crystal, the capacitor-resistance parallel connection is advantageous because a much lower impedance path is provided for the crystal current during the time the neon bulb is extinguished. This yields a considerably greater oscillation amplitude.

Some manipulation is necessary first to achieve crystal-controlled operation. Once attained, however, the operation is surefire thereafter. How is it known when the circuit functions as a crystal-controlled oscillator? There are several indica-

tions. If the oscillator is disabled by opening switch *S1*, the tone will cease abruptly if the crystal is not controlling the oscillation; a bell-like gradual diminution of the tone will be heard, however, if the crystal has properly asserted itself. If the circuit is properly adjusted for crystal-controlled operation, it will also take some time for synchronism to occur after switch *S1* has been first turned on. In this case, several tones are heard: that of the unsynchronized neon bulb oscillator, that of the crystal, and the beat frequency modulation products. As the crystal gains in activity, the relaxation frequency can plainly be heard being pulled closer to the crystal frequency. As this occurs, the most prominent beat frequency becomes lower and lower until it finally vanishes. All that remains then is a single pure tone of constant pitch. This final lock-in is also accompanied by a dip in average dc current, as indicated by a microammeter connected in one leg of the battery.

It is very important to adjust *R1* very slowly, for it takes time for the crystal to respond. A fixed resistance can be substituted once adjustment has been attained. It is well to experiment with several neon bulbs, because some show intense variation of ionization and deionization voltage. Also, occasional bulbs exhibit considerable polarity preference.

The simplicity of this oscillator and its economy make it useful for electronic organs, for techniques employed in radio control of models, and as a workhorse tone-generator wherever crystal stability is required. It is not suitable for use beyond the audio frequency range owing to the relatively long deionization time of the neon bulb. It is also more compatible with tube than transistor circuitry as a consequence of its 90-volt operating requirement. (Bulb selection can reduce this to the vicinity of 70 volts.) The circuit is quite flexible; a transformer is readily substituted for the headphones. Conversely, the headphone connections can be replaced by a small resistance, and output can be sampled through a small capacitor with respect to either battery terminal.

Irving M. Gottlieb, Menlo Park, Calif.

VOTE FOR 113

FET stabilizes Zener current in a simple voltage regulator

The need sometimes arises for constant-voltage sources more stable over variations in supply voltage than a simple resistor-Zener combination (Fig. 1a). A field-effect transistor (FET) with gate shorted to source will supply a Zener diode

with current that is stable over large changes in supply voltage (Fig. 1b). Quite simply, the desired Zener current is calculated and then a FET with that value of I_{DSS} is chosen. To maximize stability, it is best to choose a FET with low knee voltage or low gate cutoff voltage, for once the voltage across the FET drops below this value, the FET ceases to supply constant current.

In a representative circuit for use in a device powered from a 12.6-volt NiCd battery, an MPF103 FET with an I_{DSS} of 1.8 mA was combined with a 1N935A 9.0-volt Zener. The regulated voltage-vs-supply-voltage curve is compared with that for a resistor-diode regulator in Fig. 1c.

The main drawback of this circuit is the variations of I_{DSS} with temperature—typically 0.8% per degree Centigrade. This adds a negative temperature coefficient to the regulated voltage, since I_{DSS} decreases with increasing temperature. In the representative circuit, output changed +0.02 volts when temperature dropped from 20°C to -15°C. Greater temperature stability can be achieved through standard techniques, such as use of a positive-temperature-coefficient Zener diode.

There are three advantages in such a circuit. The first is the simplicity of the arrangement. The second comes from the reduction in Zener current necessary to attain a given voltage stability. There is no need to operate far out on the Zener diode's characteristic breakdown curve in an attempt to obtain reduced dynamic impedance. This is a decided advantage in portable equipment where battery drain must be minimized. The third advantage of the circuit is its low cost, especially if

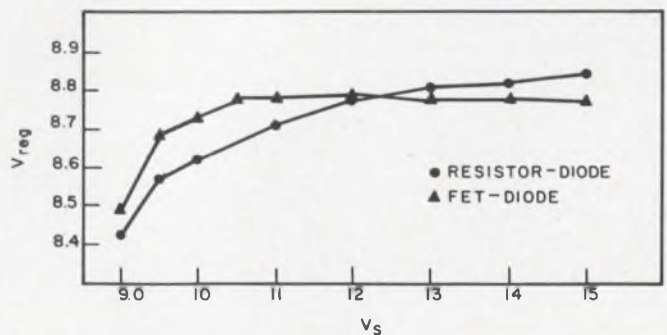

Stable voltage output results when a series resistor in a standard regulator circuit (a) is replaced by a suitable FET (b). The improvement is shown in (c).

NOW...

Break the "Dollar Barrier" with RF-IF Ampl CA3028

...98¢ (1,000+)

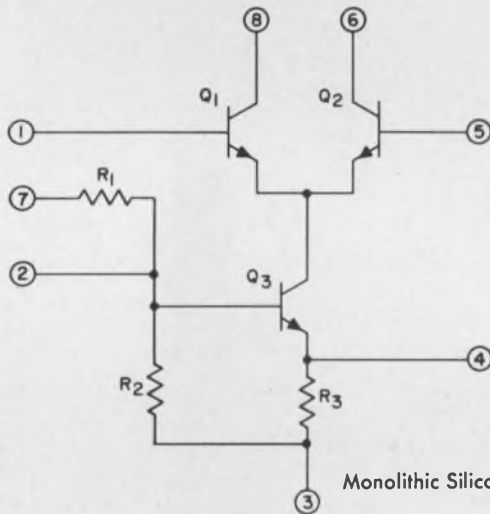

Monolithic Silicon Integrated Circuit, CA3028

TYPICAL SPECIFICATIONS

Power Gain @ 10.7 MHz	Cascode	39dB	Differential Ampl	32dB
@ 100 MHz	Cascode	20dB	Differential Ampl	17dB
Voltage Gain @ 10.7 MHz ($R_L = 1K \Omega$)	Cascode	98	Differential Ampl	32
AGC Range (Max. power output to full cut-off) @ 10.7 MHz			62dB	

APPLICATIONS

IF Ampl (differential or cascode) Mixer
 Converter in the Commercial FM band Oscillator
 Limiter

AVAILABILITY FROM STOCK

Ask your RCA Representative about CA3028. Check your RCA Distributor for his price and availability schedule. Or send for complete data, including Application Note, ICAN-5337, to Commercial Engineering, RCA Electronic Components & Devices, Section IGG5-3, Harrison, N.J. 07029

Check Your RCA Distributor for His Price and Delivery

RCA ELECTRONIC COMPONENTS AND DEVICES



The Most Trusted Name in Electronics

the required FET is chosen from among the available inexpensive devices.

Peter F. Moulton, Design Engineer, Research Section, Science Committee on Psychological Experimentation, Cambridge, Mass.

VOTE FOR 114

Pocket radio detects corona or insulation breakdown

An inexpensive transistor pocket radio makes a simple tool for checking for corona or insulation breakdown. All that is necessary is to tune the radio to a clear spot on the dial and bring the radio near the apparatus to be checked. If the

apparatus has a corona source or voltage breakdown arc, static will be heard from the radio loudspeaker. This same technique may be applied to checking transformers for adequate insulation: imminent intrawinding and interwinding failures can be quickly spotted. Where the apparatus is enclosed in a metal case, it may be necessary first to insert an "antenna" into the case or attach a one- or two-foot piece of wire to one of the terminals entering the case to obtain sufficient RFI. The equipment must have normal operating voltage applied while the checks are being performed.

K. G. Holmes, Chief Engineer, Magnetic Circuit Elements, Inc., Montrose, Calif.

VOTE FOR 115

Sequencing is easy with this expandable, wide-range circuit

Whenever you have a need for a sequence of events with varying time delays between them,

try the circuit shown in the figure. It is a programmed sequence switch that can be operated over a large time range. It has been used successfully in test equipment where a sequence of events is required with varying time delays between them.

The start input may be mechanical or electrical

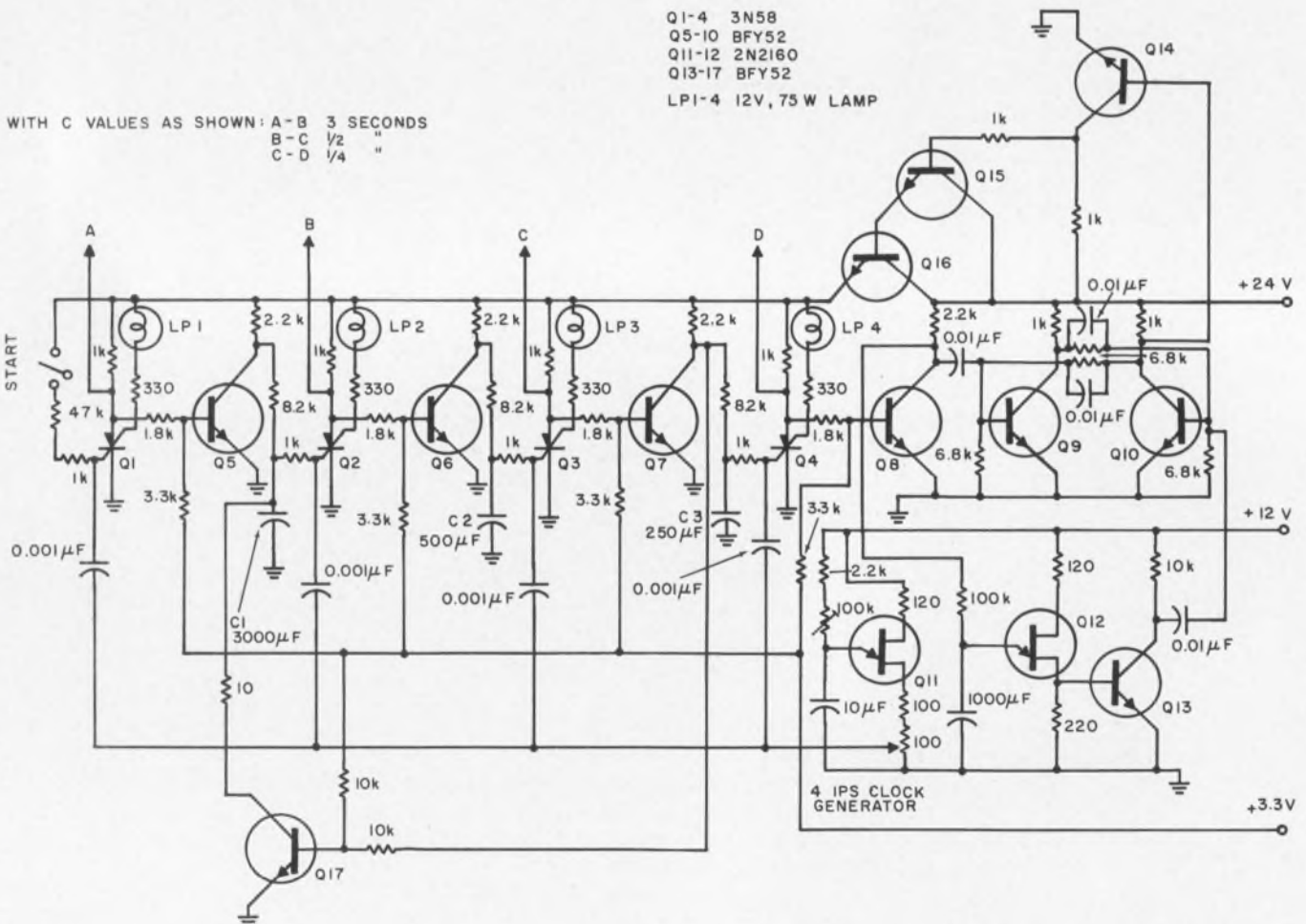

Time delay between events can be varied in this programmed sequence switch. Input to the switch may be

either mechanical or electrical. Time delay is approximately 1 ms/µF; delays up to 10 seconds are possible.

Fastest Thermal Switch.

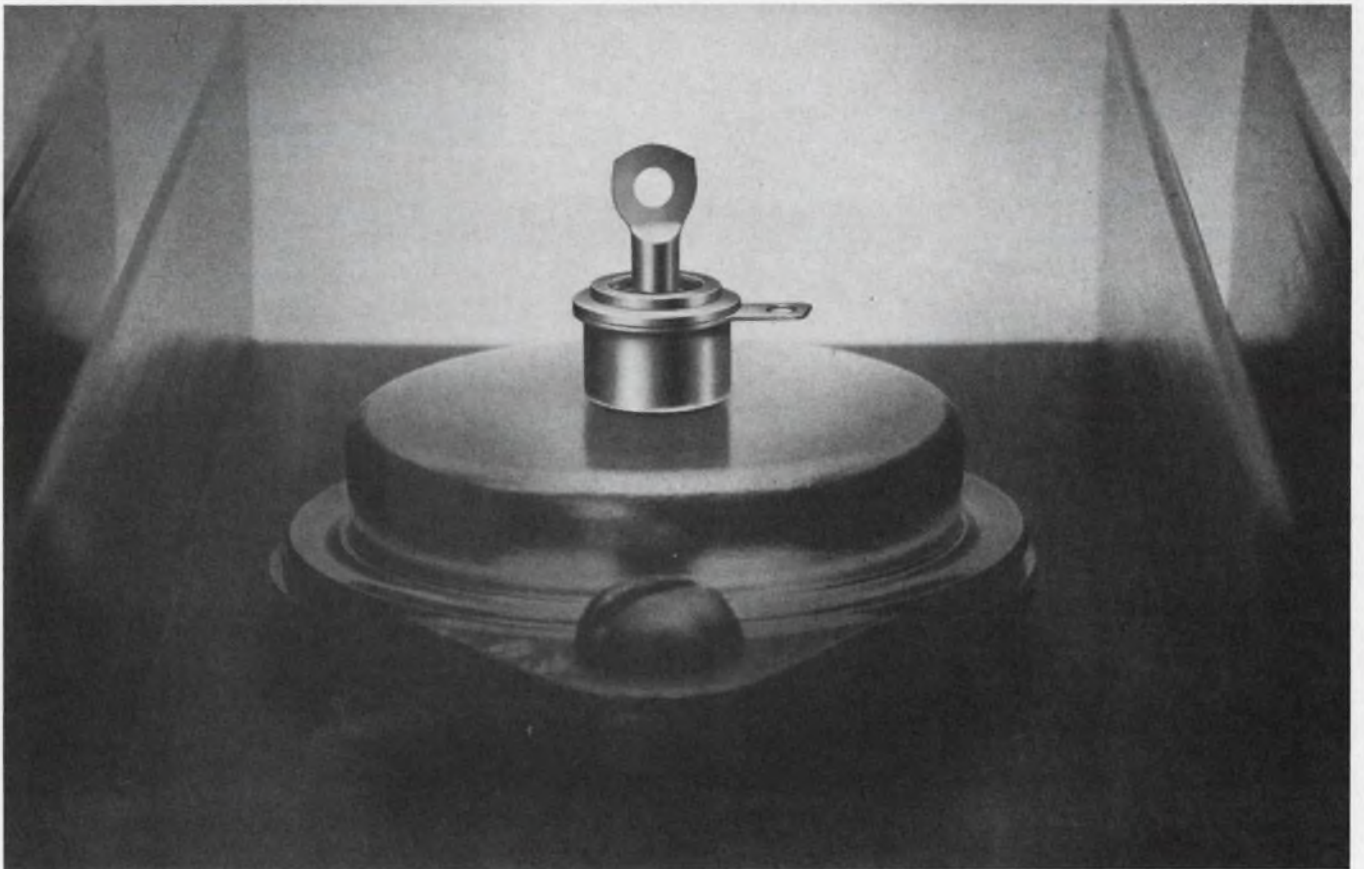

You're looking at the smallest snap-action thermal switch on the market today. That's why it has a faster thermal response than any other. It's a KLIXON® "Tiny-Stat", now widely used to control temperatures in missile radar, aircraft and commercial electronic applications.

KLIXON 3BT and 4BT Series Tiny-Stat thermal switches respond to temperature change 5

times faster than their nearest equivalents. They're rated at 1 amp, 115-ac/30v-dc for 10,000 cycles. Temperature range is 0° to 350°F, open or close on temperature rise. Vibration resistance is 5 to 2000 cps at 30 G. Their small size makes them ideal replacements for thermistors and their electronic switching circuitry.

We offer a complete line of precision thermal switches, solid

state switches, electromechanical switches, thermal and magnetic circuit breakers, cooling effect detectors, component ovens, proportional temperature controllers and power storage systems.

For complete information on your specific requirements for any one of our products in these lines write to TI Control Products Group, Attleboro, Mass. 02703 or phone (617) 222-2800.



TEXAS INSTRUMENTS
INCORPORATED

and causes $Q1$ to fire when the first pulse is received from the clock pulse generator $Q11$. The delay is provided by the 8.2-k Ω resistor and the large-value capacitor ($C1-3$) in each switch stage. The time delay is approximately 1 ms/ μ F, and time delays of up to 10 seconds have been achieved.

Any number of stages up to ten may be used with the transistor types shown for $Q15$ and $Q16$. For a greater number of stages a higher-current transistor is needed. The outputs A , B , C , and D , switch from +15 V in the OFF condition to +1 V in the ON condition. These may be used to operate bistable gating elements. An auxiliary output is provided and a lamp is used to indicate the state of the sequence.

Reset of the controlled switches is performed at the end of the count by a bistable trigger, $Q9-10$, which feeds an inverter, $Q14$, and then the compound emitter follower, $Q15-16$, which removes the +24 V from the switches for a predetermined time, controlled by the pulse generator $Q12-13$.

The additional circuit of $Q17$ allows the high-value capacitor to be discharged quickly to increase the speed of operation.

A. Thomas, Potters Bar, Hertfordshire, England.

VOTE FOR 116

Amplitude modulator uses differential amplifier

The novel circuit arrangement shown in Fig. 1a simulates the function of a full-wave chopper modulator by using the inverting and noninverting characteristics of a differential amplifier. The amplifier performs a dual function: it provides the amplitude modulated output and its gain is used to increase the signal level. The maximum modulating frequency of operation is set by the gain-bandwidth characteristic of the differential amplifier and the diode impedances.

The flip-flop $FF1$ provides the carrier frequency voltage, E_c . Both outputs from $FF1$ are utilized $-E_c$ and E_c . The signal voltage, E_s , is resistively summed with the carrier voltage and its inverted complement. Linear superposition of the signal onto the carrier by the summing network causes little distortion of the signal waveform. Diode clippers $D1$ and $D2$ allow only positive polarity voltage to pass to the inputs of the differential amplifier, $A1$. Positive or negative clipping of the signal produces the same result. Forward biasing of the diodes by voltage E_b provides an effective means for adjusting the relative amplitudes of signal and carrier voltages.

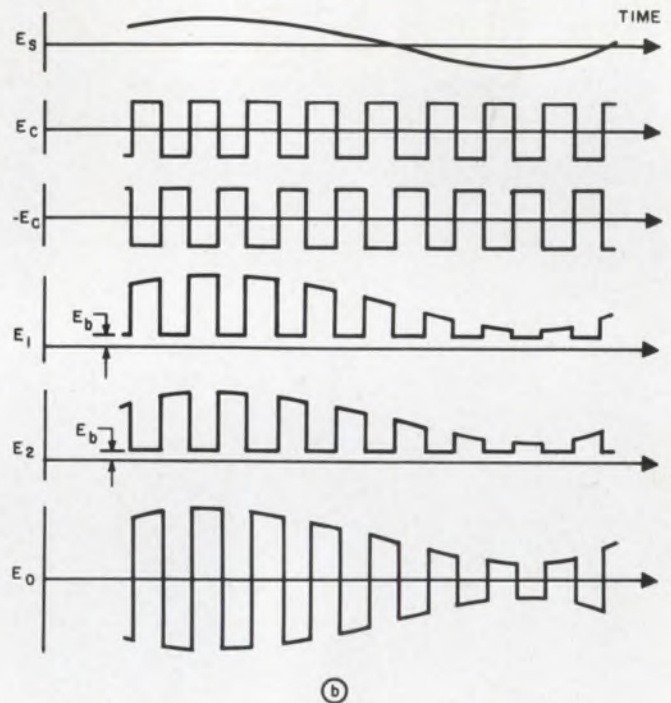
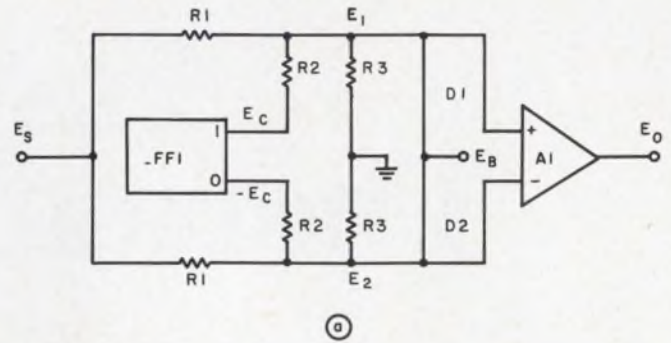

Amplitude modulated output, E_o , is obtained with the simple circuit (a). All waveforms on common time base are shown in (b).

This means full advantage can be taken of the amplifier's dynamic range to increase the signal level. Minor adjustments are all that is necessary to prevent E_b from appearing at the amplifier output.

Because of the inversion of one of the input voltages through the differential amplifier, the resulting output, E_o , will have the waveform of a full-wave chopper modulator, as shown in the waveform diagram (Fig. 1b).

George Hunka, Advanced Technology Department, RCA Defense Electronic Products, Camden, N. J.

VOTE FOR 117

Crystal-controlled oscillator employs microcircuits

Two standard Fairchild RT μ L 900 buffers can be used to build a crystal-controlled oscillator.



Close-up on quality

There are more impedance measurements made with a 1650-A than with any other bridge. Why? Here are a few reasons:

- It is versatile, essentially five bridges in one package. It measures ac or dc resistance from 1 m Ω to 11 M Ω , capacitance from 1 pF to 1100 μ F, and inductance from 1 μ H to 1100 H. It also measures D or Q over a wide range.
- It is completely self-contained and portable. It contains its own 1 kHz generator, detector, and power supply (four D-size batteries). The patented Flip-Tilt case doubles as an adjustable stand and as a storage case.
- It is accurate to 1% for R, L, and C measurements. Accuracy is maintained over a frequency range of 20 Hz to 20 kHz, ex-



Type 1650-A Impedance Bridge

ternally supplied, for L and C (to 5 kHz for R). Usable to 100 kHz with reduced accuracy.

- It has an Orthonull[®] balance finder, which eliminates sliding nulls in low-Q balancing.
- It is low-cost. Price is only \$475 in U.S.A.
- It was designed and is manufactured by a company with over 50 years of impedance-measurement know-how.

For complete information, write General Radio Company, 22 Baker Avenue, W. Concord, Massachusetts 01781; telephone. (617) 369-4400; TWX 710 347-1051.

GENERAL RADIO

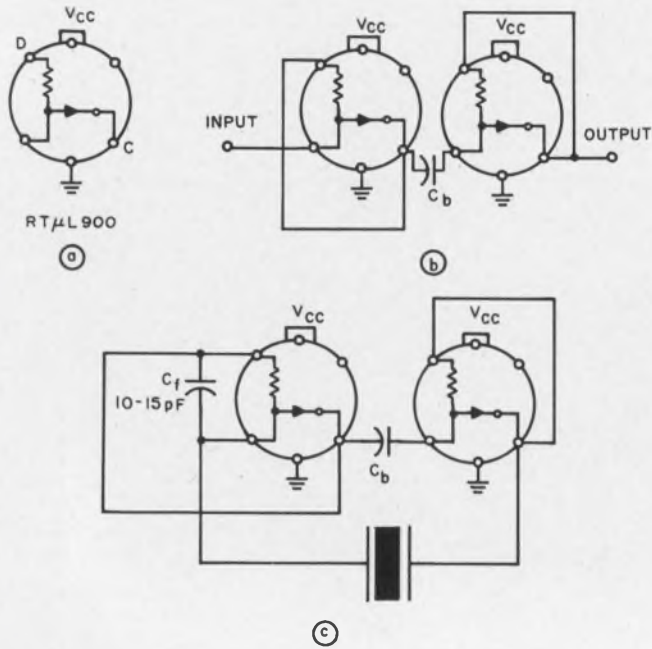

Crystal-controlled oscillator uses only two discrete capacitors in addition to the crystal.

Some of its features include:

- Few external components.
- High fan-out.
- High stability.

Figure 1a shows the buffer schematic. Connecting pins C and D yields an amplifier with low input and output impedances (Fig. 1b.) Two such amplifiers can be arranged to obtain a crystal-controlled oscillator (Fig. 1c).

The highest frequency of this oscillator is about 8 MHz. Capacitor C_f suppresses spurious oscillations due to the parallel stray capacitance of the crystal. C_b is a coupling capacitor.

B. Altieri, Engineer, Digital Group, S.G.S. Fairchild, Agrate, Milan, Italy.

VOTE FOR 118

Oscilloscope used to copy Polaroid photographs

Quite often a breadboard is taken apart and it is found that more photos are needed than originally planned. If a photocopier is not available, it is still possible to make quick copies of Polaroid photographs.

The horizontal sweep of an oscilloscope is allowed to free-run and the horizontal line adjusted so that it is fairly bright and in focus. The graticule is removed from the CRT and the photograph mounted flush to the face with black, photographic masking tape. The remainder of the CRT and the graticule lamps are masked with the tape to minimize stray light.

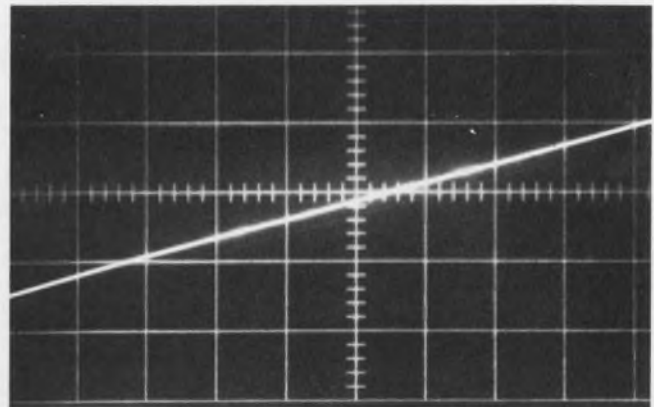

(a)

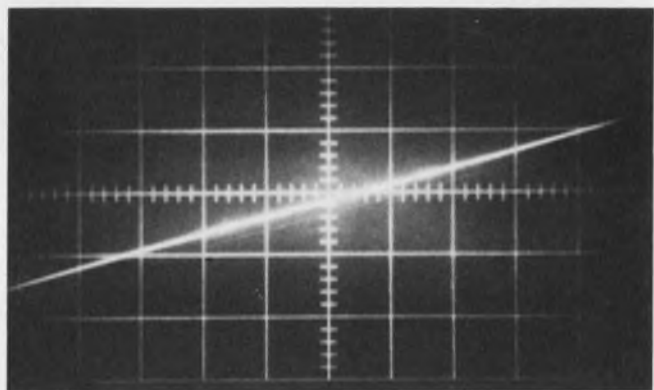

(b)

The copy (b) made with the aid of a CRT is essentially the same as the original Polaroid photograph (a).

The camera is then mounted on the oscilloscope. The camera shutter is opened and the vertical positioning knob of the oscilloscope turned steadily until the horizontal line moves vertically across the CRT face behind the photograph. Then the shutter is closed and the film developed.

If the brightness is excessive, the CRT beam intensity should be reduced. As Fig. 1b shows, except for a small change in the over-all size, the duplicate photograph is essentially the same as the original in Fig. 1a. The photographic paper is translucent enough to permit light through the white waveform but opaque enough to attenuate almost all unnecessary light.

Alfred W. Zinn, Kearfott Products Div., General Precision, Inc., Aerospace Group, Little Falls, N. J.

VOTE FOR 119

IFD Winner for Feb. 15, 1967

R. R. van den Berg, Development Engineer, NV. Peekel, The Hague, Netherlands.

His Idea, "High input impedance obtained in a differential amplifier," has been voted the \$50 Most Valuable of Issue Award.

Cast Your Vote for the Best Idea in this Issue.



insensitive to heater-voltage variations

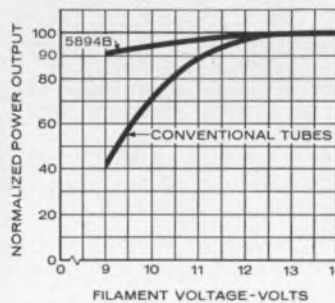

POWER PERFORMANCE vs. CATHODE VOLTAGE

It's the new version of the Amperex 5894, that famous old workhorse, now with the WIDE-RANGE CATHODE that we developed specifically for vehicular communications equipment.

Today's 5894's are being designed into transmitters for mobile vehicles that have modern alternator electrical systems. Alternators are just fine but they do create heater-voltage-regulation problems. So... the 5894B/8737, with the wide-range cathode was created.

5894B/8737 cathode emission is essentially independent of heater voltage

over a wide range. While a conventional twin tetrode produces 60% less than its rated output at 9 volts, the new tube, with its wide range cathode, puts out more than 90%. Above 13 volts, conventional cathode materials sublime, damaging the tube; the 5894B/8737 is immune to sublimation with as much as 16 volts on the heater.

Whether the alternator is idling or turning at full rpm, the Amperex 5894B/8737 gives the kind of performance that has made the 5894 the standard of the mobile vehicular communications industry.

As a 174 MHz push-pull amplifier, the 5894B/8737 delivers 96 watts ICAS; operating PTTS*, it delivers 111 watts with 5.5 watts drive, with a tube efficiency of 69%. And all this at any heater voltage from 10 to 16.

*PTTS: Push-To-Talk Service; for vehicular communications systems. Maximum duty cycle: 1 minute ON/4 minutes OFF.

For complete data on the new 5894B/8737 and other Amperex twin tetrodes for mobile applications, write: Amperex Electronic Corporation, Tube Division, Hicksville, L. I., New York 11802.

Amperex®

TOMORROW'S THINKING IN TODAY'S PRODUCTS

ON READER-SERVICE CARD CIRCLE 44

VERSATILE

You name it

CAPABLE

The Paul Bunyan of 3M Recorders

AFFORDABLE

We're almost
ashamed of the
low price

MODEL 34



VERSATILE – With direct frequency response to 600 kHz, and IRIG FM to 80 kHz, the Mincom Model 34 does many things in many ways. Rack-mounted or in

easily portable carrying cases. $\frac{1}{4}$, $\frac{1}{2}$ or 1-inch tape. 10 $\frac{1}{2}$ -inch or 7-inch reels. Speed options: $\frac{15}{16}$, $1\frac{7}{8}$, $3\frac{3}{4}$, $7\frac{1}{2}$, 15, 30, 60 or 120 ips.



CAPABLE – Practically the only thing that's *not* an option is 3M quality – that's standard on all configurations of the Model 34. Starting with the Isoloop Drive® on the tape transport (the same as on recorders costing several times as much), Model 34 can record 7 or 14 channels of the cleanest data for over twelve hours. All types of record/reproduce modules are interchangeable, allowing any channel combination desired. Push-button controls. Dynamic braking in all modes. Fail-safe braking for AC failure. End-of-tape sensing. Solid state electronics. Input/output meters.

AFFORDABLE – As you can see, there are a lot of different ways to configure a Model 34 – and there are just as many prices.

But this we can be definite about: Model 34 is *the* recorder for people who've always wanted 3M quality – but couldn't afford it *before*. Give us a call.

Revere-Mincom Division **3M**
COMPANY
300 SOUTH LEWIS ROAD • CAMARILLO, CALIFORNIA 93010

"NO NOISE WORRIES with Dale Metal Film Resistors"



Dale Metal Film Resistors provide precise voltage attenuation in the Brush Mark 200 Recorder. This highly accurate direct writing system is now in use in the Apollo Deep Space Program.

**"Piece by piece selection to insure
low noise was eliminated when we began
using Dale Metal Film Resistors"...**

*C. M. Jeffries, Works Manager, Clevite Corporation
Brush Instruments Division, Cleveland, Ohio*

Getting optimum value from a resistor may hinge on a single performance characteristic. For Brush Instruments, this characteristic was the outstanding low noise construction of Dale Metal Film Resistors. For you, optimum value may come from Dale's ability to supply metal film parts with tightly controlled T.C.; or from the excellent stability of Dale MF resistors in critical high frequency applications. Optimum value can also result from the assured fast delivery made possible by Dale's expanded metal film facilities. ■ Check metal film suppliers from every angle — including price and the ability to provide special parts tailored to your special needs. Then call Dale.



for optimum value in precision resistors



Dale Electronics, Inc. 1300 28th Avenue, Columbus, Nebraska



We're really rolling on metal film delivery!

Erase delivery from your procurement problems! Expanded metal film production facilities in Norfolk, Nebraska, have enabled us to slash delivery schedules to the bone. Production increases daily on all types listed below. Call Dale for the best *all-around value* in metal film resistors. The number is 402-564-3131.

QUICK DELIVERY REFERENCE DALE METAL FILM RESISTORS

<p>TYPE MF</p> 	<p>Epoxy-molded metal film resistor. Meets MIL-R-10509F (Char. C, D and E). Combines high stability with low noise and offers exceptional moisture protection.</p>	<p>Power: 1/20, 1/10, 1/8, 1/4, 1/2, 1 and 2 watt sizes Resistance Range: 10 Ω to 10 Megohms, depending on size and T.C. Resistance Tolerance: .1%, .25%, .5%, 1% T.C.: ± 25, ± 50, ± 100, ± 150 PPM standard</p>
<p>TYPE MFF</p> 	<p>Epoxy roll-coated metal film resistor. Designed primarily for commercial applications. Meets electrical and environmental specifications of MIL-R-10509F. Small size. Low cost.</p>	<p>Power: 1/8, 1/4, 1/2, 1 and 2 watt sizes Resistance Range: 10 Ω to 10 Megohms, depending on size and T.C. Resistance Tolerance: .1%, .25%, .5%, 1% T.C.: ± 25, ± 50, ± 100, ± 150 PPM standard</p>
<p>TYPE D</p> 	<p>Precision power film resistor molded into an aluminum housing for complete environmental protection and high stability. Wide resistance range, low reactance at high frequencies.</p>	<p>Power: 4, 8, 12 watt sizes Resistance Range: 50 Ω to 2.6 Megohms, depending on size Resistance Tolerance: .1%, .25%, .5%, 1% and 2% standard</p>
<p>TYPE MP</p> 	<p>Epoxy-molded metal film package with from 2 to 6 elements. Meets MIL-R-10509F. Available with matched T.C., matched resistance ratio. Excellent H.F. characteristics. Very low noise levels.</p>	<p>Power: 50 milliwatts per element at 125° C Resistance Range: 30.1 Ω to 80.6K Ω each element Resistance Tolerance: .1%, .25%, .5%, 1%, 2%, 5%</p>

Printed in U.S.A.

For complete information circle No. 181

Write for **Catalog A** — complete information on precision metal film, precision wirewound and industrial wirewound resistors.

DALE ELECTRONICS, INC.

1300 28th Avenue, Columbus, Nebraska
 In Canada: Dale Electronics Canada, Ltd.



Products



Submicron tungsten carbide powder averages one-fifth the size of conventional powder. The

size and high-energy shape suggest use in cermet or thermoelectric devices. Page 150



Tiny electrochemical timing cells are the heart of this auto maintenance computer. Page 122



Thin spot heaters obtain temperatures to 450°F, up to 10 watts/square inch. Page 126

Also in this section:

Strobing voltmeter makes single-shot voltage measurements on fast waveforms. Page 146

IC package uses aluminum bumps to eliminate fragile lead frames. Page 148

NiCad batteries charged to 90% capacity in less than 15 minutes. Page 154

Design Aids, Page 160 . . . **Application Notes**, Page 162 . . . **New Literature**, Page 164

Electrochemical timing cell adds three new functions

Bissett-Berman Corp.; Components Div., 3860 Centinela Ave., Los Angeles. Phone: (213) 394-3270. P&A: reusable and plug-in cell: \$25 (1 to 9), \$20 (10 to 49), \$15 (50 to 99), \$10 (100 to 999), multi-electrode cell: \$50 (1 to 9), \$40 (10 to 49), \$30 (50 to 99), \$20 (100 to 999); stock for small quantity.

Bissett-Berman's unique electrochemical circuit element, the E-cell, has been modified to add three additional capabilities. They are:

- A reusable cell.
- A multiple-electrode cell which can perform two separate timing or integration functions with separate read-out.
- A cell designed for plug-in sockets.

Basically, the E-cell employs Faraday's electroplating laws to provide precisely measured timing and integrating functions at solid-state-compatible current and voltage levels (see ED, Aug. 31, 1964, p. 68). Typical short-duration current values range from 2 μ A to 5 mA. The capacity of the cell is expressed in microampere-hours and is a direct coulometric function of the quantity of platable material put on the charged electrode (anode). As long as current flows through the electrolyte and plating action is taking place, the cell has a low equivalent impedance value as it looks to the rest of the circuit. The basic timing circuit is shown in Fig. 1 and a

fixed time-delay starting circuit designed around the cell in Fig. 2. Time delays may range from seconds to days.

When plating is complete, the cell changes state (from a low to a high equivalent impedance). This is accompanied by a voltage rise which can be as high as 0.8 volt. Bissett-Berman claims virtual immunity from shock, vibration and temperature effects from -55° to $+75^{\circ}$ C.

The reusable cells (types 400-001 and 002) differ from the standard cell in that the anode is not charged by the factory. It is supplied with no platable material at the center electrode. It can be used as an integrator by passing a current (within the operating range) proportional to the function to be integrated from the cup (+) to the center electrode (-). At the end of the desired integrating period, the value of the total integral can be read out. Read-out is accomplished by using the cell, which now has platable material on its center electrode, in a manner similar to that of a timer. With a constant current, the time to reach the voltage transition point is proportional to the integral. In this manner, the cell can be reused many times. This mode is also useful for laboratory testing and evaluation of E-cell timer circuitry. The cell can be preset with a current-time integral and then used as a timer. This process can be repeated many times if the stop voltage is kept below 0.6

volt for no longer than several minutes.

The multiple-electrode cells (type 410) have two anodes and therefore can perform two separate timing or integration functions, separately read out. The units are essentially two cells in the same can with the cup serving as common cathode. It has two anodes, one plated with a large charge and one with a smaller one. The smaller-charge anode is sealed coaxially in the center of the larger one. Functionally, the cells may be thought of as the equivalent of two separate cells, with leads for separate inputs and readouts. Maximum current acceptable in either direction ranges from 120 μ A at -55° C to 3.5 mA at 70° C. Minimum stop voltage is 700 mV at 3 μ A.

Figure 3 shows the double-integration function. Here, the cell is an indicator of distance from the voltage output of an accelerometer.

The plug-in units (type 450) were originally developed for automobile service computers (photo, p. 121). With three inputs (engine operating hours, accumulated start time and elapsed calendar time) and the plug-in cell serving as memory and arithmetic sections of the dashboard analog computer, drivers will be reminded with a "service" light that their auto needs maintenance.

Electrical parameters for the 450 are the same as for the 400. The three new cells require a very small amount of power, require minimal interfacing with solid-state components and have temperature characteristics compatible with solid-state components.

CIRCLE NO. 371

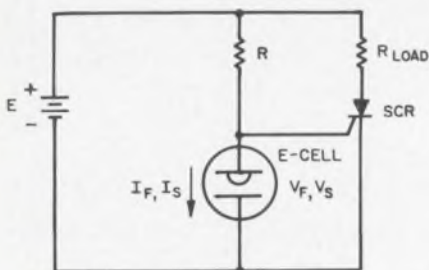

1. Basic timing circuit requires resistor and SCR. V_F is voltage in timing condition, V_S afterward. The max forward current I_F must exceed sum of stop current, I_S , and threshold current to fire SCR gate.

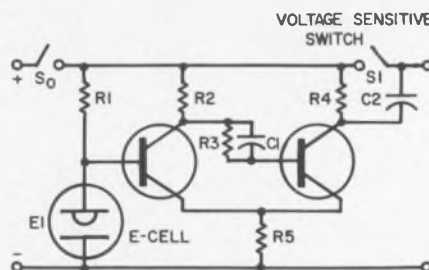

2. Fixed time-delay circuit uses an E-cell to fire Schmitt trigger. When S_0 closes, the charged cell starts timing. When it is timed out, its voltage rises, firing the Schmitt circuit at 0.5 V. This fires S_1 through C_2 .

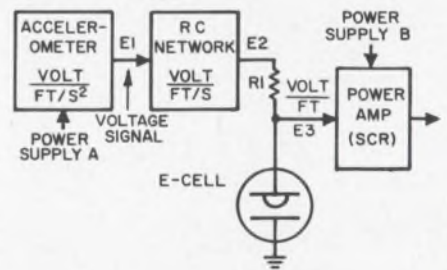

3. Double-integration function is performed as E-cell provides a signal source which indicates the distance from the voltage output of an accelerometer. Uses are in airborne cargo drops or ordnance.

The family has grown

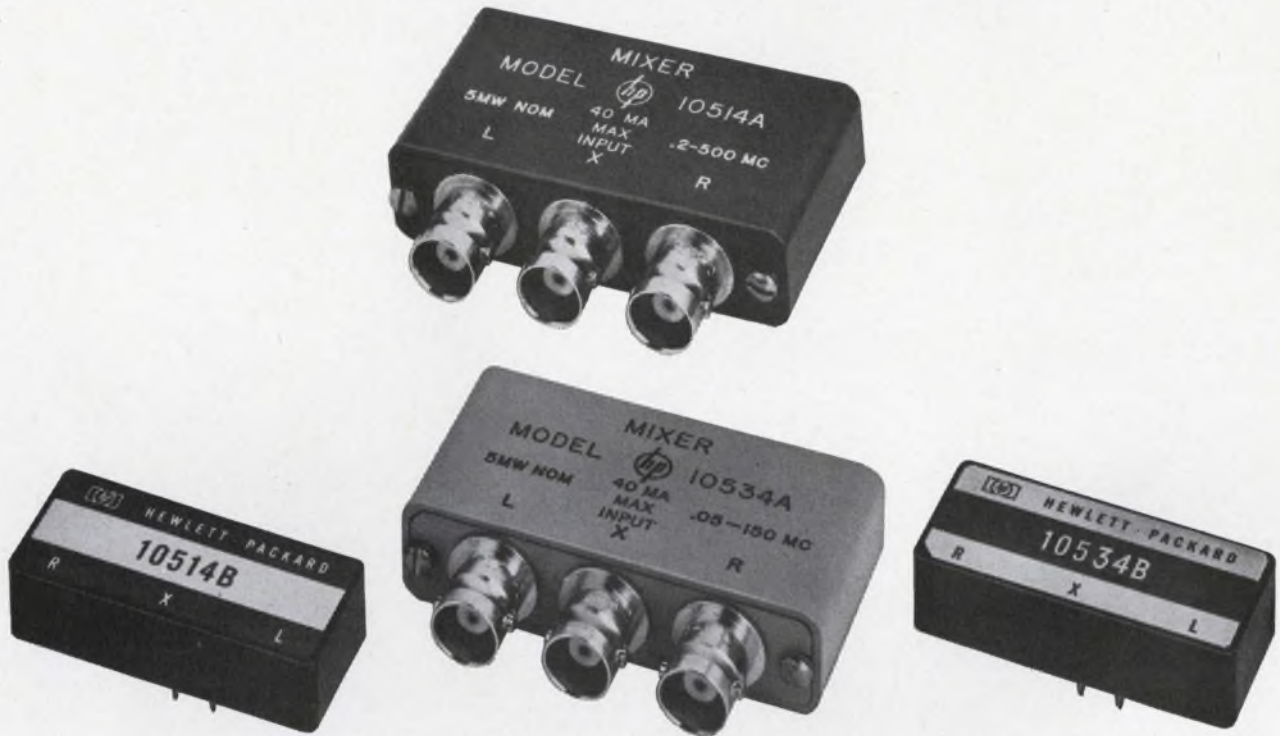

and lowered the budget

HP mixers are low in price, low in noise, high in performance. These wideband double-balanced mixers now bring performance extras to your applications—all the way to 500 MHz. New members of the family offer double-balanced performance at single-balanced mixer prices. Each member of the family offers:

- Lowest (and fully specified) 1/f noise.
- Complete testing, with all parameters specified in detail.
- Guaranteed performance over a wide environmental range.

These three new models follow the popular 10514A, a 200 kHz to 500 MHz double-balanced mixer with BNC connectors. The new 10514B is similar to its predecessor, but it's packaged for printed circuit mounting; the 10534A/B are optimized from 50 kHz to 150 MHz... and priced close to single-balanced mixers.

Low 1/f noise characteristics mean high performance in any phase detector application such as phase-locked loops or short-term stability measurements by phase noise methods. Note that single-sided noise is specified all the way down to 50 kHz on the DC-coupled port.

Consistent specs between models in the family mean that an equivalent printed circuit model can replace a BNC model in breadboard... with no trouble at all. And our testing and environmental demands save you

extra time and concern. This family meets specs and works wherever you need it.

Use these HP mixers for extracting frequency sums or differences, as modulators, spectrum or comb generators, phase detectors, current-controlled attenuators, frequency doublers... or to extend spectrum analyzer range.

For complete application information contact your local HP field engineer or write Hewlett-Packard, Palo Alto, California 94304; Europe: 54 Route des Acacias, Geneva.

Brief Specifications

Model	Freq. range MHz (2)	Conversion efficiency		Single unit (1) Price
		0.5-50 MHz	0.2-500 MHz	
10514A	0.2-500	7 dB	9 dB	\$180
10514B	0.2-500	7 dB	9 dB	\$150
		0.2 to 35 MHz 0.05-150 MHz		
10534A	0.05-150	6.5 dB	8 dB	\$ 75
10534B	0.05-150	6.5 dB	8 dB	\$ 60

(1) Prices are lower in quantity.

(2) "L and R" ports; "X" ports extend to DC for phase detector applications.

The 1/f noise is specified on all models as $100 \text{ nV per } \sqrt{\text{Hz}}$ at 10 Hz, and is typically much better. Single-sided noise figure specification is the same as the conversion efficiency specification shown above, but with the frequency of the X port extending from 50 kHz to the upper limit frequency. The balance specifications are extremely good, 12 to 45 dB (typical performance much better), depending upon frequency and test connections.

HEWLETT  PACKARD

ON READER-SERVICE CARD CIRCLE 47

State of the monolithic art

Radiation's Diode Matrices and High Voltage interface circuits provide all monolithic circuits for a cold cathode numeric display

A simplified approach to the design of BCD decode networks is now possible using Radiation 8 x 5 Monolithic Diode Matrices. Other integrated BCD decoders are limited to only one weighted binary code. However, Radiation Matrices can be "customized" to any weighted binary code to decimal conversion. This design flexibility is achieved through Radiation's fusing technique for selecting desired coding patterns.

The 8-4-2-1 BCD decoder display, shown at left, is only one example of the many possible monolithic circuit displays which can be formed. The circuit requires only two Radiation 8 x 5 RM-17 Monolithic Diode Matrices. Data storage is provided by two Radiation RD-521 Dual Pulse Triggered Binary elements, while two high-voltage RD-536 Hex Indicator Drivers directly drive the cathodes of the cold cathode numeric indicator tube.

Extremely high counting rates can be achieved, since frequency is limited only by the counters.

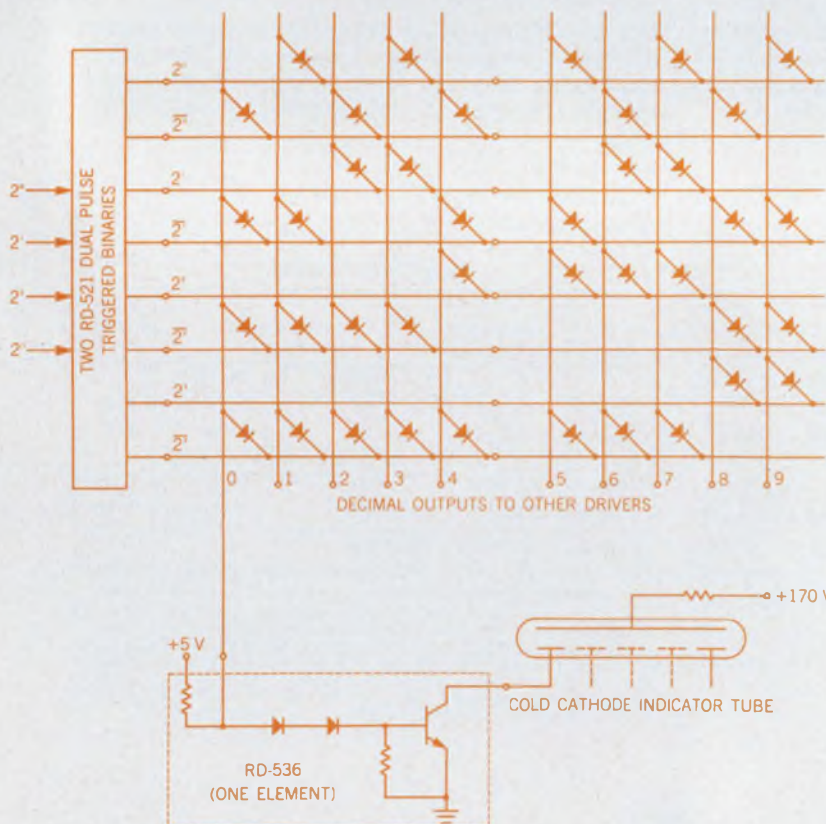

TRUTH TABLE

2^0	0	1	0	1	0	1	0	1	0	1
2^1	0	0	1	1	0	0	1	1	0	0
2^2	0	0	0	0	1	1	1	1	0	0
2^3	0	0	0	0	0	0	0	0	1	1
Decimal output	0	1	2	3	4	5	6	7	8	9

Note: True logic positive. Only one output will be true at any one time.

Radiation Monolithic Diode Matrices and interface circuits are supplied in TO-84s as well as in ceramic dual in-line packages.

State of the design art

Radiation's popular dielectrically isolated matrices provide an unusual degree of flexibility. (1) RM-17 Matrices contain 40 active devices per chip. (2) A fusible link in series with each diode permits unlimited matrix patterns to be formed. And (3), circuits can be combined to produce an almost infinite variety of size configurations.

In addition to flexibility, Radiation 8 x 5 Matrices offer the increased reliability of monolithic construction. Size and weight requirements are slashed through reduced package count. Further, cost of matching, testing and assembly of discrete diodes is eliminated.

Production has been expanded to guarantee fast shipment of ma-

trices "customized" to your exact requirements. In fact, most orders are shipped on a 24-hour basis.

A new low-cost RM-114 design in a ceramic dual in-line package is available in volume at a unit price of \$4.00—and can be supplied to any code configuration requested.

Write for data sheets on the entire line of Radiation Monolithic Diode Matrices. *Worst-case limits* are included, as well as all information required by design engineers. We'll also be glad to supply our new manual, Monolithic Diode Matrix Technical Information and Applications. For your copy, request publication number RDM-T01/A01 from our Melbourne, Florida office.

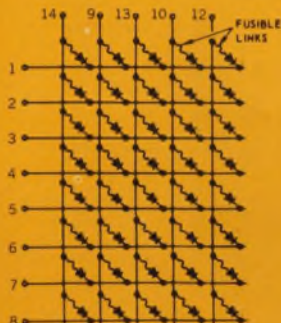

BEFORE "CUSTOMIZING"



Radiation 8 x 5 Monolithic Diode Matrices* (typical limits)

Characteristic	Symbol	RM-17	RM-19	RM-14 RM-114†	Unit	Test conditions ($T_A = +25^\circ\text{C}$)
Forward drop	V_F	1.0 0.7	1.3 0.75	1.0 0.7	V	$I_F = 20\text{ mA}$ $I_R = 1\text{ mA}$
Reverse breakdown	BV_R	60	60	50	V	$I_R = 100\ \mu\text{A}$
Reverse current	I_R	7	25	70	nA	$V_R = 25\text{ V}$
Reverse recovery	t_{rr}	7	11	30	ns	$I_F = 10\text{ mA}$ $I_R = 10\text{ mA}$
Crosspoint capacitance	C_{cp}	1.9	1.9	2.0	pF	$V_R = 5\text{ V}; f = 1\text{ MHz}$
Coupling coefficient	I_{CL}	20	20	20	μA	See data sheet

*Supplied in T0-84 packages. †Supplied in ceramic dual in-line package.

All Radiation integrated circuits are dielectrically isolated.



**RADIATION
INCORPORATED**
MICROELECTRONICS DIVISION

Sales offices: Suite 622, 650 North Sepulveda Blvd., El Segundo, Calif. (213) 772-6371—Suite 232, 600 Old Country Road, Garden City, N. Y. (516) 747-3730—Suite 201, 1725 Eye Street, N. W., Washington, D.C. (202) 337-4914—P.O. Box 37, Dept. ED-05, Melbourne, Florida (305) 723-1511, ext. 554

ON READER-SERVICE CARD CIRCLE 148

Radiation's Operational Amplifiers are ideal for use in DC servo preamplifiers. They simplify design, offer unconditional stability without external compensation, and allow accurate determination of lag and lead frequencies.

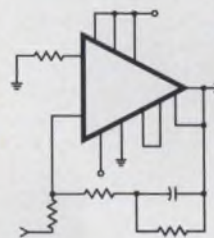

For example, Radiation's RA-239 Broadband Amplifier is used in the lag-lead DC servo preamplifier illustrated. Feedback components are selected to optimize overall preamplifier parameters...with-out regard to the active element in this configuration.

For a gain of 100, the preamplifier will provide full output up to 140 kHz. Undistorted output voltage is 21.6 V_{P-P}. Total swing is + 10.8 V to -12.2 V.

The stability and versatility of Radiation's Operational Amplifiers is made possible through advanced dielectric isolation and thin film over oxide technology.

For further information, refer to our ELECTRONICS advertisements of June 26.

Write for data sheets on our entire line of operational amplifiers. *Worst-case limits* are included, as well as all necessary design information.

We'll also be glad to send a copy of our new manual, Operational Amplifier Technical Information and Applications, ROA-T01/A01. Contact our Melbourne, Florida office for your copy.



ON READER-SERVICE CARD CIRCLE 149

Galvanometer with brains



ESI has combined the best features of the classic galvanometer and the modern electronic voltmeter in the Model 900 Nanovolt Galvanometer.

How do you create a galvanometer with true nanovolt sensitivity that is really *practical* to use... an instrument that doesn't require hours of delicate dial twiddling, trapdoor adjustments or experimental hook-ups?

You give it brains. Brains in the form of feedback circuits that automatically control speed of response and damping for each of its 12 calibrated ranges. *Our Model 900 Nanovolt Galvanometer operates from any source resistance without changes in speed of response or damping characteristics.* Noise is less than 2 nanovolts for any source impedance.

The instrument consists of *two* units—the control unit shown above, which is the brains of the outfit, and a galvanometer unit. The Model 900 is ideal for use with high-accuracy and high-resolution potentiometers and bridges; for the calibration of thermo-couples, strain gauges, thermopiles, standard cells and the like. It also has applications in the measurement of tiny voltages or currents in experimental chemistry, physics, biology or medicine. A fixed input resistance of 1 kilohm allows calibrated ranges for *both* voltages and current.

Through solid state circuitry, we've been able to combine the best of two worlds in the Model 900. It has the high sensitivity and ac rejection of mechanical galvanometers. But it also has the multiple calibrated ranges, meter readout, and operation simplicity of modern electronic voltmeters. It's an honest nanovoltmeter with high sensitivity and complete guarding to simplify measurements in the microvolt area.

You'll have more time to use your own brains if your galvanometer has some of its own.

ESI, 13900 NW Science Park Dr. Portland, Oregon 97229.

Electro Scientific Industries **esi.**

ON READER-SERVICE CARD CIRCLE 50

COMPONENTS

Thin spot heaters produce up to 450°F

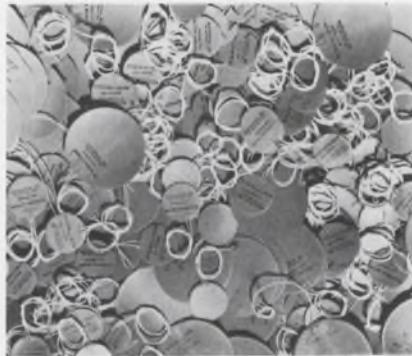

Electrofilm, Inc., 7116 Laurel Canyon Blvd., N. Hollywood, Calif. Phone: (213) 875-1000.

Spot heaters can produce 2, 5 or 10 watts/in². The heaters contain a high-reliability heating element and conductors laminated in silicone rubber. They can obtain surface temperatures up to 450°F. They are 0.045 inch thick, flexible, and have a dielectric capability of 1000 Vac. Heaters are available in 2, 4, 6, 8 and 12-inch diameters for each watt/in².

CIRCLE NO. 372

Solid 90° elbows for EMI/RFI shield

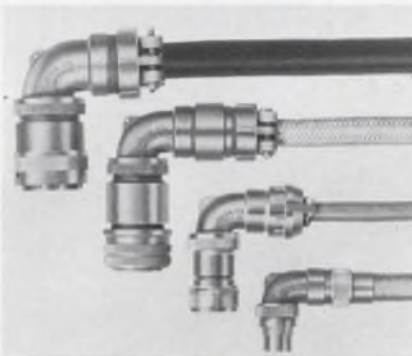

Glenair, Inc., 1211 Air Way, Glendale, Calif. Phone: (213) 245-8587.

Available in 12 cable entry sizes, these 90° solid elbows provide EMI/RFI shield termination, cable jacket sealing, cable-to-connector mating or any combination thereof. All elbows feature a positive 30° clocking action for cable orientation. Designed to fit circular connectors such as MIL-C-5015, MIL-C-26482, MIL-C-22992, MIL-C-26500, MIL-C-38300, MIL-C-3899 and NAS 1599, the elbows are available with a choice of strain reliefs.

CIRCLE NO. 373

Fine-mesh shield cuts pushbutton RFI

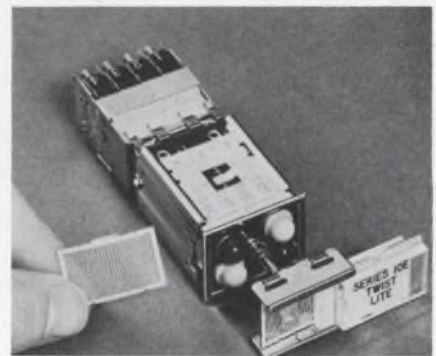

Master Specialties Co., 1640 Monrovia, Costa Mesa, Calif. Phone: (714) 642-2427.

Four-lamp lighted pushbutton switches use a built-in, fine-mesh shield to protect circuitry from radiated or conducted RFI through control panel cutouts. The shield is constructed of silver-plated beryllium copper. Attached to the switch lens retainer behind the display screen, the shield makes contact with the housing of the switch-light in four separate areas to ground any RFI.

CIRCLE NO. 374

Time delay relays range 0.1 to 60 seconds



Tele-Craft Electronics Co., 125 Schmitt Blvd., Farmingdale, N. Y. Phone: (516) 694-4300.

Time delay relays are available with fixed or adjustable delays in ranges from 0.1 to 60 seconds. Sealed timers can be provided with automatic reset if the cycle is interrupted before timing out. SCR output to operate external relay or other trip device is rated nominally 2 A and 200 V. Input to the timers is 115 Vac or 24 Vdc.

CIRCLE NO. 375

100 watt CW TWT's from Varian

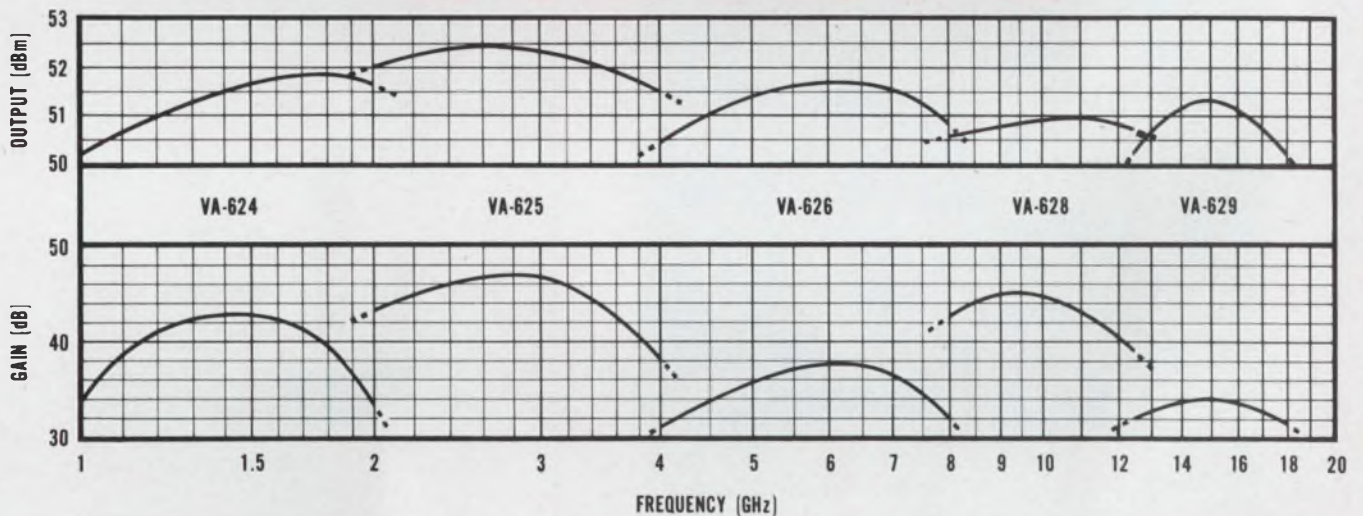

Varian's ≥ 50 dBm CW TWT's offer unmatched performance over the 1 to 18 GHz frequency range. These tubes can be supplied with air or conduction cooling and are conservatively rated at 100 watts, but can be supplied to deliver over 200 watts of r-f output power. (Similar TWT's are available at the ≥ 20 watt level).

For complete information on Varian's TWT capabilities, write the Palo Alto Tube Division, 611 Hansen Way, Palo Alto, California. In Europe: Varian A.G., Zug, Switzerland. In Canada: Varian Associates of Canada, Ltd., Georgetown, Ontario, Canada.



ON READER-SERVICE CARD CIRCLE 51

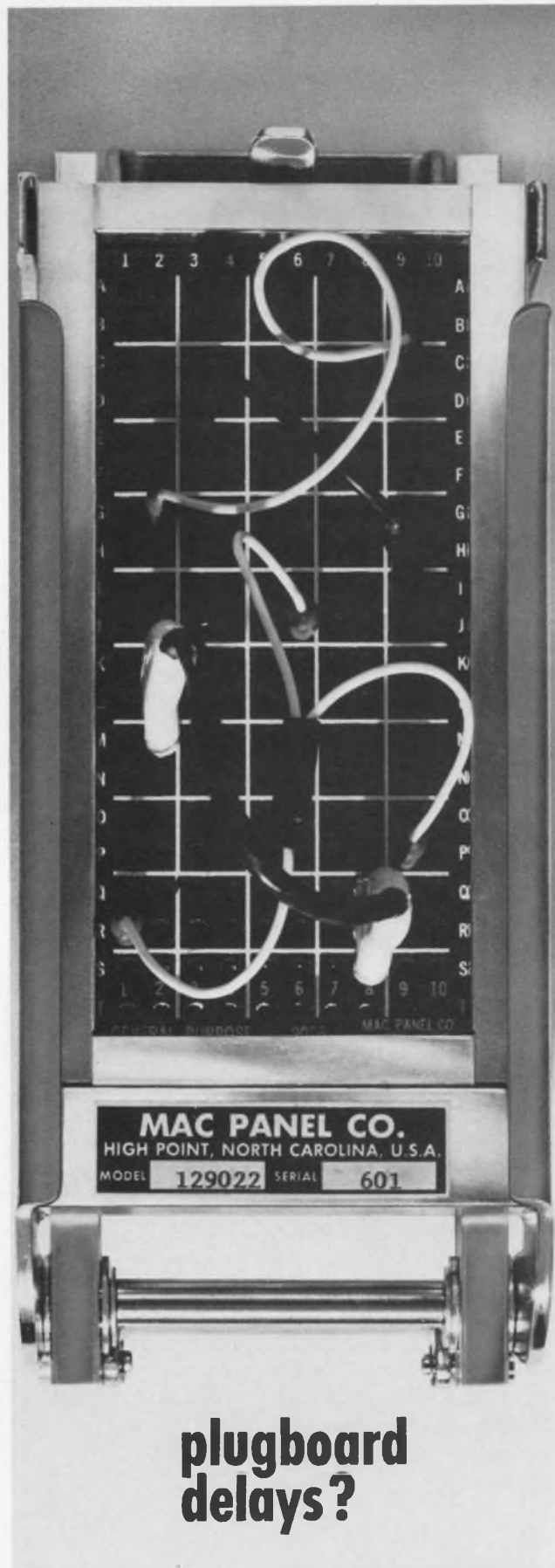

**plugboard
delays?**

MAC ships off-the-shelf!

ON READER-SERVICE CARD CIRCLE 52

COMPONENTS

Synchro/resolvers measure error to 2 s

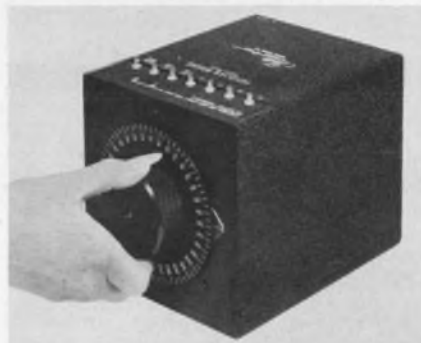

Theta Instrument Corp., Saddle Brook, N. J. Phone: (201) 843-6060. P&A: from \$300; stock.

Panel-mounted synchro and resolver bridges measure electrical error and conform to MIL-S-20708B. The bridges do not in any way affect the characteristics of the synchro itself through impedance loading or switching transients. Models are available with built-in meters or digital indicators to directly display electrical error. Range is 0 through 360° with an accuracy to 2 seconds of arc. Impedance is 10 k Ω or 100 M Ω and interval is 5°.

CIRCLE NO. 376

Test point connector for computer circuits

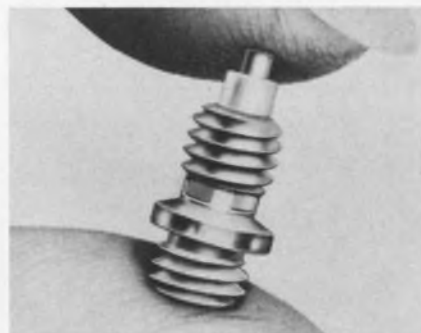

Hugh H. Eby Co., 4701 Germantown Ave., Philadelphia. Phone: (215) 324-7000.

A test point connector claims a high degree of stability and uniformity of insertion and retention values. The device is for use with an 0.031-inch diameter pin and has applications in the testing of computer circuits. The body of the test point is silver-plated brass, and the insulator is Teflon. A stamped, wrap-around type contact of gold-plated beryllium copper is used.

CIRCLE NO. 377

ASSEMBLE THIS WEATHERPROOF CONNECTION

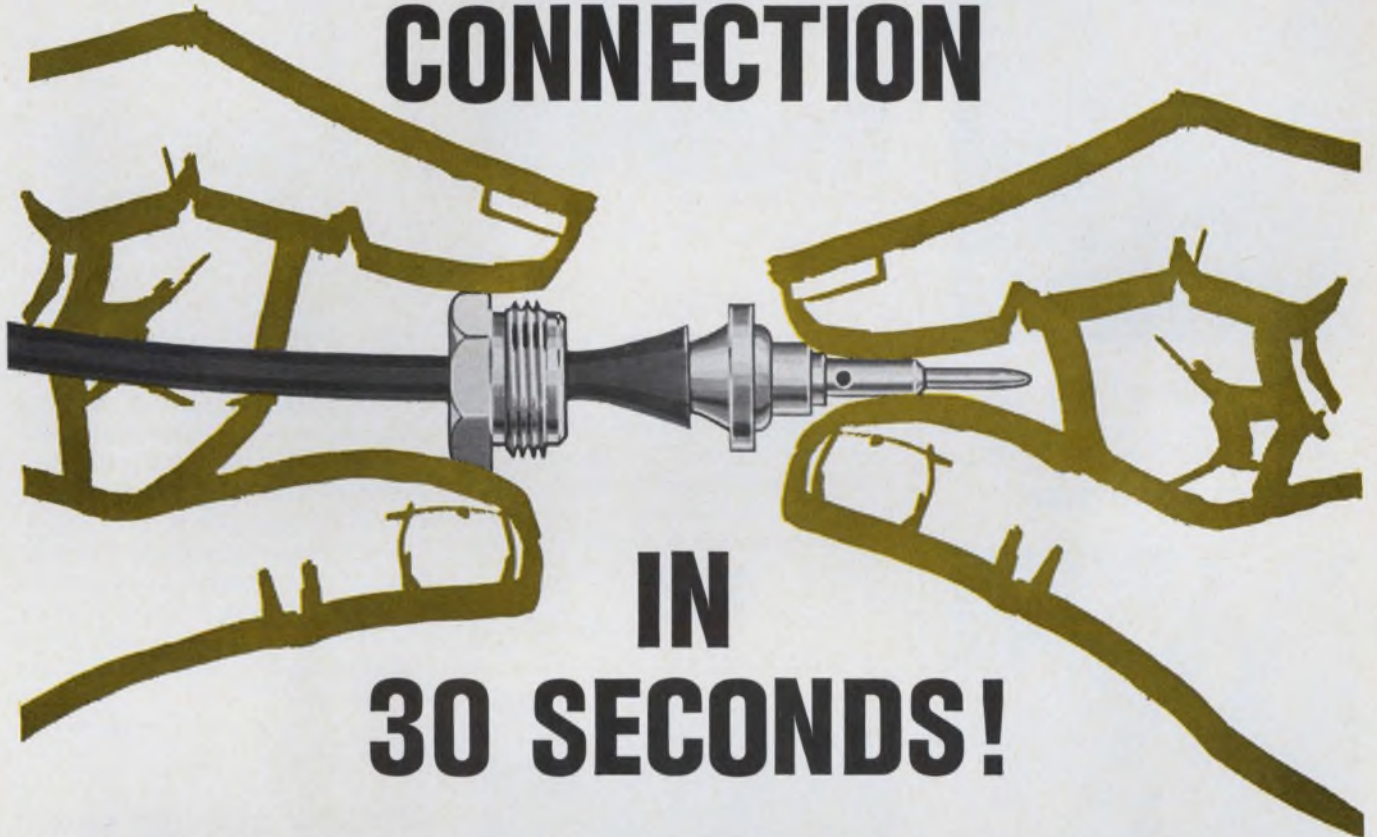

Again, BENDIX/DAGE engineering has solved a major problem for equipment builders! New DAGE Square-Cut RF Connectors reduce assembly time 50%-75% . . . produce weathertight seals with a pull test of 50 lbs. Only 3 parts—no special tools required!

Time-and-money-saving benefits of

Square-Cut Connectors are typical of BENDIX/DAGE contributions to the state of the art . . . *practical* ideas that help you design for greater capability in *your* circuitry and equipment.

Write for Square-Cut literature. If you have a special problem, call Dage Engineering Department. Call today!

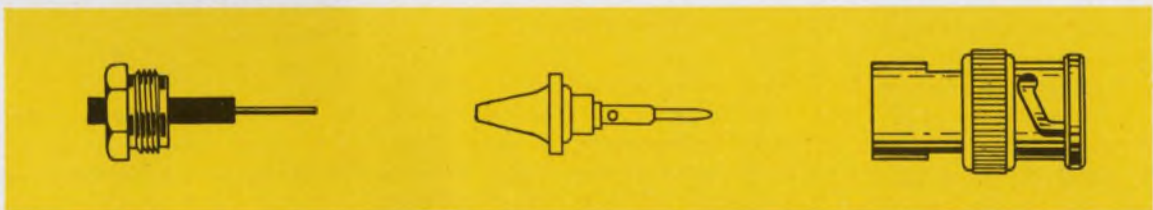

DAGE ELECTRIC COMPANY

a subsidiary of the Bendix Corporation

Hurricane Road • Franklin, Ind. • Phone 317/736-6136

FIRST WITH IDEAS • FIRST WITH QUALITY • FIRST WITH SERVICE

ON READER-SERVICE CARD CIRCLE 53

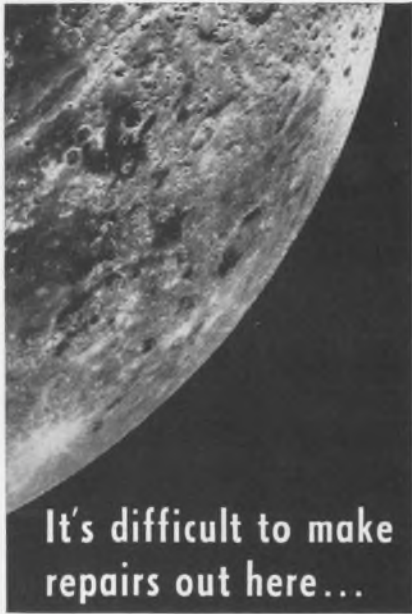

It's difficult to make repairs out here...

...so leading firms use REEVES-HOFFMAN crystals down here

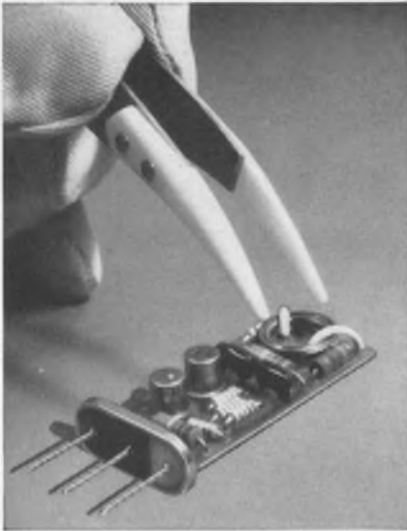

To guard against failure of the crystal "heart"—in outer space, under the sea, and in commercial and consumer applications — leading electronics firms specify Reeves-Hoffman. If reliability is important to you, we invite your inquiry concerning crystals and crystal-controlled filters and oscillators.

(Unit shown: RH 2967 microminiature oscillator in RH-13 enclosure, 1.5" x .725" x .317")



400 WEST NORTH STREET, CARLISLE, PENNSYLVANIA 17013
ON READER-SERVICE CARD CIRCLE 54

COMPONENTS

High-resolution preamp uses FET input

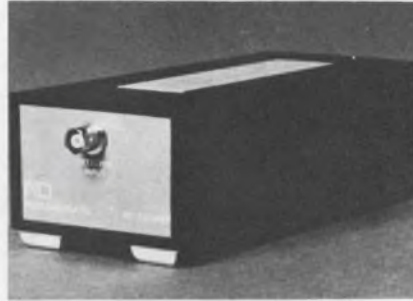

Nuclear Data, Inc., 100 W. Gold Rd., Palatine, Ill. Phone: (312) 529-4600.

A charge-sensitive preamp provides the low-noise linear preamplification necessary for application of solid-state radiation detectors. Input circuitry contains two FETs connected in parallel, to provide the low-noise performance. Inputs with four parallel-connected FETs for greater low-noise performance with detector capacitance exceeding 250 pF are available.

CIRCLE NO. 378

Vitreous enamel resistor rated at 15 watts



Ohmite Manufacturing Co., 3680 Howard St., Skokie, Ill. Phone: (312) 675-2600.

Wirewound molded vitreous enamel resistors are rated at 15 watts. They are offered in a resistance range of 0.1 Ω to 243 k Ω . The resistor is available in three styles: a commercial type with a standard tolerance of 5%, a high-stability type with a standard tolerance of 3% (tolerances to 0.25% available) and a resistor which complies with style RW56 (14 watts) of MIL-R-26 but has a slightly higher wattage rating. Uniform thickness of the enamel jacket guarantees 1000-Vac insulation breakdown.

CIRCLE NO. 379

Resistance thermometer barely a thumbful

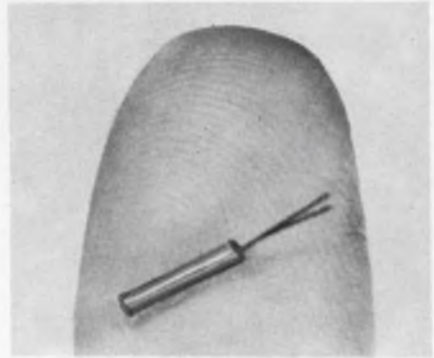

Minco Products, Inc., 740 Washington Ave. North, Minneapolis. Phone: (612) 338-6753. Price: \$12 to \$52.50.

Measuring 0.08 inch in diameter and 0.46 inch long, this thermometer has a CP nickel element that has a resistance of approximately 284 Ω at -40°F and 673 Ω at $+250^{\circ}\text{F}$. The device has applications in compact or lightweight instrumentation packages, medical, laboratory, and other applications where small size, light weight, and high gain are desired.

CIRCLE NO. 380

Crossbar selector switch replaces 30 wafers

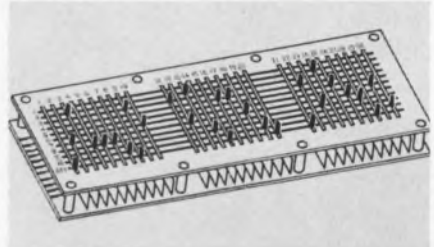

Cherry Electrical Products Corp., 1650 Old Deerfield Rd., Highland Park, Ill. Phone: (312) 432-8182. P&A: \$43; stock.

Time, effort and expense involved in using rotary switches for programming are reportedly reduced by the C10-43A crossbar type selector switch. This high-density switch replaces 30 single wafer switches (10 position), occupies 41 in² of panel space and requires no soldering. The switch can be installed in less than five minutes. The C10-43A selector switch has 300 crosspoints.

CIRCLE NO. 381

Now—the broadest line of convection-cooled, all silicon, .015% regulated power supplies

For test equipment and lab use—rack or bench
0-10, 0-20, 0-40, 0-60, 0-120 VDC, from 0-.5 amp to 0-66 amps—

Features and Data

- Full five year guarantee on materials and labor
- Convection Cooled
- Remote Programming
- Regulation—.015% or 1 MV (Line or Load)
- Temp. Coef. .015%/°C
- Completely Protected—Short circuit proof—Continuously adjustable Automatic current limiting
- Remote Sensing
- Constant I./Constant V. by automatic crossover
- Series/Parallel Operation
- No Voltage Spikes or Overshoot on "turn on", "turn off" or power failure
- Ripple—LK models—500 μ V RMS
LH models—250 μ V RMS, 1 MV P-P
- Meet MIL Environment Specs

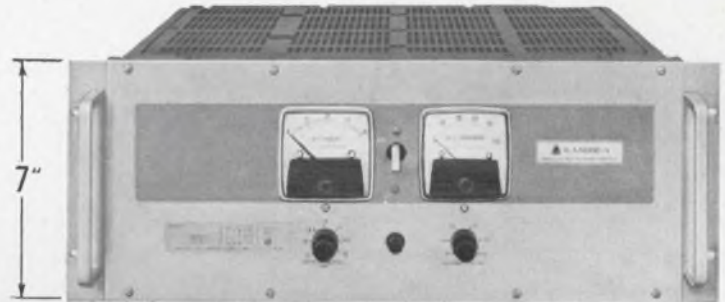

Full Rack 7" LK Series

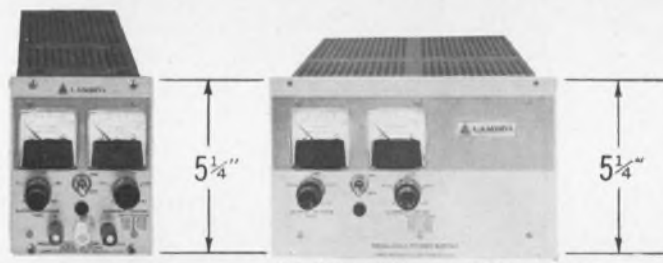

1/4 Rack LH Series

1/2 Rack LK Series-LH Series

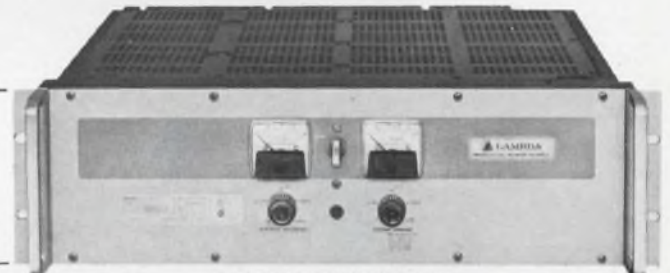

Full Rack 5 1/4" LK Series

3 Full-rack Models — Size 7" x 19" x 18 1/2"

Model ¹	Voltage Range	CURRENT RANGE AT AMBIENT OF: ¹				Price ²
		40°C	50°C	60°C	71°C	
LK 360 FM	0-20VDC	0-66A	0-59A	0-50A	0-40A	\$995
LK 361 FM	0-36VDC	0-48A	0-43A	0-36A	0-30A	950
LK 362 FM	0-60VDC	0-25A	0-24A	0-22A	0-19A	995

3 Full-rack Models — Size 5 1/4" x 19" x 16 1/2"

Model ¹	Voltage Range	CURRENT RANGE AT AMBIENT OF: ¹				Price ²
		40°C	50°C	60°C	71°C	
LK 350	0-20VDC	0-35A	0-31A	0-26A	0-20A	\$675
LK 351	0-36VDC	0-25A	0-23A	0-20A	0-15A	640
LK 352	0-60VDC	0-15A	0-14A	0-12.5A	0-10A	650

5 Quarter-rack Models — Size 5 3/16" x 4 7/16" x 15 1/2"

Model ¹	Voltage Range	CURRENT RANGE AT AMBIENT OF: ¹				Price ²
		30°C	50°C	60°C	71°C	
LH 118	0-10VDC	0-4.0A	0-3.5A	0-2.9A	0-2.3A	\$175
LH 121	0-20VDC	0-2.4A	0-2.2A	0-1.8A	0-1.5A	159
LH 124	0-40VDC	0-1.3A	0-1.1A	0-0.9A	0-0.7A	154
LH 127	0-60VDC	0-0.9A	0-0.7A	0-0.6A	0-0.5A	184
LH 130	0-120VDC	0-0.50A	0-0.40A	0-0.35A	0-0.25A	225

11 Half-rack Models — Size 5 3/16" x 8 3/8" x 15 1/2"

Model ¹	Voltage Range	CURRENT RANGE AT AMBIENT OF: ¹				Price ²
		40°C	50°C	60°C	71°C	
LK 340	0-20VDC	0- 8.0A	0- 7.0A	0- 6.1A	0-4.9A	\$330
LK 341	0-20VDC	0-13.5A	0-11.0A	0-10.0A	0-7.7A	385
LK 342	0-36VDC	0- 5.2A	0- 5.0A	0- 4.5A	0-3.7A	335
LK 343	0-36VDC	0- 9.0A	0- 8.5A	0- 7.6A	0-6.1A	395
LK 344	0-60VDC	0- 4.0A	0- 3.5A	0- 3.0A	0-2.5A	340
LK 345	0-60VDC	0- 6.0A	0- 5.2A	0- 4.5A	0-4.0A	395

Model ¹	Voltage Range	CURRENT RANGE AT AMBIENT OF: ¹				Price ²
		30°C	50°C	60°C	71°C	
LH 119	0-10VDC	0- 9.0A	0- 8.0A	0- 6.9A	0-5.8A	\$289
LH 122	0-20VDC	0- 5.7A	0- 4.7A	0- 4.0A	0-3.3A	260
LH 125	0-40VDC	0- 3.0A	0- 2.7A	0- 2.3A	0-1.9A	269
LH 128	0-60VDC	0- 2.4A	0- 2.1A	0- 1.8A	0-1.5A	315
LH 131	0-120VDC	0- 1.2A	0- 0.9A	0- 0.8A	0-0.6A	320

- ¹ Current rating applies over entire voltage range.
² Prices are for non-metered models (except for models LK360FM thru LK362FM which are not available without meters). For metered models, add suffix (FM) and add \$25 to price of LH models; add \$30 to price of LK models.
³ Overvoltage Protection: add suffix (OV) to model number and add \$60 to the price of LH models; add \$70 to price of half-rack LK models; add \$90 to price of 5 1/4" full-rack LK models; add \$120 to price of 7" full-rack LK models.
⁴ Chassis Slides for full rack models: Add suffix (CS) to model number and add \$60 to the price.



LAMBDA ELECTRONICS CORP.

515 BROAD HOLLOW ROAD • MELVILLE, L.I., NEW YORK 11746 • (516) 694-4200 A  SUBSIDIARY

Here's What Heath Means By Value . . .

**New Solid-State High Impedance V-O-M
Factory Assembled \$115; Kit \$80**



The Unique New Heathkit IM-25 With Features and Performance Never Before Available At Less Than \$200

- Built-in 120/240 VAC, 50-60 Hz Power Supply Plus In-Cabinet Holders For Battery Supply During Portable Operation • 13 Silicon Transistors Plus 2 Field Effect Transistors • 11 Megohm Input Impedance on DC • 10 Megohm Input Impedance on AC • 9 DC Voltage Ranges from 150 Millivolts Full Scale to 1500 Volts Full Scale . . . Accuracy $\pm 3\%$ Full Scale • 9 AC Voltage Ranges from 150 Millivolts Full Scale to 1500 Volts Full Scale . . . Accuracy $\pm 5\%$ Full Scale • 7 Resistance Ranges, 10 Ohms Center Scale $\times 1$, $\times 10$, $\times 100$, $\times 1k$, $\times 10k$, $\times 100k$, $\times 1$ meg . . . Measures from one ohm to 1000 megohms
- 11 Current Ranges from 15 μ A Full Scale to 1.5A Full Scale • Superior Accuracy on Current Measurements . . . $\pm 4\%$ on DC; . . . $\pm 5\%$ on AC • AC Response to 100 kHz • 6", 200 μ A Meter With Zero Center Scales For Positive and Negative Voltage Measurements Without Switching • 1% Precision Resistors • Separate Switch For Each Function Eliminates Constant Changing • Ten-Turn Thumbwheel Zero Adjustment For Precision Settings • Easy Circuit Board Assembly • New Heath Instrument Styling With "Unitized" Construction and Low Profile Appearance; Color Styled in Handsome Beige and Black

Kit IM-25, 10 lbs. (Available May) **\$80.00**
Assembled IMW-25, 10 lbs. (Available June) **\$115.00**

New Lower Kit Price on Professional IO-14 DC Oscilloscope . . . Now Save \$40



**A Better Buy
Than Ever . . .**

Kit Now Only \$259, Factory Assembled \$399

- High stability 5" DC oscilloscope with triggered sweep • DC to 8 MHz bandwidth, 40 nanosecond rise time • Vertical signal delay through high linearity delay lines — capable of faithful reproduction of signal waveforms far beyond the bandwidth of the scope • Calibrated vertical attenuation • Calibrated time base • Forced air cooling • Input for Z axis modulation • Input for direct access to vertical deflection plates • Easy circuit board construction & wiring harness assembly • Components are packaged separately for each phase of construction • Easy to align • Fulfills many production and laboratory requirements at far less cost • Wiring options enable 115/230 volt, 50-60 Hz operation

Kit IO-14, 53 lbs. Was \$299.00, **Now Only \$259.00**
Assembled IOW-14, 47 lbs. **\$399.00**

HEATH COMPANY, Dept. 520-26 Benton Harbor, Mich. 49022 In Canada, Daystrom Ltd.		
<input type="checkbox"/> Please send my FREE 1967 Heathkit Catalog.		
<input type="checkbox"/> Enclosed is \$ _____, plus postage.		
Please send model(s) _____		
Name _____		
Address _____		
City _____ State _____ Zip _____		
Prices & Specifications subject to change without notice. TE-161		

ON READER-SERVICE CARD CIRCLE 56

COMPONENTS

Polycarbonate caps mount PC boards

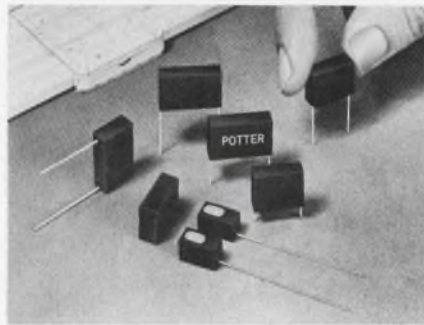

Potter Co., Wesson, Miss. Phone: (601) 643-2216. P&A: 32¢ to \$1.50; 4 to 6 wks.

Metallized polycarbonate capacitors with radial leads for PC board mounting range from 0.001 to 2 μ F. The 3908 series operate at full rated voltage from -55° to $+125^{\circ}$ C without derating and are available in three voltage ratings: 200, 400 and 600 Vdc. They will withstand the application of 140% rated voltage at 125° C for 250 hours and have a dissipation factor of less than 0.5% at 25° C and 1 kHz. Standard tolerance is $\pm 20\%$, but ± 10 , ± 5 , ± 2 and $\pm 1\%$ are available.

CIRCLE NO. 382

Component breadboard for discretes, ICs

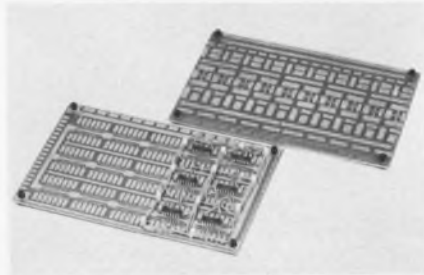

Andresen Enterprises, Inc., 3691 Lee Rd., Cleveland. Phone: (216) 561-4100. Price: \$4.85 (1 to 9).

Components are tacked on top of conveniently arranged pads on these printed circuit breadboards to form expedient connections. IC dual-in-line modules are similarly tacked on and interconnected with hook-up wire. Since no cutting of component leads is necessary, all components can be salvaged after use. The breadboards are made on a phenolic base with 2-oz copper-clad 60/40 solder-plated.

CIRCLE NO. 383

read a little



Pay a Little. The price is as small as the product. It's a miniature rear projection readout, and it costs as little as \$14.00. The new IEE Series 345 Readout requires very little space, but it offers the readability and versatility available only with rear projection readouts. And the price is comparable to other types of readouts with limited messages and cluttered displays.

The Series 345 operates on the rear projection principle. A lamp in the rear of the unit illuminates one of the 11 film messages, and projects it to the front viewing screen. A single plane display on the non-glare screen, so you get no distortion or confusion. It is very versatile, since anything that can be put on film can be displayed on the screen. You can display a variety of messages or colors.

The Series 345 has a front plug-in feature. It can be quickly inserted into the housing. It can be just as easily removed to insert a new readout with a different display, or to replace a lamp.



Series 345 Readout: 1/2" wide x 3/4" high. Six digits will fit in a 3" wide panel space. Depth, 2 1/2". Character height, 3/8". Weight, 3/4 oz. Six available colors, including white, amber, yellow, blue, red or green.

Straight decimal input. Vertical and horizontal viewing angle 175° with V-1 viewing screen, or 160° with standard screen.



"I double-E," the world's largest manufacturer of rear projection readouts.
Industrial Electronic Engineers, Inc., 7720 Lemona Ave., Van Nuys, California

ON READER-SERVICE CARD CIRCLE 57

DESIGN PROBLEMS?

solve them with
PIONEER
PHOTOCELLS



A 1" photocell, especially designed for numerous applications in outside or inside lighting, flame control, and relay applications where the light source is incandescent. Proven by

hundreds of thousands of photocell years of service. Shown actual size—standard models available.



Has the same general characteristics as the CDS-9 but a smaller size (1/2") for use where space is at a minimum. Shown actual size—standard models available.

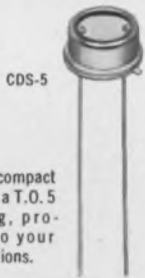

A very compact unit with a T.O. 5 housing, produced to your specifications.

Our engineering department will work with you on any special application of photosensitive layers.

STANDARD MODELS

CDS Type No.	1 FC Simulated Daylight 50 V AC Mean* Output	Nominal Resistance 50 FC 2800* K Incand.	Max. Dark Current** or Min. Dark Resistance	Max. Dissip.	Max. Volt Dark
701	1.5 ma		25 ua		500 V
702	3 ma		25 ua	all rated	500 V
703	6 ma		40 ua	1/4 watt continuous	350 V
710		1330 ohms	4 meg.	1 watt	500 V
711		670 ohms	4 meg.	1 minute	500 V
712		330 ohms	2.5 meg.		350 V
901	1.5 ma		25 ua	All rated	1000 V
902	3 ma		25 ua		1000 V
903	6 ma		40 ua	1/2 watt	700 V
904	12 ma		200 ua	contin-uous	500 V
910		1330 ohms	4 meg.		1000 V
911		670 ohms	4 meg.	2 watts	1000 V
912		330 ohms	2.5 meg.	1 minute	700 V
913		165 ohms	0.5 meg.		500 V

*Range of values in any category equal to $\pm 33\%$ of mean.
**Measured at 100 V, 5 seconds after 50 FC light extinguished.

THE **PIONEER**

ELECTRIC & RESEARCH CORPORATION
Subsidiary of **QORON** Controls, Inc.
743 Circle Ave., Forest Park, Ill. 60130
Telephone: (312) 771-8242

COMPONENTS

15-turn dial mounts on pot shafts

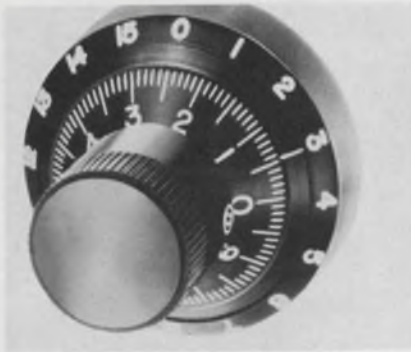

IRC, Inc., 401 N. Broad St., Philadelphia. Phone: (215) 922-8900. P&A: \$6.50 (100 lots); 30 days.

Two 15-turn dials are designed for use with multiturn precision potentiometers. The 1-inch diameter dials have an angular surface for easy readout. Primary and secondary scale presentation is 000 to 1499. Set-screwed directly to a potentiometer shaft, there is no backlash and no necessity for extra panel holes. Designated RDK-411 (black with white figures) and RDK-461 (clear with black figures), they accept a 1/4-inch shaft and mount on a 3/8-32 NEF 2A threaded bushing.

CIRCLE NO. 384

Piston trimmer operates over full MIL range

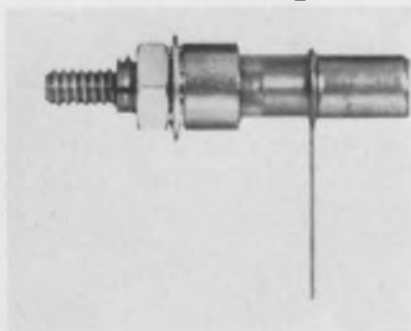

Erie Technological Products, Inc., Erie, Pa. Phone: (814) 456-8592.

A direct-drive piston trimmer operates over the full military temperature range of -55 to $+85^\circ\text{C}$. The unit incorporates a dielectric of polyphenylene oxide with a typical Q of 1000 at 3 GHz. Rated at 250 wVdc, the part has tuning resolution of 0.37 pF/360° turn and offers a capacitance range of 0.8 to 4.5 pF.

CIRCLE NO. 385

Bandpass filters stable to 0.5%

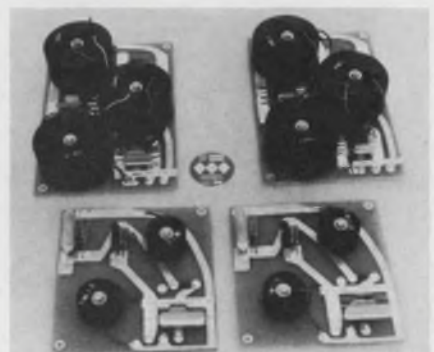

TRF, Inc., 6641 Backlick Rd., Springfield, Va. Phone: (703) 451-5131. P&A: \$40 to \$240; 15 to 30 days.

Low-frequency passive bandpass filters are based on computer-derived tables and feature zero insertion loss. They are available in single or multiple-pole configurations and offer symmetrical and other customer-specified passband characteristics with 0.5% frequency stability over a 0° to 50°C temperature environment. Center frequency is 1 kHz to 1 MHz with a 3-dB bandwidth of 3 to 20%.

CIRCLE NO. 386

Programmable switch cuts output reset time

Marconi Instruments, 111 Cedar Lane, Englewood, N. J. Phone: (201) 567-0607. Price: \$120 (2-way), \$170 (4-way), \$245 (8-way).

Users of signal generators on production line testing of receivers can use this programmable switch. Previously, to make receiver sensitivity and overload measurements using a signal generator, the piston attenuator had to be moved through its complete travel. By using this switch in conjunction with fixed pads, two levels of output (100 mV and 0.1 μV) can be selected. Operation of the coax switch can be automated or manually controlled from an external switch. Since the output level is set by the fixed pad, exact reduplication of settings is achieved with high absolute accuracy. Insertion loss of the switch is 0.9 dB at 1 GHz with vswr of 1.25. Four- and eight-position models are available.

CIRCLE NO. 387

don't confuse it with a tube...



Actual Size

RCA's new 40468 (MOS)FET performs like a tube with its exceptionally low cross modulation, high unneutralized gain and wide dynamic range, but it's a solid state device.

Now for the first time you can design solid-state front-ends for hi-fi FM radios, receivers, and tuners without compromising performance or sacrificing gain...at economy prices!

Because of its excellent square law characteristics and wide dynamic range, the new RCA 40468 (MOS)FET can greatly reduce spurious responses and interference from undesired signals. Very low cross modulation distortion makes it an exceptionally fine RF amplifier or mixer, offering noticeably better performance than is possible with bipolar transistors.

Extremely low feedback capacitance (0.2 pF max.) provides as much gain *without* neutralization as junction

FET types do with neutralization, so you can reduce production costs. If neutralization is added, even more stable gain can be achieved.

In addition, the RCA 40468 (MOS)FET's insulated gate permits large signal swings to be handled at the maximum gain point without input circuit detuning or loading.

Investigate the advantages of designing RCA's 40468 (MOS)FET into FM receivers, tuners, and auto radios. Your RCA Field Representative will be glad to give you complete information, including price and delivery. For a technical data sheet, write RCA Commercial Engineering, Section EG5-2, Harrison, New Jersey 07029.

ALSO AVAILABLE THROUGH YOUR RCA DISTRIBUTOR.



RCA Electronic Components and Devices

The Most Trusted Name in Electronics.

ON READER-SERVICE CARD CIRCLE 59

From the recognized leader in

CLARE offers

Two SIZES

Three PACKAGE CONFIGURATIONS

Four DIFFERENT SWITCHES

Five COMPLETE LINES



- A. Clareed Open-coil Relays for pcb (CRT, CRTN)
- B. Clareed Metal-enclosed Modules for pcb (CRM)
- C. Clareed Relays (plug-in or solder type) for wired assemblies (CRA, CRB)
- D. MicroClareed Epoxy-molded Modules for pcb (MRME)
- E. MicroClareed Open-coil Relays for pcb (MRMC)

CLAREED RELAY CHARACTERISTICS				
	GENERAL PURPOSE	HIGH VOLTAGE	MERCURY-WETTED	MICROCLAREED
Contact Arrangements Enclosed Modules (up to 3 spaces) Open Coil Modules (up to 12 spaces) Round Cans (up to 12 spaces)	Forms A, B, C A, B, C A, B, C	Forms A, B, C A, B, C A, B, C	Forms A, B A, B A, B	Up to 5 form A Up to 5 form A
Contact Rating Switched Load Carry Load	15 va max., non-inductive 1 amp max., 250 v max. 5 amps max., not switched	15 va max., non-inductive 1 amp max., 250 v max. 5 amps max., not switched	50 va max., non-inductive 3 amps max., 500 v max. 5 amps max., not switched	10 va max., non-inductive .750 amp max., 200 v max. 2 amps max., not switched
Life Expectancy High Level Load Low Level	20 x 10 ⁶ operations .500 amp, 28 v 100 x 10 ⁶ operations	20 x 10 ⁶ operations .500 amp, 28 v 100 x 10 ⁶ operations	100 x 10 ⁶ operations 3 amps, 16.5 v 1 x 10 ⁶ operations	10 x 10 ⁶ operations .125 amp, 28 v 100 x 10 ⁶ operations
Stand-Off Voltage	500 v rms	1500 v rms, Standard 5000 v peak, Special*	1000 v rms, Standard 3000 v peak, Special*	250 v rms
Operate Time** (nominal coil power, including bounce)	As low as .6 ms			* As low as .5 ms
Must Operate Sensitivity	As low as 80 mw			As low as 60 mw

*AVAILABLE WITH SPECIAL ASSEMBLIES **DEPENDING ON NUMBER OF CONTACTS

sealed-contact reed relays -

Maximum Choice in

REED RELAYS

Your application determines the Clareed® Relay you use...with the versatile Clareed and MicroClareed lines!

These high-reliability, long-life reed relays offer you the inherent maintenance-free reliability of contacts sealed in glass... switching speeds in the low millisecond range...a variety of operate power and contact loads...plus your choice of en-

closed pcb modules, open-coil pcb relays, or round cans for wired assemblies.

Clareed and MicroClareed® Relays are Clare-built from start to finish...with automated, superclean production assuring you Clare quality and Clare reliability. All are 100% tested for dielectric strength, operating characteristics, contact resistance, and seal integrity.

Choose the relay characteristics you need. Clare will help you specify for long life and utmost economy in operation.

For complete information, ask your Clare sales engineer, circle the Reader service number below, or write

Group 5A4
C. P. CLARE & CO.
3101 Pratt Blvd.
Chicago, Illinois 60645

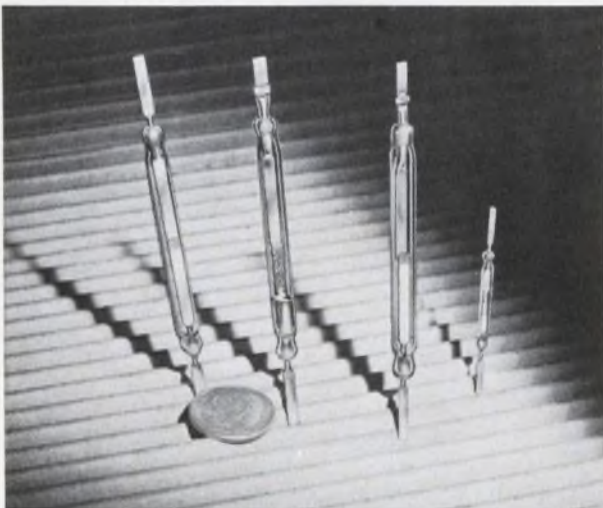

Left to right: General Purpose, Mercury-Wetted, High Voltage, MicroClareed



relays and related control components

ON READER-SERVICE CARD CIRCLE 60

Now! TCXO's from Bulova!

Stability:
±0.5 PPM!



Now you can get Temperature Compensated Crystal Oscillators from Bulova, with all the quality and dependability that have made Bulova the leader in frequency control products. Our new Model TCXO-5 is just four-cubic-inches, consumes only 50 mW, and employs a computer-selected-and-optimized compensation network designed to maintain frequency stability over wide temperature ranges without the need for an oven (± 0.5 PPM from -40°C to $+70^{\circ}\text{C}$). Perfect for aerospace and military applications where power, space and weight restrictions are severe.

SPECIFICATIONS

Frequency Range: 2MHz to 5MHz
 Frequency Stability: ± 0.5 PPM from -40°C to $+70^{\circ}\text{C}$
 Output: Sine Wave, 1VP-P into a 1000 OHM Resistive Load
 Input: 50 mW
 Size: Just 4 cu. in.
 Weight: Only 5 oz.

Other frequencies, output wave shapes, output levels and load impedances can also be supplied.

Write today for more information about Bulova's new TCXO-5, or assistance with any Crystal Oscillator problem. Address: ED-27.

Try Bulova First!

FREQUENCY CONTROL PRODUCTS

ELECTRONICS DIVISION
OF BULOVA WATCH COMPANY, INC.

61-20 WOODSIDE AVENUE
WOODSIDE, N.Y. 11377, (212) DE 5-6000

ON READER-SERVICE CARD CIRCLE 61

138

COMPONENTS

Micromin connector 19/32 inch across



Frazar & Hansen, Ltd., 150 California St., San Francisco. Phone: (415) 981-5262. P&A: \$2 to \$15; 3 to 5 wks.

Microminiature connectors measuring 19/32 inch in diameter are designed for coaxial and multipin (up to 14) applications. With an overall plug length of 1 inch, series C is available in four configurations: straight plug panel-mounted receptacle, panel-mounted with back shell, and clamp and cable receptacle. The multipin models have a 2-A rating, a contact-to-contact test voltage of 1.2 kV and a contact-to-ground test voltage of 1.4 kV. Wire size is AWG #24 or 26. Coaxial models have 50 and 75- Ω impedance and Teflon inserts.

CIRCLE NO. 388

Reference power source fully regulated



Instrulab, Inc., 1205 Lamar St., Dayton, Ohio. Phone: (513) 223-2241.

Tiny reference power sources achieve a constant dc voltage output, regardless of temperature or line voltage variations. Stable reference diodes and a high-gain operational amplifier are used. Regulation is 0.01% or ± 1 mV, load and line. Output is 10 Vdc ± 1 mV.

CIRCLE NO. 389

Fiber optic faceplates for line-scan CRTs

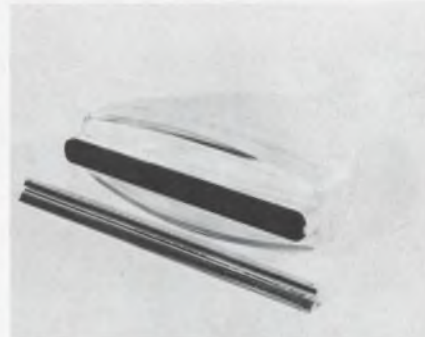

Chicago Aerial Industries, Inc., 550 W. Northwest Hwy., Barrington, Ill. Phone: (312) 381-2400.

A fiber optic faceplate for line-scan CRTs brings the intensity-modulated line display of the CRT to the front surface, eliminating parallax. By moving photosensitive paper past the line scan, contact prints can be generated of photos or charts. The faceplate is available up to 10-1/2 inches long by 2 inches wide. Any thickness can be supplied to meet voltage standoff or three atmosphere pressure test requirements. It is directly solder-glass sealable to KG-12, 0120, or glasses with equivalent coefficients of expansion.

CIRCLE NO. 390

Vhf transmitter withstands 1000 G



International Electronic Research Corp., 135 W. Magnolia Blvd., Burbank, Calif. Phone: (213) 849-2481.

A 0.5-watt, solid-state, FM transmitter is capable of operating in severe acceleration environments to 1000 G. The model 465 is a full IRIG, crystal-controlled unit operating in the 215-to-260-MHz band. The unit's small size (2-1/4 x 2-1/4 x 1 inch) and weight (6 oz) suit it for missile applications.

CIRCLE NO. 391

This integrating DVM *still* offers better performance than any other of its kind.

Measure low-level signals even in the presence of extreme noise with Hewlett-Packard's 2401C Integrating Digital Voltmeter. It has a floating and guarded input for minimizing the effects of common mode noise; and integration averages out all noise superimposed on the signal.

But the 2401 DVM could do that when it was first introduced. Since then there have been two new models and many additional features to keep the 2401 the industry's most useful bench and system DVM.

Here's why :

5 ranges, 100 mV, 1 V and the 3 usuals; 300% over-ranging on the 4 most sensitive ranges, 6th digit for overrange display; integration through zero; full programmability; BCD output for systems use; independent internal calibrate source stable to 0.006% / 6 mo.; 300 kHz frequency counting ability; optional autoranger with 34 msec maximum change time.

If this isn't enough, a full repertoire of options and compatible systems instruments is available to satisfy your measurement needs.

Price : still \$3950.

Call your local Hewlett-Packard field engineer or write direct to Dymec Division of Hewlett-Packard, 395 Page Mill Rd., Palo Alto, California 94306, Tel. (415) 326-1755; Europe : 54 Route des Acacias, Geneva.

HEWLETT
PACKARD  DYMEC
DIVISION

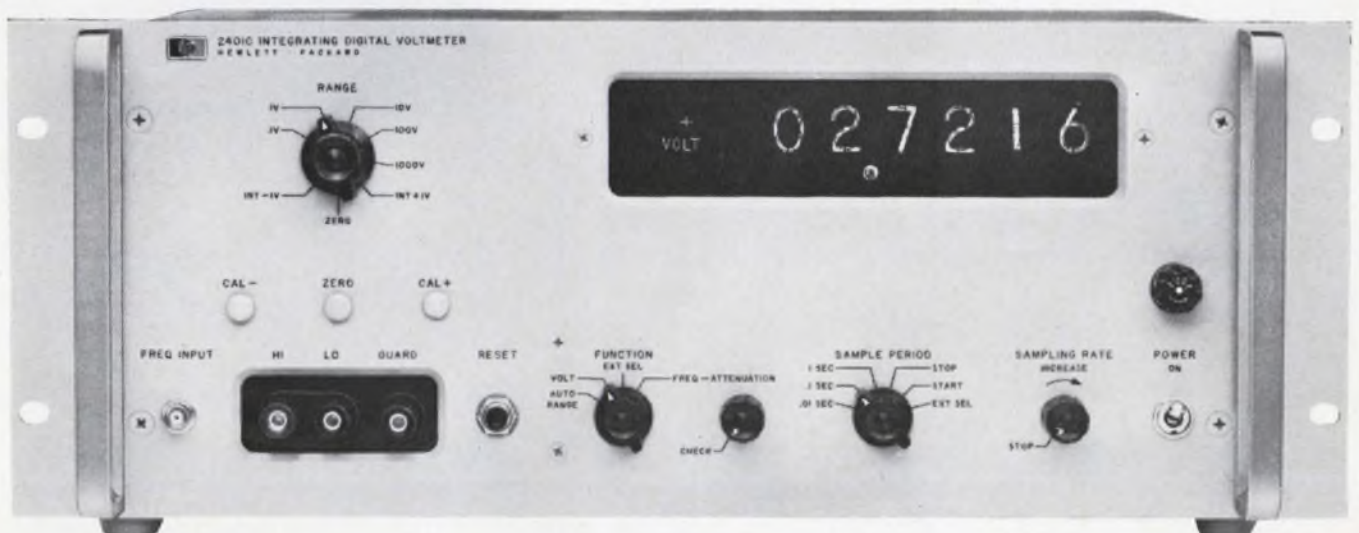

ON READER-SERVICE CARD CIRCLE 62

Meet The "Short" T-1...

especially designed



for **EDGE
LIGHTING!**



For visibility and legibility without eye strain, the edge lighted instrument panel is unsurpassed, especially under adverse ambient light conditions.

The T-1 incandescent lamp, developed by Chicago Miniature, has proved an effective light source for edge lighting. To make it even more suitable for this application, Chicago Miniature has developed the "Short" T-1—only .145" max. overall length.

With "Shorty", thinner instrument panels and more compact packaging are now possible—another example of how Chicago Miniature designs its lamps "to meet the need."

For complete information, write for Catalog No. CMT-2.

CHICAGO MINIATURE  LAMP WORKS

4433 Ravenswood Ave., Chicago, Illinois 60640

ON READER-SERVICE CARD CIRCLE 63

COMPONENTS

Magnetic circuit boosts reed relay sensitivity



Babcock Relays, 3501 Harbor Blvd., Costa Mesa, Calif. Phone: (714) 540-1234.

A magnetic circuit, said to increase relay sensitivity, is featured in this miniature 7-pin plug-in mercury-wetted relay. The unit uses two independent permanent-pole magnets with separate induction bars for improved magnetic field return. The relay is available in single-side-stable and bistable types. Specifications include a max power dissipation of 1 watt, contact rating of 2 A and max contact resistance of 40 mΩ.

CIRCLE NO. 392

Tiny circuit protector replaces fuses



Micro Devices Corp., P. O. Box 501, Far Hills Station, Dayton, Ohio. Phone: (513) 298-5246.

The resistance of this tiny circuit protector is only a fraction of that offered by fuses. This permits use in lower voltage and lower power circuits but does not prevent use in high power circuits. The Microtime protectors, which open when current increases critically, may be specified to respond to such an increase within microseconds.

CIRCLE NO. 393



SIEMENS



self-healing

... and the smallest film capacitors available anywhere!

The secret? A metal deposit between two dielectric films each .00005 inch thick, forms a truly two-layer construction with improved insulation resistance and voltage reliability. Siemens MKL capacitors are specially designed for circuits requiring the absolute minimum of space, such as space and satellite equipment. Typical applications include bypassing, coupling, time circuits, etc. Let a Siemens engineer show you how Siemens components can improve your product. It's child's play.

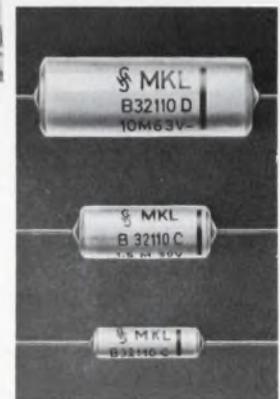

SIEMENS MKL FILM CAPACITORS

Double, self-healing characteristic at both high and low voltages (even milli-volts). Small size: a 10 mF capacitor for conservative 25 volt D.C. is only .43" diameter by .99" length. Available out of stock, in axial leaded case from .1 mF through 10 mF for 25, 63, 100, 160 and 250 volt. Special 630 volt version available from .033 mF through 4.7 mF. Higher values available up to 100 mF on request.

SIEMENS AMERICA INCORPORATED

Components Division • 230 Ferris Avenue, White Plains, N.Y. 10603

ON READER-SERVICE CARD CIRCLE 64

**FOR
DESIGN ENGINEERS,
MANUFACTURERS AND
USERS OF
CERAMIC
CAPACITORS**

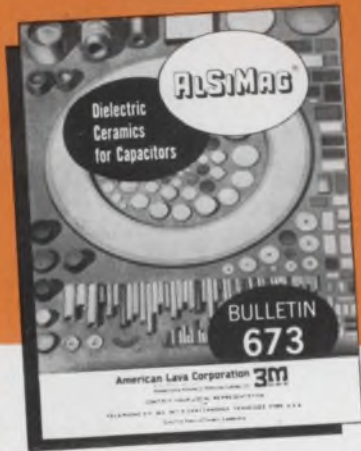

**FREE to
technical personnel**

. . . The latest edition of the only known publication on Ceramic Dielectrics for Capacitors. 36 pages of data, charts, graphs, specifications. Valuable to any producer or user of ceramic capacitors.

Please request Bulletin 673 on business letterhead, giving your title or work assignment.

American Lava Corporation pioneered the development and manufacture of special purpose ceramics for use as ceramic capacitors. Many of the major advances in the art resulted from its research.

This research over a period of years forms a strong background for further advances under our continuous research and development program.

American Lava Corporation 3M
A SUBSIDIARY OF 3M COMPANY

Titania Division
Chattanooga, Tennessee 37405
Sixty-Fifth Year of Ceramic Leadership

ON READER-SERVICE CARD CIRCLE 65

TEST EQUIPMENT

**Dc insulation testers
for wire and cable**



Hipotronics, Inc., Box 1, Brewster, N. Y. Phone: (914) 279-8091. P&A: \$700 to \$1800; stock.

Portable dc insulation testers are designed for wire, cable and insulation testing. Surge devices, an instantaneous overload relay, an internal and an output shorting relay with discharge resistor aid in equipment protection. Other features include triple-range output-connected kV meter with recalibration facilities, triple-range current meter in grounded return, continuously adjustable output control and square Weston meters with 2% accuracies.

CIRCLE NO. 394

**Frequency synthesizers
range dc to 100 kHz**



Measurements, P. O. Box 180, Boonton, N. J. Phone: (201) 334-2131. P&A: \$2850; stock.

Model 500A frequency synthesizer spans the frequency range from dc to 100 kHz with digital selection of 0.01 cycle. A variable oscillator provides continuous frequency selection over the range of any digit except the 10-kHz digit. It operates on the direct synthesis principal avoiding the problems common to methods involving phase-locked oscillators.

CIRCLE NO. 395

**Light beam oscillograph
at pen-and-ink price**



Century Electronics & Instruments, Inc., 6540 E. Apache St., Tulsa, Okla. Phone: (918) 835-9951. Price: under \$1000.

A two-to-six-channel light-beam recording oscillograph is priced to compete with pen-and-ink recorders. The instrument, with two signal conditioners and two galvanometers, reportedly can handle higher frequency events than mechanical recorders. The galvanometers offer a flat frequency response to 2 kHz. Plug-in signal conditioners such as attenuators, amplifiers, and differential amplifiers are available. Each is calibrated. Operators may select any of 12 different paper speeds from 0.1 to 80 ips.

CIRCLE NO. 396

**Phase-sensitive
voltmeter has high Z_{in}**



Dytronics Co., Inc., 4800 Evanswood Dr., Columbus, Ohio. Phone: (614) 885-3303. P&A: \$880; 1 wk.

This phase-sensitive voltmeter reportedly overcomes the problem of circuit loading when using isolation transformers. It incorporates isolation transformers with an input impedance of 1.5 M Ω . This high input impedance permits floating circuit measurements without appreciable loading. It will measure in-phase voltages, quadrature voltages, total and fundamental voltages, as well as phase angle.

CIRCLE NO. 397

V for... Butterfly®

The unique Licon® Butterfly® double-break switch design is as simple as that—two blades that flex simultaneously, then actuate with a positive snap. That simple engineering concept has led to a full line of 2, 4 and 6-circuit miniature, sub-miniature and heavy-duty Butterfly® switches that fight hard to keep your products reliable and durable. It takes a book to tell the story. **This is what it looks like.**

We'd like to send you a copy. Ask.



**Be Victorious with LICON ...
fastest growing
full-line switch supplier**

it LICON
DIVISION ILLINOIS TOOL WORKS INC.

6615 WEST IRVING PARK ROAD - CHICAGO, ILLINOIS 60634

**Remember, you're never more than a few feet away from a product of ITW®*

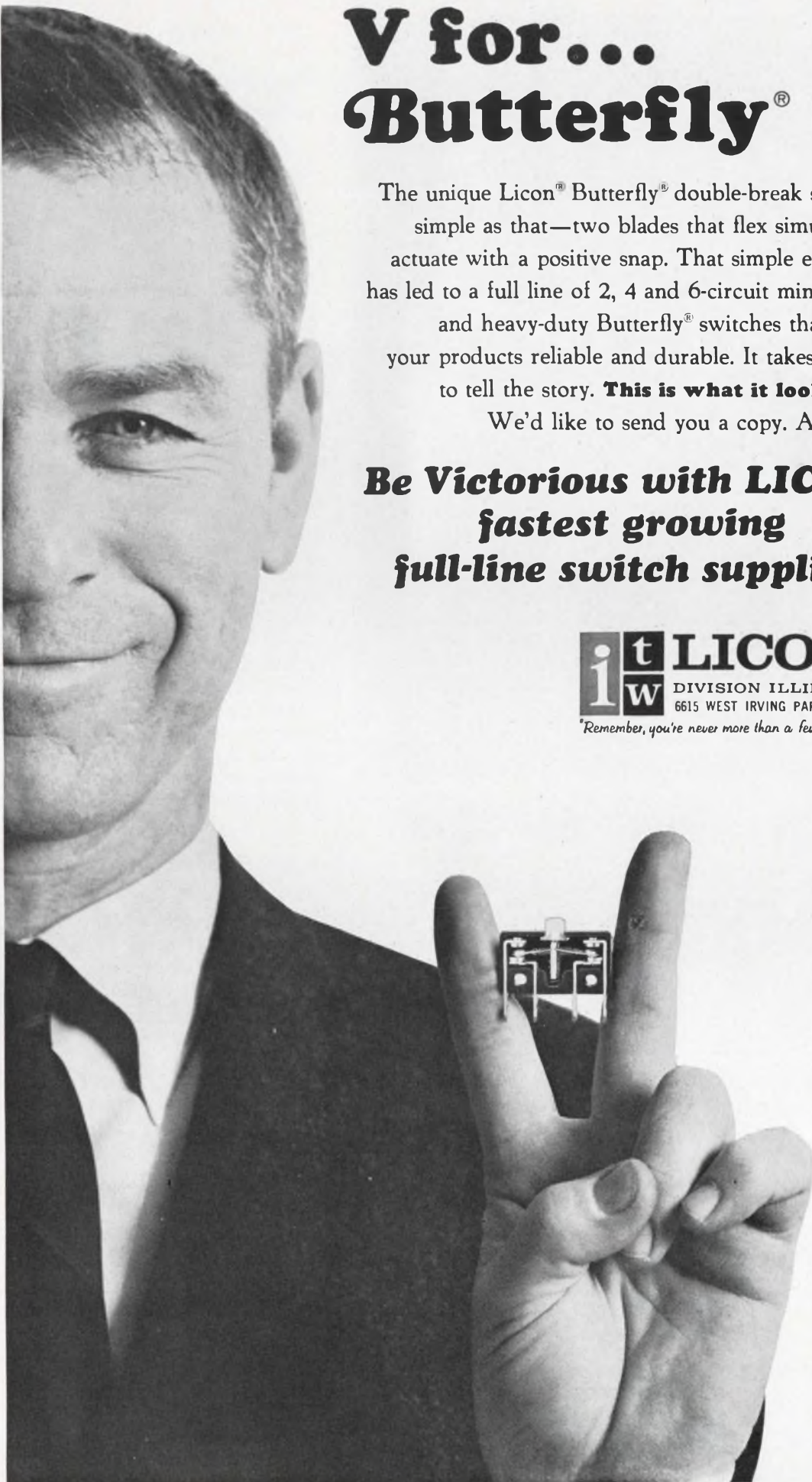

ON READER-SERVICE CARD CIRCLE 66



The game is called Swept VSWR

And the winner receives a fast, precise answer to a difficult test problem. Until Telonic developed the Rho-Tector impedance comparator, swept VSWR measurement was usually a fairly complex, and always an expensive, procedure. Now it's simply a matter of hooking up and reading directly from a Telonic Rho-Meter or scope display, or XY recorder at any frequency from .5 to 4000 MHz.

And what kind of accuracies can you expect from something so easy? How about 50 dB?

Model	TRB-1	TRB-2	TRB-3	TRB-4*	TRB-5	TRB-8	TRB-9*	TRB-10
Range in MHz	.5-1000	.5-2500	.5-1000	.5-1000	200-4000	.5-2500	.5-1000	200-4000
Min. Unbalance (Return Loss) in dB	30	30	50	50	30	30	50	30

*with ALC Detector

Complete Guaranteed Specifications in Catalog C-101. Available on request.



For a complete VSWR measuring system, Telonic provides eight Rho-Tector Models,



Microwave Terminations in 21 VSWR values, (also available in VSWR kits with Rho-Tectors) and



the Rho-Meter for direct read-out of VSWR values.



ENGINEERING CO.

A DIVISION OF TELONIC INDUSTRIES, INC.

P.O. Box 277, Laguna Beach, California 92651 • Tel. 714-494-9401 • TWX 910-596-1320

REPRESENTATIVES THROUGHOUT THE U.S. AND OVERSEAS. FACTORY OFFICES IN MAIDENHEAD, ENGLAND AND FRANKFURT, GERMANY.

ON READER-SERVICE CARD CIRCLE 67

TEST EQUIPMENT

High-impedance preamp virtually noiseless



Servo Corp. of America, 111 New South Rd., Hicksville, N. Y. Phone: (516) 938-9700.

A high-impedance, low-noise pre-amplifier measures 1.12 x 1.56 x 0.9 inches. The noise figure of the preamp at 100-Hz bandwidth is less than 1 dB with a source impedance of 1 MΩ and less than 3 dB with a source impedance of 100 kΩ. The device provides an adjustable voltage gain up to 60 dB and has a 0.1-Hz-to-50-kHz bandwidth range at 3 dB below peak. Input impedance is more than 20 MΩ and output impedance is less than 30 Ω. Maximum voltage output is 3 V rms and the voltage supply is ±15 Vdc at 8 mA.

CIRCLE NO. 398

Regulated 66 A, 60 Vdc in 7-inch package



Lambda Electronics Corp., 515 Broad Hollow Rd., Melville, N. Y. Phone: (516) 694-4200. Price: \$950 and \$995.

Convection-cooled all-silicon regulated supplies rated to 60 Vdc and 66 A measure 7 inches high. The 0-to-60-Vdc model has a current rating of 0 to 25 A at 40°C, 0 to 24 at 50°C, 0 to 22 at 60°C and 0 to 19 at 71°C. Current ratings apply over the entire voltage range. Temperature coefficient is 0.15%/°C. Current limiting is settable to 105% of load. Regulation is 0.015% or 1 mV, whichever is greater, line or load.

CIRCLE NO. 399

Diff-amp operates with 500-V common-mode

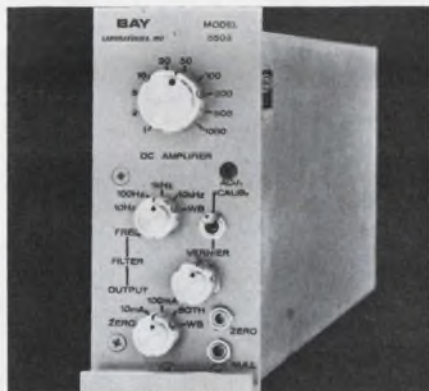

Bay Laboratories, Inc., 20160 Center Ridge Rd., Cleveland. Phone: (216) 333-3898. P&A: \$600 (1 to 10); 30 days.

The series 5000 differential dc data amplifier allows operation in a direct-coupled configuration with up to ± 500 volts common-mode voltage. Since choppers or modulators are not used, a bandwidth of 100 kHz is possible and output noise is reportedly free from intermodulation, hash or spikes. Other features are 120-dB common-mode ratio (1-k Ω unbalance), 50-M Ω input impedance and linearity of $\pm 0.01\%$.

CIRCLE NO. 400

Lock-in amplifiers find signals in noise

Teltronics, Inc., P. O. Box 466, Nashua, N. H. Phone: (603) 882-6264. Price: \$1795.

Measurement of ultra-low-level signals in a high-noise environment is provided by synchronous detection techniques used in this coherent amplifier. It compares, amplifies, filters, synchronously detects and integrates a low-level signal despite high noise. The amplifier is continuously tunable over 1.5 Hz to 200 kHz with a full-scale sensitivity of 100 nV. It operates from broadband to a Q of 25 without gain change. Output is determined from a built-in meter and from output connections suited to a DVM, high-impedance recorder or recording galvanometer. Reference voltage can be obtained from an external source within a range of 0.5 to 300 V rms as well as from the internal tunable oscillator.

CIRCLE NO. 401

Columbia Components Thick-film hybrids.

Send us your specs for fast action.

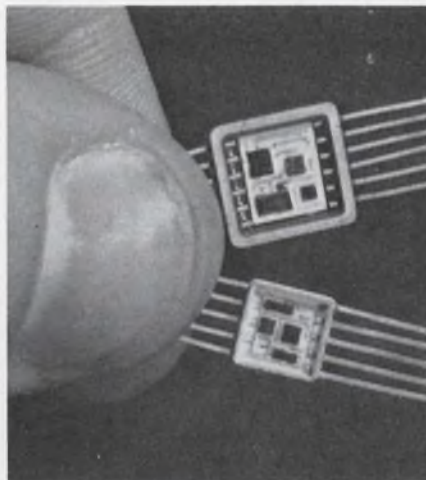

The answers to your micro-packaging problems are as close as this coupon.

The hybrid circuit is a versatile tool in the hands of the design engineer faced with problems in high power ratings, thermal tracking, precision component tolerances, intermixing monolithic IC's and other interfacing circuitry and components. In applications where the design may undergo changes up to the first production article, the hybrid offers the designer freedom to institute necessary changes with minimal cost and time.

Columbia Components Corporation's Thick-Film Hybrid Circuits are capable of reproducing any given circuit without degradation in circuit functions. These hybrids also present the most economical approach to most problems.

Please sketch schematic (or print, if available) and attach.						R	Value	Tol.	T.C.	Wattage	Q	Generic Type	Tol.
Application _____						R1						Q1	
_____						R2						Q2	
Customer Print # _____						R3						Q3	
Rev: _____						R4						Q4	
Lead Forming _____						R5						Q5	
Is qualification acceptance required? _____						R6						Q6	
Is lot acceptance required? _____						R7							
Package style & size: _____						R8							
Body Material: _____						R9							
Lead materials: _____						R10							
MAXIMUM RATINGS						C	Value	Tol.	Rated Voltage	CR	Generic Type	Tol.	
Storage Temp. Range _____						C1					CR1		
Operating Temp. _____						C2					CR2		
Ambient Temp. _____						C3					CR3		
Power Dissipation of 25°C _____						C4					CR4		
<input type="checkbox"/> Have your engineer call.						C5					CR5		
<input type="checkbox"/> Send descriptive literature.						C6					CR6		
						C7							
						C8							
						C9							
						C10							
Environmental Specifications _____													
Military Specs., if any _____						Frequency _____							
Other applicable specs _____													
Voltages _____													
Name _____						Title _____							
Company _____													
Address _____						Telephone _____							
City _____						State _____				Zip _____			
 COLUMBIA COMPONENTS CORP. A Subsidiary of Computer Instruments Corp., Woodside, N. Y. 11377. Tel: (212) 726-2600													

ON READER-SERVICE CARD CIRCLE 68

Need high-flown data on, say, a one-man chopper in action?



Lockheed's 28-lb. 417 recorder goes and gets it.

You can't top the 417's portability. Carry it almost anywhere with one hand. Any comparable recorder scales at least 50 lbs. more. And accuracy? The 417 matches even large rack machines.

Durability is another advantage. The 417's dual capstan transport provides precision operation under vibration and in any position.

The 417 operates from its internal battery or from 110/220 volts AC with power consumption as low as 10 watts. Frequency response is 100kc direct, 10kc FM. And it comes in a neat 14" x 15" x 6" package—small enough to fit under an airplane seat. The price is compact, too. Starting at \$7,000.

Next time you're in a spin for data, remember the lightweight 417. For more information, write Dept.ED524, Edison, New Jersey.

LOCKHEED

LOCKHEED ELECTRONICS COMPANY
A Division of Lockheed Aircraft Corporation

TEST EQUIPMENT

Single-shot tests with strobing voltmeter



E-H Research Labs., Inc., 163 Adeline St., Oakland, Calif. Phone: (415) 834-3030. Price: \$2940.

Model 153 strobing voltmeter is one approach to the problem of making voltage measurements on fast waveforms at precisely located points on the time axis. It uses a balanced diode-bridge gate to isolate its measuring circuitry from its 50- Ω feedthrough signal line. This gate is held closed except for the strobe period of several ns. The time location of the strobe, which opens the gate and allows signal information to reach the memory-amplifier chain, is variable by panel controls or by remote program inputs. The voltage present on the signal line at the end of the strobe pulse is passed through a memory-amplifier chain which has a voltage gain of 10 and stretches the measurement pulse to an output step with a decay constant of 250 ms. An additional amplifier block with a gain of ten, and a X10 attenuator pad allow scale factors of X1, X10 and X100.

Measurement cycle time is controlled by a fixed ramp-trigger time-block generator which effectively locks out the input trigger recognition circuit for a period of approximately 1 ms after a trigger is accepted. The standard instrument is thus essentially a single-shot device which is capable of making up to 1000 measurements a second. The design achieves excellent noise characteristics and dot-transient response by using high sampling efficiency. The amplifier-memory chain is dc coupled throughout.

CIRCLE NO. 370

Volt-controlled generator ranges to 12 MHz



Wavetek, 8159 Engineer Rd., San Diego, Calif. Phone: (714) 279-2200. P&A: \$595; 60 days.

A high-frequency voltage-controlled generator allows external voltage control of frequency and amplitude. The unit generates sine waves from 100 kHz to 12 MHz. The instrument offers control of frequency and amplitude by external voltage, either dc programming or wide-band ac frequency modulation. Output is variable from 0.001 to 1 V rms in three attenuator ranges, calibrated into a 50- Ω load.

CIRCLE NO. 405

Ac/dc voltmeter compact, portable



Precision Standards Corp., 911 Westminster Ave., Alhambra, Calif. Phone: (213) 289-2453.

A solid-state ac/dc voltmeter features dc accuracy of 0.02% of reading, ac accuracy of 0.2% of reading, 100- μ V null sensitivity and a 6-digit in-line readout. The portable unit is available with a self-contained, rechargeable battery that provides up to 60 hours of operation. Ranges are 1100, 110 and 11 V and 1100 mVac and dc and 110 mVdc.

CIRCLE NO. 406

TUNG-SOL 28 GP SERIES POWER SUPPLIES

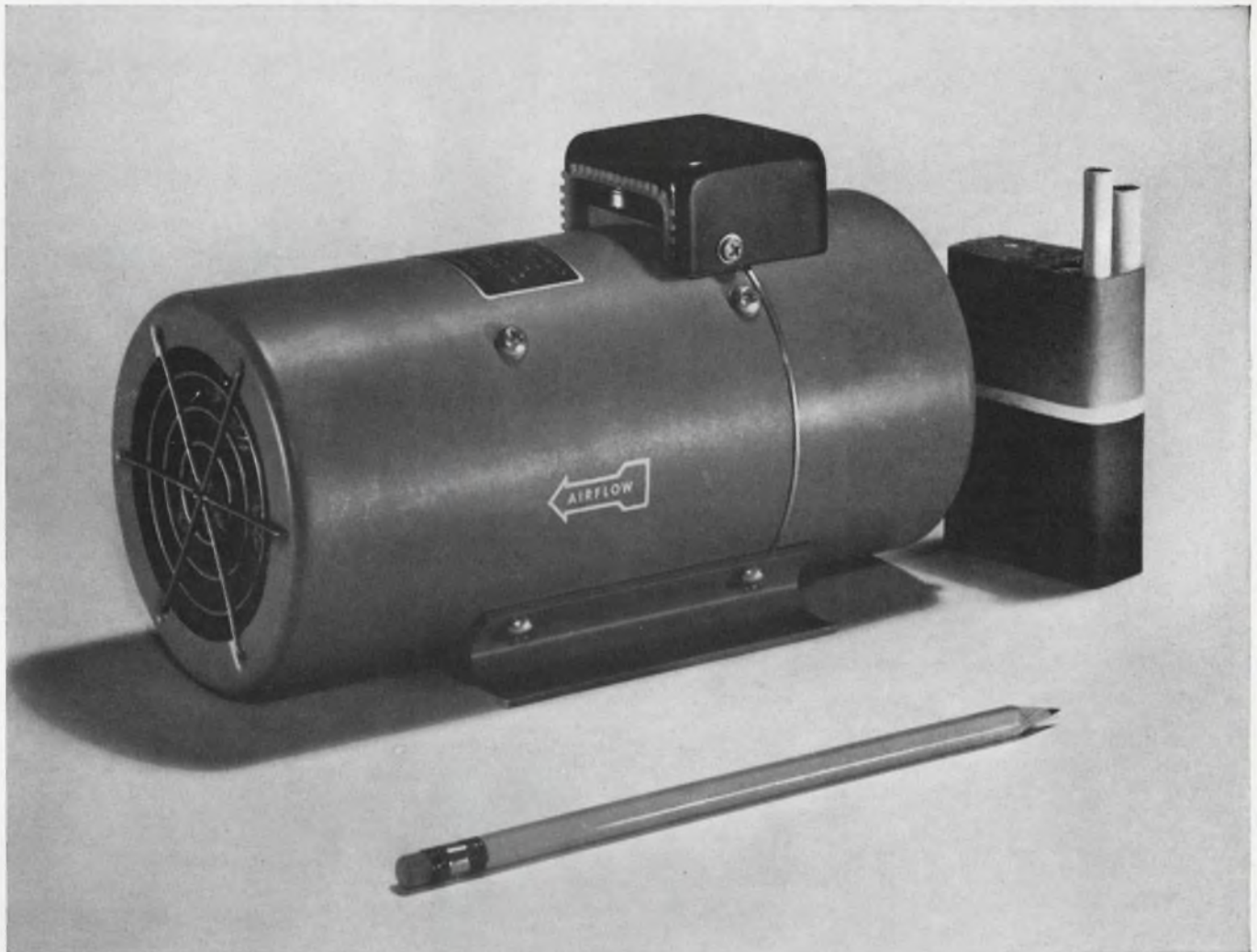

up to 400 AMPS. D.C. in new weight-saving package

A tremendous break-through was achieved in space and weight reduction of air-borne power supplies when the Tung-Sol Y-series configuration was first developed. Now, this unique design has been adapted to the requirements of ground-based equipment, to provide the same advantages for applications in the 100 amp. to 400 amp. range.

The Tung-Sol 28 GP series consists of four standard units that supply 100, 200, 300 or 400 amps. at 28 volts D.C. They are production items available on an off-the-shelf basis. All units embody high-performance characteristics. They have high environmental adaptability and are especially suited to seaborne installations. Important, also, is the fact that they can be mounted in any attitude. For equipment that is to be transported by air, the weight factor is an exceptional advantage.

<p>28 GP 100</p> <p>Output: 100 Amps. Size: 8½" L x 4" W x 5½" H Weight: 7.5 lbs.</p>	<p>28 GP 300</p> <p>Output: 300 Amps. Size: 10½" L x 6" W x 7½" H Weight: 19 lbs.</p>
<p>28 GP 200</p> <p>Output: 200 Amps. Size: 10½" L x 5" W x 6¾" H Weight: 13 lbs.</p>	<p>28 GP 400</p> <p>Output: 400 Amps. Size: 13" L x 6" W x 7½" H Weight: 26 lbs.</p>

For full technical information write for Bulletin.

TUNG-SOL DIVISION
Wagner Electric Corporation

630 West Mt. Pleasant Ave. • Livingston, N.J. 07039

ON READER-SERVICE CARD CIRCLE 70

VITRO

Micro Modules

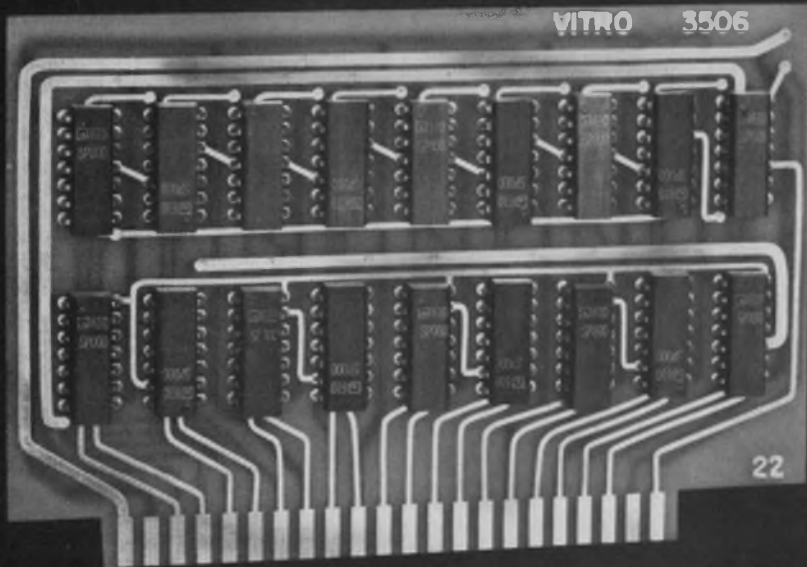

- all-new, highly competitive prices
- built-in drivers, inverters and buffers eliminate most interconnecting wiring
- up to 18 microcircuits per card enable high density and lower costs
- boards designed to meet MIL- and NASA standards
- boards keyed to assure proper mounting
- dual in-line packages easily replaced for ease of maintenance
- off-the-shelf delivery

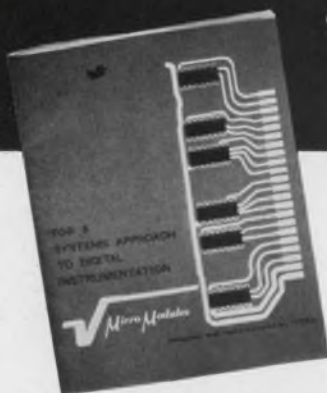

WRITE for this FREE 36 page catalog describing our complete line of card-mounted digital microcircuits. Brochure contains logic diagrams, connections, performance data, power supplies and card drawers. NEW price sheet is also included.

V-31

Vitro ELECTRONICS

Producers of NEMS-CLARKE Equipment
A Division of Vitro Corporation of America

919 Jesup-Blair Drive · Silver Spring, Maryland (301) 585-1000
2301 Pontius Avenue · Los Angeles 64, California (213) 477-6717

ON READER-SERVICE CARD CIRCLE 71

MICROELECTRONICS

Aluminum bumps bond DTL ICs

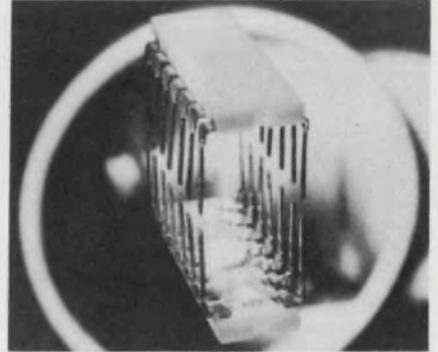

Fairchild Semiconductor, 318 Fairchild Dr., Mountain View, Calif.
Phone: (415) 962-2530.

Dual-in-line packages, which incorporate a face-down bonded die, are available for Fairchild DTL elements 9930, 9932, 9945 and 9946. The Fairpak design (ED 4, Feb. 15, 1967, p. 17) employs special bonding fixtures to assemble a 14-lead microcircuit die in a single operation. Bonds are now machine-made and demonstrate uniformity.

The need for any lead frame or metal structures to be encapsulated within the hermetic seal area is eliminated. Instead, a conductive ceramic pattern (a printed ceramic circuit) is deposited on an aluminum substrate and serves as the conductor between the die and the dual-in-line type leads. This printed circuit is enclosed in the seal area instead of the leads. By this process, hermeticity on the order of 10^{-8} is achieved. The process permits use of existing masks. The conventional wafer diffusion and metallization goes through two additional processing steps including deposition of a glass layer over the die circuit to provide physical isolation between the circuitry on the die and the bonding pads. The second operation is the deposition of the aluminum pads. Through a vacuum deposition process, the pads are formed to sufficient thickness and diameter to permit an ultimate bond strength to the substrate of roughly five times that of the conventional wire bonded package.

Other features are equivalent thermal dissipation to eutectic die attachments, a lower package profile and a 50% weight savings.

CIRCLE NO. 402

Breadboard components with pegs and pegboard

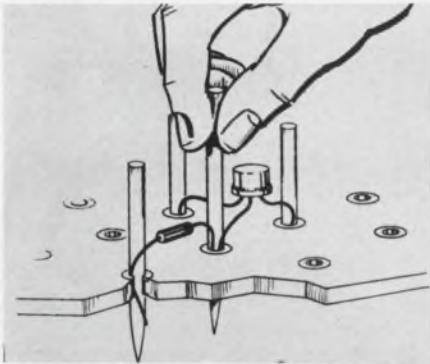

Berkeley Applied Research Corp.,
P. O. Box 181, Alamo, Calif. Phone:
(415) 934-0806. Price: \$11.90.

Here's a fast way of breadboarding your electronics. This 9 x 12-inch pegboard with brass eyelets spaced to accommodate electronic components comes with a supply of tapered pegs for securing component leads in the eyelets. Components can be used without preparation and are not damaged by installation.

CIRCLE NO. 403

Mounting receptacle accepts dual-in-lines

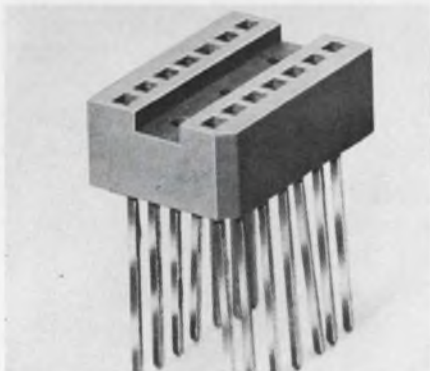

Elco Corp., Willow Grove, Pa.
Phone: (215) 659-7000.

A mounting device accepts all dual-in-line packages with 14 round or blade leads. The low-profile design permits side-by-side mounting on 0.5-inch centers or in-line mounting on 0.8-inch centers. Wire-wrap contacts are double-leaf type and are made of spring-temper phosphor bronze with a gold flash over a nickel underplate. Mounting is by interference fit between contacts and PC holes.

CIRCLE NO. 404

HOW CAN YOU USE THIS NEW WRINKLE IN PLASTIC TUBING?

FLEXITE SHRINKDOWN TUBING is fast becoming an indispensable to design engineers. It shrinks 50% in diameter, upon application of moderate heat, to form a tough, tight-fitting sheath of plastic around objects of irregular shape. Primarily intended for insulation, it is also being used in many other ingenious ways. Like binding things together — adding strength and rigidity — protecting against abrasion, wear, breakage — resisting corrosion, heat, moisture — preventing vibration and noise — etc. How can you use it? We'll be glad to send you our "Hot Idea" experimental sample kit of all 3 types of Markel Shrinkdown. Just write for it. No cost or obligation.



L. FRANK MARKEL & SONS

Norristown, Pa. 19404 • 215-272-8960

INSULATING TUBINGS AND SLEEVINGS
HIGH TEMPERATURE WIRE AND CABLE

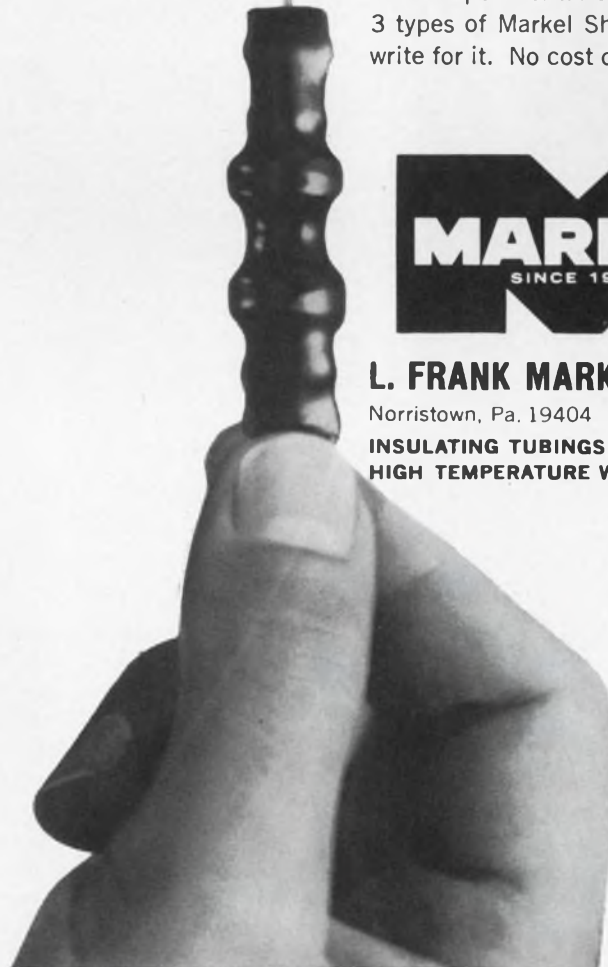

ON READER-SERVICE CARD CIRCLE 72

*** NEW**
FROM
HATHAWAY

MINIATURE
FORM *** C**

**DRIVEED
RELAYS**



4PDT

RELIABILITY

3PDT

HIGH
ISOLATION
SWITCHING

DPDT

LONGER
LIFE

SPDT

TRUE
TRANSFERING
FAST

**80 mw, INTEGRATED CIRCUIT
DRIVEN DEVICES AVAILABLE**

For detail information call or write.

HATHAWAY INSTRUMENTS, INC.
5250 EAST EVANS AVENUE
DENVER, COLORADO 80222
(303) 756-8301 • TWX 292-2935
*Distributed Nationally by
COMPAR CORPORATION*

ON READER-SERVICE CARD CIRCLE 73

MATERIALS

**Tungsten carbide
powder in submicron size**

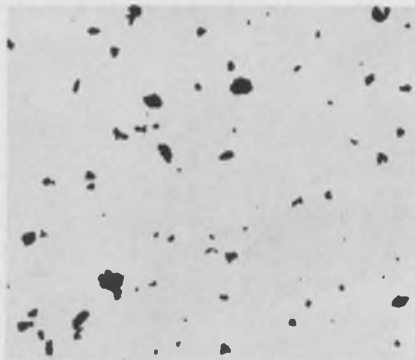

Shwayder Chemical Metallurgy Corp., 700 E. Woodbridge, Detroit. Phone: (313) 965-4850. P&A: \$9/lb.; stock.

Submicron tungsten carbide powder can be used in composite materials and in devices requiring high emissivity. An electron microscope, using a magnification of 15,000 times, shows the high-surface-energy Mikrocarbide 77 (above) averaging one-fifth the size of conventionally produced powders. The small size of the particles, down to 0.5 micron Fisher, and its high-energy shape, showing multiple sharp edges, make this form of tungsten carbide useful to manufacturers of cermets, thermoelectric devices and high-temperature fiber composites. Tungsten carbide's high melting point, over 5000°F, and metal-carbon bond make it compatible as a heat-resistant filler in plastic bearings and neat shields.

CIRCLE NO. 407

**Be-Cu alloy in
thin-wall tubes**

Uniform Tubes, Inc., 1200 W. 7th, Collegeville, Pa. Phone: (215) 489-7293.

Free-machining beryllium-copper alloy 33-25 is available as thin-wall, seamless tubing with OD from 0.01 to 0.625 inch. Wall thicknesses range from 0.05 inch to 0.0005 inch. Machining time for RF connectors and other electronic tubular parts is reportedly reduced by as much as 60% with the new alloy tubing. Electrical and spring properties of the alloys are similar to Be-Cu 25.

CIRCLE NO. 408

**Polishing material
for wafer makers**



Geoscience Instruments Corp., 435 E. Third St., Mt. Vernon, N. Y. Phone: (914) 664-5100.

Politex Microfin is designed for high-speed polishing of silicon wafers, laser rods, ferrites and memory substrates. The material is highly porous, practically inert and withstands the corrosive environments encountered in chemomechanical polishing systems for finishing solid-state materials. This cloth is made from a reinforced substrate of polyurethane bonded polyester, with a uniform poromeric structure similar to fine leather. The polishing cloth may be sueded, perforated, densified and textured. It is available in various thicknesses with a pressure-sensitive adhesive back.

CIRCLE NO. 409

**Thin-wall wire insulated
with polyethylene**

General Electric, Wire and Cable Dept., Bridgeport, Conn. Phone: (203) 334-1012.

Thin-wall, general-purpose electronic wire is insulated with cross-linked polyethylene. The Vulkene wire can be used as replacement for PVC, silicone rubber, irradiated polyethylene and fluoroethylene types. The wire exhibits good resistance to solder damage, radiation and fungus. It lends itself to encapsulation in epoxy, polyurethane or silicone-rubber types of potting compounds. No treatment of the wire surface is required. It is rated at 600 volts, and can be used for missile and aerospace use at a conductor temperature of 125°C or for electronic use at 90°C.

CIRCLE NO. 410

P W

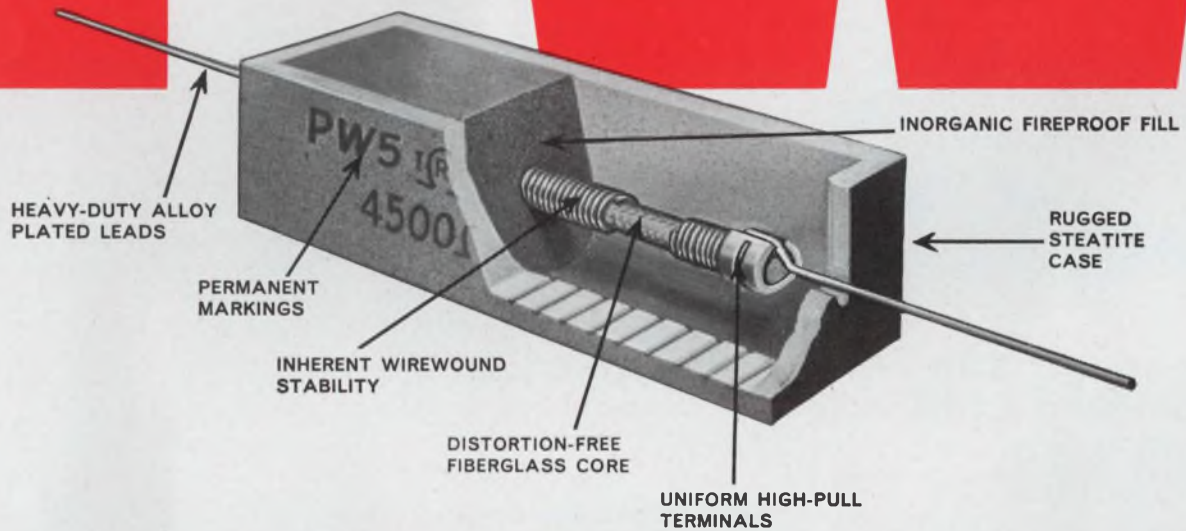

Protect low power circuits

Fireproof construction...plus lowest cost per watt

Exclusive from IRC . . . a fireproof resistor that can't be matched for the price. Inorganic fireproof construction withstands high temperatures and high overloads. Ideal low-cost protection for transistor and low-power circuits in radios, TV's and industrial equipment.

High quality wire and automated assembly allow resistance values nearly 50% higher than comparably rated power wirewound units. Easily solderable axial leads for point-to-point wiring or PC board insertion.

PW types are also available as fusible resistors, and with special positive temperature coefficient wire for temperature compensating applications. Write for data, prices and sample. IRC, Inc., 401 N. Broad Street, Philadelphia, Pa. 19108.

CAPSULE SPECIFICATIONS

RATINGS:	2, 3, 5, 7, 10 and 15 watts
RESISTANCE:	0.1 ohm to 30K
TOLERANCES:	
Standard	±10%
Special	±5%
TEMPERATURE COEFFICIENT:	
Standard	+300 to 600ppm/°C max.
Special	+1300 to +5500ppm/°C



ON READER-SERVICE CARD CIRCLE 74

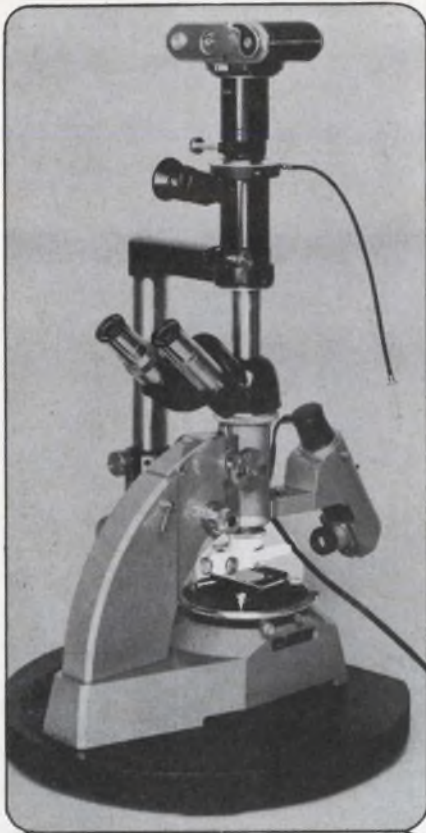

Measure Film Thickness . . .

accurately & conveniently measure the thickness of thin film layers, coatings and platings with the **Watson Interference Objectives**

Successfully used today in semiconductor metallurgy and engineering, computer research, capacitor and quartz crystal manufacture, paint laboratories, printing, ceramics, diamond cutting, and in surface finish assessment.

Attaches easily to any upright microscope with RMS Objective Thread. More effective, convenient and economical than much more expensive systems.

Hacker

For particulars or demonstration, write to:
WILLIAM J. HACKER & CO., INC.
Box 646, W. Caldwell, N.J., CA 6-8450 (Code 201)

ON READER-SERVICE CARD CIRCLE 75

MATERIALS

Epoxy and urethane stripped chemically



Emerson & Cuming, Inc., Canton, Mass. Phone: (617) 828-3300. P&A: \$1.50 to \$2/lb; stock.

A line of stripping agents for epoxy and urethane resins is offered. Eccostrip 57 is a general-purpose stripping agent which disintegrates many polymer systems. It is recommended for flexible epoxy systems and rigid systems that use aliphatic amine hardeners. Eccostrip 93 is useful on many hard rugged systems. Eccostrip 94 is designed for coatings up to about 1/8 inch thick and Eccostrip 95 is used at elevated temperatures for epoxy systems cured with aromatic amine hardeners, as well as for rigid urethane castings and foams.

CIRCLE NO. 411

Glass-ceramics outdo alumina

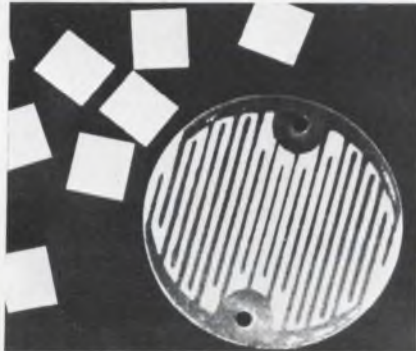

Fusite Corp., 6000 Fernview, Cincinnati. Phone: (513) 731-2020.

A family of glass-ceramics can be substituted for more expensive alumina in many applications without performance loss. Two types are available. One is a high-strength sealing glass with a crystalline phase. The other is a structural material unaffected by sealing temperatures. Both offer twice the thermal conductivity and mechanical strength of glass. They can be metallized and some compositions are self-glazing.

CIRCLE NO. 412

Composite substrates for 3-D circuitry

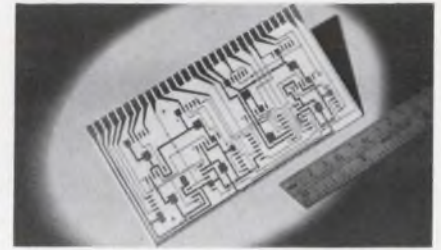

American Lava Corp., Manufacturers Rd., Chattanooga, Tenn. Phone: (615) 265-3411.

Composite ceramic substrates permit the designer to bury metal patterns in planes in a monolithic, high-alumina ceramic and provide ready access to any level from any other level. Circuit planes can be stacked one on top of the other and connected wherever desired. Each plane is hermetically sealed from its neighbors above and below. Greater concentration in the same surface area is gained since conductors can cross over and under each other without destroying electrical integrity. The interconnections, permanently encased in alumina, are secure against unintentional shorts. Shorter electrical paths result in faster switching and lower electrical resistance. Narrow line widths, sometimes necessary to place the required number of connectors in a small device area, can be avoided by taking some of the lines through to another plane. Normal line widths are 7 mils on 14-mil centers. Line widths of 4 mils spaced on 8-mil centers converging about a chip area are feasible. Line resistance down to 10 mΩ per square or better is possible.

CIRCLE NO. 413

Teflon tubing shrinks to 50% in seconds

Penntube Plastics Co., Inc., Holley St. & Madison Ave., Clifton Heights, Pa. Phone: (215) 622-2300.

A 2:1 heat-shrinkable Teflon FEP tubing heat shrinks up to 50% in diameter in seconds upon application of heat up to 400°F. The see-through tubing encapsulates and insulates components and won't split when shrunk on parts over full shrinkage range. It is available up to 1-inch ID.

CIRCLE NO. 414

**Insulating washers
conduct like mica**

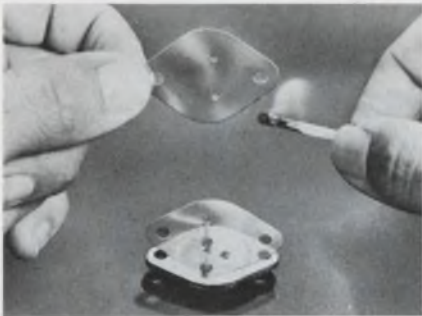

Thermalloy Co., 8717 Diplomacy Row, Dallas. Phone: (214) 637-3333. P&A: \$12/M; stock.

Insulating washers for power semiconductors utilize a special plastic film material which has the thermal conductivity, low cost, and dielectric strength of mica washers, yet will not puncture, fracture or peel. Breakdown voltage is 7000 V/mil, temperature range is -269° to +400°C and types available are 14 JEDEC styles including TO-3, TO-36, TO-66, power epoxy, and round washers. The material is 2 mils thick.

CIRCLE NO. 415

**Vinyl slip-on cover
protects connectors**

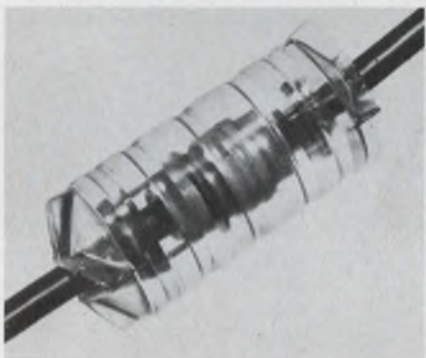

Molded Devices, 2170 Colorado Ave., Santa Monica, Calif. Phone: (213) 393-0558.

A protective vinyl cover for cable connectors, tube fittings, and conduit fitting protects against impact damage, scratches and nicks and prevents dust damage and contamination. It simply slips on and off the component. The guard sleeves resist ozone, salt water, and nearly all chemicals and gases. They are available in more than 30 sizes for connectors up to 3-1/2 inches OD.

CIRCLE NO. 416

MINITAN[®]

MICROMINIATURE SOLID TANTALUM CAPACITORS

from the world's leader

IN ANY CONFIGURATION



USED IN EVERY MAJOR SPACE LAUNCH, AVIONIC SYSTEMS, MINIATURE COMMUNICATIONS EQUIPMENT.

COMPLETE CAPACITANCE RANGE .001 MFD THRU 220 MFD. MICROMINIATURE CASE SIZES.

EXTENSIVE RELIABILITY DATA AVAILABLE TO SATISFY MOST STRINGENT REQUIREMENTS.

IDEAL FOR USE IN MICRO-CIRCUIT APPLICATIONS.

BEST DELIVERY IN THE INDUSTRY

FREE SAMPLE, AND TECH DATA ON REQUEST AVAILABLE ON REQUEST:

- TECHNICAL LITERATURE
- RELIABILITY DATA
- SAMPLE MINITAN[®] UNITS.



COMPONENTS, INC.

MAINE DIVISION

SMITH STREET / BIDDEFORD, MAINE / 207-284-5956

New from Helipot

First \$1¹⁰ cermet trimmer sealed for board washing



New Helitrim® Model 77:

only trimmer in its price class made fail-safe for solvent washing on the board... and offering essentially infinite resolution, 10 ohm — 2 megohm resistance range and 105°C. max. operating temp. No general purpose adjustment potentiometer has wider performance parameters. Directly interchangeable with competitive models 3067, 3068. \$1.10 in quantity — ask your Helipot rep for a free sample.

Beckman

INSTRUMENTS, INC.
HELIPOD DIVISION
FULLERTON, CALIFORNIA • 92634

INTERNATIONAL SUBSIDIARIES: GENEVA; MUNICH; GLENROTHES, SCOTLAND; TOKYO; PARIS; CAPETOWN; LONDON; MEXICO CITY

ON READER-SERVICE CARD CIRCLE 77

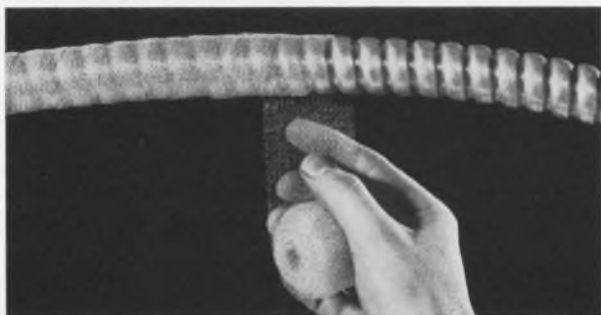

Metex RFI Shielding Tape

...the ideal inexpensive approach for shielding cable assemblies

Shielding tapes can be provided in several materials. The most popular materials are monel, aluminum, silver plated brass and tin plated copper clad steel. These tapes can be provided in continuous lengths in widths from 1/2"

They are highly flexible and easy to apply to odd shaped cable assemblies or equipment to provide excellent shielding coverage. Write for free samples, prices, literature, or ask us for engineering assistance!

METEX Corporation

970 New Durham Road, Edison, N.J. 08817
(201) 287-0800 • TWX 710-744-4530
West Coast: Cal-Metex Corp., 509 Hindry Ave., Inglewood, Calif.



ON READER-SERVICE CARD CIRCLE 78

PRODUCTION EQUIPMENT

NiCad batteries charged to 90% in 15 minutes

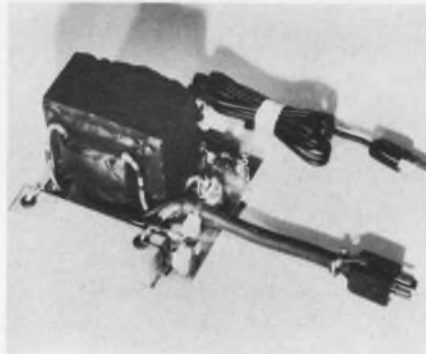

General Electric, Battery Business Section, Gainesville, Fla. Phone: (904) 462-3911.

High-rate charging of nickel cadmium batteries to 90% of their capacity in 15 minutes, rather than the typical 16 hours, is now possible with this charging system. The fast-charge circuit charges at a high constant-current rate to a temperature-dependent cutoff voltage and then reverts to a 12-hour rate which can be sustained indefinitely. Batteries are charged at the high rate to approximately 90% of their capacity before switching to the lower rate.

The charge current is supplied by a high-reactance transformer. An SCR passes high-rate charge current until a reed switch is closed by the sensing circuit at a cutoff voltage which is governed by battery temperature. The rectifier protects the SCR gate from reverse voltage and rectified low-rate charge current. The resistor which limits SCR gate current is in parallel with another resistor, establishing the low-rate charging current.

The sensor circuit is a temperature-compensated voltage-sensitive relay made up of a reed switch and coil. Due to the low drop-out voltage of the reed switch relay, the battery will remain in low-rate charge until sensor circuit continuity is broken. Whenever continuity is re-established, the charger will again operate at the high rate until the proper cutoff voltage is reached. If the charge control should fail for any reason, the battery temperature will rise and the thermal protective device will terminate the charge.

CIRCLE NO. 417

Momentary or Push On, Push Off

MINIATURE Push Button Switches



Exceptionally high current. Positive snap-action with fast make and break contacts. SPDT, DPDT & 4PDT, useable as either a Normally Open or Normally Closed switch. Silver contacts and terminals.

FREE
12-PAGE
CATALOG
WRITE!

ALCOSWITCH

DIV. OF ALCO ELECTRONIC PRODUCTS INC., LAWRENCE, MASS.

ON READER-SERVICE CARD CIRCLE 79

Simplify Component Replacement!

CERAMIC Terminal Strips



The uniform manufacturing of the miniature terminal strips gives the assembly a neater appearance; adds a quality look overall. Tinned copperplate on silvered ceramic facilitates soldering of components and leads. Withstands excess heat. Available with 3-5-7-9-13-16-20 terminals.

FREE
12-PAGE
CATALOG
WRITE!

ALCOSTRIP

By ALCO ELECTRONIC PRODUCTS, INC., LAWRENCE, MASS.

ON READER-SERVICE CARD CIRCLE 80

This coupon could
help you
breathe easier.

A CHRISTMAS SEAL SERVICE

NTA
GPO, Box 2400
New York, N. Y. 10001

Send me the free booklet, "Your Breathing Troubles: Understand Them, Face Them, Treat Them"

Name _____

Address _____

City _____

State _____

Zip Code _____

Free booklet published by Emphysema-Bronchitis,
National Tuberculosis Association



We'll take your tough coil jobs!



Sioux-produced video detector transformer. Frequency—44.75 mc. Bandwidth—11%. Trap circuit provides attenuation of at least 40 db at a point only 7% removed from the center frequency.

AT Dale's Sioux Division we're specialists in inductive technology—sought out for our ability to make wirewound components do precision jobs in difficult sizes and configurations. Of course, we're geared for commercial production, too—but we relish the tough jobs. When your next project calls for precision inductors—or custom assemblies using inductors—get in touch with the Sioux Division. We can help every step of the way from design through production.



DALE ELECTRONICS, INC.
SIoux DIVISION Dept. E.D
Yankton, South Dakota

Write for New Facilities Report

Producers of: Toroids, Series Resonant Traps, Variable Pitch Inductors, Miniature High Frequency Inductors, De-gaussing Coils, Industrial and Military Coils, Sub-Miniature Coils, Surge & Lightning Arresters, Custom Assemblies.

ON READER-SERVICE CARD CIRCLE 81



DIAL-A-SOURCE

(DIALABLE "ZERO IMPEDANCE" VOLTAGE SUPPLY)

- 1 PPM RESOLUTION
- SECONDARY STANDARD
- 25 M.A. (ZERO IMPEDANCE)
- 1 MICROVOLT TO 10 VOLT RANGE
- 5 PPM OUTPUT REGULATION (NO LOAD TO 25 M.A.)
- DIALABLE IN-LINE VOLTAGE READOUT
- ± 10 PPM STABILITY
- FLOATING OUTPUT; 1000 MEGS ISOLATION
- REMOTE SENSING SUPPLIES .0025% CALIBRATED VOLTAGE AT THE LOAD
- NOISE AND RIPPLE LESS THAN 3 PPM OF OUTPUT OR 20 MICROVOLTS PEAK

Also available Model DAS46 $\pm .005\%$, \$875.00. Write for Bulletin #512



Model DAS46L
.0025% Transportable Accuracy



DIAL-A-VOLT

(DIALABLE VOLTAGE REFERENCE)

- D.C. VOLTAGE ACCURACY, 5 MODELS - .0015% TO .005%
- RANGE 1 MICROVOLT TO 10 VOLTS
- 6 DIAL, 1 PPM RESOLUTION
- 10 PPM STABILITY
- TEMPERATURE COEFFICIENT TO ± 1 PPM/ $^{\circ}$ C
- DESIGNED FOR D.C. CALIBRATION AND REFERENCE
- FINGERTIP DIALABLE CONTROL

Priced from \$399.00. Write for Bulletin #407



GENERAL RESISTANCE, INC

430 Southern Blvd. • Bronx, New York 10455 • Tel.: 212-292-1500 • TWX 212 824-4880

ON READER-SERVICE CARD CIRCLE 82

off-the-shelf

EQUIPMENT PROTECTION

Standard Fiberglass and ABS Thermoplastic Transportation and Operating Cases

Skydyne maintains industry's most complete line of standard, off-the-shelf fiberglass and ABS thermoplastic transportation and operating cases . . . over 33 standard fiberglass cases and 29 ABS cases . . . all with published price lists. Equipment protection against every environmental hazard, including shock, vibration, and moisture, is assured with the fastest possible delivery cycle at realistic prices. Slightly modified versions of these standard cases completely conform to Military Specs.

Skydyne also can supply, with extremely fast delivery, custom designed Sandwich Panel cases from stock components to meet all Military Requirements.

Write for our complete set of Case Design Manuals, Standard Case Catalogs, and price information.



Skydyne, Inc

RIVER ROAD, PORT JERVIS, N. Y. Telephone (914) 856-5241

ON READER-SERVICE CARD CIRCLE 83

PRODUCTION EQUIPMENT

Lead trimmer/former handles 500 per hour

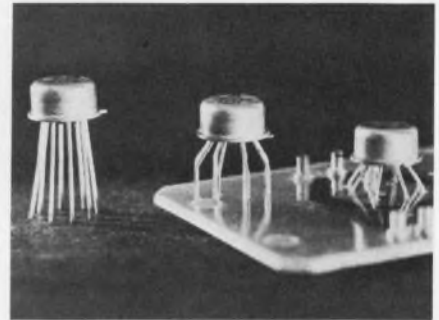

Versitron, Inc., 6310 Chillum Pl. N. W., Washington, D. C. Phone: (202) 882-8464. Price: \$275.

A tool for forming and trimming IC leads handles TO-5 and equivalent IC modules with a 90° turn of the operating lever. The leads are angled outward to the diameter of the TO-5 housing, then directed downward, and finally sheared to a predetermined length. The resulting module stands clear of a PC board by 1/8 inch.

CIRCLE NO. 418

Quartz crystal monitors thin-film deposition

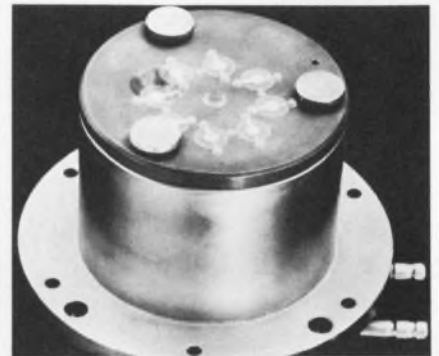

Bendix Corp., Vacuum Div., 1645 St. Paul St, Rochester, N. Y. Phone: (716) 342-0400.

Quartz crystal monitors for thickness measurement during vacuum deposition combine fast response and high stability. The monitor provides twin instrumentation for the measurement and control of both film thickness and deposition rate. It operates on the principle of the frequency change of a crystal as the thickness of the evaporated film increases. Easily changed crystal holders cooling (shown above) permit an increase in frequency stability by a factor of 30.

CIRCLE NO. 419

Transfer molding press for soft-flow epoxy



Morris Enterprises, Inc., 16799 Schoenborn St., Sepulveda, Calif. P&A: \$1450; 6 wks.

A compact molding machine is designed for use with inexpensive aluminum (hand) molds and soft-flow epoxy molding compounds. The press is designed for the encapsulation of components such as transformers, coils, and semiconductors, or for molding cups, cases, lead forms and terminal blocks. The JD-11 molding press features a 5-ton hydraulic clamp, fully adjustable air transfer system and front panel gauges that indicate hydraulic ram force in tons and psi, air transfer pressure and top and bottom platen temperatures.

CIRCLE NO. 420

Soldering tools have coated tip

E. V. Roberts & Associates, Inc., 9601 West Jefferson Blvd., Culver City, Calif. Phone: (213) 870-9561.

A miniature soldering tool has coated tips that allow extended soldering operations without loss of heat content of the tip caused by dressing of the soldering face. The tool has a 1/8-inch tip shaft diameter, a 610°F tip face temperature and a 12-W rating. It offers two types of coated tips. One is sealed against effects of flux fumes, preventing waste of shank and freezing of the tip in the barrel due to oxidation of exposed copper. The second has an additional heavy coating on the soldering face.

CIRCLE NO. 421

If your signal conditioners don't stack up...

CEC has the ones that do.

In other words, a *complete line* of dc and ac signal conditioning equipment specifically created to do the job at a realistic price. Furthermore, this wide range of instruments assures a compatible match with virtually any transducer device being used today.

Now add the advantage of single-source responsibility from event to readout, and you know why so many users prefer to come to CEC.

Taking it from the top, here are some highlights about the conditioners that make up our "signal tower":

8-108 Bridge Balance provides coupling between as many as eight strain gages or resistive-bridge-type pickups and any suitable recording or indicating device.

1-162A Galvanometer Driver Amplifier is a solid state, low-gain, wideband power amplifier for driving high frequency light beam galvanometers.

1-165 DC Amplifier is a differential, high-gain, wide-band instrument featuring four terminals to provide isolation between input and output and circuitry and ground, thus offering greater application versatility than a single-ended galvo driver.

1-118 3 KHz Carrier Amplifier is a completely self-contained four-channel carrier amplifier designed to amplify the output of strain gages and other transducers.

1-163 DC Amplifier can match and deflect all CEC galvanometers to full scale rated deflection, plus properly damp and drive any other available recording galvo.

1-127 20 KHz Carrier Amplifier raises the level of small signals produced by resistance-bridge

or variable-reluctance-type transducers to a level suitable for operation of companion CEC galvanometers.

3-140 Voltage Supply—a solid-state, precision power source specifically designed for excitation of strain gage transducers and other devices requiring a dc excitation voltage.

System D is a multi-channel, dual-purpose system incorporating both linear-integrating and carrier amplifiers. Consequently, any single oscillograph record can indicate strain, pressure, acceleration, vibration and other physical phenomena.

APPLICATIONS
Aerospace, industry and medicine... wherever there is a need to acquire, measure and display dynamic or static data. For complete information about any or all of these signal conditioning instruments, call your nearest CEC Office, or write Consolidated Electrodynamics, Pasadena, California 91109. A subsidiary of Bell & Howell. Bulletin Kit #307-X5.

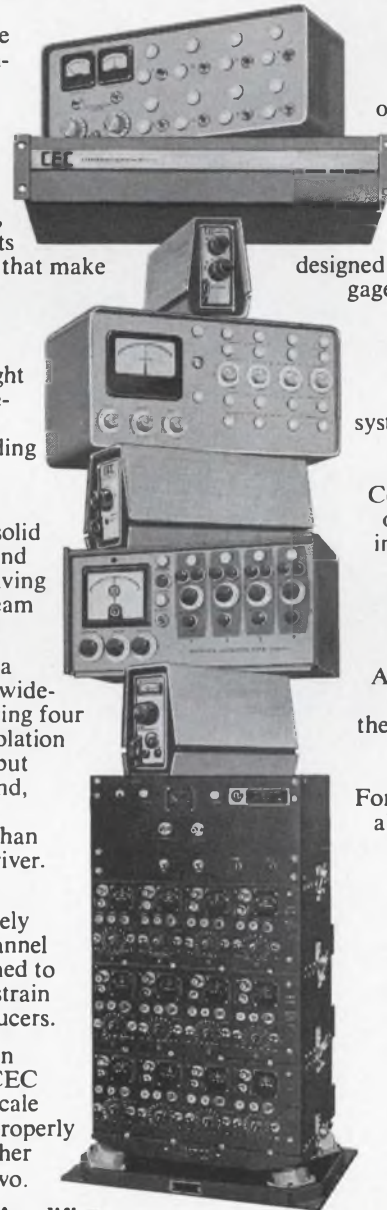

CEC

DATAGRAPH PRODUCTS

BELL & HOWELL

ON READER-SERVICE CARD CIRCLE 84

FOR MARKING PRODUCTS OF ANY SIZE, SHAPE, OR FINISH.



When you mark more than a few — but less than a lot, with changing words and/or numbers. **NO SCREWS TO LOSE, NO TOOLS TO USE.**

1/16	ABC123
3/32	ABC123
1/8	ABC123
5/32	ABC12

Note the man-size winding adjustment button that controls the clamps quickly, easily and holds type in perfect alignment. No need to fiddle with screws, tools, or troublesome attachments.

BAKELITE TYPE HOLDER "A" (Type Styles to Fit) | **BAKELITE TYPE HOLDER "B"** (Type Styles to Fit)

Type area 1" wide @ \$3.95	Type area 1" wide @ \$5.00
Type area 2" wide @ \$4.25	Type area 2" wide @ \$5.30
Type Style Set — Size 1/16" @ \$9.95	Type Style Set — Size 1/16" @ \$9.95
Type Style Set — Size 1/32" @ \$9.95	Type Style Set — Size 1/32" @ \$9.95
Type Style Set — Size 1/8" @ \$9.95	Type Style Set — Size 1/8" @ \$9.95

Set type easily, change it speedily, lock it in. It aligns automatically. Type is engraved, deep-kut vinylite, acid-resistant, clog-free — lasts indefinitely. Markings are razor-sharp and permanent. Inks available in all colors.

These low priced sets are available by mail only, from:

KRENGEL **MANUFACTURING COMPANY, INC.**
323 West 39th Street New York, N. Y. 10018 Tel. 524-2030

NOTE! WRITE FOR OUR FREE CATALOG OF ALL MARKING PRODUCTS ON READER-SERVICE CARD CIRCLE 85



Cool your "overheat" problem! Get the Littelfuse miniature heat fuse for thermal overload protection. 7/8" long x 7/64" dia. Fully insulated. Crimp style connections.

LITTELFUSE
DES PLAINES, ILLINOIS

ON READER-SERVICE CARD CIRCLE 86

SYSTEMS

Computer designs passive filters

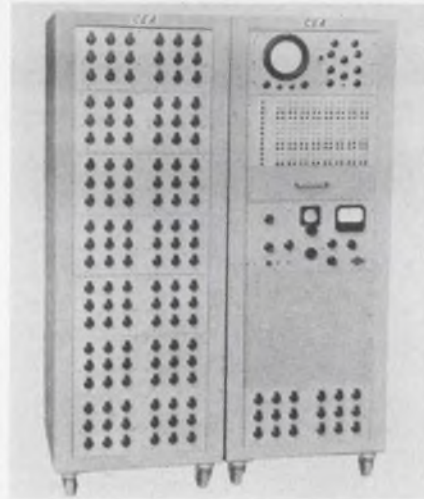

CEA Div. of Berkleonics, Inc., 1221 S. Shamrock Ave., Monrovia, Calif. Phone: (213) 359-9261. Price: \$10,000 to \$100,000.

A filter design computer can simulate simple and complex filters with up to 125 discrete passive elements. It includes built-in voltage sources and readout devices. The computer can be programmed and response data obtained in minutes. The average-size model is housed in two 6 x 9-ft. portable racks and requires minimal power with no air-conditioning and no peripheral equipment. This system simulates complex filters with up to 48 discrete passive elements.

CIRCLE NO. 422

Military core memory easy to maintain

Information Control Corp., 1320 E. Franklin Ave., El Segundo, Calif. Phone: (213) 322-6930.

Military random-access core memory systems are organized to be expandable from 512 words to 8192 words, and from 4 bits to 24 bits. The memory is a 4-wire coincident-current system using 22-mil lithium ferrite cores. It can be operated in clear/write, read/restore, read/modify write and read only modes. Full cycle times are 1.5 μ s. Interface characteristics are compatible with DTL and TTL IC output voltages. The 8192-word x 10-bit memory utilizes less than 100-W prime power.

CIRCLE NO. 423

Digital data adapters control 8 serial circuits

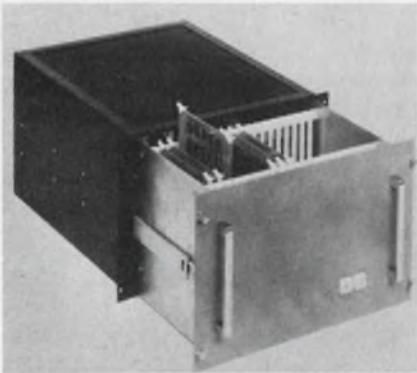

Western Telematic, Inc., 5507 Peck Rd., El Monte, Calif. Phone: (213) 442-1862.

These multichannel digital data communications adapters control up to 8 complete and independent serial data circuits including serial-deserializer, vertical and longitudinal parity checking, dataset control and externally selected operating modes. The TM series is specifically designed for 5- to 8-level codes. Each channel serializer flags and synchronizes its internal register to transfer a parallel character from the processor.

CIRCLE NO. 424

Stepping drum programs 400 steps/minute

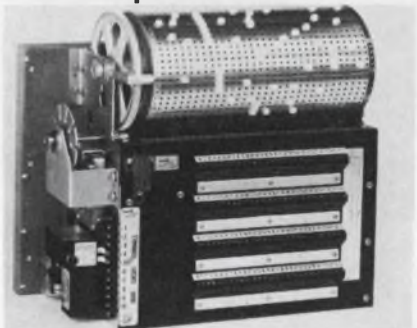

Tenor Co., P. O. Box 2766, Milwaukee. Phone: (414) 781-4800.

High-speed drum programmers can sequence at up to 400 steps per minute. This programmer is available in models with 16 to 93 output switches operating through 30, 60 or 100 steps. It is a pulse-actuated, motor-driven switching device which automatically sequences operations according to a preset program. The program pattern is established by inserting switch-actuating plugs in the drum.

CIRCLE NO. 425



waldom solderless terminals & connectors

You can be sure of neater, stronger, more positive terminations if you use Waldom Solderless Terminals and Connectors. Though designed primarily for sophisticated quality circuitry, more and more economy circuits now use Waldom Solderless Terminals for savings in assembly time. From any angle, Waldom is the Industry's fastest growing line.

- * Broad selection including Quick Disconnects
- * All construction styles
- * Absolute dependability
- * Saves time and labor
- * Easier servicing
- * All types made to military specs.

Fast delivery from your electronics or electrical distributor. Write for FREE Waldom catalog listing more than 3000 electronic hardware items.



waldom

ELECTRONICS, INC.

4643 West 53rd Street, Chicago, Illinois 60632

ON READER-SERVICE CARD CIRCLE 87

NEW *StabilTMac* 400 INVERTER PROVIDES ULTRA STABLE 400 CYCLE OUTPUT



STABIL-AC is a trademark of MIL ASSOCIATES, INC.

Overall stability of ± 1 cycle ($\pm .25\%$) is particularly useful for airborne synchronous servo equipment. Also, ability to adjust output $\pm 1\%$ permits compensation for mechanical tolerances in frequency-related drive or timing devices.

28 VDC input provides isolated 400 (or 800) cycle, 115 VAC output, 15 watts maximum for loads with a power factor of .8 or greater. STABIL-AC inverters with lower voltages and lower power outputs are also available.

STABIL-AC inverters have very low susceptibility to input audio transients — noise and ripple. Price is less than \$400 in small quantity. Technical bulletin with performance and physical specifications on request.



MIL ASSOCIATES, INC.
Dracut Road Hudson, N.H.
(603) 882-5193

ON READER-SERVICE CARD CIRCLE 88

New high efficiency, high frequency Photochopper Modules

- High stability from -25 to $+75^{\circ}\text{C}$, efficiency varies less than 5% over temperature range
- 50% efficiency at 1000 Hz
- Internal electrostatic shielding
- CdS cells for fast warm up

Write for new Bulletin 201/ITD3-67



INC. ■ 1239 BROADWAY, NEW YORK, N.Y. 10001

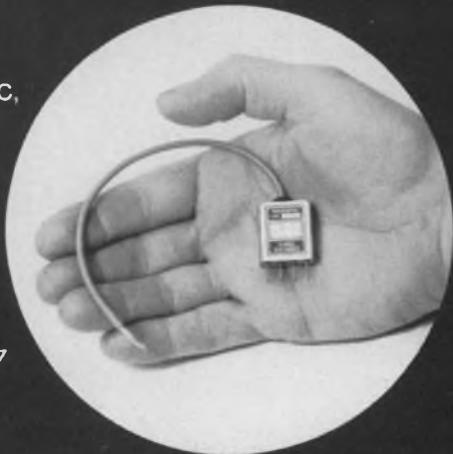

ON READER-SERVICE CARD CIRCLE 89

Design Aids

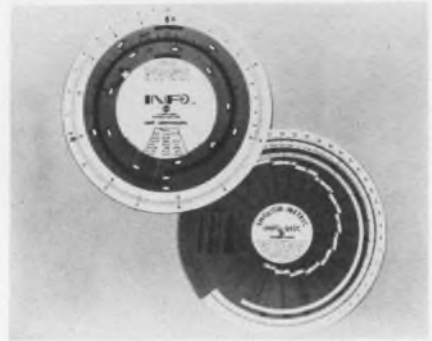

English-to-metric rule

Fast, accurate conversion between inches and millimeters in graduations of thousandths or 64ths from 0 to 12 inches are made in a single setting of this calculator. A table gives values for converting up to 1000 inches and 100 feet. The back features a Fahrenheit-to-Centigrade temperature scale that converts to the nearest degree from absolute zero to 6332°F . A conversion factor table gives 70 common conversions for length, area, volume, pressure, power and weight.

Available for \$4.50 from Info Inc., 13 Boyd St., Newton, Mass.

Cryogenic copper data

Ten graphs summarize the cryogenic performance of OFHC and AMZIRC copper. The data show that tensile and yield strengths, elasticity, elongation, notched tensile strength and fatigue properties all increase substantially when temperatures are lowered to 4°K . The data is drawn from research programs conducted at the NBS and other institutions to determine what extreme cold does to properties of materials and how induced changes can be used in devices intended for operation in the cryogenic range. Metals Refining Div., American Metal Climax, Inc.

CIRCLE NO. 426

Electrolyte evaluation chart

Thirty-five different metals and alloys with recommended electrolytes to produce light or dark marks are tabulated on this chart. The chart also includes the type of current necessary and general comments. Wall-hung, it is a handy reference. Electromark Corp.

CIRCLE NO. 427

GIANNINI on Stepping Relays

"Why do so many engineers make sequence switching so complex and expensive, when a stepping relay is really the best answer?"

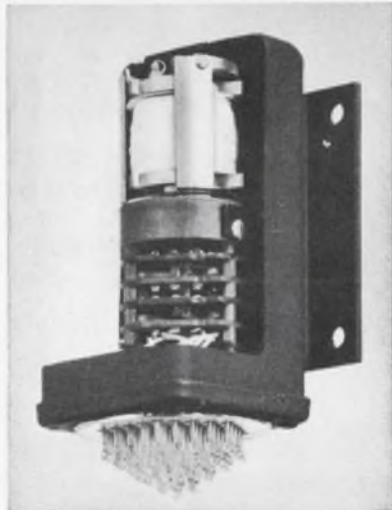

Our G-13 Series Stepping Relay shown here, for instance, is about the simplest and most reliable device for almost any sequential switching function. Vibration and shock exceed the requirements of MIL-R-6106, Class B8, and therefore are not a problem. This stepping relay is fast operating with low power consumption, and is, in fact, the only hermetically sealed stepping relay of its type designed specifically for airborne applications.

At Giannini-Voltex, we make stepping relays in a wide range of pole and contact configurations, and up to 10 Amps switching capability.

Next time you have a problem in sequence switching, get in touch with us. We'll help you find a simple way out.

Giannini

GIANNINI || **VOLTEX**

12140 E. RIVERA RD., WHITTIER, CALIF. 90606
PHONE: 213-723-3371, TELETYPE: 213-685-6261
An Independent Company/An Equal Opportunity Employer

ON READER-SERVICE CARD CIRCLE 90

Application Notes

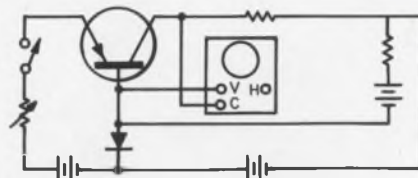

Junction temp calculation

In order to ensure reliability in power transistor circuits, it is necessary that the maximum junction temperature remain below the maximum rated value. The calculation of the junction temperature under steady-state conditions is relatively simple. However, in many switching applications, short pulses of very high power are encountered. In this discussion, a simple method (above) for calculating instantaneous maximum junction temperatures under pulsed conditions is presented. This calculation makes use of the concept of "thermal capacity," defined as the energy in watt-seconds stored per °C. Delco.

CIRCLE NO. 428

Ac/dc converter design

Design considerations for high-speed, wideband, ac-to-dc converters are detailed in an 8-page note. The paper is oriented to the requirements of ac-to-dc converters at the input of high-accuracy digital voltmeters. Particular attention is paid to questions of frequency response, settling time, stability, accuracy and convenience. The discussion deals primarily with the average-responding converters used to extend the measuring power of DVMs from dc volts to ac volts. Dana Laboratories, Inc.

CIRCLE NO. 429

Peak, rms and average power

A discussion of modulation envelope shapes and their effect on RF power measurement is the subject of a 4-page application note. The essay treats cw, AM, SSB, and pulsed RF transmissions, comparing the peak envelope power and average heating power with eight examples. Bird Electronic Corp.

CIRCLE NO. 430

Milliwatt RTL design

Design rules for milliwatt RTL IC logic elements are covered in a 20-page application note. It defines the terms used in design and develops design rules for use in designing logic with mW RTL elements. Explanations are also presented for noise margins, propagation delay and power consumption along with descriptions and applications of mW RTL elements. Data sheets for each mW RTL device furnish the design engineer with complete information on how to accomplish the logic design. Sprague Electric Co.

CIRCLE NO. 431

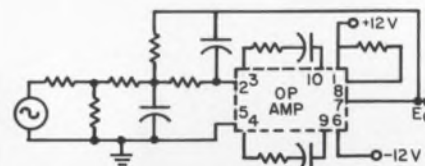

Servo-filter network design

Servo-filter design using an integrated op-amp is described in this application note. The WC 161 operational amplifier used as an active low-pass filter has a gain of 54 dB and a frequency response to 15 Hz. Since the designer of servo systems must consider the frequency band-pass of the error signals, this network is particularly suitable for use in guidance and control applications. The design of a servo filter network is one such application. The complete design procedure is outlined in the 4-page note. Curves, schematics and tables aid the discussion. Westinghouse, Molecular Electronics Div.

CIRCLE NO. 432

Vhf diode tuner design

This bulletin describes a vhf tuner which is designed with two silicon transistors and two variable capacitance diodes. The necessary supply voltage is 9 V. For tuning through the receiving range (87 to 104 MHz) the tuning voltage is varied from 4 to 20 V. The eight-page discussion includes schematics, charts and necessary design equations. Telefunken Sales Corp.

CIRCLE NO. 433

Lamb Electric engineering turns your product on.

Common-coupling problems

The circuit engineer is confronted with the common-coupling problem in any amplifier design which involves high gain and wide bandwidth. Common coupling, a conducting feedback mechanism due to parasitic circuit elements, can introduce amplifier performance faults of poor stability, low gain, reduced bandwidth and distortion of the band-pass and phase responses. The microcircuit can provide the gain and bandwidth performance of a complete discrete circuit amplifier to make terminal connections to ground, supply, source and load significantly more sensitive to parasitic inductances of the leads. To illustrate a practical approach to this problem, calculated limitations of lead inductance are established for a broadband monolithic microelectronic amplifier. Equations, charts and schematics aid the development of the design. Philco/Ford Microelectronics.

CIRCLE NO. 434

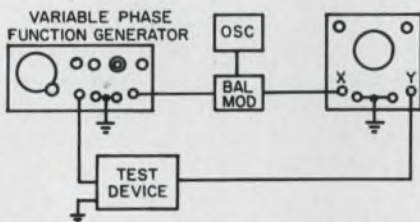

Phase-shift measurements

An 11-page application note describes techniques for making phase-shift measurements at frequencies ranging from 60 kHz to lower than 0.01 Hz. The note discusses how the phase delay encountered by a signal in passing through the device under test, such as a servo system, is measured by oscilloscope comparison with the variable phase output of a variable-phase function generator. The bow-tie method shown above is one example. A method of overcoming flicker in the scope display at very low frequencies is also described and illustrated. Hewlett-Packard, Loveland Div.

CIRCLE NO. 435



Example: the whole world of floor care

If your product has got to vacuum, scrub or polish, you need Lamb engineering. Lamb products turn on the whole range of equipment that cares for floors.

For example, you might be interested in our gear motors customized from standard Lamb parts . . . or one of our many vacuum motors that assure you of the right combination of performance, life and cost. Whatever floor care product you manufacture, Lamb Electric has the motor that will do the job for you.

Let Lamb engineers turn your product on. Write for motor details and performance curves. Put us to the test. We'll turn your product on . . . with exactly the motor that you need. Ametek, Inc., Lamb Electric Division, Kent, Ohio 44240.

AMETEK / Lamb Electric

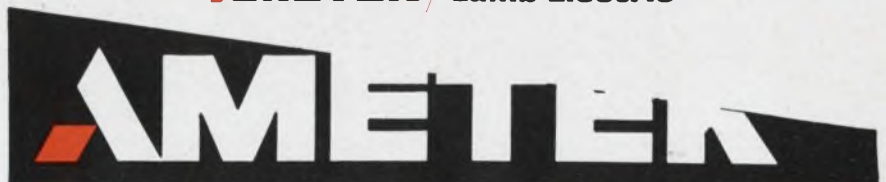

ON READER-SERVICE CARD CIRCLE 91

New Literature

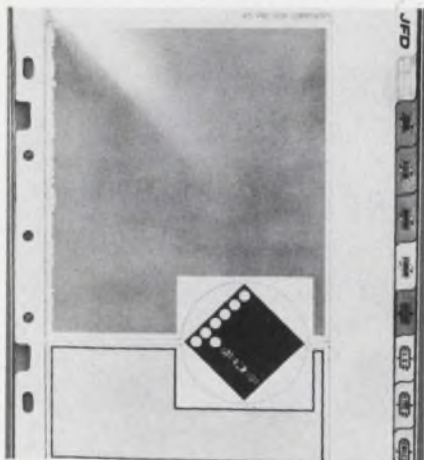

Components compendium

This "non-catalog" components catalog is a modular information storage and retrieval system. Presented at one time is the full spectrum of the manufacturer's component capabilities and details on product lines. Covered in the brochure is product information including piston trimmers, air-variable capacitors, ceramic variables, standard capacitors, fixed capacitors and miniature tuners. Each product contains formatted data sheets with photos, drawings, and specifications. As a general design aid, the book is a reference file of tables, charts, formulas and nomographs used by the design engineer. JFD Electronics Co.

CIRCLE NO. 436

Recorder selection

A 20-page bulletin makes it easy to select the most suitable recorder for your application. Applications including measurements of volts, amperes, power factor, watts, frequency, motor horsepower output or speed are covered. The manual includes a guide for specifying and applying recorders. Graphs are shown for plotting load trend data and converting kW input to horsepower output of a motor. They show how to tabulate the following data in less than one minute: systems kW, kVAR, power factor, kVA and the rating of capacitors required to change the system power factor. General Electric.

CIRCLE NO. 437

Printed-circuit design

This 16-page technical booklet describes techniques for the design and production of printed circuits and assemblies for high-reliability applications. It covers such design/production considerations as manufacturing methods, how to select electroplates, hints for specifying dielectric base materials and eyelet vs plated-through holes in two-sided circuit patterns. Charts illustrating current-carrying capacities, performance characteristics of base materials, and a table giving applications and properties of plated coatings are included. Industrial Circuits Co.

CIRCLE NO. 438

Infrared radiometry manual

Information describing the theory and practical application of radiometric measurements using infrared techniques is contained in this bulletin. The theory of emitted radiation, its measurement, and spectral filtration techniques for wideband or monochromatic measurements is described, along with radiometric techniques for the conversion of surface radiance into temperature information without contact with the surface. Huggins Laboratories, Inc.

CIRCLE NO. 439

Electronic counters

A 24-page catalog contains information on frequency counters, timers, preset controllers, frequency difference meters, D-to-A converters and algebraic data comparators. Performance and mechanical specifications along with prices are included. Atec, Inc.

CIRCLE NO. 440

Magnetic shielding alloys

This brochure gives the engineer and designer a choice of shielding alloys over a range of coercive forces. It includes magnetization as well as attenuation curves to optimize the choice of foils and sheet materials. Primec Corp.

CIRCLE NO. 441



RF shielded chambers

This folder describes the construction and performance of various types of RF shielded chambers. It lists the typical insertion loss vs frequency achievable with each type of construction. The shielding effectiveness against magnetic fields, electric fields and plane waves is shown. Emerson & Cuming, Inc.

CIRCLE NO. 442

Electronics cements

Cements for the electronics industry are described in a four-page technical data bulletin. It lists and describes the applications and characteristics of 40 cements, lacquers and enamels. Maas & Waldstein.

CIRCLE NO. 443

Tantalum capacitor data

"Parameters of Tantalum Capacitors—Physical, Electrical and Chemical" is a 40-page book of 5 articles. They are: "Introduction to Tantalum Capacitors," "Types of Tantalum Capacitors," "The Parameters of Tantalum Capacitors," "Tantalum Capacitor Fundamentals" and "Applications." Each article provides an easy-to-use reference. Also included are a number of helpful graphs, photographs and illustrative diagrams, which help define the operating characteristics of tantalum capacitors.

Available on company letterhead from Tansitor Electronics, Inc., West Rd., Bennington, Vt.



First full-range*
DC Voltage Calibrator
with .01% accuracy for under \$1000—



Cohu's new Model 324!

- *Output voltage ranges: 10-V Range: 0 to 11.11110 volts (10 μ V steps)
 100-V Range: 0 to 111.1110 volts (100 μ V steps)
 1000-V Range: 0 to 1111.110 volts (1 mV steps)
- Output current capability: 0 to 25 milliamperes nominal at any voltage setting.
- Accuracy: 0.01% of setting.
- Stability: Within 30 PPM for 24 hours, 50 PPM for 30 days.
- Dimensions: Cabinet: 10½" W x 5¼" H x 15½" D.
 Rackmount: 19" W x 5¼" H x 15½" D.
- Price: Cabinet (324): \$995. Rackmount (324R): \$1050.
 F.O.B. San Diego. Additional export charge.
- Delivery: Immediate, from stock.

For full details, contact your Cohu engineering representative.



Box 623
 San Diego, California 92112
 Phone: 714-277-6700

ON READER-SERVICE CARD CIRCLE 92

420 CFM FAN



McLEAN VENTURI

Installation's a Breeze!

Just bolt this fan to the enclosure opening and it's ready to go. You save space and have the performance of a centrifugal with this high-pressure, dual-purpose unit. Mounts against top, bottom, or side of a rack. Propeller and motor guards are flush with the venturi to permit either-way airflow. Best of all, it's low cost too!

No collars, guards or sleeves to be assembled or disassembled. Motor mounts and propeller guards are heavy-gauge wire, luster-zinc plated. Depth, 3 $\frac{3}{4}$ ". Diameter, 10". Motor, 115 VAC, 50/60 Hz. Life lubricated. Double-shielded ball bearings. Fungus and corrosion resistant. Operates to +250°F.

Full details in our new 1967 Catalog.

McLEAN ENGINEERING LABORATORIES

Princeton Junction, N. J. 08550
Phone 609-799-0100
TELEX 083-4345

NEW LITERATURE

Operational manifolds

A brochure describing operational manifolds—analogue instruments for breadboarding, computing, modeling, measuring and on-line controlling—has been released. The units are designed for applications in instrumentation, on-line analogue data processing, circuit development experimentation and for teaching feedback technology. Circuit diagrams of typical applications are also included along with descriptions of accessory kits for connection hardware, computing components and 15-contact uncommitted plug-in boards. Philbrick Researches, Inc.

CIRCLE NO. 444

NiCad battery data

A reference catalog on rechargeable nickel-cadmium batteries and cells is offered. The brochure lists information in tabular form, and gives specifications on dimensions, weights, capacities and charging rates. The data cover commercial sealed cells, commercial aircraft batteries, military aircraft batteries, special-purpose batteries and high-reliability space batteries. Sontone Corp.

CIRCLE NO. 445

Coil winding machinery

This 68-page catalog has data on machines for coil winding needs in high production, prototype or laboratory applications. A page of winding formulas and a page describing a high-speed wire scraping machine is included. The catalog also contains data on 22 tensions and 6 counters and 9 pages devoted to tailstocks, accessories and optional equipment. Stevens Mfg. Co., Inc.

CIRCLE NO. 446

Microwave equipment

A 16-page catalog describes microwave receivers, transmitters, mixer-preamps, linear, log IF, RF and microwave amplifiers. The catalog contains information on 270 individual models and series. Photos, curves, specifications and block diagrams illustrate the equipment. RHG Electronics Lab.

CIRCLE NO. 447



CONSTRUCTION ■ ALL SILICON ■ OVER 100,000 HOURS MTBF ■ NO HEAT SINK REQUIRED
OVERLOAD RECOVERY ■ SHORT CIRCUIT PROOF ■ CONTINUOUS RATINGS AT 71°C W
1,000 HOURS MTBF ■ COMPONENTS ACCESSIBLE FOR EASY MAINTENANCE ■ ALL SILICON

POWER/MATE
REGULATED POWER SUPPLY MODULES

Power supply catalog

A 16-page volume lists thousands of power supply modules. It covers mechanical data pertaining to the power supplies along with connections, impedances, weights and accessories. Power/Mate Corp.

CIRCLE NO. 448

Kit and instruments catalog

A 36-page catalog featuring a line of 200 electronic kits and factory-assembled instruments is available. The fields of CB, ham, and short wave communications, mono/stereo hi fi, test instruments for education, lab, hobby, electronic technicians, and industry are covered. An easy-to-build professional-component project is also included. EICO Electronic Instrument Co., Inc.

CIRCLE NO. 449

36-page diode brochure

A thirty-six page catalog on controlled avalanche rectifiers and Zener diodes includes information on lead materials, applications, mounting, derating and reliability. A new reliability specification, HR-201, is contained in the volume. Unitrode Corp.

CIRCLE NO. 450

88-page module catalog

An 88-page catalog contains information on solid-state modules and related equipment. The volume lists specifications, schematics, applications and prices for the logic modules. BRS Electronics.

CIRCLE NO. 451

ZIP code guide

Are you doing your marketing by mail? This "Guide to ZIP Coding" can help. The 24-page illustrated booklet contains information for bulk mailers. It describes the fundamentals of ZIP coding, procedures for bundling and stacking, post office sorting and post office mailing-list services and contains a third-class postage cost comparison along with other important facts. Major multi-ZIP-coded post offices are listed. Addressograph Multi-graph Corp.

CIRCLE NO. 452

Catalog of coil forms

A 36-page catalog describing ceramic, resinite and Velvetork coil forms is available. PC board and bushing-mounted coil forms covered in the catalog permit operation over a frequency range extending to 300 MHz. The brochure gives dimensional drawings, specifications and prices for coil forms with diameters from 0.162 to 0.5 inch. Contained are specifications and prices for 13 series of commonly used adjustable RF coils. J. W. Miller Co.

CIRCLE NO. 453

Radiation detectors

This 12-page reference guide describes neutron and gamma radiation detectors. It contains specifications and schematics for each detector type, with a brief technical discussion of theory and application. Also included are charts showing the operating ranges for each detector type, and a diagram telling where and how each type should be used. Westinghouse Corp.

CIRCLE NO. 454

Galvanometer strips

An alloy of 10% nickel/90% platinum with high tensile strength and resistance to corrosion is described in a bulletin which outlines its basic advantages. It contains information on suspension vs pivots, apparatus for measuring torque, pendulum mass, etc. It also includes two comparative tables on platinum/10% nickel band strip and 14K gold suspension strip. Sigmund Cohn Corp.

CIRCLE NO. 455

How are you fixed for space?

If electronic packaging is your problem and you are looking for the best utilization of space, see Chassis-Trak of Indianapolis. Chassis-Trak's ultra-thin slides, in capacities of from 50 lb. to 1,000 lb., and a complete inventory of cabinets, chassis, cable retractors and hardware make Chassis-Trak your department store for electronic packaging.

Find out how easy it is to obtain a single source for your electronic packaging from Chassis-Trak of Indianapolis.



D-600 to 125 lbs.



VENT-RAK Modular Chassis



C-300 to 50 lbs.



C-230 to 100 lbs.



CTB to 175 lbs.



CB to 1000 lbs.



1000 Series

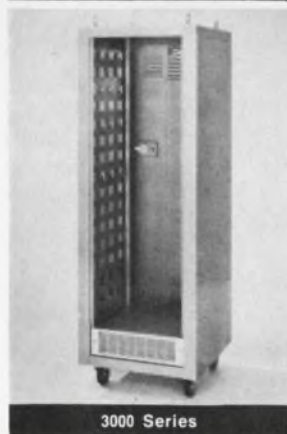

3000 Series

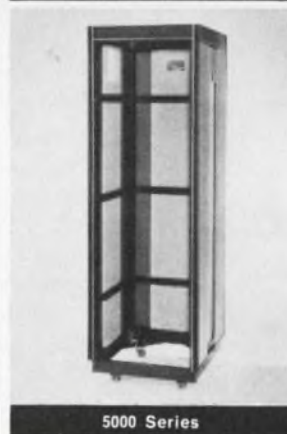

5000 Series



5050 Series



... A Package for Every Major Missile Project

525 South Webster Avenue, Indianapolis, Indiana 46219

ON READER-SERVICE CARD CIRCLE 94

NOW
Modiflex[®]
 the Capacitor
 with the high
**INSULATION
 RESISTANCE**

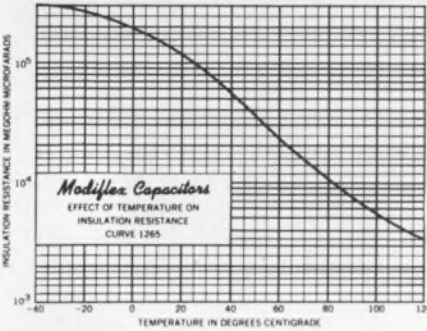

The new Modiflex Capacitors utilize a synthetic film and a liquid plastic dielectric to produce a capacitor with highly desirable characteristics.

High insulation resistance (see curve above) plus excellent capacitance-temperature characteristics contribute to the unusual performance of the Modiflex.

Because of their low power factor they are suitable for AC as well as DC circuitry.

Modiflex Capacitors are available in values to 250 MFD. For complete specifications.....

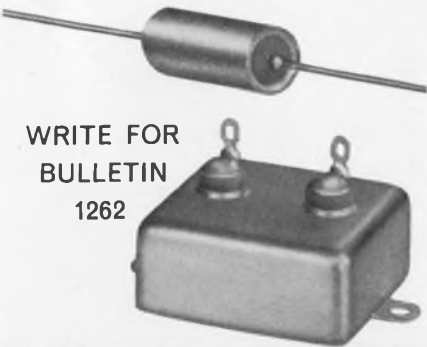

WRITE FOR
 BULLETIN
 1262

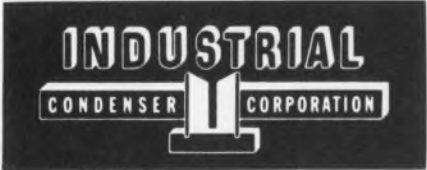

3243 No. California Ave.
 Chicago, Illinois 60618

NEW LITERATURE

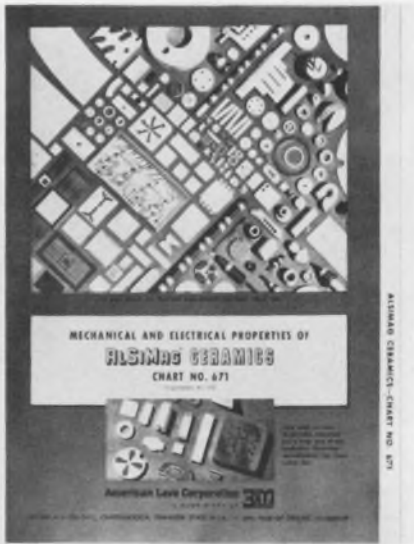

Ceramics for electronics

Properties of 27 ceramics are tabulated in this fold-out chart. Mechanical, electrical, thermal, chemical and other characteristics are included. American Lava.

CIRCLE NO. 456

Solenoid data

Complete and up-to-date facts on solenoids are contained in this 36-page catalog. A valuable feature is an article which outlines the four factors involved in getting best performance from a solenoid. These are work requirements vs solenoid capabilities, operating temperature and duty cycles, methods of increasing life expectancy, and electrical requirements and power limitations. Guardian Electric Manufacturing Co.

CIRCLE NO. 457

128-page antenna catalog

A 128-page catalog gives product information and engineering data on microwave, uhf, vhf and telemetry antennas, flexible coaxial cables and elliptical waveguides, and switching and pressurization equipment. Also included are system accessories such as radomes, positioners and telescoping masts. Andrew Corp.

CIRCLE NO. 458

MIL-spec ac fans

A bulletin describing compact MIL-spec ac fans is available. It gives dimensional and performance data for 115-Vac, 60-Hz 1-phase units. Globe Industries, Inc.

CIRCLE NO. 459

Fluidic technology

A booklet describing Corning's fluidic devices is available. The publication begins with an introduction to fluidics followed by text and photos describing the material used to make the devices. The devices, discrete and integrated, are made of a glass-ceramic material that withstands nuclear radiation, corrosive liquids and gases, and physical shock and vibration. Corning Glass Works.

CIRCLE NO. 460

Solar energy converters

A brochure describing solar energy converters includes descriptions of the cell structure, functions of the converter, applications and uses, cell characteristics and design data and specifications. Illustrated diagrams on voltage-current, spectral response and output variation with temperature complete the presentation. Sensor Technology, Inc.

CIRCLE NO. 461

High-voltage test equipment

A catalog illustrating high-voltage equipment contains technical data, photos, prices and delivery information. Included in the volume are 1-to-300-kV ac and dc power packs, power supplies and test sets for dielectric strength, breakdown, leakage, corona and continuity tests. Peschel Instruments, Inc.

CIRCLE NO. 462

Reliability evaluation

A 67-page booklet describing methods for evaluating contractor reliability programs describes the key factors which make a reliability assurance program effective. It gives specific criteria for evaluating each of fourteen reliability program areas. The description of criteria for evaluating each reliability task is directed toward fundamentals and should be of use to contractors and subcontractors in aerospace and other industries which employ reliability assurance programs.

Available for \$3 (NASA SP-6501) from Clearinghouse, Springfield, Va. 22151.

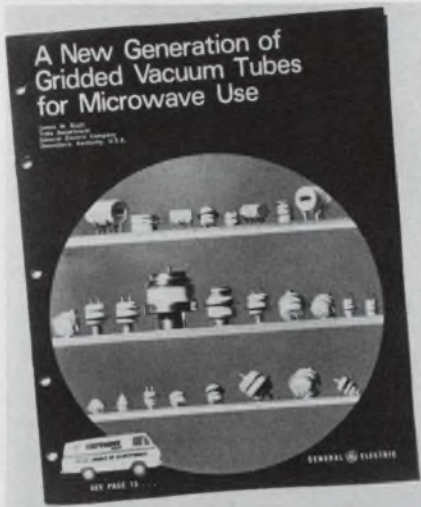

Microwave vacuum tubes

"A New Generation of Gridded Vacuum Tubes for Microwave Use" describes the GE family of gridded ceramic planar tubes. The illustrated publication provides a summary of the required electrical and mechanical features of gridded tubes designed to work into the higher microwave frequencies. Introductory pages cover the electrical and mechanical requirements of advanced radar equipment. The brochure goes on to describe the ceramic planar tubes. The brochure also includes detailed application notes, with full coverage of oscillator and amplifier tube/cavity combinations. General Electric Co.

CIRCLE NO. 463

Thermistors and varistors

A selection of frequently used thermistors, varistors and assemblies are covered in this catalog. Included are technical data covering resistance-temperature characteristics, dissipation and time constants, electrical properties, dimensions and other operating and performance characteristics. Victory Engineering Corp.

CIRCLE NO. 464

Rotary stepping switches

A 36-page catalog describes a line of rotary stepping switches. The brochure gives specs and application information as well as mounting data on each type of switch. It concludes with sections on hermetic and protective enclosures, and reference data. Automatic Electric Co.

CIRCLE NO. 465

VICTOREEN HIGH VOLTAGE VACUUM TUBES SOLVE SWITCHING PROBLEMS



Victoreen high-voltage vacuum tubes make ideal components for switching circuits... as series or shunt regulators... as deflection amplifiers... or as inputs to pulse forming networks. Other uses which can capitalize on their superior performance, longer life, and compactness include—dunking, clamping, and crowbar circuits

Tube illustrated above, the Victoreen 6842 pentode with plate voltages to 4 kV, is shown in a typical shunt regulator circuit with two Victoreen Corotron corona type voltage regulators.

Other tubes in the Victoreen line include —

- 7683** — Triode or pentode with plate voltages to 1 kV
- VX-80** — Triode with plate voltages to 4 kV
- VX-76** — Pentode with plate voltages to 5 kV
- 7235** — Triode with plate voltages to 10 kV
- 7234** — Pentode with plate voltages to 10 kV
- VX-107** — Beam pentode with plate voltages to 15 kV
- VX-68** — Vacuum high-voltage rectifier with 28,000 PIV; application as rectifier or clipper

8982-A

VICTOREEN INSTRUMENT DIVISION
10101 WOODLAND AVENUE • CLEVELAND, OHIO 44104
IN EUROPE: GROVE HOUSE, LONDON RD., ISLEWORTH, MIDDLESEX, ENGLAND



ON READER-SERVICE CARD CIRCLE 96

PRECISION POTENTIOMETERS



"MITE-E-MITE"

"KWIK-TRIM"

SINGLE
MULTI / TURN

GET RID OF THAT BIG POT!

USE LITTLE WIRE WOUND POTS LIKE OURS!

"MITE-E-MITE" Dime-size, comes in three styles:
bushing mount, servo mount and solder mount

"KWIK-TRIM" Tiny trimming potentiometers with
triple adjustment and dual visual indicators

SINGLE / TURN Accurate, gangable, phaseable
MULTI

WRITE FOR CATALOGUE



GENERAL SCIENTIFIC CORPORATION

A DIVISION OF SAN FERNANDO ELECTRIC MFG. CO.
1509 FIRST STREET ■ SAN FERNANDO, CALIFORNIA 91341
TELEPHONE: (213) 365-9411 ■ TWX (213) 764-5963

ON READER-SERVICE CARD CIRCLE 97

NEW LITERATURE



Terminal selection

Consisting of 28 pages, this catalogue gives instructions for the selection and use of the correct terminals and the correct crimps to assure good terminations or splices for every wiring need. Vaco Products Co.

CIRCLE NO. 466

Pushbutton switch catalog

A 22-page catalog describes a line of pushbutton switches. The brochure contains information and illustrations on the modular design of these switches. It also describes the basic module elements, module functions and assemblies as well as accessories. Mechanical, electrical and environmental specifications are included in the catalog as are dimensional drawings for three basic series of switches. Centralab.

CIRCLE NO. 467

Metal-clad laminates

Design information and materials data for PC boards are contained in an 8-page brochure which describes metal-clad laminated plastics. Included in the discussion are thin-film laminates and prepregs for multilayer circuitry along with a brief note on laminates clad with electro-deposited nickel foil. Synthane Corp.

CIRCLE NO. 468

PC connector catalog

This 64-page guide describes and illustrates a line of printed circuit connectors, enclosures and installation equipment. Described are suggested applications, mounting data, PC card layouts and specifications. The catalog covers plug-and-receptacle and card-edge connector types. Elco Corp.

CIRCLE NO. 469

CUT CONSTRUCTION DELAY

with pre-punched
VECTORBORD,*
PLUGBORDS and
Push-in TERMINALS

Make circuits the fast, easy way . . . simply insert Vector push-in terminals (wide variety available) and component wires into pre-punched Vectorbord, or use punched copper clad for do-it-yourself etching; and, for production, we're geared to omit the holes not required and assemble terminals, eyelets, etc. to your specifications. Eleven patterns available with .025", .040", .062", .093" holes in XXXP phenolic, glass silicone, glass or paper epoxy and copper clad. Plugbords supplied in many sizes with etched pads, .040" dia. Edge-Pins or Elco Varicon® contacts.

Save time — Save work — Save money!

® TRADE MARK



Send for complete literature

VECTOR ELECTRONIC CO., INC.

1100 Flower St., Glendale, Calif. 91201 Area 213 Phone 245-8971

ON READER-SERVICE CARD CIRCLE 98

Advertising Representatives

New York 10022

Robert W. Gascoigne
Thomas P. Barth
Samuel M. Deitch
William C. Repetto
850 Third Avenue
(212) PLaza 1-5530
TWX: 867-7866

Philadelphia

Fred L. Mowlds, Jr.
P. O. Box 206
Merion Station, Pa. 19066
(215) MO 4-1073

Boston

Richard Parker
7 Redstone Lane
Marblehead, Mass. 01945
(617) 742-0252

Chicago 60611

Thomas P. Kavooras
Berry Conner, Jr.
720 N. Michigan
(312) 337-0588

Cleveland

Robert W. Patrick
8410 Treetower Drive
Chagrin Falls, Ohio 44107
(216) 247-7670

Los Angeles 90303

Stanley I. Ehrenclou
Terrence D. Buckley
W. James Bischof
2930 W. Imperial Highway
Inglewood, Calif.
(213) 757-0183

San Francisco

Ashley P. Hartman
175 South San Antonio Rd.
Ste. 243
Los Altos, Calif. 94022
(415) 941-3084

Southwestern 75206

Tommy L. Wilson
6200 North Central Express-
way
Dallas, Tex.
(214) EMerson 1-2311

London W. 1

Brayton C. Nichols
44 Conduit Street

Verviers, Belgium

Andre Jamar
1, Rue Mallar, 1
(087) 253.85

Tokyo

Yoshihiro Takemura
International Planning
Service, Inc.
Room 231 Tokyu-Mita Bldg.
1. Shiba-Mita Koun-cho
Minato-ku, Tokyo



1/100TH SECOND STOP CLOCK!

RAPID • ACCURATE • DIGITAL READOUT

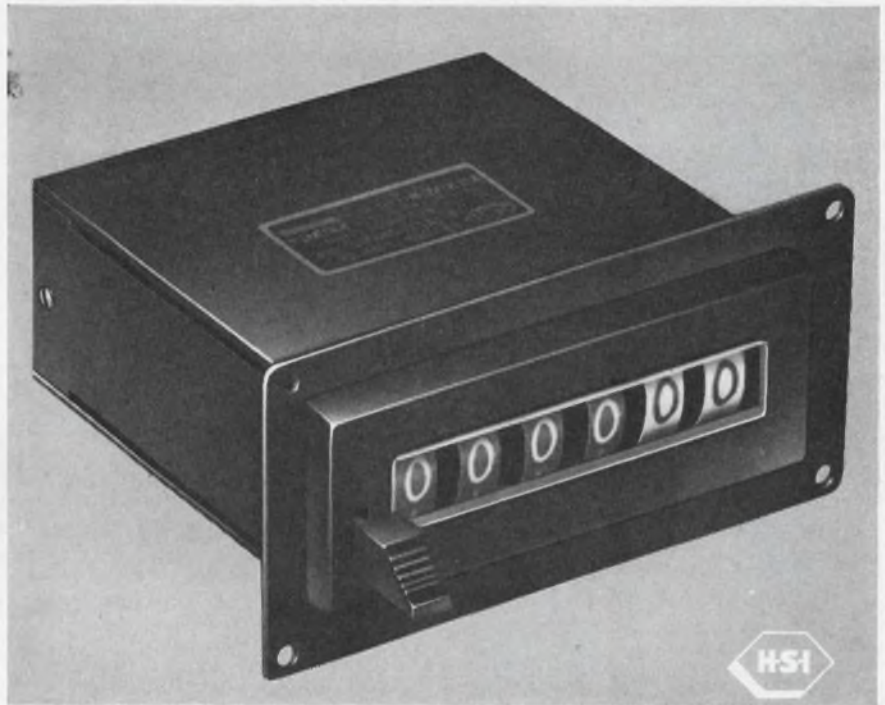

THE HSI SERIES 42 PLANETGEAR® STOP CLOCK makes it possible to measure, integrate or totalize with high accuracy and reliability. Average error over 10 or more readings is less than 5 ms. Well under this figure for integrating. Instant start-stop motor plus patented Planetgear low-torque transfer provide 5 exclusive features . . .

- No pre-start or stabilizing
- Memory lock for power loss
- No spurious counts due to line transients
- Quiet operation
- Extremely long life

Series 42 has large 5/16" high figures, 6 drum display, manual or electrical reset. Operates on 110v 60Hz. 6 watts.

**HSI PLANETGEAR TRANSFER...
YOUR BEST BET IN THE LONG RUN!**

Send for HSI Bulletin 42-3



HAYDON SWITCH & INSTRUMENT, INC.

Where Optimum Performance Is Standard

1500 Meriden Road, Waterbury, Conn. 06720/Area Code (203) 756-7441
ON READER-SERVICE CARD CIRCLE 99

NEED HIGH VOLTAGE CAPACITORS FAST?

... Prompt Delivery -

NO!

... Immediate Delivery

YES!



GLASS
CONTAINERS



METAL CAN
CONTAINERS

Our list of satisfied "blue chip" customers is growing and growing which necessitated a large expansion of our manufacturing and engineering facilities. Now, we can supply a complete range of voltages from 2,000 to 50,000 volt capacitors from our expanded "stock on hand". Don't take excuses, we'll supply you faster than at any time in our many years in the field—BETTER PRODUCTION FROM US—BETTER DELIVERY FOR YOU!

Write for complete list of Standard High Voltage Capacitors in stock—or, send specifications for custom quotations.



Plastic Capacitors, INC.

2620 N. Clybourn • Chicago 14, Ill.
DI 8-3735

Advertisers' Index

Advertiser	Page	Advertiser	Page
Aladdin Electronics, A Div. of		MIL Associates Inc.	160
Aladdin Industries, Inc.	88	McLean Engineering Laboratories	166
Alco Electronic Products, Inc.	155	Mac Panel Company	128
Allen-Bradley Co.	89	Magnetics, Inc.	19
Alliance Manufacturing Co., Inc.	73	Markel & Sons, L. Frank	149
American Lava Corporation	142	Measurements, A McGraw Edison Division	48
Ametek, A Division of Lamb Electric	163	Metex Corporation	154
Amperex Electronic Corporation	119	Motorola Semiconductor Products, Inc.	8, 53
Beckman Instruments, Inc.		Non-Linear Systems, Inc.	46, 47
Helipot Division	154	Ohmite Manufacturing Company	15
Bourns, Inc.	67	Philbrick Researches, Inc.	34, 35
Bulova Electronics Division of		Philips Electronic Measuring Instruments	7
Bulova Watch Company	138	Pioneer Electric & Research Corporation	134
Burndy Corporation	74	Plastic Capacitors, Inc.	172
By-Buk Company	175	Polarad Electronic Instruments	
CELCO Constantine Engineering		Polarad Electronics Corporation	25
Laboratories Co.	33	Potter & Brumfield Division of American	
Chassis-Trak Inc.	167	Machine & Foundry Company	45
Chicago Miniature Lamp Works	140	Power/Mate Corp.	174
Clairex Corporation	160	Prentice-Hall, Inc.	174, 175
Clare & Co., C. P.	136, 137	Princeton Applied Research Corp.	16
Cohu Electronics, Inc.	165	RCA Electronic Components and	
Columbia Components, Inc.	145	Devices	7, 113, 135, Cover IV
Components, Inc.	153	RCL Electronics, Inc.	99
Computer Measurements Company	2	RCA Institutes, Inc.	72
Consolidated Electrodynamics, A		Radiation, Incorporated	124, 125
Subsidiary of Bell & Howell	157	Raytheon Computer	52
Coors Porcelain Company	83	Reeves Hoffman Division of DCA	130
Cutler-Hammer	55	Revere-Mincom Division, 3M Company	120
Dage Electric Company, Inc.	129	San Fernando Electric Mfg. Co.	170
Dale Electronics, Inc.	120A-B, 155	Siemens America, Incorporated	141
Damon Engineering, Inc.	22	Simpson Electric Company	31
ESI/Electro Scientific Industries, Inc.	126	Skydyne, Inc.	156
Eimac, A Division of Varian Associates	6	Sperry Microwave Electronics Co.	27
Eldre Components, Inc.	175	Sprague Electric Company	10, 12, 20
Electronic Design	173	Sylvania, Subsidiary of General	
Ellis and Watts Company	54	Telephone & Electronics	32 A-H
Erie Technological Products, Inc.	9	TRW Semiconductors, Inc.	58
General Electric Company		Tektronix, Inc., Oscilloscopes	60
Electronic Components, Sales Operation	28	Telonic Engineering Co.	144
General Radio Company	117	Telonic Instruments, A Division of	
General Resistance Inc.	156	Telonic Industries, Inc.	109
Genisco Technology Corporation	161	Texas Instruments Incorporated	115
Giannini-Voltex	162	Tung-Sol Division,	
Hacker, Wm. J. & Co., Inc.	152	Wagner Electric Corporation	147
Hathaway Instruments, Inc.	150	Union Carbide Corporation	56, 56A-F, 57
Haydon Switch & Instrument Inc.	171	United Transformer Co.	Cover II
Heath Company	132	Varian, Palo Alto Tube Division	127
Heinemann Electric Company	49	Vector Electronic Co., Inc.	170
Hewlett-Packard, Dymec Division	139	Victoreen Instrument Company, The	169
Hewlett-Packard	1, 123, Cover III	Vitramon, Incorporated	174
Honeywell, Precision Meter Division	51	Vitro Electronics, A Division of	
IRC, Inc.	151	Vitro Corporation of America	148
ITT Cannon Electric, A Division of		Waldom Electronics, Inc.	159
International Telephone and Telegraph		Waters Manufacturing, Inc.	32
Corporation	4-5	Weston Instruments, Inc.	
ITT Integrated Circuits	176	Archbald Division	95
Industrial Condenser Corp.	168	Career Advertising:	
Industrial Electronic Engineers, Inc.	133	Collins Radio Company	106, 107
Krengel Mfg. Co., Inc.	158	Hughes Aircraft Company	
Lambda Electronics Corp.	131	Aerospace Divisions	104
Licon, Division Illinois Tool Works, Inc.	143	National Cash Register Company, The	102, 103
Line Electric Company	108	San Francisco Bay Naval Shipyard	105
Littelfuse	158	Univac, Division of	
Lockheed Electronics Company	146	Sperry Rand Corporation	100

IMPACT

Union Carbide Electronics, Mountain View, California has just placed the largest exclusive advertising campaign in magazine publishing history.

Their objective: To become an even greater factor in the fast-paced twenty-one billion dollar electronics industry.

Their campaign: 138 pages over the next 12 months.

Their magazine: **Electronic Design.**

Union Carbide Electronics and their agency, Hal Lawrence, Inc., decided the best return on their advertising investment would be achieved by concentrating in the magazine read by the greatest number of their prime customers and prospects.

They backed up their decision by scheduling multi-page semiconductor advertise-

ments in every bi-weekly issue of **Electronic Design.**

Advertisements that will be selling the men who specify what goes into what the sales department sells, the accounting department accounts, the production department produces.

138 pages over the next 12 months . . . that's **impact.**



Electronic Design

MOST READ BY THE MEN WHO SPECIFY

Winner of Industrial Marketing and Jesse Neal Awards for Editorial Excellence in 1966

Hayden Publishing Co., Inc., 850 Third Avenue, New York 10022

Publishers of **Electronic Design** and **Microwaves** Magazines . . . Hayden, Rider and Ahrens Books

Design Data from

Electronic Design

ELECTRONIC DESIGN's aim is fourfold. It aids progress in the electronics manufacturing industry by promoting good design. It gives the electronic design engineer concepts and ideas that will make his job easier and more productive. The magazine serves as a central source of timely, up-to-the-minute electronics information. And finally it seeks to encourage two-way communication between manufacturer and engineer.

Want a subscription? ELECTRONIC DESIGN is circulated free of charge to qualified engineers and engineering management doing design work, supervising design or establishing standards in the United States, Western Europe and the United Kingdom. If you think that you are entitled to a free subscription, use the postfree application form that you will generally find inside the back cover. When it is not included, write to us direct for an application form.

If you are not qualified, you may take out a paid subscription at the following rates: \$25 a year if you live in the U.S.A. or \$35 a year if you live elsewhere. Single copies may be purchased for \$1.50 each.

If you change your address, send us an old mailing label and your new address; there is generally a prepaid postcard for this inside the back cover. If you have been receiving ELECTRONIC DESIGN free of charge, you will have to requalify to continue doing so.

We strive for accuracy. We take the utmost pains to ensure the highest standard of accuracy throughout the magazine. A single mistake in practical design information can have serious consequences. But to err is human, and for all the care we take, an occasional error slips through. Whenever this occurs, we publish a correction at the earliest opportunity. You will find these corrections printed at the end of the Letters column. If you should spot an error, be sure to let us know. You may save your colleagues heartaches.

Microfilm copies are available of complete issues of ELECTRONIC DESIGN that have been published since the beginning of 1961, and of single articles. Complete issues cost 4¢ a page, individual pages cost 50¢ each; shipping and handling charges are extra. The minimum charge is \$3; delivery time runs from 10 days for single pages to five weeks for complete issues. For further details and to place orders, get in touch directly with University Microfilms, Inc., 300 N. Zeeb Road, Ann Arbor, Mich. 48106; telephone (313) 761-4700.

Want to contact us? If you have any inquiries about these or other matters, or if you have a manuscript outline or article idea, address your correspondence to:

Howard Bierman, Editor,
ELECTRONIC DESIGN,
850 Third Avenue,
New York, N.Y. 10022.

Transistor Circuit Analysis And Design

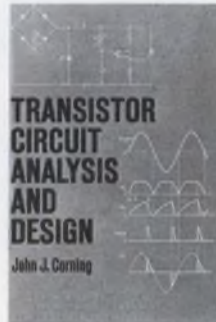

Quickly see how to apply circuit analysis principles to design circuits with the specific performance attributes you want. You get discussions of a broad scope of circuits in detail—d-c bias techniques, a-c equivalent circuits, small and large signal amplifiers, frequency effects, high frequency amplifiers, oscillators, pulse circuits and power supplies. Written by John J. Corning, Manager of Monolithic Circuit Packaging Engineering at IBM, 448 pp., pub. Sept. 1965. Send for your 15 day examination copy by circling the number to the right.

Prentice-Hall, Inc.
Englewood Cliffs, N. J. 07632

174

Capacitor and Component Catalog



This catalog features the 20 standard "VY" Porcelain and "VK" Ceramic Capacitor series and components offered by Vitramon, Inc. Each series is featured on individually removable data sheets containing photos, diagrams, specifications, ordering instructions, and typical curves. A handy selector locates the exact component you need. Included are 5 new products; special *Thin Line*, high current and voltage, chip, wafer, high reliability capacitors; and other high quality, monolithic series. 60 pages.

Vitramon, Incorporated
P. O. Box 544
Bridgeport, Connecticut 06601

175

Equipment Under Test Sign



Bright red and white signs to attach to equipment while it is under test to forestall accidental interference are available from POWER/MATE CORP., Hackensack, N. J. The company is offering these heavy cardboard signs along with their new Power Supply Module Catalog No. 117. The Catalog lists all of the many supplies available from PMC. The package will also include information about their new Uni-88—a 0-34 volt, 1.5 amp. supply that sells for only \$88.00. Racks and other accessories are also available. Write today.

Power/Mate Corp.
163 Clay St.
Hackensack, N. J. 07601

176

Manufacturers

Advertisements of booklets, brochures, catalogs and data sheets. To order use Reader-ServiceCard.
(Advertisement)

Laminated and Molded Bus Bars For Power Distribution



A 16 page Technical Bulletin is now available, describing a new concept in power distribution. Basic mechanical and electrical design principles, along with descriptive pictures and diagrams, are included in this bulletin. These compact buses can replace bulky cable harnesses and repetitive wiring for computer or modular application. This method of construction satisfies the demanding requirements of low inductance and resistance of high speed, solid state systems, while controlling electrical noises.

Eldre Components, Inc.
1239 University Avenue
Rochester, New York 14607

177

New "Tape Lift" Printed Circuit Drafting Aids



No engineer or draftsman should be without the most up-to-date cross-reference guide to better Printed Circuit Drafting Catalog. It is complete with prices and illustrations of over 1200 sizes of "Tape Lift" pads, shapes and other aids for faster, more accurate, distortion-free printed circuit master drawings. Write for FREE catalog.

By-Buk Company
4326 West Pico Blvd., Los Angeles, Calif. 90019
Telephone: (213) 937-3511

178

Intgd. & Active Ntwk. Anlys. & Syn.

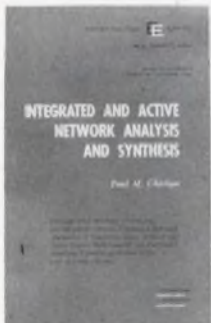

Integrated and active network analysis and synthesis, shows you the latest techniques for handling difficult circuit design problems.

Covers lumped and distributed networks and gives you fully worked out examples for every synthesis procedure. Written by Paul M. Chirlian, approx. 416 pp., pub. May 1967. Send for your 15 day examination copy by circling the number to the right.

Prentice-Hall, Inc.
Englewood Cliffs, N. J. 07632

179

Designer's Datebook

JUNE						
S	M	T	W	T	F	S
			1	2	3	
4	5	6	7	8	9	10
11	12	13	14	15	16	17
18	19	20	21	22	23	24
25	26	27	28	29	30	

JULY						
S	M	T	W	T	F	S
						1
2	3	4	5	6	7	8
9	10	11	12	13	14	15
16	17	18	19	20	21	22
23	24	25	26	27	28	29

For further information on meetings, use Reader Service card.

June 6-8

Microwave Exposition/67 (New York City) Sponsors: Microwave Expositions, Inc., and Hayden Publishing Co.; M. Meisels, Hayden Publishing Co., 850 Third Ave., New York, N. Y. 10022.

CIRCLE NO. 470

June 6-8

Conference on Laser Engineering and Applications (Washington, D. C.) Sponsors: IEEE; L. Winner, 152 W. 42 St., New York, N. Y. 10036.

CIRCLE NO. 414

June 13-15

National Electronic and Packaging Conference (NEP/CON) Sponsor: Electronic Packaging and Production Magazine; M. Kiver, Industrial and Scientific Mgt. Conf., 222 W. Adams St., Chicago, Ill. 60606.

CIRCLE NO. 471

June 19-20

Microelectronics Symposium (St. Louis) Sponsor: IEEE; T. F. Murtha, Conductron-Missouri, P. O. Box 426, 2600 N. Third St., St. Charles, Mo. 63301.

CIRCLE NO. 472

June 25-28

National Consumer Electronics Show (New York City) Sponsor: Electronic Industries Assoc.; EIA, 200 Eye St., N.W., Washington, D.C. 20006.

CIRCLE NO. 473

June 28-30

Joint Automatic Control Conference (Philadelphia) Sponsor: IEEE; L. Winner, 152 W. 42 St., New York, N. Y. 10036.

CIRCLE NO. 474

The Predictables.

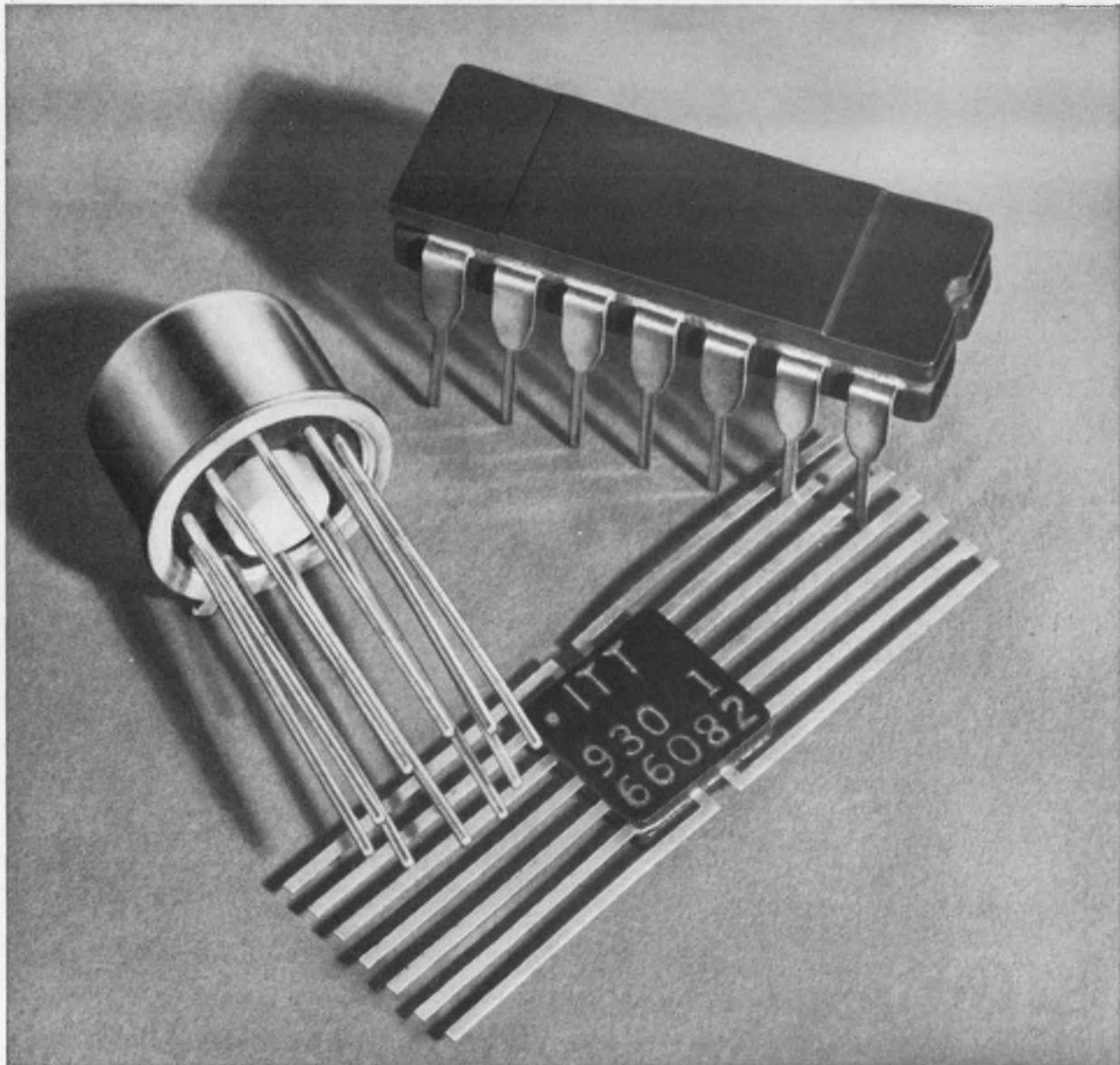

100% DC and dynamic testing verifies the performance of every circuit in ITT's full line of Series 930 DTL

When your order of ITT Series 930 DTL arrives, you can have absolute confidence in its performance. First of all, every circuit gets full DC and dynamic testing at 25°C, plus temperature cycling, centrifuge, and fine leak tests. Then there's 1% AQL testing at -55°C, +25°C and +125°C for 15 DC parameters and at +25°C for 2 dynamic parameters. If circuits flunk, we just don't ship them.

ITT's Series 930 "predictables" come in 15 circuit functions and three package styles. If you're tired of rejecting and returning DTL, try ordering it from ITT. It's available off-the-shelf from your distributor or direct from the factory through your ITT representative. ITT Semiconductors is a Division of International Telephone & Telegraph Corporation.

integrated circuits **ITT**

FACTORIES IN WEST PALM BEACH, FLORIDA; PALO ALTO, CALIFORNIA; LAWRENCE, MASSACHUSETTS; HARLOW AND FOOTSCRAY, ENGLAND; FREIBURG AND NURENBERG, GERMANY

ON READER-SERVICE CARD CIRCLE 101



new disciplines in DC



take the high voltage models with all-silicon circuitry

3 Power Supplies Offer Choice of Voltage, Performance, Price

High Voltage

Select the model with 0 to 1600 volts DC output at 0 to 5ma. Regulation, less than 0.01%, and less than 5mv p-p ripple and noise. Stability better than 0.05%.

Model 6515A — 3½" High, Half-Rack Width. Price \$235.

Higher Voltage + 4-Digit Voltage Programmer

Add 1400 volts and get 0 to 3000 volts at 0 to 6ma, plus a 4-digit front panel programmer for selecting the output voltage. Ripple and noise less than 5mv p-p, stability better than 0.05%.

Model 6516A — 5¼" High, Half-Rack Width. Price \$295.

5-Digit Voltage Programmer + Better Regulation, Stability

Add an all solid-state temperature-controlled oven and sophisticated circuit refinements, plus another digit of resolution to the output programmer, and achieve stability and resettability of 0.01%, regulation of 0.001%, and less than 1mv p-p ripple. Output is 0 to 3000v DC at 0 to 6ma.

Model 6110A — 5¼" High, Half-Rack Width. Price \$495.

Low p-p Ripple and Noise • Line and Load Regulation An Order of Magnitude Better Than High Quality Laboratory Supplies • Output Continuously Adjustable Down to Zero • Self-Protecting — Current Limit Circuit • Low Output Impedance • Less Than 100 μsec Load Transient Recovery • No Overshoot on Turn-On, Turn-Off or AC Power Removal Floating Output — Ground Either Positive or Negative Terminal • Half-Rack Width — Rack Mounting Hardware Available.

Contact your nearest Hewlett-Packard Sales Office for full specifications



From RCA Hometaxial-Base... The industry's most powerful plastic power transistors— Dissipation up to 83 Watts

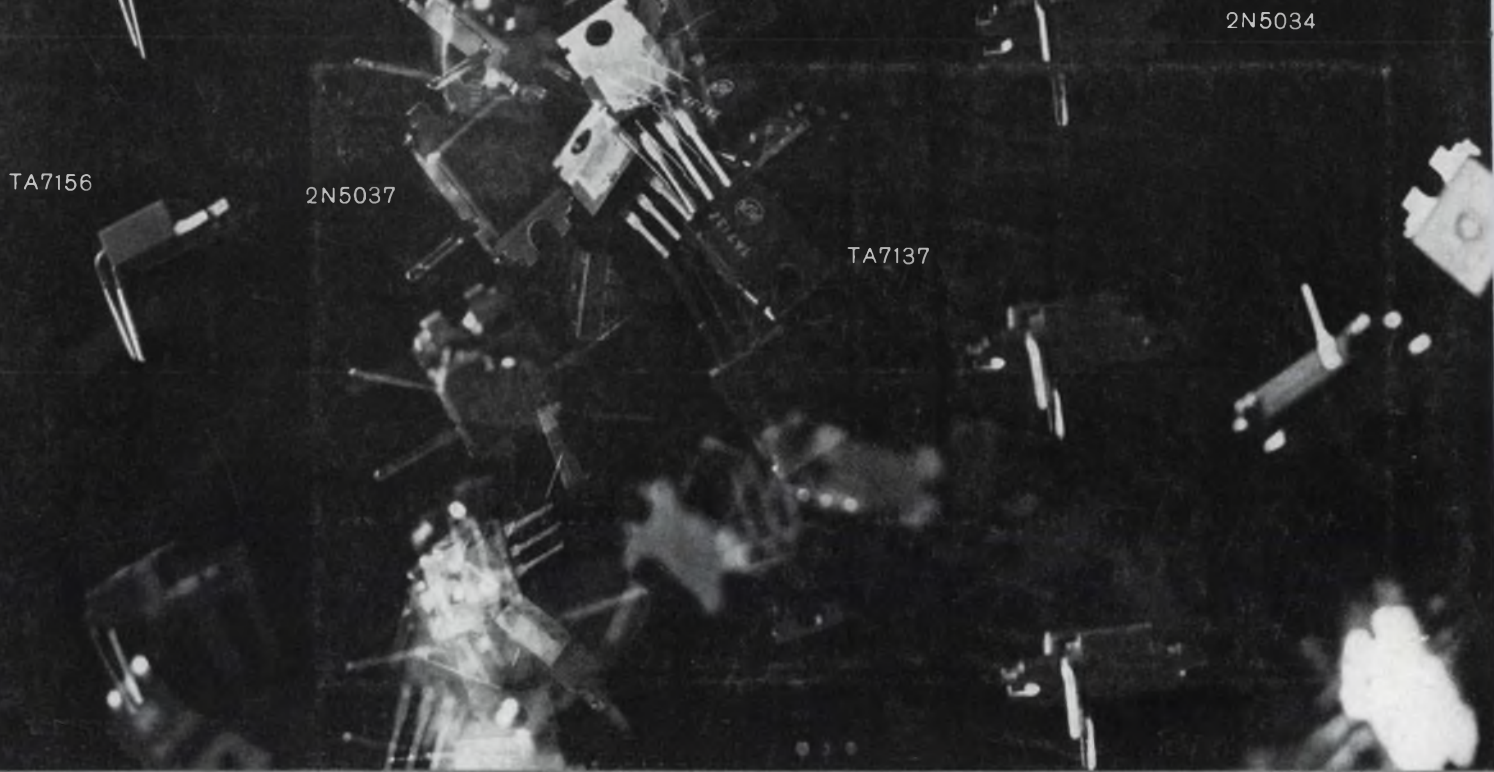

Tomorrow's action needs are here today... as RCA, leader in silicon power, now introduces its famous Hometaxial-Base technology in plastic!

Eight transistors in all, RCA's new power program is the first to combine the low cost of plastic with brute power-handling ability—83 watts or 36 watts—each is an industry-high for plastic! And this power comes in your choice of package... a

straight-lead design for PC-board mounting or a bent-lead design compatible with standard TO-3 or TO-66 mounting techniques.

Performance is tops—RCA mounts the silicon chip directly onto a solid copper base for better current handling, thermal resistance, and dissipation capabilities. You get unsurpassed freedom from second breakdown... the inherent advantage of RCA Hometaxial-Base technology.

Put the cost and performance benefits of RCA plastic transistors in your circuits... they'll do the job for audio amplifiers and a broad range of industrial applications.

Call your RCA Representative for more information or write Commercial Engineering, Section IG5-4, Harrison, N. J. 07029.

Also available through your RCA distributor.

TYPE	PACKAGE	V_{CE} (sus)	I_C	h_{FE}	θ_{JC}	P_D @ 25°C
2N5036 2N5037	TO-3 equivalent P.C. type	60 V @ $R_{\theta J} = 100$ ohms	8A	20-70 @ 3A	1.5 °C/W	83 W
2N5034 2N5035	TO-3 equivalent P.C. type	45 V @ $R_{\theta J} = 100$ ohms	6A	20-70 @ 2.5A	1.5 °C/W	83 W
TA7155 TA2911	TO-66 equivalent P.C. type	60 V @ $R_{\theta J} = 100$ ohms	4A	25-100 @ 0.5A	3.5 °C/W	36 W
TA7156 TA7137	TO-66 equivalent P.C. type	50 V @ $R_{\theta J} = 500$ ohms	4A	20-120 @ 1A	3.5 °C/W	36 W

RCA Electronic Components and Devices



The Most Trusted Name in Electronics

ON READER-SERVICE CARD CIRCLE 134