

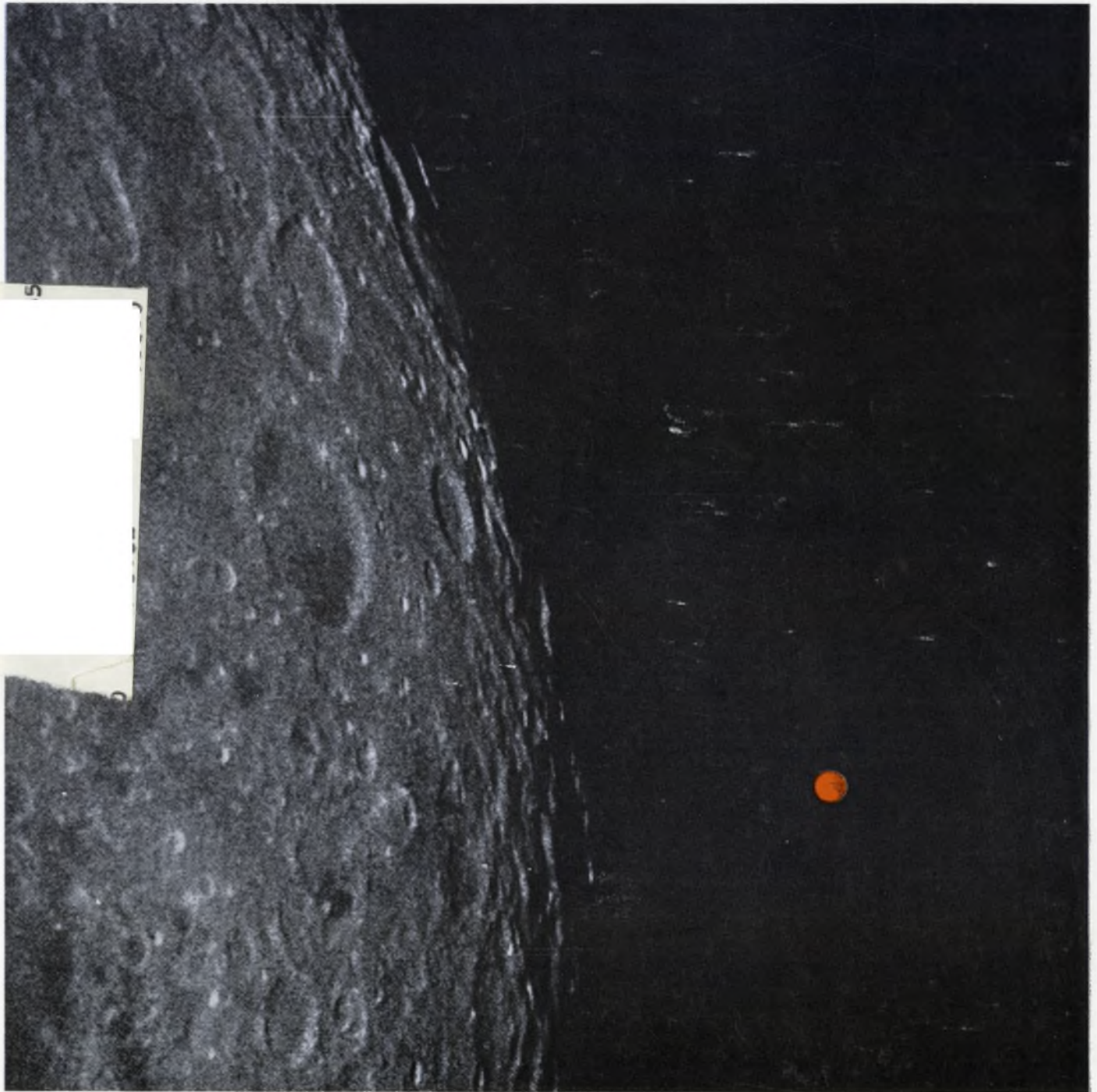
Electronic Design 24

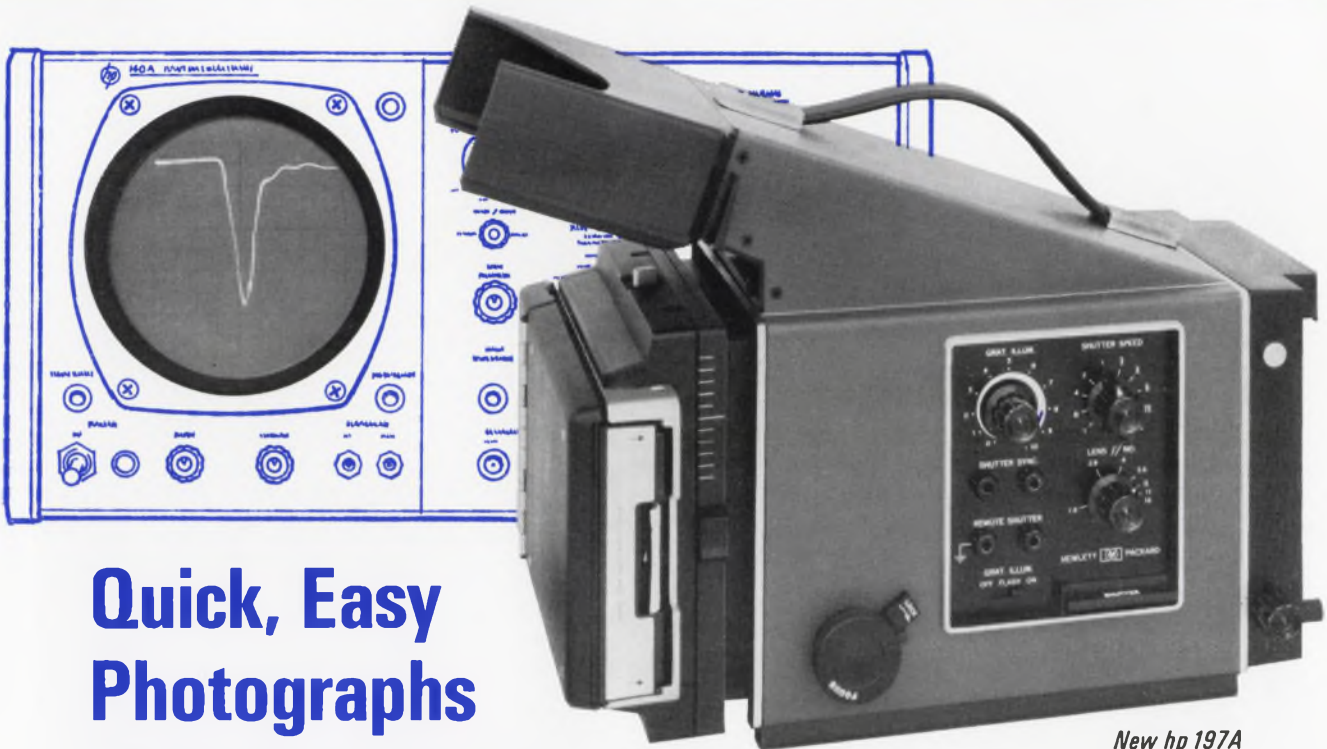
VOL. 14, NO.

THE MAGAZINE OF ESSENTIAL NEWS, PRODUCTS AND TECHNOLOGY

OCTOBER 25, 1966

The robots we rocket to Mars will search for forms of life that may not resemble anything on this planet. Investigations beyond the moon require machines that can peer about, decide what to chase, make tests and send their findings back to the earth. Such expendable scientists will rely on new electronics. See page 17.





*New hp 197A
Scope Camera*

Quick, Easy Photographs of Scope Traces

- External color-coded controls offer easy camera operation
- Electronically controlled shutter provides remote operation, long life
- Interchangeable camera backs, adjustable reduction ratio offer camera versatility, to match your photo needs

Fast camera operation is yours with easy to read, easy to adjust controls on an external panel. Color coding of controls indicates best settings for normal applications; lets you get the right picture the first time. Even photos of single-shot events are easy to take. The ultraviolet light for illuminating the hp internal graticule can be automatically flashed to provide graticule lighting simultaneously with the trace, eliminating the need for double exposures.

The solid-state electronic shutter circuitry assures accurate shutter speeds and permits remote triggering for such applications as operating several cameras simultaneously or in synchronization with other equipment. Photography is reliable and repeatable. A sync output is available for triggering external equipment.

Interchangeability of the standard Polaroid® camera back with an optional 4"x5" Graflok® back provides in-

creased versatility. A continuously adjustable reduction ratio lets you utilize the entire film area. The camera can be focused quickly with an external control and a split-image focusing plate which is provided. For multiple exposures the backs are rotatable and can be moved vertically through eleven detented positions. The entire camera swings away from its mounting when not in use.

Brief additional specifications here indicate the usefulness of this, today's most advanced scope camera. Further information is available with a call to your Hewlett-Packard field engineer or by writing Hewlett-Packard, Palo Alto, California 94304, Tel. (415) 326-7000; Europe: 54 Route des Acacias, Geneva.

HEWLETT  **PACKARD**
An extra measure of quality

SPECIFICATIONS

Reduction ratio: continuously adjustable, 1:1 to 1:0.7, simple screwdriver adjustment

Lens: Wollensak 75 mm, f/1.9, standard; aperture ranges f/1.9-f/16. Oscillo-Raptor 88 mm f/1.4 optional at extra cost

Shutter: electronically operated and timed; available speeds: Time, Bulb, 4, 2, 1, 1/2, 1/4, 1/8, 1/15, 1/30 sec.; input jack for remote operation; sync contact closure for triggering external equipment

Viewing: direct-viewing hood with flexible face mask; hood is removable and can be replaced with a panel to facilitate stacking on 7" rack-mounted scopes

Camera backs: Polaroid® Land Pack Film Back, interchangeable with optional 4 x 5 Graflok® back; backs can be rotated in 90° increments

Multiple exposure: back moves vertically through 11 detented positions

Mounting: direct on all Hewlett-Packard scopes, adapters available for other models; camera swings away to left

Price: 197A Oscilloscope Camera, \$475; Option 01 (without UV light), \$425

Prices f.o.b. factory.

®—"Polaroid" by Polaroid Corporation; "Graflok" by Graftek, Inc. 1185

With this NEW instrument you can test practically any capacitor



... especially electrolytics to MIL or EIA Standards

THIS CAPACITANCE BRIDGE

- ... has a C range of 10^{12} , from 1 pF to 1.1F... with an accuracy of $\pm 1\%$ to 0.11F and $\pm 2\%$ from 0.11F to 1.1F.
- ... has a D range from 0 to 10 with an accuracy of approximately $\pm 2\%$.
- ... is completely self-contained; just plug it into a power line and start making measurements. The 120-Hz generator, tuned detector, adjustable dc polarizing voltage and bridge circuits are all contained in a GR-patented, Flip-Tilt cabinet/carrying case.
- ... has an internal, metered dc polarizing voltage that is adjustable from 0 to 600 volts.
- ... provides for 2-, 3-, 4- or 5-terminal connections; effects of residual impedances are practically eliminated.
- ... measures leakage current down to $0.5 \mu\text{A}$.

- ... can be used up to 1000 Hz with an external generator.
- ... has panel safety lights to indicate when bias voltage is being applied and when the charge on the unknown capacitor exceeds one volt.
- ... has ORTHONULL® balance finder, which eliminates sliding balance when high-D capacitors are measured.
- ... has a phase-reversible 120-Hz generator to reduce the effects of stray voltage; amplitude is selectable and limited to 0.2V, 0.5V, or 2V.
- ... meets or exceeds requirements of standards including MIL-C-39003 (Solid Tantalum), MIL-C-39018 (Aluminum Oxide), MIL-C-62 B (Polarized Aluminum), MIL-C-26655 B (Solid Tantalum), MIL-C-3965 C (Tantalum Foil and Sintered Slug), (EIA) RS 154 B (Dry Aluminum), (EIA) RS 205 (Electrolytic), (EIA) RE 228 (Tantalum).
- ... Price is \$1195, Type 1617-A Capacitance Bridge.



Models are available for portable use, rack mounting, 115- or 230-V input, 50- or 60-Hz.

Please write for complete information.

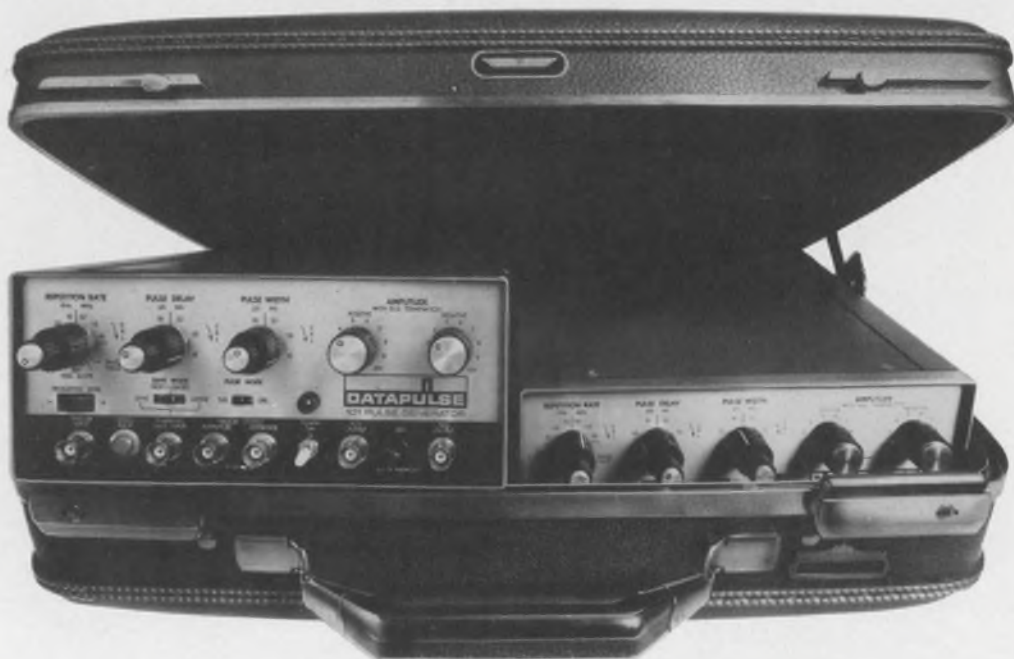
BOSTON • NEW YORK • CHICAGO • PHILADELPHIA • WASHINGTON, D.C.
SYRACUSE • DALLAS • SAN FRANCISCO • LOS ANGELES • ORLANDO
CLEVELAND • TORONTO • MONTREAL

BOURNE END, ENGLAND ZURICH, SWITZERLAND

GENERAL RADIO

WEST CONCORD, MASSACHUSETTS

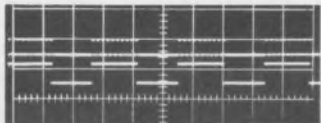
ON READER-SERVICE CARD CIRCLE 3



A Brief Case for a New Pulse Generator

MODEL: 101. PRICE: \$395.00. DELIVERY: 4 weeks. MAJOR SPECS: rep. rates from 10 Hz to 10 MHz, single or double pulses, 5 ns rise time, simultaneous $\pm 10V$ output, variable width and delay from 35 ns to 10 ms, duty cycles to 70%, ± 250 mV trigger sensitivity, and both synchronous and asynchronous gating. ■ TYPICAL APPLICATIONS:

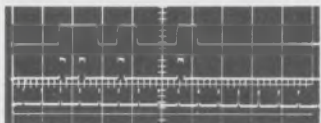
STABLE GENERATION OF PULSE BURSTS



Output
Gate

Output synchronously gated. 10 kHz pulse burst.

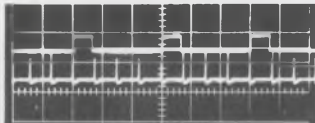
GATED DIGITAL SIGNALS



NRZ
Information
RZ Derivative
Adv. Trig.

Output asynchronously gated against NRZ digital signals. Provides full control over RZ derivative. Advanced trigger outputs also serve as uninterrupted system clock.

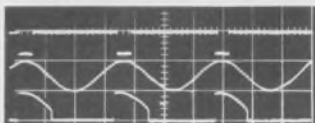
REP RATE COUNTDOWN



Output
Adv. Trig.

Output counted down from internal clock (or external triggers) for frequency division.

DESIGN OF POWER CONTROL CIRCUITRY

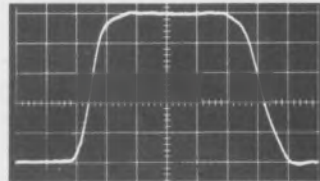


Trig.
Line

SCR

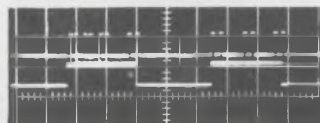
Output may be triggered from any point on an AC line voltage waveform. Allows phase control of SCRs, thyatrons, etc.

STORAGE AND RECOVERY TIME STUDIES



Clean pulses at 5 ns rise time.
Horiz., 5ns/cm.

BEACON INTERROGATION



Unit
No. 1
Unit
No. 2

Outputs of two 101s shown. First unit determines pulse separation and pair separation. Second unit determines burst rate and pairs per burst.

EXTRA BENEFITS: Weight: 8 lbs. Height: 3½ inches. Width: 8½ inches. Rack mount two in 3½ inches of panel height. Rack mount for one unit leaves space for a data source or system control. ■ Convinced that the 101 offers champagne pulses on a beer budget? Ask for more evidence! See our Technical Bulletin 101 or a demonstration.

Datapulse welcomes technical employment inquiries.

DATAPULSE®

Electronic Design 24

VOL. 14, NO

THE MAGAZINE OF ESSENTIAL NEWS, PRODUCTS AND TECHNOLOGY

OCTOBER 25, 1966

NEWS

- 13 News Scope
- 17 **Electronic frog eyes may search for life on Mars**
Computer-controlled vidicon in moving robot proposed for extraterrestrial life hunt.
- 26 **High costs still bar commercial fuel cells**
Platinum elimination seen as major design problem.
- 31 Washington Report
- 33 Computers to read handwritten numbers.
- 36 Accuracy increased in TWT inspection.
- 40 A 35-lb radar set destined for Vietnam.
- 46 Automatic channel switching overcomes RF interference.
- 48 Letters
- 51 **Editorial: It's time we took the plunge in oceanology.**

TECHNOLOGY

- 54 **Switch over to field-effects for digital needs.** Both the J-FET and the MOS-FET offer high fan-out, temperature stability and low component count in these applications.
- 64 **Reduce thin-film circuit size** with this set of design curves that predict thermal effects and simplify circuit design.
- 72 **Start your computer design** with this comprehensive checklist. It will help you to select the right set of IC modules for the job.
- 84 **Estimate the boresight error** before getting a radome for your radar. For the least error at reasonable cost, you must know the trade-off.
- 88 **A manager can't do it all himself.** Learn to delegate authority, and you'll be coordinating a highly successful project group.
- 98 Ideas for Design

PRODUCTS

- 108 **Semiconductors:** "Field plate," nichrome resistors raise planar performance.
- 126 **Components:** TO-87 flat pack houses 1/4-A, 28-V magnetic relay.
- 116 Microelectronics
- 130 Production Equipment
- 132 Materials
- 138 Test Equipment
- 144 Systems
- 149 Microwaves
- 154 Power Equipment

Departments

- 94 Book Reviews
- 156 Design Aids
- 158 Application Notes
- 160 New Literature
- 166 Advertisers Index
- 168 Designer's Datebook

ELECTRONIC DESIGN is published biweekly by Hayden Publishing Company, Inc., 850 Third Avenue, New York, N. Y. 10022. James S. Mulholland, Jr., President. Printed at Poole Bros., Inc., Chicago, Ill. Controlled-circulation postage paid at Chicago, Ill., and New York, N. Y. Application to mail at controlled postage rates is pending at Cleveland, Ohio and St. Louis, Mo. Copyright © 1966, Hayden Publishing Company, Inc. 59,721 copies this issue.

A hand is shown holding a dark, rectangular film strip that displays a high-contrast, black-and-white topographic map. The map features contour lines, roads, and various landmarks. Below the film strip, a white paper map of the same area is visible, showing the original source of the image. The film strip is held at the top left and bottom right corners. The background is a plain, light color.

Du Pont Announces DRY Reproduction Film-CROLUX™*

*Du Pont's trademark for its photopolymer reproduction film.



Expose it!
Peel it!
There's your working intermediate.
Draw on it!
Dry erase it!
Reproduce it!

No more wet processing.

Think of the convenience. Think of the time savings. New CROLUX™ photopolymer reproduction film puts the darkroom really in the shade. With roomlight-handling CROLUX™ you get high-quality drafting intermediates right from your diazo machine or any other high-intensity UV light source.

Dry-erasable reproductions.

No more chemical eradicator. No more water.

That's right! Simply peel away a thin "negative" cover sheet to reveal a completely dry-erasable reproduction on dimensionally stable polyester drafting film.

No image deterioration.

Maximum image life. Superior shelf life.

CROLUX™ offers a reproduction with ink-like black lines on a clean background that will not darken or deteriorate with age.

Superior drafting surface.

CROLUX™ has the world's finest matte drafting surface especially designed for graphite, plastic and combination pencils. Its "balanced tooth" is neither too rough nor too smooth—takes just the right amount of lead.

Too good to be true? If you're from Missouri, challenge your CROLUX™ dealer to a demonstration, or contact:

Northeastern District

Clifton, New Jersey 07012
380 Allwood Road
Allwood Station
(201) 473-4004

Boston, Mass. (617) 423-6078

New York, N. Y.
(212) 924-3100
Philadelphia, Pa.
(215) 925-4872

Washington, D. C.
(202) 347-5998

Southeastern District

Atlanta, Georgia 30325
1737 Ellsworth
Industrial Drive, N. W.
(404) 355-1230

Midwestern District

Niles, Illinois 60648
6161 Gross Point Road
(312) 222-5000

Southwestern District

Dallas, Texas 75247
Box 10486
3120 Commonwealth Drive
(214) 631-7810

Western District

Hollywood, California 90038
7051 Santa Monica Blvd.
(213) 469-5147

Government Sales

Washington, D. C. 20002
415 Second Street, N. E.
(202) 547-3124, 3125, 3126

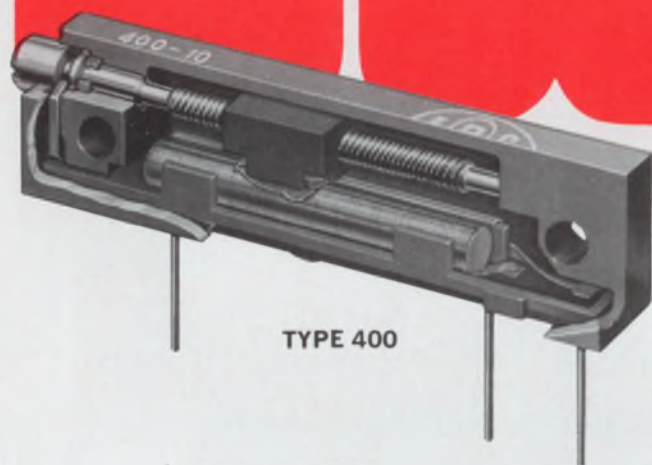
See CROLUX™ demonstrated at the
Du Pont V.C.C. exhibit, Booth No. 556.

Better Things for Better Living . . . through Chemistry

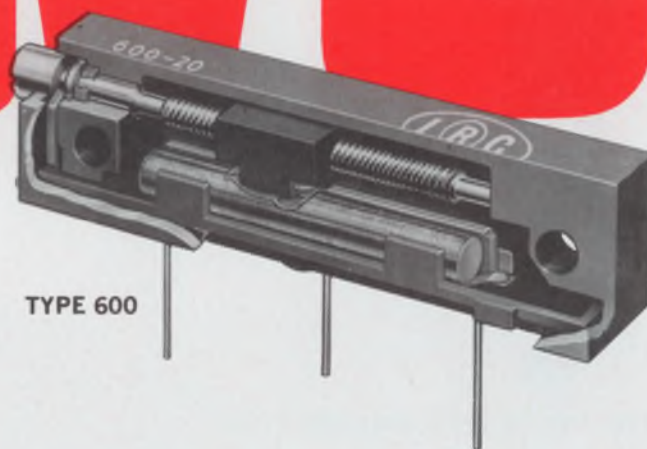


Photo
Products
Department

SAVE



TYPE 400



TYPE 600

Military quality at industrial prices

IRC wirewound rectangular trimmers save space and dollars

IRC's CIRCUITRIM potentiometers offer MIL characteristics at the same price as industrial types. Benefit by upgraded performance and reliability for your industrial needs and impressive savings for your MIL applications.

Both series are designed to perform under environmental requirements of MIL-R-27208. Molded diallyl phthalate cases are rugged, light and practical for use in any military or high grade industrial application. A one-piece, corrosion-resistant shaft and specially designed wiper block system isolate electrical elements and assure "set-and-forget" stability.

The 600 series is designed to MIL-Style RT-11 and is offered with staggered P.C. pins or teflon insulated leads. The 400 series is designed to MIL-Style RT-12 with P.C. pins in-line or teflon insulated leads. It is also available in a thin-line version of RT-11 (Type 400-20) with staggered P.C. pins which offer 30% space savings and complete interchangeability on pre-printed boards.

These low-cost MIL-type units are the result of IRC's years of experience in building high-quality trimmers. Samples available

from local sales offices. For prices and data, write: IRC, Inc., 401 N. Broad St., Philadelphia, Pa. 19108.

ONLY IRC OFFERS ALL 4 POPULAR STYLES
Wirewound or infinite resolution elements



CAPSULE SPECIFICATIONS

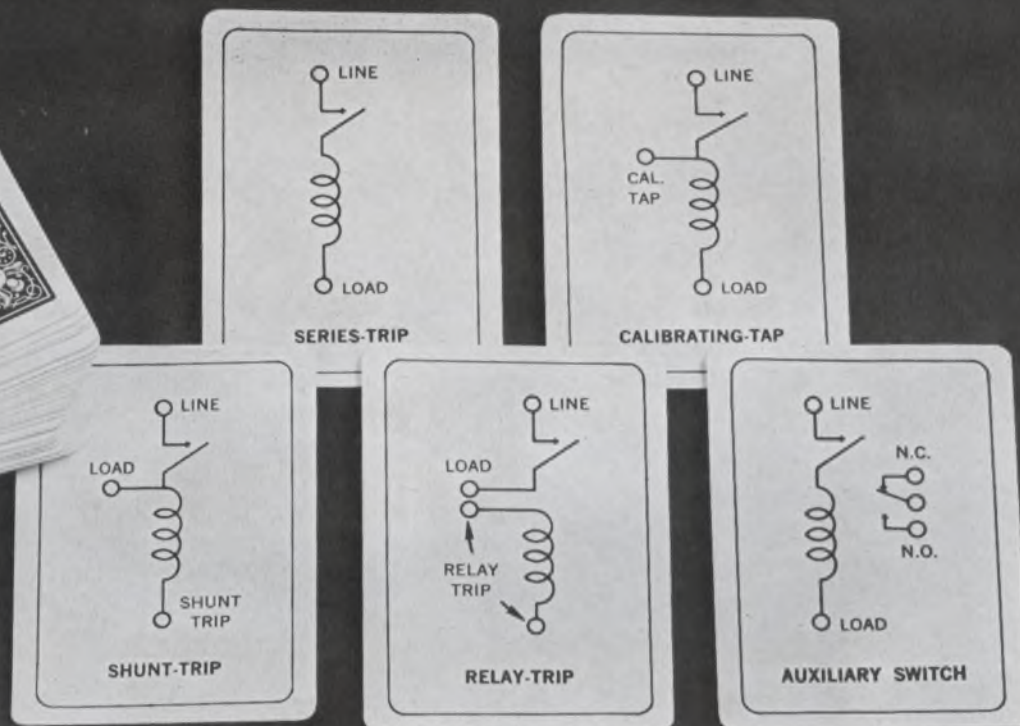
	TYPE 400	TYPE 600
MIL STYLE	RT-12*	RT-11
POWER	1 W @ 70°C	1 W @ 70°C
TOLERANCE	± 5%	± 5%
RESISTANCE	10Ω to 50KΩ	10Ω to 50KΩ
TEMPERATURE	-55°C to 150°C	-55°C to 150°C

*Plus thin-line version of RT-11 (Staggered P.C. pins)



Speed Inquiry to Advertiser via Collect Night Letter
ON READER-SERVICE CARD CIRCLE 6

Our remarkably versatile Series JA circuit breaker comes with five different circuits inside



and nine colors outside.



At a very modest price.

In the plain-jane world of circuit breakers, the new little Heinemann Series JA is something of a surprise package. There's that snappy white handle, for one thing. And 'instant color' caps that convert the mounting boss from hum-drum black to an attractive and functional bit of p'zazz.

The five internal circuit options, though, are old standbys in the Heinemann line of hydraulic-magnetic circuit breakers. Many of you alert fellows out there have been using them ingeniously for years.

For the uninitiated, we offer herewith a brief description of each.

Series-trip is our standard construction. You use it wherever you want simple—and precisely calibrated—in-series overload protection.

Calibrating-tap construction lets you

control two loads with one breaker. But overcurrent tripping occurs only in the main circuit through the breaker coil.

The shunt-trip circuit provides a convenient means of obtaining remote tripping through appropriate circuit-closing contacts in an associated control or safety device.

Relay-trip construction is similar to shunt-trip, except that you can use different voltages or currents in the coil and contact circuits, which are electrically isolated from one another.

The auxiliary switch is a miniature snap-action SPDT switch enclosed within the breaker case. You can use it to operate a pilot light, a fan, or any other sort of gadget that doesn't draw more than 5 amps (at 125 or 250 VAC).

The foregoing internal circuits, interestingly enough, can be combined in endless variety in multi-pole breaker configurations. If we have piqued your curiosity, we hasten to offer our Bulletin 3350, which is yours for the asking. We might first point out that the JA is available with any integral or fractional current rating from 0.100 to 20 amps, with or without time-delay, for operation at voltages up to 250 VAC (60 or 400 Hz) or 50 VDC.

Oh yes, we almost forgot—the price.

That, too, is something of a surprise. A very pleasant one. Heinemann Electric Company, 2604 Brunswick Pike, Trenton, N.J. 08602.



HEINEMANN

Twenty-two new high voltage silicon transistors from

Voltages up to 700 and priced for your next application.

With voltages from 250 to 700 and 5 amps, this new Bendix B-176000 series of NPN silicon power transistors is made-to-order for breaking those tough voltage and gain problems—without breaking the budget.

There are 22 types, six designed specifically for high voltage fast switching applications. With matrices that let you pick the precise voltage and gain character-

istics you require. No need to pay for an overspecified device.

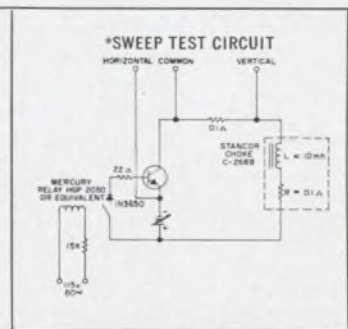
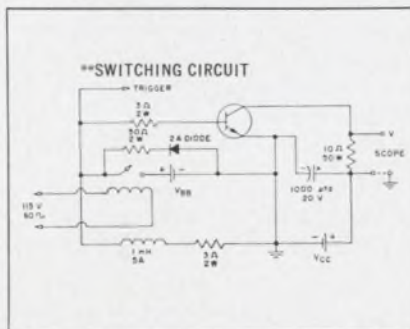
The B-176000 series was designed to zero right in on the demands of CRT deflection circuits and line-operated inverters, regulators and amplifiers. The convenient TO-3 configuration makes them easy to use in many other applications as well. For complete details, write us in Holmdel, New Jersey.



Baltimore (Towson), Md.—(301) 828-6877; **Chicago**—(312) 637-6929; **Dallas**—(214) 357-1972; **Detroit**—(313) JOrdan 6-1420; **Holmdel, N. J.**—(201) 946-9400; **Los Angeles**—(213) 776-4100; **Miami Springs, Fla.**—(305) 887-5521; **Minneapolis**—(612) 926-4633; **Redwood City, Calif.**—James S. Heaton Co., (415) 369-4671; **Seattle**—Ray Johnston Co., Inc., (206) LA 4-5170; **Syracuse, N. Y.**—(315) 474-7531; **Waltham, Mass.**—(617) 899-0770; **Export**—Cable: "Bendixint," 605 Third Avenue, New York, (212) 973-2121; **Ottawa, Ont.**—Computing Devices of Canada, P.O. Box 508—(613) TAlbot 8-2711.

the Bendix powerhouse.

4 Gain Groups	4 Saturation Groups	4 Voltage Groups	
hFE	VCE(s)	VCEX	VCEO(sus)
≥ 10 to 25 at 0.1 A to 2.5 A and 5 V	≤ 0.5 V to 2 V VBE(s) ≤ 1 V to 2.5 V at 0.1 A to 2.5 A and 20 mA to 500 mA	≥ 250 V, 400 V, 550 V and 700 V at 1 mA and -1.5 V	≥ 200 V and 325 V sweep tested at 2 A*
Typical fall time (tf) of 1.5 μ s at 2.5A, 27V, & 4V**			
Pc=75W at TC=100°C, 15V & 5A			

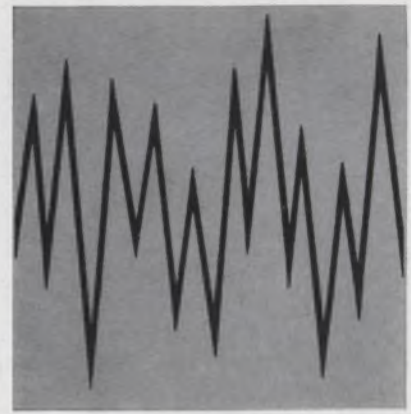


Bendix Semiconductor Division
HOLMDEL, NEW JERSEY



ON READER-SERVICE CARD CIRCLE 8

Sprague has what it takes to cope with any problem in electromagnetic interference or susceptibility control



And we mean any problem . . . arising at any point in the development of any equipment or system!

Sprague's interference control facilities provide one of the most complete, fully integrated capabilities you can call on . . . embracing *every* aspect of interference and susceptibility control.

Design Assistance: Black boxes . . . subsystems . . . complete systems. Using advanced interference prediction techniques, Sprague engineers replace design by "hunch" with precise analysis of electrical schematics. Suppression and shielding can be designed into pre-prototype plans so accurately that little or no modification is required upon evaluation of the model. With today's more complex equipment and increasingly stringent EMI requirements, Sprague assistance in initial design can pay for itself in a dozen different ways by helping you be right the *first* time!

Measurement, Evaluation: Sprague can help you measure interference and susceptibility characteristics of your breadboard, prototype, or production equipment to the applicable interference specification. You know where you stand before investing in further development. We can also research such areas as shielding effectiveness, screen room integrity, transient susceptibility of digital equipment, and cable cross coupling.

Component Design: Sprague Filter Engineering Specialists can design, evaluate, and sample interference control devices to your particular requirements. These range from standard feed-thru capacitors and radio interference filters to the more sophisticated packages, such as frequency-controlling electric wave filters.

Component Production: Each of four Filter Development Centers maintains a well stocked model shop for the rapid fabrication of special

components in prototype quantities. Full scale production facilities are maintained in Visalia, Calif.; North Adams, Mass.; and Vandalia, Ohio.

Compliance Testing: Sprague can test your equipment or system and report on its compliance to the applicable specification: MIL-I-6181, MIL-I-26600, MIL-I-16910, MIL-E-6051 or to such other specialized interference documents as GM07-59-2617A, AFBSD Exhibit 62-87 (Minuteman WS133B), LSMC Specification ERS11897 (Polaris A3) or MIL-STD-449. If compliance is not indicated, a Sprague engineer will make concise recommendations and will, if you desire, give you every assistance in achieving that compliance.

Regional Service: Wherever you may be, this integrated EMI capability is readily available to you from strategically located Filter Development Centers in North Adams, Mass.; Annapolis Junction, Md.; Vandalia, Ohio; and Los Angeles, Calif. Each is fully equipped and staffed to evaluate, modify, or qualify your equipment.

In-plant Service: Sprague can put competent Interference Control Specialists at your service in your plant for consultation on, or supervision of, special projects.

Whether your work involves military or industrial electronic equipment or systems, Sprague Filter Development Center personnel can help assure substantial savings in dollars and hours at many points during development. Get complete information from the development center nearest you or by writing for a comprehensive brochure (FD-101) to Technical Literature Service, Sprague Electric Company, 347 Marshall Street, North Adams, Mass. 01247

FILTER DIVISION PRODUCTS AND SERVICES

INTERFERENCE FILTERS AND CAPACITORS
PRECISION TOROIDAL INDUCTORS
FREQUENCY SPECTRUM SIGNATURES
COMPONENT ENVIRONMENTAL TEST FACILITIES

ELECTRIC WAVE FILTERS
TELEMETRY FILTERS
EMI TEST FACILITIES
EMI SYSTEMS ENGINEERING

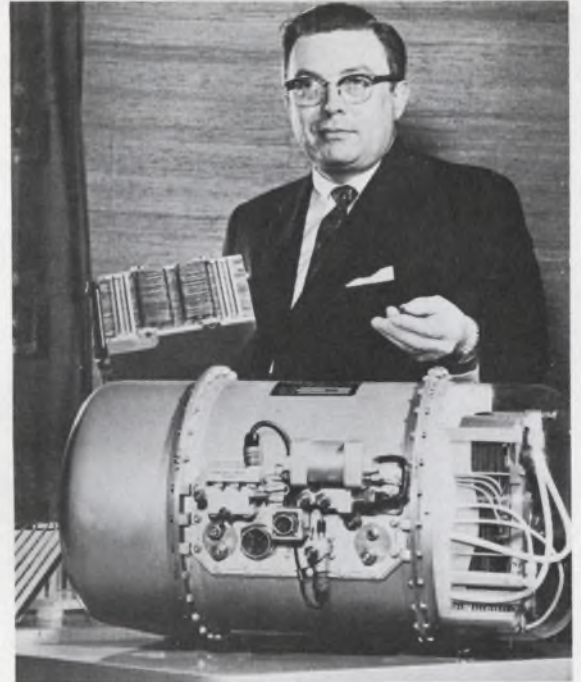


'Sprague' and '®' are registered trademarks of the Sprague Electric Co.

News



Scientists study use of computerized robots to search for life on Mars. Page 17.



Fuel cells are great—but still too expensive for commercial use. Page 26.



A 35-lb portable radar can detect a walking man a mile away. Page 40.

Also in this section:

Computers can read hand-written numbers . . . Page 33

Automatic channel switching overcomes interference . . . Page 46

News Scope, Page 13 . . . **Washington Report**, Page 31 . . . **Editorial**, Page 51.

Tina proves that anyone can measure microwave frequencies with a Systron-Donner counter



Tina is a fashion model. We lured her to our lab to show you that technically unskilled people can now measure microwave frequencies with our Counter/ACTO® system.

True, we set the trigger level and the gate time for her. But that's what you do with any simple frequency counter. The rest went just as you see. And Tina produced the correct answer accurate to eight significant figures.

Microwave measurements of this

speed and simplicity are possible only with ACTOs,® our Automatic Computing Transfer Oscillator plug-ins. Three plug-ins cover the full range from 0.3 to 12.4 GHz. They fit into any Systron-Donner 50 MHz or 100 MHz counter and produce measurements of counter accuracy because the input is phase locked.

Though we didn't design ACTOs for other brands of counters, we find that a slightly modified ACTO will work beau-

tifully with an HP5245L frequency counter. So if you already have an HP counter, you don't have to buy another counter to get ACTO performance.

Send for complete technical data on Counter/ACTO systems.

Expansion has created many professional opportunities in engineering and marketing at Systron-Donner. Interested engineers may phone Ronald Abdo, Personnel Manager, collect at (415) 682-6161.

News Scope

Electronic giants plan to build modern cities

Top executives of both General Electric and Litton Industries, among other large corporations, are planning to build entire cities with highly advanced technology. Construction won't start next month or even next year, but long range plans are being drawn.

The theory is that the giant, diversified electronics corporations are in an excellent position to support creative, imaginative city planning with the latest technological innovations and strong financial backing.

The president of Litton Industries, Roy Ash, told *ELECTRONIC DESIGN*: "We are developing and perfecting plans for a complete new city, but it is, as you can imagine, an extremely long-range plan." Informed sources say that Litton is hoping for some Federal support for its city. Reportedly Litton envisions a city that would have a population of around 20 million by the year 2000.

General Electric's plans for a city are being formulated at its Community Systems Development Div., Louisville, Ky. Industry reports are that GE is presently picking a site for the new city and plans to finance construction with its own funds.

The Goodyear Corp. is already planning construction of Litchfield Park, Ariz., a futuristic city 18 miles from downtown Tucson. The American-Hawaiian Steamship Co. is also reported to have similar plans at an undisclosed location.

Computers help locate 150,000 freight cars

One of the railroad industry's largest computerized communications networks, capable of pinpointing in a second the locations of 150,000 freight cars along 11,000 miles of track, will go into operation later

this year on the Chesapeake & Ohio-Baltimore & Ohio Railroads.

The elaborate system consists of four Radio Corp. of America 3301 computers. Two of the computers will control a teletype message-switching system at the company's Huntington, West Va., facilities. They will be linked to another pair of RCA 3301's, which will handle message switching and also control an electronic car-tracing file at the C&O-B&O headquarters in Baltimore.

William C. Prinn, project manager for the affiliated railroad systems, said that more than 25,000 teletype messages a day are sent and received on nearly 700 teletype terminals on the railroad's network. The messages are concerned primarily with train and car movements, sales office reports, and the general administration of the railroad.

'Dead' lunar probe shows spark of life

After 86 days of silence, the nation's moon probe, Surveyor, came to life on Oct. 8, and began to send back signals to earth that described its condition.

According to a spokesman for the Jet Propulsion Laboratory, Pasadena, Calif., the probe's main battery is not dead, but it is far too weak to power the camera that successfully took 11,000 pictures of the moon's terrain.

Tracking stations for the Surveyor project were directed to cease operations early in August, because the mission was officially over. But a group associated with the project, led by Jay Holladay, a tracking network engineer, insisted upon making one last attempt to communicate with Surveyor. An antenna at Johannesburg, South Africa, transmitted the command that elicited

the response from the craft's telemetry equipment.

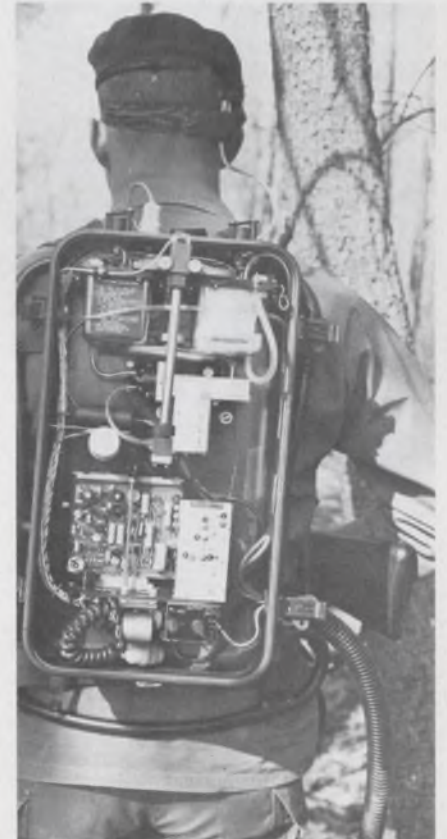
Then the engineers decided to use some power from the Surveyor's auxiliary battery to move its solar panel into a position from which it could draw more of the sun's energy. Later that day a tracking station at Canberra, Australia, detected some more signals.

Air sampler to help Army spot enemy

An electronic "bloodhound" may soon tell GIs on patrol in Vietnam if there are Vietcong around.

The Army Limited War Laboratory unveiled the Manpack Personnel Detector (E-63) at the annual meeting in Washington of the Association of the U.S. Army.

The unit is a lightweight point air sampling device. It "breathes" the air in the vicinity of its intake nozzle and forces it through a detection cell. The detection cell, which picks up "submicroscopic agents or particles given off by humans," puts



Portable electronic "bloodhound," developed by General Electric, tests the air for evidence of an unseen enemy and alerts the soldier-operator.

out an electric alarm that alerts the soldier-operator. He can then search the area closely.

Work on the detector program has been carried out by the Ordnance Dept. of General Electric under direction of the Army at the Aberdeen Proving Ground, Md.

Satellites suggested for sea navigation

Navigation and communications for merchant vessels could be significantly improved, a consulting engineer believes, with a system of six satellites equally spaced in synchronous equatorial orbits.

Roy Anderson, consultant to the General Electric Co., suggested the scheme at a recent Institute of Navigation meeting at Kings Point, N. Y.

One main advantage of satellite communication for merchant ships, he explained, would be the virtual elimination of fading and blackouts in high-frequency communications.

Anderson said that it would cost only \$2000 for the simplest fully automatic equipment to enable a vessel to obtain position fixes anywhere in the world from a satellite navigation and communications system.

Such a system, he added, could provide digital communications, such as teletype, as well as voice. The equipment, he said, would be comparable in cost to that of present ship communications systems.

Dyes in solution lase very brightly

Organic dyes in solution will bring the best of two possible lasers together.

Pumped by a large ruby rod, the high-power, pulsed output of the organic dye amplifiers exhibits extremely high spatial coherence and very low beam divergence. Ruby rods can amplify big pulses, but extreme spatial coherence has been observed only in gas lasers.

In addition the dye amplifiers can handle hundreds of megawatts of power and have recently achieved efficiencies of 50%, according to Dr. Peter Sorokin and Dr. W. H. Culver, experimenters at IBM's Research Div., Yorktown, N. Y.

The desirable property of spatial coherence means that the light is in phase across a plane perpendicular to the axis of the beam. This feature and the low divergence of the beam keep it intense and bright over long distances. This makes the organic dye amplifiers extremely useful for laser radars and range finders.

Lasing has been independently observed recently in two other laboratories, one at the Hughes Aircraft Co. and the other at the Institute of Physics and Chemistry, University of Marburg, Germany. The IBM developments are reported in the current issue of the IBM Journal of Research and Development.

Dr. Condon to head 15-month UFO study

Dr. Edward U. Condon, the theoretical physicist who played a key role in developing the first atomic bomb, will direct the Air Force-sponsored study of unidentified flying objects (UFO's).

The study will take 15 months and will attempt to determine if the UFO's are visitations from other worlds, as some observers believe. The Air Force has engaged the University of Colorado to conduct the investigation, and Dr. Condon will be acting in his capacity as professor of physics at the university.

It's Philco-Ford now, but same management

Philco Corporation has changed its name to Philco-Ford Corporation.

Robert Fickes, chief executive officer of the newly named Ford subsidiary, said that the management and corporate organization of Ford-Philco would remain unchanged.

The name change, he said "is intended to establish greater public recognition of the direct parent-subsidiary relationship of the two organizations."

'On target' laser sought for war communications

A method of keeping laser beams "on target" is being developed for communications between Army field commanders and their mobile computers. Laser beams are particularly attractive for combat communications, as they cannot be monitored inobtrusively by the enemy.

Though lasers, operating in the micron wavelength band, can transmit a great quantity of information at high speed, heat waves in the air and mechanical disturbances on the ground, such as bomb shocks, can throw the pencil-thin beam off its target, according to Gerard Ratcliffe, a research engineer at Sylvania, Waltham, Mass.

But if the transmitting beam is kept on target by a solenoid-controlled, gimballed mirror, laser communications can be reliable.

The beam, diverging about 1/4 milliradians, scans until it hits the target: a photoreceptor on the mobile computer. A corner reflector mounted in the center of the photoreceptor sends a small part of the beam back to the transmitter.

If the transmitter's image divider finds that the returning signal matches the transmission signal, the communication of information proceeds. Should the returning signal weaken, the transmitter's feedback circuit moves the mirror to strengthen it. Thus the beam is steered onto the target and continues to track it. The Sylvania system will tolerate random variations up to 1 degree.

Any interference, such as enemy deflection of the beam, instantly cuts off transmission. According to Ratcliffe, the system should be delivered to the Army by early 1967.

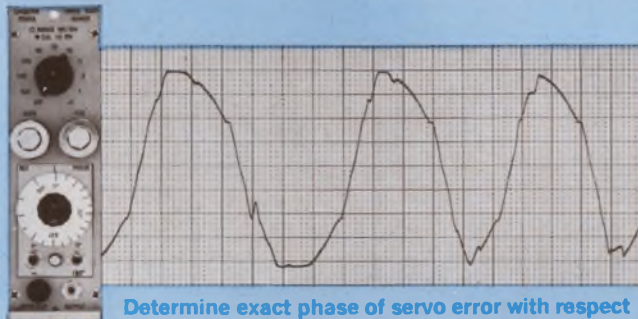
Long-distance computer aiding NASA engineers

Engineers at NASA's Electronics Research Center, Cambridge, Mass. are now programming their complex space-flight problems into computers 2000 miles away at the Manned Spacecraft Center, Houston.

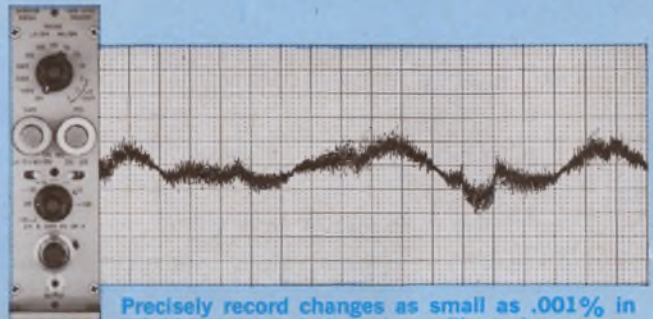
Known as the NASA Experimental Terminal System, the long-distance computer network is said to be the first NASA intercity large-scale computer network making use of Government-owned computers.

Bring on your complex, small, noisy, difficult signals.

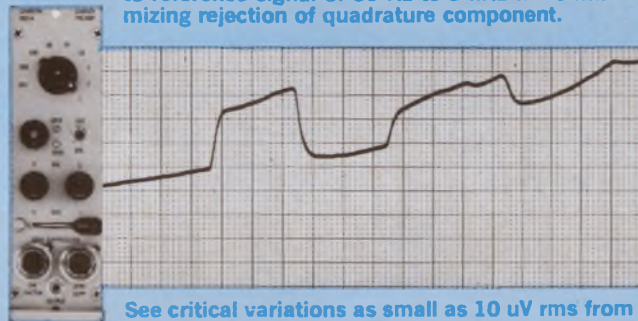
We'll give you traces that show them for what they really are.



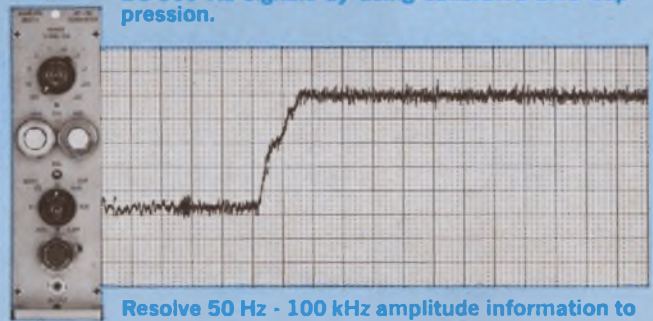
Determine exact phase of servo error with respect to reference signal of 60 Hz to 5 kHz while maximizing rejection of quadrature component.



Precisely record changes as small as .001% in DC-100 Hz signals by using calibrated zero suppression.



See critical variations as small as 10 uV rms from strain gages, other AC-excited transducers.



Resolve 50 Hz - 100 kHz amplitude information to 0.02% of full scale signals from 1 volt to 500 volts.

When you need the greatest possible degree of signal-conditioning precision and operational control, Sanborn 7700 Series oscillographs with solid-state "8800" plug-ins will give you chart recordings of maximum resolution and intelligibility.

Seven highly versatile signal conditioners offer unique performance capabilities: three DC types with a 1 uV - 250 V dynamic range, floating differential input and calibrated zero suppression . . . an AC-DC Converter with calibrated zero suppression and scale expansion permitting resolution better than 0.1%, 10 ms response and isolated, 1 meg. input . . . a phase-sensitive demodulator with calibrated reference phase shift, 90° calibrated dial with four quadrant selections, and a frequency range of 60 Hz to 5 kHz . . . a carrier preamp with 2400 Hz internal transducer excitation supply, calibrated zero suppression, cal. factor control and conversion gain of 10,000 . . . and a general-purpose DC preamp particularly useful for 100 mm wide chart recording.

Use any of these "8800" plug-ins in the 7700 thermal writing oscillograph matched to your packaging and channel requirements — 4-, 6- and 8-channel 7704A, 7706A and 7708A console types . . . 2-channel 7702A system in rack-mount or mobile cart versions . . . single-channel 7701A wide chart (100 mm) portable system. Every one of these thermal

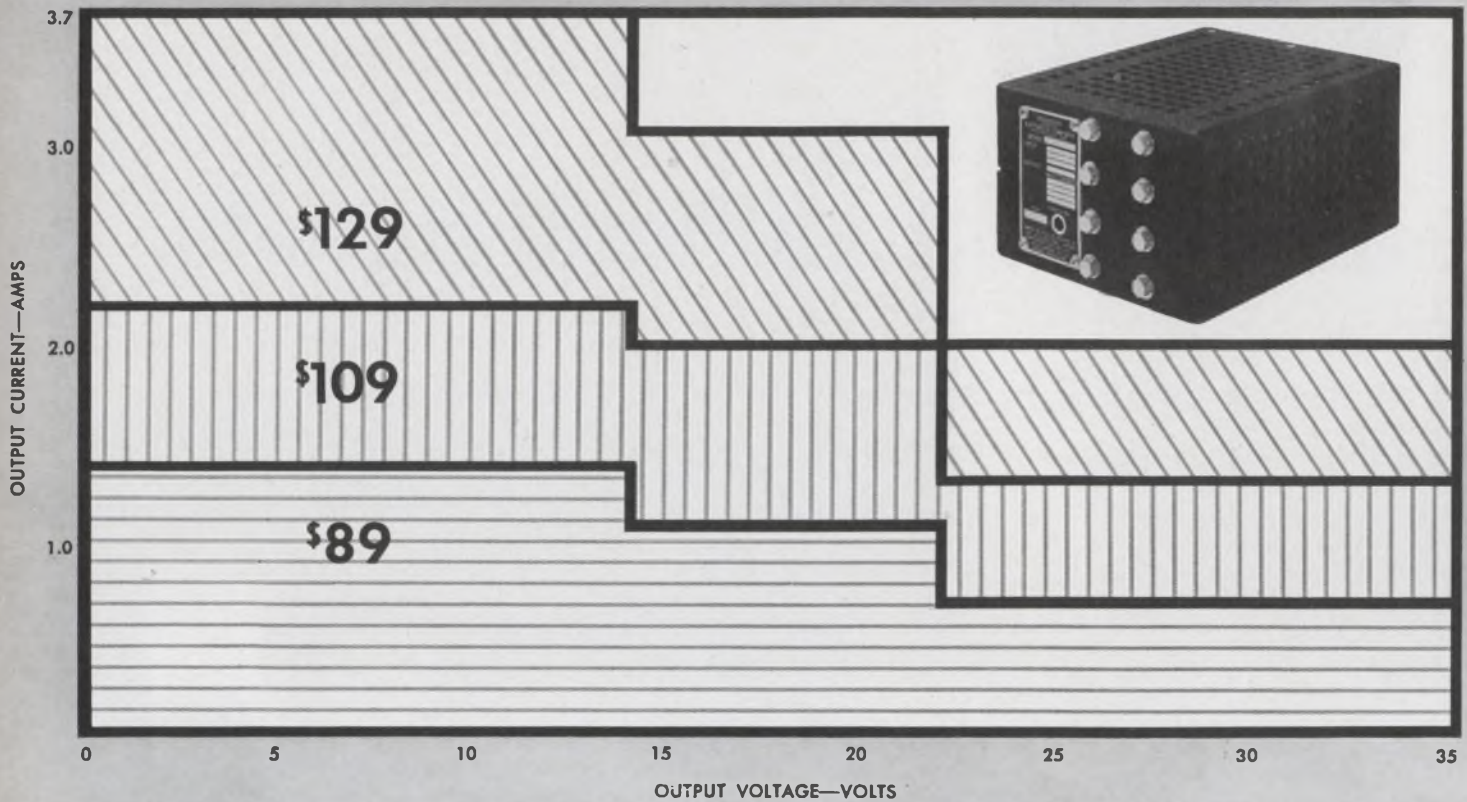
writers will give you permanent, rectangular-coordinate recordings whose resolution and accuracy make all your measurements more useful.



For a new brochure describing the advantages and wide choice of Sanborn thermal writing oscillographs, write Hewlett-Packard Company, Sanborn Division, 175 Wyman Street, Waltham, Mass. 02154.



HEWLETT
PACKARD  SANBORN
DIVISION



All-silicon QSA Series: 12 models; regulation $\pm .005\%$; response time $20 \mu s$.

New Sorensen Modular Power Supplies

The new Sorensen QSA Series offers the only modular power supply line in the 0 to 35 volt range that combines $\pm .005\%$ regulation line and load, $20 \mu s$ response time, $71^\circ C$ operating temperatures, $300 \mu V$ ripple—all at prices below other lines having lesser performance specifications. Sorensen's QSA Series modules are ideal for OEM, lab or system applications. They can be used as bench models (mounted in any position) or mounted in combinations of 3 or 4 in an optional 19" ($3\frac{1}{2}$ " high) rack adapter. Other design features include: Load current vs. temperature, $110\% @ 40^\circ C$ — $100\% @ 50^\circ C$ — $85\% @ 60^\circ C$ — $66\% @ 71^\circ C$ • Temperature coefficient $0.01\%/^\circ C$ • Stability

$0.025\%/8$ hrs. • Models QSA10-1.4, QSA10-2.2 and QSA10-3.7 permit operation of up to 20 units in series; other units permit operation of 2 units in series; All models permit operation of 4 units in parallel • No turn-on/turn-off overshoots • Remote sensing • Remote programming • Ripple voltage peak to peak 3mV. All Sorensen power sources conform to proposed NEMA standards. For additional QSA Series details or for data on other standard/custom DC power supplies, AC line regulators or frequency changers, call your local Sorensen representative, or write: Raytheon Company, Sorensen Operation, Richards Avenue, Norwalk, Conn. Tel: 203-838-6571, TWX: 710-468-2940.

SPECIFICATIONS

MODELS (RANGES)	QSA10-1.4 (0-10V, 1.4A) QSA12-1.4 (8-14V, 1.4A) QSA18-1.1 (14-22V, 1.1A) QSA28-.7 (22-35V, .7A)	QSA10-2.2 (0-10V, 2.2A) QSA12-2.2 (8-14V, 2.2A) QSA18-2.0 (14-22V, 2.0A) QSA28-1.3 (22-35V, 1.3A)	QSA10-3.7 (0-10V, 3.7A) QSA12-3.7 (8-14V, 3.7A) QSA18-3.0 (14-22V, 3.0A) QSA28-2.0 (22-35V, 2.0A)
SIZES (IN.)	7 x 3-5/16 x 3-7/8	7 x 3-5/16 x 5-1/8	10 x 3-5/16 x 5-1/8
PRICES (U.S. List)	\$89	\$109	\$129

RAYTHEON

Electronic frog eyes may search for life on Mars

Computer-controlled vidicons in moving robot may engage in extraterrestrial life hunt.

Roger Kenneth Field
News Editor

Some time after we land a man on the Moon, we will send a sterilized probe more than 34 million miles through space, soft-land it on Mars, and have it send back a description of any life or topographical features it finds. But NASA is evaluating scores of proposals from scientists and engineers now, even though the soft-landed probe may not be sent aloft until 1977.

One proposal, to be made by a group of scientists at MIT, would send a self-propelled probe, or robot, with highly advanced electronic visual-sensing and decision-making capabilities.

Such a robot would roll along or walk along the surface of Mars, and stop when it sees or hears something interesting. If the object that caught its interest moved, the robot could possibly follow it. If the object were a formidable barrier, the robot could back up and move around it. In any case, the robot would send back to earth only the information that described the in-

teresting topographical features and distinctive sounds of Mars and, hopefully, any encounters with moving objects.

Since we know nothing about the nature of possible life on the big, red planet, we have no idea what or who might greet our robot. It could be anything from a few bacteria basking in the sun to a big, hairy, green arm.

The best tests, under these circumstances, are the most general tests: tests that make the fewest assumptions about life on Mars. And only the proposed visual tests are based on assumptions that are very nearly independent of the biochemistry of Mars.

What is life?

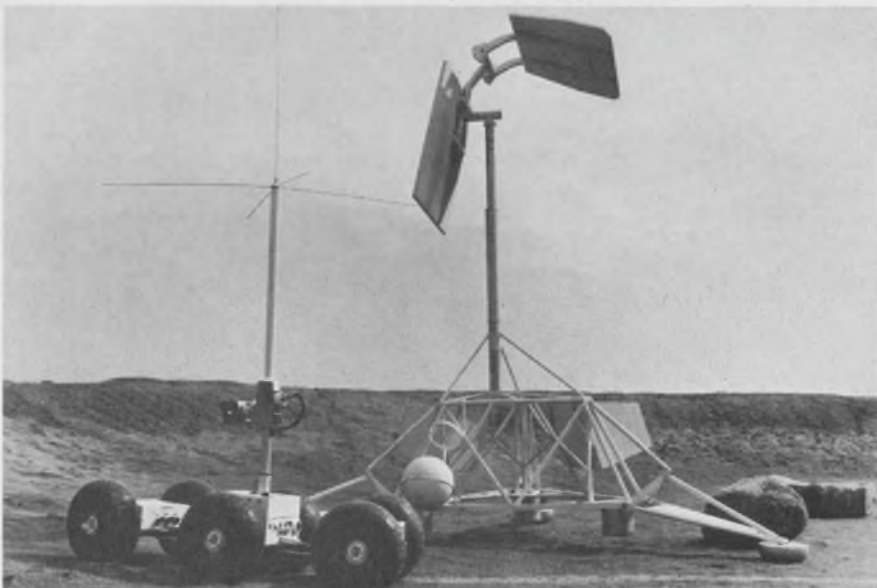
Even life on earth has never been precisely defined. Scientists have noted both the necessary conditions for life (such as ability to reproduce) and the sufficient conditions (non-Brownian mobility is clearly indicative of life), but no single condition is both a necessary and

sufficient condition for life.

Regardless of just which tests we include in our probe, and whether or not we successfully answer the philosophic question, "What is life?", there is no doubt that our tests will have more meaning if many different sites are sampled.

Two companies have built self-propelled vehicles for extraterrestrial exploration. Bendix has designed a manned vehicle it calls the Local Scientific Survey Module. General Motors has built an unmanned vehicle that has a built-in stereoscopic vidicon system for guidance (see Fig. 1).

The great distance from earth to Mars (it varies from 34.5 to 250 million miles) presents a communications problem when a moving probe is used. Electromagnetic radiation, traveling at the speed of light (11 million miles a minute), takes from three to 23 minutes to make a one-way trip. When visual images indicate that the robot needs redirection to avoid impending danger, the signals from earth will reach it on the average of 30 minutes after the robot signals for help. A robot can walk over lots of cliffs in half an hour. There is little doubt that a moving probe must



1. The Mars robot can have mobility if it uses an extraterrestrial vehicle, such as this one made by General Motors. Behind it is Surveyor's frame.



The photograph on the cover shows the Moon in the foreground and Mars in the background. It is an unretouched photograph taken at the Lowell Observatory, Flagstaff, Arizona (colors added by artists). This shows the relative distance from the Moon to Mars.

NEWS

(search for life, *continued*)

carry a considerable decision-making capability.

For the past three years Dr. Warren McCulloch, a neurophysiologist and Louis Sutro, electrical engineer, have studied at MIT the role to be played by artificial visual perception in the exploration of Mars.

"We cannot yet describe the operation of a human brain well enough to fashion a computer after it," says McCulloch "so a natural step would be to use the computers we have, and put more logic in the robot's eye. This is just what happens in lower forms of life. A primate's eye is far less complicated than a frog's eye, for example.

"A human brain carries out logic or reasoning in three ways: deductive, abductive and inductive. Its deductive logic is evident when it compares a particular case to a general rule and makes a decision. Its abductive logic is effected when it weighs a number of factors and arrives at a decision that maximizes the probability of an advantageous

outcome. These two types of logic can be simulated by a computer, but it is helpless when it tries to reason inductively. A man will reason meticulously to a point, but a good mind will suddenly leap to the creation of a hypothesis. It's that final leap that gets you when you try to simulate a brain with a computer. Without inductive reasoning we can only make very stupid computers, and we don't yet have the mathematics to describe the process of inductive reasoning. We must be content to simulate lower levels of intelligence. That puts a greater importance on the visual system."

McCulloch believes that the studies of the frog's eye, presently underway at MIT, will be useful in understanding the operations of any eyes in nature. "The frog's eye is complicated," says McCulloch, "and if we understand it thoroughly and build a working model of it, we should be able to understand and approximate the other eyes quite easily."

A team including physicist Dr. Roberto Moreno-Diaz, Richard Warren and Louis Sutro have been collaborating for many months to du-

plicate the frog's eye with available electronic components. Moreno-Diaz has arrived at a functional model of the eye, and to it he has correlated a model that might be implemented with electronics (Fig. 2a, b). Some time ago, Warren demonstrated feasibility by simulating part of an eye and its logic on one of the Institute's computers along with a simulated "scene." Recently the group has experimented with actual hardware consisting of a stereoscopic vidicon camera.

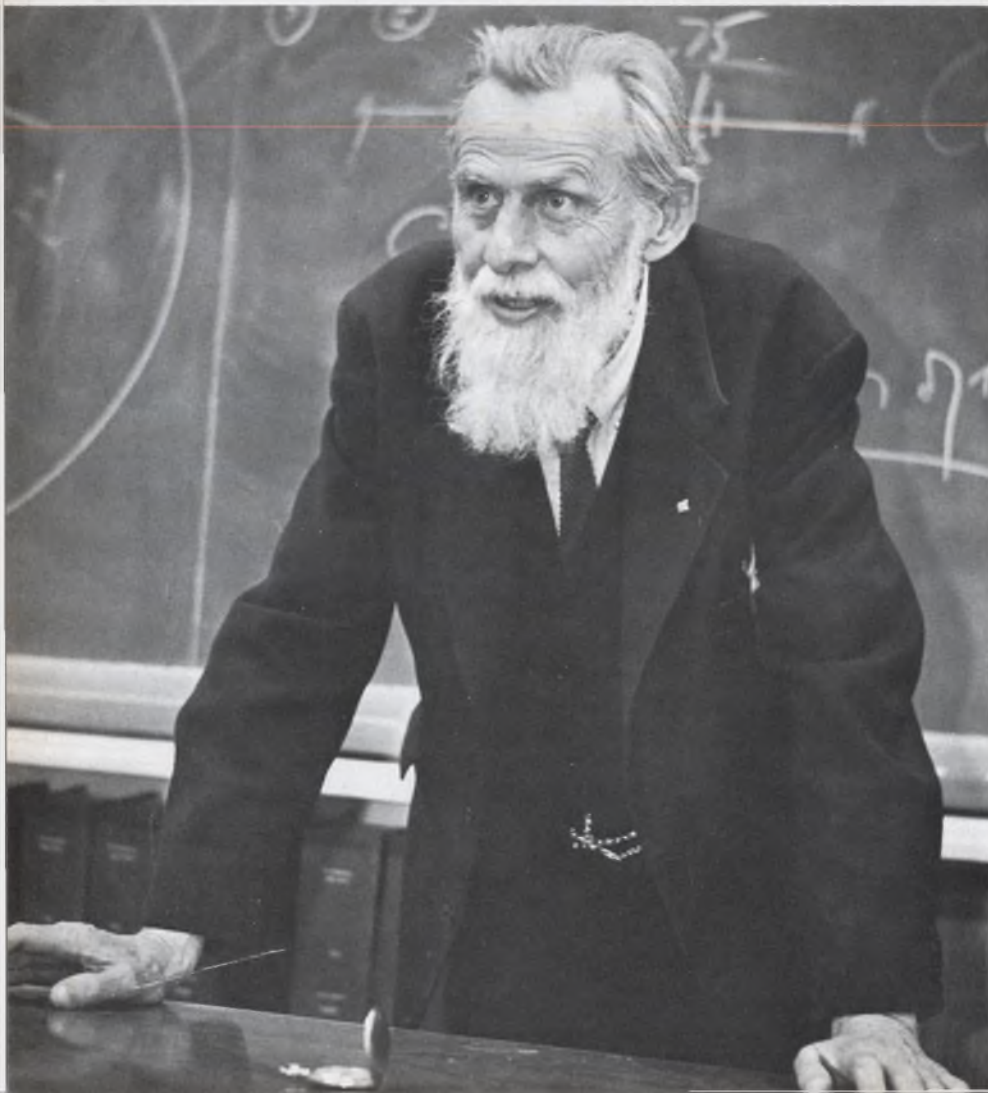
Ganglion cell simulated

The particular part of the frog's eye they simulated is the bug-detecting ganglion cell—four sets of ganglion cells actually detect these patterns: edges, over-all dimming, any time-varying visual event, and movement of a dark convex edge (bugs). This bug-detecting ganglion, according to the MIT scientists, has a rather complex response. It responds to an object that moves centripetally into the field of the retina provided that the object is relatively small, is darker than the background, and has a sharp leading edge.

The bug-detecting ganglion cell does not respond to a moving straight edge, changes in level of illumination, changes in the speed of an object, amount of contrast, or light-colored moving convex edges.

The model of the cell in Fig. 2a calls for a layer of bipolar cells connected to a layer of photoreceptors by two delay lines. One line delays the signal more than the other and the off-bipolar cells only trigger if the leading signal is weaker than the trailing signal. This corresponds to a dimming of the photoreceptor. Other on-bipolar cells trigger in response to brightening.

The output from each bipolar cell is a pulse of unit amplitude, r . In level 1, the storage fibers lengthen the pulses from the responsive retinal field, R_1 , allowing them to per-



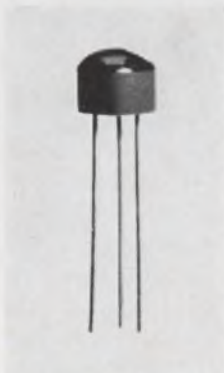
Dr. Warren McCulloch discusses proposed plans for the search for extraterrestrial life on Mars. His ideas are the basis for much of the work being done at MIT's Electronic Instrumentation Laboratory.

EPOXY JUNCTION FET

50¢

Pay less, get more: Fairchild's new 2N4360 is a low noise, low cost P-Channel junction FET you can get. You can get it immediately in any quantity, and pay much less than you would for devices with lesser performance specifications (only 50¢ in quantities of 1000). The 2N4360 features an extremely low noise figure, high gain, and high input impedance. The TO-18 epoxy package withstands an operating junction temperature of +125°C and can be stored at any temperature -55°C to +125°C. (TO-18 cans also available, 2N4381, 2N4382.) Get samples from your Fairchild Distributor, or get our data sheet.

FAIRCHILD
SEMICONDUCTOR

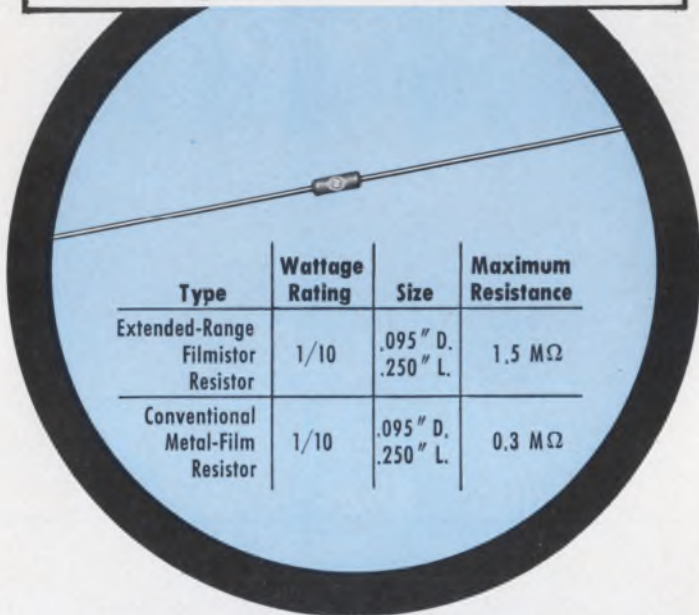


2N4360 Typical Specifications:

Equivalent Input Noise Voltage	0.02 μ V/Hz @ f=100Hz
Equivalent Input Noise Figure	0.1db @ f=100Hz
Gate to Source Breakdown Voltage (BV _{ess})	20V min.
Forward Transconductance (Y _{fs})	4000 μ mhos @ f=1kHz
Drain Current (I _{oss})	10mA
Gate Reverse Current (I _{ess})	0.15nA

New from Sprague!

**5 Times the Resistance of
a Conventional Metal-Film Resistor
of Equal Size!**



EXTENDED-RANGE FILMISTOR[®] METAL-FILM RESISTORS

**Substantial saving of space in all wattage ratings —
1/20, 1/10, 1/8, 1/4, 1/2, and 1 watt — with
absolutely NO SACRIFICE IN STABILITY!**

Extended-Range Filmistor Resistors now offer, in addition to accuracy . . . stability . . . reliability . . . resistance values in size reductions which were previously unobtainable. Size and weight advantages of Filmistor Resistors now make them ideal for applications in high-impedance circuits, field-effect transistor circuits, etc. Many designs which previously had to settle for the higher temperature coefficients of carbon-film resistors in order to obtain required resistance values can now utilize the low and controlled temperature coefficients of Filmistor Metal-Film Resistors.

Other key features are $\pm 1\%$ standard resistance tolerance, low inherent noise level, negligible voltage coefficient of resistance, and tough molded case for protection against mechanical damage and humidity.

For complete technical data, write for Engineering Bulletin 7025C to Technical Literature Service, Sprague Electric Co., 347 Marshall Street, North Adams, Massachusetts 01247.

SPRAGUE COMPONENTS

RESISTORS
CAPACITORS
TRANSISTORS
INTEGRATED CIRCUITS
THIN-FILM MICROCIRCUITS
INTERFERENCE FILTERS
48R-0120

PACKAGED COMPONENT ASSEMBLIES
FUNCTIONAL DIGITAL CIRCUITS
MAGNETIC COMPONENTS
PULSE TRANSFORMERS
CERAMIC-BASE PRINTED NETWORKS
PULSE-FORMING NETWORKS



'Sprague' and '®' are registered trademarks of the Sprague Electric Co.

ON READER-SERVICE CARD CIRCLE 14

NEWS

(search for life, continued)

sist. This permits the comparison of many pulses that may not have originated at precisely the same time.

At level 1(b), the pulses of unit amplitude are divided by an amount proportional to the number of photoreceptors being dimmed by the leading edge of the image.

Layer 2(a)* takes the output of level 1 and compares it with the total number of photoreceptors that have been dimmed. In effect, it divides D_1 , the total area of dimming, by d_1 , the length of the leading edge. The fraction D_1/d_1 is a measure of the penetration of the bug into the frog's field of view. Level 2(a) performs the same function for photoreceptors that lie in R_2 but outside the responsive retinal field, R_1 .

Level 3 simply stores and sums the pulses from the on-bipolar cells in R_1 . These cells respond only to brightening, and not to dimming.

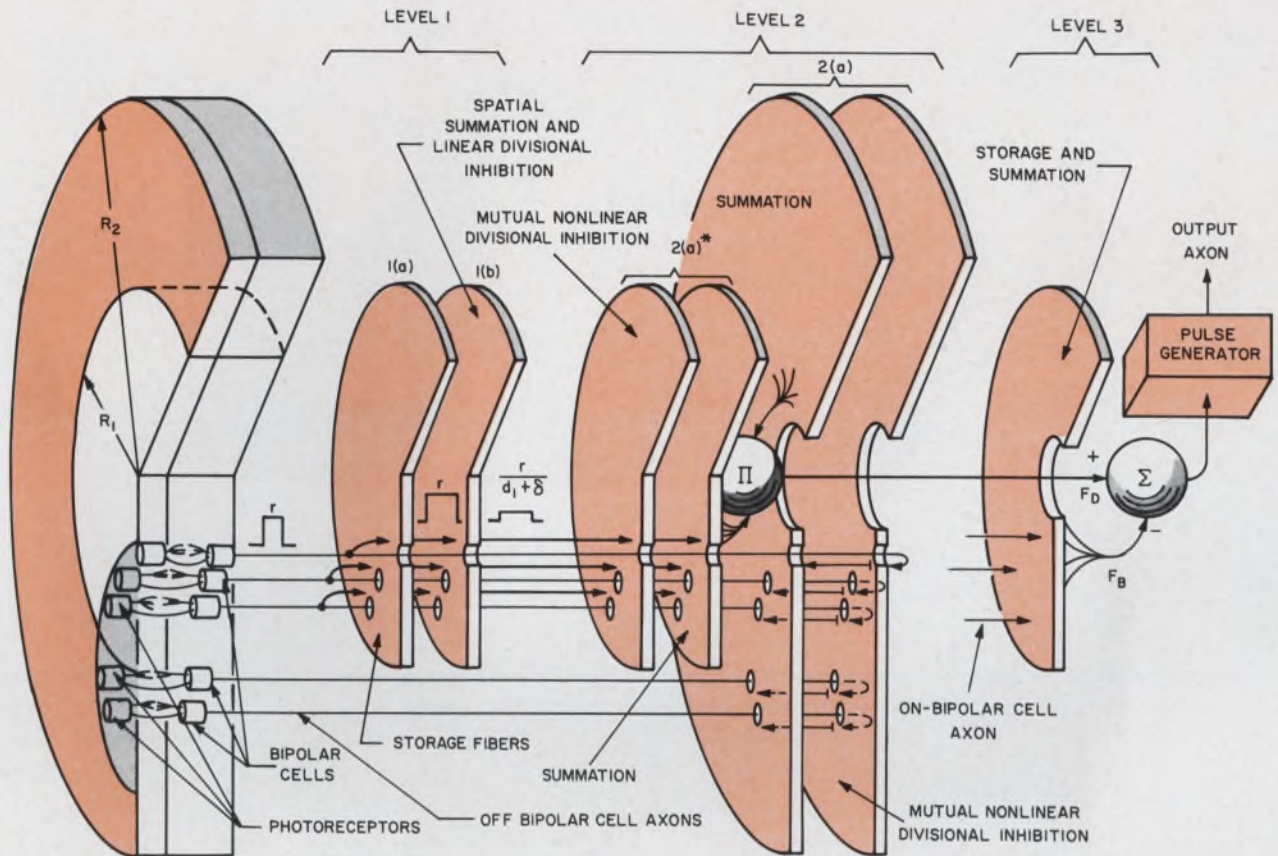
This information, together with all the information about the dimming patterns emanating from the II multiplication operator between level 2(a)* and 2(a), is fed to a pulse generator. It responds if, and only if, a dark round object subtending between 3° and 5° at the eye moves centripetally into the field of view.

An electronic frog eye

Moreno-Diaz and Sutro have collaborated on a functional model of the possible electronic instrumentation for this bug-detecting ganglion cell (see Fig. 2b).

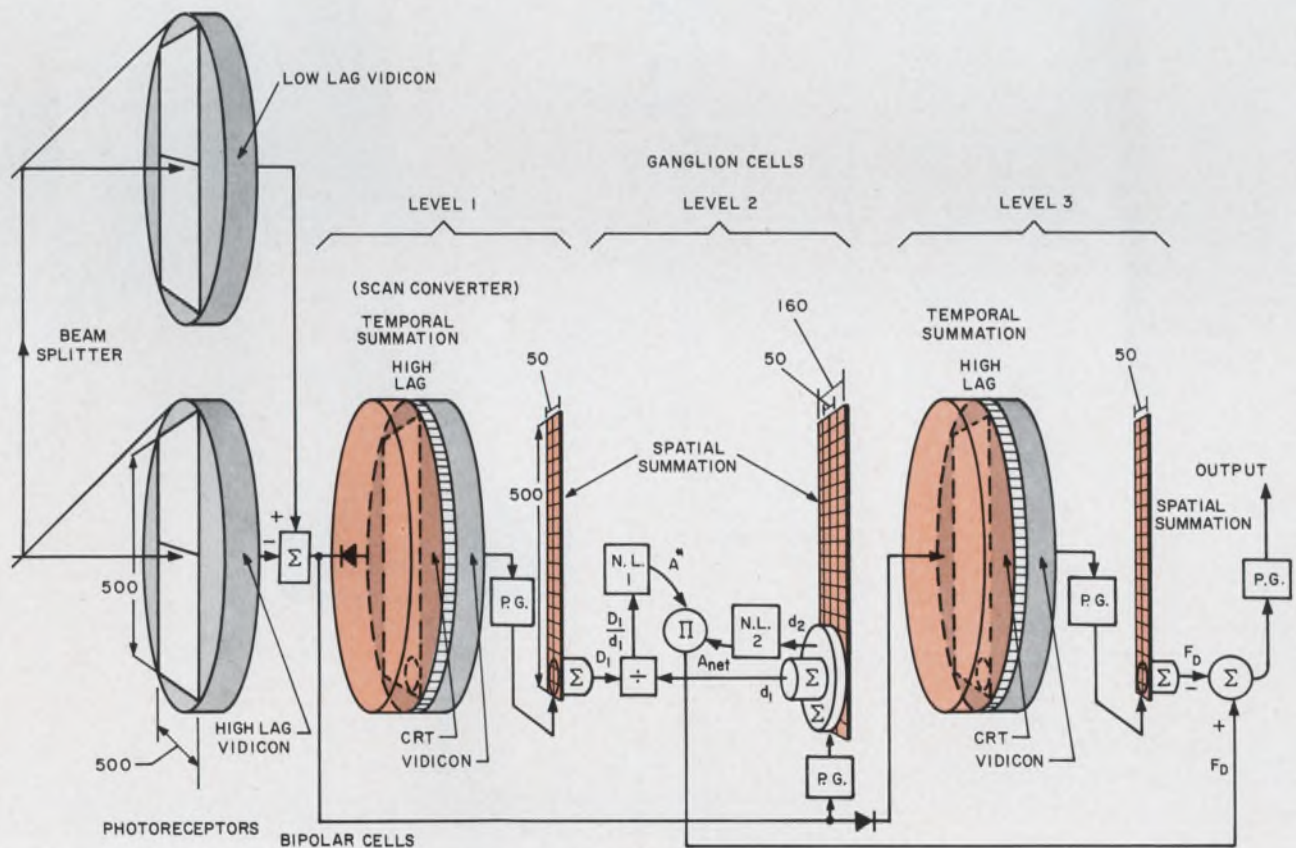
A beam splitter and two vidicon tubes simulate the photoreceptors in the frog's retina. The frog's delay lines are approximated by using two vidicon tubes that each have photosensitive surfaces of different lag times. A point-to-point summer and two diodes send dimming traces to the scan converter in level 1 and brightening traces to the corresponding unit in level 3. Persistence of trace in the scan converter's CRTs and high lag in their vidicons enable them to arrive at a value for D_1 , the total area of dimming. The CRTs and vidicons in the converters are attached by fibre optics.

The logic in level 2 performs the



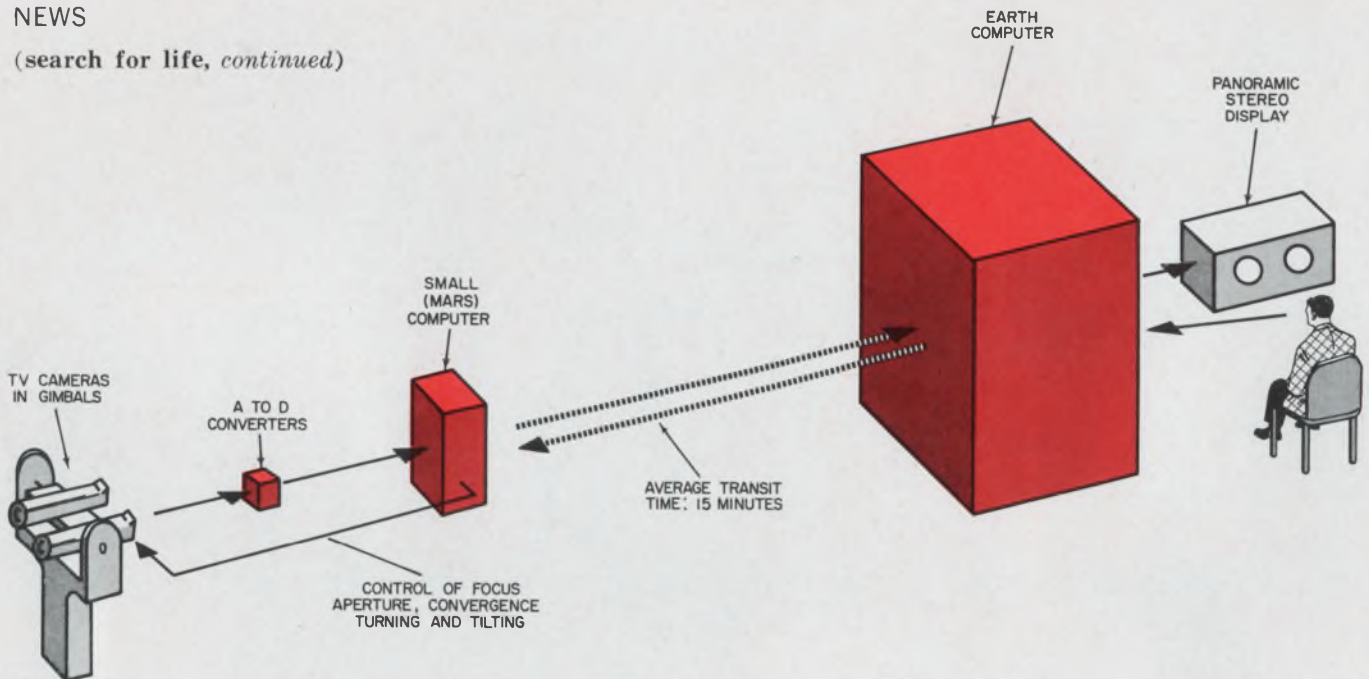
2a. Model of the bug-detecting ganglion cell in a frog's eye. The dark area at the left is the image of a bug mov-

ing centripetally into the eye's field of view. Delay lines connect photoreceptors to bipolar cells.



2b. Electronically simulated bug-detecting ganglion cell. A limited number of copies of the paper that describes

these models in detail is available. Single copies will be sent to readers who circle Reader-Service number 150.

(search for life, *continued*)

3. **Stereoscopic vidicon** is controlled and focused by computer in robot. The robot's computer could save much

time by making decisions without consulting with earth computers or people.

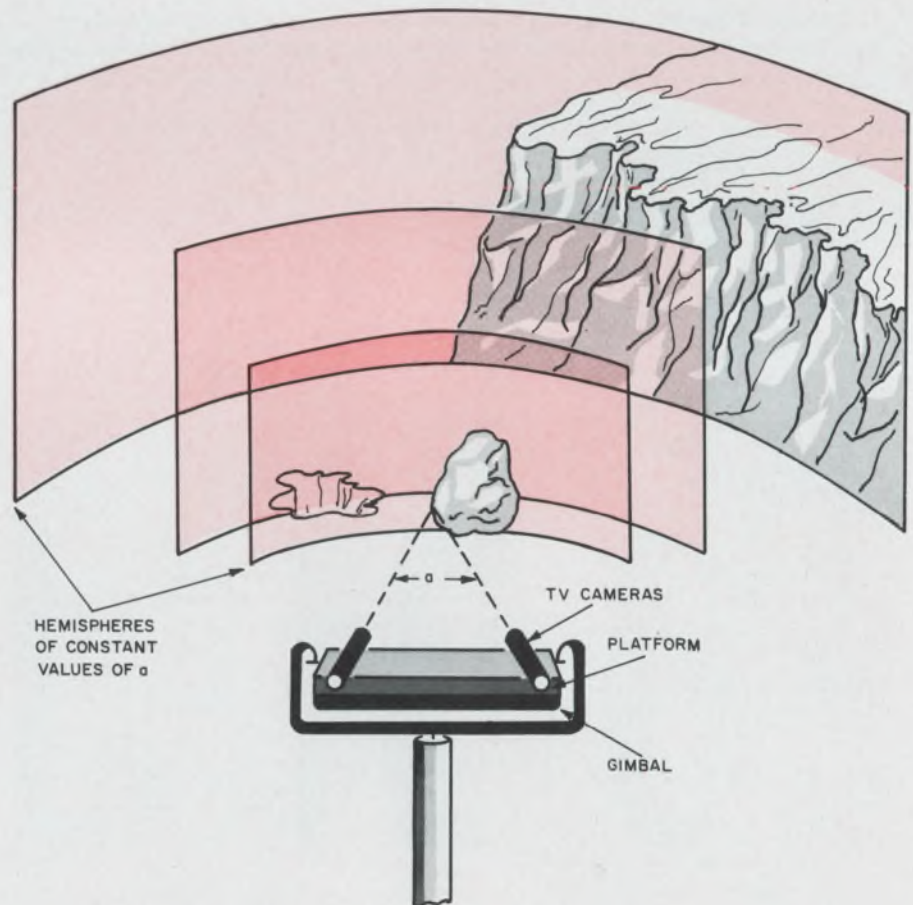
same kind of division, summing and nonlinear inhibition as the layers in the model frog's level 2.

The group proposes to make the logic with integrated circuits, and if its development is rapid enough, use solid-state vidicons for the photoreceptor layer. Westinghouse and RCA are actively engaged in the development of these devices and the MIT group has experimented with the Westinghouse units.

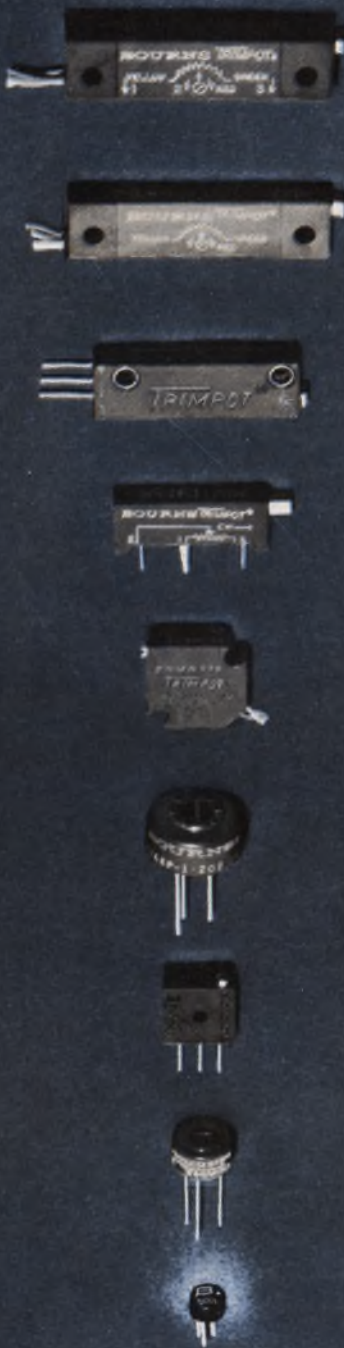
The MIT scientists are now building a stereoscopic vidicon camera with interchangeable lenses. It would be mounted on a platform that has three degrees of freedom. It would be connected to a small Mars computer, which, in turn, would control its focus, angle of convergence, and direction of aim (see Fig. 3). Such a unit would scan a scene and select only the distinctive topological features for transmission back to Earth (see Fig. 4).

The decision-making equipment will be a series of small integrated computers. They will evaluate all information coming from the camera and select one of a number of possible courses of action of the robot. Dr. William Kilmer, consulting at MIT, proposes the following:

- Advance to _____.
- Turn right.
- Turn left.
- Right itself (after overturn).



4. **Platform with stereovidicon** scans imaginary hemispherical shells for contrasting edges. When it finds one, such as this rock, it then proceeds to transmit back to earth pictures of the object. When the computer finds a line in corresponding frames on the vidicon, it traces that line, end to end, around the object. In this way it can seek out and identify salient details of a scene.





WHO ELSE WOULD DEVELOP THE WORLD'S SMALLEST POTENTIOMETER?

It should come as no surprise that Bourns has introduced the world's smallest adjustment potentiometer. We started the trend in 1952 with the original compact TRIMPOT® Potentiometer. Now, the commercial, single-turn Model 3317 is Bourns' newest answer to industry's need for even smaller components. It measures $\frac{3}{16}$ " in diameter, is less than $\frac{1}{8}$ " high, has only six parts for greater reliability, and costs under \$2.00 in quantity. Offered with top or side adjustment, the wirewound 3317 has flat gold-plated grade A nickel leads for improved solderability and weldability.

While it is a true commercial potentiometer . . . not a downgraded military type . . . the Model 3317 receives the same closely controlled in-process and final inspections as all Bourns products. Periodic environmental requalification is provided by Bourns exclusive Reliability Assurance Testing Program. In size, price and performance, the model 3317 Adjustment Potentiometer is unmatched. Write today for complete technical data.

Standard Specifications

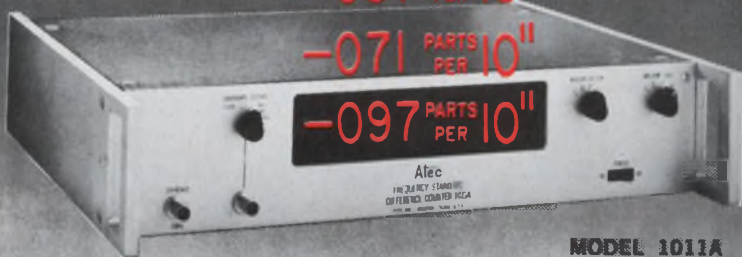
Model		Model	
3317P		3317W	
Resistance range	20 ohms to 5K ohms		
Resistance tolerance	±10 percent		
Temperature range	-65 to +105°C		
Power rating	0.2 watt at 25°C		
Shock	20G		
Vibration	10G		
Size — 3317P	.188" dia. x .105" high		
Weight— „	.08 grams		



BOURNS, INC., TRIMPOT DIVISION · 1200 COLUMBIA AVE., RIVERSIDE, CALIF.
PHONE (714) 684-1700 · TWX: 714-682-9582 · CABLE: BOURNSINC.

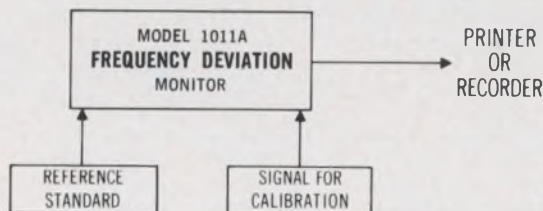
TRIMPOT® AND PRECISION POTENTIOMETERS — RELAYS — MICROCOMPONENTS: TRANSFORMERS, INDUCTORS, RESISTORS AND CAPACITORS

Buy The Numbers



Atec HAS A BETTER WAY TO MEASURE FREQUENCY DEVIATION! THE MODEL 1011A TELLS YOU, IN GOOD OLD DECIMAL NUMBERS, THE DIFFERENCE BETWEEN YOUR REFERENCE STANDARD AND THE FREQUENCY UNDER OBSERVATION. DOWN WITH SPINNING GREEN BLIPS AND POINTY METERS! JOIN THE Atec REBELLION—DO IT BY THE NUMBERS. (1011A IS A GOOD NUMBER TO START WITH.)

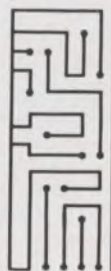
- RESOLUTION IN PARTS PER 10^5 , 10^6 , 10^7 , 10^8 , 10^9 , 10^{10} , 10^{11} AT THE FLICK OF A SWITCH—AND WITH AUTOMATIC DIRECT READOUT.
- SAMPLE TIMES OF .1, 1, 10 AND 100 SECONDS.
 - OBSOLETES OTHER METHODS—WORKS 1000 TIMES AS FAST.
 - PRINTER OUTPUT FOR PERMANENT RECORD—OR USE Atec 9DA3A D-A CONVERTER AND STRIP CHART RECORDER FOR DRIFT PLOTS.
 - DISPLAY STORAGE HOLDS LAST READING (VISUAL AND PRINTER OUTPUT) FOR FAST SAMPLE RATES.
 - \$2475 (ANOTHER GOOD NUMBER)



JOIN THE ATEC
REBELLION!

Atec, Inc.

1125 LUMPKIN • (713) 468-7971
P. O. BOX 19426 • HOUSTON, TEXAS 77024



NEWS

(search for life, continued)

1. Perform experiment 1.
2. Perform experiment 2.
3. Maintenance cycle.
4. Communicate mode 1.
5. Communicate mode 2.

The small computers in the robot that issue these commands would check each other and continuously "vote" on the order of importance of all possible commands. The computers would either be interconnected, or they would actually time-share one complex computer.

Certain over-all modes of operation would have priority, like "righting after overturn," and certain problems could be sent to earth for decisions by either a giant computer or by men.

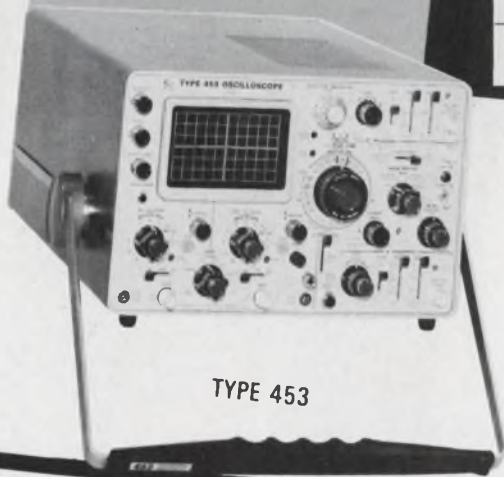
Chemical tests use electronics

Besides the frog's-eye investigation, NASA is supporting the development of more conventional tests for life. Dr. Carl Bruch, the biologist who until recently headed NASA's search for extraterrestrial life, has compiled a report of many such tests. For example, gas chromatographs of the pyrolytic products could identify proteins, lipids, carbohydrates, peptides and possibly even nucleic acids. Mass spectrometers, visible-light spectrophotometers, ultraviolet spectroscopes and equipment to measure optical rotation could detect these substances, which are common to life on earth. This report appears in a book entitled *Biology and the Exploration of Mars*, National Academy of Science, Washington, D. C.

One of the most interesting tests simulates the glowing tail of an ordinary firefly. The glow is due to a chemical reaction between luciferin, luciferase, magnesium ions, oxygen and adenosine triphosphate. The space probe could be set up to carry all of the firefly chemicals except the phosphate compound. The presence of the compound in a sample gathered on a planet would complete the chemical reaction, and a glow would result. A simple photomultiplier could detect this light and relay its presence to earth. Adenosine triphosphate is found in all cellular material, and its presence would strongly suggest life. ■ ■

3

Tektronix Portable Oscilloscopes



TYPE 453



TYPE 422



TYPE 321A

CHOOSE ONE FOR YOUR OWN MEASUREMENT REQUIREMENTS

TYPE 453

TYPE 422

TYPE 321A

	TYPE 453	TYPE 422	TYPE 321A
Bandwidth	DC-50 MHz	DC-15 MHz	DC-6 MHz
Deflection Factor	5 mV/div to 10 V/div	10 mV/div to 20 V/div	10 mV/div to 20 V/div
Channels	Dual	Dual	Single
Delay Line	Yes	Yes	No
Sweep Delay	Yes	No	No
Size	Height	7 $\frac{1}{4}$	8 $\frac{1}{4}$
	Width	12 $\frac{1}{2}$	10
	Depth	20 $\frac{1}{2}$	14
Weight (pounds)	28 $\frac{3}{4}$	22	14
Power Requirements	AC: 96-137 V or 192-274 V; 45-440 Hz; approx 100 watts.	AC: 115 V or 230 V $\pm 10\%$; 45-440 Hz; approx. 40 watts. DC: 11.5-35 V; approx. 23 watts; accepts Tektronix 24 V battery pack.	AC: 115 V or 230 V $\pm 10\%$; 45-800 Hz; approx. 20 watts. DC: 11.5-35 V; or 10 size D batteries; approx. 700 mA
Rack Mount Available	Yes (7" Rack Height)	Yes (7" Rack Height)	No
Probes and Accessories Included	Yes	Yes	Yes
Price	\$2050	\$1400 (AC Model) *\$1750 (AC/DC Model)	*\$900

U.S. Sales Prices f.o.b. Beaverton, Oregon

*without batteries

A TEKTRONIX PORTABLE will fit your specific requirements. Your Tektronix field engineer will be happy to demonstrate any of these oscilloscopes at your location. Just call him, or write Tektronix, Inc., P. O. Box 500, Beaverton, Oregon 97005.

Tektronix, Inc.

High costs still bar commercial fuel cells

Cheaper components and elimination of platinum as reaction catalyst are called major problems.

Neil Sclater
East Coast Editor

The fuel cell, often heralded as the possible successor to the battery, has a long way to go before it becomes an important commercial power source. Experimental fuel cells are already used in spacecraft and are economically feasible for military, ocean and remote-area applications. But they are still too expensive for domestic use. These opinions were stated by speakers at the recent National Electronics Conference in Chicago.

The first practical use of an experimental fuel cell by the Army in Vietnam is expected within the year.

The excessive cost of power from fuel cells can be accepted in space, military and remote-location applications. For powering commercial vehicles and industrial equipment, however, the cost

per kilowatt hour is still excessive, and not yet competitive with conventional batteries.

Two views on the problem

According to one engineer, John Moncrief of the U.S. Army's Electronics Command, Ft. Monmouth, N. J., the practical use of fuel cells depends on decreasing the costs of pumps, heat exchangers and accessories. He believes that this will come about with increased production.

Another engineer, Roy Mushrush, manager of General Electric's Direct Energy Conversion Operation, Lynn, Mass., views the problem as one of reducing or eliminating the use of platinum as the reaction catalyst within the fuel cells.

The fuel cell has most of the advantages of a battery. It is compact, has no moving parts and is silent. It is also capable of steady

electrical output without recharging, has long life and in most cases can operate on air and conventional fuels. It makes more efficient use of conventional fuel than conventional generators, by converting the energy of fuel oxidation directly into electricity (30% to 50% vs less than 20% for most conventional converters). Finally, fuel cells do not give off noxious fumes.

These qualities, according to Moncrief, are attractive to the Army and justify the high cost of the devices. Moncrief says that the Army would like to reduce the necessity for shipping vast quantities of fuel to overseas areas and believes that fuel cells could help by making more effective use of the fuel shipped.

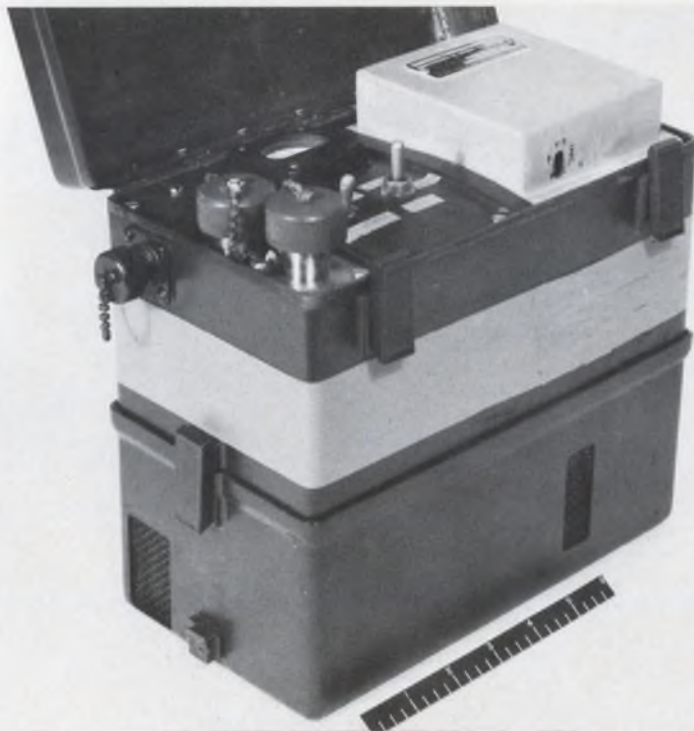
The most advanced fuel cell systems now operating are in the Gemini spacecraft. They convert hydrogen and oxygen directly. The Army is about to give an actual combat-condition field-test to small portable systems using direct liquid fuel, hydrazine, and air. The nitrogen in the hydrazine (N_2H_4) is merely vented to air after the reaction, leaving water as in the hydrogen-oxygen system.

Hydrazine is an expensive fuel at the present time, but the Army considers this a first step toward utilizing more common standard hydrocarbon fuels or gasses.

The Army plans to test a 60-watt hydrazine fuel cell in parallel with a 300-watt nickel-cadmium storage battery. This hybrid system, to be used to power radio transmitters, will weigh about 22 pounds and will have a volume of 0.5 cubic foot.

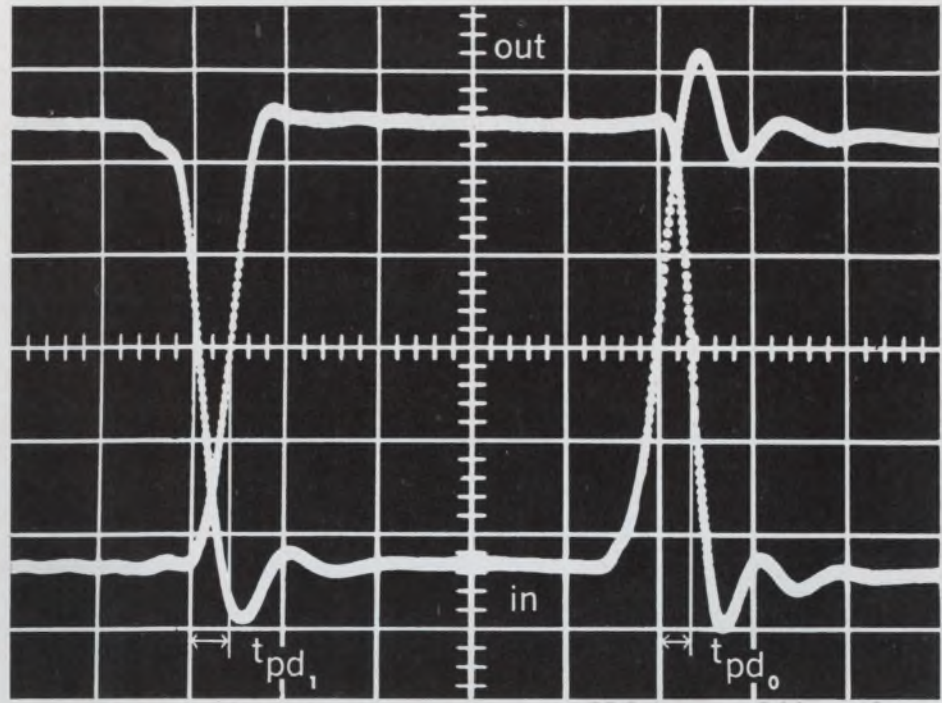
The battery supplies most of the short-duration load (up to 300 watts) and the fuel cell provides stand-by power and recharges the battery.

Moncrief says that, except for some experimental vehicular applications, nearly all of the planned uses of fuel cells are related to powering portable, mobile or remotely-located electronic



Army's hydrazine/air fuel-cell system can supply 28 volts. The unit, made by Monsanto Chemical Co., has a 12-hour fuel supply. With electrolyte, it weighs 12 pounds. Internal gas pressure produced by internal electrodes forces the fuel into the electrolyte. Used with a nickel-cadmium battery in a matching case, the fuel-cell system becomes a 60-300-w hybrid.

RCA
integrated
circuits 



NOR Output, each division = 10 nsec.

3.6 NSEC^{*} LOGIC

- In high-volume production
- \$3.25 (1000+ price)

RCA'S ULTRA-HIGH-SPEED ECCSL (Emitter-Coupled Current-Steered Logic) integrated circuits—offering the speed of non-saturated switching and the flexibility of complementary OR/NOR logic—are now available immediately.

FEATURES

- Built-in reference voltage source. Temperature tracking of reference voltage with "0" and "1" levels provides increased noise immunity.
- Single negative 5-volt power supply.
- Constant-current differential switching—minimizes power supply noise.
- 100-ohm terminated transmission line drive capability.
- Reliable aluminum-to-aluminum ultrasonic bonding.

RCA'S UNIQUE 14-lead hermetically sealed, flat pack features welded top closure and exclusive brazed-lead construction. Since leads do *not* pass through body of package, lead handling and flexing put no stress on device.

THESE THREE TYPES FOR YOUR PRODUCTION REQUIREMENTS

- CD 2150 dual 4-input ECCSL gate.
- CD 2151 dual 4-input ECCSL gate with "wired OR" output capability.
- CD 2152 8-Input ECCSL gate with "wired OR" output capability.

For prices and availability in quantities of 1-999, contact your local RCA Distributor. For immediate engineering and volume-delivery information, call your local RCA Representative or Art Liebschutz at (201) RA 2-3200, Ext. 617.

EXTENSIVE technical and application information is available in RCA Technical Bulletin CD2150-CD2152 and Application Note ICAN-5025—write to: Commercial Engineering, Section ICG10-4 RCA Electronic Components and Devices, Harrison, N. J. 07029.



*Typ average propagation delay 3.6 nsec for fan-out of 1+10pF/7.3 nsec for fan-out of 6+60pF

NOW AVAILABLE FROM DISTRIBUTOR STOCK

RCA Electronic Components and Devices



The Most Trusted Name in Electronics

(fuel cells, *continued*)

equipment.

He says that the U.S. Government has been spending over six million dollars per year for the past few years on fuel-cell research and he estimates that industry has been investing about three times that amount.

The fuel cell, despite some advance publicity, has a place as a

direct-power source, but for the foreseeable future it will not dominate the power-source field. In fact, it is quite likely that the first practical, commercial fuel cells will be hybrids similar to that used by the Army.

Moncrief reports that the hydrogen/oxygen system is fully developed and available for space applications. For ground use it will be available in about a year. He also says that hydrogen/air sys-

tems are progressing satisfactorily but that they are inherently less efficient because of the low percentage of oxygen available in air.

Hydrazine/air systems capable of producing 500 watts will reach the production stage in 1968, Moncrief predicts. Indirect hydrocarbon/air systems, including natural-gas types, could be produced by 1970. He says, however, that the real objective of the fuel-cell R&D is to produce hydrocarbon/air fuel cells that use standard fuels and are capable of 15 kW. But this is still 10 years away, he adds.

Mushrush told the conference about heat rejection. He said that low-temperature systems require much bigger radiator surfaces and these add weight and complexity, particularly for applications such as spacecraft. The high-temperature systems require less radiation surface, so that fuel-cell development is aimed toward higher-temperature reactions.

The cost of materials for fuel cells is another major handicap in their transition to commercial production. Fuel cells for space and high-power applications make use of large quantities of platinum and, in order to be commercially acceptable, it is almost mandatory that the amount of costly platinum be reduced or eliminated.

So far, no one has found a good substitute for platinum. The design direction that has been taken has been toward fuel cells that function without platinum. For example, alcohol systems operating at approximately 1000° F could use nickel as a catalyst successfully.

Mushrush said that General Electric is working on fuel cells for space, land and sea operation. The company recently announced a buoy-type fuel cell that is roughly the size of a 2-ft cube. It is capable of operating under water at depths of up to 400 ft. Completely self-contained, it does not require external fuel.

Platinum is not a significant factor in this design because of its relatively small 5-watt-average, 500-watt-peak power output. Both fuel cell specialists agree that the best prospect for the fuel cell in the near future is a hybrid combination with conventional batteries. ■ ■

How the fuel cell operates

A fuel cell is an electrochemical device that continuously changes the chemical energy of a conventional fuel and of oxygen into low-voltage direct current. Simply, it produces electric power directly from a continuous chemical reaction.

The fuel cell, like the battery, has an anode and a cathode. As shown in the diagram, they are joined both internally and externally. Electrons flow from the fuel in the external circuit and ions pass between the electrodes internally through the electrolyte.

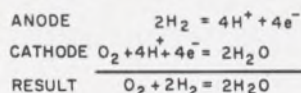
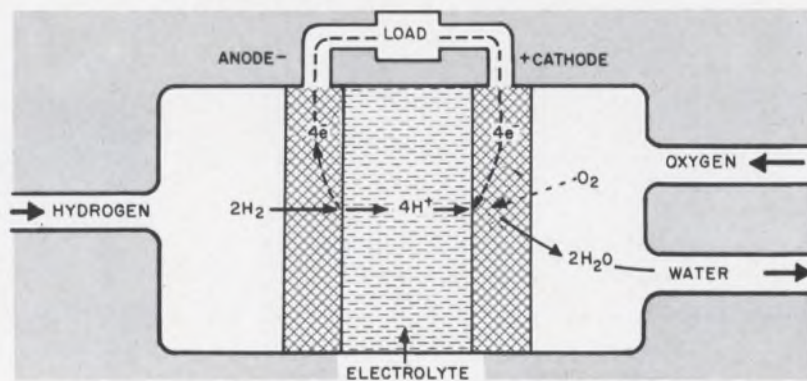
A conventional battery stores energy but does not convert it. It is limited by the amount of its primary charge and the need for periodic recharging. The fuel cell, however, operates as long as fuel and oxygen are supplied.

The hydrogen-oxygen fuel cell reverses the process of electrolysis. Instead of breaking down water into its components by passing an electric current

through it, water is formed in the fuel cell by a chemical reaction that liberates electrical energy.

The typical fuel cell with an acidic electrolyte is shown here. Hydrogen reacts at the anode to give up an electron (e^-) to the load while simultaneously releasing hydrogen ions (H^+) into the solution. At the cathode, those hydrogen ions combine with oxygen and the electrons from the load circuit to produce water.

Migration of both electrons and ions maintains internal and external charge and material balance. If the electron flow in the external circuit or the ion flow in the internal circuit is interrupted, power output will cease. Breaking the external electrical circuit essentially stops the use of fuel. Other fuels besides hydrogen may be used directly in certain fuel-cell systems. These include propane, methyl alcohol, ammonia and hydrazine.



GREGARIOUS!

The tighter you cram little Turbowrap™ wires together, the happier they are. Kynar and polysulfone insulation make them as tough in tight spots as much bigger wires.

Think of the opportunities that Turbowrap 312 (with Kynar) and Turbowrap 412 (with polysulfone) open up for higher-density wiring.

Made in sizes as small as 30 AWG, with walls as thin as .004" — these wires zip through automated wire-wrap operations with never a jam, skip, nick, short or break. And they perform faithfully, once in place.

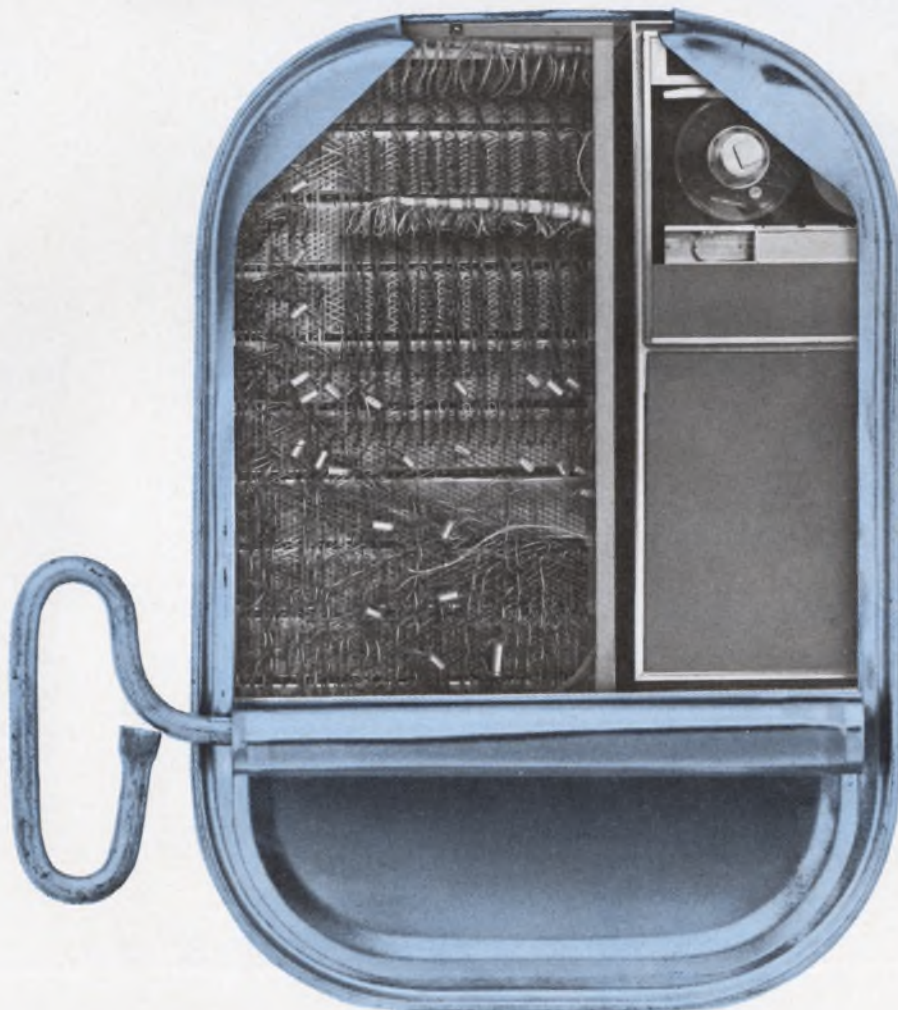
Special thin-wall extruding techniques, plus the fine electricals and mechanicals of the insulation, have made it possible for Brand-Rex to produce small O.D. wires with excellent cut-through resistance.

Looking for ways to put more wire into less space? Call on our tough little extroverts, Turbowrap 312 and 412.

AMERICAN ENKA CORPORATION

BRAND-REX DIVISION

WILLIMANTIC, CONNECTICUT 06226
PHONE 203 423-7771



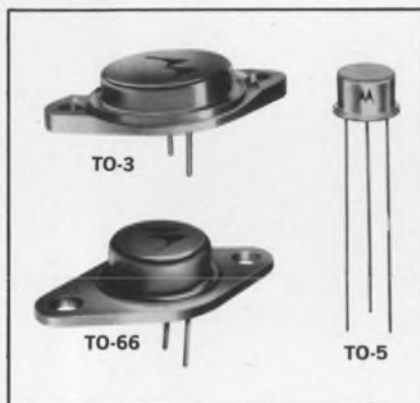
Speed Inquiry to Advertiser via Collect Night Letter
ON READER-SERVICE CARD CIRCLE 19

Semiconductor Report



SILICON POWER DEVELOPMENTS FROM MOTOROLA

NOW, PNP SILICON POWER TRANSISTORS TO 30 AMPS . . .



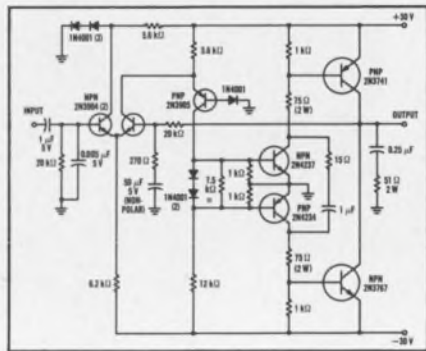
An industry "first", Motorola's new 30-amp PNP silicon power transistors let you choose the optimum device for your application from the widest array of PNP transistors available — with collector currents ranging from 1 to 30 amps in three package configurations!

Use these PNP silicon devices for direct replacements of germanium transistors in existing sockets or with Motorola NPN silicon types to provide efficient low-cost, reliable complementary circuits. Both PNP and NPN categories are available in these premium and economy versions: **Circle Reader Service No. 108**

ELIMINATE TRANSFORMERS, CUT COSTS WITH ECONOMICAL PNP/NPN COMPLEMENTARY CIRCUITS!

You can design direct-coupled complementary circuits which eliminate expensive transformers and reduce costs by combining Motorola PNP and NPN silicon power transistors. Complementary designs furnish a high degree of frequency stability and reliability as well as the ability to drive both ac and dc loads.

The 10-watt servo amplifier below exemplifies the many applications which can be served by complementary circuitry. Higher power outputs can be achieved with minor circuit modifications and by the substitution of components capable of handling greater power.



It may be necessary to adjust this resistor to establish proper quiescent current (10-30mA) in the output stage.

COMPLEMENTARY SERVO AMPLIFIER

Driving 20Vrms into a 40Ω load, this circuit provides a 10W output. The voltage-gain is 37dB ± 1dB (at 25°C). "Gain" variations are less than ± 0.5dB (from -55 to +100°C). Power-gain is 60dB (min). The circuit has a 15KΩ input-impedance while its output-impedance is under 1Ω.

NOTE: All resistors ± 5% - ½ watt (unless otherwise specified).

Motorola has prepared an informative series of Application Notes on both audio and servo amplifier complementary circuits. These comprehensive reports are yours for the asking. See your local Motorola representative or write: Technical Information Center, Motorola Semiconductor Products Inc., Box 955, Phoenix, Arizona 85001.

Circle Reader Service No. 109

PREMIUM TYPES . . . V _{CE0} — 60 & 80V						
CASE TYPE	P ₀ @ 25°C case	I _C (max) (cont.)	PNP	NPN	Typ h _{FE} @ I _C	V _{CE(sat)} @ I _C
TO-3	200W	30A	2N4398-99	—	15-60 @ 15A	1.0V @ 15A
	150W	10A	2N3789-90	2N3713-14	25-90 @ 1A	1.0V @ 5A
			2N3791-92	2N3715-16	50-150 @ 1A	
TO-66	20W	3A	2N3740-41	MJ5203-04	25-100 @ .50A	0.6V @ 1A
TO-5	5W	1A	2N4235-36	2N4238-39	30-150 @ 0.25A	0.6V @ 1A
ECONOMY TYPES . . . V _{CE0} — 40 & 50V						
TO-3	175W	30A	MJ450	—	20 min @ 10A	1.0V @ 10A
	120W	15A	MJ2901	MJ2801	15-60 @ 8A	1.5V @ 8A
	80W	5A	MJ490	MJ480	20 min @ 2A	1.0V @ 2A
TO-66	20W	3A	MJ3702	MJ5202	20-100 @ .50A	0.6V @ 1A
TO-5	5W	1A	2N4234	2N4237	30-150 @ 0.25A	0.6V @ 1A
			MJ430	MJ440	25-150 @ 0.25A	0.5 @ 0.75A



MOTOROLA Semiconductors

— where the priceless ingredient is care!

"Technical Marshall Plan" for Europe?



"Technical Marshall Plan" studied

Electronics and fields that rely heavily on electronics are key features in a so-called "technical Marshall Plan," now getting serious study at the State Department and at the White House Office of Science and Technology. Proposed by Italian Premier Amintore Fanfani, the plan is designed partly to help nations that lag behind the industrial leaders, but mostly it would help pull the Atlantic Alliance back together through a major effort in which NATO nations could cooperate.

President Johnson has expressed basic agreement with the plan and has asked several panels to study it. In its first phase, the plan would transmit U. S. technology to other NATO nations. In its second phase, the upgraded technology of NATO countries would be transmitted to lagging Eastern European nations. This, Fanfani believes, would be a major step toward bridging East-West differences and perhaps open markets in both directions.

Fanfani has approached all NATO nations with the proposal, but the U. S. would bear the burden of transmitting technological knowledge and hardware, just as it shipped agricultural and construction knowledge, food and hardware under the original Marshall Plan. The new plan calls for assistance in six areas: aeronautics, computers, space research, satellites (for scientific, industrial and commercial purposes), atomic and fossil-energy research, and environmental health and resources, including water desalination and air and water-pollution technology.

Officials at the State Dept. and the Office of Science and Technology are generally pleased with the basic outline of the plan, partly for the international political opportunities it presents but largely for the opportunity it offers to generate world-wide

Washington Report

S. DAVID PURSGLOVE,
WASHINGTON EDITOR

markets for several emerging technologies. A Pentagon official put the Defense Dept.'s position this way: "This isn't our bailiwick, and I don't think we have an official position, but I think it's a great opportunity for a lot of companies that are going to have to start worrying pretty soon about what happens when we get things cooled off in Vietnam."

Industry awaits EROS progress

Industry will have but a small role, if any, in the preliminary design of the Interior Dept.'s Earth Resources Observation Satellites (EROS). Studies on the feasibility of the program are under way. They are to be completed this year. A sampling of electronics and aerospace industry representatives shows no widespread unhappiness however. The representatives point out that no funds of any consequence will be available until late next year. Besides, one added, "We want to let the Interior fellows spend their own money, making sure they will really go ahead with this thing, before we start plowing our funds into proposal-making."

Interior says a typical EROS will weigh a half ton and likely be put into orbit atop a Thor-Delta rocket. The first launching is tentatively set for 1969, and the estimated cost of the program to that time is about \$20 million. The program is similar to one started at the Agriculture Dept. There, under a NASA contract, officials are taking a low-priority look at the potential for satellites to help underdeveloped nations increase food production and develop their natural resources. Both Agriculture and NASA officials expect that optical and electronic sensors, can be used to identify the types, conditions and extent of agricultural and forest soil, water and crops. Early stages of what could, without proper action, become widespread plant diseases or insect infestations would be detected. Agriculture's program is being

Washington Report

CONTINUED

pushed by the Agriculture Research Service and the Forest Service.

Interior's program stems from considerable work already performed in the U.S. Geological Survey, and the EROS project is headed by Dr. William T. Pecora, director of the survey agency. He contends that high-altitude satellites, equipped with appropriate sensors could not only examine large land masses and simultaneously compare conditions in one area with those in another, but that they could also enable researchers to "see" more easily beneath water, forest and earth cover. First priority among the EROS anticipated missions seems to have gone to advanced cartography, according to Pecora.

The first EROS will have, Dr. Pecora anticipates, an optical photo system coupled with "a small telecommunications unit, so that we may relay data to and from ground stations that will aid in interpreting the television images."

Submarine identification plan scuttled

Why did the Navy strongly urge the Pentagon and State Department to turn down the proposals of some of its own senior officers to set up international underwater Submarine Defense Identification Zones similar to the Air Defense Identification Zones? One Defense Dept. official says both submariners and the Intelligence community feared that the Navy might be its own chief victim of such an agreement. Under the air-defense zones—and presumably the submarine would follow the same basic lines—nations have the right to challenge aircraft headed toward their shores long before 3-mile or 12-mile limits are reached. But submarines patrolling near or in other national waters are among America's prime sources of intelligence on foreign shipping and naval maneuvers and shore activities.

Although the proposed Submarine Defense Identification Zones would have set up two major commands—East Coast and West Coast—that would have manned much advanced gear, largely electronic, the same international agreements that would have allowed the U.S. to challenge submarines headed in our direction would have permitted other nations

to challenge our own craft.

So far as Pentagon R&D officials are concerned, failure to implement the submarines identification plan will not affect antisubmarine warfare electronic R&D. They say that it would only have utilized the same sort of equipment already under development in various antisubmarine-warfare programs.

Quality control rides the rails

Electronics concerns have long been used to demands for quality control from the aerospace industry and military users. They are starting to get used to such demands from the Commerce Dept. for its High Speed Ground Transportation Program. The agency has called attention to the need for precision signaling and reliable communications when several trains are operating at speeds to 150 mph on the same tack. Now, even the conventional railroading industry is calling for more electronics quality control.

The theme kept popping up at a recent Washington meeting of about 1,000 railway communications and signal officers. In addition to asking for tighter quality control, they also urged the electronics industry to come up with new equipment and modifications of older equipment. They want better freight-car numeral readers, better visual displays of the wide variety of information now being gathered and transmitted electronically, and improved hot-box detection and warning systems. The need for the electronic sensors and alarms to spot and warn of over-heated axle journal boxes was considered imperative.

NBS completes 10-MW nuclear reactor

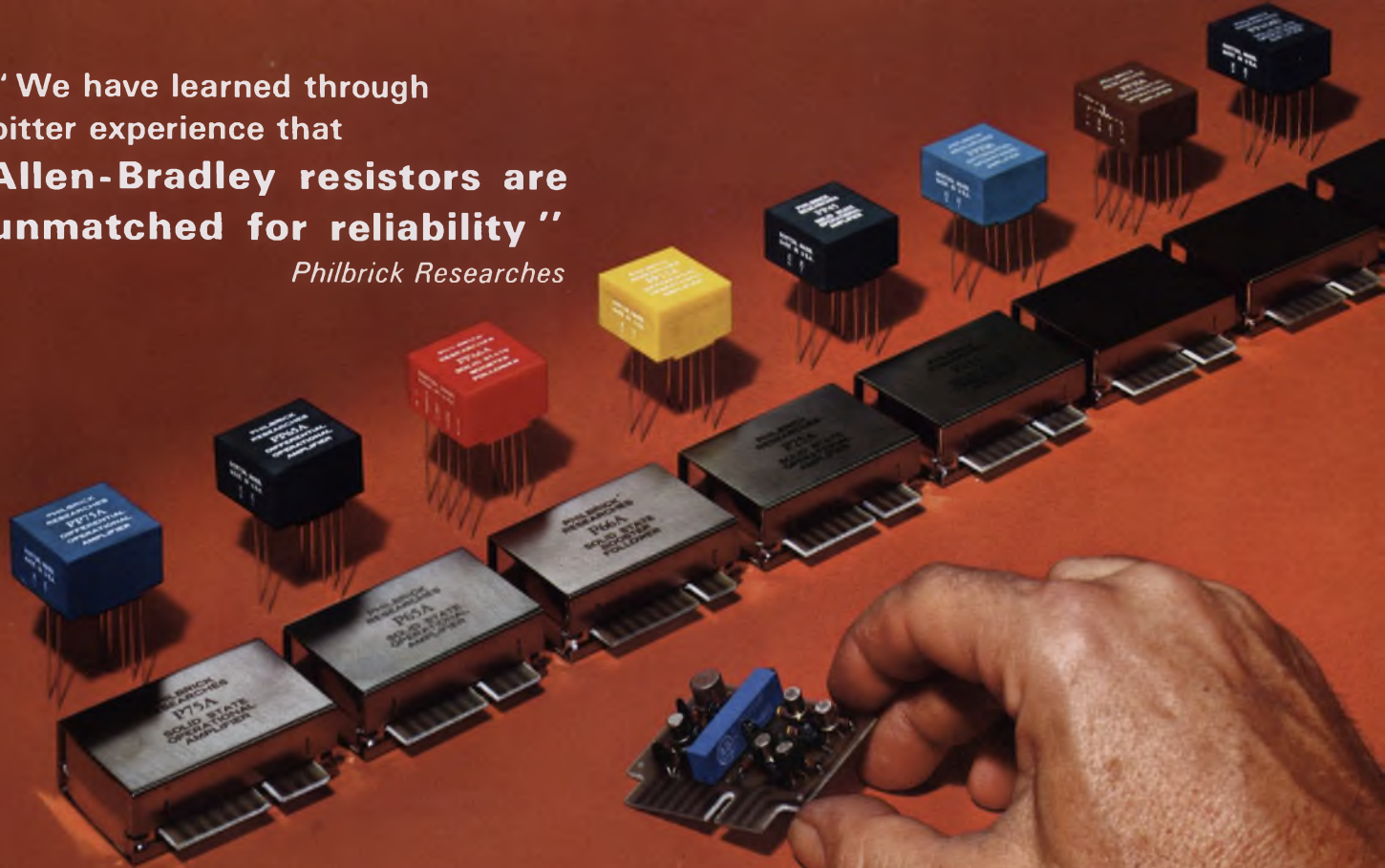
The National Bureau of Standards has just finished assembling a U-235 fueled nuclear reactor that emits intense neutron beams.

Located at the new NBS facilities, Gaithersburg, Md., the reactor will provide the Bureau and the other laboratories near Washington, D. C., with an extensive neutron beam facility that can be used for fundamental research on crystal structure, intermolecular forces and chemical bond strengths.

The NBS will use the reactor's high flux to study fission and neutron capture. Presently, an inadequate understanding of the fission process and lack of information on neutron yields limit the design of breeder reactors, according to a Bureau spokesman. The NBS also plans to use the reactor to generate radioisotopes for distribution as radioactivity standards.

“ We have learned through bitter experience that **Allen-Bradley resistors are unmatched for reliability** ”

Philbrick Researches

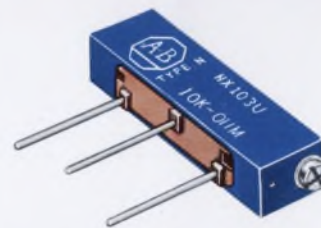


Typical Philbrick solid state operational amplifiers. The Model P65A differential operational amplifier with cover removed shows the use of Allen-Bradley hot molded fixed resistors and an Allen-Bradley Type N adjustable fixed resistor for zero balance adjustment.

TYPE BB 1/8 WATT		MIL TYPE RC 05
TYPE CB 1/4 WATT		MIL TYPE RC 07
TYPE EB 1/2 WATT		MIL TYPE RC 20
TYPE GB 1 WATT		MIL TYPE RC 32
TYPE HB 2 WATTS		MIL TYPE RC 42

HOT MOLDED FIXED RESISTORS are available in all standard EIA and MIL-R-11 resistance values and tolerances, plus values above and below standard limits. Shown actual size.

The need for a yearly production capacity of well over a billion units is a testimonial to the uniformity and reliability of all Allen-Bradley hot molded resistors.



Type N hot molded adjustable fixed resistor rated 1/2 watt at 50°C ambient. Available with nominal resistance values from 100 ohms to 2.5 megohms with tolerances of ±10% and ±20%.

■ “Why have Allen-Bradley hot molded resistors been our first choice since the late 1940’s? In a word: Reliability!” states Philbrick—the leading manufacturer of operational amplifiers. There’s nothing accidental about this superiority of A-B resistors. A unique hot molding process using completely automatic machines, eliminates the “human element” and produces such uniformity from one resistor to the next—year in and year out—that long resistor performance can be accurately predicted. No instance of “catastrophic failures” has ever come to our attention.

Allen-Bradley Type N adjustable fixed resistors likewise use a solid hot molded resistance track. Adjustment is so smooth, it approaches infinite resolution—and settings remain fixed. Being noninductive, Type N controls can be used at high frequency, where wire-wound units would be completely unsatisfactory.

For more details on the full line of Allen-Bradley quality electronic components, please write for Publication 6024: Allen-Bradley Co., 222 W. Greenfield Ave., Milwaukee, Wis. 53204. Export Office: 630 Third Ave., New York, N.Y., U.S.A. 10017.



ALLEN-BRADLEY
QUALITY ELECTRONIC COMPONENTS

An Allen-Bradley announcement of importance to motor designers

The new MO6-C ferrite magnet having 30% higher intrinsic coercive force

■ The new Allen-Bradley MO6-C ceramic permanent magnets provide at least 30% increase in the highest previously available intrinsic coercive force—obtainable with A-B's MO5-C material. This advance is achieved with the same high residual flux density.

Designers of permanent magnet motors have a choice of these advantages—30% higher resistance to demagnetization, or 30% increase in motor output, or 30% increase in cold temperature protection. In fact, where the higher coercive force is not required, the designer can give himself a 30% reduction in magnet size.

This new Allen-Bradley MO6-C material opens the door to such motor designs where permanent magnets heretofore were not practical, namely for motors used in many portable tools and appliances. Like with the MO5-C material, these new MO6-C magnets are radially oriented, and are available in virtually all sizes and shapes currently being produced in segments for motors from 3/4" diameter to 10 hp. While MO5-C magnets will continue to satisfy most needs, MO6-C enables designers to satisfy more exacting motor design requirements because of its unusually high intrinsic coercive force.

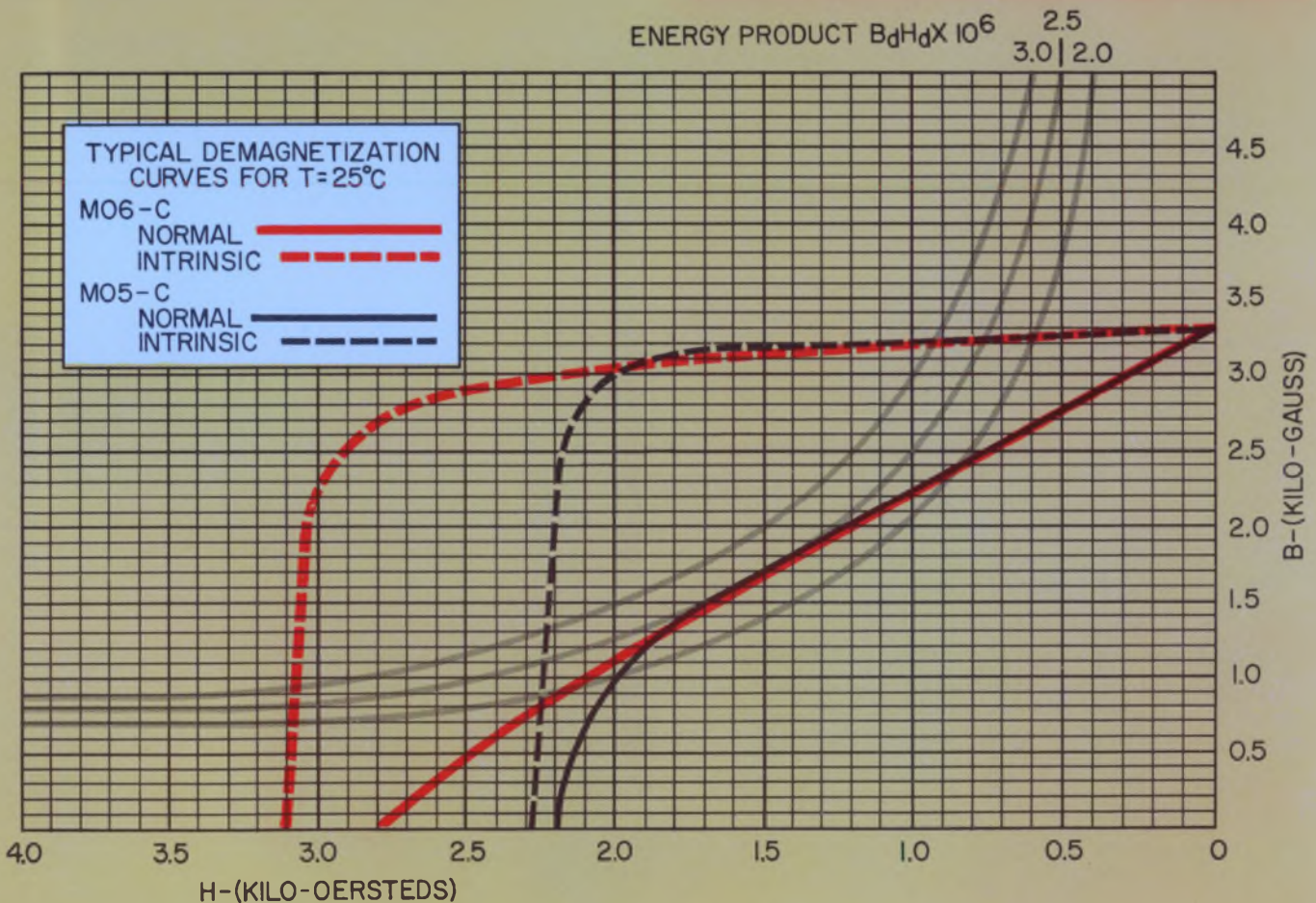
Allen-Bradley application engineers will be pleased to help you obtain maximum economy in your motor design through optimizing magnet performance. Please let us hear from you. Allen-Bradley Co., 222 West Greenfield Avenue, Milwaukee, Wisconsin 53204. In Canada: Allen-Bradley Canada Limited. Export Office: 630 Third Ave., New York, N.Y., U.S.A. 10017.

TYPE MO6-C CERAMIC PERMANENT MAGNETS

Typical Characteristics

—stated values have been determined at 25°C.

Property	Unit	Nominal Value
Residual Induction (B_r)	Gauss	3300
Coercive Force (H_c)	Oersteds	2800
Intrinsic Coercive Force (H_{ci})	Oersteds	3100
Peak Energy Product ($B_d H_d \max$)	Gauss-Oersteds	2.5×10^4
Reversible Permeability	—	1.09
Curie Temperature	+°C	450
Temperature Coefficient of Flux Density at B_r	%/°C	-0.20
Specific Gravity	—	4.9
Weight per Cu. In.	Lbs.	0.177



ALLEN-BRADLEY

QUALITY MOTOR CONTROL
QUALITY ELECTRONIC COMPONENTS

Computers to read handwritten numbers

Non-technical people will now find it easier than ever to "converse" directly with a computer.

This view was expressed by G. B. Beitzel, president of IBM's Data Processing Div., as he introduced what he called the first machine that reads handwritten numbers directly into a computer for processing.

Designed for use with IBM's System/360, the 1287 optical reader can recognize numbers and five different hand-printed alphabetic characters, pencil-written, on a wide variety of business documents.

The 1287 also reads machine-printed and credit-card-imprinted numbers and feeds the information into the computer for processing.

Because the data are transmitted directly from source documents into the computer, Beitzel says, the process saves time and money and eliminates conversion errors.

IBM has solved the problem of identifying handwritten numbers by means of a tiny "flying spot" of light, about five one-thousandths of an inch in diameter.

Projected by the 1287's sensing

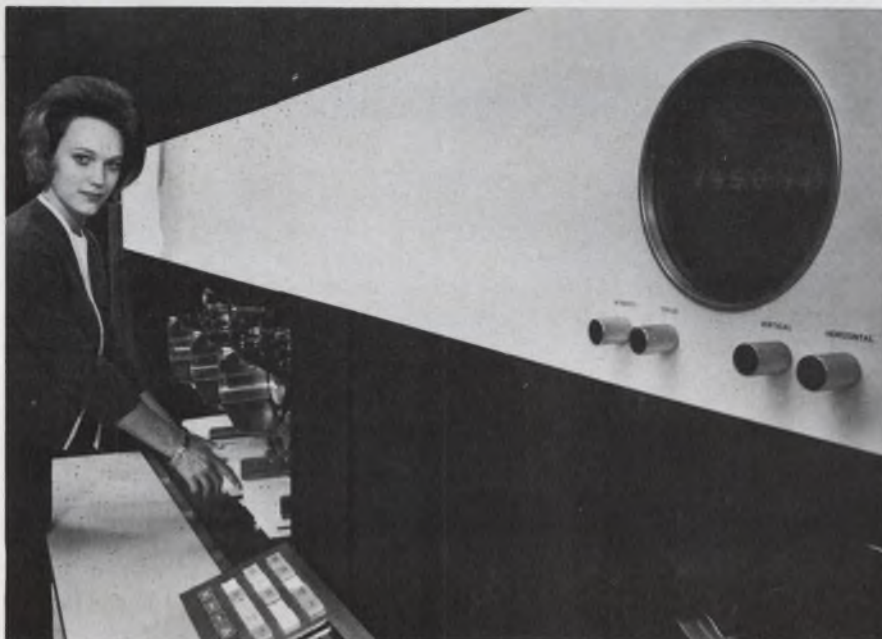
unit, the flying spot scans lines or fields of numbers on a document. When it crosses any part of a handwritten or printed number, it spirals (curve-follows) completely around the number before moving on.

Logic, built into the 1287, interprets the values of numbers traced by the flying spot and automatically transmits them to the System 360 for processing.

The five hand or machine-printed alphabetic characters—"C," "S," "T," "X" and "Z"—are read by the machine in the same manner. The five letters are used as information coding symbols on 1287 documents.

The flying spot scans and curve-follows machine-printed numbers at a rate of about 300 a second, Beitzel said. Document reading speeds vary, however, he said, depending on the size of the document, the amount of information to be read and the mix of written, printed, imprinted and pencil-marked numbers.

Multiline documents containing 30 to 40 handwritten numbers are read by the 1287 at a rate of about 125 a minute. ■ ■



Handwritten numbers can now be read directly into a computer by means of IBM's 1287 optical reader. Designed for use with the company's System/360, the machine can recognize numbers and five different hand-printed alphabetic characters pencil-written on a variety of business documents.

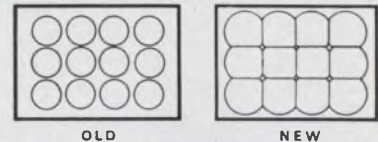
◀ ON READER-SERVICE CARD CIRCLE 20

Why the most readable readouts have a new lens system.

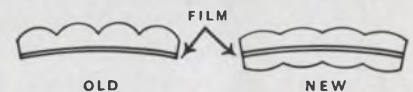


We've just designed a totally new lens system for our miniature rear-projection readouts, the Series 120 and the Series 220 (front plug-in model). Since we already had the most readable readouts made—even with the old lens system—why all the effort?

Frankly, the most important thing we (or any other readout manufacturer) have to sell is readability. That's why we keep on working to make the best just a little bit better. This time it really paid off. Our new lens system delivers a significant increase in character sharpness and a 50% increase in brightness! Here's what we did:



First we squared our circular lenses. That gives us greater usable lens area for a two-fold effect: the new larger lenses collect more light; magnification required is reduced. Both factors increase brightness and sharpness.



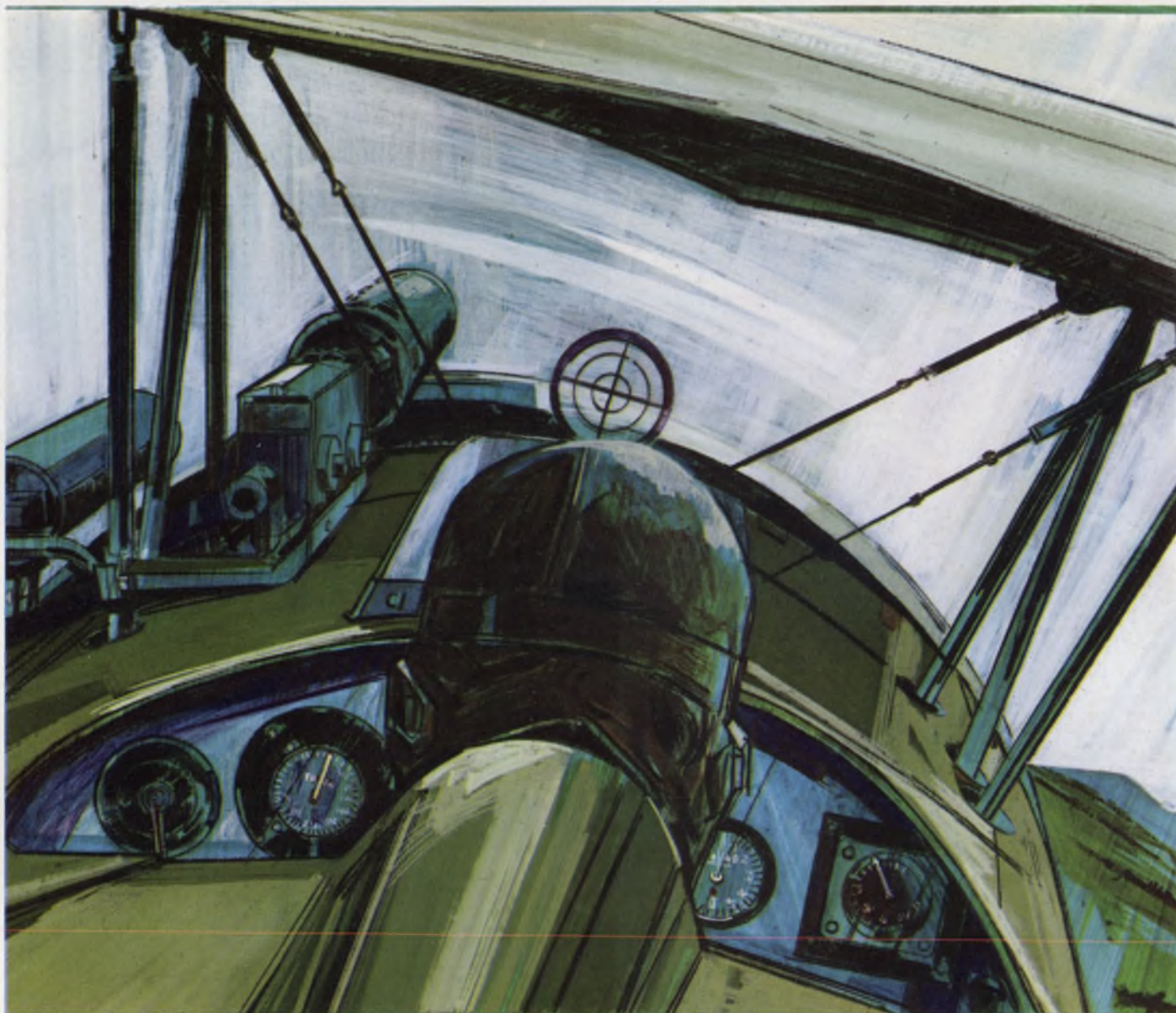
Second, we split the old single condenser lens and made a lens-film-lens sandwich. The old lens refracted light rays toward the projection lens before the rays passed through the film. Of necessity, the lens had steep curvature which limited the usable size of film. The new split-lens condenser refracts light in two stages: before it passes through film and after. By comparison, the new lenses are practically flat, permitting use of larger film and reducing aberration associated with thick lenses. The effect builds up: larger film means less magnification which in turn means greater brightness and sharpness.

So that's why the most readable readouts have their new lens system. Frankly, this new lens system may not seem earthshaking to you, unless you happen to be using readouts. In any case, send us your inquiry. We'll give you the reading on readability!

IEE INDUSTRIAL ELECTRONIC ENGINEERS, INC.

7720 LEMONA AVENUE, VAN NUYS, CALIFORNIA
PHONE: (213) 787-0311 • TWX: (910) 495-1707
© 1966 IEE Representatives in Principal Cities

ON READER-SERVICE CARD CIRCLE 21



The Kind of Knowledge that makes progress possible...

It was World War I. Man had already learned to fly, but he was an uneasy "bird" in flight. With the war came instrument flying. It gave man a new ability and confidence in the air, and galvanized his dream to conquer space. Now, in an age of electronic sophistication, man's dream beckons reality.

It took many minds of different skills to accomplish this dramatic progress in aviation. Mental perception of the highest order. Perseverance. Dedication in the face of setbacks. Step by step, a priceless knowledge of experience was stockpiled.



IS THE KIND OF KNOWLEDGE YOU GET FROM KESTER

This knowledge of experience is the kind of knowledge you get from Kester. Back in 1899, years before the Wright Brothers' first flight, Kester Solder products and soldering knowledge were already contributing to the changing needs of industry. And as technology accelerated, Kester kept pace.

Today, after 67 years of working with development engineers in the technology of solders and fluxes and their applications, Kester's knowledge of experience stands ready to serve you. Write, phone or wire for specific information.



KESTER SOLDER COMPANY

4216 Wrightwood Avenue, Chicago, Illinois 60639 • Newark, New Jersey 07105 • Anaheim, California 92805 • Brantford, Ontario, Canada

1899-1966—67 years manufacturing highest quality solders and fluxes

ON READER-SERVICE CARD CIRCLE 22

SHIELDED "BLACK BOXES"

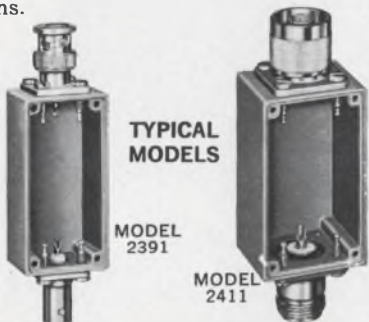


Typical application with Model 2413

protect custom test circuits with effective RF shielding

Use these unique component-mounting die-cast aluminum containers to package active, passive, or isolation networks, voltage dividers, attenuators, or other specific testing circuitry... with RF shielding.

Select from 12 different connector combinations to fit existing test equipment. Aluminum cover secured by four self-tapping screws. Solder turret terminals provide permanent, noise-free connections.



TYPICAL MODELS

MODEL 2391

MODEL 2411

The complete series of Shielded "Black Boxes" is described and illustrated in the new Pomona General Catalog, 11-66. Write for your free copy today.

POMONA
ELECTRONICS CO., INC.
1500 East Ninth Street, Pomona, California 91766
Telephone (714) 623-3463

ON READER-SERVICE CARD CIRCLE 23

NEWS

Accuracy increased in TWT inspection

An automatic production-control device has eliminated a major bug in traveling-wave tube production: helixes, or spiraled wires, that deviate from the specified pitch and impair the tubes' operation.

To insure production of uniform helixes, RCA's Industrial Tube and Semiconductor Division in Harrison, N. J., now checks the helix, turn-by-turn, before it is assembled in the TWTs. The automatic inspection device determines any deviation from the required pitch, with an accuracy greater than previously available units, an RCA spokesman said.

A key component in the system is a memory encoder. Called Mem-O-Tizer, it provides a fast and accurate readout that shows whether the pitch of the helix deviates from the prescribed norm, and by how much. Deviations as small as one micron can be detected.

Other components in the system include a microscope, preset controller and a moving stage containing a precision gear train and drive motor. Here is how the system operates:

The helix is formed by winding tungsten or molybdenum wire around a mandrel. Still on the mandrel, the helix is placed horizontally on the moving stage under a microscope. The first turn of the helix or wire spiral is manually focused under the microscope, and the required pitch between windings is dialed on the preset controller.

When the controller is switched on, the remaining operations are performed automatically by the equipment.

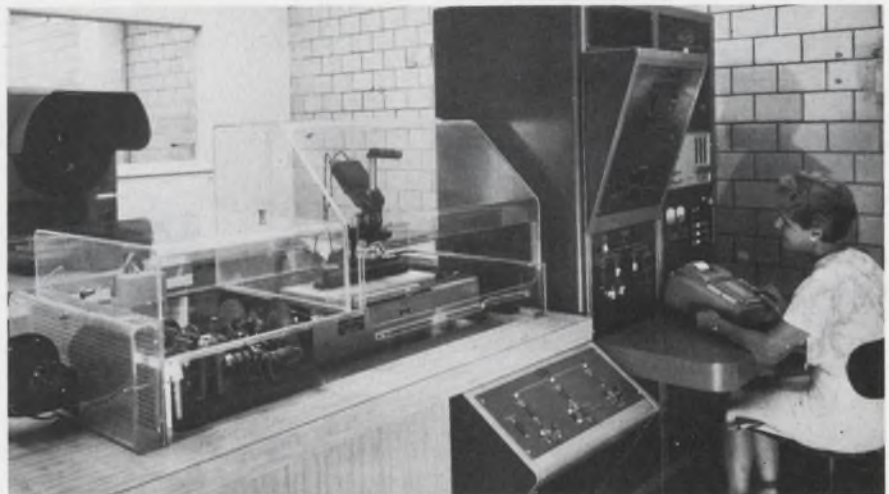
A drive motor moves the helix in increments of five microns, while a "scoreboard" on the system's control panel records the measurement of the pitch. When the mandrel has traversed the same number of microns dialed on the control panel, the drive motor shuts itself off. If the pitch is correct, the second turn of the helix should then be exactly centered in the optical system of the microscope.

If the second turn is centered, the operation is repeated for successive turns. If it is not centered, two photo-electric cells in the microscope cause the mandrel to move forward or backward until the second turn comes into sharp focus. This deviation is displayed on the control panel.

Each reading on the control panel is recorded by the operator to provide a permanent record. In case of future tube breakdowns, these records will provide a clue to the cause.

To insure controlled atmospheric conditions, the microscope, drive motor, precision gear train and Mem-O-Tizer are enclosed in a protective transparent plastic cabinet.

Previously RCA used a comparator to check pitch deviation. In that hand-operated system, the comparator inspects a helix in spans of 10 turns rather than turn-by-turn. ■ ■



Automatic traveling-wave tube inspection system checks for production errors. Developed by RCA the device measures the pitch of helixes.

They
laughed
when I
sat down to play. . .



. . . my **Midwestern Oscillograph** in the **20 KHz** range! Nobody knew that Midwestern Instruments makes the **ONLY** oscillograph capable of recording lightning, FM and other transients to 20 KHz directly . . . but we **do**, because with our new "super galvo" (Model 131-20,000) as a replacement, **any** Midwestern oscillograph can be readily expanded to this new high-frequency, direct-capability recording. . . 50% better than our "nearest" competitor. . . and you can rely on Midwestern Instruments for prompt, dependable service.

If you want a copy of the score, write or phone your nearest Midwestern office.




Model 800 B
36 channels;
8-inch chart;
0.1 to 150 ips

**MIDWESTERN
INSTRUMENTS** / **TELEX**

A SUBSIDIARY OF THE TELEX CORPORATION
41st AND SHERIDAN ROAD, P. O. BOX 1526
TULSA, OKLAHOMA 74101
PHONE 918-627-1111 • TWX 918-627-6030 • TELEX 049-589

ON READER-SERVICE CARD CIRCLE 24





Pioneering?

You don't have to have someone re-invent the wheel

The answer to your latest switching problem may already have been developed. And, if there's any place in the world where you can get it right off-the-shelf, it's MICRO SWITCH.

Many of our switches would be considered specials by some people. But at MICRO SWITCH they are available without special engineering costs. They are available now. And they are application-proved reliables.

Main reason for this extra service is that we've specialized in nothing but switches for over 30 years. And in the process have come up with the world's largest selection of switches.

Engineering and application help is also available from MICRO SWITCH. Our field engineers are thoroughly experienced in solving switching problems. You will find them a cost-saving addition to your design team.

Call a local MICRO SWITCH Branch Office (See Yellow Pages, "Switches, Electric"). Or write . . .

MICRO SWITCH

FREEPORT, ILLINOIS 61032

A DIVISION OF HONEYWELL

HONEYWELL INTERNATIONAL • Sales and service offices in all principal cities of the world.
Manufacturing in United States, United Kingdom, Canada, Netherlands, Germany, France, Japan.

Speed Inquiry to Advertiser via Collect Night Letter
ON READER-SERVICE CARD CIRCLE 25

*Organized for your purpose
and satisfaction!*

NEW SUBMINIATURE SWITCH SERIES

Provision for Illumination
with Replaceable Lamp



Unlimited Code
Capability

1-2-2-4
(COM) DECIMAL BCD
DIODE ETC.

Designed to Meet or Exceed
Requirements of MIL-S-22710

6000
Family
--Sealed--

5000
Family
--Unsealed--

Cable Termination



6100 SERIES

P. C. Board Termination



5300 SERIES

Wire Loop Termination



6200 SERIES

EECoSWITCH[®]
ROTARY THUMBWHEEL SWITCHES

*A leader
at any level!*

Digital Circuit Modules ■ Custom Welded and Packaged Circuits ■ Systems
Area Phone Numbers: Boston (617) 275-0540 ■ New York City (201) 444-3220
Washington, D.C. (301) 779-3636 ■ San Francisco (408) 253-5951

ENGINEERED ELECTRONICS Company

1441 EAST CHESTNUT AVENUE, SANTA ANA, CALIFORNIA 92702
PHONE: (714) 547-5651 TWX: 714-531-5522 CABLE: ENGELEX

ON READER-SERVICE CARD CIRCLE 26

NEWS

A 35-lb radar set destined for Vietnam

A battery-operated radar set, small enough to be carried about and operated by one man, may soon be used in Vietnam to detect moving enemy guerrillas or moving vehicles.

The 35-lb unit is less than one-seventh the weight of models now used in Vietnam, say officials of the Radio Receptor Div. of the General Radio Corp., Hicksville, N. Y., builder of the set.

The miniaturized device can be set up in less than five minutes and is so designed that a trained operator can distinguish between an individual, groups of men and vehicles by doppler frequencies associated with the distinct movements of each, the company says.

The radar set can detect a crawling target or a walking man at a range of 1500 meters, or a small moving vehicle at 3000 meters. A moving target is revealed by a distinctive tone in the operator's headset; the quality of the tone indicates the type of target detected.

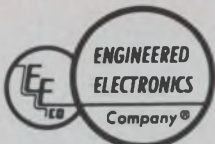
A sighting telescope mounted on top of the unit is also available to aid in visual location of the detected target. The electronic system simultaneously gives range readouts from a counter and azimuth readouts from a graduated scale. The entire unit is mounted on a tripod and is said to be completely silent in operation.

General Radio said it would provide the new radar sets initially to the Naval Ships Systems Command for use by the Marine Corps. ■ ■



Portable radar in operation.

ON READER-SERVICE CARD CIRCLE 27 ➤



Boeing wants it that way. One Microstack provides permanent nondestructive memory for operating instructions and data words with a design reliability goal of 100,000 hours MTBF. The other provides a temporary memory for incoming and outgoing messages with a design reliability goal of 5,000,000 hours MTBF.

One of the reasons Boeing uses Microstacks is their unique design. A folded-array originated by Indiana General. The

"X" and "Y" axis of all the memory planes are continuously wired. This reduces solder connections 80%, greatly increasing reliability as well as cutting size and weight. This folded-array is specially-packaged to meet Mil. Spec. temperature, humidity, shock and vibration, and extreme environment requirements.

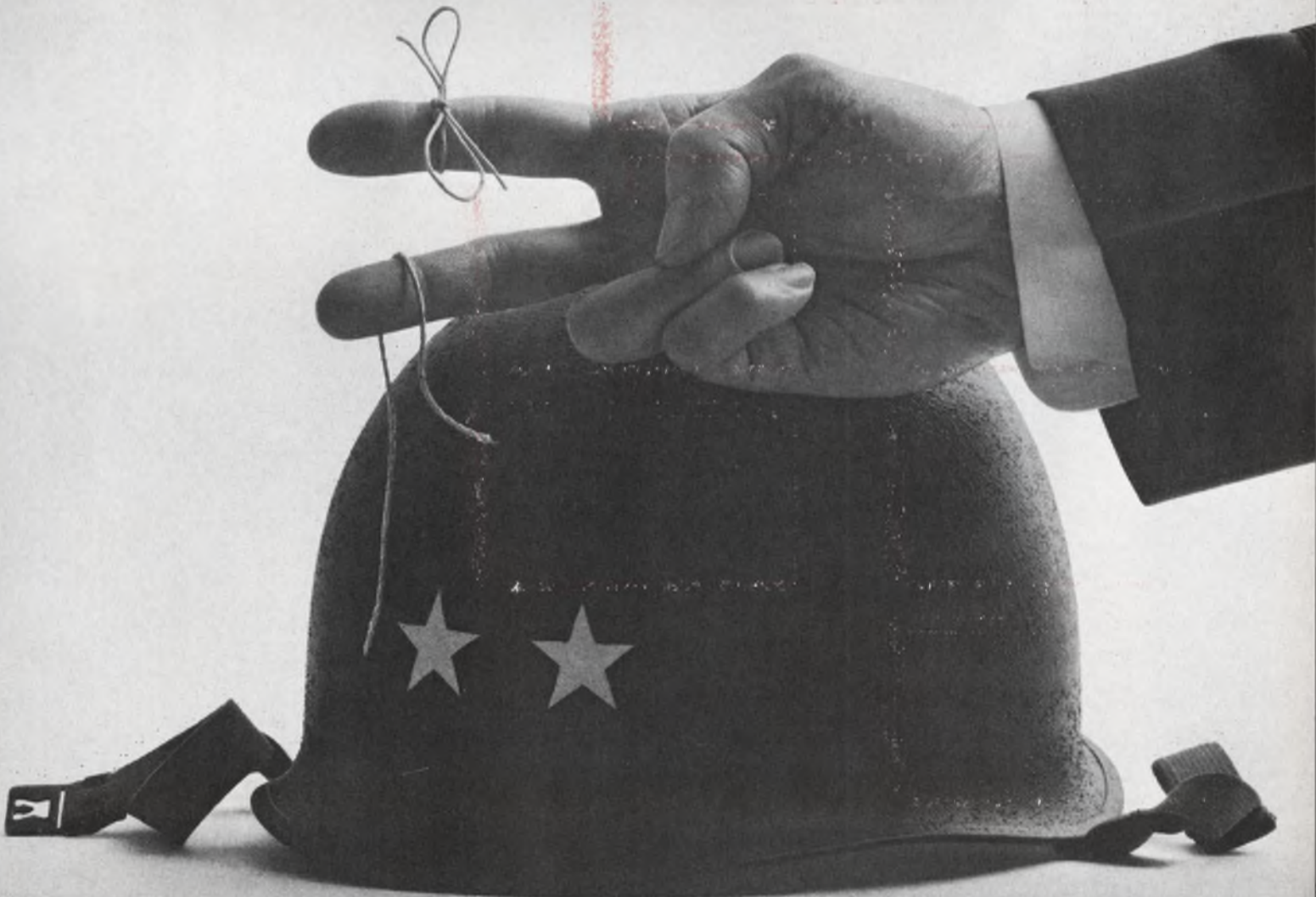
Another reason was our ability to develop cores to Boeing's specifications. We invented the ferrite memory core and

make and sell more of them than anyone. Our facilities for developing and producing cores and stacks are second to none.

If you need Mil. Spec. type memory units find out about Microstacks and our core capabilities. Write Mr. Thomas Loucas, Manager of Sales, Indiana General Corporation, Electronics Division/Memory Products, Keasbey, N. J.

INDIANA GENERAL 

**There are two Microstack[®] memory units
in Minuteman II. One remembers. The other forgets.**





Type 01-700



Type 01-370



01-600



Type 04-590



Type 01-Round



Type 02-800



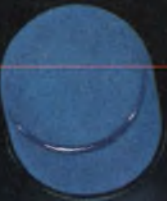
Type 44
Splashproof



Barrier Mount



Type 04-570



Type 01-Square



Mechanical Interlocks



Multi-Station Key Boards



Subminiature
Neon



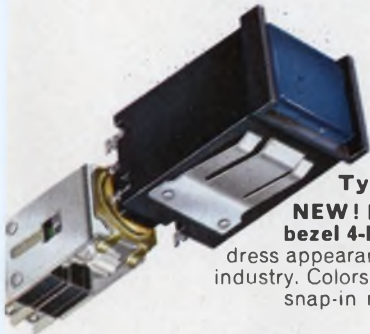
Type 01-800

YOU CAN IMPROVE YOUR CONTROL AND
 PRODUCT APPLICATIONS WITH NEW
 DESIGNS, TECHNIQUES AND INNOVATIONS
 IN LIGHTED SWITCHES FROM

LICON[®]

SWITCHES

THE GOOD LOOKING SUPPLIER LINE THAT
 KEEPS AHEAD OF THE FIELD.



Type 04-590
NEW! Extruded bezel 4-lite Finest dress appearance in the industry. Colors, legends, snap-in mounting.



NEW! Sub-miniature Neon switch for rapid computer indication. Longest possible bulb life.



Type 01-370
NEW! Slide-base long-life bulb 1-lite push button switch. Plunger action.



Type 44
NEW! Splashproof water-sealed 4-lite switch. Snap-on switch module. Available in projected or screen colors, engraved legends.



Type 02-800
NEW! Economy 2-lite designed for easy snap-in. Front-of-panel mounting, servicing. Bezel-barriers for horizontal or vertical dress mounts.



Type 01-700
NEW! Economy 1-lite Screw-in mounting, front-of-panel bulb servicing.

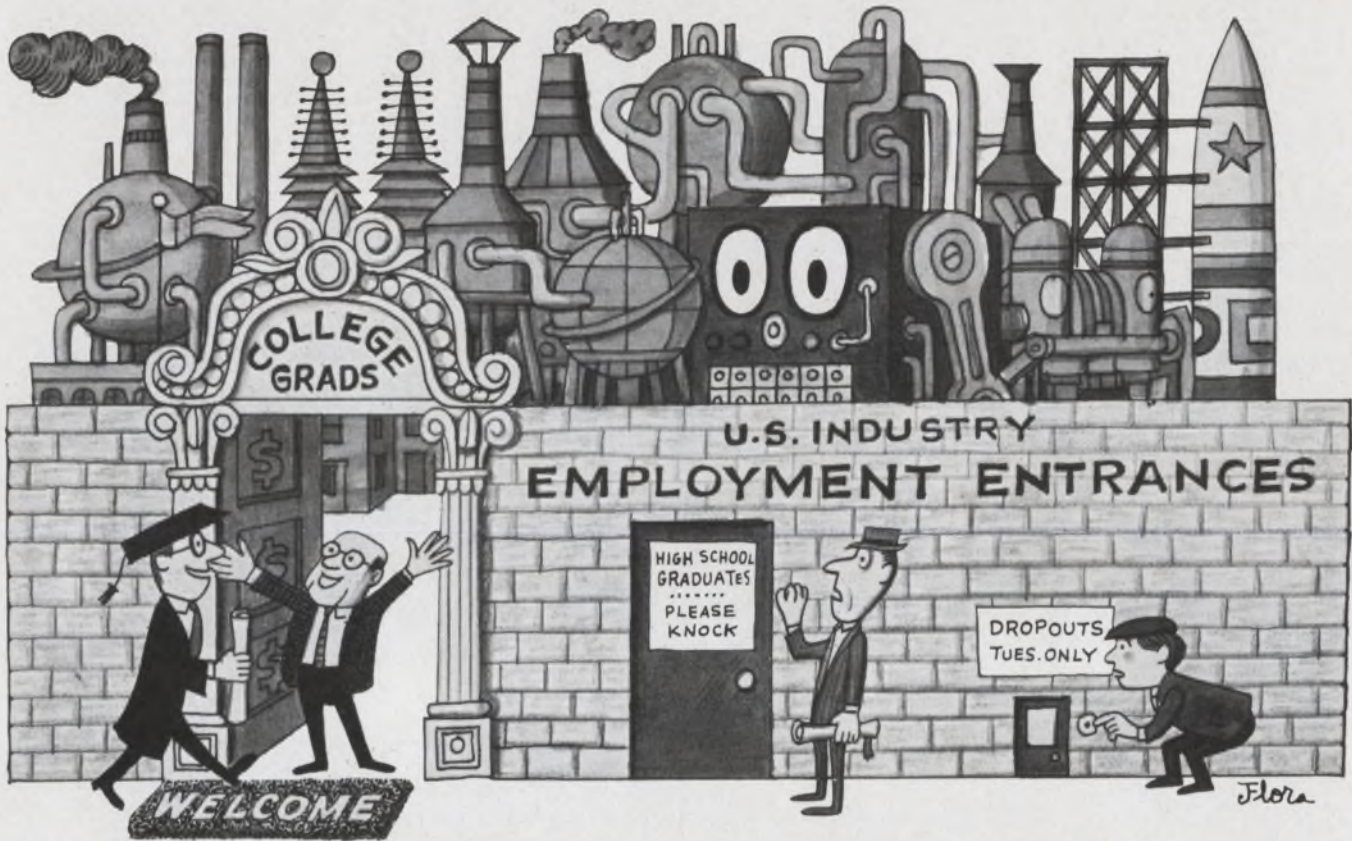
WRITE FOR LATEST
 LICON LIGHTED
 SWITCH CATALOG



LICON

DIVISION ILLINOIS TOOL WORKS INC.
 6615 W. IRVING PARK ROAD • CHICAGO, ILLINOIS 60634

"Remember, you're never more than a few feet away from a product of ITW"[®]



It takes a good education, to get a good job today

As a businessman, you know what it takes to get ahead in today's industry. But most young people don't.

Of all those who will enter the labor force by 1970, 7.5 million will not have completed high school. It's a big problem for our country. A real problem for our economy . . . and for industry, too.

What can you do about it?

Plenty! In your own community, make it *your* business to show how important a good education is in business today. Talk about it. Write about it. Urge your business and civic organizations to cooperate.

Convincing young people of the value of get-

ting all the education and training they can is not only good for your community, it's good for your business, too. After all, the quality of your future employees depends a lot on their education. Even your present employees can benefit greatly by up-grading their skills through on-the-job training or night school.

For more information on how you can help solve the continuing education problem in your community, write: The Advertising Council, 25 West 45th Street, New York, New York 10036.



Published as a public service
in cooperation with The Advertising Council

Solve RFI problems fast and economically with CDE stock standard filters.

These stock standard filters, available for immediate delivery from CDE's Authorized Industrial Distributors, offer speed and economy in new design or prototype applications. From a wide range of configurations and ratings, Design and Specification Engineers can select the RFI suppression device that best meets their need. In situations where special designs

must be developed, the CDE Filter Engineering Staff — backed by many years of design and manufacturing experience—can provide expert technical assistance.

CDE has prepared a new Filter Brochure that fully describes the unique and highly useful selection of Stock Standards, and details the services of CDE's custom filter facility. To obtain

your copy, call your nearest CDE Authorized Industrial Distributor, or write: Cornell-Dubilier Electronics, Division of Federal Pacific Electric Company, 50 Paris St., Newark, New Jersey 07101.



CDF Power Line and Screen Room Filters

Provide a minimum attenuation of 100 db over the frequency spectrum of 14 KHz to 10 GHz. Unmatched for performance in screen room and power line applications. Versatile mounting either with threaded fitting termination through shield room enclosures, or with universal conduit mounting. Rated 25 amps to 200 amps up to 250 VAC, 0 to 400 CPS.

WFV Audio Communications Filters

Designed for use in 600 ohm balanced lines or in 300 ohm individual lines. Removes spurious noise from audio source lines entering screen rooms or other shielded enclosures. Stocked in two configurations: for universal conduit mounting; or with threaded fitting terminations.

NF Rectangular Pi Filters

Designed to meet performance requirements of MIL-F-15733. High attenuation over the range of 150 KHz to 1 GHz. Stocked in 1, 5 and 10 amp ratings. Line frequency range from 0 to 400 cps up to 250 VAC or 600 VDC. For bulkhead mounting or chassis shielded flange mount.

NFR Tubular Pi Filters

Designed for high attenuation of RF interference over the ranges of 150 KHz to 10 GHz and 14 KHz to 10 GHz. Stocked in 1, 5 and 10 amp ratings, up to 250 VAC or 600 VDC. Styles suitable for both prototype and production requirements. For bulkhead mounting.

STF Solid Tantalum Feed-Through

Type STF-2 (30 amps, 35 VDC) provides high attenuation from 14 KHz through 10 GHz. Sub-miniature device with 20:1 size reduction over comparable paper feed-through capacitors. Type STF-5 (5 amps, 35 VDC) designed for use on DC low power applications. Provides approximately 10:1 size reduction over comparable paper feed-through capacitors.

NFT 15 Amp, 125C Feed-Through Filter

Available in 100 and 600 VDCW ratings. Capacitance ranges of .1, .22, .33, .47 and 1.0 Mfd.



μsec/millisecond delays

VIDEO

5 to 500MHz

MULTI-CHANNEL

TRIPLE

TRAVEL

PROPORTIONAL CONTROL

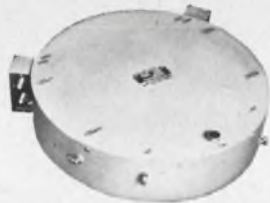
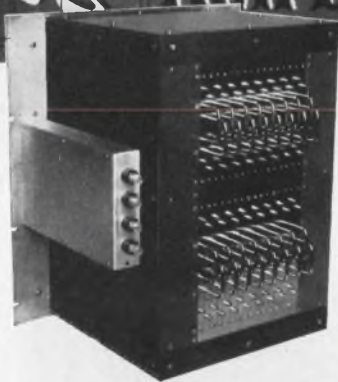
Analog

ISOTHERMAL

WIDEBAND

AMPLIFIERS

LOW LOSS



In a word, LFE

for quartz or glass ultrasonic delay lines

You'll find the complete text — applications information — theory — technical data — specifying information for standard and custom delay lines for your application — in these authoritative LFE Catalog-Handbooks. Get them, now!



ELECTRONICS DIVISION

Laboratory For Electronics, Inc.
WALTHAM, MASSACHUSETTS 02154
Tel: 617-894-6600 • TWX: 710-324-0681

ON READER-SERVICE CARD CIRCLE 31

NEWS

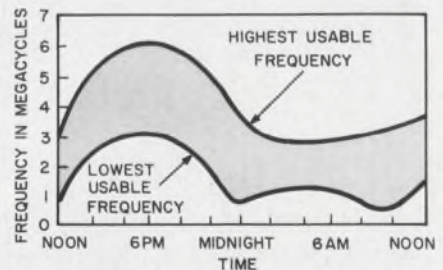
Automatic switching may solve RF noise

Automatic frequency selection may be developed for high-frequency communications some day, if engineers determine that this approach can reduce atmospheric disturbances of radio waves.

Sylvania's Electronic Systems Division has just set up two receiving/transmitting stations 400 miles apart to determine the effects of atmospheric changes on broadcasting. "Accurate measurements of these disturbances will assist us in the design of automated long-distance communications equipment," says Stuart Morrison, the division's director of engineering.

It has been known for many years that sunspots interfere with high-frequency radio waves. An automatic transmitter such as that visualized by Morrison would detect the onset of interference in one portion of the frequency spectrum and shift a broadcast to a channel in an unaffected portion. Also, a certain amount of historical information could be programed into the system. "Frequencies employed for daytime transmission differ from those used at night," says Morrison. "The best frequencies for communications also vary from month to month and from year to year, depending on sun spots."

"At present," he continued, "radio operators must monitor signals continuously to ensure that changing conditions in the ionosphere — several layers of electrically charged air between 50 and 400 miles above the earth—do not disrupt communications." ■ ■



Transmitted signals may reflect back and forth between the ionosphere and ground (like the 3.5-MHz signal above), but they might just continue out into space. The insert shows the nature of variations in the usable band during a typical day.

ON READER-SERVICE CARD CIRCLE 32 ➤



Make sure Honeywell's revolutionary new Auto-Torque mechanism is inside. It's the first substantial improvement in meter technology in ages — a new kind of band-type meter — first to be machine manufactured. Auto-Torque is more reliable (since there are 50% fewer parts, you can practically wave



good-bye to service problems). Auto-Torque is more durable (since the moving system is suspended on metal bands under tension, there's no friction and wear). Auto-Torque is more accurate (since the mechanism is self-shielded, it can be mounted on any panel without special calibration — without worrying about "sticks", either).

Auto-Torque is more economical (quantity-order prices for volume buyers are below comparable pivot and

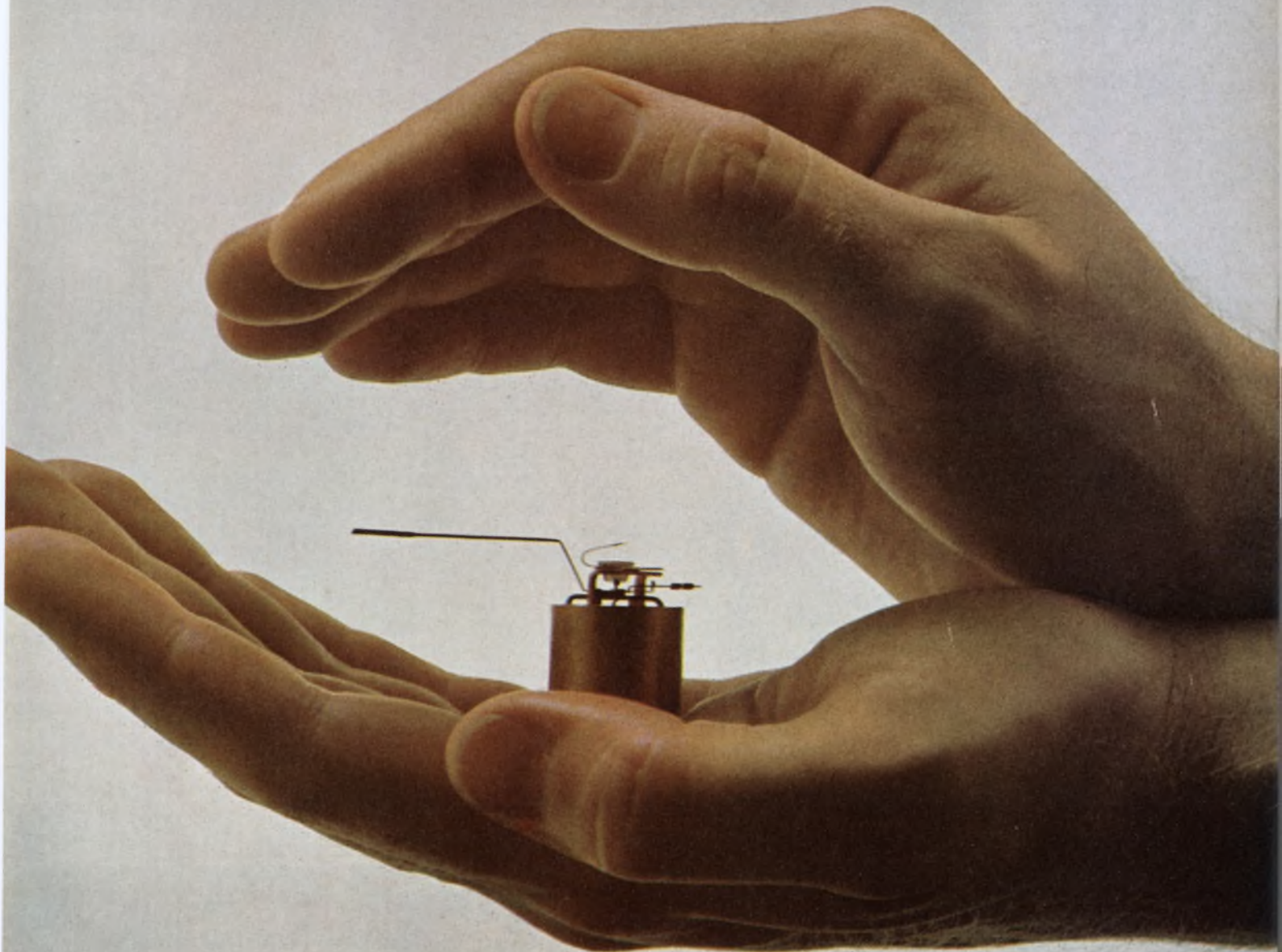


jewel meters). Auto-Torque is under the hood of the world's smartest-looking meters. And there are plenty of styles to choose from. In fact, Auto-Torque meters come to you in the widest selection of band-type meters available today . . .

For more information on Auto-Torque, write to Honeywell Precision Meter Division in Manchester, N. H. 03105.

Honeywell Auto-Torque Meters

**Before you
pick out a new meter,
better look under the hood.**



"9 years ago we had a great idea that put us in the high-rel relay business.



It's still a great idea, and now we've put it in a one-inch package!"

Wedge-action* was the great idea. By combining long precious-metal contact wipe with high contact force, it gives Electro-Tec relays the highest dry-circuit confidence level ever reached. (90%, based on a failure rate of only .001% in 10,000 operations.)



Packing wedge-action into a one-inch envelope wasn't easy. But it was worth it. It gives you maximum reliability in minimum space. And it's available for both 6PDT and 4PDT operations, in relays that exceed all requirements of MIL-R-5757/1 and /7.

The one-inch relay is just one of our family of wedge-action relays, which cover almost every dry-circuit to 2 amp application. When you need a high-rel relay that really works, remember our great idea, and put it to work for you.

*U.S. Patent No. 2,866,046 and others pending.



Electro-Tec Corp.

SLIP RINGS • RELAYS • SWITCHES • OPTICS

P.O. Box 867 • Ormond Beach, Florida
(904) 677-1771 • TWX 810-857-0305

Manufacturing Facilities:
Ormond Beach, Fla. • Blacksburg, Va.

ON READER-SERVICE CARD CIRCLE 33

Letters

Henry not an unknown and here's proof

Sir:

Although he lives and works in Copenhagen, a city whose libraries are the envy of the less fortunate, Mogens Boman did not succeed in finding biographies of Joseph Henry and asks: "Henry? Who was he?" [ED 19, Aug. 16, 1966, pp. 54-56]. By the same token, a good case could be made out for the question: "Who was H. C. Oersted?"

With the help of one specialist librarian it took only a few minutes, at the Oslo Municipal Library, to get on the track of the following information.

Joseph Henry died on May 13, 1878. In January, 1879, the U.S. Congress ordered "Memorial Exercises" to be published in the *Congressional Record*. In addition, 15,000 copies of a "Memorial Volume" were printed: 7000 for the House of Representatives, 3000 for the Senate and 5000 for the Smithsonian Institution.

This 528-page book was published in 1881 as Vol. 21, No. 356, of the "Smithsonian Miscellaneous Collections," a series found in scientific libraries all over the world. Perhaps copies can be obtained even today. Presumably, this is the book of which Mr. Boman says: "The British Museum Library possesses the only copy." With very slight effort, six copies were found in Norway; one, from the Oslo University Library, lies in front of me. The essential part of *Memorial of Joseph Henry* is the contribution by Prof. W. B. Taylor, "The Scientific Work of Joseph Henry," which, with "Supplementary Notes" and a chronological, 131-item "List of the Scientific Papers of Joseph Henry," occupies 221 pages.

In 1886, the Smithsonian Institution published, in two volumes, *The Scientific Writings of Joseph Henry*, totaling 1082 pages. This book, too, was very widely distributed.

In this manner, Joseph Henry's

name was splendidly honored by his countrymen, shortly after his death, in a way which seems more than adequate to preserve his fame for all time. One wishes that other scientists could share his fate.

During the past 80 years many books have devoted chapters to Henry (e.g. MacLaren, 1943; Sharlin, 1963; etc.). The *Dictionary of American Biography*, 1946, has more than six columns. More recently, there appeared a 352-page biography (i.e., the second one on J. Henry), which must also have escaped the notice of the U.S. Embassy in Copenhagen: Thomas Coulson's *Joseph Henry, His Life and Work* (Princeton, N. J., 1950).

Gold, Mr. Boman, is where you find it.

Kaye Weedon

Electrical Engineer
Blomenholm
Norway

Accuracy is our policy

In "Better isolation boosts IC performance," ED 21, Sept. 13, 1966, pp. 17-23, Radiation, Inc., of Melbourne, Fla., has drawn attention to a number of inaccuracies. Therefore, delete the top paragraph on p. 22 and substitute the following:

Warren Vergason, Radiation's manager of public information, says of the company's product line: "The dielectric isolation process has provided the industry with the highest-speed DTL digital gate family, the only monolithic diode matrices (see Fig. 3), and now the new, unconditionally stable operational amplifiers. The dielectric isolation process provides radiation-hardened circuits that withstand higher radiation dosages before degradation occurs."

In the second (middle) column on p. 21, all references should be to Figs. 2a through 2f, not to 3a through 3f as printed.

ON READER-SERVICE CARD CIRCLE 34 ➤



RCA Hometaxial-Base Transistors

A look at a power
density problem
called second breakdown...
and the solution offered by
RCA Silicon Power
Transistors

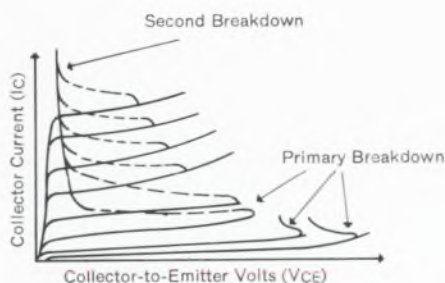


PROBLEM:

Second Breakdown

WHAT IS SECOND BREAKDOWN?

Second breakdown is a potentially destructive phenomenon resulting from the formation of localized "hot spots" induced by high-current concentrations. It is so named because it is the secondary voltage breakdown as opposed to predicted or primary breakdown. Second breakdown is characterized by an abrupt collapse in V_{CE} with a simultaneous increase in I_C . The resulting combination of high current and voltage destroys the transistor unless adequate current-limiting techniques are used. While second breakdown can occur in all transistors, it is of particular significance in power devices where high currents and voltage are encountered.

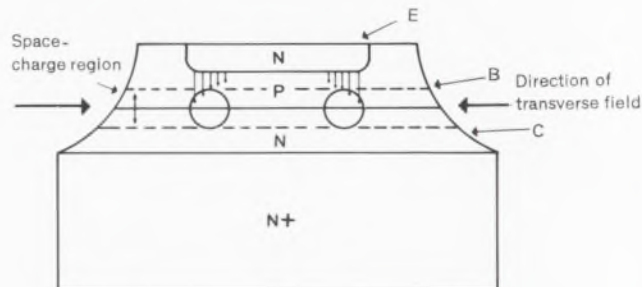


IN WHAT MODES OF CIRCUIT OPERATION IS SECOND BREAKDOWN ENCOUNTERED?

Second breakdown can occur in both forward- and reverse-bias modes of operation of the emitter-base junction. The operating principle differs in each mode, as does the amount of energy or voltage initiating the effect. Forward-bias second breakdown occurs most often in linear circuits using power transistors. Reverse-bias second breakdown usually occurs in inductive power-switching circuits.

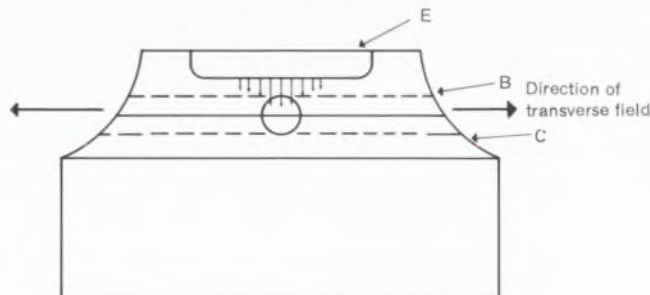
WHAT HAPPENS IN FORWARD-BIAS SECOND BREAKDOWN?

During forward-bias operation, a transverse electric field is set up in the base region, and a "space-charge" layer is formed at the base-collector-junction. As current flows from the emitter to the collector, the transverse field focuses the current flow into a narrow region under the emitter edge. When the current flows through the "space-charge" layer, a significant amount of heat is generated by the combined product of current and voltage. With current flow focused into a small area, the heating effect is localized and the formation of hot spots (circled areas in diagram) may result. If unchecked, these hot spots initiate a regeneration cycle of highly focused current which may destroy the transistor.



WHAT HAPPENS IN REVERSE-BIAS SECOND BREAKDOWN?

During reverse-bias operation of the emitter, the direction of the transverse field is reversed by the polarity change. As a result, the emitter current is focused into a small region at or near the center of the emitter. Because of the crowding of current flow into a region smaller than that under forward-bias conditions, reverse-bias second breakdown can be encountered at substantially lower power levels. The resistance of a transistor to reverse-bias second breakdown is reduced



by any design alteration which increases current density or prevents emitter current from fanning out. Power transistor designs which have (1) narrow base width, (2) an accelerating base field, or (3) insufficient emitter size for their operating current generally exhibit reverse-bias second breakdown at lower power levels than transistors without these factors.

WHAT IS THE RELATIONSHIP BETWEEN ENERGY REQUIRED FOR SECOND BREAKDOWN AND FREQUENCY CAPABILITY?

In the design of high-frequency transistors, the base width is minimized to reduce the transit time of emitter current through the device. The resulting short path does not permit significant current spreading or fan out. As a result, focused current flows across the collector junction with a resultant increase in power density and localized heating. Also, because of the narrower base region, this heating effect is more closely coupled to the emitter junction, promoting thermal regeneration and second breakdown. Designers should note that the selection of devices having higher frequency capability than needed for a given design greatly compromises circuit reliability and resistance to second breakdown.

SOLUTION:

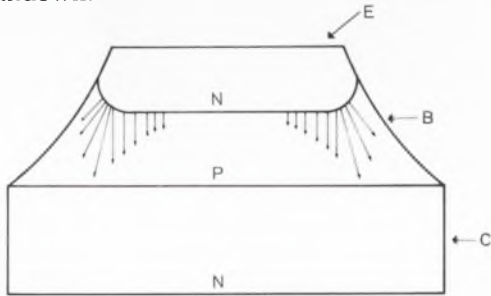
RCA Hometaxial-Base Transistors

WHAT IS RCA HOMETAXIAL-BASE TECHNOLOGY?

Hometaxial-Base technology is an RCA-developed process which has proved to be effective in preventing second breakdown. In this technology, a single-diffusion process is used to form both emitter and collector junctions in a uniformly doped silicon slice. The result is a *homogeneously* doped base region free from accelerating fields in the *axial* (collector-to-emitter) direction—hence the name Hometaxial. The Hometaxial-Base transistor is also characterized by a wide base region, further enhancing the ability of the device to resist second breakdown. The attendant simplicity of this technology has resulted in a family of reliable, low-cost power transistors.

HOW DOES HOMETAXIAL-BASE TECHNOLOGY IMPROVE SECOND BREAKDOWN CHARACTERISTICS IN THE FORWARD-BIAS MODE?

Hometaxial-Base technology greatly minimizes the risk of second breakdown in the forward-bias mode by allowing the emitter current to fan out before it enters the collector region. Because uniform doping levels are employed, there is no field to accelerate the current. And because of the wide base width, the current fans out by electron diffusion before reaching the collector junction. Although these two factors limit somewhat the high-frequency performance of Hometaxial-Base transistors, they are most significant in preventing second breakdown.

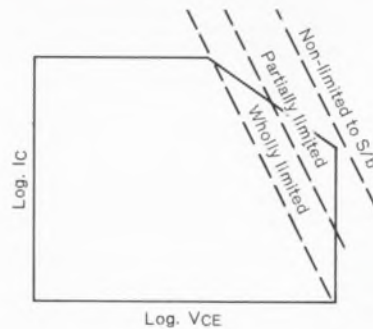


HOW DOES HOMETAXIAL-BASE TECHNOLOGY IMPROVE SECOND BREAKDOWN CHARACTERISTICS IN THE REVERSE-BIAS MODE?

Because of the high-current densities under reverse-bias conditions, wide base structure and uniform doping are even more important than in the forward-bias mode. In addition, the collector of the Hometaxial-Base unit is designed to prevent “localized widening” of the base region into the collector layer. This “localized widening” occurs in multiple-diffused designs when the emitter current density increases beyond a value consistent with the fixed impurity doping level of the collector. The collector region of Hometaxial-Base transistors is designed to minimize this widening and the degradation of breakdown voltage which accompanies it in multiple-diffused structures.

WHAT DEVICE RATINGS ARE AVAILABLE TO ASSURE MAXIMUM SAFE OPERATION IN THE FORWARD-BIAS MODE?

Every transistor is subject to second breakdown at some combination of voltage and current in the forward-bias mode. Accordingly, RCA has developed a series of “Safe Area of Operation” curves for both dc and pulse conditions. These curves show at what point a given transistor may be wholly limited, partially limited, or non-limited in terms of second breakdown. Such curves are now included in all recently published data for RCA Hometaxial-Base devices and are being added to the earlier published data sheets.



ARE COMPARABLE DESIGN CURVES AVAILABLE TO ASSURE MAXIMUM SAFE OPERATION IN THE REVERSE-BIAS MODE?

Specifying devices for maximum safe operation in the reverse-bias mode is somewhat more complex than for forward-bias conditions. As a result, RCA supplies a series of three curves which relate source voltage, source resistance, and output inductance to the power required for second breakdown. With such a rating system, the designer can determine whether circuit operation conditions fall within the safe-operating region indicated. Again, RCA is adding such design curves to its new data sheets and is revising existing sheets to include them.

SUMMARY

RCA's family of low-cost Hometaxial-Base transistors offers the user of silicon power devices two distinct benefits. First, it provides him with a proved transistor structure which, because of its wide-base, uniform doping, and special collector design, is inherently superior in eliminating second breakdown. Second, it provides him with a complete system of ratings curves which specify maximum safe operation in both forward- and reverse-bias modes. This combination of device design and application assistance equips the designer with a unique solution to the problem of second breakdown.

RCA HOMETAXIAL-BASE TRANSISTORS...

a family of low-cost reliable
silicon power transistors offering you
freedom from the problems of second breakdown

FOR POWER APPLICATIONS UP TO 50 KHz, FROM 1A TO 30A

TO-5 I_C (Max) TO 1A P_T (Max) TO 5W	TO-66 I_C (Max) TO 4A P_T (Max) TO 29W	TO-3 I_C (Max) TO 15A P_T (Max) TO 117W	TO-3 I_C (Max) TO 30A P_T (Max) TO 150W
40347 $h_{FE} = 20-80$ @ $I_C = 450$ mA V_{CEV} (Max) = 60V	40250 $h_{FE} = 25-100$ @ $I_C = 1.5$ A V_{CEV} (Max) = 50V	40251 $h_{FE} = 15-60$ @ $I_C = 8$ A V_{CEV} (Max) = 50V	2N3771 $h_{FE} = 15-60$ @ $I_C = 15$ A V_{CEV} (Max) = 50V
40348 $h_{FE} = 30-100$ @ $I_C = 300$ mA V_{CEV} (Max) = 90V	2N3054 $h_{FE} = 25-100$ @ $I_C = 0.5$ A V_{CEV} (Max) = 90V	2N3055 $h_{FE} = 20-70$ @ $I_C = 4$ A V_{CEV} (Max) = 100V	2N3772 $h_{FE} = 15-60$ @ $I_C = 10$ A V_{CEV} (Max) = 100V
40349 $h_{FE} = 25-100$ @ $I_C = 150$ mA V_{CEV} (Max) = 160V	2N3441 $h_{FE} = 20-80$ @ $I_C = 0.5$ A V_{CEV} (Max) = 160V	2N3442 $h_{FE} = 20-70$ @ $I_C = 3$ A V_{CEV} (Max) = 160V	2N3773 $h_{FE} = 15-60$ @ $I_C = 8$ A V_{CEO} (sus) (Min) = 160V
		2N4347 $h_{FE} = 20-70$ @ $I_C = 2$ A V_{CEV} (Max) = 140V	2N4348 $h_{FE} = 15-60$ @ $I_C = 5$ A V_{CEV} (Max) = 140V

For more information on Hometaxial-Base transistors and how they help you solve the problems of second breakdown, see your local RCA representative. For technical bulletins on specific types, write Commercial Engineering, RCA Electronic Components and Devices, Harrison, N. J.

ALSO AVAILABLE THROUGH YOUR RCA DISTRIBUTOR



The Most Trusted Name in Electronics

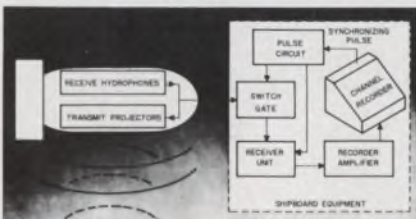
In "5-capacitor flat pack," in the Products Section of ED 18, Aug. 2, 1966, p. 95, the Erie Technological Products' flat packs are shown priced at \$1.50 (1 to 49) and \$0.98 (250 to 499). The company has corrected the price to \$5.00 each in lots of 1000.

In "Fluidics: a simple pipeline to rugged control," ED 20, Aug. 30, 1966, pp. 17-21, the caption under Fig. 6 on p. 21 should read: "Any control cancels all outputs" (not, "Each control cancels opposite output," as printed).

In "Sonar looks askance at sea bottom," ED 22, Sept. 27, 1966, pp. 17-21, the captions under the illustration on p. 21 and under the middle of the three pictures on p. 18 were wrong. The two pictures are republished below together with their correct captions.



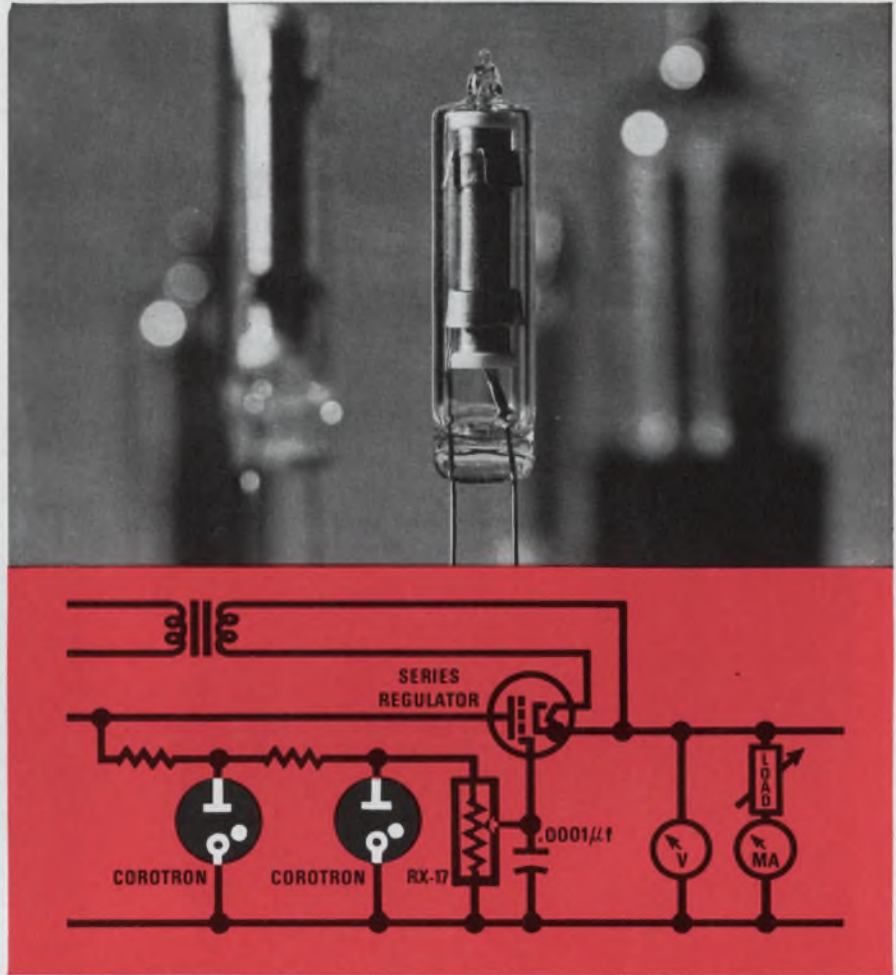
Westinghouse version of SLS fish is prepared for launch. Main frame of the unit is 6-in. steel I-beam. Transducer cases (black stripe) are along the beam sides, the electronic package is above, the batteries are below.



Arrangement of transducer fish and shipboard elements of basic side-looking sonar equipment.

The caption that was printed under the middle illustration on p. 18 rightfully applied to a picture that we did not publish.

Versatility and simplicity in variable, regulated power supplies



REFERENCE AND REGULATION TO 30KV

Voltage regulation can never be better, nor more stable, than the reference voltage. And you'll never find a better reference than Victoreen diodes, high-voltage equivalents of Zener diodes. But, unlike Zeners, Victoreen HV diodes are available in voltage ranges from 350 to 30,000 volts.

Unexcelled as a stable reference voltage source, a Victoreen HV diode can also be used alone as a simple shunt regulator, as a DC coupling element, etc. For Space-Age applications, you get a lot of bonuses, too — small cubage, light weight, resistance to high heat, high vibration and high accelerations to 2000g in some models. Victoreen HV diodes are unaffected by ambient light.

From the positively exotic to the commercial, if you have a voltage regulation problem in the range of 350 - 30,000 volts, quickly contact our Applications Engineering Department.

Components Division
THE VICTOREEN INSTRUMENT COMPANY
 10101 WOODLAND AVENUE • CLEVELAND, OHIO 44104
 EUROPEAN SALES OFFICE GROVE HOUSE LONDON RD ISLEWORTH MIDDLESEX ENGLAND



Speed Inquiry to Advertiser via Collect Night Letter
 ON READER-SERVICE CARD CIRCLE 35

7324-A

**TRW
CAPACITORS
ARE
SMUG**



...especially our new metallized polycarbonates!

TRW has now extended its leadership in film capacitors to include metallized polycarbonate types. Two features of the X463UW are outstanding. Precise processing assures low TC through temperature ranges to 125° C. Metallized construction reduces size to less than one half that of film-foil designs. Other features of the line include:

- Capacity range from .01 to 10.0 mfd
- Low dielectric absorption
- Available in tolerances to $\pm 1\%$
- Humidity resistance per MIL-C-27287

For full information contact: TRW Capacitors, Box 1000, Ogallala, Nebraska. Phone: 308-284-3611 • TWX: 910-620-0321.

TRW CAPACITORS

ON READER-SERVICE CARD CIRCLE 36

Co-Publishers

James S. Mulholland, Jr.
Robert E. Ahrens Dorf

Editorial Director

Edward E. Grazda

Editor

Howard Bierman

Managing Editor

Robert C. Haavind

Technical Editors

Peter N. Budzilovich
Joseph J. Casazza
Rene Colen
Maria Dekany
Frank Egan

News Editors

Ralph Dobriner
Roger K. Field

East Coast Editor

Neil Sclater

West Coast Editors

Peer Fossen
Ronald S. Gechman

Copy Editor

Peter Beales

New Products Editor

David Sorgan

Washington Editor

S. David Pursglove

Editorial Production

Dollie S. Viebig
Mary Lou Goldstein

Art Director

Clifford M. Gardiner

Art Assistant

William Kelly

Technical Illustrators

Lewis D. Hill
Cheh Nam Low
Douglas Luna

Production Manager

Thomas V. Sedita

Asst. Production Manager

Helen De Polo

Production Assistants

Bernard Wolinsky
Robert M. Henry

Circulation Manager

Nancy L. Merritt

Reader Service

Diane Pellechi

EDITORIAL



It's time we took the plunge in oceanology

Many industrial and academic leaders are standing on the shore of oceanology, drawn by the rich promise of research and development under the seas, but uncertain about plunging in. The prospects are virtually unlimited; yet at present their realization appears remote because of a lack of a unified approach. The organizations participating are divided into special-interest disciplines and factions. There is no strong movement for a unified attack on the problems of ocean exploitation, as there is in space. And up to now the likelihood of a big increase in government spending to support ocean science has been dim.

This picture may change in the near future because of legislation recently approved by Congress. The Senate and House have passed bills to grant funds to qualified colleges for education and research in the marine sciences along the lines of a proposal first advanced by Senator Clairborne Pell (D-R.I.). The bills—called sea-grant college bills—are now in joint committee to iron out minor differences between them. What should emerge is a version that will spread among ocean institutes and departments a fixed sum every year, starting with about \$10 million. Final passage by both houses and presidential enactment seem assured.

This will at least establish a broad academic base for all future oceanographic efforts. Engineers, scientists and educators can be brought together to consider the social as well as the technical problems of marine exploitation. The guarantee of funds from the Government will encourage long-range applied engineering and science research projects without the need for specifying immediate goals. Electronics engineering, whose place is already well established in oceanological studies, would gain as much from this broad approach as other engineering disciplines.

But what are the benefits to industry? From a co-ordinated academic approach, scientists and engineers will emerge knowledgeable about many of the secrets of the ocean. This cadre will be prepared to plan the methods and design the tools for a greater assault on the riches of the sea.

The prospects for goods and services to support this effort are huge—underwater communications, vehicles, shelters and exploration equipment, to mention but a few. And there is the prospect that the yield from the sea may cover the costs, an incentive less likely from space exploration.

One area that holds great promise, for example, is fishing. Our present methods are as primitive as the cavemen's search for food with a bow and arrow. Why not sea ranches, with schools of fish rounded up like cattle?

The sea-grant college measure is a giant step toward preparing ourselves intellectually and technically for the conquest of what has been called "inner space."

NEIL SCLATER

If you have a good old frequency counter around, here's how to make it new again. Use our VLF Receiver to maintain your house standard and our Distribution Amplifier to conveniently place precise time base frequencies. Now, achieve an accuracy 1000 times better than when it was new.

The Fluke/Montronics Model 203 Distribution Amplifier provides an economical means of distributing precision frequencies from the standards laboratory to many different locations. There's no need to tie up your standards lab calibration equipment around the clock. And you'll never have to make time base oscillator adjustments or buy a counter with a crystal.

Used with a precision oscillator and a Fluke/Montronics VLF Receiver, all frequency dependent test equipment can be operated to an accuracy of 2 or 3 parts in 10^{11} . Pertinent specifications include: Inputs—Individual preamplifiers with level adjustment for 100 kc, 1 mc, and 5 mc, 0.5 to 5.0 vrms into 50 ohms; Outputs—12 separate outputs may be any combination of 3 input frequencies, 4 to 5 vrms into 50 ohms; Stability—Better than 1×10^{-11} standard deviation for one-second interval at 1 mc; Harmonics—At least 60 db below signal level; Spurious—At least 80 db below signal level; Power requirements—115/230 volts $\pm 10\%$, 50-440 cps, approximately 35 watts; Price—\$1,395.

For details and a demonstration call your Fluke/Montronics representative or write.

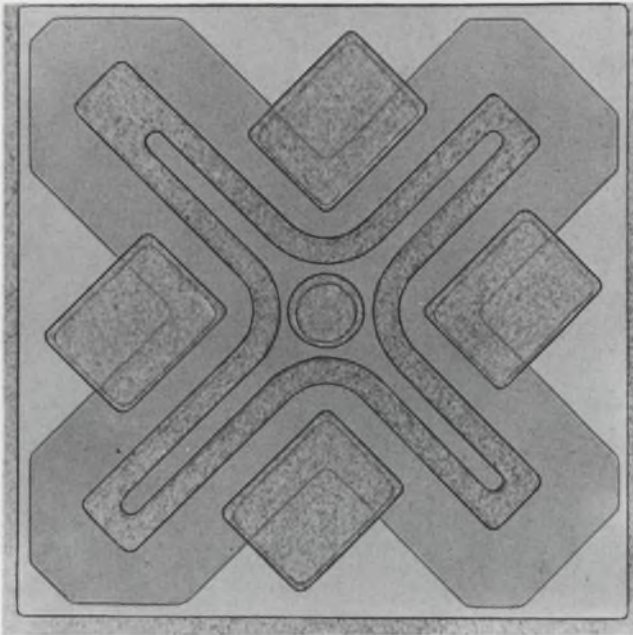


MONTRONICS • Box 7428, Seattle, Wash. • Phone: (206) PR6-3141 • TWX: (910) 449-2852

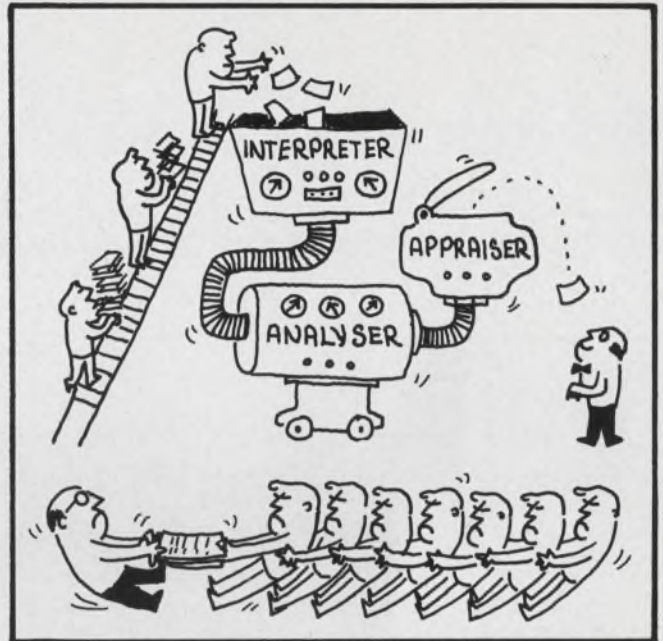


Model 203 Distribution Amplifier shown with Model 207-1 VLF Receiver/Comparator

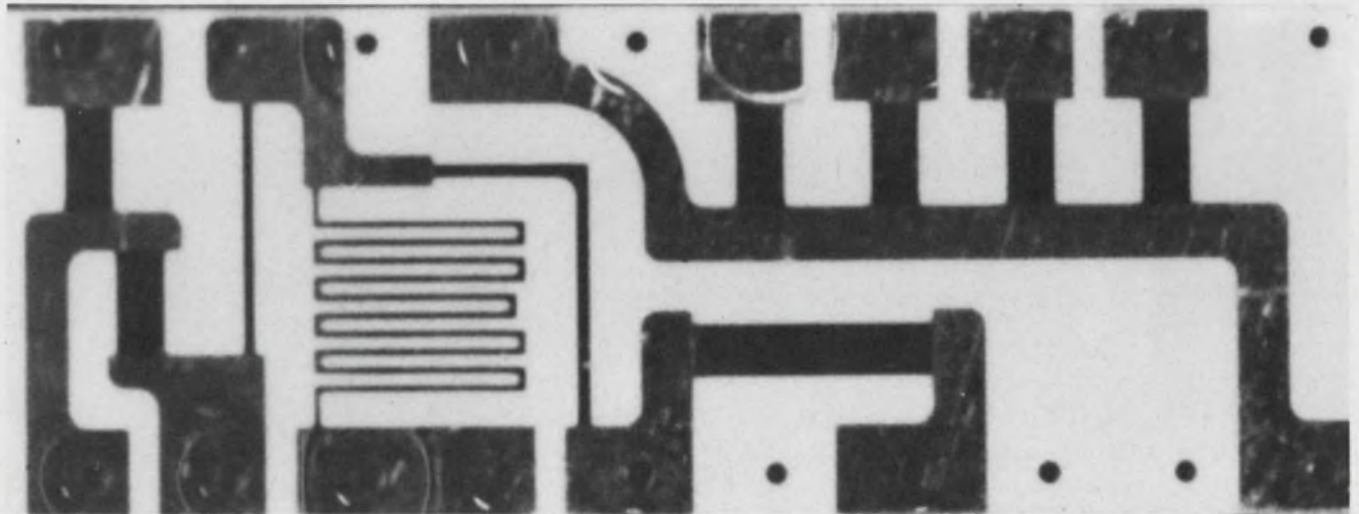
Technology



FETs designed for switching functions excel when employed for digital circuitry. Page 54



Wise delegation of work is the key to success for the manager of a project group. Page 88



Predict thin-film circuits' hot-spot temperature with a set of curves that help to reduce

circuit size and simplify design. Results surpass those of constant ratings. Page 64

Also in this section:

Use a comprehensive checklist to select the right modules for your computer design. Page 72

Estimate the boresight error before getting a radome for your radar. Page 84

Ideas for Design. Pages 98 to 104

Switch over to field-effects for digital needs. Both the J-FET and the MOS-FET offer high fan-out, temperature stability and low component count in these applications.

Part 1 of a two-part article

Field-effect devices specifically designed for switching functions can play a valuable part in digital circuitry. Both the junction (J-FET) and metal-oxide-semiconductor (MOS-FET) types offer design and performance advantages not found in other semiconductors.

Although FETs will not eclipse either bipolar transistors or integrated circuits in logic applications, they do offer unique switching properties. Among the primary benefits characteristic of FET switching networks are:

- High fan-out capabilities.
- Direct-coupled circuitry and lower component count.
- Low temperature-coefficient behavior.
- Extremely low power dissipations.

The fan-out superiority is due to the high Z_{in} property of all FETs; coupling ease is a result of the capacitive input of MOS-FETs; thermal and power advantages arise when complementary FETs are used. By examining the properties of J-FETs and MOS-FETs as basic switching elements, the designer will come to understand how to apply them to meet digital circuit needs. Moreover, this study will reveal the essential differences between the field-effect and bipolar approaches to logic design. It will also sharpen his ability to choose between them when he has to.

Inverter is basic building block

The primary building block of digital subsystems is the inverter circuit. A common inverter circuit configuration using an n-channel J-FET is shown in Fig. 1. This simple circuit will serve to illustrate important FET characteristics in this application.

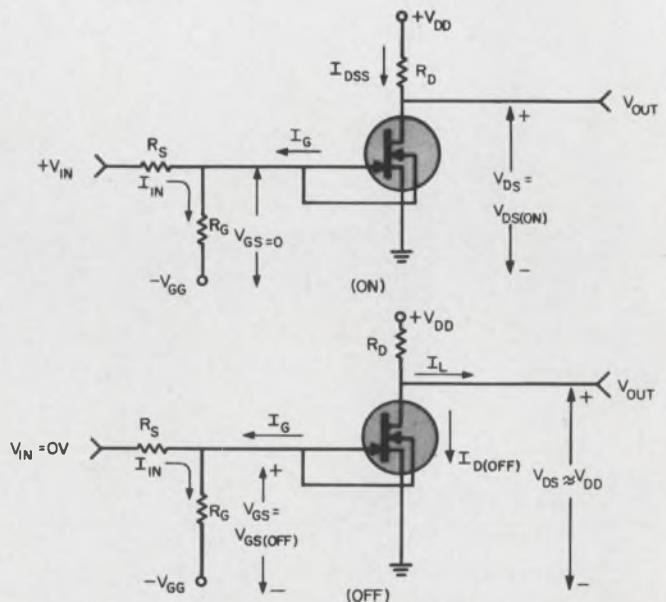
James Kane, Applications Engineer, Motorola Semiconductor Products Inc., Phoenix, Ariz.

A reverse voltage is provided by V_{GG} to hold the J-FET OFF, while a positive voltage at the input drives the device ON. Both the ON and OFF states of the inverter appear in the diagram.

With the input voltage at a positive level ($+V_{IN}$), the voltage divider circuit (R_S and R_G) is designed to bring the common gates of the J-FET to near ground potential. The J-FET when $V_{GS} = 0$ is ON, conducts a drain current of I_{DSS} . In the ON condition, the output voltage is at a low value, called $V_{DS(ON)}$.

The input circuit design must account for a current, I_G , coming from the J-FET. I_G is the junction leakage current of the gates; typically, it is a few nanoamperes or less. With the 3N126 as a representative device, $I_G = 0.25$ nA at 25°C.

In the OFF condition, the input is grounded,



1. Inverter circuit is the primary building block of digital systems. With a typical n-channel junction-FET the inverter is shown in the ON and OFF states. In the ON condition the output is at a low value; during the OFF situation it is nearly equal to the high V_{DD} supply level.

and the gates are reverse-biased to $V_{GS(OFF)}$. This is a voltage that reduces I_D to approximately $0.001 I_{DSS}$. Again, a nanoampere leakage current of I_G appears in the input circuit. The output voltage is now at $+V_{DD}$ volts with only a small leakage current ($0.001 I_{DSS}$) flowing through the J-FET.

In view of these ON-OFF conditions, the pertinent static characteristics of J-FETs that are necessary for adequate switching design are:

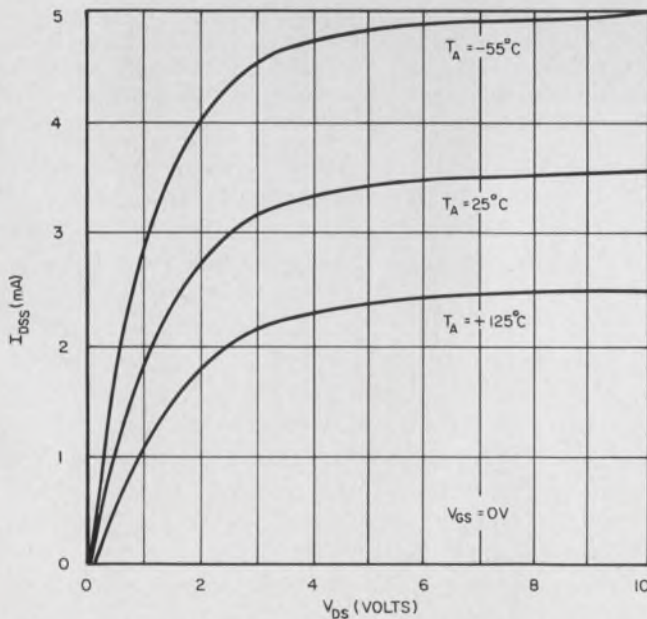
- I_{DSS} —Drain-to-source current (at $V_{GS}=0$).
- $V_{DS(ON)}$ —Drain-to-source ON voltage.
- I_G —Gate leakage current.
- $V_{GS(OFF)}$ —Gate-to-source OFF bias voltage.

The information about I_{DSS} that is of interest is its magnitude and its behavior with temperature and drain voltage. For a junction FET, I_{DSS} is related to the device geometry and the resistivity of the channel. In the low-current region (when $V_{GS}=0$), V_{DS} is linearly related to the drain current. As V_{DS} is increased, the slope of the I_D-V_{DS} curve decreases because of channel depletion. When V_{DS} reaches pinch-off voltage, V_P , I_{DSS} saturates and is no longer sensitive to further increases in V_{DS} . The basic curve of I_{DSS} vs V_{DS} and temperature is displayed in Fig. 2.

High temperature reduces current level

As the plot shows, I_{DSS} decreases as the temperature is increased. The slope of the characteristic in the low-voltage region (where I_{DSS} is linearly related to V_{DS}) is a measure of the channel resistance. As can be seen from the graph, the channel resistance increases with rising temperature.

Figure 3 shows the $V_{DS(ON)}$ characteristics of



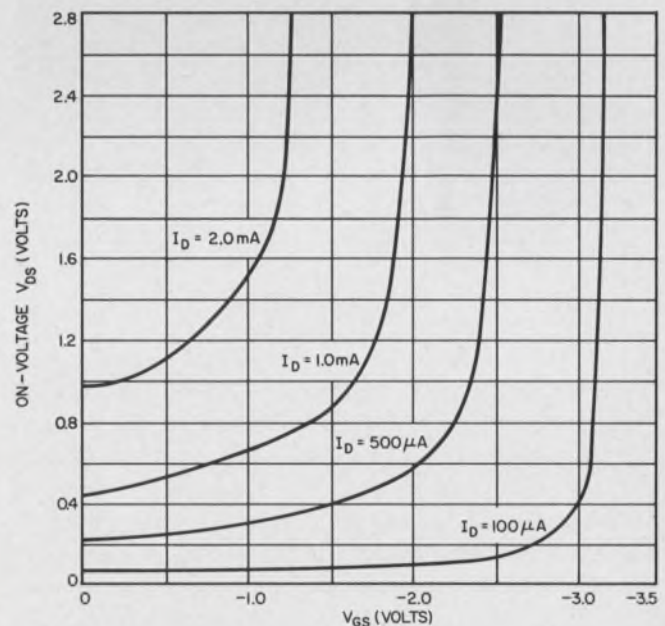
2. Drain-to-source current (I_{DSS}) of a J-FET (at $V_{GS}=0$) is a function of drain voltage (V_{DS}) and ambient temperature (T_A). When V_{DS} reaches a "pinch-off" value, I_{DSS} saturates and becomes insensitive to further V_{DS} increase.

the 3N126 for various drain currents. These curves are used for designing the ON condition of the inverter. The resulting output voltage when the FET is ON can be determined from Fig. 3. Normally, the output of the inverter circuit is used as a logic level; consequently, there is a restriction on the allowable value of $V_{DS(ON)}$. For a specified limit for $V_{DS(ON)}$ then, a minimum value of V_{GS} can be chosen from the plot.

Practical problems normally faced in designing the inverter circuit (see Fig. 1) are the tolerance factors of the resistors, the input voltage and V_{GG} . The J-FET is usually restricted to use with reverse bias only. A practical design that considers tolerance factors results in a nominal V_{GS} that is somewhat less than zero volts. As Fig. 3 shows, slight changes in V_{GS} when $I_D=2$ mA changes $V_{DS(ON)}$ drastically.

On the other hand, if the circuit is designed for a drain current of 0.5 mA and a nominal V_{GS} of -0.5 volts, output voltage V_{DS} does not vary appreciably for variations of gate voltage up to ± 0.5 volts. Thus by utilizing this portion of the device characteristics, circuits with quite good component tolerance and noise immunity can be designed.

In the OFF condition, I_{GSS} and $V_{GS(OFF)}$ are the critical FET parameters affecting circuit design. Figure 4a exhibits I_{GSS} vs temperature for the 3N126 and indicates the expected junction leakage-current curve. Parameter $V_{GS(OFF)}$ (Fig. 4b) increases with temperature; consequently, when calculating the input circuit of the inverter, the highest expected temperature should be considered. Doing this will provide an adequate value of



3. The ON-state inverter behavior is determined from a plot of drain voltage (V_{DS}) vs gate voltage (V_{GS}) as a function of drain current (I_D). V_{DS} here refers to a heavily conducting condition for the J-FET. For a given $V_{DS(ON)}$, the minimum value of V_{GS} may be found.

$V_{GS(OFF)}$ over the expected temperature range. This wraps up the static FET conditions—the inverter circuit design is now complete.

The switching (dynamic) characteristics of the FET inverter circuit can now be examined. Figure 5 shows the equivalent model of the J-FET inverter. The J-FET is represented by a gate capacitance, C_{gs} , to ground, a feedback capacitance, C_{gd} , and, a resistor, r_{ds} , representing the channel resistance. This last parameter is a function of V_{GS} .

Gate-source capacitance C_{gs} can be calculated from the measured values of C_{iss} and C_{rss} . C_{iss} is the parallel combination of C_{gd} and C_{gs} ; C_{rss} is by definition equal to C_{gd} . Thus, C_{gs} is simply the difference between C_{iss} and C_{rss} , measured at the same voltage. The behavior of C_{iss} , C_{gd} and r_{ds} , with bias, are the dynamic characteristics of the J-FET that affect switching times. C_{iss} and C_{rss} are simply junction capacitances—they follow well-predicted voltage relationships. Factor r_{ds} , however, holds the key to the switching performance since it is related to gate voltage V_{GS} .

Switching times function of r_{ds} , C values

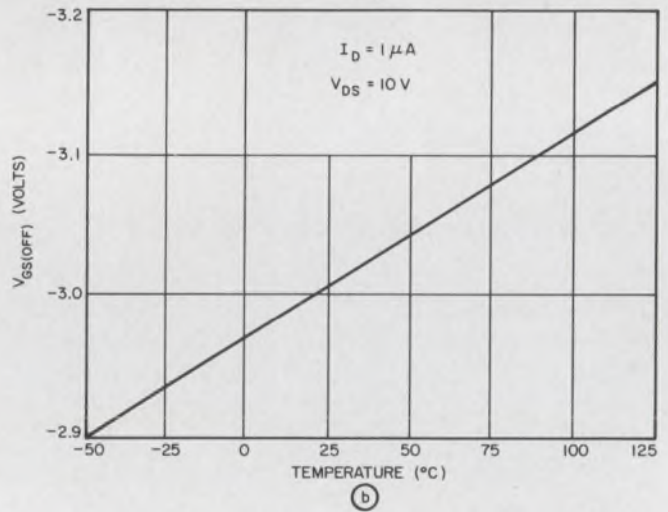
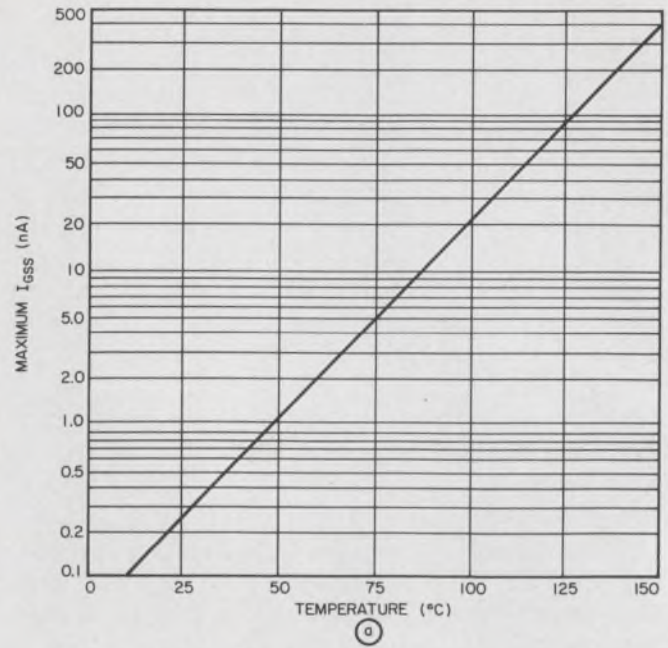
Consider the switching behavior of the J-FET inverter of Fig. 5. At the beginning of the turn-on switching interval, C_{gs} is charged to $-V_{GS(OFF)}$, C_{gd} is charged to $[V_{DD} + V_{GS(OFF)}]$ and load capacitance C_L is charged to $+V_{DD}$. Assuming V_{IN} is a step of voltage from a generator of zero impedance, the input network can be "Theveninized" as a resistor R_T equal to the parallel combination of R_K and R_G . The discharge time of C_{gs} is governed by this resistor, according to a time constant equal to $R_T C_{gs}$.

In operation, C_{gd} discharges through R_T and the parallel combination of R_D and channel resistance r_{ds} . During the turn-on interval, r_{ds} is decreasing; hence, at the start of the turn-on interval, R_D predominates. At the end of this interval r_{ds} is the performance-determining resistor. In effect then, the discharge time constant of C_{gd} is nonlinear. The time constant for C_{gd} is given approximately by:

$$\tau_{gd} \approx C_{gs} [R_T + R_D r_{ds} / (R_D + r_{ds})], \quad (1)$$

where r_{ds} is a function of V_{gs} . Figure 6b displays the nonlinear relationship of r_{ds} that affects the switching time. Figure 7 shows the actual switching times of the 3N126 as a function of drain current. For these curves, R_K and R_G were changed (along with R_D) for each value of drain current. The parallel combination of R_K and R_G was always set equal to R_D to simulate a practical switching situation where the inverter would be driven from a similar inverter with a drain resistance equal to R_D .

Consider first the turn-on delay time t_{d1} . An examination of this curve shows that t_{d1} decreases

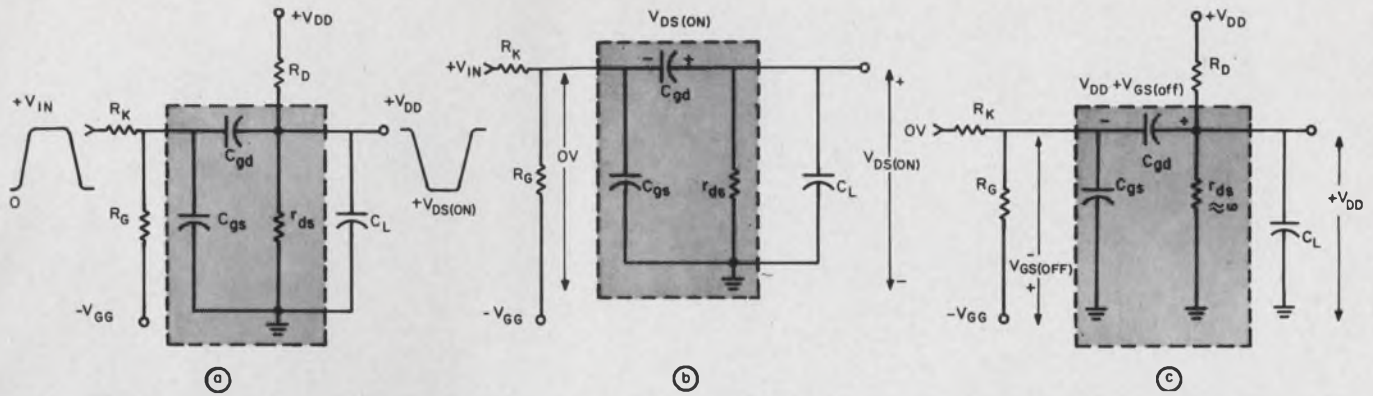


4. The key OFF-state parameters in the J-FET inverter are (a) the gate leakage current (I_{GSS}) and the (b) gate-to-source bias voltage for non-conduction ($V_{GS(OFF)}$). Both factors are dependent upon ambient temperature.

in direct relation to I_D . This is because t_{d1} is solely determined by the combination of R_T and R_D as long as the channel has not yet turned ON. Both of these resistors are varied in direct relation to I_D , and thus t_{d1} also becomes directly related to I_D . If I_D is doubled, t_{d1} is reduced by a factor of 2.

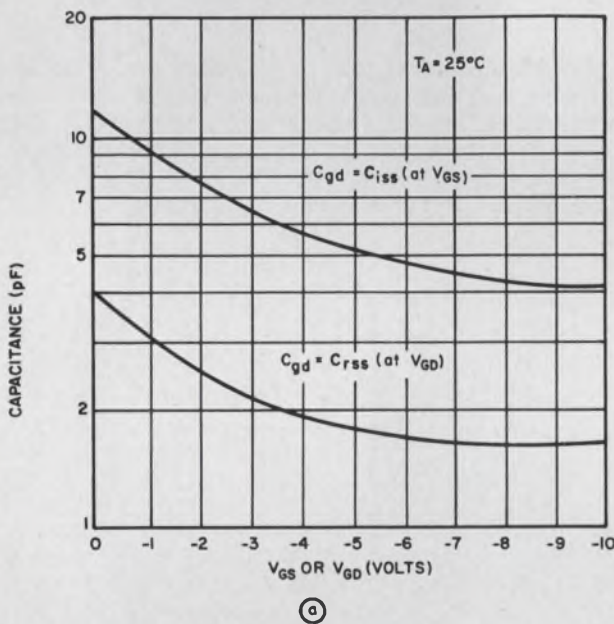
This same behavior is noted on the rise-time (t_r) curve. Owing to the relatively large gate time constant, $R_T C_{gs}$, for this particular device, the channel resistance does not affect the turn-on time until near the end of the interval. In effect, the rise time simply reflects changes in the external resistors and is directly related to I_D .

The turn-off time of a J-FET is quite different from that of a bipolar junction-transistor. First, the turn-off delay time of a J-FET is not a storage-time phenomenon, it is simply a part of the charge time of C_{rss} and C_L . Secondly, the turn-off time is a function of the input time constant as



5. Equivalent circuit of J-FET inverter (see Fig. 1) is used to determine the dynamic behavior. Here (a) C_{gs} is the gate capacitance to ground, C_{gd} the device's feedback

capacitance and r_{ds} the channel resistance. Changing voltage levels for the OFF state (b) and ON state (c) demonstrate the FET switching action.

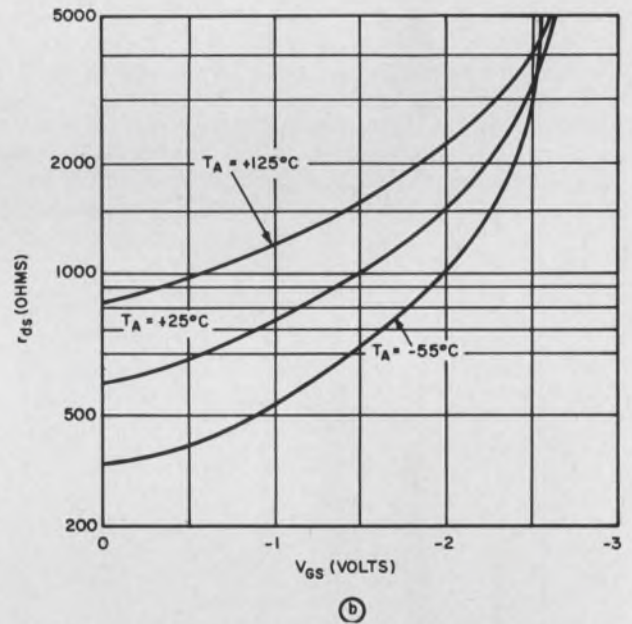


6. Capacitance and resistance parameters of the J-FET affect switching times. Factors C_{iss} and C_{rss} are voltage-

well as the feedback and load capacitance.

Compared to the turn-on delay time of the J-FET, the curve of turn-off delay time, t_{d2} , has a steeper slope as drain current is increased. During the turn-off delay time, the channel resistance is increasing. For a standard measurement of delay time, i.e., to the 90% point, r_{ds} has risen to 1/10 of R_D at the conclusion of the delay time.

For the test circuit, when I_D is 2 mA, R_D is calculated to be 5 k Ω . In Fig. 6b, V_{GS} does not change very much from zero volts to bring r_{ds} to 1/10 of R_D —500 ohms. At low currents, however, the required change in V_{GS} is greater. For example, when $I_D = 0.2$ mA, R_D is 50 k Ω . Again with reference to Fig. 6b, it takes about -2.7 volts to bring r_{ds} to 5 k Ω . Therefore, at low currents V_{GS} must change by a large amount during the delay time in comparison with the small voltage change required at higher currents.



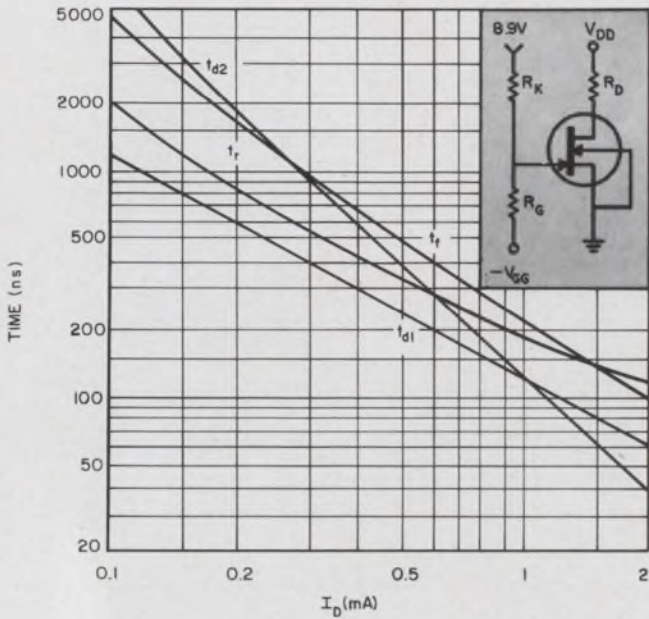
dependent junction capacitances (a). Channel resistance r_{ds} is a function of both voltage and temperature (b).

One additional fact tends to make the turn-off time longer than the turn-on time. In Fig. 6a, both C_{iss} and C_{rss} are at their largest when the bias is zero. This condition is nearly met with the device ON. When the device is OFF, both capacitors are reverse-biased, resulting in a much lower capacitance during turn-on.

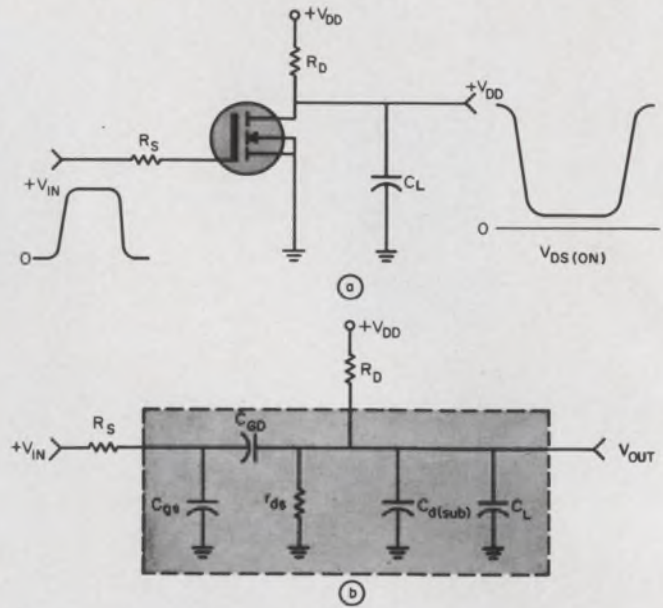
MOS-FET has lower leakage current

The MOS-FET is a 4-terminal semiconductor, as opposed to the 3-element junction-FET.

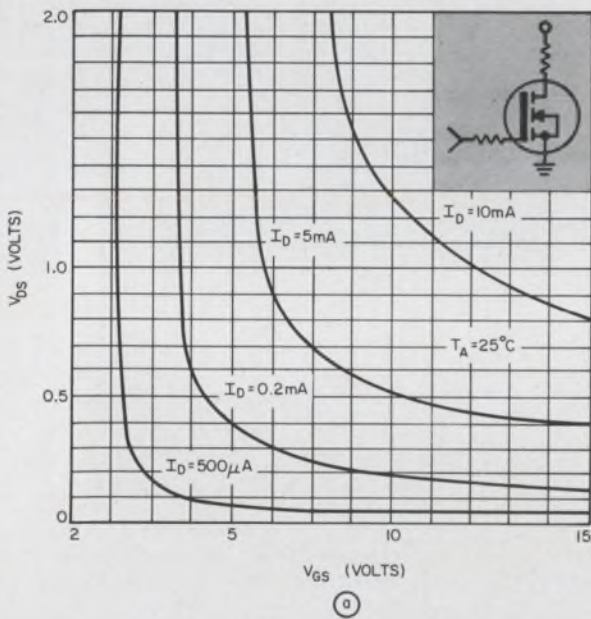
The characteristics of the MOS-FET which affect digital circuit design can also be examined by looking at the basic inverter circuit (Fig. 8). Note that the MOS-FET equivalent circuit is the same as the J-FET circuit, except for the drain-substrate capacitance, $C_{d(sub)}$. Despite this similarity, however, the switching characteristics of the two



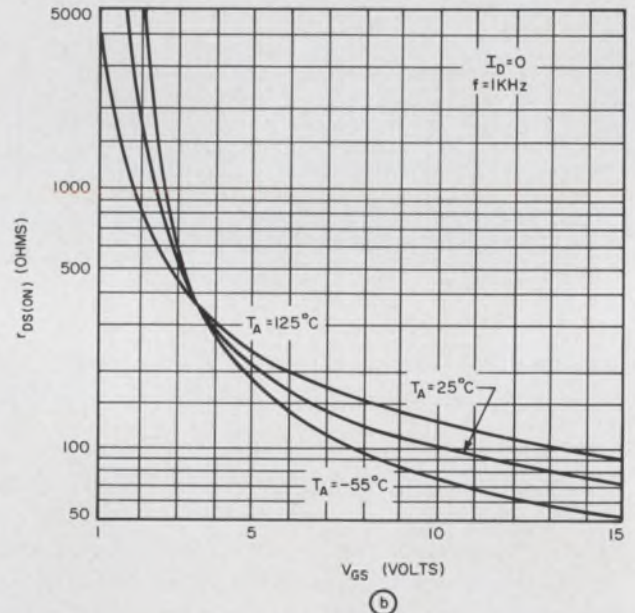
7. Switching time for the J-FET inverter (see Figs. 1 and 5) is a function of drain current. For the circuit representation shown in the insert, $V_{DD} = 10$ V, $V_{GG} = -20$ V and $V_{GS(OFF)} = -5$ V. Also, t_{d1} is the turn-on delay time, t_r the rise time, t_f the fall time and t_{d2} the turn-off delay time. The parallel combination of R_K and R_G is equal to R_D .



8. MOS-FET inverter (a) and its equivalent circuit (b) are used to analyze MOS digital switches. Comparison of circuits with J-FET inverters (see Figs. 1 and 5) reveals that a drain-to-substrate capacitance must be considered here. Also, gate leakage of MOS-FETs is lower than that of J-FETs and an OFF bias supply is not needed.



9. A key static characteristic of MOS-FET inverters is $V_{DS(ON)}$. Its variation with V_{GS} and as a function of drain current I_D (a) is useful for designing the ON (saturation)



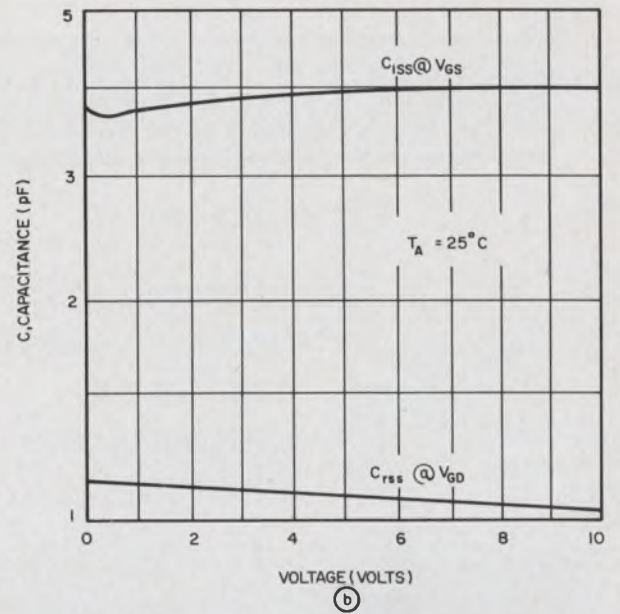
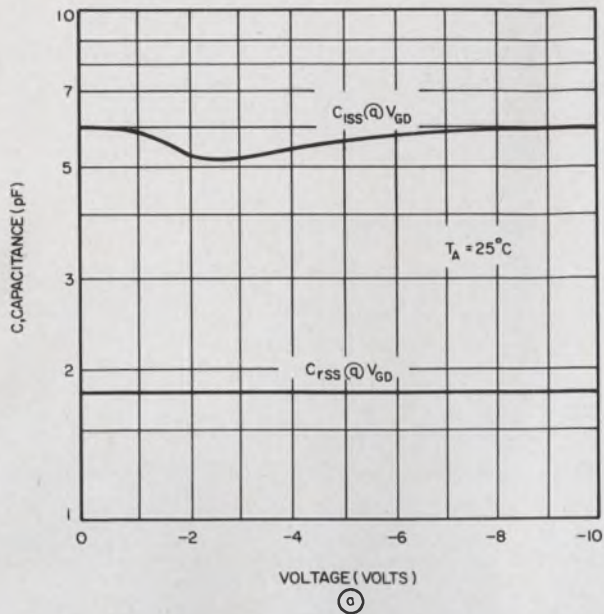
state of the inverter. ON resistance ($r_{DS(ON)}$) is another switching parameter (b). It is less influenced by temperature than its J-FET counterpart, channel resistance.

circuits are quite different.

The MOS-FET inverter does not require an OFF bias supply as did the J-FET circuit. The input is represented simply as a source resistance, R_S , and an ideal pulse generator. With the input at zero, the MOS-FET is OFF. Drain current I_{DSS} here is typically lower than in the case of J-FETs. If the 2N4351 device is taken as a representative MOS-FET, the maximum value of I_{DSS} is 10 nA in the OFF state. The output is at the high logic-

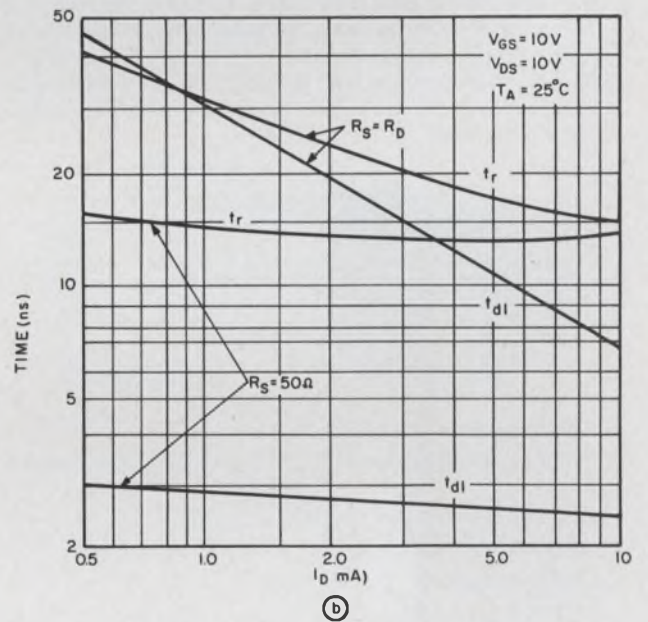
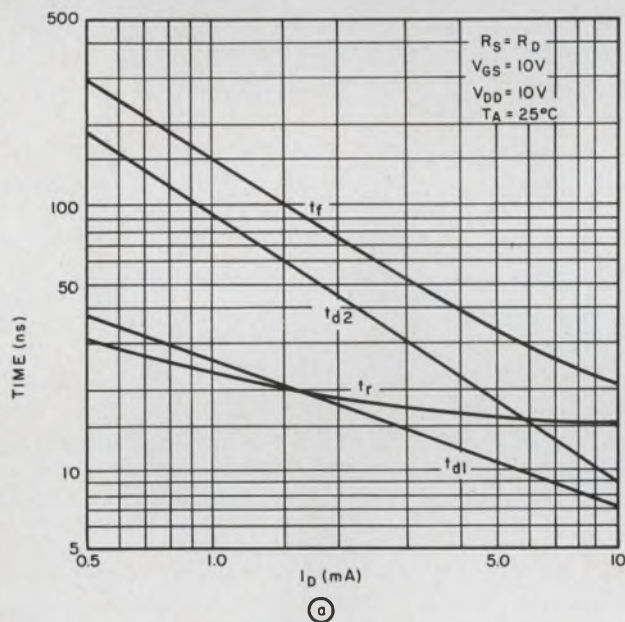
level, $+V_{DD}$. With the input at $+V_{IN}$, the MOS-FET is biased to the ON condition and the output is at the low logic-level, $+V_{DS(ON)}$. The gate leakage current of the MOS-FET is several orders of magnitude below that of the J-FET. Moreover, it is only slightly affected by voltage and temperature changes. Therefore, I_{GSS} is of only passing interest in the design of the MOS-FET switching circuits.

The remaining static characteristic of interest



10. Another switching time factor, capacitance, is not very dependent on bias voltage variations. Both C_{iss} and C_{rss} are reasonably flat over wide biasing ranges in p-channel

MOS-FETs (a) and n-channel units (b). Note, however, that $C_{d(sub)}$ (not shown) is voltage dependent—in a square-root fashion.



11. MOS-FET inverter switching times as functions of drain current are plotted (a). Here t_{d1} is the turn-on delay time, t_r the rise time, t_f the fall time and t_{d2} the turn-off

times are lessened, making the device function faster. delay time. Driving source resistance R_s has a major effect on t_{d1} and t_r (b). As R_s is lowered, these switching

is $V_{DS(ON)}$ (Fig. 9a). The $V_{DS(ON)}$ curves for the MOS-FET resemble the $V_{CE(sat)}$ curves of conventional bipolar transistors. Figure 9a can be used as a design curve in much the same manner as are the $V_{CE(sat)}$ curves of bipolar transistors. For a given drain current—for example 2 mA—the designer wants to know what value of V_{GS} is required to keep $V_{DS(ON)}$ below 0.5 volts. From the intersection of the $I_D = 2$ mA curve and the $V_{DS} = 0.5$ V level, he can see that V_{GS} must be greater than 5.3 volts to ensure that V_{DS} will be below 0.5 V.

FET capacitances can be determined. The voltage variation across C_{gs} is simply V_{IN} ; the voltage change across $C_{d(sub)}$ is $V_{DD} - V_{DS(ON)}$; and the voltage change across C_{rss} is $V_{DD} + V_{IN} - V_{DS(ON)}$. In short, it turns out to be the same ΔV swing as encountered with the J-FET inverter.

From Fig. 8 the voltage swing across the MOS-

As with the J-FET, the variations of these capacitances and r_{ds} are responsible for the switching behavior. A plot of r_{ds} vs gate-source voltage and temperature for the MM2102 appears in Fig. 9b. For the MOS-FET, channel resistance decreases as V_{GS} is increased. The plot shows the variation of r_{ds} with temperature to be less than that

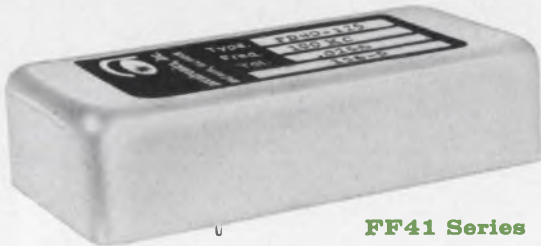
OSCILLATORS

1 hz to 125 mhz



**ACCUTRONICS, INC.
ANNOUNCES A COMPLETE
OSCILLATOR LINE
COMPATIBLE WITH I.C.
APPLICATIONS**

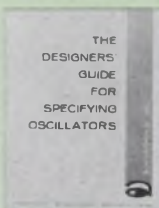
If your new system is utilizing integrated circuits, let Accutronics assist you with your oscillator requirement. Operating on voltages as low as 3 volts the I.C. series can provide an output level to drive all forms of gates, flip-flops, multivibrators, etc. Typical output levels would be 2 volts to 2.8 volts peak to peak with a 3 volt supply. Rise and fall times of <20 nanosec. are typical. Sine wave outputs can be provided with <5% distortion and frequency stabilities from $\pm 0.0001\%$ to $\pm 0.5\%$. Size of the oscillators vary with frequency and output characteristics. "Worst case" design coupled with advanced production techniques insures a long life with trouble free performance. The Accutronics oscillator is guaranteed for 2 years! Can we be of service? Call collect Area 312, 879-1000.



FF41 Series

FREQUENCY: <400 HZ TO 50 MHZ
 FREQUENCY TOLERANCE: $\pm 0.015\%$ or better over temperature range
 TEMPERATURE RANGE: -25°C to $+70^{\circ}\text{C}$
 SUPPLY VOLTAGE RANGE: 3V dc to 30V dc as specified
 LOAD IMPEDANCE: $1\text{K}\Omega$ to $10\text{K}\Omega$
 OUTPUT WAVEFORM: Sine or Square as specified
 OUTPUT VOLTAGE: Square wave 3.5 to 4V p/p with <20 ns
 Sine Wave 1-2 rms with <5% distortion
 Note: The above outputs are typical with a supply voltage of 3.5 volts and frequency of 1 KHZ

PRICE: \$87.50 to \$118.75



FREE:
**"The Designers' Guide For
 Specifying Oscillators"**

This new brochure takes the guess work out of oscillator specifying. It covers in detail all of the many parameters involved and their importance to your overall system design. Order your free copy by circling the reader service number or writing to Accutronics, Inc.

accutronics, inc.

12 S. Island Ave., Batavia, Illinois

ON READER-SERVICE CARD CIRCLE 38

of the J-FET. If $V_{GS}=10$ V, for instance, r_{ds} changes by only $0.15 \Omega/^{\circ}\text{C}$ over the temperature range of -55°C to $+125^{\circ}\text{C}$. This compares to the $3\text{-}\Omega/^{\circ}\text{C}$ variation of the 3N126 J-FET at zero gate voltage.

C_{iss} , C_{rss} immune to bias variations

Parameters C_{iss} and C_{rss} are essentially independent of bias voltage (Fig. 10). The dip in the C_{iss} curves occurs at the start of conduction in the channel. $C_{d(sub)}$ (not shown), however, is a junction capacitance; it varies roughly as the square root of the voltage.

The switching curves for the MM2101 are shown in Fig. 11. For this device, the gate time constant ($R_T C_{gs}$) is short compared to the drain time constant:

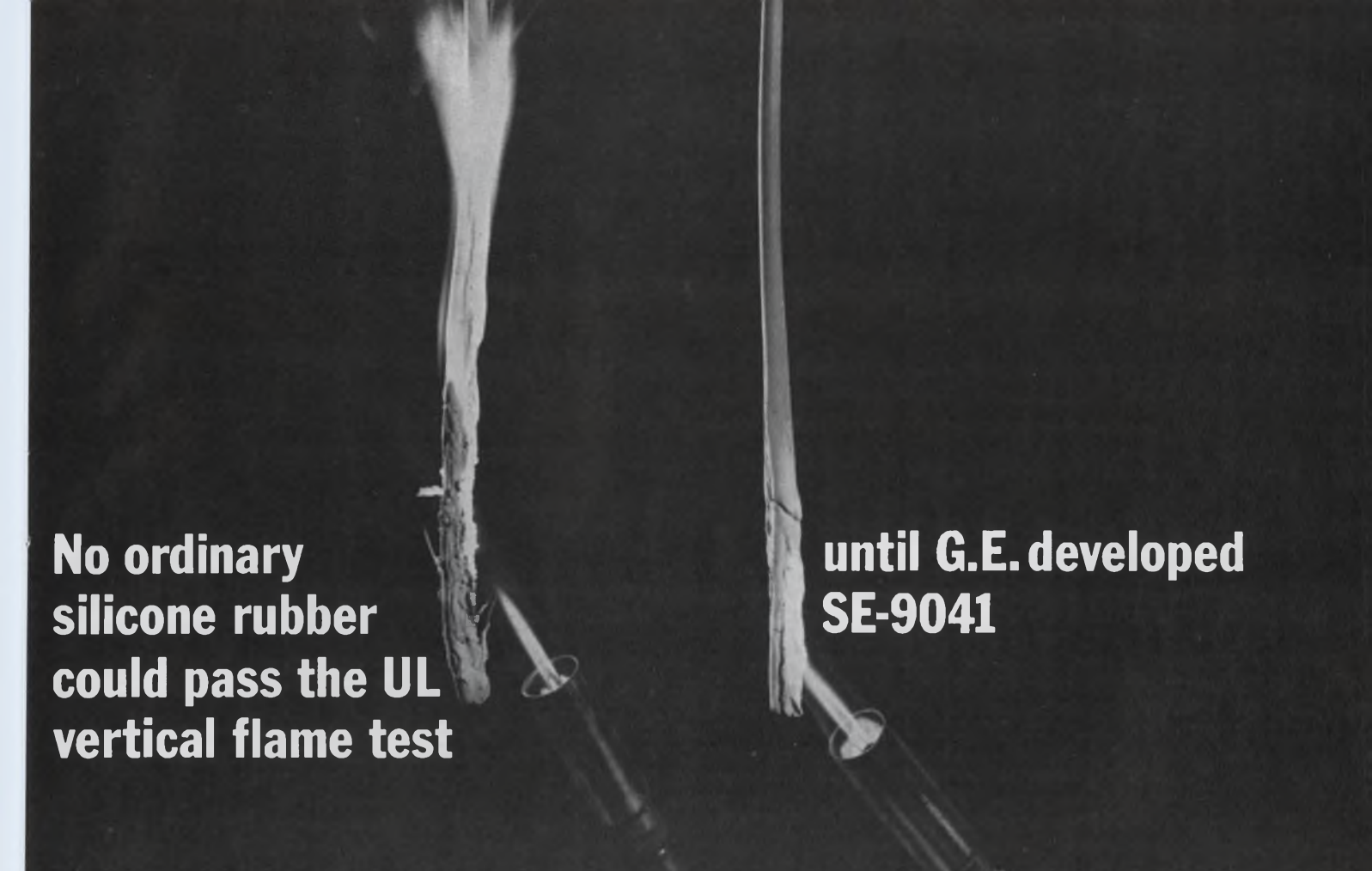
$$\tau_{gd} \approx C_{gd} [R_T + R_D r_{ds} / (r_{ds} + R_D)]; \quad (2)$$

and during turn-on the channel is ON for most of the switching interval. The results are shallow t_{d1} and t_r vs I_D curves. The gate and drain time constants do not track over the current range; consequently, the effect of decreasing the driving resistance R_S as I_D increases appears in the delay and rise time curves.

During turn-off, however, the channel is essentially OFF, and the charge time is determined by R_S and R_D alone. Thus the curves of t_{d2} and t_f vary directly with the drain current.

To emphasize the effect of driving-source resistance R_S on the switching times, the turn-on switching times were measured with a very low source-resistance (Fig. 11b). The turn-on delay time t_{d1} was most drastically affected, while the rise time at low I_D showed a similar improvement. At higher drain-current levels, the source resistor used for the $R_S=R_D$ condition was already low and so the improvement was not as great.

All in all, the switching properties of both J-FETs and MOS-FETs are none too easy to predict, since they depend upon the voltage variation of several characteristics, some of which are inter-related. It will be shown that the switching speed of FETs is comparable to that achieved by many junction transistors operating in the same current range. The dynamic behavior, as a function of the gate voltage, determines the switching performance. A reasonable approach to giving design information, then, is to specify the switching characteristics under a variety of conditions. This approach will be used in the second part of this article, which covers the actual design of J-FET and MOS-FET digital circuits. Moreover, the basic inverter building block will be applied to the NOR and NAND gate logic units which compose the field-effect switching networks. Part 2 of this article will appear in ED 25, Nov. 8, 1966. ■ ■



No ordinary
silicone rubber
could pass the UL
vertical flame test

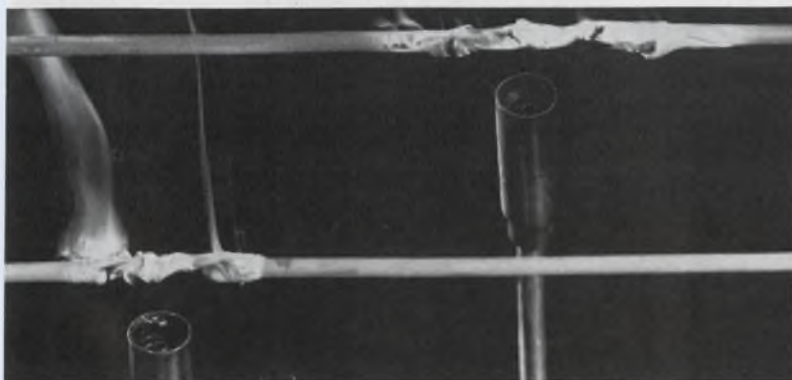
until G.E. developed
SE-9041

Ordinary silicone rubber wire insulation was only half-safe. It met Underwriters' Laboratories requirements when held *horizontally* over a flame, but flunked UL's *vertical* flame test. That's why General Electric developed SE-9041 — the first economical silicone rubber insulation to pass *both* UL flame tests. New SE-9041 meets UL specifications as insulation for any size conductors without flame-retardant exterior braids or saturants.

SE-9041 is versatile too. Although it was originally developed specifically for television wiring, this new

silicone compound can be used in any high voltage circuit from ignition wiring to klystron wiring. In electrostatic precipitators or magnetrons, for example.

But that's only part of the story. SE-9041 is also superior in dielectric strength. A No. 22 AWG conductor insulated with a 75 mil wall of SE-9041 would have a typical breakdown voltage of 500 volts/mil a-c. About 50% higher than values obtained with previous silicone rubber compounds! We especially formulated this new silicone rubber insulation to hold high-voltage stresses for prolonged periods of time.



For horizontal wiring requirements, any silicone rubber insulation provides superior resistance to flame propagation. It's on the vertical jobs that SE-9041 built a reputation as a firefighter. First among lower-priced silicone insulations to pass the demanding UL vertical flame test.

Want a sample for evaluation? Be our guest.

Section L10236, Silicone Products Dept.
General Electric Co., Waterford, N. Y. 12188

Send me a free sample of SE-9041, plus all the literature you can put your hands on.

Name _____

Title _____

Company _____

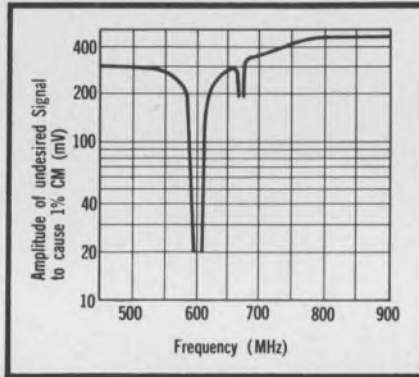
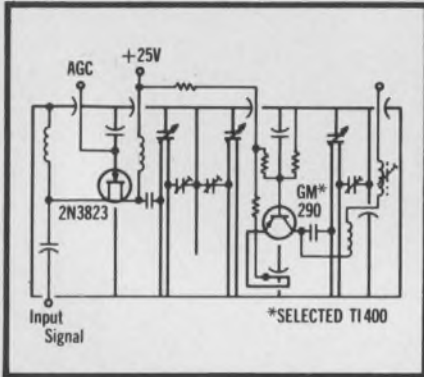
Address _____

City _____ State _____ Zip _____

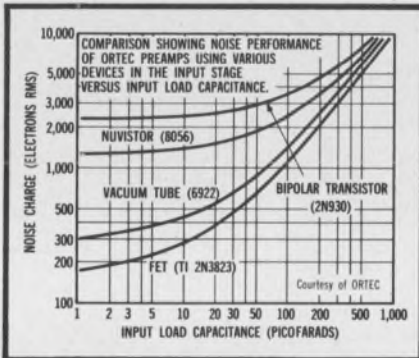
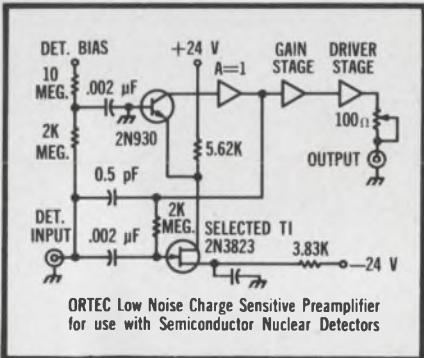
GENERAL  ELECTRIC



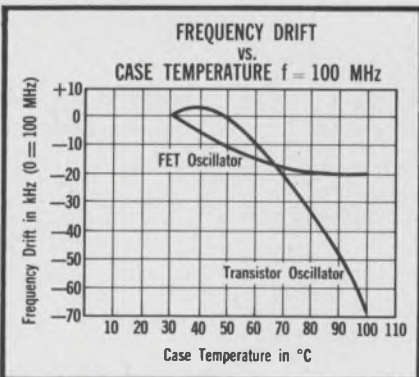
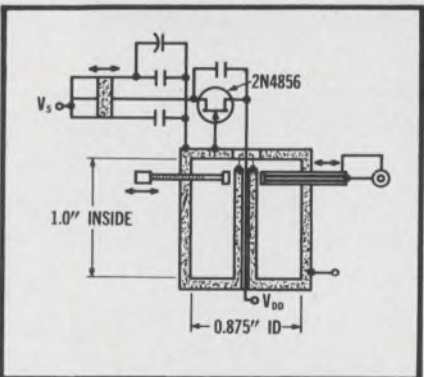
Five unique applications of FETs from



1. UHF tuner employs a TI 2N3823 N-channel silicon FET for improved cross modulation performance



2. ORTEC charge-sensitive preamplifier uses FET for accurate measurement of low-energy radiation



3. 500 MHz FET oscillator. Graph shows frequency stability over a temperature spread of 75°F

1. UHF tuner employs FET for low cross modulation

Here — for the first time — is a practical UHF tuner which offers considerable cross-modulation improvement in the RF stage. This circuit is made possible by the superior high-frequency performance of TI's 2N3823 N-channel silicon FET. In addition to its low cross-modulation characteristics, the circuit has a power gain of 12 to 15 dB from 400 to 900 MHz and a VSWR of less than 2 from 500 to 900 MHz with an input impedance of 50 Ω.

The accompanying graph shows the excellent cross-modulation performance of the tuner.

Circle 291 on the Reader Service card for application note on this tuner.

2. Charge-sensitive preamplifier uses TI FET for lowest noise, highest resolution

This preamplifier, developed by Oak Ridge Technical Enterprises Corporation for nuclear detectors, limits noise to only 170 electrons rms when used with low-capacitance detectors. The extremely low noise level of field-effect transistors from TI permits detection and accurate measurement of low energy X-rays and gamma rays (less than 20 keV).

ORTEC determined that specially-selected 2N3823s resulted in superior amplifier performance. The graph at the left illustrates improvement in noise level compared with vacuum tubes, nuvistors and bipolar transistors.

Circle 292 on the Reader Service card for data sheet on the 2N3823.

3. 500 MHz FET oscillator achieves frequency stability without temperature compensation

This oscillator demonstrates the excellent high-frequency characteristics of the 2N4856 N-channel silicon FET from Texas Instruments. Power output, at 500 MHz with a V_{DD} of 20 V, is greater than 140 mW.

Frequency stability is a major advantage of FET oscillators. The graph at left compares frequency drift with temperature change for a 100 MHz FET oscillator versus a bipolar transistor. FET oscillators result in simpler biasing and possible elimination of AFC circuitry.

Circle 293 on Reader Service card for Silicon Technology Seminary paper on FET oscillators.

TI cannot assume any responsibility for any circuits shown or represent that they are free from patent infringement

demonstrate versatility

Texas Instruments

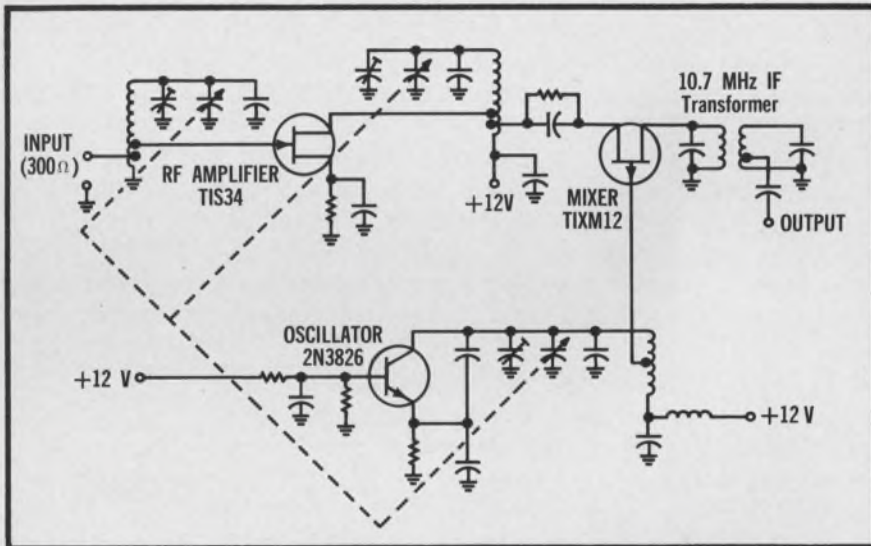
4. FM tuner employing FETs has $2.0 \mu\text{V}$ sensitivity, spurious response rejection > 79 dB

This FM tuner uses both N-channel silicon and P-channel germanium FETs for high performance with simple circuitry and low component costs.

The RF stage employs a TIS34 N-channel silicon FET for better than $2.0 \mu\text{V}$ sensitivity with 30 dB quieting.

For maximum conversion gain, the RF stage is coupled to a TIXM12 P-channel germanium FET. The TIXM12, being an almost perfect "square law" device, gives better than 79 dB spurious response rejection. Image rejection of the tuner is 70 dB, 6-dB bandwidth is 525 KHz, and power gain neglecting loss of IF transformer secondary is 25 dB.

Circle 294 on Reader Service card for application information on this circuit.



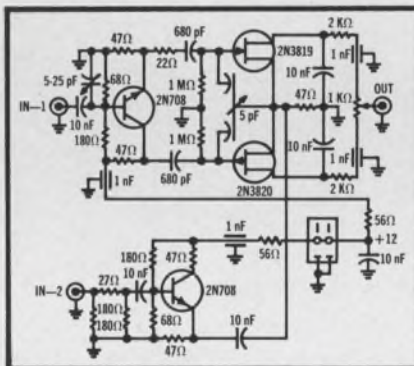
4. FM tuner employing complementary FET's features simple circuitry and low component cost

5. Wideband correlator uses complementary FETs for signal multiplication

This correlator, developed by the National Laboratory for Radio Astronomy, Bologna, Italy, employs SILECT™ FETs from TI to provide exceptional rejection of unwanted responses. A 35 dB rejection of uncorrelated components is achieved for random signals on a 10 percent band centered at 300 MHz. Previously tested correlators had rejections ranging from 15 to 30 dB.

Complementary 2N3819 and 2N3820 silicon FETs are used as direct multipliers operating in the near-zero region of the I_{DSS} vs. V_{DS} curve. Spurious responses are balanced out by the complementary characteristics of the FETs.

Circle 295 on the Reader Service card for data sheets on 2N3819 and 2N3820 plastic-encapsulated, economy FETs.



5. Wideband correlator uses complementary FETs for 35 dB rejection of unwanted responses



6. FET Fact File — industry's most comprehensive FET reference guide — contains 270 pages

6. FET Fact File by TI — the most complete collection of FET information available

Here, in one handy 8½ x 11" file folder, is 270 pages of the most up-to-date FET information. Included are data sheets, performance and reliability data, and application notes containing circuit diagrams, circuit theory, and design suggestions.

It is all yours for only five dollars. This low price includes periodic supplements which will keep your file current and continuously useful. Get your copy from any authorized TI distributor.

TEXAS INSTRUMENTS

INCORPORATED

For specific information on these circuits and devices write us at P.O. Box 5012, Dallas, Texas 75222

Reduce thin-film circuit size with this set of design curves that predict thermal effects and simplify circuit design.

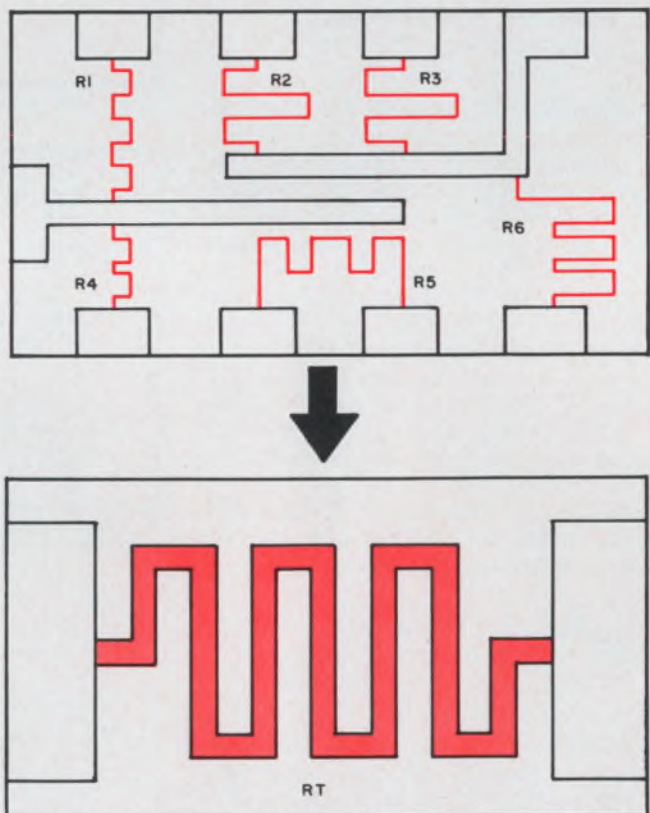
To take full advantage of the thin-film technology, circuits should be operated at the maximum permissible temperature and their size reduced to a minimum. In doing this, however, the power rating of a substrate or resistive film cannot be assumed to be constant. Though these ratings are chosen after thousands of hours of life studies, they are not unchanging, but do in fact vary according to circuit size. If this value is taken to be constant, then final designs will often fall short of size requirements.

Instead, to determine the power rating more accurately and to apply such information to a specific design easily, try the technique that is described here.

This method neither predicts the temperature of all the resistors in the circuit nor does it determine a circuit design where the resistors will be at a prescribed temperature. Rather, it predicts the hot-spot temperature (the highest temperature on the circuit) and its location in the circuit. With this goes a design procedure that produces a circuit with a predetermined hot-spot temperature. Though the results are far from the ideal solution, this design technique is superior to one that uses the constant watts-per-square-inch rating.

The crux of the method is the assumption that all the resistors in a circuit are equivalent to one resistor that has an area equal to the total area of all the resistors and a power dissipation equal to the total power dissipation, as illustrated in Fig. 1. With this assumption, a series of resistor samples is measured to obtain a relationship between the watts-per-square-inch rating (P_D), temperature (T), and the ratio (r_s) of substrate area (A_s) to resistor area (A_R). Plotting these relationships makes it possible to develop a series of design graphs. These graphs will predict the hot-spot temperature of multiple-resistor circuits or provide circuit design information on the basis of a known hot-spot temperature.

One important point should be emphasized: The graphs given in this article refer to the particular substrate and the particular resistance film developed at Western Electric Co., where the work was performed. Should there be any change in materials, new graphs, using the same techniques, would have to be drawn. The substrate material used here is an unglazed, 25-mil-thick, 99.5% alumina ceramic body. The film material is sputtered tantalum nitride at 35 ohms per square. The leads are solder-dipped copper to a diameter of 23 mils.

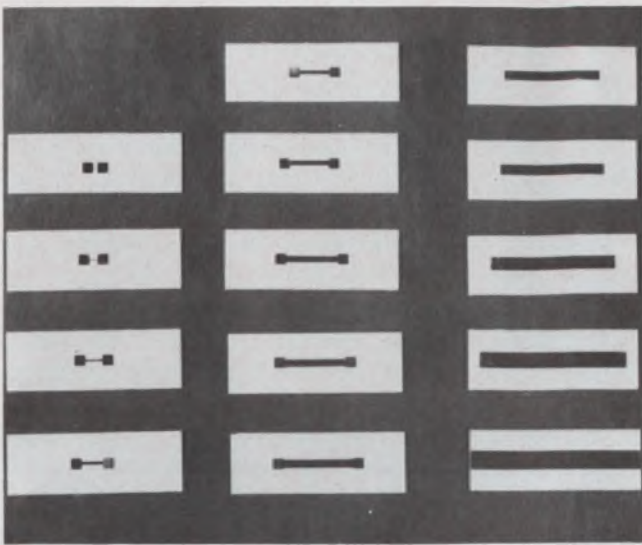


$$A_{RT} = A_{R1} + A_{R2} + A_{R3} + A_{R4} + A_{R5} + A_{R6}$$

$$P_{RT} = P_{R1} + P_{R2} + P_{R3} + P_{R4} + P_{R5} + P_{R6}$$

1. A single thin-film resistor approximates the power consumed and the area covered by the thin-film resistor network.

John R. Peek, Development Engineer, Western Electric Co., Inc., Allentown, Pa.



2. Sample set of thin film resistors is tested and the test results plotted in the accompanying figures. Note the constant substrate area.

Metered samples provide graph information

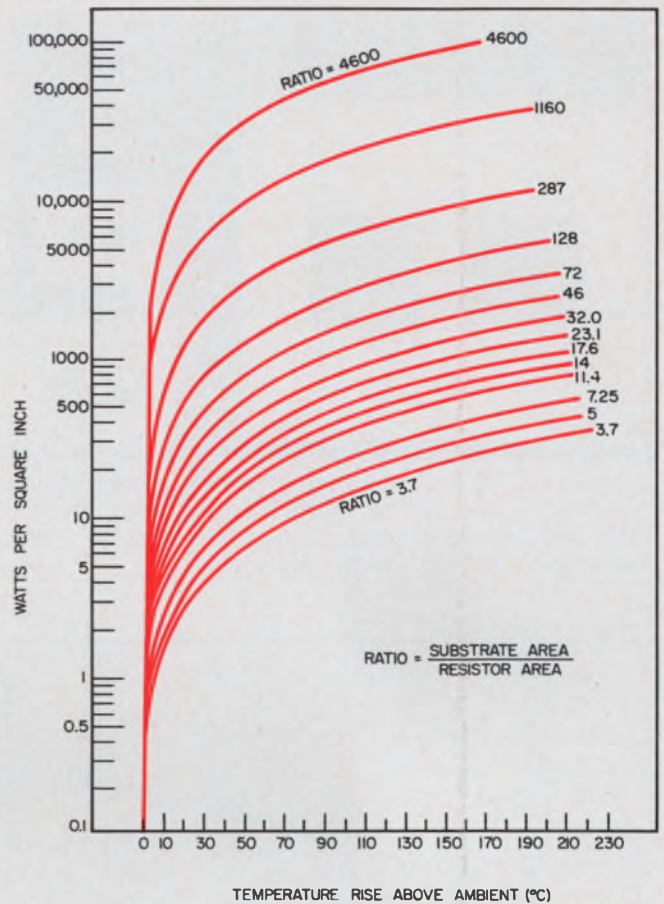
Shown in Fig. 2 are the experimental samples that were used to determine the relationship between P_D (watts per square inch) and film temperature for different ratios of substrate area to resistor area. The area of the substrate (888,250 square mils = 550 x 1615 mils) and the length-to-width ratio of the resistors (8:1) are fixed. So long as the length-to-width ratio is fixed, each resistor has the same resistance. The resistor area does vary and so, therefore, does the ratio of substrate area to resistor area. The linewidth of the resistors varies from 10 mils to 175 mils.

This set of resistors was then tested by the application of a series of known potentials across each resistor and the simultaneous measurement of the hot-spot temperature with an infrared detecting device. With known potentials and resistances, a family of curves of power per area versus temperature rise above ambient can be plotted, as shown in Fig. 3. Note that the term watts per square inch here always refers to the area of the resistor film and not the area of the substrate.

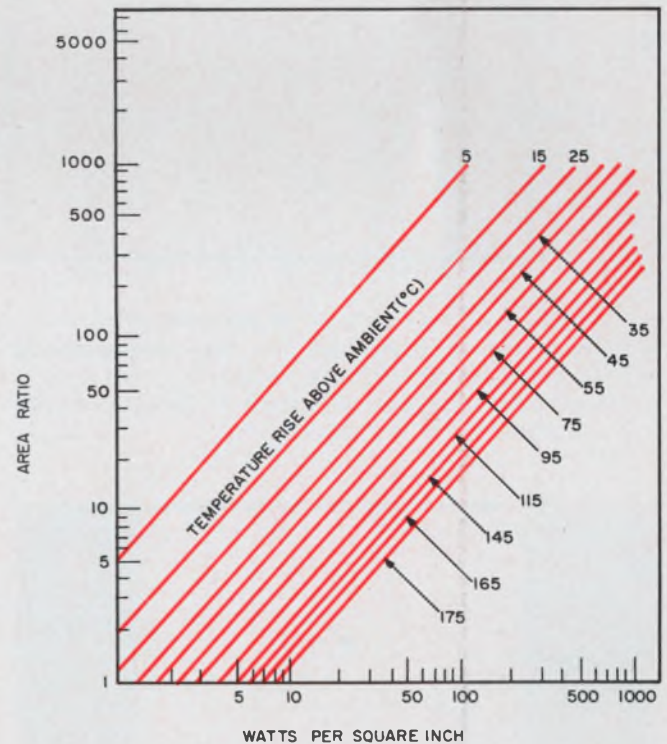
Fig. 3 graphically indicates the fallacy of assuming a constant watts-per-square-inch rating for the rating varies substantially. Figure 3 is hard to use with unlisted ratios, and thus Fig. 4 (extrapolated from Fig. 3) proves much more useful in temperature prediction. With these curves it is possible to predict the hot-spot temperature of any thin-film resistor circuit, so long as all the resistors are assumed to be one resistor. The watts-per-square-inch rating is given by:

$$P_D = 1000 P_T / A_{RT}, \quad (1)$$

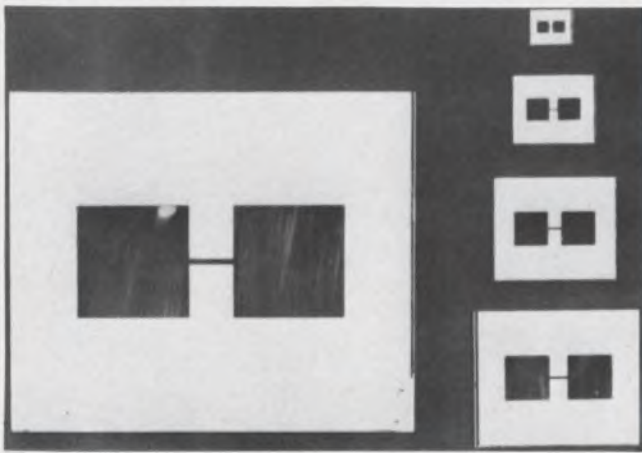
where P_T = total power of the circuit in milliwatts, and A_{RT} = total area of the resistors in square mils.



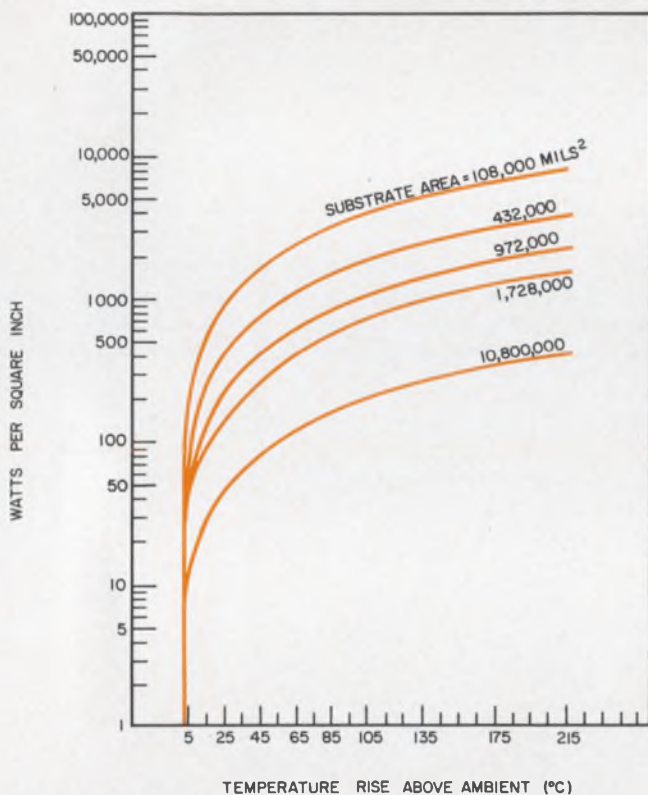
3. Fallibility of a constant watt-per-square-inch rating is obvious in this plot of temperature versus power: as the area ratio changes, the power rating varies considerably.



4. Plot of area ratio versus watts per square inch, extrapolated from Fig. 3, is useful. The temperature lines refer to the temperature above ambient.



5. Tests on this sample set of resistors provide the correction curves for the variation in substrate area. As the substrate area changes, the variation in power rating is so great that it cannot be ignored.



6. Varying the substrate and film area simultaneously produces this family of curves. Though the area ratio is constant, there is a large difference in temperature rise as the substrate area is changed.



7. Sample for temperature variance versus area test has index lines to denote the various areas that are used.

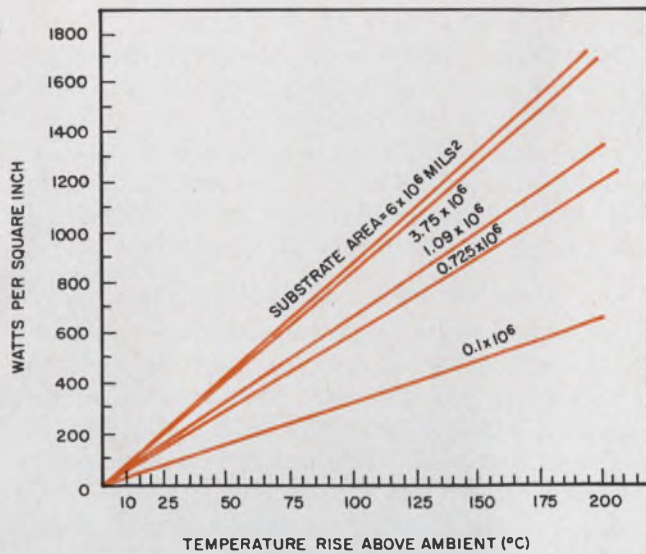
A number of thin-film circuits were evaluated and the measured results compared with calculated results based on these curves. This comparison showed that the calculated and measured results had a high correlation so long as the area of the tested substrate approximated that of the experimental substrate used in determining the curves. When the areas differed, the temperature predictions were inaccurate and this inaccuracy followed a definite pattern: When the tested substrate was larger in area than the experimental substrate, the predicted temperature was lower than the actual temperature; when the tested substrate was smaller, the predicted temperature was higher than the actual temperature.

Evidently, a correction factor that compensates for variations in the substrate area must be developed. To this end the sample resistors shown in Fig. 5 were made. In these units, substrate area to resistor area is kept constant (540:1), while the substrate areas are varied. Linewidths are 5, 10, 15, 20, and 50 mils and the length-to-width ratio is fixed at 8:1. A series of potentials was applied to each resistor and the hot-spot temperature measured. The results, shown in Fig. 6, indicate that, even though two circuits have the same substrate-area-to-resistor-area ratio and dissipate the same watts-per-square-inch value, the temperature varies with substrate area.

One final test was performed to determine the effect of substrate size on the hot-spot temperature. In this experiment, the area of the resistor remained constant while the area ratio was varied by changing the substrate area. The test sample is shown in Fig. 7 and the results appear in Fig. 8. A correction factor, as a function of substrate area, can be developed by calculating the results (from Fig. 4) of a sample, and then comparing these results with the values calculated by using Figs. 6 and 8. The correction curves for temperature and for watts per square inch are shown in Figs. 9a and 9b.

Once a set of design curves has been established, the following procedure will determine the hot-spot temperature of a particular thin-film circuit:

- Total the individual resistor's dissipation ratings to obtain a total power rating (P_T).
- Add the individual resistor area, in square mils, to obtain the total film area (A_{RT}).
- Calculate the watts-per-square-inch rating, using Eq. 1.
- Divide the substrate area by the resistor area to get the area ratio ($r_A = A_S/A_{RT}$).
- Plot the watts-per-square-inch rating and the area ratio on Fig. 4, and predict the hot-spot temperature.
- Determine the correction factor for that substrate area from Fig. 9a, and multiply the predicted hot-spot temperature by this correction



8. Results of varying the substrate area and the area ratio of a thin-film resistor. For a given power rating and a two-to-one change in substrate area, the hot-spot temperature can be as much as 10°C higher.

factor to get the actual hot-spot temperature of the circuit.

The number of leads plays an important part in the cooling of the film area. The samples used in the experimental investigations contain only two leads while the majority of thin-film circuits contain many more. An additional correction factor compensates for the variation in the number of leads. This factor was determined experimentally: Circuits were evaluated by applying various potentials to the resistors and noting the temperature change as the leads of the circuit were eliminated one by one. Though the effect per lead varies with film temperature, resistor location and other factors, an average number which provides a reasonable prediction is obtained. For the type of lead used in the investigation (23-mil solder-dipped copper) the temperature effect per lead is 1.1%. A circuit with six leads would thus manage to reduce the actual temperature as calculated by $(6 - 2) \times 1.1\% = 4.4\%$.

Design example has ten resistors

The ten-resistor circuit, shown in Fig. 10, will be used as a design example. The substrate area is 825,000 mils² and the circuit has 14 leads.

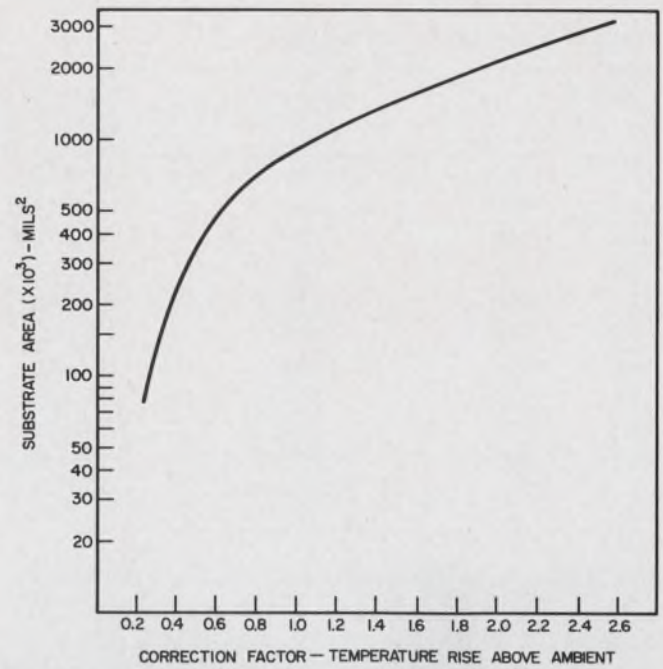
The accompanying Table lists all the individual resistor characteristics as well as the total power rating and the total film area. The next step in the design procedure is to calculate the watts-per-square-inch rating:

$$P_D = 1000 P_T / A_{RT} = 28.06 \text{ W/in}^2.$$

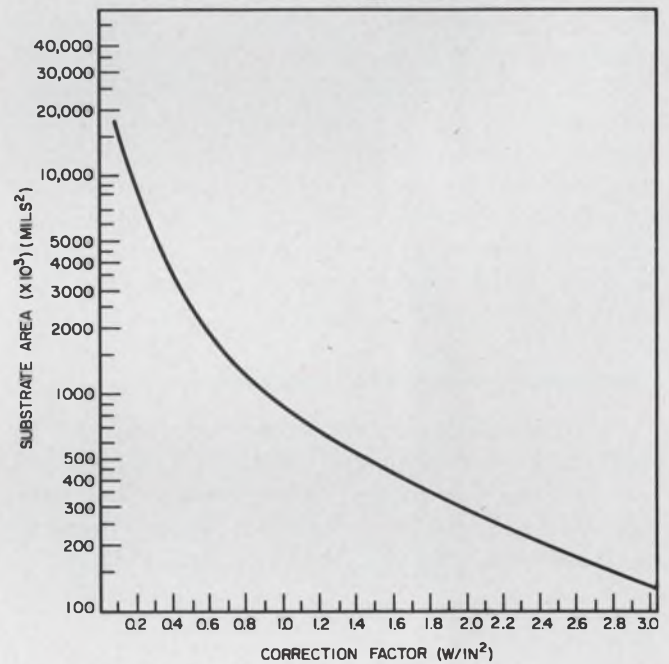
The substrate-area-to-film-area ratio is:

$$r_A = A_S / A_{RT} = 9.25.$$

These values are plotted on Fig. 4 and the rise in

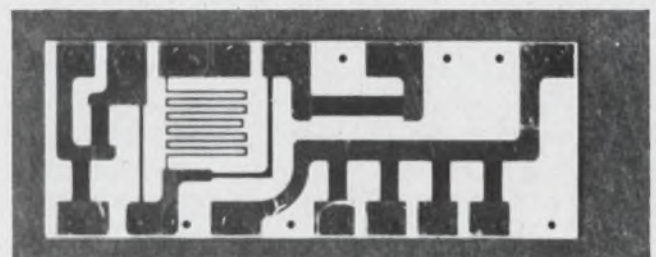


(a)



(b)

9. Correction factor for temperature (a) and power rating (b). The correction factor is equal to 1.0 when the substrate area is 888,250 square mils—the substrate area used in developing Fig. 4.



10. Thin-film network contains 10 resistors. The hot-spot temperature (91.2°C above ambient) occurs in the resistor with the highest power-dissipation rating.

Resistor values for circuit example

Resistor (Ω)	Power (mW)	Film area (mils ²)
R1 - 80	136	6,272
R2 - 80	136	6,272
R3 - 80	136	6,272
R4 - 80	136	6,272
R7 - 80	136	6,272
R9 - 80	136	6,272
R6 - 201	500	15,840
R5 - 914	100	7,770
R8 - 922	110	4,095
R10 - 12,066	986	24,200
	<u>2512</u>	<u>89,537</u>

temperature is found to be 95°C. Two correction factors, one for substrate areas and one for the number of leads, have to be included. From Fig. 9a, the correction factor for the substrate area is 0.94, and the corrected temperature becomes 89.3°C. The lead correction factor is arrived at by multiplying the 1.1% factor by 12 (14 leads less 2). This factor becomes 13.2% of the temperature rise. Multiplying the temperature rise (89.3°C) by this factor and subtracting the result from the temperature rise gives a final calculated temperature rise of 77.2°C. Generally this hot-spot temperature will occur on the resistor that has the highest watts-per-square-inch rating. In this example this would be R10.

Circuit design with known temperature

The experimental curves can also be used to design a circuit where the hot-spot temperature is not to exceed a predetermined value. The data curves in Fig. 5 are described by the general equation of a straight line, $y = mx + b$, or

$$\log r_A = m (\log P_D) + \log b, \quad (2)$$

or

$$\log A_s/A_{RT} = m \log (1000 P_T/A_{RT}) + \log b. \quad (3)$$

Since $m = 1.12$ for the substrate material discussed here:

$$\log A_{RT} = 8.4 (1.12 \log 1000 P_T + \log b - \log A_s). \quad (4)$$

Two correction factors must be added to this equation. The first compensates for the decrease in hot-spot temperature due to the heat-sinking effect of the leads. The actual hot-spot temperature (T) is equal to the calculated hot-spot temperature (T') less the effect of the leads (for every lead above two, the hot-spot temperature is lowered by 1.1%). This can be written as:

$$T = T' - (0.011) (N_L - 2) T', \quad (5)$$

or

$$T' = T / [1 - 0.011 (N_L - 2)], \quad (6)$$

where $N_L =$ number of attached leads.

The second correction factor compensates for the error due to substrate area. This is not a difficult task. The correction factor, obtained from Fig. 9b, simply shifts the temperature line of Fig. 5 to the left or right. The slope remains the same and thus the only thing that changes in Eq. 4 is intercept b . A new intercept is calculated by:

$$\log b = \log b' - \tan \phi (\log CF), \quad (7)$$

where b is the new y -intercept in Eq. 4, b' is the y -intercept of Fig. 5, ϕ is the angle between the temperature line and the watts-per-square-inch line, and CF is the correction factor from Fig. 9b.

This is a general equation. In this article only the unglazed ceramic is discussed, and thus $\tan \phi$ in Eq. 7 is equal to 1.12; a glazed ceramic would have a different $\tan \phi$.

To design a circuit with a known hot-spot temperature, the procedure is as follows:

- Select the desired hot spot temperature.
- Add the correction for the number of leads in the circuit.
- Determine the power, P_T , that the circuit dissipates.
- Assume a value of substrate area and determine the intercept value b from Eq. 7.
- Calculate A_{RT} from Eq. 4.

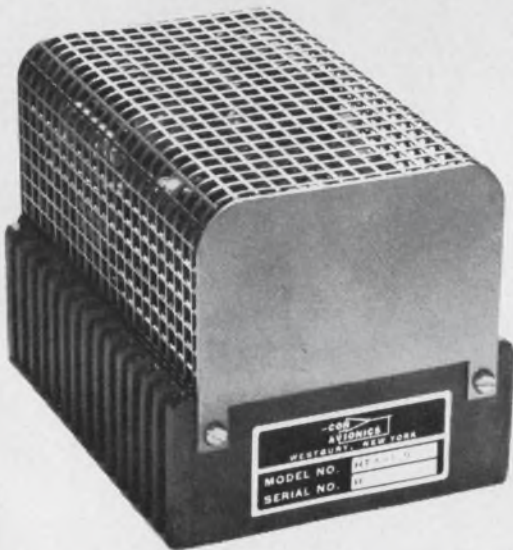
A practical example illustrates this concept. Assume the intended circuit will have 12 leads, will dissipate 2000 mW and, to fulfill the reliability and life requirements, will maintain a hot-spot temperature of 100°C at a 25°C ambient. The calculations are:

- The allowable temperature rise is 75°C.
- From Eq. 6, $T' = 86^\circ\text{C}$.
- P_T is given as 2000 mW.
- Assume $A_s = 400,000$ mils²; from Fig. 9b, $b = 0.22$, $\phi = 48.2^\circ\text{C}$, $CF = 1.7$; from Eq. 7, $\log b = 9.08201 - 10$.
- Substitute all these values into Eq. 4: $A_{RT} = 32,410$ mils².

Thus with a substrate area of 400,000 mils², a total resistor area of 32,410 mils² would maintain the hot-spot temperature at 100°C at an ambient of 25°C. It is possible that other combinations of A_s and A_{RT} could produce the same result. The idea is to optimize the solution and get the smallest substrate and resistor area that fulfills the circuit requirements. The calculations should be repeated until this goal is achieved.

Naturally, the procedure does not give an absolutely "accurate" answer. There are so many variables that have to be accounted for that this ideal solution does not always work. For example, consider the effect of subsequent heat-sinking of the substrate. The results do, however, provide a method of evaluating existing circuits and of designing new circuits with greater accuracy than by any previous method. ■ ■

Systems power supplies. Silicon. Unconditionally guaranteed 5 yrs. 100,000 hrs MTBF. \$65



CONSOLIDATED AVIONICS

800 Shames Drive, Westbury, L. I., New York
(516) ED 4-8400 TWX: 510-222-6151

SPECIFICATIONS

Total Regulation (line and load)

Standard Model "A" Model

±0.5%

±0.05% or 2mv (whichever is greater)

Ripple (rms max.)

10 mv

0.003% or 1mv (whichever is greater)

Temperature Coefficient

0.07%/°C

0.015%/°C or 1.8mv (whichever is greater)

ALL MODELS

Input

105-125v ac, 47 to 440 cps

Temperature

75°C ambient max. — 90°C base plate max.

Response Time

10 microseconds

Military Specifications

Certified to meet the environmental requirements of MIL-E-5272 and the RFI requirements of MIL-1-6181

Mean Time Between Failure

100,000 hours typical, calculated according to Mil Handbook 217

Short Circuit Protection

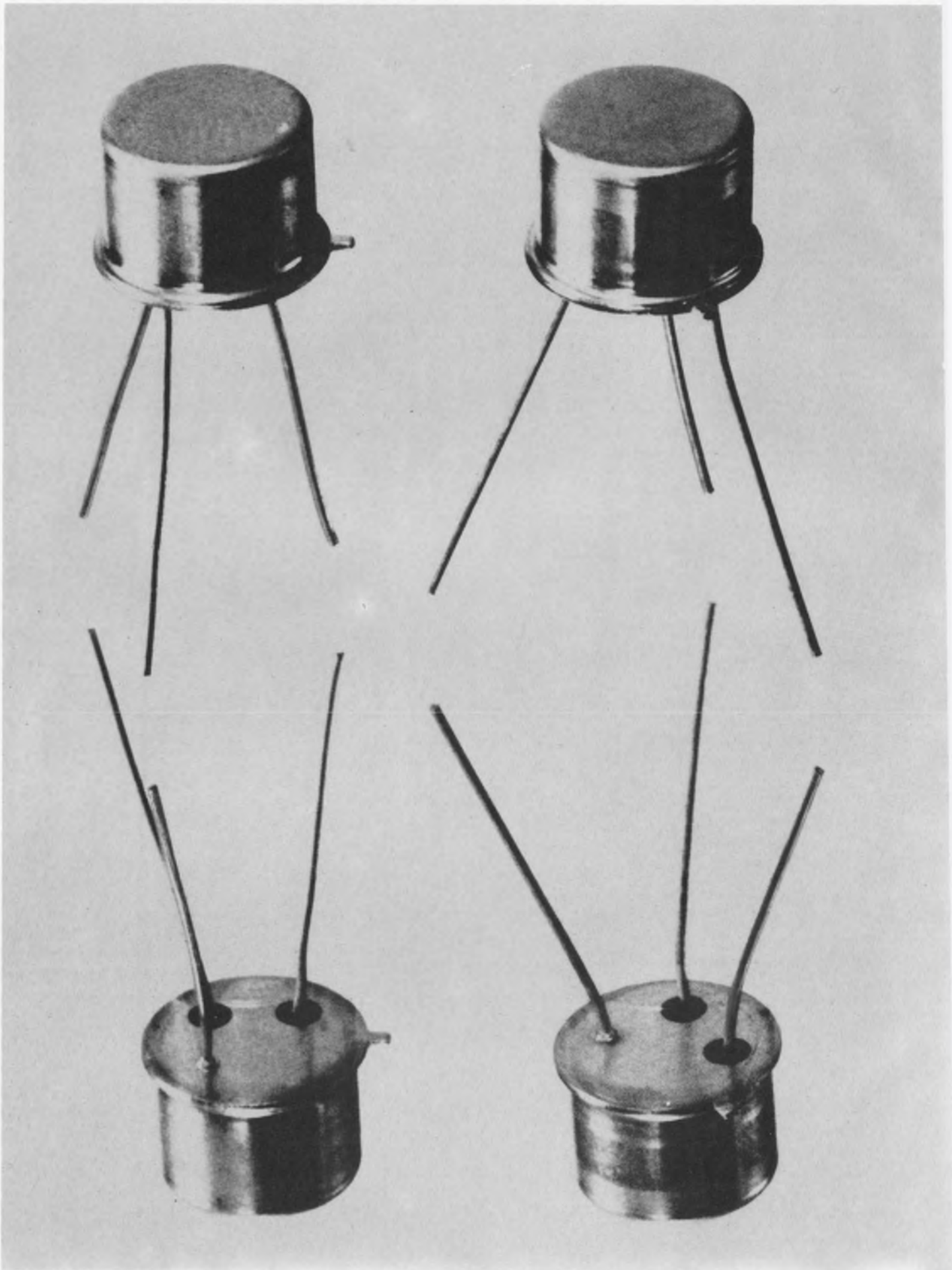
Automatic, current limiting

A DIVISION OF

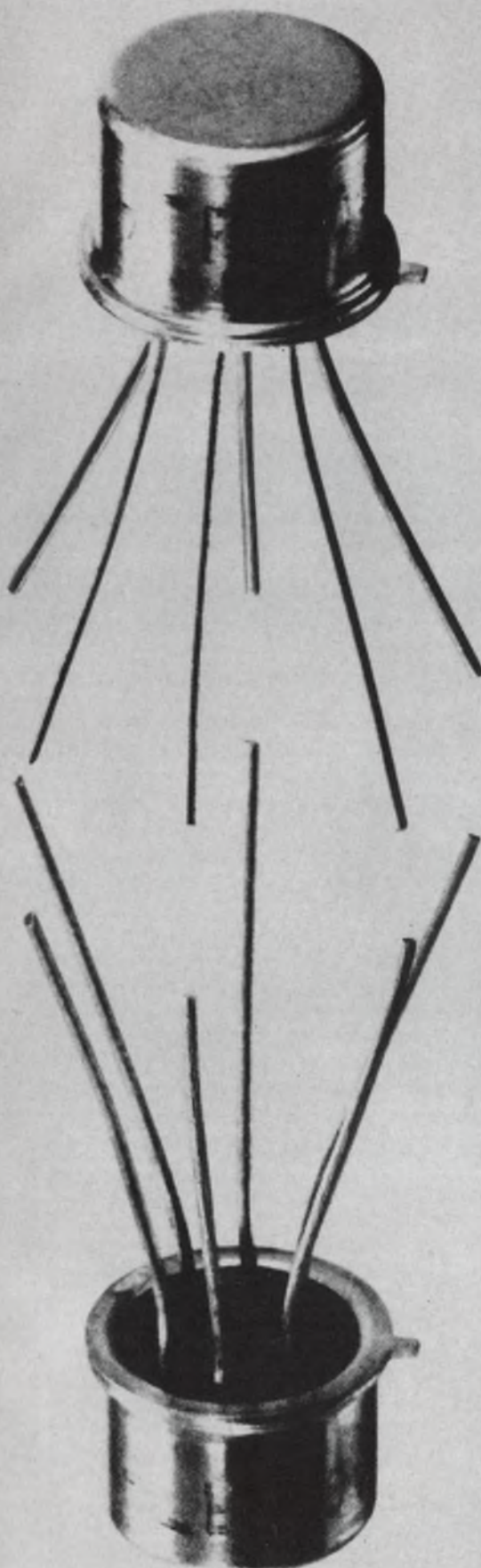


CORPORATION

ON READER-SERVICE CARD CIRCLE 41



Two for the space of one.



Fairchild dual transistors and differential amplifiers save space, give you greater design flexibility and provide uniform performance for the lifetime of the device. ■ **Space savers:** With Fairchild dual or differential amplifiers you can get the performance of two discrete transistors into the space normally occupied by one. You can manipulate the space available to you better, and at a lower cost than you'd pay for integrated circuits. ■ **Greater flexibility:** Fairchild makes more basic chips available for double encapsulation than anyone else. Mix or match virtually any of our catalog transistors to get the exact characteristics you want in your function. ■ **Uniform performance:** Two devices encapsulated in a single can are subjected to identical environmental conditions, and their performance remains uniform throughout their useful life. For differential amplifiers we select adjacent chips off the same wafer, to give you the closest possible match of electrical characteristics. ■ **Low cost, immediate delivery:** We offer you the widest chip selection, new low prices and immediate delivery. Get the complete story on Fairchild duals and differential amplifiers. It's in our new brochure. Write for it.

FAIRCHILD
SEMICONDUCTOR

FAIRCHILD SEMICONDUCTOR / A Division of Fairchild Camera and Instrument Corporation
313 Fairchild Drive, Mountain View, California (415) 962-5011 ■ TWX: 910-379-6435

ON READER-SERVICE CARD CIRCLE 42

Start your computer design with this comprehensive checklist. It will help you to select the right set of IC modules for the job.

Part 2 of a series

When you select a family of IC logic modules for a digital computer, think first of the functions (adders, decoders, etc.) that the machine will have. This way you will get the most out of the hardware used and cut the number of module types that your design requires. There are two stages in the selection of logic modules:

- Check your function needs against the checklist of generalized module functions (see Box).
- Choose the best set of modules for the job, once you know what your module needs are.

Selection is simplified if the modules are divided into four categories according to their degree of complexity: nonfunctional, semifunctional, functional and system-functional. Each category is based on the operations that the module can perform and on its component density.

The checklist is basically a compilation of the functions that a module set must perform, as discussed in Part 1 of this series.* With each function goes a list of questions about how that function will be implemented in a specific machine. Once these questions have been answered,

*See "Digital computers are no mystery," Ed 22, Sept. 27, 1966, p. 86-91.

John Earle, Advisory Engineer, IBM, Palo Alto, Calif.

the designer can analyze the module sets and select that which best meets his design needs.

How to form a module set

In the four categories into which the modules are split, the words "function" and "functional" apply specifically to what the module does—for example, adds, shifts, etc.

▪ *Nonfunctional*—Every circuit AND, OR, NOT, and their variants NAND and NOR, have all inputs and outputs connected directly to the module pins.

▪ *Semifunctional*—These modules differ from the previous category in that some of their internal circuits are interconnected on the module or some of their circuits have inputs in common. They thus have more complex but still nonspecific general functions for a variety of functional applications.

▪ *Functional*—The circuits are interconnected on the module to form specific functions. For example, the module may implement a group of register positions, a slice of an adder, a segment of a shifter, or a portion of some type of checker.

▪ *System-Functional*—An entire system function is encapsulated on the module. For example, the module may contain an entire adder, a whole shifter, or a complete slice of the data path.

Checklist helps to evaluate module requirements

Registers

- How many in gates?
- How many out-gates?
- Do several registers share a common bus?
- Are all bits of a register logically identical?
- Are both phases required from the register bits?
- Is a separate reset line required?
- Does the clock timing philosophy of the machine affect the clock input logic?
- Does the register or its out-gates require powering?
- Is a double register or single register required?

Shifters

- Does it shift left only, right only, or both left and right?
- Is it a digital shift (several bits) or a bit shift?
- How are end conditions handled when bits are shifted off the end of a word?

Bus

- How many data lines are bused together?
- Does the bus require a power driver at the output of the OR?

Adder

- Is the adder binary, decimal or other?

Checklist continued

- What kind of checking features?
- Are all bits logically identical?
- How many inputs?
- Will the inputs be bused at the adder input?
- Are there special inputs to certain bits?
- How will subtraction be performed: 1's or 2's complement?
- Will the adder use a ripple-carry or a high-speed look-ahead, carry-predict or other means?
- What are the end conditions?
- Is there end-around-carry provision for a "hot one" insert in the low-order bit?
- Does one input require a true-complementing network?
- Does the output need to be available in both true and complemented form?
- What phase of the sum is required?

Checking

- What is the checking scheme? Is it parity?
- Is parity carried on a digit, byte, half-word, or word basis?
- Does a parity tree always drive a latch, i.e., it holds an output after the input is gone? If so, should the latch be included on the module?
- What loading effect will checking have on data lines?
- Do error signal lines have to be powered?

Leading zero detector

- Is normalization done on a bit or digit basis?
- Is leading zero detection a critical path?
- What output code—binary or one-out-of- n ?

Counters

- What code will it count in—binary, decimal, one-out-of- n ?
- Must it count down as well as up?
- Does it skip sequences?
- What output states must be detected?
- Is a counter reset line required?
- How fast must it count?
- Will a carry-look ahead scheme be required for a fast add-one?
- If counting is done in a redundant code, can advantage be taken of "don't care" and "won't occur" states?
- Is it a simple counter or is the complexity of state sequence skipping so great that some more general sequence than a counter is preferable?
- Do outputs require powering?
- Are both output phases required?

Shift register

- Will this operate as a simple data shift register or will it have more general use?
- Are both phases required at the output?
- Have race conditions been taken care of?
- Can it be used easily to form a binary counter or a ring?

Must it be capable of forming a set-dominant or reset-dominant trigger?

- Will it be used with several inputs?
- Does it require out-gating?

Decoders

- How many bits must be decoded?
- Is it complete decoder? Are all 2^n input states of n variables to be uniquely decoded?
- Will inputs require powering?
- Are both phases available on inputs or must they be generated?
- Are both phases required at outputs?
- Do outputs require powering?
- If only a partial decode is required, must there be a facility for adding outputs later?
- Should the decoder be gated?
- Must it be general-purpose so that it may be used to form large decoders out of the smaller one?

Control sequence triggers

- Should there be double triggers or are latches and triggers separate?
- Will there be a complex of input conditions?
- Must reset be controllable as well as set?
- Is set or reset dominant or are both facilities required?
- Are both phases required at output?
- Will output require powering?
- Will timing philosophy affect the clock logic?

High fan-in gate

- Are there facilities for construction of a high fan-in AND and OR? (This usually requires the ability to have an AND drive an AND and an OR drive an OR, otherwise fan-in capability is limited and speed reduced).
- Can the high fan-in gates be cascaded to arbitrary depths, for example, for monolithic memories and scratch-pad address decoding and output ORing?

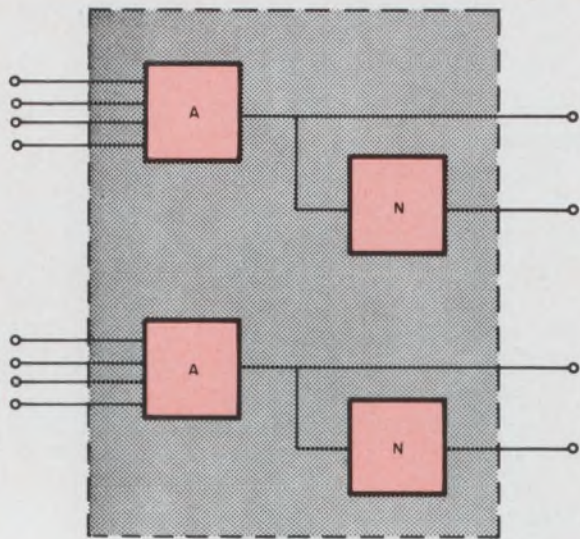
- Are both phases required at the output and, if not, should the output be AND or NAND?
- Does the output require drivers?

High fan-out gate

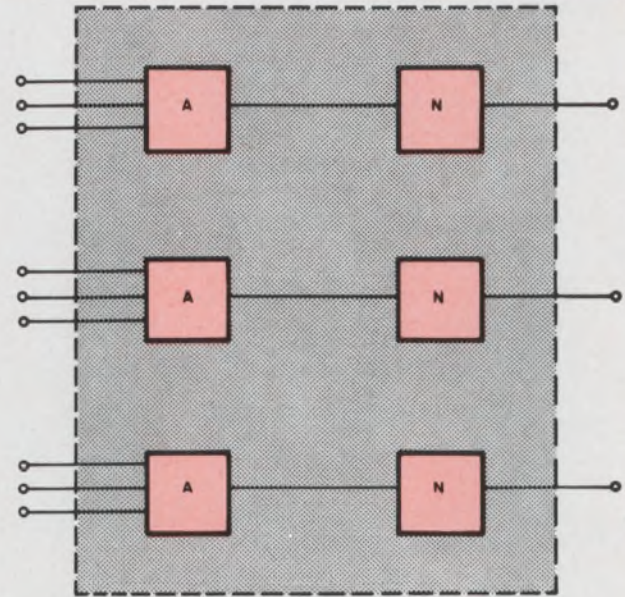
- Is a power driving facility available when logic fan-out is exceeded? (Facilities must be available for distributing a signal in different directions, especially in clock-powering trees.)
- Are the drivers gated?
- How much logic is required at the drivers?

Memory stacks

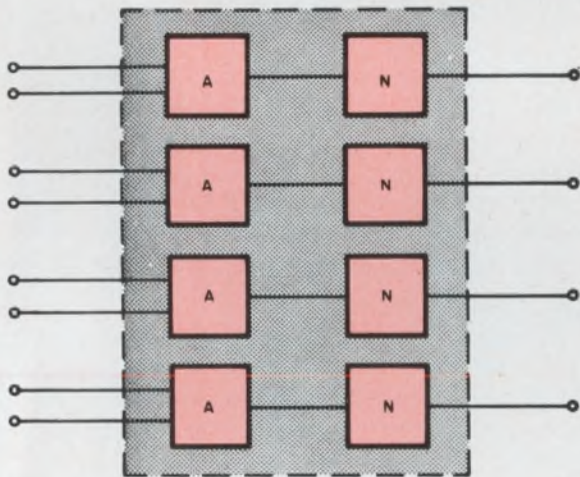
- How many registers of how many bits each are to be stacked, fed by a common bus, and driving a common bus?
- Is there to be more than one in-gate?
- Is there to be more than one out-gate?
- How fast must the output bus be?
- What phase of the output signal is required?
- Does the bus require powering?



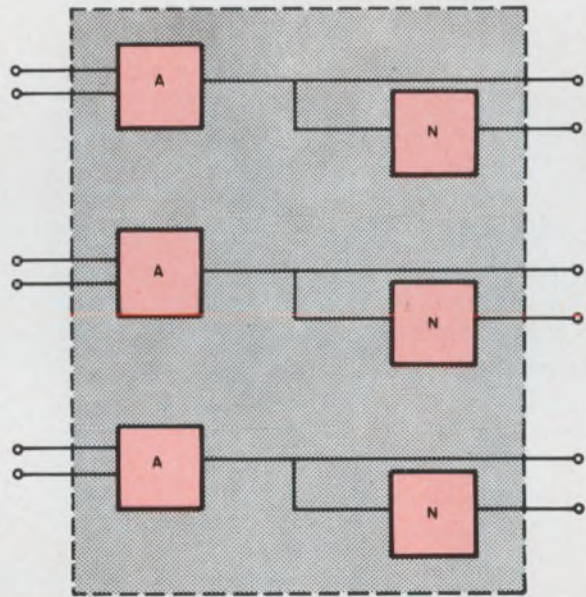
(a)



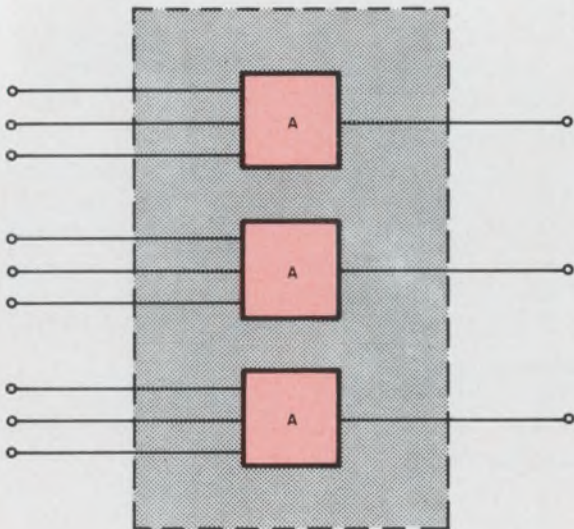
(d)



(b)



(e)



(c)

- (a) Two 4-way ANDs (ORs) with both phases out 4 circuits
- (b) Four 2-way NANDs 8 circuits
- (c) Three 3-way ANDs 3 circuits
- (d) Three 3-way NANDs 6 circuits
- (e) Three 2-way ANDs (NANDs) with both phases out 6 circuits

1. **Nonfunctional modules are versatile and simple.** All circuits in the modules have their inputs and outputs available at pins.

For a fixed number of module pins, these four categories tend to define modules of increasing density. They also specify an increasing order of difficulty in generalizing about such modules. For example, the system-functional category is entirely machine-dependent, and what can be said generally about modules in this category is therefore very restricted. This category will not be dealt with until later in this series of articles.

The accompanying illustrations are not suggested module sets, but rather are intended to indicate how, in each of the first three categories, a module set might be formed that would implement checklist requirements.

Number of pins has been chosen arbitrarily, and any upper limits on the number of circuits, crossovers or power dissipation have been ignored. No account has been taken of most circuit considerations in this non-hardware-oriented implementation, except for fan-in and fan-out. Nor has any notice been taken of what severe wiring rules in high-performance circuits would do to the design. The more functional types of module are oriented to parallel or serial-parallel machines rather than toward serial-by-bit machines.

For the three categories in question, non-hardware-oriented descriptions in terms of ANDs, ORs and NOTs will be used. We will assume a fan-in and fan-out of four and a module with 12 signal pins (exclusive of voltage).

At each of the three module densities considered, any module set will be presumed to include modules of the lower-density categories—that is, a module set with semifunctional modules may also include nonfunctional modules; a functional module set may include semifunctional and non-functional types.

Nonfunctional modules

Figure 1 shows five nonfunctional modules. One prominent characteristic is their symmetry. Each module has a number of identical circuits each of which has the same number of inputs. Symmetry is desirable for parallel data paths; in fact, experience has shown that symmetry is the best way to proceed as a general principle. Provision of both true and complemented phases at the outputs of some of the circuits pulls many otherwise scattered inverters onto the source module.

While more functions could be added to the group in Fig. 1, the modules shown form a versatile group that the designer can use in most design situations. The ratio of unused to used inputs and outputs could probably be improved in some cases, but this "circuit waste" should be considered as a trade-off to obtain maximum module applicability across as broad a range of machines as possible. A comparison of the modules of Fig. 1 against the checklist shows how easily they can be adapted to

meet many processing and control functions. For example, the module shown in Fig. 1a can be used to build a leading zero detector for hexadecimal numbers.[†] The 3-way AND module of Fig. 1c can be used as a basis for a data path register[†] or for a four-way shifter.[†]

With such potentials, any designer worth his salt should be able to build his own module set according to his particular circuit requirements.

Semifunctional modules

In the semifunctional category, a module set is of value only to the extent that it is accompanied by a detailed description of the specific functions that each module can be used for. This list should be updated continuously to keep it complete. The versatility of these modules is not always obvious, even to the experienced designer. Therefore, whenever a designer finds a new application for one of these modules, he should document it accurately and completely. This can eliminate time wasted on later duplication of effort. Manufacturers of off-the-shelf semifunctional modules can provide such information.

An idea of the many uses of semifunctional modules is given by the seven modules in Fig. 2. Figure 2a is a high fan-in gate with both phases—that is, both true and complemented versions—out. One input can be brought in as a fast or late input. In general this module can be used as a high-input AND or as an OR.

Figure 2b illustrates the logic that lies at the heart of a carry-look-ahead high-speed adder[†] designed for use as generalized AND-OR logic. It can also be used to build a latch—that is, a circuit that will hold its output even after the input is removed. For example, a latch having a reset to the OR can be made by feeding the output back into an appropriate input.

Another very handy module (Fig. 2c) consists essentially of a power driver on a four-way AND block driving up to 16 loads. Since each driver is gated separately, the module can distribute four out gates on a register. It can also provide clock powering with separate inhibit lines and even perform partial decode functions.

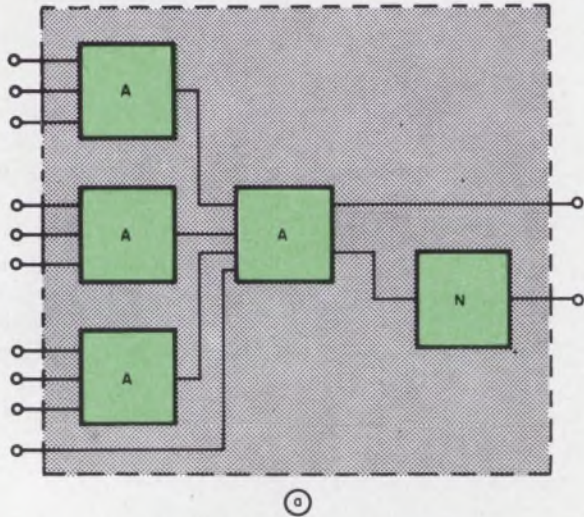
One of the simplest ways to obtain more logic for the same number of pins with semifunctional modules is to have the signal on one input pin drive more than one gate. If this is done judiciously, more logic arrangements can be achieved without significant reduction of the module's usefulness. For example, in Fig. 2d, there are four two-way ANDs, ORed together with both phases out. This is the most common function found in

(text continued on p. 78)

[†]See illustrations in Part 1.

[†]See "Microelectronics Opens the Gate," ED 16, July 5, 1966, pp. 52-57.

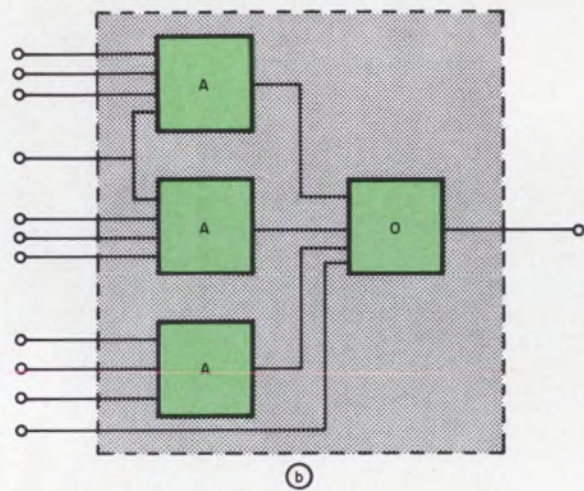
Semifunctional modules



(a) 10-way AND (OR) or NAND both phases out (note fast input at bottom) (5 circuits)

Functions:

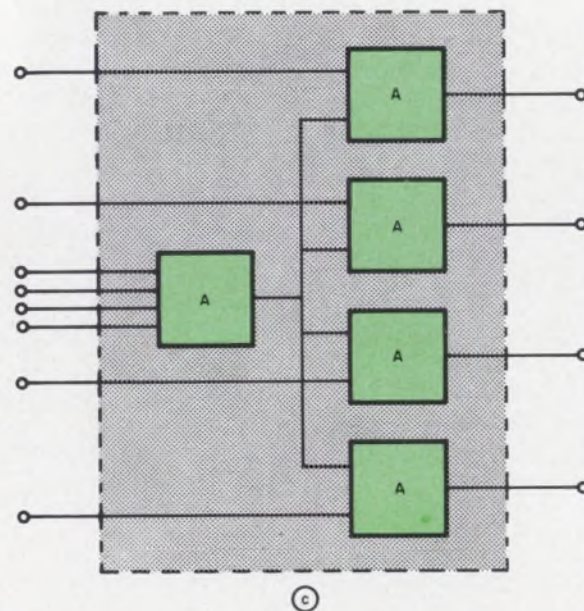
- High fan-in gate
- Complex interlocks
- Register all-zero detect
- Busing of control conditions to open a gate
- ORing a fat data bus
- ORing of error signals



(b) Three 3-way ANDs, ORed together with fourth input common to two ANDs, with additional input to OR. (4 circuits)

Functions:

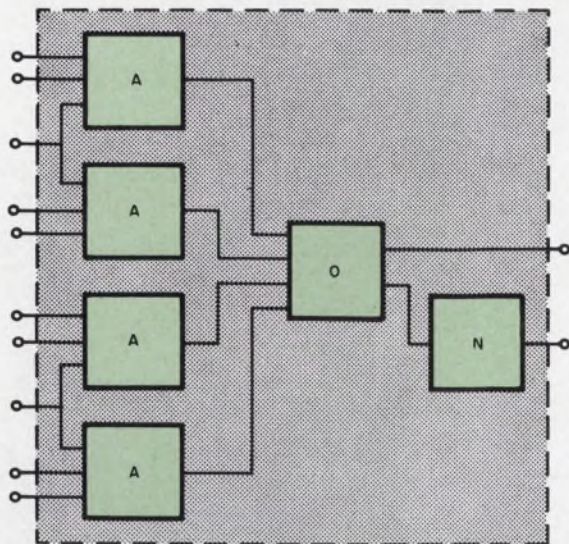
- Latch
- In-gate
- Look ahead carry generate
- Look ahead carry in
- General AND-OR logic



(c) 4-way AND driving four 2-way ANDs. (5 circuits)

Functions:

- 4-way AND power driver
- Separately gated parallel power drivers
- Distributor
- Partial decoder

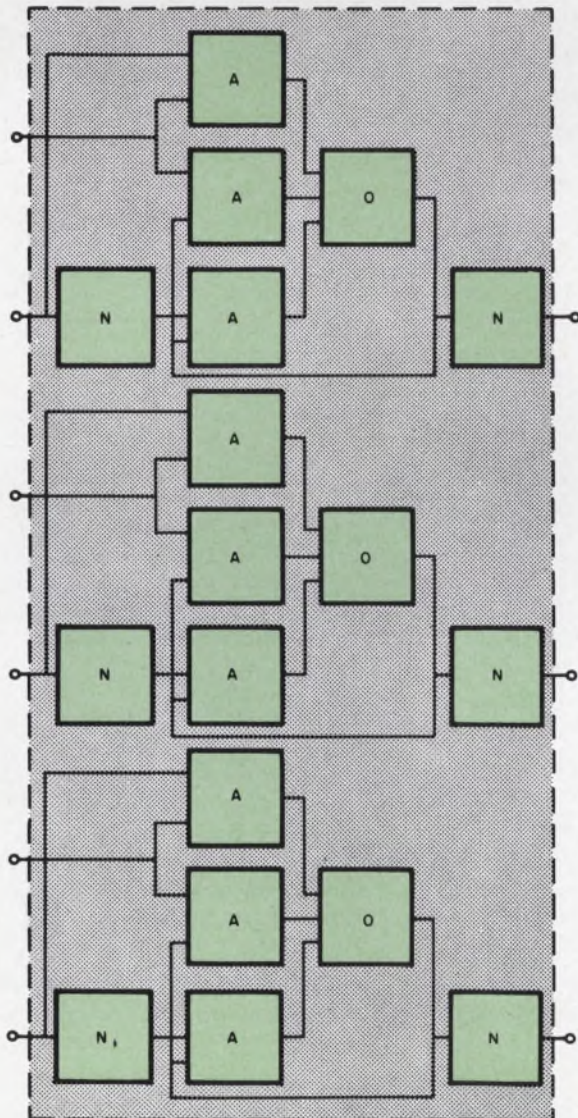


(d)

(d) Four 2-way ANDs, ORed with two additional shared inputs, both phases out (6 circuits)

Functions:

- Bus
- Out-gating
- In-gating
- Shifter
- Three ingate register
- Set dominant control trigger
- Reset dominant control trigger
- ANDs ORed together
- General AND-OR logic



(e)

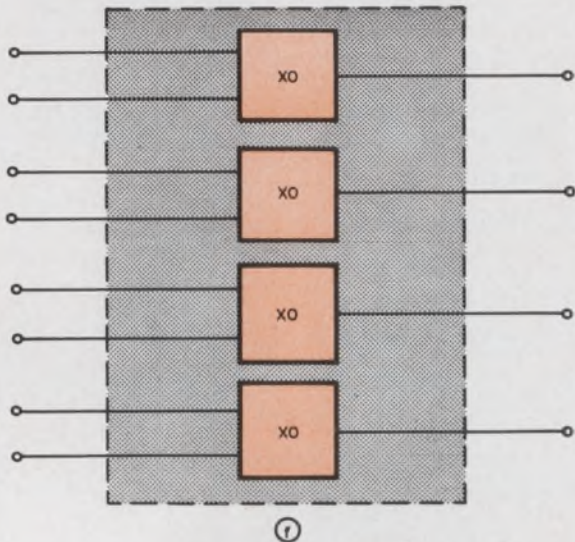
(e) Three latches with both phases out (18 circuits)

Functions:

- Data registers
- Control triggers
- Ring counters
- Binary counters
- Miscellaneous storage

(illustration continued)

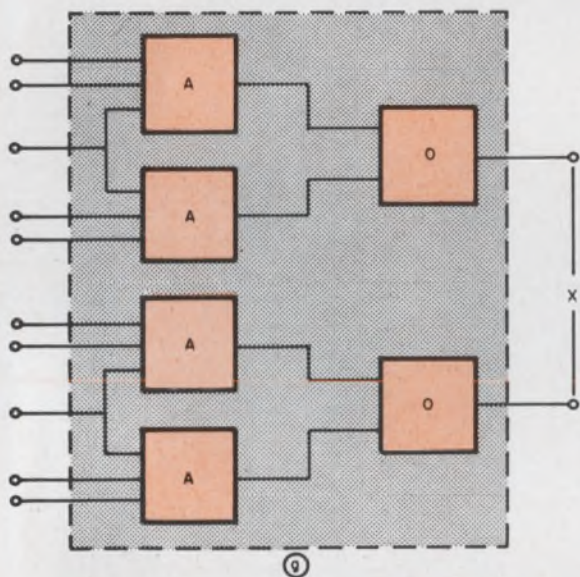
Semifunctional modules continued



(f) Four 2-way exclusive—ORs 20 circuits

Functions:

- True complementing of data
- Parity generation
- Parity checking
- Binary sum
- Comparator
- General equivalence detection



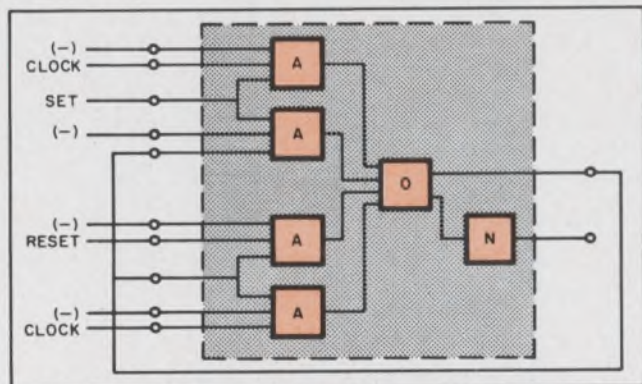
(g) Two 2-way gated AND-ORs. This function can be extended, external to the module, by common-collector dot OR, if circuit family permits.

Functions:

- Gating
- Busing
- Decoding
- Gated latch
- General logic

2. Semifunctional modules have a variety of applications. Unlike the modules in Fig. 1, not all inputs and outputs

are available externally. These modules are versatile and may be used for many functional applications.



3. Module of Fig. 2d connected to form a set-dominant control trigger with separately controlled set and reset [(-) represents biasing which for some circuitry is not required since inputs may float].

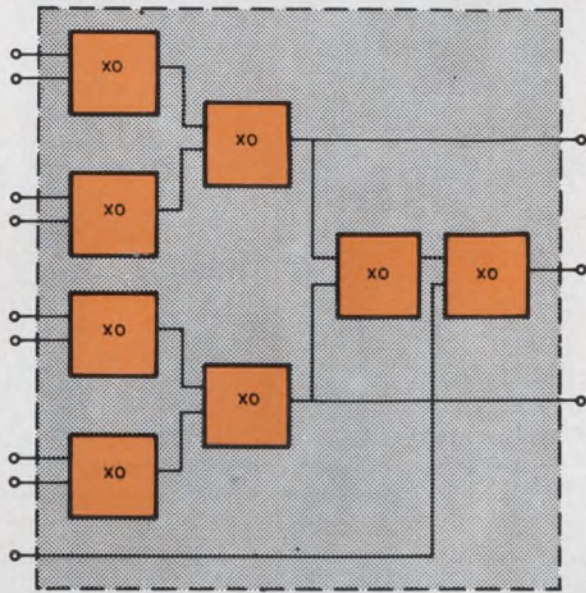
(text continued from p. 75)

data paths (see Part 1). If the inputs are shared between gate pairs, the two remaining pins can then be used to increase the four gates to three inputs. Thus, in addition to the many applications of two-way ANDs Ored together, there is also a capacity for gating or clocking—either separately, in pairs or collectively, or for feeding back to form a set-dominant or reset-dominant control trigger. (These last two configurations are shown in Fig. 12 of Part 1.)

Another use of this same module is shown in Fig. 3, which illustrates how the module can be used as a reset-dominant control trigger with separately controlled set and reset capabilities.

(text continued on p. 81)

Functional modules

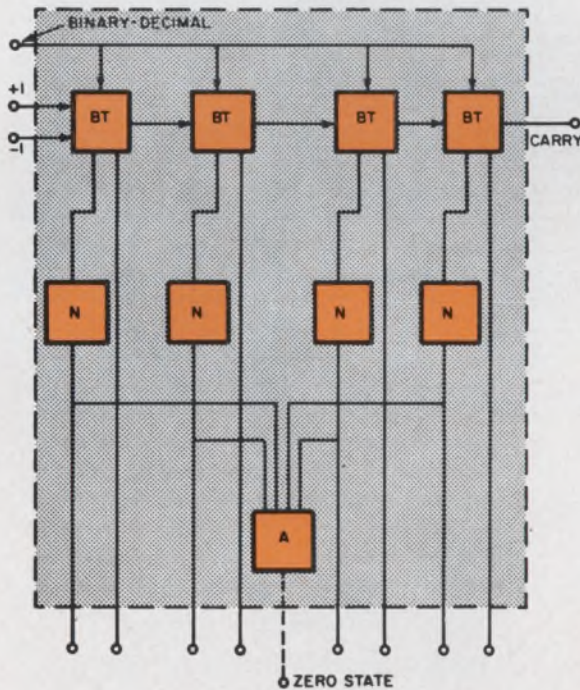


⊙

(a) Exclusive—OR tree 40 circuits

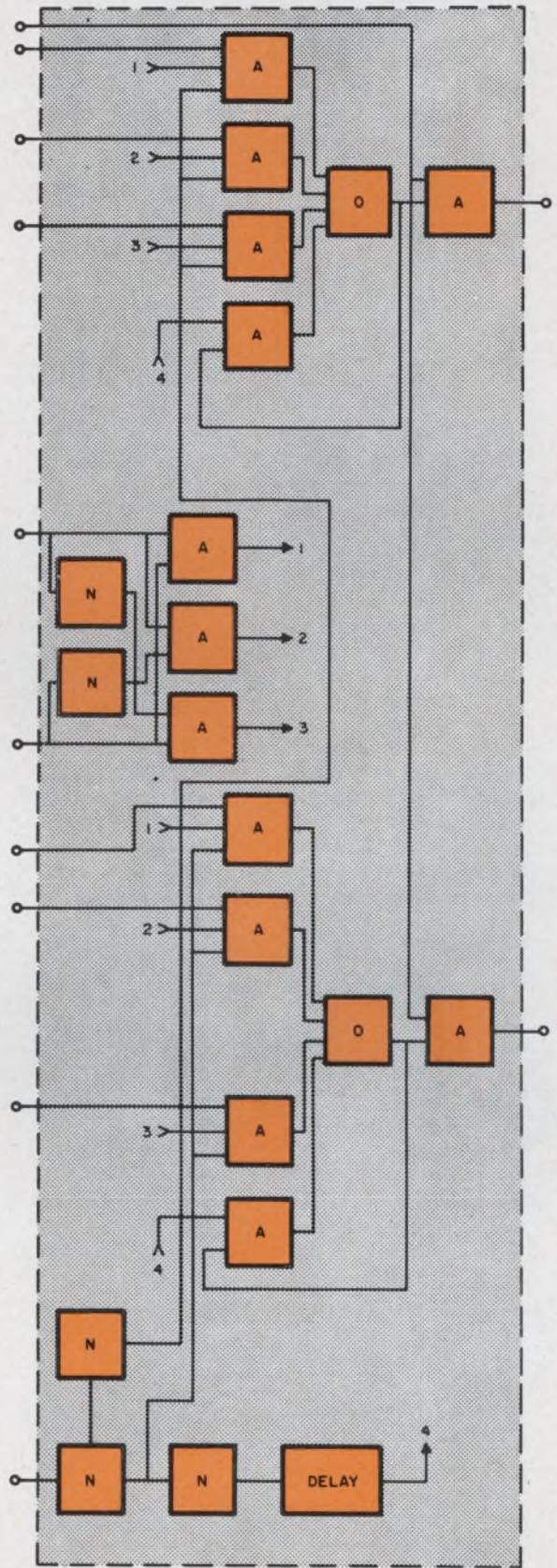
Functions:

- Digital byte parity generation or check
- 4-way, 8-way, 9-way, parity



⊙

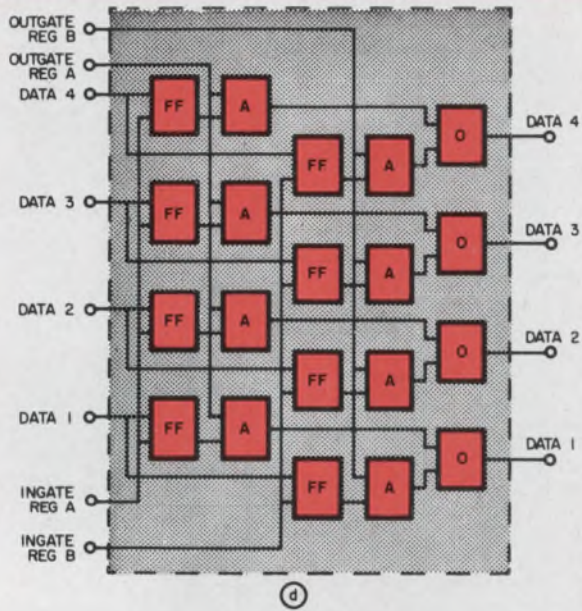
(b) Count up—count down binary or decimal counter (BT= binary trigger) (≈ 50 circuits)



⊙

(c) Two bit three in-gate register with outgate 20 circuits

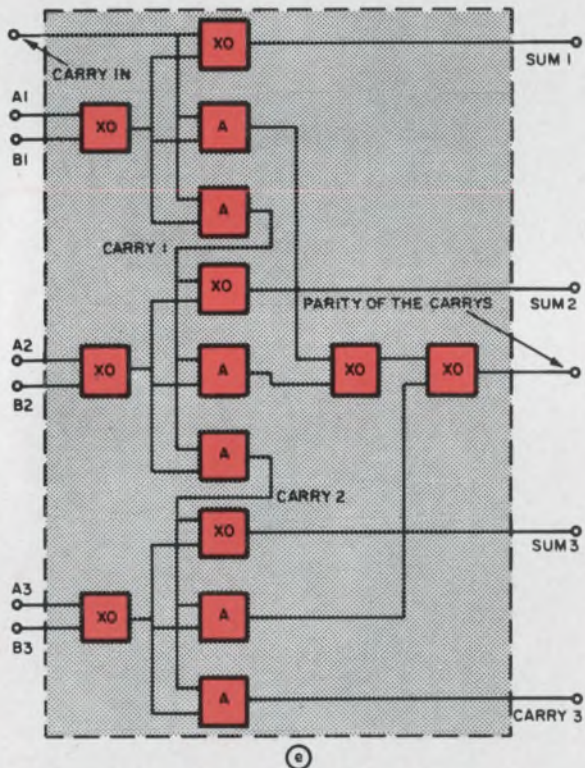
(illustration continued)



(d) 2x4 memory (≈ 55 circuits)

Functions:

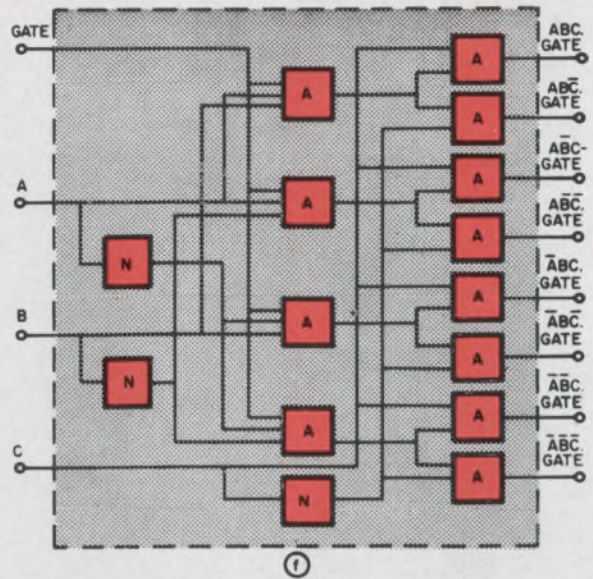
- Memory array
- Two registers driving a common bus



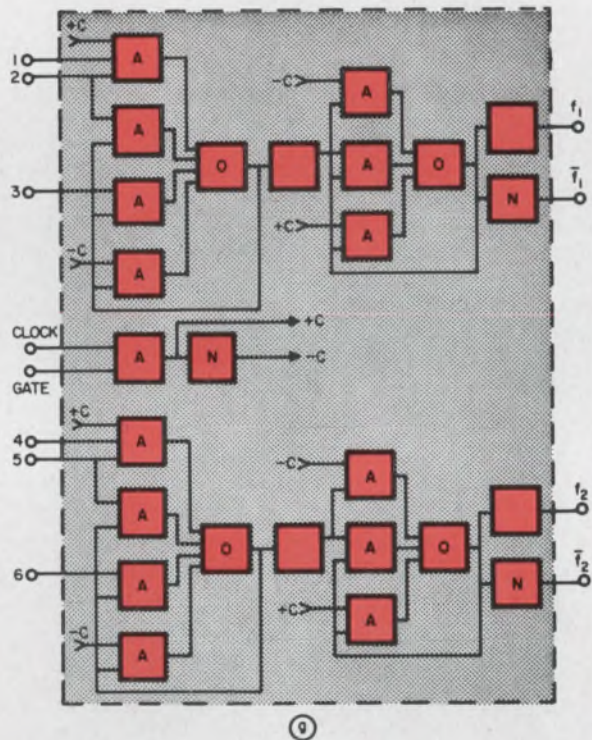
(e) 3-bit adder with carry parity (Carry is duplicated so that single failures are caught in carry lines) (46 circuits)

Functions:

- Binary adder with ripple carry and parity product checking



(f) 3-bit gated decoder (16 circuits)



(g) Two double registers (26 circuits)

Functions:

- Shift register
- Set-dominant control latch trigger
- Reset-dominant control latch trigger
- Binary counter
- Ring counter
- General double register

4. Functional modules are the most complex of the three types shown with circuits internally connected to form

specific functions. The module may implement a group of register positions, or a part of a shifter, for example.

Likewise an out-of-phase output could be fed back through a delay line to form a gated oscillator out of the module.

The adaptability of semifunctional modules is further pointed up by the three general-purpose latches of Fig. 2e. These can be used in registers, in the second half of double register control triggers, in ring counters, in binary counters and for miscellaneous storage purposes. The module could be designed with four latches, if only one phase-out were adequate.

In the four simple, two-way exclusive ORs in Fig. 2f, the circuit count is based on a design of two inverters feeding two ANDs, which in turn feed into an OR. This module has a variety of general uses—for instance, for true complementation of data in a subtractor, for binary sum formation, in comparators and in general equivalence detectors.

Functional modules

More complex than the semifunctional modules, functional modules contain both AND and OR circuits, plus their variants, interconnected on the module to form specific functions (i.e., part of an adder, shifter, etc.)

Seven functional modules are shown in Fig. 4. The parity tree of exclusive-ORs (Fig. 4a) generates or checks digit and/or byte parity. With this module, parity checking becomes so inexpensive that it encourages increased use of checking.

Figure 4b shows a count-up or count-down counter, in binary or decimal, where there is a choice of having either a carry output or a zero-state indicator. Both phases are available at each of the four bit positions. The detailed logic is not shown specifically, to help emphasize the functional job being performed. Thus the circuit count is only an estimate.

Two bits of a three-bit in-gate register with one out-gate appear in Fig. 4c. The control lines selecting one of the three data bus in-gates are brought in, to conserve pins in encoded form on two control lines instead of three (two bits can represent four combinations). Three of the combinations are used for register selection; the fourth state represents the no-gate-open condition. The delay noted in the diagram is needed to ensure that there will be no timing failure at the latch. There are both logical and circuit means of achieving this delay or its equivalent.

A module that would be used in the formation of a small integrated circuit memory or scratch pad (Fig. 4d) is a 2-by-4 memory array of four bits of two registers with common data-in and data-out buses. The module is general enough to be used in implementing data path registers as well.

Greater density—that is, nine bits rather than eight—could be obtained on this 12-pin module if

we had a 3-by-3 array. However, odd-numbered arrays are less generally useful, since data words usually contain an even number of bits. The detailed flip-flop logic is essentially like that of the latches in Fig. 2e.

Another functional module, a three-bit adder, is illustrated in Fig. 4e. Twelve pins are not adequate for a full four bits and, since the three bits implemented need only 11 pins, the twelfth is used for the parity of the carries. (A fourth bit would require two operand inputs plus one sum output for a total of 14 pins per module.) The module illustrated would be used in a parity prediction checking scheme. An alternative module (Fig. 4f) might have a two-bit adder with input-output available in either true or complement form for subtraction. Carry parity and a register on the sum output could also be provided. This would lead to substantially greater circuit density.

A three-bit gated decoder (Fig. 4g) also exemplifies what is essentially an 11-pin function—three inputs decoded to eight outputs. In this module the twelfth pin is used for a gating signal. But for greater density, a latch could be designed into each of the three input lines and the 12th pin used as an in-gate clock control line. This would provide gating as well as temporary storage at the input of the decoder.

For some applications it might be desirable to have the latches on the output lines, although this would require considerably more silicon “real estate,” since there are normally more inputs than outputs.

Finally, a functional module may contain two double registers driven by a common clock with the clock gated on the module (Fig. 4h). This furnishes the general functions needed for shift registers, set- or reset-dominant control latch-trigger combinations, binary counters, ring counters, and for general double registers. Running both registers off a common clock and gate line is not a serious restriction.

In computing the average circuits per module for each of the three categories, we find:

<i>Nonfunctional:</i>	5.4 circuits per module
<i>Semifunctional:</i>	9.1 circuits per module
<i>Functional:</i> §	36.1 circuits per module

If a machine were constructed out of the modules of Figs. 1, 2 and 4, and it were assumed that 50% of the modules are nonfunctional, 25% semifunctional and the remaining 25% functional, the over-all average density of the machine would be 14 circuits per module.

These figures provide a rough idea of the densities that can be obtained with a 12-signal-pin module set.

Part 3 of this series will deal with the choice of a logic circuit family. ■ ■

§Choosing the much lower-density module of Fig. 4e rather than Fig. 4f.

Meet any programable or fixed voltage need

Up to 150 volts • Up to 95 amps



FEATURES and DATA

Full line of accessories and options to meet your system needs. Meet Mil. Environment Specs. RFI—MIL-I-16910: Vibration: MIL-T-4807A: Shock: MIL-E-4970A • Proc. 1 & 2: Humidity: MIL-STD-810 • Meth. 507: Temp. Shock: MIL-E-5272C • (ASG) Proc. 1: Altitude: MIL-E-4970A • (ASG) Proc. 1: Marking: MIL-STD-130: Quality: MIL-Q-9858: Fungus Proofing (optional) all models available with MIL-V-173 varnish for all nutrient components.

Convection cooled—no heat sinking or forced air required
Wide input voltage and frequency range—105-132 VAC, (200-250 VAC, optional at no extra charge) 45-440 cps
Regulation (line) 0.05% plus 4MV (load) 0.03% plus 3MV:
Ripple and Noise—1 MV rms, 3MV p to p
Overvoltage protection available for all models up to 70 VDC

High Performance Option—All models available with these specifications for \$25.00 extra: Line regulation—.01% + 1MV; Load regulation—.02% + 2MV; Ripple and Noise—½MV rms; 1½MV p to p: Temp. Coef.—.01%°C

ACCESSORIES and OPTIONS



System Rack Adapters

LRA-5 • 3½" height by 27/16" depth. Price \$35.00

LRA-4 • 3½" height by 14" depth. (For use with chassis slides) Price \$55.00

LRA-5 and LRA-4 mount the following combinations of LM models: up to 4 A package sizes • 3 B or 3 C package sizes • 2 A and 1 B or 1 C package sizes

LRA-3 • 5¼" height by 27/16" depth. Price \$35.00

LRA-6 • 5¼" height by 14" depth. (For use with chassis slides) Price \$60.00

LRA-3 and LRA-6 mount the following combinations of LM models: up to 4 A, B or C package sizes • 3 CC package sizes • 2 D or 2 E package sizes • 2 A, B or C and 1 CC or 1 D or 1 E package sizes • 1 CC and 1 D or 1 E package sizes • 1 D and 1 E package sizes

Metered Panels • 3½" Metered panel MP-3 is used with rack adapters LRA-4, LRA-5 and packages A, B and C. Price \$40.00

5¼" Metered panel MP-5 is used with rack adapters LRA-6, LRA-3 and packages A, B, C, CC, D and E. Price \$40.00

To order these accessory metered panels, specify panel number which MUST BE FOLLOWED BY the MODEL NUMBER of the power supply with which it will be used.

F and G LM Packages are full rack power supplies available metered or non-metered. For metered models, add suffix M to the Model No. and \$30 to the non-metered price.

Other Options • Also available are Overvoltage Protectors, Fungus Proofing, and High Performance Options at moderate surcharges.

WIDE VOLTAGE RANGE PROGRAMABLE LM SERIES MODELS

PACKAGE A 3½"×3½"×6½"	ADJ. VOLT. RANGE VDC	*MAX. AMPS AT AMBIENT OF:				Price**
		40°C	50°C	60°C	71°C	
LM 251	0-7	0.35	0.31	0.29	0.27	\$ 69
LM 201	0-7	0.85	0.75	0.70	0.55	79
LM 202	0-7	1.7	1.5	1.4	1.1	89
LM 252	0-7	2.0	1.8	1.4	1.1	99
LM 257	0-14	0.27	0.24	0.23	0.22	69
LM 203	0-14	0.45	0.40	0.38	0.28	79
LM 204	0-14	0.90	0.80	0.75	0.55	89
LM 258	0-14	1.2	1.1	1.0	0.80	99
LM 259	0-24	0.18	0.16	0.15	0.14	69
LM 260	0-24	0.35	0.30	0.25	0.20	79
LM 261	0-24	0.70	0.65	0.60	0.45	89
LM 262	0-24	0.80	0.75	0.70	0.60	99
LM 263	0-32	0.14	0.12	0.11	0.10	69
LM 205	0-32	0.25	0.23	0.20	0.15	79
LM 206	0-32	0.50	0.45	0.40	0.30	89
LM 264	0-32	0.66	0.60	0.50	0.32	99
LM 265	0-60	0.08	0.07	0.07	0.06	79
LM 207	0-60	0.13	0.12	0.11	0.08	89
LM 208	0-60	0.25	0.23	0.21	0.16	99
LM 266	0-60	0.35	0.31	0.28	0.25	109
LM 267	0-120	0.10	0.09	0.08	0.07	109
LM 268	0-120	0.13	0.12	0.10	0.09	119

PACKAGE B 3½"×4½"×6½"	ADJ. VOLT. RANGE VDC	*MAX. AMPS AT AMBIENT OF:				Price**
		40°C	50°C	60°C	71°C	
LMB-0-7	0-7	2.8	2.6	2.3	1.5	\$109
LMB-0-14	0-14	1.6	1.5	1.3	1.2	109
LMB-0-32	0-32	0.80	0.70	0.60	0.5	109
LMB-0-60	0-60	0.45	0.40	0.35	0.3	109
LM-217	8.5-14	2.1	1.9	1.7	1.3	119
LM-218	13-23	1.5	1.3	1.2	1.0	119
LM-219	22-32	1.2	1.1	1.0	0.80	119
LM-220	30-60	0.70	0.65	0.60	0.45	129

PACKAGE C 3½"×4½"×9½"	ADJ. VOLT. RANGE VDC	*MAX. AMPS AT AMBIENT OF:				Price**
		40°C	50°C	60°C	71°C	
LM-225	0-7	4.0	3.6	3.0	2.4	\$139
LMC-0-14	0-14	2.2	2.0	1.8	1.5	139
LMC-0-32	0-32	1.1	1.0	0.90	0.80	139
LMC-0-60	0-60	0.60	0.55	0.50	0.45	139
LM-226	8.5-14	3.3	3.0	2.5	2.0	139
LM-227	13-23	2.3	2.1	1.7	1.4	139
LM-228	22-32	2.0	1.8	1.5	1.2	139
LM-229	30-60	1.1	1.0	0.80	0.60	149

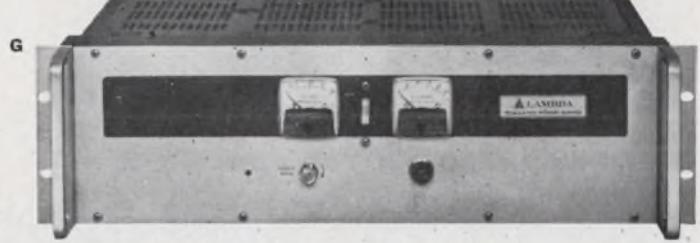
PACKAGE D 4½"×7½"×9½"	ADJ. VOLT. RANGE VDC	*MAX. AMPS AT AMBIENT OF:				Price**
		40°C	50°C	60°C	71°C	
LM-234	0-7	8.3	7.3	6.5	5.5	\$199
LMD-0-14	0-14	4.9	4.2	3.4	2.7	199
LMD-0-32	0-32	2.5	2.1	1.7	1.3	180
LMD-0-60	0-60	1.3	1.1	0.95	0.75	239
LM-235	8.5-14	7.7	6.8	6.0	4.8	199
LM-236	13-23	5.8	5.1	4.5	3.6	209
LM-237	22-32	5.0	4.4	3.9	3.1	219
LM-238	30-60	2.6	2.3	2.0	1.6	239

PACKAGE E 4½"×7½"×11½"	ADJ. VOLT. RANGE VDC	*MAX. AMPS AT AMBIENT OF:				Price**
		40°C	50°C	60°C	71°C	
LME-0-7	0-7	12.0	10.5	8.5	6.8	\$249
LME-0-14	0-14	7.4	6.4	5.2	4.1	249
LME-0-32	0-32	3.7	3.2	2.6	2.1	249
LME-0-60	0-60	2.1	1.7	1.4	1.1	249

PACKAGE F 3½"×19"×16½"	ADJ. VOLT. RANGE VDC	*MAX. AMPS AT AMBIENT OF:				Price**
		40°C	50°C	60°C	71°C	
LMF-0-7	0-7	25.0	21.0	17.0	14.0	\$425

PACKAGE G 5½"×19"×16½"	ADJ. VOLT. RANGE VDC	*MAX. AMPS AT AMBIENT OF:				Price**
		40°C	50°C	60°C	71°C	
LMG-0-7	0-7	35.0	29.0	24.0	20.0	\$575

with Lambda Modular Power Supply Systems



FIXED VOLTAGE RANGE LM SERIES MODELS

PACKAGE B 3 1/2" x 4 1/2" x 8 1/2"	ADJ. VOLT. RANGE VDC	*MAX. AMPS AT AMBIENT OF:				Price**
		40°C	50°C	60°C	71°C	
LM B3	3 ±5%	3.8	3.3	2.6	1.6	\$119
LM B3P3	3.3±5%	3.8	3.3	2.6	1.6	119
LM B3P6	3.6±5%	3.8	3.3	2.6	1.6	119
LM B4	4 ±5%	3.8	3.3	2.6	1.6	119
LM B4P5	4.5±5%	3.7	3.2	2.5	1.5	119
LM B5	5 ±5%	3.7	3.2	2.5	1.5	119
LM B6	6 ±5%	3.2	2.9	2.4	1.4	119
LM B8	8 ±5%	3.2	2.9	2.4	1.4	119
LM B10	10 ±5%	2.7	2.5	2.2	1.4	119
LM B12	12 ±5%	2.5	2.3	2.1	1.3	119
LM B15	15 ±5%	2.2	2.0	1.8	1.3	119
LM B18	18 ±5%	2.0	1.8	1.7	1.3	119
LM B20	20 ±5%	1.8	1.6	1.5	1.2	119
LM B24	24 ±5%	1.4	1.3	1.2	1.1	119
LM B28	28 ±5%	1.3	1.2	1.1	1.0	119
LM B36	36 ±5%	1.1	1.0	0.90	0.85	129
LM B48	48 ±5%	0.9	0.85	0.80	0.75	129
LM B60	60 ±5%	0.7	0.65	0.60	0.54	129
LM B100	100 ±5%	0.37	0.34	0.30	0.28	139
LM B120	120 ±5%	0.30	0.28	0.25	0.23	139
LM B150	150 ±5%	0.25	0.23	0.20	0.19	149

PACKAGE C 3 7/8" x 4 1/2" x 9 3/8"	ADJ. VOLT. RANGE VDC	*MAX. AMPS		Price**
		40°C	60°C	
LM C3	3 ±5%	5.3	3.7	\$139
LM C4	4 ±5%	5.2	3.6	139
LM C4P5	4.5±5%	5.1	3.5	139
LM C5	5 ±5%	5.1	3.4	139
LM C6	6 ±5%	4.8	3.3	139
LM C12	12 ±5%	4.0	2.9	139
LM C15	15 ±5%	3.5	2.8	139
LM C20	20 ±5%	3.1	2.6	139
LM C24	24 ±5%	2.5	2.2	139
LM C28	28 ±5%	2.3	2.0	139
LM C48	48 ±5%	1.6	1.3	149
LM C150	150 ±5%	0.39	0.33	169

PACKAGE E 4 1/8" x 7 1/2" x 11 1/8"	ADJ. VOLT. RANGE VDC	*MAX. AMPS		Price**
		40°C	60°C	
LM E3	3 ±5%	22.0	16.5	\$269
LM E4	4 ±5%	21.0	16.5	269
LM E4P5	4.5±5%	20.0	16.4	269
LM E5	5 ±5%	20.0	16.4	269
LM E6	6 ±5%	19.0	15.6	269
LM E12	12 ±5%	15.0	12.3	269
LM E15	15 ±5%	14.0	11.5	269
LM E20	20 ±5%	12.0	9.8	269
LM E24	24 ±5%	11.0	9.0	269
LM E28	28 ±5%	10.0	8.0	269
LM E48	48 ±5%	6.0	4.9	299
LM E150	150 ±5%	1.4	1.2	299

NEW PACKAGE CC 4 1/2" x 4 1/2" x 9 3/8"	ADJ. VOLT. RANGE VDC	*MAX. AMPS		Price**
		40°C	60°C	
LM CC3	3 ±5%	11.0	8.2	\$179
LM CC4	4 ±5%	11.0	8.2	179
LM CC4P5	4.5±5%	10.5	8.0	179
LM CC5	5 ±5%	10.5	8.0	179
LM CC6	6 ±5%	9.0	7.7	179
LM CC12	12 ±5%	7.3	5.9	169
LM CC15	15 ±5%	6.0	5.1	169
LM CC20	20 ±5%	5.0	4.2	169
LM CC24	24 ±5%	4.0	3.4	169
LM CC28	28 ±5%	3.5	3.1	169
LM CC48	48 ±5%	2.5	2.2	189
LM CC150	150 ±5%	0.7	0.62	199

PACKAGE F 3 1/2" x 19" x 16 1/2"	ADJ. VOLT. RANGE VDC	*MAX. AMPS		Price**
		40°C	60°C	
LM FA3	3 ±5%	31.5	24.0	\$375
LM FA4	4 ±5%	31.5	24.0	375
LM FA4P5	4.5±5%	31.5	24.0	375
LM FA5	5 ±5%	31.5	23.7	375
LM FA6	6 ±5%	30.5	22.0	375
LM FA12	12 ±5%	22.0	16.2	375
LM FA15	15 ±5%	19.4	15.2	375
LM FA20	20 ±5%	16.0	12.6	350
LM FA24	24 ±5%	14.0	11.4	350
LM FA28	28 ±5%	13.5	10.4	350
LM FA48	48 ±5%	8.1	6.5	375
LM FA150	150 ±5%	2.4	1.8	410
LM F3	3 ±5%	48.0	34.0	425
LM F4	4 ±5%	48.0	34.0	425
LM F4P5	4.5±5%	48.0	34.0	425
LM F5	5 ±5%	48.0	33.0	425
LM F6	6 ±5%	47.0	32.0	425
LM F12	12 ±5%	33.0	22.0	425
LM F15	15 ±5%	28.0	19.0	425
LM F20	20 ±5%	23.0	17.0	395
LM F24	24 ±5%	20.0	14.0	380
LM F28	28 ±5%	19.0	13.0	380
LM F48	48 ±5%	10.0	7.5	425
LM F150	150 ±5%	3.1	2.1	460

PACKAGE D 4 1/2" x 4 1/2" x 9 3/8"	ADJ. VOLT. RANGE VDC	*MAX. AMPS		Price**
		40°C	60°C	
LM D3	3 ±5%	13.1	9.2	\$199
LM D4	4 ±5%	13.1	9.2	199
LM D4P5	4.5±5%	13.1	9.2	199
LM D5	5 ±5%	12.6	9.2	199
LM D6	6 ±5%	12.4	8.9	199
LM D12	12 ±5%	10.0	8.3	199
LM D15	15 ±5%	9.0	7.9	209
LM D20	20 ±5%	7.4	6.5	209
LM D24	24 ±5%	6.7	5.8	219
LM D28	28 ±5%	6.0	5.2	219
LM D48	48 ±5%	4.1	3.6	239
LM D150	150 ±5%	1.1	0.90	254

PACKAGE G 3 1/4" x 19" x 16 1/2"	ADJ. VOLT. RANGE VDC	*MAX. AMPS		Price**
		40°C	60°C	
LM G3	3 ±5%	95.0	62.0	\$575
LM G4	4 ±5%	85.0	62.0	575
LM G4P5	4.5±5%	85.0	62.0	575
LM G5	5 ±5%	80.0	62.0	575
LM G6	6 ±5%	80.0	62.0	525
LM G12	12 ±5%	56.0	37.0	525
LM G15	15 ±5%	45.0	36.0	525
LM G20	20 ±5%	35.0	28.0	525
LM G24	24 ±5%	32.0	21.0	480
LM G28	28 ±5%	28.0	21.0	480
LM G48	48 ±5%	17.0	12.0	575
LM G150	150 ±5%	5.5	4.5	675

NOTE:

Space does not permit listing all LM Series fixed-voltage power supplies. In every package size there are models for each voltage range listed under the B package and all units are multi-current-rated for 40°C, 50°C, 60°C and 71°C. Call or write for data and prices.

* Current rating is from zero to I max. at ambient. Current rating applies over entire output voltage range.

Current rating applies for input voltage 105-132 VAC 55-65 cps.

For operation at 45-55 cps derate current rating 10%.

For operation at 360-440 cps consult factory for ratings and specifications.

** Prices F.O.B. Factory, Melville, N. Y. All specifications and prices subject to change without notice.



SEND FOR NEW CATALOG ON FIXED VOLTAGE
AND WIDE RANGE MODULAR POWER SUPPLIES

ON READER-SERVICE CARD CIRCLE 43

LAMBDA ELECTRONICS CORP. A **Veeco** SUBSIDIARY
615 BROAD HOLLOW ROAD · MELVILLE, L. I., NEW YORK · 616 MYRTLE 4-4200

Estimate the boresight error before getting a radome for your radar. For the least error at reasonable cost, you must know the trade-offs.

Radomes introduce errors into the boresight of radars. The question is: How much is the error, what factors affect it and what can be done to reduce it? It is impossible to eliminate the error completely, but careful considerations and trade-offs can reduce it to an acceptable level. The limitations imposed by available materials, structural requirements and environmental conditions are the main points that have to be accounted for.

By definition, the boresight error is the angular deviation of a ray from its true projection as it passes through the radome. The error is due basically to radome curvature and is a function of the incident angle of the microwave ray to the radome surface.

The deviation of the microwave ray as it passes through a single-wall radome may best be understood with the aid of Fig. 1. The deviation angle, D , of the ray from the true projection is given by:

$$D = i_2 - r_2 - i_1 + r_1, \quad (1)$$

where

$i_{1,2}$ = incident angles of ray to the normals, ($n_{1,2}$), at the points of entering or leaving the radome skin, and

$r_{1,2}$ = refraction angles.

Note that D is the actual boresight error.

Through geometric considerations, D may be resolved to functions of the ratio of interior-incidence-angle thickness to radius, and of the index of refraction. In complete form this equation may be stated as:

$$D = \sin^{-1}[\sin i_1 / (1 + t/R)] - i_1 + \sin^{-1}(\sin i_1 / \mu) - \sin^{-1}\{\sin i_1 / [\mu(1 + t/R)]\}, \quad (2)$$

where

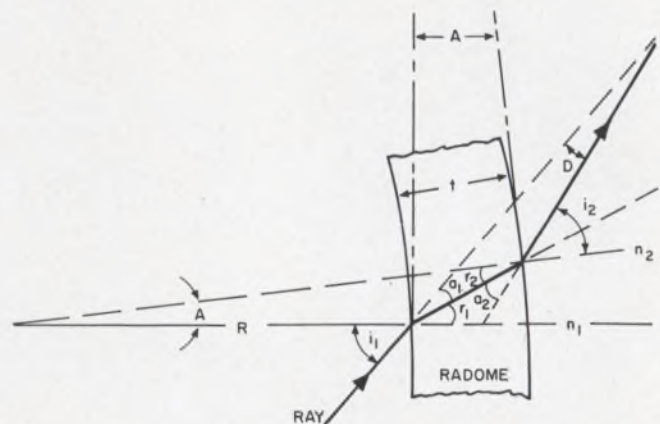
R = radome radius,

t = radome thickness,

μ = index of refraction = $\sin i / \sin r = (\epsilon/\epsilon_0)^{1/2}$
= (dielectric constant)^{1/2}.

Theoretically the beam at the antenna and radome center will not be deflected. The error is introduced only where the incidence angle of the beam is other than 90°. For example, consider a parabolic dish in the center of the radome. The angle of incidence of the reflected rays is largest at the edge of the dish. This increase in the angle results in increasing boresight error, which, in turn, introduces a diffusion, or spread, of the antenna pattern. In practice the boresight error is also affected by the dielectric constant of the material at microwave frequencies, the thickness of the material and the radome's diameter. Let's examine the effect of each individually.

Angle of Incidence. The greater the angle of incidence, the greater the boresight error. This is shown quite clearly in the graph of Fig. 2. By simple deduction it may be seen that, when considering boresight error only, the antenna should be located at the geometric center of the radome in order to minimize the angle of incidence. This, however, may not always be feasible because of the antenna design (such as with a horn antenna), or where the resultant radome would be signifi-



1. Deviation of the microwave ray, as it passed through a single-wall radome is the boresight error, D . It is determined by the index of refraction, the interior angle of incidence, i_1 , and the thickness-to-radius ratio, t/R .

Milton B. Punnett, Asst. Chief Engineer, Birdair Structures, Inc., Buffalo, N. Y.

cantly oversize and economically unjustifiable. By oversize is meant that the radome is much larger than needed merely to house the antenna with a reasonable amount of clearance (6-8% of the antenna's radius is considered a minimum clearance).

Dielectric Constant. The exact effect of increasing the dielectric constant is not readily apparent from inspection of the equations. In typical applications, an increase in dielectric constant tends to increase the boresight error. The dielectric constant may be controlled by careful compounding of the coating. Unfortunately, it is much easier to increase the constant (by adding such materials as carbon black or titanium dioxide) than it is to achieve and hold a small reduction.

Thickness. As t is reduced, the angle A in Fig. 1 approaches zero and the radome's skin resembles two parallel surfaces with zero spacing. This configuration would obviously reduce error to zero. It may thus be concluded that reducing the thickness will reduce the error. It is also clear that such measures will reduce the physical strength of the radome. The relation of reduced thickness for improved electrical performance vs increased thickness for improved physical properties is frequently a basic trade-off in radome design. Some specific dimensions, which are typical of actual installations, are used as examples in the graphs.

Diameter. An increase in the radome diameter tends to reduce the boresight error, as shown in Fig. 3. This is true even if the angle of incidence remains the same, and even though the thickness may have to be increased to obtain sufficient strength. Other factors, such as increased transmission loss through the thicker skin, must be considered in the over-all selection.

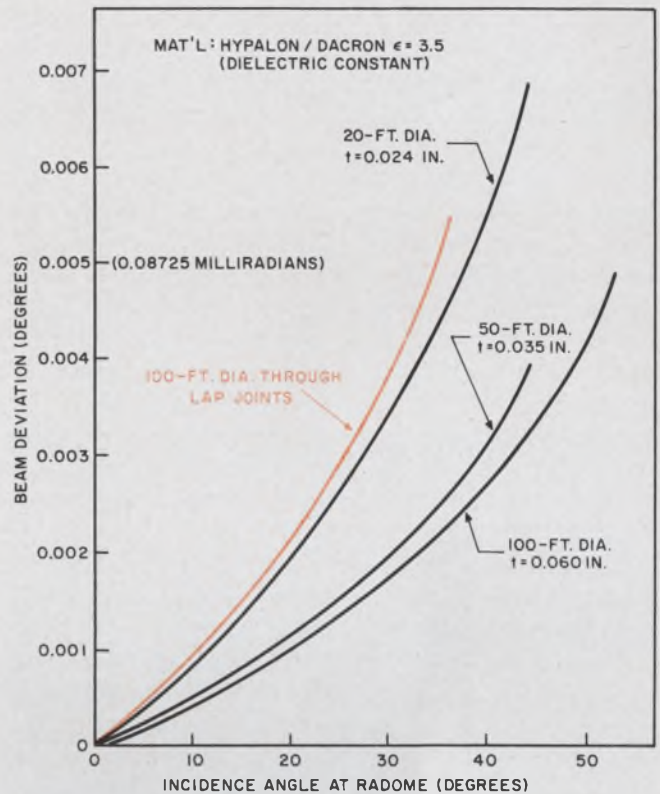
The price is high for good materials

Although many compounds and fabric-coating materials are available, three basic types are used for the majority of air-inflated radomes.

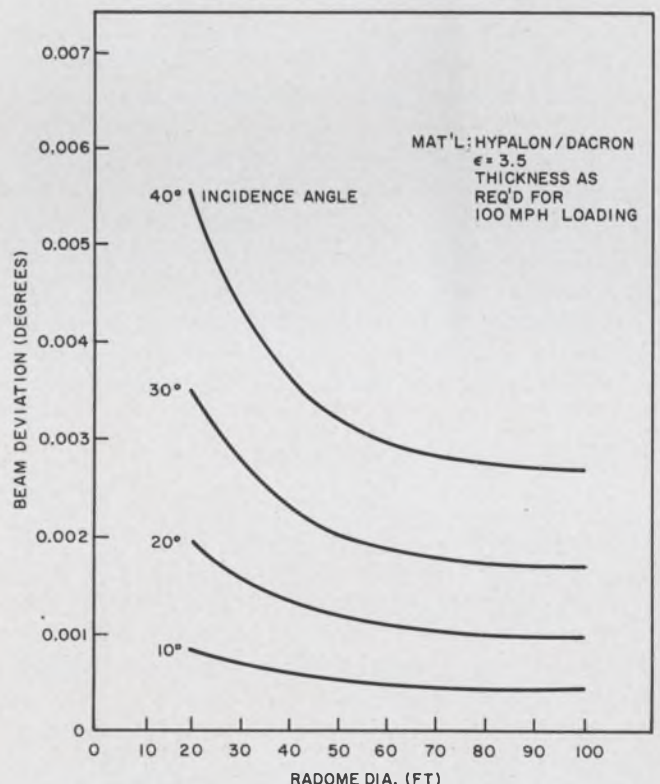
Neoprene with nylon fabric is structurally sound and allows easy fabrication. However, it normally has dielectric constants exceeding 4, even in the most favorable compounds. It also tends to absorb water.

Hypalon with Dacron fabric is used today in the majority of critical radome applications. It has superior strength, life, and electrical performance compared with the original neoprene materials. With careful compounding, the dielectric constant can be held at 3 to 3.5. It is the most expensive material and normally custom-made for specific applications.

Vinyl with nylon fabric is the least expensive. In most cases it also has the lowest dielectric constant, frequently averaging 2.5 to 3. Unfortunately, its fabrication does not lend itself to two-



2. Boresight error increases with the angle of incidence, which is measured from the normal at the point of incidence. Considering boresight error alone, the antenna should be located at the geometric center of the radome. The error doubles through the lap joints (in color).



3. An increase in the radome diameter tends to reduce boresight error, even though the wall thickness may have to be increased too. The curves are plotted for a single-skin air-supported radome.

plying and this it is not possible to develop the strength characteristics of the Hypalon-Dacron. In addition, the plasticizer tends to be dissipated during exposure and thus its service life is not equal to that of the Hypalon.

A general idea of the range of application for these three basic substances may be formulated. Bear in mind, however, that in each case there can be considerable latitude in the selection of base fabric, plying, and coating. In addition, different safety factors normally apply to each material, and these factors are frequently modified for applications of unusual exposure or service.

Neoprene-nylon is available in two-ply thickness up to approximately 0.050 inch, which is suitable for radome diameters of up to about 110 ft with 100-mph wind loads.

Hypalon-Dacron has been used in two-ply thickness up to 0.072 inch in radomes of 210-ft diameter with 100-mph wind loads.

Vinyl-nylon is available in single-ply thickness up to approximately 0.030 inch. With 100-mph winds loads, this is sufficient for radomes slightly over 50 ft in diameter. Of course, larger diameters may be used where maximum winds are below 100 mph, or where shorter life, reduced safety factor and increased wind distortion are acceptable.

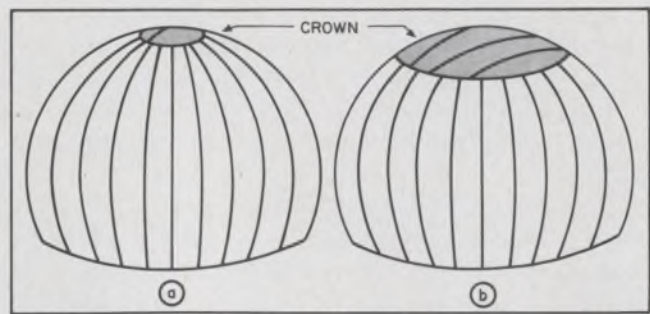
In all three compounds, materials as thin as 0.008 inch are available in a single ply. Such material, however, must be used with care as it is susceptible to accidental abrasion and tear damage.

It should be realized that only certain thicknesses are readily available, even though it is possible to develop a specific material for a specific application. A very limited selection is available as stock from the various suppliers. A much larger selection is available from previously developed combinations (whose specifications may be considered as proprietary to a particular radome fabricator), and special thicknesses can generally be produced if they are compatible with physical requirements. It is the responsibility of the purchaser or radome fabricator to insure satisfactory properties and assume any associated risk.

Examples illustrate typical errors

As the most frequent application involves Hypalon-Dacron, the following example and the graphs shown are based on this material (Two-ply Hypalon-Dacron is used on all the larger air-inflated radomes covering the satellite communication antennas in the United States, France, Germany, and Canada.)

Consider the case where a 100-ft diameter radome is required. A typical high-strength radome of this size would have a total thickness of 0.060 inch. Assume that the antenna is offset 13 ft from the center, which results in an angle of incidence of 15° . Calculation of the boresight



4. Errors through the lap joints may be reduced by careful design. Conventional construction increases the number of joints near the crown (a). Multiple-gore crown area cuts back joint concentration near the crown and reduces boresight error (b).

error would be:

$$\begin{aligned} R &= 50 \text{ ft} = 600 \text{ in.}, \\ t &= 0.060 \text{ in.}, \\ t/R &= 0.0001, \quad 1 + t/R = 1.0001, \\ \mu &= (\epsilon/\epsilon_0)^{1/2} = 3.5^{1/2} = 1.872, \\ i &= 15^\circ, \quad \sin i = 0.2588190. \end{aligned}$$

Enter these values into Eq. 2:

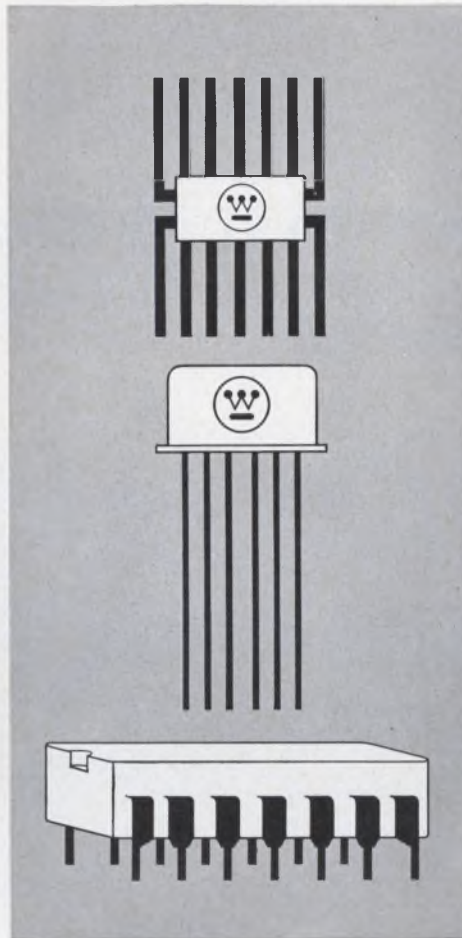
$$\begin{aligned} D &= \sin^{-1}(0.2588190/1.0001) - 15^\circ \\ &+ \sin^{-1}(0.2588190/1.872) \\ &- \sin^{-1}[0.2588190/1.872(1.0001)] \\ &= -0.007408^\circ. \end{aligned}$$

The minus sign indicates that $a_1 < a_2$ in Fig. 1 and the beam is deviating away from the straight projection.

The deviation for three typical radomes, as a function of angle of incidence, is shown in Fig. 2. In each case the actual thickness corresponding to each radome size has been used. (Each radome was designed for wind loads exceeding 100 mph.)

The error doubles through the lap areas where the radome panels are joined together (Fig. 2). Even though the lap joint is only about 8% of the total surface area, in normal radome gore patterning the concentration of lap joints increases towards the crown. This tends to increase the error in this region to the vicinity of the values shown for the lap joint. Repatterning the crown area (Fig. 4) and selection of premeasured, low-boresight-error material for the crown region can reduce the error. Such techniques increase costs and, on large radomes, result in longer lead time, since a significant portion of the material must be received, tested and assigned a location prior to assembly.

The incident angle may be converted to the distance from the center of the radome for a specific ray. This would correspond to a specific point on an antenna dish when the antenna is located at the center of the radome. For example, if an 80-ft parabolic reflector is centrally mounted in the 100-ft radome, the beam deviation at the edge of the dish would be 0.005° . A mounting error of 0.0004 inch in a 6-ft section of an antenna at one edge of the dish would yield the same error as that caused by the radome. ■ ■



Workhorse DTL

Four reasons why Westinghouse WC 200 IC's are a clear first choice for trouble-free computer and control systems.

The Westinghouse DTL line has been designed into so many successful computer and control equipments that it has won the supreme endorsement: It is being second-sourced by four major integrated circuit producers.

Reasons? First — reliability. WC 200 series designs have been proved by 5 million hours of life testing since their introduction in 1962 and have been continually improved since then. Major users report a 20 to 1 improvement in system reliability over previous discrete-component circuits. Just try to find any other digital line backed by such massive proof of reliability!

Second reason — speed. WC 200's six volt design with or without built in collector resistors increases speed and flexibility, keeps power dissipation down. And the use of the single-stage JK flip-flops rather than a master-slave arrangement makes WC 200 inherently fast.

Third reason — the greatest versatility in commercial DTL. Circuits are available in all 3 industry accepted packages. The line includes 15 gate circuits with 1 to 6 gates per package in a variety of input arrangements, 2 RS flip-flops, 2 JK flip-flops, 1 pulse binary counter, plus diode expanders and a large variety of interface circuits.

Fourth reason — immediate local availability at competitive prices. Behind the Westinghouse WC 200 line are both the most advanced IC plant in the industry and the longest production experience in integrated DTL. Result: high yields, and the greater production, increased reliability, and lower costs that you would expect to go with them.

These should be all the reasons you need to investigate WC 200 series DTL now. For immediate delivery, call your Westinghouse electronic distributor. For technical data, write Westinghouse Molecular Electronics Division, P.O. Box 7377, Elkridge, Maryland 21227.

You can be sure if it's Westinghouse



J-09134

ON READER-SERVICE CARD CIRCLE 44

A manager can't do it all himself. Learn to delegate authority, and you'll be coordinating a highly successful project group.

Maybe you're not a manager now, but you may be tomorrow. Your chances of success will be immeasurably improved if you follow one basic principle: delegate work wisely.

A manager's effectiveness depends upon his ability to get work done through people. He must delegate work so efficiently that high productivity results, with profits to his company. To achieve this, a healthy, cooperative atmosphere must exist between employee and manager.

Delegation of work is an art. It takes conscious effort to cultivate certain attitudes. If you aspire to be a successful manager, here are three rules to start with:

- Keep an "open mind."
- When an employee makes an honest mistake, try to turn it to advantage.
- Don't overdirect subordinates.

The manager must be receptive to new ideas, new methods. This does not mean that all managerial decisions must be subject to debate by employees. But there is such a thing as listening to suggestions from them. There is such a thing as tact in issuing orders and seeing that they are carried out. And what employee doesn't appreciate praise for a job well done?

One of the easiest things in the world is to fly off the handle when a subordinate makes a mistake—particularly a mistake that looks costly at first glance. It takes a trained manager to analyze the mistake for possible gain. How many discoveries, after all, resulted from "mistakes" in the laboratory?

Of course, we all know how irritating it can be to be assigned a flexible job and then have the supervisor stand over us and hound us until, step by step, the job is finished in precisely the way he would have done it himself. Such a manager wants automata, not people, on his staff.

Let's observe a good manager in operation. John is the engineering chief of an electronics plant. One day he had to supervise a fairly tough

job: the mechanical attachment of a 0.003-in.-diameter tantalum wire to an OFHC copper base. He set down his guidelines for a proposed method and discussed the problem with Harry, one of his engineers. Harry suggested that a swaging method—quite different from John's approach—might work out better. John listened. The idea seemed to have merit, but he cautioned Harry on several difficulties that could arise. He mentioned the extremely tight work schedule that the plant had to meet, but gave Harry the green light to try his idea.

Within a day, when John checked the progress on the job, Harry admitted that dimensional tolerance of the copper had been lost with the swaging method. Discouraged, he was about to scrap his idea. John took stock of the situation and discussed the positive aspects of Harry's method. He particularly noted that the swage method did a better job of fastening than had been achieved before and that the dimensional loss in the copper was due only to upsetting the material in the wrong direction.

"What can you do to your swage tool that will move the metal down and in toward the lead wire?" John asked Harry.

A day later Harry came in with a handful of parts that were better than any ever before produced by the company. And within a week there was a bonus: an automatic wire feeder, spinner and cut-off mechanism—made possible by the original swage tool.

A little encouragement goes a long way.

(continued on p. 90)



Louis S. Saiia, Director, VALTEC/Value Technology, Sunnyvale, Calif.

Planning

- Determine the objectives of the work to be performed.
 - Analyze past and present trends.
 - Elicit ideas and participation from person to whom you intend to delegate work.
- Establish policies and goals.
 - Determine priorities for the objectives.
 - Anticipate obstacles or difficulties to be encountered and select practical steps to overcome them.
 - Anticipate interface with other organizations and devise means for coordinating with them.
- Formulate ideas, schedules and standards of performance; be realistic in your planning with respect to time schedules, budget and manpower.
- Make the objectives and plan known to all who will be affected.
- Use the results of Measuring to adjust the work of Planning.



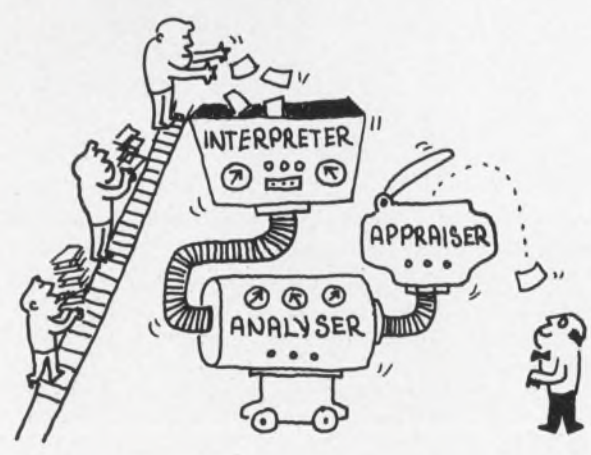
Organizing

- Determine and classify the work required by dividing it into manageable components.
 - Classify into logical and easily understood kinds of work.
 - Don't overload subordinates with responsibility and work.
- Assign the proper authority needed to accomplish the work.
 - Define responsibility, accountability and authority (both that required for the job and that which will be reserved).



Integrating

- Show the common purpose that integrates all aspects of this work.
- Obtain sincere voluntary acceptance of the assignment.
- Encourage individual self-development.



Measuring

- Establish a measuring system that has an orderly recording and reporting method (informal oral reports; weekly, semimonthly or monthly written reports; and a formal quarterly report).
- Create an interpreting, analyzing and appraisal system.
 - Appraise by comparison with other projects that are similar in nature.
 - Determine performance and deviations.
- Adjust the Planning stages to reflect the measured results.

Ralph J. Cordiner, president of General Electric, has passed this bit of advice on to those who would be good managers:¹

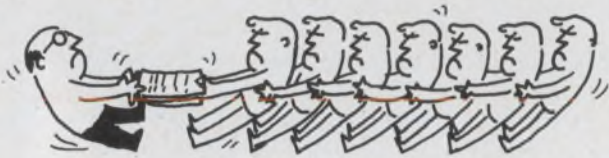
"The work of the manager requires conscious selection of the tasks reserved for himself. Then it requires deliberate delegation of everything else to others in the organization within the framework of his well-designed organization pattern, *no matter what wrench this will require* from his working habits."

Executives like Cordiner have found that, though there are no absolute laws for dealing with people, there are general methods of good management that are effective.

The American Management Association lists 15 problem areas to avoid in delegating authority.² Here they are, rephrased into five "don'ts" and five "do's":

- Don't use vague language when you delegate work. For instance, suppose you want a contract reviewed. Don't just ask your engineer to review the specifications. Clearly establish what the objectives are and set down guidelines in clear, readily intelligible language.

- Don't use haphazard and poorly organized ideas. Many managers have a tendency to say that if they want anything done right away, they have



to do it themselves. Actually, this is merely a cover-up for their own shortcomings and false starts, for each of their own abortive beginnings helps them to clarify more exactly what they in fact want. Now, if they plan carefully before any work commences, they will avoid most mistakes regardless of who does the job.

- Don't assume that the person to whom you delegate work automatically knows what you want done. Spell it out for him specifically, and include background details, if these are important.

- Don't talk down to employees. Listen to their suggestions. Many of us have spent so much time in classrooms, either as students or teachers, that we tend to revert to the classic professorial role when we become managers in industry. Employees resent being treated as dense students. So do managers, only they sometimes forget how irritating it can be.

- Don't nag after you have delegated work. Establish your reporting and follow-up schedule before you delegate the task. That's the time to make it clear that the schedule will be adhered to, unless something unforeseen occurs to change it.

Explain that if something should threaten the deadline, you must be informed.

The moral of these "don'ts" is clear: if you want to delegate work successfully, you must first get your own house in order.

Then make these "do's" part of your routine:

- Do select the proper employee for the job. Know the abilities, limitations and work needs of your staff. Assign projects and work within an employee's capacity but also keep him stretching for new knowledge and skills.

- Do use examples and demonstrations, if necessary, before turning a subordinate loose on his own. Good delegating practice is a training tool. By informative examples, visual aids and effective presentation, the manager sets the pace of his organization.

- Do limit the number of orders given at one time. There is no set rule on this, but if the length or complexity of the job warrant it, break down the instructions into small, logical parts.

- Do allow reasonable time schedules. Take into account contingencies aside from the time that it might normally take to perform the task—the ability to procure scarce materials, for example.

- Do follow up in an orderly fashion. Demonstrate a genuine involvement with your staff. Tour the shop, look over the work in progress, tackle on the spot any special problems that your employees



might be having. Save open criticism of work for private meetings in your office.

When Harry S. Truman was President, he had a now famous sign on his desk: "The buck stops here." The sign was a reminder that some jobs, some responsibilities can't be delegated to others. You alone must face these. You simply cannot, for example, delegate to anyone else the responsibility for disciplinary action or for matters of standard company operating policies.

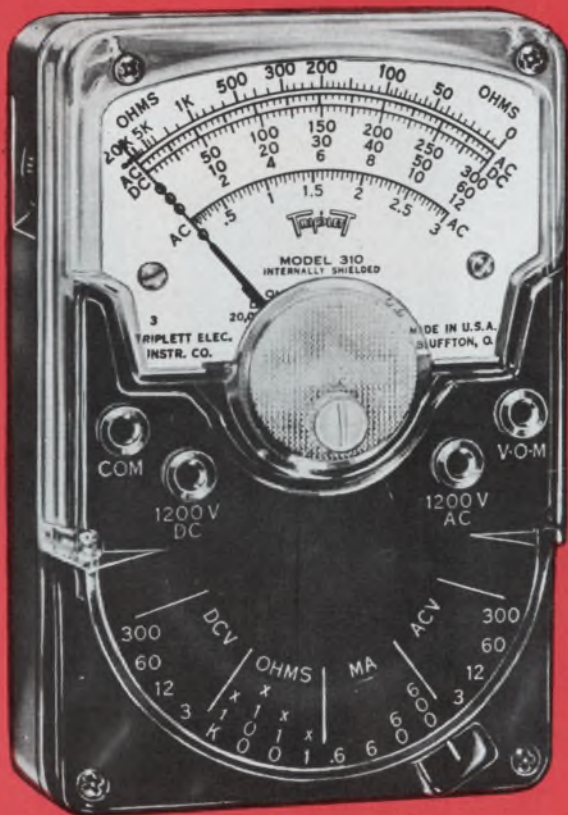
Finally, remember this: the fact that you delegate authority doesn't mean that you are no longer answerable for your subordinates' mistakes. Upper management will still hold you at fault. And that's why it's to your advantage to delegate authority wisely. ■■

References:

1. "Professional Management in General Electric," *Estter Business Management Course* (Schenectady, N. Y.: General Electric Co., 1954), Book 3.
2. M. J. Doohar (ed.), *Pointers on Giving Orders* (American Management Association, 1956).

**WORLD'S LARGEST SELLING
AND WORLD'S NEWEST**

Hand Size V-O-M's



MODEL 310
World's Largest Selling
Volt-Ohm-Milliammeter

MODEL 310-C
World's Newest
Volt-Ohm-Milliammeter



**BOTH TESTERS
SHOWN
ACTUAL SIZE**

- 1** HAND SIZE AND LIGHTWEIGHT, but with the features of full-size V-O-M's.
- 2** 20,000 OHMS PER VOLT DC; 5,000 AC (310)—15,000 AC (310-C).
- 3** EXCLUSIVE SINGLE SELECTOR SWITCH speeds circuit and range settings. The first miniature V-O-M's with this exclusive feature for quick, fool-proof selection of all ranges.

SELF-SHIELDED Bar-Ring instrument; permits checking in strong magnetic fields. FITTING INTERCHANGEABLE test prod tip into top of tester makes it the common probe, thereby freeing one hand. UNBREAKABLE plastic meter window. BANANA-TYPE JACKS—positive connection and long life.

Model 310—\$40.00 Model 310-C—\$50.00 Model 369 Leather Case—\$3.50

ALL PRICES ARE SUGGESTED U.S.A. USER NET, SUBJECT TO CHANGE

THE TRIPLETT ELECTRICAL INSTRUMENT COMPANY, BLUFFTON, OHIO

310-C PLUS FEATURES

1. Fully enclosed lever range switch
2. 15,000 Ohms per volt AC (20,000 O/V DC same as 310)
3. Reversing switch for DC measurements

MODELS 100 AND 100-C

Comprehensive test sets. Model 100 Includes: Model 310 V-O-M, Model 10 Clamp-on Ammeter Adapter; Model 101 Line Separator; Model 379 Leather Case; Model 311 leads. (\$73.50 Value Separate Unit Purchase Price.)

MODEL 100—U.S.A. User Net. \$70.00

MODEL 100-C — Same as above, but with Model 310-C. Net.\$80.00



USES UNLIMITED: FIELD ENGINEERS • ELECTRICAL, RADIO, TV, AND APPLIANCE SERVICEMEN • ELECTRICAL CONTRACTORS • FACTORY MAINTENANCE MEN • ELECTRONIC TECHNICIANS • HOME OWNERS, HOBBYISTS
THE WORLD'S MOST COMPLETE LINE OF V-O-M's • AVAILABLE FROM YOUR TRIPLETT DISTRIBUTOR'S STOCK

**ENGINEERS
ENGINEERS
ENGINEERS
ENGINEERS
ENGINEERS
ENGINEERS
ENGINEERS
ENGINEERS
ENGINEERS
ENGINEERS
ENGINEERS
ENGINEERS
ENGINEERS
ENGINEERS
ENGINEERS
ENGINEERS
ENGINEERS
ENGINEERS**

**expect a call from
LOCKHEED**

If you're a qualified aerospace engineer interested in a career in developmental aviation with a company that is setting the pace in subsonic, supersonic and hypersonic speed regimes, fill out the simple form below and mail it to Mr. E. W. Des Lauriers, Professional Placement Manager, Lockheed-California Company, Dept 6005, 2401 No. Hollywood Way, Burbank 91503. Lockheed will call you!

Gentlemen: Please have a Lockheed representative phone me at home to discuss the opportunities available at Lockheed. The most convenient time I can be reached is:

Day _____ Time _____ A.M. _____ P.M.

Name _____

Home Phone No. _____

Street Address _____

City _____ State _____

My field of interest is: _____

LOCKHEED - CALIFORNIA COMPANY
A DIVISION OF LOCKHEED AIRCRAFT CORPORATION
LOCKHEED IS AN EQUAL OPPORTUNITY EMPLOYER

ON CAREER-INQUIRY FORM CIRCLE 901

92

*Would you believe... NOT ALL
MARRIAGES ARE MADE IN HEAVEN!*



The squiggly engineers vs. the angular engineers. RF vs. digital. How could Motorola possibly achieve a harmonious marriage between these two hostile technologies? It wasn't easy, but we did it. With the know-how gained from our S-band Rendezvous System, we used the best features of tone ranging, plus the advantages of digital (pseudo random noise) ranging — and came up with a real love-match: Motorola's Hybrid Ranging System.

We're still a bit short-handed to make this a prolific marriage. Sorry about that. So if you can do systems analysis, circuit design (you can play the squiggles or work the angles) — or have picked up some specialty of your own — write Phil Nienstedt, Manager of Recruitment, Department 629.

Other Specific Opportunities are:

Space Communications
Radar Systems
Tracking & Telemetry
Fuzing
Digital Data Transmission
Guidance & Navigation
ECM & Elint

Checkout Systems
Coherent Transponders
Radar Transponders
Integrated Electronics
Antennas & Propagation
Reliability & Components
Advanced RF & Microwave Techniques



Government Electronics Division · Aerospace Center

P.O. Box 6210, Scottsdale, Arizona

MOTOROLA ALSO OFFERS OPPORTUNITIES AT CHICAGO, ILLINOIS — AN EQUAL OPPORTUNITY EMPLOYER

ON CAREER-INQUIRY FORM CIRCLE 902

ELECTRONIC DESIGN 24, October 25, 1966

CAREER INQUIRY – confidential

Respond to the career opportunities advertised in this issue. Fill out and send us this handy resume. **Electronic Design** will do the rest – neatly typed copies of this form will be mailed to the companies of your choice, indicated by the circled Career Inquiry Numbers at the bottom of this page.

24

Name		Home Phone	
Home Address (Street)		City	State
			ZIP Code
Age	U.S. Citizen <input type="checkbox"/> Yes <input type="checkbox"/> No	Security Clearance	

Prime Experience	Secondary Experience

Desired Salary	Availability Date
----------------	-------------------

Employment History – present and previous employers

Company	City, State	Dates	Title	Specialty
		to		
		to		
		to		

Education – indicate major if degree is not self-explanatory

Degree	College	City, State	Dates
			to
			to

Additional Training – non-degree, industry, military, etc.

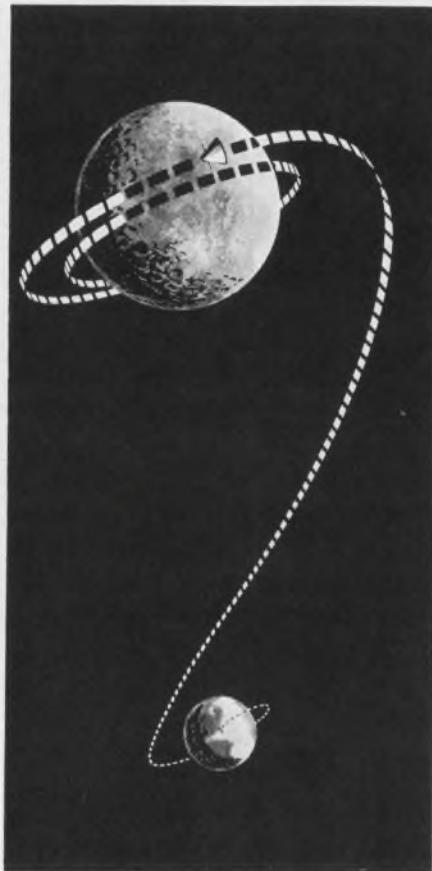
Professional Societies

Published Articles

Career Inquiry Numbers:

900	901	902	903	904	905	906	907	908	909
910	911	912	913	914	915	916	917	918	919

ELECTRONIC DESIGN
 850 Third Avenue
 New York, New York 10022



Challenge:

Which path would you take to the moon?

This question is easy compared to some of the problems of developing mission programs for Apollo. Yet—unless you are involved, you may not realize that the minimum energy trajectory is the one on the right. The flight computer programs to guide each Apollo mission will be developed, programmed, and certified beforehand. Typically, over seventy-two thousand, sixteen-bit words and one computation, occurring every twelve microseconds, will be involved. It's another example of AC's guidance and navigation systems for the Command Module and the Lunar Module. Other AC projects: SABRE, a new reentry system for missiles; the new Ships' Self-Contained Navigation System (SSCNS); navigation systems for low-level aircraft; the guidance system for the Titan III; a computerized fire-control system for the new Main Battle Tank, a joint U.S.-Federal Republic of Germany program; ILAAS (Integrated Avionics System).

These are just a few of the challenging opportunities that await you at AC Electronics. Check the opportunities, listed below, for our three locations . . . Milwaukee, Santa Barbara, Boston. Then send your resumé, including salary requirements, to: Mr. R. E. Schroeder, Dir. of Scientific & Professional Employment, Dept. 5753, AC Electronics Div., Milwaukee, Wis. 53201.

MECHANICAL DESIGN ENGINEERS
ELECTROMECHANICAL PACKAGING ENGINEERS
STRESS/VIBRATION/THERMAL ANALYSTS
SCIENTIFIC PROGRAMMERS
COMPUTER SYSTEMS ANALYSTS
GUIDANCE/TRAJECTORY ANALYSTS
GUIDANCE/NAVIGATION EQUATION ANALYSTS
DIGITAL FLIGHT CONTROL ENGINEERS
PRODUCTION ENGINEERS

DIGITAL CIRCUIT DESIGNERS
COMPUTER LOGIC DESIGNERS
ELECTRONIC DESIGN ENGINEERS
DIGITAL SYSTEMS ENGINEERS
SYSTEMS DESIGN ENGINEERS
SYSTEMS ANALYSIS ENGINEERS
SYSTEMS MECHANIZATION ENGINEERS
TEST ENGINEERS
TEST EQUIPMENT DESIGNERS



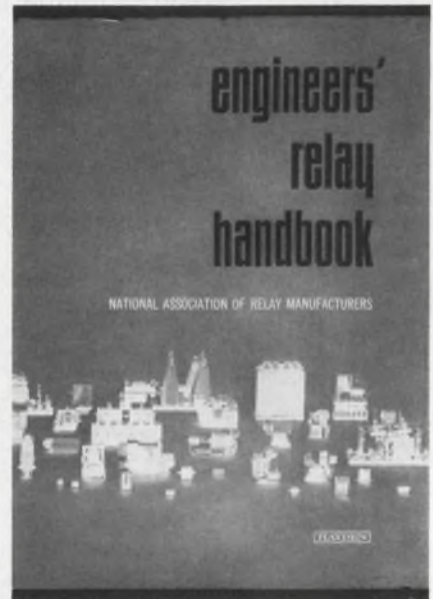
AC ELECTRONICS
DIVISION OF GENERAL MOTORS
AN EQUAL OPPORTUNITY EMPLOYER M & F



MARK OF EXCELLENCE

ON CAREER-INQUIRY FORM CIRCLE 903

Book Reviews



Relay Handbook

Over 32 member companies of the National Association of Relay Manufacturers have joined forces to produce this definitive relay reference work. The book will serve readers as a comprehensive source of information on the operating principles, properties, performance characteristics, application requirements, specifications and testing of the numerous relay types now in use.

The organization and language of the book are aimed at the relay user rather than the relay designer. This in itself makes it unique from previous works of its kind.

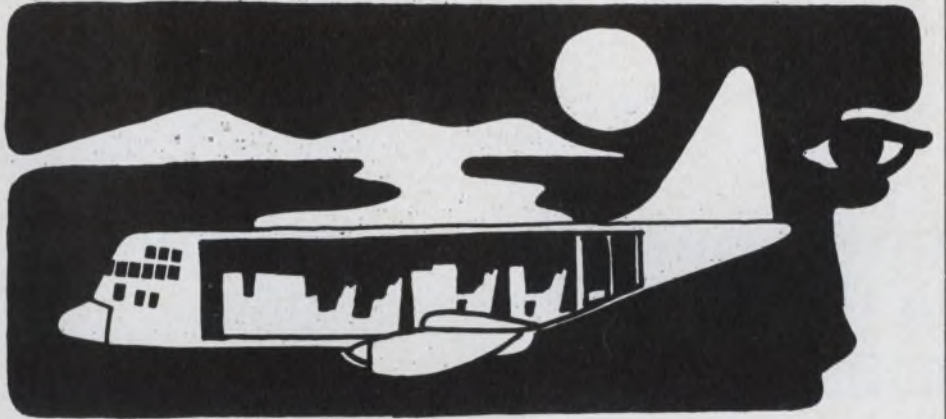
While the book provides a thorough discussion and description of relay technology, the main emphasis is practical. In this context, an entire chapter is devoted to the considerations involved in specifying the right relay for a particular application. Other chapters describe the different classes of use and the relays developed for these classes; explain the measurement and expression of relay reliability; and demonstrate the effective use of government and military specifications, with a discussion of the problem of overspecifying. The appendix contains extensive information valuable to engineers for the incorporation of relays into circuits or

CHALLENGE

"an invitation to join in a contest"



The challenge offered by a career with LTV Electrosystems is not unlike an invitation to a contest. This "contest" — an intense, high-spirited competition within a framework of unlimited opportunity. At LTV Electrosystems you'll also be an indispensable part of a larger challenge: to help us compete in a crowded marketplace by producing a better idea, a better product. That we have met this challenge with success is a matter of record. Combining



youth with experience we have grown on all fronts: a sales curve shooting off the top of the chart, new facilities, expanded

tronics systems for ground, air and space environments; nuclear detection; command and control; communications; information processing and display; antennas; electronic warfare; range instrumentation and tracking; satellite tracking, and more. R & D capabilities are channelled into four basic technical fields: systems analysis, information collection, information processing and vehicle support. Our place in the sun is Greenville, Texas (near Dallas), in a pleasant region of great recreational, cultural and educational opportunity. (For example, an exclusive closed circuit TV system will soon link our Greenville facility with special graduate engineering classes beamed from Southern Methodist University in Dallas.) If you are a family man, you will appreciate the superior educational system, the suburban hospitality and the serene and easy living in Greenville.



R & D programs, a growing backlog. All of this points to greater opportunity for the individual scientist and engineer. Programs include sophisticated elec-

Consider this an invitation to join us — a once-in-a-lifetime challenge to get in on the ground floor of something great. Right now we are interviewing specialists in the following disciplines:

- | | |
|-------------------------|-------------------------------------|
| RF SYSTEMS ANALYSIS | DIGITAL SYSTEMS ANALYSIS |
| DIGITAL CIRCUITS DESIGN | ANTENNA SYSTEMS DESIGN |
| RADAR SYSTEMS | AIRCRAFT STRUCTURES DESIGN |
| MECHANICAL SYSTEMS | STRESS ANALYSIS |
| ELECTRO-OPTICS | SCIENTIFIC AND BUSINESS PROGRAMMING |
| RF CIRCUIT DESIGN | |

Please write or send resume (including telephone number with dates and times we may reach you) to: Mr. C. L. Waller, Professional Placement, P.O. Box 1056, Greenville, Texas 75401.

GREENVILLE DIVISION

LTV ELECTROSYSTEMS, INC.

A SUBSIDIARY OF LING-TEMCO-VOUGHT, INC.

AN EQUAL OPPORTUNITY EMPLOYER — M/F

ON CAREER-INQUIRY FORM CIRCLE 904

design engineers

NAVAL ARCHITECT • MARINE • MECHANICAL
STRUCTURAL • ELECTRICAL • ELECTRONICS
ARCHITECTURAL • CIVIL

Investigate your opportunities in the world's largest ship- building complex.

The San Francisco Bay Naval Shipyard provides service to surface and underwater ships and deep submersibles. Assignments include new construction of Polaris nuclear submarines and guided missile frigates; and the repair, overhaul and conversion of all classes of ships. Other projects include research on noise reduction, ASW, replenishment-at-sea, Trieste II and Sea Lab II and III.

Openings exist at all levels in these program areas.

Ship Structure Development	Shipboard Mechanic
Ship Weight Control	Plant Facilities
Structural Mechanics	Ordnance, Guided Missile,
Nuclear and Conventional	Fleet Ballistic Missile and
Propulsion Systems	Electronic Systems
Navigation and	Shipboard Aeronautical
Communication Systems	Material and Equipment
Sound and Vibration Control	Shipboard Electrical and
Cargo Replenishment-at-Sea	Power Systems
Development	Naval Tactical Data Systems

Job Locations: San Francisco Bay Naval Shipyard has two work sites located 40 miles apart: San Francisco and Vallejo, California. Each location has ready access to the full cultural advantages of San Francisco and the mild year-round climate of the "Bay Area." All types of recreation from ocean surfing to skiing on the slopes of the Sierras are within easy driving distance.

Send your resume or Standard Form 57, Application for Federal Employment, to:

Coordinator, Professional and Technical Recruitment
(Code 174A4)
Employment Division
San Francisco Bay Naval Shipyard
Vallejo, California 94592

AN EQUAL OPPORTUNITY EMPLOYER

MUST BE A U.S. CITIZEN

ON CAREER-INQUIRY FORM CIRCLE 905

BOOK REVIEWS

systems. Among the many other features of the book is the first comprehensive bibliography of relay technology—an invaluable aid to user, designer, or manufacturer.

Engineers' Relay Handbook, sponsored by the National Association of Relay Manufacturers, (Hayden Book Co., Inc., New York) 300 pp, \$11.95.

Drafting and design

This presentation is a coverage of components, materials, graphic symbols, standards, industrial diagrams, wiring harnesses, printed circuits, reference designations and electronic equipment design. A special feature is the coverage of military equipment, specifications and design. More than 375 illustrations are found as well as over 50 tables and a bibliography. Questions and exercises at the end of each chapter make the book a self-study.

Electronic Drafting and Design, Nicholas M. Raskhodoff (Prentice-Hall, Inc., Englewood Cliffs, N. J.) 594 pp. \$15.95.

Electronic cable

A general introduction explains in detail the design, construction and handling of various types of modern electronic cable—including installation techniques. It gives advanced information, presenting the latest state-of-the-art on cable design, specifications and applications.

This handbook covers specific applications in detail, devoting sections to cables for intercom systems, hi-fi, home entertainment systems, f-m, two-way radio, etc. Covers military and nonmilitary specifications.

An appendix contains many useful tables and a glossary. Written in easily understood terms it is intended as a comprehensive guide for everyone who uses or specifies electronic cable.

Electronic Cable Handbook, Engineering Staff of Belden Manufacturing Co., (Howard W. Sams & Co., Inc. Indianapolis, Ind.) 244 pp \$3.95.

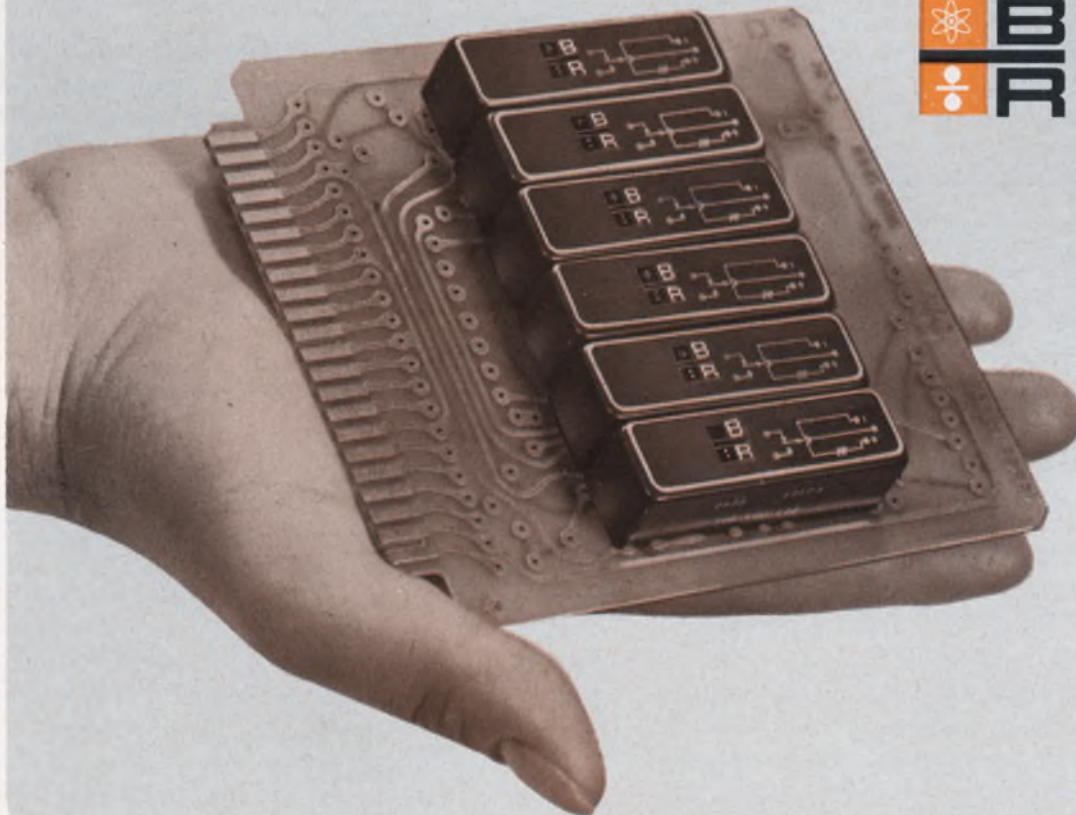
**Babcock
mercury-wetted
relays...
much more
sensitive!**



Power at a premium?
You'll find Babcock Series BW Mercury-Wetted non-bridging relays more sensitive to your system requirements, providing billions of trouble-free operations on a mere 1.2 milliwatts or less. And more...the industry's most efficient magnetic circuit. Two independent permanent pole magnets are used, with separate induction bars for better magnetic field return. Whatever your system application — chassis or circuit-board components, or complete control board modules — you'll find a Series BW unit to your liking. Get the complete story today — write Babcock Relays, Division of Babcock Electronics Corp., 3501 Harbor Blvd., Costa Mesa, Calif; (714) 540-1234.

SPECIFICATIONS

MUST-OPERATE POWER: Low as 1.2 mw.	CONTACT ARRANGEMENT: 1 Form C
CONTACT RATING: 2 amps.	CONTACT RESISTANCE: 25 milliohms, Typ.
OPERATE SPEED: To 1 ms.	NO CONTACT BOUNCE

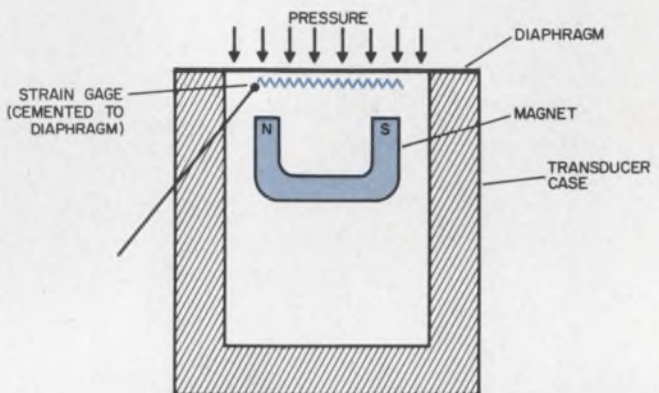


Magnetostriction boosts output of strain transducer

The magnetostrictive properties of nickel wire can be used to design wire strain-gauge transducers that have larger outputs than conventional types.

Present wire strain-gauges normally consist of a bridge arrangement of alloy wire, such as constantan, and deliver low-level millivolt signals as outputs. If the strain-gauge wire is changed to Nickel 204 or Nickel 205, which are magnetostrictive, and a magnet is incorporated into the transducer, the output signal level can be considerably improved.

A device of this sort is shown in the illustration. The nickel element consists of four wires: two in tension and two in compression. As the wires are strained they enter and leave the strong magnetic field produced by the magnet. The change in the magnetization of the wires produces, by magnetostriction, a change in their length additional to that produced by the applied pressure. As a result, a greater resistance change and therefore a larger output signal are generated.



Magnetostrictive property of the nickel wire increases the output signal level of this bonded strain-gauge pressure transducer.

The magnet's field should be aligned so that the lines of force lie in the same direction as the strain-gauge wires. For best results a permanent magnet is desirable.

A basic experiment can demonstrate the operation of the magnetostrictive transducer. Construct a 100-ohm bridge, using a Weston Aircraft or Lewis temperature bulb as one leg. When a magnetic field is applied to the bulb, the flux that enters through the bulb shell will produce large output signals.

Edwin Kaufman, Research Specialist, Lockheed-California Company, Burbank, Calif.

VOTE FOR 110

VOTE! Circle the Reader-Service-Card number corresponding to what you think is the best Idea-for-Design in this issue.

SEND US YOUR IDEAS FOR DESIGN. Submit your IFD describing a new or important circuit or design technique, the clever use of a new component, or a cost-saving design tip to our Ideas-for-Design editor. If your idea is published, you will receive \$20 and become eligible for an additional \$30 (awarded for the best-of-issue idea) and the grand prize of \$1000 for the idea of the Year.

One-shot offers high power and no stand-by current drain

High-current, square-cornered pulses are available with this one-shot which draws no current while the circuit is on stand-by. The circuit (see illustration) operates as follows:

Initially, Q_1 and Q_2 are OFF and C_2 has no charge across it. A small positive pulse is applied to the base of Q_1 which immediately starts to turn ON. The collector of Q_1 pulls down the voltage at the base of Q_2 and Q_2 starts to turn ON. The voltage across R_5 increases and turns Q_1 ON harder. This regenerative action continues until

both transistors are fully ON. As capacitor C_2 charges through R_3 , the voltage across R_3 decreases and reduces the current in Q_1 and Q_2 . When the current from the base of Q_2 becomes too low to sustain Q_2 in saturation, the voltage across R_5 starts to decrease thus shutting OFF Q_1 . With Q_1 shut OFF, no current can flow from the base of Q_2 and Q_2 will shut OFF. Capacitor C_2 then discharges through R_2 , R_3 and R_5 . If R_5 is of a low value, and if diodes are placed across R_2 and R_3 as shown, a fast recovery time will be obtained.

In the circuit shown, the minimum input pulse requirements are 2.5-V amplitude and 0.04- μ s pulse-width. The output pulse into 20 ohms is of 26-V amplitude and 1-ms duration. The output

This is the world's **SECOND** smallest power supply



Here's the **FIRST**



(Both are rugged, reliable and ready **NOW** for Advanced Aerospace Systems)

These new Bourns Power Supplies are not only the smallest available, they are the toughest! Both are specifically designed for advanced instrumentation systems where miniature size and exceptional environmental performance are mandatory. The $\frac{1}{2}$ cubic inch Model 3960, with an output of 5VDC and 0-100mA, is ideal for multiple transducer excitation; while the even tinier Model 3965 (5VDC, 0-5mA) is suitable for single transducer use.

Both models feature a completely isolated and regulated DC output. Carefully designed circuits insure protection from reverse polarity, short circuits, and overvoltage. Bourns extensive experience in molding of plastics has resulted in sealed modules impervious to moisture and salt spray. Other outstanding environmental characteristics are wide temperature range of -55 to $+100^{\circ}\text{C}$, 100 G shock and 20 G vibration. High quality microminiature components are used throughout the modules. Bourns Model 4210 Microtransformer is used in the converter circuits and a small TRIMPOT[®] potentiometer adjusts the output voltage.

Bourns famous Reliability Assurance Program guarantees performance by thorough inspection and test of each unit and by periodic requalification to all published specifications. All units receive a 100-hour burn-in prior to shipment for added reliability.

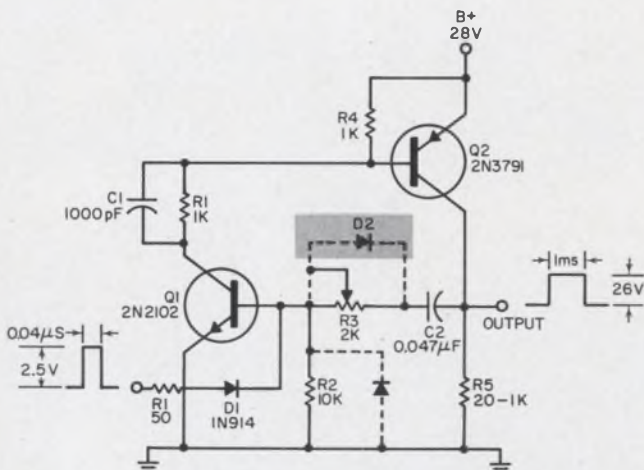
As for delivery, these units are **SHELF STOCKED**. Convince yourself how good these power supplies are. Send for detailed technical data. Certified test data is available on request.

SPECIFICATIONS

	Model 3960	Model 3965
Input Voltage Range	24-32 VDC	24-32 VDC
Nominal Output Voltage	5.000 VDC	5.000 VDC
Stability	± 0.005 V	± 0.010 V
Load Current	100 mA	5 mA
Line Regulation, 24-32V	0.1%	0.3%
Load Regulation	1.0%	Not applicable
Temperature Shift, max. -55 to $+100^{\circ}\text{C}$	0.01 %/ $^{\circ}\text{C}$	0.01 %/ $^{\circ}\text{C}$
Output Isolation at 100V	1000 megohms	1000 megohms
Size	1" x 1" x .50"	.73" x .5" x .52"
Weight	0.60 oz.	0.24 oz.



BOURNS, INC. TRIMPOT DIVISION · 1200 COLUMBIA AVE., RIVERSIDE, CALIF.
PHONE (714) 684-1700 · TWX: 714-682 9582 · CABLE: BOURNSINC.



Transistor one-shot delivers high-current and square pulses with no stand-by current drain. Diode D2 speeds recovery time.

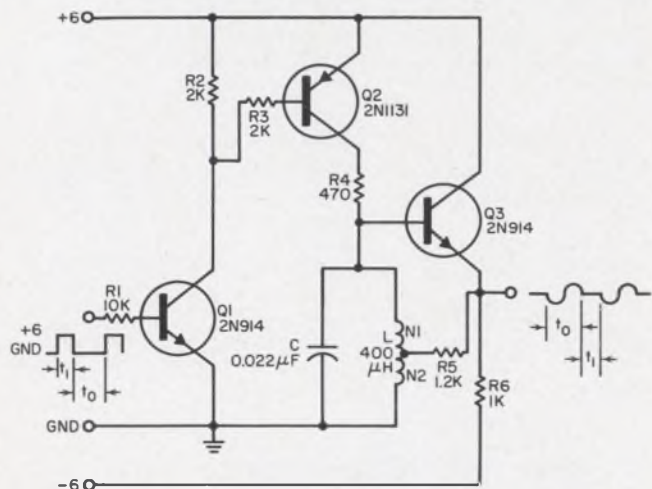
rise time is 0.2 μ s to 0.3 μ s. Capacitor C1 is a speed-up capacitor and is unnecessary for slow circuits. Without C1, the output rise time into 20 ohms will be less than 5 μ s and the output rise time into 1000 ohms will be less than 0.5 μ s.

Jordan L. Miller, Design Engineer, Systems Div., EG&G, Inc., Bedford, Mass.

VOTE FOR 111

Pulsed oscillator reduces switching transients

The designer often requires a normally quiescent oscillator circuit that can be turned ON for the duration of a gating waveform. During the interval that it is ON, it should provide a sinusoid of fixed amplitude, frequency and phase with zero output before and after the gate. But usually when the oscillator is turned ON, a switching transient appears and makes the first few cycles



Modified Hartley oscillator delivers timing signals with minimum turn-on transient effects.

of the output waveform unsuitable for timing purposes.

A simple pulsed LC oscillator, similar to a Hartley circuit with minor modifications, can be used to generate the desired waveform (see schematic). Circuit operation is dependent on the state of transistor Q2. During interval t_1 , transistor Q1 is driven into saturation by the keying pulse. Q2 is in turn driven into saturation by Q1. The initial current in L is thus current I:

$$I = (V_{cc} - V_{sat}) / R = 6 - 0.5 / 470 = 11.7 \text{ mA.}$$

At the end of interval t_1 , transistors Q1 and Q2 are turned OFF and the tank circuit will begin to oscillate with initial amplitude:

$$\begin{aligned} E_{max}(0 \text{ to peak}) &= (L/C)^{1/2} \\ &= 11.7 \times 10^{-3} [(460 \times 10^{-6}) / 0.022 \times 10^{-6}]^{-1/2} \\ &= 1.7 \text{ V,} \end{aligned}$$

and period:

$$t_0 = 2 \pi (LC)^{1/2} = 20 \mu\text{s.}$$

If the oscillator transistor Q3 were omitted, the voltage across the tank could be expected to decay because of the losses within the tank circuit. However, with the addition of positive feedback from the emitter of Q3 to adjust loop gain to unity, a sinusoidal signal of constant amplitude can be obtained. The value of feedback resistor R5 is adjusted experimentally, but it is possible to calculate an approximate value by making the following assumptions: Gain of emitter follower Q3 is nominally unity; the coil is tapped at its midpoint; and the coupling between the two coil halves is perfect. Thus, the impedance seen looking into the tap is one-fourth of the resonant impedance of the tank circuit, or $R_{tap} = 1/4 \omega L Q$. For the loop gain to be unity, since the tank voltage is twice the voltage at the tap, $E_{out} / E_{tap} = 2$. Therefore:

$$R_{tap} / (R_{tap} + R5) = 1/2$$

or

$$\begin{aligned} R5 &= 1/4 \omega L Q. \\ R5 \text{ (theoretical)} &= 1/4 (2\pi) (50 \times 10^3) (460 \times 10^{-6}) (35) \\ &= 1.32 \text{ k}\Omega. \end{aligned}$$

Paul Berger, Design Engineer, CBS Laboratories, Stamford, Conn.

VOTE FOR 112

Analog multiplication and division circuits use log diodes

Diodes with exponential current-voltage relationships, together with packaged differential amplifiers, are the basic components of a pair of circuits—a multiplier and a divider. Aside from

Reducing a connector's length is one thing. Reducing its weight is another.

Bendix Solder and Hermetic-Type "Pancake" connectors do both.

One thing you can say about Bendix® JT Pancake connectors: they reduce connector length by up to 50% and weight up to 60%, making them the smallest, lightest models available.

Equally impressive is the wide range of types we've got on hand, all ready to be delivered in rapid, off-the-shelf fashion. Among them are wall mount,

box mount, jam nut, straight plug and 90° plug; nine different sizes; 34 different insert patterns; 16-, 20-, 22- and 24-contact sizes that will accept a wire range of 16 through 28 gage.

(You'll find most of these types available in our crimp-type JT Pancake connector line, too.)

What about performance? These light-

weights have nine major design improvements. There are provisions for up to 128 contact pins, increased resistance to pin bending, greater contact retention, temperature capabilities to 392°F, and improved electrical characteristics through rigid, glass-filled epoxy inserts, to name a few. For complete information, write us in Sidney, New York.



Scintilla Division

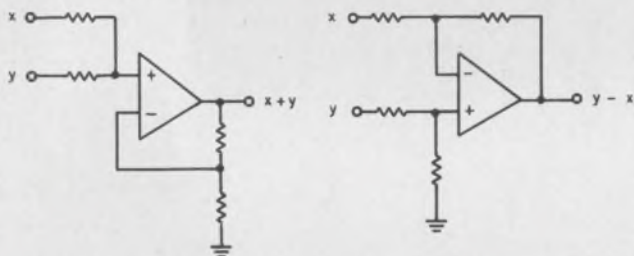


IDEAS FOR DESIGN

their simplicity, the circuits are fairly economical.

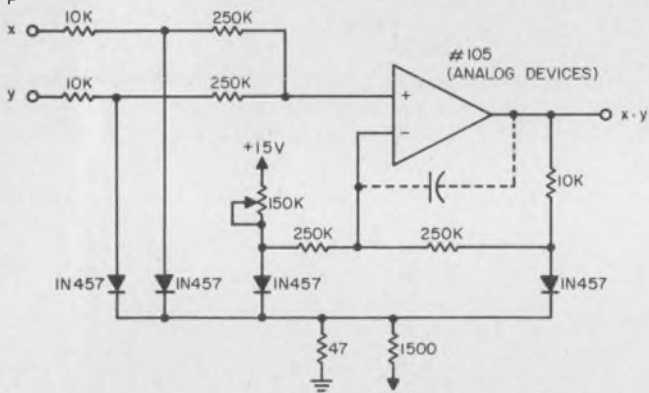
Similar to a slide rule, operations are performed by acting on the logarithms of the inputs and then obtaining an antilogarithm output. This involves use of a summing circuit for the multiplier and a subtracting circuit for the divider (Fig. 1). Since the two circuits are quite similar, only the multiplier is described here.

In Fig. 2, the analog inputs drive the diodes through the 10KΩ resistors to provide a logarithmic voltage at the inputs of a noninverting operational amplifier. If the output is assumed to be the final product, then the logarithm of it must match the logarithmic sum of the inputs. If the logarithm of the output is taken (in the same way that logarithms of the inputs are taken) and fed

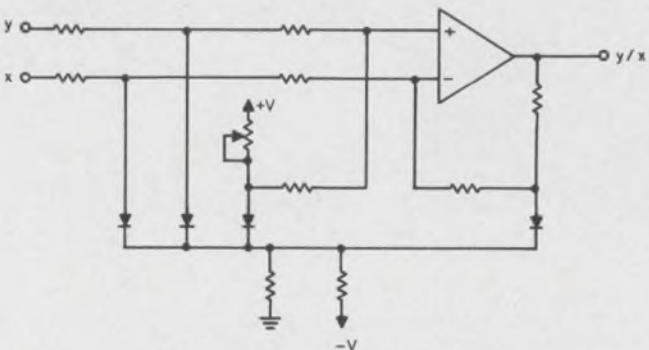


SUMMING CIRCUIT SUBTRACTING CIRCUIT

1. Either sum or subtract circuit can be affected by adjustment of the feedback network in the differential amplifier.



2. Analog multiplier uses summing technique for logarithmic inputs. By taking the logarithm of the output and comparing it with the input, the output goes to the true product.



3. Divider circuit uses subtracting circuit to compare logarithmic input and output and develop a divided output.

back to the differential input of the amplifier, the two values are matched, and the desired antilogarithm operation is accomplished.

In Fig. 2, the 47 ohm-1500 ohm resistor combination sets the diode bias and the 150-kilohm rheostat adjusts the reference for the feedback loop. Actual test results had a multiply accuracy of $\pm 5\%$ full scale for an input and output range of 0 to +10 volts. Fig. 3 is a schematic of the divider circuit implementation.

G. Richwell, Staff Engineer, Reflectone Electronics, Stamford, Conn.

VOTE FOR 113

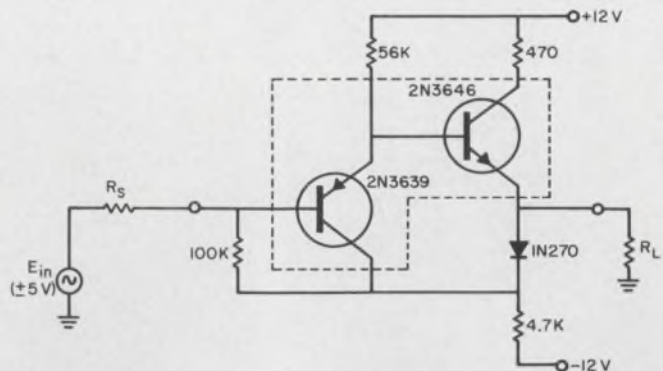
Complementary darlington: a leading emitter-follower

The simple conversion of a conventional darlington-type emitter-follower into a complementary unit brings about improved performance.

Among the benefits are:

- A lower offset voltage.
- A lower temperature coefficient.
- A lower input capacitance.
- A nulling capability.
- A higher frequency response.
- A better voltage-handling capability.

With conventional circuits in dc amplifier applications the input to output voltage level shift (offset voltage) is often troublesome. Typically, a strong temperature coefficient nominally of -4.0 mV/°C is the major cause of this. The complementary configuration (see schematic) reduces



Complementary darlington emitter-follower exhibits enhanced performance over conventional darlington. Offset voltage, temperature coefficient and input capacitance are all lower; frequency response is raised.

this temperature coefficient by a factor of 20 or better, thus nearly eliminating the offset.

Convenient bootstrapping of the input stage makes it possible for the input capacitance to be greatly reduced as well; only the output transistor need have a voltage rating greater than the peak-

FAIRCHILD cleans the beam!

New electron optics provides unassisted focus and astigmatism correction

- NO DEFOCUSING WITH DEFLECTION
- NO ASTIGMATISM
- HIGH WRITING SPEED

Breakthrough at Fairchild! The Fairchild clean-beam tube, KC 2656, is a new 12-inch electrostatic deflection and focus CRT with a new electron gun. The electron gun design represents a major breakthrough. This design provides increased writing speed and significantly reduced deflection defocusing

and astigmatism, with increased resolution.

Fairchild calls this "the clean beam tube" because of the excellent spot size over the entire useful screen area. Dynamic or programmed correction is not required to compensate defocusing or astigmatism resulting from deflection.

This tube is the result of extensive research and development which produced new departures in deflection structure and electron gun design. The design changes have improved the compatibility between the beam generation and beam deflection functions.

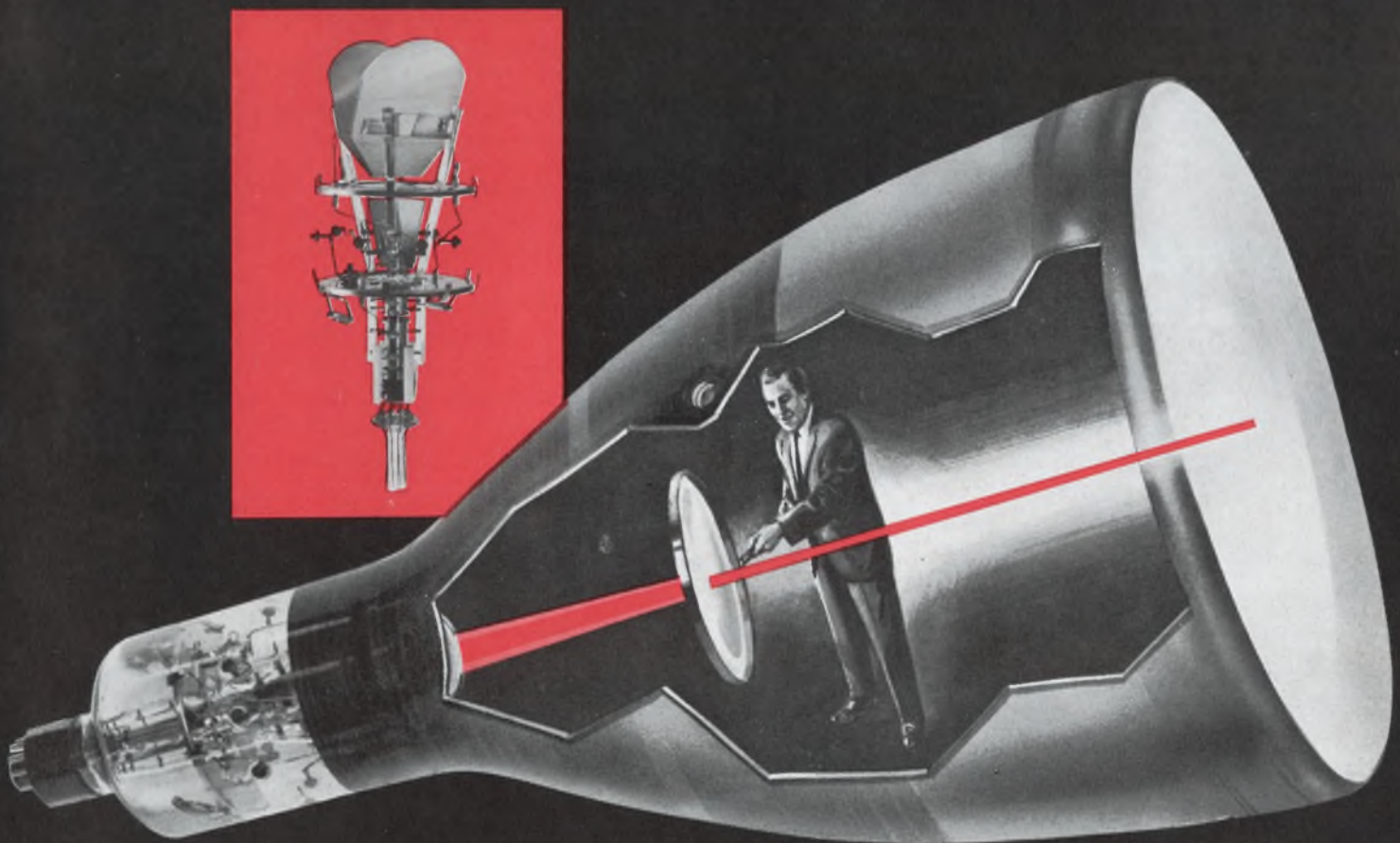
Write or call for *informed* application assistance on the new KC 2656, or ask for our new 48-page catalog listing over 4,000 tubes that we make.

*WORLD'S LEADING MANUFACTURER
OF DISPLAY TUBES*

FAIRCHILD

DUMONT ELECTRON TUBES

A DIVISION OF FAIRCHILD CAMERA AND INSTRUMENT CORPORATION
CLIFTON, N.J.



to-peak signal voltage swing. Bootstrapping also allows the input current to be nulled out effectively. The input stage may then be operated at a relatively high emitter current for good frequency response. This is achieved without developing another temperature-variable offset voltage due to input base current responding to the external source impedance.

The germanium diode provides a level shift to bias the input. The bias resistor is selected to null the input current and produce approximately zero-volts output with the input open-circuited. The diode voltage reduces the bias with increasing temperature to compensate for the increase of β with temperature.

This circuit has a voltage gain of 0.992 and a current gain of 360 with a load of 5 k Ω and when $R_s = 0$. Its maximum offset is -0.2 V and its offset temperature coefficient is 160 $\mu\text{V}/^\circ\text{C}$, under the same conditions.

When $R_s = 1 \text{ M}\Omega$, the current offset is +0.08 μA and the input impedance is 1.8 M Ω . This latter figure rises to 2.3 M Ω when the 5-k Ω load is open-circuited. Also, the offset temperature coefficient drops to only -4.0 nA/ $^\circ\text{C}$.

When a one-volt peak-to-peak signal is applied to the input, the circuit's rise time and band-width are 0.1 μs and 1.5 MHz, respectively. Note that the diode and 100 k Ω selected resistor components in the circuit are only necessary if high source-impedance generators are used at the input. With low R_s units, input current offset cancellation is not a requirement typically.

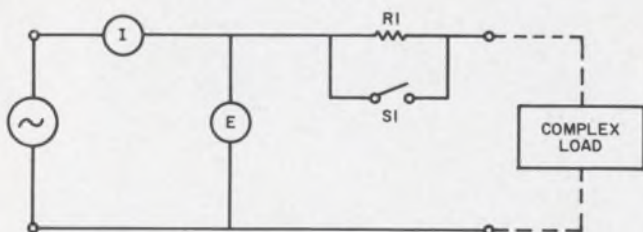
Robert W. Pargee, Senior Engineer, Electronic Engineering Co. Santa Ana, Calif.

VOTE FOR 114

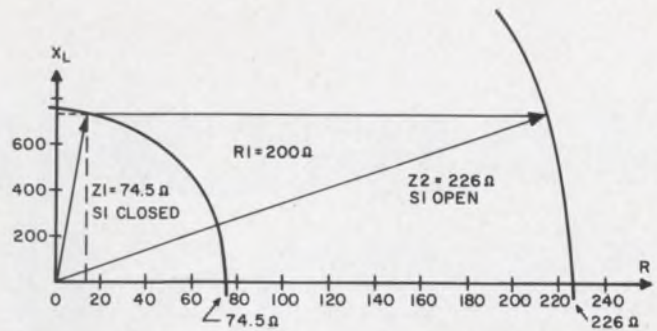
Impedance diagram simplifies complex load characterization

Here's a simple technique for determining the resistive and reactive terms of complex load. This method is quite useful when vendor data are not readily available or actual measurements have to be performed.

The test setup (Fig. 1) is simple to build and



1. Switch (S1) allows impedance measurement to be made with known resistance (R1) in and out of the circuit.



2. Plotting the locus of the complex impedances and the locus of the known real value (R1) yields a single solution from which the real and imaginary components of the unknown load may be determined.

uses any value of R_1 that is easily available. With S_1 closed, Z_1 (E/I) is measured and the value entered on the impedance diagram (Fig. 2). Then S_1 is opened, Z_2 is measured and its value entered on the impedance diagram. With a compass point at the origin, draw an arc through Z_1 and one through Z_2 . The only difference between Z_1 and Z_2 is the value of R_1 , and R_1 is a real and known value. As a result, there is only one place on the diagram where a line parallel to the origin and of a known length (R_1) can fit between the two arcs. The point where this line intersects the arc of Z_1 will determine the value of R and X of the unknown load, and may be scaled from the diagram.

In the diagram given, a 200-ohm resistor is used for R_1 and the load is a 26-V, 400-Hz synchro motor. The voltage and current measurements yield a value of $Z_1 = 74.5$ ohms and $Z_2 = 226$ ohms. The calculated reactance is 73.5 ohms and the resistance is 13.5 ohms.

J. L. Earl, Instrumentation Engineer, Lockheed Missiles & Space Co., Sunnyvale, Calif.

VOTE FOR 115

Two IFD Winners for July 5, 1966

The voting by our readers resulted in a tie between two Ideas published in the July 5 issue. Winners were:

E. K. Howell, Applications Engineer, General Electric Co., Auburn, N. Y. for his Idea, "Tandem dimmer uses Triac power controllers."

Frank A. Memmo, Sr. Project Engineer, EIMAC, Div. of Varian Assoc., San Carlos, Calif. for his Idea, "Phase-controlled oscillator has electronic frequency-tuning."

Both authors will receive the \$50 Most Valuable of Issue Award.

Cast Your Vote for the Best Idea in this Issue.

IFD Winner for July 19, 1966

J. L. Divilbiss, Sr. Research Engineer, Dept. of Computer Science, Univ. of Ill., Urbana, Ill.

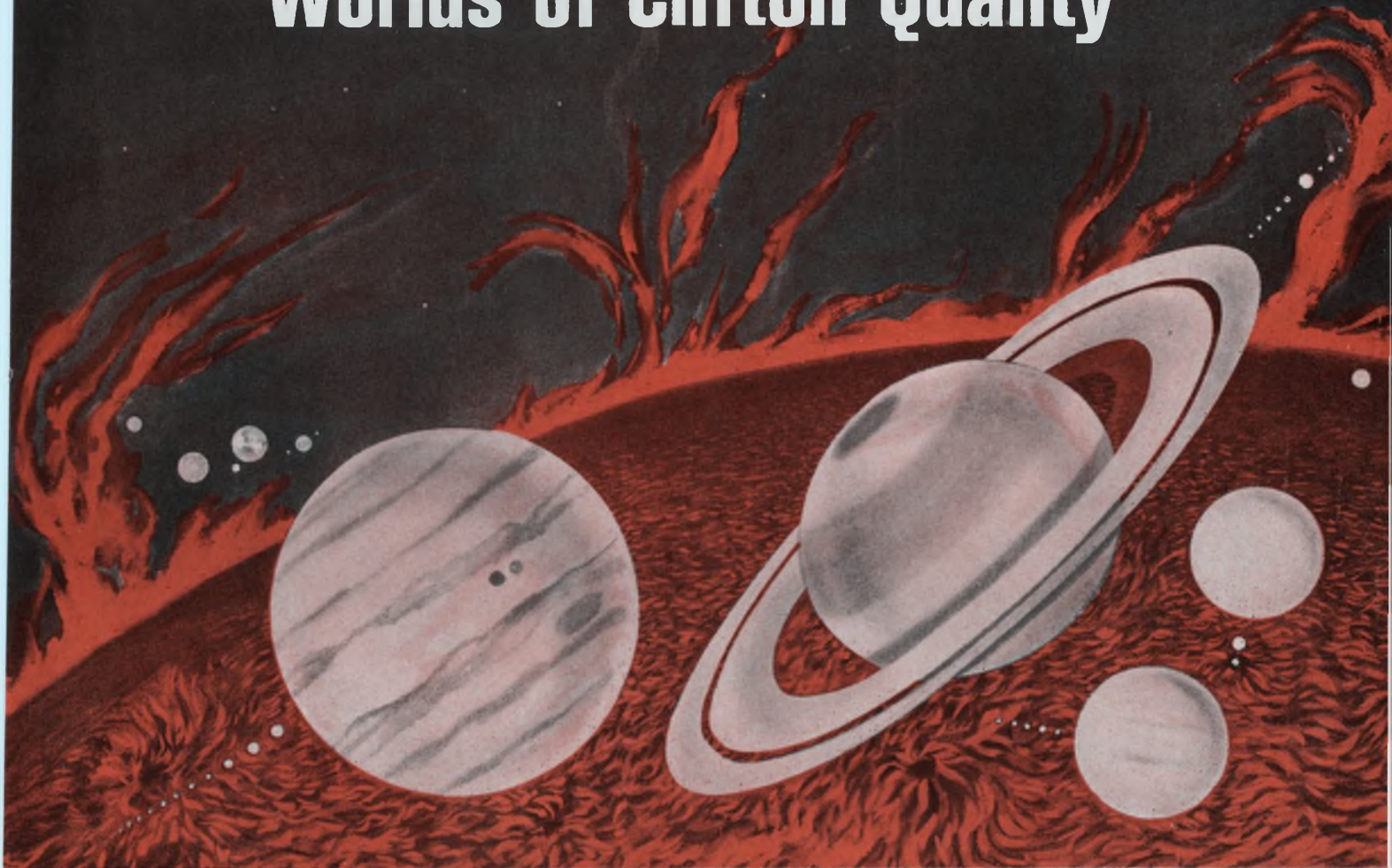
His Idea, "Diode tester offers no risk to components," has been voted the \$50 Most Valuable of Issue Award.

Cast Your Vote for the Best Idea in this Issue.

Speed Inquiry to Advertiser via Collect Night Letter >

ON READER-SERVICE CARD CIRCLE 50 >

Worlds of Clifton Quality



in our **NEW**, Competitively Priced DC Motors



The illustration of our Solar System shows the nine planets and their 31 satellites in scale with each other and the enormous sun. The procession starts with Mercury at the left and ends with Pluto on the far right.

Built to exacting Clifton and MIL-E-5272 standards, these DC motors are a completely new design. They offer many advantages such as: stainless steel, corrosion resistant housings and ball bearings, and brush springs which maintain constant pressure over brush life. Brush life itself is up to 1000 hours depending upon environmental conditions and application.

These motors feature a five bar commutator. Due to the inherent design, the rotor produces a magnetic detent under zero excitation which minimizes gear train drift. Units available in both 14 and 28 volt excitation. Special voltages, shafts and housings available upon request.

Clifton Precision Products, Division of Litton Industries, Clifton Heights, Pa., Colorado Springs, Colo.

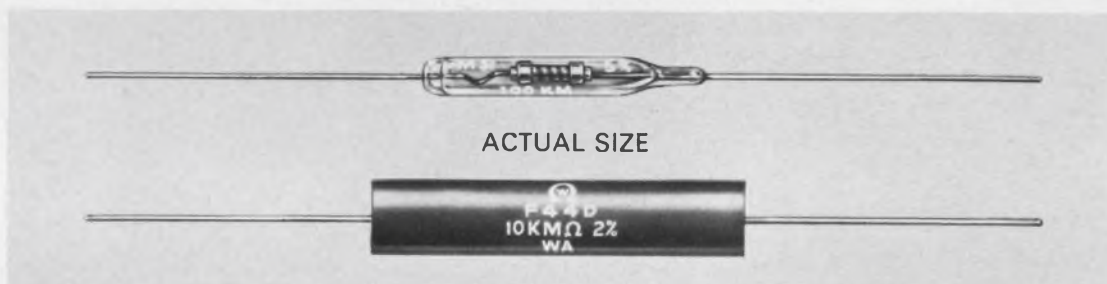
cppe

CLIFTON
PRECISION PRODUCTS
DIVISION OF LITTON INDUSTRIES



Welwyn, major producer of all types of resistance products

(and recent recipient of Lockheed Zero Defects Award)



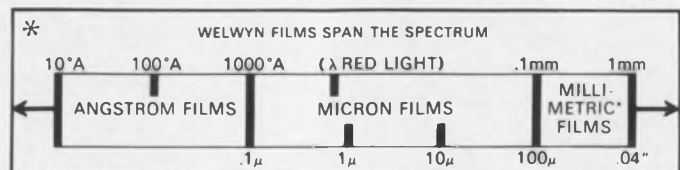
Now offers new millimetric* tin oxide film ultra high value and high voltage resistors with stability heretofore unattainable

These new products are the latest result of Welwyn's many years of experience in the manufacture and supply of High Voltage/High Value resistors. Produced by an entirely new process and incorporating films many orders of magnitude thicker, their improvement in performance is impressive, and particularly so if compared with other types now available.

The condensed data outlines the increased stability in both load and life now achieved; other significant characteristics are also shown.

HIGH VOLTAGE—Stability on long-term continuous or pulse loading better than 1% per year. Shelf life better than 0.5% per annum. T.C. typically 1500 PPM (negative). Available with wire leads or screw terminals. Tol. 2% and 5%. Half watt units 4KV working voltage, 15KV pulse, 2 Meg. to 3,000 Meg. One watt units 14KV working voltage, 50KV pulse, 2 Meg. to 10,000 Meg. Bulletin M7B. Types F43, F44.

ULTRA HIGH VALUE Glass Enclosed—Stability typically 0.3% per annum, negligible thereafter; after 10 one-hour cycles at 150°C 3.0% max-change. Values up to 1,000,000 Meg. T.C. 800-1500 PPM (negative) over the entire range 10^7 - 10^{12} . V.C. negligible. Noise not normally measurable. Tol. 2% & 5%. Bulletin HV8A. Type M51.



We urge all designers specifying this type of product to investigate further, and suggest you contact our nearest Sales Office or write direct for detailed information.



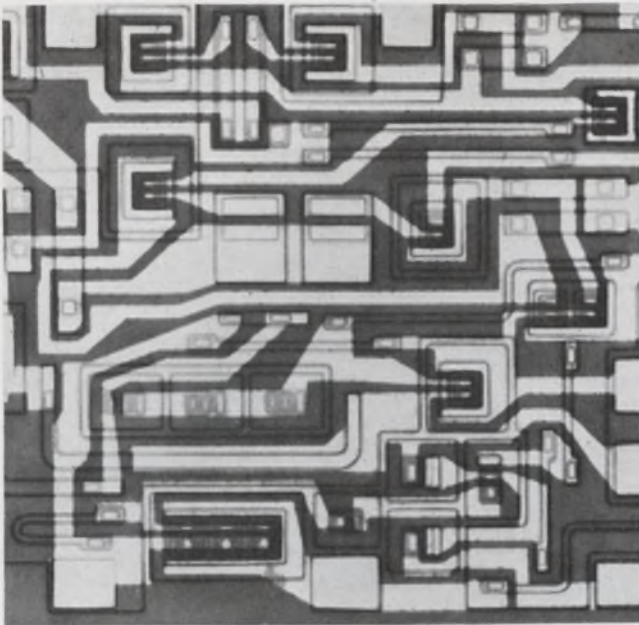
WELWYN INTERNATIONAL INC. (216) 871-7980

811 SHARON DRIVE, WESTLAKE, OHIO
TWX 216-871-3470 • TELEX 098-5276 • CABLE WELINT

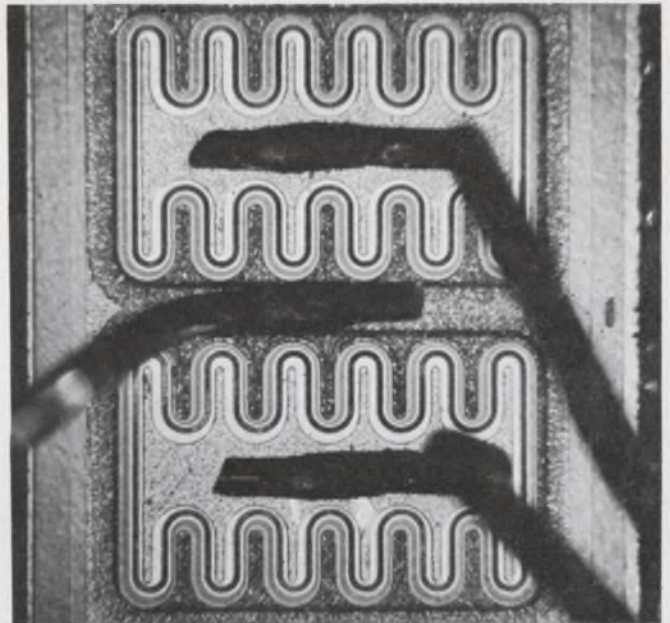
SALES OFFICES New York: S-J Sales (518) AX1-3232 • San Francisco: R. A. Banks (415) 941-0900 • Los Angeles: Web. Elect. (213) 671-8297 • Chicago: Lightner Assoc. (815) SP4-1500 • Boston: Cirolia-LeBlanc (617) TW3-2742 • Cleveland-Cincinnati: Tri-State Electronics (513) 631-5060 • Baltimore: B. White Corp. (301) 484-5400 • Fort Worth: Fralia Co. (817) PE8-2394 • Orlando-Miami-Huntsville: NBS Inc. (305) 423-4856 • Seattle: Farwest Agencies (206) SH7-1515 • Detroit: Villani-Pitcher (313) 271-4600 • Minneapolis: Robt. Marshall Co. (612) 929-4132

ON READER-SERVICE CARD CIRCLE 51

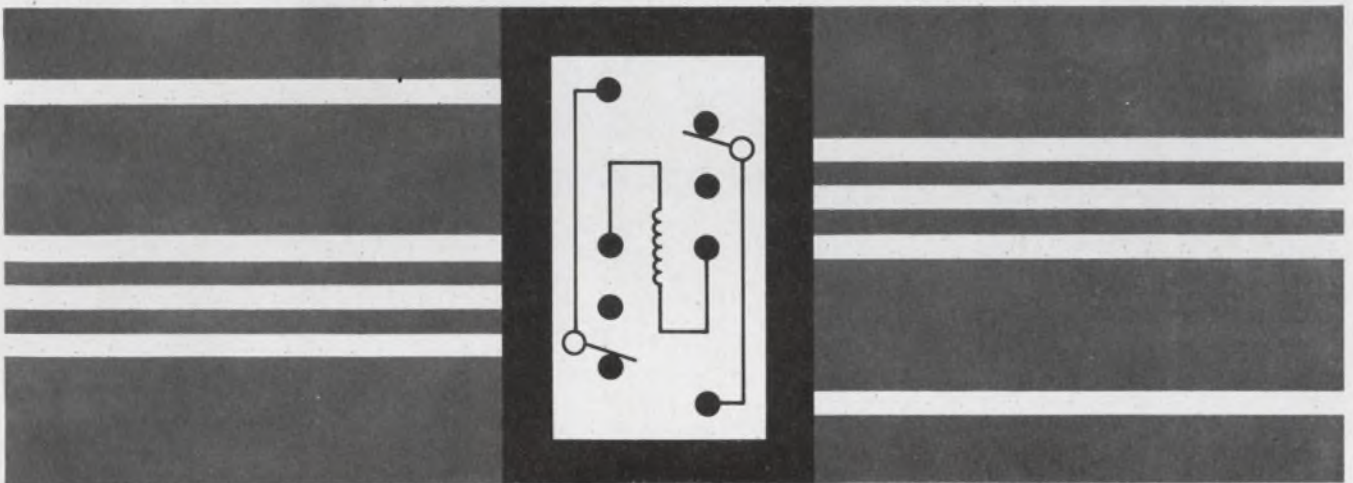
Products



Monolithic sense amplifier has 40-ns response, 50- and 80-ns recoveries. Page 116



Power planars use "field plate," nichrome resistors to boost RF performance. Page 108



A relay in a flat pack? This 1/4-A, 28-V dpdt magnetic relay fits snugly in its 8-lead JEDEC

TO-87 flat pack, mounts neatly on low-profile (0.1-in.) printed circuit cards. Page 126

Also in this section:

Parasitic-free DTL ICs use dielectric isolation. Page 118

Aerosol freezing agent cools components for quick go-no go tests. Page 132

Solid-state plug-in gives scopes 3-D display capability. Page 138

'Field plate,' nichrome resistors push planar performance

Three innovations have been made in the design of high-power RF silicon planar transistors. They could extend peak voltage and frequency capabilities to 1 kV and 1 GHz, according to Fairchild Semiconductor, manufacturer of the devices.

The innovations are as follows:

- A "field plate," which gives the npn type SE7020 a 300-V breakdown.

- Nichrome thin-film resistors in series with the emitter, which give

the npn 2N4115 and 4116 a 30-W dc safe area output with 5-A, 80-V and 80-MHz capabilities.

- Multiple emitters with nichrome resistors, which enable the FT502 power transistor to offer 25 W at 150 MHz.

High-voltage breakdown in the planar npn SE7020 is accomplished by using the "field plate" (Fig. 1). This is base metallization, extended over the collector-base junction, which serves to distribute the field at that point. The technique avoids

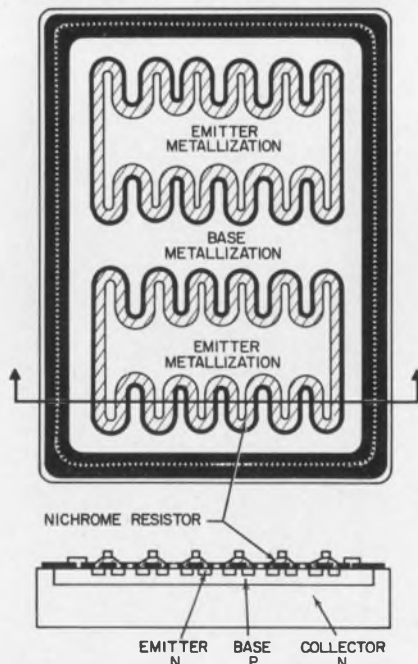
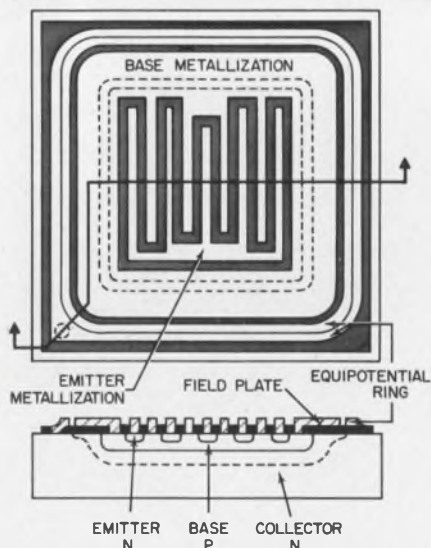
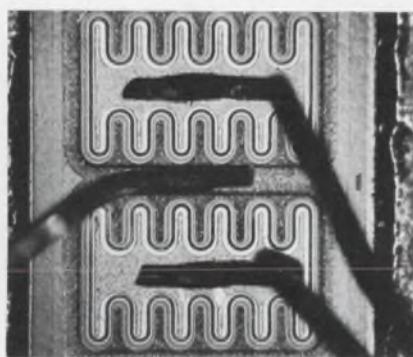
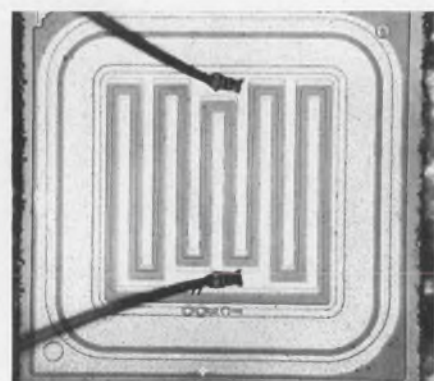
field concentration and possible subsequent breakdown. (Such failures formerly limited planar devices to about 200 V). To add to the stability, channels are completely eliminated by electrically connecting the equipotential ring to the collector. Packaging of the device is in a TO-66 can.

The deposition of nichrome thin-film resistors in series with the emitters (Fig. 2) during planar epitaxial processing results in the high-power (30-W dc safe area) output of the 2N4115 and 4116. Power transistors, in general, can be considered as several smaller equivalent transistors in parallel. With the nichrome resistors, when one of these equivalent transistors begins to draw enough current to cause overheating, the excess current is diverted by negative feedback to an adjacent parallel transistor. This diversion delays secondary breakdown caused by excess current concentration ("current hogging") and ultimate transistor failure. The result is a high-voltage (80-V BV_{CEO}), high-current (5-A) RF transistor. Beta is 40 to 120 at 2 A and gain-bandwidth product is 70 MHz (4115), and 100 to 300 at 2 A with an 80-MHz gain-bandwidth (4116). Packaging is in the isolated collector TO-59. Pnp complements are available.

Multiple emitters in conjunction with nichrome resistors on a single silicon chip are used to extend high-frequency performance and safe operating areas of the high current FT502. (Fairchild is shooting for a 1-GHz, 5-W device). The FT502, capable of 25 W at 150 MHz, is currently available. The device is packaged in a TO-66 can.

The transistors may be used in RF amplifiers, servo amplifiers, converters, inverters, and regulators, as well as two-way mobile radio telephones, marine radios, single-sideband transmitters and citizens band and portable communications systems. A secondary advantage, excellent resistance to radiation, makes the devices attractive for satellite and missile applications.

P&A: \$24 (2N4115), \$36 (2N4116), \$0.80 (SE7020), (100-999); stock. FT502; December. Fairchild Semiconductor, 313 Fairchild Dr., Mountain View, Calif. Phone: (415) 962-5011.

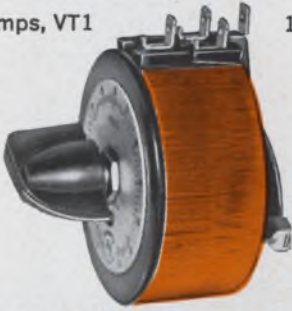


1. "Field plate" (base metallization) is extended over collector-base junction to distribute the field and avoid concentration. Channels are eliminated by electrically connecting the equipotential ring to the collector, thus adding to stability. The result is a device with 300-V breakdown.

2. Thin-film nichrome resistors in series with emitters eliminate hot spots and delay breakdown caused by "current hogging."

Six ratings from 1 to 3 amps...

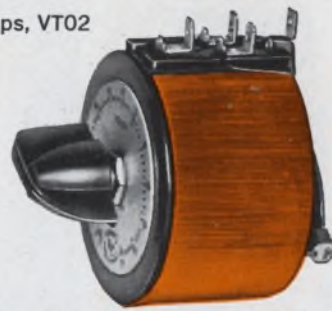
1.0 amps, VT1



1.2 amps, VT1N



1.75 amps, VT02



2.0 amps, VT02N



2.6 amps, VT3



3.0 amps, VT3N



CUT COSTS by SPECIFYING CLOSER to YOUR NEEDS

with OHMITRAN v.t.[®] Low Power, Variable Transformers

You don't have to be satisfied any longer with a few meager ratings in low power variable transformers. Make your selection from 1.0, 1.2, 1.75, 2.0, 2.6, and 3.0-amp Ohmitran v.t.[®] ratings. No other manufacturer offers this extensive selection, or the exclusive series VT1 and VT3 units.

By specifying closer to actual needs, you normally can cut component cost and make your equipment more competitive.

Ohmitran units offer some unique engineering features, too:

Adjustable shaft (extends from either end) for mounting convenience or for operating auxiliary controls.

Multi-purpose terminals for soldering, quick connectors or screws.

Replaceable brushes with rapid, snap-in design and husky heat sink.

Same silhouette and mounting arrangement for all six ratings allowing standardization of panel treatment.

Model variations include fixed and portable enclosures, ganged assemblies, and motor-driven assemblies.

The Industry's Fastest Growing Line of Variable Transformers . . . 1 to 25 Amps, Hundreds of Stock and Made-To-Order Models. Write for Catalog 500.



Resistors



Rheostats



Variable Transformers



Relays



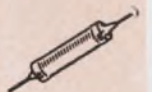
Tap Switches



Tantalum Capacitors



Semiconductor Diodes



R.F. Chokes

OHMITE

MANUFACTURING COMPANY

3643 Howard Street • Skokie, Illinois 60076

Phone: (312) ORchard 6-2600

ON READER-SERVICE CARD CIRCLE 52



"BLUE CHIP" TRANSFORMERS for printed circuit applications FROM STOCK!

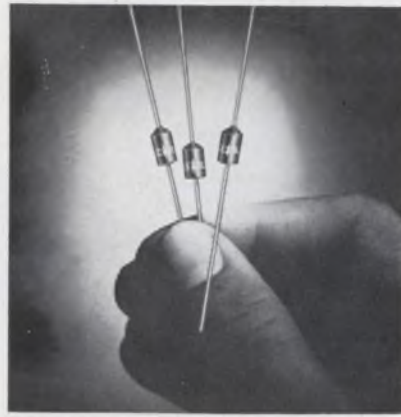
Available in five case sizes (.10 to 1.2 cubic inches) with 62 new power ratings, Blue Chip transformers provide maximum flexibility for electrical and mechanical transistor circuit applications. Blue Chip transformers meet Mil-T-27B, Grade 5, Class S requirements. Typically the smallest size Blue Chip has a frequency response of ± 2 db, 300 to 100,000 cps. Maximum distortion of 10% at 30 milliwatts, 300 to 100,000 cps. Distortion on all types—10% or less. Write for your copy of complete electrical and mechanical specifications on Blue Chip transformers.



ADC PRODUCTS
A DIVISION OF MAGNETIC CONTROLS CO.
6405 CAMBRIDGE STREET ■ MINNEAPOLIS, MINN. 55428

ON READER-SERVICE CARD CIRCLE 53

SEMICONDUCTORS



Zener voltage regulator

A line of molded zener voltage regulators in the DO-27 case style is rated from 3.3 to 15 V with maximum current ratings from 300 mA to 60 mA. The 1-W zeners are designed as regulators and protection devices for control, regulating and monitoring functions. Industrial applications include process control, instrumentation, switching, measurement, modulation and energy conversion, generation and transmission.

P&A: \$0.60 to 1.10 (100 to 999); stock to 6 wks. International Rectifier, 233 Kansas St., El Segundo, Calif. Phone: (213) 678-6281

Circle No. 154

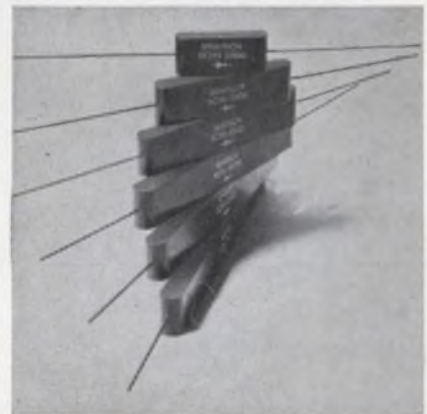


Germanium transistors

Germanium npn power transistor series 2N2869 and 2N2870 are replacements for 2N301 and 2N301A types. Packaged in a TO-3 case, they are capable of 55-V collector-to-emitter operation and 80-V collector-to-base operation. The devices have low saturation voltages and usable gain at 10 A collector current.

Solitron Devices, Inc., 1177 Blue Heron Blvd., Riviera Beach, Fla. Phone: (305) 848-4311.

Circle No. 155



Rectifiers have 15-kV PIV

High-voltage, coax lead mounting silicon rectifiers have PIV ratings of 2500, 5000, 7500, 10,000, 12,500 and 15,000 V. The units are rated at 2 A in free air and 4 A in oil. The devices feature low forward drop, low leakage (10 μ A at PIV and 25°C) and operating and storage temperatures of -55 to 175°C. Internally, solid double heat sink junctions welded together eliminate the use of solders. The package is 0.375 inches by 0.687 in. The length will vary with the PIV rating from 1.5 to 6.5 in.

Semtech Corp., 652 Mitchell Rd., Newbury Park, Calif. Phone: (213) 628-5392.

Circle No. 156

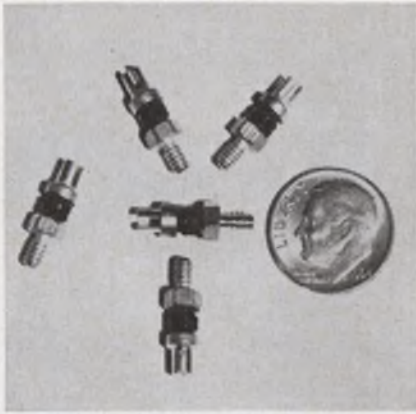


Germanium transistors

Packaged in a TO-1 case, these npn germanium transistors exhibit very good beta linearity and are suitable for Class B push-pull applications. A pair of either the 2N2430 or 2N2431 jointly used in transformerless circuitry give complementary symmetry.

Nucleonic Products Co. Inc., 3133 E. 12th St., Los Angeles, Calif. Phone: (213) 268-3464.

Circle No. 157



9-A stud rectifiers

Offering controlled avalanche characteristics, this stud mount rectifier has a current rating of 9 A and PIV of 400 V max. Surge rating is 150 A max for 1 cycle. Recovery times of 250 ns min permit operation at frequencies up to 40 kHz square wave or greater for sine wave. The unit is monolithic, voidless and whisker-free and is bonded to two terminal pins.

P&A: \$8.50 to \$22; stock. Uni-trode Corp., 580 Pleasant St., Woburn, Mass. Phone: (617) 926-0404.

Circle No. 158

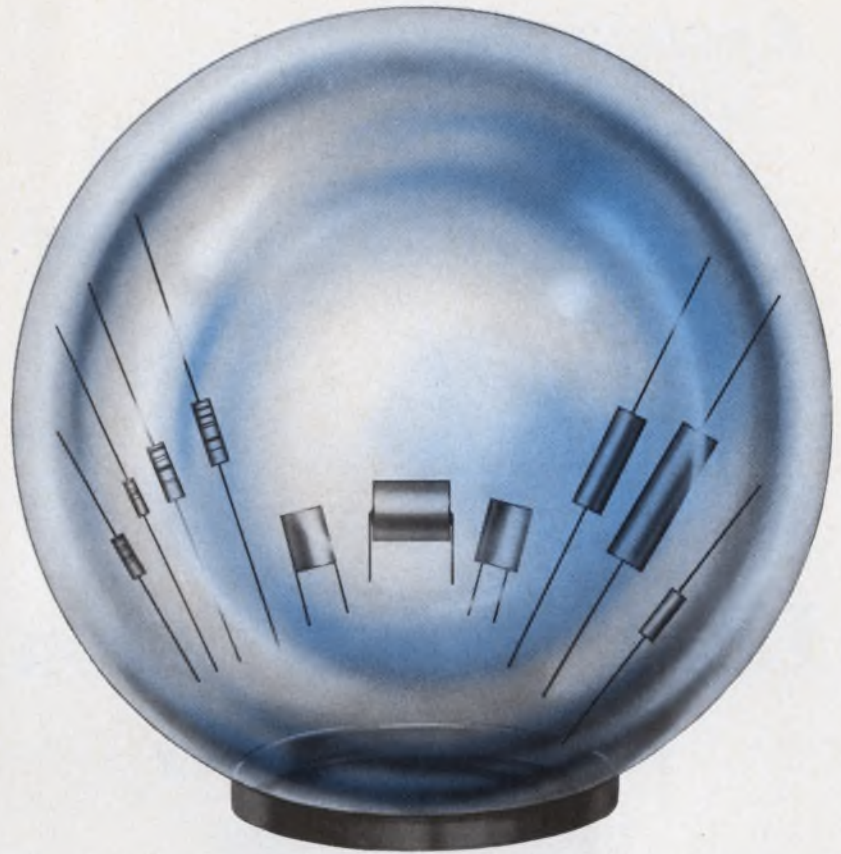


5-A power transistors

Collector-to-emitter sustaining voltages of up to 200 V are available with this line of 5-A npn planar power transistors. The units can dissipate 20 W at 100°C case temperature. Collector current is 1 A and V_{CE} (sat) is 0.50 V max. Each of the two gain (h_{FE}) families (20 to 60 and 40 to 120) is available with a V_{CE} (sus) of 125, 150, 175 or 200 V.

Solitron Devices, Inc., 1177 Blue Heron Blvd., Riviera Beach, Fla. Phone: (305) 848-4311.

Circle No. 159



Our crystal ball told us you'd be needing inductors like these!

Because Nytronics pioneered the concept of standardized quality components by anticipating your circuitry requirements — you can now order immediate, off-the-shelf, delivery from a wide range and immense inventory of standardized inductors.

WEE DUCTOR — Magnetically shielded with inductance range 0.1 to 180,000uH, designed to MIL-C-15305, Grade 1, Class B. Encapsulated Envelope: 0.157" diameter x .450" length.

SUPER WEE DUCTOR — Magnetically shielded with inductance range 0.1 to 100,000uH all $\pm 10\%$ tolerance. Meets MIL-C-15305. Molded Envelope: 0.157" diameter x .410" length.

WEE WEE DUCTOR — Magnetically shielded with inductance range 0.1 to 1000uH. Designed to MIL-C-15305. Encapsulated Envelope: 0.125" diameter x 0.335" length.

DECI-DUCTOR — Subminiature with inductance range 0.1 to 1000uH. Designed to MIL-C-15305, Grade 1, Class B. Molded Envelope: 0.100" diameter x 0.250" length.

S-M-L INDUCTORS — Non-shielded with inductance range 0.1 to 10,000uH. Designed to

MIL-C-15305, Grade 1, Class B. Molded Envelope: "S" Type — 0.188" diameter x 0.44" length, "M" Type — 0.25" diameter x 0.60" length, "L" Type — 0.31" diameter x 0.90" length.

VARIABLE INDUCTOR — Unshielded with adjustable range 0.1 to 4700uH. Designed to meet MIL-C-15305, Grade 1, Class B. Encapsulated Envelope: 0.400" diameter x 0.500" length. Vertical or Horizontal mounting.

WEE V-L — Magnetically shielded, adjustable range 0.1 to 100,000uH. Designed to MIL-C-15305, Grade 1, Class B. Epoxy Molded 0.300" diameter x 0.400" length.

90537 TYPE — Manufactured in accordance with MS90537, Molded, Magnetically shielded with inductance range 0.1 to 100,000uH $\pm 10\%$ tolerance. Molded Envelope: 0.157" diameter x 0.410" length.

Our inventory of other standardized, high quality components includes capacitors, delay lines, and resistors. Custom component capability is also available. Write today for complete engineering data.



NYTRONICS

...for Precision Electronic Components

550 Springfield Ave., Berkeley Heights, N.J. 07922 ■ (201) 464-9300 ■ TWX: 710-984-7977

ON READER-SERVICE CARD CIRCLE 54

Exclusive!

New Wayne Kerr B331 Autobalance[®] Bridge Provides Automatic Measurement Lead Compensation for L, C, R, G



*...and it is accurate to
0.01% at Point of Measurement*

Automatic Measurement Lead Compensation means you no longer have to measure lead capacity, lead resistance, and then subtract from your original reading . . . With Wayne Kerr's new B331 Autobalance Precision Bridge, this is accomplished by means of a six-wire system which automatically compensates the bridge for any lead capacity and resistance.

Equally important, 0.01% accuracy is maintained, not only at the measuring terminals as in other bridges, but at the point of measurement — the resistor or other component under test.

And, Autobalance — Wayne Kerr's electronic nulling process — is combined

with three decades of push-buttons for precise backing-off to provide a new simplicity of operation — even non-skilled personnel can achieve precise measurements in less than 30 seconds.

SPECIFICATIONS

Ranges for 0.01% Accuracy: 1pF–10 μ F;
10n Ω –100m Ω (10 Ω –100M Ω)

Overall Measurement Ranges: 100aF–
0.25 Farad; 1p Ω –1k Ω ; 1m Ω –1T Ω ;
100nH–250MH. (100aF = 0.0001pF,
1T Ω = 1000kM Ω , max. L is 2.5 \times 10⁸H)

Frequency: 1.00kHz (Internal); 50Hz–
20kHz (External)

Price: \$2200. FOB Montclair, N. J.

For literature and detailed specifications, write:



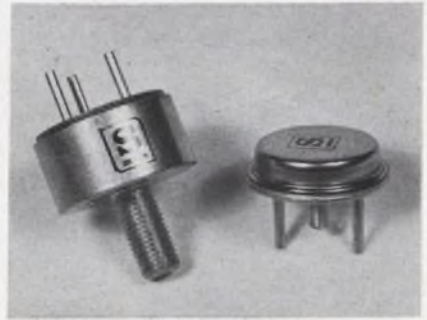
Wayne Kerr CORPORATION

18A Frink St., Montclair, N. J. 07042 • Phone (201) 746-2438

INNOVATIONS IN INSTRUMENTATION

ON READER-SERVICE CARD CIRCLE 55

SEMICONDUCTORS



65-A high-gain transistor

High-current germanium power transistors offer a higher efficiency than any other general purpose transistor now on the market. The SDT1860 and SDT1960 series are capable of maximum efficiency because of their low collector saturation voltage (0.3 V), low input voltage and high current gain. The transistors are available in the TO-36 can as well as in a double-ended package which offers less restrictive hook-up of large conductors. As an option, both packages come in flattened or pierced terminals, eliminating the need for an additional terminal connector. A terminal hole size of 0.12-in. x 0.19-in. can be provided. H_{FE} exceeds 20 at a full 65-A collector current. The devices are suited for motor speed control, converters, and other switching and amplifier applications.

Solitron Devices Inc., 1177 Blue Heron Blvd., Riviera Beach, Fla. Phone: (305) 848-4311.

Circle No. 160

50-cent plastic FETs for AF amplifiers, switching

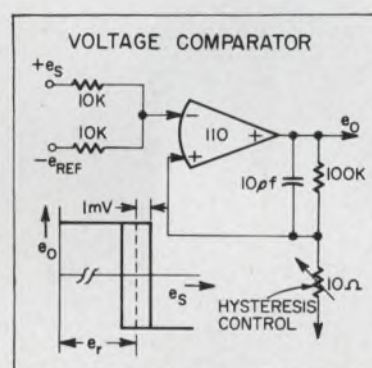
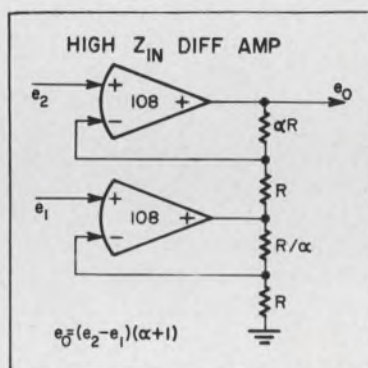
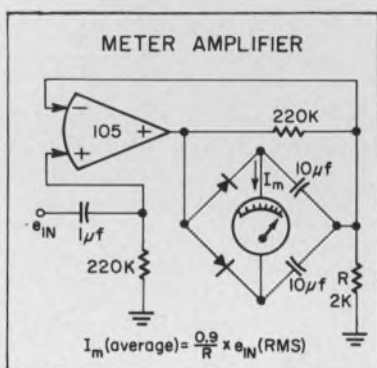
Three n-channel, one-piece molded plastic junction FETs (types MPF-103, 104 and 105) are designed for general purpose audio amplifier and switching applications in industrial and consumer equipment. Forward transfer admittances are 3000, 4000 and 4500 μ mho. Gate-to-source cutoff voltages are -6, -7, and -8 Vdc. Gate-to-source breakdown voltage is -25 Vdc, input capacitance is 7 pF, output admittance is 50 μ mho and reverse transfer capacitance is 3 pF.

P&A: \$0.50 (1000-up); stock. Motorola Semiconductor Products, Inc., P. O. Box 955, Phoenix, Phone: (602) 273-6900.

Circle No. 161

OPERATIONAL AMPLIFIERS

Broad line of economy amplifiers from \$19 to \$58 optimizes performance-versus-cost for vast range of analog circuits.



Model	Voltage Gain Min.	Output Rating	Current Drift* (each input)	Current Drift* (Diff.)	Bandwidth	Price (1-9)
105—General Purpose, Low Cost	30,000	±10V @ 2.2ma	1.5na/°C	0.5na/°C	1.5mHz	\$19.
106—High Gain	150,000	+10V @ 5ma	1.5na/°C	0.5na/°C	1.5mHz	\$26.
108—Low Current Drift	50,000	±10V @ 2.5ma	0.3na/°C	0.1na/°C	0.5mHz	\$35.
109—High Output Current	150,000	±10V @ 20ma	1.5na/°C	0.5na/°C	1.5mHz	\$55.
110—Wideband 100V/µS Slewing	50,000	±10V @ 20ma	1na/°C	0.3na/°C	20mHz	\$58.
150—±2.7V Battery Powered	50,000	±1.5 @ 2.5ma	1.5na/°C	0.5na/°C	1.5mHz	\$30.
160—High Voltage	150,000	±20V @ 2.5ma	1.5na/°C	0.5na/°C	1.5mHz	\$45.

*Maximum drift from -25°C to +85°C. Model A:20µV/°C, Model B:10µV/°C over same range.

Mark reader service card to receive Economy Line catalog giving full details on 11 different low-cost amplifiers. Remember that amplifiers can be specially selected, or modified at low cost, to meet your exact requirements. Why not request one for evaluation in your circuit?

Write for free application manuals on op amp theory and circuits.

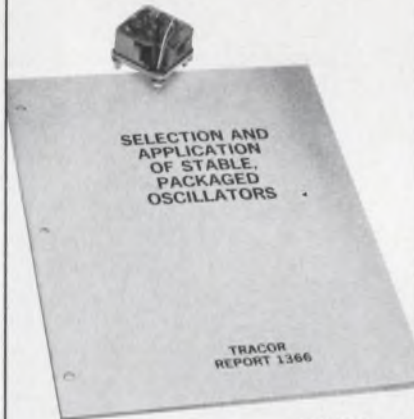
ANALOG



ANALOG DEVICES, INC.
221 FIFTH STREET
CAMBRIDGE, MASS. 02142
PHONE: 617/491-1650

How do you evaluate audio oscillators?

How can you be sure of the right selection for your particular application?



TFA-1066

TRACOR® has an answer

"Selection and Application of Stable, Packaged Oscillators" is a comprehensive two-part report. Section I outlines the availability of standard oscillators in the 0.5% to 0.0001% accuracy range. Section II offers guidelines for choosing a specific oscillator.

The report is free from TRACOR.

Whether or not you want a copy, may we help you evaluate oscillators in your next application?

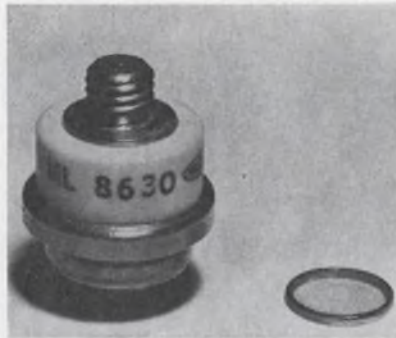
TRACOR, Inc.
General Sales Offices
6500 Tracor Lane
Austin, Texas 78721



REPRESENTATIVES IN PRINCIPAL CITIES

ON READER-SERVICE CARD CIRCLE 57

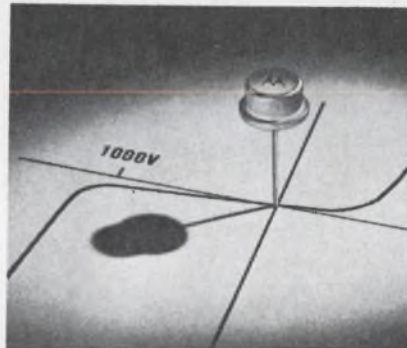
SEMICONDUCTOR



Planar triode tubes

With a thin 24 carat gold coating on all exposed metallic surfaces, this planar triode tube series has applications in DME and transponder equipment. Inside the tube a very thin gold coating on the 0.0008-in. diameter tungsten wire grid, spaced with more than 150 turn/in., suppresses electron emission from the grid. The grid operates at temperatures above 1500°F without deformation.

Engelhard Industries Inc., 113 Astor St., Newark, N. J. Phone: (201) 242-2700. *Circle No. 162*



Silicon rectifiers

This series of silicon rectifiers has an average forward voltage of 0.6 V at a forward current of 25 A. PIV and average reverse current is 500 V and 3 mA for type MR327, 600 V and 2.5 mA for type MR 328, 800 V and 2 mA for type MR330 and 1 kV and 1.5 mA for type MR331. Failure rate of the series is 0.005%/1000 hours. The units are designed for use as a free-wheeling diode in inductive surge suppressor circuits and in 440-Vac circuits where transient protection has been designed in.

Price: \$1.60 to \$6.50. Motorola Semiconductor Products Inc., P. O. Box 955, Phoenix, Ariz. Phone: (602) 273-6900. *Circle No. 163*



Silicon switching FETs

The CM640 series of silicon epitaxial junction switching FETs feature R_{ON} of 25 Ω , I_{OFF} of 0.4 nA, V_p from 1.5 V and C_{DG} of 5.0 pF. The package is an isolated 3-lead TO-18. Typical applications include digital-to-analog converters, multiplexers and chopper-stabilized amplifiers.

P&A: from \$8.80; stock. Tele-dyne Inc., Crystalonics Div., 147 Sherman, Cambridge, Mass. Phone: (617) 491-1670.

Circle No. 164



Silicon power transistor

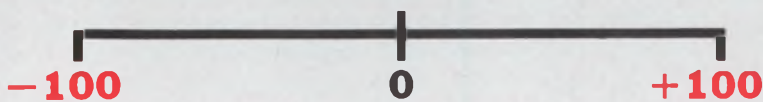
A V_{CEO} (sus) of 325 V and V_{CER} of 400 V is provided by this npn silicon power transistor. Applications include high voltage, wide band amplifiers, relay drivers, waveform amplifiers, converters and inverters. H_{FE} is greater than 30 at collector current of 1 A and a V_{CE} of 5 V. The unit has an h_{FE} of 10 min at 2.5-A collector current and a V_{CE} of 5 V.

Industro Transistor Corp., 35-10 36th Ave., Long Island City, N. Y. Phone: (212) 392-8000.

Circle No. 165

CTC

trims size, cuts cost and eliminates temperature compensating circuits



New IRC metal film resistors with any specified TC between -100 and +100ppm

Controlled Temperature Characteristic—a new IRC line of high-stability precision metal film resistors—is made by a technology so refined that TC can be controlled to any desired point between -100 and +100ppm, ± 5 ppm.

In analog computers, CTC resistors offer fast rise times, precision and stability over a wide temperature range. They can simplify or completely eliminate temperature compensating devices in a wide range of delicate sensing instruments.





Inductance and capacitance are negligible. CTC resistors replace wire-wound types with space and cost savings, and are far more reliable . . . even at higher resistance values. Write for complete data and prices. IRC, Inc., 401 North Broad Street, Philadelphia, Pa. 19108.



CAPSULE SPECIFICATIONS

SIZE	RN65
TC	Any TC between -100 and +100ppm, ± 5 ppm
TEMP. SPAN	Any 50°C increment between -55°C and 165°C
RESISTANCE	50 Ω to 360K Ω
POWER	¼-W @ 125°C, ½-W @ 70°C
STD. TOLERANCES	0.1, 0.05, 0.025%

INDUSTRY'S LARGEST SELECTION OF METAL FILM RESISTORS

 <p>ASSURED RELIABILITY METAL FILM</p> <p>An industry first. 0.1, 0.01 or 0.001% levels. 1/20 to 2 watts. 20 ohms to 1 meg. $\pm 25, 50$ and 100ppm. 0.25, 0.5 and 1% tolerances.</p>	 <p>HIGH STABILITY METAL FILM</p> <p>Molded and coated types, including microminiature, 1/10 to 2 watts. 30 ohms to 10 meg. 8 TC's from ± 25ppm. Tolerances from 0.05%.</p>	 <p>ECONOMICAL METAL FILM</p> <p>Molded and coated types for MIL-R-10509. TC guaranteed to within 100ppm. 1/10 to 2 watts, 10 ohms to 10 meg. 0.5 and 1% tolerances.</p>	 <p>DEPOSITED CARBON FILM</p> <p>Molded types from ¼ to 2 watts, coated types from ½ to 2 watts. 10 ohms to 1 meg. 0.5, 1 and 2% tolerances. MIL-R-10509.</p>
--	--	---	---



Speed Inquiry to Advertiser via Collect Night Letter
ON READER-SERVICE CARD CIRCLE 58



REFERENCE ELEMENTS

THE MOST COMPLETE LINE OF
TCREs AVAILABLE FROM A
SINGLE MANUFACTURING SOURCE

WHATEVER YOUR T. C. R. E.
NEED MAY BE SEMCOR
CAN SATISFY!

SERIES	DESCRIPTION	PACKAGE
1N3154-1N3157A (USN)	8.4 nominal voltage; passivated, low voltage, alloy silicon diode	Glass
1N821-1N829 (USN)	6.2 nominal voltage; passivated low voltage, alloy silicon diode	Glass
1N941-1N945B	11.7 nominal voltage; diffused junction silicon diode	Glass
1N935-1N939B (USN)	9.0 nominal voltage; voltage regulating diode	Glass
1N2163-1N2171A	9.4 nominal voltage; diffused junction silicon diode	Metal
1N2620-1N2624B	9.3 nominal voltage; diffused junction silicon diode	Metal
1N3580-1N3584B	11.7 nominal voltage; diffused junction silicon diode	Metal
HRE-16-HRE-96	Nominal voltage 16 thru 96; diffused junction silicon diode	Metal
SRE-33-05-SREA-12B-05	9.4 nominal voltage; diffused junction silicon diode with 0.5 MV stability for one-year periods.	Metal
GRE-70-GRE-10B	9.0 nominal voltage; diffused junction silicon diode measured at 4 milliamps	Glass
1N1735-1N1742A	6.2 through 49.6 nominal voltage; diffused junction silicon diode	Epoxy
1N2765-1N2770A	6.8 through 40.8 nominal voltage; diffused junction silicon diode	Epoxy
1N4057-1N4085A	12.4 through 200 nominal voltage; diffused junction silicon diode	Epoxy

What do you need in temperature-compensated reference elements? High voltage, high (Standard Cell) stability, passivated alloy, low current, glass or metal cases, 11.7-volt, 9.3-volt, 9-volt, 9-volt low-current, 8.4-volt, and 6.2-volt devices — all are built with the reliability for which Semcor is known.

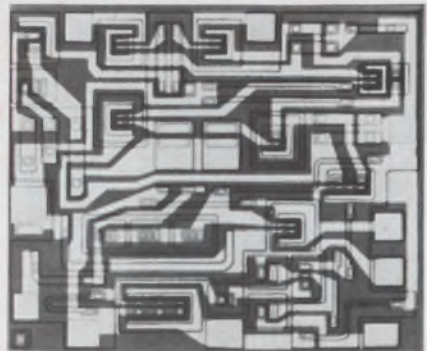


DIVISION OF
COMPONENTS, INC.

3540 WEST OSBORN RD. PHOENIX, ARIZ. 85019
PHONE: 602-272-1341 TWX: 902-255-0479

ON READER-SERVICE CARD CIRCLE 59

MICROELECTRONICS



Sense amplifier has fast response, recovery

Consisting of a wideband, two-stage, differential amplifier, a dc restoration circuit and a DTL output gate, the MC1540 monolithic sense amplifier is designed to detect bipolar differential signals originating from core memories with cycle times as low as 0.5 ms and to translate these signals into saturated logic output signals. Response time is 40 ns and recovery time is 50 ns with a 2-V common-mode signal and 80 ns with a 400-V differential signal.

The dc restoration circuit has facilities to externally adjust the input threshold level from 10 to 25 mV without changing the width of the transition region. When pin 6 of the 10-pin TO-5 package is held to 6 V, the nominal threshold is 17 mV. Threshold drift is 10 $\mu\text{V}/^\circ\text{C}$. The DTL output gate makes strobing the sense amplifier possible from any saturated logic family.

P&A: \$24.50 (over 100); stock. Motorola Semiconductor Products, P. O. Box 955, Phoenix, Ariz. Phone: (602) 273-6900.

Circle No. 166

14-lead connector

This device is designed for testing, breadboarding and production packaging of plug-in devices having up to 14 leads. The connector has 14 positions consisting of two rows of seven lead sockets on 0.1-in. centers spaced 0.3-in. apart. Socket locations are numbered on the top and on the bottom of the connector and one corner is chamfered for indexing of devices.

Texas Instruments Inc., 34 Forest St., Attleboro, Mass. Phone: (617) 222-2800.

Circle No. 167



Our new Mother...all-silicon solid state

We're normally a hard-nosed, unsentimental bunch at CMC, dedicated to giving the other two major makers of electronic counters (Hewlett-Packard and Beckman) a run for their money. So you wouldn't think we'd have time for motherhood or advancing the counter art. **But**, we've scored on all three with our new 600-Series. (1) It's the first all-silicon solid state counter. (2) We're the first of the big three to use the advanced "Mother-Board" technique. So we've cut size, weight, and components while increasing reliability and ease-of-maintenance. (3) Operating temperatures from -30° to $+75^{\circ}\text{C}$ are available. (Other folks we know strain to claim -25° to $+65^{\circ}\text{C}$). Model 607 provides a frequency range of 0 to 5 Mc and period measurement of 0 to 1 Mc. Other models have readout from 2 cps to 2.5 Mc. That's eight times faster than any competitive counter at the price. All this, and a price that's competitive with ordinary germanium counters. **Something free!** We give a glorious Crusading Engineers' medal to engineers who have the courage to compare **everyone's** performance specs before buying a counter. Get yours by writing today for our new stimulating technical catalog. It's free, too. And your Mother will be so proud of your shiny medal.



12973 Bradley • San Fernando, California • Phone (213) 367-2161 • TWX 213-764-5993

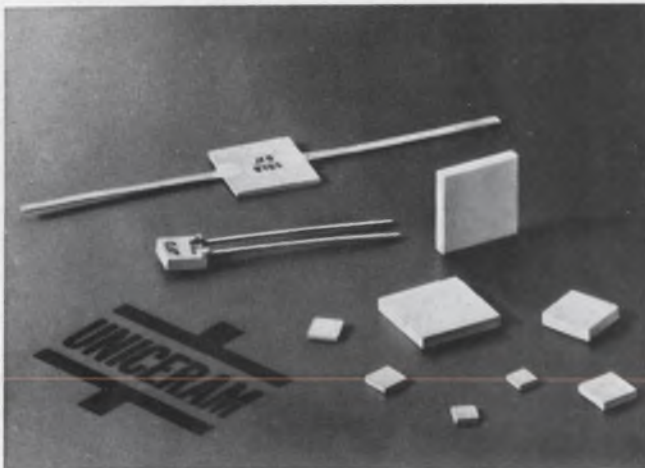
COMPUTER MEASUREMENTS COMPANY IS A LEADING DESIGNER AND MANUFACTURER OF ELECTRONIC INSTRUMENTATION TO COUNT, MEASURE, AND CONTROL.

Speed Inquiry to Advertiser via Collect Night Letter

ON READER-SERVICE CARD CIRCLE 60

The ultimate in Q

JFD Uniceram capacitors



Capacitors shown enlarged 25%

Glass encapsulated or unencapsulated wafer Uniceram monolithic High Q ceramic fixed capacitors—offer a high ratio of capacitance per unit volume. They combine exceptional stability and a guaranteed minimum Q in a smaller size package than competitive units.

Over 1,000 glass encapsulated models, with capacitance values from 0.5 to 3000 pf, provide the ultimate in High Q—proven reliability and stability. All models meet applicable requirements of MIL-C-11272B.

Uniceram High Q capacitors are also available as wafers with metalized edges. These lower-cost units in the same capacitance values offer the same outstanding electrical properties. These wafers, or chips, ideally suited for hybrid integrated circuits, can be soldered directly to printed circuit boards or used as discrete components.

A High K series of encapsulated Uniceram fixed capacitors with up to 1 mfd capacitance is also available.

Write for Catalog UNM 65-2

JFD "TODAY'S COMPONENTS BUILT FOR TOMORROW'S CHALLENGES"

JFD ELECTRONICS CO. / COMPONENTS DIVISION 15th Avenue at 62nd Street
Brooklyn, N. Y. 11219 / Phone 212-331-1000 • Sales Offices—Arcadia, Calif.
Chi., Ill. / Balt., Md. / Saxonville, Mass. / Bklyn., N. Y. / New Hartford, N. Y.
Cinn., Ohio / Phila., Pa. / Pitts., Pa. / Paris, France / Azor, Israel

MICROELECTRONICS

Parasitic-free DTL ICs

Eight DTL ICs using dielectric isolation offer parasitic-free operation and a wide temperature range. Two new dual pulse triggered binary ICs, intended for use in high-speed low-power digital systems, will operate in binary counters at speeds exceeding 20 MHz. Both are capable of driving large capacitive loads. The RD-221 has a fan-out of 10 and the RD-321 has a fan-out of 5. Both dissipate 24 mW with a noise immunity of 800 mV. Input and output voltage is 6 V, V_{cc} is 8 V and output current is ± 100 mA.

Four hex inverters are also offered. The RD-223 is a high-voltage unit with a typical propagation delay of 15 ns. Power dissipation is 10 mW and noise immunity is 800 mV. Output breakdown is 40 V. The RD-220, RD-320 and RD-520 offer a choice of either 5 or 8 fan-outs.

Completing the line are two 4-input logic gate expanders, one covering -55 to 125°C and the other 0 to 75°C . Other maximum ratings for the logic gate expanders are the same: input is 6 V, input current is -20 mA and reverse current is 15 mA.

Radiation Inc., Melbourne, Fla.
Phone: (305) 723-1511.

Circle No. 168

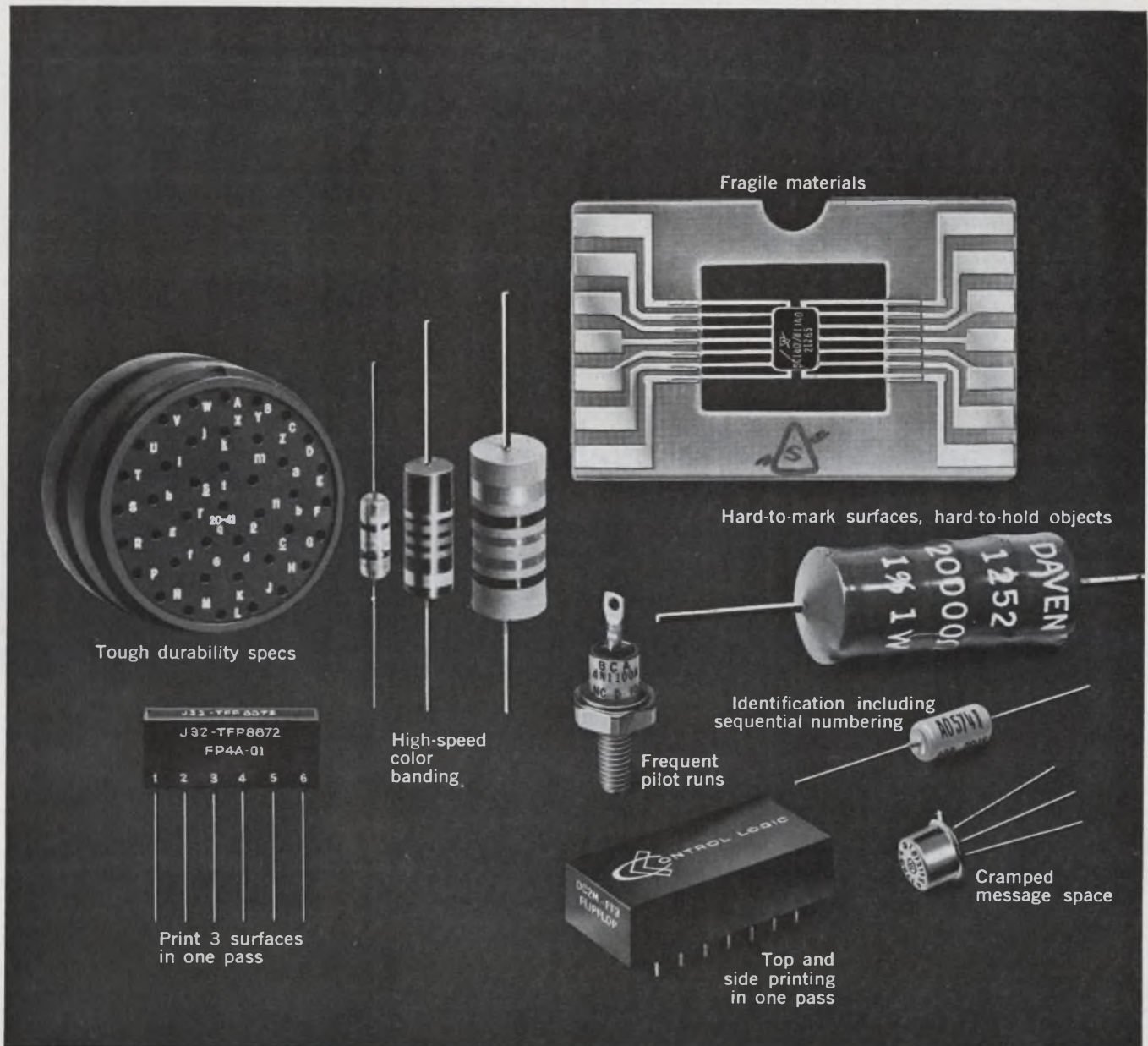


IR-emitting diodes

Optical immersion and a built-in miniature parabolic reflector enable this IR-emitting GaAs diode to provide up to 40 mW continuous output at 0.92 microns in a 15° cone when operated at room temperature with 2 A dc input. Conversion efficiencies are greater than 1%. With 12-A/10- μs pulses and 10-KHz rep rate, output is typically 130 mW. Operating threshold current is less than 2 mA.

Price: \$135 (1 to 9). Microelectronics Division, Philco Corp., 2920 San Ysidro Way, Santa Clara, Calif.
Phone: (408) 245-2966.

Circle No. 169



What marking job can we help you do better?

These are only a few of hundreds of marking jobs you can do more efficiently and more economically with Markem machines. So why waste time improvising and experimenting?

Call in a Markem man and get acquainted with today's broadest line of marking equipment. New high-speed color banding machines — some capable of putting three tiny bands on a miniature diode. Machines that combine sequential numbering with identification. Type so small you can print 14 characters plus trademark in an 0.125" diameter area. Quick-change type for short or pilot runs. New techniques combining special ink with flash-curing to help you meet severe durability specs. A production-speed imprinter so gentle you can safely mark flat pack ceramic components. And many other machines, specialty inks and printing elements. Right now our research engineers and chemists are working on even better ways to mark components. We'd like to be working with you. Markem Machine Company, 319 Congress St., Keene, N.H.

MARKEM[®]

HELPING YOUR PRODUCT SPEAK FOR ITSELF

ON READER-SERVICE CARD CIRCLE 62

ELECTRONIC TIMING AT MOTOR TYPE PRICES!

...choose the packaging

look what \$15.50 buys (1-24 price)



REPLACES POPULAR MOTOR TYPES

±5% REPEAT ACCURACY

1-90 SECOND ADJUSTABLE DELAY

DPDT OUTPUT RATED 10A.

Packaged to directly replace all popular motor type time delay relays... far more reliable than motor types. Budget priced—real savings when critical timing parameters are not required. 117VAC input. DPDT output rated 10A. AEMCO type LC.

look what \$24.00 buys (1-24 price)



PLUG-IN CONVENIENCE

2% REPEAT ACCURACY

SCR TIMING CIRCUIT

0-100 SECOND ADJUSTABLE DELAY

The convenience of plug-in with precision timing parameters at moderate prices. Catalog units have delay periods up to 300 seconds. Reset time is 25 MS maximum. Only 2" x 2" x 3 1/2". 117VAC input. AEMCO type ED.

look what \$25.00 buys (1-24 price)



SCREW TERMINAL CONNECTIONS

2% REPEAT ACCURACY

SCR TIMING CIRCUIT

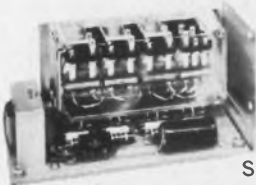
0-100 SECOND ADJUSTABLE DELAY

Screw terminal connections with precision timing parameters at moderate prices. Catalog units have delay periods up to 300 seconds. Reset time is 25 MS maximum. Only 3 1/4" x 3 1/2" x 2". 117VAC input. AEMCO type ES.

SPECIAL ORDER options include: fixed delay types; timing ranges to 10 minutes; other output relays; solid state output; push-on terminals; etc.

AEMCO CUSTOM PACKAGED & DESIGNED ELECTRONIC TIMERS

electronic multi-circuit cycle timer



REMOTE CONTROLLED

4 OUTPUT CIRCUITS

EXCELLENT TIMING PARAMETERS

HIGH RELIABILITY AND LONG LIFE

Specially designed. Four output circuits with delay periods created by RC networks in conjunction with semi-conductor switches. Each output circuit timed individually from start of cycle. Approximately 7" x 3" x 4".

We solve unusual timing problems for OEM's.
We are eager to serve you, too.

Any unusual timing problems we can help you with?

AEMCO DIVISION

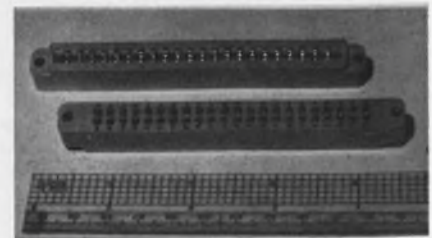
MANKATO, MINNESOTA 56001

formerly TELEX / AEMCO



ON READER-SERVICE CARD CIRCLE 63

MICROELECTRONICS



Taper pin receptacle

Dual-contact, PC board receptacles accept taper pin terminations. An 18-contact version is 3-21/32-in. long, 7/16-in. wide and weighs 1.2 oz. It accepts boards ranging from 0.054- to 0.071-in. thick with contact spacing of 0.156-in. The dual contacts are heat-treated beryllium copper, gold flashed over silver plate and reinforced by a stainless steel ring on the taper pin side. The body is glass-fiber-filled diallyl phthalate. Contact current rating is 5 A, average breakdown voltage between contacts is 1800 Vac and operating voltage is 500 Vac.

U.S. Components Inc., 1320 Zerega Ave., Bronx, N. Y. Phone: (212) 824-1600.

Circle No. 211

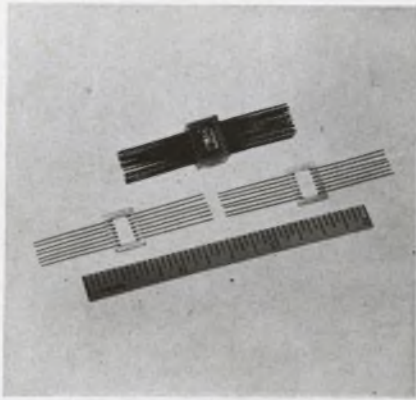


14-lead contactor

For use in production, aging and breadboarding of carrier-held 14-lead flat-pack ICs, this contactor features one-hand operation with a push-pull steel latch. Polarization pins assure correct orientation of the carrier in the contactor. With a body molded of polysulfone, the unit can operate at temperatures from -65 to 150°C. Contacts are beryllium copper, hard gold over nickel plated. Contact resistance is less than 0.01 Ω.

P&A: \$1.75 to \$5; stock to 2 wks. Barnes Development Co., Lansdowne, Pa. Phone: (215) 622-1523.

Circle No. 212

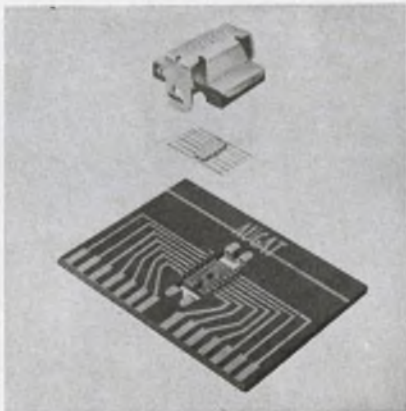


Flat-pack connector

The leads and hermetic seal of IC flat-packs are protected on this flat-pack mounting frame connector during computer assembly. The flat-pack connector is tailored for 14-lead 1/8- x 1/4-in. IC flat-packs. A frame-support surrounds the flat-pack with a rigid molded plastic assembly. Connections to the flat-pack leads are provided within the connector frame by welds onto the flattened ends of nickel molded-in wires.

Hughes Aircraft Co., Electronic Products Div., 500 Superior Ave., Newport Beach, Calif. Phone: (714) 548-0671.

Circle No. 213

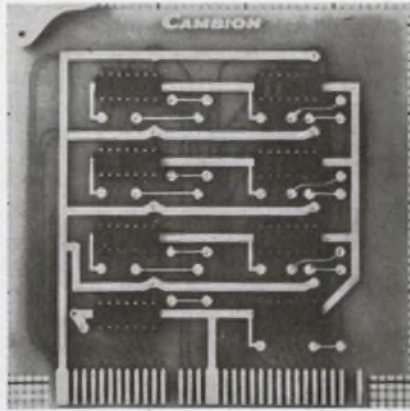


IC test socket

The snap-action cover of this test socket provides positive contact and eliminates soldering or welding IC leads. Leads are not damaged in loading. The unit accepts any pack up to 1/4 x 3/8 in. with up to 14 leads. Test sockets are also available for dual in-line packages and TO-5 cans.

P&A: \$0.95 to \$2.50; 1 to 2 wks. Augat Inc., 33 Perry Ave., Attleboro, Mass. Phone: (617) 222-2202.

Circle No. 214



DTL shift registers

General purpose shift registers are offered in 19 different logic configurations, including one 8-stage, two 4-stage, three 3-stage and four 2-stage combinations. The registers may be used for a variety of computer shifting requirements, including ring counters and serial operating systems. They incorporate J-K flip-flops in each stage and use DTL ICs throughout. Shift rates are up to 5 MHz. The in-line packages are assembled on glass epoxy boards printed on both sides. The boards are spray-etched and wavesoldered. All conductors are 0.02-in. wide with 0.02-in. minimum spacing. Power conductors are 0.1-in. wide with 0.021-in. minimum spacing. Input/output connections are made via a 70-pin connector.

P&A: from \$45.05 (10 to 49); stock. Cambridge Thermionic Corp., 445 Concord Ave., Cambridge, Mass. Phone: (617) 876-2800.

Circle No. 215

Thick film resistors

Thick film resistor/conductor modules for hybrid integrated circuitry are offered in values from 10 Ω to 10 M Ω , tolerances from $\pm 20\%$ to $\pm 1\%$ and temperature coefficients to 150 ppm/ $^{\circ}\text{C}$. The 96 alumina substrates are screen printed and fired at temperatures up to 1000 $^{\circ}\text{C}$. Resistors are hermetically sealed in fused glass and conductors are solderable and weldable. Wattage ratings are to 20 W/in.² with external heat sink.

P&A: about \$1; 3 to 6 wks. Dicotograph Products Inc., Danbury, Conn. Phone: (203) 744-1900.

Circle No. 216



... 35 YEARS LEADERSHIP
IN ROTARY SWITCHES



Oak pushbutton
switches...
lowest in
cost
highest
reliability

Built-in economies reduce costs and maintenance. Modern Oak[®] styling gives smart appearance for simplified or complicated arrangements. More flexible circuit design than provided by many rotary switches because of the large number of blade shapes combined with plunger actions. Oak-pioneered double-wiping action contacts are used in push-button switches. Special frames for lamps prevent vibration and shock, give long lamp life. Lighted push-buttons use one lamp to illuminate 1, 2 or 4 buttons. Unlighted pushbutton switches also.

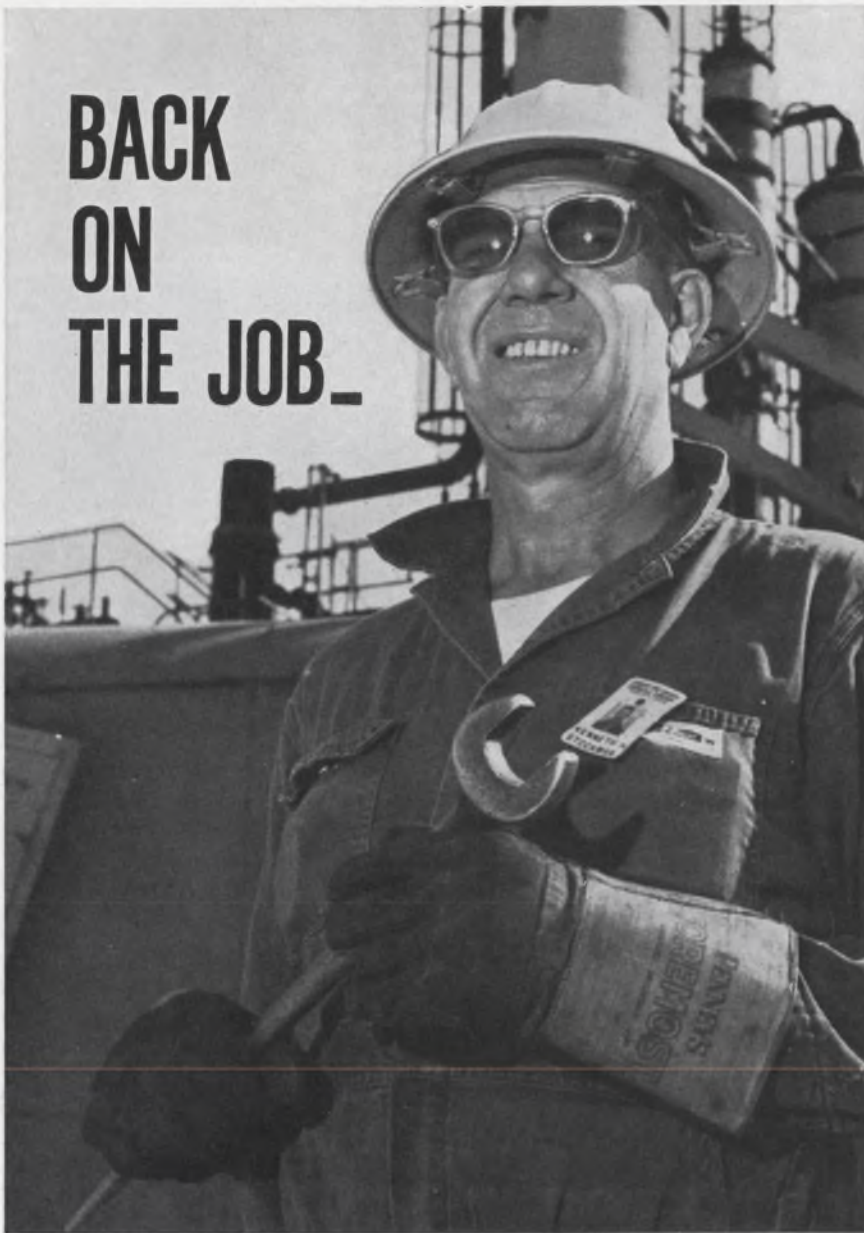
For full details, write for Bulletin SP-165.

OAK MANUFACTURING CO.

A DIVISION OF OAK ELECTRO/NETICS CORP.
CRYSTAL LAKE, ILLINOIS 60014 • Telephone: 815-459-5000
TWX: 815-459-5628 • Cable Address OAKMANCO

ON READER-SERVICE CARD CIRCLE 64

**BACK
ON
THE JOB...**



Ken Stockman, Iron Worker, Survived His Heart Attack

Like most heart attack victims, Ken Stockman survived his first attack and went back to his job. Three out of four now do! Heart Fund dollars invested in research have helped make such progress possible through advances in diagnosis, treatment and rehabilitation.

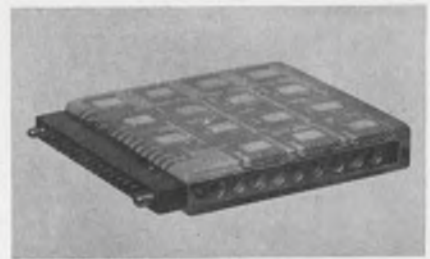
But heart attack still kills 550,000 in the U.S. annually. Fight this Number 1 killer with the best weapon you have — a generous gift to your Heart Fund volunteer.

**Give... so more will live
HEART FUND**



Contributed by the Publisher

MICROELECTRONICS



Flat pack interconnect

Multilayer interconnect modules for IC flat packs eliminate through holes for layer-to-layer connections. The circuitry is flame-sprayed through a photoetched mask. Layer-to-layer interfaces can not be detected visually or electrically. The aluminum substrate can be utilized as a heat sink or, due to the method of application of the insulation layers, as a ground or voltage plane. The remaining exposed surface can either be a complete level of circuitry or serve as copper pads for IC mounting. Mounting can be accomplished by conventional or resistance soldering or welding. With minor design changes, the board can be fabricated to accept through hole mounting of dual in-line packages.

Solitron Devices, Inc., 256 Oak Tree Rd., Tappan, N. Y. Phone: (914) 359-5050.

Circle No. 217



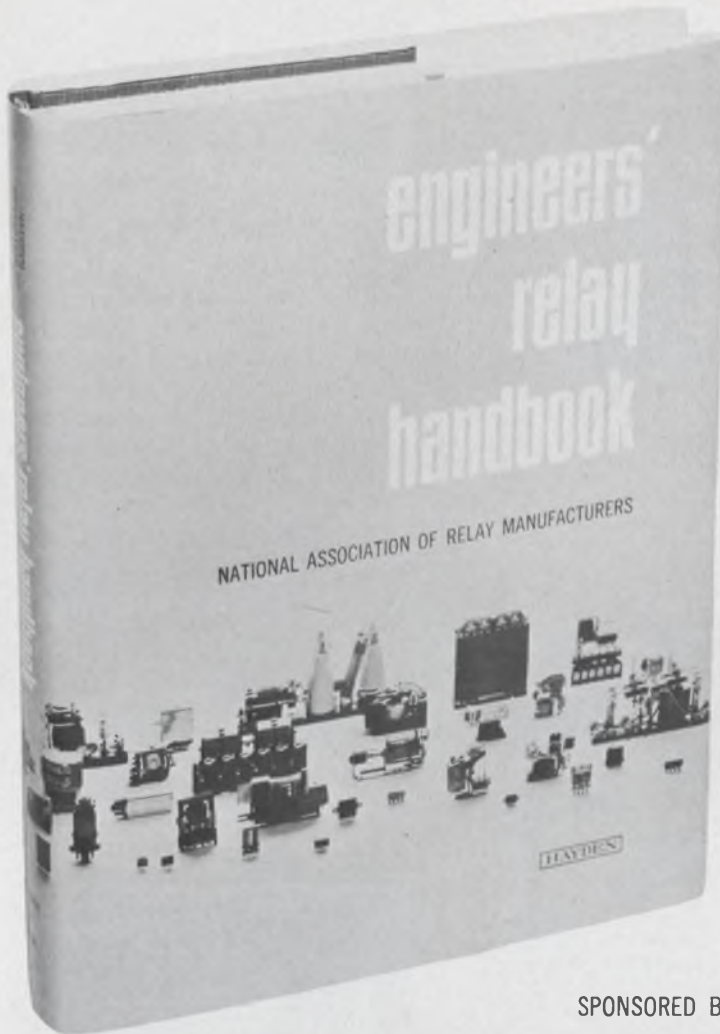
Breadboarding kits

Breadboarding kits to introduce designers to ICs contain a variety of basic circuits and breadboarding sockets. Sample diagrams for such applications as converters, counters, adders and amplifiers are given. The kits cover TTL and DTL digital circuits and operational amplifiers. Two of the kits contain seven and eight ICs each, plus four to six breadboard sockets. The third kit, for amplifier applications, contains four amplifier circuits and two sockets.

Price: \$49.50. Texas Instruments Inc., 13500 N. Central Expressway, Dallas, Texas. Phone: (214) 235-3111.

Circle No. 218

"a relay handbook to rely on"



That's how *Product Engineering* described the *Engineers' Relay Handbook*, just published by Hayden. And with good reason. It was sponsored and produced by the National Association of Relay Manufacturers to provide the relay user with a complete guide to all aspects of relay technology. This is a book the design or systems engineer can't afford to miss. Whether you seek information on the types, reliability, economics, or government specifications of relays, the answer is clearly and thoroughly presented in this invaluable reference.

engineers' relay handbook

SPONSORED BY THE NATIONAL ASSOCIATION OF RELAY MANUFACTURERS

- the first complete roundup of objective relay information
- specifically prepared for the relay user
- detailed coverage of specification parameters
- clarification of performance terminology
- practical emphasis maintained throughout
- complete bibliography of relay literature
- 300 pages, Fully illustrated, Clothbound, \$11.95.

CONTENTS

Relay Terminology • Classes of Service • Relay Classification • Principles of Relay Operation • Relay Application Considerations • Relay Reliability • How to Specify a Relay • Testing Procedures • Government Specifications • Appendices • Bibliography

SEND FOR YOUR 10-DAY FREE EXAMINATION COPY NOW!

Dept. ED-28, Hayden Book Company, Inc., 116 W. 14 St., New York, N.Y. 10011

Send me the "Engineers' Relay Handbook" for a free examination. At the end of ten days, I will either remit \$11.95 plus postage or return the book with no further obligation.

Name _____ Title _____

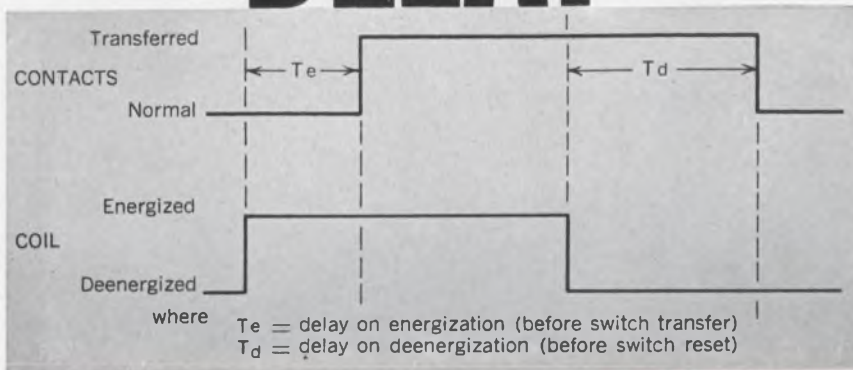
Company _____

Address _____

City _____ State _____ Zip _____

- Check here if payment enclosed. Publisher pays postage with same return guarantee. (Foreign orders, except Canada, must include payment in \$ U.S.)

TWO WAY DELAY



You get "on-delay" and "off-delay" operation in sequence in the same unit with the new AGASTAT® Double Head time/delay/relay. Each delay can be independently set on the unit's time-calibrated dials, in any of eight ranges covering a total span from .01 second to a full thirty minutes. Thus, the unit can take the place of two conventional timers, with substantial savings in panel space and installation time.

This new model of the 2400 Series is supplied for operation on all standard ac and dc voltages. Pneumatic timing offers high repeat accuracy, not affected by normal voltage and temperature fluctuations. DPDT switches handle loads up to 20 amps.

Want more complete data? Write the leader in time/delay instrumentation since 1931. Department A33

AGASTAT TIMING INSTRUMENTS
 ELASTIC STOP NUT CORPORATION OF AMERICA
 AGASTAT DIVISION • ELIZABETH, NEW JERSEY

IN CANADA: ESNA LIMITED, 271 PROGRESS AVENUE, SCARBOROUGH, ONTARIO

ON READER-SERVICE CARD CIRCLE 66

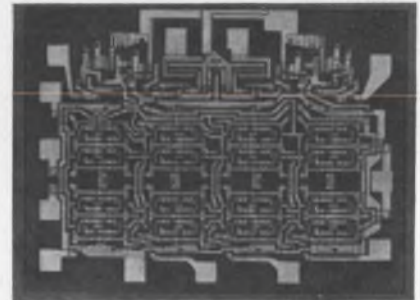


3- and 4-lead test sockets

Series MS sockets accept stud, TO-5 and other style packages having 3 or 4 leads on a 0.2-in. diameter circle. Molded of Teflon FEP or polysulfone, their flanged bodies are designed for press mounting in 7/16-in. holes. The sockets have pyramid tops, polarization indices and polarization notches along the body. Both units have tapered lead entrances. Contacts and terminals are beryllium copper, spring tempered and hard-gold over nickel plated. Terminals are tubular and pierced at the ends.

P&A: \$0.80 to \$2.25; stock.
 Barnes Development Co., 24 N. Lansdowne Ave., Lansdowne, Pa.
 Phone: (215) 622-1525.

Circle No. 219



16-bit memory

Temperature ratings on this 16-bit, 10-MHz TTL memory have been extended to cover -55 to 125°C . The monolithic elements consist of 16 two-transistor flip-flops arranged in a 4 x 4 matrix providing information storage. Two write and two sense amplifiers are also built into the element. Both data and data complement are available at the sensing outputs, which can be paralleled for larger arrays. Delay between addressing and read or write is 20 ns. The memories are packaged in a 14-lead flat pack or dual in-line plug-in.

Transitron Electronic Corp., 168 Albion St., Wakefield, Mass. Phone: (617) 245-4500.

Circle No. 220



SIEMENS

ELECTROLYTIC CAPACITORS

Highest quality and longest operation life have been achieved and proven through actual performance tests of up to 64,000 hours (approx. 8 years).

99.99% pure aluminum for the anode and a positively noncorrosive electrolyte make it possible for Siemens to project performance capability and failure rates accurately for usage up to 100,000 hours (approx. 12 years). Special sealing technique and choice of materials assure longest possible operational span of electrolyte.

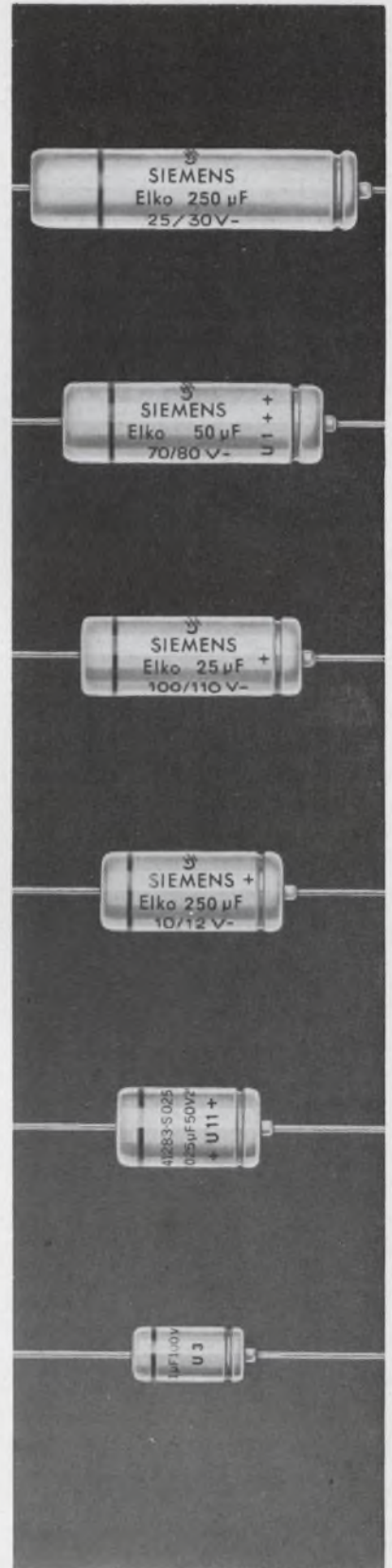
Siemens electrolytic capacitors are capable of operating as long as other more conventionally designed capacitors—such as foil, etc.—due to the special composition of the electrolyte. This composition achieves an optimum of dissipation factor and corrosion. Siemens capacitors operate perfectly at temperatures up to 85° C.

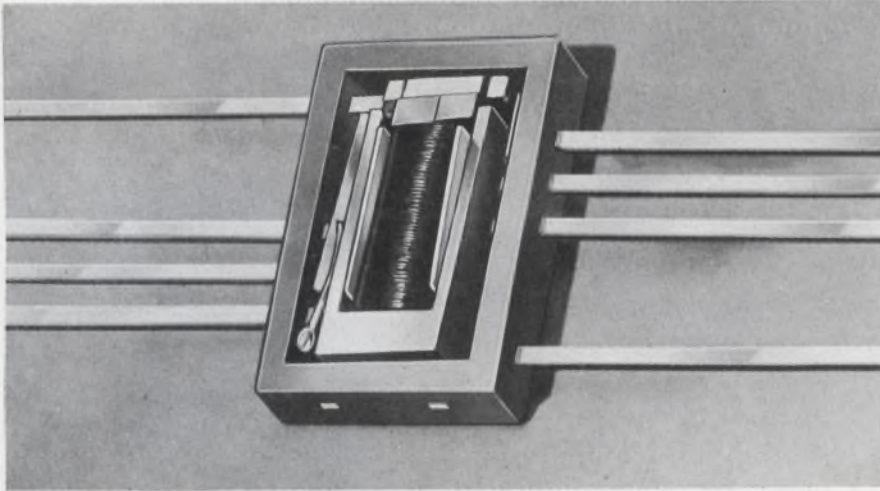
Siemens electrolytic capacitors feature minimum size, maximum performance, and overall adaptability for new applications. Available out of stock in White Plains, N.Y. Send for literature.

SIEMENS AMERICA INCORPORATED
Components Division
230 Ferris Avenue,
White Plains, N.Y. 10603

In Canada: SIEMENS CANADA LIMITED
407 McGill Street, Montreal 1, P. Q.

ON READER-SERVICE CARD CIRCLE 67





TO-87 flat pack houses 1/4-A, 28-V magnetic relay

Still another discrete component, the relay, has been brought to the circuit board via the flat pack. Top dimensions, lead center line distance, lead indexing and numbering of this magnetic relay conform to the JEDEC TO-87 IC package. Designed for low-profile PC board applications, the package measures 3/8 x 1/4 x 1/10-in. with eight peripheral ribbon leads 1/2-in. long and 0.006 x 0.02-in. wide. The leads provide symmetrical connections to the coil and the 1/4-A resistive, 28-V dpdt contacts.

The relay assembly itself has 11 moving parts, including all contacts and case. The armature surrounding the coil is center pivoted to provide static and dynamic balance. The ends of the one-piece core serve as magnetic poles which mate with the armature. The entire magnetic circuit consists of two parts fabricated from heat-treated silicon steel and requires 250 mW of coil power at nominal voltage.

As voltage is applied to the coil, which is wrapped directly on the core over an insulating film, glass-tipped actuators on the armature move the gold-plated silver-magnesium-nickel contacts within each pole with a typical operate and release time of 1 ms. Standard coil resistance for 6, 12 and 24 V is available with special coils to order.

The flat pack is an alumina case entirely insulated from ground (alumina dissipates any moderate

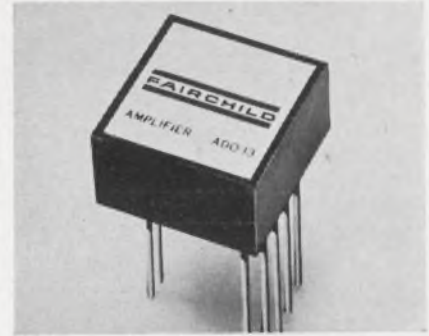
coil temperature rise). The eight gold-plated Kovar leads are hermetically sealed through the walls of the package by 1200°C hard glass. The 1/2-in. lead length keeps contact and lead resistance under 0.1 Ω. The cover is hermetically sealed by fluxless gold germanium brazing in an inert gas atmosphere.

Packaging has not compromised relay reliability. The inherent balance of the armature makes it immune to vibrations up to 300 Hz at 50-G levels. The calculated resonant frequency of the moving contact is just under 5 kHz and the relay is rated for 150-G shocks. With factory specified contact pressure, a worst-case plane shock of 265 G would be required to cause a momentary opening of closed contacts. Non-gassing and radiation-resistant materials are used throughout the flat pack relay, rated for Class B temperature, -65 to 125°C.

The extremely small size, light weight (1 gram) and volume (0.01-in.³) of the relay suggest uses in "manportable" communications and weapons delivery equipment. The low profile makes it a natural for high-density printed circuit board packaging of aircraft and missile control systems.

P&A: \$45; 60 days (sample quantities). Branson Corp., P. O. Box 845, Denville, N. J. Phone: (201) 625-0600.

Circle No. 221

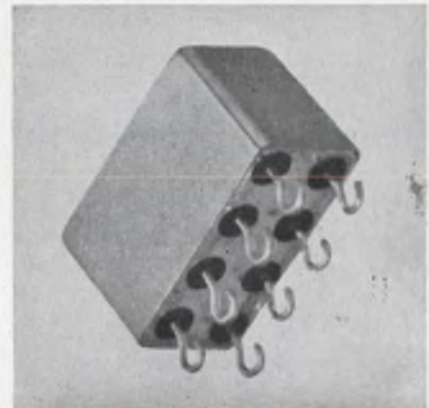


Low-cost 2-mA diff amp

The low-cost ADO-13 differential amplifier delivers 2 mA load current at ±10 V and exhibits good gain stability with changes in load and temperature. Dc open loop gain is 40,000 and gain-bandwidth product is 2 MHz. Voltage drift is 20 μV/°C over a -25 to +85°C range.

P&A: \$17 (100 lots); stock. Fairchild Camera & Instrument Corp., Instrumentation Div., Mountain View, Calif. Phone: (415) 962-2011.

Circle No. 222



IC clock oscillator

Model 716 IC clock oscillator is a 0.16-in.³ package with digital output for computer, missile guidance and other digital applications. The 716 features a low-aging, high-reliability crystal combined with integrated circuitry for 450-ppm stability over -55 to 90°C at frequencies from 701 to 1000 kHz. Output voltage at load is logic zero (0.2 ± 0.2 Vdc) and logic one is ±2.8 Vdc minimum. Waveform is square with 20 ns rise time. Current drain is 15 mA. The encapsulated unit is available with pin or cane hook header.

Monitor Products Co., Inc., 815 Fremont, S. Pasadena, Calif. Phone: (213) 682-3761.

Circle No. 223

HELIPOT CUTS THE SIZE OF ITS 10-TURN POT



but there's not a spec of difference

It's true . . . Helipot *actually* cut the length of its $\frac{7}{8}$ " diameter 10-turn in half. No hocus pocus. The new Model 7266 is $\frac{3}{4}$ " long . . . the shortest 10-turn $\frac{7}{8}$ " diameter precision potentiometer you can buy. Yet its precision performance is unscathed, and the wirewound resistance element is actually *longer* than that of its predecessor. It is a *precision* pot in every respect. Resolution is better, the total resistance range is still 10 ohms to 125K, with $\pm 0.2\%$ linearity as good as ever.

How much was the price raised? Not a penny — it's priced at \$10 for 1—9 pieces and well below \$8 in quantity. (And you get two for the size of one.) Complete product information is available now from your local Helipot sales office.

Beckman

INSTRUMENTS, INC.

HELIPOT DIVISION

FULLERTON, CALIFORNIA • 92634

INTERNATIONAL SUBSIDIARIES: GENEVA; MUNICH;
GLENROTHES, SCOTLAND; TOKYO; PARIS; CAPETOWN; LONDON;
MEXICO CITY

Speed Inquiry to Advertiser via Collect Night Letter
ON READER-SERVICE CARD CIRCLE 69

**nothing's
special
but the
delivery**



**special cables to solve
special problems are
an everyday job at
Columbia Wire. If
we don't have the
cable in stock for
immediate delivery
we have the knowledge
skill and facilities
for producing it fast.**

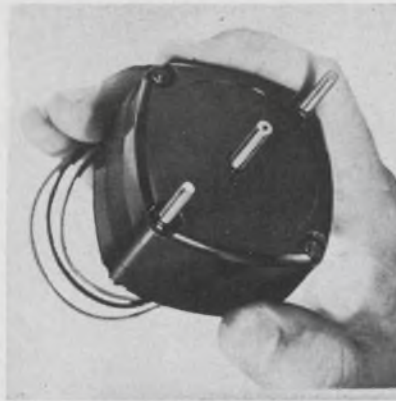
write for our fully-illustrated catalog



Columbia
WIRE PRODUCTS COMPANY
2850 Irving Park Rd., Chicago, Ill. 60618

ON READER-SERVICE CARD CIRCLE 70

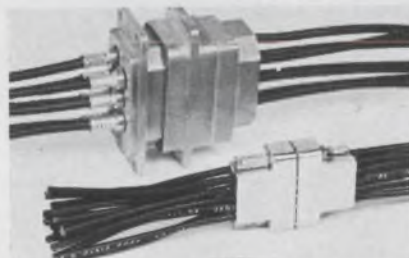
COMPONENTS



Epoxy-insulated motors

This line of synchronous and induction motors has an epoxy-insulated stator. The motors have speeds from 1 to 1800 rpm at torques from 0.3 to 150 oz-in. Two permanently lubricated ball bearings support the aluminum die-cast rotor. End thrust and rotor are individually adjusted. The 4-pole single-phase motors operate on 115 volts, 50 or 60 Hz. The reversible motors will satisfactorily operate under continuous or intermittent duty applications.

Amphenol, 120 S. Main St.,
Janesville, Wis. Phone: (608) 754-
2211. *Circle No. 224*



Plated plastic connector

Ground loops, oscillations and feedback RFI are reduced by this plated plastic connector. The metal-plated plastic connector maintains shielding throughout and has removable coax contacts. The connector is molded glass-filled phenolic and plated tin over nickel.

When the contacts are inserted into the connector body, the shield termination contacts the metallic coating of the body via springs in contact with both the connector body and contacts. Thus, all cable shields are commoned through the metallic coating of the connector body.

Burndy Corp., Norwalk, Conn.
Phone: (203) 838-4444.

Circle No. 225



33-channel comb filter covers 22 to 45,000 Hz

The frequency range of 22 Hz to 45 kHz may be divided into 33 equal-resolution frequency bands by this octave comb filter. The frequency divider consists of 33 fixed 1/3-octave band filters followed by 33 emitter followers for channel isolation. Each filter may be loaded with a minimum of 15 k Ω in parallel with a maximum capacity of 300 pF. Coax connecting cables up to 10 ft in length may be used. The instrument may be easily adapted to many applications including parallel or real-time frequency analysis, transient analysis, and correlation or cross-spectrum analysis. It can also be used as a sequentially read-out 1/3-octave band analyzer or as the frequency divider of high-speed data analysis systems.

The all solid-state device may be rack-mounted and operated without access to the front panel.

P&A: \$3270; stock. B&K Instruments Inc., 5111 W. 164th St.,
Cleveland. Phone: (216) 267-4800.

Circle No. 226

Transistor active filters

LC band pass responses are simulated by these transistor active filters at audio and sub-audio frequencies. A single-resonant or a double-tuned coupled-circuit band pass response is obtained by using a twin-T null network in negative feedback around a linear high-gain transistor op-amp. The silicon transistor amplifiers with emitter-follower output have a low-noise silicon input transistor or high-impedance field effect input transistor.

White Instrument Laboratories,
Box 9006, Austin, Tex. Phone:
(512) 453-6621. *Circle No. 227*

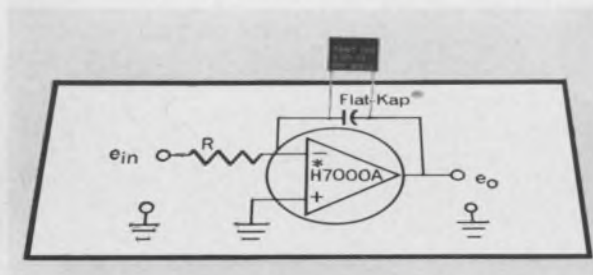
How to make a better integrator smaller.

Put a KEMET Flat-Kap capacitor in the circuit. Minimize integrating errors by combining Flat-Kap's high IR with extremely low input current (100 picoamperes in our H7000A

Operational Amplifier, for instance). And you add real miniaturization to this high accuracy because Flat-Kaps are smaller than ordinary polystyrene, glass or mica capacitors.

The reason is Flat-Kap's remarkable new dielectric, a Union Carbide development called Parylene. It is vacuum-vapor-deposited in micron-range thickness on the aluminum foil conductor. Yet, even in such a thin layer, it holds Flat-Kap's IR at rated voltage and 25°C to 10⁶ megohms, minimum.

Typical retrace stability for Flat-Kaps is 0.1% from cycling, use or storage, over the full operating range from -55° to +125°C, with nominal



TC -200 ppm/°C. They are available in any value from 0.001 to 0.100μF, 50 VDC, with tolerances as tight as ± 1%.

Where you want maximum volumetric efficiency in a stable capacitor for such applications as integrators, filters and timing circuits—think of KEMET Flat-Kaps. For details, mail the coupon, or see your nearby sales representative.

Clip, fill in name and title, attach to letterhead.

Union Carbide Corporation
Electronics Division, Dept. ED-104
270 Park Avenue, New York 10017

Please send Engineering Bulletin #22, on
KEMET Flat-Kap film-foil capacitors

**UNION
CARBIDE**

Name _____

Title _____

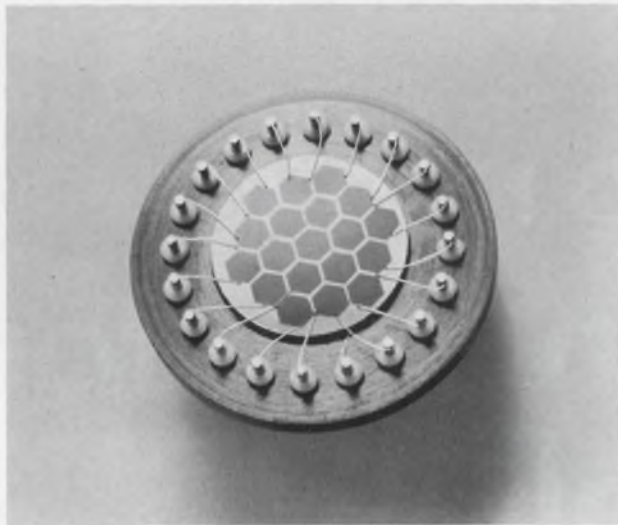
ELECTRONICS

KEMET is a registered trade mark of Union Carbide Corporation.

REGIONAL SALES OFFICES. New England: T. J. Roper, 300 First Ave., Needham Heights, Mass. Phone: 617-444-5400. Mid-Atlantic: R. H. Robecki, 1341 Hamburg Turnpike, Wayne, New Jersey 07472. Phone: 201-696-2710. Mid-West and South: K. S. Collart, P. O. Box 6087, Cleveland, Ohio 44101. Phone: 216-221-0600. West Coast: D. Purcell, 701 East Whittier Boulevard, Whittier, California 90605. Phone: 213-698-8077.

ON READER-SERVICE CARD CIRCLE 71

New facts and figures on infrared mosaic detectors...



or...how dense can we get?

We are now supplying high-density infrared arrays covering the spectrum from 0.4 to 15 microns — with a packing density in excess of 100 elements per square centimeter.

Cross-talk specs of less than 0.1% between any two elements are made possible by our fabrication techniques.

Uniformity of output? Element-to-element deviation in sensitivity is less than 10% throughout the mosaic. And the output from a single detector when scanned with a high-resolution target varies less than 10%.

The various arrays are made of:

- Silicon (0.4μ to 1.0μ)
- Indium Arsenide (1.0μ to 4.0μ)
- Indium Antimonide (1.0μ to 5.5μ)
- Gold-doped Germanium (1.0μ to 11μ)
- Mercury-doped Germanium (1.0μ to 15μ)

These are all Quantum Detectors which have time constants of 1 microsecond or less.

If you have read to this point, chances are that you have some interest in the building of a high-resolution search/track set or an infrared scanning/imaging system. If so, why not let Philco help you solve your mosaic detector problems? For immediate information call, write or wire the Spring City Operation Marketing Department. Or circle the Reader Service Card. (Phone: 215-948-8400.)

Microelectronics Division

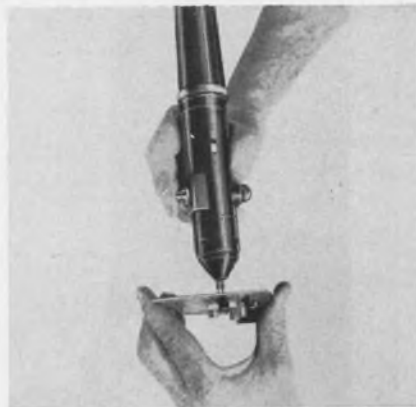
SANTA CLARA, CALIF. • LANSDALE, PA. • SPRING CITY, PA.

PHILCO

A SUBSIDIARY OF Ford Motor Company.

Speed Inquiry to Advertiser via Collect Night Letter
ON READER-SERVICE CARD CIRCLE 72

PRODUCTION



Transistor tester

A hand-held tester checks transistors and diodes without unsoldering while they are still in the circuit. The SC-4 consists of three parts: a battery holder at the rear, a central housing incorporating electronics, indicator light, and selector switches, and a forward pick-up section consisting of three spring-loaded pins with TO-5 spacing. The entire unit weighs 6 oz and measures 9-in. long by 1-1/4-in. diameter.

The operator sets the selector switch to npn or pnp and presses the contact pins against the transistor's PC connections. Cut-off conditions are determined by noting the pilot light on the tester. The push-button is then depressed and conduction conditions are determined by again observing the pilot light. Burned out and shorted devices are readily identified. An adapter to test diodes and a set of extending leads and clips are furnished to test unmounted components.

P&A: under \$90; stock. Jensen Tools & Alloys, 3630 E. Indian School Rd., Phoenix, Ariz. Phone: (602) 955-0180. Circle No. 228

Continuity tester

At a rate of two a second, this device can test up to 944 circuits or wires in a cable form. With a bridge or universal measuring instrument, the continuity tester can check levels of inductance, capacitance and resistance. The front panel contains banks of 91-hole sockets arranged in pairs. Corresponding plugs are connected to the wires at the end of the cable form.

Price: \$1932. Technivision Engineers Ltd., Braywick House, Maidenhead, Berks., England.

Circle No. 229



Disc Memories! No one has more to offer than Librascope

General Precision, Inc., Librascope Group offers the most complete line of disc memories. There's a Librascope memory to meet your requirements. Librascope head-per-track memories are proven in performance in computer, communications, and control systems designed for military, business, engineering, and educational applications. With Librascope, you design with confidence.



Series L100:
Inexpensive 10"-disc memories with capacities to 300,000 bits.



Series L200:
Low-cost, high-performance 10"-disc memories with capacities to 2 million bits.



Series L400:
Versatile, high-performance 16"- and 24"-disc memories with capacities to 50 million bits.



MASS MEMORIES

For integrating scattered multicomputer systems... for getting more work from present systems... for simplifying random-access programming, Librascope's

LIBRAFILE mass memories are your answer. Large-capacity, high-speed memory systems easily adaptable to any large data-base application presently being performed by a mix of computers.

LIBRAFILE 4800:
48"-disc mass memory capable of transferring data at up to 432 megabits/sec.

LIBRAFILE 3800:
48"-disc mass memory capable of transferring data at up to 342 megabits/sec.

Now finding use in document retrieval, communications, intelligence, simulation, management information, command and control, process control, and time-sharing. New OEM prices.



Militarized Series:

Small, compact 6 1/4"-disc memories designed for airborne (MIL-E-5400, Class 2) applications, and larger, high-speed random-access 14"- and 24"-disc information storage systems for shelter, van, or shipboard applications.

ENGINEERS:

For career openings, call or send resume in confidence to L. C. Kelley, General Precision, Inc., Librascope Group, 808 Western Avenue, Glendale, Calif., 91201. An equal opportunity employer. A Plans-For-Progress Company.

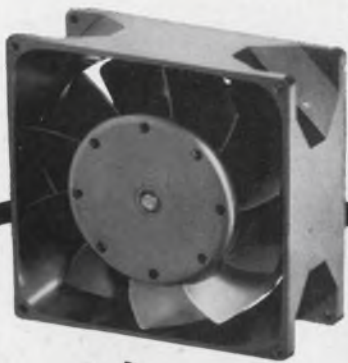
See the Librascope disc-memory line at the Fall Joint Computer Conference. Booth 528-534.

LIBRASCOPE GROUP

GP GENERAL PRECISION INC.

808 Western Ave., Glendale, California 91201

ON READER-SERVICE CARD CIRCLE 73



New

4 1/2"

SHADED-POLE Model 2500 PAMOTOR Miniature Axial Fans

- 20,000+ operational hours at 45°C
- Low-cost design
- All metal construction
- Unexcelled performance and reliability
- Universal 4 1/8" mounting for interchangeability
- 50-60 cycles at 110 or 220 vac

IN STOCK FOR IMMEDIATE DELIVERY!

Write for technical data on the Model 2500 and other PAMOTOR axial fans to:

PAMOTOR, INC.

312 SEVENTH STREET • SAN FRANCISCO, CALIF.

ON READER-SERVICE CARD CIRCLE 74

MATERIALS



Aerosol freezing agent cools hot components

Sprayed on a suspected resistor, capacitor or other circuit element, "Component Freeze" reduces the surface temperature of the component to -50°F in seconds for a go-no-go test. This saves time lost in waiting for a circuit to cool before testing for the intermittent component. Another application is in the prevention of heat transfer during soldering or welding. A removable extension nozzle confines the spray to a very small area, which is advantageous for both testing and soldering operations. The product is nontoxic and nonflammable.

Miller-Stephenson Chemical Co., Inc., Rte. 7, Danbury, Conn. Phone: (203) 743-4447.

Circle No. 230

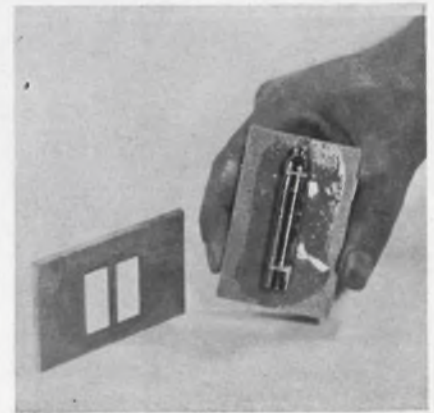


Miniature pins

Provided with rounded ends for plug-in relays and semiconductor devices, miniature pins are available in copper, nickel, nickel-clad copper, copper-clad iron, nickel-iron-cobalt alloys and Dumet. Pin lengths run up to 1/2 in. and diameters range from 0.015 to 0.05 in. Pin diameter tolerance is ± 0.00025 in. and length tolerance is ± 0.003 in.

Price: \$0.25 to \$0.50/M. General Electric Co., 21800 Tungsten Rd., Cleveland. Phone: (216) 241-0405.

Circle No. 231



Temporary adhesive for substrates and crystals

"Crystalbond 509" is an acetone-soluble adhesive designed as a temporary bond for holding crystals, glass components and ceramic substrates for machining, slicing, grinding and polishing. The thermoplastic polymer material will bond readily to metals, glass or ceramic surfaces, and will not clog cutting blades or grinding media. After machining, the adhesive can be removed with an acetone rinse. Application is made by pressing a 7/8-in. diameter, 7-in. long stick of the material against a preheated plate at 160 to 170°F so that a melted layer is deposited. After spreading, the substrate or crystal is worked into the adhesive, and as the temperature drops below 150°F, the bond solidifies.

P&A: \$25 (5 sticks); stock. Ar-emco Products Inc., P. O. Box 145, Briarcliff Manor, N. Y. Phone: (914) 762-0685.

Circle No. 232

Metal crystals

Produced by electron beam processes, single crystals of very high purity metals such as aluminum, copper, gold and other low melting point metals and their alloys are available. Sizes are up to 1 in. diameter and 6 in. length. Surfaces can be provided to within 1° of specified orientation.

P&A: about \$40/in. (1/2-in. diameter); stock to 1 wk. Materials Research Corp., Orangeburg, N. Y. Phone: (914) 359-4200.

Circle No. 233

The top name in portable power



Sonotone rechargeable nickel-cadmium sealed cells, of course.

Whenever the need for portable, rechargeable power is indicated, you'll find Sonotone nickel-cadmium sealed cells playing a powerful supporting role.

Pioneer in the development of low weight, constant voltage, sintered-plate nickel-cadmium batteries, Sonotone today is a leader in the production of rechargeable portable power cells.

Produced in more than 27 shapes and sizes, Sonotone sealed cells provide the dependable, continuous voltage output needed to turn motors, light lights, activate switches, power electronics . . . in everything from Titans to cordless carving knives.

If you need any better indication of Sonotone's

capabilities in the rechargeable sealed cell field, just tell us your problem. We'll help you with whatever technical data or engineering aid you require. And probably just the cell you need, whether you're looking for 1 or 1 million. If not—we'll make it.

No idle claim. Sonotone has more technical experience in designing, developing and producing nickel-cadmium cells and batteries than any other manufacturer around!

Sonotone Batteries 
portable power—from Titan to toothbrush

SONOTONE CORPORATION, BATTERY DIV., ELMSFORD N. Y. 10523

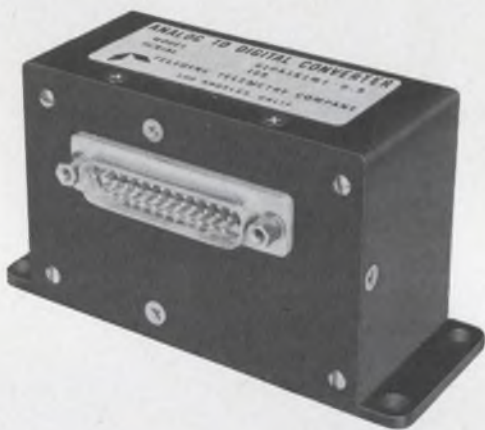
Aircraft, Missile and Satellite Batteries • Power Supplies • Battery Charger/Analyzer

Looking for a more challenging opportunity? Join Sonotone's fast-growing engineering team in the skyrocketing field of nickel-cadmium battery design and development. *An equal opportunity employer.*

Speed Inquiry to Advertiser via Collect Night Letter
ON READER-SERVICE CARD CIRCLE 75



Take a good look...



at our TYPE 610
MICROCIRCUIT AIRBORNE A-D CONVERTER

Space age designed . . . for space age applications, Type 610 Analog-to-Digital Converters use only reliable integrated circuits and military approved parts to provide the optimum in performance for critical missile, satellite, space probe or aircraft A-D conversion requirements.

- Throughout rates from 1 to 100,000 words per second
- Up to 10-bit resolution
- Overall accuracy up to ± 0.1 percent
- Choice of output formats, parity and synchronization codes
- Lightweight-small size
- High reliability under extreme environmental conditions

Next time you have an analog-to-digital conversion requirement, contact your local TELEDYNE TELEMETRY COMPANY Sales Representative or contact us directly . . . and TAKE A GOOD LOOK AT OUR TYPE 610 MICROCIRCUIT AIRBORNE A-D CONVERTER.

TELEDYNE TELEMETRY COMPANY

A Division of Teledyne, Inc.



AEROSPACE DIVISION

12964 Panama Street
Los Angeles, California 90066
Telephone (213) 870-9831
TWX: 910 343 6855

DYNAPLEX DIVISION

P.O. Box 341 Alexander Road
Princeton, New Jersey 08540
Telephone (609) 452-2550
TWX: 510 685 2379

ON READER-SERVICE CARD CIRCLE 76

MATERIALS

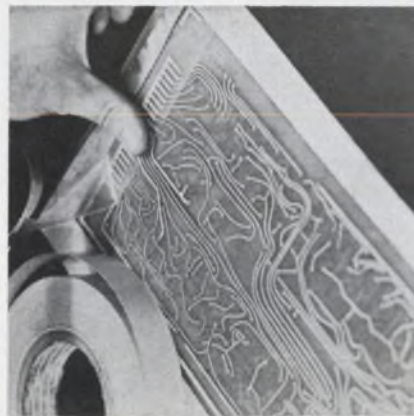


Fiber optic light guides

Transmitted light intensity is not lost when this plastic fiber optic light guide is bent into arcs having a 1/4-in. radius. The protectively-jacketed material withstands repeated vibration and is amenable to machining processing. The light guides are available in a kit which includes two 2-ft lengths of light guide, one with 16 fibers and one with 64, concentrating lens, penlight source, an adapter for connecting guides and polishing and capping materials.

P&A: \$10; stock. Edmund Scientific Co., 105 E. Gloucester Pike, Barrington, N. J. Phone: (609) 547-3488.

Circle No. 234



Stop-off film for PC board etching

Pressure-sensitive film in roll form is used for stop-off or masking purposes during etching or secondary operations in processing printed circuits. The film is unaffected by most sulphates including sulphuric acid, ammonia persulphide and metex, ferric chloride, and rhodium, gold, copper and nickel salts. Thickness of the film is 0.002-in., roll length is 200-ft and widths available are 1/2, 3/4, 1, 2, 3 and 4-in.

Morgan Adhesives Co., 4560 Darrow Rd., Stow, Ohio. Phone: (216) 688-8255.

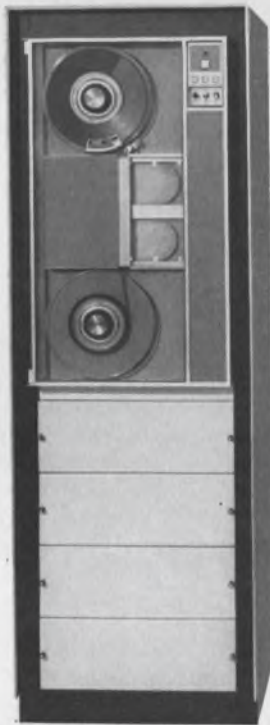
Circle No. 235

This New 3M Asynchronous Digital Recorder writes data at the rate of 2000 characters per second

See it at Booth 1139, Fall Joint Computer
Conference, Nov. 8-10, San Francisco



Revere-Mincom's new ADR-100 records during the start interval — that's why you never lose any data in the asynchronous mode, and why this 3M system accepts data at least four times faster than any other asynchronous digital recorder available to date. 2000 characters per second, internally produced inter-record gap if required.



Perfect backup for all IBM systems. Using IBM-compatible 7- or 9-channel tape format, ADR-100's packing density (up to 800 bpi) is due to improved skew control with skew rated at less than 250 microinches. Single-capstan friction drive, no pinch rollers.



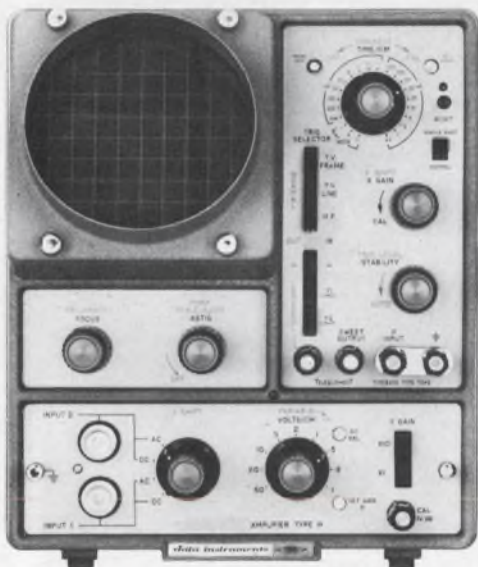
Developed and manufactured by the leader in instrumentation recording — Revere-Mincom in Camarillo.

Revere-Mincom Division **3M**
COMPANY
300 SOUTH LEWIS ROAD • CAMARILLO, CALIFORNIA 93010

ON READER-SERVICE CARD CIRCLE 77

Takes what hurts out of Megahertz

\$23 a MHz*



*
Main Frame \$420
25MHz Amplifier \$160

Is your budget too tight for your bandwidth? Here's quick and permanent relief—Data Instruments S43A. Everything about this instrument is designed for sophisticated requirements—except the price. The main frame including the time base and horizontal amplifier is \$420. Six vertical amplifiers ranging in price from \$85 to \$170 give the unit broad operating capabilities—Bandwidths to 25MHz with a risetime of 14 nsec. And sensitivities to 100 μ v/cm. Narrow band and wide band amplifiers are also available as well as an envelope monitor with a tuned bandwidth to 32MHz.

The 4 inch, flat-faced PDA tube provides accurate and unambiguous viewing. It is available in a variety of phosphors and has a removable graticule with controlled edge lighting. An extremely reliable time base provides sweep speeds to .5 μ sec/cm in 22 precisely calibrated ranges with single shot and lockout. It also has neon indication when the time base is armed. It features rock steady triggering in a number of modes and the horizontal amplifier provides 10X expansion to 500KHz.

For those who want even more performance there is the D43A. This is a double beam scope giving two simultaneous 25MHz traces on a 4 inch tube. The main frame is \$515, and it accepts the same vertical amplifiers as the S43A. Each instrument is fully guaranteed for one year, and field and factory servicing are provided.

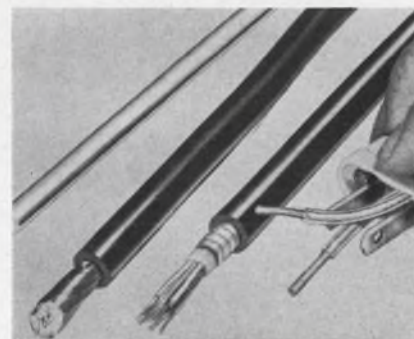
If your budget is pinching you (and even if it isn't) why not arrange for a demonstration of the S43A? We have a man in your area and it doesn't hurt to look. At \$23 a MHz it doesn't hurt at all.

data instruments

Data Instruments Division • 7300 Crescent Boulevard, Pennsauken, N.J. 08110

ON READER-SERVICE CARD CIRCLE 78

MATERIALS

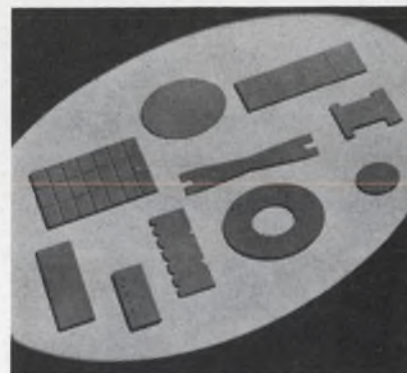


Copper-clad Al wire

This metallurgically bonded copper/aluminum composite is for use in copper-conserving applications including communications cable, coax cable, bus bar, magnet wire and harnesses. Copper-clad aluminum wire is lighter and less expensive than solid copper. Wire sizes are available from 0.3 to 0.005 in. in diameter and in coil weights up to 5000 lbs.

Texas Instruments Inc., Attleboro, Mass. Phone: (617) 222-2800.

Circle No. 236



Thick film substrates

High-alumina ceramic substrates are designed for the integrated thick film circuitry used in telecommunications, computers and control units. The nonporous substrates are made from a sintered alumina ceramic which rivals diamonds in hardness. The material is highly resistant to mechanical and thermal shock, and will withstand most chemicals and corrosive atmospheres. The substrates can be shaped to a number of configurations, including holes or notches for anchoring terminals and depressions or cut-outs for locating discrete components.

Royal Worcester Industrial Ceramics Inc., 11 E. 26th St., New York. Phone: (212) 683-7139.

Circle No. 237



Coax cable

RF shielded by a solid jacket, this cable has a 0.013-in. OD and can bend on a 1/16-in. radius. Available in lengths up to 10 ft, the cable has an impedance of 50 Ω and capacitance of 29.3 pF/ft. The outer conductor is a close-tolerance seamless tube of OFHC copper and the center conductor is silver-plated copper-clad steel wire of 0.0025-in. diameter.

Uniform Tubes, Inc., Collegeville, Pa. Phone: (215) 489-7293.

Circle No. 238

Polyester film

Transparent mylar polyester film is made from polyethylene terephthalate. It functions as an electrical barrier in capacitors and motors. This film has a dielectric strength of 7500 V/mil for one mil film and tensile strength of 25,000 psi. Dielectric constant at 25°C and 60 Hz is 3.30 and dissipation factor is 0.0025. Volume resistivity is 10^{18} Ω -cm.

E. I. DuPont DeNemours & Co., Wilmington, Del. Phone: (302) 774-1000.

Circle No. 239

Acid-gold plating

Producing gold electroplate of 99.99% purity, this acid-gold plating process yields a pore-free highly ductile deposit meeting MIL-G-45204. A deposit of 0.0001-in. over nickel will withstand temperatures of up to 700°C for 5 minutes without discoloration. This process is well adapted to plating PCs, transistors, contacts, diodes, connectors, switches and relays.

Engelhard Industries Inc., 113 Astor St., Newark, N. J. Phone: (201) 242-2700.

Circle No. 240

Reliability and Quality are a product of experience. Jennings has 24 years experience manufacturing vacuum capacitors. Time enough to design a lot of them. Here are a few:

CADB 30



Capacity (Range) 3-30 pf
Peak Test Voltage 15 KV
RF Current Rating 40 Amps RMS
Length 4.55"
Width 1.312"

USLS 465



Capacity (Range) 5-465 pf
Peak Test Voltage 5 KV
RF Current Rating 42 Amps RMS
Length 5.52"
Width 2.312"

VMMC 5000



Capacity (Range) 100-5000 pf
Peak Test Voltage 15 KV
RF Current Rating 125 Amps RMS
Length 21.31"
Width 9.25"

JSLF 5000



Capacity (Range) 5000 pf
Peak Test Voltage 5 KV
RF Current Rating 100 Amps RMS
Length 2.875"
Width 4.125"

CVJW 200 (Water-Cooled)



Capacity (Range) 25-200 pf
Peak Test Voltage 100 KV
RF Current Rating 1000 Amps RMS
Length 15.50"
Width 8.00"

CVHC 650 (Air-Cooled)



Capacity (Range) 25-650 pf
Peak Test Voltage 45 KV
RF Current Rating 250 Amps RMS
Length 10.75"
Width 7.56"

Close to 100% of the Free World's high frequency transmitters use vacuum capacitors of Jennings design. In fact, practically every major advancement in vacuum capacitors has originated at Jennings. These include capacitor designs ranging from 100 watts to over a megawatt power ratings. Which means that in all likelihood the capacitor you need has already been designed, field tested, and proven reliable—plus possessing all the latest advances in vacuum capacitor design.

The vacuum capacitors shown here are only a few of the hundreds of standard designs available from Jennings to fit practically every RF application. If a

new design is necessary however, Jennings has an experienced applications engineering staff and Quick-Reaction Laboratory ready to solve your problem in the shortest possible time. Jennings also offers the only complete rf lab in existence for proper testing of vacuum capacitors in high power rf circuits through 100 kw that duplicate actual operating conditions.

For detailed information about Jennings vacuum capacitors request our new catalog #101. Jennings Radio Manufacturing Corporation, Subsidiary of International Telephone and Telegraph Corporation, 970 McLaughlin Avenue, San Jose, California 95108.

ITT Jennings



21-range dc meter

Quantitative readings from 0.2 μ A full scale to 1 A are made by this dc meter. The unit has a bifilar suspension system with a weightless light beam pointer which projects a sharp hairline for direct readout. Reading resolution is better than 0.1% and resistance is about 20 k Ω at 0.2 μ A. Energy consumption is 8×10^{-10} W. The meter can be provided with an accuracy of 0.25% or 0.5% full scale.

Greibach Instruments Corp., 315 North Ave., New Rochelle, N. Y. Phone: (914) 633-7900.

Circle No. 241

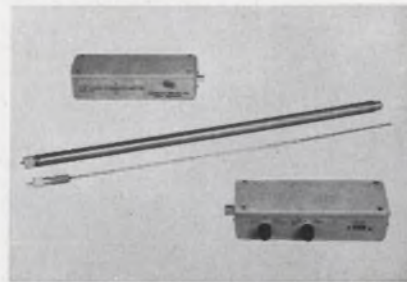


Radiometer

Without any balancing this radiometer measures capacitance directly from 0.02 to 1000 pF or makes comparison measurements where the difference between a standard capacitor and an unknown capacitor is measured from 0.02 to 1000 pF. The 1-MHz crystal-controlled test signal meets MIL specs. Stray capacitance from a capacitor to its surroundings does not affect the measurement. A guard circuit is included.

The London Co., 811 Sharon Dr., Westlake, Ohio. Phone: (216) 871-7980.

Circle No. 242



Vlf field strength meter

Operating from an internal rechargeable Ni/Cd battery, this meter measures field intensity at two crystal-controlled frequencies within the vlf band. The whip antenna may be calibrated directly to a standard field. With solid-state silicon design this unit has a 100-dB dynamic range from 1.5 μ V/m to 150 mV/m. The 1-kHz sine wave output may be used for recording field intensity or for audio monitoring with headphones.

Aerospace Research, Inc., 130 Lincoln St., Boston. Phone: (617) 254-7200.

Circle No. 243

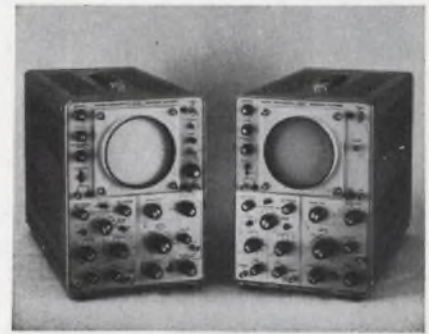


S-band signal generator

For calibration of FM receivers, these generators cover the 1435- to 1535-MHz and 2200- to 2300-MHz bands. The coded FM output may be applied directly to receiver/decoders to determine sensitivity or decoder response. With a simple antenna, the units may be used as a calibrated low-power transmitter. They provide an internal 10-channel coder for frequency-modulating the RF signal. RF output is calibrated in carrier frequency, amplitude and deviation.

Pacific Industries Inc., RS Electronics Div., 795 Kifer Rd., Sunnyvale, Calif. Phone: (408) 739-3230.

Circle No. 244



5-MHz scopes

Both model 802 storage scope and model 831 standard scope offer single-switch selection of seven operating modes and single channel operation of either A or B channels at 5 MHz and 20-mV/division sensitivity. Also offered are dual channel operation chopped or alternate, A and B added algebraically and X-Y operation fully calibrated in both axes. Common mode rejection is 1000:1 and selectable bandpass is 600 or 10 kHz. These scopes have stable triggering beyond the bandpass of the scope.

P&A: \$995 (model 831); stock. Hughes Aircraft Co., 2020 Ocean-side Blvd., Oceanside, Calif. Phone: (714) 722-2101.

Circle No. 245

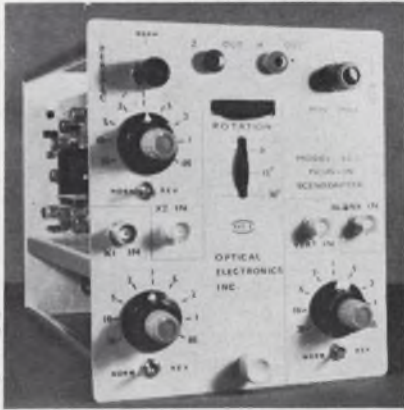


Power signal generator

Covering the frequency range of 2.3 to 7.0 GHz in one band, this signal generator features up to 3-W output. Type SLRC is a disc-seal triode oscillator which is capable of being synchronized. Using a built-in directional coupler, output power is indicated on a panel meter. For lower power levels, a 100-dB relative calibrated piston attenuator is used. Frequency indication is on a digital read-out.

P&A: \$6600; stock. Rohde & Schwarz Sales Co., 111 Lexington Ave., Passaic, N. J. Phone: (201) 773-8010.

Circle No. 246



Plug-in converts scopes to 3-D

With the model 627 plug-in "Scen-adapter," the user can quickly convert series 530, 540 or 580 Tektronix scopes into three-dimensional display instruments. The all-solid-state plug-in features controllable linear perspective, aerial perspective (intensity shading) and operator-controlled scene rotation in two degrees of freedom. Frequency response is 1 Hz to 100 kHz, input impedance is 1 MΩ on each of the three independent orthogonal deflection inputs and maximum sensitivity is 0.05 V/division.

P&A: \$1095; 30 days. Optical Electronics Inc., P. O. Box 11140, Tucson, Ariz. Phone: (602) 624-3605. *Circle No. 248*



Transistor tester

With automatic handlers, this go/no-go test instrument tests over 4000 transistors per hour. It performs standard industrial dc tests in 35 ms each. The tester has built-in oscillation suppression and detection circuits and a pin-board matrix which translates test results into single bin decisions. The device tests power transistors and diodes up to 600 V and 1 A. Cutoff and leakage tests can be made down to 100 pA.

P&A: \$16,500; 90 days. Teradyne, Inc., 183 Essex St., Boston. Phone: (617) 426-6560.

Circle No. 247

Ballantine Announces a New Solid State DC Digital Voltmeter



Model 353

Gives you fast, accurate readings to 0.02% ± 0.01% f.s. and at a low cost of just \$490

Ballantine's new Model 353 enables you to speed up dc measurements materially over those made on multi-knob differential voltmeters. And with laboratory accuracy from 0 to 1000 volts dc.

It requires just two steps: (1) Set knob to NORMAL mode and read voltage; (2) dial in the first digit in EXPAND mode and read voltage to four places with over-range to five; and, in addition, interpolate to another digit.

The NORMAL mode error becomes submerged by more than ten to one, and the operation is fast and accurate to 0.02% of reading ±0.01% f.s. If the input signal is varying, the last digit may be followed visually, thus providing the advantage of analog display.

Note these other interesting features of the new 353: a left-to-right digital readout; an automatic display of "mV" or "V"; proper placement of the decimal point; 10 megohms input resistance; an automatic disabling of the motor during the "expand" dialing; a red light to indicate overrange or wrong polarity; and provision for a foot-operated switch for a "read" or "hold" function.

Step 1. NORMAL Mode 8.342 V	
Step 2. EXPAND Mode 8.3420 V	
Example of "Overrange" presentation 108.340 V	

Write for brochure giving many more details



— Since 1932 —

BALLANTINE LABORATORIES INC.
Boonton, New Jersey

CHECK WITH BALLANTINE FIRST FOR DC AND AC ELECTRONIC VOLTMETERS/AMMETERS/OHM METERS, REGARDLESS OF YOUR REQUIREMENTS. WE HAVE A LARGE LINE, WITH ADDITIONS EACH YEAR. ALSO AC/DC LINEAR CONVERTERS, AC/DC CALIBRATORS, WIDE BAND AMPLIFIERS, DIRECT-READING CAPACITANCE METERS, AND A LINE OF LABORATORY VOLTAGE STANDARDS FOR 0 TO 1,000 MHz.

Speed Inquiry to Advertiser via Collect Night Letter

ON READER-SERVICE CARD CIRCLE 81

GET DOUBLE-DEPENDABILITY

AND ON-THE-DOUBLE DELIVERY

SWITCHCRAFT'S NEW



double-wipe
PRECISION SLIDE SWITCHES

TOPS IN "COST-TO-QUALITY RATIO" —

Even though per unit cost is low, Switchcraft's new line of completely hand-crafted precision slide switches (formerly known as Muter switches) feature exclusive DOUBLE-WIPE action for true bifurcated contact reliability. Special silver-plated "U" shaped sliders assure positive contact, are self-cleaning and retard oxidation or increased contact resistance.

An exceptionally wide variety of single and multiple-pole switches are available from stock. Eight basic series including general purpose, tandem, quadrum, rocker and miniature. Contacts rated at 0.5 amp, 125 VAC/VDC; 3 amps AC only. Wide choice of knob colors. It is the broadest line of high quality, low cost precision slide switches available.

PRICED RIGHT!

Switchcraft hand crafting and double-wipe reliability costs little more than other switches without these exclusive features.

ANY QUANTITY... QUICKLY!

Even super-size orders are ready for delivery in a matter of two or three weeks. Small orders delivered in a week... often in only days.

SEND YOUR DRAWING FOR A QUOTATION AND SAMPLE:

Samples of *specific* types can be shipped the day your request is received.



FOR ADDITIONAL INFORMATION,
SEND FOR CATALOG S-330

SWITCHCRAFT[®]

5529 ELSTON AVE., CHICAGO, ILL. 60630

TEST EQUIPMENT

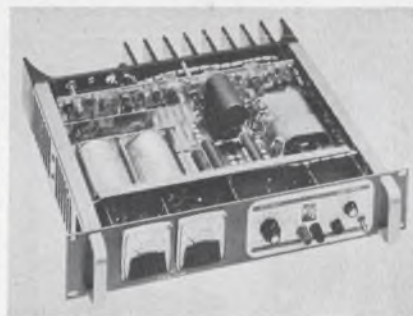


Angle indicator

This angle indicator receives synchro and/or resolver information from a remote location and provides a digital readout with a resolution of one minute of arc. The design of the gear train allows the addition of up to six size 11 components to provide re-transmission of the input data in other forms or at different impedance levels. A self-contained source will drive the unit to 0° at any time. Standard accuracy is ± 6 minutes with a repeatability of 30 s and slew speed is 25°/s.

Linair Design Corp., 1016 E. Elizabeth Ave., Linden, N. J. Phone: (201) 925-4970.

Circle No. 249



Regulated dc supply

Simultaneously offering current or voltage limiting, this regulated dc supply may be used alternatively as a voltage regulated power supply or as a current regulated power supply. The unit has an output of 0 to 36 V and 0 to 5 A with a 4-A input. Regulation for load and line changes is 0.005% or 0.5 mV and 0.01% or 1 mV respectively when operated as a voltage regulated power supply. Current regulation load is 1 mA/V change in output and 1 mA in constant current lines.

Price: \$330. NJE Corp., 20 Boring Ave., Kenilworth, N. J. Phone: (201) 376-7300.

Circle No. 250

ON READER-SERVICE CARD CIRCLE 82

Send us a cable.



Send us a small sample, at least one foot, of the coaxial cable you're using and tell us what you're using it for. Then we'll install the Burndy crimp removable coax contact that'll do the job best. Guaranteed.

A tough job? Not really.

Remember, crimp removable contacts began at Burndy. As a result Burndy offers the most complete line of coaxial connectors for standard, miniature and sub-miniature coaxial cables. And

they're available for all rectangular, rack and panel and terminal block configurations.

Send your sample along to Mr. M. Elkind, Product Manager, Burndy, Norwalk, Conn. He'll see that the job is done and returned quickly. You'll receive our latest coax connector catalog, too.



INTERNATIONAL SALES HEADQUARTERS AND MANUFACTURING FACILITIES:
CANADA: Scarboro, Ontario / ENGLAND: St. Helens, Lancs. / BELGIUM: Mechelen / MEXICO: Naucalpan de Juarez / BRAZIL: Sao Paulo / JAPAN: Tokyo / Sales Offices in Other Major Cities

ON READER-SERVICE CARD CIRCLE 83



Symbol
of
Superiority

IN PRECISION WIRE-WOUND RESISTORS

- CLOSER TOLERANCES
- BETTER STABILITIES
- LOWER TEMPERATURE COEFFICIENTS
- PROVEN RELIABILITIES



HIGH RELIABILITY

Series "HRL" - Documented failure rate of .009%/1000 hours at a 60% confidence level. Further advancements in failure rates are anticipated through reliability controls and use of acceptance inspection procedures. See special Bulletin HR-04.

SUB-MINIATURE and STANDARD

Series "EP" - Available in sub-miniature types solving space and weight problems. Typical size: .125" x .125". Diameters down to .080". Standard types offer choice of over 40 sizes with resistance as low as .01 ohm. Resistance tolerances to .005%. Temperature coefficients to 1 PPM.



PRINTED CIRCUIT

Series "PC" - For mass production assembly and optimum space utilization. Available in special "high density" (rectangular) packaging and standard round configurations.

HIGH STABILITY - .003% Per Year.

Series "O" - Used where resistance matching or accurate voltage division is required over long periods of time. Heavily utilized in A to D converters, analog computers, differential voltmeters and guidance computers for military applications. Long term resistance stability of .003% maximum per year and standard TC of 10 PPM. Available in all standard physical sizes down to .187" x .375".



FAST RISE TIME

Series "RT" - Ideal in fast switching circuits. Exceptional high frequency performance with rise times in the range of 50 to 100 nanoseconds, depending on style and resistance value.

RESISTOR NETWORKS

Custom resistor, diode and capacitor combination networks. Built to meet special requirements. Used as voltage dividers, summing and integrator networks, binary resistive networks and other network applications. Ratio tolerances to .0005%. TC tracking as close as 1 PPM to military requirements.

OTHER FEATURES OF ALL KELVIN RESISTORS

- Standard leads are both weldable and solderable
- All welded internal construction
- Non inductive windings
- Vacuum encapsulated with high temperature epoxide material
- Special winding technique for assured stability

Write for complete new catalog.



KELVIN

5919 Noble Avenue, Van Nuys, Calif.
(213) 782-6662

TEST EQUIPMENT

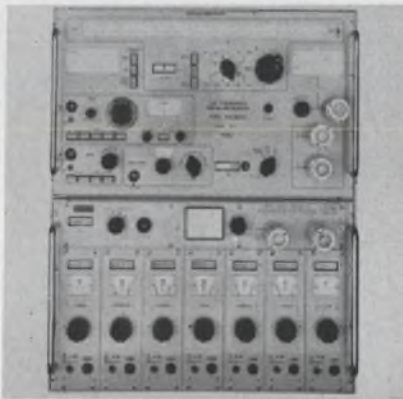


Digital voltmeters

Featuring $\pm 0.05\%$ reading ± 1 digit, these digital voltmeters provide reading time of 0.6 s filtered or 20 ms with filter bypassed, constant input impedance of 10 M Ω and BCD output. A reading storage feature provides bidirectional tracking without blinking. Model 251 has resolution to 1 part in 10³ and ranges of 9.999, 99.99 and 999.9 V. Model 252 has resolution to 1 part in 3000 and ranges of 2, 20, 200 and 1000 V.

P&A: \$525 (model 251), \$435 (model 252). United Systems Corp., 918 Woodley Rd., Dayton, Ohio. Phone: (513) 254-3567.

Circle No. 251



Signal generator

For AM/FM measurements requiring a carrier in the 300-Hz to 470-MHz range, this synthesizer generator has a crystal accuracy of 0.003 ppm. Output level is 1 V stabilized with 50- Ω impedance. Spurious rejection is better than 80 dB for nonharmonics. Deviation range is 0 to 100 kHz internal and external (phase locked). Sweep provision is ± 100 kHz electronically and 1 to 10 MHz mechanically. Attenuator is 0 to 99 dB, 40 to 139 dB in 1-dB steps.

P&A: \$8200; 90 to 120 days. E. F. Associates Inc., 207 Park Ave., Scotch Plains, N. J. Phone: (201) 322-6471.

Circle No. 252

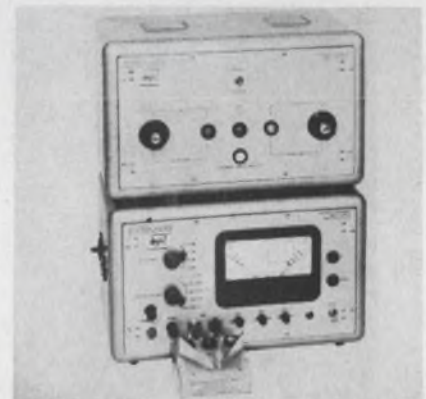


Signal monitor

Parameter sensors in real time are monitored by this differential dc millivoltmeter. Model 1007 has an adjustable zero point up to $\pm 100\%$ of full scale and dc input range selectable from 5 to 50 mV full scale. Input impedance is 100 k Ω , linearity is 2% of full scale and input isolation is 100 M Ω from ground. Ac pumpout is 1 mV rms, dc pumpout is 10 μ V max and drift is 0.1% max. Output drift is 1% max over an 8-hour period.

Zeltex Inc., 1000 Chalomar Rd., Concord, Calif. Phone: (415) 686-6660.

Circle No. 253

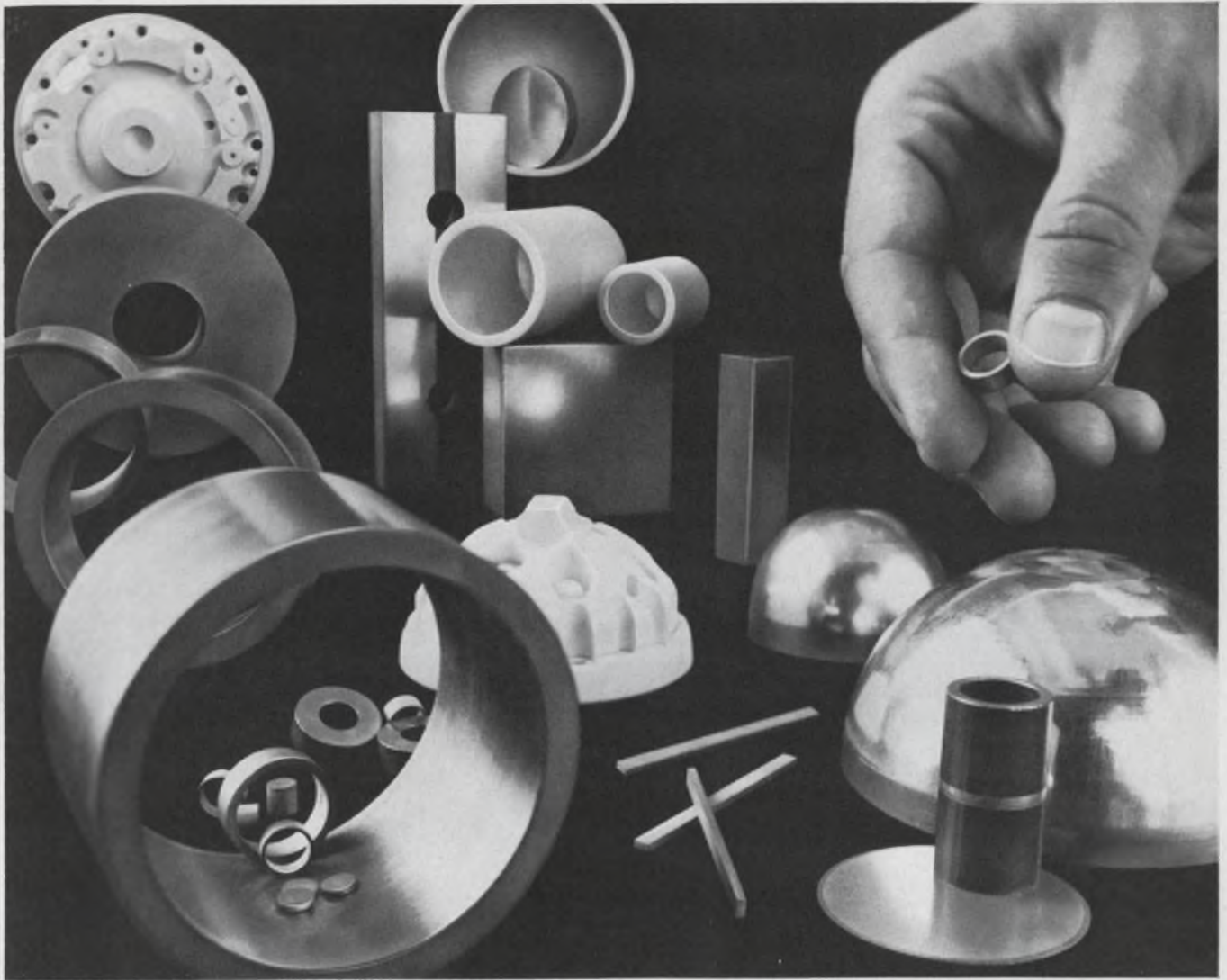


Component comparator

Model CZ 457 compares resistors, capacitors and inductors with a standard and indicates the percentage deviation. Measuring ranges are 0.01 Ω to 15 M Ω , 0.02 pF to 10 μ F and 2 pH to 100 H. Over-all accuracy is 0.1%. With an automator (CZII 457) the system becomes a high speed test set with relay outputs for sorters. Tolerances can be asymmetrically set by pots between 0.2% and 22%.

P&A: \$450 (comparator), \$490 (automator); 2 wks. Amark Corp., 31 Commercial St., Plainview, N. Y. Phone: (516) 938-3322.

Circle No. 254



HERE ARE A FEW EXAMPLES that illustrate Honeywell's unique capabilities in piezoelectric ceramics for fuzing, sonar, ultrasonic

cleaning and ignition applications . . . extending to special piezoelectrics for jobs involving advanced electro-mechanical transducers.

Every day of the year Honeywell solves somebody's piezoelectric problems.

(whether it's an order for 1 or 100,000 units)

Today it might be a single ignition application. Last Thursday's challenge could have been a complex accelerometer configuration. Or an advanced transducer for an ASW vehicle.

Because Honeywell has the technical know-how and the production capacity to tackle almost anything. Both simple jobs or complex . . . 10 units or 100 times that many . . . we take them all in stride.

But volume capability isn't all we offer. We can deliver the quality to match:

FACT: Honeywell ceramics have been a major factor in ASW programs . . . the toughest specifications of all.

FACT: Honeywell ceramics have proved to be so consistently uniform, many customers use the sampling technique of testing rather than testing each element.

To achieve such quality, Honeywell maintains stringent quality control procedures. Samples of raw materials are put through our production process before the entire lot is accepted for use. Automated equipment controls and records each critical step in the production process.

The result is exact reproducibility of electrical and mechanical properties . . . the ability to meet the most demanding design specifications—yours included.

WRITE TO HONEYWELL on your letterhead for complete information on Honeywell piezoelectric and structural ceramics. Write to Vern E. Umholtz, Honeywell Inc., Mail Station 847, 600 2nd Street, Hopkins, Minnesota 55343.

Honeywell

ON READER-SERVICE CARD CIRCLE 85

Hitching Post for High-Spirited Electrons...



**JOHNSON'S NEW
MINIATURE "6-WAY"
111-200 BINDING POST**

- * Compact Pre-Assembled Design
- * Short Front Panel Projection
- * 5,000 VDC Breakdown

Hold your horses! Look first at Johnson for binding posts . . . for instance, at the #111-200 series designed for compact test equipment applications. Tough, low-loss polyamide body fully insulates stud, provides higher voltage breakdown. Front projection 25/32" max. with thumb nut open . . . only 21/32" closed. Thumb nut is self-captivated . . . cannot work loose. Equipped with single 1/4"-32 nut for fast mounting — no time consuming spacers or mounting hardware required. 6-Way feature permits connection by tip plug, alligator clip to stud, wire wrapped around stud and clamped, wire (max. size #12) through center hole, clamped, and clamped spade lug.

ELECTRICAL CHARACTERISTICS:

Current rating 15 amps. thumb nut to terminal; five amps. tip jack to terminal.

Capacitance to 1/8" panel 3 pf.

Insulation resistance greater than 200 megohms after MIL-T-5422B humidity test.

Also available in Series 111-100 (15 amps, 8,000 VDC Breakdown) and Series 111-300 (40 amps, 7,000 VDC Breakdown).

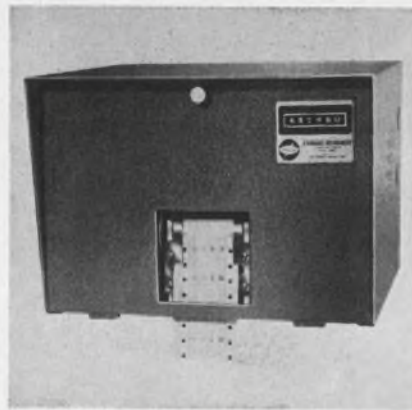
**WRITE NOW FOR FREE SAMPLE
AND COMPLETE INFORMATION ON
JOHNSON CONNECTOR LINE**



E. F. JOHNSON COMPANY
3334 Tenth Ave. S.W. • Waseca, Minnesota 56093

ON READER-SERVICE CARD CIRCLE 86

SYSTEMS



Impulse printer

Operating at 1000 counts per minute, this impulse printer automatically totals and prints units counted or elapsed job time on a strip-chart at preset time intervals or at a selected time. It monitors and prints a record of units counted and time of day. The printer can also operate at 10,000 per minute with an optional 10:1 scaler. Chart rolls can operate at speeds of 1, 4, 12 and 60-in./h.

Standard Instrument Corp., 115 Fifth Ave., New York. Phone: (212) 673-3311.

Circle No. 255



Tape recorder

Equipped with 8-1/2-in. reels, this magnetic tape recorder has three selectable speeds from 15 to 150 ips. Compatible with 7- and 9-channel IBM 360 tape formats, the units are mounted on slides for complete access to all components. Start time is 50 ms max, stop time is 100 ms max and temperature range is 32 to 125°F. Shock is 5 G for 11 ms for all axes and vibration is 5 to 35 Hz.

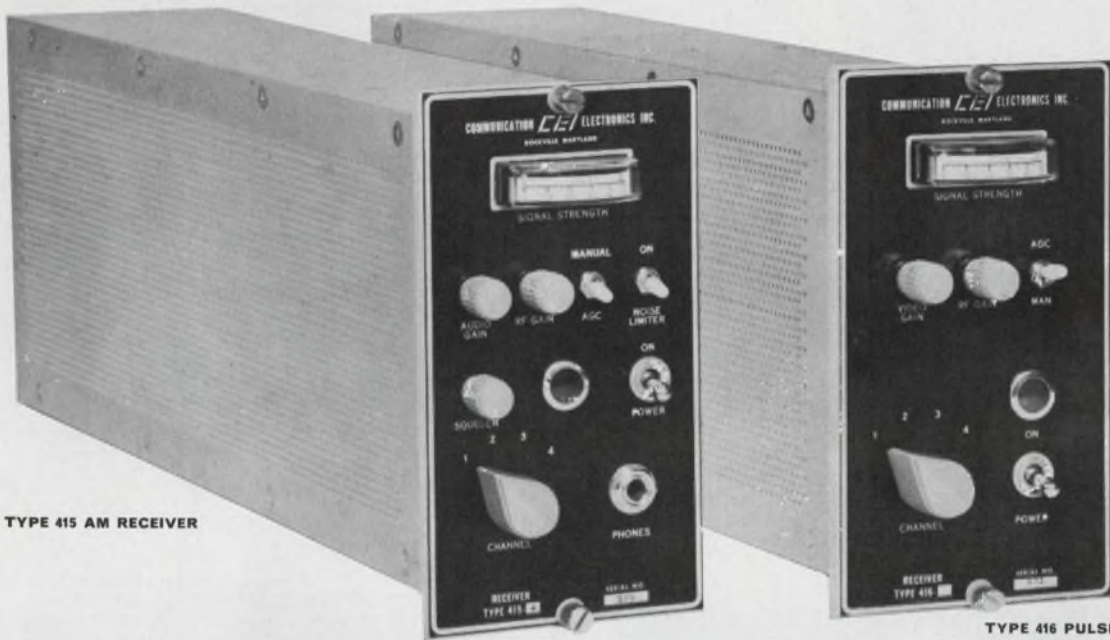
Potter Instrument Co., Inc., 151 Sunnyside Blvd., Plainview, N. Y. Phone: (516) 681-3200.

Circle No. 256

From CEI . . . a New Family of Pre-Tuned, Crystal-Controlled

Pulse and AM Receivers

• 4 AM AND 4 PULSE MODELS • COVER 60 MHz TO 150 MHz • COMPACT, ALL SOLID STATE



TYPE 415 AM RECEIVER

TYPE 416 PULSE RECEIVER

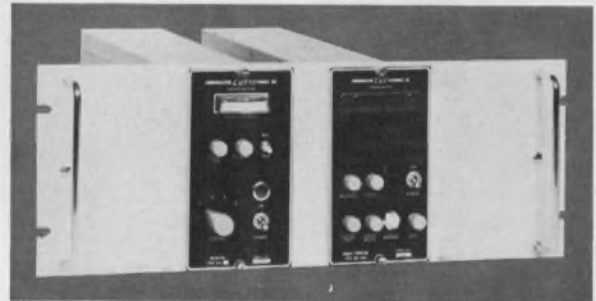
Introducing two new series of top-performing CEI receivers . . . the Type 415 for AM and Type 416 for Pulse reception. Both series cover the 60-150 MHz range using standard tuners.

Each receiver is a completely transistorized, fixed-tuned unit allowing the selection of any of four preset channels within its frequency range (see table at right for ranges of individual receivers). The four channels are factory-set to your requirements and may be easily and swiftly reset, when necessary, by field maintenance personnel.

The AM units are available with a choice of 50 or 100 kHz bandwidth. Compact and lightweight, all these receivers offer high sensitivity and reliability and require very little power—just 3½ watts.

Signal monitor outputs of 21.4 MHz have been provided, and a matching signal monitor (CEI Type SM-4301) may be mounted alongside one or more of the receivers to provide a visual display around the tuned frequency.

Special rack-mount equipment frames are also available, designed to accommodate two, three or four of the Type 415, 416, and/or SM-4301 units.



RACK-MOUNTS & SIGNAL MONITOR AVAILABLE— Shown here is a Type 416 Pulse receiver and matching Type SM-4301 signal monitor in an EF-402 equipment frame. Equipment frames are available to mount two, three or four units.

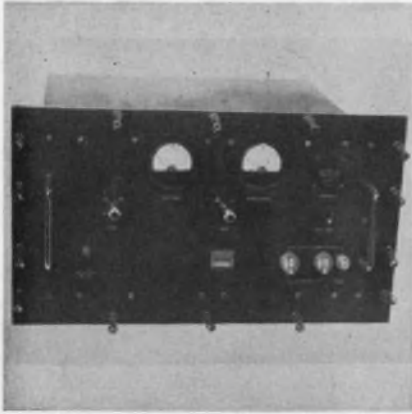
Table of Standard Tuning Ranges
(other frequency combinations on request)

Receiver Type	Overall Frequency Range (MHz)	Band A Frequency Range (MHz)	Band B Frequency Range (MHz)
415-1 416-1	60-90	60-75	75-90
415-2 416-2	75-110	75-90	90-110
415-3 416-3	90-130	90-105	105-130
415-4 416-4	110-150	110-125	125-150



For complete information and specifications, please contact:
COMMUNICATION ELECTRONICS INCORPORATED
 6006 Executive Blvd., Rockville, Md. 20852 • Phone: (301) 933-2800 • TWX: 710-824-9603

ON READER-SERVICE CARD CIRCLE 87



Parametric amplifier

Operating over 2.3 to 2.4 GHz, this parametric amplifier features a noise figure of 2 dB and one-knob frequency tuning. Instantaneous bandwidth is 15 MHz and gain is 18 dB min. Applications include use in communications, radar, radio astronomy and satellite or missile tracking.

Alpha Industries, Inc., 381 Elliot St., Newton Upper Falls, Mass. Phone: (617) 969-6480.

Circle No. 257

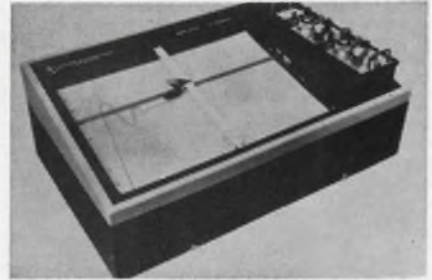


300-kHz recorder

Weighing 90 lbs in a 14-channel record and reproduce configuration, this unit records signals from dc to 300 kHz. On dc models the low-inertia direct-drive capstan rotates at constant speed, phase-locked to a crystal oscillator to provide less than 0.4% p-p flutter. Flutter on ac models is less than 0.3%. The unit accommodates 1/4-, 1/2-, or 1-in. wide tape on standard 10.5-in. reels. Switch-selectable tape speeds range from 15/16 to 60 ips.

Pemco, 942 Commercial Ave., Palo Alto, Calif. Phone: (415) 321-1177.

Circle No. 258



X-Y recorder

Featuring optional plug-in control modules, this X-Y recorder uses 11- x 16.5-in. paper and has 15-in./s pen speed. The T-O module records dc signals with a sensitivity of 1 mV/in. max. The T-1 module records any variable vs time. The T-2 module, which incorporates functions of the T-0 and T-1, has a wider sweep range speed and parallel-T input filters for ac pickup rejection. The TN module for point plotting data has a null detector. Accuracy of the basic unit is 0.2%.

P&A: from \$1500; 2 wks. Houston Instrument Corp., 4951 Terminal Ave., Bellaire, Tex. Phone: (713) 667-9307. Circle No. 259

**LOOK WHAT'S HATCHED AT
LITTELFUSE**

The world's smallest fuse—Picofuse.
1/8 thru 5 amps... 1/6 gram... 125 v.

LITTELFUSE
DES PLAINES, ILLINOIS

ON READER-SERVICE CARD CIRCLE 88

FREE
528-Page Catalog

Lists over 30,000
PRECISION INSTRUMENT PARTS
and ASSOCIATED COMPONENTS
Available From STOCK!

**GEARS
RACKS
CLAMPS
SHAFTS
COLLARS
COUPLINGS**

**DIFFERENTIALS
HELICAL GEARS
WORM & WHEELS
BREADBOARD KITS
UNIVERSAL JOINTS
ANTI-BACKLASH GEARS**

ASK FOR CATALOG #33
PIC DESIGN CORP.
Subsidiary of **BENRUS WATCH COMPANY Inc.**
477 ATLANTIC AVE., EAST ROCKAWAY, N. Y. 11518

ON READER-SERVICE CARD CIRCLE 89

ELECTRONIC DESIGN 24, October 25, 1966



Weston Model 1423 Integrating DVM 1 μ V Sensitivity at 50 M Ω for \$1950.

FEATURES: Strain gage and thermocouple type measurements are made with meaningful accuracy due to integrating and high sensitivity features of Model 1423. High common mode rejection allows low level measurement of potentials well above ground. Loading errors are reduced by 1000 times as compared to conventional DVM's.

SPECIFICATIONS: Accuracy: 0.02% \pm 1 digit. Common Mode Rejection: 150 db DC & 130 db at 60Hz—with up to 5K unbalance between input leads, and filter in use. Series (Normal) Mode Rejection: 60 db at 60Hz with filter. Overranging: 15% with fifth digit display. Display Time Control: From 4 reading/second to 1 reading/15 seconds. Overall Dimensions: 6 $\frac{1}{2}$ " x 14 $\frac{1}{4}$ " x 16 $\frac{1}{4}$ ". Price: Bench mount, \$1950; rack mount, \$1995. Price subject to change without notice.

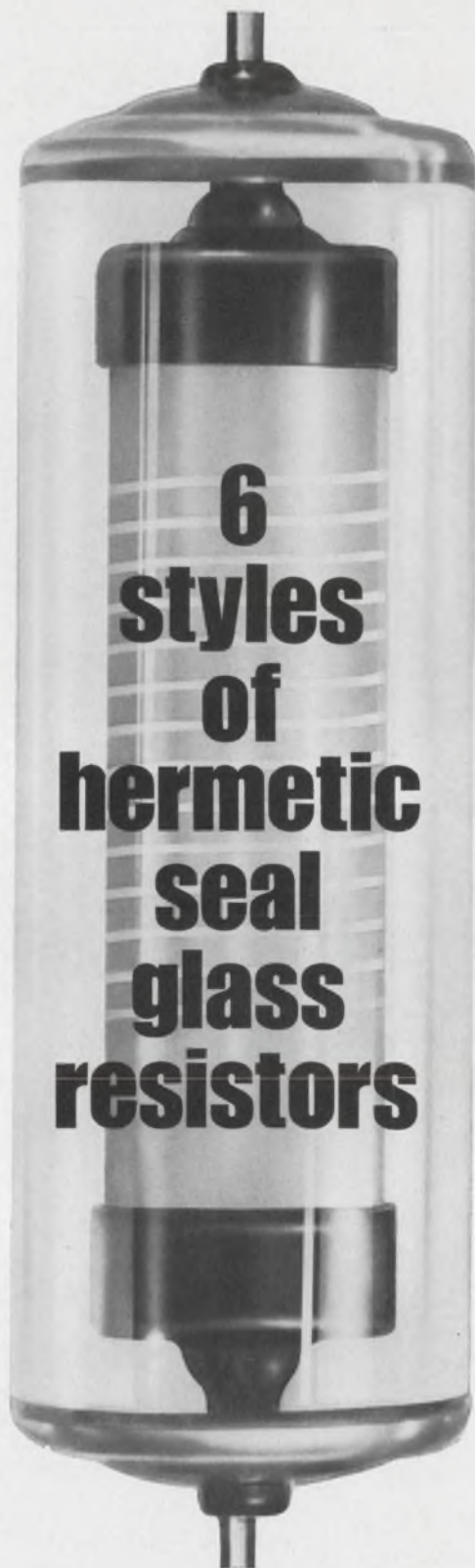
Input Impedance & Sensitivity

Range	Input Impedance		Sensitivity
	Minimum		
10.000 mV	50 megohms*	1 μ V	
100.00 mV	500 megohms*	10 μ V	
1000.0 mV	5000 megohms*	100 μ V	
10.000/100.00/1000.0 volts	10 megohms	1/10/100 mV	

*Typical values twice as large

Contact **Weston Instruments, Inc., Rotek Division, 11 Galen Street, Watertown, Mass. 02172**

WESTON[®] prime source for precision . . . since 1888



RNR 55 through RNR 70
(characteristics C and E)

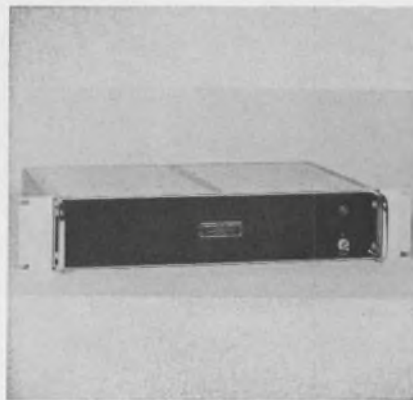
Mepco is the one source for all six styles (RNR 55, 57, 60, 63, 65, 70) of established reliability Metal Film Resistors to MIL-R-55182.



MEPCO, INC.
Columbia Road, Morristown,
New Jersey 07960
(201) 539-2000
TWX (201) 538-6709

ON READER-SERVICE CARD CIRCLE 91

SYSTEMS



Distribution amplifier

This audio distribution amplifier incorporates five identical etched-circuit amplifiers which deliver 150-Hz to 10-kHz response 2 dB. The unit provides five isolated outputs from a common high impedance input up to 2 V rms. Both 600- Ω (balanced) and 150- Ω outputs are offered. Individual gain levels are adjustable from -6 to 6 dB. Gain stability is within 0.75 dB from 0 to 85°C.

Communication Electronics Inc.,
6006 Executive Blvd., Rockville,
Md. Phone: (301) 933-2800.

Circle No. 260



Peripheral-drive recorder

This bidirectional magnetic tape recorder employs tape reels with peripheral drive. A polyester belt rides in contact with the tape as it is wound on the flangeless reels. This unit stores up to 2250 ft of 1.1-mil tape to record analog data from dc to 120 kHz or digital data up to 120 kbps. The recorder exhibits 0.9% p-p flutter max. A motor reversing current gives this unit bidirectional operation.

Kinelogic Corp., 29 S. Pasadena
Ave., Pasadena, Calif. Phone:
(213) 684-0434.

Circle No. 261

MICROWAVES

L- and S-band preamps

Covering 1435 to 1550 MHz and 2200 to 2300 MHz, these two preamps feature 5- and 6-dB noise figures and do not burn out with 1/2-W max cw input. Power output for both units is 0 dBm at 1 dB and input is -15 Vdc at 25 mA. Minimum gain is 25 dB, input vswr is 1.5 and output vswr is 2.

Availability: 15 to 30 days. AvanteK Inc., 3001 Copper Rd., Santa Clara, Calif. Phone: (408) 739-6170.

Circle No. 262

Parabolic antenna

Measuring 4 ft in diameter, this multi-element grid parabola is designed for the 940- to 960-MHz communications band. Gain is 18.9 dBi and beamwidth is 18.9°. Wind loading which is 23% that of a solid dish, gives a thrust of 110 lbs with winds of 100 mph. The antenna has a 7/8-in. EIA termination.

Mark Products, 5439 West Fargo Ave., Skokie, Ill. Phone: (312) 675-1500.

Circle No. 263

Metal-ceramic triode

This metal-ceramic triode can be used as a plate-pulse oscillator or amplifier at up to 6 GHz. Designed for use in a cavity, the 7910 provides 100-W C-band oscillation. The unit has 1200-V peak plate voltage, 1.5-W max plate dissipation and 600-mA video peak plate current. Peak power output at C-band is over 100 W.

General Electric Co., 1 River Rd., Schenectady, N. Y. Phone: (518) 374-2211.

Circle No. 264








Tunnel diode amplifiers

Over a spectrum of 1 to 10 GHz this line of tunnel diode amplifiers has noise figures varying from 4 to 6 dB. Typical noise variation over a 10% bandwidth is 0.5 dB max. Up to 20% bandwidth is available with 3-dB max gain variation and signal gain typically 10 to 20 dB.

P&A: \$1500; 60 days. Varian Assoc., 611 Hansen Way, Palo Alto, Calif. Phone: (415) 326-4000.

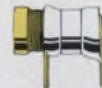
Circle No. 265

IN VARIABLE AIR CAPACITORS JOHANSON CRAFTSMANSHIP ASSURES THE HIGHEST "Q" QUALITY

WE TAKE A PRECISION STATOR
ELEMENT  THAT IS IN-
SULATED  WITH ALUMINA
CERAMIC  FROM THE
ROTOR ELEMENT  THAT
IS WIPED BY COIN SILVER
CONTACTS  AND TRAV-
ELS IN THE BUSHING 
THAT IS HERMETICALLY
SEALED  TO PRO-
DUCE A BASIC UNIT



OR A PRINTED CIRCUIT
VERSION ...



OR A PANEL MOUNTED
VERSION ...



OR DUPLICATE IN ...

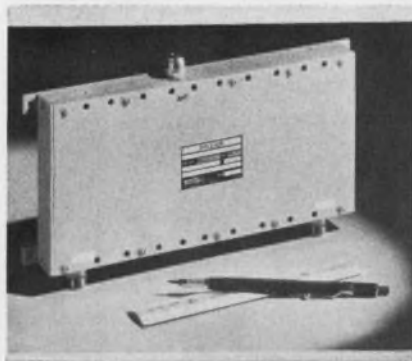


MINIATURE SIZE



Johanson Manufacturing Corp.
Boonton, New Jersey

ON READER-SERVICE CARD CIRCLE 92

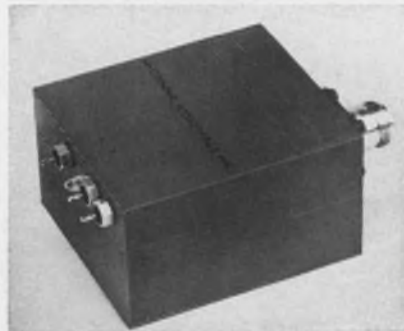


Interdigital diplexer

This interdigital diplexer enables two pieces of equipment of adjacent frequency bands to operate with one broadband antenna. For a band from 650 to 890 MHz, vswr is less than 2.5 and insertion loss is 1.5 dB. For a band from 960 to 1220 MHz, vswr is 2.5. Isolation from the first band to the second band is 65 dB and from the second band to the first is 30 dB. The diplexer meets MIL-E-5400.

Transco Products, Inc., 4241 Glencoe Ave., Venice, Calif. Phone: (213) 391-7291.

Circle No. 266

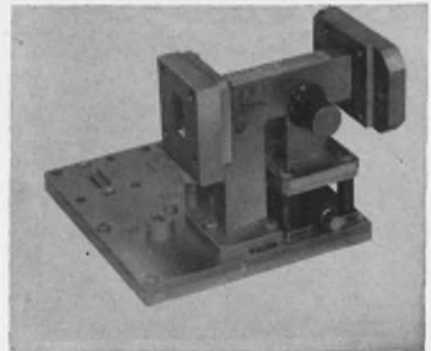


FM-cw tunable source

Capable of accepting FM inputs, this FM-cw tunable source provides an output of 200 mW at 4 GHz. Frequency response is flat within ± 1 dB from 5 to 5.5 GHz. Linearity is within 2% for 5-MHz peak deviation. Modulation sensitivity is 30 MHz/V. A diode switch provides 90-dB isolation and can switch up to 7 W cw in 500 ns. This transmitter/-exciter operates from 28 V at 300 mA or -28 V at 250 mA and 5 to 10 V for frequency tuning.

Microwave Assoc., Inc., Northwest Industrial Park, Burlington, Mass. Phone: (617) 272-3000.

Circle No. 267



Ku-band mixer-duplexer

Designed for use in airborne radar, this miniature mixer-duplexer has an "air-strip" portion containing a balanced signal mixer and a single-ended automatic frequency control mixer. Local oscillator power is controlled by a 5-dB pad attenuator, a power divider and separate variable attenuators (0 to 10 dB) for each mixer. All microwave inputs are standard Ku-band waveguide.

Micro-Radionics, Inc., 14844 Oxnard St., Van Nuys, Calif. Phone: (213) 873-1100.

Circle No. 268

Who Said Precision Scopes Have To Be Expensive?

Compare the new **HEATHKIT® DC-8 MHz triggered-sweep scope kit**
IO-14 \$299.00
 wired
IOW-14 \$399.00



• DC to 8 mc bandwidth — 0.04 usec rise time • Triggered sweep — 18 calibrated rates • Delay-line vertical amplifiers for fast-rise signal analysis • 3% calibrated vertical attenuator — 0.05 v/cm to 120 v/cm, 600 v. (max.) input • Electronically regulated power supplies • Forced air ventilation • Built for continuous-duty industrial & lab use



FREE CATALOG

Describes this and over 250 other Heathkits. Save up to 50%. Use this coupon for your free copy.

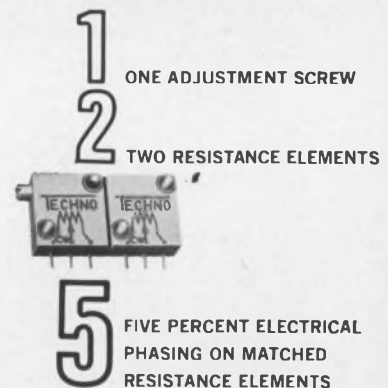
Prices & specifications subject to change without notice.

Heath Company, Dept. 60-10
 Benton Harbor, Michigan 49022
 Please send FREE Heathkit Catalog & information describing the New Heathkit IO-14 Oscilloscope
 Enclosed is \$_____, plus shipping. Please send model _____
 Name _____
 Address _____
 City _____ State _____ Zip _____

TE-146

ON READER-SERVICE CARD CIRCLE 93

trimmer news



miniature dual trimmer

Here's the precision way to make simultaneous adjustments, balance or null two circuits and be sure of tandem settings and phasing. One adjustment screw (25:1 ratio) sets both wirewound resistance elements. Set it once and forget it! In the Series 190, resistance is stable under vibration or thermal shock. Units meet applicable MIL-SPEC paragraphs.

SPECIFICATIONS

Resistance range (per section):	10 to 50K ohms
Power rating (per section):	1 watt at 50°C
Operating temperature:	-65° to 175°C
Standard tolerance:	±5%
Size:	.405" x .775" x .185"

Technical data sheets are available from:



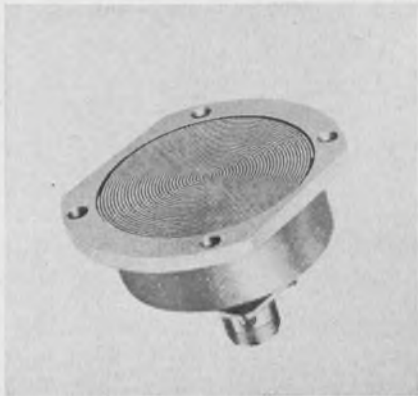
TECHNO-COMPONENTS CORP.

TECHNO

7803 Lemona Avenue ■ Van Nuys, California 91405 ■ (213) 781-1642 ■ TWX: 910-495-2015

ON READER-SERVICE CARD CIRCLE 94

ELECTRONIC DESIGN 24, October 25, 1966

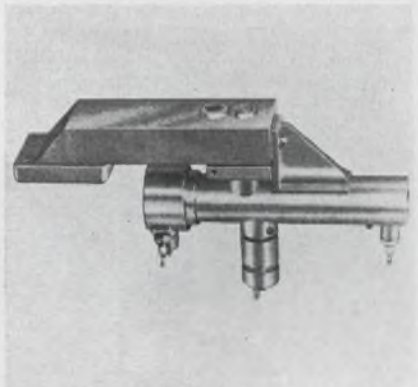


Spiral antenna

Constant impedance and pattern performance are maintained from 2 to 11 GHz by this cavity-backed spiral antenna. Capable of operating at 350°F, the device has envelope dimensions of less than 3 x 2.5 x 2.14 in. A gain level of 7 to 8 dB is maintained over better than a 3:1 band. The circularly polarized antenna has a vswr of 1.5, 3-dB beamwidth of 75°, front to back ratio of 15 dB and axial ratio of 1 dB.

P&A: \$325; 6 wks. American Electronic Laboratories, Inc., Box 552, Lansdale, Pa. Phone: (215) 822-2929.

Circle No. 269



X-band oscillator

A range of 9 to 10 GHz with single screw tuning of 300 MHz or electronic tuning of 10 MHz is provided by this X-band oscillator/multiplier. Output is 150 mW min and input requirements are 150 V at 35 mA and 6.3 V at 220 mA. Frequency stability vs temperature is 10 ppm/°C from -54 to 95°C, frequency stability vs plate voltage is 200 kHz/V nominal and frequency stability vs filament voltage is 3 MHz/V nominal.

Trak Microwave Corp., 4726 Kennedy, Tampa, Fla. Phone: (813) 877-8341.

Circle No. 270

**Now available
from Matheson
for epitaxial
crystal growth**

Silane & Germane

**Deposit with greater efficiency
Create thinner, more efficient layers
Provide purer deposits, greater resistivity**

Matheson Company ships Silane and Germane as pure gases or in convenient gas mixtures from East Rutherford, New Jersey. These gases can also be stocked at any one of our six other branches, on request, to serve your specific requirements.

Mail coupon for data sheets providing equipment recommendations and handling information on Silane and Germane.

Doping Gases

In addition to Silane and Germane, Matheson offers dopants as gas mixtures or as pure gases available in a range of cylinder sizes. We supply Phosphine, Arsine, Diborane and Hydrogen Selenide. Mail coupon for data sheets and catalog.

MATHESON P. O. Box 85, East Rutherford, N.J., 07073

Please send data sheets on _____ Silane, _____ Germane, _____ Phosphine,
_____ Arsine, _____ Diborane, _____ Hydrogen Selenide,
_____ Matheson Gas Catalog.

Firm _____

Name _____

Address _____

City, State, Zip _____

ON READER-SERVICE CARD CIRCLE 95

HATHAWAY

NO. 1 DRIREED



smart "C" choice

The form "C" — another of Hathaway's refined electronic-switching elements. The FCD in your choice of 4 double throw relay packages—SPDT to 4 PDT.

Distributed Nationally by
COMPAR CORPORATION

For detail information call
or write...

HATHAWAY INSTRUMENTS, INC.
5250 EAST EVANS AVENUE
DENVER, COLORADO 80222
(303) 756-8301 • TWX 292-2935

MICROWAVES



Frequency multiplier

With an input of up to 400 mW from 10 MHz to 4 GHz this uhf/vhf frequency multiplier produces high harmonic energy in the 20-MHz to 8-GHz range at efficiencies approaching 200% divided by N, where N is harmonic number. A 100-ps step-recovery diode with a self-contained bias circuit generates the harmonics. Dc blocking is provided at both ports to isolate and protect the bias circuit. A tunable bandpass filter can be used to select the desired output harmonic.

P&A: \$130; 10 days. Somerset Radiation Laboratory, Inc., 2060 N. 14 St., Arlington, Va. Phone: (703) 525-4255. *Circle No. 271*

Elliptical waveguide

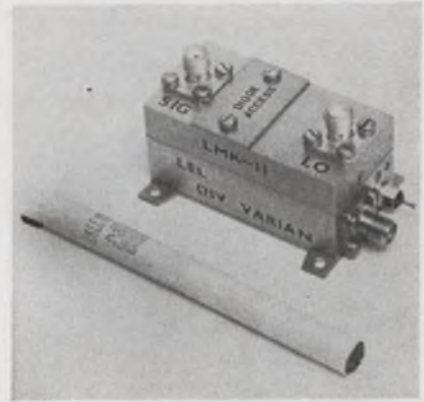
Designed for 1.7- to 2.4-GHz scattered communication systems, this elliptical waveguide has an attenuation of 0.29 dB/100 ft and average power rating of 27 kW. With tuned connectors, a 200-ft length has a vswr of 1.1 max. Available in continuous lengths of up to 500 ft, this flexible waveguide may be formed to a radius of 28 in. in the E plane.

Andrew Corp., Box 807, Chicago. Phone: (312) 349-3300.

TWT amplifier

Providing a noise figure of 6 dB typically, this 2- to 8-GHz double-octave TWT amplifier has a small signal gain of 25 dB min ± 3 dB. Vswr input and output is 2.5 max, primary voltage is 115 Vac ± 10 Vac and primary frequency is 48 to 420 Hz. Input is 25 W and output is 0 dBm. The amplifier may be mounted in any orientation and can withstand shock, vibration and temperature specs of MIL-E-5400. The unit measures 4.75 x 4.74 x 12 in. and weighs under 18 lbs.

Watkins-Johnson Co., 3333 Hillview Ave., Palo Alto, Calif. Phone: (415) 326-8830. *Circle No. 272*



Mixer/preamps

Consisting of a microwave mixer integrated with a solid-state IF preamp, these units provide conversion over a range of 0.1 to 12 GHz. IF outputs are available at 30 or 60 MHz in 20-MHz bandwidth. Overall conversion gain is 20 dB and maximum signal input for linear operation is -24 dBm. The 2-oz unit is 2 in.³ and requires -20 Vdc at 10 mA.

P&A: \$695 to \$995; 5 wks. Varian Assoc., LEL Div., Akron St., Copaugue, N. Y. Phone: (516) 264-2200 *Circle No. 273*



Antenna pedestal system

Reflectors up to 40 ft in diameter can be accommodated by this pedestal system. Rms pointing accuracy is 0.002° equivalent to 7.2 arc seconds or 0.035 mils. The orthogonality of the axes is aligned to within 10 arc-seconds, position readout encoders are direct coupled for an error of 3 arc-seconds max due to coupling and the azimuth and elevation bearings are accurate to within 6 arc-seconds.

Canoga Electronics Corp., 8966 Comanche Ave., Chatsworth, Calif. Phone: (213) 341-3010.

Circle No. 274

The Standard Reference For Electronic Test Instruments

DIRECTORY OF TECHNICAL SPECIFICATIONS

5

FREQUENCY METERS

upper frequency limit 1 - 15Mc

Photo See Page	MANUFACTURER	MODEL	FREQUENCY				Stability		SENSITIVITY		Inter-connection	OUTPUT		Cali- bration Power Required	Operating Circuit Type	Con- nector Type
			Min Mc	Max Mc	Number of Bands	Max Acc %	Long Term	Short Term	Min # Freq	Max # Freq		Main	Aux			
29	MILLER (A)	90619	350kc	1	1	1.5	N/A	N/A	N/A	N/A	N/A	*	N/A	direct	none	Re-
	SELL-TRONIC	401A	10cps	1	9	1na	1na	1na	100mv above 700kc	200mv above 700kc	1na	phone jack	none	direct		
	GENERAL RADIO (A)	1142-A	3cps	1.5	5	+0.2 full scale	0.2% warm up	0.2% warm up	*20mv rms	*200mv rms	0.68V 4800Ω	*1-5				
	GENERAL RADIO (A)	1106-A	100kc	2	9	+0.1	1na	1na	15mv	0.1						
	MILLER (A)	90611	1.5	3.5	1	* 1.5	N/A	N/A								
	MEASUREMENTS (A)	59LP	100kc	4.5	4											
	AIRCRAFT RADIO	R-37A	1													
	MILLER (A)	90625														
	MILLER (A)	90612														
	TECHNICAL WATERTEL (A)	PHO-5 PHO-6														
	MILLER (A)	90682														
	MILLER (A)	90605														

FREQUENCY METERS

SYMBOLS

- C - Cabinet
- B - Rack
- P - Portable
- ina - information not available
- na - not applicable
- N/A - cross over counter
- coc - This manufacturer has cooperated by checking the accuracy prior to final printing and pricing.
- * - See NOTES following column numbers.
- q - Photo of similar instrument appears on page noted.

NOTES

1 - Also transfer oscillator. CALIBRATION: 10kc @ highest frequency; 1kc @ lowest frequency.

2 - ACCEPTABLE WAVE FORM: pulse square sawtooth, sine, etc. DUTY CYCLE: 1% to 100% @ 100kc. TRANSISTORIZED. INPUT IMPEDANCE: 10kΩ @ 100kc. 1MΩ @ 10kc. 10MΩ @ 100kc.

3 - 1% of reading above 10% of full scale. 7.8. From 20cps-150kc. 200mv rms @ 1.5Mc. 1na @ 2.7Mc maximum. 10 5ma @ 190k.

4 - Also transfer oscillator. CALIBRATION: 10kc @ highest frequency; 1kc @ lowest frequency.

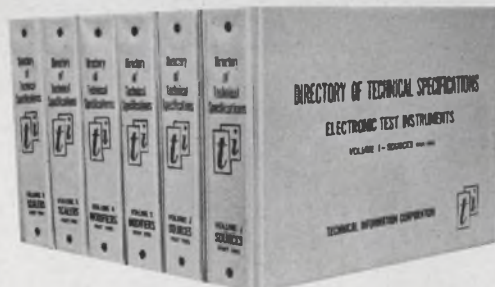
5 - Straight line frequency. 16. Dimensions are of contour fitting cover.

6 - GRID CURRENT METER: 100ma. 50 divisions.

7 - Special order. 4. 1 part in whatever range selected. Provided for use with an external recorder. 500ma acms. 1kΩ. Dimensions are of contour fitting cover.

8 - are of contour fitting cover.

9 - @ 4Mc



CONVENIENT TABULAR FORMAT PROVIDES QUICK AND EASY MODEL-TO-MODEL COMPARISONS

One look at the specimen pages will show you—better than words—the extent of the information furnished by the DIRECTORY OF TECHNICAL SPECIFICATIONS and the comparative arrangement of the data. These convenient tables are designed for rapid and accurate point-by-point comparison of instruments having similar functional capabilities. By providing a thorough across-the-market analysis, all alternatives can be considered in selecting the right instrument for any application.

SAVE HOURS OF ENGINEERING TIME

The Directory eliminates once and for all the necessity of searching catalogs, sales literature and periodicals to find suppliers, specifications, performance characteristics and prices. It provides in one comprehensive source, arranged and indexed for convenient use, all the information you need to keep completely up-to-date on available instruments, to evaluate competitive products and to select the best instrument at the best price.

NO NEED FOR CATALOG FILES

Keeping and maintaining your own files of manufacturers catalogues, brochures and loose data sheets is completely unnecessary. The DIRECTORY OF TECHNICAL SPECIFICATIONS

gives you all the required data to select and specify electronic test instruments—all in one compact and easy to use reference. No other reference source is as complete or efficiently organized. The six-volume Directory lists approximately 14,000 instruments of more than 500 manufacturers and comprises 46 sections, each covering a different type of instrument.

ALWAYS COMPLETE AND UP-TO-DATE

The constant changes in specifications and performance of electronic test instruments is making it increasingly difficult to keep abreast of the latest developments. The Directory is kept continuously up-to-date by the mailing of section revisions to subscribers at the rate of approximately one each week. The information in the entire Directory is completely revised in less than a year.

AVAILABLE ON FREE 30-DAY TRIAL

The DIRECTORY OF TECHNICAL SPECIFICATIONS may be obtained on a FREE 30-DAY TRIAL BASIS for your examination and use. A one-year subscription includes the six-volume set of 46 sections plus the up-dating service to keep all information complete and current.

PRICE... \$300. per year

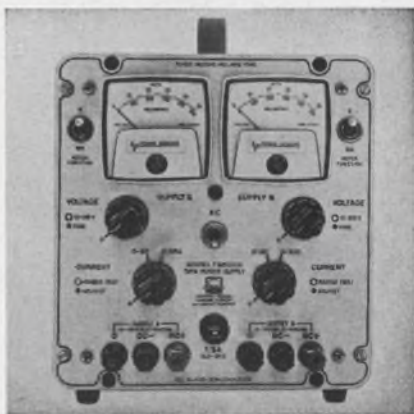
For further information write or telephone...

TECHNICAL INFORMATION CORP.

P. O. Box 514, Smithtown, N. Y. (516 234-0100)



ON READER-SERVICE CARD CIRCLE 97

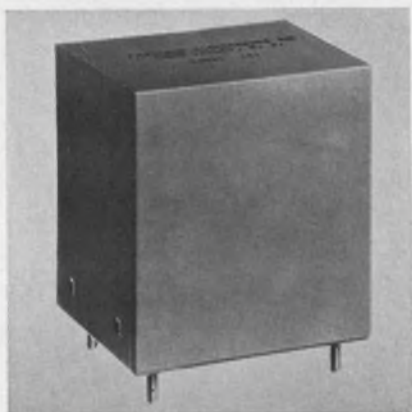


50-V 500-mA supply

Supplying two independent 50-V 500-mA sources, this power supply automatically limits current. Each source has regulation better than 0.005% ±1 mV at both outputs, 1-mV max p-p ripple and temperature coefficient of 0.02%/°C. Impedance is 0.1 Ω max in the constant-voltage mode and more than 200 kΩ in the constant-current mode. Resolution is better than 5 mV and 0.25 mA.

Power Designs Inc. 1700 Shames Dr., Westbury, N. Y. Phone: (516) 333-6200.

Circle No. 275



Op-amp power supply

For energizing op-amps or other circuits requiring both positive and negative voltages, this dual supply has a 0.1% regulation when subjected to loads varying from 0 to 50 mA. Two voltages, one at 15 Vdc and the other at -15 Vdc, each delivering 50 mA, track each other to within 0.01%. Stability is better than 0.01% and ripple is less than 0.005%. Input voltage may vary from 105 to 130 Vac at 60 to 400 Hz.

P&A: \$75; stock. Fairlane Electronics, Box 335, Long Valley, N. J. Phone: (201) 832-2217.

Circle No. 276



20-kV supply

With an input of 24 Vdc and 1.8 A and an output of 20 kV at 0.5 mA, this dc to dc supply shows a ripple of less than 0.01%. Output may be varied from 1 to 20 kV by controlling the dc input voltage. A 10-kV output at 1 mA requires an input of 15 V at 1.6 A. Frequency is about 20 kHz. The unit is completely shielded and measures 5-3/4 x 8-1/4 x 6-3/4 in.

P&A: \$75; 1 wk. Spellman High Voltage Co. Inc., 1930 Adeo Ave., Bronx, N. Y. Phone: (212) 547-0306.

Circle No. 277

specify
CHICAGO SWITCH
for
Reliability, Repeatability and
Ingenuity

New



SERIES
203-021

MINI-SLIDE SNAP

does 10 times as many jobs in 1/4 the space!

Computer Grade Reliability & Quality in a Rugged, Sub-Miniature Switch. For transistor and integrated circuits applications, for "dry" circuit and moderate power use.

FEATURES: • Smallest in its field (next size available 4X larger) • NEW Anti-tease design • 4 pin 1A, 1B, 1C circuits • Contact rating: 2 amps at 120 VAC, 1/2 amp at 120 VDC • Panel mount or printed circuit • Thermoset base and slide block • All metal parts corrosion proof • Life: 250,000 operations.

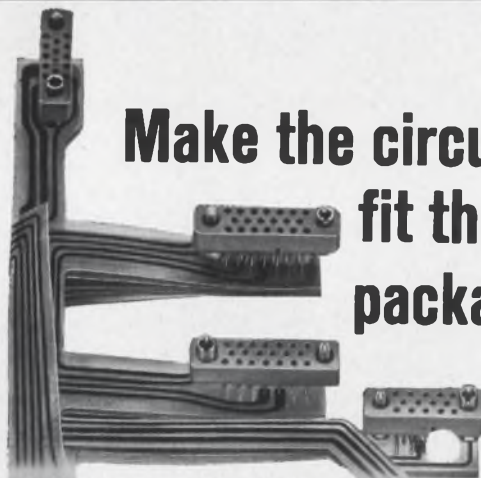
Sound good . . . Want to learn more?
Send for Technical Bulletin and free sample!



CHICAGO SWITCH DIVISION • F & F ENTERPRISES, INC.
2039 Wabansia Avenue • Chicago, Illinois 60647 • 312/489-5500

ON READER-SERVICE CARD CIRCLE 98

Make the circuit fit the package



FLEXPRINT® circuitry solves interconnection problems . . . it fits the package and lowers installed costs. It also offers repeatability, ease of assembly, reliability and reduction of rework. Got a circuit interconnection problem? Call us (area code 603) 627-3811. Free literature. Sanders Associates, Inc., FLEXPRINT Products Division, Grenier Field, Manchester, New Hampshire.

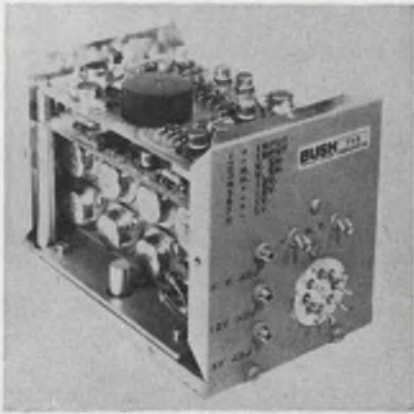
SANDERS ASSOCIATES, INC.
FLEXPRINT PRODUCTS DIVISION



Creating New Directions in Electronics

*T.M. Sanders Associates, Inc.

ON READER-SERVICE CARD CIRCLE 99



2-kV supply

Operating from a 24- to 30-Vdc input, this supply puts out 1.7 to 2 kV. Adjustable regulation is 2%. This constant current source with adjustable output charges a 150-mF storage capacitor to 0.3 C in 6 s. Two regulated outputs rated at 5 Vdc adjustable at 3.5 A and 12 Vdc at 0.25 A operate associated circuitry. The unit is suitable for operating laser optic systems.

Bush Transformer Corp., 20 S.W. Park, Westwood, Mass. Phone: (617) 326-8950. *Circle No. 278*

Logic module supply

Capable of supplying 2 A at 12 Vdc, this power supply is convection cooled and uses silicon semiconductors. In an overload condition, output voltage, which cannot exceed 15 V, and current are automatically reduced. Voltage input is 95 to 130 V rms and ripple is 1.25 V rms. Regulation is 1.5% for load and 2.5% for line. Operating temperatures is 0 to 165°F.

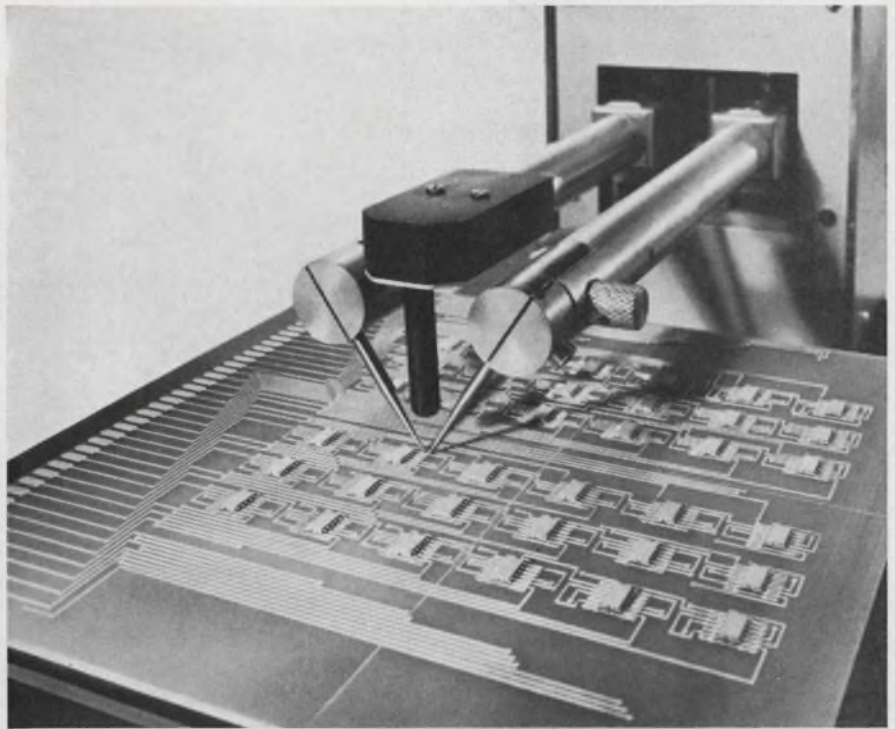
Ault Inc., 3501 48 Ave. N., Minneapolis. Phone: (612) 588-0556. *Circle No. 279*

High-voltage power

Thirty high-voltage power supplies range from 1 kV at 10 mA to 10 kV at 500 mA. All have 0.01% regulation and exhibit 0.002% p-p ripple. They operate from 105 to 125 or 210 to 250 Vac. Metered $\pm 1\%$ for voltage and current, they include adjustable overload protection and, with the exception of the 10 kV types, can be floated off ground up to 7500 Vdc.

P&A: \$1550 to \$3000; 90 to 120 days. Alto Scientific Co. Inc., 4083 Transport St., Palo Alto, Calif. Phone: (415) 321-3434.

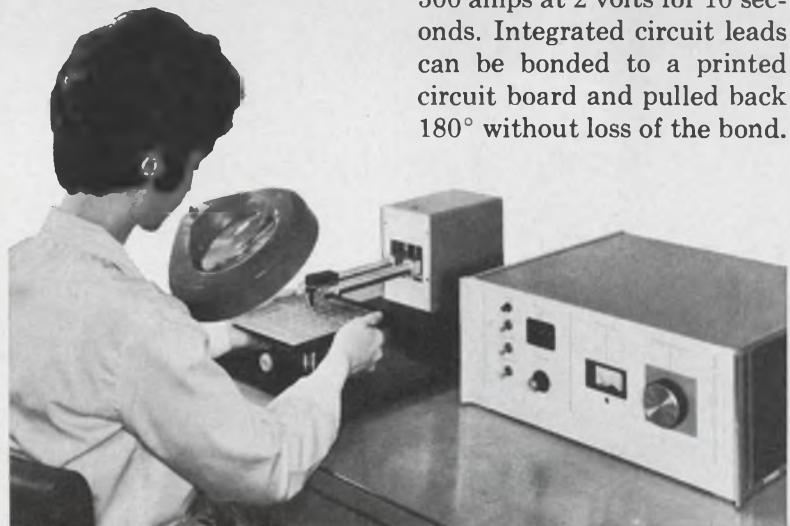
Circle No. 280



make reliable, secure IC bonds ...with automatic temperature control

Bond, hard solder, soft solder or weld by using a single machine that automatically regulates joint temperature. The Model 730 IC Bonder controls soldering and bonding temperature from 300° F to 1400° F with an accuracy of $\pm 3\%$ or better, using a precise infrared detector. Simple

controls allow inexperienced operators to set the joint temperature and operating mode. After these settings are made, the process is automatically controlled by the instrument. The Model 730 Bonder is available with parallel-gap or opposed electrodes, and can supply 10,000 watt-seconds: 500 amps at 2 volts for 10 seconds. Integrated circuit leads can be bonded to a printed circuit board and pulled back 180° without loss of the bond.



TEXAS INSTRUMENTS
INCORPORATED

APPARATUS DIVISION
P. O. BOX 66027 HOUSTON, TEXAS 77008

ON READER-SERVICE CARD CIRCLE 100

794

155

would you believe...?

well, it's true . . .

automate . . . coaxial switches are being made as small as the one shown below, with "built-in" reliability!

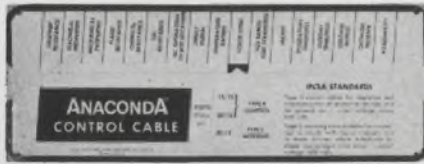


SERIES 151
TYPICAL SPECIFICATIONS
 DC-2.5GC* • VSWR: 1.3:1 max.
 Crosstalk: > -80db
 Shock: 100G, 11 milliseconds.
 Sinusoidal Vibration:
 20G 55-2000CPS, 06"D.A. 10-55CPS.
 Random Vibration:
 0.13 1/2 CPS 20-2000CPS.
 * Usable to 4GC

For further information about the above and many other high reliability miniature and micro-miniature coaxial switches, write to:

automatic
 METAL PRODUCTS CORPORATION
 323 Berry St., B'klyn, N.Y. 11202 • Tel: (212) EV 8-6057

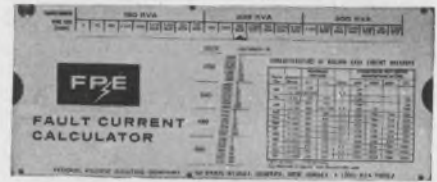
Design Aids



Control cable calculator

Such characteristics as temperature rating, size range and stranding, insulation thickness and voltage rating can be determined for type B (15/10 and 20/10) control cables and type C (30/15) metering control cable. Type B cables are for operation and interconnection of protective devices and general use. Type C cables are for connection to circuits with heavy magnetic trip or break devices where inductively induced overvoltages may occur. Anaconda Wire and Cable Co.

Circle No. 281



Fault current calculator

For any transformer rated from 150 to 2000 kVA, any copper wire size, voltage ratings from 208 to 600 V and distance from 0 to 200 feet, this slide chart calculates the fault current. Once the fault current is determined, a protective device with adequate interrupting rating can be selected immediately. In addition, this calculator lists characteristics of molded-case circuit breakers and fuses as well as dry-type transformer data. Federal Pacific Electric Co.

Circle No. 282



Reactance slide rule

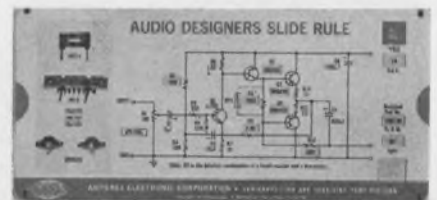
The reactance slide rule is a helpful time-saving means for solving resonant frequency capacitive reactance, inductive reactance, coil Q and dissipation factor problems. For example, if inductance is set opposite capacitance in one window, resonant frequency is read out in another. Or, if resonant frequency is set in one window, L and C are read out in another. The rule covers a frequency range of 5 Hz to 10 GHz. Detailed instructions and a complete set of sample problems.

Available for \$1 from Shure Bros., Inc., 222 Hartrey Ave., Evanston, Ill.

Pitch diameter table

A handy 22 x 28-in. wall-type thread chart contains tables of pitch diameters and gage limits, helix angles, best-size thread wires, and constants and tolerances for plug gages. Size Control Co.

Circle No. 283

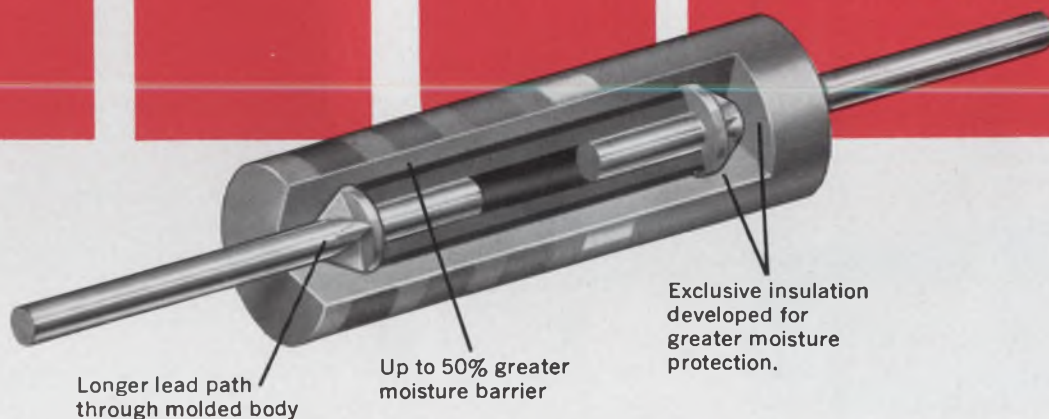


Audio design slide rule

By selecting wattage desired in one window of this audio slide rule, the amplifier circuit rated at that wattage appears complete with component values and 2N numbers. In addition, other windows give the complementary pair for the output stage and the speaker impedance. The reverse side of the rule determines V_{cc} , I_c , V_{rms} and I_{rms} for known wattages or load resistances. A set of complementary symmetry formulas is included.

Available for \$0.50 from Ampere Electronic Corp., 230 Duffy St., Hicksville, N. Y.

IRCE



Fixed composition resistors offer

Greater moisture resistance

When tested to MIL-R-11 moisture resistance requirements, IRC's $\frac{1}{2}$ and 1 watt fixed composition resistors exhibit resistance changes of less than 3%. Five times better than the 15% MIL allowance. Under more stringent conditions of 75°C, 100% RH for 120 hours, resistance changes are typically less than 5%. Even IRC's small $\frac{1}{4}$ watt unit has moisture resistance changes well within MIL limits.

Molding makes the difference. IRC's resistance element is a carbon composition film that is thermally bonded to a glass body. This exclusive IRC design permits up to 50% more molded protection completely around the resistance element.

The molding material was developed by IRC specifically for superior moisture, electrical, and mechanical characteristics. This exclusive molding material, plus added insulation thickness, brings an extra measure of moisture protection to your circuit design. Write for catalog, prices and samples to: IRC, Inc., 401 North Broad Street, Philadelphia, Pa. 19108.



IRC COMPOSITION RESISTORS ALSO OFFER

- Lower operating temperature
- Better resistance-temperature characteristics
- Superior high frequency characteristics
- Outstanding load life
- Stronger lead assembly
- Excellent solderability
- Values to 100,000 megohms



Speed Inquiry to Advertiser via Collect Night Letter
ON READER-SERVICE CARD CIRCLE 102



MIDGET
IN SIZE
GIANT

IN POWER
TYPE LK
rectangular high voltage
CAPACITORS

"The little one" with the tremendous power!
4 times the life of MIL-C-25A in case sizes
reduced up to 80%! And you also get:
superior resistance, better power factor,
withstands greater overloads, may be operated
to 125°C and voltage ratings from
600 to 500,000 volts.

Write today for Bulletin LK

Also ask for FREE pocket size
"Comparator" and "Conversion" chart

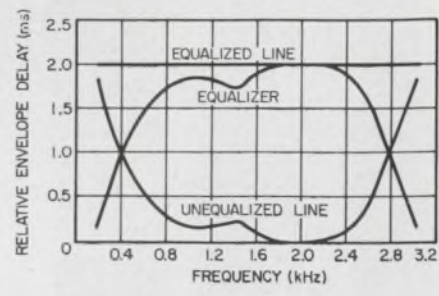


PE Engineering at
Production Prices

Plastic Capacitors, Inc.
2620 N. Clybourn • Chicago 14, Illinois
DI 8-3735

ON READER-SERVICE CARD CIRCLE 103

Application Notes



Delay equalization

This 8-page engineering bulletin explains the equalization of telephone lines to make them suitable for high-speed data communications. The illustrated brochure discusses the basic problem of delay distortion, talks about delay equalizers and considers various methods of employing equalization devices. Delay characteristics are plotted for 0.6-, 1.6- and 2.8-kHz all-pass networks. Rixon Electronics, Inc.

Circle No. 284

Log amplifier testing

Some common pitfalls in testing logarithmic amplifiers can be avoided with the help of this technical note. Unusual test results with log amplifiers result from the logarithmic nature of their output. On a linear to log output scale, high output values are represented by compressed voltage levels, while smaller outputs have a relatively larger portion of the possible output devoted to them. Difficulties which arise in testing as a result of this logarithmic output, together with both a theoretical and practical interpretation of these test results, are discussed. RHG Electronics Laboratory Inc.

Circle No. 285

Hybrid circuitry

Featured in this 4-page brochure are a series of five photographs illustrating the step-by-step assembly of a typical hybrid circuit, from the polished ceramic substrate to the completed circuit assembly. Diagrams of a power supply regulation circuit, an analog gate using FETs and a high-performance amplifier with a voltage gain of 100,000 are also included. Amelco Semiconductor.

Circle No. 286

New CDS Type 6C PHOTOCHOPPER CELLS

- High Efficiency
- Low Temperature Coefficient
- Resistance Tolerance $\pm 50\%$
- Internal Electrostatic Shielding
- Dumet Leads

Write for new
4-page Bulletin
110/170 866

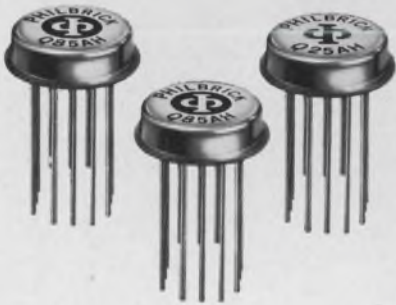


CLAIREX

"The LIGHT Touch in Automation and Control"
1239 Broadway, New York, N. Y. 10001
212 MU 4-0940

ON READER-SERVICE CARD CIRCLE 104

Philbrick's NEW BREED Micro-Hybrid Operational Amplifiers Obsolete Monolithics



If you are still using monolithic-chip operational amplifiers, your system may be on its way to obsolescence — perhaps even before it gets off the board. A full year of industry-wide evaluation has proved it.

Philbrick's NEW BREED of "micro-hybrid" operational amplifiers combines the best of the linear-monolithic and discrete-component technologies. The result: a line of "micro-hybrid" operational amplifiers unequalled in reliability and performance. You'd expect premium amplifiers like these to cost more. They do — but your total system cost, including design, development, materials, and production, is usually substantially lower when you use NEW BREED Operational Amplifiers.

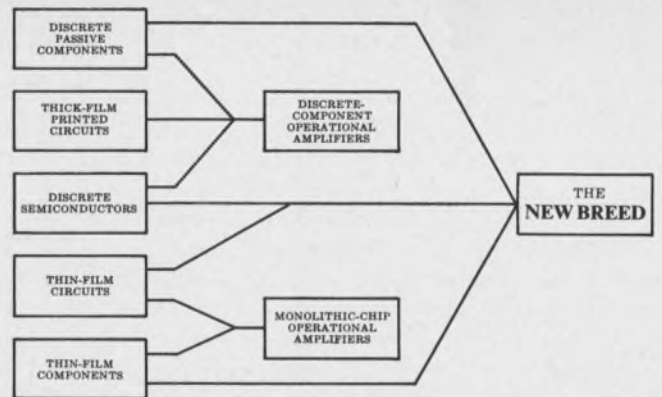
You can bid, win, and build highly superior "third-generation" systems with the NEW BREED — systems with an order of magnitude better performance, and absolute immunity to overloads, shorts, and supply-voltage stresses. Without the NEW BREED, your analog Aerospace/Weaponry designs are no longer competitive — technologically or economically.

More than 200 systems organizations have evaluated (and many have already approved) the NEW BREED. The facts are all assembled in our report entitled "THE NEW

BREED MICRO-HYBRID — A STATUS REPORT." Write, wire, or phone for your copy. Philbrick Researches, Inc., 46-0 Allied Drive at Route 128, Dedham, Massachusetts 02026. TWX (617) 326-5754. Telephone (617) 329-1600.



GENETIC EVOLUTION OF THE NEW BREED HYBRID



ELECTRONIC ANALOG COMPUTING EQUIPMENT for MODELLING, MEASURING, MANIPULATING and MUCH ELSE



PHILBRICK

"See us at the NEC Show October 3-5—Booths 3 & 4 and the ISA Show October 24-27—Booth 1541."

ON READER-SERVICE CARD CIRCLE 105

New Literature



Dc power supplies

Applications of regulated dc power supplies are described with ratings and parameters in this 82-page catalog. In addition to presenting specs on rack and bench supplies, the catalog contains a 32-page application section covering power supply circuit principles, operational features and options, special application problems, specifications, definitions and measurements. Hewlett-Packard/Harrison Div.

Circle No. 287

Testing solder assemblies

A simple test for use after soldering, to determine the presence of chloride ions in rinse water or on cleaned electronic hardware is described fully in this technical report. The publication includes complete instructions for carrying out the test using an aqueous silver nitrate solution. Alpha Metals Inc.

Circle No. 288

Vibrator replacement guide

An 8-page vibrator replacement guide for communications and CB equipment is offered. Section one is a cross-index of communications manufacturer's vibrator numbers and replacement vibrators. Section two is a communications replacement guide by alphabetical listing of manufacturer's trade name showing replacements for each. Section three deals with replacements for CB manufacturer's vibrators. Cornell-Dubilier Electronics.

Circle No. 289

Servo components guide

A 6-page, 2-color dc direct-drive servo components condensed selection guide describes a line of torque motors, tach generators, tach torquers and duplex torquers. The guide describes basic operating principles and outlines advantages. Also included are complete electrical and mechanical characteristics on a group of representative models from each product line and basic formulas and data that offer selection guidelines. Inland Motor Corp.

Circle No. 290

Potentiometer catalog

Wirewound single- and multi-turn precision pots and turns-counting dials are covered in this 4-page brochure. The catalog contains complete electrical, mechanical and environmental specs and prices. Duncan Electronics, Inc.

Circle No. 296

Differential amplifiers

This 12-page applications bulletin covering differential amplification includes a section on basic theory together with diagrams, formulas and applications. Other sections provide discussions of design requirements and performance characteristics and limits of differential circuits. Zeltex Inc.

Circle No. 297

Copper wire soldering

The technology of soldering the fine copper wire in microcircuit devices and low-power circuitry is covered in a 4-page bulletin. It summarizes methods for overcoming the difficulties of soldering this type of wire through control of alloy composition, soldering temperature, type of flux, and use of appropriate soldering procedures. The publication discusses the metallurgical aspects involved in soldering magnet wire, and describes dip, wave and hand soldering. Areas of potential trouble are outlined, and suggested solutions are enumerated. Alpha Metals Inc.

Circle No. 298

Micromin glass semis

An unusual booklet, "Story of the Little Giant," describes the evolution of IC-compatible micro glass components. The 20-page "Little Giant" covers the microminiature glass-encapsulated zener regulator in a picture/copy fashion. Hoffman Electronics Corp.

Circle No. 299

Film firing kilns

Conveyorized furnaces used for film firing of capacitors, resistors, terminals and integrated circuitry are covered in this brochure. Inside and outside dimensions, zones, ratings and voltages, temperature ranges, and a complete description of the process are given. Firing requirements of resistor and capacitor compositions are included. Trent, Inc.

Circle No. 300

Switch catalog

A full line of rotary, pushbutton, lever and slide switches is described in this 8-page catalog. Complete specifications, from finishes to insulation materials, for each type of switch are listed. Also included is a special section on switch hardware which enables design engineers to assemble their own switches for prototype work. Oak Mfg. Co., Div. of Oak Electro/Netics Corp.

Circle No. 301

Trimming capacitor catalog

Standard precision, non-rotating piston trimmer capacitors are covered in this 16-page catalog. The brochure includes over 300 types in PC, vertical and panel mount styles with easy reference charts. Voltronics Corp.

Circle No. 302

Binary ladder networks

Information on current-summing networks is given in this 10-page bulletin. In addition to a discussion of test methods for ladder networks, formulas for determining proper resistor values to establish various attenuation factors are included. Angstrom Precision Inc.

Circle No. 303

From .5 to 10,000 μ f, the CYFM is the second best capacitor you can buy.



μ f for μ f, you can't buy more stability and reliability per dollar than you get in the CORNING® CYFM Capacitor.

You get the kind of stability that only a glass dielectric can hold, that's invariable with time, temperature, and environment.

You get reliability that's inherent in the way they're made, which is basically the same process that turns out our ultra-high-reliability CYFR Capacitor.

But you save dollars on the CYFM because we don't put it through all the rigorous CYFR testing.

A CORNING CYFM Capacitor is practically indestruct-

ible under severe environmental stresses. We have boiled them in salt water, immersed them in saturated steam, subjected them to 96 hours of salt spray, without a failure or degradation.

After 2000 hours at 125°C with 150% of full rated voltage, capacitance change on a CYFM is less than 0.5%.

Why ever risk an entire system on capacitors that can't give you the assurance of Corning dielectric stability? Get all the economical facts on the CYFM Capacitor in our new CORNING® Glass Capacitor Guide. Send to Corning Glass Works, 3909 Electronics Dr., Raleigh, N.C.



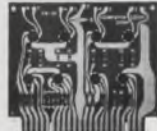
CORNING
ELECTRONICS

Speed Inquiry to Advertiser via Collect Night Letter
ON READER-SERVICE CARD CIRCLE 106

**BET
YOU
CAN'T
BUY
BETTER
INTEGRATED
LOGIC
CARDS!**

**BET YOU INVERTERS ARE
NEVER NEEDED!**
WHY PAY \$4 TO \$5 FOR INVERTERS YOU DO NOT NEED? ONLY CLC OFFERS BOTH HIGH-TRUE AND LOW-TRUE NAND GATES. ERGO, INVERTERS ARE NEVER NEEDED IN AND-TO-AND, OR-TO-OR, AND-OR, OR-AND GATING.

WANT
TO BET?



BETTER LOGIC ALSO BECAUSE OUR FAN-OUT IS 30 WITHOUT POWER DRIVER.

Bet you can't get better delivery, price, design, or service... why not bet us today!



COMPUTER LOGIC CORP.

1528 20th Street • Santa Monica, California • Phone: 213 - 451-9754
A COMPLETE FAMILY OF COMPATIBLE TRUE-BLUE LOGIC CARDS
ON READER-SERVICE CARD CIRCLE 181

NEW LITERATURE

Digital circuit modules

A 48-page technical catalog describes a line of low-noise digital circuit modules. The catalog includes physical characteristics, operating specs, related equipment, design aids and application notes for 28 encapsulated modules. Typical modules include most configurations of flip-flops, NAND/NOR gates, relay and indicator drivers, voltage comparators, power drivers and multicircuits. Engineered Electronics Co.

Circle No. 304

Carbon-film resistors

This 12-page brochure details a line of precision metal- and carbon-film resistors for severe applications. One section covers conformal and molded metal-film resistors. Hard-glass hermetic precision resistors, and carbon-film resistors are described in other sections. Cut-away diagrams, tables and graphs provide complete specs and typical characteristics of the resistors. Texas Instruments, Inc.

Circle No. 305

Capacitor reliability

A 26-page brochure describes a report on the reliability of tantalum-foil capacitors. The bulletin states GE's definition of reliability and why it is important to the capacitor industry. Product reliability is discussed in terms of features and capabilities. Graphs illustrate normal reliability tests and results. Test equipment photographs are included along with charts showing yearly quality control audits of tests, and life test and failure rate status reports. General Electric Co.

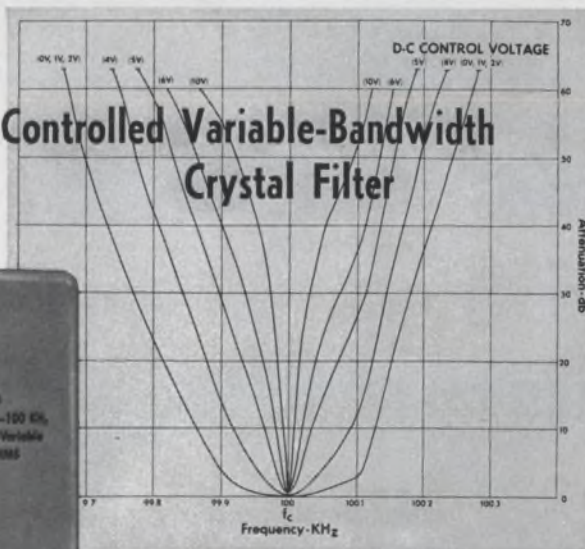
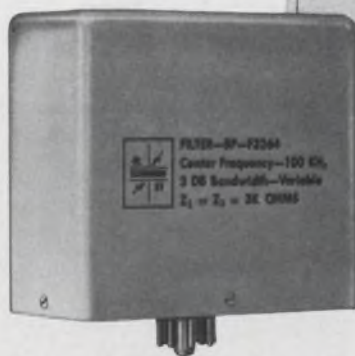
Circle No. 306

Computer books

Current books of interest to computer programmers and designers are described in this 4-page bulletin. The 21 books cover numerical analysis and computing methods, business data processing, digital computing, mathematical machine theory, sequential machines, linear data smoothing, switching systems, approximation of functions and language and information. Addison-Wesley Publishing Co., Inc.

Circle No. 307

NEW Voltage-Controlled Variable-Bandwidth Crystal Filter



Reeves-Hoffman's new filter performs the functions of several filters of different bandwidths, making it ideal for applications where space is a problem. Bandwidth at 3 db can be varied from 5 to 200 Hz by regulating input voltage from 0 to 10, either linearly or in a series of discrete steps. Center frequency of 100 KHz is standard, but other center frequencies can be provided upon request. We invite your inquiry.

Curves above for Model F3264 (illustrated) show transfer functions of two basic variable-bandwidth sections and a standard fixed bandwidth filter, which limits the 60 db bandwidth. Model F3264 is 4 3/4" x 2" x 3 3/8" high.



400 WEST NORTH STREET, CARLISLE, PENNSYLVANIA 17013

ON READER-SERVICE CARD CIRCLE 182

Power supply modules

A 4-page, short form catalog includes listing of low-voltage midget modules, a new series of subminiature modules for mounting on PC boards, two new series of medium current transistorized power supplies and an expanded list of unregulated power supplies. Data is also included on the characteristics of dual output modules for application with op-amps. Ferrotran Electronics Co., Inc.

Circle No. 121

Timing handbook

The "Design Engineer's Timing Handbook," a 12-page manual, covers a wide range of electronic timing devices, both military and industrial. Complete electronic and mechanical specs are featured with a glossary of terminology and environmental characteristics. Artisan Electronics Corp.

Circle No. 122

Testing magnetic tape

A new certification process which locates all defects in digital computer tape is described in this 12-page folder. A special center fold has pull-out sections comparing the area tested by the new process to those checked by usual procedures. U.S. Magnetic Tape Co.

Circle No. 123



Potentiometer wire

Low-resistivity gold alloy wires are described in "Data on LR Potentiometer Wire." Included are tables indicating resistivity, tensile strength, temperature coefficient of resistance, precious metal content and diameter/resistance values of the wires. A typical scope pattern shows the typical noise level of potentiometers wound with these alloys. Sigmund Cohn Corp.

Circle No. 124

HOW SMALL CAN A MICROWAVE COUPLER GET?



Pellet and connector actual size.

Would you believe Merrimac has produced an ultra-miniature microwave quadrature hybrid coupler $\frac{1}{8}$ inch in diameter and $\frac{3}{16}$ inch long? Size reduction was made possible by using a novel lumped element synthesis (U. S. Patents applied for). The Model QHU-2 is intended primarily for use with printed circuit boards and is highly suitable for aircraft and space applications. The pellet can be provided in a miniature connector housing, designated Model QHM-2. The new hybrid coupler, with or without connector, is presently available in the 2.1-to-2.3 GHz frequency range. Merrimac also can provide, on request, couplers at frequencies within 1-to-4 GHz. Inquiries on special requirements are invited.

Applications include image rejection mixers, phase comparators, phase shifters, attenuators, single sideband modulators, solid state power amplifiers, discriminator networks and power dividers.

Models QHU-2 and QHM-2 exhibit more than 23 db isolation with VSWR of 1.2:1; impedance 50 ohms. Other specifications include: Bandwidth 10%, phase quadrature $90^\circ \pm 3^\circ$; output equality ± 0.3 db; insertion loss typically less than 0.3 db; and power 5 watts average.

For further information, write or phone:



MERRIMAC RESEARCH AND DEVELOPMENT, INC.

41 FAIRFIELD PL., W. CALDWELL, N. J. 07007 201-228-3890

Design Data from Manufacturers

Advertisements of booklets, brochures, catalogs and data sheets. To order use Reader-Service Card.

(Advertisement)

Kemet Solid Tantalum Capacitor Guide



The Schweber Guide to the selection of Kemet solid capacitors (military types) is a 4 page compilation of solid tantalum capacitors from .0047 MFD thru 330 MFD in voltages from 6 to 100 Vdc. The layout is unique because the capacitors are listed in numerical sequence by microfarads, thus enabling the engineer and buyer to quickly and easily select the proper capacitor needed. Also listed is MIL-C-26655B chart showing meaningful breakdown of each part number.

Schweber Electronics

Westbury, N. Y. 11591

(516) ED 4-7474

171

Power Conversion Equipment



This new technical catalog describes equipment you may use to simplify your system design, test installation or laboratory setup. Data included on megawatt power sources for industrial applications as well as uniquely packaged regulated supplies for aerospace. Emphasis on general purpose dc power supplies, high power converters, variable frequency inverters, ac-dc converters. Free to qualified engineers.

Cal-Power Corporation

140 Kansas Street
El Segundo, California

172

Books For The Electronics Engineer



The 1966 Hayden Book Company, Inc., catalog contains such new titles as "Microelectronic Design," "100 Ideas for Design '66," "The Electron in Electronics," "Synthesis of RC Networks with Arbitrary Zeros," "Transistor and Diode Network Calculations," and "Matrix Algebra for Electronic Engineers." As well as the expanded list for design engineers, the catalog includes Hayden and John F. Rider Publisher training texts at all levels. Send for your free catalog today.

Hayden Book Company, Inc.

116 West 14th Street
New York, N. Y. 10011

173

NEW LITERATURE

Iron-base resistance alloy

Complete physical, mechanical and electrical data on the properties of Fe-Cr-Al-Co resistance heating alloys is contained in this brochure. The brochure describes four different alloys. Kanthal Corp.

Circle No. 308

Op-amp catalog

Full specifications and performance data on the manufacturer's op-amps are given in this 8-page catalog. Also included are specs on boosters, power supplies and accessories. A special page includes diagrams of case styles and connectors. Zeltex Inc.

Circle No. 309

Accuracy Policy

It is the policy of ELECTRONIC DESIGN:

To make reasonable efforts to insure accuracy of editorial matter.

To publish promptly corrections brought to our attention.

To reserve the right to refuse any advertisement deemed misleading or fraudulent.

All editorial correspondence and manuscripts should be sent to:

Howard Bierman, Editor
ELECTRONIC DESIGN
850 Third Avenue
New York, N. Y. 10022

Subscription Policy

ELECTRONIC DESIGN is circulated free of charge to qualified design engineers in the U.S., Western European Continent and Britain. To establish your qualifications, send ELECTRONIC DESIGN the following information on your company's letterhead: Your name, engineering title, description of your design duties and a list of your company's major products. The letter must be signed by you personally.

Subscription rates for nonqualified subscribers—\$25 a year in the U.S., \$35 in all other countries. Single copy, \$1.50.

Change of Address

A subscriber's change of address requires a restatement of his qualifications. To expedite the change, and to avoid missing any issues, send along a label from a back copy.

Microfilm Copies

Microfilm copies of all 1961, 1962, 1963, 1964 and 1965 issues of ELECTRONIC DESIGN are available through University Microfilms, Inc., 313 N. First Street, Ann Arbor, Mich.

Electronic Design

Advertising Representatives

New York 10022
Robert W. Gascoigne
Thomas P. Barth
Samuel M. Deitch
Richard W. Nielson
850 Third Avenue
(212) PLaza 1-5530
TWX: 867-7866

Philadelphia 19066
Fred L. Mowlds, Jr.
P. O. Box 206
Merion Station, Pa.
(215) MO 4-1073

Marblehead 01945
Richard Parker
7 Redstone Lane
(617) 742-0252

Chicago 60611
Thomas P. Kavooras
Berry Conner, Jr.
720 N. Michigan
(312) 337-0588

Cleveland 44107
Robert W. Patrick
8410 Treetower Drive
Chagrin Falls, Ohio
(216) 247-7670

Los Angeles 90303
Stanley I. Ehrenclou
Terrence D. Buckley
W. James Bischof
2930 W. Imperial Highway
Inglewood, Calif.
(213) 757-0183

San Francisco
Ashley P. Hartman
175 South San Antonio Rd.
Ste. 243
Los Altos, Calif. 94022
(415) 941-3084

Southwestern 75206
Tommy L. Wilson
6200 North Central Express-
way
Dallas, Tex.
(214) EMerson 1-2311

London W. 1
Brayton C. Nichols
44 Conduit Street

Tokyo
Yoshihiro Takemura
International Planning
Service, Inc.
Room 231 Tokyu-Mita Bldg.
1, Shiba-Mita Koun-cho
Minato-ku, Tokyo



General Electric can make 50 million miniature pins a week.



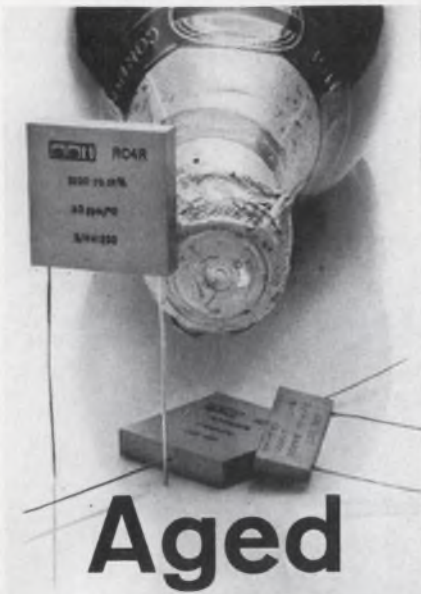
You'll get the pins you want when you want them.

Pins we've got, pins for plug-in relays, modules, etc. Cost? From 25c to 50c per thousand, roughly. It depends on what kind you want and we can make just about any kind you like. Dumet? Sure, and also copper, nickel, nickel clad copper, copper clad iron, nickel-iron-cobalt alloys too. Length can run up to a half-inch and sometimes more and diameters range between .015 to .050 in. Ends are rounded and tolerances are held tightly. Need 50,000 or more? We'd sure like to hear from you... because we can make 50,000,000 miniature pins a week.

Write: General Electric Company, Lamp Metals & Components Department,
21800 Tungsten Road, Cleveland, Ohio 44117, or telephone: (216) 266-3472.

GENERAL ELECTRIC

ON READER-SERVICE CARD CIRCLE 184

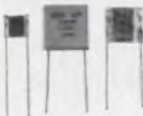


Aged

Our precision resistors are aged to improve reliability, and we guard the process like a vintage champagne maker. Ageing is just one of many extra steps that make our precision components the most reliable you can specify. A few of our components are described briefly below.

1. Precision Wire-Wound Card Resistors

Consider ESI resistors whenever small changes in the resistive element can affect the performance of the final assembly. Initial accuracy to $\pm 0.0015\%$. Yearly stability to ± 10 ppm.



2. Dekastat® Decade Resistors

Designed for use with dc and at audio frequencies, these multi-decade resistors feature an accuracy of $\pm 0.02\%$. All units carry a two-year guarantee.



3. Dekapot® Resistive Voltage Dividers

These rapid-setting potentiometers have a terminal linearity up to 0.002%. Kelvin-Varley circuitry provides constant input impedance.



4. Dekatran Transformer Voltage Divider

The patented coaxial dial is easy to read and adjust. Accuracy of 0.001% and long-term stability are achieved through gapless toroidal cores of very high permeability.



Electro Scientific Industries, Inc.
13900 NW Science Park Drive
Portland, Oregon 97229

ON READER-SERVICE CARD CIRCLE 185

Advertisers' Index

*PARTICIPANTS IN NIGHT LETTER PROGRAM

Advertiser	Page	Advertiser	Page
ADC Products, A Division of Magnetic Control Co.	110	Johanson Manufacturing Corp.	149
Accutronics, Inc.	60	Johnson Company, E. F.	144
Ad-Yu Electronics, Inc.	168	Kelvin Electric Co.	142
*Agastat Timing Instruments, Elastic Stop Nut Corporation of America	124	Kester Solder Company	34, 35
Allen-Bradley Co.	32A-B	LFE Electronics, Division of Laboratory of Electronics, Inc.	46
Analog Devices, Inc.	113	Lambda Electronics Corp.	82, 83
Atec, Inc.	24	Licon, Division Illinois Tool Works, Inc.	42, 43
Automatic Metal Products Corporation	156	Littelfuse	146
Babcock Relays, A Div. of Babcock Electronics Corporation	97	Markem Machine Company	119
*Ballantine Laboratories, Inc.	139	Matheson Company, Inc.	151
*Beckman Instruments, Inc., Helipot Division	127	Mepeco, Inc.	148
Bendix Corporation, The, Scintilla Division	101	Merrimac Research and Development, Inc.	163
Bendix Corporation, The, Semiconductor Division	8, 9	*MicroSwitch, A Division of Honeywell	38, 39
*Bourns, Inc.	23, 99	Midtex, Incorporated Aemco Division	120
*Brand Rex, Div. of American Enka Corporation	29	Midwestern Instruments, A Subsidiary of the Telex Corporation	37
Burdny Corporation	141	Montronics, Inc.	52
Cal-Power Corporation	164	*Motorola Semiconductor Products, Inc.	30
Chicago Switch Division F & F Enterprises, Inc.	154	Nytronics, Inc.	111
Clairex Corporation	158	*Oak Manufacturing Co.	121
*Clifton Precision Products, Division of Litton Industries	105	Ohmite Manufacturing Company	109
Columbia Wire Products Company	128	Pamona Electronics Co., Inc.	48
Communications Electronics, Incorporated	145	Pamotor, Inc.	132
Components, Inc.	116	Philbrick Researchers, Inc., George A.	159
Computer Logic Corporation	162	*Phileo, Microelectronics Division	130
*Computer Measurements Company	117	PIC Design Corp.	146
*Consolidated Avionics, A Division of Condec Avionics	69	Plastic Capacitors, Inc.	158
Cornell-Dubilier Electronics	45	RCA Electronics Components and Devices	27, 48A-B-C-D, Cover IV
*Corning Glass Works	161	Reeves Hoffman Division of DCA	162
*Dale Electronics, Inc.	Cover III	Revere-Mincom Division, 3M Company	135
Data Instruments Division	136	Sanders Associates, Inc.	154
*Datapulse, A Division of Datapulse, Incorporated	2	Schweber Electronics	164
DuPont de Nemours & Co., E. I. Photo Products Department	4, 5	Siemens America, Incorporated	125
ESI Electro Scientific Industries, Inc.	166	*Sonotone Corporation	133
Electro Tec Corp.	36	Sorenson Operation, Raytheon Company	16
Electronic Design	167	Sprague Electric Company	10, 20
Engineered Electronics Company	40	Switchcraft, Inc.	140
*Fairchild Du Mont Laboratories, Electronic Tube Division	103	*Systrom-Donner Corporation	12
Fairchild Semiconductor, A Division Fairchild Camera and Instrument Corporation	19, 70, 71	TRW Capacitors	50
*Fluke Mfg. Co., Inc. John	52	Technical Information Corp.	153
General Electric Company, Lamp Metals & Components Dept.	165	Techno-Components Corp.	150
General Electric Company, Silicone Products Dept.	61	Tektronix, Inc. Oscilloscopes	25
General Precision, Librascope Group	131	Teledyne Telemetry Company	134
General Radio Company	1	Texas Instruments Incorporated	155
Hathaway Instruments, Inc.	152	Texas Instruments Incorporated, Semiconductors-Components Division	62, 63
Hayden Book Company, Inc.	123, 164	Tracor, Inc.	114
Heath Company	150	Triplett Electrical Instrument Company	91
Heinemann Electric Company	7	Union Carbide Corporation, Electronics Division	129
Hewlett-Packard, Sanborn Division	15	*Victoreen Instrument Company, The	49
Hewlett-Packard	Cover II	Wayne Kerr Corporation	112
Honeywell, Inc.	143	Welwyn International Inc.	106
Honeywell, Precision Meter Division	47	Westinghouse Molecular Electronics Division	87
IRC, Inc.	6, 115, 157	Weston Instruments, Inc.	147
Indiana General Corporation	41	Career Advertising:	
Industrial Electronic Engineers, Inc.	33	A C Electronics Division of General Motors	94
*JFD Electronics Co. Components Division	122	LTV ElectroSystems, Inc.	95
Jennings Radio Mfg. Corp.	137	Lockheed-California Company	92
		Motorola, Government Electronics Division Aerospace Center	92
		U. S. Navy—San Francisco Bay Naval Shipyard	96



MARKETERS' CASE STUDY
Kurz-Kasch, Inc.
 MOULDERS  of PLASTICS

“WE ENJOYED A 50% HIGHER RESPONSE RATE IN QUALIFIED-RETURNED (SALES LEADS)..... FROM ELECTRONIC DESIGN”
 —Reports Thomas E. Barth, Field Sales Manager & Advertising Manager, Kurz-Kasch, Inc.

Kurz-Kasch, Inc. has developed a system of qualifying inquiries received from their advertising and promotion program. As a result, they are able to rate “the qualifications” or quality of readership of publications. Field Sales and Advertising Manager, Thomas E. Barth writes:

“Interestingly enough, of the inquiries received from our April 12 ad in Electronic Design, we enjoyed a 50% higher response rate in qualified - returned questionnaires than from any of the other publications we have used. “What better test of a publication’s value can be made?”

IF YOUR AD CAN SELL, IT WILL SELL BEST IN
Electronic Design

a HAYDEN publication 850 Third Avenue, New York, N.Y. 10022 (212) PL 1-5530

New FROM AD-YU

ELECTRONICS INC.

249-259 TERHUNE AVENUE, PASSAIC, N. J.
Phone (201) 472-5622 • CABLE: ADYU PASSAIC

DIGITAL PHASE METER TYPE 524A3

±0.03 Degree Accuracy, 20 CPS to 500 KC



Type 524A3 with indicator. Computer alone (bottom panel) can produce analog output to drive recorder and d.c. digital voltmeter. Price \$999.

FEATURES:

Phase reading directly in degrees in 5 digits (or 4 digits).

No amplitude adjustment from 0.3v to 50v.

No frequency adjustment up to 500 kc.

Analog output available for recorder or programmable system.

USES:

Plot phase vs. frequency curve of unknown network.

Plot envelope delay curve with RF sweep oscillator.

A standard phase meter with 5-digit readout.

WIDEBAND PHASE STANDARD TYPE 209

0.015° Accuracy 50 CPS to 10 KC



Directly traceable to National Bureau of Standards.

FEATURES:

Accuracy 0.015° resolution 10 micro-degrees (10⁻¹)

Self-calibration, self-checking by means of fundamental bridge balancing without the use of an external standard.

Phase shift can be set from 0° to 360° with 7-digit resolution.

No error due to loading of both output signals.

SPECIFICATIONS:

FREQUENCY RANGE:

Continuous coverage from 50 cps to 10 kc.

PHASE RANGE:

Can be set for any phase angle from 0° to 360° with 7-digit resolution.

ACCURACY:

±0.015° for 50 cps to 1 kc; gradually increases to ±0.07° at 10 kc.

RESOLUTION:

0.00001 degree (10 micro-degrees)

Designer's Datebook

NOVEMBER						
S	M	T	W	T	F	S
		1	2	3	4	5
6	7	8	9	10	11	12
13	14	15	16	17	18	19
20	21	22	23	24	25	26
27	28	29	30			

DECEMBER						
S	M	T	W	T	F	S
				1	2	3
4	5	6	7	8	9	10
11	12	13	14	15	16	17
18	19	20	21	22	23	24
25	26	27	28	29	30	31

Nov. 2-4

1966 Northeast Electronics Research and Engineering Meeting (NEREM) (Boston, Mass.) Sponsor: IEEE, New England sections; T. A. Longo, IEEE Boston Office, 31 Channing St., Newton, Mass.

Nov. 8-10

1966 Fall Joint Computer Conference (San Francisco, Calif.) Sponsor: American Federation of Information Processing Societies; W. Estler, 965 Lincoln Ave., Palo Alto, Calif.

Nov. 14-17

19th Annual Conference on Engineering in Medicine and Biology (San Francisco, Calif.) Sponsor: IEEE and ISA; T. Weber, Beckman Instruments, 2500 Harbor Blvd., Fullerton, Calif.

Nov. 15-17

Fifth Annual Symposium on the Physics of Failure in Electronics (Columbus, Ohio) Sponsor: USAF & Battelle Memorial Inst.; T.S. Shilliday, Battelle Memorial Inst., 505 King Ave., Columbus, Ohio.

Nov. 15-18

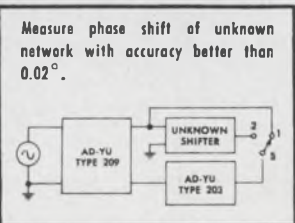
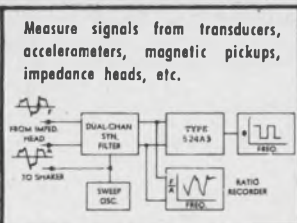
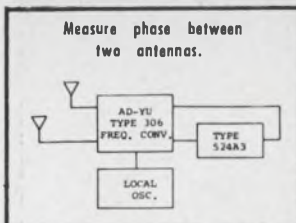
Twelfth Annual Conference, Magnetism and Magnetic Materials (Washington, D. C.) Sponsor: IEEE and the American Inst. of Physics; V. J. Folen, Code 6452 U.S. Naval Research Lab., Washington, D. C.

Nov. 16-18

1966 Eastern Analytical Symposium (New York City) Sponsor: American Chemical Society, American Microchemical Society and Society for Applied Spectroscopy; Ivor L. Simmons, M&T Chemicals Inc., P.O. Box 471, Rahway, N. J.

Nov. 29-Dec. 2

AIAA Third Annual Meeting and Technical Display (Boston, Mass.) Sponsor: AIAA; Vincent J. Coates, Jr., Avco Everett Research Lab., 2385 Revere Beach Pkwy., Everett, Mass.



See our booth No. 1A70 at the NEREM Show
ON READER-SERVICE CARD CIRCE 186

New Dale commercial wirewounds...**priced right!**









Dale expands with new silicone coated resistors to replace & outperform vitreous enamel



- **Expanded Commercial Line** provides direct replacements for the full range of vitreous enamel styles and sizes. You pay no more—less in many cases
- **Proven Reliability:** Over 1,800,000 unit test hours prove maximum HL failure rate to be .05% per 1,000 hours (full power, 25°C; failure defined as 3% ΔR, 60% confidence level)
- **Superior Stability:** Multi-layer silicone coating provides lower T.C. (±30 ppm). Standard tolerance ±5%. Precision tolerances available.

Write for ■ **New Commercial Resistor Brochure** ■ **Complete Resistor Catalog A**

BUY NEW MODELS...NEW SIZES...FROM THIS COMPLETE COMMERCIAL WIREWOUND LINE!

TYPE	APPLICATION	APPLICABLE MIL SPEC AND TYPES	WATTAGE RATING	RESISTANCE RANGE	CORE SIZES	TOLERANCE
CW Axial Lead 	Axial leads. For applications requiring high performance at low cost	MIL-R-26 RW-57, 58, 59	4.25-13 watts	.1 ohm to 273K ohms	Body Dia. .188 to .375" Body Length .500 to 1.781" Leads 1.5 to 2"	±5%
HL Tubular 	Silicone-coated general purpose wirewound resistor. A direct replacement in both cost and performance for vitreous enamel types.	MIL-R-26C RW-29, 30, 31, 32, 33, 35, 36, 37, 38, 47	5-225 watts	.1 ohm to 1.3 Megohms	O.D. ¼ to 1½" Length 1-10½"	±5% (10% below 1 ohm)
NHL Non-Inductive 	High frequency circuits and applications requiring low inductive effect and minimum distributed capacity	None	5-225 watts	1 ohm to 90K ohms	O.D. ¼ to 1½" Length 1-10½"	±5%
HL Flat 	High power-to-size ratio. Self-stacking hardware for vertical or horizontal mounting.	MIL-R-26C RW-20 thru RW-24	24-95 watts	.1 ohm to 150K ohms	Length 1¼ to 6"	±5% (10% below 1 ohm)
HLM Miniature Flat 	For limited space, high power-to-size requirements particularly in high vibration areas.	None	10-20 watts	.1 ohm to 51K ohms	Length ¾ to 2-1/16"	±5% (10% below 1 ohm)
HLA Adjustable 	For resistance or voltage adjustment	MIL-R-19365C RX-29, 32, 33, 35, 36, 37, 38, 47	12-225 watts	1 ohm to 100K ohms	O.D. 5/16 to 1½" Length 1½ to 10½"	±5% (10% below 1 ohm)
HLT Tapped 	For voltage divider networks	None	11-225 watts	.1 ohm to 1.1 Megohms	O.D. 5/16 to 1½" Length 1½ to 10½"	±10% each section (±10% total)
HLW Tubular 	General application where terminal wires are required for direct electrical connection	None	5-20 watts	.1 ohm to 80K ohms	O.D. ¼ to 7/16" Length 1 to 2"	±5% (10% below 1 ohm)



DALE ELECTRONICS, INC.
1328 28th Avenue, Columbus, Nebraska



Speed Inquiry to Advertiser via Collect Night Letter
ON READER-SERVICE CARD CIRCLE 187

This is a triode?

This is a triode?

This is a triode?

This is a triode?

This is a triode?



**RCA's new 40461
N-channel, depletion-
type, insulated full-
gate (MOS) transistor
may not be a triode...**

**but it works like one in
critical audio and wideband
amplifier applications from
DC to 100 MHz...with
solid state reliability!**

RCA's new Metal-Oxide-Semiconductor transistor makes it easy to design solid state devices into your high impedance control and instrumentation circuits. Unlike bipolar transistors, the 40461 has an extremely high input resistance (10^{15} ohms typical) which is relatively insensitive to temperature, at any gate polarity.

Further, this RCA MOS transistor features high transconductance and low input capacitance. Long-term stability is assured by a metallized gate which covers the *entire* source-to-drain channel. The 40461 is hermetically sealed in a TO-72 4-lead metal case.

With these features, the 40461 can do the job done by conventional triode devices and you gain the extra advantages of transistors! And this new MOS transistor can be used where conventional bipolar semiconductor devices were not previously applicable. You can also use two of these MOS transistors in cascode for greater versatility in your circuit design.

FOR YOUR CRITICAL CHOPPER APPLICATIONS use the new RCA 40460 solid state chopper. It eliminates problems associated with mechanical choppers. The full-gate construction permits symmetrical operation and assures long-term stability. Offset voltage is virtually zero. And you can use the new RCA 40461 triode in the chopper amplifier's high impedance second stage.

Design these devices into your existing circuits. Check your RCA Field Representative for complete information on both the 40460 and 40461 MOS transistors. Write RCA Electronic Components and Devices, Commercial Engineering, Section CG10-4, Harrison, N.J. 07029, for data sheets.

ALSO AVAILABLE THROUGH YOUR RCA DISTRIBUTOR

RCA Electronic Components and Devices



The Most Trusted Name in Electronics