

Is there a bug in your rug?

It's not as farfetched as you think. Hidden microphones and tapped telephones are becoming almost commonplace. And

these electronic spies are often as sophisticated as the latest in aerospace and military equipment. For a probing report on these devices turn to page 34.

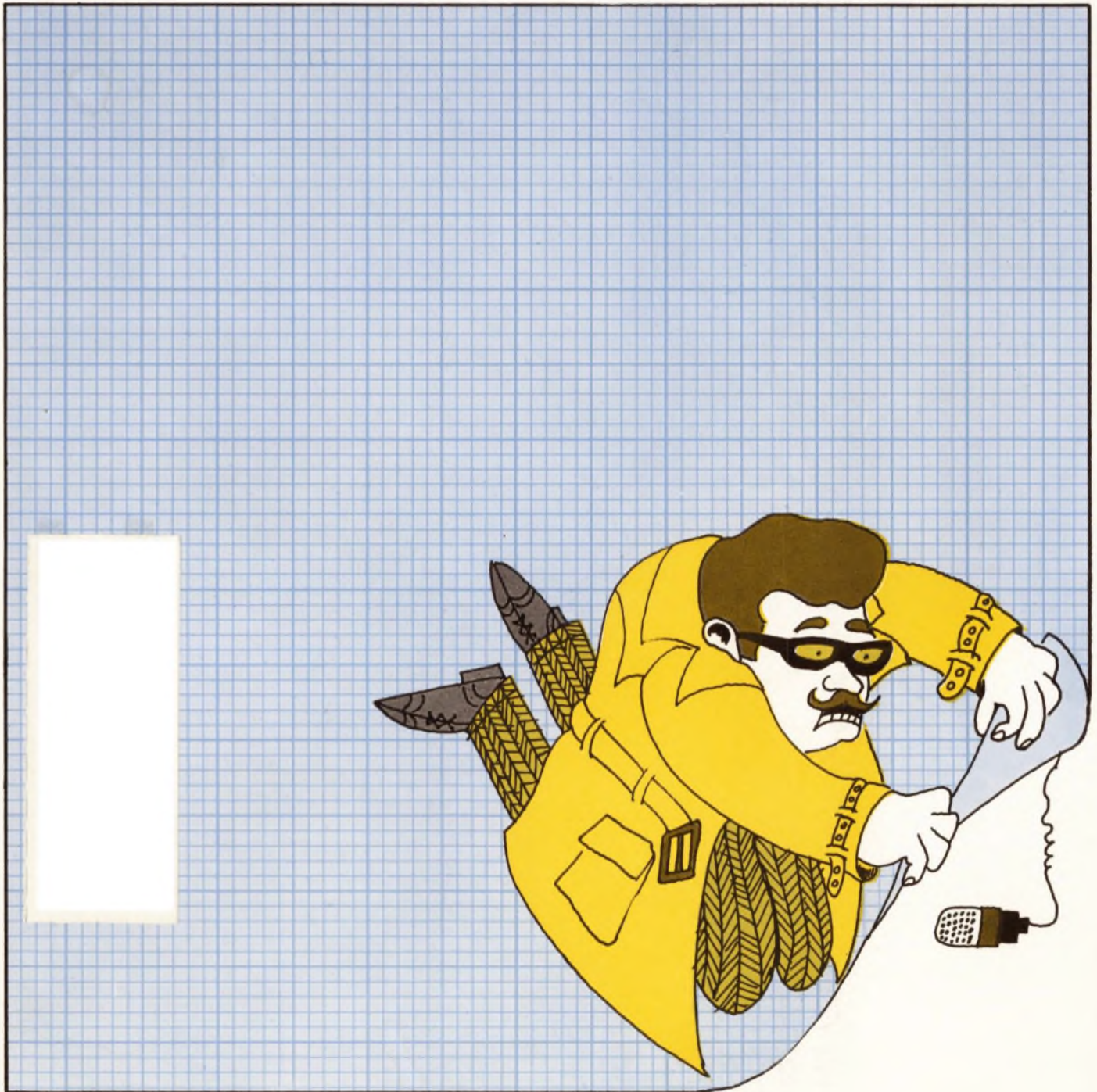

AUDIO TRANSFORMERS

DO-T No.	Pri. Imp.	D.C. Ma.† in Pri.	Sec. Imp.	Pri. Res. DO-T	Pri. Res. DI-T	Mw Level	DI-T No.
DO-T44	80 CT 100 CT	12 10	32 split 40 split	9.8	11.5	500	DI-T44*
DO-T29	120 CT 150 CT	10 10	3.2 4	10		500	
DO-T12	150 CT 200 CT	10 10	12 16	11		500	
DO-T13	300 CT 400 CT	7 7	12 16	20		500	
DO-T19	300 CT	7	600	19	20	500	DI-T19
DO-T30	320 CT 400 CT	7 7	3.2 4	20		500	
DO-T43	400 CT 500 CT	8 6	40 split 50 split	46	50	500	DI-T43*
DO-T42	400 CT 500 CT	8 6	120 split 150 split	46		500	
DO-T41	400 CT 500 CT	8 6	400 split 500 split	46	50	500	DI-T41*
DO-T2	500 600	3 3	50 60	60	65	100	DI-T2
DO-T20	500 CT	5.5	600	31	32	500	DI-T20
DO-T4	600	3	3.2	60		100	
DO-T14	600 CT 800 CT	5 5	12 16	43		500	
DO-T31	640 CT 800 CT	5 5	3.2 4	43		500	
DO-T32	800 CT 1000 CT	4 4	3.2 4	51		500	
DO-T15	800 CT 1070 CT	4 4	12 16	51		500	
DO-T21	900 CT	4	600	53	53	500	DI-T21
DO-T3	1000 1200	3 3	50 60	115	110	100	DI-T3
DO-T45	1000 CT 1250 CT	3.5 3.5	16,000 split 20,000 split	120		100	
DO-T16	1000 CT 1330 CT	3.5 3.5	12 16	71		500	
DO-T33	1060 CT 1330 CT	3.5 3.5	3.2 4	71		500	
DO-T5	1200	2	3.2	105	110	100	DI-T5
DO-T17	1500 CT 2000 CT	3 3	12 16	108		500	
DO-T22	1500 CT	3	600	86	87	500	DI-T22
DO-T34	1600 CT 2000 CT	3 3	3.2 4	109		500	
DO-T51	2000 CT 2500 CT	3 3	2000 split 2500 split	195	180	100	DI-T51
DO-T37	2000 CT 2500 CT	3 3	8000 split 10,000 split	195	180	100	DI-T37*
DO-T52	4000 CT 5000 CT	2 2	8000 CT 10,000 CT	320	300	100	DI-T52
DO-T18	7500 CT 10,000 CT	1 1	12 16	505		100	
DO-T35	8000 CT 10,000 CT	1 1	3.2 4	505		100	
*DO-T48	8,000 CT 10,000 CT	1 1	1200 CT 1500 CT	640		100	
*DO-T47	9,000 CT 10,000 CT	1 1	9000 CT 10,000 CT	850		100	
DO-T6	10,000	1	3.2	790		100	
DO-T9	10,000 12,000	1 1	500 CT 600 CT	780	870	100	DI-T9
DO-T10	10,000 12,500	1 1	1200 CT 1500 CT	780	870	100	DI-T10
DO-T25	10,000 CT 12,000 CT	1 1	1500 CT 1800 CT	780	870	100	DI-T25
DO-T38	10,000 CT 12,000 CT	1 1	2000 split 2400 split	560	620	100	DI-T38*
DO-T11	10,000 12,500	1 1	2000 CT 2500 CT	780	870	100	DI-T11
DO-T36	10,000 CT 12,000 CT	1 1	10,000 CT 12,000 CT	975	970	100	DI-T36
DO-T1	20,000 30,000	.5 .5	800 1200	830	815	50	DI-T1
DO-T23	20,000 CT 30,000 CT	.5 .5	800 CT 1200 CT	830	815	50	DI-T23
DO-T39	20,000 CT 30,000 CT	.5 .5	1000 split 1500 split	800		50	
DO-T40	40,000 CT 50,000 CT	.25 .25	400 split 500 split	1700		50	
DO-T46	100,000 CT	0	500 CT	7900		25	
DO-T7	200,000	0	1000	8500		25	
DO-T24	200,000 CT	0	1000 CT	8500		25	

†DCMA shown is for single ended usage (under 5% distortion—100MW—1KC) for push pull. DCMA can be any balanced value taken by 5W transistors (under 5% distortion—500MW—1KC) DO-T & DI-T units designed for transistor use only. U.S. Pat. No. 2,949,591; others pending.
§Series connected; §§Parallel connected



DO-T & DI-T

Transistor TRANSFORMERS and INDUCTORS

ALL ITEMS SUCCESSFULLY TESTED TO COMPLETE MIL-T-27B ENVIRONMENTAL REQUIREMENTS

***16 New Items Added to Stock Line IMMEDIATE DELIVERY FROM STOCK**

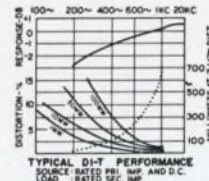
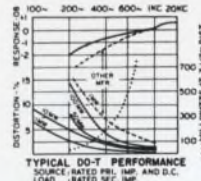

- High Power Rating up to 10 times greater
- Excellent Response twice as good at low end
- Low Distortion reduced 80%
- High Efficiency up to 30% better . . . compare DCR
- Moisture Proof hermetically sealed to MIL-T-27B
- Rugged Grade 4, completely metal cased
- Anchored Leads will withstand 10 pound pull test
- Printed Circuit Use (solder melting) nylon insulated leads
- Suited to Clip Mounting use Augat #6009-8A clip

INDUCTORS

DO-T No.	Inductance Hys @ ma	DO-T DCRΩ	DI-T DCRΩ	DI-T No.
*DO-T50 (2 wdgs.)	£.075 Hy/10 ma, .06 Hy/30 ma £.018 Hy/20 ma, .015 Hy/60 ma	10.5 2.6		
DO-T28	.3 Hy/4 ma, .15 Hy/20 ma	25		
	.1 Hy/4 ma, .08 Hy/10 ma		25	DI-T28
DO-T27	1.25 Hys/2 ma, .5 Hy/11 ma	100		
	.9 Hy/2 ma, .5 Hy/6 ma		105	DI-T27
DO-T8	3.5 Hys/2 ma, 1 Hy/5 ma	560		
	2.5 Hys/2 ma, .9 Hy/4 ma		630	DI-T8
DO-T26	6 Hys/2 ma, 1.5 Hys/5 ma	2100		
	4.5 Hys/2 ma, 1.2 Hys/4 ma		2300	DI-T26
*DO-T49 (2 wdgs.)	£20 Hys/1 ma, 8 Hys/3 ma £5 Hys/2 ma, 2 Hys/6 ma	5100 1275		

POWER TRANSFORMERS

*DO-T400	Pri 28V 380-1000 cycles, Sec 6.3V @ 60 ma
*DO-T410	Pri 28V 380-1000 cycles, 2-Sec 6.3 @ 30 ma each
*DO-T420	Pri 28V 380-1000 cycles, Sec 28V @ 20 ma (Isol. Electrostatic Shld.)

UNITED TRANSFORMER CORP.

150 VARICK STREET, NEW YORK 13, N. Y.

PACIFIC MFG. DIVISION: 3630 EASTHAM DRIVE, CULVER CITY, CALIF.
EXPORT DIVISION: 13 EAST 40th STREET, NEW YORK 16, N. Y. CABLE: "ARLAB"

ON READER-SERVICE CARD CIRCLE 232

Write for catalog of over 1,300 UTC TOP QUALITY STOCK ITEMS IMMEDIATELY AVAILABLE from your local distributor.



100 μV full-scale sensitivity from this new 20 Hz-4 MHz solid-state ac voltmeter

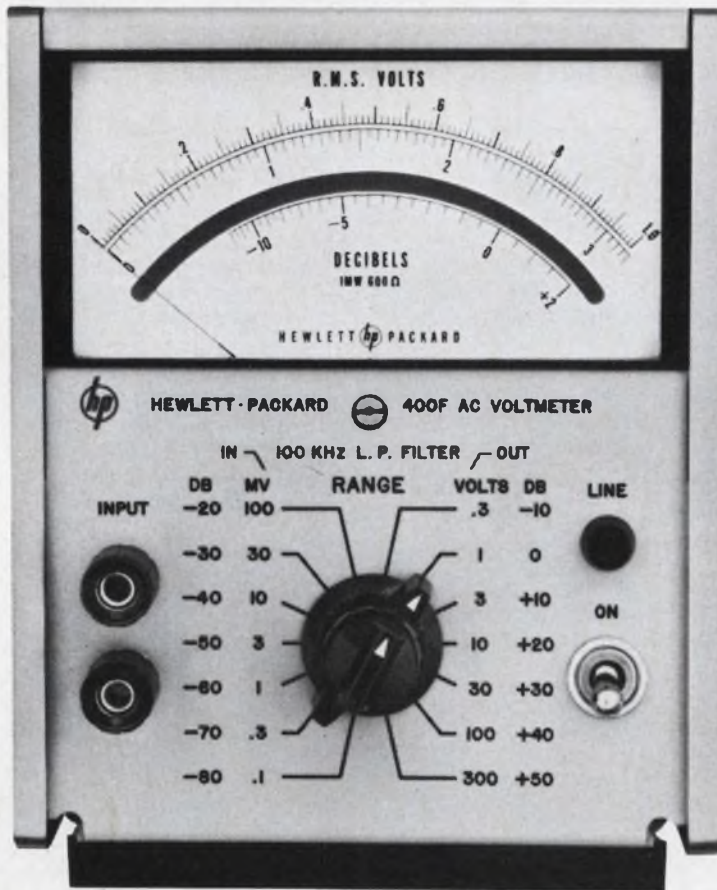

100 μV sensitivity—for unprecedented low-level ac measurements

Fast response—a reading in less than 2 seconds after turn-on; fast overload recovery, too

80 db low-noise amplifier, 1 v f. s. output, all ranges

Accuracy $\frac{1}{2}\%$ of reading + $\frac{1}{2}\%$ of full scale

Low-pass filter for controlling bandwidth of noise

10 Meg input impedance for minimum circuit loading (10-25 pf capacity)

Uses all Hewlett-Packard accessories, such as current shunts, voltage dividers

Special meter scales available for db measurements



The highest level of performance available today is yours with the new hp 400F/FL General-Purpose AC Voltmeters. Measure 100 μV to 300 v full scale on an individually calibrated linear meter that lets you measure as low as 10 μV with 1 μV resolution. The 400FL, \$285, offers a linear 12 db log scale with accuracy of 1% of reading. Specified accuracy of the 400F is $\frac{1}{2}\%$ of reading plus $\frac{1}{2}\%$ of full scale. The 400F, Option 01., puts the db scale uppermost for greater db resolution (\$30 extra).

As a low-distortion amplifier, the 400F/FL has a noise spec $<5 \mu\text{V}$ referred to input, typically 3.5 μV . The instrument can be battery operated through rear-panel terminals. The 1 v ac output is available on all ranges.

The low-pass 100 kHz filter, activated by a front-panel switch, reduces the effect of unwanted high frequencies for low-level audio measurements. The 11074A Voltage Divider Probe (10:1) is available.

The front panel shows the ease of use that's yours with this truly state-of-the-art ac voltmeter. Ideal for low-level audio, servo, communications measurements . . . one instrument for the widest variety of applications. For complete specifications . . . or for a demonstration . . . call your Hewlett-Packard field engineer. Or write Hewlett-Packard, Palo Alto, Calif. 94304, Tel. (415) 326-7000; Europe: 54 Route des Acacias, Geneva.

Data subject to change without notice. Prices f.o.b. factory.

HEWLETT  **PACKARD**
An extra measure of quality

Open a savings account here!



Just like a piggybank, our Digi-Twin 800-Series solid state counter really is a great place to save money. The reason is that big space where the plug-ins go. The two **other** big names in counters (Hewlett-Packard and Beckman) offer function plug-ins only. So you're stuck. That didn't seem fair to us, so our Digi-Twin is the only counter offering **three frequency range plug-ins**: 25 Mc, 50 Mc, and 110 Mc. So if you now need only 25 Mc, why pay for 50 Mc? Then if your next project requires a different frequency range you can buy a whole new counter from them... or just an inexpensive 50 Mc or 110 Mc plug-in for ours. ■ Maybe it's our attitude in giving you the best instrument, without charging you all the traffic will bear, that has earned us our solid third place in counter sales. If so, maybe you'll be interested in our ripening plans to offer you more and better instruments. And not just counters, either! ■ Say, have you earned your Crusading Engineers medal yet? It's the newest status symbol given to honor engineers like you who have the guts to compare the performance specs of **all three** major brands of counters. After that it's up to you to decide which counter actually fits your needs best. Earn your medal by writing now for our technical catalog. **It's free.** Incidentally, this counter is delivered without the cash inside.



12973 Bradley • San Fernando, California • Phone (213) 367-2161 • TWX 213-764-5993

FUNCTION MODULES: Counter-Timer Function Module • Frequency-Period (2 modules available) • 600 Mc Heterodyne Converter • Integrating Digital Voltmeter • 100 Mc Direct Counting Adapter • Digital Phase Meter • More Functions Due Soon

COMPUTER MEASUREMENTS COMPANY IS A LEADING DESIGNER AND MANUFACTURER OF ELECTRONIC INSTRUMENTATION TO COUNT, MEASURE, AND CONTROL.

Speed Inquiry to Advertiser via Collect Night Letter

ON READER-SERVICE CARD CIRCLE 3

NEWS

- 13 News Scope
 - 17 **Major advance in wafer-making forecast**
Researcher foresees the use of laser holograms to print semiconductor etching patterns at lower cost.
 - 21 **Lack of inductors blocks microwave ICs**
Performance, not size reduction, will determine the fate of microwave ICs once the inductance problem has been solved.
 - 23 Plastic fiber optics developed.
 - 26 Spacecraft designers look ahead to Mars.
 - 29 Washington Report
 - 34 **Special Feature: Electronic Eavesdropping Devices**
A report on the techniques and equipment that are being "borrowed" from the electronic and aerospace industries for private spying.
 - 50 Letters
 - 67 **Editorial: Training for tomorrow's job must begin today.**
-

TECHNOLOGY

- 70 **Neurons generate parity** in simple and inexpensive systems. The circuits are designed with threshold logic and use tunnel diodes.
 - 76 **Nonlinear design yields linearity**—a Zener-switching, nonlinear feedback amplifier gives a linear relationship between output power and input voltage.
 - 82 **Replace expensive coils** with pulse transformers in phase-lock detectors that operate up to 20 MHz. The change will also simplify circuitry.
 - 86 **Simplify low-frequency FET designs.** Use this application-oriented parameter guide to meet your differential and single-ended circuit needs.
 - 92 **Differentiator noise is no problem**, if your application is low-frequency. In fact, the simpler the circuit, the better.
 - 98 **Cure force-transducer inaccuracies** in error-signal detection by using a pulse-width multiplier to broaden the response time. It's a simple, inexpensive remedy.
 - 102 Ideas for Design
 - 116 NASA Tech Briefs
-

PRODUCTS

- 120 **Semiconductors:** Germanium FET goes plastic, bears \$1 price tag.
 - 140 **Components.** Varactor bridge op-amp provides pico-level performance.
 - 129 Test Equipment
 - 180 Systems
 - 188 Microwaves
 - 194 Materials
 - 198 Production Equipment
 - 204 Power Equipment
 - 210 Microelectronics
-

Departments

- 214 Design Aids
 - 215 Application Notes
 - 216 New Literature
 - 220 Reprints
 - 222 Advertisers' Index
 - 224 Designer's Datebook
-

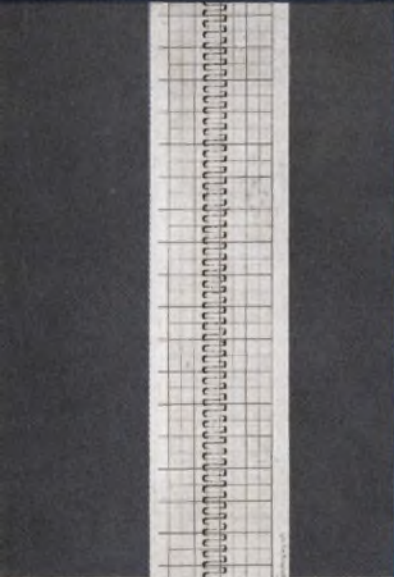
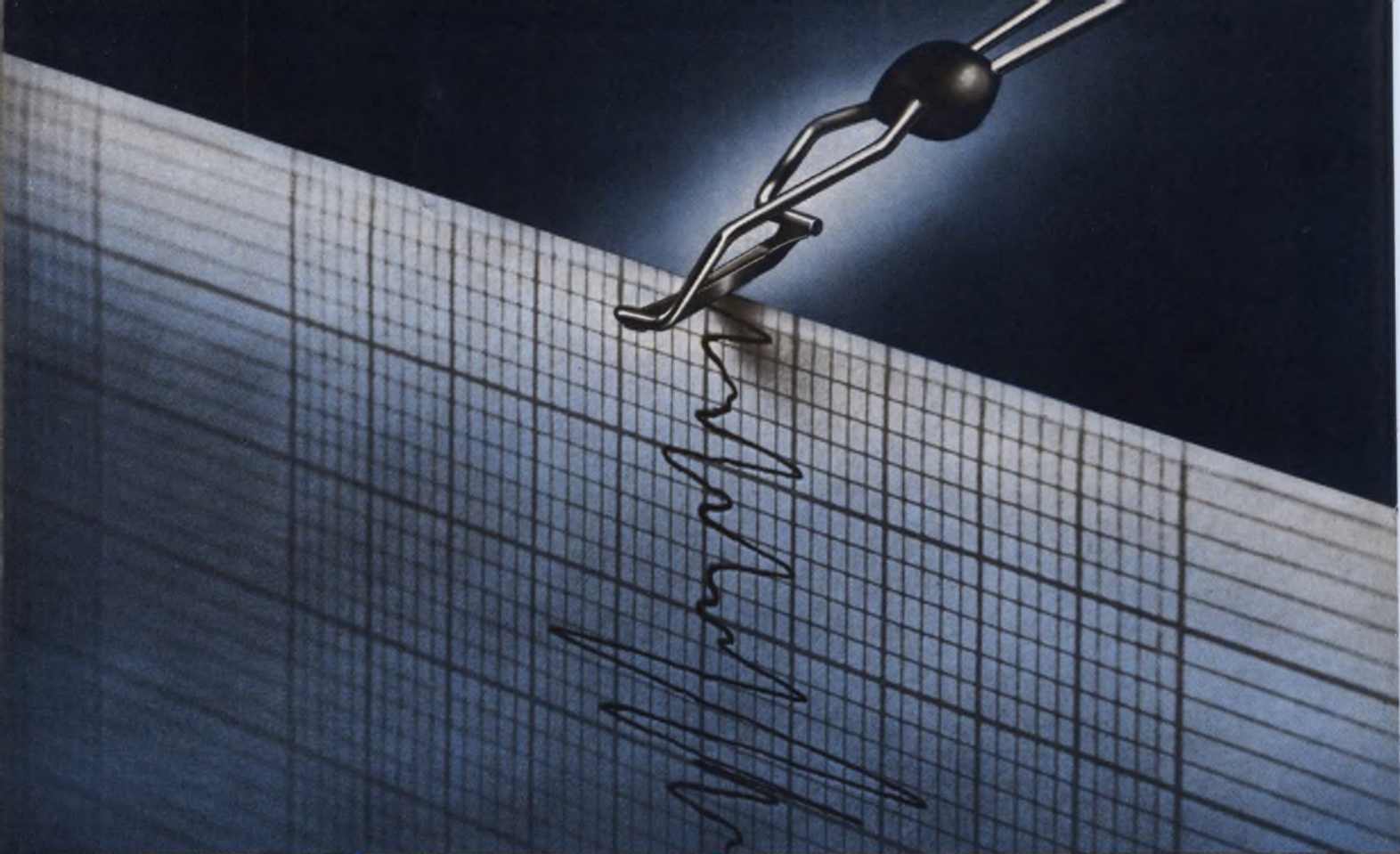

SINGLE-CHANNEL

Economical "briefcase-size" recorders. MODEL 7701A — 100 mm chart. Frequency Range DC to 30 cps. Linearity 0.5%. Sensitivity (depending on "8800" Preamp used) 1 uv/div to 5 v/div. Four chart speeds, 4 more optional. With case: \$1150 plus preamp. MODELS 299, 301 — 32 mm chart. Frequency Range DC to 100 cps. Linearity 0.625%. Sensitivity 10 mv/div (Model 299), 10 uv rms/div (Model 301). 2 chart speeds. Model 299: \$800, Model 301: \$850.

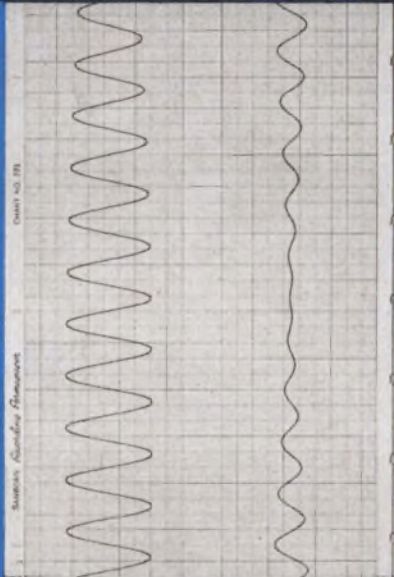

DUAL-CHANNEL

In portable, rack-mount, or mobile cart units. MODEL 7702A — Two 50 mm channels. Frequency Range DC to 125 cps. Linearity 0.5% Sensitivity (depending on "8800" Preamp used) 1 uv to 5 v/div. Four chart speeds, more on special order. Prices on request. MODEL 7712 — Uses "350" Preamps. Sensitivity 2 uv to 5 v/div. With mobile cart: \$1,715, plus preamps. 320 SERIES — Two 50 mm channels. Frequency Range DC to 125 cps. Linearity 0.5%. Sensitivity: 0.5 to 20 mv/div and v/cm (Model 320), 10 uv rms/div to 2 mv/div (Model 321), 10 mv to 10 v/div (Model 322). Four chart speeds, more on special order. Model 322 has zero suppression. Prices with cases: Model 320: \$1,650, Model 321: \$1,650, Model 322: \$1,395.

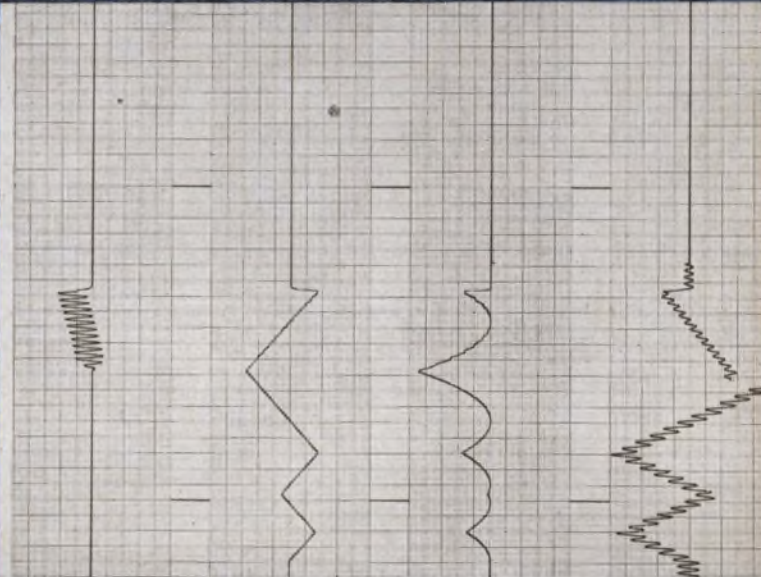

FOUR-CHANNEL

Sanborn MODEL 7714A recording system combines the convenience of horizontal table-top chart marking with the flexibility and high performance of interchangeable individual-channel 350 Series preamps. Four 50 mm channels. Frequency Range DC to 125 cps. Linearity 0.5%. Sensitivity (depending on "350" preamp used) 2 uv/div to 5 v/div. Nine chart speeds. With 4-channel cabinet, \$3,970 plus preamps.



See all measurements — down to the last microvolt

with high resolution Sanborn thermal writing oscillography

Resolve and read the smallest variations in your test parameters — even at *higher* frequencies, *small* amplitudes, and at *slow* chart speeds. Sanborn heated stylus oscillographic recording on matching Permapaper® charts gives you an immediate, permanent and clear record of test variables . . . lets you make “straight across” comparisons and correlations of multiple channels quickly and accurately because of rectangular coordinate traces . . . lets you clearly see what happened — as it is happening, and at any future time for more study or proof of performance.

The advantages of Sanborn thermal writing are available in many combinations of standard catalog system choices. The extensive Sanborn line allows you to select the number of channels, chart speeds, and the type of signal conditioning circuits you need, and to choose the packaging method that best suits your facilities. The wide range of signal conditioners includes low-cost built-in units, all-channels-alike amplifiers in six or eight-channel modules, and two series of individual channel plug-in units — miniaturized solid-state signal conditioners and highly sophisticated, maximum performance units.

Check the brief specifications of the systems shown below or call the H-P field engineering office in your locality for complete technical data and application engineering assistance. Offices in 47 U.S. and Canadian cities, and major areas overseas. Sanborn Division, Hewlett-Packard Company, Waltham, Massachusetts 02154. Europe: Hewlett-Packard S.A., 54 Route des Acacias, Geneva, Switzerland.

HEWLETT
PACKARD  SANBORN
DIVISION

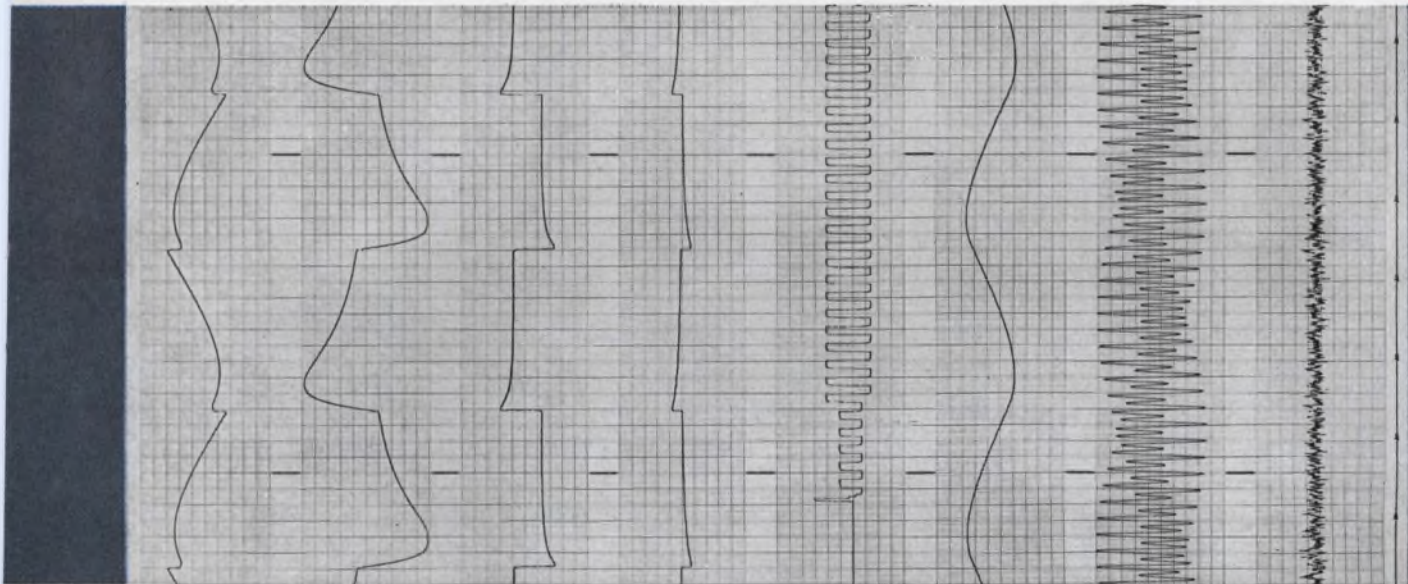

SIX AND EIGHT-CHANNEL

These versatile recorders have a wide range of input capacities, are completely integrated from signal input to galvanometer, and field-proven electronics. Six channel systems have 50 mm charts, and eight channel systems have 40 mm charts. All have DC to 150 cps frequency range. Linearity 0.5%. Nine chart speeds, nine more optional. MODELS 7706A, 7708A — (depending on “8800” preamp used) Sensitivity 1 uv/div to 5 v/div. With 6-channel cabinet (7706A) \$4,750 plus preamps, with 8-channel cabinet (7708A) \$5,425 plus preamps. MODELS 7716A, 7718A — Sensitivity (depending on “350” preamp used) 2 uv/div to 5 uv/div. With 6-channel cabinet (7716A) \$5,225 plus preamps, with 8-channel cabinet (7718A) \$6,250 plus preamps. MODEL 7728A — Sensitivity (depending on “950” amplifier used) 10 uv/div to 5 v/div. With 8-channel cabinet \$3,300 plus amplifiers.

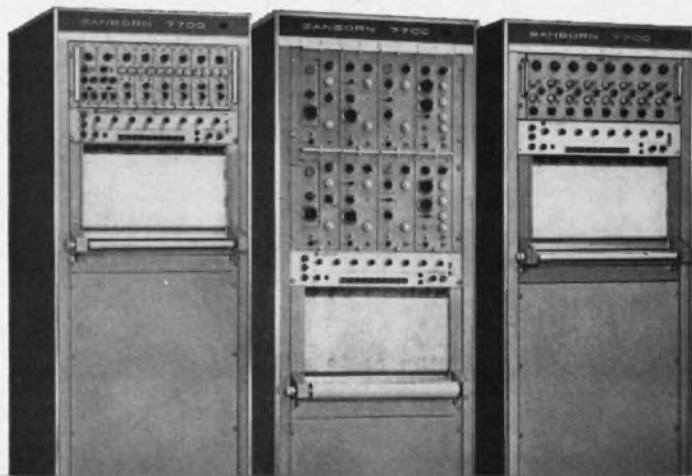

ON READER-SERVICE CARD CIRCLE 212

NAND logic is old hat.

We've invented SDS Natural Logic for our T Series integrated-circuit modules. It's a comprehensive set of gating structures that permit the terms of any Boolean logic equation to be converted directly into hardware.

Now you won't have to manipulate equations to make them fit the restrictions of NAND or NOR gates. With Natural Logic the hardware fits the equations without unnecessary inversions.

So you won't need nearly as many circuits to build your logic system. Your system will cost you a lot less. It will be faster and more reliable. It will be easier to mechanize. And it will take up less room.

Naturally.

Scientific Data Systems

1649 Seventeenth Street, Santa Monica, California
Offices in principal cities throughout the world



With NAND logic you are stuck with only this, no matter what the equations call for.

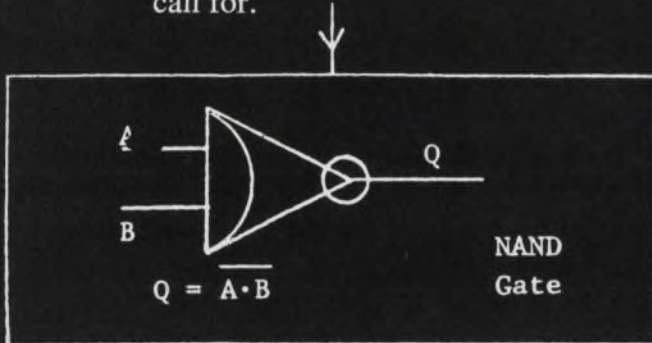

With T-Series NATURAL logic you have all these to choose from at a lower price per circuit.

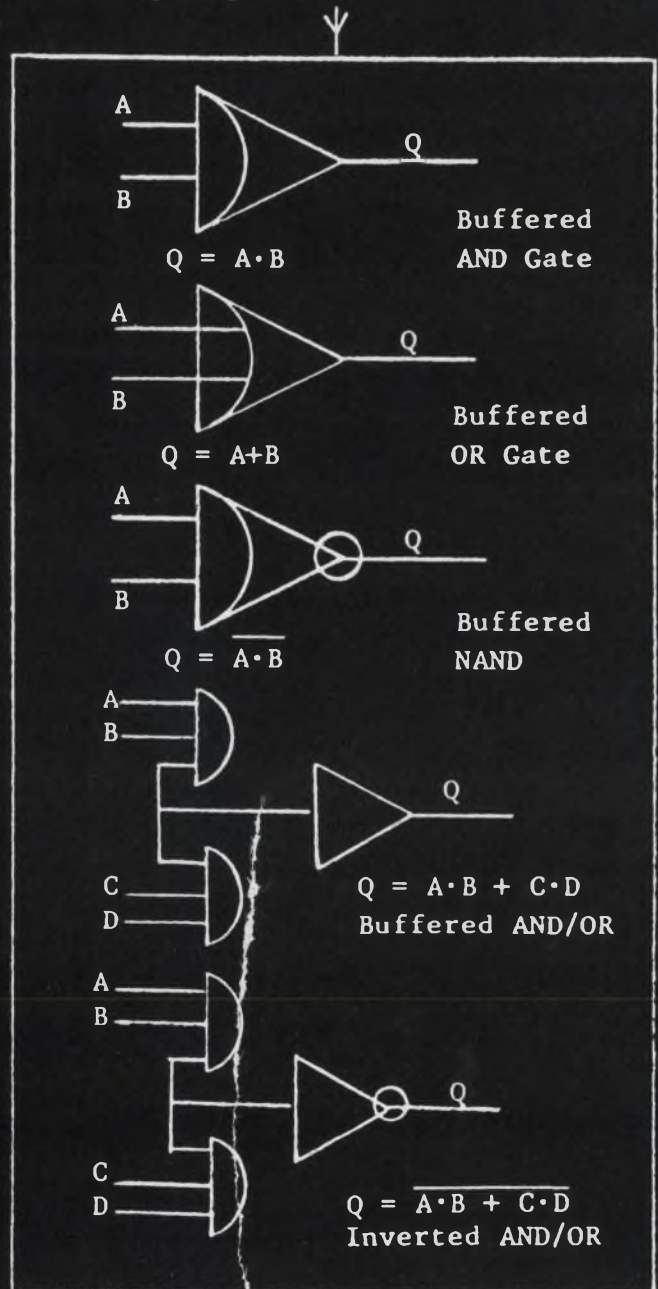

New, low-cost Philbrick Operational Amplifiers



Philbrick has always produced a wide variety of cool, reliable, solid state operational amplifiers for measurement, computing, control, data processing and testing. They provide premium performance and are priced accordingly. Their specified operating temperature exceeds -25° to $+85^{\circ}\text{C}$. Now Philbrick also offers economical equivalents of many of the most popular types in a utility grade, at substantially reduced prices. Savings generally exceed 50%. Yet, these utility grade amplifiers have identical performance with their premium grade equivalents within a limited temperature range, usually 0° to 60°C , but operate over the full range. And they too carry a two-year warranty. For a chart giving detailed comparative specifications of more than 60 Philbrick Operational Amplifier types write, wire or phone: Philbrick Researches, 46-H Allied Drive at Route 128, Dedham, Massachusetts. Telephone (617) 329-1600.

Engineering Representatives

Ala.: Huntsville (205) 536-8393, Mobile (205) 954-9298; Ariz.: Phoenix (602) 265-3629; Cal.: Los Angeles (213) 937-0780, Palo Alto (415) 326-9800, San Diego (714) 222-1121; Colo.: Denver (303) 733-3701; Conn.: West Hartford (203) 233-5503, Greenwich (203) 661-5140; Fla.: Ft. Lauderdale (305) 564-8000, Orlando (305) 425-5505; Ill.: Chicago (312) 676-1100, (312) 676-1101; Ind.: Indianapolis (317) 356-4249; La.: New Orleans (504) 242-5575; Md.: Baltimore (301) 727-1999; Mass.: Wakefield (617) 245-5100; Mich.: Detroit (313) 838-7324; Minn.: Minneapolis (612) 545-4481; Mo.: St. Louis (314) 741-3779; N. M.: Albuquerque (505) 268-3941; N. Y.: Buffalo (716) 835-6186, DeWitt (315) 446-0220, Valley Stream (516) 561-7791; N. C.: Winston-Salem (919) 725-5384, (919) 725-5385; Ohio: Dayton (513) 298-9964, Westlake (216) 871-8000; Okla.: Tulsa (918) 627-6199; Pa.: Philadelphia (215) 277-0559, Pittsburgh (412) 371-1231; Tex.: Dallas (214) 526-8316, Houston (713) 781-1441; Utah: Salt Lake City (801) 466-4924; Va.: Alexandria (703) 836-1800; Wash.: Seattle (206) 723-3320.

EXPORT: N.Y.: New York (212) 246-2133.

CANADA: Quebec: Montreal (514) 482-9750, Ontario: Toronto (416) 789-4325.

ELECTRONIC ANALOG COMPUTING EQUIPMENT for MODELLING, MEASURING, MANIPULATING and MUCH ELSE



PHILBRICK

ON READER-SERVICE CARD CIRCLE 4

Would You Believe...\$39⁵⁰ ?

PC210
G6621

It may be hard to believe that a microelectronic operational amplifier — which can outperform monolithic amplifiers in such critical parameters as noise figure, offset voltage drift, output voltage swing and slew rate — can still sell for as little as \$39.50 in quantities of 100 and up. Nevertheless, General Instrument's new PC-210 and PC-212 can and do.

A new method of employing thick-film/cermet resistors in these low noise, wide band multichip hybrid units provides an open loop voltage gain stability of ± 1.5 dB over the entire military temperature range of -55°C . to

$+125^{\circ}\text{C}$., and a linear output voltage swing of ± 15 volts (This appreciably exceeds swings available in monolithic amplifiers). Low noise, low offset voltages and input currents are obtained by extremely close matching of two high quality 2N930 transistors. For these reasons and others, GI's PC-210/212 operational amplifiers are particularly suitable for low level pulse and high frequency signal amplification, and high speed voltage comparisons.

The table below shows how the PC-210 and PC-212 outperform the most popular operational amplifiers now in use. And you can believe the price. It's only \$39.50.

Typical Characteristics	G.I. Hybrid Operational Amplifiers		Commonly Used Monolithic Operational Amplifiers		
	PC-210	PC-212	Type 2	Type 9	Type 10
Bandwidth (kHz) 3dB Open Loop	1500	1200	800	20	3000
Noise Figure dB Rs = 10 K Ω fo = 10 kHz $\Delta f = 10$ kHz	1	1	Not Specified		
RMS Input Noise Broadband (11 mHz)	4 μV	4 μV	Not Specified		
Slew Rate (Volts/ μsec)	± 100	± 100	Not Specified		± 100
Output Voltage Swing (Volts)	± 15	± 10	± 5 (with 100 k load)	± 10	+2.05 -1
Differential Input Current (nA)	40	30	700	50	1000
Input Bias Current (nA)	600	500	4000	200	25000
Offset Voltage Drift -55 $^{\circ}\text{C}$ to +25 $^{\circ}\text{C}$ +25 $^{\circ}\text{C}$ to +125 $^{\circ}\text{C}$ -55 $^{\circ}\text{C}$ to +125 $^{\circ}\text{C}$ } $\mu\text{V}/^{\circ}\text{C}$	4	4	10 5 -	6 3 -	5
Voltage Gain V/V	3200	1600	2600	45000	1200

Available now in hermetically sealed flat packs from your authorized GI Distributor.

For full information call or write



**GENERAL INSTRUMENT CORPORATION
SEMICONDUCTOR PRODUCTS GROUP**

600 West John Street, Hicksville, L. I., N. Y.

ON READER-SERVICE CARD CIRCLE 5

ELECTRONIC DESIGN, June 21, 1966

...NOW IN A NEW MINIATURIZED SIZE

Hermetically Sealed ERIE BUTTON® MICA capacitors designed for -55° to +200°C at 2000 Mc.

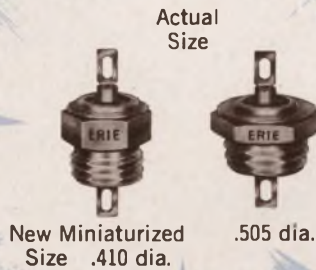

Featuring 508 MECHANICAL VARIATIONS TO SUIT
ANY HIGH TEMPERATURE—HIGH FREQUENCY CAPACITOR APPLICATION

With the addition of these new miniatures, Erie further broadens the most complete selection of Button Mica Capacitors in the industry. These new miniaturized micas provide 33% reduction in mounting area.

Erie Button Mica Capacitors are designed for use in radio frequency circuits for tuning, bypassing and coupling. The outstanding properties of metallized mica dielectric combined with the radial current pattern, make Erie Button Capacitors ideal for low inductance, high frequency applications.

These high quality capacitors are designed for microwave and filter applications, for use in carrier equipment, parametric and RF amplifiers, oscilloscopes... any application where high temperature and high frequency are factors.

The welded hermetic seal of these excellent broad frequency Gold Seal® capacitors for military and commercial use is 100% tested under pressure steam/salt water during production to guarantee a positive moisture seal.

Consider the advantages of Erie Button Mica Capacitors in the equipment you are designing. Write for Gold Seal Bulletin 500-2 or Resin Seal Bulletin 318-3.

GENERAL SPECIFICATIONS

Capacitance:	5 pf. thru 2500 pf.	Frequency Range:	to 2Gc and beyond
Tolerance:	1% or .25 pf thru ± 20%	Operating Temp.:	-55°C to +200°C
Working Voltage:	500 WVDC for 1/2" dia. units		-55°C to +150°C
	250 WVDC for 3/8" dia. units		-55°C to + 85°C

Q: per MIL-C - 10950

TYPES AVAILABLE

HERMETICALLY SEALED (GOLD SEAL®)	RESIN SEALED
.410" O. D. or .505" O. D.	.375", .447" or .657" O. D.



MINIATURE BYPASS CAPACITOR SYSTEMS FOR TRANSMITTING TUBES...

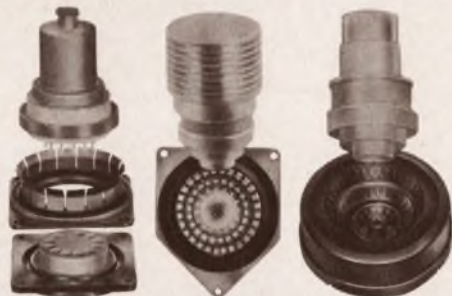

Designed for the 10 to 3,000 megacycles range—and beyond

Erie now provides effective capacitive bypassing and coupling or filtering of all RFI signals in the range of 10 to 3,000 megacycles. Variety of systems to meet your requirements.

Write for Bulletin 525-R

Formerly Erie Resistor Corporation

Another Series of Components in Erie's Project "ACTIVE"
Advanced Components Through Increased Volumetric Efficiency

ERIE

TECHNOLOGICAL

PRODUCTS, INC.



644 West 12th Street
Erie, Pennsylvania

New from Sprague!

1966
SPRAGUE
METFILM 'A'
CAPACITORS



1963

ULTRA-THIN
METALLIZED
POLYESTER FILM
CAPACITORS

1956

METALLIZED
POLYESTER FILM
CAPACITORS

1947

METALLIZED PAPER
CAPACITORS

1944
OIL-IMPREGNATED
PAPER
CAPACITORS

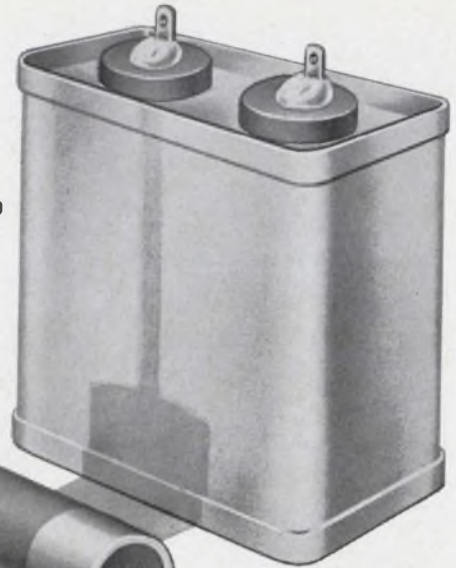

METFILM* 'A' CAPACITORS ... dramatically smaller in size, yet more reliable than military-grade capacitors of the past!

Just a few years ago, the only 10 μ F capacitor considered dependable enough for military applications was Type CP70 (to JAN-C-25), and was a block-busting 3 $\frac{3}{4}$ " wide x 1 $\frac{3}{4}$ " thick x 4" high. Today, you can get a military-quality 10 μ F tubular capacitor measuring only $\frac{1}{2}$ " in diameter x 2 $\frac{1}{4}$ " long. And it's more reliable than any capacitor of the past!

Sprague Type 680P Metfilm 'A' Metallized Capacitors meet all environmental requirements of MIL-C-18312, yet they occupy only one-third the volume of conventional metallized film capacitors of equivalent capacitance and voltage rating. Employing a new thin organic film dielectric system, Type 680P capacitors use a dual film totalling only 0.00008" thick, as compared to conventional polyester-film capacitors with a single film measuring 0.00015".

*Trademark

Another distinct advantage of the Metfilm 'A' dielectric system is minimum degradation of electrical properties during life.

Hermetically sealed in corrosion-resistant metal cases, capacitor sections are effectively of non-inductive construction, resulting in capacitors with performance characteristics superior to those of comparably-sized capacitors.

Type 680P Metfilm 'A' Capacitors are available with capacitance values to 10 μ F in both 50 and 100 volt ratings.



For complete technical data, write for Engineering Bulletin 2650 to Technical Literature Service, Sprague Electric Company, 347 Marshall St., North Adams, Mass. 01247.

SPRAGUE COMPONENTS

CAPACITORS
TRANSISTORS
RESISTORS
INTEGRATED CIRCUITS
THIN-FILM MICROCIRCUITS

PULSE TRANSFORMERS
INTERFERENCE FILTERS
PULSE-FORMING NETWORKS
TOROIDAL INDUCTORS
ELECTRIC WAVE FILTERS

CERAMIC-BASE PRINTED NETWORKS
PACKAGED COMPONENT ASSEMBLIES
BOBBIN and TAPE WOUND MAGNETIC CORES
SILICON RECTIFIER GATE CONTROLS
FUNCTIONAL DIGITAL CIRCUITS

SPRAGUE[®]
THE MARK OF RELIABILITY

'Sprague' and '®' are registered trademarks of the Sprague Electric Co.

ON READER-SERVICE CARD CIRCLE 7

News

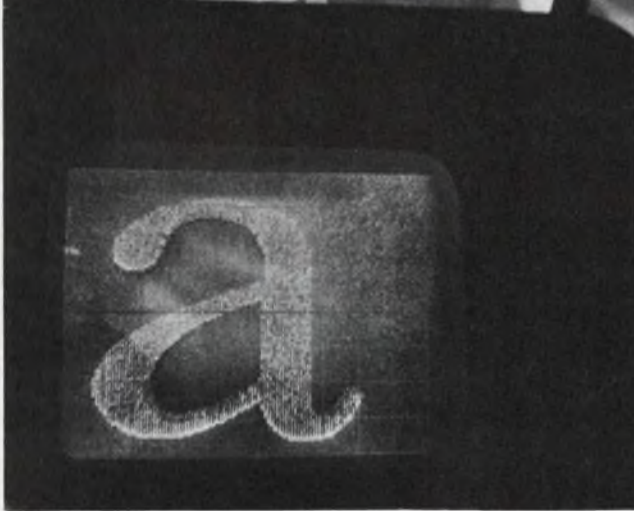

Electronic typesetting combines computer and television techniques. Page 24

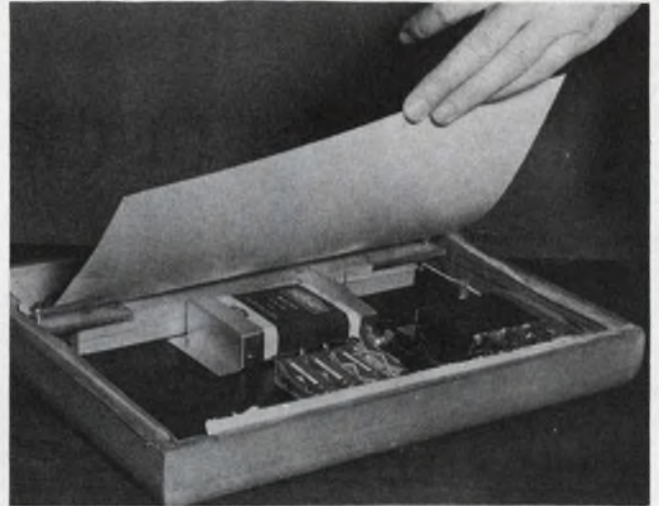

Electronic snooping takes many forms. Even picture frames can be bugged. Page 34



Laser holograms to print semiconductor etching patterns at reduced cost. Page 17

Also in this section:

Microwave integrated circuits are here to stay. . . . page 21

Scientists look ahead to unmanned exploration of Mars. . . . page 26

Transistor failure predicted by heat aging. . . . page 20

Fiber-optic bundles use plastic instead of glass. . . . page 23

New from Sprague!

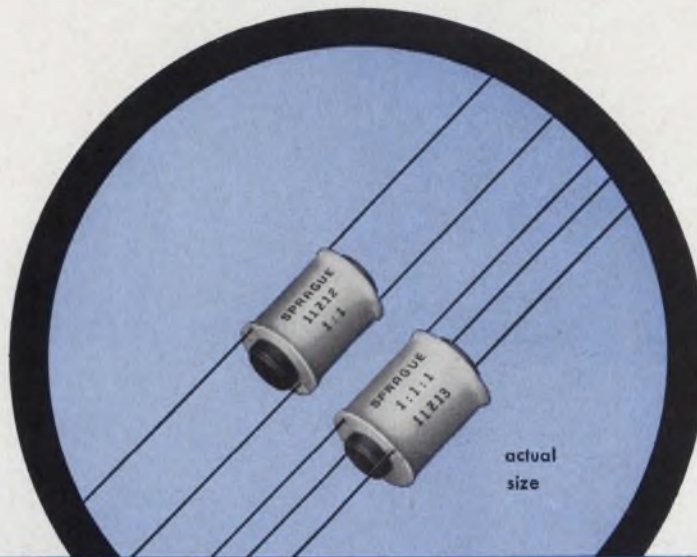

TRIGATE* PULSE TRANSFORMERS... the industry's lowest-cost SCR triggers!

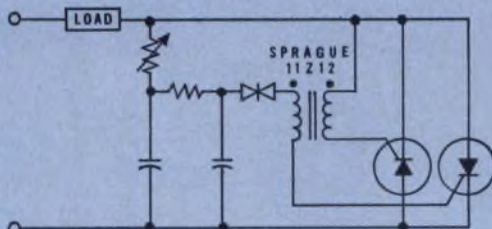

This breakdown-diode/transformer triggering circuit is a typical application for Type 11Z12 Trigate Pulse Transformers.

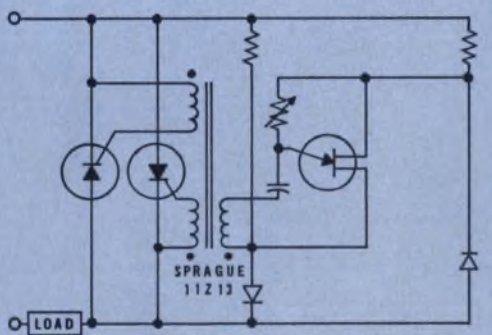

This unijunction-transistor/transformer triggering circuit is a typical application for Type 11Z13 Trigate Pulse Transformers.

*trademark

Dependable enough for industrial equipment, yet priced for high-volume commercial applications

Here's good news for designers of appliances; lighting controls; air-conditioning and heating controls; industrial controls. You can actually cut costs while upgrading your present method of SCR triggering!

Type 11Z Trigate* Pulse Transformers offer these unique features:

1. Balanced pulse characteristics and energy transfer from primary to secondary and tertiary windings.
2. Minimum saturation effect to allow operation where increased pulse widths are required.
3. Fast pulse rise time and increased current capability to prevent SCR di/dt failure.
4. Increased energy transfer efficiency.

Designed for operation over the temperature range of -10°C to $+70^{\circ}\text{C}$, Trigate Pulse Transformers are available in 2-winding and 3-winding configurations for half-wave and full-wave applications. Both designs are rated for use with line voltages up to 240 VAC.

For complete information, write for Engineering Bulletin 40,003 to the Technical Literature Service, Sprague Electric Co., 347 Marshall St., North Adams, Mass. 01247.

SPRAGUE COMPONENTS

PULSE TRANSFORMERS
CAPACITORS
TRANSISTORS
THIN-FILM MICROCIRCUITS
INTEGRATED CIRCUITS

RESISTORS
INTERFERENCE FILTERS
PULSE-FORMING NETWORKS
TOROIDAL INDUCTORS
ELECTRIC WAVE FILTERS

CERAMIC-BASE PRINTED NETWORKS
PACKAGED COMPONENT ASSEMBLIES
BOBBIN and TAPE WOUND MAGNETIC CORES
SILICON RECTIFIER GATE CONTROLS
FUNCTIONAL DIGITAL CIRCUITS

SPRAGUE
THE MARK OF RELIABILITY

'Sprague' and '®' are registered trademarks of the Sprague Electric Co.

ON READER-SERVICE CARD CIRCLE 8

OGO-3 upstaged by Surveyor 1; Gemini 9

Project officials for the Orbiting Geophysical Observatory (OGO-3), launched shortly after the flights of Surveyor 1 and Gemini 9, feel like the vaudeville performer who goes on after the animal act. Even a 100-per-cent performance will pale in comparison with the publicized success of Surveyor and Gemini.

Despite this lack of public acclaim, OGO is an integral part of NASA's Project Apollo plans, measuring as it will high-energy proton storms from the sun that could jeopardize astronauts bound for the moon. But it is the Surveyor and Gemini flights that have captured the public imagination and given tangible evidence of NASA's progress toward landing a man on the moon.

The Surveyor project was three years over schedule, almost ten times over budget and buffeted by mounting Congressional criticism. So unsure of initial success had project officials become that they labeled the first three Surveyor vehicles "engineering test vehicles." But almost overnight Surveyor 1's successful flight dispelled most of the criticism and all of the

apprehension. In its first six days on the moon Surveyor 1 sent back almost 3000 pictures and responded to thousands of radio commands from Earth.

According to a spokesman at the Jet Propulsion Laboratory control center, Surveyor 1 is so successful that it is posing a problem. The center can either work it to death or give it an easy schedule to see how long it can last. After just one week the spacecraft and all its systems had exceeded all expectations and researchers were running out of new things to do with it.

If officials decide to prove the endurance of Surveyor 1, the most crucial test will be whether it can withstand the lunar night, when temperatures hit minus 300°F for as long as 14 days. There is fear that its batteries may freeze and crack under such conditions. The spacecraft is equipped with heaters, but prolonged use of them would be a large drain on the batteries.

The flight of Gemini 9, in spite of its vicissitudes, contributed many firsts to the manned space program. Even though final hook-

up with the Augmented Target Docking Adapter (ATDA) vehicle was not made, three new rendezvous procedures were demonstrated. These were catching a target in only three orbits, finding the target without radar, and approaching the target from above rather than below.

In addition, astronaut Cernan set a record with his spacewalk, even though the walk was curtailed because of fogging of his suit visor. And lastly, Gemini 9 returned to Earth a mere three miles from the recovery ship and in full view of tv sets throughout the world.

The next Gemini flight, that of Gemini 10, is set to begin July 18. It will be a three-day mission.

Army goes Ivy League to study avionics

The Army's Electronics Command is establishing a research program in aviation electronics at Princeton University and the University of Pennsylvania. The government and the two participating universities will collaborate in joint research into aircraft communications, controls, navigation and instrumentation.

During the next three years, the government will provide nearly \$3 million for the investigations, which will also include environmental sensing, man-machine integration and ground support systems, as well as instrumentation and controls for future vertical take-off and landing aircraft and helicopters.

The Electronics Command aims to use the talent of high-caliber civilian scientists and engineers who might not normally enter government service.

A new design

News Scope is a redesign of our former News Report column. Its purpose is to keep you up-to-date on the latest happenings in the electronics industry, with emphasis on their underlying causes and significance to the design engineer. We would appreciate receiving your comments on News Scope. Use the Editorgram at the rear of the issue.

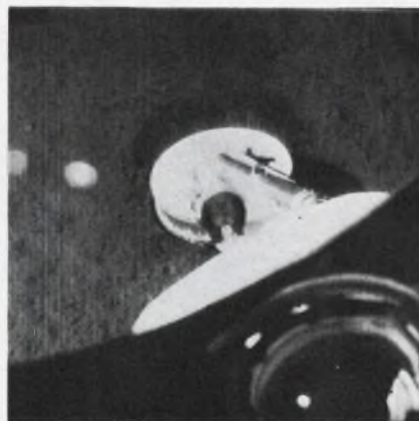
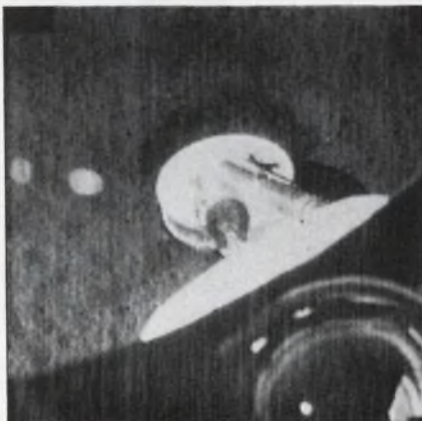

Surveyor 1 transmits both 200-line pictures (left) and 600-line pictures (right). The increased resolution of the 600-line pictures is apparent from these photographs that Surveyor took of its own landing foot resting on the lunar surface.

NASA seeking jumbo solar cell arrays

The National Aeronautics and Space Administration is making final negotiations with the Boeing Co., Seattle, Wash. on a contract for a high-power array of solar cells.

The three-year contract allocates about \$5 million for the design and fabrication of an experimental 1250-ft² panel. Covered with solar cells, the panel would have an output of 12.5 kW.

Four such panels, weighing less than 2500 lbs, would develop 50 kW, or 50 lbs/kW. The solar cells aboard Mariner IV weighed 100 lbs/kW.

NASA is trying to develop the technology needed for the power requirements of future space missions. This might include power for an electric propulsion system, NASA says.

Gold flow from NASA's coffers slackens slightly

The National Aeronautics and Space Agency dealt out contracts totaling \$2.779 billion during the first half of 1966. This is 5% less than the same period last year, when the agency contracted for \$2.927 billion of goods and services.

North American Aviation received the largest amount of contract money (\$731 million) and maintained its lead over Boeing (\$208 million). North American's contracts account for nearly 32% of all NASA expenditures.

The top four companies—all aircraft firms—were in the same order as last year (third and fourth are Grumman Aircraft Corp. and Douglas Aircraft Co.). Three firms leapfrogged up the list; General Motors moved from eighteenth last year to seventh this year; Vitro Corp. of America went from 72 to 33; and Telecomputing Services Inc., charged up the list from 100 to 48.

California again received more NASA dollars than any other state—a total of \$1.1 billion.



Floating showroom . . .

By sea and air—electronic marketing is on the move

New innovations are made in the design and production of electronic products every day. Not to be outdone, the marketing arm of the electronic industry is likewise constantly developing and applying new tools and techniques. Traveling showrooms, in which a manufacturer stocks a truck or bus with his products and travels to the customer, have been around for some time. Now new dimensions are being added to the traveling showroom.

A floating showroom is being used by Hewlett-Packard to bring their equipment to Latin American customers. Several staterooms on the Moore-McCormack Lines freighter Mormacwave have been remodeled to display a line of Hewlett-Packard scientific instruments at each port of call. Engineers, scientists, doctors and other professional people will be invited aboard to view the equipment.

Hamilton Standard will use a flying showroom to bring customers up to date on the latest advances in the company's aerospace products. The showroom will be a converted Douglas DC7 airliner specially fitted with displays. Fifteen cities in the United States and Canada will be visited by the flying showroom over a five-week period.

For computers to come bank signatures must go

Computer are invading the local bank, but attempts to automate banking and financial institutions completely are stymied by one deep-rooted fixture: the customer's signature.

Computers cannot, and will not for the foreseeable future be able positively to identify the scrawl of a human hand. And this "almost Biblical reverence for visual recognition" could inhibit the effects of the electronic age on banking, according to Raymond Hinton, director of Analysis and Network Engineering, Communication Systems, Inc., Paramus, N. J.

During a conference held by the American Bankers' Association, Hinton proposed that banking must adopt and legalize one of the myriad ways that an individual can be identified electronically in order to speed financial transactions.

Electrical signals could be used for the deposit, withdrawal and transfer of funds, he suggested. The new touch-tone telephones might make the perfect terminal device for the banking system of the future.

He noted several factors conducive to a fully automated banking system: the world-wide use of Arabic numerals, the growing availability of international communication links, and the compatibility of most data-handling systems in use throughout the world. "American banks must take the lead in upgrading banking methods in the electronic age," he said.

An agreement to collaborate in the development, production and marketing of new and advanced medical devices has been announced by RCA and Hoffmann-La Roche, Inc., of Nutley, N. J. According to the two companies, "the agreement will bring together the scientific, technical, productive and marketing skills of a major electronics enterprise and a leading pharmaceutical company." Hoffmann-La Roche is the world's largest producer of vitamins.

Initial production of the Army's Chaparral air defense missile system will be carried out by Philco Corps' Aeronutronic Div. Chaparral is one of two systems recently selected by the Army for low-altitude air defense in forward battle areas. It uses the Navy sidewinder 1C.



It isn't that Stan takes nuclear radiation lightly. But his 5-amp silicon transistors do.

With power transistors like these, an applications engineer like Stan can afford to be nonchalant.

Take the new BR100A-F and BR101A-F series. (R stands for Radiation-Resistant.) With base transit times reduced to a maximum of less than 0.5 nanoseconds at one ampere collector current, they're perfect for use in advanced circuits hardened for application in nuclear radiation environments.

Case types? Six of them. All pictured below.

Stan's regular 3-, 5-, and 10-amp units are easy to take, too. B-3460 and B-3461 5-watt switches and B-

3465 and B-3466 RF power amplifiers. (Plus 75 other type numbers specified for your application.) These low-cost epitaxial NPN transistors are already at work in such diversified applications as high-speed, high current core drivers, high-frequency pulse generators, high voltage nonsaturated switching applications, power supplies, relay and solenoid drivers, and power amplifiers and oscillators for HF/VHF communications transceivers.

Write or call our nearest sales office soon, won't you? See if Stan can't put his small wonders to work for you.

3 AMP TYPES

VCEO = 40 V to 60 V
VCBO = 80 V to 100 V
Pc = 5 W to 7.5 W
VCE(s) = 0.32 V Typ at IC = 1 A, IB = 100 mA
Switching Types: $t_{on} \leq 35$ ns at IC = 1.5 A, IB = 150 mA
$t_{off} \leq 75$ ns
Amplifier Types: $P_o \geq 4.5$ W at f = 50 MHz, VCC = 28 V, P _{in} = 0.5 W

5 AMP TYPES

VCEO = 40 V to 80 V
VCBO = 50 V to 90 V
Pc = 5 W
VCE(s) = 0.4 V Typ at IC = 3 A, IB = 0.3 A
Switching Types: $t_{on} \leq 40$ ns at IC = 3 A, IB = 0.3 A
$t_{off} \leq 300$ ns
Amplifier Types: $P_o \geq 8$ W at f = 50 MHz, VCC = 30 V, P _{in} = 1 W

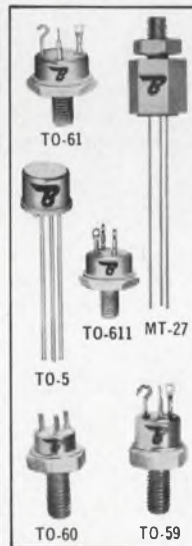

10 AMP TYPES

VCEO = 40 V to 80 V
VCBO = 50 V to 90 V
Pc = 25 W
VCE(s) = 0.7 V Typ at IC = 5 A, IB = 0.5 A
Switching Types: $t_{on} \leq 40$ ns at IC = 3 A, IB = 0.3 A
$t_{off} \leq 300$ ns
Amplifier Types: $P_o \geq 25$ W at f = 50 MHz, VCC = 30 V, P _{in} = 5 W

RADIATION TYPES

Max Radiation Level Exposure = 5×10^{14} NVT								
Symbol	Type	PRE RAD LIMIT			POST RAD LIMIT			UNIT CONDITIONS
		MIN	TYP	MAX	MIN	TYP	MAX	
VCEO	BR100	40	50	—	40	—	—	V IC _{EO} = 50 mA
	BR101	75	—	—	75	—	—	
hFE	BR100	40	100	200	15	25	—	— IC = 3 A, — VCE = 5 V
	BR101	30	—	150	7	10	—	
VCE(s)	BR100	—	0.5	1.0	—	1.5	2.0	V IC = 3 A, V IB = 0.3 A
	BR101	—	0.5	1.0	—	2.0	3.0	

Bendix Semiconductor Division

HOLMDEL, NEW JERSEY



Baltimore (Towson), Md.—(301) 828-6877; Chicago—(312) 637-6929; Dallas—(214) 357-1972; Detroit—(313) Jordan 6-1420; Holmdel, N. J.—(201) 946-9400; Los Angeles—(213) 776-4100; Miami Springs, Fla.—(305) 887-5521; Minneapolis—(612) 926-4633; Seattle—Ray Johnston Co., Inc., (206) LA 4-5170; Syracuse, N. Y.—(315) 474-7531; Waltham, Mass.—(617) 899-0770; Export—(212) 973-2121, Cable: "Bendixint," 605 Third Avenue, New York; Ottawa, Ont.—Computing Devices of Canada, P.O. Box 508—(613) TAibot 8-2711.

ON READER-SERVICE CARD CIRCLE 9

New PAR Lock-In Amplifier Measures Signals in the Presence of Noise by Crosscorrelation

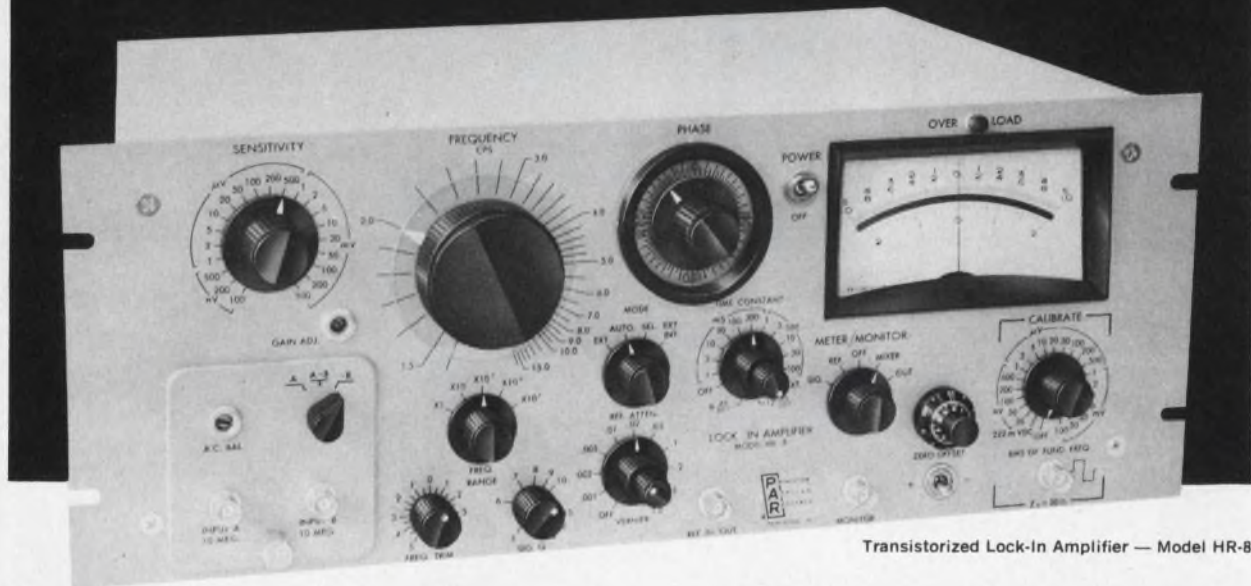

Transistorized Lock-In Amplifier — Model HR-8

The PAR Model HR-8 Lock-In Amplifier represents a significant advance in signal processing equipment for experimentalists who must measure low-level signal intensities in the presence of noise. It employs the theoretically optimum technique for signal recovery, and can be incorporated into a large class of experiments in which the signal of interest is, or can be made periodic, and in which a reference voltage related in frequency and phase to the signal can be obtained. The Model HR-8 first amplifies and bandlimits the input signal and then crosscorrelates it with the reference signal, suitably phase shifted and shaped. The crosscorrelation of input and reference signals yields a DC output voltage proportional to the signal of interest, while the crosscorrelation of the reference and noise results in no net DC voltage. The system can also be described as a continuously integrating, highly sensitive, phase conscious voltmeter, the response of which is "locked" to that particular frequency and phase at which the signal information has been made to appear.

Technical Features:

Frequency Range: 1.5 cps to 150 KC continuously tunable in 5 ranges.

Time Constants: 11 values in 1-3 sequence extending from 0.001 to 100 seconds. Single or double section RC filtering.

Pre-Amplifiers: Interchangeable low-noise pre-amplifiers, operable either within the HR-8 or remotely, are used.

Type A: Differential 10 megohm input.

Type B: Low impedance transformer input for low source impedances.

Sensitivity: 21 calibrated full scale ranges in 1-2.5 sequence.

With Type A Pre-Amplifier: 100 nanovolts to 500 millivolts rms.

With Type B Pre-Amplifier: 1 nanovolt to 5 millivolts rms.

Output: ± 10 volts full scale, single-ended with respect to ground. Will drive galvanometric and servo recorders.

Frequency Selective Amplifiers: Notch network in negative feedback loop used in both signal and reference channel tuned amplifiers. Reference channel Q of 10. Signal channel Q adjustable from 5 to 25 with calibrated dial (no gain change with Q adjustment).

Phase Adjustment: Calibrated 360° phase shifter, providing continuous rotation as well as a four position quadrant switch which shifts phase in 90° increments.

Price: \$2,250 with either Type A or Type B Pre-Amplifier.

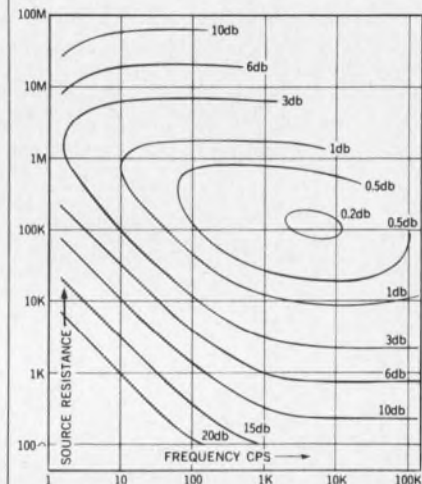

Contours of constant noise figure for a typical PAR Type A preamplifier plotted to show dependence on frequency and source resistance at 300° K. Amplifier operated single-ended.

Write for bulletin No. 120 on the HR-8 or ask for information on PAR's complete line of Lock-In Amplifiers and accessories.

PAR

PRINCETON
APPLIED RESEARCH CORP.
Dept. E

Box 565, Princeton, N. J., Tel. (609) 924-6835

Major advance in wafer-making forecast

Researcher sees use of laser holograms to print semiconductor etching patterns at reduced cost.

Roger Kenneth Field
News Editor

A breakthrough in semiconductor production—the use of laser holography to print etching patterns on wafers—is believed near.

The new method promises to reduce dust problems and eliminate expensive mask copies. Its ability to resolve one micron across a field of one centimeter may bring faster, smaller devices to the market.

Until now holography—a lensless method of three-dimensional photography that uses coherent light from a laser—has been merely an optical curiosity. But by this time next year holograms will be used in the semiconductor industry to print the etching patterns on wafers, according to Kenneth Poole, head of Bell Laboratories' optical device department.

Bell has already turned over to Western Electric the results of bas-

ic research it has been conducting, and Western Electric is now striving to adapt the technique to the production line.

One semiconductor specialist, Dr. Leland Seely, General Instruments' director of research, told *ELECTRONIC DESIGN*: "If it works, it's fantastic!"

Based on the research thus far, Poole is confident that it will work. He and his colleagues at Bell Laboratories have demonstrated that holographic reconstruction of real images can resolve one micron over an area of one square centimeter (see photos). Thus, for a reasonable cost, semiconductor manufacturers can now make a projection system that will offer resolution roughly equal to that of the photoresist on which the image is printed.

A spokesman for Fairchild called the development, "Quite a breakthrough." He added, "The masks would live forever and one of the

biggest expenses for a semiconductor maker is replacing scratched masks. Also, any projection system makes automation a possibility whereas no one, to our knowledge, has truly automated the present contact printing method. By reducing foreign matter problems (hence increasing yield) and simultaneously reducing costs, the projection system may make possible an across-the-industry price reduction."

At present glass lenses can resolve only about 3000 lines across their field (by comparison, the hologram photos below resolve 10,000 lines). Because of this, manufacturers must make master etching masks with a step-and-repeat process.

In this process a microscope is set up in reverse of its normal operation: it reduces an image of the mask of a single device to the actual size of the device and projects it onto a photographic emulsion coated on an optically flat glass slide. Then an extremely fine lead screw moves the glass slide to a new posi-

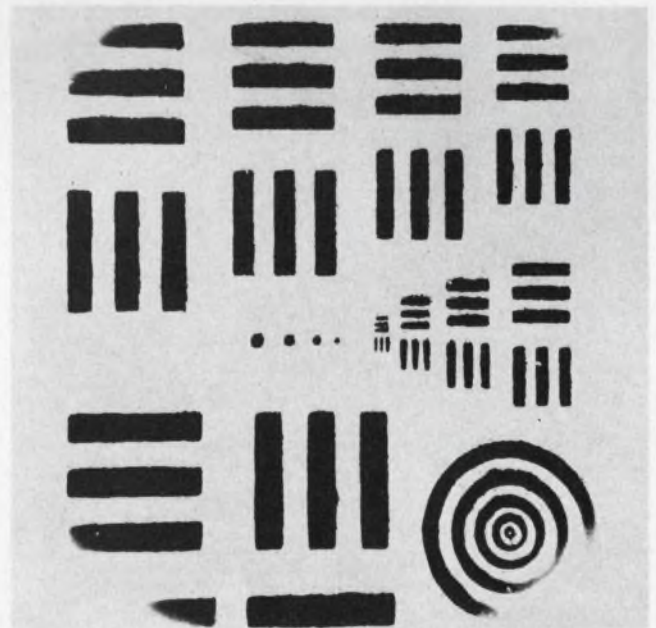
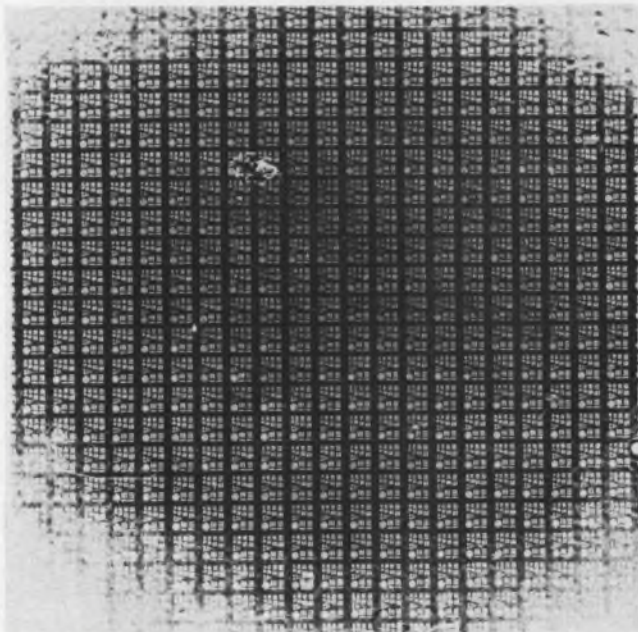

Below, left: 441 test patterns were made by a hologram. A real image was printed on a high-resolution photographic emulsion of one square centimeter. Right: A photomicrograph of just a single pattern on the original negative. The diameter of the tiny dot in the center of the pattern is 2.5 microns, indicating a resolution of roughly one micron. The holograms were taken by Dr. L. H. Lin of Bell Laboratories, Murray Hill, N. J.

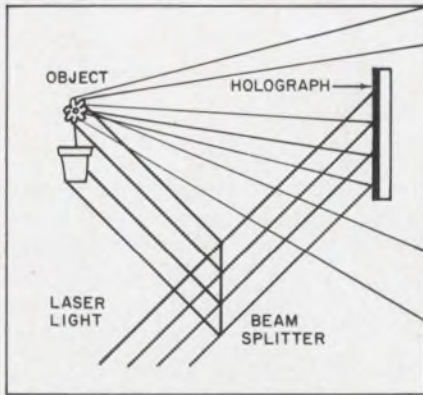
(holograms *continued*)

1. **Holograms are exposed** when an uninterrupted laser beam strikes the photosensitive surface at the same time as the laser light that diffuses from the surface of the object. Unlike photographs, which record amplitude patterns, holograms record both amplitude and phase in interference patterns.

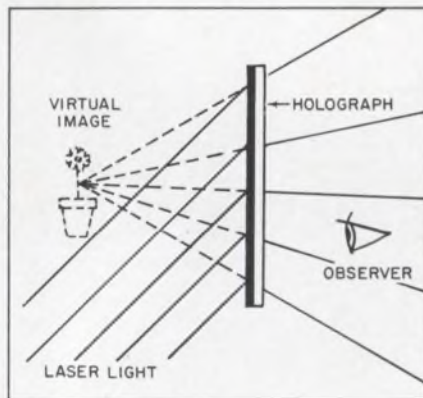

2. **An observer sees a virtual image** of the object when the holograph is illuminated with laser light that strikes it at the same angle as it did during exposure.

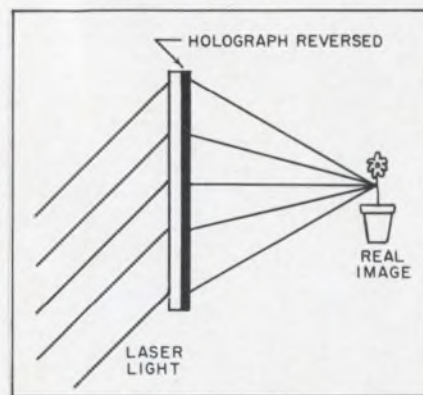

3. **Holograph can reconstruct real image** (just like that of a slide projector) if it is reversed in its holder after it is developed. Images always appear on emulsion side of film. For the best resolution, holograms should be made on very slow spectroscopy plates with argon laser light.

tion for the next exposure.

The process is continued, until anywhere from 100 to 1000 etching patterns are printed on the master mask. Copies of the master are used to make the wafers: Copies and wafers are placed in contact and illuminated. Herein lies the problem: contact printing is a method of reproduction that is not well suited to ultra-high resolution of extremely small images.

To get any decent resolution at all, the emulsion on the slide must be in intimate contact with the photoresist. The master masks and the copies are made on optically flat glass slides. But after the first diffusion, the surface of the wafer is no longer flat. Resolution of images in the troughs falls off. And repeated handling of the glass copy on the production line limits its usable life to a few dozen printings (it costs \approx \$10.)

The slide must be placed in contact with the etched surface of the wafer. The slightest scratch—even dust that alights on its surface—impairs its ability to produce a flawless image. Any projection system would eliminate handling of the slide, but dust could still be a problem. In addition, if the system had a lens, then it, too, would have to be kept dust-free.

The hologram image is produced without lenses. Like a lens, its theoretical ability to resolve fine details is a direct function of the angle of incidence of the light that arrives at a point on the image. But unlike a lens, this theoretical resolution is very nearly achievable in practice.

Until now the hologram has been used mainly to recreate three-dimensional objects in three dimensions. The recreation is a virtual image—it can be seen by the eye, but it can not be projected onto a screen. Holographers have devoted most of their efforts to perfecting and investigating these three-dimensional, virtual images. They have devised ways to store many images on one film. They can recreate images with only slightly coherent light or even with completely incoherent white light. They are able to recreate the object in full color, and recently they demonstrated a three-dimensional, color reconstruction with ordinary white light.

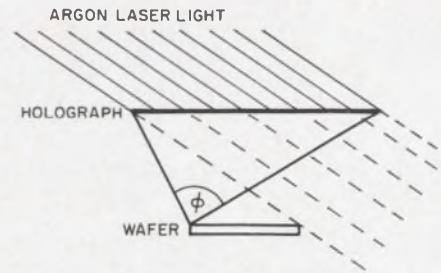

4. **Holograms resolve best** when the angle they subtend at the wafer, ϕ , is large. But residual light from the laser beam (broken lines) must not fall on photoresist.

But when a hologram is placed backwards in its holder and illuminated with laser light, it can produce a real image—one that can be projected onto a screen (see diagrams 1, 2, & 3). Also, since any small piece of the hologram can recreate the entire image, the hologram is practically immune to dust and scratches. This is because it stores each point of the image evenly in an interference pattern across its face, unlike ordinary film, which must maintain an exact point-to-point correspondence with its image.

The organic photoresist used in processing semiconductors is (like panchromatic photographic emulsions) most sensitive to the blue-green and ultraviolet portion of the spectrum. But most lasers emit light in the red portion, and until very recently the argon laser (blue-green) was very expensive and would only lase for a few hours. Now, however, at least one manufacturer, Raytheon, will guarantee its 5 watt argon laser tube for at least 300 hours. The Bell Lab photos were made with a 5 milliwatt laser. Tubes with outputs from 5 to 500 milliwatts last 1200 to 1500 hours, according to Raytheon.

The scientists at Bell say that the best contrast and resolution are achieved when the holograph's dimensions are approximately twice those of the wafer (see diagram 4). This is because resolution is a direct function of the angle, ϕ , that the holograph subtends at the surface of the wafer. But if the hologram is too large or too close to the image, residual light that passes through it will spill onto the wafer and "fog" the photoresist. If the incident light is inclined too closely to the plane of the holograph, the contrast suffers. ■ ■



Average human hair magnified 500 times.



0.000069" rolled metal magnified 500 times.

0.000069"

IS A "THINNESS", NOT A THICKNESS

Sixty-nine millionths of an inch is the thinness to which The Arnold Engineering Company has precisely rolled metals and alloys as soft as copper. Alloys as hard as Type 302 stainless, Elgiloy, S-816, Nichrome V and other hard materials have been rolled to 0.0002" and less.

Orders to these specifications obviously aren't average. Then Arnold isn't average, either. The Arnold Engineering Company is fully equipped to roll ultra-thin gauges of ferrous and non-ferrous metals to extremely close tolerances. With dual source, non-contacting beta-ray gauges Arnold has held tolerances totalling 0.000017" on a week's run of .0011 gauge.

Clean room techniques are observed in order that ultra-thin gauge foils for photo etching, shims, strain gauges, honeycomb structures, capacitors, etc. can be rolled virtually free of pin holes. All facilities housed in pressurized, air conditioned and filtered clean rooms to minimize foreign particles which could cause pin holes in finished work. Centerless grinding facilities to maintain complete control over roll grinding and lapping.

The Arnold Engineering Company has the capability of precision rolling over 55 different metals within tolerances of millionths of an inch.

Now's the time to put Arnold engineering know-how to work for you.



THE ARNOLD ENGINEERING COMPANY, Main Office: MARENGO, ILL.
BRANCH OFFICES and REPRESENTATIVES in PRINCIPAL CITIES
Speed Inquiry to Advertiser via Collect Night Letter
ON READER-SERVICE CARD CIRCLE 11

New from Sprague!

ISOLAYER[★] DIFFERENTIAL AMPLIFIERS WITH DIELECTRIC ISOLATION



**V_{BE} voltage differential down to 3 mV
Tight beta matching · Low capacitance**

Low Silhouette 10-S Case		UD-2118	UD-2119	UD-2120	UD-2121
BV_{CEO}		50V	50V	30V	30V
h_{FE}	@ 10 μ A	80	80	40	40
	@ 1 mA	150	150	100	100
$ V_{BE_1} - V_{BE_2} $		3 mV	5 mV	3 mV	5 mV
$\Delta V_{BE_1} - V_{BE_2} $		5 μ V/ $^{\circ}$ C	10 μ V/ $^{\circ}$ C	5 μ V/ $^{\circ}$ C	10 μ V/ $^{\circ}$ C
C_{ob}		2 pF	2 pF	2 pF	2 pF

Sprague Electric also makes a broad line of standard differential amplifiers, pairs, quads, and Darlington amplifiers

*trademark For complete information, write to Technical Literature Service,
Sprague Electric Co., 347 Marshall St., North Adams, Mass. 01247

SPRAGUE COMPONENTS

TRANSISTORS
CAPACITORS
RESISTORS
INTEGRATED CIRCUITS
THIN-FILM MICROCIRCUITS
INTERFERENCE FILTERS

PACKAGED COMPONENT ASSEMBLIES
FUNCTIONAL DIGITAL CIRCUITS
MAGNETIC COMPONENTS
PULSE TRANSFORMERS
CERAMIC-BASE PRINTED NETWORKS
PULSE-FORMING NETWORKS



® Sprague and ® are registered trademarks of the Sprague Electric Co.

15-6124

ON READER-SERVICE CARD CIRCLE 12

NEWS

Heat-aging detects transistor failure

Leakage-current measurements can forecast transistor failures well before they occur in germanium-alloy types, according to a recent study made at the National Bureau of Standards.

After aging the transistors for 1000 hours at 100 $^{\circ}$ C their leakage currents were compared with comparable measurements made before the aging process. Transistors that show an increase in leakage current in excess of 1.6 times their earlier leakage current should be rejected.

The Bureau test results conclude that early increases in leakage current are consistently associated with the first of the transistors that fail. In one test batch of 160 transistors the first three failures would be expected within about four years of normal use.

In the testing procedure, the junction temperature can be raised to 100 $^{\circ}$ C in two ways. The device can be made to dissipate continuously enough power to keep the junction at 100 $^{\circ}$ C. The other way to bring the junction to this temperature is to raise the ambient temperature of the air in the vicinity of the transistor. The latter method gives far more reliable results, according to the study.

Failures were due to avalanche conduction, excess leakage current, and, possibly, physical damage during an aging period of 20,000 hours. ■ ■



Ten transistors in a plug holder are placed in thermostat-controlled aging chamber.

Microwave parley sees room for IC growth

Symposium hears of need for better inductances; Hybrid designs and switching advances described

Maria Dekany
Technical Editor

"Microwave integrated circuits are here to stay. They are not going to follow the tunnel diode [into obscurity]. But they will not replace TWTs either."

In these words, Dr. Robert L. Pritchard, professor at Stanford University, summed up the optimistic outlook for miniaturized ICs at the International Microwave Symposium, held in Palo Alto, Calif.

The pessimistic side was discussed, too. The major problem facing designers of integrated circuits is to increase the value of inductances while decreasing the inductor's size, Dr. Pritchard told the symposium. Present inductances are achieved at too great a cost in space, he said: Engineers are happy to get 1 nH per mm. They would, naturally, like to do better.

The Q of the inductance is already a problem at uhf, the Stanford professor reported. The deposited inductance over the glass substrate behaves like a distributed LC transmission line with a cutoff frequency of 100-200 MHz.

At microwave frequencies, the design of integrated circuits requires innovations instead of direct translation from discrete circuits, Pritchard went on. It is not the size reduction that is the main attraction of the IC, since most circuits must have a size of the order of $\lambda/4$. Performance is the major objective, he concluded.

The popular hybrid approach to microwave ICs was demonstrated by the spst switch-driver assembly, discussed by William J. Moronay, director, semiconductor development, and Alex T. Botka, manager, integrated control devices, of Microwave Associates, Inc. Burlington, Mass. (see Fig. 1). In hybrid design, the silicon chips, which contain the active devices, are mounted on a stripline or in a cavity. For the switch, a stripline is used with alumina as the dielectric. It has high

dielectric constant, low loss, is stable and withstands high processing temperatures, Moronay explained. The switch operates from 2 to 4 GHz with a minimum of 50 dB isolation and an insertion loss of 2 dB maximum. The switching speed is 50 ns.

Very fast switching with pin diodes in X-band was reported by Dr. Bernard C. DeLoach, head, microwave semiconductor device dept., Bell Telephone Laboratories, Murray Hill, N. J. Reproducible operation, ranging from 0.4 ns at the 1-mW level to 1 ns at the 1-watt level, has been observed, Dr. DeLoach reported, with specially fabricated pin diodes having 3000-GHz cutoff frequencies. The switch is unique, he said, in that it has very low loss (0.3 dB in the passband), is insensitive to junction parameters and is faster by an order of magnitude than other pin-diode switches.

Versatile GaAs

A new aspect of gallium arsenide—well known for the so-called Gunn oscillation—was disclosed by Dr. Basil W. Hakki, member, microwave bulk-effect device group, Bell Telephone Laboratories, Murray Hill, N. J.

A GaAs sample was operated simultaneously as a microwave amplifier, mixer and oscillator under

cw conditions, he said. The implications of this performance are best illustrated by the heterodyne circuit based on the GaAs sample (see Fig. 2). The bulk sample generates a signal at 3.622 GHz that serves as the local oscillator. An external signal at 6.114 GHz, injected into the cavity holding the GaAs, mixes with the 3.622 GHz signal to produce the difference frequency at 2.492 GHz. This difference frequency is then amplified and detected. A maximum net conversion gain—from 6.114 GHz to 2.492—of 10 dB was measured, Dr. Hakki said. He noted that the oscillating and amplifying frequencies were not related harmonically. The only problem was the noise figure—about 20 dB at present, too high for most practical systems. However, programs are under way to reduce the noise to a more acceptable level, according to Dr. Hakki.

Miniaturization, if not integration, was apparent in the discussion of ferrite devices.

Ferrite phase shifter for L band

A phase shifter that combines the rapid switching speed for ferrite latching devices and the miniaturizing features of slow-wave strip transmission lines was described by the designer, Raymond R. Jones, an engineer with the Westinghouse Defense and Space Center, Baltimore. The 2-by-1-by-0.25-inch device provides between 145° and 170° differential phase shifter per inch over a 5.0-to-5.4-GHz range.

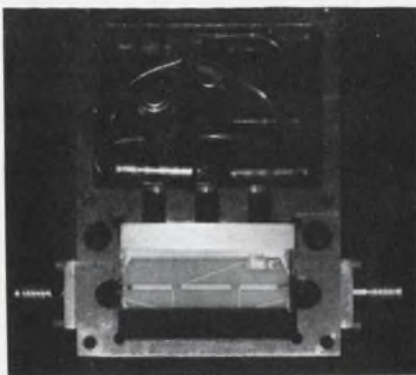

1. Integrated microwave switch and driver assembly operates from 2 to 4 GHz with a switching speed of 50 ns.

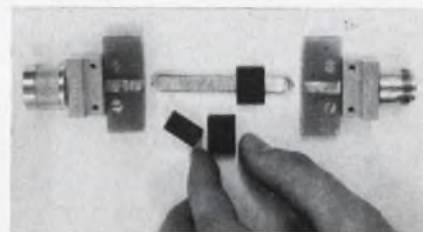

2. Simple heterodyne amplifier uses bulk GaAs as oscillator and amplifier simultaneously. The GaAs generates the local oscillator signal at 3.6 GHz; this mixes with the incoming signal (6.1 GHz). The resultant difference signal (at 2.5 GHz) is amplified. A conversion gain of 10 dB was measured at Bell Telephone Labs.

D
DAMON

VCOs

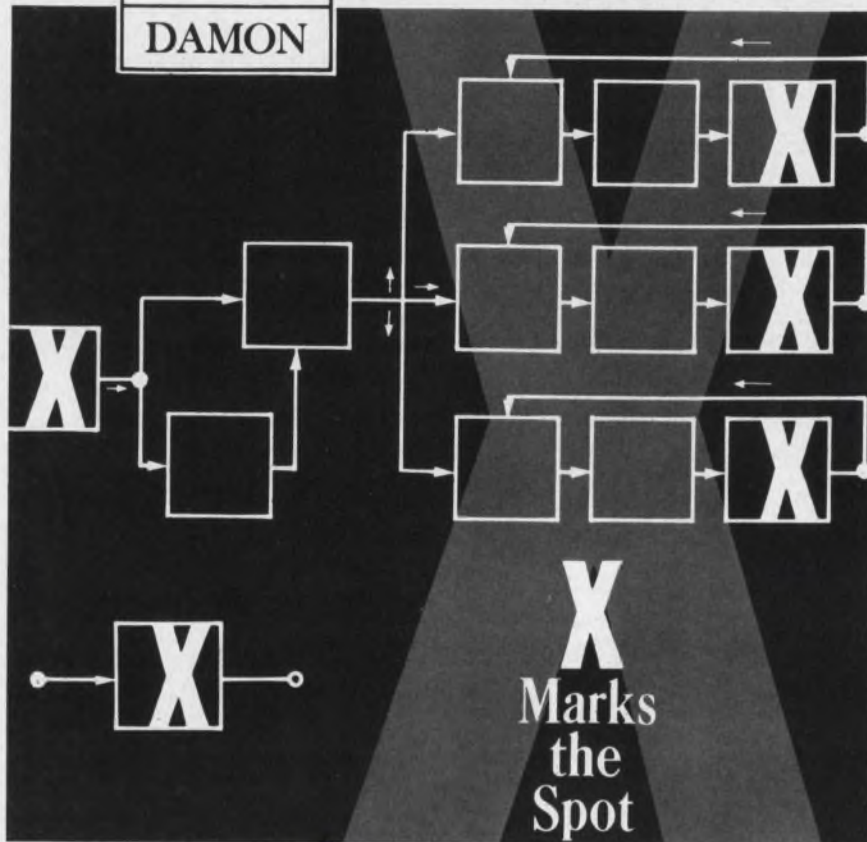

X
Marks
the
Spot
where
Precise
Control of
Frequency
begins

If you are involved in applications requiring electronic frequency control, the new Damon VCO Brochure can help you. This Brochure is packed with technical data on applying Damon VCOs to many modern electronic systems such as AFC, Coherent Radar, Phase Locked Receivers and Transmitters, Doppler Trackers, FM Generators Exciters, Frequency Synthesis and STALO. Damon VCOs are available with peak frequency deviations from 20 cps to 2 mc and with center frequencies spanning 100 cps to 300 mc.

Write for this New Damon VCO Brochure



DAMON ENGINEERING, INC.

240 Highland Ave., Needham Heights, Mass. 02194 Tel.: (617) 449-0800

Speed Inquiry to Advertiser via Collect Night Letter

ON READER-SERVICE CARD CIRCLE 13

NEWS

(Microwave parley, *continued*)

The slow-wave or tape structure has a meandering form, similar to that found in TWTs and filters (see Fig. 3). The meander line is etched on both sides of a 0.018-inch copper-clad teflon slab and inserted into the bore of a ferrimagnetic toroid. The toroid is then placed between two ground planes. The experimental model has exhibited losses of the order of 2 dB.

"This loss is not due to impedance mismatch—the vswr is below 1.5—but to radiation losses from the jagged edges of the etched line and to the fact that the connector does not fit flush against the ferrite," Jones told *ELECTRONIC DESIGN* after presentation of his paper.

"Next, we'll attempt to deposit the lines directly on a ferrite slab," he continued. "The film will be evaporated in a 1-mil-deep trough in the slab for cleaner construction and better performance. The demagnetizing field of the thin-slab geometry can be utilized as the latching field."

The four-day symposium, sponsored last month by the IEEE, drew 500 engineers. Copies of the digest may be obtained from IEEE, Inc., 345 East 47 Street, N. Y., N. Y. 10017. ■ ■

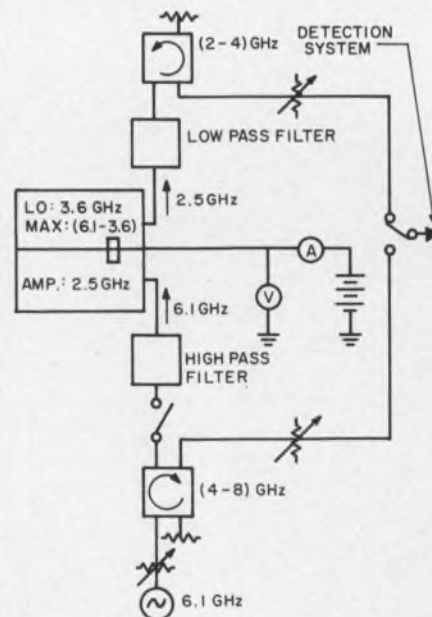

3. Slow-wave nonreciprocal phase shifter represents one approach to miniature ferrite devices. The meander line is the slow-wave structure.

Plastic used for fiber optics



Crofon light guides provide an extremely flexible form of fiber optics.

Fiber optic bundles that use plastic as the light-transmitting medium have been successfully developed by the Du Pont Company and will soon be on the market.

The new devices, called "Crofon" light guides, are tougher and more flexible than glass, which to date has been the primary material used successfully for fiber optics. An individual 0.010-inch fiber of a Crofon light guide can reportedly be tied tightly in an overhand knot without breaking. This allows the light guides to be readily bent around a small radius. They may be subjected to repeated flexing and vibration safely.

Each plastic fiber in a Crofon light guide has a core of Lucite sheathed with a plastic of a lower refractive index. The fibers are made up in bundles and jacketed in Du Pont's Alathon polyethylene resin. The number of strands in each bundle determines the amount of light that will be transmitted.

Unlike glass fiber optics, the plastic fibers can be manufactured in almost unlimited lengths. At present, limited quantities are available for development programs in lengths up to 5000 feet.

Preliminary studies for the applications of the light guides has been undertaken by Du Pont in cooperation with the Packard Electric Division of General Motors Corp. The first commercial application developed by Packard is the illumination of dashboard accessories on several leading 1967 model automobiles. ■ ■

basic measuring tools from

HEWLETT PACKARD

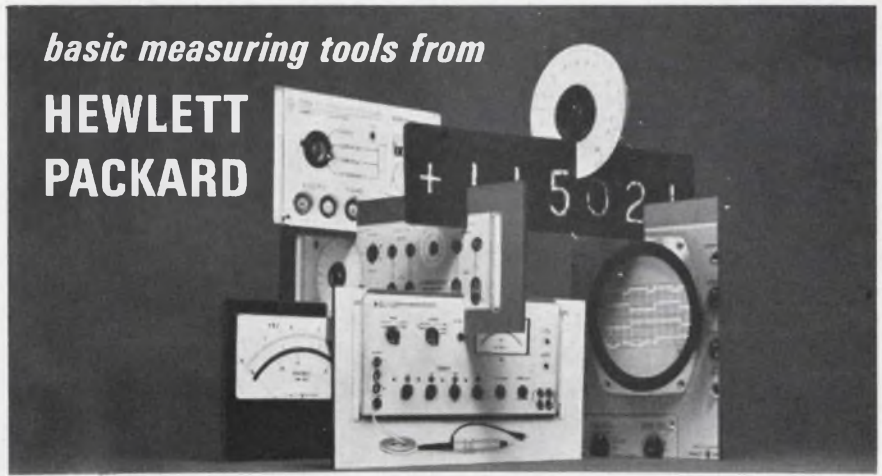

hp 741A AC-DC

Differential Voltmeter/DC Standard

Multi-purpose calibration tool—5 functions for only \$1475
Special probe for ac differential VM measurements with <math>< 5\text{ pf}</math> capacity at point of measurement

Input impedance $> 10^9$ on all ranges

Five-digit resolution, all modes of measurement

Use it as:

A dc standard, $\pm 0.02\%$ of setting $\pm 10\ \mu\text{V}$, 0-1000 v-20 ma, floating output, 0.005%/month stability

An ac differential voltmeter, 50 mv-1000 v, $\pm 0.05\%$ of reading $\pm 0.01\%$ end scale

A dc differential voltmeter, 0-1000 v, $\pm 0.02\%$ $\pm 10\ \mu\text{V}$, $> 10^9$ ohms input impedance (independent of null), 0.005%/month stability

A $\pm 2\%$ floating high-impedance voltmeter

A voltage amplifier with 60 db gain, a $\pm 0.02\%$ unity-gain power amplifier

Use in conjunction with new 463A Voltage/Power Amplifier to make measurements at: 100 mv at 0.07%, to 10 kHz; 10 mv at 0.16%, to 10 kHz; 1 mv at 0.36%, to 10 kHz. (Reduced specs to 100 kHz.)

Features include overload indicator, output sensing, low-capacity ac probe. For a

demonstration, call your Hewlett-Packard field engineer or write Hewlett-Packard, Palo Alto, California 94304, Tel. (415) 326-7000; Europe: Route des Acacias, Geneva.

Data subject to change without notice. Prices f.o.b. factory.

HEWLETT  PACKARD
An extra measure of quality

1672



ON READER-SERVICE CARD CIRCLE 14

System conditions battery cells selectively

The useful life of secondary batteries used in aerospace vehicles can be extended by a new automatic charging system developed by Electro-Optical Systems, Inc.

The system selectively conditions each individual cell in a battery automatically until the electrical characteristics of all cells achieve a high degree of balance. Previous charge equipment for aerospace applications monitors the output of cells in series at the battery terminals only, without compensating for individual cell variations. This lack of total conditioning can cause some cells to reach charged or discharged voltage limits before others, and can result in an overcharged state, with subsequent battery failure through case expansion or loss of electrolyte.

The charging system operates essentially as a digital comparator. Automatic charge and discharge cycling of all cells is controlled by charge-discharge limits manually programmed in digital form into the battery level sense logic circuits.

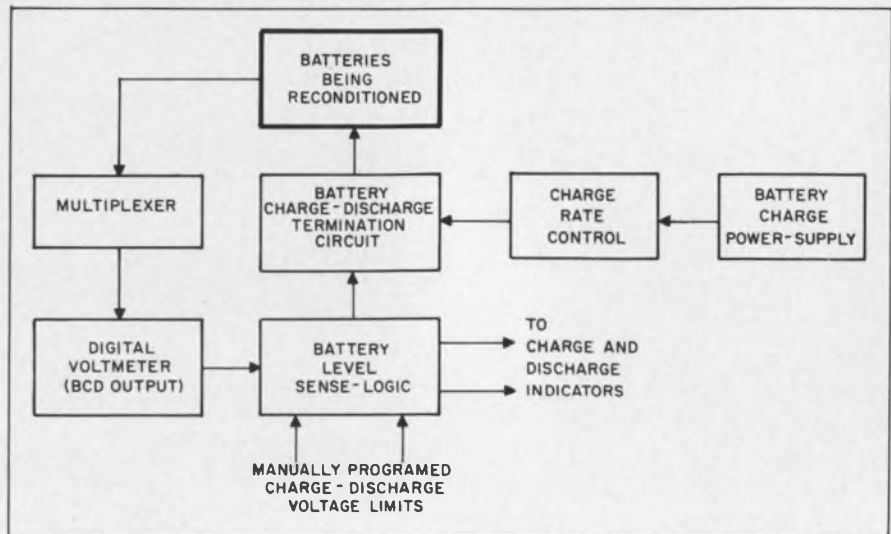

Automatic battery charging system compares individual cell voltages to preset limits. As each cell reaches the programmed level, its charge or discharge cycle is terminated.

During cycling, cell potentials are scanned by the multiplexer and fed to the digital voltmeter, which delivers a binary-coded decimal output. The voltage level of each cell is then compared to the preset limit in

the logic circuits. When coincidence is detected for a cell, the cycle for that cell is terminated.

After all cycles are completed, the logic section initiates a command to reverse the cycle. ■ ■

All-electronic typesetter put on the market

A new system for setting printers' type electronically has been introduced by the Graphic Systems Div. of RCA. Called Videocomp, the system is the first commercially available typesetter to employ all-electronic character generation.

Characters corresponding to the letters of various type faces are stored in the unit's core storage unit. Approximately 3000 bits are used to store each character. When a character is taken from memory,

it is written by means of its bits in a predetermined sequence of deflection orders on a high-resolution cathode-ray tube. As the character is written, it is projected through a precision lens and exposes sensitized paper or film.

Each character is written on the face of the tube and transferred to the film until a complete line is formed. Then the film is automatically advanced a line space and the next line is composed. Up to 600

characters a second, or 900 lines a minute, can be produced.

Type of up to four fonts can be stored in the Videocomp memory at one time. With a change in the deflection of the cathode-ray tube, any of the type faces can be written as normal, enlarged, condensed, extended or italic type. ■ ■

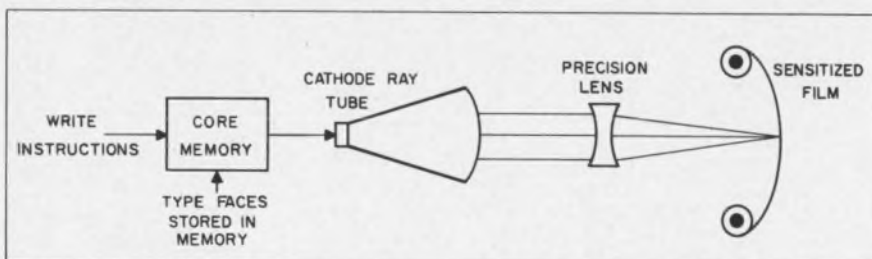

When brought from memory, characters are written on the face of the CRT and then projected through a lens on to sensitized film. Each character is stored in the form of many bits.



Videocomp system produces electronically generated characters such as these.

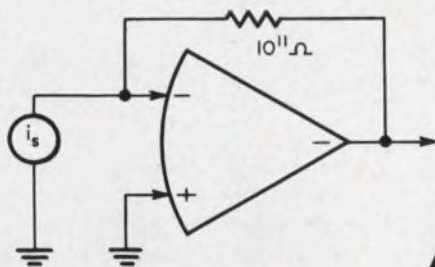

OFFSET CURRENT CHANGE
of only 30 pa from -25° to $+75^{\circ}\text{C}$, with 0.01 pa noise spec, enables current amplifier to resolve 10^{-13} amps, builds 9-decade log amplifiers

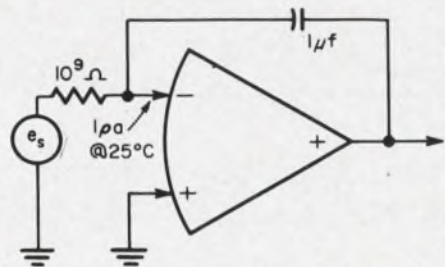

LOW OFFSET CURRENT
of 1 pa, plus 10^{10} ohms differential input impedance, permits 1,000-second integrator time-constants, also builds versatile sample-hold circuits

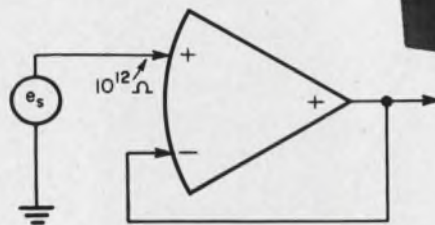

COMMON MODE IMPEDANCE
of 10^{12} ohms, $1 \mu\text{V}$ p-p noise, 10^8 CMRR, and only $30 \mu\text{V}/^{\circ}\text{C}$ max drift, provides basis for rugged electrometers with 10^{12} ohms input impedance

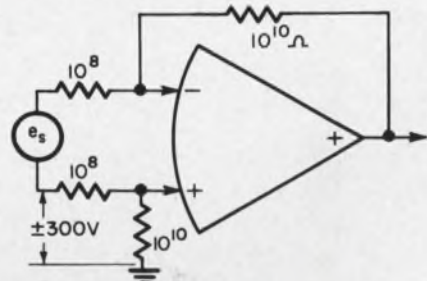

COMMON-MODE VOLTAGE
of ± 300 V, combined with low offset current, allows difference amplifiers to use 10^8 ohm input resistors and resolve millivolt signals on 300 V inputs

Op Amp Based on Varactor Bridge Resolves 10^{-13} Amps, Accommodates 10^{10} Ohm Sources

Parametric amplification principle, embodied in Model 301's varactor bridge circuit, virtually eliminates $1/f$ noise (0.01 pa & $1 \mu\text{V}$ p-p), provides 100-fold better offset and drift specs than FET amplifiers (1 pa & $0.06 \text{ pa}/^{\circ}\text{C}$ at 25°C), and achieves common-mode performance of electrometer tubes ($\pm 300 \text{ V}_{\text{CM}}$, 10^{12} ohms Z_{CM} & 10^8 CMRR). Rugged, all-solid-state DC differential op amp is encapsulated into a 3 cu-inch, microphonics-free module that mounts directly onto P-C boards, operates from -25°C to $+85^{\circ}\text{C}$.

Current amplifiers, differential amplifiers, logarithmic amplifiers, electrometer amplifiers, plus various categories of capacitor charging amplifiers, can all be based on Model 301, with advantages in performance, size, ruggedness and cost.

Offset variation of only 30 pa from -25°C to $+75^{\circ}\text{C}$ enables input resistors as high as 10^7 ohms to be used with integrators, differential ampli-

fiers, and circuits required to operate with high impedance sources. Large-value integrator input resistors allow time-constants to 1,000 seconds, permit sample-and-hold amplifiers, differentiators, and charge amplifiers to be designed with unusual flexibility. Current amplifiers, used typically with photomultiplier tubes and other current-source transducers, depend upon Model 301's 0.01 pa noise and $0.06 \text{ pa}/^{\circ}\text{C}$ offset at 25°C for ultimate sensitivity of 10^{-13} amps. Used with logarithmic feedback elements, the amplifier also permits a 9-decade (180db) input signal swing.

Another remarkable feature of the Model 301 is the ± 300 volt common-mode rating, which enables difference amplifiers to measure millivolt signals perched on 300-volt inputs. The 10^{12} ohm common-mode input impedance and 10^8 CMRR also enable Model 301 to be turned into a solid-state P-C mounting electrometer amplifier.

HOW MODEL 301 WORKS

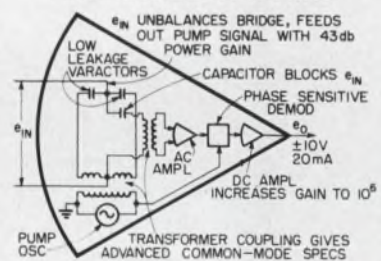

Amplifier input, e_{in} , varies varactor capacitance, unbalances bridge, and develops pump voltage output proportional to bridge unbalance. After low-noise AC amplification, pump voltage is phase-sensitively demodulated to restore correct polarity, then further boosted by DC amplifier. Final output is a replica of original input, amplified one million times.

Matched low-leakage varactors inherently eliminate $1/f$ or "flicker" noise, give excellent offset and drift specs, provide 10^{10} ohms differential input impedance. Transformer coupling contributes amplifier's advanced common-mode specs.

MODEL 301 SPECIFICATIONS

Max Offset	1 pa at 25°C , 30 pa at 75°C
Noise (DC - 1 Hz)	1 pa, $1 \mu\text{V}$, P-P
Max Voltage Drift	$30 \mu\text{V}/^{\circ}\text{C}$ (-25°C - $+85^{\circ}\text{C}$)
Input Impedance	10^{10} ohms (Diff.), 10^{12} ohms (C.M.)
Output	$\pm 10 \text{ V}$, 20 ma
Open Loop DC Gain	120 db (10^5)
Gain Bandwidth	500 KHz
PRICE (1-9)	\$198.00

ANALOG



DEVICES

ANALOG DEVICES, INC.
221 FIFTH STREET
CAMBRIDGE, MASS. 02142
PHONE: 617/491-1650

Scientists prepare to hunt for life on planets

Astronautical society meeting focuses on new equipment for unmanned exploration of Mars

Ralph Dobriner
West Coast Editor

As planning for Project Apollo rapidly nears a climax, many scientists are concentrating on what they believe will be the next important phase of space research: unmanned exploration of the planets.

This was indicated at the recent three-day American Astronautical Society meeting in Anaheim, Calif., which had as its theme "The Search for Extraterrestrial Life."

Of the 24 technical papers delivered on the philosophical aspects, scientific motivation and proposed hardware of extraterrestrial missions, more than half referred to the planet Mars. The apparent reason was NASA's proposed unmanned Voyager missions to the planet during the 1970's and the belief that Mars is the most likely body within the solar system to harbor some lower form of life.

A "progressive and economical" proposal to send unmanned vehicles toward a soft landing on the Martian surface was put forward by C. de Moraes of the Martin Co., Denver.

The scientist wants to send a series of space "buses" to the planet during the 1970's. His program would culminate in 1979 with two 3500-lb space buses flying by Mars, each launching a 650-lb capsule that would soft-land instruments on the planet. The vehicles would carry progressively more sophisticated instruments for life-detection and geological experiments and for high-resolution TV scanning of the immediate landing area, de Moraes said. The two final capsules would contain an automated biological laboratory and roving vehicles that would explore and gather samples at a distance from the landing area.

An automated biological labora-

tory (ABL) concept, under study for NASA at Philco Corp.'s Aeronutronic Div., Newport Beach, Calif., was described by W. Hostetler, space program manager.

The capsule, a potential Voyager payload, is being designed to carry out complex life-detection experiments on planetary surfaces. The experimental capacity of the ABL—an integrated system—is to be nearly double that of present capsules that weigh the same but are made up of separate experiments. The ABL is to weigh 715 lbs compared with the 1200 lbs of the average conventional payload, Hostetler said.

The complete system is to include sample acquisition, chemical processing and sample analysis, as well as computer control, power supply, communications and other supporting subsystems.

Thirty-five preprogrammed experiments would be done by the payload after it landed and was deployed on the Martian surface. Through radio links with the capsule, scientists on earth could command the ABL to perform additional tests as they interpreted data sent back by the capsule.

Robot is ultimate goal

Techniques being developed for the Voyager missions are part of a larger effort to develop a robot capable of carrying out preset programs and of self-programming within certain bounds.

Louis Sutro of MIT's Instrumentation Lab., Cambridge, Mass., reported on efforts to develop a true robot with a limited self-programming capacity that could deal with a large sequence of choices and correct its own error of judgment.

According to Sutro, each experiment for Mars will require both a sensor system designed for the problem and a data-processing system to bridge the gap between the way the sensor system works and the way the human mind works. Data from the experiments would be put through a decision system similar to that of humans. ■ ■

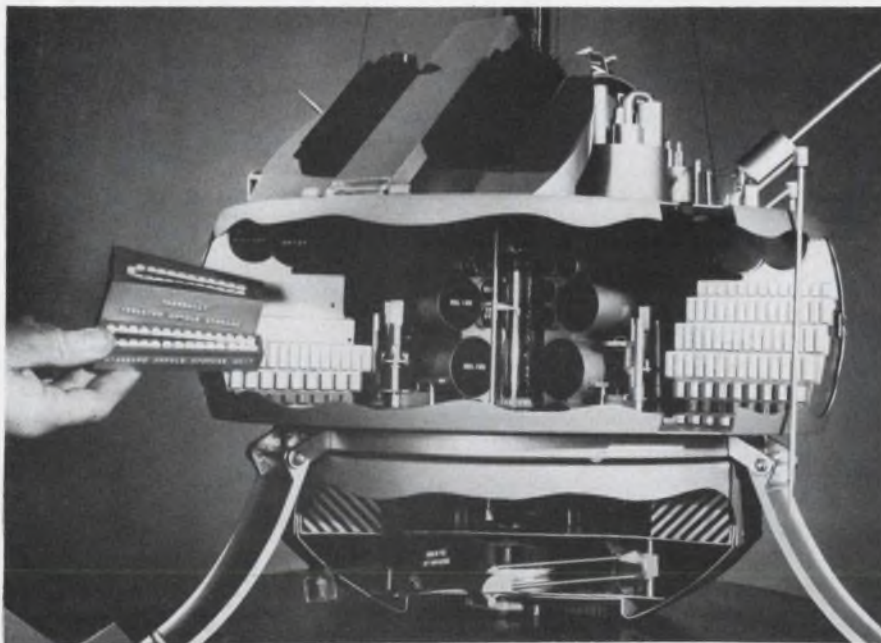

Automated biological laboratory, (ABL), similar to this model, may some day conduct life-detection experiments on the Martian surface under the control of scientists on earth. The model, developed for NASA by Philco's Aeronutronic Div., shows the actual testing area of the ABL with chemical-storage area and mechanisms for moving samples, agents, chemicals and reagents from storage to test areas.

Westinghouse offers the two IC op amps for low impedance drive applications

Drives 10 mA into 500 Ω load

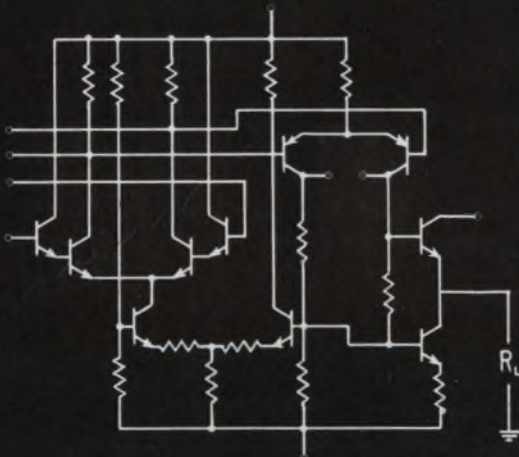

Westinghouse WS 161

Drives 20 mA into 500 Ω load

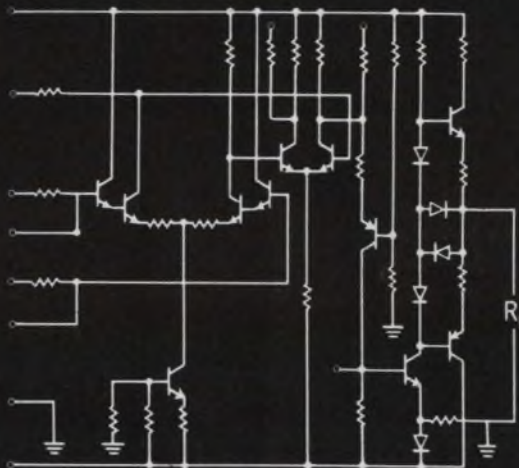

Westinghouse WM 174

You can drive sizable inductive, capacitive, or resistive loads directly with either of these two IC op amps. They're unmatched for "muscle". Using them, you can omit an intermediate driver stage or power amplifier in many applications.

The driving power of the WS 161 and WM 174 can make equipment smaller, simpler, and lower in cost. With this pair, you can fill virtually all integrated op amp requirements. They come in 14-lead, $\frac{1}{4}$ " x $\frac{1}{4}$ " Q-style packages.

If you want maximum unity gain bandwidth, moderate open loop gain, and very high current output with low voltage drift, no other IC op amp comes near the WS 161.

If you want maximum open loop gain, maximum output cur-

rent, and very high unity gain bandwidth, the WM 174 is far and away your first choice.

Get the full data on these outstanding IC's now. They'll do difficult jobs for you. Call your Westinghouse distributor. Or write Westinghouse Molecular Electronics Division, Box 7377, Elkridge, Maryland 21227.

J-09126

	WS 161	WM 174
Open Loop Gain	2,000	50,000
Unity Gain BW	20 MHz	10 MHz
Output Current	10 mA	20 mA
Output Impedance	40 Ω	70 Ω
Input Current	120 nA	120 nA

You can be sure if it's Westinghouse



ON READER-SERVICE CARD CIRCLE 16



■ COUNT 'EM! WHY SHOULD YOUR NUMERICAL READOUT CIRCUITS USE MORE COMPONENTS?

After all, why waste money? The more components you use, the more your readout circuits cost.

Both binary-to-decimal circuits shown in Figures 1 and 2 will not only reduce your component counts and circuit costs, but will also provide the gain necessary to drive, directly, the lamps in the readout.

Take the Figure 1 circuit—a standard decoder with transistor drivers on the output. This circuit not only drives the incandescent lamps, but is excel-

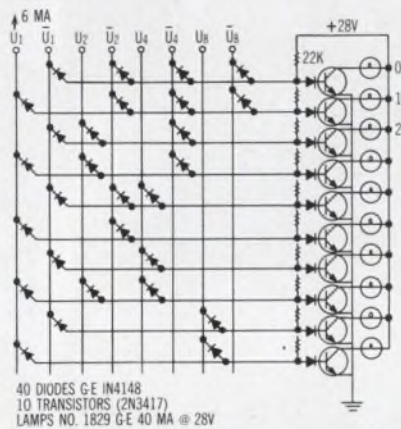

Fig. 1. Binary-to-decimal converter with drivers

lent wherever projection-type displays are needed. Use a 2N3877A transistor in it and you'll find you can also use such high voltage indicators as gas-filled, cold cathode numerical types. The Figure 2 circuit, meanwhile, is designed for incandescent lamps specifically. You'll find it a bit different in that its transistor matrix permits the transistor to do both the amplifier and the logic job required. But you need far less input current with this circuit to drive the same size lamp shown in Figure 1. Each input turns on only one transistor.

Studying applications where the readout device is driven from a counter? Try the circuit shown in Figure 3. The key to component reduction, here, lies in the economical ring counter

requiring only one active device per stage. Used to drive 250 milliamper lamps, this circuit delivers outstanding

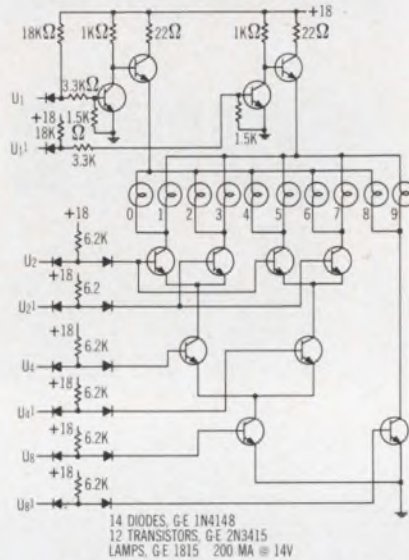

Fig. 2. Binary-to-decimal decoder drivers

savings through its use of both a G-E 2N3403 economy transistor and G-E C106 low-cost SCR. Try it. You'll find its maximum repetition rate is even

greater than 2 kilohertz and that it will operate even with the lamp burned out.

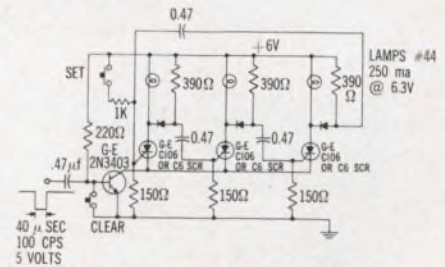

Fig. 3. High current ring counter

Circle Number 811 on the Reader's Service Card if you're interested in any of these, or any other, recent G-E readout circuit developments. They're just one more example of General Electric's total electronic capability. Or ask your G-E engineer/salesman or distributor for more information or write to General Electric Company, Schenectady, New York. In Canada: Canadian General Electric, 189 Dufferin St., Toronto, Ontario. Export: Electronic Component Sales, IGE Export Division, 159 Madison Ave., New York, N. Y. 10016.

HOT OFF THE PRESSES

Are you taking advantage of all our latest free bulletins? Specification sheets, application notes, conference papers, brochures and other useful materials... all are yours just for the asking. Try any of these, for example:

- Using the Triac for Control of AC Power—Jim Galloway. How to simplify many of your newest circuits with General Electric TRIAC's. Circle Number 812.
- Progress Report on Solid State Appliance Controls—John Mungenast. Word-for-word reprint of John's well-received paper presented at the 1965 IEEE Los Angeles Conference. Circle Number 813.
- Seminar Notes 671.3—Rick Spofford, Bob Muth, Dwight Jones. Latest circuits and application information on the new SBS and SUS, visual readouts,

timers and low-frequency oscillators. Circle Number 814.

A Low-cost, Ultrasonic-frequency Inverter Using a Single SCR—Neville Mapham. A simplified, new high frequency inverter circuit with good load regulation, even with reactive loads. Circle Number 815.

Using the Silicon Bilateral/Unilateral Switch—Bob Muth. Reprinted exactly as it originally appeared in the March, 1966 issue of EEE. Circle Number 816.

Full Line Bulletin on G.E.'s Complete Line of Semiconductor Products. Circle Number 817.

Circle the Reader's Service Card number indicated or check those you'd like on this coupon and mail it, together with your business card, to General Electric Company, Section 220-31, Schenectady, New York 12305.

Serve yourself at new post offices



Big jump likely in P.O. use of electronics

The Post Office Department is expected to step up considerably its use of electronic hardware and R&D. P. O. officials say that this will be the natural consequence of a thoroughgoing shake-up that has put two strongly electronics-oriented engineer-administrators at the top of the Office of Research and Engineering.

The P.O. has been spending heavily on electronics for the last two years and has announced plans for even greater spending yet to come. The new Postmaster General, Lawrence F. O'Brien, has been receptive to Congressional pressure for increased spending on automation (ED 11, May 10, 1966, pp. 31-32). He also conceded privately that "some old-fashioned skulls around this place" might be knocked together.

Now he has begun knocking skulls—a few right out of the Department. The Office of Research and Engineering has a new director and deputy director and its functions have been split in two.

Dr. Leo S. Packer, engineering manager of Xerox Corp. since 1962, is the new Office Director; Paul G. Hendrickson, former assistant vice-president of Defense Electronics, Inc., is his new deputy and chief administrative officer. In addition, O'Brien has ordered the Office divided into two operating branches, each headed by an associate director. The branches are the Directorate of Research and Development and the Directorate of Construction Engineering. The reason for the split was twofold: to give more emphasis to the engineering of the specialized new buildings required for new equipment, and to permit the mushrooming R&D program to grow unhampered by construction-engineering demands.

The P.O. has been handing out new contracts liberally. The largest to date was \$26 million in May to Honeywell and Control Data Corp. for equipment for the P.O.'s huge electronic source data complex. Recently, seven firms received \$19 million for mechanization hardware ranging from letter sorters and sack-parcel sorters to stamp-sensing machines

Washington Report

S. DAVID PURSGLOVE,
WASHINGTON EDITOR

and ZIP-code readers. The firms included Aerojet General, Burroughs Corp., FMC and Philco.

Self-service is coming

The biggest electronic market for the P.O. is still in the shaping-up stage. This will be the do-it-yourself post office, the "self-service postal unit." Over the next nine months 100 shopping centers throughout the nation will acquire these units complete with stamp-, postcard- and envelope-vending machines, weighing machines and mail drops. Sites for 66 units in 58 cities have already been made public. They will afford 24-hour service seven days a week as nearly automatic as possible. There will moreover be a direct-telephone-line link between each unit and a continuously manned desk at the city's main post office. Eight firms have received contracts worth \$800,000 to get the self-service unit concept under way.

The most recent P.O. contract went to Pitney-Bowes: \$1,420,400 for 95 electronic facer-cancelers. The machines are fed an unsorted jumble of letters which they face all in one direction. A photocell then seeks out the stamps and the machine cancels them at the rate of 30,000 pieces an hour. At present, there are 205 facer-cancelers in use in 72 post offices.

Crime control going automated

The role of advanced technology—especially electronics—in crime control has lately been receiving more and more attention in Washington and in many state capitals and big cities. Probably the most widely publicized move to pit electronics against crime was California's experimental application of aerospace-industry skills to the solution of civilian problems. Space General Corp. set about tackling crime and delinquency as a result. Now the Justice Department and the White House Office of Science and Technology have jointly sponsored a symposium in the nation's capital on June 22 and 23.

Of 10 areas pinpointed by the Department for possible development and research all but one were largely electronic in nature. Only a

Washington Report

CONTINUED

session to be devoted to seeking new, nonlethal weapons for police use against attackers and riots is not considered electronics-oriented.

Some 500 representatives of industry, higher education and criminal justice will attend the symposium. Both Attorney General Nicholas Katzenbach and Special Presidential Assistant for Science and Technology Donald Hornig unabashedly admit that the symposium is a plea for help: industry and university researchers will get a rundown of just what new tools and techniques are needed in the hope that they may soon be forthcoming.

One of the most intriguing areas for discussion is the identification of criminals by their voices, through recorded "voice prints." Some other, obvious electronics areas include expanded use of computers for record-keeping, analysis and decision-making by police, courts and prisons; more effective, and less expensive burglar alarms, especially of types that would trigger radio announcements; more efficient methods of retrieving court records; more efficient communications systems linking police headquarters and patrolmen; and communications systems to link the principals in court cases as their cases reach the trial stage.

Like any organization today, law enforcement is beset by the sort of administrative problems that can be solved by electronics, particularly data-processing. Sessions devoted to application of modern business procedures to prison administration are anticipated as among the most important for both prison officials and the electronics industry. Another session that will draw on industrial experience will seek ways to use modern technological devices to improve prison security.

Yet other sessions that both Katzenbach and Hornig hope will produce speedy results will explore means of developing new laboratory techniques—especially for linking a suspect with the scene of the crime.

The Justice Department is backing up its wish for industry participation by awarding financial grants to cities and regions that have developed crime control models that still need trying out. Congress a year ago authorized the Office of Law Enforcement Assistance to make the grants, but the office has been awarding them for only about six months. In that time, however, some \$4 million have been distributed. A \$257,456 grant went to the Metropolitan Washington, D.C., Council of Governments and the Metropolitan Police Department to develop a computer-based high-speed information and communication

system. The random-access system would permit any policemen in the Washington area to question the memory core and receive an immediate answer on a suspicious person, stolen automobile or possibly rabid dog. Hopefully, the Washington model will point the way for a planned national system (ED 10, Apr. 26, 1966, p. 31).

Industry seeks role in urban programs

Industry is sending droves of representatives to Washington to try to define its role in the Government's urban development programs. The hugeness of the programs has industry convinced that there must be lucrative markets for both hardware and R&D—if they can be spotted. One senior vice-president of a major electronics firm was sent here by his company just "to look around." He has been given all the time he needs and virtually a blank check to find a role for his company.

Some harried officials immersed in the new programs welcome industry's interest. They own that an industry representative—admitted by both sides to be selling his company—can often turn up a fast answer to a problem or suggest an improved way of doing something. But not all government officials are so happy. They feel that the big corporations are in a good position to find out how the new urban money is to be spent—better, indeed, than the cities that the money is supposed to help. These officials fear that the companies may thus gain the city administrators' ears early and tell them only what the companies want them to hear.

Central computer urged for Congress

Rep. William Morehead (D.-Pa.) has proposed that a Congressional read-out station be linked to a gigantic central government computer so that Congress may "tap the memory of all the other computers in the Federal Government, not to secure privileged data, but to secure facts such as economic statistics, demographic profiles and figures on such things of daily concern to a Congressman's office as funds allotted to his district, and project and contracts awards." Eventually, he said, there could be a station in each Congressman's office and in each committee office.

Possibly with the Morehead proposal in mind, a House Post Office subcommittee listened attentively and apparently favorably as University of Pennsylvania Professor Adrian M. McDonough proposed a central Federal office to oversee research into the state of the information arts and sciences. He contended that such an office could identify critical problems and set priorities for R&D.



half the picture

*When you look at electronic components
are you seeing only half the picture?*

We're the last people to argue with component purchasers who put performance, price and delivery first — meeting these three basic requirements is what keeps us in business. But most engineers are also on the lookout for something more, and many of them find it at Mullard.

Take research and development for instance. Out of Mullard R&D have come outstanding devices such as the travelling wave tubes for the New York—San Francisco and Montreal—Vancouver microwave links. Production resources? Mullard

plants are among the most efficient anywhere, with a reputation for the production of tight-tolerance devices to proved standards of reliability. As for circuit know-how, Mullard has the best equipped applications laboratories in Britain. And when it comes to technical services, you will find that Mullard provides the kind of comprehensive performance specs, survey documents and application reports that are just that much more useful.

If you want to get the *whole* picture, why not ask us to help you with some of your component problems?

ON READER-SERVICE CARD CIRCLE 213

DIODES · TRANSISTORS · PHOTO-DEVICES AND RADIATION DETECTORS
RECTIFIER DIODES AND STACKS · THYRISTORS AND STACKS · INTEGRATED
CIRCUITS · CATHODE RAY TUBES · RECEIVING TUBES · ELECTRON OPTICAL
DEVICES · PHOTSENSITIVE DEVICES · COLD CATHODE DEVICES · POWER
DEVICES · TRANSMITTING TUBES · MICROWAVE DEVICES · CAPACITORS ·
FERRITE MATERIALS AND ASSEMBLIES · COMPUTER COMPONENTS AND
ASSEMBLIES · MAGNETIC MATERIALS · SPECIAL PURPOSE MAGNETS · VACUUM
DEVICES · WOUND COMPONENTS.

Mullard

where the product is only part of the deal

MULLARD LIMITED · TORRINGTON PLACE · LONDON WC1 · ENGLAND

Bat-like detectors to direct N. Y. traffic

Small, gray boxes that operate like captive bats will soon help New York City speed its heavy traffic flow.

The boxes—each an ultrasonic antenna—will hang over busy intersections. They will count passing vehicles to determine traffic patterns and help regulate traffic lights. With the detectors in place, motorists will be able to whiz along with fewer stops and delays.

A continuous inaudible yodel is emitted from the antenna. Passing vehicles then return echoes to the antenna for use in counting and controlling traffic. The frequency-modulated probe signals have a center frequency of 40 kHz. This high frequency was selected to prevent false indications from such audio interference sources as motorcycles, sirens and whistles. Either the presence or motion of the vehicle is sensed in a manner similar to that used by bats.

The traffic detectors, developed by Sperry Gyroscope Company, are the first hardware to be delivered under a \$5.4 million contract from New York City for an automated control center. The ultrasonic detectors, in conjunction with other sensing devices, will provide input data to a central traffic-control computer.

A complete detector consists of an antenna and cabinet. The antenna contains two piezoelectric crystals: one sends and the other receives. The cabinet, which may be placed up to 300 feet from the antenna, contains a solid-state trans-



Antenna portion of ultrasonic detector is inspected by Sperry engineer.

ceiver. Circuitry within the transmitter generates the transmission signal and converts the returned signals into useful pulses. A 12-volt power supply and an output relay are also housed in the same cabinet.

No vehicle, not even a motor scooter, escapes detection. The presence or motion of a vehicle produces one relay closure. Even speeding cars cannot avoid the unseen monitoring beam—unless they are moving faster than 80 mph.

When set to detect vehicles' presence, the system produces a relay closure that lasts as long as the vehicle is in the detection zone. When

set for motion detection, it produces one 0.3-second pulse for each passing vehicle.

The lightweight antenna may be mounted at the side of the street in a side-fire mount or over the street by means of span wires or a mast arm. Up to three lanes of traffic may be monitored, regardless of the direction of traffic flow.

New York City, which has ordered 1100 detectors, expects to install them this fall. Pittsburgh, Houston, Atlanta, Fort Lauderdale (Fla.) and Baltimore will also employ the detectors in their traffic-control systems ■ ■

Bedbugs may lead Vietnamese raids

In the jungles of Vietnam, where radars, lasers and infrared devices sometimes fail to locate hiding guerilla fighters, the Army is hopeful that the hungry bedbug will succeed.

Scientists are experimenting with the bedbug's ability to smell its human quarry at a distance. Hungry bedbugs move their legs excitedly when they sense flesh. With proper control of the air that the insect

smells, a scouting party could keep them in small capsules, carry them ahead of the troops and use them to detect the unseen enemy.

The Army's Limited War Laboratory, Aberdeen, Md., has developed an amplification system that makes the insect's leg movements audible.

The bedbug is placed on a rigid screen mesh and sealed in a container. The mesh is attached to a piezoelectric crystal. When the insect

moves its legs, the movement of the grid produces a voltage. This voltage, when amplified, alerts the Army scout through earphones.

It was once thought that dogs could be used to sniff out the enemy in Vietnam, but there is at least one major drawback to their use there: the Vietnamese consider dogs a delicacy, and the Army fears too many may end up on the dinner table instead of in the K-9 kennel. ■ ■

ALLEN-BRADLEY Type J
Hot Molded Variable Resistor
rated 2.25 watts @ 70°C
shown 2 times
actual size.

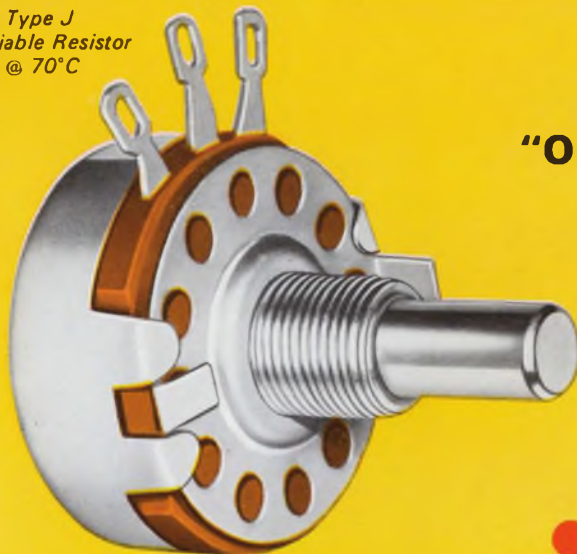

**“Only Allen-Bradley Type J pots
give us the smooth control
to maintain the high calibration
accuracy of our instruments”**

Krohn-Hite Corporation

● This quickly locates the positions of the Type J potentiometers in the illustration below.

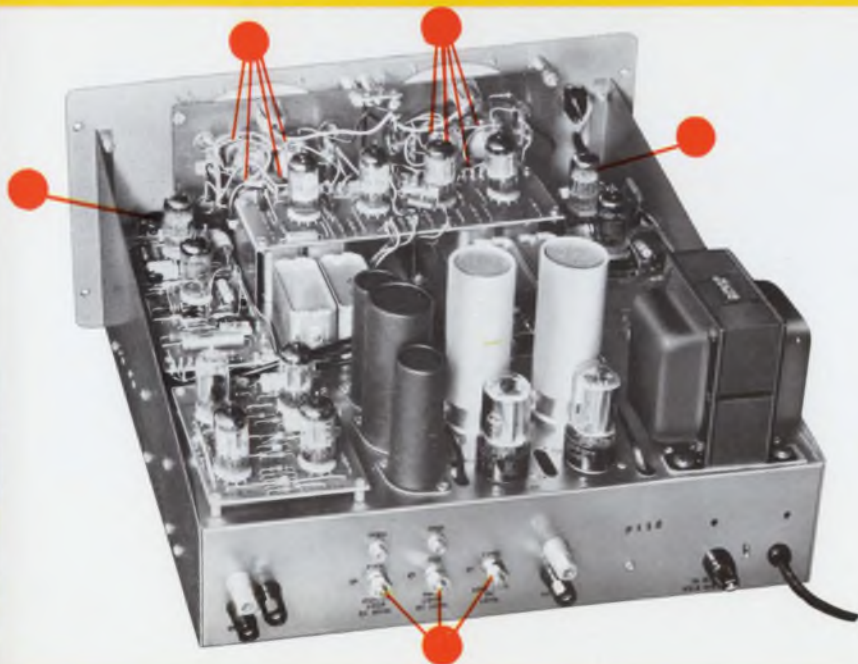

THIS KROHN-HITE VARIABLE FILTER provides low-pass, high-pass, band-pass, and band-reject operation with high and low cutoff frequencies independently adjustable from 0.02 cps to 20 kc.

IN THE MODEL 335, continuous tuning of the high and low cutoff frequencies is accomplished by simultaneously varying four potentiometers with a single knob. Only A-B Type J controls have been found to provide the smooth control and precise tracking without discontinuities to achieve the required calibration accuracy.

■ Krohn-Hite engineers have found that only Allen-Bradley Type J potentiometers provide the smooth control, low noise, long term stability, and low temperature coefficient they require for their precision instruments such as the variable electronic filter.

The Type J control has the resistor, terminals, faceplate mounting bushing, and insulating material hot molded into a solid integral unit. The solid resistance track assures smooth, quiet control that is free from the undesirable discrete steps of wire-wound units. On accelerated tests, Type J exceeds 100,000 complete operations with less than 10% resistance change.

Insure the performance of your equipment by insisting on Allen-Bradley Type J hot molded potentiometers. Besides, when you use Allen-Bradley fixed and variable hot molded composition resistors you provide your apparatus with the label of “quality.” For more complete specifications, please write for Publication 6024: Allen-Bradley Co., 222 West Greenfield Ave., Milwaukee, Wis. 53204. In Canada: Allen-Bradley Canada Ltd. Export Office: 630 Third Ave., New York, N.Y., U.S.A. 10017.

ADDITIONAL ALLEN-BRADLEY HOT MOLDED VARIABLE RESISTORS

TYPE G CONTROLS are only ½" in diameter. Quiet, stepless operation. Rated ½ watt at 70°C. Values to 5 megohms. Type L are similar in construction but rated ½ watt at 100°C.



TYPE F CONTROLS are for mounting directly on printed wiring boards by means of their terminals. Rated ¼ watt at 70°C. Values to 5 megohms. Type O are similar but rated 0.4 watt at 70°C.



TYPE R ADJUSTABLE FIXED RESISTORS are built to withstand environmental extremes. Only 1¼" in length. Have stepless adjustment. Watertight and can be encapsulated. Rated ¼ watt at 70°C. Values to 2.5 megohms. Type N for less severe environments are rated ½ watt at 50°C.



ALLEN-BRADLEY
QUALITY ELECTRONIC COMPONENTS



Here's your answer to shock and vibration problems

■ Allen-Bradley Type R adjustable fixed resistors are unexcelled for holding precise settings through extreme conditions of shock and vibration. This unusual ruggedness is the result of a manufacturing process—perfected and used only by Allen-Bradley—which hot molds the resistance and collector elements, terminals, and insulating material into an almost indestructible component. Thus, the controls can be mounted by their own rugged terminals *without* additional support.

The solid resistance track assures such smooth control that it approaches infinite resolution. Its smoothness cannot be compared with the abrupt wire-wound turn-to-turn resistance changes which may cause circuit transients. Since Type R controls are essentially non-inductive and have low distributed capacity, they can

be applied in high frequency circuits where wire-wound controls are impractical. The Type R molded enclosures are both dustproof and watertight, permitting encapsulation after adjustment.

Allen-Bradley Type R controls are suitable for use from -55°C to $+125^{\circ}\text{C}$ and are rated $\frac{1}{4}$ watt at 70°C , 300 volts max. RMS. Available as standard in total resistance values from 100 ohms to 2.5 megohms with tolerances of $\pm 10\%$ or $\pm 20\%$. As special, can be furnished down to 50 ohms. Technical Bulletin B5205 contains complete specifications. Please send for your copy today: Allen-Bradley Co., 222 W. Greenfield Ave., Milwaukee, Wisconsin 53204. In Canada: Allen-Bradley Canada Limited. Export Office: 630 Third Ave., New York, New York, U.S.A. 10017.

Allen-Bradley Type R Adjustable Fixed Resistors—Shown actual size

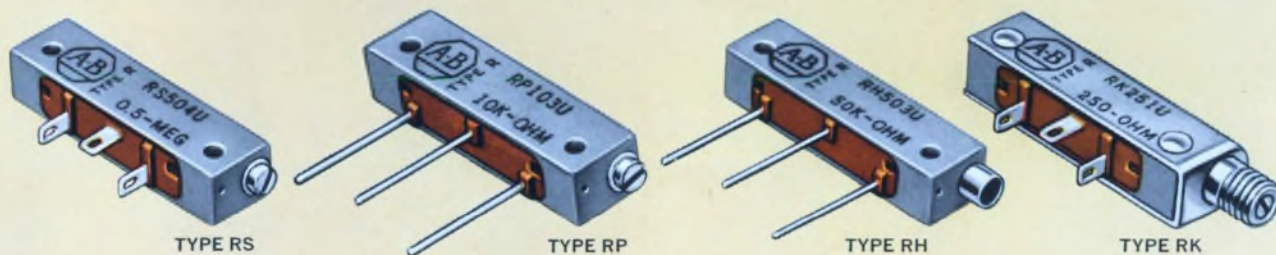

TYPE RS

TYPE RP

TYPE RH

TYPE RK



ALLEN-BRADLEY
QUALITY ELECTRONIC COMPONENTS



MHD is here—
the newest, small diode

They're here already—the next generation after the DHD's. Just as rugged and just as reliable, tiny G-E Milli Heatsink Diodes are perfect for high-density circuit card and memory applications, and for "cordwood" construction. The new diodes are available in JEDEC types 1N4531-34 and 1N4536. Each features high conductance, low capacitance and nanosecond recovery time. Circle inquiry card **Number 90** for more facts.

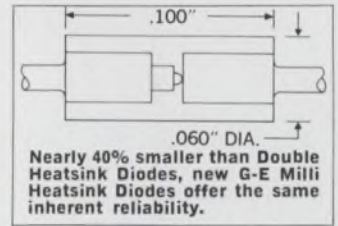

Actual size

Here's your key
to low-cost
voltage stabilization



Every G-E voltage stabilizer supplies constant output voltage to within $\pm 1\%$ —even with fluctuations up to 15%. For special economy, core-and-coil units provide the lowest cost voltage regulation obtainable. They help meet tight space requirements, make wiring connections easier, and provide all the mounting flexibility you can ask for. At General Electric, voltage stabilizers are available in ratings from 15 to 15000 volt-amperes in both standard and custom designed models. Ask your G-E engineer/salesman for publication GEA-7376 or circle magazine inquiry card **Number 91** for all details.

Typical General Electric a-c voltage stabilizer

Smaller size—
yet higher power capability
with this new
Grid Pulse Triode

2.0 KW at 1090 MC or 2300 MC. Or a full 1.0 KW at 4300 MC. That's the capability of General Electric's new Y1549 ceramic triode for grid-pulse applications. Each new triode is rated at 2000 volts, 2.5 amps peak, 0.001 duty, and 0.5 microsecond pulse width. Significant performance improvements are a certainty with its new, specially tailored cathodes and high-performance grid construction. What's more, the Y1549 is extremely tolerant of adverse environments (as are all G-E planar ceramic triodes). Typical applications include airborne navigational and communication equipment, and L-, S-, and C-band radar beacons. Circle **Number 92**.

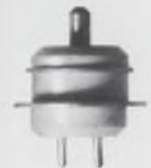

Actual size

Try G-E high-voltage
reed relays.
They're small . . . fast . . .
and reliable



For military and special applications

Rated up to 5000 volts or 50 volt-amps, these G-E reed relays are ideal for applications requiring high reliability and long life. Dimensions, excluding leads: only 0.70 inch tall, 1.09 inches wide, and 2.80 inches long. G-E Type 3SAS reed relays operate in 3 milliseconds maximum; release time: 100 micro-seconds maximum. Ask your G-E engineer/salesman about these high-voltage reed relays, or circle magazine inquiry card **Number 93**.

For those really tough
applications—
specify G-E Metallized
Polycarbonate Capacitors

They're 50% smaller than comparably-rated foil electrode units. Stable, too. A G-E metallized polycarbonate capacitor's maximum change (in percent of 25C capacitance) will not exceed $-2.5\% + 2.0\%$ over its temperature range from -55C to 125C . Ratings: 200, 300 and 400 VDC at 125C ; 0.1 to 10.0 microfarads. And they're self-healing. Each features low dissipation factor, high insulation resistance and superior high-frequency characteristics. Ideal for many a-c applications. Circle **Number 94**.

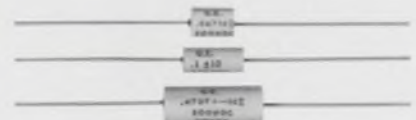

Designed for your most demanding circuits

MORE



New cooling fan assemblies for your equipment cabinets



For computers and electronic equipment

Test them yourself. They're new. They're able to generate up to 500 CMF air flow in either suction or blower applications. They're designed for all-angle mounting. Quiet, reliable G-E fan units come in either 115- or 230-volt ratings for 60-cycle operation. Each is equipped with a 10-inch diameter venturi for easy mounting. Its 5-blade fan is well-protected by a wire mesh front screen and heavy duty back grill. And the proven, unit-bearing motor insures many years of reliable operation. Optional designs are also available. Circle magazine inquiry card **Number 95**.

8 compactrons replaced 15 tubes in this color TV circuit

Depend on General Electric compactrons for circuit savings . . . for outstanding performance . . . for full-scale production availability. Nearly 60 different available compactrons are particularly suited to color TV receivers. Ask your G-E engineer/salesman about color-TV compactrons or circle **Number 96** on the magazine inquiry card.

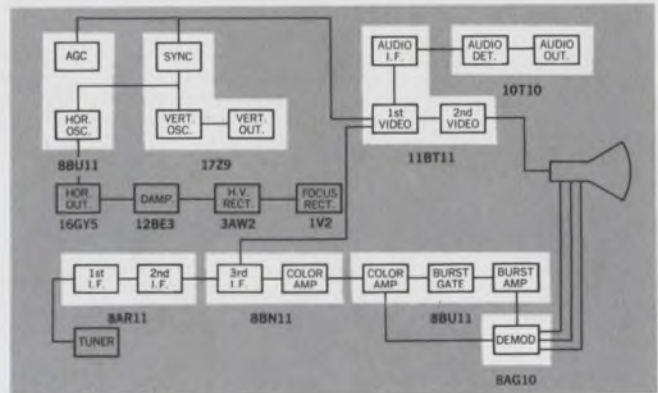

15-inch transformerless compactron color TV

Many advantages offered by G-E fast-recovery rectifiers

Some applications are just too demanding for normal silicon rectifier diodes. Take advantage of reduced recovery transients, increased circuit efficiency, and low RFI. Try G-E fast-recovery rectifiers. General Electric offers a complete line of these devices in 6-, 12-, 20- and 30-amp ratings, and with maximum recovery time of either 100 or 200 nanoseconds. Applications where they're sure to be particularly useful include free-wheeling rectifiers, sonar and ultrasonic equipment, DC-to-AC inverters, and other systems requiring high-frequency switching. You'll like their prices, too. Circle **Number 97**.

New magnetic material breakthrough—improved Alnico 8

Given the right size, shape and directionalization, this new G-E magnetic material can produce a nominal coercive force of 1850 oersteds. This means that, in some applications, you can reduce the size of your mechanism as much as 40% . . . save dollars as well as space. Higher useful recoil energy is also a fact with improved Alnico 8. Ideally suited for motors, latching applications and torque drive devices. Ask one of our experts to help you design it into your newest application. Circle **Number 98**.

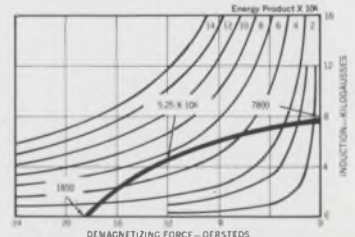

Demagnetization vs. energy output

No separate driver needed for this incandescent bulb circuit

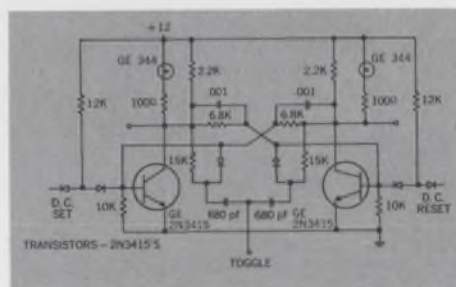

Binary counter with incandescent readout

Combine the high gain of the 2N3415 economy transistor with the low-current requirements of the G-E #344 lamp in this circuit, and you've eliminated the need for separate driver stages to drive the incandescent bulbs. This circuit will continue to operate with either or both of its bulbs burned out. It can also drive other circuits just like it to form a binary counter chain. Circle inquiry card **Number 99** to learn more about it.

WE MAY NOT OFFER EVERYTHING YOU WANT FROM ONE COMPONENTS SUPPLIER. BUT WE DO COME A LITTLE CLOSER THAN ANYONE ELSE.

Flat metal strips curl into antennas

Antennas for space vehicles can now be stored as compact rolls of flat metal strips which, as they are unrolled, curl into tubes.

These deployable antennas are being built for NASA by the Aerospace Division of the Westinghouse Defense and Space Center.

In developing the deployable antenna concept, Westinghouse designers solved two of the basic problems that have limited the potential of this type of extendable antenna for space use. A high strength-to-weight ratio was achieved by using special heat-treating processes and by putting a large number of holes in the strips. The holes also solved the distortion problem that occurs in space when the side of the antenna facing the sun is heated to a very high temperature, while the side away from the sun is cold. The holes are arranged in special patterns that allow the sun's rays to pass through and heat the side of the antenna that is away from the sun. The entire antenna thus remains at the same temperature, and distortion is avoided.

Normally, about 15 per cent of the metal in the strips is removed to form the holes. However, more than 50 per cent can be removed when the application so requires. Each square inch of the strips usually has about 100 holes.

According to Westinghouse, the extendable tubing can also be used for the deployment of equipment or instruments from spacecraft or underwater vehicles, as well as for structural elements. ■ ■



Tubular antennas, produced as flat metal strip, are unwound from drum.

ONE TOUGH WORD SAYS HUGHES QUARTZ CRYSTALS:

RUGGED

Our crystals are built to take a beating! No more mechanical failures. Hughes special mounting process eliminates them.

But, though our crystals are ruggedly built for outstanding reliability, the delicate side of their nature has not been neglected. Cut and lapped to perfection, Hughes quartz crystals will perform to your exact frequency specifications... and keep on performing.

So, whether your need is for high-frequency or low-frequency crystals, call on Hughes—we cover the frequency spectrum (from 1kc to 150mc).

For assistance or information, please write: Hughes Electronic Devices, 500 Superior Avenue, Newport Beach, California.

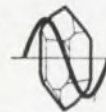

HUGHES

HUGHES AIRCRAFT COMPANY
ELECTRONIC PRODUCTS DIVISION
NEWPORT BEACH, CALIFORNIA

Leader in Frequency Control Devices



An embarrassing revelation to the United Nations in 1960. U.S. Ambassador Henry Cabot Lodge tells how the Russians tuned in on our embassy conversations.

The eavesdroppers: 'Fallout' from R&D

Aerospace and military electronics spur two-way market in clandestine listening devices

S. David Pursglove
Washington Editor

Electronic eavesdropping has become so widely publicized in recent years that it is losing its glamor. Television spy serials, popular national magazines and Congressional hearings have dispelled the aura of mystery that once enveloped the field. Today even a schoolboy knows that a martini olive, a sugar lump or a businessman's attache case can be turned into a mechanical spy—old-fashioned spies, by today's standards.

As the technology and market grow steadily, technical advances—largely "fallout" from research in aerospace and military electronics—are producing equipment on two levels:

1. Highly sophisticated, expensive devices for use by professionals only. Such devices keep pace with the newest developments in micro-miniaturization, lasers and other techniques.

2. Relatively simple equipment for the general public. While not as expensive as that for professionals, it can still be high. In many cases the packaging is unique but the circuitry is fairly basic.

An example of highly sophisticated equipment is a transducer microphone built on the head of a pin for an intelligence agency. Some telephone taps, on the other hand, rank with relatively crude equipment. They are so simple that practically anyone can install them.

Great Seal sparked interest

Although the practice of electronic eavesdropping has been around for a long time, it was limited for the most part to cloak-and-dagger circles.

Then, in 1960, U.S. Ambassador Henry Cabot Lodge displayed the now well-known Great Seal bug to

the United Nations as an example of Soviet spying on this country. With this dramatic revelation, bugging became almost a household word. Widespread public interest in the area has persisted since.

The Great Seal bug was presented to the U.S. Embassy in Moscow by a Ukrainian delegation. Its triumph was that it required no power source of its own. It had no wires that could be discovered, no batteries that could wear out. Its operation was controlled entirely from outside the embassy chancellery.

The device, which Soviet agents hung within the carved wooden seal over the desk of our Ambassador to Moscow, was extremely simple. It was only a small copper cylinder—a can—with a nine-inch copper rod attached. The can, carefully turned to close tolerances and silver-plated for long life, was a sharply tuned (high-Q) cavity. The copper rod, also silver-plated, terminated inside the cavity, with its tip in the form of a plate. That plate was coupled

capacitively with a "tuning post," also inside the can. The tuning post, in turn, was capacitively coupled with a delicate metal diaphragm, three mils thick, that covered the can opening.

The can measured 11/16 inch long, with an inside diameter of 0.775 inch. The cavity inductance was 1/100 microhenry. The entire unit, including the nine-inch antenna, weighed 1.1 ounces. The operation of the bug was the essence of simplicity. An ultra-high-frequency signal from a van parked near the embassy building would reach the device. The bug would reflect the signal back to a receiver, after first modulating it with sound waves from conversations striking its diaphragm. The sound waves that struck the diaphragm caused it to move, and that movement changed the size of the tuned cavity slightly—just enough to modulate the signals effectively.

Tests prove operation

The bug was hidden behind a hollow in the beak of the eagle carved on the Seal. Tests at the State Department showed that the device worked well in free space but that

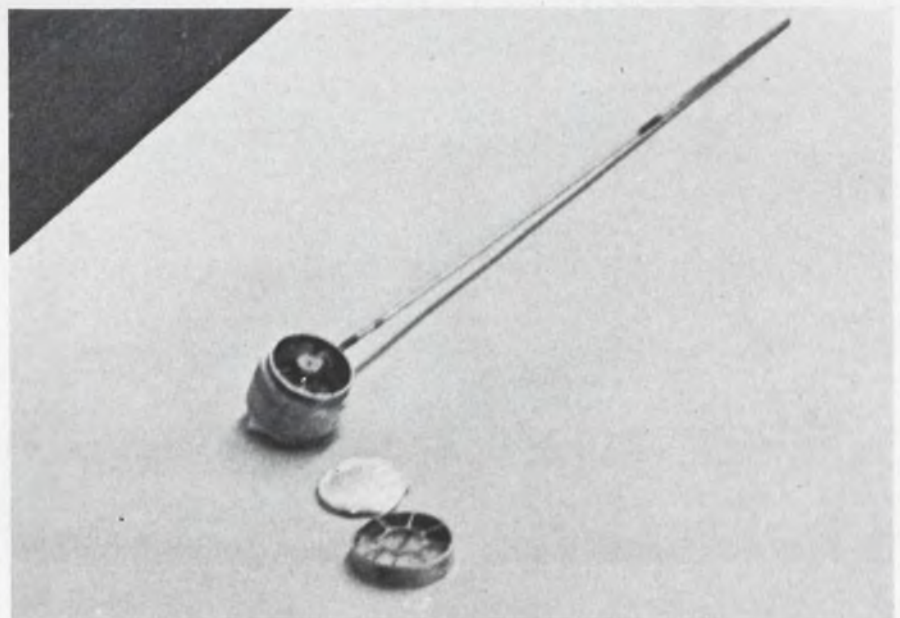

1. The Great Seal bug eavesdropped successfully in our Moscow embassy.

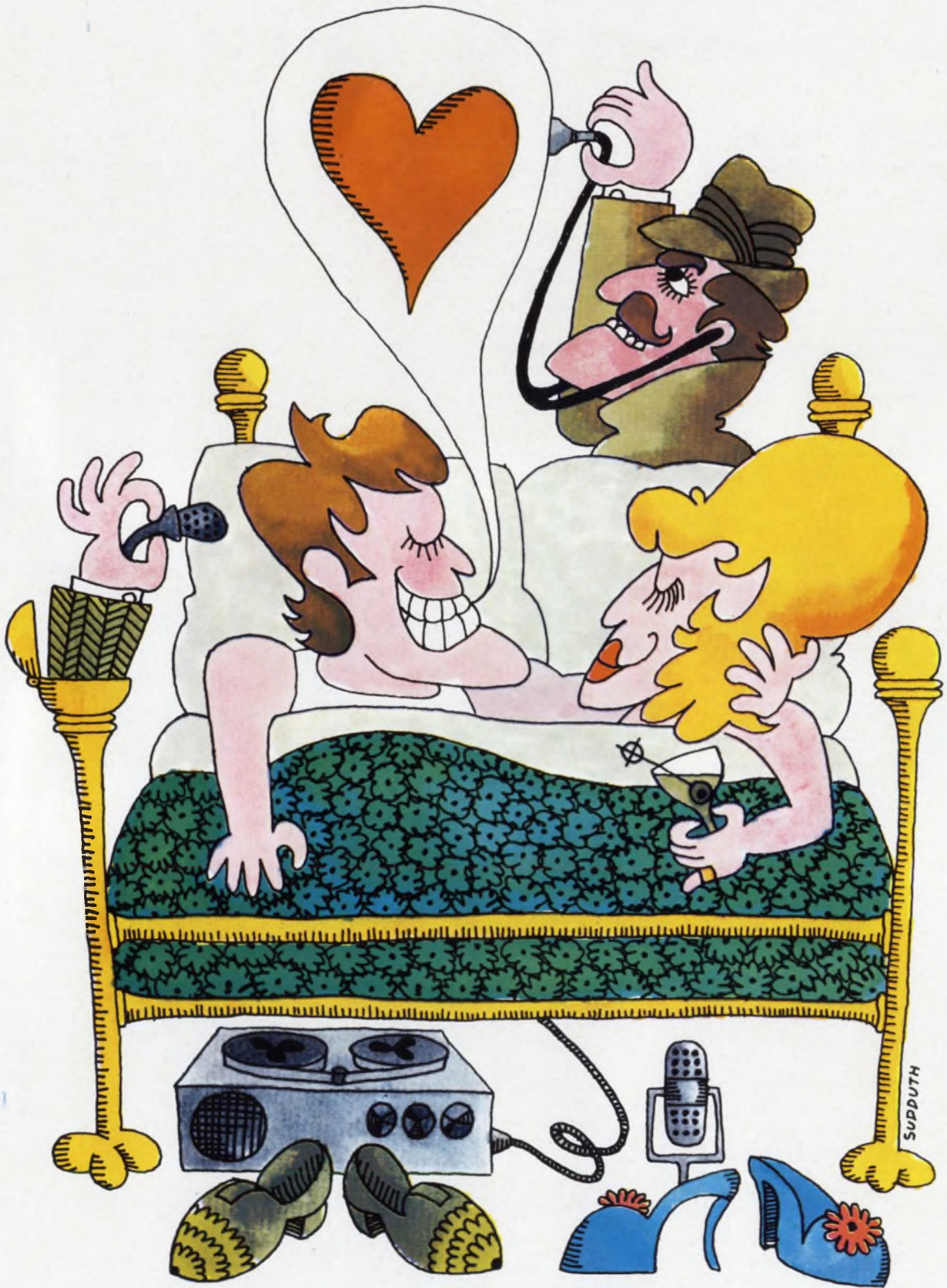

(eavesdroppers, continued)

it was very sensitive to its environment. Performance fell off when it was placed in plaster or implanted near metal or other attenuating materials. But it operated essentially in free space in the very small hollow in the Great Seal.

The Great Seal bug is an example of how modern eavesdropping has progressed. A State Department official told *ELECTRONIC DESIGN* recently that the bug was originally developed by the Russians more than 20 years ago.

Laser bugs are next

Today eavesdroppers plan to use lasers to read window vibrations corresponding to conversations in a room. In theory, a laser beam originating hundreds of yards or even several miles away would strike a window, be modulated by voice vibrations also striking the window, and bounce back to the source where it would be "read."

Laser eavesdropping is very real—right now. The problem is that it works only under ideal conditions. Auto and airplane traffic also vibrate the same window pane that is being "read" and interfere with the eavesdropping. But specialists are ironing out the trouble. They expect within five years to be able to filter out or discriminate against extraneous vibrations to the extent that windows near normal voice conversations will be read well by lasers over 100 yards away in all but the noisy heart of a city.

R&D devices often ideal

Typical of routine operations today is the experience of a three-man electronics shop in Maryland. The National Aeronautics and Space Administration had a problem: It had to measure the flow rate of gases through tubes of very small diameter, but any available transducer was so large that its insertion into the stream disturbed the flow and presented distorted data. The Maryland company accepted the design challenge and developed an extremely small transducer that produced minimum distortion when placed in the gas stream. It worked very well.

An intelligence agency heard about the pinhead-sized transducer and recognized it as a potential pinhead-sized microphone. A trial in the company's office showed that the transducer, poked through the bottom of a conical paper drinking cup, easily picked up and clearly transmitted whispers 30 feet away.

The microphone was a miniature glob of lead zirconate, molded and coated with aluminum for shielding. It was mounted for free vibration. Wires so fine they could not be detected when running through the nap of a rug were soldered to the glob. Besides being buried in a rug, the pinhead mike could be embedded in a wood picture frame or a desk top and then polished over.

One was given to a caller for photographing. When, several months later, he telephoned the company to arrange the mike's return, he was told: "Keep it. It's obsolete; we've got a much smaller one now."

Market figures unreliable

Estimates of the present annual dollar volume of the electronic eavesdropping business are unreliable, to a large extent because of the surreptitious nature of much of the business. Specialists who presume to speak with authority put the design and production figure for the country at anywhere from \$1.5 million to \$20 million—a pittance in comparison with the more than \$17 billion yearly output of the elec-

tronic industry.

But the market is expected to spurt when the long-range laser microphone is perfected and when many of the now sophisticated, expensive devices for federal agencies trickle down to local police departments, private investigators and industrial security officers.

One factor may slow the anticipated rise in business, however: Congress and other responsible bodies are looking into the rights and wrongs of electronic snooping and the question of whether strict federal controls are needed. At present such eavesdropping is conducted at the fringe of fuzzy state and local ordinances. The resulting infringement on private lives worries many legislatures and—at the other extreme—has given cartoonists and others bountiful material for humor.

Regardless of its current size, the bugging business is said to have rescued at least a few floundering small electronic R&D firms. It is a business in which there are still plenty of takers, and all the sales manager need do is to show up at the right conventions and drop the word that his firm is "open."

Among his potential customers will be private operatives, corporation security representatives, federal gumshoes (such as the Federal Bureau of Investigation, the Narcotics Bureau, and, nowadays, the Internal Revenue Service), and the



Executive attache case comes with microphone, amplifier and voice-ac-

tuated tape recorder. The unit sells for \$1400.



(eavesdroppers, continued)

cloak-and-dagger community, peopled largely by the Central Intelligence Agency and the Defense Intelligence Agency.

Many of the firms that have developed electronic devices for a space or military project, only to find them in great demand by investigative agencies, occupy spots along the Boston-Cambridge "Electronics Row," the Los Angeles R&D community, and many small R&D outlets in the suburbs of Washington, D. C.

One manufacturer who holds open house with a traveling show of electronic eavesdropping equipment says that his most frequent visitors are from the Air Force Office of Special Investigations. Like customers from other federal agencies, he says, the Air Force agents "are quite furtive in their visits but obviously more concerned about being spotted by another agency than by the Reds or the public."

"They usually buy in quantity, and they pay well," the manufacturer reports.

Big money in custom bugs

But it is not the representative who visits the manufacturer's hotel display room and places an order for a half-dozen miniature tape recorders and a mobile trailing unit who keeps the small R&D shop in business. Rather it is the agent who shows up at the laboratory late one afternoon, displays his credentials, warns the proprietor-chief engineer that the "national interest" requires the conversation to be held in the strictest of confidence and proceeds to outline a problem that can be solved only by custom design.

"We'd like to know what's going on in a particular office," he might say. "Somebody we know repairs typewriters, and he has access to the office."

The problem then is hide all the components of a bugging transmitter in various typewriter parts, and to do it in such a way that when the parts are installed, they become a working transmitter, picking up and transmitting conversations in the room. The "incentive money," as one of the agencies calls the fee, might be \$200,000.

Eavesdropping, like any other electronic development, is following a predictable business course. The newer devices may be steeply priced at the outset, but their costs are dropping with mass output. And with each step forward, the bugs are becoming harder and harder to detect.

One Florida manufacturer who has been in the bugging business since 1938 attests to the remarkable progress in the "state of the art."

"In those days," he says of his start in 1938, "a really small bug—we didn't call them bugs then, because they were hardly small enough to justify that kind of a name—was about a foot and a half

long, a foot wide and about 10 inches high. They would barely transmit to the next room. And, boy, did they heat up! We couldn't hide them in a small space at all."

As he recounted this recently, he fingered a cube-shaped transmitter about a half inch in each dimension. It had been developed for implanting in a space-borne chimpanzee to transmit data on weightlessness.

"We never would have developed this," the Florida man said. "There wouldn't have been a large enough demand and not enough money for development. It's funny, though; now that the thing has been developed, there's an increasing demand for them." ■ ■

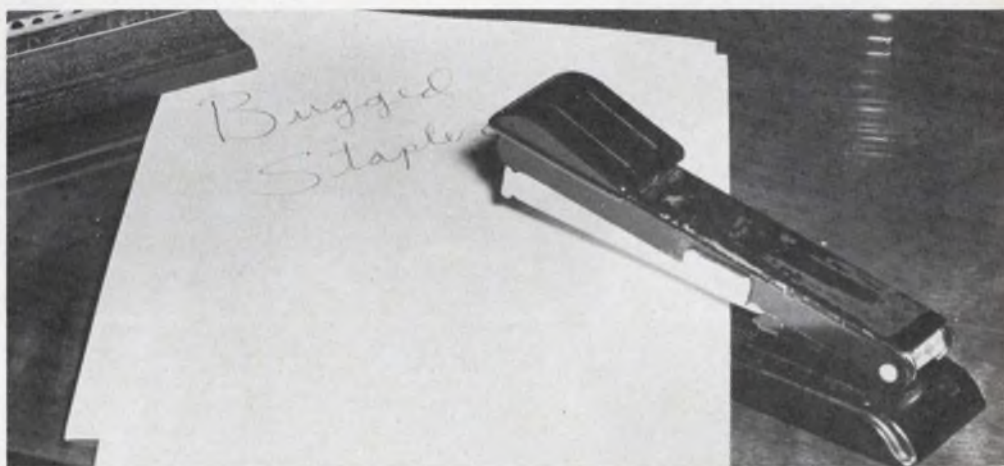

Even a harmless-looking stapler can be bugged with a hidden microphone.

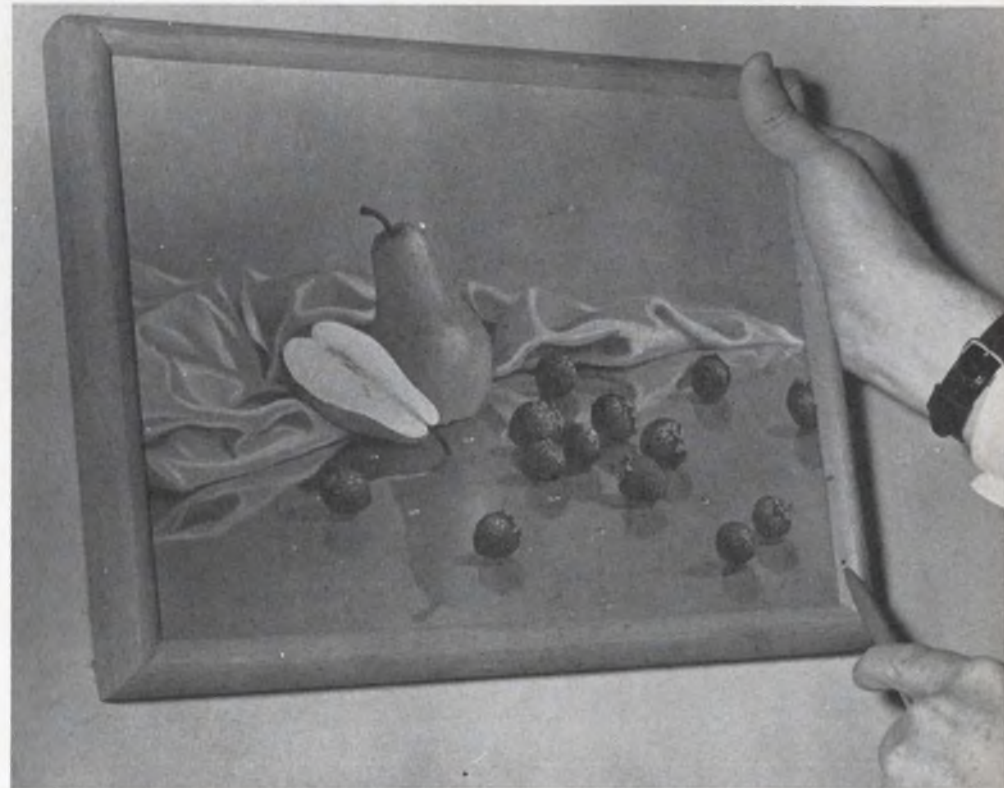

Electronic eavesdropping in hotel rooms is made convenient with pic-

tures like this one. A microphone is concealed behind the small hole.

Basic circuits turn into electronic spies

Professional eavesdroppers are firm believers in the adage, "You don't use a cannon ball to kill a fly." If a simple device will do the job, they use it. If the bug is likely to be suspected or encounter anti-bugging interference, more elaborate techniques are called for. Today's electronic eavesdropping equipment ranges from one-stage FM transmitters to microcircuits powered by radio waves from commercial broadcasting stations.

The circuits on these pages are typical of many basic types now in use. They can be built into extremely small packages. They may fall short of the requirements for international espionage, but businesses

and suspicious husbands are using them in increasing numbers.

Devices like those shown here are subject to various laws and regulations. Reputable manufacturers normally point this out to all prospective buyers. For example, one manufacturer includes the following paragraph on all order forms:

"The use of unlicensed and/or uncertified low-power transmitters is specifically prohibited within the United States and its possessions except in the audio modulated broadcast range. (See Part 15, Volume II, of the Federal Communications Commission Rules and Regulations covering incidental and restricted radiation devices.)" ■ ■

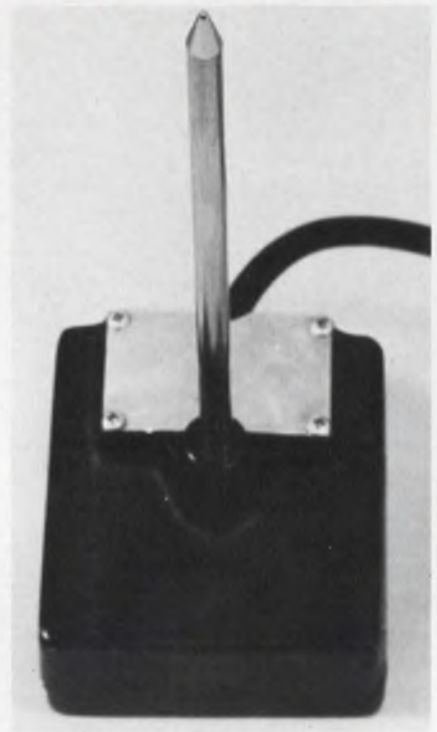

Spike mikes are used for listening to conversations in a room from an adjacent room. The spike is driven into the wall and picks up wall vibrations.

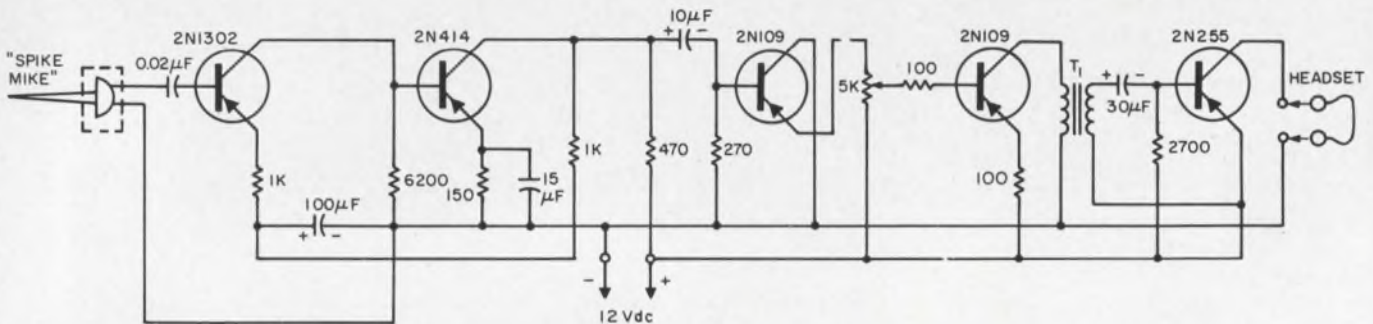

Audio amplifier for a "spike mike" can be inserted in plaster walls or doors along with the microphone. The

spike pickup makes the microphone highly sensitive and difficult to detect (see above photograph).

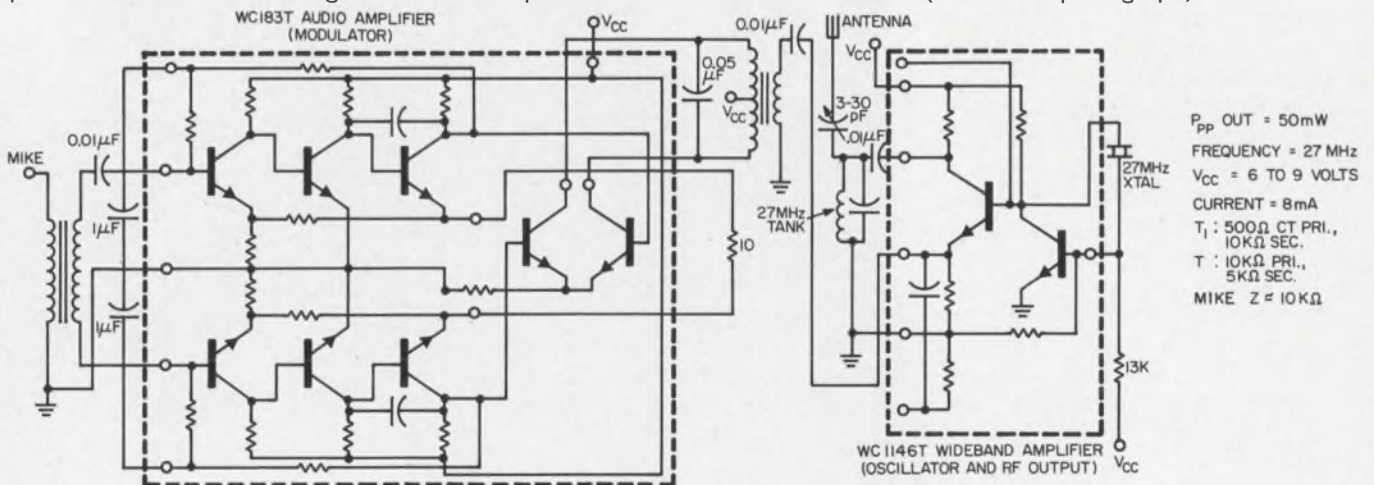

Integrated-circuit transmitters such as this can be made extremely small and consume very little power. This one

uses two Westinghouse ICs plus a few additional components and can transmit up to several hundred feet.

P_{pp} OUT = 50mW
 FREQUENCY = 27 MHz
 V_{CC} = 6 TO 9 VOLTS
 CURRENT = 8mA
 T_1 : 500Ω CT PRI., 10KΩ SEC.
 T : 10KΩ PRI., 5KΩ SEC.
 MIKE $Z \approx 10K\Omega$

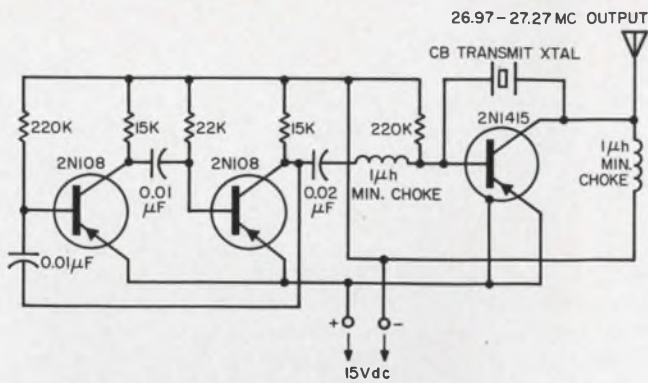

Beeper transmitter feeds audio pulses into a 27-MHz Citizen's Band oscillator. The device is often used for tracking a subject by placing it in his clothing.

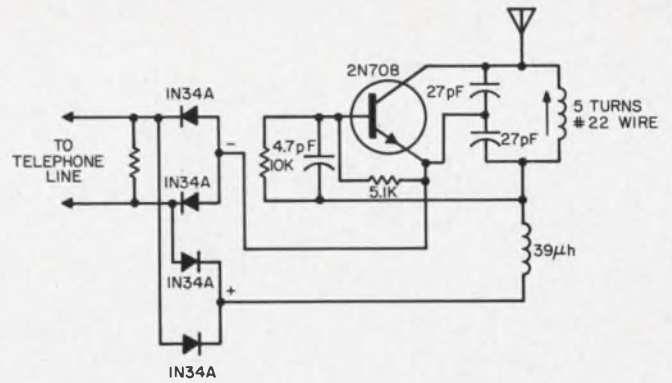

Wireless telephone bug derives power and modulation from the telephone line. It is connected in series with either side of the telephone line.

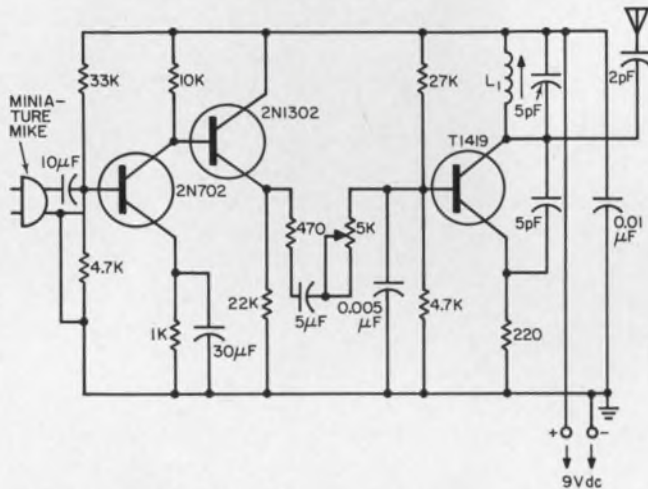

The "wireless mike," an FM eavesdropper, operates in the 88-108-MHz band. Range is approximately 50 feet with a three-inch whip antenna.

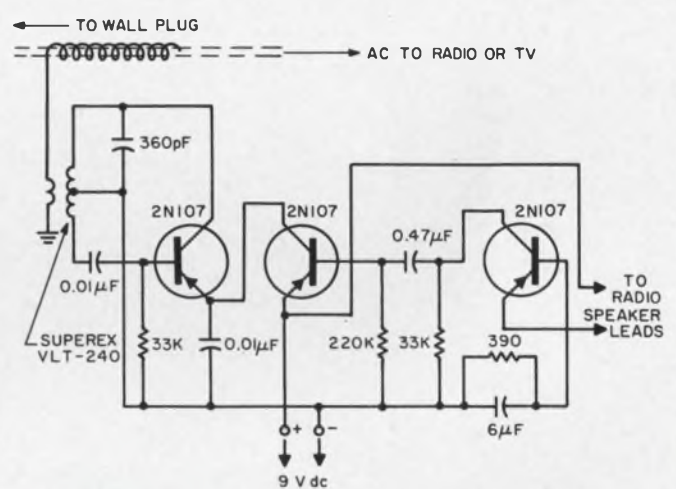

AM room bug is usually concealed in a radio or TV. It can use the speaker as a microphone and the ac line cord as an antenna. Unit operates between 500 and 700 kHz.

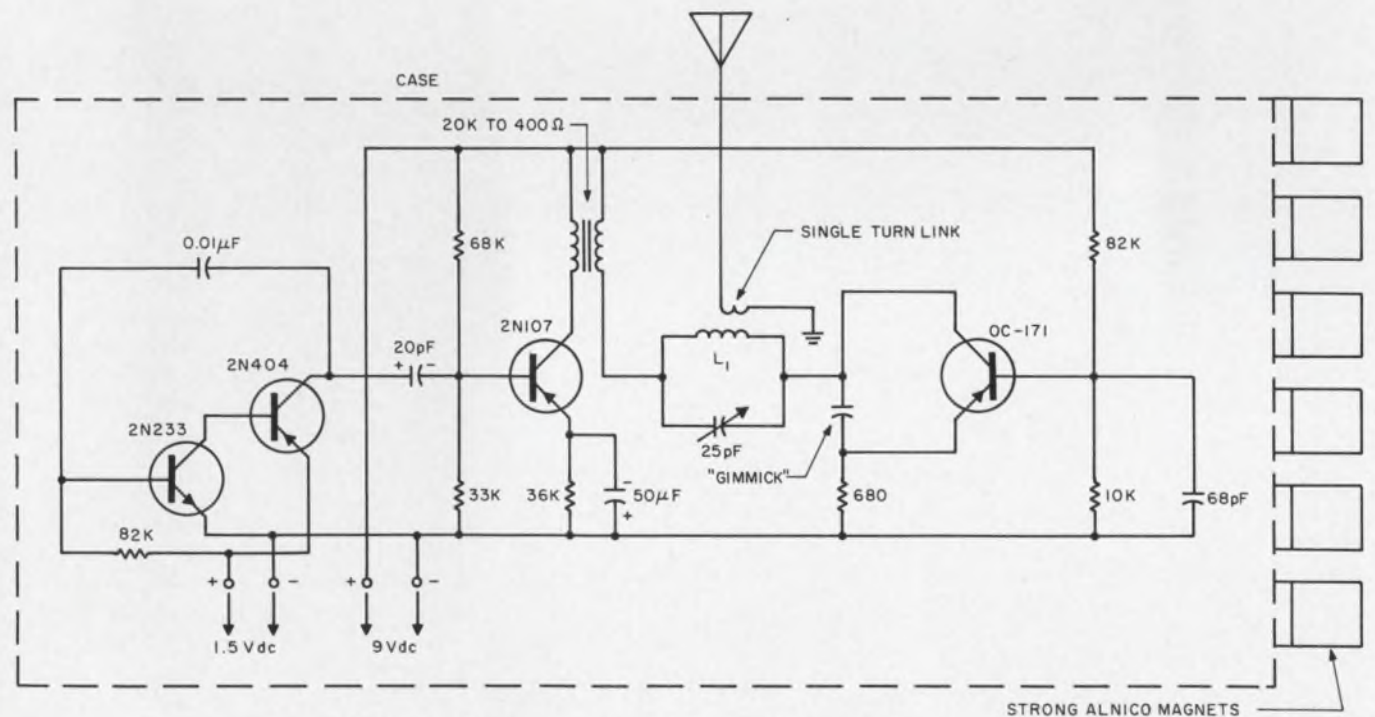

FM bumper transmitter is used for surveillance of moving vehicles. The transmitter emits a shrill audio tone near the top of the 88-108-MHz band. Magnets on the case

are used to fasten the device on to the inside of the bumper or under the gasoline tank of the vehicle to be tailed. The antenna is usually a three-inch whip wire.

Why snoopers favor telephone tapping

Frank Egan
News Editor

If there is any staple of professional eavesdropping, it is telephone-tapping. The reason for this is both social and technical. Social, in that telephones have become almost an omnipresent part of modern living, and technical because tapping is so extraordinarily sim-

ple. In effect, the person under surveillance talks directly into the tapper's microphone. The technique can be practiced by schoolboys as well as professionals.

The basic method of tapping is illustrated by the simplified schematic of a telephone circuit in Fig. 2. For tapping, the arrangement can be considered as a series circuit

that is energized by a 48-volt battery at the central office when the telephone headset is removed from its cradle. Incoming and outgoing voice signals modulate the dc circuit current to produce an ac component in the frequency range of about 300 to 3500 Hz.

Various techniques are used

Any telephone tap involves three factors: (1) The method of coupling the voice signal from the line, (2) The way in which the tapped signal is transmitted to the tapper, and (3) Power for a radio transmitter, if one is used—whether self-contained battery power or dc power drawn from the telephone circuit.

One way of tapping that uses a self-powered radio transmitter is shown in Method 1 of Fig. 2. The voice signal from the line is noninductively coupled to the input of the transmitter, where it modulates the carrier generated by the transmitter. Since the transmitter contains its own battery, no dc is drawn from the telephone line. To avoid upsetting the normal impedance of the telephone line, which is about 900 ohms, the transmitter usually has a high input impedance. Although not easy to verify, this would indicate that FETs are looked upon with favor by the more sophisticated makers of tapping transmitters.

When tapping transmitters are designed to draw their operating power directly from the telephone line, they extract both dc power and voice modulation from the line. Because of this; they tend to upset the normal characteristics of the line more than transmitters that have their own batteries. As shown in Method 2 of Fig. 2, this type of transmitter can be connected directly across the line. Other units are designed to be connected in series with either side of the line.

Power drain is a factor

Low power drain is an important requirement of transmitters that operate directly from the telephone

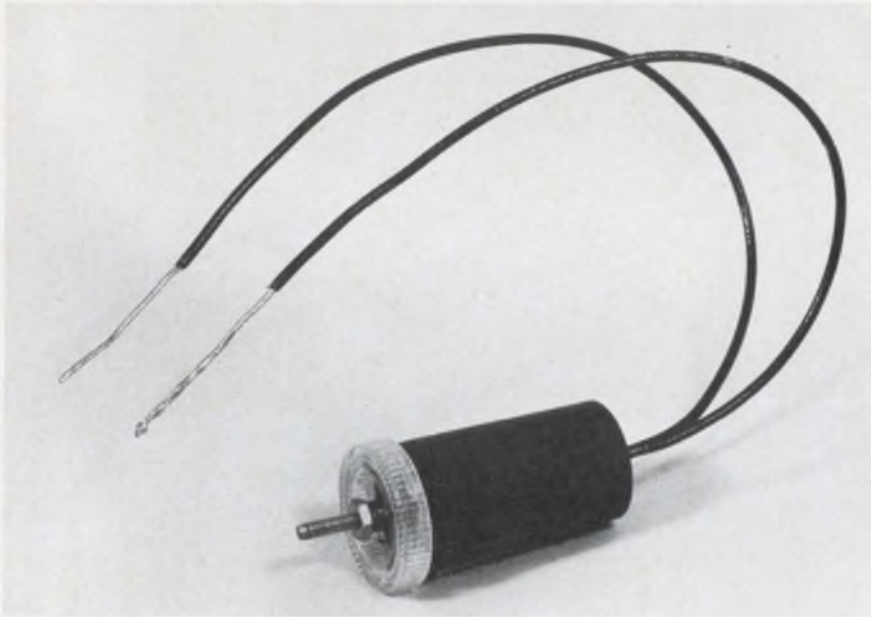

FM two-wire tap fits conveniently into the base of a telephone.

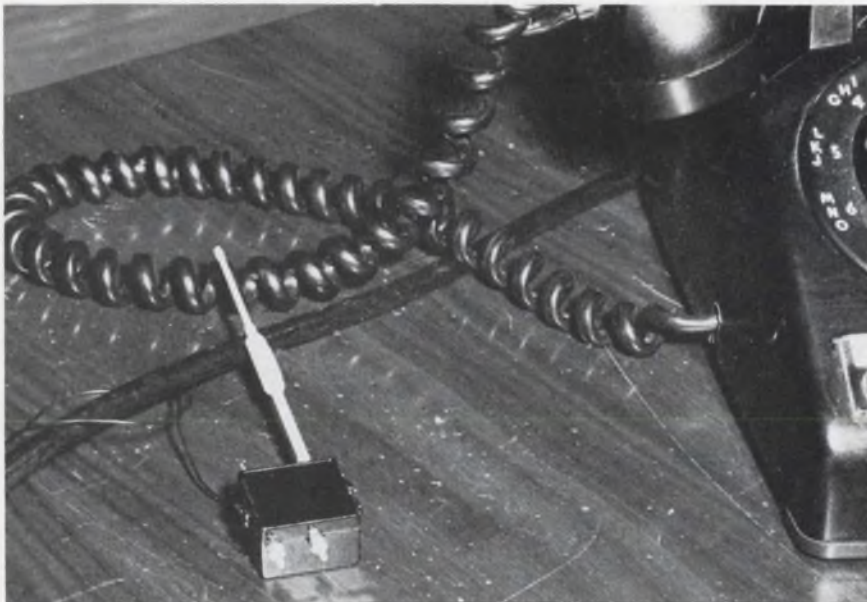

Tapping transmitter with pickup loop can be concealed anywhere along telephone line.

line. This is particularly true of the parallel types that are connected across the line, since they close the circuit between the tapped telephone and the central office, even when the phone is not in use (headset switch open). The line relay in the central office trips when line current exceeds about 40 mA. To prevent this telltale occurrence while the tapped phone is not in use, the transmitter must draw dc current of less than 40 mA. Transmitters have been designed to draw considerably less than this—something on the order of 1 mA. With this small current drain, the tap is difficult to detect by line checks made at the central office.

The minimum detectable current depends on the age and condition (leakage, etc.) of the line, and this varies from central office to central office. Sophisticated tappers know this and select their equipment and techniques accordingly.

One of the oldest methods for tapping a telephone line is the use of inductive pickup. In its crudest form this is merely a homemade coil wrapped around a nail, which is placed alongside the telephone line. But with the advent of advanced tapping techniques, homemade coils have given way to highly efficient probe coils.

A favorite tapping technique is to place a probe coil alongside the sidetone coil in the base of a telephone. The sidetone coil, which is used to generate part of the voice signal back into the earpiece, provides an excellent means of coupling the voice signal out of the line.

The probe-coil pickup may be

used to modulate the output of a transmitter, as in the noninductive pickup methods, or it may be connected by concealed wires to a tape recorder or other listening device. The advantage of connecting it directly to a listening device, of course, is that there is no radiated signal to be picked up by anti-bugging receivers.

Both the inductive and noninductive tapping techniques can be applied not only at the tapped phone itself, but also anywhere along that phone's line. This includes junction boxes and terminal boxes, or even at the tops of telephone poles. Often this remote tapping precludes the need for a radio transmitter; the tapper uses only a pickup probe, an amplifier and a listening or recording device. Such taps are virtually impossible to detect other than visually.

Three-wire taps also used

All the taps described thus far are called "two-wire taps" by professionals. There are also "three-wire taps," which keep a phone energized and operating as a microphone even when the headset is in the cradle. They do this by effectively jumping the headset switch but at the same time keeping the circuit current below the value required to trip the line relay at the central office.

To combat three-wire taps, white noise generators are used widely by security-conscious Federal agencies. When a phone is not being used, the generator applies a noise spectrum to the line that masks all room conversation.

Variations on the rudimentary tapping techniques abound. How sophisticated the variations are may depend on the value of the information to be obtained and also, to a great extent, on whether the tap is suspected. This is especially true when it comes to turning tapping transmitters on and off remotely to avoid detection.

In certain situations, such as in countries where the central telephone office is controlled by the tapper, three-wire taps have been turned on and off by the application of appropriate high voltages to the line from the central office. Tapping setups are also now used that can be activated from a remote phone by dialing the tapped phone and using a musical note or similar source to transmit a tone to the tap. Tone-sensitive switching elements then activate the tap. ■ ■



It looks like a pen, but don't expect it to write. This RF noise generator will effectively jam the output of any nearby bugging transmitter.

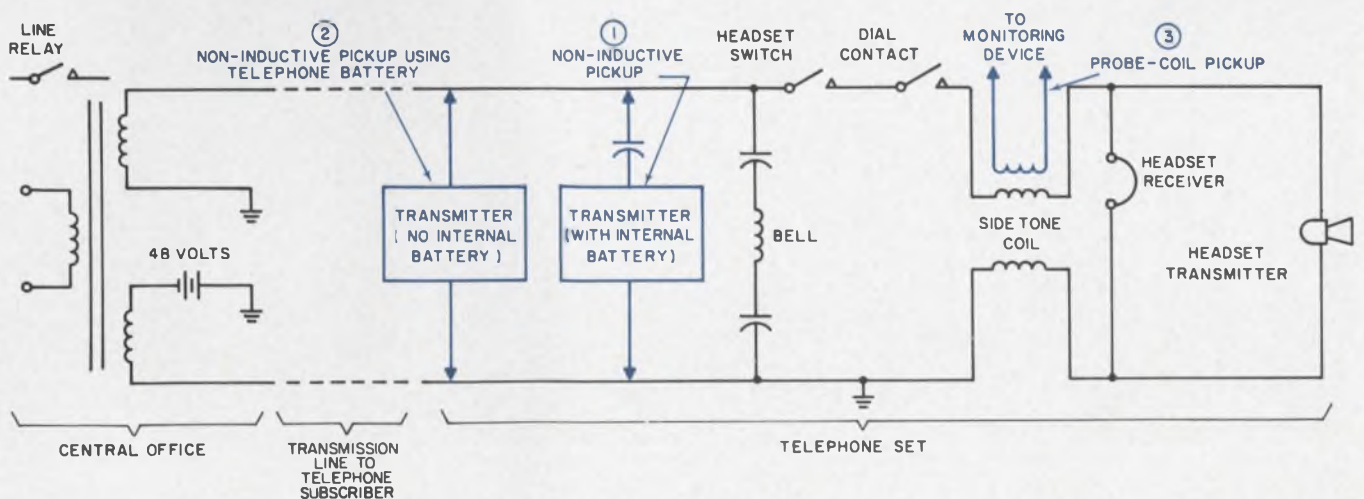

2. Telephone tapping is widely used by eavesdroppers, mainly because it is convenient and simple.



**The 7100 cures last
digit jitters.**

**It corrects itself to
compensate for component
drift and noise.**

It only measures the signal.

**The secret is a
measuring technique
called Dual Slope
integration. How it works
is no secret.**

**We'll give you all
the details in
our 7100 data sheet.**

Get it.

FAIRCHILD
INSTRUMENTATION

The solitary bug maker: A profile

Roger Kenneth Field
News Editor

In a room on the fifth floor of an old office building in lower Manhattan, Manny Mittleman sits at a workbench and makes small electronic transmitters.

There's lots of space under and behind the dial of a telephone, and Mittleman hates to see it go to waste. Mittleman makes snooping devices. His customers are eavesdroppers who will pay a stiff price to satisfy their curiosity about the utterances and whereabouts of the public.

"I just make small electronic devices," says Mittleman, "and to what use people put them is no concern of mine."

Anyone who knows a little about electronics might easily conclude that Mittleman is given to understatement, for he tailors the leads to just the right length and ends them with precisely the right connector to facilitate installation in a phone without making a Federal case of it.

Mittleman works alone. He doesn't advertise his wares; he offers no brochures or catalogs. He claims to have made \$40,000 last year, working day and night.

He makes two different transmitters to take up spare space in a telephone. One taps the telephone's line cord for power and signal and uses it for an aerial. Connected in series with the phone, the transmitter will broadcast over a range of about one-fifth of a mile. A conventional FM radio, suitably adapted by Mittleman, receives the tapped conversation.

Another device made by Mittleman permits a snoop to listen in, from anywhere in the country, to conversations in a room that has a telephone. To set this up, the eavesdropper must first secrete an electronic bug in the phone. He then simply dials that phone from any other and blows a predetermined note on a harmonica. The musical tone triggers the bug, which cuts out the phone bell but completes the

telephone connection. Thus, the tapped phone never rings, but the snooper can hear everything said in the room.

Mittleman also makes transmitters to fill spare space in cars and rooms.

The car transmitter plugs into the antenna socket of the car's radio. The antenna, in turn, plugs into the transmitter, thereby restoring the radio's reception. One insulated wire taps the car's cigarette lighter for power. With a little practice, the eavesdropper can use the device to locate the car as well as to overhear every word spoken by its passengers.

The other transmitter contains its own batteries and can be placed anywhere in a room. Its tiny, magnetic hearing-aid microphone picks up the slightest noise in the room and triggers the device on; it turns off as soon as the noise ceases. It consumes several milliamperes when operating, but during standby its current drain falls to just a few microamperes.

Mittleman will sell these devices to anyone who can pay for them. He

charges what he feels the traffic will bear: \$250 for the phone bug, \$300 for the room and car bugs, and \$400 for the harmonica-triggered unit. All are made with standard parts and transistors. They are mounted in holes drilled in a thick lucite sheet and connected by hand-soldered wires.

Mittleman has taken his phone apart so many times to demonstrate his devices that the screws that fasten its case are practically threadless. His clientele is widely varied, because, as Mittleman points out, he doesn't ask too many questions. Not too long ago, for example, while a visitor was chatting with Mittleman in his work room, a lawyer entered and self-consciously asked to see some room-bugging equipment.

"Clients of opposing lawyers tend to watch their tongues when they see a microphone," the prospective customer said. "I thought that we might be able to record their conversation without causing them to become excessively defensive."

Mittleman reached for his screwdriver and started to open the bottom of his phone again. ■ ■

Anyone for bugging—or anti-bugging?

<i>FM transmitter for telephone tapping</i>	\$250
<i>Bug eliminator (noise generator)</i>	\$250
<i>Pocket amplifier</i>	\$185
<i>Pocket FM transmitter</i>	\$295
<i>FM receiver (modified)</i>	\$195

These devices are examples of what might be called off-the-shelf, consumer bugging equipment. They can be bought by mail or cash-and-carry.

The prices reflect two things about the business: one is the relative lack of competition, which allows the manufacturers to charge what the traffic will bear; the other is the narrow extent of the market. The cost of any development work that goes into a device must be recouped over a limited number of sales.

Three of the companies that sell a wide range of bugging and

anti-bugging devices are The Continental Telephone Supply Co. of New York City, Mosler Research Products, Inc., of Danbury, Conn., and Electronic Surveillance Equipment Co. of Miami, Fla.

Is Your
Privacy
Being
Invaded?

SO FAST IS THE THREAT OF "ELECTRONIC EAVESDROPPING" THAT THE F.C.C. HAS RECENTLY PASSED NEW LEGISLATION HOPING TO PROHIBIT THE USE OF RADIO-CONTROLLED DEVICES.

"BUG" ELIMINATOR

\$250.00

• SAFEGUARD YOUR SECRETS • GUARANTEE YOUR SECURITY • PROTECT YOUR PERSONAL AFFAIRS



Computer speaks with film vocal cords

Tireless 'optical voice' answers up to 72,000 stockbrokers' queries an hour

Even when trading on the American Stock Exchange reaches fever pitch and brokers flood it with requests for stock quotations, a tireless "optical voice" gives quick, clear answers to every query.

The voice, called the Speechmaker by its manufacturers, Cognitronics Corp. of Briarcliff Manor, N. Y., is 63 audio signals recorded on as many tracks. These tracks are simply strips of photosensitive film.

During recording, the original signals modulate the intensity of a light source, thus varying the exposure of the emulsion on the moving film track.

The film is then developed, and playback is effected by shining a light through the track on to a photocell and amplifying the cell's output. This same photographic or op-

tical recording method was used to make early "talkies."

The 63 tracks and one timing track are mounted round the cylindrical surface of a rotating drum. Light from a long tube shines through a slit on to this surface. Inside the drum the light, passing through the film, falls on the surface of a row of photocells—one cell for each track. The cells' amplified outputs compose the message heard by the inquirer.

The tracks contain numerals, various common fractions and key words such as "high," "low," "closed" and "volume." When a broker dials a quotation request, a computer locates the latest price in its memory. It then directs a series of solid-state switches to tap the tracks of the Speechmaker in an or-

der that conveys the requested information. Up to 72,000 queries an hour can be handled.

For example, the broker might dial the computer and then the code number of a certain stock, say, Unexcelled Chemical. The computer would locate the latest selling price of Unexcelled Chemical in its memory and operate the Speechmaker's switches to produce the following message: "U C TWO-TWO AND-ONE-EIGHTH, UP ONE-EIGHTH, VOLUME FIVE" (500 shares).

There are other drum systems that act as vocal cords for computers. These systems are magnetic and have a number of moving parts.

The new unit has no magnetic head to wear out, and the only moving part is the drum, which rotates at a uniform speed on a set of ball bearings.

The entire system, called "Am-Quote," was built and is operated by the Bunker-Ramo Corp. ■ ■

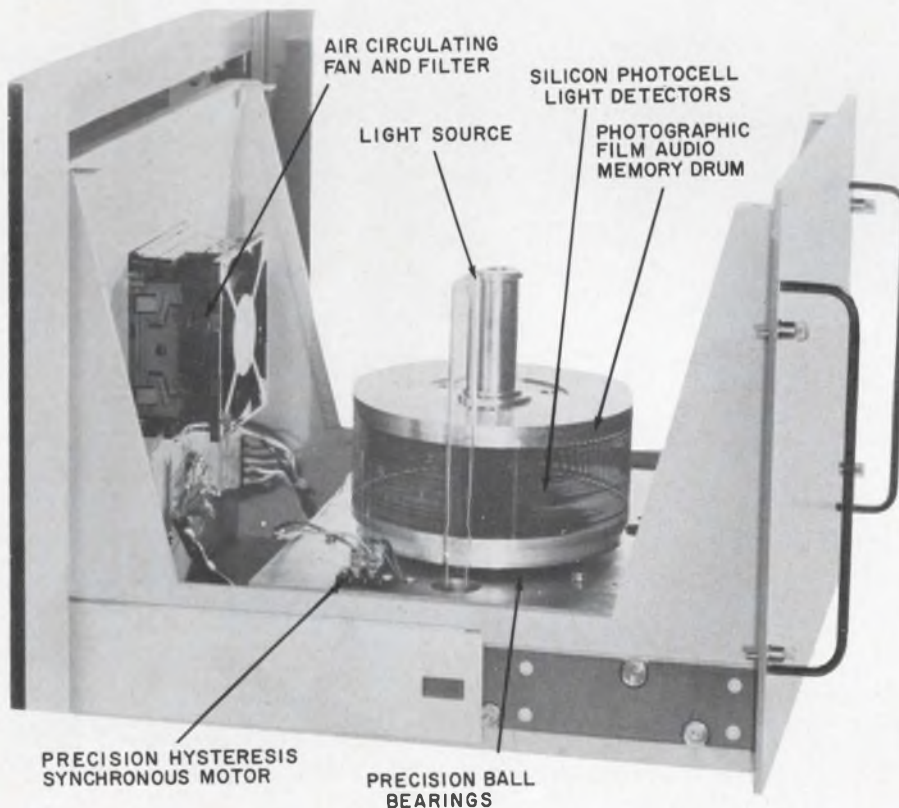

The Speechmaker's narrow light beam is modulated as it shines through the film on the drum. Photocells inside the drum detect the light.



Two coffees to go? No—on the stock exchange floor information is still passed by traditional hand signals.

Tenney couldn't let well enough alone.

When the Junior environmental chambers were first introduced, they were well in advance of the state-of-the-art. Yet our design engineers still wanted wider parameters, more precision, more economy of operation. The results of their labors are shown below:

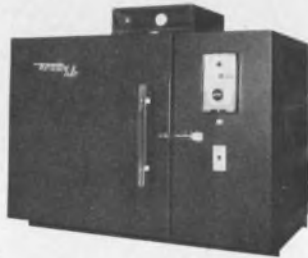

Tenney Jr. Bench Model High-Low Temperature Test Chamber

New Temperature Range From -120°F to $+350^{\circ}\text{F}$!

New mechanically-refrigerated Tenney Jr. features wider temperature range with $\pm 1/2^{\circ}\text{F}$ control throughout with indicator. Full 1,400 cu. in. test area. New, faster pull down.

greater load dissipation. New fan guard. 2¢ per hour average operating cost! Hermetically sealed inside and out. Weighs only 200 lbs. Simple plug-in operation.

Still only \$990, complete and available for immediate delivery.



Space Jr. Bench Model Thermal Vacuum Simulator

Heat, Cold & Vacuum for the Price of Vacuum Alone!

New improved mechanically-refrigerated Space Jr. for testing under deep space conditions. Temperature range from -100°F to $+350^{\circ}\text{F}$ with $\pm 1^{\circ}\text{F}$ control throughout. Standard altitude of 1,100,000 ft. with an LN₂ cold trap (approx. 7.5×10^{-8} torr). 1,728 cu.

in. test area. High vacuum construction throughout. Self-contained, air cooled, plug-in design. Temperature surfaces are blackened for high emissivity.

Available for immediate delivery.

*LN₂ shroud for lower temperature and other optional accessories

To order, or for more information, write to



Tenney
ENGINEERING, INC.

1090 Springfield Road • Union, New Jersey

Western Division: 15700 S. Garfield Ave., Paramount, Calif. 90723
Oldest and Largest Manufacturer of Aerospace and Environmental Equipment

NEWS

Computer controls model railroad

Computer-controlled railroads may be old hat but they're not too common a sight inside a convention hall. Visitors to last month's Spring Joint Computer Conference had an opportunity to see just such an indoor railroad. Computer Control Company, Framingham, Mass., exhibited an HO-gauge (approximately 1/87 actual size) railroad operated under control of its DDP-116 computer.

A miniature diesel locomotive selected box-cars from one or more of the railroads sidings until a train of desired length was made up. After pulling the train out of the sidings, the locomotive could then be directed to move the cars to an uncoupling ramp where the cars would be released one at a time and allowed to roll back into their proper siding track. If desired the entire train could be directed to run continuously around a closed loop.

All operations were under control of the DDP-116 computer. Changes in the railroads pattern of operation could be made by the operator using a teletypewriter connected to the computer's input.

Basic difference between the operation of the miniature set-up and its full-size counterpart is the method of sensing and identifying the cars. Where full-size automated railroads use photosensing to locate and uniquely identify a car, the miniature railroad used reed switches operated by magnets fastened to the underbody of each car. Also, the computer keeps track of the location of each miniature car rather than uniquely identifying it by photosensing. ■ ■



DDP-116 computer was used to control all operations of this model railroad set-up.

211

Dummy talks/hears for NASA studies

NASA can now talk and listen to a plastic-coated replica of an average astronaut.

The dummy head and torso, complete with speaker "mouth" and microphone "ears," was fashioned by a Brooklyn, N. Y., sculptor, Bruno Civitico, to within one-tenth inch of the dimensions of an average astronaut. To simulate the acoustical properties of human skin, the dummy was coated by its makers, CBS Labs., Stamford, Conn., with a plastic compound.

The dummy will be used to test communications headgear such as space helmets, earphones and microphones. The ears are the acoustic equivalent of human ears. The dummy can speak as loudly as any astronaut and hear even a whisper. ■ ■



Thermistor uses diamond element

A diamond thermistor temperature sensing device that continuously senses temperatures from cryogenic to red heat has been developed by General Electric. The unit utilizes a specially-processed diamond crystal as the electrical resistance temperature sensing element, and is reportedly the only thermistor known today that can sense over such a wide temperature range without discontinuities. Engineering samples operating between -200°C and $+650^{\circ}\text{C}$ are scheduled for introduction in September. ■ ■

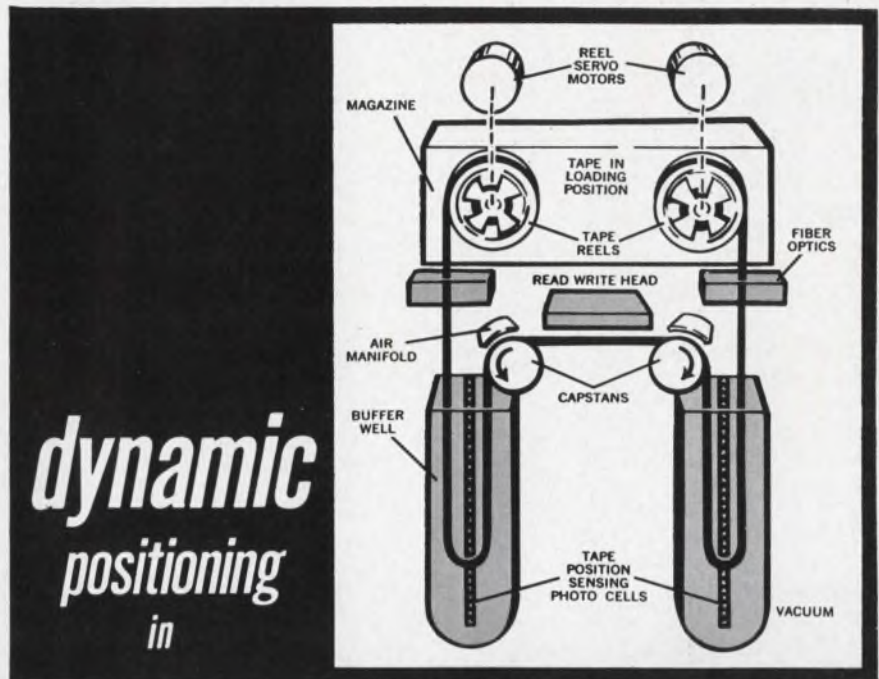

*dynamic
positioning
in*

DIGITAL TAPE TRANSPORTS

Inland's Standard DC Direct-drive Torque Motors Solve MOBIDIC Tape Transport Problems

Faced with meeting the rugged requirements of military operation, Sylvania's Electronic Systems Division of General Telephone & Electronics Corp.

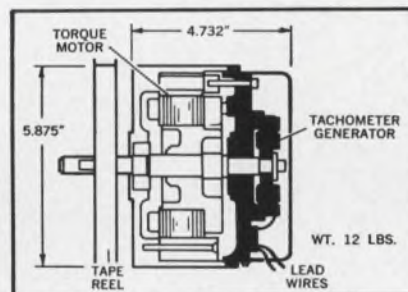

turned from conventional tape transport designs and developed a unique militarized system capable of optimum tape handling without damage or distortion. This modern, miniaturized design provides rapid reversal (less than 6 milliseconds) so programming is not restricted, high controlled acceleration and deceleration, (empty reel: 570 rad/sec^2 , full reel: 270 rad/sec^2), wide dynamic speed ranges (1000/1).

Sound impossible? Not to Inland Motor. Inland's standard Model TT-4005,

tachometer generator-torque motor combination surpasses these performance requirements. Featuring a peak torque output of 3.5 lb.-ft., the DC direct-drive torque motor, with dumping enhanced by a DC directly-driven tachometer generator, furnished the linear speed/torque characteristics required over these ranges. Easily controlled by current limiting, it also provided the desired acceleration. Dynamic braking assisted the quick reversal. Since it was direct-drive, the operation was smooth and back-lash free.

Whatever your servo application may be, you can rely on INLAND to meet your most demanding requirements.



TORQ SAYS:

If you'd like complete details on this unusual application and other interesting facts on Inland direct-drive servo components, write today.

INLAND MOTOR

CORPORATION
RADFORD, VIRGINIA
703-639-3973

SUBSIDIARY OF **KOLLMORGEN**
Speed Inquiry to Advertiser via Collect Night Letter
ON READER-SERVICE CARD CIRCLE 20

Letters

U.S. railroads run faster trains

Sir:

Your article "Full Speed Ahead of High Speed Trains" (ED 6, 3/15/66, p. 22) was extremely interesting. However, knowing your desire for accuracy in ELECTRONIC DESIGN, I feel I must point out one error.

The Canadian National Railway's "Rapido" by no stretch of the imagination is the fastest train in North America. Its top speed of 93 mph (according to the January '66 issue of *Trains* magazine, maximum allowable speed for this train is 90 mph) is below the regularly scheduled 100 mph hit by the Illinois Central R.R.'s Train No. 1, the "City of New Orleans", near Kinmundy, Ill.

Even the 67-mph average of the "Rapido" is nothing unusual. In the United States and Canada there were more than 22,000 miles of passenger runs made daily last year at average start-to-stop speeds in excess of 70 mph. To name but a few, the aforementioned I.C. Train No. 1 averages 79.5 mph over the 124.6 miles between Champaign and Centralia, Ill.; the Atlantic Coast Line's "East Coast Champion" is scheduled for 76.0-mph average between Florence and Charleston, S.C., a distance of 95 miles; and one of the present long-distance speed champions, the Santa Fe's "Super Chief", covers the 100 miles between Garden City and Lamar, Kan., at a

scorching 82.1-mph average.

Of course, all these runs will seem turtle-like once 160-mph trains are operating in the North-east corridor.

W. E. Warden

Senior Design Engineer
Specialty Control Department
General Electric Co.
Waynesboro, Va.

People who live in glass houses . . .

Sir:

In your editorial, "Engineers are too often silent on major social issues," you criticized a recent anti-Vietnam-war march down New York's Fifth Avenue and a counter-demonstration by a group of "neo-Nazi hecklers" on the sidewalk.

Why is everyone who is against the "let's surrender" groups sooner or later branded a Nazi or fanatic? You preach against warped judgment, but then you do the same thing. Were they a group of "neo-Nazi hecklers" or were they just people tired of seeing traitors and cowards use our streets to damage

our reputation? If these people are afraid to join the service and fight for their country, why don't they just admit it?

But to get back to you, the stable, considerate engineer with a cold, reasoned approach: Someone sick of demonstrators, in a momentary outburst, said, "Let's shoot 'em down," and do you coldly reason or do you jump up and down and shout. "Nazi"? Have you ever heard the old one, "Practice what you preach"? At least, don't print it if you must babble.

Paul Doerr

San Francisco Bay Naval Shipyard
Vallejo, Calif.

All for Siemens

Sir:

Thomas Parsons has asked who Siemens was [ED 10, Apr. 26, 1966, p. 35] and his question deserves an answer. Werner von Siemens lived from 1816 to 1892; he was one of Germany's great scientists, working in the field of high-current techniques. In 1866 Siemens discovered the dynamoelectric principle which became the basis for the construction of high-frequency transmitters around the turn of the century. His scientific research and a number of other inventions made Siemens' name known round the world.

Both Ohm and Siemens were great scientists and it seems to me it was a matter of questionable taste to turn Ohm's name upside (continued on p. 54)

Accuracy

The author of "Build a tone-burst generator for \$50" in ED 4, Feb. 15, 1966, p. 105, points out that the five shaded connections shown below were omitted from the lower half of the original schematic.

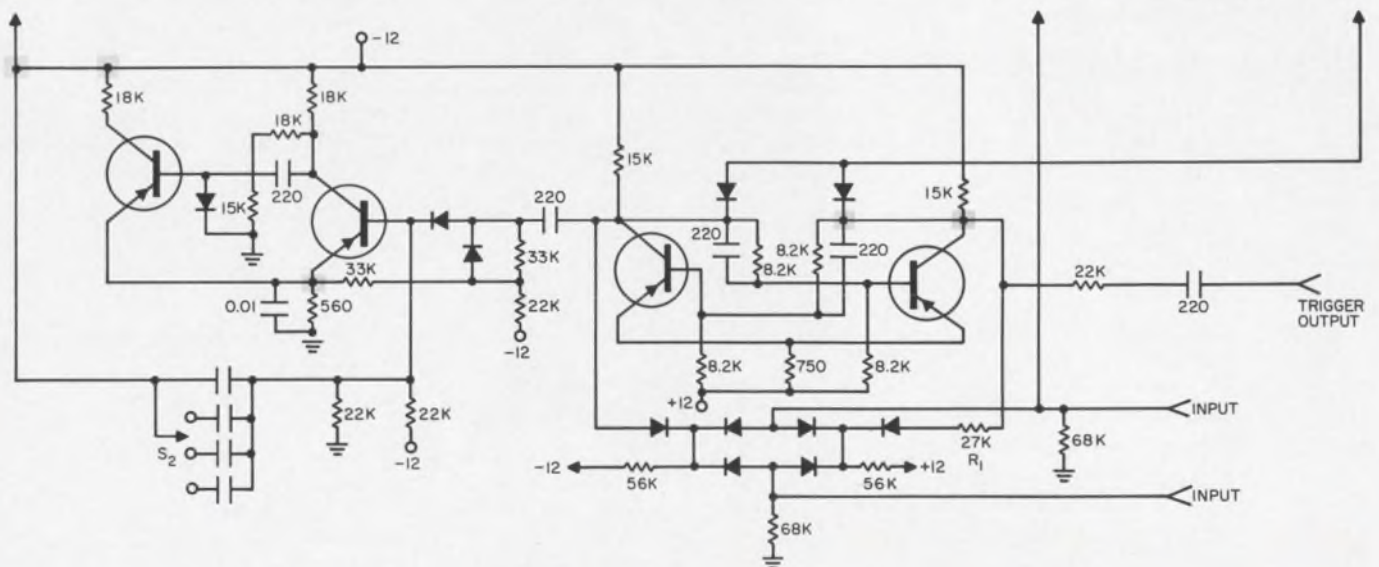



3 times out of 4
our distributor has your
switch order in the bag.

The bag
we call
Uni-Pak.

Your Cutler-Hammer Distributor sells more than 10,000 different commercial switches and military switches. One of these will do your job, or we're ready to design the special that will.

More often than not, he can fill your switch order from right off his shelf. Because of Uni-Pak.

What's Uni-Pak all about?

First, Uni-Pak covers the 350 basic commercial and military switch models that account for 75% of our Distributors' orders. Next, Uni-Pak is convenient packaging: one switch with mounting hardware per sealed plastic bag; 25 bags per carton.

Most important, Uni-Pak provides immediate local availability of all these popular, conveniently packaged switches. Your Distributor's stocks are substantial. Our factory back-up stocks truly enormous.

Now you have immediate switch selection without tying up dollars in inventory. For prototype production. To cover unexpected rush orders. The switches you need today, you order today. Or yesterday at the earliest.

Chances are excellent that our Uni-Pak switch program can pay-off in better service for you. Plan to discuss it soon with your nearby Cutler-Hammer Distributor.

CUTLER-HAMMER

Milwaukee, Wisconsin 53201



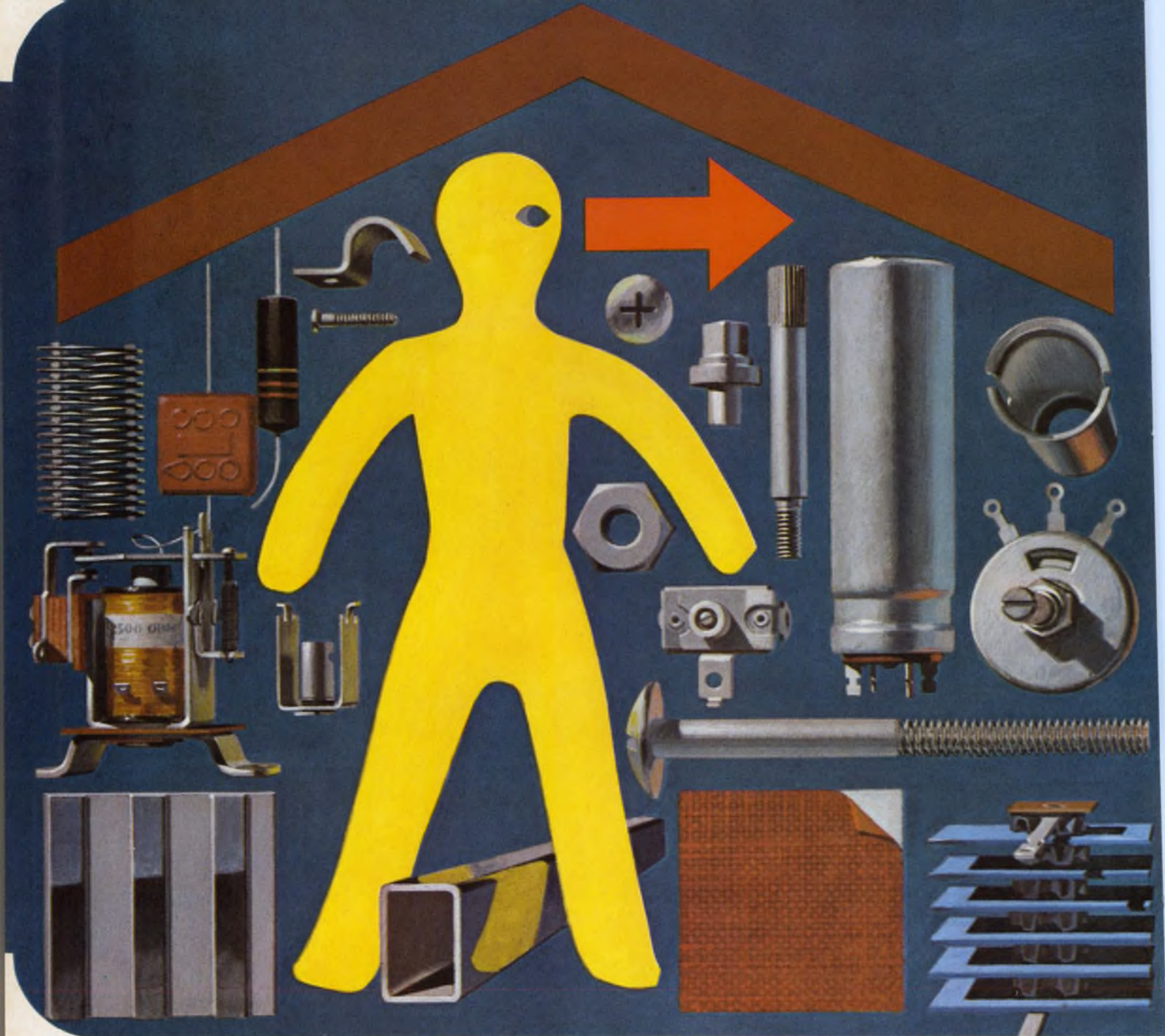

**Alcoa Aluminum
makes your choice
easier when you
must meet all
5 product-
personality
requirements.**



Environment

Alcoa® Aluminum is durable. In the lab or in the field, lightweight, corrosion-resistant Alcoa Aluminum will stand up against everyday wear and tear. Pound for pound, it's stronger than steel. And Alcoa has the alloys that can meet your most exacting requirements.



Application

Alcoa Aluminum is versatile. It's nonmagnetic, nonsparking, dampens vibration and, since it is an excellent conductor of both heat and electricity, it's suitable for a wide variety of enclosed applications.

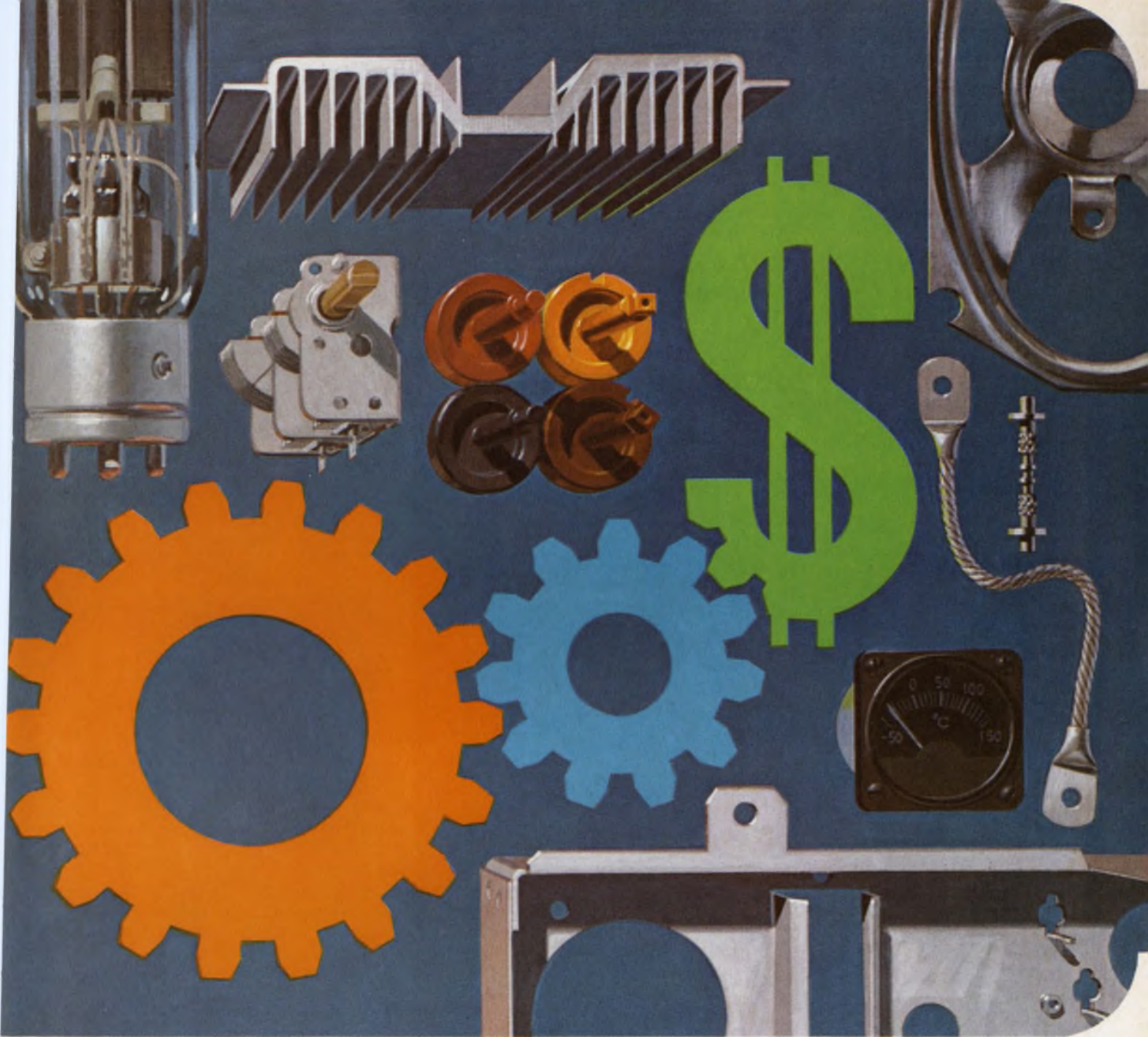

Aesthetics

Alcoa Aluminum is easy to finish. Either alone or in combination with many other materials, natural aluminum has a pleasing appearance that can be enriched by embossing the surface or by the addition of color—in a broad spectrum.

Production

Alcoa Aluminum is easy to fabricate. It can be cast, forged, extruded, machined or drawn . . . formed or fastened by practically any method, often at cost savings.

Customer Satisfaction

Alcoa Aluminum is oriented to your customer's needs. A wide variety of shapes and sizes, alloys and finishes, properly applied, assure the best performance of your product.

For complete information on how to put aluminum's five-point

personality into your product, contact your nearest Alcoa sales office. Or write: Aluminum Company of America, 1780-F Alcoa Building, Pittsburgh, Pa. 15219.



ALCOA

Change for the better with Alcoa Aluminum

MODEL T-60 60 KHZ TIME CODE RECEIVER

- Round The Clock WWVB 60 KHZ Binary Time Code Broadcasts
 - Most Accurate Time Signal Available
 - Can Be Recorded Continuously
- Radio Station WWVB is broadcasting complete time information using a level shift carrier time code (10 db level changes). This code, which is binary coded decimal (BCD) is broadcast continuously and is synchronized with the 60 khz carrier signal. The station identification is provided by a phase shift of

45 degrees forward at exactly 10 minutes after each hour and the reverse shift at exactly 15 minutes after each hour. The Schmitt BCD output can be completely automated for continuous monitoring of extremely accurate real time and time interval information.

MODEL T-60A \$480.00
3 1/2" x 19" rack panel with 5" depth behind panel. Includes 117v, 50 to 400 cps supply, or an external 12 to 16 volts may be used.



Write, wire or phone for complete catalog information.

SPECIFIC PRODUCTS

P. O. Box 425 / 21051 Costanzo Street / Woodland Hills, California 91364 / Phone: (Area Code 213) Diamond 0-3131



ON READER-SERVICE CARD CIRCLE 21

LETTERS

(continued from p. 50)
down. So I must ask: "Mho, why? Siemens, why not?"

Dr. Karl G. Lickfeld
Klinikum Essen
West Germany

Sir:

It is heartening to read Thomas Parsons' protest against the substitution of the siemens for the mho.

Our peace of mind is likewise being endangered by a similar problem. We have been earnestly asking ourselves: "Who was Inch anyway? Who was Gallon or Ounce? What did they do?" We have not yet found anyone who knows, and this strongly suggests that their exotic names do not belong in the company of Litter, Meter and Pound.

We shall take energetic and decisive action to stamp out and eradicate all units that are foreign to us and that our national pride cannot put up with.

There must be many means available for lodging a formal protest and putting a stop to the infiltration into Europe of the inch, gallon and ounce.

P.S. If Mr. Parsons is interested in logical arguments in support of his cause, he should not omit to look up *The American People's Encyclopedia*, Vol. XVII, p. 19.

Peter G. Olfs
Peter Neumann
Michael Niemeyer

Consulting engineers
Kemptenerstrasse 63
8) Munich 49
West Germany.

Sir:

For the information of Thomas Parsons and for your other readers' as well, a few words about who Siemens was. *The Encyclopaedia Britannica* states that Ernst Werner von Siemens (1816-1892) gave the world many inventions and discoveries relating to telegraph apparatus; established methods for testing underground and submarine cables; devised apparatus for duplex and diplex telegraphy; invented the modern dynamo which was the be-

ginning of the science of electro-technics.

He founded the firm of Siemens and Halske, which installed a complete telegraph line running between Berlin and Frankfurt in 1848 and demonstrated the first electric railway in 1866, among its other accomplishments.

While we do not wish to impose on anyone the use of the term siemens as a substitute for mho, we think it hardly fair to blame the suggestion on Siemens, who made no small contribution to science. All we can say is: "Have a hertz!"—Hertz is the German word for heart.

B. J. von dem Knesebeck
President
Siemens America, Inc.
New York, N. Y.

Degrees alone do not make an engineer

Sir:

I must commend your editorial, "Craftsmanship: the mark of the professional engineer" [ED 10, Apr. 26, 1966, p. 41].

From my personal experience over the years, I know that too few engineers match up to the title of "professional," let alone, "craftsman." Of course, engineering needs its specialists just like any other professional field. But it is not the specialist who gets the final job done, nor is it he who can look at a problem in its entirety and consummate a compatible, practical solution. It is the craftsman-professional engineer.

There is still available to our complex industry a relatively untapped store of these craftsmen, who in actuality can, and usually do, accomplish the real tasks unsung, while a specialist receives all the glory, as it were, for getting the job done, whether it was one of minor detail or one of the most complex design structure.

I am referring to the engineers without degrees, the men and women who have only a certain amount of higher education—not so much from the universities as in the school of hard knocks and experi-

(continued on p. 58)

Model AB-1-10
Basic Sorter for
Film Resistor Production



Model AB-8-1
Capacitor
Sorter-Leakage Tester



Model AB-4-6
Final Tester for
Resistor Manufacturers

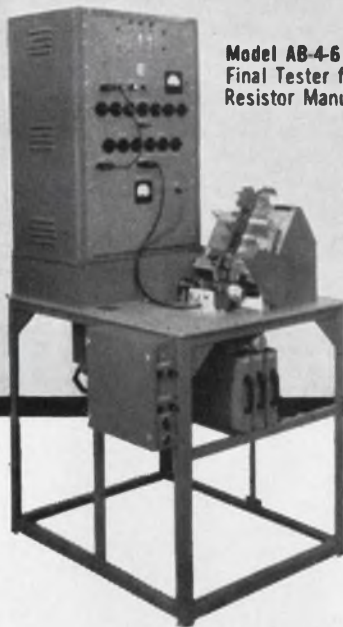

Close-up of mechanical drive
and helixing portion of Helixing Lathe

Model ABL-DC-8-2
Conveyor Fed Resistor
Helixing Lathe

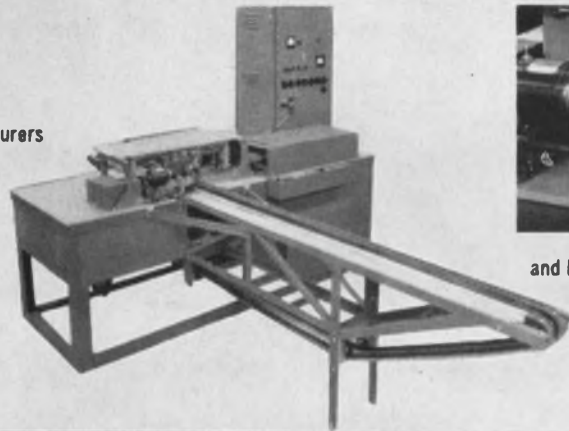

automatic component
testing equipment
for inspection and production

COMPLETE ELECTRONIC / MECHANICAL SYSTEMS

For almost two decades we have been privileged to work with manufacturers and users of electronic components in the design and manufacture of equipment to meet a variety of testing and inspection requirements. Complete electronic/mechanical systems have evolved as a result of this experience, and are now offered as standard units. Designs are thoroughly proven by actual operation.

Automatic testers generally consist of (1) the electrical and electronic circuitry required to perform the measurement involved, and (2) mechanical handling of the components to bring them to the test station, and to properly dispose of the tested components. We therefore can offer singular responsibility to customers for proper performance and operation backed up by engineering talent and manufacturing facilities experienced in the design and building of complete electronic/mechanical systems.

The units shown on this page are typical of those currently in use at some of the leading component manufacturing and user plants in the country. Our Engineering Department will be glad to study your specific requirements. Write today for a copy of our catalog describing our standard systems.

Beckman

INSTRUMENTS, INC.

CEDAR GROVE OPERATIONS
89 Commerce Road
Cedar Grove, New Jersey 07009
201-239-6200 • TWX: 201-239-4704

Formerly Industrial Instruments, Inc.

ON READER-SERVICE CARD CIRCLE 22

From the expanding line of Sigma relays...

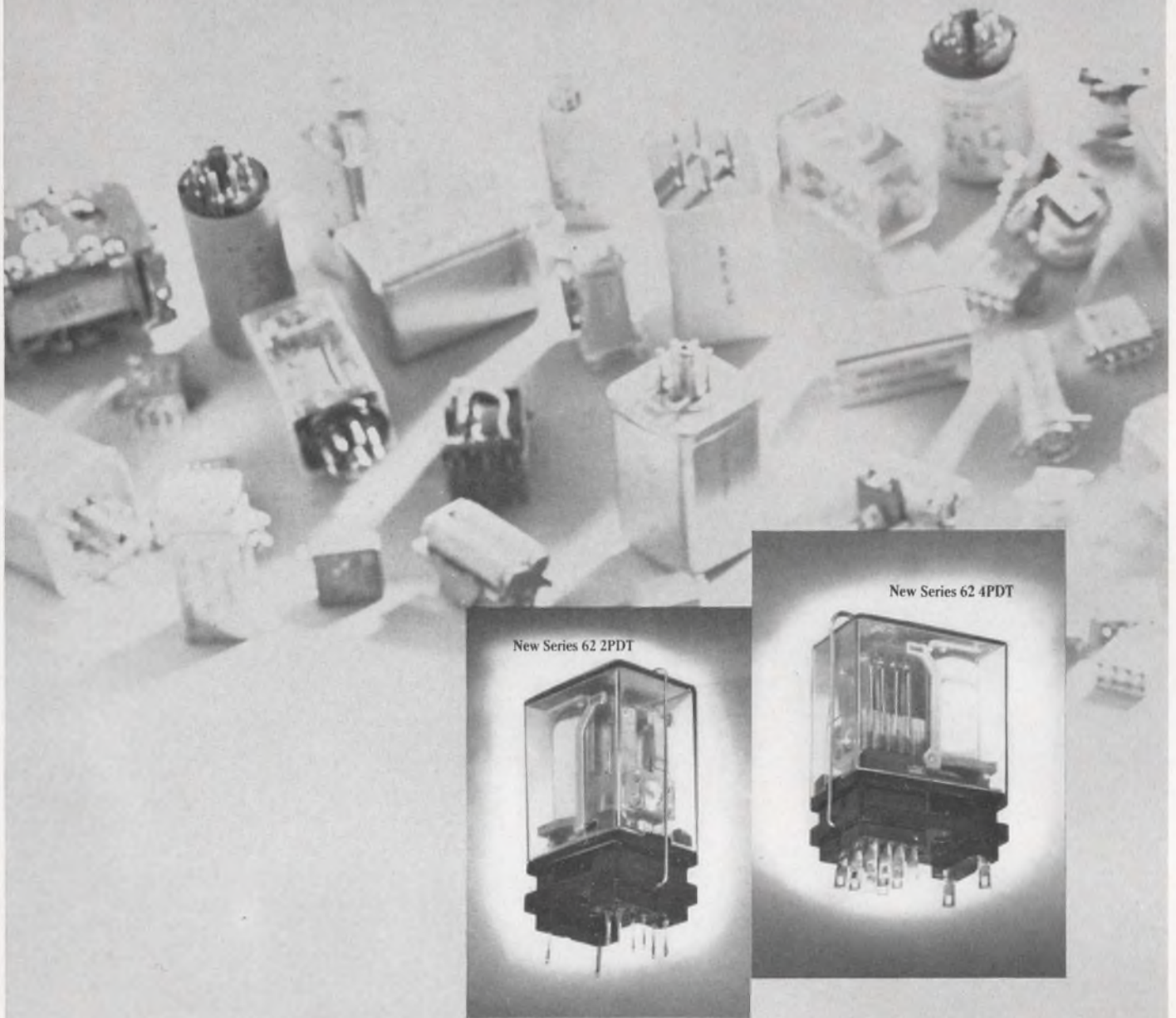

New Series 62 2PDT



New Series 62 4PDT

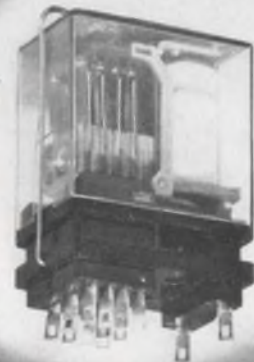

New 2, 4 and 6 pole relays* you

Here's today's closest approach to a "universal" relay—the new Sigma Series 62. These versatile, miniature relays are being used in more than 1,001 applications. Ranging from communications equipment, data processing equipment and measuring instruments to process controls, recording devices, alarm systems and many more.

You get both electrical and mechanical versatility in the new Series 62 relays. They are available in 2, 4 and 6 pole versions for lower cost switching of multiple circuits. Installation is fast and simple with solder-terminal or printed-circuit-terminal sockets designed to provide maximum space for easy soldering.

*Order them off-the-shelf.

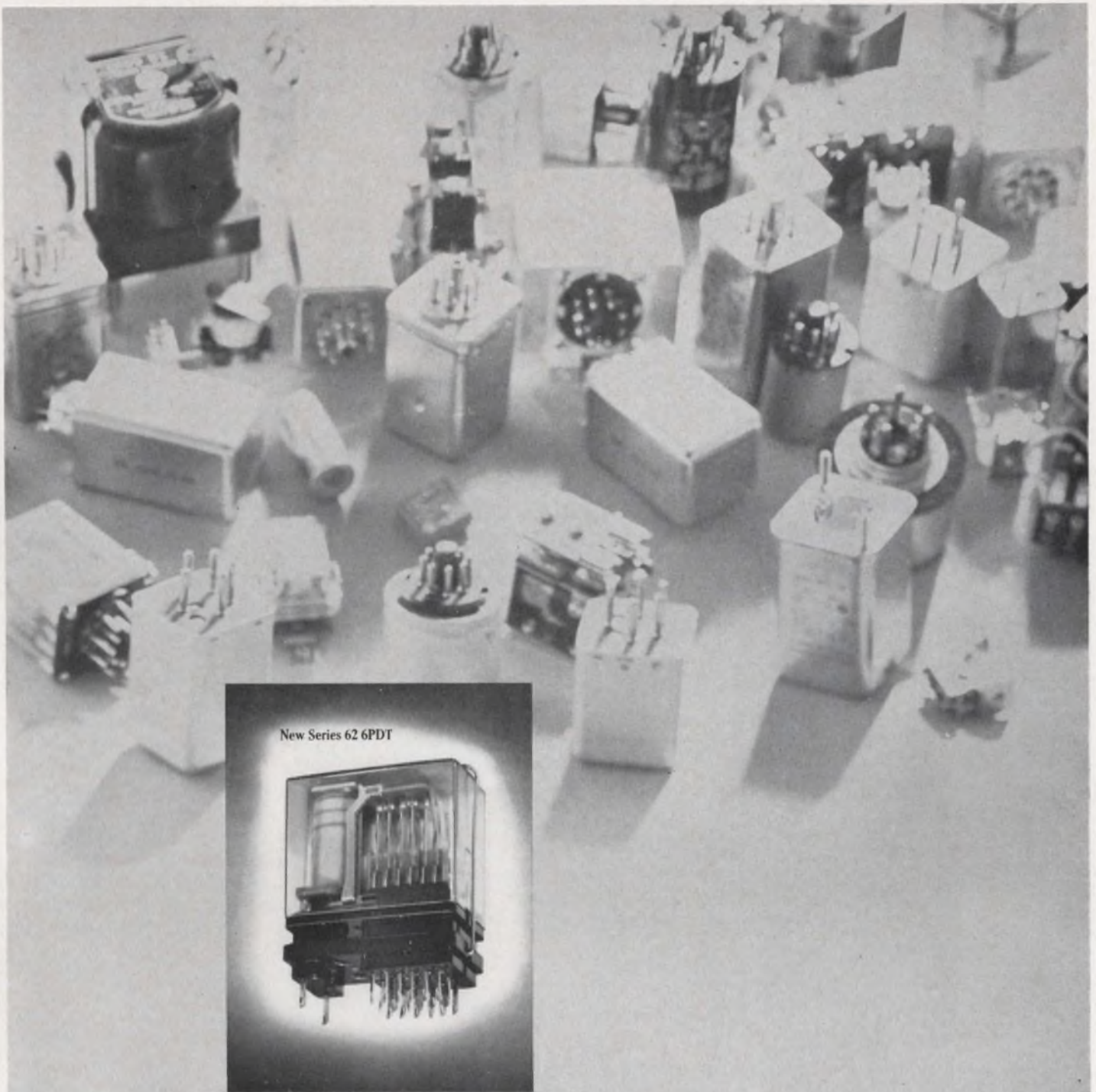

can use in 1,001 applications.

The new Series 62 exhibits excellent electrical and mechanical stability at low-level to 2 amp loads. It has an exceptionally long mechanical life of 100 million operations minimum. Each relay is available in all popular coil voltages.

There are more features you'll want to check-out in these new Series 62 "universal" relays. Your

Sigma representative or distributor will be glad to help you.

Free Catalog: Contact Sigma direct. We'll send you our new 16-page Sigma Preferred Standard and Stock Relay Catalog and an up-to-date stock listing to help you select the relays immediately available in quantity.

SIGMA DIVISION  SIGMA INSTRUMENTS INC
Assured Reliability With Advanced Design / Braintree, Mass. 02185

Sigma's line of over 100,000 relays includes Sensitive, High Performance, Pulse and Telegraph, General Purpose, Power, and Special Purpose types.

ON READER-SERVICE CARD CIRCLE 23

I-I-Is Bit J-J-Jitter



Your Problem?



FORGET IT... you haven't heard about Borg-Warner Controls Model R-150 magnetic tape recorder with electronic bit de-jittering. Bit jitter stability, caused by transport wow and flutter used to mean magnetic tape recorders were unsatisfactory for pulse-code modulation data-storage telemetry. That was before Borg-Warner Controls engineers compensated for mechanical jitter and instability electronically. Ground station telemetry input pulses are aligned to crystal clock accuracy.

IRIG Telemetry Standard limits allowable bit jitter to ± 10 per cent over a period equal to 10 times the word length. Tape transports cannot meet this requirement for any reasonable bit rate or word length—especially under environment. The BWC de-jittering buffer compensates for transport deficiencies and provides jitter free output. Send for BWC technical report 55-9401.

Solving instrumentation recorder problems through constant research is our vocation; building reliable magnetic tape recorders is our business. Tell us your recorder problems; we may have already solved them.

BWC means Built With Care

aerospace
equipment **BORG WARNER**

BORG-WARNER CONTROLS
3300 South Halladay Street
Santa Ana, California 92702

ON READER-SERVICE CARD CIRCLE 24

LETTERS

(continued from p. 54)

ence, the people who are sometimes "allowed" the titles of senior technician or, all too infrequently, junior engineer. For it takes craftsmanship, ability, ingenuity, inventiveness, stubbornness and, last but not least, fantastic pride in the job they do for these people to progress to any worthwhile level of recognition in this industry.

Let it be understood that I am by no stretch of the imagination attempting to suggest that the nondegreed engineers should degrade the degreed engineers and scientists or usurp their positions. I ask merely that they be given their fair place in the sun. I am decrying the fact that too often are they stifled, that the inventiveness and craftsmanship that they may have had has been "schooled" out of them and replaced by a false notion that competence is "above them." Many times, too, the nondegreed person has his desire to produce stamped out by his being hampered, overlooked, passed over whenever he tries to pursue his talents.

Thank goodness that there are those few left who, when told "no" or that they will never make it, set out to prove that they can and will, and *do*. These men have placed themselves among the leaders and giants of our industry and have earned their places.

W. B. Hollis

Chief Engineer
Miniquip, Inc.
Reno, Nev.

Readers split on federal auto safety measures

Sir:

I read with interest in your April 12 issue [ED 8, p. 36 ff.] the letters which criticized your stand on auto safety [ED 26, Dec. 20, 1965, p. 23]. I am as opposed to government controls *per se* as anyone, but I cannot in good conscience subscribe to a continuing policy of waiting for the auto industry to establish safety standards. It does not seem reasonable that an industry, which has not provided significant safety improvements until forced by legal action or the threat thereof for the past several years, should suddenly

claim that government interest is unwarranted, that it will solve the existing safety problems by itself.

I was astonished to read the very positive comments to the effect that at least 90% of accidents are caused by human behavior. One gentleman even suggested that those who would support intervention haven't been reading the newspapers (he must be kidding). It is a bit optimistic to expect newspapers to blame accidents directly on cars. But how many reports of accidents have stated that "the car swerved suddenly," "the driver lost control" or some similar phrase, when there was no evidence of drunkenness, excess speed, etc?

I would expect engineers to take a more open-minded view of such matters. Persons interested in automobile safety should read Ralph Nader's much publicized book, *Unsafe at Any Speed*, and take notice of the accounts of manufacturers who call back cars for "minor adjustments," etc.

I have to agree that periodic auto inspections and vigorous law enforcement will help reduce the deaths and injuries caused by accidents, but before we rule out on principle the need for government intervention to guarantee safety standards, we had better make sure to know the facts—all the facts.

R. H. Zimmerman

Senior Engineer
Data Systems Div.
Litton Systems, Inc.
Van Nuys, Calif.

Sir:

With 35 years' experience in England, the European continent, South and North America, and as a manufacturers' representative driving between 25,000 and 30,000 miles each year, I am truly flabbergasted over the sudden furore about a problem that is neither new nor original in its criminal-like consequences.

Just as radio and television have become an extension of Twentieth-Century man's communicative senses, the automobile (truck or motorcycle) has developed into an extension of man's physiological

(continued on p. 62)



100 db single-step attenuation measurements

- to ± 0.5 db accuracy
- down to -120 dbm
- at lowest cost for comparable specs

NOW...make attenuation measurements the direct and easy way. Use the new extended-capability PRD 915-A Microwave Receiver, which incorporates all the accuracy and advantages of parallel i-f substitution. The 915-A is a radiometric device with a signal sensitivity that greatly surpasses the standard superheterodyne receiver. It's a high-precision test instrument the average microwave measurement laboratory can afford.

- Measures attenuation from 10 Mc to above 40 Gc. Frequency range extended by new PRD Series 600 balanced mixers. ■ Direct-reading, easy to use. No need for calibration curves or correction charts. ■ Noise balance control for increased accuracy. ■ Automatic range-switching for ease of operation. ■ Adjustable reference oscillator allows faster measurements. ■ Reference attenuator easily removed for calibration by NBS. ■ For ultra-precision, NBS-designed and certified PRD 1904 Cutoff Attenuator provides digital readout to 0.001 db (interpolation to 0.0005 db). ■ Price: PRD 915-A, \$2,800. Immediate Delivery. ■ Send for data.



1200 PROSPECT AVENUE, WESTBURY, L. I., N. Y. 11590

ON READER-SERVICE CARD CIRCLE 216

versatile switch...

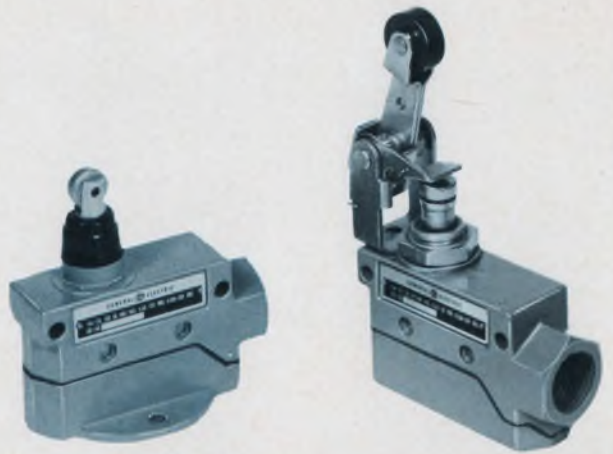

for tight spots!

NEW G-E CR115 TYPE H LIMIT SWITCH OFFERED WITH SEVEN OPERATING HEADS FOR CRITICAL-SPACE, HIGH-SPEED JOBS

Space is tight, yet you need a solid limit switch to take the mechanical punishment of a repetitive, high-speed application. General Electric's new CR115 Type H limit switch is your answer. These solidly constructed switches (32 different enclosed forms in all) adapt to any job. Seven basic switch operators make it possible: (left to right above) roller plunger, roller lever, adjustable plunger, unidirectional roller lever, spring rod lever, plunger, and a palm operator for hand operation. ■ A typical roller lever switch measures only 3 1/16 by 1 3/4 inches (a basic open switch form is even smaller). Side- and bottom-mounting further increases CR115 Type H versatility. ■ Switches are available in general-purpose and oiltight enclosures, have heavy-duty pilot ratings: 15 amps, 480 volts maximum a-c; 0.25 amps, 250 volts maximum d-c. ■ Your G-E Sales Engineer or Control Distributor can give you full details on these limit switches. Or write to General Electric Company, Section 811-66, Schenectady, N. Y. and ask for Pub. GEA-7312.



 *Leader in...*
CONTROL INNOVATION

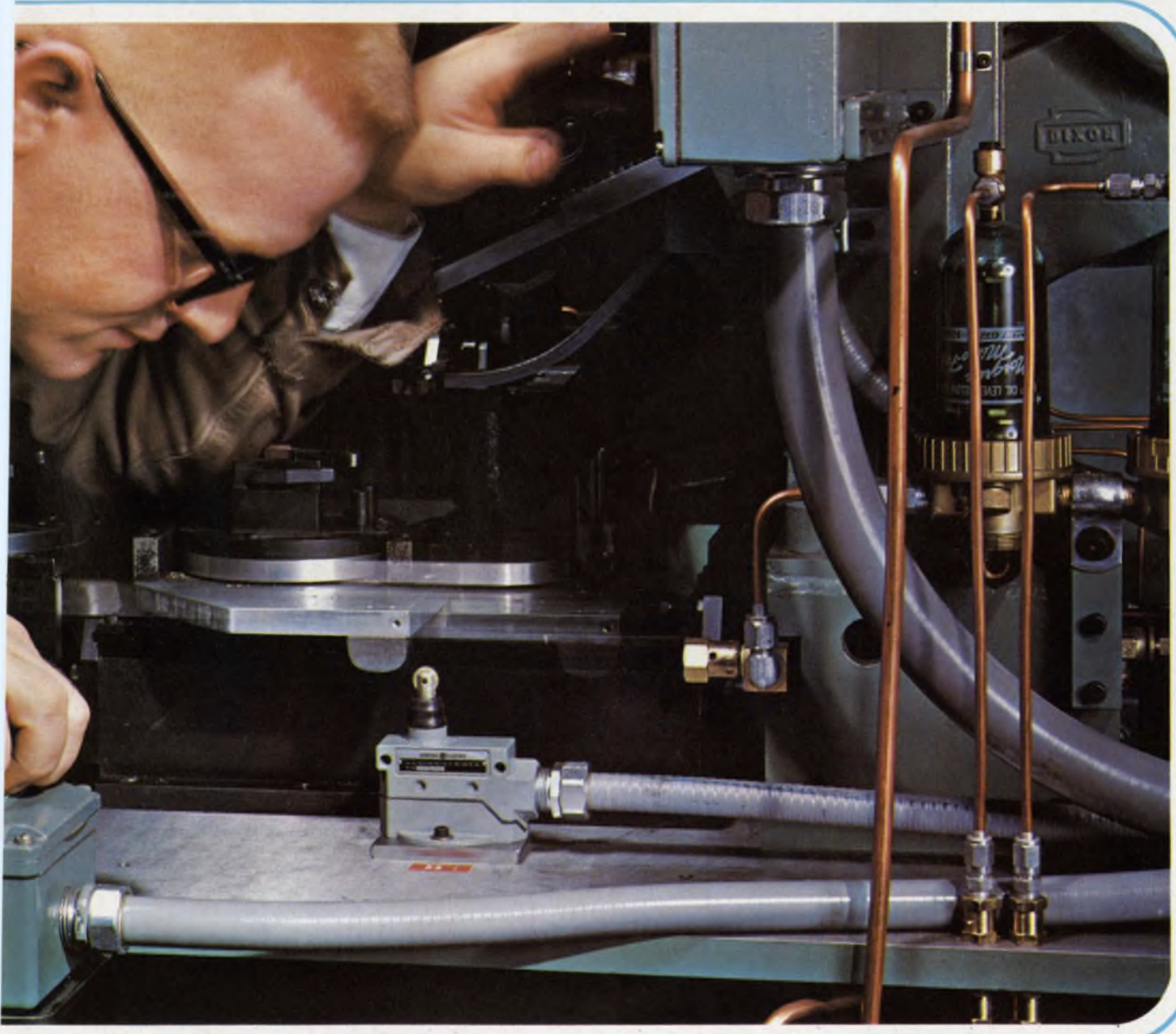
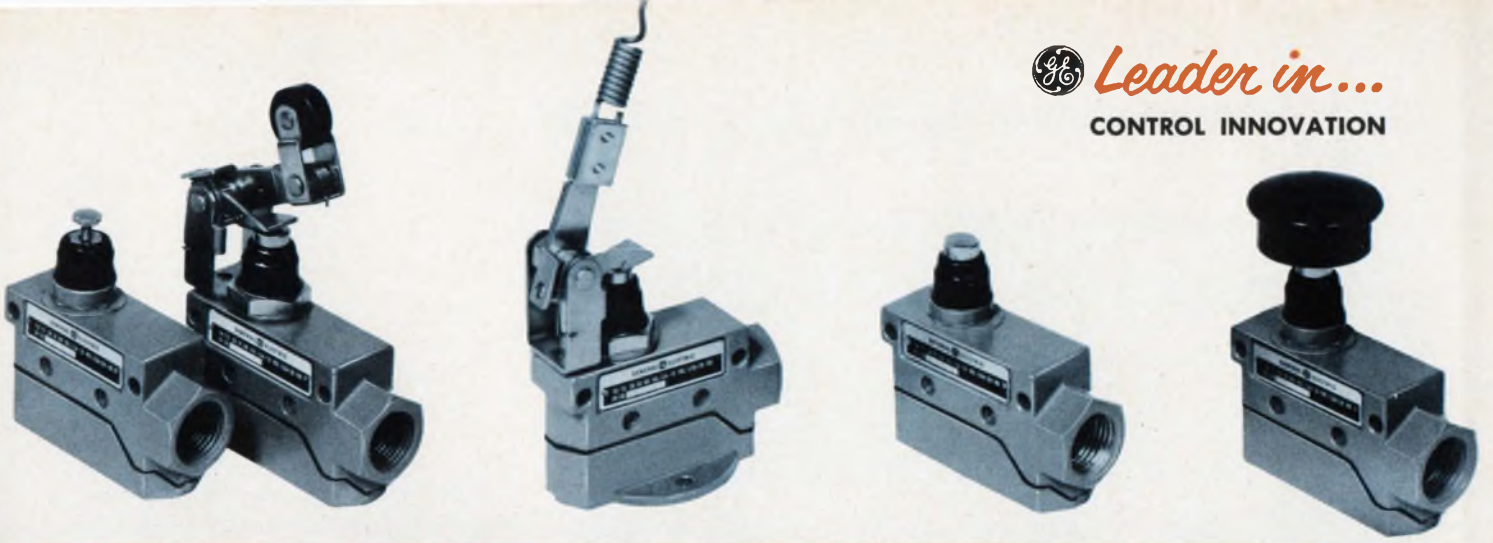

Progress Is Our Most Important Product

GENERAL  **ELECTRIC**

ON READER-SERVICE CARD CIRCLE 236



TECHNO

TRIMMING POTENTIOMETERS

An excellent variety of miniature trimming potentiometers from our broad selection of sizes and styles for precision and commercial applications. Custom variations are available for specific applications.

LETTERS

(continued from p. 58)

mobility. The former could be regarded as a passive element in a physical sense, the latter as an active element in a lethal sense.

There can be no doubt at all that the safety of any device depends solely on the capabilities of its user and on the inherently designed-in protection that the device offers against accidental misuse.

What is so extraordinary and completely incomprehensible is the American public's obvious unwillingness to demand statistical information on road accidents, i.e.:

- a) Physical condition of drivers involved (intoxicated, doped, sober, mentally or physically afflicted);
- b) age, sex and occupation of drivers involved;
- c) number of passengers in cars;
- d) make of vehicle, type, model, year and size (weight);
- e) condition of tires;
- f) type of road on which the accident occurred;
- g) condition of road, time of day;
- h) cause of death (injuries);
- i) state where accident occurred;
- j) nature of legal action; and
- k) nature of accident.

The data exist in every state and in the offices of the automobile accident insurance companies throughout the U.S. It is interesting to observe that, in spite of the recent hearings in Washington, D.C., and the avalanche of newspaper, magazine and TV editorials, such statistics were not compiled and offered to the public in general. There must be a pattern in this rising curve of fatal road accidents, a pattern that will pinpoint specific human and mechanical causes. In the case of human pattern, stricter enforcement of laws can and should be demanded. It is fantastic to contemplate that in certain states a driver "under the influence" cannot be compelled by law to submit to a blood test unless involved in a fatal accident. In the case of mechanical patterns of defects in the road system itself or in the vehicle, Federal standards become inevitable. Here again, nobody ever bothered to associate low seating position with

HUMIDITY-PROOF						
		MODEL 101	MODEL 129	MODEL 151	MODEL 176	MODEL 12
SIZE (inches)	WIDTH	.375	.375	.375	.375	.250
	LENGTH	.375	.375	.405	.405	.250
	THICKNESS	.185	.250	.185	.185	.156
RESISTANCE RANGE (ohms)		10 to 50K	10 to 50K	10 to 50K	10 to 50K	100 to 25K
TOLERANCES*		±5%	±5%	±5%	±5%	±5%
POWER RATING (watts)		1 @ 50°C	1 @ 50°C	1 @ 50°C	1 @ 50°C	0.5 @ 50°C
OPERATING TEMPERATURE		-65° to 175°C	-65° to 175°C	-65° to 175°C	-65° to 175°C	-65° to 175°C
		PANEL MOUNT				
MODEL 14		MODEL 16		MODEL 105	MODEL 160	
		.250	.250	.453	.453	
		.250	.250	.437	.468	
		.156	.185	.282	.282	
RESISTANCE RANGE (ohms)		100 to 25K	100 to 25K	10 to 50K	10 to 50K	TECHNO
TOLERANCES*		±5%	±5%	±5%	±5%	
POWER RATING (watts)		0.5 @ 50°C	0.5 @ 50°C	1 @ 50°C	1 @ 50°C	
OPERATING TEMPERATURE		-65° to 175°C	-65° to 175°C	-65° to 175°C	-65° to 175°C	
SIZE (inches)		WIDTH	LENGTH	THICKNESS		
		.250	.250	.185		
RESISTANCE RANGE (ohms)		100 to 25K	100 to 25K	10 to 50K	10 to 50K	
TOLERANCES*		±5%	±5%	±5%	±5%	
POWER RATING (watts)		0.5 @ 50°C	0.5 @ 50°C	1 @ 50°C	1 @ 50°C	
OPERATING TEMPERATURE		-65° to 175°C	-65° to 175°C	-65° to 175°C	-65° to 175°C	
DUAL		COMMERCIAL				
		MODEL 191		MODEL 20	MODEL 25	MODEL 30
SIZE (inches)	WIDTH	.775	.375	.375	.375	.453
	LENGTH	.405	.375	.375	.375	.437
	THICKNESS	.185	.218	.264	.312	
RESISTANCE RANGE (ohms)		10 to 50K	10 to 20K	10 to 20K	10 to 20K	10 to 20K
TOLERANCES*		±5%	±10%	±10%	±10%	±10%
POWER RATING (watts)		1 @ 50°C	1 @ 50°C	1 @ 50°C	1 @ 50°C	1 @ 50°C
OPERATING TEMPERATURE		-65° to 175°C	-55° to 105°C	-55° to 105°C	-55° to 105°C	-55° to 105°C

*closer tolerances available



TECHNO-COMPONENTS CORP. TECHNO

7803 LEMONA AVENUE · VAN NUYS, CALIFORNIA 91405 · (213) 781-1642

Hydro-Aire reports

a 30% reduction in installed costs

with **FLEXPRINT[®] Circuitry**

Hydro-Aire engineers turned to FLEXPRINT Circuitry instead of conventional wire for two reasons — reliability — economy.

Normally it takes at least 80 separate wires to interconnect three MS connectors and 5 printed circuit card connectors that go into a Hytrol aircraft anti-skid brake system. Now Sanders FLEXPRINT Circuitry replaces all this bulky hook-up harness, saves space and lowers the installed wiring cost of every unit by 30%.

Because FLEXPRINT Circuitry comes made to order, it assembles faster, eliminates rework time and increases reliability. There are no wires to cut, strip, tin, solder, color code or lace.

Whether your needs demand a simple circuit or sophisticated system incorporating many different components, Sanders can produce a FLEXPRINT Circuit that will make the whole package more economical. We've got the experience . . . we've produced more flexible printed circuits than anyone else in the business.

For detailed information on Sanders FLEXPRINT Circuitry, FLEXMAX flexible multilayer circuitry and INTRAMAX[®] multilayer hardboard, call your local Sanders representative or write Sanders Associates, Inc., FLEXPRINT Products Division, Nashua, New Hampshire 03060. Phone: 603-883-3321.

*T. M., Sanders Associates, Inc.

SANDERS ASSOCIATES, INC.
FLEXPRINT PRODUCTS DIVISION



Creating New Directions in Electronics



Eliminate

your cable assembly problems. Let Times take over.



Here's what happens when Times takes on the job of getting your cable assembly problems off the ground: 1) Discussion of the problem. We'll find out quickly what can and cannot be done. 2) Quick delivery of a prototype and evaluation. 3) Specs written and 4) production started.

We have the staff and facilities to solve your problems—from design through manufacture. And the know-how to answer questions like:

How to achieve VSWR of 1.05 across C-Band. What is the phase temperature coefficient of RG-142B/U and RG-214/U. How to achieve 2% balance in a balanced transmission line. A computer cable with MTBF of 10⁶ hours. A cable with a delay of 80 nanoseconds per foot. An adjustable HF delay line. A flexible cable with 30 db/100 ft. loss at 10 gigacycles.

For immediate assistance you are invited to call and discuss your problems with our Product Engineers, and to send for our helpful Assembly Design Check List.

Send for free catalog.
Write or call our Product
Engineering Department



TIMES
WIRE & CABLE
Wallingford, Conn.

A division of The International Silver Company

ON READER-SERVICE CARD CIRCLE 30

LETTERS

poor angle of sight, excessive glare and resultant fatigue symptoms.

Let us, therefore, clamor for these facts, let us demand the release of these statistics and let us have them *now!*

Fred R. Lesser

Electronic and electro-mechanical
engineering representative
Bedford, Mass.

Sir:

I was reading your letters to the editor in the April 12, 1966, issue and came across Mr. Fleming's and Mr. Gitlin's efforts [ED 8, pp. 38 & 39] concerning federal control of auto safety.

I must say I cannot agree more with Mr. Fleming, who clearly stated the case against federal control of another industry. Mr. Gitlin, however, has my sympathy for having reached physical maturity yet having retained the naïveté of an adolescent. He says he thinks that it "is a possibility" that free enterprise will disappear, but that "checks and balances" will guarantee our systems.

Mr. Gitlin has obviously never heard of the insanity that is taking place every day in our courts. For example, General Motors was recently ordered not only to divest itself of a certain percentage of its bus business, but also to build a plant, sell it to a competitor and *guarantee that the competitor would remain solvent* 'Nuff said on that point.

I have done considerable research into the relationship between faulty automobiles and accidents. It turns out that there is only a very slight correlation. As an example, Washington, D.C., has a strict, government-administered auto inspection system. It has an accident rate of approximately 1.0% due to mechanical failure. The state of Maryland up until recently had no inspection whatsoever, and the cries of its being "a dumping ground for D.C.'s derelicts" were insistently omnipresent. Maryland's accident rate attributable to mechanical failure is approximately 1.13%. This is a *reductio ad absurdum* and strengthens Mr. Fleming's argument that

accidents are caused *almost entirely by bad driving*, not "unsafe cars."

Control is needed over automobile drivers, not automobile manufacturers. Perhaps some brilliant scientist or engineer interested in reducing the accident rate could devise tests that would accurately measure a potential driver's Immaturity Index instead of harassing the Big Three for making what their customers want. One simple way to keep any auto safe is to leave it in the garage. I have yet to hear of anyone killed by a speeding auto sitting at home.

As for the loss of free enterprise, I suggest that everyone who believes as Mr. Gitlin does should read *Atlas Shrugged* by Ayn Rand. Although I do not agree with everything she says, I feel her novel pointedly depicts what has happened and is happening here and now.

David Michael Myers

Systems Engineer
"Luftschloss"
Pomfret, Md.

Sir:

I would like to add my comment to those already expressed on your auto safety editorial. I want to answer the basic question raised by Mr. Donn [ED 5, Mar. 1, 1966, p. 32]: "Should the government 'play a part' in the economic affairs of our country?"

I agree with everything in Mr. Donn's letter, and I take exception to the fact that Mr. Gitlin would call me a "States' Rights man," *if* by states' rights he means that the state government should have the power to control *instead of* the Federal Government. As Mr. Donn points out, the purpose of a government in a free society is to "prevent the initiation of force." This applies to state as well as Federal government.

Mr. Gitlin thinks that "federal intervention, control, regulation, etc." will "maintain prosperity, a high standard of living . . ." and his other goals. Let us face reality, as he suggests. What is the source of prosperity and a high standard of living? Is it government regula-

Speed Inquiry to Advertiser via Collect Night Letter ►
ON READER-SERVICE CARD CIRCLE 245 ►

new



IRC's low-cost
METAL GLAZE[®]
resistor for
MIL-R-22684

NEW LOW-COST APPROACH

TO MIL-R-22684

- Uniform molded body
- Metal Glaze stability
- Power-safety factor

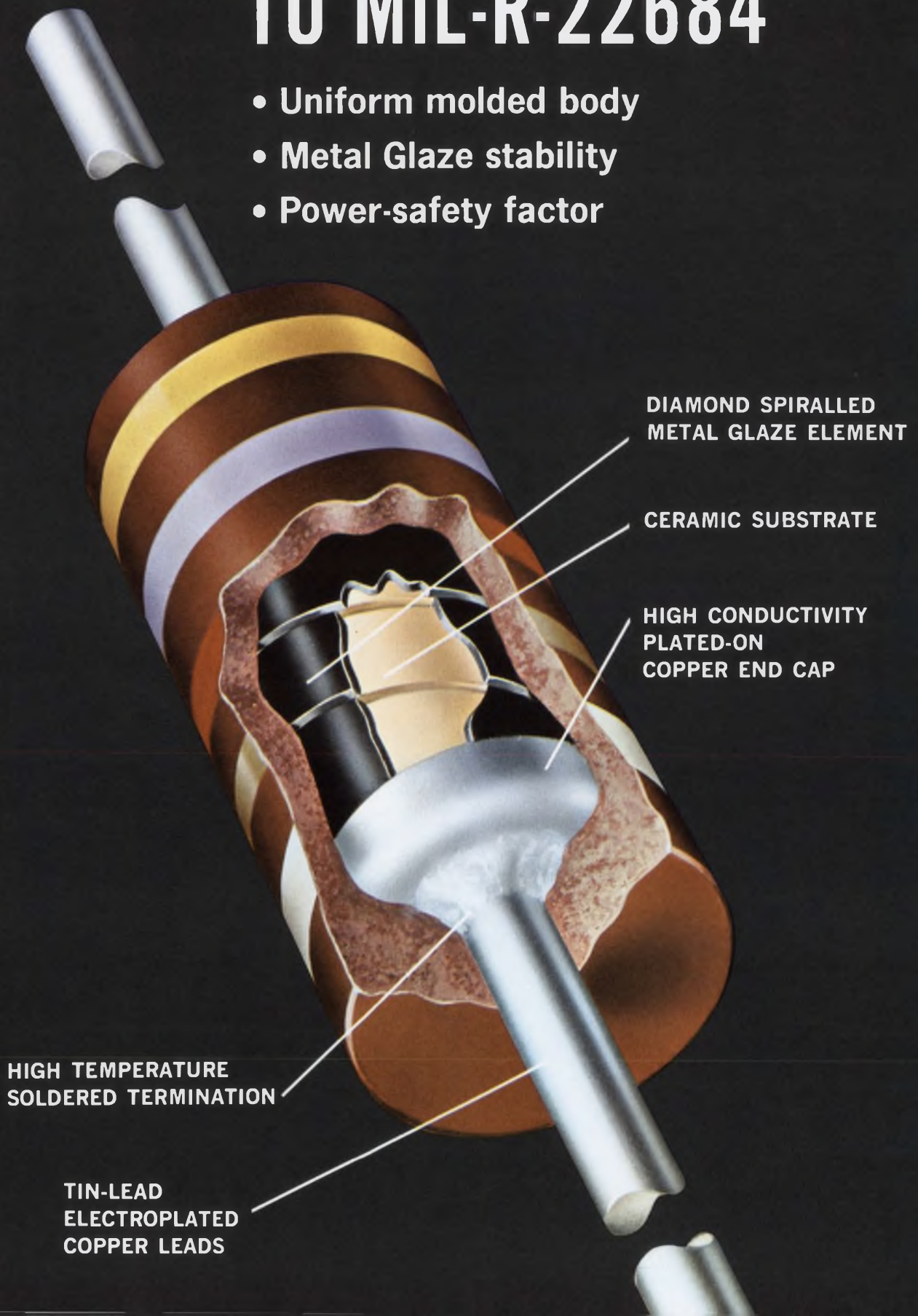

RG07

IRC, developer of the Metal Glaze resistance element, now offers a new, low-cost *molded* Metal Glaze resistor that meets or exceeds all of the tough performance and environmental requirements of MIL-R-22684. Value-engineered for optimum precision and reliability, it is the most economical MIL-R-22684 resistor available on the market today.

Load life stability is excellent. Resistance change is typically less than 0.5% after 1000 hours, ¼-watt at 70°C. Four times better than MIL allowance. Even when subjected to high temperature operation, stability is well within the MIL requirement.

Its high performance is the direct result of IRC's new thick-film Metal Glaze resistance element. 100 times thicker than conventional films, Metal Glaze resists catastrophic failure, withstands high temperatures and high overloads, and is impervious to environmental extremes.

A new, uniformly *molded* body makes automatic insertion fast and easy. Extremely rugged, it resists solvents, corrosion and the mechanical abuse of high-speed automatic machines.

With unmatched economy, this new IRC Metal Glaze resistor can upgrade circuit performance and reliability for an exceptionally wide range of applications.

SPECIFICATIONS

MIL-R-22684B	RL07 style
RESISTANCE TOLERANCES	±2% and ±5%
RESISTANCE RANGE	51 Ω through 150K Ω
POWER RATING	¼-watt @ 70°C, derates to zero @ 150°C
MAXIMUM CONTINUOUS WORKING VOLTAGE	250V
DIELECTRIC WITHSTANDING VOLTAGE	500V RMS at atmospheric pressure 325V RMS at 3.4 inches of Mercury
INSULATION RESISTANCE	10,000 meg Ω , dry
HOT SPOT SURFACE TEMPERATURE RISE AT RATED POWER	20°C
IRC TYPE	RG07

PERFORMANCE TO MIL TEST

TEST	IRC METAL GLAZE PERFORMANCE (ΔR typically less than)	MIL-R-22684 (maximum ΔR)
TEMPERATURE COEFFICIENT, ppm/°C	±200	±200
LOAD LIFE	±0.5%	±2.0%
LOW TEMPERATURE OPERATION	±0.15%	±0.5%
TEMPERATURE CYCLING	±0.2%	±1.0%
MOISTURE RESISTANCE	±1.0%	±1.5%
SHORT TIME OVERLOAD	±0.1%	±0.5%
TERMINAL STRENGTH, 5 lb pull	±0.15%	±0.5%
EFFECTS OF SOLDERING	±0.15%	±0.5%
SHOCK	±0.05%	±0.5%
VIBRATION	±0.05%	±0.5%

RG07 Actual Size

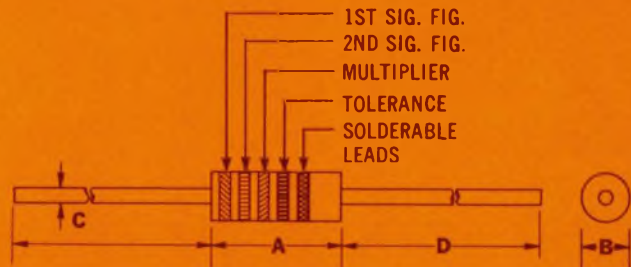

DIMENSIONS

TYPE	A	B	C	D
RG07	.250 ± .015	.090 ± .008	.025 ± .001	1.50 + .125 - .100

STANDARD RESISTANCE VALUES (For 10 to 100 decade)

10	15	22	33	47	68
11	16	24	36	51	75
12	18	27	39	56	82
13	20	30	43	62	91



Sales Offices

ALASKA

Anchorage
Ron Merritt Co., P.O. Box 759
(907) BR 2-6731

ARIZONA

Scottsdale
Carl Hower, P.O. Box 1627
(602) 947-4204

CALIFORNIA

Burlingame
Jack Logan & Assoc., 801 Mahler Rd.
(415) OX 7-6100

Hollywood
IRC, Inc., 1136 N. LaBrea Blvd.
(213) HO 6-2191

Los Altos

†Recht Associates
175 San Antonio Rd., (415) 941-0336

COLORADO

Denver
ELCOM, 2340 W. Main St.
(303) 798-8481

CONNECTICUT

Farmington
Ray Perron & Co., 10 Briarwood Rd.
(203) OR 7-9025

Trumbull
Ray Perron & Co., 36 Louis St.
(203) AM 8-9631

FLORIDA

Orlando
Hollingsworth & Still
1010 Executive Center Dr.
(305) 241-5401

GEORGIA

Atlanta
Hollingsworth & Still
3098 Piedmont Rd., (404) 261-5838

ILLINOIS

Chicago
IRC, Inc., 6020 W. Diversey Ave.
(312) 889-5800

INDIANA

Indianapolis
Macnabb, Schroeder & Loomis
820 E. 64th St., (317) CL 1-4571

Fort Wayne
Macnabb, Schroeder & Loomis
P.O. Box 879, (219) 745-8609

KANSAS

Mission
Halgin Sales Co., P.O. Box 1245
(913) RA 2-2441

LOUISIANA

Metairie
Jack F. McKinney Sales Co.
2012 Condon Ave., (504) 887-1723

MASSACHUSETTS

Boston
Ray Perron & Co.
1870 Centre St., (617) FA 3-1008

MICHIGAN

Southfield
S. Sterling Co., 21250 10½ Mile Rd.
(313) 357-3700

MINNESOTA

St. Paul
Northport Engineering, Inc.
2027 Grand Ave., (612) 698-3841

MISSOURI

Clayton
Halgin Sales Co.
201 S. Central Ave.
(314) 721-4415

NEW HAMPSHIRE

Manchester
Ray Perron & Co.
19 Caron Rd., RFD #2
(603) 472-4091

NEW MEXICO

Albuquerque
ELCOM, P.O. Box 3087
Station D
(505) 344-8130

NEW YORK

New York
IRC, Inc., 1967 Turnbull Ave.
(212) LY 7-5500

NORTH CAROLINA

Charlotte
Hollingsworth & Still
6717 Woodstock Dr., (704) 523-3372

OHIO

Cincinnati
Baehr-Greenleaf & Assoc.
9505 Montgomery Rd.
(513) TW 1-3827

OHIO (continued)

Cleveland
Baehr-Greenleaf & Assoc.
14700 Detroit Ave., (216) AC 1-9030

Columbus
Baehr-Greenleaf & Assoc.
P.O. Box 5722, Upper Arlington
(614) 486-4046

Xenia
Baehr-Greenleaf & Assoc.
3550 Maplewood Dr., (513) 426-5485

OKLAHOMA

Tulsa
Jack F. McKinney Sales Co.
P.O. Box 3958, (918) RI 2-4595

OREGON

Portland
Ron Merritt Co., 2035 S.W. 58th Ave.
(503) CA 2-7337

PENNSYLVANIA

Philadelphia
IRC, Inc., 401 N. Broad St.
(215) WA 2-8900

Pittsburgh
Covert and Newman Co.
300 Mt. Lebanon Blvd.
(412) 563-0303

TEXAS

Bellaire
Jack F. McKinney Sales Co.
P.O. Box 1026, (214) 665-3653

Dallas
Jack F. McKinney Sales Co.
1303 Chemical St., (214) ME 1-9450
*W. T. Blackburn Assoc.
P.O. Box 20073, (214) 351-9991

UTAH

Salt Lake City
ELCOM, P.O. Box 2066
(801) 262-3700

WASHINGTON

Seattle
Ron Merritt Co., 1320 Prospect St.
(206) MU 2-7337

Spokane
Ron Merritt Co., E. 127 Augusta Ave.
P.O. Box 1581, (509) FA 5-2557

*Semiconductors only

†Semiconductors & potentiometers only

Write for prices and samples



IRC, Inc., Boone Division, P.O. Box 393, Boone, N.C. 28607

tion, or is it men who have the ability to think, to produce a product, and to bring this product to a market where other men can buy it? Government regulation presupposes something to regulate. Can one imagine where the electronic industry would be if Edison hadn't invented the incandescent lamp, or if no one had then developed the diode and triode tubes? These inventions created an industry which has increased our prosperity and standard of living immeasurably. No amount of government regulation and intervention could possibly produce the wealth found in electronics today.

Mr. Gitlin "feels" that our elected officials would not do anything that would take our free-enterprise system away from us. Has Mr. Gitlin ever compared United States vs Aluminum Company of America, 1945, with the General Electric suit of 1961?

Alcoa held a monopoly in the field of primary aluminum by virtue of the fact that no one could compete with Alcoa's efficiency. What was Alcoa's reward for being the best in the industry? A lawsuit! Now look at the case of General Electric, Westinghouse, Allis-Chalmers, and the other smaller companies. They were charged with making secret agreements to fix prices and rig bids. If the large companies had not "conspired" with the smaller companies to fix prices, those smaller companies would not have been able to compete and would have been forced out of business. If this had happened, under the same Antitrust Act the large companies would have been charged with "intent to monopolize." The result of this trial: Seven men were sentenced to jail. Their crime: They produced Mr. Gitlin's toaster, refrigerator, electric stove, and generators to run them.

This is how our elected officials are protecting our free-enterprise system. What bureaucrat knows what is good for a business that he never created? By what right should he control a business whose success or failure would mean nothing to him? Should the government play a part? No! The government should control and prevent stealing, mur-

der, graft and all other forms of coercive action by any individual or group against any other individual or group. I am not forced to buy any car, nor should I be forced to buy any particular accessories for that car. If I want to install any safety accessories I feel are necessary, that should be left to my own judgment, just as my choice of car is left to my own judgment. By wearing a seat belt, I will not save anyone's life but my own.

Robert L. White

Staff Assistant
Sandia Corp.
Albuquerque, N. M.

Sir:

As a general rule, I don't write letters either pro or con, but something in the April 12th issue must have struck a resonance. I like your editorials and I agree with them in general. In particular, I agree with the one on Auto Safety Legislation. It seems to me that there is really nothing that will induce the auto industry—a quasi-monopoly—to regulate itself. It hasn't happened yet and it is not likely to happen in the future without some sort of governmental regulation; and, if this regulation saves just one life a year, it would be worth it, to my way of thinking.

I would like, however, to disagree mildly with your editorial of April 12th: "Engineers are too often silent on major social issues" [ED 8, p. 43].

The letters to the editor in your publication only reinforce my opinion that there are more engineers who are narrow and conservative than liberal (broad-minded) and generous ones. I feel that if engineers as a group became socially and politically active—which, thank goodness, they are not, being busy with mechanical things—we would make social and political "progress" in a negative direction. Solutions to social problems require open-mindedness and generosity whereas engineers are trained to be conservative, economical and efficient.

Vladimir Kenn

11 College Road
Burlington, Mass.



Cramped for space?

Use Couch 1/7-size Relays

Space/weight problem? The new Couch 2X 1/7-size crystal can relay gives you tremendous savings in space and weight. 0.1" grid — plus many outstanding specs — all in micro-miniature. Thoroughly field-proven in electronics and space applications.

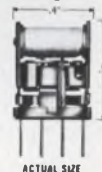

	2X (DPDT)	1X (SPDT)
Size	0.2" x 0.4" x 0.5"	same
Contacts	0.5 amp @ 30 VDC	same
Coil Operating Power	100 mw 150 mw	70 mw 100 mw
Coil Resistance	60 to 4000 ohms	125 to 4000 ohms
Temperature	-65°C to 125°C	same
Vibration	20 G	same
Shock	75 G	same

Broad choice of terminals, coil resistances, mounting styles. Write for detailed data sheets.

RUGGED ROTARY RELAYS  Dynamically and Statically Balanced

COUCH ORDNANCE INC.

3 Arlington St., North Quincy, Mass. 02171. Area Code 617.
CYpress 8-4147 • A subsidiary of S. H. COUCH COMPANY, INC.

ON READER-SERVICE CARD CIRCLE 31

TRW
Varicap
**DIODES
STRETCH
YOUR
TUNING
RANGE**



...up to 20% greater Δc !

TRW Varicap voltage-variable capacitors provide a capacitance change ratio which is a reflection of the square law function. This greater Δc when applied to a tuning circuit results in substantially increased Δf (controlled tuning range).

Characteristics inherent in the TRW abrupt junction Varicap assure C vs. V tracking, uniformity, repeatability and predictability unequalled in the industry. The

unique DO-14 package makes certain these inherent characteristics will "stay put" as proved in nearly every major space and missile program.

For complete details on the extensive line of TRW Varicap diodes contact TRW Semiconductors Inc., 14520 Aviation Boulevard., Lawndale, California. Phone: (213) 679-4561. TWX: 910-325-6206.

Varicap is the trademark of silicon voltage-variable capacitors manufactured by TRW Semiconductors Inc.

TRW SEMICONDUCTORS

ON READER-SERVICE CARD CIRCLE 32

Co-Publishers
James S. Mulholland, Jr.
Robert E. Ahrens Dorf

Editorial Director
Edward E. Grazda

Editor
Howard Bierman

Managing Editor
Robert C. Haavind

Technical Editors
Joseph J. Casazza
Rene Colen
Maria Dekany
Richard Harnar
Mark B. Leeds

News Editors
Frank Egan
Roger K. Field

East Coast Editor
Neil Sclater

West Coast Editors
Ralph Dobriner
Peer Fossen

Copy Editor
Peter Beales

New Products Editor
David Sorgan

Washington Editor
S. David Pursglove

Editorial Production
Dollie S. Viebig
Anne T. Lombardi

Art Director
Clifford M. Gardiner

Art Assistant
William Kelly

Technical Illustrators
Lewis D. Hill
Cheh Nam Low

Production Manager
Thomas V. Sedita

Asst. Production Manager
Helen De Polo

Production Assistants
Carl Merkin
Bernard Wolinsky

Circulation Manager
Nancy L. Merritt

Reader Service
Diane Pellechi



Training for tomorrow's jobs must begin today.

The electronic industry depends on workers of a wide variety of skills; yet the training of workers is usually a hit-and-miss affair that is done on the job. In fact, many electronic firms simply do not hire workers who haven't been previously trained.

How often one hears remarks like: "We just can't find any technicians or skilled machinists," at times like these when the industry is going full steam ahead. Investigation, however, generally reveals that despite this shortage problem the company is making no effort to break in any newcomer to the field.

But things don't have to be this way. There are in our industry a few companies where a "let's do something about it" attitude is paying rich dividends.*

Take Frank Burley, for example. Frank is the engineering superintendent of the Western Electric Co. plant in Indianapolis. To stem the tide of high-school drop-outs (Indianapolis had a rate of 35%), a General Advisory Committee for Vocational and Practical Arts Education was formed with Frank as chairman for 1963-1965.

Counselors were selected from various industries in the city; among them were several from Western Electric's engineering sections—designers, engineers, engineering associates, a department chief and a section head. These volunteers held semimonthly sessions during school hours with groups of eight to 20 students selected by local high-school teachers. Instructors would give half-hour talks and then spend a further hour discussing types of jobs in industry, salary levels for graduates and nongraduates, and questions brought up by the youngsters.

It's impossible to assess how many students were kept at school as a result of the program. But the fact that the program is being expanded testifies to its success.

Sperry Gyroscope Co. of Great Neck, N. Y., in 1962 instituted a training program in co-operation with the local school system. Company employees and local residents can take 15-session courses, taught by Sperry personnel, in such subjects as basic electronics, transistor theory and applications, basic electro-optics and the use of digital computer equipment. Students who successfully complete a course have their tuition reimbursed by the company.

These are isolated examples, but they illustrate what can be achieved. Our growing industry will need more and more well-trained workers to meet its labor demands. It's up to every engineer and every firm to do all they can to ensure that these demands can be met.

ROBERT HAAVIND

*Details of the case histories cited here and others are available from STEP (Solutions to Employment Problems), National Association of Manufacturers, 277 Park Avenue, New York, N. Y. 10017.

Choose Price / Performance

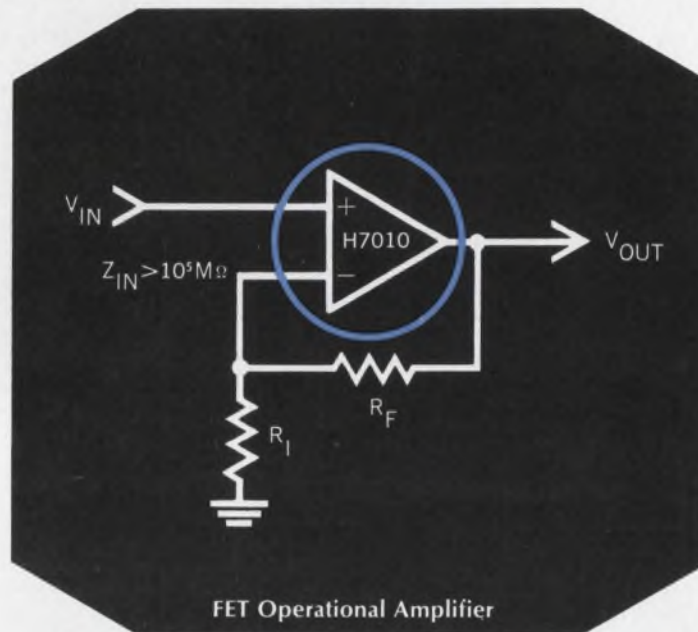

Best Values in Operational Amplifiers

Union Carbide, known leader in FET device technology, now offers the widest line of FET type operational amplifiers available. You get the best value with these units because they are designed for industrial and military requirements, and utilize hermetically sealed UCE FET transistors and MIL-grade passive components throughout. You can choose price/performance to suit your temperature range and package constraints, from the chart at right: **Order from your UNION CARBIDE ELECTRONICS distributor today.**

TYPE #	TEMP RANGE °C	OPEN LOOP GAIN db	BAND WIDTH mHz	Z _{IN} MΩ	MAX VOLTAGE DRIFT μV/°C	INPUT CURRENT pA	RATED OUTPUT V/mA	PRICE (1-4)
H7010A H7010B	-25 to 85	95	6.0	10 ⁹	± 50	50	± 10/± 2	\$ 65. 70.
H7020A H7020B	-40 to 100	95	6.0	10 ⁶	± 25	50	± 10/± 2	75. 80.
H7000 H7000A	-55 to 125	90	2.5	10 ⁶	± 25	50	± 10/± 2	110. 95.

"A" Pkg.—1.5 x 1.5 x 0.4 inches, "B" Pkg.—1.8 x 1.2 x 0.6 inches, No Letter—1-1/8 x 1-1/8 x 5/8 inches. For complete specifications write for catalog listing the entire line of operational amplifiers available from UCE.



UNION CARBIDE CORPORATION 365 Middlefield Road, Mountain View, California 94041 TWX: 415-969-9166; Telephone: (415) 961-3300
Speed Inquiry to Advertiser via Collect Night Letter

ON READER-SERVICE CARD CIRCLE 33

Technology

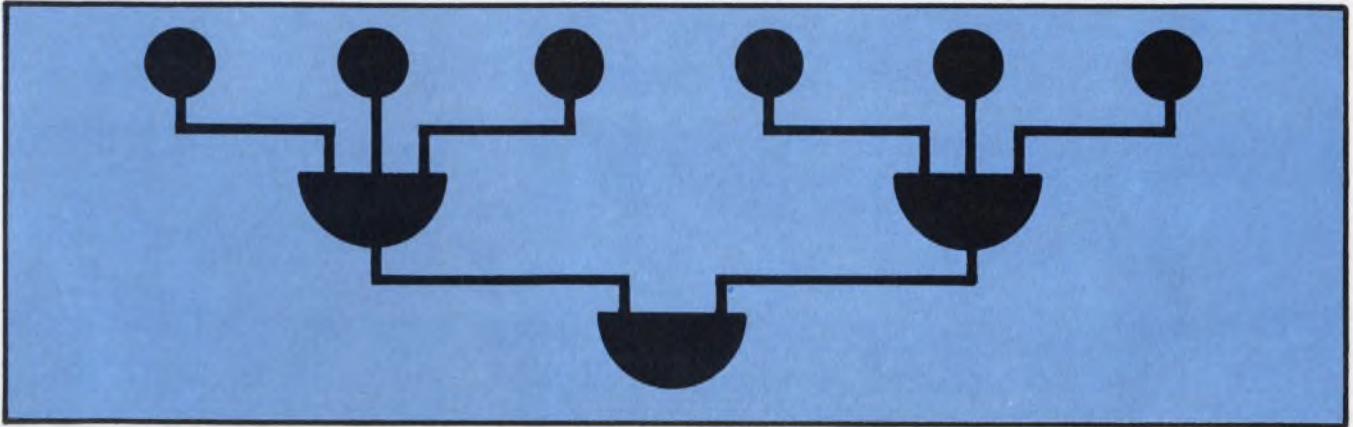

Threshold logic using tunnel diodes can serve to generate parity in a digital system. The cir-

cuitry is simple and straightforward and cuts hardware requirements. Page 70

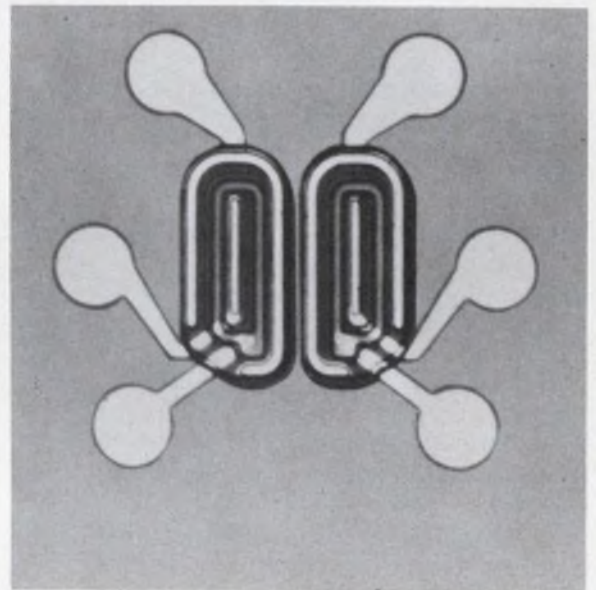
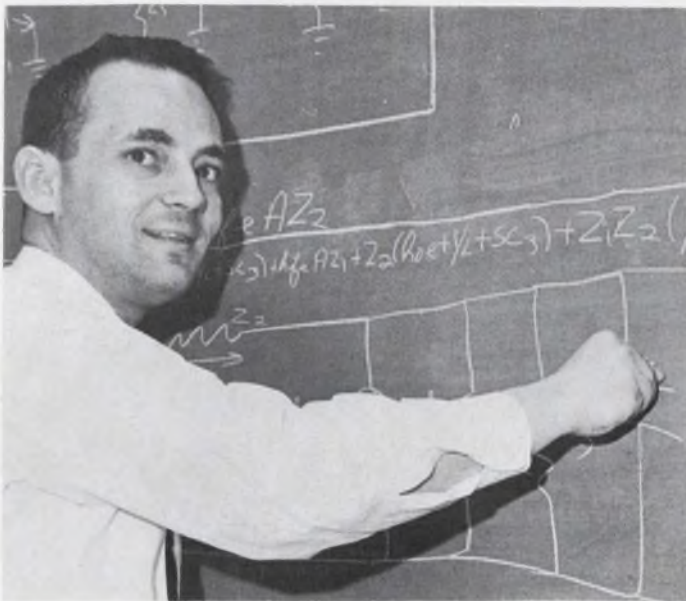

Low-frequency amplifier circuits employ FETs like the one above. Page 86

Also in this section:

Replace expensive coils with pulse transformers in phase-lock detectors . . . page 82

Differentiator noise is no problem at low frequency . . . page 92

Cure force-transducer inaccuracy in error-signal detection . . . page 98

Ideas for design . . . pages 102 to 110

Neurons generate parity in simple and inexpensive systems. The circuits are designed with threshold logic and use tunnel diodes.

By generating parity with threshold logic, the designer of a digital system can simplify his design and cut his hardware costs. The threshold logic is incorporated into neuron circuits that are built with tunnel diodes.

Parity is used as a machine self-check. A digital word is assigned a parity bit that is either zero or one, depending on whether the number of ones in the digital word is odd or even.

To appreciate the simplicity of threshold logic, consider the circuitry required to generate parity for a six-bit word with conventional techniques. Conventional parity generation would require many AND gates and one OR gate. Or, by separating the word into two groups of three bits each, six AND gates and a single half-adder could be used. In addition to these circuits, the complement of each bit is needed, calling for additional hardware.

By contrast, parity for a six-bit word can be generated with threshold logic in the relatively simple circuit shown in Fig. 1.

The circuit effectively counts the number of ones in the input digital word. If it contains an even number of ones, the output of the divide-by-two circuit becomes a logical 1, and for an odd number of ones, the output becomes zero. This counting and indicating operation requires the transformation of the input digital word into a serial chain of ones. The circuits *A* through *F*, separated by delays of 50 to 300 ns, perform this function. The incremental increase in the delay times prevents the simultaneous appearance of data from two or more bit positions. The OR gates *I*, *J* and *T* feed the pulses to the divide-by-two circuit. The latter circuit is designed to have a one output for an odd number of one inputs and a zero output for an even number of input ones.

The serial interpretation of the digital word is achieved with the aid of the neuristor concept.^{1, 2}

The neuristor is basically a threshold-sensitive monostable device that, after an external stimulation of sufficient amplitude, propagates the pulse without attenuation. The device has a recovery time immediately after excitation, or refractory period, during which it will not propagate any signal, despite excitation.

The neuristor concept is put into practice in

circuits *A* through *F*, called neurons. A tunnel-diode bistable version of such a circuit is shown in Fig. 3. The choice of tunnel diodes³ is purely discretionary. Backward diodes may do equally well. In general, the higher peak-current devices are recommended in a noisy environment, because of their stability. In Fig. 1 a 5-mA peak current device is suitable.

Let's see how the neurons generate the proper parity bit. Assume that there is an input at $t=t_0$, of the form 101101. This digital word sets neurons *A*, *C*, *D* and *F* to the high state and leaves *B* and *E* in the low state.

All neurons in the high state will provide outputs for the OR gates at $t=t_0$, resulting in a one output pulse from *T*. This sets the $\div 2$ into the high state, making *S* a logical 1.

The next pulse will arrive at the input of *T*, at $t=t_{50}$, from neuron *B*, since *B* is switched to the high state by *A* after 50 ns. The pulse from *B*, through *T*, sets the $\div 2$ into the low state, changing *S* to zero. The last pulse for the input digital word comes from *E*, at $t=t_{200}$, since *D* propagates to *E* in 200 ns. This pulse resets the $\div 2$ into the high state, making *S* again a logical 1. Note that even though *C* propagates to *D* in 150 ns, *D* is in the refractory period at t_{150} and not capable of switching and providing an output. Hence, *T* has three output pulses, at t_0 , t_{50} and t_{200} (Fig. 2).

To sum up the operating sequence, we can con-

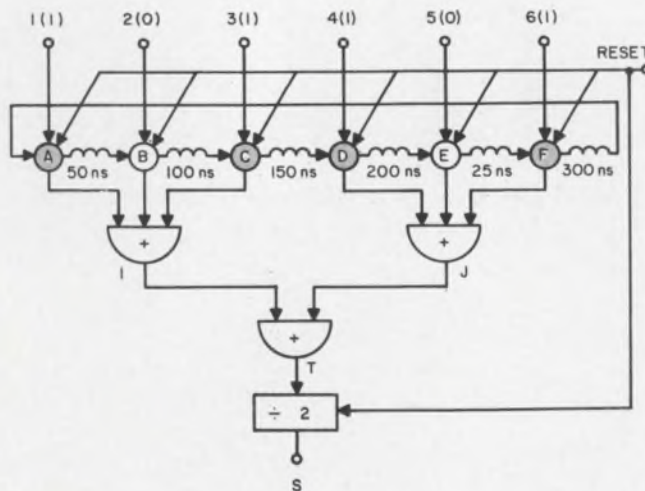

1. Parity generator, based upon threshold logic, uses neurons to simplify circuitry and cut the cost of hardware. Circuits from *A* to *F* are neurons, *I*, *J* and *T* are OR gates. The output at *S* is the parity indication.

Carl A. Budde, Member, Technical Staff, Electronic Specialty Co., Los Angeles.

clude that: The pulse generated at t_0 sets the $\div 2$ into the high state; the pulse at t_{50} resets $\div 2$ to the low state, and the pulse generated at t_{200} sets $\div 2$ back to the high state.

The final output of S is the parity bit. In this example we end with a logical one, representing an even number of ones in the digital input.

Why use three OR gates?

The gates I , J and T are monostable circuits,⁴ triggered by the outputs of A through F .

The OR gate T in Fig. 1 is sufficient to insure operation. However, because the peak current of the tunnel diodes in the circuits is a function of temperature, the tolerances on the input currents can become critical when too many inputs are converging into a single junction. To ease tolerance requirements, OR gates I and J should also be added. The result is reduced fan-in to OR gate T and increased reliability over the temperature range of -20 to $+75^\circ\text{C}$.

The design of the bistable neurons involves only straightforward circuit analysis. Fig. 3 illustrates a typical circuit.

When the input current to TD_1 , plus the bias current (supplied by R_1 and V_a) exceeds the peak current, TD_1 switches to the high state (V_F in Fig. 4) and generates an output. The dc component is coupled out by TR_1 , L_1 and R_4 , while the ac component is taken from the junction of C_1 and R_3 through TR_2 .

$$R_1 = \frac{V_a - V_1}{I_b},$$

where $I_b = 0.8 I_p$, and V_1 is the voltage at I_b (see Fig. 4). Let $(V_a - V_1)/R_1 + (V_n - V_1)/R_2$ exceed I_p by 10%. Then:

$$R_2 = \frac{V_n - V_1}{(0.1 I_p + I_p) - I_b}. \quad (2)$$

Assume that the tunnel diodes are matched to within $\pm 5\%$ of the peak current. The current changes about $\pm 5\%$ over the temperature range,

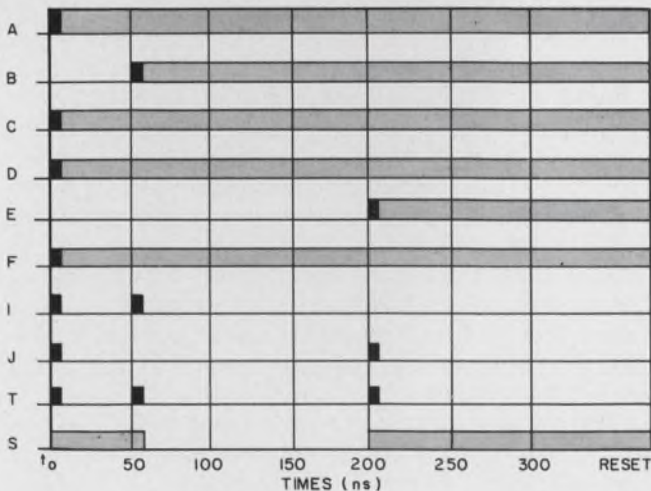

2. Timing circuit assumes that A, C, D and F are in the high state at $t=t_0$. Within the total delay period of 300 ns, B and E will be switched to the high state to yield outputs at t_{50} and t_{200} .

and so does the forward voltage. The total variation in the operating point is therefore about 15%. The fact that I_b is equal to $0.8 I_p$ allows for a 5% safety margin. Having the input current exceed I_p by 10% is a good derating factor.

The amount of current, transferred to the load, must exceed I_p by 10%, where the load, R_L , is V_1/I_b and I_1 is equal to $(0.1 I_p + I_p) - I_b$. If the voltage drop (V_{TR}) is about 100 mV across the tunnel rectifier, TR_1 , at the current level I_1 , then:

$$R_4 = \frac{V_2 - V_{TR}}{I_1} - R_L \quad (3)$$

After R_4 has been calculated, and since R_L is given, the selection of L_1 is given by the approximation $\tau (R_4 + R_L)$ where τ is the chosen inter-neuron delay.

The delay in the current rise through the inductor, L_1 , in Fig. 3 is given by:

$$\tau = \frac{-T}{\ln \left[1 - \frac{I_p - I_b}{\left(\frac{V_2 - V_{TR}}{R_4 + R_L} \right)} \right]} \quad (4)$$

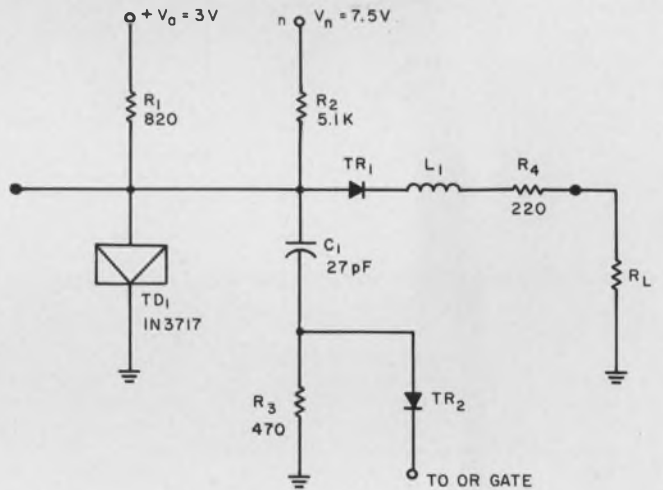

3. Basic neuron circuit is used in propagating chain and in circuits that couple to OR gates.

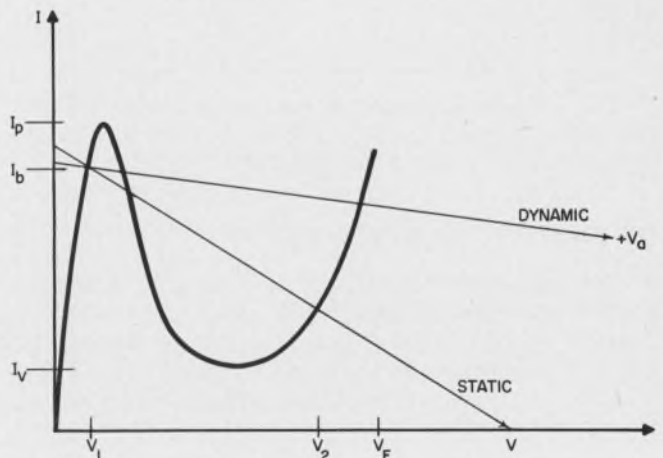

4. Dynamic and static load lines, voltages and currents of neuron circuits are valid for tunnel-diode types.

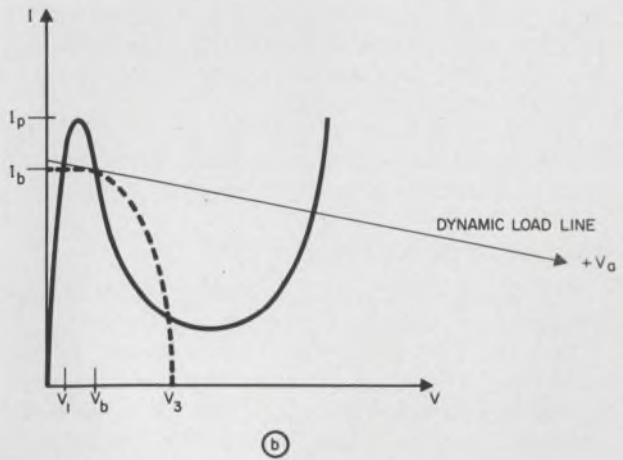
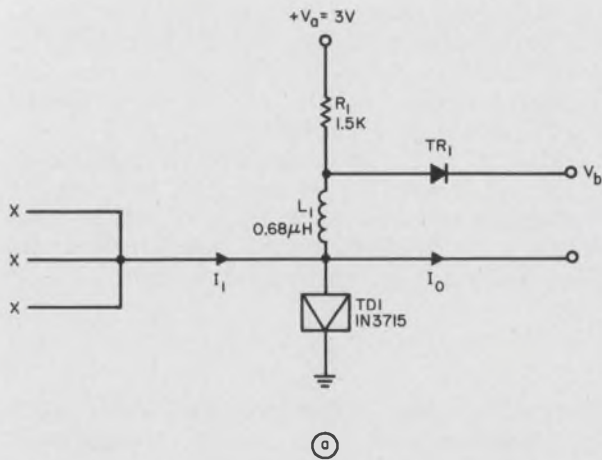

5. Monopulsing OR gate uses tunnel diodes (a). The dynamic load line (b) results from the clamping action of

rectifier TR_1 . The output pulse width depends on the inductance of L_1 .

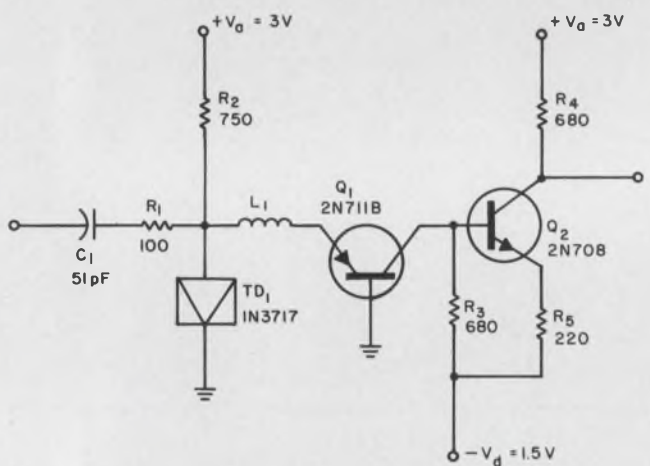

6. Divide-by-two circuit isolates the input and output. It operates at a rate that is the inverse of the minimum delay period.

it has decayed to a point below I_v , the valley current, TD_1 will switch off (Fig. 5b). The inductance L_1 determines pulse width at the output of the OR gate.

The value of L_1 may be solved by the simple approximation:

$$L_1 = \frac{\tau_w}{V_{TR} / (I_b - I_r)}, \quad (5)$$

where τ_w is the pulse width at the output of the OR gate. The recovery time of the OR gate is:

$$t_r = \frac{L_1}{R_T} \ln \left[\frac{V_3 - R_T I_r}{V_3 - R_T I_p} \right], \quad (6)$$

where

$$R_T = \frac{V_1}{I_b} + \frac{V_{TR}}{I_b - I_r}.$$

The pulse width plus the recovery time ($\tau_w + t_r$) must be less than the minimum delay period. A good rule of thumb is that the recovery period will be 3.5 times the pulse width.

Divide-by-two circuit must be last

The last circuit to consider is the divide-by-two. It must be capable of operating at an input rate equivalent to the inverse of the minimum delay period. For example, if A propagates to B when B is in a nonrefractory mode, the $\div 2$ will be triggered twice in 50 ns, or whatever the minimum delay happens to be.

To isolate the input and output, and to avoid the introduction of tight design requirements or additional loading, the circuit in Fig. 6 is recommended. The biasing for this circuit is the same as for the neuron.

The transistor in the $\div 2$ circuit must have a V_{BE} of less than V_F of the tunnel diode, which is approximately 450 mV. Therefore a germanium transistor is chosen ($V_{BE} \approx 350$ mV). For satisfactory operation, it should have an f_t about 10 times the reciprocal of the minimum delay period.

The output of OR gate T is differentiated by

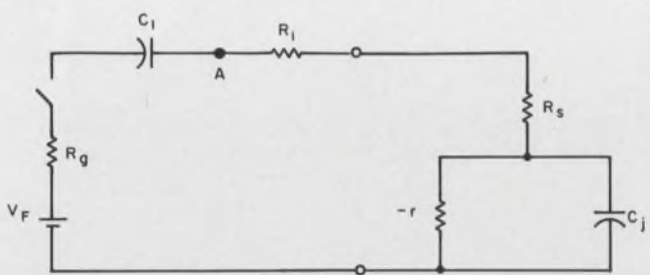

7. The equivalent circuit of the tunnel-diode and differentiating circuit, C_1, R_1 , in Fig. 5. It helps to find the charging time constant and parameter values.

OR gates are triggered by neurons

The monopulsing OR gates, J and I , are also built with tunnel diodes (Fig. 5).

Here again $I_b = 0.8 I_p$ and $I_1 = (0.1 I_p + I_p) - I_b$, or $0.3 I_p$. The voltage V_3 is chosen to be $1/2 (V_p + V_r)$. $V_p = V_3 - V_{TR}$, where V_{TR} is the voltage drop across the tunnel rectifier, TR_1 , at a current level of $I_b - I_v$.

When an input switches TD_1 of an OR gate to the high state (V_F), the current through the inductor L_1 will start to decay, since $V_b + V_{TR} < V_F$. When

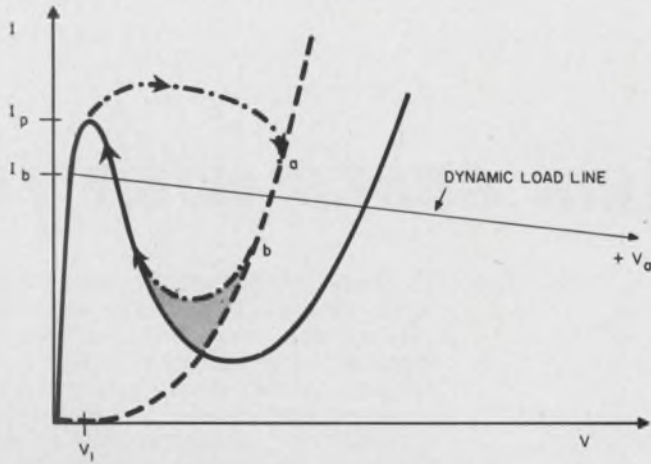

8. Combination of static characteristics of the tunnel diode and the transistor in Fig. 5 yields the operating curve.

$C_1 R_1$ and coupled to TD_1 in the $\div 2$ circuit. The leading edge of the pulse supplies a current $(0.1 I_p + I_p) - I_b = I_1$ to TD_1 . The positive-going pulse differentiated by $C_1 R_1$ switches TD_1 to the high state. Before a significant amount of bias current can be diverted to the transistor through L_1 , the trailing edge of the input pulse will have terminated. Therefore TD_1 will remain in the high state. Since a large portion of bias current is being supplied to Q_1 through L_1 (see Fig. 6), the trailing edge of the next differentiated positive-going input pulse will turn off TD_1 . The value of R_2 is given by:

$$R_2 = \frac{V_a - V_1}{0.8 I_p} \quad (7)$$

The equivalent model of the tunnel diode and the differentiating network in Fig. 7 is useful to determine the values of C_1 and R_1 that satisfy the input current requirement.

Equivalent circuit helps find time constants

For simplification, $-r$ may be neglected, and R_p and R_s can be assumed to be identical:

$$R_p = R_s = \frac{V_F}{I_p}$$

The charging time constant for the tunnel diode and the differentiating circuit in the $\div 2$ stage becomes:

$$t_c = \frac{R_o (R_1 + R_s')}{R_o + R_1 + R_s'} \cdot \frac{C_1 C_j}{C_1 + C_j}, \quad (8)$$

where

$$R_s' = \frac{V_1}{I_b}$$

Assume that $C_j \ll C_1$ and $R_s' \ll R_1$. Then the voltage developed at point A (Fig. 7) will be about $V_F/2$, if the charging time constant is short compared with the rise time of the OR gate's output pulse. This voltage, V_A , divided by $R_1 + R_s$, should be about equal to I_1 .

When TD_1 is in the high state, its equivalent impedance is equal to R_s (or R_p). The voltage developed at point A when the OR gate is turned off will be approximately $2/3 V_v$, provided $R_1 = R_s = R_p$.

When TD_1 is switched to the high state, current is diverted from TD_1 through L_1 to Q_1 . The output level goes from the peak voltage (V_p) to a point a in Fig. 8, then slides down the composite curve and comes to rest at point b . (The reason for the composite is that V_{BE} of the transistor is less than V_F of the tunnel diode.)

The current decreases through TD_1 at the following rate:

$$I_d(t) = I_b [1 - e^{-t/t_d}], \quad (9)$$

where

$$t_d = \frac{L_1}{\frac{1}{1 + h_{fe}} \left[h_{ie} + \frac{h_{ie} h_{oe} - h_{re} (1 + h_{fe})}{h_{oe} + Y_1 (1 + h_{fe})} h_{fe} \right]}, \quad (10)$$

or,

$$t_d = L_1 / \left(\frac{V_{eb}}{I_e} \right).$$

If the current's rate of change in L_1 (or away from TD_1) is greater than the pulse width from the OR gate T , the trailing edge of the pulse will turn TD_1 back off. Therefore let $t_d = 1/3 t_{z(min)}$, where $t_{z(min)}$ is the minimum delay period.

The inductance in the $\div 2$ circuit is

$$L_1 = t_{z(min)} \frac{V_{eb}}{I_e},$$

if $I_e = I_b - I_v$.

The load resistor, R_3 , of Q_1 , is

$$R_3 = \frac{-V_d}{\alpha I_{c1} - \frac{\alpha I_{c2}}{\beta + 1}}. \quad (12)$$

The emitter resistor of Q_2 is

$$R_5 = \frac{-V_d + V_{be}}{2 I_{c2}}, \quad (13)$$

and the collector load is

$$R_4 = \frac{V_a - V_{CE(sat)}}{I_c}. \quad (14)$$

The above equations completely determine the $\div 2$ circuit. ■ ■

References:

1. H. D. Crane, "Neuristor Studies," Stanford Research Institute, Tech. Report No. 1506-2, July 11, 1963.
2. J. Amodei and W. F. Kosanocky, "High-Speed Logic Circuits Using Common Base Transistors and Tunnel Diodes," *RCA Review*, December, 1961.
3. R. H. Bergman, M. Cooperman and H. Ur, "High-Speed Circuits Using Tunnel Diodes," *RCA Review*, June, 1962, No. 2.
4. C. A. Budde, "Threshold Stimulated Logic in Digital Circuits," *Electronic Design*, Sept. 28, 1964.



Reduce system costs with TI

TI linear integrated circuits mean fewer system components, less assembly and test time, increased manufacturing efficiency. In short — reduced system costs. Now you get improved performance and increased reliability, too, in such circuits as the Series 75 and Series 72 amplifiers described here.

Series 75 magnetic-core sense amplifiers

Each of these new amplifiers for magnetic core memories replaces a whole circuit board of transistors and passive components. The SN7501 circuit shown in Figure 1, for example, contains 18 transistors, 25 resistors, four diodes and one capacitor in a single tiny chip of silicon. Cost is only about 80 percent of a comparable discrete-components circuit. Soldered connections are reduced by more than 90 percent — resulting in greatly improved reliability.

Performance is excellent, as shown in Figure 2. Series 75 sense amplifiers are recommended for core memory applications with cycle time as low as 0.7 μ sec.

The SN7500 is a complete monolithic sense amplifier that includes both strobe gate and pulse-shaping output circuits as shown in Figure 3. It detects low-level bipolar differential input signals, discriminates between those representing logical "1" and logical "0", and converts them to logic levels compatible with standard integrated circuit logic, including TI's Series 54 TTL.

The amplitude-discriminating sense amplifier incorporates a threshold circuit with a narrow region of uncertainty. A strobe input is provided so the threshold detector can be activated when the signal-to-noise ratio is at maximum during the system read cycle, and is inhibited during the write cycle.

The SN7501 performs a similar sense amplifier function, but also includes an externally adjustable threshold voltage and a flip-flop output. Since the flip-flop is externally set at zero, the output pulse width can be accurately controlled. The flip-flop can be used for temporary data storage.

The SN7502 sense amplifier includes an internal one-shot multivibrator, providing a negative-going output pulse when triggered by the threshold detector. The single-ended output lends itself readily to performing DOT-OR logic.

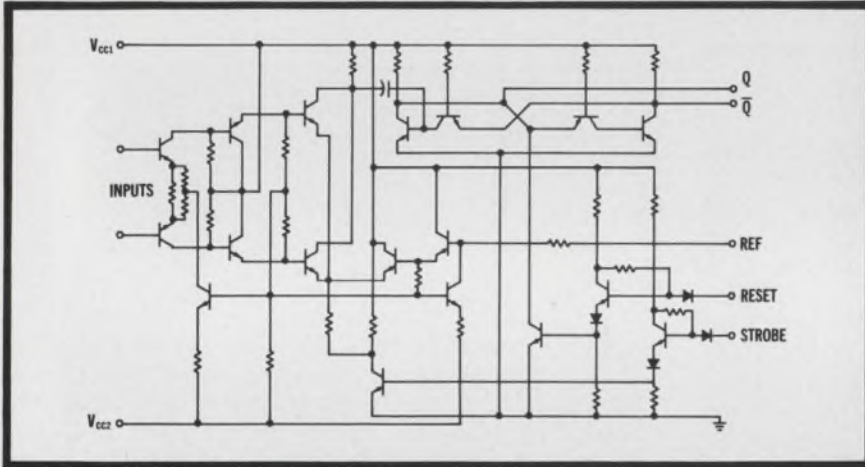

Figure 1. Circuit diagram of the SN7501 sense amplifier.

TYPICAL CHARACTERISTICS	
Input threshold voltage level	10-30 mV
"Off" output level	3.2 V
"On" output level	0.3 V
Input threshold offset	2 mV
Input impedance	3000 ohms
Propagation delay	60 nsec
Overload recovery	100 nsec
Common mode rejection	
SN7500	2 V
SN7501	1 V
SN7502	1½ V
Temperature range	0° to + 70°C

Figure 2. Series 75 sense amplifiers.

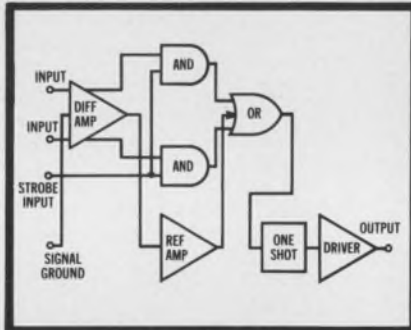

Figure 3. Functional block diagram of SN7500

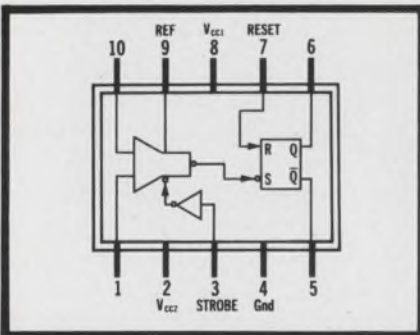

Figure 4. SN7501 incorporates flip-flop

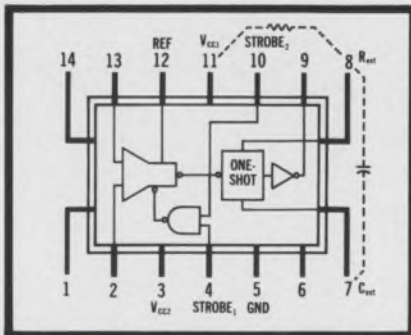

Figure 5. SN7502 includes one-shot.

linear integrated circuits

Series 75 circuits are available in the standard TO-84 flat pack, or the transistor-type TO-100 package shown in Figure 6. The SN7500 is also available in a military version (SN5500) for operation in environments of -55° to $+125^{\circ}\text{C}$. Severe temperature versions of the SN7501 and SN7502 are also available.

Circle 25 on Reader Service card for product bulletins.

Series 72 high-performance differential/operational amplifiers

Now you can get both discrete-component performance and integrated circuit reliability in differential/operational amplifiers from Texas Instruments. Figure 7 shows that performance of SN725 and SN726 integrated circuits are comparable to discrete-component amplifiers.

The SN725 differential amplifier features an open-loop gain of 88 dB, yet it is unconditionally stable when used with two external capacitors in the frequency-response-shaping network.

The SN726 high-performance operational amplifier features a class-B output stage to give a 10 V swing with a 600-ohm load. A Darlington-connected transistor pair gives an extremely high input impedance.

In both circuits, transistor pairs are close together for improved differential-input voltage offsets and temperature-drift characteristics. Improved collector saturation resistance provides high output current and voltage capability. Both amplifiers allow ± 5 V common-mode input signals before overloading, and there is no danger of latch-up from noise or output feedback.

For less demanding applications, the SN723 differential amplifier or SN724 operational amplifier may be used at a considerable saving in cost.

TI differential and operational amplifiers are available for two temperature ranges. Series 72 is recommended for 0° to $+70^{\circ}\text{C}$, while Series 52 covers the full military range of -55° to $+125^{\circ}\text{C}$.

Circle 26 on Reader Service card for more information on Series 72 and 52 integrated circuits.

Choice of Packages

TI linear integrated circuits are available in either of the package types shown in Figure 6 — The time-proven TO-89 flat pack or the transistor-type TO-100 package. Both packages feature hermetic seals for high reliability in severe environments.



Figure 6. Package types for TI

Characteristic	SN725	SN726
Gain, Open-loop, dB	88	60
Input-voltage Offset, mV	1	3
Temp. Coefficient		
Input-voltage Offset, $\mu\text{V}/^{\circ}\text{C}$	5	10
Input-current Offset, μA	0.3	0.03
Common-mode Rejection, dB	100	80
Output-voltage Swing, V	± 8	± 5
Output-current Peak, mA	1	10
Input Impedance, megohm	0.1	2

Figure 7. Typical Performance of integrated differential/operational amplifiers.

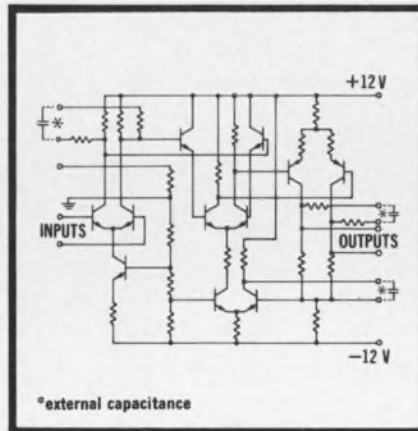

Figure 8. Circuit diagram of SN725 differential amplifier.

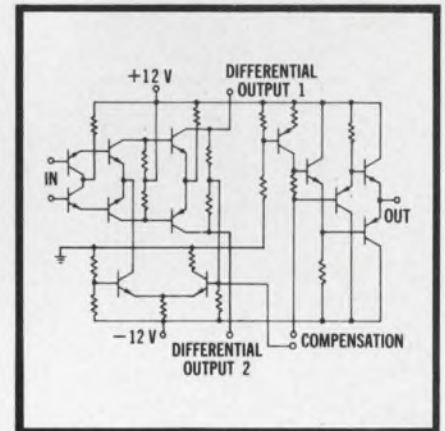

Figure 9. Circuit diagram of SN726 operational amplifier.



TEXAS INSTRUMENTS
INCORPORATED
13500 N. CENTRAL EXPRESSWAY
P. O. BOX 5012 • DALLAS 22, TEXAS

Nonlinear design yields linearity— a Zener-switching, nonlinear feedback amplifier gives a linear relationship between output power and input voltage.

Try using nonlinear techniques to obtain a linear relationship between load power and dc voltage input signal. When Zener diodes are used as switches in the nonlinear feedback loop, this method becomes especially attractive because of its simplicity and low cost.

Linearity can be achieved with nonlinear amplifiers in both ac and dc systems. The method consists of employing a number of linear load-line elements to fit a specified nonlinear curve or transfer characteristic.

Lining up the linear requirements

To test the practicality of this approach, a nonlinear feedback amplifier was designed to provide a linear relationship between the power delivered to a resistive load and the dc voltage input to the amplifier.

Figure 1 shows the desired relationship between the output power and input voltage. Since the amplifier had to deliver power to a resistive load, the output voltage for a given input voltage was calculated as follows:

$$P_{out} = kV_{in}, \quad (1)$$

$$\frac{V_{out}^2}{R} = kV_{in}, \quad (2)$$

$$V_{out} = \sqrt{kRV_{in}}, \quad (3)$$

where k in watts per volt is the slope of the power-voltage characteristic.

Equation 3 completely specifies the relationship between all values of input and output voltage for the range in question. The technique of linear approximation was applied to the input-output voltage characteristics (Fig. 2) of the amplifier function specified by Eq. 3. Four approximations were found to be more than adequate to meet the design specifications. The values of the closed loop amplifier gain were:

$$A_1 = \frac{V_{o2} - V_{o1}}{V_{in2} - V_{in1}}, \quad (4a)$$

$$A_2 = \frac{V_{o3} - V_{o2}}{V_{in3} - V_{in2}}, \quad (4b)$$

$$A_3 = \frac{V_{o4} - V_{o3}}{V_{in4} - V_{in3}}, \quad (4c)$$

$$A_4 = \frac{V_{o5} - V_{o4}}{V_{in5} - V_{in4}}. \quad (4d)$$

The change in closed-loop amplifier gain was accomplished by using Zener diodes in the feedback loop to step up the amount of feedback as output voltage increased. The simplified amplifier configuration is shown in Fig. 3a. The complete nonlinear amplifier appears in Fig. 3b. Note that the forward loop of the amplifier is dc-stabilized.

Outlining role of Zener elements

The Zener diode used in the feedback loop had to have a sharp knee to eliminate the effects of a varying Zener resistance as the diode was brought into conduction. This variation of Zener resistance would lead to distortion in the closed-loop characteristic of the amplifier and, in fact, is an indeterminate quantity that varies not only from unit to

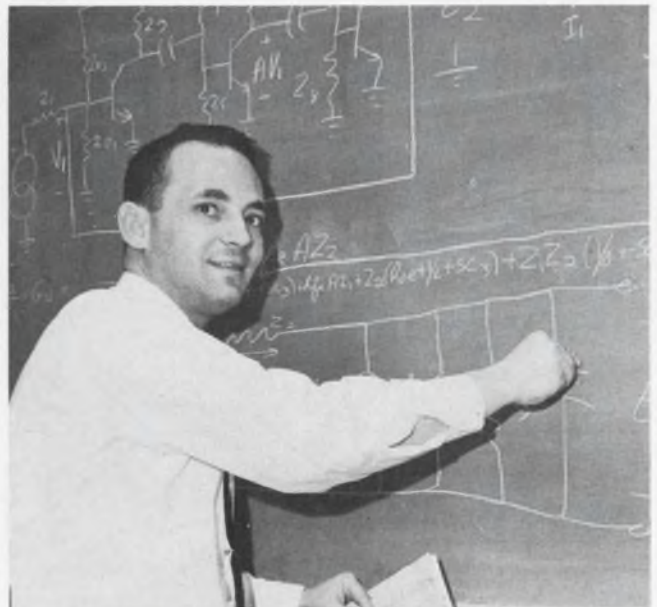

Achieve linearity via nonlinear amplification. Author Litwak shows how to go about it.

M. Litwak, senior associate engineer, Systems Development Div., IBM, Poughkeepsie, N. Y. (A portion of the work described in this article was conducted while Mr. Litwak was with General Precision Co., Inc., of Little Falls, N. J.)

unit but also with temperature. By using a "passivated" Zener diode with the characteristic that a maximum of 50 nA would flow through the diode at 80 percent of its Zener voltage—the diode can be considered to have only two states: conduction and non-conduction.

Since the Zener resistance in the conducting state is negligible in comparison with its associated series resistance, and since the Zener can be considered an open circuit in the non-conducting state, the diode can be regarded as an ideal switch.

The Zener voltage is calculated to be the difference between the breakpoint voltage (V_{04} , V_{03} , V_{02}) and the voltage at the emitter, V_E . The feedback resistors can now be calculated by application of standard feedback techniques and use of the following formulae:

$$A_1 = \frac{A_0}{1 - A_0 B_1}, \quad (5a)$$

$$A_2 = \frac{A_0}{1 - A_0 B_2}, \quad (5b)$$

$$A_3 = \frac{A_0}{1 - A_0 B_3}, \quad (5c)$$

$$A_4 = \frac{A_0}{1 - A_0 B_4}. \quad (5d)$$

In Eqs. 5a-5d, B is a voltage-divider term given by:

$$B_1 = \frac{R_E}{R_E + R_1}, \quad (6a)$$

$$B_2 = \frac{R_E}{R_E + R_1 // R_2}, \quad (6b)$$

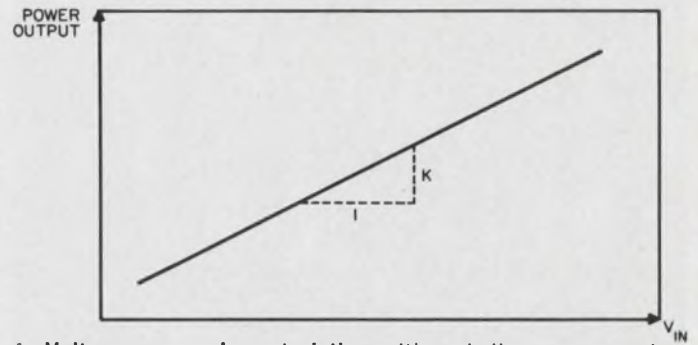

1. Voltage-power characteristics, although linear, are met by a nonlinear feedback amplifier that uses Zener diodes in the feedback loop.

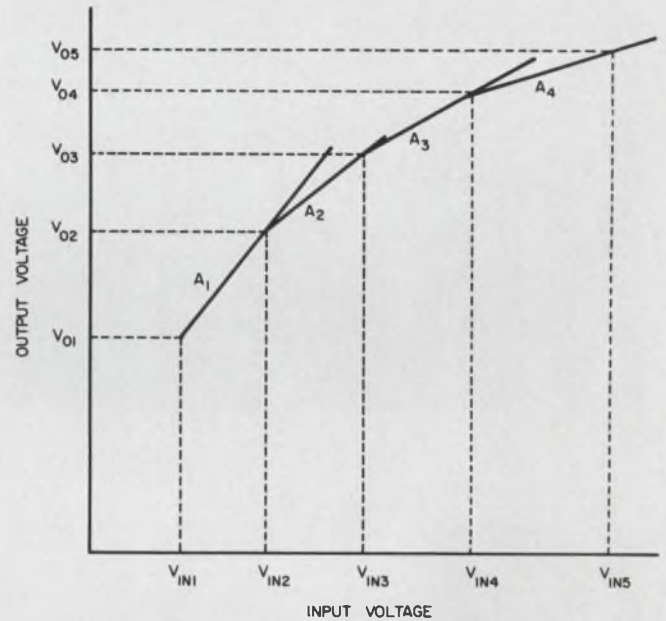

2. Output voltage vs input voltage relationship is actually a sum of linear approximations.

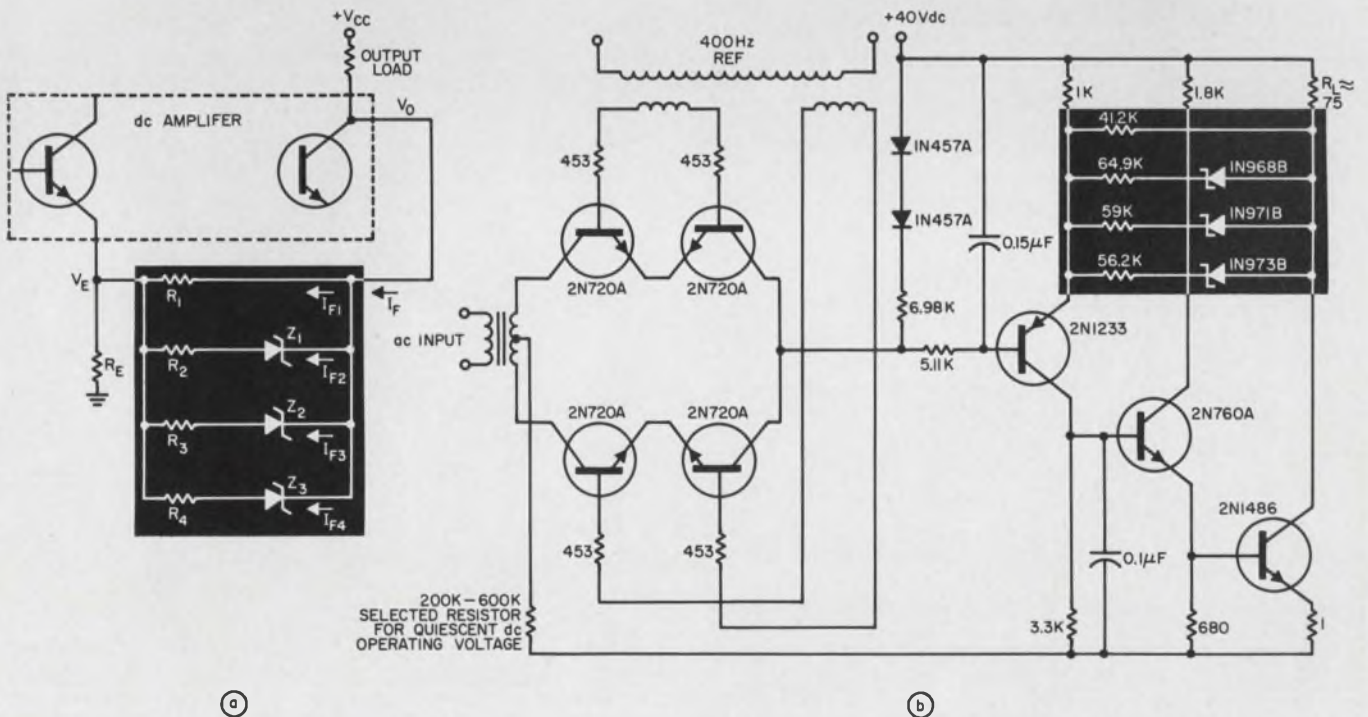

3. Nonlinear feedback amplifier uses Zener diode switches in the feedback path (a). Complete amplifier (b) has 2%

linearity over the range -55°C to $+125^\circ\text{C}$ and delivers up to 20 W to a resistive load.

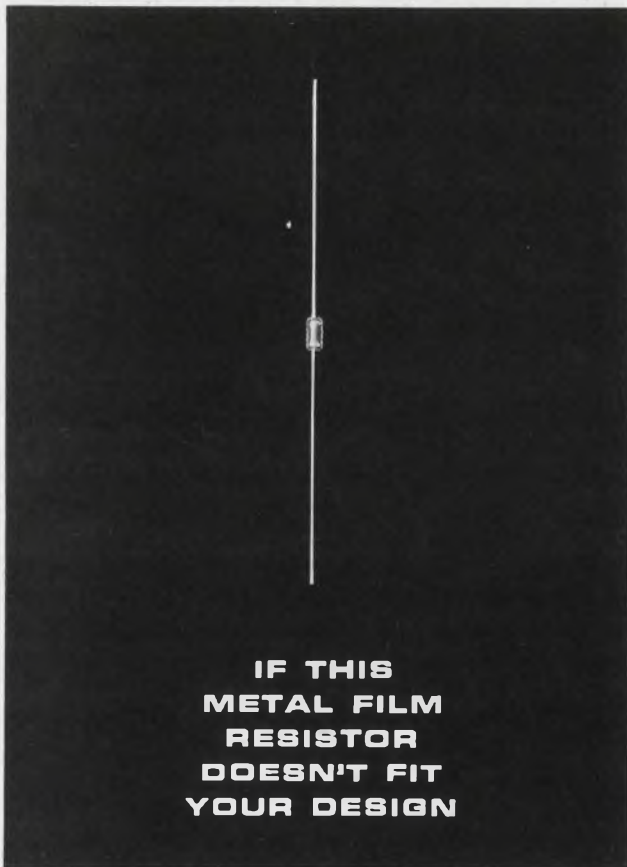

**IF THIS
METAL FILM
RESISTOR
DOESN'T FIT
YOUR DESIGN**

Try These ... high megohm resistors



Or These ... resistor networks



**Or These ... high reliability
carbon film resistors**



Pyrofilm's resistors are changing a lot of design ideas. Perhaps your design needs the small size and high performance (1/8 watt rating) of the PME 50 Pyromet metal film resistor . . . or the extremely high resistance (25 megohms) of the Pyromet PME 75 high meg metal film resistor . . . or the compact-size resistor networks matched within .01% . . . or the stability and reliability of the long accepted PyroSeal carbon film resistors.

There's a Pyrofilm resistor for your most precise circuit designs. Send for free data file which provides complete specifications on the entire Pyrofilm line.

**PYROFILM RESISTOR
COMPANY, INC.**

3 SADDLE ROAD • CEDAR KNOLLS, NEW JERSEY • 201-539-7110

ON READER-SERVICE CARD CIRCLE 34

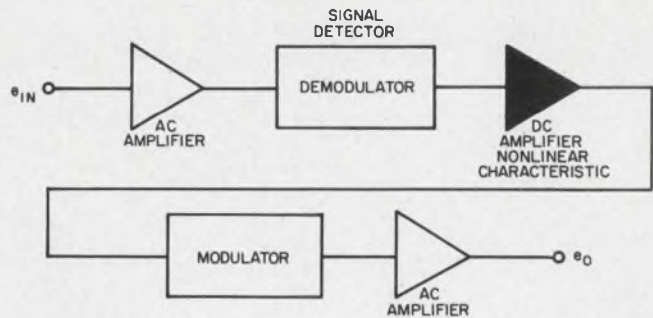

4. Nonlinear gain characteristics in an ac system can be achieved with the nonlinear dc amplifier. The dc type is employed as a stage between the demodulator and modulator circuits in this ac cascade.

$$B_3 = \frac{R_E}{R_E + R_1 // R_2 // R_3}, \quad (6c)$$

$$B_4 = \frac{R_E}{R_E + R_1 // R_2 // R_3 // R_4}, \quad (6d)$$

and A_0 is the open-loop gain. Use of standard linear amplifier techniques will guarantee ac stability for all values of feedback.

The nonlinear amplifier, as described, operated within an accuracy and linearity of 2% over the temperature range -55°C to $+125^\circ\text{C}$. The amplifier is capable of delivering from 1 to 20 watts linearly to the resistive load.

Design technique offers flexibility

The advantage of this design technique is that it can be used whenever a monotonically decreasing gain function is desired. The over-all characteristics of the amplifier must be dc for the Zener diodes to switch at the appropriate levels. The internal section of the dc amplifier, however, can be a compensated dc amplifier, a differential amplifier, a chopper-stabilized amplifier, a modulator-demodulator amplifier, or any other configuration that is innately dc-stable.

A nonlinear ac gain can be achieved if the over-all ac gain characteristics are considered to be the product of individual gains, with one of these gains resulting from the nonlinear dc amplifier already described. The over-all amplifier, therefore, would consist of a cascade of stages that would include an ac amplifier, the nonlinear amplifier and a combination demodulator (signal-detector) and modulator for ac-dc compatibility (Fig. 4). It may prove unnecessary in some cases to include two ac amplifiers, since the over-all ac gain may be produced in the dc amplifier alone.

The precise duplication of the desired nonlinear characteristic is a direct function of the number of linear approximation segments used, with each new breakpoint requiring a resistor and a Zener.

Although the amplifier in Fig. 3a is a series voltage-feedback type, the desired nonlinear characteristics can also be achieved by any other feedback amplifier technique in which the feedback element is made a function of the output voltage. ■ ■

ON READER-SERVICE CARD CIRCLE 218 ➤

ALSiMAG[®]

SNAP-STRATES

monolithic, but separable,

ALSiBase[®] Thin Ceramic Substrates

SNAP-STRATES permit multiple pattern generation, speed initial processing, eliminate many handling problems and often do away with expensive diamond sawing. Designs may include notches to identify the working surface of the Snap-Strate and assist in mechanized handling. The processor snaps the parent part into individual substrates after the film and circuit work are completed. Accurately located separation lines enable the Snap-Strate to be easily and dependably separated along straight lines into desired unit sizes.

Tolerances are usually $\pm 1/2\%$ NLT $\pm .003''$ accumulative. On the monolith, camber is standard ALSiBase camber of $.004''$ per inch.

Snap-Strates can be supplied with accurate hole patterns in the individual substrate. Separation lines can be close to or can intersect holes. Snap-Strates are available in various thicknesses, normally in the $.010''$ to $.030''$ range. The overall length and width of the monolith and the size of the individual unit partially determine the optimum thickness.

The Snap-Strate feature can be supplied in materials which include but are not limited to:

ALSiMag 614 (96% Al_2O_3) with a work-

ing surface of 25 microinches (CLA) or better; suitable for thick film processing on many applications.

ALSiMag 772 (99.5% Al_2O_3) with a working surface of 8 microinches (CLA) or better; successfully used in thin film work.

GLAZED SNAP-STRATES may be practical over a range of sizes and designs. Prototypes are especially recommended on glazed Snap-Strates.

PROTOTYPES can be supplied at reasonable cost in small quantities from economical temporary tooling to prove their practicality for your use.

BULLETIN NO. 661 sent on request.

American Lava Corporation **3M**

A SUBSIDIARY OF **3M** COMPANY

PHONE 615 265-3411, CHATTANOOGA, TENN. 37405

For service, contact American Lava representatives in Offices of Minnesota Mining and Manufacturing Company in these cities (see your local telephone directory): Atlanta, Georgia • Troy, Mich. • Boston: Needham Heights, Mass. • Chicago: Bedford Park, Illinois • Cleveland, Ohio • Dallas, Texas • Laurens, S. Carolina • Los Angeles, Calif. • Metropolitan New York: Ridgefield, New Jersey • Up-State New York: Baldwinsville, N. Y. • Philadelphia, Penn. • Roanoke, Virginia • South San Francisco, Calif. All export except Canada: Minnesota Mining and Manufacturing Co., International Division, 700 Grand Ave., Ridgefield, N. J.

65th
YEAR
OF
CERAMIC
LEADERSHIP



TYPE 16 SUBMINIATURE
Most dependable subminiature in production—A Licon exclusive! Minimum 100,000 cycles at 10 Amps.



TYPE 18 SUB-SUBMINIATURE
Smallest available single-pole, double-break, snap-action switch. Only .200" x .500" x .350". Over 15 million life cycles.



TYPE 26 4-CIRCUIT SUBMINIATURE
A subminiature double-pole, double-break switch with two "Butterfly" mechanisms. Over 20 million life cycles.



TYPE 28 4-CIRCUIT SUB-SUBMINIATURE
Double-pole sub-subminiature double-break switching. Controls four circuits in one snap.



TYPE 36 6-CIRCUIT MINIATURE
Subminiature, triple-pole, double-throw, double-break circuit control. 6-circuits.



TYPE 11 GENERAL PURPOSE
Widely used basic miniature double-break switch. Long life, high rating—20 million cycles—in a compact package.



TYPE 14 HEAVY-DUTY
Basic general purpose double-break switch built for industrial and machine applications. Exceeds 20 million cycles.



TYPE 22 4-CIRCUIT MINIATURE
Miniature double-pole, double-break. Four circuit double-break control in one snap.

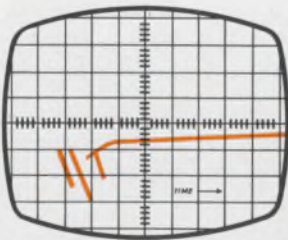
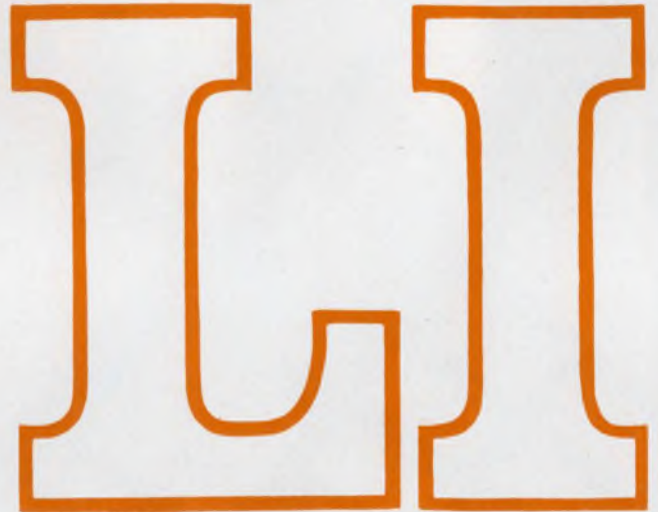

Shorter rebound, less bounce than single-breaks

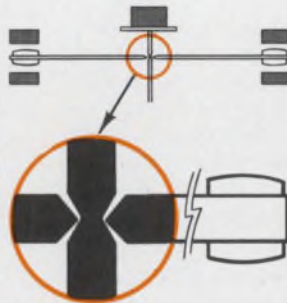

Two independent blades insure longer life

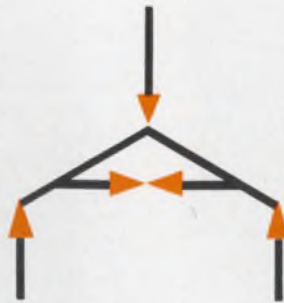

Maintains higher contact pressure longer

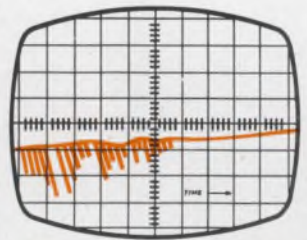

Greater resistance to vibration and shock

WRITE FOR LATEST LICON DOUBLE-BREAK SWITCH CATALOG

HERE ARE THE REASONS WHY

CON[®]

BUTTERFLY[®] SWITCHES GIVE YOU THE KIND OF DOUBLE-BREAK VALUE, RELIABILITY AND BREADTH OF LINE YOU REALLY NEED!

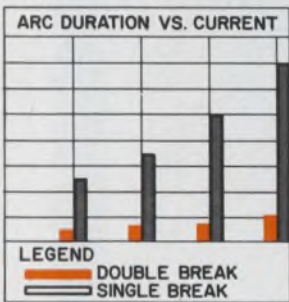

Butterfly[®] design has best dissipation of arc heat

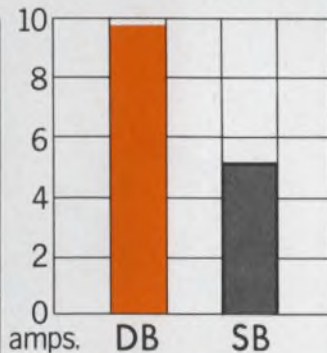

Higher electrical ratings than single-breaks

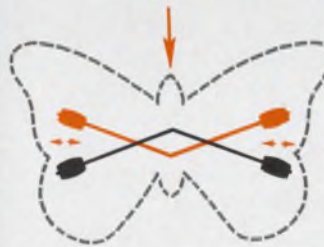

Built-in wiping action prevents contact welding

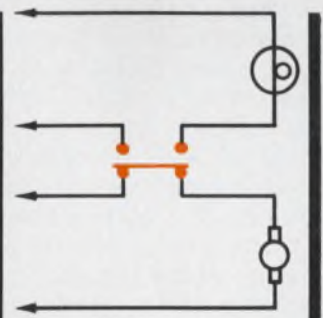

Control of two isolated circuits with one switch

itw LICON
 DIVISION ILLINOIS TOOL WORKS INC.
 6615 W. IRVING PARK ROAD • CHICAGO, ILLINOIS 60634

"Remember, you're never more than a few feet away from a product of ITW"[®]

ON READER-SERVICE CARD CIRCLE 35

Replace expensive coils with pulse transformers in phase-lock detectors that operate to 20 MHz. The change will also simplify circuitry.

A pulse transformer, instead of a specially wound high-frequency coil, is the key feature of a design for a phase-lock detector operating up to 20 MHz. This design is simple and inexpensive but still maintains required sensitivity. The detector (Fig. 1) can work with 40-nV signals at a signal-to-noise ratio of 6 dB.

The problem of precise detection of a null condition is fairly common. The accuracy of data obtained from experiments involving balanced resistance or inductance bridges, for instance, is directly dependent on the sensitivity of the null detector. Large line-frequency and/or quadrature signals will often interfere with determination of the null point. The designer has to provide a device which possesses a low noise figure, good line-frequency rejection, and the ability to reject a signal in quadrature with the desired signal. Such a device, known variously as a phase-lock detector, lock-in detector, or phase-sensitive amplifier, consists of a low-noise amplifier and a phase-discriminator circuit.

The design concept is applicable for operation at frequencies in the range from a few cycles to about 20 MHz.

For phase detection, low capacitive coupling

A phase discriminator locks onto a signal having a particular phase and produces a stable dc output proportional to the desired input signal. Signals whose phase differs from that of the phase-locked signal are attenuated according to the amount of phase difference. An external reference voltage determines the phase to be passed.

Design of such a circuit for operation at low frequencies involves no special considerations, but operation in the megahertz range requires careful evaluation of the transformers.

The two major points are:

- The self-resonant frequency of the secondary windings must be well above the operating frequency to prevent instability of the dc output.
- Low capacitive coupling from primary to secondary is essential to prevent unbalanced voltages at the secondary.

Wayne A. Rhinehart and Louis Moulam, Jr., Associate Engineers, Institute of Atomic Research, Iowa State University, Ames.

These requirements are usually fulfilled with specially wound coils, but commercially available pulse transformers are quite capable of handling them at high frequencies (Fig. 2). Ferrite-core pulse transformers have low capacitive coupling, but there is no well-defined way to find the best transformer—only experiments can help the designer here.

Input noise limits amplifier

The low-frequency narrow-band amplifier (Fig. 3) has a circuit Q of 400 with simple RC frequency-selective circuits. Its center frequency is at 400 Hz. The operating principle is useful for low-frequency detectors.

The ultimate sensitivity of a low-noise amplifier depends upon the noise generated at the input terminals. The smallest conceivable value of input noise is that attributable to the thermal noise of the source resistance. The input noise can be minimized by judicious choice of the input tube and the operating point.

The equivalent noise resistance of a vacuum tube is directly proportional to the plate voltage and inversely proportional to the plate current, owing to the dependence of noise on g_m . The input

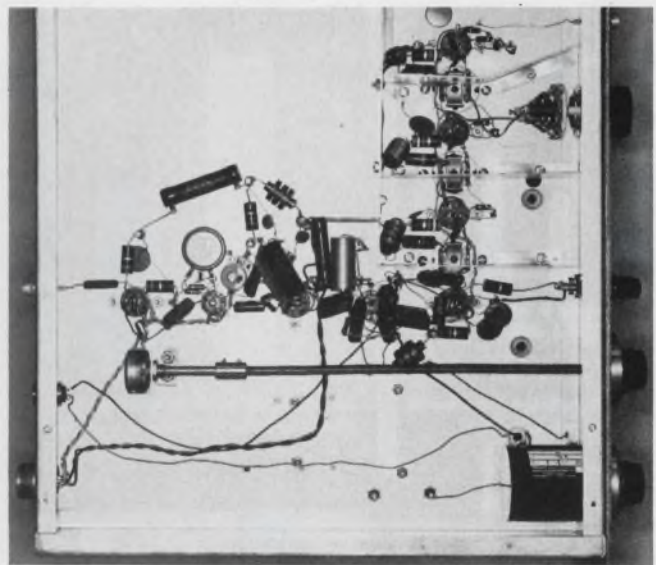

1. Internal view of a 2-MHz phase-lock detector, designed with a commercially available pulse transformer. The null-detector picks up signals as low as 40 nV, with a signal-to-noise ratio of 6 dB.

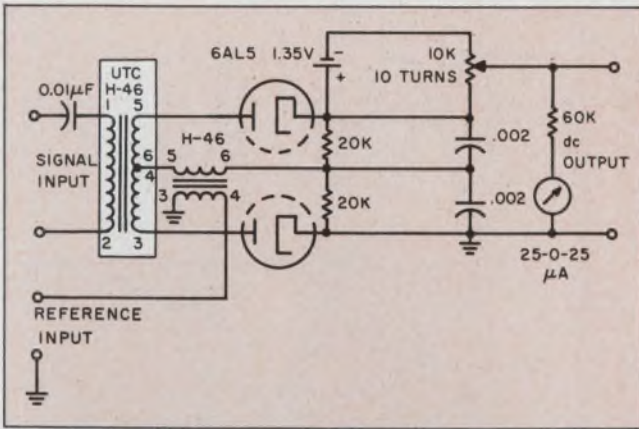

2. **Pulse transformers** replace special high-frequency coils in phase-lock detectors operating at 2 MHz. Their low capacitive coupling from the primary to the secondary side makes the change possible.

tube should have high transconductance and low microphonics.

The operating point must be carefully selected. It isn't always practical to operate at zero bias for high plate current, nor in general at low plate voltage. Though operation at zero bias yields least noise, it also results in the lowest input impedance. Low plate voltage results in undesirable low gain in the input stage which may render the noise of succeeding stages significant.

Since narrow bandwidth is a primary design requirement, any practical circuit should include high-Q, frequency-selective filters. In the frequency range of a few Hz to 20 kHz, parallel-T filters, arranged in a negative feedback configuration, have proved satisfactory. The value of R_{IN} can be chosen to fit the input impedance requirements of the particular application. It is extremely important that the parallel-T filter be loaded as little as possible. To get maximum circuit Q, the grid resistor should be larger than 1 MΩ, since the loading of the parallel-T filter broadens its band-

width. Two of these loops cascaded provide a gain of approximately one million.

The nuvistor was chosen for the input stage because of its low noise and low microphonics. The parallel arrangement of the nuvistors yields better rejection of 60-Hz signals and narrower bandwidth than the often-used cascode configuration.

The circuit in Fig. 3 can be used for frequencies above 20 kHz, if a tuned circuit more suitable to those frequencies—such as a bridged-T LC circuit—is substituted. A simpler configuration for higher frequencies is the standard plate-tuned amplifier.

Output does not depend on reference

The general expression for the dc output voltage of the phase-discriminator circuit is:

$$V_o = k \left[E_R \sin \left\{ \tan^{-1} \frac{-E_r/E_{s+\cos\phi}}{\sin\phi} \right\} - E_s \sin \left\{ \tan^{-1} \frac{-E_r/E_{s+\cos\phi}}{\sin\phi} + \phi \right\} - E_R \sin \left\{ \tan^{-1} \frac{E_r/E_{s+\cos\phi}}{\sin\phi} \right\} - E_s \sin \left\{ \tan^{-1} \frac{E_r/E_{s+\cos\phi}}{\sin\phi} + \phi \right\} \right]$$

where

- K = detection coefficient, to account for losses in the detector
- E_s = peak signal voltage
- E_r = peak reference voltage
- ϕ = phase difference between signal and reference.

The expression shows that the dc output voltage is a function of the reference voltage as well as the signal voltage. This is undesirable since the output should be related only to the signal input. To solve

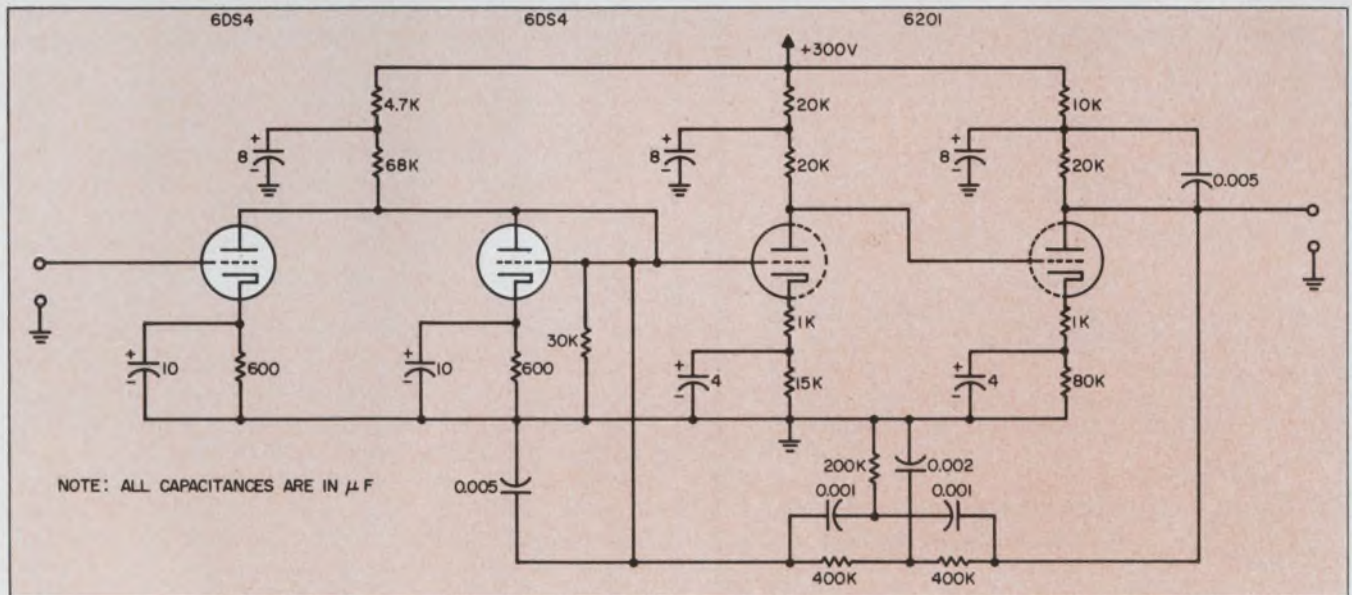

3. **Low-noise, narrow-band amplifiers** in detector use nuvistors in the input stages. The circuit may be used at

2 MHz if proper tuning circuits are used, for example, a bridged-T LC circuit.

THE



MULTI-TRACK
MIND...



Want to handle several PCM links simultaneously?
Need to rapidly switch from format to format?
DCS has the efficient answer —

Series 1100
PCM SYSTEMS



Look at these features:

- Multilink simultaneous processing, 2 to 16 links
- IBM compatible tapes
- Multilink time correlation
- Immediate format switching
- Pre-switching synchronization and data validity checking
- Memory not used for format synchronization

INTERESTED?

Write for your free copy of the new DCS Series 1100 PCM PROCESSING SYSTEMS brochure . . . or call the DCS office nearest you.

Dept. ED1, East Liberty Street, Danbury, Conn. 06813
Telephone: 203-743-9241 • TWX 744-1990



DATA-CONTROL SYSTEMS INC.
Instrumentation for Research

Sales Offices
Silver Spring, Md., Huntsville, Winter Park, Long Beach, Santa Clara,
Albuquerque

Copenhagen London Rome Paris Munich Amsterdam

ON READER-SERVICE CARD CIRCLE 36

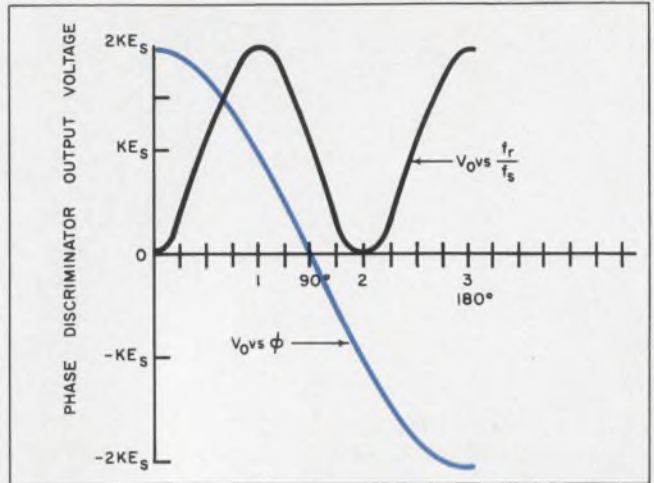

4. The output voltage is a function of the phase difference between the incoming and the reference signals (color). It also depends on the ratio of the two signals' frequencies.

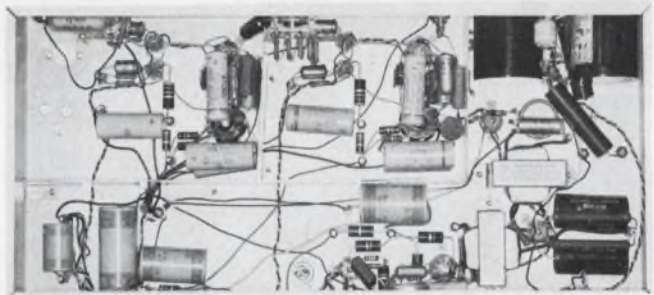

5. A 400-Hz detector, designed with conventional components, has a 1-Hz bandwidth and a 60-Hz rejection of 100 dB. The least detectable signal is 60 nV with a signal to noise ratio of 6 dB.

this, make the reference voltage amplitude large with respect to the signal voltage amplitude. The expression for V_o then becomes:

$$V_o \cong K [2E_s \sin\{\tan^{-1}(-E_r/E_s + \cos\phi/\sin\phi) + \phi\}]$$

A voltage ratio of ten or greater is normally sufficient. The output voltage (V_o) vs the phase difference and the signal-reference frequency ratio is shown in Fig. 4.

The low-pass filter across the detector output allows a compromise between response time and bandwidth, depending on the application.

A practical circuit, using a plate-tuned amplifier and the high-frequency discriminator, provides a complete phase-lock detector for operation at 2 MHz. The unit has been used to record weak signals from a pick-up coil in experiments for determining the magnetic susceptibility of metals. The circuit has a maximum center frequency gain of 1 million and a 60-Hz rejection of 120 dB. The smallest detectable signal is 40 nV with a signal to noise ratio of 6 dB.

The design principle of the low-frequency phase detector (Fig. 5) is similar to that of the high-frequency type. It has been used as a 5% ac micro-voltmeter in low-temperature specific heat tests.

In the construction of low-level circuits such as these, proper shielding and grounding practices must be followed. ■ ■

Push Null Read

Accuracy: 0.002% of reading + 0.0002% of range
Highest resolution (0.2 ppm of range) -1, 10, 100, 1000 v ranges
Stability: 1 ppm/hour, 5 ppm/day, 30-day calibration cycle
RATIO measurements: four ranges with 6-digit resolution
True isolation, battery operation

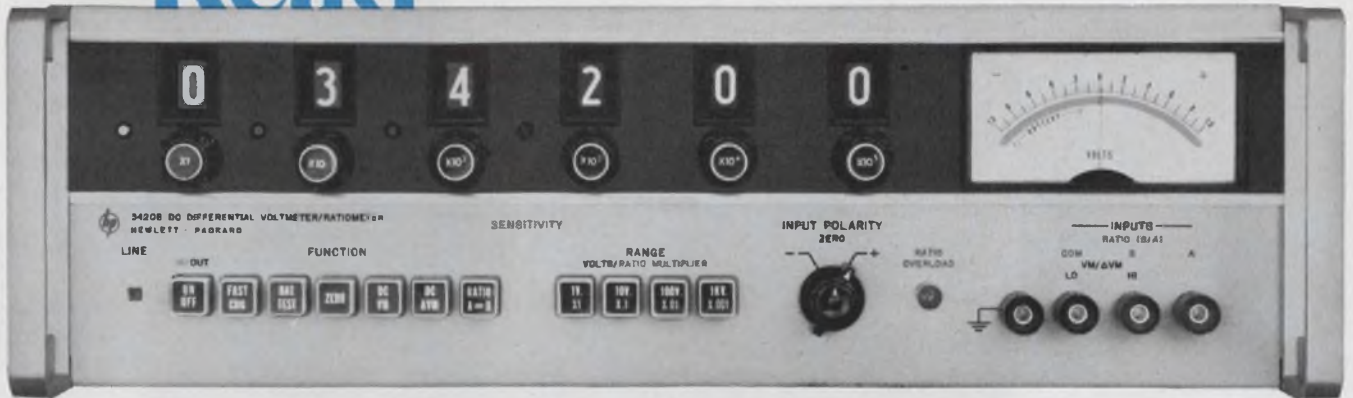

hp 3420A/B

for today's most accurate dc differential volt/ratio meter measurements!

accuracy Here's the most accurate dc voltmeter available today, backed by a minimum 30-day calibration cycle and temperature coefficient of 4 ppm/°C. With a sensitivity of $\pm 10 \mu\text{V}$ full scale, six-digit resolution is meaningful for measurements in standards and calibration labs, design labs . . . and all areas (physics, biomedical, electro-chemical, university, processes, control) where high precision and stability are essential.

ratio Then add *four ranges* of ratio capability with 0.002% accuracy and make both resistance and voltage ratio measurements. The customary precision voltage source required for resistance ratio is no longer necessary.

isolation A line/battery operated model permits true "floating" measurements and provides portability not available at this accuracy level before.

There is 10% overranging on all voltmeter functions, with overload recovery of less than three seconds, and immunity

to damage by overload. The recorder output at ± 1 volt and 1 milliamp will drive any recorder.

ease of operation Pushbutton function and range selection, plus a full in-line six-digit readout, permits convenient and time-saving measurements. Six discrete decade dividers with concentric null sensitivity pushbuttons now make nulling very simple. The zero pushbutton disconnects the input source and decades, and internally shorts input terminals . . . no need to return decades to zero.

All silicon solid-state, with plug-in circuit board design for easier maintenance in both the 3420A (line operated) at \$1175, and the 3420B (line/battery operated) at \$1300.

Ask for a demonstration by calling your Hewlett-Packard field engineer. Or get complete specifications with the same call or by writing Hewlett-Packard, Palo Alto, Calif. 94304, Tel. (415) 326-7000; Europe: 54 Route des Acacias, Geneva.

Data subject to change without notice. Prices f.o.b. factory.

HEWLETT  PACKARD
An extra measure of quality

ON READER-SERVICE CARD CIRCLE 37

Simplify low frequency FET designs. Use this application-oriented parameter guide to meet your differential and single-ended amplifier circuit needs.

Part 3 of a three-part article

Low-frequency FET amplifier circuits—as opposed to general-purpose and higher-frequency types—have a design procedure all their own. To establish the circuit requirements quickly and easily, design prescriptions have been developed on the basis of the governing parameters for these applications.

This parameter analysis will bring out the suitability of FET devices for these amplifiers. It will also distinguish those characteristics of major importance from those which apply to the devices in general and/or to other applications.

The study of FET amplifiers concludes* with the differential and single-ended (both conventional and low-drift) types. These applications are characterized by operation at lower frequencies (including dc)—usually 1 kHz or below.

Refer to the appendix at the end of this article for definitions of the FET terms used and how they are measured.

Pairing FETs for differential amplifiers

Two differential amplifiers using FETs appear in Fig. 1. Circuit (a) is a pair of matched source-followers used for impedance match purposes only. The circuit in (b) is a true source-coupled differential amplifier which provides voltage gain. In either circuit, one gate (for example, that of Q_2) may be grounded for a single-ended input. In (a), the FET with grounded input is then required merely to compensate for temperature drift of the other.

In (b), the FET with the grounded input continues to act as an amplifier, but it must also exhibit equal drift with temperature. For good linearity, the transconductance of the two FETs should be nearly equal at the operating point. If the gate-to-source voltages of the two FETs (offset voltage) were identical at equal drain currents, R_o would not be needed in either case. Since this condition is rarely met, R_o is often

*See Parts 1 and 2 ED 13, May 24, p. 38 ff., and ED 14, June 7, p. 40 ff.) for details of the other FET amplifier categories—general-purpose, low-noise and high-frequency. Also, see ED 12, May 17 Semiconductor reference issue, pp. 94-102, for additional design information, parameter evaluation and circuit contrasts involving field-effect devices (FETs and MOSs).

James S. Sherwin, Senior Applications Engineer, Siliconix, Inc., Sunnyvale, Calif.

included in the circuit to equalize the V_{GS} of the FETs when a zero offset is required.

Important circuit parameters in the selection of differential FET pairs (operation at dc or low frequency is assumed) are:

- $|V_{GS1} - V_{GS2}|$ — Offset.
- $\Delta|V_{GS1} - V_{GS2}|/\Delta T$ — Drift.
- $|I_{G1} - I_{G2}|$ — Differential gate current.
- g_{fsx} — Transconductance at operating point.
- g_{fsx1}/g_{fsx2} — Transconductance match.

It is to the user's advantage if all matching characteristics are specified under recommended operating conditions. The subscript notation "x" in g_{fsx} may be used to denote biasing conditions other than at $V_{GS} = 0$. Specifications for differential amplifiers are generally given for a particular V_{DG} and I_D recommended for general use. Often, the g_{fs} match is specified only at $V_{GS} = 0$. This does not necessarily ensure a match under operating conditions.

However, if g_{fs} at $V_{GS} = 0$ and $I_D = I_{DSS}$ are both well matched, the chances for a g_{fsx} match at $I_D < I_{DSS}$ are very good. In fact, the match under operating conditions may be substantially better than at $V_{GS} = 0$. It is reasonable to operate at other voltages and at lower I_D than those specified. However, operation at higher I_D may cause forward biasing of the gate-source junction in order to maintain a set I_D at the highest operating temperatures. That is, V_{GS} may approach zero and invert. This possibility is most likely in

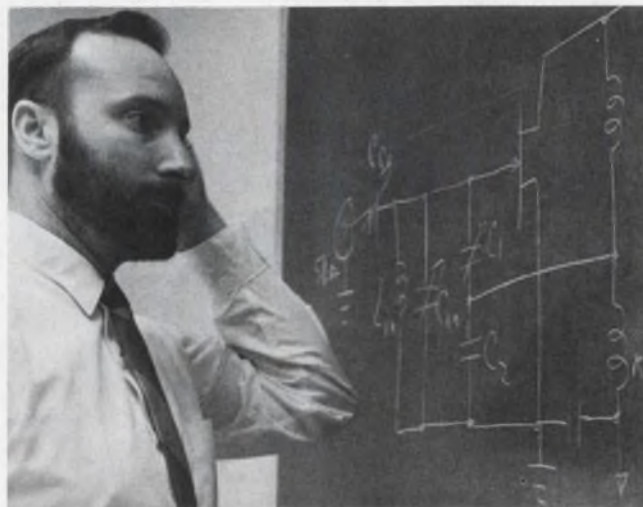

Author Sherwin ponders a FET circuit problem. In this article he tells how he tackles the tough ones at low frequencies.

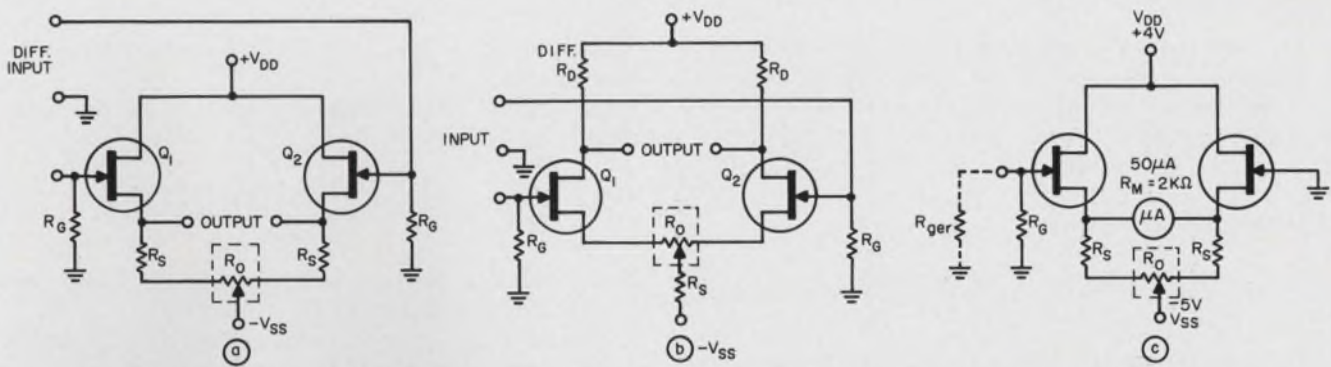

1. Matching minimizes the differences of FET pairs in differential amplifiers. Shown are a source-follower pair for impedance-matching (a), a source-coupled circuit for

voltage gain (b) and a simple voltmeter circuit (c). In each design, R_S is used to equalize the V_{GS} values of the FETs when a zero offset is desired.

units having I_{DSS} values just greater than the operating I_D , and is due to a decrease in I_{DSS} as temperature is increased. The match in gate currents, $|I_{G1} - I_{G2}|$, is normally specified at an elevated temperature near 100°C. The I_G match is important to ensure equal voltage rise due to I_G in the gate resistors as temperature increases.

The differential FET pair chosen for any particular application will, of course, be specified only for that degree of match which is consistent with the application requirements. It is very important not to over-specify either the V_{GS} match or the differential V_{GS} drift for a given application. This affects cost and can delay delivery, even on relatively small quantities.

Designing bench-type FET voltmeters

To demonstrate the simplicity of FET differential amplifier design, we will use a bench-type voltmeter application (Fig. 1c). The design of differential amplifiers may be executed quite quickly by direct use of the information on the manufacturers' specification sheets. Gain for each half of the differential source-follower and dc operating point are determined in a manner similar to that used in general purpose amplifiers.* For FET voltmeter circuit, the design approach would be as follows:

1. Select a supply voltage. Let us use 9 volts.
2. Select a FET with $V_{GS(OFF)max}$ less than about half the supply voltage. If the FET has a maximum $V_{GS(OFF)}$ of 3 volts, a positive supply voltage V_{DD} of 4 volts is satisfactory. Then the negative supply, V_{SS} , will be 5 volts. The requirement is that $V_{DG} > V_{GS(OFF)}$ for operation in the saturated region.
3. Choose R_S so that I_D on the minimum I_{DSS} device is sufficiently below its zero V_{GS} drain current (I_{DSS}) to allow for an I_{DSS} decreasing with temperature (Fig. 2). Use the relationship

$$R_S < \frac{V_{SS}}{I_{DSS(MIN)}} \quad (1)$$

4. Choose R_O such that a reasonable match in V_{GS} is required. Using the values shown in Fig. 2, a V_{GS} match of approximately 0.3 volt is all that

would be necessary.

5. Determine allowable differential V_{GS} drift according to the application. For a bench instrument, the operating temperature range is small, so that the $\Delta|V_{GS1} - V_{GS2}|/\Delta T$ requirements would be moderate in this application.
6. Determine allowable I_G for the value of R_G to be used and the acceptable zero shift. Use

$$I_{G(MAX)} < \frac{V_{zero\ shift}}{R_G} \quad (2)$$

This would account for a zero shift when R_S is shunted across R_G . Note that the $I_{G(MAX)}$ value must be determined at the highest operating temperature.

Higher complexity in low-drift type

The design of a low-drift differential amplifier (Fig. 1B) is complex in comparison to the conventional type. The approximate gain function is given by

$$A_v = -g_{fs}/(g_{oss} + G_o) \quad (3)$$

if $R_O = 0$ and $g_{fs1} = g_{fs2}$.

The step-by-step design procedure resembles that used in the FET voltmeter:

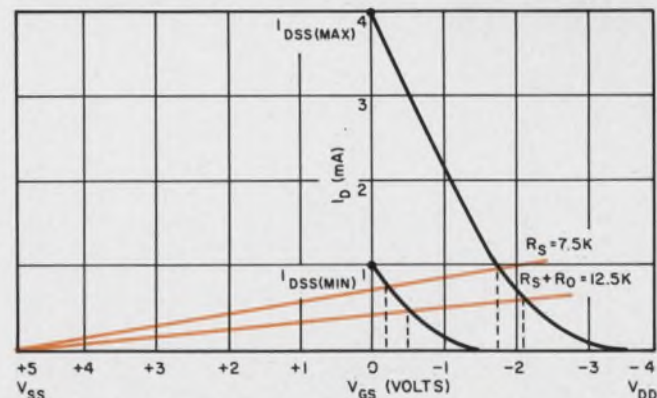

2. FET transfer characteristic curves are used to find the value of source resistance (R_S) for a simple voltmeter application (see Fig. 3a). Intersections of the proposed resistive load lines with the $I_D - V_{GS}$ curve of both min and max units are necessary. The load lines must pass beneath $I_{DSS(MIN)}$ point to allow for temperature changes in that parameter.

*See part 1 of this article.

1. Choose the operating point at or below the I_D value recommended in the device specifications (at least 25 percent below I_{DSS} in any case).
2. Determine $R_S \approx V_{SS}/2I_D$, or use a constant-current supply to increase the common-mode rejection.
3. Determine R_D using

$$R_D + R_S = \frac{(V_{DD} - V_{SS} - V_{DS}^+)}{I_D} \quad (4a)$$

An approximate value may be determined in most cases by using

$$R_D < \frac{V_{DD} - V_{GS(OFF)max}}{I_D + g_{fs} v_{in}} \quad (4b)$$

4. Choose a device to meet the stipulated offset $|V_{GS1} - V_{GS2}|$

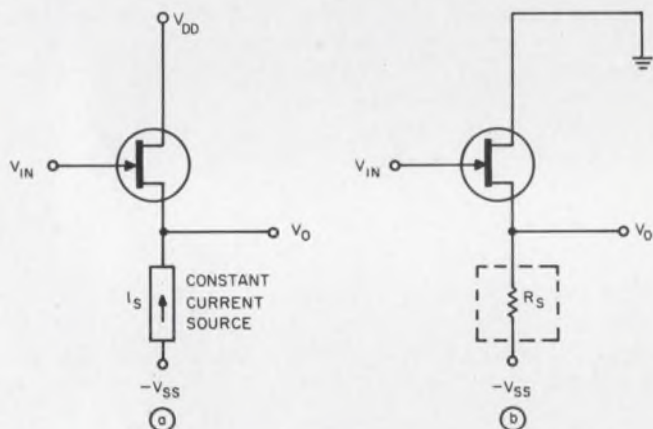

3. In low-drift, single-ended FET amplifiers, either a constant-current source (a) or a large R_S returned to a high-valued V_{SS} supply (b) may be used for the current bias. Low-drift operation is obtained by biasing at or near the zero temperature coefficient point.

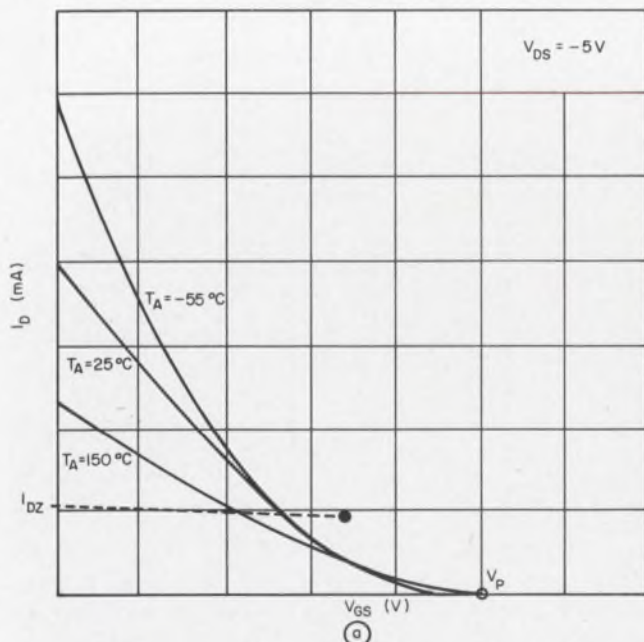

4. The zero temperature coefficient current bias (I_{DZ}) may be found in the transfer characteristic (a). Plots of I_D vs V_{GS} at different temperatures are made; their common intercept is the zero tc point. Drift as a function of tem-

$V_{GS2}|$ and drift $\Delta|V_{GS1} - V_{GS2}|/\Delta T$ performance requirements.

5. If exactly zero offset is required R_o is determined by using:

$$R_o = \frac{|V_{GS1} - V_{GS2}|(\text{specified})}{I_D} \quad (5)$$

Note that the addition of the component, R_o , will decrease the common-mode rejection.

6. Resistor R_G is calculated from the allowable drift with temperature limits (due to the differential I_G). Or, conversely, $|I_{G1} - I_{G2}|$ is established by allowable temperature drift with a given R_G . In evaluating device specifications for Item 4, allowance must be made for the sum of $\Delta|V_{GS1} - V_{GS2}|/\Delta T$ and $R_G |I_{G1} - I_{G2}|$ at the highest operating temperature.

Bias critical in single-ended amplifier

Nearly any FET may be operated as a single-ended, low-drift amplifier when it is biased to a zero temperature-coefficient point. The conditions which set the zero temperature-coefficient operation were outlined in Part 1 of this article. This point is usually found at a V_{GS} bias of from 0.6 to 0.8 volt less than the V_P value. That is, a device with V_P of 3 volts would be likely to have a zero temperature coefficient operation is given by:

It is often more convenient to bias at a specific value of I_D at which the zero temperature coefficient occurs. The approximate I_D for zero temperature coefficient operation is given by:

$$I_{DZ} \approx \frac{0.4 I_{DSS}}{V_P^2} \quad (6)$$

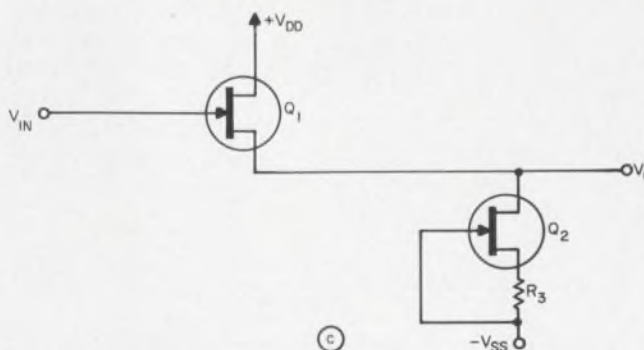
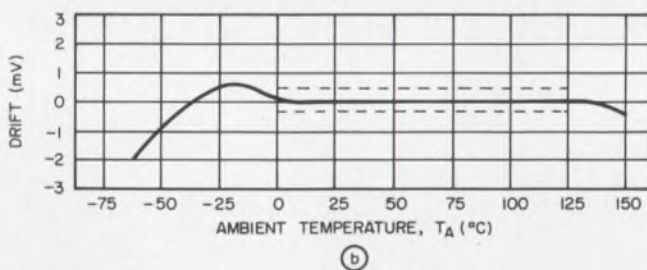

perature is plotted (b) for a low-drift single-ended FET amplifier (see Fig. 5b). Note the very small drift from 0° to 125°C. A second FET, operating at its zero tc, as a current source (c) provides even more stable operation.

Observe that I_{DZ} decreases with increasing I_{DSS} because the $V_p - I_{DSS}$ relationship is such that V_p increases at a greater rate than does I_{DSS} for a given FET geometry or device type.

In the low-drift circuits (Fig. 3), either a constant-current supply (a) or a large R_s returned to a large V_{SS} (b) may be used to current-bias at the zero temperature coefficient point. In theory it is practical to operate a FET having a $V_p \approx 0.6$ volt at zero bias to realize a source-follower matching circuit with a zero temperature coefficient and zero offset.

In fact, however, the gate-source voltage for a zero temperature coefficient value of V_{GSZ} exhibits a spread, so that V_{GSZ} is not always equal to $V_p - 0.6$ volts. Thus, it is not practical to select accurately for zero temperature coefficient exclusively on the basis of V_p . The range of I_{DZ} may be specified by the manufacturer, or it may be approximated from Eq. 6 after measuring I_{DSS} and V_p . Alternatively, it may be measured directly. In actual designs, empirical methods must be used to establish the exact zero temperature-coefficient point.

The simplest method of measuring I_{DZ} is to plot the $I_D - V_{GS}$ transfer curve of the FET on an X-Y plotter (Fig. 4a). Then, carefully heat the FET with a soldering iron or any other convenient means and replot the transfer curve. The I_{DZ} and V_{GSZ} may then be read directly from the I_D and V_{GS} scales at the intercept of the two curves. The temperature to which the device is heated is not important, only the change in the curve due to the heat applied counts. This is easily understood if a third curve is plotted at another temperature. If that is done, the third curve will pass through the same zero temperature coefficient point.

Zeroing in on key parameters

After the zero temperature-coefficient point is found, it is wise to measure the temperature coefficient of V_{GS} prior to final selection of the individual FET. This is necessary to ensure that V_{GS} behaves well at the zero temperature-coefficient point. Occasionally, a particular FET may drift several millivolts over a 50°C range. However, when accurately biased, performance as indicated in Fig. 4b may be expected.

For any given low-drift, single-ended amplifying application, the design characteristics of importance are:

- $I_{DZ} = I_D$ for zero temperature-coefficient operation.
- $V_{GSZ} = V_{GS}$ at zero temperature-coefficient bias.
- $g_{fsz} = g_{fs}$ at zero temperature-coefficient bias.
- $I_{GZ} = I_G$ at zero temperature coefficient bias.

The design procedure is as follows:

1. Select a FET with a g_{fsz} high enough to suit the application.
2. Select for V_{GSZ} low enough to suit the input-output offset requirements.
3. Determine I_{DZ} .
4. Select R_s and V_{SS} , or a current source, to provide the proper bias. Use

who said plugwires can't be interchangeable between systems?



MAC Panel's series 140 are!

MAC Panel's new Series 140 Plugwires are interchangeable with most existing systems. Another important engineering feature is the Ball-D-Tent design. It prevents accidental dislodging of the plugwires, and yet provides closely controlled extraction forces. Won't mar insert surface, either.

The complete line of Series 140 Plugwires is available in color-coded lengths ranging from 5 to 35 inches, and is available with Gold or Nickel plating in the following types:

GOLD PLATED 140 WIRES

Manual Single Conductor Stack Plugs	Manual Dual Conductor Manual Single Conductor Shielded
Manual 3 Pin Common	Two Conductor Shielded
Manual 4 Pin Common	Three Conductor Shielded
Manual 6 Pin Common	Four Conductor Shielded

NICKEL PLATED 140 WIRES

Manual Single Conductor Stack Plugs	Manual 4 Pin Common Manual 6 Pin Common
Manual 3 Pin Common	Manual Dual Conductor

ORDER NOW . . . AVAILABLE FOR IMMEDIATE DELIVERY

MAC
O.E.M. DIVISION

MAC PANEL CO. High Point, N.C.

ON READER-SERVICE CARD CIRCLE 38

$$R_s = (V_{SS} + V_{GSZ}) / I_{DZ} \quad (7)$$

If very accurate zero temperature coefficient operation is desired, R_s , V_{SS} and/or the current source must be temperature compensated. One method of providing a zero temperature coefficient

source is to use a second FET connected as a current generator (Fig. 4c). Then FET units Q_1 and Q_2 are selected for a matched I_{DZ} , and Q_2 is voltage-biased at V_{GSZ} by means of the voltage drop across R . The R_s value is given by V_{GSZ} / V_{DZ} . ■ ■

APPENDIX-HOW FET PARAMETERS ARE SPECIFIED

Parameter	Test Conditions (must be specified)	Meaning of specification
I_{GSS}	V_{GS} $V_{DS} = 0$	Gate-channel leakage with $V_{DS} = 0$. This represents total gate leakage current at a point below breakdown voltage. Specified at $1/2$ to 1 times the minimum specified BV_{GSS} . When specified at min BV_{GSS} , I_{GSS} may replace the BV_{GSS} specification in that I_{GSS} is $< I_G$ in the BV_{GSS} specification.
I_{DGO}	V_{DG} $I_B = 0$	Drain-to-gate leakage current with source open. As $V_{GS} \approx V_{GS(OFF)}$ for reasons indicated under BV_{DGO} , $I_{GS} \neq 0$. Then $-I_{DGO} = I_{GD}$ [at specified V_{DG}] + I_{GS} [at $V_{GS} \approx V_{GS(OFF)}$]. I_{DGO} is representative of I_G under worst probable operating conditions when $V_{GS} = V_{GS(OFF)}$ and $V_{DG} =$ maximum allowable.
I_G	V_{DS} or V_{DG} V_{GS}	Gate leakage current under certain operating conditions. I_G is usually somewhat lower than I_{DGO} since I_{DGO} is the limiting case of I_G .
I_{DSS}	V_{DS} $V_{GS} = 0$	Drain saturation current, the value of I_D measured above the knee of the $V_{DS}-I_D$ characteristic curve, where $V_{DS} > V_P$. I_{DSS} is actually defined as I_D at the V_{DS} required for channel pinch-off when the two gate-channel-junction depletion regions meet near the drain. V_{GS} must be zero. At this point I_D is self-limiting, and any increase in V_{DS} causes only slight increase in I_D . In Type-C MOS devices, I_{DSS} is essentially the drain-substrate leakage plus any residual drain-source channel current.
I_D	V_{DS} or V_{DG} V_{GS}	Drain-source current under certain specified operating conditions.
I_{DX}	V_{DS} or V_{DG} V_{GS}	Same as I_D but a particular set of operating conditions is implied.
I_{DZ}	V_{DS} or V_{DG} V_{GS}	Same as I_{DX} but often used to denote drain current for zero temperature-coefficient operation.
$V_{GS(OFF)}$	V_{DS} I_D	Gate cut-off voltage. Gate-source voltage required to cut-off channel current.

Parameter	Test Conditions (must be specified)	Meaning of specification
V_P		Pinch-off voltage, interchangeable with $V_{GS(OFF)}$.
V_{GS}	V_{DS} I_D	Gate-source voltage at any given operating point.
V_{GSX}	V_{DS} or V_{DG} I_D	Same as V_{GS} but a particular set of operating conditions is implied.
V_{GSZ}	V_{DS} or V_{DG} I_D	Same as V_{GSX} but often used to denote V_{GS} for zero temperature coefficient operation.
$ V_{GS1}-V_{GS2} $	V_{DG} I_S or I_D	Magnitude of gate-to-gate differential offset voltage in differential (matched) pairs.
$\Delta V_{GS1}-V_{GS2} $	V_{DG} I_S or I_D	Change in $ V_{GS1}-V_{GS2} $ over given temperature range.
$\frac{\Delta V_{GS1}-V_{GS2} }{\Delta T}$	T_{A1} & T_{A2}	Incremental change in $ V_{GS1}-V_{GS2} $ expressed in $\mu V / ^\circ C$.
$\frac{I_{DSS1}}{I_{DSS2}}$	V_{DS} $V_{GS} = 0$	Match in I_{DSS} of differential pairs, expressed as a fraction.
$ I_{G1}-I_{G2} $	V_{DS} & V_{GS} V_{DG} or I_D T_A	Magnitude of match in I_G for differential pairs. Usually specified at an elevated temperature near $100^\circ C$.
$r_{DS(ON)}$	I_D V_{DS} & /or V_{GS}	Static drain-source resistance when biased to full ON condition (maximum operating I_D).
$ g_{rs} $		Magnitude of common-source forward transfer conductance. Sometimes the magnitude signs are omitted. This is perhaps a more informative term than y_{rs} . At 1kHz, $y_{rs} \approx g_{rs}$. However, at high frequencies y_{rs} includes the effect of gate-drain capacity, hence may be misleadingly high. The term g_{rs} should be used for all high-frequency measurements.
g_{rxx}	V_{DS} & V_{GS} or V_{DG} & I_D frequency	Same as g_{rs} but a particular set of operating conditions is implied.
$\frac{g_{r*1}}{g_{r*2}}$		Match in g_{r*} for differential pairs. Expressed as a fraction.
$\frac{g_{r*1}}{g_{r*2}}$		Match in g_{r*} for differential pairs.
g_{r*}		Same as g_{r*} but often used to denote g_{r*} when biased for zero temperature coefficient operation.
g_m		Mutual conductance. Sometimes used in lieu of g_{r*} .
g_{o*}		Common-source output conductance with input shorted.



Now 10 solid state differential voltmeter models for immediate off-the-shelf delivery!

($\pm .05\%$ to $\pm .005\%$)

Immediate delivery is now offered on these 10 precision AC-DC differential voltmeter models.

Why the choice of models? To fit your measurement accuracy requirements and budget limitations! Accuracy from $\pm .05\%$ to $\pm .005\%$, priced from \$455 to \$1925.

Key Voltmeter Features—Selected and aged precision wire wound resistors • Ultra stable Zener reference operates in a proportional control oven • KVD output accessible from rear panel • Specified accuracies are of reading, not full scale • All silicon, transistorized circuitry • Voltage range 0-1,000 volts AC and DC in 5 ranges • Potentiometric input impedance to 10 volts •

CHECK YOUR CHOICE	MODEL	*DC ACCURACY (+5 μ V)	*AC ACCURACY (+25 μ V)	PRICE	DECADES OF RESOLUTION
<input type="checkbox"/>	DC-100B	$\pm .05\%$	—	\$455.00	5
<input type="checkbox"/>	AC-100B-1	$\pm .05\%$	$\pm .20\%$	855.00	5
<input type="checkbox"/>	DC-110B	$\pm .02\%$	—	575.00	5
<input type="checkbox"/>	AC-110B-1	$\pm .02\%$	$\pm .10\%$	995.00	5
<input type="checkbox"/>	DC-150B	$\pm .01\%$	—	775.00	5
<input type="checkbox"/>	AC-150B-1	$\pm .01\%$	$\pm .10\%$	1190.00	5
<input type="checkbox"/>	DC-200B	$\pm .0075\%$	—	965.00	6
<input type="checkbox"/>	AC-200B-1	$\pm .0075\%$	$\pm .10\%$	1390.00	6
<input type="checkbox"/>	DC-210B	$\pm .005\%$	—	1480.00	6
<input type="checkbox"/>	AC-210B-1	$\pm .005\%$	$\pm .10\%$	1925.00	6

*Accuracy specified over temperature range of 15°C - 35°C

metric input impedance to 10 volts • 4½" taut band meter for maximum visual resolution • Lightweight portable, compact size.

Check off the model which best fits your needs, then for immediate delivery, contact your nearest Honeywell sales office or write to: Honeywell, Test Instruments Division, San Diego Operation, 8611 Balboa Ave., San Diego, California 92112.

DATA HANDLING SYSTEMS

Honeywell

HONEYWELL IS WORLDWIDE • Sales and service offices in all principal cities of the world. Manufacturing in Brazil, Canada, France, Germany, Japan, Mexico, Netherlands, United Kingdom, United States.

ON READER-SERVICE CARD CIRCLE 39

Differentiator noise is no problem,

if your application is low-frequency. In fact, the simpler the circuit, the better.

Analog differentiators, which many engineers avoid using because of inherent noise problems, can be simply modified to reduce noise to as low as 15 mV. Application is limited to low-frequency operation, but circuit economies make the pure differentiator worth considering. Only one operational amplifier need be used to achieve the cited noise level, instead of complex "quasi-differentiation" circuits.

Usually a rearrangement of the design can eliminate the need for differentiators. Less noisy integrators can be used instead. But in at least one case the designer must ordinarily cope with them, like it or not: when it is necessary to develop the first derivative of a given analog signal, such as a process variable.

Three circuits are basic

An analysis of the noise characteristics and transfer functions in three basic differentiator circuits will prove that the simplest circuit may be the best for your application. Many other differentiator circuits have been discussed in the literature,^{1,2,3,4} but they are, in general, modifications of the fundamental circuits shown in Table 1.

Circuit I is the simplest, most straightforward method, with only one operational amplifier. Circuit II uses another network to generate the transfer function $(1 + sT)$.¹ The required function sT is obtained by adding the input voltage E_s to the output of the first operational amplifier. Finally, in Circuit III, differentiation is gained by putting an integrator into the feedback path of a closed loop.⁴ The output of this integrator is forced, by feedback action, to be identical with the input signal E_s ; thus the integrator input is obviously the derivative of the input signal.

To test their relative noise sensitivity, the performance of the three basic circuits was analyzed by introducing additional noise sources to simulate worst-case conditions at the inputs of the operational amplifiers. Amplifier noise and noise picked up by the circuit (mainly hum) were taken into account. The test proved noise to be handled in almost the same way by all three circuits.

Instability then is the real villain. An inspec-

tion of the transfer functions of the basic configurations reveals that all are either unstable or operate near the limit of stability. Most inherent noise in differentiators is amplified by this tendency to instability, since damped oscillations are likely to be triggered by even the smallest noise peaks. To ensure stable operation, the true differentiation is normally dropped and the ideal transfer function, sT , replaced by $sT/(1 + ksT)$.

This had the same effect for all three circuits, and no reason could be found for abandoning the simple one-amplifier circuit in favor of other circuits requiring two or more operational amplifiers.

General transfer function for noise

A generalized equivalent circuit of an operational amplifier allowing for both signal and noise is shown in Fig. 1. For a complete analysis, two noise generators are introduced: both voltage and current.⁵ The noise voltage generator, E_N , represents induced noise of low internal impedance, e.g., as produced by inductive pickup. The noise current generator, I_N , accounts for disturbances of high internal impedance such as capacitive coupling. The output voltage of the circuit is:

$$E_o(s) = - \frac{1}{1 + \frac{1}{A} \left(1 + \frac{Z_f}{Z_i} \right)} \left(\frac{Z_f}{Z_i} E_s + \left[1 + \frac{Z_f}{Z_i} \right] E_N + Z_f I_N \right). \quad (1)$$

Within the useful frequency range of the amplifier, $A \rightarrow \infty$, and the above expression may be simplified to:

$$E_o(s) \approx - \left(E_s \frac{Z_f}{Z_i} + E_N \left[1 + \frac{Z_f}{Z_i} \right] + I_N Z_f \right). \quad (2)$$

The three basic differentiator circuits shown in Table 1 also include noise sources. The noise circuit generator at the operational amplifier in circuit III, however, is omitted, since amplifier 1 is driven from low-impedance sources. The output voltage of each circuit, as derived by Eq. 2, is also noted in Table 1. The output noise level is most favorable for circuit I, and worst for circuit II, since both the noise voltage E_{N1} and the noise current I_{N1} are

Roland E. Best, Electronics Laboratory, Sandoz, Ltd., Basel, Switzerland

Table 1. Noise transfer functions

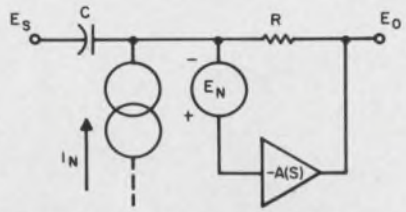
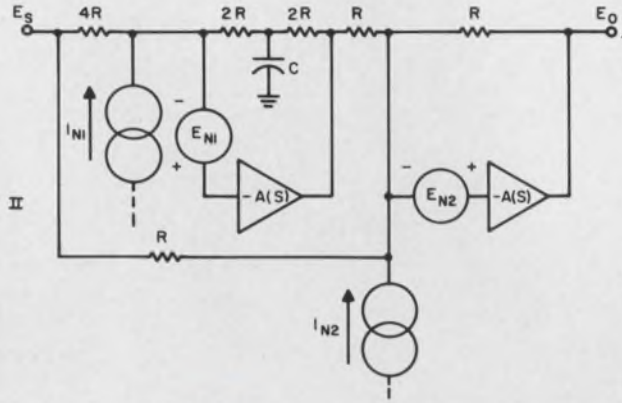
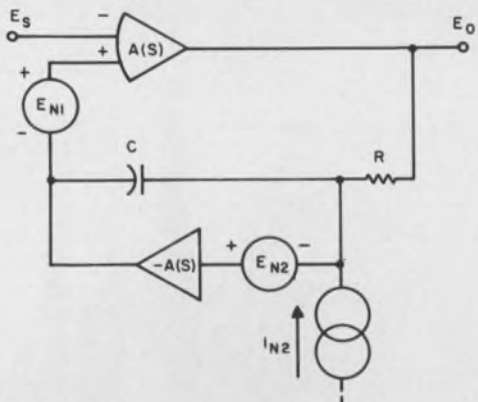
BASIC CIRCUIT + NOISE SOURCES	BASIC TRANSFER FUNCTION	NOISE TRANSFER FUNCTION (T=RC)
	$E_o = -sTE_s$	$E_o(s) = -sTE_s - (1+sT)E_N - RI_N$
	$E_o = +sTE_s$	$E_o(s) = +sTE_s + (2+sT)E_{N1} + 4R(1+sT)I_{N1} - 3E_{N2} - RI_{N2}$
	$E_o = -sTE_s$	$E_o(s) = -sTE_s + sTE_{N1} - (1+sT)E_{N2} - RI_{N2}$

differentiated.

Phase shift causes instability

Applying the servo philosophy to circuit I, the differentiator represents a closed loop consisting of an RC-lag network connected in cascade with the operational amplifier.⁵ Generally, the voltage transfer function of an operational amplifier is given as:

$$A = \frac{A_o}{1 + sT_o} \tag{3}$$

The frequency response is shaped by passive networks to have a constant-gain rolloff of 20 dB per decade of frequency above the corner frequency, $\omega_o = 1/T_o$. Consequently, the phase shift will approach asymptotically -90° at frequencies higher than ω_o . The RC-lag network also contributes a -90° phase shift at higher frequencies. Theoretically the total phase shift cannot exceed

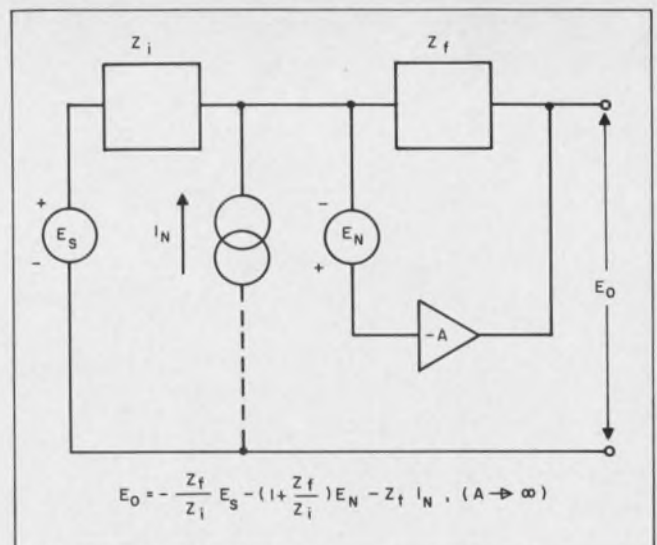

1. Generalized equivalent circuit of noise in an operational amplifier, and the transfer equation, including noise voltage generator, E_N , and noise current generator, I_N .

Table 2. Basic circuits modified for low noise

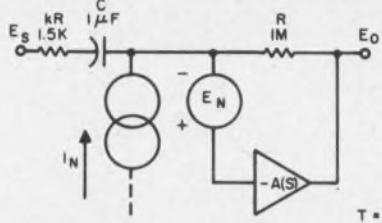
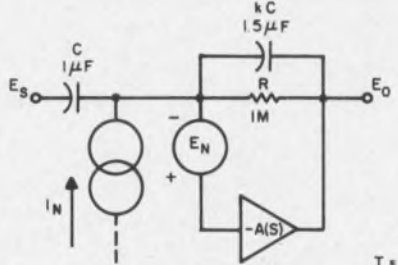
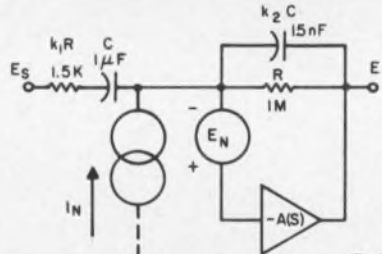
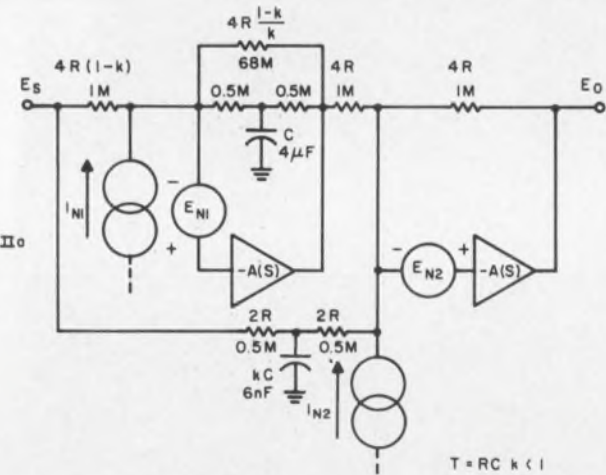
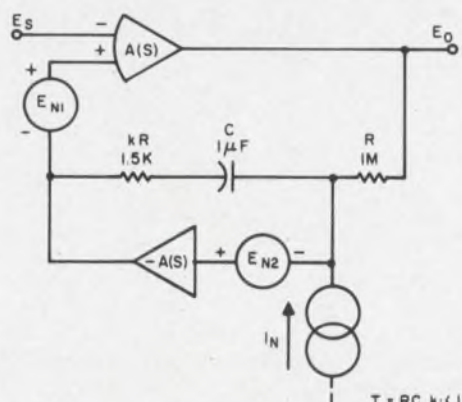
MODIFIED CIRCUIT	MODIFIED TRANSFER FUNCTION	MEASURED * NOISE
<p>I a</p>  <p style="text-align: right;">$T = RC \ k < 1$</p>	$E_O = \frac{-sT}{1+skT} E_S - \frac{1+sT(1+k)}{1+skT} E_N - RI_N$	<p>30 mVp-p</p>
<p>I b</p>  <p style="text-align: right;">$T = RC \ k < 1$</p>	$E_O = -\frac{sT}{1+skT} E_S - \frac{1+sT(1+k)}{1+skT} E_N - \frac{R}{1+skT} I_N$	<p>20 mVp-p</p>
<p>I c</p>  <p style="text-align: right;">$T = RC \ k_1, k_2 < 1$</p>	$E_O = -\frac{sT}{(1+sk_1T)(1+sk_2T)} E_S - \frac{1+sT(1+k_1+k_2)+s^2T^2k_1k_2}{(1+sk_1T)(1+sk_2T)} E_N - \frac{sT}{(1+sk_1T)(1+sk_2T)} I_N$	<p>15 mVp-p</p>
<p>II a</p>  <p style="text-align: right;">$T = RC \ k < 1$</p>	$E_O = +\frac{sT}{1+skT} E_S + \frac{2+sT(1+k)}{1+skT} E_{N1} + 4R(1-k) \frac{1+sT}{1+skT} I_{N1} - \frac{3+2skT}{1+skT} E_{N2} - 4RI_{N2}$	<p>50 mVp-p</p>
<p>III a</p>  <p style="text-align: right;">$T = RC \ k < 1$</p>	$E_O = -\frac{sT}{1+skT} E_S + \frac{sT}{1+skT} E_{N1} - \frac{1+sT(1+k)}{1+skT} E_{N2} - RI_{N2}$ <p style="text-align: center;">* MEASURED WITH INPUT GROUNDED T = 1sec, k = 0.0015, E_S = 0</p>	<p>50 mVp-p</p>

180°, below which point the circuit would be stable. In practice, however, the phase shift of operational amplifiers can slightly exceed the theoretical limit of -90° due to component variations. If this occurs at a frequency where the total gain is larger than 0 dB, the system becomes unstable. But even when the phase shift of the amplifier is less than 90° , the stability of the differentiator is borderline.

The damping factor, ζ , is often used as a quantitative measure of system stability. The damping factor can be obtained⁶ from a Bode plot of the closed-loop transfer function by means of the formula, $\zeta \approx \alpha/3n$, where α is the phase crossover in degrees and n is the slope of the gain curve with the unit dB/decade. Since α is near 0° , the damping factor also approaches 0.

The same considerations apply to the other circuits of Table 1. In order to achieve satisfactory operation, the basic differentiator circuits have to be modified by the addition of compensating elements. These will provide additional phase-lead at higher frequencies, thus increasing the phase crossover α and the damping factor ζ , and thereby improving stability.

Simple modification achieves 15-mV noise

Five modified versions of the three basic differentiator circuits are shown in Table 2, along with the transfer functions for signal and noise. The transfer functions for the signal E_s are the same for all circuits with the exception of circuit Ic which exhibits one additional phase lag. The transfer functions for the noise terms are somewhat different. The signs of the noise terms can be ignored, since in order to calculate the total output noise voltage, it is necessary to sum up the rms values of the terms.

In order to verify the noise performance predicted by the formulas in Table 2, the differentiator circuits were built experimentally. For all five circuits the noise voltages at the output were measured peak-to-peak with the input shorted and under the same conditions of hum pickup for all circuits. The measured values are listed in Table 2. The magnitudes of the noise voltages correspond well with the theoretical results. For comparison, noise figures measured in the unmodified circuits were typically 0.3 V p-p for circuit I, 10 V for circuit II and 0.35 V for circuit III. ■ ■

References:

1. H. Chestnut and R. W. Mayer, *Servomechanisms and Regulating Systems* (New York: John Wiley & Sons, Inc., 1959).
2. B. T. Fairchild and L. J. Krovets, "10 Circuits for Differentiation in Analog Computers," *Control Engineering*, Feb., 1965.
3. P. Tarnoff, "Low Noise Differentiator Features Fast Response," *Control Engineering*, Nov., 1963.
4. S. Fifer, *Analogue Computation* (New York: McGraw-Hill, Inc., 1961).
5. *Analog Computer Techniques Applied to Industrial Instrumentation and Control* (Geo. A. Philbrick Researches, Inc., Report No. REP 18/3M/AND/462 [New York]).
6. K. Izawa, *Introduction to Automatic Control* (New York: Elsevier Publishing Co., 1963).



PHOTOELECTRIC BLOCK READER



40 LINE MODEL

Use the EECO 5000 Readers for

• Programmed testing • Micro positioning • Automatic component selection... or wherever from 40 to 320 bits of information on punched tape is needed.

• PHOTOELECTRIC READING • ALL SILICON SEMI-CONDUCTORS • ALL SOLID STATE DRIVE—NO CLUTCHES, RELAYS OR SOLENOIDS • VOLTAGE LEVEL OR CURRENT SWITCHING OUTPUTS—FROM 100 MA TO 2 AMPS SWITCHING

7 standard block sizes—from 5 lines to 40 lines. Frame stepping rates from 2 to 12 frames/sec.
Special block sizes and output options.



Electronic Engineering Company of California

1601 East Chestnut Avenue (Box 58)
Santa Ana, California 92702
Phone: (714) 547-5501 • TWX: 714-531-5711

Useful new data on AE'S dry reed switches for printed circuits

Our new 8-page brochure gives complete application and specification data on PC (Printed-Circuit) Correeds by Automatic Electric, one of the nation's leading suppliers of dry reed switches.

PC Correeds are specifically designed for direct insertion into printed circuit boards. They're high-speed, structurally strong, compact. They feature unstressed contact leads and firm, positive connections.

Glass-filled plastic bobbins prevent moisture absorption. Low profiles, magnetic shielding and standard

PC terminal spacing (multiples of 0.200") permit high-density packaging.

PC Correeds are available with 1, 2, 3 and 5 reedcapsules, in contact Forms A, B, C and magnetic latching. You can get many of these modules directly from stock.

There's a lot of helpful, detailed design information in AE's new

PC Correed brochure. Just ask your nearest AE representative for Circular 1070-B, or write to the Director, Electronic Control Equipment Sales, Automatic Electric Company, Northlake, Illinois 60164.



AUTOMATIC ELECTRIC

SUBSIDIARY OF
GENERAL TELEPHONE & ELECTRONICS **GTE**

ON READER-SERVICE CARD CIRCLE 41

Check out P&B as a big new source for precision snap-action switches

with this 28-page catalog

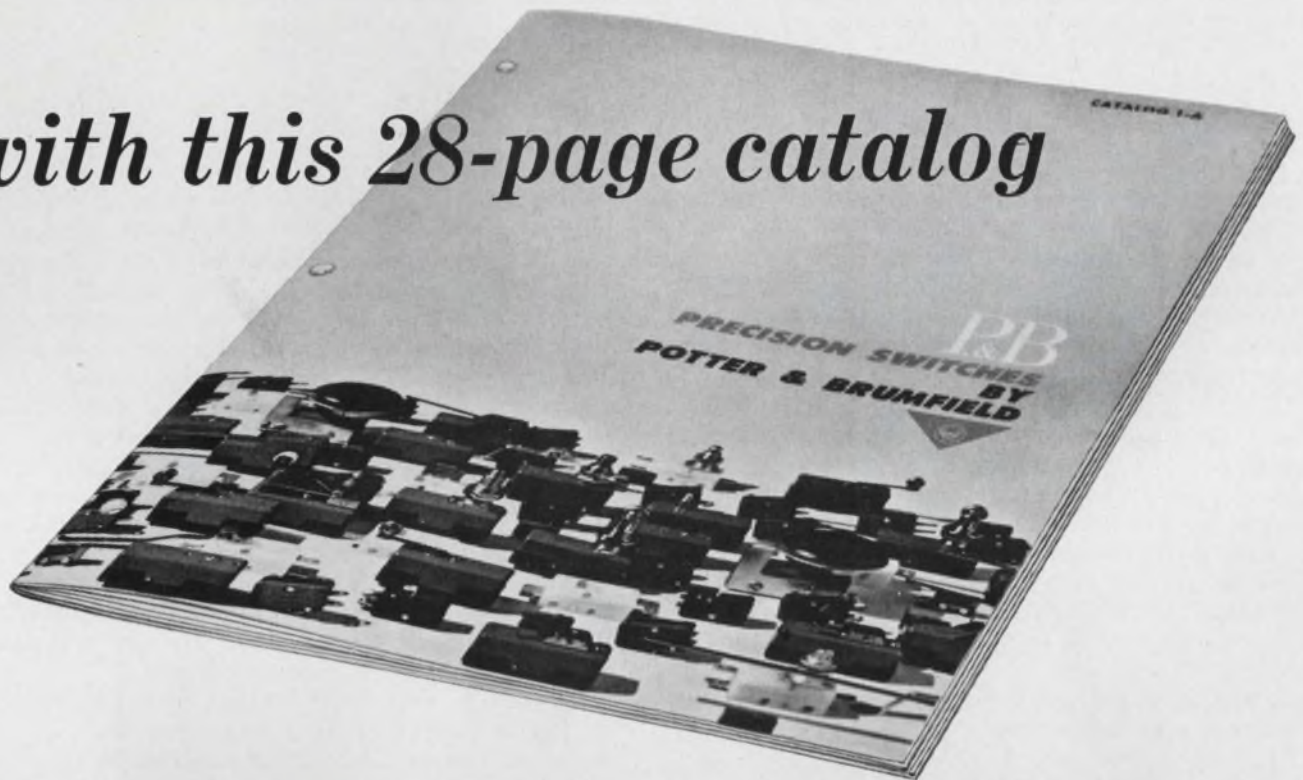

This catalog shows a wide variety of precision snap-action switches including general purpose, miniature, subminiature and appliance. Most are directly interchangeable with many competitive types. All meet U/L and CSA requirements and are available with

a wide choice of actuators, contact arrangements and terminals. Mounting dimensions and materials meet military specifications. The designs lend themselves to almost limitless modification for adaptation to individual requirements. Send for your copy.

PRECISION GENERAL PURPOSE SWITCHES



Accurate performance and high repeatability for heavy load application. Available with 15 and 20 ampere ratings with a broad variety of actuators.

PRECISION MINIATURE SWITCHES



These high speed snap-action switches are highly sensitive and feature small size long operating life and high electrical capacity. Available with various contact and terminal arrangements.

PRECISION SUBMINIATURE SWITCHES



Designed for applications requiring small size and low operating force. Suitable for electronic equipment, business machines and other precision equipment.

LOW COST NYLON-ENCASED APPLIANCE SWITCHES



Sturdy mechanical construction capable of withstanding considerable impact at full overtravel thus reducing positioning adjustment.



POTTER & BRUMFIELD

Division of American Machine & Foundry Company, Princeton, Indiana
Export: AMF International, 261 Madison Avenue, New York, N. Y.

P&B Precision Switches are available at Authorized Distributors

Speed Inquiry to Advertiser via Collect Night Letter
ON READER-SERVICE CARD CIRCLE 42

Cure force-transducer inaccuracy in error-signal detection by using a pulse-width multiplier to broaden the response time. It's a simple, inexpensive remedy.

Many control systems often use force transducers to handle error-signal information in pulse form. The weak spot in this data-processing link is usually the transducer's response time: It may be the cause of inaccurate outputs or a total lack of response dead-band at low-level pulse inputs. The use of a pulse-width-multiplier (PWM) stage overcomes this liability.

The PWM multiplies the widths of error pulses by a constant, which can be changed to meet the demands of a particular force transducer's response time. In comparison with other means for achieving this pulse conversion (such as a pulse-train-to-dc converter), the PWM approach is simple and inexpensive. The PWM, which contains three basic switching units and one energy-storing element, can also be employed in digital computer systems. It can convert digital outputs directly into analog pulses, which in turn are used in conventional control systems.

Sensing out the transducer problem

The need for a PWM system became apparent

Nelson J. Groom, Research Engineer, NASA Langley Research Center, Hampton, Va.

in a project involving a horizon scanner and its associated attitude sensors. The form of the basic output from most spacecraft attitude sensors is such that it must be modified to activate the vehicle's force transducers. The resulting signal must be accurately used in the vehicle's control system.

In an infrared horizon scanner developed at the Langley Research Center, the basic output was in the form of pulses whose width was proportional to the pointing error. The problem here was that with very small attitude errors, the pulse width output might go as low as 0.5 ms. This was, of course, below the response time of conventional force transducers.

A simple PWM was developed to solve the problem. It overcame the need for a more complicated pulse-width-to-dc conversion at the low-frequency (2 Hz) region of the scanner output.

The PWM (Fig. 1a) consists of a capacitor, a charge source, a discharge source and a level detector. The detailed circuit diagram is shown in Fig. 1b.

Here C_1 is the capacitor and R_2 the charge source. Transistor Q_1 , zener diode Z_1 and resistor R_3 form the discharge source, and the Schmitt trigger formed by Q_2 and Q_3 is the level detector. Transistor Q_4 merely serves as a switch to refer-

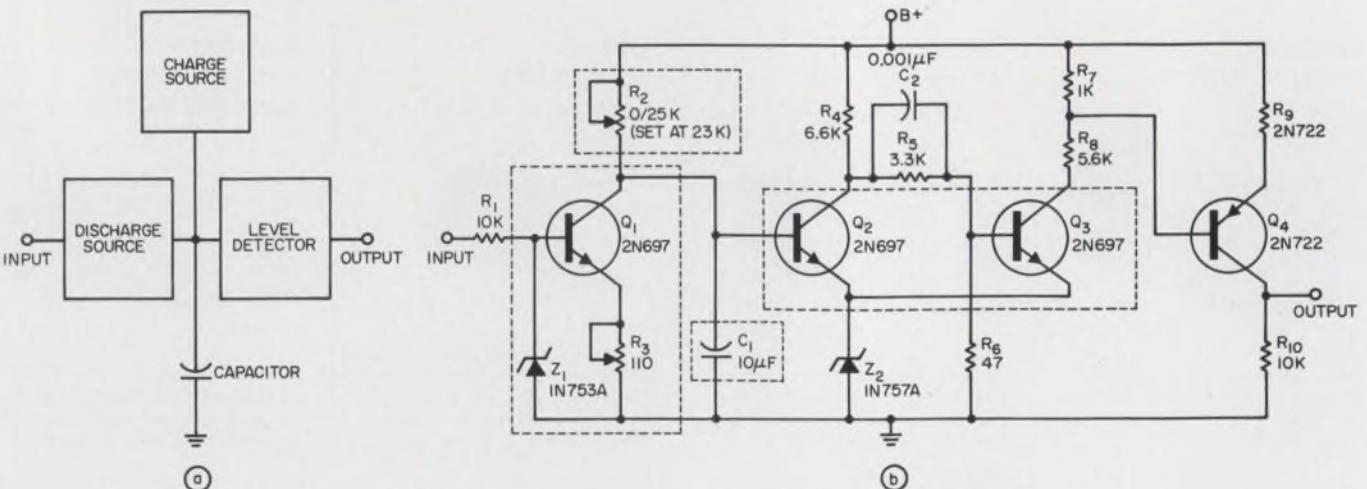

1. Pulse-width-multiplier system broadens the operating range and improves the low-level accuracy of force transducers. In the block diagram (a), input pulses are stretched so that output signals are within the response-

time limits of the transducer. Complete circuit diagram (b) uses Q_1 , Z_1 and R_3 as the discharge source, R_2 as the charging source, C_1 as the capacitor and the Q_2 - Q_3 Schmitt trigger for the level-detection function.

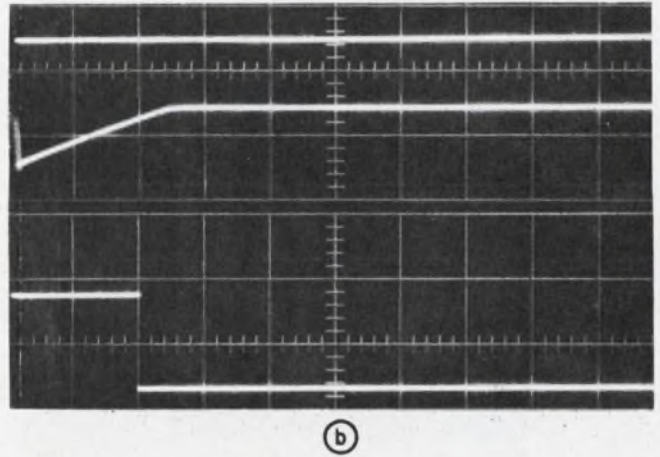
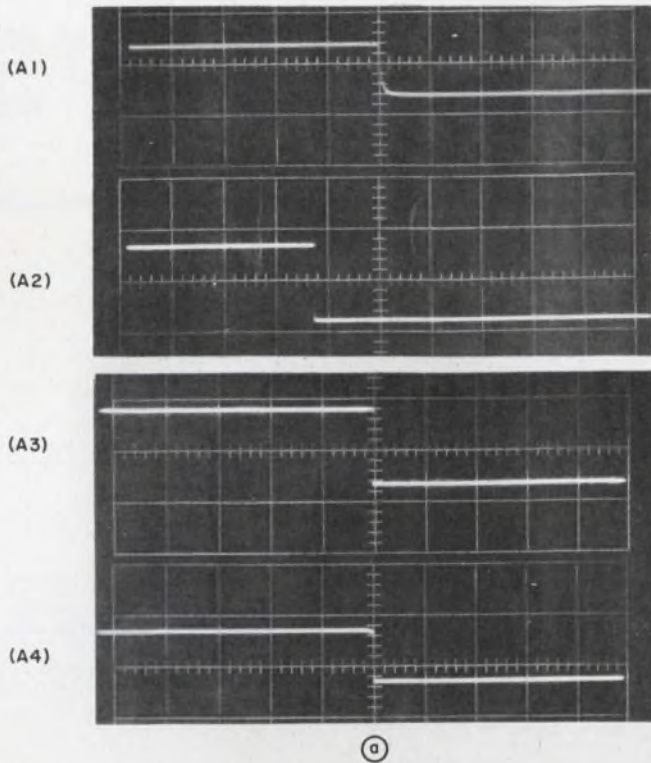

ence the output to ground.

Under quiescent conditions Q_1 is off, and C_1 is charged through R_2 to the zener voltage of Z_2 . This causes the Schmitt trigger to be in the ON state and, consequently, Q_4 is cut off. When a square wave pulse is applied to the input terminal, the leading edge turns on Q_1 , which in turn discharges C_1 through R_2 . Note that the voltage across R_3 is clamped to a level determined by Z_1 , thus producing a fairly linear discharge of C_1 .

Since the Schmitt trigger has practically zero hysteresis (because of Z_2), it changes state almost immediately after C_1 begins discharging. This turns Q_4 on and produces the leading edge of the output pulse. At the termination of the input pulse, Q_1 is returned to a cut-off state, and C_1 begins to recharge through R_2 . When the voltage on C_1 reaches the zener voltage of Z_2 , the Schmitt again changes state and cuts Q_4 off. This action produces the trailing edge of the output pulse.

PWM stretches pulse duration

Figure 2a shows the relationship between input and output for two different input pulse widths. Figure 2b shows the relationship between input pulse width, capacitor voltage and output pulse.

Rise and fall time for the output pulse was found to be $0.2 \mu\text{s}$ and $1.0 \mu\text{s}$, respectively. A graph showing the measured relationship of input pulse width to output pulse width over a range of $5.0 \mu\text{s}$ to 0.6 ms , with a pulse-repetition rate of 30 pps and pulse height of 20 volts, appears in Fig. 3. The multiplication factor was set at 50 with a 0.1-ms input pulse width. As can be seen, the curve is essentially linear, except for small pulse-width inputs. The over-all linearity results from use of

2. Pulse-stretching ability of the PWM system is demonstrated in the waveform (a). The upper trace in each photograph is the input pulse, and the lower trace displays the resulting output pulse for various multiplication factors. Shown are a $2 \mu\text{s/cm}$ -scaled input and the resulting output on a 0.1 ms/cm scale (A1 and A2, respectively); also, a $20 \mu\text{s/cm}$ -scaled input and its 1.0 ms/cm -scaled output (A3 and A4). The switching relationships are demonstrated in (b), where the input (top), capacitor voltage (middle) and output (bottom) are synchronized to a 2.0 ms/cm scale.

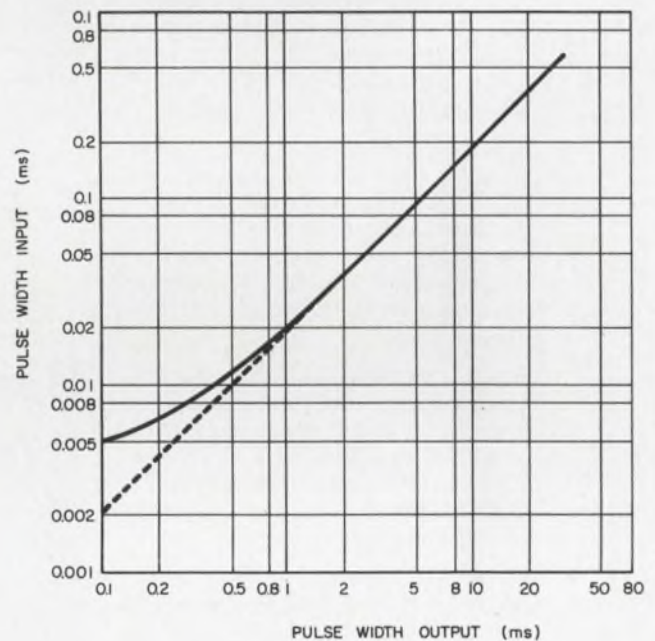

3. Linearity over a major portion of the input range is another feature of the PWM system. A different multiplying factor can be used in the non-linear portion to provide over-all accuracy.

only a small portion of the almost linear part of the charge curve of C_1 .

The pulse-stretching ability and broad range of the PWM system can be seen in the performance data. The multiplication factor itself can be varied (via R_2) from unity to a maximum determined by the input pulse width and the pulse-repetition rate. The pulse range over which the PWM will operate on an essentially linear curve is established by potentiometer R_3 . ■ ■

DESIGNER'S

P. R. MALLORY & CO. INC., INDIANAPOLIS, INDIANA 46206

New solid-state audible signal has low current drain, high reliability



The Sonalert® signal is a unique solid-state device which produces a compelling tone on as little as 3 milliamps. It consists of a piezoelectric transducer driven by a transistorized oscillator. It has no arcing contacts which cause explosion hazard and RF interference.

Sound intensity varies with applied voltage, and ranges from 68 to 80 db. Frequency is fixed by transducer characteristics, cannot be altered by external means, and is not affected by voltage. The device operates over a wide range of applied voltage.

Starting current is the same as operating current, and is exceptionally low. The 6 to 28 volt model draws only 3 milliamperes at 6 volts. The 110-volt AC model draws only 14 milliamperes (about the same as a neon pilot lamp).

Standard frequency is 2800 ± 300 cycles; a 4500 ± 500 cycle model is also available. AC and DC models are available, operating over the range from 6 to 28 volts; also a 110-volt AC model. A pulsed model produces "beeps" at a rate of 3 to 5 pulses per second. The high and low frequency units can be used in combination to indicate high or low limit alarms, or they can be used simultaneously to deliver a beat frequency signal.

Because of its solid-state design, the Sonalert has maximum reliability. It is being used as an over-voltage or undervoltage failure alarm on computers, as a "wheels

ON READER-SERVICE CARD CIRCLE 192

New polystyrene film capacitors have superior stability, low cost

Now available from Mallory is a line of polystyrene capacitors which have temperature and life stability exceeding that of polyester film types. They are made of a unique form of stretched polystyrene film and high purity aluminum foil. The manufacturing process fuses the polystyrene to form a self-sealed case with excellent humidity protection.

Insulation resistance of these capacitors is exceptionally high—in the order of 100,000 megohms—and stays high throughout life. Temperature stability is excellent: from -10°C to $+70^{\circ}\text{C}$, total capacitance change is less than -1.3% . Temperature coefficient is $-150 \text{ ppm}/^{\circ}\text{C}$, $\pm 60 \text{ ppm}/^{\circ}\text{C}$. Dissipation factor is less than 0.05% , and is constant over this temperature range.

ON READER-SERVICE CARD CIRCLE 191

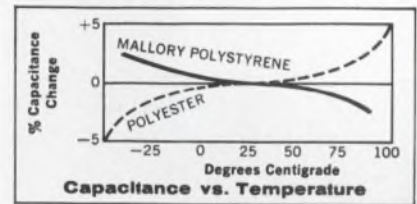

Temperature stability of Mallory Polystyrene Capacitors compared with polyester film capacitors.

73 standard ratings from 5 pf to .01 mfd, all at 600 volts DC, are available. Standard tolerance is $\pm 5\%$. Maximum operating temperatures are -40°C to $+85^{\circ}\text{C}$. Production quantities can be obtained immediately from Franchised Mallory Distributors, at prices below polyester film capacitors.

UL-recognized switch and control for light dimmers



down" signal on aircraft, as a security or overheat alarm. Because of its low power requirements, it can be actuated by batteries, directly by photo-sensitive devices; and it can be connected in fail-safe circuits where breaking a safety switch will apply full voltage across the Sonalert. Operating temperatures from -60 to $+120^{\circ}\text{F}$ are permissible. The complete unit is compact and is mounted on a single $1\frac{1}{4}$ " panel hole.

A combined push-push three-way switch and intensity control, especially designed for use in light dimmers, is now available from Mallory Controls Company. The front section carbon control and the integral switch are both designed to meet Underwriters' Laboratories requirements for voltage breakdown test and for dimensional spacing for use in electronic light dimmer controls.

The intensity control is rated 1 watt nominal, and is supplied in values from 100 to 10,000K ohms, in standard linear taper... also with other tapers and with fixed end resistances. The switch is single pole double throw, permanently attached to the same shaft with the control. It has been designed to handle dimmer loads up to 5 amperes at 117 volts, 60 cycles.

ON READER-SERVICE CARD CIRCLE 193

Wet slug tantalum capacitors are best choice for timing circuits

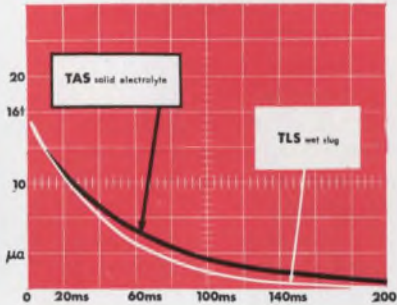

Compare charging current-time traces, reproduced from oscilloscope photographs. Sweep speed: 20 millisecc/div. Vertical sensitivity: $3\frac{1}{2}$ μ A/div.

In an RC timing circuit, the value of time constant is usually calculated from the nominal value of capacitance and the value of the timing resistor. When tantalum

capacitors are used in timing circuits, the effects of error introduced by DC leakage should be considered. Wet slug tantalum capacitors, because they have DC leakage in the order of 10% that of solid electrolyte types, have inherently far lower time error.

The effect of the leakage resistance path, in parallel with capacitor terminals, is to cause an apparent increase in time constant. The time error is, of course, zero in a perfect capacitor where the leakage path has infinite resistance... and increases as leakage resistance approaches the value of the timing or series resistance of the circuit.

For this reason, Mallory engineers often recommend wet slug tantalum capacitors for use in timing circuits where maximum precision is required. We have an engineering report on this subject, and will be glad to send copies on request.

ON READER-SERVICE CARD CIRCLE 194

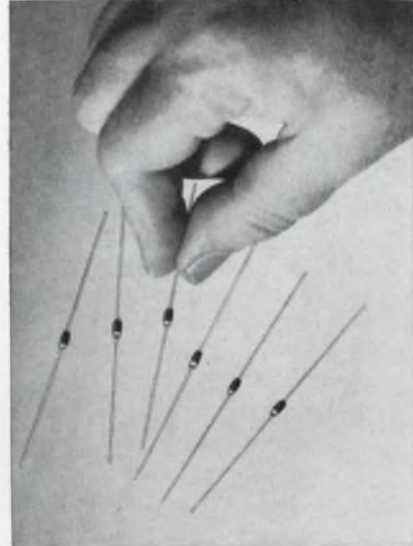

New small-size, low-price silicon rectifier line

The Mallory Type B rectifier is specifically designed for applications which require current capability up to 1 ampere in minimum size. It uses a passivated silicon junction for high temperature stability.

It's a new shape in rectifiers: the epoxy package is only .275" long and .135" maximum diameter, self-supported on .032" diameter axial leads. It needs no heat sink other than its own leads. Yet in this tiny size, it affords ratings of $\frac{3}{4}$ ampere and 1 ampere, at 50°C ambient. Peak inverse voltage ratings from 50 to 1000 volts are available.

Forward drop is only .9 volts for the 1-ampere units, and 1.0 volts for the $\frac{3}{4}$ -ampere type, at full rated current. Maximum surge current (4 millisecc) is 35 amperes. Accelerated environmental tests have demonstrated the Type B's ability to withstand severe humidity exposure.

Prices are as low as 10 cents in quantities of 100,000.

ON READER-SERVICE CARD CIRCLE 196

World's Smallest Primary Battery

Mallory can now offer electronic designers the world's smallest primary cell actually in production. Only 0.130" high by 0.225" diameter, this 1.35 volt miniature power source is rated to produce 16 milliampere hours.

Because the battery energy is created through Mallory's mercuric oxide-potassium hydroxide-zinc system, voltage is extremely accurate and stable, and shelf life extraordinarily long.

Among the possible applications for the battery (designated as Mallory RM-212) are hearing aids small enough to hide inside the ear canal, "radio" capsules to transmit information from inside the body, and extremely small proximity fuses and telemetry devices.

If you're looking for extremely small power sources, this may be it. Or perhaps this breakthrough in battery size suggests designs not possible until now.

ON READER-SERVICE CARD CIRCLE 195

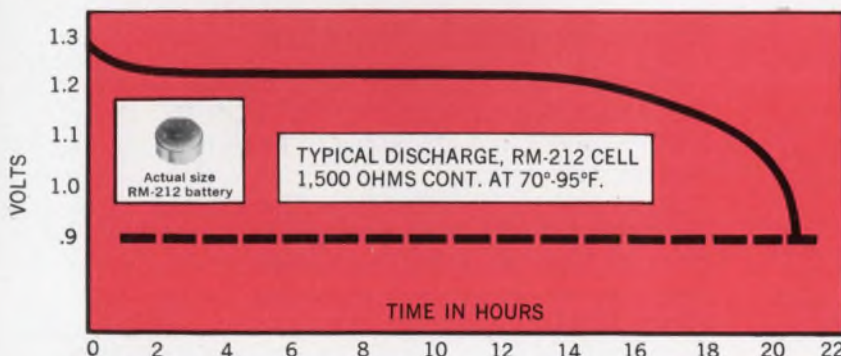

Avalanche circuit produces ultrafast light pulses

A light-emitting diode (LED) driven by an avalanche transistor can be used for avalanche relaxation oscillators with very fast rise times. Such a circuit is simple to construct and features rise times in the sub-nanosecond region for pulse durations of a few nanoseconds.

Fast-rise-time, nanosecond-duration light sources

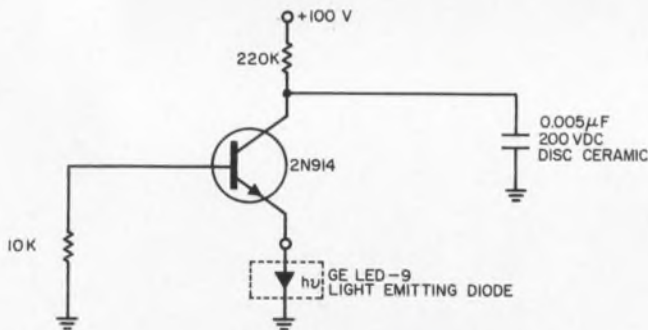

1. **Avalanche relaxation oscillator** is formed by this light-emitting diode—avalanche transistor circuit. A main feature is its sub-nanosecond rise time.

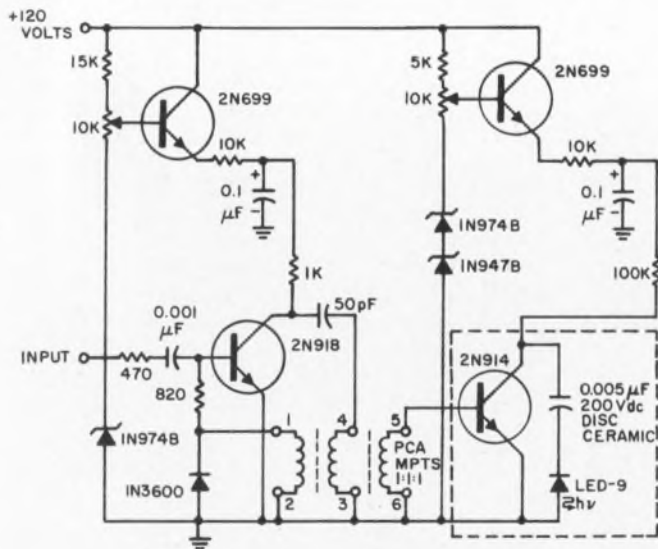

2. **The basic light-pulse generator** may be converted into a voltage generator. Here an avalanche blocking oscillator is driving the LED relaxation circuit.

es are extensively used for testing laser range-finder receivers and other electro-optical applications. Such light pulses usually are obtained with bulky apparatus, such as triggered spark gaps, flash tubes, Kerr cell modulators. Consequently, it may take a lot of time, space and equipment to produce a good light pulse. A more straightforward approach where infrared light pulses can be used is to drive an inexpensive, non-coherent LED with an avalanche transistor.

Figure 1 shows such an avalanche relaxation oscillator. Light power output is on the order of a few milliwatts with a pulse repetition frequency of a few kilohertz. Pulse rise time is typically less than one nanosecond.

Figure 2 shows an avalanche blocking oscillator driving an avalanche transistor. The circuit pulses only when driven by a relatively slow-rise-time positive input signal (+2.0 volts), such as derived from the square-wave calibration signal obtained from an oscilloscope. Pulse rise times here may be several nanoseconds. Parameters for the constant voltage regulators for Q_1 and Q_2 should be chosen such that the regulator voltage is approximately BV_{ces} for each transistor.

Substitution of a small-value resistance, such as 10 ohms, for the LED converts the light pulse into a handy voltage generator. Pulse amplitudes are 10 to 20 volts with sub-nanosecond to nanosecond rise times, depending on circuit layout and the components used. Both circuits are small, inexpensive, and easy to construct as long as good vhf construction techniques are followed.

Burton E. Dobratz, Aerospace Group, Hughes Aircraft Co., Culver City, Calif.

VOTE FOR 110

FET-bipolar oscillator features notch network

An n-channel FET, driving a bipolar emitter-follower, forms an oscillator. The high Z_{in} of the FET enables a "notch" network to be used in the degenerative loop.

Regenerative feedback from the emitter of Q_2 (see schematic) through a tungsten filament lamp gives the amplitude-limiting necessary for output stability. Q_2 is a high-input-impedance, bootstrapped emitter-follower that properly loads Q_1 . It provides the low output impedance necessary

IDEAS FOR DESIGN: Submit your idea for Design describing a new or important circuit or design technique, the clever use of a new component, or a cost-saving design tip to our Ideas for Design editor. If your idea is published, you will receive \$20 and become eligible for an additional \$30 (awarded for the Best of Issue Idea) and the grand prize of \$1000 for the Idea of the Year.

Try a new source

for planar 2N2222 & 2N2369 families

If you've been wishing for a new source of silicon planar general purpose amplifiers or high speed switches, ITT has now provided the answer.

ITT is in full production on the popular 2N2222 amplifier family and the 2N2369 high-speed switching family. You can have the same transistor performance you've been getting from other suppliers, plus the supplier

performance you can only get from ITT.

If you're buying silicon planars from either of these families, evaluate the new source. Order them today . . . get them today . . . from any distributor of ITT Semiconductors. ITT Semiconductors, 3301 Electronics Way, West Palm Beach, Florida, is a division of the International Telephone and Telegraph Corporation.

The logo for ITT Semiconductors, featuring the letters 'ITT' in a large, bold, stylized font above the word 'SEMICONDUCTORS' in a smaller, all-caps font. The logo is enclosed within a red hand-drawn oval.

FACTORIES IN PALO ALTO, CALIFORNIA; LAWRENCE, MASSACHUSETTS; WEST PALM BEACH, FLORIDA; HARLOW AND FOOTSCRAY, ENGLAND; FREIBURG AND NURENBERG, GERMANY.

ON READER-SERVICE CARD CIRCLE 43

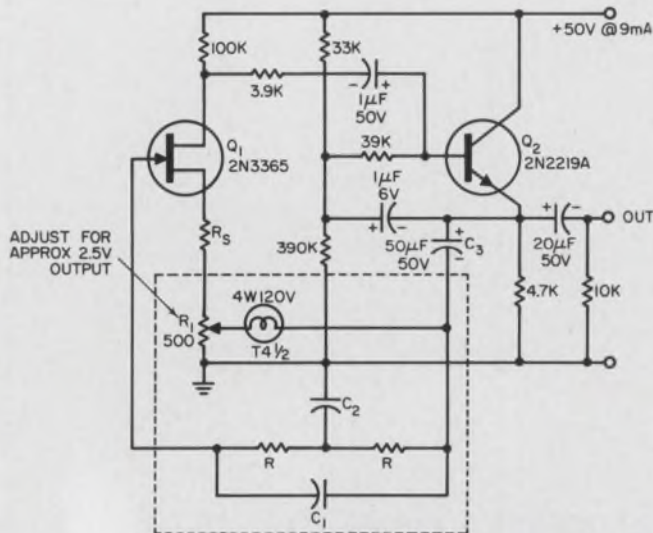

N-channel FET and emitter-follower are employed in this oscillator circuit. Notch network and lamp form degenerative and regenerative feedback loops, respectively. The latter feedback is used for output stability.

for driving the parallel combination of the notch network and the low resistance of the lamp.

Resistor R_1 should be adjusted for approximately 2.5 volts at the oscillator output. The distortion at higher frequencies will be very low; but at lower frequencies (below 25 Hz), the lamp will cause some distortion. However, the distortion at 12.5 Hz measured less than 0.5 per cent.

Source resistor R_1 must be adjusted for maximum output. This in turn will be the optimum bias for Q_1 . This can be done simply by disconnecting C_3 from the emitter of Q_2 , exciting the FET gate with an oscillator, and then adjusting R_1 for maximum signal out. Part of R_1 contributes to this bias operation point and the adjustment of R_1 will be affected if R_1 (output level adjustment of oscillator) has to be changed. All resistors are rated at 0.5 W.

The frequency of oscillation is given by:

$$f = 1/2 \pi RC,$$

where $C = \sqrt{C_1 C_2}$.

Jack A. Bryant, Engineer, National Tape Service, Inc., Parsippany, N. J.

VOTE FOR 111

Crystal and recovery diode used in RF calibrator

The combination of a simple crystal oscillator and a step-recovery diode produces a straightforward calibrator for use with communication receivers and RF signal sources. As an external accessory or internal calibrator, the circuit provides crystal harmonics for receiver dial calibration from 500 kHz to above 50 MHz.

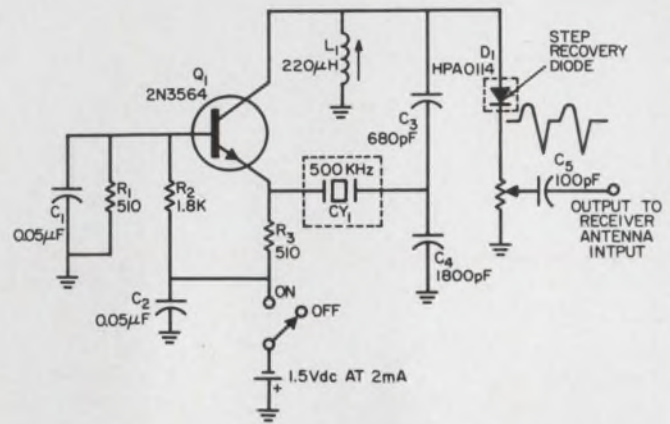

Crystal oscillator and step-recovery diode combine to form an RF calibrator. Battery operated, the harmonic-rich circuit draws only 2 mA.

Its output, rich in harmonics (the circuit employs a fundamental oscillator at 500 kHz), can either be directly connected to the receiver's antenna input or coupled internally at the RF section (see schematic). The circuit draws 2 mA from a 1.5-Vdc "C" or "D" size battery, will operate continually for a 1-2-week period.

The crystal oscillator is in a grounded base Colpitts configuration and employs a silicon 2N3564 transistor and a 500-kHz series resonance quartz crystal (0.01% for -40 to $+65^\circ\text{C}$). Feedback is achieved through the crystal CY_1 by way of the capacitive voltage divider $C_3 - C_4$. Inductor L_1 and capacitors C_3 and C_1 make up the oscillator resonant circuit which acts as a low-impedance drive for the harmonic generator D_1 .

The step-recovery diode (D_1) stores charges while conducting in the forward direction. When the oscillator changes polarity, the diode will conduct for a brief period until the stored charge is removed—then conduction ceases abruptly. The resultant waveform is full of 500-kHz harmonics that can be selected or filtered out by the receiver's tuned circuits. The harmonic energy is coupled to the receiver by way of variable attenuator R_1 and isolation capacitor C_5 .

C. Douglas Rasmussen, *Electronic Technician*, Syracuse University Research Corp., Syracuse, N. Y.

VOTE FOR 112

Current transformer protects regulator against overloads

A current transformer can be used in high-voltage transistorized power supplies as a more effective short-circuit protection than conventional means. The latter often are inadequate because large values of current in conjunction with high voltage quickly exceed the control transistor's power capability. But if a current transformer is used to sample overloads, the power expended in the control transistor during overloads is small.

How to spot the highest-power 400 MHz transistor available

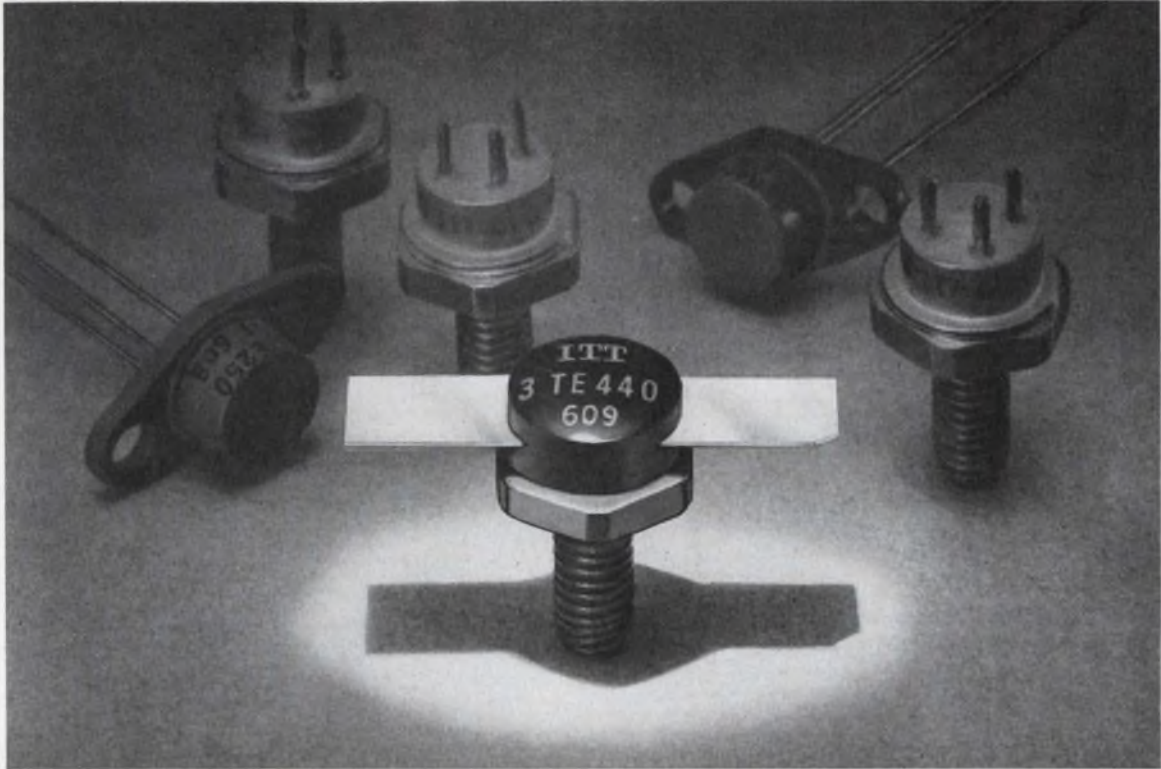

Look for the one with the strip line leads — ITT's 3TE440. The 3TE440 delivers 15 watts minimum at 400 MHz with 8.6 db gain. The low-inductance strip line package provides greatly-improved stability and circuit bandwidth. Typical efficiency is 60% when $P_{oe} = 10$ watts at 400 MHz.

The planar passivated, interdigitated 3TE440 has a BV_{CEO} rating of 80 V, allowing better up-modulation and reducing danger of damage from transients. Resistor stabilization provides high second breakdown characteristics and built-in bias stability for Class A and AB amplifiers. In many applications, the 3TE440's higher performance can reduce the number of transistors required.

It is now available off the shelf. Contact any ITT distributor or your ITT factory representative. ITT Semiconductors, a division of International Telephone and Telegraph Corporation, 3301 Electronics Way, West Palm Beach, Florida.

40V CLASS B POWER OUTPUT VS FREQUENCY

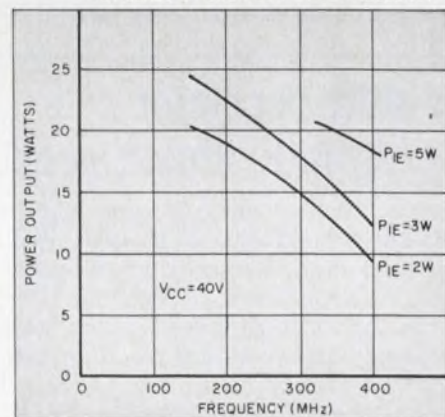

ITT
SEMICONDUCTORS

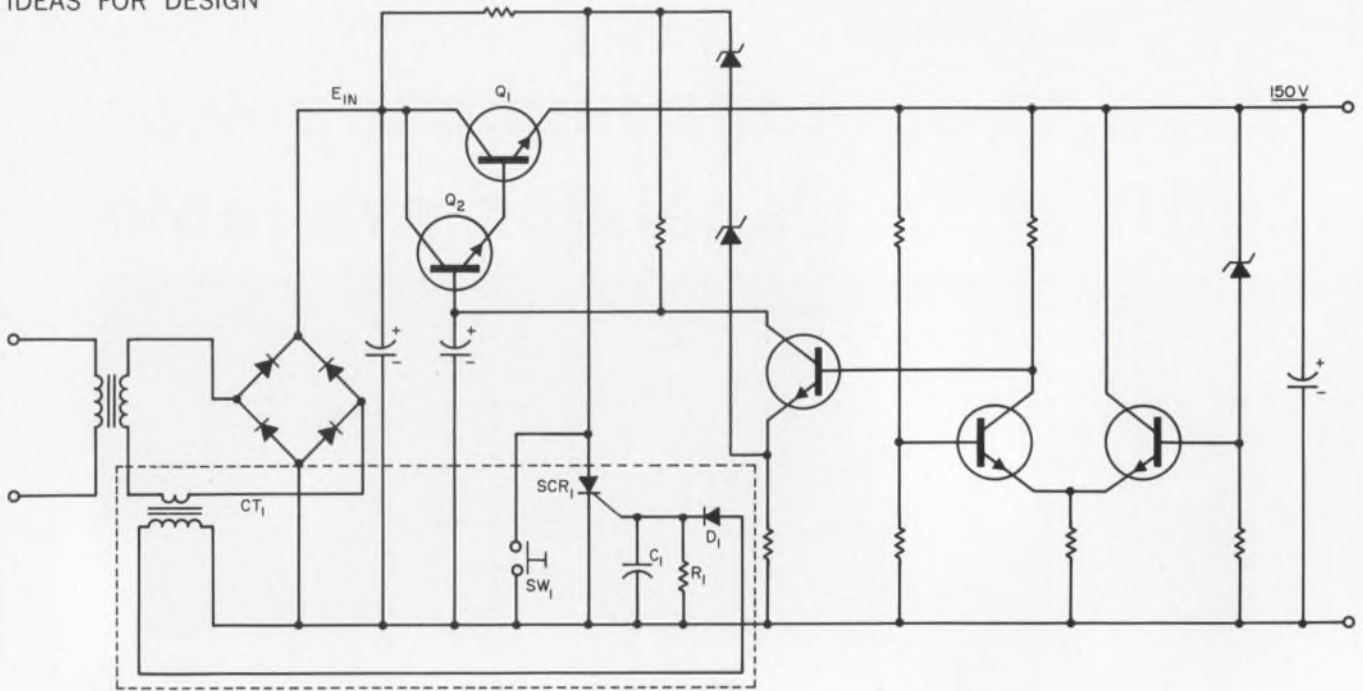

Current transformer and SCR circuit protect voltage regulator from overload damage.

The current transformer, CT_1 (see schematic), is used to sample the current supplied to the voltage regulator. Diode D_1 rectifies the sampled current which in turn produces a voltage drop across R_1 . Resistor R_1 is adjusted to trigger SCR_1 when a predetermined value of overload current is reached. Capacitor C_1 serves as a filter for the rectified signal.

When a current overload occurs, the additional voltage generated across R_1 triggers SCR_1 ON. When SCR_1 is conducting, no base current is made available to control transistors Q_1 and Q_2 , and they are thus turned OFF. With Q_1 OFF, the transistor is required to sustain only the unregu-

lated voltage, E_{in} , and its expended power is thus reduced to a negligible amount.

The circuit can be reset by removing the input voltage; this will eliminate the holding current of the SCR . If a manual reset switch, SW_1 , is provided to shunt the SCR , the holding current will also be dropped below the SCR 's sustaining needs.

Typical component values with 0.5 A as the maximum overload current conditions are: SCR_1 —MCR 2304-4; D_1 —IN457A; C_1 —1.0 $\mu F/50V$; R_1 —20 Ω ; and CT_1 (turns ratio)—1:10.

S. J. Arnold, Senior Engineer, Welx, Houston, Tex.

VOTE FOR 113

Phase-shift oscillator measures inductance precisely

A decade oscilloscope preamplifier, counter, potentiometer, two diodes and a precision capacitor comprise a high-accuracy inductance-measuring system. A measurement accuracy of ± 0.1 per cent accrues with this phase-shift system.

A reliable system was needed to inspect precision iron-core inductors for the correct value of inductance. Because large quantities of parts were involved, the system had to be fast, accurate, and usable by unskilled personnel.

A system that fulfills these requirements is shown in the accompanying diagram. When the test inductor is connected into the circuit, the audio amplifier oscillates at a frequency f_o . This oscillation occurs only when the phase shift through the series RLC feedback loop is zero degrees. This occurs when $f_o = 1/2 \pi \sqrt{LC}$. Therefore, limits for f_o may be calculated for any tolerance limits of inductance when C is known.

Frequency f_o is then read out by a precision digital frequency counter or frequency meter. The accuracy of results depend above all on the accuracy of frequency measurement and the precision to which C is known.

To function properly, the audio amplifier must

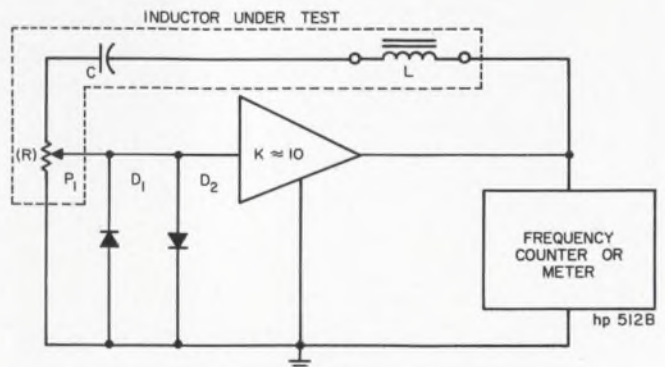

Phase-shift oscillator arrangement provides very accurate measurements of inductance. Feedback loop is formed by RLC phase network.

SERIES 930 DTL

Evaluate ITT

ITT
SEMICONDUCTORS

ITT SEMICONDUCTORS IS A DIVISION OF THE INTERNATIONAL TELEPHONE AND TELEGRAPH CORPORATION
FACTORIES IN WEST PALM BEACH, FLORIDA, PALO ALTO, CALIFORNIA, LAWRENCE, MASSACHUSETTS, HARLOW AND FOOTSCRAY, ENGLAND, FREIBURG AND NURENBERG, GERMANY

ON READER-SERVICE CARD CIRCLE 45

have negligible phase shift at f_o and be a non-inverting type. The output impedance should be low enough to drive P_1 as a load. D_1 and D_2 are back-to-back germanium signal diodes which prevent saturation of the amplifier.

The value of P_1 is not critical, but should not exceed $\sqrt{L/C}$. Once the wiper of P_1 has been set to provide the proper loop gain, it need not be readjusted, unless the inductor type being tested is changed. In practice, measurement of L to a ± 0.1 per cent tolerance has been achieved.

Kenneth G. Holmes, Chief Engineer, Magnetic Circuit Elements Inc., Montrose, Calif.

VOTE FOR 114

Remote-control time delay needs no turn-off signal

An SCR and unijunction transistor (UJT) can be combined in a remote-control time-delay circuit that requires no turn-off signal. The circuit can handle inductive as well as resistive loads.

The time-delay circuit (see schematic "a") is turned on by a pulse, remains on for a predetermined period, then shuts itself off. Operation is as follows: The positive input pulse is applied to the

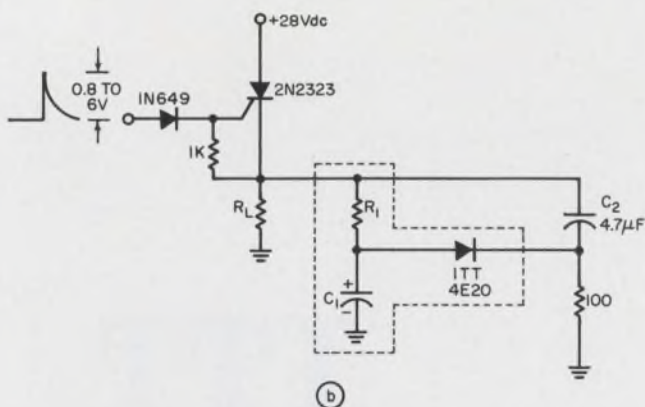
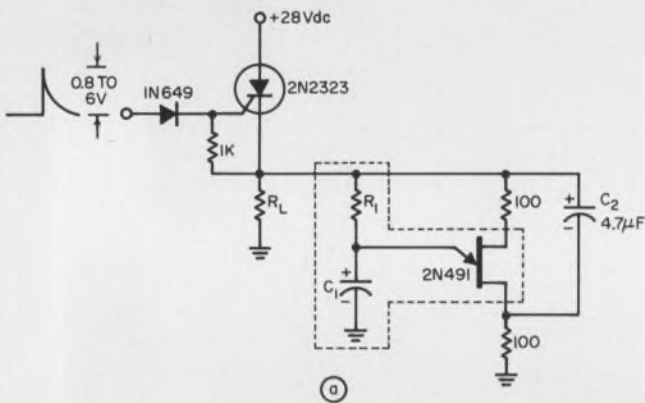

1. Remote-control time delay is formed by SCR-UJT combination (a). For higher load currents, a 4-layer diode is substituted for the UJT (b). No shut-off signal is required in either case. Delay duration is set by R_1C_1 in both circuits.

gate of the SCR, causing conduction of current through the load to the ground return. Simultaneously capacitors C_1 and C_2 begin to charge.

When capacitor C_1 reaches the emitter peak-point voltage of the UJT, the UJT conducts and discharges capacitor C_1 into resistor R_2 . Since capacitor C_2 cannot charge instantaneously, the voltage appearing between ground and the cathode of the SCR is momentarily increased above the supply voltage by an amount almost equal to the peak-point voltage. The SCR becomes reverse-biased long enough to reduce the forward current to less than the holding current and ceases to conduct. Voltage is thus removed from the load.

The circuit was originally developed to light a lamp in an airborne towed target, and so indicate the presence of an interfering signal in a control receiver. Since the interfering signal was present only intermittently, the lamp had to be turned off automatically after a 15-second interval—just long enough to permit observation. This was achieved with an R_1 of 680 kΩ and a C_1 of 22 μF.

The circuit has been used to initiate and maintain a tone signal for a prescribed time period, and to control a hydraulic valve delivering anti-icing fluid to aircraft windshields. The latter application is the only one in which a primarily inductive load was controlled. The valve solenoid current of 1.0 A at 28 Vdc represented a 28-watt load.

Although the components shown are capable of controlling only an 80-watt load (1.6 A at 50 volts), the circuit is suitable with appropriate changes for regulating more than a kilowatt.

Note that the R_1C_1 time constant must be long enough to permit C_2 to charge to the SCR cathode potential, thus setting a minimum time delay. Maximum time delay is limited only by available resistance and capacitance and could conceivably be hours or longer.

In another version, the UJT is replaced by a 4-layer avalanche diode (see schematic "b"). Operation here is virtually the same as in schematic "a", except that the load capabilities are slightly higher. Current capability is determined by the SCR. The 4-layer diode circuit has been operated with a 7-A load. Increasing the size of capacitor C_2 improves the operation of both circuits. The time delay is essentially equal to the product of R_1C_1 .

Edward G. Olson, Design Engineer, Naval Air Development Center, Johnsville-Warminster, Pa.

VOTE FOR 115

Nuvistor and bipolars form low-noise preamplifier

A nuvistor may be combined with a number of transistor stages to form a low-noise, hybrid preamplifier. This design is especially attractive for very-low-frequency, narrow-band, signal-processing applications.

The use of a nuvistor front end for preamplifiers to be operated at sub-audio frequencies has

RCA 2N4068
(actual size)



NEW RCA NPN SILICON TRANSISTOR FOR CRITICAL INDUSTRIAL APPLICATIONS: Wide-band amplifiers—Distributed amplifiers—Video amplifiers in TV cameras, camera chains, monitors, oscilloscopes—Video marker generators—Relay drivers—NIXIE[®], neon-indicator and electro-luminescent-indicator driver circuits—Direct on-off control circuits... much more

[®]Registered Trade Mark: Burroughs Corporation

$BV_{CE0} = 150\text{ V min.}$

$C_{cb} = 3.5\text{ pF max.}$

$f_T = 50\text{ Mc/s min.}$

PLUS

- Low Leakage Current— $I_{CBO} = 50\text{ nA max at } V_{CB} = 120\text{ V}$
- High Gain— $h_{FE} = 30\text{ min at } I_C = 30\text{ ma, } V_{CE} = 10\text{ V}$
- Low Saturation Voltages— $V_{CE}(\text{sat}) = 1\text{ V typ, } V_{BE}(\text{sat}) = 0.68\text{ V typ, at } I_C = 30\text{ mA, } I_B = 1\text{ mA}$
- High Current Capability— 200 mA max.
- High Power Dissipation— $0.5\text{ watts free air at } 25^\circ\text{C}_{TFA}$
- Wide Temperature Range—operates from -65°C to $+175^\circ\text{C}$
- Hermetically Sealed Metal Case

PRICE 95¢*

RCA 2N4069 is the same as RCA 2N4068, except for an integral heat sink to provide twice the dissipation capability (1W). **99¢***



*In quantities of 1,000 and up

As Wide-band amplifiers the 2N4068 and 2N4069 easily cover bandwidths to 4.5 Mc/s and higher; as general purpose amplifiers, they operate up to 100 Mc/s. The very high BV_{CE0} , the low collector-to-base feedback capacitance, the low leakage and saturation voltages give assurance of top performance in critical applications. The RCA 2N4068 and 2N4069 also feature exceptionally linear transfer characteristic and high-temperature capability compared with germanium and plastic-encapsulated silicon devices.

Available through your RCA distributor

RCA Electronic Components and Devices



The Most Trusted Name in Electronics

ON READER-SERVICE CARD CIRCLE 189



For delivery information, and for your copy of RCA Technical Bulletin 2N4068-2N4069 (which has all pertinent performance curves, applications data and electrical and mechanical specifications), call your local RCA Field Office; or write: RCA Commercial Engineering, Section EC6-3, Harrison, N. J.

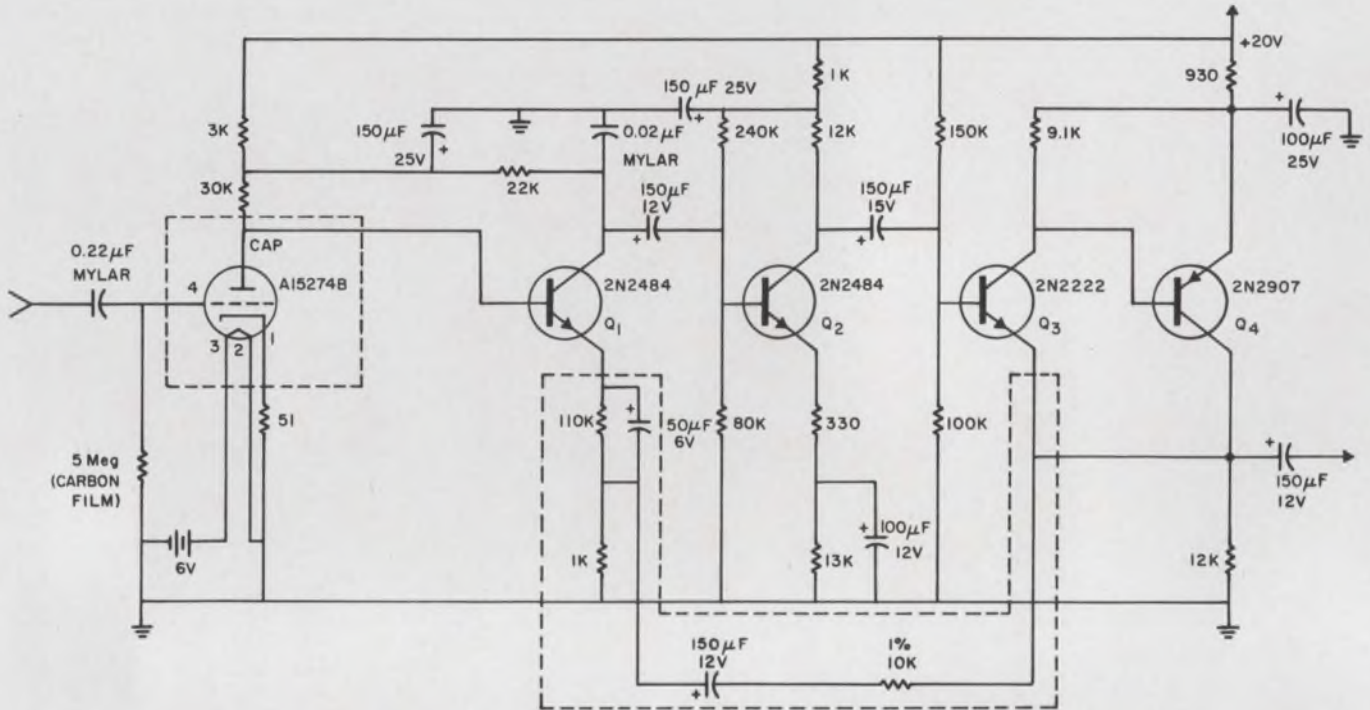

Nuvistor and bipolars form low-noise, hybrid preamplifier. The emitter-coupled feedback loop is used for providing

closed-loop gain stability, and higher input impedance and lower output impedance to the open loop.

become popular in power-limited, low-noise, preamplifier applications. Here (see schematic) a hybrid preamplifier was designed to operate at 15 Hz with a source impedance of approximately 300 kΩ.

Because the nuvistor's equivalent noise resistance is significantly below that of a bipolar transistor at these frequencies, it is important for good hybrid operation that—even while the nuvistor is operating in the starved condition—sufficient amplification be provided in the nuvistor stage. This ensures that the noise contribution of the succeeding transistor stage is negligible. From noise considerations, the value of quiescent plate current for *T* was chosen to be 400 μA. At this value, the amplification factor of the nuvistor is reduced below 35 (its rated value) to 10; the dynamic plate resistance is increased to approximately 10 kΩ—the output impedance of the first stage.

The 2N2484 low-noise, high-beta transistor exhibits minimum noise figure in the range of 5-15 kΩ source resistance and was used to follow the nuvistor stage. To achieve an input impedance that does not load the nuvistor output, and at the same time to retain a good temperature stability factor, bootstrapping or direct coupling may be used. In this direct-coupled configuration, the nuvistor furnishes a stable dc bias voltage to the base of *Q*₁, thereby realizing an excellent dc temperature stability for *Q*₁. The collector current of *Q*₁ was set at 150 μA for optimum noise performance.

The simple, emitter-coupled feedback loop increases the open-loop input impedance and decreases the open-loop output impedance while stabilizing the ac closed-loop gain. Open-loop gain at 15 Hz is 90 dB and closed-loop gain is 40 dB. This yields an excess gain for the loop of 50 dB.

The preamp output circuit consists of a unity-gain, low-output-impedance buffer amplifier which ensures that the feedback network does not load the amplifier. Also, it provides a low impedance source for further processing circuitry.

Gain of the preamp is 40 dB with an equivalent noise resistance of 50 kΩ measured in a 6-Hz bandwidth centered at 15 Hz. Noise bandwidth limiting in the preamp itself is approximately 1.5 kHz. The input impedance is 4 MΩ, and the output impedance, 10 Ω. The gain variation over an operating range of -40 to 60°C is less than 0.1 dB.

George C. Kuipers, Associate Sr. Research Engineer, General Motors Defense Research Laboratories, Santa Barbara, Calif.

VOTE FOR 116

IFD Winner for March 15, 1966

Robert B. Jones, Project Engineer, Continental Device Corp., Hawthorne, Calif.

His idea, "Analog-to-frequency converter has improved linearity, range," has been voted the \$50 Most Valuable of Issue Award.

Cast Your Vote for the Best Idea in this Issue.

HIGH GAIN FLAT BETA PNP AMPLIFIER

Unique features allow great applications versatility: No other group of low level, low noise amplifiers can approach the beta linearity of our 2N3965 and 2N4250 families. To this, add our high gain of 250 at $100\mu\text{A}$, state-of-the-art noise figure of 2 db at 1kHz, and high breakdown voltage ratings. Then consider the added versatility of availability in both metal can (2N3962-5) and epoxy packages (2N4248-50), Planar II epitaxial construction, and off-the-shelf distributor delivery. No wonder this new group of amplifiers already looks like a record-setter. Write for complete specifications.





Metal Package



Epoxy Package

SAMPLE SPECIFICATIONS: 2N4250 / 2N3965

NF (f = 1kHz)	0.5db (typ.), 2.0 db (max.) @ $I_c = 20\mu\text{A}$; $R_s = 10k\Omega$
NF (wide band)	0.7db (typ.), 2.0 db (max.) @ $I_c = 20\mu\text{A}$; $R_s = 10k\Omega$
h_{FE}	350 (typ.), 250 (min.) @ $I_c = 100\mu\text{A}$; $V_{CE} = -5V$
LV_{CE0} (2N4250)	40V (min.) @ $I_c = 5\text{mA}$; $I_b = 0$
LV_{CE0} (2N3965)	60V (min.) @ $I_c = 5\text{mA}$; $I_b = 0$

Planar is a patented Fairchild process.

FAIRCHILD SEMICONDUCTOR / A Division of Fairchild Camera and Instrument Corporation ■ 313 Fairchild Drive, Mountain View, California (415) 962-5011 ■ TWX: 910-379-6435

ON READER-SERVICE CARD CIRCLE 46



What do they mean by "an engineer's company"?

Some very successful companies are "sales oriented"—others, equally successful, receive their primary impetus from accounting, legal or business-management directions. Probably because of the highly technical nature of its product, Motorola has always been a company wherein engineering has been the moving force. At any management conference at Motorola, you'll find men think like engineers, and talk like engineers, because so many in the management echelon *are* engineers.

At Motorola the engineer achieves full professional status—because he is working in an environment where the state of the art has progressed to the point where only an "engineering oriented" management can direct the flow of achievement.

In this dynamic atmosphere, of course, the challenges are great—but equally rewarding for truly qualified engineers. Would you like to talk to us?

SYSTEMS ENGINEERS advanced R & D in radio communications systems related to Two-way, portable, mobile and radio-telephone equipment.

EQUIPMENT DESIGN high performance solid state receivers, transmitters, and data processing equipment for radar, communications, command and control, tracking and telemetry.

FAMILIARITY WITH STATE-OF-THE-ART statistical communications theory, advanced signal processing techniques, solid state r. f. techniques, ultra-reliability, antenna systems, advanced structural and thermal designs.

SECTION MANAGER direct engineers and support personnel in state-of-the-art communications, including r.f. systems and input-output devices.

CHIEF ENGINEER technical management of R & D group in advanced technology related to solid state r.f. communications.

CIRCUIT DESIGN ENGINEERS advanced R & D in receivers, transmitters, RF, digital, Color TV and automotive electronics.

DEVELOPMENT ENGINEERS advanced communications products in consumer, industrial and military electronics.

Excellent opportunities also available in Phoenix, Ariz.

Mr. W. H. HAUSMANN, Engineering Personnel Mgr., Dept. B, 4545 Augusta Blvd., Chicago 51, Illinois

An equal opportunity employer.



MOTOROLA inc.

ON CAREER-INQUIRY FORM CIRCLE 901

Looking for a New Job?

- Fill out one application . . .
- Check off the companies that interest you . . .
- We do the rest

Contacting the job market takes only ten minutes with ELECTRONIC DESIGN's Career Inquiry Service. To put Career Inquiry Service to work for you, fill in the attached resume. Study the employment opportunity ads in this section. Then circle the numbers at the bottom of the form that correspond to the numbers of the ads that interest you.

ELECTRONIC DESIGN will be your secretary, type neat duplicates of your application and send them to any number of companies you select—the same day the resume is received.

Career Inquiry Service is a fast, efficient way to present your job qualifications to companies recruiting engineering personnel—as confidentially and discreetly as you would in person. This service is the first of its kind in the electronic field, and one that engineers have used effectively since its inception in 1959.

We take the following precautions to ensure that your application receives complete, confidential protection

- All forms are delivered unopened to one reliable specialist at ELECTRONIC DESIGN.
- Your form is kept confidential and is processed only by this specialist.
- The "circle number" portion of the form is detached before the application is sent to an employer, so that no company will know how many numbers you circled.
- All original applications are placed in confidential files at ELECTRONIC DESIGN and after a reasonable lapse of time they are destroyed.

CAREER INQUIRY SERVICE

After completing, staple, fold and mail career form to ELECTRONIC DESIGN, 850 Third Avenue, New York, N. Y. Our Reader Service Department will forward copies to the companies you select below.

(Please print with a soft pencil or type.)

Name _____ Telephone _____

Home Address _____ City _____ Zone _____ State _____

Date of Birth _____ Place of Birth _____ Citizenship _____

Position Desired _____

Educational History

College	Dates	Degree	Major	Honors

Recent Special Training _____

Employment History

Company	City and State	Dates	Title	Engineering Specialty

Outstanding Engineering and Administrative Experience _____

Professional Societies _____

Published Articles _____

Minimum Salary Requirements (Optional) _____

Use section below instead of Reader Service Card. Do not write personal data below this line. This section will be detached before processing.

Circle Career Inquiry numbers of companies that interest you

- 900 901 902 903 904 905 906 907 908 909 910 911 912 913 914 915 916 917 918 919 920 921 922 923 924
- 925 926 927 928 929 930 931 932 933 934 935 936 937 938 939 940 941 942 943 944 945 946 947 948 949

Systems Engineers

Monsanto Company needs system engineers with 3-8 years experience. Background should include circuit and logic design. Knowledge of the application of integrated circuit elements is desirable. The positions are in the area of data acquisition units in computer controlled systems.

Send resume in confidence to:

Manager, Professional Recruiting
Department CL-412
Monsanto
800 North Lindbergh Boulevard
St. Louis, Missouri 63166



An Equal Opportunity Employer

ON CAREER-INQUIRY FORM CIRCLE 902



To
**ELECTRONIC
ENGINEERS**
with a sense
of timing ...

BENDIX (KANSAS CITY DIV.) **IS ON THE MOVE!**

This is the opportune moment to investigate your career potential at Bendix, Kansas City Division. As prime contractor for the AEC, we have enjoyed an enviable, orderly 16-year growth. Now we are entering a unique developmental phase, opening new fields of activity in microminiaturization, microwave and logic circuitry. This situation adds up to a ground-floor opportunity in a well-established corporation noted for advanced engineering. Cooperative, professional atmosphere, plus excellent living conditions. Let us hear from you promptly so we may detail more clearly the many advantages we can offer you.

Please mail résumé at once to:

Mr. E. C. McGurren, Tech. Personnel Repr.
THE BENDIX CORPORATION, Box 303-HE
Kansas City, Missouri 64141

AN EQUAL OPPORTUNITY EMPLOYER



ON CAREER-INQUIRY FORM CIRCLE 907

Fold here, staple and Mail.

FIRST CLASS
Permit No. 725
New York, N. Y.

BUSINESS REPLY MAIL

No Postage Stamp Necessary if Mailed in the United States

POSTAGE WILL BE PAID BY

ELECTRONIC DESIGN

READER SERVICE

850 THIRD AVENUE
NEW YORK, NEW YORK 10022

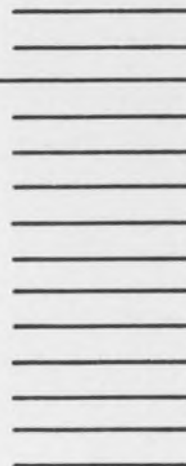

Engineers
Physicists

Can you make major contributions in advancing the Microelectronic Materials Technology?

If your answer is "yes" then you may be interested in current openings at IBM's Thomas J. Watson Research Center. At the present time several select positions are available for Research Engineers and Physicists who can make major contributions in vacuum deposition of insulators and metals and the use of glass and ceramic substrates and techniques for the etching of micro-strip transmission lines.

Qualified applicants should possess a BS, MS or PhD in Electrical Engineering or Physics and a minimum of two years' laboratory experience in materials research, materials engineering and micro-miniature fabrication techniques.

The Thomas J. Watson Research Center at Yorktown Heights, New York, is located in suburban Westchester County, 40 miles north of New York City. Liberal company-paid benefits include relocation expenses.

Please write, outlining your experience and education, to R. L. Meyers, Dept. 555-T3, Thomas J. Watson Research Center, P. O. Box 218, Yorktown Heights, New York 10598. IBM is an equal opportunity employer (M/F).

IBM

Opportunities for Professional Growth

in the famed
San Francisco Bay Area

Widen your technical horizons! Here advanced techniques, stimulating projects, and creative activity offer unusual opportunities in equipment, systems, test, design and fabrication of surface and underwater vessels, both conventional and nuclear powered.

ENGINEERING POSITIONS AVAILABLE:
**Naval Architects • Marine • Mechanical
Nuclear Power • Structural • Electrical
Electronics • Chemical • Welding • Civil**

New materials require the development of new processes. High-strength, light-weight material is required for the Navy's needs. Super-strength steel fabrication requires exotic welding methods and unique testing techniques to attain zero defect quality control. Ships design includes equipment and systems for the Navy's modern fleet, both surface and submersible. Engineers check out, test and evaluate the installation of nuclear and conventional marine propulsion systems; perform field engineering on electrical

and miniaturized sophisticated electronic systems including sonar, communication and radar equipment; learn new concepts in hull design and fabrication techniques such as explosive forming for deep submergence; and apply computer application to missile and Naval Tactical Data Systems.

These, and many other fascinating phases of the Navy's fleet requirements, will offer you a challenge in any engineering discipline at the San Francisco Bay Naval Shipyard.

OPENINGS EXIST AT ALL LEVELS IN THESE PROGRAM AREAS:

Ship Structure Development

Ship Weight Control

Structural Mechanics

Clear and Conventional Propulsion Systems

Navigation and Communication Systems

Sound and Vibration Control

Cargo Replenishment-at-sea Development

Shipboard Mechanization

Ordnance, Guided Missile, Fleet Ballistic
Missile and Electronic Systems

Value Engineering

Shipboard Aeronautical Material and Equipment

Shipboard Electrical and Power Systems

Naval Tactical Data Systems

Quality Assurance

Present construction, repair, alteration and conversion workload alone assures stability of employment for at least five years. Opportunities are available for promotion in all fields.

In professional and personal growth potential, financial and career benefits, today's San Francisco Bay Naval Shipyard openings offer unmatched opportunities. Requirements include a B.S. degree in engineering or naval architecture from an accredited university. Opportunities are available for experienced engineers and those newly graduated. Starting salaries up to \$10,619 depending upon experience.

JOB LOCATIONS: San Francisco Bay Naval Shipyard has two work sites located 40 miles apart: Hunters Point in

San Francisco and Mare Island in Vallejo, California. Each location has ready access to the full cultural advantages of San Francisco and the mild year-round climate of the "Bay Area." All types of recreation from ocean surfing to skiing on the slopes of the Sierras are within easy driving distance.

HOW TO APPLY: You may investigate these openings by sending your resume or Standard Form 57 (Application for Federal Employment) to:
Coordinator, Professional and Technical Recruitment (Code 174P)
Employment Division
San Francisco Bay Naval Shipyard
Vallejo, California 94592

An Equal Opportunity Employer

NASA Tech Briefs

FET to replace bulky transformer

Problem: Design an analog-gate circuit using microelectronic integrated-circuit techniques to reduce size and weight. Conventional gate circuits use a heavy, bulky transformer in the drive circuit to isolate the gate from the fixed voltages.

Solution: A metal-oxide semiconductor field-effect transistor (MOS FET) analog-gate circuit, that adapts well to integrated circuits and provides better system isolation than a transformer.

This analog-gate circuit consists essentially of the MOS FET Q_1 , and a npn control transistor, Q_2 . With Q_2 in saturation, a conducting channel is formed from the source of Q_1 to its drain and the analog gate conducts. With Q_2 off, the potential on the gate of Q_1 becomes greater than its source or drain potential and the gate is open-circuited.

The FET provides complete isolation of the gate elements, resulting in zero offset voltages.

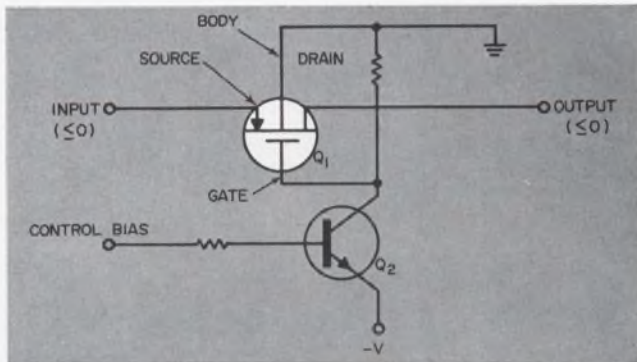

Because the input and output signals are less than or equal to zero, the body of Q_1 is grounded and the source and drain junction leakage is kept in the nanoampere range. Body junctions can withstand voltages up to 25 volts without excessive leakage or breakdown, thus permitting a wide range of input voltages. Crosstalk is minimized by a source-to-drain capacitance of less than 1 pF.

This circuit should be of particular interest in the area of telemetry.

For further information, contact: Technology Utilization Officer, Goddard Space Flight Center, Greenbelt, Maryland, 20771. (B65-10284).

COMMUNICATIONS D&D ENGINEERS

BSEE or Physics. Several positions, from beginning to senior levels, call for one to ten years' experience in any or all of the following areas: design of varactor multipliers up to 15Gc; parametric and/or tunnel diode amplifiers for receiver front ends; microelectronics, stripline techniques, solid state. Your responsibilities will encompass design and development of communications systems involving receivers and/or transmitters at 2, 4, 8 gigacycles, varactor multipliers, microminiaturization of microcircuitry, parametric amplifiers.

SECTION HEAD—ENGINEERING

BS degree. Project Manager for Underwater Instrumentation type of program. Knowledgeable in underwater acoustics, transducer systems, underwater arrays, underwater instrumentation systems (including beacon transponders, acoustic decoys), and marine hardware. Projected use on complex underwater arrays systems for test and calibration, impact location systems and underwater navigation systems.

DIGITAL COMPUTER SPECIALIST

BSEE—5 years' hardware experience preferred. An excellent opportunity for an engineer ready to assume technical responsibilities in the design of a Special Purpose Airborne Computer, to solve navigational and coordinate translation problems. Background in design of logic and memory systems as well as experience in programming and organization essential.

SPACE COMMUNICATIONS ENGINEERS

BSEE or Physics, MSEE for senior posts. Depending upon positions sought, one to several years' experience in communications theory (solid knowledge of fundamentals), knowledge of communications receivers and modulation equipment, digital hardware, high-power transmitters, antenna components. Ability to design and build to prove your ideas very helpful. Responsibilities will include system analysis, design and development of communication transmitters and receivers, and system studies for space communication equipment and systems. Frequency ranges are from UHF through EHF.

ELECTRONIC SWITCHING ENGINEER

BSEE plus 5-10 years' experience in telephone switching systems, message switching systems, and secure communications for both military and commercial applications plus special design and development of electronic solid state switching equipment. Knowledge of and background in at least 3 of the following: electronic switching, logic synthesis, microminiaturization, computer orientation and mathematics.

TECHNICAL SPECIALIST—ACOUSTICIAN

Familiar with problems of underwater acoustics, effects of environment on acoustic signal transmissions, knowledge of acoustic transmission systems. Minimum of 3 years' experience including underwater acoustics, signal transmission analysis, and acoustic signal processing.

SPECIALIST OR SR. PROGRAMMER

(Bachelor's or a Master's degree in Mathematics preferred.)

Develop programs required for computer solution and processing, prepare detailed flow charts. Write required and associated documentation and write appropriate machine language or symbolic language instructions, receives instructions and explanations of the over-all programming objectives of the project and his assignment from his supervisor and is responsible for implementing programs, making octal and symbolic corrections to the operational and/or applicable programs, analyzes and describes problems so that other personnel may locate and correct faults. He will work with well defined problems and concepts under the guidance of Program Analyst and/or as directed by section supervisor.

PROGRAMMER

(Bachelor's degree from accredited college or university is preferred; however, two years of college and/or one year of direct applicable experience in programming or computer operation is acceptable.)

Writes and/or participates in the preparation and debugging of machine language or symbolic language instructions and works from detailed flow charts and/or detailed mathematical equations under the guidance of Sr. Programmers and Program Analysts.

ITT

If your ideas on communications keep expanding beyond the boundaries of your present job,

we've got space for you at the labs

Space to develop in — as broadly as you like, and as fast (possibly faster). Because creating progressively more advanced communications systems that incorporate both spacecraft and ground stations is one among many avenues we're pursuing here in Nutley with something approaching proprietary success.

Take these examples.

We're developing all the ground-based electronics for COMSAT's global system's two 85' antenna stations in Washington and Hawaii . . . also another in Spain . . . plus two terminals for Apollo support in the Canary Islands. Beyond this we've completed a study program covering *all* the spacecraft communication telemetry & command electronics for a project of exciting magnitude — the first *fully* global and *fully* operational communications satellite system.

In addition, under a NASA contract, we are building a complete experimental prototype for a time division multiple access system, to optimize the traffic-handling

capabilities of space repeaters. No cinch technically, because absolutely precise synchronization in time is mandatory — despite the fact that each transmission originates from a different point on earth and therefore has a different and varying path length and time constant.

If, with all this vast range of activity you were to suppose that you might get lost, or pigeon-holed, you'd be wrong. For although we have an awesomely big corporation behind us, ours is a closely knit and highly individualized organization. The freedom you'll have to advance and be recognized professionally is matched only by the spaciousness of the challenges you'll confront.

So if space is what you're looking for, and if you have the imagination and flexibility to cope with the explosive demands of high level aerospace technologies, we'd like to know more about you. And we'd like you to know more about us.

Our specific opportunities are listed to the right. Let's talk about one of them.

For more information, forward your resume in strictest confidence to Mr. W. F. Bieszard, Room 36B, ITT Federal Laboratories, 500 Washington Avenue, Nutley, N. J.

ITT **FEDERAL LABORATORIES**
An Equal Opportunity Employer

ON CAREER-INQUIRY FORM CIRCLE 906

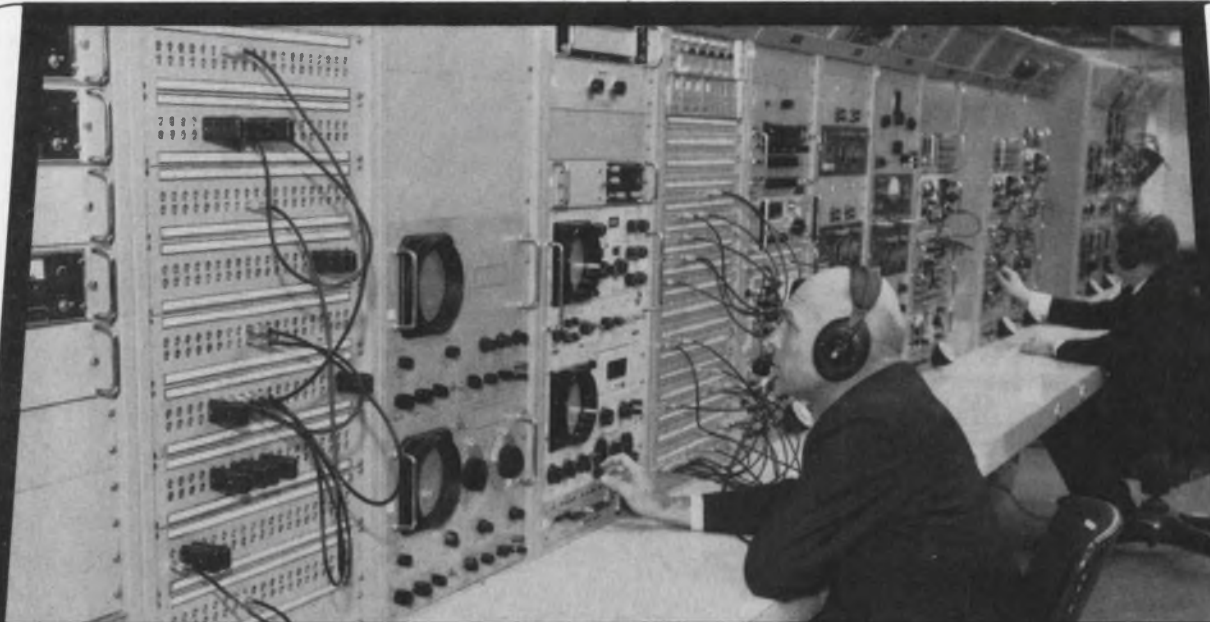

Top— For quick reaction in airborne and ground based electronic systems, LTV ElectroSystems' Greenville Division is the experienced leader. Range instrumentation and tracking, ground-based satellite tracking stations, command and control systems — all are in production or in use.

Right— Designer and builder of the world's most powerful transmitting equipment, Continental Electronics, an LTV ElectroSystems subsidiary, was the prime contractor for the NATO VLF installation at Anthorn, England. Continental is the Free World's most experienced organization specializing in super-power electronics.

Left— Powerful, compact units such as the ESC-1000 Long Range Ground/Air/Ground Secure Digital Communications System demonstrate only one phase of LTV ElectroSystems' Garland Division's experience and capability in systems design. The ESC-1000 system will communicate up to 6000 miles in conventional applications and up to 12,000 miles in conjunction with a satellite.



complete spectrum of opportunity for creative challenge

At LTV ElectroSystems, Inc., talented electronic systems oriented engineers know the excitement of creativity, the satisfaction of personal and professional advancement and contribution in an expanding organization, the flexibility and creative freedom of small product groups. Still they enjoy big company growth and opportunity.

LTV ElectroSystems is an organization delivering highly complex new electronic systems to meet defense and space

demands of today and the future. Major fields of capability include: space/air/ground electromagnetic reconnaissance and surveillance systems; command and control systems; high-power radar and radio; nuclear detection and surveillance equipment; information processing and display systems; super power equipment; VLF transmitters; commercial radio transmitters; guidance systems; antennas; electronic warfare systems; satellite tracking systems . . . and more.

These vital programs offer exceptional career positions to engineers in the following disciplines: **RF SYSTEMS ANALYSIS / RF CIRCUIT DESIGN / DIGITAL CIRCUITS DESIGN / DIGITAL SYSTEMS ANALYSIS / WEAPONS SYSTEMS ANALYSIS / GUIDANCE SYSTEMS / RADAR SYSTEMS / ANTENNA SYSTEMS DESIGN / ELECTRO-MECHANICAL PACKAGING / AIRCRAFT ELECTRICAL INSTALLATION DESIGN / AIRCRAFT STRUCTURES DESIGN / MECHANICAL SYSTEMS / ELECTRO-OPTICS / STRESS ANALYSIS / SCIENTIFIC PROGRAMMING . . . plus others.**

For complete information about a career with LTV ElectroSystems, Inc., write: Professional Placement, Dept. 166A, P. O. Box 6118, Dallas, Texas 75222. LTV is an equal opportunity employer.

LTV
ELECTROSYSTEMS, INC.

A SUBSIDIARY OF LING-TEMCO-VOUGHT, INC

GREENVILLE AND DALLAS, TEXAS

ON CAREER-INQUIRY FORM CIRCLE 905

Products

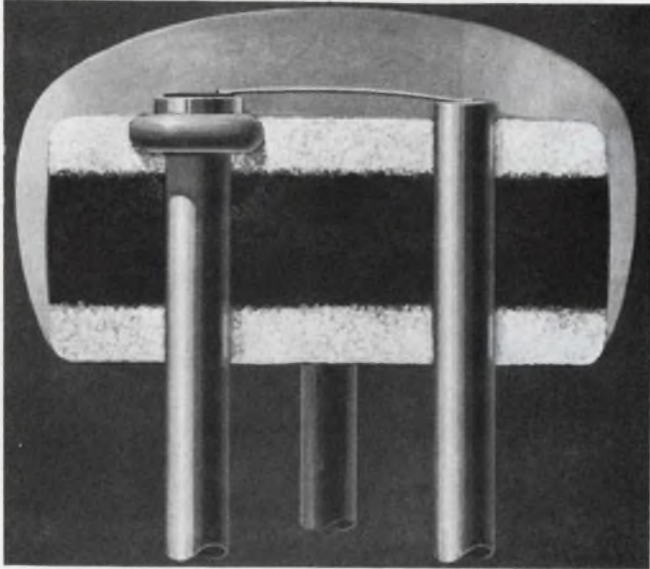

Epoxy encapsulation of germanium FET cuts cost, still ensures hermeticity. Page 120

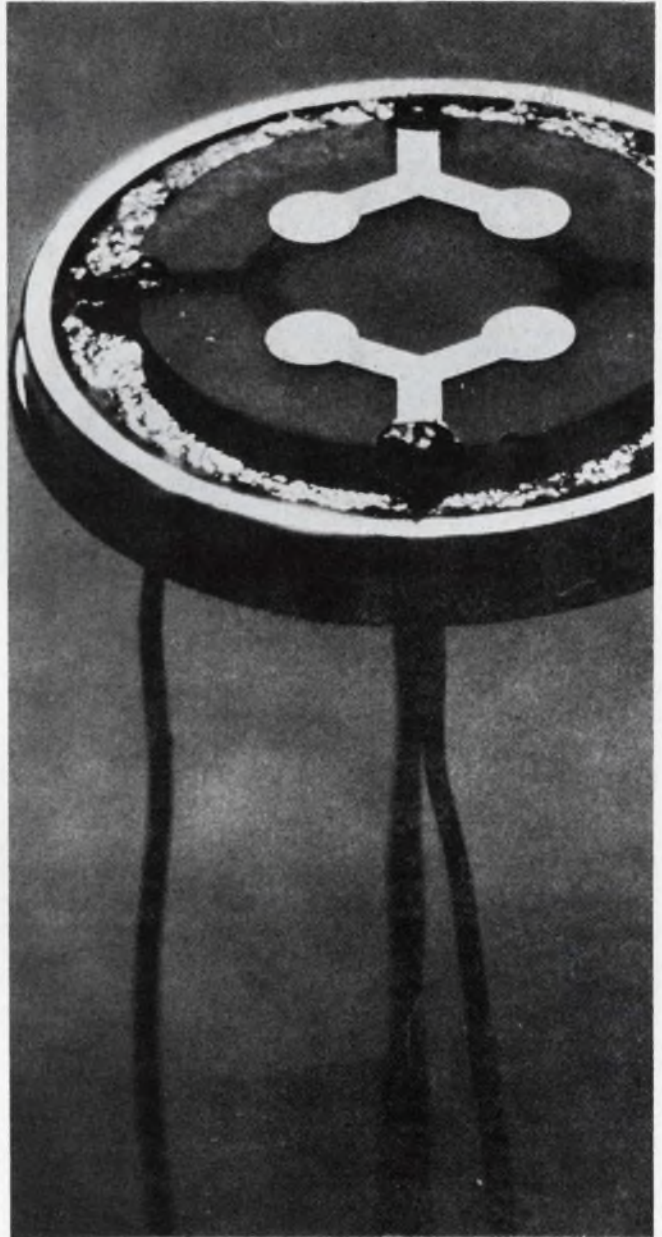

Multielectrode quartz wafers provide precision filtering in micromin package. Page 174

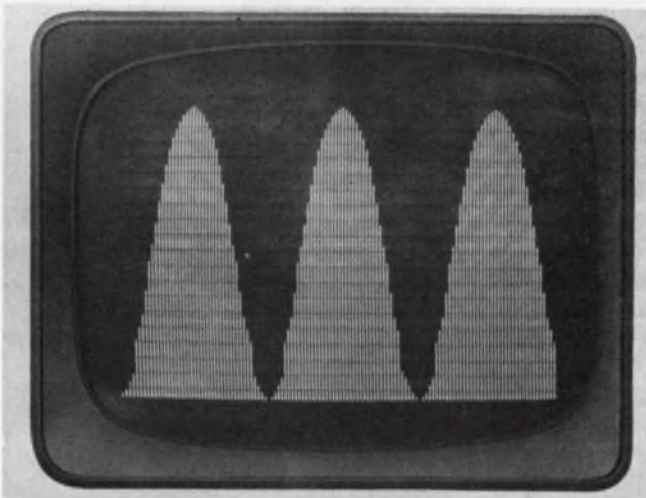

Display system compares 128 continuously changing channels simultaneously. Page 180

Also in this section:

Varactor bridge op-amp goes to dc with big Z_{in} and low noise. . . . page 140

Ambilogical multiplying element for hybrid systems. . . . page 178

Photoelectric relay system detects correct frequencies. . . . page 183

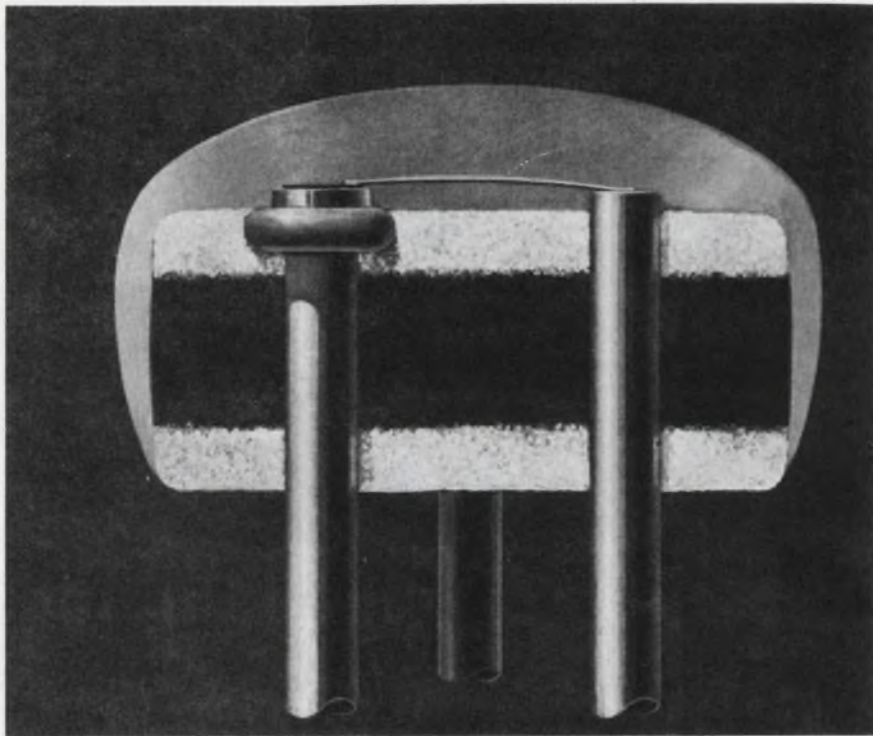

Price of germanium FET falls below \$1 with use of plastic

Plastic encapsulation of a germanium FET has slashed the volume price to below \$1. This planar epitaxial p-channel junction FET is designed for economy applications in the consumer market, particularly in RF mixers and amplifiers. Common source maximum available gain (MAG) ranges from 8 dB at 500

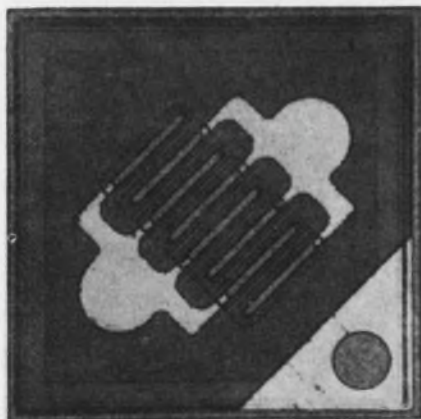

Transistor geometry features interdigitated construction.

MHz to 26 dB at 100 MHz.

The package measures 1/4-in. in diameter in a standard TO-18 10-pin circle configuration. The opaque package insures light insensitivity. The header is a ceramic-glass sandwich with a hermetic seal between it and the leads. The transistor is capable of meeting hermeticity standards of MIL-202C, method 103b. Wrap-around construction prevents separation of the plastic from the header under temperature stress. Operating range extends to 100°C.

Germanium devices have higher room-temperature leakage current than silicon units. But, the high majority-carrier mobility of germanium improves high-frequency FET performance. Transconductance-to-feedback capacitance ratio (y_{fs}/C_{RSS}) is increased. Smaller parasitic resistances result in higher input resistance at frequencies above 50 MHz. Common-source forward transfer admittance [$Re(y_{fs})$] of

the TIXM12 is 6.5 mmho at 100 MHz and feedback capacitance is 3 pF. Common-source forward transfer admittance varies from 1.3 to 8 mmho as the drain current increases from 0.2 to 10 mA. At an ambient temperature of 25°C, a drain current of -5 mA, a drain-to-source voltage of -8 V and a frequency of 100 MHz, common-source input admittance is 0.3 mmho.

Being a FET, the device features low cross-modulation distortion and low noise. Typical noise figure of the TIXM12 at 100 MHz is 2 dB.

Dc characteristics include BV_{GSS} of 20 V min and I_{DSS} ranging from 5 to 25 mA.

P&A: under \$1 (over 1000); July. Texas Instruments Inc., 13500 N. Central Expwy., Dallas. Phone: (214) 235-3111.

Circle No. 700

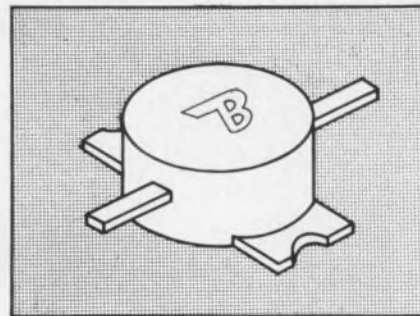

25-W npn transistor priced under 40 cents

An encapsulated plastic, npn, silicon mesa power transistor, the B-5000, is priced under \$0.40 in high volume. This low-cost transistor is rated at 25 W at V_{CE} of 10 V, collector current of 2.5 A and case temperature of 100°C.

Collector-to-emitter voltage is 35 V min, collector current is 3 A max and base current is 1 A max. β ranges from 30 to 250 at 14 V and 0.5 A.

Leads and collector strip are highly conductive silver for soldering ease in mounting. The unit is operable over a -65 to 150°C range.

P&A: \$0.99 (1 to 99), \$0.75 (100-999), under \$0.40 (high volume); stock. Bendix Semiconductor Div., South St., Holmdel, N. J. Phone: (201) 747-5400.

Circle No. 701

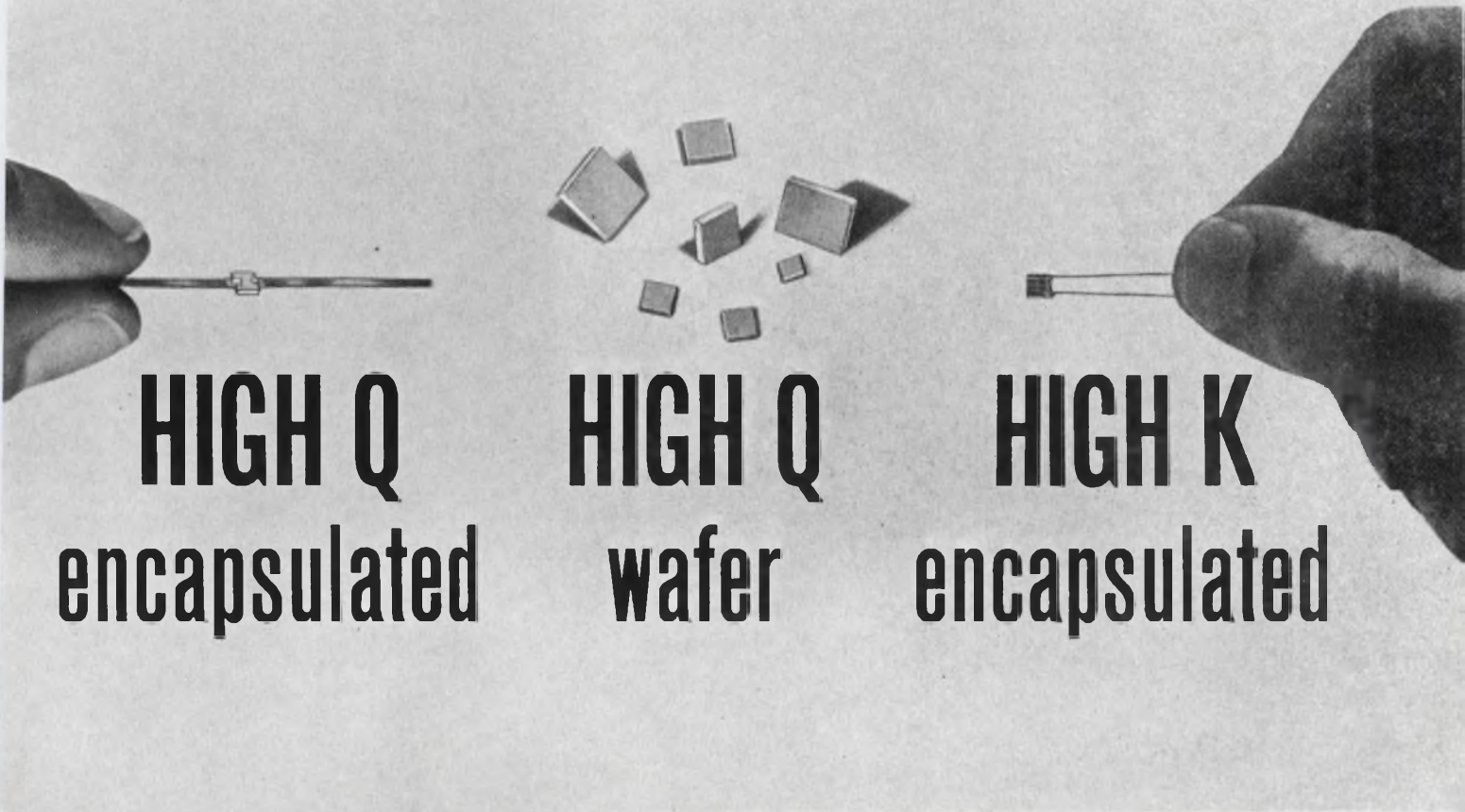

HIGH Q
encapsulated

HIGH Q
wafer

HIGH K
encapsulated

Now, JFD Uniceram® Fixed Capacitors Come THREE ways

High Q Uniceram High Q ceramic fixed capacitors offer a unique combination of small size, exceptional stability and a guaranteed minimum Q of 5000 . . . with up to ten times more capacitance per unit volume than competitive units . . . up to .206 mfd/in³.

GLASS ENCAPSULATED—105 models, with capacitance values from 0.5 to 3000 pf, provide the ultimate in High Q, reliability and stability. All models meet applicable requirements of MIL-C-11272B.

WAFERS—Uniceram High Q capacitors are also available as unencapsulated wafers with metalized edges. 88 low-cost units, with capacitance values from 0.5 to 3000 pf.

offer the same outstanding electrical properties. These wafers are ideally suited for hybrid Integrated circuits, can be soldered directly to printed circuit boards or used as discrete components.

High K ENCAPSULATED—A High K series of Uniceram ceramic fixed capacitors with up to 1 mfd capacitance is also available. These glass encapsulated units meet applicable requirements of MIL-C-11015C. Volumetric efficiency . . . up to 48 mfd/in³.

WAFERS—Uniceram High K capacitors will soon be available as unencapsulated wafers, also.

WRITE FOR CATALOG UNM 65-2

ON READER-SERVICE CARD CIRCLE 220

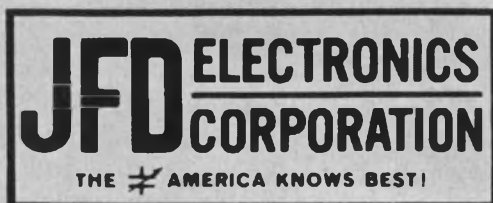

Components Division
 JFD ELECTRONICS CORPORATION, 15th Ave. at 62nd St., Brooklyn, N. Y. 11219
 Tel: 212 DE 1-1000
 JFD NORTHEASTERN, Ruth Drive, P. O. Box 228, Marlboro, Mass. 07152
 JFD NEW YORK-NORTHERN, Damiano Pl., P. O. Box 96, New Hartford, N. Y. 13503
 JFD MID-ATLANTIC, P. O. Box 5055, Philadelphia, Pa. 19111
 JFD MID-ATLANTIC-MARYLAND, P. O. Box 7676, Baltimore, Md. 21207
 JFD MIDWESTERN, 6330 W. Hermione St., Chicago, Ill. 60646
 JFD MIDWESTERN-OHIO, P. O. Box 8086, Cincinnati, Ohio 45208
 JFD WESTERN, 9 Morlan Place, Arcadia, California 91006
 JFD ISRAEL LTD., Industrial Area B, Bldg. 23, Azor, Israel
 JFD ELECTRONICS, EUROPE S A, 7 Rue de Rocroy, Paris, 10, France

Click, whirrr

All that moves in the world's fastest printer is a motor and a fan.



Monroe Datalog's[®] MC 4000 ultra high speed optical printer offers the unique reliability of only two moving parts. But reliability is only one feature. The MC 4000 records 6000 lines per minute, or any speed less that your application requires. Truly synchronous or asynchronous. Available in numeric or alphanumeric models—both 32 columns wide.

Features: character serial input, bit parallel. 6 microseconds per character data transfer time. Exceptional compactness— $10\frac{1}{2}''$ x $10\frac{3}{4}''$ x $21\frac{1}{2}''$. Any

4 or 6 line code with any logic level. All solid state. Cathode ray tube with fiber optics. Permanent copy option available.

And a full year's warranty. Price: \$5650 for numeric model; \$5850 for alphanumeric model.

For information, contact Monroe Datalog Division of Litton Industries, 343 Sansome St., San Francisco 94104. (415) 397-2813.

MONROE DATALOG 
DIVISION OF LITTON INDUSTRIES

ON READER-SERVICE CARD CIRCLE 47

Militarized versions of MC 4000 also available.

The Monroe DATALOG MC 4000 is available in any configuration or to any military specifications that your application requires.

For further information, call the Monroe DATALOG Division of Litton Industries, 343 Sansome St., San Francisco 94104. (415) 397-2813.

MONROE DATALOG 
DIVISION OF LITTON INDUSTRIES

ON READER-SERVICE CARD CIRCLE 48
ELECTRONIC DESIGN, June 21, 1966

SEMICONDUCTORS

Contact protector

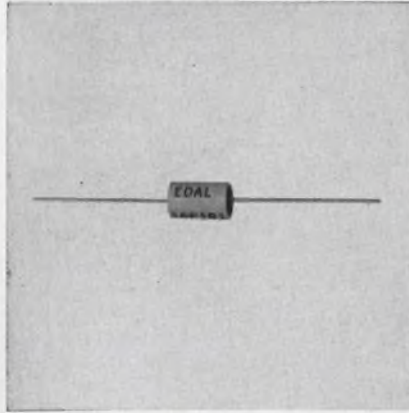

Connected across an inductive circuit element, series R selenium contact protectors suppress voltage surges from switching and offer protection against arcing. The devices can handle coil voltages from 26 to 250 V and currents from 150 mA to 1.2 A. The protectors are suitable for ac and dc applications and custom epoxy packages and spring clips are available.

Edal Industries Inc., 4 Short Beach Rd., East Haven, Conn. Phone: (203) 467-2591.

Circle No. 702

Tuning varactors

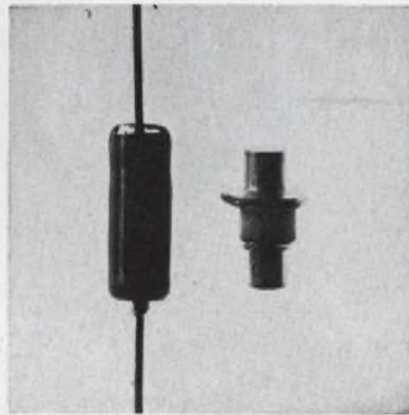

Two silicon planar epitaxial tuning varactors for vhf and uhf use are encased in a coaxial or TO-7 package. Any capacitance value from 6 to 25 pF for type MC301 and 26 to 47 pF for MC302 may be specified. Both have a PIV of 40 V and an operating range of -65 to $+175^{\circ}\text{C}$. They dissipate 500 mW derating at $1.67 \text{ mW}/^{\circ}\text{C}$ from 25°C .

P&A: \$5 ea. (1000 lots); stock to 30 days. Fairchild Semiconductor, 313 Fairchild Dr., Mountain View, Calif. Phone: (415) 962-2530.

Circle No. 703

TO-18 silicon photodiode

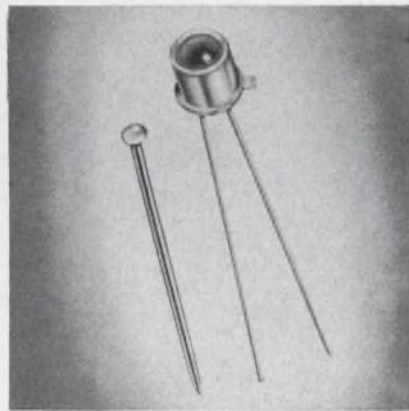

A silicon photodiode in a TO-18 package is designed to operate with bias conditions required by low cost silicon transistors. Typical reverse dark current at 55°C with -1.0 V is $0.4 \mu\text{A}$. Typical short circuit current output at 500 foot candles is $180 \mu\text{A}$. Spectral response peak is at 0.85 microns and speed of response is $1 \mu\text{s}$.

Price: \$2.25 (100 lots). National Semiconductors Ltd., 2150 Ward St., Montreal, Canada. Phone: (514) 744-5507.

Circle No. 704

Silicon rectifiers

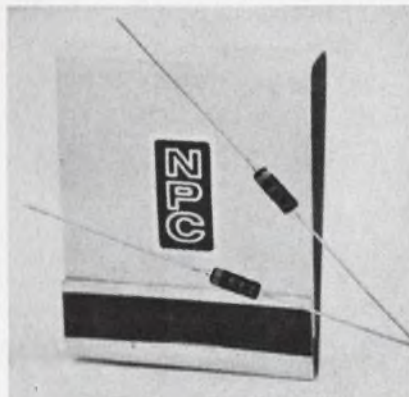

Types 1N645 through 1N649 miniature glass rectifiers are packaged in a TO-7 case. At 25°C , peak reverse voltage ranges from -225 V for 1N645 to -600 V for 1N649. Minimum reverse breakdown voltage at $-100 \mu\text{A}$ is available from 275 V to 720 V . Average rectified current at 150°C is 150 mA and max reverse current is available from $-15 \mu\text{A}$ to $-25 \mu\text{A}$ at 150°C .

Nucleonic Products Co. Inc., 3133 E. 12th St., Los Angeles. Phone: (213) 268-3464.

Circle No. 705



EDISON HOME PHONOGRAPH

DOW CORNING

Before you freeze that new design...

check with us

If *today's* electronic know-how had been available to designers fifty years ago, would the phonograph have looked like this?

No!

If *tomorrow's* know-how were available to you right now, would it affect your next product design?

At Dow Corning it is... and it can!

Dow Corning, the acknowledged leader in silicone research and development for over twenty years, has a history of producing materials to meet unheard of performance requirements... and materials is our *only* business.

More often than not, the suggestions of our Electronic Products Development Laboratory will spark new concepts, new versatility and capabilities for your product... *if* you include us in the early stages of your design thinking.

We manufacture high-performance, premium-quality encapsulating rubbers, rigid molding compounds, flexible casting resins and grease-like compounds which meet the most stringent requirements of the electronic industry.

Our Electronic Products Laboratory offers prompt technical assistance in solving *your* specific problem. Write Dept. 3506, Electronic Materials Department, Dow Corning Corporation, Midland, Michigan 48640. Or phone (517) 636-8940 for more information and the name of the Dow Corning representative in your area.

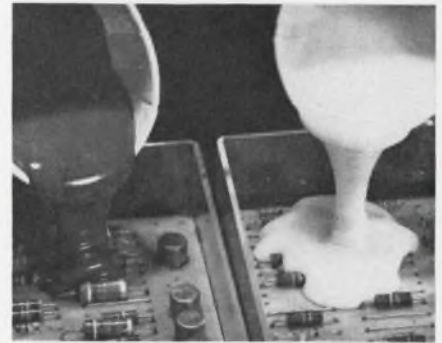

Dow Corning® 3110 RTV encapsulant can be readily color coded by mixing in master batch pigments. It is a low viscosity, deep section curing compound that cures at room temperature and is designed for potting, encapsulating and embedding of electronic circuit and components. It flows readily into place and cures to form a tough, resilient solid. (Circle No. 851)



Ready-to-use silicone adhesive encapsulates, seals, bonds. Silastic® 732 RTV rubber is a tough, squeeze-on adhesive/sealant that bonds metal, glass, plastics, rubber and most other materials. It cures at room temperature in 24 hours to a solid rubber... stays flexible from -85 to 500 F. Also recommended as adhesive for Silastic® brand heat shrinkable tubing. (Circle No. 852)

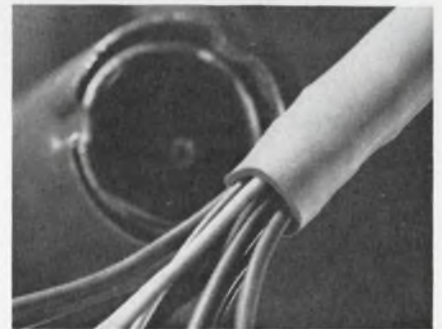

Shrinkable silicone rubber tubing can be the answer where wiring harness and electronic devices or components must be protected. Silastic® brand heat shrinkable tubing simplifies processing - reduces cost - where quick, easy fabrication of a close-fitting insulating covering for splices, leads, or components is required. Shrinks to 1/2 dia. when heated to 300 F or higher... in length less than 5%. (Circle No. 853)

We're a materials producer exclusively. Let us tailor a material to your need.

Speed Inquiry to Advertiser via Collect Night Letter
ON READER-SERVICE CARD CIRCLE 851, 852, 853

...and to take the curse out of fluctuating battery voltage
in mobile communications, there's the new Amperex 8643...
with a new, wide-range cathode

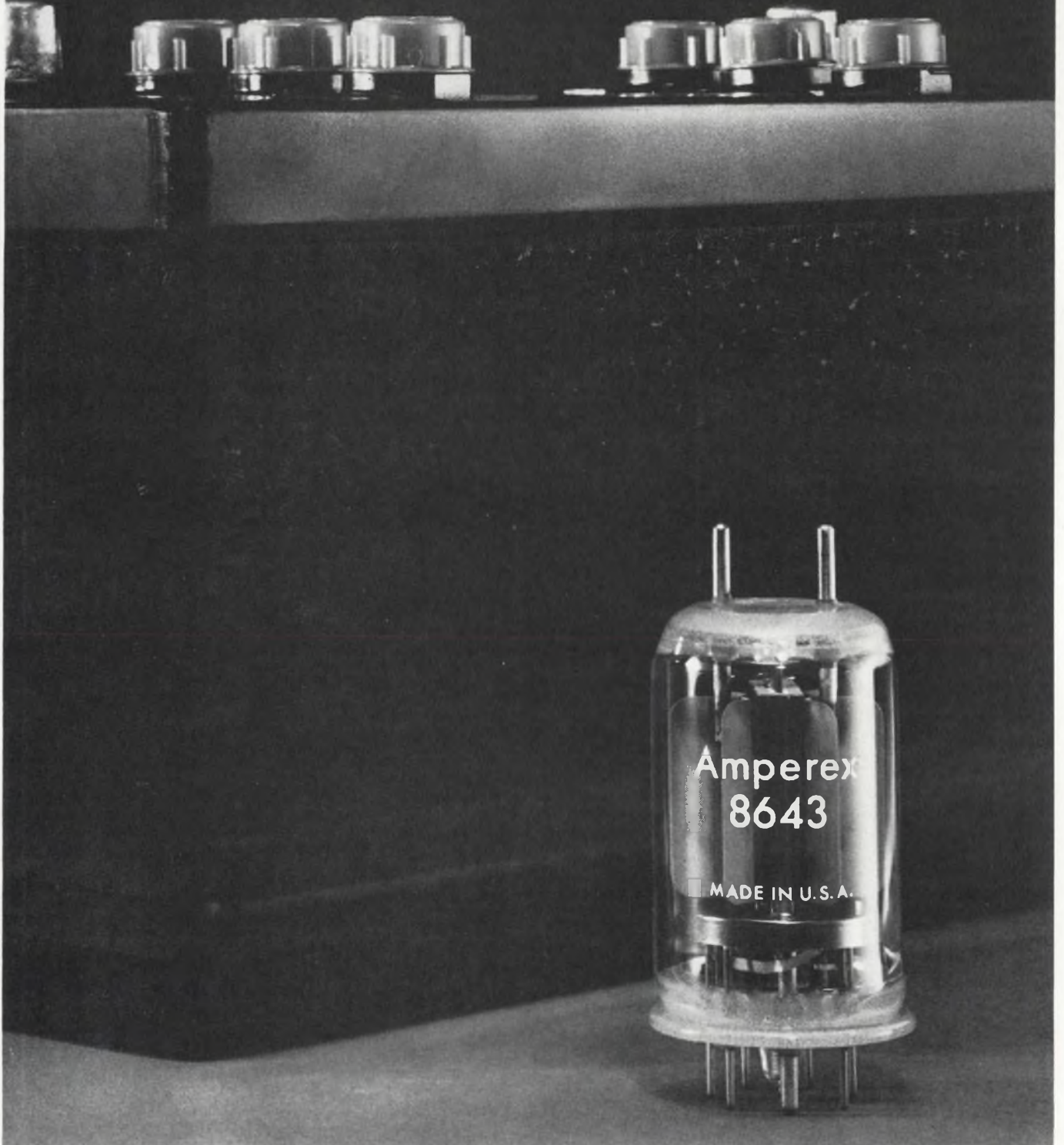

SEMICONDUCTORS

Glass diode pellets

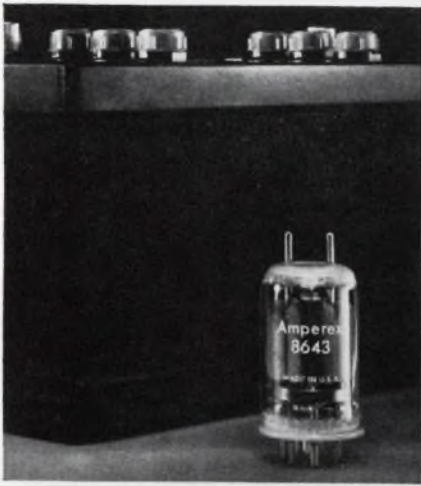

There's a new Amperex cathode in a new Amperex tube, which was specifically designed to handle variations in power supply voltage.

At its high end, this revolutionary, wide-range cathode is immune to high temperatures, and hence, to sublimation; at its low end, it insures adequate talk-power for any emergency!

Now, whether the battery delivers as little as ten volts or as much as sixteen—(all other parameters constant) the end result is the same—never less than 90% of full talk-power and no danger of damage to the tube!

The new cathode is being made available for the first time with the introduction of a new Amperex twin tetrode, the 8643, forerunner of a family of wide-range cathode tubes for mobile equipment.

The 8643 was designed for use as an RF power amplifier, oscillator and frequency multiplier up to 175Mc. It is rated for Push-To-Talk Service, capable of producing 135 watts from less than 4 watts drive as a 175Mc amplifier under PTTS conditions.

POWER PERFORMANCE VS. CATHODE VOLTAGE

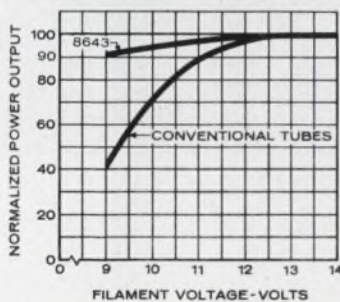

PUSH-PULL FM AMPLIFIER (HEAT SINK OPERATION)

ICAS (175Mc) PTTS* (175Mc)

Plate Voltage (Volts)	750	750
DC Plate Current (ma)	240	264
Drive Power (Watts)	3.5	4.0
Useful Power Output (Watts)	123.0	135.0

*PUSH-TO-TALK SERVICE, MAX. DUTY CYCLE 1 MIN. ON, 4 MINS. OFF.

For data on the 8643 and other Amperex twin tetrodes for mobile communications, write: Amperex Electronic Corporation, Tube Division, Hicksville, L. I., New York 11802.

Amperex®

ON READER-SERVICE CARD CIRCLE 49
ELECTRONIC DESIGN, June 21, 1966

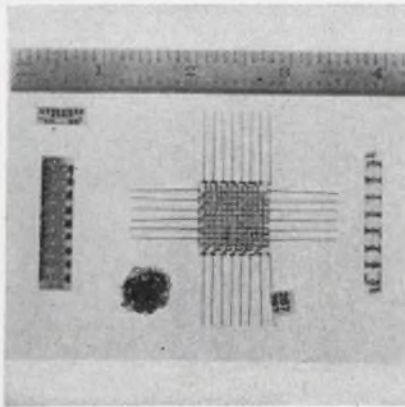

MIL-S-19500 passivated oxide glass sealed silicon diode pellets are typically 0.05-in. diameter by 0.02-in. thick. Terminations are high-temperature solder tabs. With power heat sinking, the units dissipate 1 W min.

The whiskerless diodes are available as general purpose diodes, logic switches, core drivers, core driver matrix assemblies and zeners.

MicroSemiconductor Corp., 11250 Playa Ct., Culver City, Calif. Phone: (213) 391-8271.

Circle No. 706

Capacitance diodes

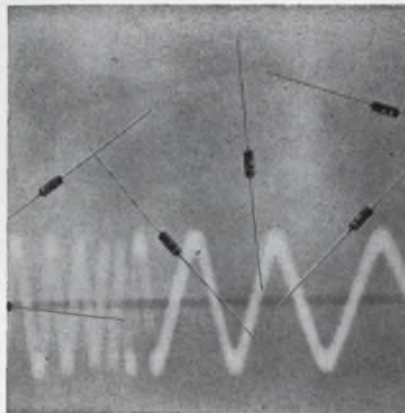

Types 1N5139 to 48 and 1N5139-A to 48A voltage-variable capacitance diodes are designed for RF tuning in the vhf band and above. Reverse leakage current is 20 nA max. Minimum Q is 200 to 350 at 50 MHz and 4 Vdc bias. Tuning ratio is typically 2.9 to 3.4. The "Epi-caps" are available in ten types with capacitances of 6.8 to 47 pF at 4 V. Tolerances are 5 and 10%.

Price: \$3.90 to \$4.30 (over 100). Motorola, P. O. Box 955, Phoenix. Phone: (602) 273-6900.

Circle No. 707

Power transistors



Series MHT 7901 through 7904 transistors are 10-A planar npn devices featuring sustaining voltages from 200 to 300 V. The transistors are offered in a TO-66 package with a power rating of 25 W at 100°C case temperature. I_{CBO} is 1 μ A max, $V_{CE/SAT}$ is 0.5 V max at 5 A and h_{FE} is 50 MHz.

Solitron Devices Inc., 1177 Blue Heron Blvd., Riviera Beach, Fla. Phone: (305) 848-4311.

Circle No. 708

Fast switching diode

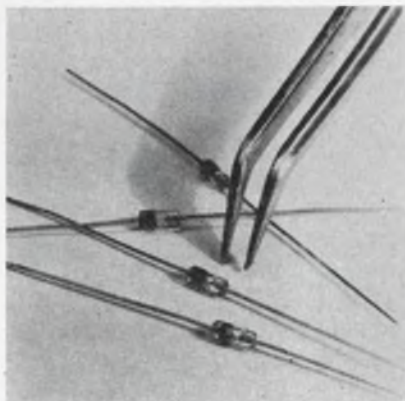

Fast switching microwave silicon diodes are designed for low loss switch applications at frequencies up to and including Ku band. Model MO 2800A of the 2800 series features a forward switching time of 1.0 ns max, total capacitance of 0.1 pF max, voltage breakdown of 80 V min and dynamic forward impedance of 3 Ω max.

Alpha Industries Inc., 381 Elliott St., Newton Upper Falls, Mass. Phone: (617) 969-6480.

Circle No. 709

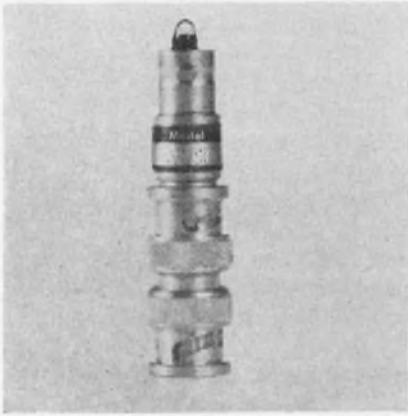

GaAs light transmitter

A vhf visible-light transmitter can be driven up to 165 MHz and pulsed with turn-on and turn-off times of 10 ns. Minimum brightness is 50 foot-lamberts and spectral line width is 400 Å between 6000 and 7000 Å. Power requirement of model A950 is 150 mA at 1.65 V. Applications include optical transmission of vhf sinusoidal and pulsed signals, circuit isolation and light strobe. Both male and female BNC connectors are supplied.

P&A: \$55; stock to 10 days. Somerset Radiation Lab. Inc., P. O. Box 201, Edison, Pa. Phone: (215) 348-8883.

Circle No. 710

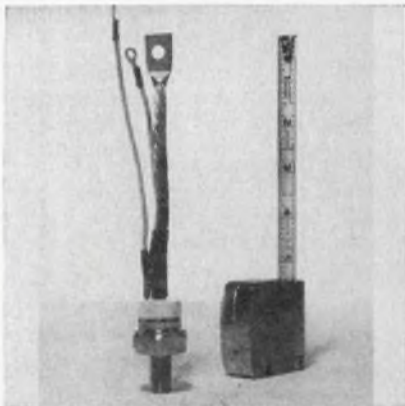

Thyristor SCR

Type 254 thyristor silicon-controlled rectifier is rated at 70 A half-wave average (110 A rms) at 50 to 1300 V. This JEDEC-registered device is designed for cycling loads such as inverters, motor controls and primary-controlled power systems. The SCR has a 1600-A surge rating.

P&A: \$15.10 to \$248 (1 to 100); stock. Westinghouse, Youngwood, Pa. Phone: (412) 925-7272.

Circle No. 711

Diodes

Glass-passivated silicon mesa devices are packaged in double-plug cases, 0.22-in. long, 0.085-in. in diameter with 0.02-in. lead diameters. Power dissipation up to 200 mW at 25°C can be tolerated. These whiskerless diodes have been designated IN456-IN459, IN461-IN464, and IN482-IN-485.

Price: \$0.35 to 0.85, (1 to 99), \$0.28 to \$0.60 (100 to 999) Texas Instruments, 13500 N. Central Expwy., Dallas. Phone: (214) 235-3111.

Circle No. 712

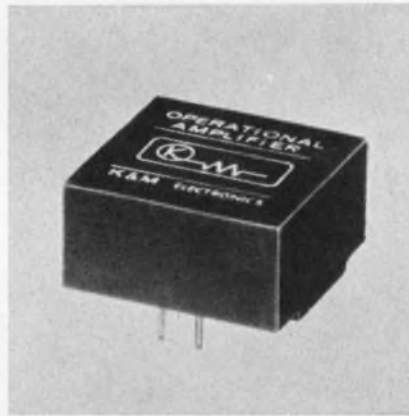

FET op-amp

Series KM40 FET operational amplifiers feature input impedances up to $10^{14} \Omega$. Current offset is less than 10 pA and voltage offset drift is $3 \mu\text{V}/^\circ\text{C}$. All units are available with integral power supply.

P&A: from \$50, stock to 2 wks. K&M Electronics Corp., 102 Hobart St., Hackensack, N. J. Phone: (201) 343-4518.

Circle No. 713

High-gain transistors

Two new silicon planar epitaxial transistors, the A467 and A473, together make possible an unneutralized, 3-stage TV IF amplifier with an over-all minimum gain of 90 dB. This circuit capability is due to the feedback capacitances of 150 mpF and 220 mpF respectively. Cut-off frequencies are 350 and 400 MHz and breakdown voltages are 30 and 35 V. Both types are mounted in a standard TO-18 can.

Amperex Electronics Corp., Slatersville, R. I. Phone: (401) 762-9000.

Circle No. 714

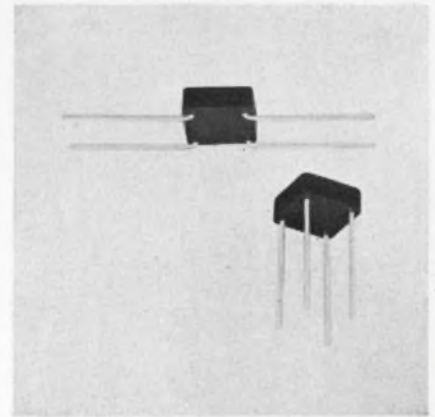

Bridge rectifier

A miniature single-phase bridge silicon rectifier contains double-diffused passivated controlled avalanche junctions in a cold case design. Silver leads are available straight for plug-in or bent for terminal strip mounting. The rectifiers are available with a current of 2 A from 50 to 1200 V PIV.

Edal Industries Inc., 4 Short Beach Rd., East Haven, Conn. Phone: (203) 467-2591.

Circle No. 715



Uhf noise diode

Constructed to match the impedance of a 50- Ω coax line, the TT-1 diode is for use as a hf and uhf noise source. Noise output is a direct function of anode current. Coax construction permits use with tuned or untuned circuits. Maximum anode voltage and current ratings are 300 Vdc and 100 mA. Filament ratings are 3.2 Vac or dc and 2.5 mA. Anode dissipation is 30 W max. Frequency range extends to 3 GHz max and dynamic impedance is 16 k Ω min.

Signalite Inc., 1933 Heck Ave., Neptune, N. J. Phone: (201) 775-2490.

Circle No. 716



DALE

RELIABILITY

TOTAL CAPABILITY IN
PRECISION RESISTANCE

To get the best
METAL FILM deal...

forget
about
price!

(Dale is competitive... and a better buy besides)

Price should be the least of your worries. Right now, several metal film manufacturers (including Dale) are offering MIL-R-10509 RN parts in a price range which is more competitive than ever before.

But price doesn't equalize quality. Neither does it assure you of the delivery you need. Or the part-to-part homogeneity that can turn a good price into an outstanding one because of the overall savings it makes possible.

You can get these quality, delivery and homogeneity assurances—at a competitive price—by dealing with Dale. Continued expansion utilizing the most advanced automated equipment plus long-

established systems of value analysis enable us to be fiercely competitive—without sacrificing quality standards. Standards which enable Dale MF, MFF and MFH resistors to go *beyond* the Mil. Spec. in meeting your needs.

Don't be bashful about asking us to prove all this. We're continually developing good metal film customers who, at first, were surprised to find we were in the business. As a matter of fact, we'll be pleased to show you that there's still a lot more to a metal film resistor than price. To see what we mean, just take a look on the back of this page.



DALE ELECTRONICS, INC.

1336 28th Avenue, Columbus, Nebraska

For more information circle No. 150.

Turn page for METAL FILM CHECK LIST 



NEW HOUSED D SERIES opens new design areas for use of precision power metal film resistors

Dale's new D Series are the industry's first housed power film resistors. They combine a heat sink housing already proven by Dale Wirewounds, with a precision power metal film element. The result:

1. As **FILM RESISTORS**, Dale's D Series offer power/size ratio unmatched by conventional parts (see chart).

2. As **HOUSED RESISTORS**, Dale's D Series offer higher maximum resistance values and low reactance at high frequencies.

We'll send you complete details on this amazing design flexibility.

D SERIES SPECIFICATIONS

■ **Resistance Range:** 50Ω to 2 Megohms (D5), 30Ω to 2 Megohms (D10), 50Ω to 2.6 Megohms (D15)

■ **Tolerance:** ±0.1%, 0.25%, 0.5%, 1% and 2%

■ **Power Rating:** D5 4 watts, D10 8 watts (mounted on 4"x6"x.040" aluminum chassis) D15 12 watts (mounted on 5"x7"x.040" aluminum chassis).

■ **Temperature Coefficient:** ±25 and ±50 ppm/°C (-55°C to +175°C). Higher T.C.'s on request.

■ **Maximum Working Voltage:** 500 (D5), 600 (D10), 700 (D15)

■ **Dielectric Strength:** 1000 VAC on D5, 1500 VAC on D10 and 2000 VAC on D15

■ **Construction:** Aluminum screw-mount radiator housing with resistance element molded inside for complete environmental protection. Meets all applicable requirements of MIL-R-18546C and MIL-R-10509E.

FILM RESISTOR POWER/SIZE COMPARISON

CHARACTERISTIC	D SERIES			2-WATT METAL FILM	5-WATT CARBON FILM	4-WATT TIN OXIDE
SIZE						
	D5 .334 W X .600 L	D10 .420 W X .750 L	D15 .550 W X 1.062 L			
Power Rating	4 Watts	8 Watts	12 Watts	2 Watts	5 Watts	4 Watts
Volume	0.064 in. ³	0.123 in. ³	0.320 in. ³	0.242 in. ³	0.600 in. ³	0.145 in. ³
Power Density (25° C)	62.0 w/in. ³	65.0 w/in. ³	37.5 w/in. ³	8.3 w/in. ³	8.3 w/in. ³	27.6 w/in. ³
Power Density (125° C)	20.4 w/in. ³	21.4 w/in. ³	12.4 w/in. ³	8.3 w/in. ³	2.1 w/in. ³	13.8 w/in. ³
Life Stability (Typical) *	.1%	.1%	.1%	0.5%	0.5%	3%
Temp. Coefficient	25 or 50 ppm/° C			50 ppm/° C	500 ppm/° C	300 ppm/° C
Max. Operating Temp.	175° C	175° C	175° C	175° C	150° C	200° C

*Maximum resistance shift in 1000 hours of operation at rated power.

When specifying metal film resistors look for these features at a competitive price--

DALE has them!

LOW NOISE CONSTRUCTION Dale maximum for standard resistance range is 0.10 micro-volt per volt over a decade of frequency, with low and intermediate values below 0.05 micro-volt per volt. Dale uses a unique production method in which a terminating band of low-resistance metal alloy is deposited in the same vacuum as the metal film element. This results in a uniform, OXIDE-FREE, low noise contact area between film, band and press-fit cap.

CONTROLLED TEMPERATURE COEFFICIENT Available in 11 standard T.C. Codes from 0±150 ppm/°C to 0±25 ppm/°C. Close T.C. matching between pairs or sets is also available.

GOOD H.F. CHARACTERISTICS Low reactance is standard and results in excellent stability at high frequencies. For extremely critical applications above 100 megacycles, non-helixed or laterally-adjusted units can be supplied.

SPECIAL CAPABILITIES At your request, Dale can readily supply: ■ Special terminals in any commercial material. ■ Special pre-conditioning (power aging, temperature cycling, etc.). ■ Close tolerance matching in pairs or sets. ■ Resistor networks packaged in various configurations and encapsulants.

MAXIMUM FLEXIBILITY IN ENVIRONMENTAL PROTECTION Three types of specially-developed protective coatings are offered to give maximum flexibility of choice: MFF epoxy coated. Meets electrical and environmental requirements of Char. B, C, D, E; MIL-R-10509E, but is dimensionally smaller. MFH hermetically sealed in ceramic tube. Meets requirement G; MIL-R-10509E. MF transfer molded in epoxy. Meets all requirements of Char. B, C, D, E, F; MIL-R-10509E.

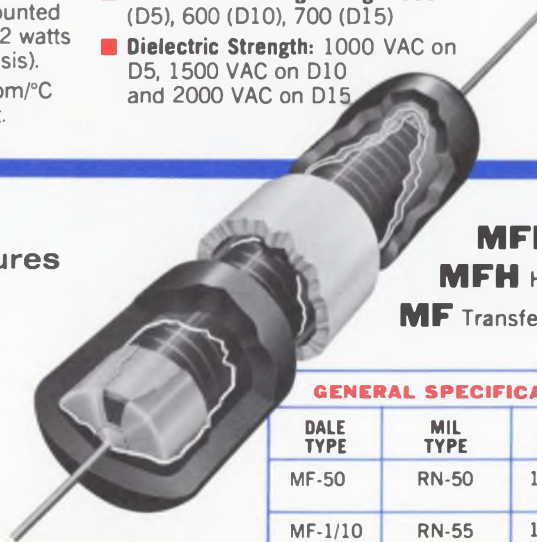

MFF Epoxy coated.

MFH Hermetically sealed in ceramic tube.

MF Transfer molded in epoxy.

GENERAL SPECIFICATIONS—TYPE MF¹ MIL-R-10509E

DALE TYPE	MIL TYPE	125° C RATING	RESISTANCE RANGE	DIMENSIONS (LxD)
MF-50	RN-50	1/20 watt	10 ohms to 100K ohms	.140x.065
MF-1/10	RN-55	1/10 watt	10 ohms to 200K ohms	.250x.093
MF-1/8	RN-60	1/8 watt	10 ohms to 1 Megohm	.406x.140
MF-1/4	RN-65	1/4 watt	10 ohms to 2 Megohms	.593x.203
MFS-1/2	RN-70	1/2 watt	10 ohms to 2 Megohms	.750x.250
MF-1	RN-75	1 watt	10 ohms to 4 Megohms	1.093x.375
MF-2	NA	2 watts	100 ohms to 10 Megohms	2.188x.375

*Tolerance: ±1% standard; ±.5%, ±.25%, ±.1% available.

ENVIRONMENTAL SPECIFICATIONS*

Dale MF resistors are manufactured to the environmental specifications of MIL-R-10509E. Characteristics D, C or E apply depending on T.C. Code specified at purchase.	DALE T.C. CODE	APPLICABLE CHAR. OF MIL-R-10509E
	T-1 (100 P.P.M./°C)	D
	T-2 (50 P.P.M./°C)	C
	T-9 (25 P.P.M./°C)	E

*Specifications for MFF and MFH are similar, but vary dimensionally.

WRITE FOR CATALOG A—giving comprehensive information on Dale's complete Film and Wirewound Resistor line.

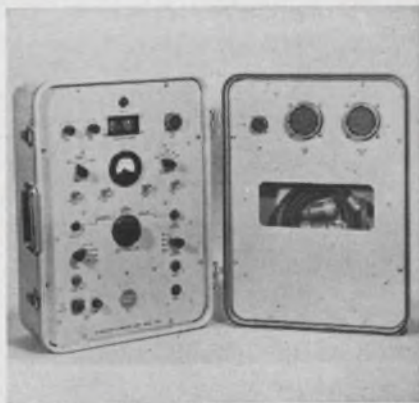
Field cable tester

Automatic field tests to NASA specs are made with QC 275 cable tester. Resistance testing is performed with simulated load currents from 40 mA to 1 A. Leakage resistance is measurable to 5000 M Ω with go no-go settings at 50, 100, 150 and 200 M Ω . Total capacity is 75 circuits with adjustable dwell time from 0.5 to 15 s.

P&A: \$12,040; 4 wks. Automation Dynamics Corp., Industrial Pkwy., Northvale, N. J. Phone: (201) 768-9200.

Circle No. 319

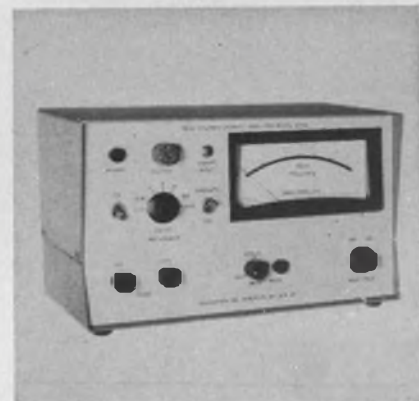
Charge amplifier

Model 624 A peak holding charge amplifier with 10-turn potentiometer and 7-step range switch accepts inputs from 50 to 1000 pC. A continuously adjustable automatic reset has periods ranging from 10 to 30 s. Input impedance is 10^{14} Ω for calibration and 10^{11} Ω in operation. Sensitivity can be adjusted from 0.1 to 100 mV/psi, G or lb.

P&A: \$995; stock. Sensonics Inc., P. O. Box 395, Falls Church, Va. Phone: (703) 534-7800.

Circle No. 320

Dual waveform generator

Sine and square wave signals from 20 Hz to 200 kHz are generated by model 636. For the sine wave output, frequency response is flat within ± 1.5 dB with accuracy of $\pm 5\%$ and distortion of less than 0.25%. Output is 0 to 10 V rms across a 600 Ω load. For the square wave output, rise time is 0.15 μ s. Output is 0 to 10 V p-p into 600 Ω load.

Designatronics Inc., 76 E. Second St., Mineola, N. Y. Phone: (516) 741-7070.

Circle No. 321

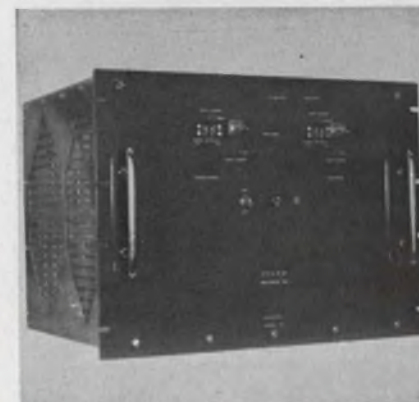
Deflection amplifier

This deflection amplifier is a ± 40 V driver with regulated power supplies and safety current limiting. The all-silicon unit provides a 12-A change in less than 9 μ s with a linearity of 0.02%. Requiring 115 Vac, the amplifier handles from dc to pulses. This unit is compatible with single-ended yokes and needs no synthesizing networks.

Constantine Engineering Labs. Co., 70 Constantine Dr., Mahwah, N. J. Phone: (201) 327-1123.

Circle No. 322

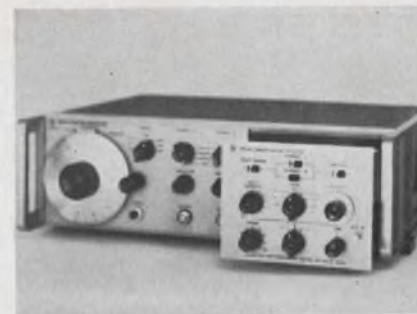
**Sweep/offset plug-in**

Model 3304A sweep/offset plug-in internally sweeps the manufacturer's 3300A function generator over any decade of its range at rates from 0.01 Hz to 100 kHz. The plug-in also produces outputs which are dc-offset up to ± 16 V.

The sweep bandwidth can be adjusted at any value up to a decade. The sweeping voltage is available at an external output to drive an X-Y recorder or a scope. The 3304A also provides sawtooth waves with independent frequency control. Two channels deliver a choice of sine, square, or triangular waves.

P&A: \$210; 6 to 8 wks. Hewlett Packard, 1501 Page Mill Rd., Palo Alto, Calif. Phone: (415) 326-7000.

Circle No. 323

Semiconductor analyzer

A portable battery-powered semiconductor analyzer is designed for testing transistors, diodes and low power SCRs. The unit tests semiconductor junctions for low or high impedance and leakage and determines the dc current gain of transistors and the gating function of SCRs. In-circuit shorts and dc current gain may be measured without disconnecting circuit leads.

Short or low impedance junctions and open or high impedance junctions for diodes and transistors are tested on a go no-go basis. Reverse bias leakage is measurable for selectable junction voltages to 30 volts. Diode forward and reverse current characteristics for voltages to 30 volts may be analyzed. Shorts are located with in-circuit impedances as low as 3 Ω . Dc current gain scale for npn or pnp transistors extends to 300. The 5-lb unit uses 1.5-V "D" cells.

Dahlberg Electronics Inc., Golden Valley, Minneapolis, Minn. Phone: (612) 545-3722.

Circle No. 324

TEST EQUIPMENT



Resistance bridge

Fixed film or hybrid microcircuit resistors may be continuously monitored as they are adjusted to final value. This resistance trimming bridge automatically halts the trimming process at the programmed "stop" value and performs a high-low-accept check. Typical trimming and testing speed is 1 resistor per second. Final values are selectable from 10 Ω to 10 M Ω and tolerances may be programmed individually from 0 to 11% in 0.1% increments. Over-all accuracy is 0.05%.

Boonton Electronics Corp., Rte. 287 & Smith, Parsippany, N. J. Phone: (201) 887-5110.

Circle No. 325



Power pulse generator

PM 1355-R power pulser, in conjunction with an existing dc supply, superimposes a pulse onto the lines. Load capability is 100 A max and amplitude is 44 ± 6 V. Frequency is 1 to 10 Hz and pulse width is 7.5 ± 2.5 μ s. Rise time is 1 μ s max and fall time is 2 μ s max.

Pioneer Magnetics Inc., 1745 Berkeley St., Santa Monica, Calif. Phone: (213) 393-0136.

Circle No. 326

Gate generator



The GG200 gate generator has 6 outputs including system logic and gate signals and their complements. Delayed positive and negative trigger signals at the end of each cycle permit use as a delay generator. Gating time range is 100 ns to 11 s in 8 overlapping ranges. The cycle may be started and stopped by ± 5 - to ± 50 -V pulses as well as logic signals. All outputs drive 50- Ω loads.

EG&G, Inc., 35 Congress St., Salem, Mass. Phone: (617) 745-3200.

Circle No. 327

Dc amplifier

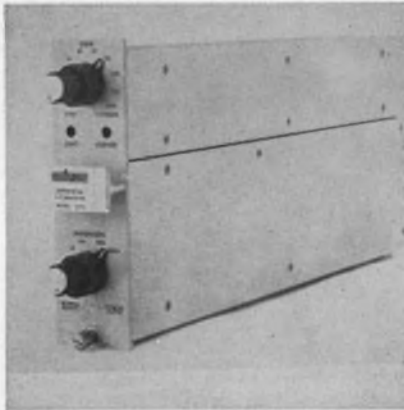

An all-silicon solid state differential dc amplifier features ± 300 V common-mode voltage capability and gains from 1 to 2500, with 100 M Ω input impedance. Output is ± 10 V- at ± 100 mA. Common mode rejection is 160 dB at dc. Switch-selected bandwidth filters have standard values of 10 kHz, 1 kHz, 100 Hz and 10 Hz. Settling time is 100 ms max.

P&A: \$745; stock to 45 days. California Instruments Corp., 3511 Midway Dr., San Diego, Calif. Phone: (714) 224-3241.

Circle No. 328

Capacitance bridge



This capacitance bridge has a range of 1 pF to 1.1 farads and incorporates a 120-Hz generator, detector and adjustable dc polarizing supply. Three-, four- and five-terminal measurements can be made with the type 1617-A bridge. The built-in bias supply has six ranges to 600 V. External bias up to 800 V can be applied. The bridge measures dissipation factors up to 10.

Price: \$1195. General Radio Co., West Concord, Mass. Phone: (617) 369-4400.

Circle No. 329

IC tester



A portable test console measures electrical characteristics of all 1- to 14-lead ICs. The unit contains 6 power supplies, four of which are individually front-panel adjusted over 0 to ± 15 V. Readout is on the front panel meter or on an external DVM. Accuracy is 1% full-scale with panel meter, and 0.1% with a DVM. Voltages to 30 V and currents of 1 nA can be measured.

P&A: \$995; stock to 3 wks. Continental Device Corp., Hawthorne, Calif. Phone: (213) 772-4551.

Circle No. 330

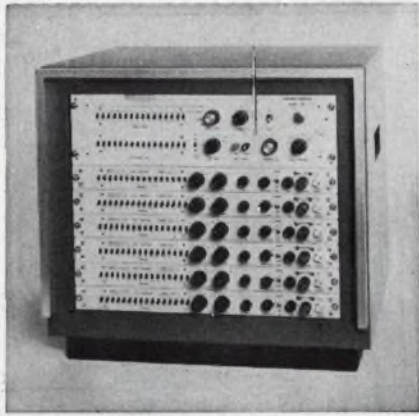

Pulse generator

Model 1010B programed current pulse generator provides 1-A current pulses with rise times to 10 ns. The unit delivers a serial/parallel train up to 16 steps with a clock rate to 5 MHz. It contains a program generator, up to 6 current drivers, and a power supply. Either polarity with any sync pulse or step repeat function on any step may be programmed.

RFS Engineering Co., 2nd & Westmoreland Sts., Philadelphia. Phone: (215) 425-6909.

Circle No. 331



Pre-set digital clock

Model PC-16 miniature digital clock system uses ICs and features dual pre-set knobs for variable time schedule adjustments. Six internal fixed time schedules are also available. Display configurations include seconds, minutes and 12 or 24 hours. BCD or 10-line decimal outputs are available. Bench-top or rack mount models are offered.

P&A: \$595; 4 wks. United Computer Co., Palo Verde Industrial Pk., 930 W. 23rd St., Tempe, Ariz. Phone: (602) 967-3131.

Circle No. 332

Ballantine High Voltage AC/DC Calibrator

Model 421A

Price: \$650

Portable

0-111 V dc

0-1110 V ac

400 or 1000 Hz,
RMS or Peak-to-Peak

May be used with
Optional Error
Computer



NEW!

Accurately Calibrates to 0.15% Vm's, 'Scopes, Recorders...

Ballantine's new Model 421A is an accurate source of dc or ac voltage that can be set precisely to any value desired up to 111 volts on dc or up to 1110 volts on ac. It's small, rugged, portable . . . enabling you to check with ease a wide range of instruments without loss of down time. You'll find it useful, too, as an accurate, stable source for measurements of gain or loss, and as a stable source for bridges or strain gauges.

The selected voltage is indicated digitally to four significant figures on each of six decade ranges. The voltage indicated may be dc, or it may be ac at 400 Hz or 1000 Hz, RMS or Peak-to-Peak.

Note, for example, the settings in the photo — 42.35 volts RMS at 1000 Hz output. And with an accuracy that you can be sure is better than 0.15%. The receptacle on the lower right of the instrument is for high voltage outputs from 100 volts to 1110 volts at 400 Hz, RMS or Peak-to-Peak.

The new instrument also features a connection for an optional Model 2421 Error Computer that enables you to read calibration errors directly in percentages, speeding up your calibrations considerably.

In addition to its greater voltage range on ac, the Model 421A has a lower source impedance on ac than the Model 421 it replaces. Line voltage effects on the instrument are negligible. A $\pm 10\%$ line voltage change, for instance, causes less than a 0.05% change in output voltage.



Model 2421
Error
Computer
Price: \$75

Write for brochure giving many more details



BALLANTINE LABORATORIES INC.

Boonton, New Jersey

CHECK WITH BALLANTINE FIRST FOR DC AND AC ELECTRONIC VOLTMETERS/AMMETERS/OHM METERS, REGARDLESS OF YOUR REQUIREMENTS. WE HAVE A LARGE LINE, WITH ADDITIONS EACH YEAR. ALSO AC/DC LINEAR CONVERTERS, AC/DC CALIBRATORS, WIDE BAND AMPLIFIERS, DIRECT-READING CAPACITANCE METERS, AND A LINE OF LABORATORY VOLTAGE STANDARDS FOR 0 TO 1,000 MHz.

Speed Inquiry to Advertiser via Collect Night Letter
ON READER-SERVICE CARD CIRCLE 55



PROTECT YOUR INSTRUMENTS WITH AMALCO ALUMINUM CARRYING CASES



Amalco aluminum carrying cases are perfect for carrying instruments safely. Tightly sealed to prevent dust, sprays and dirt to enter, these cases are ruggedly constructed to sustain unusual abuse. The Amalco carrying cases come in eight economical sizes and can be modified to suit your specific needs.

Write for descriptive literature and specifications on the Amalco Aluminum Carrying Cases.

OTHER PRODUCTS & SERVICES OF AMERICAN ALUMINUM

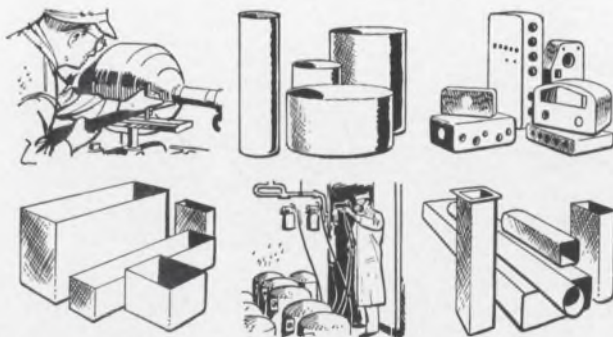

SPECIALISTS IN CONTRACT MANUFACTURING OF ALUMINUM

COMPLETE FABRICATING FACILITIES FOR DEEP DRAWING, HEAT TREATING, SPINNINGS, ASSEMBLY, SHEET METAL, STAMPINGS, ANODIZING, WELDING, FINISHING.

Send for brochure "Aluminum Fabricating For Industry"



AMERICAN ALUMINUM COMPANY

Manufacturers of Aluminum Products for Industry since 1910

230 Sheffield St. • Mountainside, N. J. • 201-233-3500

ON READER-SERVICE CARD CIRCLE 50

TEST EQUIPMENT

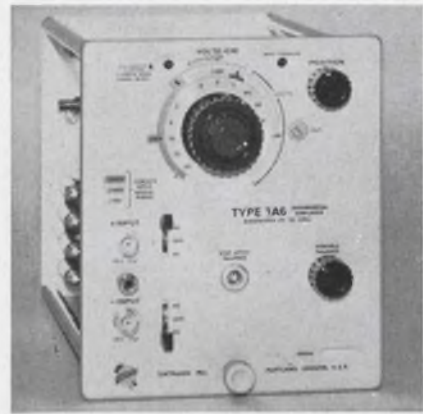

Differential amplifier

The manufacturer's 530, 540, 550 and 580 scopes will accept the 1A6 plug-in differential amplifier. A constant dc to 2 MHz bandwidth and calibrated deflection factor from 1 mV/cm to 50 V/cm are featured.

Output is the instantaneous difference between signals applied to the + and - inputs. Common-mode rejection ratios of 10,000:1 from dc to 100 kHz (1 mV/cm to 50 mV/cm), and 1000:1 (0.1 V/cm to 50 V/cm) allow cancellation of unwanted signals. Dual inputs allow floating-input measurements between above-ground points. A single control selects the deflection factor and indicates the allowable common-mode signal range from ± 15 to ± 500 V (combined dc and peak ac).

P&A: \$230; July. Tektronix Inc., P.O. Box 500, Beaverton, Oregon. Phone: (503) 644-0161.

Circle No. 333

High-range wattmeter

Single- and poly-phase power levels from 1.5 to 50 kW without external current transformers may be measured with this wattmeter. Current ranges are 0 to 10/20/50/100 A rms. A 0- to 50-mVdc output signal, proportional to kilowatts, is available on each power range. Accuracy of this analog signal is $\pm 0.5\%$ full scale. Over-all meter accuracy is $\pm 1\%$ of full scale. The portable wattmeter requires no external power source.

P&A: \$890; stock to 4 wks. Scientific Columbus Inc., 1035 W. Third Ave., Columbus, Ohio. Phone: (614) 291-4681.

Circle No. 334

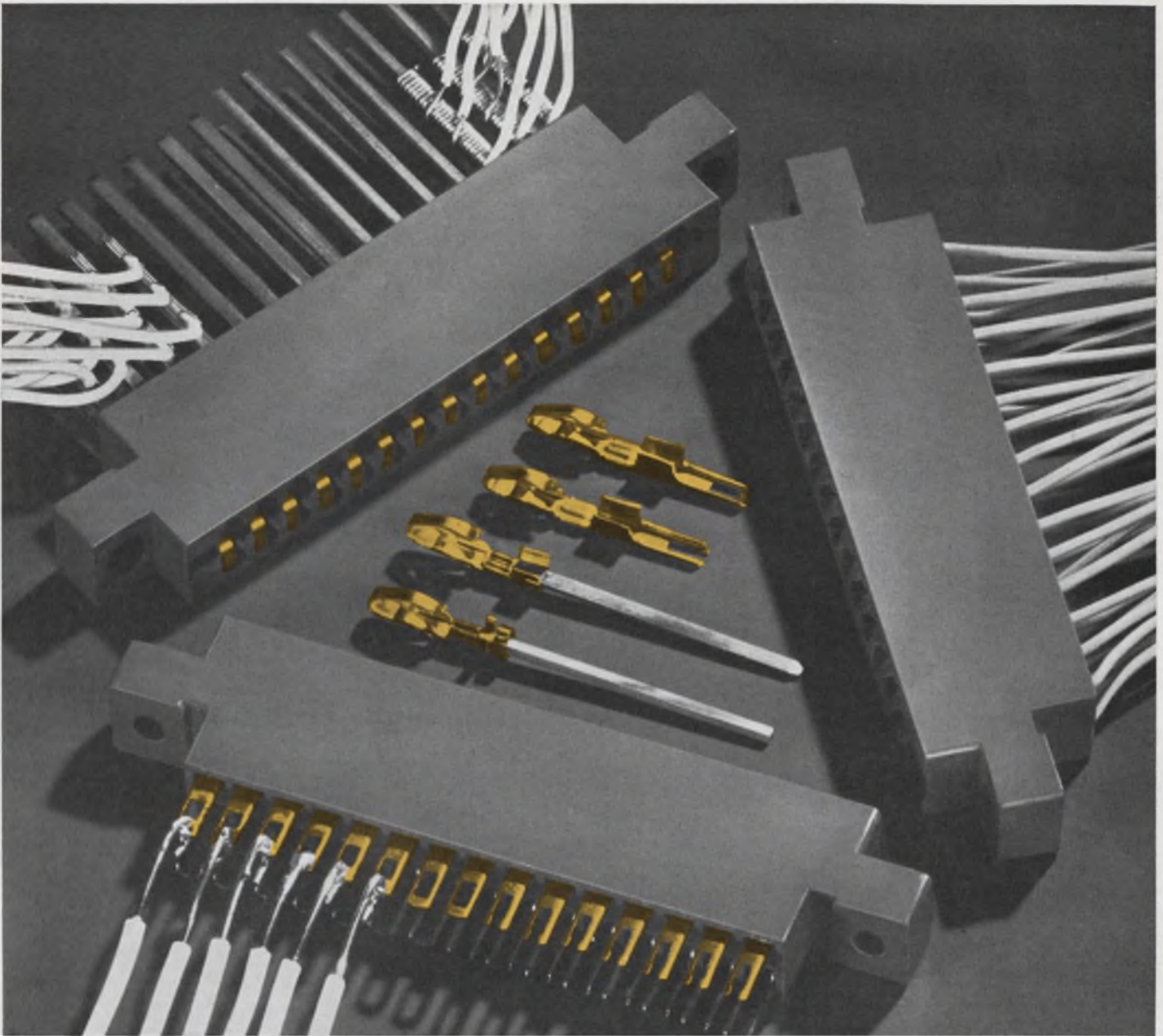

Five-way termination choice

Choose our A-MP* Printed Circuit Connectors for their superior performance features. Then, use any one of five ways to terminate the circuit contacts.

You can crimp and snap-in contact and conductor . . . loading only those positions you need.

Solder them.

Weld, if you like.

Wrap, if that's the way you've always done it.

And finally, a new way—clip-on terminations! This is done with our TERMI-POINT* point-to-point wiring devices, which make a reliable, gas-tight connection by merely pushing a spring-clip and wire onto the contact post. You can use any one of a variety of wires—stranded, solid, tinsel, enamel and printed . . . TERMI-POINT devices accept all of them.

No matter which method you choose, you get all these important advantages in our one-piece printed circuit connector:

finest quality-controlled construction

- gold over nickel plated contacts to prevent oxide creep
- precisely controlled contact pressures for longer contact life and less wear on circuit paths
- alpha-numerical coded housings
- available in 8, 15, 22, 30 and 32 positions

Write today for the full story on the big choice in printed circuit connectors. You'll get complete information on printed circuit connectors with crimp type contacts or with special post and tab adaptations—plus details on our new TERMI-POINT terminals and tools.

*Trademark of AMP INCORPORATED

AMP
INCORPORATED
 Harrisburg, Pennsylvania

A-MP* products and engineering assistance are available through subsidiary companies in: Australia · Canada · England · France · Holland · Italy · Japan · Mexico · Spain · West Germany

Speed Inquiry to Advertiser via Collect Night Letter
 ON READER-SERVICE CARD CIRCLE 51

Just 16 oz.
and
humidity proof
shock proof
acceleration proof
temperature proof
noise proof
storage proof...

that's the miniature AGASTAT[®] time / delay / relay

All these proofs (meeting MIL specs) mean miniature AGASTAT pneumatic time/delay/relays remain accurate under the most rugged operating conditions.

Environmental hazards can't foul these AGASTAT timers, because they're hermetically sealed.

Tight squeezes don't cramp AGASTAT timers—they measure only 1½" square by about 5" long, weigh only 16 ozs.

Voltage changes, temperature changes or transients can't fool them—their timing action is pneumatically controlled. (Pneumatic timing also means you get instant recycling, with full delay periods regardless of how often the cycle is interrupted before re-



lay "times out." And because timing is pneumatic, it can even time without electric power!

Another advantage is an exclusive dial head that lets you make simple, but accurate, linear adjustments over the full timing range of each unit with just a single revolution of the adjustment screw. (Nine timing ranges cover a total span from 0.03 second to 3 minutes.)

AGASTAT timers are available with delay on pull-in or drop-out or both in one unit. You can also choose from a wide selection of mounting and terminal styles. They operate on all popular ac or dc voltages.

Send for our catalog.

M6

AGASTAT TIMING INSTRUMENTS
ELASTIC STOP NUT CORPORATION OF AMERICA
AGASTAT DIVISION ■ ELIZABETH, NEW JERSEY
IN CANADA: ESNA LIMITED, 271 PROGRESS AVENUE, SCARBOROUGH, ONTARIO
ON READER-SERVICE CARD CIRCLE 52

TEST EQUIPMENT

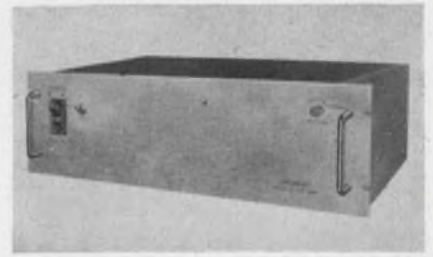

Frequency converters

This frequency converter provides a 115-Vac output at 60 Hz $\pm 1\%$ from an input of 105 to 125 V, 380 to 420 Hz at 250 or 500 VA output power. Also standard is a 115-Vac output at 400 Hz $\pm 1\%$ with power levels of 250, 500 or 1000 VA from an input of 105 to 125 Vac 60 Hz $\pm 10\%$. Regulation is $\pm 2\%$ from no load to full load. The sinusoidal output has a distortion of 3% total rms.

Protran Co. Inc., 7 Commercial St., Hicksville, N. Y. Phone: (516) 931-1880.

Circle No. 335



Dual beam scope

Model D53 dual beam 25 MHz scope has the signal and sweep delays built-in to the main frame eliminating delay lines. Signal delay is 0.25 μs and sweep delay is continuously variable to 50 ms in 2 ranges. The CRT is a split-beam 8.5 kV tube. Plug-ins provide time base and horizontal and vertical amplification. Horizontal deflection of both beams is up to 0.5 $\mu\text{s}/\text{cm}$ in 22 calibrated ranges. The unit will trigger on 2 mm of internal display or 0.2 V p-p external.

P&A: \$915 (main frame); \$80 to \$160 (vertical amplifiers); stock to 3 wks. Data Instruments, 7300 Crescent Blvd., Pennsauken, N. J. Phone: (609) 662-3031.

Circle No. 336

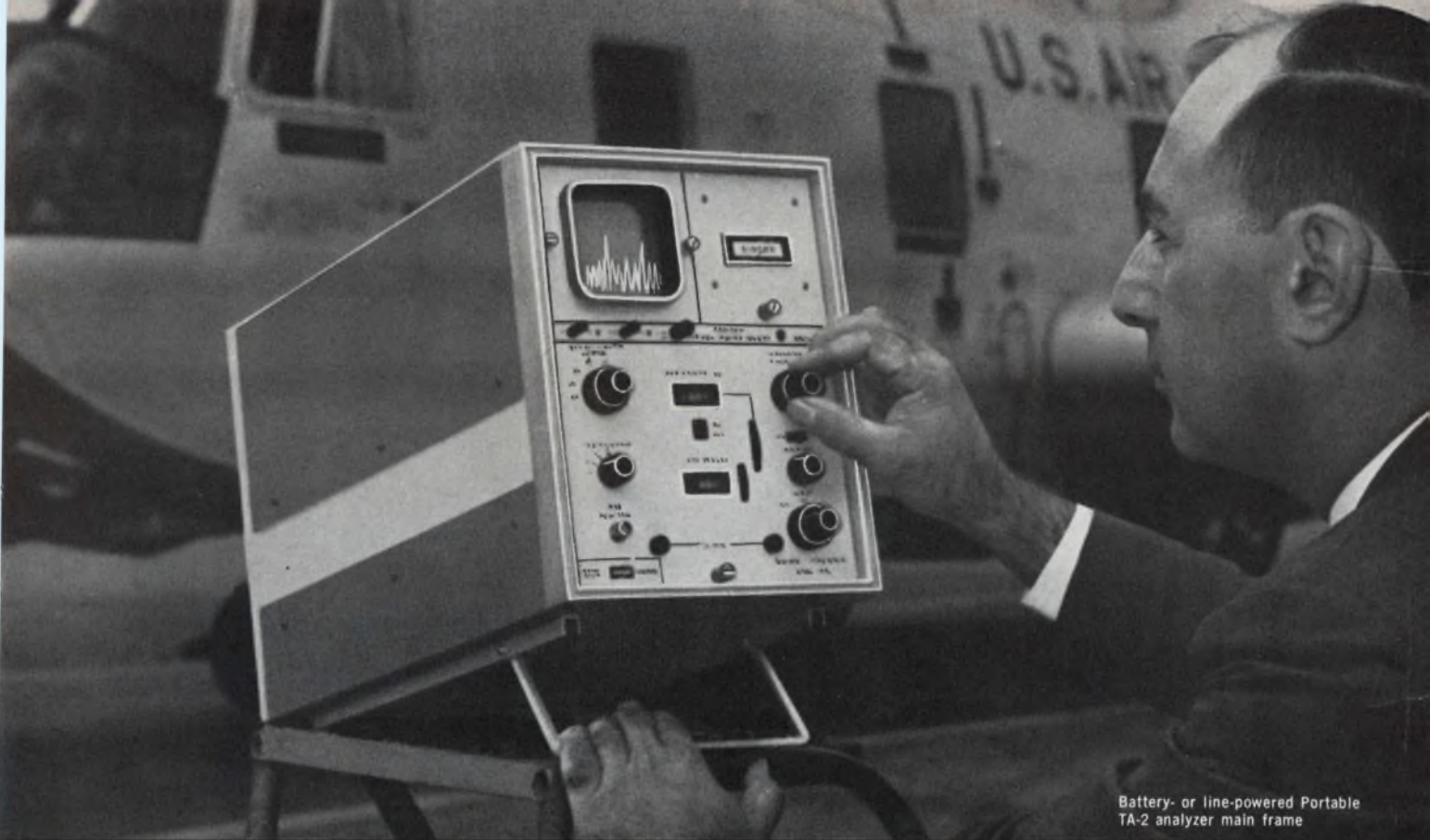

Battery- or line-powered Portable
TA-2 analyzer main frame

THE STANDARDS

Panoramic* UNIVERSAL SPECTRUM ANALYZERS 20 cps to 27.5 Mc

Portable TA-2 and Rack or Bench Mount RTA-5 with 4 Solid State Interchangeable Modules



Rack- or bench-mount
RTA-5 Analyzer main frame

Make precise, rapid swept band analyses anywhere! Check out and pinpoint troubles in communications signals, sound, vibration, noise and RFI.

The standard—feature-by-feature AC/DC or internal battery operation Bright, easily read calibrated spectrum displays Digital frequency readout of scanned band Calibrated linear and 40 db log level scales Built-in Xtal markers for self-checking Simplified—few controls, many preset for optimum results.

4 solid state plug-in modules feature digital center frequency and sweep width controls "Quick-look" overall analysis and highly resolved narrow scans are quickly set up Advanced design provides excellent dynamic range, sensitivity, resolution and sweep repeatability.

Choice of analyzer main frames for all modules Compact RTA-5 main frame is only 19" wide, 7" high, and 18 1/2" deep—ideal for space saving, rack- or bench-mounting Portable, solid-state TA-2 weighs only 40 pounds, complete with module and internal rechargeable battery pack—also operates from almost any AC or DC source.

Modules For TA-2 & RTA-5 Main Frames	OFF SHELF DELIVERY			NEW
	AR-1 (Sonic)	AL-2 (log-scan sonic)	UR-3 (Ultrasonic)	VR-4 (Video)
Frequency Range	20-35,000 cps	20-35,000 cps	100 cps-700 kc	1 kc-27.5 mc
Sweep Widths	0.2, 1, 5, 20 kc	0.2, 1, 5, 20 kc; 25-25,000 cps log	adjust. to 0-400 kc	adjust. to 0-5 mc
Resolution	Automatic optimum to 25 cps		adjust. to 100 cps	adjust. to 200 cps
Residual distortion	All unwanted products at least 60 db down			-50 db
Sensitivity	30 μ v full scale deflection			
Marker Spacing	0.02% Accuracy-Fundamentals shown-Harmonics Usable			
	2.5 kc	2.5 kc	25 kc	25 kc, 500 kc, 100 Mc

Write for brochure, or contact your local Singer Instrumentation representative



*A Trademark of THE SINGER COMPANY

EMPIRE • GERTSCH • PANORAMIC • SENSITIVE RESEARCH

SINGER
INSTRUMENTATION

THE SINGER COMPANY, METRICS DIVISION • 915 Pembroke St., Bridgeport, Conn. 06608, U. S. A. • PHONE (203) 366-3201

**NOW! a NEW Shielded
High Q Variable Inductor
with exceptional stability!**



**The NEW
Wee V-L**

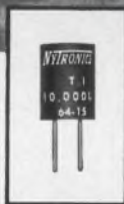

ACTUAL SIZE

Adjustable Inductance range 0.15 μ h to 100,000 μ h in 0.300" by 0.400" molded case with 0.200" grid spacing.

24 HOUR DELIVERY!

The new Wee V-L now offers the design engineer these important advantages: Meets requirements of MIL-C-15305C; unitized epoxy molded construction; 77 stock values; and shielded for minimum coupling.

The Wee V-L is the newest product to join the Nytronics subminiature family of inductors, ceramic capacitors, precision wire wound resistors, thin film resistors and delay lines. Use coupon for engineering data!

NYTRONICS

Design leaders
STANDARD components to meet
CUSTOM requirements

550 Springfield Ave., Berkeley Heights, N. J.

**MAIL COUPON TODAY FOR COMPLETE
ENGINEERING DATA ON THE NEW WEE V-L**

TO: NYTRONICS, INC. Dept. ED
550 Springfield Avenue, Berkeley Heights, N. J.
Please send complete engineering data on the Wee V-L

NAME _____
TITLE _____
FIRM _____
ADDRESS _____
CITY _____ STATE _____ ZIP _____

ON READER-SERVICE CARD CIRCLE 53

TEST EQUIPMENT

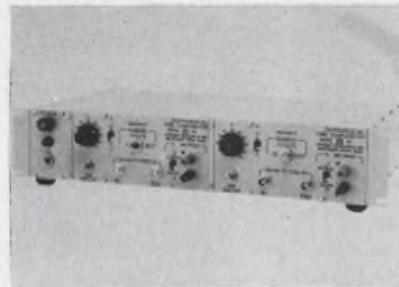

Time comparator

Model 113 differential time comparator produces a linear full-scale output equivalent to ± 5 ns. Frequency differences of 1 part in 10^{13} in approximately 15 minutes to 1 part in 10^{10} in 1 s may be determined. Differential switches calibrated in ns, along with a zero set control, eliminate phase-adjusting either input at the start of a measurement. The unit accepts 21 frequencies from 100 kHz to 10 MHz in both inputs. It requires 115 Vac or 22 to 30 Vdc with 100 mA drain at 26 Vdc.

P&A: \$980 (single-channel) \$1640 (dual channel); stock to 30 days. Parzen Research Inc., 48 Urban Ave., Westbury, N. Y. Phone: (516) 334-4900.

Circle No. 337

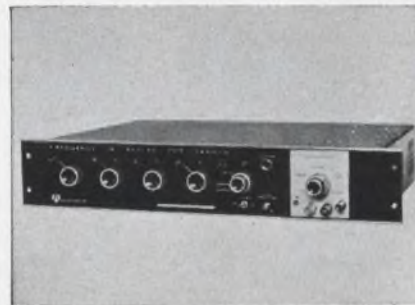

Power oscillator

The AC15 power oscillator delivers 15 VA from 0.1 Hz to 20 kHz with less than 0.05% distortion and amplitude stability within 10 ppm. Output voltage ranges from "0" to 150 Vrms. Frequencies are set and read with 4-digit selector switches with moving decimal point plus vernier. Frequency accuracy is 0.1%. Line and load regulation are less than 0.01% and internal resistance is adjustable through zero.

P&A: \$1090 to \$1600; stock to 30 days. Optimization Inc., 7243 Atoll Ave., North Hollywood, Calif. Phone: (213) 877-0221.

Circle No. 338

BIG = 200 small

- BIG:** Big performance, big economy.
small: $\frac{5}{8}$ " diameter size.
200: CTS Series 200 composition variable resistor for numerous limited space industrial and commercial applications.
NEW: New straight and concentric tandems.
 New solder lug terminals.

High Dependability CTS Composition Element: Proven over the years in all kinds of environments. Over 1 billion elements made; over 300,000,000 now in active service.

Resistance Range: 200 ohms through 5 megohms.

Availability: 3-6 weeks in quantity. CTS has the industry's largest output of controls.

New Constructions

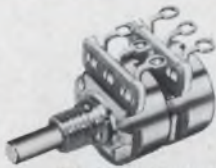

Straight Tandem
Solder Lug Terminals



Concentric Tandem
Solder Lug Terminals

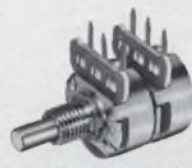

Straight Tandem
P. C. Terminals

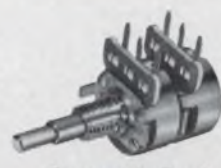

Concentric Tandem
P. C. Terminals

Sample constructions showing Series 200 versatility
(Many other combinations available.)



Basic 200 Control
Ear Mounted



Rear Extended Shaft
Bushing Mounted



ND On-Off Switch
Bushing Mounted



Q On-Off Switch
Ear Mounted



Basic 200 Control
Bushing Mounted



Rear Extended Shaft
Ear Mounted



Mounted with Shaft
Perpendicular to
Panel



ND On-Off Switch
Shaft Perpendicular
to Panel



Q On-Off Switch
Bushing Mounted



Founded 1896

CTS CORPORATION
Elkhart, Indiana

Sales Offices and Representatives conveniently located throughout the world.

Principal Products

Variable Resistors
Selector Switches
Loudspeakers
Trimming Potentiometers
Fixed Resistor Micromodules
& Microelectronic Circuitry
Crystals, Filters,
Oscillators & Ovens

Subsidiaries

CTS of Asheville, Inc., Skyland, N.C.
CTS of Berne, Inc., Berne, Indiana
CTS of Paducah, Inc., Paducah, Ky.
Chicago Telephone of California, Inc.,
South Pasadena, Calif.
CTS of Canada, Ltd., Streetsville, Ontario
CTS Microelectronics, Inc., Lafayette, Ind.
CTS Research, Inc., Lafayette, Ind.
CTS Knights, Inc., Sandwich, Ill.

ON READER-SERVICE CARD CIRCLE 54



Vlf receiver

Type 354 receiver tunes 1 to 600 kHz in a single band and receives AM, SSB, CW, MCW and FSK signals. A choice of four IF bandwidths (150 Hz, 1, 2 and 6 kHz), two audio bandwidths (100 Hz to 7 kHz or 825 Hz to 1175 Hz) and four levels of input attenuation (0, -20, -40 and -60 dB) is offered. Image rejection is 70 dB, IF rejection is 60 dB and dynamic range (AGC or manual) is 55 dB. BFO can be adjusted ± 7 kHz and incidental FM is less than 20 Hz peak deviation.

Totally solid state, the 354 weighs 20 lbs. and requires 3-1/2 in. of rack space. It operates from 115 Vac, 50 to 400 Hz, and consumes approximately 4 W. A long steel tape dial is employed for tuning.

P&A: \$2000; 60 days. Communication Electronics Inc., 6006 Executive Blvd., Rockville, Md. Phone: (301) 933-2800.

Circle No. 339

Null detector

Model 96016-A tunable null detector has a sensitivity of $1 \mu\text{V}$ full scale and a range of 25 Hz to 100 kHz. Either a linear or a logarithmic response can be switch-selected. The unit operates from two 6-V internal dry cells. Input impedance is 25 k Ω to 1 M Ω depending on gain control setting and output impedance is 300 Ω in series with 5 pF. Maximum output is 1 Vrms.

Standard Telephones & Cables Ltd., STC House, 190 Strand, London.

Circle No. 340



Isolation amplifier

The triple-buffered model 5801 has a self-contained power supply. This unit has 3 independent ± 1 dB amplifiers with a capacitor input of 100 Hz to 5 MHz or transformer input of 100 kHz to 1 MHz. Outputs are at 1 V rms into 50 Ω with an isolation of 60 dB between them. Gain is adjustable over a 2:1 range. The all-silicon circuitry employs tantalum capacitors.

P&A: \$300; 6 wks. RMS Engineering Inc., 486 14th St., N. W., Atlanta. Phone: (404) 873-5257.

Circle No. 341

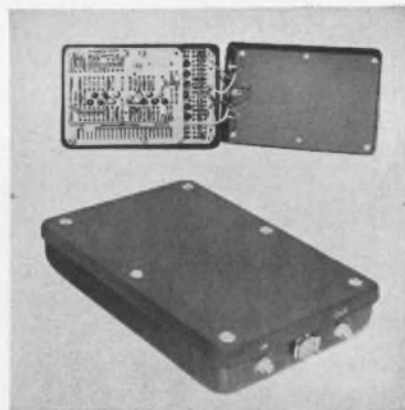

Logarithmic amplifier

Five decades (100 dB) of current input are compressed into a logarithmic voltage output. Model 157 chopper-stabilized log amplifier has a dc to 250 kHz frequency range. Full scale output is 5 V at 25 mA and accuracy is ± 2 dB/decade. The amplifier consumes 3 W.

Price: \$795. Missouri Research Labs. Inc., 2109 Locust St., St. Louis. Phone: (314) 241-7875.

Circle No. 342

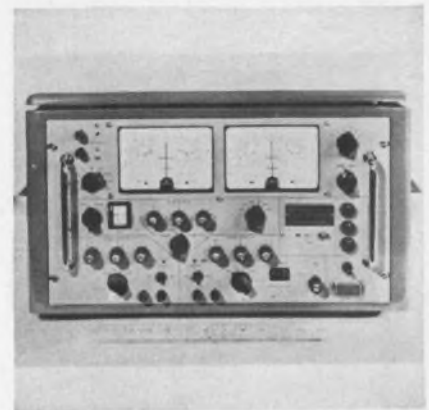

Sine wave analyzer

Combining a sine-wave generator and analyzer, this transfer function analyzer operates from 24 Hz down to 1 cycle/minute. Either of the 2 output channels may be varied through 360° , permitting frequency response to be read off in polar co-ordinates. Readout is in 8 ranges, from 50 mV to 150 V. Generator outputs are 10 V max with output impedance of 10 Ω . Overall accuracy is $\pm 2\%$ in amplitude and $\pm 1^\circ$ in phase. Modulated signals having a 400-Hz carrier may also be generated and analyzed.

S. Smith & Sons Canada Ltd., 172/76 Baisley Blvd., Jamaica, N. Y. Phone: (212) 528-1900.

Circle No. 343



Volt-ohm-milliammeter

A transistorized switching circuit protects this portable 500-kHz VOM against accidental burnouts and overloads and eliminates changes in accuracy due to overheating. Sensitivity is 20 k Ω /Vdc and 5 k Ω /Vac and accuracy is $\pm 1-1/2\%$ dc and $\pm 3\%$ ac. The meter has a polarity reversing switch and diode network to protect against transients.

P&A: \$95; stock to 30 days. Triplett Electrical Instrument Co., Bluffton, Ohio. Phone: (419) 351-4912.

Circle No. 344

only from Burroughs

IMMEDIATE DELIVERY READOUT DRIVERS

and from your local Burroughs stocking dealer



Actual size all
six modules

Industry's enthusiastic acceptance of the type BIP-8211P NIXIE® tube readout driver and the versatility of its basic design has led to the development of other circuit variations. These compact, attractive modules not only save you design, development, testing and production costs, but also give you the best device for translating low-level BCD inputs to decimal readout. Modules currently available from stock include:

- BIP-8211P—accepts 8-line low-level (2V-35V separation) 8-4-2-1 BCD and drives the standard-size rectangular NIXIE tube, type 8422.
- BIP-8224P—accepts low-level 4-line, 8-4-2-1 BCD and drives the standard-size rectangular NIXIE tube, type 8422.
- BIP-8227P—identical to the BIP-8211P except it accepts logic-level separations as low as 0.7V (from 0° C to +85° C) making it compatible with low-level, monolithic, integrated circuits.
- BIP-8225P—used for computer readout, it drives a NIXIE tube with an integral decimal point (type B-59956). Type BIP-8225P accepts twelve 4-bit, binary-input

combinations (numerals 0-9, decimal point and blanking) and has the capability of being electronically dimmed via a separate low-level control input.

- BIP-8222P—drives the type B-59956 NIXIE tube with integral decimal point from low-level, 8-line, 8-4-2-1 BCD. Decimal point is independent of BCD input and can either be "on" or "off" when a numeral is "on".
- BIP-8223P—identical to the BIP-8211P except it operates over the wide temperature range of -55° C to +85° C.

Other modules which accept other BCD codes as well as decimal inputs are also available individually or in complete Bezel Assemblies. They are completely described in a new brochure, Bulletin 1108. For further information contact your Burroughs Stocking Dealer in your area or Burroughs Corporation in Plainfield, New Jersey. Dealers names, addresses and phone numbers are listed for your convenience.

Only Burroughs manufactures NIXIE Tubes



Burroughs Corporation

ELECTRONIC COMPONENTS DIVISION

PLAINFIELD, NEW JERSEY 07061

BURROUGHS STOCKING DEALERS

CALIFORNIA
Los Angeles, 90036
Tech-Stok,
(213) 937-0780; TWX 213-937-2788.
Palo Alto, 94303
Tech-Ser, Inc.,
(415) 326-9800; TWX 415-492-9482.
San Diego, 92110
Tech-Ser, Inc.,
(714) 222-1121.
CONNECTICUT
West Hartford, 06117
Instrument Dynamics, Inc. of Connecticut
(203) 233-5503.
INDIANA
Fort Wayne, 46802
R.O. Whitesell & Assoc., Inc.
(219) 743-4411; TWX 219-241-0894
Indianapolis, 46219
R.O. Whitesell & Assoc., Inc.
(317) 359-5374; TWX 317-635-9766.

KENTUCKY
Louisville, 40207
R. O. Whitesell & Assoc., Inc.
(502) 893-7303.
MARYLAND
Silver Spring, 20910
Technical Distributors, Inc.,
(301) 585-7512; TWX 301 439-2200
MASSACHUSETTS
Wakefield, 01880
TRICO Electronics Sales Corp.
(617) 245-5100; TWX 617-245-7479
NEW JERSEY
Plainfield, 07061
Burroughs Corp., ECD, P.O. Box 1226
(201) 757-5000; TWX 710-981-7907
NORTH CAROLINA
Winston-Salem, 27102
L. G. White & Co., Inc.
(919) 725-3612; TWX 919-725-6262.

OHIO
Cincinnati, 45231
R.O. Whitesell & Assoc., Inc.
(513) 521-2290; TWX 513-577-1750.
Cleveland, 44126
R.O. Whitesell & Assoc., Inc.
(216) 333-2585; TWX 216-333-3250.
Columbus, 43212
Electronic Marketing Corp.
(614) 299-4161; TWX 614-759-0096
Dayton, 45439
R. O. Whitesell & Assoc., Inc.
(513) 298-9546; TWX 513-944-0526.
OKLAHOMA
Midwest City, 73110
Arnold Barnes Company
(405) 737-4556.
PENNSYLVANIA
Philadelphia, 19107
Herbach & Rademan, Inc.
(215) 567-4309.

Pittsburgh, 15235
R.O. Whitesell & Assoc., Inc.,
(412) 242-0100.
TEXAS
Houston, 77027
Arnold Barnes Company
(713) 622-3620; TWX 713-571-2470.
Richardson, 75081
Arnold Barnes Associates, Inc.
(214) 235-4541; TWX 214-231-1405.
San Antonio, 78216
Arnold Barnes Company
(512) 342-7311.

Parametric op-amp achieves pico-level offset, drift and noise

Introduction of the parametric principle (in this case a balanced varactor bridge) to an operational amplifier allows order of magnitude improvements in offset and drift currents and in noise levels. This performance, along with high input impedance and wide common-mode voltage, could answer the needs of bio-medical instrumentation, process controls, electrometry and oceanography. The model 301 parametric op-amp also finds many applications in measurement, control and signal-conditioning.

Although individual improvements in offset, drift or noise performance have been achieved in other devices, the combined performance has apparently never been found in one package thus far. The input impedance of $10^{12} \Omega$ common-mode and $10^{10} \Omega$ differential is matched by FET types. However, the relative instability of FETs prevents those op-amps from achieving the $0.06\text{-pA}/^\circ\text{C}$ (at 25°C) drift current of the parametric amplifier. Input offset current (1 pA at 25°C) is also at least an order of magnitude lower than that of FET types. The low-level ($\approx 30\text{ mV}$) pump signal of 10 MHz contributes to the input current capabilities.

The low noise figures of the 301— 0.01 pA and $1\text{ }\mu\text{V}$ p-p at sub-audio frequencies—derive from the balanced varactor bridge input. With no active devices or biasing, it is virtually noise-free. "Flicker" ($1/f$) noise, due to the bias in active-device amplifiers, is eliminated. Johnson noise (random electron motion in resistors) and Schottky noise (junction leakage current) are inherently low. The high power gain of the varactor stage also swamps much of the noise generated in succeeding stages.

The transformer coupling allows a $\pm 300\text{-V}$ common-mode voltage swing. Common-mode rejection ratio of $10^8:1$ is equivalent to that of vacuum-tube electrometers. Sub-millivolt inputs can be resolved even in the presence of a 300-V common-mode input.

Voltage drift is $30\text{ }\mu\text{V}/^\circ\text{C}$ from -25 to 85°C . Bandwidth is 500 kHz and max frequency for the full $\pm 10\text{-V}$, $\pm 20\text{-mA}$ output is 5 kHz . Open loop dc voltage gain is 10^6 and slewing rate is $0.3\text{ V}/\mu\text{s}$.

P&A: \$198; stock to 3 wks. Analog Devices, 221 Fifth St., Cambridge, Mass. Phone: (617) 491-1650.

Circle No. 345



Cermet trimming pot measures 3/8-in.²

The choice between large trimmers or smaller ones with spatial advantage but limited range is eliminated by this $3/8\text{-in.}^2$ cermet trimmer. Model 63P trimming pot has a range of $10\text{ }\Omega$ to $2\text{ M}\Omega$. Previously, square cermet trimmers have not been available in sizes less than $1/2\text{-in.}^2$. Model 63P requires 55% of the board space and 80% of the height required by other trimmers.

The use of cermet provides essentially infinite resolution and reduces the possibility of burn-out due to power surges caused by circuit imbalance.

The unit has a 25-turn adjustment screw with clutches at both ends to avoid damage during adjustment. The diallyl phthalate housing meets the immersion test of MIL-R-22097B.

Power rating is 0.5 W at 85°C , derating to 0 at 150°C , and total operating temperature range is -65 to 150°C . Standard resistance tolerance is $+20\%$.

P&A: \$7; July, Beckman Instrument Inc., Helipot Div., 2500 Harbor Blvd., Fullerton, Calif. Phone: (714) 871-4849.

Circle No. 346

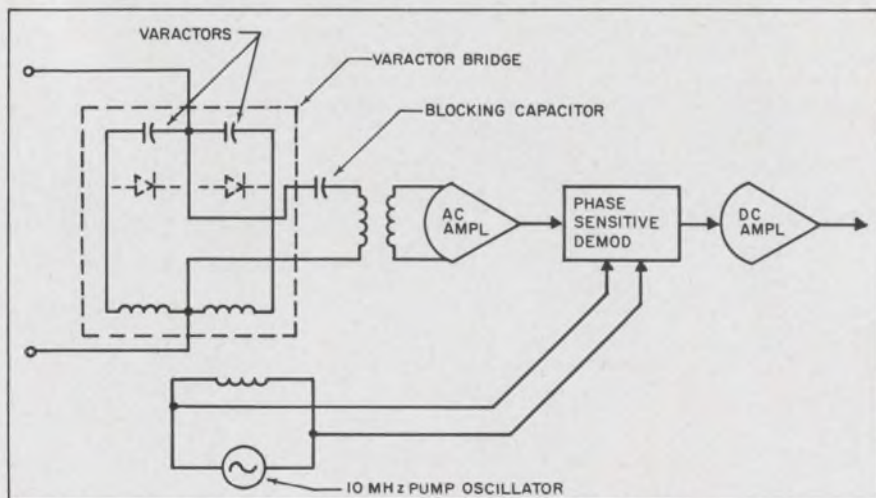

Varactor bridge has stored charge modulated by input and pump signals and provides 43 dB power gain. Noise-free output of this stage is proportional to the bridge unbalance or input error signal.

Feedback wanted

ELECTRONIC DESIGN would like to know how you rate our New Products section. Does it do the job for you? Does every issue contain at least a sampling of products you use? (We try to cover the field from amplifiers to zeners.) Any suggestions for improvements? Please send along your replies on the handy Editorgram card at the back of this issue. It's free.

Why specify Mallory wet slug tantalum capacitors?

One reason:

- proven freedom from catastrophic failure.

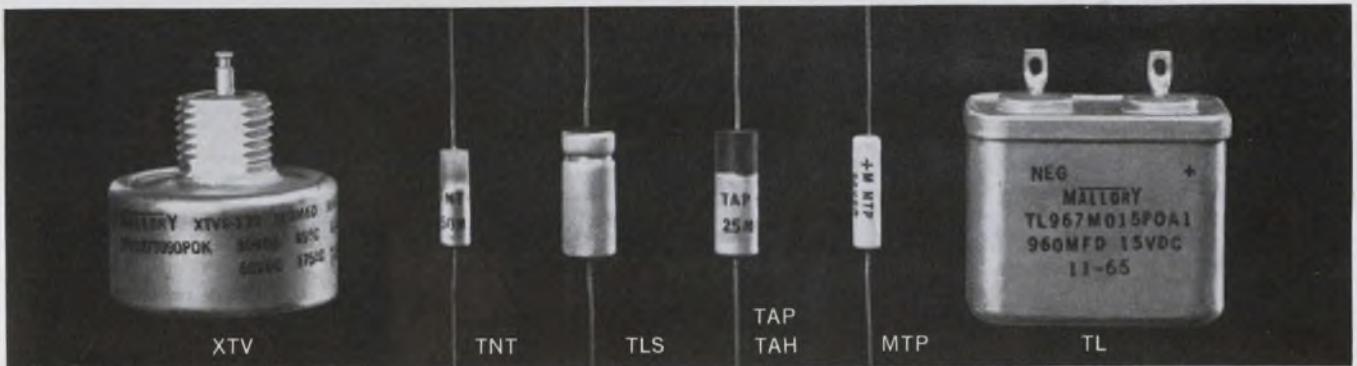

Look at these quality control figures:

MTPH tests at rated voltage, 85°C; XT tests at rated voltage, 125°C and 175°C.

	Unit test hours	Catastrophic failures	% failure* /1000 hours	MTBF*
Type MTPH miniature wet slug	5,259,311	1	0.038%	2.7×10^6
Type XT wet slug	8,291,100	6	0.09%	1.1×10^6

*60% confidence level

Want more reasons? Mallory Wet Slug Tantalum capacitors have up to five times higher microfarad-volt rating per unit volume than solid electrolytic types . . . far lower DC leakage . . . and need no voltage derating. We can help by recommending without bias the best

type for your application because we make all types—wet slug, solid and foil. Write or call Mallory Capacitor Company, a division of P. R. Mallory & Co. Inc., Indianapolis, Indiana 46206.

50th
ANNIVERSARY

MALLORY

Speed Inquiry to Advertiser via Collect Night Letter
ON READER-SERVICE CARD CIRCLE 57

PRECISION FILM RESISTORS

SAVE WEIGHT AND SPACE
AT NO SACRIFICE IN
PERFORMANCE

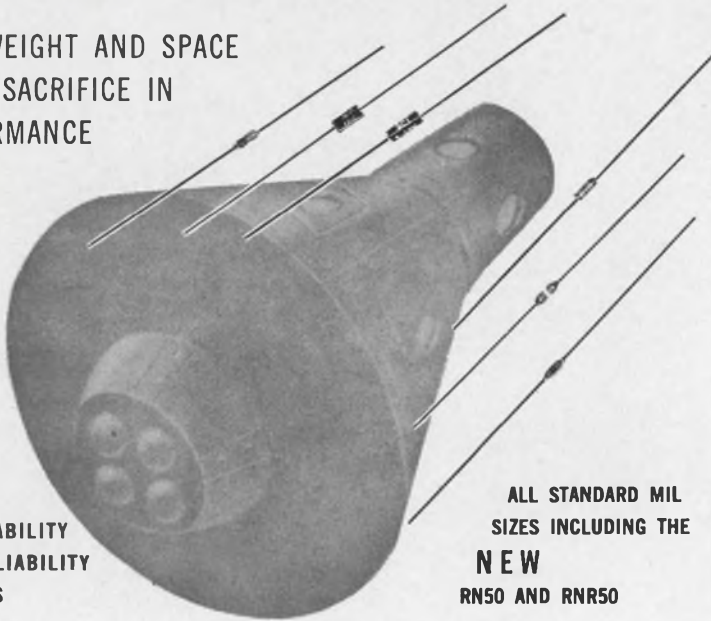

HIGH STABILITY
HIGH RELIABILITY
LOW TC'S

ALL STANDARD MIL
SIZES INCLUDING THE
NEW
RN50 AND RNR50

CONFORMANCE TO MIL-R-10509 AND MIL-R-55182
MICRO-MINIATURIZATION • PERFORMANCE • VARIETY • ECONOMY

aci

AMERICAN COMPONENTS, INC.

8th & Harry Streets, Conshohocken, Pa., Area 215 TA 8-6240

ON READER-SERVICE CARD CIRCLE 58

RCL 1/2" ROTARY SWITCHES

ESTABLISHING A NEW SET
OF PERFORMANCE STANDARDS!

- Up to 12 positions per deck with stops.
- As many as 6 poles per deck.
- Shorting and non-shorting poles may be grouped on one deck in any combination.
- All individual deck parts are self-contained, and are permanently molded into place.
- Wiring to switches possible "in the flat".
- Easily assembled and disassembled with WireEasy construction.

"Off-The-Shelf" Delivery

RCL

Write for complete engineering information

ELECTRONICS, INC.

General Sales Office: One Hixon Place,
Maplewood, New Jersey 07040



ON READER-SERVICE CARD CIRCLE 59

COMPONENTS



Hall multipliers

The HM-3000 series of Hall multipliers consists of temperature-compensated and un-compensated, error voltage-compensated and completely compensated models. The multipliers consist of a Hall element in the gap of a laminated silicon steel core with two identical field coils. An output voltage proportional to the product of the field input current and the Hall input current is produced. The units are epoxy-potted in a hermetically sealed steel case with 9-pin header.

P&A: \$44 to \$69.50; stock. F. W. Bell Inc., 1356 Norton Ave., Columbus, Ohio. Phone: (614) 294-4906.

Circle No. 347



Panel meter

The "Wide Vue" panel meter with 8-in. scale has ranges from 25 μ A to 50 A and 10 mV to 500 V. Standard ranges have taut-band construction while pivot-and-jewel construction is available. Low power consumption and hysteresis and $\pm 2\%$ full-scale accuracy are featured.

Simpson Electric Co., 5200 W. Kinzie St., Chicago. Phone: (312) 379-1121.

Circle No. 348

ELECTRONIC DESIGN, June 21, 1966

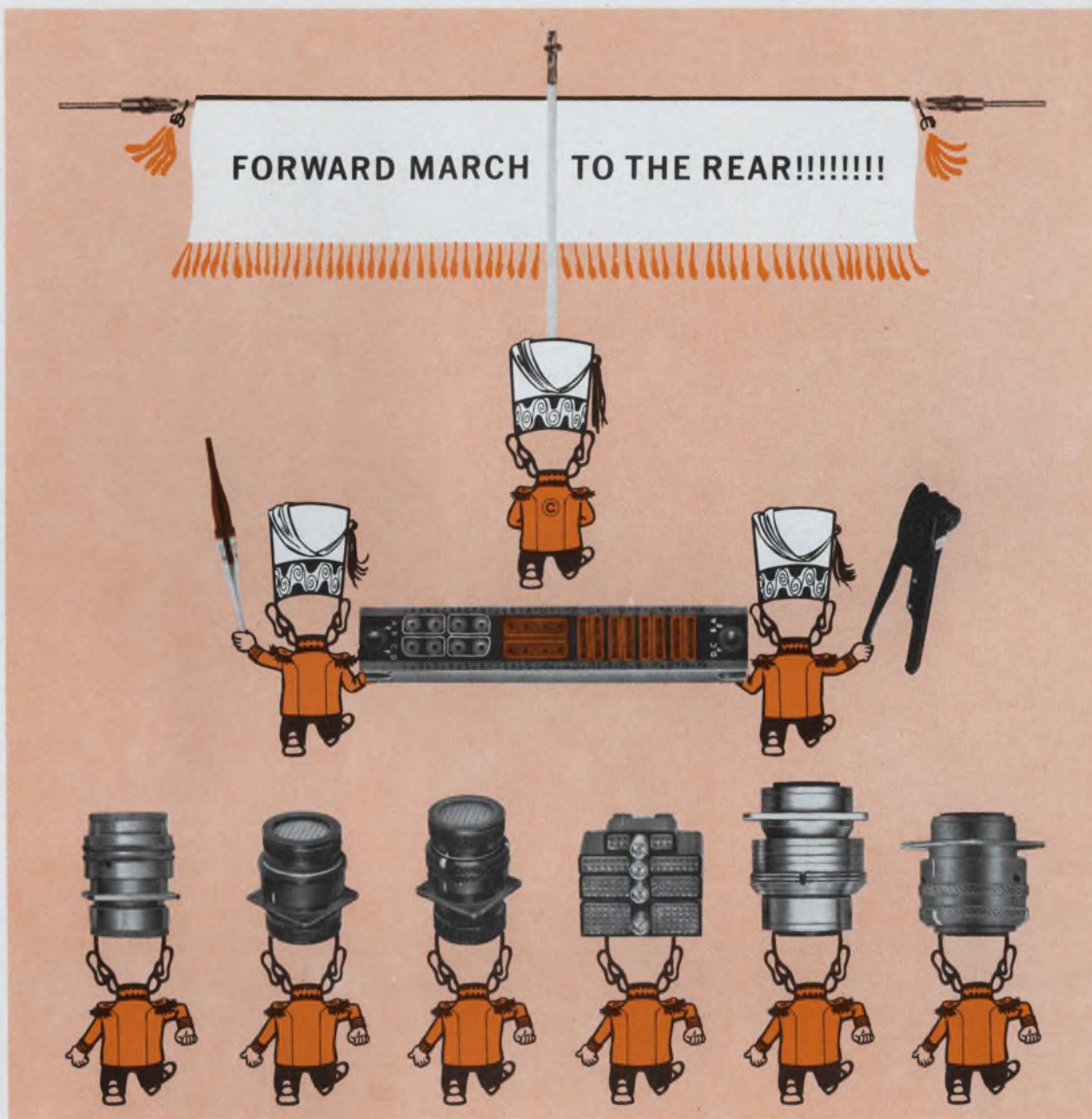

WITH DEUTSCH REAR RELEASE HIGH PERFORMANCE CONNECTORS

Break away from the rank and file! Head for the rear release connectors using uniform standards and tooling to meet the toughest service requirements. The leader in this battalion of total performers is the Deutsch rear release contact system needing one standard crimp tool, one assembly procedure, and one fail-safe, expendable insertion/removal tool. Use this system to march away from logistics problems and simplify field maintenance and repair.

Be prepared! On land, sea, in the air or outer space, there is a squad of Deutsch rear release products to perform beyond the call of duty; environmental series for aerospace, and non-environmental versions for support equipment.

You can bivouac from 3 to 199 conductors in:

- Miniature cylindricals with bayonet, push-pull-quick-disconnect, or thread coupling.
- Subminiature cylindricals with bayonet or push-pull-quick-disconnect coupling.
- Subminiature, high density rectangular types.
- PLUS, solve your terminal, bus and feed-through problems with Terminal Junctions... the answer to high performance replacement of terminal strips.

Quick-step now, contact your Deutschman for full information about how you can go forward with rear release. Ask for Data File R-1.

DEUTSCH

ELECTRONIC COMPONENTS DIVISION • Municipal Airport • Banning, California

ADVANCED SPECIFICATION REAR RELEASE ELECTRICAL CONNECTORS

ON READER-SERVICE CARD CIRCLE 60

Tilt!



No stoop, stretch, or missed readings with Behlman-Invar's exclusive



Mount this DC power supply at floor level or above your head — you'll be able to tilt the meters for easy viewing and accurate settings and readings from any operator position!

6 VOLTAGE RANGES: from 0-5 to 0-100 VDC

6 CURRENT RANGES: from 0-6.5 to 0-0.60 AMP

The most power per dollar with silicon reliability... in quarter-rack size. Liberally derated circuit elements. Load regulation: 0.01%. Stability: 10mv/8 hrs. Remote voltage and current programming and sensing. Constant voltage, constant current, with automatic cross-over. Provision for external modulation. **Tilt Meter. LIFETIME WARRANTY.**

Model	Nom. Volts	Current, Amps 30°C	71°C	Ripple P-P (rms)	Price
QS-5	0-5	0-6.5	0-4.7	1.0mv/150 μ v	\$214
QS-10	0-10	0-4.2	0-3.0	1.0mv/170 μ v	\$200
QS-20	0-20	0-2.5	0-1.8	1.0mv/200 μ v	\$184
QS-40	0-40	0-1.4	0-1.0	1.0mv/250 μ v	\$179
QS-60	0-60	0-0.96	0-0.69	1.0mv/300 μ v	\$209
QS-100	0-100	0-0.60	0-0.43	1.0mv/400 μ v	\$229

Send now for QS data sheet, 4 pages of comprehensive technical data.



"POWER TO MATCH THE ART"

**BEHLMAN-INVAR
ELECTRONICS CORP.**

1723 Cloverfield Blvd., Santa Monica, Calif. 90404
Representatives in principal U.S. Cities & Canada

ON READER-SERVICE CARD CIRCLE 61

COMPONENTS

Thermocouple reference

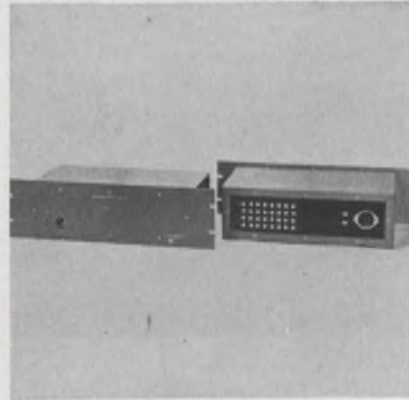

Model LRJR49 thermocouple reference junction provides a precise 150°F reference for up to 12 measurement channels. Designed for 105 to 125 Vac operation, the unit has stability and uniformity of $\pm 0.1^\circ\text{F}$, channel-to-channel, over an ambient range of 20 to 120°F. Power consumption is 30 W max and warmup time is 15 minutes.

Pace Engineering Co., 13035 Satcoy St., North Hollywood, Calif. Phone: (213) 877-0727.

Circle No. 349

Potentiometers



Series 7 ac potentiometers are size 11 20-turn units. Typically, output impedance is 20 Ω and absolute linearity is $\pm 0.01\%$. Input impedance is 100 k Ω and input voltage is 30 V max, 400 Hz. Output current is 25 mA max. The pots are designed for servo and control systems and meet MIL-specs.

Perkin-Elmer Corp., Main Ave., Norwalk, Conn. Phone: (203) 847-0411.

Circle No. 350

Pressure transducer

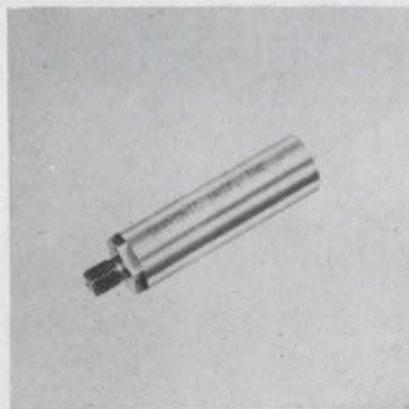

A potentiometer-type pressure transducer with a 0.655-in. diameter has accuracy exceeding 1%. Absolute or gage pressure ranges are 0 to 350 to 0 to 20,000 psi. Resistances are 2, 5, 7.5 and 10 k Ω $\pm 5\%$. The ac or dc output can be used for telemetry, control or actuating systems without amplification.

Servonic Instruments Inc., 1644 Whittier Ave., Costa Mesa, Calif. Phone: (714) 646-2400.

Circle No. 351

Capacitors



For an energy-storage capacity of 312 J at 25 kV, model ESC-259 parallel-plate capacitors have 0.5 nH self-inductance. Q in excess of 250 at 5 MHz results from the use of impregnated mica-paper as dielectric. Capacitors are available from 500 pF to 10 μF at voltage ratings to 25 kV.

Tobe Deutschmann Laboratories, 550 Turnpike St., Canton, Mass. Phone: (617) 828-3366.

Circle No. 352

The Midas touch in a new solid tantalum capacitor

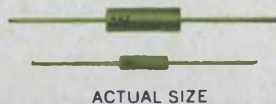

The KEMET Golden Z-Series gives you up to three times the capacitance and voltage of standard solid tantalums... cuts space requirements up to 67%. Has gold-flashed lead wires—at standard prices. Two subminiature case sizes, ideal for cordwood modules, printed circuits, and other high density packaging.

Case lengths of 0.250" and 0.375" match standard resistors and diodes... diameters of 0.085" and 0.127" are as much as 67% smaller than other solid tantalums. Other

features: excellent stability; very low leakage, dissipation factor, and impedance over a wide range of frequency and temperature. Meets electrical environmental characteristics of MIL specs C-39003 and C-26655B. Available from 0.0047 to 22 microfarads; in 6 to 125 VDC; to operate from -80 to +125°C. Want more details on the new Z-Series solid tantalum capacitors? Get the new KEMET Engineering Bulletin from our sales office or representative nearest you—or mail the coupon.

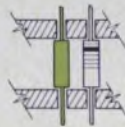
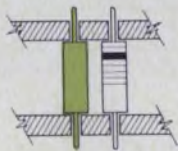

KEMET Golden Z-Series solid tantalum capacitors—sized to match resistors and diodes in cordwood modules, with maximum packing density. Case A2 (left) is 0.127" dia. x 0.375" long. Case A3 (right) is 0.085" dia. x 0.250" long.

Regional Sales Offices

East Coast: J. G. Egan, 1341 Hamburg Turnpike, Wayne, New Jersey 07472. Phone: 201-696-2710.
 Mid-Atlantic: R. H. Robecki, 1341 Hamburg Turnpike, Wayne, New Jersey 07472. Phone: 201-696-2710.
 Mid-West and South: K. S. Collart, P. O. Box 6087, Cleveland, Ohio 44101. Phone: 216-221-0600.
 West Coast: B. G. Bryant, 701 East Whittier Blvd., Whittier, California 90605. Phone: 213-698-8077.

KEMET is a registered trade mark of Union Carbide Corporation.

Clip, fill in name and title, attach to letterhead

Union Carbide Corporation
 Linde Division, Dept. ED-63
 270 Park Avenue, New York 10017

Please send Engineering Bulletin #6, on
 KEMET Golden Z-Series Polar Solid
 Tantalum Capacitors

Name _____

Title _____



Speed Inquiry to Advertiser via Collect Night Letter
 ON READER-SERVICE CARD CIRCLE 62

COMPONENTS

Rotary reed switches

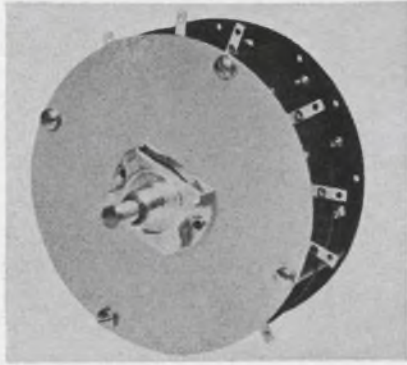

A line of magnetic reed rotary switches consists of eight models. They are available with form A or C contacts, or in combination. The rhodium contacts are isolated so that each stack handles up to 12 individual circuits. Models are available handling 1000 V max, 15 A in-rush and 3 A steady.

Hart Mfg. Co., 110 Bartholomew Ave., Hartford, Conn. Phone: (203) 525-3491.

Circle No. 357

Porcelain capacitors

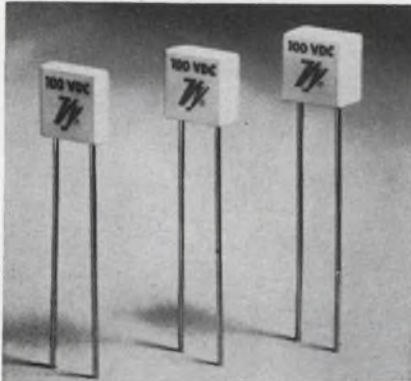

Radial porcelain capacitors with a ± 25 ppm/ $^{\circ}$ C temperature coefficient, 0.2-in. lead spacing and ratings to 200 Vdc are offered. The VY03 line consists of 13 standard values in a 5.1- to 1000-pF range. Dissipation factor is 0.001 at 25 $^{\circ}$ C and 0.002 at 125 $^{\circ}$ C. They operate from -55 to +125 $^{\circ}$ C without voltage derating.

Vitramon Inc., P. O. Box 544, Bridgeport, Conn. Phone: (203) 268-6261.

Circle No. 358

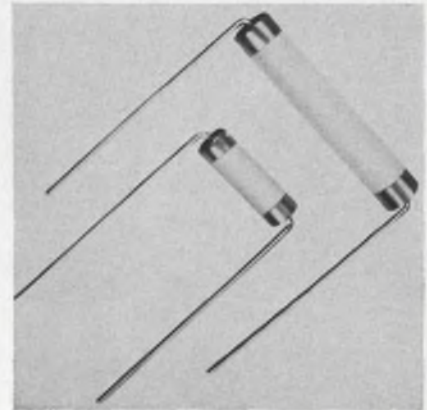

Power resistors

Specifically designed for PC board mounting, series TR radial lead power resistors have a high-temperature silicone coating. Standard temperature coefficient is ± 10 ppm/ $^{\circ}$ C. The resistors are available from 1/2 to 10 W in resistance values from 0.5 Ω to 275 k Ω . Temperature range is -65 to +275 $^{\circ}$ C. Units with a rise time of 20 ns are available.

RCL Electronics Inc., One Hixon Pl., Maplewood, N. J. Phone: (201) 763-2820.

Circle No. 359

INTEGRATED LOGIC MODULES

*Lowest Prices in the Industry**

- 30 FAN-OUT, ALL SOURCES
- UP TO 4V NOISE REJECTION
- DC TO 5 MC
- 0 TO 70 $^{\circ}$ C

We have solved the Noise Problem



NEW logic and circuit techniques, thoroughly tested for 9 months, have resulted in a minimum fan-out of 30 from all sources, 25% lower prices, and REALISTIC noise immunity from 0.9V to 4V. Delivery from stock. Send for complete and ACCURATE data.

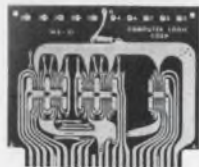
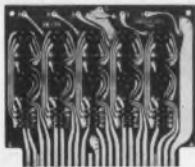

Phone: 213 451-9754

COMPUTER LOGIC CORP.



* \$11.20 per JK Flip-Flop Unit Load Concept

1528 20th Street • Santa Monica, California

A COMPLETE FAMILY OF COMPATIBLE TRUE BLUE LOGIC MODULES

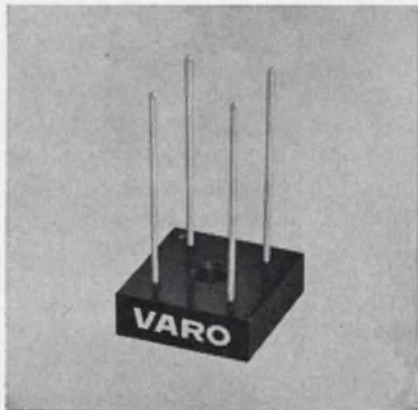

Epoxy bridge rectifier

This epoxy bridge rectifier is a 2-A, full-wave bridge designed for consumer rectifier applications. The devices are available with 200, 400 and 600 V PRV ratings and working voltages of 140, 280 and 420 V rms. Peak one-cycle surge current is 100 A max. All devices have 2000 Vdc minimum circuit-to-case insulation. Controlled and noncontrolled avalanche series are available.

Price: under \$1. Varo Inc., 2201 Walnut St., Garland, Tex. Phone: (214) 276-6141.

Circle No. 360



Voltage programmer

A solid-state voltage programmer for low-voltage power supplies generates a positive or negative going ramp function. Solid-state circuitry allows for variable ramp rates. The unit can be used with any dc supply with a remote voltage program resistance of 500 to 1000 Ω/V in the range of 0 to 40 V. Overshoot, undershoot and noise problems are eliminated.

Sparton Southwest Inc., P. O. Box 1784, Albuquerque, N. M. Phone: (505) 898-1150.

Circle No. 361

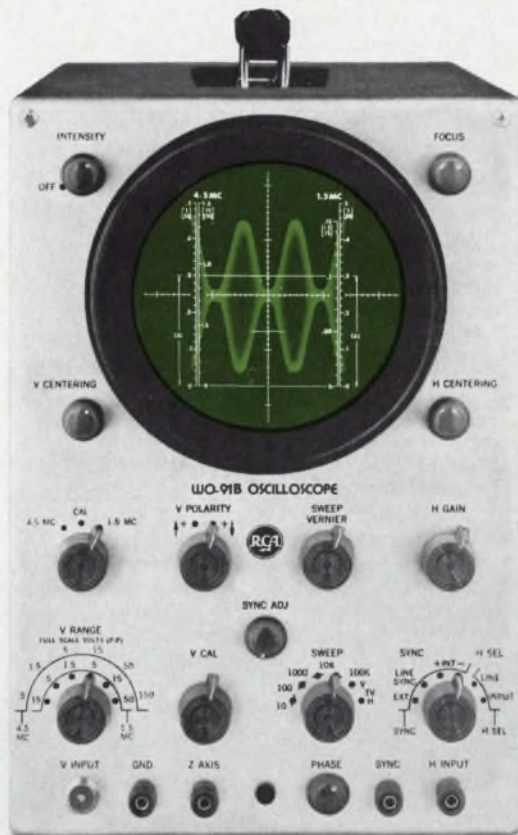

THE
'SCOPE
WITH THE
HIGH
IQ*

RCA WO-91B...
* INEXPENSIVE QUALITY

Why pay for Oscilloscope capabilities you don't really need?

There are many situations—production line work, product quality checks, basic laboratory measurements—that require a large number of scopes or employ standard measurements... and where simplicity of operation is essential.

That's where you need the RCA WO-91B!

Of course the so-called "industrial/laboratory" type scopes will make certain measurements that ours won't. They may feature triggered sweep, horizontal deflection in microseconds, and other costly refinements. Whenever you need these extras... capability for those extremely precise measurements... spend the money and buy an expensive scope.

Actually, for many very precise research, experimental and lab measurements, we don't even recommend ours (we use theirs).

But if your requirements call for scopes with characteristics such as the following, the RCA WO-91B is probably your best buy:

- Built-in voltage calibration—large 5-inch screen with VTVM-type voltage scales for fast, simultaneous peak-to-peak measurements and waveshape display
- Flat response (± 1 dB) from 10 cps to 4.5 Mc
- 0.018 rms volt per inch maximum sensitivity for use at low signal levels
- Continuously adjustable (to 100 kc) sweep oscillator with excellent linearity
- Z-axis input for direct modulation of CRT permitting use of timing and calibration markers on trace
- Provision for connecting signals directly to the vertical deflection plates of the CRT.

The Optional User Price of the RCA WO-91B is \$249.50. It is available locally from your Authorized RCA Test Equipment Distributor. Ask to see it or write for complete specifications to RCA Commercial Engineering, Section F18W-5, Harrison, N.J.

RCA ELECTRONIC COMPONENTS AND DEVICES



The Most Trusted Name in Electronics

ON READER-SERVICE CARD CIRCLE 64

NO BRUSH FAILURES IN THESE SYNCHROS

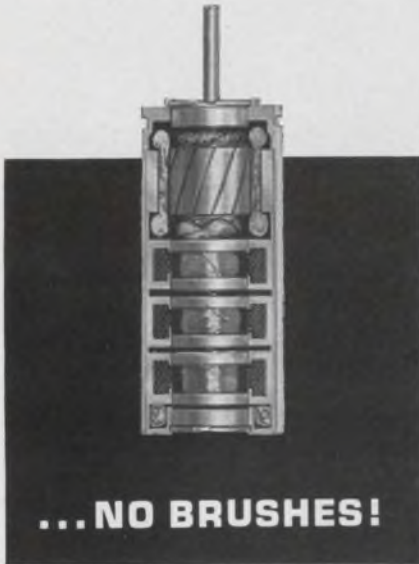

Rotary transformers couple power into rotors without contact, eliminating the number-one cause of early synchro failure. Without brushes, synchro life depends on bearing life alone—normally at least 5 or 6 times average brush life.

Harowe brushless synchros are available for all functions: control and torque transmitters, control transformers, differentials, resolvers. Sizes 5, 8, 10, and 11 are standard; larger sizes available. Use them to boost life expectancy of new systems; upgrade existing systems. Write for complete specs—



HAROWE SERVO CONTROLS, INC.
22 Westtown Road
West Chester, Pa. 19380
(215) 692-2700

SERVO, SYNCHRONOUS AND STEPPER MOTORS
MOTOR GENERATORS • SYNCHROS • RESOLVERS
PANCAKE SYNCHROS • GEARHEADS

ON READER-SERVICE CARD CIRCLE 65

COMPONENTS

Transient protector

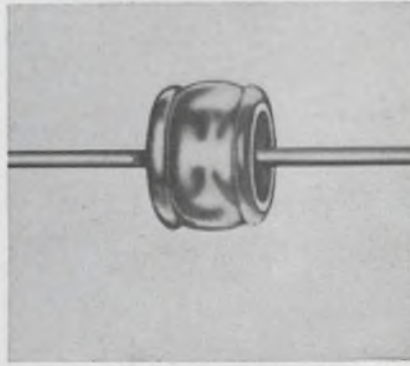

A miniature spark gap has a striking voltage of 90 Vdc. It is a radio-active isotope prompted gas-filled surge voltage protector. Current carrying capacity is 5000A for a 10- to 20- μ s waveform. Capacitance is 2 pF and insulation resistance under unignited condition is $10^{10} \Omega$. The protector measures 0.38-inch in diameter and 1/4-inch in length.

Siemens America Inc., 350 Fifth Ave., New York. Phone: (212) 564-7674.

Circle No. 353

Sequence cam switch

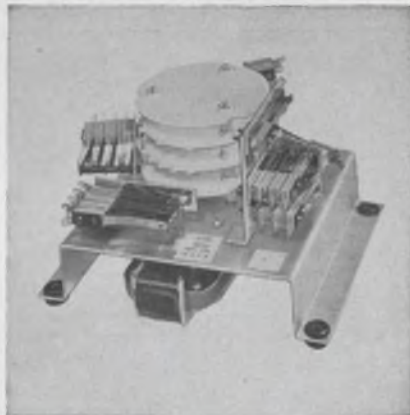

This 80-circuit motor-driven sequence cam switch has a 10^6 cycle life. Up to 80 spdt contacts can be operated at speeds of 1 through 35 cycles/minute. A maximum of 20 notches on each cam can be obtained. Four notched or unnotched cams are maximum for standard unit. The switch is designed for repeat cycle control.

P&A: \$9 to \$12; stock to 60 days. Chicago Dynamic Industries, Inc., 1725 Diversey Blvd., Chicago. Phone: (312) 935-4600.

Circle No. 354

Micromin resistor

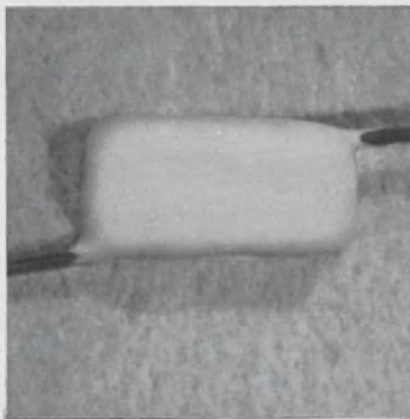

Standard resistance range of this 0.0015-in.³ resistor is 50 to 200 k Ω . Applications include amplifiers and preamps, wave shaping networks and logic modules. Model 4200 offers a cermet element, an alumina substrate and weldable and solderable leads. Power rating is 70 mW at 100°C, temperature range is -65 to +150°C and resistance tolerances available are 1, 5 or 10%.

Bourns, Inc., 1200 Columbia, Riverside, Calif. Phone: (714) 684-1700.

Circle No. 355

High-altitude switch



Switching over a pressure range of 30 to 0.04 mmHg (70,000 to 230,000 feet) is accomplished by this high-altitude pressure switch. The switch withstands 20 G vibration, 150 G linear acceleration and has an operating range of -20 to +165 °F. A temperature-controlled thermocouple pressure sensor a constant-voltage source, a dc amplifier and flip-flop switching are used.

MetroPhysics Inc., 331 N. Milpas St., Santa Barbara, Calif. Phone: (805) 965-2526.

Circle No. 356

Our group.

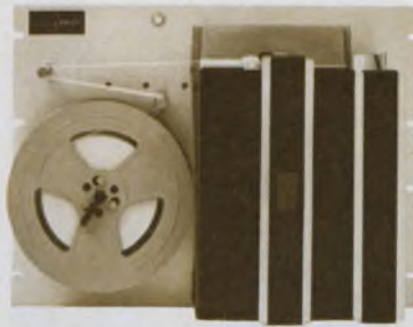

A family of three perforators is just right when it satisfies about 99 percent of the applications. And these Tally perforators do. Easily the best known perforator on the market today is the wonderfully reliable Tally 420 which operates at 60 characters per second. Some of our customers have operated this perforator up to 500 million cycles without overhaul.

Fastest perforator in the family is the Tally P-150, which, as you might guess, operates at 150 characters per second. Rounding out the line is our popular 120 character per second perforator, the P-120.

The Tally P-120 and P-150 offer a remarkable degree of sophistication. With the parity option they catch their own mistakes while working at maximum speed. Here's how it works. Parity contacts in the perforating mechanism allow

interrogation during a punching cycle and before the tape is advanced to the next character. If an incorrect parity code is sensed, (1) tape advance is inhibited, (2) the code in error is overpunched with an all-hole delete code, (3) tape is advanced and the same character punched again. Clean accurate tapes are a virtual certainty.

All Tally perforators accept paper, plastic, or foil tapes. They feature asynchronous operation so that punch commands can be accepted at any time interval up to maximum speed. Tally perforators handle 5 through 8 channels on any standard tape up to 1 inch without modification. Tally perforators have high quality die blocks and precision honed punch pins individually fitted for long life punching. All models offer integral reeling. All Tally perforators are available in 50/60 Hz, 115/230 vac models.

Options include bit echo verification, remote backup, end of

tape, low tape, tape motion sensors, and teletypesetter configuration.

Write for more wisdom. Complete data on each and every member of the Tally group of perforated tape equipment is yours for the asking. For your information please address K. Crawford, Tally Corporation, 1310 Mercer Street, Seattle, Washington 98109. Phone: (206) MA 4-0760. TWX: (910) 444-2039. In the U.K. and Europe, address H. Ulijohn, Tally Europe, Ltd., Radnor House, 1272 London Road, London, S.W. 16, England. Phone POLLards 9199.

"See us at DPMA"

Speed Inquiry to Advertiser via Collect Night Letter
ON READER-SERVICE CARD CIRCLE 66

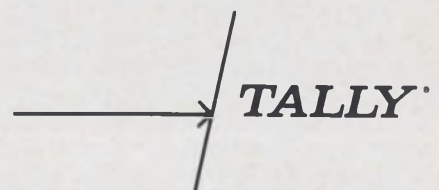
 **TALLY**

ANY ENCLOSURE... ...ANY WEIGHT

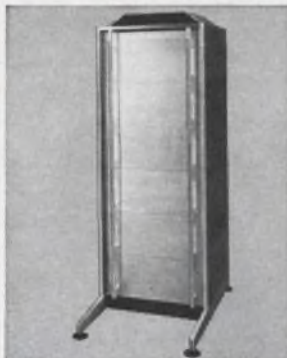

VENT-RAK 3500 Series Cabinet

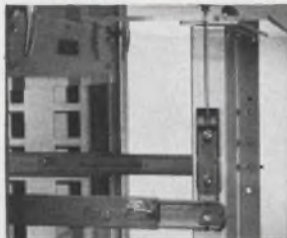

C-300 to 50 lbs.

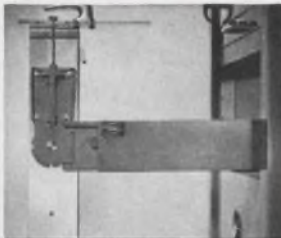

C-230 to 100 lbs.



D-600 to 125 lbs.



CTB to 175 lbs.

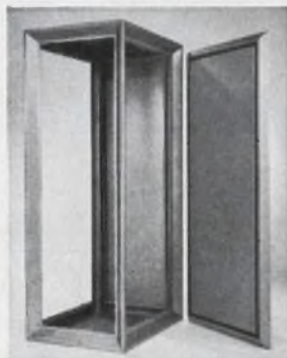

VENT-RAK 1000 Series Cabinet



CTHRD to 275 lbs.



VCB to 350 lbs.

**FROM
CUSTOM
OR
STANDARD:**



CB to 1000 lbs.



VENT-RAK Modular Chassis

From Chassis-Trak you get the broadest range of slide weight capacities and the ideal enclosure for your application. Flexibility . . . plus uncompromising Chassis-Trak quality . . . have made Chassis-Trak a part of the package on every major missile project.

Just make sure the slides you order have the Chassis-Trak of Indianapolis, Seal of Quality . . . your protection against inferior imitations . . . ask about Vent-Rak cabinets.

A Package for Every Major Missile Project from

525 South Webster Avenue, Indianapolis, Indiana

ON READER-SERVICE CARD CIRCLE 67

With Chassis-Trak, you get:

- Ultra-thin slides for standard racks and cabinets
- Choice of tilt, non-tilt, tilt-lock versions in most models
- Poxylube 75 dry-film lubricant
- Choice of solid or roller bearings
- Delivery from stock in standard models



COMPONENTS

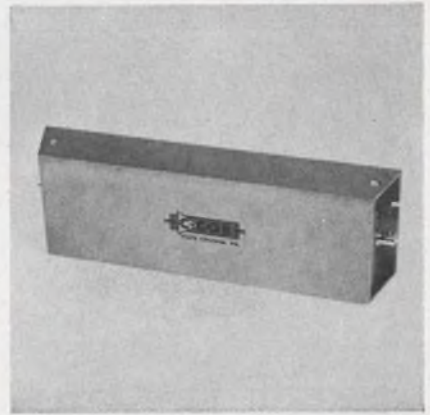

Distributed amplifiers

High-output distributed amplifiers deliver 30 V p-p into 75 Ω or 25 V p-p into 50 Ω . Bandpass ranges are 1 to 30 MHz, 10 to 30 MHz, 50 to 100 MHz or 75 to 125 MHz. Gain is 20 dB min. Other bandpass ranges, gains and characteristics are available.

C-Cor Electronics, Inc., 60 Decibel Rd., State College, Pa. Phone: (814) 238-2461.

Circle No. 362



Adjustable time switch

Timing periods from a few minutes to more than 13 months may be set on this adjustable switch. The unit switches at the end of the timing period with an aggregate error of 1 hour/year. Model 6410 contains a jeweled timepiece driven by a brushless dc motor. The internal battery powers the unit for 10,000 hours. Switch contacts are rated at 1 A resistive and inductive at 28 V.

General Oceanographic Co., P. O. Box 66006, Los Angeles. Phone: (213) 398-8790.

Circle No. 363

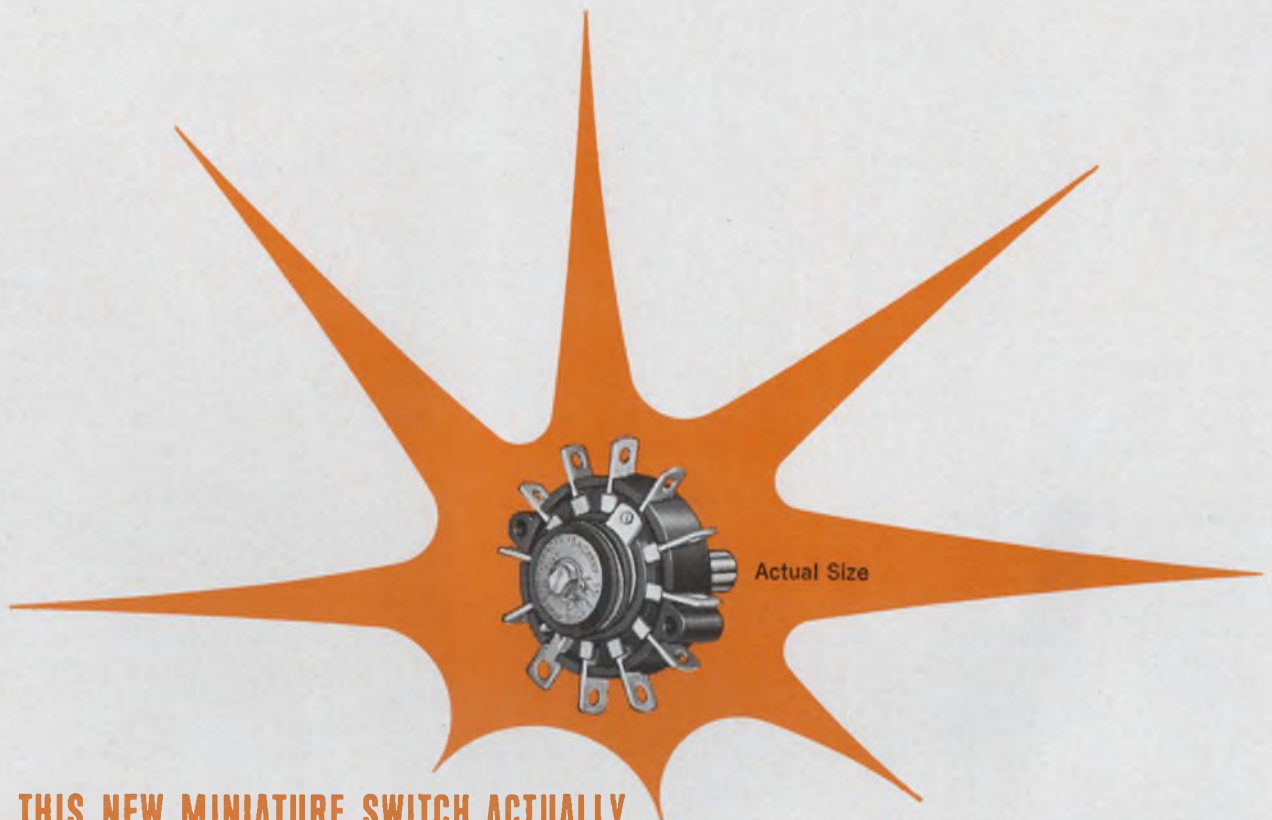

YES, THIS NEW MINIATURE SWITCH ACTUALLY

BREAKS 7 AMPS AT 125 VAC

CARRIES 15 AMPS AT 125 V

Model 711 is a single-pole, nonshorting selector switch that reaches a new high in compactness. It's a load-break, power switch beyond any doubt, but with a $1\frac{1}{8}$ " body diameter, it is smaller than many instrument switches of much lower rating.

How can Ohmite cram such a whopping rating into such a small "package?" Only because the Model 711 reflects 25 years of experience in switches up to 100 amps. It's your guarantee for reliability and long life.

Small: Only $1\frac{1}{8}$ " in body diameter; extends $\frac{13}{16}$ " behind panel.

Breaks: 7 Amps, 125 VAC (75% power factor) load.

Carries: 15 Amps, AC or DC, 125 volts.

Contacts: Solid-silver-alloy to solid-silver-alloy; 2 to 11 contacts.

Dual-Purpose Terminals: Solder 'em, or push on a $\frac{3}{16}$ " quick-connect terminal.

Slow-Break, Quick-Make Action: Minimizes sparking

and increases contact life with AC. Wiping-action contacts are self cleaning. 30° Indexing.

Superb Construction: Melamine-phenolic body has high insulation rating and resists arc-tracking. Unlike most small switches, thick conductors, not thin springs, carry the current. Stainless steel shaft, $\frac{3}{8}$ "-32 brass mounting bushing.

Singles and Gangs: Single decks can be supplied enclosed; gangs of two or more decks are enclosed. All mount on $\frac{1}{8}$ " thick maximum panels.



2-Gang Model

NEED SWITCHES UP TO 100 AMPS? Then write for Catalog 400. It covers nonshorting, power-type switches with load-break ratings from 15 to 100 amperes (2 to 12 taps) and an extensive line of unenclosed types with 2 to 77 taps. Many variations are described along with valuable information on switch selection.

Write for Bulletin 403

RHEOSTATS • POWER RESISTORS • PRECISION RESISTORS • VARIABLE TRANSFORMERS • RELAYS
TAP SWITCHES • TANTALUM CAPACITORS • SEMICONDUCTOR DIODES • R.F. CHOKES

OHMITE

MANUFACTURING COMPANY
3643 Howard Street • Skokie, Illinois 60076
Phone: (312) ORchard 5-2600



ON READER-SERVICE CARD CIRCLE 68

CUT BREADBOARDING TIME 4 WAYS

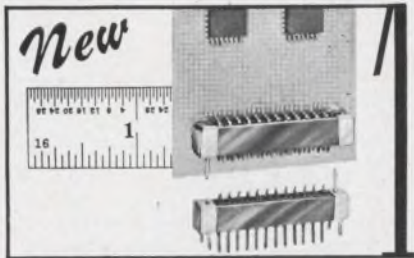

New **MICRO PLUGBORDS** with subminiature connectors. The .042" or .025" dia. holes on .1" or .05" centers allow greater packaging density than possible before with pre-punched boards. Available also without connectors and in copper clad epoxy glass.

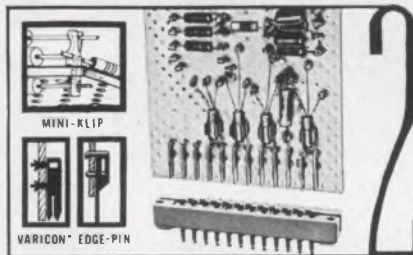

Pre-punched **PLUGBORDS** with Varicon® or Vector Edge-Pin contacts ready for your components. Insert Mini-Klip Push-In terminals where needed. JEDEC hole spacing matches transistor leads. ®Elco Trademark.

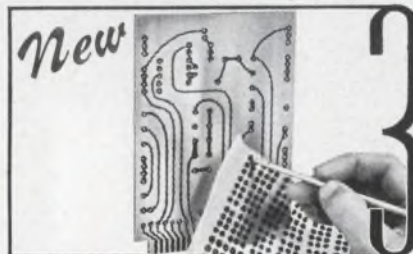

ETCHED CIRCUIT KITS 27X and 27XA provide all materials for making quick, inexpensive etched circuits. New 27XA has time-saving Vectoresist, the "rub-on" transfer resist sheet with lines, circles, ellipses, pads and standard .156" contacts, plus Vectorboard and unpunched copper clad cards and ready-to-use etch bags.

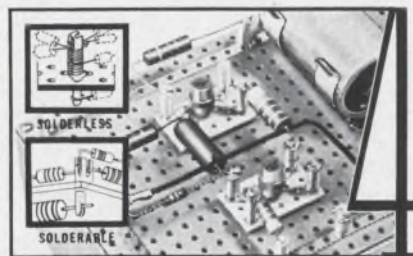

Large and small **BREADBOARD KITS** with complete hardware systems for faster breadboarding in Lab. or school experiments. Complete with solderless Springclip, solderable push-in terminals, transistor and tube sockets. New Hi Frequency breadboard kit now available.

May we send you literature and prices?

VECTOR ELECTRONIC CO. INC.
1100 Flower St., Glendale, Calif. 91201
Phone (213) 245-8971 • TWX (213) 240-2162

ON READER-SERVICE CARD CIRCLE 103

COMPONENTS

Ni/Cd batteries



Rechargeable "power plant" nickel-cadmium batteries can be repeatedly discharged and recharged. Three basic cell types (button, cylindrical and rectangular) are available in twenty-three capacities from 20 mA-hours to 23 A-hours. Operating voltage is 1.2 V. The hermetically sealed cells are also available in custom configurations.

Bright Star Industries, 600 Getty Ave., Clifton, N. J. Phone: (201) 772-3200.

Circle No. 364

500-G accelerometer

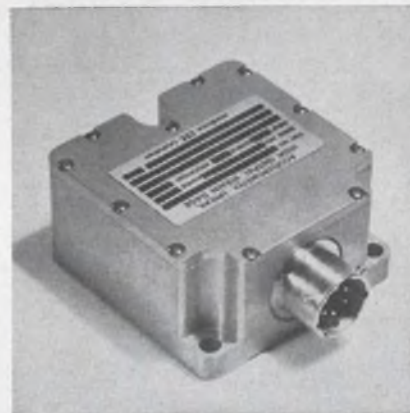

This strain gage accelerometer has a built-in amplifier capable of directly driving magnetic tape or oscillograph recorders. Output of the type 4-290 is amplified by an integral stable differential dc amplifier to ± 5 Vdc. Acceleration range is ± 5 to ± 500 G. Operable temperature range is -65 to $+250^\circ\text{F}$, and weight is less than 7 oz. The unit measures acceleration perpendicular to the mounting surface.

P&A: \$995; 45 days. CEC, Data Instruments Div., Monrovia, Calif. Phone: (213) 796-9381.

Circle No. 365

High-voltage capacitors

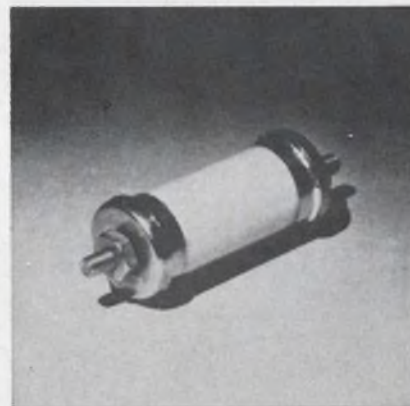

Glass-cased capacitors are suitable in high-voltage applications from -55 to $+125^\circ\text{C}$ with no voltage derating. The paper-plastic film dielectric, the high dielectric strength of the impregnant, and the thermal glass tubing provide size and weight reductions.

The tubular capacitors provide high resistance to mechanical stresses.

Gudeman Co., 340 W. Huron St., Chicago. Phone: (312) 337-7400.

Circle No. 366

Ratchet counter

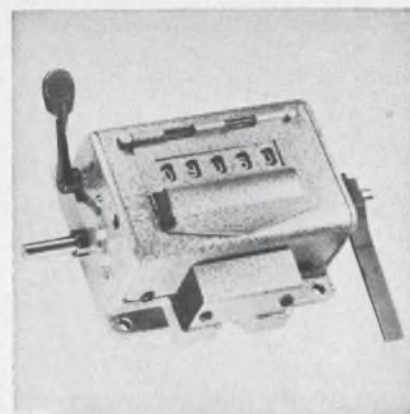

The wheels of this subtracting type predetermining ratchet counter may be preset to any figure up to 99,999. In operation, the counter subtracts from the pre-set number to 00,000. At the passage of 00,000 an spdt switch is actuated. Maximum counting speed is 500 strokes/minute. Angle of throw is 36 to 60°. The 5-digit unit is rated at 5 A, 220 Vac.

Landis & Gyr Inc., 45 W. 45th St., New York. Phone: (212) 586-4644.

Circle No. 367

THESE CON AVIONICS
POWER SUPPLIES
COST \$200 LESS
THAN THE
GOING RATE.
WHAT DO YOU
TRADE OFF WHEN
YOU BUY THEM?



This rack holds two HS power supplies. Each power supply is rated at 12 volts, 20.5 amps.

NOTHING.

You certainly don't trade off quality. Our power supplies are guaranteed unconditionally for five years. They have an M.T.B.F. of 35,000 hours, calculated according to Mil Handbook 217. Silicon transistors are used exclusively.

The secret in manufacturing these units for \$200 less than the going rate is designing systems power supplies right from the start. (Most other manufacturers just warm over their designs for lab supplies.) So our way, with a lot of value analysis and some new techniques, we're able to pack a lot of value into just 5 1/4" of panel height.

If you buy systems power supplies it could very well be worth \$200 to you to have Con Avionics' data available.

PARTIAL SPECIFICATIONS

INPUT: 105-125 VAC, 47-63 cps
REGULATION: (Line and load combined) $\pm 0.05\%$
RIPPLE: 1 mv RMS max
RESPONSE TIME: 25 microseconds
TEMPERATURE COEFFICIENT: 0.015%/°C or 18 mv/°C., whichever is higher
TEMPERATURE: 75°C max.
M.T.B.F.: 35,000 hours
GUARANTEE: 5 years, unconditional

The entire voltage range between 0 vdc and 51.0 vdc is covered in 42 models. Currents range from 5.5 amps to 46.0 amps. Wattages from 55 to 816.

A DIVISION OF  CORPORATION

CONSOLIDATED AVIONICS

800 SHAMES DRIVE / WESTBURY, N.Y. 11591 / (516) ED 4-8400 TWX: 510-222-6151

Speed Inquiry to Advertiser via Collect Night Letter
ON READER-SERVICE CARD CIRCLE 69

60-cycle source?

**Stability $\pm 0.2\%$
to a second
per month**

(3×10^{-6} per 24 Hour)

Price \$60 up.

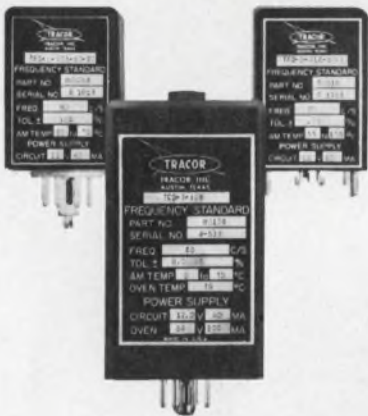

TFA-866

Think TRACOR

For further information:
TRACOR, Inc.
General Sales Office
6500 Tracor Lane
Austin, Texas 78721
Phone: 512-926-2800

TRACOR COMPONENTS

REPRESENTATIVES IN PRINCIPAL CITIES

We are looking for EE's, ME's and Physicists for design consultation or systems development in ASW and undersea problems—experience in penetrations aids—design studies, tests, analysis and reports on electronic and mechanical systems. Your reply strictly confidential.

ON READER-SERVICE CARD CIRCLE 70

COMPONENTS

Hybrid dc amplifier

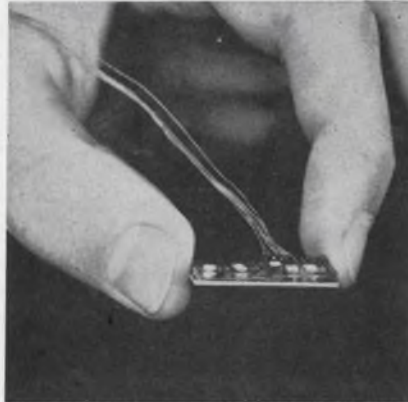

A hybrid microelectronic dc amplifier, TMS 1301, occupies less than 0.1-in.³. The amplifier operates from a power supply voltage of ± 12 V and has a minimum dynamic range of ± 8 V. Bandwidth is 1 MHz, gain is nominally 1000 and offset at the input is 4 mV. Packaging arrangements are available to special order.

Price: \$195. Solitron Devices Inc., 256 Oak Tree Rd., Tappan, N. Y. Phone: (914) 359-5050.

Circle No. 368

2-pin quartz crystal

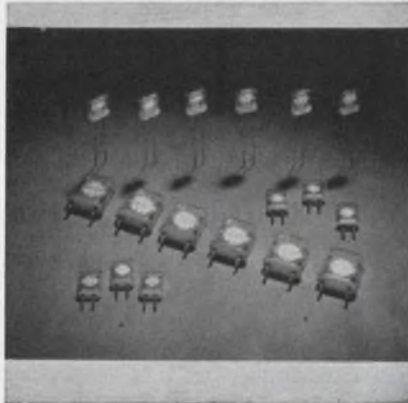

Two-pin quartz crystal units are offered encased in evacuated glass envelopes. The three styles meet Mil-C-3098. Evacuated glass construction improves frequency tolerances, aging characteristics, long-term reliability and enables operation at up to 150°C. Type 4444 is available in frequencies from 1.6 to 100 MHz and types 4445 and 4446 cover the 5 to 100 MHz band.

Standard Telephone & Cables, Harlow, Essex, England.

Circle No. 369

1-in. vertical attenuator



A new 1-in.-wide vertical or slide attenuator has either 20 or 30 steps in a balanced or unbalanced ladder, T or potentiometer circuit. Impedance ranges are 30 to 600 Ω on ladders or T's and up to 1 M Ω on potentiometers. Standard dB per step is 1.5. All contacts and wipers are solid silver alloy and terminals are located at the upper back end.

Tech Labs. Inc., 50 E. Edsall Blvd., Palisades Park, N. J. Phone: (201) 944-2221.

Circle No. 370

Sine wave inverter



A 115-Vrms, 400-Hz sine wave inverter is rated at 100 W. The inverter operates from an input of 24 to 30 Vdc. Output power is rated at 100 VA at 50°C or 80 VA at 71°C. The wave shape is sinusoidal with 4% max harmonic distortion at full load.

P&A: \$500; stock to 8 wks. Arnold Magnetics Corp., 6050 W. Jefferson Blvd., Los Angeles, Calif. Phone: (213) 870-7014.

Circle No. 371



What's the
charge?

GLASKYD[®]

ALKYD

the
better
molding
compound
for
electrical—
electronic
products

Here's why GLASKYD glass-reinforced alkyd compounds in continuous rope and cut slug form gain wider acceptance every day:

- excellent dielectric strength •
- dimensional stability •
- resistance to heat, flame and moisture •
- wide choice of colors.

GLASKYD offers economy through new, automated cold plunger molding — with fast cure, short cycles, high production rates. This alkyd also can be molded by compression or transfer techniques.

Widely used in such applications as electrical housings, connectors, coil bobbins and strips, switches and collector rings, GLASKYD also is ideal for arc-less switches, phase barriers, brush holders and tuner strips.

Rope in new markets, new product quality — with GLASKYD.

For details, write:

CYANAMID

American Cyanamid Company, Plastics & Resins Division, Wallingford, Conn.

Sales offices in: Charlotte • Chicago • Cincinnati • Cleveland • Dallas • Detroit • Los Angeles • Minneapolis • New York
Oakland • Philadelphia • St. Louis • Seattle • Wallingford. Also available in Canada.

What is really important when evaluating crystal frequency standards?

How much can you find out from aging-rate data?

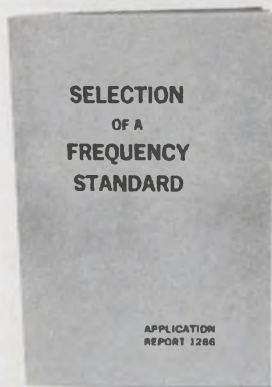

TFA-1166

Two reports will be of special help if you want to know the fine points in evaluating a crystal frequency standard.

One is "Selection of a Frequency Standard", Application Report 1266.

The other is a National Bureau of Standards report on a specific oscillator of this type.

Both are yours via the reader-service card in this magazine — or for faster response write directly to:

TRACOR, Inc.
General Sales Offices
6500 Tracor Lane
Austin, Texas 78721
Phone: 512-926-2800



**SULZER
DIVISION**

REPRESENTATIVES IN PRINCIPAL CITIES

COMPONENTS

Multi-turn pot

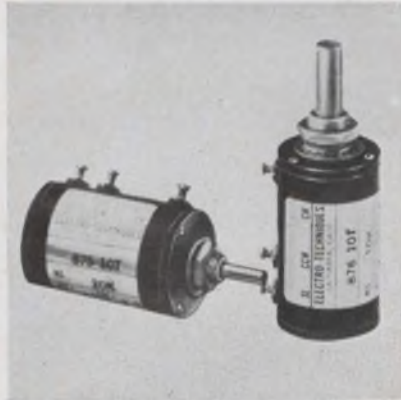

Models 875 and 876 7/8-in. potentiometers are available in 3, 5 and 10 turns, 1/8 or 14-in. shaft, with standard bushing or servo mounting. Resistance range is 25 Ω to 250 k Ω with a linearity tolerance of $\pm 0.25\%$. These 1-oz pots have a 3-W power rating at 40°C ambient. Life expectancy is 2×10^6 shaft revolutions.

Electro-Techniques, 11301 E. Ocean Ave., LaHabra, Calif. Phone (213) 691-0741.

Circle No. 372

Toroidal inductors

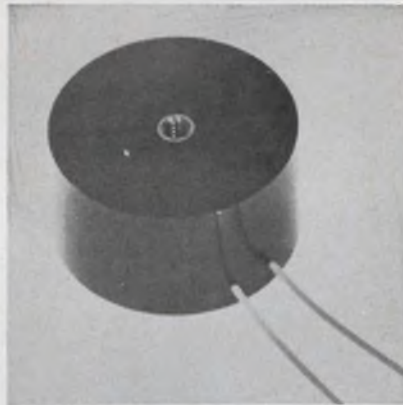

Series L toroidal inductors provide 1 to 40,000 mH from 100 Hz to 100 kHz. Inductance is stable to within $\pm 2\%$ from -55 to $+85^\circ\text{C}$. Due to the closed field, magnetic shielding is not required. The units have 5-in. teflon leads. Adjacent stacking results in a minimum of mutual coupling.

Price: \$8.08 to \$28.54 (1 to 9). Solid State Electronics Corp., 15321 Rayen St., Sepulveda, Calif. Phone: (213) 894-2271.

Circle No. 373

Single-turn pot

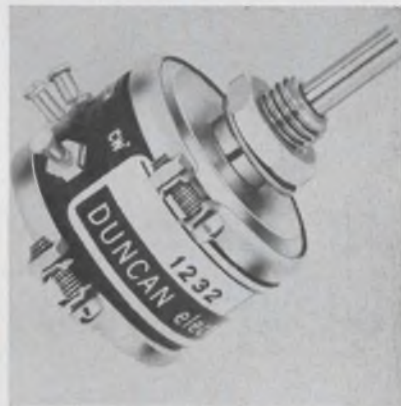

A 7/8-in. bushing mount potentiometer, model 1232, is available in single and multi-cup configurations. Resistance range is 100 Ω to 20 k Ω . Resistance tolerance is $\pm 5\%$ and linearity tolerance is $\pm 0.5\%$. Life expectancy is 2×10^6 revolutions and power rating is 1.25 W at 40°C. Up to 9 taps and 6 cups can be accommodated.

P&A: \$6.75 (over 250); stock. Duncan Electronics Inc., 2865 Fairview Rd., Costa Mesa, Calif. Phone: (714) 545-8261.

Circle No. 374

Cermet trimming pot

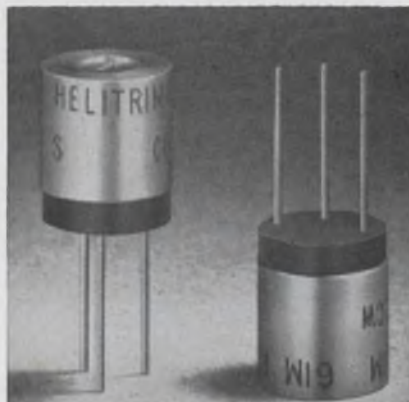

This trimming potentiometer is a 1/4-in. diameter, single-turn unit with pins spaced on a 0.1-in. grid. Pin length is 3/16-in. Standard resistances available are 10 Ω to 1 M Ω . The cermet element offers a power rating of 0.5 W at 85°C, derating to 0 at 150°C. The 0.75-gram unit is available in continuous rotation or stop configurations.

Beckman Instruments, 2500 Harbor Blvd., Fullerton, Calif. Phone: (714) 781-4848.

Circle No. 375



Small amplifier . . .
Small price (\$85.) . . .

Big input impedance

■ Here is a new operational amplifier from NEXUS that brings you a happy combination of extremely high input impedance; low, low input leakage current; and a very favorable price.

■ Utilizing field effect transistors in its input, the LFT-1 presents an input impedance of well over a thousand megohms. FET input leakage currents are typically 50 picoamps at 25°C and 1 nanoamp at 85°C.

■ The LFT-1 costs only \$85* in quantities of 1 to 9 . . . substantially less in larger quantities. Delivery is generally within two weeks.

■ The new FET unit is ideally suited to applications requiring extremely low error currents, such as integrators, sample and hold circuits, and electrometer circuits. The high input impedance and low error currents permit both inverting and non-inverting amplifier configurations, using input and feedback resistors with values of the order of hundreds of megohms.

■ Send for new data sheet.

NEXUS
RESEARCH LABORATORY, INC.

480 NEPONSET STREET, CANTON, MASS. 02021
TEL: (617) 828-9000 TWX (617) 828-1022

* Prices F.O.B. Canton, Massachusetts - Prices apply to North America only.

TYPICAL LFT-1 CHARACTERISTICS (at 25°C unless otherwise stated)

Differential input Z @ d-c.	10 ¹⁰ ohms
Open loop gain @ d-c (R _{LL} = 10K)	50K
Unity gain crossover frequency	1 mc
f _p	10 kc
Input leakage current @ 25°C	50 picoamps
Input leakage current @ 85°C	1 na
Output	±10v @ ±2ma (min.)
Input common mode voltage range	±10v (max.)
ΔE _{os} /ΔT (-25°C to +85°C)	±10 μv/°C
Supply voltage	±15v
Operating temp. range	-25°C to +85°C
Storage temp. range	-55°C to +100°C
Case size	2.02" (l) x 1.14" (w) x 0.62" (h)



Latronics

CONTROLLED RECTIFIER HOUSINGS

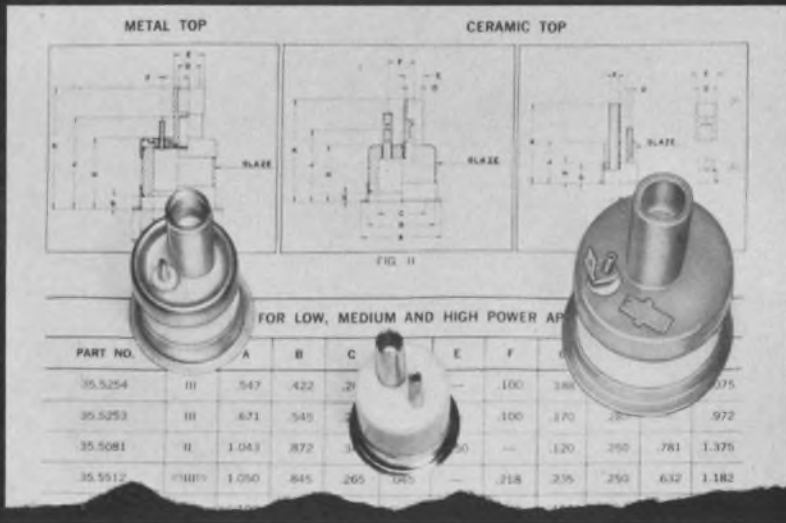

This is a typical sheet from Latronics new catalog on Ceramic and Glass-to-Metal Seals.

SEND for Latronics Catalog 100-266-1.

Latronics Corporation

1004 Lloyd Avenue, Latrobe, Pa. 15650 • Phone 412-539-1626 • TWX 412-594-7857

ON READER-SERVICE CARD CIRCLE 72

**VISIBLE
& IR
INJECTION
LUMINESCENT
SOURCES**
(GaP & GaAs Diodes)

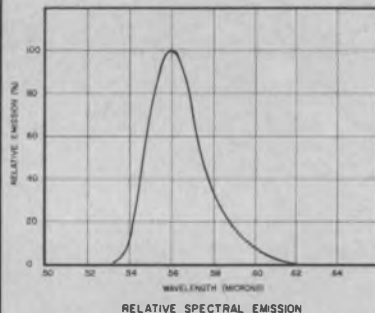

TYPE 482 GALLIUM PHOSPHIDE DIODE (Green Emission):

- 5600 Å peak wavelength emission • Ultra-pure epitaxially grown GaP, p-n junction • High conversion efficiency; emission $> 10^{-5}$ photons/electron

GALLIUM ARSENIDE DIODES (IR Emission):

- Wide choice of packaging: glass diode housing, TO-5 can with or without lens, TO-18 can, micro-miniature ceramic and metal package • Low capacitance and fast response • Long-term stability in output

Typical Applications:

- Calibrating Si photodiodes and PM tubes • Sources for tape and card readers, encoders, level indicators • Optical radar transmitter, range finder, and tracking applications

For further information, write or call:



ELECTRO-NUCLEAR LABORATORIES, INC.

115 Independence Drive, Menlo Park, Calif. 94025; (415) 322-8451

ON READER-SERVICE CARD CIRCLE 73

COMPONENTS

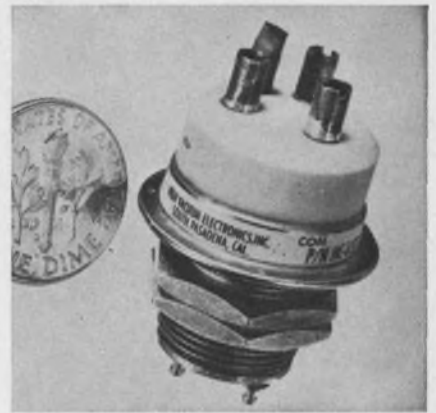

Ceramic vacuum relay

Model HC-1 ceramic vacuum relay is capable of switching up to 2.5 kVdc and carrying up to 18 A rms. The spdt unit has a max operating time of 6 ms, a coil resistance of 335Ω and a coil voltage of 26.5 Vdc. It is evacuated to 10^{-8} mm of Hg.

P&A: \$59 (1 to 9); stock to 30 days. High Vacuum Electronics Inc., 538 Mission St., South Pasadena, Calif. Phone: (213) 682-3661.

Circle No. 378



IF phase shifters

Variable phase shifters from 1 to 200 MHz incorporate a reactive circuit of lumped parameter devices. Voltage variable capacitors control desired phase shift. Center frequencies of 30, 60 and 70 MHz are offered. All have typical bandwidths of 10% and can be biased to shift 0 to 180° over insertion phase shift. To sweep the full 180° phase variation, 50 V are required. Impedance is 50Ω at each port, vswr is 1.5 and insertion loss is 1 dB max.

Merrimac Research and Development Inc., 517 Lyons Ave., Irvington, N. J. Phone: (201) 371-1616.

Circle No. 379

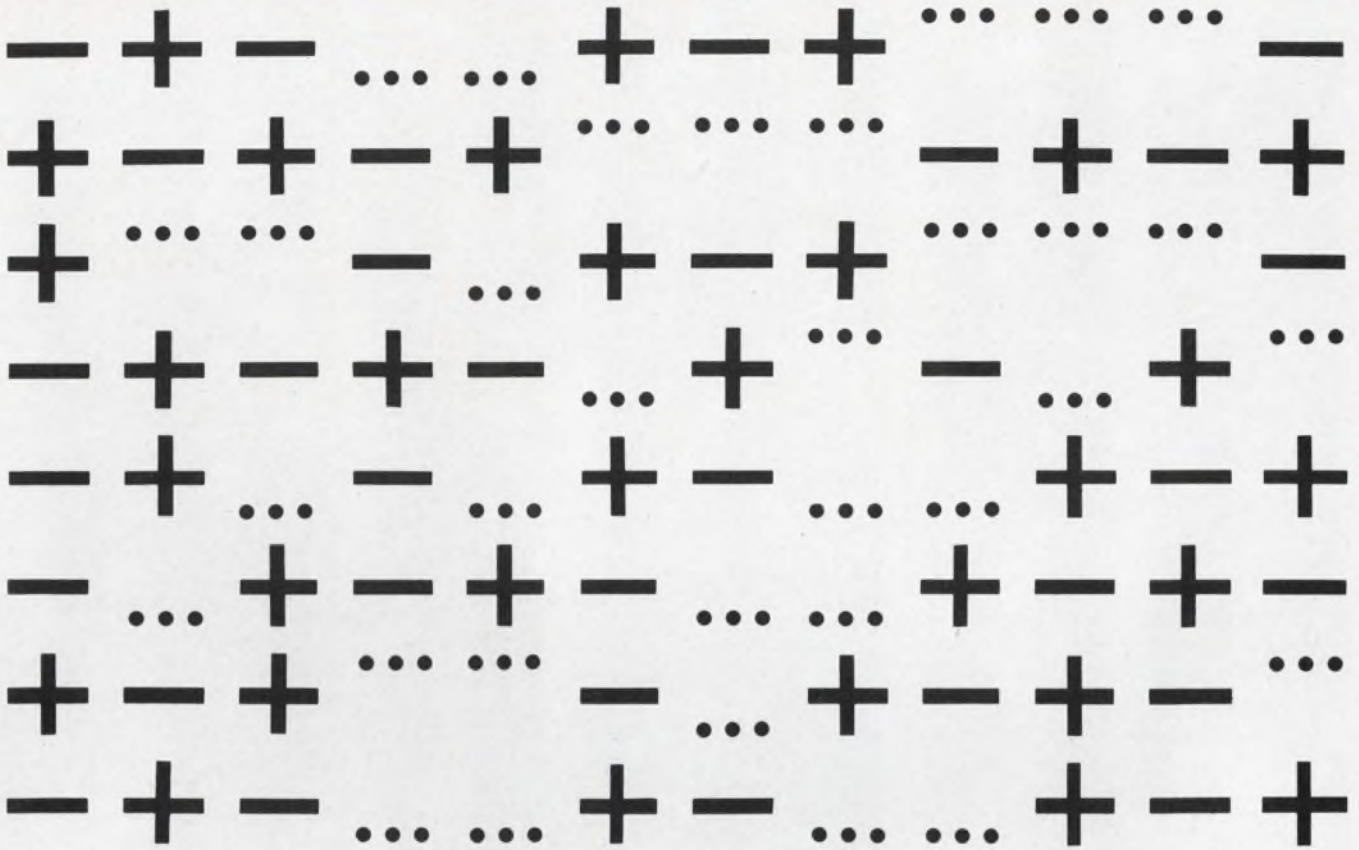

The Hoffman HCD-4 microminiature planar epitaxial passivated diode is designed for computer memory core driver and similar switching applications under 6 nanoseconds.

It features controlled forward conductance, with specified maximum limits on junction capacity and stored charge, to provide devices of uniform reproducible performance.

The conventional method of characterizing the switching speed of a diode by the measurement of the reverse recovery time is not used for fast switching diodes.

Hoffman uses a direct measurement of stored charge of the diode by integrating the reverse current of the diode. The stored charge represents an inherent characteristic of the diode and provides a single, unambiguous figure of merit which has minimal dependence on test conditions or jigs.

Repeatability of storage value measurement to within 5% can be made on direct reading low cost equipment.

For additional information regarding this product write Hoffman Electronics, Dept. A, El Monte, California.

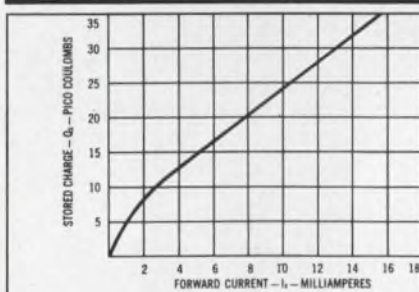
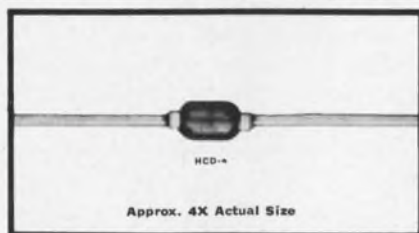

FIGURE 1 TYPICAL VARIATION OF STORED CHARGE WITH FORWARD CURRENT



MAXIMUM RATINGS

Power Dissipation: 500 Milliwatts (Derate 3.3mW/°C above 25°C)
 Operating Temperature Range: -65°C to +175°C
 Storage Temperature Range: -65°C to +200°C

Electrical Specifications: 25°C unless otherwise specified

Parameter	Symbol	Min.	Max.	Units
Forward Current (Note 1)				
$I_f = 100 \mu A$	V_{f1}	430	550	mV
$I_f = 1 \text{ mA}$	V_{f2}	540	660	mV
$I_f = 10 \text{ mA}$	V_{f3}	650	800	mV
$I_f = 100 \text{ mA}$	V_{f4}	790	990	mV
$I_f = 500 \text{ mA}$	V_{f5}	960	1350	mV
Breakdown Voltage				
$I_r = 100 \mu A$	B_{VR}	75		Volts
Reverse Current				
$V_R = 50 \text{ Volts}$	I_{R1}		100	nA
$V_R = 50 \text{ Volts } T_A = 100^\circ C$	I_{R2}		20	μA
Stored Charge (Note 2)				
$I_f = 10 \text{ mA}$	Q_s		60	P Coul
Capacitance				
$V_R = 1 \text{ Volt}, f = 1 \text{ mc}$	C_j		2.0	pf

Note 1 - Test time at each forward test current 30-40 milliseconds.
 Note 2 - Measured on B-Line Electronics Model QS-3 Stored Charge Meter.
 Conditions: Pulse Amplitude = 5 Volts
 Pulse Width = 50 nSec
 Rise Time = 4 nSec
 Source Impedance = 10 Ohms
 Stored charge measurement accuracy $\pm 4\%$ of full scale

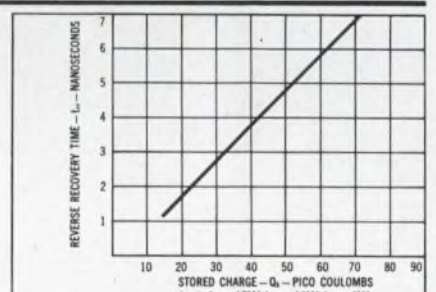

FIGURE 2 TYPICAL CORRELATION BETWEEN STORED CHARGE AND REVERSE RECOVERY TIME



SEMICONDUCTORS

ON READER-SERVICE CARD CIRCLE 74



Propeller fan performs like blower

The 7-in.² "Tarzan" fan delivers the performance of squirrel-cage blowers. The compact unit is designed for cooling microelectronic modules, PC card chassis for discrete components, computers and communications transmitters. Range of application is 150 to 300 cfm. Axial depth is 4-11/32-in.

Price: \$23.50 (1,000 lots). Rotron Mfg. Co., Inc., Hasbrouck Lane, Woodstock, N. Y. Phone: (914) 679-2401. *Circle No. 380*

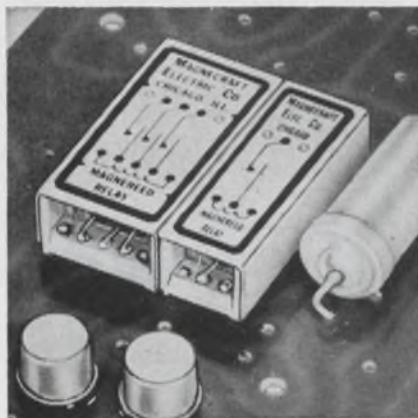

PC reed relays

Mercury-wetted contact and dry reed relays for PC applications measure 3/8-in. high. The units are available in dry reed contact configurations up to 3pst-NO or dpdt and in mercury-wetted contact configurations of spst-NO or dpst-NO. Dry contacts are rated for 10 VA non-inductive loads at up to 250 mA or 100 V max. Mercury-wetted contacts are rated for 28 VA non-inductive loads up to 1 A or 100 V max. Operate time is 1 ms.

Magnecraft Electric Co., 5575 N. Lynch Ave., Chicago. Phone: (312) 282-5500. *Circle No. 381*

X-Y sawtooth generator

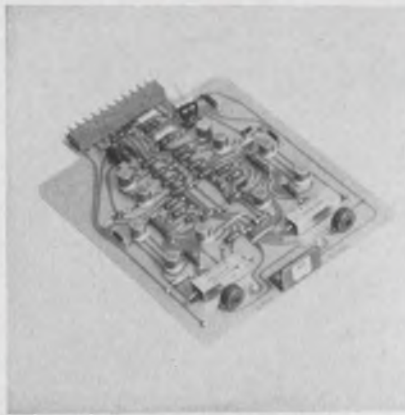

Two highly stable and linear gated sawtooth generators are combined to form the SG415. Each is dc coupled, and screwdriver adjustable pots provide a $\pm 50\%$ width adjustment. Nominal sawtooth widths can be specified from 6 ns to 500 ms. Provisions are made for the connection of external timing capacitors.

Availability: 3 wks. Beta Instrument Corp., 377 Elliot St., Newton Upper Falls, Mass. Phone: (617) 969-6510.

Circle No. 382

Multi-tap delay line

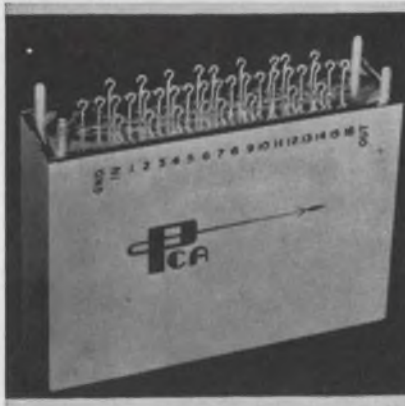

Featuring a built-in pulse equalization network, a multiple tap delay line is designed for pulse encoders and decoders. The pulse network provides an output amplitude at each tap within ± 1 dB on the nominal pulse amplitude at the end of the line. The hermetically sealed units measure 3-1/8- x 4-1/2- x 1-1/4-in.

P&A: \$100; stock to 8 wks. PCA Electronics Inc., 16799 Schoenborn St., Sepulveda, Calif. Phone: (213) 892-0671.

Circle No. 383

Notch filter

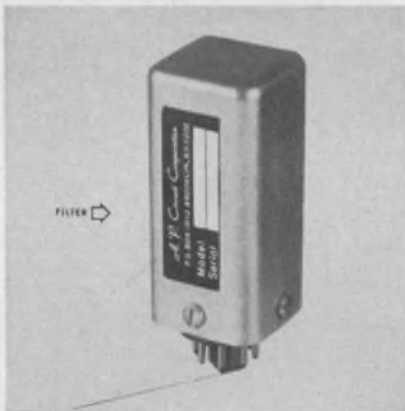

Model APN-60 is an active notch-filter which eliminates the 60-Hz frequency without signal distortion. Rejection bandwidth of this filter can be narrowed to 2 Hz without a phase shift in the pass band. Pass band is dc to 25 kHz with a max insertion loss of 0.5 dB. Power required is a regulated ± 12 V at 2.5 mA. Input impedance is 1 M Ω .

P&A: \$155; stock. A. P. Circuit Corp., 865 West End Ave., New York. Phone: (212) 222-0876.

Circle No. 384

A/D converter card



This analog-to-digital converter card uses integrated circuits. Input range is ± 5 V and conversion time is 1 μ s/bit max. Output format is 10 parallel binary bit data. Conversion frequencies exceed 100 kHz with internal or remote clock command. Resolution is 10 bits and linearity is 0.05% or 1/2 bit.

P&A: \$1200; stock to 60 days. Pastoriza Electronics Inc., 385 Elliot St., Newton Upper Falls, Mass. Phone: (617) 332-2131.

Circle No. 385

Johnson gives you the most moves in capacitor selection

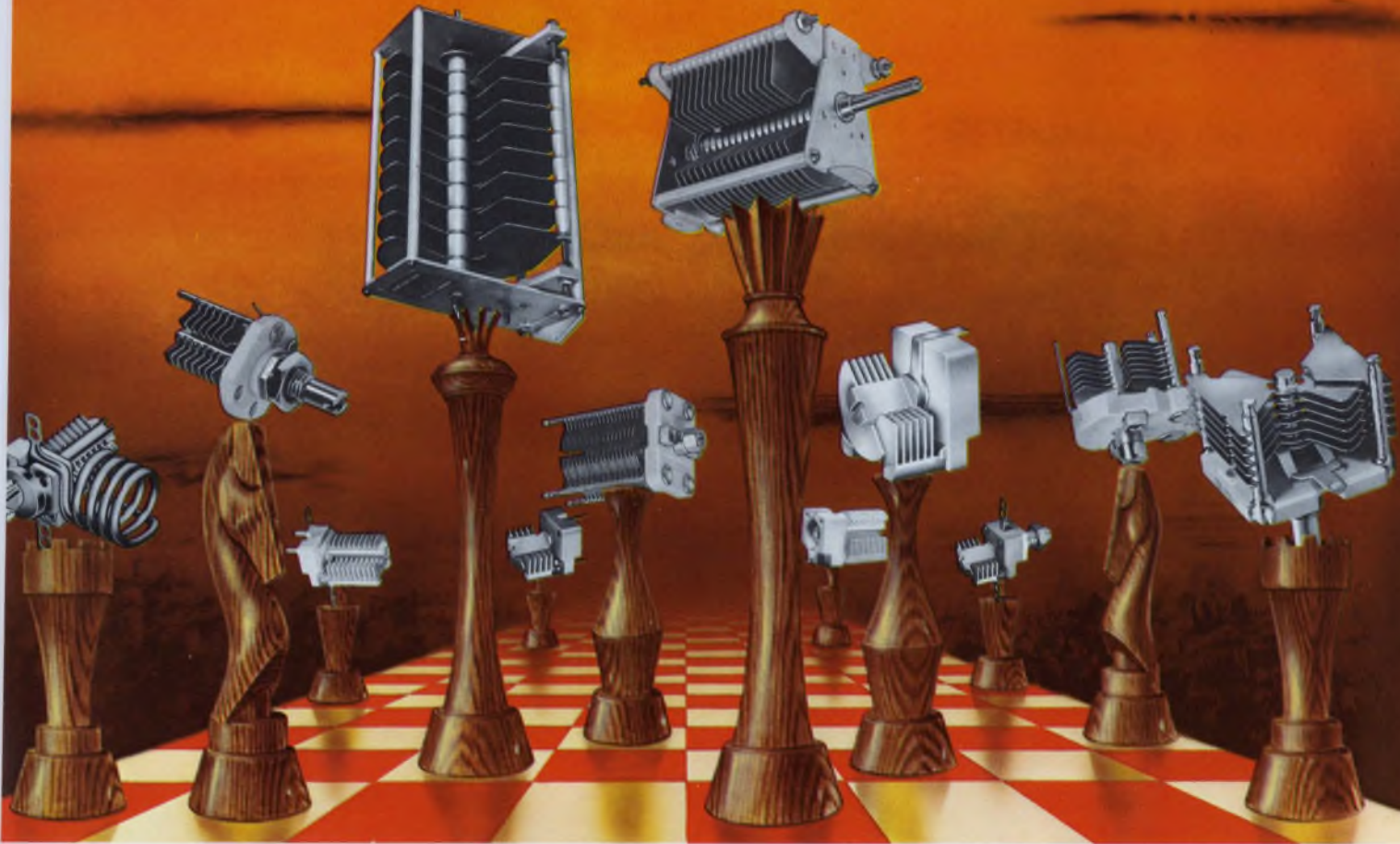

MORE THAN 11 BASIC SERIES AVAILABLE IN A WIDE SELECTION OF SINGLE SECTION, DUAL SECTION, BUTTERFLY AND DIFFERENTIAL TYPES. FOR MORE DETAILS, TURN THE PAGE.



Now from a new, expanded air variable capacitor line, you can satisfy your capacitor needs in more ways at low cost. From the Johnson line, offering capacitance values up to 1700 pf. and peak voltage ratings from 650 to 13,000 volts, you can specify air variables and be assured your design will yield a product that's competitively priced. Johnson air variable capacitors range from sub-miniature types to large units suitable for heavy duty applications. Whatever the use, they provide excellent stability, high Q, uniform capacitance, and exhibit low "hook" in applications involving a square wave form.

For complete capacitor information write on company letterhead for free, detailed Johnson components catalog No. 700.



E. F. JOHNSON COMPANY
W A S E C A, M I N N E S O T A 5 6 0 9 3

CAPACITORS

MACHINED PLATE TRIMMER AND TUNER TYPES — U, UA, UB, U-LC, V, AND W — Available in both printed circuit and chassis mounting types. U types available in differential and butterfly printed circuit mounting types in addition to single section types. V and W capacitors available in single section type only. Maximum capacities of up to 54 pf. Tuners consist of a machined plate trimmer and high Q air wound silver plated inductor, in resonant frequencies of 100 to 750 Mc.

SOLDER PLATE TYPES — Type M: Capacity values to 30 pf. Voltage ratings to 1250 volts peak. Available in single section, differential and butterfly types.

Type S: Capacity values to 100 pf. Voltage ratings to 3000 volts peak. Available in single section, differential and butterfly types.

Type K: Capacity values to 150 pf. Voltage ratings to 3800 volts peak. Available only in single section types. May be furnished in production quantities in full compliance to MIL-C-92A.

Type R: Capacity values to 340 pf. Voltage ratings to 4400 volts peak. Available only in single section type.

Type L: Capacity values to 200 pf. Voltage ratings to 3500 volts peak. Available in single section differential, butterfly and dual section types.

SPACER TYPES — Type C: Capacity values to 1500 pf. Voltage ratings to 13,000 volts peak. Available in single section and dual section types.

Type D: Capacity values to 1700 pf. Voltage ratings to 9000 volts peak. Available in single section and dual section types.

STAKED PLATE TYPES — Type E: Capacity values to 1000 pf. Voltage ratings to 4500 volts peak. Available in single section and dual section types.

Type F: Capacity values to 400 pf. Voltage ratings to 3000 volts peak. Available in single section and dual section types.

CONNECTORS

SUB-MINIATURE INSULATED TYPES — Designed for printed circuit applications. Operating voltages to 1500 volts RMS . . . 5 amperes current carrying capacity . . . contact resistance less than 2 milliohms. Capacitance between two adjacent jacks less than one pf at 1 Mc. 10 colors available. Test-Point Strip/Handle — rapid-mounting polyamide body contains 12 test points each rated at 5 amps., maximum current capacity. Operating voltage 1500 volts RMS at sea level, 350 volts RMS at 50,000 feet. Contact resistance less than 2 milliohms.

STANDARD INSULATED CONNECTORS — A complete line of connectors molded of tough, low-loss, shock-proof polyamide in 10

colors meeting Fed. Std. 595. Tip, Banana and Dual Banana Plugs; Tip and Banana Jacks; Metal-Clad Tip Jack, Military; Jack and Sleeve; Binding Posts.

RIB-LOC TERMINALS — A new line of miniature, one-piece, insulated terminals with a unique serrated conical design, which resists loosening and turning. Provides an inexpensive approach to convenient press-in type terminals. Six colors conforming to Federal Color Standard No. 595. Terminal styles include single and double turret feed-thrus and stand-offs, .040" dia. tip plug and mating jack for .040 plug.

Tube Sockets, Insulators, Pilot Lights, and Hardware

ULTRA HIGH FREQUENCY SOCKETS — Continuous heat resistance to 500°F. with low loss, glass filled silicone base and heat treated beryllium copper contacts. Low inductance screen bypass capacitor available for VHF and UHF operation.

KEL-F SERIES — Molded of low dielectric loss-factor Kel-F plastic — designed for use with a wide selection of high power transmitting tubes.

STEATITE WAFER TYPES — Available in 4, 5, 6, 7, and 8-pin standard socket types, as well as Super Jumbo 4-pin types. Also giant 5 pin, and 7 pin Septar and VHF Septar Sockets.

SPECIAL PURPOSE TYPES — Includes sockets for special purpose tubes.

Note: For detailed specifications, request Socket Standardization Booklet 536 on your company letterhead.

INSULATORS — Low loss, high-voltage breakdown in either steatite or porcelain. Complete line includes Thru-panel Bushings and Insulators, Antenna Strain and Feeder Types, Cone and Stand-off Insulators, Lead-in Bushings and Feed-Thru Bowl Assemblies.

PILOT LIGHTS — Over 47 separate assemblies. Continuous indication neon types, models for high and low voltage incandescent bulbs, standard or wide angle glass, and lucite jewels. Specials, including types meeting military specifications, also available in production quantities.

PANEL BEARINGS — For use on $\frac{1}{4}$ " shafts and panels up to $\frac{3}{8}$ " thick. **CRYSTAL SOCKETS** — For low capacity, high voltage and high temperature operation. Glazed steatite, Grade L-423 or better. DC-200 impregnated. **RF CHOKES** — High quality construction. For 1.7 to 30 Mc range.

CHECK Johnson for all your component requirements

Johnson also offers a complete line of heavy-duty RF components for broadcast transmitting, RF heating, antenna phasing and other commercial applications.

Equipment in this line includes fixed and variable inductors, antenna phase sampling loops, isolation filter inductors, feed-thru bowl insulators, static drain chokes, RF contactors and heavy-duty make-before-break switches.



E. F. JOHNSON COMPANY
W A S E C A , M I N N E S O T A 5 6 0 9 3

COMPONENTS

Active filter

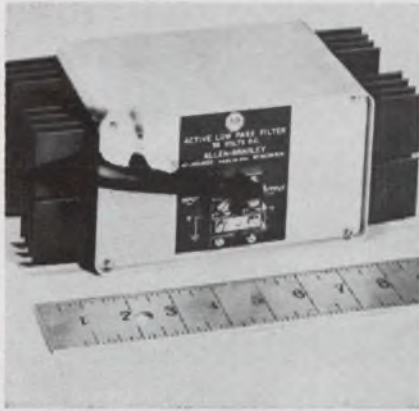

This low-pass active filter offers 60-dB min attenuation from 3 Hz to 100 kHz and handles 5 A dc. It is designed to prevent noise generated by a randomly fluctuating load from being reflected through the power supply and into the distribution system. Typically, a 30-A spike drawn by the load will be attenuated to 3 mA at the power supply. Custom units are available.

Allen-Bradley Co., 1201 S. Second St., Milwaukee, Wis. Phone: (414) 671-2000.

Circle No. 386

Band pass filter



A new passive band pass filter is designed to eliminate saturation and third harmonic distortion problems. The output signal is typically phase-adjustable to $\pm 10^\circ$ ($\pm 5^\circ$ min). Insertion loss is 3 dB.

Model BP41 has center frequencies from 400 to 10,000 Hz with a Q of 4. It provides 58 dB min attenuation for all frequencies greater than three times center frequency.

Guillemin Networks Inc., 170 Brookline Ave., Boston. Phone: (617) 536-5810.

Circle No. 387

Junction compensator

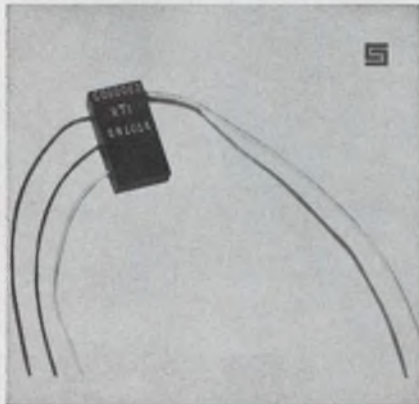

A miniature cold junction compensator for Chromel-Alumel thermocouples eliminates the need for ice baths, boiling water or transitional salts to achieve a constant temperature reference in which to embed the cold junction. With an input of 400 mV into $3.7 \text{ k}\Omega \pm 1\%$, the output of the compensator is 11 mV $\pm 3\%$ at 25°C . Tracking ability is within $80 \mu\text{V}$ from -65 to $+125^\circ\text{C}$.

Nutronics Inc., Kutztown, Pa. Phone: (215) 683-7307.

Circle No. 388

11-crystal oven

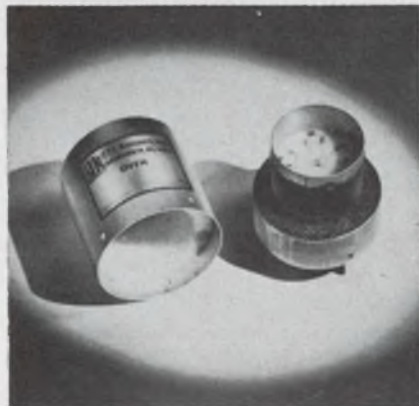

Up to 11 plug-in crystals may be installed in the low-power model 900-0153 oven. Power consumption is 6.6 W at turn-on and 1.5 W average at 25°C . Standard operating temperatures are 65, 75 and 85°C . Standard operating voltages are 12 Vdc, 24 Vac or 115 Vac. The ovens are suited for battery-powered mobile communications.

P&A: \$22 to \$29 (without crystals); stock to 6 wks. CTS Knights Inc., Sandwich, Ill. Phone: (815) 786-2141.

Circle No. 389

Bulova can supply the crystal you need



to match your specs!

Many years of supplying crystal control units for the most advanced military and space programs enable Bulova to offer a full line encompassing virtually the entire frequency spectrum—2 kc to 125 Mc for oscillator and filter applications. We can supply every type of packaging—including koldweld and glass sealed. Our military crystals meet latest MIL-C-3098D specifications. All reasons why you should make Bulova your single source of supply.

HIGH PRECISION GLASS SEALED CRYSTALS 1 Mc to 125Mc. Available in vacuum sealed, glass enclosures of the HC-26/U and HC-27/U type.

Example: Precision SSB Crystals

Frequency: 1 Mc to 5 Mc
Holder: HC-27/U
Tolerance: $\pm .0025\%$ from -55°C to $+90^\circ\text{C}$, or to specification
Aging: 3×10^{-8} per week after one week stabilization at 75°C



KOLDWELD SEALED CRYSTALS—low aging, high reliability, 1 Mc to 125 Mc. Now available in TO-5, HC-6/U and HC-18/U type cans sealed by the koldweld process to eliminate effects of heat and to reduce contamination.

Example: TO-5

Frequency: 15 Mc to 125 Mc
Tolerance: $\pm .0025\%$ from -55°C to $+105^\circ\text{C}$, or to specification
Aging: 1×10^{-7} per week after one week stabilization at 75°C



Write or call for specifications on Bulova's complete line of crystals. Address: Dept. ED-17

BULOVA

FREQUENCY CONTROL PRODUCTS

ELECTRONICS DIVISION OF BULOVA WATCH COMPANY, INC.

61-20 WOODSIDE AVENUE WOODSIDE, N.Y. 11377, (212) DE 5-6000

ON READER-SERVICE CARD CIRCLE 75

NEW! RED SHIELD LINE

of Subminiature Shielded Inductors

- Unsurpassed "Q" to "L" ratio
- Exceptional "L" to size ratio
- High Self-Resonance
- Designed to MIL-C-15305C
- Maximum Coupling—3%—units side by side
- Stock—73 predesigned values
- Non-Flammable Envelope
- Operating Temperature -55° to 125° C.

MICRO-RED

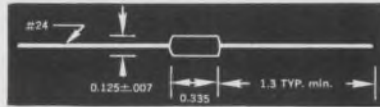

The "Micro-Red" is a shielded inductor that offers the largest inductance range 0.10 to 10,000 μ h in its size. "Q" to "L" ratio unsurpassed with excellent distributed capacity. Inductance tolerance \pm 10% measured per MIL-C-15305C. Stocked in 61 predesigned values.

MINI-RED

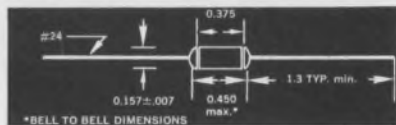

The "Mini-Red" offers the highest "Q" to "L" ratio available over inductance range 0.10 to 100,000 μ h in a shielded inductor this size. Inductance tolerance \pm 10% measured per MIL-C-15305C. Stocked in 73 predesigned values.



Data Sheets: Write or Phone

LENOX-FUGLE ELECTRONICS, INC.

475 Watchung Ave., Watchung, New Jersey 07060

Telephone code 201-756-1164-1165

ON READER-SERVICE CARD CIRCLE 76

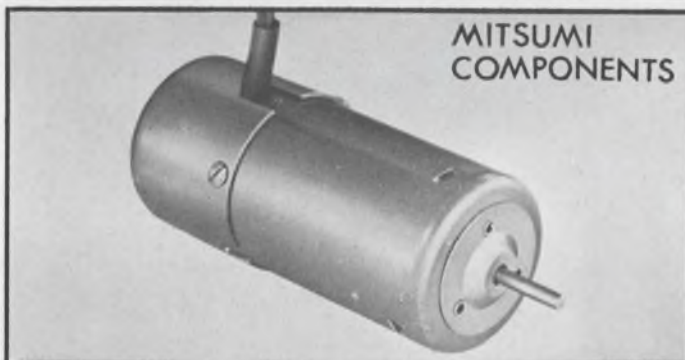

NEW MICRO-MOTOR

The most excellent characteristics of Mitsumi micro-motor is in its extremely high efficiency. Formerly it has been considered impossible to attain an efficiency of more than 50% for micro-motors with a diameter of 20mm or less. We have, however, succeeded in breaking through this common concept through the adoption of a new system in the magnetic circuit. We serves many types of micro-motors to our customers with automated and quality-controlled mass production.

Main Products

Polyvaricon · IFT · Oscillator coil · Antenna coil · Composite coil · Special coil · Micro motor · Synchronous motor · Variable resistor · Trimming potentiometer · FM tuner TV tuner · Various sockets · CdS photoconductive cell.



MITSUMI ELECTRIC CO., LTD.

New York office: 11 Broadway, New York, N.Y. 10004, U.S.A. Phone: HA-5-3085, 3086
Main office: 1056, Koadachi, Komae-machi, Kitatama-gun, Tokyo, Japan. Phone: Tokyo 415-6211/23

ON READER-SERVICE CARD CIRCLE 77

COMPONENTS

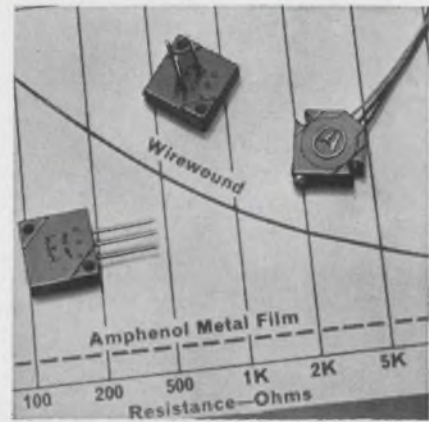

Metal-film trimmers

Low- Ω metal-film trimmers maintain essentially infinite resolution across the entire resistance range. These 1/2-in.² trimmers have a temperature coefficient of 50 ppm/ $^{\circ}$ C and a zero noise level at the trimmed position. A precious metal contact assures low contact resistance. Resistances available are from 50 to 10,000 Ω .

P&A: \$5.50; stock to 6 wks. Amphenol, 120 S. Main St., Janesville, Wis. Phone: (608) 754-2211.

Circle No. 390



Time delay relay

Series 84 single-circuit reset timers are accurate to within 1-1/2% of their total time cycle. They are available with ranges of 4, 15 and 60 s, and 3 and 5 minutes with reset times from 1/3 to 10 s. The timers are fully adjustable over their entire range and are available with or without calibrated dials or a cycle progress indicator. Contact ratings range from 5 to 25 A, 125/250 Vac.

E. W. Bliss Co., 736 Federal St., Davenport, Iowa. Phone: (319) 324-1361.

Circle No. 391

LOW COST 600-volt SCR's with peak surge currents

12X I_{rms}

30X I_{rms}

16X I_{rms}



2N4101 \$1.85*



2N4102 \$1.85*



2N4103 \$6.00*

for high-voltage supplies • instrumentation • commercial
space heaters • ignition systems (auto and boat)
• DC power supplies • motor controls

Now available in production quantities...these new all-diffused SCR's are the latest additions to RCA's family of economy devices specifically designed for *low cost* power-control and power-switching applications. Built-in overload protection further decreases your circuit costs, and standard, easy-to-mount packages are readily adaptable for printed-circuit boards and metal heat sinks. For more information on RCA 2N4101, 2, and 3 and their companion types, as well as copies of Application Notes SMA-38 and SMA-39, write RCA Electronic Components and Devices, Commercial Engineering, Section RG6-3, Harrison, New Jersey.
Also Available Through Your RCA Distributor.

	2N3528	2N3529	2N4102	2N3228	2N3525	2N4101	2N3668	2N3669	2N3670	2N4103
Standard AC Supply	120V	240V	High-Voltage Supply	120V	240V	High-Voltage Supply	Low-Voltage Supply	120V	240V	High-Voltage Supply
V_{RM} (rep)	200V	400V	600V	200V	400V	600V	100V	200V	400V	600V
V_{FBOM} (rep)	600V	600V	700V	600V	600V	700V	600V	600V	600V	700V
I_{RMS}	2.0A	2.0A	2.0A	5.0A	5.0A	5.0A	12.5A	12.5A	12.5A	12.5A

*(Prices in quantities of 1000 and up.)



The Most Trusted Name in Electronics

ON READER-SERVICE CARD CIRCLE 226

HEART of missile and radar modulators ...



PULSE FORMING NETWORKS

Always look to P.C. when there is no margin for anything but perfect performance. For minimum size plus maximum performance you can rely on P.C. As specialists, we have the training, the skills, and the facilities to produce outstanding examples of pulse forming networks for both standard and "specials" to meet your every requirement. Whatever your need or application, write today for our special bulletin on pulse forming networks; or, send your specifications including: Peak charging voltage, pulse duration, pulse rise time, characteristic impedance, rep. rate, max. ripple, temperature range, life, decay or fall time.

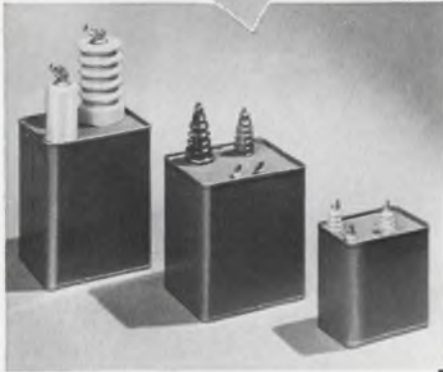

Plastic Capacitors, INC.

2620 N. Clyborn • Chicago, Ill. 60614
DI 8-3735

"Custom  Engineered at
Production Prices!"

ON READER-SERVICE CARD CIRCLE 78

GET ALL 5



IN 1 NEW PHOTOCELL ...



Now, the 5 best characteristics of CdSe and CdS are combined in 1 new Clairex CdS photosensitive material, the type "5H".

1. High speed (1-2 millisecond response)
2. Low temperature coefficient (0.5%/°C)
3. Low memory (15 X lower than CdSe)
4. High linearity (slope of 0.9 from 0.1 to 100 FC)
5. Uniform color temperature response (100% - 106%, 2854°K-6700°K)

Detailed information on type "5H" photocells plus the new Clairex 16 page Designers' Manual free on request.

CLAIREX

"The LIGHT Touch in Automation and Control"

1239 Broadway, New York, N.Y. 10001, 212 MU 4-0940

ON READER-SERVICE CARD CIRCLE 79

COMPONENTS

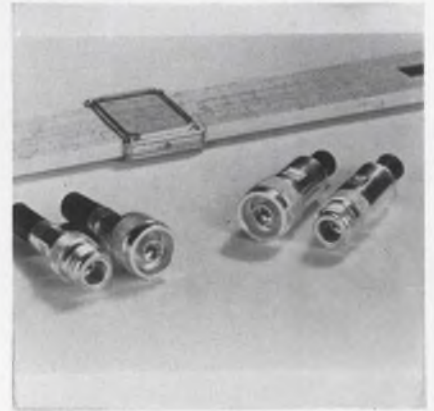

MIL-C-39012 connector

A type N coaxial connector in field-serviceable and crimp versions meets the new MIL-C-39012. Impedance of the connectors is 40 Ω , voltage rating is 1000 V rms and specified frequency range extends to 10 GHz. The crimp version has max vswr of 1.12 when soldered, 1.26 with 4-indent crimp and 1.35 with hex crimp. The center contact is gold plated, dielectric is Teflon and all other metal parts are silver plated. Operating temperature is 200°C max.

Amphenol, 33 E. Franklin St., Danbury, Conn. Phone: (203) 743-9272.

Circle No. 392

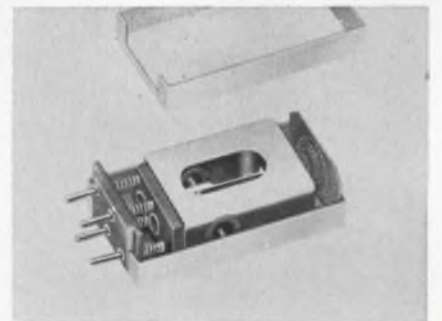

Resonant reed filter

The RF20 contact less resonant reed filter is an audio tone filter (decoder) or a frequency source (encoder) for audio tone generators. With a specified frequency input, the reed generates a predetermined sine wave signal for switching or oscillator frequency control. Frequency range is 80 to 3000 Hz and impedance is 1000 Ω at resonance. The unit requires 0.1 mW.

P&A: \$20 (1 to 9); stock to 8 wks. Ledex Inc., College & South Sts., Piqua, Ohio. Phone: (513) 773-8271.

Circle No. 393



Gyroscope

The FG23 dc free gyroscope with bearing suspension system and dc motor uses less than 8 W. It is electrically caged and uncaged with an indicator circuit. Both gimbals have 360° freedom. Potentiometer pickoffs, voltage regulator and noise filter for 24 to 30-Vdc operation are standard.

Humphrey Inc., 2805 Canon St., San Diego, Calif. Phone: (714) 223-1654.

Circle No. 394

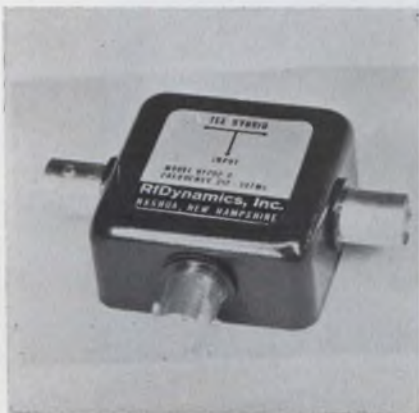

Vhf tee hybrids

The Rf250 series of vhf tee hybrids divides or combines RF power. The hybrids match a 50-Ω source to two 50-Ω loads and may be used to distribute local-oscillator voltage to two mixers, without cross-talk. Tee hybrids may be cascaded to divide power equally to 2ⁿ loads. Fifteen models cover from 27 to 968 MHz. Isolation is 20 dB min and insertion loss is 0.25 dB max over a 20% bandwidth.

P&A: \$45; 10 days. Rf Dynamics Inc., 51 Harbor Ave., Nashua, N. H. Phone: (603) 822-5854.

Circle No. 395



WE'RE PROLIFERATING!!

We've developed an entirely new line of Press-Lite switches and press-to-test indicator lights—including a high quality series of lights and switches that meet industry standards for appearance and performance.

We're proliferating in the catalog department, too. Write for complete details of the industry's finest line of neon lamps, indicator lights, illuminated push-button switches and their transistorized or EMI shielded versions. Many options available.



MARCO-OAK INDUSTRIES

A DIVISION OF OAK ELECTRO/NETICS CORP.

207 SOUTH HELENA STREET, ANAHEIM, CALIFORNIA 92803

PHONE: 714-536-6037 • TWX: 714-778-6111

ON READER-SERVICE CARD CIRCLE 80

Self-coiling NEG'ATOR® metal readout scales simplify instrument design

The NEG'ATOR, a flat strip of prestressed spring steel, tends to coil at each end and resists uncoiling *uniformly* over the entire length of the strip.

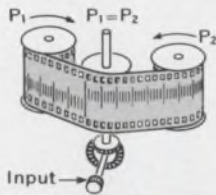

When used as a printed metal readout scale, both ends are curled on bushings of equal size. Since the opposing forces (coils) are always in balance, the span between is held taut.

With its own built-in recoiling energy, the NEG'ATOR replaces large dial scales, long strips or drum scales, *expanding* readability while saving space!

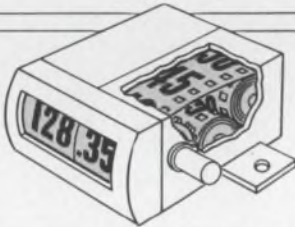

Ask for Bulletin 310T containing full details.



HUNTER SPRING

A DIVISION OF AMETEK, INC.

27 SPRING AVENUE, HATFIELD, PENNSYLVANIA 19440

ON READER-SERVICE CARD CIRCLE 81

Department ED-01
HAYDEN BOOK COMPANY, INC.
 116 W. 14 St., New York, N. Y. 10011

Gentlemen:

I don't need a lengthy sales talk to realize the idea-provoking reference values of almost 90 articles on microelectronics, compiled from **Electronic Design**. All I need is this coupon to order a 30-day approval copy. After 30 days, I'll either pay \$11.50 plus a few cents postage, or return the book. Send my copy of **MICROELECTRONIC DESIGN**, Edited by Howard Bierman, to:



Name _____

Company _____

Address _____

City _____ State _____ Zip _____

Enclosed is a check for \$11.50. You pay the postage. I'll retain the same return guarantee.

COMPONENTS

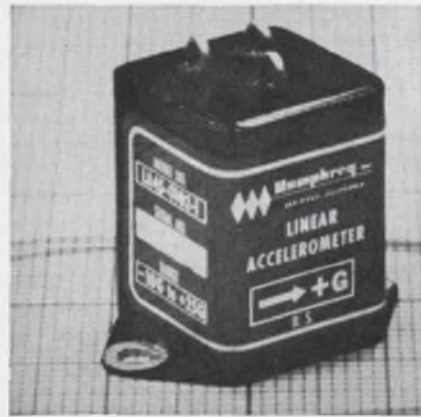

Accelerometer

The LA45 potentiometer-type accelerometer occupies 3/4-in.³ and weighs 1.5 oz. The steel case is hermetically sealed with self-compensating dry-gas damping. A 5000-Ω potentiometer output is provided. The unit is available in full scale ranges from ±2 to ±300 G with accuracies of 1 to 1-1/2%.

Humphrey Inc., 2805 Canon St., San Diego, Calif. Phone: (714) 223-1654.

Circle No. 396

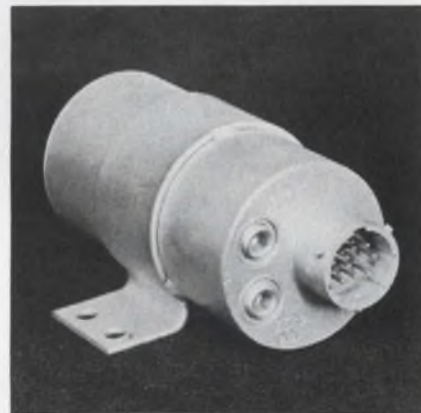

Signal conditioner

Series 10400 signal conditioners meet MIL and NASA specs. They can be used with any standard platinum resistance transducer. With a 24- to 32-V input, they provide an isolated 0 to 5 Vdc over -300 to 2000°F. The 1.5-oz devices are available as NASA or commercially soldered, or NASA welded and are potted and hermetically sealed. Units are available with power consumption of 6-mA and 115-Vac inputs.

P&A: \$100 to \$1000; stock to 4 wks. Temtech, 2202 S. Wright St., Santa Ana, Calif. Phone: (714) 549-2283.

Circle No. 397

\$1 FIELD-EFFECT TRANSISTOR OFFER

The true semiconductor equivalent of a pentode tube ...
... voltage controlled, high input Z, now available at experimenter prices!

How the FET works:

The field-effect transistor may be described as a semiconductor resistor whose channel conductance is controlled by one or more applied voltages. That's how the tube behaves—plate current changing with applied grid voltage. Consequently, there is a close resemblance between the output plate characteristic of a pentode tube and the FET's drain voltage/drain current characteristic. The FET's terminals, labeled gate, drain, and source, are analogous to the tube's grid, plate, and cathode. N-channel FETs require the same voltage polarities as the tube, i.e., positive drain voltage and negative bias on the gate. P-channel FETs, on the other hand, use the opposite voltage polarities. For amplifier design, note the transconductance, g_{fs} , since it controls the gain. Impedance matching can be accomplished with a source follower circuit. Voltage gain is almost unity and $Z_{out} \approx 1/g_{fs}$. The real advantage of the FET is its high input impedance; cascading stages presents no measurable loading on previous stages. Where the bipolar transistor's input emitter-base circuit is a low impedance, forward-biased diode, the FET offers the same design thinking as the tube. Other advantages: No power wasted on heaters, low power consumption, and solid state reliability. The \$1 and \$3 packages described below contain a full discussion of FET operation, how they compare with tubes, and complete data on the devices you order.

6 practical circuits you can build:

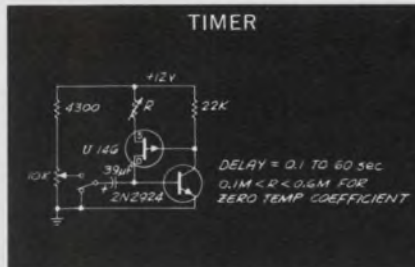

This basic circuit can be used for an enlarger timer, metronome, or other timing device.

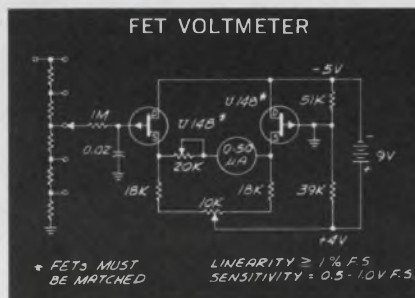

Here is a DC voltmeter with an input impedance that competes with any good VTVM, full scale sensitivity of 0.5 volts max. Add a diode and recalibrate for AC.



The high impedance of a crystal works hand-in-hand with the high-Z FET.

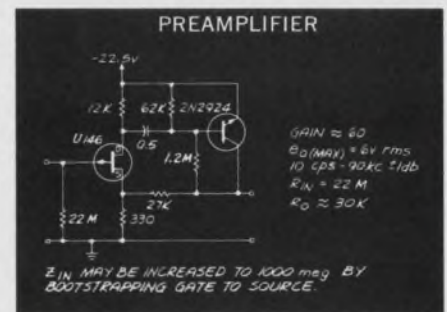

This mike preamp could be built into the mike's case, complete with battery operated by the PTT switch. A FET source-follower stage would provide a low-Z output to long mike lines.

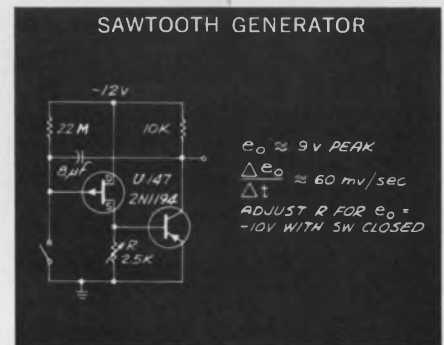
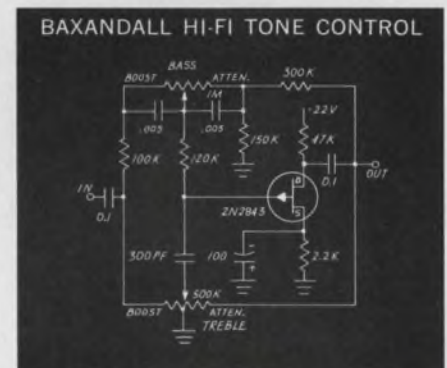

Siliconix assumes no responsibility for circuits shown, nor does it represent or warrant that they do not infringe any patents.

GET TO WORK WITH FETs FOR AS LITTLE AS \$1.00!

Here are the principal parameters (and their tube equivalents) of the two low-priced FETs available from Siliconix.

FET Parameter	I_{oss}	V_g	BV_{GDS}	g_{fs} (Min.)
Tube Equivalent Parameter	Zero Bias Plate Current	Grid Cutoff Voltage	Max. Plate Voltage	Minimum Transconductance
U110	0.1-1.0 ma	1-6 V	20 V	110 μ mho
U112	0.9-9.0 ma	1-6 V	20 V	1000 μ mho

Offer #1—\$1.00 A Siliconix U-110 field-effect transistor, data sheet with complete specification, applications notes, and a detailed discussion of FET operations. \$1.

Offer #2—\$2.00. The U-112 FET, plus all of the circuit and device information noted above. \$2.

Offer #3—Both FETs, plus all data above at a special combination price of just \$2.75.

Clip the coupon and mail today, please send check or money order; no purchase orders, please!

Siliconix Incorporated
1140 W. Evelyn Avenue • Sunnyvale, California 94086
Phone 245-1000 • Area Code 408 • TWX 408-737-9948

To: **SILICONIX INCORPORATED, Dept. E**
1140 W. Evelyn Ave., Sunnyvale, Calif. 94086

Enclosed is: \$1 for U-110 FET and data
 Check or \$2 for U-112 FET and data
 Money Order \$2.75 for both FETs and data

Name _____
 Address _____
 City _____ State _____ Zip _____

Please check one: Engineer Ham
 Hobbyist Serviceman

This is a limited offer, for experimenters only, one order to a customer. Offer closes Sept. 30, 1966. NOTE: California residents add 4c, 8c, or 11c sales tax.

ON READER-SERVICE CARD CIRCLE 82

Versatility and simplicity in variable, regulated power supplies

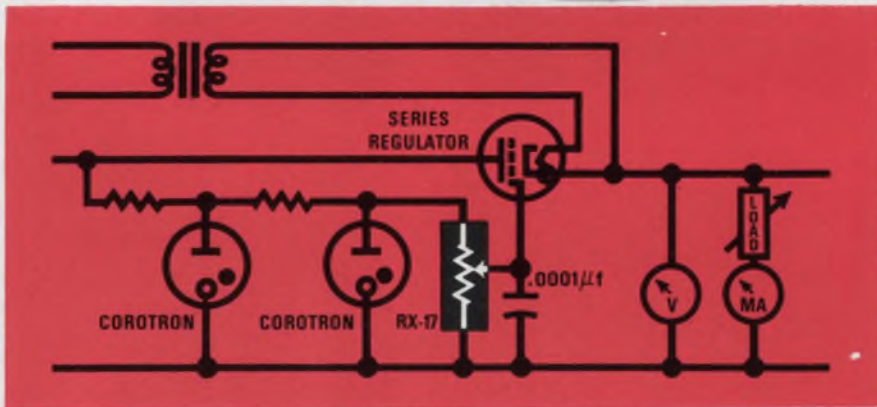
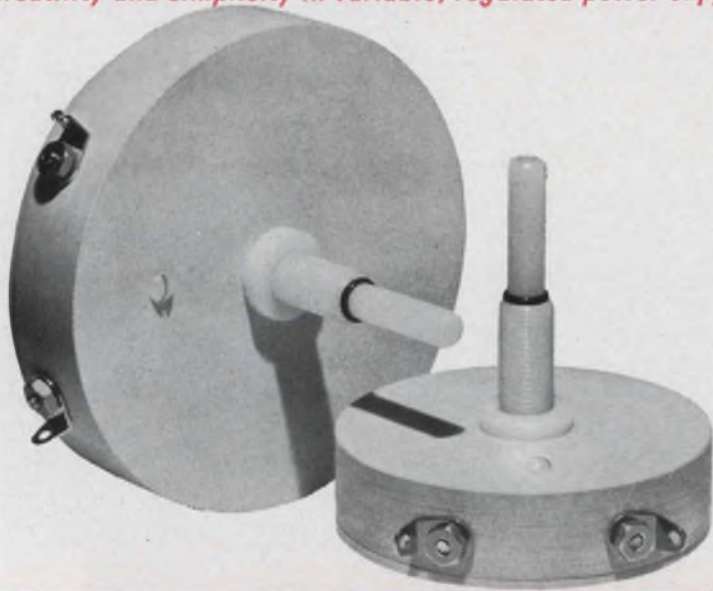

POTENTIOMETERS TO 10 KV

New Victoreen RX-17 series ceramic potentiometers, when used across a well-regulated high-voltage source, provide reference adjustment with a degree of simplicity never before available to circuit designers.

Long life, resistance stability and panel insulation capability to 20 kv make Victoreen RX-17 series potentiometers ideal for reference adjustment for variable, regulated HV supplies in CRT's, TWT's, Klystrons, GM tubes, proportional counters, etc.

Two RX-17 series are available: One for operation to 5 kv rated at 3 w, the other for 10 kv rated at 5 w. RX-17 series ceramic potentiometers are normally supplied with nominal resistance range of 1 Meg to 5000 Meg, with a linearity of $\pm 2\%$. Full technical details on request to Applications Engineering Department.

6976-A

Components Division
THE VICTOREEN INSTRUMENT COMPANY
10101 WOODLAND AVENUE • CLEVELAND, OHIO 44104
EUROPEAN SALES OFFICE GROVE HOUSE LONDON RD. ISLEWORTH MIDDLESEX, ENGLAND



Speed Inquiry to Advertiser via Collect Night Letter
ON READER-SERVICE CARD CIRCLE 83

COMPONENTS



Low pass filter

The FLH-600 flat-construction low pass filter is designed for 400-Hz applications. The filter has a source and load of 10 k Ω . Response is within 1 dB from dc to 450 Hz, 3 dB ± 1 dB at 600 Hz and at least 40 dB above 800 Hz. Case size is 2-in. square by 1/2-in. high and weight is 2.5 ounces. The hermetically sealed case is shielded to reduce hum.

United Transformer Corp., 150 Varick St., New York. Phone: (212) 255-3500.

Circle No. 398

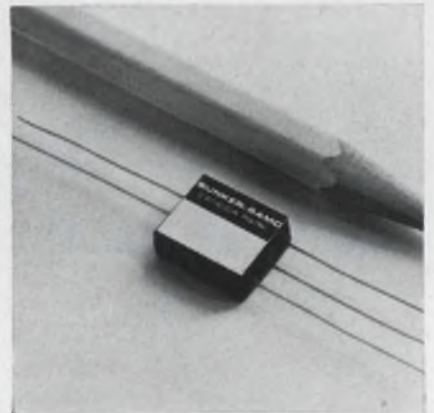

Voltage regulator

Model BR-801 is a 0.04-in.³, 2-gram regulator with an output of 10 to 25 Vdc. The output varies 15 mV with a 10-V input variation. The regulator compares the output voltage to a temperature-compensated zener reference voltage and provides regulating current to a series-regulated transistor at a rate greater than 10 $\mu\text{A}/\text{mV}$ of error. It can provide up to 75 mA of load current with a single power transistor and over 1.5 A with a Darlington pair. Operating temperature range is -55 to $+85^\circ\text{C}$. Input is 40 Vdc.

P&A: \$35.10 (100 to 499). Bunker-Ramo Corp., 8433 Fallbrook Ave., Canoga Park, Calif. Phone: (213) 346-6000.

Circle No. 399

ON READER-SERVICE CARD CIRCLE 227 ➤

BREAKTHROUGH



NJE Power Supply Model SVC-40-10-M

Constant E_{dc}/I_{dc} Automatic Crossover — all silicon

- Output:**
Voltage Range—0-40 Volts DC
Current Range—0-10 AMPS
- Load Regulation:**
Constant Voltage— $\pm 0.01\%$ or 1Mv*
Constant Current—0.5Ma Volt Change in Output
- Ripple:** Less than 1.0 Mv RMS
- Size:** $3\frac{1}{2}$ " H x 19" W x $16\frac{5}{8}$ " D
- 0°—71° C Operating Ambient
 - Less than 20 Microsecond Recovery Time
 - Input—105-125 Vac, 55-65 cps
 - Mode Indicator Lamps
 - Voltage and Current Crossover Point Selectable and Pre-settable
 - Full Range Remote Programming (E and I)
 - Remote Sensing
 - Series or Parallel Operation
 - Electronic Overload Protection
 - Short Circuit Proof
 - Improved Solid State Circuitry
 - Units Supplied with dust cover
 - Unmetered Models Available—Deduct \$20 from Price and Delete Suffix—M
 - Immediate Delivery
 - 5 Year Warranty
- *Whichever is greater

Model SVC-40-10-M is just one of a brand new line of power supplies that provides the utmost in reliability at competitive prices! Products of NJE engineering creativity, specialization and ingenious production methods, the SVC line can be used as voltage and/or current regulators as well. There are 12 SVC models in all (ranging from 0 to 125 volts and from 0 to 30 amps for complete versatility). Eight of these are 19" rack construction models.

Now, for the very first time, NJE is offering four Lab-Rak models in the SVC line! These laboratory bench units are all rack adaptable, if and when you wish to convert. Compact in size (8" x 5" x 14"), they range from 0 to 125 Volts and from 0 to 7.5 amps. For complete specs and prices on our entire line, circle Reader Service Number, or write direct.



Lab-Rak unit



N.J.E. Corporation
Kenilworth, N. J. 07033 / (201) 272-6000
Telefax: FFP • TWX: (201) 276-7630
Electronic Development and Manufacture

\$415

Transformers

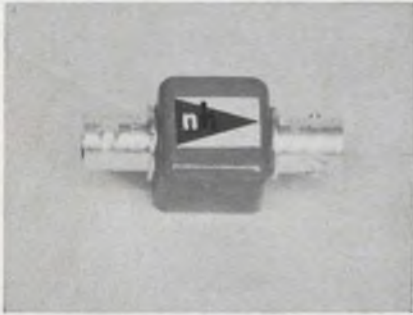

Housed in a sealed metal container, type JA transformer provides a 50- to 75- Ω unbalanced impedance match from 0.1 to 250 MHz for the 3-dB down points. It is rated at 5 W from 1 to 250 MHz.

P&A: \$39.50; stock to 10 days. North Hills Electronics Inc., Alexander Pl., Glen Cove, N. Y. Phone: (516) 671-5700.

Circle No. 501

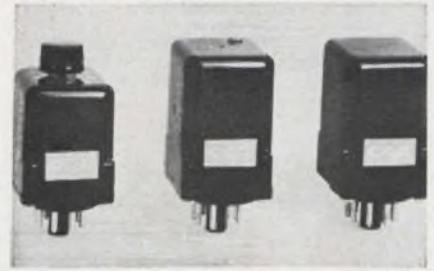

Timers

Models 51, 52 and 53 timers have ranges from 100 ns to 300 s. Reset time is less than 25 ms and repeatability is $\pm 2\%$ from -40 to 85°C . The units are mounted on standard 8- and 11-pin octal plugs, and are available as knob-adjustable, screw-driver-adjustable and fixed-time or remote resistor-adjustable models.

Cornell-Dubilier Electronics, 50 Paris St., Newark, N. J. Phone: (201) 624-7500.

Circle No. 502

Miniature High Q Air Capacitors

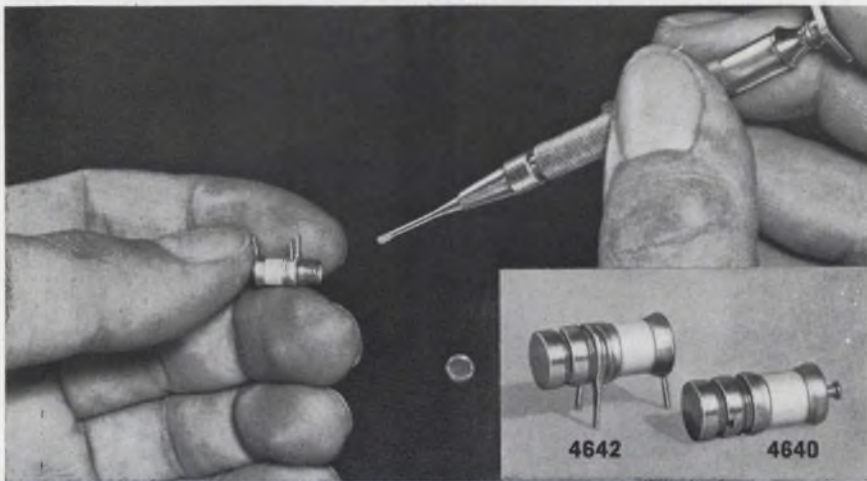

Small Size • High Q • Rugged High Selectivity • High Sensitivity

- **Size:** .220" dia. 15/32" length
- **Q @ 100 mc:** > 5000
- **Capacitance Range:** 0.4 — 6 pf
- **Non-Magnetic**

New miniature series features high quality materials and workmanship typical of all Johanson Variable Air Capacitors.

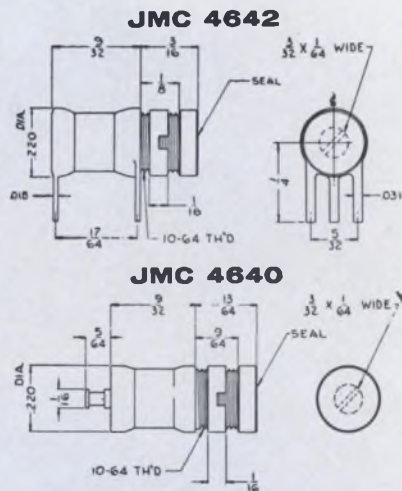

Relay

The 432 series relay is an spdt relay with a contact rating of 10^6 operations at 0.5 A. The unit requires 60 mW of operate power and is available in standard coil resistances to 11 k Ω . The 432 is hermetically sealed and welded in a TO-5 type case and meets MIL-R-5757D. The unit is designed for dry circuit applications.

Teledyne Precision Inc., 3155 W. El Segundo Blvd., Hawthorne, Calif. Phone: (203) 679-2206.

Circle No. 503

Feedback wanted

ELECTRONIC DESIGN would like to know how you rate our New Products section. Does it do the job for you? Does every issue contain at least a sampling of products you use? (We try to cover the field from amplifiers to zeners.) Any suggestions for improvements? Please send along your replies on the handy Editor-gram card at the back of this issue. It's free.

Write or Phone for Details, Prices

MANUFACTURING CORPORATION
400 Rockaway Valley Road, Boonton, N. J. 07005 • Phone (201) DEerfield 4-2676



TRAFFIC JAMS



MICROFOSSILS

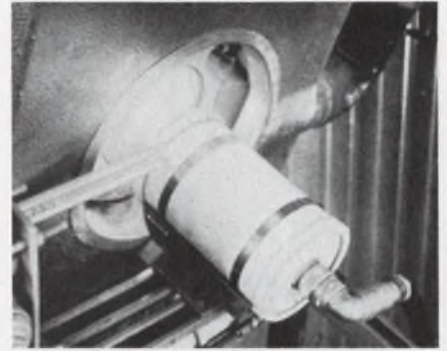

BOILER FLAMES

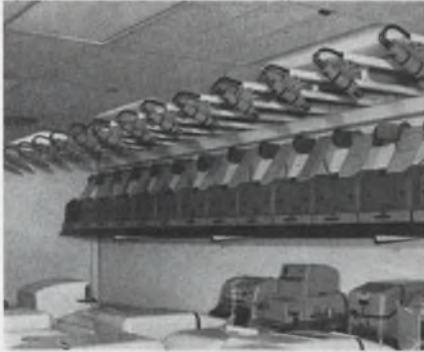

TWX MACHINES



ELECTIONS



COPPER ORE



HOSPITAL PATIENTS



UNDERWATER



GOLF MATCHES

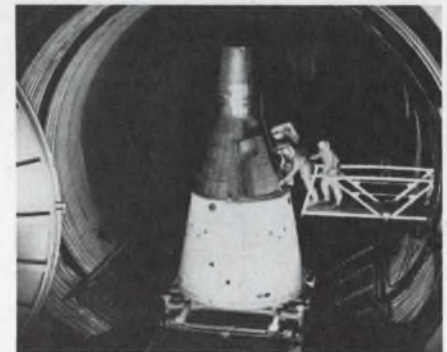

SPACE VEHICLES

COHU TV
sees everything!
 may we look
 for you?

See us at WESCON, Hollywood Park, Booth 111

Engineering Representatives in every major city

ON READER-SERVICE CARD CIRCLE 85

Box 623
San Diego, California 92112
Phone 714-277-6700
TWX 910-335-1244



PUT THE SWITCH WHERE THE ACTION IS!



WITH SWITCHCRAFT PENDANT SWITCHES FOR REMOTE CONTROL VERSATILITY

Now, an all-new, ultra-versatile line of Pendant (Cord) Switches for control, indicating, counter and data entry applications without costly relays or custom engineering. A host of never-before-available features give remote switching the kind of reliable action, long life and broad range of functions you'd expect only from console-mounted

leaf-spring switches. By all odds, the best looking switches of their type—in a broad range of consumer- or industrial-oriented colors. Choose from momentary non-locking action, locking, push-to-lock/ push-to-release, or locking with remote electrical release . . . with standard circuitry arrangements from 1-A to 2-C plus 2-A.



CORDMASTER SERIES

Most versatile line ever created. Top or edge button operation; exclusive remote lighting, standard illuminated, or non-illuminated models. Four different functions (including remote release), with choice of 5 different circuits. Lightweight, styled to fit the hand. Accepts cables up to .270 diameter.



CORDETTE SERIES

Standout styling in a momentary-action remote switch with choice of A, B or C contact arrangements. Any length standard 2- to 4-conductor cable can be permanently molded on; or switch supplied with standard phono jack termination for use with any phono-plug equipped cable.

WRITE FOR BULLETINS E-534, E-537 and 165



SWITCHCRAFT
INC.

5529 Elston Ave., Chicago, Illinois 60630

ON READER-SERVICE CARD CIRCLE 86

COMPONENTS

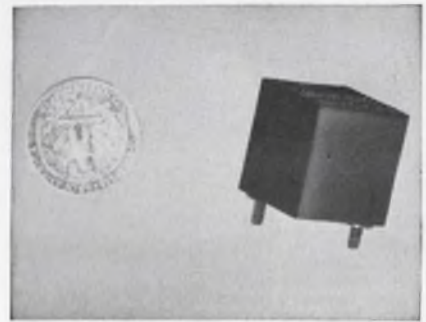

Twin T filter

The 1-in.³ model NW1778 twin T filter network provides a 60-dB attenuation at 1 kHz or at a customer-specified af. Units operate over a temperature range of -55 to +85°C and maintain a frequency stability of better than ±0.1%. At room temperature, attenuation comes to within ±0.05% of the nominal frequency. The epoxy-encapsulated unit meets MIL-E-5272.

P&A: \$60 to \$90; stock to 4 wks. General Resistance Inc., 430 Southern Blvd., Bronx, N. Y. Phone: (212) 292-1500.

Circle No. 504



Operational amplifier

Model 10M1 is a dc differential op-amp in a shielded metal case with pins for PC boards. Output current is ±30 mA and output voltage swing is ±10 V. Minimum dc gain is 100,000 into a 330-Ω load. Gain-bandwidth product is 1.5 MHz and full output frequency is 15 kHz. Differential offset drift is less than 25 μV/°C and 0.5 nA/°C.

P&A: \$90 (1 to 9); stock. Computer Dynamics Inc., 179 Water St., Torrington, Conn. Phone: (203) 482-7621.

Circle No. 505

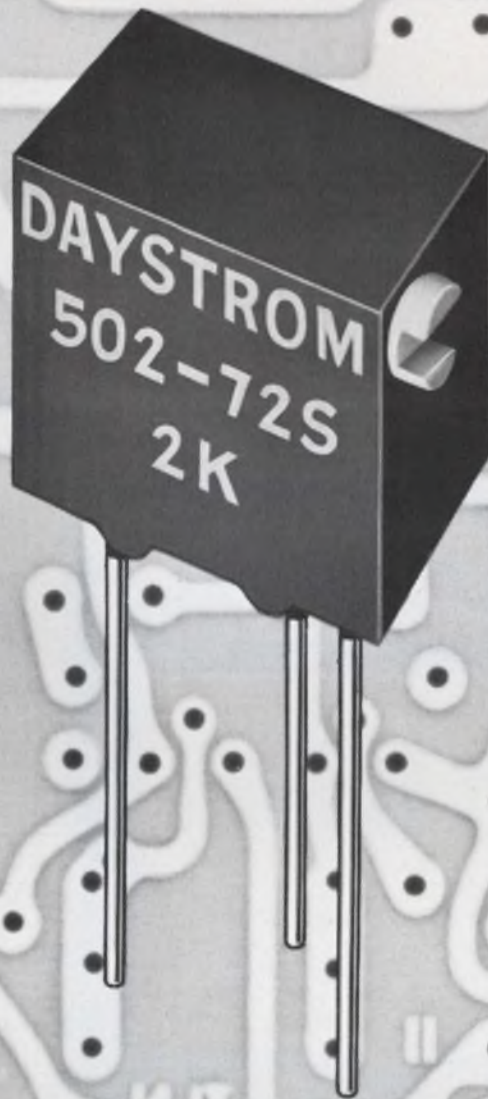

New Chairman of the Board cuts costs, creates openings

Look at the specs and you'll see why so many large users already have turned to the new Weston-Daystrom 501 & 502 5/16" commercial Squaretrim® pots. They save up to 80 per cent of the PC board space formerly required—and no extra cost. Notice the extra dividends:

Convenience 3 different configurations with adjusting screw on top, side or end • **Tolerance** $\pm 5\%$
• **Adjustability** 15 mechanical turns • **Slip Clutch** eliminates wiper damage, cuts production delays
• **Soldered Terminations** for better protection against vibration, shock and humidity—
no pressure taps • **Superior Resolution** 0.125% or less • **Wide Range** 10 Ω to 20K • **High Power**
0.6 watt in still air at 70C • **Wide Temperature Range** -55C to 150C • **Low Temperature**
Coefficient 70 ppm max. • **Low Noise** 100 ohms max. ENR • **Small Size** 5/16" x 5/16" x 3/16"

Weston Instruments, Inc. • Archbald Division • Archbald, Pa. 18403

WESTON® prime source for precision... since 1888

ON READER-SERVICE CARD CIRCLE 231

Polycarbonate capacitors

Thin film metallized polycarbonate capacitors are offered in a 100-V series in wrap and fill, epoxy-cased, radial lead and epoxy cased, axial lead configurations. Dissipation factor does not exceed 0.5%. With capacitances ranging from 0.027 to 8 mF, units rated at 1 mF max are referenced to 1 kHz at 25°C. Capacitors rated at more than

1 mF are referenced to 60 Hz. Dielectric strength terminal-to-terminal is 200% of rated dc voltage maintained for one minute. The units are applicable wherever long-term temperature and capacitance stability are required.

Marshall Industries, 1960 Walker Ave., Monrovia, Calif. Phone: (213) 681-3292.

Circle No. 506

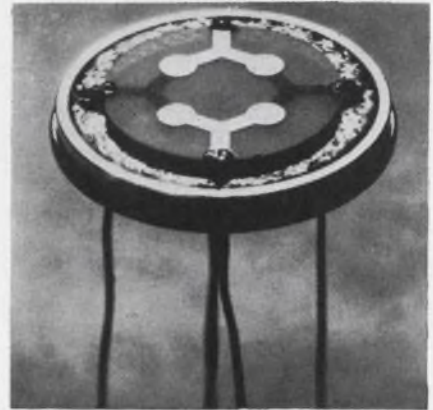

Quartz wafer filters

The "Uni-Wafer" thin film quartz filter is 60% smaller than standard filters. A 4-resonator, 2-section, cascade lattice filter is contained within a wafer 0.55-in. in diameter and 7 mils thick. Present designs range from filters with 2 resonators per lattice section to complex lattice filters with as many as 6 per section. Tuning from 8 to 100 MHz is accomplished by varying electrode thickness.

Clevite Corp., 232 Forbes Rd., Bedford, Ohio. Phone: (216) 232-8600.

Circle No. 507

RFI/EMI FILTERS

FOR COMMUNICATIONS AND DATA LINES

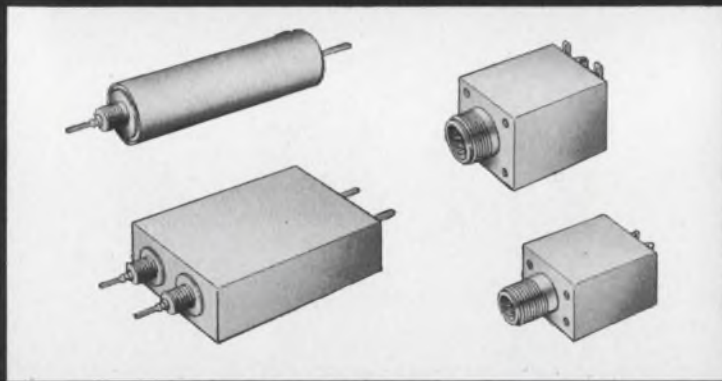

Reliability is the key word in literally thousands of filters currently in use on telephone, teletype, digital and audio transmission lines. ■ Your requirements for custom filter designs as well as standard products, can be met by Potter's extensive engineering capability and high performance criteria.

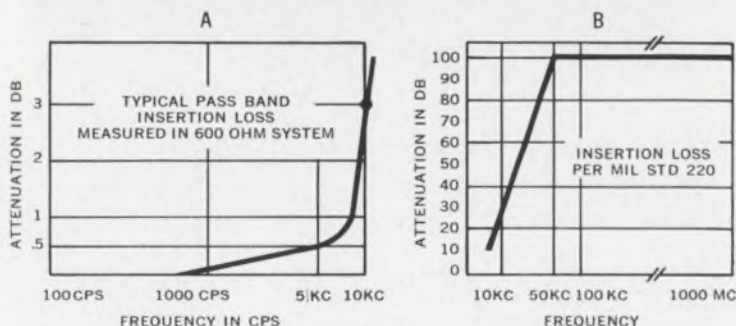

Graphs A and B show typical characteristics of Potter signal line filters. These filters are used on systems which must meet Defense Communications Agency criteria and provide maximum attenuation above the pass band with less than 1/2 db attenuation in the pass band. ■ Write for further information on these and other Potter filters.

THE POTTER COMPANY
Pioneering in Imagination Since 1925
 7351 North Lawndale Avenue ■ Skokie, Illinois
 ON READER-SERVICE CARD CIRCLE 88

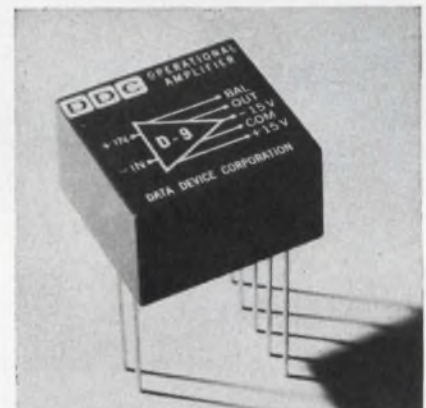
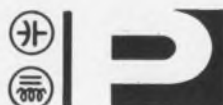

Operational amplifier

The D-9 operational amplifier has a 50 kHz typical frequency for full output (35 kHz min), and a unity gain bandwidth of 10 MHz min. The device has an output of ±10 V at 5 mA. Gain is 86 dB, offset current is 20 nA, voltage drift is 20 μV/°C and noise is 5 μV rms. The op-amp is packaged in a molded epoxy case and operates from ±15 V supplies.

P&A: \$29 (10 to 24); stock. Data Device Corp., 240 Old Country Rd., Hicksville, N. Y. Phone: (516) 433-5330.

Circle No. 508

ECONOMY!

**Versatile,
Value-priced
x-y recorder
...just \$895!**

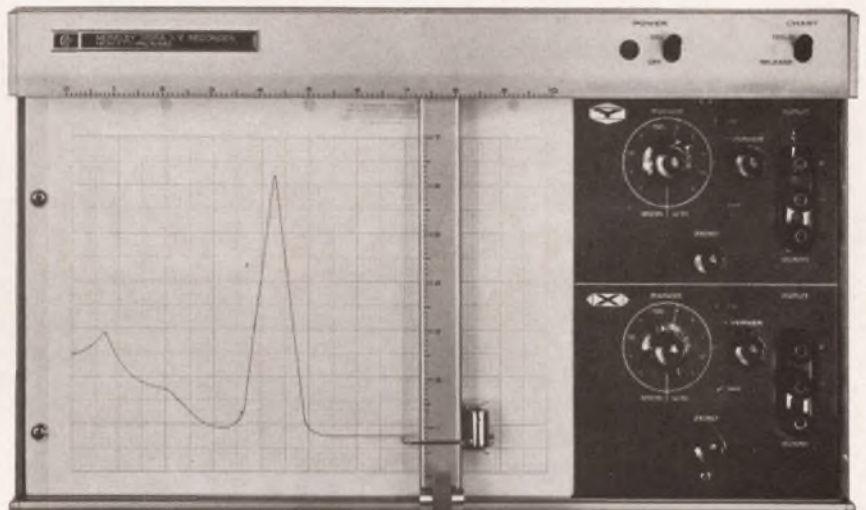

THE MOSELEY 7035A

This is a high-performance, low-cost solid-state recorder for everyday applications not requiring high dynamic performance. Five fixed calibrated ranges 1 mv/inch to 10 v/inch. High input impedance, floating guarded input, 0.2% accuracy at full scale. Adjustable zero set.

Each axis of the 7035A has an independent servo system with no interaction between channels. Maintenance-free AUTOGRIP* electric paper holddown and electric pen lift are standard. Options available include locks for zero and variable range controls, rear input, and retransmitting potentiometer for X axis.

For general-purpose applications, you can't beat the Moseley Division 7035A. Ask your Hewlett-Packard field engineer for a demonstration. Or write for complete specifications to Hewlett-Packard, Palo Alto, California 94304, Tel. (415) 326-7000; Europe: 54 Route des Acacias, Geneva

*Data subject to change without notice.
Price f.o.b. factory.*

**HEWLETT
PACKARD**  **MOSELEY
DIVISION**

An extra measure of quality

*Trade Mark Pat. pend.

ON READER-SERVICE CARD CIRCLE 89

A vacuum relay:

- Carries high rf currents due to large surface area of contacts.
- Smallest size for its power rating.
- Operates faster than other high voltage relays due to small contact separation.
- Will interrupt high dc power.
- Has highest voltage ratings due to vacuum dielectric.
- Has long contact life.
- Low and stable contact resistance from dc through 30 mc.
- Requires no contact maintenance.

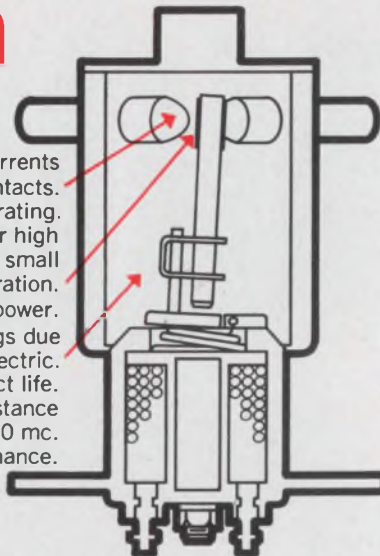

Jennings vacuum relays:

Have the additional benefit of 18 years of constant development effort and manufacturing experience. All Jennings vacuum relays have been field tested and proven successful in countless applications.

consequently:

Jennings vacuum relays are unexcelled for use in high voltage communication systems particularly in aerospace, land, or marine vehicles that cannot tolerate heavy weight and have limited space. Within their size and voltage range they also have no equal for switching dc or pulse forming networks.

Thorough knowledge of the characteristics of vacuum relays is a most useful tool in any electronic engineer's hands. It can easily be obtained by requesting Jennings new vacuum relay catalog No. 103. Jennings Radio Manufacturing Corporation, a subsidiary of International Telephone and Telegraph Corporation, 970 McLaughlin Avenue, San Jose, California 95108.

COMPONENTS



Voltage reference source replaces mV pots

A guaranteed accuracy of $\pm 0.5\%$ of indicated value is featured in this dc reference source. The units cover $10 \mu\text{V}$ to 0.1 V and have an internal power source. A precision mercury cell and 0.25% resistors yield the high accuracy. Temperature range is 0 to 40°C and output resistance ranges from 0.1 to 100Ω . The units are short-protected and thermal emf's are minimized. Measurements may be made by substitution or null-balance techniques.

P&A: \$39.50; stock. Emcee Electronics Inc., P.O. Box 32, New Castle, Del. Phone: (302) 328-1354.

Circle No. 509

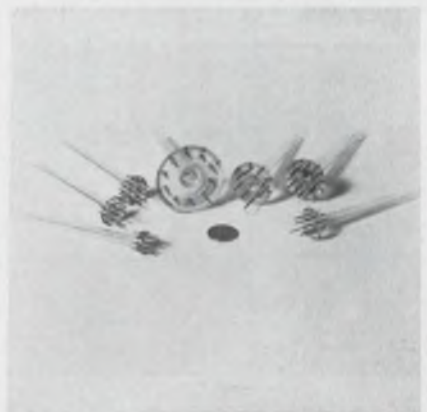







Hard glass headers

Tubulated hard glass headers are fabricated with glasses such as Uranium or Nonex. Pre-beaded versions eliminate glass-to-metal seal problems. All are fully annealed and fire-polished. A variety of sizes and pin configurations are available.

Huggins Laboratories, 999 E. Arques Ave., Sunnyvale, Calif. Phone: (408) 739-9330.

Circle No. 510

						
	RJ1A	RJ2A	RF10	RB7A	RB1E	RB4
Contact Arrangement	SPDT	SPDT	SPDT	DPDT	SPDT	4PDT
Test Voltage (Peak KV)	5	18	20	9	18	17
Operate Voltage (Peak KV) (16 mc)	2	8	10	3	8	10
Continuous Current Amps RMS (16 mc)	7	15	30	4	6	6
Interrupt DC Power (KW)	N/A	1	50	1	1	1
Contact Resistance (Max. ohms)	.010	.012	.012	.020	.012	.010

ITT Jennings

ON READER-SERVICE CARD CIRCLE 121

For the big programs

... only Norden
can supply
advanced
special-purpose
microcircuitry
routinely.



Norden, a qualified supplier to the Minuteman program, is the first manufacturer of integrated circuits to supply dielectrically-isolated units on a routine production basis.

These units are general purpose amplifiers used in the electronic systems of Minuteman missiles by Autonetics Division, North American Aviation. Designed to increase performance and reliability, these unique amplifiers resulted from new manufacturing techniques which isolate active elements on the integrated circuits.

Our leadership in manufacturing is matched by our ability to produce totally new circuitry in a matter of hours—by converting design requirements into hardware with master dice breadboards. Computer-aided design techniques developed by Norden are another guarantee that new circuitry will match your exact needs for advanced equipment.

For details, write Dept. E, Norden Division, United Aircraft Corp., Norwalk, Conn. 06856, or call (203) 838-4471.

Because of its growing role in the microcircuitry field, Norden has many openings for qualified solid state engineers. Send your resume to Personnel Department, Norden, an equal opportunity employer, M&F.

Norden
NORWALK, CONNECTICUT

U
DIVISION OF UNITED AIRCRAFT CORPORATION
A

Norden — supplier to the Minuteman
• Polaris • Apollo • Saturn • LEM • F-111
• C-5A • IHAS • B-58

examples of
MTE IF developments



from thick film



to hybrid



to IF strip

MTE Linear Transponder IF Strip
 $f_0 = 35$ MHz BW = 2.5 MHz
 3.8 dB system noise figure
 88 dB dynamic range
 65 ns delay stability
 fast charge, slow discharge AGC
 -20°C to $+70^\circ\text{C}$ operating temperature

**MTE IF-2 Universal
IF Amplifier Microcircuit**

A linear IF amplifier stage featuring:
 Wide frequency range and outstanding
 high-frequency stability due to:
 • Highly effective integral decoupling
 and package shielding.
 • Cascode configuration for extremely
 low internal feedback.
 Provision for AGC from full gain to
 insertion loss.
 Temperature stability from -55°C
 to $+85^\circ\text{C}$.

MTE also supplies IF preamplifiers •
 wide band RF amplifiers • AGC and
 video amplifiers for all your IF system
 needs. For further information on
 these and other products in the lead-
 ing line of linear high frequency mi-
 crocircuits, contact MTE Marketing.

MTE

MICROTEK ELECTRONICS INC.
 138 Alewife Brook Parkway
 Cambridge, Mass. Phone (617) 491-4330
 ON READER-SERVICE CARD CIRCLE 123

COMPONENTS

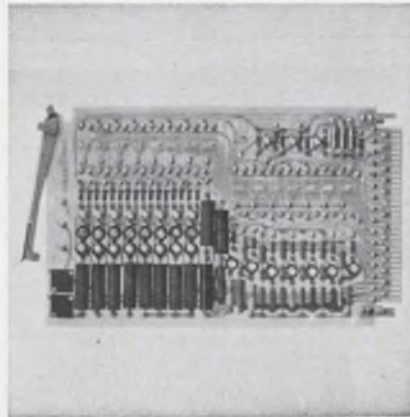

**Hybrid multiplier
for D/A systems**

In systems using digital and analog signals, these multiplying digital-to-analog converters (DAC) accept both inputs, multiply the analog value by the digital, and output the product in analog form. The hybrid multiplying elements eliminate much conversion and reversion by multiplying ambilogically. Multiplying DAC's at the front end of a data acquisition system allows scaling and "quick-look" before A/D data conversion. The elements in the "Y" series are available with 12- or 15-bit resolution, buffered or double-buffered and with outputs to ± 100 V.

Price: from \$930. Adage Inc., 1079 Commonwealth Ave., Boston. Phone: (617) 783-1100.

Circle No. 511



RFI connectors

Stainless steel miniature connectors utilize an RFI shielding component. Within the basic hardware is a stainless steel cone which grounds the braided wire strands to the cable housing to provide conductivity. 360° ground continuity provides minimum leakage and maximum noise suppression in the lf and RF ranges.

Pyle-National Co., 1334 N. Kostner Ave., Chicago. Phone: (312) 342-6300.

Circle No. 512



Accelerometer

Series 500 accelerometers employ a piezoelectric ceramic bimorph bender as the sensing element. Designed for medium frequency applications to 3000 Hz, the disk-like units can be connected directly to a scope or VTVM. A 6-ft cable, 10-ft roll of adhesive transfer tape for mounting, calibration chart and case are included.

P&A: \$75; stock to 2 wks. Metrix Instrument Co., 8200 Westglen, Houston. Phone: (713) 782-3144.

Circle No. 513

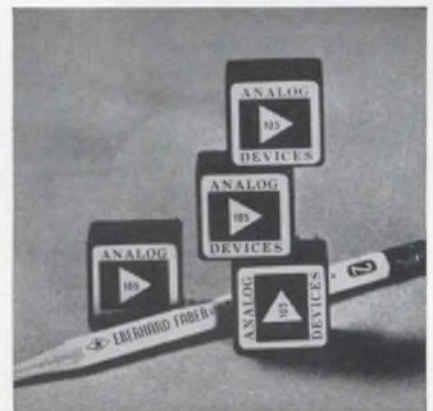

Operational amplifier

With a $20\text{-}\mu\text{V}/^\circ\text{C}$ voltage drift and a $1.5\text{-nA}/^\circ\text{C}$ current drift at each input, this low-cost dc differential op amp operates over -25 to 85°C . Offset current is 150 nA and coupling is $20\ \mu\text{V}$ and 2 nA max for each percent change in supply voltage. Model 105 has an open loop gain of 30,000, input impedance of $50\ \text{M}\Omega$ common-mode and $150\ \text{k}\Omega$ differential. Input noise is $4\ \mu\text{V}$ rms from dc to 10 kHz. Output is ± 10 V at ± 22 mA.

Price: \$14 (over 1000). Analog Devices Inc., 221 Fifth St., Cambridge, Mass. Phone: (617) 491-1650.

Circle No. 514



Relay shipments rescheduled again? Next time call Leach!

One week delivery. That's a promise. At least on standard units. Even our new **SERIES K** for example. Here's a 10 amp 4PDT polarized relay offering maximum capabilities for the most severe aircraft, missile and aerospace applications. And we have built up an inventory to cover your requirements.

The **SERIES K** holds size and weight to an absolute minimum without sacrificing operating characteristics. It will withstand 100g shock, 30g, 70 to 3000 cps vibration, meets Mil-R-6106E and has a temperature

range of -70° to $+125^{\circ}\text{C}$. Operate and release time is less than 15 milliseconds including bounce. Yet it measures only 1.000" x 1.015" x 1.015" and weighs less than 2.5 ounces. Need one? A dozen, a hundred? Even a thousand? Then call us today. You'll have them. Right on time.

Leach Corporation, Relay Division, 5915 Avalon Boulevard, Los Angeles, California 90003
Phone (Area code 213) 232-8221
Export: LEACH INTERNATIONAL S.A.

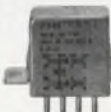

LEACH



three kinds of recording oscillographs?



Choice of three — Portable 444, Ruggedized 414 or 1000-speed 447

The Model 444 precision, 6 channel, wide-band recording oscillograph features big performance in a small package. Superior optics and a low-heat tungsten light source means less DC power, less cost, less weight. • The Model 414 is designed to perform under adverse conditions of humidity, shock, vibration and acceleration; provides 14 channels of data in a small, light-weight package. • The Model 447's highly precise electronic drive permits selection of any 12 of a possible 1000 speeds (.1"/sec to 100"/sec). The 447 also features Automatic Record Length based on time and Continuously Variable Remote Speed Control. (These three are just part of the line — our Model 409 is a standard in the industry for airborne recording, for example.) • Write to us indicating your areas of interest. We will send you complete specifications.

CENTURY
ELECTRONICS & INSTRUMENTS

Subsidiary of Century Geophysical Corp.
6540 E. Apache St., Tulsa, Oklahoma 74118

ON READER-SERVICE CARD CIRCLE 125
180

SYSTEMS

Photoelectric relay senses frequencies

A modulated-light photoelectric relay unit is unaffected by all forms of ambient or artificial light other than that emanating from the correct source. The system has a transistorized oscillator which controls a projector lamp so that its output oscillates at a set frequency. The receiver, which has a 1-MHz response time, detects the oscillation and the amplifier's tuned circuit operates the relay. If the beam is interrupted or if the frequency is changed, the relay provides a warning or performs a control function. The equipment operates at up to 100 ft using a light beam or up to 1000 ft with an IR beam. The plug-in covered relay has 2 sets of change-over contacts rated at 5 A, 25 Vac resistive.

Price: \$112 (100-ft light), \$140 (100-ft IR), \$168 (500-ft IR), \$196 (1000-ft IR). Photain Controls Ltd., Randalls Rd., Leatherhead, Surrey, England.

Circle No. 515



Transient recorder

Single transient events or intervals of continuous analog data are accepted by this recorder/reproducer. Input signals of sub-milliseconds to minutes are sampled and stored. Model 848 reproduces 256 sequential data points in time. 1024 or 40-96 additional points may be added. Reproduce mode is non-destructive, so that the stored signal may be regenerated continuously as a repetitive waveform.

P&A: \$2880; 30 days. Evans Associates, P.O. Box 5055, Berkeley, Calif. Phone: (415) 653-2616.

Circle No. 516

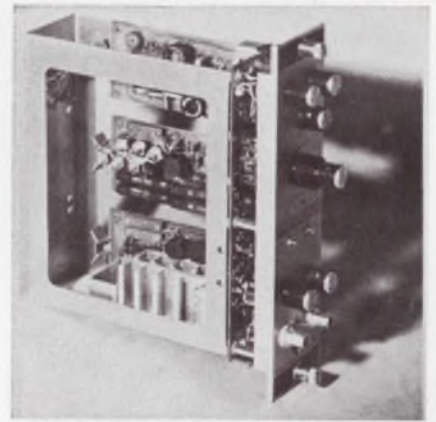

Current drivers

An improvement in overload protection is offered by these positive (type 2603) or negative (2503) current drivers. Outputs are 0.1 to 1.6 A and can be equalized with front-panel trimmers. They remain equal despite variations up to 15% in main amplitude control.

Overload protection uses a current limiting source to drive the output transistors. Limits selected prevent the transistors from over-dissipating.

Digital Equipment Corp., 146 Main St., Maynard, Mass. Phone: (617) 897-8821.

Circle No. 517



Recorders

A family of console graphic recorders with 4 to 10 crossover channels has a 10-in. span on all channels. Each channel may be operated fully floating or with grounded input. The potentiometric servo balance system is all silicon solid-state. The units have 6-speed pushbutton chart drive and are zero settable anywhere on full scale.

P&A: \$2750 to \$7150; stock to 60 days. Argonaut Associates, P.O. Box 273, Beaverton, Ore. Phone: (503) 292-3149.

Circle No. 518

Let SOLA custom-build your "tough spec" power supplies...

- HI-VOLTAGE TRANSISTORIZED POWER SUPPLIES
- LOW-VOLTAGE TRANSISTORIZED POWER SUPPLIES
- HI-VOLTAGE FERRORESONANT POWER SUPPLIES
- CVDC POWER SUPPLIES
- INVERTERS - CONVERTERS

No specs are too tough for SOLA design engineers. Proof? SOLA has custom-designed power supplies for the most sophisticated applications. Electron probe microanalysis equipment, nucleonic liquid gages for supersonic aircraft, precipitators, CRT devices, for instance.

The SOLA power supply used in liquid gages, for example, contains 120 parts, four etched circuit boards, yet measures only 1.86" in diameter, and .9" high. What's more, it provides regulation of $\pm 0.25\%$ for all conditions of line, load, and temperature. It operates in a temperature range of -55°C to 72°C , at thirty times the pull of gravity.

This is one of the many "tough spec" custom power supplies SOLA has engineered over the years. Whatever your requirements might be . . . extreme temperatures, tight regulation, low ripple, compactness, stability . . . remember, SOLA can custom-build your power supplies in OEM quantities. And at a price that's realistic.

Try us. We haven't been stumped yet. Send us your specifications, or a description of the end result required.

Write Sola Electric, Division of Sola Basic Industries, 1717 Busse Road, Elk Grove Village, Illinois 60007. Or call (312) 439-2800.

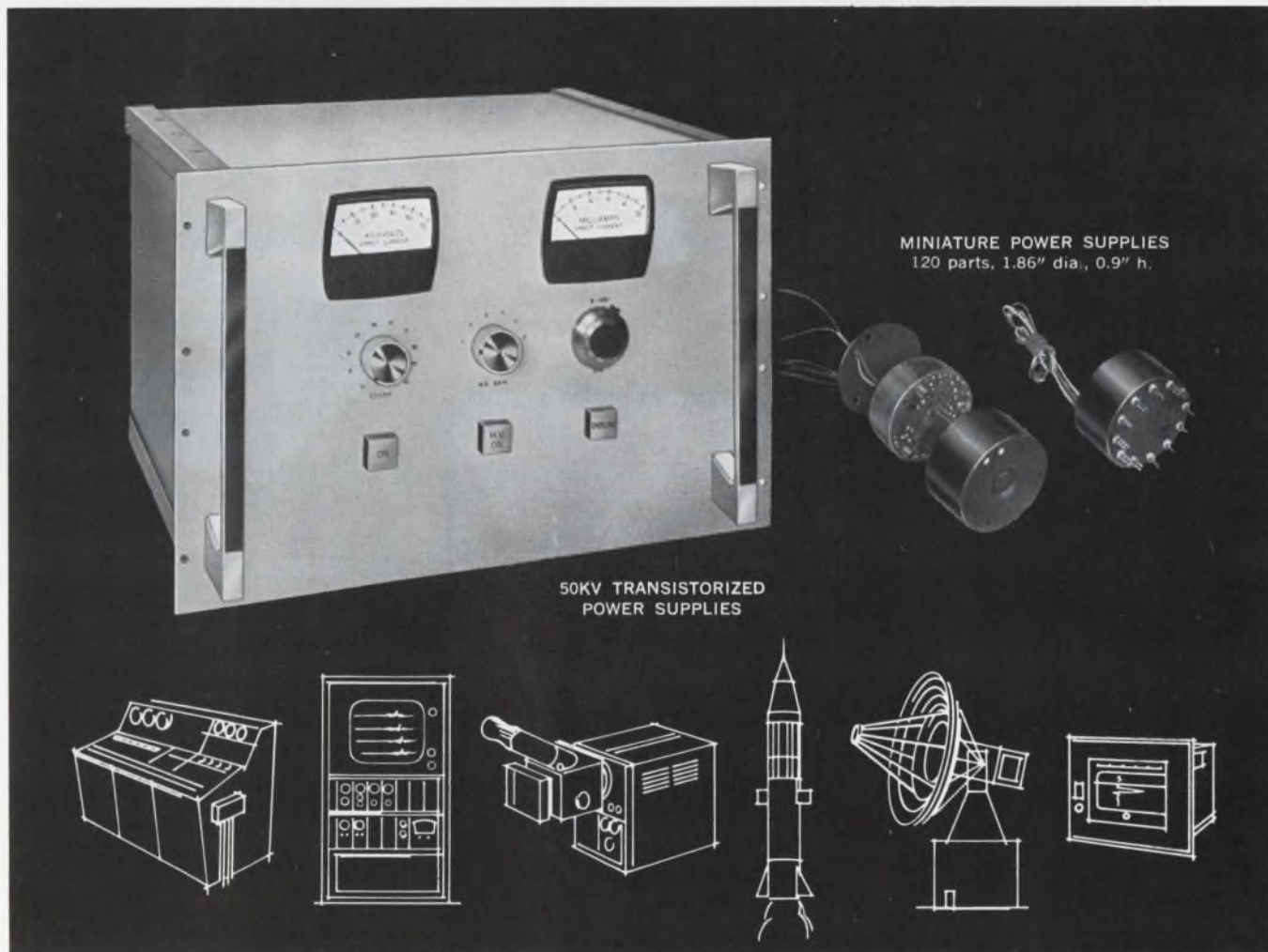

MINIATURE POWER SUPPLIES
120 parts, 1.86" dia., 0.9" h.

50KV TRANSISTORIZED
POWER SUPPLIES

SOLA ELECTRIC **SB**
DIVISION OF SOLA BASIC INDUSTRIES

Speed Inquiry to Advertiser via Collect Night Letter
ON READER-SERVICE CARD CIRCLE 126

THIS IS NO GIMMICK...

and it's not etched!

The increased acceptance and use of aci Signaflo Systems is partially a result of this unique aci advancement, "Spread-Pitch", for interconnection adaptability and versatility.

It is another reason for aci's leadership and ability to solve interconnection problems.

... new
connective
dimensions



DIVISION OF KENT CORPORATION
206 Industrial Center, Princeton, N. J. 08540

at
NEPCON
BOOTH
214-216

aci has developed a manufacturing technique, "Spread-Pitch", which can change the pitch dimension of conductors wherever required.

Thus, narrow pitch dimension cable can be used on aci Signaflo Systems and yet match hardware contact with various dimensions for interconnection simplicity without loss of any inherent characteristics, such as flexibility, strength, low total cost, weight and space savings.

INFINITELY VARIABLE

.075 to .150

.075 to .100

.025 to .100

.050 to .125

SYSTEMS

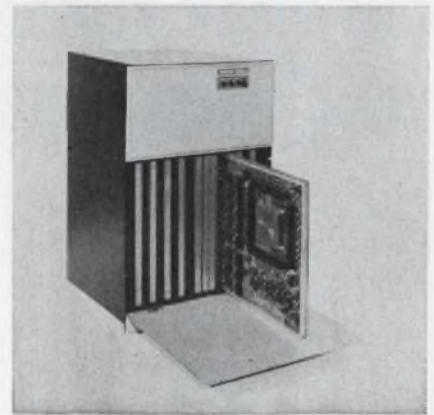

Core memories

Models RF-1, -2 and -3 expandable core memories offer a word access time of 600 ns. The family has 512 to 16,384 words in 4- to 36-bit lengths for a 2048 to 588,824-bit total capacity. PC board assemblies, ICs and silicon semiconductors are used. Full-cycle timing is 1.8 μ s and half cycle is 1 μ s. Input power required is 300 W + 10 W/bit.

Price: \$2600 to \$42,000. Ampex Corp., 401 Broadway, Redwood City, Calif. Phone: (415) 367-2011.

Circle No. 519



Sampling recorder

A 2-channel sampling recorder has a sampling rate of 3 kHz/channel. Type 1520-A recorder has a bank of 101 fixed styli which produce plots on electrosensitive paper. Paper speed can be set up to 10 ips. Vertical rise times as short as 300 μ s can be determined from the chart. Calibrated voltage ranges are 1 to 500 V (linear) and 20 and 50 dB (log) full-scale. The recorder prints its own coordinates as well as voltage and time scales. Over-all accuracy is $\pm 1\%$.

Price: \$2950. General Radio Co., West Concord, Mass. Phone: (617) 369-4400.

Circle No. 520

ON READER-SERVICE CARD CIRCLE 127



FM discriminator

A tunable FM discriminator provides $\pm 1\%$ center frequency accuracy and 0.1% linearity. Model 4140 accommodates all telemetry subcarriers from 100 Hz to 1.5 MHz. A rotary switch selects the deviation ratio: ± 7.5 , 15, 30 or 40%. Output filter cut-off frequency is switch-selectable, the 3-dB point being adjustable from 1 Hz to 300 KHz. Roll-off characteristics available are 42, 36 or 18 dB/octave.

Electro-Mechanical Research Inc.,
P. O. Box 3041, Sarasota, Fla.
Phone: (813) 955-8153.

Circle No. 521

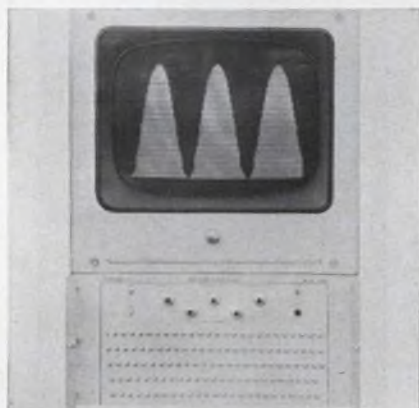

Display system

Model 650 display system simultaneously displays changing information from up to 128 data channels in bar-graph form on a 17-in. CRT. The system can hold data on as many as 256 channels in an internal core memory. Data channels which would normally require 128 separate meters are displayed on a single scope with the relative magnitude of each channel instantly visible. Calibration circuits automatically generate calibration markers at intervals of 25% full-scale. A front panel switch permits checking the calibration values stored in memory against an internal standard.

Telemetrics, 2830 S. Fairview St., Santa Ana, Calif. Phone: (714) 546-4500.

Circle No. 522

S.M.A.C.

Simultaneous Mass Attachment of Components means HIGH DENSITY Hybrid Film Microcircuits

Mepco's advanced production concepts include the application of unique add-on components to high density circuit substrates, thus permitting maximum utilization of all available space in the production of film type microcircuits. This HIGH DENSITY is saving space for you.



If your programs call for custom-designed film hybrid microcircuits, in high volume, at lower costs, and with faster delivery dates than you thought possible, then be sure to call Mepco . . . Ask about S.M.A.C. Find out how this new breakthrough in mass-producing film hybrid microcircuits can benefit your production plans.



MANUFACTURERS OF **PRECISION
ELECTRONIC DEVICES**

MEPCO, INC.

COLUMBIA ROAD, MORRISTOWN, NEW JERSEY
07960 (201) 539-2000

ON READER-SERVICE CARD CIRCLE 128

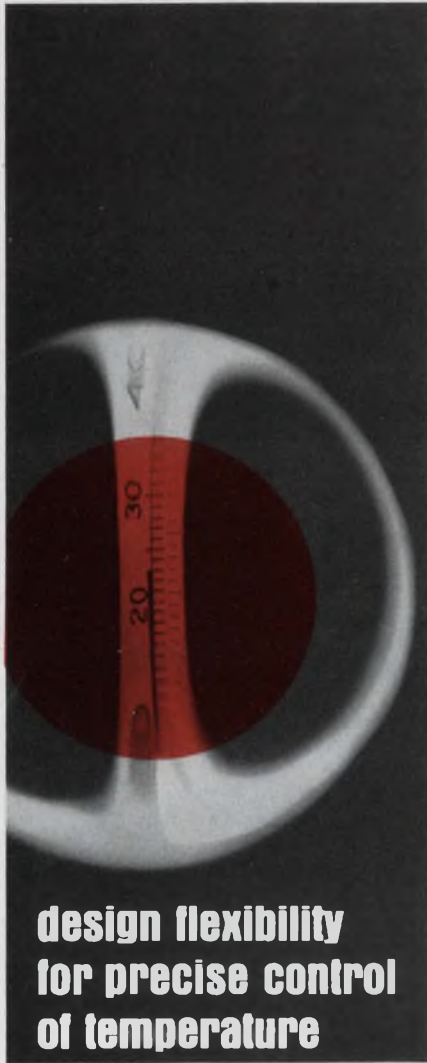

design flexibility for precise control of temperature

Whatever your temperature control requirements...AC or DC, aerospace or industry... some combination of our family of components will solve it. UCC systems provide any of the following features to match your needs:

- On/off Control
- Proportional Control
- Adjustable Differential
- Power Ramp Warmup
- Exact Set-point Control
- Set-point Stability
- Fail/safe Performance
- Solid State Control

"Control" is our middle name. Call or write for details on UCC capability.



UNITED CONTROL CORP. / REDMOND, WN. 98052
PHONE: (206) 885-3711 TWX: (206) 999-1874

ON READER-SERVICE CARD CIRCLE 129

SYSTEMS

Drum synchronization

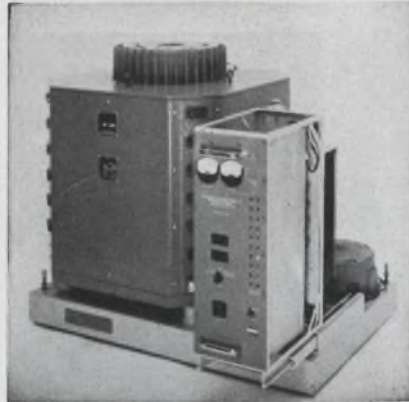

Model DS12 synchronization system provides speed/phase and indexing control of a magnetic storage drum. An unlimited number of drums may be synchronized with a time displacement error between drums of less than 200 ns. The system couples drums using an external reference frequency which becomes the clock frequency for the computer or display system.

Sequential Electronic Systems Inc., 66 Saw Mill River Rd., Elmsford, N. Y. Phone: (914) 592-8810.

Circle No. 523

2-channel recorder

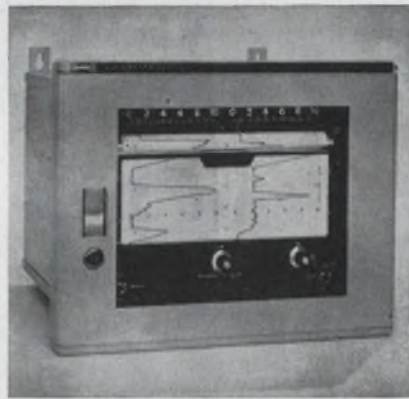

A two-channel wide chart servo recorder has 1/8-s full scale response in each of the side-by-side 4-1/2-in. channels. Source impedance is 100 k Ω and off-balance input impedance is 50 k Ω . Any calibrated span from 1 to 100 mV full scale can be measured without changing range cards or internal connections. Zero is continuously adjustable from 0 to ± 100 mV.

Esterline Angus Instrument Co. Inc., P.O. Box 24000, Indianapolis. Phone: (317) 244-7611.

Circle No. 524

Tracking receivers

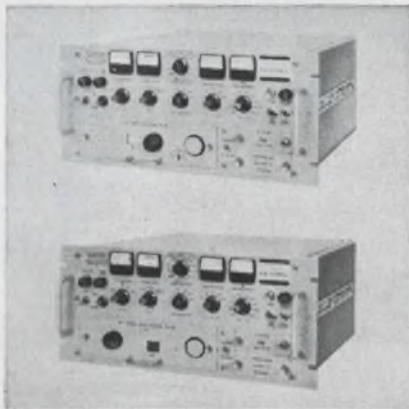

Telemetry and tracking receivers (AM, FM or PM) cover all standard IRIG and NASA frequencies from 105 to 2300 MHz. There are 4 phase-lock modes of operation. Plug-in IF filter units from 2 kHz through 3.3 MHz are available. Phase-lock loop bandwidths down to 10 Hz are standard. The receivers have been used at signal levels below -140 dBm.

Resdel Engineering Corp., 990 S. Fair Oaks, Pasadena, Calif. Phone: (213) 682-3751.

Circle No. 525

Surveillance system



An automated spectrum surveillance system covers 20 Hz to 1 GHz. The system consists of the manufacturer's interference analyzers, programmer, X-Y plotter and rack-mount scope. Model FSS-250 enables programming of any portion of the range and plotting of the spectrum profile. Each of the 16 bands of the system may be analyzed.

Price: about \$25,000. Fairchild Camera and Instrument Corp., 88 Church St., Amsterdam, N. Y., Phone: (518) 843-2600.

Circle No. 526

An Eight-Second Review.

- 8** CDE makes timers and time delay relays.
- 7** With rugged solid state circuitry.
- 6** repeatability of $\pm 2\%$.
- 5** 25 millisecond reset time, maximum.
- 4** 200 millisecond to 300 second range.
- 3** high volumetric efficiency.
- 2** design flexibility and
- 1** long, dependable life built right in.
- 0** standard stock ratings available.

If you like the subject, do some research with the CDE field engineer or authorized distributor in your area. He will gladly discuss your application requirements at no obligation.

CDE **CORNELL-DUBILIER**

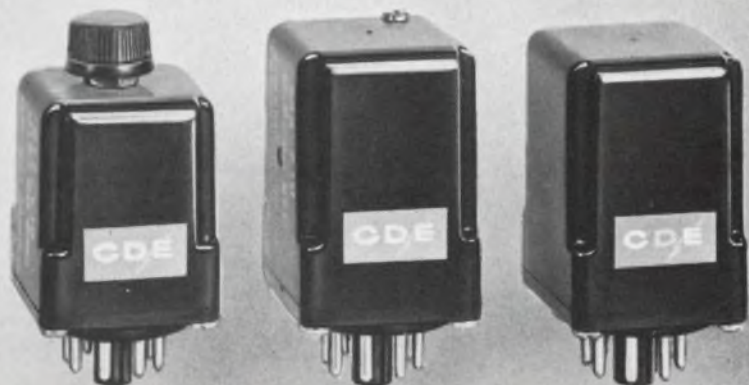

"BLUE CHIP" TRANSFORMERS NOW AVAILABLE IN CASE SIZE #7

IN STOCK—is the latest addition to the versatile family of Blue Chip transformers for printed circuit applications. This still smaller size; (Height .340 inch maximum, volume .060 cubic inches), transformer offers design engineers more flexibility for electrical and mechanical transistor circuit applications. The size #7 Blue Chip transformers provide a response of ± 2 db from 300 to 100,000 Hz in a number of impedance ranges and are designed to meet Mil-T-27B, Grade 5, Class S. Write for your copy of complete electrical and mechanical specifications.

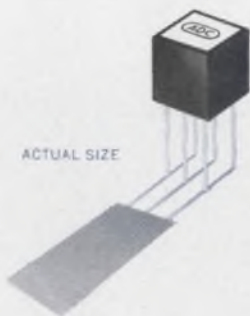

ACTUAL SIZE

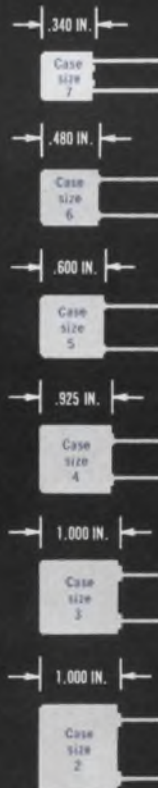

ADC

ADC PRODUCTS

6405 Cambridge Street • Minneapolis, Minnesota 55426

ON READER-SERVICE CARD CIRCLE 131

SYSTEMS

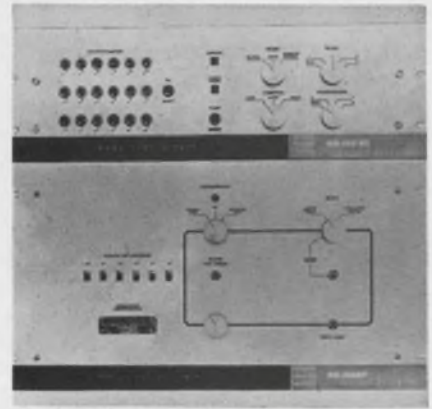

On-line storage system

A buffer tape/read search system in conjunction with the manufacturer's 4096-channel multiparameter analyzer combines the data acquisition rate of a magnetic core memory with the storage capacity of magnetic tape. In addition to providing memory-buffered on-line storage of related-address data, the ND-160BT/RS system enables rapid tape readout of arithmetic data in the memory.

Nuclear Data Inc., P.O. Box 451, Palatine, Ill. Phone: (312) 529-4600.

Circle No. 527

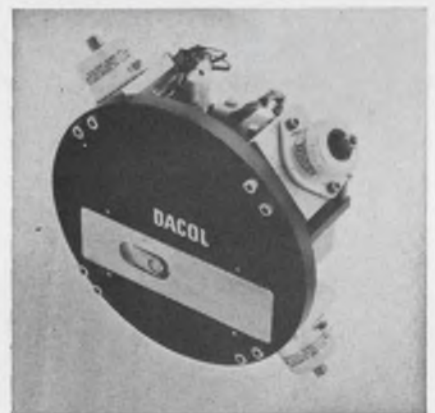

Digital recorder

Model R34 digital magnetic tape recorder records up to 250,000 characters at 130/s on a 1/2-in., 7-track cartridge. It uses 6 bits for data and 1 for parity or synchronism. The recorder requires ± 6 V at 200 mA. Input logic levels are 0 to 0.5 V for "0" and 4 to 6 V for "1." MTBF is 2000 hours with 1-ppm max bit loss through the write/read sequence.

Price: \$1850. Hersey-Sparling Meter Co., 210 W. 131 St., Los Angeles. Phone: (213) 321-6283.

Circle No. 528

HELIPOT CUTS THE SIZE OF ITS 10-TURN POT



but there's not a spec of difference

It's true . . . Helipot *actually* cut the length of its $\frac{7}{8}$ " diameter 10-turn in half. No hocus pocus. The new Model 7266 is $\frac{3}{4}$ " long . . . the shortest 10-turn $\frac{7}{8}$ " diameter precision potentiometer you can buy. Yet its precision performance is unscathed, and the wirewound resistance element is actually *longer* than that of its predecessor. It is a *precision* pot in every respect. Resolution is better, the total resistance range is still 10 ohms to 125K, with $\pm 0.2\%$ linearity as good as ever.

How much was the price raised? Not a penny — it's priced at \$10 for 1—9 pieces and well below \$8 in quantity. (And you get two for the size of one.) Complete product information is available now from your local Helipot sales office.

Beckman

INSTRUMENTS, INC.

HELIPOT DIVISION

FULLERTON, CALIFORNIA • 92634

INTERNATIONAL SUBSIDIARIES: GENEVA; MUNICH;
GLENROTHES, SCOTLAND; TOKYO; PARIS; CAPE TOWN; LONDON

Speed Inquiry to Advertiser via Collect Night Letter
ON READER-SERVICE CARD CIRCLE 132



Waveguide isolators

Low bilateral vswr and length reductions up to 25% are featured in a series of full bandwidth waveguide isolators. Typical is the model covering 5.85 to 8.2 GHz. Isolation is 30 dB min, insertion loss is 1.0 dB max, bilateral vswr is 1.1 max and length is 5 in. Minimum front-to-back ratios of 30 are maintained over each band. Twelve models cover 3.95 to 18 GHz.

E&M Laboratories, 7419 Greenbush Avenue, North Hollywood, Calif. Phone: (213) 875-1484.

Circle No. 529



Cutoff attenuator

A variable cutoff attenuator, type 198-S19, has 150 dB of variable energy decay in the 2 to 4 GHz band. Variation in dB is essentially a linear function of shaft angle except at low attenuation. The unit has an insertion loss of 17 dB, a cutoff frequency of 13.83 GHz, type N connectors, a rack and pinion drive and an attenuation resetability exceeding 1 dB.

PRD Electronics Inc., 1200 Prospect Ave., Westbury, N. Y. Phone: (516) 334-7810.

Circle No. 530

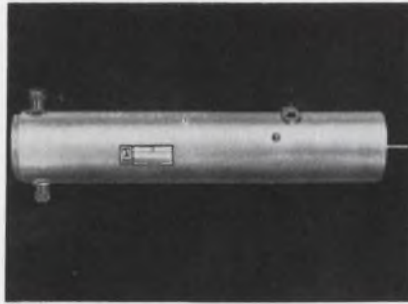

L-band oscillator

A new stable local oscillator is designed for use in L-band radar equipment. Model LC1501 has a residual FM of less than 10 Hz peak. It has non-contacting tuning plungers on ball bearings, 2 TNC output connectors and a single tuning shaft. Tuning range is from 0.97 to 1.7 GHz.

RFD Inc., 1501 W. Cass St., Tampa, Fla. Phone: (813) 253-0637.

Circle No. 531

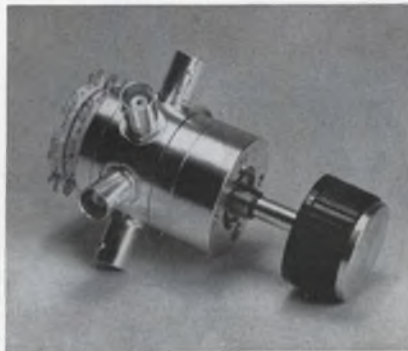

Coax switch

A dpdt RF coaxial switch, model SW-20, covers dc to 2 GHz. Characteristic impedance is 50 Ω , and insertion loss is 0.05 dB at 1 GHz and 0.1 dB at 2 GHz. Vswr is less than 1.1 and isolation exceeds 80 dB at 1GHz.

P&A: \$55; stock. Texscan Corp., 51 S. Koweba Lane, Indianapolis, Ind. Phone: (317) 632-7352.

Circle No. 532

Feedback wanted

ELECTRONIC DESIGN would like to know how you rate our New Products section. Does it do the job for you? Does every issue contain at least a sampling of products you use? (We try to cover the field from amplifiers to zeners.) Any suggestions for improvements? Please send along your replies on the handy Editorgram card at the back of this issue. It's free.



Mixer/preamp

A line of miniature mixer/preamplifiers is designed for radar, communications and ECM use. The mixers incorporate replaceable diodes and are mounted to the cast aluminum housing of the preamp. Standard models are available in frequencies from 0.25 to 12 GHz. Gain is 20 to 25 dB and typical noise figure is 10 dB. Dimensions are 2.55 x 1.95 x 0.88-in. Post amplifiers are available on special order.

RS Electronics Corp., 795 Kifer Rd., Sunnyvale, Calif. Phone: (408) 739-3230.

Circle No. 533



Oscillators

A series of high-power oscillators are electronically or manually tunable over any 200 MHz range between 2.8 and 4.2 GHz. Nominal input power required is -28 Vdc at 150 mA. Power output is 50 mW min.

Three ranges are available: 3.0 to 3.2 GHz, 3.5 to 3.7 GHz and 4.0 to 4.2 GHz.

Trak Microwave Corp., 4726 Kennedy, Tampa, Fla. Phone: (813) 877-8341.

Circle No. 534

Semiconductor Report



NEW PRODUCTS, DESIGNS AND APPLICATIONS FROM MOTOROLA

REMEMBER FOUR NEW LOW-COST PNP/NPN TRANSISTORS ...AND YOU CAN FORGET 35 OTHER TYPES!

Here are four, new low-cost UNIBLOC* plastic transistors that offer such broad performance versatility and complete specifications that you can use them to replace some 35 other current types.

For general purpose switching and amplifier service covering all commercial/industrial applications in the 10 to 100 mA range and from audio to 100 MHz frequency range, these four Motorola types, the NPN 2N4123 and 2N4124 and the PNP 2N4125 and 2N4126, cover practically *all* your application requirements!

THESE — 2N4123, 2N4124, 2N4125 and 2N4126 replace all these —

2N2711	2N3393	2N3845A
2N2712	2N3394	2N3854
2N2713	2N3395	2N3854A
2N2714	2N3396	2N3855
2N2715	2N3397	2N3855A
2N2716	2N3398	2N3856
2N2921	2N3721	2N3856A
2N2923	2N3843	2N3858
2N2924	2N3843A	2N3859
2N2926	2N3844	2N3860
2N3390	2N3844A	2N3900
2N3392	2N3845	2N3901

And, think how this simplifies your transistor selection and inventory control problems, too!

Here are the kind of specs you get with these new performers:

	2N4123/5	2N4124/6
High BV_{CE0}	30 V	25 V
h_{FE} selected to 2 ranges	50-150	120-360
Low saturation voltages — $V_{CE(sat)}$	< 0.3 V	< 0.4 V
Low C_{ob}	4 pF max	4 pF max
In any quantity, the prices are right for economy:		
	1-99	100-999
2N4123 & 5	\$.52	\$.35
2N4124 & 6	.60	.40

As with all Motorola plastic transistors, you get the added assurance of rugged Unibloc transistor construction — the solid, single-piece, pressure-molded package that offers unusual physical strength for internal leads and connections, plus improved heat transfer characteristics.

One other point, they have Motorola's patented "annular" device structure which assures you maximum reliability and stability.

Your local Motorola district office or franchised distributor have units available for immediate evaluation. For complete technical details, write: Technical Information Center, Motorola Semiconductor Products Inc., Box 955, Phoenix, Arizona 85001.

ON READER-SERVICE CARD CIRCLE 108 HIGH SPEED LOW-COST NPN LOGIC SWITCHES CHARACTERIZED ON "DESIGNERS" DATA SHEET

A pair of new low-cost NPN plastic Unibloc transistors have been characterized with limit curves which are directly applicable to "worst case" saturated switching circuit designs — giving sufficient information to permit the design engineer, in most cases, to design entirely *from the data sheet alone!*

The devices (types 2N4264 & 65) are specified in a Motorola Designers Data Sheet* at both 10 mA and 100 mA levels and feature a very low storage time of 20 nsec. Although they offer the economy of plastic devices (prices range from \$.40 to \$.45 in 100 quantities), the units

The Rugged "UNIBLOC" Package

- ① "Unibloc" package eliminates use of separate preformed header and poured cap
- ② "D" shape lays flat for easy PC board mounting
- ③ In-line leads easily adaptable to TO-18 or TO-5 lead pin circle
- ④ 1/2-inch, gold-plating nickel leads permit reliable solder connections

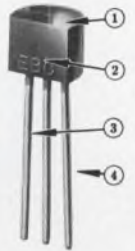

offer performance matching that of other higher-priced units. For example:

	2N4264	2N4265
BV_{CE0} (@ 1 mA)	15 V	12 V
h_{FE} min (@ 10 mA)	40	100
f_T min (@ 10 mA)	300 MHz	300 MHz
Output Capacitance	4 pF	4 pF
Input Capacitance	8 pF	8 pF
Turn-On (@ 10 mA)	25 nsec	25 nsec
Turn-Off (@ 10 mA)	35 nsec	35 nsec

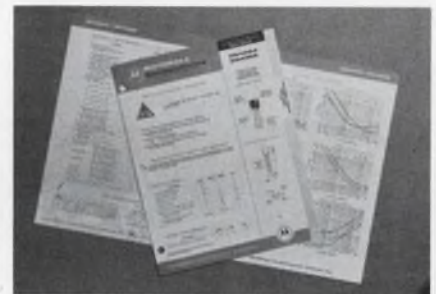

DESIGNERS DATA SHEET SHOWS "WORST-CASE" LIMIT CURVES

In addition, the rugged, high-pressure, single-piece molded-plastic encapsulation of Unibloc devices provides a uniform, dense and solid package, free of voids (and leaks). Also, they feature Motorola's exclusive "annular" device structure for optimum reliability.

For more information on these high-performance, fully-specified, low-cost devices, circle the reader service number below.

*Trademark of Motorola Inc.

ON READER-SERVICE CARD CIRCLE 109



MOTOROLA Semiconductors
- where the priceless ingredient is care!

Speed Inquiry to Advertiser via Collect Night Letter

Can you get high-speed complementary transistor design in IC's —without compromise?

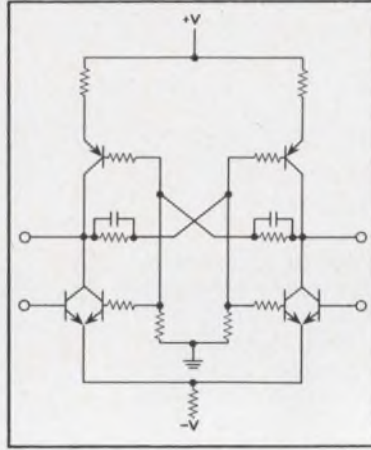
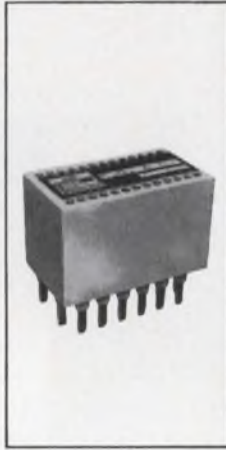

Look at Philco's hybrids.

Suppose you want your circuit design to take full advantage of complementary transistor techniques — with low standby power requirements, high speed, the ability to drive high currents and high capacitive reactance loads. Yet you'd like the advantages of integrated circuitry, too — miniaturization, reliability and cost reduction.

This is where our hybrid microcircuits can help. The CTL flip-flop microcircuit shown above, for example, has a stage propagation delay of less than 5 nsec at 100 ma. It is easily fabricated at minimum cost by hybrid techniques — requiring no compromises in achieving simultaneous NPN and PNP action.

In addition, our hybrid techniques permit the simple construction of complementary linear IC's, RF/IF amplifiers with center frequencies in excess of 100 MHz, and FET input operational amplifiers. Of course, the same advantages of high power capability and moderate cost still apply.

The examples above indicate only one or two problem areas that yield to the hybrid approach. High power and voltage requirements can also be easily met in hybrid IC's. A call to your local representative or to Philco's Marketing Department, Spring City, Pa. (215-948-8400), will bring you further information — and an invitation to submit discrete circuit plans for a quick quote on hybridization costs!

SOLID-STATE PRODUCTS OPERATION

PHILCO

A SUBSIDIARY OF *Ford Motor Company*
 LANSDALE DIVISION · SPRING CITY, PA.
 In Canada, Don Mills Road, Don Mills, Ontario, Canada

Speed Inquiry to Advertiser via Collect Night Letter
 ON READER-SERVICE CARD CIRCLE 133

MICROWAVES

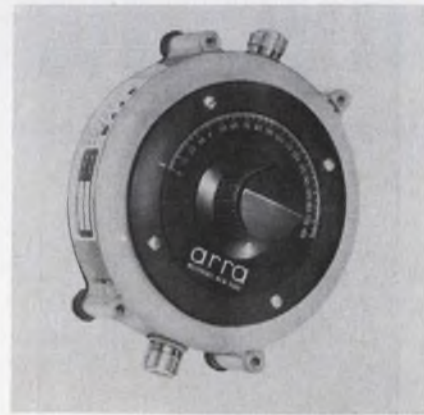

Variable attenuator

Model 3704-10B is a continuously variable coax attenuator which will withstand up to 100 W average and 10,000 W peak. Frequency range is 1350 to 1450 MHz and attenuation range is 0 to 10 dB min. Insertion loss is 0.6 dB max and vswr is 1.5 max. Attenuation vs frequency is flat to within ± 0.25 dB. The 5-in. diameter unit uses type N female connectors.

P&A: about \$500; stock to 8 wks. Arra Inc., 27 Bond St., Westbury, N. Y. Phone: (516) 334-8770.

Circle No. 535

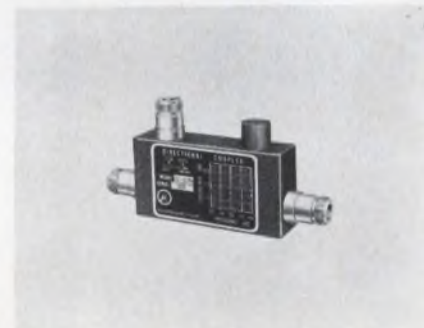

Flat coax coupler

Highly directional and physically compact coax couplers are designed to provide maximally flat coupling over full octave frequency ranges. Frequency variation is 0.2 dB/octave and directivity is 25 dB min.

The completely potted unit measures 4 x 5.6 in. The 3-terminal devices are available with 10-, 20- and 30-dB coupling values. All are calibrated at five frequencies.

P&A: \$180 and \$190; stock to 6 wks. Microlab/FXR, Livingston, N. J. Phone: (201) 992-7700.

Circle No. 536

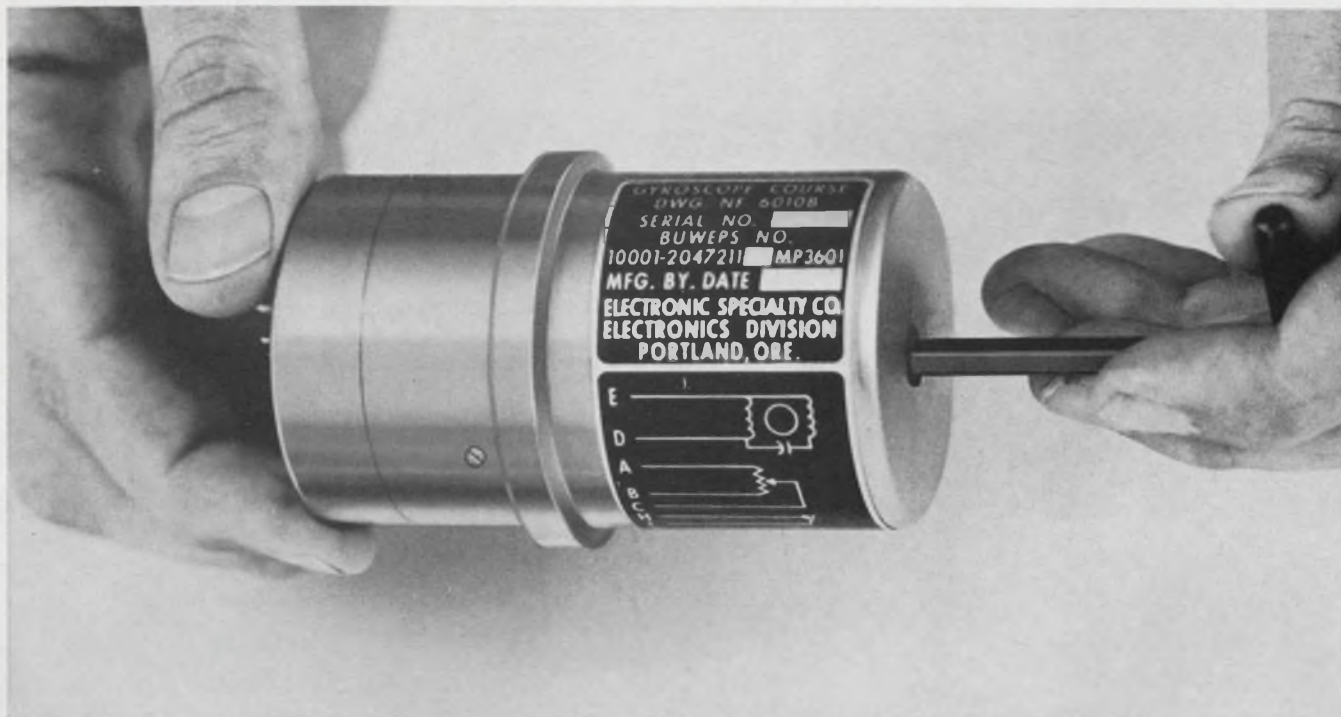

Our gyros are tops

This one can be rewound and rearmed without removing its cover

We build all our gyroscopes to be *tops* in quality and reliability. Important developments in vertical, free and directional gyros for drone, missile and aircraft applications are continually being developed by Electronic Specialty Co. in Portland, Oregon.

One of our newest gyros is the stored energy type NF 6010B, designed and produced by ES for a classified torpedo program. Used to provide a course reference, it was designed with emphasis on reliability and minimum size.

This state-of-the-art gyro has a unique rewinding feature: the gyro can be rewound and rearmed without removing the cover. This is accomplished by rotating the cover a quarter turn to expose the winding mechanism, then winding about twelve turns with a standard Allen wrench. The cover is then returned to its original position. When the process is completed a switch closes; this can be used in system readout to provide a "wound and caged" indication. This "permanent" cover further insures reliability because the mechanism

remains cleaner and is not subject to inadvertent change in adjustment.

Energy is supplied from a spring motor to bring the gyro up to running speed in less than 60 milliseconds. The gyro rotor is maintained at running speed by an A.C. induction type sustaining motor.

The unit has free gyro drift of 1 degree per minute maximum. It operates with 360° of freedom on both inner and outer gimbals, and provides potentiometer pick-off from the outer gimbal. Pick-off on both gimbals can also be provided. The gyro weighs 1.5 pounds and is approximately 2.5 inches in diameter and 3.5 inches long.

If you visit the Northwest, you are invited to inspect our new, ultra-clean modern facility in Portland, Oregon. It has the finest equipment available for the design and production of gyros and relays. For a complete description of our Portland capabilities and detailed information and specifications of the NF 6010B write for a data sheet.



ELECTRONIC SPECIALTY CO./ELECTRONICS DIVISION—Portland/18900 N.E. Sandy Blvd., Portland, Ore. (Formerly Iron Fireman Mfg. Co.)

Los Angeles, Calif./Anniston, Ala./Ft. Madison, Ia./Harrisonburg, Va./Hurst, Tex./Pomona, Calif./Portland, Ore./Thomaston, Conn./Toronto, Ont.

Speed Inquiry to Advertiser via Collect Night Letter

ON READER-SERVICE CARD CIRCLE 181

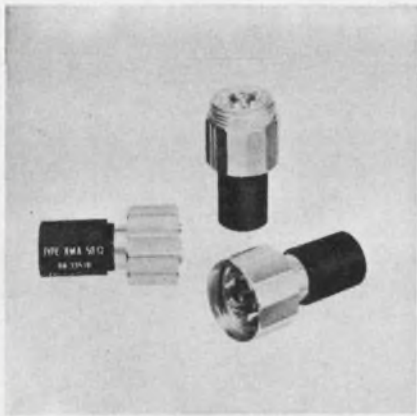

7 mm termination

Type RMA terminations are used from dc to 18 GHz as coax standards and terminations for 4-terminal measurements in 7 mm systems. Vswr is 1.0 to 1.01 up to 12 GHz and 1.05 at 18 GHz. The inner conductor is partly a deposited-carbon resistor and is spring-loaded at the end in the outer conductor. The unit does not use a coaxial support or a spring cap.

P&A: \$115; stock to 30 days. Rohde & Schwarz, 111 Lexington Ave., Passaic, N. J. Phone: (201) 773-8010.

Circle No. 537



TR-switch

The MA-3801 TR-switch covers 32.9 to 36.0 GHz and operates at peak power of 10 kW max. It combines a gas TR tube and a solid-state switch. Maximum insertion loss is 1.5 dB, spike leakage is 0.02 ergs/pulse and flat leakage is 40 mW. Recovery time is 2 μ s. It is designed for use in the receive channel of ferrite duplexer circuits.

Microwave Associates Inc., Burlington, Mass. Phone: (617) 272-3000.

Circle No. 538

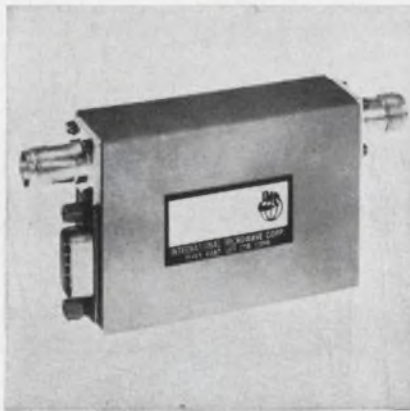

Transistor amplifier

Up to ± 12 V at 20 mA can be handled by this lightweight transistor amplifier. Center frequency is 1.3 GHz, bandwidth is 300 MHz and noise figure is 4.0 dB max. Input signal 1-dB compression level equals -25 dBm. Gain is 15 dB and input-output impedance is 50 Ω . Connectors are standard coaxial.

International Microwave Corp., River Rd., Cos Cob, Conn. Phone: (203) 661-6277.

Circle No. 539



Sweep oscillator

A compact sweeper, model 5000, has self-contained power supplies for operating any of 4 plug-in oscillators covering a range of 0.25 to 2.4 GHz. A calibrated frequency vernier, direct phase lock connection and a narrow spectrum free of spurious responses are featured. Internal PIN leveling is provided using an external RF detector. The instrument employs semiconductor oscillator circuits.

P&A: \$1490, \$1250 to 1590 (plug-ins); stock to 60 days. Kruse-Storke Electronics, 790 Hemmeter Lane, Mountain View, Calif. Phone: (415) 967-2299.

Circle No. 540

Coax terminations

Series LP-1 coaxial terminations operate from dc to 1.3 GHz with vswr less than 1.05 and to 4 GHz with vswr less than 1.15. Power dissipation is 1 W. Series MP-1 operates from dc to 1.3 GHz with vswr less than 1.1 and to 2 GHz with vswr less than 1.2. Power dissipation is 25 W. Both have 50 Ω impedance and male or female type N connectors.

P&A: \$12 (LP-1), \$25 (MP-1); stock. Radiation Devices Co., P.O. Box 8450, Baltimore, Md.

Circle No. 541



Klystrons

Seven communications klystrons covering 3.7 to 8.4 GHz comprise series A. The klystrons deliver 1.5 W min and 2.0 W typically at 750 V beam. Repeller modulation sensitivity is 0.3 MHz/V min and typically 0.4 MHz/V. Tuning is 40 MHz at 3 dB.

Raytheon Co., Willow St., Waltham, Mass. Phone: (617) 899-8400.

Circle No. 542

RF coaxial connectors

Radio frequency coaxial connectors for edge feed from strip circuitry operate from dc to 18 GHz. In 50- Ω circuits, typical vswr is 1.25. Model MOE-1 mates with male OSM connectors. It is intended for use with lines of 1/8-in. dielectric with 1/16-in. metal backing top and bottom.

P&A: \$5 (1 to 4); stock. Varian Associates, Akron St., Copiague, N. Y. Phone: (516) 264-2200.

Circle No. 543



WHAT'S NEW IN Constant Voltage Power Supplies?

...NEW LOW PRICES



MODEL PV-36 VOLTS - 15 AMPS

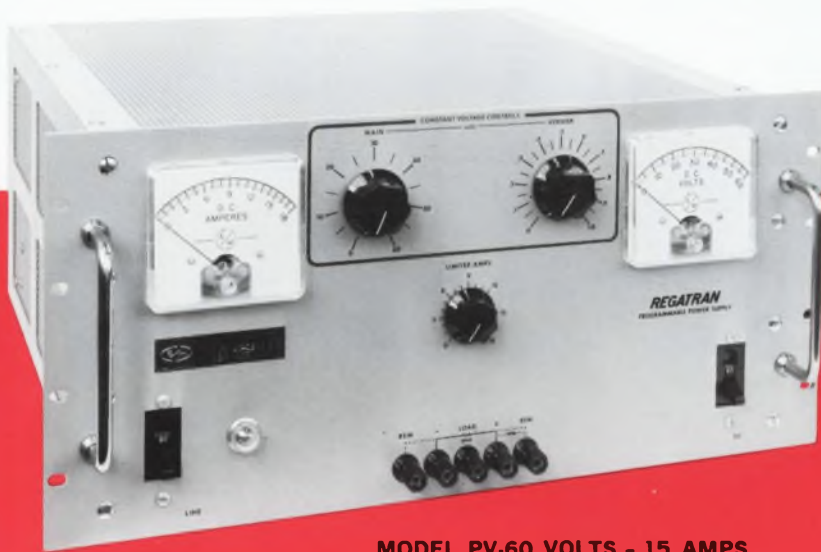

MODEL PV-60 VOLTS - 15 AMPS

- CONSTANT VOLTAGE
- AUTOMATIC E/I CROSSOVER
- SOLID-STATE, SCR INPUT
- REMOTE SENSING
- PROGRAMMABLE
- MHOGRAMMABLE[®]

UP TO 28% PRICE REDUCTIONS

The same high quality for which Electronic Measurements' Constant Voltage Power Supplies have been noted, is now available at NEW, LOW prices. Merger of the Electronic Measurements Company and The Rowan Controller Company has increased purchasing power, expanded productivity and integrated high quality components. The savings are being passed along despite today's trend of rising prices. Same high quality — lower price!!



THE ROWAN CONTROLLER COMPANY • ELECTRONIC MEASUREMENTS

OCEANPORT, N. J. 07757



DIV.



WHAT'S NEW IN Half-Rack Power Supplies? ...NEW LOW PRICES

- CONSTANT VOLTAGE
- AUTOMATIC E/I CROSSOVER
- ALL SOLID STATE
- PROGRAMMABLE
- COMPACT HALF-RACK DESIGN
- PORTABLE MODEL AVAILABLE

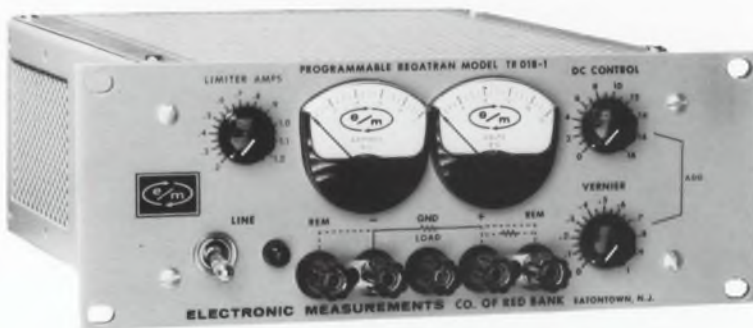

MODEL TR018-1M



MODEL TR018-1MT

UP TO 28% PRICE REDUCTIONS

The same high quality for which Electronic Measurements' Half-Rack Power Supplies have been noted, is now available at NEW, LOW prices. Merger of the Electronic Measurements Company and The Rowan Controller Company has increased purchasing power, expanded productivity and integrated high quality components. The savings are being passed along despite today's trend of rising prices. Same high quality — lower price!!

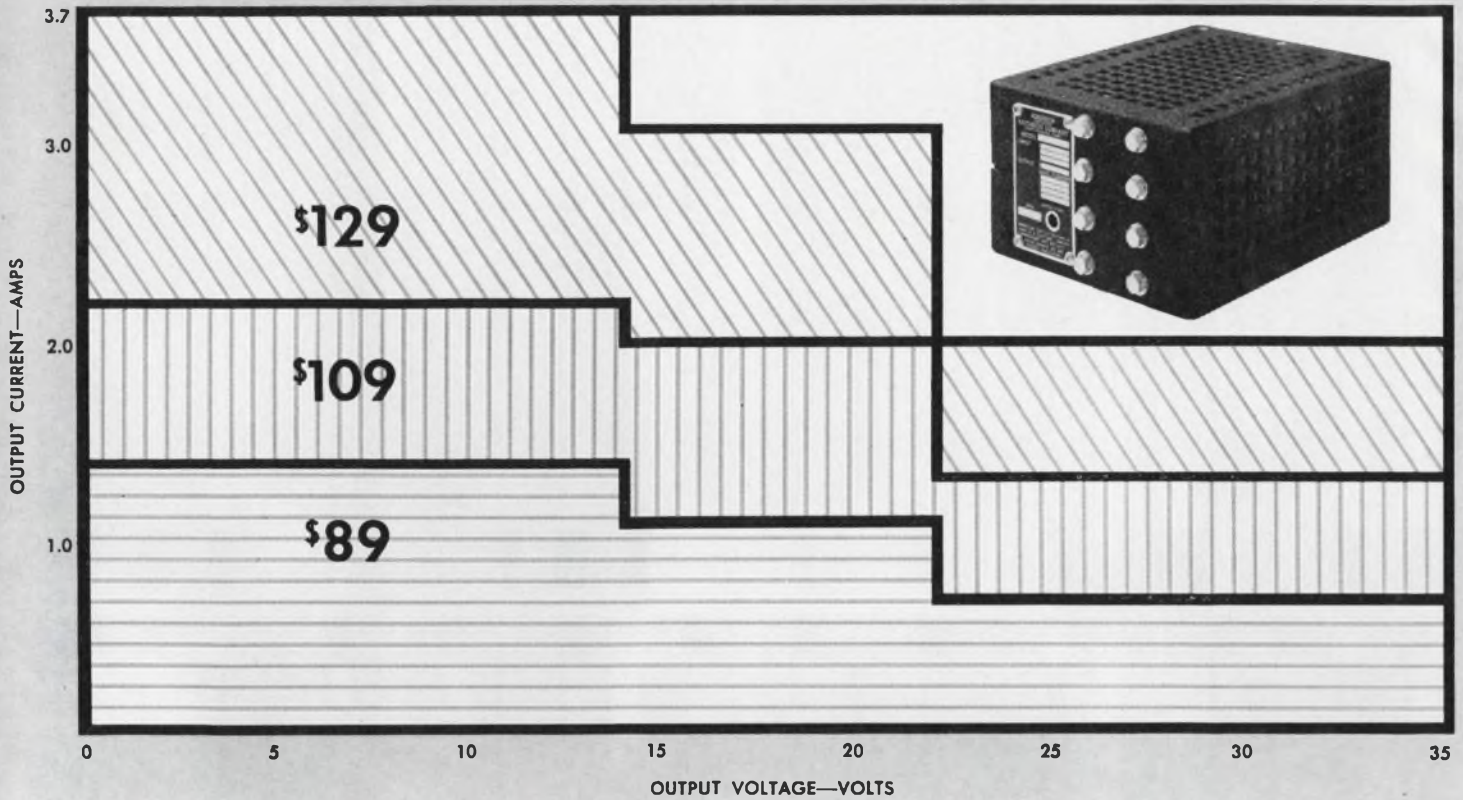

All-silicon QSA Series: 12 models; regulation $\pm .005\%$; response time $20 \mu\text{s}$.

New Sorensen Modular Power Supplies

The new Sorensen QSA Series offers the only modular power supply line in the 0 to 35 volt range that combines $\pm .005\%$ regulation line and load, $20 \mu\text{s}$ response time, 71°C operating temperatures, $300 \mu\text{V}$ ripple—all at prices below other lines having lesser performance specifications. Sorensen's QSA Series modules are ideal for OEM, lab or system applications. They can be used as bench models (mounted in any position) or mounted in combinations of 3 or 4 in an optional 19" ($3\frac{1}{2}$ " high) rack adapter. Other design features include: Load current vs. temperature, $110\% @ 40^\circ\text{C}$ — $100\% @ 50^\circ\text{C}$ — $85\% @ 60^\circ\text{C}$ — $66\% @ 71^\circ\text{C}$ • Temperature coefficient $0.01\%/^\circ\text{C}$ • Stability

$0.025\%/8$ hrs. • Models QSA10-1.4, QSA10-2.2 and QSA10-3.7 permit operation of up to 20 units in series; other units permit operation of 2 units in series; All models permit operation of 4 units in parallel • No turn-on/turn-off overshoots • Remote sensing • Remote programming • Ripple voltage peak to peak 3mV . All Sorensen power sources conform to proposed NEMA standards. For additional QSA Series details or for data on other standard/custom DC power supplies, AC line regulators or frequency changers, call your local Sorensen representative, or write: Raytheon Company, Sorensen Operation, Richards Avenue, Norwalk, Conn. Tel: 203-838-6571, TWX: 710-468-2940.

SPECIFICATIONS

MODELS (RANGES)	QSA10-1.4 (0-10V, 1.4A) QSA12-1.4 (8-14V, 1.4A) QSA18-1.1 (14-22V, 1.1A) QSA28-.7 (22-35V, .7A)	QSA10-2.2 (0-10V, 2.2A) QSA12-2.2 (8-14V, 2.2A) QSA18-2.0 (14-22V, 2.0A) QSA28-1.3 (22-35V, 1.3A)	QSA10-3.7 (0-10V, 3.7A) QSA12-3.7 (8-14V, 3.7A) QSA18-3.0 (14-22V, 3.0A) QSA28-2.0 (22-35V, 2.0A)
SIZES (IN.)	7 x 3-5/16 x 3-7/8	7 x 3-5/16 x 5-1/8	10 x 3-5/16 x 5-1/8
PRICES (U.S. List)	\$89	\$109	\$129

RAYTHEON

Sorensen represented in California by Ward-Davis Assoc., 770 S. Arroyo Parkway, Pasadena, Phone 213-684-2840; 3921 E. Bayshore, Palo Alto, Phone 415-968-7116; 3492 Pickett Street, San Diego, Phone 714-297-4619.

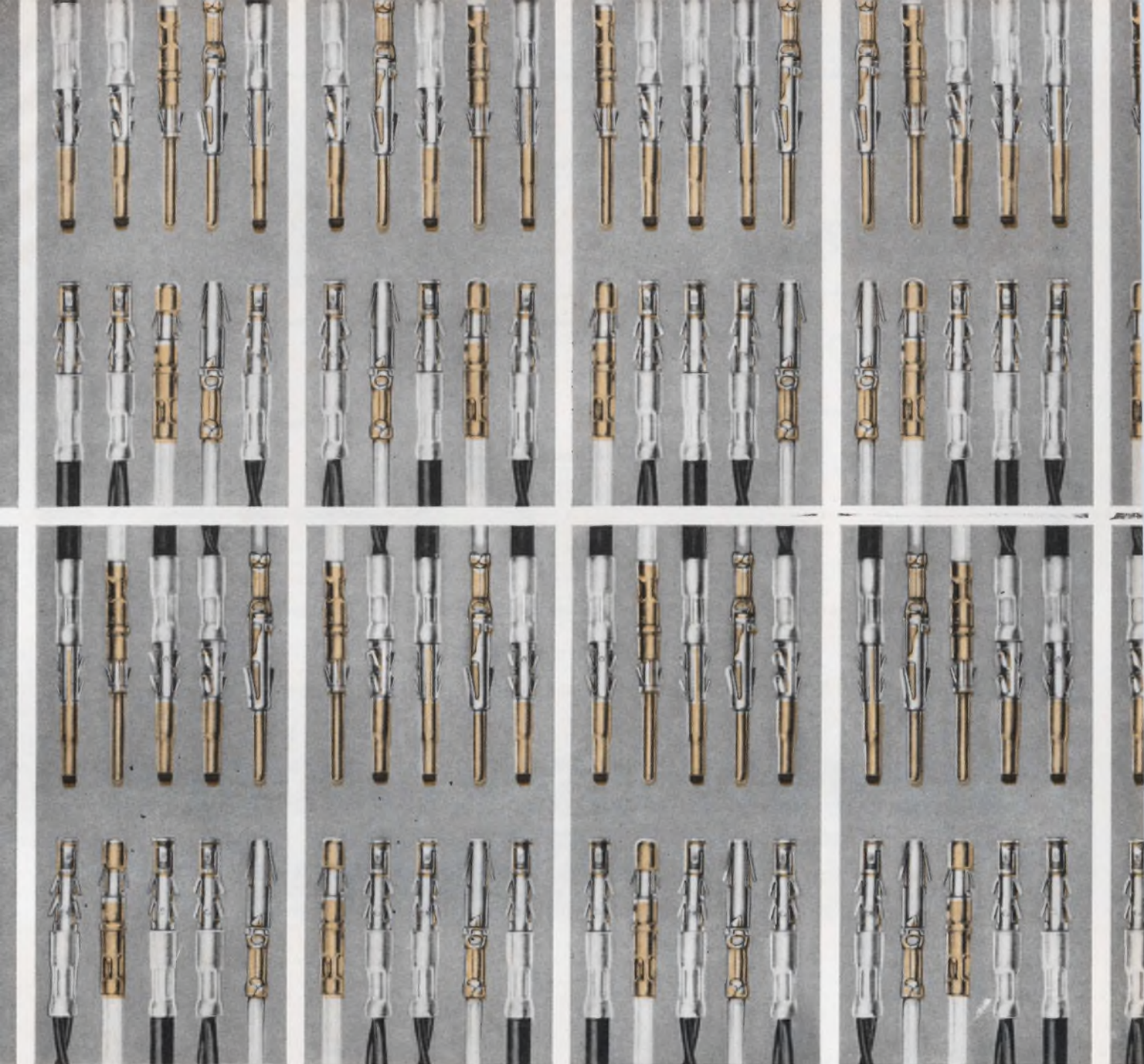

Mix these signal, power and coax leads in any combination.

Burndy Trim Trio Connectors—available in many shapes—accept three contact styles, all crimp-removable, for signal and power leads #16 thru #24, twisted pair #24 and #26, and subminiature coaxial cables.

Changing conductors is fast and simple, whether for lower voltage drop or better shielding or mechanical reasons. This makes Trim Trio Connectors ideal for breadboard and prototype work as well as

production. For large production runs you can take advantage of the economies offered by the automatic Burndy Hyfematic™ with a crimp rate of up to 3000 contacts per hour.

Get more details on how you can take advantage of the Burndy Trim Trio System—THE ACCEPTED METHOD OF INTERMIXING CONTACTS.

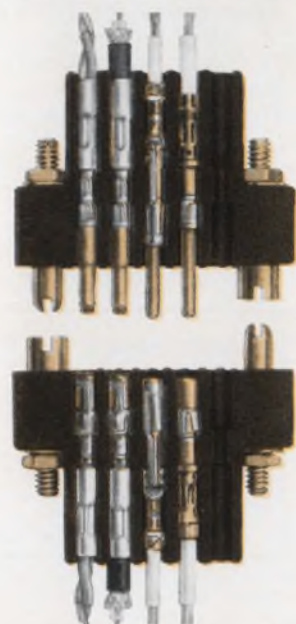



DALE

**3-in-1 T-pot design
gives you more
for your money!**



**One simple, rugged design adds reliability
to all three rectilinear Mil wirewound styles**

RT-10, RT-11, RT-12 – Dale meets all three with a single design. You benefit from this simplification through increased reliability, faster delivery, better price. Call us today!

- ① **ALL-MOLDED HOUSING** design eliminates seal problems. Meets MIL-STD-202 and MIL-R-27208A.
- ② **RUGGED COLLECTOR SYSTEM** assures you of noise levels well below mil requirements.
- ③ **FULL LENGTH WINDING** allows increased power handling capability. Permits use of large diameter thermoconductive mandrel which eliminates "hot spots" by acting as high mass heat sink.
- ④ **1-PIECE WIPER ASSEMBLY** of precious metal insures setting stability under all environmental conditions.
- ⑤ **STAINLESS STEEL ADJUSTMENT SCREW** has metal-to-metal clutching – prevents over-travel damage.
- ⑥ **CONSTANT LEAD SCREW SEAL** is assured by shaft-retaining spring which maintains unvarying pressure against high temperature silicone rubber "O" ring.

DALE MIL-R-27208A MODELS

RT-10



Model 691 P.C. Pin
Model 697 Flex. Leads

RT-11



Model 1287 P.C. Pin
Model 1288 Flex. Leads

RT-12



Model 1680 P.C. Pin
Model 1697 Flex. Leads

RT-22



5000 Series – ½" square-trim models meet RT-22, made with same basic design considerations shown here.

WRITE FOR CATALOG B – containing specifications on 57 Dale T-Pots including many special models.



DALE ELECTRONICS, INC.

1328 28th Avenue, Columbus, Nebraska



ON READER-SERVICE CARD CIRCLE 208



ROUGH WITH A REASON

Unique GVB finish cuts core winding costs

GVB encased cores mean fewer production delays because GVB does much more than seal the core box against potting material. Its matte finish provides a resilient, non-slip base for winding, and the tough epoxy skin prevents the wire from cutting through to the core box. Guaranteed not to fail, even when wound with heavy #6 wire, GVB surface also eliminates abraded wire problems. No prior taping of the core is required, so another winding operation is wiped out.

Magnetics doubles the normal guarantee on core box finishes by expressing it in this unique way: The guaranteed voltage breakdown (GVB) finish seals the box

and is capable of withstanding at least 1,000 volts at 60 cycles *between a bare winding and the aluminum case*. Quality control monitors the application and curing of GVB to assure dimensional and voltage breakdown fidelity. Performance characteristics are maintained between -65 and 200 degrees C.

To reduce production costs on your winding operations, try Magnetics' tape wound cores with GVB. Eight material types, in a wide range of sizes from 0.375" to 4.0" inside diameter, are stocked for immediate delivery. More information? Write *Magnetics Inc., Dept. ED-27, Butler, Pa.*



Speed Inquiry to Advertiser via Collect Night Letter
ON READER-SERVICE CARD CIRCLE 209

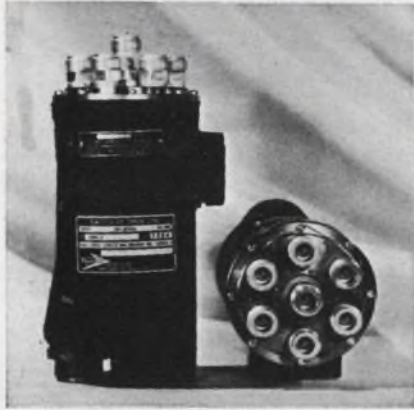

Coaxial switch

Life of the "Type-E" coax switch is claimed to be 10⁶ operations with 60 dB isolation across 0 to 11 GHz. Vswr is less than 1.4 at 11 GHz and less than 1.2 at 5 GHz. Insertion loss is less than 0.3 dB from 0 to 11 GHz. The MIL-spec switch is motor-actuated and available in spdt to sp6t, dpdt and transfer models.

Transco Products Inc., 4241 Glencoe Ave., Venice, Calif. Phone: (213) 391-7291.

Circle No. 251

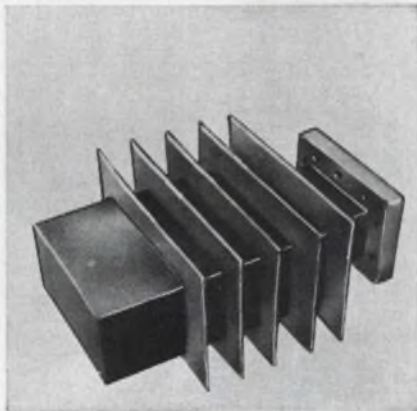

Waveguide termination

The MSP-11 is a 9-in. termination designed for the 3 to 4 GHz band. Vswr is less than 1.08 from 3 to 4 GHz. The load is supplied with round or rectangular flanges and in bronze or aluminum waveguide. The unit may be used at peak powers up to 1 mW and average powers up to 500 W. Fin temperature without fan cooling with 500-W dissipation is approximately 400°F.

P&A: \$350; stock to 60 days. Metcom Inc., 76 Lafayette St., Salem, Mass. Phone: (617) 744-5958.

Circle No. 252

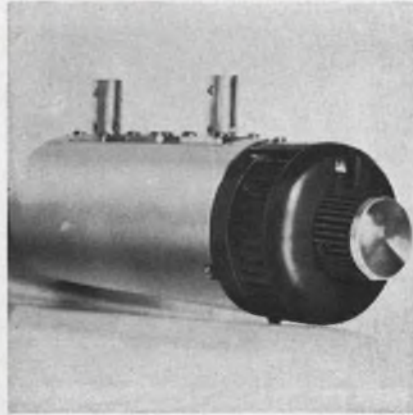

Turret attenuator

Model RA-54 turret attenuator covers 0 to 50 dB in 1-dB steps and digitally displays. Dual independently adjustable rotors provide 0 to 40-dB attenuation in 10-dB steps and 0 to 10 dB in 1-dB steps. Accuracy exceeds ±0.5 dB at 500 MHz, ± 1 dB at 1000 MHz and ± 1.5 dB at 1500 MHz. Vswr is 1.25 max and insertion loss is 0.3 dB max at 1000 MHz. Connectors are BNC, TNC or type N.

P&A: \$165; stock to 3 wks. Texscan Corp., 51 S. Koweba Lane, Indianapolis, Ind. Phone: (317) 632-7352.

Circle No. 253

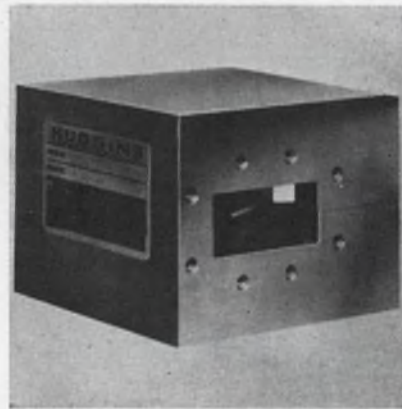

Waveguide circulator

Waveguide circulator model HC-8169 has 3 ports and covers 8.2 to 12.4 GHz. Isolation over the full bandwidth is 20 dB min, insertion loss is 0.3 dB max, and vswr is 1.20 max. Power ratings are 10 kw peak and 20 W average. Custom models with insertion loss of 0.1 dB and vswr of 1.05 are available.

P&A: \$245; 30 days. Huggins Labs., Inc., 999 E. Arques Ave., Sunnyvale, Calif. Phone: (408) 736-9992.

Circle No. 254

***NEW
FOR TELEMETRY
FROM**



**S-BAND FM
SIGNAL
GENERATOR**

- ACL TYPE SG-307
- FM, CW, PCM/FM
- 2200-2300 MHz
- SOLID STATE
- MODULAR
- TABLE OR RACK MOUNTED
- EXTREMELY LOW RESIDUAL FM
- OUTSTANDING PERFORMANCE

SEND FOR DETAILED SPECIFICATIONS

ACL ASTRO COMMUNICATION LABORATORY INC.

801 Gaither Road
Gaithersburg, Maryland
Phone: (301) 948-5210 TWX 710-828-9706

"RF Equipment for The Systems Engineer"

ON READER-SERVICE CARD CIRCLE 134

ELGENCO Noise Generators



Model 610A

SOLID STATE NOISE GENERATORS

Model 602A 5 cps to 5 mc, 3 Ranges \$ 290
Model 603A 5cps to 5 mc, 3 Ranges \$ 495
Model 610A 5 cps to 5 mc, 8 Ranges \$1,175
 Series 624 (Fixed frequency) 5 cps to 500 kc
 \$245 to \$490. Write for details on frequency
 ranges and spectral flatness.



Model 312A

VACUUM TUBE NOISE GENERATORS

Model 301A DC to 40 cps. \$1,995
Model 311A Two outputs DC to
 40 cps and 10 cps to 20 kc. \$2,395
Model 312A Two outputs DC to
 120 cps and 10 cps to 20 kc. \$2,495
Model 321A DC to 120 cps. \$2,095
Model 331A 10 cps to 20 kc. \$1,275

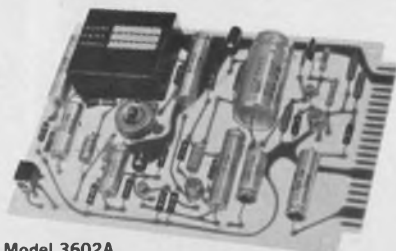

Model 3602A

NOISE GENERATOR CARDS

Series 3602, 3603, and 3606 \$144 to \$389
 Various frequency ranges and output flat-
 ness available. Size: 4½" x 6½" x 1". Write
 for details.

ENCAPSULATED NOISE SOURCE MODULES

Series 1602, 1603, and 1606 . \$95 to \$340
 Various frequency ranges and output flat-
 ness available. Size: 1¾" x 1½" x ¾". Write
 for details.

ELGENCO INCORPORATED



1550 Euclid Street
 Santa Monica, California
 Phone: (213) 451-1635
 TWX: (213) 879-0091

For a more complete listing, write for
 our short form catalog.

ON READER-SERVICE CARD CIRCLE 135

MATERIALS

Resistive paste

A line of ceramic resistive pastes for silk screen applications has typical temperature coefficients of less than ± 150 ppm/ $^{\circ}\text{C}$ on high alumina substrates. The glaze coatings are designed for fixed and variable resistor fabrication, either as discrete components or in thick film networks or microelectronic circuits. They are available in standard sheet resistivities in the decade ranges from 10 to 20,000 Ω /square. The pastes are fired at a peak temperature of 750 $^{\circ}\text{C}$ for 10 minutes. Screens of 200 to 325 mesh are suitable for depositing films 0.5 to 1.0 mils thick.

Electro-Science Labs., Inc., 1133-35 Arch St., Philadelphia. Phone: (215) 563-1360.

Circle No. 255

Epoxy molding powder

"Eccomold HT-50" is an epoxy compression molding powder that can be molded at pressures below 100 psi. The powder produces molded items with densities as low as 40 lb/ft³. Heat distortion temperature is above 500 $^{\circ}\text{F}$. Two components are supplied and the blended material has a shelf life of a month at room temperature. Cure time in the mold is typically 3 minutes at 320 $^{\circ}\text{F}$. Physical properties can be improved by an "out of mold" post-cure for 20 minutes at 320 $^{\circ}\text{F}$.

Price: \$5/lb. Emerson & Cuming Inc., Canton, Mass. Phone: (617) 828-3300.

Circle No. 256

Gold plating solution

"Pure gold SG-10" is processed from hyper-pure gold compounds and is well buffered. This solution deposits 99.99% pure gold. The plate has a center cubic structure and Rockwell hardness of 24. Contact resistance is in the m Ω range. Optical properties afford reflectivity greater than 90% in the IR region. Uses are in contacts and terminals, tube base pins, switches, printed circuits and waveguides.

P&A: \$20 (pint), \$30 (quart), \$80 (gallon); stock. Transene Co. Inc., 121 Conant St., Danvers, Mass. Phone: (617) 774-4272.

Circle No. 257

Polyurethane coating

"Conathane 1158" is supplied as two low viscosity components that develop thixotropism about 8 minutes after mixing. The coating is then suitable for application to PC assemblies by conventional screen processing techniques. The cured coating has a dielectric constant of 4.28 and a dissipation factor of 0.028 at 1 MHz. Dielectric strength is 7.0 kV/mil. It resists short time exposure to a solder bath at 550 $^{\circ}\text{F}$ and continuous exposure to 180 $^{\circ}\text{F}$.

Price: \$8 (evaluation kit). Conap Inc., 184 E. Union St., Allegany, N. Y. Phone: (716) 372-9650.

Circle No. 258

Resistor paste

Designed for use in thick film or hybrid microelectronic circuitry, four "Firon" resistor materials have sheet resistances of approximately 300 Ω , 1 k Ω , 3 k Ω and 10 Ω /square mil. The pastes are silk-screen applied, and, when fired, fuse to the substrate, providing an integrated resistor substrate. Resistors made from these pastes have a temperature coefficient of less than ± 150 ppm/ $^{\circ}\text{C}$ when measured from +55 $^{\circ}\text{C}$ to -150 $^{\circ}\text{C}$. "Firon" resistors show excellent moisture stability and no significant resistance change during dip soldering or high-temperature exposure.

Electro Materials Corp. of America, 605 Center Ave., Mamaroneck, N. Y. Phone: (914) 698-8434.

Circle No. 259

Diallyl phthalate resin

Diallyl phthalate molding powders are available as an insulating resin. Type 1F19 is a one-can system for coating, sealing, dip-encapsulating and laminating of wire wound resistors, coils, transistor chips, capacitors, diodes, transformers and motor windings. The resin is stable over a wide temperature range and will withstand dip or wave soldering. It can be dipped, brushed or sprayed and is tack-free for handling in 30 minutes.

Columbia Technical Corp., 24-30 Brooklyn-Queens Expwy. West, Woodside, N. Y. Phone: (212) 932-0800.

Circle No. 260



MICRO SWITCH Precision Switches

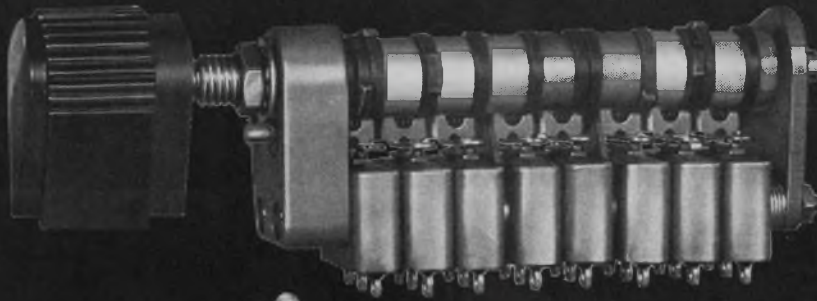

ROTARY SELECTOR ASSEMBLY

RUGGEDIZED, HIGH OVERTRAVEL ASSEMBLY

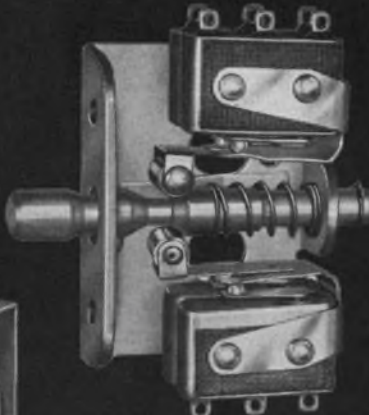
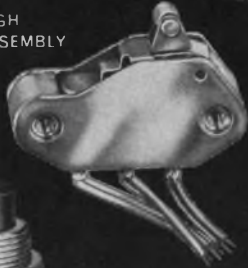

TOGGLE ASSEMBLY

INTERLOCK ASSEMBLY

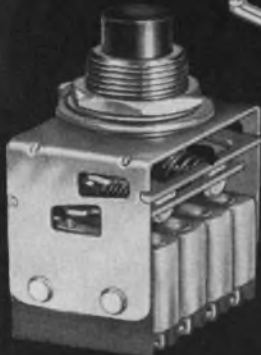

PUSHBUTTON ASSEMBLY



ROLLER LEAF



STRAIGHT LEAF



ONE-WAY ROLLER



DUAL LEAF



STRAIGHT WIRE



DUAL ROLLER LEAF



ROLLER WIRE



FORMED LEAF

switches and assemblies actual size

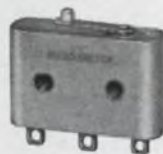

1HM SERIES



6HM SERIES



2HM SERIES

NOW, TAKE ADVANTAGE

of this Hermetically-sealed Subminiature Switch more often

"HM" Subminiature switches are available in many variations—can be used in a greater variety of applications requiring electrical or mechanical stability under abrupt changes in severe environmental conditions.

A few of the many assemblies and actuators available for a wide variety of operating requirements are shown above.

This is a true hermetically-sealed switch—sealed metal-to-metal, metal-to-glass. It assures reliable, consistent operation over long periods of time at tempera-

tures of -300°F to $+250^{\circ}\text{F}$ and -300°F to $+500^{\circ}\text{F}$, even with sudden changes in atmospheric pressure. Meets corrosion-resistant requirements of MIL-S-6743. Electrical rating: 3 amps. ind., 5 amps. res., 28 vdc.

Qualified switch engineers located in Branch Offices. Call (see Yellow Pages) or write for Data Sheet 192.



MICRO SWITCH

FREEPORT, ILLINOIS 61033

A DIVISION OF HONEYWELL

IN CANADA: HONEYWELL CONTROLS LIMITED, TORONTO 17, ONTARIO

HONEYWELL INTERNATIONAL—SALES AND SERVICE OFFICES IN ALL PRINCIPAL CITIES OF THE WORLD. MANUFACTURING IN UNITED STATES, UNITED KINGDOM, CANADA, NETHERLANDS, GERMANY, FRANCE, JAPAN.

Speed Inquiry to Advertiser via Collect Night Letter
ON READER-SERVICE CARD CIRCLE 136



*Quality and economy
in servo motors
and motor-tachs
depend on the
manufacturer's
experience*

...and CEDAR has it!

When it comes to sizes 8, 10 and 11 servo motors and motor-tachometers both with and without gear heads, Cedar is the leader, currently building at a higher rate than any other manufacturer in the country.

Because Cedar's volume is big and production techniques have been perfected and standardized, you are assured of the most economical price available. At the same time, the reliability testing and quality assurance programs built up on these units through years of experience guarantee you the finest quality and dependability.

When you need a servo motor or motor-tach, remember that the most advanced designs built with the most modern production techniques come from Cedar. Write or call us for complete information. You'll be glad you did.



5806 W. 36th St., Minneapolis, Minn. 55416 Phone (612) 929-1681
ON READER-SERVICE CARD CIRCLE 137

**GLOSSARY OF
FHP MOTOR TERMS FREE!**

Know the difference between a splash-proof motor and a waterproof motor? Between pull-in torque and pull-out torque? This glossary has clear, concise definitions for these and nearly 100 more terms applying to fractional horsepower motors; helps you and fellow staff members talk the same language. Covers motor classes, enclosure types and general engineering terms. It's free... just ask for the Motor Dictionary.

BODINE
fractional/horsepower
MOTORS

Bodine Electric Co., 2528 W. Bradley Pl., Chicago, Illinois 60618

ON READER-SERVICE CARD CIRCLE 138

MATERIALS

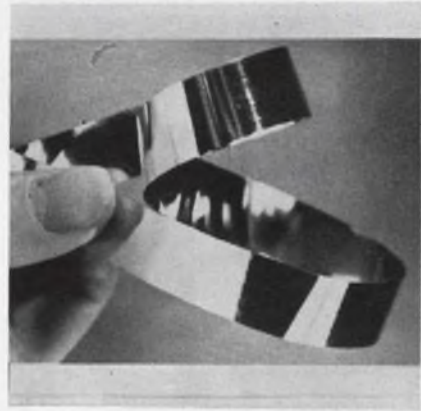

Superconductive tape

A strong and highly flexible superconducting tape is fabricated of a 0.5-in. wide ribbon of niobium/tin (Nb₃Sn) foil laminated between 2 layers of 1 mil thick tinned copper. Niobium/tin permits operation at 18°K and 200 kgauss. The material suffers no reduction in its current-carrying ability at a bending diameter as small as 0.2-in. and a tensile load up to 20,000 psi.

General Electric Co., One River Rd., Schenectady, N. Y. Phone: (518) 374-221.

Circle No. 261



RF gaskets

A new RF gasket, "Porcupine Metalastic," consists of a critically expanded sheet of monel metal impregnated with a silicone elastomer. A large number of contact points per square inch results in high attenuation at low pressure. The material is available in bulk and as finished gaskets 0.03-in. thick, 8-in. wide and 0.02-in. thick, 10-in. wide. Other sizes and elastomers are available.

Metex Corp., Walnut Ave., Clark, N. J. Phone: (201) 381-7272.

Circle No. 262

Dielectric

"Z-tron G" dielectric is a thermoplastic of electrical grade polyphenylene oxide for use in strip-line circuitry and microwave PC design. The material combines the high strength, rigidity, and thermal and dimensional stability of thermosets with the low electrical loss characteristics of thermoplastic olefins.

A low linear coefficient of thermal expansion prevents thermally induced stresses, rupture of copper circuitry or loss of bond from -270 to 375°F. Volume resistivity is 10^{17} Ω-cm, dielectric constant at 60 Hz to 3 GHz is 2.55 and dissipation factor at 3 GHz is 0.0011. Copper cladding is bonded to the substrate without the use of an adhesive. The material is available copper-clad or un-clad, in sheets up to 16- x 24-in. and in thicknesses of 0.0625 to 0.25-in. at a tolerance of ± 0.001 -in.

Polymer Corp., 2140 Fairmont Ave., Reading, Pa. Phone: (215) 376-5791.

Circle No. 263

Silicon tetrachloride

Ultra high-purity silicon tetrachloride is now available for high specification epitaxial deposition of silicon films on wafer substrates. The chemical is used in IC and semiconductor manufacture. Demands for tight control and high layer resistivity are met with a 100 Ω/cm minimum resistivity. The material is available in pyrex, teflon and stainless steel containers.

Apogee Chemical, Inc., DeCarlo Ave., Richmond, Calif. Phone: (415) 233-4684.

Circle No. 264

Epoxy compounds

These new epoxy molding compounds have been developed to meet forthcoming MIL-specs. Epoxy X-7074 will withstand 500°F for 100 hours with a 4% weight loss. The glass-fiber reinforced, resin compound is available in black.

U.S. Polymeric Inc., P. O. Box 2187, Santa Ana, Calif. Phone: (714) 549-1101.

Circle No. 265

NEW LOW DRIFT, FET CHOPPER STABILIZED OPERATIONAL AMPLIFIER

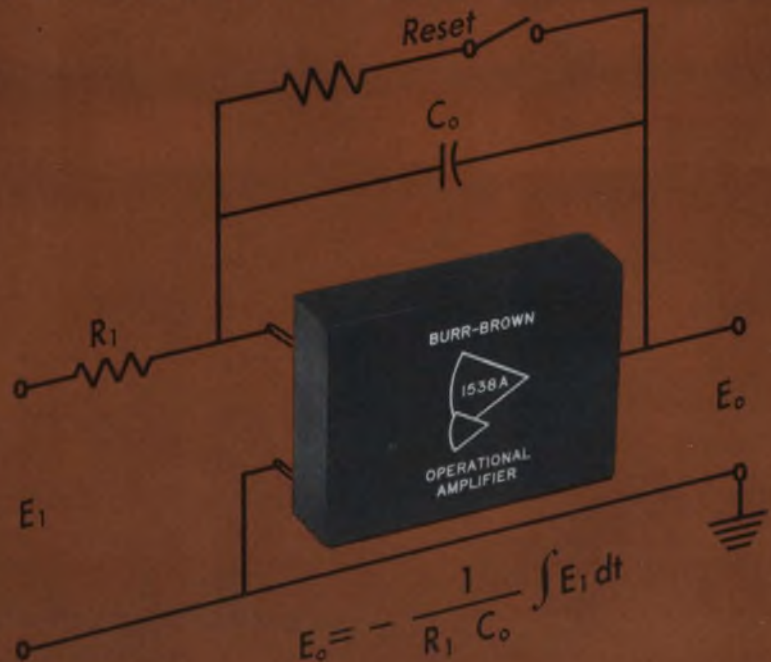

MODEL 1538A from BURR-BROWN

This new, general purpose Burr-Brown operational amplifier features an FET chopper for maximum stability in addition to excellent noise and bandwidth specifications. The small 0.8" x 1.8" x 2.4" epoxy module makes it especially suited for high density, high performance applications. It is immediately available from your local Burr-Brown representative's JET-STOCK for same day shipment. Single unit price is \$175, only \$157.50 in quantities of 10-24.

TYPICAL APPLICATIONS

The model 1538A Operational Amplifier is ideal for use in:

- analog computers
 - A to D converters
 - navigation systems
 - preamplifiers
- and any system where stability is a prerequisite.

It provides low integrator errors over a long integration time and a wide temperature range.

$$E_o \text{ error} = \pm E \text{ offset} \pm 1/R_1 C_o \int E \text{ offset dt} \pm 1/C_o \int I \text{ offset dt}$$

HIGHLIGHT SPECIFICATIONS

from -25°C to +85°C

I offset = ± 30 pA (at 25°C)

I drift = ± 1 pA/°C (typical)

E offset = ± 15 μ V (at 25°C)

E drift = ± 0.5 μ V/°C (typical)

Input Noise = 6 μ V, rms (dc -10 kHz)

= 10 μ V, peak (dc -10 kHz)

Rated Output ± 10 V at 20 mA

Also available with 20 V output

Slewing rate -30 V/ μ s

Bandwidth -15 MHz



NEW HANDBOOK OF OPERATIONAL AMPLIFIER ACTIVE RC NETWORKS

This 104 page handbook presents the practical side of Active RC Networks. You may obtain your copy simply by requesting it on your company letterhead.

ENGINEERING REPRESENTATIVES: ALABAMA, HUNTSVILLE (205) 534-1648
ALASKA, ANCHORAGE (907) 272-5231 / ARIZONA, PHOENIX (602) 254-6085
CALIF., LOS ANGELES (213) 245-9501, SAN FRANCISCO (415) 968-1608
COLO., DENVER (303) 388-4391 / CONN., MILFORD (203) 874-9222 / FLORIDA,
ORLANDO (305) 425-2764 / ILLINOIS, CHICAGO (312) 286-6824 / MD., SILVER
SPRING (301) 311-8134 / MASS., BOSTON (617) 245-4870 / MICH., DETROIT
(313) 353-3822 / MINN., MINNEAPOLIS (612) 781-1611 / MO., ST. LOUIS (314)
JA 4-4800 / N.C., GREENSBORO (919) 273-1918 / N.J., CAMDEN (609) 365-2450
N.M., ALBUQUERQUE (505) 255-1638 / N.Y., MT. VERNON (914) YO 8-2200
ALBANY (518) 436-9649 BINGHAMTON (607) 723-9661, NEW HARTFORD (315)
732-3775 / OHIO, CINCINNATI (513) 761-5432, CLEVELAND (216) 884-2001,
DAYTON (513) 277-8911 / OKLA., TULSA (918) TE 5-2481 / OREGON, PORT-
LAND (503) 252-8762 / TEXAS, DALLAS (214) EM 3-1671, HOUSTON (713) WA
8-5251 / UTAH, SALT LAKE CITY (801) 466-8709 / WASH., SEATTLE (206) MA
2-0177 / CANADA, VANCOUVER (604) RE 6-6377, AGINCOURT (416) 293-7011,
WINNIPEG (204) 943-3832



Speed Inquiry to Advertiser via Collect Night Letter
ON READER-SERVICE CARD CIRCLE 139

Why the most readable readouts have a new lens system.



We've just designed a totally new lens system for our miniature rear-projection readouts, the Series 120 and the Series 220 (front plug-in model). Since we already had the most readable readouts made—even with the old lens system—why all the effort?

Frankly, the most important thing we (or any other readout manufacturer) have to sell is readability. That's why we keep on working to make the best just a little bit better. This time it really paid off. Our new lens system delivers a significant increase in character sharpness and a 50% increase in brightness! Here's what we did:

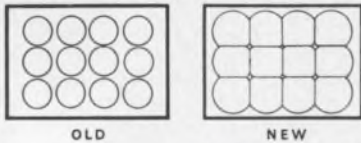

First we squared our circular lenses. That gives us greater usable lens area for a two-fold effect: the new larger lenses collect more light; magnification required is reduced. Both factors increase brightness and sharpness.



Second, we split the old single condenser lens and made a lens-film-lens sandwich. The old lens refracted light rays toward the projection lens before the rays passed through the film. Of necessity, the lens had steep curvature which limited the usable size of film. The new split-lens condenser refracts light in two stages: before it passes through film and after. By comparison, the new lenses are practically flat, permitting use of larger film and reducing aberration associated with thick lenses. The effect builds up: larger film means less magnification which in turn means greater brightness and sharpness.

So that's why the most readable readouts have their new lens system. Frankly, this new lens system may not seem earthshaking to you, unless you happen to be using readouts. In any case, send us your inquiry. We'll give you the reading on readability!

IEE INDUSTRIAL ELECTRONIC ENGINEERS, INC.

7720 LEMONA AVENUE, VAN NUYS, CALIFORNIA
PHONE: (213) 787-0311 TWX: (910) 495-1707
© 1966 IEE Representatives in Principal Cities

ON READER-SERVICE CARD CIRCLE 140

PRODUCTION EQUIPMENT



Soldering machine

A machine for continuous coating of copper PC boards with a protective solder alloy is available. The coating is claimed to give a far longer storage life and better assembly characteristics than varnish. A lower roller running in a bath of molten solder coats only the copper. Continuous production can be carried out at a speed of 6 ft/min.

Solder is heated by a 1.5 kW thermostatically controlled heater normally preset at 250°C. A safety device prevents the rollers from turning before the solder is at a safe working temperature.

Fry's Metal Foundries Ltd., Tandem Works, Merton Abbey, London S. W. 19, England. Phone: Mitcham 4023.

Circle No. 266



Dispenser

The "Vari-meter" dispenses predetermined amounts of epoxies, silicones, and other materials in dots, lines or volumes. Most compounds can be fed with repeatability of $\pm 0.1\%$ from 0.1 gram to 1 oz per cycle. The meter is set with a single control and repeat dispensation requires depression of a foot switch. The dispensing cycle automatically regulates itself.

Techcon Systems Inc., 13206 S. Western Ave., Gardena, Calif. Phone: (213) 321-6054.

Circle No. 267

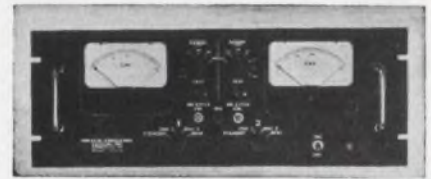

Film thickness monitor

Model C-210 temperature-compensated film thickness monitor has a sensitivity better than 10^{-9} gm/cm. The instrument measures vacuum film deposition by means of a change in the mass on the surface of a quartz crystal during the evaporation process. Rate measurement as well as cut-off at a given thickness is possible.

Range is ± 200 kHz and crystal frequency is 2 to 15 MHz in pairs. Typical loading for 10 MHz crystals is 1% accuracy to ± 100 kHz (equivalent to 0.37 to 18,500 Å of aluminum) and 2% accuracy to ± 200 kHz (0.37 to 37,000 Å of aluminum).

Heraeus-Engelhard Vacuum Inc., Seco Rd., Monroeville, Pa. Phone: (412) 372-8800. Circle No. 268

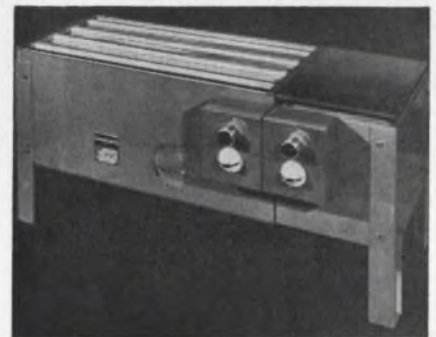

Flux dryer/pre-heater

This combination unit has separate and distinct flux-drying and pre-heating functions to prepare PC boards for soldering. The flux-dryer forces hot, dry air through a slotted stainless steel surface plate to gradually evaporate flux solvents. The pre-heater is a radiating heater-plate designed to overcome heat sink on the board prior to contact with the molten solder wave. The temperature of each unit is independently controlled in three stages (low-med-high) by a selector switch. Both units operate on 208/220 Vac, 3-wire, single-phase 60-Hz power.

Electrovert Inc., 86 Hartford Ave., Mt. Vernon, N. Y. Phone: (914) 664-6090. Circle No. 269

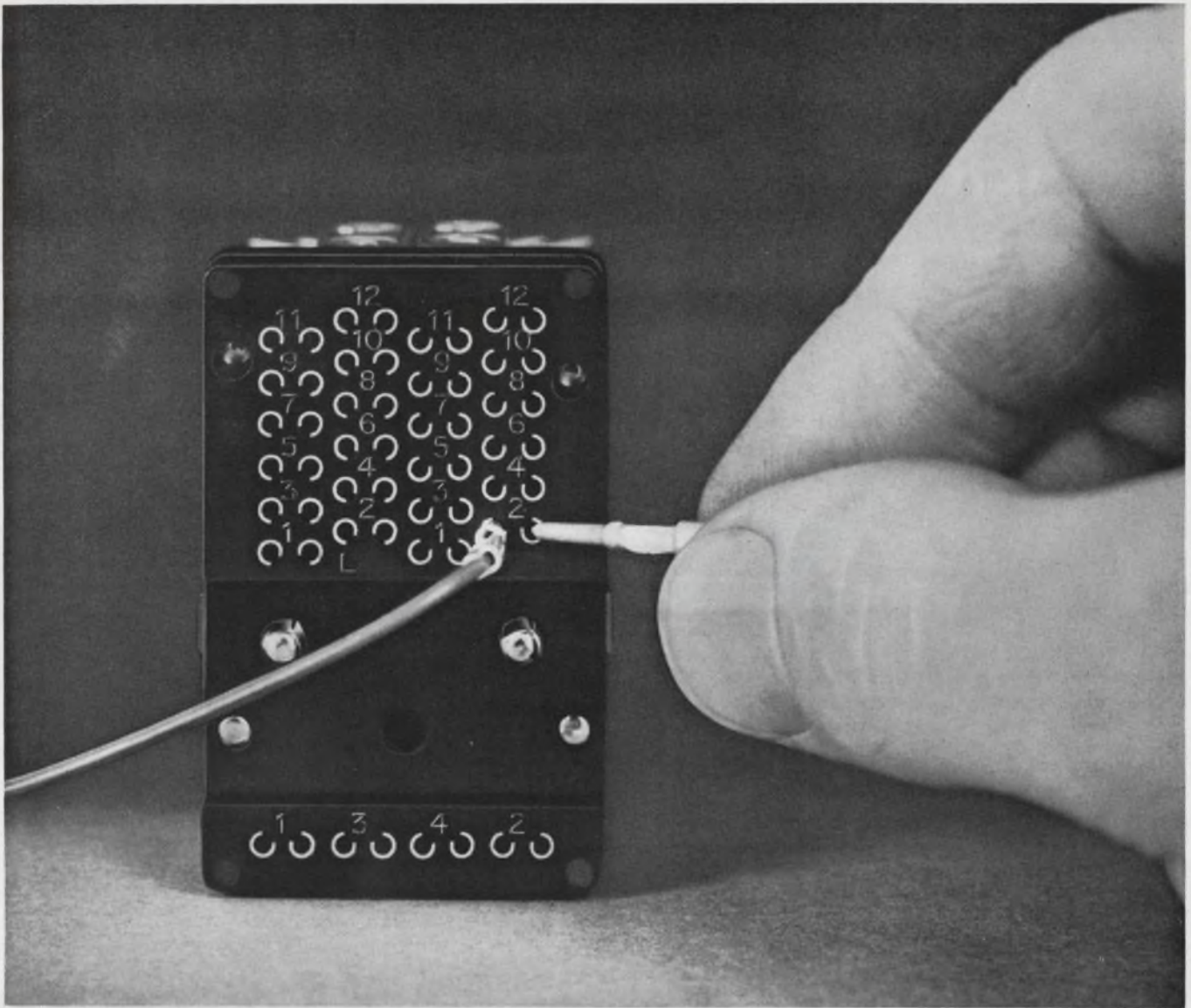

Now you can quick-connect two wires to each socket terminal of the Class E relay

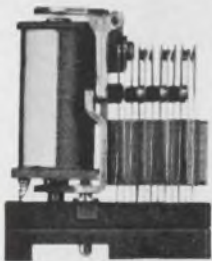

Here's new design flexibility—more than you've ever seen in plug-in Class E relays. The bottom view of our new ETP terminal* shows why.

For each terminal, the mating socket provides two taper pin receptacles. This is an AE exclusive, and it can *double* circuit capability: two wires on each contact terminal!

Connecting these wires is quick and easy. Just insert a taper pin—and get a connection that's even more secure than with conventional terminals.

And every time you make a circuit change, the connection is as good as the first one.

You can prewire the mating socket and later insert a standard Class E taper-tab relay. Add a plastic snap-on dust cover, and you've got a complete Series ETP assembly.

Sound interesting? Get some helpful details. Write for AE's Product News on the ETP socket.

Widest Mounting Choice

Besides this new ETP (taper pin) and the EIN (integral socket) versions, Class E relays are available with conventional solder, taper tabs, or wrapped-wire terminals, or pins for plug mounting. This is the widest selection of Class E relay connections in the industry—another good reason to check Automatic Electric for *all* your relay needs. Write the Director, Relay Control Equipment Sales, Automatic Electric, Northlake, Illinois 60164. *Patent applied for

AUTOMATIC ELECTRIC
SUBSIDIARY OF
GENERAL TELEPHONE & ELECTRONICS GTE

ON READER-SERVICE CARD CIRCLE 141

enter now!

new **Simpson**
INSTRUMENTS THAT STAY ACCURATE

260[®] VOM applications
contest



everyone
wins
something

Send in your ORIGINAL test application (for Simpson's famous 260 VOM) NOT ALREADY described in our new book, "1001 Uses For The 260[®] . . ." You can get a copy from your Electronic Distributor; list price, \$1.00. He also has entry rules. Contest ends Dec. 31, 1966.

Grand Prize: One week at the famous Tropicana in Las Vegas.
Other Prizes: Goof-proof VOMs and Diode Meter Protectors.
SIMPSON ELECTRIC COMPANY, 5202 W. Kinzie, Chicago, Ill. 60644

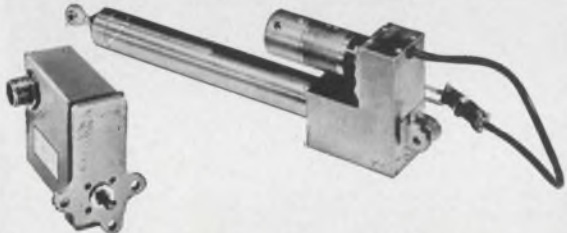

**rotary & linear
ACTUATORS
custom tailored**

Because Globe is the largest manufacturer of precision miniature a.c. and d.c. motors and compatible stock gear trains, we can design and deliver an actuator to meet your requirement in a short time. Gain the lead time advantages of Globe's thoroughly proven modular design and large inventory. A refined design can be adapted to your needs for rotary torque to 1000 in. lbs., including all necessary take-off and control elements such as limit switches, potentiometers, etc. No matter what your special requirements may be, a Globe linear actuator will combine maximum thrust in the smallest possible package. Our application specialists will recommend the optimum unit. We routinely handle actuators that must meet MIL specs, specified reliability, high shock and vibration. Request Bulletin A-1 from Globe Industries, Inc., 2275 Stanley Ave., Dayton 4, Ohio.

GLOBE

ON READER-SERVICE CARD CIRCLE 143

PRODUCTION EQUIPMENT



Ultrasonic bonder

Model WU-600 wire bonder ultrasonically bonds aluminum, gold and other soft metals from 0.0005- to 0.005-in. The bonding cycle and the wire are completely controlled. The bond at the die leaves no pigtail. The ultrasonic generator has two power and time settings allowing an alternate bond schedule at die and terminal. A selector switch permits automatic indexing at the end of each cycle for 12, 10, 8 and 6-pin headers and most transistors.

Axion Corp., 6 Commerce Park, Danbury, Conn. Phone: (203) 743-9281.

Circle No. 270



Soldering pencil

Model R soldering pencil with temperature-sensor grounded tip and temperature control and indication unit maintains a pre-set temperature at the soldering point. Temperature control is infinitely variable from 350 to 1000°F with calibration accuracy of ±2%. Power capacity is 50 W for a rapid response to loss of tip temperature.

P&A: \$235; stock. General Transducer Co., 3551 Thomas Rd., Santa Clara, Calif. Phone: (408) 248-2075.

Circle No. 271

sampling made simple

 with your existing
Type 530, 540, 550,
or 580* Series Oscilloscopes

Here's a new dc-1 GHz sampling unit with operation practically as simple as conventional plug-ins—as you can see by the front panel of the sampling plug-in. You need no pretriggers or external delay lines—the 1S1 unit has internal triggering with a built-in delay line.

Many other features add to the capabilities and operating ease of the Type 1S1, such as: A tunnel-diode trigger circuit that insures stable triggering through 1 GHz • A single control to select the sweep rate and magnify the display up to X100 when desired • Direct readout of the sweep rate even when magnified • A dc-offset control that permits observation of millivolt signals in the presence of up to ± 1 volt input levels • Less than 1 mV noise in the display, with a smoothing control for further reduction • Output signals available at the front panel for driving chart recorders—and for powering an auxiliary time domain reflectometer pulser unit.

BASIC CHARACTERISTICS

RISETIME ≤ 0.35 ns. SENSITIVITY from 2 mV/cm through 200 mV/cm, in 7 steps. DYNAMIC RANGE ± 2 V. Safe overload is ± 5 V. DC OFFSET range is greater than ± 1 V. SWEEP RATES from 100 ps/cm to 50 μ s/cm, with $\pm 3\%$ accuracy normal or magnified. SAMPLES/CM continuously variable. TRIGGERING ac-coupled, \pm internal, \pm external, and free run. DISPLAY MODES are repetitive, single display, manual scan, or external scan. VERTICAL OUTPUT is 200 mV per displayed cm through 10 k. HORIZONTAL OUTPUT is 1 V per displayed cm through 10 k.

Type 1S1 Sampling Plug-In Unit \$1100
Type 281 TDR Pulser Unit \$95

U.S. Sales Prices, f.o.b. Beaverton, Oregon

*used with Type 81 Plug-In Adapter.

For a demonstration,
call your Tektronix field engineer.

Tektronix, Inc.

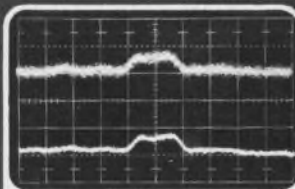
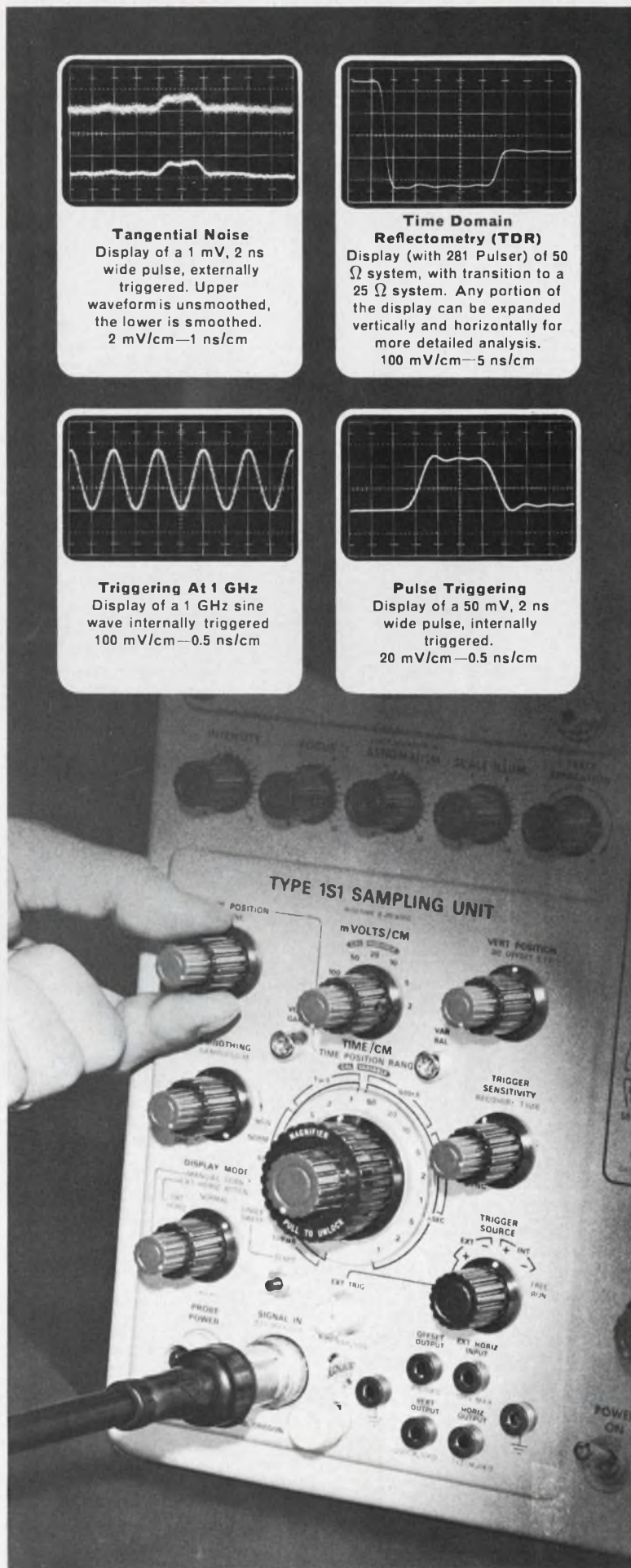

Tangential Noise
Display of a 1 mV, 2 ns wide pulse, externally triggered. Upper waveform is unsmoothed, the lower is smoothed.
2 mV/cm—1 ns/cm

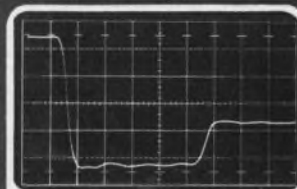

Time Domain Reflectometry (TDR)
Display (with 281 Pulser) of 50 Ω system, with transition to a 25 Ω system. Any portion of the display can be expanded vertically and horizontally for more detailed analysis.
100 mV/cm—5 ns/cm

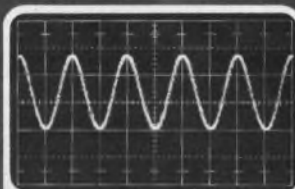

Triggering At 1 GHz
Display of a 1 GHz sine wave internally triggered
100 mV/cm—0.5 ns/cm

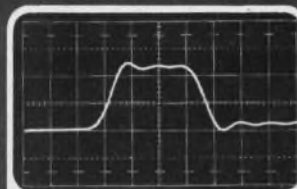

Pulse Triggering
Display of a 50 mV, 2 ns wide pulse, internally triggered.
20 mV/cm—0.5 ns/cm

INSULTITE

heat-shrinkable tubing

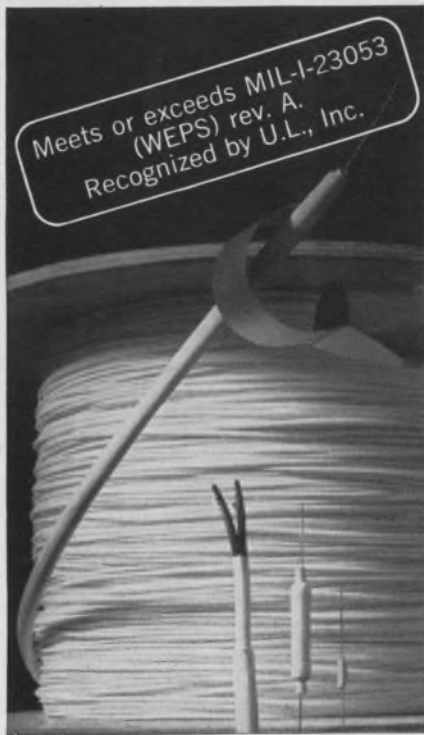

first of the INSULRAD family of irradiated polyolefins from E.C.C.

Now there's an important new source of heat-shrinkable tubing—INSULTITE from Electronized Chemicals Corporation.

INSULTITE meets competitive heat-shrinkable tubing requirements spec for spec—outperforms other shrinkables in volume resistivity, longitudinal change, water absorption, and resistance to solvents.

INSULTITE is the answer wherever skin-tight packaging or encapsulating covers are needed. Apply heat: INSULTITE molds itself around smooth or irregular shapes to form a tight protective jacket.

INSULTITE is available in standard colors and sizes and is supplied in four-foot or specified lengths... all competitively priced and available now. For more information on this new product, write, wire or call Electronized Chemicals Corporation, Burlington, Mass. Tel. 617-272-2850. Dealer inquiries are invited.



**ELECTRONIZED
CHEMICALS
CORPORATION**

a subsidiary of

HIGH VOLTAGE ENGINEERING

**See us at NEP/CON '66, Booth 702,
New York Coliseum, June 21-23.**

ON READER-SERVICE CARD CIRCLE 145

202

PRODUCTION EQUIPMENT



Epitaxial reactor

An epitaxial reactor, model HIER, for the growth of silicon or germanium layers, has a capacity for 25 1-in. wafers, with a growth factor of 1.2 micron/minute. Features include solenoid valves for exact duplication of optimum settings, timing control, and lines, valves and fittings of teflon, glass, stainless steel and monel.

Hugle Industries, 587 N. Mathilda Ave., Sunnyvale, Calif. Phone: (408) 738-1700.

Circle No. 272

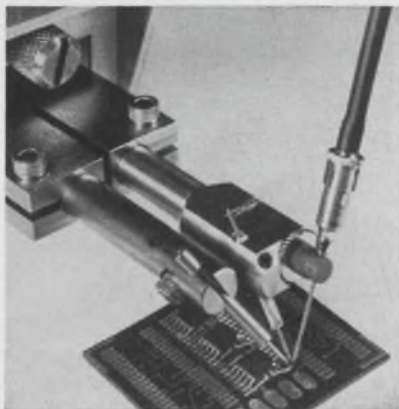

Soldering system

This 3-probe soldering system, model 3080, allows single-schedule soldering of multi-layer and other PC boards with variable heat sink masses. Soldering heat is created by passing ac current between two tungsten electrodes on the first pack lead. The third probe, a small thermocouple, senses interface temperature.

Development Associates Controls, 123 W. Padre, Santa Barbara, Calif. Phone: (805) 963-3708.

Circle No. 273



Die tester

A tester for "flip-chip" semi-conductors offers positive contact during testing through the "pad contact" method. The chip is lifted with a vacuum pickup and placed face down onto flexible pads. After testing, the instrument selects the proper sorting bin and counts the tested devices automatically.

P&A: \$2500; stock to 4 wks. Hughes Aircraft Co., Centinela Ave., & Teale St., Culver City, Calif. Phone: (213) 391-0711.

Circle No. 274

Relay tester

Model RT-6000 relay tester is designed to facilitate inspection and adjustment of electromagnetic relays. The unit uses a crystal-controlled pulse generator as a timing reference and a high-speed counter, gated by the test relay, as the time interval indicator. Power to the relay coil is controlled by a momentary or latching contact on the panel. Time interval of the desired relay action is read directly on a 3-digit Nixie display covering 0.1 ms to 999 s.

Front-panel adjustments allow the measurement of the time from application of coil power to the closing of a normally-open contact, time between two successive contacts or between opening of a normally closed to closing of a normally open. The instrument accommodates any voltage rating with coil currents to 2 A. Paper tape printout facilities are optional.

Price: about \$1000. Astrosonics Inc., 190 Michael Dr., Syosset, N. Y. Phone: (516) 921-2037.

Circle No. 275



A GIRL LIKE THIS WOULD COME IN HANDY

We need skilled production workers with at least six hands.

How come? Because the increasing demand for our series 900 relays keeps our hands full to meet the production load.

Our real problem (if you can call it that) is that engineers know value when they see it. They've found that this 98c relay gives them longer trouble-free performance and greater reliability than they can find in relays costing much more. The reason is in the exclusive design with molded switches, keyed and locked lifters, encapsulated coil and greatly reduced number of parts.

Maybe we could step up productivity by relaxing quality control and inspection just a little. But you know Guardian better than that.

So if you know any girls with six hands, send them around. In the meantime, if you need 900's in quantities to 199, see your franchised Guardian distributor. If you need them in larger quantities direct from factory production, order now. We'll just ask our two-handed girls to work a little harder.

*Series 900 relay.
10 amp. resistive
load DPDT.
Size 2-11/16 x
1-11/16 x 1-25/32"
UL listed.*



GUARDIAN ELECTRIC

Guardian Electric Manufacturing Co., 1550 W. Carroll Ave., Chicago, Ill. 60607.

ON READER-SERVICE CARD CIRCLE 229

Constant voltage supply



Model 100-2 constant voltage supplies replace dry cell batteries, standard cells and standardizing mechanisms in self-balancing potentiometric type chart recorders. Ratings are 10, 6, 5, 3 and 1 mA with a 1.03-Vdc output. Voltage line regulation is $\pm 0.0016\%$ over 94 to 140 Vac. Isolation is 6 mVac rms across a 1 M Ω resistor from output to ground.

P&A: \$54.50 (1 to 9); stock to 2 wks. Dynage Inc., Hartford, Conn. Phone: (203) 249-5654.

Circle No. 276

High voltage supply



Model 240A has an output voltage from 0 to ± 1200 Vdc, front-panel selectable in calibrated 1-V steps. A pot permits interpolation with better than 5-mV resolution. Output current is 10 mA max. Line and load regulation are both $\pm 0.005\% \pm 2$ mV. Accuracy is $\pm 1\%$ of the dial setting for all outputs. Ripple and noise are 1 mV rms max.

P&A: \$345; stock to 30 days. Keithley Instruments, 12415 Euclid Ave., Cleveland. Phone: (216) 795-2666.

Circle No. 277



Klystron supply

Model CP-2055V klystron power supply has a continuously variable beam voltage of -250 to -800 Vdc at 0 to 100 mA. Ambient range is 0 to 50°C with stability of 0.02%/°C. Reflector output is 0 to -800 Vdc with respect to negative beam output at 0 to 0.5 mA. Filament output is 5.7 to 7 Vdc at 0 to 2 A. The modulator produces a -5 to -150 V square wave at 250 to 2500 Hz or a sawtooth at 50 to 500 Hz. Ripple is 1 mV beam, 0.5 mV reflector and 2 mV filament.

Vector Engineering Inc., 58 Brown Ave, Springfield, N. J. Phone: (201) 379-7800.

Circle No. 278

**NO TOOLS . . . EASY HAND INSTALLATION
SELF-LOCKING, PERMANENT**

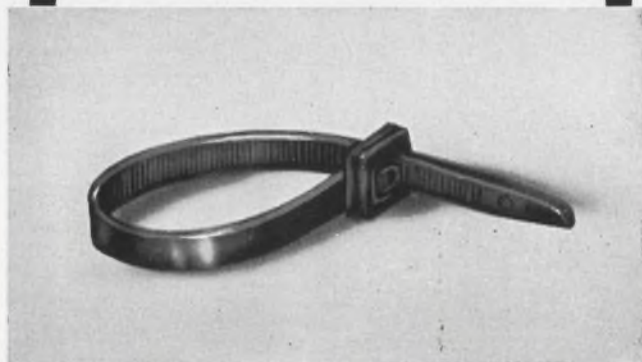

CABLE TIE

Just one component — molded of tough, flexible nylon — forms a secure, permanent harness. Easy to use without tools: just place around wires... slip end through buckle... pull taut... trim. It's virtually indestructible! Three sizes for bundle diameters up to 2 1/4".

Write for a free sample today.

OTHER ELECTROVERT PRODUCTS: Cradleclip, Strapping, Sproband, Markers, Grommet Strip, Wavesoldering Systems.
Sold Coast-to-Coast through Authorized Distributors.

ELECTROVERT INC.
86 HARTFORD AVE., MOUNT VERNON, N. Y. 10553
Burbank, California • Milwaukee, Wisconsin

give...so more will live

HEART FUND

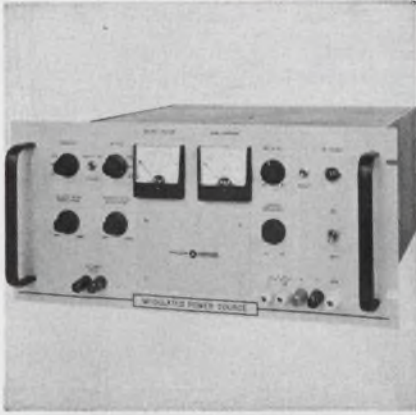

Modulated source

Model CH-50 is a modulated 5-A dc power source with an adjustable 18 to 37-V output. The source offers five modulation modes: random noise, square wave, transient, voltage spikes and external input. Random noise modulation from 10 Hz to 100 kHz is provided by an internal white noise generator. Square wave modulation from dc to 10 kHz is internal squaring of an external sine wave input. Modulation amplitude for the two modes is adjustable from 0 to 10 V p-p.

Transient modulation mode offers 20-ms pulses of +15 or -30 V. Spikes of 80 V and 10 ms duration may be superimposed on the dc output. External modulation source may be sine, square, or any waveform whose harmonic content does not require frequency response in excess of 150 kHz. Output impedance is adjustable from 0.1 to 16 Ω and regulation is 0.5%. Power required is 600 W max at 117 Vac.

Chrysler Corp., Space Div., 1312 N. Meridian St., Huntsville, Ala. Phone: (205) 837-6100.

Circle No. 376

Ac-dc modules

The PC-80 series of silicon-regulated ac-dc power modules requires little or no heat-sinking. The series offers regulation accuracy of $\pm 0.05\%$ against line and load at base temperature ratings to 80°C. Outputs ranging from 4.1 to 152 Vdc at up to 60 W are offered as standard. The modules meet MIL environmental specifications.

Technipower Inc., 18 Marshall St., Norwalk, Conn. Phone: (203) 866-9244.

Circle No. 377

21

MATTER-OF-FACT

REASONS

WHY...



BAUSCH & LOMB V.O.M. RECORDERS

ASSURE YOU OUTSTANDING PERFORMANCE

1. Directly measure and record d-c voltage, current and resistance
2. Five built-in variable chart speeds
3. Built-in event marker
4. 17 different input ranges
5. Zener diode reference supply
6. High off-balance input impedance
7. Can be used in three positions—flat on bench, at a 30° tilt or wall mounted
8. Photoelectric modulator
9. Full scale zero set—anywhere on chart span
10. Floating input with separate chassis ground
11. Built-in 100' take-up reel
12. Modular assembly and plug-in connections for rapid access service and maintenance
13. Serve as accurate vacuum tube voltmeters in measure position
14. Lightweight and portable
15. All calibration adjustments made without disassembling units
16. Zener diode d-c supply for ohms scale
17. Adjustable damping
18. Efficient pen design
19. Low cost, high quality chart paper
20. Backed by years of experience in engineering sophisticated electronic circuitry
21. An entire division is devoted exclusively to the development and production of electronic products

Bausch & Lomb V.O.M. Recorders are available in a variety of models with different full scale sensitivity. We have a wide range of accessories that make our recorders equal to just about any task required. For your special needs, we have the capability of designing customized recorders . . . modified to handle whatever applications you have in mind. Let us hear about your recorder requirements. Write for Catalog 37-2068. Better yet, ask for a personal demonstration. Bausch & Lomb, 91530 Bausch Street, Rochester, New York 14602.

BAUSCH & LOMB 

ELECTRONICS DIVISION

ON READER-SERVICE CARD CIRCLE 148



Use
**TUNING FORK
OSCILLATORS**
For Low Cost Frequency Control



New Inexpensive Model G
Frequency—from below 1 CPS to 30 KC with choice of accuracy for each of five temperature ranges. Standardized construction allows excellent delivery of prototypes or production runs. Many special features are available.
Long-term stability—2-year guarantee.
Prices start at \$35.00. Send for complete information.

Other style cases available, including models for printed circuit use.



Catalogued in **eem VSMF**

FORK
STANDARDS, INC.

217 Main Street • West Chicago, Ill. 60185
Telephone: Area Code 312 • 231-3511

POWER EQUIPMENT

Dual supply

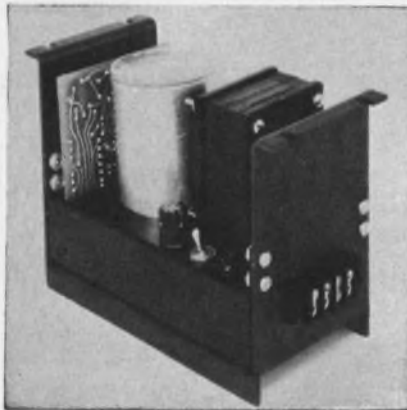

Model 506 power supply has a dual output of ± 12 to ± 24 Vdc at 150 mA for each channel. The unit features current limiting, short circuit protection and convection cooling over an operating range of -20 to 70°C . Line regulation is 0.03% and load regulation is 0.15%. The supply requires 105 to 130 Vac at 45 to 440 Hz.

P&A: \$95; stock to 2 wks. RO Associates Inc., 917 Terminal Way, San Carlos, Calif. Phone: (415) 591-9443.

Circle No. 279

Stepper motor control

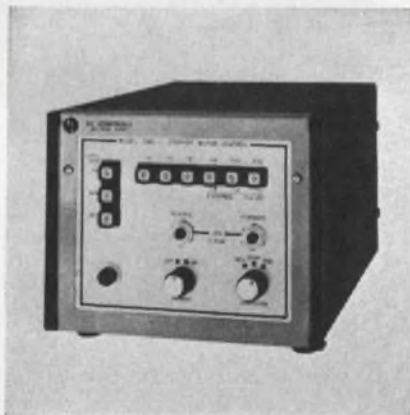

The SMC-1 stepper motor control functions as a push-button pulse generator, a translator and a power supply to control one or more stepper motors over a speed range of 144,000 to 1. Output rates are 10, 20, 40, 100, 200 and 400 steps per second, minute or hour. The unit is programable and delivers 2 A to drive 12 to 14-V center-tapped or bifilar motors.

P&A: \$750; 45 days. Houston Instrument Corp., 4950 Terminal Ave., Bellaire, Tex. Phone: (713) 667-9307.

Circle No. 280

Photomultiplier power

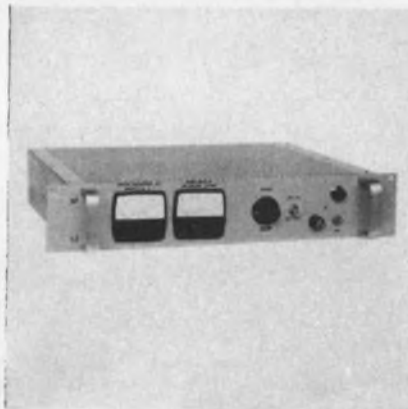

A continuously variable output of 200 to 1800 Vdc in two ranges at 0 to 10 mA is designed to power photomultiplier tubes. Line regulation of model PM-1K-01A is $\pm 0.001\%$ for a 10% change and load regulation is 0.001% from no-load to full load. Ripple is 2 mV p-p and stability is 0.01%/hour. Output voltage and current are monitored by a pair of 2%-accuracy front panel meters.

Vector Engineering Inc., 58 Brown Ave., Springfield, N. J. Phone: (201) 379-7800.

Circle No. 281

Power inverter



A solid-state transistor power inverter is designated Gemini 50-128. The device converts conventional 12 V storage battery current to a filtered 117 Vac. Rated capacity of this power inverter is 450 to 500 W.

The unit is housed in a heavy-gauge copper clad case with carrying handle.

Price: \$88. Terado Corp., Raymond Ave., St. Paul, Minn. Phone: (612) 464-2868.

Circle No. 282

Check
your
lacing
tape
requirements
here 

- HIGH TEMPERATURE**
General use Gudebrod Tapes are unaffected by temperatures to 250°F.; specially designed tapes are essentially stable in excess of 1500°F.
- LOW TEMPERATURES**
Most popular Gudebrod Tapes are stable down to -67°F., others are designed to take temperatures as low as -100°F.
- BURNPROOF**
Gudebrod has lacing tapes of completely fireproof materials, others will not support a flame.
- OUTER SPACE**
Gudebrod has a tape that won't outgas in outer space—especially suitable for space, or industrial applications in vacuum.
- FUNGISTATIC**
Whenever possible with the material of construction Gudebrod guarantees its tapes to be fungistatic or fungicidal.
- MIL-T-713A**
Gudebrod's Gudelace 18 meets all requirements of specification MIL-T-713A, type P, class two. Other Gudebrod Tapes meet or surpass these specs.
- TENSILE STRENGTH**
All Gudebrod Tapes are available in a number of widths and thicknesses to meet varying size requirements.
- CUT LENGTHS**
Gudebrod Tapes can be supplied in handy dispenser packs of cut lengths to suit your harnessing needs.
- COMPATIBLE MATERIALS**
From the wide range of basic materials and finishes used in Gudebrod Tapes the selection of a tape compatible to your insulation is easy.
- COLOR CODED TAPES**
For complicated circuitry, color coding with Gudebrod Lacing Tapes makes assembly and tracing easy.
- SPECIAL APPLICATIONS**
Gudebrod will work with your engineers to develop a special tape to meet sophisticated requirements.

THEN GET THE RIGHT TAPE FROM **GUDEBROD!**

Perhaps you are regularly using Gudebrod Gudelace 18, the standard, wax impregnated nylon tape that's known round-the-world for its non-slip knotting (meets MIL-T-713A specs, too). You are doing well then—with the finest tape and saving money on harnesses, too!

But when you are making gear for tropic or arctic use, if you are involved with outer space or

special industrial applications—come to Gudebrod. Here is your one best source for lacing tape information. Ask for a copy of our Product Data Book describing the more than 200 different tapes in our regular stock. In it you'll probably find the tape that fits your requirements—but if you don't, inquire about having one made to your particular specifications.



GUDEBROD BROS. SILK CO., INC.

FOUNDED IN 1870

Electronics Division

12 SOUTH 12th STREET, PHILADELPHIA, PENNSYLVANIA 19107

ON READER-SERVICE CARD CIRCLE 152

Area Code 215, WA 2-1122

Line conditioner

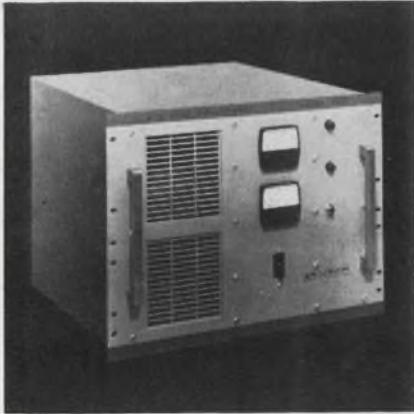

Series 3000 ac line conditioner offers complete isolation from power lines. With response time of 50 μ s max, input/output isolation of 10 dB, output distortion of 0.25% max and regulation of $\pm 0.05\%$, the units provide 2-1/2 kVA transient-free ac power. Models are available to operate at 47 to 53, 57 to 63 and 380 to 420 Hz.

P&A: \$3425 to \$3650. Elgar Corp., 5267 Linda Vista Rd., San Diego, Calif. Phone: (714) 297-3892.

Circle No. 283



Adapter

This off-the-shelf adapter/control unit converts solid-state power supplies to laboratory dc sources. A front-panel control adjusts output voltage over its full range. Plug-in power supplies are available with voltage outputs from 0 to 400 Vdc and current outputs from 0 to 25 A. All have automatic short and overload protection.

Price: \$14.95. Power/Mate Corp., 163 Clay St., Hackensack, N. J. Phone: (201) 343-6294.

Circle No. 285

Programmable supply



A fully programable, amplifier-type power supply has an output voltage of 0 to 3000 V. Programing voltage is +85 V. Line regulation is 0.001%, load regulation is 0.0007% and ripple is 5 mV rms. Model V-302 is available as a rack-mount or in a remote version. Input is 105 to 125 Vac.

Price: \$700 (rack), \$800 (remote). Gyra Electronics Corp., P.O. Box 184, La Grange, Ill. Phone: (312) 354-4644.

Circle No. 284



R. F. INTERFERENCE PLAGUING YOU?



HOW ABOUT LITTELFUSE R.F. INTERFERENCE SHIELDED FUSE POSTS. MILITARY AND COMMERCIAL APPLICATIONS Write or phone for information

LITTELFUSE
DES PLAINES, ILLINOIS

ON READER-SERVICE CARD CIRCLE 153

The widest line of
magnetic reed switches
in the industry.

SUGGESTED APPLICATIONS:

- INTERLOCKS
- COUNTING ■ KEYBOARDS
- PUSH BUTTONS ■ RELAYS

Write or call today for your **FREE** copy of the **Gordos Full Line folder . . .**
... complete with cross referencing chart.



GORDOS CORPORATION

250 GLENWOOD AVE., BLOOMFIELD, N.J. 07003 (201) 743-6800

ON READER-SERVICE CARD CIRCLE 154

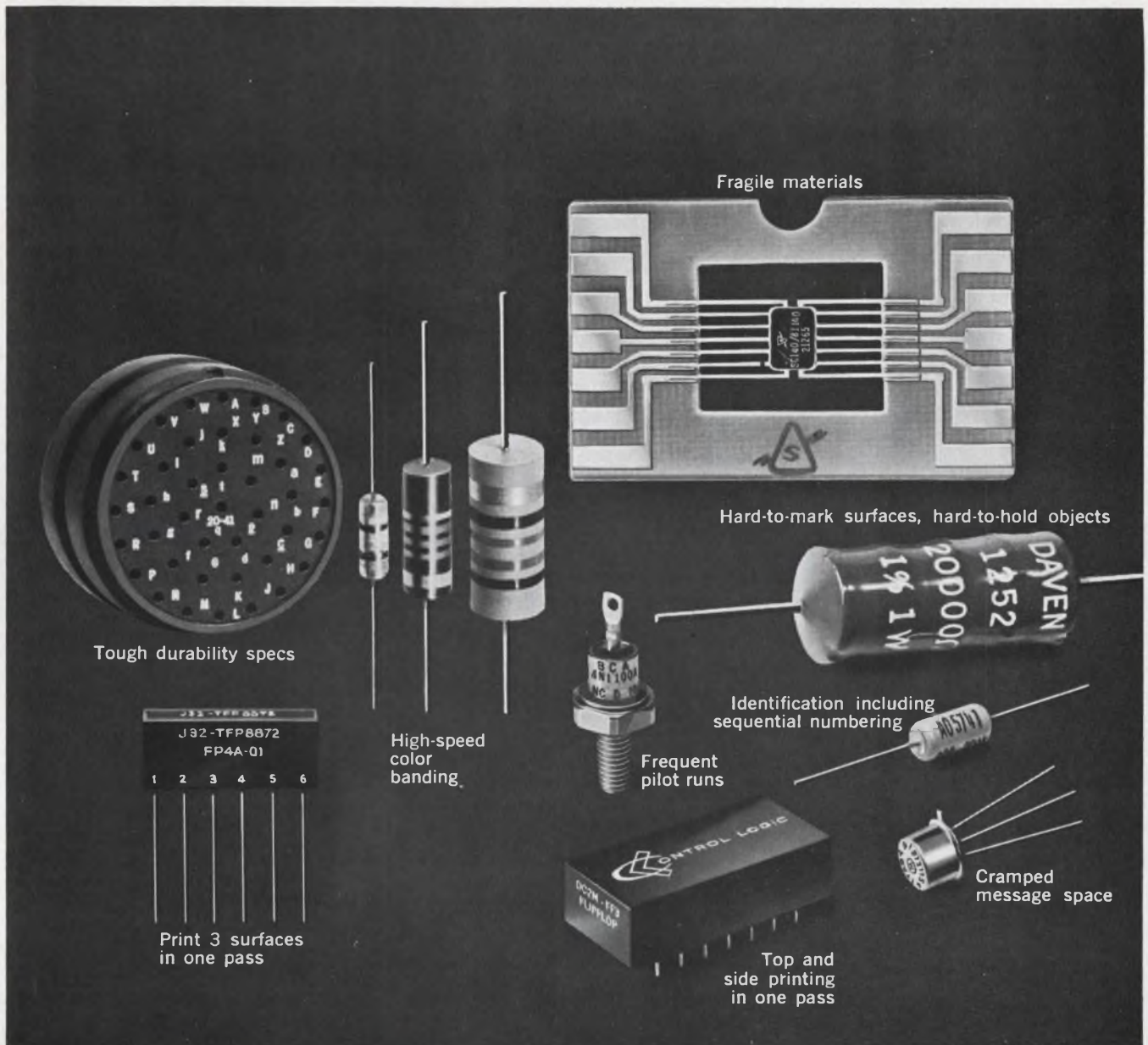

What marking job can we help you do better?

These are only a few of hundreds of marking jobs you can do more efficiently and more economically with Markem machines. So why waste time improvising and experimenting?

Call in a Markem man and get acquainted with today's broadest line of marking equipment. New high-speed color banding machines — some capable of putting three tiny bands on a miniature diode. Machines that combine sequential numbering with identification. Type so small you can print 14 characters plus trademark in an 0.125" diameter area. Quick-change type for short or pilot runs. New techniques combining special ink with flash-curing to help you meet severe durability specs. A production-speed imprinter so gentle you can safely mark flat pack ceramic components. And many other machines, specialty inks and printing elements. Right now our research engineers and chemists are working on even better ways to mark components. We'd like to be working with you. Markem Machine Company, 319 Congress St., Keene, N.H.

MARKEM[®]

HELPING YOUR PRODUCT SPEAK FOR ITSELF

ON READER-SERVICE CARD CIRCLE 155

MINIATURE TEST ACCESSORIES 1/3 smaller...

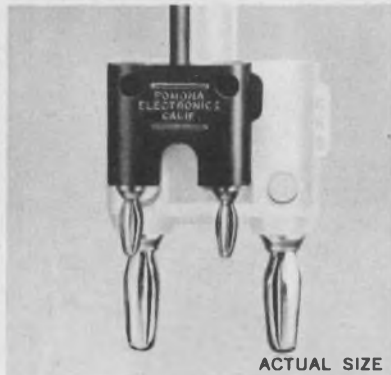

1/2" SPACING for the new generation of miniaturized test equipment

Pomona created a complete line of 1/2-inch spaced Banana plugs, jacks, cable assemblies, patch cords, adapters, and binding posts to meet the industry's continuing demand for miniaturization.

Banana plug springs formed of one piece Beryllium copper (per QQ-C-533), heat treated for long service life and low contact resistance. Tough, molded thermoplastic bodies provide maximum strength and insulation. Available in a wide selection of colors.

WRITE FOR FREE CATALOG 11-66

Lists over 230 molded test accessories, all designed to meet rigid industrial and military specifications—and built by the quality leader...

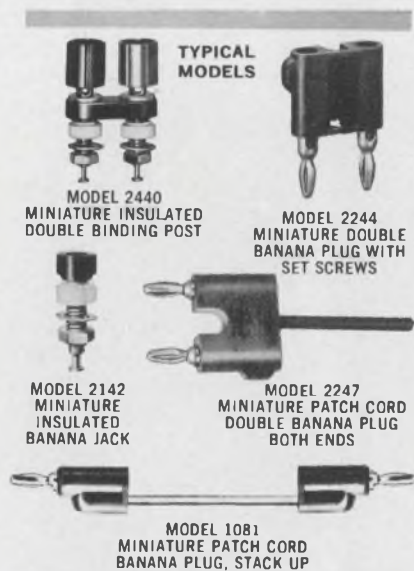

POMONA
ELECTRONICS CO., INC.
1500 East Ninth Street, Pomona, California 91766
Telephone (714) 623-3463

ON READER-SERVICE CARD CIRCLE 156

MICROELECTRONICS

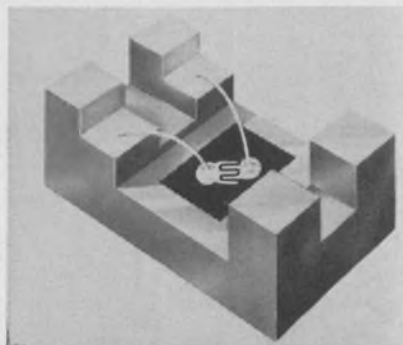

Semiconductor package

The "LID" (leadless inverted device) is a microminiature semiconductor package that can be mounted on substrates by mass production jiggling techniques. Initially, a family of high-speed switches and a family of high-gain amplifiers are offered. The all-ceramic "LID" measures $0.075 \times 0.045 \times 0.032$ in. It has four contact legs and is coated with metallized solderable gold. Any number can be mounted simultaneously and bonded to the substrate by low-temperature soldering.

Amperex Electronic Corp., Slatersville, R. I. Phone: (401) 762-9000.

Circle No. 286

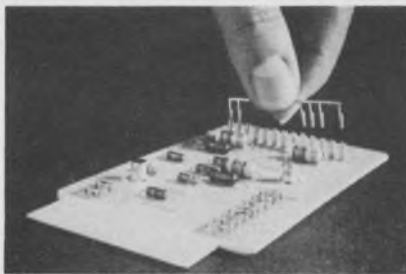

Programmable logic

Programmable digital logic cards can be converted to meet different circuit requirements. Breadboard designs may be altered by changing "program cap strip" connection points. The strip allows rapid addition or contraction of logic functions. A single card can provide two 5-input NAND gates, one 10-input NAND gate or one 8- and one 2-input NAND gates. Programing also permits optional collector loads and different switching speeds.

P&A: \$17.25 to \$31.50; stock to 30 days. IBM Corp., 1000 Westchester Ave., White Plains, N. Y. Phone: (914) 696-1900.

Circle No. 287

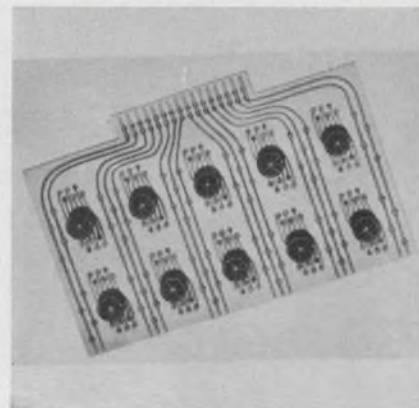

Breadboards

Series 030-TO assemblies are designed for multi-lead TO-size packages. They have 10, 20 and 30 sockets, for devices with 6, 8, 10, 12 or 14 leads. Boards are 0.062-in. thick epoxy glass for operation from -65 to 125°C . For input/output and power purposes, there are 16 flat copper busses. Boards to be permanently wired have turret-style solder lugs, and boards for evaluation have spring-loaded pin jacks. Contact resistance is less than 0.01Ω .

P&A: \$75 to \$175; stock to 3 wks. Barnes Development Co., Lansdowne, Pa. Phone: (215) 622-1525.

Circle No. 288

Ferrite memories

A monolithic ferrite memory stack with diode selection matrix has a full-cycle time of 500 to 600 ns. The 2-in.³ stacks contain 512 or 1,024 words with 32 bits/word for a max storage capacity of 32,768 bits. The devices are also available in plane form. The MF-2100 is a 64-word by 64-bit memory while the -2101 is a 64-word by 32-bit memory.

Wafers contained in these units are a "batch-processed" ferrite device eliminating core-stringing and hand-wiring. The ferrite material is fired into a solid monolithic wafer 1-in.² by 5×10^{-3} -in. thick. Each wafer contains 4096 theoretical cores with 5-mil effective diameters. They are interconnected through 16 selection matrices of 128 diodes each.

Price: \$420 (MF-2100), \$305 (-2101) (1 to 24). RCA, Components and Devices, Harrison, N. J. Phone: (201) 485-3900.

Circle No. 289



Call your local Weston Distributor for additional information. He stocks the complete Weston line, has what you need, and is primed for fast delivery!

New VOM sits up so you can sit down

Put an end to the stoop and squint routine—use the VOM that gives you real legibility with 5½" scale and refractive plastic scale overlay for parallax-free readings. New Weston Model 80 VOM permits you to reverse polarity even under load, provides a single switch for controlling functions and range, and gives you both fuses and diode overload protection. Matching family of multi-function test instruments also available.

ACCURACY: 1% dc, 1.5% ac. **DC Volts:** 0.25v to 5Kv in ten steps @ 20K ohms/volt. **AC Volts:** 2.5v to 5Kv in seven steps @ 5K ohms/volt. **DC Current:** 50µa to 10 amps in six steps. **Five Ohmmeter Ranges:** 2K to 20 meg full scale; 20 to 200K center scale. **DB Scale:** -10 to +10 db.

Ask for the portable Model 80, or the convenient rack-mounted version, MODEL 80R, for 19" relay rack panel installation.

Contact your Weston Distributor, or **Weston Instruments, Inc., Newark Division, Newark, N.J. 07114**

WESTON® prime source for precision... since 1888

ON READER-SERVICE CARD CIRCLE 157

D/A microcircuits

D/A microcircuits in hermetically sealed TO-90 and TO-91 flat packs allow up to 12-bit operation with less than 1/2-bit error. The series consists of ladder switch, ladder network and buffer. The family utilizes the combination of thin-film tantalum nitride resistors, nickel-chromium resistors and active planar devices.

Sprague Electric Co., 347 Marshall St., North Adams, Mass.

Circle No. 290

Feedback wanted

ELECTRONIC DESIGN would like to know how you rate our New Products section. Does it do the job for you? Does every issue contain at least a sampling of products you use? (We try to cover the field from amplifiers to zeners.) Any suggestions for improvements? Please send along your replies on the handy Editor-gram card at the back of this issue. It's free.

Transistor chips

A line of 15 pnp and npn silicon transistor chips is offered for hybrid circuit applications. The chips are gold-plated on the collector surface for mounting. They are also available pre-mounted on gold-plated Kovar tabs 0.05 in. square and 0.006-in. thick.

Price: \$.65 to \$1.65 (100 to 999). Raytheon Co., 141 Spring, Lexington, Mass. Phone: (617) 862-6600.

Circle No. 292

Multivibrator

A direct-coupled, high-drive, one-shot DTL monostable multivibrator provides complementary output pulses adjustable by the addition of external discrete passive components. The SW728 multivibrator is a monolithic epitaxial silicon IC with a dc noise margin exceeding 700 mV and a power drain of 50 mW. Pulse input is 20 ns min and fan-out is typically 20. Supply voltage is 8 V (continuous) and 12 V (pulsed).

Microcircuits Inc., 730 E. Evelyn Ave., Sunnyvale, Calif. Phone: (408) 245-9200. Circle No. 293

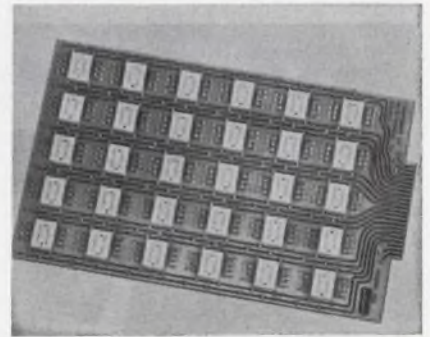

Breadboard sockets

Series 030 breadboards are available with 10, 20 or 30 sockets to accept dual in-line ICs for aging, testing or circuit development. Busses may be connected to individual sockets with turret lugs or spring-loaded pin jacks. The sockets accept 14 or 16 round, octagonal or flat leads. Body dielectric is Teflon for operation from -65 to 200°C. Interlead capacitance is 0.1 pF for opposite terminals and 0.26 pF for adjacent terminals. The boards may be interconnected for more complex configurations.

Barnes Development Co., 213 W. Baltimore, Lansdowne, Pa. Phone: (215) 622-1525. Circle No. 294



GOOD FORTUNE AND PROSPERITY AWAIT ENGINEER ORDERING E-T POTS

E-T 1/8" 10-turn precision pots:

- cost \$4.50 or less, in production quantities
- meet or exceed existing, accepted specifications
 - resistance range from 25 to 250,000 ohms
- linearity tolerance $\pm 0.25\%$ (special to $\pm 0.05\%$)
- life expectancy (shaft revolutions) 2,000,000
 - operating temperature range -55°C to +125°C

Want more details? Write or phone the company that gives you more for your money in



ELECTRO quality, price and world-wide delivery...
TECHNIQUES

11301 E. Ocean Ave., La Habra, Calif. 90631/(213) 691-0741
MFRS. OF LINEAR AND NON-LINEAR PRECISION POTENTIOMETERS SINCE 1959

to your exact specifications...



at stock prices

METALIZED MYLAR CAPACITORS

Unique, self-healing units that remain in circuit during voltage surges with little or no loss of electrical properties. Use the M2W's where size and weight are limiting factors and long life and dependability are required. The units utilize metalized Mylar* Dielectric with film wrap and custom formulated epoxy resin end fill. Available in round and flat styles.

*Du Pont Trademark for Polyester Film

Samples available on your letterhead request



DEPT ED-6, 3749 N. CLARK STREET, CHICAGO, ILLINOIS 60613
Speed Inquiry to Advertiser via Collect Night Letter

ON READER-SERVICE CARD CIRCLE 159

ON READER-SERVICE CARD CIRCLE 158

Information and the design engineer:

This definitive work fully examines this major system of information storage and retrieval

DIGITAL MAGNETIC TAPE RECORDING:

PRINCIPLES AND COMPUTER APPLICATIONS

Bernard B. Bycer

Design engineers have a dual interest in the storage and retrieval of information: they must be able to rapidly obtain and interpret large amounts of information for use in their own design work, and they are involved in the design of the systems which perform this function. Both of these interests are served in this comprehensive book by an eminent authority. The extent of the possibilities of the system is fully developed, so that the engineer may make fuller and more specific use of it; every operational aspect is covered in detail, providing a design guidebook for creation of the systems themselves, or for their inclusion in larger systems.

CONTENTS

Magnetic Tape Recording • The Digital Magnetic Tape Transport • Digital Magnetic Heads • Principles of Digital Magnetic Recording • Coding Digital Magnetic Tape • Digital Magnetic Tape • The Organization of Data on Magnetic Tape • The Digital Tape Station • Computer Applications • Recent Developments and Applications • Appendices: Tape Reservoir Length, Demagnetization, Tape Access Time

OTHER BOOKS OF INTEREST FROM HAYDEN

DESIGN OF TRANSISTORIZED CIRCUITS FOR DIGITAL COMPUTERS

Abraham I. Pressman. Complete design principles and practices. Primarily concerned with design of computer building blocks using transistors. 328 pages; illustrated, clothbound, #0215, \$9.95

BASICS OF DIGITAL COMPUTERS

John S. Murphy. An easy-to-follow, rapid means of mastering the fundamentals of digital computers. Fully illustrated for reinforcement. 416 pages, clothbound, #0073, \$9.50

BASICS OF DIGITAL COMPUTER PROGRAMMING

John S. Murphy. Thoroughly explains and illustrates the fundamental techniques of business-data computer programming. Provides the foundation for study of procedure languages. 118 pages, illustrated, clothbound, #0406, \$4.95

COMPREHENSIVE FORTRAN PROGRAMMING

Teaches the widely-employed FORTRAN languages specifically as used by the IBM 1620 computer with an attached 1311 Disk Drive; the material applies to other prominent systems. 246 pages, illustrated, clothbound, #5647, \$6.95



318 PAGES

230 ILLUSTRATIONS

FULLY INDEXED

EXTENSIVE BIBLIOGRAPHIES

CLOTHBOUND, #5031, \$11.00

1 Offers complete and concise understanding of the entire field

2 Gives useful and practical information on all design aspects

HAYDEN BOOK COMPANY, INC.

DEPARTMENT ED-62 • 116 WEST 14th ST., NEW YORK, N.Y. 10011

10 Day Free Examination Offer!

Gentlemen:

Please send me the book(s) checked below for a 10-day free examination. At the end of ten days I will remit payment plus a few cents postage, or return the book(s) with no further obligation.

- DIGITAL MAGNETIC TAPE RECORDING, #5031, \$11.00
- Design of Transistorized Circuits for Digital Computers, #0215, \$9.95
- Basics of Digital Computers, #0073, \$9.50
- Basics of Digital Computer Programming, #0406, \$4.95
- Comprehensive FORTRAN Programming, #5647, \$6.95

Name _____ Title _____

Company _____

Address _____

City _____ State _____ Zip _____

Check for \$ _____ is enclosed. Publisher pays postage with same return guarantee.

"milletuplets"

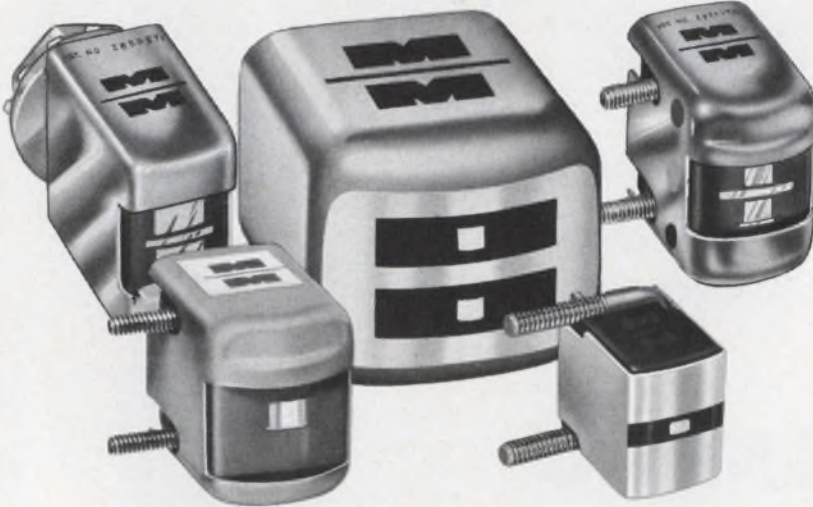

That's our way of telling you about Laminac™, our new process for manufacturing identical, high-precision, laminated tape heads by the thousands. Our high-volume production lowers unit cost. You save money. Send us your specifications and see for yourself.

Send for new
full-line catalog



MICHIGAN MAGNETICS, INC.
VERMONTVILLE, MICHIGAN
A Subsidiary of VSI Corporation

ON READER-SERVICE CARD CIRCLE 161

Design Aids

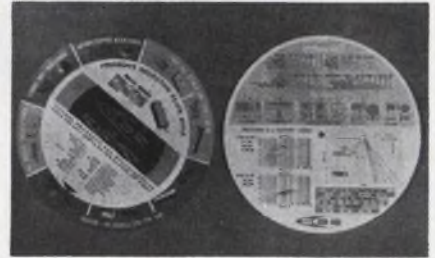

Selector slide rule

A product selector for filters, inductors and delay lines is offered in the form of a circular slide rule. With the dial turned to the product desired, complete specifications are read through the cut-out window. The rear of the rule details parts numbers and case styles, and presents various filter and inductor graphs. Stanford Applied Engineering.

Circle No. 295



Film and tape chart

A cross reference chart of relevant parameters for all currently available high-temperature and pressure-sensitive tapes and films is offered. The chart covers Teflon and related products and lists 73 types of tapes and films complete with specifications and sources. On the reverse side is an engineering and application guide. Technical Fluorocarbons Engineering Inc.

Circle No. 296

CEI Type 354 Receiver



Covers ELF-MF (1-600 KHz) Frequencies

CEI's new Type 354 receiver tunes from 1 to 600 KHz in a single band, receiving AM, SSB, CW, MCW and FSK signals with low noise and exceptional sensitivity. A steel tape dial is employed for tuning ease and accuracy.

All solid state, the Type 354 offers four IF bandwidths (150 Hz, 1, 3 and 6 KHz) and a choice of input attenuation (0, -20, -40 and -60 db), all selectable from the front panel. BFO can be adjusted ± 3 KHz, while incidental FM is less than 10 Hz peak deviation.

The same receiver is also available with a digital frequency display for extra convenience and precision. This is designated Type 351. For further information about these compact and ultra-reliable new receivers, please write:



COMMUNICATION ELECTRONICS INCORPORATED

6006 Executive Blvd., Rockville, Md. 20852 • Phone: (301) 933-2800 • TWX: 710-824-9603

ON READER-SERVICE CARD CIRCLE 162

Delay line memories

A file folder doubles as a design guide to specifying magnetostrictive delay line memories. With the aid of schematics, operating principles and associated circuitry are detailed. Fourteen practical notes considering parameters of interest for delay lines and associated circuitry complete the two-color folder. Deltime.

Circle No. 297

Application Notes



Test applications

A 90-page, paper-backed book details "1001 Uses" for the manufacturer's volt-ohm-milliammeter. Each test application is explained in text as well as by schematic or circuit diagrams. Tables, charts and formulas are included.

A section, "Other Measurements," covers tests of frequency, transistors and diodes, capacity, μV attenuation, batteries and field strength.

Available for \$1.00 from Simpson Electric Co., 5200 W. Kinzie St., Chicago.

Veto efficiency

Successful anti-coincidence or veto operation of a coincidence or AND circuit requires nearly 100% efficiency in the veto channel. Available discriminator/trigger circuits are unsatisfactory as none provide better than 50% efficiency.

This 4-page application note shows how a dual limiter module may be used to assure that the efficiency of the veto channel is limited only by the detector and the bandwidth of the limiting and veto circuits. Schematics, oscillograms and equations aid in the discussion. EG & G, Inc.

Circle No. 298

SEARCHING FOR LOW-COST, MILITARY QUALITY, $\frac{1}{2}$ INCH, 10-TURN POTS?



COMPARE THESE SPECS AGAINST COMPETITIVE EQUIVALENTS (IF YOU CAN FIND ANY!)

Resistance Range: 100 ohms to 100K ohms
 Resolution: 0.101 to 0.015% ■ Linearity: 0.30%
 Power Rating: 2 watts @ 40°C
 Operating Temperature: -55°C. to +125°C.

spectrol

Prices start at less than \$9.00 in 100 quantities, and yet these quality pots meet or exceed many military environmental specifications. For full information, send for a data sheet.

Spectrol Electronics Corporation, 17070 E. Gale Ave., City of Industry, Calif. 91745

...YOU'VE JUST FOUND THEM!

A standard $\frac{1}{2}$ -inch shaft $\frac{1}{4}$ -32 thread bushing mount, a popular $\frac{1}{4}$ -inch shaft $\frac{1}{4}$ -32 thread bushing mount, and a unique low-cost servo mount — all with rear terminals!



Speed Inquiry to Advertiser via Collect Night Letter
 ON READER-SERVICE CARD CIRCLE 163

New Literature

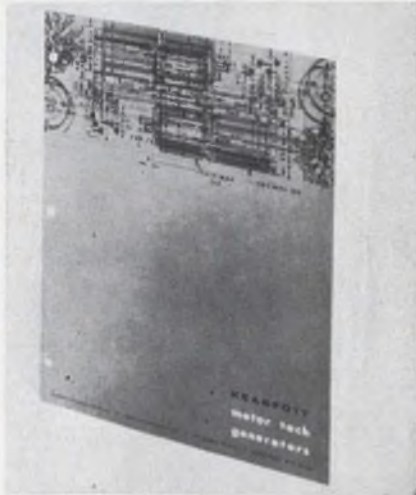

Motor tach generators

Motor tach generators from size 5 to size 23 are fully described in a 28-page booklet. Data on such related devices as integrating ac/ac mechanical filters, dc tachometers, ac motor/dc tach combinations, integrating tach generators and specialized motor generators are given. A "Definitions and Applications" section contains functional schematic and block diagrams, together with equations relating to major performance characteristics. General Precision Inc., Kearfott Products Div.

Circle No. 299

Dc power modules

Technical bulletin 56-366-5 covers a line of low-cost, wide-range dc power modules. The 6-page brochure provides descriptive and circuit information, data on model types, physical and electrical specifications, applications and operational data. Electronic Research Associates Inc.

Circle No. 300

Graphic displays

A new design portfolio details a line of automatic drafting tables, digital electronic controls and accessory systems for converting graphics to digital data. The package is complete with illustrations and specifications. Gerber Scientific Instrument Co.

Circle No. 301

Silicon rectifier guide

Complete electrical replacements for a broad range of silicon rectifiers are outlined in a new replacement guide. The guide facilitates replacement of more than 1200 competitive rectifier types, both JEDEC and house numbers. A selection guide, cross-reference charts, current/temperature derating curves and dimensional drawings are provided. Motorola Semiconductor Products, Inc.

Circle No. 302

Contacts

Innovations in contact materials and value analysis in contact applications are detailed in bulletin PEP-2. Analyzed are considerations such as combining properties of springiness, strength and conductivity into one system, heat sinks and scrap and space control. Charts and drawings illustrate techniques such as overlay, top-lay, stripe, temper top-lay and edgelay. Texas Instruments, Metals & Controls Div.

Circle No. 303

Wavesoldering

An 8-page brochure describes and illustrates automated soldering systems available to meet PC requirements. Details as wave characteristics, operating temperatures, applications and physical specifications are included for each wavesoldering machine and various fluxing, preheating, cleaning and drying units. The brochure also explains the principle of wavesoldering and hot-dip tinning. Electrovert, Inc.

Circle No. 304

Transistor guide

The "Pocket Guide to Silicon Small Signal Transistors" is a pocket-sized reference for transistor selection. The 36-page handbook covers low- and high-frequency amplifier transistors, general-purpose transistors and grown-junction transistors. Unijunctions, miniature transistors, switching transistors, consumer and industrial transistors and packages are also included. Milgray Electronics Inc.

Circle No. 305

Digital transduction

Current techniques and concepts for digital transduction are reviewed in a 100-page report. Frequency and pulse generating, photo-optical, nuclear and digital-encoder approaches are covered. Techniques for adapting digitizing principles to measurement of pressure, temperature, displacement, acceleration and position are discussed. Digital encoding methods such as the pure binary, the BCD and the "Excess-Three" codes are reviewed. The use of magnetic reluctance techniques, optical rulings, Hall generators, and ring laser approaches are discussed.

Available for \$3 from Clearinghouse, U. S. Dept. of Commerce, Springfield, Va.



Rectifier handbook

A 216-page silicon rectifier handbook provides information needed for effective selection and application of silicon rectifiers. For the experienced and the newcomer to the power control field all phases of the rectifier art are covered. Circuits for single and multi-phase systems as well as rectifier voltage multipliers and circuits for regulation, arc suppression and other specialized applications are described and analyzed. Areas of overvoltage and overcurrent protection and thermal design are discussed.

Available for \$1.50 from Motorola Semiconductor Products, P.O. Box 955, Phoenix, Ariz.

No one has a larger line of disc memories.

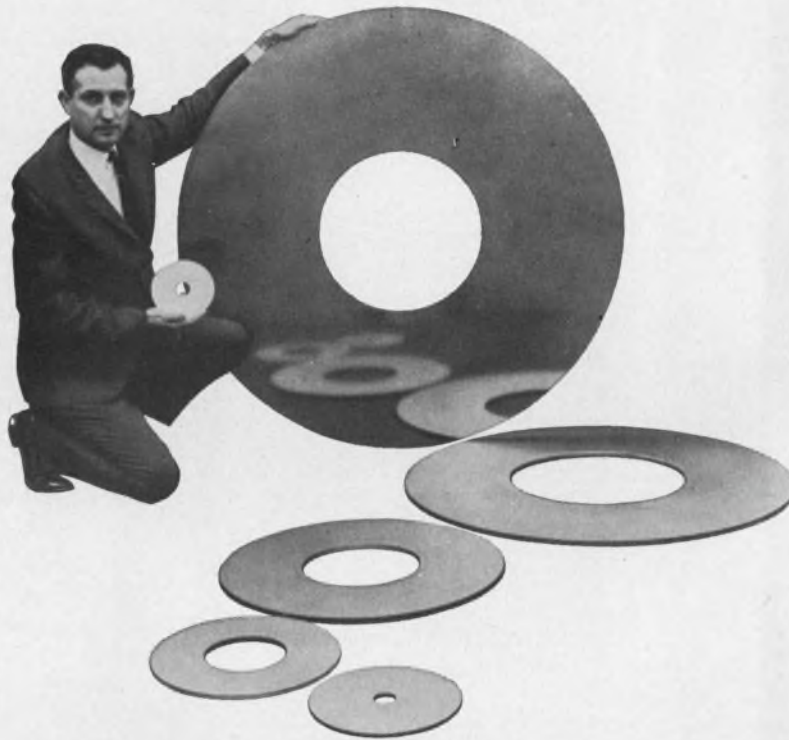

See the largest line of disc memories available at the Spring Joint Computer Conference, Booth 913-916

Whether your information storage requirements are small or require data stored in millions of bits, Librascope Group of General Precision, Inc., has a disc memory system for every application. These systems have a proven history of reliable performance in computing systems designed for military, business, engineering, and educational applications.

LIBRAFILE mass memories: Large-capacity, high-speed, random-access information storage systems. Two disc sizes available. 48" discs capable of storing up to 400 million bits. 38" discs with a capacity of 200 million bits. LIBRAFILE mass memory information retrieval is either fixed-address search or search-by-record content. Access time less than 20 ms. Data transfer rates in the megacycles.

Militarized disc-memory systems: High-speed, random-access, information-storage systems. Consists of disc memory for data storage and an electronic subsystem that provides complete interface, control, and read/write electronics. These systems can be used as a data base for shelter, van, or shipboard applications. Storage capacity of 25 million bits on 24" discs. Customized capacity up to 80 million bits.

L-400 magnetic-disc memory systems: Provide data storage and transfer in computer systems, peripheral equipment, and other systems where rapid-access memory is a requirement. 24" disc storage capacity up to 36 million bits.

Airborne disc file: Small, compact file designed for airborne (MIL-E-5400 class 2) applications, as well as for shipboard and mobile field operations. 6¼" disc with capacity of 1 million bits. Customized airborne memories available with

capacity up to 50 million bits.

L-300 disc memory: For use in computer systems and peripheral equipment as main storage, buffer storage, or as a supplemental memory. 10" disc with a capacity of 275,000 bits.

For complete details, write for our technical bulletins.

Engineers: For career openings, call or send resume in confidence to B. Larson, General Precision, Inc., Librascope Group, 808 Western Avenue, Glendale, California 91201. An equal opportunity employer.

A Plans-for-Progress Company.

**GP GENERAL
PRECISION INC.**

LIBRASCOPE GROUP

□ □ □ 808 Western Avenue □ □ □
□ □ □ Glendale, Calif. 91201 □ □ □

ON READER-SERVICE CARD CIRCLE 164

DUAL OUTPUT POWER SUPPLIES



Dual output power supplies are housed in one case 3-5/16" x 4-5/32" x 4-11/16" high. Identical or different output voltages from 1.5 to 75 are available in 1 volt increments for each of the DC outputs. The graph below furnishes maximum current corresponding to output voltage. Select the two outputs needed and telephone Acopian for all the details — plus guaranteed 3-day shipment after receipt of your order.

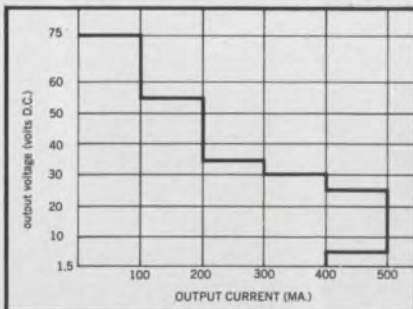

TYPICAL SPECIFICATIONS

Input Voltage: 105 to 125 VAC

Line Regulation: ± 0.5 to $\pm 0.05\%$
(depending on model)

Load Regulation: ± 1.0 to $\pm 0.05\%$
(depending on model)

Ripple: 5 to 1 mv (depending on model)

No additional external heat sinking required.

Write for Acopian's 16-page catalog and price list to: Acopian Corp., Easton, Penna., or call collect (215) 258-5441.



ON READER-SERVICE CARD CIRCLE 165

NEW LITERATURE

Frequency control

A comprehensive review of frequency control and timing instrumentation, components and systems is offered. Frequency standards, phase comparators, distribution amplifiers, digital clocks, crystal oscillators, proportionally controlled ovens and crystal controlled linear discriminators are described. The 4-page brochure includes photographs, specifications and descriptions. Frequency Electronics Inc.

Circle No. 306

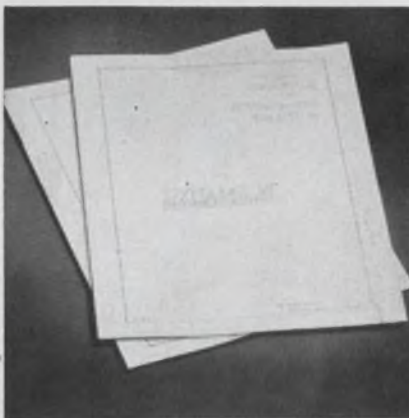

Amplifier selection

"Selecting a Differential Amplifier" discusses the wide range of differential amplifiers and the difference existent between common-mode rejection methods and rejection level capabilities. Parameters discussed include constancy of common-mode rejection with gain, common-mode slewing and overload characteristics, floating versus grounded-source conditions and input attenuation design. Dynamics Instrumentation Co.

Circle No. 307

Drum programmer

The 12-page technical bulletin 200 provides detailed information on the concept, application, construction, and specifications of a stepping drum programmer. End-point program control is explained and typical applications are graphically described. The solutions of program-control problems are compared using this programmer and other types of systems. Options, special circuits, and programming accessories are included. Tenor Co.

Circle No. 308

Resistance tests

A 12-page, pocket-size guide explains the fundamentals of insulation resistance testing. Manual P-16424 shows test hook-ups for insulation resistance evaluations on wiring, distribution panels, dc motors and generators and ac motors. Associated Research Inc.

Circle No. 309

Timing controls

A 4-page illustrated product file on automatic timing controls is offered. The folder includes complete specifications and dimensions on time delay relays, interval timers, cycle timers, running time meters, percentage timers, reset timers, time switches and program clocks. Zenith Controls Inc.

Circle No. 310

Terminal blocks

Engineering data and specification charts on a 300-V, miniature sectional terminal block line, are featured in the 30-page catalog G-104. A fold-out page containing tables 310-12 and -13 of the NEC for terminal block current ratings is included. Buchanan Electrical Products Corp.

Circle No. 311

Components catalog

A 120-page components catalog covers a line of precision and trimming potentiometers and counting dials. Electrical, mechanical and environmental characteristics are completely specified. Each pot is shown in a cut-away form to depict important product features. Amphenol.

Circle No. 312

Relays

The Proceedings of the 14th National Relay Conference, April 27, 1966, are offered. The volume contains 25 technical papers, covering areas ranging from contact geometries, materials and reliability to packaging.

Available for \$5 from Mr. James V. Roughan, National Association of Relay Manufacturers, P.O. Box 7765, Phoenix, Ariz.

Magnetrons

This bulletin outlines breakthroughs in protecting voltage-tunable magnetrons against RF interference. The 4-page brochure discusses how the shielding reduces susceptibility to degaussing. Also described are advantages including modulation rates as high as 20,000 MHz/ μ s, electronic linear tuning, and a relatively flat power variation across wide bands. General Electric, Electronic Components Div.

Circle No. 313

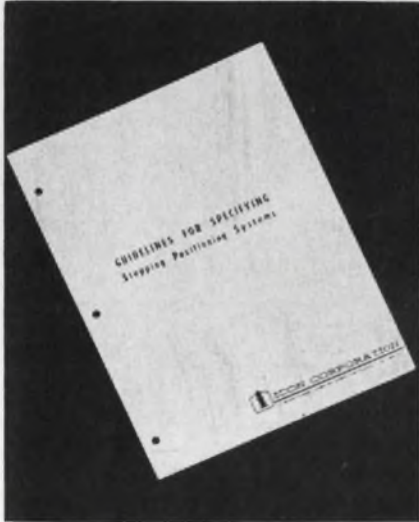

Stepping motors

A new 12-page design booklet aids in the use of stepping motors in precision positioning systems. Criteria for open- versus closed-loop systems for direct digital positioning are examined. Theory, cost and reliability are discussed and illustrated with sample applications. A table lists the specifications of most motors available today. Icon Corp.

Circle No. 314

Bellows couplings

A 2-page engineering bulletin describes a complete line of bellows couplings. Couplings for synchros, pots, shaft encoders and other rotary devices are covered. Theta Instrument Corp.

Circle No. 315

Digital printer

Bulletin 2045 describes a 63-character alphanumeric strip printer used for computer interrogation and monitoring. Specifications cover all pertinent electrical and mechanical parameters. Franklin Electronics, Inc.

Circle No. 316

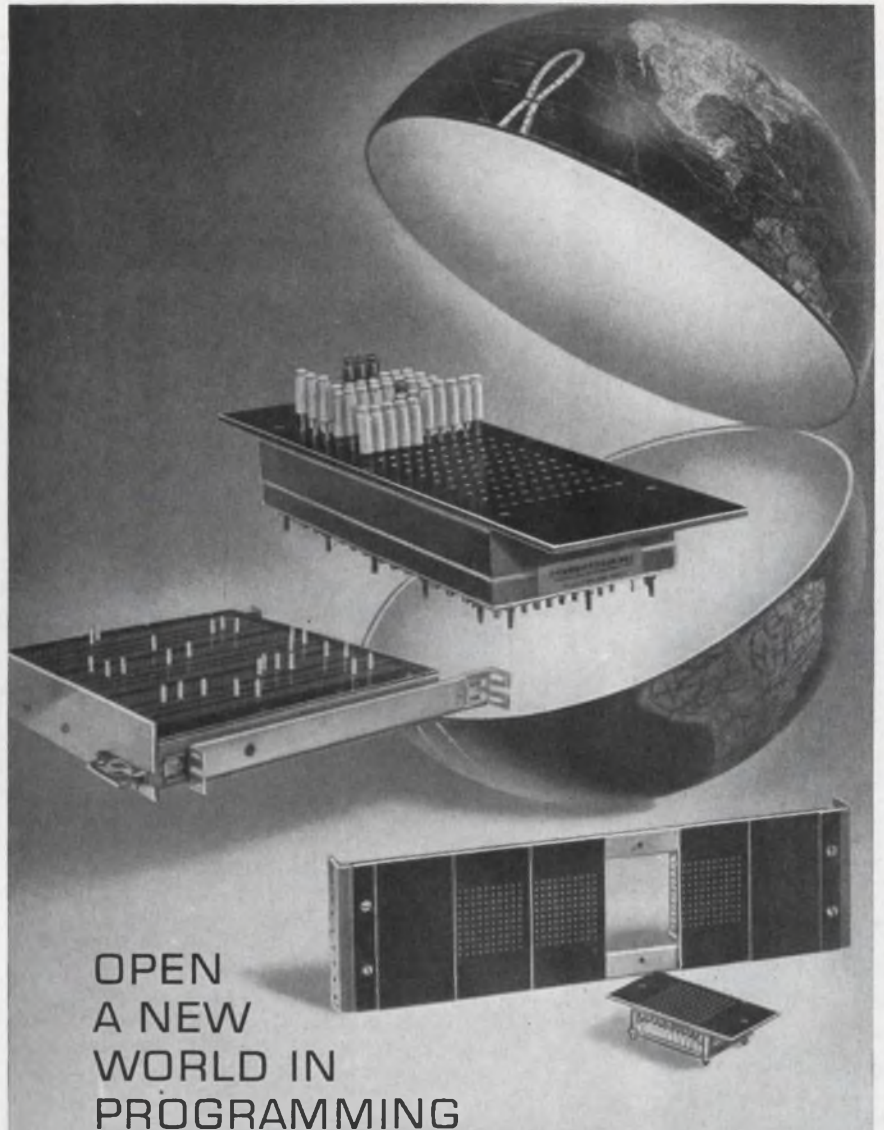

OPEN
A NEW
WORLD IN
PROGRAMMING

SEALECTOBOARD

offering unlimited versatility in programming, switching, and circuit control without patchcords or jumpers. Sealectoboard has a unit that can perform virtually any programming function with one to four contact decks, bussed contacts, shorting, skip, and component holding pins, and countless hole, contact and mounting configurations.

If your application calls for a fast, highly reliable, program-at-a-glance programming system, contact Sealectro. Our Applications Engineers are experts at solving programming problems.

P.S. The price is right, too!



PROGRAMMING DEVICES DIVISION

SEALECTRO
CORPORATION

MAMARONECK, NEW YORK

Phone: 914 698-5600 TWX: 710-566-1110

Sealectro Ltd., Portsmouth, Hants, England

Design Data from Manufacturers

Advertisements of booklets, brochures, catalogs and data sheets. To order use Reader-Service Card.

(Advertisement)

New Particle And Photon Detectors



New Bendix Catalog describing three magnetic electron multipliers and accompanying power supply is now available. Bendix electron multipliers are rugged, miniature detectors with many applications in photon, ion, and neutral-particles radiation measurement. Three models . . . each with a different configuration to meet specific size and space requirements. Also featured is the compact, convenient Power Supply that is designed specifically for the electron multipliers.

The Bendix Corporation
Cincinnati Division

3625 Hauck Rd., Cincinnati, O. 45241

171

M-F Nylon Insert Lock Nuts



This book can be a valuable guide to the engineer who must specify dependable locking fasteners. It contains sixteen pages and describes all aspects of MacLean-Fogg's complete line of Nylon Insert Lock Nuts. There are tables which outline principal features and applications of the nuts. Other tables list physical properties, chemical properties, and data on tensile strength requirements. Charts on each of the company's eight styles of Nylon Insert Lock Nuts include dimensional data, weights, and part numbers. Circle number on reply card.

MacLean-Fogg Lock Nut Company

1060 Allanson Road
Mundelein, Illinois 60060

172

Books For The Electronics Engineer



The 1966 Hayden Book Company, Inc., catalog contains such new titles as "Microelectronic Design," "100 Ideas for Design '66," "The Electron in Electronics," "Synthesis of RC Networks with Arbitrary Zeros," "Transistor and Diode Network Calculations," and "Matrix Algebra for Electronic Engineers." As well as the expanded list for design engineers, the catalog includes Hayden and John F. Rider Publisher training texts at all levels. Send for your free catalog today.

Hayden Book Company, Inc.

116 West 14th Street
New York, N. Y. 10011

173

NEW LITERATURE

Core memories

Core memories for industrial and computer applications are described in this 4-page brochure. Complete specifications are included. Rese Engineering Inc.

Circle No. 317

RF power measurement

Catalog SF-66 covers coaxial load resistors, absorption wattmeters, directional wattmeters and coaxial switches. In addition to specifications and prices, related custom-built accessories such as coaxial filters and power monitors are described. Bird Electronic Corp.

Circle No. 318

Reprints Available

The following reprints are available free and in limited quantities. To obtain single copies, circle the number of the article you want on the Reader-Service Card.

High Volume—Low Cost: Designers' Challenge (No. 740)

Which Device for High Power Switching? Part I (No. 741)

Which Device for High Power Switching? Part II (No. 742)

Harmonic Generators: Is the Step Recovery Diode Best? (No. 743)

Subscription Policy

ELECTRONIC DESIGN is circulated free of charge to qualified design engineers in the U.S., Western European Continent and Britain. To establish your qualifications, send ELECTRONIC DESIGN the following information on your company's letterhead: Your name, engineering title, description of your design duties and a list of your company's major products. The letter must be signed by you personally.

Subscription rates for nonqualified subscribers—\$25 a year in the U.S., \$35 in all other countries. Single copy, \$1.50.

Change of Address

An address change for a subscriber requires a restatement of his qualifications. To expedite the change, and to avoid missing any issues, send along a label from a back copy.

Microfilm copies of all 1961, 1962, 1963, 1964 and 1965 issues of ELECTRONIC DESIGN are available through University Microfilms, Inc., 313 N. First Street, Ann Arbor, Mich.

Electronic Design

Advertising Representatives

New York 10022

Robert W. Gascoigne
Thomas P. Barth
Samuel M. Deitch
Richard W. Nielson
850 Third Avenue
(212) PLaza 1-5530
TWX: 867-7866

Philadelphia 19066

Fred L. Mowlds, Jr.
P. O. Box 206
Merion Station, Pa.
(215) MO 4-1073

Marblehead 01945

Richard Parker
7 Redstone Lane
(617) 742-0252

Chicago 60611

Thomas P. Kavooras
Berry Conner, Jr.
720 N. Michigan
(312) 337-0588

Cleveland 44107

Robert W. Patrick
8410 Treetower Drive
Chagrin Falls, Ohio
(216) 247-7670

Los Angeles 90303

Stanley I. Ehrenclou
Terrence D. Buckley
W. James Bischof
2930 W. Imperial Highway
Inglewood, Calif.
(213) 757-0183

San Francisco 94306

Ashley P. Hartman
541 Del Medio
Suite # 301
Mountain View, Calif.
(415) 327-6536

Southwestern 75206

Tommy L. Wilson
6200 North Central Express-
way
Dallas, Tex.
(214) EMerson 1-2311

London W. 1

Brayton C. Nichols
44 Conduit Street

Tokyo

Yoshihiro Takemura
International Planning
Service, Inc.
Room No. 512 Nikkoh
Mita Building
1, Nishidaimachi, Shiba-
Takanawa
Minato-ku, Tokyo



vactec photocells



An important component in Bell & Howell's New Autoload® 431 Super 8 Movie Camera

The Optronic Eye in Bell & Howell's Model 431 Super 8 Movie Camera is described as the most precise automatic exposure system ever developed. And Vactec was selected to supply the photocells which must automatically sense, adjust, and check exposure accuracy. One more example of how manufacturers who want the finest, specify Vactec light sensitive devices.

If your product requires dependable photocells, contact Vactec. A complete line of standard types is available, or Vactec will custom design units to meet special requirements.

Write for Bulletin PCD-3 for Cadmium Sulfide and Selenide types; Bulletin SPV-4 for Selenium photovoltaic types.



2423 Northline Industrial Blvd. • Maryland Hts., Mo. 63045
Phone Area Code 314, HE. 2-4200

ON READER-SERVICE CARD CIRCLE 167

2.5 mc

FIFTH OVERTONE PRECISION CRYSTAL



for use in
laboratory accuracy
secondary frequency
standards

Model G11AW is stable to 5×10^{-10} per day. Q is in excess of 4 million. Each unit is supplied with a data sheet demonstrating performance to all mechanical and electrical specs including initial aging.

Write for Bulletin G11AW.



CTS Knights, Inc.

of Sandwich, Illinois
(formerly The James Knights Co.)
a subsidiary of CTS Corporation, Elkhart, Indiana



ON READER-SERVICE CARD CIRCLE 168

Advertisers' Index

*PARTICIPANTS IN NIGHT LETTER PROGRAM

Advertiser	Page	Advertiser	Page	Advertiser	Page
ACI Division, Kent Corporation	182	Fairchild Semiconductor, A Division		Plastic Capacitors, Inc.	164
ADC Products, Inc.	186	Fairchild Camera and Instrument Corporation	111	Potter Company, The	174
*AMP, Incorporated	133	Fork Standards, Inc.	206	*Potter & Brumfield Division of American Machine & Foundry Company	97
Acopian Corporation	218			Princeton Applied Research Corp.	16
*Agastat Timing Instruments, Elastic Stop Nut Corporation of America	134	General Electric Company		Pyrofilm Resistor Co., Inc.	78
Allen-Bradley Co.	32A-B	Component Capsules	60, 61		
Aluminum Company of America	52, 53	General Electric Company		RCA Electronic Components and Devices	109, 147, 163, Cover IV
American Aluminum Company	132	Electronic Components	28	RCL Electronics, Inc.	142
American Components, Inc.	142	General Electric Company, Electronic Components, Sales Operation	32A-B	Rowan Controller Co., The	192 A-B
American Cyanamid Company	155	General Instrument Corporation	8		
American Lava Corporation	79	General Precision, Librascope Group	217	Sanborn, A Division of Hewlett-Packard	4, 5
*Amperex Electronic Corporation, Tube Division	126, 127	Globe Industries, Inc.	200	Sanders Associates, Inc.	63
Analog Devices, Inc.	25	Gordos Corporation	208	Scientific Data Systems	6
*Arnold Engineering Company, The	19	Gudebrod Bros. Silk Co., Inc.	207	Seaelectro Corporation	219
Astro Communication Laboratory, Inc.	193	Guardian Electric Manufacturing Company	203	Sigma Instruments, Inc.	56, 57
Automatic Electric, A subsidiary of General Telephone & Electronics	96, 199			Siliconix Incorporated	167
		Harowe Servo Controls, Inc.	148	Simpson Electric Company	200
*Ballantine Laboratories, Inc.	139	Hayden Book Company, Inc.	166, 213, 220	Singer Company, The—Metrics Division	135
Bausch & Lomb, Electronics Division	205	Hewlett-Packard	1, 23, 85, 175	*Sola Electric, Division of Sola Basic Industries	181
Beckman Instruments, Inc., Cedar Grove Operations	55	Hoffman Electronics Corporation	159	Specific Products	54
*Beckman Instruments, Inc., Hellpot Division	187	Honeywell, Test Instruments Division	91	*Spectrol Electronics Corporation	215
Behlman-Invar Electronics Corp.	144	Hughes Aircraft Company, Electronic Products Division	33	Sprague Electric Company	10, 12, 20
Bendix Corporation, The	220	Hunter Spring, A Division of Ametek, Inc.	166	*Standard Condenser Corporation	212
Bendix Corporation, The, Semiconductor Division	15			Switchcraft, Inc.	172
*Bodine Electric Company	196	*IRC, Inc.	64 A-B-C-D-E		
Borg-Warner Controls	58	ITT Semiconductors	103, 105, 107	TRW Semiconductors	66
*Brush Instruments, Division of Clevite	Cover III	Industrial Electronic Engineers, Inc.	198	*Tally Corporation	149
Bulova Electronics Division, Bulova Watch Company	161	*Inland Motor Corporation	49	Technical Information Corporation	223
*Burr-Brown Research Corporation	197			Techno-Components Corp.	62
*Burroughs Corporation	131	*JFD Electronics Corporation	121	Tektronix, Inc., Oscilloscopes	201
		Jennings Radio Mfg. Corp.	176	Tenney Engineering, Inc.	48
CTS Corporation	137	Johanson Manufacturing Corp.	170	Texas Instruments Incorporated, Semiconductors-Components Division	74, 75
C T S Knights Inc.	221	Johnson Company, E. F.	160 A-B	Times Wire and Cable, Division of The International Silver Company	64
Cedar Engineering Division, Data Control Corporation	196			Tracor, Inc.	154, 156
Century Electronics & Instruments	180	Latronics Corporation	158		
Chassis-Trak Inc.	150	Leach Corporation	179	Union Carbide Corporation, Linde Division	145
Clairex Corporation	164	Lenox-Fugle Electronics, Inc.	162	*Union Carbide Corporation	68
Cohu Electronics, Inc.	171	Licon, Division Illinois Tool Works Inc.	80, 81	United Control Corporation	184
Communication Electronics, Incorporated	214	Littelfuse	208	United Transformer Corp.	Cover II
Computer Logic Corporation	146				
*Computer Measurements Company	2	McLean-Fogg Lock Nut Company	220	Vactec Inc.	221
*Consolidated Avionics, A Division of Condec Corporation	153	Mac Panel Company	89	Vector Electronic Co., Inc.	140
Cornell-Dubilier Electronics	185	*Mallory & Co., Inc., P. R.	100, 101, 141	*Victoreen Instrument Company, The	168
Couch Ordnance, Inc.	65	Marco-Oak Industries	165		
Cutler-Hammer, Inc.	51	Markem Machine Company	209	Westinghouse Molecular Electronics Division	27
		Mepco, Inc.	183	Weston Instruments Inc., Newark Division	211
*Dale Electronics, Inc.	128A-B	Michigan Magnetics, Inc.	214	Weston Instruments Inc., Archbald Division	173
*Damon Engineering, Inc.	22	*MicroSwitch, A Division of Honeywell	195		
Data Control Systems, Inc.	84	Microtek Electronics, Inc.	178	Regional Advertising	
Deutsch Electronic Components Division	143	Mitsumi Electric Co., Inc.	162	Burndy Corporation	192C
*Dow Corning Corporation	124, 125	Monroe/Data Log, Division of Litton Industries	122, 123	*Dale Electronics, Inc.	192E
		*Motorola Semiconductor Products, Inc.	189	*Magnetics, Inc.	192F
Eastern Industries, A Division of Laboratory for Electronics, Inc.	224	Mullard, Ltd.	31	Sorensen Operation, Raytheon Company	192D
Electro Nuclear Laboratories	158				
Electro Techniques	212	NJE Corporation	169	Career Advertising	
Electronic Engineering Co. of California	95	Nexus Research Laboratory, Inc.	157	Bendix Corporation, The	114
*Electronic Specialty Co.	191	New England Instrument Company	96 A-B	IBM Corporation	115
Electronized Chemicals Corporation	202	Norden Division of United Aircraft Corporation	177	ITT Federal Laboratories	116, 117
Electrovert, Inc.	204	Nytronics, Inc.	136	LTV Electrosystems Inc.	118
Elgenco, Inc.	194			Monsanto	114
Erie Technological Products, Inc.	9	Ohmite Manufacturing Company	151	Motorola, Inc.	112
Fairchild Instrumentation, A Division of Fairchild Camera and Instrument Company	44, 45			U. S. Navy	115
		PRD A Subsidiary of Harris Intertype Corporation	59		
		Pamona Electronics Co., Inc.	210		
		Philbrick Researches	7		
		*Philco, Lansdale Division	190		

The Standard Reference For Electronic Test Instruments

DIRECTORY OF TECHNICAL SPECIFICATIONS

5

FREQUENCY METERS

upper frequency limit 1 - 15Mc

Photo See Page	MANUFACTURER	MODEL	FREQUENCY				Stability		SENSITIVITY		OUTPUT		Calibration	Operating Power Required	Circuit Type	Connector Type
			Min Mc	Max Mc	Number of Bands	Meas Acc %	Long Term	Short Term	Min @ Freq	Max @ Freq	Main	Aux				
	MILLEN (A)	90619	350kc	1	1	1.5	N/A	N/A	N/A	N/A	N/A	*	N/A	direct	none	re-
	SELL-TRONIC	401A	10cps	1	9	1na	1na	1na	100mv above 700kc	200mv above 700kc	1na	phone jack	none	direct		
29	GENERAL RADIO (A)	1142-A	3cps	1.5	5	*0.2 full scale	0.2% warn up	0.2% warn up	*20mv rms	*200mv rms	0.64V 4800V	*1-5m				
	GENERAL RADIO (A)	1106-A	100kc	2	9	*0.1	1na	1na	15mv	0.1na						
	MILLEN (A)	90611	1.5	3.5	1	* 1.5	N/A	N/A								
	MEASUREMENTS (A)	59LF	100kc	4.5	4											
	AIRCRAFT RADIO	H-37A	1													
	MILLEN (A)	90625														
	MILLEN (A)	90612														
	TECHNICAL MATERIEL (A)	PHO-5 PHO-6														
	MILLEN (A)	90682	61													
	MILLEN	90605	7													

FREQUENCY METERS

Type	Width Inches	MECHANICAL Height Inches	Depth Inches	Weight Pounds	Price Dollars
1	2 1/2	3 3/4	1 1/2	22.50	10. Seen indicator. 16. Dimensions are of contour fitting cover.
2	2 1/2	3 3/4	1 1/2	249.00	ACCEPTABLE WAVE FORM: pulse square sawtooth, sine, etc. DUTY CYCLE: 1% to 100%. 2% above 100kc. INPUT IMPEDANCE: 100k & 100kΩ. TRANSISTORIZED.
3	5 7/8	7 5/8	1na	525.00	4. 1% of reading above 10% of full scale. 7. 8. Frog 20cps-150kc. 200mv @ 3cps & 3mc. 10. max @ 1.1KΩ maximum. 10 500 @ 1000 maximum. 1B. Back adapter available.
4	5 7/8	12	16	1050.00	14. Also transfer oscillator CALIBRATION: 10kc @ highest frequency; 1kc @ lowest frequency.
5	1 1/2	12 3/4	47 3/4	15.00	4. Straight line frequency. 16. Dimensions are of contour fitting cover.

SYMBOLS

- C - Cabinet
- R - Rack
- P - Portable
- ina - information not available
- 1na - not applicable
- COC - cross over counter
- N/A - This manufacturer has cooperated by checking the accuracy of this listing prior to listing and printing.
- * - See NOTES following column numbers.
- q - Photo of similar instrument appears on page noted.

CONVENIENT TABULAR FORMAT PROVIDES QUICK AND EASY MODEL-TO-MODEL COMPARISONS

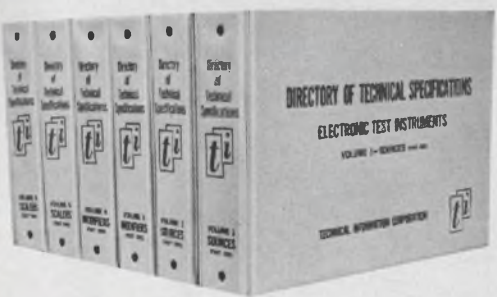

One look at the specimen pages will show you—better than words—the extent of the information furnished by the DIRECTORY OF TECHNICAL SPECIFICATIONS and the comparative arrangement of the data. These convenient tables are designed for rapid and accurate point-by-point comparison of instruments having similar functional capabilities. By providing a thorough across-the-market analysis, all alternatives can be considered in selecting the right instrument for any application.

SAVE HOURS OF ENGINEERING TIME

The Directory eliminates once and for all the necessity of searching catalogs, sales literature and periodicals to find suppliers, specifications, performance characteristics and prices. It provides in one comprehensive source, arranged and indexed for convenient use, all the information you need to keep completely up-to-date on available instruments, to evaluate competitive products and to select the best instrument at the best price.

NO NEED FOR CATALOG FILES

Keeping and maintaining your own files of manufacturers catalogues, brochures and loose data sheets is completely unnecessary. The DIRECTORY OF TECHNICAL SPECIFICATIONS

gives you all the required data to select and specify electronic test instruments—all in one compact and easy to use reference. No other reference source is as complete and efficiently organized. The six-volume Directory lists approximately 14,000 instruments of more than 500 manufacturers and comprises 46 sections, each covering a different type of instrument.

ALWAYS COMPLETE AND UP-TO-DATE

The constant changes in specifications and performance of electronic test instruments is making it increasingly difficult to keep abreast of the latest developments. The Directory is kept continuously up-to-date by the mailing of section revisions to subscribers at the rate of approximately one each week. The information in the entire Directory is completely revised in less than a year.

AVAILABLE ON FREE 30-DAY TRIAL

The DIRECTORY OF TECHNICAL SPECIFICATIONS may be obtained on a FREE 30-DAY TRIAL BASIS for your examination and use. A one-year subscription includes the six-volume set of 46 sections plus the up-dating service to keep all information complete and current.

PRICE... \$300. per year

For further information write or telephone...

TECHNICAL INFORMATION CORP.

P. O. Box 514, Smithtown, N. Y. (516 234-0100)



ON READER-SERVICE CARD CIRCLE 183

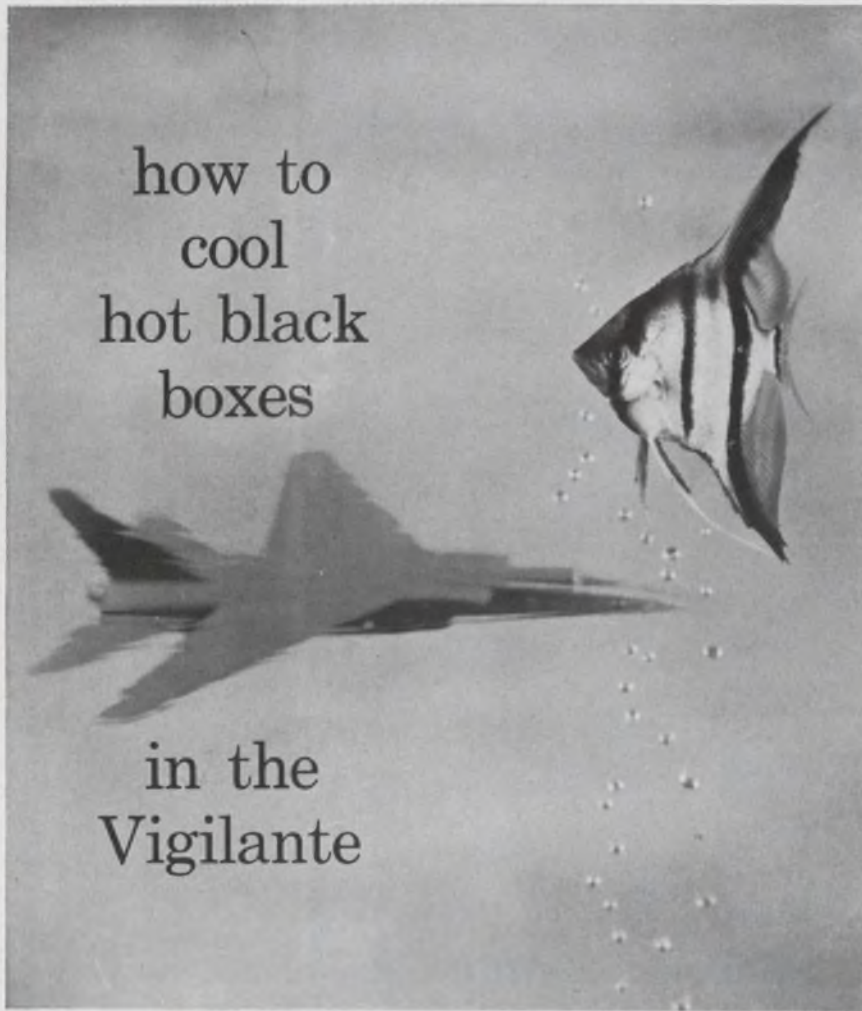

how to
cool
hot black
boxes

in the
Vigilante

Five liquid cooling systems for avionics in every bomber!

Packed into the A-5C Mach 2 two-seater are miniaturized avionic systems that replace the 10-man teams necessary in planes of World War II vintage. Crammed-in black boxes are a design problem in themselves, but cooling these miniaturized electronic systems is another.

Conventional approaches such as convection cooling, fan cooling, or heat sinks simply won't cool these advanced black boxes effectively, so North American designers turned to Eastern — an acknowledged leader in the design and production of *liquid cooling systems for avionics*.

Result: Even at heat levels generated in supersonic flight at deck level — even at peak altitudes where conven-

tional fan cooling effectiveness would fade — Eastern liquid cooling systems keep the Vigilante on the job.

If your problem is avionic hotspots for aircraft, missiles or Ground Support Equipment—turn now to Eastern cooling packs. You'll be among the league of designers that sought Eastern as their answer in avionic cooling of the Vigilante, Nike-Ajax and Hercules, Zeus, Hawk, and Minuteman.



Send for
Series C Bulletin.



EASTERN INDUSTRIES

A DIVISION OF LABORATORY FOR ELECTRONICS, INC.
100 SKIFF STREET • HAMDEN 14, CONNECTICUT

BRANCH OFFICES: Topsfield, Mass., Lyndhurst, N. J., Wilmington, Del., Chicago, Ill., Torrance, Calif. IN CANADA: ENTERPRISE AGENCIES, INC., Montreal, Quebec

ON READER-SERVICE CARD CIRCLE 169

Designer's Datebook

JUNE						
S	M	T	W	T	F	S
			1	2	3	4
5	6	7	8	9	10	11
12	13	14	15	16	17	18
19	20	21	22	23	24	25
26	27	28	29	30		

JULY						
S	M	T	W	T	F	S
					1	2
3	4	5	6	7	8	9
10	11	12	13	14	15	16
17	18	19	20	21	22	23
24	25	26	27	28	29	30
31						

June 21-23

Conference on Precision Electromagnetic Measurements (Boulder, Colo.) Sponsor: Institute for Basic Standards; John Cronland, University of Colorado, 328 University Memorial Center, Boulder, Colo.

June 27-29

2nd Annual Conference & Exhibit on "Exploiting the Ocean" (Wash., D. C.) Sponsor: Dr. James H. Wakelin Jr., Scientific Engineering Institute, Waltham, Mass.

July 6-9

Annual Meeting of the National Society of Professional Engineers (Minneapolis, Minnesota) Sponsor: National Society of Professional Engineers; Kenneth E. Trombley, 2029 K St., N.W., Washington, D. C.

July 11-13

Electromagnetic Compatibility Symposium (San Francisco, Calif.) Sponsor: IEEE, G-EMC; A. Fong, Hewlett-Packard, 1501 Page Mill Rd., Palo Alto, Calif.

July 11-14

Conference on Aerospace Systems (Seattle, Wash.) Sponsor: IEEE; Thomas J. Martin, 3811 E. Howell St., Seattle, Wash.

July 18-20

Fifth Annual Reliability and Maintainability Conference (New York) Sponsor: AIAA, SAE, ASME, EIA, ASTM, AIChE & ASTM: Stanley A. Rosenthal, Kollsman Instruments Corp., Syosset, N. Y.

July 18-20

Microelectronics Symposium (St. Louis, Mo.) Sponsor: IEEE; Dr. John W. Buttrey, McDonnell Aircraft Corp., P. O. Box 516, St. Louis, Mo.

NOW **RCA** ASSURES AEROSPACE/MILITARY RELIABILITY IN AN "OFF-THE-SHELF" UHF TRANSISTOR

RCA 40294 low-noise UHF AMPLIFIER—only 4 dB typical noise figure at 450 Mc/s—tested to meet your most exacting high reliability requirements for critical aerospace and military applications.



100% inspection of all components, and assemblies before sealing



100% testing for 450 Mc/s gain and noise figure



100% power burn-in for reliability assurance

Gone is that long costly wait for delivery on transistors to meet aerospace/military reliability standards.

At least on the RCA 40294. It's available right now—as a stock item—either directly from RCA or from your RCA Distributor. It's electrically equivalent to our familiar and popular 2N2857 low-noise silicon UHF amplifier. But the RCA 40294 is specially controlled, processed, and tested to assure *ultra-high* reliability. RCA 40294's get all these extra tests...

EXTRA! RIGOROUS CONTROLS AND INSPECTIONS of all components and assemblies before sealing.

EXTRA! 100% PRECONDITIONING AFTER SEALING AND BEFORE TESTS. Includes stabilization bake (50 hours min. at 200° C), temperature cycling from -65° C to +200° C, helium leak and bubble tests...plus sample constant-acceleration (centrifuge).

EXTRA! 100% RELIABILITY ASSURANCE TEST. Each 40294 transistor undergoes "power burn-in"—running at full power rating for 340 hours—then is *retested* to assure that I_{CBO} and h_{FE} have not deviated beyond prescribed limits.

EXTRA! 100% PERFORMANCE REQUIREMENTS TESTS. All electrical characteristics including 450 Mc/s gain and noise are then *RE-TESTED* as per MIL-STD 750 requirements.

...PLUS—A 100% MICROSCOPIC EXAMINATION FOR THE FINAL MECHANICAL INSPECTION.

For the performance assurances you need for critical aerospace/military applications, specify the RCA 40294 (or a special version to meet your particular requirements).

For complete electrical characteristics of the 40294, information on custom versions, or any other technical information, call your RCA Field Representative, or write: RCA Commercial Engineering, Section C-G-6-3, Harrison, N. J.

AVAILABLE THROUGH YOUR RCA DISTRIBUTOR

RCA ELECTRONIC COMPONENTS AND DEVICES



The Most Trusted Name in Electronics

MAXIMUM RATINGS, Absolute-Maximum Values:

COLLECTOR-TO-BASE VOLTAGE, V_{CBO} 30 max. volts
 COLLECTOR-TO-EMITTER VOLTAGE, V_{CEO} 15 max. volts
 EMITTER-TO-BASE VOLTAGE, V_{EBO} 2.5 max. volts
 COLLECTOR CURRENT, I_C 40 max. mA
 TRANSISTOR DISSIPATION, P_T 200 max. mW
 (25° C T_{FA})

TEMPERATURE RANGE:

Storage and Operating (Junction) -65 to +200° C

Another Brush Innovation in Recording:

The Brush Mark 280.
Once you've seen
it work,
the chain makes
a lot of sense.

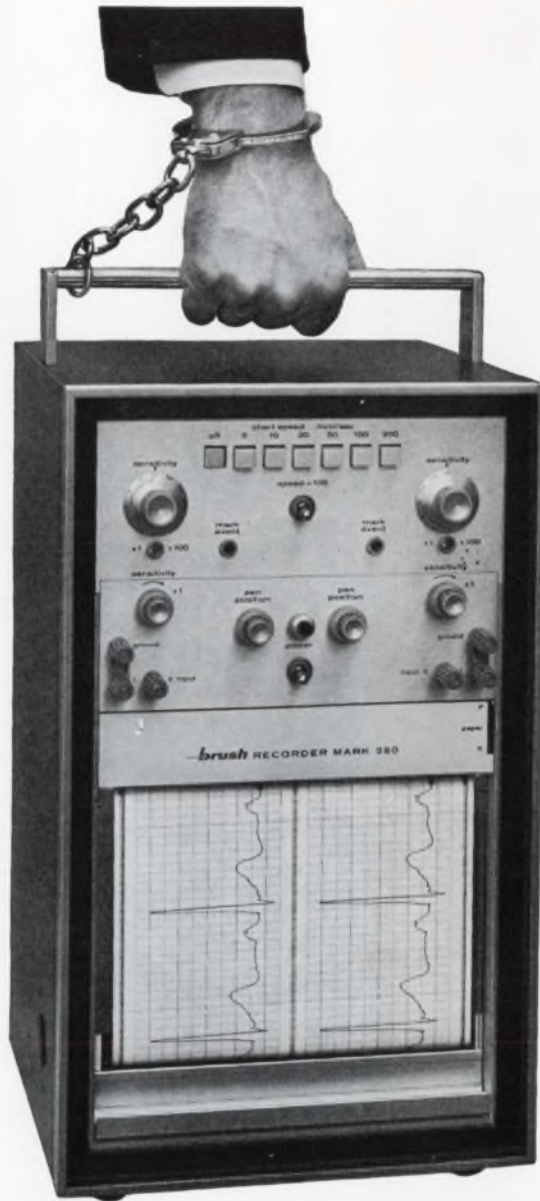

People who use the Brush Mark 280 can get pretty possessive.

No wonder.

True rectilinear traces so crisp and clear you'll never miss the message. Dual recording channels a full 80 millimeters wide. Resolution the likes of which you've never seen. A pressurized inking system. Metri-site pen positioning. Low cost chart

paper. Pushbutton choice of 12 chart speeds. Solid state electronics. Response as high as 200 cps at useable amplitude and better than 30 cps full scale. System accuracy of $\frac{1}{2}\%$!

And now get set for the big surprise: the performance-packed Brush Mark 280 measures just $10\frac{1}{2}''$ x $18\frac{3}{8}''$ x $11\frac{1}{2}''$!

Search no more for a full perform-

ance portable. No one *but no one* has anything to compare with the amazing Mark 280. Ask your Brush representative for a demonstration. Or write today for our free booklet. Brush Instruments Division, Clevite Corporation, 37th and Perkins, Cleveland, Ohio 44114.



CLEVITE

brush INSTRUMENTS DIVISION

Speed Inquiry to Advertiser via Collect Night Letter
ON READER-SERVICE CARD CIRCLE 233